

National Aeronautics and Space Administration

President's FY 2007 Budget Request

(Budget authority, \$ in millions)	FULL COST						Chapter Number
By Appropriation Account	Operating Plan						
	Jan 2006						
By Mission Directorate	<u>FY 2006</u>	<u>FY 2007</u>	<u>FY 2008</u>	<u>FY 2009</u>	<u>FY 2010</u>	<u>FY 2011</u>	
By Theme							
Science, Aeronautics, and Exploration	9,721.3	10,524.4	10,594.4	11,136.4	11,747.0	15,526.4	SAE SUM 1-1
Science	5,253.7	5,330.0	5,383.1	5,437.1	5,491.5	5,546.4	SAE SMD 1-1
Solar System Exploration	1,582.3	1,610.2	1,598.6	1,840.4	1,899.6	1,846.7	SAE SMD 2-1
The Universe	1,507.9	1,509.2	1,500.9	1,307.9	1,276.1	1,309.7	SAE SMD 3-1
Earth-Sun System	2,163.5	2,210.6	2,283.7	2,288.9	2,315.8	2,390.0	SAE SMD 4-1
Exploration Systems	3,050.1	3,978.3	3,981.6	4,499.8	5,055.9	8,775.1	SAE ESMD 1-1
Constellation Systems	1,733.5	3,057.6	3,067.6	3,612.9	4,083.8	7,698.4	SAE ESMD 2-1
Exploration Systems Res & Tech	692.5	646.1	632.2	605.1	679.2	764.6	SAE ESMD 3-1
Human Systems Res & Tech	624.1	274.6	281.8	281.8	292.8	312.1	SAE ESMD 4-1
Aeronautics Research	884.1	724.4	731.8	732.4	722.8	722.7	SAE ARMD 1-1
Aeronautics Technology	884.1	724.4	731.8	732.4	722.8	722.7	SAE ARMD 2-1
Cross-Agency Support Programs	533.5	491.7	497.9	467.1	476.8	482.2	SAE CASP 1-1
Education	162.4	153.3	152.4	153.1	154.0	153.3	SAE CASP 2-1
Advanced Business Systems	156.3	108.2	106.9	73.8	78.5	80.6	SAE CASP 3-1
Innovative Partnerships Program	214.8	197.9	205.5	206.2	209.7	212.9	SAE CASP 4-1
Shared Capabilities	0.0	32.2	33.1	33.9	34.7	35.5	SAE CASP 5-1
Exploration Capabilities	6,869.7	6,234.4	6,680.4	6,442.3	6,242.9	2,896.7	EC SUM 1-1
Space Operations	6,869.7	6,234.4	6,680.4	6,442.3	6,242.9	2,896.7	EC SOMD 1-1
Space Shuttle*	4,777.5	4,056.7	4,087.3	3,794.8	3,651.1	146.7	EC SOMD 2-1
International Space Station	1,753.4	1,811.3	2,200.3	2,255.6	2,197.1	2,360.8	EC SOMD 3-1
Space and Flight Support	338.8	366.5	392.8	392.0	394.7	389.2	EC SOMD 4-1
Inspector General	32.0	33.5	34.6	35.5	36.4	37.3	IG 1-1
TOTAL	16,623.0	16,792.3	17,309.4	17,614.2	18,026.3	18,460.4	
Year to Year Change**		3.2%	3.1%	1.8%	2.30%	2.40%	

* Includes emergency supplemental of \$349.8 million in FY 2006 for Hurricane Katrina response and recovery.

** Percent change from FY 2006 does not include emergency supplemental \$349.8 million in FY 2006.

Note: Totals may not add due to rounding.

Table of Contents

Agency Summary	SUM 1-1
Science, Aeronautics and Exploration	SAE SUM 1-1
SCIENCE MISSION DIRECTORATE	SAE SMD 1-1
(Themes and Selected Programs/Projects)	
Solar System Exploration Theme	SAE SMD 2-1
Discovery Program	
Dawn	
New Frontiers Program	
New Horizons	
Juno	
Technology Program	
Deep Space Mission Systems Program	
Solar System Research Program	
Mars Exploration Program	
Phoenix (Scouts 2007)	
2009 Mars Science Lab	
The Universe Theme	SAE SMD 3-1
Navigator Program	
Space Interferometer Mission (SIM) – PlanetQuest	
Keck Interferometer	
James Webb Space Telescope Program	
James Webb Space Telescope Project	
Hubble Space Telescope Program	
Stratospheric Observatory for Infrared Astronomy (SOFIA) Program	
Gamma-ray Large Area Space Telescope (GLAST) Program	
Gamma-ray Large Area Space Telescope (GLAST) Project	
Discovery Program	
Kepler	
Explorer Program	
Wide-field Infrared Survey Explorer	
Universe Research Program	
Beyond Einstein	
International Space Science Collaboration (SSC) Program	
Herschel	
Planck	
Earth-Sun System Theme	SAE SMD 4-1
Earth Systematic Missions Program	
Global Precipitation Mission (GPM)	
Glory Mission	
Landsat Data Continuity Mission	
Ocean Surface Topography Mission	

Table of Contents

NOAA Polar-orbiting Operational Environmental Satellite Preparatory Project	
Living with a Star Program	
Solar Dynamics Observatory	
Solar Terrestrial Probes Program	
Magnetospheric Multiscale (MMS)	
Solar Terrestrial Relations Observatory	
Solar B	
Explorer Program	
Aeronomy of Ice in Mesosphere	
Time History of Events and Macroscale Interactions During Substorms (THEMIS)	
Interstellar Boundary Explorer (IBEX)	
Earth System Science Pathfinder Program	
Cloudsat	
Cloud-Aerosol Lidar and Infrared Pathfinder Satellite Observatory	
Orbiting Carbon Observatory	
Aquarius	
Earth-Sun System Multi-Mission Operations Program	
Earth-Sun Research Program	
Applied Sciences Program	
Education and Outreach Program	
Earth-Sun Technology Program	
EXPLORATION SYSTEMS MISSION DIRECTORATE	SAE ESMD 1-1
(Themes and Selected Programs/Projects)	
Constellation Systems Theme	SAE ESMD 2-1
Constellation Systems Program	
Crew Exploration Vehicle	
Crew Launch Vehicle	
ISS Cargo and Crew Services	
Launch and Mission Systems	
Exploration Communications and Navigation Systems	
Exploration Systems Research and Technology Theme	SAE ESMD 3-1
Centennial Challenges Program	
Robotic Lunar Exploration Program	
Lunar Reconnaissance Orbiter	
Prometheus Nuclear Systems and Technology Program	
Exploration Technology Development Program	
Human Systems Research and Technology Theme	SAE ESMD 4-1
Life Support and Habitation Program	
Human Health and Performance Program	
Human Systems Integration Program	

Table of Contents

AERONAUTICS RESEARCH MISSION DIRECTORATE	SAE ARMD 1-1
(Themes and Selected Programs)	
Aeronautics Technology Theme	SAE ARMD 2-1
Aviation Safety Program	
Airspace Systems Program	
Fundamental Aeronautics Program	
Aeronautics Test Program	
CROSS-AGENCY SUPPORT PROGRAMS	SAE CASP 1-1
(Themes and Programs)	
Education Theme	SAE CASP 2-1
Elementary and Secondary Education Program	
Higher Education Program	
E-Education Program	
Informal Education Program	
Minority University Research and Education Program	
Advanced Business Systems Theme	SAE CASP 3-1
Integrated Enterprise Management Program	
Innovative Partnerships Program Theme	SAE CASP 4-1
Innovative Partnerships Program	
Shared Capabilities Theme	SAE CASP 5-1
Exploration Capabilities	EC SUM 1-1
SPACE OPERATIONS MISSION DIRECTORATE	EC SOMD 1-1
(Themes and Selected Programs/Projects)	
Space Shuttle Theme	EC SOMD 2-1
Space Shuttle Program	
International Space Station Theme	EC SOMD 3-1
International Space Station Program	
Core Development	
Environmental Control and Life Support Systems	
Space and Flight Support Theme	EC SOMD 4-1
Space Communications Program	
Launch Services Program	
Rocket Propulsion Testing Program	
Crew Health and Safety Program	
Inspector General	IG 1-1
Supporting Data	
Reconciliation of Appropriation to Budget Requests	SD 1-1
FY 2005 Appropriation by Budget Line Item	SD 2-1

Table of Contents

Reimbursable Estimates	SD 3-1
Distribution of Funds by Installation	SD 4-1
Civil Service Distribution	SD 5-1
Consulting Services	SD 6-1
Construction of Facilities	SD 7-1
National Institute of Aerospace	SD 8-1

Proposed Appropriation Language PAL 1-1

Management and Performance

Management and Performance Overview	MP 1-1
Full Cost Budgeting - FY 2007 Update	MP 2-1
President's Management Agenda Update	MP 3-1
FY 2006 Performance Plan Update	MP 4-1
FY 2007 Performance Plan	MP 5-1

Reference

Document Format for FY 2007	REF 1-1
Acronyms	REF 2-1

NATIONAL AERONAUTICS AND SPACE ADMINISTRATION



FY 2007 Budget Request Summary

Making Progress Implementing the Vision	2
FY 2005 Highlights	4
Science Mission Directorate	5
Exploration Systems Mission Directorate	8
Aeronautics Research Mission Directorate	11
Cross-Agency Support Programs	12
Space Operations Mission Directorate	16
Mission Support.....	18
Workforce	21
Management and Performance	21

NASA FY 2007 Budget Request Summary

Making Progress Implementing the Vision

On January 14, 2004, President George W. Bush announced A Renewed Spirit of Discovery: The President's Vision for U.S. Space Exploration, a new directive for the Nation's space exploration program. The fundamental goal of this directive is "to advance U.S. scientific, security, and economic interests through a robust space exploration program." In issuing this directive and in accordance with the NASA Authorization Act of 2005, the President and Congress committed the Nation to a journey of exploring the solar system and beyond: completing assembly of the International Space Station using the minimum number of Space Shuttle flights until its retirement by 2010; flying the Crew Exploration Vehicle no later than 2014, and potentially much sooner; having astronauts return to the Moon by the end of the next decade followed by future human missions to Mars and beyond. Along with this, NASA would continue a robust program of scientific discovery and aeronautics research within the resources provided. The President and Congress further challenged NASA to establish new and innovative programs to enhance understanding of our Earth, other planets, asteroids, and comets in our solar system, as well as the search for potential life around other stars. NASA's scientific inquiry is to answer questions that are as old as mankind and to ask new questions in the process. As President Bush said during a speech at NASA Headquarters, "Mankind is drawn to the heavens for the same reason we were once drawn into unknown lands and across the open sea. We choose to explore space because doing so improves our lives, and lifts our national spirit. So let us continue the journey."

Over the past two years since that announcement, NASA has made great progress in implementing the Vision for Space Exploration and carrying out national priorities of scientific discovery and aeronautics research. The FY 2007 budget for NASA identifies the resources necessary to carry out those priorities identified by the President and Congress. NASA's exploration roadmap is provided in Figure 1.

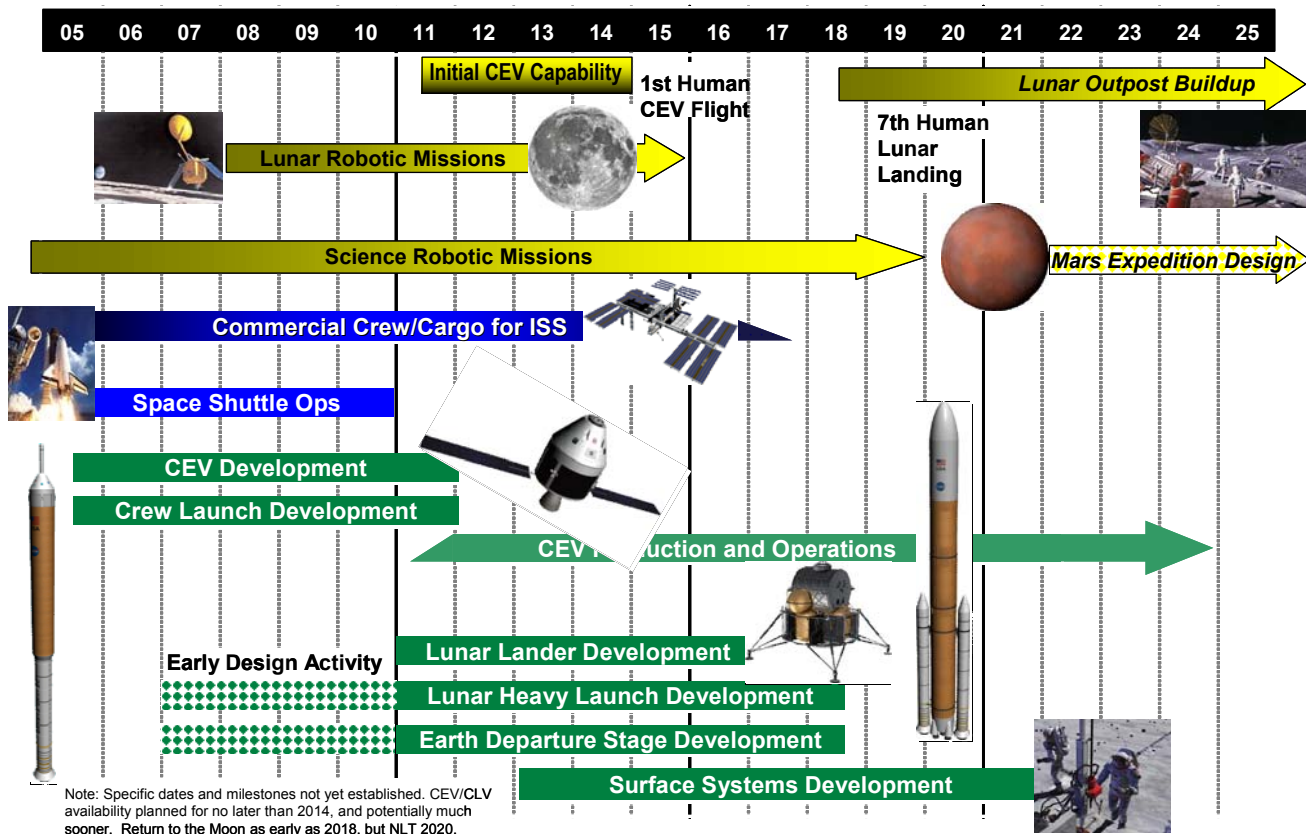

Figure 1: NASA's exploration roadmap summarizes plans over the next two decades.

NASA FY 2007 Budget Request Summary

To support NASA's exploration mission, NASA is initiating development of the Crew Exploration Vehicle and the Crew Launch Vehicle. Launches of these two paired vehicles should be safer and more reliable than the Space Shuttle and will support our astronauts' journeys to the International Space Station, the Moon, a lunar outpost, and eventually human missions to Mars and other destinations. The Crew Launch Vehicle, as well as a future Heavy Lift Launch Vehicle for the launch of other exploration cargo, is to be built from components of the Space Shuttle. This approach will allow NASA to use tried and tested components, benefit from an experienced workforce, and smoothly transition operations to the CEV/CLV when the Space Shuttle is retired by 2010.

NASA will continue to develop several satellite and robotic missions to explore the solar system and universe. The Lunar Reconnaissance Orbiter is scheduled to launch in the fall of 2008 to map the surface of the Moon and search for future landing sites. NASA's recent successful robotic investigations of Mars and Saturn will be followed by missions that will explore some of the least-known areas of the solar system, like Mercury, the asteroids, and Pluto. The Mars Science Laboratory is scheduled to launch in 2009 to sharpen scientific understanding of the Red Planet, and future spacecraft will conduct research and test technologies to support human exploration of Mars.

The Agency also will build on a legacy of revolutionizing astronomy. NASA will continue to operate space telescopes, including Hubble, Chandra, and Spitzer, while planning for the next generation of spacecraft that will enhance researchers' ability to find planets around other stars and peer deep into the history of the universe to understand its origins and structure. NASA will also continue to play a major role in the interagency Climate Change Science Program and the international Global Earth Observing System of Systems, retaining critical investments in satellites, technologies, and research that will improve forecasting of the weather, monitoring of forest fires, and tracking the spread of pollutants on Earth. The Agency also will continue to develop space probes to study the Sun's influence on Earth and the space environment.

Figure 2 below reflects the 10-year budget totals to implement key program elements for human and robotic exploration of the Moon and Mars. Based on studies completed thus far, NASA believes that the cost between now and FY 2011, the current budget horizon, will be approximately \$30 billion. This includes the cost associated with design and development of the Crew Exploration Vehicle and Crew Launch Vehicle; demonstration and payment for commercial crew and cargo transport to support the International Space Station; development of a Heavy Lift Launch Vehicle, Earth Departure Stage, Lunar Lander, and supporting Launch and Mission control systems and infrastructure; as well as requirements verification testing that will be accomplished prior to the first crew flights of the CEV in the 2010-2014 timeframe.

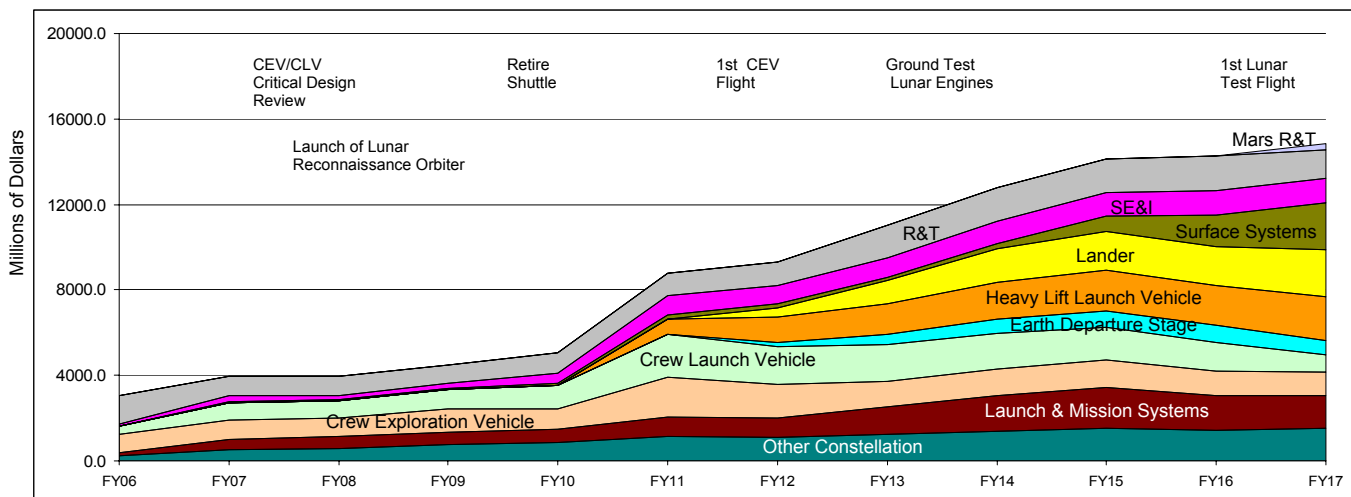

Figure 2: 10-year budget totals for Exploration Systems to implement the vision of human and robotic exploration of the Moon and Mars.

NASA FY 2007 Budget Request Summary

Over the coming year of 2006, as NASA engages its field centers and industry more fully, and as the level of design detail matures, these cost estimates will be improved. However, the current costs estimates include what NASA believes are conservative budget reserve to address problems that occur with such complex projects.

Cost estimates for the years beyond 2011 have greater uncertainty due to a variety of unknown factors, such as the number of CEV/CLV missions that may be flown each year as back-up capability for a commercial crew and cargo capability; the definition of a lunar outpost, the extent to which in situ resources on the Moon can be used to "live off the land" and other unknowns associated with long range planning.

FY 2005 Highlights

NASA completed a successful year of milestones and discoveries in 2005 as the Agency made progress in implementing the Vision for Space Exploration. Achievements included returning the Space Shuttle to flight, making architecture plans and decisions for the Crew Exploration Vehicle and Crew Launch Vehicle, and achieving other major milestones.

- Space Shuttle Discovery successfully completed a Return-To-Flight experimental test mission to the International Space Station, the first Shuttle mission since the Columbia accident in 2003. The mission included breathtaking maneuvers, spacewalks, and tests of new procedures and safety equipment.
- NASA and the International Space Station Partners marked the fifth anniversary of continuous crewed operations in November 2005. NASA scientists have gathered vital information in the Space Station's unique microgravity environment, an orbiting laboratory that cannot be duplicated on Earth.
- NASA announced plans for the next generation spacecraft and launch system that will be capable of delivering crew and supplies to the International Space Station (but only as a back-up capability for commercial crew and cargo transport to the ISS), carrying four astronauts to the Moon, and supporting up to six crewmembers on future missions to Mars.
- The Deep Impact spacecraft traveled approximately 268 million miles to meet comet Tempel 1 when the impactor collided with the target's nucleus giving researchers the best-ever comet data and images.
- The Mars Exploration Rovers continued studying the harsh Martian environment. The rover Spirit discovered the composition of rock outcrops likely altered by water, and the rover Opportunity found evidence that water once flowed across the Martian surface. Both have completed a full Martian year of geological exploration.
- The Huygens probe successfully descended through the murky atmosphere of Saturn's largest moon, Titan. Huygens discovered that this moon is remarkably Earth-like. The probe found evidence of methane rain, erosion, drainage channels, dry lake beds, volcanism, and very few craters. The Cassini spacecraft also sent back breathtaking photographs of Saturn's icy satellite moons.
- NASA's latest Mars mission launched August 12, 2005, will rendezvous with Mars on March 10, 2006. The Mars Reconnaissance Orbiter will view the planet from low orbit and provide more data than all previous Martian missions combined.
- Voyager 1 entered the solar system's final frontier. After traveling approximately 8.7 billion miles from the Sun, it entered the heliosheath, the vast, turbulent expanse where the Sun's influence ends and the solar wind crashes into the thin gas between stars.
- Using the Hubble Space Telescope, astronomers discovered that Pluto may have three moons. The discovery could offer insights into the nature and evolution of the Pluto system and the Kuiper Asteroid Belt. Hubble's resolution and sensitivity to ultraviolet light also helped researchers look for important minerals on Earth's Moon that could be critical for a sustained human presence.
- NASA's Spitzer Space Telescope captured the first light ever detected from two planets orbiting stars other than the sun. Spitzer picked up the infrared glow from the Jupiter-sized planets. The findings mark the beginning of a new age of planetary science in which extra-solar planets can be directly measured and compared.
- Through coordination of observations from several ground-based telescopes and NASA'S Swift and other satellites, scientists solved the 35-year-old mystery of the origin of powerful, split-second flashes of light

NASA FY 2007 Budget Request Summary

called short gamma-ray bursts. The flashes are brighter than a billion suns, yet last only a few milliseconds. They had been too fast for earlier instruments to catch.

Science Mission Directorate

The Science Mission Directorate (SMD) seeks answers to fundamental questions about the Universe, the solar system, and the Earth. Some of these questions are as old as humanity, and some are as recent as today's headlines. SMD seeks to understand:

- How the universe began, how it became the way it is today, and its final destiny;
- How do planets and their moons form, and how they evolved over the lifetime of the solar system;
- What conditions allowed life to arise on Earth, and whether there are similar conditions present elsewhere;
- Whether life, and possibly intelligent life, exists elsewhere;
- How the Sun affects conditions and life on Earth;
- How to predict the Sun's behavior well enough to protect human space travelers;
- How to predict changes in the Earth's system of land, oceans, atmosphere, and life and
- How human activity is affecting conditions and life on Earth.

To answer these and other questions, many of which are directly relevant to the Vision for Space Exploration, SMD engages the nation's science community, sponsors scientific research, and develops and deploys satellites and probes. SMD also cooperates closely with other U.S. government agencies, and with NASA's partners around the world. SMD missions and research continue to return spectacular and important results, which excite and inspire Americans of all ages.

Solar System Exploration Theme

People have been watching planets, moons, and comets wander amongst the stars for millennia. Yet, it was always "look, don't touch" until the 1960s, when NASA sent robotic landers, followed by humans, to Earth's Moon--and brought back lunar rock and soil for scientists to study. Since those first steps, NASA has broadened its reach with an increasingly sophisticated series of explorers that have landed on asteroids, tasted the swirling gases of Jupiter's atmosphere, and collected the breath of the Sun. Just in the past year, SMD has:

- Excavated the interior of a comet, by smashing into it with a robotic probe;
- Captured pieces of the sun in the form of solar wind particles, and returned them to earth;
- Gathered nearly irrefutable evidence that Mars once had salty seas, and a changing climate that varied from desert to wet conditions;
- Captured incredibly detailed photographs of Saturn and its moons and rings.

In the next few decades, NASA intends to deepen our understanding of the solar system, with spacecraft fanning out to destinations from the innermost planet to the very edge of the Sun's influence. Some spacecraft will stay in orbit around Earth, others will follow looping one-way trajectories through the gravitational forces of the planets, and a few will come back carrying scientifically priceless pieces of other worlds.

OVERALL BUDGET

The FY 2007 request is \$1,610.2M, a \$27.9M (or 1.8 percent) increase from the FY 2006 budget request:

- \$90.5M for Phoenix Mars lander, scheduled for launch in August 2007.
- \$347.9M for the Mars Science Laboratory, scheduled for launch in 2009.
- \$85.4M for operations of existing spacecraft at Mars.
- \$119.5M for operations of the Cassini spacecraft at Saturn, the MESSENGER mission to Mercury, and the New Horizons mission to Pluto and the Kuiper Belt.

NASA FY 2007 Budget Request Summary

- \$72.6M for development of in-space propulsion and radioisotope power system technologies.
- \$202.1M for operation of the Deep Space Network communication systems.

Major Activities Planned for FY 2007:

- The 2007 Mars Scout (Phoenix) mission is scheduled for launch in August 2007.
- Down-select up to 2 Discovery mission(s) for development
- Mars Science Laboratory (MSL) to be confirmed into the implementation phase, and to successfully complete Critical Design Review by FY 2007.
- Juno will successfully complete Preliminary Design Review by the end of FY 2007.
- Select the second Mars Scout; a fully competed, peer-reviewed, and PI-led mission.

The Universe Theme

People have gazed at the stars, given them names, and observed their changes for thousands of years. NASA joined the ancient pursuit of knowledge of the universe comparatively recently. Nevertheless, in 40 years of space science, NASA has contributed to numerous major advances in astronomy, including:

- The identification of planets around other stars.
- Observations of an atmosphere of a planet outside the solar system.
- Proof of the existence of black holes.
- Determination of the age of the universe.
- Discovery that dark energy is accelerating the expansion of the universe.

Even so, the Universe Theme still has many perplexing and important puzzles to solve:

- How did the universe begin?
- Does time have a beginning and an end?
- Are we alone?

To help answer these questions, NASA is planning a series of missions linked by powerful new technologies and complementary approaches to shared science goals. In the first few decades of this new century, astronomers will greatly advance the study of classical cosmology, the description of the universe on the largest scales and how it works. SMD also will begin to read the opening chapter of the story of galaxies, witnessing the actual birth of the stars within.

OVERALL BUDGET

The FY 2007 request is \$1,509.2M, a \$1.3 M (or 0.1 percent) increase from the FY 2006 budget request:

- \$85.4 M for the Gamma-ray Large Area Space Telescope to complete its development.
- \$443.1 M for the James Webb Space Telescope to complete formulation and enter development.
- \$336.7 M for Hubble operations and data analysis, and for preparations for a Shuttle servicing mission in early Fiscal Year 2008.
- \$98.5 M for the Space Interferometer Mission to continue formulation progress.

Major Activities Planned for FY 2007:

- Spitzer Space Telescope will celebrate 5 years of spectacular observations, exceeding cryogen life expectations by 2.5 years.
- GLAST is scheduled to launch in September of 2007.
- Results from GP-B data analysis will be released. GP-B was designed to test Einstein's theories about the universe; the spacecraft ceased operating in September of 2005.

Earth-Sun System Theme

NASA uses the unique vantage point of space to explore the Earth and the Sun as a connected system. The Sun is an active, variable star, and we live within its extended atmosphere. From that location, we are protected from harmful solar and cosmic radiation by Earth's magnetic field and atmosphere. And life on Earth prospers through a climate powered by energy from the Sun. The Earth-Sun System Theme seek to understand how the Earth system is changing, to probe the connection between the Sun, Earth and the rest of the solar system, and to understand and predict the consequences for life on Earth.

Using a constellation of spacecraft making measurements with remote sensing instruments, NASA provides accurate, objective scientific data and analyses to advance our understanding of the Earth-Sun System. Practical benefits include improved prediction and response capabilities for climate, weather, natural hazards, and human-induced disasters, as well as the protection of spacecraft and human explorers from the effects of hazardous radiation.

OVERALL BUDGET

The FY 2007 request is \$2,210.6 M, a \$47.1 M (or 2.2 percent) increase from the FY 2006 budget request:

- \$166.0 M for Solar Dynamics Observatory, to complete integration and test of the spacecraft.
- \$65.5 M for continued development through critical design and initial test of Aquarius, a satellite to measure global ocean surface salinity for the first time.
- \$52.0 M for continued development of the Glory mission.
- \$98.1 M for the Landsat Data Continuity Mission.
- \$70.1 M for the NPOESS Preparatory Project.
- \$40.9 M for the Magnetospheric Multiscale mission.
- \$68.2 M for the Orbiting Carbon Observatory mission.
- \$189.4 M for Earth-Sun system research and analysis, to support algorithm development and improvement, and laboratory and field experiments to validate satellite-based observations.

Major Activities Planned for FY 2007:

- Retrieve/distribute scientific data from CloudSat and CALIPSO.
- Continue development of Orbiting Carbon Observatory, Aquarius, and Glory.
- Solar Dynamics Observatory Integration and Test.
- Launch THEMIS.

Exploration Systems Mission Directorate

The nation is setting forth on a journey that will mark the beginning of a sustained human presence in the solar system. The Vision for Space Exploration seeks answers to fundamental questions about our existence, responds to recent discoveries, and puts in place technologies and capabilities to inspire our Nation, the world and the next generation.

The role of the Exploration Systems Mission Directorate (ESMD) is to develop a constellation of new capabilities and supporting technologies that enables sustained and affordable human and robotic exploration of the Moon, Mars, and beyond.

The Vision is a long-term strategy for increasing our knowledge of, and presence in, our solar system and worlds beyond. Instead of setting a single, fixed goal and relying on large budget increases, the Vision provides a series of goals with the schedule flexibility necessary to sustain a long-term program of space exploration.

Over the next century, The Vision for Space Exploration will set in motion activities to inspire new generations to pursue math and science. We'll see new industries and technologies evolve that will benefit all humankind. Technologies developed for and discoveries yielded from exploration will underpin and advance the U.S. economy, help ensure national security, and inspire future generations.

The ESMD currently consists of three Themes that will function cooperatively to enable exploration and scientific discovery. Those Themes are Exploration Systems Research and Technology, Human System Research and Technology, and Constellation Systems. The Theme formerly known as Prometheus Nuclear Systems and Technology will become a program under Exploration Systems Research and Technology starting in fiscal year 2007.

Constellation Systems Theme

Through the Constellation Systems Theme NASA will develop, demonstrate, and deploy the collection of systems that will enable sustained human exploration of the Moon, Mars, and beyond. These include the Crew Exploration Vehicle (CEV) for the transport and support of human crews traveling to destinations beyond low Earth orbit, as well as launch vehicles for transport of the CEV and cargo to low Earth orbit, and any ground or in-space support infrastructure for communications and operations.

The Earth Orbit, Lunar Landing, Extended Lunar Stay, and Mars Landing Capability Programs will be replaced by one program called Constellation. It is established to develop capabilities outlined in the 2005 Exploration Systems Architecture Study.

OVERALL BUDGET

The FY 2007 request is \$3,057.6 million; a \$1,324.0 million (or 76 percent) increase from the FY 2006 budget request. Major features of this budget include:

- Funding to support the development activities for Crew Exploration Vehicle (CEV) and Crew Launch Vehicle (CLV) Projects that support initial operations no later than 2014 but as close to 2010 as possible and a lunar surface expedition as early as 2018 but no later than 2020.
- Funding for the development of a Commercial Crew/Cargo Project capable of transporting humans and cargo to the ISS. The orbital cargo and human transportation demonstrations are scheduled for 2008 and 2010 respectively.
- Funding for the Launch and Mission Systems Project activities to provide support to the CEV and CLV launch and operations
- Funding for the Exploration Communications and Navigation (ECANS) Project for development of the communications infrastructure supporting near-Earth and trans-lunar operations.

NASA FY 2007 Budget Request Summary

- Funding for the Program level Systems Engineering and Integration efforts to establish rigor and control for development and integration of constellation and research and technology Themes, Programs and Projects.

MAJOR ACTIVITIES PLANNED FOR FY 2007:

- Preliminary Design Review of the initial Constellation Systems capabilities required to support the ISS, resulting in approval to begin detailed design.

Exploration Systems Research and Technology Theme

The Exploration Systems Research and Technology (ESR&T) Theme represents NASA's commitment to investing in the technologies and capabilities that will make the national vision for space exploration possible. The goals of solar system exploration, not just for ESMD, but for all of NASA, will be the primary focus of Theme activities and will demand a robust, ongoing commitment to focused innovation. Within the Theme there are four programs: Exploration Technology, Centennial Challenges, Robotic Lunar Exploration and Prometheus. The Exploration Technology Program leads the exploratory research and development of new high-leverage technologies and concepts and assures their timely transition into Exploration Systems mission development programs. The Centennial Challenges Program establishes purse awards to stimulate innovative technical accomplishments that could advance the state of civil space exploration and aeronautics. The Robotic Lunar Exploration Program develops precursor missions to characterize the lunar environment. The Prometheus program develops nuclear technologies for power and propulsion. The ESR&T Theme is working closely with other government agencies, industry, academia and other partners to leverage common requirements and identify innovative ideas.

OVERALL BUDGET

The FY 2007 request is \$646.1 million; a \$46.4 million (or 7 percent) decrease from the FY 2006 budget request. Major features of this budget include:

- Funding for these programs changed based on the results of the ESAS, which realigned programs to focus on existing programs and cancelled or deferred programs and projects that were not required in the near term.
- Funding for the technology projects in twelve focus areas to be managed and directed at NASA Centers, with partnerships in industry and academia. The development of key components for a thermal protection system for CEV is an example of activities planned.
- Funding for the Robotic Lunar Exploration Program to complete the Critical Design Review for the Lunar Reconnaissance Orbiter mission.

MAJOR ACTIVITIES PLANNED FOR FY 2007:

- Develop key components for a liquid oxygen-methane propulsion system for the Crew Exploration Vehicle.
- Develop ablative thermal protection system for the Crew Exploration Vehicle.
- Develop non-toxic auxiliary power system for the Crew Launch Vehicle.
- Complete the Critical Design Review for the Lunar Reconnaissance Orbiter.
- Conduct lunar lender trade studies, for the Robotic Lunar Exploration (RLE) Program, that will better define the mission, based on their further-developed requirements.

Human Systems Research and Technology Theme

The Human Systems Research and Technology (HSR&T) Theme continues to have a requirements-driven product-delivery focus. The Theme focuses on ensuring the health, safety, and security of humans through the course of solar system exploration. Programs within this Theme advance knowledge and technology critical for supporting long-term human survival and performance during operations beyond low-Earth orbit, with a focus on improving medical care and human health

NASA FY 2007 Budget Request Summary

maintenance. Within the Theme there are three programs: Life Support and Habitation; Human Health and Performance; and Human Systems Integration. The Life Support and Habitation Program conducts research and develops technology for life support and other critical systems for spacecraft operations. The Human Health and Performance Program delivers research on questions about human biology and physiology relevant to the human exploration of the solar system, and delivers technology to help maintain or improve human health in the space environment. The Human Systems Integration program focuses on optimizing human-machine interaction in the operation of spacecraft systems.

OVERALL BUDGET

The FY 2007 request is \$274.6 million; a \$349.3 million (or 56 percent) decrease from the FY 2006 budget. This significant drop in budget was predicated on the results of the ESAS which prioritized technology development programs by requirements and schedules. This led to a realistic set of requirements instead of the capability-based programs of the past. By adopting a requirements-based philosophy in the redirection of its Exploration programs NASA will be able to reprioritize ISS research and realize efficiencies in its investments by focusing them on technologies applicable to human exploration of the solar system. Such efficiencies allow NASA to adjust the investment profile for HSR&T and still return significant benefits to the space program.

MAJOR ACTIVITIES PLANNED FOR FY 2007:

- Renal stone countermeasure transition from research to medical operations.
 - Continue testing bone and cardiovascular countermeasures in space; bone bisphosphonate countermeasure ISS clinical trial.
 - Initiate ISS medical data exchange among the International Partners.
 - Demonstrate the ability of the advanced spacecraft air monitoring system to detect 90% of the high-priority air contaminants in ground testing.
 - Develop a revised space material flammability characterization test method and update NASA-STD-6001 accordingly.
-

Aeronautics Research Mission Directorate

Aeronautics Technology Theme

In order to ensure the continued viability of a vibrant, healthy Aeronautics program, not just within NASA but across the nation, NASA has outlined in the Agency FY 2007 budget a reshaped Aeronautics Program under a new budget structure that allows us to achieve the following goals:

- Refocus the Agency on "intellectual stewardship of the core competencies of aeronautics for the Nation," which will involve "mastery of all flight regimes, from subsonic all the way up to hypersonic;"
- Focus Aeronautics research on activities appropriate to NASA's unique capabilities rather than research more appropriately performed or funded by other Agencies or Industry; and
- Preserve our NASA Wind Tunnel facilities as critical assets to the Agency and the Nation.

NASA's Aeronautics Theme consists of three integrated research programs as well as a new National Assets Program that preserves the NASA Research Center wind tunnel infrastructure.

- The Fundamental Aeronautics Program will provide continual, long-term investment in the fundamental research and build upon that investment to develop system-level, multidisciplinary capabilities that will enable both civilian and military communities to build platforms that meet their specific needs.
- The revectorized Aviation Safety Program will focus NASA research on safety areas that are more appropriate to its unique capabilities and will address the Nation's aviation safety challenges of the future.
- The Airspace Systems Program is being realigned to directly address the needs of the Next Generation Air Transportation System (NGATS) as defined by the Joint Planning and Development Office (JPDO).
- The Aeronautics Test Program is a new Aeronautics program whose purpose is to ensure the strategic availability of a critical suite of wind tunnels which are necessary to meet Aeronautics, Agency, and National needs.

OVERALL BUDGET

The FY 2007 request is \$724.4 million, an 18 percent decrease from the FY 2006 Budget:

- \$447.2M is for Fundamental Aeronautics projects including subsonics (rotary and fixed wing), supersonics, and hypersonics.
- \$102.2M is for Aviation Safety to increase aircraft safety technologies.
- \$120.0M is for Airspace Systems to research and develop innovative solutions for a safe, efficient, high-capacity airspace system in the air and on the ground.
- \$55.0M is for the Aeronautics Test Program to ensure availability of critical Aeronautics research center wind tunnel infrastructure.

MAJOR ACTIVITIES PLANNED FOR FY 2007:

- Baseline state-of-the-art analysis methods and tools to address aeronautics challenges within hypersonics, subsonics (rotary and fixed wing), and supersonics.
- Determine fundamental propulsion system integration design issues for existing and advanced rotorcraft configurations.
- Complete baseline assessment of state-of-the-art Integrated Vehicle Health Management (IVHM) and Flight Deck systems capabilities and establish prioritized technical requirements to meet NGATS safety challenges.
- Conduct systems analysis for the development of a plan that describes incremental concept, technological, and operational changes and research needs to reach NGATS 2025 concept of operations.
- Investigating and recommending a standard format for reporting ATP wind tunnels/ground test facilities fixed costs across all Field Centers.

Cross-Agency Support Programs

This new direct budget category provides focus to several ongoing activities and establishes an improved model for managing NASA's unique facilities. This budget area consists of four Themes: Education, Advanced Business Systems, Innovative Partnerships Program (IPP), and Shared Capabilities. Under this umbrella, NASA's education activities have a renewed focus on priorities and metrics. Within the Advance Business Systems, the Integrated Enterprise Management Program (IEMP, formerly IFMP) is established as a separate direct program to improve management information and financial management. The Innovative Partnership Program has been moved from the Exploration Systems Mission Directorate to better address agency-wide needs. Shared Capabilities has been established to ensure that NASA's unique facilities are adequately funded to address NASA's strategic needs.

OVERALL BUDGET

The FY2007 request is \$491.7 million:

- \$153.3M for Education
- \$108.2M for Advanced Business Systems (IEMP)
- \$197.9M for Innovative Partnerships Program
- \$32.2M for Shared Capabilities

MAJOR ACTIVITIES PLANNED FOR FY 2007:

- Within the Education Theme, (1) continue to emphasize a seamless pipeline for all education programs that encourages students to excel in STEM disciplines and (2) ensure that NASA's Education portfolio addresses the needs of the Nation by extending students affiliation, thereby expanding the human resource pool, primarily in the STEM disciplines.
- Within the Advance Business Systems, (1) roll out the SAP Version Upgrade to all ten Centers; (2) continue implementation of the JSC Aircraft Management Information System and identify the solutions for the remaining Asset Management functional areas of Logistics, Facilities, and Environment; and (3) continue Contract Management Module implementation across the Agency.
- Within the Innovative Partnerships Program, (1) implement an IPP program that integrates formerly distinct Technology Transfer (T2), Space Products Development (SPD), Small Business Innovative Research (SBIR), Small Business Technology transfer Program (STTR), and University Research Engineering and Technology Institute (URETI) program elements such that the former distinct elements complement and leverage each other; (2) achieve partnership development primarily through a single contractor that would replace the former network of external agents; (3) implement inter-field center and intra-field center dual use technology development investment funding initiatives, where funding allocations would be performance based; (4) develop and manage to standard performance metrics; and (5) build core competencies.
- Within Shared Capabilities, (1) prioritize funding requirements with the Thermal Vacuum Chamber asset class and assess budgets for thermal vacuum chambers within Mission Directorates and/or the SCAP budget line as appropriate; (2) support agency assessment of all aircraft requirements (research program & passenger aircraft), the results of which will determine the basis for proposals to include select aircraft in SCAP; (3) prioritize funding requirements and select classes of assets for inclusion in the Shared Capability Assets Program; and (4) identify re-investment/re-capitalization opportunities within and among classes of assets and execute the approved changes.

Education Theme

Achieving NASA's mission depends upon educated, motivated people with the ingenuity to invent new tools, the passion to solve problems, and the courage to ask the difficult questions. It is not enough to depend on the excitement generated by NASA images. NASA must use its discoveries and achievements to engage students and the education community. To do so, NASA provides meaningful, educational, and content-rich programs to inspire and motivate students at all levels to

NASA FY 2007 Budget Request Summary

pursue careers in science, technology, engineering, and mathematics (STEM). NASA Education partners with academia, professional associations, industry, and other agencies to provide teachers and faculty with experiences that capitalize on the excitement of NASA's missions to spark student interest and involvement. Education Programs provides opportunities for involvement in NASA's research efforts to encourage students to pursue higher education in STEM areas. To ensure a pipeline of highly trained people prepared to meet mission requirements within NASA, as well as in industry and academia, NASA must: motivate students to pursue careers in science, technology, engineering, and mathematics; provide educators with unique teaching tools and compelling teaching experiences; ensure that public resources are invested wisely; and fully engage minority and under-represented students, educators, and researchers in NASA's education programs. The Office of the Chief Education Officer will strive to reach the masses of young people in the Nation to connect with, excite, and inspire the next generation of scientists, inventors, technicians, and explorers. For more information see: <http://www.education.nasa.gov/home/index.html>.

OVERALL BUDGET

The FY 2007 request is \$153.3M, or a \$9.1M or 5.6 percent decrease from the FY 2006 budget:

- \$47.2M for Elementary & Secondary Education
- \$54.0M for Higher Education
- \$9.0M for e-Education
- \$2.5M for Informal Education
- \$40.6M for Minority University Research & Education

MAJOR ACTIVITIES PLANNED FOR FY 2007:

- Continue to emphasize a seamless pipeline for all education programs that encourages students to excel in STEM disciplines.
- Ensure that NASA's Education portfolio addresses the needs of the Nation by extending students affiliation, thereby expanding the human resource pool, primarily in the STEM disciplines.

Advanced Business Systems Theme

The Advanced Business Systems Theme is a new theme established in FY 2006 to reflect the implementation of business systems as a direct program. Prior to FY 2006, business systems were buried within Corporate and Center General and Administrative (G&A) and did not provide the visibility as to the financial improvements being made at NASA in support of the President's Management Agenda. Since last year's budget submission, NASA's Integrated Enterprise Management Program (IEMP) has undergone several changes due to renewed focus and commitment on improving financial management practices and performance.

Three significant changes to this critical Program are described below.

- The name, Integrated Financial Management Program (IFMP), was updated to Integrated Enterprise Management Program (IEMP). The investment that NASA is making in the Program is principally aimed at improving how the Agency manages its investments and controls the operating costs of the Agency.
- Budgeting and funding for all development, implementation, and sustaining activities are managed from a single program fund source instead of the existing numerous Corporate and Center General and Administrative (G&A) funding sources as recommended by Congress.
- NASA has re-assessed its strategy for ensuring success in all of the President's Management Agenda (PMA) commitments. A key element to this improvement is the upgrade of its Core Financial system during FY 2006 in order to achieve full compliance with the Federal Financial Management Act of 1996 (FFMIA), and to implement critical process changes related to NASA's financial tracking, reporting, and other elements which contribute to its audit opinion. NASA's Integrated Asset Management (IAM) project was delayed in order to not impact the financial upgrade and to also re-assess the overall development and deployment strategy of IAM with a goal to reduce cost and complexity.

NASA FY 2007 Budget Request Summary

- The Agency time and attendance system (Web TADS) has been transferred into the IEMP for operations and sustaining support. This allows for more efficient operations and maintenance as well as continues the initiative to move NASA business systems under centralized management.

OVERALL BUDGET

The FY 2007 request is \$108.2 million; a \$48.1 (or 31 percent) decreases from the FY 2006 request. Highlights include:

- \$16.1M to complete the Core Financial Upgrade to a new version of the SAP software, My SAP;
- \$17.2M to continue the implementation of the Asset Management solutions;
- \$10.3M to finish the implementation of the Contract Management Module;
- \$48.8M to support operating and sustaining of the current IEMP Projects; and
- \$15.8M to provide infrastructure support not directly related to a Project.

MAJOR ACTIVITIES PLANNED FOR FY 2007:

- The Agency will roll out the SAP Version Upgrade to all ten Centers providing a newer software version and correctives fixes in SAP for FFMI compliance.
- NASA will continue implementation of the JSC Aircraft Management Information System as the solution for recording and tracking aircraft maintenance and Astronauts qualifications currency to comply with safety requirements. The Agency will also identify the solutions for the remaining Asset Management functional areas of Logistics, Facilities, and Environment.
- The Contract Management Module implementation will continue across the Agency to provide a comprehensive tool to support contract writing, contract administration, procurement workload management, and data reporting/management.

Innovative Partnerships Program Theme

IPP's primary mission is to provide leveraged technology alternatives for Mission Directorates, Programs, and Projects through joint partnerships with industry, academia, government agencies, and national laboratories. Accordingly, IPP integrates the following program elements so that they complement each other to achieve the Program's mission objectives: Technology Transfer (T2), Space Products Development (SPD), SBIR/STTR, and four of NASA's University Research Engineering & Technology Institutes (URETI's). T2, SPD, and SBIR/STTR are all based upon leveraging NASA's resources with private or other external resources for the primary purpose of developing new technology for NASA mission use, with the technology also having strong potential for commercial application. The primary goal of the URETI's is to provide a sustained dialogue with the academic community regarding cutting edge areas, such as nanotechnology. Therefore, all of IPP's functions primarily serve NASA's mission interests, both in the near term and long term, and with respect to a broad range of technologies and technology readiness levels. Similarly, IPP's functions target and invite a broad spectrum of U.S. industrial and non-profit interests. IPP, by virtue of all of its program elements, provides the opportunity for grass roots direct involvement, nationwide, in NASA's Exploration and other missions.

OVERALL BUDGET

The FY 2007 request is \$197.9 million; a \$16.9 million (or 8 percent) decrease from the FY 2006 budget request:

- \$102.6M for SBIR
- \$12.3M for STTR
- \$35.9M for Technology Transfer
- \$14.5M for Space Product Development
- \$12.3M for Enterprise Engine

NASA FY 2007 Budget Request Summary

MAJOR ACTIVITIES PLANNED FOR FY 2007:

- Implement an IPP program that integrates formerly distinct Technology Transfer, Space Product Development, and SBIR/STTR program elements such that the former distinct elements complement and leverage each other.
- Achieve partnership development primarily through a single contractor that would replace the former network of external agents.
- Implement inter-field center and intra-field center dual use technology development investment funding initiatives, where funding allocations would be performance based.
- Develop and manage to standard performance metrics.
- Build core civil servant in-house competencies.

Shared Capabilities Theme

The corporately managed Shared Capabilities Assets Program (SCAP) was established in FY 2006 through Operating Plan changes. The integrated budget process will decide SCAP asset budgets which will be subject to agency prioritization and decision-making. SCAP was established to ensure key capabilities and assets availability for future missions. SCAP will be used to identify and prioritize critical assets and make strategic investment decisions to replace, modify, or disposition assets. Four specific key capability/asset classes have been identified to ensure that NASA retains specialized assets and skills required for missions. These include the Aeronautics Test Program (ATP, Aeronautics) wind tunnels, rocket propulsion testing (RPT, Space Ops), thermal vacuum chambers (TVC), and High End Computing Columbia (HECC, Science). The Real Property Management Plan supports the goal of preserving key capabilities and assets critical to current/future missions. After Agency nomination, review, and selection, assets will be added to or withdrawn based on prioritization and balance among assets, and within the overall constraints of Agency priorities and resources. Note that the ATP, RPT and HECC asset classes are not in the central SCAP budget line; they are located in the discrete budgets of the Mission Directorate primarily responsible for the management and allocation of the asset class. While some asset classes may be funded centrally in the SCAP budget in the future, the funding for ATP, RPT and HECC are in the Mission Directorate that is the predominant user or has relevant expertise in the asset class. Note that the TVC budget assessments are not complete and funding within Mission Directorate(s) is not identified. No FY 2007 funding is identified for the central SCAP budget. This budget line is a placeholder to retain funding for future assets classes that are more appropriate to fund in the central SCAP account.

OVERALL BUDGET

The FY 2007 request is \$32.2M:

- \$32.2M for High-End Computing Columbia

This \$32.2M funding request is a portion of the funding for High-End Computing Columbia. The balance of the funding for this asset class is in the Science Mission Directorate.

This represents only a portion of total funding is subject to oversight and decision-making by the Shared Capabilities Assets Program. The balance of the funding is within Mission Directorate Budgets as follows: Aeronautics Test Program – ARMD, Rocket Propulsion Test – SOMD, High-End Computing Columbia – SMD as mentioned previously.

MAJOR ACTIVITIES PLANNED FOR FY 2007:

- Prioritize funding requirements and select classes of assets for inclusion in the Shared Capability Assets Program.
- Identify re-investment/re-capitalization opportunities within and among classes of assets and execute the approved changes (e.g., reallocate funds, upgrade facilities, etc.).

NASA FY 2007 Budget Request Summary

Space Operations Mission Directorate

Space Operations Mission Directorate (SOMD) programs ensure that the Nation will have reliable, safe, and affordable access to space for NASA's human and robotic explorers while opening new exploration and research opportunities through the extension of human presence in space. SOMD enables NASA to achieve its goals by providing transportation systems such as the Space Shuttle, operational research facilities in space such as the International Space Station (ISS); and space communications systems and supporting space infrastructure. SOMD also provides the unique system--the human system--necessary to open the space frontier to the broadest extent possible.

International Space Station Theme

This Theme supports the construction and operations of a research facility in low Earth orbit as NASA's first step in achieving the Vision for Space Exploration. The ISS provides a unique, continuously operating capability to develop medical countermeasures for long-term human space travel: develop and test technologies and engineering solutions in support of exploration; and provide ongoing practical experience in living and working in space. It also supports a variety of pure and applied research for the U.S. and its International Partners. ISS assembly will be completed by the end of the decade. NASA is examining configurations for the Space Station that meet the needs of both the new space exploration vision and our international partners using as few Shuttle flights as possible. The FY 2007 ISS submission also reflects the realignment of crew and cargo services to ESMD and changes to the ISS logistics philosophy that are driven by the retirement of the Space Shuttle in FY 2010.

OVERALL BUDGET

The FY 2007 request is \$1,811.3 million; a \$57.9 million (or 3 percent) increase from the FY 2006 appropriation as reflected in the initial operating plan. Major features of this budget include:

- NASA plans to continue assembly of the ISS including build out of the truss and power segments.
- NASA plans to aggressively pursue U.S. commercial cargo and crew services at the earliest availability.
- NASA also plans to work with the International Partners to develop sustainable cargo supply transportation architecture for the post-Shuttle era.

MAJOR ACTIVITIES PLANNED FOR FY 2007:

- NASA plans to continue assembly of the ISS including build out of the truss and power segments.
- NASA plans to aggressively pursue U.S. commercial cargo and crew services at the earliest availability.
- NASA also plans to work with the International Partners to develop sustainable cargo supply transportation architecture for the post-Shuttle era.

Space Shuttle Theme

The Space Shuttle is currently the only launch capability owned by the United States that enables human access to space, and the only vehicle that can support the assembly of the International Space Station (ISS). NASA will phase-out the Space Shuttle in 2010 when its role in ISS assembly is complete.

OVERALL BUDGET

The FY 2007 request is \$4,056.7 million; a \$720.8 million decrease from the FY 2006 appropriation (-\$371.0 million or -8.4% not including the FY 2006 hurricane supplemental) as reflected in the initial operating plan. This budget will enable:

- Safe return to flight;

NASA FY 2007 Budget Request Summary

- Continue activities leading to an orderly phase-out of the Space Shuttle program and transition to future exploration system by 2010.

MAJOR ACTIVITIES PLANNED FOR FY 2007:

- Safely fly the planned Space Shuttle manifest.
- Continue activities leading to an orderly phase-out of the Space Shuttle program and transition to future exploration system.

Space and Flight Support Theme

This theme encompasses Space Communications, Launch Services, Rocket Propulsion Testing, and Crew Health and Safety. Space Communications consists of (1) the Tracking and Data Relay Satellite System (TDRSS), which supports activities such as the Space Shuttle, ISS, Expendable Launch Vehicles, and research aircraft, and (2) the NASA Integrated Services Network, which provides telecommunications services at facilities, such as flight support networks, mission control centers and science facilities, and administrative communications networks for NASA Centers. The Launch Services program focuses on meeting the Agency's launch and payload processing requirements by assuring safe and cost-effective access to space via the Space Shuttle and expendable launch vehicles. Rocket propulsion testing supports a core of highly trained rocket test and engineering crews and test facilities. The Crew Health and Safety Program provide oversight and accountability for the total scope of health and safety of NASA's astronaut corps. Plum Brook Decommissioning was realigned to Corporate G&A beginning in FY 2006.

OVERALL BUDGET

The FY 2007 request is \$366.5 million; a \$27.6 million (or 8 percent) decrease from the FY 2006 appropriation as reflected in the initial operating plan. The budget supports:

- Communications support of human and science missions;
- Launch services and support
- Rocket propulsion testing; and
- Crew Health & Safety

MAJOR ACTIVITIES PLANNED FOR FY 2007:

- Complete first element of the Space Network Expansion (SNE) project.
- Launch eight Expendable Launch Vehicles (ELV) primary payloads.
- Develop and refine a standardized battery of clinical and physiological test for all crew members and continue to develop and maintain environmental standards for all space exploration platforms.
- Test capabilities implemented and upgraded for the Vision for Space Exploration will be made operationally ready to begin testing propulsion capabilities required to support missions beyond LEO.
- Complete Space Communications plan as directed in FY 2006 NASA Authorization Bill.

NASA FY 2007 Budget Request Summary

Mission Support

As a function of full cost management, the following mission support activities are included in the preceding Mission Directorate budgets as Institutional Investments charges, or as Center or Corporate General and Administrative (G&A) charges. These areas are summarized below to document the resources provided for these activities.

Center G&A

Center G&A costs include the following basic Center management and operations functions that are required to support the performance of the Agency's programs, cannot be directly identified or tied to a specific program or project requirement, but are necessary for efficient and effective administration:

- Center management, procurement, finance, human resources, public affairs, and other personnel costs, and
- Center operations such as logistics, environmental management, safety, and physical security.

FY 2007 highlights include \$1,155 million total as shown in the table below.

Center	FY 2007 (\$ in millions)
Ames Research Center	103
Dryden Flight Research Center	37
Glenn Research Center	95
Goddard Space Flight Center	188
Johnson Space Center	189
Kennedy Space Center	217
Langley Research Center	119
Marshall Space Flight Center	171
Stennis Space Center	36
Total, Center G&A	1,155

Corporate G&A

Corporate G&A provides for the management and oversight of Agency missions, functions, and centers, and the performance of some Agency-wide administrative activities. The responsibilities include the determination of programs and projects; establishment of management policies, procedures, and performance criteria; evaluation of progress; and the coordination and integration of all phases of the Agency's mission.

The majority of the budget, \$367M, supports the NASA Headquarters Mission Directorates and Mission Support Offices in the performance of those duties, and the facilities and services to enable them. Most of the remainder of Corporate G&A provides agency-wide activities and services for specific mission support projects, and provides the funding for their performance by NASA personnel and contractors at the NASA centers. Corporate G&A costs include the following Headquarters operations and Agency-wide functions:

- Corporate Management and Operations including headquarters personnel salaries, benefits, and travel; and operational costs such as rents, IT support, and facility services;
- Chief Information Officer providing agency-wide tools and systems for efficient operations, IT security, and agency E-Gov initiatives;
- Office of the Chief Engineer including engineering standards and system engineering;

NASA FY 2007 Budget Request Summary

- Office of Safety and Mission Assurance providing safety, reliability, maintainability, and quality mission assurance, risk management, & probabilistic risk assessments;
- Agency Operations providing agency-wide support including, training, awards, and payroll information services;
- Center Workforce Planning activities;
- Independent Verification and Validation Facility providing software quality assurance and validation;
- Program Analysis and Evaluation including the independent assessment of Agency programs, strategic planning functions, and the performance evaluation and analyses of programs, operational readiness and strategic investments;
- Corporate Security, including Headquarters physical security, and Agency-wide security initiatives and counterintelligence; and
- Office of the Chief Health and Medical Officer including Agency occupational health; and research of subject protection and medicine of extreme environments.

FY 2007 highlights include \$682 million total, as shown in the tables below.

Corporate G&A	FY 2007 (\$ in millions)
Corporate Management and Operations	367
Chief Information Officer	69
Office of Chief Engineer	37
Office of Safety and Mission Assurance	54
Agency Operations	45
Center Workforce Planning	41
Independent Verification and Validation Facility	27
Program Analysis and Evaluation	27
Corporate Security	10
Chief Health and Medical Officer	5
Total, Corporate G&A	682

Corporate G&A by Center	FY 2007 (\$ in millions)
NASA Headquarters	452
Kennedy Space Center	12
Johnson Space Center	13
Jet Propulsion Laboratory	10
Goddard Space Flight Center	59
Marshall Space Flight Center	37
Ames Research Center	27
Langley Research Center	45
Glenn Research Center	32
Dryden Flight Research Center	3
Stennis Space Center	1
Total, Corporate G&A	682

Institutional Investments

Effective in FY 2006, funds were transferred from Corporate and Center G&A to establish the Institutional Investments account. Institutional Investments includes non-programmatic Discrete and Minor Revitalization Construction projects previously funded in Center G&A, Facility Demolition projects, previously funded in Corporate G&A, and Environmental Compliance and Restoration activities, previously funded in Corporate G&A. FY 2007 highlights include:

Construction of Facilities, \$179.8 million for non-programmatic Construction of Facilities (CoF); includes:

- \$29.4 million for non-programmatic discrete projects;
- \$112.5 million for non-programmatic Minor Revitalization and Construction projects; and

NASA FY 2007 Budget Request Summary

- \$10.8 million for a Facility Demolition initiative, to remove unused buildings at the NASA field Centers; and

Environmental Compliance and Restoration:

The ECR program NASA employs is a phased approach that prioritizes Agency requirements for environmental remediation measures that must be implemented within the next several years, as well as needed requirements for other environmental compliance measures and management system initiatives. Among factors considered are relative urgency, safety, and potential health hazards.

\$60.0 million for Environmental Compliance and Restoration. Activities with the highest priority requirements planned for accomplishment in FY 2007 include:

- Plum Brook nuclear test reactor decommissioning and cleanup
- Remediation of groundwater contamination at JPL
- Remediation of groundwater contamination at White Sands Test Facility"
- \$60.0 million for Environmental Compliance and Restoration.

Workforce

NASA currently has about 18,000 full-time civil servant employees. Of that number, approximately 1,000 employees are "uncovered capacity" in that they are not working directly for a specific NASA project or program. This problem with uncovered capacity workforce has been exacerbated in recent years due to lack of strategic planning between projects and programs and NASA center management when hiring civil servant personnel. Some contributing factors to that lack of planning have been a significant reformulation of projects and programs in the Exploration portfolio from primarily research to development, significant growth in Congressionally-directed funds for research projects to be done by organizations outside of the agency resulting in reductions in planned program activities that NASA civil servants would nominally perform, and reductions in aeronautics research done by NASA civil servants due to budget constraints and other agency priorities. Over the past year, NASA has taken specific actions to try to address its workforce problems. Starting in November 2004, NASA implemented employee buyouts to rebalance its workforce and in January 2005 established hiring guidelines to emphasize filling vacancies from within the Agency. NASA is taking significant steps to ensure that NASA's ten field centers have a productive future and to restore and assure the government's required core capabilities to accomplish NASA's mission. With this in mind, all research, technology development, and programs and projects will be directed, to the maximum extent possible, at NASA centers. At the same time, the size of NASA Headquarters, which had grown nearly to historic levels, has been significantly reduced. To sustain the exploration agenda, critical work shall be conducted at all NASA centers. Contractors will participate as appropriate, but the government stewards of the Vision for Space Exploration need to ensure that the government maintains certain in-house intellectual property. NASA is now endeavoring to identify the specific research projects conducted at Centers where uncovered capacity is a minor problem, and shifting those research projects to centers with the skills available to manage the research projects, but where the receiving center suffers from significantly worse uncovered capacity. Also, NASA will be working aggressively to retrain the uncovered capacity workforce.

Management and Performance

NASA's planning and performance management system is key to strategic management at NASA. The Agency has in place an integrated system to plan, monitor, assess, evaluate, and measure performance, identify issues (including the status of resources), gauge the organization's overall health, and provide appropriate data and information to NASA decision-makers. NASA's system produces, and makes available, ongoing monthly and quarterly analyses and reviews, annual assessments in support of budget formulation (for budget guidance and issue identification, analysis and disposition), periodic, in-depth program or special purpose assessments, and recurring and special assessment reports to internal and external organizations.

NASA regularly responds to and reports on the Agency's internally and externally imposed performance measurement and reporting requirements, tools, and practices (e.g., reporting requirements of the Government Performance and Results Act, the President's Management Agenda [PMA], and the Office of Management and Budget's Program Assessment Rating Tool [PART]). NASA tracked six initiatives as part of the PMA this fiscal year: Strategic Management of Human Capital; Competitive Sourcing; E-Government; Budget and Performance Integration; Real Property; and Financial Performance. The latest scores that the Agency has received are summarized below. Each year, OMB uses the PART to review selected NASA programs and the findings are incorporated into NASA's investment strategy. In the coming year, NASA will work with OMB to review the following budget areas: the Solar System Exploration Theme, the Constellation Systems Theme, and the Integrated Management Program within the Advanced Business Systems Theme.

NASA FY 2007 Budget Request Summary

NASA's President's Management Agenda Scorecard

	Human Capital	Competitive Sourcing	Financial Performance	E-Government	Budget and Performance Integration	Federal Real Property Management
Status	GREEN	GREEN	RED	GREEN	GREEN	YELLOW
Progress	GREEN	GREEN	RED	GREEN	GREEN	GREEN

Scorecard status as of December 31, 2005

Human Capital

NASA has engaged in workforce planning activities to ensure that it has the right mix of employee skills and that competencies are strategically deployed. In support of workforce planning efforts, the Agency managed workforce transformation activities including job fairs, voluntary separation incentives (buyout) or voluntary early retirement (early out), and career transition services to rebalance workforce competencies in support of the President's Vision for Space Exploration. Retention and relocation bonuses have been used to retain employees with mission critical competencies. NASA has maintained an organizational culture that assures its valuable workforce is retained by recognizing excellent performance through an enhanced performance management system and a comprehensive awards system.

Competitive Sourcing

In fiscal year (FY) 2005, NASA achieved a "green" rating from OMB for both progress and status. That rating was achieved due to OMB approving the Agency's "green" plan and the completion of two standard competitions involving 237 positions. The first competition was for the Langley Research Center's Metallic Test Article Development and General and Precision and Machining Services, while the second was for the NASA Shared Services Center (NSSC). The NSSC is an Agency-wide consolidation of multiple business activities at a single location that will allow the Agency to redeploy staff and budget to core mission activities. In addition, the Agency continued to conduct science competitions under its NASA Research Announcements and Announcements of Opportunity whereby NASA scientists and engineers compete against those in academia, industry, and other Government agencies for research opportunities. In FY 2005, more than 400 FTE were exposed to competition through this process. NASA received the President's Quality Award for Innovation and Exemplary Practices for its science competitions.

Financial Performance

NASA continues to face significant challenges in improving the quality of its financial reporting; however, the Agency has developed and issued a strategic initiatives document to help guide the overall improvement in NASA's financial management including the identification of corrective actions to reduce material weaknesses and improve internal controls. Further, NASA has established a Senior Advisory Group, composed of senior government executives from several federal agencies, to provide NASA expert advice and suggestive corrective actions to improve NASA's overall financial management.

E-Government

NASA continues significant progress and success in meeting E-Government criteria. The Agency has submitted its plan to close IT workforce skills gaps and assure successful performance by Agency personnel performing services in project management, IT security, enterprise architecture (EA), solutions architecture, and IT capital planning and investment. To ensure that the Agency continues to enhance its protections for the privacy of personal information, NASA recently

NASA FY 2007 Budget Request Summary

completed Privacy Impact Assessments on all required IT systems, and provided authorization for public-facing Web sites to employ persistent tracking technology in situations where this use is justifiable. NASA has also made progress in ensuring that its e-government – and other IT investments – are reviewed and integrated with the Agency’s product lifecycle management, security, Capital Planning and Investment Control (CPIC), and strategic planning policy to assure a uniform approach to the business management of Agency systems and services. NASA’s formal EA review process was launched earlier this year, and Version 4 of NASA’s EA (based on the Federal Enterprise Architecture and associated supporting reference models) was released in August 2005, linking NASA’s strategic IT focus areas to the needs of the Agency’s missions and programs. Finally, NASA is currently participating in sixteen of the original twenty-four Presidential Electronic Government (E-Gov) initiatives applicable to the Agency, plus the E-Authentication crosscutting initiative; NASA is also actively engaged in five of the six Federal Lines of Business (LoB) initiatives. Highlights of the Agency’s PMA efforts include: recent vendor selections for both E-Training and E-Travel; posting of grant applications to Grants.gov; implementing Recruitment One-Stop’s online application process and migrating from NASA JOBS to the ROS site; and continuing implementation activities for E-Rulemaking.

Budget and Performance Integration

NASA has integrated strategic, performance, budget and program planning and reporting processes and documents, to ensure the Agency is guided by a single framework to translate strategy into executable budgets. The Agency continues to assure the process, tools and forums for monitoring and reporting performance toward its goals, and makes decisions based on that performance within these. Further, NASA incorporates past PART review findings and those of external experts into investment decisions. NASA continues to strive to find new ways to use program performance information to support decisions on strategy and budget. A main focus of NASA is on improving the policy, metrics and analysis processes for life cycle cost and schedule performance monitoring and reporting.

Federal Real Property Management

NASA is a leader in promoting efficient and economical use of its real property assets as evidenced by its real property initiatives and the approval of its Real Property Asset Management Plan. NASA uses its Asset Management Plan as a tool to integrate real property considerations into the Agency’s corporate decision-making process. NASA is also an active participant on the Federal Real Property Council, which helps inform and develop government-wide best practices.

Appropriation Summary: Science, Aeronautics and Exploration

(Millions of Dollars)	FY 2005 9/30/2005 Operating Plan*	FY 2006 Jan 2006 Operating Plan	FY 2007 Budget Request
<u>SCIENCE</u>	<u>5,501.6</u>	<u>5,253.7</u>	<u>5,330.0</u>
Solar System Exploration	1,720.5	1,582.3	1,610.2
The Universe	1,474.9	1,507.9	1,509.2
Earth-Sun System	2,306.2	2,163.5	2,210.6
<u>EXPLORATION SYSTEMS</u>	<u>2,209.3</u>	<u>3,050.1</u>	<u>3,978.3</u>
Constellation Systems	422.3	1,733.5	3,057.6
Exploration Systems Research and Technology	898.9	692.5	646.1
Human Systems Research and Technology	888.1	624.1	274.6
<u>AERONAUTICS RESEARCH</u>	<u>962.0</u>	<u>884.1</u>	<u>724.4</u>
Aeronautics Technology	962.0	884.1	724.4
<u>CROSS-AGENCY SUPPORT PROGRAMS</u>	<u>377.8</u>	<u>533.5</u>	<u>491.7</u>
Education	178.9	162.4	153.3
Advanced Business Systems	0.0	156.3	108.2
Innovative Partnerships Program	198.9	214.8	197.9
Shared Capabilities	0.0	0.0	32.2
<u>TOTAL APPROPRIATION</u>	<u>9,050.7</u>	<u>9,721.3</u>	<u>10,524.4</u>

*FY 2005 column is adjusted for presentation purposes and reflects a restructuring (with no change in content), to be consistent with the FY 2006 initial operating plan and FY 2007 budget request. As a result of the restructuring, some of the numbers shown here do not match the September operating plan.

Note: Totals may not add due to rounding.



This spectacular image of comet Tempel 1 was taken 67 seconds after it obliterated Deep Impact's impactor spacecraft. The image was taken by the high-resolution camera on the mission's flyby craft. Scattered light from the collision saturated the camera's detector, creating the bright splash seen here. Linear spokes of light radiate away from the impact site, while reflected sunlight illuminates most of the comet surface. The image reveals topographic features, including ridges, scalloped edges and possibly impact craters formed long ago.

Themes

Solar System Exploration

The Universe

Earth-Sun System

SCIENCE

Purpose

NASA's Science Mission Directorate (SMD) manages a portfolio of missions which explore the universe, the solar system, and Earth in order to understand:

- How the universe began, how it became the way it is today, and its final destiny;
- How do planets and their moons form, and how they evolved over the lifetime of the solar system;
- What conditions allowed life to arise on Earth, and whether there are similar conditions present elsewhere;
- Whether life, and possibly intelligent life, exists elsewhere;
- How the Sun affects conditions and life on Earth;
- How to predict the Sun's behavior well enough to protect human space travelers;
- How to predict changes in the Earth's system of land, oceans, atmosphere, and life; and
- How human activity is affecting conditions and life on Earth.

To answer these questions, SMD engages the Nation's science community in shaping the NASA science portfolio. This portfolio includes the development, deployment, and operation of satellites, robots, and probes which return science data and, for some missions, samples for further study. It also includes the ground and data systems needed to make mission data available to scientists, and the science grants which translate data streams into scientific breakthroughs.

In pursuing these missions, NASA coordinates with other U.S. government agencies and partners around the world. The portfolio includes a mix of strategic missions, which have pre-defined requirements, and competed missions, which allow members of the science community to propose new ideas for missions. SMD missions also provide direct support to human space exploration,

Mission Directorate: Science

ranging from Hubble investigations of lunar surface minerals to the Discovery program's Moon Mineralogy Mapper (M3) instrument which will provide the first high-resolution spatial and spectral map of the entire lunar surface.

The FY 2007 budget supports robust funding for science missions. Full funding is included for the Glory mission, a free-flying Landsat Data Continuity Mission (LDCM), and a Shuttle-based Hubble servicing mission. Additional funds for risk reduction have been provided for several missions, including the 2009 Mars Science Lab. In addition, many of the larger missions in formulation have undergone, or are currently completing, rigorous cost and schedule reviews in order to develop more realistic planning and budgeting assumptions. Enhancing the posture of these current missions requires rescheduling of some of the missions in the portfolio. By more carefully phasing-in new missions as existing missions are completed, NASA can reduce the lifecycle cost, and increase the likelihood of science success, for these new missions.

FY 2005 Accomplishments

NASA's science missions and research continue to rewrite science and change the ways we think about human life on Earth. Fiscal Year 2005 was a year of singular accomplishments.

- Deep Impact encountered a comet. The Deep Impact spacecraft traveled approximately 268 million miles to meet comet Tempel 1. Its impactor collided with the target's nucleus, giving researchers the best-ever comet data and images. (For images and information, visit: <http://www.nasa.gov/deepimpact>)
- The Mars Exploration Rovers Spirit and Opportunity kept on roving. The Mars exploration rovers continued studying the harsh Martian environment. The rover Spirit discovered the composition of rock outcrops altered by water, and the rover Opportunity found evidence that water once flowed across the Martian surface. Both have completed a full Martian year of exploration and discovery. (For images and information, visit: <http://www.nasa.gov/mars>)
- The Huygens probe was released from the Cassini spacecraft and accomplished its mission. The Huygens probe successfully descended through the murky atmosphere of Saturn's largest moon, Titan. Huygens discovered the moon is remarkably Earth-like. The probe found evidence of methane rain, erosion, drainage channels, dry lake beds, volcanism and very few craters. The Cassini spacecraft toured Saturn's moons and sent back breathtaking photographs of the icy satellites. (For images and information, visit: <http://www.nasa.gov/cassini>).
- A new Mars reconnaissance craft was successfully launched. NASA's latest Mars mission, launched Aug. 12, will rendezvous with the red planet on March 10, 2006. The Mars Reconnaissance Orbiter will view the planet from low orbit and provide more data than all previous Martian missions combined. (For images and information, visit: <http://www.nasa.gov/mro>)
- Voyager reached the final frontier and headed for deep space. After traveling approximately 8.7 billion miles from the sun, it entered the heliosheath, the vast, turbulent expanse where the sun's influence ends and the solar wind crashes into the thin gas between stars. (For images and information, visit: <http://www.nasa.gov/voyager>)
- Hubble Space Telescope continued exploration and discovery. Using Hubble, astronomers discovered Pluto may have three moons. The discovery could offer insights into the nature and evolution of the Pluto system and the Kuiper Belt. (For images and information, visit: <http://www.nasa.gov/hubble>)
- Spitzer detected first light from an extrasolar world. NASA's Spitzer Space Telescope captured the first light ever detected from two planets orbiting stars other than the Sun. Spitzer picked up the infrared glow from the Jupiter-sized planets. The findings mark the beginning of a new age of planetary science, in which extrasolar planets can be directly measured and compared. (For images and information, visit: <http://www.nasa.gov/vision/universe/newworlds/spitzer-032205.html>)
- NASA solved a 35-year-old mystery regarding gamma-ray bursts. Through coordination of observations from several ground-based telescopes and NASA'S Swift and other satellites, scientists solved the 35-year-old mystery of the origin of powerful, split-second flashes of light called short gamma-ray bursts. The flashes are brighter than a billion suns, yet last only a few milliseconds. They had been too fast for earlier instruments to catch. (For images and information, visit: <http://www.nasa.gov/swift>)
- NASA's Aura spacecraft measured the destruction of Arctic ozone in the 2004-2005 arctic winter, with an accuracy not previously possible. The destruction reached a level seen only once before in the Arctic, although transport processes compensated for the destruction to an unusual degree, resulting in near-average Arctic ozone amounts in spring.

Mission Directorate: Science

- ICESat has confirmed accelerated movement of glaciers in the Antarctic Peninsula, following the breakup of the floating ice shelf into which the glaciers flowed. ICESat also confirmed that part of the West Antarctic ice sheet has been increasingly getting thinner. By understanding changes in snow and ice, scientists have a better idea how melting areas affect the rise of sea level. (For images and information, visit: <http://www.icesat.gsfc.nasa.gov>.)

Theme Distribution

Budget Authority (\$ in millions)	FY 2005	FY 2006	FY 2007	FY 2008	FY 2009	FY 2010	FY 2011
Solar System Exploration	1,720.5	1,582.3	1,610.2	1,598.6	1,840.4	1,899.6	1,846.7
The Universe	1,474.9	1,507.9	1,509.2	1,500.9	1,307.9	1,276.1	1,309.7
Earth-Sun System	2,306.2	2,163.5	2,210.6	2,283.7	2,288.9	2,315.8	2,390.0
Total	5,501.6	5,253.7	5,330.0	5,383.1	5,437.1	5,491.5	5,546.4

Note: For all formats, the FY 2005 column reflects the FY 2005 Congressional Operating Plan, dated 9/30/2005. The FY 2006 column reflects the FY 2006 Congressional Initial Operating Plan, dated Jan 2006. The FY 2007 – 2011 columns represents the FY 2007 President's Budget Submit.

Solar System Exploration

People have been watching planets, moons, and comets wander amongst the stars for millennia. Yet, it was always "look, don't touch" until the 1960s, when NASA sent robotic landers, followed by humans, to Earth's Moon and brought back lunar rock and soil for scientists to study. Since those first steps, NASA has broadened its reach with an increasingly sophisticated series of explorers that have landed on asteroids, tasted the swirling gases of Jupiter's atmosphere, and collected the breath of the Sun.

In the next few decades, NASA Solar System Exploration missions will increase understanding of the solar system, with spacecraft fanning out to destinations from Mercury, the innermost planet, to the very edge of the Sun's influence. Some spacecraft will stay in orbit around a target planet, others will follow looping one-way trajectories through the gravitational forces of the planets, and a few will come back carrying scientifically priceless pieces of other worlds.

New Horizons, which launched on January 19, 2006, will travel to Pluto and beyond. Juno will follow New Horizons as the next New Frontiers mission to the outer planets. Juno will study Jupiter's atmosphere and internal structure. Mars missions are scheduled to provide one launch during each launch window (which occur about every 26 months), with Phoenix, scheduled for a 2007 launch following on the successful 2005 Mars Reconnaissance Orbiter (MRO) launch. DAWN heads out to observe the Vesta and Ceres asteroids. Meanwhile, scientists will be busy gaining new insights from Cassini, Messenger, Mars Rovers, and other spacecraft continuing to operate within the solar system.

Overall Budget

The FY 2007 request is \$1,610.2M, a \$27.9M (or 1.8 percent) increase from the FY 2006 budget request. Major features of this budget include:

- \$90.5M for Phoenix Mars lander, scheduled for launch in August 2007.
- \$347.9M for the Mars Science Laboratory, scheduled for launch in 2009.
- \$85.4M for operations of existing spacecraft at Mars.
- \$119.5M for operations of the Cassini spacecraft at Saturn, the MESSENGER mission to Mercury, and the New Horizons mission to Pluto and the Kuiper Belt.
- \$72.6M for development of in-space propulsion and radioisotope power system technologies.
- \$202.1M for operation of the Deep Space Network communication systems.

The Universe

People have gazed at the stars, given them names, and observed their changes for thousands of years. NASA joined the ancient pursuit of knowledge of the universe comparatively recently. In 40 years of space science, NASA has helped redefine the universe:

- Over 100 planets circling stars other than the Sun have been identified and the atmosphere of a planet outside the solar system has been detected.
- The existence of black holes has been proven.
- The age of the universe has been determined.
- Scientists have discovered that dark energy is accelerating the expansion of the universe.

Over the next few decades, NASA Universe missions will help determine how the universe began, whether time has a beginning and an end, and whether life exists elsewhere in the universe. To help answer these questions, NASA is planning a series of missions which will observe the first light in the universe, watch the birth of its oldest galaxies, and describe the structure of the universe on the largest scales. And NASA will search for and inventory extra-solar planets with known conditions required for habitation.

These advances will require some of the largest, most complex, and most carefully tuned observatories and instruments ever devised. In many cases, they require new technologies as well as careful engineering. Pending a final decision after completion of the second return-to-flight Shuttle mission, Hubble Space Telescope (HST) science will be extended and augmented through a long-planned servicing mission. The Gamma-ray Large Area Space Telescope (GLAST) will explore black holes and other high-energy phenomenon throughout the universe. The James Webb Space Telescope (JWST) will utilize the results of the Wide-field Infrared Survey Explorer (WISE) mapping of promising targets for exploration. Similarly, SIM PlanetQuest will provide evidence of planets just slightly larger than Earth, and unambiguously measure their mass, to determine whether they could retain atmosphere long enough to make it possible to harbor life. As a result of ongoing cost growth due to technical and schedule problems, NASA will conduct a review of the SOFIA project in early 2006 and coordinate the Agency's analysis and position on SOFIA with the German Aerospace Center (DLR) according to the Memorandum of Understanding between the two agencies. This review will allow NASA to determine the best course of action, given the project's status as well as competing science requirements.

Overall Budget

The FY 2007 request is \$1,509.2M, a \$1.3 M (or 0.1 percent) increase from the FY 2006 budget request. Major features of this budget include:

- \$85.4 M for the Gamma-ray Large Area Space Telescope to complete its development.
- \$443.1 M for the James Webb Space Telescope to complete formulation and enter development.
- \$336.7 M for Hubble operations and data analysis, and for preparations for a Shuttle servicing mission in early Fiscal Year 2008.
- \$98.5 M for the Space Interferometry Mission to continue formulation progress.

Earth-Sun System

NASA uses the unique vantage point of space to explore the Earth and the Sun as a connected system. NASA's missions measure with increasing precision the changes within the Earth's water cycle, atmosphere, biosphere, and even tectonic plates. Earth science research supported by NASA helps translate these measurements into predictive capabilities that help reveal where Earth is headed, on time scales ranging from tomorrow's weather to geological time.

NASA is completing seven missions in development which together will extend and expand on measurements of carbon and aerosol sources and sinks, salinity, and cloud formation and water

cycles. Two missions in formulation will provide data continuity on land measurements, and new measurements of changes in sea levels. NASA's continued operation of over twenty Earth-orbiting spacecraft will extend observations of atmospheric, oceanic, geological, and biological changes on Earth.

The Earth is a living system which survives within the extended atmosphere of an active, variable star. Life on Earth is protected from harmful solar and cosmic radiation by Earth's magnetic field and atmosphere and prospers through a climate powered by energy from the Sun. Using a constellation of spacecraft making measurements with remote sensing instruments, NASA provides accurate, objective scientific data and analyses to advance understanding of the Earth-Sun System. Practical benefits include improved prediction and response capabilities for climate, weather, natural hazards, and human-induced disasters, as well as the protection of spacecraft and human explorers from the effects of hazardous radiation.

Overall Budget

The FY 2007 request is \$2,210.6 M, a \$47.1 M (or 2.2 percent) increase from the FY 2006 budget request. Major features of this budget include:

- \$166.0 M for Solar Dynamics Observatory, to complete integration and test of the spacecraft.
- \$65.5 M for continued development through critical design and initial test of Aquarius, a satellite to measure global ocean surface salinity for the first time.
- \$52.0 M for continued development of the Glory mission.
- \$98.1 M for the Landsat Data Continuity Mission.
- \$70.1 M for the NPOESS Preparatory Project.
- \$40.9 M for the Magnetospheric Multiscale mission.
- \$68.2 M for the Orbiting Carbon Observatory mission.
- \$189.4 M for Earth-Sun system research and analysis, to support algorithm development and improvement, and laboratory and field experiments to validate satellite-based observations.

Solar System Exploration

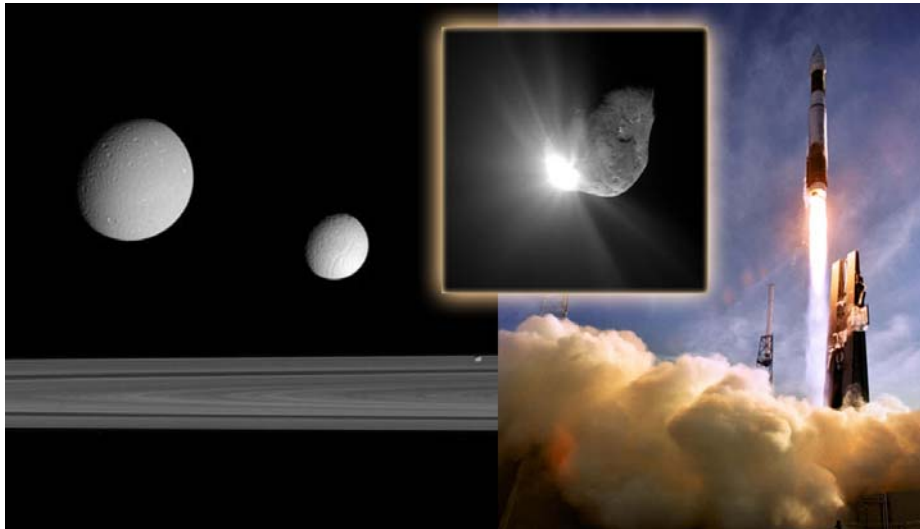

Cassini image, three moons (Dione, Tethys and Pandora) near the Saturn rings; Deep Impact successfully impacted with Comet Tempel 1 on July 4, 2005 (EST); Mars Reconnaissance Orbiter (MRO) successfully launched on August 12, 2005.

President's FY 2007 Budget Request (Dollars in Millions)

Solar System Exploration	FY2005	FY2006	FY2007	FY2008	FY2009	FY2010	FY2011
FY 2007 PRES BUD	1,720.5	1,582.3	1,610.2	1,598.6	1,840.4	1,899.6	1,846.7
Changes from FY 2006 Request	-137.6	-318.2	-737.5	-1,233.3	-1,158.6	-1,166.6	

Overview: What NASA Accomplishes through the Solar System Exploration Theme

Solar System Exploration (SSE) seeks to understand how the solar system formed and evolved, and whether there might be life in the solar system beyond Earth. SSE is founded upon the pursuit of three simple questions: Where do we come from? What is our destiny? Are we alone? These overarching questions lead to more focused questions about our solar system: How do planets and their satellites form and how have they evolved over the lifetime of the solar system? How are the planets alike and how are they now and why? What physical and chemical conditions and history must a planet have to be suitable for life? How were the ingredients for life, water and simple organic substances, brought to the inner terrestrial planets?

There are six programs within the SSE Theme: Discovery, New Frontiers, Technology, Deep Space Mission Systems (DSMS), Research and Mars Exploration. Discovery and New Frontiers are competed, peer-reviewed programs that allow the scientific community to assemble a team and design focused science investigations to complement other science explorations. Technology investments in propulsion and radioisotope power systems will reduce mission costs and increase capabilities for exploration and science return. DSMS provides capabilities and infrastructures for tracking, navigation, and data return to Earth to support interplanetary spacecraft missions. The Research program develops theoretic tools and laboratory data for new and better instrumentation to enable the next generation of flight missions. The Mars program seeks to determine the planet's physical, dynamical and geological characteristics, investigate the variability of the Martian climate in the context of understanding habitability, and investigate whether Mars ever harbored any kind of life.

Relevance to national priorities, relevant fields, and customer needs:

The planets and satellites of the solar system and the ancient icy bodies far from the Sun are "Rosetta stones" that can tell unique stories about the evolution of the solar system. As researchers learn more about the origins of living systems on Earth and about the solar system planets and moons, they may learn that life has arisen in places beyond Earth. In support of the Vision for Space Exploration, the robotic spacecraft dedicated to investigating these questions will serve as trailblazers for future human exploration. The solar system beyond low-Earth orbit is a harsh and forbidding place of hot and cold extremes and fierce high-energy radiation. Before sending astronauts into this forbidding environment, NASA must have an adequate base of scientific knowledge and technological capability to protect them. Robotic spacecraft can endure this environment and prepare the way for humans. SSE robotic planetary programs such as Galileo, Cassini, Discovery missions, and the Mars Rovers have been spectacularly successful and have vastly increased our knowledge of the solar system. Knowledge gained from these and future robotic missions are essential as NASA prepares for a return to the moon and the eventual extension of human presence to Mars and beyond. Robotic exploration is an integral part of an overall strategy to extend human presence throughout the solar system.

Relevance to the NASA mission:

The Solar System Exploration Theme supports NASA's mission to "explore the universe and search for life" by exploring the solar system, understanding the origin and evolution of life, and searching for evidence of life elsewhere.

Relevance to education and public benefits:

The Solar System Exploration (SSE) Theme uses its missions, research programs, and the human resources of the space science community to enhance the quality of American science, mathematics, and technology education, particularly at the pre-college level. SSE theme is dedicated to sharing the excitement of discoveries and knowledge generated by space science missions and research with the public, as well as contributing to the creation of the talented scientific and technical workforce needed for the 21st century.

Public benefits from SSE include a growing understanding of the solar system and Earth's significance within it. Solar System Exploration's Discovery, Mars, Research, and Technology programs were among the first at NASA to require a plan for education and public outreach, as NASA recognized the importance of communicating the excitement of space exploration to the public.

Performance

Major Activities Planned for FY 2007:

- The 2007 Mars Scout (Phoenix) will launch in August 2007.
- A new Discovery mission will be selected under the Discovery Announcement of Opportunity (AO)
- Juno will complete PDR by the end of FY 2007.
- Mars Science Laboratory (MSL) will be confirmed into the implementation phase, and will complete CDR by FY 2007.
- The second Mars Scout--a fully competed, peer-reviewed, and PI-led mission--will be selected.

Major Recent Accomplishments:

- MRO launched successfully on August 12, 2005, aboard an Atlas V launch vehicle. The Mars Rovers, Spirit and Opportunity, have exceeded their expected life by 700% and have traversed over 7.5 miles.
 - Deep Impact launched (Jan 12, 2005) and successfully impacted with the Comet Tempel 1 (July 4, 2005, EST).
 - Cassini's probe (Huygens) released successfully, descended through the atmosphere and landed on Titan in January 2005 sending back a wealth of exciting data on the mysterious moon of Saturn.
 - New Horizons mission to Pluto launched in January 2006.
 - Stardust, which launched in February 1999 and rendezvoused with the Wild 2 comet in January 2004, successfully brought samples of interstellar dust back to Earth on January 15, 2006.
-

Solar System Exploration Theme Commitment in Support of the NASA Mission :

Strategic Goals**Sub-Goals (If Applicable)***Multiyear Outcomes*

Annual Performance Goals supporting the Multiyear Outcomes

3. Develop a balanced overall program of science, exploration, and aeronautics consistent with the redirection of the human spaceflight program to focus on exploration.

3C Advance scientific knowledge of the solar system, search for evidence of life, and prepare for human exploration.

3C.1 Progress in learning how the Sun's family of planets and minor bodies originated and evolved.

7SSE1 Demonstrate progress in learning how the Sun's family of planets and minor bodies originated and evolved. Progress will be evaluated by external expert review.

7SSE2 Perform MErcury Surface, Space ENvironment, GEOchemistry, and Ranging mission (MESSENGER) second Venus flyby.

7SSE3 Complete Juno Preliminary Design Review (PDR).

3C.2 Progress in understanding the processes that determine the history and future of habitability in the solar system, including the origin and evolution of Earth's biosphere and the character and extent of prebiotic chemistry on Mars and other worlds.

7SSE4 Demonstrate progress in understanding the processes that determine the history and future of habitability in the solar system, including the origin and evolution of Earth's biosphere and the character and extent of prebiotic chemistry on Mars and other worlds. Progress will be evaluated by external expert review.

7SSE5 Complete 2009 Mars Science Laboratory Critical Design Review (CDR).

3C.3 Progress in identifying and investigating past or present habitable environments on Mars and other worlds, and determining if there is or ever has been life elsewhere in the solar system.

7SSE6 Demonstrate progress in identifying and investigating past or present habitable environments on Mars and other worlds, and determining if there is or ever has been life elsewhere in the solar system. Progress will be evaluated by external expert review.

7SSE7 Successfully launch Phoenix 2007 spacecraft.

3C.4 Progress in exploring the space environment to discover potential hazards to humans and to search for resources that would enable human presence.

7SSE8 Demonstrate progress in exploring the space environment to discover potential hazards to humans and to search for resources that would enable human presence. Progress will be evaluated by external expert review.

7SSE9 Begin Mars Reconnaissance Orbiter (MRO) primary science phase.

Efficiency Measures

7SSE10 Complete all development projects within 110% of the cost and schedule baseline.

7SSE11 Deliver at least 90% of scheduled operating hours for all operations and research facilities.

7SSE12 Peer-review and competitively award at least 80%, by budget, of research projects.

7SSE13 Reduce time within which 80% of NRA research grants are awarded, from proposal due date to selection, by 5% per year, with a goal of 130 days.

Program Management

Solar System Exploration (SSE) Theme Director is Mr. Andrew A Dantzler, Director of the Solar System Exploration Division.

Quality**Independent Reviews:**

- Each major mission has an independent review team that evaluates the project at critical junctures in the development process. These reviews occur throughout the year.
- NASA Advisory Council (NAC) - Reviews science strategy, program implementation strategy
- National Research Council - Advises on long-term scientific strategies
- National Research Council (Space Studies Board) - Reviews effectiveness and quality
- Space Science Advisory Council (SScAC) - Reviews science strategy and program implementation strategy
- Solar System Exploration Sub-Committee - Reviews science strategy and program implementation strategy
- Mars Exploration Program Advisory Group (MEPAG, Peer Review) - Refines and evaluates the scientific objectives and research focus areas

Program Assessment Rating Tool (PART):

Mars and Solar System Exploration were two separate themes prior to the FY 2006 budget and received "Effective" ratings in their previous PART assessments. Each received an overall score of 87%. The Solar System Exploration Theme will be reviewed as a single entity in 2006.

Additionally, the assessment concluded that SSE is a "well-defined, well-managed program with clear purpose and direct ties to NASA's mission." The Theme was also praised for taking seriously the research priorities of the planetary science community, having a diverse mission portfolio, and learning from mission failures.

Per OMB's recommendation, NASA will report on estimated mission life cycle cost upon entering development, key schedule milestones associated with each mission phase for those missions formally approved for formulation, the mission's cost and schedule progress achieved in each phase before entering the next, and any plans to re-baseline life cycle cost and/or schedule.

Budget Detail (Dollars in Millions)

Budget Authority (\$ millions)	FY2005	FY2006	Change	FY2007	FY2008	FY2009	FY2010	FY2011	Comments
Solar System Exploration	1,720.5	1,582.3	27.9	1,610.2	1,598.6	1,840.4	1,899.6	1,846.7	
Discovery	182.9	145.9	16.1	161.9	196.7	294.7	345.2	299.8	
New Frontiers	210.7	148.1	6.7	154.9	160.6	255.6	256.1	238.1	
Technology	128.9	56.7	15.9	72.6	63.4	65.7	67.0	67.2	
Deep Space Mission Systems (DSMS)	258.2	254.6	-7.8	246.9	256.9	265.2	270.5	270.8	
Solar System Research	351.4	326.6	-53.0	273.6	290.1	311.7	312.5	301.9	
Mars Exploration	588.5	650.4	49.8	700.2	630.9	647.4	648.4	668.9	

Theme:**Solar System Exploration**

Note: For all formats, the FY 2005 column reflects the FY 2005 Congressional Operating Plan, dated 9/30/2005. The FY 2006 column reflects the FY 2006 Congressional Initial Operating Plan, dated Jan 2006. The FY 2007 - 2011 columns represent the FY 2007 President's Budget Submit.

Changes from FY2006: The Discovery Program profile reflects the selection of a Mission of Opportunity (instrument) and Dawn project funding reflecting a schedule slip, in addition to funding for forthcoming new Discovery mission selections. The New Frontiers Program includes funding for the recently selected Juno mission to Jupiter, the recently launched New Horizons mission to Pluto, and a future mission selection. Consistent with flight mission changes, the Technology Program budget for ISP (In-Space Propulsion) and Nuclear Power is reduced and these portfolios will be evaluated in 2007. Deep Space Mission Systems (DSMS) Program has funding for continued support of the DSN (Deep Space Network) and development of a plan for next generation DSN. The Solar System Research Program includes a reduction in Astrobiology research and some grant funding. Consistent with the FY2006 Budget Amendment, the Mars Program budget reflects a goal of launching a mission every 26 months. The Mars Sample Return Mission, the Mars Telecommunications Orbiter, Optical Communication payload, and Mars Testbed activities have been cancelled or indefinitely deferred. Additional funding for Phoenix (launch 2007), and Mars Science Lab in formulation (launch 2009) reduce project risks.

President's FY 2007 Budget Request (Dollars in Millions)

Discovery	FY2005	FY2006	FY2007	FY2008	FY2009	FY2010	FY2011
FY 2007 PRES BUD	182.9	145.9	161.9	196.7	294.7	345.2	299.8
Changes from FY 2006 Request	2.3	-22.8	-57.3	-104.8	-25.0	10.9	

Overview

Robotic space exploration holds tremendous possibilities for exploration and discovery. Even with the vast amount of knowledge gained since exploration of the solar system began, there are still many more questions than answers. NASA's Discovery program gives scientists the opportunity to dig deep into their imaginations and find innovative ways to unlock the mysteries of the solar system. It represents a breakthrough in addition to the way NASA explores space, with lower-cost, highly focused planetary science investigations designed to enhance our understanding of the solar system. Discovery is an ongoing program that offers the scientific community the opportunity to assemble a team and design exciting, focused science investigations that complement NASA's larger planetary science explorations.



All completed Discovery missions (NEAR, Mars Pathfinder, Lunar Prospector, Deep Impact, and Genesis) have achieved groundbreaking science, with each taking a unique approach to space exploration. Current Discovery missions include: Stardust, Aspera-3, MESSENGER, Dawn, *Kepler, and Moon Mineralogy Mapper (M3). M3, newly selected as a Mission of Opportunity in February 2005, will be part of the scientific payload for the Indian Space Research Organization (ISRO) Chandrayaan-1 mission to the Moon. The primary objectives of the M3 are: 1) to assess the mineral resources of the Moon, and 2) to characterize and map the composition of the surface at high spatial resolution.

Discovery Program science targets, and Discovery selected missions (Dawn, Deep Impact, Stardust).

For more information, see <http://discovery.nasa.gov/missions>.
 *Note: Kepler is addressed under the Universe Theme.

Plans For FY 2007

- A new Discovery mission will be selected under the Discovery Announcement of Opportunity (AO).
- Messenger will complete Venus flyby 1 & 2.

Theme: Solar System Exploration

Program: Discovery

Changes From FY 2006

- Three (3) month stand-down causes Dawn launch delays from June 2006 to TBD; a new launch date to be determined after completion of the Independent Assessment and recommendations.
- Moon Mineralogy Mapper (M3) selected as a Discovery Mission of Opportunity, a science payload for ISRO Chandrayaan-1 mission to the Moon.
- No selection was made from proposals received for the Discovery 2004 Announcement of Opportunity (AO) for a full-size Discovery class mission in FY 2005.



















Program Management

MSFC is responsible for Discovery program management. Scientific mission priorities and assignment responsibilities reside at HQ.

Technical Parameters

Since the program's inception, 10 missions (NEAR, Mars Pathfinder, Lunar Prospector, Stardust, CONTOUR, Genesis, MESSENGER, Deep Impact, Dawn, and Kepler) and 2 Missions of Opportunities (Aspera-3 and M3) have been selected. NEAR, Mars Pathfinder and Lunar Prospector over-achieved their science goals. CONTOUR was lost due mostly to plume heating during the embedded solid-rocket motor burn. Genesis and Stardust returned science samples of the solar wind, comets and interstellar dust particles back to Earth. Deep Impact successfully created a crater on the Comet Temple 1 on July 4 (EST) 2005. MESSENGER and Aspera-3 all launched successfully, and are currently in the operation & data analysis phase. Dawn is in development, and M3 is currently in formulation.

Technical Specifications	FY 2007 President's Budget	Change from Baseline
Stardust	Launched on February 7, 1999, the first mission to collect comet and interstellar dust particles and return it back to Earth, in January 2006, for Analysis.	No Changes
MESSENGER	MESSENGER, a mission to Mercury, orbited the Earth for a gravity assist in August 2005, will flyby past Venus twice, and use Venus's gravity to rotate its trajectory closer to Mercury's orbit.	MESSENGER is on track to meet level 1 specifications as identified in the program plan. Launch delayed from 03/2004 to 08/2004
Aspera-3	A Swedish Aspera-3 experiment, with a goal to study the solar wind and Martian atmosphere interaction.	Aspera-3 will meet level 1 specifications as identified in the program plan
Dawn	Orbit and examine the geophysical and geochemical properties of two of the largest protoplanets (Ceres and Vesta) which reside between Mars and Jupiter.	Launch date change from 6/06 to TBD, pending findings and recommendations from the Independent Assessment Teams
Moon Mineralogy Mapper (M3)	The M3 Instrument will fly on the Chandrayaan-1 Spacecraft, India's first deep space mission.	Baseline to be established at mission confirmation

Implementation Schedule:																					
Project	Schedule by Fiscal Year							Purpose	Phase Dates												
	05	06	07	08	09	10	11		Beg	End											
Stardust								The first mission to collect comet and interstellar dust particles and return samples back to Earth for analysis.	Tech Form Dev Ops Res	Oct-94 Oct-95 Nov-95 Feb-99 Feb-99 Jan-06 Feb-99 Sep-06											
MESSENGER								Understanding Mercury and the forces that have shaped it is fundamental to understanding the evolution of the terrestrial planets.	Tech Form Dev Ops Res	Jul-99 Jun-01 Jun-01 Aug-04 Aug-04 Mar-12 Aug-04 Mar-13											
Deep Impact								The Deep Impact mission delivered a 370 kg impactor to the Tempel-1 comet, and ejected material from the interior of a comet nucleus for examination of its composition.	Tech Form Dev Ops Res	Jul-99 May-01 May-01 Jan-05 Jan-05 Aug-05 Jan-05 Mar-06											
Dawn								The mission will undertake a journey to the 2 oldest and most massive asteroids in our solar system, Vesta and Ceres. Launch date is currently TBD.	Tech Form Dev Ops Res	Sep-02 Feb-04 Feb-04 Jun-06											
Moon Mineralogy Mapper (M3)								The M3 mission will be part of the scientific payload for the ISRO Chandrayaan-1 mission to the Moon.	Tech Form Dev Ops Res	Apr-05 Dec-05 Dec-05 Sep-07 Sep-07 Sep-10 Sep-07 Sep-10											
<table border="0"> <tr> <td></td> <td>Tech & Adv Concepts (Tech)</td> </tr> <tr> <td></td> <td>Formulation(Form)</td> </tr> <tr> <td></td> <td>Development (Dev)</td> </tr> <tr> <td></td> <td>Operations (Ops)</td> </tr> <tr> <td></td> <td>Research (Res)</td> </tr> <tr> <td></td> <td>Represents a period of no activity for the Project</td> </tr> </table>											Tech & Adv Concepts (Tech)		Formulation(Form)		Development (Dev)		Operations (Ops)		Research (Res)		Represents a period of no activity for the Project
	Tech & Adv Concepts (Tech)																				
	Formulation(Form)																				
	Development (Dev)																				
	Operations (Ops)																				
	Research (Res)																				
	Represents a period of no activity for the Project																				

Strategy For Major Planned Acquisitions

- With the exception of future NASA Announcement of Opportunities, all major acquisitions are in place.
- Discovery Program will solicit proposals for entire missions & mission of opportunity, put together by a team led by a PI comprised of people from industry, small business, government & universities.
- Discovery 2006 Announcement of Opportunity (AO) is scheduled for release in Feb 2006. Receipt of proposals and down-selection will require approximately 16 months.

Key Participants

- MESSENGER - Principal Investigator and Lead Scientist, Department of Terrestrial Magnetism at the Carnegie Institution of Washington; Stardust - Principal Investigator and Lead Scientist, University of Washington.
- Dawn - Principal Investigator and Lead Scientist, University of California at Los Angeles; Kepler-Principal Investigator and Lead Scientist, Ames Research Center.
- Deep Impact - Principal Investigator and Lead Scientist, University of Maryland; ASPERA-3 - Principal Investigator and Lead Scientist, Southwest Research Institute.
- M3 - Principal Investigator and Lead Scientist, Brown University. Indian Space Research Organization (ISRO), spacecraft provider.

Theme: Solar System Exploration

Program: Discovery

Risk Management

- **RISK:** Dawn - Continued Dawn Project development issues have eroded project cost reserves and resulted in schedule impacts **MITIGATION:** The Project was directed to go into a stand-down, while an independent assessment team evaluates the project to identify any underlying technical and management issues. A "go-forward" plan to restore the project to health will be presented to senior NASA management prior to re-initiating full-scale development activities.

Theme: Solar System Exploration
Program: Discovery
Project In Development: DAWN

President's FY 2007 Budget Request (Dollars in Millions)

DAWN (Development)	FY2005	FY2006	FY2007	FY2008	FY2009	FY2010	FY2011
FY 2007 PRES BUD	85.9	63.6	56.1	5.7	6.0	7.0	9.3
Changes from FY 2006 Request	7.7	14.4	49.9	0.0	0.0	0.1	

Overview

Projects in Development are mature, have a sound design, and are proceeding to mission execution. NASA is committed to their lifecycle cost and schedule plans.

The Dawn mission's primary objective is to significantly increase our understanding of the conditions and processes present during the solar system's earliest history by investigating in detail two of the largest protoplanets remaining intact since their formation. Specifically, the spacecraft will examine the geophysical and geochemical properties of 1 Ceres and 4 Vesta, main belt asteroids that reside between Mars and Jupiter. This will be accomplished by sending a spacecraft to orbit these asteroids and perform science investigations using imaging, spectroscopy, and gravity measurements. For more information, see the Dawn homepage at <http://dawn.jpl.nasa.gov>.

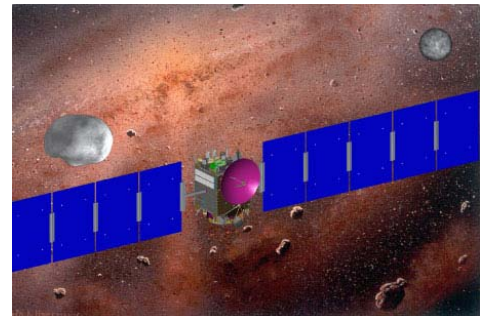

Artist's conception of Dawn with Vesta and Ceres.

Changes From FY 2006

- Dawn has had technical, schedule, and cost problems. The project is currently in a stand-down mode, while an independent assessment team evaluates the project technical and management issues.
- The primary technical issues are with the xenon tank pressure test failure and flight-worthiness of the power processing units.

Program Management

JPL is responsible for Dawn Project Management.

Theme: Solar System Exploration
Program: Discovery
Project In Development: DAWN

Technical Parameters

Dawn has a focused set of science and measurement objectives to be obtained through radio science and three instruments. The mission, originally planned for launch in June 2006, will use solar-electric propulsion to reach and orbit Vesta (for seven months) and Ceres (for five months), while performing science investigations at various altitudes and lighting conditions. The use of solar-electric propulsion readily mitigates launch injection errors and is used during the interplanetary cruise to match trajectories with the asteroids. Dawn uses a maximum of one ion thruster operating at a time (there are three thrusters on the spacecraft). Stay times at Vesta and Ceres can easily be extended. The total mission duration is nine years.

Technical Specifications	FY 2007 President's Budget	Change from Baseline
Payload	Framing camera, mapping spectrometer, and gamma ray/neutron spectrometer	Laser Altimeter and Magnetometer instruments have been deleted to fit within the project cost cap
Launch Vehicle	Delta 2925H	No change
Cruise	3 NSTAR Xenon (Xe) thrusters, one at a time; Maximum fuel mass: 288kg to Vesta and 89kg to Ceres	No change
Vesta	Orbit at 700 and 120 km altitude, 7 months	No change
Ceres	Orbit at 890 and 140 km altitude, 5 months	No change

Schedule	FY 2007 President's Budget	Baseline	Change from Baseline
Critical Design Review (CDR)	06/17/2004	April 2004	+ 2 month delay
Launch	TBD	06/2006	TBD

Strategy For Major Planned Acquisitions

- All major acquisitions are in place.

Key Participants

- Italian Space Agency (ASI) - responsible for the Mapping Spectrometer
- Los Alamos National Labs - responsible for providing the GRAND instrument
- German Aerospace Center (DLR) - responsible for providing the framing camera instrument
- University of California Los Angeles (UCLA) - Principal Investigator (PI) and provides the science leadership, education and public outreach

Risk Management

- RISK:** Continued Dawn Project development issues (primary issues with xenon tank pressure test failure & flight worthiness of Power Processing Unit) have eroded project cost reserves and resulted in schedule impacts. **MITIGATION:** The Project was directed to go into a stand-down, while an Independent Assessment team evaluates the project to identify any underlying technical and management issues. A "go-forward" plan to restore the project to health will be presented to senior NASA management prior to re-initiating full scale development activities.

Theme: Solar System Exploration
 Program: Discovery
 Project In Development: DAWN

Budget Detail/Life Cycle Cost (Dollars in Millions)

Budget Authority	Prior	FY2005	FY2006	FY2007	FY2008	FY2009	FY2010	FY2011	BTC	Total	Comments
FY 2007 PRES BUD	165.6	85.9	63.6	56.1	5.7	6.0	7.0	9.3	59.3	458.4	
Changes	1.3	7.7	14.4	49.9	0.0	0.0	0.1		12.0	85.4	
FY2006 President's Budget	164.3	78.2	49.2	6.2	5.7	5.9	7.0		47.3	363.8	

LCC increase reflects delayed launch which remains to be determined.

Lifecycle cost elements:

Spacecraft: \$162M

Instruments: \$13M

Launch vehicle: \$84M

Other: \$199.4M

President's FY 2007 Budget Request (Dollars in Millions)

New Frontiers	FY2005	FY2006	FY2007	FY2008	FY2009	FY2010	FY2011
FY 2007 PRES BUD	210.7	148.1	154.9	160.6	255.6	256.1	238.1
Changes from FY 2006 Request	-0.1	-10.4	-2.8	-2.1	-3.9	-2.9	

Overview

The New Frontiers program, comprised of medium-sized missions, constitutes a critical element of NASA's solar system exploration capability. Proposed science targets for the New Frontiers program have included Pluto and the Kuiper Belt, Jupiter, Venus, and sample returns from Earth's Moon and a comet nucleus.

On 19 January 2006, the New Horizons mission launched aboard an Atlas V launch vehicle. New Horizons is the first of the New Frontiers missions. New Horizons will conduct a reconnaissance of the Pluto-Charon system and the Kuiper Belt.

The Juno mission to Jupiter was selected in May 2005 as the second New Frontiers mission. Juno science goals are to 1) measure global abundances of oxygen and nitrogen by mapping the gravitational field and using microwave observations of water and ammonia; 2) Understand Jupiter's interior structure and dynamical properties, including internal convection and the size and mass of its core, through mapping of its gravitational and magnetic fields; 3) Map variations in atmospheric composition, temperature, cloud opacity and dynamics to depths greater than 100 bars at all latitudes; 4) Characterize and explore the three-dimensional structure of Jupiter's polar magnetosphere and auroras.

For more information, see <http://newfrontiers.msfc.nasa.gov>

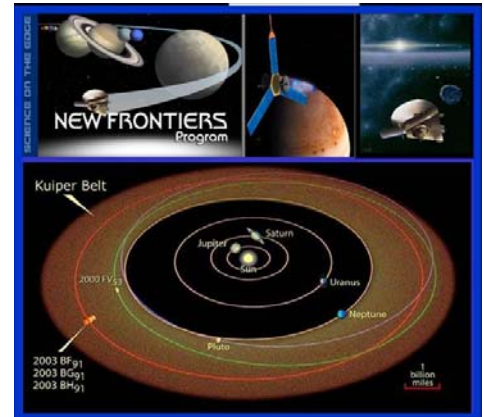

New Frontiers science targets, and the 2 selected New Frontiers missions (New Horizons and Juno).

Plans For FY 2007

- Juno is planned to complete Preliminary Design Review (PDR) by the end of FY 2007.
- New Horizons will flyby Jupiter and start Jupiter science.

Changes From FY 2006

- NASA selects Juno (New Frontiers Mission Concept Study) to fly to Jupiter.

Program Management

New Frontiers program management is MSFC. Scientific mission priorities and assignment responsibilities reside at NASA HQ.

Theme: Solar System Exploration
Program: New Frontiers

Technical Parameters

On 19 January 2006, New Horizons launched aboard an Atlas V launch vehicle. It is presently en route to swing past Jupiter for a gravity boost & scientific studies in February 2007; and will reach Pluto and its moon, Charon, in July 2015.

Juno uses a simple, spin-stabilized spacecraft in an elliptical polar orbit that minimizes radiation exposure by flying under Jupiter's radiation belts. Juno's baseline orbit remains continuously in sunlight, resulting in benign and stable thermal conditions. Max-spin stability eliminates complex, power-hungry attitude control components such as reaction wheels.

Technical Specifications	FY 2007 President's Budget	Change from Baseline
New Horizons	Launch Mass - 465kg	No change
New Horizons	Power at Pluto - 228 watts	No changes
New Horizons	Communication - X-band, 2.1-meter high gain antenna	No changes
New Horizons	Data Rate - 768 bps to 70-meter antenna	No changes
Juno	No baseline technical specifications have been established. Technical specifications to be defined at mission confirmation.	Baseline not yet established

Implementation Schedule:

Project	Schedule by Fiscal Year							Purpose	Phase Dates	
	05	06	07	08	09	10	11		Beg	End
New Horizons								To conduct reconnaissance of Pluto and its moon Charon.	Tech	
									Form	Sep-01 Mar-03
									Dev	Mar-03 Jan-06
									Ops	Jan-06 Dec-20
Juno								The overarching scientific goal is to understand the origin and evolution of Jupiter.	Tech	
									Form	May-05 Jul-08
									Dev	Jul-08 Aug-11
									Ops	Aug-11 Apr-17
									Res	Aug-11 Oct-20

Strategy For Major Planned Acquisitions

- Major acquisitions for the New Horizons and Juno project are in place. Future major acquisitions are to be defined upon mission selection.
- The New Frontiers program will solicit proposals for an entire mission, put together by a team led by a PI comprised of people from industry, small businesses, government and universities.

Key Participants

- New Horizons: The Principal Investigator is from the Southwest Research Institute; Johns Hopkins University/Applied Physics Laboratory has project management responsibility.
- Juno: The Principal Investigator is from the SouthWest Research Institute; Jet Propulsion Laboratory will provide mission project management; Lockheed Martin Space Systems will build the spacecraft.

Theme: Solar System Exploration
Program: New Frontiers

Risk Management

- RISK: No significant risk at this time. MITIGATION: N/A.

Theme: Solar System Exploration
Program: New Frontiers
Project In Development: New Horizons

President's FY 2007 Budget Request (Dollars in Millions)

<u>New Horizons (Development)</u>	<u>FY2005</u>	<u>FY2006</u>	<u>FY2007</u>	<u>FY2008</u>	<u>FY2009</u>	<u>FY2010</u>	<u>FY2011</u>
FY 2007 PRES BUD	193.5	83.3	18.6	10.2	5.8	6.1	6.6
Changes from FY 2006 Request	90.5	-4.4	2.5	0.7	0.1	0.1	

Projects in Development are mature, have a sound design, and are proceeding to mission execution. NASA is committed to their lifecycle cost and schedule plans.

Overview

On 19 January 2006, New Horizons launched aboard an Atlas V launch vehicle. It is presently en route to Jupiter for a gravity boost & scientific studies in February 2007; and will reach Pluto and its moon, Charon, in July 2015.

The New Horizons Pluto mission will conduct a reconnaissance of the Pluto-Charon system and potentially the Kuiper Belt. The mission objectives are to: a) characterize the global geology and morphology of Pluto and Charon; b) map the surface composition of Pluto and Charon; and c) characterize the neutral atmosphere of Pluto and its escape rate.

New Horizons will seek to answer key scientific questions regarding the surfaces, atmospheres, interiors, and space environments of Pluto and Charon using imaging, visible and infrared spectral mapping, ultraviolet spectroscopy, radio science, and in-situ plasma sensors.

The New Horizons Homepage can be accessed at:
<http://pluto.jhuapl.edu/>



New Horizons spacecraft launch at Kennedy Space Center on 19 January 2006.

Changes From FY 2006

- There are no major programmatic changes from FY 2006 to FY 2007.

Program Management

Johns Hopkins University/Applied Physics Laboratory has Project Management responsibility. SwRI, as PI, is responsible for mission science objectives.

Theme: Solar System Exploration
Program: New Frontiers
Project In Development: New Horizons

Technical Parameters

New Horizons launched on 19 January 2006 aboard an Atlas V launch vehicle. It is presently on route to swing past Jupiter for a gravity boost & scientific studies in February 2007; and will reach Pluto and its moon, Charon, in July 2015. The spacecraft may then head deeper into the Kuiper Belt to study one or more of the icy mini-worlds in that vast region that lies beyond Pluto.

Technical Specifications	FY 2007 President's Budget	Change from Baseline
Launch Mass	465 kg	None
Power at Pluto	228 watts	None
Launch Vehicle	Atlas V	None
Communications	X-band, 2.1-meter high gain antenna	None
Payload	Visible & infrared spectrometer; Ultraviolet imaging spectrometer; Radio Science Experiment; Long Range Reconnaissance imager; Solar wind and plasma spectrometer; Energetic particle spectrometer	None
Date Rate	768 bps to 70-meter antenna	None

Schedule	FY 2007 President's Budget	Baseline	Change from Baseline
06/2001	Approved for Formulation		None
03/2003	Approved for Implementation		None
10/2003	Critical Design Review		None
09/2005	Environmental Impact Record of Decision		None
01/2006	Launch		None
03/2007	Jupiter Flyby / Gravity Assist		None
07/2015	Pluto-Charon Encounter		None
2017-2020	Potential Kuiper Belt Object Encounters		None

Strategy For Major Planned Acquisitions

- All major acquisitions are in place.

Key Participants

- Johns Hopkins University/Applied Physics Laboratory has project management responsibility.
- Principal Investigator is at Southwest Research Institute.

Theme: Solar System Exploration
 Program: New Frontiers
 Project In Development: New Horizons

Budget Detail/Life Cycle Cost (Dollars in Millions)

Budget Authority	Prior	FY2005	FY2006	FY2007	FY2008	FY2009	FY2010	FY2011	BTC	Total	Comments
FY 2007 PRES BUD	294.4	193.5	83.3	18.6	10.2	5.8	6.1	6.6	78.4	696.9	
Changes	0.0	90.5	-4.4	2.5	0.7	0.1	0.1		6.0	95.4	
FY2006 President's Budget	294.4	103.0	87.7	16.1	9.5	5.7	6.1		72.4	594.9	

As reported in the February and July 2005 Operating Plans, additional FY 2005 funding supported a number of additional efforts to ensure meeting the January 2006 launch window and growth in launch cost services.

Lifecycle cost elements

Spacecraft: \$196M (includes S/C bus & I&T, RTG)

Launch Vehicle: \$218M

Instruments: \$62M

Other: \$220.9M

Theme: Solar System Exploration
Program: New Frontiers
Project In Formulation: Juno

President's FY 2007 Budget Request (Dollars in Millions)

Juno (Formulation)	FY2005	FY2006	FY2007	FY2008	FY2009	FY2010	FY2011
FY 2007 PRES BUD		52.3	117.2	127.9	217.8	148.8	147.6
Changes from FY 2006 Request		52.3	117.2	127.9	217.8	148.8	

Projects in Formulation are not mature in their development process and cost estimates are SUBJECT TO CHANGE as the project matures.

Overview

Juno was selected on May 24, 2005 under the New Frontiers Announcement of Opportunity (AO). The overarching scientific goal of the Juno mission is to understand the origin and evolution of Jupiter. As the archetype of giant planets, Jupiter can provide the knowledge we need to understand both the origin of our own solar system and the planetary systems being discovered around other stars. The investigation focuses on the four science objectives requested in the New Frontiers Announcement of Opportunity (AO) for a medium class mission to Jupiter:

- 1 - Origin: Determine the O/H ratio (water abundance) and constrain the core mass to decide among alternative theories of Jupiter's origin.
- 2 - Interior: Understand Jupiter's interior structure and dynamical properties through mapping of its gravitational and magnetic fields, including internal convection and the size and mass of its core.
- 3 - Atmosphere: Map variations in atmospheric composition, temperature, cloud opacity and dynamics to depths greater than 100 bars at all latitudes.
- 4 - Magnetosphere: Characterize and explore the three-dimensional structure of Jupiter's polar magnetosphere and auroras.

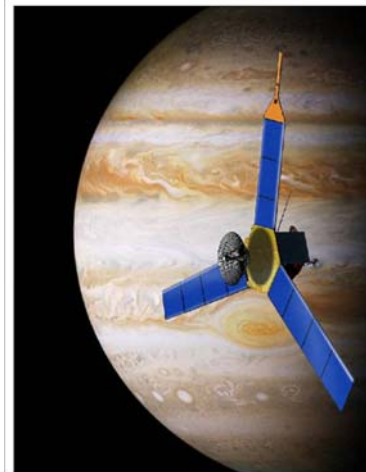

Artist concept of the Juno spacecraft in orbit around Jupiter.

These objectives have been rated very high in the National Academies' Solar System Exploration Decadal Survey and Sun-Earth Connections Decadal Survey. The Astrophysics Decadal Survey identified the study of star formation, their planetary systems, as well as giant and terrestrial planet birth and evolution as high priority. Juno fulfills key goals outlined in recent NASA and NRC studies and is relevant to NASA's Vision for Space Exploration.

Changes From FY 2006

- Juno was selected as the second mission in NASA's New Frontiers Program in May 2005. The Juno mission is currently in Phase B.

Program Management

PI, Dr. Bolton, is responsible for scientific objectives of mission within cost & schedule. JPL is responsible for overseeing day-to-day management.

Theme: Solar System Exploration
Program: New Frontiers
Project In Formulation: Juno

Technical Parameters

Juno, a spinning solar-powered spacecraft, will make global maps of the gravity, magnetic fields, & atmospheric composition of Jupiter from a unique elliptical polar orbit with a close perijove. Spacecraft carries precise, high-sensitivity radiometers, magnetometers, & gravity science systems. Juno's 32 orbits extensively sample Jupiter's full range of latitudes and longitudes. Combines in situ & remote sensing observations to explore the polar magnetosphere to determine what drives Jupiter's remarkable auroras.

Juno's scientific payload: Gravity-Radio Science, Microwave Radiometer, Magnetometer, Jovian Auroral Distribution Experiment (JADE), Energetic Particle detector (EPD), Waves Experiment, Ultraviolet Imaging Spectrometer (UVS), & color camera for glimpses of Jupiter's poles.

Technical Specifications	FY 2007 President's Budget	Change from Baseline
Launch Vehicle	Atlas V 551	N/A
Spacecraft	Will use spin-stabilized spacecraft in an elliptical polar orbit that minimizes radiation exposure	N/A
Solar Panels	Juno's solar panels are continuously illuminated by the Sun to within 35° of the solar panel unit normal vector (and within 11° after orbit 11), except for a few planned OTMs	N/A
Scientific payload	Gravity-Radio Science; Microwave Radiometer; Magnetometer; Jovian Auroral Distribution Experiment (JADE); Energetic Particle Detector (EPD); Waves Experiment; Ultraviolet Imaging Spectrometer (UVS)	N/A

Schedule	FY 2007 President's Budget	Baseline	Change from Baseline
06/2005	NASA Selects New Frontiers Mission Concept Study	N/A	None
08/2011	Launch Readiness Date	N/A	None

Strategy For Major Planned Acquisitions

- All major acquisitions are in place.

Key Participants

- Southwest Research Institute (SwRI) is: the PI institution; provides the Jovian Auroral Distribution Experiment (JADE), the Ultraviolet Camera, and Spectrometer (UVS); and is responsible to NASA for all aspects of the mission including achieving all scientific objectives and mission goals.
- Lockheed Martin to provide flight system (spacecraft with integrated payload), perform ATLO and participate in Mission Operations.
- JPL - Project Management, Business Management, Project Systems Engineering, Mission Assurance, Payload Management, Mission Systems and Operations, Telecommunications / Ka-band; Science Payload: Microwave Radiometer (MWR), Scaler Helium Magnetometer, Gravity Science.
- GSFC provides Vector Fluxgate Magnetometer science payload; Malin Space Science Systems provides JunoCam; KSC procures launch vehicle; John Hopkins University/Applied Physics Lab provides Energetic Particle Detector (EPD) Science Payload; & U. Iowa provides plasma wave (Waves).

President's FY 2007 Budget Request (Dollars in Millions)

<u>Technology</u>	<u>FY2005</u>	<u>FY2006</u>	<u>FY2007</u>	<u>FY2008</u>	<u>FY2009</u>	<u>FY2010</u>	<u>FY2011</u>
FY 2007 PRES BUD	128.9	56.7	72.6	63.4	65.7	67.0	67.2
Changes from FY 2006 Request	-1.8	-39.0	-56.6	-64.6	-63.4	-63.4	

Overview

Solar system exploration is a challenging endeavor. Robotic spacecraft use electrical power for propulsion, data acquisition, and communication. These systems ensure that they survive and function in hostile and unknown environments, acquire and transmit data throughout their lifetimes, and sometimes transport samples back to Earth. Future SSE missions will demand advances in both power and propulsion systems. Elements within the Technology Program include the Radioisotope Power Systems (RPS) and In-Space Propulsion (ISP) projects.

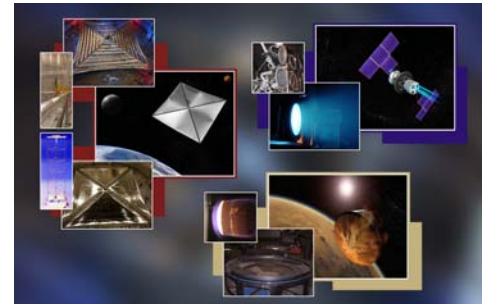

The RPS goal is to develop and demonstrate advanced radioisotope power conversion technologies for future science missions to the outer planets, small bodies, and other solar system destinations. The advanced technologies will increase power conversion efficiency, reduce the amount of plutonium fuel (which is in short supply) required for future missions, and enable more efficient exploration of the solar system with greater scientific return.

Progress in such important technologies as solar sails and aerobraking will enable future missions to explore the solar system.

The ISP goal is to develop advanced propulsion technologies for use beyond Earth orbit that reduce trip times, mass, and/or cost associated with missions to the outer planets, satellites, small bodies, and other solar system destinations. ISP supports the Vision for Exploration by providing new transportation capabilities for robotic science and exploration.

Plans For FY 2007

The In-Space Propulsion (ISP) project will: validate by test an integrated Next-Generation Xenon Thruster system for outer planet exploration, including power processor and propellant management system; complete an extended life test of the commercial BPT-4000 Hall thruster for potential use by Discovery missions; demonstrate the rigid aeroshell concept for aerocapture on the ground via mechanical and thermal testing of two different integrated aeroshell systems, incorporating thermal protection and sensors; and initiate design of a high-temperature thrust chamber for storable propellant engines (currently used on the majority of deep space missions) using high-strength/temperature materials.

Radioisotope Power Systems (RPS) Project will: assemble and test the Multi Mission Radioisotope Thermoelectric Generator (MMRTG) Qualification Unit; evaluated, with down-selection to one concept, several thermoelectric technology concepts for an advanced Radioisotope Thermoelectric Generator (RTG) with higher conversion efficiency and specific power (We/kg); demonstrate, at TRL 5 through component testing, the performance and high thermal-to-electric conversion efficiency for the next generation Stirling engine.

Changes From FY 2006

- In-Space Propulsion: Portfolio of Technology will be evaluated in 2007 based on available budget and technological progress.
- Radioisotope Power System (RPS): One year delay for the MMRTG Qualification Unit. Elimination of the SRG Qualification Unit.

Program Management

MSFC is responsible for ISP; while Headquarters is responsible for RPS project. Both technology projects reside in SMD Solar System Exploration Theme.

Technical Parameters

ISP portfolio invests in high priority technology areas such as Solar Electric Propulsion (Next-Generation Electric Propulsion), Solar Sail Propulsion and Aerocapture Technology. Additional investments are being made in areas of Advanced Chemical and Tether Propulsion.

RPS portfolio includes: (1) demonstration of performance & reliability of Stirling Radioisotope Generator (SRG), a dynamic power conversion system that reduces fuel requirement by 75 %, (2) support for development of MMRTG system, (3) development & demonstration of advanced power conversion technologies to increase specific power (We/kg) and conversion efficiency of RPS systems (4) system & mission trade studies to evaluate benefits of advanced RPS technologies for future science missions and to define technology needs.

Technical Specifications	FY 2007 President's Budget	Change from Baseline
The Stirling convertor is a dynamic power conversion technology currently under development for space-based applications	It is comprised of a free-piston Stirling engine and linear alternator for power conversion. The major advantages are: relatively high conversion efficiency (>18%), high power density & compact size.	N/A
Radioisotope Thermoelectric Generators (RTGs), a type of RPS, are compact, rugged, radiation resistant, and produce no noise, vibration or torque during operation,	The disadvantage of existing thermoelectrics is their relatively modest conversion efficiencies (5 to 7%). Research is underway to improve conversion efficiency.	N/A
Aerocapture	Advanced Aerodynamic Decelerators (trailing ballutes, attached ballutes and inflatable aeroshells).	N/A
Next Generation Ion Thruster	NASA's Evolutionary Xenon Thruster and Carbon Based Ion Optics.	N/A
Solar Sails	Sail subsystem design and fabrication and ground demonstration; Structural testing of sail booms.	N/A

Theme: Solar System Exploration
 Program: Technology

Implementation Schedule:

Project	Schedule by Fiscal Year							Purpose	Phase Dates	
	05	06	07	08	09	10	11		Beg	End
In-Space Propulsion								On-going research and develop (R&D) will extend beyond 2011; R&D includes non-nuclear in-space propulsion technologies for near, mid, and long-term NASA robotic missions.	Tech Form Dev Ops Res	Sep-11
Radioisotope Power Systems								On-going research and develop (R&D) will extend beyond 2011; R&D involves power system technologies that can enable or benefit near- and mid-term NASA robotic exploration missions.	Tech Form Dev Ops Res	Sep-11
<p> Tech & Adv Concepts (Tech) Formulation(Form) Development (Dev) Operations (Ops) Research (Res) Represents a period of no activity for the Project </p>										

Strategy For Major Planned Acquisitions

- With the exception of selections to be made via the NASA Research Opportunities in Space and Earth Sciences (ROSES), which are competitive and peer reviewed, all major acquisitions are in place.

Key Participants

- The U.S. Department of Energy (DOE) supports NASA by leading development and delivery of the MMRTG and SRG. DOE is also responsible for the purchase of Plutonium-238 (Pu-238) fuel from Russia, and processing, fabrication and integration of Pu-238 heat sources.

Risk Management

- RISK: Advanced RTG and Stirling technologies may not achieve the desired specific power (6-8 We/kg) at the system level. MITIGATION: Conduct system trade studies and conceptual design of advanced systems early on to identify technology needs. Involve the end users (industry and Department of Energy) in all stages of technology development.

President's FY 2007 Budget Request (Dollars in Millions)

Deep Space Mission Systems (DSMS)	FY2005	FY2006	FY2007	FY2008	FY2009	FY2010	FY2011
FY 2007 PRES BUD	258.2	254.6	246.9	256.9	265.2	270.5	270.8
Changes from FY 2006 Request	0.5	-2.8	-4.7	-3.8	-2.5	-2.9	

Overview

The Deep Space Mission System (DSMS) program enables human and robotic exploration of the solar system and beyond by providing reliable, high-performance, and cost-effective telecommunications and navigation services. Project elements within DSMS include the Deep Space Network (DSN), Advanced Multi-Mission Operations System (AMMOS), and Optical Communications Technology.

The DSN is a global network of antennas that supports interplanetary spacecraft missions and radio & radar astronomy observations for the exploration of the solar system and the universe, as well as for selected Earth-orbiting missions. AMMOS is a set of navigation & design tools and services which provide flight mission training, resource allocation, and undertake technology investments for improved communication and navigation technologies. NASA's work in optical communications technology provides technical guidance and development of components for future deep space optical communications. For more information, see <http://deepspace.jpl.nasa.gov/dsn/>.



This antenna is part of the Goldstone Deep Space Network Communications Complex.

Plans For FY 2007

DSN will continue to support current missions, and prioritize future technology investments to support the Vision for Space Exploration. NASA is developing a detailed 5-8 year plan to refurbish the current DSN to keep it highly reliable while simultaneously undertaking studies for a next generation DSN to support the Vision for Space Exploration. The DSN will also continue to acquire telemetry data from spacecraft, transmit commands to spacecraft, and track spacecraft position & velocity in support of about 35 missions: Dawn, Image, TOMSEP, Deep Impact, Ulysses, GOES-13 (for NOAA), Mars Science Laboratory, Genesis, RadarSat (Canadian mission), Spirit and Opportunity (the 2003 Mars Exploration Rovers), Voyagers 1 and 2, ISTP (Cluster, Geotail, Polar, Wind), Cassini, SOHO, ACE, Mars Express, Integral (ESA mission), Muses-C (Japanese), Mars Global Surveyor, Chandra, MESSENGER, MAP, Stardust, 2001 Mars Odyssey, Rosetta, MRO, Spitzer, GSSR, and Space Geodesy. DSN anticipates support of New Horizons and SELENE (Japanese).

AMMOS will continue to develop multi-mission software tools for - spacecraft navigation & mission planning, efficient spacecraft communication, and tools to facilitate getting data quickly to scientists & engineers. Ongoing AMMOS activities will be evaluated in FY06 by the AMMOS Operations Assessment Board Review. Recommendations will be implemented in FY07. Optical communications technology will continue work on technologies to implement 10-100 Mbps (Megabit-per-second) optical telecommunications systems for use with future deep space missions. With the cancellation of Mars Telecommunications Orbiter, other flight opportunities are being sought.

Changes From FY 2006

- Multiyear integrated schedule for commanding and downloading telemetry from spacecraft, antenna down time, routine maintenance, and refurbishment activities has been developed and will be implemented.
- DSN will develop a networking system capable of capturing up to 6 Mbps of data from the Mars Reconnaissance Orbiter.

Program Management



















JPL is responsible for Deep Space Mission System (DSMS) program management and oversight.

Technical Parameters

The DSN consists of three deep-space facilities placed at longitudes approximately 120 degrees apart around the world: Goldstone, California; Madrid, Spain; and Canberra, Australia. These facilities provide communications and spacecraft navigation for all of NASA's deep-space missions and most of the rest of the world's deep-space missions. AMMOS provides navigation, design tools and training to flight missions, and undertakes technology investments for improved communications and navigation technologies. The Optical Communications project develops critical flight and ground subsystems, and performs system engineering trades (such as optical-channel-specific codes, optical network design, and optical channel characterization).

Technical Specifications	FY 2007 President's Budget	Change from Baseline
DSN complex at Goldstone, California	One 26-m antenna; six 34-m antennas, one 70-m antenna	N/A
DSN complex at Madrid, Spain	One 26-m antenna, three 34-m antennas, one 70-m antenna	N/A
DSN complex at Canberra, Australia	One 26-m antenna, two 34-m antennas, one 70-m antenna	N/A

Implementation Schedule:

Project	Schedule by Fiscal Year							Purpose	Phase Dates													
	05	06	07	08	09	10	11		Beg	End												
Deep Space Network								Acquiring telemetry data from spacecraft and transmitting commands to spacecraft is on-going and will extend beyond 2011.	Tech Form Dev Ops Res	Sep-11												
Advanced Multi-Mission Operations System								Providing navigation and design tools to improve communications and navigation technologies is on-going and will extend beyond 2011.	Tech Form Dev Ops Res	Sep-11												
Optical Communications Technology								Providing technical guidance and development of components for future deep space optical communications is on-going and will extend beyond 2011.	Tech Form Dev Ops Res	Sep-11												
<table border="0"> <tr> <td></td> <td>Tech & Adv Concepts (Tech)</td> </tr> <tr> <td></td> <td>Formulation (Form)</td> </tr> <tr> <td></td> <td>Development (Dev)</td> </tr> <tr> <td></td> <td>Operations (Ops)</td> </tr> <tr> <td></td> <td>Research (Res)</td> </tr> <tr> <td></td> <td>Represents a period of no activity for the Project</td> </tr> </table>												Tech & Adv Concepts (Tech)		Formulation (Form)		Development (Dev)		Operations (Ops)		Research (Res)		Represents a period of no activity for the Project
	Tech & Adv Concepts (Tech)																					
	Formulation (Form)																					
	Development (Dev)																					
	Operations (Ops)																					
	Research (Res)																					
	Represents a period of no activity for the Project																					

Theme:	Solar System Exploration
Program:	Deep Space Mission Systems (DSMS)

Strategy For Major Planned Acquisitions

- No major acquisitions planned for FY07.

Key Participants

- DOD - Laser Communication, member in the Deep Space Network Executive Management Board.
- Russia, Europe [via European Space Agency], Japan - members of Tracking Interoperability Working Group, of which NASA is a part.
- France, Germany, Italy, Japan, and the United Kingdom - Data Transfer Protocol Standards Working Group.
- Spain and Australia - Host tracking stations near Madrid and near Canberra.

Risk Management

- **RISK:** The DSN infrastructure is becoming increasingly fragile due to aging, creating a significant risk of breakage, which would result in the loss of communications and navigation services to deep-space missions. **MITIGATION:** Several in-depth studies are ongoing regarding the requirements for DSN refurbishment. A 5-8 year refurbishment plan is due in early CY06 and will be implemented beginning in FY06.

President's FY 2007 Budget Request (Dollars in Millions)

Solar System Research	FY2005	FY2006	FY2007	FY2008	FY2009	FY2010	FY2011
FY 2007 PRES BUD	351.4	326.6	273.6	290.1	311.7	312.5	301.9
Changes from FY 2006 Request	6.2	-35.9	-96.5	-84.2	-63.1	-69.4	

Overview

The Solar System Exploration (SSE) Research Program develops theoretical tools and laboratory data needed to analyze flight data, makes possible new and better instruments to fly on future missions, and analyzes the data returned so that SSE can answer specific questions posed and fit new knowledge into the overall picture of the solar system. This program represents an essential complement to flight missions, providing the scientific research and theoretical foundation to allow the nation to fully utilize the unique data sets returned from the solar system.

The SSE Research Program includes Research and Analysis (R&A); the operations & analysis of data for Cassini-Huygens, Rosetta, and Hayabusa (Muses-C) missions; and data archives, sample holding facilities, and analysis tools needed to perform the research. The scope of R&A programs is wide because they must provide the new theories and instrumentation that enable the next generation of flight missions. Cassini-Huygens is an international collaboration mission to Saturn and is the first to explore the Saturn system of rings and moons. A major focus is Saturn's largest moon Titan, with its dense atmosphere, methane-based meteorology, and geologically active surface. Rosetta, an ESA/NASA comet rendezvous mission, launched in March 2004 and will arrive at comet Churyumov-Gerasimenko in 2014. Hayabusa (Muses-C-), a joint Japanese/NASA mission to asteroid 25143 Itokawa.



The icy moon Mimas drifts along in its orbit against the shadow of Saturn's rings on the surface of the planet itself. The image is in true color.

Plans For FY 2007

- Continue with the operations and data analysis of the Cassini and Rosetta missions.
- Continue planetary science data archiving and releasing of this data to the science community in a timely manner.
- Release Research Announcements soliciting R&A proposals and make selections.

Changes From FY 2006

- Fewer new grants and research astrobiology and other SSE science discipline awards are funded in this budget than were reflected in the FY 2006 request.

Program Management

NASA Headquarters is responsible for R&A program management; Jet Propulsion Lab (JPL) has responsibility for Cassini, Rosetta, and Hayabusa (Muses-C).

Theme: Solar System Exploration
Program: Solar System Research

Technical Parameters

Research and Analysis (R&A) provides the foundation for the formulation of new scientific questions and strategies. It supports research tasks such as astrobiology and cosmochemistry, the origins and evolution of planetary systems, the atmospheres, geology, and chemistry of the solar system's planets (other than Earth). Additionally, it provides for instrument and measurement concepts, and supports the initial definition and development of instruments for future Discovery, New Frontiers, or Mars missions.

Cassini (a mission to Saturn that will help us better understand Saturn, its famous rings, magnetosphere, icy satellites, and moon Titan), Rosetta (ESA Comet rendezvous mission), and Hayabusa/Muses-C (JAXA asteroid sample return mission) are included within the Research Program.

Technical Specifications	FY 2007 President's Budget	Change from Baseline
Cassini, Rosetta, Haybusa (Muses-C)	These missions have met Level 1 specifications as identified in each mission's respective plan.	No changes
Research & Analysis	The SMD strategic plan process specifies a series of goals, strategic objectives and research focus areas. It draws from the Solar System Decadal Survey and roadmap activities by subcommittees.	R&A does not have an established baseline
Research & Analysis	All selection processes and reviews of elements of the SSE research program use the strategic items as guideposts for selection and/or continuation. Proposals must relate to these strategic items.	R&A does not have an established baseline

Implementation Schedule:

Project	Schedule by Fiscal Year							Purpose	Phase Dates		
	05	06	07	08	09	10	11			Beg	End
Cassini Mission	[Gantt chart showing activity from FY 06 to FY 10]							A mission to Saturn and its major moon (Titan)	Tech		
									Form		
									Dev	Oct-89	Oct-97
									Ops	Oct-97	Jul-11
									Res	Oct-97	Jul-09
Rosetta Mission	[Gantt chart showing activity from FY 06 to FY 10]							ESA/NASA comet rendezvous mission	Tech		
									Form		
									Dev	Jun-97	Mar-04
									Ops	Mar-04	Sep-16
									Res	Mar-04	Sep-17
Hayabusa (Muses-C)	[Gantt chart showing activity from FY 06 to FY 10]							A joint Japanese/NASA mission to study asteroid 4660 Nereus and return a sample	Tech		
									Form		
									Dev	Feb-98	May-03
									Ops	May-03	Sep-08
									Res	May-03	Sep-09
R&A, PDS, Curation	[Gantt chart showing activity from FY 06 to FY 10]							On-going research, archiving, and data release will extend beyond 2011; to aid the science community	Tech		
									Form		
									Dev		
									Ops		
									Res	Oct-89	Sep-20

- Tech & Adv Concepts (Tech)
- Formulation(Form)
- Development (Dev)
- Operations (Ops)
- Research (Res)
- Represents a period of no activity for the Project

Theme: Solar System Exploration

Program: Solar System Research

Strategy For Major Planned Acquisitions

- The R&A FY 2007 budget will fund competitively selected activities from the ROSES-05 (Research Opportunities in Space and Earth Science) Omnibus NRA.
- All major acquisitions for Cassini, Rosetta, Hayabusa, Planetary Data System (PDS), and Astromaterial Curation are in place.

Key Participants

- Rosetta - The European Space Agency (ESA) built the spacecraft, provided the launch vehicle, and operates the spacecraft.
- Hayabusa (Muses-C) - Japan Aerospace Exploration Agency (JAXA) responsibilities include the spacecraft, launch vehicle, and operations.
- Cassini - The Italian Space Agency provided Cassini's high-gain communication antenna and the Huygens probe was built by the European Space Agency (ESA).
- R&A - Staff at many universities across the Nation propose and win grants to participate in the Universe Theme operational missions as principal investigators for observation and data analysis, as well as in the SSE Research program.

Risk Management

- RISK: There are no significant risks, at this time, within the Research & analysis (R&A), Planetary Data System, and Astromaterial Curation projects. MITIGATION: N/A

President's FY 2007 Budget Request (Dollars in Millions)

Mars Exploration	FY2005	FY2006	FY2007	FY2008	FY2009	FY2010	FY2011
FY 2007 PRES BUD	588.5	650.4	700.2	630.9	647.4	648.4	668.9
Changes from FY 2006 Request	-92.6	-72.7	-243.3	-602.5	-584.5	-611.8	

Overview

Mars has captured the imagination of generations, from the discovery of "canals" in the 19th century to H.G. Wells' War of the Worlds. Mars is the most Earth-like planet in our solar system, with land mass approximately equivalent to the Earth's and what appear to be familiar features such as riverbeds, past river deltas, and volcanoes. Mars holds valuable scientific clues to the development of the solar system, planets, and maybe life itself. The Mars Program has been developed to conduct a rigorous, incremental, discovery-driven exploration of Mars to determine the planet's physical, dynamic, and geological characteristics, investigate the Martian climate in the context of understanding habitableness, and investigate whether Mars ever had the potential to develop and harbor any kind of life.



Water ice in crater at Martian North Pole, based on actual spacecraft data, color added for emphasis.

The Mars Rovers, Spirit & Opportunity, continue to provide amazing science data & images to the science community and the public. In operation for more than a full Mars year (equivalent to 687 Earth days), they have exceeded their original design life by over 700% and traversed a combined distance of over 7.5 miles on the Martian surface. A more benign ancient Mars has been revealed, in which salty acidic waters indicate a planet with the potential for life. Mars Global Surveyor and Mars Odyssey have continued to operate exceedingly well, providing new data of a dynamic planet that has undergone episodes of relative wet and dry periods throughout its history. Mars Reconnaissance Orbiter is on its way to providing close-up pictures of this exciting landscape, followed by the 2009 Phoenix Scout and 2011 Mars Science Laboratory. For more information, see <http://mars.jpl.nasa.gov>

Plans For FY 2007

- 2005 Mars Reconnaissance Orbiter (MRO) will begin it's first year of investigations at Mars
- 2007 Mars Scout (Phoenix), completes assembly, integration, and test phase, and will launch in August 2007.
- 2009 Mars Science Laboratory (MSL) starts Critical Design Review (CDR)
- Initial selection(s) for the second Mars Scout will be made, with an anticipated 2011/13 launch.

Theme: Solar System Exploration
Program: Mars Exploration

Changes From FY 2006

- 2009 Mars Telecom Orbiter (MTO) was cancelled, along with the Optical Communication Payload demonstration.
- Funding of Mars human precursor missions and technologies was deferred.
- As communicated and summarized in the changes section here, the Mars reductions relative to the original FY 2006 budget request were a result of NASA's efforts to balance the Science portfolio.



















Program Management

JPL has program management responsibility.

Technical Parameters

The Mars Exploration Program (MEP) is composed of a number of synergistic elements that achieve the programmatic and scientific goals of the program. The technology program supports future missions through competitive selection of base, focused, and instrument-specific development. Science research is fostered through competitive selections for scientific research, and missions are developed through largely competitive processes, including core MEP missions and community driven competitive Scout missions. MEP is currently operating the Global Surveyor, Odyssey, the Mars Exploration Rovers at Mars, Mars Reconnaissance Orbiter. Missions in formulation or development include: Phoenix (2007), MSL (2009), and the second Mars Scout.

Technical Specifications	FY 2007 President's Budget	Change from Baseline
Mars Global Surveyor (MGS)	Continue examining & mapping the planet - from the ionosphere (an envelope of charged particles surrounding Mars) down through the atmosphere to the surface, and deep into Mars' interior.	Operating on an extended mission.
Mars Odyssey	Continues to map chemical elements and minerals on the surface of Mars, look for water in the shallow subsurface, and analyze radiation environment to determine its potential effects on human health.	Operating on an extended mission.
Mars Exploration Rovers (MER): Spirit and Opportunity	Continue to study the history of water on Mars to meet long-term NASA goals of determining if life ever arose on Mars; characterize the climate & geology, and prepare for Human Exploration.	Operating on an extended mission.
Mars Reconnaissance Orbiter	Take close-up pictures of the Martian surface, analyze minerals, look for subsurface water, trace how much dust and water are distributed in the atmosphere, and monitor global weather.	None
Mars 2007 Scout (Phoenix)	Study the history of water in all its phases; search for evidence of a habitable zone, and assess the biological potential of the ice-soil boundary. Baseline was recently established at confirmation.	Increased funding to better understand the Entry, Descent and Landing (EDL) process and to minimize the EDL risk.
Mars Science Laboratory (MSL)	Please refer to the MSL IBPD for detailed technical specifications. The baseline will be established at confirmation.	No baseline established.

Implementation Schedule:																					
Project	Schedule by Fiscal Year							Purpose	Phase Dates												
	05	06	07	08	09	10	11		Beg	End											
Mars Global Surveyor (MGS)								To study the entire Martian surface, atmosphere, and interior. MGS has returned more data about the red planet than all other Mars missions combined. Currently on extended mission.	Tech Form Dev Ops Res	Nov-96 Nov-96 Sep-06 Sep-97 Oct-08											
Mars Odyssey								To study the geology, geophysics and climate of Mars. Currently on extended mission.	Tech Form Dev Ops Res	Apr-01 Apr-01 Mar-07 Oct-01 Oct-11											
Mars Express								The ESA and the ISA Mars mission, with United States participation, launched in June 2, 2003, to explore the atmosphere and surface of Mars from polar orbit. Currently on extended mission.	Tech Form Dev Ops Res	Jan-00 Sep-00 Jun-03 Jun-03 Dec-05 Dec-03 Oct-08											
Mars Exploration Rovers (Spirit and Opportunity)								To search for evidence of liquid water that may have been present in the planet's past. Currently on extended mission.	Tech Form Dev Ops Res	May-00 Jul-00 Jul-03 Jul-03 Mar-05 Jan-04 Oct-07											
Mars Reconnaissance Orbiter (MRO)								To take close-up pictures of the martian surface, analyze minerals, look for subsurface water, trace how much dust and water are distributed in the atmosphere, and monitor global weather	Tech Form Dev Ops Res	Jan-01 Jul-02 Jul-02 Aug-05 Aug-05 Dec-10 Mar-06 Dec-10											
Mars Scout (Phoenix)								First in a new line of smaller competed "Scout" missions in the agency's Mars Exploration Program, Phoenix will seek to detect signatures of life by looking for complex organic molecules.	Tech Form Dev Ops Res	Aug-03 Mar-05 Mar-05 Aug-07 Oct-08 May-08 Oct-09											
Mars Science Laboratory (MSL)								To collect martian soil samples and rock cores and analyze them for organic compounds and environmental conditions that could have supported microbial life now or in the past.	Tech Form Dev Ops Res	Nov-03 Aug-05 Aug-05 Nov-09 Oct-12 Nov-10 Sep-13											
<table border="0"> <tr> <td></td> <td>Tech & Adv Concepts (Tech)</td> </tr> <tr> <td></td> <td>Formulation(Form)</td> </tr> <tr> <td></td> <td>Development (Dev)</td> </tr> <tr> <td></td> <td>Operations (Ops)</td> </tr> <tr> <td></td> <td>Research (Res)</td> </tr> <tr> <td></td> <td>Represents a period of no activity for the Project</td> </tr> </table>											Tech & Adv Concepts (Tech)		Formulation(Form)		Development (Dev)		Operations (Ops)		Research (Res)		Represents a period of no activity for the Project
	Tech & Adv Concepts (Tech)																				
	Formulation(Form)																				
	Development (Dev)																				
	Operations (Ops)																				
	Research (Res)																				
	Represents a period of no activity for the Project																				

Strategy For Major Planned Acquisitions

- NASA has set a goal of open competition for all missions. All major acquisitions for MRO, Phoenix, and MSL are in place; a major competitive acquisition for the second Mars Scout is underway.

Key Participants

- MRO - Ball Aerospace developed the primary optical instrument.
- MRO - Lockheed Martin is the Spacecraft Design/Systems Integrator.
- Phoenix - Principle Investigator and Lead Scientist resides at the University of Arizona.
- MSL - Department of Energy is developing the for Multi-Mission Radioisotope Thermo-electric Generators.

Theme: Solar System Exploration

Program: Mars Exploration

Risk Management

- **RISK:** Mars Exploration Program (MEP) manages program risk through project-specific implementation. Since majority of MEP risk is encountered during flight mission development, and each project is unique in its technical and financial challenges, risk must also be managed according to each project's specific needs. MEP, JPL, and NASA HQ require rigorous risk management to be employed on each project. **MITIGATION:** Project risks are reviewed and discussed, and mitigation approaches and progress are evaluated by the JPL program office and NASA program director on a monthly basis. Risks are ranked in the NASA 5X5 matrix and risks that are deemed to be problems are elevated and managed to closure.

Theme: Solar System Exploration
Program: Mars Exploration
Project In Development: Phoenix (Scouts 07)

President's FY 2007 Budget Request (Dollars in Millions)

Phoenix (Scouts 07) (Development)	FY2005	FY2006	FY2007	FY2008	FY2009	FY2010	FY2011
FY 2007 PRES BUD	108.9	125.6	90.5	28.6	1.0		
Changes from FY 2006 Request	12.8	31.3	-1.8	-5.3	-5.0		

Projects in Development are mature, have a sound design, and are proceeding to mission execution. NASA is committed to their lifecycle cost and schedule plans.

Overview

The Mars Phoenix overall mission is to uncover clues to the geologic history and biological potential of the Martian arctic. Phoenix will be the first mission to return data from either polar region, providing an important contribution to the Mars science strategy of "follow the water."

While providing investigator-led flexibility to the Mars Program and allowing for reduced total mission life-cycle costs and development time, this project will also enhance public awareness of, and appreciation for, Mars exploration. Educational and public outreach activities are being incorporated as integral parts of Mars science investigations.

The Phoenix mission is the first in a series of smaller, lower-cost, competed spacecraft. The Phoenix mission has two bold objectives: 1) study the history of water in all its phases and 2) search for evidence of a habitable zone and assess the biological potential of the ice-soil boundary. For more information on the Phoenix mission, visit <http://phoenix.lpl.arizona.edu>.



Phoenix landing thrusters provide a gentle touchdown on the Martian surface. (artist's representation)

Changes From FY 2006

- Increased funding to better understand the EDL (Entry, Descent, and Landing) process and to minimize the EDL risk.

Program Management

Program Management responsibility provided by JPL. Project responsibility is delegated to the PI at University of Arizona.

Theme: Solar System Exploration
Program: Mars Exploration
Project In Development: Phoenix (Scouts 07)

Technical Parameters

In the continuing pursuit of water on Mars, the poles are a good place to probe, as water ice is found there. Phoenix will land on the icy northern pole of Mars between 65 degrees and 75 degrees North latitude. During the course of the 90 Martian day primary mission, (with potential extended operations of 60 days), Phoenix will deploy its robotic arm and dig trenches up to half a meter (1.6 feet) into the layers of water ice. These layers, thought to be affected by seasonal climate changes, could contain organic compounds that are necessary for life. To analyze soil samples collected by the robotic arm, Phoenix will carry an "oven" and a "portable laboratory." Selected samples will be heated to release volatiles that can be examined for their chemical composition and other characteristics.

Technical Specifications	FY 2007 President's Budget	Change from Baseline
Landing	Land successfully on the surface of Mars	None
Picture Acquisition	Acquire a panoramic picture of the landing site, covering at least 120 degree of the circumference around the Lander	None
Soil Samples	Provide surface soil samples to either the TEGA or MECA wet chemistry instruments	None
TEGA Soil Analysis	The TEGA instruments shall analyze at least 2 soil samples to create a profile of H2O and other minerals near the surface	None
MECA Soil Analysis	MECA shall analyze the wet chemistry of 2 soil samples	None
TEGA Atmospeheric Analysis	TEGA shall also analyze an atmospheric sample in its mass spectrometer	None
Non-Atmospheric Samples	Document all non-atmospheric samples and their collection locations with images from the cameras	None

Schedule	FY 2007 President's Budget	Baseline	Change from Baseline
CDR	November 2005	November 2005	None
Start of ATLO (Assembly, Test, and Launch Operations)	April 2006	April 2006	None
Launch	August 2007	August 2007	None
End of Prime Mission	August 2008	August 2008	None

Strategy For Major Planned Acquisitions

- All major acquisitions are already in place

Key Participants

- Principal Investigator -University of Arizona, Lunar and Planetary Laboratory
- Lockheed Martin Aerospace -spacecraft provider

Theme: Solar System Exploration
Program: Mars Exploration
Project In Development: Phoenix (Scouts 07)

Risk Management

- **RISK:** Entry-Decent-Landing (EDL) process and margins (mass, loads, parachute opening, thruster performances, thermal, landing location). **MITIGATION:** Project was given additional budget augmentation to resolve the EDL problems. Special risk and work-to-go reviews are being conducted; Program-level monitoring of progress was increased; risk and schedule reserve status were tracked; final design of the EDL process is being evaluated.

Budget Detail/Life Cycle Cost (Dollars in Millions)

Budget Authority	Prior	FY2005	FY2006	FY2007	FY2008	FY2009	FY2010	FY2011	BTC	Total	Comments
FY 2007 PRES BUD	30.7	108.9	125.6	90.5	28.6	1.0				385.3	
Changes	0.1	12.8	31.3								
FY2006 President's Budget	30.6	96.1	94.4								

Phoenix entered development in November 2005 at which time the LCC baseline commitment was established. Therefore, no LCC in FY 2006 budget.

Life Cycle Cost (LCC) elements:

Spacecraft: \$154M

Launch Vehicle : \$79M

Instruments/Payloads: \$54M

Other: \$98.3M

Theme: Solar System Exploration
 Program: Mars Exploration
 Project In **Formulation**: 2009 Mars Science Lab

President's FY 2007 Budget Request (Dollars in Millions)

2009 Mars Science Lab (Formulation)	FY2005	FY2006	FY2007	FY2008	FY2009	FY2010	FY2011
FY 2007 PRES BUD	117.5	253.4	347.9	285.6	231.0	50.4	41.2
Changes from FY 2006 Request	-44.8	69.5	18.6	-7.2	62.3	9.8	

Overview

Projects in Formulation are not mature in their development process and cost estimates are SUBJECT TO CHANGE as the project matures.

The 2009 Mars Science Laboratory (MSL) will be a long-duration, roving science laboratory that will provide a major leap in surface measurement technology focusing on Mars habitability. Detailed measurements will be made of element composition, elemental isotopes and abundance, mineralogy, and organic compounds to determine if Mars has, or ever had, an environment capable of supporting life. The project will develop critical technologies for Entry, Descent, and Landing (EDL), longlife systems, autonomous operations, sample acquisition, handling and processing, and Mars proximity telecommunications. For more information, see the MSL homepage at <http://marsprogram.jpl.nasa.gov/missions/future/msl.html>.

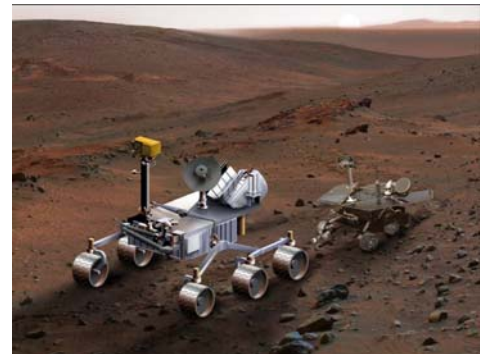

Twice as long and three times as heavy as the Mars Exploration Rovers Spirit and Opportunity, the Mars Science Laboratory (front vehicle) will collect Martian soil samples and rock cores and analyze them for organic compounds and environmental conditions that could have supported microbial life now or in the past.

Changes From FY 2006

- Funding estimates changed due to technical requirements, (increased Rover mass to accommodate selected instruments and avionics redundancy), and to preserve schedule.

Program Management

2009 MSL is a JPL-managed project. Instrument implementation has been assigned to JPL.

Theme: Solar System Exploration
Program: Mars Exploration
Project In Formulation: 2009 Mars Science Lab

Technical Parameters

MSL is planned for launch in the September-October 2009 time frame, and will arrive at Mars in August 2010. The EDL system will be designed to accommodate a wide range of possible latitude and altitude locations on Mars in order to be discovery-responsive and to have the capability to reach very promising, but difficult-to-reach scientific sites.

Technical Specifications	FY 2007 President's Budget	Change from Baseline
Flight Time	12 months	None
Course Corrections	5 to 6 course corrections during mission	
Entry and Descent	Direct entry with altimetry performed in terminal descent	
Mass of Rover	700-775 kg	
Expected operating life	2 earth years lifetime on the surface of Mars	
Expected mobility	10 kilometers	

Schedule	FY 2007 President's Budget	Baseline	Change from Baseline
Initial Confirmation Review (ICR)	2nd QTR FY 2006.	None	+2 qtrs from FY 2006 budget
Critical Design Review (CDR)	4th QTR FY 2007		+1 qtr from FY 2006 budget
Start Assembly, Test, and Launch Operations (ATLO)	2nd QTR FY 2008		N/A
Launch	November 2009		+1 mo. from FY 2006 budget
End of Prime Mission	October 2012		

Strategy For Major Planned Acquisitions

- 2009 Mars Science Laboratory - Hybrid JPL in-house and industry.
- All other major acquisitions are in place.
- All major instruments were competitively selected by NASA HQ.

Key Participants

- Malin Space Systems - Stereoscopic and Microscopic Cameras
- Honeybee Robotics - Robotic Arm Tools
- Department of Energy/Los Alamos National Laboratory - Chemistry Camera (ChemCam)
- International Partners: Canada - Alpha Particle X-ray Spectrometer (APXS), Spain - Rover Environmental Monitoring System (REMS), Russia - Dynamic Albedo of Neutrons (DAN), France - Sub-elements of the instruments SAM and ChemCam

The Universe

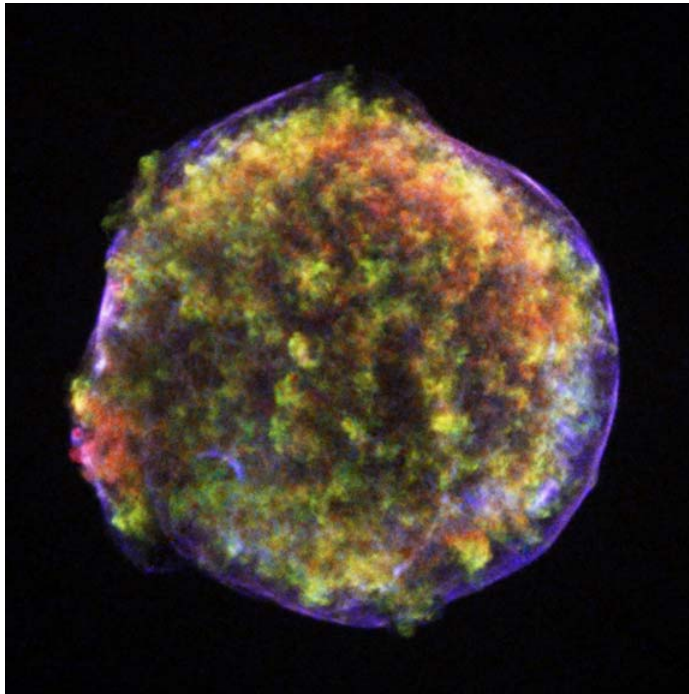

Chandra's image of a supernova remnant shows an expanding bubble of debris inside a more rapidly moving shell of extremely high energy electrons. According to theory, the outward moving shock wave should be 2 light years ahead of the debris. Instead, Chandra found that the stellar debris is half a light year behind.

President's FY 2007 Budget Request (Dollars in Millions)

The Universe	FY2005	FY2006	FY2007	FY2008	FY2009	FY2010	FY2011
FY 2007 PRES BUD	1,474.9	1,507.9	1,509.2	1,500.9	1,307.9	1,276.1	1,309.7
Changes from FY 2006 Request	-38.3	-4.3	31.2	0.5	-187.2	-130.6	

Overview: What NASA Accomplishes through the The Universe Theme

How did the universe begin? How will it end? Does time have a beginning and an end? The universe is a dynamic, evolving place, governed by cycles of matter and energy. In an intricate series of physical processes, chemical elements are formed and destroyed, passed between stars and diffuse clouds. Through The Universe Theme, NASA seeks to understand these cycles and how they created the unique conditions that support our very existence. Where are we from? Are we alone? We search for answers to these questions looking far away, towards the beginning of time, to see galaxies forming, and close to home, in search of planetary systems like our own around nearby stars.

The Universe suite of operating missions includes 3 Great Observatories, which have helped astronomers unravel the mysteries of the cosmos by allowing contemporaneous observations of objects at different spectral wavelengths. The best known is the Hubble Space Telescope, which has rewritten astronomy textbooks since its launch in 1990. Hubble was joined by the Chandra X-Ray Observatory in 1999 and the Spitzer Space Telescope in 2003. In the years to come, new technologies and more powerful instruments will allow the Universe Theme to look deeper into the cosmos, taking us to the edge of black holes and nearly to the beginning of time. In our search for origins, we will peer at hundreds of our nearest neighbor stars, inventory their planets, and search for solar systems resembling our own balmy, wet planet Earth. We do not yet know whether the worlds we seek are common or exceedingly rare, but our journey has already begun.

Relevance: *Why* NASA conducts The Universe work

Relevance to national priorities, relevant fields, and customer needs:

The Universe Theme seeks to answer questions that humankind has been pondering for millennia: How did the universe begin? How will it end? What are the limits of matter and energy, of space and time? How did the universe come to be, and what are the laws of nature that have permitted life to arise in the universe? Throughout history, these questions have served as cornerstones of mythology and philosophy: thought-provoking, but unanswerable. Now, with the aid of cutting-edge science and technology, the answers are within reach.

Knowing where we come from means understanding how the universe began and how its evolution culminated in everything that can be observed today. Knowing whether Earth alone supports life in the cosmos depends upon NASA's search for life-sustaining planets or moons, and researchers' understanding of the diversity of life here on Earth. Programs within the Universe Theme are aimed at developing the new technologies, building the instruments to make crucial observations, and performing the science that will bring answers to these questions.

Relevance to the NASA mission:

The Universe Theme supports NASA's mission to "explore the universe and search for life" by attempting to understand the origin and evolution of life, searching for evidence of life elsewhere, and exploring the universe beyond.

Relevance to education and public benefits:

Over the last decade, few scientific endeavors have contributed more to the rewriting of science textbooks, or generated more public interest and excitement, than the Universe's Great Observatories: the Hubble Space Telescope, Chandra X-Ray Observatory and Spitzer Space Telescope. As more sophisticated instruments have been added through the years, the world has witnessed the birth of stars, begun to unravel the mysteries of black holes, and looked billions of years into the past. This flood of knowledge and questions has spread across the globe via front-page press, television, Web sites, and school curricula at all levels. Programs within the Universe Theme will continue to make significant contributions toward meeting national goals for the reform of science, mathematics, and technology education, as well as elevating scientific and technological literacy throughout the country.

Performance

Major Activities Planned for FY 2007:

- Spitzer Space Telescope will celebrate 4 years of spectacular observations.
- GLAST is scheduled to launch in September of 2007.
- Results from GP-B data analysis will be released. GP-B was designed to test Einstein's theories about the universe; the spacecraft completed its scientific operations in September of 2005.
- Planning and preparation for potential HST servicing mission.

Major Recent Accomplishments:

- In July, the Spitzer Space Telescope detected organic molecules (the building blocks of life) in galaxies when our universe was one-fourth of its current age of about 14 billion years.
 - The Hubble Space Telescope completed lunar observations in search of materials critical to support sustained human presence on the moon.
 - Chandra observations determined that the supermassive black hole at the center of the Milky Way has helped spawn new stars, challenging the theory that black holes are only violent and destructive.
 - HETE II, Chandra, Hubble Space Telescope, Swift and a multitude of ground-based telescopes combined observations to solve the 35-year old mystery of the origin of short gamma ray bursts.
 - Swift, HST, Chandra and Spitzer also combined efforts to observe the Deep Impact mission as it smashed into comet Tempel 1 on the Fourth of July.
-

The Universe Theme Commitment in Support of the NASA Mission :

Strategic Goals**Sub-Goals (If Applicable)***Multiyear Outcomes*

Annual Performance Goals supporting the Multiyear Outcomes

3. Develop a balanced overall program of science, exploration, and aeronautics consistent with the redirection of the human spaceflight program to focus on exploration.

3D Discover the origin, structure, evolution, and destiny of the universe, and search for Earth-like planets.

3D.1 Progress in understanding the origin and destiny of the universe, phenomena near black holes, and the nature of gravity.

7UNIV1 Demonstrate progress in understanding the origin and destiny of the universe, phenomena near black holes, and the nature of gravity. Progress will be evaluated by external expert review.

7UNIV2 Complete Gamma-ray Large Area Space Telescope (GLAST) Operations Readiness Review (ORR).

7UNIV3.1 Complete Hubble Space Telescope Servicing Mission 4 (SM4) Test Readiness Review.

7UNIV4.1 Complete James Webb Space Telescope (JWST) Integrated Science Instrument Module (ISIM) Preliminary Design Review (PDR).

3D.2 Progress in understanding how the first stars and galaxies formed, and how they changed over time into the objects recognized in the present universe.

7UNIV3.2 Complete Hubble Space Telescope Servicing Mission 4 (SM4) Test Readiness Review.

7UNIV4.2 Complete James Webb Space Telescope (JWST) Integrated Science Instrument Module (ISIM) Preliminary Design Review (PDR).

7UNIV5 Demonstrate progress in understanding how the first stars and galaxies formed, and how they changed over time into the objects we recognize in the present universe. Progress will be evaluated by external expert review.

3D.3 Progress in understanding how individual stars form and how those processes ultimately affect the formation of planetary systems.

7UNIV3.3 Complete Hubble Space Telescope Servicing Mission 4 (SM4) Test Readiness Review.

7UNIV4.3 Complete James Webb Space Telescope (JWST) Integrated Science Instrument Module (ISIM) Preliminary Design Review (PDR).

7UNIV6 Demonstrate progress in understanding how individual stars form and how those processes ultimately affect the formation of planetary systems. Progress will be evaluated by external expert review.

3D.4 Progress in creating a census of extra-solar planets and measuring their properties

7UNIV7 Demonstrate progress in creating a census of extra-solar planets and measuring their properties. Progress will be evaluated by external expert review.

7UNIV8 Begin Kepler assembly, test, and launch operations (ATLO).

Efficiency Measures

7UNIV9 Complete all development projects within 110% of the cost and schedule baseline.

7UNIV10 Deliver at least 90% of scheduled operating hours for all operations and research facilities.

7UNIV11 Peer-review and competitively award at least 80%, by budget, of research projects.

7UNIV12 Reduce time within which 80% of NRA research grants are awarded, from proposal due date to selection, by 5% per year, with a goal of 130 days.

Program Management

The Universe Theme is managed by Dr. Anne Kinney, Director of the Universe Division, Science Mission Directorate.

Quality

Independent Reviews:

- Each major mission has an independent review team that evaluates the project at critical junctures in the development process. These reviews occur throughout the year.
- In April of 2006, the Universe Theme small operating missions are subject to a bi-annual Senior Review, during which science and budgets are prioritized by an independent external group of reviewers from the science community.
- JWST is currently undergoing a bottoms-up independent review of recent cost growth; results are scheduled to be completed by April, 2006.
- NASA Advisory Council (NAC) - Reviews science strategy, program implementation strategy
- National Research Council - Advises on long-term scientific strategies

Program Assessment Rating Tool (PART):

The Universe Theme was previously comprised of 2 themes: Structure and Evolution of the Universe (SEU), and Astronomical Search for Origins (ASO). The SEU Theme was reviewed in 2004 and received a PART rating of "effective." The ASO Theme was never reviewed. The Universe Theme will be reviewed as a single entity in 2007.

OMB found that "SEU is a well-defined, well-managed program with clear purpose and direct ties to NASA's mission. SEU embraces the research priorities of the astronomy and astrophysics community and includes those priorities within its mission plans."

Per OMB's recommendation, NASA will report on estimated mission life cycle cost upon entering development, key schedule milestones associated with each mission phase for those missions formally approved for formulation, the mission's cost and schedule progress achieved in each phase before entering the next, and any plans to re-baseline life cycle cost and/or schedule.

Budget Detail

(Dollars in Millions)

Budget Authority (\$ millions)	FY2005	FY2006	Change	FY2007	FY2008	FY2009	FY2010	FY2011	Comments
The Universe	1,474.9	1,507.9	1.2	1,509.2	1,500.9	1,307.9	1,276.1	1,309.7	
Navigator	179.2	145.5	-17.3	128.1	170.6	276.9	261.6	347.0	
James Webb Space Telescope	294.9	364.0	79.0	443.1	492.6	380.9	353.0	305.0	
Hubble Space Telescope	302.6	268.6	68.1	336.7	302.2	161.4	120.3	138.5	
Stratospheric Observatory for Infrared Astronomy (SOFIA)	71.5	48.0	-48.0						
Gamma-ray Large Space Telescope (GLAST) Program	111.4	125.9	-40.5	85.4	25.2	28.8	29.3	30.4	
Discovery	95.2	137.5	-36.7	100.8	69.9	13.8	13.4	13.0	
Explorer	56.8	85.4	-17.7	67.6	86.1	56.7	19.0	4.6	
Universe Research	321.6	305.8	0.7	306.6	309.2	297.4	288.9	259.6	
International Space Science Collaboration	17.5	13.0	6.6	19.6	23.6	38.9	38.5	36.3	
Beyond Einstein	24.1	14.1	7.1	21.2	21.4	53.0	152.2	175.4	

Note: For all formats, the FY 2005 column reflects the FY 2005 Congressional Operating Plan, dated 9/30/2005. The FY 2006 column reflects the FY 2006 Congressional Initial Operating Plan, dated Jan 2006. The FY 2007 - 2011 columns represent the FY 2007 President's Budget Submit.

Changes from FY2006: The Navigator budget reflects a rephasing and on-going replanning of SIM-PlanetQuest and a deferral of the start of TPF until after this budget horizon. The James Webb Space Telescope budget reflects on-going replanning for a launch date of no earlier than 2013. The Hubble Space Telescope budget includes full funding for a shuttle-based servicing mission in early FY2008, pending the completion of the return-to-flight test missions. The Stratospheric Observatory for Infrared Astronomy (SOFIA) budget reflects a program review in early 2006 to assess on-going project concerns. The GLAST budget reflects an adjustment to accommodate delay in instrument delivery as well as to reduce schedule risk. The Universe Discovery and Universe Explorer budgets are adjusted to reflect the confirmation baselines for the Kepler and WISE missions, respectively. The Universe Research program continues to include on-going mission operations and mission-specific research, with some adjustments to grant funding. The International Space Science Collaboration program includes small adjustments to reflect ESA schedule changes. Finally, the Beyond Einstein program budget reflects an indefinite deferral of the start of development of the LISA and Constellation-X mission activities. Technology and science studies will continue with the goal of selecting a mission for development later this decade (including Joint Dark Energy Mission).

President's FY 2007 Budget Request (Dollars in Millions)

Navigator	FY2005	FY2006	FY2007	FY2008	FY2009	FY2010	FY2011
FY 2007 PRES BUD	179.2	145.5	128.1	170.6	276.9	261.6	347.0
Changes from FY 2006 Request	-54.5	-54.0	-118.5	-223.9	-155.2	-172.5	

Overview

Are we alone? For centuries, humankind has pondered this question. Medieval scholars speculated that other worlds must exist, some harboring other forms of life. Within the past few decades, advances in science and technology have brought us to the threshold of finding an answer to this timeless question.

Recent discovery of planets around stars other than the Sun confirms that the solar system is not unique. Indeed, these extrasolar planets appear to be common in the galactic neighborhood. Although the giant, Jupiter-like planets discovered thus far are unlikely to support life, some may be in systems that also contain smaller, terrestrial planets like Mars and Earth.

Over the next 15 years, NASA will embark on a bold series of missions to find and characterize new worlds using the most sensitive instruments ever built. The Keck Interferometer will combine the light of the world's largest optical telescopes, extending NASA's vision to new distances. Using a technique known as interferometry, Keck will study dust clouds around stars where planets may be forming and provide the first direct images of giant planets outside the solar system. The Space Interferometry Mission (SIM) will measure the distances and positions of stars with unprecedented accuracy, allowing researchers to detect evidence of planets just slightly larger than Earth.



Flagship mission of the Navigator Program, SIM PlanetQuest will determine the orbits and masses of planets around other stars and detect nearby Earth-size planets. In addition, SIM will determine the distances to stars throughout the galaxy with unprecedented accuracy, paving the way for future exploration of the Universe.

Plans For FY 2007

Keck Interferometer will complete its Operational Readiness Review for Nulling Mode. SIM Phase B activity will continue while new cost and schedule plans are developed, consistent with recent funding decisions. Large Binocular Telescope Interferometer (LBTI) will be delivered and integrated into the Observatory on Mt. Graham.

Changes From FY 2006

- As reported in the May 2005 operating plan, SIM is being replanned, to be completed in spring 2006. A launch of no earlier than 2015-16, a change of approximately 3 years, is assumed in this budget.
- The Terrestrial Planet Finding project (TPF) has been deferred indefinitely.
- The proposed outrigger portion of the Keck Telescope project will not be undertaken.

Theme: The Universe
Program: Navigator

Program Management



















JPL - Navigator project management, including mission and science operations. NASA and JPL Program Management Councils - program responsibility.

Technical Parameters

The Navigator program consists of a coherent series of increasingly challenging projects, each complementary to the others and each mission building on the results and capabilities of those that preceded it as NASA searches for habitable planets outside of the solar system. The Keck Interferometer will characterize inner dust environments around other star systems, and identify long-period planets and "warm-Jupiters," while the LBTI will characterize outer dust environments and observe giant planets. SIM will search for terrestrial planets, characterize planetary systems, and determine planet mass.

Technical Specifications	FY 2007 President's Budget	Change from Baseline
Keck's two telescopes linked as an interferometer	85-meter baseline	Four additional 'outrigger' telescopes will not be added to the two main telescopes.
SIM Science Baseline Length	9 meters	

Implementation Schedule:

Project	Schedule by Fiscal Year							Purpose	Phase Dates													
	05	06	07	08	09	10	11		Beg	End												
Keck Interferometer								Detect 'super Jupiter' planets and brown dwarfs.	Tech Form Dev Ops Res	Feb-03	Feb-23											
Space Interferometry Mission (SIM)								Schedule under review. Determine distances to stars throughout the galaxy; probe nearby stars for Earth-sized planets.	Tech Form Dev Ops Res													
Large Binocular Telescope Interferometer								Development, Operations and Research dates determined at Confirmation Review.	Tech Form Dev Ops Res	Jan-01	Nov-02 Nov-07 Nov-16 Nov-19											
<table border="0"> <tr> <td></td> <td>Tech & Adv Concepts (Tech)</td> </tr> <tr> <td></td> <td>Formulation(Form)</td> </tr> <tr> <td></td> <td>Development (Dev)</td> </tr> <tr> <td></td> <td>Operations (Ops)</td> </tr> <tr> <td></td> <td>Research (Res)</td> </tr> <tr> <td></td> <td>Represents a period of no activity for the Project</td> </tr> </table>												Tech & Adv Concepts (Tech)		Formulation(Form)		Development (Dev)		Operations (Ops)		Research (Res)		Represents a period of no activity for the Project
	Tech & Adv Concepts (Tech)																					
	Formulation(Form)																					
	Development (Dev)																					
	Operations (Ops)																					
	Research (Res)																					
	Represents a period of no activity for the Project																					

Strategy For Major Planned Acquisitions

- Major acquisitions are in place.

Key Participants

- Other government agencies, Universities, and industry. See project details for more information.

Theme: The Universe

Program: Navigator

Risk Management

- **RISK:** SIM delays could result in loss of key project personnel who embody knowledge from the previous 10-year technology development investment. **MITIGATION:** Retention of core mission knowledge is being addressed in the mission replan.
- **RISK:** Potential SIM ELV cost increase. **MITIGATION:** Stabilize SIM Launch Readiness Date (LRD) and downselect vehicle to lock in price; include adequate contingency to offset increases.

Theme: The Universe
Program: Navigator
Project In Formulation: Space Interferometer Mission (SIM) - PlanetQuest

President's FY 2007 Budget Request (Dollars in Millions)

Space Interferometer Mission (SIM) - PlanetQuest (Formulation)	FY2005	FY2006	FY2007	FY2008	FY2009	FY2010	FY2011
FY 2007 PRES BUD	101.5	117.0	98.5	139.0	236.2	222.5	302.2
Changes from FY 2006 Request	-43.8	8.1	-47.9	-128.7	-51.9	21.1	

Projects in Formulation are not mature in their development process and cost estimates are SUBJECT TO CHANGE as the project matures.

Overview

Are planetary systems like this solar system common in the universe? In NASA's search for Earth-like planets, the question of where to look is key. Within the Navigator program, the Space Interferometry Mission is charged with the critical task of carrying out a census of potential target planets for subsequent planet-finding missions. SIM provides the only method for unambiguously measuring the mass of these extra-solar planets, which determines a planet's ability to retain atmosphere long enough to make it possible to harbor life.



How large is the universe? How old? What is dark matter and where is it found? In addition to searching for terrestrial planets, the SIM astrophysics program will address a host of other important questions as it maps the structure of this galaxy as well as those nearby.

SIM has successfully completed all eight technology milestones necessary to proceed to implementation.

For more information, please see:
http://planetquest.jpl.nasa.gov/SIM/sim_index.html

The Microarcsecond Metrology testbed played a key role in demonstrating the maturity of technologies SIM needed to enter the detailed design phase. Technology development involved isolating various challenges into separate testbeds and assigning teams to each problem, allowing the project to complete the process within a few years rather than several decades.

Changes From FY 2006

- During the past year, SIM underwent an extensive replan; detailed cost and schedule plans will be completed in the FY 2008 budget process.
- The architecture has been changed to a 9-meter, 3-interferometer system, compared to the 10-meter, 4-interferometer system represented in the FY 2006 budget request.
- As noted in the May 2005 operating plan, SIM is being replanned. The budget assumes an approximately three year shift in launch date to no-earlier-than 2015-2016.

Program Management

JPL is responsible for SIM project management; NASA and JPL Program Management Councils have program oversight responsibility.

Theme: The Universe
Program: Navigator
Project In Formulation: Space Interferometer Mission (SIM) - PlanetQuest

Technical Parameters

In order to reduce technology and operational risk, SIM's previous design has been simplified and mass reduced. The current mission architecture features a 9-meter science baseline, with one science and two guide interferometers. Although guide and science aperture areas have decreased, the performance impact is modest. Launched on an expendable launch vehicle, SIM will enter an Earth-trailing solar orbit to carry out a 5-year operational mission with a 10-year goal.

Technical Specifications	FY 2007 President's Budget	Change from Baseline
Baseline Length	9 meters	10 meters in the FY 2006 budget request
Science Interferometers	1	2 Science Interferometers in the FY 2006 budget request
Guide Interferometers	2	
Mission Lifetime	5.5 years	
Narrow Angle Goal	1.26 uas	
Wide Angle Goal	4.4 uas	

Schedule	FY 2007 President's Budget	Baseline	Change from Baseline
Schedule under review			

Strategy For Major Planned Acquisitions

- Northrop Grumman Space Technology (NGST) was selected via a competitive Request for Proposal issued for spacecraft Assembly, Test and Launch Operations (ATLO), and operations support.
- Science Team Members were selected through an Announcement of Opportunity; other government agencies and universities are included on this team.

Key Participants

- The SIM science team is comprised of Principal Investigators from institutions in California, Ohio, Maryland, Washington, New Hampshire and Virginia.
- U.S. Naval Observatory: SIM Science Team member with Memorandum Of Understanding for collaboration and exchange of data sets.
- Northrop Grumman Space Technology: spacecraft, ATLO, and operations support.

Theme: The Universe
Program: Navigator
Project In Development: Keck Interferometer

President's FY 2007 Budget Request (Dollars in Millions)

Keck Interferometer (Development)	FY2005	FY2006	FY2007	FY2008	FY2009	FY2010	FY2011
FY 2007 PRES BUD	11.7	8.9	8.8	8.2	6.9	5.4	5.4
Changes from FY 2006 Request	0.4	-1.6	-3.8	-4.7	-8.5	-11.6	

Projects in Development are mature, have a sound design, and are proceeding to mission execution. NASA is committed to their lifecycle cost and schedule plans.

Overview

The Keck Interferometer (KI) will help answer two basic questions: "Where do we come from?" and "Are we alone?" Key to answering these questions is finding out how galaxies, stars and planets form, and whether planets other than Earth have the conditions necessary to support life.



The project has two primary science objectives:

1. Measure 'exozodiacal' light around nearby stars. Using a technique called nulling, Keck will cancel light from nearby stars to examine the thermal emission from surrounding dust.
2. Study 'hot jupiters.' Keck will characterize the atmospheres of hot, Jupiter-mass planets orbiting within 20 million miles of their parent stars

NASA will not pursue a proposal previously under study to add 'outrigger' telescopes to the project in order to focus on meeting the primary nulling requirements.

For more information, please see:
http://planetquest.jpl.nasa.gov/Keck/keck_index.cfm

Combining light from two telescopes, the Keck Interferometer has a resolving power equivalent to a football-field sized telescope, capable of blocking the glare of starlight with an instrument called a "nuller." This capability will eventually help scientists select targets for future planet-finding missions by locating Earth-like planets in the dust rings around stars.

Changes From FY 2006

- Nuller Operational Readiness Review (ORR) delayed due to technical difficulties and bad weather on observation nights (delaying engineering runs). Differential Phase (DP) work extended as a result.
- Proposed Keck 'Outrigger' Telescopes will not be included in the project. These additional, smaller telescopes are not required in order to meet the project's minimum success criteria.
- Budget estimates reflect schedule, cost, and scope changes. Keck is being replanned to optimize project science in light of these changes.

Program Management

JPL is responsible for Keck Interferometer project management. NASA and JPL Program Management Councils have program oversight responsibility.

Theme: The Universe
Program: Navigator
Project In Development: Keck Interferometer

Technical Parameters

Keck uses a technique called interferometry to achieve its objectives, combining the light from two or more separate telescopes. The image has similar sharpness to that produced by a single telescope whose diameter is as large as the distance between the separate telescopes. The technique also allows measurement of motions of celestial bodies - in this case, a star's tiny wobble due to an orbiting planet.

Technical Specifications	FY 2007 President's Budget	Change from Baseline
Two 10-meter telescopes linked as an interferometer	85-meter baseline	Four 1.8-m outrigger telescopes will not be included in the project.
3 observing modes	Visibility, Nulling, Differential Phase	None

Schedule	FY 2007 President's Budget	Baseline	Change from Baseline
May 2005	First nulling of a star through Keck-Keck	January 2005	+ 4 months
March 2007	Nuller ORR	January 2006	+14 months
September 2009	Differential Phase ORR	September 2006	+ 3 years

Strategy For Major Planned Acquisitions

- Major acquisitions are already in place.

Key Participants

- W.M. Keck Observatory, California Association for Research in Astronomy (CARA) operates the twin Keck 10-meter telescopes.
- SAIC and Tetra Tech have supported NASA in the Environmental Impact Statement process.
- CalTech manages the project, provides technical expertise in interferometry, and develops key hardware and software components. The University of Hawaii holds the lease for the Mauna Kea Science Reserve.

Theme: The Universe
 Program: Navigator
 Project In Development: Keck Interferometer

Risk Management

- RISK: Nulling performance on sky depends on atmospheric characteristics (especially temperature and humidity fluctuations between widely separated telescope beams) which are not known and will only be characterized during instrument operation. MITIGATION: Updated schedule keeps the core team intact during early science operations, allowing further study of atmospheric characteristics/nulling performance, and continued optimization of nulling instrument and measurement technique.
- RISK: Insufficient number of runs to maintain nulling progress. Test time on-sky is needed to study atmospheric limitations and to characterize instrument performance. On-sky time is subject to unsuitable weather and instrument failure (both observatory facilities and nulling equipment). MITIGATION: Under the current schedule, limited (shared risk) science operations will begin in parallel with continued engineering, providing more on-sky time and more opportunity for characterizing the performance under a variety of conditions.
- RISK: Vibration mitigation may not be sufficient when on sky. Keck was built without attention to vibration reduction to the level required for interferometry. The Interferometer project has addressed the vibration environment, and implemented extensive mitigations sufficient for current levels of performance, but vibration could be limiting for more sensitive operation. MITIGATION: Monitor the situation. The mitigation and remediation techniques already used can be extended further if this proves necessary, but with possible schedule and cost implications.

Budget Detail/Life Cycle Cost (Dollars in Millions)

Budget Authority	Prior	FY2005	FY2006	FY2007	FY2008	FY2009	FY2010	FY2011	BTC	Total	Comments
FY 2007 PRES BUD	83.9	11.7	8.9	8.8	8.2	6.9	5.4	5.4	63.0	202.1	
Changes	-0.3	0.4	-1.6	-3.8	-4.7	-8.5	-11.6		63.0	32.8	
FY2006 President's Budget	84.2	11.3	10.4	12.6	13.0	15.4	17.0			163.9	

Because Keck is a ground-based telescope, the LCC represented here reflects estimated costs, including operational costs, through 2020.

President's FY 2007 Budget Request (Dollars in Millions)

James Webb Space Telescope	FY2005	FY2006	FY2007	FY2008	FY2009	FY2010	FY2011
FY 2007 PRES BUD	294.9	364.0	443.1	492.6	380.9	353.0	305.0
Changes from FY 2006 Request	-16.9	-7.5	70.6	164.0	153.9	163.6	

Overview

The James Webb Space Telescope (JWST)--identified by the National Research Council as a top priority new initiative for astronomy and physics for the current decade--is a large deployable, space-based, infrared astronomical observatory. One of the largest and most complex unmanned missions NASA has ever undertaken, JWST is a logical successor to the Hubble Space Telescope (HST), extending beyond Hubble's discoveries into the infrared, where the highly redshifted early universe must be observed, where cool objects like protostars and protoplanetary disks emit strongly, and where dust obscures shorter wavelengths.

During its five-year science mission, JWST will address the question: "How did we get here?" by exploring the mysterious epoch when the first luminous objects in the universe came into being after the Big Bang. The focus of scientific study will include detection of the first light in the universe, emergence of galaxies, origins of stars and planetary systems, and origins of elements necessary for life.



Artist's depiction of James Webb Space Telescope in orbit.

JWST is currently undergoing a replan, with a launch no earlier than 2013. For more information, please see: <http://www.jwst.nasa.gov/>

Plans For FY 2007

The JWST program will be implementing the updated project plan completed in FY 2006. Much of the focus of the work in 2007 will be on fabrication and assembly of primary mirror segments, since these are long-lead schedule items.

Preparation of large, cryogenic test facilities and equipment will be underway in 2007, allowing the mission to be ready in time for pathfinder testing with engineering models and, subsequently, flight article testing.

Changes From FY 2006

- JWST is currently in the midst of a replan; detailed cost and schedule plans will be completed in the spring of 2006 in conjunction with NASA's FY 2008 budget formulation process.
- The funding profile reflects identified changes in cost from previous estimates and assumes a launch of no-earlier-than 2013, roughly two years from the previous 2011 planning estimate.

Theme: The Universe
Program: James Webb Space Telescope

Program Management

GSFC is responsible for JWST project management. NASA and GSFC Program Management Councils have program oversight responsibility.

Technical Parameters

In order to provide the resolution and sensitivity required by high priority investigations, JWST's main optic is 6.5 meters in diameter, and the telescope assembly and scientific instruments must operate at minus 365 degrees Fahrenheit. A tennis court-sized shield shades these components from the Sun, Earth, and Moon, allowing them to radiate their heat to the extreme cold of deep space and thereby become very cold themselves. Since the telescope's main optic and the sunshade are too large to fit into the fairing of any existing rocket, they must be folded up for launch. Once in space, they will unfurl into their operational configuration. JWST will orbit the Sun in tandem with the Earth, around Sun-Earth Lagrange point 2 (L2), which is ideally suited for the observatory's mission.

Technical Specifications	FY 2007 President's Budget	Change from Baseline
Sensitivity - imaging	1x10e-34 W/m2/Hz (2µm flux density)	No changes from FY 2006 budget.
Sensitivity - spectroscopy	5.2x10e-22 W/m2 (2µm emission line flux)	
Telescope Aperture	25m2 (unobscured)	
Spectral Coverage	0.6-27µm	
Total Observing Time	1.1x10e8 seconds	
Mission Lifetime	5 years	
Science Data Throughput	Downlink, capture and process 229 Gbits of science data per day (compressed from 458 Gbits per day)	

Implementation Schedule:

Project	Schedule by Fiscal Year							Purpose	Phase Dates	
	05	06	07	08	09	10	11		Beg	End
JWST								Provide the next generation space telescope to observe the first stars and galaxies; determine the shape and fate of the universe.	Tech Form Dev Ops Res	Apr-96 Apr-99 Apr-07 Jun-13
<ul style="list-style-type: none"> Tech & Adv Concepts (Tech) Formulation(Form) Development (Dev) Operations (Ops) Research (Res) Represents a period of no activity for the Project 										

Theme:	The Universe
Program:	James Webb Space Telescope

Strategy For Major Planned Acquisitions

- JWST is being built by Northrop Grumman Space Technology (Redondo Beach, CA), teamed with Ball (Boulder, CO), ITT (Rochester, NY) and Alliant Techsystems (Edina, MN). Selections were made via an RFP.
- The Space Telescope Science Institute (STScI), in Baltimore, MD, is developing the science and operations center and associated services. STScI was selected by the NASA Administrator.
- The University of Arizona, Tucson, is providing the near-infrared science camera, which is the primary science instrument. The selection was made competitively via a NASA Announcement of Opportunity.

Key Participants

- The European Space Agency is providing science instrumentation--the near-infrared spectrograph and the optical bench assembly for the mid-infrared instrument (MIRI)--as well as operations support. ESA will also provide the launch vehicle and launch services.
- The Canadian Space Agency is providing the fine-guidance sensor/tunable filter for guiding the pointing of the telescope and conducting science. They are also providing operations support.

Risk Management

- **RISK:** JWST is a complicated system with unprecedented design features; therefore, cost and schedule estimates contain additional uncertainty during formulation. Further cost growth and schedule extension is possible. **MITIGATION:** JWST is undergoing a replan in FY06, as well as special review by NASA's Program Assessment and Evaluation (PA&E) office. Independent review and scrutiny of the program will continue through the remainder of mission formulation and into implementation.
- **RISK:** JWST requires advances in several technologies, which could present cost and schedule problems. **MITIGATION:** To ensure these technologies are developed and become ready when needed, NASA is aggressively developing large, lightweight cryogenic optics, wavefront sensing and control algorithms, and high-performance detectors. All technologies for JWST will be mature enough by FY 2007 to reduce risk to an acceptable level for mission confirmation.
- **RISK:** Because JWST is an international collaboration, NASA may incur schedule and cost impacts caused by challenges in Europe and Canada that are outside of NASA's control. Experience with similar collaborations indicates that this is likely to occur. **MITIGATION:** NASA has written clearly-defined interfaces and is actively managing and complying with export controls (ITAR).

Theme: The Universe
 Program: James Webb Space Telescope
 Project In **Formulation**: James Webb Space Telescope

President's FY 2007 Budget Request (Dollars in Millions)

<u>James Webb Space Telescope (Formulation)</u>	<u>FY2005</u>	<u>FY2006</u>	<u>FY2007</u>	<u>FY2008</u>	<u>FY2009</u>	<u>FY2010</u>	<u>FY2011</u>
FY 2007 PRES BUD	276.6	343.6	418.3	464.0	357.9	332.2	287.1
Changes from FY 2006 Request	-18.7	-8.0	65.3	153.7	143.2	152.9	

Projects in Formulation are not mature in their development process and cost estimates are SUBJECT TO CHANGE as the project matures.

Overview

The James Webb Space Telescope (JWST)--identified by the National Research Council as a top priority new initiative for astronomy and physics for the decade--is a large, deployable, space-based infrared astronomical observatory. JWST is currently conducting a replan, but is scheduled for launch no-earlier-than 2013. The mission is a logical successor to the Hubble Space Telescope (HST), extending beyond Hubble's discoveries into the infrared, where the highly redshifted early universe must be observed, where cool objects like protostars and protoplanetary disks emit strongly, and where dust obscures shorter wavelengths.

During its five-year science mission, JWST will address the question: "Are we alone?" by exploring the mysterious epoch when the first luminous objects in the universe came into being after the Big Bang. The focus of scientific study will include first light, assembly of galaxies, origins of stars and planetary systems, and origins of the elements necessary for life.

For more information, please see: <http://www.jwst.nasa.gov/>



18 hexagonal mirror segments are fabricated in batches of approximately six at a time. The total effort takes roughly 4.5 years. The segments have 3 prescriptions of six mirrors each and assembly line techniques can be used to make the mirrors in parallel. The 18 segments are aligned in space using special algorithms being developed and demonstrated on testbeds on the ground.

Changes From FY 2006

- JWST is currently in the midst of a replan; detailed cost and schedule plans will be completed in the FY 2008 budget process.
- The funding profile reflects identified changes in cost from previous estimates and assumes a launch of no-earlier-than 2013, roughly two years from the previous 2011 planning estimate.

Program Management

GSFC is responsible for JWST project management. NASA and GSFC Program Management Councils have program oversight responsibility.

Theme: The Universe
Program: James Webb Space Telescope
Project In Formulation: James Webb Space Telescope

Technical Parameters

In order to provide the resolution and sensitivity required by science investigations, JWST's main optic is 6.5 meters in diameter, and the telescope assembly and scientific instruments must operate at minus 365 degrees Fahrenheit. A tennis court-sized shield shades these components from the Sun, Earth and Moon, allowing them to radiate their heat to the extreme cold of deep space and thereby become very cold themselves. Since the telescope's main optic and the sunshade are too large to fit into the fairing of any existing launch vehicle, they must be folded up for launch. Once in space, they will unfurl into their operational configuration. JWST will orbit the Sun in tandem with the Earth, around Sun-Earth Lagrange point 2 (L2), which is ~ 1 million miles away from Earth.

Technical Specifications	FY 2007 President's Budget	Change from Baseline
Sensitivity - imaging	1.0x10 ⁻³⁴ W/m ² /Hz (2μm flux density)	No technical changes from FY 2006 budget, project is current being replanned.
Sensitivity - spectroscopy	5.2x10 ⁻²² W/m ² (2μm emission line flux)	
Telescope Aperture	25m ² (unobscured)	
Spectral Coverage	0.6-27μm	
Total Observing Time	1.1x1,000,000,000 seconds	
Mission Lifetime	5 years	
Science Data Throughput	Downlink, capture and process 229 Gbits of science data per day (compressed from 458 Gbits per day)	

Schedule	FY 2007 President's Budget	Baseline	Change from Baseline
Schedule under review			

Strategy For Major Planned Acquisitions

- JWST is being built by Northrop Grumman Space Technology (Redondo Beach, CA), teamed with Ball (Boulder, CO), ITT (Rochester, NY) and Alliant Techsystems (Edina, MN). Selections made via NASA RFP.
- The Space Telescope Science Institute (STScI), in Baltimore, MD, is developing the Science and Operations Center and associated services. STScI was selected by the NASA Administrator.
- The University of Arizona, Tucson, is providing the near-infrared science camera, which is the primary science instrument. The selection was made via a NASA Announcement of Opportunity.

Key Participants

- The European Space Agency is providing science instrumentation--the near-infrared spectrograph and the optical bench assembly for the mid-infrared instrument (MIRI)--as well as operations support. A launch vehicle and launch services will also be provided.
- The Canadian Space Agency is providing the fine guidance sensor/tunable filter instrument for guiding the pointing of the telescope and conducting science. They are also providing operations support.

President's FY 2007 Budget Request (Dollars in Millions)

<u>Hubble Space Telescope</u>	<u>FY2005</u>	<u>FY2006</u>	<u>FY2007</u>	<u>FY2008</u>	<u>FY2009</u>	<u>FY2010</u>	<u>FY2011</u>
FY 2007 PRES BUD	302.6	268.6	336.7	302.2	161.4	120.3	138.5
Changes from FY 2006 Request	86.9	77.9	118.5	159.0	-8.8	25.3	

Overview

Since 1990, the HST has used its pointing precision, powerful optics, and state-of-the-art instruments to explore the visible, ultraviolet and near-infrared regions of the electromagnetic spectrum. Until such time that Hubble is no longer able to carry out its scientific mission, the observatory will continue to investigate the formation, structure, and evolution of stars and galaxies, studying the history of the universe, and providing a space-based research facility for optical astronomy. Hubble development funding supports a suite of life extension activities in order to maximize science return as the telescope's capabilities degrade over time. In addition, planning is underway to carry out a shuttle-based servicing mission (SM4), tentatively scheduled for early FY 2008. Subsequent to the second return-to-flight Shuttle mission, NASA will make a final decision on the servicing mission.

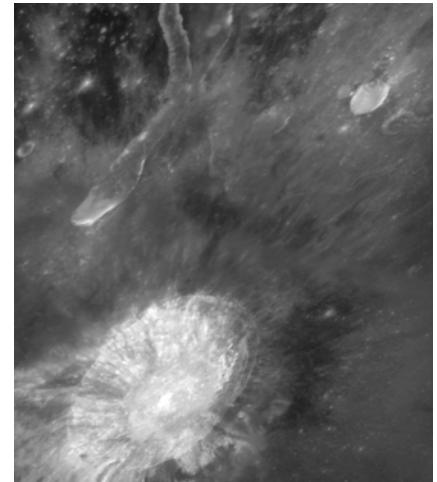

Hubble's resolution and sensitivity to ultraviolet light allowed the telescope to search for important oxygen-bearing minerals on the moon. This data combined with other measurements will help ensure the most valuable sites are targeted for future robotic and human expeditions.

While this development activity is underway, modification and upkeep of ground operations systems will continue.

For more information, please see:
<http://hubble.gsfc.nasa.gov/index.php>.

Plans For FY 2007

The HST program will continue operations and observatory life extension efforts. Pending a final decision on Hubble servicing after the second return-to-flight Shuttle missions, preparations for a fourth servicing mission will be underway.

Changes From FY 2006

- HST successfully entered two-gyro pointing mode as part of the observatory's life-extension effort.
- Plans for robotic servicing have been discontinued, and new orbital decay predictions (~2020-2025) have delayed de-orbit activity beyond the current budget horizon.
- Planning and preparations are underway to carry out a Shuttle-based servicing mission no earlier than Dec 2007, pending post Return to Flight decision to proceed.

Program Management

GSFC is responsible for HST project management. The NASA and GSFC Program Management Councils have program oversight responsibility.



















Theme: The Universe
Program: Hubble Space Telescope

Technical Parameters

Equipped with a 2.4-meter primary mirror, the Hubble Space Telescope operates in wavelengths from the near-ultraviolet to the near-infrared. The observatory was designed to be serviced and upgraded by astronauts, and four servicing missions have been carried out since its launch in 1990. In 2002, the Shuttle crew installed the Advanced Camera for Surveys (ACS) and a cryo-cooler that brought the ailing Near Infrared Camera and Multi-Object Spectrometer (NICMOS) back to life. New instruments scheduled for installation on SM4 include the Cosmic Origins Spectrograph (COS) and Wide Field Camera 3 (WFC3).

Technical Specifications	FY 2007 President's Budget	Change from Baseline
Stellar Energy w/in 0.1 arcsec	70%	none
Image Jitter	<.012 arcsec RMS/24 hr.	none
Pointing Error	<.03 arcsec	none
Mission Life	15+ years	none
Science Instruments	up to 5	none

Implementation Schedule:

Project	Schedule by Fiscal Year							Purpose	Phase Dates													
	05	06	07	08	09	10	11		Beg	End												
HST Operations								Investigate formation, structure and evolution of stars and galaxies; study the history of the universe in visible, ultraviolet and near-infrared regions of the electromagnetic spectrum	Tech Form Dev Ops Res	Apr-90 Sep-10 Apr-90 Sep-12												
HST Servicing Mission								Perform spacecraft maintenance and reboost; install Cosmic Origins Spectrograph and Wide Field Camera 3.	Tech Form Dev Ops Res	May-05 Dec-07												
<table border="0"> <tr> <td></td> <td>Tech & Adv Concepts (Tech)</td> </tr> <tr> <td></td> <td>Formulation(Form)</td> </tr> <tr> <td></td> <td>Development (Dev)</td> </tr> <tr> <td></td> <td>Operations (Ops)</td> </tr> <tr> <td></td> <td>Research (Res)</td> </tr> <tr> <td></td> <td>Represents a period of no activity for the Project</td> </tr> </table>												Tech & Adv Concepts (Tech)		Formulation(Form)		Development (Dev)		Operations (Ops)		Research (Res)		Represents a period of no activity for the Project
	Tech & Adv Concepts (Tech)																					
	Formulation(Form)																					
	Development (Dev)																					
	Operations (Ops)																					
	Research (Res)																					
	Represents a period of no activity for the Project																					

Strategy For Major Planned Acquisitions

- All major acquisitions are in place for operations and servicing.

Key Participants

- The Space Telescope Science Institute in Baltimore, MD is responsible for operation of the telescope.
- The European Space Agency (ESA) has provided instruments, solar panels and other elements of the telescope. They also participate in activities at the Space Telescope Science Institute and operate a data center in Europe to support European observers.

Theme: The Universe
Program: Hubble Space Telescope

Risk Management

- **RISK:** Degradation or failure of critical spacecraft hardware could result in loss of science program or mission. **MITIGATION:** Identify and develop life extension initiatives. Two-gyro science mode has already been implemented; battery management optimization is currently underway.
- **RISK:** Return to Flight impacts could result in additional inspection/repair requirements and loss of Shuttle resources available for HST servicing. **MITIGATION:** Engage in early, integrated planning with the Shuttle program; develop flexible mission priorities and associated flight rules.

President's FY 2007 Budget Request (Dollars in Millions)

Stratospheric Observatory for Infrared Astronomy (SOFIA)	FY2005	FY2006	FY2007	FY2008	FY2009	FY2010	FY2011
FY 2007 PRES BUD	71.5	48.0					
Changes from FY 2006 Request	20.6	-0.3	-57.1	-59.4	-60.2	-60.4	

Overview

SOFIA has been under development as an astronomical observatory consisting of a 2.5-meter aperture telescope permanently installed in a specially modified Boeing 747 aircraft. The aircraft, to be attached with an open-port telescope provided through a partnership with the German Aerospace Center (DLR), was designed to provide routine access to of the visual, infrared, far-infrared, and sub-millimeter parts of the spectrum.



The case for compelling "Great Observatory" science from SOFIA assumed a minimum 12-month overlap with Spitzer for complementary science observations and a minimum one year of operations prior to the launch of the Herschel mission. Due to a two year slip over the last year, SOFIA will have little if any useful overlap with Spitzer. In addition, even if the Herschel launch slips, the benefit of SOFIA results in science planning for Herschel will not be lost.

Artist's rendition of SOFIA's internal and external concept design.

As a result of ongoing cost growth due to technical and schedule problems, NASA will conduct a review of the SOFIA project in early 2006 and coordinate the Agency's analysis and position on SOFIA with the German Aerospace Center (DLR) according to the Memorandum of Understanding between the two agencies. This review will allow NASA to determine the best course of action, given the project's status as well as competing science requirements.

Plans For FY 2007

The agency may adjust the SOFIA budget in FY 2007 in future operating plans and budget requests based on the outcome of the review and consultation with DLR.

Changes From FY 2006

- A review will be held in early 2006 to determine the best course of action for this project.

Program Management

ARC is responsible for SOFIA project management. NASA and ARC Program Management Councils have program responsibility.

Theme: The Universe
Program: Stratospheric Observatory for Infrared Astronomy (SOFIA)

Technical Parameters

The SOFIA observatory was designed as a highly-modified 747SP aircraft with a large open-port cavity aft of the wings, housing a 2.5-meter telescope optimized for infrared/sub-millimeter wavelength astronomy. The Science and Mission Operations Center would include facility-class science instruments, principal investigator labs, data archives, science/mission planning systems, the main hangar, and supporting equipment to provide operations at a sustained rate of ~155 flights (960 science hours) per year.

Technical Specifications	FY 2007 President's Budget	Change from Baseline
Effective aperture of telescope	2.5 meters	None
Operational capability	Operate in observing configuration for 6 hours or more at altitudes of at least 41,000 feet.	None
Telescope elevation range (unvignetted)	20 - 60 degrees	None
Telescope wavelength range	0.3 to 1600 microns	None

Implementation Schedule:

Project	Schedule by Fiscal Year							Purpose	Phase Dates	
	05	06	07	08	09	10	11		Beg	End
SOFIA								A project review will be held in early 2006.	Tech Form Dev Ops Res	Mar-96 Apr-06
<p> ■ Tech & Adv Concepts (Tech) ■ Formulation (Form) ■ Development (Dev) ■ Operations (Ops) ■ Research (Res) ■ Represents a period of no activity for the Project </p>										

Strategy For Major Planned Acquisitions

- N/A

Key Participants

- An agreement with the DLR provides the telescope assembly and support during operations in exchange for 20 percent of science observation time.

Risk Management

- RISK: Utilization of existing project assets. MITIGATION: In the event of termination, work with the German Aerospace Center (DLR) in a manner consistent with the SOFIA Memorandum of Understanding to seek mutual agreement on the disposition and potential utilization of SOFIA program elements.

Theme:

The Universe

Program:

Gamma-ray Large Space Telescope (GLAST) Program

President's FY 2007 Budget Request

(Dollars in Millions)

<u>Gamma-ray Large Space Telescope (GLAST) Program</u>	<u>FY2005</u>	<u>FY2006</u>	<u>FY2007</u>	<u>FY2008</u>	<u>FY2009</u>	<u>FY2010</u>	<u>FY2011</u>
FY 2007 PRES BUD	111.4	125.9	85.4	25.2	28.8	29.3	30.4
Changes from FY 2006 Request	4.3	26.5	18.7	1.3	9.5	3.5	

Overview

A collaboration with the Department of Energy, France, Italy, Sweden, Japan, and Germany, the Gamma-ray Large Area Space Telescope (GLAST) will improve researchers' understanding of the structure of the universe, from its earliest beginnings to its ultimate fate. By measuring the direction, energy, and arrival time of celestial high-energy gamma rays, GLAST will map the sky with 50 times the sensitivity of previous missions, with corresponding improvements in resolution and coverage. Yielding new insights into the sources of high-energy cosmic gamma rays, GLAST will reveal the nature of astrophysical jets and relativistic flows and study the sources of gamma-ray bursts.

GLAST will also provide a new tool for studying how black holes, notorious for pulling matter in, can accelerate jets of gas outward at fantastic speeds. Physicists will be able to observe the effects of subatomic particles at energies far greater than those seen in ground-based particle accelerators and will also gain insights into the puzzling question of how energetic gamma rays are produced in the magnetosphere of spinning neutron stars. Perhaps the biggest return will come from understanding the nature of the high-energy gamma-ray sources that have escaped correlation at other wavelengths and constitute the unidentified bulk of nearly 300 known high-energy sources.



Artist's drawing of the GLAST satellite in orbit

For more information, please see <http://glast.gsfc.nasa.gov/>.

Plans For FY 2007

After science instrument integration, GLAST will start and complete observatory-level integration and test (I&T), including vibration and environmental testing. The ground system hardware and software will be completed during 2007 and exercised against the observatory during I&T. At the end of the fiscal year, the entire GLAST observatory will then be shipped to Kennedy Space Center for final preparation, testing and launch.

Changes From FY 2006

- The Large Area Telescope (LAT) experienced both engineering design and electrical parts problems, which resulted in an eight month delay for instrument delivery.
- Funding is provided to accommodate a four month launch delay, from May 2007 to September 2007, as well as costs associated with rephased work due to the LAT delivery delay.

Theme: The Universe
Program: Gamma-ray Large Space Telescope (GLAST) Program

Program Management

GSFC is responsible for GLAST project management. The NASA and GSFC Program Management Councils have program oversight responsibility.







Technical Parameters

The primary instrument on GLAST is the LAT, which will collect high-energy cosmic gamma rays with a 50-fold improvement in sensitivity over previous missions. During its planned primary mission of five years in Earth orbit, the telescope will both scan the sky and point at individual objects. The secondary instrument is the GLAST Burst Monitor (GBM), which will detect gamma-ray bursts and immediately send their locations to the ground to alert astronomers to make follow-up observations. Like the LAT, the GBM also has better sensitivity and spatial resolution than its predecessors.

Technical Specifications	FY 2007 President's Budget	Change from Baseline
LAT Collection Area	Peak effective area 8000 sq. centimeters	none
LAT Energy Range	30 MeV - 100 GeV	none
LAT Sensitivity (5 sigma)	<0.000000009 photons/sq cm/second	none
Operational Capability	5-year life, pointing and scanning modes, immediate burst notice to ground	none
GBM Collection Area (not a level 1 requirement)	40-110 sq centimeters (depends on photon energy and off-axis angle)	none
GBM Energy Range (not a level 1 requirement)	10 keV - 25 MeV	none
GBM Spatial Resolution (not a level 1 requirement)	15 degrees for burst alerts, 3 degrees after final processing	none

Implementation Schedule:

Project	Schedule by Fiscal Year							Purpose	Phase Dates		
	05	06	07	08	09	10	11		Beg	End	
GLAST								Study the high energy gamma rays from natural particle accelerators throughout the universe.	Tech	Jun-98	Dec-99
									Form	Dec-99	Dec-03
									Dev	Dec-03	Sep-07
									Ops	Sep-07	Nov-12
									Res	Nov-07	Nov-13

	Tech & Adv Concepts (Tech)
	Formulation(Form)
	Development (Dev)
	Operations (Ops)
	Research (Res)
	Represents a period of no activity for the Project

Strategy For Major Planned Acquisitions

- Spacecraft contractor General Dynamics/Spectrum Astro (Gilbert, AZ), was acquired via a blanket procurement through GSFC's Rapid Spacecraft Development Office.
- The primary instrument (LAT) at Stanford University and the secondary instrument (GBM) at MSFC were selected through an Announcement of Opportunity competitive selection in 2000.
- The GSFC Science Support Center will support Guest Observers (GO) and manage annual solicitation for GOs. GSFC Mission Operations Center personnel are provided by a contractor set-aside procurement.

Theme:	The Universe
Program:	Gamma-ray Large Space Telescope (GLAST) Program

Key Participants

- Large Area Telescope (LAT) development and instrument integration is managed by the Stanford Linear Accelerator Center, a Department of Energy-funded laboratory located on the Stanford University Campus.
- Stanford University is the home institution of the principal investigator of the LAT, and they are also providing science support.
- Italy is responsible for assembly of the LAT tracker towers, which form the track imaging system, as well as additional hardware used in the towers. Japan and Italy are providing a portion of LAT silicon strip detectors and science support; France is also providing science support.
- The Naval Research Laboratory, in Washington, DC, assembled the Calorimeter for the LAT and will environmentally test the integrated instrument and provide science support.

Risk Management

- **RISK:** Spacecraft assembly, integration and test delays are highly likely due to electronics parts problems and changing to pyro-release devices. Delays could affect the launch schedule.
MITIGATION: NASA is closely monitoring progress in problem resolution and helping the spacecraft contractor optimize their schedule.

Theme: The Universe
Program: Gamma-ray Large Space Telescope (GLAST) Program
Project In Development: Gamma-ray Large Space Telescope (GLAST) Project

President's FY 2007 Budget Request (Dollars in Millions)

<u>Gamma-ray Large Space Telescope (GLAST) Project (Development)</u>	<u>FY2005</u>	<u>FY2006</u>	<u>FY2007</u>	<u>FY2008</u>	<u>FY2009</u>	<u>FY2010</u>	<u>FY2011</u>
FY 2007 PRES BUD	106.0	118.9	80.7	23.8	27.1	27.6	28.7
Changes from FY 2006 Request	4.6	24.8	17.5	1.2	8.9	3.2	

Projects in Development are mature, have a sound design, and are proceeding to mission execution. NASA is committed to their lifecycle cost and schedule plans.

Overview

A collaboration with the Department of Energy, France, Italy, Sweden, Japan and Germany, the Gamma-ray Large Area Space Telescope (GLAST) will improve researchers' understanding of the structure of the universe, from its earliest beginnings to its ultimate fate. By measuring the direction, energy, and arrival time of celestial high-energy gamma rays, GLAST will map the sky with 50 times the sensitivity of previous missions, with corresponding improvements in resolution and coverage. Yielding new insights into the sources of high-energy cosmic gamma rays, GLAST will reveal the nature of astrophysical jets and relativistic flows and study the sources of gamma-ray bursts.

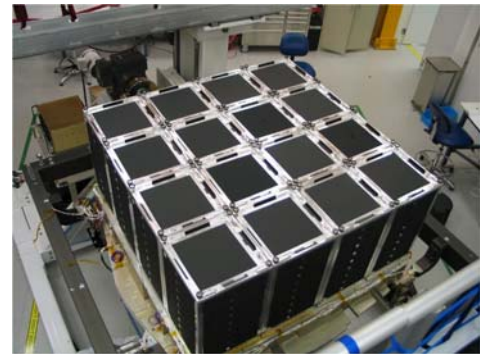

GLAST will also provide a new tool for studying how black holes, notorious for pulling matter in, can accelerate jets of gas outward at fantastic speeds. Physicists will be able to observe the effects of subatomic particles at energies far greater than those seen in ground-based particle accelerators and will also gain insights into the puzzling question of how energetic gamma rays are produced in the magnetosphere of spinning neutron stars. Perhaps the biggest return will come from understanding the nature of the high-energy gamma-ray sources that have escaped correlation at other wavelengths and constitute the unidentified bulk of nearly 300 known high-energy sources.

All 16 tracker towers have been integrated into the LAT. Using the LAT, scientists will observe blazars and other black hole systems with particle jets to learn how these jets form. The tracker towers are the main components of the instrument and will allow a variety of incident photons and particles through the telescope in order to measure the energy and direction of gamma ray incidents in space.

For more information, please see <http://glast.gsfc.nasa.gov/>

Changes From FY 2006

- The Large Area Telescope (LAT) experienced both engineering design and electrical parts problems, which resulted in an eight month delay for instrument delivery.
- Funding is provided to accomodate a four month launch delay, from May 2007 to September 2007, as well as costs associated with rephased work due to the LAT delivery delay.

Program Management

GSFC is responsible for GLAST project management. The NASA and GSFC Program Management Councils have program oversight responsibility.

Theme: The Universe
Program: Gamma-ray Large Space Telescope (GLAST) Program
Project In Development: Gamma-ray Large Space Telescope (GLAST) Project

Technical Parameters

The primary instrument on GLAST is the LAT, which will collect high-energy cosmic gamma rays with a 50-fold improvement in sensitivity over previous missions. During its planned primary mission of five years in Earth orbit, the telescope will both scan the sky and point at individual objects. The secondary instrument is the GLAST Gamma Ray Burst Monitor (GBM), which will detect gamma-ray bursts and immediately send their locations to the ground to alert astronomers to make follow-up observations. Like the LAT, the GBM also has better sensitivity and spatial resolution than its predecessors.

Technical Specifications	FY 2007 President's Budget	Change from Baseline
LAT Collection Area	Peak effective area 8000 square centimeters	-none
LAT Energy Range	30 MeV - 100 GeV	-none
LAT sensitivity (5 sigma)	<0.000000009 photons/sq cm/second	-none
Operational Capability	5-year life, pointing and scanning modes, immediate burst notice to ground	-none
GBM Collection Area (not a level 1 requirement)	40-110 square centimeters (depends on photon energy and off-axis angle)	-none
GBM Energy Range (not a level 1 requirement)	10 keV - 25 MeV	-none
GBM Spatial Resolution (not a level 1 requirement)	15 degrees for burst alerts, 3 degrees after final processing	-none

Schedule	FY 2007 President's Budget	Baseline	Change from Baseline
LAT instrument delivery	August, 2006	December, 2005	+8 months
Operations Readiness Review (ORR)	May, 2007	February, 2007	+3 months
Launch	September, 2007	May, 2007	+4 months

Strategy For Major Planned Acquisitions

- The spacecraft contractor, General Dynamics/Spectrum Astro (Gilbert, AZ), was chosen via a blanket procurement through GSFC's Rapid Spacecraft Development Office.
- The primary instrument (LAT) at Stanford University, and the secondary instrument (GBM) at MSFC, were selected through a competitive Announcement of Opportunity competitive selection in 2000.
- The GSFC Science Support Center will support guest observers (GO) and manage annual solicitation for GOs. Mission Operations Center personnel will be provided by a contractor set-aside procurement.

Theme: The Universe
Program: Gamma-ray Large Space Telescope (GLAST) Program
Project In Development: Gamma-ray Large Space Telescope (GLAST) Project

Key Participants

- Large Area Telescope (LAT) development and instrument integration is managed by the Stanford Linear Accelerator Center, a Department of Energy-funded laboratory located at Stanford University.
- Stanford University is the home institution of the principal investigator of the LAT, and is also providing science support.
- Italy is responsible for assembly of the LAT tracker towers, which form the track imaging system, as well as additional hardware used in the towers. Japan and Italy are providing a portion of LAT silicon strip detectors and science support; France is also providing science support.
- The Naval Research Laboratory, in Washington, DC, assembled the Calorimeter for the LAT, and will environmentally test the integrated instrument and provide science support.

Risk Management

- RISK: Additional spacecraft assembly, integration and test delays are highly likely due to electronics parts problems and changing to pyro-release devices. Delays could affect the launch schedule.

MITIGATION: NASA is closely monitoring progress in problem resolution and helping the spacecraft contractor optimize their schedule.

Budget Detail/Life Cycle Cost (Dollars in Millions)

Budget Authority	Prior	FY2005	FY2006	FY2007	FY2008	FY2009	FY2010	FY2011	BTC	Total	Comments
FY 2007 PRES BUD	205.8	106.0	118.9	80.7	23.8	27.1	27.6	28.7	157.3	775.9	
Changes	-0.1	4.6	24.8	17.5	1.2	8.9	3.2		157.3	217.3	
FY2006 President's Budget	205.9	101.4	94.1	63.2	22.6	18.3	24.4			529.9	

NOTE: The GLAST BTC was inadvertently left out of the FY 2006 budget request.

Lifecycle cost elements:

Spacecraft: \$97M

Launch Vehicle: \$87M

Instruments: \$141M

Other: \$451M

These LCC estimates include operations costs.

Theme: The Universe
Program: Discovery

President's FY 2007 Budget Request (Dollars in Millions)

<u>Discovery</u>	<u>FY2005</u>	<u>FY2006</u>	<u>FY2007</u>	<u>FY2008</u>	<u>FY2009</u>	<u>FY2010</u>	<u>FY2011</u>
FY 2007 PRES BUD	95.2	137.5	100.8	69.9	13.8	13.4	13.0
Changes from FY 2006 Request	-30.3	19.7	24.2	53.1	0.2	-1.1	

Overview

In space exploration, the possibilities for discovery are without limits. Even with the vast amount of knowledge gained since exploration of the solar system began, there are still more questions than answers.

The Discovery Program offers the scientific community the opportunity to dig deep into their imaginations and find innovative ways to unlock the mysteries of the solar system. Scientists assemble a team and design exciting, focused science investigations that complement NASA's larger planetary science explorations. The goal is to launch smaller missions with fast development times, each for a fraction of the cost of NASA's larger missions. The main objective is to enhance our understanding of the Solar System by exploring the planets, their moons, and small bodies such as comets and asteroids.

This approach represents a breakthrough addition to the ways in which NASA explores space, with lower-cost, highly focused planetary science investigations designed. All completed Discovery missions have achieved ground-breaking science, with each taking a unique approach to space exploration.

Kepler is the only current Discovery project supporting the Universe Theme and is in the implementation phase.

Please refer to the Discovery Program under the Solar System Exploration theme for information regarding other NASA Discovery missions.

Plans For FY 2007

Kepler will start Assembly, Test, Launch Operations (ATLO). Please refer to the Solar System Theme, Discovery Program, for further program-level information.

Changes From FY 2006

- Kepler entered the implementation phase with a scheduled launch in June 2008.
- The Universe Discovery budget reflects the Kepler baseline established at its confirmation in May 2005.

Program Management

MSFC is responsible for Discovery project management. The NASA and MSFC Program Management Councils have program oversight responsibility.



Discovery Program logo.

Technical Parameters

The Kepler instrument is a 0.95-meter aperture differential photometer with a 105-degree squared field of view. The spacecraft will be launched into an Earth-trailing, heliocentric orbit. Following a 30-day characterization period, Kepler begins acquiring its scientific data by continuously and simultaneously observing over 100,000 target stars. During the first year, terrestrial planets with orbital periods shorter than that of Mercury -- as well as a wide range of larger planets with similar periods -- should be detected. Finally, the anticipated identification of Earth-size planets in the habitable zones of other star systems will begin during the third year. Mission lifetime is four years.

Technical Specifications	FY 2007 President's Budget	Change from Baseline
Kepler mission lifetime	Four years	-none
Kepler sensitivity	Visual magnitude 9 - 15	-none
Kepler coverage	100,000 F, G, K and M stars	-none
Kepler photometric precision	1 sigma total noise < 20 parts per million for a 6.5-hour integration time on a G2 star with mv=12	-none

Implementation Schedule:

Project	Schedule by Fiscal Year							Purpose	Phase Dates		
	05	06	07	08	09	10	11		Beg	End	
Kepler								Explore the structure and diversity of planetary systems.	Tech	Dec-01	May-05
									Form	May-05	Jun-08
									Dev	Jun-08	Aug-09
									Ops	Aug-09	Aug-10
									Res		

■ Tech & Adv Concepts (Tech)
■ Formulation(Form)
■ Development (Dev)
■ Operations (Ops)
■ Research (Res)
■ Represents a period of no activity for the Project

Strategy For Major Planned Acquisitions

- With the exception of future Discovery missions, which will be selected via NASA Announcements of Opportunity, all major acquisitions are in place.
- The Discovery program solicits proposals for an entire mission, put together by a team led by a PI and comprised of people from industry, small businesses, government and/or universities.

Key Participants

- Ball Aerospace and Technology Corporation, in Boulder Colorado, is responsible for Kepler instrument and spacecraft development, test and delivery.
- Laboratory for Atmospheric and Space Physics (LASP) at the University of Colorado in Boulder is responsible for Kepler Mission Operations.

Risk Management

- RISK:** Schedule delay in delivery of prime optics could affect the launch readiness date. Likelihood of occurrence: possible. **MITIGATION:** Work on the prime optics was started early in the formulation phase, with intensive management oversight.

Theme: The Universe
Program: Discovery
Project In Development: Kepler

President's FY 2007 Budget Request (Dollars in Millions)

Kepler (Development)	FY2005	FY2006	FY2007	FY2008	FY2009	FY2010	FY2011
FY 2007 PRES BUD	90.7	129.8	95.2	65.9	13.0	12.7	12.3
Changes from FY 2006 Request	-28.2	18.3	22.7	50.0	0.2	-1.1	

Projects in Development are mature, have a sound design, and are proceeding to mission execution. NASA is committed to their lifecycle cost and schedule plans.

Overview

The centuries-old search for other Earth-like worlds has been re-energized by the intense excitement and popular interest surrounding the discovery of Jupiter-like, giant gas planets orbiting stars beyond our solar system. With the exception of the pulsar planets, a large majority of the extrasolar planets detected thus far are gas giants.

The Kepler mission is designed to survey a portion of the extended solar neighborhood. The goal is to detect and characterize hundreds of potentially habitable planets that are up to 600 times less massive than Jupiter. Transits by planets produce a fractional change in stellar brightness. From measurements of the period, change in brightness and known stellar type, the planetary size, orbital size and characteristic temperature are determined. From these properties, the question of whether or not the planet might be habitable (not necessarily inhabited) can be answered.

Kepler's specific objectives include: 1) determine the frequency of terrestrial and larger planets in or near the habitable zones of a wide variety of spectral types of stars; 2) determine the distribution of planet sizes and their orbital semi-major axes (half the longest diameter of the orbit); 3) estimate the frequency and orbital distribution of planets in multiple-stellar systems; and (4) determine the distributions of semi-major axis, albedo, size, mass, and density of short-period giant planets.

For more information please see <http://www.kepler.nasa.gov>

Changes From FY 2006

- Kepler entered the implementation phase and is scheduled for launch in June 2008.
- Project budget reflects the May 2005 confirmation baseline.

Program Management

MSFC is responsible for Discovery project management. The NASA and MSFC Program Management Councils have program oversight responsibility.



Artist's depiction of Kepler in orbit.

Theme: The Universe
Program: Discovery
Project In Development: Kepler

Technical Parameters

The Kepler instrument is a 0.95-meter aperture differential photometer with a 105-degree squared field of view. The spacecraft will be launched into an Earth-trailing, heliocentric orbit. Following a 30-day characterization period, Kepler begins acquiring its scientific data by continuously and simultaneously observing over 100,000 target stars. During the first year, terrestrial planets with orbital periods shorter than that of Mercury -- as well as a wide range of larger planets with similar periods -- should be detected. Finally, the anticipated identification of Earth-size planets in the habitable zones of other star systems will begin during the third year. Mission lifetime is four years.

Technical Specifications	FY 2007 President's Budget	Change from Baseline
Mission lifetime	Four years	-none
Sensitivity	Visual magnitude 9 - 15	-none
Coverage	100,000 F, G, K and M stars	-none
Photometric precision	1 sigma total noise < 20 parts per million for a 6.5-hour integration time on a G2 star with mv=12	-none

Schedule	FY 2007 President's Budget	Baseline	Change from Baseline
ATLO	December, 2006	December, 2006	-none
Launch Readiness Review	March, 2008	March, 2008	-none
Launch	June, 2008	June, 2008	-none

Strategy For Major Planned Acquisitions

- All major acquisitions are in place.

Key Participants

- Ball Aerospace and Technology Corporation, in Boulder Colorado, is responsible for instrument and spacecraft development, test, and delivery.
- Laboratory for Atmospheric and Space Physics (LASP) at the University of Colorado in Boulder is responsible for Mission Operations.

Risk Management

- RISK:** Schedule delay in delivery of prime optics could affect the launch readiness date. Likelihood of occurrence: possible. **MITIGATION:** Work on the prime optics was started early in the formulation phase, with intensive management oversight.
- RISK:** Schedule delay in assembly of focal plane array. Likelihood of occurrence: unlikely. **MITIGATION:** Work on the focal plane array was funded early in the formulation phase with intensive management oversight. Assembly is scheduled to be complete well in advance of launch.
- RISK:** Ground and science operations preparedness. Likelihood of occurrence: highly unlikely. **MITIGATION:** NASA management presently has Ames Center resources working on operations preparedness, well in advance of launch.
- RISK:** Incomplete ground-based characterization of Kepler field of view. Likelihood of occurrence: highly unlikely. **MITIGATION:** A high-performance camera has been provided for ground observers doing this characterization. Extensive involvement from the HQ Program Scientist with expert science team members is resulting in excellent progress.

Theme: The Universe
Program: Discovery
Project In Development: Kepler

Budget Detail/Life Cycle Cost (Dollars in Millions)

Budget Authority	Prior	FY2005	FY2006	FY2007	FY2008	FY2009	FY2010	FY2011	BTC	Total	Comments
FY 2007 PRES BUD	79.6	90.7	129.8	95.2	65.9	13.0	12.7	12.3	19.6	518.8	No LCC yet.
Changes	0.2	-28.2	18.3								No LCC yet.
FY2006 President's Budget	79.5	118.9	111.5								

Kepler was not in Development in FY 2006; therefore, no LCC for FY 2006.

Lifecycle cost elements:

Spacecraft: \$86M

Launch Vehicle: \$82M

Instruments: \$142M

Other: \$209M

President's FY 2007 Budget Request (Dollars in Millions)

Explorer	FY2005	FY2006	FY2007	FY2008	FY2009	FY2010	FY2011
FY 2007 PRES BUD	56.8	85.4	67.6	86.1	56.7	19.0	4.6
Changes from FY 2006 Request	-25.1	-15.4	45.1	65.8	45.0	9.4	

Overview

The Explorer Program provides frequent flight opportunities for world-class astrophysics and space physics investigations, utilizing an innovative and efficient approach to spacecraft development and operations. The Program is composed of a series of independent space science missions which share a common funding and management structure within the Earth-Sun System Theme. The program emphasizes missions that can be accomplished under the control of the scientific research community within Program lifecycle cost requirements. The program also seeks to enhance public awareness of, and appreciation for, space science and to incorporate educational and public outreach activities. Medium-Class Explorers (MIDEX) provide flight opportunities for focused science missions. Small Explorer (SMEX) missions provide more frequent flight opportunities for highly focused and relatively inexpensive missions. Missions of Opportunity (MO) space science investigations are flown as part of a non-NASA space mission. MOs are conducted on a no-exchange-of-funds basis with the organization sponsoring the mission.

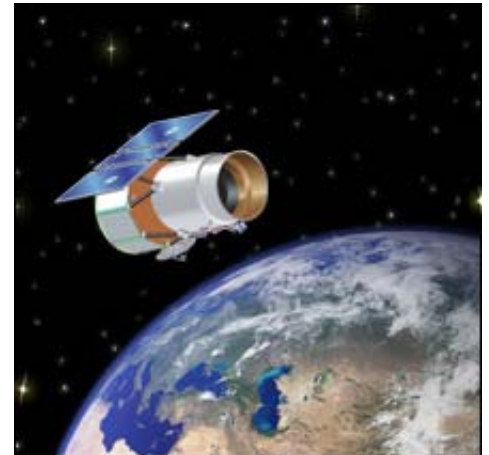

An artist's conception of the WISE satellite in orbit around Earth.

The Wide-field Infrared Survey Explorer (WISE) is the only Explorer mission in development currently supporting the Universe Theme. Please refer to the Earth-Sun System Theme for information on additional Explorer projects.

For more information, see the Explorer Program homepage for information:
<http://explorers.gsfc.nasa.gov/missions>.

Plans For FY 2007

Conduct Wide-field Infrared Survey Explorer (WISE) mission critical design review.

Changes From FY 2006

- Reduction in planned FY05 funding in the May 2005 operating plan resulted in the need to delay the launch readiness date and rephase the project budget accordingly.
- WISE Confirmation Review was delayed from July 2005 to November 2005.

Program Management

The Explorer program is a multiple-project program with program responsibility assigned to GSFC.

Technical Parameters

The Explorer program will launch MIDEX and SMEX missions commensurate with the availability of funding. The launch of MOs are as appropriate, based on date selected, funding profiles, and expected launch dates for the host missions. The projects encourage a wide variety of methods for access to space. Expendible launch vehicles (ELVs), spacecraft from other programs, and long-duration balloons are all encouraged as ways to increase program flexibility and maximize flight opportunities for space science. ESS provides access to space and launch vehicle funding. These funds are part of the total cost cap for each mission. For each mission class, launch will take place within the following number of months after implementation starts: SMEX, 33 months; MIDEX, 40 months.

Technical Specifications	FY 2007 President's Budget	Change from Baseline
SMEX Life Cycle	Development phase of no longer than 33 Months	No Change
MIDEX Life Cycle	Development phase of no longer than 40 months	No Change

Implementation Schedule:

Project	Schedule by Fiscal Year							Purpose	Phase Dates		
	05	06	07	08	09	10	11		Beg	End	
Wide-field Infrared Survey Explorer (WISE)								A four-channel, super-cooled infrared telescope design to survey the entire sky with 1,000 times more sensitivity than previous infrared missions.	Tech	Apr-02	Feb-06
									Form	Feb-06	Aug-09
									Dev	Aug-09	Sep-11
									Ops		
									Res		

■ Tech & Adv Concepts (Tech)
■ Formulation(Form)
■ Development (Dev)
■ Operations (Ops)
■ Research (Res)
■ Represents a period of no activity for the Project

Strategy For Major Planned Acquisitions

- Investigations will be selected to proceed from one phase to the next through execution of contract options, based on successful technical, cost, and schedule performance in the previous phases.
- Explorer Program has established an acquisition strategy that contracts for the whole mission (concept through delivery of science) at initial selection, with emphasis on performance incentives.
- Investigations are selected through competitive AOs, where multiple investigations are selected for initial concept studies with a competitive down-select to proceed to the next stage of formulation.

Key Participants

- Industry, academia, other government agencies and international partners, varied by mission.

Risk Management

- RISK:** Implementation of highly cost-constrained, first-of-a-kind space research missions is inherently risky. **MITIGATION:** Technical, management, and cost risks for each investigation are carefully examined as part of the selection process, and acceptable risks are documented in individual project appendices attached to the Explorer Program Plan. All technical and programmatic risks will be further reviewed as part of the project confirmation review during the PDR timeframe to ensure risks have been mitigated.

Theme: The Universe
Program: Explorer
Project In Development: Wide-Field Infrared Survey Explorer

President's FY 2007 Budget Request (Dollars in Millions)

<u>Wide-Field Infrared Survey Explorer (Development)</u>	<u>FY2005</u>	<u>FY2006</u>	<u>FY2007</u>	<u>FY2008</u>	<u>FY2009</u>	<u>FY2010</u>	<u>FY2011</u>
FY 2007 PRES BUD	28.6	69.7	53.9	71.7	44.8	8.8	4.3
Changes from FY 2006 Request	-26.3	-2.3	53.9	71.7	44.8	8.8	

Projects in Development are mature, have a sound design, and are proceeding to mission execution. NASA is committed to their lifecycle cost and schedule plans.

Overview

Planned for launch in 2009, WISE will provide a storehouse of knowledge about the solar system, the Milky Way, and the Universe. During its six-month mission, WISE will map the sky in infrared light, searching for the nearest and coolest stars, the origins of stellar and planetary systems, and the most luminous galaxies in the universe. WISE's infrared survey will provide an essential catalog for the James Webb Space Telescope (JWST).

Solar panels will provide WISE with electricity as it orbits several hundred miles above the dividing line between night and day on Earth, looking out at right angles to the Sun and always pointing away from the planet. As the telescope orbits from the North Pole to the equator to the South Pole and then back up to the North Pole, it will sweep out a circle in the sky. As the Earth moves around the Sun, this circle will shift, until WISE has observed the entire sky.

For more information, see <http://wise.ssl.berkeley.edu/science.html>.

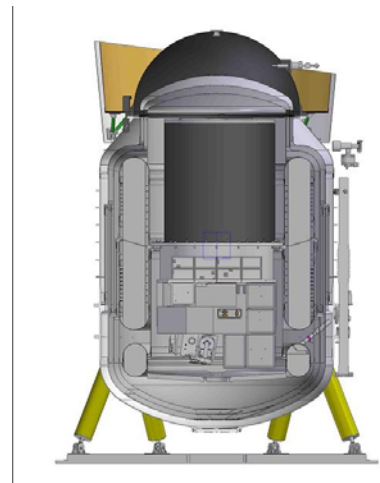

Current design for Wide-Field Infrared Survey Explorer

Changes From FY 2006

- Reduction in planned FY05 funding in the May 2005 operating plan resulted in the need to delay the launch readiness date and rephase the project budget accordingly.
- The WISE Confirmation Review was held in November 2005.

Program Management

JPL is responsible for WISE project management. NASA and JPL Program Management Councils have program oversight responsibility.

Theme: The Universe
Program: Explorer
Project In Development: Wide-Field Infrared Survey Explorer

Technical Parameters

WISE is a satellite with an infrared-sensitive telescope that will image the entire sky. Since objects near room temperature emit infrared radiation, the telescope and detectors are kept cold (below -430° F/15°K) by a cryostat -- like an ice chest filled with solid hydrogen. As WISE sweeps the sky, a small mirror will scan in the opposite direction, capturing an image onto an infrared sensitive digital camera every 11 seconds. Each picture will cover an area of the sky 3 times larger than the Moon. After 6 months, WISE will have taken nearly 1,500,000 pictures covering the sky. Data will be downloaded by radio transmission 4 times per day to computers on the ground which will combine the images into an atlas covering the entire celestial sphere with a list of all the detected objects.

Technical Specifications	FY 2007 President's Budget	Change from Baseline
Survey Sky Coverage	At least 95% of the sky will be imaged in 4 mid-infrared filters.	none
Sensitivity	Signal-to-noise ratio (SNR) will be at least 5 on a point source having fluxes of 0.12, 0.16, 0.65 and 2.6 mJy at the following respective wavelengths: 3.3, 4.7, 12 and 23 microns.	none
Photometric precision	Photometry of bright objects (SNR>100) will have uncertainties smaller than 7%.	none
Reliability of sky survey catalog entries	Sufficiently bright objects listed in the catalog (SNR > 20 in at least one filter) will have a 99.9% probability of being real.	none
Completeness of sky survey catalog	At least 95% of all sufficiently bright astronomical objects (SNR>20 in at least one filter) will be listed as entries in the catalog.	none

Schedule	FY 2007 President's Budget	Baseline	Change from Baseline
Preliminary Design Review (PDR)	July 2005		N/A
Confirmation Review	November 2005		
Begin development (phase C/D)	December 2005		
Launch Readiness Date	June 2009		

Strategy For Major Planned Acquisitions

- The cryogenic instrument is being built by Space Dynamics Laboratory; Ball Aerospace and Technologies Corporation in Colorado is building the spacecraft.

Key Participants

- UCLA is the lead Principal Investigator; the science team also includes members from Caltech, UC Berkeley, the University of Arizona, and the University of Virginia. Science operations and data processing will take place at the JPL/Caltech Infrared Processing and Analysis Center.

Theme: The Universe
Program: Explorer
Project In Development: Wide-Field Infrared Survey Explorer

Risk Management

- RISK: Because WISE spacecraft is designed without redundant components, it is at a higher risk of degraded science due to loss of critical component(s). MITIGATION: Additional rigor is being applied to parts selection and testing.
- RISK: There is a moderate risk of a payload subcontractor schedule delay. Payload subcontractors set the development pace in FY06, consuming a large portion of project resources. MITIGATION: Active participation in subcontractor's monthly mission reviews. Early payload development leaves large schedule reserves.

Budget Detail/Life Cycle Cost (Dollars in Millions)

Budget Authority	Prior	FY2005	FY2006	FY2007	FY2008	FY2009	FY2010	FY2011	BTC	Total	Comments
FY 2007 PRES BUD	13.5	28.6	69.7	53.9	71.7	44.8	8.8	4.3		295.3	
Changes	0.0	-26.3	-2.3								
FY2006 President's Budget	13.5	55.0	71.9								

WISE not in Development phase in FY 2006; therefore, no FY 2006 LCC.

Lifecycle cost elements:

Spacecraft: \$54.0 M

Instruments: \$67.0 M

Launch Services: \$77.0 M

Other: 97.3 M

President's FY 2007 Budget Request (Dollars in Millions)

Universe Research	FY2005	FY2006	FY2007	FY2008	FY2009	FY2010	FY2011
FY 2007 PRES BUD	321.6	305.8	306.6	309.2	297.4	288.9	259.6
Changes from FY 2006 Request	-10.0	-9.9	-5.0	-0.1	-5.4	-7.5	

Overview

For thousands of years, people have gazed at the stars, given them names, and observed their changes. Though NASA has only recently joined the ancient pursuit of knowledge of the cosmos, forty years of space science has yielded such astronomical advances as full-sky mapping of the oldest light in the universe.

The Universe Theme's Research Program translates Universe missions into science advances by managing mission in operation; collecting, processing and storing mission data; making mission data available to scientists; and funding grants for basic research, technology development, and data analysis from past and current missions. All data collected by missions are archived in data centers located at universities and NASA centers throughout the country and are readily available to all researchers and the general public.

Mission operations and data analyses being managed by the Universe Research Program include FUSE, Chandra, WMAP, GALEX, Spitzer, and Swift.

For more information on current operating missions, go to: <http://science.hq.nasa.gov/missions/universe.html>.

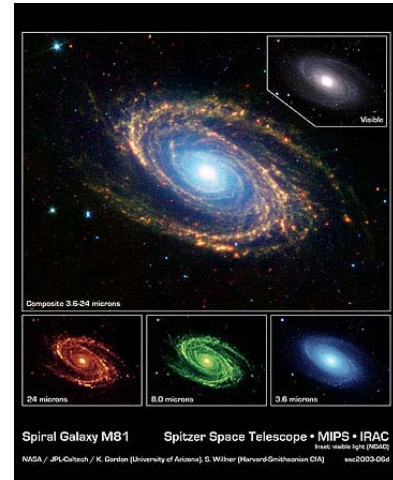

Spitzer Space Telescope multiple infrared views of spiral galaxy Messier 81.

Plans For FY 2007

The Universe Research Program will continue to provide mission data and provide it to scientists and researchers, including new data from operating missions. Gravity Probe-B will complete its analysis of the measurements to investigate two extraordinary predictions of Einstein's General Theory of Relativity: how space and time are warped by the presence of earth, and how earth's rotation drags space-time around with it. Swift will pinpoint approximately 100 gamma ray bursts a year and provide unprecedented information on the position, brightness, and physical properties of these powerful cosmic explosions. Hubble Space Telescope will continue observations. Astro-E2 (Suzaku) is maintaining an aggressive science observation plan after the loss of the XRS instrument. A reassessment of the pre-launch observation plan is underway. Chandra, NASA's X-ray Great Observatory, will continue to perform detailed studies of black holes, supernovas, and dark matter to increase our understanding of the origin, evolution, and destiny of the universe. Spitzer Space Telescope, the largest infrared telescope ever launched into space will complete its fourth year using its state-of-the-art infrared detectors to pierce the dusty darkness enshrouding galaxies, stars, and planet-forming discs around stars.

In January 2006, the Science Mission Directorate will issue the ROSES-06 (Research Opportunities in Space and Earth Science) Omnibus NRA covering all of the planned research solicitations in Earth-Sun System and Space Science for 2006. The ROSES-06 NRA describes the research goals in detail. The FY2007 budget will fund the competitively selected research activities.

Changes From FY 2006

- Fewer new grants and research awards will be selected.
- HETE-2 and CHIPS missions will terminate science operations at the end of CY 2005.

Program Management

GSFC, JPL and MSFC - project management of current missions.
 HQ and Center Program Management Councils - program responsibility.

Technical Parameters

With its large field-of-view and high sensitivity, Swift's Burst Alert Telescope computes GRB positions onboard with arc-minute position accuracy; the satellite then slews autonomously to perform follow-up X-ray and optical/UV observations. Spitzer is an IR cryogenic telescope equipped with 3 instruments to study clouds of gas and dust characteristic of star forming regions, centers of galaxies, and newly forming planetary systems. Spitzer has proactively managed the on-board cryogen so that it is anticipated that the science operations will last two years longer than the level-1 requirements. Chandra's mirrors allow the sharpest X-ray imaging ever achieved.

Technical Specifications	FY 2007 President's Budget	Change from Baseline
Other research	The SMD research priorities draw from the Astronomy and Physics Decadal Survey and roadmap activities by subcommittees.	none
Other research	All selection processes and reviews of elements of the Universe research program use strategic items as guideposts for selection and/or continuation. Proposals must relate to these strategic items.	none
Universe operating missions	All missions have met Level 1 specifications as identified in each mission's respective plan.	none

Implementation Schedule:											
Project	Schedule by Fiscal Year							Purpose	Phase Dates		
	05	06	07	08	09	10	11		Tech	Beg	End
RXTE								Observe the high-energy worlds of black holes, neutron stars, x-ray pulsars, and bursts.	Tech Form Dev Ops Res	Dec-95	Feb-07 Sep-07
FUSE								Study physical processes governing the evolution of galaxies as well as the origin the evolution of stars and planetary systems.	Tech Form Dev Ops Res	Jun-99	Sep-08 Sep-09
Chandra								Explore the hot, turbulent regions in space with images 25 times sharper than previous x-ray pictures.	Tech Form Dev Ops Res	Jul-99	Jul-10 Jul-11
XMM								Conduct sensitive x-ray spectroscopic observations of a wide variety of cosmic sources.	Tech Form Dev Ops Res	Dec-99	Sep-08 Sep-09
HETE-2								Carry out a multiwavelength study of gamma ray bursts with ultraviolet, x-ray, and gamma ray instruments.	Tech Form Dev Ops Res	Oct-00	Dec-05 Mar-06
WMAP								Probe the early universe by measuring the cosmic microwave background radiation over the full sky.	Tech Form Dev Ops Res	Jun-01	Sep-08 Sep-09
INTEGRAL								Unravel the secrets of the highest-energy, most violent phenomena in the universe.	Tech Form Dev Ops Res	Oct-02	Sep-08 Sep-09
CHIPS								Study the "Local Bubble" of hot gas surrounding the solar system.	Tech Form Dev Ops Res	Jan-03	Dec-05 Dec-05
GALEX								Explore the origin and evolution of galaxies and the origins of stars and heavy elements.	Tech Form Dev Ops Res	Apr-03	Sep-08 Sep-09
Spitzer								Study the formation of stars, galaxies, and planets via spectroscopy, high-sensitivity photometry, and imaging.	Tech Form Dev Ops Res	Aug-03	May-08 Sep-09
GP-B								Verify certain extraordinary predictions of Einstein's Theory of General Relativity.	Tech Form Dev Ops Res	Apr-04	Apr-04 Jul-05 Sep-06
Swift								Study the position, brightness, and physical properties of gamma ray bursts.	Tech Form Dev Ops Res	Nov-04	Nov-04 Jan-07 Sep-07

■	Tech & Adv Concepts (Tech)
■	Formulation(Form)
■	Development (Dev)
■	Operations (Ops)
■	Research (Res)
■	Represents a period of no activity for the Project

Theme: The Universe
Program: Universe Research

Implementation Schedule:

Project	Schedule by Fiscal Year							Purpose	Phase Dates																
	05	06	07	08	09	10	11		Beg	End															
Astro-E2								Study black holes, neutron stars and quasars to unravel the physics high-energy processes and the behavior of matter under extreme conditions.	<table border="1"> <tr><td>Tech</td><td></td></tr> <tr><td>Form</td><td></td></tr> <tr><td>Dev</td><td></td></tr> <tr><td>Ops</td><td>Apr-05</td></tr> <tr><td>Res</td><td>May-05</td></tr> <tr><td></td><td>Sep-08</td></tr> <tr><td></td><td>Dec-05</td></tr> <tr><td></td><td>Sep-09</td></tr> </table>	Tech		Form		Dev		Ops	Apr-05	Res	May-05		Sep-08		Dec-05		Sep-09
Tech																									
Form																									
Dev																									
Ops	Apr-05																								
Res	May-05																								
	Sep-08																								
	Dec-05																								
	Sep-09																								
<table border="0"> <tr><td></td><td>Tech & Adv Concepts (Tech)</td></tr> <tr><td></td><td>Formulation(Form)</td></tr> <tr><td></td><td>Development (Dev)</td></tr> <tr><td></td><td>Operations (Ops)</td></tr> <tr><td></td><td>Research (Res)</td></tr> <tr><td></td><td>Represents a period of no activity for the Project</td></tr> </table>												Tech & Adv Concepts (Tech)		Formulation(Form)		Development (Dev)		Operations (Ops)		Research (Res)		Represents a period of no activity for the Project			
	Tech & Adv Concepts (Tech)																								
	Formulation(Form)																								
	Development (Dev)																								
	Operations (Ops)																								
	Research (Res)																								
	Represents a period of no activity for the Project																								

Strategy For Major Planned Acquisitions

- The prime contractor for Chandra operations is the Smithsonian Astrophysical Observatory (SAO) in Cambridge, MA. The contract for Chandra was renewed in 2003 for a period of five years.
- Lockheed Martin in Bethesda, MD maintains the servicing contract for Hubble Space Telescope and some mission operation servicing for Spitzer Space Telescope.
- Orbital Sciences provides operational support for GALEX & FUSE; Northrop Grumman provides technical support for Chandra; operational support contracts exist with six major universities across the U.S.

Key Participants

- Smithsonian Astrophysical Observatory (SAO) operates Chandra.
- California Institute of Technology (Caltech) manages the Spitzer Science Center.
- Staff at many universities across the Nation propose and win grants to participate in the Universe Theme operational missions as principal investigators for observation and data analysis, as well as in the Universe Research program.
- Multiple international agreements are in place for operating missions.

Risk Management

- RISK: There are low to moderate risks of malfunctions in the pointing and control features of operating spacecraft. MITIGATION: NASA incorporates a rigorous personnel training program for early detection and recovery from operational anomalies.

President's FY 2007 Budget Request (Dollars in Millions)

Beyond Einstein	FY2005	FY2006	FY2007	FY2008	FY2009	FY2010	FY2011
FY 2007 PRES BUD	24.1	14.1	21.2	21.4	53.0	152.2	175.4
Changes from FY 2006 Request	-17.7	-41.3	-62.7	-143.1	-166.6	-95.3	

Overview

In attempting to understand and explain the universe, Albert Einstein devised several theories along with his theory of general relativity. Some fantastic predictions flow from these theories: the Big Bang, black holes, and existence of a "dark energy" currently blowing the universe apart. However, Einstein's theories only predict, they do not really explain the phenomena. To find answers, scientists must move beyond theory; they must employ new techniques, and launch missions to observe the universe in new and advanced ways. They must test and validate these new theories and enjoin heretofore separate fields like astronomy and particle physics.

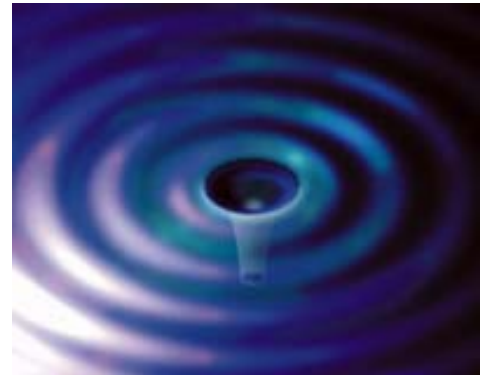

Beyond Einstein (BE) is currently undergoing a program-level review. NASA will work with the science community to assess the relative priority and technical readiness among three potential missions: an Einstein Probe to study the nature of dark energy that dominates the universe; the Laser Interferometer Space Antenna (LISA) which will detect gravitational waves ("ripples in the fabric of space-time") predicted by Einstein's theory of general relativity; and Constellation-X, four identical spacecraft performing high throughput X-ray spectroscopy to unlock the mysteries of black holes, galaxy formation, and dark matter.

The curvature of space and the workings of blackholes present challenging areas for future exploration. Artists concept of a gravitational wave.

For more information, please see: <http://universe.nasa.gov/>

Plans For FY 2007

The focus in 2007 will be on the results of a priority and technology readiness review of the three missions in the Beyond Einstein Program. NASA will proceed with advanced studies on the Joint Dark Energy Mission (JDEM, a joint activity of NASA and DoE), and minimal technology advancement on LISA and Con-X.

Changes From FY 2006

- The Beyond Einstein Program is undergoing a priority and technical readiness review of the three potential missions identified above.
- The selection and timing of mission(s) for formulation will depend on the outcome of this review. The startup of a Beyond Einstein mission is delayed commensurate with this process.

Program Management

GSFC has responsibility for Beyond Einstein project management. The NASA and GSFC Program Management Councils has program oversight responsibility.

Theme: The Universe
Program: Beyond Einstein

Technical Parameters

Studies beginning in FY 2006 will determine the technical parameters of future Beyond Einstein missions.

Technical Specifications	FY 2007 President's Budget	Change from Baseline
Refer to Technical Parameters section.		

Implementation Schedule:

Project	Schedule by Fiscal Year							Purpose	Phase Dates		
	05	06	07	08	09	10	11		Beg	End	
Technology readiness reviews and advancement.								Inform the selection of future missions for formulation.	Tech Form Dev Ops Res	Oct-04	Sep-11

Strategy For Major Planned Acquisitions

- Not applicable

Key Participants

- LISA is in an international partnership with ESA, operating under a Letter of Agreement.
- Con-X partnerships have not been identified.
- JDEM would be a partnership with DoE.

Risk Management

- RISK: No significant risk at this time. MITIGATION: N/A

President's FY 2007 Budget Request (Dollars in Millions)

International Space Science Collaboration	FY2005	FY2006	FY2007	FY2008	FY2009	FY2010	FY2011
FY 2007 PRES BUD	17.5	13.0	19.6	23.6	38.9	38.5	36.3
Changes from FY 2006 Request	4.3	0.0	-2.6	-16.2	0.5	4.4	

Overview

Herschel and Planck, two projects in the International Space Science Collaboration (SSC) Program, are ESA-led missions. They will be launched together on an Ariane-5 and then separate while being injected into their transfer orbits. The spacecraft will then proceed independently to their operational orbits.

Herschel has been designed to unveil a face of the early universe that has remained hidden until now. Thanks to its ability to detect radiation at far-infrared and sub-millimeter wavelengths, Herschel will observe dust-obscured and cold objects that are invisible to other telescopes. Targets for Herschel will include clouds of gas and dust where new stars are being born, disks out of which planets may form, and cometary atmospheres packed with complex organic molecules. Herschel's major challenge will be discovering how the first galaxies formed and how they evolved to give rise to present day galaxies like our own. NASA is participating in two of the three instruments.

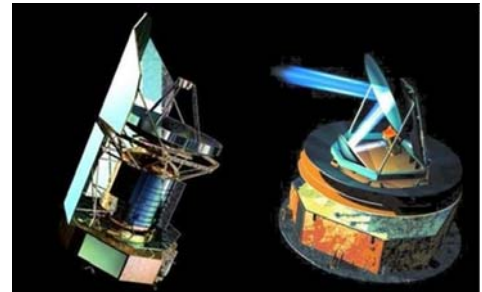

Artist's rendition of Herschel (left) and Planck (right).

Planck will help provide answers to one of the most important sets of questions asked in modern science: how did the universe begin, how did it evolve to the state we observe today, and how will it continue to evolve in the future? Planck's objective is to analyze, with the highest accuracy ever achieved, the remnants of the radiation that filled the universe immediately after the Big Bang, which we observe today as the Cosmic Microwave Background (CMB). NASA is participating in both instruments.

Herschel and Planck are scheduled to launch in 2007.

For more information go to <http://sci.esa.int/science-e/www/area/index.cfm?fareaid=16>.

Plans For FY 2007

- NASA will continue to support instrument integration and testing for Herschel and Planck in Europe.
- NASA will also continue to develop science support for Herschel and Planck.

Changes From FY 2006

- Budget reflects rephasing to accommodate updated ESA schedule.
- NASA delivered all of the hardware components for both Herschel and Planck to the principal investigator.

Program Management

JPL is responsible for Herschel and Planck project management. NASA and JPL's Program Management Council have program oversight responsibility.

Technical Parameters

Herschel will be the first observatory to cover the full far-infrared and sub-millimeter waveband. Its telescope will have the largest mirror deployed in space to date. It will be 1.5 million km away from Earth. A 3.5-meter mirror will collect light from distant and poorly known objects millions of light years away and focus it onto 3 instruments with detectors kept at temperatures close to absolute zero. Planck will collect and characterize radiation from the CMB using sensitive radio receivers operating at very low temperatures. The receivers will determine the black-body equivalent temperature of the background radiation and be capable of distinguishing temperature variations of about one microkelvin, producing the best ever maps of anisotropies in CMB radiation field.

Technical Specifications	FY 2007 President's Budget	Change from Baseline
Herschel	700 hours of science per year.	--
Planck	1.5 years of mission life.	--

Implementation Schedule:

Project	Schedule by Fiscal Year							Purpose	Phase Dates	
	05	06	07	08	09	10	11		Beg	End
Herschel								Help solve the mystery of how stars and galaxies were born.	Tech Form Dev Ops Res	Sep-97 Sep-01 Oct-01 Jul-07 Feb-08 Apr-13
Planck								Analyze remnants of the cosmic microwave background.	Tech Form Dev Ops Res	Sep-97 Sep-01 Oct-01 Jul-07 Feb-08 Feb-10

Strategy For Major Planned Acquisitions

- Completed major acquisitions.

Key Participants

- Herschel and Planck are ESA missions. NASA is providing critical components and technologies to this mission.

Risk Management

- RISK: Potential damage to NASA hardware during integration and test. MITIGATION: NASA has personnel on-site during integration and testing. NASA has developed handling procedures, and is monitoring I&T activities closely.

Theme: The Universe
Program: International Space Science Collaboration
Project In Development: Herschel

President's FY 2007 Budget Request (Dollars in Millions)

Herschel (Development)	FY2005	FY2006	FY2007	FY2008	FY2009	FY2010	FY2011
FY 2007 PRES BUD	9.7	5.9	11.7	13.4	27.2	27.4	27.6
Changes from FY 2006 Request	4.4	-1.0	-0.9	-14.5	-0.3	1.5	

Overview

Projects in Development are mature, have a sound design, and are proceeding to mission execution. NASA is committed to their lifecycle cost and schedule plans.

The Herschel Space Observatory will be the first space observatory covering the full far-infrared and sub-millimeter waveband, and its telescope will have the largest mirror deployed in space to date. It will be located 1.5 million kilometers away from Earth at the second Lagrange point of the Earth-Sun system. Herschel will permit high spatial and spectral resolution imaging in the 85-900 micron wavelength region. Superb sensitivity for both photometry and spectroscopy will result from Herschel's high throughput and low thermal background. Herschel's 3.5-meter mirror will collect the light from distant and poorly known objects, such as newborn galaxies thousands of millions of light-years away, and will focus that light onto three instruments whose detectors will be kept at temperatures close to absolute zero.



Herschel Payload Module leaving the Large Space Simulator (LSS) after the Thermal Blanket / Thermal Vacuum (TB/TV) test.

Herschel will be a multipurpose observatory serving the entire astronomical community studying: galaxy formation and evolution in the early universe; the nature of active galaxy power sources; star-forming regions; and interstellar medium physics in the Milky Way and other galaxies. The European Space Agency (ESA) is the lead agency for the mission; Herschel will be co-manifested with the Planck spacecraft.

NASA is providing components for two of the three instruments on the Herschel science payload. The first, Heterodyne Instrument for the Far Infrared (HIFI), is a very high resolution heterodyne spectrometer. The second instrument, the Spectral and Photometric Imaging Receiver (SPIRE), is an imaging photometer/ imaging Fourier transform spectrometer.

For more information, see:
<http://sci.esa.int/science-e/www/area/index.cfm?fareaid=16>

Changes From FY 2006

- NASA delivered all the hardware components for Herschel to the principal investigator.

Program Management

JPL - Herschel project management, including mission and science operations. NASA and JPL Program Management Councils - program responsibility.

Theme: The Universe
Program: International Space Science Collaboration
Project In Development: Herschel

Technical Parameters

Herschel will be the first observatory to cover the full far-infrared and sub-millimeter waveband and its telescope will have the largest mirror deployed in space to date. It will be 1.5 million kilometers away from Earth, and a 3.5-meter mirror will collect light from distant and poorly known objects millions of light years away and focus this light onto three instruments whose detectors will be kept at temperatures close to absolute zero.

Technical Specifications	FY 2007 President's Budget	Change from Baseline
Annual science output	700 hours of science per year.	-none

Schedule	FY 2007 President's Budget	Baseline	Change from Baseline
Launch Readiness Date	August 2007	August 2007	-none

Strategy For Major Planned Acquisitions

- Completed major acquisitions.

Key Participants

- Herschel is an ESA mission.
- NASA is providing critical components and technologies to this mission.

Risk Management

- RISK: Potential damage to NASA hardware during integration and test. MITIGATION: NASA has personnel on-site during integration and testing. NASA has developed safe handling procedures, and is monitoring I&T activities to ensure the procedures are followed.

Budget Detail/Life Cycle Cost (Dollars in Millions)

Budget Authority	Prior	FY2005	FY2006	FY2007	FY2008	FY2009	FY2010	FY2011	BTC	Total	Comments
FY 2007 PRES BUD	89.7	9.7	5.9	11.7	13.4	27.2	27.4	27.6	102.3	315.1	
Changes	0.0	4.4	-1.0	-0.9	-14.5	-0.3	1.5		-17.8	-28.5	
FY2006 President's Budget	89.7	5.3	6.9	12.6	28.0	27.4	25.9		120.1	315.9	

Lifecycle cost elements:
 Instruments: \$91.7M
 Other: \$223.4M

Theme: The Universe
Program: International Space Science Collaboration
Project In Development: Planck

President's FY 2007 Budget Request (Dollars in Millions)

Planck (Development)	FY2005	FY2006	FY2007	FY2008	FY2009	FY2010	FY2011
FY 2007 PRES BUD	6.6	6.3	6.8	8.8	9.4	8.9	6.6
Changes from FY 2006 Request	-0.5	1.0	-1.5	-0.8	0.5	2.5	

Projects in Development are mature, have a sound design, and are proceeding to mission execution. NASA is committed to their lifecycle cost and schedule plans.

Overview

The Planck spacecraft will help provide answers to one of the most important sets of questions asked in modern science: how did the universe begin, how did it evolve to the state we observe today, and how will it continue to evolve in the future? Planck's objective is to analyze, with the highest accuracy ever achieved, the remnants of the radiation that filled the universe immediately after the Big Bang, which researchers observe today as the cosmic microwave background (CMB). Planck will study the global characteristics of the universe (age, composition, topology, etc.) by its precision all-sky measurement of the CMB. Planck is designed to image minor variations in CMB radiation over the whole sky, with unprecedented sensitivity and angular resolution. The Planck mission is led by ESA. NASA participates on the two project instruments.



Planck QM showing the payload module with its 3 circular radiators, the huge baffle and the focal plane assembly in the center.

NASA is providing components for both the Low Frequency Instrument (LFI), a high electron mobility transistor radio receiver array as well as the High Frequency Instrument (HFI), a bolometric detector array. In addition, NASA is providing two cryo-coolers to the Planck science payload.

For more information, please see: <http://sci.esa.int/science-e/www/area/index.cfm?fareaid=17>

Changes From FY 2006

- NASA has delivered all the hardware components for Planck to the principal investigator.

Program Management

JPL is responsible for Planck project management. NASA and JPL Program Management Councils have program responsibility.

Technical Parameters

Planck will collect and characterize radiation from the CMB using sensitive radio receivers operating at extremely low temperatures. The receivers will determine the black body equivalent temperature of the background radiation and be capable of distinguishing temperature variations of about one microkelvin. The measurements will produce the best ever maps of anisotropies in the CMB radiation field.

Technical Specifications	FY 2007 President's Budget	Change from Baseline
Mission life	1.5 years of mission life.	none

Theme: The Universe
Program: International Space Science Collaboration
Project In Development: Planck

Schedule	FY 2007 President's Budget	Baseline	Change from Baseline
Launch Readiness Date	August 2007	August 2007	none

Strategy For Major Planned Acquisitions

- Completed major acquisitions.

Key Participants

- Herschel is an ESA mission. NASA is providing critical components and technologies to this mission.

Risk Management

- RISK:** Potential damage to NASA hardware during integration and test (I&T). **MITIGATION:** NASA has personnel on-site during integration and testing. NASA has developed safe-handling procedures, and is monitoring I&T to ensure the procedures are properly implemented.

Budget Detail/Life Cycle Cost (Dollars in Millions)

Budget Authority	Prior	FY2005	FY2006	FY2007	FY2008	FY2009	FY2010	FY2011	BTC	Total	Comments
FY 2007 PRES BUD	51.2	6.6	6.3	6.8	8.8	9.4	8.9	6.6	5.5	110.2	
Changes	0.1	-0.5	1.0	-1.5	-0.8	0.5	2.5		-6.7	-5.4	
FY2006 President's Budget	51.2	7.1	5.3	8.3	9.6	8.9	6.4		12.2	109.0	

Earth-Sun System

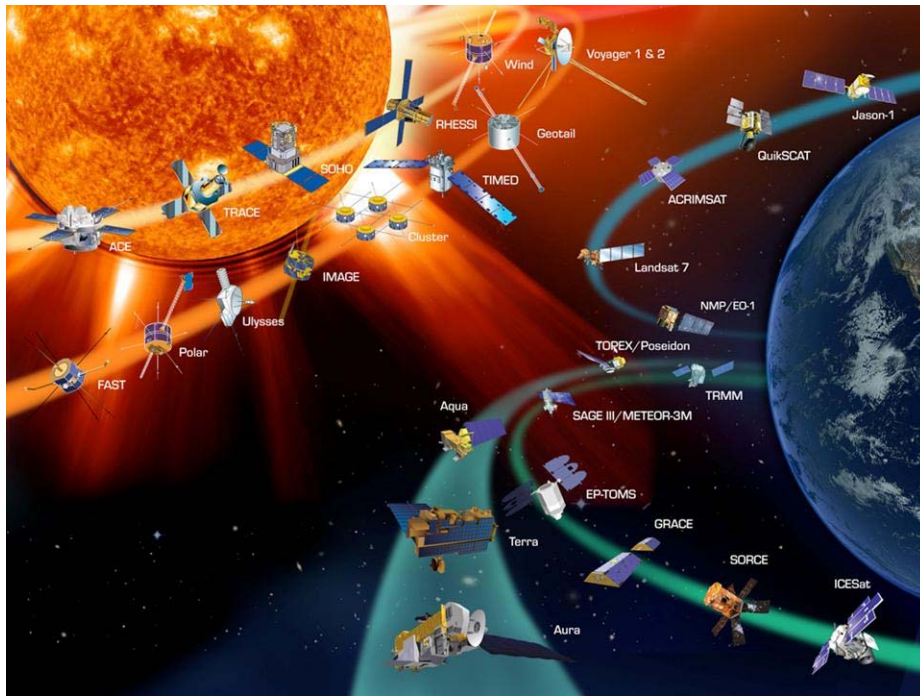

Earth Sun System spacecraft in operation.

President's FY 2007 Budget Request

(Dollars in Millions)

Earth-Sun System	FY2005	FY2006	FY2007	FY2008	FY2009	FY2010	FY2011
FY 2007 OMB Submit	2,306.2	2,163.5	2,210.6	2,283.7	2,288.9	2,315.8	2,390.0
Changes from FY 2006 Request	150.4	99.9	129.5	151.5	-70.2	-9.0	

Overview: What NASA Accomplishes through the Earth-Sun System Theme

We live in the extended atmosphere of an active star. Life on Earth's biosphere prospers through a climate powered by energy from the Sun which is moderated by water and carbon cycles. We are protected from the harshness of space by Earth's enveloping magnetic field and an atmosphere. The Earth-Sun System (ESS) Theme is comprised of programs designed to understand how the Earth system is changing, to probe the connections between the Sun, Earth and the rest of the solar system, and to discern the consequences for life on Earth. Working with the Agency's domestic and international partners, NASA provides accurate, objective scientific data and analyses to advance understanding of Earth-Sun system processes and phenomena. This advanced understanding enables improved prediction and response capabilities for climate, weather, natural hazards, and even human-induced changes. NASA is exploiting a constellation of Earth-Sun observing satellites routinely making measurements with remote sensing instruments.

NASA has defined two strategic objectives within the Earth-Sun Theme: (1) conduct a program of research and technology development to advance Earth observation from space, improve scientific understanding of Earth systems, and demonstrate new technologies with the potential to improve future operational systems; and (2) explore the Sun's connection to the Solar System to understand the Sun and its effects on Earth and the solar system, to understand the space environment conditions that will be experienced by human explorers, and to demonstrate technologies with the potential to improve future operational systems.

Relevance: *Why* NASA conducts Earth-Sun System work

Relevance to national priorities, relevant fields, and customer needs:

The ESS Theme contributes to three Presidential initiatives: Climate Change Research, Global Earth Observation, and the Vision for Space Exploration. NASA is establishing predictive capabilities for the Earth-Sun system that will enable advanced assessments of the causes and consequences of global change and solar variability. NASA is working with partner organizations to apply NASA's science results to help improve the Nation's observational and forecasting systems. These improvements will enhance scientists' ability to manage coastal environments, agriculture, water resources, and aviation safety; to monitor air quality, forest fires, and impacts of infectious diseases and invasive species; and to conduct hurricane forecasting and disaster relief efforts. In addition, space weather effects may modify the ozone layer; change the propagation of radio and radar signals in and through the ionosphere; disturb navigation, communication, and energy transmission systems on Earth; and produce significant effects on any spacecraft or person outside the atmosphere. Increasing our understanding of Earth and solar variability will improve quality of life, reduce losses from adverse events, enhance economic stewardship, lower the risk of failure or degraded performance of exploration missions, and enhance U.S. Industry's competitiveness in the global marketplace.

Relevance to the NASA mission:

The ESS Theme supports NASA's mission to understand and protect Earth by increasing understanding and enabling prediction of global change and solar variability. It also supports exploration of the universe and search for life by helping understand the space environment through which spacecraft and humans will travel.

Relevance to education and public benefits:

The ESS theme increases public awareness and understanding of global change and solar variability. It enables the use of science information in teaching and learning at all levels of education. Through the ESS Theme, NASA seeks to increase science literacy and focus attention on the dynamic Earth and the active Sun, thereby making new scientific knowledge available for use in everyday decisions by the public, businesses, and governments. NASA's partnership with educational and service-provider organizations shares the discoveries and knowledge from the Earth-Sun missions and research programs with the Nation. The ESS Theme has significant science results to share with the public. The public is informed through news releases highlighting Earth- and solar-related events, dynamic media delivery, documentaries, innovative planetarium shows, exhibits at museums and science centers, and content-rich web sites.

Performance

Major Activities Planned for FY 2007:

- Retrieve and distribute scientific data from CloudSat.
- Continue development of Orbiting Carbon Observatory (OCO), Aquarius, and Glory.
- Solar Dynamics Observatory (SDO) Integration and Test.
- Launch Themis (Time History of Events and Macroscale Interactions during Substorms).

Major Recent Accomplishments:

- Orbiting Carbon Observatory, Aquarius, and Glory successfully passed Mission Confirmation.
 - Terra (MODIS), Aqua (MODIS) and EO-1 provided imagery of Katrina devastation.
 - STEREO (Solar Terrestrial Relations Observatory) completed observatory pre-environmental review and began environmental testing.
 - Scientists from SOHO's Michelson-Doppler Interferometer investigation learned how to make images of the entire far side of the Sun, with all its active regions, using a 3 bounce sonogram technique.
-

Earth-Sun System Theme Commitment in Support of the NASA Mission:

Strategic Goals**Sub-Goals (If Applicable)***Multiyear Outcomes*

Annual Performance Goals supporting the Multiyear Outcomes

3. Develop a balanced overall program of science, exploration, and aeronautics consistent with the redirection of the human spaceflight program to focus on exploration.

3A Study Earth from space to advance scientific understanding and meet societal needs.

3A.1 Progress in understanding and improving predictive capability for changes in the ozone layer, climate forcing, and air quality associated with changes in atmospheric composition.

7ESS1 Demonstrate progress in understanding and improving predictive capability for changes in the ozone layer, climate forcing, and air quality associated with changes in atmospheric composition. Progress will be evaluated by external expert review.

3A.2 Progress in enabling improved predictive capability for weather and extreme weather events.

7ESS2 Demonstrate progress in enabling improved predictive capability for weather and extreme weather events. Progress will be evaluated by external expert review.

3A.3 Progress in quantifying global land cover change and terrestrial and marine productivity, and in improving carbon cycle and ecosystem models.

7ESS3 Demonstrate progress in quantifying global land cover change and terrestrial and marine productivity, and in improving carbon cycle and ecosystem models. Progress will be evaluated by external expert review.

7ESS4 Complete Landsat Data Continuity Mission (LDCM) Confirmation Review.

7ESS6 Complete Orbiting Carbon Observatory (OCO) Assembly, Test and Launch Operations (ATLO) Readiness Review.

3A.4 Progress in quantifying the key reservoirs and fluxes in the global water cycle and in improving models of water cycle change and fresh water availability.

7ESS5 Demonstrate progress in quantifying the key reservoirs and fluxes in the global water cycle and in improving models of water cycle change and fresh water availability. Progress will be evaluated by external expert review.

3A.5 Progress in understanding the role of oceans, atmosphere, and ice in the climate system and in improving predictive capability for its future evolution.

7ESS7 Demonstrate progress in understanding the role of oceans, atmosphere, and ice in the climate system and in improving predictive capability for its future evolution. Progress will be evaluated by external expert review.

7ESS8 Complete Glory mission Pre-Ship Review.

7ESS9 Complete Ocean Surface Topography Mission (OSTM) Critical Design Review (CDR).

3A.6 Progress in characterizing and understanding Earth surface changes and variability of Earth's gravitational and magnetic fields.

7ESS10 Demonstrate progress in characterizing and understanding Earth surface changes and variability of Earth's gravitational and magnetic fields. Progress will be evaluated by external expert review.

3A.7 Progress in expanding and accelerating the realization of societal benefits from Earth system science.

7ESS11 Issue twelve reports with partnering organizations that validate that using NASA research capabilities (e.g., observations and/or forecast products) could improve their operational decision support systems.

7ESS12 Complete five studies on plans to transition the results of NASA research and development, including scientific spacecraft and instruments, models, and research results, with potential to improve future operational systems of partner agencies.

3B Understand the Sun and its effects on Earth and the solar system.

3B.1 Progress in understanding the fundamental physical processes of the space environment from the Sun to Earth, to other planets, and beyond to the interstellar medium.

7ESS13 Demonstrate progress in understanding the fundamental physical processes of the space environment from the Sun to Earth, to other planets, and beyond to the interstellar medium. Progress will be evaluated by external expert review.

7ESS14.1 Deliver Solar Dynamics Observatory (SDO) instruments to spacecraft for integration.

7ESS15.1 Complete Magnetospheric MultiScale (MMS) instrument suite Preliminary Design Review (PDR).

7ESS16.1 Award Geospace Missions Radiation Belt Mapper Phase A instrument contracts.

7ESS17 Successfully launch Time History of Events and Macroscale Interactions during Substorms (THEMIS) spacecraft.

7ESS18.1 Release Explorer Program Announcement of Opportunity (AO).

3B.2 Progress in understanding how human society, technological systems, and the habitability of planets are affected by solar variability and planetary magnetic fields.

7ESS14.2 Deliver Solar Dynamics Observatory (SDO) instruments to spacecraft for integration.

7ESS15.2 Complete Magnetospheric MultiScale (MMS) instrument suite Preliminary Design Review (PDR).

7ESS16.2 Award Geospace Missions Radiation Belt Mapper Phase A instrument contracts.

7ESS18.2 Release Explorer Program Announcement of Opportunity (AO).

7ESS19 Demonstrate progress in understanding how human society, technological systems, and the habitability of planets are affected by solar variability and planetary magnetic fields. Progress will be evaluated by external expert review.

3B.3 Progress in developing the capability to predict the extreme and dynamic conditions in space in order to maximize the safety and productivity of human and robotic explorers.

7ESS14.3 Deliver Solar Dynamics Observatory (SDO) instruments to spacecraft for integration.

7ESS16.3 Award Geospace Missions Radiation Belt Mapper Phase A instrument contracts.

7ESS20 Demonstrate progress in developing the capability to predict the extreme and dynamic conditions in space in order to maximize the safety and productivity of human and robotic explorers. Progress will be evaluated by external expert review.

Efficiency Measures

7ESS21 Complete all development projects within 110% of the cost and schedule baseline.

7ESS22 Deliver at least 90% of scheduled operating hours for all operations and research facilities.

7ESS23 Peer-review and competitively award at least 80%, by budget, of research projects.

7ESS24 Reduce time within which 80% of NRA research grants are awarded, from proposal due date to selection, by 5% per year, with a goal of 130 days.

Program Management

The Earth-Sun System Director is Dr. Richard Fisher, Acting Director of the Earth-Sun System Division within the Science Mission Directorate.

Quality

Independent Reviews:

- Each major mission has an independent review team that evaluates the project at critical junctures in the development process. These reviews occur throughout the year.
- NASA Advisory Council (NAC) - Review science strategy and implementation strategy for the Earth-Sun System programs
- National Research Council - Decadal survey of effectiveness and quality of the Earth-Sun System programs

Program Assessment Rating Tool (PART):

The Earth-Sun System Theme was subject to a PART review in 2005 and received an "moderately effective" rating (score of 84%). The assessment found that this program is well-defined, has a clear objective, and has an effective strategic planning process. A key opportunity to increase effectiveness lies in continuing to improve efficiencies in mission operations, in reducing science data validation periods and in making NASA research available to a broader community.

To assure that this theme continues to improve performance, the program will:

1. Report on estimated mission life-cycle cost upon entering development, key schedule milestones associated with each mission phase for those missions formally approved for formulation, the mission's cost and schedule progress achieved in each phase before entering the next, and any plans to re-baseline life-cycle cost and/or schedule.
2. Assess the obstacles to improving the hand-off of NASA's research and development to other federal agencies and implement, to the extent possible, organizational and system fixes to ensure results.
3. Assure that the priorities developed in the NRC forthcoming Earth Science decadal survey are reflected in the program's portfolio to the extent feasible .

Budget Detail (Dollars in Millions)

Budget Authority (\$ millions)	FY2005	FY2006	Change	FY2007	FY2008	FY2009	FY2010	FY2011	Comments
Earth-Sun System	2,306.2	2,163.5	47.2	2,210.6	2,283.7	2,288.9	2,315.8	2,390.0	
Earth Systematic Missions	263.9	163.8	137.8	301.7	289.3	270.2	220.9	206.0	
Living with a Star	200.6	239.2	-12.9	226.3	264.2	270.6	245.8	276.3	
Solar Terrestrial Probes	116.4	94.4	-10.3	84.1	182.4	197.2	106.0	122.4	
Explorer Program	148.7	129.9	-56.5	73.4	73.3	91.1	174.1	182.3	
Earth System Science Pathfinder	110.9	141.8	19.6	161.4	111.5	97.5	172.0	207.2	
Earth-Sun System Multi-Mission Operations	287.6	267.3	-2.7	264.6	287.1	303.5	309.4	294.0	
Earth-Sun Research	920.5	882.1	-3.7	878.4	849.4	847.1	869.9	879.7	
Applied Sciences	82.2	94.8	-43.8	51.0	50.3	48.6	48.7	48.8	
Education and Outreach	23.6	22.7	0.6	23.3	23.7	25.3	27.5	27.5	
Earth-Sun Technology	151.8	127.4	19.0	146.4	152.6	137.8	141.6	145.7	

Theme:**Earth-Sun System**

Note: For all formats, the FY 2005 column reflects the FY 2005 Congressional Operating Plan, dated 9/30/2005. The FY 2006 column reflects the FY 2006 Congressional Initial Operating Plan, dated Jan 2006. The FY 2007 - 2011 columns represent the FY 2007 President's Budget Submit.

Key changes from FY2006: In the Earth Systematic Missions program, Glory and LDCM are now budgeted as free flyers; GPM is delayed two and a half years (including six month delay reflected in FY 2005 operating plans); and the NPP budget reflects a delay in the overall mission of 18 months. The Living With a Star SDO mission budget reflects a previously announced four-month launch delay to accommodate reduced FY 2005 funding. The Solar Terrestrial Probes budget includes the Magnetospheric Multiscale (MMS) mission in formulation and a three-month delay in the STEREO mission due to technical difficulties in instrument development. The Explorer program budget adds the IBEX mission in formulation. The Pathfinder program reflects the confirmation baseline for OCO and Aquarius, which have recently entered development, and removal of the Hydros mission in formulation, which was not confirmed for development because OCO and Aquarius were successfully confirmed. In FY06, Multi-Mission Operations moves out on implementation of the EOSDIS Evolution Study approved plan, which will bring information technology currency and closer science ties to the ongoing collection, archiving, and distribution of data from Earth Science satellites in the next decade. Earth-Sun Research includes funding for the new High-End Computing Capability line, part of NASA's Shared Capability Asset Program.

President's FY 2007 Budget Request (Dollars in Millions)

Earth Systematic Missions	FY2005	FY2006	FY2007	FY2008	FY2009	FY2010	FY2011
FY 2007 OMB Submit	263.9	163.8	301.7	289.3	270.2	220.9	206.0
Changes from FY 2006 Request	-36.5	-18.1	136.0	90.5	29.4	58.2	

Overview

The Earth Systematic Missions Program provides Earth-observing satellites--including LDCM, Glory, GPM, NPP, and OSTM--that contribute to the provision of long-term environmental data sets that can be used to study the evolution of the Earth system on a range of temporal scales. This information is used to analyze, model, and improve our understanding of the Earth system. Data gathered by these spacecraft will enable improved predictions of climate, weather, and natural hazards. NASA works with the science community to identify questions on the frontiers of science that have profound societal importance, and to which remote sensing of the Earth can make a defining contribution. These science questions become the foundation of a research strategy, which defines requirements for scientific observations through the vantage point of space. Each science focus area has an implementation roadmap that shows what role space-based observations play in meeting overall science objectives. This effort also provides techniques and technologies that can be employed to predict climate, weather and natural hazards on planets we plan to explore. For more information, please see <http://science.hq.nasa.gov/missions/earth/earth-sun.html>.



Earth Systematic Missions: Landsat Data Continuity Mission (LDCM), Glory, Global Precipitation Mission (GPM), and NPOESS (National Polar Orbiting Environmental Satellite System) Preparatory Project (NPP).

Plans For FY 2007

Two reviews, a system-level Mission Operations Review (MOR) and a Pre-Ship Review (PSR) for the Total Irradiance Monitor (TIM) instrument, will be conducted for Glory. A Mission Confirmation Review will be conducted for the Landsat Data Continuity Mission (LDCM) and, after successful completion of that review, the early phases of LDCM development will begin. The NPOESS Preparatory Project (NPP) will complete a Mission Operations Readiness Review (MOR) and Mission Test Readiness Review (MTRR). The Ocean Surface Topography Mission (OSTM) will complete its Pre-Environmental Review to establish readiness to start environmental testing of the observatory (spacecraft with instruments). The Global Precipitation Mission (GPM) will continue formulation activities.

Changes From FY 2006

- LDCM will be implementation as a dedicated spacecraft mission (free flyer), rather than as an instrument on the NPOESS spacecraft.
- Budget reflects previously announced decision to implement the Glory mission as a dedicated spacecraft mission, rather than as an instrument for a future mission of opportunity.
- Launch dates have been replanned for NPP (from October 2006 to April 2008), OSTM (from April 2008 to June 2008), and GPM (from June 2010 to Dec. 2012).

Theme:	Earth-Sun System
Program:	Earth Systematic Missions

Program Management

Project Management: GSFC: NPP, LDCM, Glory & GPM; JPL: OSTM. The NASA and GSFC/JPL Program Management Councils have program oversight responsibility.



















Technical Parameters

The missions are required to achieve the following critical threshold requirements: the selection of a mission profile (measurements, orbit parameters, lifetime, altitude, etc.); the successful launch of the satellite and/or instrument into the proper orbit by the prescribed launch date; and the provision for instrument control, data processing, distribution and archiving capability for each mission.

Technical Specifications	FY 2007 President's Budget	Change from Baseline
NPP Mission	Provide global imagery in a number of visible and infrared frequency bands, collect ozone data, and provide improved measurements of temperature and moisture profiles in the atmosphere.	No change
Glory Mission	Provide: measurements of global distribution of natural and anthropogenic aerosols from varying angles, in numerous spectral bands with multiple polarizations; total solar irradiance measurements.	Implemented as a dedicated spacecraft mission rather than as an instrument for a future mission of opportunity; change from FY 2006 budget.
LDCM	Provide visible and near-infrared ranges with approx. 9 bands/30-meter resolution. Will enable cross-sensor comparison of data from within the Landsat series.	Implemented as a dedicated s/c mission rather than as an instrument on the NPOESS spacecraft; change from FY 2006 budget.
GPM	Provide: near-global measurement of precipitation, its distribution, and physical processes; rain rates and latent heating measurement; and more frequent and complete sampling of Earth's precipitation.	No change from FY 2006 budget.
OSTM	Measures sea surface height to an accuracy of < 4 cm every ten days.	No change from FY 2006 budget.

Theme: Earth-Sun System
 Program: Earth Systematic Missions

Implementation Schedule:

Project	Schedule by Fiscal Year							Purpose	Phase Dates													
	05	06	07	08	09	10	11		Beg	End												
NPP Mission								Extend key environmental measurements in support of long-term monitoring of climate trends and global biological productivity.	Tech Form Dev Ops Res	Mar-00 Nov-03 Dec-03 Apr-08 May-08 May-13												
Glory Mission								Increase understanding of aerosols and their impact on climate change, and extend the baseline total solar irradiance.	Tech Form Dev Ops Res	Oct-03 Nov-05 Dec-05 Dec-08 Jan-09 Jan-12												
LDCM								Continue the global land cover data set with provision of synoptic, repetitive multispectral, high-resolution, digital imagery of Earth's land surfaces.	Tech Form Dev Ops Res	Oct-03 Feb-07 Mar-07 Jan-11 Feb-11 Feb-16												
GPM								Build upon Tropical Rainfall Measuring Mission (TRMM) to initiate the measurement of global precipitation, a key climate factor.	Tech Form Dev Ops Res	Jul-02 Oct-08 Nov-08 Dec-12 Jan-13 Jan-16												
OSTM								Measure sea surface height every ten days. Sea surface topography has numerous applications important to global environmental applications (e.g., predicting hurricane intensification).	Tech Form Dev Ops Res	Dec-02 Mar-06 Mar-06 Jun-08 Jul-08 Jul-11												
<table border="0"> <tr> <td></td> <td>Tech & Adv Concepts (Tech)</td> </tr> <tr> <td></td> <td>Formulation(Form)</td> </tr> <tr> <td></td> <td>Development (Dev)</td> </tr> <tr> <td></td> <td>Operations (Ops)</td> </tr> <tr> <td></td> <td>Research (Res)</td> </tr> <tr> <td></td> <td>Represents a period of no activity for the Project</td> </tr> </table>												Tech & Adv Concepts (Tech)		Formulation(Form)		Development (Dev)		Operations (Ops)		Research (Res)		Represents a period of no activity for the Project
	Tech & Adv Concepts (Tech)																					
	Formulation(Form)																					
	Development (Dev)																					
	Operations (Ops)																					
	Research (Res)																					
	Represents a period of no activity for the Project																					

Strategy For Major Planned Acquisitions

- LDCM: To be selected by full and open competition in early FY 2007.
- OSTM instruments: AMR is an JPL in-house build. GPS Payload and LRA are full and open competition.
- GPM: instruments and ground system will be selected via full and open competition; spacecraft is an in-house development at GSFC with avionics to be selected by full and open competition.

Key Participants

- NOAA/IPO - provides 3 of 4 instruments and ground system for NPP.
- USGS - provides data processing/distribution and on-orbit operations for LDCM.
- CNES - provides spacecraft and 2 instruments for OSTM.
- JAXA - provides dual frequency precipitation radar and launch vehicle for GPM.

Risk Management

- **RISK:** If the NPP instruments are not delivered in accordance with agreed-upon dates, then serious observatory integration and test delays may be realized. There is a very high likelihood that this risk will cause cost increases and a schedule impact of 6 months. **MITIGATION:** The NASA and NOAA/IPO team are working together to identify further work-arounds to minimize schedule impacts.
- **RISK:** If JAXA does not provide the Core S/C launch vehicle for GPM, NASA would have to provide L/V with substantial budget impact/schedule delay in order to retain the launch date. There is a moderate likelihood that JAXA will not provide the L/V. **MITIGATION:** Seek to resolve launch vehicle arrangements.
- **RISK:** If existing Landsat assets (L-5 and L-7) are lost prior to an operational LDCM mission then a data gap would ensue. **MITIGATION:** NASA and USGS have instituted a Landsat Data Gap Study Team that is chaired by both agencies with representatives from the Landsat community. This team is chartered to develop executable contingency plans to minimize the impact of a Landsat data gap.

Theme: Earth-Sun System
Program: Earth Systematic Missions
Project In Formulation: Global Precipitation Mission (GPM)

President's FY 2007 Budget Request (Dollars in Millions)

<u>Global Precipitation Mission (GPM) (Formulation)</u>	<u>FY2005</u>	<u>FY2006</u>	<u>FY2007</u>	<u>FY2008</u>	<u>FY2009</u>	<u>FY2010</u>	<u>FY2011</u>
FY 2007 OMB Submit	26.5	23.2	24.2	25.4	117.8	121.6	140.1
Changes from FY 2006 Request	0.2	-0.7	-19.7	-74.5	-36.8	-6.9	

Projects in Formulation are not mature in their development process and cost estimates are SUBJECT TO CHANGE as the project matures.

Overview

The Global Precipitation Mission (GPM) is a joint mission with the Japan Aerospace Exploration Agency (JAXA) and other international partners. Building upon the success of the Tropical Rainfall Measuring Mission (TRMM), it will initiate the measurement of global precipitation, a key climate factor. Its science objectives are: to improve ongoing efforts to predict climate by providing near-global measurement of precipitation, its distribution, and physical processes; to improve the accuracy of weather and precipitation forecasts through more accurate measurement of rain rates and latent heating; and to provide more frequent and complete sampling of the Earth's precipitation. GPM is envisioned to consist of four parts: a Core Spacecraft to measure precipitation structure and to provide a calibration standard for the constellation spacecraft; an international constellation of NASA and contributed satellites to provide frequent precipitation measurements on a global basis; calibration/validation sites distributed globally with a broad array of precipitation-measuring instrumentation; and a global precipitation data system to produce and distribute global rain maps and climate research products. For more information see <http://science.hq.nasa.gov/missions/earth-sun.html>

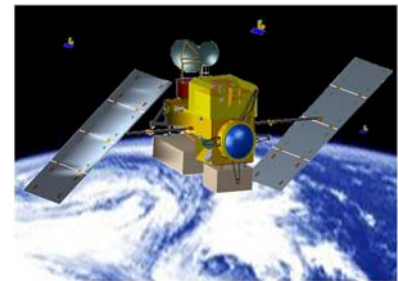

The Global Precipitation Mission Core Spacecraft and Constellation will measure precipitation at various latitudes using microwave imagers and radar. This mission will support improved climate models and weather forecasts.

Changes From FY 2006

- Budget reflects a mission rephasing to a December 2012 launch, including a 6 month delay reported in the FY 2005 operating plan. Mission confirmation is rescheduled for October 2008.
- Core Spacecraft to be in-house development at GSFC with avionics to be selected by full and open competition.

Program Management

GSFC has project management responsibility. The NASA and GSFC Program Management Councils have program oversight responsibility.

Theme: Earth-Sun System
Program: Earth Systematic Missions
Project In Formulation: Global Precipitation Mission (GPM)

Technical Parameters

The Core and Constellation Spacecraft have a three-year life with a five-year goal. The Core and Constellation Spacecraft carry three scientific instruments: Dual-frequency Precipitation Radar (DPR), and two GPM Microwave Imagers (GMI).

Technical Specifications	FY 2007 President's Budget	Change from Baseline
DPR	Measures the horizontal and vertical structure of rainfall and its microphysics	N/A
GMI	Provide additional sampling to improve measurements of global rainfall accumulations	N/A

Schedule	FY 2007 President's Budget	Baseline	Change from Baseline
Oct 2008	Mission Confirmation Review	N/A	+33 months from FY2006 budget
Dec 2012	Launch	N/A	+30 months from FY 2006 budget

Strategy For Major Planned Acquisitions

- DPR instrument and launch vehicle for core spacecraft to be provided by foreign partner (JAXA) subject to inter-agency coordination.
- GMI, Constellation Spacecraft, Constellation Spacecraft Launch Vehicle: To be selected by full and open competition.
- Core Spacecraft: In-house development at GSFC with avionics to be selected by full and open competition.

Key Participants

- JAXA; Areas of cooperation include DPR, Core Spacecraft launch, ground validation.
- CNES/ISRO; Areas of cooperation include constellation satellite, instruments, launch, ground validation.

Theme: Earth-Sun System
Program: Earth Systematic Missions
Project In Development: Glory Mission

President's FY 2007 Budget Request (Dollars in Millions)

Glory Mission (Development)	FY2005	FY2006	FY2007	FY2008	FY2009	FY2010	FY2011
FY 2007 OMB Submit	49.8	52.6	52.0	34.0	12.1	7.8	7.3
Changes from FY 2006 Request	-4.5	47.6	39.5	29.7	7.7	4.7	

Projects in Development are mature, have a sound design, and are proceeding to mission execution. NASA is committed to their lifecycle cost and schedule plans.

Overview

The Glory mission improves upon NASA's research of forcings that influence climate change in the atmosphere. The scientific knowledge such global satellite observations will provide is important to predicting climate change and to making sound, scientifically based economic and policy decisions related to environmental change. The Glory Aerosol Polarimetry Sensor (APS) is an advanced polarimeter to increase our understanding of black carbon soot and other aerosols as causes of climate change. The APS will provide unprecedented measurements of the global distribution of natural and anthropogenic aerosols and clouds with accuracy and coverage sufficient for a reliable quantification of the direct and indirect effects of aerosols on climate. The solar Total Irradiance Monitor (TIM), a second Glory instrument, provides measurements to maintain an uninterrupted solar irradiance data record by bridging the gap between the NASA's Solar Radiation and Climate Experiment (SORCE) and the National Polar Orbiting Operational Environmental Satellite System (NPOESS) missions. Solar radiation is the dominant, direct energy input into the terrestrial ecosystem, affecting all physical, chemical, and biological processes. These measurements are critical in studies to understand the Sun, its direct and indirect effect on our Earth system, and its influence on humankind. For more on the scientific questions addressed by Glory, visit <http://glory.gsfc.nasa.gov/>.



Glory will provide observations of aerosols, clouds and solar irradiance to improve the understanding of what influences climate change.

Changes From FY 2006

- Budget reflects previously announced decision to implement the Glory mission as a dedicated spacecraft mission (free flyer), rather than as an instrument for a future mission of opportunity.

Program Management

GSFC has Project Management responsibility. The NASA and GSFC Program Management Councils have program oversight responsibility.

Theme: Earth-Sun System
Program: Earth Systematic Missions
Project In Development: Glory Mission

Technical Parameters

Glory is a 3-year mission (5-year goal) comprising two scientific instruments, the APS and TIM, and leveraging a preexisting NASA spacecraft asset requiring minor modification. The Glory satellite will be able to fly in the A-Train constellation (five spacecraft flying in close proximity to provide detailed observations of the Earth system) to assess the effectiveness of combining data from multiple instruments, a mode required in the NPOESS era.

Technical Specifications	FY 2007 President's Budget	Change from Baseline
APS	Provides spaceborne measurement of aerosols by providing simultaneous multispectral, multi-polarization data while scanning in an along-track multi-angle manner	None
TIM	Provides measurements to maintain an uninterrupted solar irradiance data record	None

Schedule	FY 2007 President's Budget	Baseline	Change from Baseline
Mission Confirmation Review	Nov 2005	Nov 2005	No change
Launch	Dec 2008	Dec 2008	No change

Strategy For Major Planned Acquisitions

- There are no planned major procurements, as all instrument and spacecraft contracts are in place.

Key Participants

- Columbia University collaborates with the Goddard Institute of Space Studies on APS science requirements, algorithms, and instrument operations, with participation by NOAA and Integrated Program Office (IPO) scientists to maximize value to NPOESS.
- University of Colorado provides TIM science and instrument operations expertise.

Risk Management

- RISK: No significant risk at this time MITIGATION: N/A

Budget Detail/Life Cycle Cost (Dollars in Millions)

Budget Authority	Prior	FY2005	FY2006	FY2007	FY2008	FY2009	FY2010	FY2011	BTC	Total	Comments
FY 2007 OMB Submit	13.3	49.8	52.6	52.0	34.0	12.1	7.8	7.3	1.8	230.7	
Changes	0.0	-4.5	47.6								
FY2006 President's Budget	13.3	54.2	5.1								

Glory Mission entered Development in November 2005; therefore, no LCC in FY 2006.

Theme: Earth-Sun System
Program: Earth Systematic Missions
Project In Formulation: Landsat Data Continuity Mission (LDCM)

President's FY 2007 Budget Request (Dollars in Millions)

Landsat Data Continuity Mission (LDCM) (Formulation)	FY2005	FY2006	FY2007	FY2008	FY2009	FY2010	FY2011
FY 2007 OMB Submit	15.1	27.1	98.1	109.8	103.4	61.4	14.6
Changes from FY 2006 Request	-23.3	-27.2	28.5	45.7	48.4	51.9	

Projects in Formulation are not mature in their development process and cost estimates are SUBJECT TO CHANGE as the project matures.

Overview

The Landsat Data Continuity Mission (LDCM) is a joint NASA-United States Geological Survey (USGS) mission to extend the Landsat record of multispectral, 30-meter resolution, seasonal, global coverage of the Earth's land surface beyond the Landsat-7 lifetime. LDCM will continue the global land cover data set with provision of synoptic, repetitive multispectral, high-resolution, digital imagery of Earth's land surfaces, and will improve assessment of rates of land-cover changes. NASA and the USGS are working together to ensure the continuity of Landsat data through development of the LDCM system with the assessment of various system development and management options for a satellite system to succeed Landsat 7. Although many options are viable, the partners are focusing on a solution that will satisfy the goals set forth in the Land Remote Sensing Policy Act of 1992 of maintaining "data continuity with the Landsat system," to serve "the civilian, national security, commercial, and foreign policy interests of the United States," and to "incorporate system enhancements.. which may potentially yield a system that is less expensive to build and operate and more responsive to users." One of the key objectives of LDCM is to make all Landsat-equivalent data collected available at affordable cost. This will enable the many different sectors of the population - farmers, school children, business leaders, scientists, state and federal governments and many others-- to continue to utilize this data for high quality research and applications. For more information on LDCM, go to http://science.hq.nasa.gov/missions/satellite_56.htm.

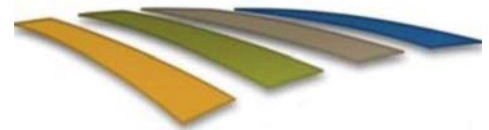

LDCM Free Flyer will provide Landsat equivalent data to extend the Landsat data record of Earth's land surface.

Changes From FY 2006

- Budget is rephased to reflect implementation of LDCM as a free flyer.

Program Management

GSFC is responsible for the LDCM project management. The NASA and GSFC Program Management Councils have program oversight responsibility.

Theme: Earth-Sun System
Program: Earth Systematic Missions
Project In Formulation: Landsat Data Continuity Mission (LDCM)

Technical Parameters

The LDCM will procure a capability with a mission lifetime of 5 years to provide continuity to the Landsat 7 dataset. LDCM will be flown in a sun-synchronous near-polar orbit, with a mid-morning equatorial crossing time. LDCM data will ensure a minimum of once-yearly, full-global coverage over the Earth's complete land mass, coastal boundaries, and coral reefs as well as high-interest shorter-repeat cycle phenomenological studies.

Technical Specifications	FY 2007 President's Budget	Change from Baseline
LDCM	Heritage emphasis is on the visible and near-infrared ranges with approximately 9 bands at 30-meter resolution and also on enabling cross-sensor comparison of any data from within the Landsat series	N/A

Schedule	FY 2007 President's Budget	Baseline	Change from Baseline
Mission Confirmation Review	Feb 2007	N/A	+7 months from FY 2006 budget
Launch	Jan 2011	N/A	N/A

Strategy For Major Planned Acquisitions

- LDCM: To be selected by full and open competition in early FY 2007.

Key Participants

- USGS: areas of cooperation include data management, data distribution, on-orbit calibration and validation, on-orbit payload operations

Theme: Earth-Sun System
Program: Earth Systematic Missions
Project In Formulation: Ocean Surface Topography Mission

President's FY 2007 Budget Request (Dollars in Millions)

Ocean Surface Topography Mission (Formulation)	FY2005	FY2006	FY2007	FY2008	FY2009	FY2010	FY2011
FY 2007 OMB Submit	24.8	20.0	40.6	30.6	14.9	11.4	26.0
Changes from FY 2006 Request	-5.7	-6.3	21.8	17.2	7.4	4.7	

Projects in Formulation are not mature in their development process and cost estimates are SUBJECT TO CHANGE as the project matures.

Overview

The Ocean Surface Topography Mission (OSTM) is a cooperative effort between NASA, the National Oceanic and Atmospheric Administration (NOAA), the European Organization for the Exploitation of Meteorological Satellites (EUMETSAT) and the Centre National d'Etudes Spatiales (CNES), the space agency of France. OSTM is a follow-on to Jason and will provide continuity of ocean topography measurements beyond Jason and TOPEX/Poseidon. Launch is targeted for FY2008. OSTM will measure sea surface height to an accuracy of < 4 cm every ten days. Sea surface topography measured by satellite altimeters has numerous applications important to global environmental monitoring including predicting hurricane intensification, improving tide models, mapping deep ocean bathymetry, monitoring and forecasting El Niño Southern Oscillation, measuring the rate of global sea-level rise and charting surface currents. Applications of OSTM data will include coastal zone management, and disaster management. For more information see <http://sealevel.jpl.nasa.gov/mission/ostm.html>.



OSTM Spacecraft will provide ocean topography measurements.

Changes From FY 2006

- Current planning assumes a delay of the mission confirmation review from April 2005 to March 2006; the launch date has been extended from April 2008 to June 2008.
- Budget reflects a delay in development of the CNES spacecraft.

Program Management

JPL has Project Management responsibility; NASA Science Mission Directorate and JPL Program Management Councils have program oversight responsibility.

Theme: Earth-Sun System
Program: Earth Systematic Missions
Project In Formulation: Ocean Surface Topography Mission

Technical Parameters

OSTM will have a three-year life with a five-year goal. It will carry 5 primary scientific instruments: the Advanced Microwave Radiometer (AMR); the Global Positioning System (GPS) Payload; the Laser Retroreflector Array (LRA); Nadir Altimeter; and the DORIS instruments. OSTM will measure sea-surface height to an accuracy of < 4 cm every ten days.

Technical Specifications	FY 2007 President's Budget	Change from Baseline
AMR	Provide atmospheric correction for the Nadir Altimeter	N/A
Nadir Altimeter	Provide vertical measurements of sea surface height	N/A
GPS Payload, LRA, and the Doppler Orbitography and Radiopositioning Integrated by Satellite (DORIS)	Provide precision orbit determination	N/A

Schedule	FY 2007 President's Budget	Baseline	Change from Baseline
Mission Confirmation Review	Mar 06	N/A	+11 months from FY2006 budget
Launch	Jun 08	N/A	+2 months from FY2006 budget

Strategy For Major Planned Acquisitions

- AMR: To be built in-house by JPL.
- GPS Payload, LRA, Launch Vehicle: To be provided by full and open competition.
- Nadir Altimeter, DORIS, Secondary Instruments (under study), Spacecraft: To be provided by foreign partner (CNES).

Key Participants

- CNES - Areas of cooperation include spacecraft, instruments, mission operations.
- EUMETSAT - Areas of cooperation include Earth terminal, data processing, and archiving.
- NOAA - Areas of cooperation include mission operations, data processing, and archiving.

Theme: Earth-Sun System
Program: Earth Systematic Missions
Project In Development: NPOESS Preparatory Project (NPP)

President's FY 2007 Budget Request (Dollars in Millions)

<u>NPOESS Preparatory Project (NPP) (Development)</u>	<u>FY2005</u>	<u>FY2006</u>	<u>FY2007</u>	<u>FY2008</u>	<u>FY2009</u>	<u>FY2010</u>	<u>FY2011</u>
FY 2007 OMB Submit	131.3	31.7	70.1	72.9	6.2	6.2	6.4
Changes from FY 2006 Request	-3.9	-30.8	58.0	66.9	0.0	0.0	

Projects in Development are mature, have a sound design, and are proceeding to mission execution. NASA is committed to their lifecycle cost and schedule plans.

Overview

The NPOESS Preparatory Project (NPP) is a joint mission with National Oceanic and Atmospheric Administration (NOAA) and the US Air Force (USAF) to extend key environmental measurements in support of long-term monitoring of climate trends and of global biological productivity. The mission of NPP is twofold. First, NPP will provide NASA with the continuation of global change observations following the Earth Observing System (EOS) missions TERRA and Aqua; specifically, atmospheric and sea surface temperatures, humidity sounding, land and ocean biological productivity, and cloud and aerosol properties. Secondly, NPP will provide the National Polar-orbiting Operational Environmental Satellite System (NPOESS) with risk-reduction demonstration and validation for the critical NPOESS sensors, algorithms, and processing. The NPP mission is planned for an operational life of 5 years. For more information see http://science.hq.nasa.gov/missions/satellite_58.htm.



The NPOESS Preparatory Project (NPP) will provide continuity of global change observations from EOS and will provide risk reduction for key NPOESS sensors.

Changes From FY 2006

- The NPP launch date is being replanned due to late sensor deliveries from the NPOESS Integrated Program Office (IPO).
- The NPP budget reflects a launch date of April 2008, an 18 month delay from the previously planned October 2006 date.

Program Management

GSFC is responsible for the NPP project management. The NASA and GSFC Program Management Councils have program oversight responsibility.

Theme: Earth-Sun System
Program: Earth Systematic Missions
Project In Development: NPOESS Preparatory Project (NPP)

Technical Parameters

The NPP spacecraft will carry four instruments which will provide continuity of imagery, sounding, and ozone mapping and profiling observations for NASA: Visible Infrared Imaging Radiometer Suite (VIIRS), Ozone Mapping and Profiler Suite (OMPS), Advanced Technology Microwave Sounder (ATMS), Cross-track Infrared Sounder (CrIS). The satellite will provide regional and global meteorological data as well as oceanographic, environmental and climactic information.

Technical Specifications	FY 2007 President's Budget	Change from Baseline
VIIRS	Provide global imagery in a number of visible and infrared frequency bands	None
OMPS	Collects ozone data	None
ATMS and CrIS	Provide improved measurements of temperature and moisture profiles in the atmosphere	None

Schedule	FY 2007 President's Budget	Baseline	Change from Baseline
ATMS Flight Model Delivery	Oct 05	Apr 05	6 month delay
CrIS Flight Model Delivery	Jun 06	Oct 05	8 month delay
OMPS Flight Model Delivery	Oct 06	Sept 05	13 months delay
VIIRS Flight Model Delivery	Mar 07	Nov 05	16 month delay
Operational Readiness Review	Nov 07	June 06	17 month delay
Launch	Apr 08	Oct 06	18 month delay

Strategy For Major Planned Acquisitions

- Not applicable. All procurements for NPP are in place.

Key Participants

- NPOESS Integrated Program Office (joint program office including NASA, NOAA, and USAF) is responsible for procuring CrIS, OMPS, VIIRS, ground system and data processing system.
- NOAA: responsible for providing long-term data archive and storage.

Risk Management

- RISK: If there is a delay in the delivery of instruments, serious observatory integration and test delays would result. LIKELIHOOD: Very High. IMPACT: Major cost increases and a schedule slip of 12 months. MITIGATION: NASA and NOAA/IPO team working together to identify further work-arounds to minimize impacts.

Theme: Earth-Sun System
Program: Earth Systematic Missions
Project In Development: NPOESS Preparatory Project (NPP)

Budget Detail/Life Cycle Cost (Dollars in Millions)

Budget Authority	Prior	FY2005	FY2006	FY2007	FY2008	FY2009	FY2010	FY2011	BTC	Total	Comments
FY 2007 OMB Submit	358.1	131.3	31.7	70.1	72.9	6.2	6.2	6.4	6.6	689.5	
Changes	-0.6	-3.9	-30.8	58.0	66.9	0.0	0.0		6.6	96.0	
FY2006 President's Budget	358.7	135.2	62.5	12.2	6.0	6.2	6.2			587.1	

The LCC increase reflects an 18 month delay from the previously planned October 2006 date.

Spacecraft: \$160.0M
 Instruments: \$194.2M
 Launch Services: \$72.9M
 Other: \$262.4M

Theme: Earth-Sun System
Program: Living with a Star

President's FY 2007 Budget Request (Dollars in Millions)

<u>Living with a Star</u>	<u>FY2005</u>	<u>FY2006</u>	<u>FY2007</u>	<u>FY2008</u>	<u>FY2009</u>	<u>FY2010</u>	<u>FY2011</u>
FY 2007 PRES BUD	200.6	239.2	226.3	264.2	270.6	245.8	276.3
Changes from FY 2006 Request	-1.9	5.2	-14.7	38.9	-21.4	-48.9	

Overview

The Sun has a period of maximum activity about every 11 years and short-term variability throughout its cycle that generates increased amounts of emitted particles and radiation. The Sun's activity couples with the heliosphere and planetary atmospheres to form a dynamic system. These dynamic variations may induce changes on Earth including climate variation, changes in the ozone layer or changes in communications/radio/radar signals. The variations may also produce effects on spacecraft or persons outside Earth's atmosphere. The Living With a Star (LWS) Program seeks to understand how and why the Sun varies, how the Earth and other planets respond, and how this variability and response affect humanity. Achieving these goals will enable reliable space weather prediction so undesirable space weather effects in space and on Earth can be accommodated or mitigated before they occur. LWS has a 3-part systems approach: a network of research spacecraft, targeted grants, and space weather effects investigations. For more information, please see <http://lws.gsfc.nasa.gov>.



The Living With A Star is a program of detection and investigation of variability in the Sun-solar system environment, leading to a predictive capability for the consequent impacts on society.

Plans For FY 2007

- Deliver the Solar Dynamics Observatory (SDO) instruments to the spacecraft for integration.
- Award Phase A instrument contracts for the Geospace Missions Radiation Belt Mapper (RBM).

Changes From FY 2006

- The SDO budget reflects the four month delay, from April 2008 to August 2008, resulting from the FY2005 reduction as reported in the May 2005 operating plan.
- The planned order of the Geospace missions has been reversed, with the Radiation Belt Mapper (RBM) now preceding the Ionosphere-Thermosphere Mapper (ITM).

Program Management

GSFC is the managing Center for the program; individual missions are implemented by GSFC or Johns Hopkins University-Applied Physics Lab (JHU-APL).

Theme: Earth-Sun System
Program: Living with a Star

Technical Parameters

By putting a spacecraft network in place near the next solar maximum (2012), scientists will be able to use SDO data to improve the scientific understanding of how and why the Sun varies. In addition, they will use Geospace Missions-Radiation Belt Mapper data to improve our understanding of the physics underlying the response of the Earth's environment to solar variability. To complete the network Lonesphere-Thermosphere Storm Mapper and Solar Sentinels will be added beyond the budget horizon. An improved understanding of the response of the Earth's environment to solar variability may have applications for other planets with atmospheres and magnetic fields.

Technical Specifications	FY 2007 President's Budget	Change from Baseline
SDO	Data rate of 1.4 terabytes per day	No Change

Implementation Schedule:

Project	Schedule by Fiscal Year							Purpose	Phase Dates	
	05	06	07	08	09	10	11		Beg	End
SDO								Investigate the Sun's magnetic field.	Tech	
									Form	Aug-02 Jul-04
									Dev	Jul-04 Aug-08
									Ops	Sep-08 Jul-13
									Res	
GM-RBM								Develop the capability to specify and predict changes in planetary radiation environments.	Tech	
									Form	Nov-06 Nov-08
									Dev	Nov-08 Mar-12
									Ops	Apr-12 Apr-14
									Res	

Strategy For Major Planned Acquisitions

- SDO launch vehicle and 2 instruments were selected through full and open competition and 1 instrument is being provided sole-source from Lockheed-Martin. The spacecraft is an in-house build at GSFC.
- RBM Mission Phase-A studies were selected through full and open competition. Launch vehicle will be selected through full and open competition and spacecraft acquisition strategy has not been decided.

Theme: Earth-Sun System
Program: Living with a Star
Project In Development: Solar Dynamics Observatory (SDO)

President's FY 2007 Budget Request (Dollars in Millions)

Solar Dynamics Observatory (SDO) (Development)	FY2005	FY2006	FY2007	FY2008	FY2009	FY2010	FY2011
FY 2007 PRES BUD	129.2	178.1	166.0	101.8	23.4	16.0	12.1
Changes from FY 2006 Request	-19.2	18.9	11.9	46.7	4.8	-0.1	

Projects in Development are mature, have a sound design, and are proceeding to mission execution. NASA is committed to their lifecycle cost and schedule plans.

Overview

The Solar Dynamics Observatory (SDO) is the Living With a Star (LWS) program's first mission. It will investigate how the Sun's magnetic field is structured and how its energy is converted and released into the heliosphere in the forms of solar wind, energetic particles, and variations in solar irradiance. Scientists will analyze data from three instruments, the Helioseismic and Magnetic Imager (HMI), the Extreme Ultraviolet Variability Experiment (EVE), and the Atmospheric Imaging Assembly (AIA), to improve the science needed to enable space weather predictions. The project includes funding for the spacecraft, launch vehicle, data analysis (6 years), project operations (5 years), education, and outreach.

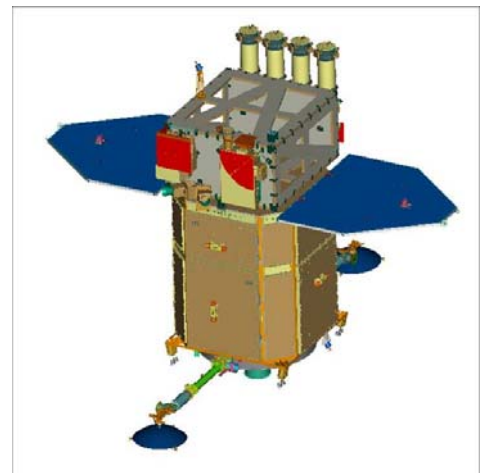

Solar Dynamics Observatory Spacecraft

SDO will explain how the Sun's changing magnetic field is generated and how it is propagated throughout our solar system. SDO's data set will also become the primary source for U.S. operational space weather activities.

For more information, please see: <http://sdo.gsfc.nasa.gov/>.

Changes From FY 2006

- The SDO budget reflects the four month launch delay, from April 2008 to August 2008, resulting from the FY2005 reduction and rephasing reported in the May 2005 operating plan.

Program Management

GSFC is responsible for mission management, design, integration, testing and operation.

Technical Parameters

SDO will be in geosynchronous orbit. It will take data (~130 Mbps), down-link it to a ground station in White Sands, NM, and then forward it to the investigators without processing.

Technical Specifications	FY 2007 President's Budget	Change from Baseline
High Data Rate	1.4 Terabytes per Day	No Change
Mission Life Design	5 Years	No Change
Orbit	Geosynchronous	No Change

Theme: Earth-Sun System
Program: Living with a Star
Project In Development: Solar Dynamics Observatory (SDO)

Schedule	FY 2007 President's Budget	Baseline	Change from Baseline
Mission Confirmation Review	June 2004	April 2004	2 month delay
Critical Design Review	April 2005	Feb 2005	2 month delay
Complete Spacecraft Structure	Mar 2006	Jan 2006	2 month delay
Instrument Delivered to Spacecraft	Feb 2007	Feb 2007	None
Launch	August 2008	April 2008	4 month delay

Strategy For Major Planned Acquisitions

- GSFC is developing the spacecraft as an in-house build.
- HMI instrument is being purchased from Stanford University and the EVE instrument from LASP at the University of Colorado via an Announcement of Opportunity (AO) competitive selection
- AIA instrument is being purchased through Lockheed Martin via sole source justification (replaced SHARPP instrument from Naval Research Laboratory when SHARPP was not approved to begin Phase B).

Risk Management

- RISK: Increase in component procurement costs due to reduction in the spacecraft market. Probability: Moderate, 40% Impact: Low cost impact. MITIGATION: Work with industry to understand cost and competition drivers and modify requirements where appropriate.
- RISK: Field Programmable Gate Array (FPGA) problems uncovered after Engineering Test Unit (ETU) build is complete. Probability: 20% Impact: Moderate schedule/cost increase for redesign and rework. MITIGATION: Work with FPGA applications experts to use best information and recommendations for FPGA use including additional analysis and testing.
- RISK: The imposition of more stringent security requirements late in the development cycle could cause redesign and rework. Probability: 20% Impact: Moderate increase to cost and schedule. MITIGATION: Allocate resources to thoroughly understand impacts from proposed new security requirements.
- RISK: New quality issues in hardware procurements uncovered late in the flight build. Probability: 20% Impact: Moderate schedule/cost increase for design and rework. MITIGATION: Work with quality engineers to understand qualification and analysis applicability and adequacy. Undertake additional testing, analysis and review if necessary.

Budget Detail/Life Cycle Cost (Dollars in Millions)

Budget Authority	Prior	FY2005	FY2006	FY2007	FY2008	FY2009	FY2010	FY2011	BTC	Total	Comments
FY 2007 PRES BUD	155.6	129.2	178.1	166.0	101.8	23.4	16.0	12.1	44.0	826.3	
Changes	-0.2	-19.2	18.9	11.9	46.7	4.8	-0.1		44.0	106.8	
FY2006 President's Budget	155.8	148.4	159.2	154.1	55.0	18.6	16.1			707.3	

Theme: Earth-Sun System
Program: Living with a Star
Project In Development: Solar Dynamics Observatory (SDO)

Lifecycle cost elements:

Spacecraft: 234.1

Launch Services: 120.6

Instruments: 181.9

Other: 289.7

President's FY 2007 Budget Request (Dollars in Millions)

Solar Terrestrial Probes	FY2005	FY2006	FY2007	FY2008	FY2009	FY2010	FY2011
FY 2007 PRES BUD	116.4	94.4	84.1	182.4	197.2	106.0	122.4
Changes from FY 2006 Request	16.2	15.6	-10.7	41.6	72.1	-22.4	

Overview

The primary goal of the Solar Terrestrial Probes (STP) Program is to understand how the Sun, heliosphere, and planetary environments are connected in a single system. To accomplish this overarching goal, STP missions will investigate the physics of the Sun from its interior through its atmosphere, the heliosphere from its inner region near the Sun to its outer reaches, Earth's magnetosphere and its interaction with the solar wind, and the ionosphere and upper atmospheres of Earth. These studies, which encompass the scientific disciplines of solar physics, heliospheric physics, magnetospheric physics, and aeronomy (the study of planetary upper atmospheres), will address questions such as the variability of the Sun, the responses of the planets to these variations, and the interaction of the Sun and solar system. Each STP mission will respond to at least one of the following objectives: to understand the changing flow of energy and matter throughout the Sun, heliosphere, and planetary environments; to explore the fundamental physical processes of plasma systems in the universe; and to define the origins of solar variability and understand its role in driving space weather. For more information, please see:

<http://stp.gsfc.nasa.gov/about.htm>, Sun-Earth Connection.

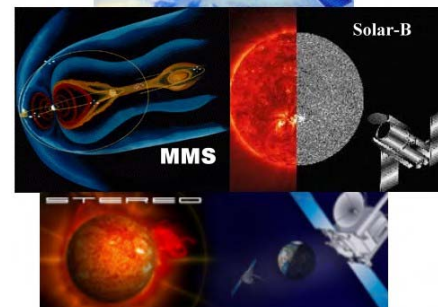
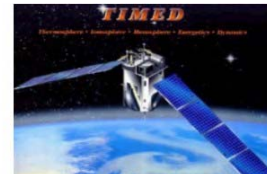

The Solar Terrestrial Probes Program explores the fundamental physical processes and conditions found in the solar system, ranging from the Sun, the planetary environment, in actions with the Sun, and the structure and evolution of space itself.

Plans For FY 2007

STEREO and Solar-B will be in their first year of operations during FY 2007. The Magnetospheric Multiscale (MMS) mission will transition to development in June 2007, after completing required design and confirmation reviews.

Changes From FY 2006

- STEREO launch delay from February 2006 to May 2006 due to technical difficulties with instrument development.
- The Magnetospheric Multiscale (MMS) mission is a project in formulation.

Program Management

Program management responsibility for the STP Program is assigned to GSFC.

Technical Parameters

A Science Definition Team will define the technical performance required for each of the projects in the STP program. These requirements become the basis for an Announcement of Opportunity for the acquisition of scientific instruments, and are ultimately documented in a project-unique Level 1 requirements document, which becomes an appendix to the program plan.

Technical Specifications	FY 2007 President's Budget	Change from Baseline
STEREO	Accuracy of order 30 degrees of solar latitude and longitude	No Change
Solar-B	Prime mission life is 3 years	No Change
MMS	Prime Mission Life is 2 Years	No Change

Implementation Schedule:

Project	Schedule by Fiscal Year							Purpose	Phase Dates													
	05	06	07	08	09	10	11		Beg	End												
STEREO								Understand the cause and consequences of coronal mass ejections.	Tech Form Dev Ops Res	Nov-99 Feb-02 Mar-02 May-06 May-06 Mar-09												
Magnetospheric Multiscale (MMS)								Gain a better understanding of why the Sun varies and how the heliosphere interacts with the galaxy.	Tech Form Dev Ops Res	May-02 May-07 Jun-07 Jul-13 Jul-13 Jul-15												
Solar-B								Measure the Sun's magnetic field and ultraviolet/x-ray radiation.	Tech Form Dev Ops Res	Dec-98 Nov-00 Nov-00 Sep-06 Oct-06 Oct-10												
<table border="0"> <tr> <td></td> <td>Tech & Adv Concepts (Tech)</td> </tr> <tr> <td></td> <td>Formulation (Form)</td> </tr> <tr> <td></td> <td>Development (Dev)</td> </tr> <tr> <td></td> <td>Operations (Ops)</td> </tr> <tr> <td></td> <td>Research (Res)</td> </tr> <tr> <td></td> <td>Represents a period of no activity for the Project</td> </tr> </table>												Tech & Adv Concepts (Tech)		Formulation (Form)		Development (Dev)		Operations (Ops)		Research (Res)		Represents a period of no activity for the Project
	Tech & Adv Concepts (Tech)																					
	Formulation (Form)																					
	Development (Dev)																					
	Operations (Ops)																					
	Research (Res)																					
	Represents a period of no activity for the Project																					

Strategy For Major Planned Acquisitions

- STP utilizes full and open competitions to the greatest extent possible for the acquisition of scientific instruments, spacecraft, and science investigations (including research & analysis).
- Certain instruments, missions or mission systems may be acquired without competitions (e.g., through international partnerships), provided there is a clear scientific or technological benefit to NASA.
- Missions may be implemented in the "out-of-house," or "PI-mode," where the entire mission is acquired through full and open competition.

Key Participants

- Japan -- contributing spacecraft, launch vehicle, major elements of each scientific instrument, and operations for the Solar-B mission.
- Applied Physics Laboratory, Johns Hopkins University - developing two spacecraft and undertaking mission operations for STEREO mission.
- Southwest Research Institute - developing four instrument suites for MMS mission.

Theme:	Earth-Sun System
Program:	Solar Terrestrial Probes

Risk Management

- **RISK:** Launch delay and cost increase. **MITIGATION:** Closely monitor schedule and cost performance. Do work-arounds and perform work in parallel, as possible.
- **RISK:** JAXA schedule delay. **MITIGATION:** Monitor JAXA schedule and ensure adequate contingency in event of a launch delay.

Theme: Earth-Sun System
 Program: Solar Terrestrial Probes
 Project In **Formulation**: Magnetospheric Multiscale (MMS)

President's FY 2007 Budget Request (Dollars in Millions)

<u>Magnetospheric Multiscale (MMS) (Formulation)</u>	<u>FY2005</u>	<u>FY2006</u>	<u>FY2007</u>	<u>FY2008</u>	<u>FY2009</u>	<u>FY2010</u>	<u>FY2011</u>
FY 2007 PRES BUD	14.2	7.8	40.9	121.4	128.9	88.6	99.5
Changes from FY 2006 Request	14.2	7.8	40.9	121.4	128.9	88.6	

Projects in Formulation are not mature in their development process and cost estimates are SUBJECT TO CHANGE as the project matures.

Overview

MMS will use a four-spacecraft cluster to study both the fundamental physical processes responsible for the transfer of energy from the solar wind to Earth's magnetosphere and the explosive release of energy during solar flares. Using the Earth's magnetosphere as a laboratory, MMS will study the microphysics of three fundamental plasma processes: magnetic reconnection, energetic particle acceleration, and turbulence. These processes occur in all astrophysical plasma systems but can be studied in situ only in our solar system and most efficiently only in Earth's magnetosphere, where they control the dynamics of the geospace environment and play an important role in the processes known as "space weather."

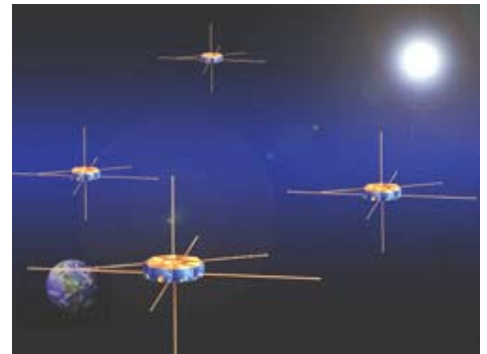

Artist's conception of the MMS spacecraft constellation. These four spacecraft will study plasma physics in the Earth's magnetosphere, improving our understanding of 'space weather' phenomena.

The MMS instrument payload will be optimized to make high-time-resolution measurements of plasmas, electric fields, and magnetic fields. The instrument suite will also make important supporting measurements of energetic particles and ion composition. These measurements will enable the first definitive study of magnetic reconnection in space.

For more information, please see:
<http://stp.gsfc.nasa.gov/missions/mms/mms.htm>

Changes From FY 2006

- MMS is a Solar Terrestrial Probes project in formulation.

Program Management

Goddard Space Flight Center has responsibility for the STP program and the MMS project.

Theme: Earth-Sun System
Program: Solar Terrestrial Probes
Project In Formulation: Magnetospheric Multiscale (MMS)

Technical Parameters

The mission design life is two years. A three-phase low-inclination orbit strategy will probe the most likely reconnection sites on both the dayside magnetopause and in the magnetotail. The primary target of Phase 1 is the dayside magnetopause reconnection region. Phase 2 will focus on the near-Earth neutral line and the Phase 3 orbit will focus on both the dayside magnetopause and the magnetotail.

Technical Specifications	FY 2007 President's Budget	Change from Baseline
Operation Capability	Four spin-stabilized spacecraft with identical performance requirements.	N/A
Mission Life Design	2 Years	N/A
Orbit	A tetrahedron formation shall be maintained throughout each orbit whenever altitude is greater than six earth radii.	N/A

Schedule	FY 2007 President's Budget	Baseline	Change from Baseline
Mission Design Review	Mar 2006		N/A
Transition to Development	June 2007		N/A
MMS Launch	July 2013		N/A

Strategy For Major Planned Acquisitions

- The instrument suite was procured via competitive AO process.
- Spacecraft acquisition strategy is TBD

Key Participants

- Southwest Research Institute (SwRI) is responsible for providing the four instrument suites.

Theme: Earth-Sun System
Program: Solar Terrestrial Probes
Project In Development: Solar Terrestrial Relations Observatory (STEREO)

President's FY 2007 Budget Request (Dollars in Millions)

Solar Terrestrial Relations Observatory (STEREO) (Development)	FY2005	FY2006	FY2007	FY2008	FY2009	FY2010	FY2011
FY 2007 PRES BUD	80.4	64.6	20.1	16.4	8.6		
Changes from FY 2006 Request	11.4	16.9	0.9	2.1	-1.3	-10.0	

Projects in Development are mature, have a sound design, and are proceeding to mission execution. NASA is committed to their lifecycle cost and schedule plans.

Overview

The STEREO project will lead to an understanding of the cause and consequences of solar coronal mass ejections (CME) by: tracing the flow of CMEs from the Sun to Earth; discovering the mechanisms and sites of energetic particle acceleration in the Sun's corona and the interplanetary medium; and developing a three-dimensional time-dependent model of the ambient solar wind. STEREO will also continuously transmit data that will be used to predict space weather. STEREO will use two identically equipped spacecraft in heliocentric orbits, with one leading Earth and the other lagging Earth. Investigations for STEREO will include: Sun Earth Connection Coronal and Heliospheric Investigation (SECCHI), a remote sensing package which will study the three-dimensional evolution of CMEs from the Sun's surface to their eventual impact at Earth; STEREO/WAVES (SWAVES), an interplanetary radio burst tracker that will trace radio disturbances traveling from the Sun to Earth; In situ Measurements of Particles and CME Transients (IMPACTS) investigation, which will provide measurements of the solar wind electrons, interplanetary magnetic fields, and solar energetic particles; and the PLAsma and Supra Thermal Ion and Composition (PLASTIC) experiment, which will study coronal-solar wind and solar-wind heliospheric processes. For more information, please see <http://stp.nasa.gov/missions/stereo/stereo.htm>.

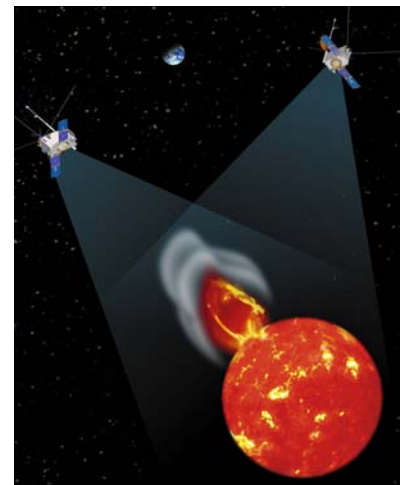

Solar Terrestrial Relations Observatory (STEREO)

Changes From FY 2006

- Budget reflects previously reported (May and July 2005 operating plans) three month launch delay, from February 2006 to May 2006, due to instrument development technology problems.

Program Management

STEREO is the third mission within the Solar Terrestrial Probes program. GSFC has program and project responsibility.

Theme: Earth-Sun System
Program: Solar Terrestrial Probes
Project In Development: Solar Terrestrial Relations Observatory (STEREO)

Technical Parameters

The mission design life is two years. Assuming a coronal mass ejection (CME) rate consistent with the solar magnetic activity cycle minimum, STEREO will observe at least 50 CMEs with remote sensing instruments and at least 24 interplanetary events in situ. STEREO will have two major science instrument suites and two science instruments. The Johns Hopkins University-Applied Physics Laboratory (APL) will provide mission operations.

Technical Specifications	FY 2007 President's Budget	Change from Baseline
Operational Capability	Prime mission life=2 yrs for both spacecraft; assumes CME rate consistent w/the solar magnetic activity cycle minimum, observe at least 60 CME w/remote sensing instruments & 24 + interplanetary events	No Change
Orbit	Heliocentric at 1 AU	No Change
CME Initiation Time	Accuracy of approximately 30 degrees of solar latitude and longitude	No Change

Schedule	FY 2007 President's Budget	Baseline	Change from Baseline
Start of Formulation	May 2001	May 2001	No Change
Start of Implementation	Mar 2002	Mar 2002	No Change
Mission Critical Design Review	Feb 2003	Feb 2003	No Change
Complete Observatory Spacecraft I & T	Feb 2006	June 2005	8 month delay
STEREO Launch	May 2006	Nov 2005	6 month delay

Strategy For Major Planned Acquisitions

- Major acquisitions complete.

Key Participants

- The United Kingdom will provide two Heliospheric Imager instruments.
- NRL will provide the SECCHI remote sensing instrument suites.
- APL will provide the spacecraft, observatory integration, testing and mission operations.

Risk Management

- RISK: Launch delay and cost increase. MITIGATION: Closely monitor schedule and cost performance. Do work-arounds and perform work in parallel, as possible.
- RISK: Boeing launch vehicle battery failure. MITIGATION: Complete battery failure analysis and monitor range safety position regarding production readiness of new batteries.

Theme: Earth-Sun System
Program: Solar Terrestrial Probes
Project In Development: Solar Terrestrial Relations Observatory (STEREO)

Budget Detail/Life Cycle Cost (Dollars in Millions)

Budget Authority	Prior	FY2005	FY2006	FY2007	FY2008	FY2009	FY2010	FY2011	BTC	Total	Comments
FY 2007 PRES BUD	288.1	80.4	64.6	20.1	16.4	8.6				478.2	
Changes	0.0	11.4	16.9	0.9	2.1	-1.3	-10.0			20.1	
FY2006 President's Budget	288.1	69.0	47.7	19.2	14.3	9.9	10.0			458.1	

Lifecycle cost elements:

Spacecraft: \$171.2

Launch Services: \$66.0

Instruments: \$121.7

Other: \$119.3

Theme: Earth-Sun System
Program: Solar Terrestrial Probes
Project In Development: Solar B

President's FY 2007 Budget Request (Dollars in Millions)

Solar B (Development)	FY2005	FY2006	FY2007	FY2008	FY2009	FY2010	FY2011
FY 2007 PRES BUD	15.4	14.1	16.4	12.4	12.4	6.0	
Changes from FY 2006 Request	4.0	-0.2	1.7	-0.1	-0.1	-4.0	

Projects in Development are mature, have a sound design, and are proceeding to mission execution. NASA is committed to their lifecycle cost and schedule plans.

Overview

The Solar-B mission is the second mission in the STP program. Solar-B is an international collaboration building on the highly successful Japan/U.S./U.K. Yohkoh (Solar-A) project. Solar-B is expected to launch in September 2006 into a sun-synchronous low Earth orbit. It will measure the Sun's magnetic field and ultraviolet/x-ray radiation and use the data to increase the understanding of the sources of solar variability. Solar-B will specifically study the interaction between the Sun's magnetic field and its high-temperature, ionized atmosphere. The result will be an improved understanding of the mechanisms that give rise to solar magnetic variability and how this variability modulates the total solar output and creates the driving force behind space weather. The U.S. responsibility is to manage development of three science instrument components: the Focal Plane Package (FPP), the X-Ray Telescope (XRT), and the Extreme Ultraviolet Imaging Spectrometer (EIS).

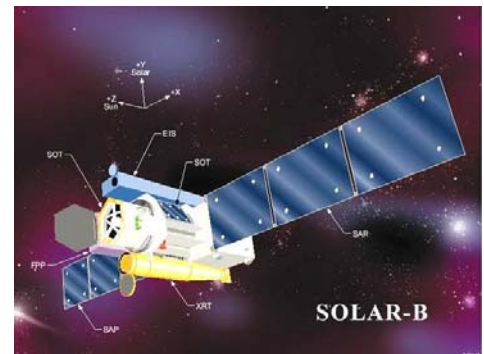

Solar-B Spacecraft design, indicating location of key instruments and features.

Changes From FY 2006

- There are no major programmatic changes from FY 2006 to FY 2007.

Program Management

The Solar-B project is within the STP program, with program management responsibility delegated to GSFC. Solar-B project management is at MSFC.

Theme: Earth-Sun System
Program: Solar Terrestrial Probes
Project In Development: Solar B

Technical Parameters

The FPP will be designed to operate in conjunction with the JAXA-provided 0.5 meter solar optical telescope; the XRT will accommodate the JAXA-provided camera and the EIS elements will be designed and constructed to be integral to the United Kingdom-provided EIS instrument. Mission design life is three years.

Technical Specifications	FY 2007 President's Budget	Change from Baseline
Prime Mission Life	3 Years	No Change
Focal Plane Package Polarimetric Accuracy	within 0.001	No Change
X-ray Telescope Angular Resolution	2.0 arcsec	No Change
EIS Spatial Resolution	2.0 arcsec	No Change

Schedule	FY 2007 President's Budget	Baseline	Change from Baseline
Solar-B Launch	Sept 2006	Sept 2005	1 year delay

Strategy For Major Planned Acquisitions

- Major acquisitions complete

Key Participants

- JAXA will provide the spacecraft, launch vehicle, major elements of each scientific instrument, observatory integration and testing, and mission operations.
- The Naval Research Laboratory will provide the EUV Imaging Spectrograph.
- Lockheed Martin Missiles and Space will provide the focal plane package.
- The Smithsonian Astrophysical Observatory will provide the x-ray telescope.

Risk Management

- RISK:** There is a potential for delay in the overall JAXA schedule. **MITIGATION:** Monitor JAXA schedule and ensure adequate contingency in the event of a launch delay.
- RISK:** The level of I&T support required in Japan could be underestimated. **MITIGATION:** Negotiate I&T support levels with Japan.

Budget Detail/Life Cycle Cost (Dollars in Millions)

Budget Authority	Prior	FY2005	FY2006	FY2007	FY2008	FY2009	FY2010	FY2011	BTC	Total	Comments
FY 2007 PRES BUD	98.9	15.4	14.1	16.4	12.4	12.4	6.0			175.6	
Changes	0.1	4.0	-0.2	1.7	-0.1	-0.1	-4.0			1.2	
FY2006 President's Budget	98.9	11.4	14.3	14.7	12.5	12.5	10.1			174.3	

Theme: Earth-Sun System

Program: Explorer

President's FY 2007 Budget Request (Dollars in Millions)

Explorer	FY2005	FY2006	FY2007	FY2008	FY2009	FY2010	FY2011
FY 2007 PRES BUD	148.7	129.9	73.4	73.3	91.1	174.1	182.3
Changes from FY 2006 Request	45.1	12.8	-33.3	-64.0	-117.5	-23.1	

Overview

The mission of the Explorer program is to provide frequent flight opportunities for world-class astrophysics and space physics investigations, utilizing innovative, streamlined and efficient management approaches to spacecraft development and operations. The Explorer program is composed of an on-going series of space science missions that are independent, but share a common funding and management structure. The program emphasizes missions that can be accomplished under the control of the scientific research community and seeks to control total mission life-cycle costs. The program also seeks to enhance public awareness of, and appreciation for, space science and to incorporate educational and public outreach activities. The Medium-Class Explorers (MIDEX) project provides flight opportunities for focused science missions. The Small Explorer (SMEX) project provides frequent flight opportunities for highly focused and relatively inexpensive missions. Mission of Opportunity (MO) space science investigations are flown as part of a non-NASA space mission. MOs are conducted on a no-exchange-of-funds basis with the organization sponsoring the mission.



The Explorer Program provides frequent flight opportunities for world-class scientific investigations.

The Explorer Program currently has several missions development and formulation in the Earth-Sun System theme. One Explorer mission, WISE, is incorporated into the Universe budget and details can be found there. Link to the Explorers program homepage for information, <http://explorers.gsfc.nasa.gov/missions.html>.

Plans For FY 2007

- Time History of Events and Macroscale Interactions during Substorms (THEMIS), the Aeronomy of Ice in Mesosphere (AIM), and the second Two Wide-angle Imaging Neutral-atom Spectrometers (TWINS-B) will be launched during FY2007.
- IBEX will be in development in FY 2007.
- A Medium-Class Explorer (MIDEX) Announcement of Opportunity will be released.

Changes From FY 2006

- Budget includes selection of Interstellar Boundary Explorer (IBEX) as a Small-class Explorers (SMEX) mission in formulation.

Program Management

The Explorer program is a multiple-project program with program responsibility assigned to GSFC.

Theme: Earth-Sun System
Program: Explorer

Technical Parameters

The Explorer program will launch MIDEX and SMEX missions commensurate with the availability of funding. The launch of MOs are as appropriate, based on date selected, funding profiles, and expected launch dates for the host missions. Projects are encouraged to utilize a wide variety of methods for access to space. Expendible launch vehicles (ELVs), spacecraft from other programs, and long duration balloons are all encouraged as ways to increase program flexibility and maximize flight opportunities for space science. Access to space and launch vehicle funding are part of the total cost cap for each mission. For each mission class, launch will take place within the following number of months after implementation: SMEX, 33 months; MIDEX, 40 months.

Technical Specifications	FY 2007 President's Budget	Change from Baseline
SMEX Life Cycle	less than or equal to 33 months development period	No Change
MIDEX Life Cycle	less than or equal to 40 months development period	No change

Implementation Schedule:

Project	Schedule by Fiscal Year							Purpose	Phase Dates		
	05	06	07	08	09	10	11			Beg	End
THEMIS								Understand the onset and evolution of magnetospheric substorms.	Tech Form Dev Ops Res	Apr-02 Apr-04 Oct-06 Oct-08	Apr-04 Oct-06
AIM								Determine the causes of Earth's highest-altitude clouds, which form in the coldest part of the atmosphere about 50 miles above the polar regions every summer.	Tech Form Dev Ops Res	Jul-02 Apr-04 Oct-06 Aug-08	Apr-04 Sep-06
IBEX								Detect for the first time the edge of the solar system, study galactic cosmic rays, and energetic particles from beyond the solar system that pose a health and safety hazard to humans.	Tech Form Dev Ops Res	Jan-05 Mar-06 Jul-08	Mar-06 Jun-08 Jul-10

Strategy For Major Planned Acquisitions

- Explorer program has established an acquisition strategy that contracts for the whole mission (concept through delivery of science data/analysis), with emphasis on performance incentives.
- Investigations are selected through the AO process, where multiple investigations are selected for initial concept studies with a competitive down-select to proceed to the next stage of formulation.
- Investigations are selected to proceed from one phase to the next through execution of contract options, based on successful technical, cost, and schedule performance in the previous phases.

Key Participants

- Industry, academia, other government agencies and international partners.

Theme: Earth-Sun System

Program: Explorer

Risk Management

- **RISK:** Implementation of first-of-a-kind, cost-capped space research missions are inherently risky. **MITIGATION:** Technical, management, and cost risks for each investigation are carefully examined as part of the selection process, and acceptable risks are documented in individual project appendices attached to the Explorer Program Plan. All technical and programmatic risks will be further reviewed as part of the project confirmation review during the PDR timeframe to ensure risks have been mitigated.

Theme: Earth-Sun System
Program: Explorer
Project In Development: Aeronomy of Ice in Mesosphere (SMEX-9)

President's FY 2007 Budget Request (Dollars in Millions)

<u>Aeronomy of Ice in Mesosphere (SMEX-9)</u> <u>(Development)</u>	<u>FY2005</u>	<u>FY2006</u>	<u>FY2007</u>	<u>FY2008</u>	<u>FY2009</u>	<u>FY2010</u>	<u>FY2011</u>
FY 2007 PRES BUD	42.7	24.5	6.0	2.9			
Changes from FY 2006 Request	12.6	-2.7	0.0	-1.0	-3.0	-3.0	

Overview

Projects in Development are mature, have a sound design, and are proceeding to mission execution. NASA is committed to their lifecycle cost and schedule plans.

AIM will determine the causes of Earth's highest-altitude clouds, which form in the coldest part of the atmosphere about 50 miles above the polar regions every summer. Recorded sightings of these "night-shining," or noctilucent, clouds began in the late 1800s and have increased in frequency. The clouds have also extended to lower latitudes over the past four decades. Scientists have hypothesized that these changes may be related to changes in atmospheric trace gas concentrations and the temperatures they produce. Similar thin, high-altitude clouds have been observed on Mars. The information AIM provides about Earth's noctilucent clouds should help scientists understand the similarities and differences between the atmospheres of Mars and Earth.



Aeronomy of Ice in Mesosphere (AIM) Spacecraft

AIM's three instruments, the Cloud Imaging and Particle Size (CIPS), Solar Occultation for Ice Experiment (SOFIE), and the Cosmic Dust Experiment (CDE), will measure all of the parameters important to understanding noctilucent cloud formation. The data from these instruments will help scientists determine the connection between the clouds and their environment and will serve as a baseline for the study of long-term changes in the upper atmosphere. For more information, please see <http://aim.hamptonu.edu/>.

Changes From FY 2006

- There are no major programmatic changes from FY 2006 to FY 2007.

Program Management

AIM is a NASA Small Explorer (SMEX) spacecraft with management responsibility delegated to Goddard Space Flight Center.

Theme: Earth-Sun System
Program: Explorer
Project In Development: Aeronomy of Ice in Mesosphere (SMEX-9)

Technical Parameters

AIM is a SMEX-class mission that will be launched from Vandenberg Air Force Base on a Pegasus XL launch vehicle in Sept 2006. The SOFIE instrument will use solar occultation to measure atmospheric constituents. CIPS will accomplish panoramic nadir imaging. The CDE instrument will measure dust particles in the upper atmosphere.

Technical Specifications	FY 2007 President's Budget	Change from Baseline
Mission Design life	2 Years	No change
Spatial resolution of Nadir images of Polar Mesospheric Clouds (PMC) backscattered radiance	At least 3km at 83km altitude	No change
Precision of cosmic dust influx measurements	10% for particles with radii <0.7 micrometer	No change
Measure absorption of sunlight in eight spectral regions	Between 0.25 and 5.3 micrometer	No change
Orbit	Sun synchronous @ 600 km altitude	No change

Schedule	FY 2007 President's Budget	Baseline	Change from Baseline
AIM Confirmation	Apr 2004	Mar 2004	N/A
Spacecraft I&T Begins	Mar 2005	Mar 2005	None
Observatory I&T Begins	Oct 2005	Oct 2005	None
Launch	Sept 2006	Sept 2006	None

Strategy For Major Planned Acquisitions

- AIM is a principal investigator (PI)-led mission. The PI, at Hampton University's Center for Astrophysical Science, leads the science, instrument, and spacecraft teams.

Key Participants

- Hampton University - Principal Investigator.
- Laboratory for Atmospheric and Space Physics (LASP) at the University of Colorado provides project management, develops the instruments (CIPS, CDE and SOFIE), and is responsible for mission operations (subcontracted to Hampton University).
- Orbital Science Corp (a subcontractor to LASP) is supplying the spacecraft bus and will provide observatory integration and testing.

Risk Management

- RISK: Launch vehicle loads characterization. MITIGATION: Monitor Pegasus launch vehicle performance.
- RISK: Cost growth. MITIGATION: Closely monitor cost and schedule performance; implement work-around as possible.

Theme: Earth-Sun System
Program: Explorer
Project In Development: Aeronomy of Ice in Mesosphere (SMEX-9)

Budget Detail/Life Cycle Cost (Dollars in Millions)

Budget Authority	Prior	FY2005	FY2006	FY2007	FY2008	FY2009	FY2010	FY2011	BTC	Total	Comments
FY 2007 PRES BUD	43.0	42.7	24.5	6.0	2.9					119.1	
Changes	0.0	12.6	-2.7	0.0	-1.0	-3.0	-3.0			2.8	
FY2006 President's Budget	43.0	30.1	27.3	6.0	3.9	3.0	3.0			116.3	

Theme: Earth-Sun System
Program: Explorer
Project In Development: THEMIS

President's FY 2007 Budget Request (Dollars in Millions)

THEMIS (Development)	FY2005	FY2006	FY2007	FY2008	FY2009	FY2010	FY2011
FY 2007 PRES BUD	54.0	41.7	9.3	6.3			
Changes from FY 2006 Request	2.5	2.9	-2.6	0.0	-4.0	-4.0	

Projects in Development are mature, have a sound design, and are proceeding to mission execution. NASA is committed to their lifecycle cost and schedule plans.

Overview

The Time History of Events and Macroscale Interactions during Substorms (THEMIS) project will lead to the understanding of the onset and evolution of magnetospheric substorms. NASA's THEMIS mission will use five identical microspacecraft (probes) to answer fundamental outstanding questions regarding magnetospheric substorm instability, a dominant mechanism of transport and explosive release of solar wind energy within Geospace.

THEMIS will also employ a dense network of ground observatories to time well known plasma particles and fields signatures in Earth's magnetotail, relative to substorm onset. In addition to addressing its primary objective, THEMIS answers critical questions in radiation belt physics and solar wind-magnetosphere energy coupling.

For more information, please see http://sprg.ssl.berkeley.edu/themis/Flash/THEMIS_flash.htm, THEMIS Spacecraft.

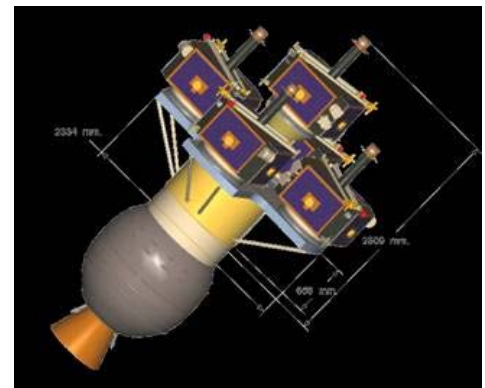

Time History of Events and Macroscale Interactions during Substorms (THEMIS) Spacecraft

Changes From FY 2006

- There are no major programmatic changes from FY 2006 to FY 2007.

Program Management

Goddard Space Flight Center has project responsibility for THEMIS, a Medium-Class Explorer (MIDEX) mission.

Technical Parameters

THEMIS will be launched from Cape Canaveral, Florida, on a Delta II in October 2006. THEMIS consists of 5 identical probes. There are five instruments on each probe: fluxgate magnetometer (FGM), search coil magnetometer (SCM), electric field instrument (EFI), electrostatic analyzer (ESA) and solid state telescope (SST).

Technical Specifications	FY 2007 President's Budget	Change from Baseline
Prime Mission Life	2 Years	No Change
Orbit	High Earth Orbit	No Change

Theme: Earth-Sun System
Program: Explorer
Project In Development: THEMIS

Schedule	FY 2007 President's Budget	Baseline	Change from Baseline
THEMIS Confirmed	April 2004	Apr 2004	N/A
Instrument I&T Begins	Mar 2005	Mar 2005	No Change
Spacecraft I&T Begins	July 2005	June 2005	1 month delay
Observatory I&T Begins	Nov 2005	July 2005	4 month delay
Launch	Oct 2006	Oct 2006	No Change

Strategy For Major Planned Acquisitions

- Swales Aerospace will provide the spacecraft, integration and test, spacecraft carrier, launch vehicle integration, and launch support to Univ. of California-Berkeley (UCB).
- UCB will provide the three U.S.-developed instruments and the mission and science operations.

Key Participants

- International Instruments: France-SCM and Germany-FGM
- University of California at Berkeley - Principal Investigator

Risk Management

- RISK:** Transponder not locking on signal. Probability: Low 10%, Impact: Moderate schedule slip. **MITIGATION:** Monitor transponders 2-5 times for repeat of failure. Modify ground support equipment to isolate problem to ground support equipment or transponder.
- RISK:** Delay in completion of integration and test for Probe #1, Probability: Moderate 20%, Impact: Large schedule/cost increase. **MITIGATION:** Implement a schedule of daily meetings and discuss potential recovery plans.

Budget Detail/Life Cycle Cost (Dollars in Millions)

Budget Authority	Prior	FY2005	FY2006	FY2007	FY2008	FY2009	FY2010	FY2011	BTC	Total	Comments
FY 2007 PRES BUD	80.9	54.0	41.7	9.3	6.3					192.2	
Changes	0.0	2.5	2.9	-2.6	0.0	-4.0	-4.0			-5.2	
FY2006 President's Budget	80.9	51.6	38.8	11.8	6.3	4.0	4.0			197.4	

Theme: Earth-Sun System
 Program: Explorer
 Project In **Formulation**: Interstellar Boundary Explorer (IBEX)

President's FY 2007 Budget Request (Dollars in Millions)

Interstellar Boundary Explorer (IBEX) (Formulation)	FY2005	FY2006	FY2007	FY2008	FY2009	FY2010	FY2011
FY 2007 PRES BUD	29.1	39.0	40.2	31.7	8.0	6.9	1.0
Changes from FY 2006 Request	29.1	39.0	40.2	31.7	8.0	6.9	

Projects in Formulation are not mature in their development process and cost estimates are SUBJECT TO CHANGE as the project matures.

Overview

The Interstellar Boundary Explorer (IBEX) is the first mission designed to detect and map the boundary between the solar system and interstellar space. The Sun and solar system move through a part of the galaxy referred to as the local interstellar medium. It is built up from material released from the stars of our galaxy through stellar winds, novae, and supernovae. The interaction encompasses the structures, dynamics, energetic particle acceleration and charged particle propagation in the complex region where the solar wind meets the interstellar medium. IBEX will provide the first global observations of the interstellar interaction disclosing its fundamental nature and gathering the data needed for detailed modeling and in-depth understanding. IBEX achieves this objective by taking a set of global energetic neutral atom (ENA) images that answer four fundamental questions in the termination shock and interactions beyond the heliotail and helipause.

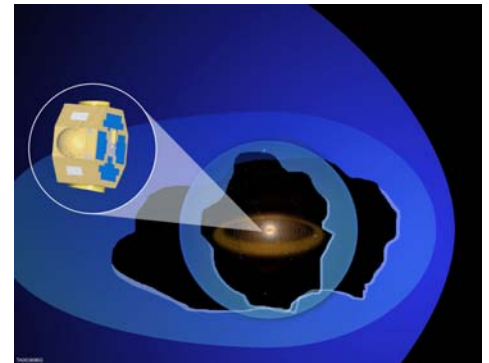

Imaging the edge of our solar system...and beyond. IBEX will discover the global interaction between the solar wind and the interstellar medium.

IBEX has two instruments, IBEX- Hi and IBEX- Lo, that are single pixel sensors to measure ENAs from the outer heliosphere. There is significant overlap energy coverage between the two instruments to allow cross calibration because the physical processes used by the sensors to convert ENAs to ions differ. The two sensors employ similar subsystems to reject incident ions, collimate the field-of-view, convert ENAs to negative or positive ions, measure the ionized ENA energy using toroidal electrostatic analyzers and detect the ionized ENAs using double and triple coincidence.

For more information, please see:
<http://www.ibex.swri.edu/>

Changes From FY 2006

- IBEX is a new project and was not included in the FY2006 request.

Program Management

Goddard Space Flight Center has project management responsibility for the IBEX Small Explorer (SMEX) spacecraft.

Theme: Earth-Sun System
Program: Explorer
Project In Formulation: Interstellar Boundary Explorer (IBEX)

Technical Parameters

IBEX is a SMEX-class mission that will be launched from Kwajalein on a Pegasus XL launch vehicle. The IBEX- Hi and IBEX- Lo are single pixel sensors that measure ENAs from the outer heliosphere. The Combined Electronics Unit (CEU) commands and stores data from the IBEX-Hi and Lo sensors, provides the low and high voltages and other electronics support needed for the IBEX-Hi and Lo sensors to capture energetic neutral atoms from the galactic frontier and is the payload interface to the spacecraft bus.

Technical Specifications	FY 2007 President's Budget	Change from Baseline
Mission Design Life	2 Years	N/A
Orbit	High Elliptical Orbit, 236,000 km (37 Re- Radius of Earth) apogee x 7000 km perigee	N/A

Schedule	FY 2007 President's Budget	Baseline	Change from Baseline
Confirmation Review	Mar 2006	TBD	N/A
Spacecraft I&T Begins	Mar 2007	TBD	N/A
Observatory I&T Begins	Nov 2007	TBD	N/A
Launch	June 2008	TBD	N/A

Strategy For Major Planned Acquisitions

- IBEX is a principle investigator (PI) led mission. The PI, at Southwest Research Institute, leads the science, instrument and spacecraft teams.

Key Participants

- Orbital Science Corporation provides the spacecraft bus and will provide observatory integration and testing.
- Southwest Research Institute (SwRI) Principal Investigator.
- Los Alamos National Laboratory (LANL) is providing the IBEX- Hi instrument.
- Lockheed Martin Advance Technology Center (LMATC) provides the IBEX-Lo instrument.

President's FY 2007 Budget Request (Dollars in Millions)

Earth System Science Pathfinder	FY2005	FY2006	FY2007	FY2008	FY2009	FY2010	FY2011
FY 2007 PRES BUD	110.9	141.8	161.4	111.5	97.5	172.0	207.2
Changes from FY 2006 Request	3.0	6.2	-4.8	-3.2	-106.0	-60.3	

Overview

The Earth System Science Pathfinder Program (ESSP) addresses unique, specific, highly-focused mission requirements in Earth science research. ESSP includes a series of relatively low-to-moderate cost, small-to-medium sized, competitively selected, Principal Investigator (PI) led missions that are built, tested and launched in a short time interval. These missions are capable of supporting a variety of scientific objectives related to Earth science, including studies of the atmosphere, oceans, land surface, polar ice regions and solid Earth. Investigations include development and operation of remote sensing instruments and the conduct of investigations utilizing data from these instruments. The ESSP Program currently has 2 missions preparing for a co-manifested 2006 Launch (CloudSat and CALIPSO), and 2 missions in development (Orbiting Carbon Observatory (OCO) and Aquarius). Future ESSP missions will be selected from proposals submitted in response to Announcements of Opportunity (AO's). These AO's will be released approximately once every 2 years, subject to funding availability. This effort also provides techniques and technologies that can be employed to predict climate, weather and natural hazards on planets we plan to explore. For more information see <http://earth.nasa.gov/essp/index.html/>.

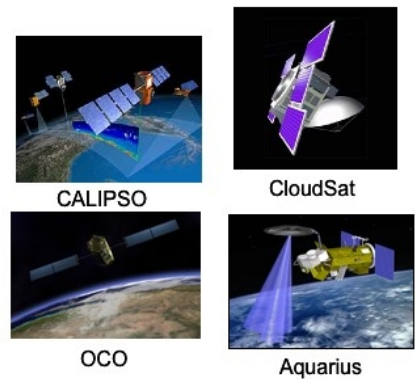

Images of Current ESSP Missions

Plans For FY 2007

OCO will complete instrument assembly, testing, and calibration in April 2007. Integration and testing of spacecraft subsystems (including Command & Data Handling, Power, RF Communications, Attitude Control, and Propulsion) will be completed prior to the arrival of the instrument in October 2007. The six month period between completion of instrument assembly/test and delivery provides adequate schedule reserve and keeps the instrument off the OCO critical path. Observatory-level (spacecraft plus instrument) integration and test begins in October 2007.

Aquarius will complete fabrication and assembly of instrument hardware (including the radiometer, scatterometer, electronics, and antenna). Instrument level testing (including calibration) will begin during this period, in preparation for delivery of the instrument to CONAE for integration with the SAC-D spacecraft in FY 2008.

Theme:	Earth-Sun System
Program:	Earth System Science Pathfinder

Changes From FY 2006

- OCO and Aquarius schedule, cost phasing, and total cost were adjusted to the Confirmation baselines that were approved in May 2005 and September 2005, respectively.
- The Hydros mission, originally funded as a back-up mission in case Aquarius or OCO failed, was not confirmed for development due to the successful Aquarius and OCO confirmation reviews.
- The CloudSat/CALIPSO launch is delayed from May 2005 to April 2006 due to technical issues and the unavailability of the planned launch opportunity.

Program Management

JPL has project management responsibility for OCO and Aquarius. The NASA and JPL Program Management Councils have program oversight responsibility.

Technical Parameters

OCO, to be launched in FY2008, will have 1 instrument with a mission life of 2 years and provide the first space-based measurement of atmospheric CO₂, characterizing its sources, sinks and seasonal variability. Aquarius, to be launched in FY09, will have 1 instrument with a mission life of 3 years and provide a global space-based measure of the sea surface salinity (SSS), giving insight into the ocean's role in climate and weather.

Technical Specifications	FY 2007 President's Budget	Change from Baseline
CloudSat Mission	The CPR, a 94-GHz nadir-looking radar that measures the power backscattered by clouds as a function of distance from the radar; CPR provides calibrated, range-resolved radar reflectivity measurements.	No change
CALIPSO Mission	Data sets to include aerosol & cloud vertical distributions, aerosol extinction & optical depth, emissivity, & effective particle size content of clouds, & cloud surface atmospheric radiative fluxes.	No change
OCO Mission	Collect the space-based measurements needed to retrieve estimates of XCO ₂ with random errors and systematic biases no larger than 0.3% (1 ppm) on regional scales (1000 km by 1000 km).	No change
Aquarius Mission	Collect the space-based measurements to retrieve SSS with global root-mean-square (rms) random errors and systematic biases no larger than 0.2 psu on 150 km by 150 km scales over the ice-free oceans.	No change

Implementation Schedule:

Project	Schedule by Fiscal Year							Purpose	Phase Dates														
	05	06	07	08	09	10	11			Beg	End												
CloudSat		Dev	Ops					Collect data to evaluate and improve the way clouds are represented in global models, contributing to better cloud predictions and more complete knowledge of their role in climate change.	Tech Form Dev Ops Res	Apr-98 Dec-00 May-06	Nov-00 Apr-06 Feb-08												
CALIPSO		Dev	Ops					Address the role of clouds and aerosols in the Earth's atmosphere, including their effects on climate.	Tech Form Dev Ops Res	Apr-98 May-01 May-06	Apr-01 Apr-06 Apr-09												
OCO		Form	Dev	Ops				Improve understanding of atmospheric carbon dioxide sources and sinks, a critical element in making more reliable climate predictions	Tech Form Dev Ops Res	Oct-03 May-05 Oct-08	Apr-05 Sep-08 Oct-10												
Aquarius		Form	Dev	Ops				To observe and model seasonal and year-to-year variations of sea surface salinity and how these relate to changes in the water cycle and ocean circulation	Tech Form Dev Ops Res	Oct-03 Oct-05 Apr-09	Sep-05 Mar-09 Apr-12												
<table border="0"> <tr> <td>■</td> <td>Tech & Adv Concepts (Tech)</td> </tr> <tr> <td>■</td> <td>Formulation(Form)</td> </tr> <tr> <td>■</td> <td>Development (Dev)</td> </tr> <tr> <td>■</td> <td>Operations (Ops)</td> </tr> <tr> <td>■</td> <td>Research (Res)</td> </tr> <tr> <td>■</td> <td>Represents a period of no activity for the Project</td> </tr> </table>												■	Tech & Adv Concepts (Tech)	■	Formulation(Form)	■	Development (Dev)	■	Operations (Ops)	■	Research (Res)	■	Represents a period of no activity for the Project
■	Tech & Adv Concepts (Tech)																						
■	Formulation(Form)																						
■	Development (Dev)																						
■	Operations (Ops)																						
■	Research (Res)																						
■	Represents a period of no activity for the Project																						

Strategy For Major Planned Acquisitions

- AO-4 mission(s): Selection by peer review.

Key Participants

- Foreign: Argentina's Comision Nacional De Actividades Espaciales (CONAE) - provides Aquarius spacecraft, ground system.

Risk Management

- RISK: No significant risk at this time. MITIGATION: N/A

Theme: Earth-Sun System
Program: Earth System Science Pathfinder
Project In Development: CloudSat

President's FY 2007 Budget Request (Dollars in Millions)

CloudSat (Development)	FY2005	FY2006	FY2007	FY2008	FY2009	FY2010	FY2011
FY 2007 PRES BUD	11.1	10.6	3.2				
Changes from FY 2006 Request	3.1	5.7	1.9				

Projects in Development are mature, have a sound design, and are proceeding to mission execution. NASA is committed to their lifecycle cost and schedule plans.

Overview

CloudSat observations will improve cloud modeling, contributing to better predictions of cloud formation and distribution and to a better understanding of the role of clouds in Earth's climate system. Clouds are the key component of the Earth's hydrological cycle, and they dominate the planet's solar and thermal radiation budgets. Even small changes in their abundance or distribution could significantly alter the climate. These considerations lead scientists to believe that the main uncertainties in climate model simulations are due to the difficulties in adequately representing clouds and their radiative properties. CloudSat will fly a millimeter-wave (94 GHz) radar that is capable of seeing a large fraction of clouds and precipitation, from very thin cirrus clouds to thunderstorms producing heavy precipitation. CloudSat will furnish data needed to evaluate and improve the way clouds are represented in global models, thereby contributing to better predictions of clouds and a more complete knowledge of their role in climate change. CloudSat is a collaboration among NASA, the Canadian Space Agency (CSA), and the US Air Force (USAF). The mission will fly in formation with CALIPSO and as part of a larger constellation with Aura and Aqua and the French satellite PARASOL. CSA is contributing instrument components and the USAF is contributing ground operations. For more information see <http://CloudSat.atmos.colostate.edu/>.

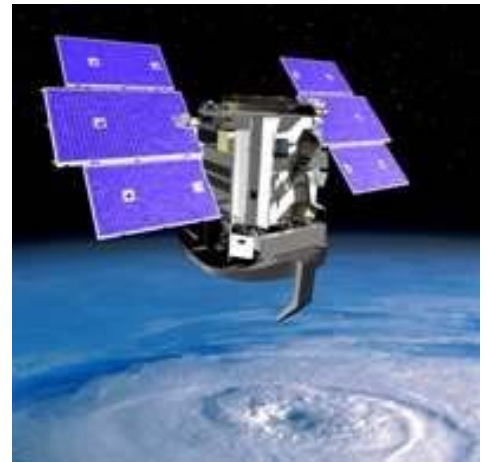

CloudSat has a nadir pointing mm wave radar optimized to penetrate clouds and reveal their interior water and aerosol content.

Changes From FY 2006

- The CloudSat launch is delayed from May 2005 to April 2006 due to the unavailability of the planned launch opportunity.

Program Management

JPL is responsible for Project Management. The NASA and JPL Program Management Councils have program oversight responsibility.

Theme: Earth-Sun System
Program: Earth System Science Pathfinder
Project In Development: CloudSat

Technical Parameters

The single CloudSat instrument is the Cloud Profiling Radar (CPR). CloudSat will be co-manifested with CALIPSO on a Delta II launch vehicle. CloudSat will fly in formation with CALIPSO as part of the A-Train constellation. The USAF will provide ground operations and manage communications to the Satellite. The data will be routed through the Air Force facility at Kirtland Air Force Base to the Colorado State University Cooperative Institute for Research in the Atmosphere (CIRA). CIRA will be responsible for processing, archiving and distributing the mission science data.

Technical Specifications	FY 2007 President's Budget	Change from Baseline
CloudSat Mission	The CPR, a 94-GHz nadir-looking radar that measures the power backscattered by clouds as a function of distance from the radar; CPR provides calibrated, range-resolved radar reflectivity measurements	

Schedule	FY 2007 President's Budget	Baseline	Change from Baseline
Launch	Apr 06	April 04	24 month delay
First data products delivered	Apr 07	Apr 05	24 month delay

Strategy For Major Planned Acquisitions

- There are no planned major procurements, as all contracts are in place.

Key Participants

- Colorado State University provides Principal Investigator and data processing.
- JPL developing the instrument and undertaking I&T in house.
- Canadian Space Agency provides a key element of the CPR.
- USAF & DoE: USAF provides ground stations and mission operations teams; DoE provides mission calibration and validation phase expertise and ground facilities.

Risk Management

- RISK:** If formation flying and insertion into the A-Train is not be achieved it would not be possible to make optimum use of the instrument synergy of the different A-Train satellite. **LIKELIHOOD:** Moderate. **IMPACT:** Optimum science results would not be achieved. **MITIGATION:** Established the A-Train constellation working group made up of representatives from all satellite organizations, led by the GSFC Earth Science Mission operations office, to identify and resolve formation flying and A-Train insertion issues.

Budget Detail/Life Cycle Cost (Dollars in Millions)

Budget Authority	Prior	FY2005	FY2006	FY2007	FY2008	FY2009	FY2010	FY2011	BTC	Total	Comments
FY 2007 PRES BUD	154.2	11.1	10.6	3.2						179.0	
Changes	5.7	3.1	5.7	1.9						16.4	
FY 2006 President's Budget	148.5	8.0	4.8	1.3						162.6	

Theme: Earth-Sun System
Program: Earth System Science Pathfinder
Project In Development: CloudSat

LCC increase reflects the launch delay due to unavailability of launch services as noted in the "Changes from FY 2006" section.

Theme: Earth-Sun System
Program: Earth System Science Pathfinder
Project In Development: CALIPSO

President's FY 2007 Budget Request (Dollars in Millions)

CALIPSO (Development)	FY2005	FY2006	FY2007	FY2008	FY2009	FY2010	FY2011
FY 2007 PRES BUD	19.7	18.9	7.0	6.4			
Changes from FY 2006 Request	5.3	15.3	2.3	3.7			

Projects in Development are mature, have a sound design, and are proceeding to mission execution. NASA is committed to their lifecycle cost and schedule plans.

Overview

The Cloud-Aerosol Lidar and Infrared Pathfinder Satellite Observations (CALIPSO) mission will address the role of clouds and aerosols in the Earth's atmosphere, providing key measurements to improve knowledge of their three dimensional distribution, radiative properties, and effects on climate. The mission will fly a 3-channel lidar (a laser) in formation with CloudSat and in a constellation with Aura and Aqua to obtain coincident observations of radiative fluxes and the atmosphere. This set of measurements is essential for quantification of global aerosol and cloud radiative effects. CALIPSO consists of a partnership between NASA and France's Centre Nationale D'Etudes Spatiale (CNES). CNES is providing a PROTEUS spacecraft, the imaging infrared radiometer (IIR), observatory integration and test (I&T), and spacecraft mission operations. Together, CALIPSO and Aqua provide: (1) a global measurement suite from which the first observation-based estimates of aerosol direct radiative forcing of climate can be made; (2) a dramatically improved empirical basis for assessing aerosol indirect radiative forcing of climate; (3) a factor-of-2 improvement in the accuracy of satellite estimates of long-wave radiative fluxes at the Earth's surface and in the atmosphere and (4) a new ability to assess cloud-radiation feedback in the climate system. CALIPSO is co-manifested with CloudSat and scheduled to launch no earlier than April 2006. For more information see <http://www-calipso.larc.nasa.gov>.



The CALIPSO satellite will provide data key to understanding the role of clouds and aerosols in the Earth's radiation budget, providing key measurements to improve climate predictions.

Changes From FY 2006

- The CALIPSO launch is delayed from May 2005 to April 2006 due to technical issues and the unavailability of the planned launch opportunity.

Program Management

GSFC/LaRC have project management responsibility. The NASA and a joint GSFC/LaRC Program Management Councils have program oversight responsibility.

Theme: Earth-Sun System
Program: Earth System Science Pathfinder
Project In Development: CALIPSO

Technical Parameters

CALIPSO carries three science instruments: a three-channel Lidar, and imaging infrared radiometer (IIR), and a wide field camera (WFC). The Lidar and WFC are provided by NASA and the IIR by CNES. CALIPSO will launch with CloudSat on a Delta II launch vehicle into a 705km altitude, 98.08 deg. inclined orbit and will fly in formation with CloudSat and in a larger constellation with Aura, Aqua and Parosol. The Mission Operations Control Center will be at LaRC and the Satellite Operations Control Center at CNES facilities in Toulouse, France.

Technical Specifications	FY 2007 President's Budget	Change from Baseline
CALIPSO Mission	Data sets will include aerosol & cloud vertical distributions, aerosol extinction & optical depth, emissivity, & effective particle size content of clouds, & cloud surface atmospheric radiative fluxes	

Schedule	FY 2007 President's Budget	Baseline	Change from Baseline
Launch	Apr 06	Apr 04	24 month delay
Delivery of 1st calibrated & validated data products	Oct 07	Oct 05	24 month delay

Strategy For Major Planned Acquisitions

- Not applicable, all procurements for CALIPSO are complete.

Key Participants

- GSFC: provides project management and shares program management with LaRC
- LaRC: provides Principle Investigator and primary instrument (Lidar) and shares project management with GSFC
- CNES: provides spacecraft, system level I&T, and satellite ground station and mission control

Risk Management

- RISK: If formation flying and insertion into the A-Train is not achieved it would not be possible to make optimum use of the instrument synergy of the different A-Train satellites. LIKELIHOOD: Moderate. IMPACT: optimum science results would not be achieved. MITIGATION: Established the A-Train constellation working group made up of representatives from all satellite organizations, led by the GSFC Earth Science Mission operations office, to identify and resolve formation flying and A-Train insertion issues.

Budget Detail/Life Cycle Cost (Dollars in Millions)

Budget Authority	Prior	FY2005	FY2006	FY2007	FY2008	FY2009	FY2010	FY2011	BTC	Total	Comments
FY 2007 PRES BUD	167.5	19.7	18.9	7.0	6.4					219.6	
Changes	8.3	5.3	15.3	2.3	3.7					34.9	
FY2006 President's Budget	159.3	14.5	3.5	4.7	2.8					184.7	

Theme: Earth-Sun System
Program: Earth System Science Pathfinder
Project In Development: CALIPSO

CALIPSO mission, LCC increase due to resolution of technical difficulties and launch delay due to unavailability of launch services, as noted in the "Changes from FY 2006" section.

Theme: Earth-Sun System
Program: Earth System Science Pathfinder
Project In Development: Orbiting Carbon Observatory (OCO)

President's FY 2007 Budget Request (Dollars in Millions)

<u>Orbiting Carbon Observatory (OCO) (Development)</u>	<u>FY2005</u>	<u>FY2006</u>	<u>FY2007</u>	<u>FY2008</u>	<u>FY2009</u>	<u>FY2010</u>	<u>FY2011</u>
FY 2007 PRES BUD	41.4	40.7	68.2	34.1	12.3	6.7	
Changes from FY 2006 Request	3.9	-6.2	23.9	30.2	7.3	6.7	

Projects in Development are mature, have a sound design, and are proceeding to mission execution. NASA is committed to their lifecycle cost and schedule plans.

Overview

The Orbiting Carbon Observatory (OCO) Mission is part of the Earth System Science Pathfinder (ESSP) Program in the NASA Science Mission Directorate (SMD). OCO was competitively selected from proposals submitted in response to ESSP Announcement of Opportunity 3. OCO will make the first space-based measurements of atmospheric carbon dioxide (CO₂) with the precision, resolution, and coverage needed to characterize its sources and sinks on regional scales and quantify their variability over the seasonal cycle. The data received from OCO will provide an improved understanding of CO₂ sinks, a critical element in making reliable climate predictions. Two important Earth Science questions OCO will help address are: 1) What human and natural processes are controlling atmospheric CO₂; and 2) What are the relative roles of the oceans and land ecosystems in absorbing CO₂? The OCO mission was authorized by the NASA Science Mission Directorate to proceed to Development (Implementation) on May 12, 2005. OCO is scheduled to launch in September 2008. For more information, please see http://science.hq.nasa.gov/missions/satellite_61.htm.



Artist's depiction of the OCO Spacecraft in orbit around Earth.

Changes From FY 2006

- OCO schedule, cost phasing, and budget have been adjusted to reflect the mission Confirmation baseline.
- OCO is baselined for a launch of September 2008, compared to the October 2007 estimate in the FY2006 budget.

Program Management

Project management responsibility resides at JPL. The NASA and JPL Program Management Councils have program oversight responsibility.

Theme: Earth-Sun System
Program: Earth System Science Pathfinder
Project In Development: Orbiting Carbon Observatory (OCO)

Technical Parameters

During its two-year mission, OCO will fly in a Sun synchronous polar orbit that provides near global coverage of the sunlit portion of the Earth with a 16-day repeat cycle. The spacecraft is a high-heritage LEO Star-2, provided by Orbital Sciences Corporation. Its single instrument incorporates three high-resolution grating spectrometers, designed to measure the near-infrared absorption by CO₂ and molecular oxygen (O₂) in reflected sunlight. The orbit's early afternoon equator crossing time maximizes the available signal and minimizes diurnal biases in CO₂ measurements associated with photosynthesis.

Technical Specifications	FY 2007 President's Budget	Change from Baseline
OCO Mission	Collect the space-based measurements needed to retrieve estimates of XCO ₂ with random errors and systematic biases no larger than 0.3% (1 ppm) on regional scales (1000 km by 1000 km)	None
Spacecraft	Orbital Sciences Corporation LEO Star 2 based design	None
Instrument	Hamilton Sundstrand incorporates three high-resolution spectrometers designed to make coincident measurements of near-infrared absorption by CO ₂ and molecular oxygen (O ₂) in reflected sunlight	None
Launch Vehicle	Orbital Sciences Corporation Taurus XL Launch Vehicle	Change from Taurus STD in the FY 2006 budget.

Schedule	FY 2007 President's Budget	Baseline	Change from Baseline
Mission Confirmation Review	April 2005	April 2005	No change
Launch	September 2008	September 2008	No change

Strategy For Major Planned Acquisitions

- There are no planned major procurements, as all instrument and spacecraft contracts are in place.

Key Participants

- There are no development partners outside of NASA.
- New Zealand's National Institute of Water & Atmospheric Research (NIWA), France's Laboratoire des Sciences du Climat et de l'Environnement (LSCE), and Germany's University of Bremen are all members of the OCO Science Team.

Risk Management

- RISK: No significant risk at this time. MITIGATION: N/A

Theme: Earth-Sun System
Program: Earth System Science Pathfinder
Project In Development: Orbiting Carbon Observatory (OCO)

Budget Detail/Life Cycle Cost (Dollars in Millions)

Budget Authority	Prior	FY2005	FY2006	FY2007	FY2008	FY2009	FY2010	FY2011	BTC	Total	Comments
FY 2007 PRES BUD	<u>23.1</u>	<u>41.4</u>	<u>40.7</u>	<u>68.2</u>	<u>34.1</u>	<u>12.3</u>	<u>6.7</u>			<u>226.5</u>	
Changes	<u>0.0</u>	<u>3.9</u>	<u>-6.2</u>								
FY2006 President's Budget	<u>23.1</u>	<u>37.5</u>	<u>46.9</u>								

No LCC in FY 2006.

Theme: Earth-Sun System
Program: Earth System Science Pathfinder
Project In Development: Aquarius

President's FY 2007 Budget Request (Dollars in Millions)

Aquarius (Development)	FY2005	FY2006	FY2007	FY2008	FY2009	FY2010	FY2011
FY 2007 PRES BUD	16.4	51.7	65.5	55.6	26.9	5.9	4.6
Changes from FY 2006 Request	-2.7	-3.6	-0.6	34.7	21.3	2.5	

Projects in Development are mature, have a sound design, and are proceeding to mission execution. NASA is committed to their lifecycle cost and schedule plans.

Overview

The Aquarius Mission is part of the ESSP Program in the NASA Science Mission Directorate (SMD). Aquarius was competitively selected from proposals submitted in response to ESSP Announcement of Opportunity 3. The ESSP Program addresses unique, specific, highly-focused mission requirements in Earth science research and is characterized by relatively low to moderate cost, small to medium sized, Principle Investigator (PI) led missions that are capable of being built, tested and launched in a short time interval. Aquarius is an instrument on the Argentine Comisión Nacional de Actividades Espaciales (CONAE) spacecraft SAC-D. Aquarius will make space-based measurements of Sea Surface Salinity (SSS) with high accuracy and resolution to investigate the links between the global water cycle, ocean circulation and climate. The objective of Aquarius is to observe and model seasonal and year-to-year variations of SSS, and how these relate to changes in the water cycle and ocean circulation. This will yield an unprecedented view of the oceans' role in climate and weather. The Aquarius mission was authorized by the NASA Science Mission Directorate to proceed to Phase C/D (Implementation) on October 12, 2005. Aquarius is scheduled to launch in March 2009. For more information, please see http://science.hq.nasa.gov/missions/satellite_59.htm.

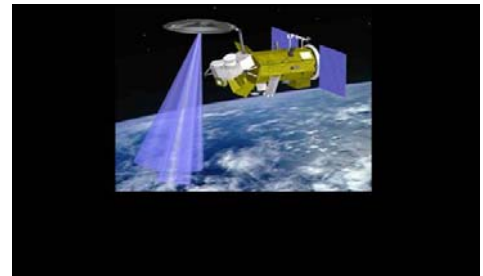

Artist's conception of the Aquarius/SAC-D Spacecraft that will measure global sea surface salinity.

Changes From FY 2006

- Aquarius schedule, cost phasing, and total cost have been adjusted to reflect the mission Confirmation Review.
- Aquarius launch is baselined for March 2009, compared to the September 2008 estimate in the FY2006 budget.

Program Management

Project management responsibility resides at JPL. The NASA and JPL Program Management Councils have program oversight responsibility.

Theme: Earth-Sun System
Program: Earth System Science Pathfinder
Project In Development: Aquarius

Technical Parameters

The combined NASA and CONAE instruments/spacecraft form the Aquarius/SAC-D observatory. This observatory will be launched into a polar, sun synchronous orbit that allows global coverage of ice-free ocean surfaces and consistent with Aquarius/SAC-D science observational targets. The Aquarius mission will provide for a 3-year data set. CONAE will conduct the operations. Aquarius will deploy an integrated passive/active L-band radiometer/scatterometer as the primary salinity-measuring payload. JPL will design and build the scatterometer that utilizes surface radar backscatter for mitigating salinity measurement errors due to surface roughness effects. GSFC will design and build the L-Band radiometer that provide the primary sea surface brightness measurement used to derive SSS.

Technical Specifications	FY 2007 President's Budget	Change from Baseline
Aquarius Mission	Collect the space-based measurements to retrieve SSS with global root-mean-square (rms) random errors and systematic biases no larger than 0.2 psu on 150 km by 150 km scales over the ice-free oceans	None
Spacecraft	CONAE SAC-D Spacecraft	None
Instrument	Integrated L-band microwave radiometer/scatterometer will be developed and deployed as the salinity measuring instrument, consisting of three beams in a pushbroom configuration	None
Launch Vehicle	Boeing Delta II	None

Schedule	FY 2007 President's Budget	Baseline	Change from Baseline
September 2005	Mission Confirmation Review	September 2005	No change
March 2009	Launch	March 2009	No change

Strategy For Major Planned Acquisitions

- There are no planned major procurements, as all instrument and spacecraft contracts are in place.

Key Participants

- CONAE (Argentina): Areas of cooperation include spacecraft, ground systems and operations.

Risk Management

- RISK: No significant risk at this time. MITIGATION: N/A

Budget Detail/Life Cycle Cost (Dollars in Millions)

Budget Authority	Prior	FY2005	FY2006	FY2007	FY2008	FY2009	FY2010	FY2011	BTC	Total	Comments
FY 2007 PRES BUD	17.4	16.4	51.7	65.5	55.6	26.9	5.9	4.6	2.2	246.2	
Changes	7.5	-2.7	-3.6	-0.6	34.7	21.3	2.5		-0.2	59.0	
FY2006 President's Budget	9.9	19.1	55.3	66.2	21.0	5.6	3.4		2.4	182.7	

No LCC in FY 2006.

President's FY 2007 Budget Request (Dollars in Millions)

Earth-Sun System Multi-Mission Operations	FY2005	FY2006	FY2007	FY2008	FY2009	FY2010	FY2011
FY 2007 PRES BUD	287.6	267.3	264.6	287.1	303.5	309.4	294.0
Changes from FY 2006 Request	-46.7	-1.0	-4.9	10.0	23.2	23.7	

Overview

Earth-Sun System Multi-Mission Operations acquires, preserves, and delivers the observation data for the Science Mission Directorate/Earth-Sun System scientific focus areas in conformance with national science objectives. Facilities involved in this undertaking include tracking and data-reception ground stations, related communications data handling systems, and data processing and archiving.

The Ground Networks (GN) project is comprised of two parts: (1) the Orbital network for space communications for both Earth science and space science, including the NASA tracking stations at KSC which provide Shuttle launch support communication; and navigation information and (2) the Wallops Research Range control and communications that supports the suborbital NASA Sounding Rocket, UAV, aircraft and Balloon programs.

Science information systems receive raw observational data from the Ground Network and, with the help of science investigators, convert these observations into useful scientific information. NASA's principal Earth science information system is called "EOSDIS," or Earth Observing System Data and Information System. EOSDIS is the largest "e-science" system in the world. EOSDIS currently acquires, processes, archives, and distributes Earth science data and information products from over four terabytes of new satellite data per day. Having successfully created this system, NASA is now working to evolve it for the future, leveraging the continuing advance of information technology while providing continuous service to the user community.



Alaska Ground Station Tracking Antennas acquire data from Earth Observing System (EOS) satellites

Plans For FY 2007

The Ground Networks space communications systems support 40,000 satellite contacts per year, retrieving 4.5 terabytes per day from domestic and international locations. Plans for FY2007 include replacing failing and improperly manufactured gears on commercial tracking antennas.

NASA is planning to add review of the Earth Science discipline data centers to the Senior Review process in FY 2007. The Senior Review currently evaluates flight missions that are in extended operations to establish priorities for continued funding.

NASA recognizes the necessity of modernizing its mission operations. The Agency has completed preliminary planning for new strategies to meet future requirements and is incrementally upgrading mission operations.

Theme: Earth-Sun System
Program: Earth-Sun System Multi-Mission Operations

Changes From FY 2006

- CloudSat/CALIPSO operations begin in 2006.
- Include Earth Science data centers in the Senior Review process.

Program Management

GSFC and JPL have program oversight responsibilities.

Technical Parameters

Earth-Sun System Multi-Mission Operations provides support for science-investigator-led processing systems utilized by hundreds of NASA-funded researchers. These systems process data into geophysical parameters, such as atmospheric temperature and pressure, sea-surface temperature, wind fields, and land -surface conditions.

The Alaska Synthetic Aperture Radar (SAR) Facility provides services in satellite data receipt, data processing, data cataloging, data archiving, and data distribution, especially for SAR data.

Ground Networks provide space communications for tracking, control and data acquisition from flight missions using 35 ground antenna systems at 10 locations to support 42 spacecraft in orbit and various suborbital vehicles.

Technical Specifications	FY 2007 President's Budget	Change from Baseline
EOSDIS and Multi-Mission Operations	Support ground ops of EOS missions; operate the 8 DAACs, which archive and distribute the data; support science processing; evolve systems to support changing science requirements	No change
Ground Networks	Safely support mission critical events at 100% proficiency and routine mission support at 99.1% proficiency; meeting agreed mission data delivery latency goals	No change

Implementation Schedule:

Project	Schedule by Fiscal Year							Purpose	Phase Dates													
	05	06	07	08	09	10	11		Beg	End												
EOSDIS and Multi-Mission Operations								Acquisition, process, archive, and distribution of Earth science data (on-going).	Tech Form Dev Ops Res	Oct-03 Sep-11												
Ground Network and Research Range								Operation and maintenance of space communications and tracking systems (on-going).	Tech Form Dev Ops Res	Oct-03 Sep-11												
Alaska SAR								Operation of Alaska SAR facility (on-going).	Tech Form Dev Ops Res	Oct-03 Sep-11												
<table> <tr> <td>■</td> <td>Tech & Adv Concepts (Tech)</td> </tr> <tr> <td>■</td> <td>Formulation(Form)</td> </tr> <tr> <td>■</td> <td>Development (Dev)</td> </tr> <tr> <td>■</td> <td>Operations (Ops)</td> </tr> <tr> <td>■</td> <td>Research (Res)</td> </tr> <tr> <td>■</td> <td>Represents a period of no activity for the Project</td> </tr> </table>											■	Tech & Adv Concepts (Tech)	■	Formulation(Form)	■	Development (Dev)	■	Operations (Ops)	■	Research (Res)	■	Represents a period of no activity for the Project
■	Tech & Adv Concepts (Tech)																					
■	Formulation(Form)																					
■	Development (Dev)																					
■	Operations (Ops)																					
■	Research (Res)																					
■	Represents a period of no activity for the Project																					

Theme:	Earth-Sun System
Program:	Earth-Sun System Multi-Mission Operations

Strategy For Major Planned Acquisitions

- The Senior Review process partly serves as a basis for Multi-Mission Operations acquisition priorities.
- Upgrades and enhancements to the GN are worked through the Space Communications Coordination and Integration Board and the SMD Steering Committee.
- Science information system support for new missions is developed in concert with missions development, reusing as appropriate existing system elements and infrastructure.

Key Participants

- International Space Agencies: Many, including Europe, Canada, Germany, France, and Japan. U.S. Agencies: NOAA, US Geological Survey, and Department of Defense. Aerospace Industry: Raytheon, Honeywell and Northrop Grumman. Universities from the U.S. and abroad.

Risk Management

- **RISK:** The aging and fragile infrastructure of the Ground Networks systems adds to mission data collection and communications risk. Changes in NASA's operating missions set over the next five years will require new strategies and planning to achieve necessary efficiencies and capabilities. **MITIGATION:** Achieve consensus for NASA's Space Communications architecture and an Integrated Near Earth Network phased to meet both Science and Exploration mission goals.

Theme: Earth-Sun System
Program: Earth-Sun Research

President's FY 2007 Budget Request (Dollars in Millions)

Earth-Sun Research (Development)	FY2005	FY2006	FY2007	FY2008	FY2009	FY2010	FY2011
FY 2007 PRES BUD	920.5	882.1	878.4	849.4	847.1	869.9	879.7
Changes from FY 2006 Request	101.8	37.0	62.7	37.6	48.3	67.4	

Overview

The Earth-Sun Research Program observations and research improve our capability for predicting climate, natural hazards and weather, including space weather. It focuses on developing and demonstrating space-based measurements to provide information about the Earth-Sun system not available by other means. Research results improve complex environmental and Earth system models of critical importance for environmental policy resource management decisions.

The Earth-Sun Research Program undertakes scientific investigations utilizing operational space-based and suborbital platforms (surface, balloon, aircraft, rocket). It also funds basic research and modeling utilizing the results of the full array of NASA's Earth missions. The program is planned and implemented with national and international collaboration and coordination. This research is a unique component of the U.S. Climate Change Science and Technology programs, the U.S. Weather Research program, the Earthscope program, and National Space Weather Program.



The Earth-Sun System Research implementation is organized in seven broad science focus areas, chosen to facilitate progress in breakthrough understanding of the inter-linked, complex system processes, enabling interdisciplinary research.

Plans For FY 2007

Earth-Sun System research is organized into seven interdisciplinary science focus areas. Research plans are a part of national plans and objectives for FY2007 as described in the Climate Change Science Program (CCSP) strategic plan (2002), and are reported by the program and the subcommittee on Global Change Research to Congress annually in the entitled "Our Changing Planet". The National Research Council's Decadal Research Strategy in Solar and Space Physics provides the scientific goals for the Heliophysics research element of this program. The Earth-Sun Research Program will fund over 4,000 U.S. scientific research tasks, responsive to programmatic goals/priorities, selected through peer review. Research will utilize the fully implemented Earth Observing System, the Heliospheric Great Observatory, and other NASA space/suborbital assets to target high-priority questions of the Earth-Sun system, continue algorithm development/improvement, conduct laboratory and field experiments to provide validation of the satellite-based observations, and distribute and archive Earth-Sun scientific data. Computing capabilities are also funded through the high-end computing program to support modeling efforts and further program prediction goals. The Science Mission Directorate will issue Research Opportunities in Space and Earth Science 06 (ROSES-06), a research announcement covering all of the planned research solicitations in Earth-Sun System Research for 2006. ROSES-06 describes the research goals in detail. The FY2007 budget will fund the proposed activities competitively selected.

Theme: Earth-Sun System
Program: Earth-Sun Research

Changes From FY 2006

- The ROSES-06 Omnibus NRA describes the new activity plans that will be initiated with FY 2007 program funds.
- Budget includes additional funding for supercomputer services.
- Fewer new R&A grants and research awards may be selected.

Program Management

NASA Headquarters has responsibility for the Earth-Sun Research program.

Technical Parameters

The Earth-Sun Research Program is responsible for NASA's activities that address the combined, interacting system of Earth and the Sun to characterize their properties on a broad range of spatial and temporal scales, to understand the naturally-occurring and human-induced processes that drive them. The content of the FY 2007 Earth-Sun System Research program is defined in ROSES-06. The program elements that are not included in ROSES-06 may be solicited in future years.

Technical Specifications	FY 2007 President's Budget	Change from Baseline
Operational Missions	Management and scientific peer reviews ensure that each mission provides data in a cost-effective manner.	No change
Research	Science focus area roadmaps describe plans for each area as well as the joint activities planned to address cross-cutting aspects of Earth-Sun science.	No change

Theme: Earth-Sun System
Program: Earth-Sun Research

Implementation Schedule:

Project	Schedule by Fiscal Year							Purpose	Phase Dates		
	05	06	07	08	09	10	11			Beg	End
Voyager								Extended mission (based on senior review)	Tech Form Dev Ops Res	Aug-77	Aug-11 Aug-12
Ulysses								Extended mission (based on senior review)	Tech Form Dev Ops Res	Oct-90	Oct-08 Oct-09
Geotail								Extended mission (based on senior review)	Tech Form Dev Ops Res	Jul-92	Jul-08 Jul-09
Wind								Extended mission (based on senior review)	Tech Form Dev Ops Res	Nov-94	Nov-11 Nov-12
Solar and Heliospheric Observatory (SOHO)								Extended mission (based on senior review)	Tech Form Dev Ops Res	Dec-95	Dec-11 Dec-12
Polar								Extended mission (based on senior review)	Tech Form Dev Ops Res	Feb-96	May-06 May-07
Fast Auroral Snapshot Explorer (FAST)								Extended mission (based on senior review)	Tech Form Dev Ops Res	Aug-96	Feb-08 Feb-09
Advanced Composition Explorer (ACE)								Extended mission (based on senior review)	Tech Form Dev Ops Res	Aug-97	Aug-11 Aug-12
Transition Region and Coronal Explorer (TRACE)								Extended mission (based on senior review)	Tech Form Dev Ops Res	Apr-98	Aug-11 Aug-12
IMAGE								Extended mission (based on senior review) Imager for Magnetopause-to-Aurora Global Exploration (IMAGE)	Tech Form Dev Ops Res	Mar-00	Mar-11 Mar-12
Cluster								Extended mission (based on senior review)	Tech Form Dev Ops Res	Jul-00	Jul-10 Jul-11
TIMED								Extended mission (based on senior review) Thermosphere, Ionosphere, Mesosphere Energetics and Dynamics (TIMED)	Tech Form Dev Ops Res	Dec-01	Dec-11 Dec-12



















Theme: Earth-Sun System
Program: Earth-Sun Research

Implementation Schedule:

Project	Schedule by Fiscal Year							Purpose	Phase Dates													
	05	06	07	08	09	10	11		Beg	End												
RHESSI								Extended mission (based on senior review) Reuven Ramaty High Energy Solar Spectroscope Imager (RHESSI)	Tech	Feb-02	Feb-11											
									Form													
									Dev													
									Ops													
									Res			Feb-02	Feb-12									
Terra								Extended mission (based on senior review)	Tech	Dec-99	Sep-09											
									Form													
									Dev													
									Ops													
									Res			Sep-11										
Aqua								Prime Mission	Tech	May-02	May-08											
									Form													
									Dev													
									Ops													
									Res			May-10										
Aura								Prime Mission	Tech	Jul-04	Jul-10											
									Form													
									Dev													
									Ops													
									Res			Jul-12										
Total Ozone Mapping Spectrometer (TOMS)								Extended mission (based on senior review)	Tech	Jul-96	Sep-08											
									Form													
									Dev													
									Ops													
									Res			Sep-10										
Tropical Rainfall Measuring Mission (TRMM)								Extended mission (based on senior review)	Tech	Nov-97	Nov-09											
									Form													
									Dev													
									Ops													
									Res			Nov-11										
ACRIMSat								Extended mission (based on senior review) Active Cavity Radiometer Irradiance Monitor Satellite (ACRIMSat)	Tech	Dec-99	Sep-09											
									Form													
									Dev													
									Ops													
									Res			Sep-11										
QuickScat								Extended mission (based on senior review)	Tech	Jun-99	Sep-09											
									Form													
									Dev													
									Ops													
									Res			Sep-11										
Earth Observing-1 (EO-1)								Extended mission	Tech	Nov-00	Nov-07											
									Form													
									Dev													
									Ops													
									Res			Nov-09										
SAGE III								Extended mission (based on senior review) Stratospheric Aerosol and Gas Experiment III (SAGE III)	Tech	Dec-01	Sep-09											
									Form													
									Dev													
									Ops													
									Res			Sep-11										
Jason								Extended mission (based on senior review)	Tech	Dec-01	Sep-09											
									Form													
									Dev													
									Ops													
									Res			Sep-11										
Ice, Clouds, and Land Elevation Satellite (ICESat)								Extended mission (based on senior review)	Tech	Jan-03	Sep-09											
									Form													
									Dev													
									Ops													
									Res			Sep-11										
<table border="0"> <tr> <td></td> <td>Tech & Adv Concepts (Tech)</td> </tr> <tr> <td></td> <td>Formulation (Form)</td> </tr> <tr> <td></td> <td>Development (Dev)</td> </tr> <tr> <td></td> <td>Operations (Ops)</td> </tr> <tr> <td></td> <td>Research (Res)</td> </tr> <tr> <td></td> <td>Represents a period of no activity for the Project</td> </tr> </table>												Tech & Adv Concepts (Tech)		Formulation (Form)		Development (Dev)		Operations (Ops)		Research (Res)		Represents a period of no activity for the Project
	Tech & Adv Concepts (Tech)																					
	Formulation (Form)																					
	Development (Dev)																					
	Operations (Ops)																					
	Research (Res)																					
	Represents a period of no activity for the Project																					

Theme: Earth-Sun System
Program: Earth-Sun Research

Implementation Schedule:

Project	Schedule by Fiscal Year							Purpose	Phase Dates													
	05	06	07	08	09	10	11		Beg	End												
Gravity Recovery and Climate Experiment (GRACE)								Extended mission (based on senior review)	Tech Form Dev Ops Res	Mar-02 Sep-09 Sep-11												
Solar Radiation and Climate Experiment (SORCE)								Extended mission (based on senior review)	Tech Form Dev Ops Res	Jan-03 Mar-08 Mar-10												
ROSES-06								To solicit basic and applied research in support of the Science Mission Directorate Research Opportunities in Space and Earth Sciences-06 (ROSES-06)	Tech Form Dev Ops Res	Jan-06 Jan-09												
<table border="0"> <tr> <td></td> <td>Tech & Adv Concepts (Tech)</td> </tr> <tr> <td></td> <td>Formulation (Form)</td> </tr> <tr> <td></td> <td>Development (Dev)</td> </tr> <tr> <td></td> <td>Operations (Ops)</td> </tr> <tr> <td></td> <td>Research (Res)</td> </tr> <tr> <td></td> <td>Represents a period of no activity for the Project</td> </tr> </table>												Tech & Adv Concepts (Tech)		Formulation (Form)		Development (Dev)		Operations (Ops)		Research (Res)		Represents a period of no activity for the Project
	Tech & Adv Concepts (Tech)																					
	Formulation (Form)																					
	Development (Dev)																					
	Operations (Ops)																					
	Research (Res)																					
	Represents a period of no activity for the Project																					

Strategy For Major Planned Acquisitions

- The Earth-Sun Research Program is based on full and open competition. Grants are peer reviewed and selected based on NRAs, and other related announcements.

Key Participants

- A broad research community across the nation, specifically universities, National Laboratories and federal agencies (e.g. National Oceanic and Atmospheric Administration (NOAA), National Science Foundation (NSF), Department of Defense (DoD), USGS, and other Federal and Foreign entities.

Risk Management

- RISK: No significant risk at this time. MITIGATION: N/A

President's FY 2007 Budget Request (Dollars in Millions)

Applied Sciences	FY2005	FY2006	FY2007	FY2008	FY2009	FY2010	FY2011
FY 2007 PRES BUD	82.2	94.8	51.0	50.3	48.6	48.7	48.8
Changes from FY 2006 Request	38.7	42.6	-0.4	-0.5	-0.3	-5.7	

Overview

The Applied Sciences program bridges the gap between scientific discoveries from space-based research and practical applications that benefit society. Through partnerships with operational organizations, the program strives to extend the benefits of NASA Earth system science to improve future operational systems. Outcomes from these partnerships have demonstrated the value of NASA's observations from research spacecraft and predictive capability from scientific models in areas such as improving forecasts of air quality conditions throughout the United States, assessing crop production estimates globally, and monitoring volcanic eruption activity to benefit aviation safety. The program also plays a vital role in transitioning mature research and development capabilities to long-term operations. Improved predictions and forecasts enabled by NASA science are systematically transitioned to serve national priority applications requiring environmental information on climate, weather, natural hazards, and sustainability. As we move forward, the NASA Applied Sciences program will continue to contribute to NASA's efforts in transitioning research to operations and in benchmarking the assimilation of NASA research results into policy and management decision-support tools that are vital for the Nation's safety, security, and pioneering enterprises. For more information, please see <http://science.hq.nasa.gov/earth-sun/applications/index.html>.



NASA researchers and our operational partners together strive to extend the benefits of NASA Earth science results to improve future operational systems that serve society.

Plans For FY 2007

Together with operational partners, the Applied Sciences Program will employ a systematic approach to turn NASA research and development results into decision-support tools for areas of national priority, including aviation, agriculture efficiency, public health, homeland security, ecological forecasting; air quality, carbon management, coastal management, disaster management, energy management, invasive species and water management. NASA emphasizes collaboration with NOAA and other Federal agencies to systematically transition Earth system science research results for operational utilization. NASA provides Earth system scientists with verification of the performance of commercial remote sensing data products for use in exploration, thereby optimizing the value to the government of private sector investments in space. In FY 2007, the DEVELOP activity will be optimized to develop human capital to meet future needs of the aerospace community. NASA will also conduct activities to institute the tenets of the Federal Enterprise Architecture and to implement the standards and protocols established by national and international data standards organizations to support improved accessibility to NASA research results.

Changes From FY 2006

- There are no major programmatic changes from FY 2006 to FY 2007.

Theme: Earth-Sun System
Program: Applied Sciences

Program Management



















Applied Sciences program responsibility is at NASA Headquarters, Earth Science Division of the Science Mission Directorate.

Technical Parameters

The Applied Sciences Program is focused on working with Federal agencies and national organizations to optimize the use of technology and data associated with NASA's constellation of Earth system observing spacecraft. These spacecraft, which routinely make measurements using dozens of research instruments, are used by a community of Earth system scientists in laboratories, universities, and research institutions throughout the country, and around the world, to model the Earth system and improve predictions, projections, and forecasts.

Technical Specifications	FY 2007 President's Budget	Change from Baseline
National Applications Program	Conduct R&D activities with partnering organizations to validate the use of NASA research capabilities (e.g., observations and/or forecast products) in improving operational decision support systems.	None
Crosscutting Solutions Program	Conduct systems integration, engineering, and prototyping activities supporting research and operations transitions to improve future operational systems and the National Applications Program.	None

Implementation Schedule:

Project	Schedule by Fiscal Year							Purpose	Phase Dates													
	05	06	07	08	09	10	11		Beg	End												
National Applications Program								In FY07, complete 12 reports with partnering organizations that validate using NASA research observations and forecast products could improve their operational decision support systems	Tech Form Dev Ops Res	Oct-04 Oct-11												
Crosscutting Solutions Program								In FY07, complete 5 studies on plans to transition the results of NASA R&D (spacecraft, instruments, models, etc.) with potential to improve future operational systems of partner agencies.	Tech Form Dev Ops Res	Oct-04 Oct-11												
<table> <tr> <td></td> <td>Tech & Adv Concepts (Tech)</td> </tr> <tr> <td></td> <td>Formulation(Form)</td> </tr> <tr> <td></td> <td>Development (Dev)</td> </tr> <tr> <td></td> <td>Operations (Ops)</td> </tr> <tr> <td></td> <td>Research (Res)</td> </tr> <tr> <td></td> <td>Represents a period of no activity for the Project</td> </tr> </table>												Tech & Adv Concepts (Tech)		Formulation(Form)		Development (Dev)		Operations (Ops)		Research (Res)		Represents a period of no activity for the Project
	Tech & Adv Concepts (Tech)																					
	Formulation(Form)																					
	Development (Dev)																					
	Operations (Ops)																					
	Research (Res)																					
	Represents a period of no activity for the Project																					

Strategy For Major Planned Acquisitions

- N/A

Theme: Earth-Sun System

Program: Applied Sciences

Key Participants

- Committee on Environment and Natural Resources, Committee on Climate Change Science and Technology Integration, U.S. Group on Earth Observations and bilateral agreements with Federal agencies and national organizations.
- NOAA and other Federal agencies: Systematically transition Earth system science research results for operational utilization.

Risk Management

- RISK: No significant risk at this time. MITIGATION: N/A

President's FY 2007 Budget Request (Dollars in Millions)

<u>Education and Outreach</u>	<u>FY2005</u>	<u>FY2006</u>	<u>FY2007</u>	<u>FY2008</u>	<u>FY2009</u>	<u>FY2010</u>	<u>FY2011</u>
FY 2007 PRES BUD	23.6	22.7	23.3	23.7	25.3	27.5	27.5
Changes from FY 2006 Request	0.7	-0.6	-0.2	-0.2	-0.1	-0.1	

Overview

The Earth-Sun System Education and Outreach program uses NASA's results from studying the Earth system and the Sun to enhance the teaching and learning of Earth, space, and environmental sciences through partnerships with educational institutions and organizations. In coordination with the NASA Office of Education, the program makes the discoveries and knowledge generated from Earth-Sun system studies accessible to students, teachers, and the public by enabling dynamic and engaging learning environments.

In addition to developing curriculum and exhibit support materials, the program places particular emphasis on teacher preparation and professional development for educators in both formal and informal education.

The program communicates through public events why and how NASA develops new space-based capabilities for the purpose of understanding and protecting Earth. The NASA Earth Observatory is also an exemplary resource, featuring stories, imagery, and data for the public and professionals who are not necessarily experts in Earth and environmental science.

The program also ensures the continued training of interdisciplinary scientists to support the study of the Earth-Sun system through graduate fellowships and early career awards.

For more information, please see
<http://science.hq.nasa.gov/strategy/index.html>,
<http://earthobservatory.nasa.gov/>.



Visitors in line to view the fulldome digital planetarium production of "Earth's Wild Ride," by Home Run Pictures, produced by Houston Museum of Natural Science and Rice University.

Theme:	Earth-Sun System
Program:	Education and Outreach

Plans For FY 2007

Support projects competitively selected in FY 2005 that will increase K-12 educator support for teaching Earth science and geography, strengthen undergraduate institutional capacity in Earth system science and applications (with particular emphasis on 2 and 4-year colleges and minority-serving institutions), and enhance public scientific literacy about the Earth system and the environment.

Continue the GLOBE program worldwide implementation and U.S. coordination of educational partnerships, in collaboration with the National Science Foundation.

Support continued development of a competent technical workforce, including approximately 150 graduate fellowships pursuing masters and/or Ph.D. degrees and 30 early-career awards for Ph.D. scientists and engineers in Earth-Sun system studies through the New Investigator effort.

Provide in public venues at least 50 stories on the scientific discoveries, practical benefits, or new technologies sponsored by the Earth-Sun System Division, and present at least five exhibits with a total of at least 50,000 attendees. Continue to publish exciting NASA Earth science imagery and provide explanations of the phenomena through the Earth Observatory and other NASA Web sites.

Changes From FY 2006

- There are no major programmatic changes from FY 2006 to FY 2007.

Program Management

The HQ program office in the Earth-Sun System Division, Science Mission Directorate, is responsible for the Earth-Sun Education and Outreach program.



















Technical Parameters

The baseline for this technical commitment is the FY 2005 budget. A systems-based implementation plan will baseline this commitment.

Technical Specifications	FY 2007 President's Budget	Change from Baseline
Investigator	Continue research and educational support for current projects and Earth and Sun scientists and/or engineers, and solicit new applications.	None
GLOBE	Continue worldwide implementation and U.S. Coordination, in partnership with the National Science Foundation.	None
K-16/Informal Education	Integrate and coordinate educational projects selected under the REASoN solicitation and the Earth Explorers solicitation.	None
Earth Sun System Science Fellowship	Support graduate students in pursuit of Masters or Ph.D. degrees in Earth Sun System Science applications.	None

Theme: Earth-Sun System
Program: Education and Outreach

Implementation Schedule:

Project	Schedule by Fiscal Year							Purpose	Phase Dates													
	05	06	07	08	09	10	11		Beg	End												
Investigator Program								Proposals due Aug. 2005, Selections Jan. 2006. (Solicitation every 2 years, ongoing.)	Tech Form Dev Ops Res													
GLOBE Program								Review of Cooperative Agreement 2008. (Ongoing)	Tech Form Dev Ops Res													
K-16/Informal Education Program								Proposals received Sept. 28, 2004. Selections made Mar. 17, 2005. (Solicitation every 18 months - next one approximately June 2006, next selections in FY 2007.) (Ongoing.)	Tech Form Dev Ops Res													
ESS Science Fellowship Program								Solicited annually. Proposals due Feb. 1. Selections by May 16. (On going)	Tech Form Dev Ops Res													
<table border="0"> <tr> <td></td> <td>Tech & Adv Concepts (Tech)</td> </tr> <tr> <td></td> <td>Formulation (Form)</td> </tr> <tr> <td></td> <td>Development (Dev)</td> </tr> <tr> <td></td> <td>Operations (Ops)</td> </tr> <tr> <td></td> <td>Research (Res)</td> </tr> <tr> <td></td> <td>Represents a period of no activity for the Project</td> </tr> </table>												Tech & Adv Concepts (Tech)		Formulation (Form)		Development (Dev)		Operations (Ops)		Research (Res)		Represents a period of no activity for the Project
	Tech & Adv Concepts (Tech)																					
	Formulation (Form)																					
	Development (Dev)																					
	Operations (Ops)																					
	Research (Res)																					
	Represents a period of no activity for the Project																					

Strategy For Major Planned Acquisitions

- The acquisition strategy is primarily peer review, competitive sourcing, and/or Space Act agreements. Non-NASA performer acquisitions are primarily grants or cooperative agreements.

Key Participants

- Performing organizations include academic and/or educational institutions (e.g., colleges, universities, museums, science centers, etc.), research and/or non-profit organizations, and state and local governments, (e.g., Boston Museum of Science, Houston Museum of Natural Science).

Risk Management

- RISK: No significant risk at this time. MITIGATION: N/A

President's FY 2007 Budget Request (Dollars in Millions)

Earth-Sun Technology	FY2005	FY2006	FY2007	FY2008	FY2009	FY2010	FY2011
FY 2007 PRES BUD	151.8	127.4	146.4	152.6	137.8	141.6	145.7
Changes from FY 2006 Request	30.0	0.0	-0.2	0.8	2.2	2.4	

Overview

NASA is dedicated to understanding the total Earth-Sun system and the effects of natural and human-induced changes on the global environment. Advanced technology plays a major role in enabling the Earth-Sun research and applications programs of the future. The Earth-Sun Technology Program (ESTP) enables Earth-Sun science and application programs by providing new capabilities, enabling previously unforeseen or infeasible science investigations, enhancing existing measurement capabilities, and reducing the cost, risk, and development times of Earth science measurements.

The Earth-Sun System Technology Office (ESTO) provides strategic, science-driven technology assessments and requirements development. The New Millennium Program (NMP) develops and validates in-space technologies to enable and expand the capability of future science missions. Both efforts pursue promising scientific and engineering concepts through open competitive solicitations.

For more information, please see: <http://esto.nasa.gov> and <http://nmp.jpl.nasa.gov>.

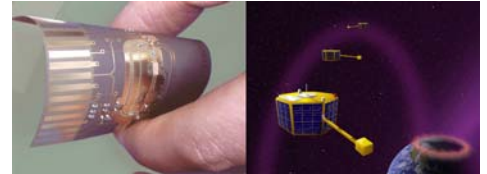

LEFT: A transmit/receive module packaged directly on a flexible, thin-film membrane. This component technology may soon enable very large, space-deployable, high-orbit antennas for many types of observations.
 RIGHT: An artist's conception of the Space Technology 5 (ST5) satellites. When launched, these three birthday cake-sized micro-satellites may aid in our understanding of Earth's magnetic fields.

Theme:	Earth-Sun System
Program:	Earth-Sun Technology

Plans For FY 2007

The ESTP will plan and implement development of new remote sensing and information systems technologies for infusion into future science missions that will enable, or dramatically enhance, measurements and data system capabilities.

Planning starts with measurement priorities established by the science community that lead to systematically developed technology requirements and priorities that are captured in a Web-accessible database. Studies are conducted to transform measurement options into technology performance requirements.

Implementation is performed through solicitations in four elements. The Instrument Incubator element develops new and innovative instruments and measurement techniques at the system level including laboratory development and airborne validation. Advanced Information Systems Technology develops end-to-end information technologies that enable new Earth observation measurements and information products. Advanced Technology Initiatives implements a broad array of technology developments for state-of-the-art components for instruments and Earth- and space-based platforms. NMP will test and validate in space critical technologies for future small satellites, will integrate and test technologies designed to enable major advances in gravitational astronomy, will complete the Formulation phase technology development of four technologies critical to future Earth and space science missions, and will complete the Concept Definition phase of a set of five system technologies that will compete for flight validation. In addition, NMP will prepare the next competitive solicitation for in-space technology validation.

Changes From FY 2006

- The basic program content has not changed from the FY 2006 budget submission.
- The change in the FY 2005 funding reflects operating plan changes from May 2005 addressing UAVSAR and laser risk reduction, as well as Congressionally directed expenditures.

Program Management

The ESTO program office is located at GSFC. The NMP program office is located at JPL. NASA HQ has oversight responsibility of both program offices.

Theme: Earth-Sun System
Program: Earth-Sun Technology

Technical Parameters

Advanced technologies enable space-based measurements that look at how the Earth system works. NMP is the primary path to develop/validate technologies in space for use in future science missions. This includes subsystem level technologies (e.g., the spacecraft, instrument subsystems), and system-level technologies (e.g., technologies that are composed of multiple technologies that must operate together). Technologies are often developed/validated at a scale less than the full mission, but are scalable to the full mission.

Technical Specifications	FY 2007 President's Budget	Change from Baseline
ESS Technology Program Task: advancement	Annually advance 25% of funded technology developments by one TRL.	None
ESS Technology Program Task: maturation	Mature 2-3 technologies to the point where they can be demonstrated in space or in an operational environment.	None
ESS Technology Program Task: infusion	Enable one new science measurement capability or significantly improve performance of an existing one.	None
New Millennium Program	In each New Millennium space flight mission, validate in space either a system technology, or several subsystem technologies.	None

Implementation Schedule:

Project	Schedule by Fiscal Year							Purpose	Phase Dates						
	05	06	07	08	09	10	11		Tech	Form	Dev	Ops	Res	Beg	End
Instrument Incubator NRA	[Gantt chart: Tech & Adv Concepts (Tech) from 05 to 08]							NASA Research Announcement (NRA) to develop remote sensing instruments to a level that mission developers would consider using the instruments for their missions	Tech	Form	Dev	Ops	Res	Jan-05	Mar-08
Advanced Info Systems Technology NRA	[Gantt chart: Research (Res) from 05 to 06, Tech & Adv Concepts (Tech) from 06 to 09]							NRA to develop information systems technologies for NASA-unique spacecraft and terrestrial uses	Tech	Form	Dev	Ops	Res	Mar-06	Mar-09
Advanced Technology Initiatives NRA	[Gantt chart: Research (Res) from 05 to 06, Tech & Adv Concepts (Tech) from 06 to 09]							NRA to develop component and subsystem technologies	Tech	Form	Dev	Ops	Res	Jul-05	Sep-08
Space Technology 5 (ST-5)	[Gantt chart: Development (Dev) from 05 to 06, Operations (Ops) from 06 to 07]							Integrated system technology space flight validation of a constellation of multiple very small (nanosat) spacecrafts.	Tech	Form	Dev	Ops	Res	Aug-99	Jun-01
Space Technology 6 (ST-6 ISC)	[Gantt chart: Development (Dev) from 05 to 06, Operations (Ops) from 06 to 07]							Inertial Stellar Compass (ISC): validation in space of advanced technology combined star tracker and gyro.	Tech	Form	Dev	Ops	Res	Nov-00	Aug-02
Space Technology 6 (ST-6 ASE)	[Gantt chart: Operations (Ops) from 06 to 07]							Autonomous Software Experiment (ASE): validation in space of autonomous science data processing on spacecraft. Operates on NMP EO-1; to be operated on Mars rovers.	Tech	Form	Dev	Ops	Res	Nov-00	Aug-02
Space Technology 7 (ST-7)	[Gantt chart: Development (Dev) from 05 to 10, Operations (Ops) from 10 to 11]							System technology space flight validation of gravitational disturbance reduction system and precision flying.	Tech	Form	Dev	Ops	Res	Jan-01	Jul-03
Space Technology 8 (ST-8)	[Gantt chart: Formulation (Form) from 05 to 06, Development (Dev) from 06 to 09, Operations (Ops) from 09 to 10]							Subsystem technology validation in space of 4 advanced spacecraft technologies. Currently in Formulation stage. Development and Operation dates are planning dates only.	Tech	Form	Dev	Ops	Res	Nov-03	Sep-06
Space Technology 9 (ST-9)	[Gantt chart: Research (Res) from 05 to 06, Formulation (Form) from 06 to 08, Development (Dev) from 08 to 10, Operations (Ops) from 10 to 11]							System technology validation in space of a competitively selected system technology. Currently in Formulation stage. Development and Operation dates are planning dates only.	Tech	Form	Dev	Ops	Res	Aug-05	Dec-07
GIFTS	[Gantt chart: Development (Dev) from 05 to 06]							Completion of Engineering Development Unit (EDU). Geosynchronous Imaging Fourier Transform Spectrometer (GIFTS)	Tech	Form	Dev	Ops	Res	Oct-04	Sep-06

■ Tech & Adv Concepts (Tech)
■ Formulation (Form)
■ Development (Dev)
■ Operations (Ops)
■ Research (Res)
■ Represents a period of no activity for the Project

Strategy For Major Planned Acquisitions

- Tasks are procured primarily through full and open competition.
- Tasks are procured for the following: Instrument Incubator, Advanced Information Systems Technology, Advanced Technology Initiatives, Technology validation concepts, New Millennium Program.

Theme:	Earth-Sun System
Program:	Earth-Sun Technology

Key Participants

- NRA task awardees include industry, academia, non-profit, other government agencies, and NASA intramural.
- Other technology programs are leveraged through partnerships with Small Business Innovative Research, the Exploration Systems Research and Technology program, NASA Institute of Advanced Concepts, and other Federal agencies.

Risk Management

- **RISK:** Selected technologies may fail to mature, or might not be utilized in a future NASA mission/application. Likelihood: possible. Selecting only those technologies that are certain to mature and be infused precludes the pursuit of promising and needed technologies that are innovative but risky. **MITIGATION:** ESS will pursue a portfolio of technologies that balance innovation and risk with requirements that are clearly traceable to the strategic objectives of the Earth-Sun System theme.



Themes

Constellation Systems

Exploration Systems Research and Technology

Human Systems Research and Technology

An artist's conception of the Constellation Systems. Far left: The Heavy Lift Launch Vehicle (HLLV) to launch Lunar bound systems, Top : CEV atop the CLV, Bottom: Earth Departure Stage launched on HLLV.

EXPLORATION SYSTEMS

Purpose

The Nation is setting forth on a journey that will mark the beginning of sustained human exploration of the solar system. The President and the Congress have committed the Nation to a journey of exploring the solar system and beyond: returning to the Moon in the next decade, then venturing further into the solar system, ultimately sending humans to Mars and beyond. The role of the Exploration Systems Mission Directorate (ESMD) is to develop new capabilities and supporting technologies that will enable sustained and affordable human and robotic exploration of the Moon, Mars, and beyond. The Vision is a long-term strategy for increasing humankind's knowledge of, and presence in, the solar system and worlds beyond. Instead of setting a single, fixed goal and relying on large budget increases, the Vision provides a series of goals with the schedule flexibility necessary to sustain an affordable long-term program of space exploration.

Over the next century, The Vision for Space Exploration will set in motion activities to inspire new generations to pursue math and science. New industries and technologies will emerge that will benefit all humankind. Technologies developed for, and discoveries yielded from exploration will underpin and advance the U.S. economy, help ensure national security, and inspire future generations.

The ESMD currently consists of three Themes that will function cooperatively to enable exploration and scientific discovery. Those Themes are Constellation Systems, Exploration Systems Research and Technology, and Human Systems Research and Technology. The Theme formerly known as

Mission Directorate: Exploration Systems

Prometheus Nuclear Systems and Technology will become a program under Exploration Systems Research and Technology starting in Fiscal Year 2007.

FY 2005 Accomplishments

- Conducted Exploration Systems Architecture Study (ESAS) to establish a focused effort for development and research programs that are fiscally and technically responsive to the Vision for Space Exploration. Budgets across all Themes have been aligned to meet this new paradigm.
- Contracted with two industry teams to compete phase 1 engineering studies for the Crew Exploration Vehicle.
- Issued engineering study contracts to two Shuttle contractors to study evolution of the Shuttle design for the Crew Launch Vehicle.
- Conducted first two prize competitions in Centennial Challenges Program to demonstrate technologies applicable to space elevators.
- Restructured the technology programs to align content with the new technology priorities for lunar exploration identified by the Exploration Systems Architecture Study.
- Conducted a zero-base review of all projects within the Human Systems Research and Technology Theme to align efforts with the ESAS.
- Human Research Facility (HRF-2) flown to ISS (will enhance human research aboard ISS). Expands HRF Rack 1 capabilities with key tools used to answer questions that reduce risk to space crews.
- Baselined the Bioastronautics Roadmaps. NASA's Bioastronautics Roadmap (BR) is "the framework used to identify and assess the risks of crew exposure to hazardous environments of space."
- Competitively selected the instruments and completed the Systems Requirements Review for the Lunar Reconnaissance Orbiter mission.
- Fluids and Combustion Facility pre-ship review completed at Glenn Research Facility. This is a critical step in the space flight development process.

Theme Distribution

Budget Authority (\$ in millions)	FY 2005	FY 2006	FY 2007	FY 2008	FY 2009	FY 2010	FY 2011
Constellation Systems	422.3	1,733.5	3,057.6	3,067.6	3,612.9	4,083.8	7,698.4
Explorations Systems Research and Technology	898.9	692.5	646.1	632.2	605.1	679.2	764.6
Human Systems Research and Technology	888.1	624.1	274.6	281.8	281.8	292.8	312.1
Total	2,209.3	3,050.1	3,978.3	3,981.6	4,499.8	5,055.9	8,775.1

Note: For all formats, the FY 2005 column reflects the FY 2005 Congressional Operating Plan, dated 9/30/2005. The FY 2006 column reflects the FY 2006 Congressional Initial Operating Plan, dated Jan 2006. The FY 2007 – 2011 columns represents the FY 2007 President's Budget Submit.

This budget affirms NASA's commitment to assuring the Nation's continued human access to space. It also reflects the difficult decisions that are required when balancing between continued leadership in human spaceflight, preserving NASA's many National assets, and maintaining a balanced Agency-wide portfolio. The changes to ESMD in this budget reflect the recommendations from the 2005 Exploration Systems Architecture Study, and continues modifications to some programs and projects outlined in the FY 2005 and FY 2006 Operating Plans. Specifically, the President's Budget focuses the ESMD technology development portfolio to support the needs of the Constellation Systems development projects, which receive an increased amount of funds compared to the President's FY 2006 Budget and the Agency's 2006 Appropriation.

Mission Directorate: Exploration Systems

In reducing the funding required for the ESMD technology Themes, funding is made available to potentially accelerate the development of the Crew Exploration and Crew Launch Vehicles. Based on studies completed so far on the Exploration program, NASA believes that the cost for all mission requirements between now and FY 2011, the current budget horizon, is reasonable and accurate. This includes the cost associated with accomplishing the necessary Exploration research and technology, design and development of the CEV and CLV, supporting Launch and Mission control systems and infrastructure, as well as requirements verification testing that will be accomplished prior to the first human flights. NASA is confident this budget provides sufficient funds to support the operational availability of these systems by no later than 2014. However, it is NASA's goal to have these critical vehicles available to the Nation as soon as possible after the Space Shuttle completes its mission to assemble the International Space Station in 2010. This budget also supports industry initiatives to supply commercial services to low Earth orbit.

Throughout FY 2006 NASA will be conducting further systems specific reviews and more fully engaging its field centers and contractors. As the level of architectural design detail deepens, cost estimates will be continually improved and NASA will be in a position to make final decisions on still-to-be-determined technical details. This may lead to refinements to the architecture recommended by ESAS, its attendant technology needs, and should lead to a more certain projection of the availability of critical systems that will enable the exploration of the solar system.

Over the next several years, the Constellation Systems Program and the Space Shuttle Program will work closely together to define an intelligent and efficient transition of hardware, software, people, and know-how. The opportunity exists to find real savings in time and in money in the development of new systems, given their heritage with the Space Shuttle. This will be the critical factor in the successful transition from the Space Shuttle to the CEV and CLV. The eventual close-out of the Shuttle Program and its replacement by the CEV and CLV is a once in a generation change, and NASA is committed to getting it right.

The Exploration Systems Research and Technology and Human Systems Research and Technology Themes have been focused to prioritize the work done in support of the Vision for Space Exploration. Significant reductions were a result of the conclusions from ESAS. Consolidation of programs and elimination of work that can be delayed or terminated, like the significant reductions to Prometheus nuclear research, has produced the needed resources for accelerating the Constellation projects within the fiscal constraints given to NASA. During FY 2006 the research and technology programs will continue to be refined and focused to provide what is needed, when it is needed, and to advance the realization of returning to the Moon and sending humans to Mars.

The changes to the research and technology portfolio is emblematic of the many difficult choices facing the Agency in this budget, and has both short term and long term impacts on NASA and its industry partners. In the next few years NASA may face successive changes to its workforce and facilities needs, but NASA always will consider the health of its Centers as it responds to these changes. In particular, exploration work will be performed across all NASA Centers and NASA's greatest national asset, its workforce, will be given the opportunity to adjust to these conditions. The ESAS recommendations include the use and modification of many facilities which are national assets, and detailed plans for these changes are a part of this budget with the introduction of the Launch and Mission Systems and the Exploration Communications and Navigation Projects within the Constellation Systems Theme and Program.

Constellation Systems Theme/Program

Through the Constellation Systems Theme/Program NASA will develop, demonstrate, and deploy the collection of systems that will enable sustained human exploration. These include the Crew Exploration Vehicle (CEV) for the transport and support of human crews traveling to destinations

Mission Directorate: Exploration Systems

beyond low Earth orbit: launch vehicles for transport of the CEV and cargo to low Earth orbit; and ground or in-space support infrastructure for communications and operations.

The Earth Orbit, Lunar Landing, Extended Lunar Stay, and Mars Landing Capability Programs have been replaced by one program called The Constellation Systems Program. It was established to develop capabilities based on the 2005 Exploration Systems Architecture Study. This is a fundamental change from a capability-based spiral development to a requirements-driven development.

Central to this Theme and Program are the systems engineering efforts to refine the requirements set forward by the Exploration Systems Architecture Study (ESAS). The Systems Engineering and Integration (SE&I) team are the glue that binds this complex architecture development over the extended period of time for this endeavor. Over the next year this team will put in place the level one and two requirements, establish the design environment (tools), develop standards, and establish interface control methods and documentation for the myriad constellation and research and technology projects.

Overall Budget

The FY 2007 request is \$3,057.6 million; a \$1,324.0 million (or 76 percent) increase from the FY 2006 budget request. Major features of this budget include:

- Funding to support the development activities for Crew Exploration Vehicle (CEV) and Crew Launch Vehicle (CLV) Projects that accelerate launch dates to support access to the ISS no later than 2014 but as close to 2010 as possible and a lunar surface expedition as early as 2018 but no later than 2020.
- Funding for the development of a Commercial Crew/Cargo Project capable of transporting humans and cargo to the ISS. The orbital cargo and human transportation demonstrations are scheduled for 2008 and 2010 respectively.
- Funding for the Launch and Mission Systems Project activities to provide support to the CEV and CLV launch and operations.
- Funding for the Exploration Communications and Navigation (ECANS) Project for development of the communications infrastructure supporting near-Earth and trans-lunar operations.
- Funding for the Program level Systems Engineering and Integration efforts to establish rigor and control for development and integration of constellation and research and technology Themes, Programs and Projects.

CREW EXPLORATION VEHICLE (CEV) PROJECT

The CEV will provide safe, affordable transportation for humans to the Moon, Mars, and beyond and return them safely to Earth. In its initial phase, the CEV also will be capable of delivering crew and cargo to the ISS. The CEV will consist of a pressurized Crew Module carrying three to six astronauts (depending on the particular mission) and a Service Module providing propulsion, power, and other support. The CEV design will be an Apollo-like capsule, as defined by the results of the ESAS. The CEV is derived from its Apollo-era counterpart, providing transportation for up to six astronauts to the ISS, and supporting the transport of four astronauts to the lunar surface. The CEV will interface with the CLV for access to low Earth orbit, and then with the Earth Departure Stage and Lunar Surface Access Module for transport to the Moon. The first human flight of the CEV to the ISS is targeted for no later than 2014, but NASA will strive to bring that date as close to 2010 as possible as it achieves efficiencies and synergies between the Constellation Systems and Space Shuttle Programs. An initial flight to the Moon is targeted for 2018 but no later than 2020.

CREW LAUNCH VEHICLE (CLV) PROJECT

The Crew Launch Vehicle (CLV) Project's mission is to deliver a safe, reliable launch system that expands America's scientific reach through space exploration. The CLV Project is dedicated to enabling the Nation's space transportation need for assured access to low Earth orbit and for eventual trips to the Moon and Mars. It is a cornerstone of NASA's future human space flight

Mission Directorate: Exploration Systems

activities and an integral part of the Vision for Space Exploration. Current plan for the CLV is to launch the CEV into orbit no later than 2014, but as close to 2010 as possible.

LAUNCH AND MISSION SYSTEMS PROJECT

The Launch and Mission Systems (L&MS) Project will develop and operate more affordable and efficient mission control and launch site infrastructure than in the past. L&MS includes the facilities, ground equipment, control systems and networks needed to develop, plan and execute the Design, Development, Test & Evaluation (DDT&E) operational flights of the CEV, CLV (crewed and uncrewed) and HLLV during processing, launch, mission operations and landing/recovery. This includes ground systems generally located at the Kennedy and Johnson Space Centers with several landing sites located within the continental United States and emergency landing sites overseas. L&MS is divided into the Ground Operations Project and the Mission Systems Project to better focus team efforts and take advantage of previous experience and personnel.

EXPLORATION COMMUNICATIONS AND NAVIGATION SYSTEMS PROJECT

The Exploration Communication and Navigation Systems (ECANS) Project will develop the end-to-end, interoperable communications and navigation infrastructure that provide the Constellation elements the connectivity required to execute the Vision for Space Exploration. These capabilities will provide the communications links between mission control and the in-space elements. ECANS will also provide tracking capabilities for space vehicle navigation. The ECANS project is being managed by ESMD as it completes its formulation, with project responsibilities transferring to a NASA Center in late fiscal year 2006.

ISS CARGO AND CREW SERVICES

The ISS Cargo and Crew Services project ensures that NASA can support its needs and commitments for transporting cargo and crew to and from the ISS. This budget is required because the limited remaining Space Shuttle flights are dedicated to ISS assembly, and the project provides an important alternative means of supporting ISS logistical needs. This project consists of two elements, international partner purchases and support for commercial cargo and crew development. In the near-term, International Partner purchases are required because no U.S. alternatives exist to the Space Shuttle. In the long-term, NASA would prefer to use U.S. commercial space transportation providers, both to ensure domestic sources and to expend taxpayer dollars domestically. The Commercial Crew/Cargo project is designed to enable future procurement of commercial orbital transportation services to re-supply the International Space Station.

Exploration Systems and Research Technology

The Exploration Systems Research and Technology (ESRT) Theme represents NASA's commitment to investing in the technologies and capabilities that will make the national vision for space exploration possible. The theme is focused on maturing key technologies to enable safe, affordable, effective and sustainable human and robotic exploration missions. ESMD is the ESRT primary customer, supporting the CEV, the CLV, the Robotic Lunar Exploration Program, and the lunar sortie missions. The advanced system concepts, technologies and engineering tools developed by ESRT are unique to NASA needs and applicable across many classes of missions. Technologies are advanced to a level where they can be considered viable for use in projects or technology flight demonstrations. The Program also develops transition plans to ensure a smooth handoff of the technology area to ESMD flight projects. Within the theme there are four programs: Exploration Technology Development, Centennial Challenges, Robotic Lunar Exploration, and Prometheus Power and Propulsion. The Exploration Technology Development Program combines the former Advanced Space Technology and Technology Maturation Programs to lead the Agency's exploratory research and development effort for new, high-leverage technologies and concepts. In addition this program develops near-term technologies for human-robotic exploration and assures

Mission Directorate: Exploration Systems

their timely transition into the development programs of the Constellation Systems Theme. The Centennial Challenges Program establishes purse awards to stimulate innovative technical accomplishments that could advance the state of civil space exploration and aeronautics. The Robotic Lunar Exploration Program develops precursor missions to characterize the lunar environment. The Prometheus Power and Propulsion program develops nuclear technologies for power and propulsion.

Overall Budget

The FY 2007 request is \$646.1 million; a \$46.4 million (or 7 percent) decrease from the FY 2006 budget request. Major features of this budget include:

- Funding for these programs changed based on the results of the ESAS, which realigned programs to focus on existing programs and cancelled or deferred programs and projects that were not required in the near term.
- Funding for the technology projects in twelve focus areas to be managed and directed at NASA Centers, with partnerships in industry and academia. The development of key components for a thermal protection system for CEV is an example of activities planned.
- Funding for the Robotic Lunar Exploration Program to complete the Critical Design Review for the Lunar Reconnaissance Orbiter mission.

EXPLORATION TECHNOLOGY DEVELOPMENT

As a result of the technology program review conducted by the Exploration System Architecture Study (ESAS), twelve technology maturation areas were identified as high priority for the exploration lunar architecture. Existing and new projects have been categorized, combined (when appropriate), and placed in these 12 technology areas. The technology areas are: Operations, Structures, Thermal Protection, Propulsion, Power, Thermal Control, Avionics and Software, Environmental Control and Life Support, Crew Support and Accommodations, Mechanisms, In-Situ Resource Utilization, and Analysis and Integration Tools. As part of the changes brought about as a result of ESAS, the Advanced Space Technology and Technology Maturation programs have been combined into one Exploration Technology Development program. The Exploration Technology Development Program request includes funding to continue developing new technologies that will enable NASA to conduct new human and robotic exploration missions, gather new types of scientific data, and reduce mission risk and cost. It will develop and validate the most promising advanced space technology concepts and mature them to the level of demonstration and space flight validation, with the goal of enabling safe, affordable, effective and sustainable human-robotic exploration. This will be done by developing and demonstrating the function of low-temperature electronics and mechanisms to enable sustained operation at the lunar surface. Examples include the development of a non-toxic auxiliary power system for CLV and ablative thermal protection materials for the CEV heat shield.

CENTENNIAL CHALLENGES

The request includes funding to continue the evolution of the Centennial Challenges Program. The Centennial Challenges Program conducts prize competitions for revolutionary, breakthrough accomplishments that advance solar system exploration and other NASA priorities. Some of NASA's most difficult technical challenges may require novel solutions from non-traditional sources of innovation. By making awards based on actual achievements instead of proposals, NASA hopes to tap innovators in academia, industry, and the public that do not normally work on NASA issues.

ROBOTIC LUNAR EXPLORATION

The Robotic Lunar Exploration Program (RLEP) will embark on a series of robotic missions to the moon in support of future exploration activities. These early steps will enable sustained human and robotic exploration of Mars and more distant destinations in the solar system. The request includes funding to support the Lunar Reconnaissance Orbiter mission whose overall objective is to obtain data that will facilitate returning humans safely to the Moon. Projects beyond LRO, like a potential

Mission Directorate: Exploration Systems

lunar lander, will support evolving lunar mission requirements in accordance with the Vision for Space Exploration. Planned international missions and collaborative ventures also will be a vital source of information. Management of the RLEP was moved from the Science Mission Directorate starting in fiscal year 2006.

PROMETHEUS POWER AND PROPULSION

This year significant restructuring of the Agency's priorities have resulted in Prometheus Nuclear Systems and Technology (PNST) becoming a program under ESRT starting in Fiscal Year 2007 titled Prometheus Power and Propulsion. Several activities are being terminated in order to support CEV and other near-term technology development priorities. The request includes funding necessary to close-out former PNST activities and initiate a modest nuclear systems and technology research program focused on meeting future high power and propulsion needs for exploration.

Human Systems Research and Technology

The Human Systems Research and Technology (HSR&T) Theme continues to have a requirements-driven product-delivery focus. The Theme focuses on ensuring the health, safety, and security of humans through the course of solar system exploration. Programs within this Theme advance knowledge and technology critical for supporting long-term human survival and performance during operations beyond low Earth orbit, with a focus on improving medical care and human health maintenance. Within the Theme there are three programs: Life Support and Habitation; Human Health and Performance; and Human Systems Integration. The Life Support and Habitation Program conducts research and develops technology for life support and other critical systems for spacecraft operations. The Human Health and Performance Program delivers research on questions about human biology and physiology relevant to the human exploration of the solar system, and delivers technology to help maintain or improve human health in the space environment. The Human Systems Integration program focuses on optimizing human-machine interaction in the operation of spacecraft systems.

Overall Budget

The FY 2007 request is \$274.6 million; a \$349.5 million (or 56 percent) decrease from the FY 2006 budget. This significant drop in budget was predicated on the results of the ESAS which prioritized technology development programs by requirements and schedules. This led to a realistic set of requirements instead of the capability-based programs of the past. By adopting a requirements-based philosophy in the redirection of its Exploration programs NASA will be able to reprioritize ISS research and realize efficiencies in its investments by focusing them on technologies applicable to human exploration of the solar system. Such efficiencies allow NASA to adjust the investment profile for HSR&T and still return significant benefits to the space program.

LIFE SUPPORT AND HABITATION

The Life Support and Habitation Program is enabling human exploration by developing technologies to support human activity in and beyond low Earth orbit. Some of the technologies to be developed by the Life Support and Habitation program include closing the loop for air, water, and food to make exploration missions feasible and to reduce mission logistics and cost; achieving a new level of reliable and maintainable life support and environmental monitoring and control systems; and developing novel technologies to enhance exploration crew autonomy.

HUMAN HEALTH AND PERFORMANCE

The Human Health and Performance Program delivers research, technology, knowledge, and tools that will enable human space exploration. Specifically, the Human Health and Performance program will guide the development of various countermeasures to aid astronauts in counteracting any deleterious effects of long-duration missions in the space environment; develop tools and techniques to improve medical care delivery to space exploration crews; increase biomedical knowledge and

Mission Directorate: Exploration Systems

improve understanding of radiation effects to reduce the uncertainty in estimating space radiation health risks to human crews; and, acquire new information in exploration biology, which will identify and define the scope of problems that will face future human space explorers during long periods of exposure to space.

HUMAN-SYSTEMS INTEGRATION

The Human-Systems Integration Program conducts research and technology development driven by Agency needs for crew health; design of human spacecraft, space suits, and habitats; efficient crew operations; medical operations; and technology development to enable safe and productive human space exploration. The program addresses identified needs in physical and cognitive performance factors, psychosocial adaptation, neurobehavioral adaptation, and sleep and circadian rhythms. This research is important because the human system has physical and cognitive interface requirements that must be addressed in spacecraft design and operation. This research will enable the development of engineering standards, guidelines, requirements, design tools, training systems and evaluation approaches to support astronauts, design engineers and missions operations.

Constellation Systems



From left: Artist's impression of the Earth Departure Stage, Lunar Surface Access Module, and Crew Exploration Vehicle during a Trans-Lunar Injection burn leaving Low Earth Orbit bound for the Moon.

President's FY 2007 Budget Request

(Dollars in Millions)

Constellation Systems	FY2005	FY2006	FY2007	FY2008	FY2009	FY2010	FY2011
FY 2007 PRES BUD	422.3	1,733.5	3,057.6	3,067.6	3,612.9	4,083.8	7,698.4
Changes from FY 2006 Request	-103.7	613.4	1,478.1	1,543.9	1,622.0	1,631.7	

Overview: *What* NASA Accomplishes through the Constellation Systems Theme

Constellation Systems develops new systems initially outlined by the Exploration Systems Architecture Study (ESAS) to continue to support the International Space Station (ISS) and enable sustainable, affordable human exploration of the Moon, Mars, and beyond. Initial capabilities (CEV, CLV, Extravehicular Activity suits and tools, and associated ground and mission operations infrastructure) will support low-Earth orbit missions including crew and cargo transportation to the ISS. Operational availability for the CEV and CLV is targeted for no later than 2014. NASA will strive to bring that date as close to 2010 as possible as it achieves efficiencies and synergism between the Constellation Systems and Space Shuttle Programs. The Commercial Crew/Cargo project will spur parallel development of a cost-effective, commercial capability to transport humans and cargo to the ISS. Following the initial capabilities, Constellation will develop crew and cargo capabilities for a lunar surface mission as early as 2018 but not later than 2020. As currently planned, this includes developing a Heavy Lift Launch Vehicle, Earth Departure Stage, Lunar Surface Access Module, and associated capabilities. Future development will provide crew, cargo, and infrastructure capabilities for human exploration of Mars and beyond. Preliminary technical details for these systems were defined by the ESAS. Throughout FY 2006 NASA will conduct a detailed review of the Constellation Systems Program to better specify and finalize technical requirements and operational dates for the CEV and CLV.

Relevance: *Why* NASA conducts Constellation Systems work

Relevance to national priorities, relevant fields, and customer needs:

The Constellation Systems Theme is responsible for developing capabilities essential to making the Nation's Vision for Space Exploration a reality. To deliver these capabilities the Constellation Systems Theme will:

- Develop the CEV and CLV to support human lunar missions as early as 2018 but no later than 2020. In its initial flights, the CEV will be capable of visiting the ISS no later than 2014, and as close to 2010 as possible.
- Develop a Heavy Lift Launch Vehicle (HLLV), based on Shuttle hardware that supports transportation of cargo into low Earth orbit and on to lunar orbit
- Enable human exploration of Mars.
- Development and demonstration of commercial space transportation services from domestic companies for ISS servicing missions.
- Ensure ISS support through CEV and CLV capability for pressurized cargo and crew services.

Relevance to the NASA mission:

The Constellation Systems Theme supports NASA's mission to explore the universe and search for life by developing the transportation and supporting systems to extend human presence to the Moon, Mars, and beyond. A human presence will enable scientific activities and discoveries not obtainable with robotic explorers.

Relevance to education and public benefits:

Constellation's programs will involve the public and educators to inspire students to enter science, mathematical, and engineering fields.

Performance

Major Activities Planned for FY 2007:

- Conduct System Design Review of the initial Constellation Systems Program resulting in approval to begin preliminary design.
- Complete Preliminary Design of the CEV and CLV first stage.
- Complete PDR of for Exploration Communications and Navigation Systems (ECANS) Project and complete architecture and engineering contracts for Launch and mission operations facilities.

Major Recent Accomplishments:

- Conducted the Exploration Systems Architecture Study for initial requirements; and technical cost and trade space necessary for Constellation Systems to implement the Vision for Space Exploration.
 - The ESAS preliminary concept for the CEV is an Apollo shaped capsule capable of transporting four people to the moon or six to the ISS. Improvements include dry-land landing and launch abort system.
 - The ESAS concept for the CLV is based on using Shuttle-derived solid rocket boosters in combination with an upper-stage to provide safe, reliable, affordable human access to low-Earth orbit.
 - ESMD has contracted with two industry teams to complete Phase 1 studies for the CEV, and has issued contracts to two contractors to study the evolution of the Shuttle design for CLV application.
 - ESMD has released a draft Solicitation for Commercial Cargo and Crew Services. This is a new approach for alternative, innovative means to provide access to low-Earth orbit and support to the ISS.
-

Constellation Systems Theme Commitment in Support of the NASA Mission :

Strategic Goals**Sub-Goals (If Applicable)***Multiyear Outcomes*

Annual Performance Goals supporting the Multiyear Outcomes

4. Bring a new Crew Exploration Vehicle into service as soon as possible after Shuttle retirement.

4.1 No later than 2014, and as early as 2010, transport three crewmembers to the International Space Station and return them safely to Earth, demonstrating an operational capability to support human exploration missions.

7CS1 Complete the Systems Design Review for the Constellation Program.

7CS2 Complete the Preliminary Design for the Crew Exploration Vehicle (CEV).

7CS3 Complete the Preliminary Design for the Crew Launch Vehicle (CLV) First Stage.

7CS4 Begin construction and/or modifications to Kennedy Space Center ground processing and launch control facilities needed to support the CEV and CLV in accordance with the Systems Requirements Document.

7CS5 Begin construction and/or modifications to Johnson Space Center flight control facilities needed to support the CEV and CLV in accordance with the Systems Requirements Document.

4.2 No later than 2014, and as early as 2010, develop and deploy a new space suit to support exploration, that will be used in the initial operating capability of the Crew Exploration Vehicle.

7CS6 Define the acquisition strategy for the design and development of the initial space suit for exploration.

7CS7 Initiate procurement/development of the initial space suit for exploration.

5. Encourage the pursuit of appropriate partnerships with the emerging commercial space sector.

5.2 By 2010, demonstrate one or more commercial space services for ISS cargo and/or crew transport.

7CS8 Complete assessment of at least two contractor deliverables that will support the development of vehicles that can provide commercial cargo or crew transport services.

Efficiency Measures

7CS9 Complete all development projects within 110% of the cost and schedule baseline.

Program Management

The Constellation Systems Program Manager is Jeffrey Hanley, Exploration Systems Mission Directorate.

Quality***Independent Reviews:***

- The Exploration Systems Architecture Study (ESAS) reviewed the Constellation Theme programs (3rd Quarter of Fiscal Year 2005) for relevance to the Exploration Vision.

Program Assessment Rating Tool (PART):

The Office of Management and Budget has not yet conducted a PART review of the Constellation Systems Theme. This theme has a planned PART review in 2006.

Theme:

Constellation Systems

Budget Detail

(Dollars in Millions)

Budget Authority (\$ millions)	FY2005	FY2006	Change	FY2007	FY2008	FY2009	FY2010	FY2011	Comments
Constellation Systems	422.3	1,733.5	1,324.1	3,057.6	3,067.6	3,612.9	4,083.8	7,698.4	
Constellation Systems Program	422.3	1,733.5	1,324.1	3,057.6	3,067.6	3,612.9	4,083.8	7,698.4	

Note: For all formats, the FY 2005 column reflects the FY 2005 Congressional Operating Plan, dated 9/30/2005. The FY 2006 column reflects the FY 2006 Congressional Initial Operating Plan, dated Jan 2006. The FY 2007 - 2011 columns represent the FY 2007 President's Budget Submit.

Funding for Constellation Systems has been increased from the 2006 President's Budget. This budget increase reflects the Agency's position based on the results of the ESAS, and the President's continuing commitment to the priorities identified in the Vision for Space Exploration. Increased funds are specifically identified for the CEV and CLV in order to ensure their availability by no later 2014.

Increased funding for the CEV supports an earlier down-select to a single contractor for CEV design; a Preliminary Design Review in FY 2007; Critical Design Review in FY 2008; potential design verification tests in 2007 (to be determined after a prime contractor is selected); and initial tests of a Launch Abort System starting in FY 2009 (or possibly sooner depending on available funding).

Increased funding for the CLV supports early design work with Space Shuttle contractors to prepare the solid rocket boosters for use as the first stage of the CLV; development of a propulsion system for the upper stage of the CLV; early design work to modify the Space Shuttle main engine for use as an expendable engine on the future Heavy Lift Launch Vehicle. During FY 2006 NASA will conduct a detailed technical review to decide what engine will serve as the upper stage of the CLV.

Funding is also necessary to support initial design efforts to modify, or in some cases start from new, necessary ground systems to support the operational requirements of the CEV and CLV. This includes potential changes to the launch infrastructure at Kennedy Space Center, as well as NASA's ground-based and in-space communications infrastructure for space exploration missions. During FY 2006 NASA will be conducting detailed trade studies and analyses to better understand technical requirements for these projects.

The Constellation Program Office at JSC manages overall development. The CEV, EVA suit, Mission Operations and ISS Cargo and Crew services project Offices are also located at JSC. CLV and HLLV are located at MSFC; Ground Operations Systems project is at KSC. Exploration Communications and Navigation System project management will be assigned to a center in FY 2006.

President's FY 2007 Budget Request (Dollars in Millions)

<u>Constellation Systems Program</u>	<u>FY2005</u>	<u>FY2006</u>	<u>FY2007</u>	<u>FY2008</u>	<u>FY2009</u>	<u>FY2010</u>	<u>FY2011</u>
FY 2007 PRES BUD	422.3	1,733.5	3,057.6	3,067.6	3,612.9	4,083.8	7,698.4
Changes from FY 2006 Request	-103.7	613.4	1,478.1	1,543.9	1,622.0	1,631.7	

Overview

The Constellation Systems Program supports the President's Vision for Space Exploration by developing the systems initially conceived during the FY 2005 Exploration Systems Architecture Study. Initial systems to be developed include the Crew Exploration Vehicle, Crew Launch Vehicle, Extravehicular Activity suits and tools required by flight crews, and associated ground and mission operations infrastructure. These are the first systems necessary to enable safe, affordable human exploration to the Moon, Mars, and beyond. In their initial phase, these systems will also support crew and cargo transportation to the International Space Station. Initial operational availability of these systems is targeted for no later than 2014, but NASA will strive to bring that date as close to 2010 as possible as it achieves efficiencies and synergies between the CEV, CLV, and Space Shuttle Programs.



Artist's impression of the Crew Exploration Vehicle approaching the International Space Station in Low Earth Orbit.

In parallel with the initial capabilities, Constellation Systems will initiate planning for the systems and vehicles necessary to transport crew and cargo for a mission to the Lunar surface by no later than 2020, and then on to Mars. These include:

- Heavy Lift Launch Vehicle, leveraging engineering design and hardware from the Shuttle Program;
- Earth Departure Stage to propel the CEV from Low Earth Orbit to Lunar Orbit;
- Lunar Surface Access Module to safely transport astronauts to and from the lunar surface; and
- the systems, capabilities, and support infrastructure required for extended human stays on the lunar surface.

Future development will provide crew and cargo transportation and destination support capabilities required for Human exploration of Mars and beyond.

Plans For FY 2007

FY 2007 activities include Directorate and Agency approval for the Constellation Systems Program to begin the Concept Development and Preliminary Design phase; Preliminary Design Reviews for CEV, CLV First Stage, ECANS, and EVA suit; and planning and conceptual development for the CLV Second Stage and the ground and mission operations systems.

Changes From FY 2006

- The Constellation Systems Program is a new program established to develop the capabilities outlined by the 2005 ESAS, and replaces the Earth Orbit Capability program discussed in the FY 2006 Budget.
- Constellation ensures optimum integration of near-term capabilities supporting missions to the ISS (CEV, CLV, etc.) with future capabilities supporting longer-term Exploration goals and objectives.
- The 2005 ESAS defined the Constellation architecture. The first ISS human mission will be no later than 2014 but as close to 2010 as possible.

Program Management



















The Constellation Systems Program is managed by Jeff Hanley at JSC; all NASA Centers support through various Project Offices and integrated teams.

Technical Parameters

Constellation's objective is to develop, demonstrate, and deploy the capabilities to transport crew and cargo for missions to the lunar surface safely return the crew to Earth. In its initial phases, the program will also be capable of delivering crew and cargo to the ISS. The Program will develop and integrate major hardware and software systems including the CEV, the CLV, and the supporting ground and space systems required to meet the lunar and ISS mission objectives. These integrated systems will perform the functions of transporting the crew from the ground to Earth orbit (including ISS), providing a habitable crew environment for the mission duration, conducting on-orbit maneuvers as required, reentering Earth's atmosphere, and safely recovering the crew.

Technical Specifications	FY 2007 President's Budget	Change from Baseline
Integrated Program System Design Review	Program Integration SDR planned for June 2007 in preparation for Pre Non-Advocate Review.	

Implementation Schedule:

Project	Schedule by Fiscal Year							Purpose	Phase Dates													
	05	06	07	08	09	10	11		Beg	End												
Crew Exploration Vehicle								Preliminary Design Review August 2007. First flight as early as 2010 but no later than 2014.	Tech Form Dev Ops Res	Oct-03 Aug-07 Sep-07 Aug-14 Sep-14 Sep-14												
Crew Launch Vehicle								Preliminary Design Review March 2008. First flight as early as 2010 but no later than 2014.	Tech Form Dev Ops Res	Oct-03 Mar-08 Apr-08 Aug-14 Aug-14 Aug-14												
Exploration Communication and Navigation Systems								Preliminary Design Review September 2009.	Tech Form Dev Ops Res	Oct-03 Jul-09 Aug-09 Aug-14 Sep-14 Sep-14												
Launch and Mission Systems								Preliminary Design Review September 2006 (TBR) to support a first CEV and CLV flight as early as 2010 but no later than 2014.	Tech Form Dev Ops Res	Oct-03 Aug-06 Sep-06 Aug-14 Sep-14 Sep-14												
<table border="0"> <tr> <td></td> <td>Tech & Adv Concepts (Tech)</td> </tr> <tr> <td></td> <td>Formulation (Form)</td> </tr> <tr> <td></td> <td>Development (Dev)</td> </tr> <tr> <td></td> <td>Operations (Ops)</td> </tr> <tr> <td></td> <td>Research (Res)</td> </tr> <tr> <td></td> <td>Represents a period of no activity for the Project</td> </tr> </table>												Tech & Adv Concepts (Tech)		Formulation (Form)		Development (Dev)		Operations (Ops)		Research (Res)		Represents a period of no activity for the Project
	Tech & Adv Concepts (Tech)																					
	Formulation (Form)																					
	Development (Dev)																					
	Operations (Ops)																					
	Research (Res)																					
	Represents a period of no activity for the Project																					

Theme:	Constellation Systems
Program:	Constellation Systems Program

Strategy For Major Planned Acquisitions

- Crew Exploration Vehicle: A Call for Improvement was issued in January 2006 and a single contractor team will be selected from the two teams competing in Phase 1 in the Summer 2006 timeframe.
- Crew Launch Vehicle: Decision on Upper Stage Acquisition in March 2006, with acquisition to follow.
- Launch and Mission Systems: Multiple, small contracts for facilities concepts and designs for Launch Systems, Mission Systems still TBD.

Key Participants

- Two industry teams (led by Northrop Grumman and Lockheed Martin) vying for CEV contract phased downselect.
- CLV design will leverage efforts of current Shuttle propulsion contractors.
- Industry will have opportunity to compete for contracts for CLV Upper Stage development and production, Launch Systems and Mission Systems development, EVA suit development, and ECANS development.
- NASA Centers will be fully integrated in this program through their participation in integrated teams and Constellation projects; overall Systems Engineering and Integration will be the responsibility of the Program Office at Johnson Space Center.

Risk Management

- RISK: A successful development of an upper stage engine (design and production) for the CLV may not be completed in time to support the ISS mission operations. MITIGATION: The Constellation Systems Program Office is currently analyzing all the programmatic and technical risks and will develop mitigation strategies. The CLV Project will identify all potential upper stage engines that meet the mission requirements and schedule and will develop testing requirements and a development schedule that provides hardware to support a first crewed mission by 2014
- RISK: Development of a Thermal Protection System for the CEV may not be completed in time to support ISS Mission operations. MITIGATION: The CEV Project is pursuing a technology development effort at NASA Ames Research Center prior to award of the CEV prime contract to provide early material testing data. This work will transition to the Prime Contractor at PDR with NASA providing independent technical review of the Prime's development effort.
- RISK: The development of the Launch Abort System (LAS) to provide crew abort on ascent of the CEV/CLV may not be completed in time to support the ISS mission operations. MITIGATION: The Program Office will develop a comprehensive Test and Verification process to ensure the successful development of the LAS along with the other Constellation spacecraft hardware and software. As part of this process, the CEV Project plans to conduct LAS pad abort tests beginning in FY2008.
- RISK: The Constellation Architecture is heavily dependent on the leveraging of Shuttle-derived assets to ESMD development programs. Inefficiency in the transition of the assets will result in schedule and cost overruns and inability to provide timely support to the ISS. MITIGATION: ESMD and SOMD are working closely to plan and monitor the transition of Shuttle assets to Constellation. NASA has established a Shuttle Transition Control Board (Chaired by the SOMD and ESMD Mission Directors) to oversee the process of transition or disposal of Shuttle assets as the Shuttle Program moves toward retirement.

Theme: Constellation Systems
 Program: Constellation Systems Program
 Project In **Formulation**: Crew Exploration Vehicle

President's FY 2007 Budget Request (Dollars in Millions)

Crew Exploration Vehicle (Formulation)	FY2005	FY2006	FY2007	FY2008	FY2009	FY2010	FY2011
FY 2007 PRES BUD	53.6	839.2	894.7	875.5	1,065.1	972.6	2,045.8
Changes from FY 2006 Request	-86.5	86.3	-245.7	-195.6	-237.5	-409.5	

Projects in Formulation are not mature in their development process and cost estimates are SUBJECT TO CHANGE as the project matures.

Overview

The Crew Exploration Vehicle will provide safe, affordable transportation for humans to the Moon, Mars and beyond. Initial missions will take astronauts to the International Space Station, and return them safely to Earth.

The CEV will consist of a pressurized Crew Module and a Service Module providing propulsion, power, and other support. Pressurized cargo modules will be developed for use to and from the ISS in place of the Crew Module for resupply missions. NASA will pursue commercial opportunities for this capability through the ISS Cargo and Crew Services Project.

The CEV design will be an Apollo-like capsule, as defined by the results of the Exploration Systems Architecture Study. The CEV provides transportation for four astronauts to the lunar surface and will initially be capable of transporting up to six astronauts to the ISS. The CEV will interface with the CLV for access to low-Earth orbit, and then with the Earth Departure Stage and Lunar Surface Access Module for transport to the Moon. The first human flight of the CEV to the ISS is targeted for no later than 2014, but NASA will strive to bring that date as close to 2010 as possible. An initial flight to the Moon is targeted for no later than 2020.

The CEV project interfaces with technology risk reduction efforts funded by the Exploration Technology Development Program. An example of critical technology development is the Thermal Protection System effort located at Ames Research Center.

Acceleration of the program has resulted in higher budget numbers than in the FY 2006 submittal. The increase in budget for FY 2011 reflects the start of production and sustaining engineering of the CEV.



Artist's impression of the Crew Exploration Vehicle (Crew Module and Service Module, left) docked with a Lunar Access Module (right) in orbit around the Moon.

Theme: Constellation Systems
Program: Constellation Systems Program
Project In Formulation: Crew Exploration Vehicle

Changes From FY 2006

- The project structure within the Constellation System Program was changed from capability-based (ie, Earth Orbit Capability) to hardware-based projects (CEV, CLV); CEV project management moved to JSC.
- The FY 2006 President's Budget assumed a Preliminary Design Review for the CEV in 2008, with a planned down-select from two contractors to a single contractor for development of the CEV.
- The FY 2007 President's budget accelerates Preliminary Design Review in FY 2007. In addition NASA is scheduled to select a single contractor for the CEV during the summer of 2006.

Program Management

The Crew Exploration Vehicle Project Office at JSC reports to the Constellation Program Office, also at JSC. All NASA Centers support CEV.

Technical Parameters

The CEV's first element is a pressurized Crew Module carrying three to six astronauts depending on the particular mission. A Launch Abort System provides emergency crew survivability in the event of a launch mishap. The Crew Module also incorporates a thermal protection system for re-entry, and a Landing Attenuation System for dry-ground landing.

Pressurized cargo modules will be developed for use with the ISS in place of the Crew Module for certain missions, if commercial services are not available.

The second element of the CEV is the Service Module, which provides propulsion for orbit correction, rendezvous, and de-orbit, as well as power for life support and other functions.

The CEV will be launched on the Crew Launch Vehicle.

Technical Specifications	FY 2007 President's Budget	Change from Baseline
Technical specifications will be developed during preliminary design in FY 2007.	The CEV design will be based on an Apollo-like capsule concept.	In the FY 2006 President's budget there were no assumptions for the CEV design, nor a baseline technical solution.

Schedule	FY 2007 President's Budget	Baseline	Change from Baseline
CEV Prime Contractor Selection	NASA will select a single prime contractor for detailed design of the CEV	Summer 2006	Decision moved up 2 years.
Preliminary Design Review	The selected contractor team and NASA organizations developing government-furnished equipment (GFE) will perform design work leading to a Preliminary Design Review in August 2007.	August 2007	
Critical Design Review	CEV Critical Design Review is now scheduled for FY 2009.	FY 2009	

Theme: Constellation Systems
Program: Constellation Systems Program
Project In Formulation: Crew Exploration Vehicle

Strategy For Major Planned Acquisitions

- Call for Improvement RFP issued in January 2006. Schedule acceleration and low risk designs are a priority.
- The CEV prime contractor is scheduled for selection in summer 2006.

Key Participants

- All NASA Centers are participating in CEV development. Major Government-furnished equipment includes the Thermal Protection System, Launch Abort System, Landing Attenuation System, and the vehicle's external shape and dimensions.
- The majority of the vehicle is provided by industry through a competitively selected contract
- ESMD is closely coordinating with the Space Operations Mission Directorate, which will operate the vehicle.

Theme: Constellation Systems
Program: Constellation Systems Program
Project In Formulation: Crew Launch Vehicle

President's FY 2007 Budget Request (Dollars in Millions)

Crew Launch Vehicle (Formulation)	FY2005	FY2006	FY2007	FY2008	FY2009	FY2010	FY2011
FY 2007 PRES BUD	11.1	384.2	836.7	827.4	917.9	1,076.6	2,209.3
Changes from FY 2006 Request	0.1	369.8	804.9	672.0	627.6	331.0	

Projects in Formulation are not mature in their development process and cost estimates are SUBJECT TO CHANGE as the project matures.

Overview

The Crew Launch Vehicle (CLV) Project's mission is to deliver a safe, reliable launch system that expands America's scientific reach through space exploration. The CLV Project is dedicated to enabling the Nation's space transportation needs necessary for exploration missions to the Moon, Mars, and beyond. It is a cornerstone of NASA's future human space flight activities and an integral part of the Vision for Space Exploration. Current plans are for the CLV to be capable of visiting the International Space Station no later than 2014, but as close to 2010 as possible.



Artist's impression of the Crew Launch Vehicle carrying the Crew Exploration Vehicle to Low Earth Orbit.

The CLV as defined by the ESAS is a shuttle derived launch vehicle. The first stage is based on the Shuttle solid rocket motors. NASA is still making its final decisions on the upper stage for the CLV.

The large budget changes in FY 2006 through FY 2010 reflect NASA's desire to accelerate the availability of the CEV so that it could be available before 2014.

For more information, please visit:
<http://www.exploration.nasa.gov/constellation/index.html>

Changes From FY 2006

- The Exploration Systems Architecture Study (ESAS) defined the launch vehicle architecture. Budget modifications have been made to accommodate technical content and schedule acceleration.

Program Management

The CLV Project Office is located at the Marshall Space Flight Center.

Technical Parameters

The CLV Project is tasked to design, develop, test, and evaluate a human-rated CLV comprised of a Shuttle-derived, Reusable Solid Rocket Motor (RSRM), Solid Rocket Booster (SRB) hardware, and a new upper stage engine. This CLV will serve as a versatile transportation system that will transport crew to Low Earth Orbit (LEO) for further exploration missions to the Moon, Mars, and beyond. In its initial phases, the project will also support the delivery of crew and cargo to the ISS.

Technical Specifications	FY 2007 President's Budget	Change from Baseline
Crew Launch Vehicle (CLV) project	CLV is designed to launch the Crew Exploration Vehicle (CEV) into orbit.	

Theme: Constellation Systems
Program: Constellation Systems Program
Project In Formulation: Crew Launch Vehicle

Schedule	FY 2007 President's Budget	Baseline	Change from Baseline
Preliminary Design Review (PDR)	April 2008		
Critical Design Review (CDR)	August 2009		

Strategy For Major Planned Acquisitions

- Avionics Design: To be selected via full and open competition. Type is purchase acquisition. Performers are TBD.
- Upper Stage Production: To be selected via full and open competition. Type is purchase acquisition. Performer is TBD.

Key Participants

- ATK: First Stage (RSRM/SRB)

Theme: Constellation Systems
Program: Constellation Systems Program
Project In Formulation: ISS Cargo Crew Services

President's FY 2007 Budget Request (Dollars in Millions)

ISS Cargo Crew Services (Formulation)	FY2005	FY2006	FY2007	FY2008	FY2009	FY2010	FY2011
FY 2007 PRES BUD		51.3	191.1	292.5	398.6	403.0	375.0
Changes from FY 2006 Request	-98.0	-108.7	31.1	132.5	-101.4	-317.0	

Projects in Formulation are not mature in their development process and cost estimates are SUBJECT TO CHANGE as the project matures.

Overview

The ISS Cargo Crew Services project ensures that NASA can support its needs and commitments for transporting cargo and crew to and from the ISS. This budget is required because the limited remaining Space Shuttle flights are dedicated to ISS assembly. The ISS Crew/Cargo budget provides an important means of supporting ISS logistical needs.

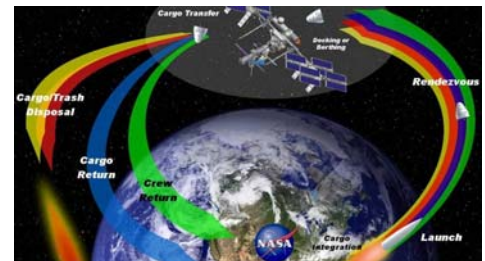

The ISS Cargo and Crew Services budget consists of two elements:

-International Partner Purchases: Government-to-government purchases of Russian Soyuz and Progress flights to meet near-term ISS logistical requirements that cannot be met by the Space Shuttle. NASA may also purchase Japanese H-II Transfer Vehicle (HTV) flights for external cargo delivery.

-Commercial Crew/Cargo Project: Development and demonstration of commercial space transportation services from domestic companies. NASA's Commercial Crew/Cargo project is designed to facilitate U.S. private industry demonstration of cargo and crew space transportation capabilities with the goal of achieving reliable, cost effective access to low-Earth orbit.

The types of transportation that support human space operations are represented by different colors above.

(Yellow) External Cargo Delivery & Disposal
 (Red) Internal Cargo Delivery & Disposal
 (Blue) Internal Cargo Delivery & Return
 (Green) Crew Transportation

In the near-term, International Partner purchases are required because no U.S. alternatives exist to the Space Shuttle. In the long-term, NASA would prefer to use U.S. commercial space transportation providers, both to ensure domestic sources and to expend taxpayer dollars domestically. The Commercial Crew/Cargo project is designed to enable future procurement of commercial orbital transportation services to resupply the International Space Station.

Changes From FY 2006

- NASA transferred Space Station Crew and Cargo to Exploration Systems to ensure sound resource allocation between International Partner purchases, commercial services, and NASA-developed systems.
- Overall budget reduction due to improved cost estimates and offsets in the outyears to accommodate CEV acceleration and ESAS architecture.
- In FY 06 SOMD and ESMD shared management and budget responsibilities . In FY 2007 ESMD will assume all programmatic control.

Theme: Constellation Systems
Program: Constellation Systems Program
Project In Formulation: ISS Cargo Crew Services

Program Management

NASA Headquarters manages International Partner purchases. The Commercial Crew/Cargo Project is located at JSC.

Technical Parameters

International Partner purchases currently include Soyuz and Progress flights to provide assured crew and cargo resupply services for the ISS. When the Japanese H-II Transfer Vehicle becomes available, NASA may also purchase flights of this vehicle for cargo resupply.

The Commercial Crew Cargo Services is currently in the formulation phase. This phase will end in May 2006 when NASA plans to award one or more Space Act Agreements to demonstrate commercial resupply services to the ISS. After a successful flight demonstration, the project will move into the operations phase where NASA will use a Request for Proposals (RFP) to solicit transportation and resupply services to the ISS. Companies responding to this RFP could provide similar space transportation services to non-NASA customers.

Technical Specifications	FY 2007 President's Budget	Change from Baseline
International Partner Purchases	Includes Soyuz and Progress flights. May also include HTV flights.	No change from baseline
Commercial Crew/Cargo Project	Culminates in one or more flights of unpressurized cargo, pressurized cargo, or crew to the Space Station.	No change from baseline

Schedule	FY 2007 President's Budget	Baseline	Change from Baseline
Operations (International Partner)	Nov 2005 to TBD (depending on need)		
Formulation (CCC)	Jun 2005 to May 2006		
Development (CCC)	May 2006 to 2008-10		
Operations (CCC)	2008-10 to 2015		

Strategy For Major Planned Acquisitions

- In FY 2007, the program will continue to execute the contract(s) awarded in FY 2006. No major acquisitions are planned for FY 2007.

Key Participants

- Space Station International Partners.
- U.S. commercial space transportation service companies.

Theme: Constellation Systems
 Program: Constellation Systems Program
 Project In **Formulation**: Launch and Mission Systems

President's FY 2007 Budget Request (Dollars in Millions)

Launch and Mission Systems (Formulation)	FY2005	FY2006	FY2007	FY2008	FY2009	FY2010	FY2011
FY 2007 PRES BUD		134.0	469.9	557.8	565.5	633.0	894.4
Changes from FY 2006 Request		134.0	469.9	557.8	565.5	633.0	

Projects in Formulation are not mature in their development process and cost estimates are SUBJECT TO CHANGE as the project matures.

Overview

The Constellation Launch and Mission Systems (L&MS) Project will develop and operate more affordable and efficient mission control and launch site infrastructure than in the past. Studies and lessons learned from previous human and robotic space systems will be used to optimize systems and processes to reduce overall LCC for Constellation systems. L&MS includes the facilities, ground equipment, control systems and networks needed to develop, plan and execute the Design, Development, Test & Evaluation (DDT&E) operational flights of the CEV, CLV (crewed and uncrewed) and HLLV during processing, launch, mission operations and landing/recovery. This includes ground systems generally located at the Kennedy and Johnson Space Centers with several landing sites located within the continental United States and emergency landing sites overseas. L&MS is divided into the Ground Operations Systems Project and the Mission Operations Systems Project to better focus team efforts and take advantage of previous experience and personnel.



Launch and Mission Systems pad 39 concept for Crew Launch Vehicle.

Changes From FY 2006

- The Exploration Systems Architecture Study (ESAS) defined the Constellation flight architecture and L&MS system technical and programmatic requirements. This is a new project this year.

Program Management

Ground Operations Systems project management is located at KSC, while the Mission Operations Systems project is managed at JSC.

Theme: Constellation Systems
Program: Constellation Systems Program
Project In Formulation: Launch and Mission Systems

Technical Parameters

Ground Operations Systems: People, launch control centers, vertical assembly buildings, launch pads, fueling systems, transporters, mobile launch platforms, recovery ships, equipment (including software) necessary to receive, inspect, assemble, integrate, test, simulate, monitor and perform launch operations and landing/recovery of the flight hardware.

Mission Operations Systems: Systems and infrastructure necessary for the Constellation command and control during ascent/descent and mission operation execution for abort test, uncrewed and crewed flights. The capabilities required include voice and video communications, telemetry reception, and data and commanding to the Constellation spacecraft elements.

Technical Specifications	FY 2007 President's Budget	Change from Baseline
Technical specifications will be developed in FY 2007.	Facility requirements and designs will be established to support facility need dates as early as September 2007 and Pad use in 2009.	

Schedule	FY 2007 President's Budget	Baseline	Change from Baseline
Formulation	October 2005 to September 2006		
Construction of Facilities	Late 2006 to 2014		
Development of Command and Control	October 2005 to 2014		
Development of L&MS and test flights	October 2005 to September 2014		

Strategy For Major Planned Acquisitions

- FY 2006 Multiple Architecture and Engineering contracts to be awarded.
- FY 2007 Multiple Construction of Facilities contracts to be awarded.
- FY 2008 Contracts for Operations Integration at KSC & JSC to be awarded.

Key Participants

- NASA Centers: MSFC, JSC, KSC, ARC, GRC, LaRC, GSFC, SSC, JPL, and DFRC

Theme: Constellation Systems
 Program: Constellation Systems Program
 Project In **Formulation**: Exploration Communications and Navigation Systems

President's FY 2007 Budget Request (Dollars in Millions)

<u>Exploration Communications and Navigation Systems (Formulation)</u>	<u>FY2005</u>	<u>FY2006</u>	<u>FY2007</u>	<u>FY2008</u>	<u>FY2009</u>	<u>FY2010</u>	<u>FY2011</u>
FY 2007 PRES BUD		50.5	102.7	50.2	104.0	140.4	286.5
Changes from FY 2006 Request		50.5	102.7	50.2	104.0	140.4	

Projects in Formulation are not mature in their development process and cost estimates are SUBJECT TO CHANGE as the project matures.

Overview

The Exploration Communication and Navigation Systems (ECANS) project mission will develop the end-to-end, interoperable communications and navigation infrastructure that provide the constellation elements the connectivity required to execute the Vision for Space Exploration. These capabilities will provide the communications links between mission control and the in-space elements. ECANS will also provide tracking capabilities for space vehicle navigation. The ECANS project is being managed by ESMD as it completes its formulation, with project responsibilities transferring to a NASA Center in late fiscal year 2006.

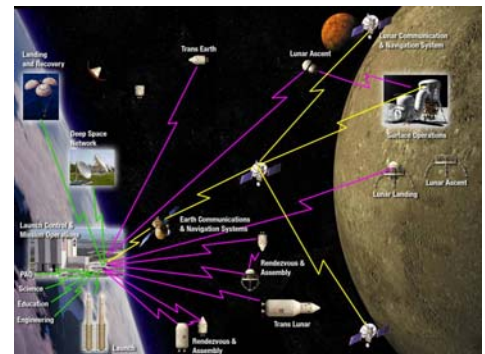

This is a new project based on the results of the ESAS. During FY 2006 communication requirements will be further defined through the Communications Systems Working Group and related studies. These enterprises will feed a System Requirements Review scheduled for late FY 2006.

Potential Elements of the Exploration Communications and Navigation System

Changes From FY 2006

- The Exploration Systems Architecture Study defined the Constellation Communications and Navigation system requirements. This new project will focus the development of these systems.
- The communications architecture study in FY 2006 will further refine ECANS requirements.

Program Management

ECANS project management will be transitioning from Headquarters project management in FY06. The NASA Center has not yet been selected.

Theme: Constellation Systems
Program: Constellation Systems Program
Project In Formulation: Exploration Communications and Navigation Systems

Technical Parameters

The initial ECANS architecture will consist of the constellation elements for the LEO and ISS missions and existing communication and tracking assets such as the Space Network, Ground Network, Deep Space Network, and NASA Integrated Services Network to meet the ESAS requirements. To support the Lunar missions this may be expanded to include infrastructure on and around the Moon. Examples are orbiting relay and navigation satellites and/or surface assets. ECANS also provides advanced development and demonstration of communication and navigation capabilities for future insertion into the overall architecture. Current advanced developments include the space-based range, software defined radio, command, control, communication and information adapter, and an experimental antenna array.

Technical Specifications	FY 2007 President's Budget	Change from Baseline
Technical specifications will be developed in FY 2007.		

Schedule	FY 2007 President's Budget	Baseline	Change from Baseline
Formulation	October 2005 to September 2009		
Development	October 2009 to September 2025		

Strategy For Major Planned Acquisitions

- FY 2008 - Project will award contracts for Lunar Communication and Navigation Systems implementation.

Key Participants

- NASA Centers: ARC, DFRC, GRC, GSFC, JPL, JSC, KSC, LaRC, MSFC industry.
- Private Industry: Major development activities will be contracted out to private

Exploration Systems Research & Technology

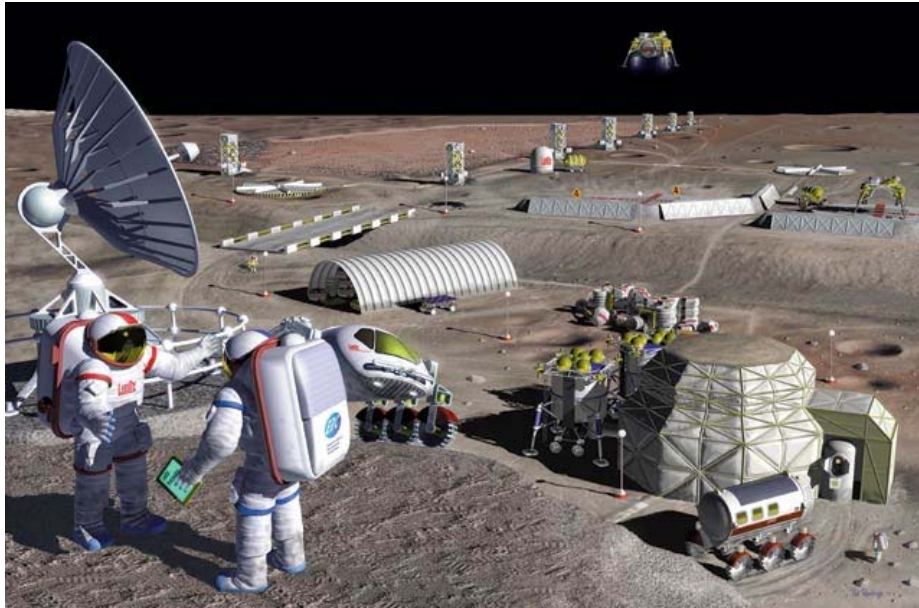

Artistic depiction of a sustainable lunar outpost supported by the development of advanced technologies such as intelligent robotics and in-situ resource utilization.

President's FY 2007 Budget Request (Dollars in Millions)

Exploration Systems Research & Technology	FY2005	FY2006	FY2007	FY2008	FY2009	FY2010	FY2011
FY 2007 PRES BUD	898.9	692.5	646.1	632.2	605.1	679.2	764.6
Changes from FY 2006 Request	176.0	-226.7	-261.2	-357.0	-445.2	-399.2	

Overview: What NASA Accomplishes through the Exploration Systems Research & Technology Theme

The Exploration Systems Research and Technology (ESRT) Theme develops and demonstrates new technologies that will enable NASA to conduct future human and robotic exploration missions, including the development of robotic precursor missions for lunar exploration. The ESRT Theme will accomplish its objectives through the execution of four programs: (1) the Centennial Challenges Program will establish purse awards to stimulate innovative technical accomplishments that could advance the state of civil space exploration and aeronautics; (2) the Exploration Technology Development Program will focus on maturing key technologies to enable safe, affordable, effective and sustainable human and robotic exploration missions; (3) the Prometheus Power and Propulsion Program will invest in nuclear technologies for power and propulsion; and (4) the Robotic Lunar Exploration Program, which will develop robotic missions to the Moon in support of the Vision for Space Exploration.

The Exploration Technology Development Program is the merging of two former ESRT programs, the Advanced Space Technology Program and Technology Maturation Program. As a result of the technology program review conducted by Exploration System Architecture Study (ESAS), these programs have been combined into one, with a new focus on twelve technology maturation areas identified as high priority for the exploration lunar architecture.

Theme:

Exploration Systems Research & Technology

Relevance: *Why* NASA conducts Exploration Systems Research & Technology work

Relevance to national priorities, relevant fields, and customer needs:

By identifying, developing, and transitioning new technologies that have broad potential to enable novel systems concepts and capabilities, the ESRT Theme makes a unique contribution to NASA's goal of expanding human presence into the solar system for exploration and discovery.

Relevance to the NASA mission:

The ESRT Theme supports the Vision for Space Exploration by developing the innovative technologies needed to implement a sustained and affordable human and robotic program to explore the solar system and beyond.

Relevance to education and public benefits:

NASA plans to partner extensively in the implementation of this program, including significant reliance on the expertise of academia in research and development efforts. This will provide educational opportunities to undergraduate and graduate students in U.S. colleges and universities. In addition, by advancing diverse, novel technologies through projects with non-traditional NASA research partners, small businesses and others, public benefits from ESRT will include new technologies for use in industry and by the general public.

Performance

Major Activities Planned for FY 2007:

- Develop key components for a propulsion system for the Crew Exploration Vehicle.
- Develop an ablative thermal protection system for the Crew Exploration Vehicle.
- Develop a non-toxic auxiliary power system for the Crew Launch Vehicle.
- Complete the Critical Design Review for the Lunar Reconnaissance Orbiter.

Major Recent Accomplishments:

- Restructured the ESMD technology programs to align their content with the new technology development priorities for lunar exploration identified by the Exploration Systems Architecture Study
 - Competitively selected the instruments and completed the Systems Requirements Review for the Lunar Reconnaissance Orbiter mission.
 - Conducted the Tether Challenge prize competition, focusing on the fundamental science of materials, with the goal of increasing material strength-to-weight ratio over and above current capabilities.
 - Conducted the Beam Power Challenge prize competition focusing on the wireless, high-density transmission of power from the power source to robotic or human exploration equipment or vehicles.
-

Exploration Systems Research & Technology Theme Commitment in Support of the NASA Mission :

Strategic Goals**Sub-Goals (If Applicable)***Multiyear Outcomes*

Annual Performance Goals supporting the Multiyear Outcomes

5. Encourage the pursuit of appropriate partnerships with the emerging commercial space sector.

5.3 By 2012, complete one or more prize competitions for independently designed, developed, launched, and operated missions related to space science or space exploration.

7ESRT3 Conduct at least two prize competitions that encourage the development and demonstration of advanced, critical technologies supporting NASA's missions and goals.

6. Establish a lunar return program having the maximum possible utility for later missions to Mars and other destinations.

6.1 By 2008, launch a Lunar Reconnaissance Orbiter (LRO) that will provide information about potential human exploration sites.

7ESRT4 Complete the Non-Advocate Review (Authority to Proceed) for the Lunar Reconnaissance Orbiter.

6.2 By 2012, develop and test technologies for in-situ resource utilization, power generation, and autonomous systems that reduce consumables launched from Earth and moderate mission risk.

7ESRT1 Demonstrate the feasibility of extracting volatiles and oxygen from lunar regolith in a laboratory environment.

7ESRT2 Demonstrate remote supervision of a robotic system to deploy and set up lunar surface infrastructure in a laboratory environment.

6.3 By 2010, identify and conduct long-term research necessary to develop nuclear technologies essential to support human-robotic lunar missions and that are extensible to exploration of Mars.

7ESRT5 Complete a focused plan and initiate research for nuclear systems technology development for lunar surface fission power generation in support of protracted missions.

Efficiency Measures

7ESRT6 Complete all development projects within 110% of the cost and schedule baseline.

7ESRT7 Increase the number of technology products transferred to Constellation Systems developers for mission application.

Program Management

The ESRT Theme Director is Carl Walz, Exploration Systems Mission Directorate.

Quality

Independent Reviews:

- The Exploration Systems Architecture Study (ESAS) reviewed ESRT's research and technology programs (3rd Quarter of Fiscal Year 2005) for relevance to the Exploration Vision.

Program Assessment Rating Tool (PART):

The Office of Management and Budget has not yet conducted a PART review of the Exploration Systems Research and Technology Theme. This theme has a planned PART review in 2007.

Theme: Exploration Systems Research and Technology

Budget Detail (Dollars in Millions)

Budget Authority (\$ in millions)	FY2005	FY2006	Change	FY2007	FY2008	FY2009	FY2010	FY2011	Comments
Exploration Systems Research and Technology	898.9	692.6	-46.4	646.1	632.1	605.1	679.2	764.6	
Centennial Challenges	9.7		10.0	10.0	10.0	0.0	0.0	0.0	
Robotic Lunar Exploration	51.6	134.3	138.4	272.7	366.9	411.3	421.0	414.5	
Prometheus Power and Propulsion	270.3	75.7	-66.3	9.4	9.5	9.9	9.7	9.7	
Exploration Technology Development	478.3	482.4	-128.4	354.0	245.7	183.9	248.5	340.3	
Hubble Space Telescope Servicing Mission Program*	89.0								

Note: For all formats, the FY 2005 column reflects the FY 2005 Congressional Operating Plan, dated 9/30/2005. The FY 2006 column reflects the FY 2006 Congressional Initial Operating Plan, dated Jan 2006. The FY 2007 - 2011 columns represent the FY 2007 President's Budget Submit.

The technical content in this Theme has been redirected and its budget reduced to focus on the technology priorities for lunar exploration identified by the Exploration Systems Architecture Study. Funding made available by this reduction has been redirected to Constellation Systems. In particular, funding for the former Advanced Space Technology (AST) and Technology Maturation (TM) programs has been reduced, and the two programs combined into a new one - the Exploration Technology Development Program. Long-term research projects on nanomaterials, advanced space robotics, inspace assembly, electric propulsion, high efficiency solar arrays, space communications, and aeroassist systems were cancelled because they were not closely aligned with the new technology priorities. New projects were started to mature critical near-term technologies such as the thermal protection system for the Crew Exploration Vehicle and a non-toxic auxiliary power system for the Crew Launch Vehicle. Funding made available by the project cancellations in ESRT was transferred to the Constellation Program.

The combination of the AST and TM programs reflects not only a change in NASA's funding and technology focus for ESRT, but a change in the ESRT management philosophy as well. Under previous management, a broad array of low Technology Readiness Level (TRL) projects were to be organized within the AST Program. These projects were to be reviewed for their progress and potentially transferred to the TM Program for new funding and management. Projects in TM would also be reviewed and if relevant transferred to Constellation Systems. With the conclusion of ESAS, the collection of ESRT investments were focused in twelve technology areas. The focus of technology investments on those projects all have relevance to the missions of Constellation Systems. The Exploration Technology Development Program manages the redirected and new projects as one broad portfolio in support of Constellation Systems.

Funding has also been reduced in NASA's nuclear research program, formerly the Prometheus Nuclear Systems and Technology Theme. Again, funding has been redirected to support Constellation Systems. Through the rest of 2006 NASA will be examining its choices for research in nuclear technology and both how and when new programs or projects may be initiated.

The Innovative Partnerships Program has been moved to the Cross Agency Support Directorate. Funding for a potential Hubble Space Telescope servicing mission is now in the Science Mission Directorate.

President's FY 2007 Budget Request (Dollars in Millions)

Centennial Challenges	FY2005	FY2006	FY2007	FY2008	FY2009	FY2010	FY2011
FY 2007 PRES BUD	9.7		10.0	10.0			
Changes from FY 2006 Request	0.0	-34.0	-15.0	0.0			

Overview

The Centennial Challenges program conducts prize competitions for breakthrough accomplishments that advance the Vision for Space Exploration and other NASA priorities. Some of NASA's most difficult technical challenges may require novel solutions from non-traditional sources of innovation. By making awards based on actual achievements, NASA hopes to tap innovators in academia, industry and the public that do not normally work on NASA's technical issues.

Centennial Challenges is modeled on past successful prize competitions, including the DARPA Grand Challenge, the X Prize, and early aviation prizes such as the Orteig Prize. Prize purses for each challenge remain available until awarded or for the duration of that challenge. Challenges are open to teams led by U.S. citizens who are not government employees or as otherwise detailed in the eligibility rules of the individual challenge.

Per direction from previous NASA Appropriations, NASA did not obligate \$10M in FY 2005 funding for Centennial Challenges as it awaited legislative authority for large prize competitions. With the passage of prize language in the 2006 NASA Authorization Act, NASA will use this funding to start new Keystone and Flagship Challenges during FY06.



Beam Power Competition Entry - Robotic climber is using wireless power at NASA's first Centennial Challenges prize competition.

Plans For FY 2007

In FY 2007, Centennial Challenges plans to continue those Flagship, Keystone, and Alliance Challenges initiated in FY 2004 and FY 2005. These include prize competitions in the areas of astronaut glove development, in situ resource utilization, high strength-to-weight materials, lunar all-terrain vehicles, lunar lander analog, personal aircraft, planetary unmanned aerial vehicles, station-keeping solar sails, wireless power transmission, low-cost space pressure suit, lunar night power source, and telerobotic construction.

Changes From FY 2006

- In this past year, NASA conducted its first Wireless Power Transmission and High Strength-to-Weight Materials competitions. Announcements have been made to initiate another six Alliance Challenges.
- In FY 2007, Centennial Challenges will initiate new Flagship and Keystone Challenges, as described below.
- The projected FY07 funding request for Centennial Challenges was reduced to offset CEV schedule acceleration and other costs associated with the ESAS architecture.

Program Management

NASA Headquarters Exploration Systems Mission Directorate manages the Centennial Challenges Program.

Technical Parameters



















Centennial Challenges conducts three types of prize competitions:

- 1) Flagship Challenges to encourage major private space missions.
- 2) Keystone Challenges to address technology priorities.
- 3) Alliance Challenges to leverage collaborations with other prize organizations

Prize competitions projected to be initiated or ongoing in FY 2007 are listed under "FY 2007 President's Budget" in Technical Specifications below. Prize competitions to be initiated in FY 2007 are listed under "Change From Baseline" in Technical Specifications below.

Technical Specifications	FY 2007 President's Budget	Change from Baseline
Flagship Challenges	Lunar Lander Analog (est. \$1.25M), Station-Keeping Solar Sail (est. \$5M), Fuel Depot Demonstration (est. \$5M), and Micro Reentry Vehicle (est. \$2M).	New in FY07 include: Fuel Depot Demonstration (est. \$5M), and Micro Reentry Vehicle (est. \$2M).
Keystone Challenges	Human Lunar All-Terrain Vehicle (est. \$1M), Low-Cost Space Pressure Suit (est. \$500K), Lunar Night Power Source (est. \$500K), and Precision Lander (est. \$500K).	New in FY07 include: Precision Lander (est. \$500K).
Alliance Challenges	\$250K purses for Astronaut Glove, High S/W Mat'ls, Regolith Excavate, Ox Extract, New ISRU Extract, Telerobotic Construct, Wireless Power, Personal Aircraft, Planetary UAV, and LOX/CH4 Engine (\$300K).	New in FY07 include: New Lunar ISRU Extraction (est. \$250K).

Implementation Schedule:

Project	Schedule by Fiscal Year							Purpose	Phase Dates													
	05	06	07	08	09	10	11		Beg	End												
Flagship Challenges								To encourage external teams to independently design, develop, launch, and operate space missions, thereby generating innovative and/or low-cost approaches to various civil space goals.	Tech Form Dev Ops Res	Oct-04	Sep-11											
Keystone Challenges								To encourage the development and demonstration of advanced technologies and innovative capabilities that support NASA's missions and have synergy with other applications where applicable.	Tech Form Dev Ops Res	Oct-04	Sep-11											
Alliance Challenges								To leverage the capabilities of various non-profit organizations with domain expertise and/or members in the organization to administer a Challenge competition at no cost to NASA.	Tech Form Dev Ops Res	Oct-03	Sep-11											
<table> <tr> <td></td> <td>Tech & Adv Concepts (Tech)</td> </tr> <tr> <td></td> <td>Formulation(Form)</td> </tr> <tr> <td></td> <td>Development (Dev)</td> </tr> <tr> <td></td> <td>Operations (Ops)</td> </tr> <tr> <td></td> <td>Research (Res)</td> </tr> <tr> <td></td> <td>Represents a period of no activity for the Project</td> </tr> </table>												Tech & Adv Concepts (Tech)		Formulation(Form)		Development (Dev)		Operations (Ops)		Research (Res)		Represents a period of no activity for the Project
	Tech & Adv Concepts (Tech)																					
	Formulation(Form)																					
	Development (Dev)																					
	Operations (Ops)																					
	Research (Res)																					
	Represents a period of no activity for the Project																					

Strategy For Major Planned Acquisitions

- While there are no major acquisitions planned for FY 2007, NASA will be conducting the prize competitions as described.

Key Participants

- Collaborators include non-profit organizations.
- Competitors include emergent and established aerospace firms, non-aerospace firms, university and non-profit researchers, student teams, and hobbyists.
- Contractors include service providers.

Risk Management

- RISK:** A key risk for Centennial Challenges is the overhead costs associated with administering prize competitions. **MITIGATION:** To ensure that these overhead costs do not overwhelm budget resources available for prizes, the program carefully considers overhead costs when constructing the rules for each prize competition. For some competitions NASA partners with external organizations that oversee and officiate Challenges at no cost to the government. For some challenges NASA uses simplified requirements to minimize cost.

President's FY 2007 Budget Request (Dollars in Millions)

Robotic Lunar Exploration	FY2005	FY2006	FY2007	FY2008	FY2009	FY2010	FY2011
FY 2007 PRES BUD	51.6	134.3	272.7	366.9	411.3	421.0	414.5
Changes from FY 2006 Request	-0.4	-0.3	-3.4	-4.5	-5.0	-6.0	

Overview

The Robotic Lunar Exploration Program (RLEP) is responsible for executing a series of robotic missions to the Moon to conduct research and prepare for future human exploration. The program's earliest missions will mark this Nation's return to the Moon, conduct research, and pave the way for future human missions.

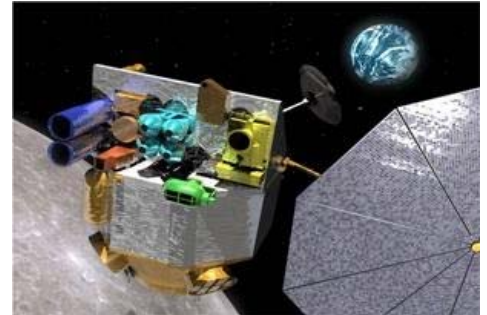

An artist's conception of the Lunar Reconnaissance Orbiter

The first mission in RLEP, the Lunar Reconnaissance Orbiter (LRO), is currently in formulation. LRO can transition to its development phase after a decision on Authority to Proceed (ATP) is made at its confirmation review in April, 2006, and is planned for launch in 2008. LRO will be designed to provide high resolution mapping and photography of the Moon's surface in order to identify potential future landing sites, and probable distribution of lunar resources.

A second RLEP mission, potentially a mission to land near the lunar South Pole, is currently in its pre-formulation phase. NASA will be conducting a detailed requirements definition activity in FY 2006 to determine whether this or other robotic missions will best meet the goals of the vision for space exploration.

Additional funding in RLEP is intended to support the RLEP program office at Ames Research Center and conduct concept studies and requirements definition for potential future missions.

Plans For FY 2007

FY 2007 will be the first full year in development for the Lunar Reconnaissance Orbiter. ESMD will also be conducting concept studies and requirements definition for potential future missions.

Changes From FY 2006

- The RLEP Program Office has been located at Ames Research Center

Program Management

The Robotic Lunar Exploration Program is managed by Ames Research Center. Theme responsibility resides in ESMD/NASA Headquarters.

Technical Parameters

The LRO contains a suite of six instruments selected through a competitive process, plus a technology demonstration payload that offers additional measurement data. Taken as a whole, the instruments will map the lunar topography, provide high resolution imaging of key areas of interest, identify the characteristic signatures that could identify precise locations of important materials like water ice, and characterize the radiation environment for human explorers in addition to providing scientific data to support the investigation of the origin and evolution of our solar system.

The LRO is scheduled for a Non-Advocate Review in the third quarter of FY 2006. At that time NASA will establish a Life Cycle Cost commitment, and provide it to Congress.

Technical Specifications	FY 2007 President's Budget	Change from Baseline
LRO-Launch in 2008.	Provide lunar topography data, information on the possible location of lunar ice, and a temperature mapping of the lunar surface in support of future robotic and human missions to the lunar surface.	

Strategy For Major Planned Acquisitions

- There are no additional major acquisitions planned.

Key Participants

- Major participants are currently ARC, GSFC, Johns Hopkins University and the Applied Physics Laboratory, KSC, and the Boeing Company (provider of the launch vehicle for LRO).

Risk Management

- RISK:** If we do not establish a fully functioning, highly capable program office at Ames within the first half of 2006, then we will be unable to maintain strong management control of the RLEP program, resulting in adverse cost, schedule, and performance impacts. **MITIGATION:** NASA has selected an experienced program manager to construct and develop the program office at Ames. NASA headquarters is conducting an "Independent Readiness Review" of the program office to identify strengths and weaknesses, areas for increased headquarters support, and recommendations for high priority focus areas.
- RISK:** If we do not manage the integration of independently selected instruments into a complete LRO mission, we will experience significant schedule delays and cost increases. **MITIGATION:** NASA has re-baselined LRO for launch on an EELV (from a Delta II), reducing risk to the LRO development by reducing pressure to retain large design contingencies and by eliminating risk of a spacecraft spin stability incompatibility with the Delta II. NASA has initiated elements of Earned Value Management (EVM) within LRO to provide an early warning system for cost and schedule variances.

Theme: Exploration Systems Research & Technology
Program: Robotic Lunar Exploration
Project In Formulation: Lunar Reconnaissance Orbiter

President's FY 2007 Budget Request (Dollars in Millions)

<u>Lunar Reconnaissance Orbiter (Formulation)</u>	<u>FY2005</u>	<u>FY2006</u>	<u>FY2007</u>	<u>FY2008</u>	<u>FY2009</u>	<u>FY2010</u>	<u>FY2011</u>
FY 2007 PRES BUD	47.4	102.2	119.4	91.0	27.9	5.3	1.7
Changes from FY 2006 Request	7.2	-2.8	4.1	3.1	-0.7	1.4	

Projects in Formulation are not mature in their development process and cost estimates are SUBJECT TO CHANGE as the project matures.

Overview

The Lunar Reconnaissance Orbiter (LRO) will represent the first element of our new Exploration architecture to return to the Moon. As such, it represents the beginning of our effort to establish sustainable human exploration beyond the confines of low earth orbit.

LRO contains a suite of six instruments selected based on a competitive process, plus a technology demonstration payload that offers additional measurement data. These instruments include: a Lunar Orbiter Laser Altimeter and LRO Camera for high resolution imaging of the lunar surface; a Lunar Exploration Neutron Detector to search for evidence of water ice; a Diviner Lunar Radiometer to map the temperature of the lunar surface; a Lyman-Alpha Mapping sensor to observe the lunar surface in the far ultraviolet; and, a Cosmic Ray Telescope to measure the Moon's radiation environment and assess its potential impact on biological tissue. In addition to the competitively selected instruments, LRO will also include a mini-RF (Radio Frequency) payload as a technology demonstrator. In addition to demonstrating advanced technologies, the mini-RF will collect radar data to complement the other LRO measurements.

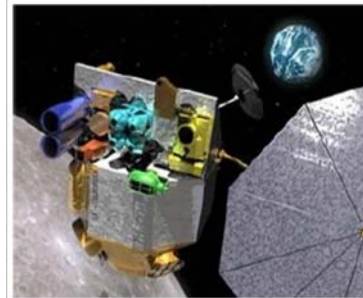

An artist's conception of the Lunar Reconnaissance Orbiter.

The LRO project will integrate the results from all six instruments to provide high fidelity information to advise future exploration activities.

Changes From FY 2006

- RLEP Program transferred to ESMD and Program Management moved from GSFC to ARC.
- LRO project retained at GSFC.

Program Management

The LRO Project is managed at GSFC.

Theme: Exploration Systems Research & Technology
Program: Robotic Lunar Exploration
Project In Formulation: Lunar Reconnaissance Orbiter

Technical Parameters

The LRO will take measurements in support of future robotic and human missions by providing highly accurate mapping of lunar topography and potential resources (including water ice). After completion of the nominal one-year primary mission, LRO will move to a second orbit (to reduce the high demand for station-keeping propellant required at the lower orbit) and continue to take measurements for up to four more years.

The LRO is scheduled for a Non-Advocate Review (NAR) in the third quarter of FY 2006. At that time, NASA will establish the Life Cycle Cost commitment, and provide it to the Congress.

Technical Specifications	FY 2007 President's Budget	Change from Baseline
LRO-Launch in 2008 to 50 km lunar orbit with one-year operational life.	Provide lunar topography accurate to 1 meter altitude and accurate to within 100 meters horizontal position. Identify potential water locations based on various signatures (hydrogen concentration and lyman-alpha detection) accurate to between 500 m and 10 km, depending on nature of the specific signature. Provide a mapping of temperature distribution over the Moon's surface, with temperature accuracy of 5 degrees Celsius and position accuracy of 500 m. Characterize the presence of lunar resources, including mineralogy. Measure the radiation environment and its effect on human tissue simulants.	

Schedule	FY 2007 President's Budget	Baseline	Change from Baseline
2/2006	Preliminary Design Reveiw	6/2005	8 months
10/2008	Launch LRO	10/2008	none

Strategy For Major Planned Acquisitions

- No new acquisitions are planned; all acquisitions are complete.

Key Participants

- Major participants are currently ARC, GSFC, Johns Hopkins University Applied Physics Laboratory, KSC, and the Boeing Company (provider of the launch vehicle for LRO).

President's FY 2007 Budget Request (Dollars in Millions)

Prometheus Power and Propulsion	FY2005	FY2006	FY2007	FY2008	FY2009	FY2010	FY2011
FY 2007 PRES BUD	270.3	75.7	9.4	9.5	9.9	9.7	9.7
Changes from FY 2006 Request	270.3	75.7	9.4	9.5	9.9	9.7	

Overview

The results of the Exploration Systems Architecture Study indicate that surface nuclear power systems are not essential in the for the early stages of implementing the vision for space exploration. However, long duration stays on the Moon and Mars will likely require the development of nuclear power and propulsion systems over the next decade. Many scientific missions may also benefit from the application of nuclear technology. In the near-term then, NASA will complete already on-going studies to define the content, appropriate funding level, and development schedule for a technology program that will lead to the systems necessary to meet NASA's more long-term requirements.

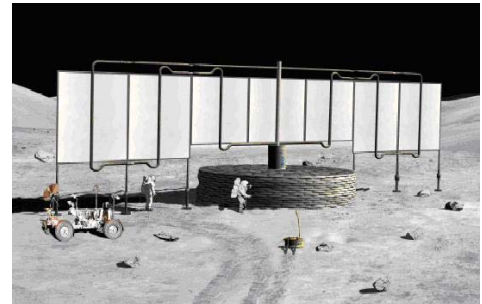

Artist's conception of a Fission Power System on the lunar surface.

Much of the near term funding planned for this program has been directed to support the development of the Crew Exploration and Crew Launch Vehicles. Remaining FY 2006 funds will support termination costs for the Jupiter Icy Moons Orbiter (JIMO), as well as provide a level of funding necessary to maintain nuclear system investments that will continue to be useful in the future. The September 2005 Operating Plan transmitted to Congress by NASA indicated the agency's plans to significantly reduce and redirect the agency's investments in nuclear technology.

Plans For FY 2007

NASA will implement a restructured program in nuclear technology research and development. This program will be defined in the current fiscal year.

Changes From FY 2006

- As a result of program restructuring, all advanced nuclear electric propulsion technology and nuclear reactor power flight system efforts, including JIMO, have been terminated.

Program Management

Program Management is currently at NASA Headquarters, with support provided by both Glenn Research Center and Marshall Space Flight Center.

Theme: Exploration Systems Research & Technology

Program: Prometheus Power and Propulsion

Technical Parameters

The Prometheus Power and Propulsion program will continue a low level of funding for key, high-priority, nuclear system R&T issues, with longer-term plans to increase funding in the future, as the need for long-duration lunar and Mars applications approaches. Key research areas will likely include nuclear fission power systems for long duration stays on the lunar surface that are extensible to Mars surface explorations, and in the longer-term, nuclear thermal propulsion for transportation systems to Mars.

Technical Specifications	FY 2007 President's Budget	Change from Baseline
Specifications are still under review.		

Strategy For Major Planned Acquisitions

- There are no acquisitions planned at this time.

Key Participants

- NASA participants and external partners are still under review. NASA will continue to work with the U.S. Department of Energy's Office of Nuclear Energy to develop space reactor technology.

President's FY 2007 Budget Request (Dollars in Millions)

<u>Exploration Technology Development Program</u>	<u>FY2005</u>	<u>FY2006</u>	<u>FY2007</u>	<u>FY2008</u>	<u>FY2009</u>	<u>FY2010</u>	<u>FY2011</u>
FY2007 PRES BUD	478.3	482.4	354.0	245.7	183.9	248.5	340.3
Changes from FY 2006 Request	42.4	-179.6	-301.2	-511.3	-644.9	-599.1	

Overview

The Exploration Technology Development Program is the merging of two former ESRT programs, the Advanced Space Technology Program (ASTP) and Technology Maturation Program (TMP). As a result of the technology program review conducted by Exploration System Architecture Study, twelve technology maturation areas were identified as high priority for the exploration lunar architecture. Existing and new projects have been categorized, combined (when appropriate), and placed in these 12 technology areas. They are: Operations, Structures, Thermal Protection, Propulsion, Power, Thermal Control, Avionics & Software, Environmental Control and Life Support, Crew Support & Accommodations, Mechanisms, In-Situ Resource Utilization, and Analysis and Integration Tools. All technology projects are managed at NASA Centers.

Research in these 12 areas will mature advanced space technologies to the level of demonstration and flight validation, and transition them to programs in Constellation Systems, by the Preliminary Design Review dates for the CEV and CLV (see Constellation Systems Theme). In addition, technology planning is using the following reference dates for long-term research and technology planning:

- Not later than 2014 for the first CEV human flight to the ISS;
- A human mission to the Moon no later than 2020.



To minimize the consumables that must be launched from Earth to sustain a lunar outpost, in-situ resources will be used to produce oxygen, water, and propellants. This picture shows an artists conception of a lunar rover excavating regolith for chemical processing in a nearby in-situ resource utilization facility.

Plans For FY 2007

FY 2007 will be the first full year ESMD will be managing its ESRT portfolio after transitioning to the new structure in FY 2006. Specific highlights include:

- Develop and demonstrate low-temperature electronics and mechanisms to enable sustained operations at the lunar surface.
- Develop high efficiency radiators and heat pumps to reject heat from lunar surface systems.
- Develop advanced engineering tools for system design and analysis, and to perform technology assessments.
- Demonstrate intelligent robotic systems to assist humans in exploring the moon and setting up lunar surface infrastructure.
- Develop reliable software to reduce risk in the operation of complex systems.
- Develop ablative thermal protection materials for the Crew Exploration Vehicle heat shield.
- Develop a non-toxic auxiliary power system for the Crew Launch Vehicle.
- Develop a prototype system for extracting volatiles from the lunar regolith.

Changes From FY 2006

- Completed Phase I of all intramural projects in the former Advanced Space Technology and Technology Maturation Programs.
- ESMD has restructured and combined ASTP and TMP to address technology priorities for lunar exploration identified by the Exploration Systems Architecture Study. The three major tasks of the technology assessment conducted during ESAS were: (1) to identify what technologies are truly needed and when they need to be available to support the development projects; (2) to develop and implement a rigorous and objective technology prioritization/planning process; and (3) to develop ESMD research and technology investment recommendations about which existing projects should continue and which new projects should be established.

Program Management

The Exploration Technology Development Program is managed by NASA Langley Research Center.

Technical Parameters

The objective of the Exploration Technology Development Program is to provide cost-effective, requirements driven technology for human and robotic exploration missions that reduce technical risks, enable cost-effective and productive exploration missions, and enhance crew safety. Key areas of focus are Structures, Thermal Protection, Propulsion, Power, Thermal Control, Avionics & Software, Environmental Control and Life Support, Crew Support & Accommodations, Mechanisms, In-Situ Resource Utilization, Analysis and Integration, and Operations. These areas were developed through a rigorous and objective process consisting of the following: (1) the identification of architecture functional needs; (2) the collection, synthesis, integration, and mapping of technology data; and (3) an objective decision analysis resulting in a detailed technology development plan.

Technical Specifications	FY 2007 President's Budget	Change from Baseline
Advanced Space Technology and Technology Maturation.	Combined to form Exploration Technology Development Program.	Technology programs refocused on near term CEV and lunar short-duration missions in 12 technology focus areas.

Theme: Exploration Systems Research and Technology
Program: Exploration Technology Development

Implementation Schedule:											
Project	Schedule by Fiscal Year							Purpose	Phase Dates		
	05	06	07	08	09	10	11			Beg	End
Structures								The purpose of this Project is to mature technologies related to lightweight cryotanks and inflatable space structures.	Tech Form Dev Ops Res	May-05	Sep-11
Protection								The purpose of this Project is to mature technologies related to ablative and human-rated thermal protection systems for the CEV.	Tech Form Dev Ops Res	May-05	Sep-11
Propulsion								The purpose of this Project is to mature technologies related to propulsion systems for the CEV, a 5 - 20 klbf thrust engine for the future Lunar Surface Access Module, and other propulsion systems.	Tech Form Dev Ops Res	May-05	Sep-11
Power								The purpose of this Project is to mature technologies related to fuel cells, lithium-ion batteries, and a non-toxic auxiliary power unit for the CLV.	Tech Form Dev Ops Res	May-05	Sep-11
Thermal Control								The purpose of this Project is to mature technologies related to heat rejection for surface systems.	Tech Form Dev Ops Res	May-05	Sep-11
Avionics & Software								The purpose of this Project is to mature technologies related to radiation-hardened, low temperature electronics, integrated system health management, spacecraft autonomy, automated rendezvous and docking, autonomous precision landing, and reliable software.	Tech Form Dev Ops Res	May-05	Sep-11
Environmental Control & Life Support								The purpose of this Project is to mature technologies related to atmospheric management, environmental monitoring and control, and advanced air and water recovery systems.	Tech Form Dev Ops Res	May-05	Sep-11
Crew Support & Accommodation								The purpose of this Project is to mature technologies necessary for an advanced Extra Vehicular Activity (EVA) suit.	Tech Form Dev Ops Res	May-05	Sep-11
Mechanisms								The purpose of this Project is to mature technologies related to low temperature mechanisms.	Tech Form Dev Ops Res	May-05	Sep-11
In-Situ Resource Utilization								The purpose of this Project is to mature technologies related to regolith excavation and material handling, and to support future oxygen production from regolith and polar volatile collection and separation.	Tech Form Dev Ops Res	May-05	Sep-11
Analysis & Integration								The purpose of this Project is to mature the analytical tools required for architecture and mission analysis and technology investment portfolio assessments.	Tech Form Dev Ops Res	May-05	Sep-11
Operation								The purpose of this Project is to mature technologies related to supportability, human-system interaction, surface handling and operations equipment, and surface mobility.	Tech Form Dev Ops Res	May-05	Sep-11
<p> ■ Tech & Adv Concepts (Tech) ■ Formulation (Form) ■ Development (Dev) ■ Operations (Ops) ■ Research (Res) ■ Represents a period of no activity for the Project </p>											

Theme: Exploration Systems Research and Technology

Program: Exploration Technology Development

Strategy For Major Planned Acquisitions

- No major acquisitions are planned.

Key Participants

- NASA Centers lead technology development projects in partnership with several external organizations. NASA partners with the U.S. Army on in-situ resource utilization research and with the Department of Energy on research into the advancement of radiation hardened electronics.

Risk Management

- **RISK:** Lack of progress in technology development. Likelihood is moderate. **MITIGATION:** Earned Value Management is used to track progress versus plans; Annual project continuation reviews.
- **RISK:** Problems transitioning technologies to potential users. Likelihood is moderate. **MITIGATION:** Critical technologies for CEV and CLV are managed by Constellation Program (e.g., thermal protection systems for the CEV). Effective transition will require joint funding of technology transition activities to insure users are committed to infusing technology products into mission applications.
- **RISK:** Changes in requirements for technology development. Likelihood is moderate. **MITIGATION:** Invest in broad portfolio of technologies. Continually update requirements with systems analysis and through interaction with the Constellation Systems Program.

Human Systems Research & Technology



Desert Research & Technology Studies (RATS) is a demo of Extravehicular Activity (EVA) surface operations in an environment analogous to the surface of the Moon or Mars.

President's FY 2007 Budget Request

(Dollars in Millions)

Human Systems Research & Technology	FY2005	FY2006	FY2007	FY2008	FY2009	FY2010	FY2011
FY 2007 PRES BUD	888.1	624.1	274.6	281.8	281.8	292.8	312.1
Changes from FY 2006 Request	-115.8	-182.4	-522.1	-530.6	-536.7	-523.0	

Overview: *What NASA Accomplishes through the Human Systems Research & Technology Theme*

The Human Systems Research and Technology (HSRT) Theme is comprised of several of the efforts of the former Biological and Physical Research Enterprise. Over the past two years these programs have been transformed from a discipline focus on intrinsic biological and physical research, to a requirements-driven product-delivery focus. With the determination of the exploration architecture, the Exploration Systems Architecture Study reviewed the HSRT portfolio and further focused our activities. The Theme will ensure the health, safety, and security of humans through the course of exploration in low-Earth orbit and beyond. Programs within this Theme advance knowledge and technology critical for supporting long-term human survival and performance during operations beyond low-Earth orbit, with a focus on improving medical care and human health maintenance. HSRT will be investing at least 15% of its total ISS research budget in areas not directly related to supporting the human exploration program, supporting basic and applied research in the following areas: cellular research, cellular biotechnology, animal research, combustion research, fluids research, botany, microbiology and immunology.

The Theme contains three programs: Life Support and Habitation (LSH); Human Health and Performance (HHP); and Human Systems Integration (HSI). LSH conducts research and development for life support and other critical systems for spacecraft operations. HHP delivers research on questions about human physiology relevant to the human exploration of the solar system, and delivers technology to help maintain or improve human health in the space environment. HSI focuses on methods to maintain astronaut behavioral health during demanding space missions and optimize human-machine interaction in the operation of spacecraft systems.

Relevance: *Why* NASA conducts Human Systems Research & Technology work

Relevance to national priorities, relevant fields, and customer needs:

HSRT is a requirements-driven program that strives to enable the Vision for Space Exploration by developing advanced capabilities, supporting technologies, and research that enables affordable and sustainable human exploration missions. HSRT will deliver solutions for crew health, safety, and productivity in deep space that reduce mission risk and cost.

Relevance to the NASA mission:

HSRT supports NASA's mission to explore the universe by reducing long-duration mission cost and risk in the areas of crew health and performance, life support and habitation, and improved extra vehicular activities. HSRT will carry out critical research using the International Space Station to enable long-duration human space missions.

Relevance to education and public benefits:

HSRT will promote the technical education of future scientists, engineers, and health care professionals by providing direct opportunity to participate in space exploration projects. The development of advanced technologies for autonomous medical care, closed-loop life support, and resource recycling will provide benefits to the quality of life across the world.

Performance

Major Activities Planned for FY 2007:

- Renal stone countermeasure transition from research to medical operations.
- Continue testing bone and cardiovascular countermeasures in space; conduct a bone bisphosphonate countermeasure ISS clinical trial.
- Initiate ISS medical data exchange among the International Partners.
- Demonstrate the ability of the advanced spacecraft air monitoring system to detect 90% of the high-priority air contaminants in ground testing.
- Develop a revised space material flammability characterization test method and update NASA-STD-6001 accordingly.

Major Recent Accomplishments:

- Zero-base review of all project within HSRT to align this research with the Exploration Vision.
 - Human Research Facility (HRF-2) flown to station (will enhance human research aboard ISS). Expands HRF Rack 1 capabilities with key tools used to answer questions that reduce risk to space crews.
 - Bioastronautics Roadmap baselined. NASA's Bioastronautics Roadmap (BR) is the framework used to identify and assess the risks of crew exposure to the hazardous environments of space.
 - Institute of Medicine report on Bioastronautics Roadmap, an independent assessment demonstrating that many of the key factors have been considered carefully and NASA is handling them appropriately.
 - Successful Preship Review at GRC of the Fluids and Combustion Facility (FCF). This is a critical step in the space flight development process.
-

Human Systems Research & Technology Theme Commitment in Support of the NASA Mission :

Strategic Goals**Sub-Goals (If Applicable)***Multiyear Outcomes*

Annual Performance Goals supporting the Multiyear Outcomes

3. Develop a balanced overall program of science, exploration, and aeronautics consistent with the redirection of the human spaceflight program to focus on exploration.

3F Understand the effects of the space environment on human performance, and test new technologies and countermeasures for long-duration human space exploration.

3F.1 By 2008, develop and test candidate countermeasures to ensure the health of humans traveling in space.

7HSRT1 Complete development of a renal stone countermeasure and validate it for use.

7HSRT2 Begin validation of bone and cardiovascular countermeasures on the ISS.

3F.2 By 2010, identify and test technologies to reduce total mission resource requirements for life support systems.

7HSRT3 Complete laboratory testing of Crew Exploration Vehicle candidate technologies for carbon dioxide (CO₂) and humidity removal, water disinfection, and solid waste volume compaction, increasing the technology maturation in all areas.

3F.3 By 2010, develop reliable spacecraft technologies for advanced environmental monitoring and control and fire safety.

7HSRT4 Complete critical design review for an ISS technology demonstration of the advanced environmental monitoring system.

7HSRT5 Conduct at least two experiments on the ISS to advance next generation technologies for fire prevention, detection, and suppression on spacecraft.

Efficiency Measures

7HSRT6 Increase percentage of HSRT procurement funding, solely dedicated to Exploration Activities.

7HSRT7 Reduce time within which 80% of NRA research grants are awarded, from proposal due date to selection, by 5% per year, with a goal of 130 days.

Program Management

HHP and HSI will be managed by the Human Research Program Office at Johnson Space Center. LSH will be managed by the Langley Research Center.

Quality**Independent Reviews:**

- The Exploration Systems Architecture Study (ESAS) reviewed HSRT's research and technology programs for relevance to the Exploration Vision.

Program Assessment Rating Tool (PART):

The HSRT Theme received a PART rating of "moderately effective" in FY2005. The Office of Management and Budget (OMB) gave NASA this rating because the Theme has a clear purpose, is designed effectively, has meaningful performance measures for both short and long-term goals, and has effective program management. An improved rating for the Theme will be possible after NASA demonstrates further progress toward its new goals for HSRT.

To continue to improve performance HSRT will take the following actions:

- 1) Establish a risk mitigation process for Bioastronautics Roadmap deliverables in human space exploration, including schedule and resource requirements.
- 2) Develop measures to ensure directed research is fully peer reviewed using the Non-Advocate Review process.
- 3) Streamline the NASA Research Announcement process to reduce time between solicitation and selection.

Budget Detail (Dollars in Millions)

Budget Authority (\$ millions)	FY2005	FY2006	Change	FY2007	FY2008	FY2009	FY2010	FY2011	Comments
Human Systems Research & Technology	888.1	624.1	-349.5	274.6	281.8	281.8	292.8	312.1	
Life Support & Habitation	308.7	209.4	-106.6	102.8	106.9	103.6	112.2	128.3	
Human Health & Performance	336.8	257.4	-101.2	156.2	159.9	162.3	164.6	167.4	
Human Systems Integration	242.6	157.3	-141.6	15.6	15.0	15.9	16.0	16.4	

Theme:**Human Systems Research & Technology**

FY05 column reflects FY05 Operating Plan, dated 9/30/2005. FY06 column reflects FY06 Initial Operating Plan, dated 1/06. FY07-11 columns represent FY07 President's Budget Submit.

Due to the Exploration Systems Architecture Study (ESAS), HSRT has undergone significant changes to better align the programs' research and technology development with the Vision for Space Exploration while maintaining fundamental research efforts on the ISS. Discipline-focused research programs (Physical Sciences Research & Fundamental Space Biology) were de-emphasized and replaced with Exploration-oriented research and technology programs that addressed specific needs of exploration architecture as outlined by ESAS. To increase the impact of these redirected programs, the research and technology developments were phased so that the near-term deliverables associated with CEV support to ISS and initial lunar sortie missions were emphasized. Also, core ISS research was identified in areas of long-term human health studies, countermeasures, and space technology testing. The budgets for these programs were reduced to be in scope with the exploration requirements as established by ESAS, and the specific areas of program emphasis are outlined below. The Human Health & Performance Program adjusted its content per ESAS direction by eliminating fundamental biology including cell and tissue research, reducing radiation research, and eliminating both sortie and ISS animal research.

The Life Support & Habitation Program adjusted content per ESAS direction by eliminating Advanced Integrated Matrix, in-situ life support processes, and in-situ fabrication and repair investigations under the Contingency Response Technologies project; fundamental physical science research in the Applied Exploration Research project; and reducing advanced life support for long-term missions and fire prevention, detection, and suppression research in the Contingency Response Technologies project as well. The program is maintaining advanced extra vehicular activities systems and advanced environmental monitoring and control research in support of the Vision for Space Exploration. This budget submission also supports orderly grant and contract terminations for cancelled projects. The Human Systems Integration Program adjusted content by redirecting its projects according to the architecture requirements of ESAS. As the mission durations anticipated for future lunar sortie missions are within an existing (and growing) knowledge base derived from previous and planned expeditions to the ISS, the investment profile has been directed to address the specific requirements associated with initial sortie and longer duration lunar missions. Remaining deliverables include updated medical standards; predictive models of cognition, behavioral health, team interaction and performance; CEV spacecraft design requirements and assessments regarding reach, strength, endurance, accuracy, speed, workload and situational awareness; analytical tools, including models and simulations; and validated astronaut selection criteria for lunar missions. In addition, responsibility for the Multi-User Systems Support effort is transferred to SOMD, and part of Human Systems Integration's budget reduction reflects that change.

President's FY 2007 Budget Request (Dollars in Millions)

<u>Life Support & Habitation</u>	<u>FY2005</u>	<u>FY2006</u>	<u>FY2007</u>	<u>FY2008</u>	<u>FY2009</u>	<u>FY2010</u>	<u>FY2011</u>
FY 2007 PRES BUD	308.7	209.4	102.8	106.9	103.6	112.2	128.3
Changes from FY 2006 Request	-23.8	-91.5	-179.9	-173.9	-163.0	-142.7	

Overview

Life Support and Habitation focuses on enabling human exploration beyond low Earth orbit in two areas. In the first area, the focus is enabling further closure of the air, water, and food/waste loops to reduce resupply logistics and mission cost. The emphasis will be on developing Advanced Life Support technologies that will further close the life support expendables loops, extending Advanced Life Support component life cycles, advancing Advanced Life Support (ALS) subsystem reliability and maintainability, validating critical low- and reduced-gravity ALS component processes, and ensuring that ALS systems will survive and function in the Lunar dust environment. In the second area, the focus is developing a more reliable and maintainable environmental monitoring and control system. Emphasis will be on enhanced reliability, maintainability, portability, and system distribution.

The Life Support and Habitation Program adjusted its content per ESAS direction by eliminating the Advanced Integrated Matrix, in-situ life support processes, and in-situ fabrication and repair investigations under the Contingency Response Technologies project; fundamental physical science research in the Applied Exploration Research project; and reducing advanced life support for long-term missions and fire prevention, detection, and suppression research in the Contingency Response Technologies project as well. The program is maintaining advanced extra vehicular activities systems and advanced environmental monitoring and control research in support of the Vision for Space Exploration. This budget submission also supports orderly grant and contract terminations for cancelled projects.



TGA (trace gas analyzer) - used by astronauts in Shuttle Mission 5A and beyond to detect ammonia and air leaks outside the International Space Station. Contains the Quadrupole Mass Spectrometer

Plans For FY 2007

- Develop advanced air monitoring systems for testing and validation on the ISS in preparation for potential use on the CEV.
- Develop a revised space material flammability characterization test method and update NASA standards accordingly.
- Support development of a new generation of reliable spacecraft smoke detectors by finishing measurements of the ISS background particulates using the DAFT experiment and delivering for launch the Smoke and Aerosol Measurement Experiment.
- Microgravity validation testing of wiped film rotating disc, a component of the spacecraft water purification system called the Vapor Phase Catalytic Ammonia Removal (VPCAR) System.
- Define requirement for the Condensing Heat Exchanger flight focused on improving space condenser reliability.

Changes From FY 2006

- The LSH Program is responsible for developing new space suit technology for lunar surface missions. Near-term developments for new EVA suit technology is managed by the Constellation Systems Program.
- The LSH Program, consistent with the results of ESAS, has focused its efforts and resources almost entirely on the technology development in support of the CEV and the first Lunar Sortie missions.

Program Management

Program management for the LSH Program is being transitioned during FY 2006 from NASA HQ to the NASA Langley Research Center in Hampton, VA.

Theme: Human Systems Research & Technology
Program: Life Support & Habitation

Technical Parameters

The objective of the Life Support and Habitation Program is to provide cost-effective, requirement-driven technology solutions for life support systems that reduce risk, enable sustainable exploration missions, and enhance crew safety. Key areas of focus are long-term sustainable spacecraft life support systems; monitoring and maintenance of crew cabin environmental conditions; contingency response capabilities (fire prevention, detection and suppression).

Technical Specifications	FY 2007 President's Budget	Change from Baseline
Fluids and Combustion Facility (FCF)	The Fluids & Combustion Facility consists of two modular racks to be flown on the ISS: the Combustion Integrated Rack and the Fluids Integrated Rack.	From basic to applied research.
Fluids Integrated Rack (FIR)	Accommodates experiments that address critical needs in thermal control, water recovery, power generation and propellant management.	From basic to applied research.
Combustion Integrated Rack (CIR)	Accommodates experiments that address critical needs in spacecraft fire safety such as, fire prevention, detection and suppression.	From basic to applied research.
Materials Science Research Rack (MSRR)	Accommodates experiments that investigate the fundamental behavior of metals and alloys, ceramics and glasses, polymers and electronic materials.	None
Microgravity Sciences Glovebox (MSG)	The MSG is a sealed chamber with built-in gloves that provide access to an enclosed work space. The MSG is capable of handling experiments with fluids, flames, particles and fumes.	None

Implementation Schedule:

Project	Schedule by Fiscal Year							Purpose	Phase Dates													
	05	06	07	08	09	10	11			Beg	End											
Advanced Life Support	[Gantt chart: Tech & Adv Concepts (Tech) from 05 to 11]							Supports development of advanced technologies to close the life support system loop to enable long-duration exploration missions.	Tech Form Dev Ops Res	Oct-04	Dec-25											
Advanced EVA Systems	[Gantt chart: Tech & Adv Concepts (Tech) from 05 to 11]							Develop next generation EVA technologies for surface exploration suits.	Tech Form Dev Ops Res	Oct-04	Dec-25											
Advanced Environmental Monitoring & Control	[Gantt chart: Tech & Adv Concepts (Tech) from 05 to 11]							Supports development of new spacecraft technologies to reliably monitor air, water, and surfaces for contamination.	Tech Form Dev Ops Res	Oct-04	Dec-25											
Contingency Response Technology	[Gantt chart: Tech & Adv Concepts (Tech) from 05 to 11]							Enhances fire safety by developing new technologies for prevention, detection, and suppression.	Tech Form Dev Ops Res	Oct-04	Dec-25											
Life Support & Habitation Program Mgt - FCF	[Gantt chart: Development (Dev) from 05 to 06, Research (Res) from 06 to 07, Operations (Ops) from 07 to 11]							Develop and operate the Fluids & Combustion Facility (FCF) on the ISS.	Tech Form Dev Ops Res	Oct-04	Mar-06 May-07 Dec-16											
Life Support & Habitation Program Mgt - MSRR	[Gantt chart: Development (Dev) from 05 to 06, Research (Res) from 06 to 07, Operations (Ops) from 07 to 11]							Develop and operate the Materials Science Research Rack (MSRR) on the ISS.	Tech Form Dev Ops Res	Oct-04	Apr-07 Oct-07 Dec-16											
Life Support & Habitation Program Mgt - MSG	[Gantt chart: Operations (Ops) from 05 to 11]							Develop and operate the Microgravity Sciences Glovebox (MSG) on the ISS.	Tech Form Dev Ops Res	Oct-04	Dec-16											
<table border="0"> <tr> <td>[Blue box]</td> <td>Tech & Adv Concepts (Tech)</td> </tr> <tr> <td>[Brown box]</td> <td>Formulation(Form)</td> </tr> <tr> <td>[Yellow box]</td> <td>Development (Dev)</td> </tr> <tr> <td>[Green box]</td> <td>Operations (Ops)</td> </tr> <tr> <td>[Purple box]</td> <td>Research (Res)</td> </tr> <tr> <td>[Black box]</td> <td>Represents a period of no activity for the Project</td> </tr> </table>											[Blue box]	Tech & Adv Concepts (Tech)	[Brown box]	Formulation(Form)	[Yellow box]	Development (Dev)	[Green box]	Operations (Ops)	[Purple box]	Research (Res)	[Black box]	Represents a period of no activity for the Project
[Blue box]	Tech & Adv Concepts (Tech)																					
[Brown box]	Formulation(Form)																					
[Yellow box]	Development (Dev)																					
[Green box]	Operations (Ops)																					
[Purple box]	Research (Res)																					
[Black box]	Represents a period of no activity for the Project																					

Strategy For Major Planned Acquisitions

- No major acquisitions are planned. The focus will be to expeditiously complete current technology developments for the CEV.

Key Participants

- NASA centers play a role in project management teams, rapid technology development teams (RTDT), and intramural research projects.
- Industry and academia participate in extramural projects, teaming arrangements with NASA centers (e.g., RTDT), and other government agencies through interagency agreements.

Theme: Human Systems Research & Technology

Program: Life Support & Habitation

Risk Management

- **RISK:** Key risks include the failure of technologies to mature in key technology areas for infusion into Constellation Systems programs. **MITIGATION:** The mitigation strategy is to focus technology developments to ensure the capability is available for the CEV and/or Lunar Sortie missions.
- **RISK:** An additional key risk includes research delays associated with Shuttle launches and payload upmass and crew time shortages. **MITIGATION:** The mitigation strategy is to have a strong ground based research program to complement the flight program.

President's FY 2007 Budget Request (Dollars in Millions)

Human Health & Performance	FY2005	FY2006	FY2007	FY2008	FY2009	FY2010	FY2011
FY 2007 PRES BUD	336.8	257.4	156.2	159.9	162.3	164.6	167.4
Changes from FY 2006 Request	-85.7	-41.4	-146.8	-159.7	-165.4	-175.3	

Overview

The Human Health and Performance Program delivers research and technology, knowledge and tools in three areas of life sciences that will enable human exploration: Human Health Measures, Space Radiation, and Exploration Medicine Capability. Human Health Countermeasures includes exercise devices and exercise prescriptions, recommendations for partial gravity use, understanding how the body reacts in space as well as requirements for the use of drugs and nutrition as effective countermeasures for individual body systems' degradation due to exposure to the space environment. Space Radiation includes research on human health effects to enable accurate risk assessment and risk reduction, identification of limiting factors for vehicle environments and crew selection and next generation warning technologies. Exploration Medicine Capability includes development of medical expertise for standards and policy development, next generation medical care and crew health maintenance technologies for six month missions and an integrated medical model for probabilistic risk assessment.



Enabling space explorers to perform their work during space flight requires an understanding of what tools it takes to keep the crew healthy. An ISS astronaut performs an experiment to quantify forces that humans exert on muscles and bone in order to design and implement effective exercise countermeasures to maintain musculoskeletal and cardiovascular health in human explorers.

The Human Health and Performance Program adjusted its content per ESAS direction by eliminating fundamental biology including cell and tissue research, reducing radiation research, and eliminating both sortie and ISS animal research.

Plans For FY 2007

- Renal stone countermeasure transition from research to medical operations.
- Continue testing bone and cardiovascular countermeasures in space; conduct a bone bisphosphonate countermeasure ISS clinical trial.
- Initiate ISS medical data exchange among the International Partners.
- Completion of the artificial gravity international Phase I Project Pilot study.
- Complete study and deliver report on lunar radiation requirements.
- Complete physics database for shielding in region above 2 GeV per nucleon.

Changes From FY 2006

- The Exploration Systems Architecture Study (ESAS) prioritized near term work in this area.
- The Program has deferred research and development efforts supporting human missions to Mars.

Program Management

This Program is now managed by the Human Research Program Office at Johnson Space Center.

Theme: Human Systems Research & Technology
Program: Human Health & Performance

Technical Parameters

This program conducts systematic studies of human physiological, behavioral, and chemical changes induced by spaceflight. The Program focuses on three subject areas: Human Health Countermeasures, Space Radiation, and Exploration Medicine Capability. NASA is accumulating long term data on adaptation to the space environment. The Human Research Facility (HRF) is hardware that provides the major on-orbit capability to perform research including high resolution imaging for diagnostics and research applications on human organs. NASA studies areas of concern to human well-being and performance, such as renal stone risk, bone loss, and the effect of ionizing radiation to ensure human safety during space exploration missions.

Technical Specifications	FY 2007 President's Budget	Change from Baseline
Human Health and Performance	Human Health and Performance is further divided into the following research projects: physiological countermeasures, space radiation, and exploration medical capability.	During alignment with the Vision for Space Exploration and as a result of the Exploration Systems Architecture Study there have been significant changes to the content of NASA's research in this area.

Implementation Schedule:

Project	Schedule by Fiscal Year							Purpose	Phase Dates		
	05	06	07	08	09	10	11			Beg	End
Human Health Countermeasures								Identify countermeasure techniques to protect astronauts from the harmful effects of the space environment.	Tech Form Dev Ops Res	Oct-05	Dec-25
Exploration Medical Capability								Identify techniques to improve astronaut medical care and crew health optimization.	Tech Form Dev Ops Res	Oct-05	Dec-25
Space Radiation								Evaluates the radiation risks to astronauts engaged in exploration missions.	Tech Form Dev Ops Res	Oct-05	Dec-25

Strategy For Major Planned Acquisitions

- FY 2006: Directed Research for Human Health Countermeasures.
- FY 2007: Directed Research & NASA Research Announcements (NRA) for physiological analogs.
- FY 2007: NRA for Space Radiation.

Key Participants

- NASA Headquarters, NASA Centers, National Space Biomedical Research Institute, academia, industry and other government agencies.

Theme: Human Systems Research & Technology

Program: Human Health & Performance

Risk Management

- **RISK:** Risks include up-mass to and down-mass from ISS, and limited number of test subjects with long-duration exposure to microgravity. Up-mass and downmass are measurements of the number and type of experiments transported to the ISS. The fewer opportunities to fly both experiments and astronauts on the ISS there are, the higher the risk in acquiring data necessary to plan future exploration missions. **MITIGATION:** The ISS Medical Program (ISSMP) takes an innovative approach toward ISS utilization, developing on orbit techniques to process medical samples, increasing modeling/analysis capability, and developing a novel mitigation strategy for biomedical risks in the Bioastronautics Roadmap using probabilistic risk assessment to prioritize ISS utilization.

President's FY 2007 Budget Request (Dollars in Millions)

Human Systems Integration	FY2005	FY2006	FY2007	FY2008	FY2009	FY2010	FY2011
FY 2007 PRES BUD	242.6	157.3	15.6	15.0	15.9	16.0	16.4
Changes from FY 2006 Request	-6.3	-49.5	-195.4	-197.0	-208.3	-205.0	

Overview

Human Systems Integration research and technology is driven by Agency needs for crew health, design of human spacecraft, space suits, and habitats; efficient crew operations; medical operations; and technology development to enable safe and productive human exploration of space. Human Systems Integration focuses on two major areas: Behavioral Health and Performance and Space Human Factors Engineering. Within Behavioral Health, the focus is on developing a core biomedical competency in human behavior and adaptation to space flight to understand mission risks and long-term astronaut health risks. Research and tools to develop behavioral health selection, assessment, intervention, training, and communication techniques to support exploration. Human Factors and Environmental Standards include development and maintenance of Agency standards and guidelines influencing human factors design and environmental control and monitoring. Research to improve state of the art for space human factors in the areas of anthropometry, usability, cognition, habitability, lighting, ergonomics, simulation, and modeling, test and evaluation.



Human exploration crews such as that shown will require specialized tools to facilitate effective communications and social interactions and maintain normal behavior in the hazardous, physically constrained, and disorienting world of space flight.

The Human Systems Integration Program adjusted its content by redirecting its projects according to the architecture requirements of the ESAS. The investment profile in this program has been directed to address the specific requirements associated with initial sortie and longer duration lunar missions. In addition, responsibility for the Multi-User Systems Support effort has been transferred to the Space Operations Mission Directorate, and part of the budget reduction in Human Systems Integration reflects that change.

Plans For FY 2007

- The Program is continuing to revise the NASA Standards-3000 for Human Factors, Human System Integration Standards.
- Begin circadian rhythm countermeasure ISS clinical trial using "blue light" to reset the body's internal clock.

Changes From FY 2006

- The Exploration Systems Architecture Study prioritized near term work in HSRT to support human missions to the lunar surface. Research in support of Mars missions has been deferred.
- Responsibility for support of the Multi User Support System has been transferred to the Space Operations Mission Directorate.

Program Management

This Program is now managed by the Human Research Program Office at Johnson Space Center.

Technical Parameters

The Human Systems Integration Program addresses behavioral health of the crew and several human factors (crew interactions with the environment). Team cohesion research focuses on stressors during long duration flight that will affect crew performance, identifying behaviors, experiences, personality traits and leadership styles that most contribute to optimal performance, and criteria for team selection. Psychological health addresses neurobehavioral dysfunction including depression, anxiety and other psychiatric, cognitive problems and those associated with sleep and chronobiology. The program will develop activities and tools that will mitigate or manage risks related to psychological incompatibility with team and individual performance, human survival, mission safety, and success.

Technical Specifications	FY 2007 President's Budget	Change from Baseline
Human Systems Integration	The Human System Integration is further broken down into Behavioral Health, Space Human Factors, Habitability, and Food Technology.	During alignment with the Vision for Space Exploration, major reductions to both content and budget occurred.

Implementation Schedule:

Project	Schedule by Fiscal Year							Purpose	Phase Dates													
	05	06	07	08	09	10	11		Beg	End												
Behavioral Health and Performance	[Gantt chart showing activity from FY 06 to FY 11]							Research in this area contributes to medical standards, guidelines, and requirements for human spaceflight operations.	Tech Form Dev Ops Res	Oct-04	Dec-25											
Space Human Factors Engineering	[Gantt chart showing activity from FY 06 to FY 11]							Research in this area identifies physical, cognitive, and team performance factors that will lead to training and operating procedures that best prepare astronauts for mission operations.	Tech Form Dev Ops Res	Oct-04	Dec-25											
Multi-User Systems and Support	[Gantt chart showing activity from FY 05 to FY 07]							Multi-User System and Support (MUSS) projects enable effective ISS operations and utilization. MUSS will be transferred to SOMD in FY 2007.	Tech Form Dev Ops Res	Oct-05	Sep-06											
<table border="0"> <tr> <td>■</td> <td>Tech & Adv Concepts (Tech)</td> </tr> <tr> <td>■</td> <td>Formulation(Form)</td> </tr> <tr> <td>■</td> <td>Development (Dev)</td> </tr> <tr> <td>■</td> <td>Operations (Ops)</td> </tr> <tr> <td>■</td> <td>Research (Res)</td> </tr> <tr> <td>■</td> <td>Represents a period of no activity for the Project</td> </tr> </table>											■	Tech & Adv Concepts (Tech)	■	Formulation(Form)	■	Development (Dev)	■	Operations (Ops)	■	Research (Res)	■	Represents a period of no activity for the Project
■	Tech & Adv Concepts (Tech)																					
■	Formulation(Form)																					
■	Development (Dev)																					
■	Operations (Ops)																					
■	Research (Res)																					
■	Represents a period of no activity for the Project																					

Strategy For Major Planned Acquisitions

- FY 2006 - Directed research for development of behavioral health & human factors.
- FY 2007 - Directed research and NASA Research Announcements to solicit proposals for psychosocial adaptation research.

Key Participants

- NASA Headquarters, NASA Centers, National Space Biomedical Research Institute, academia, industry and other government agencies.

Theme: Human Systems Research & Technology

Program: Human Systems Integration

Risk Management

- **RISK:** Risks include up-mass to and down-mass from ISS, and limited number of test subjects with long-duration exposure to microgravity. Up-mass and downmass are measurements of the number and type of experiments transported to the ISS. The fewer opportunities to fly both experiments and astronauts on the ISS there are, the higher the risk in acquiring data necessary to plan future exploration missions. **MITIGATION:** The Chief Health & Medical Officer and the Human Research Program Office are developing a risk mitigation process for biomedical risks identified in the Bioastronautics Roadmap. The IOM recommended that risks be quantified and prioritized according to probability and maturity. Using probabilistic risk assessment risks can be prioritized resulting in more efficient use of ISS capability.

Theme

Aeronautics Technology



NASA's Aeronautics Research advances knowledge in core disciplines (e.g., fluid dynamics, chemistry, materials) up through integrated multi-disciplinary system-level models, tools, and technologies to enable breakthroughs in Aeronautics. Understanding aircraft's surface pressure distributions during transonic flight (shown) helps to improve flight performance and fuel efficiency. This solution was provided by the NASA Tetrahedral Unstructured Software System (TetrUSS) team.

AERONAUTICS RESEARCH

Purpose

Advances in foundational technologies have driven the first two waves of aeronautics growth over the last century (first in propeller aircraft, then in jets). These revolutions have led to today's National Airspace System (NAS), the hub-and-spoke commercial air carrier industry, as well as innumerable military, public service, and business aviation capabilities. Aviation has improved the quality of life and created prosperity for the Nation.

The current needs of the Nation have transcended the limited solutions that aviation currently offers, requiring dramatic improvements in capacity, environmental compatibility, robustness, safety, and freedom of mobility throughout the U.S. and across the globe. Now, a third wave of aeronautics offers solutions to these challenges. This third wave is not merely an extrapolation of the existing aviation capabilities, but a radical technology shift that will enable revolutionary enhancements of both the airspace system and the aircraft that fly in it.

NASA is reshaping its Aeronautics Research Program to re-establish the Agency's dedication to the mastery of core competencies in subsonic, supersonic and hypersonic flight; increase focus on safety research; and directly address the needs of the Next Generation Air Transportation System (NGATS) in partnerships with the Federal Aviation Administration (FAA) and other agencies. The previous Vehicle Systems Program is being renamed Fundamental Aeronautics to reflect this reshaped vision. NASA will establish program thrusts within Fundamental Aeronautics that provide continual, long-term investment in the fundamentals. NASA will build upon that investment to

Mission Directorate: Aeronautics Research

develop system-level, multidisciplinary capabilities that will enable both the civilian and military communities to develop air vehicles that meet their specific needs. NASA is also transforming the Aviation Safety and Security Program into the Aviation Safety Program, that will increase the Agency's focus in research on safety areas that are in line with NASA's capabilities. The Airspace Systems Program is being realigned to directly address the needs of the NGATS Initiative as defined by the Joint Planning and Development Office (JPDO). NASA has also established an Aeronautics Test Program to ensure that key aeronautics research and test facilities are preserved for the benefit of not only the Agency, but for the Nation as a whole. An Aeronautics Decadal Survey is underway at the National Research Council to help guide NASA in determining future aeronautics research priorities. Consistent with Congressional direction, the Office of Science and Technology Policy and NASA are working together to draft a National Aeronautics Policy which will address the following: the appropriate role for Federal investment in U.S. aeronautics R&D; near- and far-term, high priority aeronautics research objectives; the roles and responsibilities of the multiple agencies involved; and infrastructure and workforce challenges.

FY 2005 Accomplishments

During FY2005, the Aeronautics Research Mission Directorate (ARMD) made substantial progress in developing aeronautics technologies.

Hypersonics. Successfully completed testing of a high Mach number wide-inlet propulsion system design. The inlet was highly integrated with the vehicle forebody, resulting in strong three-dimensional flow effects. The comparison between test data and analytical predictions will serve as a reference for analyses of future integrated configurations with three-dimensional flow spillage.

Supersonics. Addressed development of revolutionary tools for sonic boom analysis and design using Fully Unstructured Navier-Stokes (FUN3D) software with adjoint-based sensitivity derivative calculation method. This demonstrated an increased accuracy of sonic boom flow field analysis at reduced computational cost.

Fixed Wing. Selected low noise landing gear and advanced chevrons for the Quiet Technology Demonstrator 2 flight test. Computationally investigated several concepts for landing gear fairings and the resulting hardware was installed on a Boeing 777-300ER. Developed a physics-based understanding of the acoustics of propulsion system installation on an airframe. The resulting asymmetric chevron fan nozzle was developed and tested to include airframe integration effects.

Rotary Wing. Developed a unified system noise prediction capability including source noise and atmospheric propagation effects. Evaluated source noise reduction concepts and developed low noise operations. The acoustic prediction system was also used to determine acoustic characteristics of the proposed Heavy Lift Rotorcraft Systems concepts. Validations were made with model rotor data from as well with acoustic data from the MD520 helicopter.

Next Generation Weather and Synthetic Vision Systems (SVS) Technologies. NASA's Safety Program focuses on preventing accidents involving hazardous weather and icing conditions, controlled flight into terrain, and mechanical or software malfunctions. NASA also seeks to decrease injuries and fatalities when accidents do occur. Flight tests in 2005 indicate drastic improvements in pilot situational awareness and confidence in the Weather and Synthetic Vision Systems.

Integrated Full Mission Applications, Simulations, and Flight Demonstrations. Information technologies needed to build a safer aviation system and to assess situations and trends that might indicate unsafe conditions before they lead to accidents were developed and transferred directly to the FAA for daily use. Analysis indicates that if NASA-developed technologies could have been applied to the 1990-1996 National Transportation Safety Board (NTSB) set of accident causes, they would have either a direct or indirect impact on reducing the accident rate for over 80 percent of accident causes.

Mission Directorate: Aeronautics Research

Small Aircraft Transportation Systems (SATS) Public Demonstration. As part of the NASA's Airspace System Program, the SATS Project - conducted as a public-private partnership with NASA, the FAA, and the National Consortium for Aviation Mobility - successfully integrated and demonstrated four SATS operating capabilities: higher-volume operations at non-towered/non-radar airports, lower landing minimums at minimally equipped landing facilities, increased single-pilot performance crew safety and mission reliability, and en route procedures and systems for integrated fleet operations.

Operational Demonstration of Multi-Center Traffic Management Advisor (McTMA) Decision Support Tool. NASA's Airspace System Program successfully conducted live operational demonstration of the McTMA air traffic decision-support tool for arrivals to Philadelphia International Airport, whose arrival airspace is heavily congested. McTMA creates efficient and safe arrival sequences that deliver arriving aircraft to busy terminal areas using a traffic flow management technique called time-based metering.

Analysis of the Air Transportation System Using the Airspace Concepts Evaluation System (ACES). NASA's Airspace System Program successfully completed the analysis and evaluation of several capacity-increasing operational concepts and technology roadmaps with the Virtual Airspace Simulation Technologies (VAST) environment and common experiment plan. These operational concepts span the NAS, identifying promising technologies and procedures that can lead to the ability of the NAS to accommodate a doubling of passenger trips and miles.

Theme Distribution

Budget Authority (\$ in millions)	FY 2005	FY 2006	FY 2007	FY 2008	FY 2009	FY 2010	FY 2011
Aeronautics Technology	\$962.0	\$884.1	\$724.4	\$731.8	\$732.4	\$722.8	\$722.7
Total	\$962.0	\$884.1	\$724.4	\$731.8	\$732.4	\$722.8	\$722.7

Note: For all formats, the FY 2005 column reflects the FY 2005 Congressional Operating Plan, dated 9/30/2005. The FY 2006 column reflects the FY 2006 Congressional Initial Operating Plan, dated Jan 2006. The FY 2007 through FY 2011 columns represent the FY 2007 President's Budget Submit.

Aeronautics Technology

The NASA Aeronautics Research Program has defined a four-level approach to technology development: (1) conduct foundational research to further understanding of the underlying physics and the ability to model that physics, (2) leverage the foundational research to develop technologies and analytical tools focused on discipline-based solutions, (3) integrate multi-disciplinary methods and technologies to develop sub-system-level capabilities and (4) integrate the capabilities developed in (3) to provide system-level solutions for the Next Generation Air Transportation System and the next-generation air vehicles that will fly in it. Although the 18 percent decrease in the Aeronautics budget reflects reduced investment levels in all three R&D programs, the refocused program enables the Agency to accommodate the reductions by focusing NASA's investments in the highest priority areas of Aeronautics research.

The Fundamental Aeronautics Program (formerly Vehicle Systems) will conduct cutting-edge research to develop advanced tools and capabilities that will enable whole new classes of aircraft that not only meet the noise and emissions requirements of the future but that also provide fast, efficient, and economical flight. NASA will invest broadly and deeply in the core competencies of aeronautics, producing knowledge, technology, tools, and capabilities that are applicable across a broad range of air vehicles in 4 thrust areas (Hypersonics, Supersonic, Subsonic Fixed Wing and Subsonic Rotary Wing). The Aeronautics Test Program (ATP), funded within Fundamental Aeronautics in FY 2006, is being established as a separate Aeronautics Program in FY 2007. Some funds from FAP have been transferred to the newly created ATP in FY 2007. Other funding reductions are due to the elimination of activities that were closed out in FY 2006 and are not consistent with the new program direction.

Mission Directorate: Aeronautics Research

The Aviation Safety Program (formerly Aviation Safety & Security) focuses on the Nation's aviation safety challenges of the future. This vigilance for safety must continue in order to meet the projected increases in air traffic capability and realize the new capabilities envisioned for the NGATS Initiative. The Aviation Safety Program will conduct research to improve the intrinsic safety attributes of future aircraft and to eliminate safety-related technology barriers. NASA will address science and technologies that build upon and advance the Agency's unique safety-related research capabilities by conducting high-payoff research vital to aviation safety. Information Sharing Initiative, Turbulence, and Aviation Security project activities end in FY 2006. Integrated Vehicle Health Management and Aircraft Aging and Durability Projects are ramping up in FY 2007.

The Airspace Systems Program (ASP) has a primary goal to research and develop innovative solutions for a safe, efficient high-capacity airspace system in the air and on the ground. The Airspace Systems Program addresses the Joint Planning and Development Office's NGATS capability requirements. Through the development and demonstration of technologies, capabilities, and future concepts, these requirements will enable major increases in the capacity and mobility of the U.S. air transportation system as well as improve air traffic management effectiveness, flexibility and efficiency while maintaining safety. Space Based Technology, Unmanned Aerial Vehicles (UAVs) in the NAS, and SATS end in FY 2006. The Virtual Airspace Modeling and Simulation activity is phasing out as planned in FY 2007.

The Aeronautics Test Program is a new program whose purpose is to ensure the strategic availability of a critical suite of wind tunnels necessary to meet programmatic Agency and/or national needs. The Aeronautics Test Program is responsible for the strategic and business management of the aeronautics wind tunnels/ground test facilities at Ames Research Center, Glenn Research Center and Langley Research Center. The Aeronautics Test Program budget ensures sufficient funding is available for continuous operations of facilities, the appropriate level of maintenance and investments, and stable user pricing.

Overall Budget

The FY 2007 request is \$724.4 million, an 18 percent decrease from the FY 2006 Budget

- \$447.2 M is for Fundamental Aeronautics projects including subsonics (rotary and fixed wing), supersonics, and hypersonics.
- \$102.2 M is for Aviation Safety to increase aircraft safety technologies.
- \$120.0 M is for Airspace Systems to research and develop innovative solutions for a safe, efficient, high-capacity airspace system in the air and on the ground.
- \$55.0 M is for the Aeronautics Test Program to ensure availability of critical Aeronautics research center wind tunnel infrastructure.

Aeronautics Technology

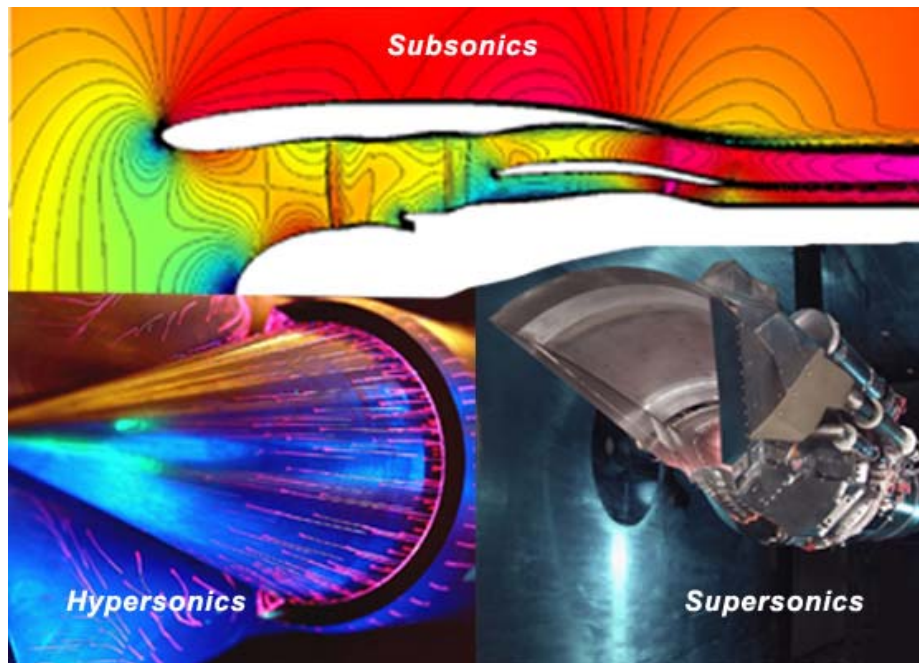

The Aeronautics Program is dedicated to the mastery of critical core competencies of Aeronautics in subsonics (rotary and fixed wing), supersonics, and hypersonics flight.

President's FY 2007 Budget Request

(Dollars in Millions)

Aeronautics Technology	FY2005	FY2006	FY2007	FY2008	FY2009	FY2010	FY2011
FY 2007 PRES BUD	962.0	884.1	724.4	731.8	732.4	722.8	722.7
Changes from FY 2006 Request	55.8	31.7	-3.2	1.1	4.9	5.1	

Overview: What NASA Accomplishes through the Aeronautics Technology Theme

NASA is refocusing the Aeronautics program to place a greater emphasis on long-term investments in foundational research. The Agency is maintaining its long-standing commitment to benefit the American public by developing technologies that accomplish the following goals: make the Nation's current and future air transportation system even safer; protect local air quality and our global climate; reduce aircraft noise to benefit airport neighbors, the aviation industry, and travelers; enable the movement of more air passengers with fewer delays; and, enable people to travel faster and farther, anywhere, anytime. The Aeronautics Technology Theme consists of three integrated research programs (Fundamental Aeronautics, Aviation Safety, and Airspace Systems) as well as a new Aeronautics Test Program. The Fundamental Aeronautics Program will conduct research and develop technology to enable revolutionary capabilities for the future of aviation. We will develop advanced tools that will enable new classes of aircraft that meet noise and emissions requirements of the future and provide fast, efficient, and economical flight. The revectorred Aviation Safety Program will focus NASA research on improving the inherent safety attributes of aircraft in order to eliminate fatal accidents and enhancing the safety of the Nation's current and future national air transportation system. The realigned Airspace Systems Program will directly address the needs of the Next Generation Air Transportation System (NGATS) initiative as defined by the Federal Aviation Administration/NASA Joint Planning and Development Office (JPDO). NGATS research will enable major increases in the capacity and mobility of the U.S. air transportation system through development of technologies, capabilities, and future concepts. The Aeronautics Test Program will ensure that a critical suite of wind tunnels are available to meet Aeronautics, Agency, and National needs.

Relevance: *Why* NASA conducts Aeronautics Technology work

Relevance to national priorities, relevant fields, and customer needs:

Two activities are currently underway to ensure the continued relevance of NASA Aeronautics research to National priorities.

First, NASA and the Office of Science and Technology Policy (OSTP), consistent with direction from Congress, are jointly developing a National Aeronautics Policy to address

- the appropriate role for Federal investment in U.S. aeronautics R&D;
- high priority aeronautics research objectives, near and far-term;
- roles and responsibilities of the multiple agencies involved; and
- related infrastructure and workforce challenges.

Second, the National Research Council (NRC) is conducting a study to provide advice for a Decadal Strategy for Aeronautics R&D that is scheduled to be completed on September 30, 2006. The goal will be to provide an overarching roadmap for Aeronautics research and technology at NASA, and define a set of key technical challenges that should be addressed as part of a long-term plan (10+ years) for NASA Aeronautics research.

The restructured Aeronautics program is highly responsive to prior NRC report recommendations calling upon NASA to "reduce the number of tasks in its Aeronautics portfolio, pursue more high-risk, high-payoff technologies, and reconstitute a long-term base research program."

Relevance to the NASA mission:

The Aeronautics Technology Theme will advance knowledge in fundamental disciplines of Aeronautics, and develop technologies for safer aircraft and higher capacity airspace systems. Aeronautics research and critical core competencies play a vital role in support of the Vision for Space Exploration.

Relevance to education and public benefits:

Under the refocused program, NASA plans to establish strong partnerships with Universities that foster close working relationships among NASA researchers, students, and faculty, while at the same time partnering with our counterparts in other government agencies and industry. NASA needs to ensure the availability of world-class resources (personnel, facilities, and knowledge) that can readily be drawn upon by civilian and military communities, as well as other Government agencies. We intend to ensure that Aeronautics contributes directly to public benefits for decades to come by creating a safer, environmentally friendly, and more efficient national aviation system.

Performance

Major Activities Planned for FY 2007:

- Baseline state-of-the-art analysis methods and tools to address aeronautics challenges within hypersonics, subsonics (rotary and fixed wing), and supersonics.
- Determine fundamental propulsion system integration design issues for existing and advanced rotorcraft configurations.
- Complete baseline assessment of Integrated Vehicle Health Management (IVHM) and Flight Deck systems capabilities and establish prioritized technical requirements to meet NGATS safety challenges.
- Conduct systems analysis for the development of a plan that describes incremental concept, technological, and operational changes and research needs to reach NGATS 2025 concept of operations.
- Investigate and recommend a standard format for reporting Aeronautics Test Program (ATP) wind tunnels/ground test facilities fixed costs across all Field Centers.

Major Recent Accomplishments:

- NASA identified, developed, and demonstrated noise reduction concepts, and will verify their potential toward achieving 10 dB noise reduction.
 - NASA completed testing of a high Mach number wide-inlet propulsion system design. The data will serve as reference for analyses of future integrated configurations with 3-dimensional flow spillage.
 - NASA analysis indicated that AvSP-developed technologies would have an impact on reducing the accident rate for over 80% of the 1990-96 National Transportation Safety Board set of accident causes.
 - NASA completed the analysis of the Air Transportation System using the Airspace Concepts Evaluation System (ACES).
 - NASA successfully completed the Small Aircraft Transportation System demonstration and conducted operational demonstration of the Multi-Center Traffic Management Advisor.
-

Aeronautics Technology Theme Commitment in Support of the NASA Mission :

Strategic Goals**Sub-Goals (If Applicable)***Multiyear Outcomes*

Annual Performance Goals supporting the Multiyear Outcomes

3. Develop a balanced overall program of science, exploration, and aeronautics consistent with the redirection of the human spaceflight program to focus on exploration.

3E Advance knowledge in the fundamental disciplines of aeronautics, and develop technologies for safer aircraft and higher capacity airspace systems.

3E.1 By 2016, identify and develop tools, methods, and technologies for improving overall aircraft safety of new and legacy vehicles operating in the Next Generation Air Transportation System (projected for the year 2025)

7AT1 Establish a baseline for state-of-the-art aircraft safety concepts and flight deck information management systems.

3E.2 By 2016, develop and demonstrate future concepts, capabilities, and technologies that will enable major increases in air traffic management effectiveness, flexibility, and efficiency, while maintaining safety, to meet capacity and mobility requirements of the Next Generation Air Transportation System.

7AT2 Complete flight test evaluation of oceanic in-trail climb and descent using an Airborne Separation Assistance System (ASAS) and an Automatic Dependent Surveillance - Broadcast (ADS-B).

7AT3 Complete development of an incremental, sustainable transition roadmap from today's air transportation system to the Next Generation Air Transportation System (NGATS) 2025 concept of operations.

3E.3 By 2016, develop multidisciplinary design, analysis, and optimization capabilities for use in trade studies of new technologies, enabling better quantification of vehicle performance in all flight regimes and within a variety of transportation system architectures.

7AT4 Baseline state-of-the-art analysis methods and tools to address aeronautics challenges within the hypersonic, subsonic (for rotary and fixed wing vehicles), and supersonic flight regimes.

7AT5 Develop preliminary engine performance models for flight-weight propulsion systems to support hypersonic reference vehicles.

7AT6 Determine fundamental propulsion system integration design issues for existing and advanced rotorcraft configurations.

3E.4 Ensure the continuous availability of a portfolio of NASA-owned wind tunnels/ground test facilities, which are strategically important to meeting national aerospace program goals and requirements.

7AT7 Develop a long-term, aeronautic test facility vision and funded plan working with all the appropriate stakeholders, to assure that the plan reflects the priorities of the long-term needs of the Nation.

Efficiency Measures

7AT8 Deliver at least 90% of scheduled operating hours for all operations and research facilities.

7AT9 Increase the annual percentage of research funding awarded to Aeronautics University Partnerships.

Program Management

Dr. Lisa J. Porter is the Associate Administrator of ARMD. The Directorate Program Management Council is the governing authority.

Quality

Independent Reviews:

- A series of Aeronautics Research "brainstorming" workshops has defined prospective revolutionary research work under new critical thrust areas for each program. A rigorous, streamlined Aeronautics competition and peer evaluation process will be conducted this year to ensure "best value" in that only the highest payoff research proposals will be selected for funding.
- A phase in the Aeronautics Independent Review process will be a full and open competition via NASA Research Announcements (NRA) for research in foundational areas where NASA needs to enhance its core competencies.
- The long-term Aeronautics investment strategy will be directly influenced by the outcome of the National Aeronautics Policy. In addition, the results of the NRC Decadal Survey will provide guidance when they are made available.

Program Assessment Rating Tool (PART):

During FY 2005, Aeronautics received an Office of Management and Budgeting (OMB) PART evaluation rating of "Moderately Effective". OMB defined a clear set of recommended improvements relating to the following: enhancing Aeronautics strategic planning; expanding the use of competitive peer review processes; establishing efficiency metrics to evaluate program performance; reexamining NASA's Federal Government role in funding Aeronautics research; and timely implementation of selected NRC Report recommendations.

NASA's refocused Aeronautics program is highly responsive to improvements recommended in the evaluation. As this program is reshaped to better fulfill these recommendations, specifically this theme will maximize performance by:

- 1) Defining new performance measures applicable to the refocused program;
- 2) Increasing the percentage of research funding that is awarded to universities through a competitive, peer review process; and,
- 3) Preserving the wind tunnel infrastructure at the NASA research Centers which are deemed mission critical and/or are a unique national asset.

Budget Detail (Dollars in Millions)

Budget Authority (\$ millions)	FY2005	FY2006	Change	FY2007	FY2008	FY2009	FY2010	FY2011	Comments
Aeronautics Technology	962.0	884.1	-159.6	724.4	731.8	732.4	722.8	722.7	
Aviation Safety	183.0	148.4	-46.3	102.2	102.1	116.1	119.9	119.8	
Airspace Systems	148.8	173.9	-53.8	120.0	124.0	105.4	91.1	89.4	
Fundamental Aeronautics	630.2	561.7	-114.5	447.2	449.3	452.9	452.5	452.8	
Aeronautics Test Program			55.0	55.0	56.4	58.0	59.2	60.7	

Theme:**Aeronautics Technology**

Note: For all formats, the FY 2005 column reflects the FY 2005 Congressional Operating Plan, dated 9/30/2005. The FY 2006 column reflects the FY 2006 Congressional Initial Operating Plan, dated Jan 2006. The FY 2007 - 2011 columns represent the FY 2007 President's Budget Submit.

Aeronautics Research Mission Directorate (ARMD) budget decreases 18% between FY2006 and FY2007. In order to accommodate the declining budget, Aeronautics is evaluating the relative priority of its Program investments. ARMD will redirect its limited resources and focus on long-term investment in fundamental research ensuring that NASA preserves the Research Centers as a vital force in Aeronautic Research for the Nation. The impact of the budget reductions is decreased funding levels in all three Aeronautics R&D Programs. This will result in less funding for out-of-house industry contracts and require targeted Civil Service and on-site Contractor workforce reductions while still maintaining the Aeronautics critical core competencies.

President's FY 2007 Budget Request (Dollars in Millions)

Aviation Safety	FY2005	FY2006	FY2007	FY2008	FY2009	FY2010	FY2011
FY 2007 PRES BUD	183.0	148.4	102.2	102.1	116.1	119.9	119.8
Changes from FY 2006 Request	-2.3	-44.5	-71.4	-68.4	-60.0	-56.5	

Overview

Focusing precisely on the Nation's future aviation safety challenges, the Aviation Safety and Security Program transformed into the Aviation Safety Program (AvSP) in FY 2006. Through the vigilance of industry and government, the U.S. air transportation system has maintained a record low accident rate for the past several decades. This vigilance must continue in order to meet the projected increases in future air traffic capacity and realize the new capabilities envisioned through the Next Generation Air Transportation System (NGATS) initiative. The AvSP will conduct research to improve the intrinsic safety attributes of future aircraft and to eliminate safety related technology barriers that may prevent full realization of the NGATS.



Aviation Safety funding decreases 31% between FY 2006 and FY 2007. The Information Sharing Initiative and Turbulence project activities will be completed on schedule in FY 2006. The Aviation Security activities will be logically phased out since these efforts align with the Department of Homeland Security research efforts. Consistent with program priorities and NASA's unique capabilities, AvSP will redirect \$33 million to augment the Integrated Vehicle Health Management and Aircraft Aging and Durability Projects.

The Aviation Safety Program will take a vehicle-centric approach to researching issues critical to safety. One example is the Integrated Vehicle Health Management (IVHM) project, which researches the ability to predict and mitigate failure conditions long before they occur. Identifying such precursors requires developing flight critical system monitoring, "health-state" reasoning and information fusion capabilities, and failure remediation technologies for aircraft systems and structures.

NASA will conduct high-payoff research that builds upon and advances the Agency's unique safety-related research capabilities. The research cuts across four levels of technology integration: (1) foundational science and discipline-centric research; (2) multidisciplinary, coupled effects, and component-based research; (3) sub-system or multidisciplinary integration; and (4) system level design.

Theme: Aeronautics Technology
Program: Aviation Safety

Plans For FY 2007

The Aviation Safety Program encompasses NASA's core capabilities in the thrust areas of Integrated Intelligent Flight Deck Technologies (IIFDT), Integrated Vehicle Health Management (IVHM), Integrated Resilient Aircraft Controls (IRAC), and Aircraft Aging & Durability (AA&D).

-IIFDT: Conduct research to develop revolutionary flight deck related technologies that will ensure crew workload and situation awareness are both safely optimized and adapted to the future operational environment.

-IVHM: Conduct research to address technical barriers to the development and full implementation of highly integrated and complex vehicle-wide health management technologies and systems.

-IRAC: Conduct research to develop methodologies to detect, mitigate, and recover from an adverse condition that could potentially lead to loss-of-control accidents.

-AA&D: Conduct research to develop advanced diagnostic and prognostic capability for detection and mitigation of aging-related hazards.

Changes From FY 2006

- Transition from Aviation Safety and Security Program to Aviation Safety Program
- Shift in focus from technology demonstrations to a full range of research (i.e., from fundamental knowledge to solving system-level safety challenges).

Program Management

Dr. Lisa Porter, ARMD AA, is responsible for portfolio approval. The Program Director oversees portfolio formulation, implementation, and evaluation.

Technical Parameters

The end products of the research activities are tools, methods, technologies, and capabilities for aviation safety that address the technical challenges associated with current and future aircraft. IIFDT will focus on revolutionary adaptive flight decks. Integrated Vehicle Health Management (IVHM) will focus on recovery from in-flight failures, systems for in-flight operability, and informed logistics and maintenance. Integrated Resilient Aircraft Controls (IRAC) will focus on hazard-resilient aircraft control and flight management. Aircraft Aging & Durability (AA&D) will focus on the detection, prediction, and mitigation/management of aging-related hazards.

Technical Specifications	FY 2007 President's Budget	Change from Baseline
Integrated Intelligent Flight Deck Technologies (IIFDT)	Conduct research to develop revolutionary flight deck related technologies that ensure crew workload and situation awareness are safely optimized and adapted to the future operational environment.	New baseline.
Integrated Vehicle Health Management (IVHM)	Conduct research to address technical barriers to the development and full implementation of highly integrated and complex vehicle-wide health management technologies and systems.	New baseline.
Integrated Resilient Aircraft Controls (IRAC)	Conduct research to develop methodologies to detect, mitigate, and recover from adverse conditions that could potentially lead to loss-of-control accidents.	New baseline.
Aircraft Aging & Durability (AA&D)	Conduct research to develop advanced diagnostic and prognostic capability for detection and mitigation of aging-related hazards.	New baseline.

Implementation Schedule:

Project	Schedule by Fiscal Year							Purpose	Phase Dates		
	05	06	07	08	09	10	11			Beg	End
IIFDT								Develop and validate tools, methods, concepts, principles, guidelines, and technologies for revolutionary adaptive flight decks that improve safety; new baseline and standing up in FY 2006.	Tech Form Dev Ops Res	Oct-05	Sep-06 Sep-11
IVHM								Develop/validate multi-disciplinary vehicle-wide health mgt system tools & technologies for in-flight recovery, systems for in-flight operability & informed logistics & maint.; new baseline.	Tech Form Dev Ops Res	Oct-05	Sep-06 Sep-11
IRAC								Develop and validate integrated modeling, control, and V&V technologies for hazard-resilient aircraft control and flight management; new baseline and standing up in FY 2006.	Tech Form Dev Ops Res	Oct-05	Sep-06 Sep-11
AA&D								Develop and validate integrated methods to enable the detection, prediction, and mitigation/management of aging-related hazards; new baseline and standing up in FY 2006.	Tech Form Dev Ops Res	Oct-05	Sep-06 Sep-11
<p> ■ Tech & Adv Concepts (Tech) ■ Formulation(Form) ■ Development (Dev) ■ Operations (Ops) ■ Research (Res) ■ Represents a period of no activity for the Project </p>											

Strategy For Major Planned Acquisitions

- Aviation Safety Research & Technology, peer-review competitive grants or cooperative agreements for innovative physics, technology, and modeling. Competed awards may be up to 5 years and 7% of budget.

Key Participants

- Federal Aviation Administration: Cooperation concerning development of safety-related technologies.
- University: Pending awards for aviation safety research grants.
- Industry: Released RFIs to form industrial partnerships for collaboration with NASA under non-reimbursable agreements.
- Department of Defense: Cooperation on development of technologies that directly address mutual safety needs.

Theme: Aeronautics Technology

Program: Aviation Safety

Risk Management

- **RISK:** Given technical stakeholder needs and requirements change, there is the possibility that long-range plans will need to be updated. **MITIGATION:** Aviation Safety will frequently monitor technical stakeholder needs through the Principal Investigators and through regular meetings with the stakeholder community. Significant changes will be reflected in an update to the long-range plan.
- **RISK:** Given significant change to cost and/or schedule in a technical deliverable, there is the possibility that lower priority activities may be descoped or eliminated. **MITIGATION:** Aviation Safety will use the peer review rating of its technical proposals during portfolio formulation, in concert with portfolio evaluations, to assess the technical merit of its work to rebalance the portfolio investment to meet the changed requirement.
- **RISK:** Given that fundamental and applied research is highly dynamic, there is the possibility that planned milestones may not be met due to knowledge gained along the way (e.g., the milestone may not be possible to achieve or may require more time or effort). **MITIGATION:** Aviation Safety will conduct yearly assessments of all research elements at all four levels. Significant changes will be reflected in an update to the long-range plan.

President's FY 2007 Budget Request (Dollars in Millions)

Airspace Systems	FY2005	FY2006	FY2007	FY2008	FY2009	FY2010	FY2011
FY 2007 PRES BUD	148.8	173.9	120.0	124.0	105.4	91.1	89.4
Changes from FY 2006 Request	-3.4	-26.4	-60.4	-50.7	-72.5	-84.6	

Overview

The Airspace Systems Program (ASP) primary goal is to develop R&D innovative solutions for a safe, efficient, high-capacity airspace system in the air and on the ground. In pursuit of this goal, the ASP is aligning its R&D portfolio to address the future air traffic management needs through the Next Generation Air Transportation System (NGATS) Initiative as defined by the Joint Planning & Development Office (JPDO).

Consistent with NGATS capabilities, ASP will focus on 2 major NGATS projects: Airspace and Airportal. ASP will perform foundational research to enable revolutionary capabilities in safety analysis and recovery methods, multi-aircraft flow and airspace optimization, trajectory design and conformance, and adaptive systems management. Products will be integrated for gate-to-gate solutions.

ASP has a 4-level approach to technology development: (1) conduct foundational research to further our understanding of the underlying physics and our ability to model that physics, (2) leverage the foundational research to develop technologies and analytical tools focused on discipline-based solutions, (3) integrate multi-disciplinary methods and technologies to create sub-system level capabilities, and (4) integrate capabilities developed in (3) provide solutions for a safe, efficient, and high-capacity airspace system.

ASP funding decreases 31% from FY 06 to FY 07. In FY 06, ASP is phasing out Space Based Technology and UAVs in the NAS and completing Small Aircraft Transportation Systems as scheduled. The Virtual Airspace Modeling and Simulation activity is ramping down, as planned in FY 07. Starting in FY 07, ASP will focus on activities that address the NGATS initiative.



The Airspace Systems Program addresses the Joint Planning and Development Office's Next Generation Air Transportation System (NGATS) capability requirements for 2025. Through the development and demonstration of technologies, capabilities, and future concepts, these requirements will enable major increases in the capacity and mobility of the U.S. air transportation system as well as improve air traffic management effectiveness, flexibility, and efficiency while maintaining safety.

Plans For FY 2007

Major focus for the NGATS Airspace project will be to develop en route capabilities in four areas: Evaluator, 4-D Trajectory Based Operations, Automated Separation Assurance and Dynamic Airspace Configuration. The NGATS Airportal project will focus on developing terminal capabilities in three areas: Airportal Evaluator, 4-D Trajectory Based Operations, and Safe Surface Traffic Optimization.

Theme: Aeronautics Technology
Program: Airspace Systems

Changes From FY 2006

- Project phase-outs: (1) Space-based Technologies - Department of Defense to address, (2) Human Factors - work integrated within projects, and (3) Unmanned Aerial Vehicles in National Airspace Systems.

Program Management

ARMD AA, Lisa Porter, is responsible for portfolio approval. Program Director is responsible for portfolio formulation, implementation, & evaluation.

Technical Parameters

ASP is working in cooperation with the JPDO to create a vision for the future National Airspace System (NAS) that will safely accommodate the projected growth in air traffic and continue to be responsive to the needs of aviation communities around the globe. It is developing, demonstrating and transferring technologies that will modernize and enable revolutionary improvements to the NAS that will improve its throughput, predictability, flexibility, efficiency, and access. The resultant benefits will allow more people and goods to travel faster, anywhere, and anytime.

Technical Specifications	FY 2007 President's Budget	Change from Baseline
NGATS Airspace	Performs foundational research in computer science and software, applied physics, mathematics, human factors, and automation design that will lead to JPDO-defined airspace automation capabilities.	New baseline.
NGATS Airportal	Performs foundational research in computer science & software, applied physics, mathematics, human factors, & automation design that will lead to JPDO-defined surface/terminal automation capabilities.	New baseline.

Implementation Schedule:

Project	Schedule by Fiscal Year							Purpose	Phase Dates												
	05	06	07	08	09	10	11		Beg	End											
NGATS Airspace								To develop en route products that will upgrade & transform the National Airspace System	Tech	Oct-05 Sep-06											
									Form												
									Dev												
									Ops												
NGATS Airportal								To develop terminal products that will upgrade & transform the National Airspace System.	Tech	Oct-05 Sep-06											
									Form												
									Dev												
									Ops												
<table border="0"> <tr> <td></td> <td>Tech & Adv Concepts (Tech)</td> </tr> <tr> <td></td> <td>Formulation (Form)</td> </tr> <tr> <td></td> <td>Development (Dev)</td> </tr> <tr> <td></td> <td>Operations (Ops)</td> </tr> <tr> <td></td> <td>Research (Res)</td> </tr> <tr> <td></td> <td>Represents a period of no activity for the Project</td> </tr> </table>											Tech & Adv Concepts (Tech)		Formulation (Form)		Development (Dev)		Operations (Ops)		Research (Res)		Represents a period of no activity for the Project
	Tech & Adv Concepts (Tech)																				
	Formulation (Form)																				
	Development (Dev)																				
	Operations (Ops)																				
	Research (Res)																				
	Represents a period of no activity for the Project																				

Strategy For Major Planned Acquisitions

- Employ peer-reviewed competitive grants or cooperative agreements for innovative modeling & simulation & software development Research & Technology (R&T). Awards may be up to 5 yrs & 7% of the budget.

Theme: Aeronautics Technology

Program: Airspace Systems

Key Participants

- Joint Planning & Development Office (JPDO): Close partnership to ensure alignment of R&T with NGATS 2025 goals.
- Industry: Released RFIs to form industrial partnerships for collaboration with NASA under non-reimbursable agreements.
- University: Pending research awards.

Risk Management

- **RISK:** Given that the NGATS requirements/needs may change, there is a possibility that the strategic roadmap and milestones will require modification. **MITIGATION:** ASP will monitor NGATS requirements through active participation with the JPDO and will modify the ASP 10-year roadmap as required.
- **RISK:** Given significant change to cost and/or schedule in a technical deliverable, there is the possibility that lower priority activities may be descoped or eliminated. **MITIGATION:** ASP will monitor and track progress, maintain descoped prioritization for the program, projects, and sub-projects, and leverage opportunities with other agencies and industry.
- **RISK:** Given that cutting-edge research is highly dynamic, there is the possibility that planned milestones may not be met due to knowledge gained along the way (e.g. the milestones may not be possible to achieve or may require more time and effort). **MITIGATION:** ASP will conduct yearly assessments of all research elements at all four levels and will update the 10-year roadmap as required.

President's FY 2007 Budget Request (Dollars in Millions)

Fundamental Aeronautics	FY2005	FY2006	FY2007	FY2008	FY2009	FY2010	FY2011
FY 2007 PRES BUD	630.2	561.7	447.2	449.3	452.9	452.5	452.8
Changes from FY 2006 Request	61.6	102.6	73.6	63.7	79.4	87.0	

Overview

The Vehicle Systems Program was transformed into the Fundamental Aeronautics Program (FAP) in FY 2006 to revitalize NASA's investment in fundamental aeronautics technology. The FAP will conduct research and develop technology to enable revolutionary capabilities for the future of aviation. NASA will develop advanced tools and capabilities that will enable whole new classes of aircraft that not only meet the noise and emissions requirements of the future but that also provide fast, efficient, and economical flight. The approach will be long-term and integrated across a wide range of aeronautics disciplines and components, with strong intellectual partnerships with industry and academia anticipated.

NASA has defined a four-level approach to technology development: (1) conduct foundational research to further our understanding of the underlying physics and our ability to model that physics, (2) leverage the results of foundational research to develop technologies and analytical tools focused on research discipline-based results, (3) integrate methods and technologies to develop multi-disciplinary solutions, and (4) solve the aeronautics challenges for a broad range of air vehicles with system-level optimization, assessment and technology integration. For more information, please see <http://www.aeronautics.nasa.gov>.

FAP funding decreases 20% from FY 2006 to FY 2007. The Aeronautics Test Program (ATP), is funded within FAP in FY 2006, and will be established as a separate program in FY 2007. The remaining reduction is due to the elimination of activities that are closed out in FY 2006, and that are not consistent with the new program direction.

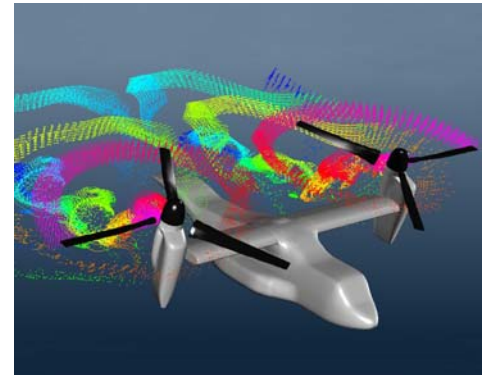

Visualization of tiltrotor wake in low-speed flight as predicted by a Computational Fluid Dynamics flow solver. Colors represent wake-vortices generated by individual blades.

Theme:	Aeronautics Technology
Program:	Fundamental Aeronautics

Plans For FY 2007

The Fundamental Aeronautics Program encompasses core capabilities in the thrust areas of Hypersonics, Supersonics and Subsonics (both Fixed and Rotary Wing). Research will be conducted in broad areas including materials and structures, tribology, power and combustion, dynamics and control, aeroacoustics, aerodynamics, aerothermodynamics and experimental methods. This research will yield system-level multidisciplinary analysis and optimization capabilities that enable design of a wide class of air vehicles to meet the challenges of the future for the civilian and military communities.

- Subsonics Fixed Wing research includes technologies for propulsion and power systems, engine and airframe noise, metallic, composite and hybrid structures and materials, advanced guidance and control, and aeroelastic control.
- Subsonics Rotary Wing research includes technologies for drive systems and alternative propulsion, simulations and flight tests, active-control, aeromechanics and aeroacoustics, and integrated diagnostic instrumentation.
- Supersonics research includes tools to predict propulsion system noise, efficiency and high altitude emissions, propulsion system performance, vehicle performance, noise and sonic boom, lift-drag, flight dynamics, stability and handling qualities, gust and maneuver loads, ride quality, and flutter suppression.
- Hypersonics research includes technologies for airbreathing hypersonic flight including high-speed turbines, mode transition between low- and high-speed flow paths, combustion physics, advanced materials and structures, cryogenic tanks and hot structures, thermal protection systems, and advanced communication and control.

Changes From FY 2006

- Transition from Vehicle Systems Program to Fundamental Aeronautics Program.
- Shift in focus from technology demonstrations to fundamental research.
- New end products will be physics-based multidisciplinary design, analysis, and optimization (MDAO) tools.

Program Management

ARMD AA, Lisa Porter, is responsible for portfolio approval. The Program Director oversees portfolio formulation, implementation, and evaluation.

Theme: Aeronautics Technology
Program: Fundamental Aeronautics

Technical Parameters

The end products of the research activities are technologies and physics-based multidisciplinary design, analysis, and optimization tools to capture advances in our understanding of fundamental physics, technology innovations, and computational approaches. Hypersonics research will address life cycle, risk, and an analysis of the gaps with respect to current capabilities. Supersonics research will focus on the capability to design vehicles that meet the coupled system requirements of low boom, efficiency, emissions, and noise. Rotary wing research will enable the design of vehicles for any mission and the ability for vehicles to fly precisely as they have been designed. Subsonic fixed wing research will enable aircraft designs to meet noise, emissions and performance requirements.

Technical Specifications	FY 2007 President's Budget	Change from Baseline
Subsonic Fixed Wing	Vehicle integration and analysis, airframe systems, flight validation, and propulsion and power systems.	- New Baseline
Subsonic Rotary Wing	Fully integrated approach to propulsion, aeromechanics, vehicle management system, rotorcraft design, and experimental systems.	- New Baseline
Supersonics	Vehicle systems integration and analysis, airframe systems, propulsion-power systems, and validation by experiment.	- New Baseline
Hypersonics	Propulsion systems design, vehicle systems design, and experimental capabilities for flight systems.	- New Baseline

Implementation Schedule:

Project	Schedule by Fiscal Year							Purpose	Phase Dates		
	05	06	07	08	09	10	11			Beg	End
Subsonic Fixed Wing	█	█	█	█	█	█	█	Validated physics-based MDAO capabilities integrated with technology development including virtual access to the flight envelope, and virtual expeditions through design space.	Tech Form Dev Ops Res	Oct-05	Sep-06
Subsonic Rotary Wing	█	█	█	█	█	█	█	Validated physics-based MDAO tools integrated with technology development that enable rotorcraft, with advanced capability, to fly as designed for any mission.	Tech Form Dev Ops Res	Oct-05	Sep-06
Supersonics	█	█	█	█	█	█	█	Validated physics-based MDAO capabilities integrated with technology development for supersonic aircraft with quantified uncertainties and known sensitivities.	Tech Form Dev Ops Res	Oct-05	Sep-06
Hypersonics	█	█	█	█	█	█	█	Validated physics-based MDAO capabilities integrated with technologies for hypersonic vehicles such as life cycle, risk and gap analyses of design space for mission performance.	Tech Form Dev Ops Res	Oct-05	Sep-06

█ Tech & Adv Concepts (Tech)
█ Formulation(Form)
█ Development (Dev)
█ Operations (Ops)
█ Research (Res)
█ Represents a period of no activity for the Project

Theme:	Aeronautics Technology
Program:	Fundamental Aeronautics

Strategy For Major Planned Acquisitions

- Fundamental Physics and Technology, peer-reviewed competitive grants or cooperative agreements for innovative physics, technology, and modeling, competed awards of up to 5 years, 7% of the budget.

Key Participants

- University: Pending fundamental physics and technology awards.
- Department of Defense: Cooperation on development of technologies for advanced air vehicles across all speed regimes.
- Industry: Released RFIs to industrial partners for collaboration with NASA under non-reimbursable agreements.
- Federal Aviation Administration: Cooperation concerning aviation environmental compatibility, aircraft noise reduction technology, impact of aviation air emissions of climate and global atmospheric composition, and joint university research in air transportation.

Risk Management

- RISK: Given that technologies from other Aeronautics programs do not meet expected technical performance and timeliness, there is the possibility that this program's cost and schedule may slip. MITIGATION: Fundamental Aeronautics will monitor and track technology development progress in other Aeronautics programs under prior agreements and maintain contingency plans.
- RISK: Given that fundamental research is highly dynamic, there is the possibility that milestones may not be met because of things learned along the way (e.g., the milestone may not be possible to achieve or may require more time or effort). MITIGATION: Fundamental Aeronautics will mitigate by conducting yearly assessments of all research elements and will update the 10-year working plan as required.
- RISK: Given significant change to cost and/or schedule in a technical deliverable, there is the possibility that lower priority activities may be descope or eliminated. MITIGATION: Fundamental Aeronautics will use the peer review rating of its technical proposals during portfolio formulation, in concert with portfolio evaluations to assess the technical merit of its work to rebalance the portfolio investment to meet the changed requirement.

President's FY 2007 Budget Request (Dollars in Millions)

Aeronautics Test Program	FY2005	FY2006	FY2007	FY2008	FY2009	FY2010	FY2011
FY 2007 PRES BUD			55.0	56.4	58.0	59.2	60.7
Changes from FY 2006 Request			55.0	56.4	58.0	59.2	

Overview

The Aeronautics Test Program (ATP) is a new program in the Aeronautics Research Mission Directorate (ARMD) and is a component of NASA's Shared Capability Assets Program (SCAP). ATP's purpose is to ensure the strategic availability of a minimum, critical suite of wind tunnels/ground test facilities which are necessary to meet Mission Directorate, Agency, and National needs and requirements. While SCAP has overall corporate responsibility for ensuring the retention and viability of key facilities and assets, ATP is managed out of ARMD where the principal Agency expertise for this asset class exists. The ATP is responsible for the strategic and business management of the aeronautics wind tunnels/ground test facilities at Ames Research Center, Glenn Research Center, and Langley Research Center. The ATP Director ensures funding levels allow for continuous operations of ATP facilities and for the appropriate levels of maintenance and investments. A major benefit of this funding is that it establishes stable pricing, as opposed to fluctuating rates driven by fluctuating usage requirements. The scope of the ATP is limited to the management of large aeronautics ground test facilities including subsonic, transonic, supersonic, and hypersonic wind tunnels, propulsion wind tunnels, and jet engine test cells. The ATP Director is responsible for ground test services and technology related alliances with the Department of Defense.



This high-wing transport aircraft model was used in the National Transonic Facility (NTF) to evaluate aerodynamic performance at flight conditions. NASA has many Aeronautics test facilities, including wind tunnels, propulsion test cells, and simulators, that are considered national assets.

This effort was funded at a comparable level in FY 2006 within the Fundamental Aeronautics Program.

Plans For FY 2007

The program will provide a percentage of the fixed costs for ground test facilities that have significant projected aeronautics NASA program usage, that are considered to be national assets for which NASA accepts stewardship responsibilities, and that are present or future requirements by other government agencies or the U.S. aerospace industry. This will achieve user price and utilization stability. In addition, for those facilities that are considered to be unique but for which there is no projected current or future usage, the ATP will provide funds to mothball these facilities. The necessary significant repairs in ATP facilities will be performed, such as wind tunnel turning vane repair and drive motor fan blade fabrication. An investment in test technology and facility upgrades (new capability) will be made. This effort will be coordinated with plans being formulated in the Defense Test Resources Management Center - Office of the Secretary of Defense (OSD) in order to leverage the limited resources of the OSD and NASA for investments in this area. Universities will have the opportunity to use ATP facilities for the development of advanced aerospace technologies.

Theme: Aeronautics Technology
Program: Aeronautics Test Program



















Program Management

Responsibilities: ATP Office (business management), SCAP (integrated strategic management); and ARC/GRC/LaRC (facilities tactical operations).

Technical Parameters

The ATP is a long-term, funded commitment by NASA to retain and invest in test capabilities that are considered to be important to the Agency and the Nation. Through the ATP, the Agency will adopt consistent management processes and procedures across the NASA Research Centers, as it relates to the operations and maintenance of ground test facilities. The ATP will review the status of its test facilities annually. In so doing, NASA is ensured that near-term decisions, such as that to close a facility, have financial gains relative to long-term capability risks. The ATP will cooperate with the DoD to coordinate investments.

Technical Specifications	FY 2007 President's Budget	Change from Baseline
Operations Support	Provides funding: 1) to stabilize facilities pricing; 2) to cover fixed costs of facilities that are required by the Nation.	New baseline.
Facility Maintenance	Significant maintenance activities that cannot be addressed as routine maintenance.	New baseline.
Facility Upgrades and Test Technology	Development and implementation of new technologies that increase test capability, improve productivity and efficiency and/or improve data quality.	New baseline.
Facility Related Research	This activity will be competed openly with a strong desire to involve a university or universities with experimental work in major facilities.	New baseline.

Implementation Schedule:																						
Project	Schedule by Fiscal Year						Purpose	Phase Dates														
	05	06	07	08	09	10		11		Beg	End											
Operations Support							Provide 60% to 75% of the facility fixed costs to ensure facility and staff availability and user price stability	Tech Form Dev Ops Res	Oct-05	Sep-11												
Facility Maintenance							Perform significant, and largely overdue, maintenance projects to ensure facility availability and viability (health)	Tech Form Dev Ops Res	Oct-05	Sep-11												
Facility Upgrades and Test Technology							Develop test technologies that enhance operations productivity/data quality that are transportable across facilities and/or enhance the performance capability of a single test facility	Tech Form Dev Ops Res	Oct-05 Oct-06 Oct-07	Sep-06 Sep-07 Sep-11												
Facility Related Research							Perform basic research in test capability development and/or performance testing in a ATP facility which furthers the understanding of basic testing principles and processes.	Tech Form Dev Ops Res	Oct-05 Oct-06 Oct-07	Sep-06 Sep-07 Sep-11												
<table border="0"> <tr> <td></td> <td>Tech & Adv Concepts (Tech)</td> </tr> <tr> <td></td> <td>Formulation (Form)</td> </tr> <tr> <td></td> <td>Development (Dev)</td> </tr> <tr> <td></td> <td>Operations (Ops)</td> </tr> <tr> <td></td> <td>Research (Res)</td> </tr> <tr> <td></td> <td>Represents a period of no activity for the Project</td> </tr> </table>												Tech & Adv Concepts (Tech)		Formulation (Form)		Development (Dev)		Operations (Ops)		Research (Res)		Represents a period of no activity for the Project
	Tech & Adv Concepts (Tech)																					
	Formulation (Form)																					
	Development (Dev)																					
	Operations (Ops)																					
	Research (Res)																					
	Represents a period of no activity for the Project																					

Strategy For Major Planned Acquisitions

- Maintenance: Machine Overhaul by Original Equipment Manufacturer is planned for Langley's Compressor #5.

Key Participants

- Other Government Agencies: DoD - Coordination of investments in test technology development and national facility operations via the National Aeronautics Testing Alliance (NATA).
- Industry: All segments of industry who use NASA aeronautics ground test facilities. This includes the large airframers and engine manufacturers, small (business jet and general aviation) airframers and engine manufacturers, and other third tier original equipment manufacturers.
- Universities: A university grant/contract effort is planned wherein the use of one or more of the ATP facilities for the development of advanced aerospace technologies will be realized.

Risk Management

- RISK: The aeronautics wind tunnel test facilities are prioritized based upon national and Agency programmatic relevance, uniqueness, and capabilities. The facilities ranked highest through this prioritization process receive increased funding. Lower priority facilities are at risk of not being readily available if major changes in programmatic needs or national priorities arise during the budget year. MITIGATION: The Agency will review the facility prioritization on an annual basis and realign the ATP budget profile in order to ensure that facilities which are critical to NASA programs, other government agency programs and to the U.S. aerospace industry are available when required at reasonable pricing levels.



Shared Capabilities provides focus to several ongoing activities and establishes an improved model for managing NASA's unique facilities.

Themes

Education

Advanced Business Systems

Innovative Partnerships Program

Shared Capabilities

CROSS-AGENCY SUPPORT PROGRAMS

Purpose

This new direct budget category provides focus to several ongoing activities and establishes an improved model for managing NASA's unique facilities. This budget area consists of four Themes: Education, Advanced Business Systems, Innovative Partnerships Program (IPP), and Shared Capabilities. Under this umbrella, NASA's education activities have a renewed focus on priorities and metrics. Within the Advanced Business Systems, the Integrated Enterprise Management Program (IEMP, formerly IFMP) is established as a separate direct program to improve management information and financial management. The Innovative Partnerships Program has been moved from a single Mission Directorate to better address agency-wide needs. Shared Capabilities has been established to ensure that NASA's unique facilities are adequately funded to address NASA's strategic needs.

Cross-Agency Support Programs

Theme Distribution

Budget Authority (\$ in millions)	FY 2005	FY 2006	FY 2007	FY 2008	FY 2009	FY 2010	FY 2011
Education	178.9	162.4	153.3	152.4	153.1	154.0	153.3
Advance Business Systems	0.0	156.3	108.2	106.9	73.8	78.5	80.6
Innovative Partnerships Program	198.9	214.8	197.9	205.5	206.2	209.7	212.9
Shared Capabilities	0.0	0.0	32.2	33.1	33.9	34.7	35.5
Total	377.8	533.5	491.7	497.9	467.1	476.8	482.2

Note: For all formats, the FY 2005 column reflects the FY 2005 Congressional Operating Plan, dated 9/30/2005. The FY 2006 column reflects the FY 2006 Congressional Initial Operating Plan, dated January 2006. The FY 2007 through FY 2011 columns represents the FY 2007 President's Budget Submit.

Education

Achieving NASA's mission depends upon educated, motivated people with the ingenuity to invent new tools, the passion to solve problems, and the courage to ask the difficult questions. It is not enough to depend on the excitement generated by NASA images. NASA must use its discoveries and achievements to engage students and the education community. To do so, NASA provides meaningful, educational, and content-rich programs to inspire and motivate students at all levels to pursue careers in science, technology, engineering, and mathematics (STEM). NASA Education partners with academia, professional associations, industry, and other agencies to provide teachers and faculty with experiences that capitalize on the excitement of NASA's missions to spark student interest and involvement. Education Programs provides opportunities for involvement in NASA's research efforts to encourage students to pursue higher education in STEM areas. To ensure a pipeline of highly trained people prepared to meet mission requirements within NASA, as well as in industry and academia, NASA must: motivate students to pursue careers in science, technology, engineering, and mathematics; provide educators with unique teaching tools and compelling teaching experiences; ensure that public resources are invested wisely; and fully engage minority and under-represented students, educators, and researchers in NASA's education programs. The Office of the Chief Education Officer will strive to reach the masses of young people in the Nation to connect with, excite, and inspire the next generation of scientists, inventors, technicians, and explorers. For more information see: <http://www.education.nasa.gov/home/index.html>.

Overall Budget

The FY 2007 request is \$153.3 million; a \$9.1 million (or 6 percent) decrease from the FY 2006 budget request. Major features of this budget include:

- \$47.2 M for Elementary and Secondary Education;
- \$54.0 M for Higher Education;
- \$9.0 M for E-Education;
- \$2.5 M for Informal Education; and
- \$40.6 M for Minority University Research and Education Program (MUREP).

Advanced Business Systems

The Advanced Business Systems Theme is a new Theme established in FY 2006 to reflect the implementation of business systems as a direct program. Prior to FY 2006, business systems were located within the Corporate and Center G&A and did not provide visibility to the financial

Cross-Agency Support Programs

improvements being made at NASA in support of the President's Management Agenda. Since last year's budget submission, NASA's Integrated Enterprise Management Program (IEMP) has undergone several changes due to renewed focus and commitment on improving financial management practices and performance.

Three significant changes to this critical Program are described below.

- The name, Integrated Financial Management Program (IFMP), was updated to Integrated Enterprise Management Program (IEMP). The investment that NASA is making in the Program is principally aimed at improving how the Agency manages its investments and controls the operating costs of the Agency.
- Budgeting and funding for all development, implementation, and sustaining activities are managed from a single program fund source instead of the existing numerous Corporate and Center General and Administrative (G&A) funding sources as recommended by Congress.
- NASA has re-assessed its strategy for ensuring success in all of the President's Management Agenda (PMA) commitments. A key element to this improvement is the upgrade of its Core Financial system during FY 2006 in order to achieve full compliance with the Federal Financial Management Improvement Act, and to implement critical process changes related to NASA's financial tracking, reporting, and other elements which contribute to its audit opinion. NASA's Integrated Asset Management (IAM) project was delayed in order to not impact the financial upgrade and to also re-assess the overall development and deployment strategy of IAM with a goal to reduce cost and complexity.
- The Agency time and attendance system (WebTADS) has been transferred into the IEMP for operations and sustaining support (O&SS). This allows for more efficient operations and maintenance as well as continues the initiative to move NASA business systems under centralized management.

Overall Budget

The FY 2007 request is \$108.2 million; a \$48.1 (or 31 percent) decrease from the FY 2006 request. Major features of this budget include:

- \$16.0 M to complete the Core Financial Upgrade to a new SAP version, MySAP;
- \$17.2 M to continue the implementation of the Asset Management solutions;
- \$10.3 M to finish the implementation of the Contract Management Module;
- \$48.8 M to support operating and sustaining of the current IEMP Projects; and
- \$15.8 M to provide infrastructure support not directly related to a Project.

Innovative Partnerships Program

IPP's primary mission is to provide leveraged technology alternatives for Mission Directorates, Programs, and Projects through joint partnerships with industry, academia, government agencies, and national laboratories. Accordingly, IPP integrates the following program elements so that they complement each other to achieve the Program's mission objectives: Technology Transfer (T2), Space Products Development (SPD), and SBIR/STTR. T2, SPD and SBIR/STTR are all based upon leveraging NASA's resources with private or other external resources for the primary purpose of developing new technology for NASA mission use, with the technology also having strong potential for commercial application. This linkage is critical to NASA'S future long-term mission success, as well as to the Nation's future physical and economic security. Therefore, all of IPP's functions primarily serve NASA's mission interests, both in the near term and long term, and with respect to a broad range of technologies and technology readiness levels. Similarly, IPP's functions target and invite a broad spectrum of primarily, but not exclusively, non-traditional (i.e., non

Cross-Agency Support Programs

aerospace) U.S. industrial interests, ranging from small entrepreneurial firms to Fortune 500 companies.

Overall Budget

The FY 2007 request is \$197.9 million; a \$16.9 million (or 8 percent) decrease from the FY 2006 budget request. Major features of this budget include:

- \$102.6 M for SBIR;
- \$12.3 M for STTR;
- \$35.9 M for Technology Transfer;
- \$14.5 M for Space Product Development; and
- \$12.3 M for Enterprise Engine.

Shared Capabilities

The Shared Capabilities Theme is a single-program theme: the Shared Capabilities Asset Program (SCAP). SCAP was established to ensure key capabilities and assets are available for future missions, and will help NASA prioritize critical capabilities and make strategic investment decisions to replace, modify, or disposition assets. SCAP was established in FY 2006. It is managed at the Agency level, with funding and day-to-day management responsibilities generally resident in the Mission Directorates. Four specific key capability/asset classes have been identified to ensure that NASA retains specialized assets and skills required for missions: wind tunnels in the Aeronautics Test Program (ATP) in the Aeronautics Research Mission Directorate, Rocket Propulsion Testing (RPT) in the Space Operations Mission Directorate, Thermal Vacuum Chambers (TVC), and High End Computing Columbia (HECC) in the Science Mission Directorate (SMD). The ATP, RPT and a portion of the HECC asset classes are not in the central SCAP budget line; they are located in the discrete budgets of the Mission Directorate primarily responsible for the management of the asset class. The TVC budget assessments are not complete and funding within Mission Directorate(s) for this asset class has not yet been identified. FY 2007 funding for a portion of HECC is identified in the central SCAP budget. This central funding reflects contributions made by Mission Directorates and Programs outside of SMD towards the funding level needed for HECC. SMD will manage day-to-day activities for the combined funding line for HECC (funds in SCAP plus funds in SMD of \$21.8M in FY 2007), and NASA anticipates combining all HECC funds within SMD in the future. Additional capabilities/assets may be added to SCAP in future years, and the SCAP budget line may contain funding for future assets classes that are more appropriate to fund in the central account.

Overall Budget

The FY 2007 request is \$32.2 million. Since it is the first year of the program, it represents a 100 percent increase from the FY 2006 budget.

- The entire \$32.2 million is for a portion of the High End Computing Columbia (HECC) costs. It represents contributions made by Mission Directorates and Programs outside of the Science Mission Directorate towards the required HECC funding level.
- All other costs for the Shared Capabilities Theme are carried within the Mission Directorates primarily responsible for the management of the particular asset class.

Education



NASA volunteers help young visitors at an ISS Remote Manipulator System exhibit, part of a NASA educational event called Bright Futures. NASA must motivate students to pursue careers in science, technology, engineering, and mathematics (STEM) to ensure that a pipeline of highly trained people are prepared.

President's FY 2007 Budget Request (Dollars in Millions)

Education	FY2005	FY2006	FY2007	FY2008	FY2009	FY2010	FY2011
FY 2007 PRES BUD	178.9	162.4	153.3	152.4	153.1	154.0	153.3
Changes from FY 2006 Request	178.9	162.4	153.3	152.4	153.1	154.0	

Overview: *What* NASA Accomplishes through the Education Theme

Achieving NASA's mission depends upon educated, motivated people with the ingenuity to invent new tools, the passion to solve problems, and the courage to ask difficult questions. It is not enough to depend on the excitement generated by NASA images. NASA must use discoveries and achievements to engage students and the education community. NASA provides meaningful, educational, and content-rich programs to inspire students at all levels to pursue careers in science, technology, engineering, and mathematics (STEM). NASA Education partners with academia, professional associations, industry, and other agencies to provide teachers and faculty with experiences that capitalize on the excitement of NASA's missions. Education Programs provide opportunities for involvement in NASA's research efforts to encourage students to pursue higher education in STEM areas. To ensure a pipeline of highly trained people prepared to meet mission requirements within NASA, as well as in industry and academia, NASA must: motivate students to pursue careers in STEM areas; provide educators with unique teaching tools and compelling teaching experiences; ensure that public resources are invested wisely; and fully engage minority and under-represented students, educators, and researchers in NASA's education programs. The Office of Education strives to reach youth with whom to connect, excite, and inspire the next generation of scientists, inventors, technicians, and explorers.

Relevance: *Why* NASA conducts Education work

Relevance to national priorities, relevant fields, and customer needs:

A lack of public understanding of scientific inquiry, a retiring aerospace workforce, and job recruitment competition for those with science and engineering degrees place future advancements in science, aeronautics, and space exploration at risk. Preparing highly qualified students for science and engineering careers is imperative if the United States is to succeed in innovation. Preparing the teachers who will influence those students is equally imperative. The No Child Left Behind Act identifies the need to enhance achievement, while international comparisons in STEM subjects demonstrate that U.S. students do not achieve to international standards in science and mathematics. Nationally, employment opportunities in the S&E fields are projected to increase about three times faster than the rate for all occupations between 2000 and 2010. The number of retirees in these fields is projected to increase dramatically over the next 20 years. A scientifically literate citizenry is also critical to lend support to policy decisions involving science and technology.

Relevance to the NASA mission:

NASA has a strong connection with education in this country, as a beneficiary receiving top talent, and as a catalyst for inspiring interest in STEM. Building on this connection, NASA launched its pathfinder initiatives: Educator Astronauts, Explorer Schools, Explorer Institutes, and the Science and Technology Scholarship programs.

Relevance to education and public benefits:

By supporting excellence in mathematics and science education and by coordinating with the Department of Education in the Math/Science Partnership, NASA Education helps broaden the reach of science and technology literacy programs to the education community and the general public. NASA Education is fully responsive to its stakeholders--taxpayers--by actively engaging with other Federal agencies and non-governmental professional education organizations.

Performance

Major Activities Planned for FY 2007:

- Continue to emphasize a seamless pipeline for all education programs that encourages students to excel in STEM disciplines.
- Ensure that NASA's Education portfolio addresses the needs of the the nation by extending students affiliation, thereby expanding the human resource pool, primarily in the STEM disciplines.

Major Recent Accomplishments:

- NASA Explorer Schools served 150 schools, 750 teachers in all states. NASA also served 300,000 students, 39,000 teachers, and engaged family members in 19,000 activities.
 - Higher Education provided career-enhancement opportunities to 18,000 faculty members and more than 70,000 students, of whom about 12,000 were at the graduate or post-doctoral level.
 - Faculty supported by the Minority University Research and Education Program generated almost 1,000 professional publications and 500 research proposals to funding agencies, resulting in 227 awards.
 - NASA Educational Technology Services attached metadata to over 200 Agency educational television program descriptions to enhance user Web capabilities and improve search results.
 - NASA Explorer Institutes conducted six workshops and eleven focus groups, with 300 participants representing 150 informal education organizations.
-

Education Theme Commitment in Support of the NASA Mission :

Strategic Goals**Sub-Goals (If Applicable)***Multiyear Outcomes*

Annual Performance Goals supporting the Multiyear Outcomes

Supports Multiple Agency Goals

ED-1 Contribute to the development of the STEM workforce in disciplines needed to achieve NASA's strategic goals through a portfolio of programs.

7ED1 Award 1,200 competitive internships, fellowships, and research opportunities for higher education students and faculty in STEM disciplines.

7ED2 Award 500 competitive scholarships, internships, fellowships, and research opportunities for underrepresented and underserved students, teachers and faculty in STEM disciplines.

7ED3 Provide 100 grants to enhance the capability of 50 underrepresented and underserved colleges and universities to compete for and conduct basic or applied NASA-related research.

7ED4 Complete a retrospective longitudinal study of student participants to determine the degree to which participants maintain affiliation with NASA through the pipeline.

7ED5 Collect, analyze, and report longitudinal data on student participants to determine the degree to which participants enter the NASA workforce or other NASA-related career fields.

ED-2 Attract and retain students in STEM disciplines through a progression of educational opportunities for students, teachers, and faculty.

7ED6 Conduct 10 Educator Astronaut workshops, involving approximately 200 educators.

7ED7 Select and support 50 additional schools to participate in the NASA Explorer Schools program, maintaining the total number at 100.

7ED8 Select 100 student experiments, involving 1,000 students, to participate in the Flight Projects program.

ED-3 Build strategic partnerships and linkages between STEM formal and informal education providers that promote STEM literacy and awareness of NASA's mission.

7ED9 Digitize and meta-tag 10 percent of NASA's approved learning materials to be delivered using technology-enabled learning systems.

7ED10 Award competitive grants to NASA Centers and informal education partners to conduct 10 Explorer Institutes projects.

Efficiency Measures

7ED11 Collect, analyze, and report that 100% of grantees annually report on their accomplishments.

7ED12 Peer review and competitively award at least 85%, by budget, of research projects.

Program Management

The responsible official for the Education Theme is Angela Phillips Diaz, Acting Associate Administrator for Education.

Quality**Independent Reviews:****Program Assessment Rating Tool (PART):**

The Office of Management and Budget analyzed the NASA Education Program using the Performance Assessment Rating Tool (PART) and rated the program "Adequate" in 2004. There are many positive attributes cited and OMB concluded NASA's Education Program can attract students to science and technology careers at NASA. The Office of Education reviewed the PART findings and will implement actions to address each finding. In particular, NASA will place increased attention to strategic planning and performance measurement to (a) better define expected outcomes, (b) identify appropriate measures to document achievements, and (c) ensure that reliable, valid, and comprehensive performance data are collected, analyzed, and reported. NASA will also conduct regular strategic portfolio reviews to (a) determine the degree to which program components are effective, (b) ensure an appropriate balance of program components, and (c) eliminate, enhance, or add needed components. Additional efforts will be made to link program participation to NASA's workforce requirements and to implement a process to longitudinally track students.

Specifically, this Theme will pursue the following program performance improvement actions:

- Continue to perform regular program reviews to ensure that only effective, relevant programs are funded.
- Require all programs to report annually on accomplishments and make these data available to the public.
- Require programs to perform self-evaluations including, as appropriate, solicitation of student feedback and collections of longitudinal data on student career paths.
- Fill the Agency's workforce needs by making a stronger effort to consider eligible Education program participants for and facilitate their entry into jobs at NASA.
- Develop appropriate performance measures, baselines, and targets.
- Develop a new education investment framework, with ensuing implementation plan, in support of the Agency strategic direction and the Vision for Space Exploration.

Budget Detail (Dollars in Millions)

Budget Authority (\$ millions)	FY2005	FY2006	Change	FY2007	FY2008	FY2009	FY2010	FY2011	Comments
Education	178.9	162.4	-9.0	153.3	152.4	153.1	154.0	153.3	
Elementary & Secondary Education	26.0	14.9	32.3	47.2	46.1	46.6	47.6	47.0	
Higher Education	62.4	69.2	-15.2	54.0	53.2	53.2	53.2	53.1	
E-Education	9.5	8.1	0.9	9.0	9.0	9.0	9.0	9.0	
Informal Education	10.3	34.0	-31.5	2.5	2.5	2.5	2.5	2.5	
Minority University Research and Education Program (MUREP)	70.7	36.1	4.4	40.6	41.7	41.7	41.6	41.6	

Theme:**Education**

Note 1: For all formats, the FY 2005 column reflects the FY 2005 Congressional Operating Plan, dated 9/30/2005. The FY 2006 column reflects the FY 2006 Congressional Initial Operating Plan, dated Jan 2006. The FY 2007 - 2011 columns represent the FY 2007 President's Budget Submit.

Note 2: In FY 2006, funding for core education requirements was redirected to address Congressionally-directed requirements, including earmarks. The FY 2007 budget request re-establishes funding for these core education requirements in the appropriate programs.

Note 3: Effective for FY 2007 and beyond, the NASA Explorer Schools, Summer High School Apprenticeship Research Program, and the Science, Engineering & Mathematics Aerospace Academy projects have been realigned from the Minority University Research & Education Program (MUREP) to the Elementary & Secondary (E&S) Education Program.

Theme: Education
Program: Elementary & Secondary Education

President's FY 2007 Budget Request (Dollars in Millions)

<u>Elementary & Secondary Education</u>	<u>FY2005</u>	<u>FY2006</u>	<u>FY2007</u>	<u>FY2008</u>	<u>FY2009</u>	<u>FY2010</u>	<u>FY2011</u>
FY 2007 PRES BUD	26.0	14.9	47.2	46.1	46.6	47.6	47.0
Changes from FY 2006 Request	-5.1	-13.6	21.9	21.3	21.0	21.9	

Overview

NASA believes that increasing the number of students involved in NASA-related activities at the elementary and secondary education levels will inspire more students to pursue higher levels of study in science, technology, engineering, and mathematics (STEM) courses. The Elementary and Secondary Education (E&S) program engages students, educators, families, and institutions through programs to increase the rigor of STEM experiences provided to K-12 students through workshops, internships, and activities; provide high-quality professional development to teachers in STEM through NASA programs; develop technological avenues through the NASA website that will allow families to learn about space exploration; encourage inquiry teaching in K-12 classrooms; improve the content and focus of grade level/science team meetings in NASA Explorer Schools; and share knowledge gained through the Educator Astronaut program with teachers, students, and families. This Program provides opportunities to the diverse education community to discuss topics applicable to classroom studies with Astronauts on the International Space Station. Classrooms also have the unique capability to integrate images taken via the Internet from a camera on the ISS into their Earth Science studies.



By increasing the number of students involved in NASA-related activities at the elementary and secondary education levels, more students will be inspired and motivated to pursue higher level of studies in STEM courses.

Note: Effective for FY 2007 and beyond, the NASA Explorer Schools, Summer High School Apprenticeship Research Program, and the Science, Engineering & Mathematics Aerospace Academy projects have been realigned from the Minority University Research & Education Program (MUREP) to the E&S Education Program.

Theme:	Education
Program:	Elementary & Secondary Education

Plans For FY 2007

NASA Education will continue to offer the following educational opportunities in FY 2007: Educator Astronaut Program (EAP), the Aerospace Education Services Program (AESP), NASA Explorer Schools (NES), Interdisciplinary National Science Program Incorporating Research and Education Experiences (INSPIRE), Science Engineering Mathematics Aerospace Academy (SEMAA), and Flight Projects. Each of these efforts provide unique experiences for educators and students to share in the NASA discovery experience beginning in the very formative K-12 period. For example, the Educator Astronaut Program selected three outstanding educators to become members of the Astronaut Corps. The program will capitalize on the excitement and visibility of the Educator Astronauts and their trainers as well as members of the Network of Educator Astronaut Teachers, to engage students and educators in NASA's Vision for Space Exploration. These Educator Astronauts can then use the visibility and educational opportunities created by their experience to inspire greater K-12 STEM achievement, to promote STEM careers, and to elevate public esteem for the teaching profession. NASA Explorer Schools will continue to work with a total of 150 teams of teachers and education administrators from diverse communities across the country. Focusing on underserved populations, NES joins educators, students, and facilities in sustained involvement with NASA.

Changes From FY 2006

- The program will evaluate projects to assure currency and to validate alignment with NASA missions, strategic goals, and objectives.
- Restored opportunities for K-12 students to gain hands-on experience as payload investigators using the Space Shuttle, the ISS, Sounding Rockets, and Scientific Balloons eliminated in FY 2006.
- To better reflect functional alignment, NASA Explorer School, INSPIRE, and SEMAA are now included in the Elementary and Secondary Program.

Program Management

Program management is the responsibility of the AA for Education and is conducted in accordance with NASA policies and procedures.

Theme:	Education
Program:	Elementary & Secondary Education

Technical Parameters

The Elementary and Secondary Education program is designed to provide students and educators with tools, experiences, and opportunities to further their education and participation in unique NASA learning experiences that enhance their knowledge of science, technology, engineering and mathematics (STEM). The individual efforts emphasize family involvement, which has been shown to enhance student achievement. The program also supports the role of educational institutions, which provide the framework to unite students, families, and educators for educational improvement. This program integrates new components with existing NASA assets into a structure that supports local education efforts to encourage student involvement in STEM.

Technical Specifications	FY 2007 President's Budget	Change from Baseline
NASA Educator Astronaut	\$2.85M	+\$0.35M
NASA Explorer Schools	\$14.10M	+4.45M
Interdisciplinary National Science Program Incorporating Research & Education Experiences (INSPIRE)	\$3.86M	+\$3.86M
Science, Engineering and Mathematics Aerospace Academy (SEMAA)	\$4.14M	-\$0.16M
Aerospace Education Services Program (AESP)	\$6.34M	+\$2.50M
Flight Projects	\$2.01M	+\$2.01M

Strategy For Major Planned Acquisitions

- A competitive cooperative agreement will be awarded to provide nationwide education and management support for the NASA Education portfolio.

Key Participants

- Primarily certified teachers from the selected schools, who will be provided professional development in STEM subject areas.
- Elementary and Secondary Education activities may involve astronauts, engineers, scientists, and mathematicians from the public and private sectors addressing NASA's related disciplines and topics.
- Students selected through competitive application processes to increase their STEM awareness and knowledge through individual experiential opportunities.

Theme:	Education
Program:	Elementary & Secondary Education

Risk Management

- **RISK:** Elementary and Secondary Education is a relatively low risk program. The primary risk is a loss of affiliation with principal participants resulting in the loss of opportunity to reach the student audience. Loss of affiliation is most often attributed to funding disruption or stoppage or to issues with informational material currency and availability. **MITIGATION:** NASA Education will monitor and mitigate program risk through continual evaluation of both program content and delivery method, adjusting the content or delivery method to assure currency. Also, NASA will carefully monitor funding levels and flow to ensure continual engagement with current and intended funding recipients.

President's FY 2007 Budget Request (Dollars in Millions)

Higher Education	FY2005	FY2006	FY2007	FY2008	FY2009	FY2010	FY2011
FY 2007 PRES BUD	62.4	69.2	54.0	53.2	53.2	53.2	53.1
Changes from FY 2006 Request	-9.0	29.8	17.4	16.4	16.5	16.5	

Overview

Higher Education supports students and faculty at universities and colleges to strengthen their research capabilities and provide opportunities that attract and prepare increasing numbers of students for NASA-related careers. Participation in NASA programs and research can stimulate a broad representation of students to continue their studies at all levels of the higher education continuum and earn advanced degrees in science, technology, engineering, and mathematics (STEM). In addition, the research conducted at institutions of higher education will contribute to research needs of NASA's Mission Directorates, the nation, and the international research and development community.



The Higher Education projects are intended to serve as a major link in the student pipeline used to address NASA's Human Capital Strategies and the President's Management Agenda by helping to build, sustain, and effectively deploy skilled, knowledgeable, diverse, and high performing workforce needed to meet the current and emerging needs of our government and its citizens.

The balloon launch is an example of how the Space Grant students gain valuable hands-on Science, Technology, Engineering, and Mathematic (STEM) skills and experiences.

The major projects in the Higher Education portfolio include Undergraduate Student Research Program (USRP), Graduate Student Research Program (GSRP), NASA Space Grant College and Fellowship Program, and Experimental Program to Stimulate Competitive Research (EPSCoR).

Plans For FY 2007

The Higher Education program will continue to engage students and universities through a variety of initiatives, with particular focus on the preparation of undergraduate and graduate students to feed the pipeline of future scientists and engineers with skills needed by the Agency. NASA Education will continue to facilitate its work through competitive research announcements, cooperative agreement notices, other procurement vehicles, and multi-year grants awarded to institutions and students in research pertinent to NASA missions. These efforts will provide recipients with assistance for their participation in collaborative scientific and/or engineering research or education projects which should lead to stronger scientific and technical infrastructure of participating institutions. All Higher Education projects will continue to focus on retaining students in STEM disciplines through their completion of undergraduate or graduate degrees and entry into the scientific and technical workforce.

Theme:	Education
Program:	Higher Education

Changes From FY 2006

- Defer implementation of the Science and Technology Scholarship Program.
- Revitalize USRP and expand GSRP to ensure a continuous set of STEM pipeline experiences that supports the Vision for Space Exploration.

Program Management

Program management is the responsibility of the AA for Education, and is conducted in accordance with NASA policies and procedures.

Technical Parameters

Higher Education focuses on supporting institutions of higher education in strengthening their research capabilities and providing opportunities that attract and prepare increasing numbers of students for NASA-related careers, primarily in the STEM disciplines.

Note: Amounts requested for NASA Space Grant and EPSCoR programs reflect a significant increase over the amounts requested in the FY 2006 President's budget request and are consistent with amounts needed to address NASA and Administration priorities.

Technical Specifications	FY 2007 President's Budget	Change from Baseline
NASA Space Grant	\$28.76M	-1.48M
Experimental Program to Stimulate Competitive Research (EPSCoR)	\$10.00M	-\$2.50M
Undergraduate Student Research Program (USRP)	\$3.69M	+\$3.69M
Graduate Student Research Program (GSRP)	\$8.62M	+\$4.78M

Strategy For Major Planned Acquisitions

- Higher Education will continue to award multi-year grants to institutions and students using a mix of competitive research and cooperative agreements or other appropriate procurement vehicles.

Key Participants

- Students and institutional researchers (both basic and applied) from selected higher education institutions.
- Higher Education activities may involve astronauts, engineers, scientists, and mathematicians from public and private sectors addressing NASA-related disciplines and topics.

Theme:	Education
Program:	Higher Education

Risk Management

- **RISK:** Higher Education is a relatively low risk program. The primary risk is loss of affiliation with a principal participant resulting in an inability to meet NASA's and the country's future workforce needs in scientific and technical disciplines. Loss of affiliation is often attributed to funding disruption or stoppage to a primary participant, and to a lack of currency in the funding targets. **MITIGATION:** NASA Education will monitor and mitigate program risks through continual evaluation of program performance and relevance, adjusting the portfolio to ensure an appropriate mix. Also, NASA will carefully monitor funding levels and flow to ensure continual engagement with current and intended funding recipients.

Theme: Education
Program: E-Education

President's FY 2007 Budget Request (Dollars in Millions)

<u>E-Education</u>	<u>FY2005</u>	<u>FY2006</u>	<u>FY2007</u>	<u>FY2008</u>	<u>FY2009</u>	<u>FY2010</u>	<u>FY2011</u>
FY 2007 PRES BUD	9.5	8.1	9.0	9.0	9.0	9.0	9.0
Changes from FY 2006 Request	-1.1	-2.0	0.1	0.0	0.1	0.1	

Overview

In the future, powerful technologies will enable new learning environments using simulations, visualizations, immersive environments, game-playing, and learner networking. These capabilities will create rich and compelling learning opportunities that meet the needs of learners while empowering educators and other adults to unlock a student's mind and their own potential. Learning will be on demand. Students, educators, and the general public will receive what they need, when they need it anywhere, anytime. NASA is working toward this education future, developing new methods for making its exciting discoveries and valuable resources available to students, educators, and the public.



The intent of e-Education is to develop infrastructure and deploy research-based technology applications, products, and services that enhance the educational process for formal and informal education. Furthermore, activities under e-Education directly support the President's Management Agenda for e-Government.

Technology moves in mysterious ways --
 Exciting, inspiring, and educating the public
 with NASA technology.

The e-Education portfolio includes the assets of Digital Learning Network (DLN), Learning Technologies Projects (LTP), NASA-sponsored Classroom of the Future (COTF), Education File on NASA TV, Web services, including the NASA Public Portal and Education home page, the suite of television and Web-based instructional series, and electronic-and site-based dissemination network.

Plans For FY 2007

NASA e-Education will continue to restructure its activities to realize efficiencies and cost savings. A business model that includes portfolio management, cost-sharing, sunrise-sunset provisions to funded projects, and insertion of standard processes and tools will continue to be implemented in order to maximize effectiveness.

The following efforts will be targeted and enhanced by projects funded within the education portfolio: implement product reviews and meta-tagging; leverage technology infrastructures to deliver exploration-related content to audiences; continue research and development of high-speed, high-capacity broadband communications and customized learning through multimedia or online information; and evaluate program performance and effectiveness to inform decision making in shaping the investment portfolio.

Theme: Education
Program: E-Education

Changes From FY 2006

- Project Management of the Learning Technologies Project moved to NASA Goddard Space Flight Center.
- Project Management of the Central Operation of Resources for Educators and NASA-sponsored Classroom of the Future will be examined for possible transition to NASA Field Centers.
- Expansion of the portfolio to include development of addressable programming for Digital NASA Television Education Channel.

Program Management

Program management is the responsibility of the AA for Education, and is conducted in accordance with NASA policies and procedures.

Technical Parameters

NASA e-Education explores ways to maximize technology's contribution to redefining and enhancing education by seeking partnerships with the private sector, the academic research community, teachers, and other key stakeholders to speed the development of these technologies.

NASA e-Education fosters public-private collaborations to develop advanced technologies, such as interactive, virtual-presence, and immersive environments and interfaces to remote instruments, that integrate the Agency's science and engineering capabilities in order to strengthen and expand K-20 science and mathematics education. NASA e-Education also provides telepresence experiences, "tools," and digital resources to aid curriculum developers, educators and informal education communities.

Technical Specifications	FY 2007 President's Budget	Change from Baseline
Learning Technology Projects (LTP)	\$2.99M	+\$1.49M
NASA Education Technologies Services	\$1.87M	+\$0.37M
Classroom of the Future	\$2.03M	+\$2.03M
Small Program	\$1.63M	+\$0.08M

Strategy For Major Planned Acquisitions

- Anticipated opportunity to be announced for creation of a NASA-HQ based technology innovation fund to encourage creative technology innovations and collaborations with the public-private communities.

Key Participants

- e-Education activities may involve astronauts, engineers, scientists, and mathematicians from public and private sectors addressing NASA's related disciplines and topics to enhance future learning at all levels of formal and informal education.

Theme:	Education
Program:	E-Education

Risk Management

- RISK: NASA e-Education is a relatively low risk program. The primary risk is a loss of affiliation with principal participants resulting in the loss of opportunity to reach the targeted audience. Loss of affiliation is most often attributed to a lack of informational material currency, to funding disruption or stoppage, or to issues related to technology deployment. MITIGATION: NASA Education will monitor and mitigate program risk through continual evaluation of both program content and delivery method, adjusting the content and deployed technology to assure currency. Also, NASA will carefully monitor funding levels and flow to ensure continual engagement with current and intended funding recipients.

President's FY 2007 Budget Request (Dollars in Millions)

<u>Informal Education</u>	<u>FY2005</u>	<u>FY2006</u>	<u>FY2007</u>	<u>FY2008</u>	<u>FY2009</u>	<u>FY2010</u>	<u>FY2011</u>
FY 2007 PRES BUD	10.3	34.0	2.5	2.5	2.5	2.5	2.5
Changes from FY 2006 Request	-0.6	31.2	0.1	0.1	0.2	0.1	

Overview

NASA continues to seek opportunities for partnerships and alliances with national, state, and local education organizations; industry; and academic institutions to encourage and provide access for more students and citizens to become active participants in our aviation research and technology and space exploration. The Nation's science centers, museums, planetaria, libraries, community-based organizations, and other informal education entities are a major source of inspiration and learning for people from all walks of life.



Informal Education provides stimulating experiences for science, technology, engineering, and mathematics (STEM) learning outside of formal classroom environments through media, exhibits, and community-based programming. Its goals are to increase interest in, understanding of, and engagement with, STEM disciplines by individuals of all ages; to establish linkages between informal and formal education; and to stimulate parents and others to support their children's STEM learning endeavors and to become informed proponents for high-quality, universally available STEM education.

Informal education provides stimulating experiences for STEM learning outside of formal classroom environments.

As NASA builds relationships with informal education institutions, all participants are better equipped to engage the public in shaping and sharing the experience of exploration and discovery and to improve public understanding and appreciation of science and technology.

Plans For FY 2007

Informal Education will continue to focus on its pathfinder initiative, NASA Explorer Institutes (NEI) as a way to broaden NASA's reach to students, their families, and the general public by strengthening the capacity of the informal education community, including science centers, museums, planetaria, and community-based organizations. The program will continue to establish linkages that promote new relationships between providers of informal and formal education, resulting in improved and creative STEM education in all learning environments. The program plans to sponsor workshops on the STEM disciplines through NASA Centers in order to better reach the traditionally underrepresented and underserved educational community. Other priorities for NEI include development of STEM products and tools, developing an infrastructure supportive of the communities needs, and ensuring the sustainability of efforts begun in previous years.

Theme:	Education
Program:	Informal Education

Changes From FY 2006

- Informal Education will evaluate its individual efforts to minimize duplication and to provide better alignment with NASA missions.
- The NASA Explorer Institute (NEI) will move to full implementation, with formative and external summative evaluations.

Program Management

Program management is the responsibility of the AA for Education, and is conducted in accordance with NASA policies and procedures.

Technical Parameters

In cooperation with the Mission Directorates and the Office of Public Affairs, the Office of Education leverages its partnerships with existing and future informal education partners to share NASA discoveries and experiences. Following its coordinated plan for the implementation of the NEIs, NASA engages science centers, museums, planetaria, community-based organizations, and other public forums to assist sharing these discoveries and experiences. The NASA Office of Education facilitates development of educational materials that incorporate these new discoveries and disseminates them to its partners.

Technical Specifications	FY 2007 President's Budget	Change from Baseline
NASA Explorer Institutes	\$2.40M	+\$1.90M

Key Participants

- The Nation's science centers, museums, planetariums, libraries, community-based organizations, and other informal education entities.

Risk Management

- **RISK:** Informal Education is a relatively low risk program. The primary risk is a loss of affiliation with principal participants resulting in the loss of opportunity to reach the targeted audience. Loss of affiliation is most often attributed to a lack of informational material currency, to funding disruption or stoppage, or to issues related to technology deployment. **MITIGATION:** NASA Education will monitor and mitigate program risk through continual evaluation of both program content and delivery method, adjusting the content and deployed technology to assure currency. Also, NASA will carefully monitor funding levels and flow to ensure continual engagement with current and intended funding recipients.

Theme:

Education

Program:

Minority University Research and Education Program (MUREP)

President's FY 2007 Budget Request (Dollars in Millions)

<u>Minority University Research and Education Program (MUREP)</u>	<u>FY2005</u>	<u>FY2006</u>	<u>FY2007</u>	<u>FY2008</u>	<u>FY2009</u>	<u>FY2010</u>	<u>FY2011</u>
FY 2007 PRES BUD	70.7	36.1	40.6	41.7	41.7	41.6	41.6
Changes from FY 2006 Request	-22.1	-50.0	-41.0	-40.2	-40.0	-40.0	

Overview

NASA's outreach to minority institutions through its Minority University Research and Education Program (MUREP) expand the Agency's research base through continued investment in minority institutions' research and academic infrastructure and contribute to the development of the science, technology, engineering, and mathematics (STEM) pipeline.

MUREP will achieve its objectives by (1) developing new research and education collaborations and partnerships with the NASA Mission Directorates, other government agencies, and interested parties; (2) providing and encouraging opportunities for faculty to conduct NASA research; (3) providing financial and other support for students to enter and complete degrees in STEM disciplines; (4) establishing measurable program goals and objectives; and (5) developing and implementing evaluation models to assess the effectiveness and outcomes of the programs and their financial performance, thereby improving program delivery and results. MUREP awards focus on building and supporting successful pathways for students to progress to higher levels of mathematics and science, and enhancing the research and academic infrastructure of minority institutions.



NASA's outreach to minority institutions contribute to the development of STEM.

Note: Effective for FY 2007 and beyond, the NASA Explorer Schools, Summer High School Apprenticeship Research Program, and the Science, Engineering & Mathematics Aerospace Academy projects have been realigned from the Minority University Research & Education Program (MUREP) to the Elementary & Secondary (E&S) Education Program.

Plans For FY 2007

The MUREP program will continue to engage under-represented populations through a wide variety of initiatives, with particular focus on retaining underrepresented and underserved students in a STEM discipline through their completion of undergraduate or graduate degrees and entry into the scientific and technical workforce. NASA Education will continue to facilitate its work through competitive research announcements, cooperative agreement notices, and multi-year grants awarded to minority institutions, faculty and students in research pertinent to NASA missions. These efforts will provide Minority Serving Institutions (MSIs) with assistance for their participation in collaborative scientific and/or engineering research or education projects which will lead to even stronger scientific and technical infrastructures of MSIs.

Theme: Education

Program: Minority University Research and Education Program (MUREP)

Changes From FY 2006

- MUREP will continue to evaluate its individual efforts to minimize duplication, provide better alignment with NASA missions, and to ensure a competitive award process.
- MASTAP, PAIR, NRTS, MIE, Undergraduate Scholars, Earth Science, and Space Science are being phased out with these needs addressed through other Education components in the portfolio.
- NASA Explorer Schools, Science Engineering Mathematics Aerospace Academy, and Integrating Research and Education Experience have been realigned to the Elementary and Secondary Education.

Program Management

Program management is the responsibility of the AA for Education, and is conducted in accordance with NASA policies and procedures.

Theme:	Education
Program:	Minority University Research and Education Program (MUREP)

Technical Parameters

MUREP is administered through NASA's Office of Education to increase the agency's responsiveness to Federal mandates related to Historically Black Colleges and Universities (HBCUs) and Other Minority Universities (OMUs), including Hispanic Serving Institutions (HSIs) and Tribal Colleges and Universities (TCUs). The programming staff is responsible for formulating and executing NASA's MUREP budget, developing agency-wide policies, procedures and guidelines that enhance the involvement of HBCUs and OMUs in the mission of the Agency.

Technical Specifications	FY 2007 President's Budget	Change from Baseline
University Research Centers	\$20.52M	+\$12.03M
Research Academy	\$1.16M	+\$0.56M
Faculty Awards for Research	\$5.04M	+\$4.04M
NASA Administrator's Fellowship	\$2.52M	+\$0.52M
Jenkins Fellowship	\$2.56M	+\$0.56
Curriculum Improvement Partnership Award (CIPA)	\$2.55M	+\$1.55M
Tribal, HSI, HBCU, Collaborations	\$1.92M	+\$1.02M
Small Programs	\$2.03	+\$1.03M
Partnership Awards for Integration of Research (PAIR)	\$0M	-\$1.00M
Space Science Collaboration	\$0M	\$0M
Math Science Teacher & Curriculum Enhancement Program (MASTAP)	\$0M	\$0M
Undergraduate Scholars	\$0M	-\$2.00M
Network Resource & Training Sites (NRTS)	\$0M	-\$0.33M
Model Institutes for Excellence (MIE)	\$0M	\$0M
Earth Science Collaborations	\$0M	\$0M

Strategy For Major Planned Acquisitions

- MUREP will award multi-year grants to minority institutions, faculty, and students using a mix of competitive research and cooperative agreements or other appropriate procurement vehicles.

Theme: Education

Program: Minority University Research and Education Program (MUREP)

Key Participants

- Students, faculty and researchers from Historically Black Colleges and Universities (HBCUs) and Other Minority Universities (OMUs).
- MUREP activities may involve astronauts, engineers, scientists, and mathematicians from public and private sectors addressing NASA's related disciplines and topics.

Risk Management

- **RISK:** The MUREP is a relatively low risk program. The primary risk is a loss of affiliation with the principal participants resulting in an inability to meet NASA's and the country's future workforce needs in scientific and technical disciplines. Loss of affiliation is often attributed to funding disruption or stoppage to the primary participants, and to a lack of currency in the funding targets. **MITIGATION:** NASA Education will monitor and mitigate program risk through continual evaluation of program performance and relevance, adjusting the portfolio to ensure an appropriate mix. Also, NASA will carefully monitor funding levels and flow to ensure continual engagement with current and intended funding recipients.

Advanced Business Systems



Advanced Business Systems will improve NASA's financial performance by implementing an integrated compliant system across the Agency for financial, asset, and contractual management with improved processes and consistent information delivery.

President's FY 2007 Budget Request

(Dollars in Millions)

Advanced Business Systems	FY2005	FY2006	FY2007	FY2008	FY2009	FY2010	FY2011
FY 2007 PRES BUD		156.3	108.2	106.9	73.8	78.5	80.6
Changes from FY 2006 Request		156.3	108.2	106.9	73.8	78.5	

Overview: *What* NASA Accomplishes through the Advanced Business Systems Theme

Advanced Business Systems is a new theme established in FY06 to reflect the implementation of business systems as a direct program. Prior to FY06, business systems were located within the Corporate and Center G&A and did not provide visibility to the financial improvements being made at NASA. Since last year's budget submission, NASA's Integrated Enterprise Management Program (IEMP) has made several changes due to renewed focus and commitment on improving financial management practices and performance. Significant changes to this critical Program include:

- Name change from Integrated Financial Management Program (IFMP) to Integrated Enterprise Management Program (IEMP) to note the investment that NASA is making in the Program aimed at improving Agency management of its investments and controlling the operating costs of the Agency.
- As recommended by Congress, the budgeting and funding for all development, implementation, and sustaining activities are managed from a single program instead of multiple Corporate and Center General and Administrative (G&A) funding sources.
- Upgrade of NASA's Core Financial system during FY06 to achieve full compliance with the Federal Financial Management Improvement Act (FFMIA) and to implement critical process changes related to NASA's financial tracking, reporting, and other elements. NASA's Integrated Asset Management (IAM) project was delayed in order to not impact the financial upgrade and to also re-assess the overall development and deployment strategy of IAM with a goal to reduce cost and complexity.
- NASA's time and attendance system (WebTADS) transfer into IEMP for operations and sustaining support to allow for more efficient operations and maintenance and continue the initiative to business systems under centralized management.

Theme:

Advanced Business Systems

Relevance: *Why* NASA conducts Advanced Business Systems work

Relevance to national priorities, relevant fields, and customer needs:

NASA is consolidating all Business Systems under one Theme to ensure integration of disparate systems in order to improve efficiencies and reduce redundant systems.

Relevance to the NASA mission:

Advanced Business Systems supports NASA's mission to achieve management and institutional excellence comparable to NASA's technical excellence by improving the financial, physical, and human resources management processes throughout the Agency.

Relevance to education and public benefits:

Integrated business systems will result in improved financial management of appropriated funds and financial confidence in NASA from the taxpayers.

Performance

Major Activities Planned for FY 2007:

- Continue the implementation across the Agency of the JSC Aircraft Management Information System as the solution for qualifications currency of aircraft and Astronauts.
- Continue the implementation of the Contract Management Module across the Agency.
- Identify solutions for the remaining Integrated Asset Management module for Logistics, Facilities and Environmental.

Major Recent Accomplishments:

- Initiated the upgrade from SAP R3 version to MySAP 2005 providing technical software fixes and improved financial processes.
 - Successfully implemented the Project Management Information Improvement initiative establishing a standard Agency budget structure for programs and projects across all Centers.
 - Successfully implemented the Labor Distribution System replacing multiple labor systems and eliminating replication of data across Agency/Center systems.
 - The Contract Management Module received a "Go" decision at the Critical Design Review for initiation of the Realization phase. It is working to a rollout to all Centers in FY 2006.
 - Successfully began the implementation of the Aircraft Management Module Phase I at seven Centers.
-

Advanced Business Systems Theme Commitment in Support of the NASA Mission :

Strategic Goals**Sub-Goals (If Applicable)***Multiyear Outcomes*

Annual Performance Goals supporting the Multiyear Outcomes

Supports Multiple Agency Goals

IEM-1 By 2008, implement Agency business systems that provide timely, consistent and reliable business information for management decisions.

7IEM1 Upgrade NASA's existing Core Financial system, through the SAP Version Update Project, resulting in improved data integrity.

IEM-2 Increase efficiency by implementing new business systems and reengineering Agency business processes.

7IEM2 Implement the Contract Management Module to increase efficiency in procurement processes.

7IEM3 Implement the Aircraft Management Module to reduce the risk of flight operations through improved tracking of crew and aircraft currency qualifications.

Program Management

The Advanced Business Systems Theme Director is Patrick Ciganer, the Program Director is Bobby German, Office of the Deputy Administrator.

Quality***Independent Reviews:***

- OCIO Review of IEMP: Enterprise Architecture Review-CMM, May 2005
- GAO Reviews of IEMP (3 in April 2003): Information Technology-Architecture Needed to Guide NASA's Financial Management Modernization, Business Modernization-Disciplined Processes Needed to Better Manage NASA's IFMP; Business Modernization-NASA's IFMP Does Not Fully Address Agency's External Reporting Issues
- GAO Review of IEMP: Follow-up on Recommendations to NASA's IFMP, March 2005.
- GAO Review of IEMP: Business Modernization-Improvements Needed in Management of NASA's IFMP in April 2002.
- OIG Audit of IEMP: Audit of the Adequacy of NASA's Governance Process for the IEMP Upgrade to the SAP Application, October 2005.
- OIG Audit of IEMP: Review of NASA's Readiness to Implement Project Management Information Improvement Phase 1, August 2005.
- OIG Audit of IEMP: Audit of the Early Planning for the IEMP's Contract Management Module's Requirement and Life-Cycle Operations, March 2005.
- OIG Audit of IEMP: FY05 Financial Statement Audit, January 2005.
- OIG Audit of IEMP: Follow-on to FY04 Financial Statement Audit-Root Cause Analysis of Core Financial Implementation, October 2004.
- OIG audit of IEMP: Implementation of IFMP Audit Recommendations, August 2004.
- OIG Audit of IEMP (2 in May 2004): IFMP Contract Oversight and Overall Audit of IFMP
- OIG Audit of IEMP: FY04 Financial Statement Audit-IT Security Findings/Recommendations, January 2004.
- OIG Audit of IEMP: IFMP Budget Formulation Module, April 2003.
- OIG Audit of IEMP: Audit of the IFMP Travel Management Module, April 2003.
- OIG Audit of FY03 Financial Statement Audit-IT Security Findings/Recommendations, January 2003.
- OIG Audits of IEMP: IFMP Core Financials Module Conversion to Full Cost, May 2003.
- OIG Audit of IEMP: Summary Report on Audit of IFMP Core Financial Module (audit of testingm data conversion, and Knowledge Sharing System, July 2002.
- OIG Audit of IEMP: IFMP Core Financial Project Information Technology Security Planning and Implementation, August 2002.
- Second Non Advocate Review of Core Financial Module, November 2002.
- First Non Advocate Review of Core Financial, August 2001.
- Independent Annual Review (IAR), October 2001 and March 2003.
- Non Advocate Review of LDS and PMII, July 2005.
- The Program Implementation Review (PIR) was conducted by the Independent Program Assessment Office (IPAO) in June 2005 (Phase I). As a result of Program direction change shortly thereafter, the PIR Phase II will be conducted in March 2006. PIRs are generally conducted every 2 years.

Program Assessment Rating Tool (PART):

OMB has not yet conducted a PART review of the Advanced Business Systems Theme nor IEMP. However, a PART review is planned for 2006.

Theme:**Advanced Business Systems****Budget Detail**

(Dollars in Millions)

Budget Authority (\$ millions)	FY2005	FY2006	Change	FY2007	FY2008	FY2009	FY2010	FY2011	Comments
Advanced Business Systems		156.3	-48.0	108.2	106.9	73.8	78.5	80.6	
Integrated Enterprise Management Program		156.3	-48.0	108.2	106.9	73.8	78.5	80.6	

Note: For all formats, the FY 2005 column reflects the FY 2005 Congressional Operating Plan, dated 9/30/2005. The FY 2006 column reflects the FY 2006 Congressional Initial Operating Plan, dated Jan 2006. The FY 2007 - 2011 columns represent the FY 2007 President's Budget Submit.

As recommended by Congress, beginning in FY 2006, the budgeting and funding for IEMP was transferred from multiple funding sources (Corporate and Center G&A) to direct program funding. The FY 2006 Corporate and Center G&A transfer was \$156.3M. The FY 2007 request is \$108.2 million, a 31 percent decrease from the FY 2006 Budget:

- \$10.3M to complete the implementation of the Contract Management Module (\$16.3M decrease),
- \$16.1M to complete the update of the current SAP version (\$27.8M decrease),
- \$17.2M to continue the implementation of the Asset Management solutions (\$5.8M increase),
- \$48.8M to maintain and sustain implemented modules (\$1.5M decrease), and
- \$15.8M for Infrastructure, Corporate G&A, and Institutional Investments overhead (\$2.9M decrease).

The additional decrease of \$5.4M represents the completion of ALDS and PMII in FY 2006.

President's FY 2007 Budget Request (Dollars in Millions)

Integrated Enterprise Management Program	FY2005	FY2006	FY2007	FY2008	FY2009	FY2010	FY2011
FY 2007 PRES BUD		156.3	108.2	106.9	73.8	78.5	80.6
Changes from FY 2006 Request		156.3	108.2	106.9	73.8	78.5	

Overview

The Integrated Enterprise Management Program (IEMP) is a large and complex initiative changing the way financial and business management is performed throughout NASA. Center and/or Mission Directorate unique approaches are being replaced with a single set of standard integrated business processes. Each and every NASA employee will be impacted by these changes. New IEMP systems are improving business processes by minimizing data redundancy, standardizing information and electronic data exchanges, processing and recording financial events effectively and efficiently, and ensuring consistent information throughout the Agency. The IEMP consists of functional projects that effect business process changes and that acquire and implement appropriate information technology tools to substantially improve the Agency's performance. The Program, reformulated in March 2000, will complete implementation in FY 2008. IEMP is composed of multiple projects. The following projects are completed: Resume Management, Position Description Management, Travel Management, Core Financials, Program Management Information Improvement, and Labor Distribution. The following projects are in planning or development: SAP Version Upgrade, Contract Management, and Integrated Asset Management.



IEMP implements standardized business processes across all NASA Centers.

Plans For FY 2007

During FY 2007, IEMP will complete the implementation of the Contract Management Module and implement the SAP version upgrade to the Core Financial Module. These two implementations will provide the initial platform that will provide the bridge for the Agency's financial integrity. It will result in improved financial audits and getting to "green" status for the President's Management Agenda Scorecard. The Competency Center will continue the Operations and Sustainment Support to all IEMP implemented modules.

Changes From FY 2006

- Beginning FY 2006, IEMP moved from Corporate and Center G&A to a Direct Program.
- The Integrated Asset Management project will be implemented using multiple solutions. The Aircraft Management Module will implement the JSC Aircraft System across 7 Centers.
- Contract Management Module implementation is extended 6 months into FY 2007 and SAP Version Upgrade will be implemented at the beginning of FY 2006.

Program Management

The IEMP Office at NASA Headquarters is responsible for the oversight of all projects. Project Offices at MSFC and JSC manage each project.

Technical Parameters

The IEMP establishes module projects to effect business process changes and to acquire and implement information technology (IT) tools, enabling Mission Directorates to achieve programmatic objectives. IEMP will implement standard systems and processes, ensure data integration, and provide a single point of data entry which will eliminate reconciliation and provide management with consistent data for decision making. IEMP will also provide analysis and reporting tools to provide information for timely, informed decisions. IEMP will implement the infrastructure and tools to facilitate the free flow of information internally and externally to increase Agency level accountability, achieve integrity of data and information, and communicate cost effectiveness of NASA's actions.

Technical Specifications	FY 2007 President's Budget	Change from Baseline
Core Financial module will be upgraded to the new version of SAP and implement SAP corrective fixes.	The upgrade will be rolled out to all Centers at the beginning of FY 2007.	Previously, this upgrade was planned for the beginning of FY 2006. In order to implement a new NASA standard data structure at the beginning of FY 2006, the upgrade was delayed one year.
Contract Management Module (CMM) will provide a comprehensive tool to support contract writing, administration, workload management, and reporting.	The Agency will complete implementation of CMM in FY 2007.	The CMM schedule has been extended six months to reduce risks associated with implementing CMM and the SAP Upgrade at the same time.
Aircraft Management Module (AMM) is the Agency solution for the aircraft maintenance and Astronaut qualifications currency.	Phase I will be implemented by the end of CY 2007. Phase II will begin implementation in mid FY 2007.	AMM was previously budgeted as part of the Integrated Asset Management project. Now the Agency will use the existing JSC aircraft management system for the seven affected Centers.
The Integrated Asset Management (IAM) project will implement a Agency wide standard system for Logistics, Facilities, and Environmental.	In the FY 2006 President's Budget, IAM was scheduled to complete implementation in FY 2007.	The Agency, under the new Administrator, decided to re-evaluate potential solutions, scope and schedule and is currently developing an Asset Strategic Plan. A revised business case is planned 2006.

Implementation Schedule:

Project	Schedule by Fiscal Year							Purpose	Phase Dates		
	05	06	07	08	09	10	11			Beg	End
Contract Management Module								CMM will provide a comprehensive tool to support contract writing, contract administration, procurement workload management, and data reporting/management.	Tech Form Dev Ops Res	Apr-04 Dec-04 Dec-06	Nov-04 Dec-06 Sep-26
Aircraft Management Module								Implement a standard aircraft solution across the Agency for recording and tracking aircraft maintenance and Astronaut qualifications currency to comply with safety requirements.	Tech Form Dev Ops Res	Jun-05 Jan-06 Apr-07	Jan-06 Mar-07 Sep-26
Upgrade Core Financial SAP version to MySAP 2005								Upgrade Core Financial Module to the new SAP version, MySAP 2005 to continue SAP support of the NASA software version and implement corrective fixes from SAP.	Tech Form Dev Ops Res	Sep-05 Nov-05 Oct-06	Nov-05 Oct-06 Sep-26
Project Management Improvement Initiative								Implements updated NASA Structure Management codes across the Agency in Core Financial module.	Tech Form Dev Ops Res	Oct-04 Jan-05 Oct-05	Jan-05 Oct-05 Sep-26
Labor Distribution System								Implements standard Agency system to distribute labor costs across Projects.	Tech Form Dev Ops Res	Feb-05 May-05 Oct-05	Apr-05 Oct-05 Sep-26
<p> ■ Tech & Adv Concepts (Tech) ■ Formulation(Form) ■ Development (Dev) ■ Operations (Ops) ■ Research (Res) ■ Represents a period of no activity for the Project </p>											

Strategy For Major Planned Acquisitions

- No major acquisitions are planned for FY 2007.

Key Participants

- Department of Interior - DOI is NASA's provider for payroll and personnel systems. Multiple interfaces exist between NASA's business systems and DOI.
- Office of Personnel Management - OPM provides position vacancy announcements and applicant resume processing for NASA through its Recruitment One Stop initiative. Interfaces exist between NASA's resume processing system and Recruitment One Stop.
- General Services Administration - GSA will be providing end to end travel processing services for NASA through it's eTravel initiative.

Theme:	Advanced Business Systems
Program:	Integrated Enterprise Management Program

Risk Management

- **RISK:** Requirements decision not made in a timely manner, impacting the implementation schedules. **MITIGATION:** Communicate requirements and timelines to functional organizations. Develop contingency measures for "assumed" requirements.
- **RISK:** Evolving Agency requirements may exceed the resources (funding and staff) available. **MITIGATION:** Continue to work with the Financial Integration Team to address requirements and prioritization issues. Continue to work with Functional Owners to define Project scope and requirements. Quantify resource impacts.
- **RISK:** Lack of adequate Agency-wide solutions (e.g., plan vs. actual reporting) leads to a continued proliferation of data marts and local reporting solutions that conflict with the IEM business drivers associated with better, more accurate information for decision makers. **MITIGATION:** Support HQ organizations in developing requirements which will eventually result in new Agency solutions.
- **RISK:** Insufficient level of NASA personnel expertise available to support all efforts. **MITIGATION:** SAP Upgrade is using fewer FTEs during Project development. Engage functional stakeholders and communicate needs to Center representatives. Define scope of Center requirements and costs to ensure each Center understands its implementation responsibilities. Monitor Center budgets and work to identify reasonable forecasts.

Innovative Partnerships Program



Partnering benefits both NASA and industry.

President's FY 2007 Budget Request

(Dollars in Millions)

Innovative Partnerships Program	FY2005	FY2006	FY2007	FY2008	FY2009	FY2010	FY2011
FY 2007 PRES BUD	198.9	214.8	197.9	205.5	206.2	209.7	212.9
Changes from FY 2006 Request	198.9	214.8	197.9	205.5	206.2	209.7	

Overview: *What* NASA Accomplishes through the Innovative Partnerships Program Theme

Innovative Partnerships Program's (IPP) primary mission is to provide leveraged technology alternatives for Mission Directorates, Programs, and Projects through joint partnerships with industry, academia, government agencies, and national laboratories. Accordingly, IPP integrates the following projects so that they complement each other to achieve the Program's objectives: Technology Transfer (T2), Space Product Development (SPD), and Small Business Innovative Research/Small Business Technology Transfer (SBIR/STTR). T2, SPD and SBIR/STTR are all based upon leveraging NASA's resources with private or other external resources for the primary purpose of developing new technology for NASA mission use, with the technology also having strong potential for commercial application. Having a link between NASA and the academic and commercial communities is critical to NASA'S future long-term mission success, as well as to the Nation's future physical and economic security. Therefore, all of IPP's functions primarily serve NASA's mission interests, both in the near term and long term, and with respect to a broad range of technologies and technology readiness levels. Similarly, IPP's functions target and invite a broad spectrum of primarily, but not exclusively, non-traditional (i.e., non-aerospace) U.S. industrial interests, ranging from small entrepreneurial firms to Fortune 500 companies.

Note: Changes from FY 2006 Budget Request shown in the above table reflect that the IPP Theme did not exist in the FY 2006 Budget. IPP is a new Theme in FY 2007.

Relevance: *Why* NASA conducts Innovative Partnerships Program work

Relevance to national priorities, relevant fields, and customer needs:

Consistent with Congressional intent, IPP provides transfer out of NASA technology for commercial or other socio-economic benefit to the Nation. In addition, IPP facilitates protection of the Government's rights in NASA's inventions, as mandated by legislation. Also, IPP implements NASA's SBIR and STTR programs in accordance with the primary objective of providing the high technology small business sector with an opportunity to develop technology for NASA.

NASA is taking steps to implement the Enterprise Engine, using FY 2005 and FY 2006 resources. The goal of this venture capital fund is to sponsor young, privately-held companies developing innovative, multi-use technologies that will meet NASA's future mission needs, as well as better position these technologies for future commercial use. Because this effort is expected to benefit multiple Mission Directorates, NASA will implement the Enterprise Engine as part of the Innovative Partnerships Program. In FY 2007 Enterprise Engine is funded at \$12.3M.

Relevance to the NASA mission:

IPP provides leveraged technological alternatives for NASA programs and projects through dual use technology development and joint partnerships with industry, academia, federal agencies and labs. By broadening NASA's connection to emerging technologies, IPP provides increased range of technological solutions for programs and cost avoidance.

Relevance to education and public benefits:

All of IPP's functions involve the transfer of scientific knowledge, thus establishing a foundation for presently intangible future benefits. Therefore, IPP provides an opportunity for grass roots direct involvement in NASA's Exploration and other missions; it invites and facilitates participation by companies of all sizes from many sectors, as well as by academic research institutions and other entities, nationwide.

Performance

Major Activities Planned for FY 2007:

- Implement an IPP program that integrates formerly distinct T2, SPD, & SBIR/STTR projects so that the former distinct elements complement and leverage each other.
- Achieve partnership development primarily through a single contractor that would replace the former network of external agents.
- Implement inter-field center and intra-field center dual use technology development investment funding initiatives, where funding allocations would be performance based.
- Develop and manage to standard performance metrics.
- Build core competencies.

Major Recent Accomplishments:

- 63 dual use technology developments signed with external entities representing a value to NASA of approximately \$159M
 - 39 license agreements for transfer of NASA technology for commercial application and other national benefits
-

Innovative Partnerships Program Theme Commitment in Support of the NASA Mission :

Strategic Goals**Sub-Goals (If Applicable)***Multiyear Outcomes*

Annual Performance Goals supporting the Multiyear Outcomes

Supports Multiple Agency Goals

IPP-1 Promote and develop innovative technology partnerships among NASA, U.S. industry, and other sectors for the benefit of Agency programs and projects.

7IPP1 Develop 20 technology-related significant partnerships that create leveraged value for NASA's programs and projects. Track both quantitative dollar value and qualitative benefits to NASA (e.g. reduced volume or mass, improved safety).

7IPP2 Complete 50 technology transfer agreements with the commercial and academic community through such mechanisms as: licenses, software use agreements, facility use agreements, and space act agreements.

7IPP3 Fully implement an annual portfolio licensing approach that targets licensing goals of greatest value/benefit to NASA. Examples of such value are: licensing royalties, and new technology products available to NASA. Royalties should be \$4M per year or greater.

7IPP4 Complete and institutionalize an enhanced Intellectual Property (IP) management process that enables stronger use of NASA's IP to support NASA's strategies. Implement such IP management together with at least two significant NASA programs or projects.

Program Management

IPP Office reports to Associate Administrator Rex Geveden; Merle McKenzie is IPP Acting Director; Lisa Lockyer is IPP Acting Deputy Director.

Quality

Independent Reviews:

- Review of Technology Transfer Program; Performer: National Academy of Public Administration; Last Review Date: Review completed 4th Q, FY 2004
- Review of Technology Transfer Program; Performer: NASA Program Analysis & Evaluation Office; Review completed: 4th Q, FY 2005.
- Review of Space Product Development; Performer: NASA Program Analysis & Evaluation Office; Expected completion date: 1/31/2006.
- Review of Space Product Development; Performer: Booz Allen Hamilton; Review completed 2nd Q of FY2004.
- Review of SBIR/STTR Program; Performer: National Research Council. Review currently in Phase II of a two-phase study; each study phase to be completed within a three year period. Phase I results are available. Phase II is planned to be completed in FY 2008.
- Review of SBIR/STTR Program; Performer: NASA Program Analysis & Evaluation Office; Review not yet scheduled.

Program Assessment Rating Tool (PART):

OMB has not yet conducted a PART review of the Innovative Partnerships Program Theme. However, a PART review is planned for 2007.

Theme:

Innovative Partnerships Program

Budget Detail

(Dollars in Millions)

Budget Authority (\$ millions)	FY2005	FY2006	Change	FY2007	FY2008	FY2009	FY2010	FY2011	Comments
Innovative Partnerships Program	198.9	214.8	-17.0	197.9	205.5	206.2	209.7	212.9	
Innovative Partnerships	198.9	214.8	-17.0	197.9	205.5	206.2	209.7	212.9	

Theme:**Innovative Partnerships Program**

Note: For all formats, the FY 2005 column reflects the FY 2005 Congressional Operating Plan, dated 9/30/2005. The FY 2006 column reflects the FY 2006 Congressional Initial Operating Plan, dated Jan 2006. The FY 2007 - 2011 columns represent the FY 2007 President's Budget Submit.

Notes:

- IPP's FY 2006 budget has been adjusted to \$214.8M (as of 1/18/06).
- FY 2006 funding of Enterprise Engine is \$6.1M. Funding for SBIR and STTR contracts was diminished by \$4.7M and \$1.4M, respectively, as a result of revision of the Agency's R&D funding base.

Changes since FY 2006 Budget:

The single contractor procurement action to be initiated in the 2nd quarter, FY 2006 will be for a contract value of approximately \$5M - \$6M per year, or approximately half of the approximate \$11.5M value for a previously contemplated, but now superceded, procurement that would have provided more comprehensive services.

Further Discussion of IPP Projects:

The T2 program element facilitates the transfer of new or improved technology alternatives into NASA mission planning and use; and, as required by law, T2 transfers out of NASA technology for commercial or other benefit to the Nation. In addition, T2 facilitates protection of NASA's intellectual property rights in its inventions, as also mandated by law. The T2 program element encourages participation by all firms, ranging from small to Fortune 500 companies, and particularly targets companies from the non-aerospace (i.e. "non-traditional") sectors that otherwise might not recognize the opportunity to partner with NASA. T2 partnerships also often involve state and other Federal agencies, academic institutions, as well as other non-profit entities. The IPP FY 2007 budget for T2 is \$35.9M, which includes all T2 procurements.

The SPD program element provides research and technology relevant to NASA mission needs, as well as associated flight hardware to support NASA by fostering strategic partnerships between academia and industry. NASA provides seed money and space flight opportunities on Shuttle and Space Station to a series of university-based Research Partnership Centers (RPCs), nationwide, as a means of incubating their development of NASA mission use technology and commercial space activities. RPC private sector member entities provide significant leveraging of resources provided by NASA. To date, the RPCs have produced a variety of technological advances in materials, agriculture, biotechnology, communications, and power that have benefited both NASA and industry. The IPP budget for SPD is \$14.5M in FY 2007.

The SBIR/STTR program element's primary objective is to provide the high technology small business sector with an opportunity to develop mission use technology for NASA. Many of the firms also seek to commercially apply the technology developed for NASA under SBIR/STTR awards. The STTR program differs from the SBIR program in that STTR awards are for smaller dollar amounts and they necessarily involve academic institutions, in addition to industry. The IPP FY 2007 budget for SBIR and STTR contract awards is \$102.6M and \$12.3M, respectively.

President's FY 2007 Budget Request (Dollars in Millions)

<u>Innovative Partnerships</u>	<u>FY2005</u>	<u>FY2006</u>	<u>FY2007</u>	<u>FY2008</u>	<u>FY2009</u>	<u>FY2010</u>	<u>FY2011</u>
FY 2007 PRES BUD	198.9	214.8	197.9	205.5	206.2	209.7	212.9
Changes from FY 2006 Request	10.6	-8.4	-29.2	-16.7	-15.2	-21.2	

Overview

IPP's primary mission is to provide leveraged technology alternatives for Mission Directorates, Programs, and Projects through joint partnerships with industry, academia, government agencies, and national laboratories. Accordingly, IPP integrates the following program elements so that they complement each other to achieve the Program's mission objectives: Technology Transfer (T2), Space Product Development (SPD), and Small Business Innovative Research/Small Business Technology Transfer (SBIR/STTR). T2, SPD, and SBIR/STTR are all based upon leveraging NASA's resources with private or other external resources for the primary purpose of developing new technologies for NASA mission use, with the technologies also having strong potential for commercial application. Therefore, all of IPP's functions primarily serve NASA's mission interests, both in the near term and long term, and with respect to a broad range of technologies and technology readiness levels. Similarly, IPP's functions target and invite a broad spectrum of U.S. industrial and non-profit interests. IPP, by virtue of all of its program elements, provides the opportunity for grass roots direct involvement, nationwide, in NASA's Exploration and other missions.



Partnering benefits both NASA and industry.

Plans For FY 2007

In FY 2007 IPP will achieve steady state operations that reflect processes that are systematic, performance driven, and that will contribute increased value to NASA missions. Major activities planned for FY 2007 include the implementation of an IPP program that integrates formerly distinct Technology Transfer, Space Product Development, and SBIR/STTR program elements such that the former distinct elements complement and leverage each other. Also, IPP will achieve partnership development primarily through a single contractor that would replace the former network of external agents. The implementation of inter-field center and intra-field center dual use technology development investment funding initiatives, where funding allocations would be performance based is planned. IPP also plans to develop and manage to standard performance metrics and build core civil servant in-house competencies.

Changes From FY 2006

- The single contractor procurement action to be initiated in 2nd quarter of FY 2006 will be for a contract value of approximately \$5M-6M per year, or approximately half the amount initially thought.
- University Research Engineering & Technology Institutes (URETI's) in the Innovative Partnerships Program will not be funded in FY07.

Program Management

The IPP is an independent mission support office reporting to the Office of the Administrator.

Technical Parameters

Within IPP, the T2 program element facilitates the transfer of new or improved technology alternatives into NASA mission planning and use. It also transfers out NASA technology for commercial or other benefits to the Nation. In addition, T2 facilitates protection of NASA's intellectual property rights in its inventions. The SPD program element provides research and technology relevant to NASA mission needs by fostering strategic partnerships between academia and industry. NASA provides seed money, which is leveraged by private sector resources, as well as space flight opportunities on Shuttle and Space Station. The SBIR/STTR program element's primary objective is to provide the high technology small business sector with an opportunity to develop mission use technology for NASA.

Technical Specifications	FY 2007 President's Budget	Change from Baseline
Complete and institutionalize an enhanced Intellectual Property management process that enables stronger use of NASA's IP to support NASA's strategies.	This upgrade will be rolled out to all Centers at the beginning of FY 2007.	Previously, NASA's Intellectual Property management process was not particularly linked to the Agency's strategies.
Fully implement an annual portfolio licensing approach that targets licensing goals of greatest value and other benefit to NASA.	This upgrade will be rolled out to all Centers at the beginning of FY 2007.	Previously, NASA's license approach was not particularly aligned with the Agency's technical needs.
Develop 20 technology-related significant partnerships that create leveraged value for NASA's programs and projects.	Implementation will represent an upgrade to the extent that all IPP program elements will be integrated and made to complement each other, and metrics will be applied.	Previously, IPP program elements operated independently, in a non-synergistic manner.
Complete 50 technology transfer agreements with the commercial and academic community through such mechanisms as licenses, software use agreements, facility use agreements, and space act agreements.	Implementation will represent an upgrade to the extent that all IPP program elements will be integrated and made to complement each other, and metrics will be applied.	Previously, IPP program elements operated independently, in a non-synergistic manner.

Shared Capabilities



The Shared Capability Assets Program sustains several key assets types or "classes," such as Wind Tunnels, Supercomputers, and Rocket Test facilities.

President's FY 2007 Budget Request (Dollars in Millions)

Shared Capabilities	FY2005	FY2006	FY2007	FY2008	FY2009	FY2010	FY2011
FY 2007 Shared Capabilities			32.2	33.1	33.9	34.7	35.5
Changes from FY 2006 Request			32.2	33.1	33.9	34.7	

Overview: *What NASA Accomplishes through the Shared Capabilities Theme*

The Shared Capabilities Theme is a single-program theme: the Shared Capabilities Asset Program (SCAP). SCAP was established to ensure key capabilities and assets are available for future missions, and will help NASA prioritize critical capabilities and make strategic investment decisions to replace, modify, or disposition assets. SCAP was established in FY 2006. It is managed at the Agency level, with funding and day-to-day management responsibilities generally resident in the Mission Directorates. Four specific key capability/asset classes have been identified to ensure that NASA retains specialized assets and skills required for missions: wind tunnels in the Aeronautics Test Program (ATP) in the Aeronautics Research Mission Directorate, Rocket Propulsion Testing (RPT) in the Space Operations Mission Directorate, Thermal Vacuum Chambers (TVC), and High End Computing Columbia (HECC) in the Science Mission Directorate (SMD). The ATP, RPT and a portion of the HECC asset classes are not in the central SCAP budget line; they are located in the discrete budgets of the Mission Directorate primarily responsible for the management of the asset class. The TVC budget assessments are not complete and funding within Mission Directorate(s) for this asset class has not yet been identified. FY 2007 funding for a portion of HECC is identified in the central SCAP budget. This central funding reflects contributions made by Mission Directorates and Programs outside of SMD towards the funding level needed for HECC. SMD will manage day-to-day activities for the combined funding line for HECC (funds in SCAP plus funds in SMD of \$21.8M in FY 2007), and NASA anticipates combining all HECC funds within SMD in the future. Additional capabilities/assets may be added to SCAP in future years, and the SCAP budget line may contain funding for future assets classes that are more appropriate to fund in the central account.

Relevance: *Why* NASA conducts Shared Capabilities work

Relevance to national priorities, relevant fields, and customer needs:

Shared Capabilities will ensure that facilities and capabilities vital to NASA's success will be sustained for the customers who need them. NASA is responsible for the stewardship of test facilities and engineering capabilities, many of which are unique in the United States. NASA must maintain appropriate levels of competency in areas such as large aeronautics ground test facilities including wind tunnels, propulsion test facilities, and supercomputing capabilities. NASA must retain and manage the necessary set of test facilities to serve national needs.

Relevance to the NASA mission:

SC assets provide high value, unique facilities/equipment, as well as the skilled workforce needed for NASA programs. For example, NASA designs, develops, tests, and operates rocket engines and performs engine test work at their Rocket Propulsion Test facilities. These enabling facilities are vital to the success of NASA's programs.

Relevance to education and public benefits:

NASA's decision to prioritize and reinvest in our key assets and capabilities will ensure that essential infrastructure will be available to support NASA's programs as well as other national needs. NASA's unique facilities are often used by other government agencies such as the Department of Defense, as well as by commercial firms. These entities perform vital research and development in support of the National defense as well as leading development and production of aircraft with commercial and civil space and aeronautics and science applications. NASA's stewardship of these vital resources ensures that NASA's and the Nation's space, science and aeronautics missions have the unique capabilities needed to carry out these NASA, other government, and industry programs.

Performance

Major Activities Planned for FY 2007:

- Prioritize funding requirements and select classes of assets for inclusion in SCAP.
- Identify re-investment/re-capitalization opportunities within and among classes of assets and execute the approved changes (e.g., reallocate funds, upgrade facilities, etc.).

Major Recent Accomplishments:

- Established SCAP in FY2006 to include ATP, RPT and HECC. Programs are mostly budgeted discretely within the Mission Directorates; budgets are integrated and prioritized at the Agency level.
 - NASA conducted a detailed assessment of costs and investments required for thermal vacuum chambers located across six NASA installations.
-

Shared Capabilities Theme Commitment in Support of the NASA Mission :Strategic Goals**Sub-Goals (If Applicable)***Multiyear Outcomes*

Annual Performance Goals supporting the Multiyear Outcomes

Supports Multiple Agency Goals

SC-1 Establish and maintain selected Agency level shared capabilities, across multiple classes of assets (e.g., wind tunnels, vacuum chambers, etc.), to ensure that they will continue to be available to support the missions that require them.

7SC1 Prioritize funding requirements and select classes of assets for inclusion in the Shared Capability Assets Program.

7SC2 Identify re-investment/re-capitalization opportunities within and among classes of assets and execute the approved changes (e.g., reallocate funds, upgrade facilities, etc.).

Program Management

The Shared Capabilities Theme Director is Steve Miley, SCAP Director (Acting), Office of Infrastructure & Administration.

Quality***Independent Reviews:***

- The Shared Capability Assets Program was initiated in FY 2006. No independent reviews of the program have been undertaken; however, an independent assessment was conducted by the RAND Corporation in 2003 titled "Wind Tunnel and Propulsion Test Facilities: An Assessment of NASA's Capabilities to Serve National Needs".

Program Assessment Rating Tool (PART):

The Shared Capability Assets Program is a new program beginning in FY2006 and has not yet been rated by OMB.

Budget Detail (Dollars in Millions)

Budget Authority (\$ millions)	FY2005	FY2006	Change	FY2007	FY2008	FY2009	FY2010	FY2011	Comments
Shared Capabilities			32.2	32.2	33.1	33.9	34.7	35.5	
High End Computing			32.2	32.2	33.1	33.9	34.7	35.5	

Note: The FY 2007 - 2011 columns represent the FY 2007 President's Budget Submit.

Note: Funding is at Program level and includes Corporate G&A and Institutional Investments.

Theme: Shared Capabilities

Total funding at the project level for SCAP in this budget (not including Corporate G & A or Institutional Investments) is as follows:

Budget Authority (\$ millions)	FY2006	FY2007	FY2008	FY2009	FY2010	FY2011
HECC (SCAP)		30.4	31.2	31.9	32.7	33.5
HECC (SMD)	50.4	21.8	22.4	22.9	23.5	24.0
ATP (ARMD)	52.0	52.0	53.2	54.5	55.8	57.2
RPT (SOMD)	60.4	64.3	63.1	63.3	67.1	66.5

Appropriation Summary: Exploration Capabilities

(Millions of Dollars)	FY 2005 9/30/2005 Operating Plan*	FY 2006 Jan 2006 Operating Plan	FY 2007 Budget Request
<u>SPACE OPERATIONS</u>	<u>7,114.4</u>	<u>6,869.7</u>	<u>6,234.4</u>
Space Shuttle	5,049.2	4,777.5	4,056.7
International Space Station	1,591.3	1,753.4	1,811.3
Space and Flight Support	473.9	338.8	366.5
<u>TOTAL APPROPRIATION</u>	<u>7,114.4</u>	<u>6,869.7</u>	<u>6,234.4</u>

* FY 2005 column is adjusted for presentation purposes and reflects a restructuring (with no change in content), to be consistent with the FY 2006 initial operating plan and FY 2007 budget request. As a result of the restructuring, some of the numbers shown here do not match the September operating plan.

Note: Totals may not add due to rounding.



Astronaut Stephen K. Robinson, STS-114 mission specialist, anchored to a foot restraint on the International Space Station's Canadarm2, participates in the mission's third session of extravehicular activity. The blackness of space and Earth's horizon form the backdrop for this image.

Themes

Space Shuttle

International Space Station

Space Flight Support

SPACE OPERATIONS

Purpose

Space Operations Mission Directorate (SOMD) programs ensure that the Nation will have reliable, safe, and affordable access to space for NASA's human and robotic explorers while opening new exploration and research opportunities through the extension of human presence in space. SOMD enables NASA to achieve its goals by providing transportation via the Space Shuttle; operational research facilities in space via the International Space Station (ISS); and space communications systems and supporting space infrastructure. SOMD also provides the unique system--the human system, NASA astronauts--necessary to open the space frontier to the broadest extent possible.

FY 2005 Accomplishments

Tests and analyses associated with resolving technical issues from the first Return to Flight mission, STS-114, were completed to support preparations for the second Return to Flight test mission, STS-121. NASA and its international partners continued to ensure uninterrupted crew and cargo transportation and other services for the ISS. Space and Flight Support provided reliable space communications, launch services, and other critical functions for space exploration, aeronautical research, and biological and physical research. Finally, NASA, SOMD, and contractor teams oversaw the securing and later recovery of NASA assets at the Michoud Assembly Facility and Stennis Space Center in the wake of Hurricane Katrina. After the storm, NASA facilities and support services were made available for local search, rescue, and recovery teams throughout the Gulf Coast.

Theme Distribution

Budget Authority (\$ in millions)	FY 2005	FY 2006	FY 2007	FY 2008	FY 2009	FY 2010	FY 2011
Space Shuttle	5,049.2	4,777.5	4,056.7	4,087.3	3,794.8	3,651.1	146.7
International Space Station**	1,591.3	1,753.4	1,811.3	2,200.3	2,255.6	2,197.1	2,360.8
Space and Flight Support	473.9	338.8	366.5	392.8	392.0	394.7	389.2
Total*	7,114.4	6,869.7	6,234.4	6,680.4	6,442.3	6,242.9	2,896.7

Note: For all formats, the FY 2005 column reflects the FY 2005 Congressional Operating Plan, dated 9/30/2005. The FY 2006 column reflects the FY 2006 Congressional Initial Operating Plan, dated January 2006. The FY 2007 through FY 2011 columns represents the FY 2007 President's Budget Submit. *FY 2005 includes Plumbrook and Environmental Compliance and Restorations, which was realigned to Institutional Investments beginning FY 2006. **FY 2007 ISS Cargo & Crew Services transferred to ESMD.

Space Shuttle

This Theme supports continued operation of the Space Shuttle until its retirement in 2010. In accordance with the Vision for Space Exploration, NASA will use the Space Shuttle to complete assembly of the International Space Station by 2010 using as few flights as possible. The Space Shuttle's ability to carry both crew and heavy cargo means that it is the only vehicle in the world that can complete this mission. Pending the results from the second Return to Flight test mission in 2006, NASA will also determine whether the Space Shuttle can safely conduct a fifth servicing mission to the Hubble Space Telescope in the late-2007/early-2008 timeframe. Because of its unique capabilities and the importance of its missions, the Space Shuttle remains essential for advancing U.S. national scientific, security, political, and economic interests. The Space Shuttle program's highest priority is to complete the mission manifest by 2010. Working through project, program, Directorate, and Agency-level processes, the Space Shuttle program will also play a key role in coordinating the smooth transition of Space Shuttle assets and capabilities to the next generation of space exploration systems without compromising the safety of ongoing flight operations.

Overall Budget

The FY 2007 request is \$4,056.7 million; a \$720.8 million (or 18 percent) decrease from the FY 2006 appropriation as reflected in the initial operating plan. This budget will enable:

- Safe return to flight;
- Continue activities leading to an orderly phase-out of the Space Shuttle program and transition to future exploration system by 2010.

International Space Station

This Theme supports the construction and operations of a research facility in low Earth orbit as NASA's first step in achieving the Vision for Space Exploration. The ISS provides a unique, continuously operating capability to develop medical countermeasures for long-term human space travel, develop and test technologies and engineering solutions in support of exploration, and provide ongoing practical experience in living and working in space. It also supports a variety of pure and applied research for the U.S. and its International Partners. ISS assembly will be completed by the end of the decade. NASA is examining configurations for the Space Station that meet the needs of both the new space exploration vision and our international partners using as few Shuttle flights as possible. The FY 2007 ISS submission also reflects the realignment of crew and cargo services to the Exploration Systems Mission Directorate and changes to the ISS logistics philosophy that are driven by the retirement of the Space Shuttle in FY 2010.

Mission Directorate: Space Operations

Overall Budget

The FY 2007 request is \$1,811.3 million; a \$57.9 million (or 3 percent) increase from the FY 2006 appropriation as reflected in the initial operating plan. Major features of this budget include:

- NASA plans to continue assembly of the ISS including build out of the truss and power segments.
- NASA plans to aggressively pursue U.S. commercial cargo and crew services at the earliest availability.
- NASA also plans to work with the International Partners to develop a sustainable cargo supply transportation architecture for the post-Shuttle era.

Space and Flight Support

This Theme encompasses Space Communications, Launch Services, Rocket Propulsion Testing, and Crew Health and Safety. Space Communications consists of (1) the Tracking and Data Relay Satellite System (TDRSS), which supports activities such as the Space Shuttle, ISS, Expendable Launch Vehicles, and research aircraft, and (2) the NASA Integrated Services Network, which provides telecommunications services at facilities, such as flight support networks, mission control centers and science facilities, and administrative communications networks for NASA Centers. The Launch Services program focuses on meeting the Agency's launch and payload processing requirements by assuring safe and cost-effective access to space via the Space Shuttle and expendable launch vehicles. Rocket propulsion testing supports a core of highly trained rocket test and engineering crews and test facilities. The Crew Health and Safety Program provide oversight and accountability for the total scope of health and safety of NASA's astronaut corps. Plum Brook Decommissioning was realigned to Institutional Investments beginning in FY 2006.

Overall Budget

The FY 2007 request is \$366.5 million; a \$27.7 million (or 8 percent) increase from the FY 2006 appropriation as reflected in the initial operating plan. The budget supports:

- Communications support of human and science missions;
- Launch services and support;
- Rocket propulsion testing; and
- Crew Health & Safety.

Space Shuttle



The Space Shuttle is the only vehicle capable of providing full crew, cargo, and assembly support to the International Space Station until the next-generation of exploration systems (built on proven Space Shuttle propulsion elements) are fielded early the next decade.

President's FY 2007 Budget Request (Dollars in Millions)

<u>Space Shuttle</u>	<u>FY2005</u>	<u>FY2006</u>	<u>FY2007</u>	<u>FY2008</u>	<u>FY2009</u>	<u>FY2010</u>	<u>FY2011</u>
FY 2007 PRES BUD	5,049.2	4,777.5	4,056.7	4,087.3	3,794.8	3,651.1	146.7
Changes from FY 2006 Request	380.2	246.9	-115.8	221.6	979.7	1,232.0	

Overview: *What* NASA Accomplishes through the Space Shuttle Theme

In accordance with the Vision for Space Exploration, NASA will use the Space Shuttle to complete assembly of the International Space Station by 2010 using as few flights as possible. The Space Shuttle's ability to carry both crew and heavy cargo means that it is the only vehicle in the world that can complete this mission. Pending the results from the second Return to Flight test mission in 2006, NASA will determine whether the Space Shuttle can safely conduct a fifth servicing mission to the Hubble Space Telescope in the late-2007 / early-2008 timeframe. Because of its unique capabilities and the importance of its missions, the Space Shuttle remains essential for advancing U.S. national scientific, security, political, and economic interests.

The Space Shuttle program's highest priority is to complete ISS assembly by 2010. Working through project, program, Directorate, and Agency-level processes, the Space Shuttle program will also play a key role in coordinating the smooth transition of Space Shuttle assets and capabilities to the next generation of space exploration systems without compromising the safety of ongoing flight operations.

Relevance: *Why* NASA conducts Space Shuttle work

Relevance to national priorities, relevant fields, and customer needs:

NASA's primary objective is to advance U.S. national scientific, security, and economic interests by ensuring the success of the nation's exploration goals as enunciated in the Vision for Space Exploration. The first step in the Vision for Space Exploration is the completion of the International Space Station (ISS) in a manner that meets our international commitments - a mission for which the Space Shuttle remains uniquely qualified. At the same time, Space Shuttle transition activities will be undertaken in a manner that safeguards the long-term viability of U.S. technical capabilities in anticipation of future challenges and opportunities.

Relevance to the NASA mission:

The Space Shuttle supports NASA's mission by providing a unique capability for critical missions in support of the Vision for Space Exploration.

Relevance to education and public benefits:

The Space Shuttle provides long-term benefits to the public by enabling the completion of the International Space Station and safeguarding those capabilities needed for long-term U.S. exploration objectives. The Space Shuttle program also remains a highly-visible activity that promotes education in math, science, and engineering - careers that are critical to U.S. national security and the future of U.S. economic competitiveness.

Performance

Major Activities Planned for FY 2007:

- Safely fly the planned Space Shuttle manifest.
- Continue activities leading to an orderly phase-out of the Space Shuttle Program and transition to future exploration system.

Major Recent Accomplishments:

- NASA safely flew the first Return to Flight (RTF) test mission, STS-114, which validated Return to Flight improvements and delivered over 15,000 pounds of hardware and supplies to the ISS.
 - NASA and its contractor teams oversaw the securing and later recovery of SSP assets at the Michoud Assembly Facility and Stennis Space Center in the wake of Hurricane Katrina.
 - The Agency provided facilities and support for local search, rescue, and recovery teams throughout the Gulf Coast following Hurricane Katrina.
 - NASA completed tests and analyses associated with resolving technical issues from STS-114 in preparation for the second Return to Flight test mission, STS-121.
-

Space Shuttle Theme Commitment in Support of the NASA Mission :

Strategic Goals**Sub-Goals (If Applicable)***Multiyear Outcomes*

Annual Performance Goals supporting the Multiyear Outcomes

1. Fly the Shuttle as safely as possible until its retirement, not later than 2010.

1.1 Assure the safety and integrity of the Space Shuttle workforce, systems and processes while flying the manifest.

7SSP1 Achieve zero Type-A (damage to property at least \$1M or death) or Type-B (damage to property at least \$250K or permanent disability or hospitalization of 3 or more persons) mishaps in FY2007.

7SSP2 Complete 100 percent of all mission objectives for all Space Shuttle missions in FY2007 as specified in the Flight Requirements Document for each mission.

1.2 By September 30, 2010, retire the Space Shuttle.

7SSP3 Demonstrate continued progress in identifying, evaluating, documenting, and dispositioning Space Shuttle program resources for phase-out or transition.

Efficiency Measures

7SSP4 Complete all development projects within 110% of the cost and schedule baseline.

7SSP5 Deliver at least 90% of scheduled operating hours for all operations and research facilities.

7SSP6 While ensuring the safety of ongoing flight operations and by working with exploration development programs, reduce Space Shuttle sustaining engineering hours, annual value of Space Shuttle production contracts, and the number of dedicated Space Shuttle facilities, where possible.

Program Management

For extensive discussion on the Space Shuttle Program Management, see "Program Management (continued)" located after the Theme Budget Detail Table.

Quality**Independent Reviews:**

- Aerospace Safety Advisory Panel - Assumes follow-on Return to Flight independent safety assessment role from the Stafford-Covey Return to Flight Task Group. Ongoing review.
- Gap Filler Assessment Group - Established to verify Orbiter tile gap filler installations, correct installation procedures where required, and define areas of rework where needed. Completed October 2005.
- Government Accountability Office Review-NASA's Shuttle workforce challenges. Report due Spring 2006.
- Government Accountability Office Review-Space Shuttle modernization plans. Report due Spring 2006.
- NASA Advisory Council-Provides top-level strategic advice to the NASA Administrator. Ongoing reviews.
- NASA Inspector General Review-NASA's Actions to Implement an Expanded Training Program for the Shuttle Mission Management Team. Report due Spring 2006.
- NASA Inspector General Review-Orbiter Wiring. Report due Spring 2006.
- STS-114 Tiger Team-Independent review chartered by the Associate Administrator for Space Operations and the Chief Officer for Safety and Mission Assurance to review unexpected external tank foam loss during the first Return to Flight test mission, STS-114. Completed October 2005.
- Stafford-Covey Return to Flight Task Group - Independent expert team chartered to perform assessment of implementation of the 14 Columbia Accident Investigation Board Return to Flight recommendations. Completed August 2005.

Program Assessment Rating Tool (PART):

The Space Shuttle Program received an FY 2005 PART rating of Adequate. The assessment found that NASA successfully flew the Space Shuttle in July 2005; however, the Shuttle has not flown since due to safety concerns. NASA is working to return the Shuttle to flight as early as May 2006. The Space Shuttle Program is taking steps to improve programmatic and financial management and to better measure and improve its performance. NASA is taking the following actions to improve the performance status of the program:

- 1) Returning the Shuttle safely to flight and continuing to use it to support the International Space Station. NASA is working to return the Shuttle to flight as early as May 2006.
- 2) Retiring the Shuttle by 2010, when it has finished its role in assembling the International Space Station.
- 3) Developing outcome-oriented measures to assess the effectiveness of the transition between the Space Shuttle and Exploration programs.
- 4) Taking steps to improve the programmatic and financial management to better measure and improve program performance.

Budget Detail (Dollars in Millions)

Budget Authority (\$ millions)	FY2005	FY2006	Change	FY2007	FY2008	FY2009	FY2010	FY2011	Comments
Space Shuttle	5,049.2	4,777.5	-720.8	4,056.7	4,087.3	3,794.8	3,651.1	146.7	
Space Shuttle Program	5,049.2	4,777.5	-720.8	4,056.7	4,087.3	3,794.8	3,651.1	146.7	

Theme:**Space Shuttle**

Note: For all formats, the FY 2005 column reflects the FY 2005 Congressional Operating Plan, dated 9/30/2005. The FY 2006 column reflects the FY 2006 Congressional Initial Operating Plan, dated Jan 2006. The FY 2007 - 2011 columns represent the FY 2007 President's Budget Submit.

A decreasing Shuttle budget reflects the completion of Return to Flight activities in FY 2006, and the realization of savings associated with Shuttle retirement over time. The changes between the FY 2006 and the 2007 President's Budget runout submit reflects the latest estimates of cost savings associated with the Space Shuttle flyout and retirement.

FY 2005 Major Accomplishments (continued)

The launch of Space Shuttle Discovery on July 26, 2005 and its safe return on August 9, 2005 were important milestones in validating the improvements made to the Space Shuttle system during return to flight and, thus, critical first steps in executing the Vision for Space Exploration. Since the Columbia accident, the Space Shuttle program invested resources into decreasing the ascent debris hazard and improving safety in many other areas. Some examples of these investments include a significantly improved ground imagery system; investment in new debris tracking radars; building a boom extension for the Shuttle robotic arm and developing new sensors mounted on the boom to inspect the orbiter's heat shield; positioning impact detection sensors in the leading edge of the wings; improving cameras delivered to the International Space Station and training their crews to take highly detailed pictures of the Shuttle as it approaches; investing in technology development of tools and processes to repair the thermal protection system on orbit.

These investments ensured the safety and mission success of STS-114 in the summer of 2005. Discovery and her crew delivered over 15,000 pounds of hardware and supplies to the International Space Station (ISS), conducted three spacewalks to restore three of the Station's four Control Moment Gyroscopes and completed other installation activities outside the Station, and brought back over 7,200 pounds of expended hardware and unneeded supplies back to Earth. STS-114 also put the Space Shuttle and ISS programs in a position to resume ISS assembly flights in 2006.

Nevertheless, STS-114 demonstrated that additional work needs to be done prior to the launch of the second return to flight test mission, STS-121. As of December 2005, the program was progressing through the normal post-flight disposition procedures for all STS-114 in-flight anomalies. In the case of the External Tank foam loss events, NASA commissioned a number of program and independent teams to determine root causes and recommend mitigation activities. At the time, these tasks were proceeding on a schedule that supported a late-spring/early summer 2006 launch opportunity for STS-121.

Return to Flight

Between the release of the Columbia Accident Investigation Board (CAIB) final report on August 26, 2003 and the launch of the first Return to Flight test mission on July 26, 2005, approximately 3.5 million engineering-hours of testing, analysis, development, and processing were invested in preparing Discovery for STS-114. Over 116 individual hardware modifications were made with the goal of eliminating, reducing, controlling, and mitigating potential hazards and risks in all critical areas of the Space Shuttle system. All improvements were vetted through a rigorous and multilayered review process. The fifteen CAIB Return to Flight recommendations were subject to further, independent assessment by the Return to Flight Task Group. The Task Group's findings provided the NASA leadership with an important alternative opinion throughout the Return to Flight process and during the STS-114 launch readiness review. The 11th Edition of NASA's Implementation Plan for Space Shuttle Return to Flight and Beyond continues to provide a comprehensive reference of both the technical improvements and costs associated with closing out all Return to Flight-related activities. The second return to flight test mission, STS-121, is expected to verify and complete all Return to Flight-related activities in FY 2006.

Hurricane Katrina

The NASA's Michoud Assembly Facility (MAF) and Stennis Space Center (SSC) were also hit by Hurricane Katrina late in FY05. The Shuttle teams have done a remarkable job of minimizing both the technical and fiscal impacts of the hurricanes. As a result of Hurricane Katrina, significant damage was sustained by MAF and SSC. MAF, near New Orleans is NASA's manufacturing site for the Space Shuttle external tanks. SSC is NASA's premier rocket propulsion testing site and also

hosts the NASA Shared Services Center (NSSC) and a number of other federal agencies on its campus.

Emergency supplemental appropriations for NASA Katrina costs totaling \$349.8 million were included as part of Title II of the FY 2006 Defense Appropriations Act (P.L. 109- 148). This supplemental appropriation supports response and recovery needs through at least May 31, 2006, for recovery needs at SSC and MAF, including repair and replacement of real property, and communications and IT infrastructure; environmental remediation; emergency operations; and, satellite and aircraft imagery for evaluation of hurricane damage. Excluded from the request were costs for programmatic recovery efforts involving Shuttle External Tank (ET) hardware and test equipment, travel and personnel relocation; contingency for facilities and infrastructure rebuilding; and hardening of buildings at MAF and SSC that could be deferred until after May 2006.

Theme: Space Shuttle

Program: Space Shuttle

President's FY 2007 Budget Request (Dollars in Millions)

<u>Space Shuttle</u>	<u>FY2005</u>	<u>FY2006</u>	<u>FY2007</u>	<u>FY2008</u>	<u>FY2009</u>	<u>FY2010</u>	<u>FY2011</u>
FY 2007 PRES BUD	5,049.2	4,777.5	4,056.7	4,087.3	3,794.8	3,651.1	146.7
Changes from FY 2006 Request	380.2	246.9	-115.8	221.6	979.7	1,232.0	

Overview

The FY 2007 budget reflects the completion of activities associated with Return to Flight, a return to recurring Space Shuttle flights, and resumption of assembly of the International Space Station to complete assembly by 2010 using as few flights as possible. The budget also takes into account the accelerating pace at which Space Shuttle Program (SSP) assets that are no longer needed for mission execution are being identified for dispensation. Those assets that are needed to support the development or operation of future exploration systems like the Crew Launch Vehicle (CLV) are being preserved for transition where appropriate. Excess assets that are not required for these purposes are being appropriately dispositioned. Wherever feasible, existing processes and institutional structures are being employed or slightly modified to support the transition effort.



Space Shuttle projects play a vital role in NASA's goal to explore space and extend human presence across the solar system by providing the critical support for launching the Shuttle to continue the assembly and operation of the International Space Station.

Plans For FY 2007

The primary objective of the Space Shuttle Program in 2007 continues to be the safe fly-out of the Space Shuttle manifest. The Space Shuttle Program will also continue to execute a coordinated plan for the orderly phase-out of the Space Shuttle program and transition of needed Space Shuttle capabilities to future exploration systems.

Changes From FY 2006

- NASA will continue to address the foam loss events seen on STS-114, including a final decision on whether to remove the external tank protuberance air load ramps for future Space Shuttle flights.
- NASA will complete planning and begin implementation of a SSP transition process that identifies, evaluates, documents, and dispositions SSP assets for either transfer to future exploration systems.

Program Management

Space Shuttle Program Manager, Wayne Hale, reports to the Associate Administrator for Space Operations, Bill Gerstenmaier (additional details continued).

Theme: Space Shuttle

Program: Space Shuttle

Technical Parameters

Space Shuttle Program activities are divided into three major functional elements - Program Integration, Flight and Ground Operations, and Flight Hardware. Program Integration assures the successful technical integration of all Shuttle elements and payloads into each mission. Flight and Ground Operations provides for pre-flight planning assurance, final integration and checkout of all hardware elements prior to launch, launch countdown and landing support, and ongoing mission operations. Flight Hardware assures the vehicle hardware and software are designed, developed, manufactured, and tested to enable safe and reliable mission execution. For further discussion on these functional elements, see "Technical Parameters (continued)" located after the Theme Budget Detail Table.

Technical Specifications	FY 2007 President's Budget	Change from Baseline
Return to Flight		Dates subject to resumption of Shuttle flights.

Implementation Schedule:

Project	Schedule by Fiscal Year							Purpose	Phase Dates													
	05	06	07	08	09	10	11		Beg	End												
Program Integration								Ensures the proper technical integration of all Shuttle elements and payloads. Includes high-priority mission assurance projects for safety, supportability, and infrastructure.	Tech Form Dev Ops Res	Dec-04 Sep-10												
Flight and Ground Operations								Provides final integration/checkout of all elements for launch. Also includes a wide variety of planning, training, operations control, crew, life sciences, and aircraft support activities.	Tech Form Dev Ops Res	Dec-04 Sep-10												
Flight Hardware								Produces and maintains the various flight hardware and software elements.	Tech Form Dev Ops Res	Dec-04 Sep-10												
<table border="0"> <tr> <td></td> <td>Tech & Adv Concepts (Tech)</td> </tr> <tr> <td></td> <td>Formulation(Form)</td> </tr> <tr> <td></td> <td>Development (Dev)</td> </tr> <tr> <td></td> <td>Operations (Ops)</td> </tr> <tr> <td></td> <td>Research (Res)</td> </tr> <tr> <td></td> <td>Represents a period of no activity for the Project</td> </tr> </table>												Tech & Adv Concepts (Tech)		Formulation(Form)		Development (Dev)		Operations (Ops)		Research (Res)		Represents a period of no activity for the Project
	Tech & Adv Concepts (Tech)																					
	Formulation(Form)																					
	Development (Dev)																					
	Operations (Ops)																					
	Research (Res)																					
	Represents a period of no activity for the Project																					

Strategy For Major Planned Acquisitions

- Space Flight Operations Contract (SFOC) prime contractor is United Space Alliance (USA). In FY07 the Space Program Operations Contract will replace SFOC through Shuttle retirement with work by USA.

Theme: Space Shuttle

Program: Space Shuttle

Risk Management

- RISK: Safety. Programmatic risk management is a distributed function in the Space Shuttle program. Each Space Shuttle project office is responsible for assessing and mitigating potential risks within its own activities. MITIGATION: The Space Shuttle program manager executes risk management responsibilities through the commit-to-flight process, the Shuttle Engineering Review Board, and regular Program Requirements Control Boards.
- RISK: Technical. The Space Shuttle program has established a chief engineer position reporting directly to the Space Shuttle program manager. MITIGATION: The chief engineer chairs the Shuttle Engineering Review Board, which is tasked with reviewing and dispositioning critical technical risks on behalf of the program manager.
- RISK: Cost. Cost risks may be associated with the need to correct in-flight anomalies or other unacceptable program and flight risks beyond the scope of Space Shuttle program reserves. MITIGATION: The Space Shuttle program manager executes cost management responsibilities through regularly scheduled Program Requirements Control Boards and the Shuttle Engineering Review Board.
- RISK: Schedule. Currently, assembly and full utilization of the International Space Station are critically dependent on the Space Shuttle, which will be retired by 2010. MITIGATION: NASA has developed a Space Shuttle manifest that ensures the launch of major international partner elements as soon as possible, with later flights devoted to logistics and the long-term supportability of the International Space Station in the post-Space Shuttle era.

Theme: Space Shuttle
Program: Space Shuttle

Technical Parameters (continued)

The Space Shuttle program is comprised of five major project flight elements: Orbiter, External Tank, Solid Rocket Booster, Reusable Solid Rocket Motor, and Space Shuttle Main Engine. The project managers report to the Space Shuttle program manager, Wayne Hale, who is responsible for leading the day-to-day implementation of the Space Shuttle manifest and ensuring that the program meets its cost, schedule, performance, and risk requirements. The program manager reports to the Associate Administrator for Space Operations, William Gerstenmaier who, along with the Acting Assistant Associate Administrator for Space Shuttle, William Hill, is responsible for overall strategic policy and coordination with other NASA functions. The Space Shuttle program transition manager reports to the Space Shuttle program manager and, in conjunction with the Space Operations Mission Directorate ensures the efficient execution of transition activities in coordination with other Agency and external stakeholders. The NASA Program Management Council is the Agency-level governing body for the Space Shuttle program.

Space Shuttle program activities are divided into Corporate G&A, Hurricane Relief, and three major functional areas: Program Integration, Flight and Ground Operations, and Flight Hardware.

Budget Authority (\$ in Millions)	FY2005	FY2006	FY2007	FY2008	FY2009	FY2010	FY2011
Space Shuttle Program	\$5,049.2	\$4,777.5	\$4,056.7	\$4,087.3	\$3,794.8	\$3,651.1	\$146.7
Development	\$41.5						
Cockpit Avionics Upgrade	\$22.0						
Advanced Health Mgmt Sys.	\$19.5						
Flight and Ground Operations	\$1,432.2	\$1,412.2	\$1,347.2	\$1,448.3	\$1,401.7	\$1,178.8	\$0.4
Flight Hardware	\$2,347.5	\$2,048.9	\$1,758.7	\$1,645.1	\$1,364.9	\$1,223.9	\$2.4
Program Integration	\$747.9	\$718.4	\$727.8	\$759.5	\$806.5	\$1,041.0	\$135.6
Hurricane Recovery	\$226.0	\$349.8					
Space Shuttle Corporate Support	\$254.1	\$248.2	\$223.0	\$234.4	\$221.7	\$207.4	\$8.3

PROGRAM INTEGRATION

The Program Integration budget includes funds for flight software; system engineering, flight operations, and management integration; safety and mission assurance; business management; propulsion system integration; construction of facilities; safety and sustainability; and all Shuttle support accounts that are performed for the Space Shuttle Program. Program integration includes payload integration into the Space Shuttle and systems integration of the flight hardware elements through all phases of flight. It provides for the engineering analysis needed to ensure that payloads are safe and meet Space Shuttle interface requirements. Finally, program integration includes the necessary mechanical, aerodynamic and avionics engineering tasks to ensure that the launch vehicle can be safely launched, fly a safe ascent trajectory, achieve planned performance and descend to a safe landing.

FLIGHT AND GROUND OPERATIONS

Flight Operations assures the successful accomplishment of pre-flight planning, crew training, operations control activities, flight crew operations support, aircraft maintenance and operations, and life sciences operations support for each mission to efficiently and effectively meet our customer requirements in exploring the fundamental principles of physics, chemistry, and biology through research in the unique environment of space. Flight operations funding also provides for the

Theme: Space Shuttle
Program: Space Shuttle

maintenance and operation of critical mission support facilities including the Mission Control Center (MCC), Integrated Training Facility (ITF), Integrated Planning System (IPS) the Software Production Facility (SPF), and the aircraft fleet used for training.

Ground Operations provides final integration and checkout of all hardware elements for launch, mission countdown and landing support, and maintenance and operations of ground infrastructure. The major launch site operational facilities at the Kennedy Space Center (KSC) are the three Orbiter Processing Facilities (OPFs), the two launch pads, the Vehicle Assembly Building (VAB), the Launch Control Center (LCC) and the three Mobile Launcher Platforms (MLPs). Shuttle landing support is provided at both KSC and Edwards runways and multiple contingency landing sites in the U.S. and other countries, often requiring coordination with other government agencies and foreign entities. The orbiters at KSC are normally in the hardware processing flow along with External Tanks, Space Shuttle Main Engines and Solid Rocket Booster components to support several missions.

FLIGHT HARDWARE

Space Shuttle Flight Hardware assures the vehicle hardware and software are designed, developed, manufactured, and tested to enable safe and reliable transportation. Five major flight elements make up the Space Shuttle system: the Orbiter, the Space Shuttle Main Engines (SSME), the External Tank (ET), the Reusable Solid Rocket Motors (RSRM) and the Solid Rocket Boosters (SRB).

The Orbiter, the winged vehicle that carries the payload and a crew of up to seven astronauts, is the principal element of the Space Shuttle system. Each orbiter measures 122 feet long, 57 feet high, with a wingspan of 78 feet, and can carry approximately 35,000 to 41,000 pounds of payload to the International Space Station depending on the configuration of the Space Shuttle, rendezvous altitude, and other mission-specific requirements. There are three reusable orbiters (otherwise known as Orbital Vehicle) in the fleet: Discovery OV-103, Atlantis OV-104, and Endeavour OV-105.

The SSME's were developed in the 1970's and still represent the most efficient liquid-fueled rocket engines ever built. Each Block II main engine can produce 418,000 pounds of thrust at sea level. The main engines are throttleable, reusable, and have a high degree of redundancy. Three main engines are mounted in a triangular configuration at the aft end of the orbiter and provide about 29 percent of the total thrust at liftoff.

The ET is the largest and heaviest (approximately 1.7 million pounds when fully loaded with liquid oxygen fuel and liquid hydrogen) element of the Space Shuttle system. The external tank serves two functions: to carry the fuel and oxidizer that feeds the main engines during ascent, and to act as the structural "backbone" to which the orbiter and solid rocket boosters are attached. Because the liquid hydrogen and liquid oxygen need to be stored at temperatures of hundreds of degrees below zero, the external tank is covered with foam insulation to keep the propellants cold on the launch pad and during ascent and prevent formation of ice from atmospheric condensation. After the main engines are shut down at an altitude of about 70 miles above the Earth, the external tank is jettisoned, reenters the atmosphere at high velocity, and breaks up harmlessly over a remote ocean area.

Two SRB's provide the main thrust that lifts the Space Shuttle off the launch pad up to an altitude of about 150,000 feet. Each SRB is made of three major subassemblies – a forward nose cone, a four-segment Reusable Solid Rocket Motor, and an aft nozzle. The solid rocket boosters for the Space Shuttle are the largest ever flown, and are designed for reuse. Each is 149 feet long, 12 feet in diameter, and weighs approximately 1.3 million pounds when loaded with fuel. The sea-level thrust of each booster is approximately 3.3 million pounds. They are fired after the thrust level of the

Theme: Space Shuttle
 Program: Space Shuttle

three main engines is verified during the first few seconds of the ignition sequence. Together, the two solid rocket boosters provide about 71 percent of the total thrust at liftoff.

The graph below shows the complex assembly sequence of a Shuttle Mission.

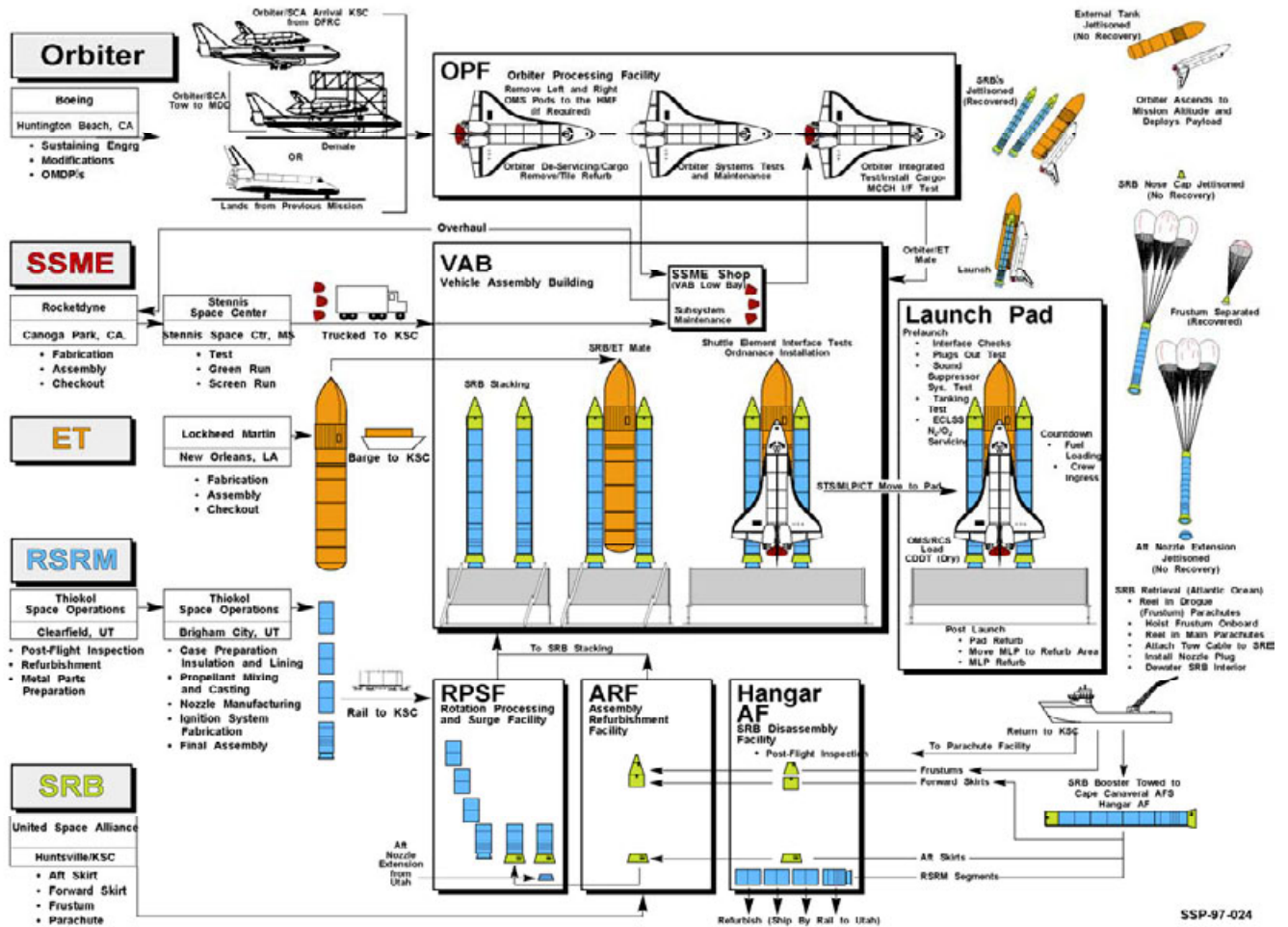

Flow 1

International Space Station



Completing assembly of the International Space Station is the next step in the Vision for Space Exploration.

President's FY 2007 Budget Request

(Dollars in Millions)

<u>International Space Station</u>	<u>FY2005</u>	<u>FY2006</u>	<u>FY2007</u>	<u>FY2008</u>	<u>FY2009</u>	<u>FY2010</u>	<u>FY2011</u>
FY 2007 PRES BUD	1,591.3	1,753.4	1,811.3	2,200.3	2,255.6	2,197.1	2,360.8
Changes from FY 2006 Request	-85.0	-103.3	-24.1	409.4	103.3	-178.4	

Overview: *What* NASA Accomplishes through the International Space Station Theme

The International Space Station (ISS) is a complex of research laboratories in low Earth orbit (LEO) in which U.S. and International astronauts conduct scientific and technological investigations in a space environment. The objective of the ISS is to support scientific research for human space exploration and other activities requiring the unique attributes of humans in space. Consistent with the Vision for Space Exploration, NASA has refocused its research on science and technology development that will prepare human explorers to travel beyond LEO. For example, ISS crews are performing experiments that will help develop countermeasures against the effects of long flight duration exposure to radiation in a microgravity environment. Two crew members are currently onboard the ISS. ISS crews are supported by resupply and crew rotation using Russian Progress and Soyuz vehicles.

The FY 2007 Budget request provides funding for ISS launch processing activities, vehicle on-orbit assembly with a crew of three, and continuation of research payload and experiment deliveries to orbit. The FY 2007 Budget includes funding for development of habitability modifications, the purchasing of additional spares to be stowed on ISS for use during the post-Shuttle period, and completion of the regenerative environmental control and life support system needed to increase future crew capacity. NASA's plan to complete the ISS will meet our commitment to the International Partners and utilize the ISS as a vital part of the Vision for Space Exploration. A key element in the future of the ISS program is the purchase of alternate cargo and crew transportation services for the post-Shuttle era. NASA is proceeding with plans to acquire commercial cargo transportation services from U.S. commercial providers. Funding for the Commercial Crew/Cargo Project is in the Constellation Systems Theme for potential synergies with exploration systems.

Relevance to national priorities, relevant fields, and customer needs:

The ISS serves as a platform for research activities that will prepare human explorers to travel beyond LEO. Research aboard the ISS is critical to:

- understanding the effects of space environments on the human body;
- developing techniques for mitigating these hazards;
- minimizing the logistical burden of supporting humans far from Earth;
- addressing remote medical emergencies; and
- demonstrating enabling technologies for human exploration.

The ISS will vastly expand the human experience of living and working in space.

The ISS represents an unprecedented level of international cooperation. The ISS Partnership agencies include NASA, the Russian Federal Space Agency (Roskosmos), the Canadian Space Agency (CSA), the European Space Agency (ESA), and the Japanese Aerospace Exploration Agency (JAXA). Additionally, there are other bilateral agreements between NASA and other nations such as Italy and Brazil, resulting in a total of 16 participating nations. International participation in the program has significantly enhanced the capabilities of the ISS.

Relevance to the NASA mission:

The Vision for Space Exploration outlines three tasks required for ISS:

- complete assembly by the end of the decade,
- focus U.S. research and use of the ISS on supporting space exploration goals, and
- conduct ISS activities in a manner consistent with international commitments.

Relevance to education and public benefits:

The benefits of ISS research cross all areas of American life, including health, medicine, economics, entrepreneurship, quality of life, research/knowledge gathering, education, and bridging cultural differences. Specific examples include devices to detect cataracts, new uses of ultrasound technology, Embedded Web Technology to allow remote monitoring and control of devices through a computer and Web browser, and work to help researchers understand and mitigate muscle, balance, and bone problems. Research performed on the ISS will contribute to a broader understanding of injury and disease in support of Earth-based medical applications. The ISS, an exploration research and technology test bed, will be used to develop and demonstrate, among other things, closed loop life support systems and remote medical care capabilities. Both technologies can be used to benefit people here on Earth; for example, water recycling technology is being used to provide potable water to places devastated by natural disasters. NASA will also demonstrate technologies on the ISS necessary for future space systems such as thermal control, power generation, and management of cryogenic fuels in space.

Performance

Major Activities Planned for FY 2007:

- NASA plans to continue assembly of the ISS including build out of the truss and power segments.
- NASA plans to aggressively pursue U.S. commercial cargo and crew services at the earliest availability.
- NASA will work with the International Partners to ensure the ISS is assembled and operated in a manner that fulfills our international commitments consistent with the safe operation of the Shuttle.

Major Recent Accomplishments:

- NASA maximized the research opportunities available on ISS through re-planning and rescheduling science activities. During FY 2005, approximately 246 hours of crew time were dedicated to research.
- NASA continues to work with our Russian partners to support crew and cargo transportation to ISS and maintain a continuous human presence in orbit.
- NASA has maintained a safe and stable ISS operation with only limited resupply capabilities.
- U.S. Flight Engineer John Phillips participated in the first ever Congressional hearing with live testimony from orbit on June 14, 2005.
- See "Major Recent Accomplishments (continued)" located after the theme level Budget Detail table.

International Space Station Theme Commitment in Support of the NASA Mission :

Strategic Goals

Sub-Goals (If Applicable)

Multiyear Outcomes

Annual Performance Goals supporting the Multiyear Outcomes

2. Complete the International Space Station in a manner consistent with NASA's International partner commitments and the needs of human exploration.

2.1 By 2010, complete assembly of the U.S. On-orbit Segment; launch International Partner elements and sparing items required to be launched by the Shuttle; and provide on-orbit resources for research to support U.S. human space exploration.

7ISS1 Based on the actual space Shuttle flight rate, number of remaining Shuttle flights, and the discussions with the International Partners, update the agreed to ISS assembly sequence and transportation plan as necessary.

7ISS2 Accomplish a minimum of 90% of the on-orbit research objectives as established one month prior to a given increment.

7ISS3 Per the final configuration agreed to by the International Partners, fly the ISS elements and logistics baselined for FY 2007.

2.2 By 2009, provide the on-orbit capability to support an ISS crew of six crewmembers.

7ISS4 Establish flight-ready status for the urine processing capability (part of the U.S. Regenerative Environmental Control Life Support System).

7ISS5 In concert with the International Partners, assure a continuous crew presence on the ISS.

Efficiency Measures

7ISS6 Complete all development projects within 110% of the cost and schedule baseline.

7ISS7 Deliver at least 90% of scheduled operating hours for all operations and research facilities.

Program Management

The ISS Theme manager is Mark Uhran, Assistant Associate Administrator for ISS, Space Operations Mission Directorate.

Quality

Independent Reviews:

- No independent reviews conducted in FY2005. ISS Safety Task Force review to be scheduled.

Program Assessment Rating Tool (PART):

The International Space Station received an FY 2004 PART rating of Moderately Effective. The assessment found that the program:

- 1) has greatly improved its management, particularly in the area of cost control,
- 2) had effectively managed its budget reserves, but the reserves have been eroded by Congressional cuts and increases in Space Shuttle costs, and
- 3) is extremely dependent on the Space Shuttle.

NASA is taking the following actions to improve the performance of the program:

- 1) Developing alternatives to the Space Shuttle for resupplying the International Space Station.
- 2) Holding program managers accountable for meeting cost, schedule and performance goals.

COMPLIANCE WITH COST LIMITATIONS:

NASA's evaluation of this budget determined that the International Space Station has exceeded the \$25 billion cost limitation imposed in the NASA Authorization Act of 2000 (P.L. 106-391) in FY2005. Due largely to an increase for Columbia-related impacts, ISS development has exceeded 5% in FY 2005 and consequently all FY 2005 ISS costs will be added to the cumulative total as required by the Act. Costs subject to the cost limitation through FY 2005 are \$25.7 billion.

Prior to the Columbia accident, NASA projected that development, as defined by the Act, would be substantially completed by the first quarter of FY 2005. Since the accident, the ISS program operations budget has been reduced significantly by appropriations action and internal budget reallocations to support Shuttle return to flight. In addition, the time to complete the ISS assembly has been extended by the grounding of the Shuttle fleet, and the reduction of ISS research budget. The combined effect of the budget reductions and the delay in completing assembly have resulted in the Space Station program technically exceeding the development cost limitation of \$25B in FY2005 even though program development is essentially complete and program performance has improved steadily over the past three years. Strict compliance with the Act would have precluded NASA from implementing safety related improvements to the ISS and upgrades in research capabilities needed to enable the Vision for Space Exploration. Space Shuttle flights supporting ISS are within the \$17.7 billion cost limitation imposed by the act.

Of the \$25.7 billion appropriated for the International Space Station and related activities from FY 1994 through FY 2005, approximately \$25.6 billion has been obligated as of September 30, 2005. Remaining FY2005 funds will be obligated in the course of the FY 2006 performance.

A separate report required by the Act will be prepared and submitted.

Theme: International Space Station

Budget Detail (Dollars in Millions)

Budget Authority (\$ millions)	FY2005	FY2006	Change	FY2007	FY2008	FY2009	FY2010	FY2011	Comments
International Space Station	1,591.3	1,753.4	57.9	1,811.3	2,200.3	2,255.6	2,197.1	2,360.8	
International Space Station Program	1,591.3	1,753.4	57.9	1,811.3	2,200.3	2,255.6	2,197.1	2,360.8	

Note: For all formats, the FY 2005 column reflects the FY 2005 Congressional Operating Plan, dated 9/30/2005. The FY 2006 column reflects the FY 2006 Congressional Initial Operating Plan, dated Jan 2006. The FY 2007 - 2011 columns represent the FY 2007 President's Budget Submit.

Budget Detail Comment: Program changes reflect the accommodation of multiple reductions in FY 2006 which resulted in content deferral into later years; the transfer of crew/cargo to ESMD; the addition of new content for Multi-User Systems and Support (MUSS); and the increase from FY 2007 to FY 2008 is primarily due to increases for the Shuttle Transition and Retirement (STAR) Activity/Project.

Relevance to education and public benefits (continued):

The Station is an exploration research and technology test bed. NASA will use the Station to develop and demonstrate, among other things, closed loop life support systems and remote medical care capabilities. Both of these technologies can be used to benefit people here on Earth; for example, water recycling technology used on the ISS is being used to provide potable water to places devastated by natural disasters. NASA will also demonstrate technologies on the Station necessary for future space systems such as thermal control, power generation, and management of cryogenic fuels in space.

NASA will allocate at least fifteen percent of the funds budgeted for ISS research to ground-based, free-flyer, and ISS life and microgravity science research that is not directly related to supporting the human exploration program. This will ensure the capacity to support ground-based research leading to space-based basic and applied scientific research in a variety of disciplines with potential direct national benefits and applications that can be advanced significantly from the uniqueness of microgravity and the space environment. NASA will continue to fund basic, applied, and commercial ISS research in fields such as molecular crystal growth, animal research, basic fluid physics, and cellular research. The budget for this research is accommodated through the Human Systems Research and Technology Theme in Exploration Systems Mission Directorate.

Major Recent Accomplishments (continued):

- NASA has maintained a safe and stable ISS operation with only limited resupply capabilities.
- Space Shuttle mission STS-114 transferred more than 15,000 pounds worth of supplies and hardware to the ISS, including food, water, nitrogen, lithium hydroxide canisters, maintenance replacement parts and scientific equipment. Discovery returned more than 7,200 pounds worth of science experiments and expended hardware from the ISS back to Earth. During the mission, two of the Station's four Control Moment Gyroscopes (which provide attitude control for ISS) were repaired and/or replaced, which restored the ISS to its full capability. The Shuttle crew also installed the External Stowage Platform-2, used for storing components, and replaced a GPS antenna. The Shuttle reboosted the orbit of the ISS and conducted a fly-around to complete a photographic survey of the ISS.
- In FY 2005, overall International Space Station (ISS) systems performance surpassed expectations. By the end of FY 2005, the ISS vehicle was in its best operational condition since early 2003 and ready for assembly resumption. The arrival of Discovery enhanced the science capacity on board the Station by transferring the Human Research Facility-2 to the U.S. Destiny module. This facility increased the on-orbit laboratory capabilities for human life science researchers to study and evaluate the physiological, behavioral, and chemical changes induced by space flight. Three new experiments were also flown up on Discovery. The crew deployed a new experiment, the Materials on International Space Station Experiment, and returned two sets of materials that had been outside the ISS as part of the experiment. Discovery also returned the first significant downmass of science data and samples since December 2002.
- Our Russian partners continue supporting crew and cargo transportation to the International Space Station. In FY 2005, automated Russian Progress vehicles resupplied the two-person Station crew four times, and Russian Soyuz vehicles transported two crews safely to and from the Station. This level of cooperation has enabled a continuous crew presence on the Station. A highlight of Russia's resupply was the delivery and successful activation of a new Elektron oxygen generation system.

Theme: International Space Station

- FY 2005 began with a Station crew exchange. The Expedition 10 crew, U.S. Commander Leroy Chiao and Russian Flight Engineer Salizhan Sharipov, replaced Expedition 9 on board the Station on October 16, 2004. Chiao and Sharipov conducted two two-person extravehicular activities (EVA) safely and successfully without a crewmember inside the Station.
- The Expedition 10 crew returned to Earth on April 24, 2005. Expedition 11 crew members Russian Commander Sergei Krikalev and U.S. Flight Engineer John Phillips arrived at the Station on April 17, 2005. Krikalev and Phillips performed one EVA while at the Station. Phillips also participated in the first ever Congressional hearing with live testimony from orbit on June 14, 2005. Expedition 11 returned to Earth in October 2005.
- Although planned science activities on the Station have been limited by the reduced crew size and transport capabilities of the Russian Progress and Soyuz spacecraft, NASA maximized the research opportunities available through re-planning and rescheduling science activities. During FY 2005, approximately 246 hours of crew time were dedicated to research.
- The International Partnership successfully met the challenge of continuing ISS operations while the Space Shuttle is grounded. Through technical and management coordination, the Partners have sustained a continuous human presence in space. The Partnership will resume assembly as soon as the Space Shuttle completes its second Return to Flight mission. NASA's Implementation Plan for ISS Continuing Flight (released in March 2005), exemplifies the Agency's commitment to safely and successfully fulfilling ISS goals.

Theme: International Space Station
Program: International Space Station

President's FY 2007 Budget Request (Dollars in Millions)

<u>International Space Station</u>	<u>FY2005</u>	<u>FY2006</u>	<u>FY2007</u>	<u>FY2008</u>	<u>FY2009</u>	<u>FY2010</u>	<u>FY2011</u>
FY 2007 PRES BUD	1,591.3	1,753.4	1,811.3	2,200.3	2,255.6	2,197.1	2,360.8
Changes from FY 2006 Request	-85.0	-103.3	-24.1	409.4	103.3	-178.4	

Overview

The International Space Station (ISS) is a complex of research laboratories in low Earth orbit (LEO) in which U.S. and international astronauts conduct scientific and technological investigations in a space environment. The objective of the ISS is to support scientific research for human space exploration. Consistent with the Vision for Space Exploration, NASA has refocused its research on science and technology development that will prepare human explorers to travel beyond LEO. For example, ISS crews are performing experiments that will help develop countermeasures against the effects of long flight duration exposure to radiation and a microgravity environment. Two crew members are currently onboard the ISS. ISS crews are currently supported by resupply and crew rotation using Russian Progress and Soyuz vehicles.

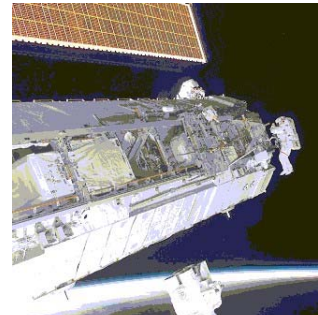

Astronauts assembling the International Space Station in Low Earth orbit.

The FY 2007 Budget request provides funding for ISS launch processing activities, resumption of vehicle on-orbit assembly with a crew of three, continuation of research payload and experiment deliveries to orbit. It also includes funding for full-scale development of habitability modifications and completion of the regenerative environmental control and life support system needed to increase the crew capacity, consistent with human space exploration research requirements. Budget changes in this submittal reflect content deferrals from FY 2006 into later years; the transfer of crew/cargo to ESMD; the addition of new content for Multi-User Systems and Support (MUSS). The increase in FY 2008 is primarily due to increases with the Shuttle Transition and Retirement (STAR) Activity/Project.

Theme:	International Space Station
Program:	International Space Station

Plans For FY 2007

NASA expects to continue assembly of the ISS including build out of the truss and power segments, and the addition of the International Partner modules. NASA plans to aggressively pursue U.S. commercial cargo and crew services at the earliest availability to develop sustainable cargo supply transportation architecture for the post-Shuttle era. NASA also plans to work with the International Partners.

Future plans, beyond FY 2007, include completing the ISS assembly at the end of the decade. NASA is examining ISS configurations that meet the needs of both the new space exploration vision and our international partners while using as few Shuttle flights as possible. A key element in the future of the ISS program is the purchase of alternate cargo and crew transportation services to supplement the Shuttle when in service and then replace it.

In full compliance with the Iran Nonproliferation Act, NASA has negotiated initial crew exchange services with the Russian Space Agency to meet US crew rescue obligations and continue cargo services on the Progress spacecraft.

Changes From FY 2006

- No major programmatic changes from FY 2006 to FY 2007.

Program Management



















The ISS Theme manager is Mark Uhran, Assistant Associate Administrator for ISS, Space Operations Mission Directorate.

Technical Parameters

The primary objective of the ISS is to conduct research on a permanently crewed platform in space, and enable NASA to develop, test, and validate the next generation of technologies and processes necessary for future exploration. NASA has focused ISS utilization on those activities that will prepare humans to explore beyond low Earth orbit.

Technical Specifications	FY 2007 President's Budget	Change from Baseline
ISS Assembly	Specific flight dates are subject to the resumption of Shuttle flight operations.	Dates subject to resumption of Shuttle flights.

Theme: International Space Station
 Program: International Space Station

Implementation Schedule:																						
Project	Schedule by Fiscal Year							Purpose	Phase Dates													
	05	06	07	08	09	10	11			Beg	End											
Core Dev't mission depends on Shuttle resumption.								Assembly Flight 12A P3/P4 Truss Segment Assembly	Tech Form Dev Ops Res		Feb-16											
Core Dev't mission depends on Shuttle resumption.								Assembly Flight 12A.1 P5 Truss Segment Assembly	Tech Form Dev Ops Res		Feb-16											
Core Dev't mission depends on Shuttle resumption.								Assembly Flight 13A S3/S4 Truss Segment Assembly	Tech Form Dev Ops Res		Feb-16											
Core Dev't mission depends on Shuttle resumption.								Assembly Flight 13A.1 S5 Truss Segment Assembly	Tech Form Dev Ops Res		Feb-16											
Core Dev't mission depends on Shuttle resumption.								Assembly Flight 15A S6 Truss Segment Assembly	Tech Form Dev Ops Res		Feb-16											
Core Dev't mission depends on Shuttle resumption.								Assembly Flight 10A Node 2 Assembly	Tech Form Dev Ops Res		Feb-16											
ECLSS mission depends on Shuttle resumption.								Regenerative ECLSS will significantly reduce upmass logistics requirements and provide experience with self-sustaining environmental control and life support systems.	Tech Form Dev Ops Res	Jan-04	Oct-06 Sep-16											
<table border="0"> <tr> <td></td> <td>Tech & Adv Concepts (Tech)</td> </tr> <tr> <td></td> <td>Formulation(Form)</td> </tr> <tr> <td></td> <td>Development (Dev)</td> </tr> <tr> <td></td> <td>Operations (Ops)</td> </tr> <tr> <td></td> <td>Research (Res)</td> </tr> <tr> <td></td> <td>Represents a period of no activity for the Project</td> </tr> </table>												Tech & Adv Concepts (Tech)		Formulation(Form)		Development (Dev)		Operations (Ops)		Research (Res)		Represents a period of no activity for the Project
	Tech & Adv Concepts (Tech)																					
	Formulation(Form)																					
	Development (Dev)																					
	Operations (Ops)																					
	Research (Res)																					
	Represents a period of no activity for the Project																					

Strategy For Major Planned Acquisitions

- Intend to issue an announcement to collaborate with industry for demonstrations of space transportation capabilities and follow-up with procurement of commercial launch services to resupply the ISS.

Key Participants

- International Partners: There are a total of 16 participating Nations working on the ISS. Russia, 11 European Space Agency member States, Japan, Canada, & Italy are providing elements for the ISS.
- Boeing: Prime contractor for International Space Station Development and Sustaining Engineering.
- Russia: In addition to ISS elements and crew members, under the partnership agreement Soyuz and Progress have provided critical crew rotation and resupply during the Shuttle down period.

Theme: International Space Station

Program: International Space Station

Risk Management

- **RISK:** ISS assembly is contingent on the resumption of Shuttle flight operations. Additional setbacks will further delay ISS assembly, increase NASA reliance on partner launch assets, impact costs and on-orbit support. **MITIGATION:** The ISS program is maintaining readiness for Shuttle return to flight. NASA has continued the development and delivery of ISS hardware. The priority elements are manifested on the Shuttle 1) power and thermal infrastructure elements 2) International Partner laboratory elements and 3) logistics and sustainment elements. Coordinated use of partner launch assets facilitated ongoing operations.
- **RISK:** Resupply of consumables and spare parts. With Shuttle grounded the ISS program has a limited ability to deliver the consumables and spare parts which sustain the crew and hardware systems. If critical functions cannot be sustained the crew will be returned to Earth by Russia's Soyuz vehicle. **MITIGATION:** NASA and its International Partners are cooperating to sustain onboard crew and vehicle systems. Onboard reserves are carefully managed so that an interruption in resupply would not deplete supply levels. NASA is proceeding with plans to acquire commercial cargo transportation services from U.S. commercial providers. Funding for the Crew/Cargo Project is in the Constellation Theme.

Theme: International Space Station

Program: International Space Station

Overview (continued)

NASA plans to complete assembly of the ISS by the end of the decade. NASA is examining ISS configurations that meet the needs of both the new space exploration vision and our international partners while using as few Shuttle flights as possible. Consistent with the ISS research agenda, and operations and international commitments, NASA is committed to provide for a crew size of six. Another key element in the future of the ISS program is the use of alternate cargo and crew transportation services to supplement the Shuttle when it is in service, and to replace it when it retires.

In accordance with recent changes in the Iran Nonproliferation Act, NASA is in the process of negotiating crew exchange services with the Russian Space Agency to meet U.S. crew rescue obligations, as well as continuing cargo services on the Progress spacecraft.

Theme: International Space Station
Program: International Space Station
Project In Development: Core Development

President's FY 2007 Budget Request (Dollars in Millions)

Core Development (Development)	FY2005	FY2006	FY2007	FY2008	FY2009	FY2010	FY2011
FY 2007 PRES BUD	103.9	87.3	79.0	62.0	22.2	14.1	20.6
Changes from FY 2006 Request	7.8	13.0	15.6	11.3	-1.6	-5.6	

Overview

Projects in Development are mature, have a sound design, and are proceeding to mission execution. NASA is committed to their lifecycle cost and schedule plans.

Space Station elements are provided by U.S. and international partners Russia, Europe, Japan, and Canada. The U.S. elements include nodes, laboratory module, airlock, truss segments, photovoltaic arrays, three pressurized mating adapters, unpressurized logistics carriers, and a cupola. Various systems have been developed by the U.S., including thermal control, life support, navigation, command and data handling, power systems, and internal audio/video. Other U.S. elements being provided through bilateral agreements include the pressurized logistics modules provided by the Italian Space Agency, and Nodes 2 and 3 provided by ESA. During FY 2006, it is expected the Space Shuttle will resume flights to the ISS and assembly will continue. Core Development is substantially complete, with a few remaining elements (such as Station to Shuttle Power Transfer System (SSPTS) and the Express Logistics Carrier (ELC).



ISS Extravehicular Activity (EVA) operation.

Changes From FY 2006

- Deletion of Centrifuge Accommodation Module and Solar Power Module from formal configuration.

Program Management

The ISS Core Development manager is Mark Uhran, Assistant Associate Administrator for ISS, Space Operations Mission Directorate.

Theme: International Space Station
Program: International Space Station
Project In Development: Core Development

Technical Parameters

The primary objective of the ISS is to demonstrate the utility of a permanently crewed platform in space, and enable NASA to develop, test and validate the next generation of technologies and processes necessary for future exploration. NASA has focused ISS utilization on those activities that will prepare human explorers to travel beyond low Earth orbit.

Program Commitment Agreement (PCA) signed August 19, 2003; Baseline defined by May 2003 Cost Analysis Requirements Document (CARD).

Technical Specifications	FY 2007 President's Budget	Change from Baseline
Crew Size	3 International Crew Members	
Ku Band Downlink	1.5 - 2.46 Terabits per day average	
Operational Life	10 Years after deployment of the U.S. Laboratory	
External Payload Sites	24 External Payload sites on Truss 10 Sites on JEM Exposed Facility	
Optical Viewing	Nadir viewing optical research window	
Power	80 Kilowatts	
Accommodations	27 U.S. Racks	

Schedule	FY 2007 President's Budget	Baseline	Change from Baseline
13A S3/S4 Truss Segment Assembly	Specific flight dates are subject to the resumption of Shuttle flight operations		
13A.1 S5 Truss Segment Assembly	Specific flight dates are subject to the resumption of Shuttle flight operations		
15A S6 Truss Segment Assembly	Specific flight dates are subject to the resumption of Shuttle flight operations		
10A Node 2 Assembly	Specific flight dates are subject to the resumption of Shuttle flight operations		
12A.1 P5 Truss Segment Assembly	Specific flight dates are subject to the resumption of Shuttle flight operations		
12A P3/P4 Truss Segment Assembly	Specific flight dates are subject to the resumption of Shuttle flight operations		

Strategy For Major Planned Acquisitions

- No major acquisitions are planned.

Theme: International Space Station
Program: International Space Station
Project In Development: Core Development

Key Participants

- International Partners: There are a total of 16 participating Nations working on the ISS. Russia, 11 European Space Agency member States, Japan, Canada, & Italy are providing elements for the ISS.
- Boeing: Prime contractor for International Space Station Development and Sustaining Engineering.
- Russia: In addition to ISS elements and crew members, under the partnership agreement, Soyuz and Progress have provided critical crew rotation and resupply during the Shuttle down period.

Budget Detail/Life Cycle Cost (Dollars in Millions)

Budget Authority	Prior	FY2005	FY2006	FY2007	FY2008	FY2009	FY2010	FY2011	BTC	Total	Comments
FY 2007 PRES BUD	12,599.3	103.9	87.3	79.0	62.0	22.2	14.1	20.6		12,988.4	
Changes	0.0	7.8	13.0	15.6	11.3	-1.6	-5.6				
FY2006 President's Budget	12,599.3	96.2	74.3	63.4	50.8	23.8	19.7			12,927.4	

Reporting on NASA development programs includes categorization as Spacecraft, Launch Vehicle or Instruments but this classification is not applicable to the buildup of Space Station, which is comprised of various systems such as thermal control, life support, navigation, command and data handling, power systems, and internal audio/video.

Theme: International Space Station
Program: International Space Station
Project In Development: Environmental Control and Life Support System (ECLSS)

President's FY 2007 Budget Request (Dollars in Millions)

<u>Environmental Control and Life Support System (ECLSS) (Development)</u>	<u>FY2005</u>	<u>FY2006</u>	<u>FY2007</u>	<u>FY2008</u>	<u>FY2009</u>	<u>FY2010</u>	<u>FY2011</u>
FY 2007 PRES BUD	34.7	5.9	0.6				
Changes from FY 2006 Request	24.2	-12.3	-7.5	-4.0	-3.4	-2.5	

Projects in Development are mature, have a sound design, and are proceeding to mission execution. NASA is committed to their lifecycle cost and schedule plans.

Overview

When the Space Shuttle returns to flight, NASA also will return to supporting three person ISS crews, then work to expand to larger crews as soon as feasible. A larger crew will be able to better maintain and more fully utilize the capabilities of the International Space Station; however, the size of the crew is dependent, in part, on the Space Station's life support capacity. Development funding for the expansion of crew size above the U.S. Core baseline is included in the FY 2007 Capability Upgrades budget. Operations and sustainment is included in the ISS Operations budget. Regenerative environmental control and life support system (ECLSS), Node 3, and habitability modifications to support a crew of 6 have been incorporated into the program baseline. Regenerative ECLSS consists of Oxygen Generator Assembly (OGA) and Water Processor Assembly (WPA). It will be mounted in Node 3, which is being developed by ESA as a barter element. Node 3 is at high risk since it is the last element to be launched in the current manifest. If Node 3 is not launched, then ECLSS will remain in the U.S. lab (Destiny) for the life of the program. Regenerative ECLSS will nominally process nearly 50 pounds of wastewater per person day, including 23 pounds of urine and flush water into crew usable potable water and oxygen. This will significantly reduce upmass logistics requirements by up to 300 lbs per day for a six person crew, and providing experience with self-sustaining environmental control and life support systems.

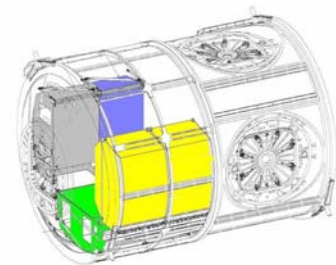

Regenerative ECLSS will significantly reduce logistics requirements to support astronauts on the International Space Station and later on the Moon and Mars.

Changes From FY 2006

- The regenerative ECLSS is now planned to be deployed in the U.S. Lab for earlier on-orbit test and check-out. It will be re-located to Node 3, as originally planned.

Program Management

The ECLSS manager is Mark Uhran, Assistant Associate Administrator for ISS, Space Operations Mission Directorate.

Theme: International Space Station
Program: International Space Station
Project In Development: Environmental Control and Life Support System (ECLSS)

Technical Parameters

ECLSS, Node 3 and Habitability upgrades will provide the ability to sustain a crew size above three during continuous ISS operations. ECLSS provides a critical test bed for exploration and will provide redundancy from the Russian Elecktron for Oxygen generation up to 7,500 pounds per year. The habitability upgrades will provide crew accommodations and the Node 3 an additional 3470 cubic feet of volume for sleep, food preparation, and waste management.

Program Commitment Agreement (PCA) signed August 19, 2003; Baseline defined by May 2003 Cost Analysis Requirements Document (CARD).

Technical Specifications	FY 2007 President's Budget	Change from Baseline
Advanced ECLSS Dissimilar Design	ECLSS redundancy (from Russian system) O ₂ Generation System-up to 41K lbs of recycled water; Water Recovery System - up to 7,500 lbs of O ₂ per year	No Change
Node 3 Length	249 inches (20.75 feet)	
Node-3 Diameter	175 inches (14.6 feet)	
Advanced ECLSS Support Increased	Crew size up to seven (7)	
Node-3 Atmosphere	14.7 psia	
Node-3 Ports	6 (5 ACBM, 1 PCBM)	

Schedule	FY 2007 President's Budget	Baseline	Change from Baseline
December 2005	Oxygen Generation System delivery to KSC	December 2005	one month to January 2006
March 2006	Water Recovery System delivery to KSC		None
January 2008	Node 3 delivery to KSC		None

Strategy For Major Planned Acquisitions

- No new major acquisitions planned.

Key Participants

- Hamilton Sundstrand - performing major ECLSS orbital replacement unit development and rack level integration for two of three racks.
- Boeing - providing critical software and hardware for Node 3 and ECLSS integration to ISS Alenia; building Node 3 under contract with ESA.

Risk Management

- **RISK:** The Advanced ECLSS is a vital new technology. During its development, there were technical challenges associated with delivery of key system components which have impacted the project schedule. Final delivery of the ECLSS could be impacted which would delay a back-up oxygen regeneration capability or a greater than three crew capability. **MITIGATION:** The program provides weekly status on all ECLSS technical issues with available schedule slack. Technical work arounds are currently in place with some contingency remaining. NASA is examining an option to accelerate the regenerative oxygen generation system (OGS) to a 2006 launch, in order to speed up developmental testing in a microgravity environment.

Theme: International Space Station
Program: International Space Station
Project In Development: Environmental Control and Life Support System (ECLSS)

Budget Detail/Life Cycle Cost (Dollars in Millions)

Budget Authority	Prior	FY2005	FY2006	FY2007	FY2008	FY2009	FY2010	FY2011	BTC	Total	Comments
FY 2007 PRES BUD	<u>231.7</u>	<u>34.7</u>	<u>5.9</u>	<u>0.6</u>						<u>272.8</u>	
Changes	<u>0.0</u>	<u>24.2</u>	<u>-12.3</u>	<u>-7.5</u>	<u>-4.0</u>	<u>-3.4</u>	<u>-2.5</u>			<u>-5.4</u>	
FY2006 President's Budget	<u>231.7</u>	<u>10.4</u>	<u>18.1</u>	<u>8.1</u>	<u>4.0</u>	<u>3.4</u>	<u>2.5</u>			<u>278.2</u>	

Reporting on NASA development programs includes categorization as Spacecraft, Launch Vehicle or Instruments but this classification is not applicable to ECLSS. Changes in the budget reflect an acceleration of the development efforts in FY 2005.

Space and Flight Support (SFS)



Space and Flight Support includes Space Communications, Launch Services, Rocket Propulsion Testing, and Crew Health and Safety program services.

President's FY 2007 Budget Request

(Dollars in Millions)

Space and Flight Support (SFS)	FY2005	FY2006	FY2007	FY2008	FY2009	FY2010	FY2011
FY 2007 PRES BUD	473.9	338.8	366.5	392.8	392.0	394.7	389.2
Changes from FY 2006 Request	-11.2	-36.9	-4.4	-7.2	-7.7	-4.4	

Overview: What NASA Accomplishes through the Space and Flight Support (SFS) Theme

Space and Flight Support, managed by the Space Operations Mission Directorate, is comprised of several distinct programs providing Agency-level services. These programs include Space Communications, Launch Services, Rocket Propulsion Testing (RPT), and Crew Health and Safety (CHS). These services are critical for conducting space exploration, aeronautical research, and biological and physical research. These services are provided to a wide range of customers, including NASA scientists and engineers, other Federal agencies, universities, foreign governments and industry interests.

Changes in the above budget history are somewhat skewed by previous transfers. Space and Flight Support transferred the Advanced Systems Program to Exploration Systems beginning in FY 2005, and the Environmental program budget (Plum Brook nuclear facility dismantling and environmental compliance and restoration) to the Institutional Investments account beginning in FY 2006.

Relevance: *Why* NASA conducts Space and Flight Support (SFS) work

Relevance to national priorities, relevant fields, and customer needs:

Space and Flight Support provides the enabling capabilities required to advance space exploration, and expand scientific knowledge of the Earth and our universe. Without these capabilities NASA could not perform many of its missions and the American public would not receive many benefits of the Nation's space program.

Relevance to the NASA mission:

Space and Flight Support provides the capability to conduct NASA missions and extend human presence across the solar system, starting with a human return to the Moon by the year 2020, in preparation for human exploration of Mars and other destinations.

Relevance to education and public benefits:

Benefits of Space and Flight Support include the relay of scientific data from space to Earth, the safe launching of Space Shuttles and expendable launch vehicles necessary for research, the assurance that rocket systems have been adequately tested, and the testing and implementation of various human health and illness prevention measures. A space program properly supported by this Theme will produce research data that can be used to generate new scientific knowledge through the study of the physical sciences, biological sciences, Earth sciences, planetary science, and more. These activities benefit both the general public and the education community.

Performance

Major Activities Planned for FY 2007:

- Complete first element of the Space Network Expansion (SNE) project.
- Launch 8 Expendable Launch Vehicles (ELV) of primary payloads.
- Develop and refine a standardized battery of clinical and physiological test for all crew members and continue to develop and maintain environmental standards for all space exploration platforms.
- Test capabilities implemented and upgraded for the Vision for Space Exploration will be made operationally ready to begin testing propulsion capabilities required to support missions beyond LEO.
- Complete Space Communications plan as directed in FY 2006 NASA Authorization Bill.

Major Recent Accomplishments:

- Successfully supported all missions utilizing the Space Network (SN) and the NASA Integrated Services Network (NISN), including Return-to-Flight.
 - Completed Critical Design Review for SNE Project and Space Communications Architecture Study Elements for Lunar Relay and Deep Space Network.
 - Successfully launched five missions: DART, Deep Impact, NOAA-N, MRO, and New Horizons.
 - Implemented the Health Maintenance System (HMS) Inventory Tracking tool, a collaborative time saving inventory tracking tool improving patient safety and knowledge sharing.
 - Orbital Services Corporation (OSC) was successfully added to the NASA Launch Services (NLS) Contract.
-

Space and Flight Support (SFS) Theme Commitment in Support of the NASA Mission :

Strategic Goals

Sub-Goals (If Applicable)

Multiyear Outcomes

Annual Performance Goals supporting the Multiyear Outcomes

5. Encourage the pursuit of appropriate partnerships with the emerging commercial space sector.

5.1 Develop and demonstrate a means for NASA to purchase launch services from emerging launch providers.

7SFS4 Realize competitive rates from emerging U.S. launch providers and open the bidding process to a larger number of launch providers.

6. Establish a lunar return program having the maximum possible utility for later missions to Mars and other destinations.

6.4 Implement the space communications and navigation architecture responsive to Science and Exploration mission requirements

7SFS1 Develop and submit in February 2007 a space communications plan based on an architecture that supports NASA's exploration and science programs for the 2010-2015 timeframe and beyond.

7SFS2 Implement technology initiatives consistent with approved baseline space communications and navigations architecture.

7SFS3 Pursue commercial opportunities for the space communication and navigation architecture.

Efficiency Measures

7SFS5 Complete all development projects within 110% of the cost and schedule baseline.

7SFS6 Deliver at least 90% of scheduled operating hours for all operations and research facilities.

Program Management

The Theme Directors are Robert Spearing (Space Communications), George Baker (Launch Services), Steven Brettel (RPT) and John Allen (CHS).

Quality**Independent Reviews:**

- The Aeronautics and Space Engineering Board of the National Research Council (NRC) is conducting a review of the Space Communications Program and is scheduled to complete its review by September 2006.

Program Assessment Rating Tool (PART):

Space and Flight Support (SFS) received an FY 2004 PART rating of Adequate.

The assessment found that the programs were generally effective in providing services to NASA and other customers, but needed better plans to improve those services in the future.

The program was comprised of a set of distinct services which, with the exception of environmental remediation, served a common goal of customer service. The environmental remediation program has since been removed from SFS.

NASA is taking the following actions to improve performance:

- 1) Continue to fund the program at an essentially flat level, but strive to improved the program's results by increasing efficiency.
- 2) Develop a plan to independently review all of the major program elements to support improvements and evaluate effectiveness and relevance. Launch Services is planning the independent review after the Jan 2006 Pluto launch. It is estimated to occur in March 2006, which coincides with the Annual Mission Assurance Reviews. Space Communications has issued a statement of work to the National Academies to begin its independent review.
- 3) Develop better measures that will help to drive program improvement.

Budget Detail (Dollars in Millions)

Budget Authority (\$ millions)	FY2005	FY2006	Change	FY2007	FY2008	FY2009	FY2010	FY2011	Comments
Space and Flight Support (SFS)	473.9	338.8	27.7	366.5	392.8	392.0	394.7	389.2	
Space Communications	298.0	155.9	17.6	173.4	193.7	193.2	192.6	192.2	
Launch Services	106.1	109.0	5.6	114.6	120.6	120.4	119.9	115.4	
Rocket Propulsion Testing	61.4	64.0	4.1	68.1	67.0	67.3	71.1	70.5	
Crew Health & Safety	8.4	10.0	0.4	10.4	11.5	11.2	11.1	11.1	

Note: For all formats, the FY 2005 column reflects the FY 2005 Congressional Operating Plan, dated 9/30/2005. The FY 2006 column reflects the FY 2006 Congressional Initial Operating Plan, dated Jan 2006. The FY 2007 - 2011 columns represent the FY 2007 President's Budget Submit.

Launch Services budget changes reflect Institutional line item reductions. The Space Communication program is increased for planned systems engineering initiatives for increased reliability. The Rocket Propulsion Test Program changes reflect Institutional line item reductions, and the Crew Health and Safety Program changes reflect only inflation adjustments.

Theme: Space and Flight Support (SFS)
Program: Space Communications

President's FY 2007 Budget Request (Dollars in Millions)

<u>Space Communications</u>	<u>FY2005</u>	<u>FY2006</u>	<u>FY2007</u>	<u>FY2008</u>	<u>FY2009</u>	<u>FY2010</u>	<u>FY2011</u>
FY 2007 PRES BUD	298.0	155.9	173.4	193.7	193.2	192.6	192.2
Changes from FY 2006 Request	105.2	-17.4	-1.4	-1.1	-1.2	-1.6	

Overview

NASA's flight missions must be linked to the Earth to accomplish their mission objectives. NASA uses a common infrastructure to provide these essential links. The responsibility of this infrastructure is vested with the Space Operations Mission Directorate's Space Communications Program. This multimission approach dramatically reduces operational costs.

When viewed as a unit, Space Communications (SpComm) activities are one part of an interdependent triad that is absolutely essential to this Nation's space programs. Space Communications functions, while often less visible, are no less vital than the payloads and the launch systems that carry them to their destinations. Mission success is possible only when all three elements meet their performance requirements.

One of the key challenges of the Program is predicting and understanding future mission communications needs and then determining how to meet those needs by incorporating new technology while stimulating and encouraging development of commercial sources. The budget for the Program is based upon operational needs of flight missions and those technological development capabilities necessary to meet future mission needs. The Program is also developing a space communication and navigation architecture that will support the Exploration and Science mission requirements.

The large increase from FY 2005 to FY 2006 reflects that the budget for Plumbrook and Environmental Compliance and Restorations (\$75.4 million) was maintained in SpComm.

The Program supports the Agency's goal to improve the provision of access to space for the Nation by making it increasingly safe, reliable, and affordable



The Tracking and Data Relay Satellite (TDRS) shown above represents a constellation of 8 operational satellites providing uplink and downlink capability for NASA and non-NASA missions.

Theme: Space and Flight Support (SFS)
Program: Space Communications

Plans For FY 2007

- Support mission operations with the Space Network (SN) and NASA Integrated Services Network (NISN).
- Complete first element of the Space Network Expansion project.
- Complete integrated planning between Space Operations and Exploration System Mission Directorates.
- Assess the total replenishment needs of the Tracking and Data Relay Satellite (TDRS) System.
- Complete Space Communications plan as directed in FY 2006 NASA Authorization Bill.
- NASA to implement two assignments for spectrum relocation in response to the new Commercial Spectrum Enhancement Act (CSEA, Title II of P.L. 108-494).

Changes From FY 2006

- There were no major programmatic changes from the FY 2006 budget submission.

Program Management

The Space Network, NASA Integrated Services Network, Ground Network, Deep Space Network, and Western Aero Test Range are managed by other Directorates

Technical Parameters

TDRS is the core of the SN providing in-flight communications with spacecraft operating in low-Earth orbit. SN provides uplink/downlink facilities at White Sands and Guam. NISN transports administrative, scientific, and mission control data among NASA facilities and its industrial/scientific partners. Both networks provide service to non-NASA missions on a reimbursable basis.

Other activities: initiating and managing communications and navigation technology initiatives to reduce cost; developing an architecture to support Exploration and Science missions; managing access to communications frequencies in order to conduct space/ground based transmissions; and conducting proof-of-concept for a new space-based search and rescue system to improve distress alert and location capability

Technical Specifications	FY 2007 President's Budget	Change from Baseline
---------------------------------	-----------------------------------	-----------------------------

Implementation Schedule:																					
Project	Schedule by Fiscal Year							Purpose	Phase Dates												
	05	06	07	08	09	10	11		Beg	End											
Space Communications, ongoing operations.								Provide Space Communications services to NASA and non-NASA missions.	Tech	Oct-11											
								Form													
								Dev													
								Ops													
								Res													
<table style="width: 100%; border: none;"> <tr> <td style="width: 20px; background-color: #00b0f0;"></td> <td>Tech & Adv Concepts (Tech)</td> </tr> <tr> <td style="width: 20px; background-color: #800000;"></td> <td>Formulation(Form)</td> </tr> <tr> <td style="width: 20px; background-color: #ffff00;"></td> <td>Development (Dev)</td> </tr> <tr> <td style="width: 20px; background-color: #008000;"></td> <td>Operations (Ops)</td> </tr> <tr> <td style="width: 20px; background-color: #800080;"></td> <td>Research (Res)</td> </tr> <tr> <td style="width: 20px; background-color: #cccccc;"></td> <td>Represents a period of no activity for the Project</td> </tr> </table>											Tech & Adv Concepts (Tech)		Formulation(Form)		Development (Dev)		Operations (Ops)		Research (Res)		Represents a period of no activity for the Project
	Tech & Adv Concepts (Tech)																				
	Formulation(Form)																				
	Development (Dev)																				
	Operations (Ops)																				
	Research (Res)																				
	Represents a period of no activity for the Project																				

Strategy For Major Planned Acquisitions

- No major acquisitions planned in FY 2007

Theme: Space and Flight Support (SFS)

Program: Space Communications

Key Participants

- Federal Government Agencies (Network support, Comm/Navigation Architecture, Standards and Spectrum Management, special studies).
- Corporations (Network and Systems implementation, Technology, Architecture, special studies).

President's FY 2007 Budget Request (Dollars in Millions)

<u>Launch Services</u>	<u>FY2005</u>	<u>FY2006</u>	<u>FY2007</u>	<u>FY2008</u>	<u>FY2009</u>	<u>FY2010</u>	<u>FY2011</u>
FY 2007 PRES BUD	106.1	109.0	114.6	120.6	120.4	119.9	115.4
Changes from FY 2006 Request	-37.7	-15.0	-1.5	-2.2	-2.6	-2.7	

Overview

Assuring reliable and cost effective access to space for civilian missions is critical to achieving the Vision for Space Exploration which NASA has been asked to undertake for the Nation. NASA has assigned responsibility for understanding the full range of civil space launch needs to the Space Operations Mission Directorate Launch Services Program. This program, which works closely with other government agencies and the launch industry, seeks to ensure that the most safe, reliable, on time, cost-effective launch opportunities are available on a wide range of launch systems. These efforts help to achieve the national goals for leadership in understanding the earth and exploring the universe. A key challenge of the Program is understanding the launch needs of the different civil government customers. These customers seek to understand Earth processes, including use of weather satellites; explore the universe with planetary probes, Mars rovers, and orbiters; and, to enhance life on earth by understanding the universe in which we live using various scientific missions. The Program purchases fixed-price launch services from domestic suppliers and provides oversight to ensure that these valuable, one of a kind missions safely leave the earth to explore the world beyond. The Program works with customers from universities, industry, government agencies and international partners from the earliest phase of a mission. The funding provides the capability for NASA to maintain critical skills providing technical management of launch services on the full fleet of existing and new launch systems.



Mars Reconnaissance Orbiter Launch
 Launched August 10, 2005
 Cape Canaveral

Plans For FY 2007

FY 2007 funding supports a wide range of activities critical to fulfilling NASA's science and exploration agenda. The planned launches for FY 2007 are DAWN, Time History of Events and Macroscale Interactions during Substorms (THEMIS), Space Tracking and Surveillance System Block 2010 Risk Reduction (STSS B2010), Space Tracking and Surveillance System (STSS), NPOESS Preparatory Project (NPP), PHOENIX, Gamma-Ray Large Area Space Telescope (GLAST), and Geostationary Operational Environmental Satellite (GOES O). DAWN, THEMIS, STSS B2010, STSS, NPP, PHOENIX, GLAST will be launched on a Delta II and GOES O on a Delta IV. See Science Mission Themes for mission details. FY 2007 Plans are to continue the advanced planning process and trade studies for some 20 scientific and exploration missions, continue the advanced planning process to support the evolving launch requirements for the Moon and Mars exploration, and complete certification of the Taurus XL and the Delta IV launch systems planned for use on NASA missions.

Changes From FY 2006

- There were no major programmatic changes from the FY 2006 budget submission.

Theme: Space and Flight Support (SFS)
Program: Launch Services

Program Management

The Program Manager for the Launch Services Program is George Baker, Assistant Associate Administrator for Launch Services.

Technical Parameters

Continuing to apply lessons learned from the Columbia Accident Investigation, the Program has Agency responsibility for acquiring launch services from private sector suppliers and/or DoD. It gathers the necessary engineering talent focused on moving scientific inquiry safely from the ground to space. The technical team is the bridge between NASA customers and launch contractors assuring the standards for safety and mission success are consistently applied with one common objective: To provide the systems level engineering oversight that strives to offer every NASA mission an opportunity to leave the Earth on a journey of exploration. This team has achieved a high level of mission success for NASA missions and consistently outperforms its goal of 95 percent or better launch success.

Technical Specifications	FY 2007 President's Budget	Change from Baseline
Meet Agency Launch Services needs.	Ongoing	

Implementation Schedule:

Project	Schedule by Fiscal Year							Purpose	Phase Dates	
	05	06	07	08	09	10	11		Beg	End
Launch Services, ongoing operations.								Responsible for enabling access to space for all NASA missions and other select government missions as required.	Tech Form Dev Ops Res	Oct-11
<ul style="list-style-type: none"> Tech & Adv Concepts (Tech) Formulation(Form) Development (Dev) Operations (Ops) Research (Res) Represents a period of no activity for the Project 										

Strategy For Major Planned Acquisitions

- Launch Services-Firm Fixed Price/IDIQ FFP tasks, competition, Boeing, Lockheed Martin, & Orbital Sciences.
- Mission Services-Combination Cost Plus & Firm Fixed Price Contract, competed, Analex Corp.

Key Participants

- Domestic launch service providers are listed under Strategy for Major Planned Acquisitions.
- Federal agency customers - Department of Defense, Missile Defense Agency, National Oceanic & Atmospheric Administration, National Reconnaissance Office, Defense Advanced Research Projects Agency, and the US Air Force.

Risk Management

- RISK: There are a very limited number of domestic providers to support scheduled launch missions. MITIGATION: Through aquisition strategy, the program will maximize the number of bidders for the various missions supported by the Launch Services program.

Theme: Space and Flight Support (SFS)
Program: Rocket Propulsion Testing

President's FY 2007 Budget Request (Dollars in Millions)

Rocket Propulsion Testing	FY2005	FY2006	FY2007	FY2008	FY2009	FY2010	FY2011
FY 2007 PRES BUD	61.4	64.0	68.1	67.0	67.3	71.1	70.5
Changes from FY 2006 Request	-4.4	-5.1	-2.1	-4.9	-4.7	-0.9	

Overview

The Rocket Propulsion Test (RPT) Program manages NASA's rocket propulsion test assets, activities, and resources; advances test technologies; and reduces propulsion test costs through the safe and efficient utilization of rocket propulsion test facilities in support of NASA programs, commercial partners, and the Department of Defense (DoD). The Program ensures appropriate levels of capability and competency are maintained for items such as engine development and certification, flight support testing, anomaly resolution, upgrades, life cycle testing, and certification extensions. The Program strategy is to perform the following: fund and maintain a core capability of skilled test and engineering crews and test stand facilities, consolidate and streamline NASA's rocket test infrastructure, establish and maintain world-class test facilities, modernize test facility equipment, provide non-project specific equipment and supplies, and develop effective facility/infrastructure maintenance strategies and performance. The performing organizations are Stennis Space Center (SSC), Marshall Space Flight Center (MSFC), Johnson Space Center-White Sands Test Facility (JSC/WSTF), and Glenn Research Center-Plum Brook Station (GRC/PBS). These facilities have a replacement value of two billion dollars. RPT supports several strategic goals including flying the Shuttle as safely as possible until its retirement, not later than 2010, and bringing a new Crew Exploration Vehicle into service as soon as possible after Shuttle retirement. Further information can be found at <https://rockettest.ssc.nasa>.



The Rocket Propulsion Test Program is performed at four NASA Centers.

Theme: Space and Flight Support (SFS)
Program: Rocket Propulsion Testing

Plans For FY 2007

Test capabilities implemented and upgraded for the Vision for Space Exploration will be made operationally ready to begin testing propulsion capabilities required to support missions beyond low Earth orbit. The RPT Program will continue to assist in the requirements definition for low Earth orbit and in-space propulsion systems and related technologies. Established testing requirements for the Exploration program will be used to identify excess and "at-risk" test facilities and will support decisions relative to test asset consolidation initiatives. Our inventory of 32 test stands is currently maintained at various states of operational readiness, ranging from active to mothballed. Test facility management, maintenance, sustaining engineering, operations, and facility modernization projects required to keep the test-related facilities in the appropriate state of operational readiness will continue to be funded. Propulsion test technology development will also be continued. Actual test planned at RPT facilities include: Space Shuttle Main Engine Testing at SSC A-2, RS-68 Engine Testing at SSC B-1, 24" Solid Rocket Test Motors Horizontal Testing at MSFC SPTA, Shuttle Reaction Control System Fleet Lead Testing at WSTF 301, Shuttle Reaction Control System Fleet Lead Testing at WSTF 328, Air Force Minuteman Testing at WSTF 401, Shuttle Orbital Maneuvering System Fleet Lead Testing at WSTF 403, Shuttle Reaction Control System Testing at WSTF 405, Shuttle Reaction Control System Testing at WSTF 406, and Exploration Propulsion System Technology Development Testing at Multiple TBD facilities.

Changes From FY 2006

- The RPT Program is a component of the Agency Shared Capabilities Assets Program, and is funded separately within SOMD. There were no major programmatic changes from the FY 2006 budget submission.

Program Management

The Program Office is located at SSC. The management of the program is accomplished through the RPT Management Board chaired by the Program Manager.



















Technical Parameters

RPT provides for non-programmatic support of test facilities at the performing Centers. This includes funding for test facility management, maintenance, sustaining engineering, operations, and facility modernization required to keep test-related facilities in a state of operational readiness. The RPT budget does not include resources to support the marginal costs of testing (e.g., direct labor, propellants, materials, program-unique facility modifications, etc.) since these activities are to be funded by programs as a direct cost when they occupy the RPT test stands. NASA, DoD, and commercial partners schedule time for the RPT-supported test stands. The scheduled time may include program-specific facility modifications in addition to the testing of the program-specific test article.

Technical Specifications	FY 2007 President's Budget	Change from Baseline
Provide non-programmatic support of rocket propulsion test facilities.	Ongoing	

Theme: Space and Flight Support (SFS)
Program: Rocket Propulsion Testing

Implementation Schedule:

Project	Schedule by Fiscal Year							Purpose	Phase Dates													
	05	06	07	08	09	10	11		Beg	End												
Rocket Propulsion Test Program, ongoing operations								Provides development of space transportation propulsion systems by sustaining "world class" core capabilities required by rocket engine development and testing programs.	Tech Form Dev Ops Res	Sep-11												
<table border="0"> <tr> <td></td> <td>Tech & Adv Concepts (Tech)</td> </tr> <tr> <td></td> <td>Formulation(Form)</td> </tr> <tr> <td></td> <td>Development (Dev)</td> </tr> <tr> <td></td> <td>Operations (Ops)</td> </tr> <tr> <td></td> <td>Research (Res)</td> </tr> <tr> <td></td> <td>Represents a period of no activity for the Project</td> </tr> </table>												Tech & Adv Concepts (Tech)		Formulation(Form)		Development (Dev)		Operations (Ops)		Research (Res)		Represents a period of no activity for the Project
	Tech & Adv Concepts (Tech)																					
	Formulation(Form)																					
	Development (Dev)																					
	Operations (Ops)																					
	Research (Res)																					
	Represents a period of no activity for the Project																					

Strategy For Major Planned Acquisitions

- The Test Operations Contract (TOC) will be completing its initial contract period, entering into a two-year contract option beginning September 2006.

Key Participants

- Rocket Propulsion Test Management Board Members: Stennis Space Center, Marshall Space Flight Center, Johnson Space Center, White Sands Test Facility, Glenn Research Center's Plum Brook Station, Kennedy Space Center (associate member), and Glenn Research Center (associate member).
- The primary contractors for Technical Services and Support are Jacobs-Sverdrup, Mississippi Space Services, Honeywell, and Plum Brook Operations Support Group.
- National Rocket Propulsion Test Management Board Department of Defense Members: Air Force Research Lab, Arnold Engineering Development Center, Redstone Technical Test Center, and Naval Air Warfare Center.

Risk Management

- RISK: The Risk Management Plan has been developed, and is currently in the review/approval process. The schedule for completion of the process has been negatively impacted by Hurricane Katrina. MITIGATION: The Risk Management Plan will continue in the review and approval process until completed.

President's FY 2007 Budget Request (Dollars in Millions)

<u>Crew Health & Safety</u>	<u>FY2005</u>	<u>FY2006</u>	<u>FY2007</u>	<u>FY2008</u>	<u>FY2009</u>	<u>FY2010</u>	<u>FY2011</u>
FY 2007 PRES BUD	8.4	10.0	10.4	11.5	11.2	11.1	11.1
Changes from FY 2006 Request	1.0	0.6	0.6	0.9	0.8	0.8	

Overview

The CHS Office is responsible for providing a program of comprehensive health care necessary to enable a healthy and productive crew during all phases of spaceflight missions, and to prevent and mitigate longterm negative health consequences as a result of spaceflight. The Crew Health and Safety (CHS) Office raises awareness and accountability for the total scope of health and safety of NASA's astronaut corps. The major functions of Crew Health and Safety are to provide headquarters leadership, advocacy and support for efforts to: design, implement, and manage a comprehensive health care program for spaceflight; provide mission support on operational health-related issues and tasks; conduct astronaut medical selection certification and health maintenance; and conduct technology development and clinical operational efforts required to support long-duration spaceflight missions.



(28 April 1998) --- Jay C. Buckey, Jr., and James A. Pawelczyk, payload specialists, conducting human autonomic experiments in the Neurolab of the Earth-orbiting Space Shuttle Columbia.

Plans For FY 2007

NASA will continue to develop and refine a standardized battery of clinical and physiological tests for all crewmembers. Workshops are planned to refine evidence-based information with the intent of applying this information to operational medicine. Crew Health Surveillance special projects include a continuing study of the effect of space flight on pharmacologic agents determining whether or not space flight significantly alters the effectiveness of medications. Real-Time Mission Evaluation supports the definition/implementation of medical care system requirements for all missions in conjunction with medical operations efforts. On-going maintenance of the Longitudinal Study of Astronaut Health (LSAH) which archives astronaut medical record information in database form and performs data analyses to support clinical care and long-term health assessments of the astronauts. Remote Medical Diagnostic and Informatics will design, implement and maintain a comprehensive data management infrastructure to support the objectives of the Space Medicine Program. Modules for real-time collection of medically relevant mission data will be added to the Mission Medical Information System this year. Additional tools such as the CHCS Manifest Tool will be implemented as operational needs and priorities are identified. NASA will continue adding all forms of clinical data to the Computerized Medical Information System, which is an electronic medical record used for real-time documentation of clinical care at the point of care. Develop and maintain environmental standards for all space exploration platforms.

Changes From FY 2006

- There were no major programmatic changes from the FY 2006 budget submission.

Theme: Space and Flight Support (SFS)
Program: Crew Health & Safety

Program Management

Crew Health and Safety is managed at Headquarters, with its core programs performed for SSP and ISS by the Life Sciences Directorate at JSC.

Technical Parameters

Provide enhancements to the health care provision environment both in space and on the ground. Manage health care for entire Astronaut Corps, both in space and during ground-based training. Certify the medical health of astronauts before flight and provide them with care throughout their careers. Medically support the FY 2006 Shuttle activities including planning, training, and medical operations support.

Technical Specifications	FY 2007 President's Budget	Change from Baseline
Manage health care for Astronaut Corps	Ongoing	

Implementation Schedule:

Project	Schedule by Fiscal Year							Purpose	Phase Dates	
	05	06	07	08	09	10	11		Beg	End
Crew Health and Safety(CHS), ongoing operations								Protects our astronauts from the hazards of space travel and identifies methods that allow astronauts to improve performance.	Tech	
									Form	
									Dev	
									Ops	
									Res	

■ Tech & Adv Concepts (Tech)
■ Formulation(Form)
■ Development (Dev)
■ Operations (Ops)
■ Research (Res)
■ Represents a period of no activity for the Project

Strategy For Major Planned Acquisitions

- No major acquisition planned.

Key Participants

- The flight surgeons and biomedical engineers are the primary participants in this area.
- The ISS International Partners are also involved in many areas of operational medicine planning.

Overview

The NASA Office of Inspector General (OIG) budget request for Fiscal Year 2007 (FY 2007) is \$33.5 million. The NASA OIG consists of 194 auditors, analysts, specialists, investigators, and support staff at NASA Headquarters in Washington, D.C., and NASA Centers throughout the United States. The FY 2007 Budget request supports the OIG's mission to prevent and detect crime, fraud, waste, abuse, and mismanagement while promoting economy, effectiveness, and efficiency within the Agency. Recognizing that the number of identified audits, investigations, and other activities significantly exceed the available resources, continuous adjustments of priorities will be necessary to ensure that a balanced coverage of NASA's programs and operations is maintained, critical and sensitive matters are promptly evaluated and investigated, and OIG customers receive timely, accurate, and complete responses.

The OIG, Office of Audits (OA) conducts independent, objective audits and reviews of NASA and NASA contractor programs and projects to improve NASA operations as well as a broad range of professional audit and advisory services. It also comments on NASA policies and is responsible for the oversight of audits performed under contract. The OA helps NASA accomplish its objectives by bringing a systematic, disciplined approach to evaluate and improve the economy, efficiency and effectiveness of NASA operations.

The OIG Office of Investigations (OI) identifies, investigates, and refers for prosecution cases of crime, waste, fraud, and abuse in NASA programs and operations. The OIG's Federal law enforcement officers investigate false claims, false statements, conspiracy, theft, computer crimes, mail fraud, and violations of Federal laws, such as the *Procurement Integrity Act* and the *Anti-Kickback Act*. Through its investigations, the OI also seeks to prevent and deter crime at NASA.

NASA's OIG FY 2007 request is broken out as follows:

- 83 percent of the proposed budget is dedicated to personnel and related costs, including salaries, benefits, training, monetary awards, worker's compensation, permanent change of station costs, metro subsidies, as well as the Government's contributions for Social Security, Medicare, health and life insurance, retirement accounts, matching contributions to Thrift Savings Plan accounts. Salaries include the required 25 percent law enforcement availability pay for criminal investigators.
- 4 percent of the proposed budget is dedicated to travel, per diem at current rates, and related expenses. The OIG staff is located at 14 offices on or near NASA installations and contractor facilities.
- 13 percent of the proposed budget is dedicated to operations and equipment – primarily funding for the Agency's annual financial audit – and also includes funding for government vehicles, special equipment for criminal investigators, and information technology equipment unique to the OIG.

Budget Authority (\$ in millions)	FY 2005	FY 2006	FY 2007	FY 2008	FY 2009	FY 2010	FY 2011
Personnel and Related Costs	25.5	26.4	27.9	28.8	29.6	30.4	31.2
Travel	1.2	1.3	1.3	1.4	1.4	1.5	1.5
Operations and Equipment	4.6	4.3	4.3	4.4	4.5	4.5	4.6
Total	31.3	32.0	33.5	34.6	35.5	36.4	37.3

Note: For all formats, the FY 2005 column reflects the FY 2005 Congressional Operating Plan, dated 9/30/2005. The FY 2006 column reflects the FY 2006 Congressional Initial Operating Plan, dated Jan 2006. The FY 2007 - 2011 columns represent the FY 2007 President's Budget Submit.

Supporting Data: Reconciliation of Appropriations to Budget Requests

(In Millions of Real Year Dollars)	TOTAL	Science, Aeronautics and Exploration	Exploration Capabilities	Inspector General
FISCAL YEAR 2005 REQUEST	16,244.0	7,760.0	8,456.4	27.6
Emergency Supplemental Appropriations for Hurricane Disasters Assistance Act, 2005, included as part of the FY 2005 Military Construction Appropriations Act (P.L. 108-132)	126.0	—	126.0	—
FY 2005 Consolidated Appropriations Act, P.L. 108-447 (including application of a 0.80% rescission)	-173.6	-81.9	-95.4	3.7
Transfers by NASA	0.0	211.4	-211.4	—
TOTAL FY 2005 BUDGET PLAN	*16,196.4	7,889.5	8,275.6	31.3

(In Millions of Real Year Dollars)	TOTAL	Science, Aeronautics and Exploration	Exploration Capabilities	Inspector General
FISCAL YEAR 2006 REQUEST	16,456.3	9,661.0	6,763.0	32.4
Science, State, Justice, Commerce, and Related Agencies Appropriations Act, 2006, P.L. 109-108 (including \$27M transfer from NOAA and application of 0.28% rescission)	-18.7	99.8	-118.5	-0.1
Department of Defense Appropriations Act, 2006, P.L. 109-148 (including application of 1.0% rescission)	-164.4	-98.2	-65.9	-0.3
Emergency Supplemental Appropriations to Address Hurricanes in the Gulf of Mexico, included as part of the Department of Defense Appropriation Act, 2006 P.L. 109-148	349.8	—	349.8	—
Transfers by NASA	0.0	58.7	-58.7	—
TOTAL FY 2006 BUDGET PLAN	16,623.1	9,721.3	6,869.7	32.0

Note: Numbers may not add due to rounding.

** Numbers indicated in the Total FY 2005 Budget Plan reflect the September 2005 Operating Plan Update.*

Supporting Data: FY 2005 Appropriation by Budget Line Item

FY 2005 APPROPRIATION STRUCTURE	Request	9/30/2005 Operating Plan
SCIENCE, AERONAUTICS and EXPLORATION	7,859.5	7,889.5
Space Science	4,258.9	4,288.9
Earth Science	1,535.0	1,535.0
Biological and Physical Research	924.6	924.6
Aeronautics	962.0	962.0
Education Programs	178.9	178.9
EXPLORATION CAPABILITIES	8,305.5	8,275.5
Exploration Systems	1,191.1	1,161.1
Space Flight	7,114.4	7,114.4
INSPECTOR GENERAL	31.3	31.3
TOTAL AGENCY	16,196.4	16,196.4

Note: Numbers may not add due to rounding.

Supporting Data: Reimbursable Estimates

Reimbursable Estimates by Appropriation

Budget Authority (\$ in millions)	FY 2005	FY 2006	FY 2007
Science, Aeronautics and Exploration	476.0	638.0	615.0
Exploration Capabilities	352.0	613.0	436.0
Total	828.0	1,251.0	1,051.0

Reimbursable agreements are agreements where the NASA costs associated with the undertaking are borne by the non-NASA partner. NASA undertakes reimbursable agreements when it has unique equipment, facilities, and services which it can make available to others in a manner that does not interfere with NASA mission requirements. As most reimbursable requests to NASA do not occur until the year of execution, the FY 2007 estimate is based on historical data and projected activity.

Supporting Data: Distribution of Funds by Installation

Distribution of Funds by Installation

(In millions of dollars)		FY 2006	FY 2007
Ames Research Center	Direct Personnel	97	83
	Direct Travel	4	3
	Center G& A	114	103
	Service Pools	55	51
	Institutional Investments	27	27
	ITA	13	12
	Total	310	279
	FTEs	1,284	1,193
Glenn Research Center	Direct Personnel	115	102
	Direct Travel	3	2
	Center G& A	115	95
	Service Pools	85	87
	Institutional Investments	24	23
	ITA	9	8
	Total	351	317
	FTEs	1,700	1,562
Langley Research Center	Direct Personnel	123	114
	Direct Travel	3	3
	Center G& A	137	119
	Service Pools	123	122
	Institutional Investments	25	29
	ITA	41	35
	Total	452	422
	FTEs	1,963	1,839
Dryden Flight Research Center	Direct Personnel	31	33
	Direct Travel	1	1
	Center G& A	37	37
	Service Pools	36	36
	Institutional Investments	4	5
	ITA	3	3
	Total	112	115
	FTEs	488	488

Supporting Data: Distribution of Funds by Installation

Goddard Space Flight Center	Direct Personnel	211	204
	Direct Travel	8	7
	Center G& A	188	188
	Service Pools	141	141
	Institutional Investments	27	21
	ITA	13	13
	Total	588	574
	FTEs	3,332	3,223
Marshall Flight Center	Direct Personnel	196	198
	Direct Travel	6	6
	Center G& A	188	171
	Service Pools	142	147
	Institutional Investments	27	23
	ITA	17	17
	Total	576	562
	FTEs	2,600	2,600
Stennis Space Center	Direct Personnel	17	17
	Direct Travel	1	1
	Center G& A	40	36
	Service Pools	22	22
	Institutional Investments	13	6
	ITA	2	2
	Total	95	84
	FTE's	284	284
Johnson Space Center	Direct Personnel	302	308
	Direct Travel	12	13
	Center G& A	188	189
	Service Pools	223	226
	Institutional Investments	34	40
	ITA	9	9
	Total	768	785
	FTEs	3,237	3,262

Supporting Data: Distribution of Funds by Installation

Kennedy Space Center	Direct Personnel	139	142
	Direct Travel	6	6
	Center G&A	211	217
	Service Pools	157	164
	Institutional Investments	39	48
	ITA	4	4
	Total	556	581
	FTEs	2,082	2,107
Headquarters	Personnel	200	192
	Travel	16	16
	HQ G&A	225	244
	Total	441	452
	FTEs	1,390	1,300
NASA Shared Services Center (NSSC)	Personnel	4	12
	Travel	1	1
	Total	5	13
	FTEs	50	121

Notes: Beginning in FY 2006, Institutional Investments includes non-programmatic Construction of Facilities and Environmental Compliance and Restoration, previously in Center and Corporate G&A.

FTEs shown are totals by Installation and include direct and mission support civil service personnel.

JPL not included since it is an FFRDC.

HQ G&A shown is HQ portion of Corporate G&A without HQ personnel and travel costs.

Supporting Data: Distribution of Funds by Installation

Corporate G&A

Corporate G&A provides for the management and oversight of Agency missions, functions, and centers, and the performance of some Agency-wide administrative activities. The responsibilities include the determination of programs and projects; establishment of management policies, procedures, and performance criteria; evaluation of progress; and the coordination and integration of all phases of the Agency's mission.

The majority of the budget, \$367M, supports the NASA Headquarters Mission Directorates and Mission Support Offices in the performance of those duties, and the facilities and services to enable them. Most of the remainder of Corporate G&A provides agency-wide activities and services for specific mission support projects, and provides the funding for their performance by NASA personnel and contractors at the NASA centers. Corporate G&A costs include the following Headquarters operations and Agency-wide functions:

- Corporate Management and Operations including headquarters personnel salaries, benefits, and travel; and operational costs such as rents, IT support, and facility services;
- Chief Information Officer providing agency-wide tools and systems for efficient operations, IT security, and agency E-Gov initiatives;
- Office of the Chief Engineer including engineering standards and system engineering;
- Office of Safety and Mission Assurance providing safety, reliability, maintainability, and quality mission assurance, risk management, & probabilistic risk assessments;
- Agency Operations providing agency-wide support including, training, awards, and payroll information services;
- Center Workforce Planning activities;
- Independent Verification and Validation Facility providing software quality assurance and validation;
- Program Analysis and Evaluation including the independent assessment of Agency programs, strategic planning functions, and the performance evaluation and analyses of programs, operational readiness and strategic investments;
- Corporate Security, including Headquarters physical security, and Agency-wide security initiatives and counterintelligence; and
- Office of the Chief Health and Medical Officer including Agency occupational health; and research of subject protection and medicine of extreme environments.

FY 2007 highlights include \$682 million total, as shown in the tables below.

Corporate G&A	FY 2007 (\$ in millions)
Corporate Management and Operations	367
Chief Information Officer	69
Office of Chief Engineer	37
Office of Safety and Mission Assurance	54
Agency Operations	45
Center Workforce Planning	41
Independent Verification and Validation Facility	27
Program Analysis and Evaluation	27
Corporate Security	10
Chief Health and Medical Officer	5
Total, Corporate G&A	682

Supporting Data: Distribution of Funds by Installation

Corporate G&A by Center	FY 2007 (\$ in millions)
NASA Headquarters	452
Kennedy Space Center	12
Johnson Space Center	13
Jet Propulsion Laboratory	10
Goddard Space Flight Center	59
Marshall Space Flight Center	37
Ames Research Center	27
Langley Research Center	45
Glenn Research Center	32
Dryden Flight Research Center	3
Stennis Space Center	1
Total, Corporate G&A	682

Institutional Investments

Effective in FY 2006, funds were transferred from Corporate and Center G&A to establish the Institutional Investments account. Institutional Investments includes non-programmatic Discrete and Minor Revitalization Construction projects previously funded in Center G&A, Facility Demolition projects, previously funded in Corporate G&A, and Environmental Compliance and Restoration activities, previously funded in Corporate G&A. FY 2007 highlights include:

Construction of Facilities, \$179.8 million for non-programmatic Construction of Facilities (CoF); includes:

- \$29.4 million for non-programmatic discrete projects;
- \$112.5 million for non-programmatic Minor Revitalization and Construction projects; and
- \$10.8 million for a Facility Demolition initiative, to remove unused buildings at the NASA field Centers; and

Environmental Compliance and Restoration:

The ECR program NASA employs is a phased approach that prioritizes Agency requirements for environmental remediation measures that must be implemented within the next several years, as well as needed requirements for other environmental compliance measures and management system initiatives. Among factors considered are relative urgency, safety, and potential health hazards.

\$60.0 million for Environmental Compliance and Restoration. Activities with the highest priority requirements planned for accomplishment in FY 2007 include:

- Plum Brook nuclear test reactor decommissioning and cleanup
- Remediation of groundwater contamination at JPL
- Remediation of groundwater contamination at White Sands Test Facility"
- \$60.0 million for Environmental Compliance and Restoration.

Supporting Data: Civil Service Distribution

Civil Service Distribution of Full Time Equivalents

The civil service workforce is the underpinning for the successful accomplishment of the Nation's civil aeronautics and space programs. These are the people who plan the programs; conduct and oversee the research; select and monitor contractors; and manage all of NASA's operations. NASA continues to restructure its civil service workforce to ensure that NASA Centers are productive contributors to the Agency's agenda and that NASA has the people and tools necessary to accomplish the long-term goals of space exploration.

Civil Service Distribution Detail

Full Time Equivalents (FTEs)	FY 2005	FY 2006	FY 2007
Johnson Space Center	3,126	3,237	3,262
Kennedy Space Center	1,981	2,082	2,107
Marshall Space Flight Center	2,668	2,600	2,600
Stennis Space Center	294	284	284
Ames Research Center	1,380	1,284	1,193
Dryden Flight Research Center	524	488	488
Langley Research Center	2,130	1,963	1,839
Glenn Research Center	1,821	1,700	1,562
Goddard Space Flight Center	3,303	3,332	3,223
Headquarters	1,397	1,390	1,300
NSSC	0	50	121
Total	18,624	18,410	17,979

Mission Directorate/Theme	FY 2005	FY 2006	FY 2007
Science Mission Directorate (Direct only)	2,362	2,384	2,133
Solar System Exploration	353	254	179
The Universe	624	763	652
Earth-Sun System	1,385	1,367	1,302
Exploration Systems Mission Directorate (Direct Only)	1,969	2,557	2,447
Constellation Systems	352	1,287	1,685
Exploration Systems Research & Technology	711	621	573
Prometheus Nuclear Systems & Technology	73	11	0
Human Systems Research & Technology	833	638	189
Aeronautics Research Mission Directorate (Direct Only)	1,969	1,618	1,562
Aeronautics Technology	1,969	1,618	1,562
Cross-Agency Support Programs (Direct Only)	124	316	277
Education Theme	58	59	46
Advanced Business Systems (IEMP)	0	186	121
Innovative Partnerships	66	71	69
Shared Capabilities	0	0	41
Space Operations Mission Directorate (Direct Only)	3,842	3,517	3,747
Space Shuttle	2,069	1,836	1,887
International Space Station	1,341	1,262	1,425
Space and Flight Support	432	420	435
G&A, Institutional Investments, Service Pools & NSSC	8,358	8,018	7,813
Total	18,624	18,410	17,979

Summary of Consulting Services

NASA uses paid experts and consultants to provide advice and expertise in addition to or beyond that available from its in-house civil service workforce. Management controls are established which assure that before entering into a consultant services arrangement with an individual that there is ample justification presented and the action is approved at top management levels.

NASA also uses experts and consultants to provide expertise on the selection of experiments for future space missions. The use of these experts and consultants, in addition to NASA civil service personnel, provides the Agency with an independent view that assures the selection of experiments likely to have the greatest scientific merit. Other individuals are used to provide independent analyses of technical and functional problems in order to give top management the widest possible range of views before making major decisions.

Expert/Consultants (Total NASA)	FY 2005	FY 2006	FY 2007
Number of Paid Experts and Consultants	36	50	50
Annual FTE Usage	8	8	8
Salaries	\$859,063	\$876,244	\$893,769
Total Salary and Benefits Costs	\$924,781	\$943,277	\$962,142
Travel Costs	\$419,275	\$431,853	\$444,809
Total Costs	\$1,344,056	\$1,375,180	\$1,406,951

Supporting Data: Construction of Facilities

Summary of Resources Included in Budget Request

In Millions of Dollars	FY 2005	FY 2006	FY 2007
Total Construction of Facilities	<u>190.4</u>	<u>344.9</u>	<u>280.6</u>
Science, Aeronautics, and Exploration Programs	2.9	86.6	76.3
Exploration Capabilities Programs	35.2	55.2	24.5
Non-Programmatic (included in Institutional Investments)*	152.3	203.1	179.8

* In FY 2005 Institutional CoF was included within Center G&A. Beginning in FY 2006 Institutional CoF is included under Institutional Investments and the amounts are shown in full cost.

The Construction of Facilities (CoF) program ensures that the facilities critical to achieving NASA's space and aeronautics programs are the right size and type, and that they are safe, secure, environmentally sound, and operated efficiently and effectively. It also ensures that NASA installations conform to requirements and initiatives for the protection of the environment and human health. NASA facilities are essential to the Agency and facility revitalization is needed to maintain infrastructure that is safe and capable of supporting NASA's missions. The facilities being revitalized or constructed in this program are expected to remain active in the long term and are consistent with current and anticipated Agency roles and missions.

Funding for construction projects required for specific programs is included in the appropriate budget line item within each Mission Directorate and summarized herein as program direct projects. Non-Programmatic CoF projects, also summarized herein, are required for components of NASA's basic infrastructure and institutional facilities. Funding for Non-Programmatic CoF projects is included within the Agency's indirect Institutional Investment account. New in FY 2006 is \$28.5 million for Construction of Office Building 4601 (MSFC) as directed by the FY 2006 appropriation. Descriptions and cost estimates of FY 2007 non-programmatic and programmatic (or "program direct") projects are provided to show a complete picture of NASA's budget requirement for facilities revitalization and construction.

The institutional facility projects requested for FY 2007 continue the vital rehabilitation, modification, and repair of facilities to renew and help preserve and enhance the capabilities and usefulness of existing facilities and ensure the safe, economical, and efficient use of NASA's physical plants. The projects repair and modernize deteriorating and obsolete building and utility systems that have reached or exceeded their normal design life, are no longer operating effectively or efficiently, and cannot be economically maintained. These projects include mechanical, structural, cooling, steam, electrical distribution, sewer, and storm drainage systems. Some projects replace substandard facilities in cases where it is more economical to demolish and rebuild than it is to restore. Projects between \$0.5 million and \$5.0 million are included as Minor Revitalization and Construction projects, and projects with an estimated cost of at least \$5.0 million are budgeted as Discrete projects. (Projects less than \$0.5 million are accomplished by routine day-to-day facility maintenance and repair activities provided for in direct program and Center operating budgets.) Should residual resources become available from any Minor Revitalization or Discrete project, they will be used for urgently needed facility revitalization requirements and Congress will be notified before work is initiated for any such Discrete projects. Funds requested for Facility Planning and Design (FP&D) cover: advance planning and design requirements for future projects; preparation of facility project design drawings and bid specifications; master planning; facilities studies; engineering reports and studies; and critical functional leadership activities directed at increasing the rate of return of constrained Agency resources while keeping the facility infrastructure safe, reliable, and available.

Supporting Data: Construction of Facilities

Summary of FY 2007 Program Direct Projects by Mission Directorate

In Millions of Dollars	FY 2005	FY 2006	FY 2007
<u>SCIENCE, AERONAUTICS, AND EXPLORATION CoF PROJECTS</u>	<u>2.9</u>	<u>86.6</u>	<u>76.3</u>
<u>SCIENCE</u>	<u>2.9</u>	<u>58.1</u>	<u>76.3</u>
Construct Exploration Sciences Building (GSFC)	----	15.0	30.0
Construct Administrative and Education Complex (JPL)	----	12.6	19.5
Construct Flight Projects Center (JPL)	----	24.0	26.8
Connect Madrid Deep Space Communication Complex to Commercial Power (JPL)	----	1.3	----
Minor Revitalization of Facilities at Various Locations (less than \$5M per project)	2.5	2.2	----
Facility Planning and Design	.4	3.0	----
<u>EXPLORATION SYSTEMS</u>	<u>----</u>	<u>28.5</u>	<u>----</u>
Construct Office Building 4601 (MSFC)	----	28.5	----
<u>EXPLORATION CAPABILITIES CoF PROJECTS</u>	<u>35.2</u>	<u>55.2</u>	<u>24.5</u>
<u>SPACE OPERATIONS (SPACE SHUTTLE)</u>	<u>24.2</u>	<u>51.6</u>	<u>20.1</u>
Repairs to Vehicle Assembly Building (KSC)	9.8	15.6	14.1
Minor Revitalization of Facilities at Various Locations (less than \$5M per project)	12.1	35.4	6.0
Facility Planning and Design	2.3	0.6	----
<u>SPACE AND FLIGHT SUPPORT</u>	<u>7.1</u>	<u>3.6</u>	<u>4.4</u>
Minor Revitalization of Facilities at Various Locations (less than \$5M per project)	6.7	3.2	4.0
Facility Planning and Design	.4	.4	.4
<u>EXPLORATION SYSTEMS</u>	<u>3.9</u>	<u>----</u>	<u>----</u>
Modification for Robotics Clean Room, Building 10 (GSFC)	3.9	----	----

Summary of FY 2007 Non-Programmatic CoF Projects

In Millions of Dollars	FY 2005	FY 2006	FY 2007
<u>NON-PROGRAMMATIC PROJECTS</u>	<u>152.3</u>	<u>203.1</u>	<u>179.8</u>
Construct New Office Facility (JSC)	----	----	15.0
Renovation of Operations & Checkout Building (KSC)	----	5.7	7.5
Rehabilitate Building Systems, Building 4207 (MSFC)	----	----	6.9
Rehabilitate Electrical Distribution System (ARC)	----	5.0	----
Repair Emergency Chiller System, Building 24 (GSFC)	----	5.7	----
Seismic Upgrade of Telecommunications Building B238 (JPL)	----	6.0	----
Upgrade Electrical Power Distribution (LaRC)	----	7.4	----

Supporting Data: Construction of Facilities

Infrastructure Upgrades to Accommodate Unmanned Aerial Vehicles (WFF)	----	4.0	----
Institute of Science Research Earmark	----	10.0	----
Realign Soil Conservation Road (GSFC)	3.2	----	----
Construct Replacement for Fire Station No. 2 at Shuttle Landing Facility (KSC)	6.4	----	----
Construct Liquid Nitrogen Plant (LaRC)	11.0	----	----
Construct First Response Facility (SSC)	6.6	----	----
Minor Revitalization of Facilities at Various Locations (less than \$5M per project)	94.3	120.8	112.5
Facility Planning and Design	20.8	28.1	27.1
Demolition of Facilities	10.0	10.4	10.8

Discrete Direct Projects within the Science, Aeronautics, and Exploration Account

Space Science Program

Project Title: Construct Exploration Sciences Building

Location: Goddard Space Flight Center (GSFC), Greenbelt, MD

Mission Directorate: Science

FY 2007 Estimate: \$30.0M

This project will construct a new 262,500 square-foot laboratory and office building at the Greenbelt site. The facility will provide state of the art laboratory, support, and office space for 750 scientists. The new facility will consolidate science work groups and is expected to increase work efficiency and scientific collaboration. The new facility will replace the 44-year old Research Projects Laboratory building and the 37-year old Space Science Data Center building. These facilities must be replaced because the electrical and mechanical systems have become unreliable, impacting science functions. The buildings require extensive repairs, and have high energy and operating costs. The new Exploration Science Building will incorporate energy reducing and environmentally friendly features that will reduce overall operating costs and generate a cost savings over the life of the facility. This is the second of three phases with a total estimated cost of \$65 million and completion planned in 2008.

Project Title: Construct Administrative and Education Complex

Location: Jet Propulsion Laboratory (JPL), Pasadena, CA

Mission Directorate: Science

FY 2007 Estimate: \$19.5M

This project replaces current Administration Building 180 and Visitor Reception Building 249 and provides public outreach and education facilities with a new Administration Building and Education Center Complex. This project will provide office, conference, and support facilities for approximately 220 people currently housed in Building 180. A new 3,345 square-meter (36,000 square feet) Education Center will be constructed to include a sloped-floor theater/auditorium, Exhibit Hall, Digital Learning Network Studio, Education Program Work Area, Educator Resource Center, Professional Development Center, and Student Events Multipurpose Room. Parking spaces to support the new complex are planned following demolition of existing Building 180. Administration Building 180 is deficient in its ability to resist a major seismic event. It is more economical to replace than to upgrade the building for seismic safety due to the inherent design of the structure, inefficiency in space utilization, extent of asbestos fireproofing, age of the building and its support systems, and

Supporting Data: Construction of Facilities

non-conformance with contemporary life-safety and accessibility codes and regulations. The Education Center will support JPL's role in carrying out the initiatives of NASA's Office of Education by providing space and facilities for conferences, data and images distribution, exhibits and displays, public outreach events, and other meetings that bring members of the educational community, the media, and the general public to JPL. This is consistent with part of NASA's Mission to educate the public. This is the second of five phases with an estimated total construction cost of \$76 million. Completion is planned in FY 2011.

Project Title: Construct Flight Projects Center

Location: Jet Propulsion Laboratory (JPL), Pasadena, CA

Mission Directorate: Science

FY 2007 Estimate: \$26.8M

This project will construct a new 17,000 square-meter (183,000 square feet) six-story building to provide office space plus conference and support facilities for approximately 620 people. The new facility will co-locate the program and project staffs for flight projects into a single building. The building will contain an integrated 400 fixed-seat sloped-floor Project Review Center to host large project reviews and JPL institutional meetings, as well as a 200 moveable-seat flat-floor conference room that will be divisible into four 50 seat conference rooms. Expensive off-site leased space will be vacated and the need for additional off-site leases will be avoided. Six 1940's vintage buildings and 44 wooden trailers will be demolished. The Flight Projects Center will provide the means to collocate essential flight project personnel into a single location for a true teaming environment. This will: increase project development efficiency; enhance communications; allow sharing of common resources; enable more efficient dissemination of lessons learned among projects; and enhance the ability of experts to support multiple program/project functions. This is the second of three phases with a total estimated cost of \$65 million and completion planned in 2008.

Discrete Direct Projects within the Exploration Capabilities Account

Space Shuttle Program

Project Title: Repairs to Vehicle Assembly Building

Location: Kennedy Space Center (KSC), Merritt Island, FL

Mission Directorate: Space Operations

FY2007 Estimate: \$14.1M

This project will repair and refurbish several of the Vehicle Assembly Building (VAB) systems and mechanisms. Secondary power systems and switch-gear will be revitalized. Fire extinguishing systems for the extensible platform in high-bay 3 will be upgraded. VAB systems are significantly deteriorated as a result of 40 years of operational use and the corrosive environment at the Kennedy Space Center. VAB mechanical and electrical systems have become unreliable. In some cases, system components are obsolete and replacement parts are no longer available. Failure to complete VAB repairs could lead to loss of flight hardware in VAB, and increased risk of injury to personnel. This is the fourth phase of a five-phase program of VAB system revitalization, and is estimated to cost a total of \$65 million and be completed in 2008.

Supporting Data: Construction of Facilities

FY 2007 Non-Programmatic Construction of Facilities in Institutional Investments

In Millions of Dollars	FY 2005	FY 2006	FY 2007
Total Non-Programmatic Construction of Facilities	<u>152.3</u>	<u>203.1</u>	<u>179.8</u>
Discrete Projects	27.2	43.8	29.4
Minor Revitalization and Construction	94.3	120.8	112.5
Facility Planning and Design	20.8	28.1	27.1
Demolition	10.0	10.4	10.8

Non-Programmatic Discrete Projects

Project Title: Construct New Office Facility

Location: Johnson Space Center, Houston, TX

FY 2007 Estimate: \$15.0M

This project provides for the construction of a new 92,000 square foot office building to be located near the central mall area of the Center and is an essential part of Johnson Space Center's plan to refurbish existing Pre-cast Exposed Aggregate Facing (PEAF) constructed office facilities. It will provide permanent space for 120 employees from temporary facility T-585 built in 1985 that will be demolished. The new facility will provide temporary housing for approximately 400 displaced employees each year during refurbishment of existing PEAFF facilities. A total of 1.38 million square feet of refurbishment is planned over the next 22 years. The facility will provide permanent housing for employees currently in metal buildings that will be demolished after the refurbishment of PEAFF facilities is completed. The refurbishment program will ultimately reduce the square footage of office space on the Center and increase building efficiency. The new facility will have open and flexible office space to accommodate churn during the refurbishment program. It will be designed to meet the US Green Building Council's Leadership in Environmental and Energy Design, Silver Certification as a minimum. This is the first of two phases with a total estimated construction cost of \$27 million with completion planned in FY 2008.

Project Title: Renovation of Operations and Checkout Building

Location: Kennedy Space Center, Merritt Island, FL

FY 2007 Estimate: \$7.5M

This project revitalizes the Operations and Checkout Building for indoor air quality, energy efficiency and life safety compliance in various locations. The revitalization will consist of installing a sprinkler system, energy-efficient office lighting, complete updating of the Heating, Ventilation, and Air Conditioning (HVAC) systems and demolishing the existing HVAC ductwork that contributes to poor indoor air quality. Asbestos abatement will also be included. Other facility systems include HVAC controls, lighting and fire protection. This phase will include the demolition and renovation of a portion of the North Wing. In addition, this project will upgrade employees' office areas, including power, communications and data systems. A critical need exists at the Kennedy Space Center to revitalize substandard housing affecting the health, safety and welfare of personnel. The deteriorated substandard housing is contributing to costly maintenance needs, highly inefficient energy consumption and unhealthy working environments. The facility has not been updated to current Florida Building Codes, Florida Fire Prevention Codes, or National Fire Protection Association Life Safety Standards. This project will relieve personnel of the health dangers associated with poor Indoor Air Quality and Building Related Illnesses. An increase in space

Supporting Data: Construction of Facilities

utilization will be realized. This is the second of six phases with a total estimated construction cost of \$37 million and completion planned for FY 2011.

Project Title: Rehabilitate Building Systems, Building 4207

Location: Marshall Space Flight Center, Huntsville, AL

FY 2007 Estimate: \$6.9M

This project will refurbish the building systems in MSFC's critical communications center, building 4207. The air conditioning system will be replaced with a new redundant system. Double ended electrical services will be provided. A new emergency generator and an uninterruptible power supply (UPS) will be installed. UPS work will include construction of a small UPS building east of the building 4207. Because of the current configuration of building 4207 utility and distribution systems, the building can not meet stringent reliability requirements for mission critical communications and IT systems. This project will improve system reliability to the industry benchmark of 99.98% reliability for critical IT systems.

Minor Revitalization & Construction of Facilities (projects less than \$5.0M each)

	Institutional Investments	SOMD Direct
FY 2007 Estimate (Millions of Dollars)	112.5	10.0
Ames Research Center	20.7	
Dryden Flight Research Center	3.4	
Glenn Research Center	16.5	
Goddard Space Flight Center	15.6	
Jet Propulsion Laboratory	6.1	
Johnson Space Center	9.1	
Kennedy Space Center	16.1	10.0
Langley Research Center	17.1	
Marshall Space Flight Center	5.1	
Stennis Space Center	2.8	

This request includes facility revitalization and construction needs greater than \$0.5 million but less than \$5.0 million per project. Projects \$0.5 million and less are normally accomplished by routine day-to-day facility maintenance and repair activities provided for in direct program and Center operating budgets. Proposed FY 2007 Non-Programmatic minor revitalization and construction projects total \$112.5 million for components of the basic infrastructure and institutional facilities, funded in Institutional Investments, and \$10 million for Space Operations Mission Directorate funded projects. These resources provide for revitalization and construction of facilities at NASA field installations and government-owned industrial plants supporting NASA activities. Revitalization and modernization projects provide for the repair, modernization, and/or upgrade of facilities and collateral equipment. Repair projects restore facilities and components to a condition substantially equivalent to the originally intended and designed capability. Repair and modernization work includes the substantially equivalent replacement of utility systems and collateral equipment necessitated by incipient or actual breakdown. It also includes major preventive measures that are normally accomplished on a cyclic schedule and those quickly needed out-of-cycle based on

Supporting Data: Construction of Facilities

adverse condition information revealed during predictive testing and inspection efforts. Modernization and upgrade projects include both restoration of current functional capability and enhancement of the condition of a facility so that it can more effectively accomplish its designated purpose or increase its functional capability or so that it can meet new building, fire, and accessibility codes.

The minor revitalization and construction projects that comprise this request are of the highest priority, based on relative urgency and expected return on investment. The titles of the projects are designed to identify the primary intent of each project and may not always capture the entire scope or description of each project. Also, during the year, some rearrangement of priorities may be necessary which may cause a change in some of the items to be accomplished.

Non-Programmatic Minor Revitalization Projects: \$112.5 million

A. Ames Research Center (ARC), \$20.7 million for the following:

1. Install Interaction Heating Facility Heat Exchanger, N238
2. Rehabilitate and Modify Utility Controls Panels/Bench Boards, N238
3. Rehabilitate Electrical Distribution System, Phase 6
4. Repair Storm Drains
5. Seismic Upgrades, N244 and N245
6. Rehabilitate and Modify Heating, Ventilation, and Air Conditioning (HVAC) System, N245
7. Repave Runway 32L
8. Repair Roof and HVAC System, N003
9. Improve Ventilation Systems, N237, N240, and N242
10. Install Emergency Generator, N233

B. Dryden Flight Research Center (DFRC), \$3.4 million for the following:

1. Repair Center Uninterruptible Power System
2. Repair Primary Electrical Distribution System, Phase 5
3. Repair B-4800 Infrastructure, Phase 4
4. Repair Roofs, Phase 2

C. Glenn Research Center (GRC), \$16.5 million for the following:

1. Repair Parking Lots and Roads, Various Locations, Phase 2
2. Repair Roofs and Masonry, Various Buildings
3. Repair Sewers, Phase 8
4. Modifications for Life Safety, Fire Alarms, and Sprinklers, Various Locations
5. Rehabilitate Model Fabrication and Instrument Facility Building 14, Phase 4
6. Rehabilitate Mechanical and Electrical Systems, Building 21 Annex
7. Rehabilitate Electrical Substation M1, West Area
8. Rehabilitate High Voltage Substations B and G
9. Repair Utility Tunnel, Buildings 23 and 77
10. Rehabilitate Mechanical and Electrical Systems, Building 60

D. Goddard Space Flight Center (GSFC), \$15.6 million for the following:

1. Repair Emergency Chiller System, Building 24, Phase 2
2. Upgrade Facilities Master Plan Roadway, Phase 1
3. Replace Wallops Orbital Tracking System 1.1 Megawatt Generator, WFF
4. Repair Roofs, Various Buildings
5. Restore Building 23, Phase 6
6. Construct Addition to Launch Project Building, WFF

Supporting Data: Construction of Facilities

E. Jet Propulsion Laboratory (JPL), \$6.1 million for the following:

1. Repair Spacecraft Assembly Facility, B179, Phase 2
2. Replace HVAC System, Space Flight Operations Facility, B230
3. Upgrade and Modify 25-Ft Space Simulator, B150
4. Replace Roofs, Various Buildings
5. Modifications for Accessibility, Various Buildings
6. Construct Perimeter Security Fence
7. Install Fire Suppression Systems, Various Facilities, Table Mountain Facility

F. Johnson Space Center (JSC), \$9.1 million for the following:

1. Replace Roofs, Various Buildings
2. Upgrade Water Systems, WSTF

G. Kennedy Space Center (KSC), \$16.1 million for the following:

1. Replace Air Handling Units, Headquarters Building M6-399, Phase 3
2. Refurbish Banana River Bridge
3. Revitalize and Upgrade Water and Waste Water Systems, Various Locations
4. Revitalize Cable and Duct Distribution, Industrial Area, Phase 4
5. Upgrade Industrial Area Chiller Plant
6. Replace Critical Transformers, Industrial and LC-39 Areas, Phase 2
7. Repairs to C-5 Substation
8. Upgrade Facilities for Disabled Access, Various Locations
9. Construct Replacement Battery and Generator Storage Facility

H. Langley Research Center (LaRC), \$17.1 million for the following:

1. Repairs to High Pressure Air Distribution System
2. Replace Electrical Systems, Various Facilities
3. Refurbish B645A
4. Upgrade Electrical Systems, B1266
5. Upgrades to Comply with American with Disabilities Act (ADA), Phase 3
6. Upgrade Stratton Road Substation, B1233

I. Marshall Space Flight Center (MSFC), \$5.1 million for the following:

1. Upgrade Building Systems for Safety and Energy Efficiency, Various Buildings, Phase 1

J. Stennis Space Center, \$2.8 million for the following:

1. Repairs to Power Distribution Site wide, Phase 2
2. Repair Pavement, Various Locations
3. Restore Fire Alarm Systems, Phase 6

Exploration Capabilities (SOMD) Direct Minor Revitalization Projects: \$10 million

A. Kennedy Space Center (KSC), \$10 million for the following:

1. Replace Water Main at Hanger AE (Space and Flight Support)
2. Renovate/Refurbish Building 840 (Space and Flight Support)
3. Upgrade HVAC Building 1628, Vandenberg Launch Site (Space and Flight Support)
4. Replace Doors and Roof, Building 836 (Space and Flight Support)
5. Replace Launch Control Center Doors (Shuttle)
6. Refurbish Rollup Doors, RPSF Surge Buildings (Shuttle)

Facility Planning and Design (FP&D)

Cognizant Office: Office of Infrastructure and Administration

FY 2007 Estimate: \$27.1

These funds are required to provide for: advance planning and design activities; special engineering studies; facility engineering research; preliminary engineering efforts required to initiate design-build projects; preparation of final designs, construction plans, specifications, and associated cost estimates; and participation in facilities-related professional engineering associations and organizations. These resources provide for project planning and design activities associated with non-programmatic construction projects. Project planning and design activities for construction projects required to conduct specific Exploration Capabilities or Science, Aeronautics and Exploration programs or projects are included in the appropriate budget line item. Other activities funded include: master planning; value engineering studies; design and construction management studies; facility operation and maintenance studies; facilities utilization analyses; engineering support for facilities management systems; and capital leveraging research activities.

Demolition of Facilities

Cognizant Office: Office of Infrastructure and Administration

FY 2007 Estimate: \$10.8M

The amount requested is required to fund major demolition projects Agency-wide. NASA owns over 2,800 buildings, and over 2,600 other structures, totaling almost 44 million square feet with a current replacement value of over \$24 billion. About two million square feet of these facilities are "mothballed" or "abandoned," another million square feet are to be closed in the next four years, and possibly more will be identified for closure due to an upcoming NASA Real Estate Strategic Review. Closed facilities are a drain on NASA resources, deteriorate into eyesores and possible safety hazards, and should be demolished. Demolition projects have accounted for a deferred maintenance reduction of \$98M and have an estimated payback period of seven years.

National Institute of Aerospace (NIA)

The National Institute of Aerospace (NIA) is a research and education institute initiated by NASA Langley Research Center (LaRC) to ensure a national capability to support NASA's mission by expanding collaboration with academia and leveraging expertise inside and outside NASA. A nation-wide competitive procurement resulted in the selection of the NIA, which is a non-profit consortium that included these founding members: American Institute of Aeronautics and Astronautics Foundation, Georgia Institute of Technology, North Carolina Agricultural and Technical State University, North Carolina State University, University of Maryland, University of Virginia, and Virginia Polytechnic Institute and State University. Hampton University became a full member and Old Dominion University and the College of William and Mary affiliate members. Since January, 2003, the NIA has significantly expanded its research portfolio and collaborations with non-member universities and colleges, industry partners, and other government agencies throughout the country. NIA's vibrant Visiting Scholars Program has expanded its boundaries by engaging nationally and internationally recognized experts/scholars.

The NIA conducts basic, formative, and leading edge research and develops revolutionary new technologies in all areas of interest to NASA through partnerships with the Nation's universities, industry, and other government agencies. NIA performs research in a broad range of disciplines relevant to NASA's Aeronautics, Space Exploration, Science and Space Operations missions. In 2005, NIA's research programs grew substantially, including research programs in Air Traffic, Rotorcraft Aeromechanics, Aviation Safety, Materials, Flight Systems, Exploration, and Atmospheric Sciences.

The NIA's Graduate Education Program offers M.S. and Ph.D. degrees in the fields of engineering and sciences relevant to the agency. The NIA, through its university partners, offers 110 graduate engineering courses, including the newly created Space Exploration Design Tools and Spacecraft and Launch Vehicle Design. Of the 42 full-time graduate students, 31 percent are Ph.D. candidates and 69 percent M.S. candidates. NIA's Continuing Education Program has also grown substantially. In 2005 they delivered 46 seminar programs, hosted and facilitated 10 workshops, and conducted 12 short courses. In 2005, the NASA Engineering and Safety Center (NESC) partnered with the NIA to develop and operate the NESC Academy. The purpose of the NESC Academy is to pass on the expertise developed by the previous generations that developed the Apollo, Saturn and the Space Shuttle to the current and next generations responsible for development of a new Crew Exploration Vehicle, a new Crew Launch Vehicle, and beyond. The NESC Academy captures the knowledge and lessons learned from NASA's most accomplished space flight engineering leaders, develops short course training materials, and offers a series of 15 short courses on university campuses throughout the Nation.

Langley Research Center has a keen interest in contributing to the Vision for Space Exploration, but that will require some realignment of workforce. NIA is positioned to develop training and/or retraining programs to support that realignment.

Budget Authority (\$ in millions)	FY 2005 Actuals	FY 2006 Estimates	FY 2007 Budget
NASA Funding	26.0	27.5	29.0
University Cost-Sharing*	<u>1.2</u>	<u>1.1</u>	<u>1.1</u>
Total Program Funding	27.2	28.6	30.1

*FY 2005 University Cost-Sharing is an estimate; actuals were unavailable from NIA at the time of this submission.

National Aeronautics and Space Administration Proposed Appropriation Language

**SCIENCE, AERONAUTICS AND EXPLORATION
(INCLUDING TRANSFER OF FUNDS)**

For necessary expenses, not otherwise provided for, in the conduct and support of science, aeronautics and exploration research and development activities, including research, development, operations, support and services; maintenance; construction of facilities including repair, rehabilitation, revitalization, and modification of facilities, construction of new facilities and additions to existing facilities, facility planning and design, and restoration, and acquisition or condemnation of real property, as authorized by law; environmental compliance and restoration; space flight, spacecraft control and communications activities including operations, production, and services; program management; personnel and related costs, including uniforms or allowances therefore, as authorized by 5 U.S.C. 5901—5902; travel expenses; purchase and hire of passenger motor vehicles; not to exceed \$35,000 for official reception and representation expenses; and purchase, lease, charter, maintenance and operation of mission and administrative aircraft, \$[9,761,400,000] 10,523,805,000, to remain available until September 30, [2007] 2008, of which amounts as determined by the Administrator for salaries and benefits; training, travel and awards; facility and related costs; information technology services; science, engineering, fabricating and testing services; and other administrative services may be transferred to "Exploration Capabilities" in accordance with section 313 342(b) of the National Aeronautics and Space Act of 1958, as amended by Public Law 406-377 108-477 [Correction] (Science, Departments of State, Justice, and Commerce and Related Agencies Appropriations Act, 2006.)

**EXPLORATION CAPABILITIES
(INCLUDING TRANSFER OF FUNDS)**

For necessary expenses, not otherwise provided for, in the conduct and support of exploration capabilities research and development activities, including research, development, operations, support and services; maintenance; construction of facilities including repair, rehabilitation, revitalization and modification of facilities, construction of new facilities and additions to existing facilities, facility planning and design, and acquisition or condemnation of real property, as authorized by law; environmental compliance and restoration; space flight, spacecraft control and communications activities including operations, production, and services; program management; personnel and related costs, including uniforms or allowances therefore, as authorized by 5 U.S.C. 5901—5902; travel expenses; purchase and hire of passenger motor vehicles; not to exceed \$35,000 for official reception and representation expenses; and purchase, lease, charter, maintenance and operation of mission and administrative aircraft, \$[6,663,000,000] 6,234,922,000, to remain available until September 30, [2007] 2008, of which amounts as determined by the Administrator for salaries and benefits; training, travel and awards; facility and related costs; information technology services; science, engineering, fabricating and testing services; and other administrative services may be transferred to "Science, Aeronautics and Exploration" in accordance with section 313 342(b) of the National Aeronautics and Space Act of 1958, as amended by Public Law 406-377. 108-477 [Correction] (Science, Departments of State, Justice, and Commerce and Related Agencies Appropriations Act, 2006.)

OFFICE OF INSPECTOR GENERAL

For necessary expenses of the Office of Inspector General in carrying out the Inspector General Act of 1978, as amended, \$[32,400,000] 33,500,000, to remain available until September 30, [2007] 2008.

ADMINISTRATIVE PROVISIONS

Notwithstanding the limitation on the availability of funds appropriated for "Science, Aeronautics and Exploration" or "Exploration Capabilities" by this appropriations Act, when any activity has been initiated by the incurrence of obligations for construction of facilities or environmental compliance and restoration activities as authorized by law, such amount available for such activity shall remain available until expended. This provision does not apply to the amounts appropriated for institutional minor revitalization and construction of facilities, and institutional facility planning and design.

Notwithstanding the limitation on the availability of funds appropriated for "Science, Aeronautics and Exploration" or "Exploration Capabilities" by this appropriations Act, the amounts appropriated for construction of facilities shall remain available until September 30, [2008] 2009.

FY 2007 Proposed Appropriation Language

Funds for announced prizes otherwise authorized shall remain available, without fiscal year limitation, until the prize is claimed or the offer is withdrawn. Funding shall not be made available for Centennial Challenges unless authorized.

[Funding made available under the headings "Exploration Capabilities" and "Science, Aeronautics and Exploration" in this Act shall be governed by the terms and conditions specified in the statement of managers accompanying the conference report for this Act.]

[The unexpired balances of prior appropriations to National Aeronautics and Space Administration for activities for which funds are provided under this Act may be transferred to the new account established for the appropriation that provides such activity under this Act. Balances so transferred may be merged with funds in the newly established account and thereafter may be accounted for as one fund under the same terms and conditions.]

Amounts made available in this Act under the headings, 'Science, Exploration, and Aeronautics' and 'Exploration Capabilities' may be transferred between such accounts, subject to the reprogramming procedures in section 605 of this Act."

GENERAL PROVISIONS

[Sec. 614. Section 313 of the National Aeronautics and Space Act of 1958, as amended (42 U.S.C. 2451 et seq.) is amended by deleting subsection (a)(2) and renumbering subsection (a)(3) as (a)(2).]

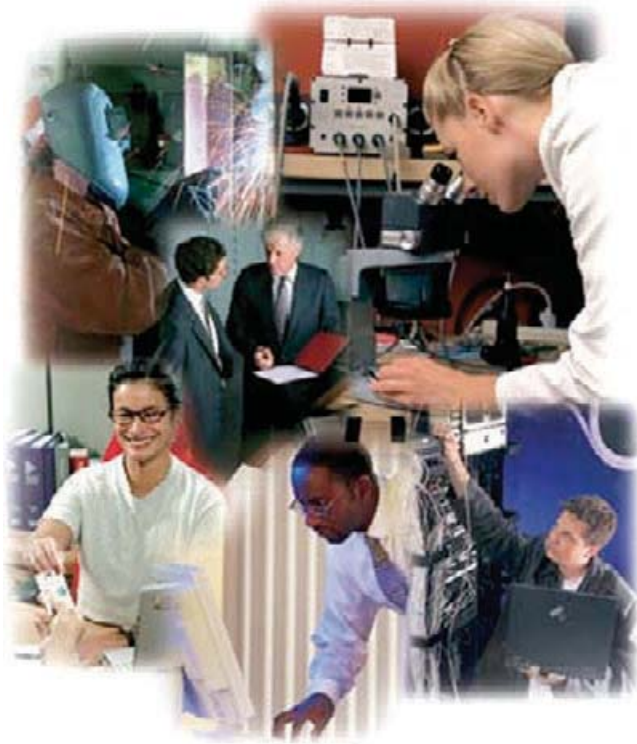

Sections

**Full Cost Budgeting –
FY 2007 Update**

**President’s Management
Agenda Update**

**FY 2006 Performance
Plan Update**

**FY 2007 Performance
Plan**

MANAGEMENT AND PERFORMANCE

Overview

NASA’s planning and performance management system is crucial to strategic management at NASA. The Agency has in place an integrated system to plan, monitor, assess, evaluate, and measure performance, identify issues (including the status of resources), gauge the organization’s overall health, and provide appropriate data and information to NASA decision-makers. NASA’s system produces, and makes available, ongoing monthly and quarterly analyses and reviews, annual assessments in support of budget formulation (for budget guidance and issue identification, analysis and disposition), periodic, in-depth program or special purpose assessments, and recurring and special assessment reports to internal and external organizations.

Through this system, NASA identifies the Agency’s long-term strategic goals, near-term outcomes, and key performance measures, develops and implements plans to achieve these objectives, and continuously measures NASA’s progress in reaching the Agency’s goals. NASA managers use these tracked performance results as a basis for key investment decisions, and NASA performance data provides a foundation for both programmatic and institutional decision-making.

NASA was the first agency in the federal government that integrated strategic, budget, and performance planning processes and documents and used full cost budgeting/accounting to identify the true costs for evaluating investment alternatives. The Agency’s approach to full cost budgeting and accounting is discussed in detail later in this section. This section also includes the updated FY 2006 and the proposed FY 2007 performance commitments for the requested resources.

NASA also regularly responds to and reports on the Agency’s internally and externally imposed performance measurement and reporting requirements, tools, and practices (e.g., reporting

Management and Performance

requirements of the Government Performance and Results Act, the President's Management Agenda [PMA], and Office of Management and Budget's (OMB) Program Assessment Rating Tool [PART]). NASA tracks six initiatives under the PMA: Strategic Management of Human Capital; Competitive Sourcing; E-Government; Budget and Performance Integration; Real Property; and Financial Performance. The progress on these is summarized within this section.

Each year, OMB uses the Program Assessment Rating Tool to review selected NASA programs. NASA then incorporates the review findings into investment decisions. NASA also agrees to a series of follow-up actions in response to OMB's findings, which may be found in the individual Theme sections of this document. In the coming year, NASA will work with OMB to review the following budget areas: the Solar System Exploration Theme, the Constellation Systems Theme and the Integrated Enterprise Management Program within the Advanced Business Systems Theme.

NASA continues to strive to find new ways to use program performance information to support decisions on strategy and budget. A main focus of NASA in the coming year is on improving the policy, metrics and analysis processes for life cycle cost and schedule performance monitoring and reporting.

Full Cost Budgeting

For the fourth consecutive year, NASA has formulated its budget in “Full Cost” advancing the methods first utilized three years ago. NASA has operated in a total full cost environment since its implementation on October 1, 2003. Since then, managers have been managing programs in terms of their total costs.

“Full cost” means that each program’s budget estimate includes all of the program’s direct and indirect costs, including all civil service salaries and infrastructure costs. Full cost budgeting directly links each program with all the resources it benefits from or consumes. This linkage is designed to provide accurate estimates and actual cost information, enabling managers to assess resources in terms of their financial cost and value to the program. Full cost budgeting also allows managers to better hold accountable those managing the resources.

Implementing full cost has been crucial to NASA’s success to integrate budget and performance as called for in the President’s Management Agenda (PMA). NASA was the first agency to receive the coveted “green” rating in this area. In response to NASA implementing the Vision for Space Exploration, the Agency has recently adapted a new budget data structure that will better facilitate full cost practices. First, budgetary reporting elements are organized according to a hierarchy: (from highest to lowest) Mission Directorate, Theme, Program and Project. Secondly, Programs and Projects are clearly distinguished from each other and managed accordingly. Moreover, the Projects and Programs are scrutinized for compliance with the NASA Procedural Requirement 7120.5C “NASA Program and Project Management Processes and Requirements” document.

Full Cost: Cost Elements and Classifications

In full cost, each project’s budget includes direct costs and indirect costs. Direct costs consist of those costs that can be obviously and cleanly linked to a project—these are the costs that are “directly” controlled by a project manager. Indirect costs are those costs that cannot be clearly or expeditiously linked to a project; they are instead linked through an allocation. Indirect costs include overhead for internal service pools and General and Administrative (G&A) costs incurred by NASA Centers. The full cost of a project is the sum of these costs. Figure 1 depicts in detail the cost components for each NASA full cost project.

Figure 1: Components of NASA’s Full Cost Budget

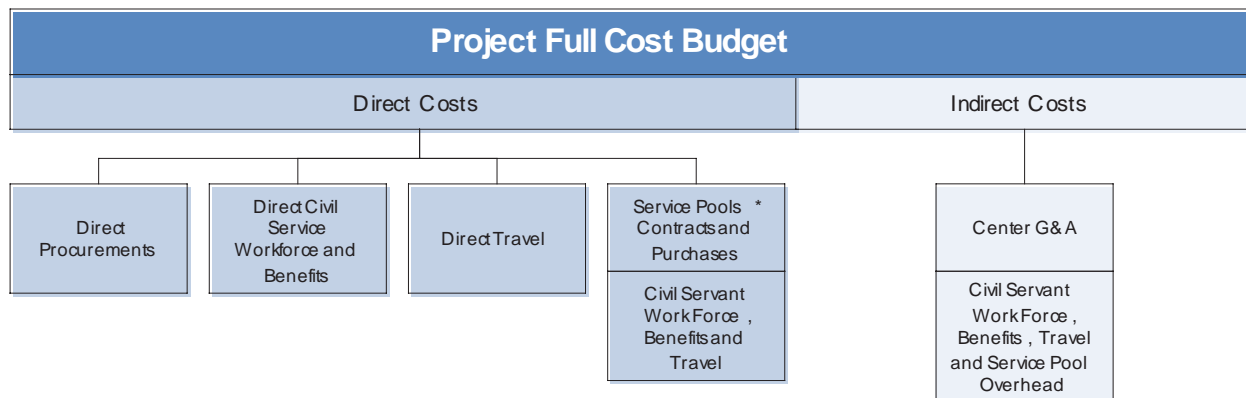

* Costs of services provided to projects based on use /consumption

Descriptions of each cost element:

Direct Project Costs

Direct Procurements: The procurements that are directly controlled and acquired by the project manager. These costs are linked to a project at the time the costs are incurred. They include purchased goods and services, contracted support, and materials.

Direct Civil Service Workforce and Benefits: The costs associated with the civil service employees that charge their time to the project. This includes their base pay as well as fringe benefits. These costs are incurred on a two-week cycle and linked to the project at that time.

Direct Travel: The costs associated with civil service personnel traveling for activities in support of the project. These costs are linked to the project at the time the costs are incurred.

Service Pools: The costs of center-provided services consumed by the project, in which the level of service is directly controlled by the project manager. These costs are linked back to the project (usually on a monthly basis) in a fair, equitable manner based on pre-determined metrics, identifying the degree to which projects benefit from the pool's services. Service pool costs include the salaries and benefits of civil servants working for the pool, as well as their travel. There is one agency service pool for the Independent Technical Authority and seven standard service pools established for use by NASA Centers: Facilities and Related Services; Information Technology; Science and Engineering; Fabrication; Test Services; Safety and Mission Assurance; and Wind Tunnel Services.

Indirect Project Costs

Center G&A Costs: The costs associated with Center services such as legal, financial, medical, security, environmental, media, logistics, public affairs, human resources, administration, financial, and procurement, as well as any Center investments. These are Center costs that cannot be allocated to specific projects based on consumption. These costs are linked to each project based on the amount of civil servants and on-site contractors working directly to support the project. Center G&A costs include the salaries and benefits of Center civil servants in G&A functions, as well as their travel, and purchased goods and services, contracted support, and materials.

Indirect Program Costs

Corporate G&A Costs: The costs associated with NASA Headquarters and Agency-wide activities (including costs of Corporate G&A functions performed at NASA Centers on behalf of the Agency). Corporate functions include the NASA Administrator's office, Mission Directorate management, Headquarters operations, and the Mission Support Offices that govern Agency-wide matters, such as public affairs, procurement, finance, and human resources policy and practice. Corporate G&A costs are assessed to programs based on their share of NASA's total cost (including service pool costs and Center G&A).

Institutional Investments Costs: The costs associated with Environmental Compliance and Restoration and non-programmatic Construction of Facilities (including costs of Institutional Investments functions performed at NASA Centers on behalf of the Agency). Institutional Investments costs are assessed to programs based on their share of NASA's total cost (including service pool costs and Center G&A).

Figure 2: Program's Full Cost Budget Elements

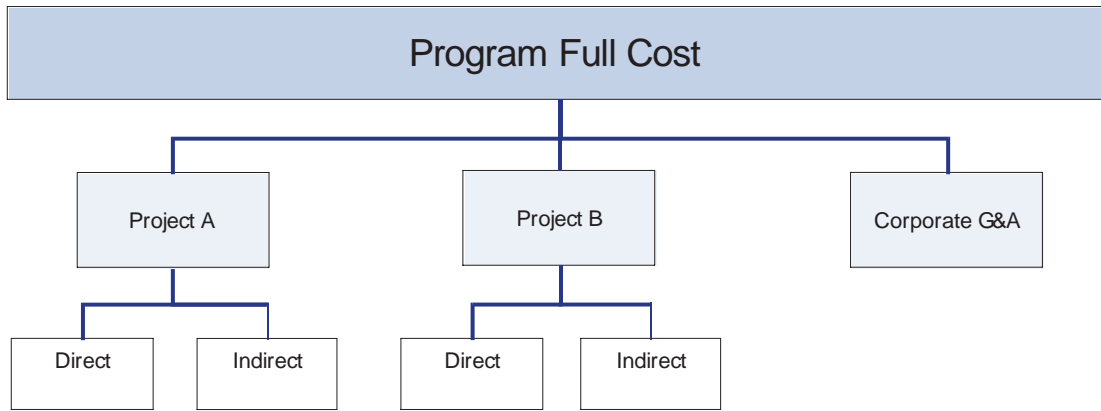

President's Management Agenda Update

President's Management Agenda

NASA has made significant progress in improving the quality of its management by continuing to implement the President's Management Agenda (PMA). This is an effort to improve the way that Government manages in five key areas across all federal agencies: Human Capital, Financial Management, E-Government, Competitive Sourcing, and Budget and Performance Integration. NASA, like several other agencies, is also working toward improvement in an additional PMA initiative: Federal Real Property Management.

NASA is a leading agency in the implementation of the PMA. This is evidenced by the fact that NASA is one of the few federal agencies to have achieved four "green" status ratings, in the PMA areas of Human Capital, Competitive Sourcing, E-Government, and Budget and Performance Integration.

NASA's progress in strengthening our enterprise management through the PMA has positioned the Agency to successfully implement *The President's Vision for U.S. Space Exploration*.

NASA's President's Management Agenda Scorecard

	Human Capital	Competitive Sourcing	Financial Performance	E-Government	Budget and Performance Integration	Federal Real Property Management
Status	GREEN	GREEN	RED	GREEN	GREEN	YELLOW
Progress	GREEN	GREEN	RED	GREEN	GREEN	GREEN

Scorecard status as of December 31, 2005

Human Capital

NASA has engaged in workforce planning activities to ensure that it has the right mix of employee skills and that competencies are strategically deployed. In support of workforce planning efforts, the Agency managed workforce transformation activities including job fairs, voluntary separation incentives (buyout) or voluntary early retirement (early out), and career transition services to rebalance workforce competencies in support of the President's Vision for Space Exploration. Retention and relocation bonuses have been used to retain employees with mission critical competencies. NASA has maintained an organizational culture that assures its valuable workforce is retained by recognizing excellent performance through an enhanced performance management system and a comprehensive awards system.

Competitive Sourcing

In fiscal year (FY) 2005, NASA achieved a "green" rating from OMB for both progress and status. That rating was achieved due to OMB approving the Agency's "green" plan and the completion of two standard competitions involving 237 positions. The first competition was for the Langley Research Center's Metallic Test Article Development and General and Precision and Machining Services, while the second was for the NASA Shared Services Center (NSSC). The NSSC is an Agency-wide consolidation of multiple business activities at a single location that will allow the Agency to redeploy staff and budget to core mission activities. In addition, the Agency continued to conduct science competitions under its NASA Research Announcements and Announcements of Opportunity whereby NASA scientists and engineers compete against those in academia, industry, and other Government agencies for research opportunities. In FY 2005, more than 400 FTE were exposed to competition through this process. NASA received the President's Quality Award for Innovation and Exemplary Practices for its science competitions.

Financial Performance

NASA continues to face significant challenges in improving the quality of its financial reporting; however, the Agency has developed and issued a strategic initiatives document to help guide the overall improvement in NASA's financial management including the identification of corrective actions to reduce material weaknesses and improve internal controls. Further, NASA has established a Senior Advisory Group, composed of senior government executives from several federal agencies, to provide NASA expert advice and suggestive corrective actions to improve NASA's overall financial management.

E-Government

NASA continues significant progress and success in meeting E-Government criteria. The Agency has submitted its plan to close IT workforce skills gaps and assure successful performance by Agency personnel performing services in project management, IT security, enterprise architecture, solutions architecture, and IT capital planning and investment. To ensure that the Agency continues to enhance its protections for the privacy of personal information, NASA recently completed Privacy Impact Assessments on all required IT systems, and provided authorization for public-facing Web sites to employ persistent tracking technology in situations where this use is justifiable. NASA has also made progress in ensuring that its E-government – and other IT investments – are reviewed and integrated with the Agency's product lifecycle management, security, Capital Planning and Investment Control (CPIC), and strategic planning policy to assure a uniform approach to the business management of Agency systems and services. NASA's formal Enterprise Architecture review process was launched earlier this year, and Version 4 of NASA's Enterprise Architecture (based on the Federal Enterprise Architecture and associated supporting reference models) was released in August 2005, linking NASA's strategic IT focus areas to the needs of the Agency's missions and programs. Finally, NASA is currently participating in sixteen of the original twenty-four Presidential Electronic Government (E-Gov) initiatives applicable to the Agency, plus the E-Authentication crosscutting initiative. NASA is also actively engaged in five of the six Federal Lines of Business initiatives. Highlights of the Agency's PMA efforts include: recent vendor selections for both E-Training and E-Travel; posting of grant applications to Grants.gov; implementing Recruitment One-Stop's online application process and migrating from NASA JOBS to the ROS site; and continuing implementation activities for E-Rulemaking.

Budget and Performance Integration

NASA has integrated strategic, performance, budget and program planning and reporting processes and documents to ensure the Agency is guided by a single framework to translate strategy into executable budgets. NASA assures that it has the processes, tools, and forums for monitoring and reporting performance toward its goals, which guides strategic, performance, and budget decisions. Further, NASA incorporates past PART review findings and those of external experts into investment decisions. NASA continues to strive to find new ways to use program performance information to support decisions on strategy and budget. A main focus of NASA is on improving the policy, metrics and analysis processes for life cycle cost and schedule performance monitoring and reporting.

Federal Real Property Management

NASA is a leader in promoting efficient and economical use of its real property assets as evidenced by its real property initiatives and the approval of its Real Property Asset Management Plan. NASA uses its Asset Management Plan as a tool to integrate real property considerations into the Agency's corporate decision-making process. NASA is also an active participant on the Federal Real Property Council, which helps inform and develop government-wide best practices.

FY 2006 Performance Plan Update

Effective in 2006, NASA will focus on six new Strategic Goals in support of the Vision for Space Exploration. This FY 2006 Performance Plan Update aligns the original FY 2006 Annual Performance Goals with the new Strategic Goals. The update also reflects the realignment and reprioritization of Agency programs and projects as a result of the FY 2006 Appropriation. Fourteen of the original commitments have been deleted and four more have changed in scope. The realignment of NASA's Aeronautics program generated six additional commitments that reflect its transition. An additional performance commitment has been added to support the advent of separate reporting to Congress on the Integrated Enterprise Management Program within the Advanced Business Systems Theme.

Strategic Goal 1: Fly the Shuttle as safely as possible until its retirement, not later than 2010.

Outcome 1.1 *Assure the safety and integrity of the Space Shuttle workforce, systems and processes, while flying the manifest.*

APG 6SSP1 Achieve zero Type-A (damage to property at least \$1M or death) or Type-B (damage to property at least \$250K or permanent disability or hospitalization of 3 or more persons) mishaps in 2006.

Strategic Goal 2: Complete the International Space Station in a manner consistent with NASA's International partner commitments and the needs of human exploration.

Outcome 2.1 *By 2010, complete assembly of the U.S. On-orbit segment; launch International Partner elements and sparing items required to be launched by the Shuttle; and provide on-orbit resources for research to support U.S. human space exploration.*

APG 6ISS1 Reach agreement among the International Partners on the final ISS configuration.

APG 6ISS3 Provide 80 percent of FY 2006 planned on-orbit resources and accommodations to support research, including power, data, crew time, logistics and accommodations.

APG 6ISS4 For FY 2006 ensure 90 percent functional availability for all ISS subsystems that support on-orbit research operations.

Strategic Goal 3: Develop a balanced overall program of science, exploration, and aeronautics consistent with the redirection of the human spaceflight program to focus on exploration.

Sub-goal 3A: Study Earth from space to advance scientific understanding and meet societal needs.

Outcome 3A.1 *Progress in understanding and improving predictive capability for changes in the ozone layer, climate forcing, and air quality associated with changes in atmospheric composition.*

APG 6ESS1 For current observations, reduce the cost of acquiring and distributing the data stream to facilitate adoption by the operational community.

APG 6ESS3 Keep 90 percent of the total on-orbit instrument complement functional throughout the year.

APG 6ESS4 Mature two to three technologies to the point they can be demonstrated in space or in an operational environment and annually advance 25 percent of funded technology developments one Technology Readiness level (TRL).

FY 2006 Performance Plan Update

APG 6ESS5 Increase the number of distinct users of NASA data and services.

APG 6ESS6 Improve level of customer satisfaction as measured by a baselined index obtained through the use of annual surveys.

APG 6ESS7 Demonstrate progress that NASA-developed data sets, technologies and models enhance understanding of the Earth system leading to improved predictive capability in each of the six science focus area roadmaps. Progress toward achieving outcomes will be validated by external review.

APG 6ESS20 Systematically continue to transfer research results from spacecraft, instruments, data protocols, and models to NOAA and other operational agencies as appropriate.

Outcome 3A.2 Progress in enabling improved predictive capability for weather and extreme weather events. (APGs are the same as 3A.1)

APG 6ESS1 For current observations, reduce the cost of acquiring and distributing the data stream to facilitate adoption by the operational community.

APG 6ESS3 Keep 90 percent of the total on-orbit instrument complement functional throughout the year.

APG 6ESS4 Mature two to three technologies to the point they can be demonstrated in space or in an operational environment and annually advance 25 percent of funded technology developments one Technology Readiness level (TRL).

APG 6ESS5 Increase the number of distinct users of NASA data and services.

APG 6ESS6 Improve level of customer satisfaction as measured by a baselined index obtained through the use of annual surveys.

APG 6ESS7 Demonstrate progress that NASA-developed data sets, technologies and models enhance understanding of the Earth system leading to improved predictive capability in each of the six science focus area roadmaps. Progress toward achieving outcomes will be validated by external review.

APG 6ESS20 Systematically continue to transfer research results from spacecraft, instruments, data protocols, and models to NOAA and other operational agencies as appropriate.

Outcome 3A.3 Progress in quantifying global land cover change and terrestrial and marine productivity, and in improving carbon cycle and ecosystem models. (APGs are the same as 3A.1)

APG 6ESS1 For current observations, reduce the cost of acquiring and distributing the data stream to facilitate adoption by the operational community.

APG 6ESS3 Keep 90 percent of the total on-orbit instrument complement functional throughout the year.

APG 6ESS4 Mature two to three technologies to the point they can be demonstrated in space or in an operational environment and annually advance 25 percent of funded technology developments one Technology Readiness level (TRL).

APG 6ESS5 Increase the number of distinct users of NASA data and services.

APG 6ESS6 Improve level of customer satisfaction as measured by a baselined index obtained through the use of annual surveys.

APG 6ESS7 Demonstrate progress that NASA-developed data sets, technologies and models enhance understanding of the Earth system leading to improved predictive capability in each of the six science focus area roadmaps. Progress toward achieving outcomes will be validated by external review.

APG 6ESS20 Systematically continue to transfer research results from spacecraft, instruments, data protocols, and models to NOAA and other operational agencies as appropriate.

FY 2006 Performance Plan Update

Outcome 3A.4 Progress in quantifying the key reservoirs and fluxes in the global water cycle and in improving models of water cycle change and fresh water availability. (With the addition of 6ESS22, APGs are the same as 3A.1)

- APG 6ESS1 For current observations, reduce the cost of acquiring and distributing the data stream to facilitate adoption by the operational community.
- APG 6ESS3 Keep 90 percent of the total on-orbit instrument complement functional throughout the year.
- APG 6ESS4 Mature two to three technologies to the point they can be demonstrated in space or in an operational environment and annually advance 25 percent of funded technology developments one Technology Readiness level (TRL).
- APG 6ESS5 Increase the number of distinct users of NASA data and services.
- APG 6ESS6 Improve level of customer satisfaction as measured by a baselined index obtained through the use of annual surveys.
- APG 6ESS7 Demonstrate progress that NASA-developed data sets, technologies and models enhance understanding of the Earth system leading to improved predictive capability in each of the six science focus area roadmaps. Progress toward achieving outcomes will be validated by external review.
- APG 6ESS20 Systematically continue to transfer research results from spacecraft, instruments, data protocols, and models to NOAA and other operational agencies as appropriate.
- APG 6ESS22 Complete Global Precipitation Measurement (GPM) Confirmation Review.

Outcome 3A.5 Progress in understanding the role of oceans, atmosphere, and ice in the climate system and in improving predictive capability for its future evolution. (With the addition of 6ESS23, APGs are the same as 3A.1)

- APG 6ESS1 For current observations, reduce the cost of acquiring and distributing the data stream to facilitate adoption by the operational community.
- APG 6ESS3 Keep 90 percent of the total on-orbit instrument complement functional throughout the year.
- APG 6ESS4 Mature two to three technologies to the point they can be demonstrated in space or in an operational environment and annually advance 25 percent of funded technology developments one Technology Readiness level (TRL).
- APG 6ESS5 Increase the number of distinct users of NASA data and services.
- APG 6ESS6 Improve level of customer satisfaction as measured by a baselined index obtained through the use of annual surveys.
- APG 6ESS7 Demonstrate progress that NASA-developed data sets, technologies and models enhance understanding of the Earth system leading to improved predictive capability in each of the six science focus area roadmaps. Progress toward achieving outcomes will be validated by external review.
- APG 6ESS20 Systematically continue to transfer research results from spacecraft, instruments, data protocols, and models to NOAA and other operational agencies as appropriate.
- APG 6ESS23 Complete Operational Readiness Review for the NPOESS Preparatory Project (NPP).

Outcome 3A.6 Progress in characterizing and understanding Earth surface changes and variability of Earth's gravitational and magnetic fields. (APGs are the same as 3A.1)

- APG 6ESS1 For current observations, reduce the cost of acquiring and distributing the data stream to facilitate adoption by the operational community.

FY 2006 Performance Plan Update

APG 6ESS3 Keep 90 percent of the total on-orbit instrument complement functional throughout the year.

APG 6ESS4 Mature two to three technologies to the point they can be demonstrated in space or in an operational environment and annually advance 25 percent of funded technology developments one Technology Readiness level (TRL).

APG 6ESS5 Increase the number of distinct users of NASA data and services.

APG 6ESS6 Improve level of customer satisfaction as measured by a baselined index obtained through the use of annual surveys.

APG 6ESS7 Demonstrate progress that NASA-developed data sets, technologies and models enhance understanding of the Earth system leading to improved predictive capability in each of the six science focus area roadmaps. Progress toward achieving outcomes will be validated by external review.

APG 6ESS20 Systematically continue to transfer research results from spacecraft, instruments, data protocols, and models to NOAA and other operational agencies as appropriate.

Outcome 3A.7 Progress in expanding and accelerating the realization of societal benefits from Earth system science.

APG 6ESS1 For current observations, reduce the cost of acquiring and distributing the data stream to facilitate adoption by the operational community.

APG 6ESS21 Benchmark the assimilation of observations and products in decision support systems serving applications of national priority. Progress will be evaluated by the Committee on Environmental and National Resources.

Sub-goal 3B: Understand the Sun and its effects on Earth and the solar system.

Outcome 3B.1 Progress in understanding the fundamental physical processes of the space environment from the Sun to Earth, to other planets, and beyond to the interstellar medium.

APG 6ESS11 Successfully demonstrate progress in understanding the structure and dynamics of the Sun and solar wind and the origins of solar variability. Progress toward achieving outcomes will be validated by external expert review.

APG 6ESS12 Successfully demonstrate progress in determining the evolution of the heliosphere and its interaction with the galaxy. Progress in achieving outcomes will be validated by external expert review.

APG 6ESS14 Successfully demonstrate progress in discovering how magnetic fields are created and evolve and how charged particles are accelerated. Progress in achieving outcomes will be validated by external expert review.

APG 6ESS15 Successfully demonstrate progress in understanding coupling across multiple scale lengths and its generality in plasma systems. Progress in achieving outcomes will be validated by external expert review.

APG 6ESS17 Complete the Solar Dynamics Observatory (SDO) spacecraft structure and begin Integration and Test (I&T).

APG 6ESS18 Initiate Geospace Phase A studies.

Outcome 3B.2 Progress in understanding how human society, technological systems, and the habitability of planets are affected by solar variability and planetary magnetic fields.

APG 6ESS8 Successfully demonstrate progress in developing the capability to predict solar activity and the evolution of solar disturbances as they propagate in the heliosphere and affect the Earth. Progress toward achieving outcomes will be validated by external expert review.

FY 2006 Performance Plan Update

APG 6ESS9 Successfully demonstrate progress in specifying and enabling prediction of changes to the Earth's radiation environment, ionosphere, and upper atmosphere. Progress toward achieving outcomes will be validated by external expert review.

APG 6ESS10 Successfully demonstrate progress in understanding the role of solar variability in driving space climate and global change in the Earth's atmosphere. Progress toward achieving outcomes will be validated by external expert review.

APG 6ESS13 Successfully demonstrate progress in understanding the response of magnetospheres and atmospheres to external and internal drivers. Progress in achieving outcomes will be validated by external expert review.

APG 6ESS16 Successfully launch the Solar Terrestrial Relations Observatory (STEREO).

APG 6ESS17 Complete the Solar Dynamics Observatory (SDO) spacecraft structure and begin Integration and Test (I&T).

APG 6ESS18 Initiate Geospace Phase A studies.

APG 6ESS19 Publish Solar Sentinels Science Definition Team Report.

Outcome 3B.3 Progress in developing the capability to predict the extreme and dynamic conditions in space in order to maximize the safety and productivity of human and robotic explorers.

APG 6ESS16 Successfully launch the Solar Terrestrial Relations Observatory (STEREO).

APG 6ESS17 Complete the Solar Dynamics Observatory (SDO) spacecraft structure and begin Integration and Test (I&T).

APG 6ESS18 Initiate Geospace Phase A studies.

APG 6ESS19 Publish Solar Sentinels Science Definition Team Report.

Sub-goal 3C: Advance scientific knowledge of the solar system, search for evidence of life, and prepare for human exploration.

Outcome 3C.1 Progress in learning how the Sun's family of planets and minor bodies originated and evolved.

APG 6SSE7 Successfully demonstrate progress in understanding the initial stages of planet and satellite formation. Progress toward achieving outcomes will be validated by external expert review.

APG 6SSE8 Successfully demonstrate progress in understanding the processes that determine the characteristics of bodies in our solar system and how these processes operate and interact. Progress toward achieving outcomes will be validated by external expert review.

APG 6SSE10 Successfully demonstrate progress in learning what our solar system can tell us about extra-solar planetary systems. Progress toward achieving outcomes will be validated by external expert review.

APG 6SSE11 Successfully demonstrate progress in determining the nature, history, and distribution of volatile and organic compounds in the solar system. Progress toward achieving outcomes will be validated by external expert review.

APG 6SSE26 Successfully return Stardust science samples to Earth.

APG 6SSE27 Successfully launch Dawn spacecraft.

APG 6SSE28 Successfully complete MErcury Surface, Space ENvironment, GEochemistry, and Ranging (MESSENGER) flyby of Venus.

FY 2006 Performance Plan Update

Outcome 3C.2 Progress in understanding the processes that determine the history and future of habitability in the solar system, including the origin and evolution of Earth's biosphere and the character and extent of prebiotic chemistry on Mars and other worlds.

- APG 6SSE9 Successfully demonstrate progress in understanding why the terrestrial planets are so different from one another. Progress toward achieving outcomes will be validated by external expert review.
- APG 6SSE12 Successfully demonstrate progress in identifying the habitable zones in the solar system. Progress toward achieving outcomes will be validated by external expert review.
- APG 6SSE13 Successfully demonstrate progress in identifying the sources of simple chemicals that contribute to prebiotic evolution and the emergence of life. Progress toward achieving outcomes will be validated by external expert review.
- APG 6SSE14 Successfully demonstrate progress in studying Earth's geologic and biologic records to determine the historical relationship between Earth and its biosphere. Progress toward achieving outcomes will be validated by external expert review.
- APG 6SSE15 Successfully demonstrate progress in characterizing the present climate of Mars and determining how it has evolved over time. Progress toward achieving outcomes will be validated by external expert review.
- APG 6SSE16 Successfully demonstrate progress in understanding the history and behavior of water and other volatiles on Mars. Progress toward achieving outcomes will be validated by external expert review.
- APG 6SSE17 Successfully demonstrate progress in understanding the chemistry, mineralogy, and chronology of Martian materials. Progress toward achieving outcomes will be validated by external expert review.
- APG 6SSE18 Successfully demonstrate progress in determining the characteristics and dynamics of the interior of Mars. Progress toward achieving outcomes will be validated by external expert review.
- APG 6SSE19 Successfully demonstrate progress in understanding the character and extent of prebiotic chemistry on Mars. Progress toward achieving outcomes will be validated by external expert review.
- APG 6SSE25 Complete Mars Science Laboratory Preliminary Design Review (PDR).

Outcome 3C.3 Progress in identifying and investigating past or present habitable environments on Mars and other worlds, and determining if there is or ever has been life elsewhere in the solar system.

- APG 6SSE20 Successfully demonstrate progress in searching for chemical and biological signatures of past and present life on Mars. Progress toward achieving outcomes will be validated by external expert review.

Outcome 3C.4 Progress in exploring the space environment to discover potential hazards to humans and to search for resources that would enable human presence.

- APG 6SSE5 Successfully demonstrate progress in determining the inventory and dynamics of bodies that may pose an impact hazard to Earth. Progress toward achieving outcomes will be validated by external expert review.
- APG 6SSE6 Successfully demonstrate progress in determining the physical characteristics of comets and asteroids relevant to any threat they may pose to Earth. Progress toward achieving outcomes will be validated by external expert review.
- APG 6SSE21 Successfully demonstrate progress in identifying and understanding the hazards that the Martian environment will present to human explorers. Progress toward achieving outcomes will be validated by external expert review.
- APG 6SSE22 Successfully demonstrate progress in inventorying and characterizing Martian resources of potential benefit to human exploration on Mars. Progress toward achieving outcomes will be validated by external expert review.

FY 2006 Performance Plan Update

APG 6SSE23 Complete successful Martian orbit insertion for Mars Reconnaissance Orbiter (MRO).

Sub-goal 3D: Discover the origin, structure, evolution, and destiny of the universe, and search for Earth-like planets.

Outcome 3D.1 Progress in understanding the origin and destiny of the universe, phenomena near black holes, and the nature of gravity.

APG 6UNIV8 Successfully demonstrate progress in searching for gravitational waves from the earliest moments of the Big Bang. Progress toward achieving outcomes will be validated by external expert review.

APG 6UNIV9 Successfully demonstrate progress in determining the size, shape, and matter-energy content of the Universe. Progress toward achieving outcomes will be validated by external expert review.

APG 6UNIV10 Successfully demonstrate progress in measuring the cosmic evolution of dark energy. Progress toward achieving outcomes will be validated by external expert review.

APG 6UNIV11 Successfully demonstrate progress in determining how black holes are formed, where they are, and how they evolve. Progress toward achieving outcomes will be validated by external expert review.

APG 6UNIV12 Successfully demonstrate progress in testing Einstein's theory of gravity and mapping space-time near event horizons of black holes. Progress toward achieving outcomes will be validated by external expert review.

APG 6UNIV13 Successfully demonstrate progress in observing stars and other material plunging into black holes. Progress toward achieving outcomes will be validated by external expert review.

APG 6UNIV15 Successfully demonstrate progress in exploring the behavior of matter in extreme astrophysical environments, including disks, cosmic jets, and the sources of gamma-ray bursts and cosmic rays. Progress toward achieving outcomes will be validated by external expert review.

APG 6UNIV19 Complete Gamma-ray Large Area Space Telescope (GLAST) Spacecraft Integration and Test (I&T).

APG 6UNIV20 Complete James Webb Space Telescope (JWST) Mission Preliminary Design Review (PDR).

Outcome 3D.2 Progress in understanding how the first stars and galaxies formed, and how they changed over time into the objects recognized in the present universe.

APG 6UNIV14 Successfully demonstrate progress in determining how, where, and when the chemical elements were made, and in tracing the flows of energy and magnetic fields that exchange them between stars, dust, and gas. Progress toward achieving outcomes will be validated by external expert review.

APG 6UNIV16 Successfully demonstrate progress in discovering how the interplay of baryons, dark matter, and gravity shapes galaxies and systems of galaxies. Progress toward achieving outcomes will be validated by external expert review.

APG 6UNIV17 Successfully demonstrate progress in learning how the cosmic web of matter organized into the first stars and galaxies and how these evolved into the stars and galaxies we see today. Progress toward achieving outcomes will be validated by external expert review.

APG 6UNIV20 Complete James Webb Space Telescope (JWST) Mission Preliminary Design Review (PDR).

Outcome 3D.3 Progress in understanding how individual stars form and how those processes ultimately affect the formation of planetary systems.

APG 6UNIV1 Successfully demonstrate progress in understanding how different galactic ecosystems of stars and gas formed and which ones might support the existence of planets and life. Progress toward achieving outcomes will be validated by external expert review.

FY 2006 Performance Plan Update

APG 6UNIV2 Successfully demonstrate progress in learning how gas and dust become stars and planets. Progress toward achieving outcomes will be validated by external expert review.

APG 6UNIV6 Successfully demonstrate progress in tracing the chemical pathways by which simple molecules and dust evolve into the organic molecules important for life. Progress toward achieving outcomes will be validated by external expert review.

APG 6UNIV18 Complete Stratospheric Observatory for Infrared Astronomy (SOFIA) Airworthiness Flight Testing.

APG 6UNIV20 Complete James Webb Space Telescope (JWST) Mission Preliminary Design Review (PDR).

Outcome 3D.4 Progress in creating a census of extra-solar planets and measuring their properties.

APG 6UNIV3 Successfully demonstrate progress in observing planetary systems around other stars and comparing their architectures and evolution with our own. Progress toward achieving outcomes will be validated by external expert review.

APG 6UNIV4 Successfully demonstrate progress in characterizing the giant planets orbiting other stars. Progress toward achieving outcomes will be validated by external expert review.

APG 6UNIV5 Successfully demonstrate progress in determining how common Earth-like planets are and whether any might be habitable. Progress toward achieving outcomes will be validated by external expert review.

APG 6UNIV7 Successfully demonstrate progress in developing the tools and techniques to search for life on planets beyond our solar system. Progress toward achieving outcomes will be validated by external expert review.

APG 6UNIV21 Begin Kepler Spacecraft Integration and Test (I&T).

Sub-goal 3E: Advance knowledge in the fundamental disciplines of aeronautics, and develop technologies for safer aircraft and higher capacity airspace systems.

Outcome 3E.1 By 2016, identify and develop tools, methods, and technologies for improving overall aircraft safety of new and legacy vehicles operating in the Next Generation Air Transportation System (projected for the year 2025).

APG 6AT4 In partnership with the FAA, the Commercial Aviation Safety Team (CAST), and the aviation community, provide an initial demonstration of a voluntary aviation safety information sharing process.

APG 6AT14 Complete Aviation Safety Program restructuring activities in order to focus research efforts more precisely on the Nation's aviation safety challenges for the Next Generation Air Transportation System (2025) and beyond. **(New APG)**

ATP 6AT15 Utilizing a competitive peer-reviewed selection process, determine the research portfolio and partnerships to enable advances in the Aviation Safety thrust areas (Integrated Intelligent Flight Deck Technologies, Integrated Vehicle Health Management, Integrated Resilient Aircraft Controls, and Aircraft Aging and Durability.) **(New APG)**

Outcome 3E.2 By 2016, develop and demonstrate future concepts, capabilities, and technologies that will enable major increases in air traffic management effectiveness, flexibility, and efficiency, while maintaining safety, to meet capacity and mobility requirements of the Next Generation Air Transportation System.

APG 6AT7 Successfully complete the SATS integrated technology demonstration and final assessment.

APG 6AT16 Complete Airspace Systems Program restructuring activities in order to align research efforts to address the Joint Planning and Development Office's Next Generation Air Transportation System (NGATS) capability requirements for 2025. **(New APG)**

FY 2006 Performance Plan Update

APG 6AT17 Utilizing a competitive peer-reviewed selection process, determine the research portfolio and partnerships to enable advances in the Airspace Systems thrust areas (Next Generation Air Transportation Systems and Super Density Surface Management.) **(New APG)**

Outcome 3E.3 *By 2016, develop multidisciplinary design, analysis, and optimization capabilities for use in trade studies of new technologies, enabling better quantification of vehicle performance in all flight regimes and within a variety of transportation system architectures.*

APG 6AT8 Identify and document engine configuration and noise reduction technologies needed to enable 10 dB reduction in aircraft system noise. **(APG revised based on FY06 Appropriation.)**

APG 6AT11 Complete trade study of unconventional propulsion concepts for a zero-emissions vehicle.

APG 6AT18 Complete Fundamental Aeronautics Program restructuring activities in order to focus efforts on fundamental research to develop physics-based multidisciplinary design, analysis and optimization tools. **(New APG)**

APG 6AT19 Utilizing a competitive peer-reviewed selection process, determine the research portfolio and partnerships to enable advances in the Fundamental Aeronautics thrust areas (fixed wing, rotary wing, supersonics, and hypersonics). **(New APG)**

Sub-goal 3F: Understand the effects of the space environment on human performance, and test new technologies and countermeasures for long-duration human space exploration.

Outcome 3F.1 *By 2008, develop and test candidate countermeasures to ensure the health of humans traveling in space.*

APG 6SFS5 Achieve a 5 percent reduction in downtime.

APG 6SFS6 Certify medical fitness of all crewmembers before launch.

APG 6HSRT9 Complete renal stone countermeasure development.

APG 6HSRT10 Start testing of bone and cardiovascular countermeasures in space.

APG 6HSRT11 Deliver report from National Council on Radiation Protection and Measurements on lunar radiation protection requirements.

APG 6HSRT20 Complete the physics database for shielding in the region above 2 GeV per nucleon.

Outcome 3F.2 *By 2010, identify and test technologies to reduce total mission resource requirements for life support systems.*

APG 6HSRT13 Start validation testing of a spacecraft water purification system called the Vapor Phase Catalytic Ammonia Removal Unit.

APG 6HSRT14 Define requirements for the Condensing Heat Exchanger Flight experiment focused on improving space condenser reliability.

APG 6HSRT15 Complete and deliver for launch the ISS Fluids Integrated Rack.

APG 6HSRT16 Complete and deliver for launch experiments to explore new lightweight heat rejection technologies.

APG 6HSRT17 Start technology testing and assessment of the Solid Waste Compaction processor.

APG 6HSRT18 Conduct next generation lithium hydroxide (LiOH) packaging tests to improve carbon dioxide removal efficiency.

APG 6HSRT19 Conduct ground testing of the Sabatier unit to demonstrate reliability in recovering oxygen and water from carbon dioxide.

FY 2006 Performance Plan Update

Outcome 3F.3 *By 2010, develop reliable spacecraft technologies for advanced environmental monitoring and control and fire safety.*

- APG 6HSRT3 Demonstrate the ability of the advanced spacecraft air monitoring system to detect 90 percent of the high-priority air contaminants in ground testing.
- APG 6HSRT4 Demonstrate the ability of the hand-held water monitoring system to detect spacecraft water biocides and high-priority metal contaminants in ground testing.
- APG 6HSRT5 Support development of a new generation of reliable spacecraft smoke detectors by finishing measurements of ISS background particulates using the DAFT experiment and delivering for launch the Smoke and Aerosol Measurement Experiment (SAME).
- APG 6HSRT6 Complete and deliver for launch the ISS Combustion Integrated Rack (CIR).
- APG 6HSRT7 Complete and deliver for launch the Droplet Flame Extinguishment in Microgravity Experiment aimed at quantifying fire suppressant effectiveness.
- APG 6HSRT8 Develop a revised space materials flammability characterization test method and update NASA-STD-6001 accordingly.

Strategic Goal 4: Bring a new Crew Exploration Vehicle into service as soon as possible after Shuttle retirement.

Outcome 4.1 *No later than 2014, and as early as 2010, transport three crewmembers to the International Space Station and return them safely to Earth, demonstrating an operational capability to support human exploration missions.*

- APG 6CS1 Conduct the Earth Orbit Capability (Spiral 1) Systems Requirements Review to define detailed interface requirements for the Crew Exploration Vehicle, the Crew Launch Vehicle, and supporting ground and in-space systems.
- APG 6CS2 Competitively award contract(s) for Phase A and Phase B design and flight demonstration of the Crew Exploration Vehicle.
- APG 6CS3 Develop detailed Crew Launch Vehicle design and operational modifications to support human rating and exploration mission architecture requirements.
- APG 6CS4 Develop a plan for systems engineering and integration of the exploration System of Systems; clearly defining systems and organizational interfaces, management processes, and implementation plans.

Outcome 4.2 *No later than 2014, and as early as 2010, develop and deploy a new space suit to support exploration, that will be used in the initial operating capability of the Crew Exploration Vehicle.*

- APG 6HSRT1 Complete the technology trade studies for both the in-space and surface EVA suits.
- APG 6HSRT2 Complete the system requirements review for both the in-space and surface exploration EVA suits.

Strategic Goal 5: Encourage the pursuit of appropriate partnerships with the emerging commercial space sector.

Outcome 5.1 *Develop and demonstrate a means for NASA to purchase launch services from emerging launch providers.*

APG 6SFS4 Define and provide space transportation requirements for future human and robotic exploration and development of space to all NASA and other government agency programs pursuing improvements in space transportation.

Outcome 5.2 *By 2010, demonstrate one or more commercial space services for ISS cargo and/or crew transport.*

APG 6ISS2 Downselect transportation service providers from FY 2005 ISS Cargo Acquisition RFP.

Strategic Goal 6: Establish a lunar return program having the maximum possible utility for later missions to Mars and other destinations.

Outcome 6.1 *By 2008, launch a Lunar Reconnaissance Orbiter (LRO) that will provide information about potential human exploration sites.*

APG 6SSE1 Complete Lunar Reconnaissance Orbiter (LRO) Preliminary Design Review (PDR).

Outcome 6.2 *By 2012, develop and test technologies for in-situ resource utilization, power generation, and autonomous systems that reduce consumables launched from Earth and moderate mission risk.*

APG 6ESRT1 Identify and test technologies to enable affordable pre-positioning of logistics for human exploration missions. Technology development includes high power electric thrusters and high efficiency solar arrays for solar electric transfer vehicles, and lightweight composite cryotanks and zero boil-off thermal management for in-space propellant depots.

APG 6ESRT2 Identify and test technologies to enable in-space assembly, maintenance, and servicing. Technology development includes modular truss structures, docking mechanisms, micro-spacecraft inspector, intelligent robotic manipulators, and advanced software approaches for telerobotic operations.

APG 6ESRT3 Identify and test technologies to reduce mission risk for critical vehicle systems, supporting infrastructure, and mission operations. Technology development includes reconfigurable and radiation tolerant computers, robust electronics for extreme environments, reliable software, and intelligent systems health management.

APG 6ESRT4 Design and test technologies for in situ resource utilization that can enable more affordable and reliable space exploration by reducing required launch mass from Earth, and by reducing risks associated with logistics chains that supply consumables and other materials. Technology development includes excavation systems, volatile material extraction systems, and subsystems supporting lunar oxygen and propellant production plants.

APG 6ESRT5 Validate the ESMD research and technology development needs and opportunities by implementing a Quality Function Deployment process, and use the results to guide ESR&T program investment decisions.

APG 6ESRT6 Develop and analyze affordable architectures for human and robotic exploration system and mission options using innovative approaches such as modular systems, in-space assembly, pre-positioning of logistics, and utilization of in-situ resources.

APG 6ESRT7 Identify and define technology flight experiment opportunities to validate the performance of critical technologies for exploration missions.

FY 2006 Performance Plan Update

APG 6ESRT8 Identify and test technologies to reduce the costs of mission operations. Technology development includes autonomous and intelligent systems, human-automation interaction, multi-agent teaming, and space communications and networking.

Outcome 6.3 *By 2010, identify and conduct long-term research necessary to develop nuclear technologies essential to support human-robotic lunar missions and that are extensible to exploration of Mars.*

APG 6PROM1 Following completion of the Prometheus Analysis of Alternatives, complete space nuclear reactor conceptual design.

APG 6PROM2 Verify and validate the minimum functionality of initial nuclear electric propulsion (NEP) spacecraft capability.

APG 6PROM3 Complete component level tests and assessments of advanced power conversion systems.

Outcome 6.4 *Implement the space communications and navigation architecture responsive to Science and Exploration mission requirements.*

APG 6SFS1 Establish the Agency-wide baseline space communications architecture, including a framework for possible deep space and near Earth laser communications services.

APG 6SFS3 Achieve at least 95 percent of planned data delivery for the International Space Station, each Space Shuttle mission, and low Earth orbiting missions for FY 2006.

Cross-Agency Support Programs

Education

Outcome ED-1 *Contribute to the development of the STEM workforce in disciplines needed to achieve NASA's strategic goals through a portfolio of programs.*

- APG 6ED3 Award approximately 1,000 competitive scholarships, fellowships, and research opportunities for higher education students and faculty in STEM disciplines. **(APG revised: awards reduced from 1,500 to 1,000 based on FY 2006 Appropriation.)**
- APG 6ED4 Complete a retrospective longitudinal study of student participants to determine the degree to which participants entered the NASA workforce or other NASA-related career fields.
- APG 6ED5 Collect, analyze, and report longitudinal data on student participants to determine the degree to which participants enter the NASA workforce or other NASA-related career fields.
- APG 6ED6 Award approximately 250 competitive scholarships, internships, fellowships, and research opportunities for underrepresented and underserved students, teachers and faculty in STEM disciplines. **(APG revised: awards reduced from 1,100 to 250 based on FY 2006 Appropriation.)**
- APG 6ED7 Provide approximately 50 grants to enhance the capability of approximately 25 underrepresented and underserved colleges and universities to compete for and conduct basic or applied NASA-related research. **(APG revised: grants reduced from 350 to 50, and the number of colleges and universities awarded reduced from 100 to 25, based on FY 2006 Appropriation.)**

Advanced Business Systems (Integrated Enterprise Management Program)

Outcome IEM-2 *Increase efficiency by implementing new business systems and reengineering Agency business processes.*

- APG 6IEM1 Deliver an analysis and recommendations for long-term solutions to account for and maintain the Agency's assets defined as Property Plant & Equipment and Operating Materials and Supplies (encompasses the major functions of Environmental, Facilities, Logistics, and all related financial activities). (New APG)

Innovative Partnerships Program

Outcome IPP-1 *Promote and develop innovative technology partnerships among NASA, U.S. industry, and other sectors for the benefit of Agency programs and projects.*

- APG 6ESRT9 Complete 50 technology transfer agreements with the U.S. private sector for transfer of NASA technologies, hardware licenses, software usage agreements, facility usage agreements or Space Act Agreements.
- APG 6ESRT10 Develop 40 industry partnerships that will add value to NASA missions.
- APG 6ESRT11 Establish at least twelve new partnerships with major ESMD R&D programs or other NASA organizations.
- APG 6ESRT12 Award Phase III contracts or venture capital funds to 4 SBIR firms to further develop or produce technology for U.S. industry or government agencies.

Efficiency Measures

Aeronautics Technology

APG 6AT12 Deliver at least 90% of scheduled operating hours for all operations and research facilities.

APG 6AT13 Increase the annual percentage of research funding subject to external peer review prior to award.

Education

APG 6ED11 Collect, analyze, and report the percentage of grantees that annually report on their accomplishments.

APG 6ED12 Peer review and competitively award at least 80%, by budget, of research projects.

Constellation Systems

APG 6CS5 Complete all development projects within 110% of the cost and schedule baseline.

APG 6CS6 Increase annually the percentage of ESR&T and HSR&T technologies transitioned to Constellation Systems programs.

Exploration Systems Research and Technology

APG 6ESRT13 Complete all development projects within 110% of the cost and schedule baseline.
and 6PROM4

APG 6ESRT14 Peer review and competitively award at least 80%, by budget, of research projects.

APG 6ESRT15 Reduce annually, the time to award competed projects, from proposal receipt to selection.
and 6PROM5

Human Systems Research and Technology

APG 6HSRT21 Deliver at least 90% of scheduled operating hours for all operations and research facilities.

APG 6HSRT22 Increase annually, the percentage of grants awarded on a competitive basis.

APG 6HSRT23 Peer review and competitively award at least 80%, by budget, of research projects.

APG 6HSRT247 Reduce time within which 80% of NRA research grants are awarded, from proposal due date to selection,
by 5% per year, with a goal of 130 days.

Earth-Sun System

APG 6ESS24 Complete all development projects within 110% of the cost and schedule baseline.

APG 6ESS25 Deliver at least 90% of scheduled operating hours for all operations and research facilities.

APG 6ESS26 Peer-review and competitively award at least 80%, by budget, of research projects.

APG 6ESS27 Reduce time within which 80% of NRA research grants are awarded, from proposal due date to selection,
by 5% per year, with a goal of 130 days.

FY 2006 Performance Plan Update

Solar System Exploration

APG 6SSE29 Complete all development projects within 110% of the cost and schedule baseline.

APG 6SSE30 Deliver at least 90% of scheduled operating hours for all operations and research facilities.

APG 6SSE31 Peer-review and competitively award at least 80%, by budget, of research projects.

APG 6SSE32 Reduce time within which 80% of NRA research grants are awarded, from proposal due date to selection, by 5% per year, with a goal of 130 days.

The Universe

APG 6UNIV22 Complete all development projects within 110% of the cost and schedule baseline.

APG 6UNIV23 Deliver at least 90% of scheduled operating hours for all operations and research facilities.

APG 6UNIV24 Peer-review and competitively award at least 80%, by budget, of research projects.

APG 6UNIV25 Reduce time within which 80% of NRA research grants are awarded, from proposal due date to selection, by 5% per year, with a goal of 130 days.

International Space Station

APG 6ISS5 Complete all development projects within 110% of the cost and schedule baseline.

APG 6ISS6 Deliver at least 90% of scheduled operating hours for all operations and research facilities.

Space Flight Support

APG 6SFS2 Maintain NASA success rate at or above a running average of 95 percent for missions on the FY 2006 Expendable Launch Vehicle (ELV) manifest.

APG 6SFS7 Complete all development projects within 110% of the cost and schedule baseline.

APG 6SFS8 Deliver at least 90% of scheduled operating hours for all operations and research facilities.

Space Shuttle

APG 6SSP2 Complete all development projects within 110% of the cost and schedule baseline.

APG 6SSP3 Deliver at least 90% of scheduled operating hours for all operations and research facilities.

Annual Performance Goals Eliminated For FY 2006

- APG 6AT1 Security system concepts defined that provide reduced vulnerability from intentional attacks, including protected asset flight system concept of operation, evaluation of information distribution vulnerabilities, evaluation of strategy for aircraft damage emulation, definition of fuel flammability needs, identification of key environmental background for on-board sensing, and requirements for processing of large security related databases. (AvSSP)
- APG 6AT2 Complete the assessment of the Security Program technology portfolio with regard to risks, costs, and benefits and project the impact of the technologies on reducing the vulnerability of the air transportation system. (AvSSP)
- APG 6AT3 Evaluate and prioritize NASA's aviation safety technology portfolio to determine the impact on the National Airspace System. (AvSSP)
- APG 6AT5 Conduct successful operational demonstration of multifacility time-based metering in complex airspace. (ASP)
- APG 6AT6 Complete development of system-wide evaluation and planning tool. (ASP)
- APG 6AT9 Propose policy changes to the FAA that would permit routine operation of HALE ROA above 40,000 feet. (VSP)
- APG 6AT10 Demonstrate a HALE ROA reconfigurable flight control architecture. (VSP)
- APG 6ED1 Conduct 12 Educator Astronaut workshops, involving approximately 240 educators. (Elementary/2nd-Ed)
- APG 6ED2 Select approximately 150 student experiments, involving approximately 1,500 students, to participate in the Flight Projects program. (Elementary/2nd-Ed)
- APG 6ED8 Select and support 50 additional schools to participate in the NASA Explorer Schools program, maintaining the total number at 150. (MUREP)
- APG 6ED9 Digitize and meta-tag up to 10 percent of NASA's approved learning materials to be delivered using technology-enabled learning systems. (e-Ed)
- APG 6ED10 Award competitive grants to NASA Centers and informal education partners to conduct up to 15 Explorer Institute workshops. (Informal-Ed)
- APG 6SFS9 Increase the throughput of the Space Network and NASA Wide Area Network per unit cost on an annual basis.
- APG 6SSE24 Complete 2009 Mars Telecommunications Orbiter (MTO) Preliminary Design Review (PDR).

FY 2007 Performance Plan

In 2004, the President charged NASA with the responsibility for planning and implementing an integrated, long-term robotic and human exploration program structured with measurable milestones and executed on the basis of available resources, accumulated experiences, and technology readiness. NASA's six Strategic Goals support this Vision. Each is clearly defined and supported by sub-goals (where appropriate), multi-year Outcomes, and Annual Performance Goals (APGs) that will enhance NASA's ability to measure and report the Agency's progress in achieving these Strategic Goals.

The table below provides a summary of all of the commitments identified by each of the 14 Themes in the preceding sections.

Strategic Goal 1: Fly the Shuttle as safely as possible until its retirement, not later than 2010.

Outcome 1.1 Assure the safety and integrity of the Space Shuttle workforce, systems and processes, while flying the manifest.

APG 7SSP1 Achieve zero Type-A (damage to property at least \$1M or death) or Type-B (damage to property at least \$250K or permanent disability or hospitalization of 3 or more persons) mishaps in FY2007.

APG 7SSP2 Complete 100 percent of all mission objectives for all Space Shuttle missions in FY2007 as specified in the Flight Requirements Document for each mission.

Outcome 1.2 By September 30, 2010, retire the Space Shuttle.

APG 7SSP3 Demonstrate continued progress in identifying, evaluating, documenting, and dispositioning Space Shuttle program resources for phase-out or transition.

Strategic Goal 2: Complete the International Space Station in a manner consistent with NASA's International partner commitments and the needs of human exploration.

Outcome 2.1 By 2010, complete assembly of the U.S. On-orbit Segment; launch International Partner elements and sparing items required to be launched by the Shuttle; and provide on-orbit resources for research to support U.S. human space exploration.

APG 7ISS1 Based on the actual Space Shuttle flight rate, number of remaining Shuttle flights, and the discussions with the International Partners, update the agreed to ISS assembly sequence and transportation plan as necessary.

APG 7ISS2 Accomplish a minimum of 90% of the on-orbit research objectives as established one month prior to a given increment.

APG 7ISS3 Per the final configuration agreed to by the International Partners, fly the ISS elements and logistics baselined for FY 2007.

Outcome 2.2 By 2009, provide the on-orbit capability to support an ISS crew of six crewmembers.

APG 7ISS4 Establish flight-ready status for the urine processing capability (part of the U.S. Regenerative Environmental Control Life Support System).

APG 7ISS5 In concert with the International Partners, assure a continuous crew presence on the ISS.

Strategic Goal 3: Develop a balanced overall program of science, exploration, and aeronautics consistent with the redirection of the human spaceflight program to focus on exploration.

Sub-goal 3A: Study Earth from space to advance scientific understanding and meet societal needs.

Outcome 3A.1 Progress in understanding and improving predictive capability for changes in the ozone layer, climate forcing, and air quality associated with changes in atmospheric composition.

APG 7ESS1 Demonstrate progress in understanding and improving predictive capability for changes in the ozone layer, climate forcing, and air quality associated with changes in atmospheric composition. Progress will be evaluated by external expert review.

Outcome 3A.2 Progress in enabling improved predictive capability for weather and extreme weather events.

APG 7ESS2 Demonstrate progress in enabling improved predictive capability for weather and extreme weather events. Progress will be evaluated by external expert review.

Outcome 3A.3 Progress in quantifying global land cover change and terrestrial and marine productivity, and in improving carbon cycle and ecosystem models.

APG 7ESS3 Demonstrate progress in quantifying global land cover change and terrestrial and marine productivity, and in improving carbon cycle and ecosystem models.

APG 7ESS4 Complete Landsat Data Continuity Mission (LDCM) Confirmation Review.

APG 7ESS6 Complete the Orbiting Carbon Observatory (OCO) Assembly, Test and Launch Operations (ALTO) Readiness Review.

Outcome 3A.4 Progress in quantifying the key reservoirs and fluxes in the global water cycle and in improving models of water cycle change and fresh water availability.

APG 7ESS5 Demonstrate progress in quantifying the key reservoirs and fluxes in the global water cycle and in improving models of water cycle change and fresh water availability. Progress will be evaluated by external expert review.

Outcome 3A.5 Progress in understanding the role of oceans, atmosphere, and ice in the climate system and in improving predictive capability for its future evolution.

APG 7ESS7 Demonstrate progress in understanding the role of oceans, atmosphere, and ice in the climate system and in improving predictive capability for its future evolution. Progress will be evaluated by external expert review.

APG 7ESS8 Complete Glory mission Pre-Ship Review.

APG 7ESS9 Complete Ocean Surface Topography Mission (OSTM) Critical Design Review (CDR).

Outcome 3A.6 Progress in characterizing and understanding Earth surface changes and variability of Earth's gravitational and magnetic fields.

APG 7ESS10 Demonstrate progress in characterizing and understanding Earth surface changes and variability of Earth's gravitational and magnetic fields. Progress will be evaluated by external expert review.

FY 2007 Performance Plan

Outcome 3A.7 Progress in expanding and accelerating the realization of societal benefits from Earth system science.

APG 7ESS11 Issue twelve reports with partnering organizations that validate that using NASA research capabilities (e.g., observations and/or forecast products) could improve their operational decision support systems.

APG 7ESS12 Complete five studies on plans to transition the results of NASA research and development, including scientific spacecraft and instruments, models, and research results, with potential to improve future operational systems of partner agencies.

Sub-goal 3B: Understand the Sun and its effects on Earth and the solar system.

Outcome 3B.1 Progress in understanding the fundamental physical processes of the space environment from the Sun to Earth, to other planets, and beyond to the interstellar medium.

APG 7ESS13 Demonstrate progress in understanding the fundamental physical processes of the space environment from the Sun to Earth, to other planets, and beyond to the interstellar medium. Progress will be evaluated by external expert review.

APG 7ESS14 Deliver Solar Dynamics Observatory (SDO) instruments to spacecraft for integration.

APG 7ESS15 Complete Magnetospheric MultiScale (MMS) instrument suite Preliminary Design Review (PDR).

APG 7ESS16 Award Geospace Missions Radiation Belt Mapper Phase A instrument contracts.

APG 7ESS17 Successfully launch Time History of Events and Macroscale Interactions during Substorms (THEMIS) spacecraft.

APG 7ESS18 Release Explorer Program Announcement of Opportunity (AO).

Outcome 3B.2 Progress in understanding how human society, technological systems, and the habitability of planets are affected by solar variability and planetary magnetic fields.

APG 7ESS14 Deliver Solar Dynamics Observatory (SDO) instruments to spacecraft for integration.

APG 7ESS15 Complete Magnetospheric MultiScale (MMS) instrument suite Preliminary Design Review (PDR).

APG 7ESS16 Award Geospace Missions Radiation Belt Mapper Phase A instrument contracts.

APG 7ESS18 Release Explorer Program Announcement of Opportunity (AO).

APG 7ESS19 Demonstrate progress in understanding how human society, technological systems, and the habitability of planets are affected by solar variability and planetary magnetic fields. Progress will be evaluated by external expert review.

Outcome 3B.3 Progress in developing the capability to predict the extreme and dynamic conditions in space in order to maximize the safety and productivity of human and robotic explorers.

APG 7ESS14 Deliver Solar Dynamics Observatory (SDO) instruments to spacecraft for integration.

APG 7ESS16 Award Geospace Missions Radiation Belt Mapper Phase A instrument contracts.

APG 7ESS20 Demonstrate progress in developing the capability to predict the extreme and dynamic conditions in space in order to maximize the safety and productivity of human and robotic explorers. Progress will be evaluated by external expert review.

Sub-goal 3C: Advance scientific knowledge of the solar system, search for evidence of life, and prepare for human exploration.

Outcome 3C.1 Progress in learning how the Sun's family of planets and minor bodies originated and evolved.

APG 7SSE1 Demonstrate progress in learning how the Sun's family of planets and minor bodies originated and evolved. Progress will be evaluated by external expert review.

APG 7SSE2 Perform MERcury Surface, Space ENvironment, GEochemistry, and Ranging (MESSENGER) mission second Venus flyby.

APG 7SSE3 Complete Juno Preliminary Design Review (PDR).

Outcome 3C.2 Progress in understanding the processes that determine the history and future of habitability in the solar system, including the origin and evolution of Earth's biosphere and the character and extent of prebiotic chemistry on Mars and other worlds.

APG 7SSE4 Demonstrate progress in understanding the processes that determine the history and future of habitability in the solar system, including the origin and evolution of Earth's biosphere and the character and extent of prebiotic chemistry on Mars and other worlds. Progress will be evaluated by external expert review.

APG 7SSE5 Complete 2009 Mars Science Laboratory (MSL) Critical Design Review (CDR).

Outcome 3C.3 Progress in identifying and investigating past or present habitable environments on Mars and other worlds, and determining if there is or ever has been life elsewhere in the solar system.

APG 7SSE6 Demonstrate progress in identifying and investigating past or present habitable environments on Mars and other worlds, and determining if there is or ever has been life elsewhere in the solar system. Progress will be evaluated by external expert review.

APG 7SSE7 Successfully launch Phoenix 2007 spacecraft.

Outcome 3C.4 Progress in exploring the space environment to discover potential hazards to humans and to search for resources that would enable human presence.

APG 7SSE8 Demonstrate progress in exploring the space environment to discover potential hazards to humans and to search for resources that would enable human presence. Progress will be evaluated by external expert review.

APG 7SSE9 Begin Mars Reconnaissance Orbiter (MRO) primary science phase.

Sub-goal 3D: Discover the origin, structure, evolution, and destiny of the universe, and search for Earth-like planets.

Outcome 3D.1 Progress in understanding the origin and destiny of the universe, phenomena near black holes, and the nature of gravity.

APG 7UNIV1 Demonstrate progress in understanding the origin and destiny of the universe, phenomena near black holes, and the nature of gravity. Progress will be evaluated by external expert review.

APG 7UNIV2 Complete Gamma-ray Large Area Telescope (GLAST) Operations Readiness Review (ORR).

APG 7UNIV3 Complete Hubble Space Telescope Servicing Mission 4 (SM4) Test Readiness Review.

FY 2007 Performance Plan

APG 7UNIV4 Complete James Webb Space Telescope (JWST) Integrated Science Instrument Module (ISIM) Preliminary Design Review (PDR).

Outcome 3D.2 Progress in understanding how the first stars and galaxies formed, and how they changed over time into the objects recognized in the present universe.

APG 7UNIV3 Complete Hubble Space Telescope Servicing Mission 4 (SM4) Test Readiness Review.

APG 7UNIV4 Complete James Webb Space Telescope (JWST) Integrated Science Instrument Module (ISIM) Preliminary Design Review (PDR).

APG 7UNIV5 Demonstrate progress in understanding how the first stars and galaxies formed, and how they changed over time into the objects we recognize in the present universe. Progress will be evaluated by external expert review.

Outcome 3D.3 Progress in understanding how individual stars form and how those processes ultimately affect the formation of planetary systems.

APG 7UNIV3 Complete Hubble Space Telescope Servicing Mission 4 (SM4) Test Readiness Review.

APG 7UNIV4 Complete James Webb Space Telescope (JWST) Integrated Science Instrument Module (ISIM) Preliminary Design Review (PDR).

APG 7UNIV6 Demonstrate progress in understanding how individual stars form and how those processes ultimately affect the formation of planetary systems. Progress will be evaluated by external expert review.

Outcome 3D.4 Progress in creating a census of extra-solar planets and measuring their properties.

APG 7UNIV7 Demonstrate progress in creating a census of extra-solar planets and measuring their properties. Progress will be evaluated by external expert review.

APG 7UNIV8 Begin Kepler assembly, test, and launch operations (ATLO).

Sub-goal 3E: Advance knowledge in the fundamental disciplines of aeronautics, and develop technologies for safer aircraft and higher capacity airspace systems.

Outcome 3E.1 By 2016, identify and develop tools, methods, and technologies for improving overall aircraft safety of new and legacy vehicles operating in the Next Generation Air Transportation System (projected for the year 2025).

APG 7AT1 Establish a baseline for state-of-the-art aircraft safety concepts and flight deck information management systems.

Outcome 3E.2 By 2016, develop and demonstrate future concepts, capabilities, and technologies that will enable major increases in air traffic management effectiveness, flexibility, and efficiency, while maintaining safety, to meet capacity and mobility requirements of the Next Generation Air Transportation System.

APG 7AT2 Complete flight test evaluation of oceanic in-trail climb and descent using an Airborne Separation Assistance System (ASAS) and an Automatic, Dependent Surveillance Broadcast (ADS-B).

APG 7AT3 Complete development of an incremental, sustainable transition roadmap from today's air transportation system to the Next Generation Air Transportation System (NGATS) 2025 concept of operations.

FY 2007 Performance Plan

Outcome 3E.3 *By 2016, develop multidisciplinary design, analysis, and optimization capabilities for use in trade studies of new technologies, enabling better quantification of vehicle performance in all flight regimes and within a variety of transportation system architectures.*

APG 7AT4 Baseline state-of-the-art analysis methods and tools to address aeronautics challenges within the hypersonic, subsonic (for rotary and fixed wing vehicles), and supersonic flight regimes.

APG 7AT5 Develop preliminary engine performance models for flight-weight propulsion systems to support hypersonic reference vehicles.

APG 7AT6 Determine fundamental propulsion system integration design issues for existing and advanced rotorcraft configurations.

Outcome 3E.4 *Ensure the continuous availability of a portfolio of NASA-owned wind tunnels/ground test facilities, which are strategically important to meeting national aerospace program goals and requirements.*

APG 7AT7 Develop a long-term, aeronautic test facility vision and funded plan working with all the appropriate stakeholders, to assure that the plan reflects the priorities of the long-term needs of the Nation.

Sub-goal 3F: Understand the effects of the space environment on human performance, and test new technologies and countermeasures for long-duration human space exploration.

Outcome 3F.1 *By 2008, develop and test candidate countermeasures to ensure the health of humans traveling in space.*

APG 7HSRT1 Complete development of a renal stone countermeasure and validate it for use.

APG 7HSRT2 Begin validation of bone and cardiovascular countermeasures on the ISS.

Outcome 3F.2 *By 2010, identify and test technologies to reduce total mission resource requirements for life support systems.*

APG 7HSRT3 Complete laboratory testing of Crew Exploration Vehicle candidate technologies for carbon dioxide (CO₂) and humidity removal, water disinfection, and solid waste volume compaction, increasing the technology maturation in all areas.

Outcome 3F.3 *By 2010, develop reliable spacecraft technologies for advanced environmental monitoring and control and fire safety.*

APG 7HSRT4 Complete critical design review for an ISS technology demonstration of the advanced environmental monitoring system.

APG 7HSRT5 Conduct at least two experiments on the ISS to advance next generation technologies for fire prevention, detection, and suppression on spacecraft.

Strategic Goal 4: Bring a new Crew Exploration Vehicle into service as soon as possible after Shuttle retirement.

Outcome 4.1 *No later than 2014, and as early as 2010, transport three crewmembers to the International Space Station and return them safely to Earth, demonstrating an operational capability to support human exploration missions.*

APG 7CS1 Complete the Systems Design Review for the Constellation Program.

APG 7CS2 Complete the preliminary design for the Crew Exploration Vehicle (CEV).

FY 2007 Performance Plan

APG 7CS3 Complete the preliminary design for the Crew Launch Vehicle (CLV) First Stage.

APG 7CS4 Begin construction and/or modifications to Kennedy Space Center ground processing and launch control facilities needed to support the CEV and CLV in accordance with the Systems Requirements Document.

APG 7CS5 Begin construction and/or modifications to Johnson Space Center flight control facilities needed to support the CEV and CLV in accordance with the Systems Requirements Document.

Outcome 4.2 *No later than 2014, and as early as 2010, develop and deploy a new space suit to support exploration, that will be used in the initial operating capability of the Crew Exploration Vehicle.*

APG 7CS6 Define the acquisition strategy for the design and development of the initial space suit for exploration.

APG 7CS7 Initiate procurement/development of the initial space suit for exploration.

Strategic Goal 5: Encourage the pursuit of appropriate partnerships with the emerging commercial space sector.

Outcome 5.1 *Develop and demonstrate a means for NASA to purchase launch services from emerging launch providers.*

APG 7SFS4 Realize competitive rates from emerging U.S. launch providers and open the bidding process to a larger number of launch providers.

Outcome 5.2 *By 2010, demonstrate one or more commercial space services for ISS cargo and/or crew transport.*

APG 7CS8 Complete assessment of at least two contractor deliverables that will support the development of vehicles that can provide commercial cargo or crew transport services.

Outcome 5.3 *By 2012, complete one or more prize competitions for independently designed, developed, launched, and operated missions related to space science or space exploration.*

APG 7ESRT3 Conduct at least two prize competitions that encourage the development and demonstration of advanced, critical technologies supporting NASA's missions and goals.

Strategic Goal 6: Establish a lunar return program having the maximum possible utility for later missions to Mars and other destinations.

Outcome 6.1 *By 2008, launch a Lunar Reconnaissance Orbiter (LRO) that will provide information about potential human exploration sites.*

APG 7ESRT4 Complete the Non-Advocate Review (Authority to Proceed) for the Lunar Reconnaissance Orbiter.

Outcome 6.2 *By 2012, develop and test technologies for in-situ resource utilization, power generation, and autonomous systems that reduce consumables launched from Earth and moderate mission risk.*

APG 7ESRT1 Demonstrate the feasibility of extracting volatiles and oxygen from lunar regolith in a laboratory environment

APG 7ESRT2 Demonstrate remote supervision of a robotic system to deploy and set up lunar surface infrastructure in a laboratory environment.

FY 2007 Performance Plan

Outcome 6.3 *By 2010, identify and conduct long-term research necessary to develop nuclear technologies essential to support human-robotic lunar missions and that are extensible to exploration of Mars.*

APG 7ESRT5 Complete a focused plan and initiate research for nuclear systems technology development for lunar surface fission power generation in support of protracted missions.

Outcome 6.4 *Implement the space communications and navigation architecture responsive to Science and Exploration mission requirements.*

APG 7SFS1 Develop and submit in February 2007 a space communications plan based on an architecture that supports NASA's exploration and science programs for the 2010-2015 timeframe and beyond.

APG 7SFS2 Implement technology initiatives consistent with approved baseline space communications and navigations architecture.

APG 7SFS3 Pursue commercial opportunities for the space communications and navigation architecture.

Cross-Agency Support Programs

Education

Outcome ED-1 *Contribute to the development of the STEM workforce in disciplines needed to achieve NASA's strategic goals through a portfolio of programs.*

- APG 7ED1 Award 1,200 competitive internships, fellowships, and research opportunities for higher education students and faculty in STEM disciplines.
- APG 7ED2 Award 500 competitive scholarships, internships, fellowships, and research opportunities for underrepresented and underserved students, teachers and faculty in STEM disciplines.
- APG 7ED3 Provide 100 grants to enhance the capability of 50 underrepresented and underserved colleges and universities to compete for and conduct basic or applied NASA-related research.
- APG 7ED4 Complete a retrospective longitudinal study of student participants to determine the degree to which participants maintain affiliation with NASA through the pipeline.
- APG 7ED5 Collect, analyze, and report longitudinal data on student participants to determine the degree to which participants enter the NASA workforce or other NASA-related career fields.

Outcome ED-2 *Attract and retain students in STEM disciplines through a progression of educational opportunities for students, teachers, and faculty.*

- APG 7ED6 Conduct 10 Educator Astronaut workshops, involving approximately 200 educators.
- APG 7ED7 Select and support 50 additional schools to participate in the NASA Explorer Schools program, maintaining the total number at 100.
- APG 7ED8 Select 100 student experiments, involving 1,000 students, to participate in the Flight Projects program.

Outcome ED-3 *Build strategic partnerships and linkages between STEM formal and informal education providers that promote STEM literacy and awareness of NASA's mission.*

- APG 7ED9 Digitize and meta-tag 10 percent of NASA's approved learning materials to be delivered using technology-enabled learning systems.
- APG 7ED10 Award competitive grants to NASA Centers and informal education partners to conduct up to 10 Explorer Institutes projects.

Advanced Business Systems (Integrated Enterprise Management Program)

Outcome IEM-1 *By 2008, implement Agency business systems that provide timely, consistent and reliable business information for management decisions.*

- APG 7IEM1 Upgrade NASA's existing Core Financial system, through the SAP Version Update Project, resulting in improved data integrity.

Outcome IEM-2 *Increase efficiency by implementing new business systems and reengineering Agency business processes.*

- APG 7IEM2 Implement the Contract Management Module to increase efficiency in procurement processes.
- APG 7IEM3 Implement the Aircraft Management Module to reduce the risk of flight operations through improved tracking of crew and aircraft currency qualifications.

Innovative Partnerships Program

Outcome IPP-1 Promote and develop innovative technology partnerships among NASA, U.S. industry, and other sectors for the benefit of Agency programs and projects.

- APG 7IPP1 Develop 20 technology-related significant partnerships that create leveraged value for NASA's programs and projects. Track both quantitative dollar value and qualitative benefits to NASA (e.g. reduced volume or mass, improved safety).
- APG 7IPP2 Complete 50 technology transfer agreements with the commercial and academic community through such mechanisms as: licenses, software use agreements, facility use agreements, and space act agreements.
- APG 7IPP3 Fully implement an annual portfolio licensing approach that targets licensing goals of greatest value/benefit to NASA. Examples of such value are: licensing royalties, and new technology products available to NASA. Royalties should be \$4M per year or greater.
- APG 7IPP4 Complete and institutionalize an enhanced Intellectual Property (IP) management process that enables stronger use of NASA's IP to support NASA's strategies. Implement such IP management together with at least two significant NASA programs or projects.

Shared Capability Assets Program

Outcome SC-1 Establish and maintain selected Agency level shared capabilities, across multiple classes of assets (e.g., wind tunnels, vacuum chambers, etc.), to ensure that they will continue to be available to support the missions that require them.

- APG 7SC1 Prioritize funding requirements and select classes of assets for inclusion in the Shared Capability Assets Program.
- APG 7SC2 Identify re-investment/re-capitalization opportunities within and among classes of assets and execute the approved changes (e.g., reallocate funds, upgrade facilities, etc.).

Efficiency Measures

Aeronautics Technology

APG 7AT8 Deliver at least 90% of scheduled operating hours for all operations and research facilities.

APG 7AT9 Increase the annual percentage of research funding awarded to Aeronautics University Partnerships.

Education

APG 7ED11 Collect, analyze, and report that 100% of grantees annually report on their accomplishments.

APG 7ED12 Peer review and competitively award at least 85%, by budget, of research projects.

Constellation Systems

APG 7CS9 Complete all development projects within 110% of the cost and schedule baseline.

Exploration Systems Research and Technology

APG 7ESRT6 Complete all development projects within 110% of the cost and schedule baseline.

APG 7ESRT7 Increase the number of technology products transferred to Constellation Systems developers for mission application.

Human Systems Research and Technology

APG 7HSRT6 Increase percentage of HSRT procurement funding, solely dedicated to Exploration Activities.

APG 7HSRT7 Reduce time within which 80% of NRA research grants are awarded, from proposal due date to selection, by 5% per year, with a goal of 130 days.

Earth-Sun System

APG 7ESS21 Complete all development projects within 110% of the cost and schedule baseline.

APG 7ESS22 Deliver at least 90% of scheduled operating hours for all operations and research facilities.

APG 7ESS23 Peer-review and competitively award at least 80%, by budget, of research projects.

APG 7ESS24 Reduce time within which 80% of NRA research grants are awarded, from proposal due date to selection, by 5% per year, with a goal of 130 days.

Solar System Exploration

APG 7SSE10 Complete all development projects within 110% of the cost and schedule baseline.

APG 7SSE11 Deliver at least 90% of scheduled operating hours for all operations and research facilities.

APG 7SSE12 Peer-review and competitively award at least 80%, by budget, of research projects.

APG 7SSE13 Reduce time within which 80% of NRA research grants are awarded, from proposal due date to selection, by 5% per year, with a goal of 130 days.

FY 2007 Performance Plan

The Universe

APG 7UNIV9 Complete all development projects within 110% of the cost and schedule baseline.

APG 7UNIV10 Deliver at least 90% of scheduled operating hours for all operations and research facilities.

APG 7UNIV11 Peer-review and competitively award at least 80%, by budget, of research projects.

APG 7UNIV12 Reduce time within which 80% of NRA research grants are awarded, from proposal due date to selection, by 5% per year, with a goal of 130 days.

International Space Station

APG 7ISS6 Complete all development projects within 110% of the cost and schedule baseline.

APG 7ISS7 Deliver at least 90% of scheduled operating hours for all operations and research facilities.

Space Flight Support

APG 7SFS5 Complete all development projects within 110% of the cost and schedule baseline.

APG 7SFS6 Deliver at least 90% of scheduled operating hours for all operations and research facilities.

Space Shuttle

APG 7SSP4 Complete all development projects within 110% of the cost and schedule baseline.

APG 7SSP5 Deliver at least 90% of scheduled operating hours for all operations and research facilities.

APG 7SSP6 While ensuring the safety of ongoing flight operations and by working with exploration development programs, reduce Space Shuttle sustaining engineering hours, annual value of Space Shuttle production contracts, and the number of dedicated Space Shuttle facilities, where possible.

Document Format

Since the FY 2004 President's Budget submission, NASA has structured its budget by the major Themes, or portfolios, of the Agency. The format is designed to be easy to navigate and to present the costs and benefits of budget items consistently and clearly. The format also integrates the budget request and annual performance plan into one document. The FY 2007 President's Budget submission continues NASA's efforts to make the document increasingly clear and comprehensive.

Budget Levels

There are four budget levels. At the first level are the Mission Directorates, NASA's primary areas of activity. At the second are Themes, programmatic subdivisions of Mission Directorates that function as program "investment portfolios." At the third level, individual programs within the Themes are discussed. Projects are the fourth level. At each of the four budget levels, the document presents consistent types of information to allow comparison across the budget at that budget level and to facilitate document navigation.

Mission Directorates

Mission Directorate sections provide a summary of each Directorate's purpose, recent and planned accomplishments, and overviews of each of its Themes.

Themes

To facilitate evaluation of the Theme as an investment, this section presents the "business case" for each Theme by displaying the budget request and discussing it in terms of the President's Research and Development Investment Criteria for relevance, quality, and performance. Theme sections include data on the programs that comprise the Theme. Also included are the Theme's performance commitments—the Outcomes and annual performance goals that the Theme will accomplish—and information on independent reviews.

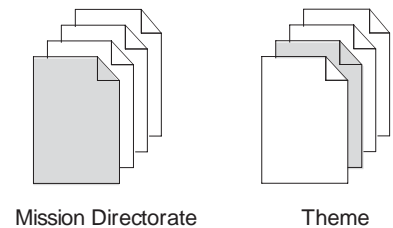

Programs

Program descriptions include their plans for FY 2007, schedules of significant projects, major risks, formulation and development schedules, and key participants. All programs are shown in this document.

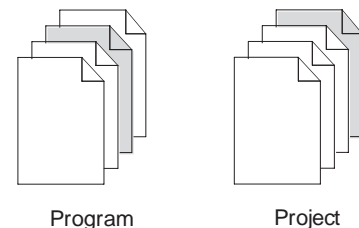

Projects

Project descriptions are intended to augment the budget request with additional information including schedule milestones, major acquisitions, risks, and development life-cycle costs. In this document, all development projects with an expected life cycle cost (LCC) greater than \$100 million and major formulation projects are shown. Operations and technology projects have not been included in this document.

Acronyms

AA	Associate Administrator	ASEB	Aeronautics and Space Engineering Board
AAA	Algorithms, Architectures, and Applications	ASI	Agenzia Spaziale Italiana (Italian Space Agency)
AAH	Advanced Animal Habitat	ASO	Astronomical Search for Origins (former NASA Theme)
AATT	Advanced Air Transportation Technologies	ASP	Airspace Systems Program
AC	Advanced Concepts	ASVM	Aircraft and Systems Vulnerability Mitigation
ACE	Advanced Composition Explorer	AT	Aeronautics Technology (Theme)
ACRIMSat	Active Cavity Radiometer Irradiance Monitor Satellite	ATAC	Air Transport Association of Canada
ACRT	Accelerated Crucible Rotation Technique	ATC	Air Traffic Control
ACS	Advanced Camera for Surveys (Hubble Space Telescope instrument)	ATCSCC	Air Traffic Control System Command Center
ADA	American with Disabilities Act	ATLO	Assembly, Test, Launch Operations
AEDC	Arnold Engineering Development Center	ATM	Air Traffic Management
AESP	Aerospace Education Services Program	ATMS	Advanced Technology Microwave Sounder (NPOESS Preparatory Project instrument)
AFRL	Air Force Research Laboratory	ATP	Aeronautics Test Program
AHMS	Advanced Health Management System	ATS	Air Transportation System
AHST	Advanced Human Support Technology	AVC	Advanced Vehicle Concepts
AIA	Atmospheric Imaging Assembly (Solar Dynamic Observatory instrument)	AvSSP	Aviation Safety and Security Program
AIM	Aeronomy of Ice in the Mesosphere	AWIPS	Advanced Weather Interactive Processing System
AIRS	Atmospheric Infrared Sounder	BAA	Broad Agency Announcement
AIST	Advanced Information Systems Technology	BE	Beyond Einstein (Program)
ALS	Advanced Life Support	BNL	Brookhaven National Laboratory
AMM	Aircraft Management Module	BOA	Basic Ordering Agreement
AMMOS	Advanced Multi-Mission Operations System	BPRAC	Biological and Physical Science Research Advisory Committee
AMR	Advanced Microwave Radiometer (Ocean Surface Topography Mission instrument)	BPRE	Biological and Physical Research Enterprise (former NASA Enterprise)
AO	Announcement of Opportunity	BPS	Biomass Production System
AOA	Analysis of Alternatives	BR	Bioastronautics Roadmap
AOS	Airspace Operations Systems	BR&C	Biomedical Research and Countermeasures
APG	Annual Performance Goal	BRP	Biological Research Project
APL	Applied Physics Laboratory (Johns Hopkins University)	BSM	Booster Separation Motors
APS	Advanced Polarimeter Sensor (Glory instrument)	BVT	Breakthrough Vehicle Technologies
APT	Advanced Platform Technology	CAASD	Center for Advanced Aviation System Development
APXS	Alpha Particle X-Ray Spectrometer	CAIB	Columbia Accident Investigation Board
AR&D	Automated Rendezvous and Docking	CALIPSO	Cloud–Aerosol Lidar and Infrared Pathfinder Satellite Observations
ARC	Ames Research Center	CAM	Centrifuge Accommodations Module
ARF	Assembly Refurbishment Facility	CAN	Cooperative Agreement Notice
ARM	Active Risk Manager	CARA	California Association for Research in Astronomy
ARMD	Aeronautics Research Mission Directorate	CARD	Cost Analysis Requirements Document
ARTCC	Air Route Traffic Control Center	CAS	Commercial Advisory Subcommittee
AS	Airspace Systems		
ASAP	Aerospace Safety Advisory Panel		

Acronyms

CASA	Carnegie, Ames, Stanford Approach	CrIS	Cross-track Infrared Sounder (an NPOESS Preparatory Project instrument)
CAST	Commercial Aviation Safety Team	CRISM	Compact Reconnaissance Imaging Spectrometer (Mars Reconnaissance Orbiter instrument)
CCC	Commercial Crew/Cargo Project	CRM	Continuous Risk Management
CCRM	Continuous Cost Risk Management	CSA	Canadian Space Agency
CCSP	Climate Change Science Program	CSOC	Consolidated Space Operations Contract
CCU	Cell Culture Unit	CXO	Chandra X-ray Observatory
CDC	Centers for Disease Control	CY	Calendar Year
CDE	Cosmic Dust Experiment (Aeronomy of Ice in the Mesosphere instrument)	DAA	Deputy Associate Administrator
CDR	Critical Design Review	DAFT	Dust and Aerosol Measurement Facility Test
CE&R	Concept Exploration and Refinement	DAN	Dynamic Albedo of Neutrons
CENR	Committee on Environment and Natural Resources Research	DARPA	Defense Advanced Research Projects Agency
CEOS	Committee on Earth Observation Satellites	DART	Demonstration of Autonomous Rendezvous Technology
CEV	Crew Exploration Vehicle	DCR	Design Certification Review
CFO	Chief Financial Officer	DDT&E	Design, Development, Test & Evaluation
ChemCam	Chemistry Camera	DEVELOP	Digital Earth Virtual Environment and Learning Outreach Program
CHIPS	Cosmic Hot Interstellar Plasma Spectrometer	DFRC	Dryden Flight Research Facility
CHS	Crew Health and Safety	DHS	Department of Homeland Security
CHSu	Crew Health Surveillance	DI	Deep Impact
CINDI	Coupled Ion Neutral Dynamics Investigation	DLN	Digital Learning Network
CIPA	Curriculum Improvement Partnership Awards	DLR	Deutsches Zentrum für Luft- und Raumfahrt (German Aerospace Center)
CIPS	Cloud Imaging and Particle Size (Aeronomy of Ice in the Mesosphere instrument)	DoD	Department of Defense
CIR	Combustion Integrated Rack	DoE	Department of Energy
CIRA	Cooperative Institute for Research in the Atmosphere	DORIS	Doppler Orbitography by Radiopositioning Integrated by Satellite (Ocean Surface Topography Mission instrument)
CLV	Crew Launch Vehicle	DoT	Department of Transportation
CMAQ	Community Multiscale and Air Quality	DPR	Dual-frequency Precipitation Radar (Global Precipitation Mission instrument)
CMB	Cosmic Microwave Background	DSMS	Deep Space Mission System
CME	Coronal Mass Ejection	DSN	Deep Space Network
CMM	Contract Management Module	DST	Decision Support Tool
CNES	Centre Nationale D'Etudes Spatiale (French Space Agency)	EAP	Educator Astronaut Program
CNS	Communication, Navigation, and Surveillance	EASI	Efficient Aerodynamic Shapes and Integration
CO2	Carbon Dioxide	ECANS	Exploration Communication and Navigation Systems
CoF	Construction of Facilities	ECLSS	Environmental Control and Life Support System
CONAE	Argentina's National Committee of Space Activities	ECR	Environmental Compliance and Restoration
CONTOUR	Comet Nucleus Tour	ECT	Enabling Concepts and Technologies
COS	Cosmic Origins Spectrograph		
COTF	Classroom of the Future		
CPR	Cloud Profiling Radar (Cloudsat instrument)		
CQUEST	Carbon Query and Evaluation Support Tools		

Acronyms

EDL	Entry, Descent, and Landing	FAST	Fast Auroral Snapshot
EELV	Evolved Expendable Launch Vehicle	FCF	Fluids and Combustion Facility
EFI	Electric Field Instrument (Thermal Emission Imaging System instrument)	FEMA	Federal Emergency Management Agency
EIS	Extreme-ultraviolet Imaging Spectrometer (Solar-B instrument)	FFMIA	Federal Financial Management Improvement Act of 1996
ELV	Expendable Launch Vehicle	FFP	Firm Fixed Price
ELVIS	Expendable Launch Vehicle Integrated Support	FFPC	Firm Fixed Price Contract
EO-1	Earth Observing One Mission	FFRDCs	Federally Funded Research and Development Centers
EOS	Earth Observing System	FGM	Fluxgate Magnetometer (Thermal Emission Imaging System instrument)
EOSDIS	Earth Observing System Data and Information System	FGS	Fine Guidance Sensor
EPA	Environmental Protection Agency	FIR	Fluids Integrated Rack
EPMC	Enterprise Program Management Council	FP&D	Facility Planning and Design
EPSCoR	Experimental Program to Stimulate Competitive Research	FPGA	Field Programmable Gate Array
ESA	European Space Agency	FPP	Focal Plane Package
ESAS	Exploration Systems Architecture Study	FR	Flight Rule
ESE	Earth Science Enterprise (former NASA Enterprise)	FSB	Fundamental Space Biology (former NASA Theme)
ESMD	Exploration Systems Mission Directorate	FTE	Full Time Equivalency
ESR&T	Exploration Systems Research and Technology (Theme)	FUSE	Far Ultraviolet Spectroscopic Explorer
ESS	Earth-Sun System (Theme)	FY	Fiscal Year
ESSP	Earth System Science Pathfinder	G&A	General and Administrative
ESTO	Earth Science Technology Office	GAJSC	General Aviation Joint Steering Committee
ESTP	Earth Science Technology Program	GALEX	Galaxy Evolution Explorer
ET	External Tank	GAO	Government Accountability Office
ETA	External Tank Assembly	GASMAP	Gas Analyzer System for Metabolic Analysis Physiology
ETF	Environmental Test Facility	GBM	Gamma-ray Burst Monitor (Gamma-ray Large Area Telescope instrument)
ETM	Enhanced Thematic Mapper	GE	General Electric
ETU	Engineering Test Unit	GEC	Global Electrodynamics Connection
EUMETSAT	European Organization for the Exploitation of Meteorological	GFE	Government-Furnished Equipment
EUV	Extreme Ultraviolet	GHz	Gigahertz
EVA	Extravehicular Activity	GIS	Geographic Information System
EVE	Extreme-ultraviolet Variability Experiment (Solar Dynamics Observatory instrument)	GLAST	Gamma-ray Large Area Space Telescope
EVM	Earned Value Management	GLOBE	Global Learning and Observations to Benefit the Environment
EWT	Embedded Web Technology	GM	Geospace Missions
EXPRESS	Expedite the Processing of Experiments to the Space Station	GMI	GPM Microwave Imager (Global Precipitation Measurement instrument)
F&SD	Flight and Systems Demonstration	GM-ITM	Geospace Missions-Ionosphere-Thermosphere Mapper
FAA	Federal Aviation Administration	GM-RBM	Geospace Missions-Radiation Belt Mapper
FAD	Formulation Authorization Document	GN	Ground Networks
		GO	Guest Observers

Acronyms

GOES	Geostationary Operational Environmental Satellite	IAR	Independent Annual Review
GP-B	Gravity Probe-B	IAT	Independent Assessment Team
GPM	Global Precipitation Measurement	IBPD	Integrated Budget and Performance Document
GPMC	Governing Program Management Council	ICAO	International Civil Aviation Organization
GPS	Global Positioning System	ICESat	Ice, Cloud, and land Elevation Satellite
GPSP	Global Positioning System Payload (Ocean Surface Topography Mission instrument)	IEM	Integrated Enterprise Management
GRACE	Gravity Recovery and Climate Experiment	IEMP	Integrated Enterprise Management Program
GRB	Gamma Ray Burst	IFMP	Integrated Financial Management Program
GRC	Glenn Research Center	IGA	Intergovernmental Agreement
GRC/PBS	Glenn Research Center-Plum Brook Station	IIFDT	Integrated Intelligent Flight Deck Technologies
GSFC	Goddard Space Flight Center	IIR	Imaging Infrared Radiometer (Cloud-Aerosol Lidar and Infrared Pathfinder Satellite Observations instrument)
GSRP	Graduate Student Research Program	IMAGE	Imager for Magnetopause-to-Aurora Global Exploration
GSS	Ground Support Systems	IMP-8	Interplanetary Monitoring Platform 8
GSSR	Goldstone Solar System Radar	IMPACT	In-situ Measurements of Particles and CME Transients (Solar Terrestrial Relations Observatory investigation)
H&RT	Human and Robotic Technology (former NASA Theme)	INSPIRE	Interdisciplinary National Science Program Incorporating Research and Education Experiences
HABSOS	Harmful Algae Blooms Observing System	INTEGRAL	International Gamma Ray Astrophysics Laboratory
HALE	High-altitude, Long-endurance	IPAO	Independent Program Assessment Office
HALE-ROA	High-altitude, Long-endurance Remotely Operated Aircraft	IPO	Integrated Program Office
HAZUS	Hazards U.S.	IPP	Innovative Partnerships Program
HBCU	Historically Black Colleges and Universities	IRA	Institutional Research Awards
HECC	High End Computing Columbia	IRAC	Integrated Resilient Aircraft Controls
HETE-2	High Energy Transient Explorer	IRT	Independent Review Team
HLLV	Heavy Lift Launch Vehicle	ISAS	Institute of Space and Astronautical Science
HMI	Helioseismic and Magnetic Imager (Solar Dynamic Observatory instrument)	ISFS	Invasive Species Forecasting System
HMP	Human Measures and Performance	ISHM	Integrated System Health Management
HMS	Health Maintenance System	ISOR	Independent Science and Operations Review
HQ	NASA Headquarters	ISP	In-Space Propulsion Project
HRF	Human Research Facility	ISPP	In-Space Propulsion Program
HRI	High Resolution Imager	ISRO	Indian Space Research Organization
HRT	High Resolution Tracker	ISS	International Space Station
HSI	Human Systems Integration	ISSMP	International Space Station Medical Program
HSR&T	Human Systems Research and Technology (Theme)	ISTP	Integrated Space Transportation Plan
HST	Hubble Space Telescope	ITAR	International Traffic in Arms Regulation
HVAC System	Heating Ventilation and Air Conditioning System	ITAS	Integrated Tailored Aerostructures
I&T	Integration and test	ITF	Integrated Training Facility
IAA	International Academy of Astronautics	ITM	Ionspheric/Thermospheric/Mesospheric
IAIPT	Interagency ATM Integrated Product Team		
IAM	Integrated Asset Management		

Acronyms

ITTP	Innovative Technology Transfer Partnerships	LOI	Lunar Orbit Injection
IVHM	Integrated Vehicle Health Management	LOX/Methane	Liquid Oxygen/Methane
IWGEO	Interagency Working Group on Earth Observations	LRA	Laser Retroreflector Array (Ocean Surface Topography Mission instrument)
JACIE	Joint Agency Committee for Imagery Evaluation	LRD	Launch Readiness Date
JAXA	Japanese Aerospace Exploration Agency	LRO	Lunar Reconnaissance Orbiter
JDEM	Joint Dark Energy Mission	LS	Launch Services
JEM	Japanese Experiment Module	LSAH	Longitudinal Study of Astronaut Health
JHU	John Hopkins University	LSG	Life Sciences Glovebox
JHU-APL	Johns Hopkins University–Applied Physics Laboratory	LSH	Life Support and Habitation (Program)
JIMO	Jupiter Icy Moons Orbiter	LTMFP	Low Temperature Microgravity Physics Facility
JPDO	Joint Planning and Development Office	LTP	Learning Technologies Project
JPL	Jet Propulsion Laboratory	LWS	Living with a Star (Program)
JSC	Johnson Space Center	M3	Moon Mineralogy Mapper
JSC-WSTF	Johnson Space Center-White Sands Test Facility	MAF	Michaud Assembly Facility
JSRA	Joint Sponsored Research Agreement	MASTAP	Math Science Teacher & Curriculum Enhancement Program
JSRDA	Joint Sponsored Research and Development Agreement	MAV	Mars Ascent Vehicle
JWG	Joint Working Group	MCC	Mission Control Center
JWST	James Webb Space Telescope	MCR	Mission Confirmation Review
KI	Keck Interferometer	McTMA	Multi-center Traffic Management Advisor
KM	Knowledge Management	MD	Mission Directorate
KSC	Kennedy Space Center	MECA	Mars Environmental Compatibility Assessment
kW	Kilowatt	MEP	Mars Exploration Program
LANL	Los Alamos National Laboratory	MEPAG	Mars Exploration Program Analysis Group
LaRC	Langley Research Center	MER	Mars Exploration Rover
LASP	Laboratory for Atmospheric and Space Physics (University of Colorado, Boulder)	MESSENGER	Mercury Surface, Space Environment, Geochemistry and Ranging
LAT	Large Area Telescope (Gamma-ray Large Area Telescope instrument)	MGS	Mars Global Surveyor
LBTI	Large Binocular Telescope Interferometer	MIDEX	Medium-class Explorer
LCC	Launch Control Center	MIE	Model Institutes for Excellence
LCC	Life-cycle Cost	MILA	Merritt Island Launch Annex
LDCM	Landsat Data Continuity Mission	MIRI	Mid-infrared Instrument (James Webb Space Telescope instrument)
LE	Lunar Exploration	MISR	Multi-angle Imaging Spectroradiometer
LEAP	Low Emissions Alternative Power	MIT	Massachusetts Institute of Technology
LEO	Low Earth Orbit	MLCD	Mars Laser Communication Demonstration
LIDAR	Light Detection and Ranging	MLP	Mobile Launch Platform
LiOH	Lithium Hydroxide	MMRTG	Multi-missions Radioisotope Thermoelectric Generators
LISA	Laser Interferometer Space Antenna	MMS	Magnetospheric Multiscale
LMA	Lockheed Martin Astronautics	MO	Missions of Opportunity
LOA	Letter of Agreement	MO&DA	Mission Operations and Data Analysis

Acronyms

MOA	Memorandum of Agreement	NGATS	Next Generation Air Transportation System
MODIS	Moderate-resolution Imaging Spectroradiometer	NGLT	Next Generation Launch Technology
MOR	Mission Operations Review	NIA	National Institute of Aerospace
MOU	Memorandum of Understanding	NIAC	NASA Institute of Advanced Concepts
MPIAT	Mars Program Independent Assessment Team	NICMOS	Near Infrared Camera and Multi-Object Spectrometer (Hubble Space Telescope instrument)
MPLM	Multi-purpose Logistic Module	NIH	National Institutes of Health
MRO	Mars Reconnaissance Orbiter	NIMA	National Imagery and Mapping Agency
MRR	Mission Requirement Request	NIRCam	Near-infrared Camera (James Webb Space Telescope instrument)
MSFC	Marshall Space Flight Center	NIRSpec	Near Infrared Spectrometer (James Webb Space Telescope instrument)
MSG	Microgravity Sciences Glovebox	NISN	NASA Integrated Services Network
MSI	Minority-serving Institute	NIWA	National Institute for Water and Atmospheric Research
MSL	Mars Science Laboratory	NLS	NASA Launch Services
MSMT	Mission and Science Measurement Technology	NLT	NASA Learning Technologies
MSR	Mars Sample Return	NMP	New Millennium Program
MSRF	Materials Science Research Facility	NOAA	National Oceanic and Atmospheric Administration
MSRR	Materials Science Research Rack	NOx	Nitrogen Oxide
MTO	Mars Telecommunications Orbiter	NPG	Nuclear Power Generation
MUREP	Minority University Research and Education Program	NPOESS	National Polar-orbiting Operational Environmental Satellite System
MUSES - C	Mu Space Engineering Spacecraft-C	NPP	NPOESS Preparatory Project
MUSS	Multi-user Systems and Support	NPR	NASA Procedural Requirement
MXER	Momentum Exchange/Electrodynamic Reboost	NRA	NASA Research Announcement
NAC	NASA Advisory Committee	NRC	Nuclear Regulatory Commission
NAPA	National Academy of Public Administration	NRC	National Research Council
NAR	Non-advocacy Review	NRO	National Reconnaissance Office
NAS	National Airspace System	NRTS	Network Resources Training Site
NASDA	National Space Development Agency of Japan	NSBRI	National Space Biomedical Research Institute
NAST	NPOESS Aircraft Sounder Testbed	NSCORs	NASA Specialized Centers of Research
NEA	NASA Educator Astronaut	NSF	National Science Foundation
NEAR	Near-Earth Asteroid Rendezvous	NSRDB	National Solar Radiation DataBase
NEI	NASA Explorer Institute	NSRL	NASA Space Radiation Laboratory
NEMS	NASA Equipment Management System	NSSC	NASA Shared Services Center
NEO	Near-Earth Object	NTTC	National Technology Transfer Center
NEP	Nuclear Electric Propulsion	O&SS	Operations and sustaining support
NEPA	National Environmental Policy Act	OA	Office of Audits
NES	NASA Explorer Schools	OBPR	Office of Biological and Physical Research
NESC	NASA Engineering and Safety Center	OBSS	Orbiter Boom Sensor System
NEXT	NASA Evolutionary Xenon Thruster	OCO	Orbiting Carbon Observatory
NExTNAS	NASA Exploratory Technologies for the National Airspace System		

Acronyms

ODA	Orbital Debris Assessment	PSO	Primary Science Orbit
OGS	Oxygen Generation System	PsR	Pre-ship Review
OIG	Office of Inspector General	PSR	Physical Sciences Research
OLI	Operational Land Imager (Landsat Data Continuity Mission instrument)	PSU	Pennsylvania State University
OMB	Office of Management and Budget	QAT	Quiet Aircraft Technology
OMC	Operations Management Council	R&A	Research and Analysis
OMM	Orbiter Major Modifications	RBM	Radiation Belt Mapper Mission
OMPS	Ozone Mapping and Profiler Suite (NPOESS Preparatory Project instrument)	REASoN	Research, Education and Applications Solutions Network
OMU	Other Minority Universities	REMS	Rover Environmental Monitoring System
OPF	Orbiter Processing Facility	RFP	Request for Proposal
ORR	Operations Readiness Review	RHESSI	Reuven Ramaty High Energy Solar Spectroscopic Imager
ORU	Orbital Replacement Unit	RLEP	Robotic Lunar Exploration (Program)
OSC	Orbital Services Corporation	ROA	Remotely Operated Aircraft
OSP	Orbital Space Plane	ROSES	Research Opportunities in Space and Earth Science
OSS	Office of Space Science (former NASA office)	ROSS	Research Opportunities In Space Science
OSTM	Ocean Surface Topography Mission	RPC	Research Partnership Center
PAIR	Partnership Awards for the Integration of Research into Undergraduate Education	RPCT	Radioisotope Power Conversion Technology
PARASOL	Polarization and Anisotropy of Reflectances for Atmospheric Sciences coupled with Observations from a Lidar (A French satellite)	RPMP	Real Property Management Plan
PART	Program Assessment Rating Tool	RPS	Radioisotope Power System
PBS	President's Budget Submit	RPSF	Rotation Processing and Surge Facility
PCA	Program Commitment Agreement	RPT	Rocket Propulsion Testing
PCS	Physics of Colloids in Space	RSA	Russian Space Agency
PDR	Preliminary Design Review	RSB	Rudder Speed Brake
PDS	Passive Dosimeter System	RSDO	Rapid Spacecraft Development Office
PEAF	Pre-cast Exposed Aggregate Facing	RSRM	Reusable Solid Rocket Motor
PER	Pre-Environmental Review	RTDT	Rapid Technology Development Teams
PI	Principal Investigator	RTF	Return-to-Flight.
PIMC	Program Institutional Management Council	RTG	Radioisotope Thermoelectric Generators
PIR	Program Implementation Review	RXTE	Rossi X-ray Timing Explorer
PKB	Pluto-Kuiper Belt (New Horizons)	S&MA	Safety and Mission Assurance
PLASTIC	Plasma and Supra-thermal Ion and Composition (Solar Terrestrial Relations Observatory investigation)	SAC-D	Satellite de Aplicaciones Cientificas-D (Argentina)
PMA	President's Management Agenda	SAGE III	Stratospheric Aerosol and Gas Experiment III
PMC	Program Management Council	SAME	Smoke and Aerosol Measurement Experiment
PNST	Prometheus Nuclear Systems and Technology	SAMPEX	Solar Anomalous and Magnetospheric Particle Explorer
POES	Polar Operational Environmental Satellites	SAO	Smithsonian Astrophysical Observatory
PRU	Plant Research Unit	SAR	Synthetic Aperture Radar
		SATS	Small Aircraft Transportation System
		SATSLab	Small Aircraft Transportation System Laboratory

Acronyms

SAU	Strategic Airspace Usage	SOFIA	Stratospheric Observatory for Infrared Astronomy
SBIR	Small Business Innovative Research	SOFIE	Solar Occultation for Ice Experiment (Aeronomy of Ice in the Mesosphere instrument)
SBT	Space-based Technology	SOHO	Solar Heliospheric Observer
SC	Shared Capabilities	SOMD	Space Operations Mission Directorate
SCAP	Shared Capability Assets Program	SORCE	Solar Radiation and Climate Experiment
SCM	Search Coil Magnetometer (Thermal Emission Imaging System instrument)	SPD	Space Products Development
SDO	Solar Dynamics Observatory	SPF	Software Production Facility
SDR	System Design Review	SPP	Science Power Platform
SEC	Sun–Earth Connection (former NASA Theme)	SPRL	Space Physics Research Laboratory
SECAS	Sun–Earth Connection Advisory Subcommittee	SRB	Solid Rocket Booster
SECCHI	Sun-Earth Connection Coronal and Heliospheric Investigation (Solar Terrestrial Relations Observatory investigation)	SRG	Stirling Radioisotope Generator
SELENE	Selenological and Engineering Explorer (Japan)	SSB	Space Studies Board
SEMAA	Science Engineering Mathematics Aerospace Academy	SSBRP	Space Station Biological Research Project
SERB	Shuttle Engineering Review Board	SSC	Stennis Space Center
SERVIR	Central American Monitoring and Visualization System	SScAC	Space Science Advisory Committee
SEU	Structure and Evolution of the Universe (former NASA Theme)	SSE	Solar System Exploration (Theme)
SFLC	Space Flight Leadership Council	SSES	Solar System Exploration Subcommittee
SFOC	Space Flight Operations Contract	SSME	Space Shuttle Main Engines
SFS	Space and Flight Support	SSMOC	SOFIA Science and Mission Operations Center
SHARAD	Shallow Radar	SSP	Space Shuttle Program
SHARP	Summer High-school Apprenticeship Research Program	SSS	Sea Surface Salinity
SHARPP	Solar Heliospheric Activity Research and Prediction Program	SST	Solid State Telescope (Thermal Emission Imaging System instrument)
SIM	Space Interferometry Mission	STEM	Science, Technology, Engineering, and Mathematics
SLAC	Stanford Linear Accelerator Center	STEREO	Solar Terrestrial Relations Observatory
SLEP	Shuttle Service Life Extension Program	STIS	Space Telescope Imaging Spectrograph (Hubble Space Telescope instrument)
SM 4	Servicing Mission 4	STP	Solar Terrestrial Probes (Program)
SMC	Strategic Management Council	STS	Space Transportation System
SMD	Science Mission Directorate	STScI	Space Telescope Science Institute
SMEX	Small Explorer	STSP	Science and Technology Scholarship Program
SMO	Systems Management Organization	STSS	Space Tracking Surveillance System
SMPMC	Systematic Measurements Program Management Council	STSS B2010	Space Tracking and Surveillance System Block 2010 Risk Reduction
SMS	Science Measurement Systems	STTR	Small Business Technology Transfer Program
SN	Space Network	SVA	Strategic Vehicle Architecture
SNE	Space Network Expansion	SVD	System Vulnerability Detection
SOA	State of the Art	SVS	Synthetic Vision System
		SWEPT	System-wide Evaluation and Planning Tool

Acronyms

SWMF	Space Weather Modeling Framework	USFS	United States Forest Service
SWOT	Strengths, Weaknesses, Opportunities, and Threats	USGS	United States Geological Survey
SwRI	Southwest Research Institute	USRA	Universities Space Research Association
T2	Technology transfer	USRP	Undergraduate Student Research Program
TCAT	21st Century Aircraft Technology Project	VAB	Vehicle Assembly Building
TCU	Tribal Colleges and Universities	VAMS	Virtual Airspace Modeling and Simulation
TDRS	Tracking and Data Relay Satellite	VAST	Virtual Airspace Simulation Technology
TDRSS	Tracking and Data Relay Satellite System	VIIRS	Visible–infrared Imager Radiometer Suite (NPOESS Preparatory Project instrument)
TEGA	Thermal and Evolved Gas Analyzer	VLTI	Very Large Telescope Interferometer
TFM	Traffic Flow Management	VPCAR	Vapor Phase Catalytic Ammonia Removal
THEMIS	Time History of Events and Macroscale Interactions during Substorms	VSP	Vehicle Systems Program
TIM	Total Irradiance Monitor (Glory instrument)	WATR	Western Aeronautical Test Range
TIMED	Thermosphere, Ionosphere, Mesosphere, Energetics and Dynamics	WAVES	Radio and Plasma Waves Instrument (Wind)
TM	Technology Maturation Program	WebTADS	Agency time and attendance system
TOC	Test Operations Contract	WFC 3	Wide Field Camera (Cloud-Aerosol Lidar and Infrared Pathfinder Satellite Observations instrument)
TOMS	Total Ozone Mapping Spectrometer	WFS&C	Wave Front Sensing and Control (James Webb Space Telescope instrument)
TOMS-EP	Total Ozone Mapping Spectrometer - Earth Probe	WGA	Western Governors Association
TOPEX	TOPOgraphic Experiment for ocean circulation	WISE	Widefield Infrared Survey Explorer
TPF	Terrestrial Planet Finder	WJHTC	William J. Hughes Technical Center
TPS	Thermal Protection System	WMAP	Wilkinson Microwave Anisotropy Probe
TRACE	Transition Region and Coronal Explorer	WORF	Window Observational Research Facility
TRL	Technology Readiness Level	WPA	Water Processor Assembly
TRMM	Tropical Rainfall Measuring Mission	WSTF	White Sands Test Facility
TSA	Transportation Security Administration	WT	Wind Tunnels
TVC	Thermal Vacuum Chambers	XMM	X-ray Multi-mirror Mission
TWINS	Two Wide–angle Imaging Neutral–atom Spectrometers	XRT	X-ray Telescope (Solar-B instrument)
UAV	Unmanned Aerial Vehicle		
UCB	University of California - Berkeley		
UEET	Ultra–efficient Engine Technology		
UHF	Ultra High Frequency		
ULF	Utilization and Logistics Flight		
UNESCO	United Nations Educational, Scientific and Cultural Organization		
URC	University Research Center		
URETI	University Research Engineering, and Technology Institute		
USA	United Space Alliance		
USAF	United States Air Force		
USDA	United States Department of Agriculture		