

NOAA Technical Memorandum NMFS-NWFSC-91



# **Biological Recovery Criteria for the Oregon Coast Coho Salmon Evolutionarily Significant Unit**

May 2008

**U.S. DEPARTMENT OF COMMERCE**  
**National Oceanic and Atmospheric Administration**  
National Marine Fisheries Service

## **NOAA Technical Memorandum NMFS-NWFSC Series**

The Northwest Fisheries Science Center of the National Marine Fisheries Service, NOAA, uses the NOAA Technical Memorandum NMFS-NWFSC series to issue scientific and technical publications. Manuscripts have been peer reviewed and edited. Documents published in this series may be cited in the scientific and technical literature.

The NMFS-NWFSC Technical Memorandum series of the Northwest Fisheries Science Center continues the NMFS-F/NWC series established in 1970 by the Northwest & Alaska Fisheries Science Center, which has since been split into the Northwest Fisheries Science Center and the Alaska Fisheries Science Center. The NMFS-AFSC Technical Memorandum series is now being used by the Alaska Fisheries Science Center.

Reference throughout this document to trade names does not imply endorsement by the National Marine Fisheries Service, NOAA.

### **This document should be referenced as follows:**

Wainwright, T.C., M.W. Chilcote, P.W. Lawson, T.E. Nickelson, C.W. Huntington, J.S. Mills, K.M.S. Moore, G.H. Reeves, H.A. Stout, and L.A. Weitkamp. 2008. Biological recovery criteria for the Oregon Coast coho salmon evolutionarily significant unit. U.S. Dept. Commer., NOAA Tech. Memo. NMFS-NWFSC-91, 199 p.



NOAA Technical Memorandum NMFS-NWFSC-91

# Biological Recovery Criteria for the Oregon Coast Coho Salmon Evolutionarily Significant Unit

Thomas C. Wainwright, Mark W. Chilcote,<sup>1</sup> Peter W. Lawson,  
Thomas E. Nickelson,<sup>2</sup> Charles W. Huntington,<sup>3</sup> Justin S. Mills,<sup>4</sup>  
Kelly M.S. Moore,<sup>5</sup> Gordon H. Reeves,<sup>6</sup> Heather A. Stout, and  
Laurie A. Weitkamp

Northwest Fisheries Science Center  
Hatfield Marine Science Center  
2032 Southeast OSU Drive  
Newport, Oregon 97365

<sup>1</sup> Oregon Department of Fish and Wildlife  
3406 Cherry Avenue Northeast  
Salem, Oregon 97303

<sup>2</sup> 75 Alydar Place  
Paso Robles, California 93446

<sup>3</sup> Clearwater Biostudies Inc.  
23252 South Central Point Road  
Canby, Oregon 97013

<sup>4</sup> Frank Orth & Associates  
4040 Lake Washington Boulevard Northeast, Suite 208  
Kirkland, Washington 98033

<sup>5</sup> Oregon Department of Fish and Wildlife  
Corvallis Research Laboratory  
28655 Highway 34  
Corvallis, Oregon 97333

<sup>6</sup> U.S. Forest Service  
Pacific Northwest Research Station, Forestry Sciences Laboratory  
3200 Southwest Jefferson Way  
Corvallis, Oregon 97331

May 2008

**U.S. DEPARTMENT OF COMMERCE**  
**National Oceanic and Atmospheric Administration**  
**National Marine Fisheries Service**

**Most NOAA Technical Memorandums  
NMFS-NWFSC are available online at the  
Northwest Fisheries Science Center  
web site (<http://www.nwfsc.noaa.gov>)**

Copies are also available from:  
National Technical Information Service  
5285 Port Royal Road  
Springfield, VA 22161  
phone orders (1-800-553-6847)  
e-mail orders ([orders@ntis.fedworld.gov](mailto:orders@ntis.fedworld.gov))

# Table of Contents

List of Figures.....	vii
List of Tables.....	ix
Executive Summary.....	xi
Acknowledgments.....	xxi
Introduction.....	1
Definition of Key Terms.....	2
Population Structure and Associated Definitions.....	4
Important Issues.....	8
Habitat.....	8
Hatchery Fish.....	9
Environmental Fluctuations.....	12
Density Dependence.....	13
Uncertainty.....	14
Population Classification and Biogeographic Strata.....	15
Relationship to Criteria for other ESUs.....	15
Relationship of Biological Criteria to the ESA.....	16
Approach to Developing the Criteria.....	18
Watershed-level Attributes.....	18
Population-level Attributes.....	18
Biogeographic Stratum-level Attributes.....	19
ESU-level Attributes.....	19
Goals and Criteria.....	20
Use of a Decision Support System.....	20
Introduction to the Criteria.....	26
Persistence.....	28
Population-level Persistence Criteria.....	28
Biogeographic Stratum-level Persistence Criteria.....	41
ESU-level Persistence Criteria.....	41
Summary—Persistence.....	42

Sustainability.....	44
Population-level Sustainability Criteria.....	44
Biogeographic Stratum-level Criteria.....	62
ESU-level Sustainability Criteria .....	65
Summary—Sustainability.....	80
Restoration .....	82
Environmental, Cultural, and Economic Benefits.....	82
Ecosystem Approach.....	83
Suggested Criteria .....	84
Summary—Restoration .....	87
Conclusions.....	89
Persistence .....	89
Sustainability .....	90
Restoration.....	90
Limitations.....	91
Glossary .....	93
References.....	101
Appendix A: Use of a Knowledge-based DSS in Determining the Recovery Status of Oregon Coast Coho Salmon.....	115
Introduction .....	115
Utilizing a DSS.....	115
Implementation of the DSS .....	116
Network Development.....	117
Sensitivity Analysis.....	118
Data Testing.....	120
Guidance for Interpreting Results.....	123
Software and Script Description.....	124
Appendix B: Genetic Effective Population Size for Oregon Coast Coho Salmon .....	135
Introduction .....	135
Genetic Concepts.....	135
Ideal vs. Real Populations .....	136
Translating Effective Population Size to Spawner Counts.....	138
Spawner Abundance Criterion.....	139
Appendix C: Population Persistence Models.....	141
Introduction .....	141

Density-dependent, Count-based PVA Model .....	146
SPAZ Hockey Stick Viability Analysis.....	157
Bayesian Salmon Analysis Model.....	159
Stochastic Habitat-based Life Cycle Model .....	163
Appendix D: Population Abundance Data and Historical Reconstructions.....	181
Contemporary Population Data for 1990–2004.....	181
Reconstruction of Historical Population Abundance for 1958–1989 .....	190





# List of Figures

Figure 1. Biogeographic strata and Independent Populations of the Oregon Coast Coho Salmon ESU. ....	6
Figure 2. Conceptual view of relationships of the four VSP parameters to habitat. ....	9
Figure 3. Relationship between population productivity and average proportion of hatchery spawners in the population during 1990–2001. ....	11
Figure 4. Relationship between biological status, other listing considerations, and listing decisions under the ESA. ....	17
Figure 5. Overview of goals and criteria. ....	21
Figure 6. Terminology used in describing truth values resulting from application of the DSS. ....	22
Figure 7. The relationship of DSS truth values to cost of restoration and risk of no action. ....	24
Figure 8. Schematic of the conceptual relationships of population, strata, and ESU criteria in the DSS. .	27
Figure 9. The decision network for the ESU Persistence Criterion. ....	29
Figure 10. Truth membership function for the Population Productivity Criterion, PP-1. ....	30
Figure 11. Truth membership function for the Probability of Persistence Criterion, PP-2. ....	34
Figure 12. Truth membership function for the Critical Abundance Criterion PP-3. ....	38
Figure 13. Persistence analysis results. ....	43
Figure 14. The decision network for the ESU Sustainability Criterion. ....	45
Figure 15. Truth membership function for the Spawner Abundance Criterion, PD-1. ....	46
Figure 16. Population Sustainability Criterion analysis results. ....	48
Figure 17. Truth membership function for the Artificial Influence Criterion, PD-2. ....	51
Figure 18. Truth membership function for Criteria W-Sp, Spawner Watershed Occupancy, and W-Ju, Juvenile Watershed Occupancy. ....	52
Figure 19. Subsection of the decision network showing the Population Diversity Criteria. ....	57
Figure 20. Truth membership function for the Population Functionality Criterion, PF. ....	60
Figure 21. Map showing estimated smolt-capacity truth values by population for the Population Functionality Criterion, PF. ....	61
Figure 22. Maps showing truth value scores for the Stratum Diversity, Stratum Functionality, and Stratum Sustainability criteria. ....	63
Figure 23. The Stratum Sustainability Criterion subsection of the ESU Sustainability Criterion decision network. ....	64
Figure 24. ES-1, All Biogeographic Strata Sustainable, subsection of the ESU Sustainability Criterion decision network. ....	65
Figure 25. Truth membership function for ESU-level Diversity Criteria. ....	66

Figure 26. ESU-level Diversity Criterion subsection of the ESU Sustainability Criterion decision network. ....	78
Figure 27. Hypothetical relative value of spawning escapement in terms of harvest, stream nutrient supply, and more general ecosystem benefits.....	85
Figure 28. Conceptual illustration of the proportion of time a system is occupied as a function of the potential size of the population in that system.....	88
Figure A-1. A fuzzy membership function.....	117
Figure A-2. DSS network diagram.....	119
Figure A-3. Response of the ESU-level ESU Persistence Criterion truth value to changes in the Probability of Persistence Criterion input data.....	120
Figure A-4. Response of the ESU-level ESU Sustainability Criterion truth value to changes in the Probability of Persistence Criterion input data.....	121
Figure C-1. Comparison of production relationships for the various models, all scaled to the same maximum production and rate of intrinsic increase.....	143
Figure C-2. Time series of naturally produced spawner abundance for the 21 Independent Populations.....	145
Figure C-3. Generic example of Ricker recruitment curve and the modified version of this curve used to simulate recruitment in the PVA.....	148
Figure C-4. Hockey stick recruitment model.....	157
Figure C-5. The production function used in the extinction risk model compared with a standard Beverton-Holt production function.....	161
Figure C-6. Results from the BaySAM model for all Independent Populations in the ESU.....	164
Figure C-7. Relationship of extinction risk to quasi-extinction threshold for the Independent Populations.....	165
Figure C-8. Box-plot time series of median spawner abundance for 34 generations.....	173
Figure C-9. Box-plot comparison of 12 model scenarios.....	176
Figure C-10. Sensitivity of the base_ref scenario to assumption of quasi-extinction thresholds.....	177
Figure C-11. Sensitivity of the A13_ms_80 scenario to assumption of quasi-extinction thresholds.....	178

# List of Tables

Table 1. Classification of Oregon Coast Coho Salmon ESU historical populations .....	5
Table 2. Population-level persistence criteria for Independent Populations of Oregon Coast coho salmon .....	31
Table 3. Summary of DSS truth values for all populations, biogeographic strata, and ESU criteria .....	32
Table 4. Population Sustainability criteria results for Independent Populations of Oregon Coast coho salmon .....	47
Table 5. Occupancy of watersheds by spawners and juveniles. ....	54
Table 6. Summary of watershed level truth values of the knowledge-based DSS as to the relative distribution of coho salmon in the Oregon Coast ESU. ....	55
Table 7. Summary of truth values for the ESU-level Diversity Criterion analysis broken down by subcriteria for Genetic Diversity, ED-1, and Phenotypic and Habitat Diversity, ED-2.....	67
Table 8. Distribution of points by review panel members for the Genetic Structure Criterion, ED-1a.....	69
Table 9. Distribution of points by review panel members for the Effects of Selection Criterion, ED-1b.....	69
Table 10. Distribution of points by review panel members for the Effects of Migration Criterion, ED-1c.....	70
Table 11. Distribution of points by review panel members for the Effects of Introgression, ED-1d .....	72
Table 12. Distribution of points by review panel members for the Phenotypic Diversity Criterion, ED-2a.....	74
Table 13. Distribution of points by review panel members for the Habitat Diversity Criterion, ED-2b... ..	76
Table 14. Distribution of points by review panel members for the Small Populations Criterion, ED-3 ...	77
Table A-1. Operators used in the DSS.....	118
Table A-2. Results of model exclusion tests.....	122
Table A-3. DSS results for different levels of adult coho at the threshold for Independent Populations.....	124
Table C-1. Comparison of the PVA models used.....	142
Table C-2. Estimated density-dependent PVA recruitment model parameters and associated information for 21 populations of Oregon Coast coho salmon.....	151
Table C-3. Forecast probability from the DD-PVA model.....	154
Table C-4. Probability of extinction estimates for 21 populations of Oregon Coast coho salmon under different parameter error scenarios .....	156
Table C-5. Relative Akaike Information Criterion for 18 Independent Populations of Oregon Coast ESU coho salmon.....	159

Table C-6. Probability of persistence of coho salmon populations estimated by the SPAZ-hs recruitment model .....	160
Table C-7. Probabilities of persistence under no harvest conditions for riverine Independent Populations of the Oregon Coast Coho Salmon ESU for five scenarios of future conditions using three quasi-extinction thresholds .....	174
Table C-8. Probabilities of persistence under PFMC Amendment 13 harvest conditions for riverine Independent Populations of the Oregon Coast Coho Salmon ESU for five scenarios of future conditions using three quasi-extinction thresholds. ....	175
Table D-1. Population estimates for Independent Populations in the Oregon Coast Coho Salmon ESU based on random spawning surveys. ....	182
Table D-2. Regression equations used.....	191
Table D-3. Estimated abundance of adult fish with or without harvested numbers of Independent Populations of the Oregon Coast Coho Salmon ESU, 1958–1989 .....	192

# Executive Summary

## Introduction

This document outlines biological recovery criteria (also called viability criteria) for the Oregon Coast Coho Salmon Evolutionarily Significant Unit (ESU) as identified in the NOAA Fisheries Service status review for West Coast coho salmon (*Oncorhynchus kisutch*) (Weitkamp et al. 1995). This report was developed by the Oregon Coast Workgroup (“the workgroup” or “we”) of the Oregon and Northern California Coasts (ONCC) Technical Recovery Team (TRT).

The criteria were developed as part of a joint federal and state effort to develop conservation goals for the ESU, and are intended to satisfy both federal and state conservation mandates. In developing these criteria, the workgroup reviewed many documents, including NOAA’s viable salmonid populations (VSP) report (McElhany et al. 2000), the draft reports of several other TRTs, the summary of the Oregon Scientific Workshop on Recovery Criteria (OSL 2002a), and the summary report of the Oregon Joint Interim Task Force on Salmon Recovery (OSL 2002b). In addition, the workgroup has had substantial interactions with staff of the Oregon Department of Fish and Wildlife during its development of viability criteria for the state’s Oregon Coastal Coho Assessment (Chilcote et al. 2005), and considered reviews of that report by the Independent Multidisciplinary Science Team (IMST 2005) and Northwest Fisheries Science Center (NWFSC 2005). We also referred to guidance on ESU-level recovery approaches from the Independent Science Advisory Board (Bilby et al. 2005).

The primary purpose of this report is to provide objective and measurable biological criteria for assessing progress toward recovery of the Oregon Coast Coho Salmon ESU. These criteria are also applied to an assessment of the current biological status of the ESU. Complete criteria are not provided for listing or delisting of the ESU under the U.S. Endangered Species Act (ESA), nor is there an evaluation as to whether the ESU should or should not be listed. In addition to evaluating the biological requirements presented here, listing and delisting decisions require evaluations regarding particular listing factors and conservation measures, which are beyond the scope of this report. Thus the biological criteria presented here provide a necessary, but not sufficient, set of criteria to determine the ESA listing status of the ESU.

## Key Terms

There are a number of legal and technical concepts that came into play in developing the criteria, in particular the concepts of recovery and restoration. The term “recovery” has a number of meanings in common English, but a very narrow meaning within the context of the ESA. Because our criteria are intended to apply to broader mandates than the ESA, it is necessary to distinguish the ESA’s narrow-sense usage of “recovery” from the broader-sense usage by the State of Oregon in its conservation planning efforts. For this reason, the term

recovery is generally avoided in favor of the terms “restoration” and “delisting” as defined below.

Restoration (broad-sense recovery) is a process leading to conditions such that the populations of naturally produced fish that make up the Oregon Coast Coho Salmon ESU are sufficiently abundant, productive, and diverse in terms of life histories and biogeographic distribution, and that the ESU as a whole will be self-sustaining and will provide environmental, cultural, and economic benefits (modified from Oregon Salmon Recovery Task Force, OSL 2002b).

Within this definition, a self-sustaining ESU is 1) able to survive prolonged periods of adverse climatic conditions without artificial support (including supplementation by hatchery fish) and 2) able to maintain its genetic legacy and long-term adaptive potential. Such a self-sustaining ESU will be composed of diverse interconnected populations. Environmental, cultural, and economic benefits include but are not limited to: providing nutrients to freshwater and terrestrial ecosystems; providing food resources for scavengers such as bears, eagles, and stream invertebrates; supporting ceremonial use by Native Americans; allowing viewing and nature study by coastal residents and tourists; and providing subsistence, recreational, and commercial harvest.

Within the narrow sense of the ESA, our concept of delisting (narrow-sense recovery) is similar to the “self-sustaining” part of the definition of restoration, but has no reference to environmental, cultural, and economic benefits (which are not part of the ESA mandate).

Delisting, based on the statutory language in the ESA, is a process resulting in the ESU being removed from the formal protections of the ESA as a consequence of no longer being an endangered or threatened species. The ESA defines those specific terms as follows (note that the legal term “species” differs from the common biological meaning, and includes ESUs):

- An endangered species is “any species which is in danger of extinction throughout all or a significant portion of its range.”
- A threatened species is “any species which is likely to become an endangered species within the foreseeable future throughout all or a significant portion of its range.”

In addition to the above terms, two specialized terms are used to relate biological risk to threatened and endangered status under the ESA, persistent and sustainable:

- A persistent population (or ESU) is one that is able to persist (i.e., not go extinct) over a 100-year period without artificial support. This includes an ability to survive prolonged periods of adverse environmental conditions, which may be expected to occur at least once in the 100-year time frame.
- A sustainable population (or ESU) is one that, in addition to being persistent, is also able to maintain its genetic legacy and long-term adaptive potential for the foreseeable future. This implies the availability of functional habitat and other conditions necessary for the full expression of the population’s (or ESU’s) life history diversity into the foreseeable future.

The terms persistent and sustainable are both part of the more general term “viable” as used in the viable salmonid populations report (McElhany et al. 2000). We use these two terms to distinguish distinct types and levels of risk. Persistence relates to the simple risk (or danger) of extinction, which is the primary determinant of endangered status under the ESA. Sustainability goes beyond this, requiring that population diversity (genetic and ecological) be sustained so that risk of extinction will not increase in the foreseeable future, thus relating to threatened status under the ESA. Neither term implies an evaluation of specific threats or a consideration of conservation measures required for listing determinations under the ESA, so these terms cannot be directly equated with thresholds of ESA listing status.

## **Approach to Developing the Criteria**

The development of criteria began with the VSP approach (McElhany et al. 2000), which identifies four key population parameters that influence the persistence of populations. These attributes are:

- Population size, the abundance of all life stages of the species
- Population growth rate (productivity), production over the entire life cycle
- Spatial structure, distribution of fish among habitat areas and connectivity among those areas
- Diversity, variation in traits (phenotypic and genetic) among individuals in a population and among populations in the ESU

The goal of recovery and restoration is not merely to meet a set of artificial criteria, but rather to restore or repair ecological processes that lead to long-term sustainability of the resource. Our approach views the ESU as a complex structure with important processes operating at scales ranging from individual spawning grounds (demes) up to the entire ESU. Along this continuum, we have identified four scales as important for defining attributes related to biological processes that define ESU status: watersheds, populations, biogeographic strata, and the entire ESU. We developed criteria at each of these scales.

## **Goals and Criteria**

Because the Oregon Coast Workgroup is part of a joint federal-state process, there are multiple goals for defining the biological status of the ESU. As discussed earlier, we used the term restoration to encompass goals of the state processes, which have requirements beyond simple sustainability. This definition is also expected to cover the requirements of the U.S. Sustainable Fisheries Act. In contrast, the term delisting is used in the narrow sense of recovery under the ESA, which itself has two considerations: Is the species endangered or is the species threatened? Only when it is neither endangered nor threatened can it be delisted.

These considerations led to a three-level structure of goals and criteria. The ultimate goal is restoration of the ESU in the sense defined by the Oregon Plan and the Joint Legislative Task Force (OSL 2002b). On the way to reaching that goal, it is necessary to also ensure meeting the goals of the ESA. Thus we focused on assessing condition of the ESU at two levels—sustainability and persistence—and considered criteria to define restoration.

To achieve restoration, coho salmon populations within the ESU must be robust enough to meet societal desires for environmental, cultural, and economic benefits. Restoration therefore requires sufficient abundance of the ESU and diversity among populations. Achieving ESA goals requires biological sustainability into the foreseeable future (as well as the absence of threats, which are not discussed in this report). This level has a number of ESU-level criteria, including the number and distribution of sustainable populations and the preservation of ESU-level diversity. Avoiding endangerment requires biological persistence, that is, assurance that all significant parts of the ESU have a high likelihood of persisting for 100 years. Achieving each level implicitly requires meeting all criteria for the lower levels.

## **Use of a Decision Support System**

A complete assessment of the biological condition of the ESU is necessarily multifaceted, including a variety of interrelated criteria, with varying data quality. These criteria relate to biological processes at a variety of time and space scales, with processes varying from individual stream reaches to the entire range of the ESU. To track this large suite of data and criteria in a transparent and logically consistent framework, we used a knowledge-based decision support system (DSS).

A DSS is a computer-based tool that can analyze and compare numerous pieces of data, producing results that assist managers in making a decision (Turban and Aronson 2001). These systems allow decision makers to perform complex evaluations quickly, present a consistent assessment that draws from a variety of data sources, and track large sets of information accurately, thus improving the choices made by decision makers without overriding human judgment (Rauscher 1999). A system evaluating ecological conditions may contain substantial uncertainty about the precise conditions that are optimal for the target organisms because of gaps in information and the lack of perfect knowledge about the interrelationships among relevant factors (Reynolds et al. 2000).

The DSS designed by the workgroup uses a network framework to link criteria at a variety of scales and aggregate them from fine-scale watershed-level criteria, through population-level criteria and biogeographic stratum-level criteria, to criteria for the entire ESU. The links take the form of logical operators that define specific relationships among the input values. In traditional Boolean logic (which evaluates propositions as either absolutely true or false), criteria are knife-edged, meaning that the result of an operation has only one of two values: true or false. In traditional Boolean logic, when the input values are near to the knife-edge criteria, the result is very sensitive to small changes in the input. In the knowledge-based system used here, a type of approximate logic extends our ability to work with the imprecise knowledge available for the system being assessed. The advantage of using this approximate logic is that it allowed us to evaluate and express the degree of certainty in an outcome, ranging from certainly false through uncertain to certainly true. Being able to work with a gradation of levels of certainty and uncertainty enables decision makers to evaluate the degree of risk inherent in a decision based on the strength of the conclusion from the DSS.

In practice, applying the DSS begins with evaluating a number of primary biological criteria that are defined in terms of logical (true/false) statements about biological processes essential to the persistence or sustainability of the ESU. Evaluating these primary criteria with



respect to available observations results in a “truth value” in the range from –1 (false) to +1 (true). Intermediate values between these extremes reflect the degree of certainty of the statement given available knowledge, with a value of zero indicating complete uncertainty about whether the statement is true or false. These primary criteria are then combined logically with other criteria at the same geographic scale and then combined across geographic scales to result in an evaluation of ESU-wide criteria. Thus the end result is an evaluation of the biological status of the ESU as a whole, with an indication of the degree of certainty of that evaluation.

## **Application of Criteria**

Our biological recovery criteria are framed within the context of the DSS. At the highest level, the DSS is structured to represent the hierarchical population structure of the ESU. Populations are grouped into biogeographic strata, which in combination make up the ESU. Within this structure, the goals of ESU persistence and ESU sustainability are evaluated using sets of logically linked and measurable criteria. The third goal, ESU restoration, is discussed but is not analyzed within this structure. Criteria for ESU persistence and sustainability are each presented in a separate section, and are presented at three levels of geographic aggregation: populations, biogeographic strata, and the entire ESU. Within each section, we present criteria at the population level first, then describe how these are combined into higher-level criteria for biogeographic strata and for the ESU as a whole.

In addition to defining criteria and metrics, we provide an assessment of the current status of the ESU by applying each metric to the data available through 2005. This analysis is provided for illustration only to demonstrate how the criteria might be used in the future to assess progress towards recovery and restoration.

### **Persistence**

Persistence refers to a population or ESU that has a high expectation of persisting (i.e., not going extinct) over a 100-year period without artificial support. This includes the ability to survive prolonged periods of adverse environmental conditions that may be expected to occur at least once during the 100-year time frame. In the ESU Persistence Criterion DSS structure, the lowest level population criteria form the basis of the analysis, with aggregations to the biogeographic stratum and ESU levels. Three criteria—Population Productivity, Probability of Persistence, and Critical Abundance—are evaluated, then combined to evaluate the overall Persistence for each population. Evaluations for individual populations are combined to arrive at a biogeographic stratum status (Stratum Persistence Criterion), then these results are combined to arrive at an ESU status (ESU Persistence Criterion). The workgroup then used recent observations of these population metrics to evaluate how certain it is that the Oregon Coast Coho Salmon ESU is persistent under recent conditions.

### **Sustainability**

Sustainability refers to a population or ESU that, in addition to being persistent, is also able to maintain its genetic legacy and long-term adaptive potential for the foreseeable future. Sustainability implies stability of habitat availability and other conditions necessary for the full expression of the population’s (or ESU’s) life history diversity into the foreseeable future. In the

ESU Sustainability Criterion DSS structure, population-level criteria form the lowest level of the analysis. At this level, there are two watershed-level subcriteria—Spawner Watershed Occupancy and Juvenile Watershed Occupancy—which relate to two Population Diversity criteria (a Spawner Distribution Criterion and a Juvenile Distribution Criterion) evaluating the distribution of fish within river basins. These, along with two other Population Diversity criteria (a Spawner Abundance Criterion and an Artificial Influence Criterion) are combined to evaluate the overall Population Diversity Criterion, which is combined with a Population Persistence Criterion (above) to assess a Population Sustainability Criterion. These results for each population are then aggregated into biogeographic strata to evaluate a Stratum Diversity Criterion. A Population Functionality Criterion is evaluated based on available habitat capacity, and these criteria are combined to evaluate a Stratum Functionality criterion. The Stratum Diversity and Stratum Functionality criteria are combined to evaluate stratum sustainability. Stratum Sustainability Criterion values are aggregated to an ESU-level criterion (All Strata Sustainable), which is finally combined with an evaluation of an ESU-level Diversity Criterion to arrive at the overall ESU Sustainability Criterion.

This framework evaluates a Population Diversity Criterion using objective measures of spawner abundance, artificial influence, spawner and juvenile distribution, and habitat capacity. In addition, we evaluated an ESU-level Diversity Criterion that includes a Genetic Diversity Criterion (a function of genetic structure and effects of selection, migration, and introgression), a Phenotypic and Habitat Diversity Criterion, and a Small Populations Criterion. Fully quantifiable criteria are not available for the ESU-level diversity measures, so an expert panel was used to evaluate them but the result was given half the weight of the more quantifiable population-level evaluations. The workgroup then used recent observations of these population metrics to evaluate how certain it was that the Oregon Coast Coho Salmon ESU is sustainable under recent conditions.

## **Restoration**

ESU restoration (or broad-sense recovery) is a process leading to conditions such that the populations of naturally produced fish that make up the Oregon Coast Coho Salmon ESU are sufficiently abundant, productive, and diverse (in terms of life histories and geographic distribution) that the ESU as a whole is self-sustaining and will provide environmental, cultural, and economic benefits.

Because these goals are fundamentally different from those for ESU persistence and ESU sustainability in having a substantial sociopolitical component beyond the scope of this report, we have not defined specific criteria, but rather have discussed general ecosystem considerations as background for restoration and have outlined types of criteria to measure progress toward restoration goals.

## **Conclusions**

The workgroup developed and applied a means to evaluate the current biological status of the Oregon Coast Coho Salmon ESU. This evaluation is intended for use in the recovery planning process. The biological recovery criteria are organized into two coherent logical frameworks to evaluate persistence and sustainability. In addition to developing criteria to

evaluate persistence and sustainability of the ESU, the workgroup also offers general guidelines regarding ESU restoration (or “broad-sense” recovery).

Uncertainty within the logical structure of the ESU Persistence and ESU Sustainability criteria is accommodated through a knowledge-based DSS. This use reflects both uncertainty about “true” parameters and errors of measurement. The results of this assessment are expressed as the degree of confidence that two overall statements regarding the status of the ESU are true: 1) the ESU is persistent, and 2) the ESU is sustainable.

The logical networks and associated data within the DSS are designed to contribute to the decision-making processes associated with both federal recovery planning and Oregon State conservation planning. It was the intention of the workgroup to honor the multiple mandates of both federal and state requirements in developing the biological recovery criteria. One requirement of recovery planning is setting objective, measurable criteria for delisting. Toward this end, the ESU Persistence and ESU Sustainability criteria provide a means to assess biological conditions related to listing status under the ESA. This evaluation does not consider other factors, including conservation measures and expectations about future conditions, that factor into the ESA definition of threatened status. Incorporating such factors requires policy decisions not reflected in this analysis. Thus the criteria presented here provide only a partial assessment of status under the ESA.

The workgroup has applied the DSS using available data, models, and best professional judgment to evaluate the current status of the ESU for two main goals: persistence and sustainability.

### **Persistence**

The DSS framework includes criteria for Population Productivity, Probability of Persistence, and Critical Abundance. The workgroup used recent observations of these population metrics to evaluate how certain it is that the Oregon Coast Coho Salmon ESU is persistent under recent conditions. The results of the analysis lead the workgroup to conclude that, if recent past conditions continue into the future, it is moderately to highly certain that the ESU is persistent; that is, it is able to persist over a 100-year period without artificial support. This means that if recent habitat conditions, climate pattern, and management policies continue into the future, there is moderate to high certainty that the ESU and most of its constituent biogeographic strata and Independent Populations will persist for 100 years. The weakest strata in this assessment were the North Coast and Mid-Coast, which had only a low certainty of being persistent. The strongest strata were the Lakes and Mid-South Coast, which had high certainty of being persistent. To increase certainty that the ESU as a whole is persistent, restoration work should focus on those populations with low persistence, particularly those in the North Coast, Mid-Coast, and Umpqua strata.

### **Sustainability**

A sustainable ESU is 1) able to survive prolonged periods of adverse climatic conditions without artificial support, and 2) able to maintain its genetic legacy and long-term adaptive potential. Additionally, a sustainable ESU is composed of diverse interconnected populations.

To evaluate population diversity, the workgroup constructed a framework using objective measures of spawner abundance, artificial influence, spawner and juvenile distribution, and habitat capacity. In addition, ESU-wide diversity was evaluated by assessing genetic diversity, phenotypic and habitat diversity, and the status of small populations. The results of the analysis lead us to the conclusion that, if recent conditions continue into the future, there is a low to moderate certainty that the ESU is sustainable; that is, it is able to maintain its genetic legacy and long-term adaptive potential for the foreseeable future. This conclusion assumes that present and recent past habitat conditions, climate patterns, and management policies reflected in the data sets used by the workgroup will continue for the foreseeable future; no attempt was made to evaluate the effects of potential future changes in environmental conditions or conservation measures.

The conclusion that there is low to moderate certainty that the ESU is sustainable can be interpreted further. This means the ESU may be sustainable if strong ecosystem, harvest, and hatchery protections are in place. Many Independent Populations, and all but one of the biogeographic strata, have moderate to high certainty of being sustainable, but many other Independent Populations have obvious problems for some criteria. On the positive side, the Lakes and Mid-South Coast strata have a high certainty of being sustainable, with most of their constituent Independent Populations having a high certainty of being sustainable. On the downside, the North Coast stratum has low certainty of sustainability, with two Independent Populations having a low certainty of being sustainable and two having low certainty of being unsustainable.

An ESU at this level has good opportunities for recovery, but is also vulnerable to harvest and ecosystem alteration and destruction. Strong protections are needed to ensure that the status of populations and strata in moderate to good condition does not degrade, because the lower the status gets the more difficult and expensive it is to bring it back up. Overall ESU status can best be improved by focusing restoration efforts on those populations that scored low on sustainability, particularly those in the North and Mid-Coast strata. There should be opportunities for limited harvest during high productivity periods, and hatchery programs should be strictly managed to prevent risks to naturally produced fish.

### **Restoration**

In addition to these analyses of persistence and sustainability, an outline has been presented for developing criteria for restoration (or broad-sense recovery), including suggestions for three types of criteria: ESU abundance, sustainable Independent Populations, and productive Dependent Populations. Metrics for these criteria depend on social, economic, and political considerations as well as biological requirements, so full metrics have not been developed at this time.

### **Limitations**

The persistence and sustainability analyses deal only with current or recent conditions without addressing future conditions, threats, or limiting factors. This approach provides a systematic method for evaluating the current status of the Oregon Coast Coho Salmon ESU as part of a recovery or conservation plan, but is not sufficient to determine the ESA listing status of

the ESU. For ESA evaluations, it is important to address not only present status, but also factors for decline, threats, and probable trends in land use patterns, harvest and hatchery management practices, and climate. These factors will play pivotal roles in the future sustainability of this ESU. Assessing these factors, which requires policy-level analysis of social and economic issues as well as a projection of climate trends, is beyond the scope of this report.

Within the limited context of current and recent conditions, this assessment may be biased by including some threats that have been largely addressed and are not expected to continue into the future. These include intense fishing pressures and negative hatchery impacts, both of which have been substantially reduced. Some of the measures of persistence and sustainability include data collected before these factors for decline had been addressed, and therefore may have a pessimistic bias. However, this assessment reflects current (data through 2004) levels of other threats (such as poor freshwater habitat conditions) that have not been fully addressed and can be expected to continue into the future. Thus the conclusions are limited to the conditions considered by the workgroup, and the status of the ESU hinges on future conditions that have not been addressed.



# Acknowledgments

Development of biological recovery criteria for the Oregon Coast coho salmon (*Oncorhynchus kisutch*) evolutionarily significant unit was conducted by a team of scientists from the Northwest Fisheries Science Center (NWFSC); Oregon Department of Fish and Wildlife (ODFW), U.S. Forest Service (USFS) Pacific Northwest Research Station, Oregon Watershed Enhancement Board, and Clearwater Biostudies Inc. This workgroup is a committee of the Oregon and Northern California Coasts Technical Recovery Team (ONCC TRT). The workgroup relied on published literature, informational reports, and unpublished data made available by state, tribal, and federal agencies. The authors acknowledge the efforts of all who contributed to this process, especially ODFW and the Oregon Watershed Enhancement Board.

Numerous scientists and fishery managers provided information that aided in preparation of this report and deserve recognition. We especially want to thank the Independent Multidisciplinary Science Team for its in-depth analysis of the State of Oregon's Viability Assessment for Oregon Coast Coho Salmon. Thanks are also due to a team of scientists from NWFSC who analyzed the state's viability and habitat assessments: Robin Waples, Paul McElhany, Martin Lierman, Rich Zabel, Michael Pollock, Tim Beechie, Peter Kiffney, Ashley Steel, Blake Fiest, and Phil Roni. These two reviews of a similar effort helped immeasurably in the development of this document. Members of the Oregon Coast Coho Project Stakeholders Team also provided helpful comments for this effort. In particular, we would like to thank those stakeholder team members who provided in-depth comments on earlier drafts: Bill Moshofsky, Wayne Hoffman, Paul Engelmeyer, and Kaitlin Lovell. Helpful public comments were received from the ODFW, the MidCoast Watersheds Council, the Native Fish Society, and Benjamin Stout. We particularly thank Jason Dunham and Eric Bjorkstedt for providing insightful peer review of the report.

Thanks are also due for Rosemary Furfey and Jeff Lockwood of the NOAA Fisheries Service Northwest Regional Office (NWR), Bruce McIntosh, Ed Bowles, and Kevin Goodson of ODFW, Brian Spence of the Southwest Fisheries Science Center (SWFSC), Kaitlin Lovell of Trout Unlimited, and Wayne Hoffman of MidCoast Watersheds Council for useful comments and discussion. We particularly appreciate the diligent editorial and production assistance of Skye Hughes of ERT Inc. and Katie Phillips of Frank Orth & Associates.

The ONCC TRT consists of Walt Duffy, U.S. Geological Survey, California Cooperative Fish Research Unit; Dave Hillemeir, Yurok Tribe fishery biologist; George Kautsky, Hoopa Valley Tribe fishery biologist; Thomas Lisle, USFS, Pacific Southwest Experiment Station; Mike McCain, Six Rivers National Forest; cochairs Tommy Williams, SWFSC, and Peter Lawson, NWFSC; Thomas Wainwright, NWFSC; Thomas Nickelson, ODFW (retired); Charles Huntington, Clearwater Biostudies Inc.; and Gordon Reeves, USFS, Pacific Northwest Research Station. Recovery coordinators are Rosemary Furfey of NWR and Greg Bryant of NOAA Fisheries Service Southwest Regional Office. Mike Rode (retired), California Fish and Game Region 1, was formerly on the ONCC TRT.

The Oregon Coast Workgroup of the ONCC TRT consists of Peter Lawson, Gordon Reeves, Thomas Wainwright, Thomas Nickelson, and Charles Huntington. Adjunct members are Mark Chilcote and Kelly Moore of ODFW, and Laurie Weitkamp of NWFSC. Heather Stout of NWFSC staffs the workgroup.



# Introduction

This document outlines biological recovery criteria (sometimes called viability criteria) for the Oregon Coast Coho Salmon Evolutionarily Significant Unit (ESU), as identified in the NOAA Fisheries Service status review for West Coast coho salmon (*Oncorhynchus kisutch*) (Weitkamp et al. 1995). This report was developed by the Oregon Coast Workgroup (hereafter “the workgroup” or “we”) of the Oregon and Northern California Coasts (ONCC) Technical Recovery Team (TRT). In developing the criteria, the workgroup reviewed several documents, including NOAA’s viable salmonid populations (VSP) report (McElhany et al. 2000), the Puget Sound TRT preliminary guidelines document (Puget Sound TRT 2002), the Willamette/Lower Columbia TRT revised report on viability criteria (Willamette/Lower Columbia TRT and ODFW 2006), the Interior Columbia Basin TRT draft viability criteria (Interior Columbia Basin TRT 2007), the summary of the Oregon Scientific Workshop on Recovery Criteria (OSL 2002a), and the summary report of the Oregon Joint Interim Task Force on Salmon Recovery (OSL 2002b).

In addition, the workgroup has had substantial interactions with staff of the Oregon Department of Fish and Wildlife (ODFW) during ODFW’s development of viability criteria for the state’s Oregon Coastal Coho Assessment (Chilcote et al. 2005), and considered reviews of that report by the Independent Multidisciplinary Science Team (IMST 2005) and Northwest Fisheries Science Center (NWFSC 2005). The workgroup also referred to guidance on ESU-level recovery approaches from the Independent Science Advisory Board (Bilby et al. 2005).

The primary purpose of this report is to provide objective and measurable biological criteria for assessing progress toward the recovery of the Oregon Coast ESU. Secondly, these criteria are applied to an assessment of the current biological status of the ESU. Complete criteria are not provided for listing or delisting of the ESU under the U.S. Endangered Species Act (ESA) of 1973, nor is an evaluation made of whether the ESU should or should not be listed. In addition to evaluating the biological requirements presented here, listing and delisting decisions require evaluations regarding particular listing factors and conservation measures (see Relationship of Biological Criteria to the ESA, page 16), which are beyond the scope of this report. Thus the biological criteria presented here provide a necessary, but not sufficient, set of criteria to determine the ESA listing status of the ESU. It is also not the intent of this report to suggest or analyze management measures; that is the role of a full ESA recovery plan. Certain past management actions, notably harvest and hatchery practices, have a predictable role in determining the current status of the ESU, and to that extent they have been accounted for in assessing current status.

Several important terms must be defined before considering ESU-level and population-level criteria. For each criterion, it is first defined and possible metrics are identified to test against the criterion before ending with a discussion of issues and alternatives.

## Definition of Key Terms

In planning for salmon recovery, the workgroup recognized that there are many considerations beyond the ESA. Both the National Marine Fisheries Service (NMFS or NOAA Fisheries Service) and the State of Oregon have mandated goals beyond simply preventing extinction of coho salmon. For this reason, we focused on defining recovery in a way that considers ESA requirements and the broader social goals associated with rebuilding populations beyond the point where ESA listing is warranted. This said, there is confusion regarding the term recovery. Under the ESA, the term has a very specialized usage, while usage is different under state mandates, and general public usage is different yet. For the present effort, however, recovery refers to the process leading to delisting of an ESU under the ESA. When broader societal goals are included, a more robust ESU status is required than merely a delisting under the ESA. The terms restoration or broad-sense recovery have been chosen to identify the process by which this second, more robust status is achieved.

The concepts of recovery and restoration, as they are used here, come from a synthesis of several previous efforts and additional development by the TRT. In particular, a scientific workshop was held in July 2002 (OSL 2002a), cosponsored by the Oregon Independent Multidisciplinary Science Team, the Oregon Legislature's Salmon Recovery Task Force (SRTF), and NOAA Fisheries Service. That workshop reached no firm consensus on a definition of recovery, but made several suggestions as to what should be included in such a definition. Following the workshop, the SRTF developed a definition of recovery within the Oregon legislative context (OSL 2002b). The workgroup reviewed the definition and concluded that it provided a good characterization of the concept of broad-sense recovery. However, to address TRT concerns about potential vagueness and inconsistency, the definition was modified somewhat. Starting from these prior efforts, the workgroup developed the following definitions for the Oregon Coast Coho Salmon ESU.

**Restoration** (broad-sense recovery) is a process leading to conditions such that the populations of naturally produced fish that make up the Oregon Coast Coho Salmon ESU are sufficiently abundant, productive, and diverse (in terms of life histories and biogeographic distribution) that the ESU as a whole will be self-sustaining and will provide environmental, cultural, and economic benefits (modified from Oregon SRTF, OSL 2002b).

A **self-sustaining** ESU is able to survive prolonged periods of adverse climatic conditions without artificial support (including supplementation by hatchery fish) and able to maintain its genetic legacy and long-term adaptive potential. A self-sustaining ESU will be composed of diverse interconnected populations.

**Environmental, cultural, and economic benefits** include, but are not limited to: providing nutrients to freshwater and terrestrial ecosystems; providing food resources for scavengers such as bears, eagles, and stream invertebrates; supporting ceremonial use by Native Americans; allowing viewing and nature study by coastal residents and tourists; and providing subsistence, recreational, and commercial harvest.

The workgroup's concept of recovery (in the narrow sense of the ESA) is basically the same as for restoration, but with the deletion of the reference to environmental, cultural, and

economic benefits. The term delisting is used to refer to recovery in this narrower sense, which only requires that a species (equivalent to an ESU) no longer be threatened or endangered, with no reference to the other societal values. This definition of delisting reflects the specific language of the ESA.

**Delisting** (narrow-sense recovery), based on the statutory language in the ESA, is a process resulting in the ESU being removed from the formal protections of the ESA as a consequence of no longer being an endangered species or a threatened species.

The ESA defines those specific terms as follows (note that the legal term “species” differs from the common biological meaning and includes ESUs).

An **endangered species** is “any species which is in danger of extinction throughout all or a significant portion of its range.”

A **threatened species** is “any species which is likely to become an endangered species within the foreseeable future throughout all or a significant portion of its range.”

During the development of this document, NOAA Fisheries Service revised its policy on artificial propagation (NMFS 2005), which includes some relevant definitions. An effort was made to keep the definitions consistent with that policy; however, criteria also are proposed that fit within the state’s efforts to recover and restore coastal salmon, so definitions in Oregon’s Native Fish Conservation Policy (ODFW 2003) were reviewed. Its definitions for hatchery and naturally produced fish were adopted with only slight modifications.

**Naturally produced fish** are fish that were spawned and reared in natural habitats, regardless of parental origin (modified from ODFW 2003).

**Hatchery-produced fish** are fish incubated or reared under artificial conditions for at least a portion of their life cycle (ODFW 2003).

In addition to the above terms, two specialized terms are used to relate biological risk to threatened and endangered status under the ESA: persistent and sustainable.

A **persistent population** (or ESU) is one that is able to persist (i.e., not go extinct) over a 100-year period without artificial support. This includes an ability to survive prolonged periods of adverse environmental conditions, which may be expected to occur at least once in the 100-year time frame.

A **sustainable population** (or ESU) is one that, in addition to being persistent, is also able to maintain its genetic legacy and long-term adaptive potential for the foreseeable future. This implies the availability of functional habitat and other conditions necessary for the full expression of the population’s (or ESU’s) life history diversity into the foreseeable future. This is similar to the definition of a self-sustaining ESU above.

The terms persistent and sustainable are both part of the more generic term “viable” as used in the viable salmonid populations report (McElhany et al. 2000). The two terms are used to distinguish distinct types and levels of risk. Persistence relates to the simple risk (or danger)

of extinction, which is the primary determinant of endangered status under the ESA. Sustainability goes beyond this, requiring that population diversity (genetic and ecological) be sustained so that risk of extinction will not increase in the foreseeable future, thus relating to threatened status under the ESA. Neither term implies evaluation of specific threats or consideration of conservation measures required for listing determinations under the ESA, so these terms cannot be directly equated with thresholds of ESA listing status.

## **Population Structure and Associated Definitions**

The foundation for the biological criteria draws heavily from conservation principles for salmon and steelhead (*Oncorhynchus mykiss*) presented by McElhany et al. (2000). One of these principles is that demographic populations are the primary units of conservation within the ESU and that the status of the entire ESU is largely a function of the status of these individual populations. Population structure is not entirely discrete, but rather forms a hierarchical continuum from individual stream reaches where spawning or rearing occur, through watersheds and river basins, to the entire range of the ESU. For practical applications, the workgroup focused on the historical populations (Lawson et al. 2007) as fundamental units, and aggregated these populations into a number of biogeographic strata within the ESU.

In Lawson et al. (2007), the workgroup relied on biological characteristics of fish and geographical and ecological characteristics of the landscape to establish historical population boundaries. A total of 56 historical populations were identified through this process, and were classified as either Dependent or Independent (Table 1, Figure 1). In addition to this population-level structure, there is also substantial genetic and geographic structure at larger scales within the ESU, with genetic similarities clustering into a few geographic units. ODFW recognized this structure by describing three gene conservation groups (GCGs) within the ESU (Kostow 1995). More recent genetic work has found similar structure, but with some indication of a fourth lake population group (Ford et al. 2004, Lawson et al. 2007). Subsequent to the 1995 report, ODFW established a set of four monitoring areas within the ESU, which are similar to GCGs, but with the northern unit divided into two monitoring areas based on geographic diversity. To account for this structure, Lawson et al. (2007) divided the ESU into five biogeographic strata, corresponding to the ODFW monitoring areas, but with the lake populations separated into a fifth stratum (Table 1, Figure 1). Because these units represent both biological diversity (genetic and ecological) and geographic variation, we assumed that preserving all of them will meet two goals: preserving the major genetic and life history variation in the ESU and spreading out the effects of risks due to catastrophes.

Some of the definitions developed in Lawson et al. (2007) are relevant to the present work.

An **ESU** represents a distinct population segment of Pacific salmon under the ESA that is substantially reproductively isolated from conspecific populations and represents an important component of the evolutionary legacy of the species (NMFS 1991, Waples 1991).

Table 1. Classification of Oregon Coast Coho Salmon ESU historical populations. Modified from Lawson et al. (2007) and listed north to south within biogeographic strata.

<b>Stratum</b>	<b>Population</b>	<b>Type</b>	<b>Stratum</b>	<b>Population</b>	<b>Type</b>
<b>North Coast</b>	Necanicum	Independent	<b>Mid-Coast</b> (continued)	Alsea	Independent
	Ecola	Dependent		Big (near Alsea)	Dependent
	Arch Cape	Dependent		Vingie	Dependent
	Short Sands	Dependent		Yachats	Dependent
	Nehalem	Independent		Cummins	Dependent
	Spring	Dependent		Bob	Dependent
	Watseco	Dependent		Tenmile	Dependent
	Tillamook Bay*	Independent		Rock	Dependent
	Netarts	Dependent		Big (near Siuslaw)	Dependent
	Rover	Dependent		China	Dependent
	Sand	Dependent		Cape	Dependent
	Nestucca	Independent		Berry	Dependent
	Neskowin	Dependent		Siuslaw	Independent
	<b>Mid-Coast</b>	Salmon		Independent	<b>Lakes</b>
Devils Lake		Dependent	Siltcoos	Independent	
Siletz		Independent	Tahkenitch	Independent	
Schoolhouse		Dependent	Tenmile	Independent	
Fogarty		Dependent	<b>Umpqua</b>	Lower Umpqua	Independent
Depoe Bay		Dependent		Middle Umpqua	Independent
Rocky		Dependent		North Umpqua	Independent
Spencer		Dependent		South Umpqua	Independent
Wade		Dependent	<b>Mid-South Coast</b>	Threemile	Dependent
Coal		Dependent		Coos	Independent
Moolack		Dependent		Coquille	Independent
Big (near Yaquina)		Dependent		Johnson	Dependent
Yaquina		Independent		Twomile	Dependent
Theil		Dependent		Floras/New	Independent
Beaver		Independent		Sixes	Independent

\*Includes coho salmon inhabiting all basins that drain directly into Tillamook Bay (Trask, Wilson, Tillamook, Miami, Kilchis, and other minor tributaries).

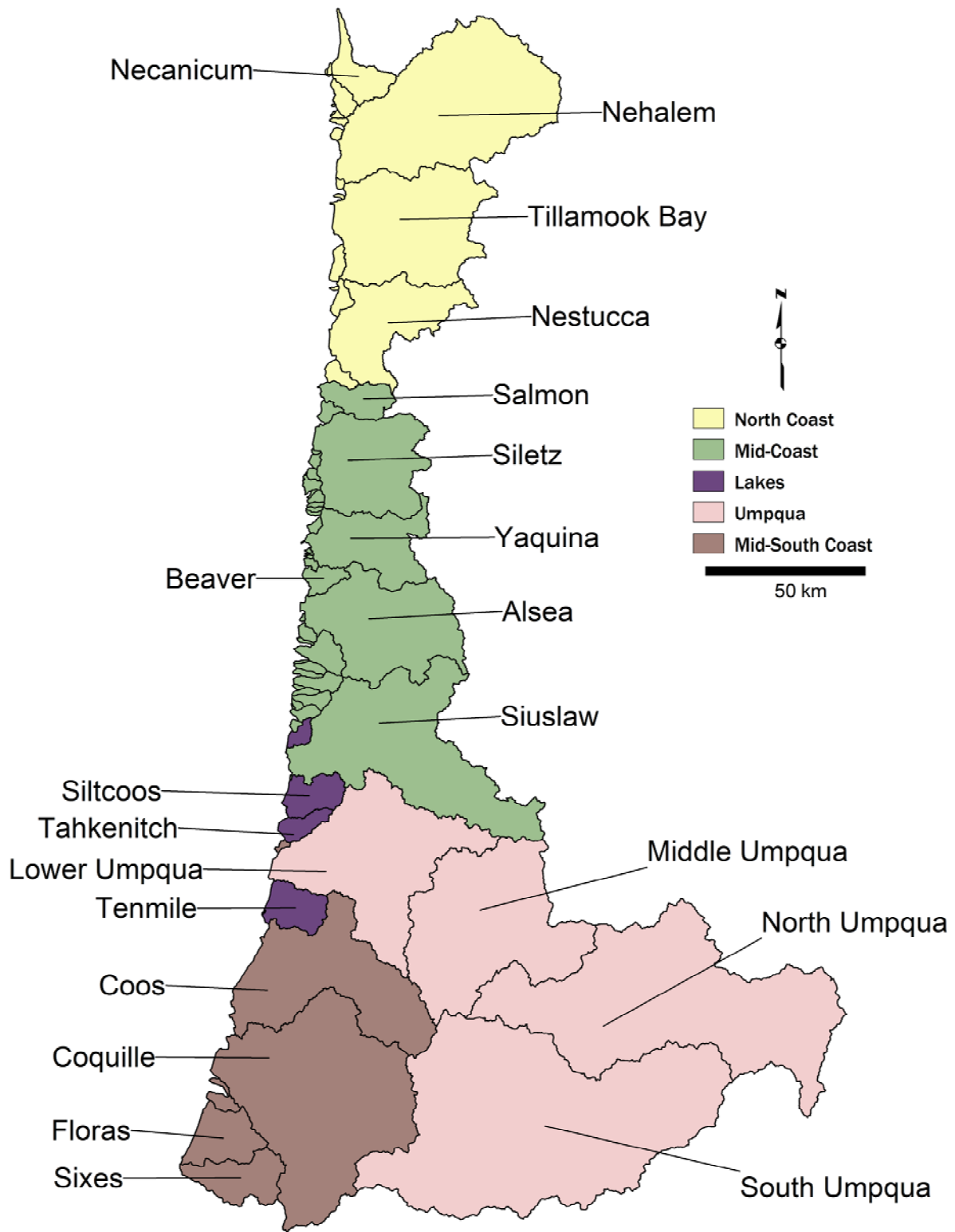

Figure 1. Biogeographic strata and Independent Populations of the Oregon Coast Coho Salmon ESU.

**Biogeographic strata** are groups of populations with biological (genetic, ecological) and geographical similarities.

A **population** is a group of fish of the same species that spawns in a particular location at a particular season and does not interbreed substantially with fish from any other group (Lawson et al. 2007). There are two major classes of populations.

**Dependent Populations** are populations that historically would not have had a high likelihood of persisting in isolation for 100 years. These populations relied upon periodic immigration from other populations to maintain their abundance (Lawson et al. 2007).

**Independent Populations** are populations that historically would have had a high likelihood of persisting in isolation from neighboring populations for 100 years (Lawson et al. 2007).

Within populations, **watersheds** are geographical areas drained by one or more rivers and tributaries where fish spawn. In the context of this report, this term generally refers to fifth-field hydrologic units (HUC5, REO 2002).

# Important Issues

Several general issues are important for the application of these criteria. These issues include:

- The relationship of fish-based criteria to habitat
- The role of hatchery fish in the ESU
- The effects of fluctuations or trends in environmental conditions (particularly in freshwater habitat conditions and marine survival)
- The role of density dependence in evaluating population-level risks
- The role of uncertainty in making decisions based on these criteria
- The consequences of assumptions made about population structure
- The relationship of these criteria to those applied to other ESUs and to requirements of the ESA

## Habitat

Habitat conditions, particularly in freshwater and associated upland areas, play a central role in the status of salmon populations (Figure 2). Habitats are diverse and dynamic, responding both to natural changes and to changes resulting from human management patterns (e.g., Burnett et al. 2007, Spies et al. 2007). Unfortunately habitat characteristics are difficult to relate quantitatively to population performance, so the criteria rely primarily on metrics related to fish performance rather than on habitat-based metrics, except for one criterion that uses a habitat-based estimate of smolt capacity. The status of habitat may be reflected in population metrics such as abundance, productivity, and distribution, although environmental variation, harvest, and artificial production can mask these relationships. Population abundance is directly related to the quantity (capacity) of habitat available, productivity (intrinsic smolts per spawner or adults per spawner) is most strongly tied to habitat quality, and distribution and diversity are both strongly influenced by the spatial arrangement and variety of suitable habitats within the population's range. Habitat, of course, is not the only determinant of population status. Direct human intervention in the form of harvest and hatcheries also affects productivity, abundance, and diversity, but in the long term it is the condition of natural habitats that determine the ability of a population to tolerate any negative effects of harvest and hatcheries.

There are risks in depending on fish-based criteria rather than including criteria that specifically address habitat condition. Fish populations will likely be the final signal of changes in habitat conditions which, because of time lags between changes in terrestrial conditions and changes in lotic habitat, are slow to affect fish populations and slow to recover. It may be that by the time serious changes in terrestrial habitat are detected in fish populations, it will be too late to do anything effective about them. Some threats, such as landslides, fires, and floods, cause local



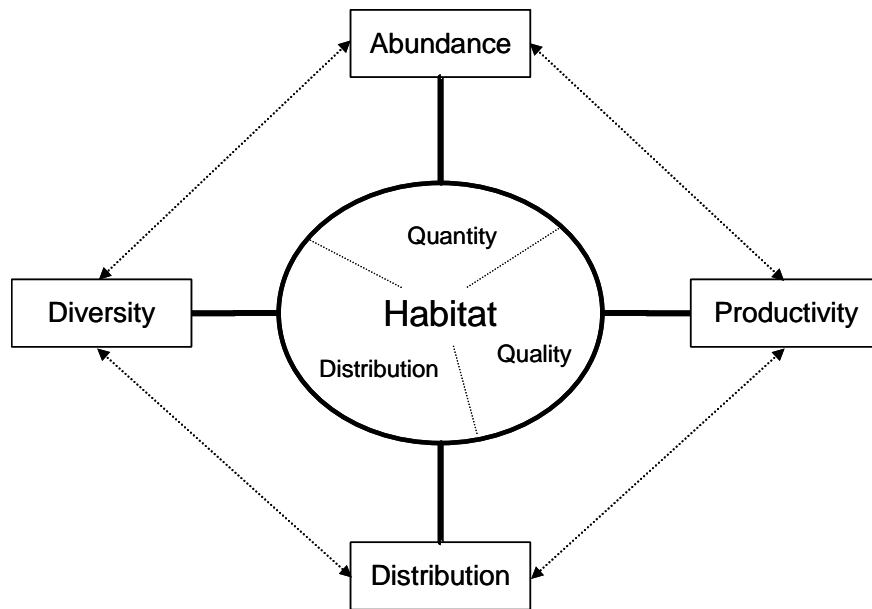

Figure 2. Conceptual view of relationships of the four VSP parameters to habitat.

effects that could threaten a population but do not pose a threat to a biogeographic stratum or ESU. The large-scale threats would probably come from human development and climate change, which set the stage for widespread drought and habitat simplification and cause smaller changes to have more effect. Thus, merely following population trends without paying adequate attention to landscape-scale changes may not assure protection or recovery of the ESU.

## Hatchery Fish

Hatchery production has been widely used for Pacific salmon to increase the abundance of fish, particularly to allow for harvest where natural production has become limited by other human activities. The biological criteria focus on the natural sustainability of populations, so attempts must be made to account for the influence of hatchery production in the criteria and metrics. Workgroup concerns relate to the effect of hatchery fish that spawn naturally along with wild fish and are twofold: 1) that the fitness (contribution to future generations) of hatchery fish spawning naturally may be less than that of wild fish (Einum and Fleming 2001, Fleming and Petersson 2001, Bisson et al. 2002, Berejikian and Ford 2004) and thus will influence estimates of the productivity of those wild populations whose adults spawn with hatchery fish, and 2) that hatchery fish may impact the sustainability of wild populations either through ecological interactions between hatchery and wild fish (Einum and Fleming 2001, Nickelson 2003) or through interbreeding of hatchery and wild fish that leads to reduced fitness of the wild population (Reisenbichler and McIntyre 1977, Bisson et al. 2002). The bases for these concerns are discussed below.

## **Fitness of Hatchery Fish**

Several studies in the Pacific Northwest have documented reduced fitness of hatchery salmonids rearing in natural environments. For example, Reisenbichler and McIntyre (1977) studying Deschutes River hatchery and wild steelhead found that survival of the offspring of hatchery fish during the first year of life was significantly less than that of the offspring of wild fish in three of four streams (74%, 72%, and 49% of wild fish). Similarly, Fleming and Gross (1993) found that hatchery male coho salmon were only 62% as successful at breeding as were wild males, and hatchery females were 82% as successful as wild females.

In a study of summer steelhead in the Kalama River (Chilcote et al. 1986, Leider et al. 1990), nonnative Skamania hatchery stock produced smolts at 31% of the rate of wild Kalama River steelhead and adults at 11–13% of the rate of wild steelhead. This study has been criticized because the hatchery stock was not a local stock. However, after the smolts left the Kalama Basin, the marine survival of the hatchery fish was still only 35–42% that of the wild fish, a difference that cannot be attributed to being a nonnative stock.

A more recent study of reproductive success of steelhead in Hood River (Araki et al. 2007) found that steelhead reared in a controlled supplementation hatchery (spawning and rearing of locally captured wild stock held for less than one year) had fitness indistinguishable from that of wild fish, while steelhead from a traditional hatchery (nonlocal origin, multiple generations in a hatchery environment) had markedly reduced fitness.

Nickelson et al. (1986) reported on the study of the supplementation of wild populations of Oregon Coast coho salmon with hatchery presmolts. Using their data, productivity of hatchery and wild fish can be calculated from summer juvenile abundance of hatchery and wild fish in 1980 and 1981 and summer juvenile abundance of wild fish three years later in stocked and unstocked streams. Results of this analysis provided estimates of productivity of hatchery coho salmon that were 6% and 24% that of wild coho salmon.

On a broader scale, extensive literature reviews (Einum and Fleming 2001, Bisson et al. 2002, Berejikian and Ford 2004) have documented variable, but usually reduced, fitness of hatchery fish compared to wild fish. Einum and Fleming (2001) in a review of more than 100 peer-reviewed publications found that “the hatchery rearing of salmonids results in increased pre-adult aggression, decreased response to predators, and decreased survival.” Bisson et al. (2002) concluded that “hatchery-origin adults returning from the ocean and spawning in the wild produce fewer progeny than adults of wild origin spawning in the wild.” Finally, Berejikian and Ford (2004) suggested that when estimating population productivity, it would be prudent to assume a range of values for relative fitness of local, multigenerational hatchery fish—advice that was followed in the analyses reported here by making precautionary assumptions and testing sensitivity of results to these assumptions.

## **Impact of Hatchery Fish on Wild Populations**

Four of the studies important to examining this issue are from Oregon. The Reisenbichler and McIntyre (1977) study of summer steelhead discussed above also compared survival of the offspring of hatchery-wild crosses with survival of the offspring of wild parents,

thus simulating the effects of interbreeding of hatchery and wild fish in the wild. They concluded that a long-term effect of hatchery adults spawning with wild adults would be the production of fewer returning adults than had the same number of exclusively wild adults spawned.

Nickelson (2003) reported a negative relationship between the productivity of wild populations of coho salmon on the Oregon coast and the number of hatchery smolts released in the basin. He hypothesized that the mechanism was increased mortality of wild smolts caused by predators attracted by large numbers of hatchery smolts.

Chilcote (2003) found a negative relationship between the proportion of hatchery fish in naturally spawning populations of steelhead in Oregon and the productivity of the population. Possible causes of such a relationship include reduced fitness of hatchery spawners, ecological interactions between hatchery and wild fish, and reduced fitness of the offspring of hatchery and wild spawners. Examination of the data presented in this report on populations of coho salmon on the Oregon Coast shows a similar result (Figure 3).

Araki et al. (2007) found that fitness in the wild of hatchery-wild crosses were reduced relative to wild/wild crosses for traditional hatchery fish, but that this was not the case for crosses with fish from a wild-stock supplementation hatchery.

Again, a broader look at the issue supports the workgroup’s concerns. Einum and Fleming (2001) suggest that “many of the current stocking practices may be detrimental to the recipient population.” Following an extensive literature review, Fleming and Petersson (2001)

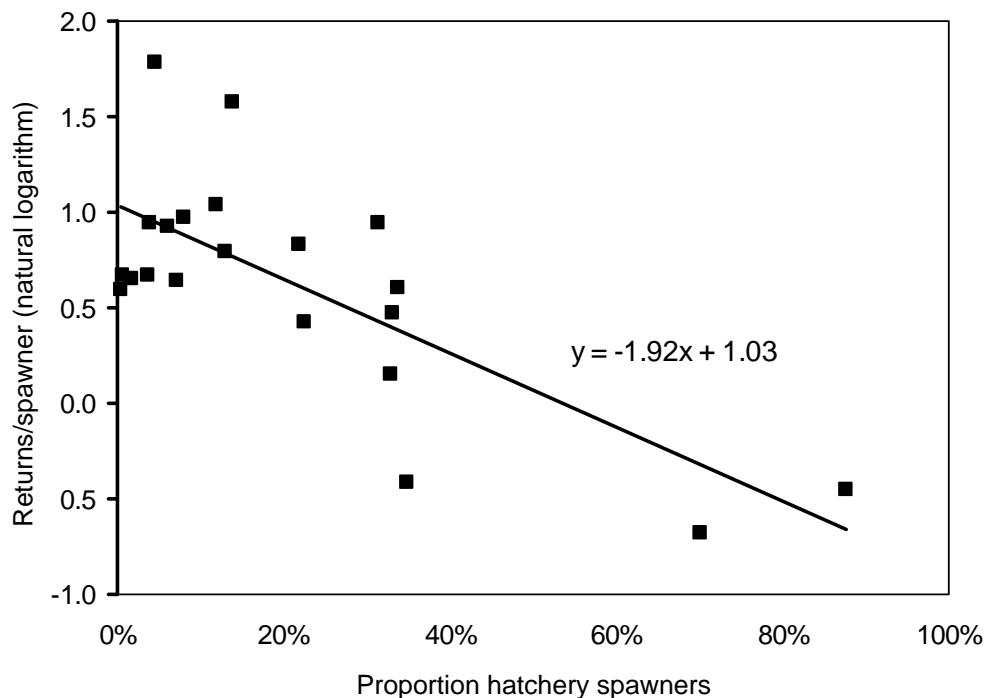

Figure 3. Relationship between population productivity (logarithm of returning spawners per spawner) and average proportion of hatchery spawners in the population during 1990–2001.

concluded that even limited interbreeding between hatchery and wild fish “may pose a concern, particularly when the scale of hatchery introductions is significantly greater than that of natural production.” Finally, Bisson et al. (2002) stated that although limited, evidence from the literature suggests that interbreeding of hatchery and wild fish can reduce the fitness of wild populations.

### **Relationship to the NMFS Hatchery Policy**

The NMFS hatchery policy (NMFS 2005) relates directly to listing decisions, not recovery, but is relevant here to the extent that recovery criteria should be compatible with listing determinations. The policy focuses evaluations of biological condition on the status of natural populations and natural production, which is consistent with the approach taken here. Under the policy, a separate analysis of the role of hatcheries in conservation efforts will be a part of listing decisions. However, conservation efforts as part of the biological recovery criteria are not evaluated in this report.

### **Environmental Fluctuations**

A major problem in setting criteria is that salmon populations fluctuate widely in response to changing environmental conditions. Such fluctuations affect measures of abundance, productivity, and distribution of populations. Because of this, assessments of these variables at any specific point in time are not necessarily informative regarding population sustainability.

For example, an observed increasing trend in abundance that coincides with a period of increasing marine survival says little about the ability of the population to survive when conditions worsen (Lawson 1993). This problem is addressed in two ways: 1) criteria are focused on measures that indicate long-term ecological sustainability, rather than short-term measures of single population variables, and 2) metrics are based on observations across multiple generations, rather than short-term measures.

Neither of these approaches is entirely satisfactory. Environmental change is multifaceted; for example, changes in marine survival are accounted for, which is relatively easily measured, but do not account for correlated changes in freshwater survival, fecundity, or habitat utilization, any of which could be equally important to the populations but are not as easily measured (Lawson et al. 2004). Using multigenerational time spans helps by picking up some of the variation in the various environmental factors, but it does not help with longer term patterns of change, such as decadal-scale shifts in climate or the slow processes of freshwater habitat development. Using a multigenerational data window means that the metrics are more stable because they do not respond to year-to-year fluctuations, but that also means there will be time lags in detecting and responding to sudden changes in ESU status.

Most of the criteria use a four-generation (12-year) data window, a time span that historically has captured a large portion of the total environmental variation. For retrospective assessments, the 12-year window includes the period of poor ocean conditions in the 1990s. The choice of a 12-year window is a compromise between two requirements: metrics need to be stable relative to environmental change so that status evaluations do not change unpredictably from year to year, but they also need to be responsive to short-term changes in management.

Too long a window would mean long delays in detecting the response of the ESU to changing management.

Change is also unpredictable. Model-based estimates of extinction risk are especially dependent on explicit assumptions about future conditions. In the current analysis of productivity and persistence, it is assumed that future conditions will be similar to observed past conditions, and in particular that future conditions will not be worse than what was observed during the 1990s. It is difficult to know if this assumption is valid, and no explicit analysis has been done of this issue. Local habitat conditions can be expected to change due to human population growth and shifts in land-use practices, and freshwater, estuarine, and ocean conditions are likely to be substantially influenced by large-scale climate change. None of these effects is readily predictable, although some simulations of habitat changes are available (e.g., Bettinger et al. 2005). To address this uncertainty in future conditions, we tested the sensitivity of a persistence model (the stochastic habitat-based life cycle model, see Appendix C) to various future-condition scenarios, which demonstrates substantial variation in predicted extinction risk depending on future conditions. However, a full analysis would require integrating human demographic prediction, climate change, and the effectiveness of management policies into evaluations of limiting factors.

## **Density Dependence**

Density dependence in population parameters is a well-established principle of population ecology (cf Wilson and Bossert 1971 or any of a number of basic ecology textbooks). For salmon, such effects are fundamental to management theory. In terms of numbers of offspring per adult, there are two general categories of effects: compensation, where the number of offspring per adult decreases with increasing abundance or density of adults, and depensation, where the effect is opposite. Typically, compensation occurs as populations grow and resource limitations begin to reduce fecundity or survival or both. Depensation typically occurs at very small population abundances, where various population processes begin to break down; these are also known as Allee effects, reviewed by Dennis (1989).

There is considerable evidence for coho salmon that the recruits per spawner metric is density dependent (Beidler et al. 1980, Nickelson and Lawson 1998, Nickelson 2003). For Oregon Coast coho salmon populations, the importance of this strong density-dependent relationship is threefold: 1) the recruit per spawner (R/S) ratio, highly variable depending on spawner density, is not a constant and should not be treated as such, 2) spawner-recruit models that assume a constant R/S ratio are poorly suited for forecasting the recruitment response of coho salmon populations when the density of spawners is low, and 3) as spawner abundance declines, the resistance to further population decline becomes greater because of the compensatory increase in the R/S ratio, although this would be offset by depensation at very low abundance.

An effect of this strong density-dependent relationship is that even a relatively low number of spawners can produce enough smolts that, if these smolts experience good marine survival, the number of returning adults will rebound considerably. This pattern was observed throughout the Oregon Coast Coho Salmon ESU in the rebound of populations from the levels of the late 1990s, especially for those populations in the northern portion of the range.

The workgroup attempted to account for these effects in its criteria by focusing on estimates of productivity below abundances where compensation is likely to be significant and by exploring a variety of density-dependent population models when models are used.

## Uncertainty

All assessments relating to these criteria involve uncertainty. Uncertainty is a difficult and often ignored issue in resource conservation, and decisions often need to be made in the face of substantial uncertainty (for example, see Ludwig et al. 1993, Regan et al. 2005). The authors of the VSP paper (McElhany et al. 2000) recognize two responses to the problems of uncertainty: a precautionary approach and the use of adaptive management. We strongly encourage the use of both as recovery planning moves forward.

For this report, three distinct types of uncertainty must be considered: scientific uncertainty as to what levels of the various metrics are needed to ensure persistence or sustainability (criterion uncertainty), statistical uncertainty in estimating the metrics from data (data uncertainty), and uncertainty in determining population structure of the ESU as it relates to specific criteria (structural uncertainty). These three types of uncertainty are addressed in different ways:

- **Criterion uncertainty** is a fundamental part of this approach, which uses a formal decision support system (DSS) to integrate this uncertainty from the lowest level criteria (those relating directly to observations) up through the highest level ESU criteria. At the lowest level, this uncertainty is expressed by using continuous functions relating observations to risk levels, rather than knife-edge (pass-fail) criteria.
- **Data uncertainty** is addressed in three ways. First, the statistical confidence (Type I error) is examined in estimating quantitative metrics from data. Second, this uncertainty has been implicitly incorporated into criteria by using precautionary values for some metrics. Third, a sensitivity analysis was conducted on the whole analysis, varying both data inputs and selected metric levels to examine the effects of uncertainty on the final high-level results (see Appendix A).
- **Structural uncertainty** involves the classification of populations into Independent and Dependent categories and the definitions of biogeographic strata that were developed by Lawson et al. (2007), who discussed a number of the uncertainties involved in determining the population structure of the ESU. In the DSS for this report, these classifications are important in applying some of the diversity criteria and in aggregating results from the population level to the ESU level. Because the population-level criteria focus on Independent Populations, the habitat-based size limit chosen by Lawson et al. (2007) to separate Independent from Dependent Populations is important. If this limit were higher or lower, the number and average size of Independent Populations would change, and this would have an effect on the results of the analysis. In general, lowering this limit would result in more but smaller Independent Populations and would increase the apparent ESU-level risk in the analysis, while raising the limit would have the opposite effect (see Appendix A).

## **Population Classification and Biogeographic Strata**

In the analysis, population-level criteria are combined into biogeographic stratum criteria and these are then combined to the ESU level. With this approach, how the populations and strata are defined could have a significant effect on the higher-level criterion values. This issue has not been explicitly addressed, but some of the effects can be described. In defining the Independent Populations that are the focus of population-level criteria, a specific lower limit to population size based on predicted intrinsic habitat production was chosen. Because some of the criteria relate to abundance, distribution, and habitat capacity, smaller basins will tend to have lower scores for these metrics. Thus if the population size limit in the definition of Independent Populations were shifted higher (or lower), it could be expected that on average population-level status scores would increase (or decrease). For this reason, it is important that the definition of Independent Populations be ecologically meaningful, that is, that the lower size limit actually corresponds closely to the definition of demographic independence (Lawson et al. 2007).

At the stratum level, the logical structure of the analysis dictates how changes in stratum size would affect ESU-level criteria. Because ESU-level persistence and sustainability depend on achieving persistence or sustainability in every stratum, defining more numerous but smaller strata would result in more likely failure at the ESU level. This failure happens for two reasons: 1) smaller strata with fewer populations would likely result in greater variation in stratum-level results, and 2) with more strata, the likelihood of one with very low persistence or sustainability increases. Thus it is important that the strata chosen actually reflect significant portions of the ESU that, if lost, would compromise the persistence or sustainability of the ESU.

## **Relationship to Criteria for other ESUs**

NMFS formed TRTs for eight geographic recovery domains, covering all the listed Pacific salmon ESUs. Several other TRTs have released draft or final biological recovery criteria for various ESUs (Puget Sound TRT 2002, Willamette/Lower Columbia TRT 2006, Interior Columbia Basin TRT 2007, Lindley et al. 2007, Spence et al. 2007, Williams et al. 2007). Although all the TRTs followed the same general principles outlined in the VSP report (McElhany et al. 2000), each adopted a different suite of specific criteria tailored to the particular species, ecosystems, and data sets specific to their recovery domain. The approach for this report differs somewhat from these approaches. In addition to a somewhat different organization reflecting the multiple mandates addressed, three differences are apparent: the role of abundance criteria, the role of population viability models, and the use of DSSs.

Most other TRTs placed a strong emphasis on abundance as an indicator of population status. That factor has been deemphasized for this report. Abundance of salmon populations is known to fluctuate widely as environmental conditions change, and abundance is inextricably linked to other VSP parameters, particularly productivity and distribution. In fact, abundance per se may be the least important criterion, because abundance levels can and will vary dramatically as a result of variations in marine survival and density-dependent freshwater survival. For example, low abundance during unfavorable ocean conditions may be a more sustainable abundance than only moderate abundance levels during favorable ocean conditions. There were only two areas where a clear link was found between abundance and risks to sustainability:

genetic diversity, where reproductive abundance can be directly related to losses of diversity over time, and small population demographics, where small-population effects (depensation or Allee effects [Dennis 1989]) may significantly reduce the probability of persistence.

Population viability models have become a standard approach in evaluating status of species at risk, but they are not without controversy. For this report, population viability models were used directly as a measure of population persistence, as one of a number of criteria. Some other TRTs (e.g., Puget Sound TRT 2002, Willamette/Lower Columbia TRT 2006) chose to use simple population viability models to develop viability curves defining combinations of productivity and abundance that result in high or low risk, and then applied those productivity and abundance combinations as criteria. The models that these TRTs used are fairly generic, and reflect little of the biology of specific species or life history types. We tried this approach, but we found that results depend on assumptions that were not appropriate for Oregon Coast coho salmon populations. We concluded it was best to use viability models directly to estimate extinction risk, rather than the indirect approach of using models to generate viability curves and comparing measured parameters with those curves. We believe that for Oregon Coast coho salmon populations this approach makes clearer the assumptions and limitations of the analysis.

The final area where the workgroup departed from the methods applied by other TRTs is the use of a formal DSS for organizing and evaluating the criteria. This approach provides a clear, logical framework for the various factors that influence extinction risk and recovery processes, and can provide explicit documentation of how criteria at different population scales are combined into ESU-wide criteria. It also provides a single quantitative evaluation of ESU condition, while allowing managers to examine the specific conditions that contribute to the overall assessment. Use of a DSS is more fully described beginning on page 20.

## **Relationship of Biological Criteria to the ESA**

The ESA outlines requirements for recovery planning, which have been clarified in agency regulations and guidelines. The most pertinent requirements of the ESA for purposes here are that a recovery plan incorporate “objective, measurable criteria which, when met, would result in a determination ... that the species be removed from the list” (ESA Sec. 4(f)). The most recent guidelines available are NMFS’ interim recovery planning guidance (NMFS 2006). Those criteria note that recovery requires a number of objectives (NMFS 2006, Sec. 5.1.8.2):

- Adequate reproduction to balance mortality
- Sufficient genetic robustness to avoid inbreeding depression and to allow adaptation
- Sufficient habitat for long-term population maintenance
- Elimination or control of threats to the species

Each of these objectives should have associated recovery criteria by which progress toward the objective may be measured. The guidance further suggests (NMFS 2006, Sec. 5.1.8.3) that these criteria should address representation (breadth of genetic makeup to conserve adaptive capabilities), resiliency (ensuring that populations can withstand stochastic events), and redundancy (sufficient number of populations to withstand catastrophic events).



In determining the ESA listing status of a species or ESU, a number of factors beyond biological conditions of the ESU must be considered (Figure 4). For example, listing determinations require consideration of conservation efforts, adequacy of existing regulations, and other risks affecting the continued existence of the ESU. For delisting, NMFS guidance requires that “recovery criteria must include the management or elimination of threats by specific mechanisms.” These requirements are not directly addressed in this report; thus, the biological criteria presented here do not provide a sufficient set of criteria to determine the ESA listing status of the ESU. Rather, this report focuses on biological recovery criteria: the characteristics of populations and their habitat that lead to biological sustainability. This is not to ignore the primary importance of removing threats in achieving recovery, but reflects the fact that analysis of threats is sufficiently complex that it deserves a more complete treatment than could be provided at this time.

When this ESU was first proposed for listing in 1997, the impact of all factors for decline resulted in Oregon Coast coho salmon abundance that was approximately 5% of that documented for the early 1900s (Weitkamp et al. 1995). Before the ESU can be considered fully recovered, it is important to analyze whether these factors for decline and threats subsequently identified have been addressed. It is also crucial to identify limiting factors for each Independent Population and, from them, ascertain the impediments to recovery for each Independent Population and the ESU as a whole.

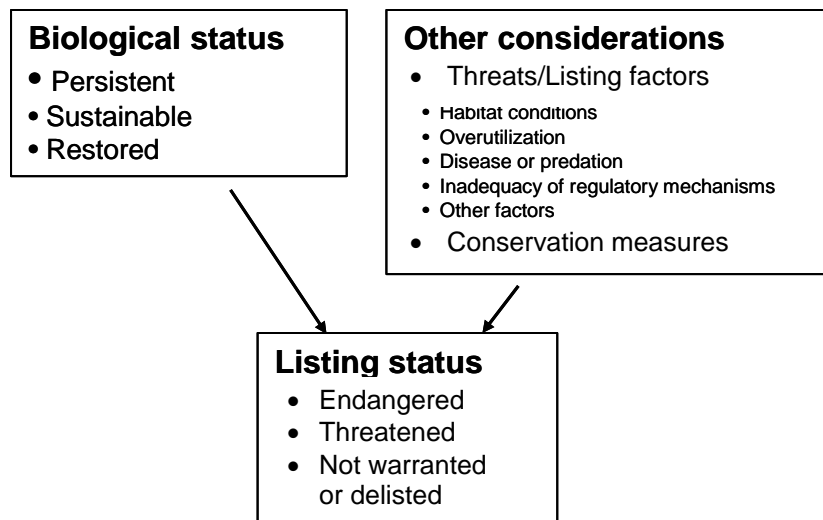

Figure 4. Relationship between biological status (criteria in this document), other listing considerations, and listing decisions under the ESA. Listing decisions are based on the biological status of the species and other considerations.

# Approach to Developing the Criteria

The development of criteria began with the VSP approach (McElhany et al. 2000), which identifies four key population parameters that influence the persistence of populations.

- Population size, the abundance of all life stages of the species
- Population growth rate (productivity), production over the entire life cycle
- Spatial structure, distribution of fish among habitat areas and connectivity among those areas
- Diversity, variation in traits (phenotypic and genetic) among individuals in a population and among populations in the ESU

While recognizing the importance of these parameters to population persistence and sustainability, some problems were found in using them as organizing principles for a consistent set of recovery criteria for an ESU. Two primary concerns were the lack of direct connection with habitat characteristics and the strong interdependencies among the four parameters.

The approach taken views the ESU as a metapopulation, with substructure at a continuum of scales from individual spawning grounds (demes) up to the entire ESU. Along this continuum, four scales were identified as important for defining attributes related to ESU status: watersheds, populations, biogeographic strata, and the entire ESU.

The goal of recovery and restoration is not merely to meet a set of artificial criteria, but rather to restore or repair ecological processes that lead to long-term sustainability of the resource. As the criteria used in these analyses were developed (see Introduction to the Criteria on page 26), the workgroup tried to focus on the connections between the criteria and those fundamental processes. Given this focus on process, attributes that contribute to sustainability at each of these four scales needed to be understood, as a first step.

## Watershed-level Attributes

Many ecological processes occur at geographic scales smaller than that of the Independent Population scale defined above. For the most part, these considerations have been subsumed into population-level attributes, but two watershed (or subbasin) scale subcriteria were used to examine within-population diversity and distribution.

## Population-level Attributes

The definition of restoration given on page 2 refers specifically to the status of the constituent populations of the ESU. Population status is multifaceted and there are a variety of attributes that contribute to population health. In the VSP report, McElhany et al. (2000) categorized these attributes into four parameters: population size, population growth rate, spatial

structure, and diversity. These same four parameters appear in the Oregon Native Fish Conservation Policy. The four are not independent of one another and their relationship to sustainability depends on a variety of interdependent ecological processes.

## **Biogeographic Stratum-level Attributes**

In the approach taken in evaluating ESU status, biogeographic strata play two important roles. First, they represent the largest pieces of habitat, genetic, and life history diversity within the ESU, thus ensuring that they preserve much of the within-ESU and among-population diversity. Second, by ensuring that all the strata are preserved, a hedge is provided against loss of the whole ESU from large-scale catastrophes. Issues related to catastrophes are discussed further in the ESU-level Attributes subsection below.

The important attributes of strata are primarily the number and status of their constituent populations and associated habitats. Thus in this analysis, stratum-level criteria are simply combinations of the status criteria of their populations.

## **ESU-level Attributes**

On the ESU scale, the VSP report focuses on catastrophes, long-term demographic processes, and long-term evolutionary potential, leaving short-term environmental, demographic, and genetic processes as the focus of population-scale assessments (McElhany et al. 2000).

### **Catastrophes**

For purposes of this report, catastrophes are considered to be sudden events that severely reduce or eliminate one or more populations. Scales vary from local (affecting only one population) to regional (affecting the entire ESU), and with expected natural frequencies of less than 1 per 100 years. Human disturbance can increase the frequency of catastrophes such as major floods and landslides; see NRC (1996, ch. 7) and Bisson et al. (1997). Severe drought or other climate events could have effects at the entire ESU scale, and frequencies of these events are likely to change in the future in response to global climate change (ISAB 2007). The primary approach here to reducing risk to coho salmon from catastrophes is to ensure that multiple sustainable populations are distributed across the range of the ESU. Biogeographic strata are used to help accomplish this.

### **Long-term Demographic and Evolutionary Processes**

Beyond the 100-year time frame, which is the focus of the ESU Persistence Criterion, larger scale processes are important to the sustainability of an ESU. At these time scales, within-ESU population structure is likely to change as catastrophes, climate variation, and habitat changes cause changes in constituent populations, including such changes as local extinctions, increases or decreases in habitat capacity, and shifts in among-population migration rates. The goal here in managing coho salmon populations within the ESU is to maintain sufficient population and habitat structure such that these changes can occur without threatening the continued existence and evolutionary potential of the ESU.

## **Goals and Criteria**

The Oregon Coast Workgroup is part of a joint federal-state process to develop a recovery and conservation plan that meets federal and state conservation requirements. Because of multiple mandates, there are multiple goals for defining the biological status of the ESU. As discussed earlier, the term restoration is used to encompass goals of the state processes, which have requirements beyond simple sustainability. This definition is also expected to cover the requirements of the U.S. Sustainable Fisheries Act. In contrast, the term delisting is used in the narrow sense of recovery under the ESA, which itself has two considerations: is the species endangered or threatened? Only when it is neither endangered nor threatened can it be delisted.

These considerations led the workgroup to a three-level structure of goals and criteria (Figure 5). The ultimate goal is restoration of the ESU in the sense defined by the Oregon Plan and the Joint Legislative Task Force (OSL 2002b). On the way to reaching that goal, it will be necessary to achieve recovery according to the ESA, and to ensure that the ESU does not drop into endangered status. Each higher level requires meeting all the criteria of the lower levels, as well as its own.

To achieve restoration, coho salmon populations within the ESU need to be robust enough to meet societal desires for environmental, cultural, and economic benefits. Restoration therefore requires sufficient abundance of the ESU and diversity among populations. Achieving ESA delisting requires biological sustainability into the foreseeable future (as well as removal of threats, which are not discussed in this report). This level has a number of ESU-level criteria, including the number and distribution of sustainable populations and the preservation of ESU-level diversity. Avoiding endangerment requires biological persistence, that is, assurance that all significant parts of the ESU have a high likelihood of persisting for 100 years. Achieving each level implicitly requires meeting all criteria for the lower levels.

## **Use of a Decision Support System**

The goals in developing these biological recovery criteria are to meet needs for:

- A scientifically based assessment of the biological conditions of the entire ESU
- Criteria that are measurable
- An approach that is useful to decision makers throughout the recovery planning process
- Logical consistency and transparency of the links from data to top-level evaluations

A complete assessment of the biological condition of the ESU is necessarily multifaceted, potentially including a variety of interrelated criteria, with varying data quality. These criteria relate to biological processes at a variety of time and space scales, with spatial processes varying from individual stream reaches to the entire range of the ESU. To track this large suite of data and criteria in a transparent and logically consistent framework, a knowledge-based DSS was used.

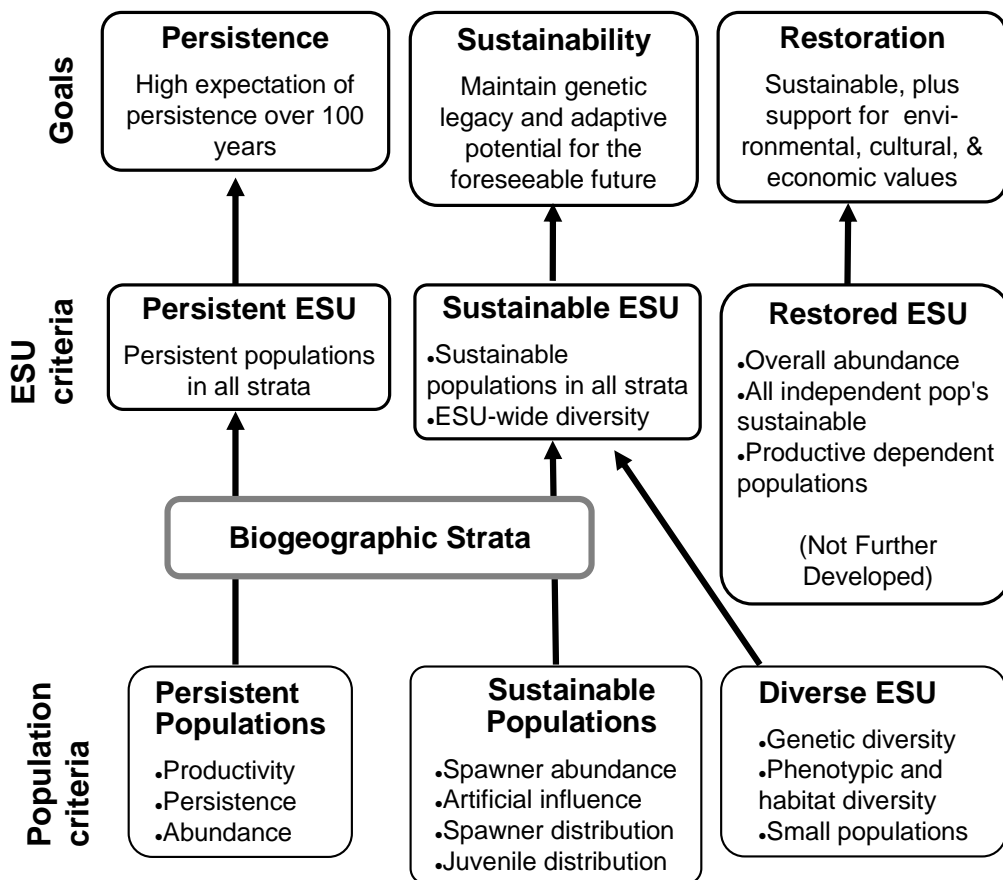

Figure 5. Overview of goals and criteria.

A DSS is a computer-based tool that can analyze and compare numerous pieces of data, producing results that assist managers in making a decision (Turban and Aronson 2001). These systems allow decision makers to perform complex evaluations quickly, present a consistent assessment that draws from a variety of data sources, and accurately track large sets of information accurately, thus improving the choices made by decision makers without overriding human judgment (Rauscher 1999). A system evaluating ecological conditions may contain substantial uncertainty about the precise conditions that are optimal for the target organisms, because of gaps in information and the lack of perfect knowledge about the interrelationships among relevant factors (Reynolds et al. 2000).

The DSS designed for this analysis uses a network framework to link criteria at a variety of scales and aggregate them from fine-scale watershed-level criteria, through population-level criteria and biogeographic stratum-level criteria, to criteria for the entire ESU. The links take the form of logical operators that define specific relationships among the input values. In traditional Boolean logic (which evaluates propositions as either absolutely true or false), criteria are “knife-edged,” meaning the result of an operation has only one of two values: true or false. In this traditional Boolean logic, when the input values are near the knife-edge criteria, the result is very sensitive to small changes in the input. In the knowledge-based system used here, a type of approximate logic (referred to as “fuzzy logic” in Appendix A) extends the ability to work with the imprecise knowledge available for the system being assessed. The advantage of using this

approximate logic is that it allows the degree of uncertainty to be evaluated and expressed in an outcome, ranging from certainly false through uncertain to certainly true. Being able to work with a gradation of levels of certainty and uncertainty enables decision makers to evaluate the degree of risk inherent in a decision based on the strength of the conclusion from the DSS. Details of the DSS and its implementation are given in Appendix A.

The criteria in this analysis have metrics, which at the population or watershed level have data inputs. These metrics are evaluated on a scale from +1.0 (completely true) to -1.0 (completely false) through the application of “truth membership curves,” that is, graphs that relate observed conditions (along the horizontal, or x-axis) to degree of truth (along the vertical, or y-axis). These curves were developed through analysis and application of the workgroup’s best professional judgment during the DSS network development. The truth membership curves, as discussed in greater detail in Appendix A, allow intermediate values between true and false, thus allowing the workgroup to capture uncertainty in the knowledge.

A disadvantage of this system is that it results in numerical truth values ranging from -1 to +1 that are difficult to interpret by those unfamiliar with the method. To aid in this interpretation, a set of verbal descriptions of the degree of certainty associated with a given metric (Figure 6) were adopted. Values near zero are considered “uncertain,” those near ±0.1 are considered to have “low” certainty, those near ±0.3 have “moderate” certainty, those near ±0.6 have “high” certainty, and values near ±1.0 are considered fully certain. Combining the sign (which indicates truth or falsity) with the magnitude (certainty) of the value, statements can be made about the propositions. For example, if the statement “the sun will rise tomorrow” is evaluated with a truth value of +1.0, one would say that this is certain. As another example, if the statement “gas prices will fall on Memorial Day Weekend” is evaluated with a value of -0.3, one would say that that statement has moderate certainty of being false. Values intermediate

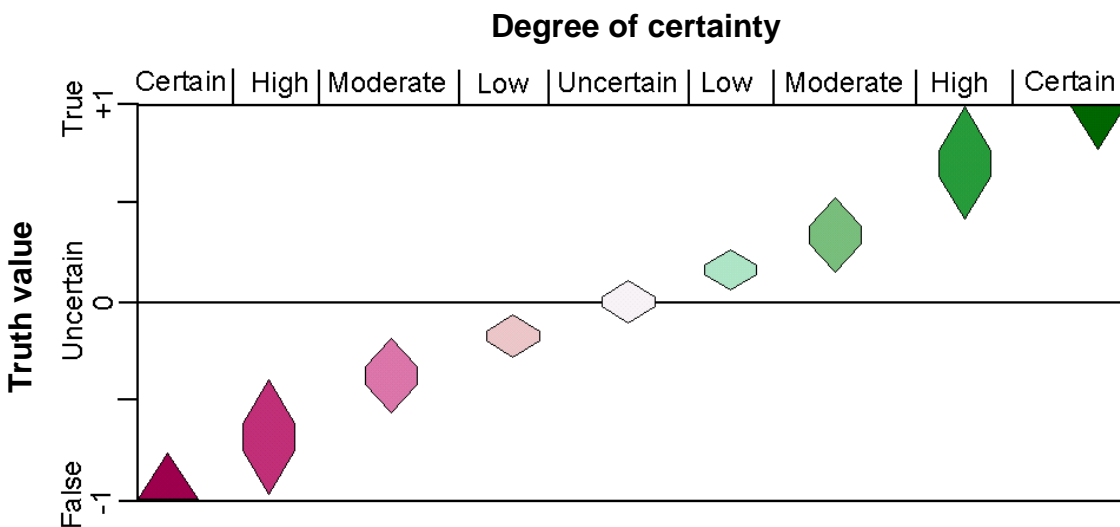

Figure 6. Terminology used in describing truth values resulting from application of the DSS. Degree of certainty is described using adjectives that relate to general ranges of truth values.

between those given above are given compound adjectives, so that a value of +0.5 would be considered true with moderate-to-high certainty.

Within the structure of the DSS network, separate criteria may be combined to determine the status of a unit (watershed, population, biogeographic stratum, or ESU). These units are then combined to determine the status of larger units (for example, the results of population criteria metrics are combined to determine biogeographic stratum status, which are then combined to determine ESU status). These combinations are performed using three logical operators:

- “AND,” which evaluates to true if all of its antecedents are true (+1) and to false if any of the antecedents are false (−1). Use of this operator means that it is essential that criteria be met for all subcomponents or subcriteria.
- “UNION” (U in the decision network diagrams), which treats its antecedents as contributing evidence in support of a proposition, approximately averaging the truth values of its antecedents. This operator is used where tradeoffs among subcomponents are acceptable, for example, a high score for one population could offset a low score for another.
- “MEDIAN” (M in the decision network diagrams), which returns the median truth value of its antecedents. Use of this operator implies that it is desirable that criteria are met for a majority of the subcomponents.

These logical operations are fully defined in Appendix A.

We considered a number of alternatives to this DSS approach. First, consideration was given to an approach with no formal DSS, where each criterion is evaluated separately and ESU-level status is decided by subjective integration of the various criteria. This approach was rejected for two primary reasons: 1) by leaving the integration of disparate criteria and the aggregation from populations to ESU open to subjective interpretation, it does not provide an objective means of evaluating ESU status, and 2) it lacks an explicit description of the logical connections among the criteria, thus reducing the reproducibility and transparency of the analysis.

Second, a DSS-like structure with strict pass-fail criteria was considered, so that the end result would be a simple pass or fail result for the entire ESU. This approach ignores uncertainties in both the science and data available for defining and evaluating criteria, and requires a determination of the acceptable level of risk prior to conducting the assessment. The workgroup believes the choice of acceptable level of risk is a sociopolitical decision, not a biological/technical exercise. Therefore, a method was sought that provided an objective evaluation of biological risk, not a pass/fail method based on a single value of acceptable risk.

Finally, other approaches to evaluating risk within the DSS framework were considered, notably statistical (Bayesian) risk assessment (e.g., Marcot et al. 2006). Such a probabilistic approach would provide a fully integrated measure of risk, resulting in a final status evaluation that is easy to interpret. However, this approach requires a number of complex assumptions regarding probability distributions of events, tending to hide the details of the analysis in complicated mathematics. The workgroup concluded the chosen logic-based DSS provided

greater transparency than statistical approaches, while retaining a full description of the logical connections leading from low-level criteria to the whole ESU evaluation.

### Interpreting DSS Results

Applying the DSS provides quantitative measures (truth values) of the biological condition of the ESU at population, biogeographic stratum, and whole ESU scales. These values can inform decisions about ESA listing and recovery, as well as more general conservation planning. However, the values do not translate directly to yes or no conclusions (except at the extreme values of +1.0 or -1.0).

As described previously, any given criterion at a value of -1.0 indicates a particular biological requirement is not met, meaning both the risk of inaction and the expected costs for restoration will be very high (Figure 7). Similarly, a value of +1.0 means that the requirement is fully met, and both risks and costs are zero. However, as illustrated in Figure 7, risks and costs behave differently at intermediate values. Costs can be expected to decline exponentially as biological conditions improve, while risks remain high until truth values are strongly positive.

To put this in more concrete terms, an example was considered for the ESU Sustainability Criterion describing typical biological conditions and needed restoration actions that correspond to each of the result categories shown in Figure 6:

- Certain false (DSS truth value near -1.0): All populations and biogeographic strata in the ESU are in very poor shape and near extinction. Abundance is generally low and declining. Distribution of juveniles and spawners is very limited. Genetic integrity of many populations is severely compromised, with little heterozygosity remaining. Diversity in the ESU has been lost due to loss of Independent and Dependent Populations

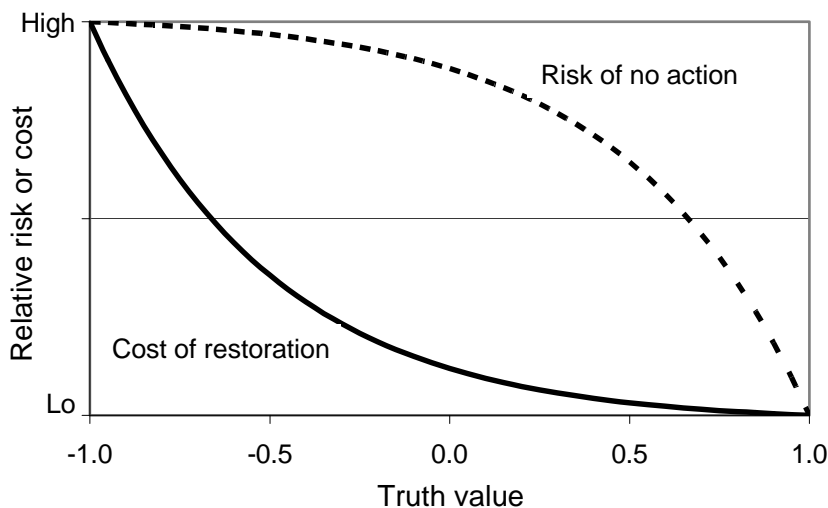

Figure 7. The relationship of DSS truth values to cost of restoration (solid curve) and risk of no action (dashed line).



or life history types, which probably means widespread destruction and alteration of ecological processes that create and maintain habitat has occurred and heroic measures are required for successful restoration to achieve a properly functioning ecosystem. There are no opportunities for harvest, and hatchery programs should be restricted to conservation activities (such as captive breeding) only.

- High certainty false (near  $-0.6$ ): Conditions similar to those for Certain false, but some populations and strata are functioning at a higher level. Effective ecosystem restoration would require extreme measures throughout the ESU over a long time frame, and the ESU can be expected to continue for a long time at low abundance with high vulnerability to extinction due to catastrophes or cycles of poor ocean conditions. Actions needed include protection of remaining habitat and ecosystems, projects to increase short-term smolt production, and other stopgap measures. Longer-term ecosystem restoration programs should be focused on areas where self-sustaining populations can be established. There are no opportunities for harvest, and hatchery activities could pose a major risk through reducing fitness and survival of naturally produced juveniles.
- Moderate certainty false (near  $-0.3$ ): Populations and strata are in generally poor condition, possibly with some in good condition. Strong and widespread ecosystem restoration efforts will be needed to bring populations up to overall adequate levels due to lack of habitat and properly functioning ecosystems. Harvest mortality must be kept to a very low level.
- Low certainty false (near  $-0.1$ ): This condition is close to the Uncertain category. Status of populations and strata are mixed, with a majority in poor condition for a number of specific biological criteria. The ESU is unlikely to be self-sustaining, and aggressive ecosystem protection and restoration efforts are needed to improve conditions and prevent further deterioration.
- Uncertain (near  $0.0$ ): This status can result from either of two conditions—biological status of the ESU is in intermediate condition relative to the various DSS criteria, or there is widespread uncertainty about conditions for many criteria because of lack of data. Most likely this means that some populations and strata are in relatively good condition (positive truth values), while others are in poor condition (negative truth values). Aggressive actions should be taken to prevent further habitat and ecosystem degradation and to restore areas that can be returned to functional ecosystems in a relatively short time. Actions should be focused on improving ecosystem functions for those populations that have low DSS results for one or more criteria, while protecting key ecological process that create and maintain habitat in populations with better DSS scores. The ESU is not self-sustaining and is likely to become in danger of extinction unless aggressive, effective ecosystems, harvest, and hatchery management measures are in place.
- Low certainty true (near  $+0.1$ ): This condition is close to the Uncertain category. Status of populations and strata are mixed, with many in poor condition for a number of specific biological criteria. The ESU may be self-sustaining, but aggressive ecosystem protection and restoration efforts are needed to prevent further deterioration. Harvest opportunities are severely limited, and hatchery programs should be strictly managed to prevent risks to naturally produced fish.

- Moderate certainty true (near +0.3): Many populations, and probably all strata, are sustainable, but some are not, and others have problems for some biological requirements. An ESU at this level has good opportunities for recovery, but is also vulnerable to harvest and ecosystem alteration and destruction. Strong protections are needed to ensure that status does not degrade, because the lower the status gets the more difficult and expensive it is to bring it back up. The ESU is likely to be sustainable unless there is a clear lack of ecosystem, harvest, and hatchery protections. There are opportunities for limited harvest during high productivity periods.
- High certainty true (near +0.6): With few exceptions, most populations and strata are self-sustaining. There are large areas of functioning ecosystems distributed throughout the ESU. Salmon at all life stages are utilizing the available habitat. Substantial economic, cultural, and social benefits are realized. There is room for improvement through restoration activities, but the urgency is low. The ESU is capable of sustaining moderate harvest pressure in most years.
- Certain true (near +1.0): Most populations and all biogeographic strata are self-sustaining. Substantial economic, cultural, and social benefits are realized. There is flexibility in ecosystem and harvest management. The emphasis should be on maintaining strong populations and functioning ecosystems throughout the ESU.

## **Introduction to the Criteria**

Our biological recovery criteria are framed within the context of the DSS described above. At the highest level, the DSS is structured to represent the hierarchical population structure of the ESU. Populations are grouped into biogeographic strata, which in combination make up the ESU (Figure 8). The goals of ESU persistence and ESU sustainability are evaluated using sets of logically linked and measurable criteria within this structure. (The third goal, ESU restoration, is discussed but is not analyzed within this structure.) Criteria for ESU persistence and sustainability are each presented in a separate section, and are presented at three levels of geographic aggregation: populations, biogeographic strata, and the entire ESU. Within each section, we present criteria at the population level first, then describe how these are combined into higher-level criteria for biogeographic strata and for the ESU as a whole.

In addition to defining criteria and metrics, an assessment is also provided of the current status of the ESU by applying each metric to data that was available in fall 2005. This analysis is provided for illustration only to demonstrate how the criteria might be used in the future to assess progress towards recovery and restoration.

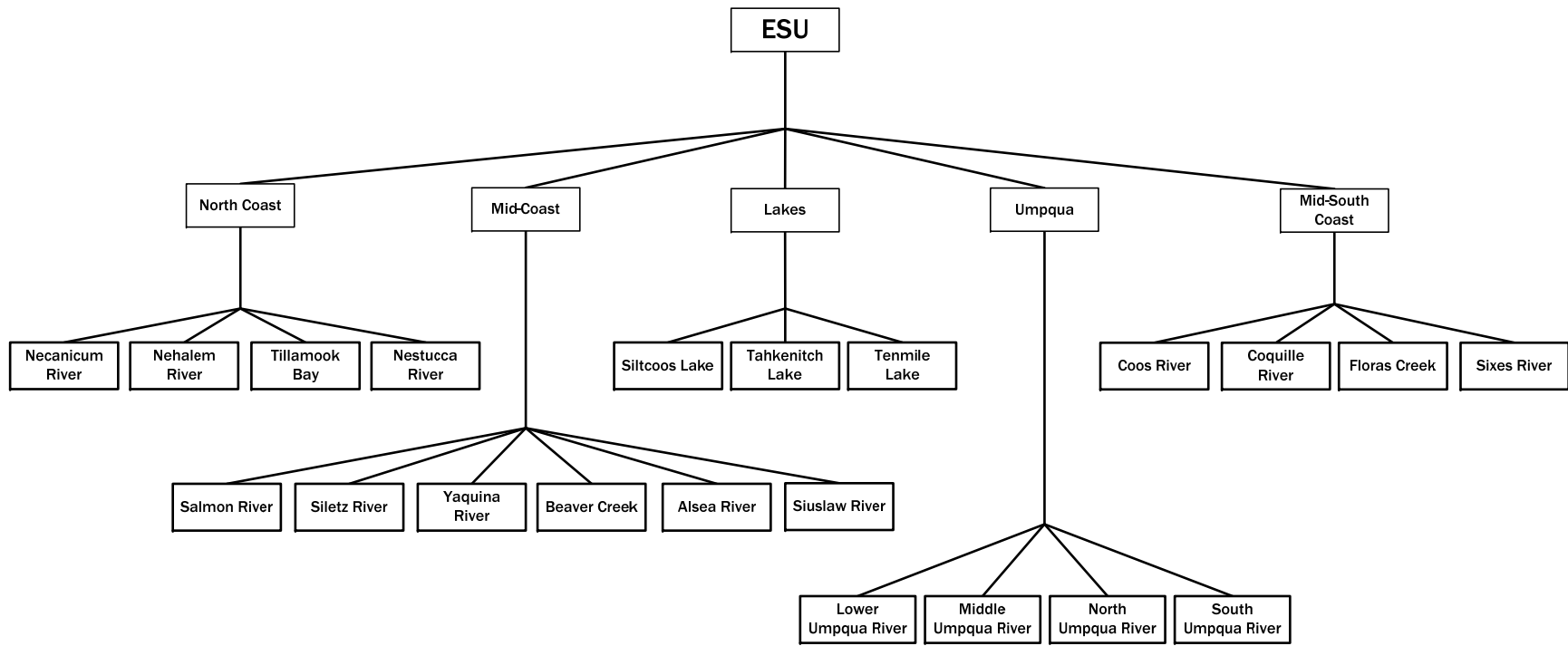

Figure 8. Schematic of the conceptual relationships of population, strata, and the ESU criteria in the DSS.

# Persistence

Persistence refers to the ability of the ESU and its populations to persist through a period of 100 years without artificial support. The DSS network used to evaluate the ESU Persistence Criterion is illustrated in Figure 9. The lowest level criteria are at the bottom, with combinations to the population, biogeographic stratum, and ESU levels higher up the figure. Stacked boxes represent points where multiple populations or strata are combined. Starting at the base of Figure 9, three criteria—Population Productivity, PP-1; Probability of Persistence, PP-2; and Critical Abundance, PP-3—are evaluated for each population to determine overall Population Persistence Criterion, PP. Evaluations for individual populations are combined to arrive at a biogeographic Stratum Persistence Criterion, SP, determination. Biogeographic stratum results are then combined to arrive at an ESU Persistence Criterion, EP, determination. Each of these criteria is defined below, starting with the lowest level population criteria, then moving up to the stratum and ESU criteria.

## Population-level Persistence Criteria

### Primary Criteria

Population persistence is evaluated on the basis of the following three primary criteria (Population Productivity, Probability of Persistence, and Critical Abundance), which are then combined into a single Population Persistence Criterion.

#### PP-1, Population Productivity

**Criterion:** Productivity at low abundance (i.e., that experienced when spawner densities are low and compensation is not substantially reducing productivity) is sufficient to sustain an Independent Population through an extended period of adverse environmental conditions (12 years with marine survival equivalent to the 1990–2001 brood year average).

**Metric:** Productivity at low abundance is estimated as the geometric mean of the natural return ratio (NRR) for brood years with spawner abundances below the median of the last 4 generations (12 years). Specifically, the metric is the statistical probability (Student's *t*-test) that NRR is greater than 1, based on available data. NRR is the ratio  $N/T$ , where  $N$  is naturally produced spawners and  $T$  is total (hatchery produced plus naturally produced) spawners in the previous generation. The truth value of the criterion is evaluated by a straight line relationship equating zero probability with false ( $-1.0$ ) and a probability of one with true ( $+1.0$ ) (Figure 10).

Estimates of naturally produced and hatchery coho salmon spawners based on random spawning surveys conducted by ODFW (Jacobs et al. 2002) are available for the period of 1990–2004 (Appendix D). To examine the current productivity ( $NRR = N/T$ ) of each population,

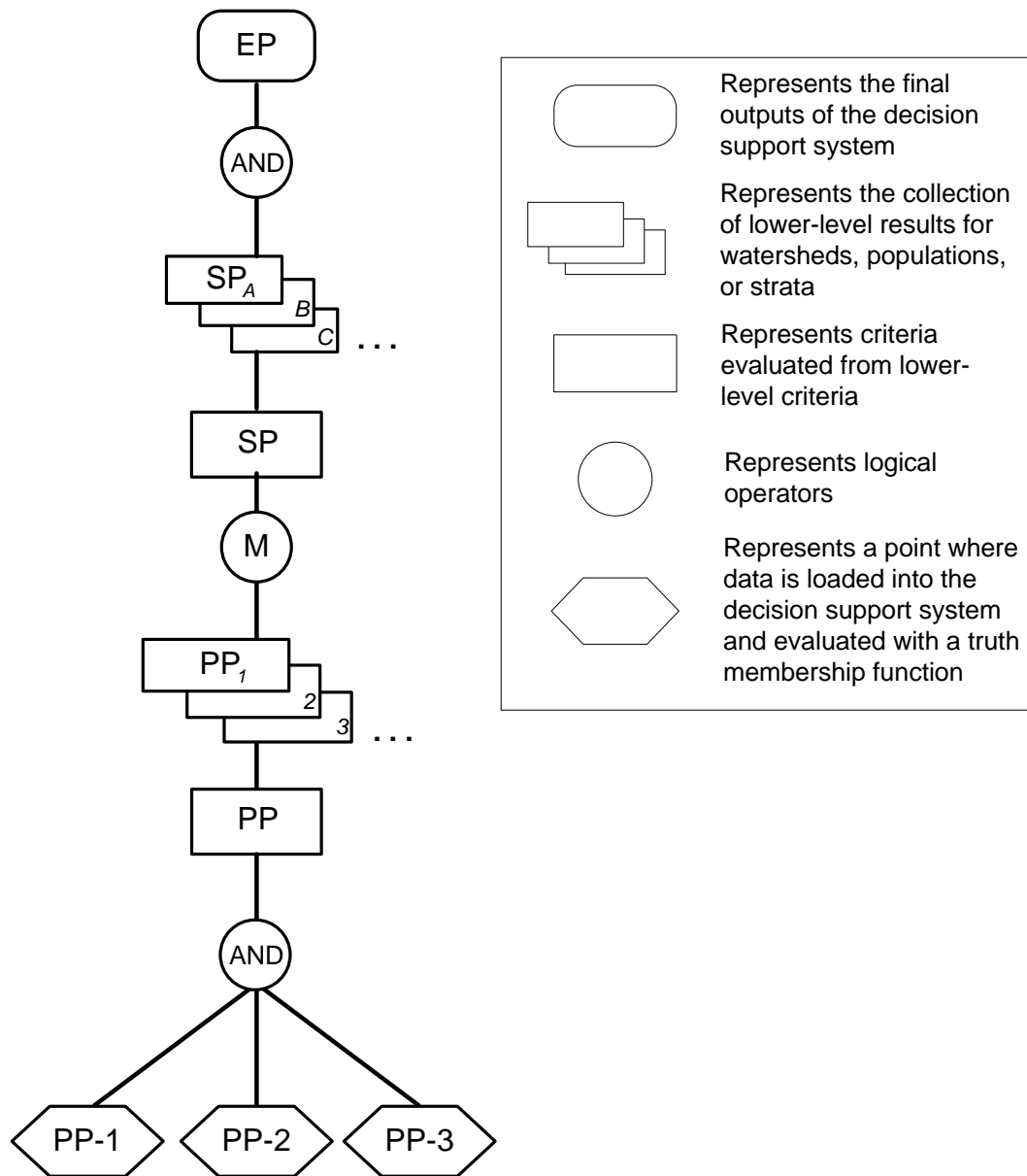

Figure 9. The decision network for the ESU Persistence Criterion. This figure shows the connections from population-level criteria, through stratum-level criteria, to the entire ESU. Criterion codes are: PP-1, Population Productivity; PP-2, Probability of Persistence; PP-3, Critical Abundance; PP, Population Persistence; SP, Stratum Persistence; and EP, ESU Persistence.

estimates of total spawner abundance,  $T$ , for the 1990–2001 broods and estimates of naturally produced spawners,  $N$ , three years later (1993–2004) were used. Productivity of each population was examined as the geometric mean of recruits per spawner for the six years of lowest spawner abundance. A precautionary assumption was made that the fitness of hatchery spawners was equal to the fitness of naturally produced spawners, which is likely conservative given that a number of studies have found hatchery fish to have less fitness than naturally produced fish (see discussion of Hatchery Fish on page 9). If hatchery spawners are actually producing fewer

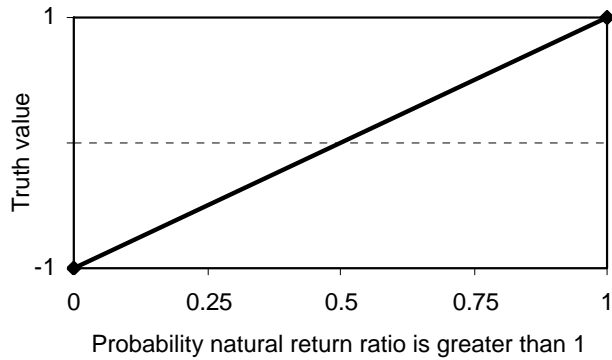

Figure 10. Truth membership function for the Population Productivity Criterion, PP-1.

offspring than naturally produced spawners, then a greater proportion of offspring would come from naturally produced parents and natural production would be higher than estimated by this metric.

**Current assessment:** Results of these analyses are reported as the mean recruits per spawner and the probability that the value is greater than 1 (Table 2). Three populations had average productivities less than 1: the Salmon, Alesa, and North Umpqua. In addition, the Nehalem population had an estimated average productivity of 1.17 but only a 57% probability that the true average was greater than 1. All four of these populations have experienced significant interactions with hatchery fish (Nickelson 2003). Estimated truth values for the Population Productivity Criterion, PP-1, are presented in Table 3 and range from  $-0.96$  (high certainty of being false) for the North Umpqua population to  $+1.00$  (true) for the Coos population. These truth values indicate the North Umpqua population does not have sufficient productivity to sustain it through an extended period of adverse conditions, while the Coos population does.

**Discussion:** Adequate productivity ensures that a population has the fundamental productivity required to survive conditions similar to the worst in recent history. However, estimating productivity is problematic, especially when environmental conditions are fluctuating; measurements taken under one environmental regime cannot be directly related to expectations under some unknown future regime. Because this metric is based on the ratio of returning spawners to parental spawners rather than the more common measure of preharvest recruits per spawner, achieving this metric demonstrates that when spawning stock was below the four-generation average, the population was able maintain itself given the actual combination of environmental conditions and harvest during that period. It gives a total assessment of the life cycle under recent past conditions without making assumptions about the relationship between productivity and environmental conditions. However, it is of course possible that some future period could be worse than recent observations, and this metric cannot directly indicate whether a population would be sustainable under such conditions (see discussion of Environmental Fluctuations, page 12).

Table 2. Population-level persistence criteria for Independent Populations of Oregon Coast coho salmon. For the Population Productivity Criterion, PP-1, the values in parentheses are the probability that recruits per spawner (R/S) are greater than 1. For the Probability of Persistence Criterion, PP-2, the two values are probabilities of persistence based on full extinction/quasi-extinction of 50. NA means result is unavailable.

Independent Population (by biogeographic stratum) Metric:	PP-1 Productivity Mean (prob.)	PP-2 Persistence Probability (over 100 years)				PP-3 Critical Abundance (Fish/mile)
		Model 1 <sup>a</sup>	Model 2 <sup>b</sup>	Model 3 <sup>c</sup>	Model 4 <sup>d</sup>	
<b>North Coast</b>						
Necanicum	2.58 (0.98)	1.00/1.00	1.00/1.00	1.00/0.99	0.92/0.18	3.77
Nehalem	1.17 (0.57)	1.00/0.99	1.00/1.00	0.99/0.99	1.00/1.00	6.27
Tillamook Bay	1.83 (0.88)	0.95/0.94	1.00/1.00	1.00/0.99	0.99/0.93	3.76
Nestucca	2.83 (0.95)	1.00/1.00	1.00/1.00	0.97/0.96	1.00/0.97	5.33
<b>Mid-Coast</b>						
Salmon	0.64 (0.24)	0.00/0.00	NA	0.99/0.86	1.00/0.91	0.57
Siletz	1.61 (0.79)	0.96/0.94	1.00/1.00	0.99/0.98	1.00/0.99	3.48
Yaquina	4.82 (0.98)	1.00/1.00	1.00/1.00	0.96/0.95	1.00/1.00	6.26
Beaver	1.89 (0.93)	1.00/1.00	1.00/1.00	0.97/0.93	1.00/0.95	22.94
Alsea	0.66 (0.20)	1.00/1.00	1.00/1.00	1.00/1.00	1.00/1.00	3.18
Siuslaw	2.30 (0.81)	1.00/1.00	1.00/1.00	1.00/1.00	1.00/1.00	4.66
<b>Lakes</b>						
Siltcoos	1.92 (0.89)	1.00/1.00	1.00/1.00	1.00/1.00	NA	52.95
Tahkenitch	1.96 (0.94)	1.00/1.00	NA	0.97/0.97	NA	62.63
Tenmile	1.81 (0.96)	1.00/1.00	1.00/1.00	1.00/1.00	NA	118.06
<b>Umpqua</b>						
Lower Umpqua	2.75 (0.94)	1.00/1.00	1.00/1.00	0.97/0.97	1.00/1.00	9.00
Middle Umpqua	2.52 (0.91)	1.00/1.00	1.00/1.00	0.98/0.97	1.00/1.00	5.35
North Umpqua	0.51 (0.02)	0.96/0.89	1.00/1.00	0.99/0.98	1.00/0.99	7.48
South Umpqua	1.53 (0.75)	1.00/1.00	1.00/1.00	0.99/0.99	1.00/1.00	5.76
<b>Mid-South Coast</b>						
Coos	5.95 (1.00)	1.00/1.00	NA	0.98/0.98	1.00/1.00	18.56
Coquille	1.95 (0.96)	1.00/1.00	1.00/1.00	0.99/0.99	1.00/1.00	15.16
Floras <sup>e</sup>	2.63 (0.91)	1.00/1.00	NA	NA	1.00/0.98	26.37
Sixes	2.21 (0.92)	0.08/0.00	NA	0.99/0.97	1.00/0.97	3.10

<sup>a</sup> Density-dependent count-based model (Chilcote et al. 2005).

<sup>b</sup> SPAZ model with hockey stick recruitment function (McElhany and Payne 2005).

<sup>c</sup> Bayesian salmon analysis model (Wainwright et al. in prep.).

<sup>d</sup> Stochastic habitat-based life cycle model (Nickelson and Lawson 1998).

<sup>e</sup> Assessment is based on a combination of random and supplemental coho salmon surveys and standard Chinook salmon (*Oncorhynchus tshawytscha*) surveys.

Table 3. Summary of DSS truth values for all populations, biogeographic strata, and ESU criteria. Criterion abbreviations are: PP-1, Population Productivity; PP-2, Probability of Persistence; PP-3, Critical Abundance; PP, Population Persistence; SP, Stratum Persistence; EP, ESU Persistence; PD-1, Spawner Abundance; PD-2, Artificial Influence; PD-3, Spawner Distribution; PD-4, Juvenile Distribution; PD, Population Diversity; PS, Population Sustainability; SD, Stratum Diversity; PF, Population Functionality; SF, Stratum Functionality; SS, Stratum Sustainability; ES-1, All Biogeographic Strata Sustainable; ES-2, ESU-level Diversity; and ES, ESU Sustainability.

Stratum	Population	Persistence						Sustainability														
		PP-1	PP-2	PP-3	PP	SP	EP	PD-1	PD-2	PD-3 <sup>a</sup>	PD-4 <sup>a</sup>	PD	PS	SD	PF	SF	SS	ES-1 <sup>b</sup>	ES-2	ES		
<b>Whole ESU:</b>								0.40						0.28 0.14 0.19								
<b>North Coast</b>								0.23						(-0.02) 0.53 0.11								
	Necanicum	0.96	(-0.44)	(-0.08)	(-0.28)							0.00	0.44	0.31	0.73	0.19	(-0.19)					0.18
	Nehalem	0.14	0.92	0.30	0.32							0.76	0.15	(-0.09)	0.42	0.09	0.15					1.00
	Tillamook Bay	0.76	0.50	(-0.08)	0.14							0.11	0.45	(-0.37)	0.44	(-0.20)	(-0.13)					1.00
	Nestucca	0.90	0.74	0.18	0.43							0.15	0.81	(-0.25)	0.82	(-0.01)	0.10					0.89
<b>Mid-Coast</b>								0.20						0.25 0.47 0.32								
	Salmon	(-0.52)	(-1.00)	(-1.00)	(-1.00)							(-1.00)	(-1.00)	(-0.97)	0.00	(-1.00)	(-1.00)					0.20
	Siletz	0.58	0.66	(-0.17)	0.05							0.07	(-0.02)	(-0.04)	0.75	0.07	0.05					0.98
	Yaquina	0.96	0.76	0.30	0.54							0.27	0.83	0.83	0.86	0.54	0.54					1.00
	Beaver	0.86	0.62	1.00	0.79							0.02	0.65	0.86	1.00	0.33	0.48					0.14
	Alsea	(-0.60)	0.96	(-0.27)	(-0.47)							0.16	0.61	(-0.15)	0.92	0.08	(-0.40)					1.00
	Siuslaw	0.62	0.98	0.09	0.35							0.93	0.88	0.38	0.76	0.62	0.44					1.00
<b>Lakes</b>								0.91						0.80 0.38 0.52								
	Siltcoos	0.78	1.00	1.00	0.91							0.43	0.92	1.00	1.00	0.72	0.80					0.32
	Tahkenitch	0.88	0.70	1.00	0.84							0.21	0.93	1.00	1.00	0.56	0.67					0.32
	Tenmile	0.92	0.98	1.00	0.96							0.85	0.99	1.00	0.73	0.87	0.92					0.59
<b>Umpqua</b>								0.44						0.20 0.88 0.41								
	Lower Umpqua	0.88	0.86	0.67	0.78							0.75	0.66	0.55	0.55	0.61	0.68					1.00
	Middle Umpqua	0.82	0.84	0.18	0.44							0.23	0.50	0.34	0.47	0.33	0.36					1.00
	North Umpqua	(-0.96)	0.52	0.46	(-0.94)							(-0.74)	(-1.00)	0.00	(-0.94)	(-1.00)	(-1.00)					0.67
	South Umpqua	0.50	0.94	0.23	0.43							0.19	0.46	-0.21	0.05	-0.08	0.04					1.00
<b>Mid-South Coast</b>								0.92						0.69 0.68 0.68								
	Coos	1.00	0.86	0.97	0.94							1.00	0.94	0.91	1.00	0.96	0.95					1.00
	Coquille	0.92	0.96	0.90	0.93							1.00	0.75	0.51	0.54	0.65	0.77					1.00
	Floras	0.82	0.92	1.00	0.90							0.17	0.95	0.38	1.00	0.44	0.61					0.87
	Sixes	0.84	(-1.00)	(-0.30)	(-1.00)							(-0.96)	(-0.57)	(-0.44)	(-1.00)	(-1.00)	(-1.00)					0.38

<sup>a</sup> Truth values at the watershed scale for PD-3 and PD-4 are in Table 6.

<sup>b</sup> Truth values contributing to ES-2 are in Table 7.



The chosen threshold for NRR of 1.0 is the most logical standard; it represents the point where a population would naturally replace itself, that is, the breakpoint between population increase and population decline. However, NRR cannot be measured without error, so if the observed value is slightly above 1.0, there is some statistical probability that the true value for the population is below the threshold. For that reason, instead of using the NRR directly the statistical probability that the NRR is greater than 1.0 as our metric has been used. Thus if the estimated NRR is exactly 1.0, the metric is a probability of 50% that the criterion would be met, which corresponds to a truth value of zero (uncertain). In addition to random statistical errors that go into the probability calculation, there are two important sources of possible bias: the proportion of hatchery fish on the spawning grounds and assumptions regarding their reproductive effectiveness. In places where the hatchery contribution is very low, these biases will have little influence on the estimates of NRR. To the extent that hatchery fish are less effective at spawning compared to naturally produced fish, the calculation of NRR is biased low; this is an intentionally conservative assumption.

Productivity is a function of life cycle fecundity, survival, and growth rates that vary with a number of factors, including freshwater habitat quality, spawner density, interactions with other species, effects of hatchery fish, and harvest. However, a major factor determining productivity is the quality of freshwater habitat (Nickelson and Lawson 1998). Because marine survival (and thus recruitment) can vary greatly from year to year, the ratio of smolts to females provides a more stable measure of freshwater productivity than does the ratio of adult recruits to spawners. However, the number of adult recruits per spawner is easier to measure and better represents the total life cycle.

The chosen metric is intended to provide a conservative proxy for intrinsic productivity, which could be estimated in a variety of ways. It may be estimated from spawner data series using stock-recruit analysis, although long data series are needed to achieve high confidence in estimates. Direct measures of smolt production and marine survival may be obtained from life cycle monitoring stations, and these data can be used to estimate smolt-production parameters; however, this would require that data is representative of the freshwater habitat available to the populations. Finally, habitat survey data can be used to estimate capacity based on statistical modeling of juvenile production from habitat characteristics. Several alternative approaches to estimating intrinsic productivity of the populations were considered, including simple spawner-to-spawner ratios, recruits-per-spawner, and smolts-per-spawner.

An empirical estimate of productivity was chosen here so that this criterion is independent of the model-based analyses used for the Probability of Persistence Criterion metrics (PP-2, below). Only the lowest 50% of spawner abundance were used as a model-independent means to estimate a lower bound on the intrinsic slope of a spawner-recruit relationship. This estimate assumes a compensatory smolt production curve, but doesn't specify its shape. Where habitat capacity is not substantially limiting population abundance, the lower 50% of observations are likely to be in the ascending range of the smolt production curve. Thus this method is likely to provide a result somewhat less than or equal to the true intrinsic productivity of the population. The approach is not fail-safe. If a population reaches its habitat capacity before delisting, then this method is likely to produce "false negative" errors. An exception should be considered if stock-recruit analysis gives high confidence that the stock is stable near maximum production levels.

## PP-2, Probability of Persistence

**Criterion:** The population has a high likelihood of persisting over the next 100 years.

**Metric:** To evaluate extinction risk, a variety of population viability models are applied to estimate the expected probability of extinction for the population. To evaluate the truth of the criterion, the results of all the models for each population were averaged. A persistence probability of 80% is considered to result in a truth value of false (-1.0), 95% to be uncertain (0), and 100% to be true (+1.0) (Figure 11).

Persistence of each population was examined using four different extinction-risk models. For each model, two different extinction thresholds were used: absolute extinction (abundance of 0 or 1), or a quasi-extinction threshold (QET) of 50 in 100 years. This use of multiple thresholds reflects uncertainty as to how well the models represent realistic population dynamics at extremely low abundances.

All four models use the same general approach: Based on a particular stock-recruit model, multiple simulations of a 100-year period are run for each population, with a different pattern of environmental variation affecting recruitment in each model run. In addition to environmental variation, two of the models incorporate variation in the parameters of the stock-recruit relationship (parameter uncertainty). This approach basically follows methodologies described by Burgman et al. (1993) and Morris and Doak (2002) where random fluctuations in environmental conditions are added to an assumed population recruitment model and spawner abundance is simulated for a specified period of time into the future. Each run of the simulation is classified as either extinction (if the modeled population drops below the extinction threshold) or nonextinction (if the population remains above the threshold). The four models differ in important characteristics that affect the dynamics of modeled populations:

- The form of the relationship between stock (spawners in one generation) and recruitment (returning adults in the next generation), including how per capita recruitment varies with stock density at high abundance (compensatory density-dependence) and at very low abundance (depensatory density-dependence)

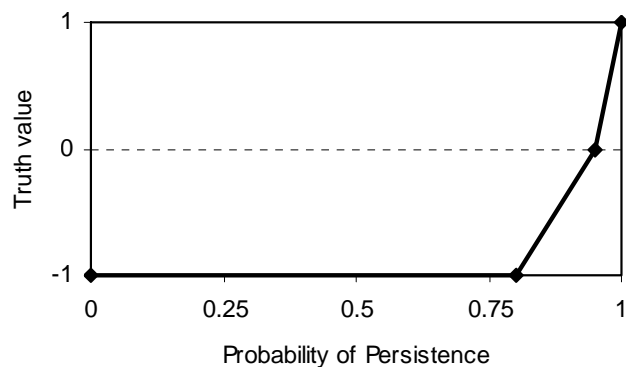

Figure 11. Truth membership function for the Probability of Persistence Criterion, PP-2.

- The sources of risk included in the model (environmental variation, demographic stochasticity, genetic stochasticity, and parameter uncertainty)
- The assumed form of environmental variability (uncorrelated random, autocorrelated random, or cyclic processes affecting marine survival)

The four extinction-risk models are described briefly below. Details of the model applications are in Appendix C.

**Model 1: Density-dependent, count-based population viability analysis (PVA)**

**model.** This model assumes that coho salmon recruitment conforms to a Ricker compensatory recruitment function, modified to remove the descending limb of the recruitment curve at higher spawner abundance levels. At low abundances, the function is truncated at low spawner densities so that no recruits are produced when spawner densities fall to less than 1 fish per mile (0.6 per km) (depensation). Parameters were estimated via multiple linear regression where the response variable was the natural log of recruits per spawner ( $\ln(R/S)$ ) and the predictor variables were spawner abundance and an index of marine survival. To simulate marine survival during each of the model runs, the values for the marine survival index observed during the period of record (1958 to present) were replicated as necessary to obtain a 100-year sequence of indices (cyclic environment). To address the issue of autocorrelation between years with respect to marine survival, the sequence of values observed from 1958 to present was maintained in all 100-year marine survival sequences used in the model runs. Although this meant the pattern of survival rates was the same, each simulation was initiated with a different (randomly selected) starting point in this generalized cycle of survival rates.

**Model 2: SPAZ hockey stick viability model.** The second model is a stochastic viability model developed by McElhany and Payne (2005) as part of a suite of models known as “SPAZ.” The model uses a “hockey stick” form of the stock-recruitment relationship, with a linear increase in recruitment at low stock abundance, and constant recruitment when the stock is at or above habitat capacity. This model has no decrease in per capita production at very low stock abundance (no depensation). The model estimates stock-recruitment parameters from spawner-recruit data. The model uses simple uncorrelated random environmental variation in simulations and also incorporates random variation in parameter estimates (parameter uncertainty).

**Model 3: Bayesian Salmon Analysis Model.** This is an application of the Bayesian Salmon Analysis Model (BaySAM) (Wainwright et al. in prep.). The model combines density-dependent freshwater production with density-independent, environmentally driven marine survival to predict future population abundance and estimate risk of extinction. Recruitment is modeled as a Beverton-Holt compensatory relationship with spawner density modified with an exponential decline in recruits (depensation) at very low spawner densities. Stock-recruit parameter estimates incorporate both information from recent stock-recruit data for each population and prior information from a meta-analysis of production in other coho salmon populations (similar to that in Bradford et al. 2000) via a nonlinear regression technique. In addition to autocorrelated environmental variation, the model incorporates randomization in parameters to characterize parameter uncertainty.

**Model 4: Stochastic habitat-based life cycle model.** The habitat-based life cycle model (Nickelson and Lawson 1998) was adapted to simulate all the river populations in the ESU. In this model, the dynamics of each population are driven by the quantity and quality of winter habitat. Instead of using a simple stock-recruit function, the model steps through the life cycle of coho salmon and includes both compensation and depensation at different life stages. Egg-to-parr survival is density dependent. Habitat quality determines smolt capacity and overwinter survival. Environmental and demographic stochasticity enters the model at each life stage. The basic model was structured as described by Nickelson and Lawson (1998) with three exceptions: the stray rate between reaches was 20% instead of 5%, a more resilient egg-to-parr survival function was used based on recent data, and the marine survival cycle was based on historical survival of Oregon Production Area hatchery coho salmon survival. This model also simulated harvest as specified by Amendment 13 to the Pacific Coast Salmon Fishery Management Plan (PFMC 1999).

**Current assessment:** Results of the analysis are reported in Table 2. For most populations, the four models suggest very high persistence probabilities (above 95%). The three models that could be applied to the Salmon population suggested a relatively high risk of quasi-extinction; this is consistent with an observed recruitment of zero in 2000 and 2001. The four models were consistent in their evaluations of most populations. Notable exceptions were the Necanicum, Salmon, North Umpqua, and Sixes populations. Estimated truth values for the Probability of Persistence Criterion, PP-2, are presented in Table 3. The Salmon and Sixes populations have truth values of  $-1.0$ , which predicts a low likelihood of persistence over the next 100 years. Conversely, the Siltcoos at a truth value of  $+1.0$  has a very high likelihood of persistence over the next 100 years.

**Discussion:** Risks associated with demographic and environmental variation are often assessed using stochastic population models, commonly termed PVA models. In these models, short-term extinction risk is largely determined by four factors: current abundance, the intrinsic rate of population change, the capacity of habitat, and variability in fecundity, growth, or survival (Lande and Orzack 1988, Lande 1993). Estimating extinction risk with such models requires specifying a time frame for the analysis; for this report a 100-year time frame was chosen as suggested in the VSP report (McElhany et al. 2000), which is consistent with the chosen definition of persistence and with viability definitions used by other TRTs (e.g., Puget Sound TRT 2002, Willamette/Lower Columbia TRT 2006).

This criterion also requires selection of a specific level of acceptable risk. A 95% probability of persistence was chosen as a definition of “high likelihood of persisting” for 100 years. This is consistent with the level of acceptable risk suggested in the VSP report and used by other TRTs. To some extent, setting this level should depend on input from policy makers, but lacking a forum for such input, a commonly used value was selected.

The use of PVA models raises a number of concerns. First, they are inherently based on assumed population dynamics models, usually derived from some form of stock-recruit analysis. Results are dependent on the form of the model used, and there is no clear agreement on which models are most appropriate for salmon. Several forms of stock-recruit relationships have been used for salmon (including the Ricker, Beverton-Holt, and hockey stick formulations), any of which may be combined with various forms of depensation (reduction in production at extremely

low densities). A subsidiary concern here is that all the models used assume that model parameters are constant through time, which is equivalent to assuming that habitat and environmental conditions have had no trends during the period for which parameters are estimated; this assumption is not likely to be true. Second, PVA models are subject to statistical error and bias. Spawner abundance estimates for individual populations have relatively high measurement error, and the combination of high measurement error and environmental variation leads to the potential for bias in parameter estimates and resulting errors in extinction probability estimates. Third, as described above, there are a large number of factors that affect extinction risk, and most models include only a few of these factors, thus giving an incomplete assessment of risk. Fourth, because the analyses involve projections 100 years into the future, relevance of the results depends critically on assumptions about future conditions, and it is unknown what the future will be like. Future conditions depend on possible changes in underlying conditions of habitat, marine survival, fishery management, etc.

Model 4 is able to simulate a variety of future conditions, and some sensitivity analyses have been conducted (see Appendix C). The model results used in this analysis assumed stable freshwater habitat and marine survival and a continuation of the current fishery management system. It is likely that these conditions will not be stable and that freshwater habitat condition, in particular, will decline over the next century in response to population growth pressures and as a legacy of past land use practices. Results from a larger set of simulations that explore the importance of freshwater habitat, marine survival, and harvest to the viability of Oregon Coast coho salmon are reported in Appendix C.

Finally, obtaining reliable absolute predictions of extinction probabilities is difficult, causing some authors to recommend against ever using PVA in situations demanding absolute answers (Reed et al. 2002). Coulson et al. (2001) note two necessary conditions for accurate PVA: 1) data must be of sufficient quality that estimates of the statistical distributions (shape, mean, variance, and autocorrelation) of vital rates are accurate, and 2) future distributions of these rates must be similar to those estimated, or changes in rates must be predictable. They argue that there are few real situations where these conditions can be met and conclude:

“... PVAs could be useful for comparing the consequences of different management or conservation strategies, and for exploring theoretically the implication of model assumptions on extinction probabilities and population dynamics. However, we doubt the general claim that they can be accurate in their ability to predict the future status of wild populations” (Coulson et al. 2001, p. 221).

In contrast, other authors (Brook et al. 2000, 2002) conclude that PVAs are reliable in classifying and managing populations despite their shortcomings, but note that:

“the results of a PVA are just one factor in any social and political decision-making context and should be a necessary precursor to good judgment” (Brook et al. 2002, p. 263).

Despite these problems, PVA is presently the only tool available to quantify the risk of extinction to populations. In addition, the Probability of Persistence Criterion is the only one that integrates the multiple factors of habitat quality, habitat quantity, life cycle survival, and

recruitment variability. To deal with problems of model structure and statistical issues, we used a variety of models with different structural assumptions; to the degree that results of these models agree, confidence is gained in the estimated level of risk.

### PP-3, Critical Abundance

**Criterion:** Population abundance is maintained above levels where small-population demographic risks (depensation or Allee effects) are likely to become significant, even during periods of adverse environmental conditions.

**Metric:** This is measured by the average peak spawner density (peak adults per mile of occupied spawning habitat) in the lowest 3 of the last 12 years. Any value of this metric below 1 adult per mile (0.6 per km) is equated with false (-1.0), 4 per mile (2.5 per km) is uncertain (0), 10 per mile (6 per km) is highly certain (+0.8), and 20 or more per mile (12 per km) is true (+1.0) (Figure 12).

To evaluate the Critical Abundance Criterion, average density of naturally produced spawners in occupied random survey sites was calculated for each population, each year, during the 12-year period 1993–2004. For the North Umpqua, where survey data was unavailable, the count of naturally produced fish at Winchester Dam was divided by the total spawning miles to estimate density. For each population, the density for the 3 lowest years was then averaged.

**Current assessment:** Values for the Critical Abundance Criterion metric are presented in Table 2, with estimated truth values in Table 3. The truth value for the Salmon population (-1.0: false) predicts it will not be possible to maintain abundance above levels where small-population demographic risks (depensation or Allee effects) are likely to become significant during some periods. The Beaver, Siltcoos, Tahkenitch, Tenmile, and Floras/New populations, with truth values of +1.0 (true), are predicted to be able to avoid small-population demographic risks.

**Discussion:** Abundance has been used as a main indicator of population status for many years, beginning with the initial concept of “minimum viable populations” developed by Shaffer (1978, 1981, 1987). Small-population effects include both directional effects and random effects. Directional effects include two contrasting density-dependent effects: compensation (a decrease in population productivity as population density increases) and depensation (a decrease

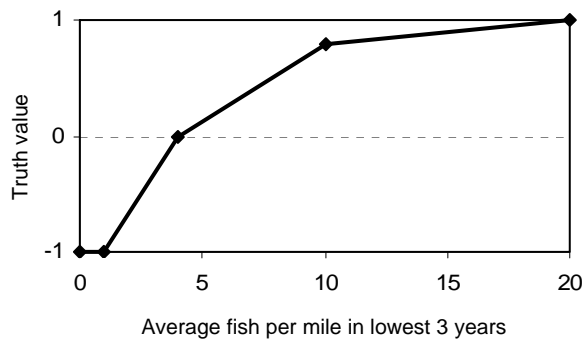

Figure 12. Truth membership function for the Critical Abundance Criterion, PP-3.

in productivity as density decreases). Typically, compensation is important at high density, and depensation at very low density, so there is in theory a crossover point in dominance of the effects. Dennis (1989) thoroughly reviewed the theory of depensation, and there have been several reviews of empirical evidence for such effects in salmon (Peterman 1987, Myers et al. 1995, Liermann and Hilborn 1997). Random effects include probabilistic variation in family size, sex ratios (Gabriel and Bürger 1992), ability of individuals to find mates (Dennis 1989), and similar processes (Lande 1998).

There is a risk that this idea of critical abundance may be confused with two other small-population concepts: minimum viable population (MVP) and QET. It is synonymous with neither. The abundance level chosen addresses only depensation effects, which are only one of several factors in evaluating extinction risk. MVPs are abundance levels sufficient to ensure a high persistence probability over some particular period of time, and their assessment should include consideration of all extinction risk factors; thus, an MVP level would be higher than the criterion used here. QETs are thresholds defined primarily for convenience in population viability modeling and may be based on a number of considerations including Allee effects and uncertainties in population functional response at very low abundance. In evaluating the Probability of Persistence Criterion (above), a QET of 50 fish per population was used, which may be above or below this criterion depending on the amount of available spawning habitat for any given population.

One issue that should be considered here is the appropriate spatial scale for assessing this criterion. The data used by Sharr et al. (2000) was similar in scale to Independent Populations as was that of Barrowman et al. (2003), so in that sense metrics developed here are consistent with the studies that support them. However, the actual processes leading to Allee effects (Dennis 1989) tend to operate on much smaller scales, such as that of individual redds or spawning areas. For salmon, the scales of interaction can be quite small, and their connectivity is important (Neville et al. 2006, Isaak et al. 2007). While this suggests that measuring spawner density at finer spatial scales might better reflect the processes the workgroup wishes to capture, it is aware of no published studies that would provide appropriate numerical criteria at those scales, and it would be very difficult to effectively sample at those scales.

To reflect this finer scale of depensatory processes, the criterion is based on the density of spawners in occupied survey reaches. At this scale it seems clear that when a single spawner is present in a 1-mile reach there is a strong risk that both sex ratio and mate-finding problems will be a factor. With four fish per mile (2.5 per km), it is unlikely that mate finding is a problem, but there is still some chance that there will be a skewed sex ratio resulting in fewer matings than at higher densities. As densities increase above this level, these risks can be expected to decline rapidly. For comparison, Barrowman (2000, Barrowman et al. 2003) found that, for natural populations of coho salmon, depensation may be a factor when spawner densities are less than 1 female per km. Sharr et al. (2000) found that 4 adults per mile (2.5 per km) was the approximate threshold of depensation in a model of Oregon Coast coho salmon.

Based on these considerations, the workgroup concluded that small-population demographic risks were very likely to be significant (−1.0: false) when spawner density was below 1 spawner per mile (0.6 per km), uncertain (0) at 4 spawners per mile (2.5 per km),

unlikely (+0.80: high degree of certainty of truth) at 10 per mile (6 per km), and very unlikely (+1.0: true) above 20 per mile (12 per km) (Figure 12).

By using the average of the 3 lowest of 12 years, our aim is to be precautionary by having a criterion that will identify potential demographic risks before it is too late to respond. Three years were chosen to reflect a single generation for coho salmon, although it is not required that the 3 years be consecutive. This allows the criterion to reflect two different risk scenarios. First, if spawners are low during all of the 3 most recent years, this would indicate that the entire population may be at elevated risk, and this would be immediately reflected in the metrics. Second, if spawners are low every third year across three or four generations, this could indicate risk of loss of a single brood cycle out of the approximate 3-year life cycle.

### **PP, Population Persistence (Combined Criterion)**

**Criterion:** The population will persist for the next 100 years.

**Metric:** This requires that populations meet each (DSS “AND” operator) of three subcriteria: Population Productivity, Probability of Persistence, and Critical Abundance (Figure 9).

**Current assessment:** The combined truth values for the Population Persistence Criterion, PP, range from  $-1.00$  (false) for the Salmon and Sixes populations to  $+0.96$  (high certainty of being true) for the Tenmile population (Table 3). These results predict that the Salmon and Sixes populations have a very low likelihood of persisting over the next 100 years. Conversely, the Tenmile is predicted to have a very high likelihood of persisting over the next 100 years. In addition to the Salmon and Sixes populations, three other populations had negative truth values: Necanicum, Alsea, and North Umpqua, which raises red flags as to the likelihood of persistence of these populations over the next 100 years as well. The remaining 16 populations had truth values greater than 0 (uncertain), with 9 greater than  $+0.50$  (moderately to highly certain that the population will persist for the next 100 years).

**Discussion:** The Population Persistence Criterion is focused on the ability of a population to persist over a short to moderate time frame ( $\approx 100$  years). The main determinants of persistence are productivity, abundance (or capacity), and variability. These factors are all interrelated, and it is impossible to set independent criteria for all. However, there are clear minimum acceptable levels for productivity and abundance. First, intrinsic productivity (i.e., the returns per spawner at low spawner density) must be sufficient for the population to replace itself under any likely conditions. This minimum ensures that the population is capable of surviving through periods of poor environmental conditions. Second, there is some level of abundance below which small population risks become significant, and populations that drop below that critical abundance are at significant risk of extinction. Finally, extinction modeling is used as a tool to integrate all relevant variables (abundance, productivity, and variability) into a persistence probability. All three of these criteria are necessary to ensure population persistence.



## Biogeographic Stratum-level Persistence Criteria

### SP, Stratum Persistence

**Criterion:** Most of the historically Independent Populations in the stratum are persistent according to the Population Persistence Criterion, PP, defined above.

**Metric:** This is measured as the median Population Persistence Criterion truth value (DSS “MEDIAN” operator) of Independent Populations in the stratum.

**Current assessment:** The results are presented in Table 3. The Mid-Coast biogeographic stratum had the lowest Stratum Persistence Criterion value (+0.20: low to moderate certainty that most of the historically Independent Populations in the stratum are persistent) and the Mid-South Coast had the highest Stratum Persistence Criterion value (+0.92: high certainty that most of the historically Independent Populations in the stratum are persistent).

**Discussion:** By using the median of population values, we ensure that the majority of Independent Populations in the stratum will persist. An alternative approach would be to use the average truth value (DSS “UNION” operator), which would indicate that the populations within a stratum meet the criteria on average. This was considered, but the workgroup concluded this would allow one or two highly persistent populations to compensate for a large number of populations in poor conditions (or conversely, for one or two populations in extremely poor condition to prevent the stratum from meeting the criteria). The important consideration here is to spread risk by ensuring that multiple populations within each stratum are persistent. Given that the number of Independent Populations per stratum ranges from three to six, this criterion guarantees that two or three populations are persistent per stratum, depending on the geographic extent of the stratum.

## ESU-level Persistence Criteria

### EP, ESU Persistence

**Criterion:** Persistence of the ESU requires that all of the biogeographic strata be persistent.

**Metric:** This requires that all (DSS “AND” operator) biogeographic strata meet the Stratum Persistence criteria.

**Current assessment:** Combining the Biogeographic Stratum Persistence Criterion values yields an ESU Persistence Criterion truth value of +0.40 (moderate to high certainty that all of the biogeographic strata are persistent) (Table 3).

**Discussion:** The ESU Persistence Criterion relates to the current danger of extinction for the ESU. The emphasis here is on protecting all significant parts of the range and avoiding risks of local catastrophes, rather than longer-term genetic diversity issues that are addressed under the ESU Sustainability Criterion, ES, (below). Accepting the 100-year time frame suggested in the VSP report (McElhany et al. 2000), the workgroup sought to ensure a high likelihood of

persistence of all the biogeographic strata over 100 years. At a coarse scale, this criterion ensures persistence of populations throughout the range of the ESU. Requiring multiple persistent populations per stratum reduces risk from changes in local conditions and population-scale catastrophes. By meeting the Population Persistence Criterion for multiple populations within each stratum, it is ensured that the ESU is not in danger of extinction throughout its range.

## **Summary—Persistence**

Persistence refers to a population or ESU that has a high expectation of persisting (i.e., not going extinct) over a 100-year period without artificial support (including supplementation by hatchery fish). This includes the ability to survive prolonged periods of adverse environmental conditions that may be expected to occur at least once during the 100-year time frame. In the ESU Persistence Criterion DSS network, the lowest level population criteria form the basis of the analysis, with aggregations to the biogeographic stratum and ESU levels moving upward in the network (see Figure 9). Three criteria—Population Productivity, PP-1; Probability of Persistence, PP-2; and Critical Abundance, PP-3—are evaluated, then combined to evaluate the overall Population Persistence Criterion, PP, for each population. Evaluations for individual populations are combined to arrive at a biogeographic Stratum Persistence Criterion, SP. Biogeographic stratum results are then combined to arrive at an ESU Persistence Criterion, EP.

The workgroup used recent observations of these population metrics to evaluate how certain it was that the Oregon Coast Coho Salmon ESU is persistent under recent conditions. Results of the current assessment for persistence are mapped in Figure 13. The results of the analysis lead to the conclusion that, if recent past conditions continue into the future, there is a moderate to high certainty that the ESU is persistent.

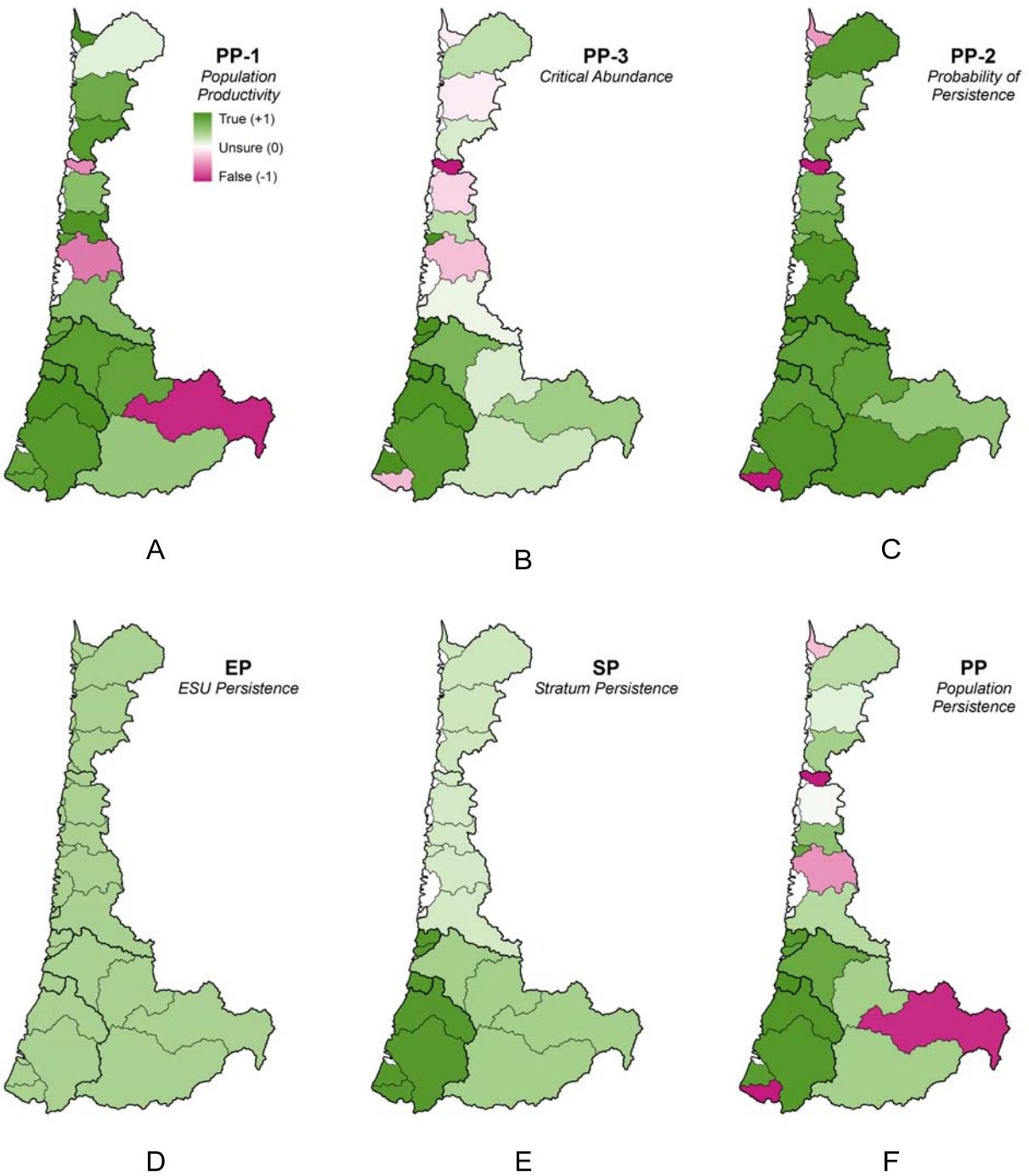

Figure 13. Persistence analysis results. Individual population-level criteria results are shown in maps A, B, and C and are combined to produce the Population Persistence Criterion scores (map D). These scores are aggregated by biogeographic strata to evaluate the Stratum Persistence Criterion (map E). The biogeographic stratum results are aggregated to evaluate the ESU Persistence Criterion (map F). These maps are color coded to represent the numerical scores found in Table 3.

# Sustainability

Sustainability refers to the ability of the ESU and its populations to maintain their genetic legacy and long-term adaptive potential for the foreseeable future. This definition implies stability of habitat availability and other conditions necessary for the full expression of life history diversity into the foreseeable future. To evaluate sustainability, the workgroup used the ESU Sustainability Criterion DSS network shown in Figure 14. The lowest level criteria are at the bottom, with combinations to the population, biogeographic stratum, and ESU levels higher up the figure. The criteria are divided into two main branches: All Strata Sustainable, ES-1, and ESU-level Diversity Criterion, ES-2.

The first branch requires that all biogeographic strata meet a Stratum Sustainability Criterion, SS, which in turn requires a Stratum Diversity Criterion, SD, and a Stratum Functionality Criterion, SF. SD in turn depends on the Population Sustainability Criterion, PS, for populations within each stratum, which requires meeting both the Population Persistence Criterion, PP (page 40), and the Population Diversity Criterion, PD. Within PD, there are four criteria: Spawner Abundance, PD-1; Artificial Influence, PD-2; Spawner Distribution, PD-3; and Juvenile Distribution, PD-4. The last two also have watershed-level subcriteria. The Stratum Functionality Criterion, SF, depends on the Population Functionality Criterion, PF.

The ESU-level Diversity Criterion branch has three ESU-level criteria: Genetic Diversity, ED-1; Phenotypic and Habitat Diversity, ED-2; and Small Populations, ED-3. The Genetic Diversity Criterion has four subcriteria: Genetic Structure, ED-1a; Effects of Selection, ED-1b; Effects of Migration, ED-1c; and Effects of Introgression, ED-1d. The Phenotypic and Habitat Diversity Criterion has two subcriteria: Phenotypic Diversity, ED-2a, and Habitat Diversity, ED-2b.

## Population-level Sustainability Criteria

### Primary Population Diversity Criteria

Population diversity is evaluated on the basis of the following four primary criteria: Spawner Abundance, Artificial Influence, Spawner Distribution, and Juvenile Distribution, which are then combined into a single Population Diversity Criterion.

#### **PD-1, Spawner Abundance**

**Criterion:** The population has sufficient naturally produced spawners to prevent loss of genetic variation due to random processes over a 100-year time frame.

**Metric:** Spawner abundance is measured as the long-term harmonic mean of naturally produced spawners (both 3-year-old adults and 2-year-old jacks) based on annual surveys. “Long-term” means including all available data (up to 100 years). The harmonic mean is

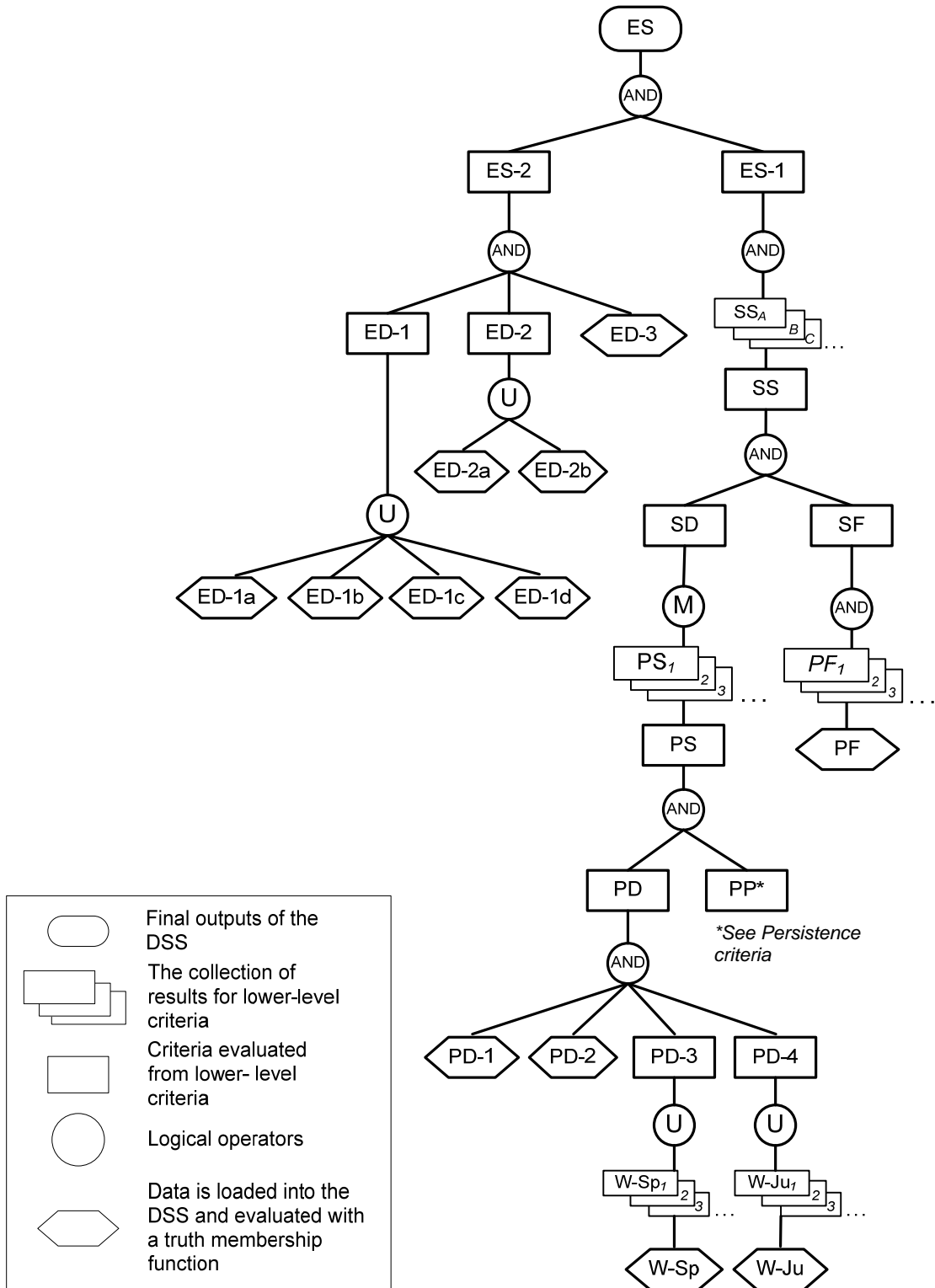

Figure 14. The decision network for the ESU Sustainability Criterion; the symbols are described in more detail in Figure 9 and criterion abbreviations are defined in the text.

calculated as the reciprocal of the mean of reciprocals (i.e.,  $n/[1/x_1 + 1/x_2 + \dots + 1/x_n]$ , where  $x_i$  is the abundance in year  $i$ , and  $n$  is the number of years of data). Any mean value below 85 naturally produced spawners is equated with false (-1.0), a value of 450 is equated with uncertain (0), and any value above 5,000 is equated with true (+1.0) (Figure 15).

This metric requires annual estimates of both adult (age 3) and jack (precocious age-2 male) spawners for each population. Such data is available for the majority of the Independent Populations of the Oregon Coast Coho Salmon ESU only for the period 1990–2003 (except the North Umpqua population, for which data is available for 1946–2003). Most of this short period was likely the lowest period of spawning abundance in the last 100 years. Thus it does not provide a very good picture of long-term spawner abundance. As an alternative, estimates were made of adult spawners for most individual populations (exceptions: Salmon, Floras/New, and Sixes) for the period 1958–2004 by developing calibrations between peak counts in standard spawning surveys (or in the case of the Middle and South Umpqua, Winchester Dam counts) for the period 1990–2004 and applying them to counts from 1958 to 1989 (Appendix D). These estimates were then modified to account for the presence of hatchery fish in the natural spawning population (see Appendix D for details). This 47-year data set provides a much better basis from which to draw conclusions about the long-term harmonic mean spawner abundance, although it provides an underestimate because it does not include jacks. Therefore, the harmonic mean was adjusted upward by dividing by one minus the average proportion of jacks observed in the standard surveys during the period 1981–2003.

**Current assessment:** Harmonic mean spawner abundances are presented in Table 4. No long-term data are available for the Salmon, Floras/New, and Sixes populations; for these populations only the 1990–2004 data were used. Estimated truth values are presented in Table 3 and Figure 16, and range from -1.0 (false: the population does not have sufficient naturally produced spawners to prevent loss of genetic variation due to random processes over a 100-year time frame) for the Salmon population to +1.0 (true: the population has sufficient naturally produced spawners to prevent loss of genetic variation due to random processes over a 100-year time frame) for the Coos and Coquille populations.

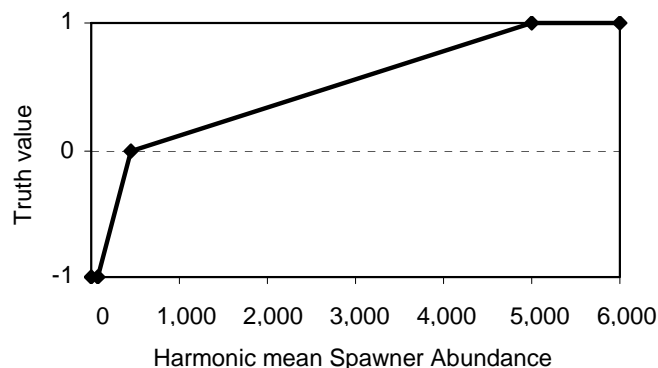

Figure 15. Truth membership function for the Spawner Abundance Criterion, PD-1.

Table 4. Population Sustainability criteria results for Independent Populations of Oregon Coast coho salmon.

<b>Independent Population Metric</b>	<b>PD-1 Spawner Abundance</b> Harmonic mean abundance of adults and jacks (1958–2004)	<b>PD-2 Artificial Influence</b> Average proportion of naturally produced spawners in last 6 years	<b>PF Population Functionality</b> Smolt capacity estimated from habitat survey data
<b>North Coast</b>			
Necanicum	463	0.944	63,200
Nehalem	3,921	0.915	1,039,000
Tillamook Bay	939	0.945	505,100
Nestucca	1,126	0.981	225,500
<b>Mid-Coast</b>			
Salmon	23*	0.338	68,600
Siletz	763	0.891	245,000
Yaquina	1,691	0.983	481,700
Beaver	540	0.965	54,700
Alsea	1,173	0.961	618,500
Siuslaw	4,664	0.988	1,080,600
<b>Lakes</b>			
Siltcoos	2,419	0.992	94,400
Tahkenitch	1,422	0.993	95,000
Tenmile	4,319	0.999	157,000
<b>Umpqua</b>			
Lower Umpqua	3,847	0.966	712,400
Middle Umpqua	1,509	0.950	616,200
North Umpqua	179	0.277	174,900
South Umpqua	1,297	0.946	639,100
<b>Mid-South Coast</b>			
Coos	6,025	0.994	840,300
Coquille	5,151	0.975	595,400
Floras/New	1,238*	0.995	220,800
Sixes	99*	0.672	110,000

\*1990–2004 adults only.

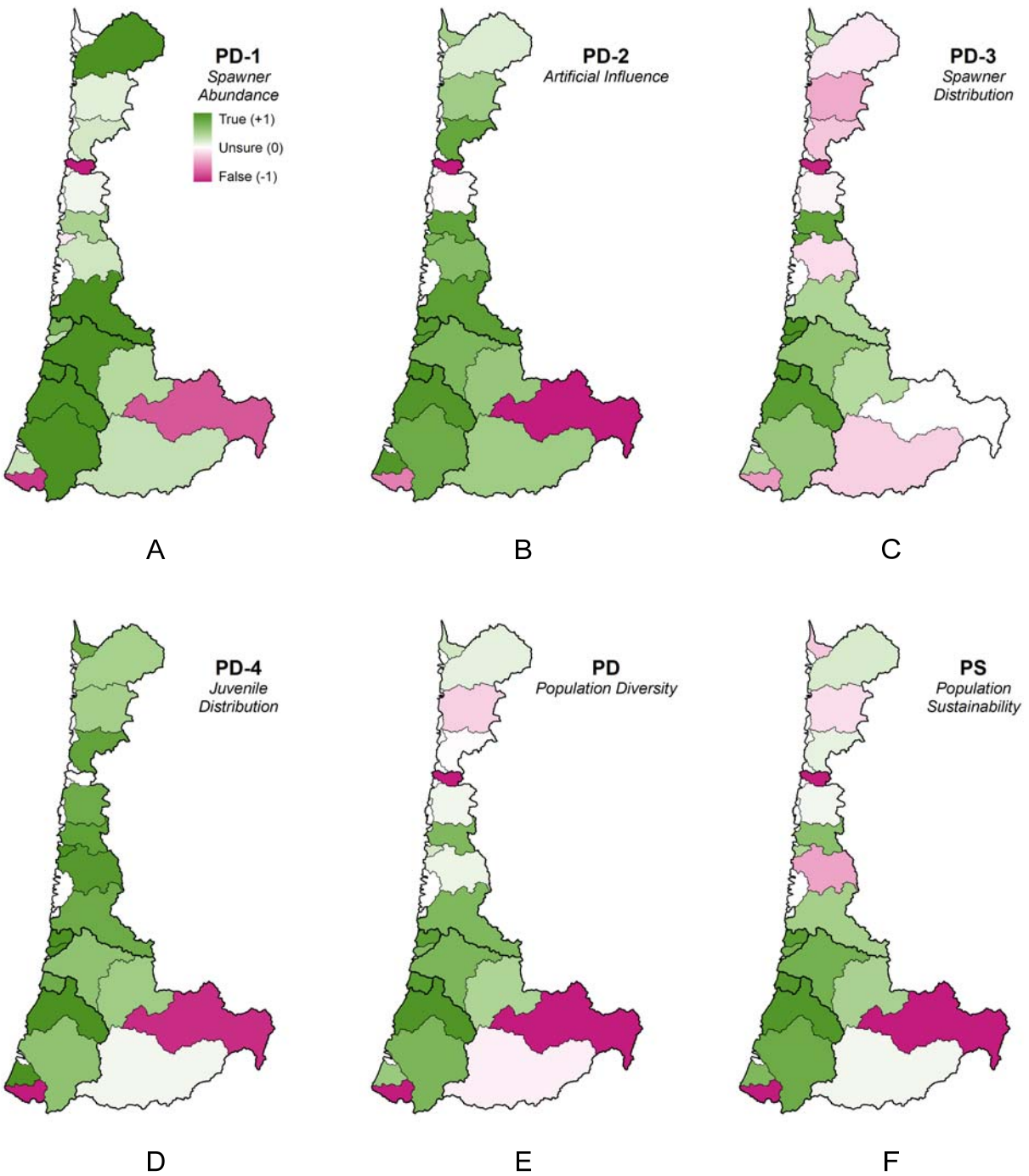

Figure 16. Population Sustainability Criterion analysis results. These results are shown in maps A, B, C, and D, and are combined to produce the Population Diversity Criterion, PD, scores (map E). These scores are aggregated with the Population Persistence Criterion, PP, (Figure 13D) to produce the Population Sustainability Criterion, PS (map F). These maps are color coded to represent the numerical scores found in Table 3.



**Discussion:** This criterion recognizes that genetic diversity is essential to long-term sustainability. The central (0 = uncertain) value used in the metric is based on an analysis of the effective population size needed to avoid inbreeding and maintain natural levels of genetic heterozygosity in a coho salmon population (see Appendix B). In Appendix B, we estimated the population size needed to maintain 95% of heterozygosity in the population over a 100-year period. Since that analysis was completed, new theory on the effective population size of fluctuating populations has become available (Kalinowski and Waples 2002, Nunney 2002, Waples 2002, Waples 2006), which suggests that the analysis presented in Appendix B is not entirely correct.

The analysis in Appendix B begins with calculation of the number of effective breeders per generation needed to preserve 95% of heterozygosity over a 100-year period based on observed Oregon Coast coho salmon spawner age distributions. This calculation resulted in target values for effective population size ( $N_e^*$ ) of between 332 (river populations) and 351 (lake populations). This is the number of spawners that would be required if the population structure is ideal, that is, there is an equal probability of reproductive success for all members of the population.

To translate this theoretical target into actual spawner numbers ( $N$ ) for a real population, adjustments need to be made for a variety of factors. First, there are within-year effects that result in variation among individual spawners within a year in reproductive success (measured by contribution of offspring to the next generation). Estimating this effect from data on family size variation for salmonids results in a ratio of annual  $N_e$  to  $N$  of about 0.53 (see Appendix B). Second, there are between-year effects that result from year-to-year variation in both spawner numbers and survival to adulthood, thus causing year-to-year variation in the annual average reproductive success of spawners.

This effect can be largely accounted for by taking the harmonic mean of annual spawner numbers (Waples 2002), but this approach typically still results in an underestimate of effective population size for salmon (Waples 2006). Waples (2006) concludes between-year effects are mainly controlled by two factors: relative variation in mean reproductive success across years, and correlations between annual mean reproductive success and spawner abundance (e.g., density dependence).

Simulations by Waples (2006, Table 3) suggest the density-independent effects on the ratio might range from 0.71 to 0.91, with the lower values representing populations with lower variation in spawner age or higher variation in mean reproductive success. Because coho salmon have both low variation in spawner age and high variation in annual recruits per spawner, this suggests a correction of about 0.71. In addition, coho salmon are strongly density dependent (see Appendix C), which should result in an even lower ratio of  $N_e$  to  $N$ , but there is insufficient information to estimate the magnitude of this effect. For now, it will be assumed that the between-year effect (combining both density-dependent and density-independent effects) to be in the range 0.40 to 0.67. Thus the target abundance, measured as the harmonic mean of annual spawner abundance ( $\tilde{N}^*$ ), can be estimated as (see Appendix B):

$$\tilde{N}^* = N_e^* / [(\text{within-year effect}) \times (\text{between-year effect}) \times (\text{mean generation time})] \quad (1)$$

Substituting values of  $N_e^*$  and generation times for both lake (2.78 year) and river (2.94 year) populations, combined with the range in estimates for between-year effects, results in  $N_e$  to  $\tilde{N}$  ratios ranging from 0.59 to 1.05 and values for  $\tilde{N}^*$  ranging from 316 to 595. A value near the midpoint of this range (450) is taken as the uncertain (0) point in the criterion.

The extreme values corresponding with false (-1.0) and true (+1.0) were derived from guidelines for gene conservation, as reviewed by Allendorf and Ryman (2002). They suggest that an effective population size per generation of 50 is the minimum needed to prevent short-term losses due to inbreeding, and this value is used as the basis of the “false (-1.0)” level. They also suggest a range in effective population per generation of 500 to 5,000 to maintain genetic integrity of a population over the long term and cite some controversy in the conservation genetics literature regarding which of these two values is appropriate, but there is agreement that populations with effective size above 5,000 will experience very little random genetic change, so this value was chosen as the “true (+1.0)” level. Translating these values from effective spawners per generation to harmonic mean annual spawners using the  $N_e$  to  $\tilde{N}$  ratios derived above, the workgroup obtained a range for the lower limit of 50 to 85, and for the upper limit of 5,000 to 8,500. Because density-dependent effects are more likely to be important when population abundance is low, the larger density-dependence adjustment were used for the lower limit, and the smaller adjustment for the upper limit, resulting in values of 85 and 5,000 for the false (-1.0) and true (+1.0) metrics.

Using the long-term harmonic mean incorporates the long-term effects of potential genetic bottlenecks during the 1990s; some populations may need long periods of fairly high abundance to overcome this deficit. As an alternative, a criterion of 1,000 spawners was considered based on the advice of Allendorf and Ryman (2002) and approaches used by Canada for upper Fraser River coho salmon viability standards (Interior Fraser Coho Recovery Team 2006), but it was decided that an analysis based specifically on coho salmon life history characteristics was more appropriate.

The workgroup also considered the issue of including hatchery fish in this criterion. There are divergent views on this issue. One argument is that hatchery fish also contribute to genetic variation; thus, basing this criterion on all spawners in the population would be most consistent with the genetic diversity goal. Another argument is that, because of artificial selection and reduced fitness among hatchery fish, their genetic contribution should not be considered here. The latter course was adopted, including only naturally produced fish in the metric. This leads to a more conservative criterion than one that included hatchery fish.

## **PD-2, Artificial Influence**

**Criterion:** The abundance of naturally spawning hatchery fish will not be so high as to be expected to have adverse effects on natural populations.

**Metric:** This is measured as the six-year (two-generation) mean of annual estimates of the proportion of naturally produced fish (one minus the proportion of hatchery fish) in spawning surveys for the population. Only years with adequate data to provide a reliable estimate are included in the average (see Appendix D). (Pending further statistical analysis, adequate data in any year is defined as at least 10 fish observed for marks denoting hatchery origin.) The

associated truth value is false (-1.0) for values below 50%, uncertain (0) for a value of 90%, and true (+1.0) at 100% (Figure 17).

The proportion of hatchery fish in the natural spawning population has been estimated each year since 1990 (Jacobs et al. 2002), originally from scale patterns and since 1998 from adipose fin clips, as most hatchery fish are now marked with an adipose fin clip. See Appendix D for a description of how the proportion of hatchery spawners was determined for each population.

**Current assessment:** Average proportions of naturally produced spawners are presented in Table 4, and range from 0.277 for the North Umpqua to 0.999 for Tenmile. Estimated truth values are presented in Table 3 and Figure 16. Truth values range from -1.0 (false: the abundance of naturally spawning hatchery fish is so high as to be expected to have adverse effects on natural populations) for the Salmon and North Umpqua populations, to +0.99 (true: the abundance of naturally spawning hatchery fish is not so high as to be expected to have adverse effects on natural populations) for the Tenmile population.

**Discussion:** Issues regarding the effects of hatchery fish on population sustainability were discussed in the Approach to Developing the Criteria section on page 18. This criterion is similar to that in Oregon's Native Fish Conservation Policy (ODFW 2003), but uses an average proportion over 6 years rather than the ODFW approach of meeting the 90% criterion in 3 of the most recent 5 years. A 6-year time frame is consistent with the other criteria, which measure time in terms of 3-year coho salmon generations. The ODFW criterion was problematic in that, by requiring the criterion be met in only 3 of 5 years, there was no restriction on genetic introgression during the other 2 years. Such unlimited introgression could result in genetic swamping of the native population in those years.

There are many statistical problems with estimating the hatchery-to-natural proportions for populations from observations of marks during spawner surveys, including observation bias, adjusting for location of samples within basins relative to hatchery release and acclimation sites, and small sample sizes. A full analysis of these problems should be conducted to develop the best statistical approach for this criterion, but that has not yet been done. As an interim measure, estimates are restricted to those years with at least 10 adult fish observed for marks; this is the

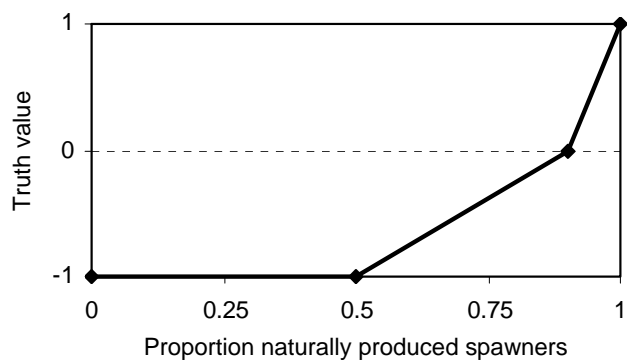

Figure 17. Truth membership function for the Artificial Influence Criterion, PD-2.

minimum sample size that could reasonably detect 10% hatchery-origin fish in a sample. Using a higher sample size limit would result in more reliable estimates, but would also mean that there would be no estimates for many populations.

**PD-3, Spawner Distribution**

**Criterion:** On average, the historically occupied watersheds in the population’s range have spawners occupying the available spawning habitat.

**Metric:** Evaluating this measure at the population level requires first evaluating a subcriterion regarding occupancy of each watershed within the population (Spawner Watershed Occupancy [W-Sp]). The truth value for the population is then the average (DSS “UNION” operator) of the watershed values.

**Subcriterion W-Sp, Spawner Watershed Occupancy**

**Criterion:** Spawners occupy a high proportion of the available spawning habitat within the watershed.

**Metric:** Watershed occupancy is measured by the average occupancy rate of watersheds during the most recent 12 years. The distribution of spawners is analyzed by fifth-field hydrologic units (HUC5) (REO 2002) for each population by examining data from randomly selected survey reaches (Jacobs and Nickelson 1998). Average occupancy is the 12-year average of the annual fraction of habitat occupied, calculated within each watershed (HUC5) as the proportion of surveyed reaches in any year that have a minimum peak count (highest count on any single survey date) of at least four naturally produced spawners per mile (2.5 per km). Truth values for each watershed are evaluated as follows: false (–1.0) for occupancy less than 20%, uncertain (0) for occupancy of 50%, and true (+1.0) for occupancy greater than 80% (Figure 18).

For the current assessment, the proportion of occupied sites within each HUC5 was averaged for 1993–2004. No data were available for one HUC5 in the South Umpqua and the three HUC5s of the North Umpqua because spawning surveys have not been routinely conducted in the area above Winchester Dam, where passage is enumerated.

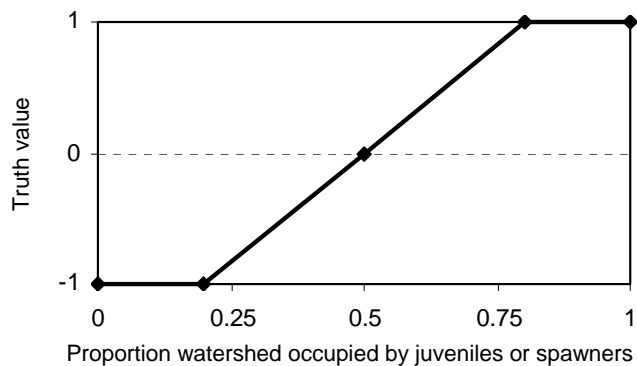

Figure 18. Truth membership function for the Spawner Watershed Occupancy Criterion, W-Sp, and the Juvenile Watershed Occupancy Criterion, W-Ju,.

**Current assessment:** Watershed-level occupancy rates are presented in Table 5, with corresponding truth values in Table 6. Population-level truth values are presented in Table 3 and Figure 16. Truth values range from  $-0.97$  (false: spawners do not occupy a high proportion of the available spawning habitat within the watershed) for the Salmon population, to  $+1.0$  (true: spawners occupy a high proportion of the available spawning habitat within the watershed) for the three lake populations (Siltcoos, Tahkenitch, and Tenmile).

**Discussion:** Spawning distribution can give a good idea of the expansion and contraction of coho salmon populations during various ocean productivity cycles. The choice of four generations (12 years) provides a period that can be expected to include wide variation in environmental conditions. The goal here is to measure occupancy rates of spawning pairs, but available data do not distinguish gender. By defining occupancy as a peak count of at least four fish, it is guaranteed that at least four fish were observed in close proximity at the same time, and four fish are very likely to have at least one male and one female. This definition also guarantees that the total annual spawner density for a given reach is higher than four spawners per mile (2.5 spawners per km), which is the density level below which depensation may be important (Sharr et al. 2000). The four-spawners-per-mile metric is used only to define occupancy for each of the sample reaches, it does not represent a target abundance level for distribution. Analysis of coho salmon spawner distribution during the 1989–2000 low-abundance cycle established that occupancy at this level in 50% of the watersheds maintained an adequate spatial distribution of spawners in habitats that helped anchor the populations (Talabere and Jones 2001). Additionally, populations that maintained occupancy at this level demonstrated rapid increases in spatial extent during the 2001–2003 period of improved ocean survival (Chilcote et al. 2005).

This metric relies on information that directly measures the occupation of habitats throughout the spawning distribution of Oregon Coast coho salmon. The sampling program that supports this criterion relies on a spatially balanced design that can be used to assess both trends and status of distribution. However, there are problems with this approach. In particular, the short time frame for the evaluation—7 years under current levels of implementation—makes it difficult to evaluate long-term risk. Observations during a period of good environmental conditions may not predict occupancy patterns during future, less-favorable periods.

The Oregon Plan assessment of occupancy patterns, although based on a less robust data set, demonstrated that this metric is sensitive to changes in spawner distribution over a range of environmental conditions, including the period of poor ocean survival during the 1990s. The minimum interpretation of this criterion would be that there is a distribution of habitat that is functional under very recent environmental conditions. A population with a spawner distribution that has a moderate or high score for this criterion during a period of high marine survival might experience severe difficulties the next time marine survival rates are low. Issues of fluctuating environmental conditions were discussed in the Approach to Developing the Criteria section on page 18.

Table 5. Occupancy of watersheds (HUC5) by spawners, W-Sp, and juveniles, W-Ju. See text, pages 52 and 56, for definitions of occupancy.  
 ND = no data.

Population	HUC	Percentage of sites occupied		Population	HUC	Percentage of sites occupied		Population	HUC	Percentage of sites occupied	
		W-SP	W-Ju			W-SP	W-Ju			W-SP	W-Ju
Necanicum	1710020101	59	73	Alsea	1710020501	41	89	North	1710030110	ND	25
Nehalem	1710020201	64	74		1710020502	40	72	Umpqua	1710010111	ND	0
	1710020201	55	72		1710020503	70	75		1710010112	ND	0
	1710020201	58	94		1710020504	22	75	South	1710030202	50	3
	1710020201	38	29	Siuslaw	1710020601	58	58	Umpqua	1710030203	50	60
	1710020201	22	58		1710020602	60	100		1710030204	ND	50
Tillamook Bay	1710020301	40	69		1710020603	67	100		1710030205	43	58
	1710020301	46	69		1710020604	63	52		1710030207	51	96
	1710020301	47	65		1710020605	71	79		1710030208	57	50
	1710020301	41	63		1710020606	67	85		1710030209	34	67
	1710020301	21	50		1710020607	64	92		1710030210	18	50
Nestucca	1710020301	49	92	Siltcoos	1710020608	41	72		1710030211	51	33
	1710020302	36	69						1710030212	41	100
Salmon	1710020408	21	50	Tahkenitch	1710020701	81	83	Coos	1710030213	34	0
					1710020701	92	83		1710030401	72	85
Siletz	1710020405	58	75	Tenmile	1710030403	92	72		1710030402	80	88
	1710020407	40	70						1710030404	92	83
Yaquina	1710020401	72	100	Lower Umpqua	1710030304	45	100	Coquille	1710030501	62	33
	1710020402	84	93		1710030305	60	50		1710030502	64	88
	1710020403	72	67		1710030306	68	88		1710030503	54	58
					1710030307	80	100		1710030504	90	67
					1710030308	80	42		1710030505	77	82
Beaver	1710020505	76	100	Middle Umpqua	1710030301	56	96		1710030506	55	100
					1710030302	79	40	Floras/New	1710030604	61	80
					1710030303	46	72				19
							Sixes	1710030603	37		

Table 6. Summary of watershed (HUC5) truth values of the knowledge-based DSS as to the relative distribution of coho salmon in the Oregon Coast ESU.

Population	HUC	W-SP	W-Ju	Population	HUC	W-SP	W-Ju	Population	HUC	W-SP	W-Ju		
Necanicum	1710020101	0.31	0.73	Alsea	1710020501	(-0.31)	1.00	North	1710030110	0.00	(-0.83)		
					1710020502	(-0.04)	1.00		Umpqua	1710030111	0.00	(-1.00)	
Nehalem	1710020201	0.46	0.80		Siuslaw	1710020503	0.68	0.83			1710030112	0.00	(-1.00)
						1710020202	0.16	0.73	South		1710030202	0.00	(-1.00)
				1710020203		0.25	1.00	Umpqua		1710030203	0.00	0.33	
				1710020205		(-0.41)	(-0.70)		1710030204	0.00	0.00		
				1710020206	(-0.93)	0.27	1710030205		(-0.23)	0.27			
Tillamook Bay	1710020303	(-0.33)	0.63		1710020601	0.27	0.27		1710030207	0.03	1.00		
				1710020304	(-0.14)	0.63	1710020602	0.34	1.00		1710030208	0.24	0.00
				1710020305	(-0.11)	0.50	1710020603	0.56	1.00		1710030209	(-0.54)	0.57
				1710020306	(-0.30)	0.43	1710020604	0.42	0.10		1710030210	(-1.00)	0.00
				1710020307	(-0.97)	0.00	1710020605	0.69	0.97		1710030211	0.04	(-0.57)
Nestucca	1710020301	(-0.03)	1.00	Siltcoos	1710020701	1.00	1.00		1710030212	(-0.29)	1.00		
									1710020302	(-0.47)	0.63	1710030213	(-0.53)
Salmon	1710020408	(-0.97)	0.00	Tahkenitch	1710020701	1.00	1.00	Coos	1710030401	0.72	1.00		
									1710030402	1.00	1.00		
Siletz	1710020405	0.26	0.83	Tenmile	1710030403	0.73	0.73		1710030404	1.00	1.00		
									1710020407	(-0.34)	0.67	Lower Umpqua	1710030501
Yaquina	1710020401	0.75	1.00	Lower Umpqua	1710030304	(-0.16)	1.00		1710030502	0.46	1.00		
					1710030305	0.33	0.00		1710030503	0.14	0.27		
				1710020402	1.00	1.00	1710030306	0.61	1.00		1710030504	1.00	0.57
				1710020403	0.74	0.57	1710030307	1.00	1.00		1710030505	0.89	1.00
Beaver	1710020505	0.86	1.00	Middle Umpqua	1710030308	0.99	(-0.27)		1710030506	0.15	1.00		
					1710030301	0.21	1.00	Floras/New	1710030604	0.38	1.00		
				1710030302	0.97	(-0.33)	Sixes		1710030603	(-0.44)	(-1.00)		
	1710030303	(-0.15)	0.73										

## PD-4, Juvenile Distribution

**Criterion:** On average, the historically occupied watersheds in the population's range have juveniles occupying the available juvenile habitat.

**Metric:** Evaluating this measure at the population level requires first evaluating a subcriterion regarding occupancy of each watershed within the population (Juvenile Watershed Occupancy [W-Ju]). The truth value for the population is then the average (DSS "UNION" operator) of the watershed values.

### Subcriterion W-Ju, Juvenile Watershed Occupancy

**Criterion:** Juveniles occupy a high proportion of the available rearing habitat within the watershed.

**Metric:** Juvenile occupancy is measured by the average occupancy rate of surveyed reaches in each watershed during the most recent 12 years. As with spawners, the distribution of juvenile coho salmon during summer was analyzed by HUC5s for each population by examining data from randomly selected survey reaches sampled in 1998–2004. Occupied is defined as the presence of fish in at least two pools within any survey reach that contains two or more pools; survey reaches with fewer pools are excluded from the statistics. Truth values for each watershed are evaluated as follows: false (–1.0) for occupancy less than 20%, uncertain (0) for occupancy of 50%, and true (+1.0) for occupancy greater than 80% (Figure 18).

**Current assessment:** Watershed-level occupancy rates are presented in Table 5, with corresponding truth values in Table 6. Population-level truth values are presented in Table 3 and Figure 16. Values range from –1.0 (false: juveniles do not occupy a high proportion of the available rearing habitat within the watershed) for the Sixes population to +1.0 (true: juveniles occupy a high proportion of the available rearing habitat within the watershed) for five populations (Beaver, Siltcoos, Tahkenitch, Coos, and Floras/New).

**Discussion:** Juvenile distribution can give a good idea of the expansion and contraction of coho salmon populations during various ocean productivity cycles and reflects the ability of spawning habitat to produce juveniles. The definition of occupancy used here reflects local biologists' opinion that 1) survey reaches with only a single pool do not provide adequate habitat for juvenile coho salmon, and 2) it is extremely rare to find fish in one pool with nearby pools unoccupied. Issues discussed under the adult Spawner Distribution Criterion, PD-3, apply here as well.

There are problems with this approach. In particular, the short time frame for the evaluation makes it difficult to relate to long-term risk; observations during a period of good environmental conditions tell us little about what occupancy patterns might be during a poor period (such as the 1990s). The minimum interpretation of this criterion would be that there is a distribution of habitat that is functional under very recent environmental conditions. A population with a juvenile distribution that barely met this criterion during a period of high marine survival might experience severe difficulties the next time marine survival rates are low. Another issue is that available data are generally for summer rearing, which may be spatially



separated from winter rearing areas. Issues of fluctuating environmental conditions were discussed further in “Environmental Fluctuations” on page 12.

### PD, Population Diversity (Combined Criterion)

**Criterion:** The population has sufficient diversity and distribution to ensure continued fitness in the face of environmental change.

**Metric:** This requires that the population meet each (DSS “AND” operator) of four subcriteria: Spawner Abundance, PD-1; Artificial Influence, PD-2; Spawner Distribution, PD-3; and Juvenile Distribution, PD-4 (see Figure 19).

**Current assessment:** The combined truth values for PD-1 through PD-4 ranged from –1.00 (false: the population does not have sufficient diversity and distribution to ensure continued fitness in the face of environmental change) for the Salmon, North Umpqua, and Sixes populations, to +0.96 (true: the population has sufficient diversity and distribution to ensure continued fitness in the face of environmental change) for the Coos population (Table 3, Figure 16). In addition to the Salmon, North Umpqua, and Sixes populations, three other populations had negative values: Tillamook Bay, Nestucca, and South Umpqua.

**Discussion:** Maintaining sufficient within-population genetic diversity is an issue of both short-term and long-term survival of the population. Such diversity is controlled by a variety of forces including: evolutionary legacy, immigration from other populations, mutation,

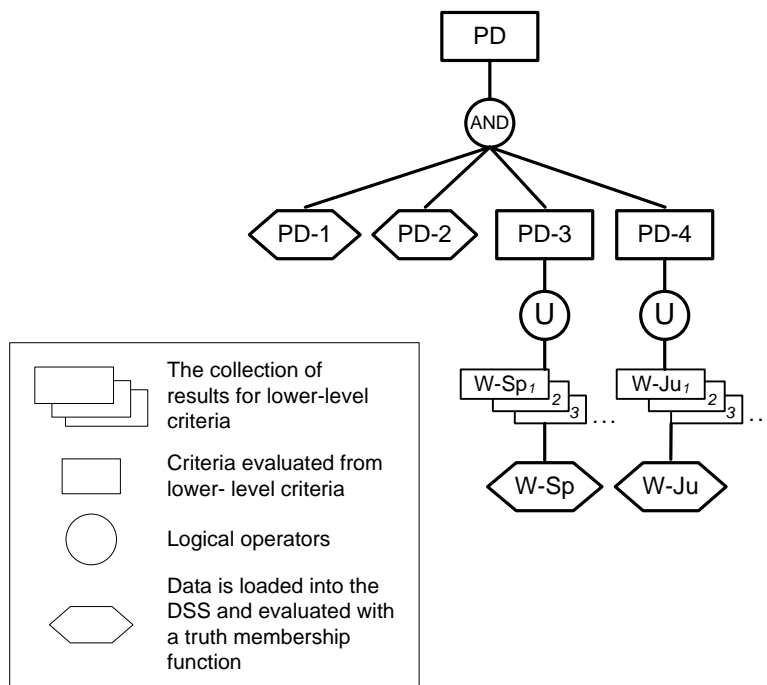

Figure 19. Subsection of the decision network showing the Population Diversity criteria.

selection (both natural and artificial), and random loss of genetic variation due to small population size. Within-population diversity reflects phenotypic differences among groups of individuals and is a product of underlying genetic diversity and its interaction with the existing environmental diversity. These differences provide the flexibility for the population as a whole to respond successfully to short-term environmental variations. The genetic underpinning of diversity is the basis by which populations are able to adapt and evolve as conditions within their home range go through changes that are more permanent. Natural levels of genetic variation and its phenotypic expression are vital to maintaining the evolutionary potential of individual populations and the ESU. There are two important aspects of within-population diversity: maintaining adaptive potential and maintaining local adaptations.

The genetic consequences of small population size and numerous approaches to defining minimum population abundance thresholds have been investigated widely (Soulé 1980, Lande 1995, Franklin and Frankham 1998, Rieman and Allendorf 2001). In nearly all cases, this becomes an exercise of identifying a rate at which genetic variation can be lost without causing a risk to a population's short-term or long-term persistence. Our first genetic diversity criterion (PD-1) reflects this approach.

Equally important to maintaining local adaptation is ensuring that natural selective processes are able to operate without undue human influence. Interbreeding of hatchery and natural fish can reduce natural local adaptations (see discussion of Hatchery Fish on page 9). Our second criterion (Artificial Influence, PD-2) addresses this concern.

Criteria for protecting within-population adaptive diversity are not straightforward. There is little information on the differences, if any, among individuals that spawn in different parts of their respective basins, let alone what differences may have existed historically. However, the assumption is made that if coho salmon spawners and juveniles are distributed in high quality habitats across the landscape, there are potential differences that have the opportunity to be expressed. Adaptive diversity criteria can thus be addressed by documenting the distribution of fish and habitat throughout the basin or basins occupied by the population. For long-term sustainability, spatial distribution of fish throughout their natural range must be ensured; doing so will help secure the existing genetic diversity of the population. Some aspects of diversity (such as life history type or run timing) may be related to subbasin structure, but may also be expressed within subunits as much as between them. For this reason, we chose criteria that do not depend on specific subbasin structure. Distribution criteria were developed for two important life history stages: spawners and freshwater juveniles. These two criteria (Spawner Distribution, PD-3, and Juvenile Distribution, PD-4) are based on the distribution of fish among watersheds within the historical range of the population.

These distribution criteria are intended to achieve two goals. The first goal is to maintain natural rates and levels of movements and migrations within populations. This criterion is intended to minimize the likelihood that populations will be lost due to local catastrophes (e.g., flood, fire, drought, or accidental introduction of toxic pollutants), to maintain natural rates of re-colonization within the population, and to maintain other functions that depend on the population's spatial structure.

The second goal is to maintain patterns of variation. This goal serves to ensure that the populations can withstand environmental variation in both the short term and the long term. Mechanisms to achieve these goals include maintaining natural phenotypic expression, maintaining natural patterns of gene flow, maintaining occupancy in a natural variety of available habitat types, and maintaining integrity of natural systems (this mechanism focuses directly on observed genotypic and phenotypic variation within populations and on changes in that variation). By ensuring that naturally produced fish are abundant and widespread across available habitats, it is ensured that populations maintain the potential for these mechanisms. Changes in these natural patterns are possible evidence that the population is at risk for diversity.

Two other approaches to distribution were considered: 1) spawner and juvenile distribution among habitat types, and 2) direct assessment of the amount and distribution of different habitat types (such as estuarine and lowland wetlands). The workgroup also discussed more direct ways to assess life history diversity. However, for coho salmon this type of diversity is expressed across larger spatial scales rather than single populations, so these issues are addressed at the whole ESU level (see ESU-level Diversity Criterion, ES-2, on page 77).

### **PS, Population Sustainability**

**Criterion:** The population is able to sustain itself into the foreseeable future.

**Metric:** This requires that the population is persistent and has sufficient diversity and distribution (DSS “AND” operator on the Population Persistence Criterion, PP, and the Population Diversity Criterion, PD).

**Current assessment:** The Population Persistence Criterion and Population Diversity Criterion values were combined into a Population Sustainability Criterion value for each population (Table 3 and Figure 16). These values ranged from –1.00 (false: the population is not able to sustain itself into the foreseeable future) for the Salmon, North Umpqua, and Sixes populations, to +0.95 (high certainty that the population is able to sustain itself into the foreseeable future) for the Coos population. In addition to the Salmon, North Umpqua, and Sixes populations, three other populations had negative truth values (moderate to high certainty that the population will not be able to sustain itself into the foreseeable future): Necanicum, Tillamook Bay, and Alsea. The remaining 15 populations had Population Sustainability Criterion truth values greater than 0, with eight greater than +0.50.

**Discussion:** Population sustainability, beyond simple persistence, requires maintaining sufficient diversity and distribution to ensure continued fitness of populations in the face of environmental change. Fitness is determined by the interaction between genetics and environment. To ensure continued fitness, both basic genetic diversity and local adaptations to diverse environments must be preserved. The sustainability criteria reflect these two requirements.

### **PF, Population Functionality Criterion**

Population functionality is evaluated on the basis of a single primary criterion describing habitat capacity.

**Criterion:** Habitat quality and quantity are adequate to support sufficient abundance to maintain long-term genetic integrity of the population.

**Metric:** This criterion is measured as the estimated smolt capacity for the basin as estimated by the ODFW limiting factors model (Habitat Limiting Factors Model [HLFM] version 6.0 [Nickelson et al. 1992, Nickelson 1998, Nickelson<sup>1</sup>]). Truth of the criterion is evaluated according to whether this smolt capacity is sufficient to produce spawners to meet the Population Diversity Criterion, PD-1, under poor ocean conditions (i.e., at 2% marine survival). Thus the criterion for smolt capacity is 50 (=1/0.02) times the PD-1 spawner criterion. This results in truth values of false (-1.0) for smolts below 4,250, uncertain (0) at 22,500 smolts, and true (+1.0) for greater than 250,000 smolts (Figure 20).

For the current assessment, the HLFM model was used to estimate smolt capacity for all populations (except the lakes) based on ODFW aquatic inventory data. The model applies juvenile densities to estimated quantities of different types of fast- and slow-water habitats and converts total numbers to smolts via a survival rate. For the purpose of this application, winter habitat was assumed to be limiting, which has been found to typically be the case in previous applications of the model (Nickelson 1998). For the lake populations, where much of the juvenile habitat is in lakes to which the HLFM model doesn't apply, the highest recent (since 1980) recruit abundance was divided by 10% marine survival to estimate smolt capacity. This calculation assumes that habitats for the lake populations were fully seeded and that marine survival was 10% for the highest-producing cohort during that time period.

**Current assessment:** Capacity estimates ranged from 36,600 to 1,080,600 smolts (Table 4). Estimated truth values for the Population Functionality Criterion, PF, are presented in Table 3 and Figure 21. The values ranged from +0.14 (low certainty that habitat quality and quantity are adequate to support sufficient abundance to maintain long-term genetic integrity of the population) for the Beaver population, to +1.00 (true: habitat quality and quantity are adequate to support sufficient abundance to maintain long-term genetic integrity of the population) for 10 populations.

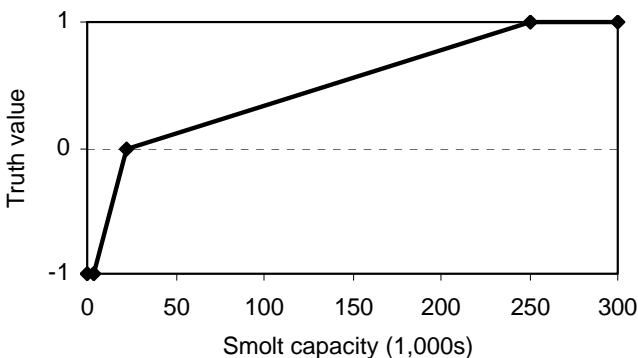

Figure 20. Truth membership function for the Population Functionality Criterion, PF.

<sup>1</sup> T. E. Nickelson, Oregon Dept. Fish and Wildlife, Corvallis Research Laboratory, Corvallis. Pers. commun., 15 August 2005.

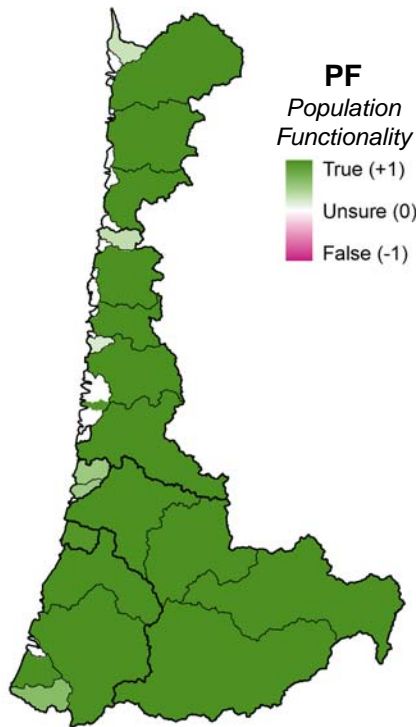

Figure 21. Map showing estimated smolt-capacity truth values by population for the Population Functionality Criterion, PF. This map is color coded to represent the numerical scores found in Table 3.

**Discussion:** Even though a population may not be sustainable (for a variety of reasons), this criterion is intended to ensure that its base of habitat would be sufficient for sustainability. Sustainability requires both population processes and habitat. To some degree, population parameters reflect habitat adequacy, but that relationship can be masked by fluctuations in environmental conditions (e.g., ocean conditions, drought, and temperature). Here, the adequacy of habitat is addressed directly, by keying this criterion to observations of in-stream habitat conditions.

There are three significant problems with this approach, which should be addressed in the future. First, the data used in this evaluation is primarily upland stream habitat, thus missing important habitat types such as lowland and estuarine wetlands and likely underestimating overall smolt potential. Second, the limiting factors model provides an approximate estimate of carrying capacity based on the assumption that winter habitat limits smolt production. For populations where this is not a good assumption, model estimates will be in error. Third, the limiting factors method does not apply to lake-rearing populations, and a potentially inaccurate method was used to estimate capacity for these populations. The workgroup encourages future improvements of both habitat monitoring and models relating habitat to fish productivity and capacity. A possible approach is that used by the Coastal Landscape Analysis and Modeling Study, which uses mapped physical characteristics of streams to estimate potential high-quality habitat (Burnett et al. 2007).

Criteria relating to specific types of habitats are not specified, even though these may be important for sustaining the ESU. For example, recent work in Oregon estuaries (Miller and Sadro 2003, Simenstad et al. 2000, Bottom,<sup>2</sup> van de Wetering,<sup>3</sup> Adamus 2006) has demonstrated the utilization of tidal riverine-sourced habitats (stream-estuary ecotone) for parr-stage coho salmon juveniles, as well as the utilization of marine-sourced marshes for coho salmon parr and smolt rearing and migration. However, the impact of these areas relative to population extinction risk has not been quantified and not including these areas in the estimates of habitat will result in underestimates of smolt potential.

Also, connectivity among habitats needed by different life history stages is undoubtedly important. However, we believe that sufficient connectivity will be demonstrated by meeting the criteria specified here; if connectivity were lacking, this would be reflected in the distributions of spawners or juveniles (criteria PD-3 and PD-4).

## **Biogeographic Stratum-level Criteria**

### **SD, Stratum Diversity**

**Criterion:** Most historically Independent Populations in the stratum (as defined in Lawson et al. 2007) are at present sustainable according to the population-level sustainability criteria.

**Metric:** This is measured as the median Population Sustainability Criterion, PS, truth value (DSS “MEDIAN” operator) of Independent Populations in the stratum.

**Current assessment:** Truth values for the strata are presented in Table 3 and Figure 22. Values range from -0.02 (uncertain whether most of the historically Independent Populations in the stratum [as defined in Lawson et al. 2007] are at present sustainable according to the Population Sustainability Criterion) for the North Coast stratum, to +0.69 (highly certain that most of the historically Independent Populations in the stratum are at present sustainable according to the Population Sustainability Criterion) for the Mid-South Coast stratum.

**Discussion:** Requiring multiple sustainable populations per stratum reduces each stratum’s risk from changes in local conditions and population-scale catastrophes. By basing this criterion on the median Population Sustainability Criterion values within a stratum, it can be ensured that the majority of populations within the stratum are sustainable.

### **SF, Stratum Functionality**

**Criterion:** All of the historically Independent Populations in the stratum are functional according to the Population Functionality Criterion, PF, criteria defined on page 59.

**Metric:** This is measured by applying the DSS “AND” operator to the Population Functionality Criterion truth values for all Independent Populations in the stratum.

---

<sup>2</sup> D. Bottom, NWFSC, Newport Research Station, Newport, OR. Pers. commun., April 2004.

<sup>3</sup> S. van de Wetering, Confederated Tribes of Siletz Indians of Oregon, Siletz. Pers. commun., April 2004.

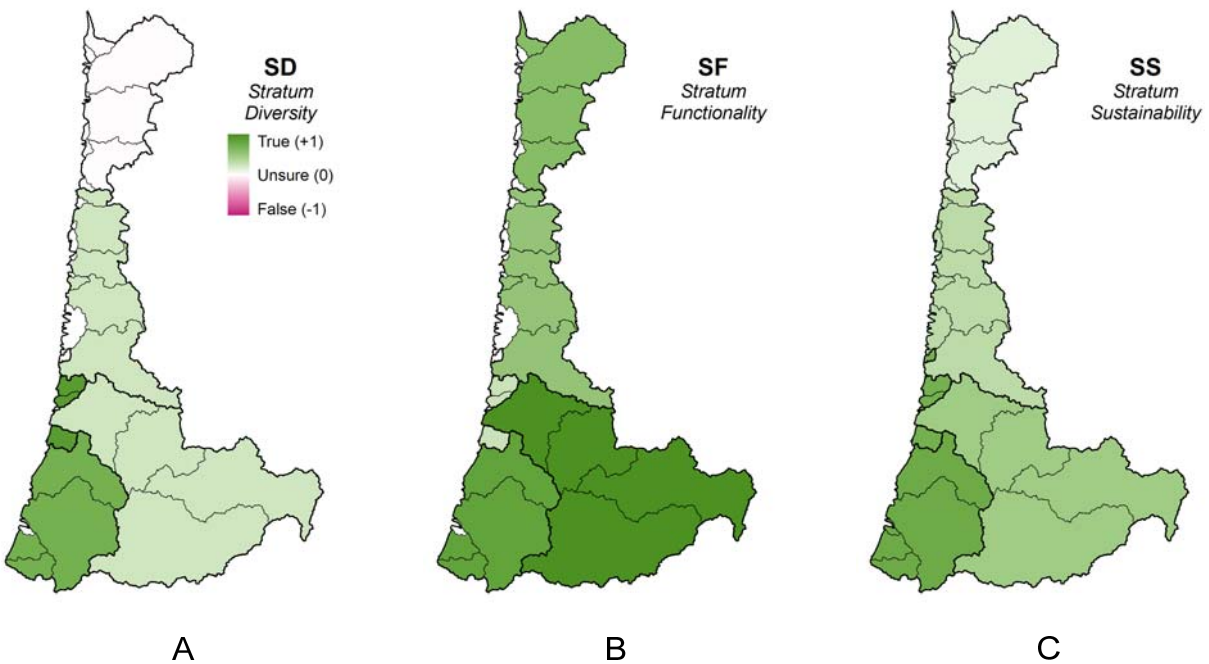

Figure 22. Maps showing truth value scores for the Stratum Diversity, Stratum Functionality, and Stratum Sustainability criteria. The scores for the Stratum Diversity Criterion, SD, are shown in map A. These are combined with scores for the Stratum Functionality Criterion, SF, shown in map B, with the resulting scores shown in the Stratum Sustainability Criterion, SS, in map C. These maps are color coded to represent the numerical scores found in Table 3.

**Current assessment:** Truth values for the biogeographic strata are presented in Table 3 and Figure 22. Values range from +0.38 (a low degree of certainty that all of the historically Independent Populations in the stratum are functional according to the population criteria defined above) for the Lakes stratum to +0.88 (a high degree of certainty that all of the historically Independent Populations in the stratum are functional according to the population criteria defined above) for the Umpqua stratum.

**Discussion:** This criterion provides assurance that Independent Populations that may not be sustainable still have sufficient habitat to allow them to contribute to the evolution of the ESU. Within the ESU, it is anticipated that the condition of populations will shift over time, so that populations that are in poor condition at one time may later become sustainable, and vice versa. This variation in condition reflects the historical condition (Reeves et al. 1995) where the habitat reflected a dynamic landscape. There were areas that had lower habitat quality for periods of time. However, all populations retained the capacity to redevelop habitat quality through the processes of natural disturbance. The workgroup assumed this historical template is still appropriate and those populations not presently sustainable should retain the capacity to become sustainable in the future. This criterion ensures a minimum level of habitat for all Independent Populations so that all are able to respond to shifting environmental conditions and those presently in poor condition are available for restoration should an effort be made to improve their status.

Nonsustainable populations may also provide a refuge in case of major catastrophes affecting other more sustainable populations in the stratum. Note that Dependent Populations are not included here, even though they may have an important ecological and evolutionary role—occupancy standards for those areas were initially included here, but we concluded that the role of these populations is more important on a whole-ESU basis, rather than within biogeographic strata, because some strata have no Dependent Populations, and several Dependent Populations are near stratum boundaries, so are probably connected to two (or more) strata. Also, at this time there is insufficient data to estimate smolt capacity for these populations. For these reasons, criteria relating to Dependent Populations are included in ESU Diversity, ES-2, below (page 77).

### SS, Stratum Sustainability

**Criterion:** The stratum is self-sustaining (in terms of both diversity and functionality) into the foreseeable future.

**Metric:** This requires that the stratum meets both the Stratum Diversity Criterion, SD, and the Stratum Functionality Criterion, SF, (DSS “AND” operator) illustrated in Figure 23.

**Current assessment:** The Stratum Sustainability Criterion, SS, is a combination of the Stratum Diversity and Stratum Functionality criteria, which respectively depend on the Population Sustainability Criterion, PS, and the Population Functionality Criterion, PF. The estimated truth values are shown in Table 3 and Figure 22. North Coast had the lowest value

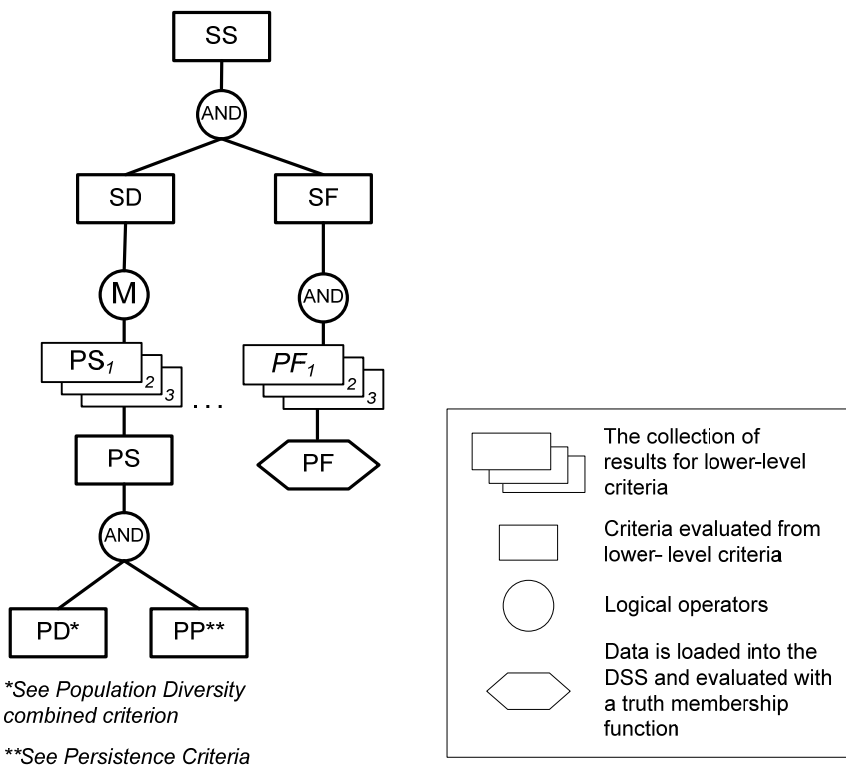

Figure 23. The Stratum Sustainability Criterion subsection of the ESU Sustainability Criterion decision network.



at +0.11 (low certainty that the stratum is self-sustaining, in terms of both diversity and functionality, into the foreseeable future). Mid-South Coast had the highest value at +0.68 (high certainty that the stratum is self-sustaining, in terms of both diversity and functionality, into the foreseeable future).

**Discussion:** By requiring that these two criteria are met, it is guaranteed that 1) there are sufficient sustainable populations within the stratum to maintain genetic and ecological diversity, and 2) there remains functional habitat in all populations (whether sustainable or not) so that population dominance can shift over time as local environmental conditions change (see discussion under Stratum Functionality on page 63).

## ESU-level Sustainability Criteria

### ES-1, All Biogeographic Strata Sustainable

**Criterion:** All of the biogeographic strata within the ESU are sustainable.

**Metric:** This is evaluated by applying the DSS “AND” operator to all Stratum Sustainability Criterion, SS, truth values shown in Figure 24.

**Current assessment:** Combining the Stratum Sustainability Criterion values across strata resulted in a truth value of +0.28 (low to moderate certainty that all of the biogeographic strata within the ESU are sustainable) for this criterion (Table 3).

**Discussion:** At a coarse scale, this criterion ensures sustainability of populations throughout the range of the ESU. The historical genetic structure of the ESU is not yet fully described, thus the division of the ESU into these strata should be considered tentative. In addition to providing for diversity and distribution, preserving these large strata should also meet the “significant portion of the range” language of the ESA. Requiring multiple sustainable populations within each biogeographic stratum provides for security of the stratum against catastrophes, as discussed by the Willamette/Lower Columbia TRT (Willamette/Lower Columbia TRT 2006).

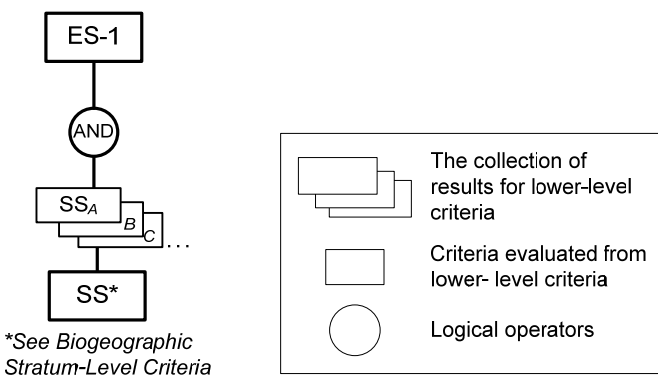

Figure 24. ES-1, All Biogeographic Strata Sustainable, subsection of the ESU Sustainability Criterion decision network.

## ESU Diversity—Evaluation Methods

The following ESU-wide diversity criteria (ED-1 to ED-3) are used to evaluate the degree of genetic and phenotypic diversity present at the ESU level to ensure the continued fitness of the ESU in the face of environmental change. Given the threats to diversity discussed above, these criteria fall into three categories: genetic diversity, phenotypic and environmental diversity, and small population effects. Within each category, criteria are used to evaluate both the degree of diversity present in the ESU and the factors that may have degraded it, using healthy ESUs or historical conditions (pre-European-settlement) as the standard for comparison.

Because these criteria are not as readily quantified as the previous criteria, a different method has been used to evaluate them. The method is a modification of the risk matrix approach (Wainwright and Kope 1999) used by NMFS Biological Review Teams for evaluating the biological status of ESUs. For each criterion, a 5-point scoring scale ranging from healthy or historical condition (score 5) to poor condition (score 1) was developed, with the third choice (score 3) representing either intermediate conditions or no information. Members of the workgroup examined all information relating to each criterion, and each member assigned a score for each criterion. To account for uncertainty in evaluating risks, a “likelihood-point” method referred to as the “FEMAT (Forest Ecosystem Management Assessment Team) method” was used because it is similar to that used to evaluate options under former President Clinton’s Forest Plan (FEMAT 1993). Under this method, each member was directed to distribute 100 points to the five possible scores for each diversity criterion. Members were instructed to distribute their points to reflect their professional judgment of the status of the ESU for each criterion, using all 100 points. Thus if an evaluator was certain that a single score was applicable, all 100 points could be placed on that score; if there was great uncertainty, points could be evenly distributed across all categories. A similar method has been used for all NMFS Pacific salmon status reviews since 1999. Mean scores resulting from all awarded points were used to calculate truth values; a mean criterion score of 5.0 had a truth value of +1.0 (true), while a mean score of 1.0 had a truth value of -1.0 (false) (Figure 25).

### ED-1, Genetic Diversity

**Criterion:** ESU-level genetic diversity is sufficient for long-term sustainability of the ESU.

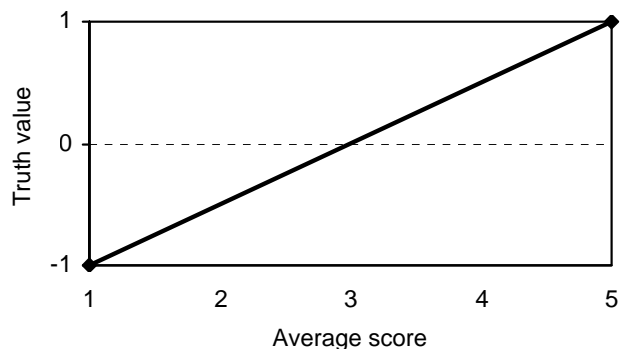

Figure 25. Truth membership function for all ESU-level diversity criteria.

**Metric:** This is evaluated as the average (UNION) of four subcriteria: Genetic Structure, ED-1a; Effects of Selection, ED-1b; Effects of Migration, ED-1c; and Effects of Introgression, ED-1d.

**Current assessment:** Truth values for the subcriteria and full criterion are presented in Table 7. The average score for this criterion was +0.22, indicating low certainty that ESU-level genetic diversity is sufficient for long-term sustainability of the ESU.

**Discussion:** Genetic diversity within and among populations provides the raw material for surviving long-term environmental change. Actions that affect the natural processes that form and maintain genetic diversity (e.g., mutation, selection, genetic drift, recombination, and migration) have the potential to reduce or alter adaptive patterns of diversity. The following criteria first evaluate the level of genetic diversity currently present in the ESU, then consider how the processes of selection, migration, and introgression may have reduced genetic diversity.

### ED-1a, Genetic Structure

**Criterion:** Genetic diversity within the ESU is comparable to healthy coho salmon ESUs (e.g., Olympic Peninsula, Southeast Alaska) and forms the basis for some life history diversity.

**Metric:** This is evaluated by answering the question: Are populations genetically distinguishable (based on allozyme or DNA variation) from each other such that they form groups based on geography, ecology, or life history types? The five possible scores are:

5. All populations within the ESU are genetically distinct, overall genetic diversity is comparable or exceeds that of healthy ESUs, and genetic information indicates many groups that have common geography, ecology, or life history.
4. Most populations within the ESU are genetically distinct, overall genetic diversity is almost as high as healthy ESUs, and genetic information indicates some groups that have common geography, ecology, or life history.

Table 7. Summary of DSS truth values for the ESU-level diversity criteria, broken down by subcriteria for Genetic Diversity, ED-1, and Phenotypic and Habitat Diversity, ED-2. The Small Populations Criterion, ED-3, has no subcriteria.

Subcriterion	ED-1 Genetic Diversity	ED-2 Phenotypic and Habitat Diversity	ED-3 Small Populations
a	0.28	0.30	
b	0.00	(-0.20)	
c	0.26		
d	0.34		
Value for full criterion:	0.22	0.05	0.40

3. Some populations within the ESU are genetically distinct, overall genetic diversity is modest compared to healthy ESUs, and genetic information indicates that a few groups may be present that have common geography, ecology, or life history, or no information is available.
2. Only a few populations within the ESU are genetically distinct, overall genetic diversity is low compared to healthy ESUs, and genetic information provides slight evidence for groups that have common geography, ecology, or life history.
1. Few populations within the ESU are genetically distinct, overall genetic diversity is extremely low comparable to healthy ESUs, and genetic information provides little evidence for groups that have common geography, ecology, or life history.

Genetic data considered to address this criterion included the 1995 status review (Weitkamp et al. 1995), recent published genetic results (Ford et al. 2004), and discussion of initial results of ongoing genetic analyses (Johnson and Banks 2008). Preliminary results of recent genetic analyses using microsatellites suggest that most genetic diversity in coho salmon occurs within Independent Populations (Lawson et al. 2007), rather than between populations. This pattern has also been observed in California and British Columbia.<sup>4</sup> The possible causes for high within-basin diversity were discussed with respect to their implications for ESU-level life history and genetic diversity and the definitions of populations.

**Current Assessment:** The mean score for this criterion was 3.55, resulting in a truth value of +0.28 (low certainty that genetic diversity within the ESU is sufficient) (Table 7). The full point distributions from the panel are in Table 8, showing that the majority of votes were cast for scores of 4 and 3, and no votes were cast for 1.

**Discussion:** This criterion indicates whether genetic diversity exists within the ESU and the amount of diversity relative to baseline conditions (healthy ESUs). It indirectly assesses whether factors such as mutation, genetic drift, introgression, or migration have compromised genetic diversity within the ESU. The presence of genetically based groupings indicates a genetic basis for at least some of the observed diversity in life history types (the other major source of life history diversity results from environmental variation). Such groupings point to extant genetic diversity that is important for long-term sustainability of the ESU.

### **ED-1b, Effects of Selection**

**Criterion:** Human-driven selection is not sufficient to decrease genetic diversity.

**Metric:** This is evaluated by answering the question: Has selection decreased genetic diversity? The five possible scores are:

5. Genetic diversity has not been decreased by selection relative to the historical template.
4. Genetic diversity has been mildly decreased by selection.
3. Genetic diversity has been moderately decreased by selection or no evidence is available to determine the degree of alteration by selection.

---

<sup>4</sup> See footnote 3.

Table 8. Distribution of points by review panel members for the Genetic Structure Criterion, ED-1a.

Panel member	Score				
	5	4	3	2	1
1	0	30	50	20	0
2	0	80	20	0	0
3	0	20	70	10	0
4	0	50	50	0	0
5	50	50	0	0	0
6	0	40	50	10	0
Total	50	270	240	40	0

2. Genetic diversity has been fairly severely decreased by selection.
1. Genetic diversity has been severely decreased by selection to the point that they have little in common with the historical template.

There was little information available to indicate whether selection had affected life history or genetic diversity. The workgroup was able to point to many human activities that likely select for or against life history types and genetic diversity, although little, if any, evidence exists to document such selection. The activities considered included fishing, which may select for particular run timing, size, or age classes (i.e., jacks have much lower harvest rates than adults), disease resistance, a variety of hatchery practices, and habitat alterations, which may be selective for or against particular groups of fish.

**Current assessment:** The mean score for this criterion was 2.98, resulting in a truth value of  $-0.01$  (uncertain that human-driven selection is not decreasing genetic diversity) (Table 7). The full point distributions from the panel are in Table 9, showing that the vast majority of votes were cast for 3, and no votes were cast for 5 or 1.

**Discussion:** Selection refers to the differential fitness expressed by individuals exhibiting one version of a trait in comparison to individuals exhibiting a different version of the trait. Selection due to either natural or human-caused factors may alter genetic diversity. For example,

Table 9. Distribution of points by review panel members for the Effects of Selection Criterion, ED-1b.

Panel member	Score				
	5	4	3	2	1
1	0	30	40	30	0
2	0	25	50	25	0
3	0	10	70	20	0
4	0	0	100	0	0
5	0	0	100	0	0
6	0	15	70	15	0
Total	0	80	430	90	0

drought conditions extending into late fall may favor coho salmon with late river entry and spawning timing over those with earlier run timing. Alternately, advancement of spawn timing associated with hatchery practices may increase mortality for early emerging fry during spring freshets to a greater degree than for later emerging fry (Nickelson et al. 1986).

**ED-1c, Effects of Migration**

**Criterion:** Genetic diversity is not compromised by changes in the movements of fish.

**Metric:** This is evaluated by answering the question: Have normal movement patterns been restricted or altered either within or between populations? The five possible scores are:

5. Normal movement patterns within and between populations have not been altered; they represent the historical template.
4. Normal movement patterns within and between populations have been mildly altered.
3. Normal movement patterns within and between populations have been moderately altered or no information is available to determine whether they have been altered.
2. Normal movement patterns within and between populations have been fairly severely altered.
1. Normal movement patterns within and between populations have been severely altered; they no longer represent the historical template.

There was little information available to indicate whether migration patterns had changed beyond natural levels. The workgroup was able to point to several dams in the ESU that block coho salmon access, but concluded that such blockages, although locally important, were of very minor importance at the ESU scale.

**Current assessment:** The mean score for this criterion was 3.52, resulting in a truth value of +0.26 (low certainty that genetic diversity is not compromised by changes in the movements of fish) (Table 7). The full point distributions from the panel are in Table 10, showing that the majority of votes were cast for 3 and 4, and no votes were cast for 1.

**Discussion:** Straying and gene flow strongly influence patterns of diversity within and among populations (McElhany et al. 2000). Rates of straying are usually estimated from

Table 10. Distribution of points by review panel members for the Effects of Migration Criterion, ED-1c.

Panel member	Score				
	5	4	3	2	1
1	0	25	50	25	0
2	20	50	30	0	0
3	0	15	70	15	0
4	10	50	40	0	0
5	10	90	0	0	0
6	0	40	60	0	0
Total	40	270	250	40	0

experiments that involve monitoring the spawning location of fish that are marked or tagged in their home area as juveniles (e.g., Labelle 1992). The rate of gene flow among populations is estimated by fitting population genetic models to observed patterns of molecular genetic variation (Slatkin 1985). Because such experiments and models are not widely available for Oregon Coast coho salmon, movement patterns within and between populations were used as a proxy for potential changes to genetic diversity due to straying and gene flow. In doing so, it was assumed that changes in movement patterns likely have some genetic effect on population structure, and that the effect is proportional to the change in movement patterns. Accordingly, major changes in movement patterns are expected to have greater impact on genetic diversity than minor changes in movements.

**Metric:** This is evaluated by answering the question: Have populations been genetically altered due to introgression of exotic genes (e.g., from use of out-of-basin or out-of-ESU hatchery stocks)? The five possible scores are:

5. Populations are completely unaltered by introgression of exotic genes and represent the historical template.
4. Populations have been mildly altered by introgression of exotic genes.
3. Populations have been moderately altered by introgression of exotic genes, or no evidence is available to indicate the degree of alteration.
2. Populations have been fairly severely altered by introgression of exotic genes.
1. Populations have been completely altered by introgression of exotic genes and no longer represent the historical template.

Information considered when addressing this criterion included the genetic dendrogram in the West Coast status review (Weitkamp et al. 1995), recent genetic analyses (Ford et al. 2004), a summary of the potential effects of hatchery production on Oregon Coast coho salmon (Weitkamp 1997), and the proportion of naturally spawning hatchery fish by basin for Oregon Coast coho salmon populations (Appendix D). The workgroup concluded that the opportunity for introgression had been high, based on the numbers of hatchery fish released, the stocks used, the percent of hatchery fish spawning naturally, and the genetic distinctiveness of older hatchery stocks.

However, evidence indicating whether introgression occurred was much more difficult to determine. It was suggested that there are few examples from coho and other Pacific salmon indicating that introgression of exotic genes from hatchery fish has occurred, despite numerous opportunities to do so. For example, the extensive releases of Puget Sound stocks from the Oregon Aqua Foods facility in the Yaquina basin apparently had little effect on the genetics of local coho salmon populations. The only example of introgression in the Oregon Coast Coho Salmon ESU comes from the Nehalem population of coho salmon, where a reduction in resistance of some wild coho salmon to the parasite *Ceratomyxa shasta* (Wade 1987) has been attributed to introgression from hatchery fish with a significant out-of-basin ancestry. Whether introgression remains in the Nehalem population has not been determined.

**Current assessment:** The mean score for this criterion was 3.68, resulting in a truth value of +0.34 (low to moderate certainty that genetic diversity is not altered by the introgression

of exotic genes) (Table 7). The full point distributions from the panel are in Table 11, showing that the majority of votes were cast for 4 and 3, and no votes were cast for 1.

**Discussion:** One clear risk to genetic diversity is the introgression of exotic genes. These exotic genes come from fish that are adapted to a different suite of environmental conditions than those in which they are located. The degree of difference ranges from slight (i.e., fish originating from an adjacent basin) to extreme (fish originating from a different ESU). The most common vector for the introgression of exotic genes into natural populations are hatchery fish, which either inadvertently or deliberately spawn with natural fish. Although most Oregon Coast coho salmon hatchery stocks were derived from local populations, there has been considerable movement of fish between hatcheries and between ESUs (Weitkamp et al. 1995). These widespread exotic releases provide the potential for deleterious genetic impacts to natural populations.

### ED-2, Phenotypic and Habitat Diversity

**Criterion:** ESU-level phenotypic and habitat diversity are sufficient for long-term sustainability of the ESU.

**Metric:** This is evaluated as the average (DSS “UNION” operator) of two subcriteria: Phenotypic Diversity, ED-2a, and Habitat Diversity, ED-2b.

**Current assessment:** Truth values for the subcriteria and full criterion are presented in Table 7. The average score for this criterion was +0.05, indicating uncertainty whether ESU-level phenotypic and habitat diversity are sufficient for long-term sustainability of the ESU.

**Discussion:** Phenotypic diversity is expressed as variable life history traits such as run timing, spawn timing, smolt age, and ocean distribution patterns. Phenotypic diversity allows species to use a wider array of environments and protects species against short-term spatial and temporal changes in environment. Phenotypic diversity is strongly influenced by environmental variation, which allows unique phenotypes to be expressed when the proper conditions (e.g., particular habitat types) are available. Consequently, not only is detectable phenotypic diversity

Table 11. Distribution of points by review panel members for the Effects of Introgression Criterion, ED-1d.

Panel member	Score				
	5	4	3	2	1
1	0	45	50	5	0
2	25	75	0	0	0
3	0	10	80	10	0
4	40	40	20	0	0
5	0	100	0	0	0
6	0	30	60	10	0
Total	65	300	210	25	0



important for sustainability of ESUs, but habitat diversity is also important to allow expression of a wide range of phenotypes.

### **ED-2a, Phenotypic Diversity**

**Criterion:** Phenotypic diversity is present within the ESU at levels comparable to healthy ESUs or the historical template.

**Metric:** This is evaluated by answering the question: Do populations display variation in life history traits such as smolt age, age and size at maturity, juvenile run timing, adult run timing, and spawn timing (do upstream and downstream migrations extend for more than 2 months), comparable to healthy ESUs or the historical template? The five possible scores are:

5. There is extensive variation in life history traits comparable to healthy ESUs and the historical template.
4. There is considerable variation in life history traits, although slightly less than in healthy ESUs or the historical template.
3. There is moderate variation in life history traits, somewhat diminished from healthy ESUs or the historical template, or there is no evidence to indicate changes in life history diversity.
2. Life history trait variation has been reduced and is well below that of healthy ESUs or the historical template.
1. Life history trait variation has been greatly reduced and no longer represents either healthy ESUs or the historical template.

Life history data provided in the original status review (Weitkamp et al. 1995) and the population document (Lawson et al. 2007) formed the basis of discussions about current levels of phenotypic variation. We concluded that available life history data on parameters such as run timing or size were unremarkable, in the sense that most variables are strongly influenced by environmental variation and the level of spatial and temporal variation in the traits along the Oregon Coast was similar to other ESUs. Data on other life history traits that might be more informative for addressing the criterion are not readily available for Oregon Coast populations. The general consensus of the group was that Oregon Coast coho salmon were highly variable in phenotypes.

**Current assessment:** The mean score for this criterion was 3.61, resulting in a truth value of +0.30 (low to moderate certainty that phenotypic diversity is present within the ESU at levels comparable to healthy ESUs or the historical template) (Table 7). The full point distributions from the panel are in Table 12, showing that the majority of votes were cast for 4 and 3, and no votes were cast for 1.

**Discussion:** Compared to other Pacific salmon species with their spring and fall runs or complex age structure, coho salmon generally display relatively little variation in most life history traits. For example, the vast majority of coho salmon in the Pacific Northwest enter the ocean as yearling smolts, become sexually mature after 6 months (jacks) or a year (adults) in the ocean, enter rivers in the fall and spawn shortly afterwards (Sandercock 1991, Weitkamp et al.

Table 12. Distribution of points by review panel members for the Phenotypic Diversity Criterion, ED-2a.

Panel member	Score				
	5	4	3	2	1
1	0	30	40	30	0
2	20	50	30	0	0
3	0	40	60	0	0
4	5	35	40	20	0
5	10	80	10	0	0
6	40	30	30	0	0
Total	75	265	210	50	0

1995). Despite this similarity at the gross scale, there may be unappreciated fine-scale life history variation that is generally overlooked because it is extremely difficult to measure. For example, Nielsen (1994) identified four discrete life history types in northern California streams that combined unique microhabitat distributions, foraging behavior, growth, and developmental patterns. Similarly, discrete stream-rearing and lake-rearing life history types have been identified in the Tenmile Lake basin (Reimers 1989).

We assumed that some life history types are more successful than others as conditions vary (e.g., Reimers 1973). Accordingly, the more variation there is in life history diversity, the greater the chances that some life history pathways will be successful each year, leading to greater sustainability. However, without an extensive research effort or development of new technologies (e.g., otolith microchemistry), it is impossible to determine how many life history types are present in each basin or how this number has varied over time. Because of this lack of data, the workgroup was forced to examine variation in readily measured traits, such as juvenile run timing, age and size at maturity, and adult run and spawn timing. While variation in these traits may not be exceptionally informative with regards to variation in life history pathways present within the ESU, it is the best available information on phenotypic variation. Consequently, although moderately high diversity in these life history traits may or may not be associated with high life history pathway diversity, lack of diversity in these traits would clearly be a cause for concern.

### ED-2b, Habitat Diversity

**Criterion:** Habitats are sufficiently productive, diverse, and accessible to promote phenotypic plasticity.

**Metric:** This is evaluated by answering the question: Do multiple habitat types exist within basins, are they accessible to coho salmon, and are they structured by processes that support and maintain each habitat type? These habitat types include lakes, ponds, tributary pools and glides, mainstem rearing areas, off-channel pools, low-salinity estuarine habitats, tributary junctions, and active floodplains. The five possible scores are:

- Habitats within basins are as accessible, productive, and diverse as those of healthy ESUs or the historic template.

4. Habitats within basins are slightly less accessible, productive, or diverse as those of healthy ESUs or the historic template.
3. Habitats within basins are not as accessible, productive, or diverse as those of healthy ESUs or the historic template, or nothing is known about habitat productivity or diversity or coho salmon access.
2. Habitats within basins are considerably less accessible, productive, or diverse as those of healthy ESUs or the historic template.
1. Habitats within basins bear little resemblance to healthy ESUs or the historic template with respect to accessibility, productivity, or diversity.

The information considered for making this assessment included:

- Estimates of existing or filled estuarine habitats for 22 basins in the Oregon Coast ESU (Scranton 2004)
- Estimates of the change in total area for Oregon Coast estuaries between 1870 and 1970 (OSP 2000)
- Categories of riparian vegetation and land use for the Coast Range (OSP 2000)
- Estimates of old growth forests in the nineteenth century and at present in the Coast Range (OSP 2000)
- Information about culverts (e.g., barriers to passage, quality of habitat upstream of culvert, etc.) by county for western Oregon (IMST 2002)
- Water quality conditions for western Oregon (e.g., miles listed as 303(d), miles meeting standards, parameters out of compliance, etc.) (IMST 2002)
- Water quality as determined by the Oregon Water Quality Index for coastal Oregon streams (IMST 2002)
- ODFW habitat benchmarks for pools, riffles, shade, large woody debris, and riparian conifers (WPN 1999)

Team members discussed the adequacy of the available information for determining habitat diversity, productivity, and accessibility and found it generally lacking. For example, from the available information on culverts it was not possible to determine the extent of coho salmon habitat above impassable culverts. Similarly, information on changes in estuarine areas did not consider how such modifications affected fish. Overall, the group concluded that current conditions have been altered compared to the historical template, although the degree of alteration was difficult to determine. The greatest habitat alterations have occurred in lowland portions of basins. The most significant water quality issue is high temperatures. With respect to the benchmarks, few if any basins meet the criteria for large woody debris, which is likely related to the fact that most old growth forests have been replaced by much younger stands. As a whole, habitats may be considered to be more uniform than they were historically.

It was generally assumed that a wide range of life history patterns could still be expressed with current habitat. However, the production from some habitat types has been greatly reduced

because habitat degradation or alteration has reduced the carrying capacity for life history patterns that rely on those habitat types.

**Current assessment:** The mean score for this criterion was 2.60, resulting in a truth value of  $-0.20$  (low to moderate certainty that habitats are not sufficiently productive, diverse, and accessible) (Table 7). The full point distributions from the panel are in Table 13, showing that the majority of votes were cast for 3, and no votes were cast for 5.

**Discussion:** There is compelling evidence that patterns of phenotypic diversity within and among Pacific salmon populations are strongly influenced by the environments these populations inhabit (reviewed by Ricker 1972, Taylor 1991, Healey and Prince 1995). Nielsen (1994) identified four discrete coho salmon life history types, yet found little genetic basis for the variation. Accordingly, providing access to a diversity of productive habitat types allows expression of phenotypes that may not otherwise occur. Although it is extremely difficult to determine which particular life history type is successful in a given year, the expectation is for some life history types to be more successful than others. Consequently, by ensuring that a wide range of productive habitats are accessible to coho salmon, the opportunity is provided for greater expression of life history diversity, which, in turn, should increase the chances that at least some coho salmon life history types will be successful.

### ED-3, Small Populations

**Criterion:** Dependent Populations within the ESU are not permanently lost.

**Metric:** This is evaluated by answering the question: Is there any evidence that Small Populations have been permanently lost from the ESU? The five possible scores are:

5. All Dependent Populations that were historically present in the ESU still currently exist.
4. Most Dependent Populations that were historically present in the ESU still currently exist.
3. Some Dependent Populations that were historically present in the ESU still currently exist, or no information exists to indicate whether Dependent Populations have been lost.
2. Only a few Dependent Populations that were historically present in the ESU still currently exist.

Table 13. Distribution of points by review panel members for the Habitat Diversity Criterion, ED-2b.

Panel member	Score				
	5	4	3	2	1
1	0	0	0	50	50
2	0	10	60	30	0
3	0	30	60	10	0
4	0	0	40	50	10
5	0	0	100	0	0
6	0	20	40	40	0
Total	0	60	300	180	60

1. All Dependent Populations that were historically present in the ESU have been lost.

Information used to evaluate the persistence of small populations consisted of presence or absence of coho salmon recorded in the ODFW spawner surveys in years with productive ocean conditions (ca. 2000–2002), known restrictions to salmon access (e.g., Rocky Creek), and data for midcoast streams provided by the MidCoast Watersheds Council (MidCoast Watersheds Council 2005). For many Dependent Populations, no information was available to indicate whether these populations persist, resulting in considerable uncertainty. There was some discussion that the absence of coho salmon during spawner surveys does not necessarily mean no coho salmon were present. This apparent conflict stems from such zero counts occurring in systems in which some juvenile coho salmon are observed the following summer (e.g., Cummins Creek). There was also discussion that the random spawner surveys typically conducted in these small populations may not provide a complete picture of spawner abundances because they are designed to be random and therefore are not conducted in the same location each year, nor do they necessarily occur in the best spawning areas.

**Current assessment:** The mean score for this criterion was 3.80, resulting in a truth value of +0.40 (moderate certainty that Dependent Populations within the ESU are not permanently lost) (Table 7). The full point distributions from the panel are in Table 14, showing that the vast majority of votes were cast for 4, and no votes were cast for 2 or 1, suggesting fairly high confidence that most small populations in the ESU have not been lost.

**Discussion:** This evaluation only applies to identified Dependent Populations (Lawson et al. 2007) that have a historical production potential of at least 2,000 smolts (see Population Structure and Associated Definitions on page 4). It was considered that populations smaller than this threshold (often consisting of less than 50 spawners under moderate ocean conditions) were not likely to persist long enough to fix alleles and provide unique diversity to the ESU.

These populations are assumed over the long term to be supported by larger nearby populations, but may also serve an important evolutionary role as being more efficient in retaining new mutations than larger populations. Small populations, by their small size, generally contribute little to overall ESU abundance and may be temporarily extirpated when environmental conditions are unfavorable and recolonized when conditions improve. However, they are important to evaluating the status of the ESU for three reasons:

Table 14. Distribution of points by review panel members for the Small Populations Criterion, ED-3.

Panel member	Score				
	5	4	3	2	1
1	0	75	25	0	0
2	10	70	20	0	0
3	0	60	40	0	0
4	0	90	10	0	0
5	0	90	10	0	0
6	0	75	25	0	0
Total	10	460	130	0	0

- They may serve a critical role in ESU diversity by providing reservoirs of potentially adaptive diversity.
- They may be important for adaptive radiation (e.g., Wright 1948) by providing habitat important to certain life history types and providing a locus for adaptive mixing.
- Small populations are most susceptible to overexploitation (Hilborn 1985, Halupka et al. 2000) and other sources of mortality, and thus may be important indicators of successful management.

Although the exact degree to which these populations support ESU diversity is unknown, assuming they are important for ESU diversity seems the most far-sighted approach to their management. Because of these considerations, and in the face of substantial uncertainty regarding the role of these populations in the ESU as a whole, a precautionary approach suggests the importance of preserving as many of the pieces of the historical ESU as is feasible.

### ES-2, ESU-level Diversity

**Criterion:** The ESU has sufficient broad-scale diversity to maintain its ecological and evolutionary functions into the foreseeable future.

**Metric:** This requires meeting each (DSS “AND” operator) of three criteria: the Genetic Diversity Criterion, ED-1; Phenotypic and Habitat Diversity Criterion, ED-2; and Small Populations Criterion, ED-3, shown in Figure 26.

**Current assessment:** The analysis combined the results of the analyses of the Genetic Diversity Criterion, ED-1; Phenotypic Diversity Criterion, ED-2; and Small Populations

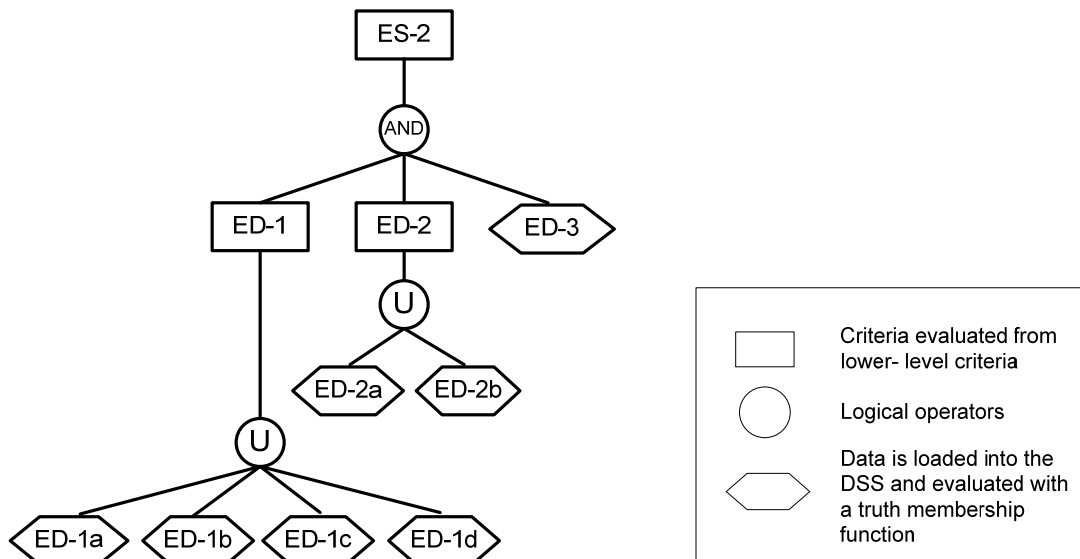

Figure 26. ESU-level Diversity Criterion subsection of the ESU Sustainability Criterion decision network.

Criterion, ED-3 (Table 3). The resulting truth value was +0.14 (low certainty the ESU has sufficient broad-scale diversity to maintain its ecological and evolutionary functions into the foreseeable future).

**Discussion:** For Pacific salmon, diversity is expressed by variable life history traits, including anadromy, morphology, fecundity, run timing, spawn timing, juvenile behavior, smolt age, age at reproduction, egg size, development rate, ocean distribution patterns, spawning behavior, physiology, and molecular genetic characteristics (McElhany et al. 2000). Diversity is important for ESU sustainability because 1) it allows species to use a wider array of environments than they otherwise could, 2) it protects species against short-term spatial and temporal changes in the environment, and 3) genetic diversity provides raw material for surviving long-term environmental change (McElhany et al. 2000).

Life history traits are typically the product of both genetic and environmental variation. These traits may be affected by both naturally occurring and anthropogenic forces. For example, genetic diversity within and among populations is affected by mutation, selection, genetic drift, recombination, and migration. Phenotypic diversity is influenced by genes that guide development, by random environmental effects, and by phenotypic plasticity. To protect against the deleterious effects of these factors on species or population sustainability, the following guidelines were developed (McElhany et al. 2000):

1. Human-caused factors such as habitat changes, harvest pressures, artificial propagation, and exotic species should not substantially alter variation in traits (e.g., run timing, age structure, size, etc.).
2. Natural processes of dispersal should be maintained. Human-caused factors should not substantially alter the rate of gene flow among populations.
3. Natural processes that cause ecological variation should be maintained.
4. Population status evaluations should take uncertainty about requisite levels of diversity into account.

At the ESU level, it is also important to consider the role played by small or peripheral populations. While small populations are less likely to persist than large populations and make only minor contributions to overall abundance, they may serve a critical role in ESU diversity by providing reservoirs of potentially adaptive diversity. Although it is impossible to predict whether the potential diversity provided by small populations will contribute to ESU sustainability, prudent management would hedge bets by avoiding the loss of these populations (Bilby et al. 2005). Accordingly, the persistence of small populations is viewed as beneficial to the overall diversity of the ESU.

This ESU-level Diversity Criterion assessment differs from the Population Diversity criteria (PD 1–4 and PF), which evaluate the diversity of each population independently. While genetic and phenotypic diversity can also be evaluated at a population level, it is unrealistic to expect that every population should contain a large number of life history types or have access to all possible habitat types, making such evaluations difficult. Rather, it is genetic, phenotypic, and habitat diversity and the existence of small populations within the ESU as a whole that are essential for ESU sustainability. Accordingly, while the Population Diversity criteria consider

population attributes such as abundance, fish distributions, hatchery influence, and habitat capacity as measures of individual population diversity, the criteria presented here evaluate the diversity of the ESU as a single unit.

### **ES, ESU Sustainability**

**Criterion:** The ESU is self-sustaining into the foreseeable future.

**Metric:** The ESU Sustainability Criterion requires (DSS “AND” operator) sustainability of the biogeographic strata (All Biogeographic Strata Sustainable, ES-1) and the ESU-level Diversity Criterion, ES-2, but with reduced weight placed on ES-2. Thus the truth value is derived by combining the biogeographic Stratum Sustainability Criterion, SS, values into ES-1, then combining the resulting value with the ES-2 value, with a weight of 0.5 placed on the ES-2 value. The entire sustainability network is illustrated in Figure 14 (page 45).

**Current assessment:** The resulting ESU Sustainability Criterion, ES, truth value is +0.19 (low to moderate certainty that the ESU is self-sustaining into the foreseeable future) (Table 3).

**Discussion:** This criterion ensures a resilient and diverse ESU in two ways. First, Stratum Sustainability ensures broad geographic and ecological distribution of fish throughout the range of the ESU, and this distribution provides fundamental ecological diversity as well as insurance against local catastrophes. Second, the ESU Diversity criteria ensure maintenance of broad-scale diversity that may not be reflected in the stratum structure. The weight on the ESU-level Diversity Criterion was reduced because of the greater level of uncertainty in assessing the subcriteria via professional judgment.

### **Summary—Sustainability**

Sustainability refers to a population or ESU that, in addition to being persistent, is also able to maintain its genetic legacy and long-term adaptive potential for the foreseeable future. Sustainability implies stability of habitat availability and other conditions necessary for the full expression of the population’s (or ESU’s) life history diversity into the foreseeable future. In the ESU Sustainability Criterion DSS network, population-level criteria form the lowest level of the analysis. At this level, there are two watershed-level subcriteria (a Spawner Watershed Occupancy Criterion, W-Sp, and a Juvenile Watershed Occupancy Criterion, W-Ju), which relate to two Population Diversity criteria (a Spawner Distribution Criterion, PD-3, and a Juvenile Distribution Criterion, PD-4).

These, along with two other Population Diversity criteria (a Spawner Abundance Criterion, PD-1, and an Artificial Influence Criterion, PD-2) are combined to evaluate a Population Diversity Criterion, PD. The Population Diversity Criterion, PD, and the Population Persistence Criterion, PP, combine to assess a Population Sustainability Criterion, PS. Populations are then aggregated into biogeographic strata to evaluate a biogeographic Stratum Diversity Criterion, SD. A Population Functionality Criterion, PF, is evaluated and populations are aggregated to evaluate a Stratum Functionality Criterion, SF. The Stratum Diversity, SD, and Stratum Functionality, SF, criteria are combined to evaluate stratum sustainability. Stratum



Sustainability Criterion, SS, values are aggregated to the ESU level (All Biogeographic Strata Sustainable, ES-1), which is combined with an evaluation of the ESU-level Diversity Criterion, ES-2, to arrive at the ESU Sustainability Criterion, ES.

This framework evaluates population diversity using objective measures of spawner abundance, artificial influence, spawner and juvenile distribution, and habitat capacity. In addition, the workgroup evaluated the ESU-level Diversity Criterion that includes a Genetic Diversity Criterion (a function of genetic structure and effects of selection, migration, and introgression), a Phenotypic and Habitat Diversity Criterion, and a Small Populations Criterion. Fully quantifiable criteria are not available for the ESU-level diversity measures, so an expert panel was used to evaluate them but the result was given half the weight of the more quantifiable population-level evaluations.

Recent observations of these population metrics were used to evaluate how certain it is that the Oregon Coast Coho Salmon ESU is sustainable under recent conditions. Results of the current assessment for the ESU Sustainability Criterion are mapped in Figure 13 on page 43. The results of the analysis lead to the conclusion that, if recent conditions continue into the future, there is low to moderate certainty that the ESU is sustainable. This conclusion depends strongly on the assumption that recent conditions continue into the future. Because this report focuses on biological conditions, and future conditions depend to a large extent on socioeconomic factors, this assumption has not been evaluated. To the extent that freshwater habitat conditions, ocean conditions, harvest management, and hatchery practices may change in the future, so may the sustainability of the ESU.

# Restoration

Restoration (or broad-sense recovery), as defined in the Introduction on page 2, includes sustainability as well as the provision of environmental, cultural, and economic benefits. Thus, restoration extends beyond the requirements of the ESA, and criteria involve social, economic, and political considerations as well as biological requirements. The TRT's work is limited to scientific and technical considerations, and for that reason a full set of restoration criteria with clearly defined metrics was not developed. Rather, only general guidelines regarding the structure of restoration criteria are provided.

The general approach taken was to 1) define the types of environmental, cultural, and economic benefits that may be desired beyond minimal sustainability, 2) describe an ecosystem approach to ESU conservation that should be considered to ensure those benefits, and 3) describe a minimal set of criteria that could be used to assess progress toward restoration.

## Environmental, Cultural, and Economic Benefits

Environmental benefits of coho salmon include such things as providing nutrients for stream ecosystems (e.g., aquatic invertebrates, other fishes, streamside vegetation), providing food for wildlife (e.g., bears, eagles, osprey, etc.), and providing an indication of water quality and watershed function. In addition, conservation measures for coho salmon have an influence on other sensitive species (e.g., brook lamprey [*Lampetra richardsoni*]), spring-run Chinook salmon [*Oncorhynchus tshawytscha*). To provide these benefits, the abundance of the ESU should be a substantial portion of the historical abundance, with abundant populations distributed throughout the historical range of the ESU. The best example of a fully functional coho salmon ESU for this region is the historical ESU as it existed prior to major landscape changes following European settlement. Thus historical abundance and distribution can serve as an idealized template against which to compare restoration criteria.

Cultural benefits are harder to define. These include use of salmon for Native American ceremonies, availability of salmon for viewing and nature study, and the intangible psychological benefits of the abundance of wild salmon and healthy stream ecosystems. As an example of the potential role of salmon in society, there is strong evidence that the abundance of salmon in the Pacific Northwest was a major factor in structuring Northwest Coast tribal societies (Netting 1977). There is also a distinct culture surrounding the sport and commercial salmon fishing communities that have developed since European settlement, cultures that have also been influenced by the strength of salmon runs.

Economic benefits include both direct and indirect values. The most obvious direct benefits are those resulting from subsistence, commercial, and sport harvest, including benefits that coho salmon conservation may have on harvest of other coastal salmonids, notably Chinook salmon and steelhead. There is also direct economic benefit from subsistence harvest for all salmonids. Indirect benefits include the economic multiplier effects of direct harvest benefits,

plus less tangible benefits such as the increase in local land values resulting from environmental or cultural benefits associated with salmon restoration.

## **Ecosystem Approach**

Conservation programs, such as the one that will lead to the restoration of Oregon Coast coho salmon, need to be tailored to the features and behaviors of the species of concern, and to the landscape within which habitat for the species is embedded. Because interactions between disturbance and recovery processes make landscapes dynamic (Lugo et al. 1999), habitat suitable for a given species will be found in a mosaic of patches whose ecological conditions vary spatially and over time (White and Pickett 1985). Holling (1973) noted that attempts to view and manage ecosystems and associated resources in a static context may increase the rate of extirpation or extinction of some organisms. Biotic populations persist in dynamic landscapes in two basic ways. One strategy is to be an ecological generalist capable of persisting in a wide range of conditions (Huff and Raley 1991). An alternative strategy is to be a specialist that moves between patches of favorable habitat (May 1994).

The historic landscape of the Oregon Coast, including the aquatic component, was very dynamic in space and time because of the natural disturbance regime. Coho salmon populations likely persisted in this environment as ecological specialists, occupying areas of suitable habitat for periods of time and then moving to new areas of similar habitat as such habitat developed or as occupied areas became less suitable over time (Reeves et al. 1995). Collections of interacting populations of specialists, such as that just described for the coho salmon of the Oregon Coast, are referred to as metapopulations. Metapopulation issues are apparent at a variety of scales from individual spawning grounds (e.g., Neville et al. 2006, Isaak et al. 2007) to interconnections among basin-scale populations (e.g., Hilborn et al. 2003, Hastings and Botsford 2006). For salmonids, metapopulation processes can be quite variable depending on species, life history, and landscape patterns (see review by Rieman and Dunham 2000).

Conservation of metapopulations requires sufficient numbers of patches of suitable habitat through time and the potential for dispersal among the patches (Harrison 1994). Where there are currently insufficient numbers of patches of high quality habitat, it is important to protect existing high quality patches in the near term (Frissell 1997). Minimizing or eliminating external threats increases the likelihood of these patches persisting (Meffe and Carroll 1997) so that they can serve as sources of individuals to colonize new patches of favorable habitat as they develop. Development of future patches of favorable habitat, another important component of conservation, requires the protection or restoration of critical ecological processes that create such habitat over time (Meffe and Carroll 1997). The key to any conservation program will therefore be to protect against losses of existing patches of favorable habitat, to establish a program that leads to the development of favorable habitat in the future by focusing on the ecological processes that create such habitat, and to maintain and develop conditions that allow movement between the favorable patches. The importance of these dynamic landscape processes on the Oregon Coast has been demonstrated by recent work of the Coastal Landscape Analysis and Monitoring Study (Spies et al. 2007, Burnett et al. 2007).

Habitat losses can result from human activities that directly destroy habitats or that change the long-term dynamics of landscapes and their embedded ecosystems (Rapport et al.

1985, Webb and Thomas 1994). For coho salmon and other anadromous salmonids, naturally variable ocean conditions increase the importance of good freshwater habitat (FEMAT 1993, Lawson 1993, Nickelson and Lawson 1998) and the consequences of reduced habitat abundance and quality. Past approaches to management of the freshwater habitats of these fish have focused almost solely on mitigating losses rather than preventing them. This strategy has generally not been successful (Bisson et al. 1992) and large-scale habitat improvement and meaningful increases in fish numbers are slow to occur. Past attempts were generally unsuccessful because the focus was on local areas of in-stream habitat and not on ecosystem processes at a watershed scale (Moyle and Sato 1991, Naiman et al. 1992, Williams et al. 1989).

As a consequence of the coho salmon's dependence on freshwater habitats and the extensive amount of habitat degradation that has occurred within Oregon Coast watersheds, protection and restoration of upslope and fluvial processes that create and maintain habitats must be an integral component of any recovery program for the species. Recent proposals for restoring and protecting habitats of at-risk fishes (e.g., FEMAT 1993, Moyle and Yoshiyama 1994, Reeves et al. 1995) addressed habitat destruction, primarily through the establishment of watershed-level reserves in which human impacts would be minimized, as advocated by Sheldon (1988) and Williams et al. (1989). Williams et al. (1989) called for recovery efforts to restore and conserve ecosystems rather than habitat attributes.

Efforts to restore Oregon Coast coho salmon have begun to reflect a broader, watershed-level and regional perspective on the species' needs, but continued substantial improvement will be required to restore the natural ecosystem processes needed to sustain high quality freshwater habitats. This is particularly true if the intent is to move beyond avoidance of species imperilment and to broad-sense recovery. For example, while actions being taken on federal public lands managed under the President's Forest Plan, and some actions taken on private and state-owned public lands under the funding or guidance of the Oregon Plan, will protect or restore natural processes linked to high-quality coho salmon habitat, ongoing activities in other areas may be less helpful.

Conventional management practices on private and state-owned forest lands limited only by the state's Forest Practices Act do not fully protect or restore such processes (Botkin et al. 1995, IMST 1999). Conventional agricultural, rural-residential, or urban practices allowed in lowland areas also fall short, and sometimes substantially so, of what is needed to protect or restore the habitat of Oregon Coast coho salmon in those areas (IMST 2002). This is particularly important for coho salmon, as land ownership patterns and past land use policies have concentrated high-impact land uses in areas of high potential for coho salmon, and these patterns are likely to limit coho salmon production into the foreseeable future (Burnett et al. 2007). Further improvements will be necessary in watersheds across the Oregon Coast and on lands managed for a variety of uses.

## **Suggested Criteria**

Considering the desire for environmental, cultural, and economic benefits within the context of an ecosystem approach, we suggest that a minimum of three types of criteria be considered: overall ESU abundance, the sustainability of Independent Populations, and the productivity of Dependent Populations. These criteria focus on measures of fish abundance and

sustainability rather than directly on the ecosystem processes described above, but it should be recognized that goals for fish populations can only be achieved by restoring the ecosystem processes that support those populations.

### ESU Abundance

ESU spawning abundance must be sufficient to meet economic, cultural, and environmental benefits. Overall abundance of the ESU is an important determinant of all three types of benefits and is an indicator of ecosystem function. In a natural system, abundance will fluctuate widely, depending on changing conditions in both the freshwater and marine environments. As a result, thresholds for this criterion need to allow for substantial year-to-year variation, while ensuring that habitats are sufficiently healthy to ensure that ecosystem functions will be met over the long term. Because this criterion is based on economic, cultural, and environmental benefits, the exact level is clearly a policy choice and should be chosen after weighing the value of societal benefits against costs of achieving those benefits.

Some economic and environmental benefits can be quantified. For example, Figure 27 shows hypothetical relationships between salmon abundance and three categories of benefits: commercial harvest, where surplus production theory predicts that economic return is maximized at some intermediate level of spawner abundance; stream nutrients, which start out very low but increase to a saturation value at moderate to high abundances; and general ecosystem benefits (food for wildlife, other interactions with the broader coastal ecosystem), which may not reach a maximum until abundance approaches that of pristine conditions.

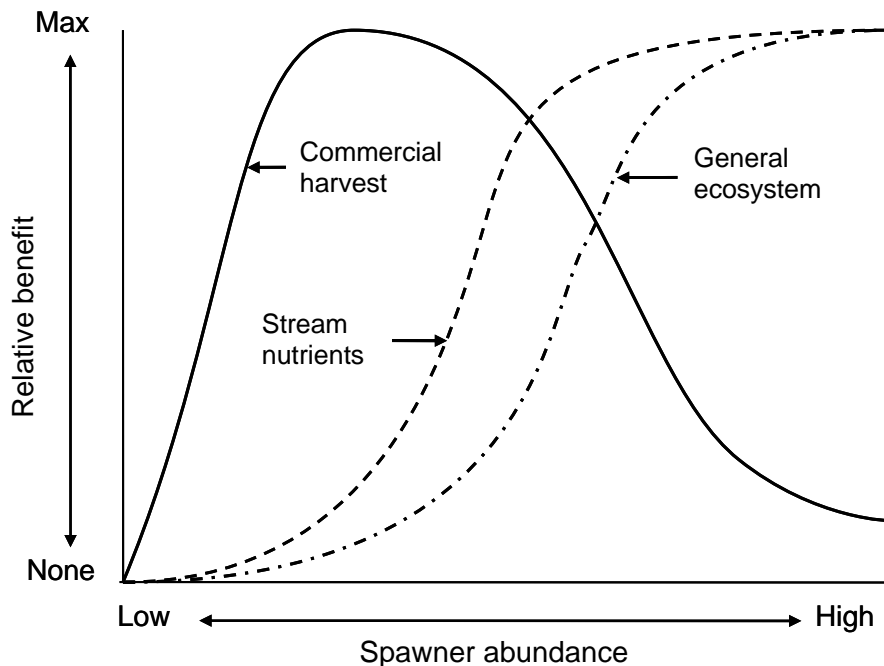

Figure 27. Hypothetical relative value of spawning escapement in terms of harvest, stream nutrient supply, and more general ecosystem benefits.

Commercial harvest benefits can be estimated based on stock-recruit analysis and surplus-production theory, resulting in a dome-shaped value curve where value increases with abundance up to a maximum value, then decreases because harvest rates would need to be reduced to achieve higher escapements. Alternatively, it could be assumed that harvest management will continue into the foreseeable future according to Amendment 13 to the Pacific Salmon Fishery Management Plan (FMP) (PFMC 2003), and benefits could be calculated on that basis given the relationship between average run size and allowable harvest rate. A minimum level of 125,000 spawners is suggested during periods of poor ocean conditions, which would essentially meet the fishery management plan rebuilding goal, estimated to be 126,700 spawners (Table 3-3 in PMFC 2003). This would ensure that harvest would not be restricted by spawner abundance under the FMP (but may still be restricted by marine survival conditions). Managing the ESU for levels greater than the 125,000 fish threshold is largely a policy choice of balancing benefits with costs of achievement. If the minimum criterion is met during poor ocean conditions, something likely to require about a four-fold increase in high-quality habitat for Oregon Coast coho salmon, substantially higher abundance under moderate or good ocean conditions, would be expected.

Coho salmon are an important contributor to stream nutrient supply, and Bilby et al. (2001) estimated the density of coho salmon carcasses that would maximize nutritional benefit to juvenile coho salmon at approximately 120 carcasses per km of spawning habitat. Given about 6,900 km (4,300 miles) of spawning habitat in the range of the ESU, this translates to an escapement of about 830,000 spawners to saturate the stream nutrient supply.

Another approach to ensuring cultural, economic, and environmental benefits could be restoring salmon abundance to a specified substantial portion of historical abundance. We suggest that somewhere between 25% and 75% of historical abundance may be sufficient to meet these goals. Given a range of estimated historical peak abundance of 1 million to 2 million spawners (Appendix C in Lawson et al. 2007), this would translate to a goal of between 250,000 and 1.5 million spawners during periods of high marine survival.

To reduce year-to-year variation in the metric, the workgroup suggests that abundance be measured as a 4-generation (12-year) average of naturally produced spawners for the entire ESU estimated from ODFW's annual spawner surveys. By using a 12-year average, this metric is likely to span a range of conditions in both ocean and freshwater environments. However, long periods of extreme environmental conditions could make this metric hard to interpret in terms of health of the ESU. The issue of environmental fluctuations is discussed more thoroughly in the Important Issues section on page 8.

### **Sustainable Independent Populations**

To maintain the distribution of coho salmon populations as close to the historical template as possible, all of the historically Independent Populations should meet Population Sustainability Criterion, PS, defined under Sustainability (page 59). By ensuring widespread distribution of sustainable populations among varied habitats, this would help maintain the long-term adaptive potential of the ESU. We also expect that society would wish to ensure that the benefits of restoration accrue across the range of the ESU and to populations of diverse character, not just in portions of the largest populations. Requiring that all Independent

Populations are sustainable into the foreseeable future provides assurance that some economic, cultural, and ecological benefits are available in all of the occupied basins.

### **Productive Dependent Populations**

Habitats that historically supported Dependent Populations should be intact and accessible to fish. Ensuring intact habitats (as evidenced by occupancy and moderate production) for the smaller Dependent Populations would further distribute benefits and provide additional insurance for the ESU. The role of small populations in the ESU is not well understood, but was discussed under the Small Populations Criterion, ED-3 (page 76).

Populations that were historically dependent on other populations for long-term persistence are, nonetheless, important to the health of the ESU. These smaller populations are likely to experience periodic local extinctions and be maintained, at times, by the immigration of spawners from other, usually independent, populations. They play a role in genetic diversity and may be sources of novel adaptations that can more easily arise in small populations, and then find their way into the larger ones, facilitating more rapid adaptation to changing conditions. While it is difficult to set conservation standards for these populations, effort should be directed toward ensuring that most of the existing systems with the potential to support such small populations (see Lawson et al. 2007) are accessible to fish, and that habitat in these systems is relatively intact.

Because basins that support Dependent Populations, by definition, have limited habitat, even small amounts of habitat loss can seriously affect their ability to support coho salmon; therefore it is important to retain an adequate quantity and variety of habitat, including spawning, summer rearing, and winter rearing areas. Habitat loss could be expressed as the proportion of historical habitat, stratified by spawning and rearing, that is currently available. A baseline assessment of productivity, as expressed by smolts per spawner, could be used to confirm habitat assessments.

Simple presence or absence of fish has limited usefulness as a criterion for assessing the health of Dependent Populations because periodic extinction and recolonization events are expected. Smaller systems will likely experience more frequent extinctions, while larger basins should be populated a greater proportion of the time (see Figure 28). While the number of occupied systems is expected to vary, a downward trend in occupancy would be a concern. Such trends could be identified over time through the use of periodic, comprehensive, rapid bioassessment (RBA) surveys. Interpretation of survey results must account for periodic variations in marine survival conditions.

### **Summary—Restoration**

ESU restoration (or broad-sense recovery) is a process leading to conditions such that the populations of naturally produced fish that make up the Oregon Coast Coho Salmon ESU are sufficiently abundant, productive, and diverse (in terms of life histories and geographic distribution) that the ESU as a whole is self-sustaining and will provide environmental, cultural, and economic benefits.

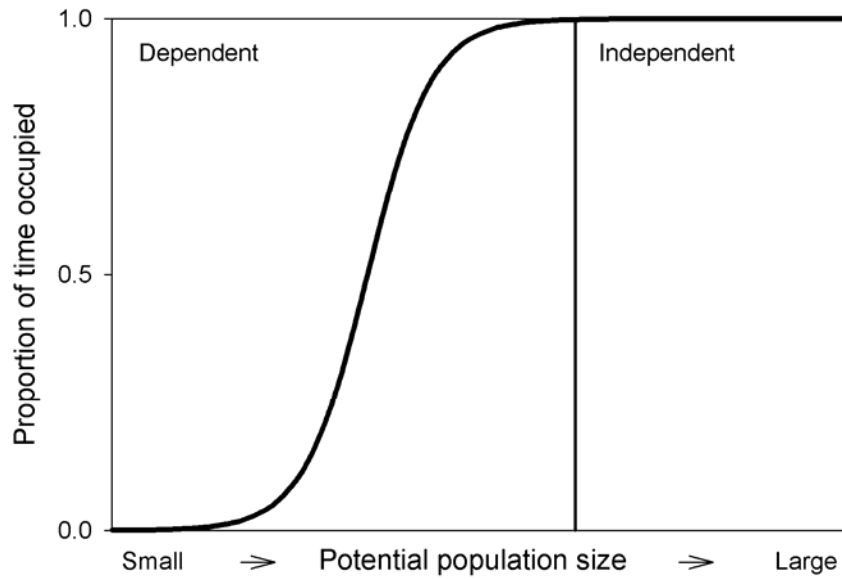

Figure 28. Conceptual illustration of the proportion of time a system is occupied as a function of the potential size of the population in that system. Larger systems are expected to be occupied for a greater proportion of the time.

Because these goals are fundamentally different from those for persistence and sustainability in having a substantial sociopolitical component beyond the scope of this report, specific criteria have not been defined. Rather, general ecosystem considerations have been discussed as background for restoration, and a few types of criteria have been outlined to measure progress toward restoration goals.



# Conclusions

The workgroup developed and applied a means to evaluate the current biological status of the Oregon Coast Coho Salmon ESU that is intended for use in the recovery planning process. The biological recovery criteria are organized into two coherent logical frameworks to evaluate persistence and sustainability. In addition to developing criteria to evaluate persistence and sustainability of the ESU, the workgroup also offers general guidelines regarding ESU restoration (or broad-sense recovery).

Uncertainty within the logical structure of the ESU Persistence and ESU Sustainability criteria is accommodated through a knowledge-based DSS. This use reflects both the uncertainty about “true” parameters and errors of measurement. The results of this assessment are expressed as the degree of confidence that two overall statements regarding the status of the ESU are true: 1) the ESU is persistent, and 2) the ESU is sustainable.

The logical networks and associated data within the DSS are designed to contribute to the decision-making processes associated with both federal recovery planning and Oregon State conservation planning. It was the intention of the workgroup to honor the multiple mandates of both federal and state requirements in developing the biological recovery criteria. One requirement of recovery planning is setting objective, measurable criteria for delisting. Toward this end, the ESU Persistence and ESU Sustainability criteria provide a means to assess biological conditions related to listing status under the ESA. This evaluation does not consider other factors, including conservation measures and expectations about future conditions, that factor into the ESA definition of threatened status. Incorporating such factors requires policy decisions not reflected in this analysis. Thus the criteria presented here provide only a partial assessment of status under the ESA.

The workgroup has applied the DSS using available data, models, and best professional judgment to evaluate the current status of the ESU for two main goals: persistence and sustainability.

## Persistence

The DSS framework includes criteria for Population Productivity, Probability of Persistence, and Critical Abundance. The workgroup used recent observations of these population metrics to evaluate how certain it is that the Oregon Coast Coho Salmon ESU is persistent under recent conditions. The results of the analysis lead the workgroup to conclude that, if recent past conditions continue into the future, it is moderately to highly certain (truth value +0.40) that the ESU is persistent; that is, it is able to persist over a 100-year period without artificial support. This means that, if recent habitat conditions, climate patterns, and management policies continue into the future, there is moderate to high certainty that the ESU and most of its constituent biogeographic strata and Independent Populations will persist for 100 years. The weakest strata in this assessment were the North Coast and Mid-Coast, which had

only low certainty of being persistent. The strongest strata were the Lakes and Mid-South Coast, which had high certainty of being persistent. To increase certainty that the ESU as a whole is persistent, restoration work should focus on those populations with low persistence, particularly those in the North Coast, Mid-Coast, and Umpqua strata.

## **Sustainability**

A sustainable ESU is 1) able to survive prolonged periods of adverse climatic conditions without artificial support, and 2) able to maintain its genetic legacy and long-term adaptive potential. Additionally, a sustainable ESU is composed of diverse interconnected populations. To evaluate population diversity, the workgroup constructed a framework using objective measures of spawner abundance, artificial influence, spawner and juvenile distribution, and habitat capacity. We also evaluated ESU-wide diversity by assessing genetic diversity, phenotypic and habitat diversity, and the status of small populations. The results of the analysis lead us to the conclusion that, if recent conditions continue into the future, there is low to moderate certainty (truth value +0.19) that the ESU is sustainable; that is, it is able to maintain its genetic legacy and long-term adaptive potential for the foreseeable future. This conclusion assumes that present and recent past habitat conditions, climate patterns, and management policies reflected in the data sets used by the workgroup will continue for the foreseeable future; no attempt was made to evaluate the effects of potential future changes in environmental conditions or conservation measures.

The conclusion that there is low to moderate certainty that the ESU is sustainable can be interpreted further. This means the ESU may be sustainable if strong ecosystem, harvest, and hatchery protections are in place. Many Independent Populations, and all but one of the biogeographic strata, have moderate to high certainty of being sustainable, but many other Independent Populations have obvious problems for some criteria. On the positive side, the Lakes and Mid-South Coast strata have high certainty of being sustainable, with most of their constituent Independent Populations having high certainty of being sustainable. On the downside, the North Coast stratum has low certainty of Sustainability, with two Independent Populations having low certainty of being sustainable, and two having low certainty of being unsustainable.

An ESU at this level has good opportunities for recovery, but is also vulnerable to harvest and ecosystem alteration and destruction. Strong protections are needed to ensure that the status of populations and strata in moderate to good condition does not degrade, because the lower the status gets the more difficult and expensive it is to bring it back up. Overall ESU status can best be improved by focusing restoration efforts on those populations that scored low on sustainability, particularly those in the North and Mid-Coast strata. There should be opportunities for limited harvest during high productivity periods, and hatchery programs should be strictly managed to prevent risks to naturally produced fish.

## **Restoration**

In addition to these analyses of persistence and sustainability, an outline has been presented for developing criteria for restoration (or broad-sense recovery), including suggestions for three types of criteria: ESU abundance, sustainable Independent Populations, and productive

Dependent Populations. Metrics for these criteria depend on social, economic, and political considerations as well as biological requirements, so full metrics have not been developed at this time.

## **Limitations**

The persistence and sustainability analyses deal only with current or recent conditions without addressing future conditions, threats, or limiting factors. This approach provides a systematic method for evaluating the current status of the Oregon Coast Coho Salmon ESU as part of a recovery or conservation plan, but is not sufficient to determine the ESA listing status of the ESU. For ESA evaluations, it is important to address not only present status, but also factors for decline, threats, and probable trends in land use patterns, harvest and hatchery management practices, and climate. These factors will play pivotal roles in the future sustainability of this ESU. Assessing these factors requires policy-level analysis of social and economic issues, as well as a projection of climate trends, and is beyond the scope of this report.

Within the limited context of current and recent conditions, this assessment may be biased by including some threats that have been largely addressed and are not expected to continue into the future. These include intense fishing pressures and negative hatchery impacts that have been substantially reduced. Some of the measures of persistence and sustainability include data collected before these factors for decline had been addressed, and therefore may have a pessimistic bias. However, the assessment reflects current (data through 2004) levels of other threats (such as poor freshwater habitat conditions) that have not been fully addressed and can be expected to continue into the future. Thus the conclusions are limited to the conditions considered by the workgroup, and the status of the ESU hinges on future conditions that have not been addressed.



# Glossary

**abundance.** The number of fish in a population.

**AIC.** For *Akaike Information Criterion*. A statistical criterion for selecting among models of different complexity, based on the difference between the number of parameters in the model and the goodness of fit to a particular data set.

**allele.** Any one of a number of alternative forms of a gene that can occur at the same location (locus) on a chromosome. A population can have many alleles for a particular locus. See also DNA, heterozygosity, and mutation.

**allozyme.** One of several alternative forms of an enzyme that have the same function, but are produced by different genetic alleles.

**arithmetic mean.** The average of a set of values, calculated as the sum of the values divided by the number of values in the set.

**artificial propagation.** Hatchery spawning and rearing of salmon, usually to the smolt stage.

**AUC.** For *area under the curve*. A statistical technique for estimating an annual total number of spawners from periodic spawner counts.

**Bayesian analysis (or Bayesian estimation).** A branch of statistics concerned with estimating parameters for models from multiple sources of information. Bayesian analysis divides information into two classes: prior information that is known before considering a new set of observations, and posterior information that incorporates both the prior information and the new information contained in the new observations.

**best professional judgment.** A process of analyzing a problem by utilizing an expert or expert panel to use collective experience in relation to the problem.

**biogeographical strata.** Groups of populations with genetic, ecological, and geographical similarities.

**Boolean logic.** A system of logic that allows organizing things in sets using AND, OR, UNION, and other operators. Any item is either fully a member of a particular set or not at all a member of that set. In this type of logic, statements are typically described as true or false.

**bootstrapping.** A statistical method for estimating the variability of a parameter for a population where a small sample is repeatedly resampled and analyzed. This allows for statistical analysis using a relatively small sample compared to analysis on a traditional single sample from the population.

**carrying capacity.** The number of individuals that the resources of a habitat can support.

**catastrophic events.** Sudden events that disastrously alter large areas of landscape. These can include floods, landslides, forest fires, and volcanic eruptions.

**CV.** For *coefficient of variation*. In describing variation in a population, the standard deviation is expressed as a fraction of the mean.

**compensation.** A decrease in productivity with increasing abundance, which results in an approach to some maximum level of production.

**compensatory smolt production curve.** A decrease in smolt productivity with increasing abundance, which results in an approach to some maximum level of production.

**DSS.** For *decision support system*. A computer application that assists users in using data and models to solve problems (Scott Morton 1971). Typically, decision support systems are computer programs that analyze many pieces of data or models, producing results that aid in decision making rather than replacing human judgment (Turban and Aronson 2001).

**delisting (or narrow-sense recovery).** A process resulting in the ESU being removed from the formal protections of the ESA as a consequence of no longer being endangered nor likely to become endangered within the foreseeable future in a significant portion of its range.

**demographic.** Pertaining to the processes of birth, development, growth, and mortality that control the dynamics of populations.

**demographic stochasticity.** “Chance events in the survival and reproductive success of a finite number of individuals” (Shaffer 1981).

**dendrogram.** A branching diagram, sometimes resembling a tree, that provides one way of visualizing similarities between different groups or samples.

**Dependent Populations.** Populations that rely upon immigration from surrounding populations to persist. Without these inputs, Dependent Populations would have a lower likelihood of persisting over 100 years (Lawson et al. 2007).

**depensation.** The effect where a decrease in spawning stock leads to reduced survival or production of eggs through either 1) increased predation per egg given constant predator pressure, or 2) the “Allee effect” (the positive relationship between population density and the reproduction and survival of individuals) with reduced likelihood of finding a mate.

**DNA.** For *deoxyribonucleic acid*. A complex molecule that carries an organism’s heritable information.

**effective population size.** The size of an idealized (panmictic) population that would have the same rate of loss of heterozygosity as the real (nonpanmictic) population.

**endangered species.** In the context of the ESA, any species which is in danger of extinction throughout all or a significant portion of its range.

**ESA.** For U.S. *Endangered Species Act* of 1973.

**escapement.** Usually refers to adult fish that “escape” from fisheries and natural mortality to reach the spawning grounds.

**estuarine habitat.** Areas available for feeding, rearing, and smolting in tidally influenced lower reaches of rivers. These include marshes, sloughs and other backwater areas, tidal swamps, and tide channels.

**ESU.** For *evolutionarily significant unit*. An ESU represents a distinct population segment of Pacific salmon under the ESA that 1) is substantially reproductively isolated from conspecific populations, and 2) represents an important component of the evolutionary legacy of the species.

**exploitation rate.** The proportion of adult fish in a population that die as a result of fisheries.

**extinction.** The loss of a species or ESU. May also be used for the extirpation of local populations.

**extinction risk.** The probability of a species going extinct within a particular time period.

**factors for decline.** These are factors identified that cause a species to decrease in abundance and distribution and become threatened or endangered.

**fecundity.** The number of offspring produced per female.

**fishery mortality rate.** The number of fish that die when intercepted by a fishery in relation to the number of fish as a whole.

**freshwater habitat.** Areas available for spawning, feeding, and rearing in freshwater.

**fry.** Young salmon that have emerged from the gravel and no longer have an egg sack.

**fully seeded.** Having enough spawners to fully occupy available juvenile habitat with offspring.

**fuzzy logic.** A type of logical analysis that allows a system to use imprecise information in evaluating conditions (Zadeh 1965, Reynolds et al. 2000). It is discussed in Appendix A and referred to as “approximate logic” in the body of this technical memorandum.

**gamma distribution.** A continuous probability distribution usually used to describe the amount of time until the nth occurrence of a process with a Poisson distribution.

**genetic drift.** Random changes in gene frequencies of populations.

**genetic stochasticity.** Random changes in the genetic makeup of populations.

**geometric mean.** A measure of central tendency similar to the arithmetic mean, except that the computation uses multiplication instead of addition to summarize data values. It is a useful statistic for summarizing highly skewed data values. For two numbers the geometric mean equals the square root of the product of the two numbers, i.e.  $(x_1x_2)^{-0.5}$ .

**habitat quality.** The suitability of physical and biological features of an aquatic system to support salmon in the freshwater and estuarine system.

**harmonic mean.** The harmonic mean is another way of calculating an average. It is the reciprocal of the arithmetic mean of reciprocals of the data. For  $n$  numbers  $x_1, x_2, \dots, x_n$ , the harmonic mean equals  $n/(1/x_1 + 1/x_2 + \dots + 1/x_n)$ .

**hatchery.** A facility for the artificial propagation of fish. Salmon hatcheries typically spawn adults in captivity and raise the progeny in fresh water for release into the natural environment.

**hatchery fish.** Fish incubated or reared under artificial conditions for at least a portion of their life cycle (ODFW 2003).

**heterozygosity.** The variation in alleles at the same locus on a chromosome. Loss of heterozygosity in populations could be damaging to the ability of a population to adapt to changes in the environment.

**historical abundance.** The number of fish that were produced before the influence of Western settlement.

**HUCs.** For *hydrologic unit codes*. “The United States is divided and subdivided into successively smaller hydrologic units which are classified into four levels: regions, subregions, accounting units, and cataloging units. Hydrologic units are arranged within each other, from the smallest (cataloging units) to the largest (regions). Each hydrologic unit is identified by a unique hydrologic unit code (HUC) consisting of two to eight digits based on the four levels of classification in the hydrologic unit system” (online at <http://water.usgs.gov/GIS/huc.html>).

**immigration.** The movement of individuals into a population that they were not born into.

**inbreeding depression.** Reduced survival rates of individuals in a population suffering from the effects of harmful recessive genes through matings between close relatives. Inbreeding depression may become a problem when populations become very small.

**Independent Population.** A population that historically would have a high likelihood of persisting in isolation from neighboring populations for 100 years (Lawson et al. 2007).

**intrinsic growth rate.** The growth rate of a population in the absence of compensation.

**intrinsic productivity.** Productivity of a population in the absence of compensation, estimated as the mathematical limit of population productivity as abundance approaches zero.

**introgression.** Introduction of genes from one population or species into another.

**isolation.** Being unaffected by migration to and from other populations.

**jack.** A male coho salmon that matures at age two and returns from the ocean to spawn one or more years before full-sized adults return. For coho salmon in California, Oregon, Washington, and southern British Columbia, jacks are 2-years-old, having spent 6 months in the ocean, in contrast to adults, which are 3-years-old after spending 1½ years at sea.

**juvenile.** A fish that has not matured sexually.

**juvenile capacity.** The capacity of habitat to provide conditions for rearing for nonadult fish that have not smolted and subsequently migrated to sea.

**life history.** The specific life cycle of a fish from egg to adult.



**limiting factors.** Factors that limit survival or abundance. They are usually related to habitat quantity or quality at different stages of the life cycle. Harvest and predation may also be limiting factors.

**marine survival rate.** The proportion of smolts entering the ocean that survive to be harvested or return to freshwater.

**mean.** One of several methods of calculating an average, usually referring to an arithmetic mean.

**metric.** A clearly defined measurement of some quantity or quality.

**migration.** Movement of fish from one population to another.

**migration rate.** The proportion of spawners that migrate from one population to another.

**Monte Carlo simulation.** A method for solving a statistical problem by generating suitable pseudorandom numbers and observing that fraction of the numbers obeying some property or properties.

**mutation.** A change in an allele at a locus. This can happen through random events or exposure to chemicals and radiation.

**NRR.** For *natural return ratio*. The ratio  $N/T$ , where N is naturally produced spawners in one generation and T is total (hatchery produced + naturally produced) spawners in the previous generation.

**naturally produced fish.** Fish that were spawned and reared in natural habitats, regardless of parental origin (see also **wild fish**).

**OCN coho.** For *Oregon Coast naturally produced coho* salmon.

**ODFW.** For *Oregon Department of Fish and Wildlife*.

**ONCC TRT.** For *Oregon and Northern California Coasts Technical Recovery Team*.

**Oregon Plan.** “In 1997, with the support and participation of a wide spectrum of stakeholders from all sectors and regions of the state, the Oregon Legislature and governor established the Oregon Plan for Salmon and Watersheds. Motivated at first by the conviction that Oregon must devise its own response to listings of coho salmon and other salmon species under the federal Endangered Species Act, the plan quickly evolved and expanded into an unprecedented statewide program to preserve and profit from Oregon’s natural legacy” (online at <http://www.oregon-plan.org>).

**OPI.** For *Oregon Production Index*. An estimate of coho salmon adult abundance for the marine area extending from Leadbetter Point, Washington, to the U.S.-Mexico border.

**OWEB.** For *Oregon Watershed Enhancement Board*.

**parr.** The life stage of salmonids that occurs after fry and is generally recognizable by dark vertical bars (parr marks) on the sides of the fish.

**persistent population** (also referred to as **ESU**). One that is able to persist (i.e., not go extinct) over a 100-year period without artificial support. This includes an ability to survive prolonged periods of adverse environmental conditions, which may be expected to occur at least once in the 100-year time frame.

**phenotypic diversity.** Variation in the set of observable characteristics of an individual or group as determined by the genotype and the environment.

**phenotypic plasticity.** The ability to vary the set of observable characteristics of an individual or group as determined by the genotype and the environment generally in response to environmental change.

**Poisson distribution.** A discrete statistical probability distribution, expressing the probability of a number of independent events occurring in a fixed interval of time or region of space.

**population.** A group of fish of the same species that spawns in a particular locality at a particular season and does not interbreed substantially with fish from any other group.

**population dynamics.** Changes in the number, age, and sex of individuals in a population over time, and the factors that influence those changes. Five components of populations that are the basis of population dynamics are birth, death, sex ratio, age structure, and dispersal.

**population structure.** The distribution of characteristics (such as age, size, or physiological state) of individuals within a population.

**PVA.** For *population viability analysis*. “[A] set of analytical and modeling approaches for assessing the risk of extinction. Life history, demography, and genetics of a species are integrated with environmental variability to project the future course of populations” (Beissinger and McCullough 2002, p. xiv).

**posterior distribution.** The statistical distribution of a parameter (or set of parameters) that is obtained by combining the prior distribution with information resulting from a new set of observations (see **Bayesian analysis**).

**prior distribution.** The statistical distribution of a parameter (or set of parameters) that is known before incorporating a new set of observations (see **Bayesian analysis**).

**production.** The number of fish produced by a population in a year.

**productivity.** The rate at which a population is able to produce reproductive offspring.

**QET.** For *quasi-extinction threshold*. A threshold representing the minimum allowable population abundance in population viability modeling, below which the population is assumed to be essentially extinct. It is defined primarily for convenience and may be based on a number of considerations including Allee effects and uncertainties in population functional response at very low abundance.

**reach.** A segment of a stream with uniform physical characteristics.

**recovery.** A general term for the reestablishment or restoration of populations at risk. Here, it is used in two senses: a “narrow sense” as defined in the ESA (see **delisting**), and a “broad sense” to include efforts that extend beyond the requirements of the ESA (see **restoration**).

**recovery domain.** The geographic area for which a technical recovery team is responsible.

**recovery plan.** Under the ESA, a document identifying actions needed to improve the status of a species or ESU to the point that it no longer requires protection.

**recruit.** A preharvest maturing adult salmon, that is, an adult in the ocean that would be expected to return to spawn in freshwater if it is not harvested.

**recruitment.** 1) The number of recruits during a given year or generation. Typically estimated as the number of adults that return to spawn divided by the total fishery escapement rate (one minus the total harvest rate). 2) The number of recruits in one generation per spawner in the previous generation (also “recruitment rate”).

**restoration (or broad-sense recovery).** A process leading to conditions such that the populations of naturally produced fish that make up the Oregon Coast Coho Salmon ESU are sufficiently abundant, productive, and diverse (in terms of life histories and biogeographic distribution) that the ESU as a whole: 1) will be self-sustaining, and 2) will provide environmental, cultural, and economic benefits (modified from Oregon SRTF, OSL 2002b).

**run timing.** The time of year (usually identified by week) when spawning salmon return to the spawning beds.

**salmonid.** Any of the species of fish in the family Salmonidae, including salmon, trout, and char.

**selection.** An evolutionary process that drives adaptation to environmental change through differential reproductive success of organisms that have variability in their genetic makeup.

**smolt.** A life stage of salmon that occurs just before the fish leaves freshwater. Smolting is the physiological process that allows salmon to make the transition from freshwater to salt water.

**smolt capacity.** The maximum number of smolts a basin can produce. Smolt capacity is related to habitat quantity and quality.

**spawner.** A reproductive adult fish.

**spawner surveys.** Efforts to estimate the number of adult fish on spawning grounds. Spawner surveys utilize counts of redds and fish carcasses to estimate spawner escapement and identify spawning habitat. Annual surveys can be used to compare the relative magnitude of spawning activity between years.

**spawner-to-spawner ratio.** A measure of the productivity of salmon populations, based on the ratio of the number of spawners in one generation to the number of spawners in the previous generation. A spawner-to-spawner ratio of 1.0 indicates that, on average, each spawner produced one offspring that survived to spawn.

**species.** In the ESA, either a recognized biological species, or any recognized subspecies, or (for vertebrate fish or wildlife) any distinct population segment which interbreeds when mature. By NOAA policy, the last definition includes ESUs of salmon.

**STEP.** For *Salmon and Trout Enhancement Program* of the Oregon Department of Fish and Wildlife.

**stochastic.** Influenced by random variation.

**SRS.** For *stratified random survey*. A statistical design used to sample subgroups more effectively with fewer samples needed than if the entire population was randomly sampled.

**stray rate.** The proportion of spawning adults that return to a stream other than their natal stream within a basin. (See also *Migration rate*.)

**stream-estuary ecotone.** The area where the physical characteristics of a stream change to the physical characteristics of an estuary. This is where water becomes brackish, there is mixing of stream and estuary nutrients, and the physical attributes are affected by tides and ocean water influences. This tends to be a very productive area due to phosphorus and nitrogen inputs from both oceanic and upland influences.

**Student's *t*-test.** A statistical test for the significance of the difference between a sample mean and a specified criterion.

**sustainable population (or ESU).** One that, in addition to being persistent, is also able to maintain its genetic legacy and long-term adaptive potential for the foreseeable future. "Sustainable" implies stability of habitat availability and other conditions necessary for the full expression of the population's (or ESU's) life history diversity into the foreseeable future.

**threatened species.** Under the ESA, any species which is likely to become an endangered species within the foreseeable future throughout all or a significant portion of its range.

**TRT.** For *technical recovery team*.

**upwelling.** The upward transport of cold, nutrient-rich water to the surface; conditions that favor the survival and growth of salmon and other fish species. Upwelling along the Oregon Coast occurs in spring and summer, driven by winds from the Northwest.

**variance.** A statistical measure of how spread out a distribution is. For example, a small variance would mean that the observations were similar to each other, while a large variance would mean that observations were less similar to each other.

**viability.** The likelihood that a population will sustain itself over a 100-year time frame.

**viability criteria.** A prescription of the biological conditions for populations, biogeographic strata, and ESUs that together imply that the ESU will have a negligible risk of extinction over a 100-year time frame.

**wild fish.** Fish whose ancestors have always lived in natural habitats, i.e., those with no hatchery heritage (see also **naturally produced fish**).

## References

- Adamus, P. 2006. Hydrogeomorphic (HGM) assessment guidebook for tidal wetlands of the Oregon Coast, Part 1: Rapid assessment method. Produced for the Coos Watershed Association, Oregon Dept. State Lands, and U.S. EPA Region 10. Charleston, OR. Online at [http://www.oregon.gov/DSL/WETLAND/docs/tidal\\_HGM\\_pt1.pdf](http://www.oregon.gov/DSL/WETLAND/docs/tidal_HGM_pt1.pdf) [accessed 28 February 2008].
- Allendorf, F. W., and N. Ryman. 2002. The role of genetics in PVA. *In* S. R. Beissinger and D. R. McCullough (eds.), *Population viability analysis*, p. 50–85. University of Chicago Press, Chicago.
- Allendorf, F. W., D. Bayles, D. L. Bottom, K. P. Currens, C. A. Frissell, D. Hankin, J. A. Lichatowich, W. Nehlsen, P. C. Trotter, and T. H. Williams. 1997. Prioritizing Pacific salmon stocks for conservation. *Conserv. Biol.* 11(1):140–152.
- OSL (Oregon State Legislature). 2002a. Joint interim task force on salmon recovery: Summary of the scientific workshop on measurable salmonid recovery criteria. Oregon State Legislature, Salem. Online at [http://www.leg.state.or.us/comm/commsrvs/jt\\_salmon/](http://www.leg.state.or.us/comm/commsrvs/jt_salmon/) [accessed 28 February 2008].
- OSL (Oregon State Legislature). 2002b. Summary of the task force on salmon recovery to the Joint Interim Committee on Natural Resources, 10 December 2002. Oregon State Legislature, Salem. Online at [http://www.leg.state.or.us/comm/commsrvs/jt\\_salmon/final\\_summary\\_12\\_9.pdf](http://www.leg.state.or.us/comm/commsrvs/jt_salmon/final_summary_12_9.pdf) [accessed 28 February 2008].
- Araki, H., W. R. Ardren, E. Olsen, B. Cooper, and M. S. Blouin. 2007. Reproductive success of captive-bred steelhead trout in the wild: Evaluation of three hatchery programs in the Hood River. *Conserv. Biol.* 21:181–190.
- Barrowman, N. J. 2000. Nonlinear mixed effects models for meta-analysis. Doctoral thesis. Dalhousie University, Halifax, NS.
- Barrowman, N. J., and R. A. Myers. 2000. Still more spawner-recruitment curves: The hockey stick and its generalizations. *Can. J. Fish. Aquat. Sci.* 57:665–676.
- Barrowman, N. J., R. A. Myers, R. Hilborn, D. G. Kehler, and C. A. Field. 2003. The variability among populations of coho salmon in the maximum reproductive rate and depensation. *Ecol. Appl.* 13:784–793.
- Beidler, W. M., T. E. Nickelson, and A. M. McGie. 1980. Escapement goals for coho salmon in coastal Oregon streams. *Info. Rep.* 80–10. Oregon Dept. Fish and Wildlife, Portland.
- Beissinger, S. R., and D. R. McCullough. 2002. *Population viability analysis*. University of Chicago Press, Chicago.
- Berejikian, B. A., and M. J. Ford. 2004. Review of relative fitness of hatchery and natural salmon. U.S. Dept. Commer., NOAA Tech. Memo. NMFS-NWFSC-61.
- Bettinger, P., M. Lennette, K. N. Johnson, and T. A. Spies. 2005. A hierarchical spatial framework for forest landscape planning. *Ecol. Model.* 182:25–48.

- Beverton, R. J. H., and S. J. Holt. 1957. On the dynamics of exploited fish populations. Fishery Investigations (Series II) 19. U.K. Ministry of Agriculture, Fisheries, and Food, London.
- Bilby, R. E., B. R. Fransen, J. K. Walter, C. J. Cederholm, and W. J. Scarlett. 2001. Preliminary evaluation of the use of nitrogen stable isotope ratios to establish escapement levels for Pacific salmon. *Fisheries* 26(1):6–14.
- Bilby, R. E., P. A. Bisson, C. C. Coutant, D. Goodman, S. Hanna, N. Huntly, E. J. Loudenslager, L. McDonald, D. P. Philipp, B. Riddell, J. Olsen, and R. Williams. 2005. Viability of ESUs containing multiple types of populations. Independent Scientific Advisory Board for the Northwest Power and Conservation Council, ISAB Report 2005-2. Online at <http://www.nwcouncil.org/library/isab/isab2005-2.htm> [accessed 28 February 2008].
- Bisson, P. A., D. Phillip, B. Riddell, C. C. Coutant, D. Goodman, R. Gramling, D. Lettenmaier, J. Lichatowich, W. Liss, E. Loudenslager, and L. McDonald. 2002. Hatchery surpluses in the Pacific Northwest. *Fisheries* 27:16–27.
- Bisson, P. A., T. P. Quinn, G. H. Reeves, and S. V. Gregory. 1992. Best management practices, cumulative effects, and long-term trends in fish abundance in Pacific Northwest river systems. *In* R. J. Naiman (ed.), *Watershed management: Balancing sustainability and environmental change*, p. 189–232. Springer-Verlag, New York.
- Bisson, P. A., G. H. Reeves, R. E. Bilby, and R. J. Naiman. 1997. Watershed management and Pacific Salmon: Desired future conditions. *In* D. J. Stouder, P. A. Bisson, and R. J. Naiman (eds.), *Pacific salmon and their ecosystems: Status and future options*, p. 447–474. Chapman and Hall, New York.
- Borgerson, L. A. 1999. Scale Analysis. Annual Progress Report F144-R-09. Oregon Dept. Fish and Wildlife, Portland. Online at <http://oregonstate.edu/Dept/ODFW/progress-reports/98scale.pdf> [accessed 28 February 2008].
- Botkin, D., K. Cummins, T. Dunne, H. Reiger, M. Sobel, and L. Talbot. 1995. Status and future of salmon of western Oregon and northern California: Findings and options. The Center for the Study of the Environment, Santa Barbara, CA. Online at <http://www.naturestudy.org> [accessed 28 February 2008].
- Bradford, M. J., R. A. Myers, and J. R. Irvine. 2000. Reference points for coho salmon (*Oncorhynchus kisutch*) harvest rates and escapement goals based on freshwater production. *Can. J. Fish. Aquat. Sci.* 57:677–686.
- Brook, B. W., J. J. O'Grady, A. P. Chapman, M. A. Burgman, H. R. Akçakaya, and R. Frankham. 2000. Predictive accuracy of population viability analysis in conservation biology. *Nature* 404:385–387.
- Brook, B. W., M. A. Burgman, H. R. Akçakaya, J. J. O'Grady, and R. Frankham. 2002. Critiques of PVA ask the wrong questions: Throwing the heuristic baby out with the numerical bath water. *Conserv. Biol.* 16(1):262–263.
- Burgman, M. A., S. Ferson, and H. R. Akçakaya. 1993. Risk assessment in conservation biology. Chapman and Hall, London.
- Burnett, K. M., G. H. Reeves, D. J. Miller, S. Clarke, K. Vance-Borland, and K. Christiansen. 2007. Distribution of salmon-habitat potential relative to landscape characteristics and implications for conservation. *Ecol. Appl.* 17(1):66–80.

- Caputi, N. 1988. Factors affecting the time series bias in stock-recruitment relationships and the interaction between time series and measurement error bias. *Can. J. Fish. Aquat. Sci.* 45:178–184.
- Chilcote, M. W. 2003. Relationship between natural productivity and the frequency of wild fish in mixed spawning populations of wild and hatchery steelhead. *Can. J. Fish. Aquat. Sci.* 60:1057–1067.
- Chilcote, M. W., S. A. Leider, and J. J. Loch. 1986. Differential reproductive success of hatchery and wild summer-run steelhead under natural conditions. *Trans. Am. Fish. Soc.* 115:726–735.
- Chilcote, M., T. Nickelson, and K. Moore. 2005. Oregon coastal coho assessment. Part 2: Viability criteria and status assessment of Oregon coastal coho. Oregon Dept. Fish and Wildlife, Portland. Online at <http://www.dfw.state.or.us/fish/ONFSR/final/Vol%20II%20References.pdf> [accessed 11 March 2008].
- Coulson, T., G. M. Mace, E. Hudson, and H. Possingham. 2001. The use and abuse of population viability analysis. *Trends Ecol. Evol.* 16:219–221.
- Dennis, B. 1989. Allee effects: Population growth, critical density, and the chance of extinction. *Nat. Resource Model.* 3(4):481–538.
- Efron, B., and R. J. Tibshirani. 1993. An introduction to the bootstrap: Monographs on statistics and applied probability, No. 57. Chapman and Hall, London.
- Einum, S., and I. A. Fleming. 2001. Implications of stocking: Ecological interactions between wild and released salmonids. *Nordic J. Freshwat. Res.* 75:56–70.
- (ESRI) Environmental Systems Research Institute. 2005. ArcGIS Desktop software. ESRI, Redlands, CA.
- FEMAT (Forest Ecosystem Management Assessment Team). 1993. Forest ecosystem management: An ecological, economic, and social assessment. U.S. Forest Service, U.S. Fish and Wildlife Service, National Park Service, National Marine Fisheries Service, Bureau of Land Management, and Environmental Protection Agency. No. 793-071, IX-24. U.S. Government Printing Office, Washington, DC.
- Fleming, I. A., and M. R. Gross. 1993. Breeding success of hatchery and wild coho salmon (*Oncorhynchus kisutch*) in competition. *Ecol. Appl.* 3:230–245.
- Fleming, I. A., and I. Petersson. 2001. The ability of released hatchery salmonids to breed and contribute to the natural productivity of wild populations. *Nordic J. Freshwat. Res.* 75:71–98.
- Flitcroft, R. L., K. K. Jones, K. E. M. Reis, and B. A. Thom. 2002. Year 2000 stream habitat conditions in western Oregon. Monitoring Program Report OPSW-ODFW-2001-05. Oregon Dept. Fish and Wildlife, Portland.
- Ford, M. J., D. Teel, D. M. Van Doornik, D. Kuligowski, and P. W. Lawson. 2004. Genetic population structure of central Oregon Coast coho salmon. *Conserv. Genet.* 5:797–812.
- Franklin, I. R., and R. Frankham. 1998. How large must populations be to retain evolutionary potential? *Anim. Conserv.* 1:69–34.

- Frissell, C. A. 1997. Ecological principles. *In* J. E. Williams, C. A. Wood, and M. P. Dombeck (eds.), *Watershed restoration: Principles and practices*, p. 96–115. American Fisheries Society, Bethesda, MD.
- Gabriel, W., and R. Bürger. 1992. Survival of small populations under demographic stochasticity. *Theor. Popul. Biol.* 41:71.
- Geiger, H. J., W. W. Smoker, L. A. Zhivotovsky, and A. J. Gharrett. 1997. Variability of family size and marine survival in pink salmon (*Oncorhynchus gorbuscha*) has implications for conservation biology and human use. *Can. J. Fish. Aquat. Sci.* 54:2684–2690.
- Gelman, A., J. B. Carlin, H. S. Stern, and D. B. Rubin. 1995. *Bayesian data analysis*. Chapman and Hall, London.
- Ginzburg, L. R., L. B. Slobodkin, K. Johnson, and A. G. Bindman. 1982. Quasi-extinction probabilities as a measure of impacts on population growth. *Risk Anal.* 2:171–181.
- Halupka, K. C., M. D. Bryant, M. F. Willson, and F. E. Everest. 2000. Biological characteristics and population status of anadromous salmon in southeast Alaska. Gen. Tech. Rep. PNW-468. U.S. Forest Service, Pacific Northwest Research Station, Portland, OR.
- Harrison, S. 1994. Metapopulations and conservation. *In* P. J. Edwards, R. M. May, and N. R. Webb (eds.), *Large scale ecology and conservation biology*, p. 111–128. Blackwell Scientific Publications, Oxford, UK.
- Hartl, D. L. 2000. *A primer of population genetics*. 3rd edition. Sinauer Associates, Sunderland, MA.
- Hastings, A., and L. W. Botsford. 2006. Persistence of spatial populations depends on returning home. *Proc. Natl. Acad. Sci. USA.* 103:6067–6072.
- Healey, M. C., and A. Prince. 1995. Scales of variation in life history tactics of Pacific salmon and the conservation of phenotype and genotype. *In* J. L. Nielsen (ed.), *Evolution and the aquatic ecosystem: Defining unique units in population conservation*, p. 176–184. *Am. Fish. Soc. Symp.* 17, Bethesda, MD.
- Hilborn, R. J. 1985. Apparent stock recruitment relationships in mixed stock fisheries. *Can. J. Fish. Aquat. Sci.* 42:718–723.
- Hilborn, R. J., T. P. Quinn, D. E. Schindler, and D. E. Rogers. 2003. Biocomplexity and fisheries sustainability. *Proc. Natl. Acad. Sci. USA.* 100:6564–6568.
- Holling, C. S. 1973. Resilience and stability of ecological systems. *Ann. Rev. Ecol. Syst.* 4:1–23.
- Huff, M. H., and C. M. Raley. 1991. Regional patterns of diurnal breeding bird communities in Oregon and Washington. *In* L. F. Ruggiero, K. B. Aubry, A. B. Carey, and M. H. Huff (tech. coordinators), *Wildlife and vegetation of unmanaged Douglas fir forests*, p. 177–206. General Tech. Rep. PNW-GTR-285. U.S. Forest Service, Portland, OR.
- IMST (Independent Multidisciplinary Science Team). 1999. Defining and evaluating recovery of OCN coho salmon stocks: Implications for rebuilding stocks under the Oregon Plan. Tech. Rep. 1999–2 to the Oregon plan for salmon and watersheds, Governor’s Natural Resources Office, Salem. Online at <http://www.fsl.orst.edu/imst/reports/1999-2.pdf> [accessed 28 February 2008].
- IMST (Independent Multidisciplinary Science Team). 2002. Recovery of wild salmonids in Western Oregon lowlands. A report of the independent multidisciplinary science team, Oregon plan for



- salmon and watersheds. Tech. Rep. 2002–1 to the Oregon plan for salmon and watersheds, Governor’s Natural Resources Office, Salem. Online at <http://www.fsl.orst.edu/imst/reports/2002-01.pdf> [accessed 28 February 2008].
- IMST (Independent Multidisciplinary Science Team). 2005. IMST review of State of Oregon’s draft Oregon coastal coho assessment documents: Viability assessment, PECE certainty analysis and synthesis. Online at <http://nrimp.dfw.state.or.us/OregonPlan/default.aspx?p=152&path=ftp/reports/Reviewer%20Comments&title=&link=#> [accessed 28 February 2008].
- ISAB (Independent Scientific Advisory Board). 2007. Climate change impacts on Columbia River Basin fish and wildlife. Northwest Power and Conservation Council, Portland, OR. Online at <http://www.nwcouncil.org/library/isab/isab2007-2.pdf> [accessed 28 February 2008].
- Interior Columbia Basin TRT (technical recovery team). 2007. Viability criteria for application to interior Columbia Basin salmonid ESUs. Review draft, March, 2007. NWFSC, Seattle, WA. Online at [http://www.nwfsc.noaa.gov/trt/trt\\_viability.cfm](http://www.nwfsc.noaa.gov/trt/trt_viability.cfm) [accessed November 2007].
- Interior Fraser Coho Recovery Team. 2006. Conservation strategy for coho salmon (*Oncorhynchus kisutch*), interior Fraser River populations. Dept. Fisheries and Oceans Canada, Sidney, BC.
- Isaak, D. J., R. T. Thurow, B. E. Rieman, and J. D. Dunham. 2007. Chinook salmon use of spawning patches: Relative roles of habitat quality, size, and connectivity. *Ecol. Appl.* 17(2):352–364.
- Jacobs, S., J. Firman, G. Susac, D. Stewart, and J. Weybright. 2002. Status of Oregon coastal stocks of anadromous salmonids, 2000–2001 and 2001–2002. Monitoring Program Rep. OPSW-ODFW-2002-3. Oregon Dept. Fish and Wildlife, Corvallis.
- Jacobs, S. E., and T. E. Nickelson. 1998. Use of stratified random sampling to estimate the abundance of Oregon coastal coho salmon. Fish Research Project Final Rep. F-145-R. Oregon Dept. Fish and Wildlife, Portland. Online at <http://oregonstate.edu/dept/ODFW/spawn/pdf%20files/reports/SRS.PDF> [accessed 28 February 2008].
- Johnson, M., and M. Banks. 2008. Genetic structure, migration and patterns of allelic richness among coho salmon (*Oncorhynchus kisutch*) populations of the Oregon Coast. *Can. J. Fish. Aquat. Sci.* 65(7):1274–1285. Online at <http://pubs.nrc-cnrc.gc.ca/rp-ps/issueDetail.jsp?jcode=cjfas&lang=eng&vol=65&is=7> [accessed 12 June 2008].
- Kalinowski, S. T., and R. S. Waples. 2002. Relationship of effective to census size in fluctuating populations. *Conserv. Biol.* 16(1):129–136.
- Kehler, D. G., R. A. Myers, and C. A. Field. 2002. Measurement error and bias in maximum reproductive rate for the Ricker model. *Can. J. Fish. Aquat. Sci.* 59:854–864.
- Kostow, K. (ed.). 1995. The natural production program. Biennial report on the status of wild fish conservation policies. Oregon Dept. Fish and Wildlife, Portland.
- Labelle, M. 1992. Straying patterns of coho salmon (*Oncorhynchus kisutch*) stocks from southeast Vancouver Island, BC. *Can. J. Fish. Aquat. Sci.* 49:1843–1855.
- Lande, R. 1998. Demographic stochasticity and Allee effect on a scale with isotropic noise. *Oikos* 83:353–358.
- Lande, R. 1993. Risks of population extinction from demographic and environmental stochasticity and random catastrophes. *Am. Nat.* 142:911–927.

- Lande, R. 1995. Mutation and conservation. *Conserv. Biol.* 9:782–791.
- Lande, R., and S. H. Orzack. 1988. Extinction dynamics of age-structured populations in a fluctuating environment. *Proc. Natl. Acad. Sci. USA* 85:7418–7421.
- Lawson, P. W. 1993. Cycles in ocean productivity, trends in habitat quality, and the restoration of salmon runs in Oregon. *Fisheries* 18:6–10.
- Lawson, P. W., E. A. Logerwell, N. J. Mantua, R. C. Francis, and V. N. Agostini. 2004. Environmental factors influencing freshwater survival and smolt production in Pacific Northwest coho salmon (*Oncorhynchus kisutch*). *Can. J. Fish. Aquat. Sci.* 61:360–373.
- Lawson, P. W., E. P. Bjorkstedt, M. W. Chilcote, C. W. Huntington, J. S. Mills, K. M. S. Moore, T. E. Nickelson, G. H. Reeves, H. A. Stout, T. C. Wainwright, and L. A. Weitkamp. 2007. Identification of historical populations of coho salmon (*Oncorhynchus kisutch*) in the Oregon Coast evolutionarily significant unit. U.S. Dept. Commer., NOAA Tech. Memo. NMFS-NWFSC-79.
- Leider, S. A., P. A. Hulett, J. J. Loch, and M. W. Chilcote. 1990. Electrophoretic comparison of the reproductive success of naturally spawning transplanted and wild steelhead trout through the returning adult stage. *Aquaculture* 88:239–252.
- Liermann, M., and R. Hilborn. 1997. Depensation in fish stocks: A hierarchic Bayesian meta-analysis. *Can. J. Fish. Aquat. Sci.* 54:1976–1984.
- Linstone, H. A., and M. Turoff (eds.). 1975. *The Delphi method: Techniques and applications*. Addison-Wesley, Reading, MA.
- Lindley, S. T., R. S. Schick, E. Mora, P. B. Adams, J. J. Anderson, S. Greene, C. Hanson, B. May, D. McEwan, R. B. MacFarlane, C. Swanson, and J. G. Williams. 2007. Framework for assessing viability of threatened and endangered Chinook salmon and steelhead in the Sacramento-San Joaquin Basin. *San Francisco Estuary and Watershed Science* 5: Article 4. Online at <http://repositories.cdlib.org/cgi/viewcontent.cgi?article=1051&context=jmie/sfew> [accessed 28 February 2008].
- Ludden, T. M., S. L. Beal, and L. B. Sheiner. 1994. Comparison of the Akaike information criterion, the Schwarz criterion and the F test as guides to model selection. *J. Pharmacokinet. Biopharm.* 22(5):431–45.
- Ludwig, D. 1996. Uncertainty and the assessment of extinction probabilities. *Ecol. Appl.* 6:1067–1076.
- Ludwig, D., R. Hilborn, and C. Walters. 1993. Uncertainty, resource exploitation, and conservation: Lessons from history. *Science* 260:17–18.
- Lugo, A. E., J. S. Baron, T. P. Frost, T. W. Cundy, and P. Dittberner. 1999. Ecosystem processes and functioning. In R. C. Szaro, N. C. Johnson, W. T. Sexton, and A. J. Malick (eds.), *Ecological stewardship: A common reference for ecosystem management*, p. 219–254. Vol. 2. Elsevier Science Ltd., Oxford, UK.
- Marcot, B. G., P. A. Hohenlohe, S. Morey, R. Holmes, R. Molina, M. C. Turley, M. H. Huff, and J. A. Laurence. 2006. Characterizing species at risk II: Using Bayesian belief networks as decision support tools to determine species conservation categories under the Northwest Forest Plan. *Ecol. Soc.* 11(2):12. Online at <http://www.ecologyandsociety.org/vol11/iss2/art12> [accessed 28 February 2008].

- May, R. M. 1994. The effects of spatial scale on ecological questions and answers. *In* R. J. Edwards, R. M. May, and N. R. Webb (eds.), *Largescale ecology and conservation biology*, p. 1–17. Blackwell Scientific Publications, London.
- McElhany, P., and J. Payne. 2005. Salmon population analysis program (SPAZ). Computer program and user manual. (Available from P. McElhany, NWFSC, 2725 Montlake Blvd. E., Seattle, WA 98112.)
- McElhany, P., M. Ruckelshaus, M. J. Ford, T. C. Wainwright, and E. P. Bjorkstedt. 2000. Viable salmonid populations and the recovery of evolutionarily significant units. U.S. Dept. of Commer., NOAA Tech Memo. NMFS-NWFSC-42. Online at [http://www.nwfsc.noaa.gov/assets/25/5561\\_06162004\\_143739\\_tm42.pdf](http://www.nwfsc.noaa.gov/assets/25/5561_06162004_143739_tm42.pdf) [accessed 11 March 2008].
- Meffe, G. K., and C. R. Carroll. 1997. *Principles of conservation biology*. Sunderland, Boston, MA.
- MidCoast Watersheds Council. 2005. Rapid bio-assessment 2005: Coastal ESU ocean tributaries final report. OWEB Grant # 205-100. MidCoast Watersheds Council, Newport, OR.
- Miller, B. J. 2003. NetWeaver Developer software. Rules of Thumb Software Inc., North East, PA.
- Miller, B. A., and S. Sadro. 2003. Residence time and seasonal movements of juvenile coho salmon in the ecotone and lower estuary of Winchester Creek, South Slough, Oregon. *Trans. Am. Fish. Soc.* 132(3):546–559.
- Mills, J., and P. W. Lawson. In prep. Enhancing expert opinion: A decision support system for evaluating Oregon Coast coho salmon (*Oncorhynchus kisutch*) critical habitat. (Available from P. Lawson, NWFSC, Newport Research Station, 2032 SE OSU Drive, Newport, OR 97365.)
- Morris, W. F., and D. F. Doak. 2002. *Quantitative conservation biology: Theory and practice of population viability analysis*. Sinauer Associates Inc., Sutherland, MA.
- Moyle, P. B., and G. M. Sato. 1991. On the design of preserves to protect native fishes. *In* W. L. Minckley and J. E. Deacon (eds.), *Battle against extinction: Native fish management in the American West*, p. 155–169. The University of Arizona Press, Tucson.
- Moyle, P. B., and R. Yoshiyama. 1994. Protection of aquatic biodiversity in California: A five-tiered approach. *Fisheries* 19:6–18.
- Murphy, D. D., K. E. Freas, and S. B. Weiss. 1990. An environment-metapopulation approach to population viability analysis for a threatened invertebrate. *Conserv. Biol.* 4:41–51.
- Myers, R. A., N. J. Barrowman, J. A. Hutchings, and A. A. Rosenberg. 1995. Population dynamics of exploited fish stocks at low population levels. *Science* 269:1106–1108.
- Naiman, R. J., T. J. Beechie, L. E. Benda, D. R. Berg, P. A. Bisson, L. H. MacDonald, M. D. O'Connor, P. L. Olson, and E. A. Steel. 1992. Fundamental elements of ecologically healthy watersheds in the Pacific Northwest coastal ecoregion. *In* R. J. Naiman (ed.), *Watershed management: Balancing sustainability and environmental change*, p. 127–188. Springer-Verlag, New York.
- Netting, R. M. 1977. *Cultural ecology*. Benjamin/Cummings, Menlo Park, CA.
- Neville, H. M., D. J. Isaak, J. B. Dunham, R. F. Thurow, and B. E. Rieman. 2006. Fine-scale natal homing and localized movement as shaped by sex and spawning habitat in Chinook salmon: Insights from spatial autocorrelation analysis of individual genotypes. *Mol. Ecol.* 15:4589–4602.

- Nickelson, T. E. 1998. A habitat-based assessment of coho salmon production potential and spawner escapement needs for Oregon coastal streams. Info. Rep. 98-4. Oregon Dept. Fish and Wildlife, Fish Division. Online at <http://oregonstate.edu/Dept/ODFW/inforeports/98-4.pdf> [accessed 11 March 2008].
- Nickelson, T. E. 2003. The influence of hatchery coho salmon (*Oncorhynchus kisutch*) on the productivity of wild coho salmon populations in Oregon coastal basins. *Can. J. Fish. Aquat. Sci.* 60:1050–1056.
- Nickelson, T. E., and P. Lawson. 1998. Population viability of coho salmon (*Oncorhynchus kisutch*) in Oregon coastal basins: Application of a habitat-based life cycle model. *Can. J. Fish. Aquat. Sci.* 55:2383–2392.
- Nickelson, T. E., J. D. Rodgers, S. L. Johnson, and M. F. Solazzi. 1992. Seasonal changes in habitat use by juvenile coho salmon (*Oncorhynchus kisutch*) in Oregon coastal streams. *Can. J. Fish. Aquat. Sci.* 49:783–789.
- Nickelson, T. E., M. F. Solazzi, and S. L. Johnson. 1986. Use of hatchery coho salmon (*Oncorhynchus kisutch*) psmolts to rebuild wild populations in Oregon coastal streams. *Can. J. Fish. Aquat. Sci.* 43:2443-2449.
- Nielsen, J. L. 1994. Invasive cohorts: Impacts of hatchery-reared coho salmon on the trophic, developmental, and genetic ecology of wild stocks. In D. J. Stouder, K. L. Fresh, and R. J. Feller (eds.), *Theory and application in fish feeding ecology*, p. 361–385. University of South Carolina Press, Columbia.
- NMFS (National Marine Fisheries Service). 1991. Notice of policy: Policy on applying the definition of species under the Endangered Species Act. *Federal Register* [Docket No. 9120248-1255, 20 November 1991] 56(224):58612–58616.
- NMFS (National Marine Fisheries Service). 2005. Policy on the consideration of hatchery-origin fish in Endangered Species Act listing determinations for Pacific salmon and steelhead. *Federal Register* [Docket No. 040511148-5151-02, 28 June 2005] 70(123):37204–37216.
- NMFS (National Marine Fisheries Service). 2006. Interim endangered and threatened species recovery planning guidance. National Marine Fisheries Service, Silver Spring, MD. Online at <http://www.nmfs.noaa.gov/pr/pdfs/recovery/guidance.pdf> [accessed 11 March 2008].
- NRC (National Research Council). 1996. *Upstream: Salmon and society in the Pacific Northwest*. National Academy Press, Washington, DC.
- NWFSC (Northwest Fisheries Science Center). 2005. Northwest Fisheries Science Center Review of Oregon's Viability Criteria and Status Assessment of Oregon Coastal Coho (20 December 2004). (Available from Science Director's Office, NWFSC, 2725 Montlake Blvd. East, Seattle, WA 98112.)
- Nunney, L. 2002. The effective size of annual plant populations: The interaction of a seed bank with fluctuating population size in maintaining genetic variation. *Am. Nat.* 160:195–204.
- ODFW (Oregon Department of Fish and Wildlife). 1981. *Comprehensive plan for production and management of Oregon's anadromous salmon and trout. Part I, coho salmon plan*. Oregon Dept. Fish and Wildlife, Fish Division, Portland. (Available from Oregon Dept. Fish and Wildlife, 3406 Cherry Ave. NE, Salem, OR 97303.)

- ODFW (Oregon Department of Fish and Wildlife). 2003. Native fish conservation policy. Revised 12 September 2003. Oregon Dept. Fish and Wildlife, Portland. Online at <http://www.dfw.state.or.us/fish/nfcp/nfcp.pdf> [accessed 11 March 2008].
- OSP (Oregon Science Panel). 2000. Oregon state of the environment report 2000. Online at <http://www.oregon.gov/DAS/OPB/soer2000index.shtml> [accessed 11 March 2008].
- OWEB (Oregon Watershed Enhancement Board). 2007. Oregon plan biennial report 2005–2007. OWEB, Salem.
- PMFC (Pacific Fishery Management Council). 1999. Final amendment 13 to the Pacific Coast salmon plan. Pacific Fishery Management Council, Portland, OR. Online at: <http://www.pcouncil.org/salmon/salfmp/salfmp.html> [accessed 11 March 2008].
- PMFC (Pacific Fishery Management Council). 2003. Pacific Coast salmon plan. Revised September 2003. Pacific Fishery Management Council, Portland, OR. Online at <http://www.pcouncil.org/salmon/salfmp/fmpthrua14.pdf> [accessed November 2007].
- Peterman, R. M. 1987. Review of the components of recruitment in Pacific salmon. *Am. Fish. Soc. Symp.* 1:417–429.
- Puget Sound TRT (technical recovery team). 2002. Planning ranges and preliminary guidelines for the delisting and recovery of the Puget Sound Chinook salmon evolutionarily significant unit, 30 April 2002. Northwest Fisheries Science Center, Seattle, WA. Online at <http://www.nwfsc.noaa.gov/publications/displayinclude.cfm?incfile=report.inc#2002> [accessed 28 February 2008].
- Quinn, T. J. I., and R. B. Deriso. 1999. Quantitative fish dynamics. Oxford University Press, New York.
- R Development Core Team. 2003. R: A language and environment for statistical computing. R Foundation for Statistical Computing, Vienna, Austria. Online at <http://www.r-project.org> [accessed 28 February 2008].
- Rapport, D. J., H. A. Regier, and T. C. Hutchinson. 1985. Ecosystem behavior under stress. *Am. Nat.* 125:617–640.
- Rauscher, H. M. 1999. Ecosystem management decision support for federal forests in the United States: A review. *Forest Ecol. Manag.* 114:173–197.
- Reed, J. M., L. S. Mills, J. B. Dunning Jr., E. S. Menges, K. S. McKelvey, R. Frye, S. R. Beissinger, M. C. Anstett, and P. Miller. 2002. Emerging issues in population viability analysis. *Conserv. Biol.* 16(1):7–19.
- Reeves, G. H., L. E. Benda, K. M. Burnett, P. A. Bisson, and J. R. Sedell. 1995. A disturbance-based ecosystem approach to maintaining and restoring freshwater habitats of evolutionarily significant units of anadromous salmonids in the Pacific Northwest. *Am. Fish. Soc. Symp.* 17:334–349.
- Regan, H. M., Y. Ben-Haim, B. Langford, W. G. Wilson, P. Lundberg, S. J. Andelman, and M. A. Burgman. 2005. Robust decision-making under severe uncertainty for conservation management. *Ecol. Appl.* 15:1471–1477.
- Regional Ecosystem Office. 2002. Hydrologic unit boundaries for Oregon, Washington, and California. Northwest forest plan. Regional Ecosystem Office. Online at <http://www.reo.gov/gis/projects/watersheds/reohucv13.zip> [accessed 28 February 2008].

- Reimers, P. E. 1973. The length of residence of juvenile fall Chinook salmon in Sixes River, Oregon. Res. Rep. Fish Comm. Region 4:2:43.
- Reimers, P. E. 1989. Management of wild and hatchery coho salmon in the Tenmile Lakes system. Rep. 98-5. Oregon Dept. Fish and Wildlife, Salem.
- Reisenbichler, R. R., and J. D. McIntyre. 1977. Genetic differences in growth and survival of juvenile hatchery and wild steelhead trout, *Salmo gairdneri*. J. Fish. Res. Board Canada 34:123–128.
- Reynolds, K. M., M. Jensen, J. Andreasen, and I. Goodman. 2000. Knowledge-based assessment of watershed condition. Comput. Electron. Agr. 27:315–333.
- Reynolds, K. M., S. Rodriguez, and K. Bevans. 2002. Building EMDS models and applications: The ecosystem management decision support system version 3.0. U.S. Forest Service, Pacific Northwest Research Station, Corvallis, OR. Online: <http://www.institute.redlands.edu/emds/manuscripts/docs/EMDS%20Training%20Manual.pdf> [accessed January 2008].
- Ricker, W. E. 1972. Stock and recruitment. W. B. Saunders Co., London, UK.
- Rieman, B. E., and F. W. Allendorf. 2001. Effective population size and genetic conservation for bull trout. N. Am. J. Fish. Manag. 21:756–764.
- Rieman, B. E., and J. B. Dunham. 2000. Metapopulations and salmonids: A synthesis of life history patterns and empirical observations. Ecol. Freshw. Fish 9:51–64.
- Sabo, J. L., E. E. Holmes, P. Kareiva. 2004. Efficacy of simple viability models in ecological risk assessment: Does density dependence matter? Ecology 85(2):328–341.
- Sandercock, F. K. 1991. Life history of coho salmon (*Oncorhynchus kisutch*). In C. Groot and L. Margolis (eds.), Pacific salmon life histories, p. 395–446. University of British Columbia Press, Vancouver, BC.
- Scott Morton, M. S. 1971. Management decision systems. Harvard University, Graduate School of Business Administration, Division of Research, Boston, MA.
- Scranton, R. W. 2004. The application of geographic information systems for delineation and classification of tidal wetlands for resource management of Oregon's coastal watershed. Master's thesis. Oregon State University, College of Oceanic and Atmospheric Sciences, Corvallis.
- Seamons T. R., P. Bentzen, and T. P. Quinn. 2003. The mating system of steelhead (*Oncorhynchus mykiss*), inferred by molecular analysis of parents and progeny. Environ. Biol. Fishes 69:333–344.
- Shaffer, M. 1978. Determining minimum viable population sizes: A case study of the grizzly bear (*Ursus arctos*). Doctoral dissertation. Duke University, Durham, NC.
- Shaffer, M. L. 1981. Minimum population sizes for species conservation. BioScience 31:131–134.
- Shaffer, M. 1987. Minimum viable populations: Coping with uncertainty. In M. E. Soulé (ed.), Viable populations for conservation, p. 69–86. Cambridge University Press, Cambridge, UK.
- Shaffer, M. L. 1990. Population viability analysis. Conserv. Biol. 4:39–40.
- Sharr, S., C. Melcher, T. Nickelson, P. Lawson, R. Kope, and J. Coon. 2000. 2000 review of amendment 13 to the Pacific Coast salmon plan. Exhibit B.3.b. OCN workgroup report. Pacific Fisheries Management Council, Portland, OR.

- Sheldon, A. L. 1988. Conservation of stream fishes: Patterns of diversity, rarity, and risk. *Conserv. Biol.* 16:149–156.
- Simenstad, C. A., W. G. Hood, R. M. Thom, D. A. Levy, and D. L. Bottom. 2000. Landscape structure and scale constraints on restoring estuarine wetlands for Pacific coast juvenile fishes. *In* D. A. Kreeger and M. P. Weinstein (eds.), *Concepts and controversies in tidal marsh ecology*, p. 597–630. Kluwer Academic Publishers, Boston, MA.
- Simon R. C., J. D. McIntyre, A. R. Hemmingsen. 1986. Family size and effective populations size in a hatchery stock of coho salmon (*Oncorhynchus kisutch*). *Can. J. Fish. Aquat. Sci.* 43:2434–2442.
- Slatkin, M. 1985. Gene flow in natural populations. *Annu. Rev. Ecol. Syst.* 16:393–430.
- Soulé, M. E. 1980. Thresholds for survival: Maintaining fitness and evolutionary potential. *In* M. E. Soulé and B. A. Wilcox (eds.), *Conservation biology: An evolutionary-ecological perspective*, p. 151–169. Sinauer Associates, Sunderland, MA.
- Soulé, M. E. (ed.). 1987. *Viable populations for conservation*. Cambridge University Press, Cambridge, UK.
- Spence, B., E. Bjorkstedt, J. C. Garza, D. Hankin, J. Smith, D. Fuller, W. Jones, R. Macedo, T. H. Williams, and E. Mora. 2007. A framework for assessing the viability of threatened and endangered salmon and steelhead in North-central California recovery domain. Public review draft. Online at <http://swfsc.noaa.gov/textblock.aspx?Division=FED&id=2266> [accessed 28 February 2008].
- Spies, T. A., K. N. Johnson, K. M. Burnett, J. L. Ohmann, B. C. McComb, G. H. Reeves, P. Bettinger, J. D. Kline, and B. Garber-Yonts. 2007. Cumulative ecological and socioeconomic effects of forest policies in coastal Oregon. *Ecol. Appl.* 17(1):5–17.
- Talabere, A., and K. K. Jones. 2001. Pacific salmon conservation: Designating salmon anchor habitat areas, a process to set priorities for watershed protection and restoration. Oregon Dept. Fish and Wildlife, Conservation Biology Program, Corvallis.
- Taylor, E. B. 1991. Behavioural interaction and habitat use in juvenile Chinook (*Oncorhynchus tshawytscha*) and coho (*O. kisutch*) salmon. *Anim. Behav.* 42(5):729–744.
- Taylor, B. L. 1995. The reliability of using population viability analysis for risk classification of species. *Conserv. Biol.* 9:551–558.
- Turban, E., and J. E. Aronson. 2001. *Decision support systems and intelligent systems*. Prentice Hall, Upper Saddle River, NJ.
- Van Doornik, D. M., M. J. Ford, and D. J. Teel. 2002. Patterns of temporal genetic variation in coho salmon: Estimates of the effective proportion of 2-year-olds in natural and hatchery populations. *Trans. Am. Fish. Soc.* 131:1007–1019.
- Wade, M. G. 1987. The relative effects of *Ceratomyxa shasta* on crosses of resistant and susceptible stocks of summer steelhead. Masters' thesis. Oregon State University, Corvallis.
- Wade, P. R. 2002. Bayesian population viability analysis. *In* S. R. Beissinger and D. R. McCullough (eds.), *Population viability analysis*, p. 213–238. University of Chicago Press, Chicago.
- Wainwright, T. C., and R. G. Kope. 1999. Methods of extinction risk assessment developed for U.S. West Coast salmon. *ICES J. Mar. Sci.* 56:444–448.

- Wainwright, T. C., P. D. Spencer, and S. T. Lindley. In prep. Evaluating demographic extinction risk for salmon populations. Draft, Northwest Fisheries Science Center, Seattle. (Available from T. Wainwright, NWFSC, Newport Research Station, 2032 SE OSU Drive, Newport, OR 97365.)
- Waples, R. S. 1990. Conservation genetics of Pacific salmon. III. Estimating effective population size. *J. Hered.* 81:277–289.
- Waples, R. S. 1991. Pacific salmon, *Oncorhynchus* spp., and the definition of “species” under the Endangered Species Act. *Mar. Fish. Rev.* 53(3):11–2.
- Waples, R. S. 2002. Effective size of fluctuating salmon populations. *Genomics* 161:783–791.
- Waples, R. S. 2006. Seed banks, salmon, and sleeping genes: Effective population size in semelparous, age-structured species with fluctuating abundance. *Am. Nat.* 167(1):118–135.
- WPN (Watershed Professionals Network). 1999. Oregon Watershed Assessment Manual. Governor’s Watershed Enhancement Board, Salem. Online at [http://www.oregon.gov/OWEB/docs/pubs/OR\\_wsassess\\_manuals.shtml#OR\\_Watershed\\_Assessment\\_Manual](http://www.oregon.gov/OWEB/docs/pubs/OR_wsassess_manuals.shtml#OR_Watershed_Assessment_Manual) [accessed 28 February 2008].
- Webb, N. R., and J. A. Thomas. 1994. Conserving intact habitats in heathland biotypes: A question of scale. *In* R. J. Edwards, R. M. May, and N. R. Webb (eds.), *Large scale ecology and conservation*, p. 129–151. Blackwell Scientific Publication, London.
- Weitkamp, L. 1997. Artificial propagation and coho salmon along the Oregon Coast. *Restoration*, Summer 1997, p. 2-5. Oregon State University, Oregon Sea Grant, Corvallis. Online at <http://seagrant.oregonstate.edu/sgps/restoration/rest297.pdf> [accessed 17 March 2008].
- Weitkamp, L. A., T. C. Wainwright, G. J. Bryant, G. B. Milner, D. J. Teel, R. G. Kope, and R. S. Waples. 1995. Status review of coho salmon from Washington, Oregon, and California. U.S. Dept. Commer., NOAA Tech. Memo. NMFS-NWFSC-24.
- White, P. S., and S. T. A. Pickett. 1985. Natural disturbance and patch dynamics: An introduction. *In* S. T. A. Pickett and P. S. White (eds.), *The ecology of natural disturbance and patch dynamics*, p. 3–13. Academic Press, Orlando, FL.
- Willamette/Lower Columbia TRT (technical recovery team). 2006. Revised viability criteria for salmon and steelhead in the Willamette and Lower Columbia River basins. Review Draft, 1 April 2006. NWFSC, Seattle, WA. Online at [http://www.nwfsc.noaa.gov/trt/wlc\\_docs/Revised\\_WLC\\_Viability\\_Criteria\\_Draft\\_Apr\\_2006.pdf](http://www.nwfsc.noaa.gov/trt/wlc_docs/Revised_WLC_Viability_Criteria_Draft_Apr_2006.pdf) [accessed 28 February 2008].
- Williams, J. E., J. E. Johnson, D. A. Hendrickson, S. Contreras-Balderas, J. D. Williams, M. Navarro-Mendoza, D. E. McAllister, and J. E. Deacon. 1989. Fishes of North America endangered, threatened, or of special concern: 1989. *Fisheries* 14(6):2–20.
- Williams, T. H., B. C. Spence, W. Duffy, D. Hillemeier, G. Kautsky, T. Lisle, M. McCain, T. Nickelson, G. Garman, E. Mora, and T. Pearson. 2007. Framework for assessing viability of threatened coho salmon in the Southern Oregon/Northern California Coast evolutionarily significant unit. External review draft, July 2007. Online at <http://swfsc.noaa.gov/textblock.aspx?Division=FED&id=2268> [accessed 28 February 2008].
- Wilson, E. O., and W. H. Bossert. 1971. *A primer of population biology*. Sinauer Associates, Stamford, CT.
- Wright, S. 1948. On the roles of directed and random changes in gene frequency in the genetics of populations. *Evolution* 2(4):279–294.



- Wright, S. 1969. Evolution and the genetics of populations. Vol. 2, The theory of gene frequencies. University of Chicago Press, Chicago.
- Zadeh, L. A. 1965. Fuzzy Sets. Inform. Contr. 8:338–353.
- Zhou, S. 2000. Stock assessment and optimal escapement of coho salmon in three coastal lakes. Information Report 2000-7. Oregon Dept. Fish and Wildlife, Fish Division, Salem.



# Appendix A: Use of a Knowledge-based DSS in Determining the Recovery Status of Oregon Coast Coho Salmon

## Introduction

While developing technical recovery analyses, technical recovery teams have been asked by policy makers to develop measurable criteria for evaluating the status of evolutionarily significant units (ESUs). The usual approach to developing measurable criteria has been to combine modeled goals with expert opinion assessments of the status of populations in relation to these goals. This development process, however, is difficult to apply consistently over many populations and is difficult to document. The Oregon Coast Workgroup of the Oregon and Northern California Coasts Technical Recovery Team chose to use a combination of aids to assist in this development, including data analysis, computer models, and expert opinion integrated into a decision support system (DSS). The DSS assists in ensuring that expert opinion will be well-documented, repeatable, and transparent. Results from the DSS can provide guidance to policy makers in evaluating the status of the Oregon Coast Coho Salmon (*Oncorhynchus kisutch*) ESU. This appendix introduces the DSS concept and provides guidance for interpreting the results.

## Utilizing a DSS

Typically, DSSs are computer programs that analyze and compare numerous pieces of data, producing results that assist decision makers in making a decision (Turban and Aronson 2001). Rather than specifying outcomes, these systems serve as aids to decision makers by allowing them to perform complex calculations quickly, presenting a consistent analytical product from many data sources and enhancing their ability to understand and recall information accurately. DSSs can improve the choices made by decision makers without overriding human judgment (Rauscher 1999).

DSSs have been developed for use in medicine, groundwater pollution, and conservation biology (Rauscher 1999, Turban and Aronson 2001), among other fields. Using a DSS (Mills and Lawson in prep.), several members of the workgroup participated in the rating of habitat parameters in 82 fifth field Hydrologic Unit Codes (REO 2002) and found the DSS process superior to the Delphi method (Linstone and Turoff 1975) for capturing best professional judgment.

A system evaluating ecological conditions may contain substantial uncertainty about the precise conditions that are optimal for the target organisms, because of uncertainty in both the expert knowledge and the associated monitoring data. Fuzzy logic (referred to as “approximate logic” in the body of this technical memorandum) is a type of logical analysis that allows a

system to use such imprecise information in evaluating conditions (Zadeh 1965, Reynolds et al. 2000). DSSs based on fuzzy logic can evaluate data with infinite gradations based on the degree to which the data satisfy a condition, while traditional rule-based systems only evaluate whether a condition is true or false. The resulting value reflects how strongly the expert panel judges whether the statement being evaluated is true. A fuzzy logic function will evaluate the degree to which the proposition is true. For this project, the workgroup used this degree of truth to indicate how certain they were that each criterion was fulfilled.

The workgroup chose to use a DSS based on a fuzzy logic knowledge base because it allowed us to summarize and synthesize information from disparate data sets over a variety of scales in a uniform way. The DSS also facilitated documentation of the methods used and the logical structure of the decision process. Fuzzy logic allowed the workgroup to express not only its assessment of the ESU status, but also its confidence in the assessment. Policy makers can thereby be informed of the uncertainty associated with the biological assessment in their decision-making process. For the purposes of recovery planning, the fuzzy logic DSS can accommodate analysis of the full range of options for assessing whether the populations and ESU are persistent and the ESU is sustainable or restored.

## **Implementation of the DSS**

Initially, the viability committee of the workgroup developed a system of pass/fail criteria for testing ESU status. Dissatisfaction with the arbitrary nature of some of the knife-edged criteria led the workgroup to translate the criteria into a fuzzy logic DSS. This translation also allowed us to incorporate an expression of uncertainty in our criteria, addressing one of the criticisms (IMST 2005, NWFSC 2005) of a similar product created by the State of Oregon (Chilcote et al. 2005).

### **Knowledge Base Development**

The viability committee constructed the knowledge base with review and comment from the rest of the workgroup. Members designed fuzzy membership functions to reflect mathematical analyses, benchmarks, or best professional judgment for each criterion. Each of these functions was quantified as a curve that rates the chosen metric between  $-1.0$  and  $+1.0$ , with  $-1.0$  being entirely false (no membership) and  $+1.0$  being entirely true (total membership). For example, the workgroup evaluated the statement “the population has sufficient naturally produced spawners to prevent loss of genetic variation due to random processes over a 100-year time frame.” The metric was the long-term harmonic mean of naturally produced spawner abundance. An abundance of 85 or less evaluated to a truth value of  $-1.0$  (certainly not sufficient) (see Figure A-1), 450 evaluated to  $0.0$  (the value that, in our pass/fail system, was the minimum acceptable abundance and therefore represented uncertain status), and 5,000 or above evaluated to  $+1.0$  (certainly sufficient). Intermediate values of the metric produced intermediate truth values.

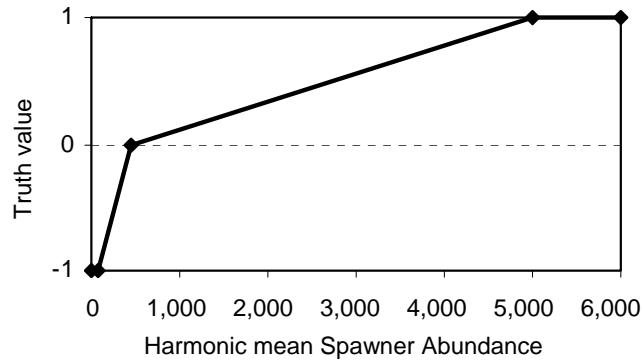

Figure A-1. A fuzzy membership function. This function evaluates the statement “the population has sufficient naturally produced spawners to prevent loss of genetic variation due to random processes over a 100-year time frame.” Input data values are indicated on the x-axis, and the truth values returned are indicated on the y-axis.

## Network Development

The viability committee originally developed recovery criteria reflecting important components of biological persistence and sustainability based on the viable salmonid populations document (McElhany et al. 2000) designed with pass/fail tests. Once the decision to convert to a DSS was made, the committee fit these criteria as well as new ones into a logic network. Each measurable criterion was reexamined in the context of the new decision structure. Based on data, analysis, and expert opinion, each criterion was mapped to a truth value as described above. The individual values were then linked using logical operators.

We used three fuzzy logic operators in the DSS that are analogs to their like-named Boolean logic operators, and we used one operator chosen specifically for this task (Table A-1). Each type of logic implies a different relationship among the input variables. The UNION operator specifies a simple arithmetic average of the inputs. This means that, in terms of the network, the inputs can be present in any combination. For example, with a union of two populations in a geographical stratum (Figure A-2), the stratum evaluates the same whether the individual values are 1 and -1 or 0.2 and -0.2. A UNION operator allows the network to balance weak populations with corresponding strong ones. The AND operator requires that all inputs are at least partially “true,” (i.e., greater than -1). In other words, AND means all of the inputs are needed and none of them can be entirely false. This operator returns a value that is strongly weighted toward the lowest of the inputs. The OR operator returns the value of the highest input, as if to say at least one of these is needed, and the stronger that one is, the better. The MEDIAN operator returns the median of the inputs, allowing the workgroup to require most of the inputs to fulfill the criterion. While the MEDIAN operator is not a traditional fuzzy logic operator, it was found useful for this application as a way to address the distribution of scores within a group.

By combining these analyses according to the network, two evaluations of ESU status were obtained: ESU Persistence and ESU Sustainability criteria. The structure of the network documents the logical relationship of the individual analyses. The fuzzy knowledge base

Table A-1. Operators used in the DSS. These operators are based on those in the NetWeaver DSS development system. The abbreviations shown in parentheses appear in the knowledge base diagrams.

Operator	Equation	Use
OR	$OR(x) = \max(x_1, x_2, \dots, x_i)$	Returns the antecedent truth value closest to fully true.
AND	$AND(x) = x_{min} + \left( \left( \frac{\sum x_i \times w_i}{\sum w_i} \right) - x_{min} \right) \times \frac{ x_{min} - FALSE }{ TRUE - FALSE }$	Serves as a limiting factors analysis; returns FALSE if any one input is entirely false.
MEDIAN (M)	$MEDIAN(x) = \text{median}(x_1, x_2, \dots, x_i)$	Returns the median antecedent truth value; tests for majority satisfying criterion.
UNION (U)	$UNION(x) = \left( \frac{\sum (x_i \times w_i)}{\sum w_i} \right)$	Returns the weighted average of inputs.

documents the relationship between the metrics and the contribution of that metric to the status of the ESU as a whole. The network includes tests for diversity and persistence at the population, biogeographic strata and ESU scales (for example, see Figure A-2).

## Sensitivity Analysis

The workgroup tested the DSS's sensitivity to changes in the data and the criteria, the effects of removing specific models used in the Probability of Persistence Criterion, PP-2, and the effects of changing the lower size limit in the definition of Independent Populations. A series of testing programs in R (R Development Core Team 2003) (an open-source statistical data analysis and plotting software package) were constructed that recorded the ESU-level results while changing the DSS inputs and criteria. While these tests did not evaluate every condition the DSS might encounter, they did explore how sensitive the DSS results are to changes in the on-the-ground conditions (changing data inputs) or changes in the state of science (changes in criteria and models).

In general, the DSS results changed proportionally to the changes in the inputs to the DSS. Small changes to the population data caused small changes in the ESU-level results. Large changes to the ESU-level data caused large changes. The structure of the fuzzy membership functions lead to higher sensitivity in some criteria than others. For example, the Probability of Persistence Criterion, PP-2, becomes positive at values high in the available range

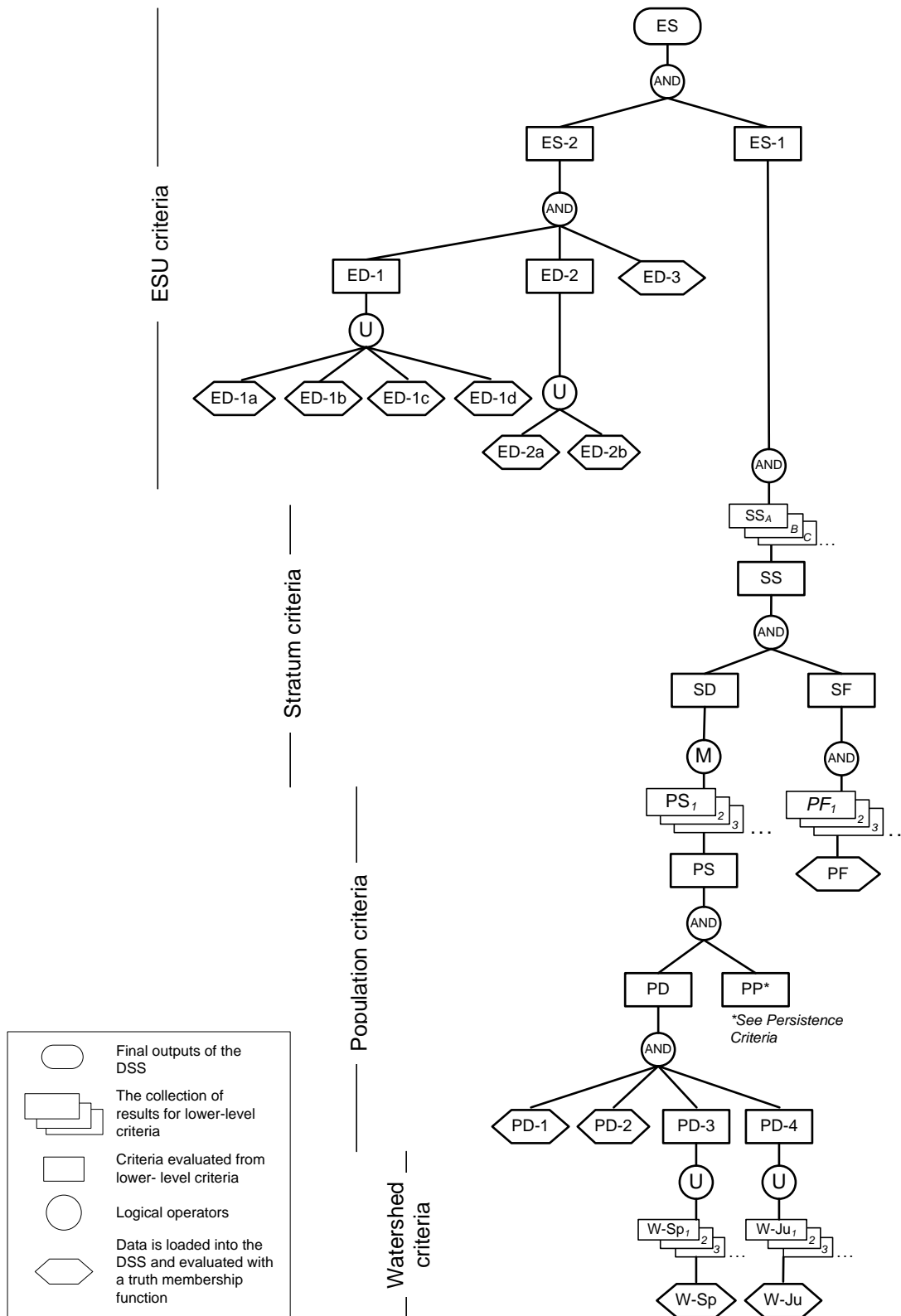

Figure A-2. The DSS network diagram. The DSS and knowledge base fuzzy membership functions document data analysis and the application of best professional judgment consistently and transparently on population, biogeographic strata, and ESU scales.

(see Figure 11), and responds most strongly to very high data values. Thus it responds strongly to changes in either the data or the criteria.

## Data Testing

To test how the DSS would respond to change in the environmental data, an R script was applied to increase and decrease the data for each criterion requiring such input and the DSS was run on the resulting data. For each criterion input, all values were increased and decreased (e.g., each population's value) by 20%, in 0.5% increments. Each criterion input was tested individually.

As an example of this process, the program selected the Spawner Abundance, PD-1, column, decreased each population's value for the harmonic mean annual spawners by 20% (of their original value), and ran the DSS to return truth values for the ESU Persistence Criterion, EP, and ESU Sustainability Criterion, ES. The program recorded these results, then increased the values by 0.5% and ran the DSS again. The program repeated this until the values had been increased by 20%. It then began processing the next criterion requiring data, the Artificial Influence Criterion, PD-2.

Most changes to the environmental data had small effects on the ESU Sustainability and ESU Persistence criteria scores. As the results from the DSS were near zero, small variations in the truth value lead to misleadingly large percent changes.

The most influential changes were those to the PP-2 data (the average persistence probabilities from the population viability analysis [PVA] models). A 10% decrease in the average persistence probability lead to a sharp decrease in the ESU Persistence Criterion, EP (from about +0.40 to -0.25; see Figure A-3) and the ESU Sustainability Criterion, ES, (from about +0.19 to 0.00; see Figure A-4). This result is unsurprising, given the steep slope of the PP-2 membership function. For example, increasing a value of 0.95 by 5% increases the resulting truth value from 0.0 to +1.0, or uncertain to fully true. This behavior is by design, as the workgroup considered high probability of persistence to be essential to support the proposition that a population is persistent, and designed the criterion's membership function accordingly.

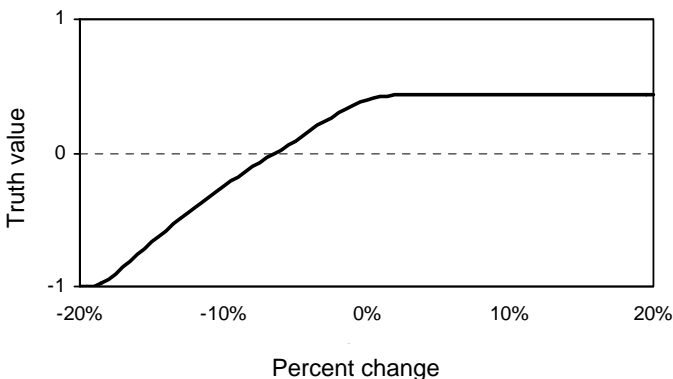

Figure A-3. Response of the ESU-level ESU Persistence Criterion, EP, truth value to changes in the Probability of Persistence Criterion, PP-2, input data.



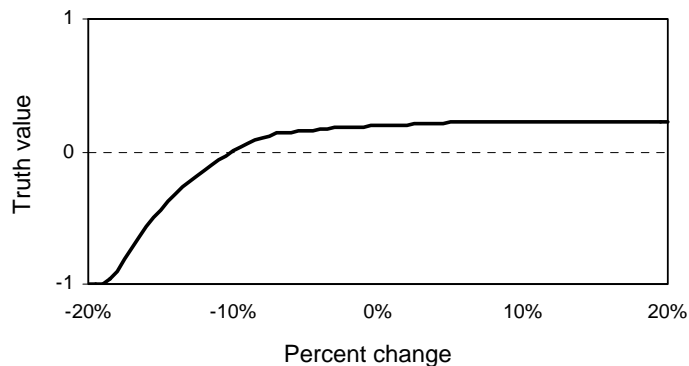

Figure A-4. Response of the ESU-level ESU Sustainability Criterion, ES, truth value to changes in the Probability of Persistence Criterion, PP-2, input data.

### Criteria Testing

The workgroup also tested how changing the membership functions for each criterion would affect the ESU-level results. We did so with another R program that adjusted the true, uncertain, and false points individually for each criterion. This program increased and decreased the input data value for each point by 20% in 0.5% increments. This showed the workgroup how sensitive the DSS would respond to changes in scientific knowledge, expert opinion, or other factors influencing the membership functions.

As with the data testing, the membership function testing showed that changes to single points defining the membership functions had small effects on the ESU-level results. Again, the notable effects were in the Probability of Persistence Criterion, PP-2. Increasing the point where the PP-2 function returns a truth value of 0.0 (uncertain) from 95% to 98% caused the ESU Persistence Criterion, EP, to drop from 0.40 to 0.36, while increasing it to 99% caused EP to drop to 0.28. Changes in the other direction had less of an effect; reducing this critical point from 95% to 90% resulted in an increase of EP to 0.41.

### Model Testing

The high sensitivity of the Probability of Persistence Criterion, PP-2, to both input data and membership function changes led us to conduct further testing on the influence of each PVA model. While the DSS averaged all of the PVA model results for each population to calculate the value of PP-2, some models appeared to have results consistently different from others. We built another program in R that tested the effect of removing each PVA model individually from the DSS inputs. Both were tested, removing just one of the eight model runs at a time, as well as removing both model runs of the same type (SPAZ, Beverton-Holt, etc.).

The results of these tests were highly variable (Table A-2). The ESU Persistence Criterion, EP, was less sensitive to model removal than the ESU Sustainability Criterion, ES, with each test resulting in the EP truth values varying by less than 0.010. In general, effects on truth values for ES were less responsive, but ES responded more strongly to removals of

Table A-2. Results of model exclusion tests.

Model(s) excluded	QET	ESU		ESU	
		Persistence (EP)	EP change	Sustainability (ES)	ES change
1 <sup>a</sup>	1	0.401	0.002	0.194	0.000
"	50	0.405	0.006	0.194	0.000
"	Both	0.407	0.008	0.194	0.000
2 <sup>b</sup>	1	0.396	-0.003	0.193	0.000
"	50	0.396	-0.003	0.193	0.000
"	Both	0.392	-0.007	0.192	-0.001
3 <sup>c</sup>	1	0.399	0.000	0.194	0.000
"	50	0.401	0.002	0.194	0.001
"	Both	0.407	0.008	0.194	0.001
4 <sup>d</sup>	1	0.395	-0.004	0.193	0.000
"	50	0.403	0.004	0.224	0.031
"	Both	0.400	0.001	0.224	0.030
None <sup>e</sup>		0.399		0.194	

<sup>a</sup> Density-dependent count-based model (Chilcote et al. 2005).

<sup>b</sup> SPAZ model with hockey stick recruitment function (McElhany and Payne 2005).

<sup>c</sup> Bayesian salmon analysis model (Wainwright et al. in prep.).

<sup>d</sup> Stochastic habitat-based life cycle model (Nickelson and Lawson 1998).

<sup>e</sup> Raw DSS results, as returned with all models present.

Model 4, varying by as much as 0.030 in single run removals and 0.031 when the entire model was removed. The different responses of EP and ES result from the way the population scores are aggregated. For EP, the Population Persistence Criterion, PP, scores are aggregated directly to the Stratum Diversity Criterion level, SD, via the MEDIAN operator. For ES, PP scores are combined first with the Population Diversity Criterion, PD, scores via the AND operator to compute the Population Sustainability Criterion, PS, score, and then aggregated to the SD via the MEDIAN operator. Because the MEDIAN operator depends on the ranking of populations within each stratum, and rankings for PD were substantially different than those for PP, the effect of sensitivity of a single population to exclusion of a particular model can result in greater changes for ES than for EP.

The model testing indicates the DSS responds conservatively to the model inputs. While declining input values for PP-2 will lower the ES and EP results, increasing input values will not substantially increase the results. This has the effect of insulating the ESU-level results from over-estimation in the model results, in keeping with the conservative approach to risk favored throughout this process.

## **Population Definition Testing**

As a final set of sensitivity tests, the workgroup considered the response of the DSS to changes in the lower size limit for Independent Populations, as defined by Lawson et al. (2007). The original size limit was defined on the basis of historical potential habitat, and was set at 24 km of habitat (equivalent to 15,000 adult spawners at 10% marine survival). Variations of 50% about this limit (i.e., values of 7,500 and 22,500 adult spawners) were considered to test the effects of this choice on numbers of Independent Populations (Figure 25 in Lawson et al. 2007). These two values were used to test the sensitivity of the DSS results to this limit.

Increasing the limit to 22,500 resulted in removing a single population (Salmon River, Mid-Coast stratum) from the list of Independent Populations. Decreasing the limit to 7,500 resulted in the addition of five Independent Populations: Sand Creek (North Coast stratum), Yachats River, Devils Lake, Sutton Creek (Mid-Coast stratum), and Twomile Creek (Mid-South stratum). Results of these tests are in Table A-3. Results for the ESU Persistence Criterion, EP, were highly sensitive to these changes, particularly to the addition of more small populations. This was largely due to a lack of data for these small populations, which resulted in truth scores of 0.0 for most population-level criteria for these populations. Results for the ESU Sustainability Criterion, ES, were less sensitive, largely because ES scores were nearer to zero to start with and population-specific scores are combined with ESU Diversity criteria, which buffers the ESU-level result from changes in a few populations.

These results are logically consistent with both the DSS structure and the data available. The Salmon River scores poorly in most of the criteria, so it would be expected that the EP and ES scores would increase somewhat with it removed. While this increase is slight, it is not unreasonable given the results of previous sensitivity testing that showed fair stability in the DSS scores. The much larger decrease in EP with the added populations is also expected. Most populations had high scores in the Persistence criteria and the presence of these new populations with scores of 0.0 in four of the five strata would have strong effects on the stratum-level scores, pulling the results toward zero.

## **Guidance for Interpreting Results**

There are several advantages to using a DSS to guide the deliberation of an expert panel such as the workgroup. It allows us to document the consistent application of criteria across the ESU. It also allows the entire best professional judgment analysis to be as transparent as possible, so other scientists can apply the same information and get similar results. The truth membership curves are documented; therefore, when new information becomes available, application of the DSS may yield different results.

However, one of the drawbacks of having a number between +1.0 and -1.0 as a result is the interpretation that is made. Unlike a pass/fail system, the results should be thought of in levels of uncertainty. For example, if the result is +1.0, then the proposition is completely true; conversely, if the result is -1.0, then the proposition is completely false. If the result is 0.0, then the proposition is uncertain, or unknown.



## Script to Run Program

```
##### BiRDSS v. 4.5 #####
# This R program implements the Biological Recovery Decision Support
# System version 4.5 as designed by the Oregon Coast coho workgroup
# of the ONCC Technical Recovery Team. Fuzzy logic operators (AND, OR, Median,
# and UNION) are implemented as functions. The membership functions
# are generated on the fly from the provided criteria. The model uses
# a criteria parameter file, watershed, population, and ESU-level data
# in other comma separated value files. The file formats required are
# as follows:
#
# All files will be comma separated value text files, using quotation
# marks (") to delimit text fields.
#
# Criteria file: Header row has one pair of columns, one each for X and Y
# for each criterion. The columns will contain pairs of X and Y values. It is
# allowable for there to be unequal numbers of pairs for different criteria.
# That is, some criteria can have only two pairs (or points) defined while
# others have three or more. Simply leave blanks where there are no points.
# Example:
# "W.SP.X", "W.SP.Y", "W.JU.X", "W.JU.Y"
# 0.2, -1, 0.2, -1
# 0.8, 1, 0.5, 0
# , , 0.8, 1
#
# Watershed Data File: Header row has columns for population, watershed
# (stored as HUC5 number), W-Ju (juvenile data) and W-Sp (spawning data).
# Example:
# "Population", "Watershed", "W.Ju", "W.Sp"
# "Necanicum", "1710020101", 0.723, 0.592
# "Nehalem", "1710020201", 0.746, 0.636
# "Nehalem", "1710020202", 0.828, 0.548
#
# Population Data File: Header row has columns for Stratum, Population,
# and various criteria (PP 1-3, PD 1-2, and PF).
# Example:
# "Stratum", "Population", "PP.1", "PP.2", "PP.3", "PD.1", "PD.2", "PF"
# "North Coast", "Necanicum", 0.98, 0.8, 3.77, 480, 0.944, 63200
# "North Coast", "Nehalem", 0.57, 0.98, 6.26, 4141, 0.915, 1039000
# "North Coast", "Tillamook Bay", 0.88, 0.88, 3.75, 1003, 0.945, 505100
#
# Stratum Data File: Header row has columns for Stratum and criteria
# (S-Ju, S-Sp).
# Example:
# "Stratum", "S.Ju", "S.Sp"
# "North Coast", 0.843, 0.224
# "Mid-Coast", 0.522, 0.128
#
# ESU Data File: Header row has columns for ESU, ED.1.A, ED.1.B, ED.1.C,
# ED.1.D, ED.2.A, ED.2.B, ED.3
# Example:
# "ESU", "ED.1.A", "ED.1.B", "ED.1.C", "ED.1.D", "ED.2.A", "ED.2.B", "ED.3"
# "OC coho salmon", 3, 3, 3, 3, 3, 3, 3
#
#####

##### Settings for this model used throughout #####
# In this section, you may set the working directory and file names.

## Edit this line to change the working directory
DIRECTORY.WORK <- "C:/BiRDSS" # Project working directory

## The following lines are for filename constants
# Inputs
DIRECTORY.INPUT <- "input" # Input file directory
FILE.CRITERIA <- "Criteria.csv" # The criteria file
FILE.DATA.WATERSHED <- "WatershedData.csv" # The watershed data file
FILE.DATA.POPULATION <- "PopulationData.csv" # The Population data file
FILE.DATA.STRATUM <- "StratumData.csv" # The Stratum data file
```

```

FILE.DATA.ESU <- "ESUData.csv"                                # The ESU-level data file

# Outputs
DIRECTORY.OUTPUT <- "output"                                # Output file directory
FILE.RESULTS.WATERSHED <- "WatershedResults.csv"            # Watershed Results file
FILE.RESULTS.POPULATION <- "PopulationResults.csv"          # Population Results file
FILE.RESULTS.STRATUM <- "StratumResults.csv"                # The Stratum Results file
FILE.RESULTS.ESU <- "ESUResults.csv"                        # The ESU Results file

## Fuzzy logic constants
# defines TRUE for the purposes of this model
FUZZY.TRUE <- 1
# defines FALSE for this model
FUZZY.FALSE <- -1
# defines undetermined/intermediate for this model
FUZZY.UNDETERMINED <- 0

##### DO NOT MAKE ANY CHANGES BELOW THIS LINE #####
startTime <- Sys.time()

##### General functions for model processing #####
readDataFiles <- function() {
  ## readDataFiles
  ## This function (which takes no inputs other than preset variables) reads the
  ## data files and stores them in data frames.

  # Let the user know what it is doing
  cat("Loading input data files from", paste(DIRECTORY.WORK, DIRECTORY.INPUT, sep = '/'), "\n")

  # Create the file names to work from by concatenating the work directory and the
  # file name. The paste function concatenates strings. The separator is the /,
  # used to denote the directory structure.
  filenameCriteria <- paste(DIRECTORY.WORK, DIRECTORY.INPUT, FILE.CRITERIA, sep = '/')
  filenameWatershedData <- paste(DIRECTORY.WORK, DIRECTORY.INPUT, FILE.DATA.WATERSHED, sep = '/')
  filenamePopData <- paste(DIRECTORY.WORK, DIRECTORY.INPUT, FILE.DATA.POPULATION, sep = '/')
  filenameStratumData <- paste(DIRECTORY.WORK, DIRECTORY.INPUT, FILE.DATA.STRATUM, sep = '/')
  filenameEsuData <- paste(DIRECTORY.WORK, DIRECTORY.INPUT, FILE.DATA.ESU, sep = '/')

  # Create the list of file names to loop through for testing below
  fileNames <- c(filenameCriteria, filenameWatershedData, filenamePopData, filenameStratumData,
filenameEsuData)

  # Loop through all the file names to test that they exist
  for (i in 1:length(fileNames)) {
    # Make sure the file exists
    if (file.exists(fileNames[i])== FALSE) {
      stop(paste(fileNames[i], "is missing."))
    }
  }

  # Read the data files into the appropriate data frames for later use. The
  # double << is needed to ensure global scope for the objects being populated.
  criteriaDf <<- read.table(filenameCriteria, header = TRUE, sep = ",")
  watershedDataDf <<- read.table(filenameWatershedData, header = TRUE, sep = ",")
  populationDataDf <<- read.table(filenamePopData, header = TRUE, sep = ",")
  stratumDataDf <<- read.table(filenameStratumData, header = TRUE, sep = ",")
  esuDataDf <<- read.table(filenameEsuData, header = TRUE, sep = ",")
}

writeOutputTables <- function() {
  ## writeOutputTables
  ## This function writes the DSS results to the appropriate data tables

  directoryOutput <- paste(DIRECTORY.WORK, DIRECTORY.OUTPUT, sep='/')

  # Test for the output directory's existence
  if (file.exists(directoryOutput)== FALSE) {
    stop(paste(directoryOutput, "is missing."))
  }
}

```

```

}

# Paste together the directory names
directoryFullOutput <- paste(directoryOutput, timeStamp, sep='/')
# Create the timestamp'ed output directory.
dir.create(directoryFullOutput)
# Write the output files as CSVs
write.csv(watershedResultsDf, file=paste(directoryFullOutput, FILE.RESULTS.WATERSHED, sep='/'))
write.csv(populationResultsDf, file=paste(directoryFullOutput, FILE.RESULTS.POPULATION,
sep='/'))
write.csv(stratumResultsDf, file=paste(directoryFullOutput, FILE.RESULTS.STRATUM, sep='/'))
write.csv(esuResultsDf, file=paste(directoryFullOutput, FILE.RESULTS.ESU, sep='/'))

# Report the location of the output files
cat("Results stored in", directoryFullOutput, "\n")
}

```

```

calcFuzzyOr <- function(data) {
## calcFuzzyOr
## Implements the fuzzy OR function. Takes a vector (data) and returns the
## maximum input in the vector. If you want to combine several pieces of data
## that are not in a vector already, use the c() function to convert a comma-
## separated list into a vector.
## Usage: resultVector <- calcFuzzyOr(inputVector)
## Example: temp <- calcFuzzyOr(c(0.5, 0.3, 0.1)) returns vector temp = 0.5

# NAs need to be converted to undetermined to allow for missing data
data[is.na(data)] <- FUZZY.UNDETERMINED
out <- max(data)
out
}

```

```

calcFuzzyAnd <- function(data, isWeighted=FALSE) {
## calcFuzzyAnd
## Implements the fuzzy AND function. Takes a vector (data) and returns the
## "limiting factor" based result. It is limited by how close the lowest
## input is to being entirely false. If you want to combine several pieces of
## data that are not in a vector already, use the c() function to convert a
## comma-separated list into a vector.
## If the results are to be weighted, use the isWeighted parameter set to
## TRUE. You will need to make matrix with two columns, one for the data and
## one for the weights. The simplest way to do this is with the matrix()
## function. Just put all your data values followed by the weights, in
## order of the matching data values, into a vector with the c() function.
## Then, use the matrix() function with the vector, followed by the number of
## data values (rows), and the number of columns (should always be 2, one for
## data, one for weights). Please refer to the example below.
##
## Usage: resultVector <- calcFuzzyAnd(inputVector, isWeighted=TRUE|FALSE)
##        resultVector <- calcFuzzyAnd(inputVector, FALSE)
##        resultVector <- calcFuzzyAnd(matrix(inputVector, rows, 2), TRUE)
## Example: If you want an unweighted AND of 0.5, 0.3, and 0.1, use:
##          temp <- calcFuzzyAnd(c(0.5, 0.3, 0.1), FALSE)
##          returns vector temp = 0.21
##
##          For a weighted AND, using three rows, use:
##          Data|Weight
##          ----|-----
##          0.5 | 1
##          0.3 | 1
##          0.1 | 0.5
##          Data      Weights      # of rows
##          _____|_____  _____|_____ |
##          temp <- calcFuzzyAnd(matrix(c(0.5, 0.3, 0.1, 1, 1, 0.5),3,2), TRUE)
##          returns vector temp = 0.232

# NAs need to be converted to undetermined to allow for missing data

```

```

data[is.na(data)] <- FUZZY.UNDETERMINED

#Calculate the unweighted (or equal weighted) AND
if (isWeighted == FALSE ) {
  # NAs need to be converted to undetermined to allow for missing data
  data[is.na(data)] <- FUZZY.UNDETERMINED
  # Find the minimum input data value
  inputMin <- min(data)
  # Find the arithmetic mean of the inputs
  inputMean <- mean(data)

  # We use a different calculation if calculating a weighted AND
} else if (isWeighted == TRUE ) {
  # Find the minimum input data value
  inputMin <- min(data[,1])
  # The weighted.mean() function uses the data values from column 1, and
  # weights from column 2 of the matrix created when calling the function.
  inputMean <- weighted.mean(data[,1], data[,2])
}

# Calculate the AND, then store the result to be returned later. Weighted
# and unweighted ANDs use the same calculation; it's the pre-processing the
# weighted mean that makes the difference.
out <- inputMin + (inputMean - inputMin)*(inputMin - FUZZY.FALSE)/(FUZZY.TRUE - FUZZY.FALSE)

# Return the data value
out
}

calcFuzzyUnion <- function(data) {
  ## calcFuzzyUnion
  ## Implements the fuzzy UNION function. Takes a vector (data) and returns the
  ## arithmetic mean of the inputs. If you want to combine several pieces of
  ## data that are not in a vector already, use the c() function to convert a
  ## comma-separated list into a vector.
  ## Usage: resultVector <- calcFuzzyUnion(inputVector)
  ## Example: temp <- calcFuzzyUnion(c(0.5, 0.3, 0.1)) returns vector temp = 0.3

  # NAs need to be converted to undetermined to allow for missing data
  data[is.na(data)] <- FUZZY.UNDETERMINED
  # Calculate the unweighted arithmetic mean and store for output
  out <- mean(data)
  # Return the data value
  out
}

calcFuzzyMedian <- function(data) {
  ## calcFuzzyMedian
  ## Implements the fuzzy median function. Takes a vector (data) and returns the
  ## median of the inputs. If you want to combine several pieces of data that
  ## are not in a vector already, use the c() function to convert a comma-
  ## separated list into a vector.
  ## Usage: resultVector <- calcFuzzyMedian(inputVector)
  ## Example: temp <- calcFuzzyMedian(c(0.5, 0.3, 0.1))
  ##           returns vector temp = 0.3

  # NAs need to be converted to undetermined
  data[is.na(data)] <- FUZZY.UNDETERMINED
  out <- median(data)
  # Return the data value
  out
}

```



```

calcFuzzyMembership <- function(data, criterion) {
  ## calcFuzzyMembership
  ## Implements the fuzzy membership functions. Takes a vector (data) for the
  ## input data and applies the appropriate membership function. Takes a string
  ## (criterion) of the name of the criterion to evaluate, e.g. "W.SP". Returns
  ## a vector of truth value results.
  ## Usage: resultVector <- calcFuzzyMembership(data, criterion)
  ## Example: temp <- calcFuzzyMembership(0.3, "W.SP") returns the truth value
  ## for 0.3 as evaluated against criterion W.SP.

  # Get the points for the membership function, with NAs removed, ordered by X
  # Get Xs and Ys
  critPoints <- criteriaDf[, c(paste(criterion, c("X","Y"), sep = "."))]
  # Sort by X column (the first column)
  critPoints <- critPoints[order(critPoints[,1]),]

  xColumn <- critPoints[,1]           # Store the Xs in a vector
  xColumn <- xColumn[!is.na(xColumn)] # Remove NAs from X vector
  yColumn <- critPoints[,2]           # Store the Ys in a vector
  yColumn <- yColumn[!is.na(yColumn)] # Remove NAs from Y vector

  # We need matching numbers of X and Y values for each criterion
  if (length(xColumn) != length(yColumn)) {
    # If the number of X and Y values differs, halt with an error
    stop(paste("The number of X values does not match the number of Y values
    provided for",criterion,' '))
  } else {
    # If the counts match, count the number of points provided
    numCriterionRows <- length(xColumn)
  }
  # Run the fuzzy membership function on each row of the data vector
  # and store the results. This line does the work of calculating the truth
  # value for each data point in the input table.
  results <- sapply(data, function(dataInput) applyFuzzyCurve(dataInput, xColumn, yColumn,
numCriterionRows))
}

```

```

applyFuzzyCurve <- function(dataInput, xColumn, yColumn, numCriterionRows) {
  ## applyFuzzyCurve
  ## This will apply a fuzzy membership function to the data from the criterion
  ## points supplied in the criteria file. Based on the dataInput value (the
  ## input data for which you are calculating a truth value), the function first
  ## checks whether the input is equal to or below the minimum X value in the
  ## criterion. If so, it assigns the appropriate Y value. It then checks if
  ## the input is equal to or greater than the maximum X value, then assigns
  ## the Y value if appropriate. If the input value is between the minimum and
  ## maximum specified X values, the function finds the bounding X values and
  ## calculates the slope and intercept of the line connecting these values. It
  ## then calculates the truth value of the input data from the slope and
  ## intercept.

  # The default value is undetermined
  truthValue <- FUZZY.UNDETERMINED

  # Check if dataInput is supplied; if it's NA, skip all this
  # and go to the end of this function to return FUZZY.UNDETERMINED

  if (!is.na(dataInput)) {

    # Get the highest and lowest pairs of (X, Y). They are ordered by X value.
    xMin <- xColumn[1]
    yMin <- yColumn[1]
    xMax <- xColumn[numCriterionRows]
    yMax <- yColumn[numCriterionRows]

    # Check against the smallest X value supplied. If the input (dataInput) is

```

```

# less than or equal to the smallest X value supplied, return the truth
# value for the smallest X
if (dataInput <= xMin) {
  truthValue <- yMin

# Check against the greatest X value supplied. If the input (dataInput) is
# greater than or equal to the greatest X value supplied, return the truth
# value for the greatest X
} else if (dataInput >= xMax) {
  truthValue <- yMax

# If the data input is between the smallest and greatest X values provided,
# step through the X values, find the appropriate bounding values, and
# calculate the truth value for dataInput.
} else {
  # Loop through all the criterion rows provided
  for (i in 1:numCriterionRows) {
    # Check if dataInput is between the current and next points
    if ((dataInput >= xColumn[i]) & (dataInput < xColumn[i+1])) {
      # Calculate the slope of the curve
      m <- (yColumn[i+1] - yColumn[i]) / (xColumn[i+1] - xColumn[i])
      # Calculate the intercept of the curve
      b <- (yColumn[i] - (m * xColumn[i]))
      # Apply the membership function in the form mx + b = y
      truthValue <- (m * dataInput) + b
      # Exit the for loop; we have calculated the output
      break
    }
  }
}

# Return the truth value and exit the function
truthValue
}

runDss <- function() {
##### WATERSHED MEMBERSHIP FUNCTIONS #####

## Create results data frame by copying the Population and Watershed fields
watershedResultsDf <- data.frame(watershedDataDf["Population"], watershedDataDf["Watershed"])

## Process the watershed file for W-Ju and W-Sp
watershedResultsDf$W.Ju <- calcFuzzyMembership(watershedDataDf$W.Ju, "W.JU")
watershedResultsDf$W.Sp <- calcFuzzyMembership(watershedDataDf$W.Sp, "W.SP")

##### POPULATION MEMBERSHIP FUNCTIONS #####

## Create results data frame
populationResultsDf <- data.frame(populationDataDf["Stratum"], populationDataDf["Population"])

## Process the population data file for PP-1, -2, -3, and PD-1, PD-2, and PF
populationResultsDf$PP.1 <- calcFuzzyMembership(populationDataDf$PP.1, "PP.1")
populationResultsDf$PP.2 <- calcFuzzyMembership(populationDataDf$PP.2, "PP.2")
populationResultsDf$PP.3 <- calcFuzzyMembership(populationDataDf$PP.3, "PP.3")
populationResultsDf$PD.1 <- calcFuzzyMembership(populationDataDf$PD.1, "PD.1")
populationResultsDf$PD.2 <- calcFuzzyMembership(populationDataDf$PD.2, "PD.2")
populationResultsDf$PF <- calcFuzzyMembership(populationDataDf$PF, "PF")

## Calculate PP, PD-3, PD-4, and PS for each population

for (i in 1:length(populationResultsDf$Population)) {

## PD-3 - For each population, UNION the watershed results and
## store them in PD-3
# The conversion to as.vector is required to prevent level errors

```

```

    populationResultsDf$PD.3[i] <<-
    calcFuzzyUnion(watershedResultsDf[as.vector(watershedResultsDf$Population) ==
    as.vector(populationResultsDf$Population[i]), "W.Sp"])

    ## PD-4 - For each population, UNION the watershed results and
    ## store them in PD-4.
    # The conversion to as.vector is required to prevent level errors
    populationResultsDf$PD.4[i] <<-
    calcFuzzyUnion(watershedResultsDf[as.vector(watershedResultsDf$Population) ==
    as.vector(populationResultsDf$Population[i]), "W.Ju"])

    # Attach the results table for easier access below
    attach(populationResultsDf)

    ## PP - For each population, AND the PPs
    populationResultsDf$PP[i] <- calcFuzzyAnd(c(PP.1[i], PP.2[i], PP.3[i]))

    ## PD -- AND PD-1 through PD-4
    # Build the vector of results to tack together
    tempPD <- c(PD.1[i], PD.2[i], PD.3[i], PD.4[i])

    # Detach the results table so it will refresh
    detach(populationResultsDf)

    # Compute PD by AND-ing PD-1 through PD-4
    populationResultsDf$PD[i] <- calcFuzzyAnd(tempPD)
    # Clean up
    rm(tempPD)

    ## PS -- AND PD, PP
    populationResultsDf$PS[i] <- calcFuzzyAnd(c(populationResultsDf$PD[i],
    populationResultsDf$PP[i]))
}

##### STRATUM MEMBERSHIP FUNCTIONS #####
# This section processes the stratum level results by stepping through a list
# of all the strata listed in the populationResultsDf table. This will draw
# data for the various stratum level operators from the same table, and store
# the results in the stratumResultsDf table.

## Run the Stratum functionality for dependence membership functions

# Create results data frame
stratumResultsDf <- data.frame(unique(populationResultsDf["Stratum"]))

# Attach the completed population results table for easier use
attach(populationResultsDf)

# Loop through all the strata
for (i in 1:length(stratumResultsDf$Stratum)) {

    ## SP -- Run the stratum aggregation for SP by median-ing the PP values
    ## within each stratum
    stratumResultsDf$SP[i] <- calcFuzzyMedian(PP[as.vector(Stratum) ==
    as.vector(stratumResultsDf$Stratum[i])])

    ## SD -- Run the stratum aggregation for SD by median-ing PP and all PS
    ## criteria
    stratumResultsDf$SD[i] <- calcFuzzyMedian(PS[as.vector(Stratum) ==
    as.vector(stratumResultsDf$Stratum[i])])

    ## SF -- Run the stratum aggregation for SF by AND-ing PF
    stratumResultsDf$SF[i] <- calcFuzzyAnd(PF[as.vector(Stratum) ==
    as.vector(stratumResultsDf$Stratum[i])])

    ## SS -- Run the stratum aggregation for SS by AND-ing SS-1 and SS-2
    stratumResultsDf$SS[i] <- calcFuzzyAnd(c(stratumResultsDf$SD[i], stratumResultsDf$SF[i]))
}

```

```

} # Close strata loop

# Detach the population results table as it is no longer needed
detach(populationResultsDf)

##### ESU MEMBERSHIP FUNCTIONS #####

# Prepare a data frame with the list of ESUs covered
esuResultsDf <- data.frame(esuDataDf["ESU"])

## EP -- Calculate EP by AND-ing all stratum results for SP
esuResultsDf$EP[1] <- calcFuzzyAnd(stratumResultsDf$SP)

## ED -- Calculate fuzzy membership for ESU Diversity criteria; all use the
## same ED criterion, so all refer to "ED" when calculating the fuzzy membership
## value.
# Genetic -- Structure
esuResultsDf$ED.1.A <- calcFuzzyMembership(esuDataDf$ED.1.A, "ED")
# Genetic -- Effects of selection on genetic diversity
esuResultsDf$ED.1.B <- calcFuzzyMembership(esuDataDf$ED.1.B, "ED")
# Genetic -- Effects of migration on genetic diversity
esuResultsDf$ED.1.C <- calcFuzzyMembership(esuDataDf$ED.1.C, "ED")
# Genetic -- Effects of introgression on genetic diversity
esuResultsDf$ED.1.D <- calcFuzzyMembership(esuDataDf$ED.1.D, "ED")
# Phenotypic -- Phenotypic variation
esuResultsDf$ED.2.A <- calcFuzzyMembership(esuDataDf$ED.2.A, "ED")
# Phenotypic -- Habitat diversity
esuResultsDf$ED.2.B <- calcFuzzyMembership(esuDataDf$ED.2.B, "ED")
# Dependent Populations
esuResultsDf$ED.3 <- calcFuzzyMembership(esuDataDf$ED.3, "ED")

# Attach ESU results table for easy access
attach(esuResultsDf)

## ED-1 -- Calculate ED-1 by AND-ing ED-1A through D
esuResultsDf$ED.1 <- calcFuzzyUnion(c(ED.1.A,ED.1.B, ED.1.C, ED.1.D))

## ED-2 -- Calculate ED-2 by AND-ing ED-2A and B
esuResultsDf$ED.2 <- calcFuzzyUnion(c(ED.2.A,ED.2.B))

# Detach ESU results table
detach(esuResultsDf)

## ES-1 -- Calculate ES-1 by AND-ing all stratum results for SS
esuResultsDf$ES.1 <- calcFuzzyAnd(stratumResultsDf$SS)

## ES-2 -- Calculate ES-2 by AND-ing ED-1, -2, and -3
esuResultsDf$ES.2<- calcFuzzyAnd(c(esuResultsDf$ED.1,esuResultsDf$ED.2,esuResultsDf$ED.3))

## ES -- Weighed AND of ES-1 (weight = 1) and ES-2 (weight = 0.5)
esuResultsDf$ES <- calcFuzzyAnd(matrix(c(esuResultsDf$ES.1, esuResultsDf$ES.2,1,0.5),2,2),
isWeighted=TRUE)
}

##### BEGIN BiRDSS LOGIC NETWORK RUN #####

# Current date and time for directory timestamp; The date is returned as
# yymmdd_hhmmss and will be used to create a directory for the current model run
timeStamp <- format(Sys.time(), "%y%m%d_%H%M%S")

# Read the input data files into the appropriate data frames to start the run.
readDataFiles()

# Run the DSS
cat("Starting BiRDSS run. \n")
runDss()

```

```
# Display some results
cat("EP:", esuResultsDf$EP, "\n")
cat("ES:", esuResultsDf$ES, "\n")

# Write the output data files
writeOutputTables()

# Calculate the running time
endTime <- Sys.time()
elapsedTime <- difftime(endTime, startTime, units = "secs")
cat("BiRDSS run complete. Processing time was", elapsedTime, "second(s).\n")

# Clean up by removing all objects used
rm(list=ls(all=TRUE))

##### FINISH BiRDSS LOGIC NETWORK RUN #####
```



# Appendix B: Genetic Effective Population Size for Oregon Coast Coho Salmon

*[Note: This appendix was prepared in 2006, before the Oregon Coast Workgroup of the Oregon and Northern California Coasts Technical Recovery Team made revisions to some criteria and metrics. Some of the formulations described here are not consistent with those in the body of this technical memorandum, which was revised based on reviewer comments and more recent literature.]*

## Introduction

Within-population diversity is an important component of the sustainability criteria described in the body of this report. Such diversity results from phenotypic differences among individuals that provide the flexibility for the population as a whole to respond successfully to short-term environmental variations. It is also the basis by which populations are able to adapt and evolve as conditions within their home range go through changes that are more permanent. Therefore, maintaining sufficient within-population diversity is an issue for both short-term and long-term survival.

Within-population diversity is controlled by a variety of forces, including evolutionary legacy, immigration from other populations, mutation, selection, and random loss of genetic variation due to small population size. However, it is this last factor that is most commonly recognized as a concern for species that are vulnerable to extinction. The genetic consequences of small population size and numerous approaches to defining minimum population abundance thresholds have been investigated widely (Soulé 1980, Lande 1995, Franklin and Frankham 1998, Rieman and Allendorf 2001). In nearly all cases, this becomes an exercise in identifying a rate at which genetic variation can be lost without causing a risk to a population's short-term or long-term persistence.

## Genetic Concepts

A large factor in maintaining the genetic diversity of a population is the abundance of the population, and our approach focuses on that factor. A common measure of within-population genetic diversity is heterozygosity, a measure of the average amount of genetic variation within individual loci within chromosomes. In an idealized population, rate of loss of heterozygosity is a simple function of population size, but no real populations meet the assumptions of the idealized theory. For this reason, geneticists have developed the concept of "genetic effective population size," which is the size of an idealized population having the same loss rate as a corresponding real population. In general, the real population size will be larger than the corresponding effective population size. In what follows, theory is applied to determine the

effective population size ( $N_e$ ) needed to achieve a particular rate of loss of heterozygosity, then translate that number into the size of corresponding real populations.

After considerable review of the genetics and conservation biology literature, it was concluded that maintaining at least 95% (or losing no more than 5%) of a population's heterozygosity over a 100-year period, as recommended by Allendorf and Ryman (2002), would be used as a conservation threshold. Heterozygosity is used here as a metric to represent genetic diversity. However, having defined the threshold in these terms, a method to actually measure or forecast this heterozygosity loss rate for Oregon Coast coho salmon (*Oncorhynchus kisutch*) populations was needed. For this purpose, the workgroup used a well-known relationship between a theoretical population size and the rate at which heterozygosity is lost. For an "ideal" population, this relationship, developed by Wright (1969), can be described by the following equation:

$$\Delta H = (-1/2N_e)(100\%) \quad (2)$$

where  $\Delta H$  is the expected amount of genetic variation lost in one generation (expressed as percent of heterozygosity lost), and  $N_e$  is the number of adults in a population, where each member has equal probability of contributing offspring to the next generation (expressed as the effective population size). Based upon this equation, the value for  $N_e$  necessary to retain 95% of the genetic variation after a certain number of generations ( $t$ ) can be expressed as:

$$N_e = 1/[2(1 - 0.95^{(1/t)})] \quad (3)$$

To solve the calculation of  $N_e$  in Equation 3 for coho salmon, a value for the number of generations expected for a coho population over a period of 100 years (the reference time period) is required. Although coho salmon spawn primarily at age 3, some precocious males (jacks) from each brood spawn at age 2. The proportion of jacks appears to vary among coastal populations, with stream populations averaging about 6% and lake populations averaging about 22% (Chilcote et al. 2005). The result is that the average age at maturity for stream populations is 2.94 years (34.01 generations in 100 years), and is 2.78 years (35.97 generations in 100 years) for lake populations. Therefore, substituting these values for  $t$  into Equation 3, values for  $N_e$  of 332 and 351 are obtained for stream and lake populations, respectively. In other words, if these values for  $N_e$  are obtained, no more than 5% of the population's heterozygosity will be lost over a period of 100 years.

## Ideal vs. Real Populations

The calculation of minimum values of  $N_e$  for Oregon Coast coho is mathematically valid only if coho populations meet the conditions of an "ideal" population. An "ideal" population, whose abundance is represented by the symbol  $N_e$ , must meet certain conditions, such as: no overlapping generations, equal sex ratio, constant population size, and equal probability of reproductive success for all members of the population. The problem is that nearly all populations (regardless of species) fail to meet these "ideal" constraints. Therefore, to estimate the rate of genetic loss based upon the number of spawners, a significant number of "corrections" need to be made. Essentially, the goal of these corrections is to build a metric that represents  $N_e$  but which can be applied to the species and data in question.



Typically, when these corrections are made, the number of individuals necessary to achieve the genetic behavior of an “ideal” population is greater than the size of the corresponding “ideal” population. By convention,  $N_e$  is used to represent the number of adults in an ideal population and  $N$  is the number of adults actually counted in the population. In most real life situations, the ratio of  $N_e/N$  is less than 1.0, (i.e.,  $N$  is greater than  $N_e$ ). For salmonids, Allendorf et al. (1997) suggest that  $N_e/N$  ratios in the range of 0.20 may be typical. Likewise, McElhany et al. (2000) suggest that a  $N_e/N$  ratio of 0.30 is a reasonable expectation. Rather than using these rough guidelines, factors more specific to Oregon Coast coho salmon populations were examined to estimate the  $N_e/N$  ratio, specifically considering variation in family size and the effects of overlapping generations.

### Family-size Variation

One factor that can cause  $N_e$  to be less than  $N$  is unequal probabilities of producing offspring among individual spawners, resulting in variation in family sizes among spawners. In some extreme examples, only a few members of the spawning population produce all of the surviving offspring. In effect, the genetic contribution to the next generation comes from a much smaller number of individuals than a simple count of spawning individuals would suggest. Obviously, the challenge of estimating how many offspring each spawner in a wild population produces is a daunting proposition. However, several estimates of offspring produced per individual spawner have been made for salmonids in recent years (Simon et al. 1986, Geiger et al. 1997, Seamons et al. 2003). Results from these studies can be compared in a standardized manner by calculating  $V_K/K$ , where  $V_K$  is the variance in offspring produced per spawner, and  $K$  is the mean number of offspring produced per spawner. Among these studies, the values for  $V_K/K$  are confined to a surprisingly narrow range from 2.63 to 2.96, with a mean of 2.77. We will use this value in the following calculation of effective population size.

An “ideal” population, represented by  $N_e$ , is assumed to have a pattern of offspring per parent across all parents that follow a Poisson distribution characterized by a ratio of  $V_K/K \approx 1$ . With salmonid populations, apparently having a ratio that is much greater than 1 (for example 2.77 in the studies discussed above), there is a need to adjust  $N_e$  calculations to account for this difference. As described by Hartl (2000), the ratio of  $V_K/K$  can be used to adjust the calculation of  $N_e$  for unequal probabilities of reproductive success using the following equation:

$$N_e = 2N/[1 + (V_K/K)] \quad (4)$$

When a value of 2.77 (the mean of the three studies cited above) is substituted for  $V_K/K$  in Equation 4, the relationship between  $N$  and  $N_e$  becomes:  $N_e = 0.53N$ . In other words, to account for unequal reproductive success probabilities,  $N$  should be reduced by 0.53 in the computation of the effective population size,  $N_e$ , or effective population size.  $N_e$  represents a value of about half of the number of adults that should be in the population ( $N$ ).

### Overlapping Generations

Another factor that needs to be considered in the estimation of  $N_e$  is the effect of year-to-year variation in recruitment for species with overlapping generations. For example, Waples (2002) suggests that such variability in Chinook salmon (*Oncorhynchus tshawytscha*) results in a

40% to 60% reduction in the value calculated for  $N_e$ . Although coho salmon have less variation in age of maturity than Chinook salmon, Van Doornik et al. (2002) demonstrated that jacks (2-year-olds) contribute enough to gene flow between different age-classes that genetically, coho should be treated as a species with overlapping generations. Therefore, even though the majority of the reproduction comes from 3-year-old fish, coho salmon should not be treated like pink salmon (*Oncorhynchus gorbuscha*), for which the year classes do not overlap. Based upon a synthesis of these two studies (Waples 2002, VanDoornik et al. 2002), an additional reduction of 60% was applied to the calculation of  $N_e$  for Oregon Coast coho salmon. Although a 60% reduction is the upper portion of the range suggested by Waples (2002), his analysis was based on Chinook salmon, which have a greater overlap in generations than do coho salmon. Therefore, it seemed appropriate to use the higher reduction value (60%). The net result of the overlapping generation adjustment and the one for unequal reproductive contribution among families (Equation 4) is the following:

$$N_e = (0.53N)(1-0.60) = 0.212N \quad (5)$$

It is reassuring that this level of reduction ( $N_e = 0.212N$ ) is similar to values suggested for salmonids by Allendorf et al. (1997) ( $N_e = 0.20N$ ) and by McElhany et al. (2000) ( $N_e = 0.30$ ).

## Translating Effective Population Size to Spawner Counts

Spawner abundance estimates for salmon are typically collected on an annual basis. However, for a species with overlapping generations (such as salmon), the value for  $N$ , such as in Equation 5, needs to incorporate the fact that each year's spawning population is composed of individuals from different year classes. Waples (1990) demonstrated that for Pacific salmon, this problem of overlapping generations can be accounted for in the calculation of  $N_e$  using the relationship described below:

$$N_e = g (N_b) \quad (6)$$

where  $g$  is the average age at maturity for the species and  $N_b$  is the harmonic mean of annual counts of spawners for the entire data set. As previously discussed, the average age at maturity was  $g = 2.78$  years for lake populations (i.e., Siltcoos, Tahkenitch, and Tenmile) and  $g = 2.94$  years for all other populations (stream populations). The harmonic mean of annual spawner counts ( $N_b$  in Equation 6) is calculated from:

$$N_b = 1 / (1/t)(\sum(1/N_i)) \quad (7)$$

where  $t$  is the number of years counted and  $N_i$  is the number of spawners counted for each year. It should also be noted that using a harmonic mean to characterize spawner abundance essentially gives greater weight to the smaller numbers in the data set. This approach is generally accepted as a way to incorporate the errors that will occur in estimating  $N_e$  if population abundance fluctuates widely, as is frequently the case for coho salmon. Finally, bringing together the previous adjustments described by Equation 5 for estimating  $N_e$  with those of Equation 6 to account for overlapping generations yields the following equation:

$$N_e = 0.212 g (N_b) \quad (8)$$

Substituting the average maturity age for lake populations ( $g = 2.78$ ) and stream population ( $g = 2.94$ ), Equation 8 can be simplified to

$$N_e = 0.589 N_b \quad (9)$$

for lake populations and

$$N_e = 0.623 N_b \quad (10)$$

for stream populations.

As presented earlier (see Equation 3 discussion),  $N_e$  values that must be achieved to retain at least 95% of the population's heterozygosity over a 100-year time period are 351 for lake populations and 332 for stream populations. Equations 9 and 10 can be used to calculate  $N_e$  values directly from an easily measurable quantity—annual spawner abundance, expressed as a harmonic mean over several years. These equations can also be rearranged such that given a desired  $N_e$ , the harmonic mean necessary to achieve this  $N_e$  can be calculated. Substituting these values for  $N_e$  into Equations 9 and 10 yields an  $N_b$  for lake populations of  $351 / 0.589 = 595$ , and an  $N_b$  for stream populations of  $322 / 0.623 = 533$ .

### **Spawner Abundance Criterion**

To establish a single criterion applicable to all populations, the workgroup averaged the critical  $N_b$  values for the lake and stream populations (average = 564) and rounded this number to 600. This provides a conservative estimate of the harmonic mean annual spawner abundance required to meet our goal of retaining 95% of heterozygosity over a 100-year time period.



# Appendix C: Population Persistence Models

## Introduction

One of the population-level criteria—Probability of Persistence, PP-2—requires the use of quantitative models to estimate the probability that populations will persist for the next 100 years. In evaluating this criterion, population viability analysis (PVA) models were used to estimate population-scale extinction risk over a 100-year time frame. This appendix describes in detail the methods and results of those modeling exercises.

PVA is a “... systematic process for species-, location-, and time-specific criteria for persistence ...” of populations (Soulé 1987, p. 5). In general, the term includes a variety of quantitative analyses to predict the future status of a population or collection of populations, especially to predict the risk of extinction (or quasi-extinction) over time. The history of PVA spans slightly more than 20 years, beginning with early applications in predicting minimum viable populations (Shaffer 1981).

To assess population viability, four different extinction-risk models were applied to the Oregon Coast coho salmon (*Oncorhynchus kisutch*) Independent Populations. These were:

- A density-dependent, count-based PVA model (DD-PVA) developed by Mark Chilcote and used by the State of Oregon in its Oregon Plan assessment (Chilcote et al. 2005)
- The SPAZ hockey stick model (SPAZ-hs), which uses the “hockey stick” recruitment function option in the SPAZ population analysis software package developed by McElhany and Payne (2005)
- A Bayesian salmon analysis model (BaySAM) developed by Wainwright et al. (in prep).
- A stochastic habitat-based life cycle model (NL) developed by Nickelson and Lawson (1998)

## Comparison of the Models

The four models used make different assumptions about important aspects of coho salmon population dynamics: the form of the stock-recruit relationship (including compensation and depensation), sources of risk, data used, future conditions, and uncertainty in parameter estimates. These differences are summarized in Table C-1 and discussed in the following paragraphs.

### Stock-recruit relationships

Each of the models assumes a particular form of relationship between spawner abundance and subsequent production of either smolts or adult recruits. All of the models assume some

Table C-1. Comparison of the PVA models used.

Model	Stock-recruit relationship			Data used		Future conditions		
	Form of compensation	Form of depensation	Sources of risk	Stock-recruit data	Habitat data	Environmental variation	Average conditions	Parameter uncertainty
Density-dependent, count-based	Modified Ricker	Logistic with threshold	Environmental	1958–2004 (Appendix D)	None	Cyclic + random variation	Like 1958–2004	None, point estimates
SPAZ hockey stick	Linear increase with ceiling	None	Environmental, parameter	1958–2004 (Appendix D)	None	Uncorrelated random variation	Like 1958–2004	Bayesian for three key parameters
Bayesian salmon analysis	Beverton-Holt	Exponential	Environmental, demographic, parameter	1958–2004 (Appendix D)	Estimated smolt capacity	Autocorrelated random variation	Like 1958–2004	Bayesian for all parameters
Habitat-based life cycle	Complex egg-to-parr and parr-to-smolt functions	Complex, demographic and genetic	Environmental, demographic, genetic	None	Reach-scale habitat quality	Cyclic + random variation	Harvest, habitat change, lower marine survival	None, point estimates

form of compensation (i.e., a decrease in productivity with increasing abundance, resulting in an approach to some maximum level of production), and most assume some form of depensation (a decrease in productivity as abundance becomes very low, also known as Allee effects). These assumptions are compared in Table C-1, and stock-recruit curves for three of the four models are shown in Figure C-1. (The habitat-based life cycle model does not have a distinct stock-recruit curve.) Further details can be found in the model description subsections below.

### Sources of risk

The extinction risk for a population is a function of the average conditions that affect population dynamics and variations in those conditions into the foreseeable future. In addition to these biological factors, to estimate this risk one must include the uncertainties in model structure, parameter estimates, and recent population conditions. Shaffer (1987) classified random variations (or stochasticity) affecting viability into four broad categories: 1) demographic (random events in the survival and reproduction of individuals), 2) environmental

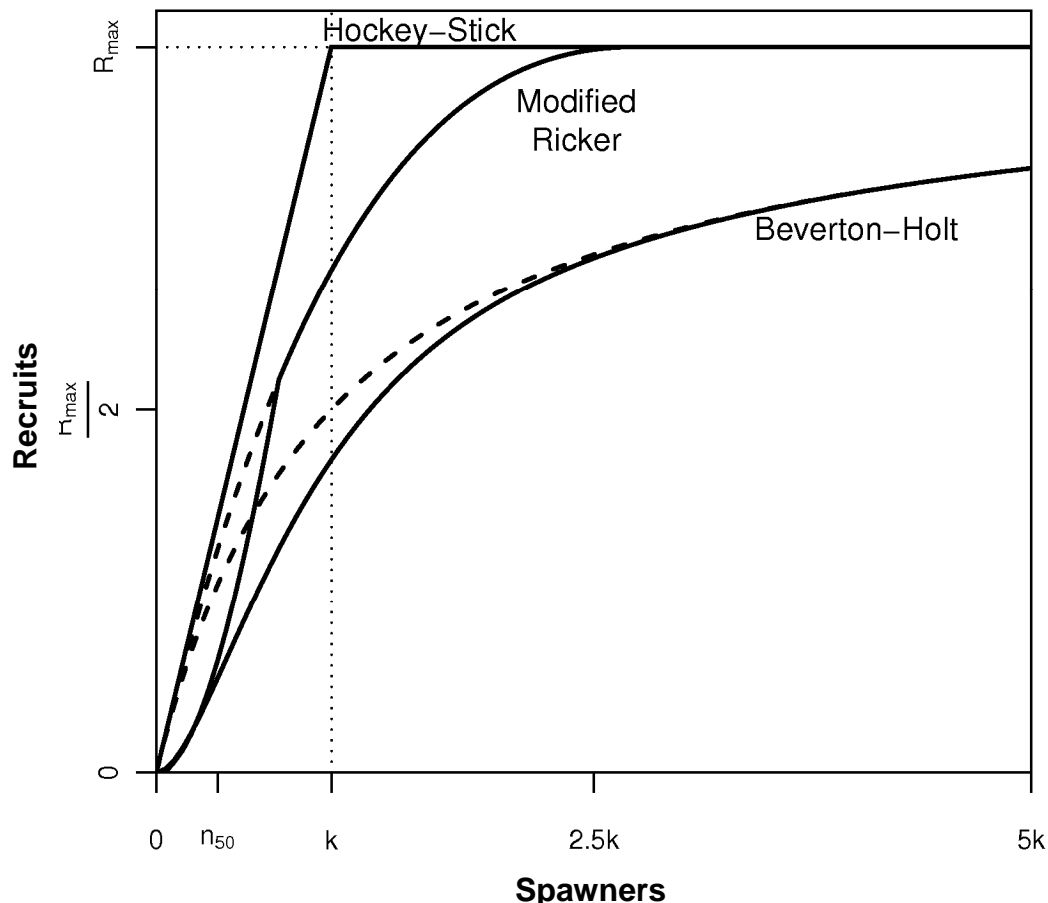

Figure C-1. Comparison of production relationships for the various models, all scaled to the same maximum production ( $R_{max}$ ) and rate of intrinsic increase. Solid curves are the relationships with depensation as used in the modeling work, dashed lines show the relationships without the effects of depensation. Spawners are scaled to the parameter  $k$ , which is equal to  $R_{max}$  divided by intrinsic production (slope at the origin) of the nondepensatory relationships.

(unpredictable changes in environmental variables affecting the population), 3) catastrophic (large events such as floods, fires, or droughts that occur at unpredictable intervals), and 4) genetic (random changes in genetic makeup of populations).

An ideal viability model would include all of these, but such models are rare. Of the models, two (DD-PVA and SPAZ-hs) include only environmental variation, one (BaySAM) includes both environmental and demographic variation, and the final model (NL) includes environmental, demographic, and genetic variation. None of the models include catastrophes, which are difficult to evaluate on the short (100-year) time scale being assessed; catastrophes are considered at the stratum and evolutionarily significant unit (ESU) levels in the criteria. Regarding model uncertainty, uncertainty in model structure was addressed by using a variety of models. Two of the models also account for parameter estimation uncertainty through the use of Bayesian analysis (a statistical technique that allows the mathematical combination of uncertainty in parameters with environmental variation to derive a single risk estimate, discussed further in Parameter uncertainty on page 146).

### **Data used**

Three of the models base their predictions on stock-recruit curves fitted to spawner abundance time series. These three models all used the population reconstructions described in Appendix D as their primary data; these data are shown in Figure C-2. The habitat-based model does not use population abundance data, but rather is driven by fine-grain measures of habitat quality from field sampling (e.g., Flitcroft et al. 2002) along with statistical relationships relating juvenile capacity and survival to habitat quality (Nickelson and Lawson 1998). Finally, three of the models (DD-PVA, BaySAM, and NL) incorporate variation in the marine environment based on the Oregon Production Index (OPI) marine survival estimates.<sup>5</sup>

### **Future conditions**

Assumptions about future conditions (especially the mean and interannual variation in freshwater and marine survivals) are critical in estimating extinction risk. Each model takes a different approach to future conditions. The DD-PVA model incorporates variation in marine survival by repeating the observed time series of OPI marine survival estimates cyclically into the future, randomly choosing a different starting point in the series for each simulation. The SPAZ-hs model assumes environmental variation is temporally autocorrelated (i.e., the variation in a given year is more likely to be like the variation in the years preceding it than would be expected if drawn from a random normal sample). This tends to create runs of bad years or good years. BaySAM assumes that future marine survivals are temporally autocorrelated random variables, with mean, variance, and autocorrelation estimated from a combination of the historical OPI marine survival series with residuals from the stock-recruit model fit.

All three of these models assume that future conditions will be on average like average conditions during 1958–2004, but they take different approaches to modeling the variation about average conditions. The final model (NL) incorporates marine survival by repeating the pattern

---

<sup>5</sup> C. Melcher, Oregon Dept. Fish and Wildlife, Clackamas. Pers. commun., July 2005.



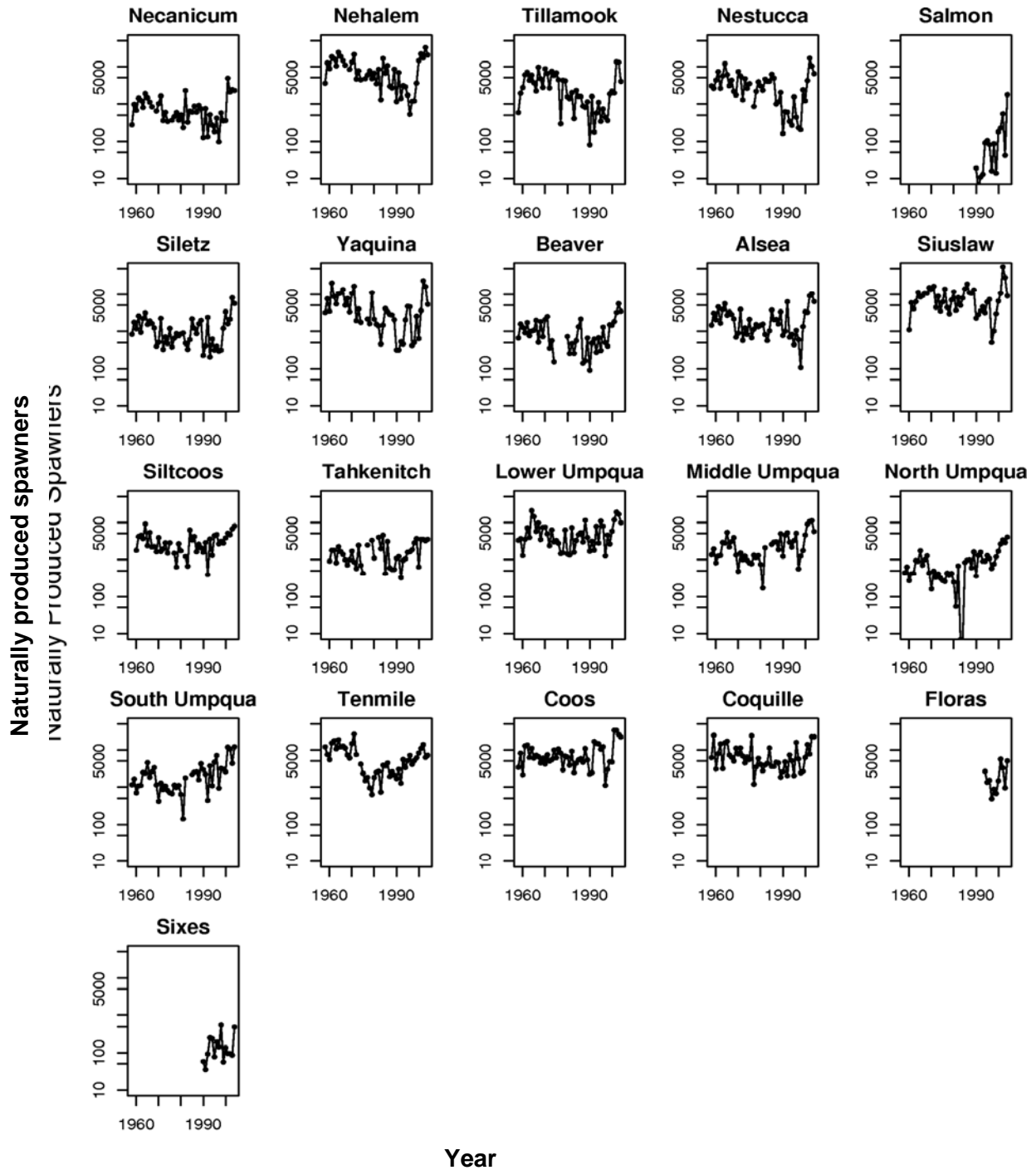

Figure C-2. Time series (1958–2004) of naturally produced spawner abundance (logarithmic scale) for the 21 Independent Populations, based on data and reconstructions in Appendix D.

of OPI marine survivals, with variability, into the future. The average survival rate can be adjusted up or down to simulate possible changes in future ocean cycles. Environmental variability in freshwater is a random process that affects all reaches the same in a given year.

### **Parameter uncertainty**

Only two of the models specifically address parameter uncertainty, and both incorporate this uncertainty in terms of Bayesian analysis to incorporate uncertainty in parameters directly into the estimate of extinction risk. The SPAZ-hs analysis includes uncertainty in three key parameters, while BaySAM incorporates uncertainty in all biological and environmental parameters.

### **Cautions**

The use of viability modeling to estimate extinction probabilities is somewhat controversial, in particular regarding whether results should be interpreted as absolute or relative. If PVA is to be used, for example, for making decisions as to whether a population should be listed under the U.S. Endangered Species Act, then absolute predictions of the likelihood of extinction are necessary. On the other hand, if the analysis is used just to compare the merits of two or more management options, or to prioritize conservation efforts (for example, in Allendorf et al. 1997), then relative predictions may be adequate.

Obtaining reliable absolute predictions of extinction probabilities is difficult, causing some authors to recommend against ever using PVA in situations demanding absolute answers (Reed et al. 2002). Coulson et al. (2001) note two necessary conditions for accurate PVA: 1) data must be of sufficient quality that estimates of the statistical distributions (shape, mean, variance, and autocorrelation) of vital rates are accurate, and 2) future distributions of these rates must be similar to those estimated, or changes in rates must be predictable. They argue that there are few real situations where these conditions can be met and conclude (p. 221) that “PVAs could be useful for comparing the consequences of different management or conservation strategies, and for exploring theoretically the implication of model assumptions on extinction probabilities and population dynamics. However, the workgroup doubts the general claim that they can be accurate in their ability to predict the future status of wild populations.” In contrast, other authors (Brook et al. 2000, 2002) conclude that PVAs are reliable in classifying and managing populations despite their shortcomings, but note that “the results of a PVA are just one factor in any social and political decision-making context and should be a necessary precursor to good judgment” (Brook et al. 2002, p. 263).

## **Density-dependent, Count-based PVA Model**

### **Introduction**

A wide variety of viability models have been used by conservation biologists to estimate the vulnerability of populations to extinction (Shaffer 1981, Shaffer 1990, Murphy et al. 1990, Nickelson and Lawson 1998). The viability analyses used in this assessment to estimate population persistence were based upon methods described by Burgman et al. (1993) and Morris and Doak (2002). In general, such methods combine a deterministic recruitment model and a

Monte Carlo simulation of random fluctuations in environmental conditions to forecast future population abundance. Forecasts are made for an extended period of time (often 100 years) and are examined to determine how many times or how frequently the forecast number of spawners decreased below an abundance threshold defined as the minimum abundance needed to conserve the species.

One of the primary characteristics of PVAs is that population abundance forecasts over a period of future time are generated more than once. Random variation in the recruitment process is incorporated into the model via this repetition, which ensures that each forecast will differ slightly from another. It is not unusual in this type of analysis to perform 5,000 forecasts for each population. To summarize such results, the proportion of all of the forecasts that yield a prediction of extinction is calculated. This extinction proportion is then used as an estimate of the probability of extinction for the population. Populations with a low probability of extinction risk are considered to be viable.

The forecasts are based upon the combination of a population recruitment model and environmental variation that has a certain degree of randomness. In this appendix, the recruitment model and the associated parameter estimates used are discussed for each population. Then the details of the PVA model itself are described and how it integrates with each population's recruitment process.

## **Recruitment Model**

### **The model**

The Ricker population recruitment relationship was chosen as the basis from which a DD-PVA was developed for Oregon coho salmon. In the most basic form of this recruitment model, the number of spawners is used to predict the number of offspring (recruits) in the next generation. The mathematical formula used to make these predictions (illustrated in Figure C-3) is described by:

$$R = S \times \exp(a + BS) \tag{11}$$

where  $R$  is the total number of adult recruits (preharvest) produced from the spawners 3 years previously,  $S$  is the number of spawners that produced those recruits,  $a$  is the parameter for intrinsic population growth rate, and  $B$  is the parameter inversely proportional to habitat capacity.

The Ricker relationship is one of several alternative recruitment models commonly used by fish conservationists. The Beverton-Holt (Beverton and Holt 1957) and hockey stick (Barrowman and Myers 2000) recruitment models also see frequent use. The decision in this case to use the Ricker model was based on an ad hoc assessment that it fit the data as well as either of the two alternatives and that it seemed most consistent with the observed performance of Oregon Coast coho salmon when the density of spawners was low. The ratios  $R/S$  observed for Oregon Coast coho salmon populations show an inverse relationship with spawner abundance (i.e., as spawner abundance decreases,  $R/S$  increases). This pattern is inconsistent with the fixed  $R/S$  assumption of the hockey stick model when spawner abundance is below full seeding.

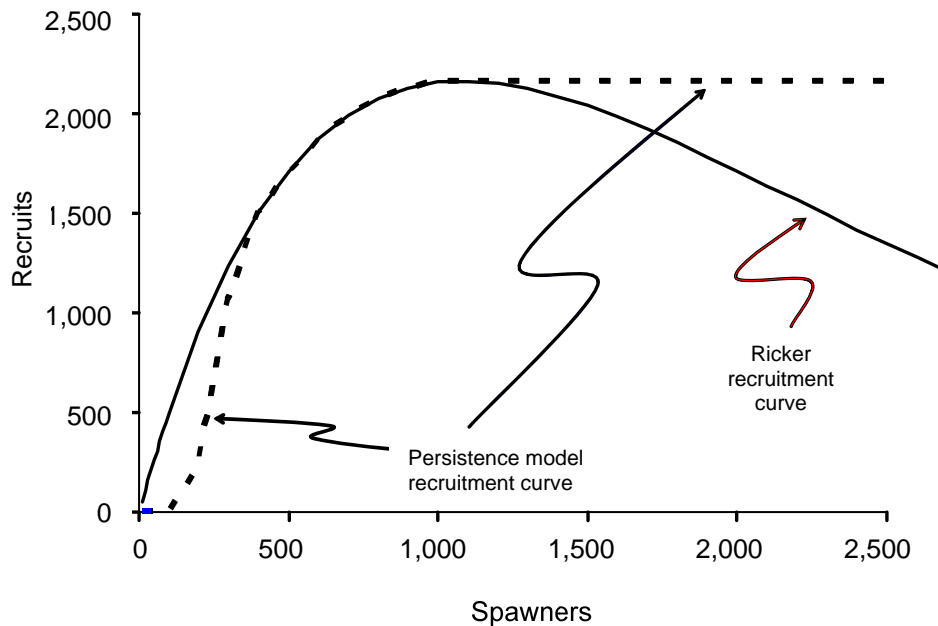

Figure C-3. Generic example of Ricker recruitment curve and the modified version of this curve used to simulate recruitment in the PVA (persistence model).

Therefore, it would be expected that at low spawner density the hockey stick model would under predict recruitment performance (negative recruitment bias). In contrast to the hockey stick model, preliminary scoping with the Beverton-Holt recruitment model suggested it may over predict recruitment at lower spawner abundance (positive recruitment bias). In addition, earlier work by Zhou (2000) suggested the Ricker model was preferable to the Beverton-Holt model for modeling recruitment in populations of Oregon Coast coho salmon.

Some authors (e.g., Caputi 1988, Quinn and Deriso 1999) have suggested that when the Ricker model is fitted to population recruitment data containing substantial measurement error, the resulting recruitment curve will be biased and overestimate  $R/S$  at low spawner density. However, Kehler et al. (2002) found that, in general, low density  $R/S$  was not overestimated in the fitting the Ricker recruitment model to “noisy” data.

A potential weakness of using the Ricker model for coho salmon is that it predicts that a reduction in the number of recruits produced will occur when the parental spawner abundance is high (see Figure C-3). Most populations of Oregon coho salmon do not show a strong decrease in recruits when the spawner escapement level is high. The right-hand, descending limb of the Ricker recruitment curve does not seem to match these observations. However, for evaluating populations with respect to the question of vulnerability to extinction, the recruitment performance of populations at high spawner abundance is of less concern. The function of population recruitment at high spawner abundance is a more critical question to fishery management than to assessing the risk of extinction. For conservation purposes, it is more important that the recruitment predictions are as accurate as possible when the spawner levels are low. In this respect, the Ricker relationship was judged to have this advantage relative to the Beverton-Holt and hockey stick curves.

One shortcoming on the use of any model that forecasts recruits solely on the basis of parental abundance is that it ignores one of the key factors that influence coho salmon abundance: ocean survival conditions. Variation in marine survival has a strong influence on the number of coho salmon returning to spawn in any particular year. As a consequence, the relationship between spawners and recruits is heavily modified by variations in marine survival. To account for this important factor, a marine survival variable was added to the recruitment model, modifying Equation 11 to the resulting form:

$$R = S \times \exp (a + BS + cO) \quad (12)$$

where  $c$  is an additional parameter for marine survival and  $O$  is a standardized index of annual smolt-to-adult survival rates for ocean conditions from 1960 to 2002 based on the OPI. The value for each year's index was expressed in terms of its deviation from the 1960 to 2002 natural-log-transformed mean of smolt-to-adult survivals. This standardized index was calculated from the equation:

$$O_{yr} = \ln(OPI_{yr}) - \ln(OPI_{1960-2002mean}) \quad (13)$$

The OPI is based on the smolt-to-adult survival of hatchery coho salmon, primarily originating from the Columbia River. As such it is not a direct measurement of wild coho salmon survival; rather it is an observable indicator likely to have a correlation with the annual variations in the marine survival of wild coho salmon.

### Parameter estimation

The values for the parameters  $a$ ,  $B$ , and  $c$  of Equation 12 must be estimated for each population in order to fit the recruitment model. The data used to make these fits (i.e., estimate the recruitment model parameters) were derived from spawner and recruit data for Oregon Coast coho salmon as presented in this report. The number of recruits corresponding to each brood year was calculated by dividing the spawner abundance observed 3 years later by one minus the fishery mortality rate. For example, the number of recruits produced by the fish that spawned in 1996 was calculated as the spawner abundance observed in 1999 divided by one minus the fishery mortality rate observed for 1999. Fishery-related mortality rates for wild Oregon Coast coho salmon as presented in this report are based on information provided by the Oregon Department of Fish and Wildlife (ODFW).<sup>6</sup>

To estimate  $R/S$  for each brood year, both wild and naturally spawning hatchery fish were counted as spawners (combined for the denominator,  $S$ ), whereas only wild fish were counted as recruits (the numerator,  $R$ ). For each population, a data table was constructed having a row for each brood year from 1958 to 2000 and three columns with data for  $\ln(R/S)$ , the number of parental spawners, and the index of marine survival for the recruits corresponding to each brood year. Recruitment model parameters were estimated via multiple regression using the following equation:

$$\ln(R/S) = a + BS + cO \quad (14)$$

---

<sup>6</sup> See footnote 5.

However, rather than estimate these parameters from a single multiple regression analysis, Monte Carlo bootstrapping methodology was used. This methodology is considered to be a more reliable means of estimating model parameters (Efron and Tibshirani 1993). The bootstrapping approach is based on a successive series of randomly resampling observed data, which generates a large number of pseudo data sets. In the case of Oregon coho salmon data, a program was written to randomly select brood years from the 43 years of data, drawing a specific value for  $\ln(R/S)$ , spawner abundance, and marine survival index with each brood year sampled. The sampling protocol was done with replacement and continued until 43 brood years of data were obtained. Because the sampling was done with replacement, it was nearly certain that data for a single brood year could be drawn more than once. Likewise, it was nearly certain that at least some of the brood years in the original data set would not be drawn at all. Once 43 selections were made, these data were stored in an array for future computations. The program then repeated the selection process until 2,000 pseudo data sets (each having 43 brood years of data) were generated. Following this step, a multiple regression, based on Equation 14 was performed on each of the 2,000 pseudo data sets and results recorded. The mean values of  $a$ ,  $B$ , and  $c$  from these multiple regression analyses were used as the estimated recruitment relationship parameters for each population.

### Population parameters

Using the bootstrap method as described, recruitment equation parameters were estimated for each population. The average  $R^2$  value for the multiple regressions across all of the populations was 0.54 and indicates that for most populations the combination of the two variables (spawner abundance and marine survival) may account for most of the observed variation in population recruitment (Table C-2). However, for the Salmon, Floras/New, and Sixes populations, the parameter estimates were obtained from multiple regression analyses that involved 11 or fewer data points. As cautioned by Burgman et al. (1993), estimation of recruitment parameters from data sets with fewer than 15 points is likely to give inaccurate results. Therefore, for these three populations the resulting recruitment equations may describe a population recruitment behavior that is substantially different from the true manner in which these populations function. Only with additional years of data will the accuracy of the present parameter estimates for these populations be known.

## Population Viability (PVA) Model

### Forecasting viability and persistence

The DD-PVA model is a series of calculations implemented via a MS Excel Visual Basic program. The mathematical protocol used to forecast recruits over multiple generations was basically Equation 12 modified such that the value for the  $a$  parameter was randomly selected from a normal distribution having a mean equal to the estimated mean value. This change was represented by replacing  $a$  in Equation 13 with  $a_{rand}$  as follows:

$$R = S \times \exp(a_{rand} + BS + cO_{yr}) \quad (15)$$

Therefore,  $a_{rand}$  signifies that the parameter is a randomly picked number from a normal distribution having a mean equal to the estimated value for the Ricker a parameter and a standard

Table C-2. Estimated density-dependent PVA recruitment model parameters and associated information for 21 populations of Oregon Coast coho salmon.

<b>Population</b>	<b><i>a</i></b>	<b><i>B</i></b>	<b><i>c</i></b>	<b>SD</b>	<b>R<sup>2</sup></b>	<b>n</b>
Necanicum	1.694	-0.000925	0.876	0.634	0.61	43
Nehalem	1.871	-0.000110	1.271	0.634	0.76	43
Tillamook	1.219	-0.000117	0.963	0.884	0.39	43
Nestucca	1.723	-0.000223	0.882	0.883	0.36	43
Salmon	-0.126	-0.002565	0.310	0.936	0.68	11
Siletz	1.550	-0.000535	0.782	0.724	0.53	43
Yaquina	1.821	-0.000185	0.852	1.156	0.36	43
Beaver	1.694	-0.000831	0.573	0.701	0.54	35
Alsea	1.526	-0.000304	0.772	0.741	0.54	43
Siuslaw	2.325	-0.000153	0.882	0.827	0.55	41
Lower Umpqua	1.956	-0.000163	0.578	0.617	0.56	43
Middle Umpqua	2.115	-0.000433	0.318	0.749	0.52	43
North Umpqua	0.861	-0.000257	0.721	0.896	0.54	43
South Umpqua	1.933	-0.000479	0.260	0.796	0.48	43
Siltcoos	2.123	-0.000383	0.388	0.664	0.53	41
Tahkenitch	1.991	-0.000558	0.473	0.761	0.51	41
Tenmile	1.447	-0.000064	0.465	0.656	0.27	43
Coos	2.432	-0.000181	0.368	0.710	0.59	43
Coquille	1.564	-0.000078	0.603	0.681	0.45	43
Floras*	2.087	-0.001649	0.675	0.455	0.89	7
Sixes*	1.724	-0.007369	-0.183	0.702	0.71	11

\*Parameter estimates and associated statistics may be unreliable because of the small number of data records available from which to make these estimates.

deviation (SD) equal to the SD of the multiple regression estimated from the fitting of observed population data as reported in Table C-2. For example, in the case of the Necanicum population, the estimated value for the  $a$  parameter and the SD for the multiple regression fit were 1.694 and 0.634, respectively. In simulating recruitment, each time another forecast for recruits was made, the computer would execute a routine to pick a new value for  $a_{rand}$  by randomly selecting a value from a normal distribution having a mean of 1.694 and SD of 0.634.

The minor notation change from  $O$  to  $O_{yr}$  for marine survival in Equation 14 signifies that, for each year of the model run, a different value for marine survival was assumed. Since most of the model runs were made for a time period of 100 years (about 33 generations), it was necessary to select a sample of marine survival rates in order to more accurately model recruitment. This could have been done in a manner similar to the process used to randomly pick values for the Ricker  $a$  parameter (i.e., randomly draw a number from a normal). However, this approach has problems in that marine survival does not occur in a random pattern, but is rather more cyclic. For example, if poor marine survival is observed in one year, the likelihood is that a poor marine survival will also occur in the next year. For a coho salmon population, the challenge of surviving poor marine survival conditions is not one of dealing with the occasional

rare event, but rather facing these rare events in a block of years together. The latter situation results in a greater challenge to the survival of the population, and it was this likely situation that the viability model was modified to simulate.

It is possible to correct for this problem of temporal autocorrelation with respect to annual environmental conditions with modifications to the structure of a viability model, using a variety of approaches including those proposed by Morris and Doak (2002). The approach used for Oregon Coast coho salmon, however, was basically to make this modification using the observed marine survival rates, in the order that they occurred between 1960 and 2002, as a template for the future 100-year period modeled. Because the observation period covers only 43 years, it had to be replicated to provide enough points for the 100-year simulation of the model. The mechanics of how the model prepared the sequence of marine survival rates for the recruitment calculations was to first artificially string together four replications of the marine survival rates observed from 1960 to 2002. Essentially this created a cyclic string of 172 values having 4 high and 4 low periods of marine survival. For each 100-year simulation, a different starting place was randomly selected (from a uniform distribution) within the first 43 years of the 172-year string. The first 100 years after this starting point were then used as the marine survivals ( $O_{yr}$ ) for the model run.

Another key element of the persistence simulation model was the assumption made about population recruitment when the number of spawners was extremely low (i.e., depensation effects). Barrowman (2000) suggested that for natural coho salmon populations, depensation may be a factor when spawner densities are less than the equivalent of 3.2 spawners per mile. For the purposes of the persistence model, it was assumed that an abundance level equal to 3.2 spawners per mile was the depensation threshold, below which population recruitment would be adversely impacted. The persistence simulation model was constructed to incorporate these depensation thresholds, with explicit protocol for how recruitment would function once the number of spawners had fallen below these thresholds. This protocol worked in the following manner. When the persistence simulation model yielded a spawner abundance less than the depensation threshold, the number of recruits forecast was adjusted downward as described by:

$$\begin{aligned}
 &\text{If } S \leq 0.10S_{Depn}, \text{ then } R_{adj} = 0.0, \\
 &\text{If } S > 0.10S_{Depn} \text{ and } S < S_{Depn}, \text{ then} \tag{16} \\
 &R_{adj} = R \times [S_{obs} - (0.10S_{Depn})] / [S_{Depn} - (0.10S_{Depn})]
 \end{aligned}$$

where  $S_{Depn}$  is the depensation threshold for the population,  $R_{adj}$  is the depensation adjusted number of recruits,  $R$  is the number of recruits forecast by the recruitment model without depensation adjustment, and  $S_{obs}$  is the observed number of spawners. This protocol essentially treats any spawner escapement less than one-tenth of the depensation value the same as if no recruitment had taken place. Between this zero recruitment level and the depensation threshold, the number of recruits is scaled up proportionally such that when the spawner level reaches the depensation threshold (and above), no depensation discounting is applied to the forecast number of recruits (i.e.,  $R_{adj} = R$ ).



As noted, one possible shortcoming of using the Ricker function is that it yields decreasing number of recruits as the number of spawners increase beyond the level needed to achieve maximum recruits. While this feature may be relatively unimportant for assessments that are focused on the performance of the population when the abundance is at low or moderate levels, such as this one, this characteristic can cause problems for PVA models. Within the model runs, if a very large spawner number is generated, mathematically, the Ricker function will forecast a very low number of recruits because of the descending shape of the recruitment curve at high spawner abundance (Figure C-3). Particularly when the value for  $a$  parameter is greater than 2.0, this can set up extraneous oscillations in abundance that are an artifact of recruitment function and unlikely to be mimicked by a real populations (Sabo et al. 2004).

Although the  $a$  parameter values for most of the populations were less than 2.0 (Table C-2) and therefore less susceptible to this “pathological” oscillation problem, modifications to the recruitment function within the persistence simulation model were made to prevent this behavior from occurring. This consisted of a step inserted into the program code to check spawner abundance before each use of the recruitment equation. If this check revealed a spawner abundance value greater than the number of spawners needed to fully seed the habitat (i.e.  $S_{max}$ , estimated as  $-1/B$ ), then the spawner abundance was reset to a value equal  $S_{max}$ . The effective result of this change was to level out the recruitment curve at spawner densities greater than  $S_{max}$ . This modification, in addition to the modification for a presumed depensation effect at extremely low spawner densities, resulted in the population recruitment function used for PVA modeling to effectively assume more of a hockey stick appearance as illustrated in Figure C-3.

### **Mechanics of the model runs**

To estimate the probability of extinction, 3,000 iterations of a 100-year recruitment simulation were completed for each population. Upon completion, the sequence of spawner escapements generated for each 100-year trial were inspected to determine if at any point in this sequence there was a 3-year consecutive string of spawner abundance that averaged less than the test threshold. Three test thresholds were examined: zero spawners, 50 spawners, and the equivalent of 1 fish per mile. These test thresholds were intended to represent effective (or absolute) extinction of the population.

After inspection, those trials with spawner abundance output that contained a 3-year average spawner abundance less than the test threshold were classified as extinction events. After the results from all of the trials were inspected, the probability of extinction was calculated for the number of trials that were classified as extinction events divided by the total number of trials (i.e., 3,000).

### **Results**

The DD-PVA model predicts that for most populations, if the environment conditions of the last 50 years are repeated for the next 100, the likelihood of extinction is low. Using test thresholds of zero, 50, and 1 fish per mile (1 fpm), the number of populations with a higher than 5% risk of failure were only 3, 5, and 6, respectively (Table C-3). Further, there was a clear pattern that the more northerly populations were more vulnerable than the southerly populations (except the Sixes). It is also worth noting that populations comprised primarily of wild fish, with

the exception of the Sixes, were all predicted to persist. In contrast, the populations that were at risk of failing the threshold happen to be the ones that also contain the highest proportions of naturally spawning hatchery fish. Although it is not clear if hatchery fish per se are the cause of this increased risk, a correlation between hatchery fish and extinction risk does appear to exist.

### Parameter estimation errors

Assessing coho salmon populations using the DD-PVA model was dependent on obtaining reliable estimates for the parameters used to describe the recruitment equation for each population. Even though two factors thought to be important to population recruitment for coho salmon (spawner abundance and marine survival) were integrated into the DD-PVA model, rarely could more than 60% of the variation in population recruitment be explained by the model (Table C-2). Such results were a clear warning that even using the bootstrap estimation procedures, the probability of errors in estimating the correct values for the recruitment model parameters were likely.

Table C-3. Forecast probability from the DD-PVA model. This forecast predicts that the 3-year average wild spawner abundance will fall below conservation thresholds of zero, 50, and 1 fish per mile (fpm) at least once within a simulated future 100-year period.

Population	Threshold		
	0	50	1 fpm
Necanicum	0.000	0.002	0.002
Nehalem	0.005	0.006	0.077
Tillamook	0.052	0.057	0.155
Nestucca	0.000	0.000	0.001
Salmon	1.000	1.000	1.000
Siletz	0.038	0.065	0.248
Yaquina	0.000	0.001	0.005
Beaver	0.000	0.000	0.000
Alsea	0.003	0.003	0.034
Siuslaw	0.000	0.000	0.000
Lower Umpqua	0.000	0.000	0.000
Middle Umpqua	0.000	0.000	0.000
North Umpqua	0.042	0.115	0.115
South Umpqua	0.000	0.000	0.000
Siltcoos	0.000	0.000	0.000
Tahkenitch	0.000	0.000	0.000
Tenmile	0.000	0.000	0.000
Coos	0.000	0.000	0.000
Coquille	0.000	0.000	0.000
Floras/New	0.000	0.000	0.000
Sixes	0.923	0.998	0.998

To test the first part of this question, the parameter values for each population were changed and the net impacts on the persistence assessment were determined. As a precautionary measure, this sensitivity analysis focused only on the concern that the risk of extinction determined for each population was higher than reported because of errors in estimating model parameters. In other words, the sensitivity analysis only examined recruitment parameter values that would result in increased extinction risk relative to that estimated with the base parameter values.

Furthermore, in the interests of brevity, the sensitivity analysis results presented here represent only a small portion of the full combination of possible parameter values that could have been tested. However, the parameter values tested were intended to represent the likely outward boundaries of the magnitude of these errors.

For each population, persistence model runs were made under four different parameter error scenarios. The first scenario evaluated the impact of reducing the value for the  $a$  parameter such that the  $R/S$  value used in the recruitment calculations was essentially reduced by 30%. Effectively, this resulted in a scenario where the true values for the  $a$  parameter yielded a recruitment rate that was 30% lower than that used to evaluate the persistence and diversity criteria. The second test focused on the value for the  $B$  recruitment equation parameter, adjusting it such that the maximum number of adults that could be produced by the population was reduced by 30%. In the third sensitivity test, the value for the marine survival parameter  $c$  was increased such that the weighting given to changes in the OPI marine survival index was increased by 30%. This was anticipated to cause a weaker recruitment potential when the population cycled through the period of poor marine survival in the persistence model simulations. Finally, a fourth simulation was run wherein all of the adjustments to individual parameters were the same as in test one through three; however, rather than separate, all of these changes were combined for a “perfect storm,” scenario for recruitment parameter errors.

As illustrated in Table C-4, the probability of extinction increased substantially for each of the parameter error scenarios. With the exception of the second sensitivity test involving the  $B$  parameter, a sufficient number of populations failed each test. Among the populations there was a clear north to south pattern. The model output under any of the sensitivity test scenarios was more likely to yield a change from a pass to a fail for the persistence for populations in the northern portion of the range.

The results for the fourth sensitivity test, which assumed the errors for each of the three parameters occurred together, were predictable given the outcomes for the analyses when these parameters were considered separately. In this “perfect storm” scenario of parameter estimation bias and error, the model estimates of extinction were substantially larger than any of the first three scenarios. However, even in this case the north to south pattern of sensitivity to these errors was clearly evident.

One interpretation of the results from these parameter sensitivity analyses might be that the persistence model forecasts are not reliable and may significantly underestimate risk. However, there are several counter arguments to this interpretation. First, the sensitivity analyses examined parameter errors in only the direction that were anticipated to increase

Table C-4. Probability of extinction estimates for 21 populations of Oregon Coast coho salmon under different parameter error scenarios. Extinction probabilities for the Base column are the same as those reported for the 1 fpm abundance test threshold (Table C-3). Probabilities given for test 1, test 2, and test 3 represent, respectively, a 30% reduction in R/S (*a*), a 30% effective reduction in the maximum number of recruits that can be produced (*B*), and a 30% increase in the sensitivity of population recruitment to changes in the OPI marine survival index (*c*). The results in the last column combine parameter changes of test 1, test 2, and test 3 into a single, worst-case scenario (*a + B + c*). Values greater than 0.05 are highlighted in bold.

Population	Base	<i>a</i>	<i>B</i>	<i>c</i>	<i>a + B + c</i>
		sensitivity test 1	sensitivity test 2	sensitivity test 3	sensitivity test 4
Necanicum	0.002	<b>0.125</b>	0.012	<b>0.124</b>	<b>0.962</b>
Nehalem	<b>0.077</b>	<b>0.649</b>	<b>0.323</b>	<b>0.718</b>	<b>1.000</b>
Tillamook	<b>0.155</b>	<b>0.713</b>	<b>0.358</b>	<b>0.608</b>	<b>0.987</b>
Nestucca	0.001	0.031	0.003	0.022	<b>0.575</b>
Salmon	<b>1.000</b>	<b>1.000</b>	<b>1.000</b>	<b>1.000</b>	<b>1.000</b>
Siletz	<b>0.248</b>	<b>0.882</b>	<b>0.641</b>	<b>0.811</b>	<b>1.000</b>
Yaquina	0.005	<b>0.075</b>	0.011	<b>0.072</b>	<b>0.555</b>
Beaver	0.000	0.000	0.000	0.000	0.047
Alsea	0.034	<b>0.501</b>	<b>0.192</b>	<b>0.413</b>	<b>0.987</b>
Siuslaw	0.000	0.004	0.001	0.022	<b>0.557</b>
Lower Umpqua	0.000	0.000	0.000	0.000	0.018
Middle Umpqua	0.000	0.000	0.000	0.000	0.000
North Umpqua	<b>0.115</b>	<b>0.747</b>	<b>0.288</b>	<b>0.545</b>	<b>0.986</b>
South Umpqua	0.000	0.000	0.000	0.000	0.043
Siltcoos	0.000	0.000	0.000	0.000	0.000
Tahkenitch	0.000	0.000	0.000	0.000	0.000
Tenmile	0.000	0.000	0.000	0.000	0.000
Coos	0.000	0.000	0.000	0.000	0.000
Coquille	0.000	0.000	0.000	0.000	0.046
Floras/New	0.000	0.000	0.000	0.000	<b>0.635</b>
Sixes	<b>0.998</b>	<b>1.000</b>	<b>1.000</b>	<b>0.995</b>	<b>1.000</b>

extinction probabilities. Second, the magnitude of these “one-way” errors was assumed to be at the upper end of what was plausible. Thirdly, while the individual population results could be strongly influenced by estimation bias in one or more of the recruitment parameters, it seems unlikely that this bias would occur equally for all 21 populations at the same time. Presumably, it is more likely that by chance, the errors would cause bias in the opposite direction for some of the populations and result in overestimates of risk, perhaps canceling the effect at the ESU level of underestimating risk for other populations. Finally, the probabilities of extinction for many of the populations equal one (certainty of extinction) or nearly so for several of scenarios tested, particularly for test 4. However, for such dire forecasts to be true it would be expected that many of the populations in the northerly portion of the range would have already become extinct over the last 50 years; an outcome that did not occur.

# SPAZ Hockey Stick Viability Analysis

## Introduction

“SPAZ” (McElhany and Payne 2005)<sup>7</sup> is a computer program that analyzes the viability of salmon populations. It uses spawner abundance time series to estimate parameters for several population models and then uses the models to make projections of future population trajectories. These trajectories are then used to estimate extinction risk. In the current application of the program, a hockey stick recruitment model (Barrowman and Myers 2000, Bradford et al. 2000) was used to estimate extinction risk for 16 of 21 Independent Populations of the Oregon Coast Coho Salmon ESU.

The hockey stick recruitment model is more conservative than Beverton-Holt and Ricker recruitment models because it assumes that recruits per spawner remains constant as spawner abundance decreases, rather than increasing as in the other two models (Barrowman and Myers 2000). This model assumes linearity in the relationship between recruits and spawners up to some spawner level, above which recruits remain constant (Figure C-4).

## Methods

SPAZ-hs uses the “Markov-Chain Monte-Carlo” (Gelman et al. 1995) Bayesian estimation method to estimate parameters for various recruitment curves, including the hockey stick, from adult abundance data. Models can be compared using the Akaike Information Criterion (AIC) (Ludden et al. 1994). Models with relative AIC values (the difference between the AIC for a particular model and the lowest AIC value for any model) of two units or less are considered to be contenders for the “best” model.

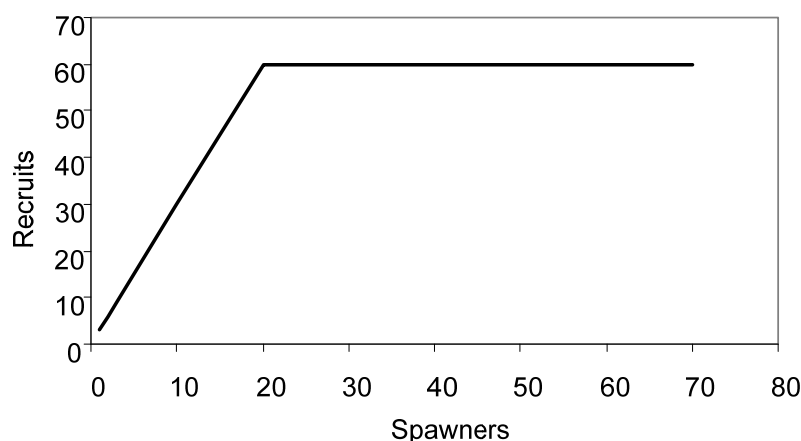

Figure C-4. The hockey stick recruitment model. This model has a linear increase in recruits from zero spawners until maximum recruitment is reached. To the right of this point, recruitment is constant.

---

<sup>7</sup> Note: A beta version of SPAZ was used, which means the program is still undergoing development and testing and may contain errors that affect the results presented here.

A total of 500,000 repetitions are used to fit the model parameters. Prior distributions for the Bayesian model-fitting analysis were set as:

- Intrinsic growth rate: a uniform distribution from 0.1 to 40
- Carrying capacity: a uniform distribution with a range of 1,000 to 100,000
- Process error: a log-normal distribution with a range of 0.01 to 5.0

The range of the distribution for intrinsic growth rate represented an approximate doubling of the range of spawners per spawner observed at low abundance in our analysis of the Population Productivity Criterion, PP-1. The range of the distribution for carrying capacity was based on the range in the size of estimated historic abundance of the Independent Populations in the ESU (Lawson et al. 2007). The process error distribution was recommended by McElhany and Payne (2005).

The model was applied to data on the abundance of wild and hatchery coho salmon adult spawners for the 18 Independent coho salmon populations identified for the Oregon Coast for which long-term data is available (1958–2003 [Appendix D]). Relative AIC was compared to determine whether the hockey stick model was a reasonable model to use in the forecasting portion of the risk analysis (Table C-5). Results show that the hockey stick model is an appropriate model for all populations except for the Tahkenitch and Coos populations. Thus 16 of the 21 Independent Populations of the Oregon Coast Coho Salmon ESU were included in the analysis.

During the risk analysis portion of the model runs, uncertainty about model parameters was dealt with by sampling the posterior distributions of the parameters. For each of 1,000 simulated population trajectories, new values for growth rate, carrying capacity, and variance were randomly sampled from the saved posterior distribution of each parameter.

## **Results**

### **Results of risk analysis**

The probability of persistence for 100 years based on the SPAZ-hs model was either 100% or very near 100% for all populations tested (Table C-6).

### **Sensitivity to quasi-extinction level**

Because of the uncertainty about demographic processes at very low abundances, true extinction (i.e., abundance of 0) was replaced by a quasi-extinction threshold (QET) (Ginzburg et al. 1982). QETs of 1 and 50 were tested for a period of 100 years. The frequency that any 3-year average fell below the QET was considered the probability of extinction. Results using the two QETs were not significantly different ( $P=0.24$ ).

Table C-5. Relative AIC for 18 Independent Populations of coho salmon of the Oregon Coast ESU. The AIC for four alternative recruitment models is shown. Asterisks indicate populations where the hockey stick does not compete for the best model. Populations are grouped by biogeographic strata.

Population	Models tested			
	Constant recruitment	Beverton-Holt	Ricker	Hockey stick
Necanicum	5.46	0.06	0.00	0.22
Nehalem	0.00	1.58	3.01	2.00
Tillamook	24.00	0.68	0.24	0.00
Nestucca	20.10	1.49	1.47	1.54
Siletz	1.62	0.00	0.45	0.27
Yaquina	5.78	0.00	0.66	1.52
Beaver	4.54	0.63	0.00	0.90
Alsea	2.23	1.64	0.00	0.12
Siuslaw	0.04	0.00	1.27	1.31
Lower Umpqua	0.93	0.00	2.04	0.63
Middle Umpqua	0.00	3.45	6.19	2.00
North Umpqua	12.37	3.76	4.01	0.00
South Umpqua	0.00	2.93	4.90	1.99
Siltcoos	0.00	2.00	5.46	1.91
Tahkenitch	3.82	5.60	0.00	4.13*
Tenmile	22.07	0.05	0.04	0.00
Coos	5.66	7.61	0.00	5.96*
Coquille	5.64	0.66	0.49	0.00

### Sensitivity to fitness of hatchery fish

Two assumptions were made as to the fitness of hatchery fish: 1) hatchery fish have the same fitness as wild fish, and 2) hatchery fish have half the fitness of wild fish. Results using the two different assumptions as to fitness of hatchery fish were not significantly different (P=0.47).

## Bayesian Salmon Analysis Model

### Introduction

This analysis is an application of the BaySAM (Wainwright et al. in prep.). The model combines density-dependent freshwater production with density-independent, environmentally driven marine survival to predict future population abundance and estimate risk of extinction. Smolt production is modeled as a Beverton-Holt function of spawner density, modified with an exponential decline in recruits (depensation) at very low spawner densities (Figure C-5). Unlike

Table C-6. Probability of persistence of coho salmon populations estimated by the SPAZ-hs recruitment model. Populations are grouped by diversity strata.

Population	QET*	
	1	50
Necanicum	0.999	0.986
Nehalem	1.000	1.000
Tillamook	1.000	1.000
Nestucca	1.000	1.000
Salmon	NA	NA
Siletz	1.000	1.000
Yaquina	1.000	0.998
Beaver	1.000	1.000
Alsea	1.000	1.000
Siuslaw	1.000	1.000
Lower Umpqua	1.000	1.000
Middle Umpqua	1.000	1.000
North Umpqua	1.000	1.000
South Umpqua	1.000	1.000
Siltcoos	1.000	1.000
Tahkenitch	NA	NA
Tenmile	1.000	1.000
Coos	NA	NA
Coquille	1.000	1.000
Floras/New	NA	NA
Sixes	NA	NA

\* Quasi-extinction threshold.

the other models applied here, this model produces a Bayesian estimate of extinction risk (Taylor 1995, Ludwig 1996, Wade 2002) rather than a simple extinction probability. The model does not provide a full assessment of extinction risk as it excludes important issues such as population genetics, changes in habitat condition, the influence of hatchery production, and the influence of migration among populations. However, the results provided a basis for evaluating risks resulting from the major demographic factors of population abundance, productivity, and variability.

## Methods

### Biological model

The BaySAM model assumes that all density-dependence occurs in freshwater habitats, while environmental variation has its strongest influence during early ocean life. Smolt production was modeled with a Beverton-Holt stock-recruitment curve modified with



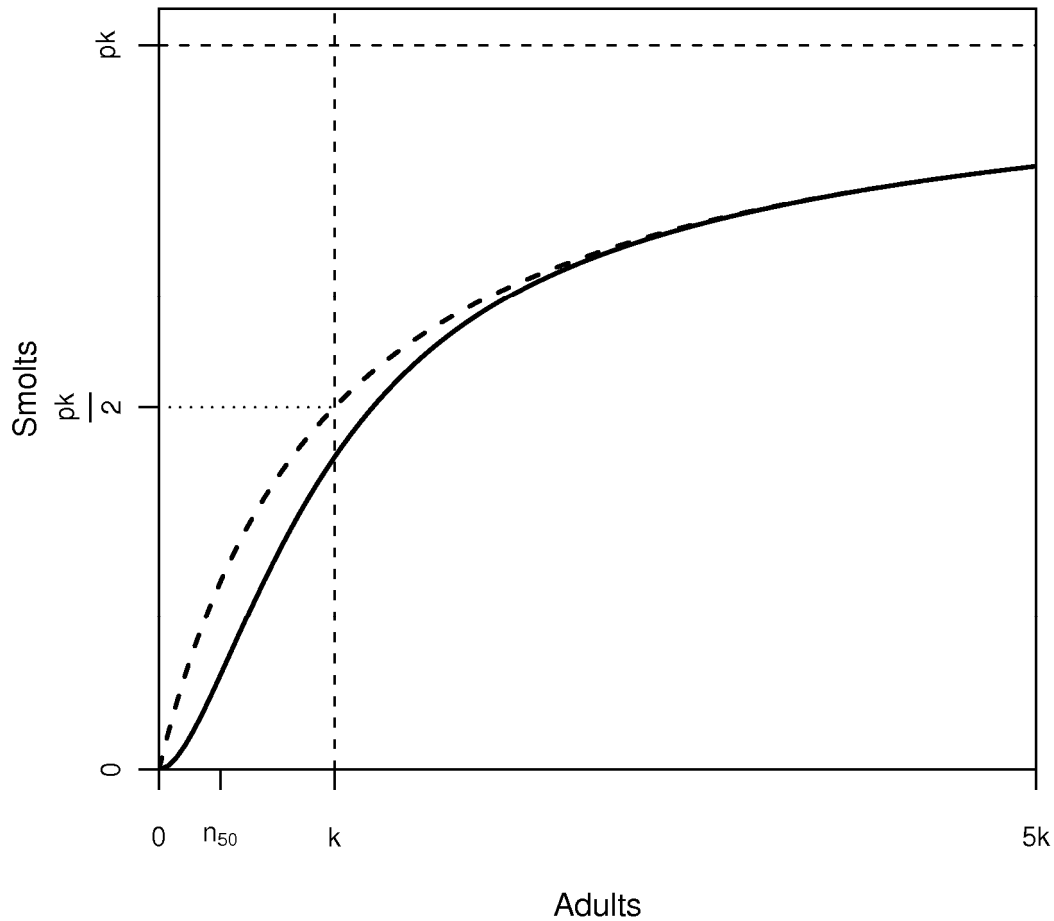

Figure C-5. The production function used in the extinction risk model (solid curve) compared with a standard Beverton-Holt production function (dashed curve). Dotted lines indicate the relationships of the model parameters to important biological indicators:  $pk$  is smolt capacity,  $k$  is the adult abundance that produces smolts equal to one-half of capacity, and  $n_{50}$  is the adult abundance where depensation reduces production to one-half of the standard Beverton-Holt function.

exponential depensation. Starting with the number of spawning females ( $N_f$ ) in brood year  $t$ , the number of female smolts ( $n_f$ ) produced by those females was calculated as:

$$n_{ft} = \frac{pN_{ft}}{1 + \frac{N_{ft}}{k}} \left[ 1 - \exp\left(\frac{N_{ft} \ln(0.5)}{n_{50}}\right) \right] \quad (17)$$

On the right-hand side, the first term is the traditional Beverton-Holt recruitment curve and the second term represents depensation at low abundance. The parameters of the standard (nondepensatory) Beverton-Holt relationship are  $p$ , the slope of the curve at low spawner abundance, and  $k$ , the female spawner abundance that produces one-half of the maximum number of smolts. Maximum smolt production is  $pk$ , which is approached asymptotically as

spawner abundance increases. The depensation parameter,  $n_{50}$ , is the spawner abundance at which depensation reduces smolt production to 50% of what would be produced with no depensation. The smolt-production model is illustrated in Figure C-5. Assuming an even sex ratio, the number of male smolts ( $n_m$ ) is equal to the number of female smolts ( $n_f$ ).

Smolts predicted by this relationship then enter the ocean, where they face variable marine survival and harvest. In simplified form, the number of recruits ( $R_t$ ) is

$$R_t = n_{t-3} m_t (1 - h_t) \quad (18)$$

where  $m_t$  is marine survival and  $h_t$  is harvest rate for the return year ( $t$ ). To represent temporal autocorrelations in the marine environment, marine survival is modeled as a first-order autoregressive random process with lognormal errors (see Wainwright et al. in prep. for details).

### Parameter estimation

In Bayesian analysis, statistical distributions of model parameters are estimated from a combination of preexisting (prior) information and the likelihood of the model predictions relative to new data, resulting in a posterior distribution of the parameter values. The prior information used in the original application (Wainwright et al. in prep.) came from two sources: a meta-analysis of smolt-recruit data from other coho salmon populations along the West Coast (Bradford et al. 2000, Barrowman et al. 2003) for distributions of intrinsic productivity and capacity parameters, and an analysis of environmental time series (Wainwright et al. in prep.) for distributions of the variance and autocorrelation parameters for marine survival.

Data used included spawning population abundance, estimated harvest rates, and an index of marine survival. For most populations, the spawning data was the number of naturally produced spawners estimated from two time series: the ODFW random sampling spawner abundance estimates (1990–2003), and the longer index stream area-under-the-curve spawner abundance index (1981–2003). Exceptions were the North Umpqua, where counts at Winchester Dam were used, and the lake populations (Tahkenitch, Siltcoos, and Tenmile), where standard ODFW lake population estimates were used.

### Modifications

The model bases its parameters on smolt and spawner density (i.e., number per unit of habitat) rather than total population abundance. The original application (Wainwright et al. in prep.) was designed to be generic, without detailed habitat data for the populations modeled. For that reason, parameters were based on a habitat base indexed to total accessible stream length in the occupied basin (i.e., population density was numbers per accessible kilometer). This metric was the basis for the parameter estimates used as priors in that model, derived from a previous meta-analysis of coho salmon freshwater production (Bradford et al. 2000). However, for the current analysis, initial model results using the original methodology were counter-intuitive, resulting in higher risks for some large basins with good quality habitat than for smaller, poor habitat basins. This was apparently the result of variation in the ratio of actual coho salmon habitat to total basin stream miles. For this reason, total smolt capacity (as estimated in Lawson et al. 2007) was used here as the habitat metric, and parameters are thus expressed as density of

fish per thousand potential smolts. Prior distributions for the capacity, depensation, and intrinsic productivity parameters used by Wainwright et al. (in prep.) were adjusted to this new density metric.

## **Results**

Extinction risks over a 100-year time frame were estimated by applying the model independently to each of the historically Independent Populations, with the exception of Floras/New Creek, where the Beverton-Holt model failed to adequately fit the data. These estimates are shown in Figure C-6. Results are shown for both absolute extinction (upper panel) and for quasi-extinction (defined as spawner abundance below 50 fish per generation at any time in the 100-year prediction period). The two results are essentially the same except for the smaller river systems (Necanicum, Salmon, Beaver, and Sixes). Mean extinction risk is quite low for all populations, but quasi-extinction risk is somewhat higher for the smaller river systems. However, there is high uncertainty in results for most populations, as demonstrated by the long upper tails of the extinction probability distributions in Figure C-6.

### **Sensitivity to Quasi-extinction Thresholds**

To test sensitivity of these results to the choice of QET, risk was estimated for each population using a range of QET values from 0 to 1,000 spawners per generation (Figure C-7). There is apparently little sensitivity of results over this range of QET values for most populations; however, results for the populations in smaller basins are quite sensitive. As an example, the Salmon risk goes from near zero for absolute extinction (QET=0) to more than 90% risk for a QET of 300. This appears to be related to the ratio of QET to the capacity of the system: estimated risk does not increase substantially until QET is a substantial fraction of estimated spawner capacity. For the Salmon, the model estimates a median smolt capacity of only 66,000 (range 20,000 to 320,000), which would produce a median of 660 adults at 1% marine survival. The combination of environmental variation and variation in estimated capacity (parameter uncertainty) results in a high likelihood that this population will drop below QETs of a few hundred fish in the 100-year simulation time frame.

## **Stochastic Habitat-based Life Cycle Model**

### **Introduction**

PVA is intended to quantify the likelihood that a population will persist into the future. Implicit in projecting a population's future are assumptions about future conditions that affect the population. Healthy populations are expected to persist through a wide variety of future conditions, especially if those conditions are similar to historical conditions the population has experienced. If conditions have changed from the historical, or a population is compromised in its viability, changing conditions may have a greater effect on future prospects. One role of PVA is to explore the effects of possible changes in future conditions on a population's viability.

The model used here, based on the habitat-based life cycle model of Nickelson and Lawson (1998), enables the exploration of three factors with potentially important implications for the future viability of Oregon Coast coho salmon: freshwater habitat conditions, marine

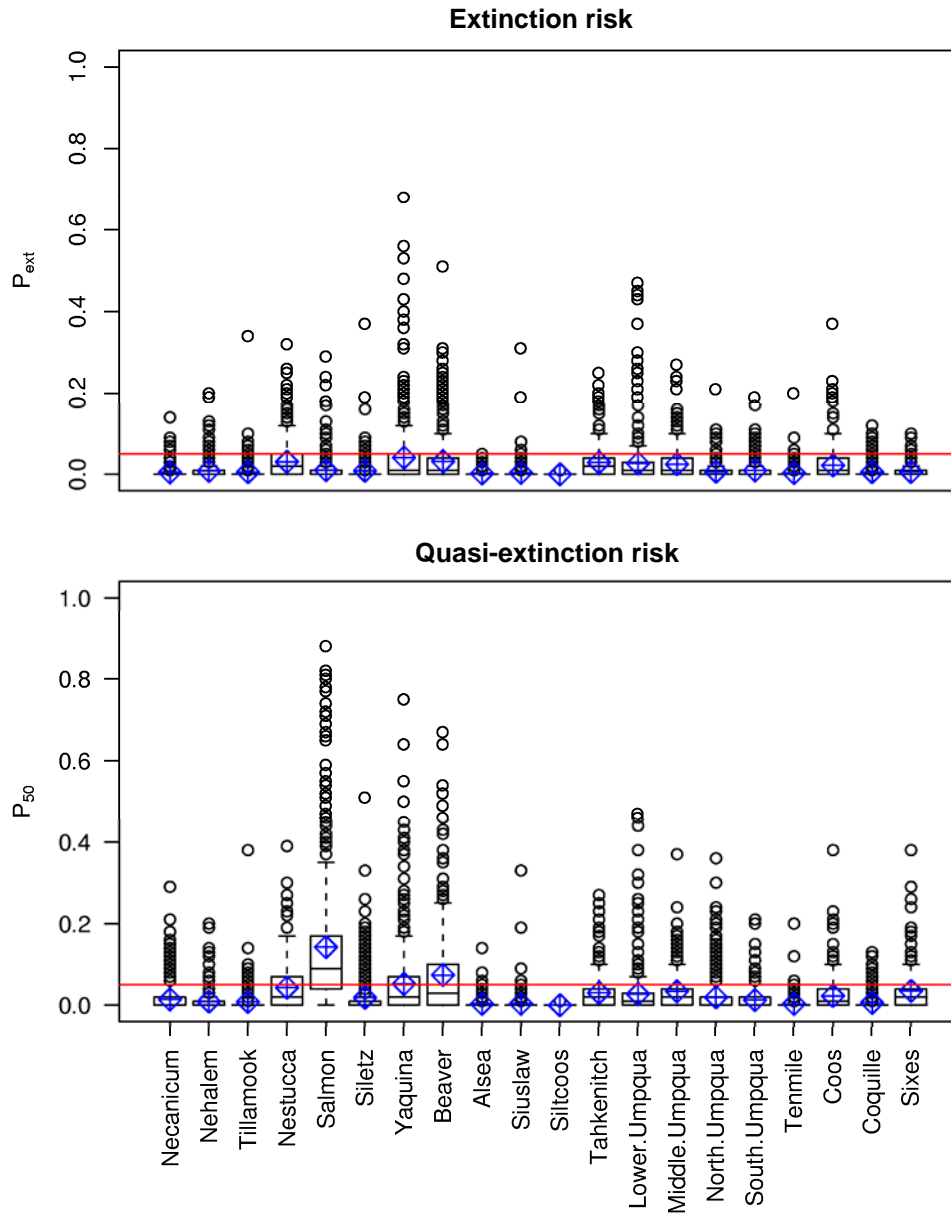

Figure C-6. Results from the BaySAM model for all Independent Populations in the ESU. Diamonds mark the mean risk of extinction, box plots illustrate the distribution of extinction probability estimates as a function of parameter uncertainty. The upper panel is for absolute extinction, lower panel is for a quasi-extinction threshold of 50 spawners per generation. The horizontal line marks the 5% risk threshold.

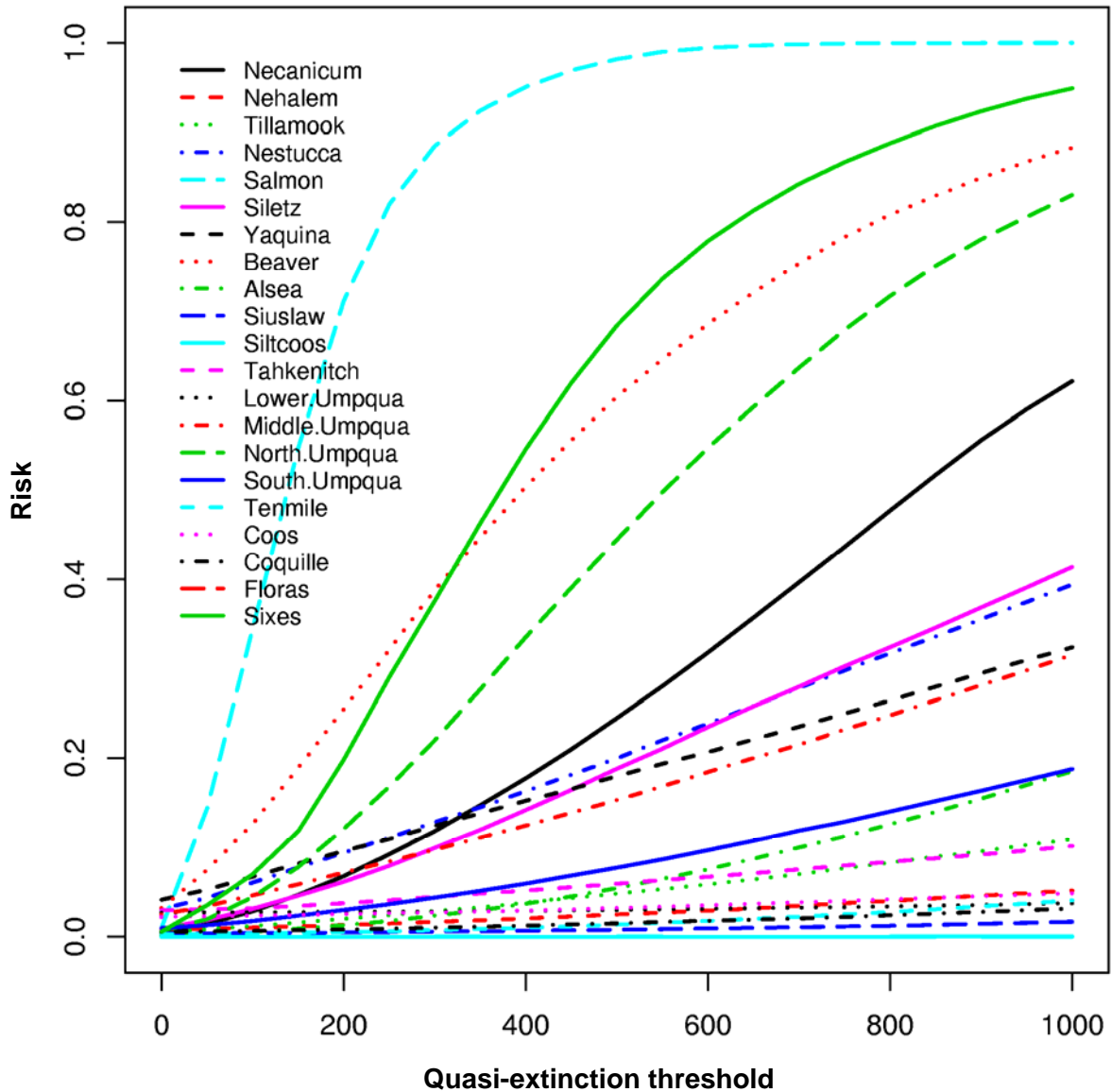

Figure C-7. Relationship of extinction risk to QET, for the Independent Populations.

survival, and harvest. In this analysis, a baseline condition was established reflecting the best assessment of current conditions. Hypothetical future conditions were then modeled by applying, singly and in combination, a harvest regime, two trends in habitat quality (increasing and decreasing), and a generally poorer marine survival regime. Extinction probabilities are increased markedly with the addition of harvest, declining habitat trend, and poorer ocean survival.

### Stochastic Habitat-based Life Cycle Modeling

The habitat-based life cycle model (NL) of Nickelson and Lawson (1998) simulates a coho salmon life cycle using data based on fine-grained measurements of habitat quality.

Habitat is divided into river reaches. Each reach has an egg-to-smolt survival rate and smolt capacity determined by habitat quality and based on field sampling of habitat. Spawning adults produce eggs that survive to parr at a rate that is dependent on the density of parr. These parr survive to a number of smolts that is dependent on habitat quality and capacity. Smolts enter the ocean where they experience variable marine survival and harvest, then return as spawning adults to their natal reach. In the model a constant proportion of returning adults strays to other reaches, allowing repopulation of depleted reaches. The model works with a single brood cycle, so the basic time step is 3 years. The model uses a stochastic Monte Carlo technique in which most model parameters have associated error distributions. As the model is run, error values are chosen at random from the distributions and added to the fixed parameter values. This occurs with every time step. For this analysis, 33 time steps were modeled, following one brood cycle through 99 years. The model was then run 1,000 times and a range of possible results was produced that represents the uncertainty about salmon biology, future environmental conditions, and (for some model runs) management actions (Nickelson and Lawson 1998).

The NL model is based on the principle that habitat quality and quantity govern the production of coho salmon. Population dynamics in the model include compensation, depensation, and straying. The structure of the model is flexible enough to incorporate a variety of factors such as harvest, variable marine survival, and changes in habitat quality over time. It also explicitly includes uncertainty arising from random (stochastic) environmental factors and uncertainty in estimating various biological parameters. It does not include any effects of hatchery fish. The habitat database does not include some of the lower reaches that are thought to have been the most productive coho salmon habitat in the past, so this potential source of rearing habitat is not part of the simulation. Despite these omissions, model results provide a good basis for exploring the relative importance of harvest, habitat, and ocean conditions to the viability of naturally produced coho salmon on the Oregon Coast.

The model used for the current assessment differs from the version reported in Nickelson and Lawson (1998) in several respects:

- The stray rate was increased from 5% to 20% in response to more recent information about actual stray rates<sup>8</sup> and comparisons of model behavior with observations.
- The river reach database was updated with new information from more recent habitat surveys. In addition, these reach data were expanded to represent the entire basin in proportion to the relationship between habitat type and land use. Thus there was no longer a need in the model to expand from sampled reaches to represent an entire basin.
- The marine survival time series was based on OPI hatchery survival rates, similar to the method used in the density-dependent, count-based PVA model (see page 146).
- All model runs used the same marine survival time series, starting at the same point in time, rather than starting at a random point in the series as was done in Nickelson and Lawson (1998). This reduced overall model variability somewhat, and made it easier to interpret results.

---

<sup>8</sup> T. Nickelson, Oregon Dept. Fish and Wildlife, Corvallis. Pers. commun., 10 February 2002.

- The model was modified to include all riverine Independent Populations on the coast, including the four Umpqua River populations.

Together these changes serve to make the model more representative of Oregon Coast coho salmon, with population structure as defined by the technical recovery team (TRT) (modified from Lawson et al. 2007). Coastal lakes are not included in this simulation as their population dynamics are considerably different from the river populations.

Because harvest is an important component of the ecology of modern salmon populations and may present a considerable risk to the viability of stocks, for this assessment the Nickelson and Lawson (1998) life cycle model was extended to include a model of the current harvest regime. This modification was first applied to the risk assessment of Amendment 13 to the Salmon Fishery Management Plan of the Pacific Fishery Management Council (PFMC 1999). For the PFMC assessment, the model was used to evaluate the relative risk of two management systems. In this assessment, only the adopted (Amendment 13) management system was modeled.

### **Modeling of the Amendment 13 Management Regime**

Amendment 13 specifies total allowable exploitation rates (total fishery-related mortalities including marine and freshwater landed catch and nonlanded mortalities) for naturally produced coho salmon on the Oregon Coast. Allowable exploitation rate is a function of marine survival and parental spawner numbers. If either marine survival or parental escapement is low, then exploitation rate is low. The highest rate is allowed only when both marine survival and parental escapement are high.

Management under Amendment 13 is based on geographically based “subaggregates” of Oregon Coast coho salmon. In order to simulate this regime, all populations had to be modeled simultaneously, and management “decisions” were made based on the performance of the subaggregates. The population structure used for fisheries management differs from that used by the TRT (modified from Lawson et al. 2007). In particular, the TRT has subdivided the Umpqua River into four populations. The four Umpqua River populations reported in this analysis were aggregated into a single population for the purposes of simulating harvest management.

The simulation of Amendment 13 management recognizes that managers operate with imperfect information on stock size predictions and spawner escapement estimates. Amendment 13 requires an index of marine survival based on the ratio of hatchery smolts released to jack returns in the Columbia River; spawner abundances are estimated from surveys. Thus the Amendment 13 harvest rate control rule is implemented with error, meaning that actual post-season harvest rates differ from those set by the agencies pre-season. These factors were included in the analysis as sources of variability arising from harvest management. In other words, the modeling simulated the management regime given the information actually available to the managers.

## Management Information

### Oregon Coast natural coho salmon predictor

Oregon Coastal Natural (OCN) coho salmon are the natural production component of the Oregon Coast ESU. For the purposes of harvest management, their abundance is predicted from a multiple regression of spring upwelling and winter sea surface temperature. It was not practical to reproduce this predictor in simulation. As a simpler alternative, the workgroup started from the modeled abundance and added an error term sampled from a gamma distribution with a mean of the known abundance (from the model) and a coefficient of variation (CV) similar to that of the predictor.

A gamma distribution was used because it will always return a positive integer. The right-hand tail is not as extreme as a standard normal distribution, so it conforms better to the observed distribution of abundance. Parameters for the gamma distribution were estimated from OCN recruitments reconstructed from catch data and Stratified Random Survey (SRS) escapement estimates applied to the years 1970–1997. The mean of SRS ocean recruits from this reconstruction was 176,000 with a CV of 0.84. The gamma distribution was given an alpha of 2, corresponding to a CV of 0.7071. This is a fairly pessimistic view of the power of prediction. However, the error is applied to the actual recruitment rather than to the mean, and gamma distributions with high CVs are skewed to the right, with the median values lower than the mean. This results in a predictor that is more often low than high. Over the past 10 years, OCN predictors have more often been high than low, so this method of approximating the predictor may result in lower modeled risk to the stocks than the actual management regime.

### Spawner estimates

Administration of the harvest regime specified in Amendment 13 requires estimates of spawners in 13 coastal basins. These estimates are generated from spawner surveys in each basin. We simulated the spawner survey methodology by specifying a number of sampled reaches, based on a 10% sampling rate, in each basin.<sup>9</sup> In the model, reaches were sampled at random from each basin, and spawners in the sampled reaches were expanded by the sampling fraction to estimate total spawners. This captures only the sampling errors, and does not include variability in numbers of spawners observed or in other statistical estimates that are applied to the survey data. As a result, spawner estimates in the model are more accurate and, potentially, less biased than in practice.

### Marine survival predictor

Predicted marine survival of Columbia River hatchery coho is one of the control variables for Amendment 13 management. Marine survival is the ratio of adult recruits per smolt released. Adult returns are not available at the time the harvest regulations are set, so an index of marine survival is needed. The relationship between jacks per smolt in the Columbia River is correlated with adults per smolt. To arrive at an estimate of marine survival for Amendment 13 management purposes, the PFMC uses a regression of log-transformed jacks per smolt on log-transformed adults per smolt for the years 1970–1996. The fitted regression was:

---

<sup>9</sup> K. Moore, Oregon Dept. Fish and Wildlife, Corvallis. Pers. commun., 10 February 2005.



$$\ln(\text{adults/smolt}) = 2.2725 + 0.9093 \times \ln(\text{jacks/smolt}) \quad (19)$$

with  $r^2 = 0.80$  and a standard error of 0.4045. Indexed marine survival was estimated, with error, from the actual modeled marine survival:

$$\text{indexed\_marine\_survival} = \exp(\ln(\text{marine\_survival}) + 0.4045 \times \text{std\_norm}) \quad (20)$$

where *std\_norm* is a random draw from a standard normal distribution.

### **Post-season exploitation rate**

Exploitation rate targets that are set preseason are different from the actual exploitation rate that results from the fishery. However, there was no way to separate these fishery implementation errors from other sources of error (prediction, spawner estimation) being modeled. As a result, a statistical comparison of preseason vs. postseason exploitation rates overestimates harvest implementation errors. For this analysis, management implementation errors were not modeled. Sensitivity analysis indicated that modeling without this error produced a slight increase in modeled viability. The results reported here assume management targets are implemented without error (although they may be set incorrectly). Therefore, the modeled risk from harvest may be slightly lower than actual risk.

### **Management Model**

The management model was implemented as target exploitation rates based on the rules set forth in Amendment 13 and the current state of the fishery, estimated with error. It is relatively simple in this kind of modeling to capture the harvest formulas. However, managers frequently use discretion to alter harvest regimes in a given year. This discretion can include variable interpretation of data, opening of terminal fisheries, or even changing predictors. These actions are more difficult to model in a risk assessment context; therefore, we have modeled only the prescribed regimes.

### **Amendment 13**

Amendment 13 specifies an exploitation rate matrix based on parental escapements and predicted marine survival. We have only implemented the ocean portion of the amendment; there are in-river harvest opportunities that have not been modeled here. This leaves the potential for exploitation rates on some stocks to be higher than those modeled. The original Amendment 13 exploitation rate harvest rule was modified in a review of the amendment in 2000. For simplicity the model of Amendment 13 implemented here was restricted to the original matrix, but with exploitation rates changed to reflect the newer values. For the purposes of risk assessment, this makes very little difference to the outcome because the increased complexity of the revisions would largely be balanced by increased implementation error.

Parental escapement is based on “subaggregates,” geographical groupings of river basins. There are three subaggregates in Amendment 13; North Coast, North-Central Coast, and South-Central Coast. These differ from the TRT-defined strata.

Amendment 13 was modeled using five escapement levels for management triggers. The specific rules modeled were:

1. Full seeding of high-quality habitat. (Seeding refers to the number of eggs relative to the carrying capacity of the habitat.) In-river harvest is not to reduce the run below this level, based on predicted run size.
2. 75% seeding of high-quality habitat.
  - Subaggregate parental escapement at this level triggers exploitation rate of 0.45 if predicted marine survival is also high.
  - Subaggregate parental escapement at this level triggers exploitation rate of 0.38 if predicted marine survival is medium.
3. 50% seeding of high-quality habitat.
  - Subaggregate parental escapement at this level triggers exploitation rate of 0.30 if marine survival is high.
  - Subaggregate parental escapement at this level triggers exploitation rate of 0.20 if marine survival is medium.
4. 38% seeding of high-quality habitat.
  - Subaggregate parental escapement above this level but below 50% seeding triggers exploitation rate of 0.15.
  - Subaggregate parental escapement below this level and low marine survival triggers exploitation rate of 0.08.
  - Subaggregate parental escapement below this level and medium or high marine survival triggers exploitation rate of 0.15.
5. 10% seeding of high-quality habitat. Any basin escapement below this level reduces parental spawner status for the subaggregate by one level.

Marine survival was divided into three levels based on the predicted marine survival. These are high ( $ms > 0.05$ ), medium ( $0.05 \geq ms > 0.021$ ), and low ( $ms \leq 0.021$ ).

To model Amendment 13 management, spawner estimates were produced for each basin and subaggregate. Marine survival was predicted and classified as high, medium, and low. Based on these estimates, an allowable exploitation rate for each subaggregate was chosen. The subaggregate with the lowest exploitation rate determined the exploitation rate for the aggregate.

### **Modeled Scenarios**

A strength of the modeling approach employed here is the ability to explore potential effects of different future conditions. We tested different assumptions about future marine survival and future trends in habitat quality. Twelve scenarios were modeled using combinations of two levels of marine survival (historical average and reduced survival), three trends in habitat quality (stationary, increasing, and decreasing), and two levels of harvest (current regulations

and no harvest). Scenarios with no harvest were prefixed “base,” while those with harvest were labeled “A13.” Scenarios modeled with and without harvest were:

- Reference (ref): recent historical marine survival, based on stationary habitat and the observation that naturally produced coho salmon survive at a higher rate than OPI area hatchery fish.
- Marine survival (ms): lower marine survival, as if naturally produced coho salmon survived at the same rate as hatchery fish or actual marine survival declined.
- Habitat  $\times$  0.8 (80): habitat quality declined exponentially over the simulation to a final value 20% lower than starting values.
- Habitat  $\times$  1.2 (120): habitat quality increased exponentially over the simulation to a final value 20% higher than starting values.
- Marine survival and habitat  $\times$  0.8 (ms\_80): lower marine survival and declining habitat.
- Marine survival and habitat  $\times$  1.2 (ms\_120): lower marine survival and improving habitat.

### **Extinction Thresholds**

Populations at extremely low abundances or spawner densities are thought to depart from classical density-dependent population dynamics (Dennis 1989). At low abundance, random events become more important, so that a single mortality event such as a landslide or toxic spill may affect most or all of a small population. At low densities adult fish may not find each other on the spawning grounds. This results in “depensatory” population dynamics, where the population becomes less productive and more variable as numbers drop. While this model attempts to capture some of these low-density dynamics, uncertainty remains.

PVA frequently specifies a threshold below which the population, if not technically extinct, has ceased to function as a population and is functionally extinct. Because of the difficulty (and undesirability) in making observations as populations spiral toward extinction, there is much uncertainty in specifying these “QETs.” We report results for three QETs: zero fish, 50 fish, and 1 fish per mile of spawning habitat as specified in Chilcote et al. (2005). In addition, the effect of choosing a range of QETs was examined.

A QET of 50 fish is somewhat standard in the viability literature. However, smaller basins are expected to have smaller populations under normal circumstances, and some of the smaller Independent Populations on the Oregon Coast may be expected to fall below 50 spawners at times. At the same time, a large population reduced to 50 spawners would be a serious situation. Results from this model and analysis by Barrowman et al. (2003) suggest that at densities of 1 fish per mile, depensatory dynamics are apt to occur. We explored the use of one fish per mile as a QET.

Each scenario was modeled with 1,000 Monte Carlo simulations of 33 generations. If at any time during the simulation the number of spawners dropped below a specified QET, the population was counted as “extinct.” Once a population went extinct, as defined by QET, it was considered to remain extinct through the duration of a single 33-generation simulation.

## Results

Spawner abundance over the 33 generations of the model runs showed the cyclical pattern of marine survival (Figure C-8) for the reference run with and without Amendment 13 harvest. Variability was quite large, indicating the natural variability of these populations as well as our uncertainty in their dynamics. Probabilities of persistence in 100 years for the base and Amendment 13 runs are reported in Table C-7 and Table C-8, respectively. Persistence probabilities were sensitive to all factors tested, including QET, habitat, marine survival, and harvest. Umpqua and South Coast populations showed generally higher persistence probabilities than North-central or North Coast populations. Necanicum and Salmon populations had the basins with the lowest persistence values. A QET of 50 substantially decreased persistence values compared with a QET of 0, and the 1 fish per mile criterion was the most severe. Decrease in probability of persistence was about equal for the habitat degradation (80) and lower marine survival (ms) scenarios, with marine survival having a slightly greater effect. As expected, the combined effect of 80 and marine survival was greater than either alone, while the habitat improvement scenario (120) provided some increase in persistence probability. The Amendment 13 harvest regime had roughly the same effect as the habitat degradation scenario (80). These patterns are also evident in Figure C-9, a box plot comparison of the number of spawners in the final generation for the 12 scenarios.

### Sensitivity to Quasi-extinction Threshold

The QET is intended to reflect the uncertainty and increased risk of very low abundances. Selection of a QET depends on our knowledge (or lack thereof) of population dynamics at low densities, how well the model captures these dynamics, and how willing the workgroup is to take the risk of failing to identify resulting extinction events. The sensitivity of the model used here to the value selected for QET was tested by assessing the output of two scenarios (base\_ref and A13\_ms\_80) using a range of QETs.

For each population, the probability of quasi-extinction (pQE) was calculated for QETs of 0, 50, 100, 200, 400, 800, 1,600, and 1 fish per mile (1 fpm) (Figure C-10, Figure C-11; Table C-7, and Table C-8). For all populations, pQE rose rapidly as QET increased, leveling off at  $pQE = 1$ . The shape of the curves was approximately logistic; steep in the middle and flat on the ends. The rate of increase of pQE was dependent on population size, with smaller populations being much more sensitive to small increases in the threshold. The 1 fpm criterion, by definition, always placed QET at or above 50 fish. Larger basins had more gradually sloping curves, but higher QETs led to higher pQEs under this criterion.

### Conclusion

Assessment of extinction risk or, conversely, persistence probability, depends on assumptions about present and future conditions, and on assumptions about population dynamics at low abundances or densities. This modeling effort evaluated the persistence probabilities of Oregon Coast Coho Salmon ESU riverine Independent Populations using a habitat-based stochastic simulation model. Relative effects of harvest, habitat changes (improvement or degradation), and marine survival were assessed, as was the selection of a QET. One population, the Necanicum, was at high risk in most scenarios. This small system has some intact wetland

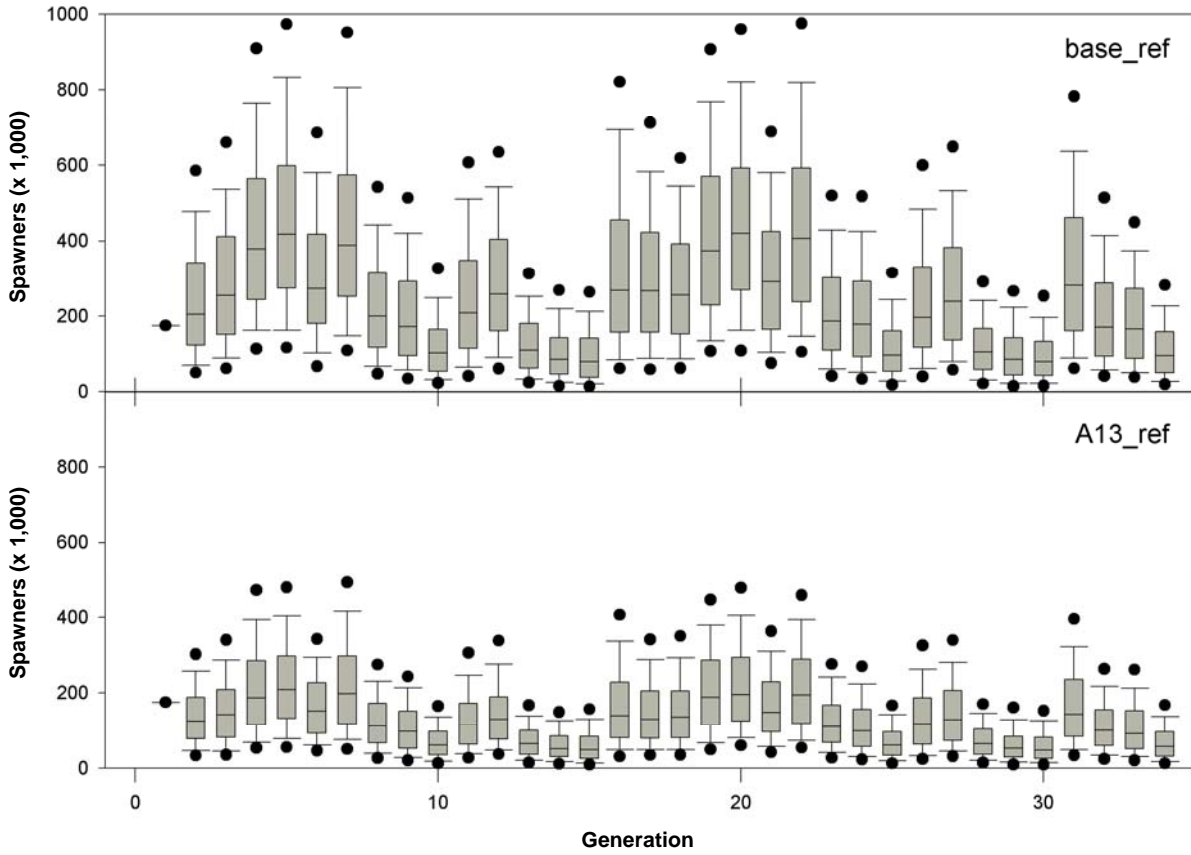

Figure C-8. Box-plot time series of median spawner abundance for 34 generations. The boxes are 25th to 75th percentile, the whiskers are 10th and 90th percentile, and dots are 5th and 95th percentile. The upper graph (base\_ref) shows abundance without harvest. The lower graph (A13\_ref) shows results with Amendment 13 harvest regulations. This figure illustrates the lower escapements expected as a result of harvest.

Table C-7. Probabilities of persistence under no harvest (base) conditions for riverine Independent Populations of the Oregon Coast Coho Salmon ESU for five scenarios of future conditions using three QETs. Scenarios include current conditions (ref), 20% habitat improvement (120), 20% habitat degradation (80), lower marine survival (ms), lower marine survival with habitat improvement (ms\_120), and lower marine survival with habitat degradation (ms\_80). QETs are 0 fish (0), 50 fish (50) and 1 fish per mile (fpm). Bold numbers highlight areas with < 90% probability of persistence.

	base_ref			base_120			base_80			base_ms			base_ms_120			base_ms_80		
	0	50	fpm	0	50	fpm	0	50	fpm	0	50	fpm	0	50	fpm	0	50	fpm
Necanicum	97.4	<b>68.7</b>	<b>68.7</b>	99.0	<b>75.8</b>	<b>75.8</b>	96.1	<b>51.6</b>	<b>51.6</b>	90.6	<b>23.5</b>	<b>23.5</b>	93.2	<b>39.2</b>	<b>39.2</b>	<b>83.9</b>	<b>14.4</b>	<b>14.4</b>
Nehalem	100.0	100.0	96.9	99.9	99.9	97.8	100.0	100.0	94.0	100.0	99.3	<b>84.4</b>	100.0	99.7	90.9	100.0	99.3	<b>76.3</b>
Tillamook	99.5	98.6	93.0	99.8	99.3	95.8	99.7	98.0	<b>86.9</b>	98.6	91.1	<b>71.2</b>	99.0	95.1	<b>82.4</b>	96.8	<b>83.9</b>	<b>59.4</b>
Nestucca	100.0	99.0	97.4	100.0	99.8	97.8	99.8	98.9	95.1	99.5	95.3	<b>86.8</b>	99.9	97.0	92.3	99.4	91.6	<b>78.7</b>
Salmon	100.0	96.4	96.4	100.0	97.1	97.1	100.0	93.8	93.8	99.8	<b>85.4</b>	<b>85.4</b>	99.8	90.9	90.9	99.7	<b>78.9</b>	<b>78.9</b>
Siletz	100.0	99.6	97.3	99.9	99.8	97.7	100.0	99.7	94.9	99.8	98.1	<b>86.0</b>	100.0	99.1	92.3	99.8	98.0	<b>79.9</b>
Yaquina	100.0	99.9	99.4	100.0	99.9	99.8	100.0	100.0	99.6	100.0	99.6	98.3	100.0	99.9	99.2	99.9	99.5	97.5
Beaver	100.0	98.2	98.2	100.0	98.8	98.8	100.0	96.1	96.1	100.0	91.7	91.7	100.0	94.9	94.9	100.0	<b>86.9</b>	<b>86.9</b>
Alsea	100.0	99.9	99.1	100.0	99.9	99.8	100.0	99.9	99.0	100.0	99.6	97.1	100.0	99.8	97.6	99.8	99.5	93.9
Siuslaw	100.0	100.0	98.0	100.0	99.9	98.7	100.0	100.0	96.5	100.0	99.9	91.4	100.0	99.9	95.1	99.9	99.8	<b>85.9</b>
Lower Umpqua	100.0	99.9	98.7	100.0	99.9	99.2	99.9	99.9	98.0	99.9	99.8	93.7	100.0	99.8	95.9	99.8	99.1	<b>89.6</b>
Middle Umpqua	100.0	99.9	99.6	100.0	99.9	99.9	100.0	99.9	99.9	100.0	99.6	98.1	100.0	99.8	99.3	99.9	99.3	97.1
North Umpqua	100.0	99.2	99.2	100.0	99.9	99.9	100.0	99.4	99.4	100.0	98.1	98.1	100.0	98.8	98.8	99.9	96.8	96.8
South Umpqua	100.0	99.9	99.4	100.0	99.9	99.8	100.0	99.9	99.4	100.0	99.6	97.9	100.0	99.8	98.5	99.8	99.0	96.2
Coos	100.0	100.0	99.6	100.0	100.0	99.9	100.0	100.0	99.8	100.0	100.0	99.0	100.0	100.0	99.8	100.0	99.9	99.2
Coquille	100.0	99.9	98.7	100.0	99.9	99.5	100.0	99.9	98.5	100.0	99.7	95.5	100.0	99.9	96.9	100.0	99.5	91.6
Floras	100.0	98.8	98.8	100.0	99.6	99.6	100.0	98.8	98.8	100.0	96.7	96.7	100.0	97.4	97.4	100.0	93.1	93.1
Sixes	100.0	98.7	98.7	100.0	99.2	99.2	100.0	98.1	98.1	100.0	94.5	94.5	100.0	96.4	96.4	100.0	91.3	91.3
Total	100.0	100.0	98.8	100.0	100.0	99.8	100.0	100.0	98.6	100.0	100.0	95.1	100.0	100.0	96.7	100.0	100.0	92.0

Table C-8. Probabilities of persistence under PFMC Amendment 13 harvest (A13) conditions for riverine Independent Populations of the Oregon Coast Coho Salmon ESU for five scenarios of future conditions using three QETs. Scenarios include current conditions (ref), 20% habitat improvement (120), 20% habitat degradation (80), lower marine survival (ms), lower marine survival with habitat improvement (ms\_120), and lower marine survival with habitat degradation (ms\_80). QETs are 0 fish (0), 50 fish (50) and 1 fish per mile (fpm). Bold numbers highlight areas with less than 90% probability of persistence.

	A13_ref			A13_120			A13_80			A13_ms			A13_ms_120			A13_ms_80		
	0	50	fpm	0	50	fpm	0	50	fpm	0	50	fpm	0	50	fpm	0	50	fpm
Necanicum	92.3	<b>18.3</b>	<b>18.3</b>	94.6	<b>32.3</b>	<b>32.3</b>	<b>88.3</b>	<b>8.8</b>	<b>8.8</b>	<b>71.6</b>	<b>2.6</b>	<b>2.6</b>	<b>77.0</b>	<b>5.6</b>	<b>5.6</b>	<b>61.5</b>	<b>0.6</b>	<b>0.6</b>
Nehalem	100.0	99.5	90.4	100.0	99.7	92.8	100.0	99.5	<b>84.2</b>	99.4	97.8	<b>62.0</b>	99.8	99.1	<b>72.0</b>	99.5	95.2	<b>46.9</b>
Tillamook	99.1	92.9	<b>74.4</b>	99.3	95.0	<b>83.7</b>	97.8	<b>87.1</b>	<b>59.5</b>	91.7	<b>68.1</b>	<b>35.6</b>	96.4	<b>77.5</b>	<b>47.5</b>	<b>87.3</b>	<b>50.9</b>	<b>19.6</b>
Nestucca	99.9	96.7	90.1	100.0	98.4	93.8	99.8	94.8	<b>85.1</b>	97.9	<b>83.4</b>	<b>66.9</b>	99.1	<b>89.4</b>	<b>76.5</b>	96.4	<b>72.8</b>	<b>51.5</b>
Salmon	99.9	90.7	90.7	99.9	94.3	94.3	99.9	<b>85.4</b>	<b>85.4</b>	98.4	<b>70.5</b>	<b>70.5</b>	99.6	<b>80.0</b>	<b>80.0</b>	96.8	<b>57.6</b>	<b>57.6</b>
Siletz	99.9	99.1	92.8	100.0	99.4	95.3	99.9	98.9	<b>87.9</b>	99.0	95.8	<b>72.7</b>	99.9	97.2	<b>81.4</b>	98.9	91.3	<b>62.5</b>
Yaquina	100.0	99.9	99.1	100.0	100.0	99.3	100.0	99.8	98.3	99.6	98.4	95.8	100.0	99.4	97.2	99.9	97.4	92.1
Beaver	100.0	95.4	95.4	100.0	96.7	96.7	100.0	93.7	93.7	99.5	<b>85.8</b>	<b>85.8</b>	100.0	<b>89.4</b>	<b>89.4</b>	99.9	<b>76.3</b>	<b>76.3</b>
Alsea	100.0	99.8	98.2	100.0	99.9	98.9	100.0	99.8	97.0	99.4	98.3	91.1	100.0	99.5	94.4	99.6	97.2	<b>85.0</b>
Siuslaw	100.0	99.8	95.0	100.0	100.0	96.5	100.0	99.8	92.2	99.8	98.5	<b>80.9</b>	100.0	99.6	<b>86.6</b>	99.8	98.4	<b>71.3</b>
L. Umpqua	100.0	99.8	96.5	100.0	99.8	98.0	100.0	99.7	94.0	99.4	98.1	<b>85.1</b>	99.8	99.3	90.0	99.7	96.7	<b>76.5</b>
M. Umpqua	100.0	99.8	99.2	100.0	99.9	99.4	100.0	99.9	98.6	99.4	98.1	96.3	100.0	99.1	97.6	99.8	97.0	91.3
N. Umpqua	100.0	99.0	99.0	100.0	99.0	99.0	100.0	98.5	98.5	99.4	95.2	95.2	99.9	97.2	97.2	99.6	90.8	90.8
S. Umpqua	100.0	99.9	99.1	100.0	99.9	99.1	100.0	99.7	97.9	99.4	98.1	94.5	99.9	99.0	96.4	99.5	95.4	<b>88.5</b>
Coos	100.0	100.0	99.7	100.0	100.0	99.6	100.0	100.0	99.7	99.9	99.6	97.9	100.0	100.0	99.1	100.0	99.8	97.3
Coquille	100.0	99.9	97.6	100.0	100.0	98.4	100.0	99.8	95.8	99.4	99.0	91.3	100.0	99.6	93.6	100.0	98.4	<b>83.8</b>
Floras	100.0	98.2	98.2	100.0	98.8	98.8	100.0	96.3	96.3	99.8	93.9	93.9	100.0	95.6	95.6	100.0	<b>87.9</b>	<b>87.9</b>
Sixes	100.0	97.3	97.3	100.0	98.0	98.0	100.0	95.3	95.3	99.9	<b>88.9</b>	<b>88.9</b>	100.0	93.7	93.7	100.0	<b>86.0</b>	<b>86.0</b>
Total	100.0	100.0	97.7	100.0	100.0	98.4	100.0	100.0	95.9	99.9	99.9	<b>89.4</b>	100.0	100.0	92.9	100.0	100.0	<b>81.3</b>

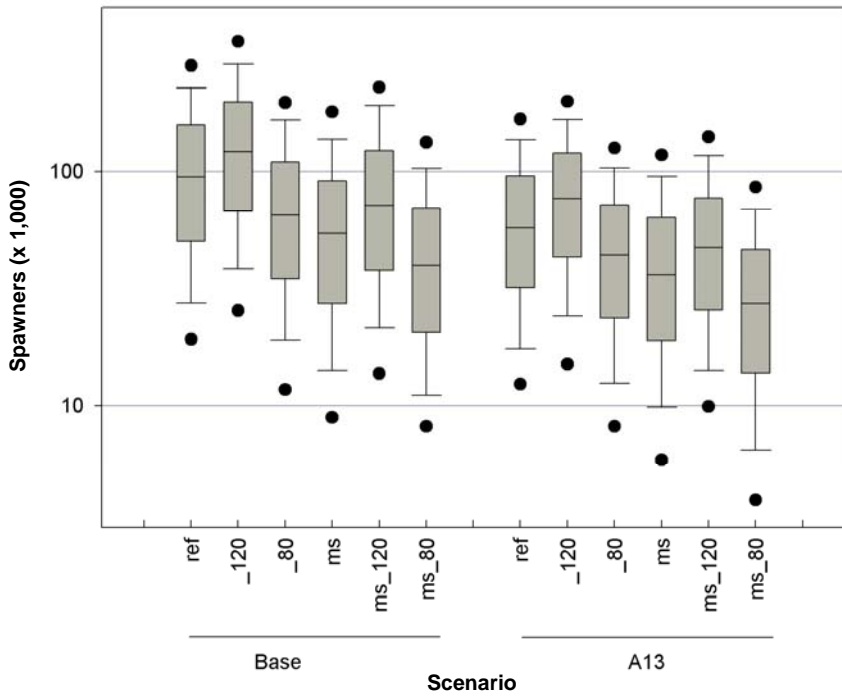

Figure C-9. Box-plot comparison of 12 model scenarios. These comparisons are grouped as base (no harvest) and A13 (harvest) scenarios. Scenarios are described in Modeled Scenarios, page 170. Spawner axis (y-axis) is a log scale.



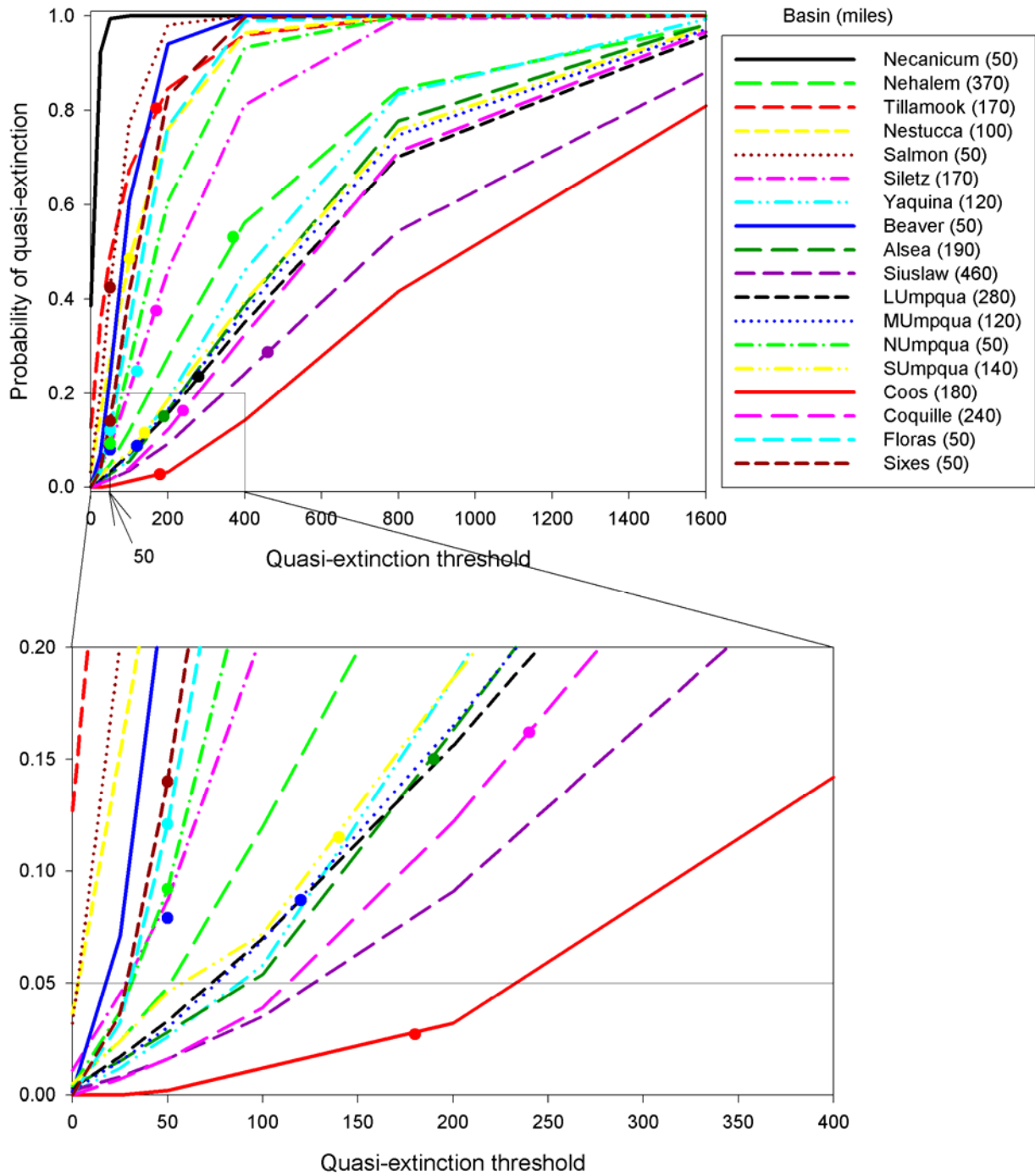

Figure C-10. Sensitivity of the base\_ref scenario to assumption of QETs. Lines represent 18 Independent Populations. Dots show status relative to the 1 fpm threshold. Miles are in parentheses following basin names in legend. The lower graph shows a subset of the upper graph: the area near the origin.

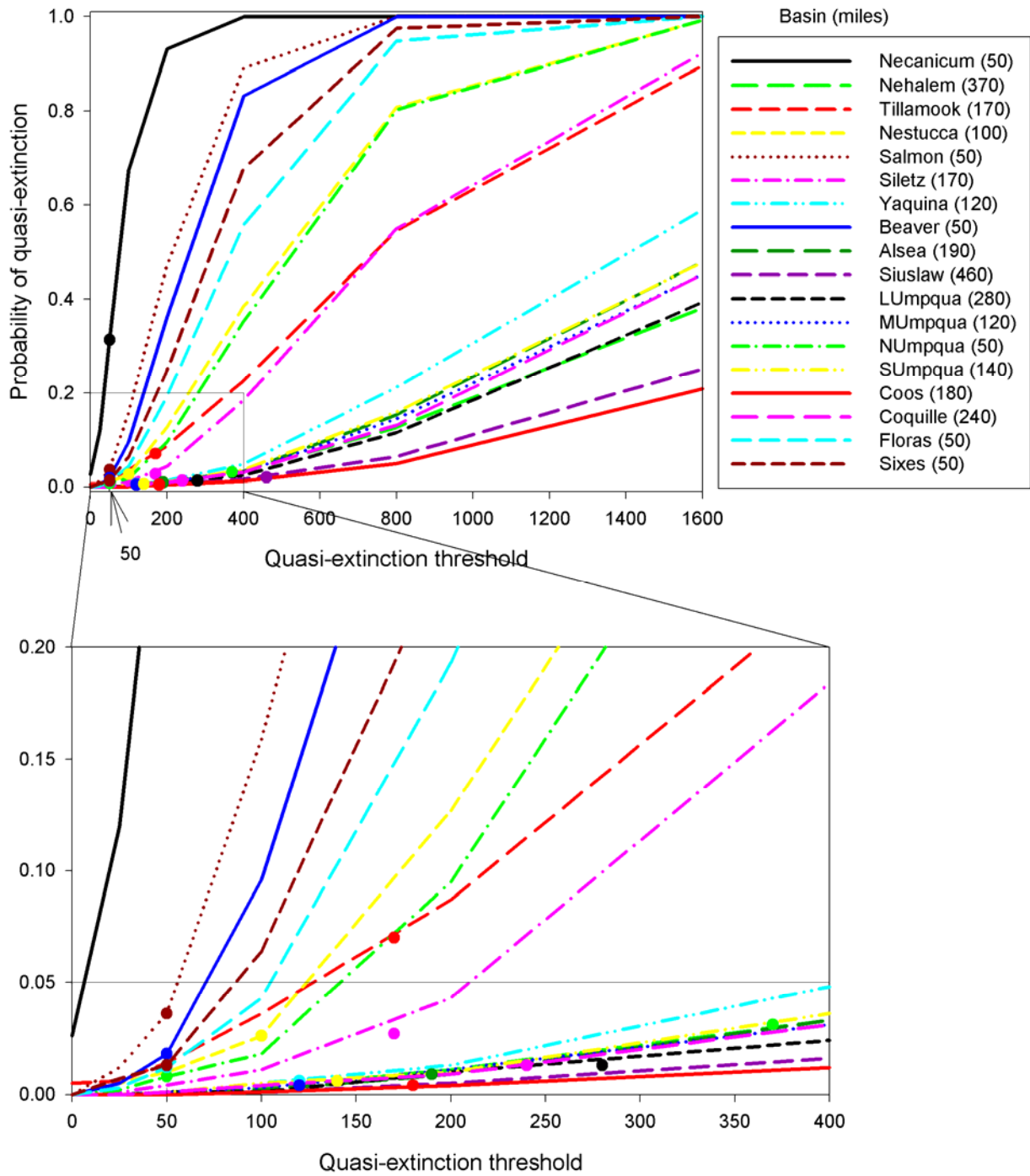

Figure C-11. Sensitivity of the A13\_ms\_80 scenario to assumption of QETs. Lines represent 18 functional populations. Dots show status relative to the 1 fpm threshold. Miles are in parentheses following basin names in legend. The lower graph shows a subset of the upper graph: the area near the origin.

habitat that was not represented in the model and would be likely to improve this population's status. Other small systems were also more vulnerable to extinction or quasi-extinction than larger systems.

Three factors were tested for effect on extinction probabilities: habitat change, decreased marine survival, and harvest; all had approximately equal levels of risk for the populations. This is the only model that includes an analysis of the Amendment 13 harvest regime that has been adopted by the PFMC as posing minimal risk to the viability of the Oregon Coast Coho Salmon ESU. However, this analysis shows that even conservative harvest management, by itself, can pose a substantial risk. The other PVA models do not include this factor and therefore will underestimate overall risk.

Extinction risk in this model is very sensitive to assumptions about marine survival. If marine survival is good it seems there is little risk to the ESU. However, if current projections for warmer temperatures and accompanying lower marine survival are borne out, there could be serious implications for the status of the ESU.

Habitat quality and quantity are the most visible factor affecting the Oregon Coast Coho Salmon ESU. While there are concerted efforts to protect and restore habitat, there is also strong pressure to relax land use regulations. This model shows that extinction risk for this ESU is directly tied to habitat. This is where restoration opportunities are greatest and where lasting and long-term harm can be inflicted.

Given that harvest will continue, if marine conditions continue to degrade and habitat issues are not dealt with effectively, the status of this ESU could worsen. Conversely, with effective habitat protection and restoration activities and effective land use planning, the ESU could improve in status even given the pressures of harvest and declining marine survival.



# Appendix D: Population Abundance Data and Historical Reconstructions

## Contemporary Population Data for 1990–2004

### Estimation of Abundance of Coho Salmon for Independent Populations

This appendix explains the methods of estimating populations abundance used in population productivity and spawner abundance analyses. Abundances of Independent Populations were estimated by expanding area-under-the-curve (AUC) estimates of spawner abundance in randomly selected survey sites (Jacobs and Nickelson 1998, Jacobs et al. 2002). Table D-1 presents the abundance estimates used in analyses in this report. The following notes describe differences in estimation methods from those described by Jacobs et al. (2002).

#### Necanicum

In past estimates of spawner abundance, the Necanicum and Ecola populations were combined into one estimate. For this assessment, the total abundance of adult coho salmon (*Oncorhynchus kisutch*) spawners in the Necanicum population was estimated independently by multiplying mean spawners per mile in random surveys by a stream length of 59.8 miles of spawning habitat. The number of wild fish each year was estimated by multiplying the total population by one minus the proportion of hatchery fish observed on the spawning grounds.

#### Nehalem

Because the preponderance of stray hatchery fish are found in the North Fork Nehalem River (the location of Nehalem Hatchery), AUC estimates for individual random survey reaches were adjusted for the different percentage of hatchery fish observed above and below the mouth of the North Fork. Estimates of mean adult spawners per mile were made for total fish before making the hatchery adjustment and for wild fish after making the adjustment. In each case, the population was estimated by multiplying mean spawners per mile by a stream length of 434 miles of spawning habitat.

#### Tillamook Bay

Because the preponderance of stray hatchery fish are found in the Trask River (the location of the hatchery), AUC estimates for individual random survey reaches were adjusted for the different percentage of hatchery fish observed in the Trask and the rest of the basin (i.e., Miami, Kilchis, Wilson, and Tillamook rivers combined). Estimates of mean adult spawners per mile were made for total fish before making the hatchery adjustment and for wild fish after making the adjustment. In each case, the population was estimated by multiplying mean spawners per mile by a stream length of 249 miles of spawning habitat.

Table D-1. Population estimates for Independent Populations in the Oregon Coast Coho Salmon Evolutionarily Significant Unit (ESU) based on random spawning surveys.

Year	Necanicum		Nehalem		Tillamook Bay		Nestucca	
	Wild	Hatchery	Wild	Hatchery	Wild	Hatchery	Wild	Hatchery
1990	126	84	1,158	5,464	80	145	160	29
1991	752	501	6,837	3,012	1,577	1,498	618	110
1992	133	89	1,392	2,373	176	142	604	80
1993	512	342	3,049	14,014	571	1,146	340	61
1994	269	179	2,844	2,712	1,105	817	266	47
1995	181	120	1,700	2,118	341	755	1,537	274
1996	416	277	527	3,766	733	246	440	79
1997	97	64	1,187	1,351	437	44	230	41
1998	575	383	1,206	51	358	26	202	36
1999	351	19	3,555	600	1,831	147	2,357	0
2000	359	19	14,462	118	2,178	299	1,219	50
2001	4,832	280	21,928	414	1,944	175	4,164	207
2002	2,047	96	17,164	698	13,334	373	16,698	55
2003	2,377	158	32,517	284	13,008	121	10,194	109
2004	2,262	145	20,471	95	3,975	66	6,402	100

Year	Salmon		Siletz		Yaquina		Beaver	
	Wild	Hatchery	Wild	Hatchery	Wild	Hatchery	Wild	Hatchery
1990	19	415	228	213	318	63	90	0
1991	5	34	410	575	317	63	484	0
1992	11	132	2,386	954	528	105	618	0
1993	13	351	207	193	458	91	275	0
1994	91	1,463	621	579	2,040	408	675	0
1995	105	1,220	314	293	4,723	945	308	0
1996	82	2,621	395	368	4,578	1,526	1,296	405
1997	16	401	298	38	419	110	497	147
1998	86	346	316	41	510	134	401	119
1999	14	159	1,209	155	2,563	4	1,511	0
2000	179	215	3,387	0	637	1	1,464	46
2001	225	652	1,595	859	3,589	171	1,832	282
2002	543	565	2,129	375	23,800	0	3,217	143
2003	42	1,696	8,038	383	16,484	0	5,552	0
2004	1,758	2,014	5,612	0	5,293	108	3,451	0

Table D-1 continued. Population estimates for Independent Populations in the Oregon Coast Coho Salmon ESU based on random spawning surveys.

Year	Alesia		Siuslaw		Siltcoos		Tahkenitch	
	Wild	Hatchery	Wild	Hatchery	Wild	Hatchery	Wild	Hatchery
1990	775	422	2,269	674	1,578	44	1,085	0
1991	1,011	550	2,808	1,434	2,868	27	1,215	0
1992	6,273	2,214	3,554	1,717	385	6	317	1
1993	694	377	4,600	1,278	3,569	53	954	0
1994	828	451	3,159	1,904	1,302	124	1,056	6
1995	441	240	6,161	1,406	4,415	82	1,577	50
1996	1,060	577	7,234	4,136	4,707	68	1,627	0
1997	601	327	501	174	2,653	0	1,842	16
1998	108	1,624	1,020	362	3,122	0	2,817	0
1999	1,341	730	2,980	213	2,756	63	3,664	105
2000	3,363	0	6,532	0	3,835	0	634	0
2001	3,228	692	10,606	0	5,104	0	3,510	16
2002	9,073	181	55,445	250	4,636	113	3,480	7
2003	10,281	0	29,003	56	6,628	0	3,188	15
2004	6,328	0	9,036	0	8,025	0	3,496	0

Year	Lower Umpqua		Middle Umpqua		North Umpqua		South Umpqua	
	Wild	Hatchery	Wild	Hatchery	Wild	Hatchery	Wild	Hatchery
1990	1,678	95	1,222 <sup>a</sup>	83 <sup>a</sup>	355	1,258	2,934	530
1991	3,123	0	4,546 <sup>a</sup>	308 <sup>a</sup>	1,301	2,430	2,233	992
1992	1,797	0	5,275 <sup>a</sup>	358 <sup>a</sup>	1,579	3,170	435	79
1993	7,877	161	2,947 <sup>a</sup>	200 <sup>a</sup>	906	1,513	3,723	673
1994	2,762	156	2,162	147	899	990	1,081	1,442
1995	10,854	0	3,250	0	1,293	1,756	4,715	555
1996	7,985	450	5,086	345	1,069	3,743	7,040	7,040
1997	1,257	188	563	38	577	1,379	937	187
1998	4,552	0	1,257	79	765	3,379	3,177	1,430
1999	2,623	85	1,748	166	1,194	1,979	3,011	198
2000	5,781	115	4,555	164	1,677	7,585	2,581	329
2001	11,639	1,233	8,940	877	2,634	14,094	11,871	1,554
2002	18,881	906	10,738	931	3,368	6,695	10,517	0
2003	16,494	35	11,090	0	2,862	8,884	4,337	0
2004	9,778	70	5,668	52	4,025	6,836	12,077	454

Table D-1 continued. Population estimates for Independent Populations in the Oregon Coast Coho Salmon ESU based on random spawning surveys.

Year	Tenmile		Coos		Coquille	
	Wild	Hatchery	Wild	Hatchery	Wild	Hatchery
1990	1,687	0	2,243	30	2,589	123
1991	3,033	108	2,426	1,387	4,782	869
1992	1,271	6	16,722	257	2,033	82
1993	5,544	25	14,932	1,140	7,291	260
1994	3,354	0	14,500	707	5,119	0
1995	5,092	0	10,302	145	2,034	82
1996	7,092	0	12,128	0	15,814	355
1997	4,092	0	1,112	15	5,720	0
1998	5,169	0	2,985	0	2,412	0
1999	6,123	0	4,818	0	2,667	0
2000	8,278	0	4,704	0	6,253	0
2001	10,990	49	33,595	664	13,833	1,832
2002	13,861	0	33,120	145	7,676	190
2003	6,260	0	25,761	189	22,403	162
2004	7,148	18	22,046	106	22,408	42

Year	Floras/New		Sixes	
	Wild	Hatchery	Wild	Hatchery
1990	NA <sup>b</sup>	NA	58	5
1991	NA	NA	35	3
1992	NA	NA	92	8
1993	NA	NA	253	23
1994	2,653	240	238	22
1995	1,351	400	77	7
1996	1,519	109	194	17
1997	482	43	143	13
1998	879	79	558	50
1999	670	60	56	5
2000	1,477	0	136	12
2001	5,664	88	95	182
2002	3,272	296	95	9
2003	952	86	86	8
2004	5,069	0	491	0

<sup>a</sup> Estimate based on the relationship between Winchester Dam counts and abundance in Middle Umpqua (see Umpqua River subsection on Page 185).

<sup>b</sup> NA = no estimate available.



## **Beaver**

In past estimates of spawner abundance, the Beaver and Devils Lake populations were combined into one estimate. For this assessment, the total abundance of adult coho salmon spawners in the Beaver population was estimated independently by multiplying mean spawners per mile in random surveys (except in years with less than three samples when the standard survey was also used to calculate the mean) by a stream length of 22 miles of spawning habitat. The number of wild fish each year was estimated by multiplying the total population by one minus the proportion of hatchery fish observed on the spawning grounds.

## **Siuslaw**

Because the preponderance of stray hatchery fish were found in the Lake Creek subbasin (the location of hatchery releases) in 1990–1998, AUC estimates for individual random survey reaches for those years were adjusted for the different percentage of hatchery fish observed in the Lake Creek subbasin and the rest of the basin. Estimates of mean adult spawners per mile were made for total fish before making the hatchery adjustment and for wild fish after making the adjustment. In each case, the population was estimated by multiplying mean spawners per mile by a stream length of 502 miles of spawning habitat. For 1999–2003, the standard method was used to estimate total abundance, which was then adjusted for hatchery fish.

## **Umpqua River**

Past estimates of spawner abundance have not divided the Umpqua River basin into the same four populations that are identified in this report: the Lower Umpqua, Middle Umpqua, North Umpqua, and South Umpqua. Therefore new estimates were made for these populations.

**Lower Umpqua:** Annual estimates of mean spawner density (fish per mile) in random surveys were multiplied by 335 miles of spawning habitat. The number of wild fish each year was estimated by multiplying the total population by one minus the proportion of hatchery fish observed on the spawning grounds.

**Middle Umpqua:** Annual estimates of mean spawner density (fish per mile) in random surveys were multiplied by 375 miles of spawning habitat. The number of wild fish each year was estimated by multiplying the total population by one minus the proportion of hatchery fish observed on the spawning grounds.

**North Umpqua:** Abundance estimates for the North Umpqua population are based on counts of fish at Winchester Dam. Marked hatchery fish counted at the dam were expanded by mark rates to estimate passage of hatchery fish. These estimates were subtracted from the total to estimate wild fish. Hatchery and wild fish removed by the hatchery and the fishery were subtracted from their respective totals in years where such data was available.

**South Umpqua:** Annual estimates of mean spawner density (fish per mile) in random surveys were multiplied by 612 miles of spawning habitat. The number of wild fish each year was estimated by multiplying the total population by one minus the proportion of hatchery fish observed on the spawning grounds.

## **The Lakes**

Estimates of abundance of coho salmon for the Siltcoos, Tahkenitch, and Tenmile populations were calculated from standard spawner surveys following the methods described by Jacobs et al. (2002).

## **Floras/New**

Spawning surveys for coho salmon were not conducted in the Floras/New (Fourmile) basin until 1994, when supplemental surveys began in several stream reaches. These reaches have been surveyed since 1994 on a hit-or-miss basis. Beginning in 1997, three to four randomly selected reaches have been surveyed each year in addition to the supplemental reaches. AUC data from all survey reaches were used to calculate mean spawner density (fish per mile), which was multiplied by 26.5 miles of spawning habitat to estimate the annual population. Since 1994, 16–30% of the Floras/New population's spawning habitat has been surveyed annually.

## **Sixes**

Prior to 1994, when supplemental spawning surveys began, coho salmon data is available from two standard Chinook salmon (*Oncorhynchus tshawytscha*) surveys on Dry Creek that make up 11% of the coho salmon spawning habitat in the basin. Since 1994, five supplemental surveys have been surveyed in most years. In addition, during 1997–2002, a total of one to two random surveys were conducted in the Sixes Basin. AUC data from all survey reaches were used to calculate mean spawner density (fish per mile), which was multiplied by 32 miles of spawning habitat to estimate the annual population.

### **Estimation of the Proportion of Hatchery Spawners**

The hatchery programs affecting the various populations went through changes in smolt releases of varying degrees midway through the 1990–2004 period. These changes affected the proportions of hatchery fish observed on the spawning grounds. Data on naturally spawning hatchery fish was collected from carcasses collected in random survey reaches. For 1990–1997, estimates of hatchery fish were based on interpretation of scale patterns (e.g., Borgerson 1999). For 1998–2004, estimates of hatchery fish were based on the number of carcasses that were fin marked, adjusted by the mark rate of the nearest hatchery. A minimum of 10 observations per population per year was used to estimate the proportion of hatchery spawners. For years with less than 10 observations, an average based on years with similar magnitude of smolt releases was applied. Details for each population follow.

## **Necanicum**

Samples were inadequate to make an annual estimate of the proportion of hatchery spawners in each year from 1990 to 2000. For 1990–1998, the proportion of all observations during the period was applied to each year. Because production from Nehalem Hatchery (the nearest coastal hatchery) was greatly reduced beginning with 1999 returns, the proportion of hatchery fish in all observations during 1999–2003 was applied to 1999 and 2000. Marks observed in 1998–2003 were expanded for proportion of hatchery fish marked based on data from Nehalem Hatchery.

## **Nehalem**

In the Lower Nehalem, sample sizes were inadequate in 1998–2000. As with the Necanicum, the proportion of hatchery fish in all observations during 1990–1998 was used for 1998, and the proportion of hatchery fish in all observations during 1999–2003 was used for 1999 and 2000.

The Upper Nehalem was more complicated because in 1990, 1993, and 1996, hatchery fish returned to Fishhawk Lake. Scales determined to be hatchery fish that were found in the vicinity of Fishhawk Lake in other years were reclassified as wild fish because lake-reared fish can produce a scale pattern similar to hatchery fish. Sample sizes were inadequate in 1990 and 1994–1996. The proportion of hatchery fish in all observations during 1990, 1993, and 1996 was used for 1990 and 1996. The proportion of hatchery fish in all observations during 1991, 1992, 1994, 1995, 1997, and 1998 was used for 1994 and 1995. Marks observed beginning in 1998 were expanded based on the proportion of hatchery fish marked at Nehalem Hatchery.

## **Tillamook Bay**

In the Trask subbasin, sample sizes were inadequate in 1990–1992, 1998, 1999, and 2001. Because the Trask Pond production was eliminated after 1995 returns, the proportion of hatchery fish in all observations during 1990–1995 was used for 1990–1992, and the proportion of hatchery fish in all observations during 1996–2003 was used for 1998, 1999, and 2001. Marks observed beginning in 1998 were expanded based on the proportion of hatchery fish marked at Trask Hatchery.

In the remainder of the Tillamook Bay basin, sample sizes were inadequate in all years from 1990 to 1998, except 1994 and 1996. As with the Trask subbasin, the proportion of hatchery fish in all observations during 1990–1995 was used for 1990–1993 and 1995, and the proportion of hatchery fish in all observations during 1996–2003 was used for 1997 and 1998. Marks observed beginning in 1998 were expanded based on the proportion of hatchery fish marked at Trask Hatchery.

## **Salmon**

Sample sizes were inadequate to make an annual estimate of the proportion of hatchery spawners in only 1995 and 1999. The proportion of hatchery fish in all observations during 1990–1999 was used for both years. Smolt releases into the Salmon River from Salmon River Hatchery was reduced beginning with 2000 returns. Marks observed in 1998–2003 were expanded for the proportion of hatchery fish marked based on data from Salmon River Hatchery.

## **Siletz**

Sample sizes were inadequate in all years from 1990 to 1999, except 1991 and 1992. Because of changes in the release of hatchery coho salmon into the Siletz River, the proportion of hatchery fish in all observations during 1990–96 was used for 1990 and 1993–1996, and the proportion of hatchery fish in all observations during 1997–2003 was used for 1997–1999. Marks observed in 1998–2003 were expanded for the proportion of hatchery fish marked based on data from fish released into the Siletz River.

## **Yaquina**

Sample sizes were inadequate in all years from 1990 to 2000, except 1996. During this period, hatchery fish returned in 1996–1998 from releases into Yaquina Bay. Because of changes in the release of hatchery coho salmon into the Yaquina River, the proportion of hatchery fish in all observations during 1990–1995 was used for 1990–1995, the proportion of hatchery fish in all observations during 1996–1998 was used for 1997 and 1998, and the proportion of hatchery fish in all observations during 1999–2003 was used for 1999 and 2000. Marks observed in 1998–2003 were expanded for the proportion of hatchery fish marked based on data from fish released into the Yaquina River (1998) or the Siletz River (2001).

## **Beaver**

Returns of hatchery fish released in the Yaquina River influence the proportion of hatchery fish found in Beaver Creek. Sample sizes were inadequate in all years from 1990 to 2000, except 1996 and 1999. Because of changes in the release of hatchery coho salmon into the Yaquina River, the proportion of hatchery fish in all observations during 1990–1995 was used for 1990–1995, the proportion of hatchery fish in all observations during 1996–1998 was used for 1997 and 1998, and the proportion of hatchery fish in all observations during 1999–2003 was used for 2000. Marks observed in 1998–2003 were expanded for the proportion of hatchery fish marked based on data from fish released into the Yaquina River (1998) or the Siletz River (1999–2003).

## **Alsea**

Sample sizes were inadequate in all years from 1990 to 1999, except 1992 and 1998. The release of hatchery coho salmon into the Alsea River was greatly reduced in 1998 brood, then terminated in 1999. Therefore, the proportion of hatchery fish in all observations during 1990–1998 was used for 1991 and 1993–1997. Marks observed in 1998–2003 were expanded for the proportion of hatchery fish marked based on data from fish released into the Alsea River (1998–1999) or the Siletz River (2000–2003).

## **Siuslaw**

In the Lake Creek subbasin, sample sizes were inadequate in 1990–1993, 1997, and 1998. Hatchery fish returned in 1991–1998 from releases into Lake Creek. The proportion of hatchery fish in all observations during 1990–1998 was used for 1990–1993, 1997, and 1998.

In the remainder of the Siuslaw Basin, sample sizes were inadequate from 1990 to 1998, except 1991 and 1996. The proportion of hatchery fish in all observations during 1990–1998 was used for 1990, 1992–1995, 1997, and 1998.

The percent of hatchery spawners in 1999–2003 were based on recoveries of carcasses in the entire basin. Marks observed in 1998–2003 were expanded for the proportion of hatchery fish marked based on the average mark rates for hatchery fish on the Oregon Coast each year.

## **Umpqua River Populations**

**Lower Umpqua:** Sample sizes were inadequate in 1990, 1994, and 1996. The proportion of hatchery fish in all observations during 1990–2001 was used for 1990, 1994, and 1996. Marks observed in 1998–2003 were expanded for the proportion of hatchery fish marked based on data from fish released from Rock Creek Hatchery.

**Middle Umpqua:** Sample sizes were inadequate in all years from 1990 to 1997, except 1995. The proportion of hatchery fish in all observations during 1990–2001 was used for 1990–1994, 1996, and 1997. Marks observed in 1998–2003 were expanded for the proportion of hatchery fish marked based on data from fish released from Rock Creek Hatchery.

**North Umpqua:** See Middle Umpqua above.

**South Umpqua:** Sample sizes were inadequate in 1990, 1992, and 1993. The proportion of hatchery fish in all observations during 1990–2001 was used for 1990, 1992, and 1993. Marks observed in 1998–2003 were expanded for the proportion of hatchery fish marked based on data from fish released from Rock Creek Hatchery.

## **The Lakes**

Very few fish thought to be of hatchery origin have been observed in the lake populations and there is a strong possibility that some of those were actually wild fish with a scale pattern similar to hatchery fish. The proportion of hatchery fish in all observations during 1990–2003 in the Siltcoos Basin was used for 1992. The proportion of hatchery fish in all observations during 1990–2003 in the Tahkenitch Basin was used for 1992, 2000, 2001, and 2003. The proportion of hatchery fish in all observations during 1990–2003 in the Tenmile Lakes Basin was used for 1992 and 1993. Marks observed in 1998–2003 were expanded for the proportion of hatchery fish marked based on the average mark rates for hatchery fish on the Oregon Coast each year.

## **Coos**

Sample sizes were inadequate in 1990 and 1997. The proportion of hatchery fish in all observations during 1990–2003 was used for 1990 and 1997. Marks observed in 1998–2003 were expanded for the proportion of hatchery fish marked based on data from fish released from Noble Creek Salmon and Trout Enhancement Program Hatchery.

## **Coquille**

Sample sizes were inadequate in 1992 and 1995. Releases of hatchery coho salmon were reduced beginning with the 1994 brood. Therefore, the proportion of hatchery fish in all observations during 1990–1996 was used for 1992 and 1995. Marks observed in 1998–2003 were expanded for the proportion of hatchery fish marked based on data from fish released in the Coquille River.

## **Floras/New**

Sample sizes were inadequate in all years from 1990 to 2003, except 1995, 1996, 2000, and 2001. Because hatchery fish were not released in the basin during this period, the proportion of hatchery fish in all observations during 1990–2003 was used for 1990–1994, 1997–1999, 2002, and 2003. Marks observed in 1998–2003 were expanded for the proportion of hatchery fish marked based on data from fish released in the Coquille River.

## **Sixes**

Sample sizes were inadequate in all years from 1990 to 2003, except 2001. Because hatchery fish were not released in the basin during this period and the data is limited to the four most recent years, the proportion of hatchery fish in all observations in the Floras Basin during 1990–2003 was used for all years except 2001, the only year hatchery fish were observed. Marks observed in 1998–2003 were expanded for the proportion of hatchery fish marked based on data from fish released in the Coquille River.

# **Reconstruction of Historical Population Abundance for 1958–1989**

## **Estimation of Abundance of Coho Salmon for Independent Populations**

Annual abundance during the period 1958–89 was estimated for 18 of the 21 Independent Populations that make up the Oregon Coast Coho Salmon ESU. Estimates were not made for the Salmon, Floras/New, and Sixes populations because data were not available. Also, it was not possible to make estimates for every year for some populations due to a lack of data. The primary method of estimation was to calibrate the total abundance estimate for a population (see Contemporary Population Data for 1990–2004 on page 181) to the average peak counts in standard spawner surveys found in the range of the population by fitting a linear regression with a zero intercept (Table D-2). The calibrations explained 38–92% of the variation in abundance during 1990–2003. In the case of the lake populations, methods described by Jacobs et al. (2002) were used. Abundance of the North Umpqua population was based on counts at Winchester Dam. Abundance of the Middle Umpqua and South Umpqua populations were calibrated to Winchester Dam counts. The proportion of hatchery fish in recent years was applied to the estimated total abundance each year by population as described below for each population. This likely resulted in an overestimate of the proportion of hatchery fish spawning naturally in coastal streams during the first few years, as hatchery production was not as successful prior to improvements in rearing procedures implemented in the early 1960s (ODFW 1981). Table D-3 presents the abundance estimates used in analyses in this report. Notes on individual populations follow.

## **Necanicum**

Standard spawning surveys have been conducted in the Necanicum Basin only since 1981 and these were used in the calibration that was used to estimate abundance during 1981–1989. Estimates prior to 1981 were based on a calibration between Necanicum abundance estimates and average peak counts in the Nehalem Basin for the years 1990–2003. However, these

Table D-2. Regression equations used.  $R^2$  is the proportion of total variance explained by the regression;  $p$  is the significance probability for the slope of the regression.

<b>Population</b>	<b>Period</b>	<b>Equation</b>	<b><math>R^2</math></b>	<b><math>p</math></b>
Necanicum	1958–1980	Total Necanicum = $72.459 \times$ Nehalem peak count	0.30	0.035
	1981–1989	Total Necanicum = $73.066 \times$ Necanicum peak count	0.44	0.008
Nehalem	1958–1989	Total Nehalem = $685.214 \times$ Nehalem peak count	0.61	0.001
Tillamook	1958–1989	Total Tillamook = $212.341 \times$ Tillamook peak count	0.89	0.000
Nestucca	1958–1989	Total Nestucca = $517.279 \times$ Nestucca peak count	0.58	0.002
Siletz	1958–1989	Total Siletz = $82.390 \times$ Alsea peak count	0.65	0.000
Yaquina	1958–1989	Total Yaquina = $134.350 \times$ Yaquina peak count	0.92	0.000
Beaver	1958–1989	Total Beaver = $50.952 \times$ Beaver peak count	0.69	0.000
Alsea	1958–1989	Total Alsea = $147.499 \times$ Alsea peak count	0.88	0.000
Siuslaw	1958–1989	Total Siuslaw = $751.435 \times$ Siuslaw peak count	0.82	0.000
Lower Umpqua	1958–1989	Total Lower Umpqua = $104.266 \times$ Lower Umpqua peak count	0.71	0.000
Middle Umpqua	1958–1989	Wild Middle Umpqua = $3.075 \times$ Winchester Dam Wild	0.89	0.000
South Umpqua	1958–1989	Wild South Umpqua = $2.629 \times$ Winchester Dam Wild	0.45	0.007
Coos	1958–1989	Total Coos = $340.616 \times$ Coos peak count	0.65	0.001
Coquille	1958–1989	Total Coquille = $320.995 \times$ Coquille peak count	0.68	0.000

Table D-3. Estimated abundance of adult fish with or without harvested numbers of Independent Populations of the Oregon Coast Coho Salmon ESU, 1958–1989. NA means no estimate is available.

Year	Necanicum		Nehalem		Tillamook Bay		Nestucca	
	Wild	Hatchery	Wild	Hatchery	Wild	Hatchery	Wild	Hatchery
1958	274	161	3,535	576	586	263	3,005	616
1959	977	574	12,611	2,053	1,904	856	2,576	528
1960	675	397	8,721	1,420	2,710	1,218	4,294	879
1961	1,424	837	18,386	2,993	6,007	2,699	7,299	1,495
1962	1,251	734	16,147	2,628	7,032	3,160	2,576	528
1963	803	472	10,372	1,688	4,249	1,909	5,582	1,143
1964	1,872	1,099	24,161	3,933	5,861	2,633	12,022	2,462
1965	1,452	852	18,739	3,051	3,663	1,646	6,011	1,231
1966	1,123	659	14,496	2,360	2,198	987	3,005	616
1967	840	493	10,843	1,765	9,597	4,311	4,294	879
1968	NA	NA	NA	NA	4,689	2,106	2,146	440
1969	648	381	8,368	1,362	2,710	1,218	1,717	352
1970	1,022	601	13,200	2,149	8,717	3,917	7,299	1,495
1971	1,634	960	21,097	3,434	6,447	2,896	5,582	1,143
1972	356	209	4,597	748	2,637	1,185	1,288	264
1973	593	349	7,661	1,247	7,472	3,357	4,723	967
1974	338	198	4,361	710	5,714	2,567	2,576	528
1975	NA	NA	NA	NA	6,740	3,028	3,435	703
1976	365	215	4,715	767	4,395	1,975	NA	NA
1977	457	268	5,893	959	293	132	859	176
1978	593	349	7,661	1,247	4,249	1,909	2,146	440
1979	365	215	4,715	767	4,103	1,843	3,864	792
1980	512	300	6,600	1,074	1,539	691	3,005	616
1981	230	135	3,418	556	1,392	625	2,290	469
1982	2,255	1,325	8,368	1,362	1,978	889	4,580	938
1983	322	189	1,296	211	403	181	4,007	821
1984	644	379	16,500	2,686	2,271	1,020	4,007	821
1985	599	351	6,600	1,074	1,575	708	6,154	1,260
1986	874	514	10,607	1,727	1,575	708	4,865	997
1987	599	351	2,946	480	879	395	1,002	205
1988	920	541	2,631	1,754	809	518	1,145	234
1989	736	433	8,469	5,646	1,145	235	2,004	410



Table D-3 continued. Estimated abundance of adult fish with or without harvested numbers of Independent Populations of the Oregon Coast Coho Salmon ESU, 1958–1989. NA means no estimate is available.

Year	Siletz		Yaquina		Beaver		Alsea	
	Wild	Hatchery	Wild	Hatchery	Wild	Hatchery	Wild	Hatchery
1958	837	451	3,213	13	662	0	1,466	796
1959	1,765	951	7,564	30	1,580	0	3,090	1,679
1960	1,165	627	3,481	14	1,274	0	2,039	1,108
1961	2,621	1,411	20,616	83	917	0	4,588	2,492
1962	946	510	8,701	35	1,732	0	1,657	900
1963	2,220	1,196	5,421	22	764	0	3,887	2,111
1964	3,185	1,715	10,442	42	1,019	0	5,575	3,029
1965	1,547	833	10,843	44	1,070	0	2,708	1,471
1966	1,911	1,029	13,655	55	1,987	0	3,345	1,817
1967	1,620	872	5,020	20	510	0	2,836	1,540
1968	1,238	666	7,765	31	1,834	0	2,166	1,177
1969	400	216	3,347	13	713	0	701	381
1970	510	274	10,509	42	2,089	0	892	485
1971	2,239	1,205	16,801	67	2,497	0	3,918	2,129
1972	328	176	1,941	8	357	0	573	312
1973	710	382	4,016	16	560	0	1,242	675
1974	473	255	1,740	7	153	0	828	450
1975	1,201	647	NA	NA	NA	NA	2,103	1,142
1976	382	206	NA	NA	NA	NA	669	363
1977	655	353	2,142	9	NA	NA	1,147	623
1978	874	470	1,607	6	NA	NA	1,529	831
1979	764	412	11,111	45	NA	NA	1,338	727
1980	852	786	2,124	3,185	727	853	1,467	1,409
1981	906	837	1,559	2,339	258	302	1,561	1,500
1982	480	444	1,398	2,097	469	550	827	795
1983	328	302	457	685	258	302	564	542
1984	601	554	1,478	2,218	563	660	1,034	994
1985	2,173	2,006	4,140	6,209	1,336	1,568	3,742	3,596
1986	1,210	1,478	3,387	8,710	2,147	2,846	2,077	2,643
1987	871	557	2,837	1,397	141	165	2,081	426
1988	1,594	590	2,758	871	164	193	1,572	2,263
1989	1,976	61	2,064	423	662	0	3,362	215

Table D-3 continued. Estimated abundance of adult fish with or without harvested numbers of Independent Populations of the Oregon Coast Coho Salmon ESU, 1958–1989. NA means no estimate is available.

Year	Siuslaw		Siltcoos		Tahkenitch		Tenmile	
	Wild	Hatchery	Wild	Hatchery	Wild	Hatchery	Wild	Hatchery
1958	NA	NA	NA	NA	NA	NA	12,043	61
1959	NA	NA	NA	NA	NA	NA	7,471	38
1960	1,104	23	1,768	27	912	5	5,464	28
1961	5,891	120	4,169	64	1,785	9	15,277	77
1962	4,050	83	4,492	68	1,783	9	17,619	89
1963	6,259	128	3,650	56	820	4	10,594	53
1964	11,414	233	9,059	138	2,221	11	18,734	94
1965	8,469	173	2,366	36	1,642	8	12,043	61
1966	9,205	188	5,351	82	1,381	7	12,713	63
1967	11,047	225	2,171	33	986	5	11,151	56
1968	10,678	218	2,224	34	714	4	7,248	37
1969	15,464	316	1,630	25	986	5	6,022	30
1970	13,255	271	3,889	60	1,692	9	14,726	74
1971	16,753	342	1,666	25	865	5	26,540	134
1972	4,419	90	1,931	30	573	3	7,471	38
1973	8,837	180	2,826	43	2,434	12	NA	NA
1974	3,498	71	1,497	23	699	4	4,143	21
1975	6,186	126	2,817	43	420	2	2,338	12
1976	13,991	286	NA	NA	NA	NA	1,486	7
1977	4,419	90	1,484	23	2,468	12	1,832	9
1978	2,946	60	634	9	NA	NA	957	5
1979	6,996	143	2,652	40	3,297	16	627	3
1980	11,783	240	1,719	26	1,099	5	1,816	9
1981	3,682	75	NA	NA	NA	NA	2,509	13
1982	8,101	165	1,214	18	3,991	20	2,685	14
1983	4,971	101	664	11	1,967	9	729	4
1984	7,916	162	6,219	95	4,531	23	3,866	19
1985	14,360	293	3,356	51	417	2	3,715	19
1986	19,331	394	4,164	64	3,074	15	4,444	23
1987	11,047	225	1,624	25	594	3	1,933	9
1988	10,596	676	2,579	39	540	2	2,627	13
1989	13,226	1,803	2,051	32	542	3	2,130	10

Table D-3 continued. Estimated abundance of adult fish with or without harvested numbers of Independent Populations of the Oregon Coast Coho Salmon ESU, 1958–1989. NA means no estimate is available.

Year	Lower Umpqua		Middle Umpqua		North Umpqua		South Umpqua	
	Wild	Hatchery	Wild	Hatchery	Wild	Hatchery	Wild	Hatchery
1958	3,300	0	1,356	0	441	0	1,159	0
1959	3,648	0	1,937	0	630	0	1,656	0
1960	1,285	0	818	0	266	0	699	0
1961	3,509	0	1,258	0	409	0	1,075	0
1962	7,157	0	1,298	0	422	0	1,109	0
1963	3,926	0	2,906	0	945	0	2,484	0
1964	20,671	0	2,761	0	898	0	2,361	0
1965	14,314	0	5,357	0	1,742	0	4,580	0
1966	5,698	0	2,171	0	706	0	1,856	0
1967	9,693	0	3,066	0	997	0	2,621	0
1968	3,439	0	3,899	0	1,268	0	3,334	0
1969	7,365	0	1,335	0	434	0	1,141	0
1970	7,504	0	483	0	157	0	413	0
1971	4,933	0	1,510	0	491	0	1,291	0
1972	2,362	0	996	0	324	0	852	0
1973	6,254	0	1,242	0	404	0	1,062	0
1974	2,988	0	956	0	311	66	818	0
1975	3,231	0	821	0	267	214	702	0
1976	2,745	0	772	0	251	82	660	0
1977	1,459	0	1,319	0	429	7	1,128	0
1978	1,529	0	1,141	0	371	107	975	0
1979	6,254	0	1,292	0	420	0	1,104	0
1980	1,424	0	744	0	242	1	636	0
1981	1,320	0	166	0	54	0	142	0
1982	7,195	379	2,079	133	676	1,981	1,777	314
1983	1,585	83	NA	NA	7	1,196	NA	NA
1984	3,267	172	NA	NA	6	3,195	NA	NA
1985	4,720	248	2,577	164	838	4,023	2,203	389
1986	5,281	278	2,958	189	962	9,581	2,529	446
1987	2,971	156	3,023	193	983	2,165	2,584	456
1988	11,321	596	1,845	118	600	1,196	1,577	278
1989	3,927	207	4,975	318	1,618	2,734	4,254	751

Table D-3 continued. Estimated abundance of adult fish with or without harvested numbers of Independent Populations of the Oregon Coast Coho Salmon ESU, 1958–1989.

Year	Coos		Coquille	
	Wild	Hatchery	Wild	Hatchery
1958	3,403	0	6,195	466
1959	8,167	0	24,554	1,848
1960	2,155	0	3,060	230
1961	12,818	0	7,986	601
1962	13,498	0	14,429	1,086
1963	6,239	0	3,134	236
1964	11,003	0	15,464	1,164
1965	6,012	0	17,076	1,285
1966	7,146	0	7,284	548
1967	6,579	0	6,344	477
1968	4,424	0	5,015	378
1969	6,012	0	11,105	836
1970	4,197	0	7,762	584
1971	7,373	0	11,224	845
1972	4,991	0	6,866	517
1973	5,445	0	4,478	337
1974	9,868	0	6,448	485
1975	6,125	0	5,522	416
1976	10,549	0	24,031	1,809
1977	8,167	0	1,194	90
1978	2,892	0	3,508	264
1979	6,806	0	5,971	449
1980	6,431	715	4,080	307
1981	3,879	431	2,746	207
1982	9,188	1,021	3,940	297
1983	2,450	272	4,359	328
1984	4,389	488	11,224	845
1985	5,411	601	3,582	270
1986	5,819	647	3,582	270
1987	4,638	693	4,657	351
1988	10,880	1,484	4,475	982
1989	5,366	873	1,849	1,233

estimates are not very reliable because the calibration explained only 38% of the variation in abundance. The average proportion of hatchery fish observed during the period 1989–1998, prior to reductions in hatchery programs, was applied to the total abundance estimates prior to 1990.

### **Nehalem**

The average proportion of hatchery fish observed in the upper Nehalem Basin (where the standard surveys are located) during the period 1989–1998 (except for 1990, 1993, and 1996 when hatchery fish returned to Fishhawk Lake) was applied to the total abundance estimates prior to 1990.

### **Tillamook Bay**

The average proportion of hatchery fish observed in the Tillamook Bay subbasins except the Trask (no standard surveys are located in the Trask subbasin) during the period 1988–1995 (a period when Trask Pond was in operation) was applied to the total abundance estimates prior to 1990.

### **Nestucca**

The average proportion of hatchery fish observed during the period 1988–1998, prior to reductions in coastal hatchery programs, was applied to the total abundance estimates prior to 1990.

### **Siletz**

Standard spawning surveys have been conducted in the Siletz Basin only since 1981. A calibration using this data (one survey) was compared to a calibration using average peak count from the Alsea River Basin (four surveys). The Alsea calibration was used to estimate abundance for the Siletz population for all years prior to 1990 for three reasons: 1) the Alsea calibration was superior ( $R^2 = 0.65$  compared to  $R^2 = 0.45$ ), 2) estimates derived from the two calibrations for 1981–1981 showed a similar trend, and 3) when doing analyses of the abundances there is an advantage to using a consistent calibration factor for all years. Determination of the proportion of hatchery fish in the Siletz also presented a problem because this population received strays from the private hatchery in Yaquina Bay and it had a state hatchery on a tributary during this period. Data from 1986 to 1988 were used to compute an average proportion of hatchery fish that was applied to 1980–1988. Because the state hatchery is no longer located in the basin, the proportion of hatchery fish in the Alsea River Basin during 1990–1998 (a similar situation with a state hatchery on a tributary) was applied to the Siletz estimates prior to 1980.

### **Yaquina**

The estimation of hatchery strays in the Yaquina during 1958–1989 is complicated by the private hatchery that was located in the basin for several years. Data from 1986 to 1988 were used to compute an average proportion of hatchery fish that was applied to 1980–1988. The

average proportion of hatchery fish observed during the period 1990–2003, exclusive of hatchery return years 1996–1998, was applied to the total abundance estimates prior to 1980.

### **Beaver**

Determination of the proportion of hatchery fish in Beaver Creek presented a problem because it received strays from the private hatchery in Yaquina Bay. Data from 1986 to 1988 were used to compute an average proportion of hatchery fish that was applied to 1980–1988. The average proportion of hatchery fish observed during the period 1990–1995 was applied to the total abundance estimates prior to 1980.

### **Alsea**

The Alsea River is similar to the Siletz in that it was influenced by private hatchery strays and had a state hatchery located on a tributary for many years that was ultimately closed. Data from 1986 to 1988 were used to compute an average proportion of hatchery fish that was applied to 1980–1988. The average proportion of hatchery fish observed during the period 1990–1998, prior to the closing of Fall Creek hatchery, was applied to the total abundance estimates prior to 1980.

### **Siuslaw**

The average proportion of hatchery fish observed during the period 1988–2003, in non-Lake Creek subbasins, was applied to the total abundance estimates prior to 1990. This removes the influence of returns of hatchery smolts that were released in Lake Creek only in the mid-1990s.

### **Umpqua River**

**Lower Umpqua:** The first significant return from the hatchery program in the Umpqua River Basin was in 1982. Therefore, the average proportion of hatchery fish observed during the period 1990–2001, prior to the reduction in the hatchery program, was applied to the total abundance estimates during 1982–1989. Prior to 1982, hatchery strays were assumed to be insignificant.

**Middle Umpqua:** The first significant return from the hatchery program in the Umpqua River Basin was in 1982. Therefore, the average proportion of hatchery fish observed during the period 1990–2001, prior to the reduction in the hatchery program, was applied to the total abundance estimates during 1982–1989. Prior to 1982, hatchery strays were assumed to be insignificant.

**North Umpqua:** Hatchery and wild fish were determined based on counts at Winchester Dam. Hatchery fish were first recorded in 1974 but did not exceed 214 until 1982, when 1,981 were counted.

**South Umpqua:** The first significant return from the hatchery program in the Umpqua River Basin was in 1982. Therefore, the average proportion of hatchery fish observed during the period 1990–2001, prior to the reduction in the hatchery program, was applied to the total

abundance estimates during 1982–1989. Prior to 1982, hatchery strays were assumed to be insignificant.

### **The Lakes**

The average proportion of hatchery fish observed in Siltcoos, Tahkenitch, and Tenmile Lakes populations during the period 1990–2003 was applied to the total abundance estimates prior to 1990.

### **Coos**

The Coos River population was influenced by private hatchery fish in the 1980s and by a STEP hatchery in recent years. The average proportion of hatchery fish observed in each population during the period 1986–1988 was applied to the total abundance in 1980–1988. Prior to 1980, hatchery strays were assumed to be insignificant.

### **Coquille**

The average proportion of hatchery fish observed during the period 1988–1996, prior to reductions in Bandon Hatchery program, was applied to the total abundance estimates prior to 1990.





# Recent NOAA Technical Memorandums

published by the  
Northwest Fisheries Science Center

## NOAA Technical Memorandum NMFS-NWFSC-

- 90 **Ward, L., P. Crain, B. Freymond, M. McHenry, D. Morrill, G. Pess, R. Peters, J.A. Shaffer, B. Winter, and B. Wunderlich. 2008.** Elwha River Fish Restoration Plan—Developed pursuant to the Elwha River Ecosystem and Fisheries Restoration Act, Public Law 102-495. U.S. Dept. Commer., NOAA Tech. Memo. NMFS-NWFSC-90, 168 p. NTIS number pending.
- 89 **Holt, M. 2008.** Sound exposure and Southern Resident killer whales (*Orcinus orca*): A review of current knowledge and data gaps. U.S. Dept. Commer., NOAA Tech. Memo. NMFS-NWFSC-89, 59 p. NTIS number pending.
- 88 **Olson, O.P., L. Johnson, G. Ylitalo, C. Rice, J. Cordell, T. Collier, and J. Steger. 2008.** Fish habitat use and chemical contaminant exposure at restoration sites in Commencement Bay, Washington. U.S. Dept. Commer., NOAA Tech. Memo. NMFS-NWFSC-88, 117 p. NTIS number pending.
- 87 **Keller, A.A., B.H. Horness, V.H. Simon, V.J. Tuttle, J.R. Wallace, E.L. Fruh, K.L. Bosley, D.J. Kamikawa, and J.C. Buchanan. 2007.** The 2004 U.S. West Coast bottom trawl survey of groundfish resources off Washington, Oregon, and California: Estimates of distribution, abundance, and length composition. U.S. Dept. Commer., NOAA Tech. Memo. NMFS-NWFSC-87, 134 p. NTIS number pending.
- 86 **Keller, A.A., V.H. Simon, B.H. Horness, J.R. Wallace, V.J. Tuttle, E.L. Fruh, K.L. Bosley, D.J. Kamikawa, and J.C. Buchanan. 2007.** The 2003 U.S. West Coast bottom trawl survey of groundfish resources off Washington, Oregon, and California: Estimates of distribution, abundance, and length composition. U.S. Dept. Commer., NOAA Tech. Memo. NMFS-NWFSC-86, 130 p. NTIS number pending.
- 85 **Norman, K., J. Sepez, H. Lazrus, N. Milne, C. Package, S. Russell, K. Grant, R.P. Lewis, J. Primo, E. Springer, M. Styles, B. Tilt, and I. Vaccaro. 2007.** Community profiles for West Coast and North Pacific fisheries—Washington, Oregon, California, and other U.S. states. U.S. Dept. Commer., NOAA Tech. Memo. NMFS-NWFSC-85, 602 p. NTIS number pending.
- 84 **Brand, E.J., I.C. Kaplan, C.J. Harvey, P.S. Levin, E.A. Fulton, A.J. Hermann, and J.C. Field. 2007.** A spatially explicit ecosystem model of the California Current's food web and oceanography. U.S. Dept. Commer., NOAA Tech. Memo. NMFS-NWFSC-84, 145 p. NTIS number PB2008-102578.

**Most NOAA Technical Memorandums NMFS-NWFSC are available online at the Northwest Fisheries Science Center web site (<http://www.nwfsc.noaa.gov>).**