

# RECLAMATION

*Managing Water in the West*

---

## Windy Gap Firming Project

## Three Lakes Water-Quality Model Documentation

---



U.S. Department of the Interior  
Bureau of Reclamation  
Great Plains Region

March 2008

# **Three Lakes Water-Quality Model Documentation**

## **Windy Gap Firming Project**

prepared by:

**AMEC Earth & Environmental  
(formerly Hydrosphere Resource Consultants)  
1002 Walnut Street, Suite 200  
Boulder, Colorado 80302  
(303) 443-7839**

## Table of Contents

Windy Gap Firming Project Three Lakes Water-Quality Model Documentation .....	1
I. Introduction .....	1
II. Model Overview .....	2
III. Model Theory .....	4
IV. Input Data for Model Calibration.....	17
V. Calibration and Model Results .....	20
References.....	24

## Tables

Table 1: Inflows and Outflows Represented in the Model.....	3
Table 2: Simulated Water-Quality Parameters.....	3
Table 3: Reservoir Layer Thicknesses Used in the Model.....	3
Table 4: Model State Variables .....	5
Table 5: Overall Median Relative Absolute Error Statistics.....	22
Table 6: Average Observed Water-Quality Conditions for Reservoirs (WY05 – 06).....	22
Table 7: Model Statistics for Granby Reservoir.....	22
Table 8: Model Statistics for Shadow Mountain Reservoir.....	23
Table 9: Model Statistics for Grand Lake .....	23

## Figures

Figure 1: Map of Three Lakes System .....	1
Figure 2: Model Schematic .....	2
Figure 3: Kinetic Diagram for the Three Lakes Water-Quality Model.....	6
Figure 4: Schematic of SOD-nutrient Flux Model of the Sediments (From Chapra and Martin, 2004).....	16

## Appendices

Appendix A: Three Lakes Water-Quality Model Calibration - Rate and Physical Parameters	
--	--

Appendix B: Three Lakes Water-Quality Model Calibration - Comparison between Model Predictions and Observed Data

# WINDY GAP FIRING PROJECT THREE LAKES WATER-QUALITY MODEL DOCUMENTATION

## I. INTRODUCTION

The purpose of this report is to provide technical documentation for the Three Lakes Water-Quality Model. This model is used as part of the Windy Gap Firing Project (WGFP) EIS to estimate potential impacts of the project to the water quality of Grand Lake, Shadow Mountain Reservoir, and Granby Reservoir (Figure 1). The model algorithms were written using Microsoft VBA for EXCEL. Model input data are set up using EXCEL worksheets while model results are output to EXCEL worksheets.

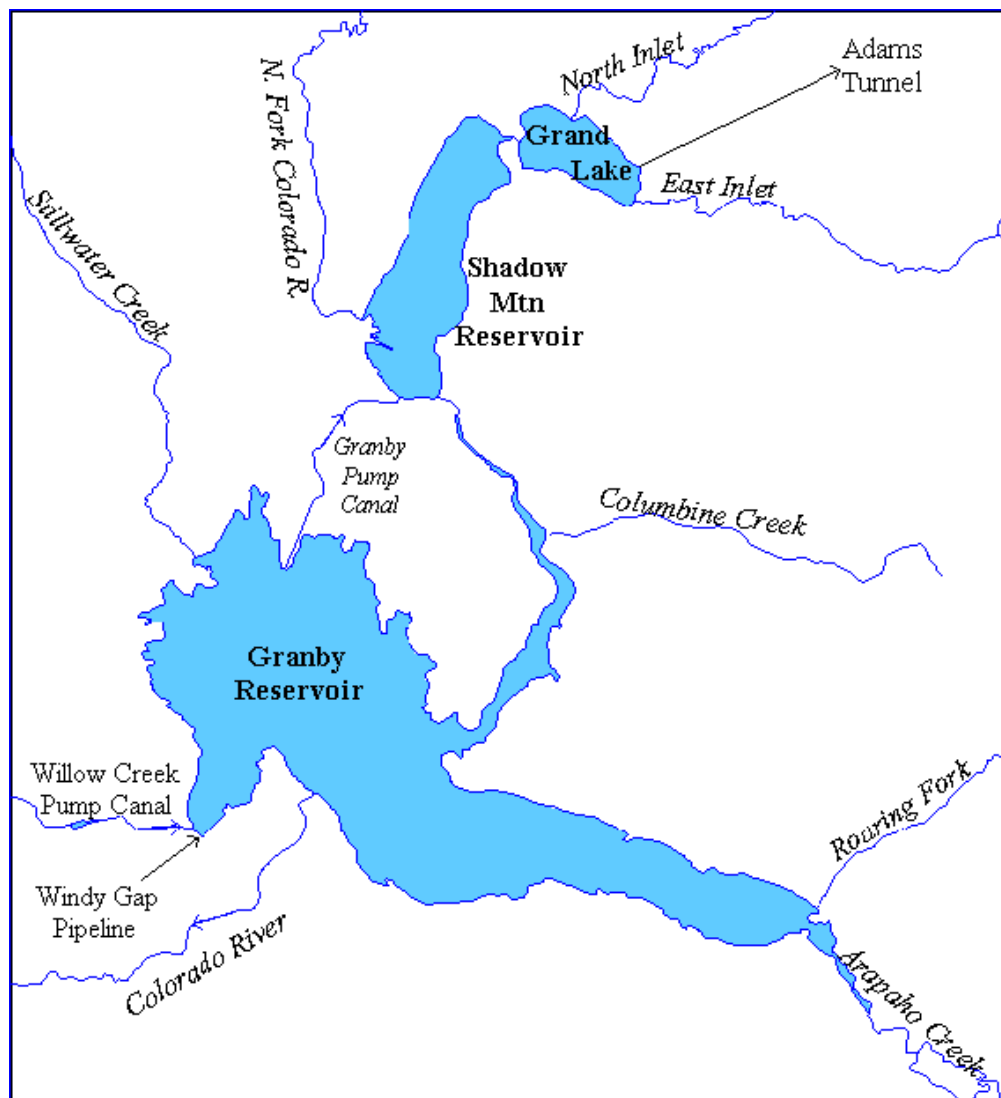
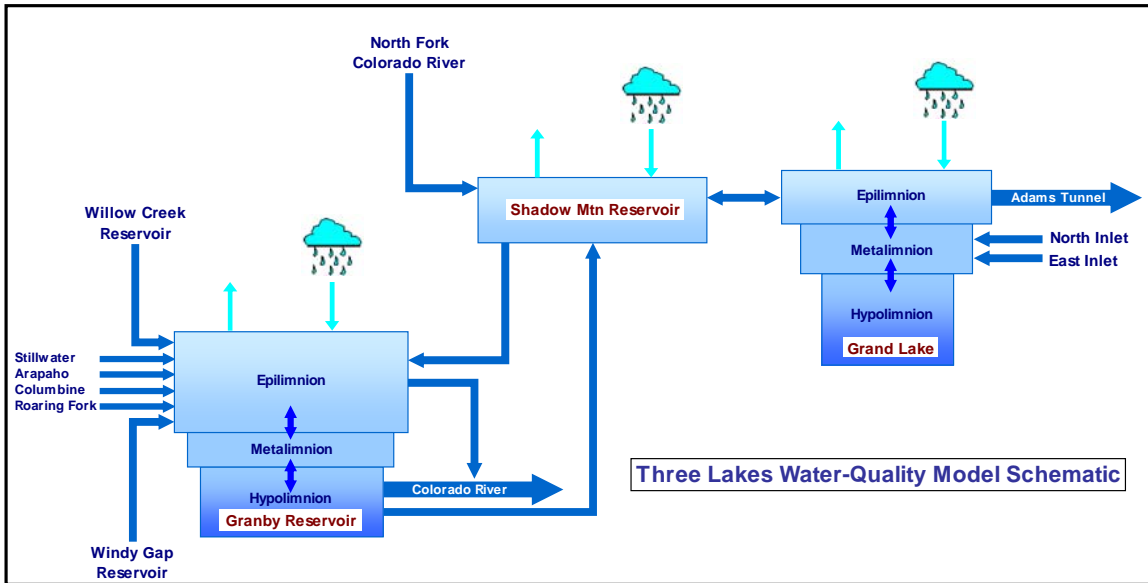

Figure 1: Map of Three Lakes System

## II. MODEL OVERVIEW

The Three Lakes Water-Quality Model is a dynamic, mechanistic water-quality model that simulates flow and water-quality of the Three Lakes System in an integrated fashion. The Three-Lakes Water-Quality Model simulates the constituents associated with the eutrophication process. This type of model is also referred to as a nutrient / food chain model. Grand Lake and Granby Reservoir are simulated as three-layer systems to account for reservoir stratification. Shadow Mountain Reservoir is represented as a one-layer, well-mixed reservoir due to its shallow depth (Figure 2).



**Figure 2: Model Schematic**

Inflows and outflows into and out of the reservoirs<sup>1</sup> are listed in Table 1. Precipitation and miscellaneous gains and losses are also taken into account to complete the water balance. The user specifies the depths of the epilimnion and metalimnion for Grand Lake and Granby Reservoir.

Water-quality constituents simulated in the model are listed in Table 2. In-reservoir water temperatures are user-specified on a monthly basis. The user provides flow and water-quality characteristics for the inflows and flow for the outflows. The model then simulates in-reservoir and outflow water quality.

The thickness of the epilimnions and metalimnions in Grand Lake and Granby Reservoir were determined after a review of profiles taken by USBR (Leiberman, 2007a). The values were chosen to best represent the stratified season. The thicknesses are presented in Table 3.

<sup>1</sup> Although Grand Lake is a lake and not a reservoir, Granby Reservoir, Shadow Mountain Reservoir, and Grand Lake are generally referred to as reservoirs in the text of this report. This is to avoid having to refer to them as “the reservoirs and the lake”.

**Table 1: Inflows and Outflows Represented in the Model**

<b>Tributary Inflows:</b>	<b>Location of Inflow/Outflow</b>
North Inlet	Grand Lake Metalimnion
East Inlet	Grand Lake Metalimnion
N. Fork of the Colorado River	Shadow Mountain Reservoir
Arapaho Creek	Granby Reservoir Epilimnion
Stillwater Creek	Granby Reservoir Epilimnion
Roaring Fork	Granby Reservoir Epilimnion
Columbine Creek	Granby Reservoir Epilimnion
<b>Inflows Due to Pumping:</b>	
Windy Gap	Granby Reservoir Epilimnion
Willow Creek	Granby Reservoir Epilimnion
<b>Outflows:</b>	
Adams Tunnel	Grand Lake Epilimnion
Releases to the Colorado River	Granby Reservoir Hypolimnion

**Table 2: Simulated Water-Quality Parameters**

**Nutrients:**

- Total Phosphorus
- Orthophosphate
- Total Nitrogen
- Ammonia
- Nitrate / Nitrite

Dissolved Oxygen

Chlorophyll a

Secchi-Disk Depth

Total Suspended Solids

Total Organic Carbon

**Table 3: Reservoir Layer Thickness Used in the Model**

	<b>Grand Lake</b>	<b>Granby Reservoir</b>
Epilimnion (m)	4.6	7
Metalimnion (m)	25.9	10

### III. MODEL THEORY

#### **Flow and Reservoir Contents**

The model characterizes Grand Lake and Granby Reservoir as one-dimensional systems consisting of three vertical layers -- an epilimnion (top layer), a metalimnion (mid-layer), and a hypolimnion (bottom layer). Reservoir layers are assumed to be fully mixed. The volumes of the epilimnion and metalimnion layers are held fixed whereas the hypolimnion is allowed to change as total reservoir contents varies over time. Shadow Mountain Reservoir is simulated as a one layer system.

A dynamic water balance for each lake layer is computed as in:

$$\frac{dV}{dt} = Q_{in} + Q_p + Q_g - Q_{out} - Q_l \pm Q_{int} \quad (1)$$

where  $V$  = layer volume [ $m^3$ ],  $t$  = time (d),  $Q_{in}$  = inflow via tributaries and pumping sources into the layer [ $m^3/d$ ],  $Q_p$  = precipitation [ $m^3/d$ ] (if the layer is the epilimnion),  $Q_g$  = miscellaneous gains [ $m^3/d$ ],  $Q_{out}$  = outflow via releases from the layer [ $m^3/d$ ],  $Q_l$  = miscellaneous losses, (including evaporation, for the epilimnion) [ $m^3/d$ ], and  $Q_{int}$  = interflow between the reservoirs and between the layers to maintain an epilimnion of constant thickness [ $m^3/d$ ]. This equation is integrated to simulate how the layer volumes change as a function of time. The total reservoir volume equals the sum of the layer volumes.

To compute the interflows, this equation is first computed for Grand Lake assuming that the change in lake volume is zero. From this computation, the interflow between Grand Lake and Shadow Mountain can be determined. Equation 1 is then solved for Shadow Mountain Reservoir and the flow from Shadow Mountain Reservoir to Granby Reservoir via Columbine Bay is computed (note that the user specifies the flow in the Granby Pump canal to Shadow Mountain Reservoir). The change in volume for Shadow Mountain Reservoir is assumed to be zero. The third step is to solve Equation 1 for Granby Reservoir from which the change in contents of that reservoir is computed.

#### **Water-Quality Constituents**

The constituents simulated in the Three Lakes Water-Quality Model are listed in Table 4.

A mass balance is written for each constituent and for each vertical layer. For the epilimnion, this equation becomes:

$$V_1 \frac{dc_1}{dt} = Q_{in}c_{in} - Q_{out}c_1 + E'_1(c_2 - c_1) + S_1V_1$$

where subscript 1 is the epilimnion, subscript 2 is the metalimnion,  $c_i$  = the concentration of layer  $i$  [ $mg/L$  or  $\mu g/L$ ],  $c_{in}$  = the concentration of the inflow [ $mg/L$  or  $\mu g/L$ ],  $E'_i$  = the bulk turbulent diffusion coefficient across the lower boundary of layer  $i$  [ $m^3/d$ ] and  $S_i$  = sources and sinks of the constituent due to reactions and mass transfer mechanisms [ $g/m^3/d$  or  $mg/m^3/d$ ]. Similar balances are written for the metalimnion and hypolimnion.

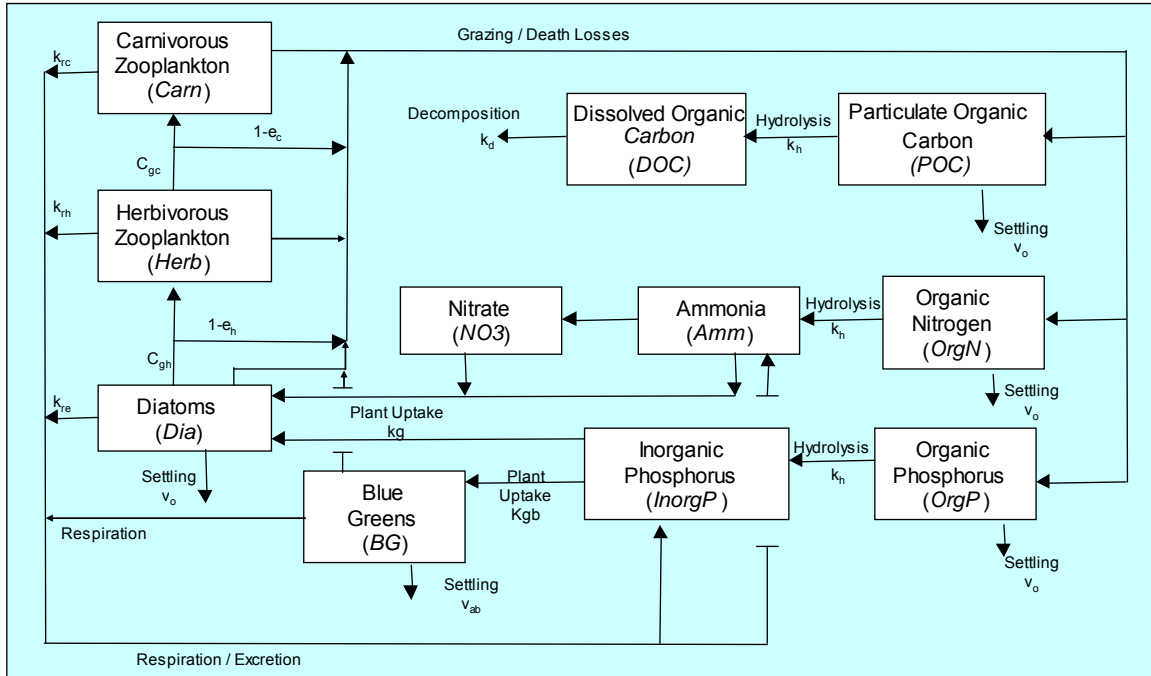

**Table 4: Model State Variables**

<b>Water-Quality Constituent</b>	<b>Symbol</b>	<b>Units</b>
<b>Inorganic Suspended Solids</b>	<b><i>ISS</i></b>	<b>mg/l</b>
<b>Dissolved Oxygen</b>	<b><i>DO</i></b>	<b>mgO<sub>2</sub>/l</b>
<b>Particulate Organic Carbon</b>	<b><i>POC</i></b>	<b>mgC/l</b>
<b>Dissolved Organic Carbon</b>	<b><i>DOC</i></b>	<b>mgC/l</b>
<b>Organic Nitrogen</b>	<b><i>OrgN</i></b>	<b>µgN/l</b>
<b>Ammonia Nitrogen</b>	<b><i>Amm</i></b>	<b>µgN/l</b>
<b>Nitrate / Nitrite Nitrogen</b>	<b><i>NO3</i></b>	<b>µg N/l</b>
<b>Organic Phosphorus</b>	<b><i>OrgP</i></b>	<b>µg P/l</b>
<b>Inorganic Phosphorus</b>	<b><i>InorgP</i></b>	<b>µg P/l</b>
<b>Diatoms</b>	<b><i>Dia</i></b>	<b>µg A/l</b>
<b>Blue-Green Algae</b>	<b><i>BG</i></b>	<b>µg A/l</b>
<b>Herbivorous Zooplankton</b>	<b><i>Herb</i></b>	<b>mg C/l</b>
<b>Carnivorous Zooplankton</b>	<b><i>Carn</i></b>	<b>mg C/l</b>

C = Carbon, P = Phosphorus, N = Nitrogen, A = Chlorophyll a

The sources and sinks for the most of the state variables are depicted in Figure 3. The mathematical representation of the processes used in the Three Lakes Water-Quality Model are similar to those used in the LAKE2K model (Chapra and Martin, 2004) and are presented in the following sections.



**Figure 3: Kinetic Diagram for the Three Lakes Water-Quality Model**

### Inorganic Suspended Solids (ISS)

Inorganic suspended solids are lost from the water column via settling:

$$S_{ISS} = -ISS\_Set$$

where for layer  $i$ ,

$$ISS\_Set = -v_{ISS} \frac{A_{i-1}}{V_i} ISS_{i-1} + v_{ISS} \frac{A_i}{V_i} ISS_i$$

where  $v_{ISS}$  = inorganic suspended solids settling velocity [m/d] and  $A$  = surface area of layer  $i$  [m<sup>2</sup>].

### Diatoms (Dia) and Blue-Green Algae (BG)

The simulations of diatoms and blue-green algae are essentially the same. The differences come into play via the parameters used for the reactions. The one exception to this is the assumption that herbivorous zooplankton do not graze on blue-green algae. For this discussion, diatoms and blue-green algae are collectively referred to as algae (Alg).

Algae biomass increases due to photosynthesis. It is lost via respiration, death, grazing, and settling:

$$S_{Alg} = Alg\_Photo - Alg\_Resp - Alg\_Death - Herb\_Graz - Alg\_Set$$

Note that the term Herb\_Graz is not used in the simulation of blue-green algae.

### Photosynthesis

Phytoplankton photosynthesis is computed using an algal growth rate ( $k_g$  [day<sup>-1</sup>]):

$$Alg\_Photo = k_g Alg$$

The algal growth rate is a function of temperature, light, and the limiting nutrient. It is computed based on the maximum growth rate that is user-specified via the following relationship

$$k_g = k_{g,max} \phi_T \phi_l \phi_N$$

where  $\phi_T$  = the attenuation factor for temperature,  $\phi_l$  = the attenuation factor for light, and  $\phi_N$  = the attenuation factor for nutrients. The impacts of these three factors on the maximum growth rate are described below.

The influence of temperature is based on a formulation developed by Cerco and Cole (1994):

$$\phi_T = e^{-\kappa_1(T-T_{opt})^2} \quad T \leq T_{opt}$$

$$\phi_T = e^{-\kappa_2(T-T_{opt})^2} \quad T > T_{opt}$$

where  $\kappa_1$  and  $\kappa_2$  are parameters that determine the shape of the relationship of growth to temperature below and above the optimal temperature, respectively,  $T_{opt}$  = the optimal temperature for algal growth, and  $T$  = water temperature. This formulation is more often used when more than one algal group is simulated (Chapra, 1997).

The influence of light is characterized using the Half-Saturation (Michaelis-Menten) light model (Baly, 1935), which is combined with the Beer-Lambert law and integrated over depth (Chapra and Martin, 2004):

$$\phi_l = \frac{f}{K_{d,i}H_i} \ln\left(\frac{K_{Lp} + PAR(d_i)}{K_{Lp} + PAR(d_i)e^{-K_{d,i}H_i}}\right)$$

where  $PAR(d_i)$  = average daylight PAR or:

$$PAR(d_i) = \frac{(PAR)(I_{daily})}{f}$$

$f$  = the photoperiod (sunlight fraction of the day),  $PAR$  = photosynthetically available radiation [ly/day],  $K_{d,i}$  = light extinction coefficient of layer  $i$  [ $m^{-1}$ ],  $H_i$  = the thickness of layer  $i$  [m],  $I_{daily}$  = average solar radiation over the daylight hours [ly/day], and  $K_{Lp}$  = the phytoplankton light parameter.

The influence of nutrients is described by the nutrient in the shortest supply:

$$\phi_N = \min\{\phi_p, \phi_n\}$$

where

$$\phi_p = \frac{InorgP}{k_{sp} + InorgP}$$

$$\phi_n = \frac{(Amm + NO3)}{k_{sn} + (Amm + NO3)}$$

$k_{sp}$  = half saturation constant for phosphorus, and  $k_{sn}$  = half-saturation constant for inorganic nitrogen.

### Respiration

Algal respiration is represented as a first-order rate,

$$Alg\_Resp = k_r(T) Alg$$

where  $k_r(T)$  = temperature-dependent algal respiration rate [1/d].

### Death

Algal death is represented as a first-order rate,

$$Alg\_Death = k_d(T) Alg$$

where  $k_d(T)$  = temperature-dependent algal death rate [1/d].

### Grazing

Algae are lost due to herbivorous zooplankton grazing,

$$\text{Herb\_Graz} = \left( C_{gh} \theta_{gh}^{T-20} \frac{Dia}{k_{sa} + Dia} Herb \right) Dia$$

where  $C_{gh}$  = herbivorous zooplankton grazing rate [ $\text{m}^3/(\text{gC d})$ ],  $\theta_{gh}$  = temperature parameter for herbivorous zooplankton grazing [dimensionless], and  $k_{sa}$  = chlorophyll half-saturation constant [ $\text{mgA}/\text{m}^3$ ].

### Settling

Algal settling is represented for layer  $i$  as

$$\text{Alg\_Set} = -v_a \frac{A_{i-1}}{V_i} \text{Alg}_{i-1} + v_a \frac{A_i}{V_i} \text{Alg}_i$$

where  $v_a$  = algal settling velocity [ $\text{m}/\text{d}$ ],  $A_i$  = the surface area of the bottom boundary of layer  $i$  [ $\text{m}^2$ ], and  $V_i$  = the volume of layer  $i$  [ $\text{m}^3$ ]. Note that for all settling computations, the input from above is set to zero for the top layer.

### Herbivorous Zooplankton (Herb)

Herbivorous zooplankton increase due to algal grazing. They are lost via respiration, death, and carnivorous zooplankton grazing. The combined non-predation loss due to respiration and excretion are lumped into the respiration term. Grazing of herbivorous zooplankton by fish and other organisms above zooplankton in the food chain are represented in the model through the zooplankton death terms.

$$S_{\text{Herb}} = r_{ca} \varepsilon_h \text{Herb\_Graz} - \text{Herb\_Resp} - \text{Herb\_Death} - \text{Carn\_Graz}$$

where  $\varepsilon_h$  = herbivorous zooplankton grazing efficiency [dimensionless] and  $r_{ca}$  = the stoichiometric ratio of carbon to chlorophyll  $a$ .

### Respiration

Herbivorous zooplankton respiration is represented as a first-order rate,

$$\text{Herb\_Resp} = k_{rh}(T) \text{Herb}$$

where  $k_{rh}(T)$  = temperature-dependent herbivorous zooplankton respiration rate [ $1/\text{d}$ ].

### Death

Herbivorous zooplankton death is represented as a first-order rate,

$$\text{Herb\_Death} = k_{dh}(T)\text{Herb}$$

where  $k_{dh}(T)$  = the temperature-dependent herbivorous zooplankton death rate [/d].

#### Grazing by Carnivorous Zooplankton

Herbivorous zooplankton are lost due to carnivorous zooplankton grazing,

$$\text{Carn\_Graz} = \left( C_{gc} \theta_{gc}^{T-20} \frac{\text{Herb}}{k_{sc} + \text{Herb}} \text{Carn} \right) \text{Herb}$$

where  $C_{gc}$  = carnivorous zooplankton grazing rate [ $\text{m}^3/(\text{gC d})$ ],  $\theta_{gc}$  = temperature parameter for carnivorous zooplankton grazing [dimensionless], and  $k_{sc}$  = herbivore carbon half-saturation constant [ $\text{gC}/\text{m}^3$ ].

#### Carnivorous Zooplankton (Carn)

Carnivorous zooplankton increase due to grazing on herbivorous zooplankton. They are lost via respiration and death. The combined non-predation loss due to respiration and excretion are lumped into the respiration term. Grazing of carnivorous zooplankton by fish and other organisms in the food chain are represented in the model through the zooplankton death terms.

$$S_{\text{Carn}} = \varepsilon_c \text{Carn\_Graz} - \text{Carn\_Resp} - \text{Carn\_Death}$$

where  $\varepsilon_c$  = carnivorous zooplankton grazing efficiency [dimensionless].

#### Respiration

Carnivorous zooplankton respiration is represented as a first-order rate,

$$\text{Carn\_Resp} = k_{rc}(T)\text{Carn}$$

where  $k_{rc}(T)$  = temperature-dependent carnivorous zooplankton respiration rate [/d].

#### Death

Carnivorous zooplankton death is represented as a first-order rate,

$$\text{Carn\_Death} = k_{dtc}(T)\text{Carn}$$

where  $k_{dtc}(T)$  = the temperature-dependent carnivorous zooplankton death rate [/d].

### Organic Nitrogen (OrgN)

Organic nitrogen increases due to zooplankton egestion of algae and herbivorous zooplankton, and death of algae, herbivorous zooplankton, and carnivorous zooplankton. It is lost via hydrolysis and settling.

$$S_{OrgN} = r_{na}(1 - \varepsilon_h)Herb\_Graz + r_{nc}(1 - \varepsilon_c)Carn\_Graz + r_{na}Alg\_Death \\ + r_{nc}Herb\_Death + r_{nc}Carn\_Death - OrgN\_Hydr - OrgN\_Set$$

Hydrolysis is represented by:

$$OrgN\_Hydr = k_{hn}(T)OrgN$$

where  $k_{hn}(T)$  = the temperature-dependent organic nitrogen hydrolysis rate [/d].

Organic N settling is represented for layer  $i$  by

$$OrgN\_Set = -v_{OrgN} \frac{A_{i-1}}{V_i} OrgN_{i-1} + v_{OrgN} \frac{A_i}{V_i} OrgN_i$$

where  $v_{OrgN}$  = organic nitrogen settling velocity [m/d].

### Ammonia Nitrogen (Amm)

Ammonia nitrogen increases due to organic nitrogen hydrolysis, respiration, and releases of ammonia from the sediment. It is lost via nitrification and plant photosynthesis:

$$S_{Amm} = OrgN\_Hydr + r_{na}Alg\_Resp + r_{nc}Herb\_Resp + r_{nc}Carn\_Resp \\ - Nitrif - r_{na}P_{ref}Alg\_Photo + J_a A_{sed}$$

where  $J_a$  = the flux of ammonia from the sediments (see Sediment Oxygen Demand / Sediment Nutrient Fluxes, below) and  $A_{sed}$  = the area of the layer in contact with the sediments.

The ammonia nitrification rate is computed as

$$Nitrif = k_n(T)Amm$$

where  $k_n(T)$  = the temperature-dependent nitrification rate for ammonia nitrogen [/d].

The coefficient  $P_{ref}$  is the algae preference for ammonia as a nitrogen source,

$$P_{ref} = \frac{AmmNO3}{(k_{hnxp} + Amm)(k_{hnxp} + NO3)} + \frac{Ammk_{hnxp}}{(Amm + NO3)(k_{hnxp} + NO3)}$$

where  $k_{hnxp}$  = preference coefficient of algae for ammonia [mgN/m<sup>3</sup>].

### Nitrate Nitrogen (NO3)

Nitrate nitrogen increases due to nitrification of ammonia and releases of nitrate from the sediment. It is lost via denitrification and plant photosynthesis:

$$S_{NO3} = \text{Nitrif} - \text{Denitr} - r_{na}(1 - P_{ref}) \text{Alg\_Photo} + J_n A_{sed}$$

where  $J_n$  = the flux of nitrate from the sediment (see Sediment Oxygen Demand / Sediment Nutrient Fluxes, below).

The denitrification rate is computed as

$$\text{Denitr} = f_{dnitr} \frac{DOC}{K_{sdoc} + DOC} k_{dn}(T) NO3$$

where  $k_{dn}(T)$  = the temperature-dependent denitrification rate of nitrate nitrogen [1/d],  $K_{sdoc}$  = DOC half-saturation constant for denitrification [gC/m<sup>3</sup>], and  $f_{dnitr}$  = the effect of low oxygen on denitrification [dimensionless] which is estimated by:

$$f_{dnitr} = \frac{0.6}{DO + 0.6}$$

### Organic Phosphorus (OrgP)

Organic phosphorus increases due to zooplankton egestion of phytoplankton and herbivorous zooplankton, and death of phytoplankton, herbivorous zooplankton, and carnivorous zooplankton. It is lost via hydrolysis and settling.

$$S_{OrgP} = r_{pa}(1 - \varepsilon_h) \text{Herb\_Graz} + r_{pc}(1 - \varepsilon_c) \text{Carn\_Graz} + r_{pa} \text{Alg\_Death} \\ + r_{pc} \text{Herb\_Death} + r_{pc} \text{Carn\_Death} - \text{OrgP\_Hydr} - \text{OrgP\_Settl}$$

Hydrolysis is represented by:

$$\text{OrgP\_Hydr} = k_{hp}(T) \text{OrgP}$$

where  $k_{hp}(T)$  = the temperature-dependent organic phosphorus hydrolysis rate [1/d].



Organic P settling is represented for layer  $i$  by

$$\text{OrgP\_Settl} = -v_{\text{OrgP}} \frac{A_{i-1}}{V_i} \text{OrgP}_{i-1} + v_{\text{OrgP}} \frac{A_i}{V_i} \text{OrgP}_i$$

where  $v_{\text{OrgP}}$  = organic phosphorus settling velocity [m/d].

### Inorganic Phosphorus (InorgP)

Inorganic phosphorus increases due to organic phosphorus hydrolysis, respiration, and sediment releases. It is lost via plant photosynthesis:

$$S_{\text{InorgP}} = \text{OrgP\_Hydr} + r_{pa} \text{Alg\_Resp} + r_{pc} \text{Herb\_Resp} + r_{pc} \text{Carn\_Resp} - r_{pa} \text{Alg\_Photo} + J_p A_{\text{sed}}$$

Where  $J_p$  = the flux of inorganic phosphorus from the sediment (see Sediment Oxygen Demand / Sediment Nutrient Fluxes, below).

### Particulate Organic Carbon (POC)

Particulate organic carbon (POC) increases due to zooplankton egestion of phytoplankton and herbivorous zooplankton, and death of phytoplankton, herbivorous zooplankton, and carnivorous zooplankton. It is lost via hydrolysis and settling.

$$S_{\text{POC}} = (1 - \varepsilon_h) \text{Herb\_Graz} + (1 - \varepsilon_c) \text{Carn\_Graz} + r_{ca} \text{Alg\_Death} \\ \text{Herb\_Death} + \text{Carn\_Death} - \text{POC\_Hydr} - \text{POC\_Set}$$

Hydrolysis is represented by:

$$\text{POC\_Hydr} = k_{hc}(T) \text{POC}$$

and  $k_{hc}(T)$  = the temperature-dependent POC hydrolysis rate [/d]. POC settling is represented for layer  $i$  by

$$\text{POC\_Set} = -v_{oc} \frac{A_{i-1}}{V_i} \text{POC}_{i-1} + v_{oc} \frac{A_i}{V_i} \text{POC}_i$$

where  $v_{oc}$  = POC settling velocity [m/d].

### Dissolved Organic Carbon (DOC)

Dissolved organic carbon is gained via the hydrolysis of particulate organic carbon and the release of methane from the sediment. It is lost via decomposition.

$$S_{\text{DOC}} = \text{POC\_Hydr} - \text{DOC\_Decomp} + J_m A_{\text{sed}}$$

where  $J_m$  = the flux of methane from the sediment (see Sediment Oxygen Demand / Sediment Nutrient Fluxes, below).

Decomposition is represented by:

$$DOC\_Oxid = k_{dc}(T)DOC$$

where  $k_{dc}(T)$  = the temperature-dependent DOC decomposition rate [1/d].

### Dissolved Oxygen (DO)

Dissolved oxygen increases as a result of algal growth. Decreases occur due to sediment oxygen demand, decomposition, nitrification, and respiration. Dissolved oxygen can increase or decrease due to reaeration:

$$S_{DO} = r_{oc}Alg\_Photo - f_{ac}r_{oc}DOC\_Decomp - SOD - r_{on}Nitri\text{f} - r_{ca}r_{oc}Alg\_Resp - r_{oc}Herb\_Resp - r_{oc}CarnResp + Reaer$$

Where  $f_{ac}$  = a factor to account for the effect of oxygen concentrations on decomposition and

$$Reaer = \frac{K_L A_0}{V_1} (DO_s(T_1, elev) - DO)$$

$K_L$  = the oxygen mass-transfer coefficient [m/d],  $DO_s(T_1, elev)$  = the saturation concentration of oxygen [mgO<sub>2</sub>/L] at the temperature of the surface layer,  $T_1$  [°C], and the elevation of the reservoir's surface above mean sea level,  $elev$  [m].

The oxygen mass transfer coefficient is computed using the Banks-Herrera formula (Banks and Herrera, 1977):

$$K_L = \left(0.728U_w^{0.5} - 0.317U_w + 0.0372U_w^2\right)\theta_{ka}^{T_1-20}$$

Where  $U_w$  = wind speed (m/sec) and  $\theta_{ka}$  = the temperature parameter for oxygen gas transfer [dimensionless].

Oxygen saturation is computed according to APHA, 1995:

$$\ln DO_s(T_1, 0) = -139.34411 + \frac{1.575701 \times 10^5}{T_a} - \frac{6.642308 \times 10^7}{T_a^2} + \frac{1.243800 \times 10^{10}}{T_a^3} - \frac{8.621949 \times 10^{11}}{T_a^4}$$

where  $DO_s(T_1, 0)$  = the saturation concentration of dissolved oxygen in freshwater at 1 atm [ $\text{mgO}_2/\text{L}$ ] and  $T_a$  = absolute water temperature [K] where  $T_a = T_1 + 273.15$ .

The effect of elevation is accounted for by:

$$DO_s(T_1, elev) = e^{\ln DO_s(T_1, 0)} (1 - 0.0001148 elev)$$

### Secchi-Disk Depth (SD)

Secchi-disk depth in meters is computed using the following formulation (Tyler, 1968; Preisendorfer, 1986):

$$SD = \frac{8.7}{K_d + c}$$

where  $K_d$  = the light extinction coefficient [ $\text{m}^{-1}$ ] and  $c$  = beam attenuation coefficient [ $\text{m}^{-1}$ ]. The beam attenuation coefficient equals the sum of the absorption and scattering coefficients:

$$c = a + b$$

The absorption coefficient ( $a$ ) in  $\text{m}^{-1}$  is computed as:

$$a = a_w + a_c + \alpha_{chl} a_p + \alpha_{POC} r_{dc} c_p + \alpha_i m_i$$

where  $a_w$  = the absorption coefficient due to water [ $\text{m}^{-1}$ ],  $a_c$  = the absorption coefficient due to color [ $\text{m}^{-1}$ ],  $\alpha_{chl}$  = absorption proportionality constant for chlorophyll  $a$  [ $\text{m}^2/\text{mgA}$ ],  $a_p$  = concentration of phytoplankton [ $\mu\text{gA/l}$ ],  $\alpha_{POC}$  = absorption proportionality constant for POC expressed as dry weight [ $\text{m}^2/\text{gD}$ ],  $r_{dc}$  = stoichiometric ratio of mg ISS / mg C [],  $c_p$  = concentration of POC [ $\text{mg/l}$ ]  $\alpha_i$  = absorption proportionality constant for inorganic solids [ $\text{m}^2/\text{gD}$ ] and  $m_i$  = concentration of ISS [ $\text{mg/l}$ ].

The scattering coefficient ( $b$ ) in  $\text{m}^{-1}$  is computed as:

$$b = b_w + \beta_{chl} a_p + \beta_{POC} r_{dc} c_p + \beta_i m_i$$

where  $b_w$  = the scattering coefficient due to water [ $\text{m}^{-1}$ ],  $\beta_{chl}$  = scattering proportionality constant for chlorophyll  $a$  [ $\text{m}^2/\text{mgA}$ ],  $\beta_{POC}$  = scattering proportionality constant for POC expressed as dry weight [ $\text{m}^2/\text{gD}$ ], and  $\beta_i$  = scattering proportionality constant for inorganic solids [ $\text{m}^2/\text{gD}$ ].

The extinction coefficient ( $K_d$ ) is computed using the formulation developed by Di Toro, (1978).

$$K_d = a + (1 - \gamma)b$$

where  $\gamma$  = the fraction of particle scattering that is directly forward scattered [dimensionless].

**Sediment Oxygen Demand / Sediment Nutrient Fluxes**

Sediment oxygen demand (SOD) and sediment nutrient fluxes of nutrients (ammonia, nitrate, inorganic phosphorus, and methane) are computed using formulations originally developed by Di Toro (Di Toro et al. 1991, Di Toro and Fitzpatrick. 1993, Di Toro 2001) and finally constructed by Chapra and Martin (2004).

A schematic of the model is shown in Figure 4. Sediment oxygen demand and nutrient fluxes are computed as a function of the amount of particulate organic matter sinking from the water column to the sediments. Figure 4 provides a summary of the various components considered when computing the sediment oxygen demand and fluxes of nutrients from the sediments. The sediments are divided into an aerobic zone and an anaerobic zone. The details of this sub-model are described in Chapra and Martin, 2004.

Sometimes, the presence of organic matter deposited to the sediments prior to the summer steady-state period (e.g., during spring runoff), can impact the total SOD in the reservoir. Thus, it is possible that the downward flux of particulate organic matter is insufficient to generate the observed SOD. In such cases, a supplementary SOD can be entered by the user.

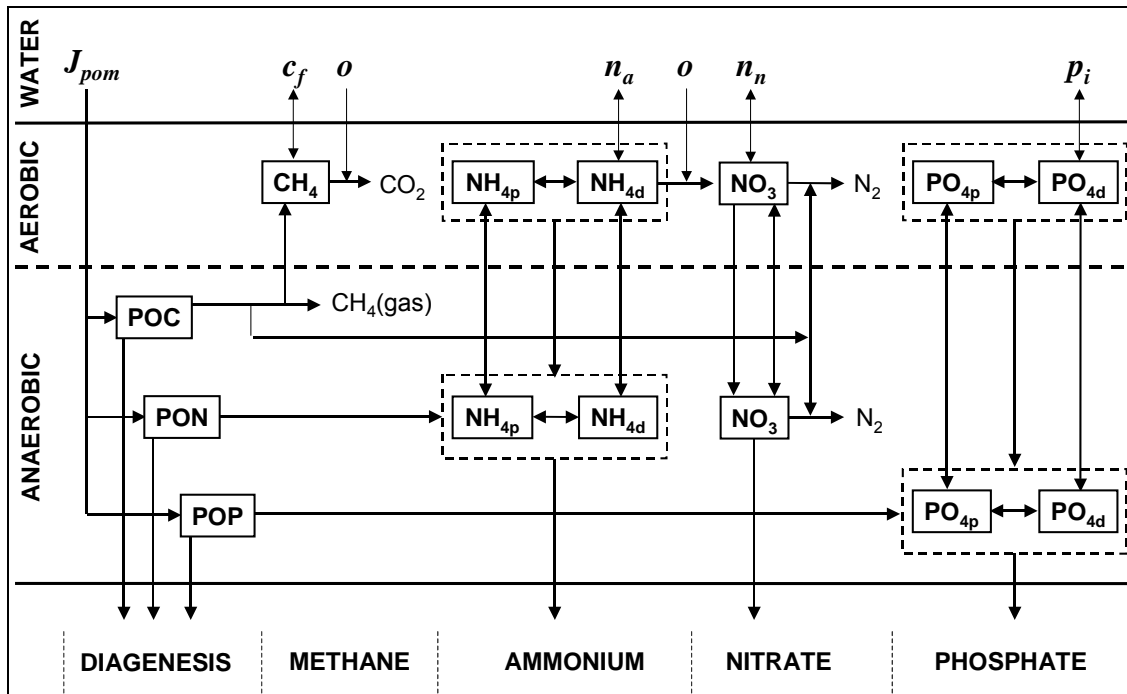

**Figure 4: Schematic of SOD-nutrient Flux Model of the Sediments (From Chapra and Martin, 2004)**

## IV. INPUT DATA FOR MODEL CALIBRATION

### Flow Data

The Three Lakes Water-Quality Model requires a daily flow time-series for each of the inflowing tributaries, inflowing pumped sources (Windy Gap and Willow Creek pipelines), and the outflows. The data sources used for the model calibration period (10/04 – 9/06) are described below.

#### North Fork of the Colorado River

NCWCD provided daily flows for the North Fork during the May – September periods of the calibration period (Pineda, 2007). In order to fill in the periods where no data were available, data from the USGS NWISWeb database were used ([www.usgs.gov](http://www.usgs.gov)).

The USGS gauge located at the mouth of the North Fork (Colorado River Near Grand Lake – 09011000) has data from 1904 through 1986. The USGS gauge upstream of the gauge at the mouth (Colorado River below Baker Gulch Near Grand Lake – 09010500) is active and has been in operation since 1953. A correlation between the two gauges has an  $R^2$  of 0.97. Thus, the flows at the gauge below Baker Gulch from 10/04 – 9/06 were used to characterize the flows entering Shadow Mountain Reservoir during the October to April timeframes.

#### Willow Creek Pumping

Daily flows through the Willow Creek Pump Canal for 10/04 through 9/06 were obtained from NCWCD (Pineda, 2007).

#### Windy Gap Pumping

Daily flows through the Windy Gap Pump Canal for 10/04 through 9/06 were obtained from NCWCD (Pineda, 2007).

#### Arapaho Creek

Fifteen-minute depth data from a data logger data for Arapaho Creek were obtained from the USGS for the period March 14, 2001 – April 17, 2007 (Lewis, 2007). Accompanying these data were instantaneous discharge measurements over the same period. In order to transform these data into average daily flow in acre-feet, six steps were taken.

First, the instantaneous discharge measurements (spot measurements) were used to create a rating curve, using the flow/staff gage readings. Secondly, the offset between the staff gage and the data logger depth was determined by comparing the data logger depth with the staff gage reading for dates and times when the spot flow measurements were taken (e.g., What is the offset between the zero points on the staff gage and the data logger?) Third, the offset was added to the data logger data. Fourth, flows were calculated for the data logger depth + offset by interpolating from the rating curve. Fifth, the data logger data were checked for quality control for missing data and unlikely values. Finally, the 15-minute data were averaged to obtain mean daily flows.

### East Inlet

Fifteen-minute depth data from a data logger data for East Inlet were obtained from the USGS for the period March 14, 2001 – April 17, 2007 (Lewis, 2007). Accompanying these data were instantaneous discharge measurements over the same period. In order to transform these data into average daily flow in acre-feet, six steps were taken.

First, the instantaneous discharge measurements (spot measurements) were used to create a rating curve, using the flow/staff gage readings. Secondly, the offset between the staff gage and the data logger depth was determined by comparing the data logger depth with the staff gage reading for dates and times when the spot flow measurements were taken (e.g., What is the offset between the zero points on the staff gage and the data logger?) Third, the offset was added to the data logger data. Fourth, flows were calculated for the data logger depth + offset by interpolating from the rating curve. Fifth, the data logger data were check for quality control for missing data and unlikely values. Finally, the 15-minute data were averaged to obtain mean daily flows.

### North Inlet

NCWCD provided daily flows for the North Inlet during the May – September periods of the calibration period (Pineda, 2007). The data were extended to develop a year-round daily time series using a correlation between daily flows in the North Inlet (NCWCD, 2007) and daily flows from the East Inlet gauge, which has data year-round (see above). The  $R^2$  for the correlation was 0.91, based on the 2003-2006 record for the two stations. Thus, measured flows were used when observations were available and the correlated flows were used when they were not.

### Precipitation

Precipitation was estimated based on precipitation data supplied by the US Bureau of Reclamation Eastern Colorado Projects reports at the Grand Lake Station (Bricker, 2006; Bricker, 2007) and reservoir area.

### Evaporation

Evaporation from each reservoir was estimated based on evaporation data supplied by the US Bureau of Reclamation Eastern Colorado Projects reports (Bricker, 2006; Bricker, 2007).

### Adams Tunnel Flows

Daily flows through the Adams Tunnel for 10/04 through 9/06 were obtained from NCWCD (Pineda, 2007).

### Colorado River Releases

Daily releases from Granby Reservoir to the Colorado River for 10/04 through 9/06 were obtained from NCWCD (Pineda, 2007).

### Pumping from Granby Reservoir to Shadow Mountain Reservoir

Daily data for flows through the Farr Pumping Plant were obtained from the US Bureau of Reclamation Eastern Colorado Projects reports (Bricker, 2006; Bricker, 2007).

### Miscellaneous Gains / Losses

A daily time series of miscellaneous gains and losses was computed in order to ensure that the water balance resulted in the observed Granby Reservoir contents. These gains and losses were based on the flows described above and the historical contents of Granby Reservoir.

### Inflow Water-Quality Data

The Three Lakes Water-Quality Model requires a daily time series of concentrations for water flowing into the system. Data for Arapaho Creek, North Inlet, East Inlet, Stillwater Creek, and the North Fork of the Colorado River were obtained from the USGS ([www.usgs.gov](http://www.usgs.gov); Solberg, 2007). Data for Windy Gap and Willow Creek Pump Canals were obtained from NCWCD (Vincent, 2007). It was assumed that the water quality in Columbine Creek and the Roaring Fork was the same as Arapaho Creek. Daily time series were developed for each of these inflows using the time-interval method (Scheider, et al., 1979).

### Rates

The Three Lakes Water-Quality Model requires numerous rate and physical parameters. The published literature (Mills, et al., 1985; Chapra, 1997; Chapra and Martin, 2004) contains guidance on typical values and ranges for many of these parameters. The final values determined during the model calibration process are listed in Appendix A.

### Initial Conditions

The characteristics of the system at the start of the calibration simulation were defined based on measured data. Reservoir volumes and initial water-quality conditions for each reservoir layer were based on the available measured data that was closest in time to October 1, 2004.

## V. CALIBRATION AND MODEL RESULTS

The Three Lakes Water-Quality Model was calibrated by adjusting model parameters, to obtain the best match between the model predictions and measured water-quality data. This iterative process involved attempts to match both averages and patterns for the water-quality variables in each water body, in each layer.

Goodness-of-fit techniques were used to assess the model's performance. Comparisons between model predictions and measured data were made qualitatively (time-series graphics) and quantitatively (statistics). Graphical comparisons are very useful for judging the results of a model calibration. Time-series graphics of model predictions versus measured data provide insights into the model's characterization of pertinent factors often overlooked by statistical comparisons. Thus, the performance of the model was primarily determined via interpretation of the time-series graphics. These graphics are provided in Appendix B and cover the two-year calibration period beginning on October 1, 2004 and continuing through September 30, 2006. Overall, the model performs very well, especially given the nature of how the three reservoirs interact with one another. For purposes of these graphs, observations that were below the detection limit were assumed to equal one-half of the detection limit.

Note that although chlorophyll *a* peaks were simulated, the magnitudes of the predicted peak concentrations were under-predicted. It is very difficult to capture the full extent of the peak chlorophyll *a* values in water-quality models given the sampling frequency of the inflow chemistry and the limitations in being able to fully characterize the biological processes that occur with the growth of algae. The model does a good job at predicting mean concentrations and does simulate algae blooms. Note that the purpose of the model for this EIS effort is to determine the changes between different scenarios. Based on the calibration results, the Three Lakes Water-Quality Model serves this purpose.

There are a number of statistical metrics than can be used to assess model performance. Those chosen for this effort include mean error (ME), mean absolute error (MAE), median relative error (MRE), and median relative absolute error (MRAE). These statistics were computed for key constituents for each reservoir. In addition, the aggregate MRAE was computed overall for each reservoir and overall for the integrated model of the Three Lakes.

$$ME = \frac{1}{n} \sum_{i=1}^n (pred_i - obs_i)$$

$$MAE = \frac{1}{n} \sum_{i=1}^n |pred_i - obs_i|$$

$$MRE = median\left[\left(\frac{pred_i - obs_i}{obs_i}\right), \text{for all } i\right]$$

$$MRAE = median\left[\left(\frac{|pred_i - obs_i|}{obs_i}\right), \text{for all } i\right]$$



Where  $pred_i$  and  $obs_i$  are a corresponding pair of model prediction and observed data, respectively,  $n$  = number of comparisons. The measured data were used directly. Sampled data are assumed to represent the average quantity during the day of sampling. With this assumption, the measured data were directly compared to the model output. The measure of model error from measured data assumed all measurements were of equal value, the calculation of the overall model error did not weight errors in Grand Lake or Granby Reservoir higher.

There are no widely accepted thresholds for how much error is acceptable for a calibrated model. In general, Chapra (2004) suggests an error of plus or minus 30% or less for eutrophication models. Hayter (2006) used a MRE of plus or minus 30% for the performance measure for a fate and transport model of a Massachusetts river. EPA (1990) suggests plus or minus 45% for water-quality variables simulated in estuarine eutrophication models.

The overall MRAE statistics are displayed in Table 5. Each reservoir is well within the performance thresholds mentioned above. The overall model has a median relative absolute error of 20%.

Statistics by key constituent for each reservoir are listed in Tables 6-9. Averages of key constituents for each reservoir are presented in Table 6. All constituents have a MRAE below a 30% performance threshold with the exception of chlorophyll a in Granby Reservoir. The MRAE in this case is 46% which is close to the EPA suggested criteria. Some sources of error include: the use of monthly kinetic rates as a function of monthly water temperature for chemical equations, assumption of fully mixed reservoir compartments, and errors in reservoir forcing functions (e.g., flow and water quality of reservoir inflow) that drive errors in water-quality simulation.

The results of both the qualitative and quantitative measures of goodness-of-fit support the use of this tool in estimating the relative impacts of the alternatives for the WGFP EIS.

**Table 5: Overall Median Relative Absolute Error Statistics**

	<b>Granby Reservoir</b>	<b>Shadow Mountain Reservoir</b>	<b>Grand Lake</b>	<b>Overall Three Lakes Water-Quality Model</b>
Overall Median Relative Absolute Error	22%	13%	23%	20%

**Table 6: Average Observed Water-Quality Conditions for Reservoirs (WY 05 – 06)**

	Total Phosphorus (µg/l)	Total Nitrogen (µg/l)	Chlorophyll a (µg/l)	Secchi-disk Depth (m)	Hypolimnetic Oxygen (mg/l)
Granby Reservoir	10.3 epi 14.5 hyp	283 epi 261 hyp	5.4	3.9	5.3
Shadow Mountain Reservoir	15.5	324	7.2	2.4	7.5
Grand Lake	9.6 epi 8.4 hyp	342 epi 329 hyp	6.6	3.3	5.9

epi – epilimnion, hyp - hypolimnion

**Table 7: Model Statistics for Granby Reservoir**

	Total Phosphorus (µg/l)	Total Nitrogen (µg/l)	Chlorophyll a (µg/l)	Secchi-disk Depth (m)	Hypolimnetic Oxygen (mg/l)
Mean Error	0.7	23	-2.0	-0.5	0.2
Mean Absolute Error	4.3	77	2.7	1.0	0.5
Median Relative Error	8%	19%	-19%	-9%	4%
Median Relative Absolute Error	25%	24%	46%	17%	12%

**Table 8: Model Statistics for Shadow Mountain Reservoir**

	Total Phosphorus (µg/l)	Total Nitrogen (µg/l)	Chlorophyll a (µg/l)	Secchi-disk Depth (m)	Hypolimnetic Oxygen (mg/l)
Mean Error	-0.04	-34	-3.2	-0.4	-0.01
Mean Absolute Error	3.6	54	3.5	0.7	0.6
Median Relative Error	-2%	0%	15%	-15%	4%
Median Relative Absolute Error	18%	10%	21%	20%	7%

**Table 9: Model Statistics for Grand Lake**

	Total Phosphorus (µg/l)	Total Nitrogen (µg/l)	Chlorophyll a (µg/l)	Secchi-disk Depth (m)	Hypolimnetic Oxygen (mg/l)
Mean Error	-0.4	-85	-2.0	-0.6	0.3
Mean Absolute Error	3.9	99	2.3	0.9	0.7
Median Relative Error	15%	-20%	-22%	-16%	8%
Median Relative Absolute Error	29%	23%	23%	23%	11%

## REFERENCES

- APHA (American Public Health Association). 1995. Standard Methods for the Examination of Water and Wastewater. 19<sup>th</sup> ed. Washington DC.
- Baly, E.C.C. 1935. The Kinetics of Photosynthesis. Proc. Royal Soc. London Ser. B, 117:218-239.
- Banks, R. B. and Herrera, F. F. 1977. Effect of Wind and Rain on Surface Reaeration. *J. Environ Engr. Div. ASCE*. 103(EE3): 489-504.
- Bricker, K. 2006. US Bureau of Reclamation. Files sent via email to Jean Marie Boyer, Hydrosphere. September 13, 2006.
- Bricker, K. 2007. US Bureau of Reclamation. Files sent via email to Jean Marie Boyer, Hydrosphere. April 18, 2007.
- Cerco, C.F. and Cole, T. 1994. Three-Dimensional Eutrophication Model of Chesapeake Bay, Vol 1: Main Report. U.S. Army Corps of Engineers, Waterways Experiment Station. Tech. Report EL-94-4.
- Chapra, S.C. 1997. Surface Water-Quality Modeling. McGraw-Hill Companies, Inc.
- Chapra, S.C. 2004. Professor, Berger Chair, Department of Civil and Environmental Engineering, Tufts University. Personal communication with Jean Marie Boyer, Hydrosphere.
- Chapra, S.C. and Martin, J.L. 2004. LAKE2K: A Modeling Framework for Simulating Lake Water Quality (Version 1.2): Documentation and Users Manual. Civil and Environmental Engineering Dept., Tufts University, Medford, MA., [Steven.Chapra@tufts.edu](mailto:Steven.Chapra@tufts.edu)
- Di Toro, D.M. 1978. Optics of Turbid Estuarine Waters: Approximations and Applications. *Water Res.* 12:1059-1068.
- Di Toro, D.M. 2001. Sediment Flux Modeling. Wiley-Interscience, New York, NY.
- Di Toro, D. M. and J. F. Fitzpatrick. 1993. Chesapeake Bay sediment flux model. Tech. Report EL-93-2, U.S. Army Corps of Engineers, Waterways Experiment Station, Vicksburg, Mississippi, 316 pp.
- Hayter, E.J. 2006. Evaluation of the State-of-the-Art Contaminated Sediment Transport and Fate Modeling System. EPA/600/R-06/108. September, 2006.
- Lewis, M. 2007. US Geological Survey. Data file sent to J.M. Boyer, Hydrosphere via Nicole Seltzer, Northern Colorado Water Conservancy District. June 18, 2007.

- Lieberman, D. 2007a. Physical Attributes of Five Reservoirs on the Colorado – Big Thompson Project, 2005 to 2006: Lake Granby, Grand Lake, Shadow Mountain Reservoir, Horsetooth Reservoir, and Carter Lake (Draft). U.S. Bureau of Reclamation.
- Mills, W.B., D.B. Porcella, M.J. Unga, S.A. Gherini, K.V. Summers, Lingfung Mok, G.L. Rupp, G.L. Bowie, and D.A. Haith. 1985. Water Quality Assessment: A Screening Procedure for Toxic and Conventional Pollutants in Surface and Ground Water. EPA/600/6-85/002a.
- NCWCD (Northern Colorado Water Conservancy District). 2007. Data obtained from website (<http://www.ncwcd.org/datareports/westflow.asp>) by J. Winchester, Hydrosphere.
- Pineda, A., Northern Colorado Water Conservancy District. Data file sent to J.M. Boyer, Hydrosphere. June 6, 2007.
- Preisendorfer, R.W. 1986. Secchi Disc Science: Visual Optics of Natural Waters. *Limnol. Oceanogr.* 31(5):909-926.
- Scheider, W.A., Moss, J.J., and Dillon, P.J. 1979, Measurement and uses of hydraulic and nutrient budgets—Proceedings, national conference on lake restoration, Minneapolis, Minnesota, August 22-24, 1978: U.S. Environmental Protection Agency Report EPA 440/5-79-001, p. 77-83.
- Solberg, P.A. 2007. US Geological Survey. Data file sent to R. Blair Hanna, Hydrosphere via email. June 21, 2007.
- Tyler, J.E. 1968. The Secchi Disc. *Limnol. Oceanogr.* 13(1):1-6.
- Vincent, E. 2007. Northern Colorado Water Conservancy District. Access database provided to J.M. Boyer, Hydrosphere via NCWCD ftp site. May 4, 2007.

## **APPENDIX A**

### **Three Lakes Water-Quality Model Calibration Rate and Physical Parameters**

<b>Three Lakes Water-Quality Model</b>									
<b>Rate Parameters</b>									
	<b>Granby Reservoir</b>			<b>Shadow Mountain Reservoir</b>			<b>Grand Lake</b>		
<b>Organics:</b>									
Hydrolysis (P)	0.001	/d		0.0001	/d		0.0001	/d	
Hydrolysis (N)	0.001	/d		0.0001	/d		0.0001	/d	
Hydrolysis (C)	0.0001	/d		0.0001	/d		0.0001	/d	
Temp Correction	1.07			1.07			1.07		
Settling Velocity, Epi (P)	0.5	m/d		0.05	m/d		0.5	m/d	
Settling Velocity, Meta (P)	0.1	m/d					0.5	m/d	
Settling Velocity, Hypo (P)	0.1	m/d					0.4	m/d	
Settling Velocity, Epi (N)	0.001	m/d		0.001	m/d		0.001	m/d	
Settling Velocity, Meta (N)	0.001	m/d					0.001	m/d	
Settling Velocity, Hypo (N)	0.001	m/d					0.001	m/d	
Settling Velocity, Epi (C)	0.2	m/d		0.2	m/d		0.2	m/d	
Settling Velocity, Meta (C)	0.2	m/d					0.2	m/d	
Settling Velocity, Hypo (C)	0.2	m/d					0.2	m/d	
<b>Dissolved Organic Carbon:</b>									
Decomposition	0.01	/d		0.01	/d		0.001	/d	
Temp Correction	1.047			1.047			1.047		
<b>Algae:</b>	<b>Diatom</b>	<b>Blue-Green</b>		<b>Diatom</b>	<b>Blue-Green</b>		<b>Diatom</b>	<b>Blue-Green</b>	
Max Growth	3	0.5	/d	3.5	0.5	/d	2.5	0.5	/d
Temp Correction	1.07	1.07		1.07	1.07		1.07	1.07	
Respiration	0.01	0.1	/d	0.001	0.1	/d	0.001	0.1	/d
Temp Correction	1.07	1.07		1.07	1.07		1.07	1.07	
Algal Death	0.01	0.005	/d	0.0005	0.005	/d	0.005	0.005	/d
Temp Correction	1.08	1.08		1.08	1.08		1.08	1.08	
Temperature K1	0.01	0.01		0.01	0.01		0.0005	0.03	
Temperature K2	0.005	0.1		0.25	0.3		0.01	0.01	
Optimal Temperature	10	13	degrees C	11	13.5	degrees C	10	13	degrees C
Phos Half Sat Constant	1	1	ugP/L	1	1	1	1	1	ugP/L
Nitr Half Sat Constant	5		ugN/L	5		ugN/L	5		ugN/L
Settling Velocity, Epi	0.05	0	m/d	0	0	m/d	0	0	m/d
Settling Velocity, Meta	0.05	0	m/d				0.05	0	m/d
Settling Velocity, Hypo	0.05	0	m/d				0.1	0	m/d

### Three Lakes Water-Quality Model

#### Rate Parameters

	Granby Reservoir		Shadow Mountain Reservoir		Grand Lake	
Optimal Light	175	350 cal/cm2/d	150	375 cal/cm2/d	155	350 cal/cm2/d
Ammonia Preference	5.1	ugN/L	6	ugN/L	4	ugN/L
Herbivorous Zooplankton:						
Maximum Grazing	6	m3/g/d	4	m3/g/d	5	m3/g/d
Temp Correction	1.07		1.07		1.07	
Respiration	0.1	/d	0.1	/d	0.2	/d
Temp Correction	1.07		1.07		1.07	
Death	0.01	/d	0.01	/d	0.01	/d
Temp Correction	1.07		1.07		1.07	
Grazing Efficiency	0.6		0.6		0.5	
Algae Half Sat Constant	10	ugChla/L	10	ugChla/L	10	ugChla/L
Carnivorous Zooplankton:						
Maximum Grazing	4.7	m3/g/d	6	m3/g/d	4.7	m3/g/d
Temp Correction	1.07		1.07		1.07	
Respiration	0.1	/d	0.1	/d	0.2	/d
Temp Correction	1.07		1.07		1.07	
Death	0.05	/d	0.05	/d	0.05	/d
Temp Correction	1.07		1.07		1.07	
Grazing Efficiency	0.6		0.6		0.6	
Herb Half Sat Constant	0.4	mgC/L	0.3	mgC/L	0.4	mgC/L
Nitrogen:						
Nitrification	0.02	/d	0.03	/d	0.03	/d
Temp Correction	1.07		1.07		1.07	
Denitrification	0.04		0.01		0.01	
Temp Correction	1.07		1.07		1.07	
Oxygen Parameters:						
Sup SOD	0.1	g O2 / m2 / day	0	g O2 / m2 / day	0.15	g O2 / m2 / day
Inorganic Suspended Solids:						
Settling Velocity, Epi (ISS)	0.4	m/d	0.2	m/d	0.4	m/d
Settling Velocity, Meta (ISS)	0.2	m/d			0.2	m/d
Settling Velocity, Hypo (ISS)	0.2	m/d			0.2	m/d



**Three Lakes Water-Quality Model**

**Physical Parameters:**

**Light Parameters:**

Background Light Extinction	0.2	/m
Mean Photoperiod	0.5	d
Amplitude Photoperiod	0.12	d
Time of Peak Photoperiod	170	d
Mean Ave Daylight Solar	325	cal/cm2/d
Amplitude of Ave Daylight Solar	250	cal/cm2/d
Time of Peak Ave Daylight Solar	234	d
PAR	45%	

Temperature	Month	Granby Reservoir			Shadow Mountain	Grand Lake		
		Temp-epi (C)	Temp-meta (C)	Temp-hypo (C)	Temp (C)	Temp-epi (C)	Temp-meta (C)	Temp-hypo (C)
	Jan	1.9	2.6	3.1	1.7	2.0	3.4	3.4
	Feb	1.8	2.3	2.9	2.1	1.8	2.0	3.2
	Mar	1.7	3.1	3.3	2.3	1.5	2.0	3.3
	Apr	3.3	3.5	3.7	7.0	1.7	2.4	3.3
	May	6.3	5.8	4.8	8.4	5.5	4.7	4.0
	Jun	13.6	9.4	6.3	11.3	9.7	6.4	4.2
	Jul	16.5	11.1	7.0	13.6	12.6	7.5	4.2
	Aug	18.8	11.7	7.3	13.5	15.9	7.7	4.3
	Sep	14.9	12.7	7.8	10.7	13.3	8.0	4.3
	Oct	11.1	10.9	7.9	8.4	9.4	7.6	4.4
	Nov	7.9	7.9	7.9	6.7	5.5	5.4	4.3
	Dec	5.0	5.0	5.0	2.5	4.0	4.4	3.9

Thermocline Diffusion	Granby Reservoir				Shadow Mountain	Grand Lake					
	Day	Epi-Meta		Meta-Hypo		Day	Epi-Meta		Meta-Hypo		
		Vert. Mixing (m/d)	Vert. Mixing (m/d)	Vert. Mixing (m/d)			Vert. Mixing (m/d)	Vert. Mixing (m/d)	Vert. Mixing (m/d)	Vert. Mixing (m/d)	
First Day of Year	1	2.00	2.00	2.00		1	2.00	2.00	2.00	2.00	
Day Spring Mixed Period Ends	151	2.00	2.00	2.00		151	2.00	2.00	2.00	2.00	
Day Full Stratification Occurs	181	0.05	0.05	0.05		181	0.05	0.05	0.05	0.05	
Day when Full Stratification Ends	273	0.05	0.05	0.05		273	0.05	0.05	0.05	0.05	
Day of Total Fall Overturn	333	2.00	2.00	2.00		333	2.00	2.00	2.00	2.00	
Last Day of Year	365	2.00	2.00	2.00		365	2.00	2.00	2.00	2.00	

## **APPENDIX B**

### **Three Lakes Water-Quality Model Calibration Comparison between Model Predictions and Observed Data**

# GRAND LAKE

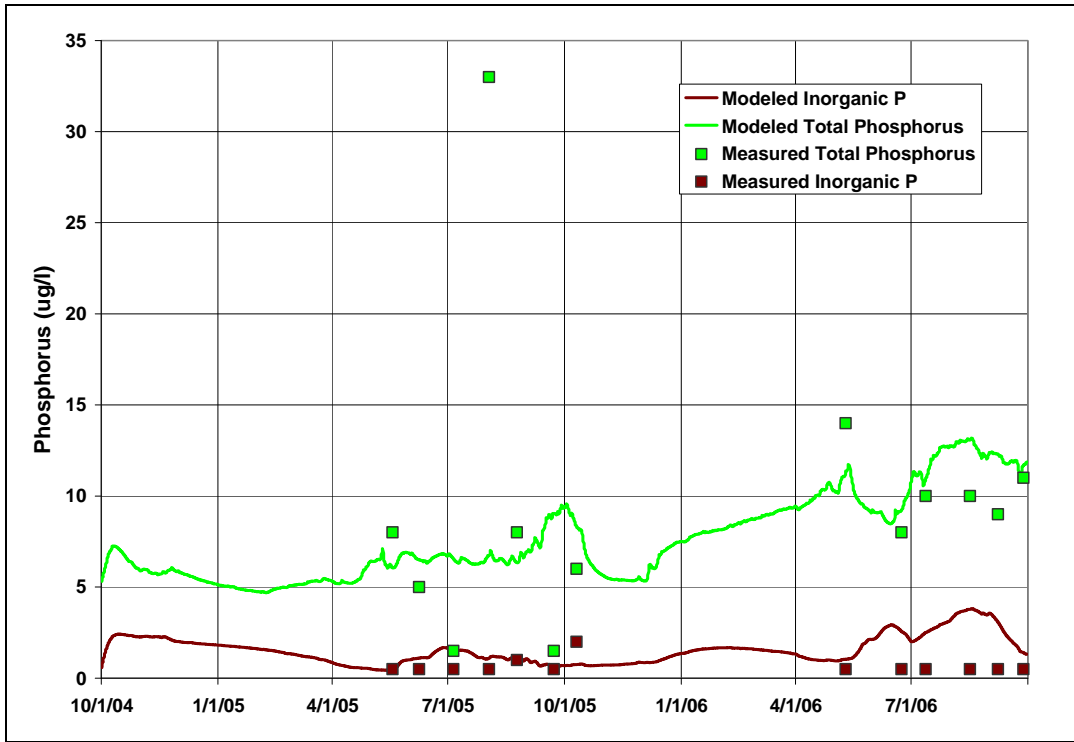

Figure B-1: Simulated versus Measured Epilimnetic Phosphorus - Grand Lake

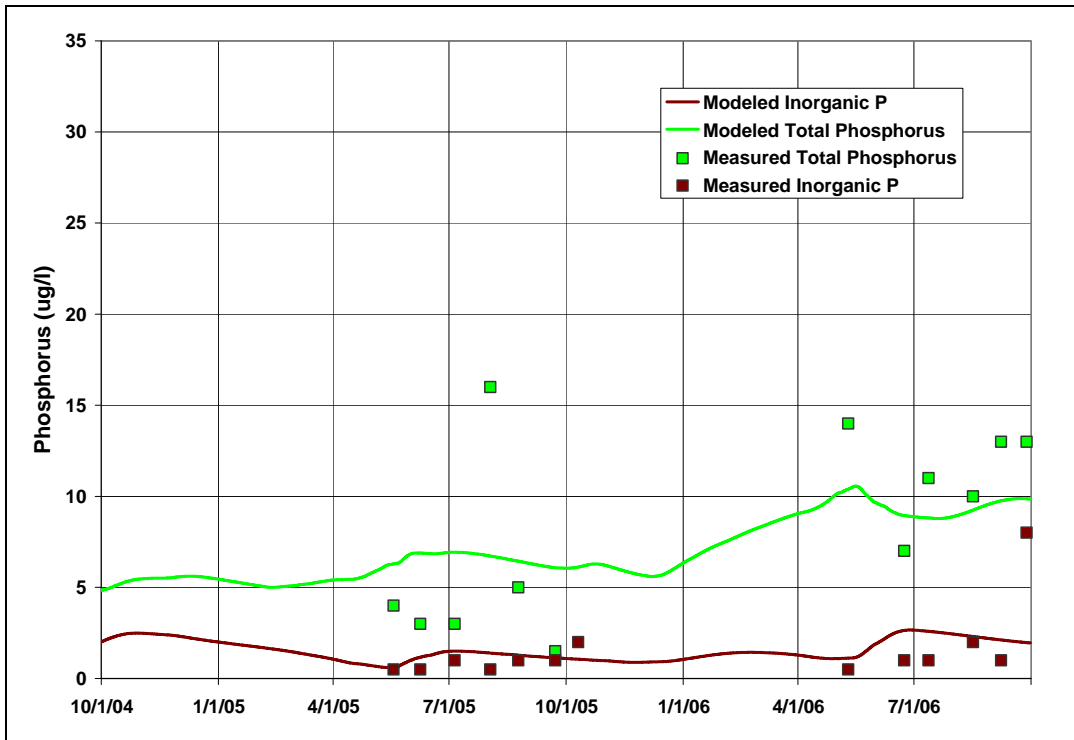

Figure B-2: Simulated versus Measured Hypolimnetic Phosphorus - Grand Lake

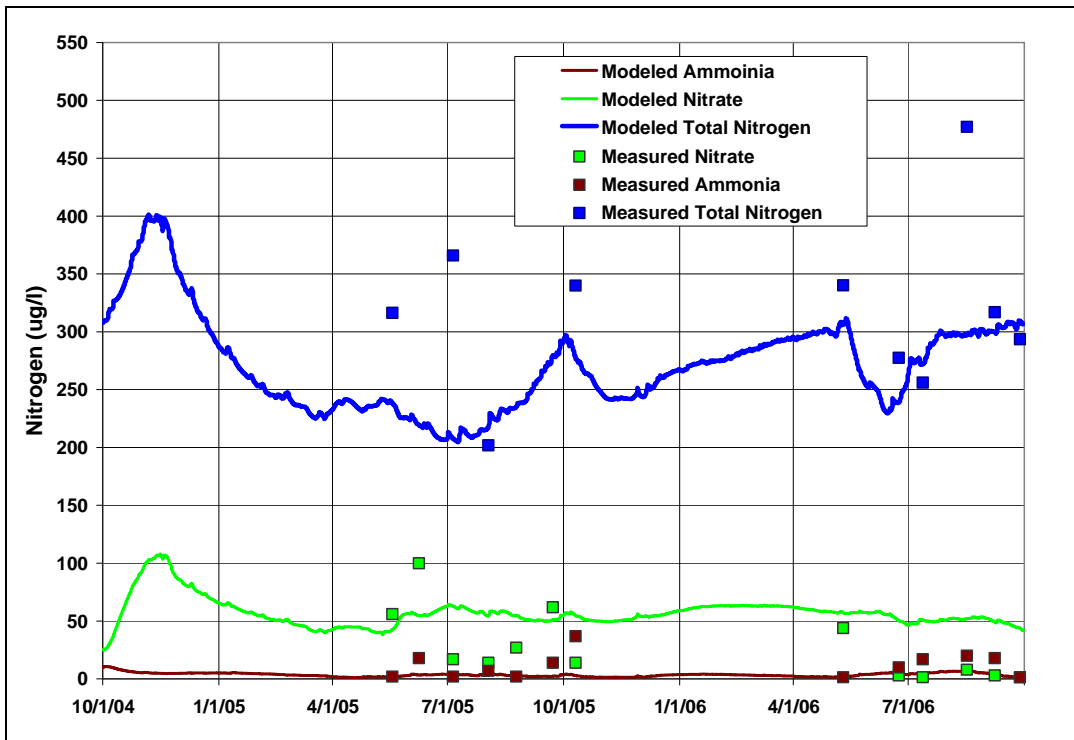

Figure B-3: Simulated versus Measured Epilimnetic Nitrogen - Grand Lake

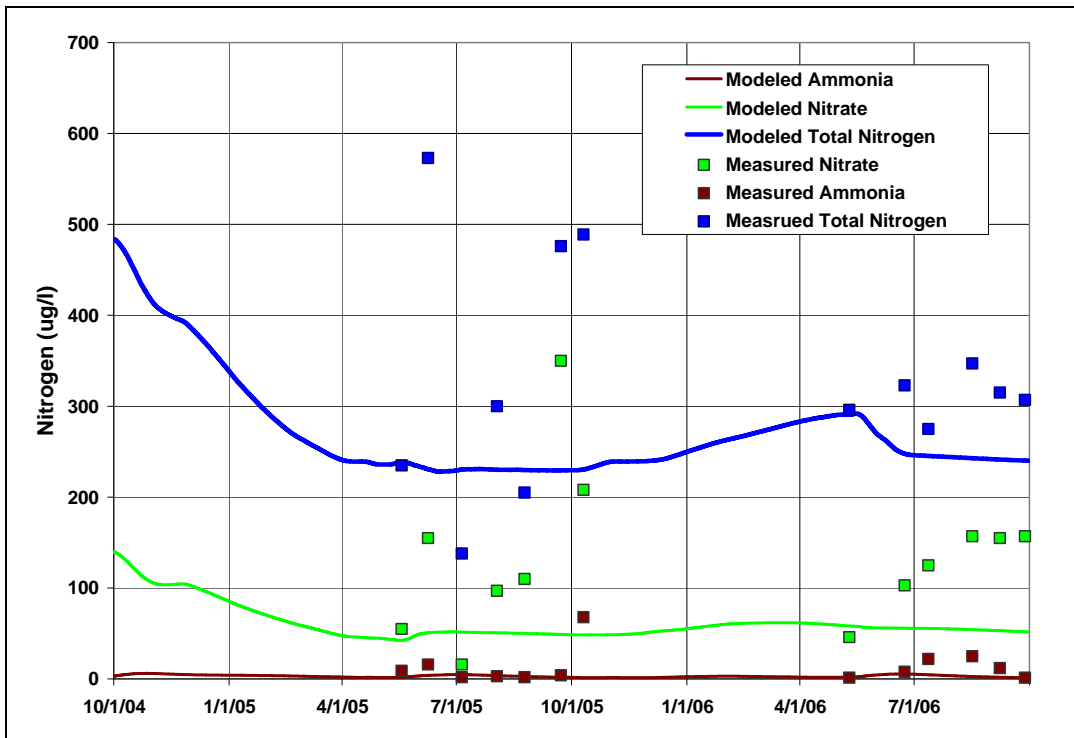

Figure B-4: Simulated versus Measured Hypolimnetic Nitrogen - Grand Lake

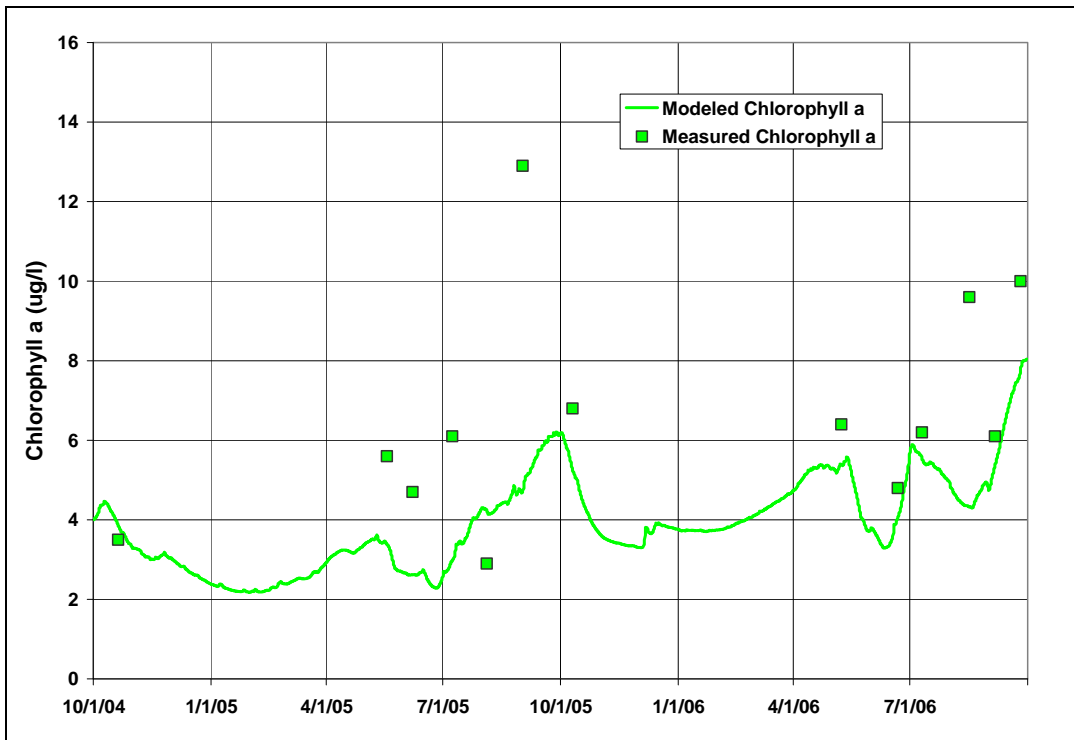

Figure B-5: Simulated versus Measured Chlorophyll a - Grand Lake

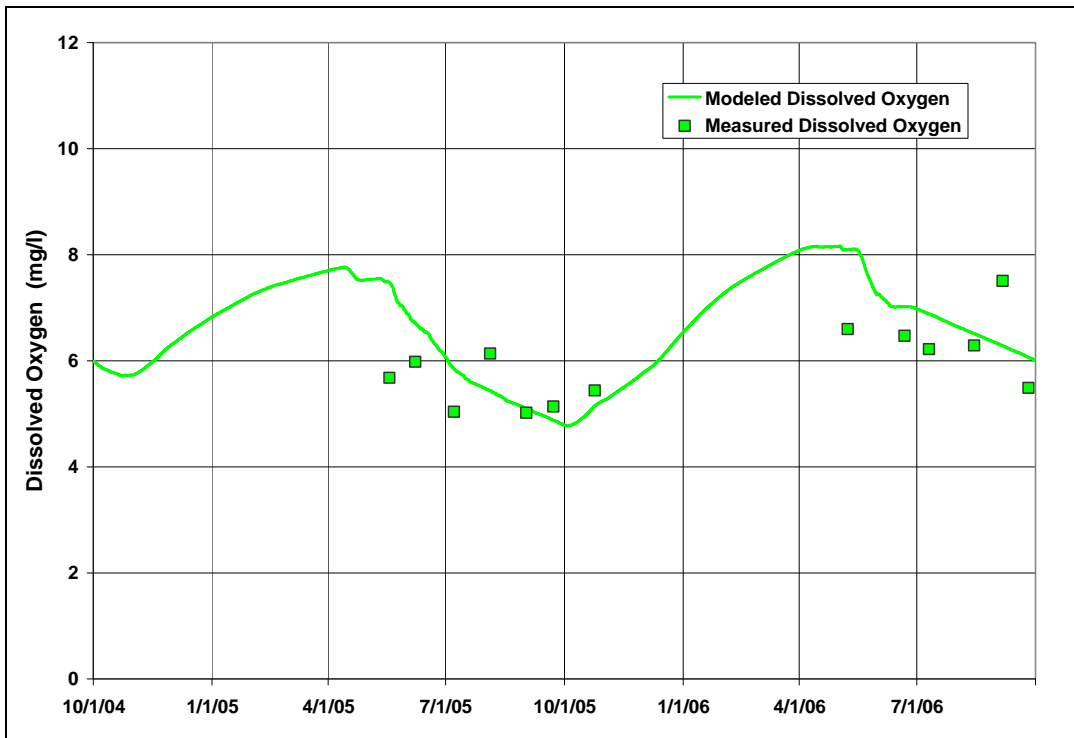

Figure B-6: Simulated versus Measured Hypolimnetic Oxygen - Grand Lake

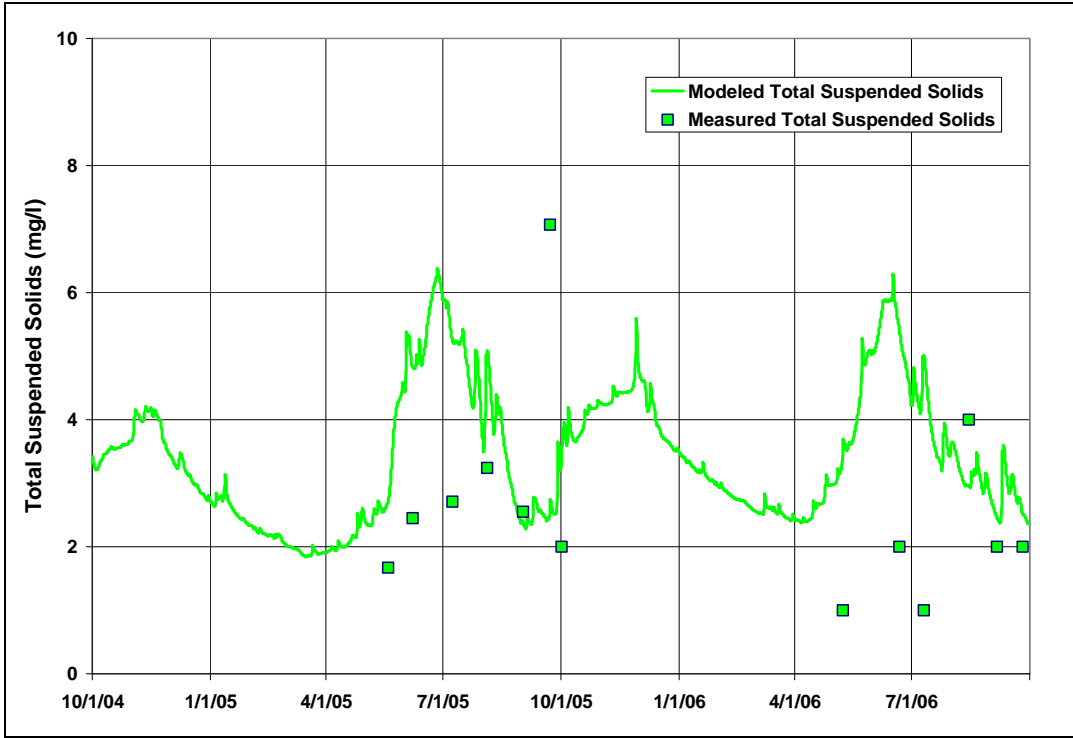

Figure B-7: Simulated versus Measured Epilimnetic Total Suspended Solids - Grand Lake

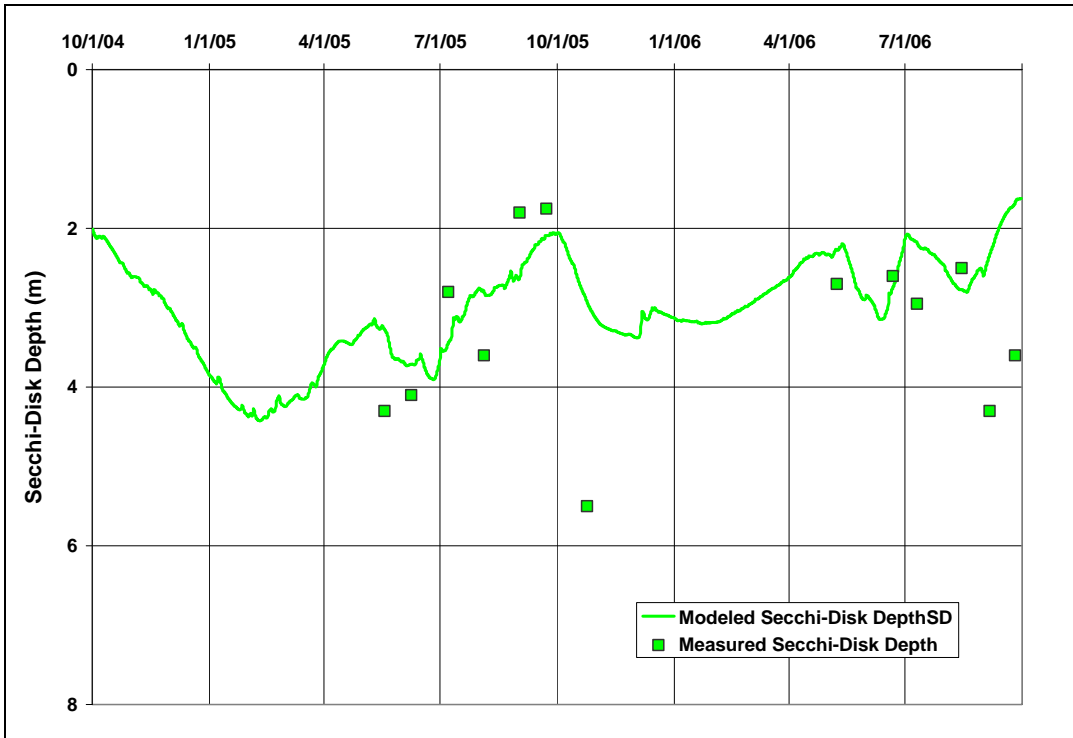
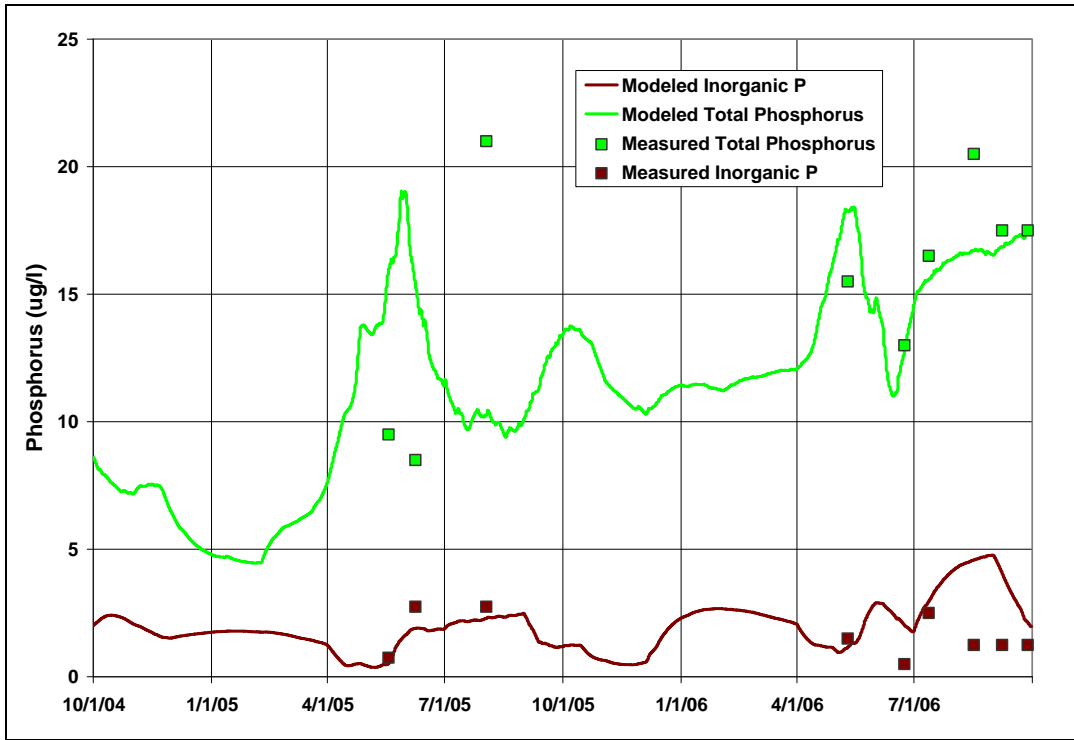
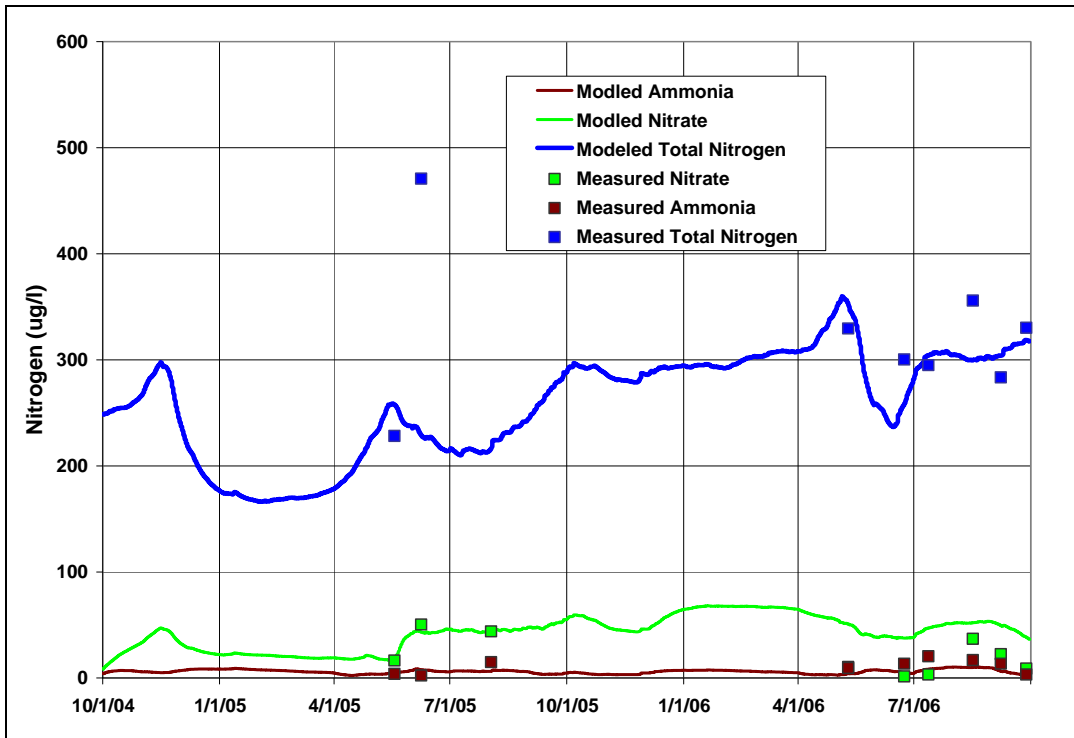

Figure B-8: Simulated versus Measured Secchi-Disk Depth - Grand Lake

**SHADOW MOUNTAIN RESERVOIR**



**Figure B-9: Simulated versus Measured Phosphorus - Shadow Mountain Reservoir**



**Figure B-10: Simulated versus Measured Nitrogen - Shadow Mountain Reservoir**

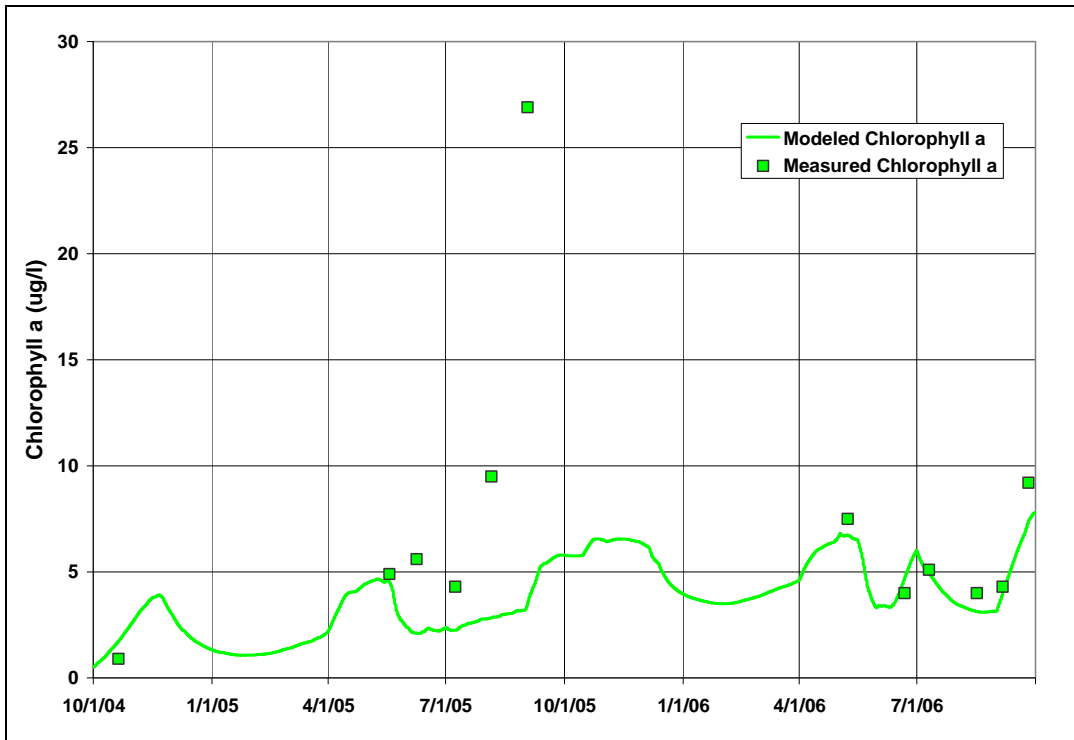

Figure B-11: Simulated versus Measured Chlorophyll a - Shadow Mountain Reservoir

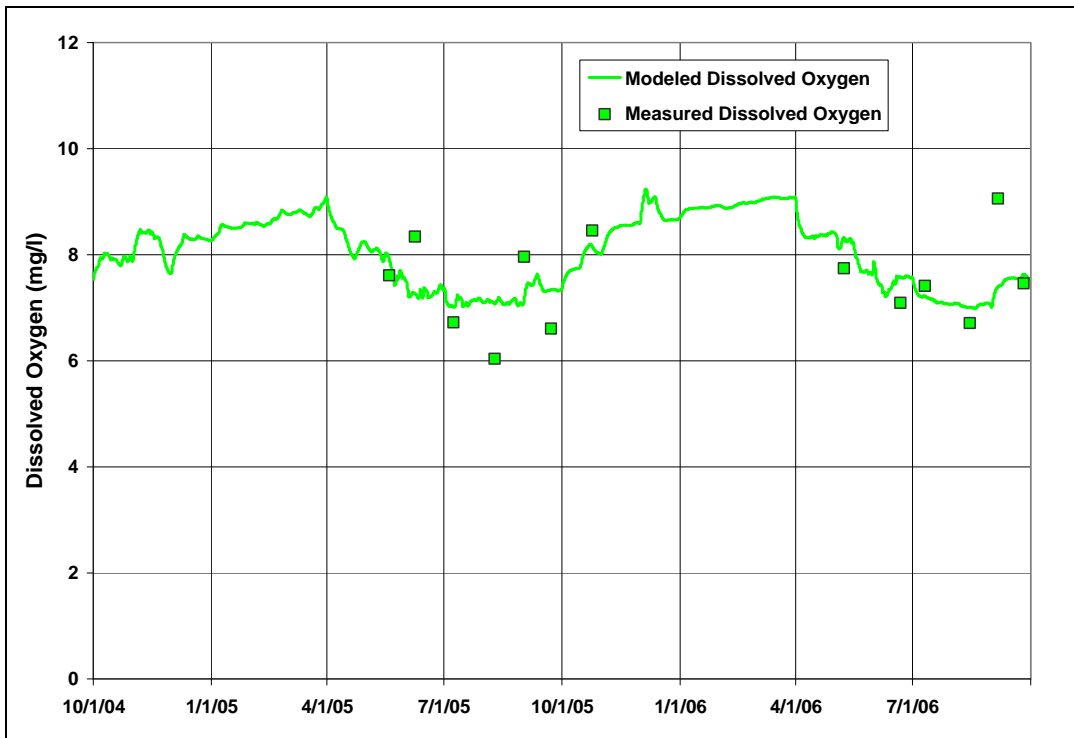

Figure B-12: Simulated versus Measured Dissolved Oxygen - Shadow Mountain Reservoir



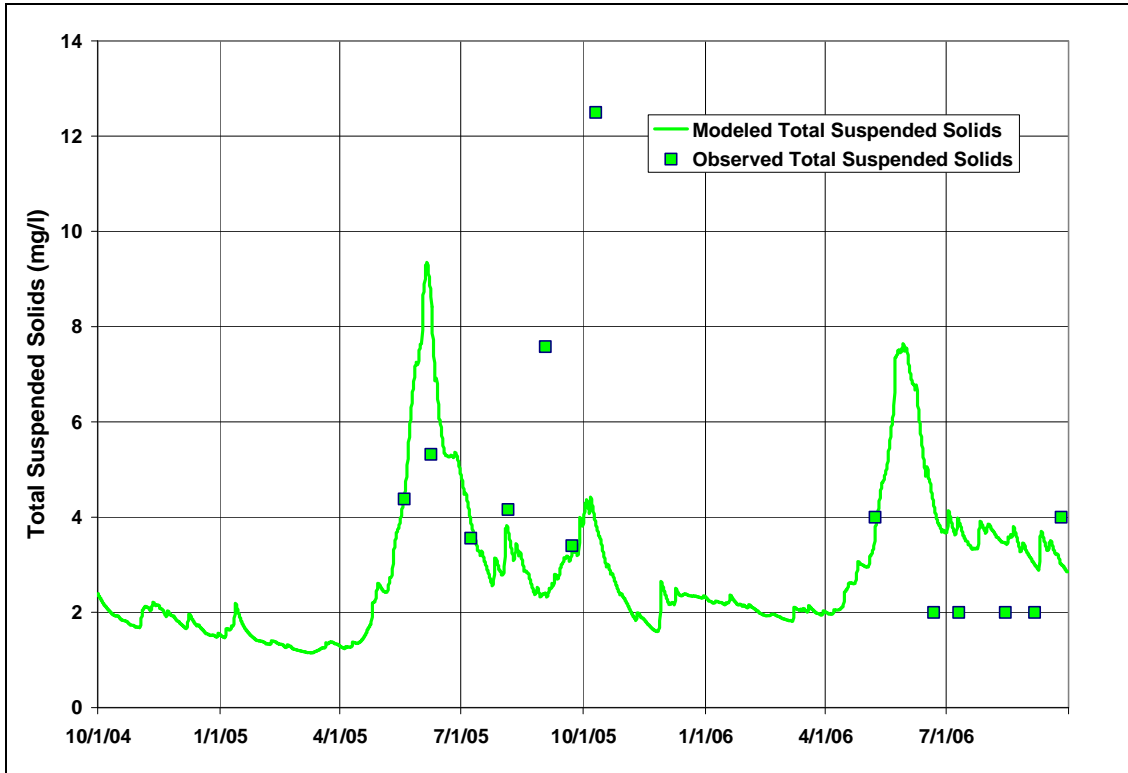

Figure B-13: Simulated versus Measured Epilimnetic Total Suspended Solids - Shadow Mountain Reservoir

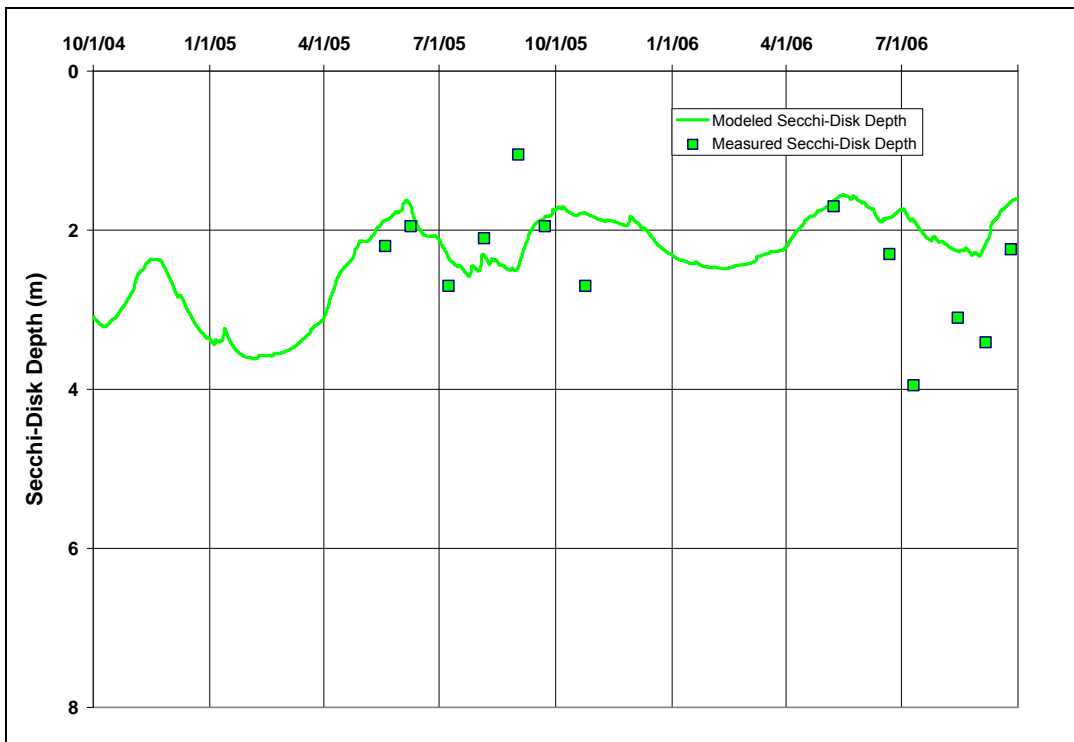

Figure B-14: Simulated versus Measured Secchi-Disk Depth - Shadow Mountain Reservoir

## GRANBY RESERVOIR

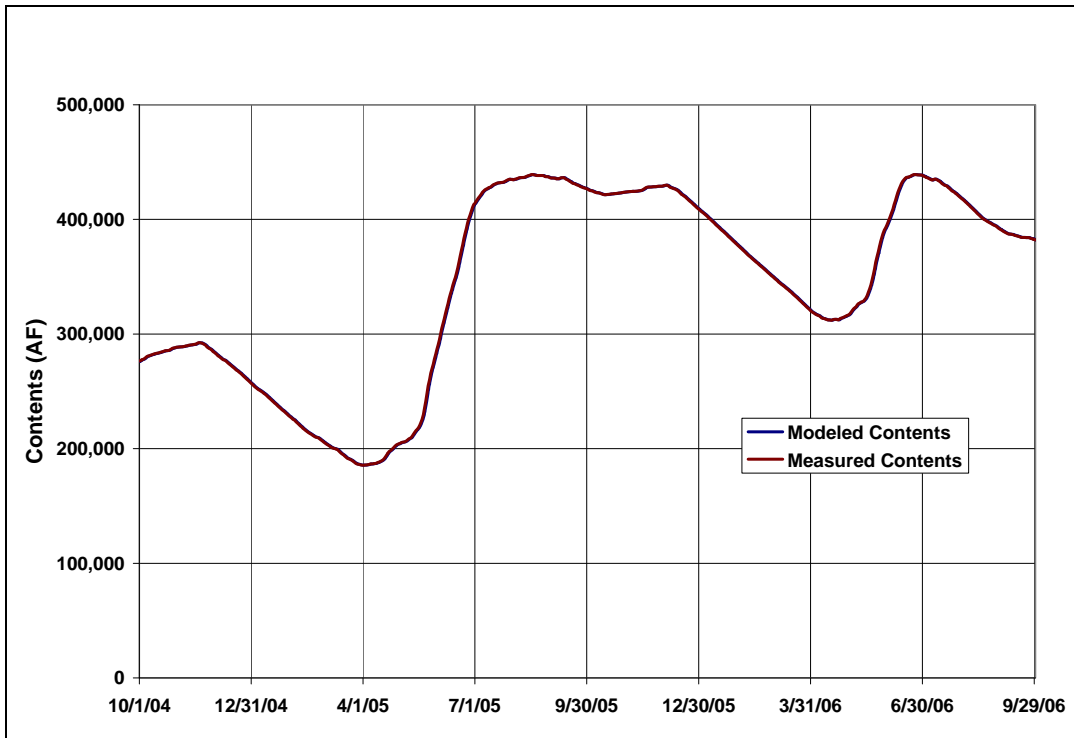

Figure B-15: Simulated versus Measured Granby Reservoir Contents

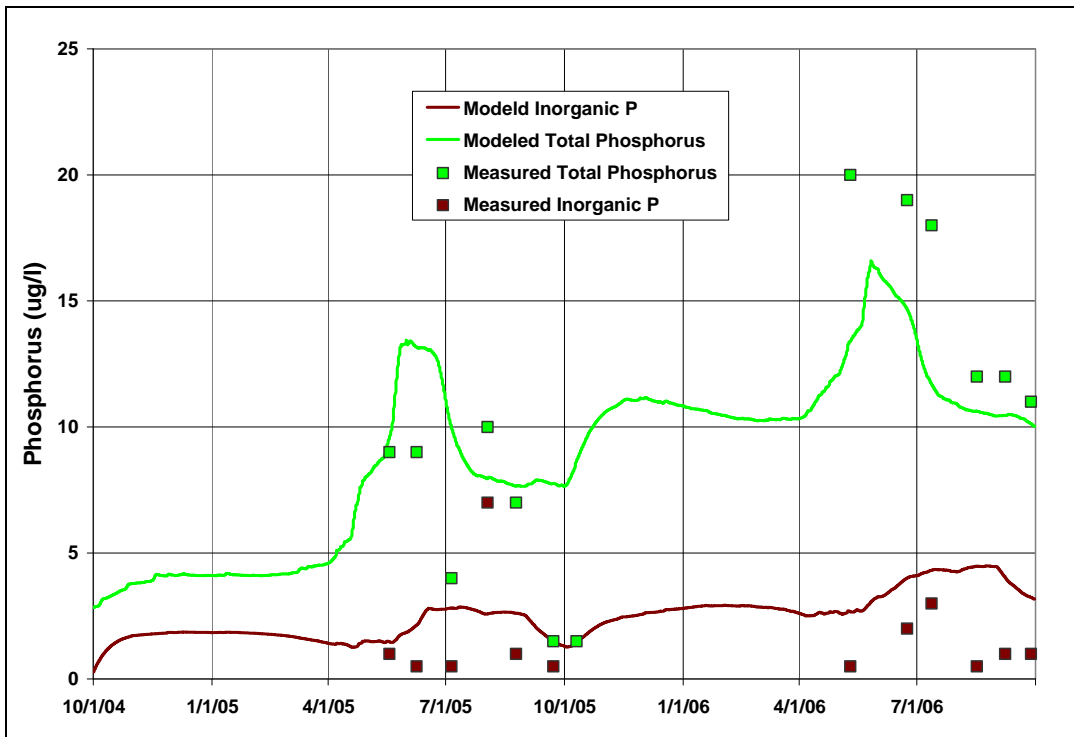

Figure B-16: Simulated versus Measured Epilimnetic Phosphorus - Granby Reservoir

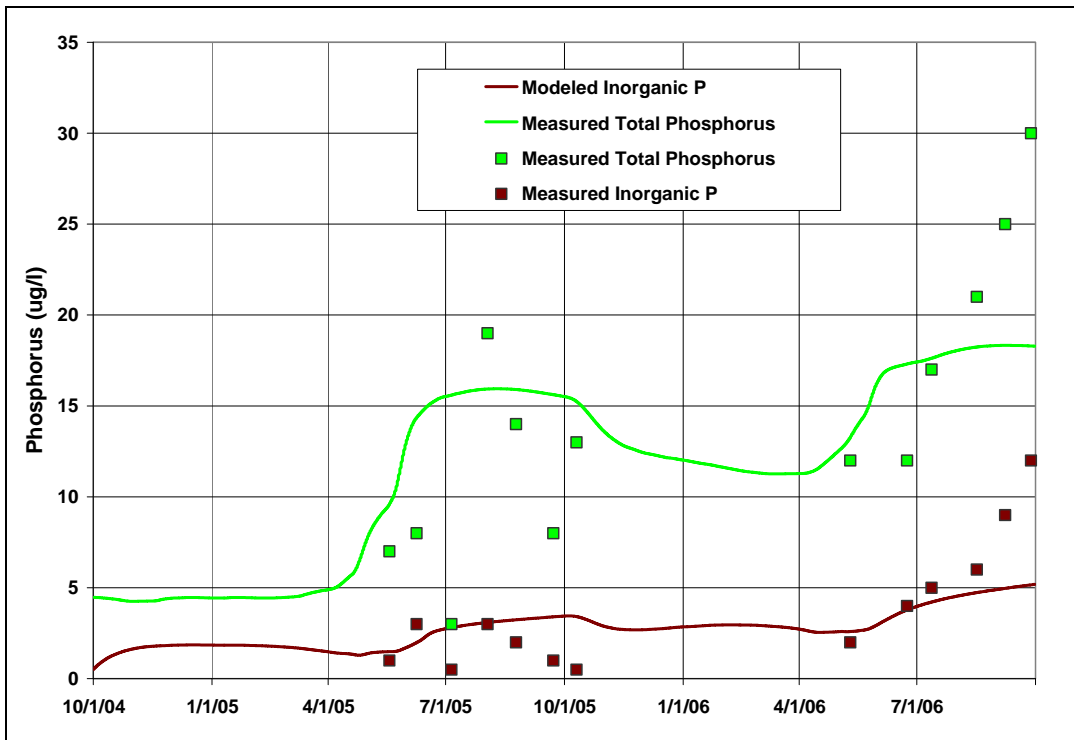

Figure B-17: Simulated versus Measured Hypolimnetic Phosphorus - Granby Reservoir

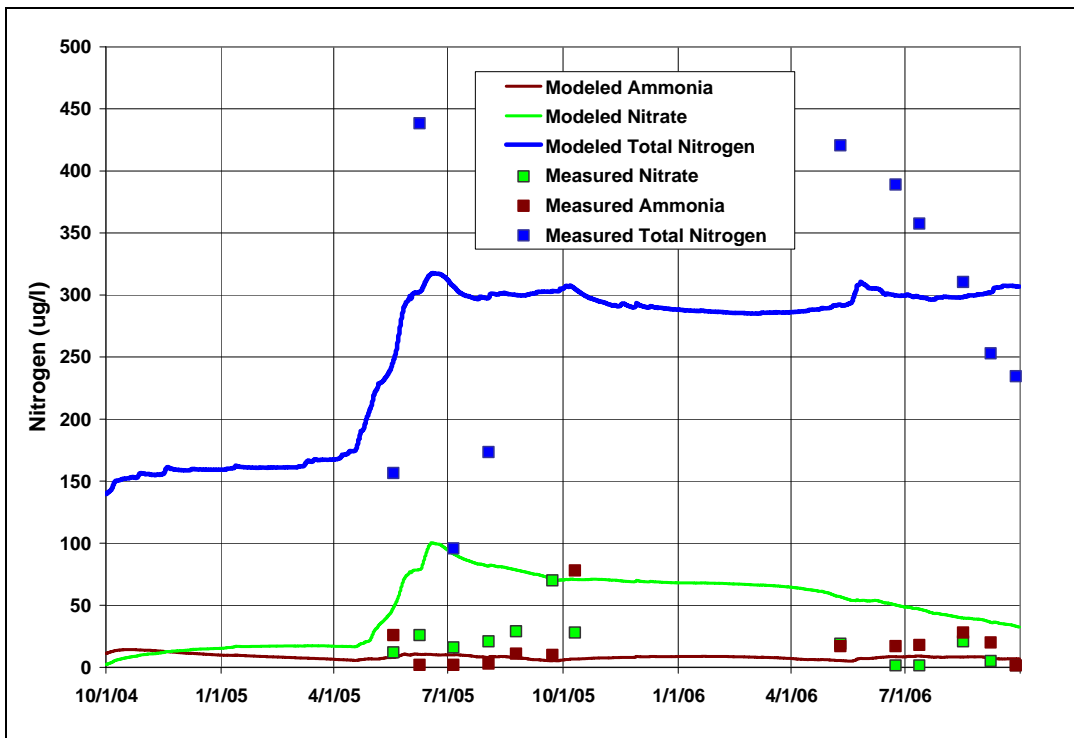

Figure B-18: Simulated versus Measured Epilimnetic Nitrogen - Granby Reservoir

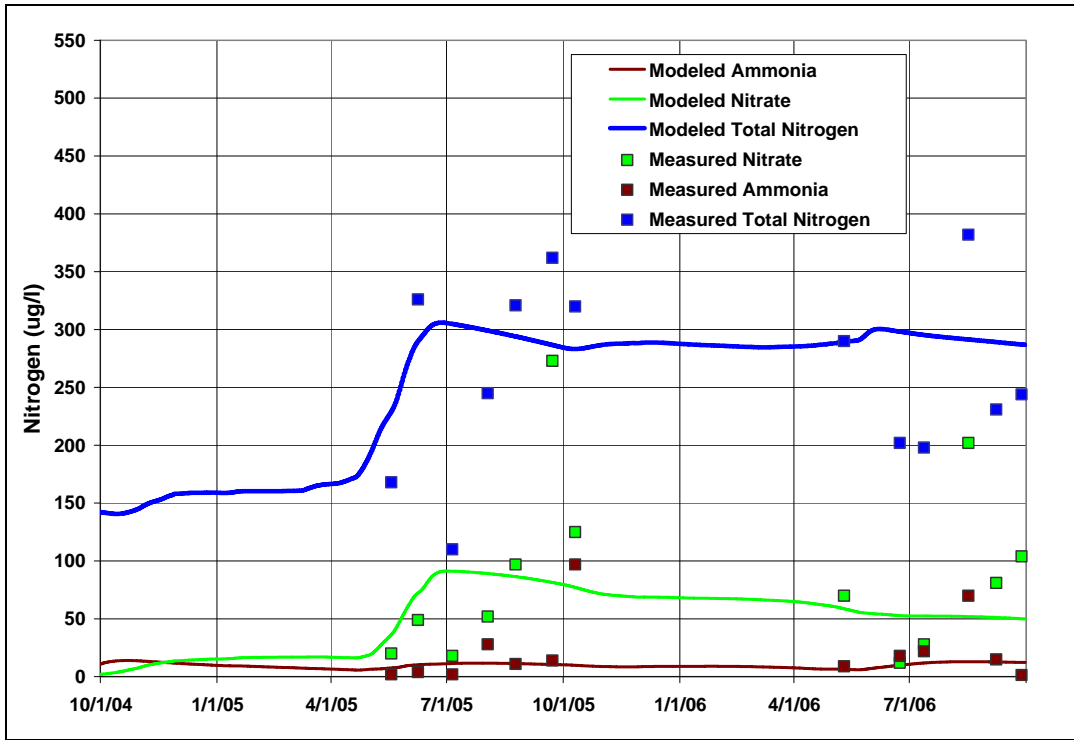

Figure B-19: Simulated versus Measured Hypolimnetic Nitrogen - Granby Reservoir

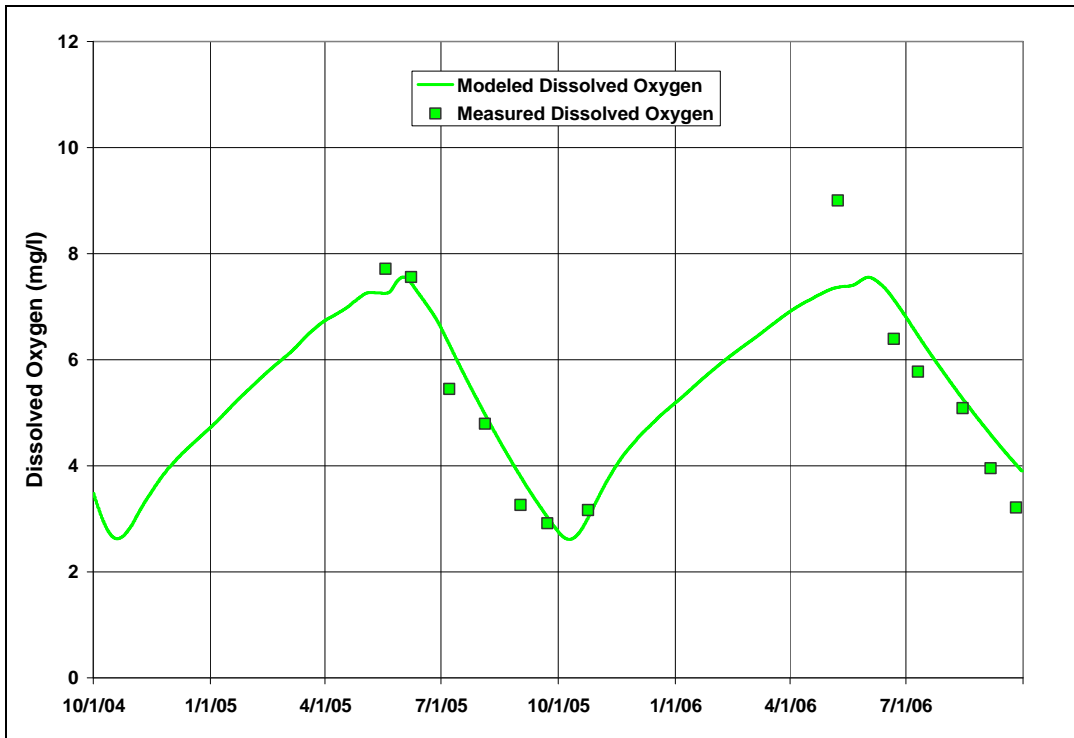

Figure B-20: Simulated versus Measured Hypolimnetic Oxygen - Granby Reservoir

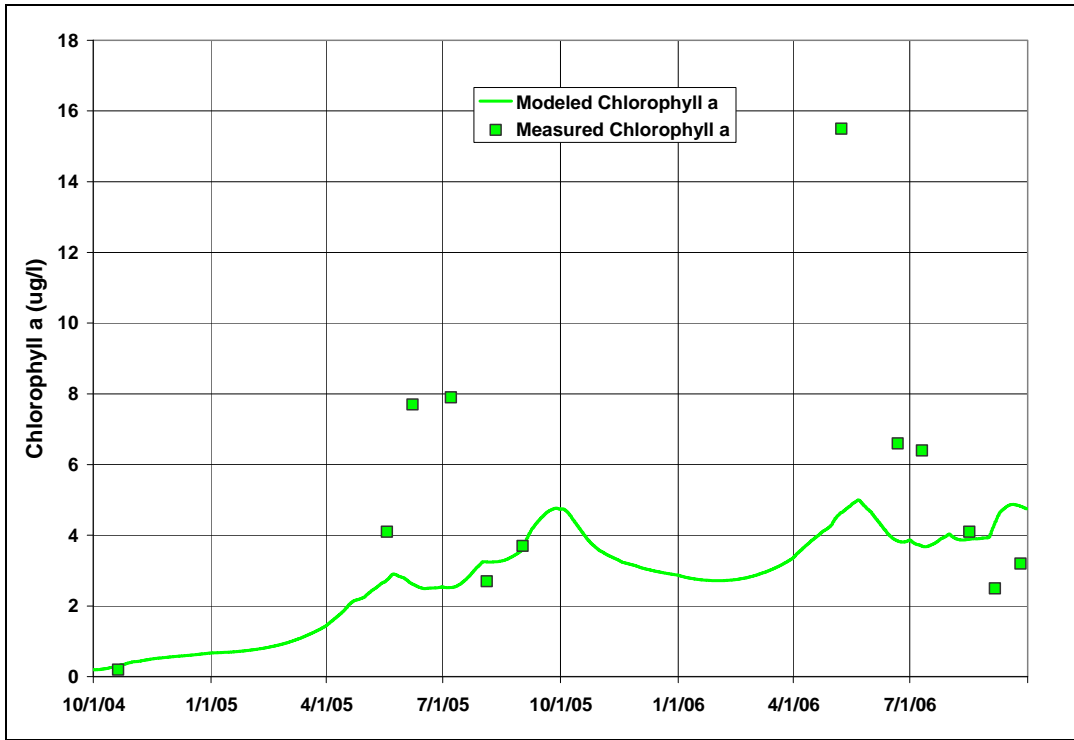

Figure B-21: Simulated versus Measured Chlorophyll a - Granby Reservoir

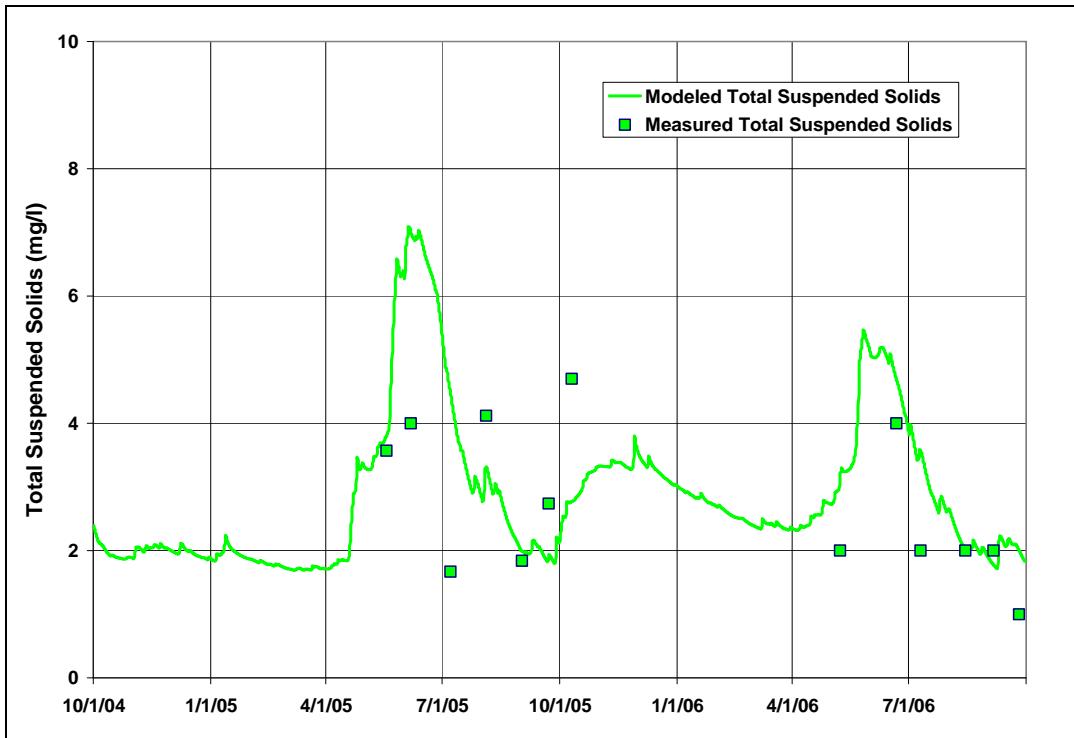

Figure B-22: Simulated versus Measured Epilimnetic Total Suspended Solids - Granby Reservoir

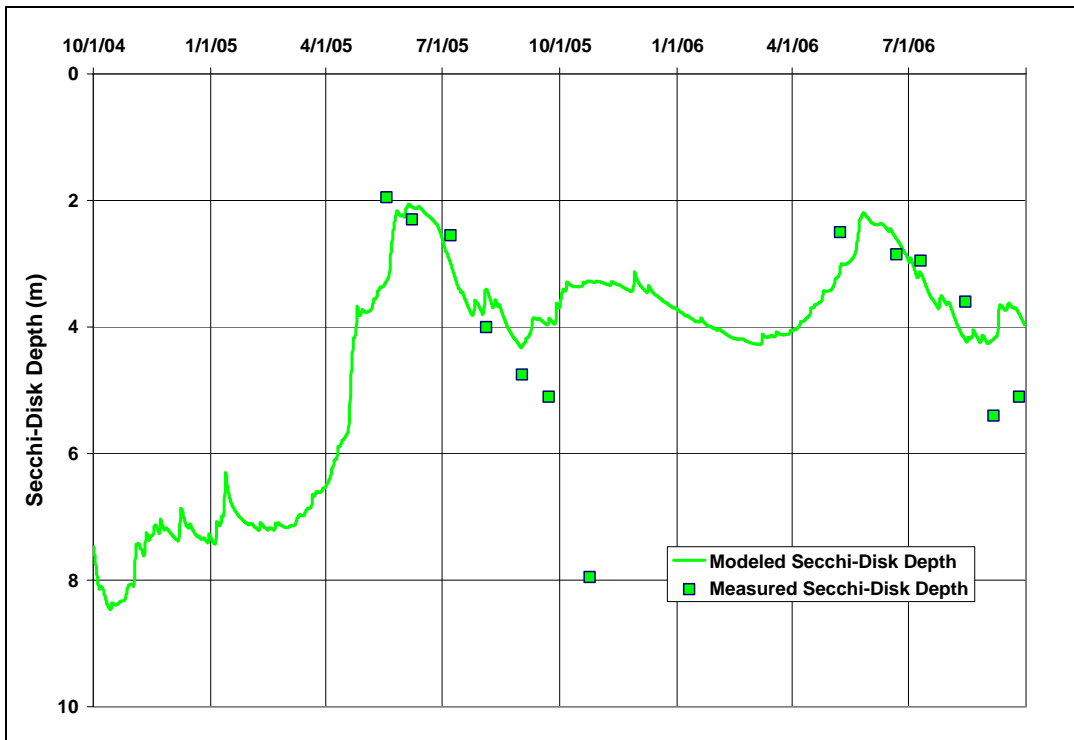

Figure B-23: Simulated versus Measured Secchi-Disk Depth - Granby Reservoir