

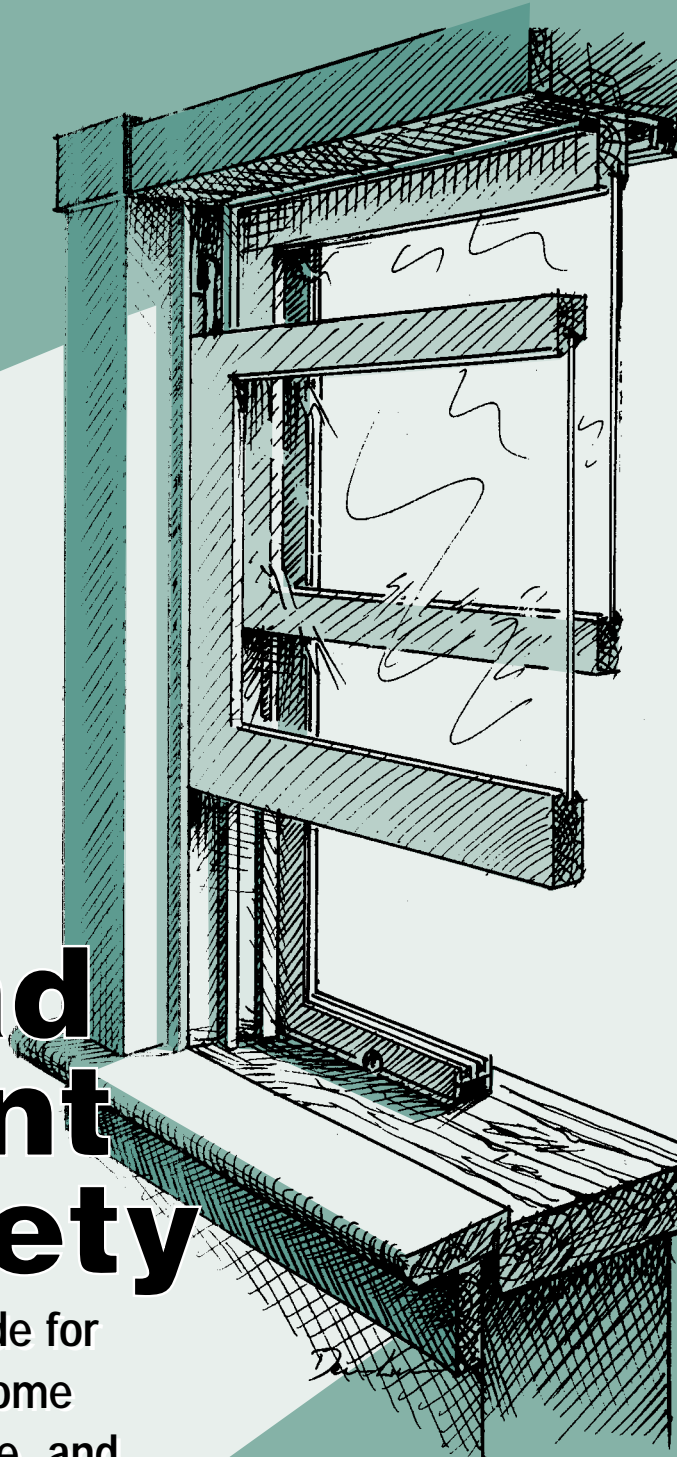

Lead Paint Safety

A Field Guide for
Painting, Home
Maintenance, and
Renovation Work

U.S. Department of Housing
and Urban Development
Office of Healthy Homes and
Lead Hazard Control



Foreword

Every child should have a lead-safe home. That's why HUD is working to create lead-safe affordable housing through outreach and public education, a lead hazard control grant program, worker training, and the enforcement of regulations.

This guide is one part of HUD's comprehensive approach to lead safety in the home. If you perform routine maintenance on homes or apartments built before 1978, this guide will help you plan and carry out your work safely. Step-by-step instructions and illustrations explain and show what you need to do to protect yourself and your clients if you are working in older housing that could contain lead paint. This Field Guide is a valuable tool that thousands of workers and contractors across the country are using as part of a national effort to eliminate childhood lead poisoning.

Thank you for working lead-safe. It's helping protect America's children.

A handwritten signature in black ink that reads "Mel Martinez". The signature is fluid and cursive, with the first letters of the first and last names being capitalized and prominent.

Mel Martinez, Secretary
U.S. Department of Housing and Urban Development

Acknowledgements

The U.S. Department of Housing and Urban Development (HUD) developed this guide with the assistance and input of the Centers for Disease Control and Prevention (CDC), the U.S. Environmental Protection Agency (EPA), and the Occupational Safety and Health Administration (OSHA). HUD would like to thank the staff of these agencies for their participation in developing this Field Guide. HUD would also like to thank all of the renovation, painting, maintenance, and lead professionals who provided useful feedback. Vicki Ainslie, Dana Bres, Robert Brown, Kevin Cleary, Alan Isaac, David Levitt, Linda Lewis, Dennis Livingston, Eric Oetjen, Roy Reveilles, Ron Rupp, Joe Shirmer, Aaron Sussell, Peter Tiernan, David Thompson, Richard Tobin, Ellen Tohn, Veda Watts, and Mike Wilson served on the Technical Panel for this project. A special thanks goes to these individuals for their contributions.

This Guide was developed by the U.S. Department of Housing and Urban Development's Office of Healthy Homes and Lead Hazard Control through a contract with ICF Incorporated. Dennis Livingston created the illustrations and provided technical content for this Field Guide.

WHY SHOULD I FOLLOW THIS GUIDE?

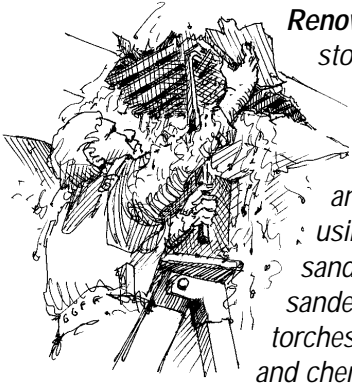

Renovation of a two-story, 19th century house included removing paint from floors and woodwork using power sanders, hand sanders, scrapers, torches, heat guns, and chemical paint strip-

pers. Ceilings were also repaired, and wallpaper and paint were removed from several walls. The family that owned the home temporarily moved out of the house. They returned when the work was only partly completed. There was dust throughout the house.

The family discovered that something was wrong when one of the family's dogs began to have seizures. A veterinarian found that the dog had been lead poisoned. The mother and children had their blood tested, and found that all of them had very high levels of lead in their blood. All three were admitted to the hospital for severe lead poisoning.

A painter was hired to repaint the exterior of an old

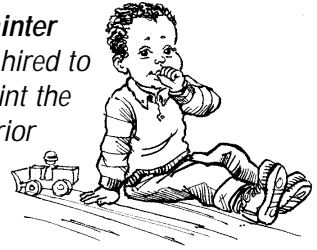

Vermont home occupied by a couple expecting the birth of their first child. The painter used a power grinder to remove the old paint from the exterior siding. While the painter worked, the window to the baby's nursery was left open, and the entire room, including the crib, became covered with dust. Fortunately, the couple noticed the dust, and understood the potential risk. They called in another painter who was qualified to control lead hazards. He cleaned up the paint dust and the newborn baby moved into a clean, safe home.

Most Old Homes Contain Lead-Based Paint

- Most homes built before 1978 contain some lead-based paint. Lead-based paint is more common and was used more extensively in homes built before 1950.

Probability of a House Containing Lead

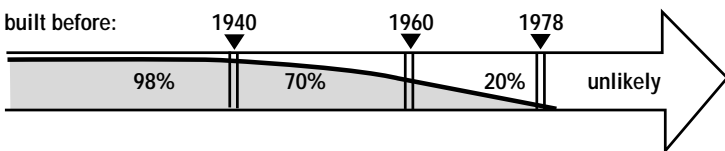

- Homes built before 1950 also used paint that had a higher concentration of lead.

WHY FOLLOW THIS GUIDE?

Poor Maintenance Endangers Children

- In poorly maintained houses, lead-based paint, which may be several layers down, flakes and peels off. Paint failure is usually caused by moisture problems. Sometimes rubbing or impact causes paint failure. Doing work improperly can also cause a lot of dust.
- Lead-based paint chips and dust then mix with house dust and build up in window troughs and on floors.
- Children are endangered when lead in paint chips, dust, and soil gets on their hands and toys which they may put in their mouths.
- Lead can make children very sick and cause permanent brain and nerve damage. It can also result in learning difficulties and behavior problems. This damage is irreversible. It is a tragedy we can prevent.
- If paint is kept intact and surfaces are kept clean, children can live safely in a home painted with lead-based paint.
- Uncontrolled or uncontained dust and debris from repainting and/or renovation that disturbs lead-based paint in a well-maintained home can also expose children to unsafe levels of lead.

Changing Common Work Practices Can Protect Workers and Children

- Lead-based paint can also pose a threat to workers by causing damage to their brains, and nervous and reproductive systems.
- With small changes in work practices, workers can protect themselves and their customers from lead exposure.
- These changes include:
 - Keeping dust to a minimum.
 - Confining dust and paint chips to the work area.
 - Cleaning up during and after work. Special cleanup procedures must always be used.
 - Taking dust wipe samples to make sure cleaning removed lead-contaminated dust. (Dust wipe sampling is described in Section 5D, p. 71.)

Who Should Use This Guide?

- Building maintenance workers and their supervisors
- Painters
- Repair, renovation, and remodeling contractors
- Property managers and owners
- Homeowners
- Local housing agency staff and public health staff

When Should I Follow This Guide?

- To fix a specific problem.
- During routine maintenance or apartment turnover.
- In homes where there may be a young child or a pregnant woman.
- During work supported by Federal funds that must be performed using safe work practices under Federal regulations.

HOW TO USE THIS GUIDE

This guide is divided into 5 sections.

To locate a section, bend the bottom of these pages. Look for the section you want by lining up the boxes at the bottom of each page.

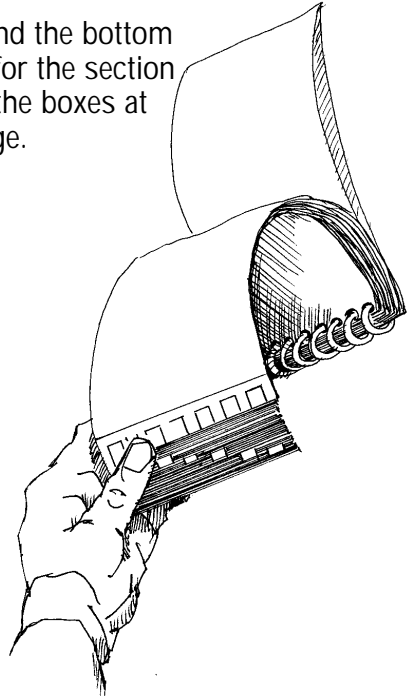

The Basics

Before You Start Work

Doing the Work

At the End of the Job

Resources
(Includes Glossary)

1

2

3

4

5

CONTENTS OF THIS GUIDE

1. The Basics	5
Remember these Principles	5
Routine Work Practices	6
Correcting the Cause of the Problem	7
Restricted Practices	9
Key Stages of a Job	11
2. Before You Start Work	13
Set Up the Work Area - Interior	13
Set Up the Work Area - Exterior	15
Worker Protection	17
3. Doing the Work	19
Painting Jobs	
❑ Interior Surface Prep	19
❑ Exterior Surface Prep	22
❑ Paint Removal	23
Home Maintenance and Renovation Jobs	
❑ Walls/Ceilings	25
❑ Windows	29
❑ Doors	37
❑ Stairs/Floors	41
❑ Trim	43
❑ High Dust Jobs	45
4. At The End of the Job	47
Cleaning Up	47
Disposal of Waste	49
Checking Your Work	51
Ongoing Monitoring & Maintenance	53
5. Resources	55
A. Glossary	55
B. For More Information	57
C. Getting the Word Out	65
❑ <i>How Owners and Occupants Can Work Together to Improve Lead-Safety in Homes</i>	
❑ <i>Notice Prior to Renovation</i>	
❑ <i>Why Lead Safety Makes Sense for Property Owners and Contractors</i>	
D. More About Technical Topics	69
❑ <i>Respiratory Protection</i>	
❑ <i>Testing Dust for Lead</i>	
❑ <i>Setting Up a Dust Room</i>	
❑ <i>Building a Door Hold</i>	
E. Tool and Supply List	75
F. Notes and Special Instructions	77
G. Work Checklist and Disclaimer	Back Cover

REMEMBER THESE PRINCIPLES

- 1. ASSUME:** **Paint in Homes Built Before 1978 Contains Lead**
(Unless a lead-based paint inspection shows it doesn't.)
Exposing Anyone to Dust, Especially Children, is Bad

- 2. CHECK:** **Federal, State, and Local Regulations**
 - OSHA has rules for worker safety
 - EPA and your local community have rules for waste disposal

- 3. AVOID:** **Creating Dust**
 - Use low dust work practices (for example, mist surfaces with water before sanding or scraping)**Spreading Dust**
 - Cover area under work with durable protective sheeting (plastic or poly)
 - Keep dust contained to immediate work area

- 4. PROTECT:** **Occupants, Particularly Children**
 - Keep them away from work area
 - Clean up work site before they return**Workers**
 - Wear proper respiratory protection for lead dust
 - Keep clean
 - Don't take dust home

- 5. CLEAN UP:** **After All Work**
 - Clean up is particularly important if painted surfaces were broken or wall cavities were opened
 - Take dust wipe samples to make sure that it is safe for children to return

- 6. MAINTAIN:** **A Dry Building**
 - Moisture problems can cause paint failure, building deterioration, and encourage pests**All Painted Surfaces**
 - Well-maintained paint generally does not pose a health risk**Clean and Cleanable Surfaces**
 - Keep floors and painted surfaces smooth
 - Damp mop them often
 - Clean rugs and carpet well

ROUTINE WORK PRACTICES

The following pictures appear throughout the Guide and refer to specific sections covering these practices.



Correct the Cause of the Problem. Before work starts, correct the conditions causing damage to the home. See Correcting the Cause of the Problem, p. 7.

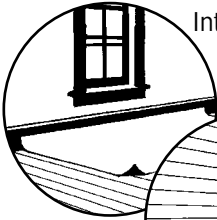

Interior

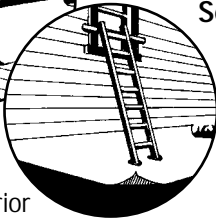

Exterior

Set Up Work Area. Set up the work area properly. See Section 2: Set Up the Work Area - Interior & Exterior, p. 13 and p. 15, respectively.



Clean Up and Clear. Thoroughly clean up the work area using the procedures described in this guide. Then, take dust wipe samples to see if it is safe for children to return. See Section 4: Cleaning Up, p. 47 and Check Your Work, p. 51.

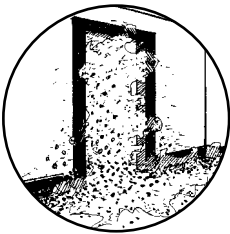

High Dust Jobs. Some activities are likely to create high amounts of dust during the job. See Section 3: High Dust Jobs, p. 45 and follow the guidelines in this section to ensure that this work is performed safely.



Important!! This symbol points out important details where special attention is needed.

CORRECTING THE CAUSE OF THE PROBLEM

If a job involves repairs to a damaged paint surface, it is important to correct the cause of the damage, or the damage will occur again. Damaged surfaces that contain lead-based paint represent a health threat to the occupants.



The following conditions are examples of potential causes of damage to painted surfaces. Be sure that the planned work will correct these conditions if they are present.

Moisture From Outside

Roof leaks; incorrectly installed flashing; defective downspouts and gutters; water collecting in window troughs; puddles of water at foundations; leaking basement walls; wet crawl spaces.

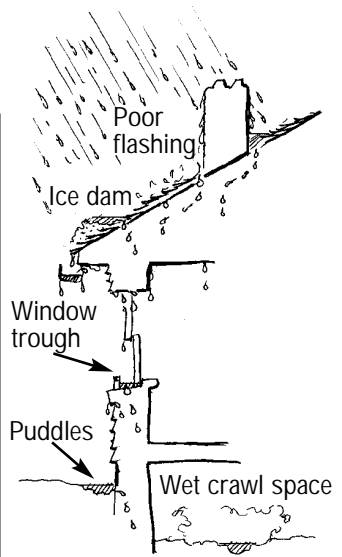

Moisture From Inside

Attic condensation due to poor ventilation; unvented steam from showers and cooking; leaking plumbing and failed seals around tubs and toilets; condensation in walls; unvented dryers; wet and poorly maintained basements.

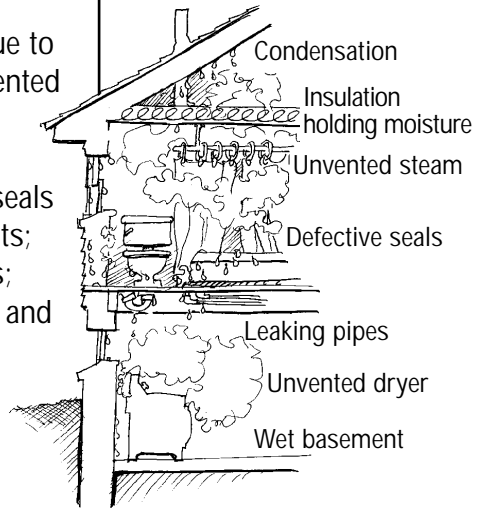

Rubbing and Impact of Painted Surfaces

Binding doors; unprotected painted walls and trim; and rubbing from opening and closing painted windows.

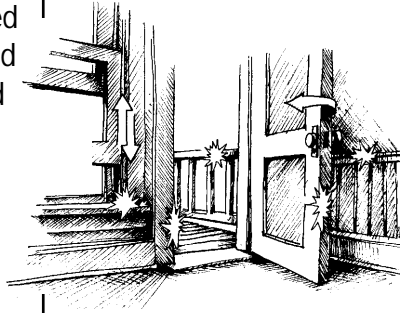

Places that Collect Dust and Paint Chips

Where feasible, repair or remove places where dust and paint chips may accumulate and can't be easily cleaned (such as old wall-to-wall carpet and unused items stored in the basement).

If these places are damp, they may also be home to mold.

Keep flat surfaces (such as window stools or interior sills and troughs)

clean and cleanable.

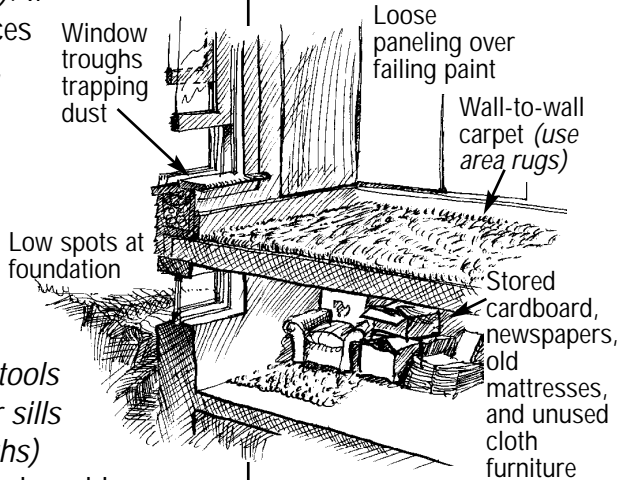

Structural Damage

Some surface damage may be caused by structural damage such as wood rot, termites, foundation settlement, and foundation shift. These problems must be addressed before surface repairs are made.

RESTRICTED PRACTICES

Goal: Don't use unsafe work methods. Some work methods create such high levels of dust that they must not be used when working on surfaces that may contain lead-based paint.



Don't Use Power Sanders or Grinders Without HEPA Vacuum Attachment.

These machines create a lot of dust that can contaminate a building and the ground around a building endangering workers, neighbors, and occupants.

Controlled Sanding or Grinding With HEPA Vacuum Attachment Is Acceptable.

If the sanding or grinding machines are "shrouded," which means surrounded with a barrier that prevents dust from flying out around the perimeter, AND attached to a HEPA vacuum, they can be used. Because some dust may still blow out around the perimeter, workers near the machine should wear half-mask respirators rated by NIOSH as N100 (or HEPA) at a minimum. Also, the work area must be completely isolated if the machine is used inside (see Section 3: [High Dust Jobs](#), p.45). Because these tools can create high levels of dust and require additional precautions, their use is beyond the scope of this guide.

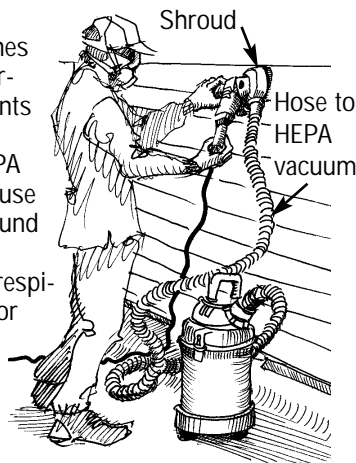

Don't Use Open Flame/High Heat Removal of Paint.

There is no acceptable use of an open flame torch or high temperature heat gun (above 1100 degrees F) to remove paint.

- It produces toxic gases that a HEPA dust canister on a respirator cannot filter out on its own (a second, organic filter is necessary).
- It creates high levels of very toxic dust that is extremely difficult to clean up.
- It can burn down a house.

Do Use a Heat Gun on Low Setting.

A heatgun set below 1100 degrees F may be used with caution. It is recommended for small areas only, such as the edge of a door, the top of a window stool, or the friction surface of a window jamb.



Don't Use Paint Strippers Containing Methylene Chloride.

Many paint strippers are potentially dangerous. Strippers containing methylene chloride should not be used because this chemical is extremely toxic and is known to cause cancer.

Other Chemical Strippers with Appropriate Precautions Are Acceptable.

Chemical strippers without methylene chloride are safer to use, as long as the precautions printed on the container are followed. Take extra precautions to mask areas near stripping.



Don't Use Uncontained Hydroblasting.

Removal of paint using this method can spread paint chips, dust, and debris beyond the work area. This result makes it difficult to clean up these hazards at the end of the job.

Contained Pressure Washing Is Acceptable.

Removal of paint using contained pressure washing within a protective enclosure to prevent the spread of paint chips, dust, and debris may be done. Because this method requires additional precautions that are beyond the scope of this guide, it should only be used by certified lead abatement workers.



Don't Use Uncontrolled Abrasive Blasting.

This work method can also spread paint chips, dust, and debris beyond the work area. This result makes it difficult to clean up these hazards at the end of the job.

Contained Blasting Is Acceptable.

Contained abrasive blasting within a protective, locally exhausted enclosure to prevent the spread of paint chips, dust, and debris may be used. Because this method requires additional precautions that are beyond the scope of this guide, it should only be used by certified lead abatement workers.



Avoid Extensive Dry Scraping or Sanding.

Extensive dry scraping or sanding create large amounts of paint chips, dust, and debris that are hard to contain.

Use Wet Methods or Limited Dry Scraping and Sanding.

Mist surfaces before scraping and sanding. Continue to mist while working. Dry scraping or sanding of very small areas (for example, around light switches or outlets) may be done if flat surfaces below these areas are covered with protective sheeting. These methods should be avoided on areas larger than 2 square feet per room, and workers must have adequate respiratory protection.

KEY STAGES OF A JOB

Quality work requires thinking through the job from start to finish. Here are the basic stages of the jobs described in this guide.

Before Starting	<ul style="list-style-type: none">• Find the causes of damage• Prioritize work• Hand out lead hazard information pamphlet (see note below)
Work	<ul style="list-style-type: none">• Set up work area<ul style="list-style-type: none">— Separate work space from occupied space— Isolate high dust areas• Correct cause(s) of problem(s)• Complete the job using safe work practices, such as those shown in this guide
Finish the Job	<ul style="list-style-type: none">• Clean up thoroughly• Dispose of waste safely• Check quality of work and correct problems
Maintain the Work	<ul style="list-style-type: none">• Educate occupants about risks from lead-based paint• Maintain a safe and healthy home

Renovation Notice About Lead Safety

Note: Federal law requires that owners and occupants of a house or apartment built before 1978 receive the pamphlet *Protect Your Family From Lead In Your Home* prior to the start of renovation work. The requirement applies to any work that will disturb a painted surface larger than 2 square feet when the work is done by:

- Contractors who have been hired to do any kind of work. Among others, this can apply to painting, drywall, and electrical trades.
- Owners of rental properties who have work performed by maintenance staff.

See p. 67 for more information about this requirement.

SET UP THE WORK AREA — INTERIOR

Restrict Access

- Ask occupants to leave the room where work will be done.
- Have them stay out until final cleanup.
- Place “DO NOT ENTER” tape across doorway or post sign.



Caution: If the work will create a large amount of dust, follow the guidelines in Section 3: High Dust Jobs, p. 45.

Protect Floor

- Place protective sheeting on floor extending about 5 feet from the work area.
- Tape protective sheeting to the baseboard under work area using masking tape (or durable tape where masking tape doesn't work).

Protect Furnishings

- Remove drapes, curtains, furniture, and rugs within 5 feet of work area.
- Cover any furniture within 5 feet of work area that cannot be moved.

Stock the Work Area

- Put all necessary tools and supplies on protective sheeting before beginning work to avoid stepping off the protective sheeting.

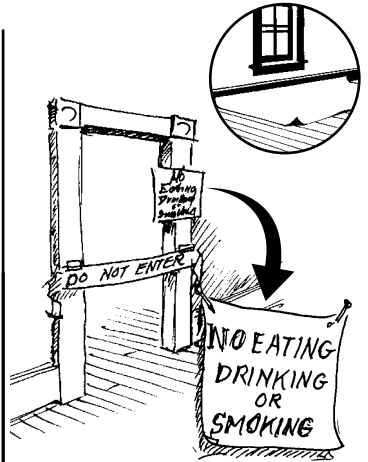

Use protective sheeting, such as poly

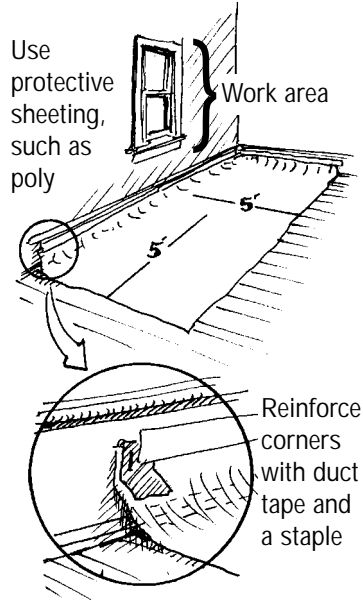

Reinforce corners with duct tape and a staple



BEFORE YOU START WORK

Tracking

- To avoid tracking dust off the protective sheeting, wear non-skid shoe covers on protective sheeting and remove them each time you step off the protective sheeting.

OR

- Wipe both top and bottom of shoes with a damp paper towel each time you step off the protective sheeting.

OR

- Clean off shoes using a tack pad (a large sticky pad that helps remove dust).

OR

- Remove shoes every time you step off the protective sheeting.



Shoe cover

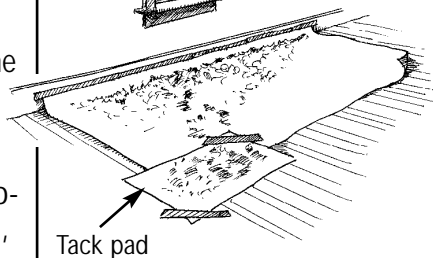
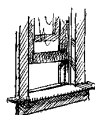
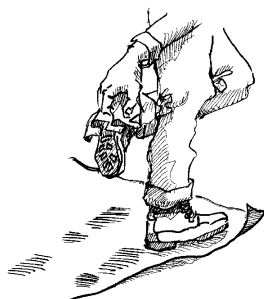

Set Up Dust Room (Optional)

- When working on components that can be moved, such as doors and window sashes, consider setting up a dust room. A dust room is an area isolated from occupied areas where workers can do dust generating work. The door of the room is covered with a flap and the floor is covered with protective sheeting. See Section 5D: [Setting Up a Dust Room](#), p. 73.

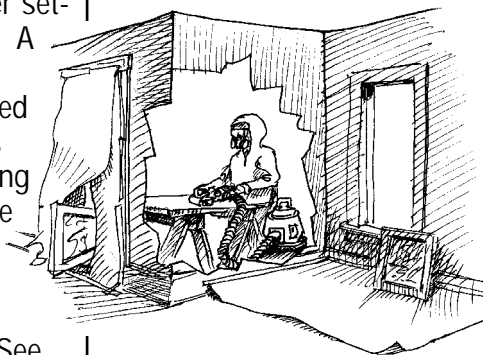

- Using a dust room contains dust and paint chips, and makes cleanup easier. It also helps protect occupants, as well as other workers.

SET UP THE WORK AREA — EXTERIOR

Protect Ground

- When working on the ground floor, lay protective sheeting 10 feet from work surface or as space permits. When working on the 2nd story or above, extend the sheeting farther out.
- Vertical shrouding on scaffolding should be used if work is close to a sidewalk, street, or another property, or the building is more than three stories high.

Important: Covering the ground protects the soil from contamination by lead-based paint chips and dust.



Attach Protective Sheeting to Wall

- Protective sheeting can be taped and/or stapled to wood siding or ribbon board. A wood strip may need to be attached to a masonry wall.

Build Curb

- Build a curb around work perimeter when a sidewalk or another property is near, or when wind may blow debris off protective sheeting.

Caution: This may pose a tripping hazard.

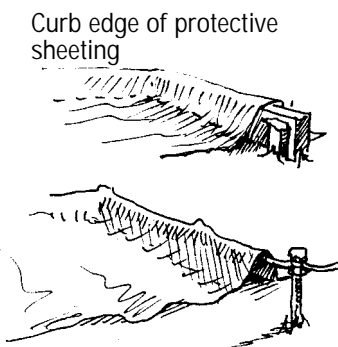
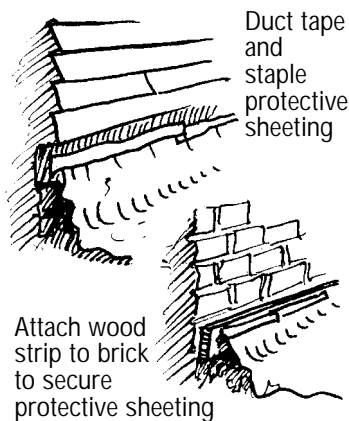
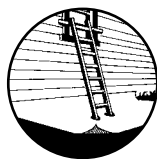

BEFORE YOU START WORK

Cover Windows and Doors

- All windows and doors within 20 feet of the work area must be closed. If they cannot be closed, seal with protective sheeting during work.
- If an entrance must be used that is closer than 20 feet, place a shroud above and on the sides of the entrance.

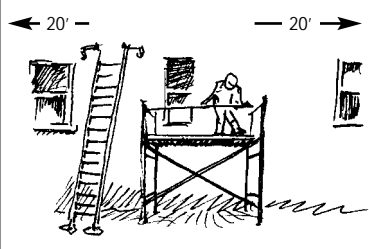

Use Ladder Safely

- Don't use a metal ladder near power lines.
- Check feet and rungs of ladder to make sure they are sound.
- Place the base of the ladder at a distance from the wall using a height to base ratio of 4:1.
- Ladder should extend 3 feet past the top of the surface area where work will be done.
- If using protective sheeting to cover the ground, cut slots in the sheeting and place the ladder feet directly on the ground—not on top of the protective sheeting.
- Tie off the top of the ladder, where possible.
- If the work is taking place at heights above 10 feet, tie off the ladder and secure yourself with a lanyard and harness.

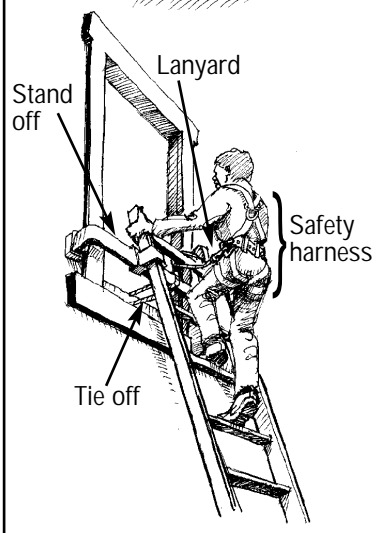
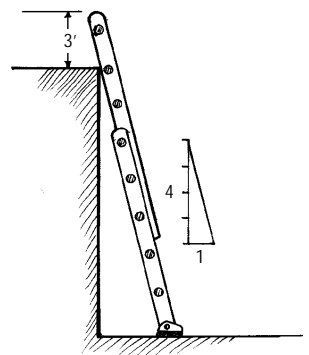
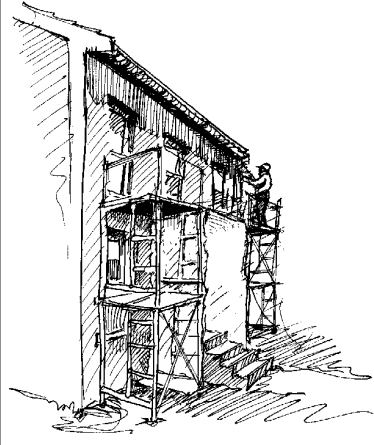

WORKER PROTECTION

Protect Your Eyes

- Always wear safety goggles or safety glasses when scraping, hammering, etc.

Keep Clothes Clean

- At end of work period, remove dusty clothes and/or vacuum off dust. Wash them separately. Do not use compressed air to blow dust off clothing.

OR

Use Disposable Covers

- Wear disposable protective clothing covers. Disposable protective clothing covers can be stored in a plastic bag and reused if fairly clean and there are no rips. Small tears can be repaired with duct tape.
- Wear painter's hat to protect head from dust and debris.

Wear Respiratory Protection

- When work creates dust or paint chips, workers should wear at least a NIOSH-approved respirator for lead work. See Section 5D: Respiratory Protection, p. 69.

Post Warning

- Post sign and avoid eating, drinking, or smoking on site.

Wash Up

- Wash hands and face each time you stop working.

Disposable suit & shoe covers

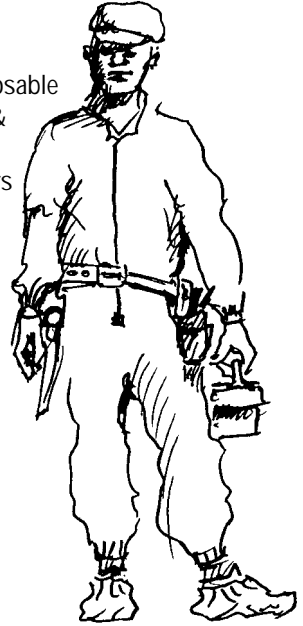

Sign at work site entrance

BEFORE YOU START WORK

INTERIOR SURFACE PREP

PROBLEM

A wall or ceiling is sound, but has holes, uneven surfaces, or flaking and peeling paint.

SOLUTION

Prepare wall or ceiling to create a sound, intact surface for painting. Use methods that create a minimum amount of dust.

Set Up

- See Section 2, p. 13.

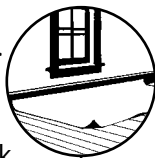

Remove Deteriorated Paint

- Wet scrape any loose, peeling, or flaking paint.



Fill and Patch Holes

- If removal of damaged edges is necessary, mist surface before removal.
- Skim and fill holes and cracks less than 1/16 inch wide with a non-shrinking spackle compound.
- If sanding is necessary to feather edge, use wet abrasive sponge or wet-dry sandpaper with water.



Prep Surface

- Clean wall, particularly in kitchen area.
- De-gloss surfaces as necessary (use liquid sandpaper or wet-dry sandpaper with water).



Important: Allow surface to thoroughly dry before priming.

- Prime surface using high-grade primer.
- Apply top coat. Use one or two coats as necessary.



Clean Up and Clear

- See Section 4, p. 47.

INTERIOR SURFACE PREP CONT'D

PROBLEM A wall or ceiling has cracking, peeling, or alligating paint, but most of the surface is sound.

SOLUTION Use a coating designed for longer durability than paint. Some of these coating systems include mesh.

Set Up

- See Section 2, p. 13.

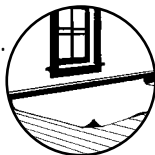

Liquid Coating

Test Surface

- Where a long-lasting system (sometimes called encapsulant) is to be brushed, sprayed, or rolled, surface preparation is very important.
- If an encapsulant is used, use one that is approved by a state government. If your state does not have a list of approved encapsulants, it is recommended that you check with a state that does. Contact the National Lead Information Center at 1-800-424-LEAD for the telephone numbers of states with lists.
- A sample area should be tested before application. Follow manufacturer's instructions exactly.

Apply System Base Coat

- Apply system base coat with a high nap (approximately 3/4 inch) roller. Follow the product instructions.

Mesh System

Apply Mesh

- Where there is extensive cracking or alligating, consider using a system that includes mesh because it can add strength and durability.
- Cut the mesh leaving a 2 inch overlap at ceiling and baseboard.
- Install so that mesh is plumb.

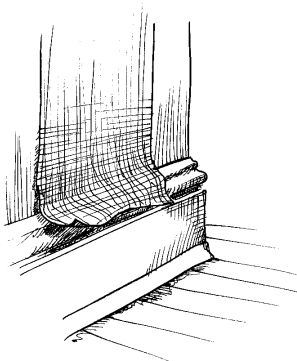
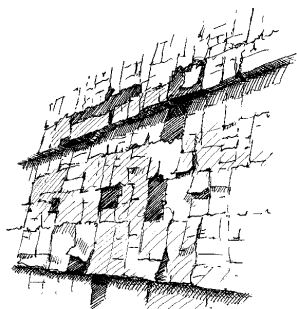

Important: For mesh systems, follow manufacturer's instructions exactly.

Apply Mesh Cont'd

- Press mesh into the base coat with a wall-paper brush, spackle knife, or roller.
- Overlap seams by 1 inch. Cut down the center of the seam and remove the 2 waste strips. Let seams butt against each other.
- Using a spackle knife, press the mesh at the bottom and top. Then cut off the excess.
- Roll on the top coat. Make sure that there is complete and even coverage.
- If there is a risk of further peeling, the top edge of mesh can be reinforced with cove or crown molding, and the bottom reinforced with base cap.

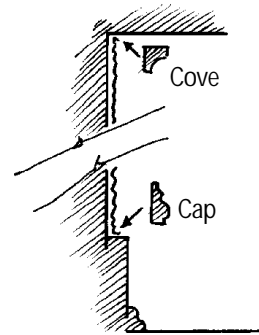
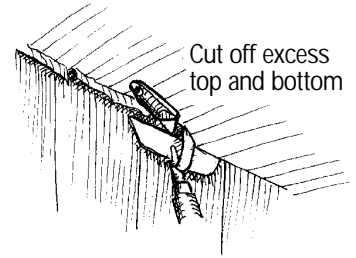
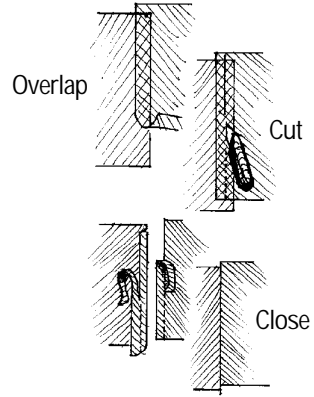

Clean Up and Clear

- See Section 4, p. 47.

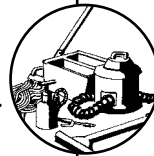

EXTERIOR SURFACE PREP

PROBLEM Exterior wood surface is chipping and peeling and may be painted with lead-based paint.

SOLUTION Prepare a sound, intact surface for painting. Use methods that create minimal dust.

Set Up

- See Section 2, p. 15.

**Clean Surface**

- Clean wood with detergent (or lead-specific cleaner) and scrub brush.

Wet Scrape

- Wet scrape woodwork and siding. Mist small areas frequently to keep down dust. Using a pump sprayer in a knapsack is convenient.

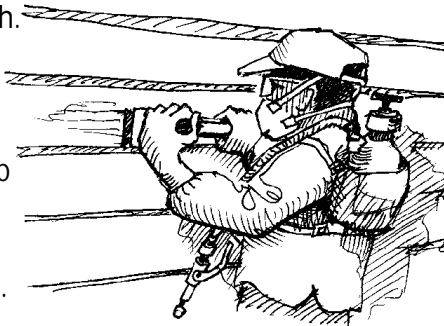
**Mist and Sand**

- Wet sand using wet-dry sandpaper or wet sanding sponges. A power sander may be used if attached to a HEPA vacuum, and the worker is wearing respiratory protection.

Paint

- Prime and paint.

Clean Up and Clear

- See Section 4, p. 47.

**Dispose of Water**

- If you dislodge paint using pressure washing, water must be collected and may need to be tested (see local regulations for water disposal procedures in your area).

P A I N T R E M O V A L

PROBLEM Areas of paint are peeling or flaking or there is evidence that a child has been chewing on a painted surface. An example of a surface accessible to children is the inside nose of a window stool (inside sill).

SOLUTION Remove all paint using methods that do minimum harm to the surface, create minimal dust, and are safe for workers.

Set Up

- See Section 2, p. 13 or p. 15.
- When using chemical strippers, the edge of the protective covering below the painted surface must be tightly fastened to the wall so that the stripper doesn't damage other surfaces.

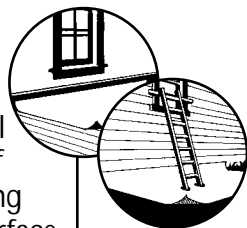

- Recommendations:
 - Use a second layer of protective sheeting to collect stripping waste. The first layer remains in place to protect surfaces below.
 - For removable components, consider having paint stripped off-site or installing an entirely new component.

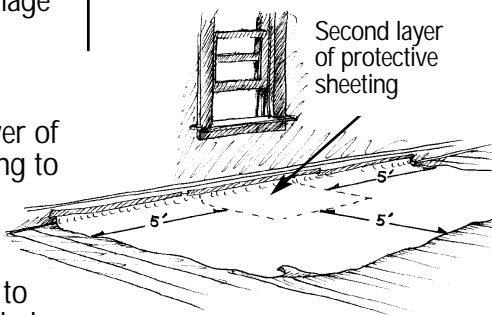

Chemical Removal

- If a large area of paint is to be stripped, consider hiring a professional.
- Follow the manufacturer's instructions carefully when using chemical paint strippers.



Caution: If using a caustic stripper, neutralize the surface according to the manufacturer's directions before applying new paint.

Chemical Removal Cont'd

- After stripping paint from wood, a paint residue will remain in the wood. Use caution when sanding the bare wood because it may contain lead residue.

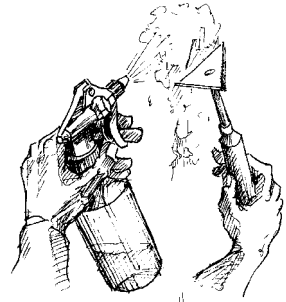

Hand Stripping

- Paint can also be removed with a paint scraper. Be sure to mist areas where paint is to be removed. Using a hand plane removes all paint and all residue. It also creates very little dust.

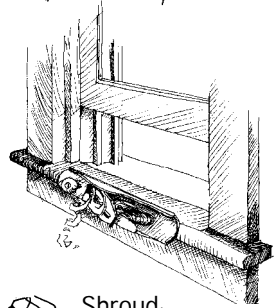

Mechanical Stripping

- When using power tools, such as sanders or grinders to remove or feather paint, make sure the tool is shrouded and attached to a HEPA vacuum. Respiratory protection is still necessary.

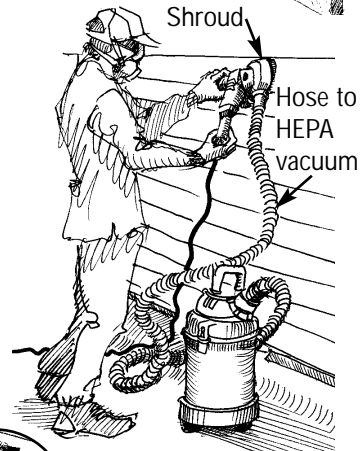

Caution: High dust potential.



Heat Stripping

- When using a heat gun to remove paint, be sure the temperature setting is kept below 1100 degrees F.

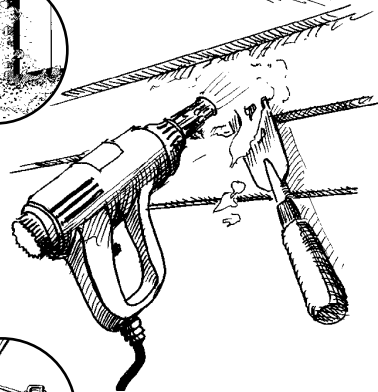

Clean Up and Clear

- See Section 4, p. 47.

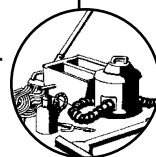

DAMAGED INTERIOR WALL OR CEILING

PROBLEM Wall or ceiling area is too badly damaged to repair, and demolition would create a large amount of dust.

SOLUTION Install a new durable surface over the damaged area using methods that create little dust and do not require demolition.

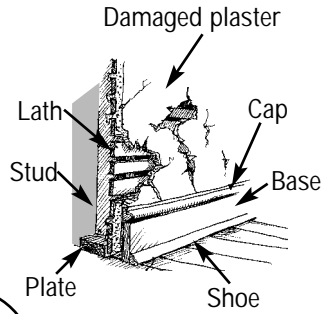

Set Up

- See Section 2, p. 13.

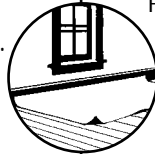

Cover With Drywall

- Mechanically fasten drywall or veneer board through damaged plaster to studs.
- Seal the perimeter, particularly the bottom edge.

Drywall laminate sits on old base

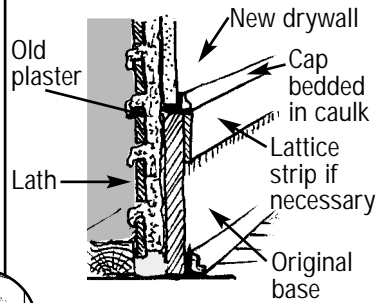

—On Base

- Avoid removing existing base.



Caution: High dust potential.



- Where drywall laminate will end above existing base, install shoe or cove molding into bead of caulk to seal.
- If laminate comes close to flush with base face, a strip of lattice bedded in caulk can be used to seal joint.

New base over drywall laminate

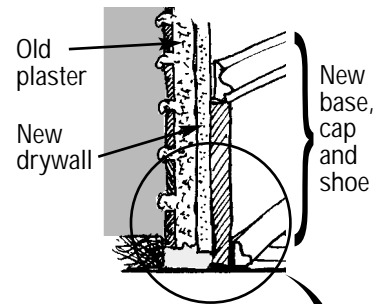

—Behind Base

- Where base will be replaced, bed the new base in bead of caulk on the back and bottom. Then, bed shoe molding in a bead of caulk to seal.

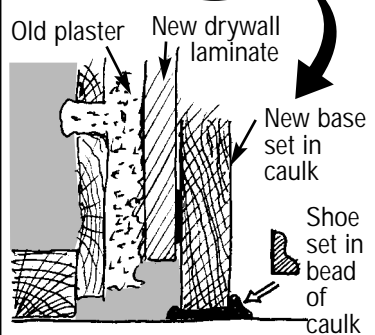

DOING THE WORK

Install Wainscoting

- Where bottom 3 or 4 feet of wall is damaged beyond repair, the wall can be enclosed with wainscoting. The wainscoting can be installed above the existing baseboard.
- Bed the lower edge in a bead of caulk with a trim piece also bedded in caulk.
- Finish top with cap molding.

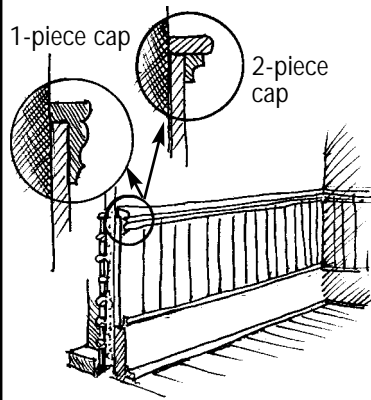

Repair Holes in Ceilings

- When laminating drywall to ceilings, it is critical to screw into joists, not lath.
- Old joists may be irregularly spaced, so each joist center must be located.
- A drywall dagger can be used to find the joist edge, as can a heavy gauge wire pushed through the plaster.
- The drywall edges should be taped and spackled.
- If walls will not be spackled, perimeter edges can be finished with "J" channel bedded in a bead of caulk.

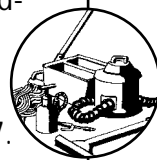
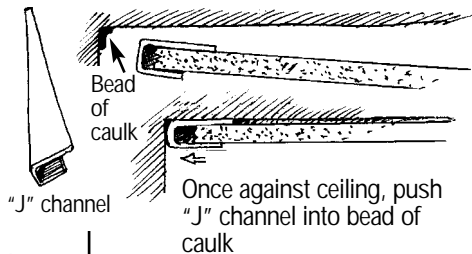
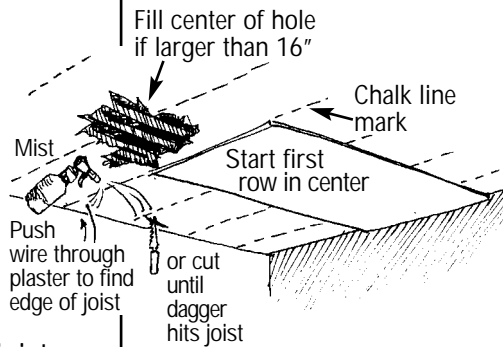

- See Section 4, p. 47.

Clean Up and Clear

DETERIORATED EXTERIOR SURFACES

PROBLEM An exterior painted surface is badly damaged.

SOLUTION Whenever possible, repair the surface, prep, prime, and paint exterior trim and siding, and then maintain the surface. This method is the preferred approach.

When a surface is too badly damaged to repair, install vinyl or aluminum siding, or aluminum wrap to create a safe, durable covering that protects the surface and does not cause further deterioration.

Note: Siding must be installed correctly or it may lead to wood rot and/or interior paint failure. Siding may also become home to insects and mold. Correct installation is critical in both hot and cold climates.

Cover Deteriorated Surface With Siding

Set Up

- See Section 2, p. 15.



Install Siding

- Carefully follow the manufacturer's instructions for installing siding over an existing surface.
- Use a styrene backboard with an R-value of at least R2.
- Take care to properly install flashing, especially at horizontal trim and window and door heads.
- The siding system must be well vented but sealed at the bottom to prevent flaking and peeling paint from falling from behind the siding to the ground.
- Be sure that water can drain out.

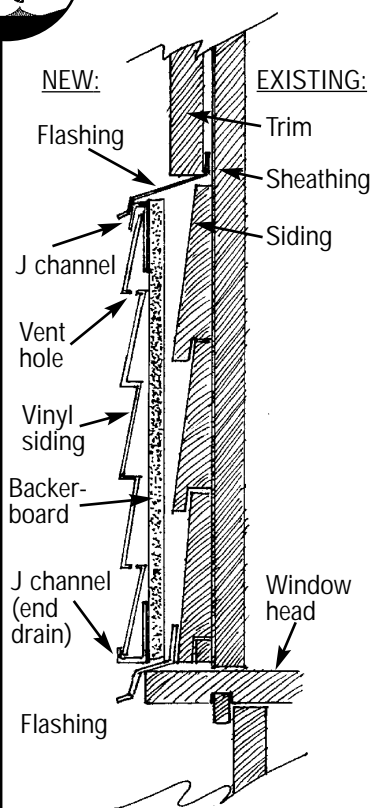

DOING THE WORK



***Important:** The entire home should be well ventilated to prevent moisture build-up that can cause structural damage and/or paint failure.*

Clean Up and Clear

- See Section 4, p. 47.



STICKING WINDOW

PROBLEM Window sticks, and paint on window is flaking.

SOLUTION Remove window, scrape or plane, repaint, and reinstall, OR install a new window.

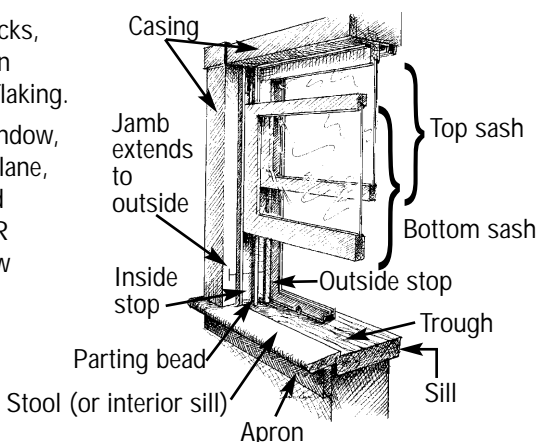

Set Up

- See Section 2, p. 13.

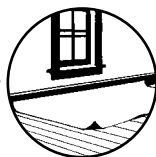

Loosen Painted Sashes

- If window is painted shut, mist and cut window joint with utility knife. Then open joint between sash and stop with a "window opener." Mist while working.

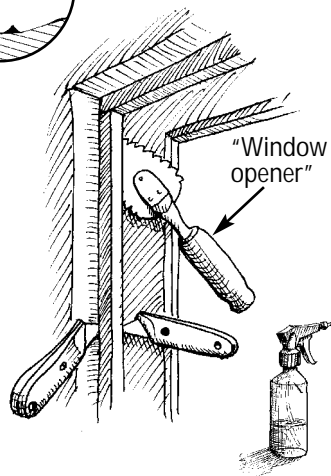

Remove Inside Stop Molding

- Mist and remove stop molding from sides and head. Dispose of properly unless it has historic value.

Remove Bottom Sash

- If counterweight cord or chain is attached to the sash, knot it or tie it to a stick when removing from sash so it does not get pulled into the weight compartment.



Remove Top Sash

- Mist and remove parting bead. Then remove the top sash.

Wet Scrape or Plane

- Set sash on a work bench, clamp, and wet scrape all surfaces. Or use a power planer attached to a HEPA vacuum.

Wet scrape these ridges of paint

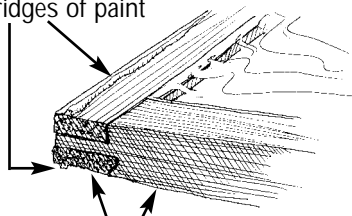

Seal this bottom edge very well, particularly the end grain. Use linseed oil or other sealant.



Caution: High dust potential. This work can be done in a dust room. See Section 5D: Setting Up a Dust Room, p. 73.

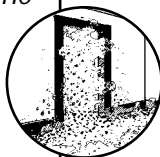

Repair, Reglaze, Seal, and Paint

- Reglaze and repair as necessary. Wet sand, prime, and paint sash and jamb. Seal, but do not paint sash edges.



Important: Seal bottom edge of sash, particularly end grain.

Repair and Paint Jamb

- Repair jamb if necessary.
- To prevent dust and chips from falling outside the window, install a scoop of protective sheeting.
- Then wet scrape, prime, and paint.

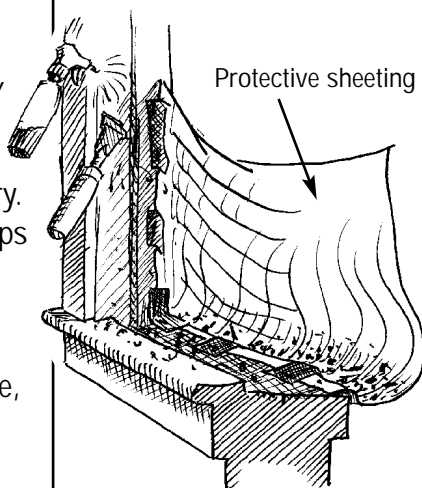

Reinstall Sash

- Reinstall sash with new or wet scraped and repainted stop and parting bead.

Clean Up and Clear

- See Section 4, p. 47.



L O O S E W I N D O W

PROBLEM Loose sashes (lower and upper) do not operate smoothly, and they allow heat loss. Also, sashes rubbing against a painted jamb create paint dust.

SOLUTION Install sashes in window compression jamb liner to seal window and allow sashes to move easily without rubbing against jamb. If sashes or window components are badly deteriorated, replace window.

Set Up

- See Section 2, p. 13.

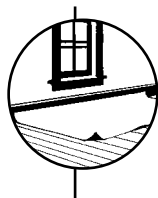

Install Window Jamb Liners

Remove Sashes and Paint

- Follow directions on pages 29 and 30.

Cut Jamb Liners

- Cut liners to fit in jamb (1/4 inch short of dimension). If pulley system is being saved, cut off directly below pulley.

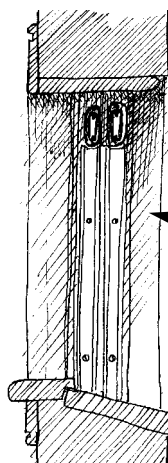

Install Jamb Liners

- Press jamb liners onto sash.
- Attach jamb liners with brass screws on top and bottom of each side.

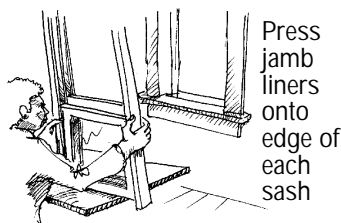

Slide sashes and liners into jamb and put two brass screws into each side

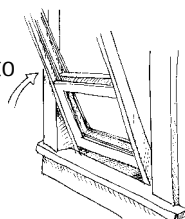

Install Stop Molding

- Install new inside stop molding tight against jamb liner.

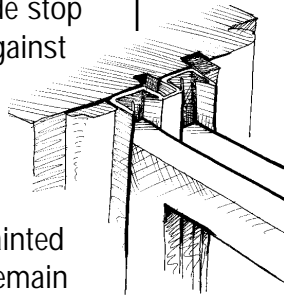

- If top sash is painted shut and is to remain fixed, adjust the above steps as follows:
 - Cut away flange between channels of jamb liner.
 - Leave parting bead intact and install bottom sash as above.

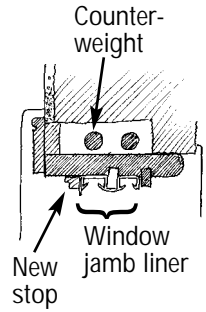

Cut flange of jamb liner with plexiglass cutter.

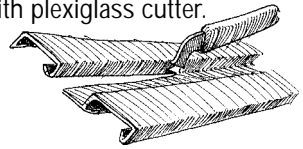

Replace Sash/Window

Choose an Option

- If the sashes or other components are too badly deteriorated to save, consider one of the following options:
 - Install new sashes in tilt-in jamb liners.
 - Replace sashes, stops, and parting bead with a vinyl or aluminum window unit.
 - Replace entire window including jamb casing, stool, and apron.

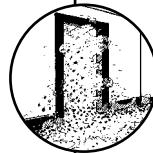

Clean Up and Clear

- See Section 4, p. 47.

WINDOW WON'T STAY OPEN

PROBLEM Window sash is loose and won't stay up without support. Propping the window open presents a danger to occupants, particularly children. When a window jamb liner is used, it may not be sufficient to keep the window open. (See page 31.)



SOLUTION Repair counterweight system or install hardware so the window will stay open securely, or replace window.

Set Up

- See Section 2, p. 13.

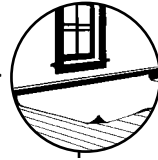

Option #1: Reinstall Counterweight System

Open Counterweight Panel

- Find top of panel. Mist and scrape paint from top edge to find screw or nail holding in panel. Remove screw and pry off panel.

Vacuum

- Vacuum weight compartment with HEPA vacuum.

Remove Counterweight System

- Remove old rope or chain from counterweight and edge of sash.

Reinstall Counterweight System

- Cut chain so weight is above bottom of weight compartment when open and weight is below pulley when closed.

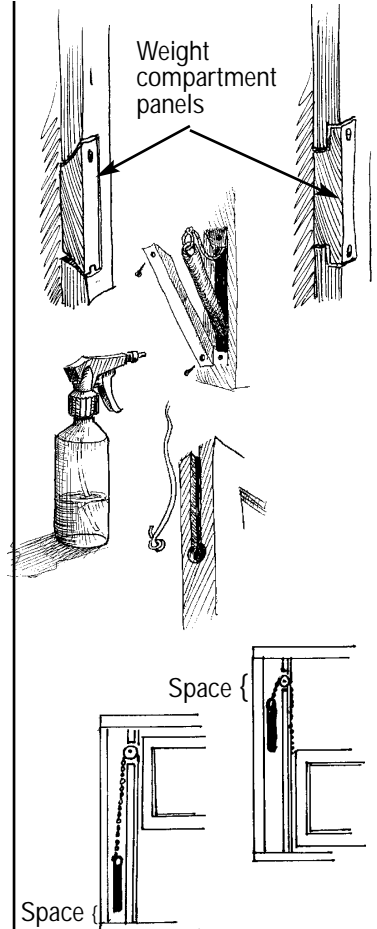

Reinstall Counter Weight System Cont'd

- Drop chain over pulley into weight compartment, pull out through panel opening, and attach to weight.
- Attach other end to edge of window sash using spring fixture. You may want to secure chain with fence staple.

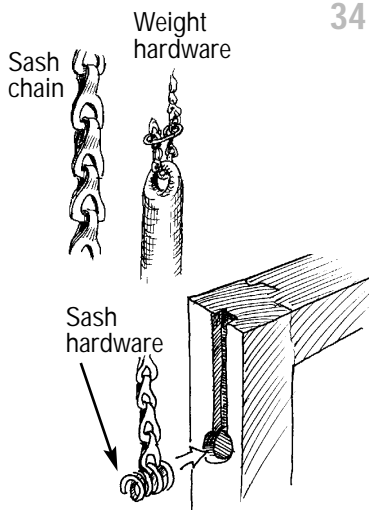

Option #2: Install Spring Clips

Install Spring Clips

- Screw spring clips on to window as directions indicate. (2 styles shown.)

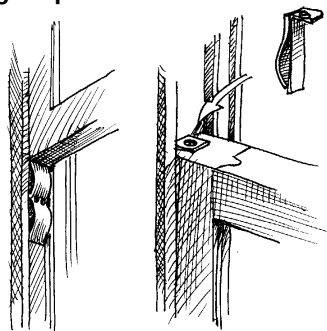

Option #3: Install "Hold Open" Hardware

Install Slide Bolt

- Screw slide bolt to bottom of window sash. Tap bolt to mark where you want to drill holes for bolt. Drill holes in inside stop at 3 or 4 points.

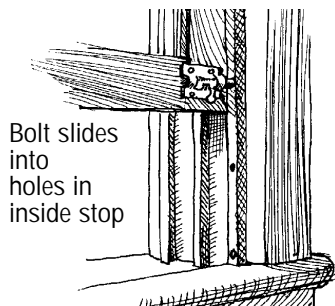

OR

Attach Hardware

- Attach hardware that uses spring to press against stop. To move sash, press lever. Release lever when window is at desired height.



Clean Up and Clear

- See Section 4, p. 47.



DETERIORATED WINDOW TROUGH

PROBLEM Storm window traps water behind the frame causing paint deterioration and damage to the sill.

SOLUTION Drill a drain hole through bottom of the storm window frame.

PROBLEM Window trough surface is damaged and difficult to clean.

SOLUTION Install smooth and cleanable surface in window trough.

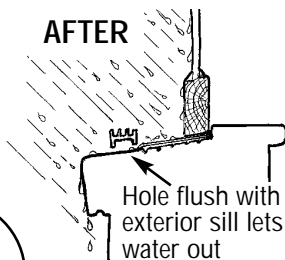
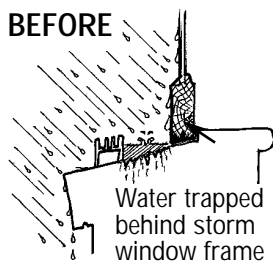

Set Up

- See Section 2, p. 13.

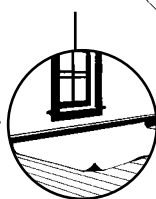

Drill Drain Hole

Drill

- To allow drainage, drill 2 holes through frame of storm window flush with sill. Drill holes approximately one quarter of the way from both sides. First, drill a 1/8 inch pilot hole, then the 3/8 inch hole.

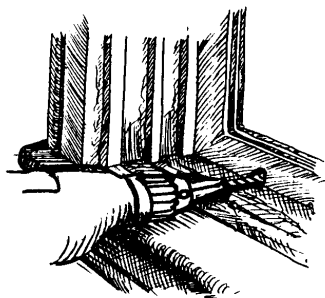

Dent

- If flashing is installed in window trough and covers any part of the drain hole, run awl through drain hole. Tap with hammer to form dent in flashing to drain out water.

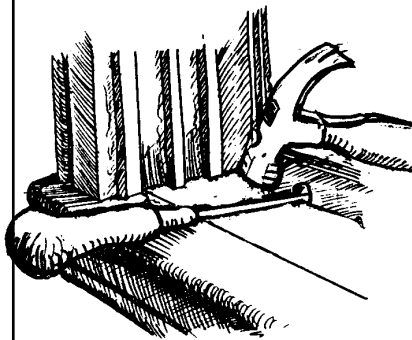

Cover Trough with Flashing

Wet Scrape

- To make surface flat, wet scrape high points and remove any fasteners from trough.



Cut

- Cut flashing 1/4 inch shorter than the width and length of trough.

Chisel or Notch

- To allow flashing to fit tight to jamb, drive chisel under parting bead and outside stop — or notch each side of the flashing at these two points.

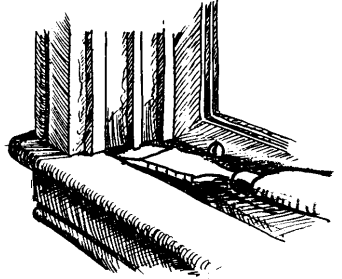

Check Fit

- Then slide flashing in to check fit. Remove and trim if needed.

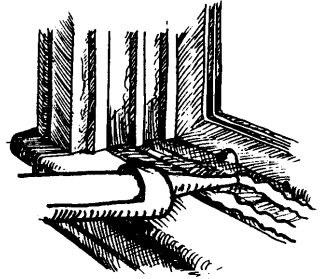

Fasten

- To fasten flashing, run bead of adhesive caulk around perimeter of trough.

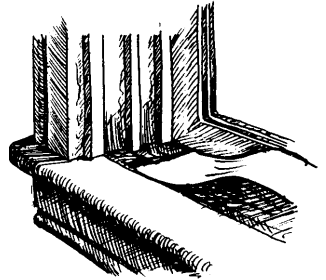

Install Flashing

- Bed flashing in adhesive caulk bead and press down.

Seal

- Run a bead of caulk around perimeter of flashing. If necessary wipe off excess caulk with damp cloth. Try not to smear caulk on face of flashing.

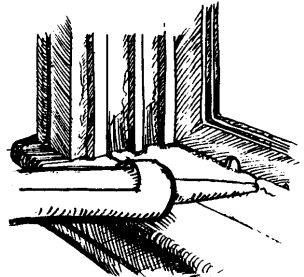

Important: Do not cover drain hole with caulk.



Clean Up and Clear

- See Section 4, p. 47.

DOOR NEEDS ADJUSTMENT

PROBLEM Edge of door is crushing against jamb on hinge side; or door is rubbing on latch side because hinges are loose. When paint on a door rubs or is crushed, dust and paint chips can result.

SOLUTION Adjust the door so that it opens and closes without damaging painted surfaces.

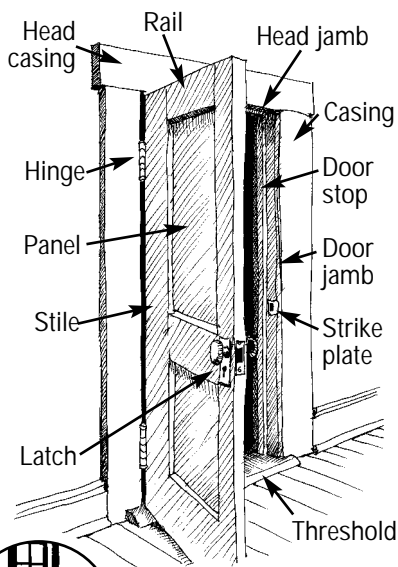

Set Up

- See Section 2, p. 13.

Check Door

- Grasp knob and try to move door up and down. If hinges are loose, door will move.

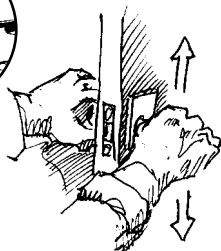

Remove Screws

- Remove screws that are most loose, but not all screws, so door remains hung.
 - Clear paint from screw notch with hammer and small screwdriver.
 - Unscrew. If screw head is stripped, use screwdriver bit in a brace.

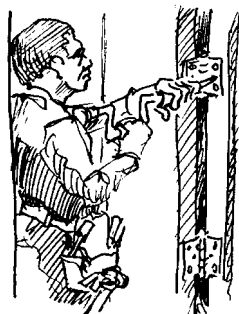

Fill Hole

- Drive 3/16 inch or 1/4 inch dowel into screw holes as necessary to fill each hole. Cut dowels flush.

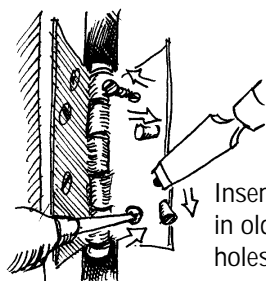

Insert dowel in old screw holes

DOING THE WORK

Install New Screws

- Replace screws. Use longer screws if necessary. Using a screwdriver bit on a brace makes this easier. Then remove and replace remaining screws as necessary.

Adjust Stop

- Face of door should only contact the stop on the latch side of door frame. It should not crush or rub head or hinge side stop.
- Where stop is nailed, remove and replace with new matching stop. Leave 1/8 inch space between hinge, head stop, and the face of the door.

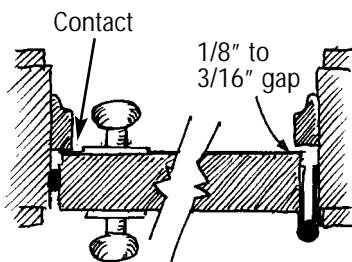

Check perimeter of door for clearance of 1/8" to 3/16"

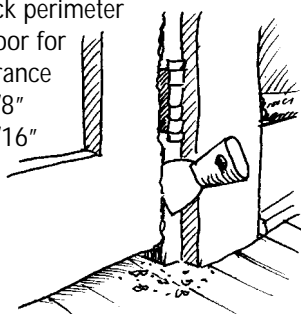

Check Clearance

- If putty knife can't fit in gap between door and jamb at all points, crushing of painted surfaces may be occurring.

Adjust Depth of Hinge Leaf

- If door is crushing hinge side and there is more clearance than necessary on the latch side, install metal shims behind hinge leaves. Keep at least 1/8 inch clearance on leaf side and 1/8 inch clearance on latch side. If not enough clearance, see p. 39.
- If only a small increase is needed between leaves of hinge to create a gap between door edge and jamb, place a steel rod between hinge leaves near pin and close door to slightly bend apart leaves.

Crushing



Space



Add shim stock

Use steel rod (like screwdriver) to bend open hinge

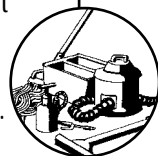
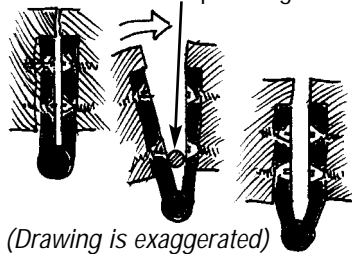

Clean Up and Clear

- See Section 4, p. 47.

DOOR RUBS OR STICKS

PROBLEM Door is scraping on latch side; or door is crushing jamb on latch side and there is not enough clearance on latch side to add shims to hinges. When paint on a door rubs or is crushed, paint chips can result.

SOLUTION Plane edges of door so that it operates smoothly and does not rub.

Set Up

- See Section 2, p. 13.

Remove Hinge Leaves

- Remove pins from hinges and hinge leaves from door.
- Set door on edge in a door hold. (See Section 5: Building a Door Hold, p. 74.)

Hand Plane Edge

- Mist surface and hand plane a chamfer edge.
- Use a smooth bench or jointer plane (not a block plane) to remove the rest of the paint from the edge. Continue to mist while working. If a power planer is used to remove paint, it must be attached to a HEPA vacuum. Some power planers need an adaptor to accept HEPA attachments.
- Once paint is removed, use either a hand or power planer.

Recut Gains

- Then, recut gains as necessary so hinge leaf is set about halfway into gain.

Seal Edges

- Seal edges of door, particularly the bottom, and rehang.

Clean Up and Clear

- See Section 4, p. 47.

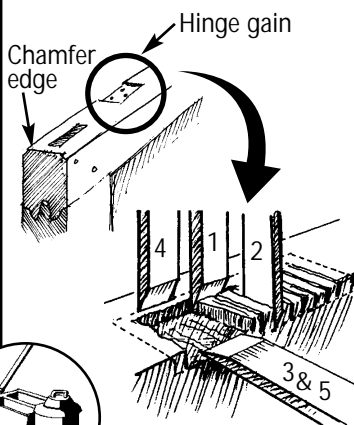
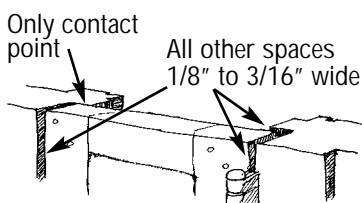
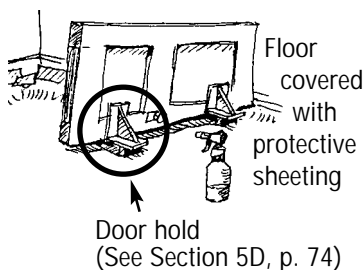

CHIPPING PAINT ON STAIRS OR FLOOR

PROBLEM Painted staircase treads, risers or floors are worn, or the paint is chipping. Paint and other coatings used on staircases and floors in older homes often contain lead. Everyday friction and wear can produce paint chips and dust.

SOLUTION Cover portions of stairs or floor that are worn with durable material.

Set Up

- See Section 2, p. 13.

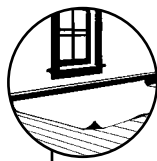

Stairs – Option #1: Install Tread Covers and Riser Enclosures

Wet Scrape

- Mist and wet scrape any loose paint on treads and risers, particularly on edges.

Prime and Paint

- Prime treads and risers. Paint edges that will not be covered by enclosures.

Install Riser Enclosure

- Cut 1/4 inch lauan plywood to fit each riser. Sand exposed edges of lauan.

Fasten

- Back caulk perimeter of riser with adhesive caulk. Press tight or nail with finish nails.

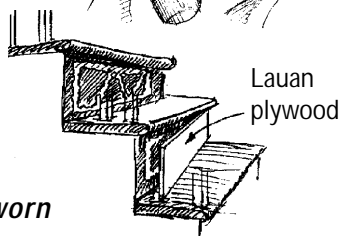
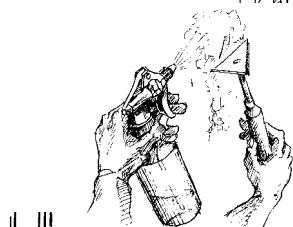
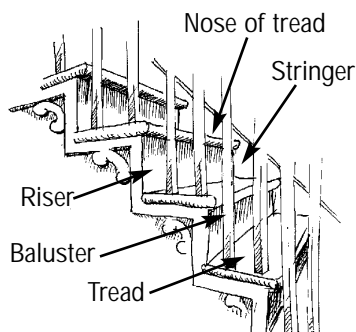

If nose tread is not worn

Cut and Install Tread Cover

- Cut cover to fit over the tread and nose.
- Install cover with adhesive caulk or screws.

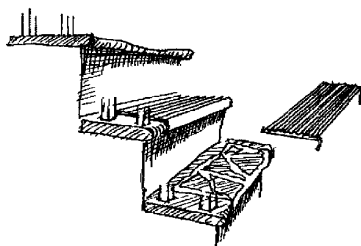

If nose tread is worn

PROBLEM

Installing a rubber tread over a worn tread nose creates a hollow space under the rubber tread cover. This can cause the rubber tread cover to tear, posing a tripping hazard.

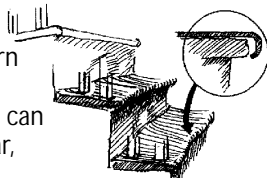

Cut and Install Tread Cover

- Cut tread cover to fit from the riser to rear edge of nose. Install with adhesive caulk or screws.

Install Metal Nose Cover

- Screw metal cover over edge of tread nose. It will span the worn area of the nose.

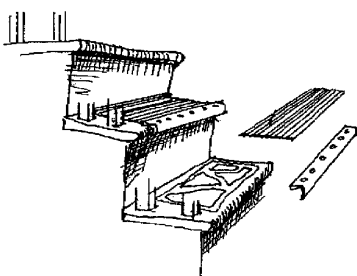

Stairs – Option #2: Install Staircase Runner

Wet Scrape

- Mist and wet scrape any loose paint on tread and riser, particularly on edges.

Prime and Paint

- Prime and paint treads and risers.

Install Runner

- Staple runner to top of top riser. Then fasten with staircase bars so runner may be easily removed for cleaning.



Important: Do not install runner or tread cover on landing of upper floor where its rear edge may become a tripping hazard.

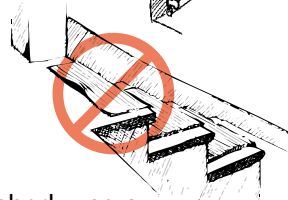
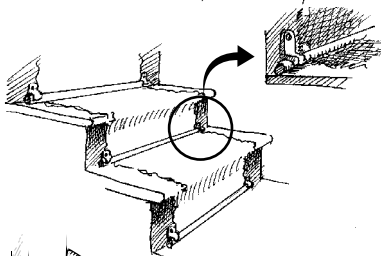
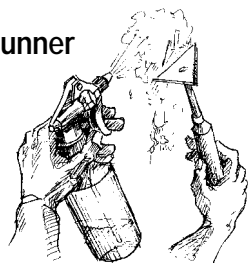

Floors

Prep Surface

- If a floor needs to be refinished, use a floor sander attached to a HEPA vacuum.



Caution: High dust potential.

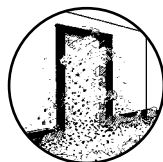

Cover

- Apply a coating to the floor to keep it smooth and cleanable.
- To maintain a smooth and cleanable surface, it is recommended that the use of wall-to-wall carpeting be avoided. Area rugs can be used instead.



Clean Up and Clear

- See Section 4, p. 47.

CHIPPED OR DAMAGED IMPACT SURFACES

PROBLEM Outside corners of walls, edges at passages, as well as trim, base cap, and shoe molding are being chipped due to impact from doors, furniture, and other objects. If these surfaces are covered with lead-based paint, the paint chips and the dust created may pose a health threat.

SOLUTION Protecting these surfaces with a durable material can prevent the creation of paint chips and dust.

Set Up

- See Section 2, p. 13.



Enclose Outside Corner

- Cover outside corners of walls with corner molding. Attach with nails and/or with a bead of adhesive.

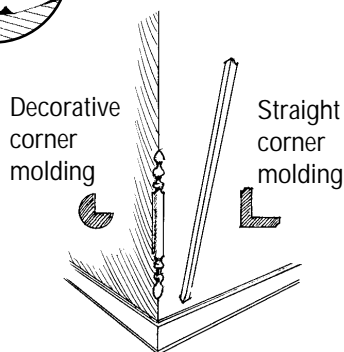

Protect Base

- In places where a base-board shows signs of impact, replace shoe and protect cap with lattice strip.
- When replacing shoe, bed new shoe in bead of caulk to seal out moisture and prevent infiltration of dust.

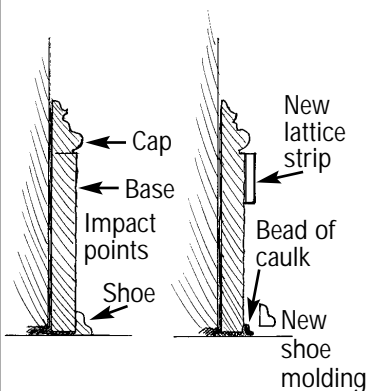

Clean Up and Clear

- See Section 4, p. 47.



H I G H D U S T J O B S

Some jobs create large amounts of dust. To be safe, workers doing this type of work should:

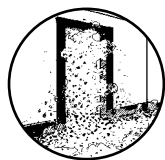

1. Wear half-mask respirators rated by NIOSH as N100 (or HEPA) at a minimum and be trained to wear and maintain them, or conduct air monitoring to show that they are not needed. (See Section 5D: [Respiratory Protection](#), p. 69.)
2. Completely isolate the work space from occupied spaces and use containment to protect other workers. (See next page.)
3. Receive lead worker or supervisor training from an accredited trainer. In most states, accredited courses are available. To locate a course in your state, contact the Leadlisting at 1-888-Leadlist (1-888-532-3547) or www.leadlisting.org.



Remember: All house dust is unhealthy to breathe. It may contain lead, mold, asbestos, gypsum, roach waste, dust mites, coal dust, fiberglass, etc.

Examples of High Dust Jobs

The following types of work are likely to create high levels of dust:

Demolition. Demolition includes tearing off siding and/or demolishing old plaster walls or ceilings.

Opening Up Wall Cavities. These jobs include:

- Removing old paneling and baseboards
- Removing door casings and frames or window casings or jambs



"It's not just what's on the wall, it's the dust behind it."

Removing Old Drop Ceilings. Lots of dust can accumulate above ceiling panels.

Improperly Removing Wall-To-Wall Carpet. A carpet that's been on the floor for many years has gathered large amounts of household dust, which may include lead dust. Improperly removing it can release a large amount of dust.

Paint Scraping. Scraping large painted areas, such as the side of a house or an entire room, even when done correctly, can create a large amount of dust.

Containing Dust

Use this system to keep dust from spreading to another room.

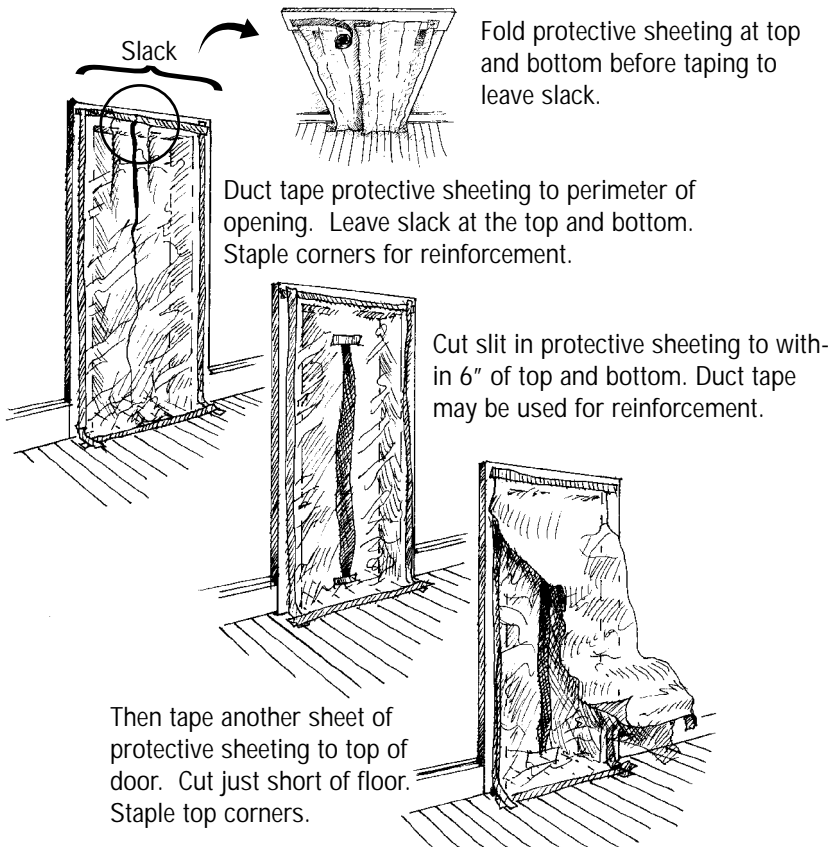

If a job creates extremely high amounts of dust (for example, demolition) or large amounts of dust in the air for more than short periods, the protective flap system shown above may not be sufficient to prevent dust from spreading beyond the work area.

For these types of jobs, a more protective system called "isolation" is needed so that dust does not spread beyond the work area. Isolation means that the work area is sealed with no direct access to occupied areas of the home. Workers need to use an entrance that is separate from occupants until cleanup is completed.

C L E A N I N G U P

It is very important to use proper cleanup procedures at the end of the job. Dust and paint chips left behind at the end of the job may contain lead and may endanger children. Have dust wipe samples collected at the end of the job to be sure that it is safe for children to return.



Pick Up Work Area

- Pick up large chips with damp paper towel.
- AND/OR**
- Mist then push dust into dust pan.

Make dust pan from flashing and clean with a whisk broom.

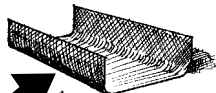

Pick Up Protective Sheeting

- Clean off protective sheeting. Fold dirty side inward (dirty side to dirty side). Dispose of protective sheeting at the end of each job. Protective sheeting may be used again within the same work area if it has not already been folded.

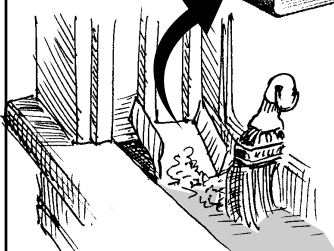

Mist and push dust

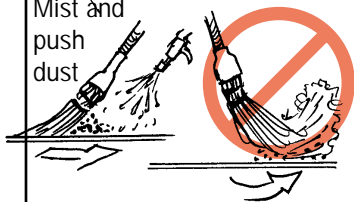

Vacuum

- HEPA vacuum all horizontal surfaces—slowly.
- Vacuum all ledges, sills, stools, molding tops, dusty surfaces, etc.
- Vacuum floor under work area. Use corner tool in corners, cracks of trim, and between floor boards.
- Vacuum floor with floor brush and carpet with a carpet tool.

Vacuuming the cracks is very important.

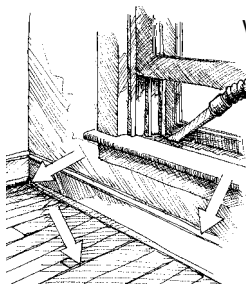

Mist and Scrub

- Important:** Vacuum carpet very slowly.
- Wet rag with detergent then wring out.
 - Mist surface or rag as you clean.
 - Lead needs scrubbing, not just wiping.

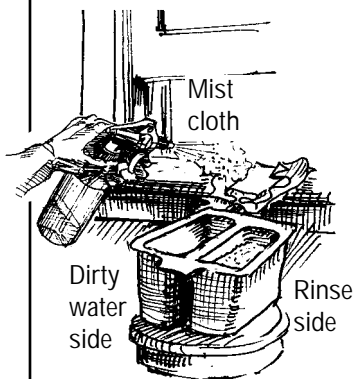

Rinse Rag

- Squeeze rag into empty side of split bucket. Rinse out rag. Squeeze into empty side. Repeat as needed.
- Change rinse water often.
 - Use paper towels first if surfaces are very dirty.
 - Replace rag when it looks dirty.
- Clean until dust and debris are removed.

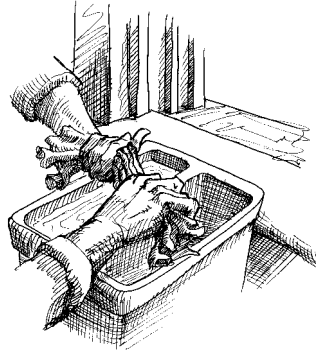
**Cleaning Floors****Mist and Scrub**

- At start of cleaning, soak mop in detergent water then mist small area with detergent before mopping.
- Scrub with mop.

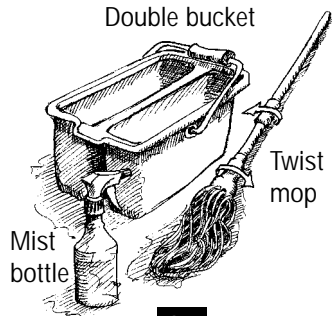
**Squeeze Out and Wash**

- Squeeze mop into empty bucket then rinse in rinse water. Rinse often. Squeeze out and rinse again. Mop small areas at a time.

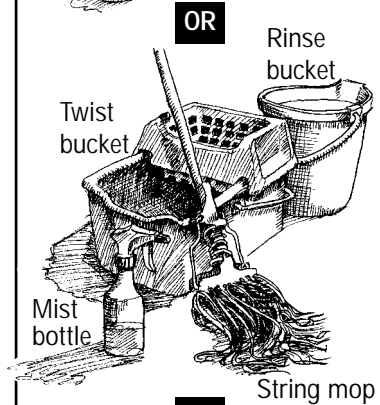
**OR**

Rinse bucket

Twist bucket

Mist bottle

String mop

OR**For large jobs****Rinse**

- Repeat above process using clean water rather than detergent. When cleaning up a work site, use a new mop head for rinse stage.

Recommendation: Make a final pass with a HEPA vacuum.

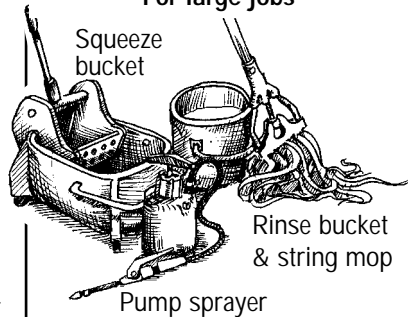
**Dispose of Waste**

- See following section.

Take Dust Wipe Sample

- See Section 5D: Testing Dust for Lead, p. 71.

DISPOSAL OF WASTE

After cleanup of the work area, take care to safely handle and remove dust and debris from the job. Supervisors should check with the EPA and their state's agency responsible for waste to find out about specific Federal, state, and local regulations regarding disposal of waste that may contain lead-based paint.

Key Principle:

Confine dust and waste to the work area that will be cleaned.

Disposal Practices

Specific guidelines are:

- Avoid carrying construction waste through an occupied space. If you must carry it through an occupied space, first place it in a heavy duty plastic bag or wrap it in protective sheeting and seal with tape.
- When a dumpster is used, keep the dumpster covered. If a chute is used, cover the chute (or use a barrel chute) and cover the dumpster.
- Store all waste in a secure container or dumpster until disposal. Do not transport waste in an open truck, unless it is bagged and sealed.

Water

Water used for clean up should be dumped into a toilet. Never dump this water in a sink, tub, on the ground, or down a storm drain.

Water used to remove paint through pressure washing must be collected in drums and may need to be tested to determine if it is hazardous. Check with your state agency responsible for waste.

CHECK YOUR WORK!

Check Quality of Work & Cleanup

Check work quality **during the job** and at the **end of the job**.

- **Was the cause of the problem corrected?**
- **Were proper work practices used?**
- **Was cleanup done thoroughly?**

How to Check:

Checking your work involves two important steps.

1. Visual Checks

Use the checklist inside the back cover of this guide when performing visual checks.

- **During the Job.** Be sure that:
 - the cause of the problem is being corrected;
 - the work area is safely set up;
 - the practices in this guide are being used; and
 - dust and debris are not spreading beyond the work area.
- **End of the Job.** Be sure that the repairs were done properly and that no dust or paint chips remain.

2. Take a Dust Wipe Sample

When interior work disturbs painted surfaces or produces dust, have dust wipe samples taken at the end of the job to check for harmful levels of lead-contaminated dust.

To be accurate, these tests must be done according to specific procedures. See Section 5D, p. 71, for more information about these tests, and who should perform them.

How to Check Cont'd

Dust wipe testing is recommended at the end of any job that disturbs paint or produces dust. It is **strongly recommended** when:

- Work that disturbs paint is done in homes built before 1978.
- A young child or pregnant woman lives in the home.
- Performing unit turnover or regular maintenance in rental properties.

Why Is It Important to Check Work?

Checking that work was done properly is important because:

- Failing to correct conditions causing damage or deterioration results in repairs that do not last.
- Work that fails to follow the recommendations in this guide may spread dust and paint chips beyond the work area and may endanger children in the home.
- Dust and paint chips left behind due to poor cleaning may contain lead and may also endanger children in the home.
- For contractors, checking your work improves the quality of a job and is likely to reduce the risk of a lawsuit in the event a child in the home is later found to have high levels of lead in his/her blood.
- Leaving a clean job site is greatly appreciated by customers.

ONGOING MONITORING & MAINTENANCE

Regularly Check Repairs for Deterioration, Paint Chips, and Dust	<p>Property owners should regularly monitor painted surfaces where maintenance or improvements were performed.</p> <p>Check to see if:</p> <ul style="list-style-type: none">• New evidence of deterioration or paint failure is present.• The cause of the problem was corrected.• Lead dust hazards are present. <i>Important: This can only be done by dust wipe sampling.</i>
Maintain Surfaces and Thoroughly Clean	<p>Then:</p> <ul style="list-style-type: none">• Perform repairs, as needed, to maintain surfaces in a smooth and cleanable condition using the methods recommended in this guide; and• Clean the area thoroughly using the practices described earlier in this section.
Methods of Monitoring	<p>Follow the same methods used to check your work:</p> <ul style="list-style-type: none">• Visual Check. Look for deterioration, paint failure, dust and paint chips. Use the checklist inside the back cover of this guide.• Test for Lead Dust. Have dust wipe samples taken to check for dust that may be contaminated with lead. A test is needed to determine when dust contains harmful amounts of lead. <p>To be accurate, these tests must be done according to specific procedures. See Section 5D, p. 71, for more information about these tests, and who should perform them.</p>
When to Monitor?	<ul style="list-style-type: none">• Annually. Perform a visual check of past repairs and improvements involving painted surfaces.• During Unit Turnover or Routine Maintenance. Perform a visual check of past repairs and improvements involving painted surfaces.• Every Two Years. Get a dust wipe test done at least every two years. This type of test is strongly recommended when a young child or pregnant woman lives in the home.

**Why Is It
Important to
Monitor &
Maintain
Work?**

Monitoring and maintenance helps:

- Plan and implement maintenance tasks
- Protect occupants and neighbors, particularly children, from lead exposure
- Give owners, contractors, and residents a record of the condition of the unit

Aluminum flashing - thin aluminum sheeting, also known as coil stock.

Aviation snips - metal cutters.

Chamfer - a small bevel on an edge.

Enclosure - a rigid, durable construction material that is mechanically fastened to the structure to cover painted surfaces.

Fit testing - a method to check if a respirator fits properly over the face.

Gain - notch chiseled in a door for a hinge leaf.

HEPA filter - High-Efficiency Particulate Air filter. A filter that can remove particles of 0.3 micrometers or larger from the air at 99.97 percent or greater efficiency.

HEPA vacuum - a vacuum with a HEPA filter.

HUD Guidelines - HUD's *Guidelines for the Evaluation and Control of Lead-Based Paint Hazards in Housing*.

Interim controls - a set of measures to reduce exposure to lead hazards. Interim control measures include special cleaning, repairs, paint stabilization, enclosure, and containment. For a full discussion, see HUD's *Guidelines for the Evaluation and Control of Lead-Based Paint Hazards in Housing*.

Lauan plywood - 1/4 inch plywood made of lauan with a smooth face.

N100 - a NIOSH filter class that describes a respirator's ability to filter airborne particles. A respirator filter rated as N100 removes particles of 0.3 microns or larger from the air at 99.97 percent or greater efficiency.

NIOSH - National Institute for Occupational Safety and Health, an agency within the Centers for Disease Control and Prevention that tests and certifies safety equipment including respirators.

OSHA - Occupational Safety and Health Administration, an agency of the U.S. Department of Labor that oversees worker safety.

Paint stabilization - a process of wet scraping, priming, and finish coating of a deteriorated painted surface to prevent further deterioration.

Permissible Exposure Limit (PEL) - a dust exposure threshold set by OSHA. Work that creates lead dust levels in the air greater than the PEL must meet OSHA lead safety requirements for workers. OSHA has set the PEL for airborne lead dust at 50 micrograms per cubic meter ($\mu\text{g}/\text{m}^3$) as a time weighted average. See Section 5D, p. 69, for technical information about OSHA requirements and Section 5B, p. 61, for information about OSHA regulations.

Pilot hole - a small hole drilled to guide the drilling of a larger hole.

Protective sheeting - made of plastic, poly or other material. Protective sheeting must be puncture and tear resistant, impermeable to liquids, durable, flexible, and lightweight.

R-value - a measure of heat containment; used for rating insulation effectiveness.

Shim - small piece of wood or metal used to fill space between two fastened components.

Shroud - a protective covering that contains dust and chips.

Substrate - a solid surface such as plaster, drywall, wood, etc.

Tack pad - a sticky pad that helps remove dust from shoes.

Window trough - the area of the sill between a window stool or interior sill and the frame of the storm window where the bottom sash rests when closed (also called a window well or exterior sill).

B. FOR MORE INFORMATION

This section lists useful documents, web sites, and other lead-based paint information resources. Additional sources also exist. Use the reference letter on the right to locate the contact for each information resource. Contacts are listed by letter on pages 62-64. Publications marked with an * are for sale; others are available for free.

Where can I get more information on...

Work practices and lead-safety?

Publications	Reference Letter
<ul style="list-style-type: none">• <i>Guidelines for the Evaluation and Control of Lead-Based Paint Hazards in Housing (July 1995).</i>* Technical guidance on methods for identifying and controlling lead-based paint and lead-based paint hazards. The <i>Guidelines</i> can also be downloaded for free from the HUD Office of Lead Hazard Control web site. (About 750 pages)	B, C
<ul style="list-style-type: none">• <i>Residential Lead Desktop Reference (2nd Edition, June 1998).</i>* A CD-ROM containing a large variety of lead-based paint information resources.	C
<ul style="list-style-type: none">• <i>Maintaining a Lead Safe Home (1997).</i>* A do-it-yourself manual for homeowners and property managers. (89 pages)	B
<ul style="list-style-type: none">• <i>Lead-Based Paint: Operations and Maintenance Work Practices Manual for Homes and Buildings (May 1995).</i>* Technical guidance on safe work practices. (200 pages)	G
<ul style="list-style-type: none">• <i>Guide Specifications for Reducing Lead-Based Paint Hazards (May 1995).</i>* Technical guidance on purchasing lead-hazard control reduction services and developing lead-hazard reduction work specifications. (About 500 pages)	G
<ul style="list-style-type: none">• <i>Lead Safety for Nonprofit Property Owners, Developers, and Managers (July 1998).</i> Practical guide to developing policies and activities that incorporate lead safety in property management. (About 30 pages)	F

Reference
Letter

Publications

- *Guide to Working Safely with Residential Lead Paint (1999)*. Pamphlet with key lead safety precautions to follow during repainting and home improvement. **F**
- *Reducing Lead Hazards When Remodeling Your Home (September 1997)*. Pamphlet providing basic information about lead-based paint risks and precautions when remodeling pre-1978 homes. **B, I, K**

Web Sites

- HUD, Office of Lead Hazard Control. Provides information on HUD regulations, technical and educational documents, and links to other lead resources. **B**
- EPA, Office of Pollution Prevention and Toxics. Provides information on EPA regulations, technical and educational documents, and links to other lead resources. **K**

Worker protection methods?

Publications

- *Protecting Workers and Their Communities from Lead Hazards: A Guide for Protective Work Practices and Effective Worker Training (1993)*.^{*} Guidance on worker protection methods, training workers, and complying with OSHA regulations. (About 500 pages) **L**
- *Lead Exposure in the Construction Industry (1993)*. Fact sheets that describe worker protection measures needed to meet OSHA requirements for lead including respiratory protection and protective clothing. (Series of 6 fact sheets) **J**

Web Site

- OSHA. Occupational Safety and Health Administration. Provides information on OSHA regulations, technical and educational documents, and links to other lead resources. **J**

Preventing children’s exposure to lead hazards?

Publications

- *Protect Your Family From Lead In Your Home (May 1995)*. Pamphlet that provides basic information about addressing and preventing lead-based paint hazards in the home.
- *Lead Poisoning Prevention: Directory of State Contacts (1997-98)*.^{*} Booklet that contains profiles of state programs to reduce lead hazards. (150 pages)
- *Directory of State and Local Lead Poisoning Prevention Advocacy Organizations (1998)*.^{*} List of state and local non-profit organizations that are working to prevent lead poisoning. (About 300 pages)

Web Site

- [Alliance to End Childhood Lead Poisoning](#). Information on lead poisoning prevention, lead issues, and program design. Site has publications that can be copied from the web.

Public education and outreach materials?

Web Site and Hotline

- [National Lead Information Center](#). Information about lead hazards and poisoning prevention.

Locating certified abatement contractors and clearance inspectors?

Web Site and Hotline

- [Leadlisting](#). List of qualified lead professionals including inspectors, risk assessors, abatement contractors, and analysis laboratories.

Reference
Letter

B, I, K

E

A

A

I

D

Disclosure requirements?

Publications

Reference Letter

- *Protect Your Family From Lead in Your Home (May 1995)*. Pamphlet that provides basic information about addressing and preventing lead-based paint hazards in the home. B, I, K
- *Disclosure of Lead-Based Paint Hazards in Housing (March 1996)*. Fact sheet that provides information on how to meet Federal disclosure requirements. K
- *Questions and Answers on the HUD/EPA Disclosure Rule*. Answers to commonly asked questions about Federal disclosure requirements. (5 pages) K
- *Interpretive Guidance for the Real Estate Community on the Requirements for Disclosure of Information Concerning Lead-Based Paint in Housing, Parts I and II (1996)*. In-depth guidance on the disclosure requirements for real-estate professionals. (27 pages) K
- *Resource Handbook on Lead Hazard Disclosure for Homes and Apartments (1996)*.^{*} Comprehensive reference book on disclosure procedures including advice for renters and owners, a glossary of key terms, and copies of disclosure documents. (Approximately 300 pages) A

Respirators?

Web Sites

- National Institute of Occupational Safety and Health. Provides information on the proper use of respiratory protection and various types of NIOSH-approved respirators that are available. H
- Occupational Safety and Health Administration. Provides information on OSHA regulations regarding the use of respiratory protection. J

Where can I find...

Reference
Letter

HUD's lead regulations?

- 24 Code of Federal Regulations (CFR) 35 (Lead Rule). Contains lead hazard evaluation and reduction requirements for properties that receive HUD funding.

B

OSHA's lead regulations?

- 29 CFR 1926.62 (Lead in Construction) and 29 CFR 1910.1025 (Lead in General Industry). These regulations cover Federal worker protection requirements for workers in industry, construction, remodeling, and renovation.

J

EPA's lead regulations?

- 40 CFR 745 (Lead-Based Paint Poisoning Prevention in Certain Residential Structures). Contains the Federal regulations for the disposal of lead waste and contractor notification requirements.
- 40 CFR 745.80 (Residential Property Renovation). Federal rule requiring contractors to provide notification before the start of any work that disturbs a painted surface in pre-1978 homes.

K

K

Disclosure regulations?

- 24 CFR 35 (HUD) and 40 CFR 745 (EPA). Regulations for disclosure of known lead-based paint and lead-based paint hazards by home sellers and landlords. This rule was published jointly by HUD and EPA.

B, K

State lead laws?

Publication

- *Summary of Lead Poisoning Prevention Statutes (February 1999)*. A state-by-state listing of local lead-related regulations, such as waste disposal requirements. Available by fax. (24 pages)

Reference Letter

E

Contacts

Reference Letter	Organization	Types of Resources
A	Alliance to End Childhood Lead Poisoning 227 Massachusetts Avenue, NE, Suite 200 Washington, DC 20002 202-543-1147 http://www.aeclp.org	Publications
B	Office of Healthy Homes and Lead Hazard Control; U.S. Dept. of Housing and Urban Development (HUD) 451 Seventh Street, SW, Room P-3206 Washington, DC 20410 202-755-1785 http://www.hud.gov/offices/lead	Publications Program development
C	HUD USER P.O. Box 6091 Rockville, MD 20849 1-800-245-2691 http://www.huduser.org	Publications
D	Leadlisting 1-888-Leadlist (1-888-532-3547) http://www.leadlisting.org	Technical consultation
E	National Conference of State Legislatures 1560 Broadway, Suite 700 Denver, CO 80202 303-830-2200 http://www.ncsl.org	Publications

Reference Letter	Organization	Types of Resources
F	National Center for Lead Safe Housing 10227 Wincopin Circle, Suite 205 Columbia, MD 21044 410-992-0712 http://www.leadshousing.org	Publications Technical consultation
G	National Institute of Building Sciences (NIBS) Publications Department 1201 L Street, NW, Suite 400 Washington, DC 20005-4014 202-289-7800 http://www.nibs.org	Publications Training
H	National Institute of Occupational Safety and Health (NIOSH) Hubert H. Humphrey Building, Room 7154 200 Independence Avenue, SW Washington, DC 20201 800-35-NIOSH (800-356-4674) http://www.cdc.gov/niosh/home-page.html	Publications
I	National Lead Information Center (NLIC) 8601 Georgia Avenue, Suite 503 Silver Spring, MD 20910 Information Clearinghouse: 1-800-424-Lead (1-800-424-5323) http://www.epa.gov/lead/nlic.htm	Publications Training

Reference Letter	Organization	Types of Resources
J	<p>Occupational Safety and Health Administration (OSHA) U.S. Department of Labor, OSHA Publications Office 200 Constitution Avenue, NW, Room N3101 Washington, DC 20210</p> <p><i>OSHA Lead web page:</i> http://www.osha-slc.gov/SLTC/lead/index.html</p> <p><i>OSHA Respirator web page:</i> http://www.osha-slc.gov/SLTC/respiratory_advisor/mainpage.html</p>	<p>Technical consultation Enforcement</p>
K	<p>Office of Pollution Prevention and Toxics (OPPT) U.S. Environmental Protection Agency (EPA) 401 M Street, SW (7401) Washington, DC 20460 202-260-3810 http://www.epa.gov/lead</p>	<p>Publications Program development</p>
L	<p>Society for Occupational & Environmental Health 6728 Old McLean Village Drive McLean, VA 22101 703-556-9222 http://www.soeh.org</p>	<p>Publications</p>

C. GETTING THE WORD OUT

How Owners and Occupants Can Work Together to Improve Lead Safety In Homes

Gaining tenant cooperation can help rental property owners and managers respond promptly to conditions that could pose a health threat to occupants.

Owner Responsibilities

1. Check the building to be sure that:

- The building shell is sound.
- Water isn't coming in from the outside and causing damage.
- Sources of moisture inside are not causing damage.
- Painted surfaces are intact.
- Doors and windows work properly.
- All surfaces are clean and cleanable.

2. Maintain the building.

- Train maintenance staff to minimize dust, clean up effectively, and protect themselves.
- Conduct regular building checks for potential problems, such as:
 - Flaking or peeling paint
 - Water damage to paint, plaster, or wood
 - Plumbing or roof leaks
 - Painted doors and windows that do not operate smoothly

3. Educate occupants and gain their cooperation.

- Fulfill Federal notice and disclosure requirements.
- Have occupants inform you of damaged paint and other maintenance problems.

When Maintenance or Renovation Work is Done

Give occupants the Lead Safety pamphlet required by Federal regulations (see page 66).

Tell occupants:

- ✓ Why repairs are necessary.
- ✓ The work schedule.
- ✓ How they and their possessions will be protected.
- ✓ Why they may need to leave during the work.

- ❑ Explain to occupants why steps, such as regular cleaning, prevent lead-based paint hazards. (See below.)
- ❑ Consider providing cleaning supplies and tools (see page 75) to occupants to encourage cleaning.
- ❑ Remind tenants that it is a good practice to provide notice of problems in writing.
- ❑ Make sure occupants understand the property's maintenance reporting procedures and indicate that these problems require priority attention.

Precautions Tenants Can Take to Protect Their Family

Occupants should pay special attention to page 7 of the pamphlet *Protect Your Family From Lead In Your Home*. It describes steps that occupants can take to reduce the chance that they will be exposed to lead hazards. Suggestions from this pamphlet include:

- ❑ Clean floors, window frames, interior window sills, and other flat surfaces each week using warm water and an all-purpose cleaner.
- ❑ Clean up any paint chips immediately.
- ❑ Keep child play areas clean.
- ❑ Wash children's hands often.
- ❑ Keep children from chewing interior window sills and other painted surfaces.

Federal Notice and Disclosure Requirements

(24 CFR Part 35 or
40 CFR Part 745)

- ✓ Landlords and home sellers must notify future occupants about lead-based paint hazards by giving them the pamphlet *Protect Your Family From Lead in Your Home*.
- ✓ Landlords and home sellers must disclose information about known lead-based paint and/or lead-based paint hazards before dwelling leases or home sales contracts take effect. Leases and sales contracts must also include a form about lead-based paint that meets Federal requirements. Contact HUD or EPA for more information about these requirements (see Section 5B, p. 57).

Notice Prior to Renovation

Federal law requires contractors and owners of rental properties to inform occupants about the risks of lead-based paint before non-emergency repair, maintenance, and home renovation work begins. This law applies for all work on surfaces greater than 2 square feet per component. Contractors and property owners must distribute copies of the pamphlet *Protect Your Family From Lead In Your Home* before any work starts. See EPA's regulation at 40 CFR 745.80. Also see Section 5B, p. 57, for sources that can provide copies of this pamphlet.

Contractors and owners must make sure that occupants have received the pamphlet.

- For owner-occupied homes, the contractor must have the homeowner sign an acknowledgement form after receiving the pamphlet. Or, the contractor can send the pamphlet by certified mail.
- For tenants, the contractor or property owner must have an adult occupant sign an acknowledgement form after receiving the pamphlet. Or, the contractor or owner can send the pamphlet by certified mail. If the contractor cannot get a signed acknowledgement, the contractor must sign a statement documenting this.
- For work in common areas, such as the lobby, of an apartment building, the contractor must give the pamphlet to the owner and to the occupants of all affected areas and inform them of the nature, location, timing, and length of the job.

Why Lead Safety Makes Sense for Property Owners and Contractors

Property owners and contractors that use safe work practices benefit in several ways.

Advantages for Owners of Residential Rental Properties

Owners who maintain their rental properties using work practices that increase lead safety can use this information to attract tenants who are concerned for their child's health. Some local agencies may even maintain a listing of housing units that meet certain lead-safety standards. When giving prospective tenants the lead-based paint pamphlet and the required disclosure information, they can tell the tenant that the property has a program to minimize the risk of hazards from lead-based paint. A safety program would include:

- Educating and training maintenance workers.
- Examining property at turnover and then every year for deteriorating paint.
- Correcting conditions that may cause paint to flake and peel (excessive moisture, binding doors, etc.).
- Doing work safely and cleaning up well.
- Making sure surfaces are cleanable and doing a professional cleaning at turnover.
- Performing dust wipe tests before occupancy, and after every maintenance job that disturbs old paint. It is also recommended to perform a dust wipe sample test at least every two years. Keep the results on file.
- Encouraging tenants to inform property owners if there is a problem.

Advantages for Contractors

Doing work safely can enhance a contractor's reputation, maintain the safety of workers, and protect the health of customers and their children.

A program for lead safety can also help contractors when bidding new jobs. For example, contractors performing repairs and improvements in homes built before 1978 must give potential customers a pamphlet about the risk of lead-based paint during renovation.

Contractors that follow practices for lead safety can demonstrate to customers that they understand the risks and show that their workers take specific precautions to protect against lead-based paint hazards. Lead-safety can help "*give you a leg up*" on the competition.

Safe work practices also offer benefits that are important to customers:

- Dust and debris are confined to the work area.
- A "clean" work area at the end of the job.
- Some work offers additional benefits. (*For example, repairs to windows can improve their operation, prevent damage from moisture, and lower energy and maintenance costs.*)
- Lead safety also helps protect you as a contractor. For example, having an independent, certified professional take dust wipe samples of the work area promptly after cleanup provides strong documentation that no lead hazards were present in the work area at the end of the job.

D. MORE ABOUT TECHNICAL TOPICS

Respiratory Protection

Respiratory protection helps prevent workers from breathing harmful amounts of lead and other substances, touching their mouths with dusty hands, or swallowing paint chips.

When work creates high levels of dust in the air, properly trained and certified lead-based paint professionals should do these high dust jobs. If you work for someone, and plan on doing this type of work, your employer must meet the requirements of the OSHA Lead in Construction Standard (29 CFR 1926.62). These requirements include respiratory protection when work creates lead dust in air that exceeds the “permissible exposure limit” (PEL) — see Air Monitoring and Results sections below. See Section 5B, p. 57, for sources of information about OSHA requirements.

Respirators may be required for activities that generate high levels of dust such as:

- Demolishing painted surfaces
- Opening up wall and ceiling cavities
- Using power tools on painted surfaces
- Dry scraping large painted areas

For this type of work, OSHA requirements include the following:

- Training workers on how to properly use and maintain respirators.
- Making sure proper respirators are always available and that workers have been fit tested. Where respirator use is required, workers must be part of a written respiratory protection program that meets OSHA standards (29 CFR 1910.134).

Many types of respirators can be used:

- Disposable respirators can be used if they are rated by NIOSH as N100 (or HEPA) — this information can be found on the respirator’s package or the respirator itself.



Dust mask not NIOSH approved

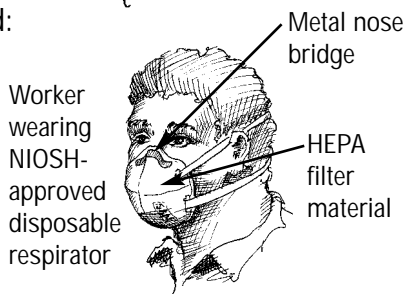

Worker wearing NIOSH-approved disposable respirator

- Non-disposable respirators, also rated by NIOSH as N100, often have replaceable cartridges and require regular maintenance.
- Having a trained person do air monitoring that measures the amount of dust in the air to determine if respirators are required by OSHA, and the appropriate level of protection. Workers must wear proper respirators while air monitoring is being done.



Worker wearing a non-disposable respirator

Air Monitoring

Air monitoring is done to ensure that workers are not being exposed to dangerous levels of lead dust in the air, and to comply with OSHA requirements. It must be done by a person with special training. A worker being monitored wears a small plastic canister clipped to his/her clothing near the face. A pump in a device clipped to the belt draws air and dust into the canister. The canister is then sent to a lab to measure how much lead dust was in the air.

What Do the Results Mean?

The results are measured in micrograms per cubic meter ($\mu\text{g}/\text{m}^3$). If the amount of lead dust in the air exceeds the permissible exposure limit (PEL) of $50 \mu\text{g}/\text{m}^3$, workers must wear at least a half-face respirator with an N100 (or HEPA) rating and certain OSHA requirements must be followed.

Results may show that respirators are not necessary or that a greater level of protection is needed. If the results show lead dust levels in the air above $500 \mu\text{g}/\text{m}^3$, a more protective respirator is required.

Other Protection

In addition to respiratory protection for activities that generate high levels of dust, compliance with OSHA's Lead in Construction Standard may involve blood tests for workers, medical monitoring, hand washing facilities, other personal protective equipment, shower and changing areas, and additional training.

Testing Dust for Lead

By having dust wipe samples taken, job supervisors and property owners can locate dust lead hazards and test the effectiveness of cleaning at the end of a job.

Where Are Dust Samples Taken?

Samples are taken in the area of the dwelling where work has been completed. The following surfaces within the work area should be sampled:

- Floor
- Interior window sills (*also referred to as window stools*)
- Window troughs

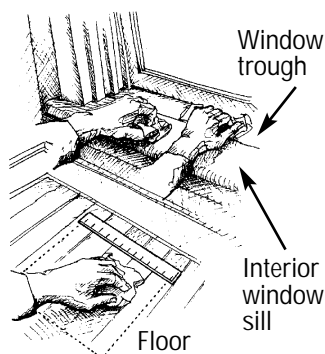

When Should Dust Samples Be Taken?

- At the end of a job
- If there is a child or pregnant woman living in the home
- Before a family moves into a home

What Do the Results Mean?

The results of the laboratory analysis will show the amount of lead found in the dust from the area sampled. The results are measured in micrograms per square foot ($\mu\text{g}/\text{ft}^2$).

To determine if a lead-based paint hazard exists, based on EPA's requirements, compare the results to the following standards:

- 40 $\mu\text{g}/\text{ft}^2$ on the floor
- 250 $\mu\text{g}/\text{ft}^2$ on the interior window sill (stool)

If the results for a sample are higher than these standards, a dust lead hazard is present. For clearance purposes only, a value of 400 $\mu\text{g}/\text{ft}^2$ should be used for window troughs.

Who Can Take Dust Wipe Samples?

Following painting, home maintenance, and renovation work:

- In homes receiving Federal assistance, dust wipe samples, if required by regulations, must be taken by appropriately trained personnel who were not involved in the work. This “clearance” testing may be done by a lead-based paint inspector, risk assessor, or sampling technician certified by a State or the EPA. Clearance testing may also be done by a person trained as a sampling technician, as long as a certified lead-based paint inspector or risk assessor approves the technician’s work and signs the clearance examination report.
- For all other homes, it is recommended that dust wipe samples be taken by a trained sampling technician, or, preferably, a certified lead-based paint inspector, risk assessor, or sampling technician. Some states require that dust wipe samples be taken by a certified person.

What Actions Do I Take Based On the Results?

If the results show dust lead levels higher than the standards listed above, the area where the work was performed should be cleaned to remove the dust lead hazard.

If the dust wipe samples were taken as part of ongoing monitoring by maintenance staff or the property owner, the surfaces where work was performed should be examined to see if the work has failed or new conditions that generate dust have developed. In either case, these conditions should be corrected using lead-safety principles and work practices.

If the work required to correct the likely source of the dust lead hazard is beyond the scope of this guide, the property owner should seek the help of a lead-based paint professional trained to safely correct lead-based paint hazards.

Setting Up a Dust Room

A dust room can be useful for dusty work on building components that can be moved. For example, scraping or planing doors or window sashes can be done in a dust room. A dust room is particularly useful when working in occupied spaces.

The dust room can be any room that can be closed off. The door can be covered with a flap system (see page 46) and the floor can be covered with protective sheeting taped to the baseboard.

Workers in this room should wear disposable clothing and wear respiratory protection. Wall and ceiling vents inside the room should be sealed off.

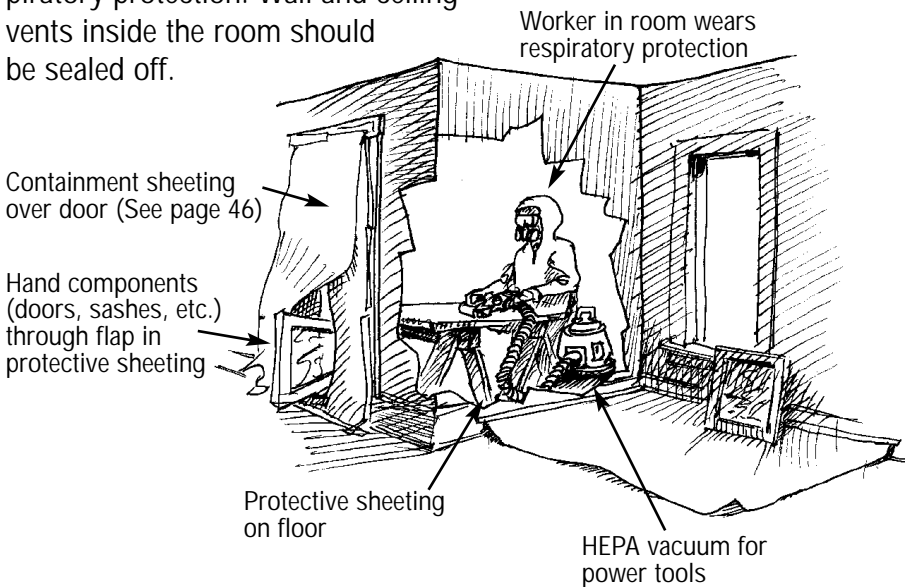

Building a Door Hold

A door hold makes working on doors easier and safer.

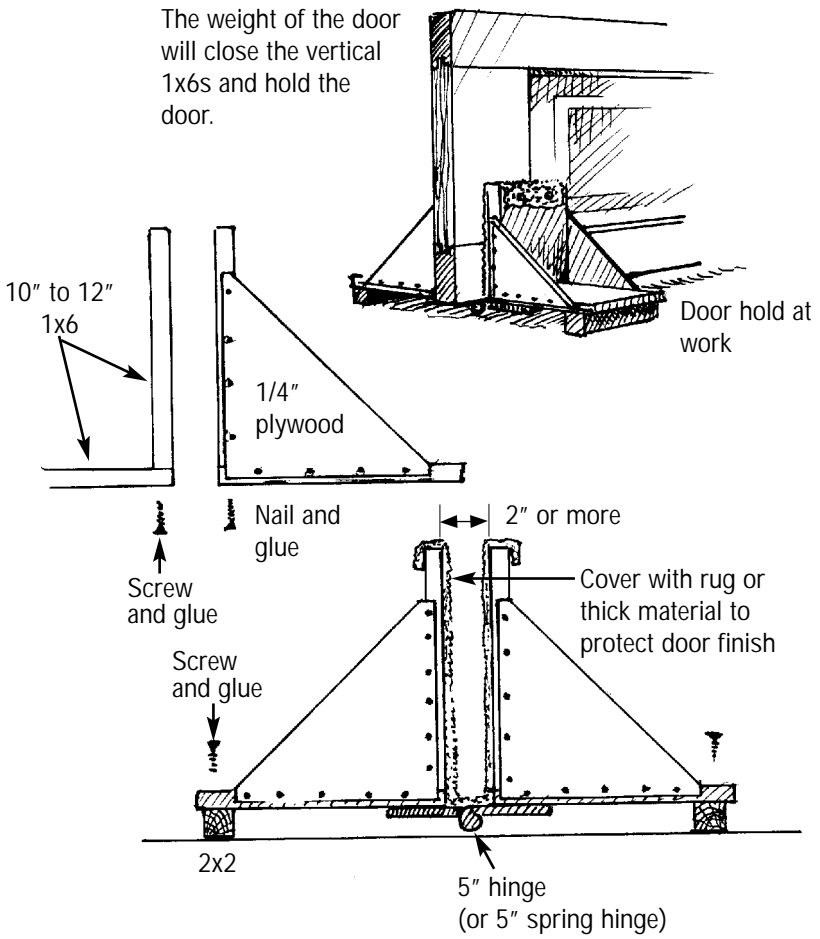

E. TOOL AND SUPPLY LIST

Additional Tools Needed for Lead-Safety Work

(Not every tool is needed for every job.)

Paint scrapers - A variety of scrapers are useful; carbon blades last longest. A mill file works well to keep scraper blades sharp.

Sanding sponges and wet/dry sandpaper - Where areas need to be smoothed or feathered, these abrasive tools, when used wet, keep dust to a minimum.

Mist bottles - Misting a surface being scraped or cut keeps down dust. Squeeze bottles work best in small areas. For larger jobs, a pump pressure sprayer in a knapsack works best.

Plane - A jack, smooth, or jointer (not block) plane. Hand planes are good for removing paint from edges such as the edge of a window, stool, or door. They create very little dust.

Cleanup station - A kitchen counter with a working sink is a good place for a cleanup station. If not available, set up a board with 3 buckets and a pump sprayer.

The station should have:

- Paper towels and soap
- Pads for cleaning respirators
- A 2-bottle eye-wash station
- A first aid kit
- Clipboard with emergency numbers
- Drinking water and cups

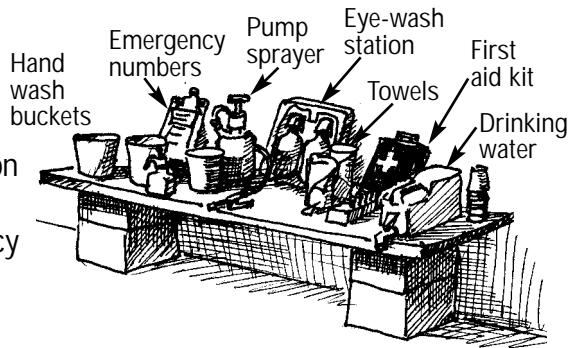

Personal Protective Clothing and Equipment

- A disposable respirator rated by NIOSH as N100 (or HEPA)
- A half-face, air cartridge respirator rated by NIOSH as N100 (or HEPA)
- Protective, lightweight, disposable suits with elastic sleeves and ankles
- Shoe covers (slip resistant is recommended)
- Safety glasses (vented goggles if working in high dust conditions or when using liquids or strippers)
- Ear protection if using power tools

Cleaning Equipment

- Bottle mister and pump sprayer for detergent
- Mops and buckets
- Tack cloths for wiping furnishings that may be damaged by water
- Heavy-duty paper towels and/or rags

Vacuums - At the end of a job, use a HEPA vacuum because it will capture even the finest dust. For regular household cleaning, use a HEPA vacuum if available. If one is not available, use a fine filter in your vacuum known as micron or allergen bags.

Painting Supplies

- Use commercial grade cleaners; there are also lead-specific cleaners. (Note: Trisodium phosphate [TSP] is banned in some states.)
- Degreasers may be necessary on some walls.
- Use deglosser or wet sanding supplies.
- Where wood is exposed, use a sealer and then apply a best grade primer or primer-sealer.

Other Tools

- Coil stock for covering window troughs. Coil stock is available with white and brown sides to match window trim color (see page 36).
- Window opening tool for windows that are painted shut (see page 29).
- Brace with screwdriver tips for removing and replacing hinge screws.
- Power planer with exhaust port that can be attached to HEPA vacuum. A power planer can be used for stripping window sashes and doors in a contained work area with respiratory protection.



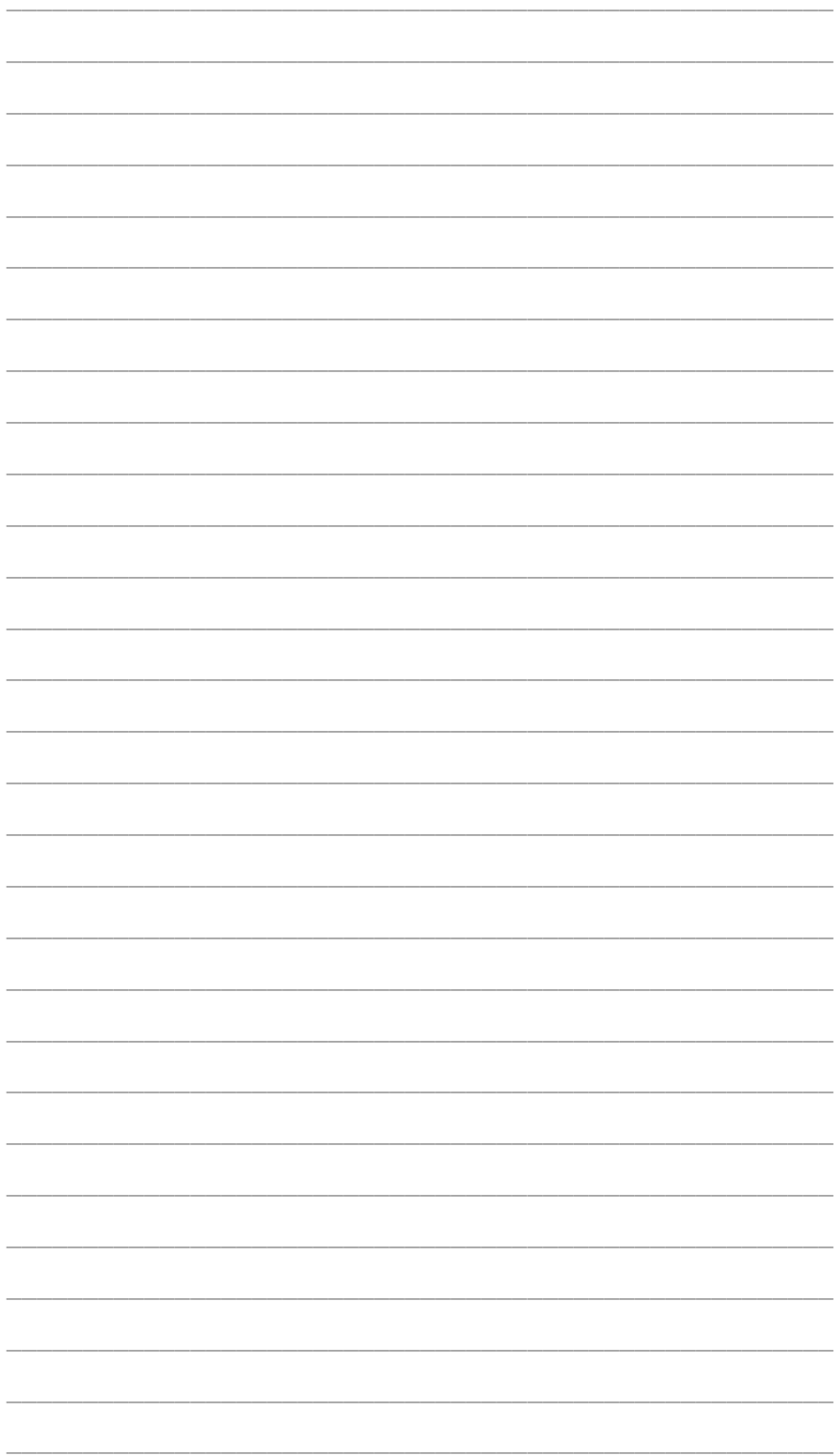

G . W O R K C H E C K L I S T

Before Work Begins

- Are the possible risks to occupants identified?
- Are the occupants informed of the possible risks and their responsibilities?
- Are the causes of the problems located?
- Is the work area set up?
- Is the work area closed off from occupants?

During Work

- Are dust and debris being contained in the work area?
- Are workers wearing necessary protective clothing and equipment?
- Are workers cleaning up each time they leave the work site?

At the End of the Job

- Did workers fix the cause of the problem?
- Did workers remove visible dust and debris?
- Did workers properly dispose of dust and debris?
- Did workers wet wash the surfaces?
- Were dust samples taken to make sure that cleanup worked?

For Long-Term Maintenance

Is there a plan to:

- Maintain painted surfaces?
- Keep surfaces clean and cleanable?
- Prevent water and moisture damage?

This Guide may be reproduced and distributed without prior permission from the U.S. Department of Housing and Urban Development or any other Federal Agency.

Disclaimer: The guidance offered in this document is based upon the latest lead hazard control knowledge and technology available at the time it was written. Users bear all risks associated with reliance on these work practices and have sole responsibility for evaluating the information it contains. Users bear sole responsibility to form their own independent judgments on the document's use, modification, and adaptation as appropriate. Neither the United States Government nor any of its employees makes any warranty, expressed or implied, or assumes any legal liability for any use of, or the results of, any information, product, or process discussed in this document.

Why Follow this Guide?



The Simple Work Practice Changes in this Guide Can Protect Children and Workers

- This Guide contains practical steps for lead safety.
- With small changes in work practices, workers can protect themselves, their families, and their customers, especially children, from lead exposure.

Painting, Home Improvement, and Maintenance Work in Older Homes Can Endanger Children

- Most homes built before 1978 contain lead-based paint.
- Doing work improperly can create a lot of paint chips and dust that may contain lead.
- Lead in paint chips, dust, and soil gets on children's hands and toys which they may put in their mouths.
- Lead can make children very sick and cause permanent brain and nerve damage, learning difficulties, and behavior problems.

Poor Maintenance Also Endangers Children

- Paint flaking and peeling is often caused by moisture.
- Rubbing or impact on doors, windows, and trim can cause paint failure.

Who Should Use This Guide?

- Building maintenance workers and supervisors
- Painters
- Repair, renovation, and remodeling contractors
- Property managers and owners
- Homeowners



Ordering Additional Copies

Single copies of *Lead Paint Safety: A Field Guide for Painting, Home Maintenance, and Renovation Work* on paper or on CD-ROM can be ordered from the National Lead Information Center at 1-800-424-5323 or downloaded from the HUD Office of Healthy Homes and Lead Hazard Control web site at www.hud.gov/offices/lead.

For information about obtaining multiple copies, contact the National Lead Information Center.

March 2001
HUD-1779-LHC

