

# **Water Resources Data**

## **California**

### **Water Year 2001**

Following is the PDF version to one of the four volume set of Water Resources Data for the state of California. For your convenience the Table of Contents, Surface-Water and Water-Quality Stations in Downstream Order, and the Index have been linked to the appropriate page within the volume. In addition, those items that are colored dark blue are also linked to the appropriate page and all web links have been activated.

All comments/suggestions on format should be forwarded to [kengelki@usgs.gov](mailto:kengelki@usgs.gov).

U.S. Department of the Interior  
U.S. Geological Survey

# Water Resources Data California Water Year 2001

## Volume 4. Northern Central Valley Basins and the Great Basin from Honey Lake Basin to Oregon State Line

By G.L. Rockwell, J.R. Smithson, M.F. Friebel, and M.D. Webster

Water-Data Report CA-01-4

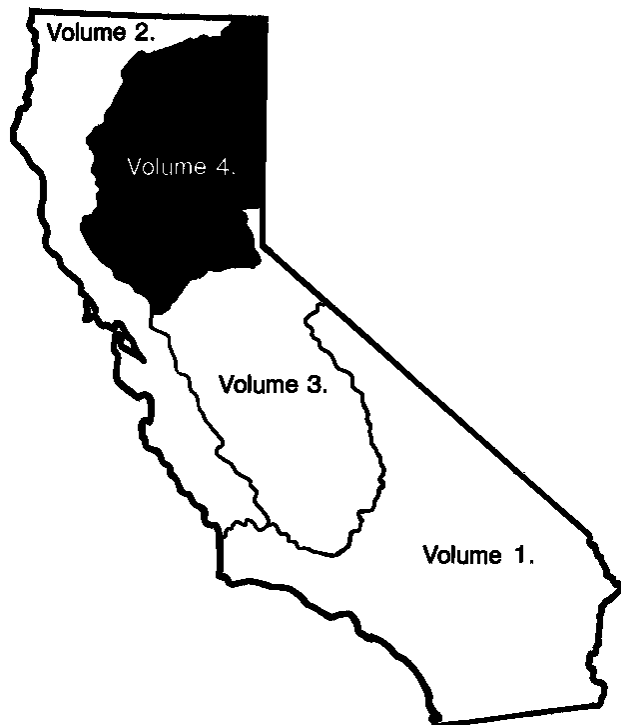

Prepared in cooperation with the  
California Department of Water Resources and with other agencies



**U.S. DEPARTMENT OF THE INTERIOR**

**GALE A. NORTON, Secretary**

**U.S. GEOLOGICAL SURVEY**

**Charles G. Groat, Director**

---

For information on the water program in California write to:  
District Chief, Water Resources Division  
U.S. Geological Survey  
Placer Hall, Suite 2015  
6000 J Street  
Sacramento, California 95819-6129

## PREFACE

This volume of the annual hydrologic data report of California is one of a series of annual reports that document hydrologic data gathered from the U.S. Geological Survey's surface- and ground-water data-collection networks in each State, Puerto Rico, and the Trust Territories. These records of streamflow, ground-water levels, and water quality provide the hydrologic information needed by Federal, State, and local agencies, and the private sector for developing and managing our Nation's land and water resources. Hydrologic data for California are contained in four volumes:

- Volume 1. Southern Great Basin from Mexican Border to Mono Lake Basin and Pacific Slope Basins from the Tijuana River to Santa Maria River
- Volume 2. Pacific Slope Basins from Arroyo Grande to Oregon State Line except Central Valley
- Volume 3. Southern Central Valley Basins and The Great Basin from Walker River to Truckee River
- Volume 4. Northern Central Valley Basins and The Great Basin from Honey Lake Basin to Oregon State Line

This report is the culmination of a concerted effort by dedicated personnel of the U.S. Geological Survey who collected, compiled, analyzed, verified, and organized the data. In addition to the authors, who had primary responsibility for assuring that the information contained herein is accurate, complete, and adheres to U.S. Geological Survey policy and established guidelines, the individuals contributing significantly to the collection, processing, and tabulation of the data are given on page V.

This report was prepared in cooperation with the California Department of Water Resources and with other agencies, under the general supervision of Michael V. Shulters, District Chief, California.

# REPORT DOCUMENTATION PAGE

*Form Approved*  
OMB No. 0704-0188

Public reporting burden for this collection of information is estimated to average 1 hour per response, including the time for reviewing instructions, searching existing data sources, gathering and maintaining the data needed, and completing and reviewing the collection of information. Send comments regarding this burden estimate or any other aspect of this collection of information, including suggestions for reducing this burden, to Washington Headquarters Services, Directorate for Information Operations and Reports, 1215 Jefferson Davis Highway, Suite 1204, Arlington, VA 22202-4302, and to the Office of Management and Budget, Paperwork Reduction Project (0704-0188), Washington, DC 20503.

1. AGENCY USE ONLY (Leave blank)		2. REPORT DATE April 2002	3. REPORT TYPE AND DATES COVERED Annual—Oct. 1, 2000, to Sept. 30, 2001	
4. TITLE AND SUBTITLE Water Resources Data—California, Water Year 2001. Volume 4. Northern Central Valley Basins and The Great Basin from Honey Lake Basin to Oregon State Line			5. FUNDING NUMBERS	
6. AUTHOR(S) G.L. Rockwell, J.R. Smithson, M.F. Friebel, and M.D. Webster				
7. PERFORMING ORGANIZATION NAME(S) AND ADDRESS(ES) U.S. Geological Survey, Water Resources Division, California District Placer Hall, Suite 2015 6000 J Street Sacramento, CA 95819-6129			8. PERFORMING ORGANIZATION REPORT NUMBER USGS-WDR-CA-01-4	
9. SPONSORING / MONITORING AGENCY NAME(S) AND ADDRESS(ES) U.S. Geological Survey, Water Resources Division, California District Placer Hall, Suite 2015 6000 J Street Sacramento, CA 95819-6129			10. SPONSORING / MONITORING AGENCY REPORT NUMBER USGS-WDR-CA-01-4	
11. SUPPLEMENTARY NOTES Prepare in cooperation with the California Department of Water Resources and with other agencies.				
12a. DISTRIBUTION / AVAILABILITY STATEMENT No restriction on distribution. This report may be purchased from the National Technical Information Service, Springfield, VA 22161			12b. DISTRIBUTION CODE	
13. ABSTRACT (Maximum 200 words) Water-resources data for the 2001 water year for California consist of records of stage, discharge, and water quality of streams, stage and contents in lakes and reservoirs, and water levels and water quality in wells. Volume 4 contains discharge records for 191 gaging stations, stage and contents for 53 lakes and reservoirs, gage-height records for 1 station, and water quality for 18 stations. Also included are 3 miscellaneous partial-record sites, and 3 parital-record water-quality stations. These data represent that part of the National Water Data System operated by the U.S. Geological Survey and cooperating State and Federal agencies in California.				
14. SUBJECT TERMS *California, *Hydrologic data, * Surface water, *Water quality, Flow rate, Sampling sites, Gaging stations, Lakes, Reservoirs, Chemical analyses, Sediment, Water temperatures, Water analyses			15. NUMBER OF PAGES 480	
			16. PRICE CODE	
17. SECURITY CLASSIFICATION OF REPORT Unclassified	18. SECURITY CLASSIFICATION OF THIS PAGE Unclassified	19. SECURITY CLASSIFICATION OF ABSTRACT Unclassified	20. LIMITATION OF ABSTRACT	

## WATER RESOURCES DIVISION

Robert R. Mason, Chief, Operations  
James C. Bowers, Assistant Chief, Operations

Kevin Bazar, Hydrologic Technician  
William L. Boults, Hydrologic Technician  
William R. Brazelton, Hydrologic Technician  
Susan Brockner, Hydrologic Technician  
Lynda R. Christensen, Hydrologic Technician  
Karl Davidek, Hydrologic Technician  
Kimberly S. Engelking, Editorial Assistant  
Cory A. Escobedo, Hydrologic Clerk  
Jon E. Ferguson, Hydrologic Technician  
Laureen J. Fong-Frydendal, Hydrologic Technician  
James J. Gibbons, Lead Hydrologic Technician  
Kim L. Hanson, Computer Specialist  
William J. Hardy, Hydrologic Technician  
Darren Hart, Hydrologic Technician  
Paul D. Honeywell, Hydrologic Technician  
Rick T. Iwatsubo, Hydrologic Technician  
Joel D. Johnson, Supervisory Hydrologist  
Mark V. Johnson, Hydrologic Technician  
Michael Judd, Hydrologic Technician  
Michael P. Mann, Hydrologist  
Ken Markham, (Retired U.S.G.S.)  
Jon C. McNulty, Hydrologic Technician  
Delia A. Millers, Hydrologic Clerk  
Roger Mitchell, Hydrologic Technician  
Allan C. Mlodnosky, Hydrologic Technician  
James R. Mullen, (Retired U.S.G.S.)  
Denis J. O'Halloran, Hydrologic Technician  
Christine S. O'Neil, Hydrologic Technician  
David Pratt, Hydrologist  
Lee A. Price, Hydrologic Technician  
M. Kathy Shay, Computer Specialist  
Carol J. Simons, Hydrologic Technician  
David M. Sparks, Hydrologic Technician  
Kenneth Stumpf, Hydrologic Technician  
Gregory F. Susich, Hydrologic Technician  
Steven P. Wells, Hydrologic Technician  
M. Kay Witter, Editor  
Mark H. Woloszyk, Hydrologic Technician  
Kevin S. Wright, Hydrologic Technician  
George S. Yamamoto, Scientific Illustrator  
David K. Yancey, Computer Specialist  
Brian T. Yost, Hydrologic Technician

Richard A. Hunrichs, Surface Water Hydrologist  
Robert W. Meyer, Surface Water Hydrologist

## CONTENTS

	Page
Preface.....	iii
Surface-Water and Water-Quality Stations in Downstream Order for Which Records are Published in this Volume.....	viii
Discontinued Gaging Stations.....	xiv
Discontinued Lakes and Reservoirs.....	xix
Discontinued Water-Quality Stations.....	xix
Introduction.....	1
Cooperation.....	1
Special Networks and Programs.....	2
Explanation of the Records.....	3
Station-Identification Numbers.....	3
Downstream-Order System.....	3
Latitude-Longitude System.....	3
Records of Stage and Water Discharge.....	3
Data Collection and Computation.....	4
Data Presentation.....	5
Identifying Estimated Daily Discharge.....	7
Accuracy of the Records.....	7
Other Records Available.....	7
Records of Surface-Water Quality.....	8
Changes in National Trends Network Procedures.....	8
Classification of Records.....	8
Arrangement of Records.....	8
Onsite Measurements and Sample Collection.....	8
Water Temperature.....	9
Sediment.....	9
Cross-Sectional Data.....	9
Laboratory Measurements.....	9
Water Quality-Control Data.....	10
Data Presentation.....	11
Access to USGS Water Data.....	11
Definition of Terms.....	13
Publications on Techniques of Water-Resources Investigations.....	25
Surface-Water-Discharge and Surface-Water-Quality Records.....	51
Remark Codes.....	51
Discharge at Partial-Record Stations and Miscellaneous Sites.....	442
Analyses of Samples Collected at Water-Quality Partial-Record Sites.....	444
Index.....	451

## ILLUSTRATIONS

Figure 1. Diagram showing system for numbering miscellaneous site (latitude and longitude).....	3
2–23. Maps showing location of discharge and water-quality stations	
2. Alpine County.....	29
3. Amador County.....	30
4. Butte County.....	31
5. Colusa County.....	32
6. El Dorado County.....	33
7. Glenn County.....	34
8. Lake County.....	35
9. Lassen County.....	36
10. Modoc County.....	37
11. Napa County.....	38
12. Nevada County.....	39
13. Placer County.....	40
14. Plumas County.....	41
15. Sacramento County.....	42
16. Shasta County.....	43
17. Sierra County.....	44

## CONTENTS

	Page
18–23. Maps showing location of discharge and water-quality stations—Continued:	
18. Siskiyou County.....	44
19. Solano County.....	46
20. Sutter County.....	47
21. Tehama County.....	48
22. Yolo County.....	49
23. Yuba County.....	50
24–36. Schematic diagrams showing diversions and storage:	
24. Pit and McCloud River Basins.....	53
25. Upper Sacramento River Basin.....	92
26. Battle Creek and Cow Creek Basins.....	99
27. Lower Sacramento River Basin.....	135
28. South Fork Feather River Basin.....	157
29. North Fork Feather River Basin.....	173
30. Feather River at Lake Oroville.....	202
31. North Yuba River Basin.....	214
32. South Yuba River Basin.....	249
33. Bear River Basin.....	255
34. Middle Fork American and Rubicon River Basins.....	333
35. South Fork American River Basin.....	365
36. Schematic diagram showing principal inflows and diversions, Sacramento–San Joaquin Delta.....	441



**SURFACE-WATER AND WATER-QUALITY STATIONS  
IN DOWNSTREAM ORDER, FOR WHICH RECORDS ARE PUBLISHED IN THIS VOLUME**

[Letters after station name designate type of data collected: (d), discharge;  
(l), elevation, gage heights, or contents; (c), chemical; (b), biological; (p), precipitation;  
(g) gage height; (t), water temperature; and (s), sediment]

	Station No.	Page
<b><u>PACIFIC SLOPE BASINS IN CALIFORNIA</u></b>		
<b>SACRAMENTO RIVER BASIN</b>		
Sacramento River at Delta (d) .....	11342000	54
Shasta Lake:		
North Fork Pit River (head of Pit River):		
South Fork Pit River near Likely (d) .....	11345500	56
Pit River near Canby (d) .....	11348500	57
Collett Reservoir near Little Valley (l) .....	11351600	59
Pit River below diversion to Muck Valley Powerplant, near Bieber (d) .....	11351950	60
Pit No. 1 Powerplant near Fall River Mills (d) .....	11354200	61
Pit River below Pit No. 1 Powerplant, near Fall River Mills (d) .....	11355010	62
Hat Creek:		
Lost Creek below diversion to Lost Creek Powerplant No. 1, near Old Station (d) .....	11358020	64
Hat Creek below Hat No. 1 Diversion Dam, near Burney (d) .....	11358700	65
Hat Creek Powerplant No. 1 near Burney (d) .....	11358800	66
Hat No. 2 Power Canal Diversion to Hat Creek, near Burney (d) .....	11359100	67
Lake Britton near Burney (l) .....	11361400	68
Pit River below Pit No. 4 Dam (d) .....	11362500	70
Nelson Creek below diversion to Nelson Creek Powerplant, near Big Bend (d) .....	11362900	72
East Fork Nelson Creek below diversion to Nelson Creek, near Big Bend (d) .....	11362950	73
Pit River at Big Bend (d) .....	11363000	74
Iron Canyon Creek:		
James B. Black Powerplant near Big Bend (d) .....	11363910	76
Iron Canyon Reservoir near Big Bend (l) .....	11363920	68
Iron Canyon Creek below Iron Canyon Dam, near Big Bend (d) .....	11363930	77
Hatchet Creek below diversion to Hatchet Creek Powerplant, near Montgomery Creek (d) .....	11364300	78
Pit River near Montgomery Creek (d) .....	11365000	79
McCloud River near McCloud (d) .....	11367500	81
McCloud–Iron Canyon Diversion Tunnel near McCloud (d) .....	11367720	83
Lake McCloud near McCloud (l) .....	11367740	68
McCloud River below McCloud Dam, near McCloud (d) .....	11367760	84
McCloud River at Ah-Di-Na, near McCloud (d) .....	11367800	85
McCloud River above Shasta Lake (d) .....	11368000	87
Shasta Lake near Redding (l) .....	11370000	89
Sacramento River at Keswick (d) .....	11370500	90
Anderson–Cottonwood Irrigation District Canal at Sharon Street, at Redding (d) .....	11370700	93
Clear Creek:		
Whiskeytown Lake:		
Judge Francis Carr Powerplant near French Gulch (d) .....	11525430	94
Spring Creek Powerplant at Keswick (d) .....	11371600	95
Whiskeytown Lake near Igo (l) .....	11371700	96
Clear Creek near Igo (d) .....	11372000	97
South Cow Creek (head of Cow Creek):		
South Cow Creek Canal:		
South Cow Creek Canal Diversion to South Cow Creek, near Whitmore (d) .....	11372080	100
Old Cow Creek:		
Kilarc Canal:		
Kilarc Canal Diversion to Old Cow Creek, near Whitmore (d) .....	11372325	101
Old Cow Creek below diversion to Olsen Powerplant, near Whitmore (d) .....	11372350	102
Cow Creek near Millville (d) .....	11374000	104
Middle Fork Cottonwood Creek below diversion to Arbuckle Mountain Powerplant, near Platina (d) .....	11374305	106
Cottonwood Creek near Cottonwood (d) .....	11376000	107
North Fork Battle Creek (head of Battle Creek):		
North Fork Battle Creek below North Battle Creek Dam, near Manzanita Lake (d) .....	11376015	109
North Fork Battle Creek below McCumber Dam, near Manzanita Lake (d) .....	11376025	110

**SURFACE-WATER AND WATER-QUALITY STATIONS  
IN DOWNSTREAM ORDER, FOR WHICH RECORDS ARE PUBLISHED IN THIS VOLUME—Continued**

	Station No.	Page
<b><u>PACIFIC SLOPE BASINS IN CALIFORNIA—Continued</u></b>		
<b>SACRAMENTO RIVER BASIN—Continued</b>		
Sacramento River—Continued:		
North Fork Battle Creek (head of Battle Creek)—Continued:		
Volta No. 1 Powerplant near Manton (d) .....	11376043	111
Volta No. 2 Powerplant near Manton (d) .....	11376046	111
North Fork Battle Creek below diversion to Keswick Ditch, near Manton (d) .....	11376050	112
Bailey Creek below diversion to Ponderosa–Bailey Creek Powerplant, near Manton (d) .....	11376120	113
North Fork Battle Creek below diversion to Cross Country Canal, near Manton (d) .....	11376140	114
North Fork Battle Creek below diversion to Eagle Canyon Canal, near Manton (d) .....	11376150	115
North Fork Battle Creek below diversion to Wildcat Canal, near Manton (d) .....	11376160	116
South Fork Battle Creek:		
South Powerplant near Manton (d) .....	11376410	111
South Fork Battle Creek below diversion to South Battle Creek Canal, near Manton (d) .....	11376420	117
Inskip Powerplant near Manton (d) .....	11376430	111
South Fork Battle Creek below diversion to Inskip Canal, near Manton (d) .....	11376440	118
Coleman Powerplant near Cottonwood (d) .....	11376458	111
South Fork Battle Creek below diversion to Coleman Ditch, near Manton (d) .....	11376460	119
Battle Creek below Coleman Fish Hatchery, near Cottonwood (d) .....	11376550	120
Sacramento River above Bend Bridge, near Red Bluff (d) .....	11377100	122
Elder Creek near Paskenta (d) .....	11379500	124
Mill Creek near Los Molinos (dt) .....	11381500	126
Deer Creek near Vina (dts) .....	11383500	130
Stony Creek:		
East Park Reservoir near Stonyford (l) .....	11385100	136
Stony Gorge Reservoir near Elk Creek (l) .....	11386100	136
Sacramento River at Colusa (dc) .....	11389500	137
Butte Creek below diversion dam, near Stirling City (d) .....	11389720	141
Butte Creek below forks of Butte Diversion Dam, near De Sabla (d) .....	11389740	142
Butte Creek below Centerville Diversion Dam, near Paradise (d) .....	11389780	143
Toadtown Canal above Butte Canal, near Stirling City (d) .....	11389800	144
Butte Creek near Chico (dts) .....	11390000	145
Sacramento River below Wilkins Slough, near Grimes (dt) .....	11390500	150
Sacramento Slough near Knights Landing (cs) .....	11391100	153
Middle Fork Feather River (head of Feather River):		
Lake Oroville:		
South Fork Feather River:		
Little Grass Valley Reservoir near La Porte (l) .....	11395020	158
South Fork Feather River below Little Grass Valley Dam (d) .....	11395030	159
South Fork Tunnel near Strawberry Valley (d) .....	11395150	161
South Fork Feather River below diversion dam, near Strawberry Valley (d) .....	11395200	162
Lost Creek:		
Sly Creek Reservoir near Strawberry Valley (l) .....	11395400	164
Oroville–Wyandotte Canal near Clipper Mills (d) .....	11395500	165
Lost Creek near Clipper Mills (d) .....	11396000	166
South Fork Feather River below Forbestown Dam (d) .....	11396200	168
Miners Ranch Canal below Ponderosa Dam, near Forbestown (d) .....	11396310	170
Bangor Canal below Miners Ranch Reservoir, near Oroville (d) .....	11396330	171
Sucker Run at Kanaka diversion, near Feather Falls (d) .....	11396395	172
North Fork Feather River:		
Lake Almanor at Prattville (l) .....	11399000	174
North Fork Feather River near Prattville (d) .....	11399500	175
Butt Creek below Almanor–Butt Creek Tunnel, near Prattville (d) .....	11400500	177
Butt Valley Reservoir near Caribou (l) .....	11401050	179
North Fork Feather River below Belden Dam (d) .....	11401112	180

**SURFACE-WATER AND WATER-QUALITY STATIONS  
IN DOWNSTREAM ORDER, FOR WHICH RECORDS ARE PUBLISHED IN THIS VOLUME—Continued**

	Station No.	Page
<b><u>PACIFIC SLOPE BASINS IN CALIFORNIA—Continued</u></b>		
<b>SACRAMENTO RIVER BASIN—Continued</b>		
Sacramento River—Continued:		
Middle Fork Feather River (head of Feather River)—Continued:		
North Fork Feather River—Continued:		
Indian Creek (head of Each Branch North Fork Feather River):		
Ward Creek:		
South Branch Ward Creek below diversion dam, near Genesee (d) .....	11401165	182
Spanish Creek above Blackhawk Creek, at Keddie (d) .....	11402000	183
North Fork Feather River below Rock Creek Diversion Dam (d) .....	11403200	185
Milk Ranch Creek:		
Three Lakes Reservoir:		
Milk Ranch Conduit at outlet, near Bucks Lodge (d) .....	11403450	186
Bucks Creek:		
Bucks Lake near Bucks Lodge (l) .....	11403500	187
Lower Bucks Lake near Bucks Lodge (l) .....	11403520	188
Bucks Creek below diversion dam, near Bucks Lodge (d) .....	11403530	189
Grizzly Creek:		
Grizzly Forebay near Storrie (l) .....	11404250	191
Grizzly Creek below diversion dam, near Storrie (d) .....	11404300	192
North Fork Feather River below Grizzley Creek (d) .....	11404330	194
Camp Creek near Pulga (d) .....	11404380	196
North Fork Feather River below Poe Dam (d) .....	11404400	197
North Fork Feather River at Pulga (d) .....	11404500	198
West Branch Feather River:		
Philbrook Creek below Philbrook Dam, near Butte Meadows (d) .....	11405120	200
West Branch Feather River below Hendricks Diversion Dam, near Stirling (d) .....	11405200	201
Lake Oroville near Oroville (l) .....	11406800	203
Palermo Canal near Oroville (d) .....	11406810	205
Power Canal:		
Thermalito Afterbay near Oroville (l) .....	11406870	206
Western Canal at Intake, near Oroville (d) .....	11406880	207
Richvale Canal at Intake, near Oroville (d) .....	11406890	208
Pacific Gas and Electric Co. Lateral at Intake, near Oroville (d) .....	11406900	209
Sutter–Butte Canal at Intake, near Oroville (d) .....	11406910	210
Thermalito Afterbay Release to Feather River, near Oroville (d) .....	11406920	211
Feather River at Oroville (d) .....	11407000	212
Middle Yuba River (head of Yuba River):		
Jackson Meadows Reservoir near Sierra City (l) .....	11407800	215
Middle Yuba River controlled release at Jackson Meadows Dam, near Sierra City (d) .....	11407815	216
Milton–Bowman Tunnel Outlet near Graniteville (d) .....	11408000	217
Middle Yuba River below Milton Dam, near Sierra City (d) .....	11408550	219
Lohman Ridge Tunnel at intake, near Camptonville (d) .....	11408870	221
Middle Yuba River below Our House Dam, near Camptonville (d) .....	11408880	222
Oregon Creek:		
Camptonville Tunnel at intake, near Camptonville (d) .....	11409350	223
Oregon Creek below Log Cabin Dam, near Camptonville (d) .....	11409400	224
Middle Yuba River near North San Juan (dts) .....	11410000	226
North Yuba River below Goodyears Bar (d) .....	11413000	232
Slate Creek:		
Slate Creek Tunnel near Strawberry Valley (d) .....	11413250	234
Slate Creek below diversion dam, near Strawberry Valley (d) .....	11413300	235
Deadwood Creek near Strawberry Valley (d) .....	11413320	236
Owl Gulch near Strawberry Valley (d) .....	11413323	237
New Bullards Bar Reservoir:		
New Colgate Powerplant near French Corral (d) .....	11413510	238

**SURFACE-WATER AND WATER-QUALITY STATIONS  
IN DOWNSTREAM ORDER, FOR WHICH RECORDS ARE PUBLISHED IN THIS VOLUME—Continued**

	Station No.	Page
<b><u>PACIFIC SLOPE BASINS IN CALIFORNIA—Continued:</u></b>		
<b><u>SACRAMENTO RIVER BASIN—Continued</u></b>		
Sacramento River—Continued:		
Feather River—Continued:		
Middle Yuba River (head of Yuba River)—Continued		
New Bullards Bar Reservoir near North San Juan (l) .....	11413515	239
North Yuba River below New Bullards Bar Dam, near North San Juan (d) .....	11413520	240
Yuba River (continuation of Middle Yuba River):		
Yuba River below New Colgate Powerplant, near French Corral (dts) .....	11413700	242
South Yuba River:		
Upper Cascade Lake near Soda Springs (l) .....	11413943	247
Lower Cascade Lake near Soda Springs (l) .....	11413945	248
Lake Spaulding:		
White Rock Lake near Soda Springs (l) .....	11414050	250
Meadow Lake near Cisco (l) .....	11414070	251
Lake Sterling near Cisco (l) .....	11414080	252
Fordyce Lake near Cisco (l) .....	11414090	253
Fordyce Creek below Fordyce Dam, near Cisco (d) .....	11414100	254
Lake Spaulding near Emigrant Gap (l) .....	11414140	256
Drum Canal at tunnel outlet, near Emigrant Gap (d) .....	11414170	257
South Yuba Canal near Emigrant Gap (d) .....	11414200	259
South Yuba River controlled release at Lake Spaulding, near Emigrant Gap (d) .....	11414210	260
South Yuba River at Langs Crossing, near Emigrant Gap (d) .....	11414250	261
Blue Lake near Emigrant Gap (l) .....	11414260	262
Rucker Creek below Blue Lake, near Emigrant Gap (d) .....	11414265	263
Rucker Lake near Emigrant Gap (l) .....	11414275	264
Rucker Creek below Rucker Lake, near Emigrant Gap (d) .....	11414280	265
Canyon Creek:		
Feeley Lake near Graniteville (l) .....	11414345	266
Lake Creek below Feeley Lake, near Graniteville (d) .....	11414350	267
Carr Lake near Graniteville (l) .....	11414355	268
Lake Creek below Carr Lake, near Graniteville (d) .....	11414360	269
French Lake near Cisco (l) .....	11414400	270
Canyon Creek below French Lake, near Cisco (d) .....	11414410	271
Faucherie Lake near Cisco (l) .....	11414440	272
Canyon Creek below Faucherie Lake, near Cisco (d) .....	11414450	273
Sawmill Lake near Graniteville (l) .....	11414465	274
Canyon Creek below Sawmill Lake, near Graniteville (d) .....	11414470	275
Jackson Lake near Sierra City (l) .....	11414690	276
Jackson Creek below Jackson Lake, near Sierra City (d) .....	11414700	277
Bowman Lake near Graniteville (l) .....	11415500	278
Bowman–Spaulding Canal at Jordan Creek Siphon Venturi, near Emigrant Gap (d).....	11416100	279
Canyon Creek below Bowman Lake (d) .....	11416500	280
Rock Lake near Graniteville (l) .....	11416580	282
Texas Creek below Rock Lake (d) .....	11416585	283
Lower Rock Lake near Graniteville (l) .....	11416590	284
Texas Creek below Lower Rock Lake, near Graniteville (d) .....	11416610	285
Culbertson Lake near Graniteville (l) .....	11416618	286
Texas Creek Tributary below Culbertson Lake, near Graniteville (d) .....	11416620	287
Upper Lindsey Lake near Graniteville (l) .....	11416650	288
Middle Lindsey Lake near Graniteville (l) .....	11416660	289
Lindsey Creek below Middle Lindsey Lake (d) .....	11416670	290
Lower Lindsey Lake near Graniteville (l) .....	11416680	291
Lindsey Creek below Lower Lindsey Lake, near Graniteville (d) .....	11416700	292
South Yuba River at Jones Bar, near Grass Valley (dts) .....	11417500	293
Yuba River below Engelbright Dam, near Smartville (dts) .....	11418000	299
Deer Creek near Smartville (d) .....	11418500	305

**SURFACE-WATER AND WATER-QUALITY STATIONS  
IN DOWNSTREAM ORDER, FOR WHICH RECORDS ARE PUBLISHED IN THIS VOLUME—Continued**

	Station No.	Page
<b><u>PACIFIC SLOPE BASINS IN CALIFORNIA—Continued</u></b>		
<b>SACRAMENTO RIVER BASIN—Continued</b>		
Sacramento River—Continued:		
Yuba River (continuation of Middle Yuba River) near Marysville (dt) .....	11421000	307
Bear River near Emigrant Gap (d) .....	11421710	311
Bear River below Drum Afterbay, near Blue Canyon (d) .....	11421770	312
Bear River below Dutch Flat Afterbay, near Dutch Flat (d) .....	11421790	313
Rollins Reservoir near Colfax (l) .....	11421800	315
Bear River Canal intake near Colfax (d) .....	11422000	316
Bear River below Rollins Dam, near Colfax (d) .....	11422500	318
Bear River fish release below New Camp Far West Reservoir, near Wheatland (d) .....	11423800	320
Bear River near Wheatland (d) .....	11424000	321
Mormon Ravine near Newcastle (d) .....	11425418	323
Sacramento River at Verona (d) .....	11425500	324
Sacramento Weir Spill to Yolo Bypass, near Sacramento (d) .....	11426000	326
North Fork American River (head of American River):		
North Fork of North Fork American River:		
Lake Valley Reservoir near Cisco (l) .....	11426170	327
Sixmile Valley:		
Kelly Lake near Cisco (l) .....	11426180	328
Canyon Creek near Blue Canyon (d) .....	11426195	329
Canyon Creek below Towle Diversion Dam, near Blue Canyon (d) .....	11426196	330
North Fork American River at North Fork Dam (d) .....	11427000	331
Middle Fork American River:		
French Meadows Reservoir near Foresthill (l) .....	11427400	334
Middle Fork American River at French Meadows (d) .....	11427500	335
Duncan Canyon Creek near French Meadows (d) .....	11427700	337
Duncan Creek below diversion dam, near French Meadows (d) .....	11427750	339
Middle Fork American River above Middle Fork Powerplant, near Foresthill (d) .....	11427760	340
Middle Fork American River below Interbay Dam, near Foresthill (d) .....	11427770	341
Rubicon River:		
Rubicon–Rockbound Tunnel near Meeks Bay (d) .....	11427940	343
Rubicon River below Rubicon Dam, near Meeks Bay (d) .....	11427960	344
Little Rubicon River:		
Buck Island Lake:		
Buck–Loon Tunnel near Meeks Bay (d) .....	11428300	345
Little Rubicon River below Buck Island Dam, near Meeks Bay (d) .....	11428400	346
Hell Hole Reservoir near Meeks Bay (l) .....	11428700	347
Rubicon River below Hell Hole Dam, near Meeks Bay (d) .....	11428800	348
South Fork Rubicon River:		
Gerle Creek below Loon Lake Dam, near Meeks Bay (d) .....	11429500	350
South Fork Rubicon River below Gerle Creek, near Georgetown (d) .....	11430000	352
Pilot Creek above Stumpy Meadows Lake (d) .....	11431800	354
Pilot Creek below Mutton Canyon, near Georgetown (d) .....	11433040	356
South Fork Long Canyon Creek (head of Long Canyon Creek):		
South Fork Long Canyon Creek Diversion Tunnel near Volcanoville (d) .....	11433060	357
South Fork Long Canyon Creek below diversion dam, near Volcanoville (d) .....	11433065	358
North Fork Long Canyon Creek:		
North Fork Long Canyon Creek Diversion Tunnel near Volcanoville (d) .....	11433080	359
North Fork Long Canyon Creek below diversion dam, near Volcanoville (d) .....	11433085	360
Middle Fork American River near Foresthill (d) .....	11433300	361
North Fork American River at Auburn Dam Site, near Auburn (t) .....	11433790	363

SURFACE-WATER AND WATER-QUALITY STATIONS  
IN DOWNSTREAM ORDER, FOR WHICH RECORDS ARE PUBLISHED IN THIS VOLUME—Continued

	Station No.	Page
<b><u>PACIFIC SLOPE BASINS IN CA—Continued</u></b>		
<b>SACRAMENTO RIVER BASIN—Continued</b>		
Sacramento River—Continued:		
North Fork American River (head of American River)—Continued:		
South Fork American River—Continued:		
Lake Aloha near Phillips (l) .....	11434900	366
Pyramid Creek at Twin Bridges (d) .....	11435100	367
Silver Lake (head of Silver Fork of South Fork American River) near Kirkwood (l) .....	11435900	368
Silver Lake Outlet near Kirkwood (d) .....	11436000	369
Caples Lake near Kirkwood (l) .....	11436950	371
Caples Creek Release below Caples Dam, near Kirkwood (d) .....	11436999	372
South Fork American River near Kyburz (d) .....	11439500	373
Silver Creek:		
Junction Reservoir:		
South Fork Silver Creek near Ice House (d) .....	11441500	376
Silver Creek below Junction Dam, near Pollock Pines (d) .....	11441800	378
Silver Creek below Camino Diversion Dam (d) .....	11441900	379
Slab Creek Reservoir:		
Brush Creek below Brush Creek Dam, near Pollock Pines (d) .....	11442700	381
South Fork American River near Camino (d) .....	11443500	382
Rock Creek near Placerville (d) .....	11444201	384
South Fork American River near Placerville (d) .....	11444500	386
South Fork American River near Pilot Hill (t) .....	11446030	387
Folsom Lake near Folsom (l) .....	11446200	389
American River below Folsom Dam, near Folsom (t) .....	11446220	390
American River at Fair Oaks (dt) .....	11446500	392
American River at William B. Pond Park, at Carmichael (t) .....	11446700	396
American River below Watt Avenue Bridge, near Carmichael (t) .....	11446980	398
Natomas East Main Drainage Canal:		
Dry Creek at Vernon Street Bridge, at Roseville (d) .....	11447293	400
Arcade Creek near Del Paso Heights (dcts) .....	11447360	402
Sacramento River at Freeport (dcts) .....	11447650	408
Yolo Bypass:		
Clear Lake (head of Cache Creek):		
Kelsey Creek near Kelseyville (d) .....	11449500	419
Clear Lake at Lakeport (g) .....	11450000	421
Cache Creek near Lower Lake (d) .....	11451000	422
North Fork Cache Creek at Hough Springs, near Clearlake Oaks (d) .....	11451100	423
North Fork Cache Creek near Clearlake Oaks (d) .....	11451300	425
Harley Gulch near Wilbur Springs (d) .....	11451540	427
Davis Creek at Knoxville (d) .....	11451600	428
Sulphur Creek at Wilbur Springs (d) .....	11451690	429
Bear Creek above Holsten Chimney Canyon, near Rumsey (d) .....	11451715	431
Cache Creek at Yolo (d) .....	11452500	433
Yolo Bypass near Woodland (d) .....	11453000	434
Putah Creek near Guenoc (d) .....	11453500	435
Lake Berryessa near Winters (l) .....	11453900	437
Putah Creek near Winters (d) .....	11454000	438
Putah South Canal near Winters (d) .....	11454210	440

**WATER RESOURCES DATA—CALIFORNIA, WATER YEAR 2001**  
**DISCONTINUED GAGING STATIONS**

The following continuous-record streamflow stations in California have been discontinued or converted to partial record stations. Daily records were collected and are stored in USGS Water Data for the period of record shown for each station.

Station No.	Station name	Drainage area (mi <sup>2</sup> )	Period of record
10354000	Long Valley Creek near Scotts	125	1917, 1919, 1989–94
10354700	Mill Creek at Milford	2.26	1963–69
10355000	Baxter Creek near Janesville	19.6	1913–16, 1918–19
10355500	Schloss Creek at Janesville	1.05	1915, 1918–19
10356500	Susan River at Susanville	184	1900–05, 1913, 1917–21, 1951–94
10357000	Gold Run Creek near Susanville	15.1	1915–16
10358470	Willow Creek Tributary near Susanville	3.08	1966–71
10358500	Willow Creek near Susanville	90.4	1951–94
10359100	Shaffer Creek near Litchfield	5.63	1970–73
10359250	Pine Creek near Westwood	24.8	1951–61
10359300	Pine Creek near Susanville	226	1961–66, 1968, 1970–82
10359350	Eagle Lake Tributary near Susanville	.91	1963–65
10360230	Eagle Creek at Eagleville	6.36	1962–64, 1966–68, 1970
10360900	Bidwell Creek below Mill Creek, near Fort Bidwell	25.6	1961–82
10361000	Bidwell Creek at Fort Bidwell	—	1912, 1918–19
11341400	Sacramento River near Mount Shasta	135	1960–87
11341500	Sacramento River at Castella	256	1911–17, 1920–23
11342500	Sacramento River at Antler	460	1911, 1920–41
11343000	Parker Creek near Alturas	80.9	1931
11343500	North Fork Pit River near Alturas	203	1930–32, 1958–67
11344000	North Fork Pit River at Alturas	212	1929–31, 1972–85
11344500	South Fork Pit River at Jess Valley	100	1929–31
11346000	Crooks Canyon Creek near Likely	33.8	1929–31
11346500	Fitzhugh Creek near Alturas	36.7	1930–31
11347500	Pine Creek near Alturas	23.5	1919–31
11348000	Pit River at Alturas	857	1929–31
11348200	Pit River near Alturas	1,080	1966–71
11349000	Pit River near Lookout	1,585	1929–31, 1958–71, 1978–80
11349500	Ash Creek at Ash Valley	136	1929–31
11350500	Ash Creek at Adin	258	1904–06, 1929–33, 1958–70, 1972–82
11351000	Willow Creek near Adin	—	1930–31
11351500	Widow Valley Creek near Lookout	27.7	1930–31
11352000	Pit River near Bieber	2,475	1904–08, 1922–26, 1929–31, 1952–70, 1972–75
11352500	Horse Creek at Little Valley, near Pittville	237	1929–31, 1960–67
11352900	Beaver Creek near Hat Creek	23.2	1970–73
11353500	Bear Creek near Dana	84	1921–26
11353600	Dry Creek near Dana	6.46	1967–70
11353700	Fall River near Dana	123	1959–67
11354500	Fall River at Fall River Mills	—	1912–13, 1922
11355000	Pit River at Fall River Mills	3,651	1921–51, 1981
11355500	Hat Creek near Hat Creek	162	1926–29, 1930–94
11356500	Hat Creek at Hawkins Ranch, near Hat Creek	190	1912–13
11357000	Hat Creek at Wilcox Ranch, near Cassel	193	1922
11358000	Lost Creek near Bald Mountain	7.51	1930
11358500	Rising River near Cassel	22.2	1912–13, 1921–22
11359500	Hat Creek at Carbon	364	1922

## WATER RESOURCES DATA—CALIFORNIA, WATER YEAR 2001

## DISCONTINUED GAGING STATIONS—Continued

Station No.	Station name	Drainage area (mi <sup>2</sup> )	Period of record
11360000	Burney Creek above Burney	60.1	1922
11360500	Burney Creek at Park Avenue, near Burney	94.6	1912–13, 1921–22, 1958–64, 1966–75, 1977–80
11363500	Kosk Creek near Henderson	54.8	1911–13, 1915–16
11364000	Pit River above Hatchet Creek	4,819	1926–37
11365500	Squaw Creek above Shasta Lake	64	1945–66
11366000	Squaw Creek at Ydalpom	99.5	1912–13
11366500	Pit River near Ydalpom	5,030	1911–43
11367000	Mud Creek near McCloud	—	1927–32
11367200	McCloud River below Big Springs, near McCloud	322	1956–59
11367300	Angel Creek near McCloud	17.1	1955–59
11367700	McCloud River above Panther Creek, near McCloud	401	1955–59
11368500	McCloud River near Gregory	633	1903–08
11369000	McCloud River at Baird	673	1911–43
11369500	Sacramento River at Kennett	6,355	1926–42
11371000	Clear Creek at French Gulch	115	1950–93
11371500	Clear Creek near Shasta	172	1912–13
11372050	Churn Creek near Redding	9.35	1961–66
11372060	Churn Creek below Newton Creek, near Redding	11.9	1966–72
11372200	South Cow Creek near Millville	77.3	1957–72
11372700	Clover Creek near Oak Run	19	1957–59
11373200	Oak Run Creek near Oak Run	11.0	1957–66
11373300	Little Cow Creek near Ingot	60.8	1958–65
11374060	Shingle Creek near Shingletown	3.25	1964–67
11374100	Bear Creek near Millville	75.7	1960–67
11374400	Middle Fork Cottonwood Creek near Ono	244	1957–75
11375500	North Fork Cottonwood Creek at Ono	58.8	1908–13
11375700	North Fork Cottonwood Creek near Igo	88.7	1957–80
11375810	Cottonwood Creek near Olinda	395	1971–86
11375815	Cottonwood Creek above South Fork, near Cottonwood	478	1982–85
11375820	South Fork Cottonwood Creek near Cottonwood	217	1963–78
11375870	South Fork Cottonwood Creek near Olinda	371	1977–86
11375900	South Fork Cottonwood Creek at Evergreen Road, near Cottonwood	397	1982–85
11376038	Manzanita Creek at park boundary, near Manzanita Lake	11.6	1979–81
11376450	Coleman Canal above Coleman Forebay, near Cottonwood	—	1979–85
11376490	Battle Creek above Coleman Powerhouse, near Cottonwood	355	1979
11376500	Battle Creek near Cottonwood	356	1941–61
11377200	Sacramento River at Bend Bridge	8,900	1968–70
11377500	Paynes Creek near Red Bluff	92.8	1950–66
11378500	Sacramento River at Red Bluff	9,077	1957–66
11378800	Red Bank Creek near Red Bluff	89.6	1960–82
11378860	Red Bank Creek at Rawson Road Bridge, near Red Bluff	109	1965–67
11379000	Antelope Creek near Red Bluff	123	1941–82
11380000	Elder Creek near Henleyville	130	1931–41
11380500	Elder Creek at Gerber	136	1941–69, 1977–79
11381000	Mill Creek near Mineral	21.2	1929–32
11381595	Mill Creek at Sherwood Bridge, near Los Molinos	13.3	1977–78
11381990	Thomes Creek tributary at Paskenta	.65	1968–70
11382000	Thomes Creek at Paskenta	203	1921–97
11382090	Thomes Creek at Rawson Road Bridge, near Richfield	28.4	1978–80
11382500	Deer Creek at Deer Creek Meadows	50.5	1929–32
11382550	Deer Creek below Slate Creek, near Deer Creek Meadows	69.4	1961–70
11383000	Deer Creek at Polk Springs	134	1929–31
11383600	Deer Creek at Red Bridge, near Vina	210	1977



WATER RESOURCES DATA—CALIFORNIA, WATER YEAR 2001  
DISCONTINUED GAGING STATIONS—Continued

Station No.	Station name	Drainage area (mi <sup>2</sup> )	Period of record
11383730	Sacramento River at Vina Bridge, near Corning	—	1945–78
11383800	Sacramento River near Hamilton City	10,833	1945–80
11384000	Big Chico Creek near Chico	72.4	1931–86
11384340	Mud Creek at Cohasset Road, near Chico	21.9	1968–69
11384350	Mud Creek near Chico	48.9	1966–74
11384500	Stony Creek near Stonyford	102	1914–15, 1919–34
11384600	Little Stony Creek above East Park Reservoir, near Lodoga	45.6	1967–82
11385000	Little Stony Creek near Lodoga	98.2	1909–34
11385500	Stony Creek above Stony Gorge Reservoir	281	1934–41
11386500	Grindstone Creek near Elk Creek	157	1936–37, 1940, 1966–72
11387000	Stony Creek near Fruto	597	1901–12, 1961–78
11387200	Stony Creek above Black Butte Lake, near Orland	623	1909, 1981–83
11387500	Stony Creek near Orland	635	1920–34
11387800	North Fork Stony Creek near Newville	63.4	1963–73
11387990	South Diverson Canal near Orland	—	1955–90
11388000	Stony Creek below Black Butte Dam, near Orland	738	1955–90
11388500	Stony Creek near Hamilton City	773	1941–73
11389000	Sacramento River at Butte City	12,080	1921–95
11389700	Butte Creek at Butte Meadows	44.4	1960–74
11389950	Little Butte Creek at Magalia	11.4	1969–85
11390200	Gold Run Creek Tributary near Nelson	1.31	1961
11390210	Cherokee Canal near Nelson	—	1970–74
11390655	South Fork Willow Creek near Fruto	38.9	1963–78
11390660	Walker Creek at Artois	60.4	1965–81
11390672	Stone Corral Creek near Sites	38.2	1958–64, 1966–85
11390890	Colusa Basin Drain at Road 99E, near Knights Landing	—	1996
11391000	Sacramento River at Knights Landing	14,535	1941–80
11391100	Sacramento Slough near Knights Landing	—	1996
11391400	Little Last Chance Creek below Frenchman Dam, near Chilcoot	81.1	1959–80
11391460	Berry Creek near Sattley	7.54	1973–81
11391500	Big Grizzly Creek at Grizzly Valley Dam, near Portola	44	1926–32, 1951–53, 1955–67, 1969–80
11392100	Middle Fork Feather River near Portola	586	1969–76, 1978–80
11392500	Middle Fork Feather River near Clio	686	1926–79
11393000	Middle Fork Feather River at Sloat	775	1911–27
11393500	Middle Fork Feather River below Sloat	819	1941–62
11394000	Middle Fork Feather River near Nelson Point	883	1924–32
11394500	Middle Fork Feather River near Merrimac	1,062	1952–86
11394620	Fall River near Feather Falls	9.89	1963–79
11394800	South Fork Feather River above Little Grass Valley Reservoir	8.09	1961–79
11395300	Lost Creek above Sly Creek Reservoir, near Strawberry Valley	14.1	1961–70
11396300	South Fork Feather River near Forbestown	105	1958–61
11396350	South Fork Feather River at Ponderosa Dam	108	1962–87, 1990
11396400	Sucker Run near Forbestown	18.7	1965–87
11396500	Palmero Canal at Enterprise	—	1912–65
11397000	South Fork Feather River at Enterprise	132	1912–66
11397500	Feather River at Bidwell Bar	1,341	1912–64
11400000	Butt Creek above Almanor–Butt Creek Tunnel, near Prattville	69.0	1937–64
11401000	Butt Creek at Butt Valley	81.3	1905–21
11401100	Butt Creek near Caribou	85.5	1970, 1976–81
11401125	Indian Creek near Boulder Creek Guard Station, near Taylorsville	68.6	1966–80
11401150	Red Clover Creek near Genesee	122	1959–65
11401180	Little Grizzly Creek near Genesee	29.6	1964–79

## WATER RESOURCES DATA—CALIFORNIA, WATER YEAR 2001

## DISCONTINUED GAGING STATIONS—Continued

Station No.	Station name	Drainage area (mi <sup>2</sup> )	Period of record
11401200	Indian Creek near Taylorsville	526	1958–73, 1975–76, 1979–80
11401300	Lights Creek near Taylorsville	57.6	1958–62
11401500	Indian Creek near Crescent Mills	739	1906–09, 1911–18, 1930–93
11401900	Spanish Creek near Quincy	69.1	1959–63
11401940	Mill Creek near Quincy	6.72	1966–71
11402500	Spanish Creek at Keddie	194	1912–33
11403000	East Branch of North Fork Feather River near Rich Bar	1,025	1951–61, 1968–82
11403510	Bucks Creek Tunnel inlet near Storrie	—	1970, 1976
11404000	Grizzly Creek near Storrie	5.20	1930–44
11404100	Bucks Creek Tunnel Outlet near Storrie	—	1986–94
11405000	North Fork Feather River at Big Bend	1,965	1905–11
11405300	West Branch Feather River near Paradise	—	1958–86
11405500	Spring Valley Diversion near Yankee Hill	—	1926–52
11406000	Concow Creek near Yankee Hill	15.1	1928–30, 1932–52
11406500	West Branch Feather River near Yankee Hill	146	1931–63
11407150	Feather River near Gridley	3,676	1965–98
11407300	North Honcut Creek near Bangor	47.1	1961–81
11407500	South Honcut Creek near Bangor	30.6	1951–86
11407700	Feather River at Yuba City	3,974	1965–84
11407810	Middle Yuba River at Jackson Meadows Dam, near Sierra City	37.6	1989–94
11407900	Middle Yuba River below Jackson Meadows Dam, near Sierra City	38.3	1965–87
11408500	Middle Yuba River at Milton	39.8	1926–34, 1935–64
11408700	Middle Yuba River near Alleghany	96.6	1958–66
11408850	Middle Yuba River near Camptonville	136	1967–89
11409000	Middle Yuba River above Oregon Creek, near North San Juan	162	1941–69
11409300	Oregon Creek at Camptonville	23	1967–2000
11409500	Oregon Creek near North San Juan	34.4	1912–69
11410400	Haypress Creek near Sierra City	18.2	1961–66
11410500	North Yuba River near Sierra City	94.7	1924–44
11411000	Downie River at Downieville	72.7	1911–26
11411500	North Yuba River at Goodyears Bar	221	1911–31
11412000	Rock Creek at Goodyears Bar	8.98	1911–33
11412500	Goodyears Creek at Goodyears Bar	12.9	1911–33
11413100	North Yuba River above Slate Creek, near Strawberry Valley	351	1968–87
11413500	North Yuba River below Bullards Bar Dam	487	1941–66
11413600	Sweetland Creek near North San Juan	2.68	1969–73
11413900	Upper Castle Creek at Soda Springs	3.96	1958–63
11413950	South Yuba River Tributary near Soda Springs	.92	1972–73
11414000	South Yuba River near Cisco	51.8	1942–94
11414190	Drum Canal above Drum Forebay, near Blue Canyon	—	1964–91
11414500	Canyon Creek above Jackson Creek	16.6	1926–30
11415000	Jackson Creek at Mouth	5.45	1926–30
11417000	South Yuba River near Washington	198	1942–53, 1957–72
11417100	Poorman Creek near Washington	23.1	1961–71
11419000	Yuba River at Smartville	1,200	1904–41
11420000	Dry Creek near Brownsville	20.4	1949–60
11420500	Dry Creek at Virginia Ranch	71.3	1949–61
11420700	Dry Creek near Browns Valley	87.1	1964–80
11421500	Yuba River at Marysville	1,344	1944–57
11421700	Feather River below Shanghai Bend, near Olivehurst	5,334	1970–80
11421720	Boardman Canal near Emigrant Gap	—	1965–86
11421730	Bear River below Boardman Diversion Dam, near Emigrant Gap	4.01	1979–85
11423000	Bear River near Auburn	140	1941–67

## WATER RESOURCES DATA—CALIFORNIA, WATER YEAR 2001

## DISCONTINUED GAGING STATIONS—Continued

Station No.	Station name	Drainage area (mi <sup>2</sup> )	Period of record
11423500	Bear River at Van Trent	265	1905–27
11423940	Kidd Lake near Soda Springs	1.00	1991–2000
11424500	Dry Creek near Wheatland	99.9	1947–62
11424600	Wellman Creek near Smartville	.59	1968–73
11425000	Feather River at Nicolaus	5,921	1942, 1944–83, 1985
11425410	Rock Creek Lake near Auburn	—	1999–2000
11426110	Onion Creek Tributary No. 3 near Soda Springs	.65	1959–64, 1966–67
11426120	Onion Creek Tributary No. 5A near Soda Springs	.39	1959–64, 1966
11426130	Onion Creek Tributary No. 2 near Soda Springs	.48	1958–64, 1966–67
11426140	Onion Creek Tributary No. 1 near Soda Springs	.19	1958–64, 1966–67
11426150	Onion Creek near Soda Springs	3.58	1960–79
11426160	Onion Creek Tributary No. 7 near Soda Springs	.80	1959–64
11426200	North Fork Forbes Creek near Dutch Flat	1.68	1956–85
11426400	North Shirttail Creek near Dutch Flat	9.10	1957–85
11426500	North Fork American River near Colfax	308	1912–41
11428000	Rubicon River at Rubicon Springs, near Meeks Bay	31.4	1910–13, 1957–86
11429000	South Fork Rubicon River at sawmill, near Quintette	16.1	1910–14
11429800	Robbs Peak Tunnel near Riverton	—	1963–67
11430500	South Fork Rubicon River at Mouth, near Georgetown	56.9	1956–62
11431000	Rubicon River near Georgetown	195	1910–14, 1944–65
11431500	Georgetown Divide Ditch above Pilot Creek, near Georgetown	—	1951–62
11432000	Georgetown Divide Ditch near Georgetown	—	1947–60
11432500	Pilot Creek near Georgetown	15.1	1946–60
11433100	Long Canyon Creek near French Meadows	18.0	1960–92
11433200	Rubicon River near Foresthill	315	1959–84
11433260	North Fork of Middle Fork American River, near Foresthill	88.9	1965–85
11433400	Canyon Creek near Georgetown	12.7	1966–79
11433420	Maine Bar Canyon Creek near Greenwood	.75	1973–86
11433500	Middle Fork American River near Auburn	614	1912–86
11433800	North Fork American River below Auburn Damsite, near Auburn	973	1972–86
11434000	North Fork American River at Rattlesnake Bridge	996	1931–37, 1939–55
11435000	Pyramid Creek near Phillips	3.73	1961–64, 1966–70
11435500	South Fork American River at Kyburz	73.2	1924
11437000	Caples Lake Outlet near Kirkwood	13.5	1922–92
11438000	Silver Fork of South Fork American River, near Kyburz	107	1925–44
11439950	Alder Creek Pipeline Diversion near Whitehall	—	1976–82
11440000	Alder Creek near Whitehall	22.1	1923–81
11440500	Plum Creek near Riverton	7.32	1923–39
11440850	Picket Pen Creek near Kyburz	.49	1964–68
11441000	Silver Creek at Union Valley	83.0	1925–60
11442000	Silver Creek near Placerville	177	1922–61
11442500	South Fork American River below Silver Creek, near Pollock Pines	449	1923, 1970–93
11443000	American River Flume near Camino	—	1923–57
11445000	South Fork American River at Coloma	631	1930–41
11445500	South Fork American River near Lotus	673	1951–95
11446000	Weber Creek near Salmon Falls	97.6	1943–59
11447000	American River at Sacramento	1,936	1944–59
11447030	Strong Ranch Slough at Sacramento	5.02	1972–75
11447300	Dry Creek Tributary near Roseville	.39	1964–67
11447330	Magpie Creek near Del Paso Heights	2.03	1996–97
11447500	Sacramento River at Sacramento	23,502	1904–05, 1921, 1949–79, 1986–96
11448500	Adobe Creek near Kelseyville	6.36	1955–78
11448900	Highland Creek above Highland Creek Dam	11.9	1963–78

## WATER RESOURCES DATA—CALIFORNIA, WATER YEAR 2001

## DISCONTINUED GAGING STATIONS—Continued

Station No.	Station name	Drainage area (mi <sup>2</sup> )	Period of record
11449000	Highland Creek near Kelseyville	12.6	1955–62
11449010	Highland Creek below Highland Creek Dam, near Kelseyville	14.2	1966–77
11449100	Scotts Creek near Lakeport	55.2	1961–80
11449350	Burns Valley Creek near Clearlake Highlands	4.37	1963–69
11449450	Copsey Creek near Lower Lake	13.2	1961–68
11449460	Seigler Creek at Lower Lake	12.5	1966–73
11450500	Cache Creek at Lower Lake	488	1901–15
11451500	North Fork Cache Creek near Lower Lake	197	1931–81
11451700	Bear Creek Tributary near Wilbur Springs	4.49	1962–63
11451720	Bear Creek near Rumsey	100	1959–80
11451760	Cache Creek above Rumsey	955	1961–62, 1965–73, 1976–82, 1984–86
11451950	Cache Creek near Brooks	1,041	1983–86
11452000	Cache Creek near Capay	1,044	1943–77
11453170	Dry Creek above Appletree Creek, near Middletown	.83	1978
11453200	Dry Creek near Middletown	8.35	1960–72, 1979–80
11453550	Hunting Creek near Knoxville	37.8	1969–76
11453570	Adams Creek near Knoxville	7.42	1970–76
11453580	Nevada Creek near Knoxville	7.06	1969–76
11453600	Pope Creek near Pope Valley	78.3	1961–80
11453700	Capell Creek Tributary near Wooden Valley	.87	1962–65
11454100	Pleasants Creek near Winters	15.9	1960–68
11454500	Putah Creek at Winters	635	1906–31
11455000	Putah Creek near Davis	638	1949–63

## DISCONTINUED LAKES AND RESERVOIRS

The following continuous-record lake stations in California have been discontinued. Daily records were collected and are stored in NWIS for the period of record shown for each location.

Station No.	Station name	Drainage area (mi <sup>2</sup> )	Period of record
11362650	Pit no. 5 Powerplant Forebay near Big Bend	—	1986–89
11387995	Black Butte Lake near Orland	738	1964–90
11403300	Three Lakes Reservoir near Bucks Lake	1.0	1984–87
11423700	New Camp Far West Reservoir near Wheatland	283	1967–76, 1977–83
11425300	Halsey Forebay near Auburn	—	1980–86
11425320	Lake Arthur near Auburn	.86	1982–83
11425330	Halsey Afterbay near Auburn	—	1980–85

## DISCONTINUED CONTINUOUS WATER-QUALITY STATIONS

The following continuous-record water-quality stations in California have been discontinued. Daily records were collected and are stored in USGS Water Data for the period of record shown for each location.

Station No.	Station name	Drainage area (mi <sup>2</sup> )	Type of record	Period of record
10356500	Susan River at Susanville	184	WQ,B,S	1952–93
11341400	Sacramento River near Mt. Shasta	135	T	1966–71, 1973–87
11342000	Sacramento River at Delta	425	WQ,T	1951–81
11345500	South Fork Pit River near Likely	247	WQ,T,S	1951–79

WATER RESOURCES DATA—CALIFORNIA, WATER YEAR 2001  
DISCONTINUED CONTINUOUS WATER-QUALITY STATIONS—Continued

Station No.	Station name	Drainage area (mi <sup>2</sup> )	Type of record	Period of record
11348500	Pit River near Canby	1,431	WQ,T,S	1951–79
11365000	Pit River near Montgomery Creek	4,952	WQ,T	1951, 1953–81
11368000	McCloud River above Shasta Lake	604	T	1957–59
11370000	Shasta Lake near Redding	6,421	WQ	1978–80
11370500	Sacramento River at Keswick	6,468	B,WQ,C, T,S	1951–94
11371000	Clear Creek at French Gulch	115	S	1966–67
11372000	Clear Creek near Igo	228	WQ,T	1958–79
11372200	South Cow Creek near Millville	77.3	T	1966–71
11374000	Cow Creek near Millville	425	WQ,T,S	1959–71, 1973–76, 1978–79
11374400	Middle Fork Cottonwood Creek near Ono	244	T,S	1965, 1968–73, 1977–79
11375700	North Fork Cottonwood Creek near Igo	88.7	T	1977–79
11375810	Cottonwood Creek near Olinda	395	T,S	1973–80
11375820	South Fork Cottonwood Creek near Cottonwood	217	T	1977–79
11375870	South Fork Cottonwood Creek near Olinda	371	T,S	1878, 1977–80
11376000	Cottonwood Creek near Cottonwood	927	WQ,T,S	1957–67, 1977–85
11376038	Manzanita Creek at park boundary, near Manzanita Lake	11.6	C,T	1980–81
11376550	Battle Creek below Coleman Fish Hatchery, near Cottonwood	357	WQ,T,S	1962–79
11377100	Sacramento River above Bend Bridge, near Red Bluff	8,900	WQ,C,T,S	1955–81, 1996–98
11377200	Sacramento River at Bend Bridge	—	T,S	1959–63, 1967, 1969–70
11378000	Sacramento River near Red Bluff	9,020	T,S	1961–68
11378500	Sacramento River at Red Bluff	9,077	T,S	1958–66
11379500	Elder Creek near Paskenta	92.4	WQ,T,S	1959–70
11380500	Elder Creek at Gerber	136	T,S	1972–79
11381595	Mill Creek at Sherwood Bridge, near Los Molinos	133	T,S	1977–79
11382000	Thomes Creek at Paskenta	203	WQ,T,S	1959–83
11382090	Thomes Creek at Rawson Road Bridge, near Richfield	284	T,S	1978–80
11383600	Deer Creek at Red Bridge, near Vina	210	T,S	1977
11383800	Sacramento River near Hamilton City	10,833	T,S	1977
11384600	Little Stony Creek above East Park Reservoir, near Lodoga	45.6	T	1967–79
11387000	Stony Creek near Fruto	597	T	1971–78
11387200	Stony Creek above Black Butte Lake, near Orland	623	T,S	1981–83
11387900	Masterson Hollow Creek near Newville	.96	T	1982
11388000	Stony Creek below Black Butte Dam, near Orland	738	WQ,S,T	1958–94
11389000	Sacramento River at Butte City	12,080	WQ,T,S	1955–67, 1969–80
11389470	Colusa Weir Spill, Butte Basin, near Colusa	—	T,S	1975
11389500	Sacramento River at Colusa	12,090	C,T	1975, 1977–80, 1995–98
11390000	Butte Creek near Chico	147	WQ	1953–79
11390210	Cherokee Canal near Nelson	—	T,S	1970–74
11390425	Sutter Bypass at Long Bridge, near Meridian	—	T,S	1979
11390480	Tisdale Weir near Grimes	—	S	1978–80
11390600	Sacramento River at Boyers Bend, near Dunning	—	T	1960–63
11390890	Colusa Basin Drain at Road 99E, near Knights Landing	—	WQ,C,T,S	1996–98
11391000	Sacramento River at Knights Landing	14,535	T,S	1959–60, 1978–80
11391050	Sutter Bypass near Nicolaus	—	T,S	1980–81
11391100	Sacramento Slough near Knights Landing	—	WQ,C,T,S	1996–98
11391500	Big Grizzly Creek at Grizzly Valley Dam, near Portola	44	T	1963–67
11392500	Middle Fork Feather River near Clio	686	T	1964–82
11394500	Middle Fork Feather River near Merrimac	1,062	T	1963–82
11396350	South Fork Feather River at Ponderosa Dam	108	T	1963–67
11401180	Little Grizzly Creek near Genesee	29.6	T	1964–79

WATER RESOURCES DATA—CALIFORNIA, WATER YEAR 2001  
DISCONTINUED CONTINUOUS WATER-QUALITY STATIONS—Continued

Station No.	Station name	Drainage area (mi <sup>2</sup> )	Type of record	Period of record
11401500	Indian Creek near Crescent Mills	739	WQ,T,S	1951–79
11404500	North Fork Feather River at Pulga	1,953	WQ,T	1963–83
11405300	West Branch Feather River near Paradise	—	T	1963–80
11406870	Thermolito Afterbay at river outlet	—	T	1968
11406920	Thermolito Afterbay Release to Feather River near Oroville	—	T	1969–92
11407000	Feather River at Oroville	3,624	WQ,C,T,S	1906–07, 1951–92
11407150	Feather River near Gridley	3,676	WQ,T,S	1965–93
11407700	Feather River at Yuba City	3,974	T	1964–76
11409000	Middle Yuba River above Oregon Creek, near San Juan	162	T	1965–69
11409400	Oregon Creek below Log Cabin Dam, near Camptonville	29.1	T	1972–79
11409500	Oregon Creek near San Juan	34.4	T	1965–69
11410000	Middle Yuba River near North San Juan	198	T	1974–77
11413100	North Yuba River above Slate Creek, near Strawberry Valley	351	T	1968–69, 1974–77
11413520	North Yuba River below New Bullards Bar Dam, near North San Juan	490	T	1971–74
11413700	Yuba River below Colgate Powerhouse, near French Corral	729	T	1975–78
11417500	South Yuba River at Jones Bar, near Grass Valley	308	T,S	1965–79
11418000	Yuba River below Englebright Dam, near Smartville	1,108	T	1973–78
11418500	Deer Creek near Smartville	84.6	T,S	1974–79
11420800	Yuba River at Daquerra Point Dam, near Browns Valley	1,330	T	1975–77
11421000	Yuba River near Marysville	1,339	WQ	1951–52, 1973–80,
11421500	Yuba River at Marysville	1,344	WQ,T,S	1961–66, 1973–76 1996–98
11425100	Feather River near Nicolaus	—	T	1969–72, 1974
11425500	Sacramento River at Verona	21,251	WQ,C,T,S	1952, 1969–70, 1980, 1996–98
11427000	North Fork American River at North Fork Dam	342	T,WQ,S	1959–83
11429350	Loon Lake near Meeks Bay	—	WQ	1996
11433300	Middle Fork American River, near Foresthill	524	WQ,B	1979
11433400	Canyon Creek near Georgetown	12.7	T	1966–71, 1973–79
11433800	North Fork American River below Auburn dam site, near Auburn	973	T	1983–86
11439500	South Fork American River near Kyburz	193	WQ,T,B,S	1966–79, 1980
11441001	Union Valley Reservoir near Riverton	—	WQ	1996
11441100	Ice House Reservoir near Kyburz	27.2	WQ	1996
11445500	South Fork American River near Lotus	673	B,S,WQ,T	1957–68, 1970–94
11446500	American River at Fair Oaks	1,888	WQ	1960–62
11447000	American River at Sacramento	1,936	WQ,S	1978, 1996–98
11447030	Strong Ranch Slough at Sacramento	5.02	C	1973–75
11447360	Arcade Creek near Del Paso Heights	31.5	WQ,T,C,S	1996–98
11447500	Sacramento River at Sacramento	23,502	S	1957–79
11447650	Sacramento River at Freeport	—	B,C	1974–81, 1989–98
11447810	Sacramento River at Greens Landing	—	C	1974–81
11449010	Highland Creek below Highland Creek Dam, near Kelseyville	14.2	T,S	1967–77
11451760	Cache Creek above Rumsey	955	T,S	1960–70, 1976, 1984–86
11451950	Cache Creek near Brooks	1,041	T,S	1984–86
11452500	Cache Creek at Yolo	1,139	T,S	1959–65, 1966–67, 1986
11453000	Yolo Bypass near Woodland	—	S	1957–61, 1980
11453170	Dry Creek above Appletree Creek, near Middletown	.83	C,T	1978
11453500	Putah Creek near Guenoc	113	T,S	1960–73
11453550	Hunting Creek near Knoxville	37.8	T,S	1973–74
11454000	Putah Creek near Winters	574	WQ,T	1951–81

Type of record: WQ (Water quality); B (Biological); C (Conductivity); T (Temperature); S (Sediment); P (Precipitation).

*THIS  
PAGE  
INTENTIONALLY  
LEFT  
BLANK*

WATER RESOURCES DATA—CALIFORNIA, WATER YEAR 2000  
VOLUME 4—NORTHERN CENTRAL VALLEY BASINS AND THE GREAT BASIN  
FROM HONEY LAKE BASIN TO OREGON STATE LINE

---

By S.W. Anderson, G.L. Rockwell, J.R. Smithson, M.F. Friebel, M.D. Webster, *and* G.L. Pope

---

## INTRODUCTION

The Water Resources Division of the U.S. Geological Survey, in cooperation with State and Federal agencies, obtains a large amount of data pertaining to the water resources of California each water year. These data, accumulated during many water years, constitute a valuable database for developing an improved understanding of the water resources of the State. To make these data readily available to interested parties outside the U.S. Geological Survey, the data are published annually in this report series entitled "Water Resources Data—California."

This volume of the report includes records on surface water in the State. Specifically, it contains: (1) discharge records for 191 streamflow-gaging stations and 3 partial-record station; (2) stage and content records for 53 lakes and reservoirs; (3) gage-height records for 1 station; and (4) water-quality records for 18 streamflow-gaging stations and 3 partial-record stations. Records included for stream stages are only a small fraction of those obtained during the water year.

The series of annual reports for California began with the 1961 water year with a report that contained only data relating to the quantities of surface water. For the 1964 water year, a similar report was introduced that contained only data relating to water quality. Beginning with the 1975 water year, the report format changed to include data on quantities of surface water, quality of surface and ground water, and ground-water levels. From the 1985 through the 1993 water years, a separate volume for ground-water levels and quality was published for California.

Prior to introduction of this series and for several water years concurrent with it, water-resources data for California were published in U.S. Geological Survey Water-Supply Papers. Data on stream discharge and stage and on lake or reservoir contents and stage, through September 1960, were published annually under the title "Surface-Water Supply of the United States, Parts 10 and 11." For the 1961 through 1970 water years, the data were published in two 5-year reports. Data on chemical quality, temperature, and suspended sediment for the 1941 through 1970 water years were published annually under the title "Quality of Surface Waters of the United States," and water levels for the 1935 through 1974 water years were published under the title "Ground-Water Levels in the United States." These Water-Supply Papers may be consulted in public libraries of principal cities of the United States, or if not out of print, they may be purchased from U.S. Geological Survey, Information Services, Box 25286, Denver Federal Center, Denver, CO 80225-0046.

Publications similar to this report are published annually by the U.S. Geological Survey for all States. Each report has an identification number consisting of the two-letter State abbreviation, the last two digits of the water year, and the volume number. For example, this volume is identified as "U.S. Geological Survey Water-Data Report CA-00-4." For archiving and general distribution, the reports for 1971–74 water years also are identified as water-data reports. These water-data reports are for sale, in paper copy or on microfiche, by the National Technical Information Service, 5285 Port Royal Road, Springfield, VA 22161. For further ordering information, the Customer Inquiries telephone number is (703) 487-4650, between 8:30 a.m. and 5:30 p.m. Eastern Standard Time.

Additional information for ordering specific reports may be obtained from the District Office at the address given on the back of the title page or by telephone at (916) 278-3100.

## COOPERATION

The U.S. Geological Survey and organizations of the State of California have had cooperative agreements for the systematic collection of records since 1903. Organizations that supplied data are acknowledged in station descriptions. Organizations that assisted in collecting data through cooperative agreement with the Survey are:

- California Department of Water Resources, Thomas M. Hannigan, Director.
- Georgetown Divide Public Utility District, Marie E. Davis, General Manager.
- Hidden Valley Lake Community Services District, Mel Aust, General Manager.
- Placer County, Edward McCarthy, Senior Civil Engineer.
- Sacramento County Department of Public Works, Warren H. Harada, Administrator.
- Shasta Valley Resource Conservation District, Pete Talley, General Manager.



## WATER RESOURCES DATA—CALIFORNIA, WATER YEAR 2001

Yolo County Flood Control and Water Conservation District, James F. Eagan, General Manager.

Yuba County Water Agency, Donn Wilson, Engineer-Administrator.

Assistance in the form of funds or services was given by the Bureau of Reclamation, U.S. Department of Interior.

The following organizations aided in collecting records: Arbutle Mountain Project; California Department of Water Resources; Energy Growth Partnership I; Five Bears Hydro, Inc.; Malacha Power Project, Inc.; Nelson Creek Power Co.; Nevada and Oroville–Wyandotte Irrigation Districts; Pacific Gas and Electric Co.; Placer and Yuba County Water Agencies; Sacramento Municipal Utility District; Shasta Hydroelectric; Sithe Energies, Inc.; Snow Mountain Hydroelectric; South Sutter Water District; STS Hydropower; and Synergies, Inc.

### SPECIAL NETWORKS AND PROGRAMS

Hydrologic Benchmark Network is a network of 50 sites in small drainage basins around the country whose purpose is to provide consistent data on the streamflow representative undeveloped watersheds nationwide, and to provide analyses on a continuing basis to compare and contrast conditions observed in basins more obviously affected by human activities. At 10 of these sites, water-quality information is being gathered on major ions and nutrients, primarily to assess the effects of acid deposition on stream chemistry. Additional information on the Hydrology Benchmark Program can be found at:

<http://water.usgs.gov/hgn/>

National Stream-Quality Accounting Network (NASQAN) monitors the water quality of large rivers within the Nation's largest river basins. From 1995 through 1999, a network of approximately 40 stations were operated in the Mississippi, Columbia, Colorado, and Rio Grande. From 2000 through 2004, sampling was reduced to a few index stations on the Colorado and Columbia so that a network of 5 stations could be implemented on the Yukon River. Samples are collected with sufficient frequency that the flux of a wide range of constituents can be estimated. The objective of NASQAN is to characterize the water quality of these large rivers by measuring concentration and mass transport of a wide range of dissolved and suspended constituents, including nutrients, major ions, dissolved and sediment-bound heavy metals, common pesticides, and inorganic and organic forms of carbon. This information will be used (1) to describe the long-term trends and changes in concentration and transport of these constituents; (2) to test findings of the National Water-Quality Assessment Program (NAWQA); (3) to characterize processes unique to large-river systems such as storage and re-mobilization of sediments and associated contaminants; and (4) to refine existing estimates of off-continent transport of water, sediment, and chemicals for assessing human effects on the world's oceans and for determining global cycles of carbon, nutrients, and other chemicals. Additional information about the NASQAN program can be found at:

<http://water.usgs.gov/nasqan>

The National Atmospheric Deposition Program/National Trends Network (NADP/NTN) provides continuous measurement and assessment of the chemical constituents in precipitation throughout the United States. As the lead federal agency, the USGS works together with over 100 organizations to provide a long-term, spatial and temporal record of atmospheric deposition generated from a network of 225 precipitation chemistry monitoring sites. This long-term nationally consistent monitoring program, coupled with ecosystem research, provides critical information toward a national scorecard to evaluate the effectiveness of ongoing and future regulations intended to reduce atmospheric emissions and subsequent impacts to the Nation's land and water resources. Reports and other information on the NADP/NTN Program, as well as all data from the individual sites, can be found at:

<http://bqs.usgs.gov/acidrain/>

The National Water-Quality Assessment (NAWQA) Program of the U.S. Geological Survey is a long-term program with goals to describe the status and trends of water-quality conditions for a large, representative part of the Nation's ground- and surface-water resources; provide an improved understanding of the primary natural and human factors affecting these observed conditions and trends; and provide information that supports development and evaluation of management, regulatory, and monitoring decisions by other agencies.

Assessment activities are being conducted in 59 study units (major watersheds and aquifer systems) that represent a wide range of environmental settings nationwide and that account for a large percentage of the Nation's water use. A wide array of chemical constituents will be measured in ground water, surface water, streambed sediments, and fish tissues. The coordinated application of comparative hydrologic studies at a wide range of spatial and temporal scales will provide information for decision making by water-resources managers and a foundation for aggregation and comparison of findings to address water-quality issues of regional and national interest.

Communication and coordination between USGS personnel and other local, State, and federal interests are critical components of the NAWQA Program. Each study unit has a local liaison committee consisting of representatives from key federal, State, and local water resources agencies, Indian nations, and universities in the study unit. Liaison committees typically meet semiannually to discuss their information needs, monitoring plans and progress, desired information products, and opportunities to collaborate efforts among the agencies. Additional information about the NAWQA Program can be found at:

[http://water.usgs.gov/nawqa/nawqa\\_home.html](http://water.usgs.gov/nawqa/nawqa_home.html)

## WATER RESOURCES DATA—CALIFORNIA, WATER YEAR 2001

### EXPLANATION OF THE RECORDS

The surface-water records published in this report are for the 2001 water year that began October 1, 2000, and ended September 30, 2001. A calendar of the water year is provided on the inside of the front cover. The records contain streamflow data, stage and contents data for lakes and reservoirs, and water-quality data for surface water. The following sections of the introductory text are presented to provide users with a more detailed explanation of how the hydrologic data published in this report were collected, analyzed, computed, and arranged for presentation.

#### Station-Identification Numbers

Each streamsite data station in this report is assigned a unique identification number. This number is unique in that it applies specifically to a given station and to no other. The number usually is assigned when a station is first established and is retained for that station indefinitely. The systems used by the U.S. Geological Survey to assign identification numbers for surface-water stations and for ground-water well sites differ, but both are based on geographic location. The "downstream-order" system is used for regular surface-water stations and the "latitude-longitude" system is used for surface-water stations in California where only miscellaneous measurements are made.

#### Downstream-Order System

Since October 1, 1950, the order of listing hydrologic-station records in Survey reports has been in a downstream direction along the main stream. All stations on a tributary entering upstream from a mainstream station are listed before that station. A station on a tributary that enters between two mainstream stations is listed between them. A similar order is followed in listing stations on first rank, second rank, and other ranks of tributaries. The rank of any tributary with respect to the stream to which it is immediately tributary is indicated by an indentation in the "List of Stations" in the front of this report. Each indentation represents one rank. This downstream order and system of indentation show which stations are on tributaries between any two stations and the rank of the tributary on which each station is situated.

The station-identification number is assigned according to downstream order. In assigning station numbers, no distinction is made between partial-record stations and other stations; therefore, the station number for a partial-record station indicates downstream-order position in a list made up of both types of stations. Gaps are left in the series of numbers to allow for new stations that may be established; hence, the numbers are not consecutive. The complete eight-digit number for each station such as 11119750, which appears just to the left of the station name, includes the two-digit part number "11" plus the six-digit downstream-order number "119750." The part number designates the major river basin; for example, part "11" is the Pacific Slope Basins in California.

#### Latitude-Longitude System

The identification numbers for miscellaneous surface-water sites are assigned according to the grid system of latitude and longitude. The number consists of 15 digits. The first six digits denote the degrees, minutes, and seconds of latitude, the next seven digits denote degrees, minutes, and seconds of longitude, and the last two digits (assigned sequentially) identify the other sites within a 1-second grid. This site-identification number, once assigned, is a pure number and has no locational significance. In the rare instance where the initial determination of latitude and longitude are found to be in error, the station will retain its initial identification number; however, its true latitude and longitude will be listed in the LOCATION paragraph of the station description (fig. 1).

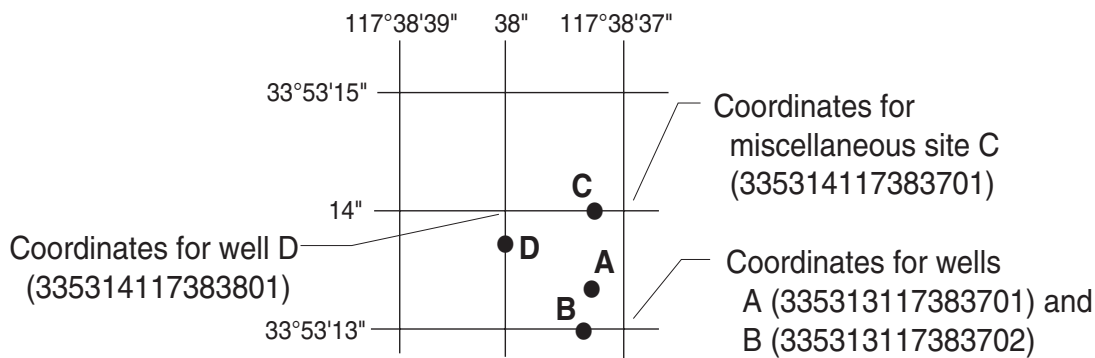

**Figure 1.** System for numbering miscellaneous sites (latitude and longitude).

#### Records of Stage and Water Discharge

Records of stage and water discharge may be complete or partial. Complete records of discharge are those obtained using a continuous stage-recording device through which either instantaneous or mean daily discharges may be computed for any time, or any period of time, during the period of record. Complete records of lake and reservoir contents, similarly, are those for which stage

## WATER RESOURCES DATA—CALIFORNIA, WATER YEAR 2001

or contents may be computed or estimated with reasonable accuracy for any time, or period of time. They may be obtained using a continuous stage-recording device, but need not be. Because daily mean discharges and end-of-day contents commonly are published for such stations, they are referred to as "daily stations."

By contrast, partial records are obtained through discrete measurements without using a continuous stage-recording device and pertain only to a few flow characteristics, or perhaps only one. The nature of the partial record is indicated by table titles such as "Crest-stage partial records" or "Low-flow partial records." Records of miscellaneous discharge measurements or of measurements from special studies, such as low-flow seepage studies, may be considered as partial records, but they are presented separately in this report. Location of all complete-record stations for which data are given in this report are shown, by county, in figures 2 through 12.

### Data Collection and Computation

The data obtained at a complete-record gaging station on a stream or canal consist of a continuous record of stage, individual measurements of discharge throughout a range of stages, and notations regarding factors that may affect the relation between stage and discharge. These data, together with supplemental information, such as weather records, are used to compute daily discharges. The data obtained at a complete-record gaging station on a lake or reservoir consist of a record of stage and of notations regarding factors that may affect the relation between stage and lake contents. These data are used with stage-area and stage-capacity curves or tables to compute water-surface areas and lake storage.

Continuous records of stage are obtained with digital recorders, data-collection platforms, or data loggers that sample stage values at selected time intervals. Measurements of discharge are made with current meters using methods adapted by the U.S. Geological Survey as a result of experience accumulated since 1880. These methods are described in standard textbooks, in U.S. Geological Survey Water-Supply Paper 2175, and in U.S. Geological Survey Techniques of Water-Resources Investigations (TWRI), Book 3, Chapters A1 through A19, and Book 8, Chapters A2 and B2. The methods are consistent with the American Society for Testing and Materials (ASTM) standards and generally follow the standards of the International Organization for Standards (ISO).

In computing discharge records, results of individual measurements are plotted against the corresponding stages, and stage-discharge relation curves are then constructed. From these curves, rating tables indicating the approximate discharge are prepared for any stage within the range of the measurements. If it is necessary to define extremes of discharge outside the range of current-meter measurements, the curves are extended using (1) logarithmic plotting; (2) velocity-area studies; (3) results of indirect measurements of peak discharge, such as slope-area or contracted-opening measurements, and computations of flow-over-dam or weirs; or (4) step-backwater techniques.

Daily mean discharges are computed by applying the daily mean stages (gage heights) to the stage-discharge curves or tables. If the stage-discharge relation is subject to change because of frequent or continual change in the physical features that form the control, the daily mean discharge is determined by the shifting-control method, in which correction factors based on individual discharge measurements and notes of the personnel making the measurements are applied to the gage heights before the discharges are determined from the curves or tables. This shifting-control method also is used if the stage-discharge relation is changed temporarily because of aquatic growth or debris on the control. For some stations, formation of ice in the winter may so obscure the stage-discharge relations that daily mean discharges must be estimated from other information such as temperature and precipitation records, notes or observations, and records for other stations in the same or nearby basins for comparable periods.

At some stream-gaging stations, the stage-discharge relation is affected by backwater from reservoirs, tributary streams, or other sources. This necessitates the use of the slope method in which the slope or fall in a reach of the stream is a factor in computing discharge. The slope or fall is obtained by means of an auxiliary gage set at some distance from the base gage. At some stations the stage-discharge relation is affected by changing stage; at these stations the rate of change in stage is used as a factor in computing discharge.

At some gaging stations, acoustic velocity meter (AVM) systems are used to compute discharge. The AVM system measures the stream's velocity at one or more paths in the cross section. Coefficients are developed to relate this path velocity to the mean velocity in the cross section. Because the AVM sensors are fixed in position, the adjustment coefficients generally vary with stage. Cross-sectional area curves are developed to relate stage, recorded as noted above, to cross-section area. Discharge is computed by multiplying path velocity by the appropriate stage-related coefficient and area.

In computing records of lake or reservoir contents, it is necessary to have available surveys, curves, or tables defining the relation of stage and contents. The application of stage to the stage-content curves or tables gives the contents from which daily, monthly, or yearly changes then are determined. If the stage-content relation changes because of deposition of sediment in a lake or reservoir, periodic resurveys may be necessary to redefine the relation. When this is done, the contents computed may become increasingly in error as time increases since the last survey. Discharges over lake or reservoir spillways are computed from stage-discharge relations in the same manner as other stream discharges are computed.

For some gaging stations, there are periods when no gage-height record is obtained, or the recorded gage height is so faulty that it cannot be used to compute daily discharge or contents. This happens when the recorder stops or otherwise fails to operate properly, intakes are plugged, the float is frozen in the well, or for various other reasons. For such periods, the daily discharges are estimated from the recorded range in stage, previous or following record, discharge measurements, weather records, and comparison with other station records from the same or nearby basins. Likewise, daily contents may be estimated from operator's logs, previous

## WATER RESOURCES DATA—CALIFORNIA, WATER YEAR 2001

or following records, inflow-outflow studies, and other information. Information explaining how estimated daily-discharge values are identified in station records is included in the next two sections, "Data Presentation" (REMARKS paragraph) and "Identifying Estimated Daily Discharge."

### Data Presentation

Streamflow data in this report are presented in a new format that is considerably different from the format in data reports prior to the 1991 water year. The major changes are that statistical characteristics of discharge now appear in tabular summaries following the water-year data table and less information is provided in the text or station manuscript above the table. These changes represent the results of a pilot program to reformat the annual water-data report to meet current user needs and data preferences.

The records published for each continuous-record surface-water discharge station (gaging station) now consist of four parts, the manuscript or station description; the data table of daily mean values of discharge for the current water year with summary data; a tabular statistical summary of monthly mean flow data for a designated period, by water year; and a summary statistics table that includes statistical data of annual, daily, and instantaneous flows as well as data pertaining to annual runoff, 7-day low-flow minimums, and flow duration.

#### Station manuscript

The manuscript provides, under various headings, descriptive information, such as station location; period of record; historical extremes outside the period of record; record accuracy; and other remarks pertinent to station operation and regulation. The following information, as appropriate, is provided with each continuous record of discharge or lake content. Comments follow to clarify information presented under the various headings of the station description.

**LOCATION.**—Information on locations is obtained from the most accurate maps available. The location of the gaging station is given with respect to the cultural and physical features in the vicinity and with respect to the reference place mentioned in the station name. River mileages, given for only a few stations, were determined by methods given in "River Mileage Measurement," Bulletin 14, Revision of October 1968, prepared by the Water Resources Council, or were provided by the U.S. Army Corps of Engineers.

**DRAINAGE AREA.**—Drainage areas are measured using the most accurate maps available. Because the type of maps available varies from one drainage basin to another, the accuracy of drainage areas likewise varies. Drainage areas are updated as better maps become available.

**PERIOD OF RECORD.**—This indicates the period for which there are published records for the station or for an equivalent station. An equivalent station is one that was in operation at a time when the present station was not, and whose location was such that records from it reasonably can be considered equivalent with records from the present station.

**REVISED RECORDS.**—Published records, because of new information, occasionally are incorrect, and revisions are printed in later reports. Listed under this heading are all the reports in which revisions have been published for the station and the water years to which the revisions apply. If a revision did not include daily, monthly, or annual figures of discharge, that fact is noted after the year dates as follows: "(M)" means that only the instantaneous maximum discharge was revised; "(m)" that only the instantaneous minimum was revised; and "(P)" that only peak discharges were revised. If the drainage area has been revised, the report is given in which the most recently revised figure was published.

**GAGE.**—The type of gage currently in use, the datum of the current gage referred to sea level (see glossary), and a condensed history of the types, locations, and datums of previous gages are given under this heading.

**REMARKS.**—All periods of estimated daily-discharge record will either be identified by date in this paragraph of the station description for water-discharge stations or flagged in the daily-discharge table. (See next section, "Identifying Estimated Daily Discharge.") If a REMARKS paragraph is used to identify estimated record, the paragraph will begin with this information presented as the first entry. The paragraph also is used to present information relative to the accuracy of the records, to special methods of computation, to conditions that affect natural flow at the station, and possibly to other pertinent items. For reservoir stations, information is given on the dam forming the reservoir, the capacity, outlet works and spillway, and purpose and use of the reservoir.

**COOPERATION.**—Records provided by a cooperating organization or obtained for the U.S. Geological Survey by a cooperating organization are identified.

**EXTREMES FOR PERIOD OF RECORD.**—Extremes may include maximum and minimum discharges or content. Unless otherwise qualified, the maximum discharge or content is the instantaneous maximum corresponding to the highest stage that occurred. The highest stage may have been obtained from a graphic or digital recorder, a crest-stage gage, or by direct observation of a nonrecording gage. If the maximum stage did not occur on the same day as the maximum discharge or content, it is given separately. Similarly, the minimum is the instantaneous minimum discharge, unless otherwise qualified, and was determined and is reported in the same manner as the maximum.

**EXTREMES OUTSIDE PERIOD OF RECORD.**—Included is information concerning major floods or unusually low flows that occurred outside the stated period of record. The information may or may not have been obtained by the U.S. Geological Survey.

**EXTREMES FOR CURRENT YEAR.**—Extremes given are similar to those for the period of record, except the peak discharge listing may include secondary peaks. For stations meeting certain criteria, all peak discharges and stages occurring during the water year that are greater than a selected base discharge are presented under this heading. The peaks greater than the base

## WATER RESOURCES DATA—CALIFORNIA, WATER YEAR 2001

discharge, excluding the highest one, are referred to as secondary peaks. Peak discharges are not published for canals, ditches, drains, or streams for which the peaks are subject to substantial control by man. The time of occurrence for peaks is expressed in 24-hour local standard time. For example, 12:30 a.m. is 0030, and 1:30 p.m. is 1330.

**REVISIONS.**—If a critical error is discovered in published records, a revision is included in the first report published following discovery of the error.

Occasionally the records of a discontinued gaging station may need revision. Because for these stations there would be no current or, possible, future station manuscript published to document the revision in a "Revised Records" entry, users of data for these stations who obtained the record from previously published data reports may wish to contact the District Office to determine if the published records were revised after the station was discontinued. If the data were obtained by computer retrieval, the data would be current and there would be no need to check because any published revision of data is always accompanied by revision of the corresponding data in computer storage.

Manuscript information for lake or reservoir stations differs from that for stream-gaging stations in the nature of the "Remarks" and in the inclusion of a skeleton stage-capacity table when daily contents are given.

### Data table of daily mean values

The daily table of discharge records for stream-gaging stations gives mean discharge for each day of the water year. In the monthly summary for the table, the line headed "TOTAL" gives the sum of the daily figures for each month; the line headed "MEAN" gives the average flow in cubic feet per second for the month; and the lines headed "MAX" and "MIN" give the maximum and minimum daily mean discharges, respectively, for each month. Discharge for the month also usually is expressed in cubic feet per second per square mile (line headed "CFSM"); or in inches (line headed "IN."); or in acre-feet (line headed "AC-FT"). Figures for cubic feet per second per square mile and runoff in inches or in acre-feet may be omitted if there is extensive regulation or diversion or if the drainage area includes large noncontributing areas. At some stations monthly and (or) yearly observed discharges are adjusted for reservoir storage or diversion, or diversion data or reservoir contents are given. These figures are identified by a symbol and corresponding footnote.

### Statistics of monthly mean data

A tabular summary of the mean (line headed "MEAN"), maximum (line headed "MAX"), and minimum (line headed "MIN") of monthly mean flows for each month for a designated period is provided below the mean values table. The water years of the first occurrence of the maximum and minimum monthly flows are provided immediately below those figures. The designated period will be expressed as "FOR WATER YEARS \_\_\_—\_\_\_, BY WATER YEAR (WY)," and will list the first and last water years of the range of years selected from the PERIOD OF RECORD paragraph in the station manuscript. It will consist of all of the station record within the specified water years, inclusive, including complete months of record for partial water years, if any, and may coincide with the period of record for the station. The water years for which the statistics are computed will be consecutive, unless a break in the station record is indicated in the manuscript.

### Summary statistics

A table titled "SUMMARY STATISTICS" follows the statistics of monthly mean data tabulation for tables containing complex data for the current water year. This table consists of four columns, with the first column containing the line headings of the statistics being reported. The table provides a statistical summary of yearly, daily, and instantaneous flows, not only for the current water year but also for the previous calendar year and for a designated period, as appropriate. The designated period selected, "WATER YEARS \_\_\_—\_\_\_," will consist of all of the station record within the specified water years, inclusive, including complete months of record for partial water years, if any, and may coincide with the period of record for the station. The water years for which the statistics are computed will be consecutive, unless a break in the station record is indicated in the manuscript. All of the calculations for the statistical characteristics designated ANNUAL (see line headings below), except for the "ANNUAL 7-DAY MINIMUM" statistic, are calculated for the designated period using complete water years. The other statistical characteristics may be calculated using partial water years.

The date or water year, as appropriate, of the first occurrence of each statistic reporting extreme values of discharge is provided adjacent to the statistic. Repeated occurrences may be noted in the REMARKS paragraph of the manuscript or in footnotes. Because the designated period may not be the same as the station period of record published in the manuscript, occasionally the dates of occurrence listed for the daily and instantaneous extremes in the designated-period column may not be within the selected water years listed in the heading. When this occurs, it will be noted in the REMARKS paragraph or in footnotes. Selected streamflow duration curve statistics and runoff data also are given. Runoff data may be omitted if there is extensive regulation or diversion of flow in the drainage basin.

The following summary statistics data, as appropriate, are provided with each continuous record of discharge. Comments follow to clarify information presented under the various line headings of the summary statistics table.

**ANNUAL TOTAL.**—The sum of the daily mean values of discharge for the year. At some stations the annual total discharge is adjusted for reservoir storage or diversion. The adjusted figures are identified by a symbol and corresponding footnotes.

**ANNUAL MEAN.**—The arithmetic mean of the individual daily mean discharges for the year noted or for the designated period. At some stations the yearly mean discharge is adjusted for reservoir storage or diversion. The adjusted figures are identified by a symbol and corresponding footnotes.

**HIGHEST ANNUAL MEAN.**—The maximum annual mean discharge occurring for the designated period.

## WATER RESOURCES DATA—CALIFORNIA, WATER YEAR 2001

**LOWEST ANNUAL MEAN.**—The minimum annual mean discharge occurring for the designated period.

**HIGHEST DAILY MEAN.**—The maximum daily mean discharge for the year or for the designated period.

**LOWEST DAILY MEAN.**—The minimum daily mean discharge for the year or for the designated period.

**INSTANTANEOUS PEAK FLOW.**—The maximum instantaneous discharge occurring for the water year or for the designated period. Note that secondary instantaneous peak discharges above a selected base discharge are stored in District computer files for stations meeting certain criteria. Those discharge values may be obtained by writing to the District Office. (See address on back of title page of this report.)

**INSTANTANEOUS PEAK STAGE.**—The maximum instantaneous stage occurring for the water year or for the designated period. If the dates of occurrence for the instantaneous peak flow and instantaneous peak stage differ, the REMARKS paragraph in the manuscript or a footnote may be used to provide further information.

**INSTANTANEOUS LOW FLOW.**—The minimum instantaneous discharge occurring for the water year or for the designated period.

**ANNUAL RUNOFF.**—Indicates the total quantity of water in runoff for a drainage area for the year. Data reports may use any of the following units of measurement in presenting annual runoff data:

Acre-foot (AC-FT) is the quantity of water required to cover 1 acre to a depth of 1 foot and is equivalent to 43,560 cubic feet, or about 326,000 gallons, or 1,233 cubic meters.

Cubic feet per second per square mile (CFSM) is the average number of cubic feet of water flowing per second from each square mile of area drained, assuming that the runoff is distributed uniformly in time and area.

Inches (IN.) indicates the depth to which the drainage area would be covered if all the runoff for a given period were distributed on it uniformly.

**10 PERCENT EXCEEDS.**—The discharge that is exceeded 10 percent of the time for the designated period.

**50 PERCENT EXCEEDS.**—The discharge that is exceeded 50 percent of the time for the designated period.

**90 PERCENT EXCEEDS.**—The discharge that is exceeded 90 percent of the time for the designated period.

Data collected at partial-record stations follow the information for continuous-record sites. Data for partial-record discharge stations are presented in two tables. The first is a table of annual maximum stage and discharge at crest-stage stations, and the second is a table of discharge measurements at low-flow partial-record stations. The tables of partial-record stations are followed by a listing of discharge measurements made at sites other than continuous-record or partial-record stations. These measurements generally are made in times of drought or flood to give better areal coverage to those events. Those measurements and others collected for some special reason are called measurements at miscellaneous sites.

### Identifying Estimated Daily Discharge

Estimated daily-discharge values published in the water-discharge tables of annual State data reports are identified either by flagging individual daily values with the letter symbol "e" and printing the table footnote, "e Estimated," or by listing the dates of the estimated record in the REMARKS paragraph of the station description.

### Accuracy of the Records

The accuracy of streamflow records depends primarily on (1) the stability of the stage-discharge relation or, if the control is unstable, the frequency of discharge measurements, and (2) the accuracy of measurements of stage and discharge, and interpretation of records.

The accuracy attributed to the records is indicated under "REMARKS." "Excellent" means that about 95 percent of the daily discharges are within 5 percent of the true; "good," within 10 percent; and "fair," within 15 percent. Records that do not meet the criteria mentioned, are rated "poor." Different accuracies may be attributed to different parts of a given record.

Daily mean discharges in this report are given to the nearest hundredth of a cubic foot per second ( $\text{ft}^3/\text{s}$ ) for values less than  $1 \text{ ft}^3/\text{s}$ , to the nearest tenth between  $1.0$  and  $10 \text{ ft}^3/\text{s}$ , to whole numbers between  $10$  and  $1,000 \text{ ft}^3/\text{s}$ , and to three significant figures for more than  $1,000 \text{ ft}^3/\text{s}$ . The number of significant figures used is based solely on the magnitude of the discharge value. The same rounding rules apply to discharges listed for partial-record stations and miscellaneous sites.

Discharge at many stations, as indicated by the monthly mean, may not reflect natural runoff due to the effects of diversion, consumption, regulation by storage, increase or decrease in evaporation due to artificial causes, or to other factors. For such stations, figures of cubic feet per second per square mile and of runoff, in inches, are not published unless satisfactory adjustments can be made for diversions, for changes in contents of reservoirs, or for other changes incident to use and control. Evaporation from a reservoir is not included in the adjustments for changes in reservoir contents, unless it is so stated. Even at those stations where adjustments are made, large errors in computed runoff may occur if adjustments or losses are large in comparison with the measured discharge.

### Other Records Available

The National Water Data Exchange (NAWDEX), U.S. Geological Survey, Reston, VA 20192, maintains an index of sites as well as an index of records of discharge collected by other agencies but not published by the U.S. Geological Survey. Information on records at specific sites can be obtained from that office upon request.

## WATER RESOURCES DATA—CALIFORNIA, WATER YEAR 2001

Information used in the preparation of the records in this publication, such as discharge measurement notes, gage-height records, temperature measurements, and rating tables are on file in the District Office. Also, most of the daily mean discharges are in computer-readable form and have been analyzed statistically. Information on the availability of the unpublished information or on the results of statistical analyses of the published records may be obtained from the District Office.

### Records of Surface-Water Quality

Records of surface-water quality ordinarily are obtained at or near stream-gaging stations because interpretation of records of surface-water quality nearly always requires corresponding discharge data. Records of surface-water quality in this report may involve various types of data and measurement frequencies.

### Change in National Trends Network Procedures

Sample handling procedures at all National Trends Network stations were changed substantially on January 11, 1994, in order to reduce contamination from the sample shipping container. The data for samples before and after that date are different and not directly comparable. A tabular summary of the differences, based on a special intercomparison study, is available from the NADP Program Office, Illinois State Water Survey, 2204 Griffith Drive, Champaign, IL 61820-7495 (Telephone: 217-333-7873).

### Classification of Records

Water-quality data for surface-water sites are grouped into one of three classifications. A continuing-record station is a site where data are collected on a regularly scheduled basis. Frequency may be one or more times daily, weekly, monthly, or quarterly. A partial-record station is a site where limited water-quality data are collected systematically over a period of years. Frequency of sampling is usually less than quarterly. A miscellaneous sampling site is a location other than a continuing or partial-record station, where random samples are collected to give better areal coverage to define water-quality conditions in the river basin.

A careful distinction needs to be made between "continuing records" as used in this report and "continuous recordings," which refers to a continuous graph or a series of discrete values punched at short intervals on a paper tape or stored electronically in a data logger. Some records of water quality, such as temperature and specific conductance, may be obtained through continuous recordings; however, because of costs, most data are obtained only monthly or less frequently. Locations of stations for which records on the quality of surface water appear in this report are shown in figures 2 through 12.

### Arrangement of Records

Water-quality records collected at a surface-water daily record station are published immediately following that record, regardless of the frequency of sample collection. Station number and name are the same for both records. Where a surface-water daily record station is not available or where the water quality differs significantly from that at the nearby surface-water station, the continuing water-quality record is published with its own station number and name in the regular downstream order sequence. Water-quality data for partial-record stations and for miscellaneous sampling sites appear in separate tables following the table of discharge measurements at miscellaneous sites.

### Onsite Measurements and Sample Collection

In obtaining water-quality data, a major concern is the assurance that the data obtained represent the in situ quality of the water. To assure this, certain measurements, such as water temperature, pH, and dissolved oxygen, are made onsite when samples are taken. To assure that measurements made in the laboratory also represent the in situ water, carefully prescribed procedures are followed in collecting the samples, in treating the samples to prevent changes in quality pending analysis, and in shipping the samples to the laboratory. Procedures for onsite measurements and for collecting, treating, and shipping samples are given in "Techniques of Water-Resources Investigations," Book 1, Chapter D2; Book 3, Chapter C2; and Book 5, Chapters A1, A3, and A4. All these references are listed in the section "Publications on Techniques of Water-Resources Investigations." Also, detailed information on collecting, treating, and shipping samples may be obtained from the District Office.

One sample can adequately define the water quality at a given time if the mixture of solutes throughout the stream cross section is homogeneous. However, the concentration of solutes at different locations in the cross section may vary widely with different rates of water discharge, depending on the source of material and the turbulence and mixing of the stream. Some streams must be sampled through several vertical sections to obtain a representative sample needed for an accurate mean concentration and for use in calculating load. All samples obtained for the National Stream-Quality Accounting Network (see definitions) are obtained from at least several verticals. Whether samples are obtained from the centroid of flow or from several verticals depends on flow conditions and other factors which must be evaluated by the collector.

Chemical-quality data published in this report are considered to be the most representative value available for the stations listed. The values reported represent water-quality conditions at the time of sampling as much as possible, consistent with available sampling techniques and methods of analysis. In the rare case where an apparent inconsistency exists between a reported pH value and the relative abundance of carbon dioxide species (carbonate and bicarbonate), the inconsistency is the result of a slight uptake of carbon dioxide from the air by the sample between measurement of pH in the field and determination of carbonate and bicarbonate in the laboratory.

## WATER RESOURCES DATA—CALIFORNIA, WATER YEAR 2001

For chemical-quality stations equipped with digital monitors, the records consist of daily maximum and minimum values for each constituent measured and are based on hourly punches beginning at 0100 hours and ending at 2400 hours for the day of record. More detailed records (hourly values) may be obtained from the District Office.

Historical and current (2001) dissolved trace-element concentrations are reported herein for water that was collected, processed, and analyzed by using either ultraclean or other than ultraclean techniques. If ultraclean techniques were used, then those concentrations are reported in nanograms per liter (ng/L). If other than ultraclean techniques were used, then those concentrations are reported in micrograms per liter ( $\mu\text{g/L}$ ) and could reflect contamination introduced during some phase of the procedure.

### Water Temperature

Water temperatures are measured at the water-quality stations. In addition, water temperatures are taken at time of discharge measurements for water-discharge stations. For stations where water temperatures are taken manually once or twice daily, the water temperatures are taken at about the same time each day. Large streams have a small diurnal temperature change; shallow streams may have a daily range of several degrees and may follow closely the changes in air temperature. Some streams may be affected by waste-heat discharges.

At stations where recording instruments are used, either mean temperatures or maximum and minimum temperatures for each day are published. Water temperatures measured at the time of water-discharge measurements are on file in the District Office.

### Sediment

Suspended-sediment concentrations are determined from samples collected by using depth-integrating samplers. Samples usually are obtained at several verticals in the cross section, or a single sample may be obtained at a fixed point and a coefficient applied to determine the mean concentration in the cross section.

During periods of rapidly changing flow or rapidly changing concentration, samples may have been collected more frequently (twice daily or, in some instances, hourly). The published sediment discharges for days of rapidly changing flow or concentration were computed by the subdivided-day method (time-discharge weighted average). Therefore, for those days when the published sediment discharge value differs from the value computed as the product of discharge times mean concentration times 0.0027, the reader can assume that the sediment discharge for that day was computed by the subdivided-day method. For periods when no samples were collected, daily discharges of suspended sediment were estimated on the basis of water discharge, sediment concentrations measured immediately before and after the periods, and suspended-sediment loads for other periods of similar discharge. Methods used in the computation of sediment records are described in the TWRI Book 3, Chapters C1 and C3. These methods are consistent with the ASTM standards and generally follow ISO standards.

At other stations, suspended-sediment samples were collected periodically at many verticals in the stream cross section. Although data collected periodically may represent conditions only at the time of observation, such data are useful in establishing seasonal relations between quality and streamflow and in predicting long-term sediment-discharge characteristics of the stream.

In addition to the records of suspended-sediment discharge, records of the periodic measurements of the particle-size distribution of suspended sediment, bed material, and bed load are included for some stations.

Estimates of bed-load and total-sediment discharge are included for some stations. Computations of monthly bed-load discharges are based on the relation between instantaneous water discharge and corresponding bed-load discharge for the station. Values of bed-load discharge used in defining this relation are based on samples obtained by use of the Helley-Smith or BL 84 bed-load samplers or by modified-Einstein or Meyer-Peter Muller computation procedures. Application of the bed-load-transport relation at a station was made on a daily basis or subdivided-day basis. The bed-load samplers are designed to collect time-weighted samples for the sediment moving within 0.25 ft of the streambed. Sediment moving in this portion of the flow cannot be sampled with standard suspended-sediment samplers. Calibration of the bed-load samplers has not been completed, and a trap efficiency of 1.0 has been assumed applicable to these devices. Error sources in the theoretical methods, based on analysis of bed-material characteristics, channel geometry, and associated hydraulic factors, are also undefined. In consequence, figures of bed-load discharge must be used with caution. They are estimates, at best, and are subject to revision.

### Cross-Sectional Data

Cross-sectional surveys of water temperature, pH, specific conductance, dissolved oxygen, and suspended sediment are done at all NASQAN, NAWQA, and Hydrologic Benchmark Stations during various seasons and surface-water discharges. Documentation of cross-section variation of water quality is essential in order to determine how many samples in a cross section are necessary to ensure a representative composite sample.

### Laboratory Measurements

Sediment samples, biochemical-oxygen-demand (BOD) samples, indicator-bacteria samples, and daily specific-conductance samples are analyzed locally. All other samples are analyzed in the U.S. Geological Survey's National Water-Quality Laboratory in Arvada, Colorado. Methods used to analyze sediment samples and to compute sediment records are described in the Techniques of Water-Resources Investigations, Book 5, Chapter C1. Methods used by the U.S. Geological Survey laboratories are given in TWRI Book 1, Chapter D2; Book 3, Chapter C2; and Book 5, Chapters A1, A3, A4, and A5. These methods are consistent with ASTM standards and generally follow ISO standards.



## WATER RESOURCES DATA—CALIFORNIA, WATER YEAR 2001

## Quality-Control Data

Data generated from quality-control (QC) samples are a requisite for evaluating the quality of the sampling and processing techniques as well as data from the actual samples themselves. Without QC data, environmental-sample data cannot be adequately interpreted because the errors associated with the sample data are unknown. The various types of QC samples collected by this District are described in the following section. Procedures have been established for the storage of water quality-control data within the U.S. Geological Survey. These procedures allow for storage of all derived QC data and are identified so that they can be related to corresponding environmental samples.

Blank Samples

Blank samples are collected and analyzed to ensure that environmental samples have not been contaminated by the overall data-collection process. The blank solution used to develop specific types of blank samples is a solution that is free of the analytes of interest. Any measured value signal in blank samples for an analyte (a specific component measured in a chemical analysis) that was absent in the blank solution is believed to be due to contamination. There are many types of blank samples possible, each designed to segregate a different part of the overall data-collection process. The types of blank samples collected in this District are:

**Source solution blank** is a blank solution that is transferred to a sample bottle in an area of the office laboratory with an atmosphere that is relatively clean and protected with respect to target analytes.

**Ambient blank** is a blank solution that is put in the same type of bottle used for an environmental sample, kept with the set of sample bottles before sample collection, and opened at the site and exposed to the ambient conditions.

**Field blank** is a blank solution that is subjected to all aspects of sample collection, field processing preservation, transportation, and laboratory handling as an environmental sample.

**Trip blank** is a blank solution that is put in the same type of bottle used for an environmental sample and kept with the set of sample bottles before and after sample collection.

**Equipment blank** is a blank solution that is processed through all equipment used for collecting and processing an environmental sample (similar to a field blank but normally done in the more controlled conditions of the office).

**Sampler blank** is a blank solution that is poured or pumped through the same field sampler used for collecting an environmental sample.

**Pump blank** is a blank solution that is processed through the same pump-and-tubing system used for an environmental sample.

**Standpipe blank** is a blank solution that is poured from the containment vessel (stand-pipe) before the pump is inserted to obtain the pump blank.

**Filter blank** is a blank solution that is filtered in the same manner and through the same filter apparatus used for an environmental sample.

**Splitter blank** is a blank solution that is mixed and separated using a field splitter in the same manner and through the same apparatus used for an environmental sample.

**Preservation blank** is a blank solution that is treated with the sampler preservatives used for an environmental sample.

**Canister blank** is a blank solution that is taken directly from a stainless steel canister just before the VOC sampler is submerged to obtain a field blank sample.

Reference Samples

Reference material is a solution or material prepared by a laboratory whose composition is certified for one or more properties so that it can be used to assess a measurement method. Samples of reference material are submitted for analysis to ensure that an analytical method is accurate for the known properties of the reference material. Generally, the selected reference material properties are similar to the environmental sample properties.

Replicate Samples

Replicate samples are a set of environmental samples collected in a manner such that the samples are thought to be essentially identical in composition. Replicate is the general case for which a duplicate is the special case consisting of two samples. Replicate samples are collected and analyzed to establish the amount of variability in the data contributed by some part of the collection and analytical process. There are many types of replicate samples possible, each of which may yield slightly different results in a dynamic hydrologic setting, such as a flowing stream. The types of replicate samples collected in this District are:

**Concurrent sample** is a type of replicate sample in which the samples are collected simultaneously with two or more samplers or by using one sampler and alternating collection of samples into two or more compositing containers.

**Sequential sample** is a type of replicate sample in which the samples are collected one after the other, typically over a short time.

**Split sample** is a type of replicate sample in which a sample is split into subsamples contemporaneous in time and space.

Spike Samples

**Spike samples** are samples to which known quantities of a solution with one or more well-established analyte concentrations have been added. These samples are analyzed to determine the extent of matrix interference or degradation on the analyte concentration during sample processing and analysis.

## WATER RESOURCES DATA—CALIFORNIA, WATER YEAR 2001

**Concurrent sample** is a type of spike sample that is collected at the same time with the same sampling and compositing devices then spiked with the same spike solution containing laboratory-certified concentrations of selected analytes.

**Split sample** is a type of spike sample in which a sample is split into subsamples contemporaneous in time and space then spiked with the same spike solution containing laboratory-certified concentrations of selected analytes.

### Data Presentation

For continuing-record stations, information pertinent to the history of station operation is provided in descriptive headings preceding the tabular data. These descriptive headings give details regarding location, drainage area, period of record, type of data available, instrumentation, general remarks, cooperation, and extremes for parameters currently measured daily. Tables of chemical, physical, biological, radiochemical data, and other data obtained at a frequency less than daily are presented first. Tables of "daily values" of specific conductance, pH, water temperature, dissolved oxygen, and suspended sediment follow in sequence.

In the descriptive headings, if the location is identical to that of the discharge gaging station, neither the LOCATION nor the DRAINAGE AREA statements are repeated. The following information, as appropriate, is provided with each continuous-record station. Comments that follow clarify information presented under the various headings of the station description.

LOCATION.—See Data Presentation under "Records of Stage and Water Discharge"; same comments apply.

DRAINAGE AREA.—See Data Presentation under "Records of Stage and Water Discharge"; same comments apply.

PERIOD OF RECORD.—This indicates the periods for which there are published water-quality records for the station. The periods are shown separately for records of parameters measured daily or continuously and those measured less than daily. For those measured daily or continuously, periods of record are given for the individual parameters.

INSTRUMENTATION.—Information on instrumentation is given only if a water-quality monitor, temperature recorder, sediment-pumping sampler, or other sampling device is in operation at a station.

REMARKS.—Remarks provide added information pertinent to the collection, analysis, or computation of the records.

COOPERATION.—Records provided by a cooperating organization or obtained for the U.S. Geological Survey by a cooperating organization are identified here.

EXTREMES.—Maximums and minimums are given only for parameters measured daily or more frequently. None are given for parameters measured weekly or less frequently because the true maximums or minimums may not have been sampled. Extremes, when given, are provided for both the period of record and for the current water year.

REVISIONS.—If errors in water-quality records are discovered after publication, appropriate updates are made to the Water-Quality File in the U.S. Geological Survey's computerized data system, National Water Information System (NWIS), and subsequently by monthly transfer of update transactions to the U.S. Environmental Protection Agency's STORET system. Because the usual volume of updates makes it impractical to document individual changes in the State data-report series or elsewhere, potential users of U.S. Geological Survey water-quality data are encouraged to obtain all required data from the appropriate computer file to ensure the most recent updates.

The surface-water-quality records for partial-record stations and miscellaneous sampling sites are published in separate tables following the table of discharge measurements at miscellaneous sites. No descriptive statements are given for these records. Each station is published with its own station number and name in the regular downstream-order sequence.

### ACCESS TO USGS WATER DATA

The U.S. Geological Survey provides near real-time stage and discharge data for many of the gaging stations equipped with the necessary telemetry and historic daily-mean and peak-flow discharge data for most current or discontinued gaging stations through the world wide web (WWW). These data may be accessed at

<http://water.usgs.gov>.

Some water-quality and ground-water data also are available through the WWW. In addition, data can be provided in various machine-readable formats on magnetic tape or 3-1/2 inch floppy disk. Information about the availability of specific types of additional data or products, and user charges, can be obtained locally from each of the Water Resources Division District Offices. (See address on the back of the title page.)

*THIS  
PAGE  
INTENTIONALLY  
LEFT  
BLANK*

## DEFINITION OF TERMS

Specialized technical terms related to streamflow, water-quality, and other hydrologic data, as used in this report, are defined below. Terms such as algae, water level, precipitation are used in their common everyday meanings, definitions of which are given in standard dictionaries. Not all terms defined in this alphabetical list apply to every State. See also table for converting English units to International System (SI) Units on the inside of the back cover.

**Acid neutralizing capacity (ANC)** is the equivalent sum of all bases or base-producing materials, solutes plus particulates, in an aqueous system that can be titrated with acid to an equivalence point. This term designates titration of an “unfiltered” sample (formerly reported as alkalinity).

**Acre-foot (AC-FT, acre-ft)** is a unit of volume, commonly used to measure quantities of water used or stored, equivalent to the volume of water required to cover 1 acre to a depth of 1 foot and equivalent to 43,560 cubic feet, 325,851 gallons, or 1,233 cubic meters. (See also “[Annual runoff](#)”)

**Adenosine triphosphate (ATP)** is an organic, phosphate-rich, compound important in the transfer of energy in organisms. Its central role in living cells makes ATP an excellent indicator of the presence of living material in water. A measurement of ATP therefore provides a sensitive and rapid estimate of biomass. ATP is reported in micrograms per liter.

**Algal growth potential (AGP)** is the maximum algal dry weight biomass that can be produced in a natural water sample under standardized laboratory conditions. The growth potential is the algal biomass present at stationary phase and is expressed as milligrams dry weight of algae produced per liter of sample.

**Alkalinity** is the capacity of solutes in an aqueous system to neutralize acid. This term designates titration of a “filtered” sample.

**Annual runoff** is the total quantity of water that is discharged (“runs off”) from a drainage basin in a year. Data reports may present annual runoff data as volumes in acre-feet, as discharges per unit of drainage area in cubic feet per second per square mile, or as depths of water on the drainage basin in inches.

**Annual 7-day minimum** is the lowest mean value for any 7-consecutive-day period in a year. Annual 7-day minimum values are reported herein for the calendar year and the water year (October 1 to September 30). Most low-flow frequency analyses use a climatic year (April 1–March 31), which tends to prevent the low-flow period from being artificially split between adjacent years. The date shown in the summary statistics table is the initial date of the 7-day period. (This value should not be confused with the 7-day 10-year low-flow statistic.)

**Aroclor** is the registered trademark for a group of polychlorinated biphenyls that were manufactured by the Monsanto Company prior to 1976. Aroclors are assigned specific 4-digit reference numbers dependent upon molecular type and degree of substitution of the biphenyl ring hydrogen atoms by chlorine atoms. The first two digits of a numbered aroclor represent the molecular type and the last two digits represent the weight percent of the hydrogen substituted chlorine.

**Artificial substrate** is a device that is purposely placed in a stream or lake for colonization of organisms. The artificial substrate simplifies the community structure by standardizing the substrate from which each sample is taken. Examples of artificial substrates are basket samplers (made of wire cages filled with clean streamside rocks) and multiplate samplers (made of hardboard) for benthic organism collection, and plexiglass strips for periphyton collection. (See also “[Substrate](#)”)

**Ash mass** is the mass or amount of residue present after the residue from the dry mass determination has been ashed in a muffle furnace at a temperature of 500°C for 1 hour. Ash mass of zooplankton and phytoplankton is expressed in grams per cubic meter ( $\text{g}/\text{m}^3$ ), and periphyton and benthic organisms in grams per square meter ( $\text{g}/\text{m}^2$ ). (See also “[Biomass](#)”)

**Bacteria** are microscopic unicellular organisms, typically spherical, rodlike, or spiral and threadlike in shape, often clumped into colonies. Some bacteria cause disease, while others perform an essential role in nature in the recycling of materials; for example, by decomposing organic matter into a form available for reuse by plants.

**Base discharge (for peak discharge)** is a discharge value, determined for selected stations, above which peak discharge data are published. The base discharge at each station is selected so that an average of about three peaks per year will be published.

**Base flow** is sustained flow of a stream in the absence of direct runoff. It includes natural and human-induced streamflows. Natural base flow is sustained largely by ground-water discharge.

**Bedload** is material in transport that is supported primarily by the streambed. In this report, bedload is considered to consist of particles in transit from the bed to an elevation equal to the top of the bedload sampler nozzle (ranging from 0.25 to 0.5 ft) that are retained in the bedload sampler. A sample collected with a pressure-differential bedload sampler may also contain a component of the suspended load.

**Bedload discharge** (tons per day) is the rate of sediment moving as bedload, reported as dry weight, that passes through a cross section in a given time. NOTE: Bedload discharge values in this report may include a component of the suspended-sediment discharge. A correction may be necessary when computing the total sediment discharge by summing the bedload discharge and the suspended-sediment discharge. (See also “[Bedload](#)” and “[Sediment](#)”)

**Bed material** is the sediment mixture of which a streambed, lake, pond, reservoir, or estuary bottom is composed. (See also “[Bedload](#)” and “[Sediment](#)”)

## WATER RESOURCES DATA—CALIFORNIA, WATER YEAR 2001

**Benthic organisms** are the group of organisms inhabiting the bottom of an aquatic environment. They include a number of types of organisms, such as bacteria, fungi, insect larvae and nymphs, snails, clams, and crayfish. They are useful as indicators of water quality.

**Biochemical oxygen demand (BOD)** is a measure of the quantity of dissolved oxygen, in milligrams per liter, necessary for the decomposition of organic matter by microorganisms, such as bacteria.

**Biomass** is the amount of living matter present at any given time, expressed as mass per unit area or volume of habitat.

**Biomass pigment ratio** is an indicator of the total proportion of periphyton which are autotrophic (plants). This is also called the Autotrophic Index.

**Blue-green algae** (*Cyanophyta*) are a group of phytoplankton organisms having a blue pigment, in addition to the green pigment called chlorophyll. Blue-green algae often cause nuisance conditions in water. Concentrations are expressed as a number of cells per milliliter (cells/mL) of sample. (See also "[Phytoplankton](#)")

**Bottom material** (See "[Bed material](#)")

**Cells/volume** refers to the number of cells of any organism that is counted by using a microscope and grid or counting cell. Many planktonic organisms are multicelled and are counted according to the number of contained cells per sample volume, and are generally reported as cells or units per milliliter (mL) or liter (L).

**Cells volume (biovolume)** determination is one of several common methods used to estimate biomass of algae in aquatic systems. Cell members of algae are frequently used in aquatic surveys as an indicator of algal production. However, cell numbers alone cannot represent true biomass because of considerable cell-size variation among the algal species. Cell volume ( $\mu\text{m}^3$ ) is determined by obtaining critical cell measurements on cell dimensions (for example, length, width, height, or radius) for 20 to 50 cells of each important species to obtain an average biovolume per cell. Cells are categorized according to the correspondence of their cellular shape to the nearest geometric solid or combinations of simple solids (for example, spheres, cones, or cylinders). Representative formulae used to compute biovolume are as follows:

$$\text{sphere } \frac{4}{3} \pi r^3 \quad \text{cone } \frac{1}{3} \pi r^2 h \quad \text{cylinder } \pi r^2 h.$$

pi is the ratio of the circumference to the diameter of a circle; pi = 3.14159

From cell volume, total algal biomass expressed as biovolume ( $\mu\text{m}^3/\text{mL}$ ) is thus determined by multiplying the number of cells of a given species by its average cell volume and then summing these volumes over all species.

**Cfs-day** (See "[Cubic foot per second-day](#)")

**Chemical oxygen demand (COD)** is a measure of the chemically oxidizable material in the water and furnishes an approximation of the amount of organic and reducing material present. The determined value may correlate with BOD or with carbonaceous organic pollution from sewage or industrial wastes. [See also "[Biochemical oxygen demand \(BOD\)](#)"]

***Clostridium perfringens* (*C. perfringens*)** is a spore-forming bacterium that is common in the feces of human and other warm-blooded animals. Clostridial spores are being used experimentally as an indicator of past fecal contamination and presence of microorganisms that are resistant to disinfection and environmental stresses. (See also "[Bacteria](#)")

**Coliphages** are viruses that infect and replicate in coliform bacteria. They are indicative of sewage contamination of waters and of the survival and transport of viruses in the environment.

**Color unit** is produced by 1 milligram per liter of platinum in the form of the chloroplatinate ion. Color is expressed in units of the platinum-cobalt scale.

**Confined aquifer** is a term used to describe an aquifer containing water between two relatively impermeable boundaries. The water level in a well tapping a confined aquifer stands above the top of the confined aquifer and can be higher or lower than the water table that may be present in the material above it. In some cases the water level can rise above the ground surface, yielding a flowing well.

**Contents** is the volume of water in a reservoir or lake. Unless otherwise indicated, volume is computed on the basis of a level pool and does not include bank storage.

**Continuous-record station** is a site where data are collected with sufficient frequency to define daily mean values and variations within a day.

**Control** designates a feature in the channel downstream from a gaging station that physically influences the water-surface elevation and thereby determines the stage-discharge relation at the gage. This feature may be a constriction of the channel, a bedrock outcrop, a gravel bar, an artificial structure, or a uniform cross section over a long reach of the channel.

**Control structure** as used in this report is a structure on a stream or canal that is used to regulate the flow or stage of the stream or to prevent the intrusion of saltwater.

**Cubic foot per second (CFS,  $\text{ft}^3/\text{s}$ )** is the rate of discharge representing a volume of 1 cubic foot passing a given point in 1 second. It is equivalent to approximately 7.48 gallons per second or approximately 449 gallons per minute, or 0.02832 cubic meters per second. The term "second-foot" sometimes is used synonymously with "cubic feet per second" but is now obsolete.

**Cubic foot per second-day (CFS-DAY, Cfs-day,  $[(\text{ft}^3/\text{s})/\text{d}]$ )** is the volume of water represented by a flow of 1 cubic foot per second for 24 hours. It is equivalent to 86,400 cubic feet, 1.98347 acre-feet, 646,317 gallons, or 2,446.6 cubic meters. The daily-mean discharges reported in the daily-value data tables are numerically equal to the daily volumes in cfs-days, and the totals also represent volumes in cfs-days.

**Cubic foot per second per square mile [CFSM,  $(\text{ft}^3/\text{s})/\text{mi}^2$ ]** is the average number of cubic feet of water flowing per second from each square mile of area drained, assuming the runoff is distributed uniformly in time and area. (See also "[Annual runoff](#)")

## WATER RESOURCES DATA—CALIFORNIA, WATER YEAR 2001

**Daily mean suspended-sediment concentration** is the time-weighted concentration of suspended sediment passing a stream cross section during a 24-hour day. (See also "[Mean concentration of suspended sediment](#)", "[Sediment](#)", and "[Suspended-sediment concentration](#)")

**Daily-record station** is a site where data are collected with sufficient frequency to develop a record of one or more data values per day. The frequency of data collection can range from continuous recording to periodic sample or data collection on a daily or near-daily basis.

**Data Collection Platform (DCP)** is an electronic instrument that collects, processes, and stores data from various sensors, and transmits the data by satellite data relay, line-of-sight radio, and/or landline telemetry.

**Data logger** is a microprocessor-based data acquisition system designed specifically to acquire, process, and store data. Data are usually downloaded from onsite data loggers for entry into office data systems.

**Datum** is a surface or point relative to which measurements of height and/or horizontal position are reported. A vertical datum is a horizontal surface used as the zero point for measurements of gage height, stage, or elevation; a horizontal datum is a reference for positions given in terms of latitude-longitude, State Plane coordinates, or UTM coordinates. (See also "[Gage datum](#)", "[Land-surface datum](#)", "[National Geodetic Vertical Datum of 1929](#)", and "[North American Vertical Datum of 1988](#)")

**Diatoms** are the unicellular or colonial algae having a siliceous shell. Their concentrations are expressed as number of cells per milliliter (cells/mL) of sample. (See also "[Phytoplankton](#)")

**Diel** is of or pertaining to a 24-hour period of time; a regular daily cycle.

**Discharge**, or flow, is the rate that matter passes through a cross section of a stream channel or other water body per unit of time. The term commonly refers to the volume of water (including, unless otherwise stated, any sediments or other constituents suspended or dissolved in the water) that passes a cross section in a stream channel, canal, pipeline, etc., within a given period of time (cubic feet per second). Discharge also can apply to the rate at which constituents such as suspended sediment, bedload, and dissolved or suspended chemical constituents, pass through a cross section, in which cases the quantity is expressed as the mass of constituent that passes the cross section in a given period of time (tons per day).

**Dissolved** refers to that material in a representative water sample that passes through a 0.45-micrometer membrane filter. This is a convenient operational definition used by Federal and State agencies that collect water-quality data. Determinations of "dissolved" constituent concentrations are made on sample water that has been filtered.

**Dissolved oxygen (DO)** is the molecular oxygen (oxygen gas) dissolved in water. The concentration in water is a function of atmospheric pressure, temperature, and dissolved-solids concentration of the water. The ability of water to retain oxygen decreases with increasing temperature or dissolved-solids concentration. Photosynthesis and respiration by plants commonly cause diurnal variations in dissolved-oxygen concentration in water from some streams.

**Dissolved-solids concentration** in water is the quantity of dissolved material in a sample of water. It is determined either analytically by the "residue-on-evaporation" method, or mathematically by totaling the concentrations of individual constituents reported in a comprehensive chemical analysis. During the analytical determination, the bicarbonate (generally a major dissolved component of water) is converted to carbonate. In the mathematical calculation, the bicarbonate value, in milligrams per liter, is multiplied by 0.4926 to convert it to carbonate. Alternatively, alkalinity concentration (as mg/L CaCO<sub>3</sub>) can be converted to carbonate concentration by multiplying by 0.60.

**Diversity index (H)** (Shannon Index) is a numerical expression of evenness of distribution of aquatic organisms. The formula for diversity index is:

$$\bar{d} = - \sum_{i=1}^s \frac{n_i}{n} \log_2 \frac{n_i}{n},$$

where  $n_i$  is the number of individuals per taxon,  $n$  is the total number of individuals, and  $s$  is the total number of taxa in the sample of the community. Index values range from zero, when all the organisms in the sample are the same, to some positive number, when some or all of the organisms in the sample are different.

**Drainage area** of a stream at a specific location is that area upstream from the location, measured in a horizontal plane, that has a common outlet at the site for its surface runoff from precipitation that normally drains by gravity into a stream. Drainage areas given herein include all closed basins, or noncontributing areas, within the area unless otherwise specified.

**Drainage basin** is a part of the Earth's surface that contains a drainage system with a common outlet for its surface runoff (See "[Drainage area](#)")

**Dry mass** refers to the mass of residue present after drying in an oven at 105°C, until the mass remains unchanged. This mass represents the total organic matter, ash and sediment, in the sample. Dry-mass values are expressed in the same units as ash mass. (See also "[Ash mass](#)", "[Biomass](#)", and "[Wet mass](#)")

**Dry weight** refers to the weight of animal tissue after it has been dried in an oven at 65°C until a constant weight is achieved. Dry weight represents total organic and inorganic matter in the tissue. (See also "[Wet weight](#)")

**Enterococcus bacteria** are commonly found in the feces of humans and other warm-blooded animals. Although some strains are ubiquitous and not related to fecal pollution, the presence of enterococci in water is an indication of fecal pollution and the possible presence of enteric pathogens. Enterococcus bacteria are those bacteria that produce pink to red colonies with black or reddish-brown precipitate after incubation at 41°C on mE agar and subsequent transfer to EIA medium. Enterococci include *Streptococcus faecalis*, *Streptococcus faecium*, *Streptococcus avium*, and their variants. (See also "[Bacteria](#)")

**EPT Index** is the total number of distinct taxa within the insect orders Ephemeroptera, Plecoptera, and Trichoptera. This index summarizes the taxa richness within the aquatic insects that are generally considered pollution sensitive, the index usually decreases with pollution.

***Escherichia coli* (*E. coli*)** are bacteria present in the intestine and feces of warm-blooded animals. *E. coli* are a member species of the fecal coliform group of indicator bacteria. In the laboratory, they are defined as those bacteria that produce yellow or yellow-brown colonies on a filter pad saturated with urea substrate broth after primary culturing for 22 to 24 hours at 44.5°C on mTEC medium. Their concentrations are expressed as number of colonies per 100 mL of sample. (See also "Bacteria")

**Estimated (E) value** of a concentration is reported when an analyte is detected and all criteria for a positive result are met. If the concentration is less than the method detection limit (MDL), an 'E' code will be reported with the value. If the analyte is qualitatively identified as present, but the quantitative determination is substantially more uncertain, the National Water Quality Laboratory will identify the result with an 'E' code even though the measured value is greater than the MDL. A value reported with an 'E' code should be used with caution. When no analyte is detected in a sample, the default reporting value is the MDL preceded by a less than sign (<).

**Euglenoids (*Euglenophyta*)** are a group of algae that are usually free-swimming and rarely creeping. They have the ability to grow either photosynthetically in the light or heterotrophically in the dark. (See also "Phytoplankton")

**Extractable organic halides (EOX)** are organic compounds that contain halogen atoms such as chlorine. These organic compounds are semi-volatile and extractable by ethyl acetate from air-dried streambed sediments. The ethyl acetate extract is combusted, and the concentration is determined by microcoulometric determination of the halides formed. The concentration is reported as micrograms of chlorine per gram of the dry weight of the streambed sediments.

**Fecal coliform bacteria** are present in the intestine or feces of warm-blooded animals. They are often used as indicators of the sanitary quality of the water. In the laboratory, they are defined as all organisms that produce blue colonies within 24 hours when incubated at 44.5°C plus or minus 0.2°C on M-FC medium (nutrient medium for bacterial growth). Their concentrations are expressed as number of colonies per 100 mL of sample. (See also "Bacteria")

**Fecal streptococcal bacteria** are present in the intestine of warm-blooded animals and are ubiquitous in the environment. They are characterized as gram-positive, cocci bacteria that are capable of growth in brain-heart infusion broth. In the laboratory, they are defined as all the organisms that produce red or pink colonies within 48 hours at 35°C plus or minus 1.0°C on KF-streptococcus medium (nutrient medium for bacterial growth). Their concentrations are expressed as number of colonies per 100 mL of sample. (See also "Bacteria")

**Fire algae (*Pyrrophyta*)** are free-swimming unicells characterized by a red pigment spot. (See also "Phytoplankton")

**Flow-duration percentiles** are values on a scale of 100 that indicate the percentage of time for which a flow is not exceeded. For example, the 90th percentile of river flow is greater than or equal to 90 percent of all recorded flow rates.

**Gage datum** is a horizontal surface used as a zero point for measurement of stage or gage height. This surface usually is located slightly below the lowest point of the stream bottom such that the gage height is usually slightly larger than the maximum depth of water. Because the gage datum itself is not an actual physical object, the datum usually is defined by specifying the elevations of permanent reference marks such as bridge abutments, and survey monuments, and the gage is set to agree with the reference marks. Gage datum is a local datum that is maintained independently of any National geodetic datum. However, if the elevation of the gage datum relative to the National datum (North American Vertical Datum of 1988 or National Geodetic Vertical Datum of 1929) has been determined, then the gage readings can be converted to elevations above the National datum by adding the elevation of the gage datum to the gage reading.

**Gage height (G.H.)** is the water-surface elevation, in feet above the gage datum. If the water surface is below the gage datum, the gage height is negative. Gage height is often used interchangeably with the more general term "stage," although gage height is more appropriate when used in reference to a reading on a gage.

**Gage values** are values that are recorded, transmitted, and/or computed from a gaging station. Gage values typically are collected at 5-, 15-, or 30-minute intervals.

**Gaging station** is a site on a stream, canal, lake, or reservoir where systematic observations of stage, discharge, or other hydrologic data are obtained. When used in connection with a discharge record, the term is applied only to those gaging stations where a continuous record of discharge is computed.

**Gas chromatography/flame ionization detector (GC/FID)** is a laboratory analytical method used as a screening technique for semivolatile organic compounds that are extractable from water in methylene chloride.

**Green algae** have chlorophyll pigments similar in color to those of higher green plants. Some forms produce algae mats or floating "moss" in lakes. Their concentrations are expressed as number of cells per milliliter (cells/mL) of sample. (See also "Phytoplankton")

**Habitat quality index** is the qualitative description (level 1) of instream habitat and riparian conditions surrounding the reach sampled. Scores range from 0 to 100 percent with higher scores indicative of desirable habitat conditions for aquatic life. Index only applicable to wadable streams.

**Hardness** of water is a physical-chemical characteristic that is commonly recognized by the increased quantity of soap required to produce lather. It is computed as the sum of equivalents of polyvalent cations (primarily calcium and magnesium) and is expressed as the equivalent concentration of calcium carbonate (CaCO<sub>3</sub>).

**High tide** is the maximum height reached by each rising tide. The high-high and low-high tides are the higher and lower of the two high tides, respectively, of each tidal day. See NOAA web site:

<http://www.co-ops.nos.noaa.gov/tideglos.html>

## WATER RESOURCES DATA—CALIFORNIA, WATER YEAR 2001

**Hilsenhoff's Biotic Index** (HBI) is an indicator of organic pollution which uses tolerance values to weight taxa abundances; usually increases with pollution. It is calculated as follows:

$$HBI = \text{sum} \frac{(n)(a)}{N}$$

where  $n$  is the number of individuals of each taxon,  $a$  is the tolerance value of each taxon, and  $N$  is the total number of organisms in the sample.

**Horizontal datum** (See "Datum")

**Hydrologic benchmark station** is one that provides hydrologic data for a basin in which the hydrologic regimen will likely be governed solely by natural conditions. Data collected at a benchmark station may be used to separate effects of natural from human-induced changes in other basins that have been developed and in which the physiography, climate, and geology are similar to those in the undeveloped benchmark basin.

**Hydrologic index stations** referred to in this report are four continuous-record gaging stations that have been selected as representative of streamflow patterns for their respective regions. Station locations are shown on index maps.

**Hydrologic unit** is a geographic area representing part or all of a surface drainage basin or distinct hydrologic feature as defined by the former Office of Water Data Coordination and delineated on the State Hydrologic Unit Maps by the USGS. Each hydrologic unit is identified by an 8-digit number.

**Inch** (IN., in.) as used in this report, refers to the depth to which the drainage area would be covered with water if all of the runoff for a given time period were uniformly distributed on it. (See also "Annual runoff")

**Instantaneous discharge** is the discharge at a particular instant of time. (See also "Discharge")

**Laboratory Reporting Level** (LRL) is generally equal to twice the yearly determined long-term method detection level (LT-MDL). The LRL controls false negative error. The probability of falsely reporting a non-detection for a sample that contained an analyte at a concentration equal to or greater than the LRL is predicted to be less than or equal to 1 percent. The value of the LRL will be reported with a "less than" (<) remark code for samples in which the analyte was not detected. The National Water Quality Laboratory collects quality-control data from selected analytical methods on a continuing basis to determine LT-MDLs and to establish LRLs. These values are reevaluated annually based on the most current quality-control data and may, therefore, change. [Note: In several previous NWQL documents (Connor and others, 1998; NWQL Technical Memorandum 98.07, 1998), the LRL was called the non-detection value or NDV—a term that is no longer used.)

**Land-surface datum** (lsd) is a datum plane that is approximately at land surface at each ground-water observation well.

**Light-attenuation coefficient**, also known as the extinction coefficient, is a measure of water clarity. Light is attenuated according to the Lambert-Beer equation

$$I = I_o e^{-\lambda L},$$

where  $I_o$  is the source light intensity,  $I$  is the light intensity at length  $L$  (in meters) from the source,  $\lambda$  is the light-attenuation coefficient, and  $e$  is the base of the natural logarithm. The light-attenuation coefficient is defined as

$$\lambda = -\frac{1}{L} \log_e \frac{I}{I_o}.$$

**Lipid** is any one of a family of compounds that are insoluble in water and that make up one of the principal components of living cells. Lipids include fats, oils, waxes, and steroids. Many environmental contaminants such as organochlorine pesticides are lipophilic.

**Long-Term Method Detection Level** (LT-MDL) is a detection level derived by determining the standard deviation of a minimum of 24 method detection limit (MDL) spike sample measurements over an extended period of time. LT-MDL data are collected on a continuous basis to assess year-to-year variations in the LT-MDL. The LT-MDL controls false positive error. The chance of falsely reporting a concentration at or greater than the LT-MDL for a sample that did not contain the analyte is predicted to be less than or equal to 1 percent.

**Low tide** is the minimum height reached by each falling tide. The high-low and low-low tides are the higher and lower of the two low tides, respectively, of each tidal day. See NOAA web site:

<http://www.co-ops.nos.noaa.gov/tideglos.html>

**Macrophytes** are the macroscopic plants in the aquatic environment. The most common macrophytes are the rooted vascular plants that are usually arranged in zones in aquatic ecosystems and restricted in the area by the extent of illumination through the water and sediment deposition along the shoreline.

**Mean concentration of suspended sediment** (Daily mean suspended-sediment concentration) is the time-weighted concentration of suspended sediment passing a stream cross section during a given time period. (See also "Daily mean suspended-sediment concentration" and "Suspended-sediment concentration")

**Mean discharge** (MEAN) is the arithmetic mean of individual daily mean discharges during a specific period. (See also "Discharge")



## WATER RESOURCES DATA—CALIFORNIA, WATER YEAR 2001

**Mean high or low tide** is the average of all high or low tides, respectively, over a specific period.

**Mean sea level** is a local tidal datum. It is the arithmetic mean of hourly heights observed over the National Tidal Datum Epoch. Shorter series are specified in the name; for example, monthly mean sea level and yearly mean sea level. In order that they may be recovered when needed, such datums are referenced to fixed points known as benchmarks. (See also "Datum")

**Measuring point (MP)** is an arbitrary permanent reference point from which the distance to water surface in a well is measured to obtain water level.

**Membrane filter** is a thin microporous material of specific pore size used to filter bacteria, algae, and other very small particles from water.

**Metamorphic stage** refers to the stage of development that an organism exhibits during its transformation from an immature form to an adult form. This developmental process exists for most insects, and the degree of difference from the immature stage to the adult form varies from relatively slight to pronounced, with many intermediates. Examples of metamorphic stages of insects are egg-larva-adult or egg-nymph-adult.

**Method Detection Limit (MDL)** is the minimum concentration of a substance that can be measured and reported with 99-percent confidence that the analyte concentration is greater than zero. It is determined from the analysis of a sample in a given matrix containing the analyte. At the MDL concentration, the risk of a false positive is predicted to be less than or equal to 1 percent.

**Methylene blue active substances (MBAS)** are apparent detergents. The determination depends on the formation of a blue color when methylene blue dye reacts with synthetic anionic detergent compounds.

**Micrograms per gram (UG/G,  $\mu\text{g/g}$ )** is a unit expressing the concentration of a chemical constituent as the mass (micrograms) of the element per unit mass (gram) of material analyzed.

**Micrograms per kilogram (UG/KG,  $\mu\text{g/kg}$ )** is a unit expressing the concentration of a chemical constituent as the mass (micrograms) of the constituent per unit mass (kilogram) of the material analyzed. One microgram per kilogram is equivalent to 1 part per billion.

**Micrograms per liter (UG/L,  $\mu\text{g/L}$ )** is a unit expressing the concentration of chemical constituents in water as mass (micrograms) of constituent per unit volume (liter) of water. One thousand micrograms per liter is equivalent to 1 milligram per liter. One microgram per liter is equivalent to 1 part per billion.

**Microsiemens per centimeter (US/CM,  $\mu\text{S/cm}$ )** is a unit expressing the amount of electrical conductivity of a solution as measured between opposite faces of a centimeter cube of solution at a specified temperature. Siemens is the International System of Units nomenclature. It is synonymous with mhos and is the reciprocal of resistance in ohms.

**Milligrams per liter (MG/L,  $\text{mg/L}$ )** is a unit for expressing the concentration of chemical constituents in water as the mass (milligrams) of constituent per unit volume (liter) of water. Concentration of suspended sediment also is expressed in  $\text{mg/L}$  and is based on the mass of dry sediment per liter of water-sediment mixture.

**Minimum Reporting Level (MRL)** is the smallest measured concentration of a constituent that may be reliably reported by using a given analytical method (Timme, 1995).

**Miscellaneous site**, miscellaneous station, or miscellaneous sampling site, is a site where streamflow, sediment, and/or water-quality data or water-quality or sediment samples are collected once, or more often on a random or discontinuous basis to provide better areal coverage for defining hydrologic and water-quality conditions over a broad area in a river basin.

**Most probable number (MPN)** is an index of the number of coliform bacteria that, more probably than any other number, would give the results shown by the laboratory examination; it is not an actual enumeration. MPN is determined from the distribution of gas-positive cultures among multiple inoculated tubes.

**Multiple-plate samplers** are artificial substrates of known surface area used for obtaining benthic invertebrate samples. They consist of a series of spaced, hardboard plates on an eyebolt.

**Nanograms per liter (NG/L,  $\text{ng/L}$ )** is a unit expressing the concentration of chemical constituents in solution as mass (nanograms) of solute per unit volume (liter) of water. One million nanograms per liter is equivalent to 1 milligram per liter.

**National Geodetic Vertical Datum of 1929 (NGVD of 1929)** is a fixed reference adopted as a standard geodetic datum for elevations determined by leveling. It was formerly called "Sea Level Datum of 1929" or "mean sea level". Although the datum was derived from the mean sea level at 26 tide stations, it does not necessarily represent local mean sea level at any particular place. (See "North American Vertical Datum of 1988") See also NOAA web site:

<http://www.ngs.noaa.gov/faq.shtml#WhatVD29VD88>

**Natural substrate** refers to any naturally occurring immersed or submersed solid surface, such as a rock or tree, upon which an organism lives. (See also "Substrate")

**Nekton** are the consumers in the aquatic environment and consist of large free-swimming organisms that are capable of sustained, directed mobility.

**Nephelometric turbidity unit (NTU)** is the measurement for reporting turbidity that is based on use of a standard suspension of Formazin. Turbidity measured in NTU uses nephelometric methods that depend on passing specific light of a specific wavelength through the sample.

**North American Vertical Datum of 1988 (NAVD 1988)** is a fixed reference adopted as the official civilian vertical datum for elevations determined by Federal surveying and mapping activities in the U.S. This datum was established in 1991 by minimum-constraint adjustment of the Canadian, Mexican, and U.S. first-order terrestrial leveling networks.

**Open or screened interval** is the length of unscreened opening or of well screen through which water enters a well, in feet below land surface.

## WATER RESOURCES DATA—CALIFORNIA, WATER YEAR 2001

**Organic carbon (OC)** is a measure of organic matter present in aqueous solution, suspension, or bottom sediments. May be reported as dissolved organic carbon (DOC), particulate organic carbon (POC), or total organic carbon (TOC).

**Organic mass** or volatile mass of the living substance is the difference between the dry mass and ash mass and represents the actual mass of the living matter. Organic mass is expressed in the same units as for ash mass and dry mass. (See also "[Ash mass](#)", "[Biomass](#)", and "[Dry mass](#)")

**Organism count/area** refers to the number of organisms collected and enumerated in a sample and adjusted to the number per area of habitat, usually square meter (m<sup>2</sup>), acre, or hectare. Periphyton, benthic organisms, and macrophytes are expressed in these terms.

**Organism count/volume** refers to the number of organisms collected and enumerated in a sample and adjusted to the number per sample volume, usually milliliter (mL) or liter (L). Numbers of planktonic organisms can be expressed in these terms.

**Organochlorine compounds** are any chemicals that contain carbon and chlorine. Organochlorine compounds that are important in investigations of water, sediment, and biological quality include certain pesticides and industrial compounds.

**Parameter Code** is a 5-digit number used in the USGS computerized data system, National Water Information System (NWIS), to uniquely identify a specific constituent or property.

**Partial-record station** is a site where discrete measurements of one or more hydrologic parameters are obtained over a period of time without continuous data being recorded or computed. A common example is a crest-stage gage partial-record station at which only peak stages and flows are recorded.

**Particle size** is the diameter, in millimeters (mm), of a particle determined by sieve or sedimentation methods. The sedimentation method utilizes the principle of Stokes Law to calculate sediment particle sizes. Sedimentation methods (pipet, bottom-withdrawal tube, visual-accumulation tube, Sedigraph) determine fall diameter of particles in either distilled water (chemically dispersed) or in native water (the river water at the time and point of sampling).

**Particle-size classification** as used in this report agrees with the recommendation made by the American Geophysical Union Subcommittee on Sediment Terminology. The classification is as follows:

Classification	Size (mm)	Method of analysis
Clay . . . . .	0.00024–0.004	Sedimentation
Silt . . . . .	.004–.062	Sedimentation
Sand . . . . .	.062–2.0	Sedimentation/sieve
Gravel. . . . .	2.0–64.0	Sieve

The particle-size distributions given in this report are not necessarily representative of all particles in transport in the stream. Most of the organic matter is removed, and the sample is subjected to mechanical and chemical dispersion before analysis in distilled water. Chemical dispersion is not used for native water analysis.

**Peak flow (peak stage)** is an instantaneous local maximum value in the continuous time series of streamflows or stages, preceded by a period of increasing values and followed by a period of decreasing values. Several peak values ordinarily occur in a year. The maximum peak value in a year is called the annual peak; peaks lower than the annual peak are called secondary peaks. Occasionally, the annual peak may not be the maximum value for the year; in such cases, the maximum value occurs at midnight at the beginning or end of the year, on the recession from or rise toward a higher peak in the adjoining year. If values are recorded at a discrete series of times, the peak recorded value may be taken as an approximation to the true peak, which may occur between the recording instants. If the values are recorded with finite precision, a sequence of equal recorded values may occur at the peak; in this case, the first value is taken as the peak.

**Percent composition or percent of total** is a unit for expressing the ratio of a particular part of a sample or population to the total sample or population, in terms of types, numbers, weight, mass, or volume.

**Percent shading** is determined by using a clinometer to estimate left and right bank shading. The values are added together and divided by 180 to determine percent shading relative to a horizontal surface.

**Periodic-record station** is a site where stage, discharge, sediment, chemical, physical, or other hydrologic measurements are made one or more times during a year, but at a frequency insufficient to develop a daily record.

**Periphyton** is the assemblage of microorganisms attached to and living upon submerged solid surfaces. While primarily consisting of algae, they also include bacteria, fungi, protozoa, rotifers, and other small organisms. Periphyton are useful indicators of water quality.

**Pesticides** are chemical compounds used to control undesirable organisms. Major categories of pesticides include insecticides, miticides, fungicides, herbicides, and rodenticides.

**pH** of water is the negative logarithm of the hydrogen-ion activity. Solutions with pH less than 7 are termed "acidic," and solutions with a pH greater than 7 are termed "basic." Solutions with a pH of 7 are neutral. The presence and concentration of many dissolved chemical constituents found in water are, in part, influenced by the hydrogen-ion activity of water. Biological processes including growth, distribution of organisms, and toxicity of the water to organisms are also influenced, in part, by the hydrogen-ion activity of water.

**Phytoplankton** is the plant part of the plankton. They are usually microscopic, and their movement is subject to the water currents. Phytoplankton growth is dependent upon solar radiation and nutrient substances. Because they are able to incorporate as well as release materials to the surrounding water, the phytoplankton have a profound effect upon the quality of the water. They are the primary food producers in the aquatic environment and are commonly known as algae. (See also "[Plankton](#)")

**Picocurie** (PC, pCi) is one trillionth ( $1 \times 10^{-12}$ ) of the amount of radioactive nuclide represented by a curie (Ci). A curie is the quantity of radioactive nuclide that yields  $3.7 \times 10^{10}$  radioactive disintegrations per second (dps). A picocurie yields 0.037 dps, or 2.22 dpm (disintegrations per minute).

**Plankton** is the community of suspended, floating, or weakly swimming organisms that live in the open water of lakes and rivers. Concentrations are expressed as a number of cells per milliliter (cells/mL) of sample.

**Polychlorinated biphenyls** (PCBs) are industrial chemicals that are mixtures of chlorinated biphenyl compounds having various percentages of chlorine. They are similar in structure to organochlorine insecticides.

**Polychlorinated naphthalenes** (PCNs) are industrial chemicals that are mixtures of chlorinated naphthalene compounds. They have properties and applications similar to polychlorinated biphenyls (PCBs) and have been identified in commercial PCB preparations.

**Primary productivity** is a measure of the rate at which new organic matter is formed and accumulated through photosynthetic and chemosynthetic activity of producer organisms (chiefly, green plants). The rate of primary production is estimated by measuring the amount of oxygen released (oxygen method) or the amount of carbon assimilated (carbon method) by the plants.

**Primary productivity (carbon method)** is expressed as milligrams of carbon per area per unit time [ $\text{mg C}/(\text{m}^2/\text{time})$ ] for periphyton and macrophytes or per volume [ $\text{mg C}/(\text{m}^3/\text{time})$ ] for phytoplankton. Carbon method defines the amount of carbon dioxide consumed as measured by radioactive carbon (carbon-14). The carbon-14 method is of greater sensitivity than the oxygen light and dark bottle method and is preferred for use in unenriched waters. Unit time may be either the hour or day, depending on the incubation period. (See also "[Primary productivity](#)")

**Primary productivity (oxygen method)** is expressed as milligrams of oxygen per area per unit time [ $\text{mg O}/(\text{m}^2/\text{time})$ ] for periphyton and macrophytes or per volume [ $\text{mg O}/(\text{m}^3/\text{time})$ ] for phytoplankton. Oxygen method defines production and respiration rates as estimated from changes in the measured dissolved-oxygen concentration. The oxygen light and dark bottle method is preferred if the rate of primary production is sufficient for accurate measurements to be made within 24 hours. Unit time may be either the hour or day, depending on the incubation period. (See also "[Primary productivity](#)")

**Radioisotopes** are isotopic forms of an element that exhibit radioactivity. Isotopes are varieties of a chemical element that differ in atomic weight, but are very nearly alike in chemical properties. The difference arises because the atoms of the isotopic forms of an element differ in the number of neutrons in the nucleus; for example, ordinary chlorine is a mixture of isotopes having atomic weights of 35 and 37, and the natural mixture has an atomic weight of about 35.453. Many of the elements similarly exist as mixtures of isotopes, and a great many new isotopes have been produced in the operation of nuclear devices such as the cyclotron. There are 275 isotopes of the 81 stable elements, in addition to more than 800 radioactive isotopes.

**Recoverable from bed (bottom) material** is the amount of a given constituent that is in solution after a representative sample of bottom material has been digested by a method (usually using an acid or mixture of acids) that results in dissolution of readily soluble substances. Complete dissolution of all bottom material is not achieved by the digestion treatment and thus the determination represents less than the total amount (that is, less than 95 percent) of the constituent in the sample. To achieve comparability of analytical data, equivalent digestion procedures would be required of all laboratories performing such analyses because different digestion procedures are likely to produce different analytical results. (See also "[Bed material](#)")

**Recurrence interval**, also referred to as return period, is the average time, usually expressed in years, between occurrences of hydrologic events of a specified type (such as exceedances of a specified high flow or non-exceedance of a specified low flow). The terms "return period" and "recurrence interval" do not imply regular cyclic occurrence. The actual times between occurrences vary randomly, with most of the times being less than the average and a few being substantially greater than the average. For example, the 100-year flood is the flow rate that is exceeded by the annual maximum peak flow at intervals whose average length is 100 years (that is, once in 100 years, on average); almost two-thirds of all exceedances of the 100-year flood occur less than 100 years after the previous exceedance, half occur less than 70 years after the previous exceedance, and about one-eighth occur more than 200 years after the previous exceedance. Similarly, the 7-day 10-year low flow ( $7Q_{10}$ ) is the flow rate below which the annual minimum 7-day-mean flow dips at intervals whose average length is 10 years (that is, once in 10 years, on average); almost two-thirds of the non-exceedances of the  $7Q_{10}$  occur less than 10 years after the previous non-exceedance, half occur less than 7 years after, and about one-eighth occur more than 20 years after the previous non-exceedance. The recurrence interval for annual events is the reciprocal of the annual probability of occurrence. Thus, the 100-year flood has a 1-percent chance of being exceeded by the maximum peak flow in any year, and there is a 10-percent chance in any year that the annual minimum 7-day-mean flow will be less than the  $7Q_{10}$ .

**Replicate samples** are a group of samples collected in a manner such that the samples are thought to be essentially identical in composition.

**Return period** (See "[Recurrence interval](#)")

**River mileage** is the curvilinear distance, in miles, measured upstream from the mouth along the meandering path of a stream channel in accordance with Bulletin No. 14 (October 1968) of the Water Resources Council, and typically used to denote location along a river.

**Runoff** is the quantity of water that is discharged ("runs off") from a drainage basin in a given time period. Runoff data may be presented as volumes in acre-feet, as mean discharges per unit of drainage area in cubic feet per second per square mile, or as depths of water on the drainage basin in inches. (See also "[Annual runoff](#)")

## WATER RESOURCES DATA—CALIFORNIA, WATER YEAR 2001

**Sea level**, as used in this report, refers to one of the two commonly used national vertical datums, (NGVD 1929 or NAVD 1988). See separate entries for definitions of these datums. See [conversion of units page](#) (inside back cover) for identification of the datum used in this report.

**Sediment** is solid material that originates mostly from disintegrated rocks; when transported by, suspended in, or deposited from water, it is referred to as "fluvial sediment." Sediment includes chemical and biochemical precipitates and decomposed organic material, such as humus. The quantity, characteristics, and cause of the occurrence of sediment in streams are influenced by environmental and land-use factors. Some major factors are topography, soil characteristics, land cover, and depth and intensity of precipitation.

**Seven-day 10-year low flow** (7Q10) is the discharge below which the annual 7-day minimum flow falls in 1 year out of 10 on the long-run average. The recurrence interval of the 7Q10 is 10 years; the chance that the annual 7-day minimum flow will be less than the 7Q10 is 10 percent in any given year. (See also "[Recurrence interval](#)" and "[Annual 7-day minimum](#)").

**Sodium adsorption ratio** (SAR) is the expression of relative activity of sodium ions in exchange reactions within soil and is an index of sodium or alkali hazard to the soil. Sodium hazard in water is an index that can be used to evaluate the suitability of water for irrigating crops.

**Specific electrical conductance** (conductivity) is a measure of the capacity of water (or other media) to conduct an electrical current. It is expressed in microsiemens per centimeter at 25°C. Specific electrical conductance is a function of the types and quantity of dissolved substances in water and can be used for approximating the dissolved-solids content of the water. Commonly, the concentration of dissolved solids (in milligrams per liter) is from 55 to 75 percent of the specific conductance (in microsiemens). This relation is not constant from stream to stream, and it may vary in the same source with changes in the composition of the water.

**Stable isotope ratio** (per MIL/MIL) is a unit expressing the ratio of the abundance of two radioactive isotopes. Isotope ratios are used in hydrologic studies to determine the age or source of specific waters, to evaluate mixing of different waters, as an aid in determining reaction rates, and other chemical or hydrologic processes.

**Stage** (See "[Gage height](#)")

**Stage-discharge relation** is the relation between the water-surface elevation, termed stage (gage height), and the volume of water flowing in a channel per unit time.

**Streamflow** is the discharge that occurs in a natural channel. Although the term "discharge" can be applied to the flow of a canal, the word "streamflow" uniquely describes the discharge in a surface stream course. The term "streamflow" is more general than "runoff" as streamflow may be applied to discharge whether or not it is affected by diversion or regulation.

**Substrate** is the physical surface upon which an organism lives.

Substrate Embeddedness Class is a visual estimate of riffle streambed substrate larger than gravel that is surrounded or covered by fine sediment (<2mm, sand or finer). Below are the class categories expressed as percent covered by fine sediment:

0	< no gravel or larger substrate
1	>75%
2	51-75%
3	26-50%
4	5-25%
5	<5%

**Surface area of a lake** is that area (acres) encompassed by the boundary of the lake as shown on USGS topographic maps, or other available maps or photographs. Because surface area changes with lake stage, surface areas listed in this report represent those determined for the stage at the time the maps or photographs were obtained.

**Surficial bed material** is the upper surface (0.1 to 0.2 ft) of the bed material such as that material which is sampled using U.S. Series Bed-Material Samplers.

**Suspended** (as used in tables of chemical analyses) refers to the amount (concentration) of undissolved material in a water-sediment mixture. It is operationally defined as the material retained on a 0.45-micrometer filter.

**Suspended, recoverable** is the amount of a given constituent that is in solution after the part of a representative suspended water-sediment sample that is retained on a 0.45-micrometer membrane filter has been digested by a method (usually using a dilute acid solution) that results in dissolution of only readily soluble substances. Complete dissolution of all the particulate matter is not achieved by the digestion treatment and thus the determination represents something less than the "total" amount (that is, less than 95 percent) of the constituent present in the sample. To achieve comparability of analytical data, equivalent digestion procedures are required of all laboratories performing such analyses because different digestion procedures are likely to produce different analytical results. Determinations of "suspended, recoverable" constituents are made either by directly analyzing the suspended material collected on the filter or, more commonly, by difference, based on determinations of (1) dissolved and (2) total recoverable concentrations of the constituent. (See also "[Suspended](#)")

**Suspended sediment** is the sediment maintained in suspension by the upward components of turbulent currents or that exists in suspension as a colloid. (See also "[Sediment](#)")

## WATER RESOURCES DATA—CALIFORNIA, WATER YEAR 2001

**Suspended-sediment concentration** is the velocity-weighted concentration of suspended sediment in the sampled zone (from the water surface to a point approximately 0.3 ft above the bed) expressed as milligrams of dry sediment per liter of water-sediment mixture (mg/L). The analytical technique uses the mass of all of the sediment and the net weight of the water-sediment mixture in a sample to compute the suspended-sediment concentration. (See also "[Sediment](#)" and "[Suspended sediment](#)")

**Suspended-sediment discharge** (tons/day) is the rate of sediment transport, as measured by dry mass or volume, that passes a cross section in a given time. It is calculated in units of tons per day as follows:

$$\text{concentration (mg/L)} \times \text{discharge (ft}^3\text{/s)} \times 0.0027.$$

(See also "[Sediment](#)", "[Suspended sediment](#)", and "[Suspended-sediment concentration](#)")

**Suspended-sediment load** is a general term that refers to a given characteristic of the material in suspension that passes a point during a specified period of time. The term needs to be qualified, such as "annual suspended-sediment load" or "sand-size suspended-sediment load," and so on. It is not synonymous with either suspended-sediment discharge or concentration. (See also "[Sediment](#)")

**Suspended, total** is the total amount of a given constituent in the part of a water-sediment sample that is retained on a 0.45-micrometer membrane filter. This term is used only when the analytical procedure assures measurement of at least 95 percent of the constituent determined. Knowledge of the expected form of the constituent in the sample, as well as the analytical methodology used, is required to determine when the results should be reported as "suspended, total." Determinations of "suspended, total" constituents are made either by directly analyzing portions of the suspended material collected on the filter or, more commonly, by difference, based on determinations of (1) dissolved and (2) total concentrations of the constituent. (See also "[Suspended](#)")

**Suspended solids, total residue at 105°C concentration** is the concentration of inorganic and organic material retained on a filter, expressed as milligrams of dry material per liter of water (mg/L). An aliquot of the sample is used for this analysis.

**Synoptic studies** are short-term investigations of specific water-quality conditions during selected seasonal or hydrologic periods to provide improved spatial resolution for critical water-quality conditions. For the period and conditions sampled, they assess the spatial distribution of selected water-quality conditions in relation to causative factors, such as land use and contaminant sources.

**Taxa richness** is the total number of distinct species or groups and usually decreases with pollution. (See also "[Percent Shading](#)")

**Taxonomy** is the division of biology concerned with the classification and naming of organisms. The classification of organisms is based upon a hierarchical scheme beginning with Kingdom and ending with Species at the base. The higher the classification level, the fewer features the organisms have in common. For example, the taxonomy of a particular mayfly, *Hexagenia limbata* is the following:

Kingdom .....	Animal
Phylum .....	Arthropoda
Class .....	Insecta
Order .....	Ephemeroptera
Family .....	Ephemeridae
Genus .....	<i>Hexagenia</i>
Species .....	<i>Hexagenia limbata</i>

#### Temperature preferences:

Cold — preferred water temperature for the species is less than 20°C or spawning temperature preference less than 16°C and native distribution is considered to be predominantly north of 45° N. latitude.

Warm — preferred water temperatures for the species is greater than 20°C or spawning temperature preference greater than 16°C and native distribution is considered to be predominantly south of 45° N. latitude.

Cool — intermediate between cold and warm water temperature preferences.

**Thermograph** is an instrument that continuously records variations of temperature on a chart. The more general term "temperature recorder" is used in the table descriptions and refers to any instrument that records temperature whether on a chart, a tape, or any other medium.

**Time-weighted average** is computed by multiplying the number of days in the sampling period by the concentrations of individual constituents for the corresponding period and dividing the sum of the products by the total number of days. A time-weighted average represents the composition of water resulting from the mixing of flow proportionally to the duration of the concentration.

**Tons per acre-foot** (T/acre-ft) is the dry mass (tons) of a constituent per unit volume (acre-foot) of water. It is computed by multiplying the concentration of the constituent, in milligrams per liter, by 0.00136.

**Tons per day** (T/DAY, tons/d) is a common chemical or sediment discharge unit. It is the quantity of a substance in solution in suspension, or as bedload that passes a stream section during a 24-hour period. It is equivalent to 2,000 pounds per day, or 0.9072 metric tons per day.

**Total** is the amount of a given constituent in a representative whole-water (unfiltered) sample, regardless of the constituent's physical or chemical form. This term is used only when the analytical procedure assures measurement of at least 95 percent of the constituent present in both the dissolved and suspended phases of the sample. A knowledge of the expected form of the constituent

## WATER RESOURCES DATA—CALIFORNIA, WATER YEAR 2001

in the sample, as well as the analytical methodology used, is required to judge when the results should be reported as "total." (Note that the word "total" does double duty here, indicating both that the sample consists of a water-suspended sediment mixture and that the analytical method determined at least 95 percent of the constituent in the sample.)

**Total coliform bacteria** are a particular group of bacteria that are used as indicators of possible sewage pollution. This group includes coliforms that inhabit the intestine of warm-blooded animals and those that inhabit soils. They are characterized as aerobic or facultative anaerobic, gram-negative, nonspore-forming, rod-shaped bacteria that ferment lactose with gas formation within 48 hours at 35°C. In the laboratory, these bacteria are defined as all the organisms that produce colonies with a golden-green metallic sheen within 24 hours when incubated at 35°C plus or minus 1.0°C on M-Endo medium (nutrient medium for bacterial growth). Their concentrations are expressed as number of colonies per 100 mL of sample. (See also "**Bacteria**")

**Total discharge** is the quantity of a given constituent, measured as dry mass or volume, that passes a stream cross section per unit of time. When referring to constituents other than water, this term needs to be qualified, such as "total sediment discharge," "total chloride discharge," and so on.

**Total in bottom material** is the amount of a given constituent in a representative sample of bottom material. This term is used only when the analytical procedure assures measurement of at least 95 percent of the constituent determined. A knowledge of the expected form of the constituent in the sample, as well as the analytical methodology used, is required to judge when the results should be reported as "total in bottom material."

**Total length** (fish) is the straight-line distance from the anterior point of a fish specimen's snout, with the mouth closed, to the posterior end of the caudal (tail) fin, with the lobes of the caudal fin squeezed together.

**Total load** refers to all of a constituent in transport. When referring to sediment, it includes suspended load plus bed load.

**Total organism count** is the number of organisms collected and enumerated in any particular sample. (See also "**Organism count/volume**")

**Total recoverable** is the amount of a given constituent in a whole-water sample after a sample has been digested by a method (usually using a dilute acid solution) that results in dissolution of only readily soluble substances. Complete dissolution of all particulate matter is not achieved by the digestion treatment, and thus the determination represents something less than the "total" amount (that is, less than 95 percent) of the constituent present in the dissolved and suspended phases of the sample. To achieve comparability of analytical data for whole-water samples, equivalent digestion procedures are required of all laboratories performing such analyses because different digestion procedures may produce different analytical results.

**Total sediment discharge** is the mass of suspended-sediment plus bed-load transport, measured as dry weight, that passes a cross section in a given time. It is a rate and is reported as tons per day. (See also "**Sediment**", "**Suspended sediment**", "**Suspended-Sediment Concentration**", "**Bedload**", and "**Bedload discharge**")

**Total sediment load** or total load is the sediment in transport as bedload and suspended-sediment load. The term may be qualified, such as "annual suspended-sediment load" or "sand-size suspended-sediment load," and so on. It differs from total sediment discharge in that load refers to the material whereas discharge refers to the quantity of material, expressed in units of mass per unit time. (See also "**Sediment**", "**Suspended-Sediment Load**", and "**Total load**")

### Trophic groups:

**Filter feeder**—diet composed of suspended plant and/or animal material.

**Herbivore**—diet composed predominantly of plant material.

**Invertivore**—diet composed predominantly of invertebrates.

**Omnivore**—diet composed of at least 25-percent plant and 25-percent animal material.

**Piscivore**—diet composed predominantly of fish.

**Turbidity** is the reduction in the transparency of a solution due to the presence of suspended and some dissolved substances. The measurement technique records the collective optical properties of the solution that cause light to be scattered and attenuated rather than transmitted in straight lines; the higher the intensity of scattered or attenuated light, the higher the value of the turbidity. Turbidity is expressed in nephelometric turbidity units (NTU). Depending on the method used, the turbidity units as NTU can be defined as the intensity of light of a specified wavelength scattered or attenuated by suspended particles or absorbed at a method specified angle, usually 90 degrees, from the path of the incident light. Currently approved methods for the measurement of turbidity in the USGS include those that conform to EPA Method 180.1, ASTM D1889-00, and ISO 7027. Measurements of turbidity by these different methods and different instruments are unlikely to yield equivalent values. Consequently, the method of measurement and type of instrument used to derive turbidity records should be included in the "REMARKS" column of the Annual Data Report.

**Ultraviolet (UV) absorbance (absorption)** at 254 or 280 nanometers is a measure of the aggregate concentration of the mixture of UV absorbing organic materials dissolved in the analyzed water, such as lignin, tannin, humic substances, and various aromatic compounds. UV absorbance (absorption) at 254 or 280 nanometers is measured in UV absorption units per centimeter of pathlength of UV light through a sample.

**Vertical datum** (See "**Datum**")

**Volatile organic compounds (VOCs)** are organic compounds that can be isolated from the water phase of a sample by purging the water sample with inert gas, such as helium, and subsequently analyzed by gas chromatography. Many VOCs are human-made chemicals that are used and produced in the manufacture of paints, adhesives, petroleum products, pharmaceuticals, and refrigerants. They are often components of fuels, solvents, hydraulic fluids, paint thinners, and dry cleaning agents commonly used in urban settings. VOC contamination of drinking-water supplies is a human health concern because many are toxic and are known or suspected human carcinogens (U.S. Environmental Protection Agency, 1996).

## WATER RESOURCES DATA—CALIFORNIA, WATER YEAR 2001

**Water table** is the level in the saturated zone at which the pressure is equal to the atmospheric pressure.

**Water-table aquifer** is an unconfined aquifer within which is found the water table.

**Water year** in USGS reports dealing with surface-water supply is the 12-month period, October 1 through September 30. The water year is designated by the calendar year in which it ends and which includes 9 of the 12 months. Thus, the year ending September 30, 2001, is called the "2001 water year."

**WDR** is used as an abbreviation for "Water-Data Report" in the REVISED RECORDS paragraph to refer to State annual hydrologic-data reports. (WRD was used as an abbreviation for "Water-Resources Data" in reports published prior to 1976.)

**Weighted average** is used in this report to indicate discharge-weighted average. It is computed by multiplying the discharge for a sampling period by the concentrations of individual constituents for the corresponding period and dividing the sum of the products by the sum of the discharges. A discharge-weighted average approximates the composition of water that would be found in a reservoir containing all the water passing a given location during the water year after thorough mixing in the reservoir.

**Wet mass** is the mass of living matter plus contained water. (See also "[Biomass](#)" and "[Dry mass](#)")

**Wet weight** refers to the weight of animal tissue or other substance including its contained water. (See also "[Dry weight](#)")

**WSP** is used as an acronym for "Water-Supply Paper" in reference to previously published reports.

**Zooplankton** is the animal part of the plankton. Zooplankton are capable of extensive movements within the water column and are often large enough to be seen with the unaided eye. Zooplankton are secondary consumers feeding upon bacteria, phytoplankton, and detritus. Because they are the grazers in the aquatic environment, the zooplankton are a vital part of the aquatic food web. The zooplankton community is dominated by small crustaceans and rotifers. (See also "[Plankton](#)")

## WATER RESOURCES DATA—CALIFORNIA, WATER YEAR 2001

### TECHNIQUES OF WATER-RESOURCES INVESTIGATIONS OF THE U.S. GEOLOGICAL SURVEY

The U.S. Geological Survey publishes a series of manuals describing procedures for planning and conducting specialized work in water-resources investigations. The material is grouped under major subject headings called books and is further divided into sections and chapters. For example, Section A of Book 3 (Applications of Hydraulics) pertains to surface water. The chapter, the unit of publication, is limited to a narrow field of subject matter. This format permits flexibility in revision and publication as the need arises.

The reports listed below are for sale by the U.S. Geological Survey, Information Services, Box 25286, Federal Center, Denver, Colorado 80225 (authorized agent of the Superintendent of Documents, Government Printing Office). Prepayment is required. Remittance should be made in the form of a check or money order payable to the "U.S. Geological Survey." Prices are not included because they are subject to change. Current prices can be obtained by writing to the above address. When ordering or inquiring about prices for any of these publications, please give the title, book number, chapter number, and mention the "U.S. Geological Survey Techniques of Water-Resources Investigations."

#### Book 1. Collection of Water Data by Direct Measurement

##### Section D. Water Quality

- 1-D1. *Water temperature—influential factors, field measurement, and data presentation*, by H.H. Stevens, Jr., J.F. Ficke, and G.F. Smoot: USGS–TWRI Book 1, Chapter D1. 1975. 65 p.
- 1-D2. *Guidelines for collection and field analysis of ground-water samples for selected unstable constituents*, by W.W. Wood: USGS–TWRI Book 1, Chapter D2. 1976. 24 p.

#### Book 2. Collection of Environmental Data

##### Section D. Surface Geophysical Methods

- 2-D1. *Application of surface geophysics to ground-water investigations*, by A.A.R. Zohdy, G.P. Eaton, and D.R. Mabey: USGS–TWRI Book 2, Chapter D1. 1974. 116 p.
- 2-D2. *Application of seismic-refraction techniques to hydrologic studies*, by F.P. Haeni: USGS–TWRI Book 2, Chapter D2. 1988. 86 p.

##### Section E. Subsurface Geophysical Methods

- 2-E1. *Application of borehole geophysics to water-resources investigations*, by W.S. Keys and L.M. MacCary: USGS–TWRI Book 2, Chapter E1. 1971. 126 p.
- 2-E2. *Borehole geophysics applied to ground-water investigations*, by W.S. Keys: USGS–TWRI Book 2, Chapter E2. 1990. 150 p.

##### Section F. Drilling and Sampling Methods

- 2-F1. *Application of drilling, coring, and sampling techniques to test holes and wells*, by Eugene Shuter and W.E. Teasdale: USGS–TWRI Book 2, Chapter F1. 1989. 97 p.

#### Book 3. Applications of Hydraulics

##### Section A. Surface-Water Techniques

- 3-A1. *General field and office procedures for indirect discharge measurements*, by M.A. Benson and Tate Dalrymple: USGS–TWRI Book 3, Chapter A1. 1967. 30 p.
- 3-A2. *Measurement of peak discharge by the slope-area method*, by Tate Dalrymple and M.A. Benson: USGS–TWRI Book 3, Chapter A2. 1967. 12 p.
- 3-A3. *Measurement of peak discharge at culverts by indirect methods*, by G.L. Bodhaine: USGS–TWRI Book 3, Chapter A3. 1968. 60 p.
- 3-A4. *Measurement of peak discharge at width contractions by indirect methods*, by H.F. Matthai: USGS–TWRI Book 3, Chapter A4. 1967. 44 p.
- 3-A5. *Measurement of peak discharge at dams by indirect methods*, by Harry Hulsing: USGS–TWRI Book 3. Chapter A5. 1967. 29 p.
- 3-A6. *General procedure for gaging streams*, by R.W. Carter and Jacob Davidian: USGS–TWRI Book 3, Chapter A6. 1968. 13 p.
- 3-A7. *Stage measurement at gaging stations*, by T.J. Buchanan and W.P. Somers: USGS–TWRI Book 3, Chapter A7. 1968. 28 p.



## WATER RESOURCES DATA—CALIFORNIA, WATER YEAR 2001

- 3-A8. *Discharge measurements at gaging stations*, by T.J. Buchanan and W.P. Somers: USGS–TWRI Book 3, Chapter A8. 1969. 65 p.
- 3-A9. *Measurement of time of travel in streams by dye tracing*, by F.A. Kilpatrick and J.F. Wilson, Jr.: USGS–TWRI Book 3, Chapter A9. 1989. 27 p.
- 3-A10. *Discharge ratings at gaging stations*, by E.J. Kennedy: USGS–TWRI Book 3, Chapter A10. 1984. 59 p.
- 3-A11. *Measurement of discharge by the moving-boat method*, by G.F. Smoot and C.E. Novak: USGS–TWRI Book 3, Chapter A11. 1969. 22 p.
- 3-A12. *Fluorometric procedures for dye tracing*, Revised, by J.F. Wilson, Jr., E.D. Cobb, and F.A. Kilpatrick: USGS–TWRI Book 3, Chapter A12. 1986. 34 p.
- 3-A13. *Computation of continuous records of streamflow*, by E.J. Kennedy: USGS–TWRI Book 3, Chapter A13. 1983. 53 p.
- 3-A14. *Use of flumes in measuring discharge*, by F.A. Kilpatrick and V.R. Schneider: USGS–TWRI Book 3, Chapter A14. 1983. 46 p.
- 3-A15. *Computation of water-surface profiles in open channels*, by Jacob Davidian: USGS–TWRI Book 3, Chapter A15. 1984. 48 p.
- 3-A16. *Measurement of discharge using tracers*, by F.A. Kilpatrick and E.D. Cobb: USGS–TWRI Book 3, Chapter A16. 1985. 52 p.
- 3-A17. *Acoustic velocity meter systems*, by Antonius Laenen: USGS–TWRI Book 3, Chapter A17. 1985. 38 p.
- 3-A18. *Determination of stream reaeration coefficients by use of tracers*, by F.A. Kilpatrick, R.E. Rathbun, Nobuhiro Yotsukura, G.W. Parker, and L.L. DeLong: USGS–TWRI Book 3, Chapter A18. 1989. 52 p.
- 3-A19. *Levels at streamflow gaging stations*, by E.J. Kennedy: USGS–TWRI Book 3, Chapter A19. 1990. 31 p.
- 3-A20. *Simulation of soluble waste transport and buildup in surface waters using tracers*, by F.A. Kilpatrick: USGS–TWRI Book 3, Chapter A20. 1993. 38 p.
- 3-A21. *Stream-gaging cableways*, by C. Russell Wagner: USGS–TWRI Book 3, Chapter A21. 1995. 56 p.

### Section B. Ground-Water Techniques

- 3-B1. *Aquifer-test design, observation, and data analysis*, by R.W. Stallman: USGS–TWRI Book 3, Chapter B1. 1971. 26 p.
- 3-B2. *Introduction to ground-water hydraulics, a programed text for self-instruction*, by G.D. Bennett: USGS–TWRI Book 3, Chapter B2. 1976. 172 p.
- 3-B3. *Type curves for selected problems of flow to wells in confined aquifers*, by J.E. Reed: USGS–TWRI Book 3, Chapter B3. 1980. 106 p.
- 3-B4. *Regression modeling of ground-water flow*, by R.L. Cooley and R.L. Naff: USGS–TWRI Book 3, Chapter B4. 1990. 232 p.
- 3-B4. *Supplement 1. Regression modeling of ground-water flow—Modifications to the computer code for nonlinear regression solution of steady-state ground-water flow problems*, by R.L. Cooley: USGS–TWRI Book 3, Chapter B4. 1993. 8 p.
- 3-B5. *Definition of boundary and initial conditions in the analysis of saturated ground-water flow systems—An introduction*, by O.L. Franke, T.E. Reilly, and G.D. Bennett: USGS–TWRI Book 3, Chapter B5. 1987. 15 p.
- 3-B6. *The principle of superposition and its application in ground-water hydraulics*, by T.E. Reilly, O.L. Franke, and G.D. Bennett: USGS–TWRI Book 3, Chapter B6. 1987. 28 p.
- 3-B7. *Analytical solutions for one-, two-, and three-dimensional solute transport in ground-water systems with uniform flow*, by E.J. Wexler: USGS–TWRI Book 3, Chapter B7. 1992. 190 p.
- 3-B8. *System and boundary conceptualization in ground-water flow simulation*, by T.E. Reilly: USGS–TWRI Book 3, Chapter B8. 2001. 29 p.

### Section C. Sedimentation and Erosion Techniques

- 3-C1. *Fluvial sediment concepts*, by H.P. Guy: USGS–TWRI Book 3, Chapter C1. 1970. 55 p.
- 3-C2. *Field methods for measurement of fluvial sediment*, by T.K. Edwards and G.D. Glysson: USGS–TWRI Book 3, Chapter C2. 1999. 89 p.
- 3-C3. *Computation of fluvial-sediment discharge*, by George Porterfield: USGS–TWRI Book 3, Chapter C3. 1972. 66 p.

## Book 4. Hydrologic Analysis and Interpretation

### Section A. Statistical Analysis

- 4-A1. *Some statistical tools in hydrology*, by H.C. Riggs: USGS–TWRI Book 4, Chapter A1. 1968. 39 p.
- 4-A2. *Frequency curves*, by H.C. Riggs: USGS–TWRI Book 4, Chapter A2. 1968. 15 p.

## WATER RESOURCES DATA—CALIFORNIA, WATER YEAR 2001

### Section B. Surface Water

- 4-B1. *Low-flow investigations*, by H.C. Riggs: USGS–TWRI Book 4, Chapter B1. 1972. 18 p.
- 4-B2. *Storage analyses for water supply*, by H.C. Riggs and C.H. Hardison: USGS–TWRI Book 4, Chapter B2. 1973. 20 p.
- 4-B3. *Regional analyses of streamflow characteristics*, by H.C. Riggs: USGS–TWRI Book 4, Chapter B3. 1973. 15 p.

### Section D. Interrelated Phases of the Hydrologic Cycle

- 4-D1. *Computation of rate and volume of stream depletion by wells*, by C.T. Jenkins: USGS–TWRI Book 4, Chapter D1. 1970. 17 p.

## Book 5. Laboratory Analysis

### Section A. Water Analysis

- 5-A1. *Methods for determination of inorganic substances in water and fluvial sediments*, by M.J. Fishman and L.C. Friedman, editors: USGS–TWRI Book 5, Chapter A1. 1989. 545 p.
- 5-A2. *Determination of minor elements in water by emission spectroscopy*, by P.R. Barnett and E.C. Mallory, Jr.: USGS–TWRI Book 5, Chapter A2. 1971. 31 p.
- 5-A3. *Methods for the determination of organic substances in water and fluvial sediments*, edited by R.L. Wershaw, M.J. Fishman, R.R. Grabbe, and L.E. Lowe: USGS–TWRI Book 5, Chapter A3. 1987. 80 p.
- 5-A4. *Methods for collection and analysis of aquatic biological and microbiological samples*, by L.J. Britton and P.E. Greeson, editors: USGS–TWRI Book 5, Chapter A4. 1989. 363 p.
- 5-A5. *Methods for determination of radioactive substances in water and fluvial sediments*, by L.L. Thatcher, V.J. Janzer, and K.W. Edwards: USGS–TWRI Book 5, Chapter A5. 1977. 95 p.
- 5-A6. *Quality assurance practices for the chemical and biological analyses of water and fluvial sediments*, by L.C. Friedman and D.E. Erdmann: USGS–TWRI Book 5, Chapter A6. 1982. 181 p.

### Section C. Sediment Analysis

- 5-C1. *Laboratory theory and methods for sediment analysis*, by H.P. Guy: USGS–TWRI Book 5, Chapter C1. 1969. 58 p.

## Book 6. Modeling Techniques

### Section A. Ground Water

- 6-A1. *A modular three-dimensional finite-difference ground-water flow model*, by M.G. McDonald and A.W. Harbaugh: USGS–TWRI Book 6, Chapter A1. 1988. 586 p.
- 6-A2. *Documentation of a computer program to simulate aquifer-system compaction using the modular finite-difference ground-water flow model*, by S.A. Leake and D.E. Prudic: USGS–TWRI Book 6, Chapter A2. 1991. 68 p.
- 6-A3. *A modular finite-element model (MODFE) for areal and axisymmetric ground-water-flow problems, Part 1: Model Description and User's Manual*, by L.J. Torak: USGS–TWRI Book 6, Chapter A3. 1993. 136 p.
- 6-A4. *A modular finite-element model (MODFE) for areal and axisymmetric ground-water-flow problems, Part 2: Derivation of finite-element equations and comparisons with analytical solutions*, by R.L. Cooley: USGS–TWRI Book 6, Chapter A4. 1992. 108 p.
- 6-A5. *A modular finite-element model (MODFE) for areal and axisymmetric ground-water-flow problems, Part 3: Design philosophy and programming details*, by L.J. Torak: USGS–TWRI Book 6, Chapter A5. 1993. 243 p.
- 6-A6. *A coupled surface-water and ground-water flow model (MODBRANCH) for simulation of stream-aquifer interaction*, by Eric D. Swain and Eliezer J. Wexler: USGS–TWRI Book 6, Chapter A6. 1996. 125 p.

## Book 7. Automated Data Processing and Computations

### Section C. Computer Programs

- 7-C1. *Finite difference model for aquifer simulation in two dimensions with results of numerical experiments*, by P.C. Trescott, G.F. Pinder, and S.P. Larson: USGS–TWRI Book 7, Chapter C1. 1976. 116 p.
- 7-C2. *Computer model of two-dimensional solute transport and dispersion in ground water*, by L.F. Konikow and J.D. Bredehoeft: USGS–TWRI Book 7, Chapter C2. 1978. 90 p.
- 7-C3. *A model for simulation of flow in singular and interconnected channels*, by R.W. Schaffranek, R.A. Baltzer, and D.E. Goldberg: USGS–TWRI Book 7, Chapter C3. 1981. 110 p.

**Book 8. Instrumentation****Section A. Instruments for Measurement of Water Level**

- 8-A1. *Methods of measuring water levels in deep wells*, by M.S. Garber and F.C. Koopman: USGS–TWRI Book 8, Chapter A1. 1968. 23 p.
- 8-A2. *Installation and service manual for U.S. Geological Survey manometers*, by J.D. Craig: USGS–TWRI Book 8, Chapter A2. 1983. 57 p.

**Section B. Instruments for Measurement of Discharge**

- 8-B2. *Calibration and maintenance of vertical-axis type current meters*, by G.F. Smoot and C.E. Novak: USGS–TWRI Book 8, Chapter B2. 1968. 15 p.

**Book 9. Handbooks for Water-Resources Investigations****Section A. National Field Manual for the Collection of Water-Quality Data**

- 9-A1. *National Field Manual for the Collection of Water-Quality Data: Preparations for Water Sampling*, by F.D. Wilde, D.B. Radtke, Jacob Gibs, and R.T. Iwatsubo: USGS–TWRI Book 9, Chapter A1. 1998. 47 p.
- 9-A2. *National Field Manual for the Collection of Water-Quality Data: Selection of Equipment for Water Sampling*, edited by F.D. Wilde, D.B. Radtke, Jacob Gibs, and R.T. Iwatsubo: USGS–TWRI Book 9, Chapter A2. 1998. 94 p.
- 9-A3. *National Field Manual for the Collection of Water-Quality Data: Cleaning of Equipment for Water Sampling*, edited by F.D. Wilde, D.B. Radtke, Jacob Gibs, and R.T. Iwatsubo: USGS–TWRI Book 9, Chapter A3. 1998. 75 p.
- 9-A4. *National Field Manual for the Collection of Water-Quality Data: Collection of Water Samples*, edited by F.D. Wilde, D.B. Radtke, Jacob Gibs, and R.T. Iwatsubo: USGS–TWRI Book 9, Chapter A4. 1999. 156 p.
- 9-A5. *National Field Manual for the Collection of Water-Quality Data: Processing of Water Samples*, edited by F.D. Wilde, D.B. Radtke, Jacob Gibs, and R.T. Iwatsubo: USGS–TWRI Book 9, Chapter A5. 1999. 149 p.
- 9-A6. *National Field Manual for the Collection of Water-Quality Data: Field Measurements*, edited by F.D. Wilde and D.B. Radtke: USGS–TWRI Book 9, Chapter A6. 1998. Variously paginated.
- 9-A7. *National Field Manual for the Collection of Water-Quality Data: Biological Indicators*, edited by D.N. Myers and F.D. Wilde: USGS–TWRI Book 9, Chapter A7. 1997 and 1999. Variously paginated.
- 9-A8. *National Field Manual for the Collection of Water-Quality Data: Bottom-Material Samples*, by D.B. Radtke: USGS–TWRI Book 9, Chapter A8. 1998. 48 p.
- 9-A9. *National Field Manual for the Collection of Water-Quality Data: Safety in Field Activities*, by S.L. Lane and R.G. Fay: USGS–TWRI Book 9, Chapter A9. 1998. 60 p.

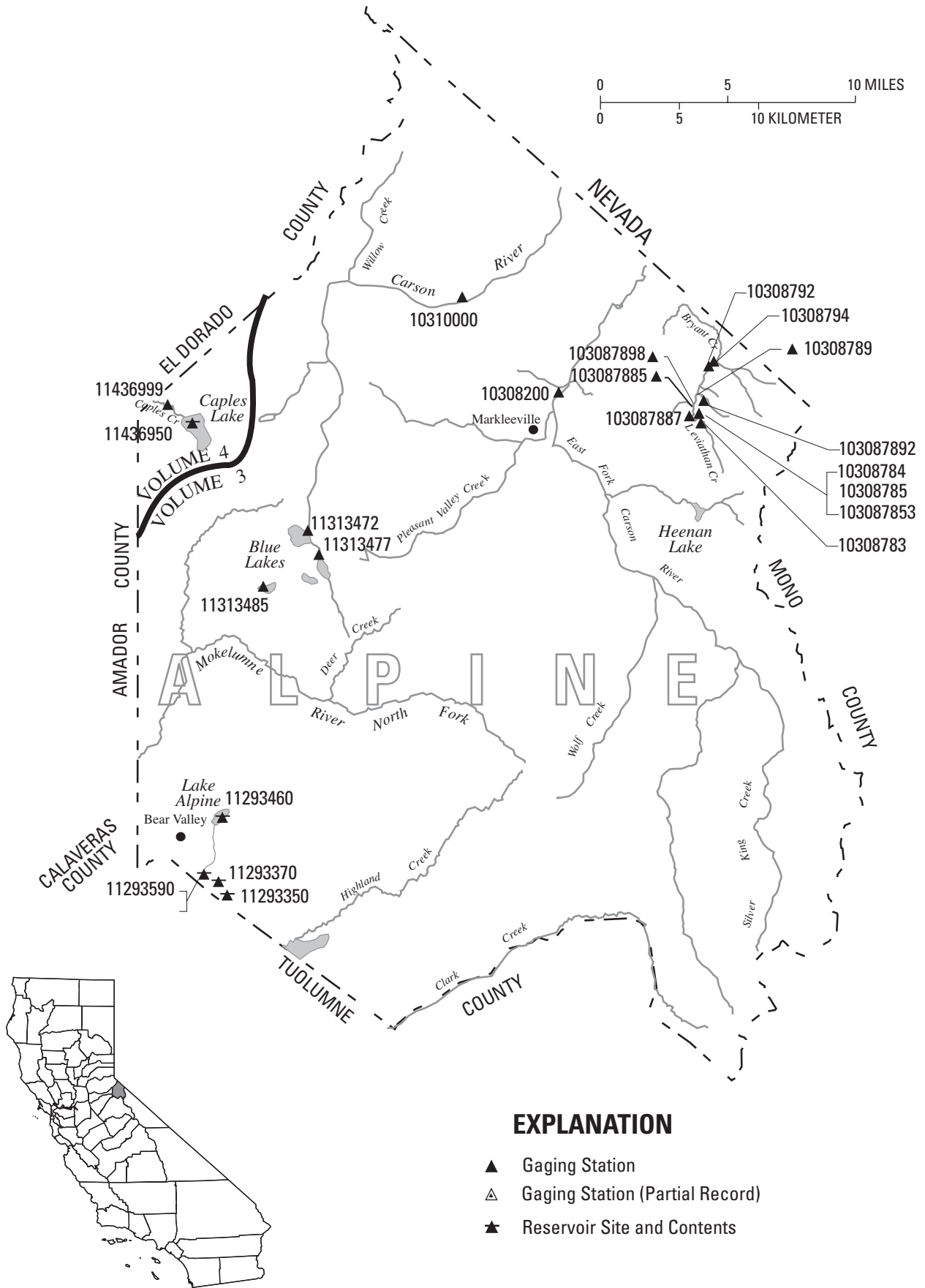

**Figure 2.** Location of discharge stations in Alpine County.

(NOTE: Records for stations 10308200 through 10310000 and 11293350 through 11313485 published in volume 3.)

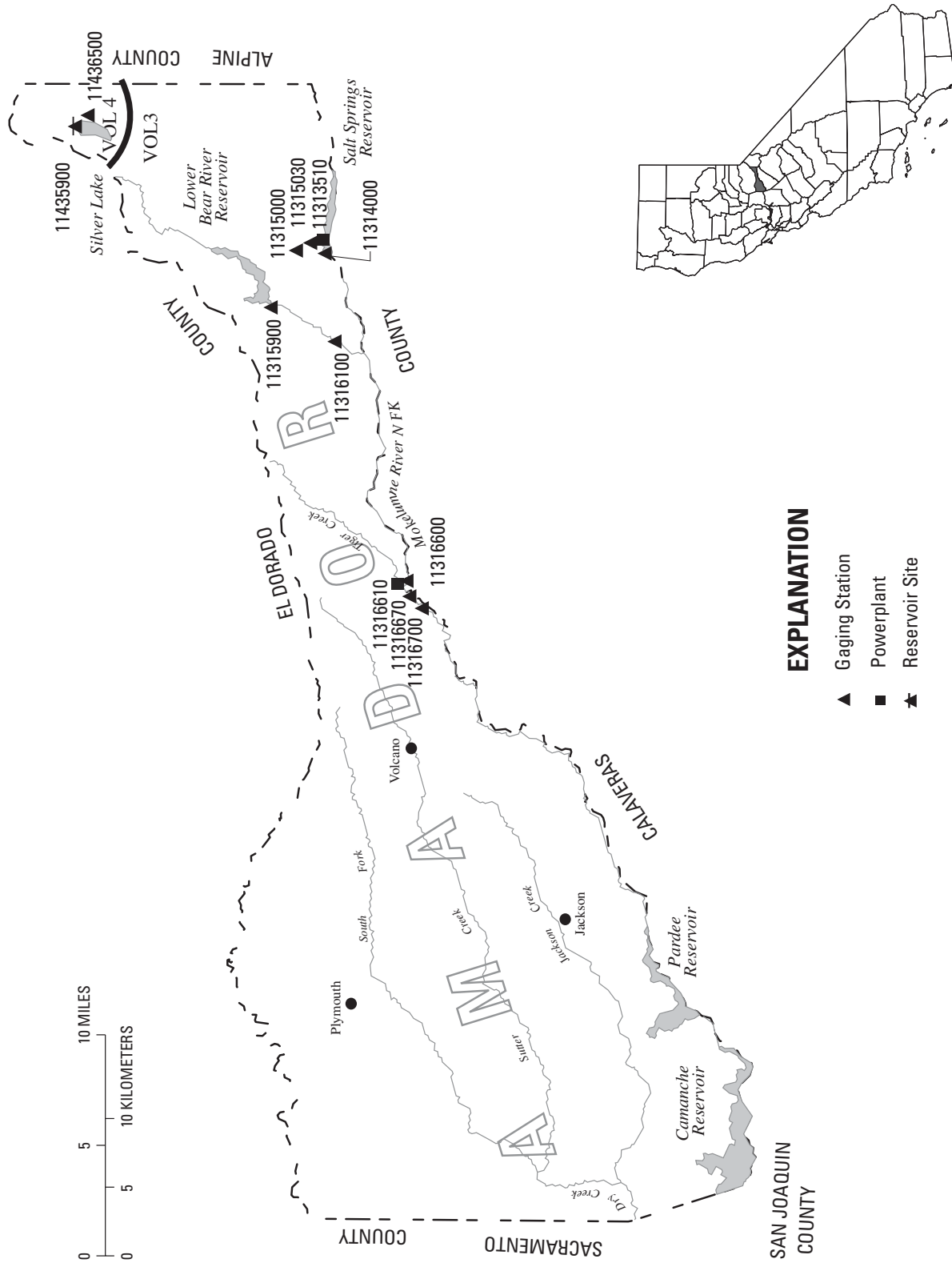

**Figure 3.** Location of discharge stations in Amador County.  
 (NOTE: Records for stations 11313510 through 11316700 published in volume 3.)

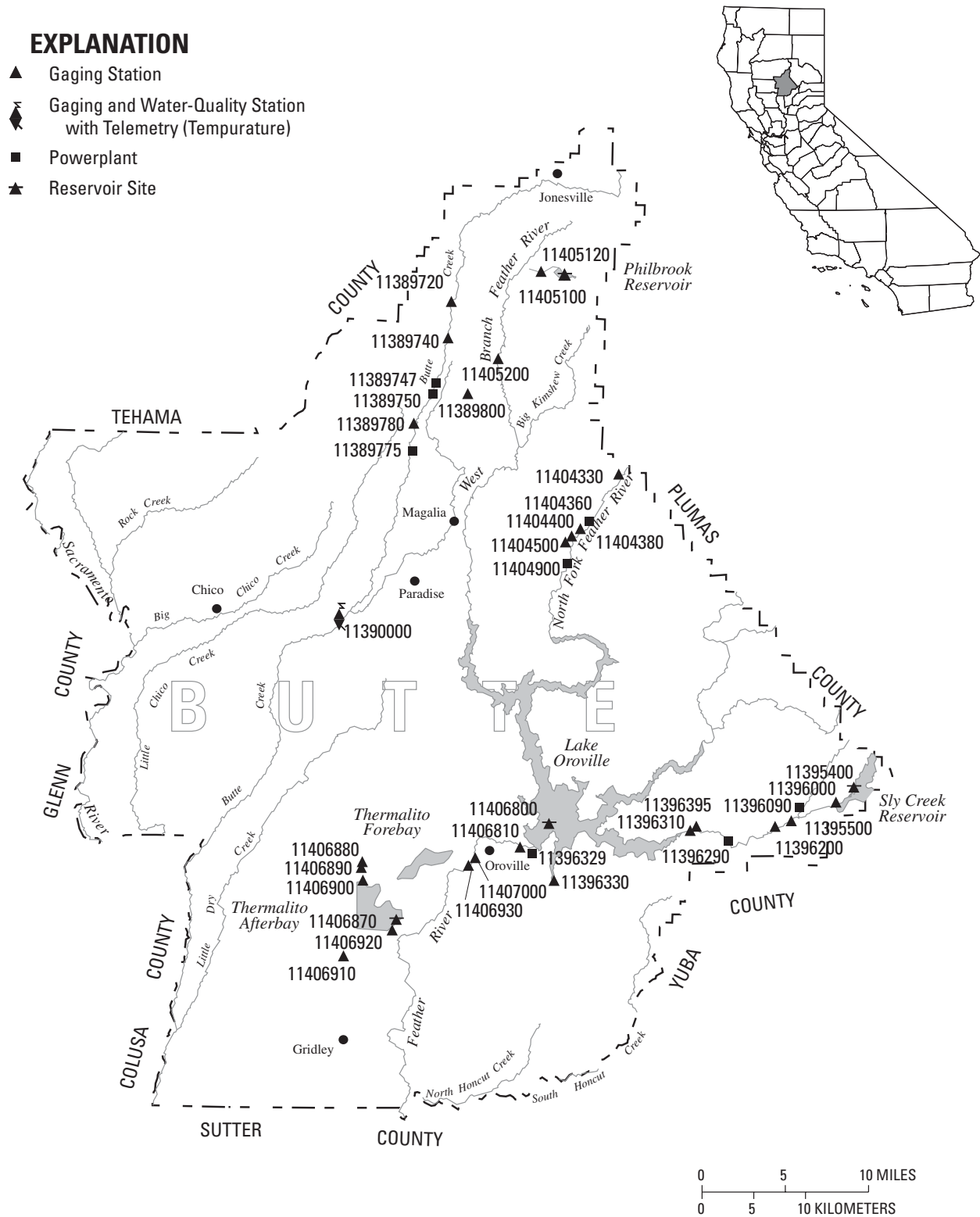

Figure 4. Location of discharge and water-quality stations in Butte County.

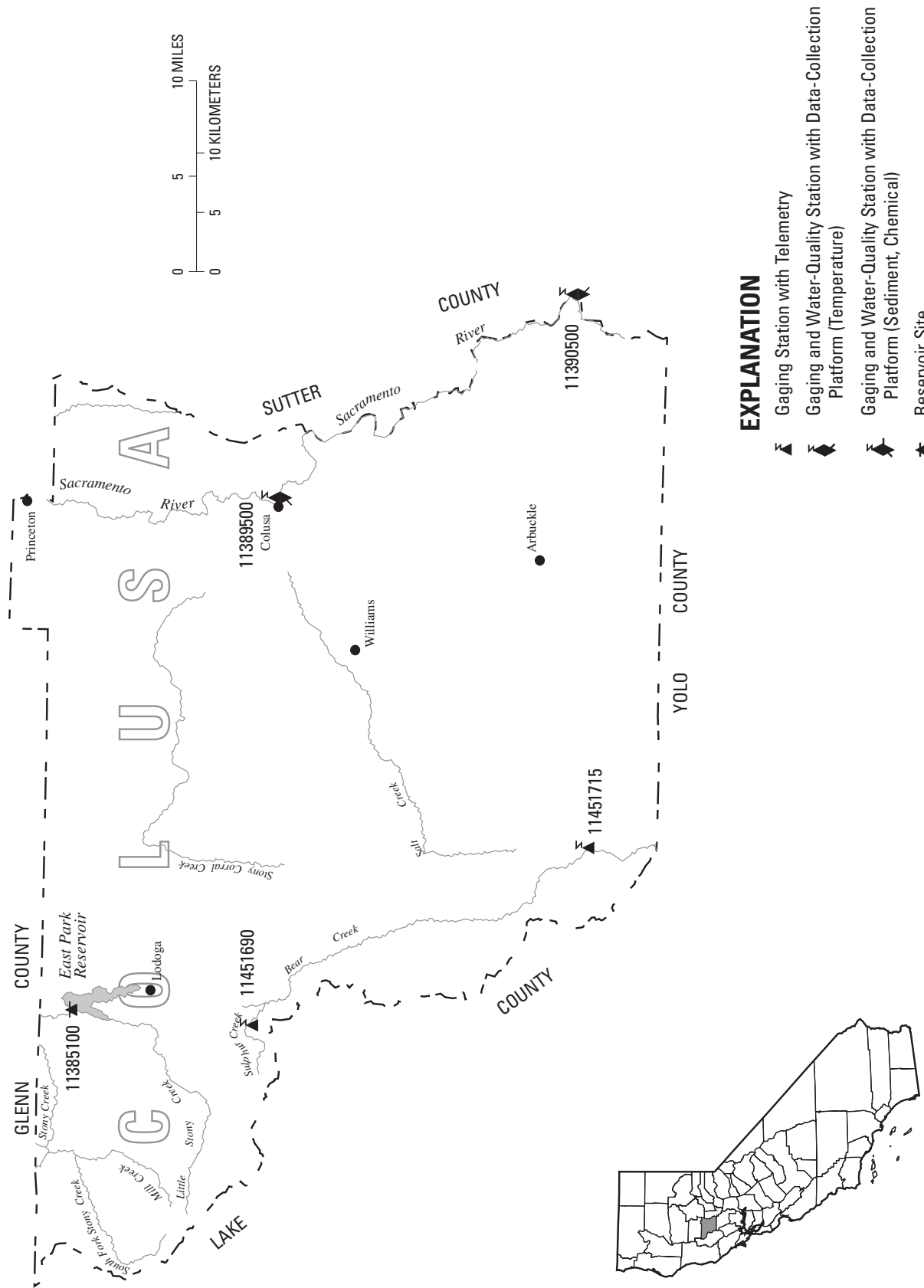
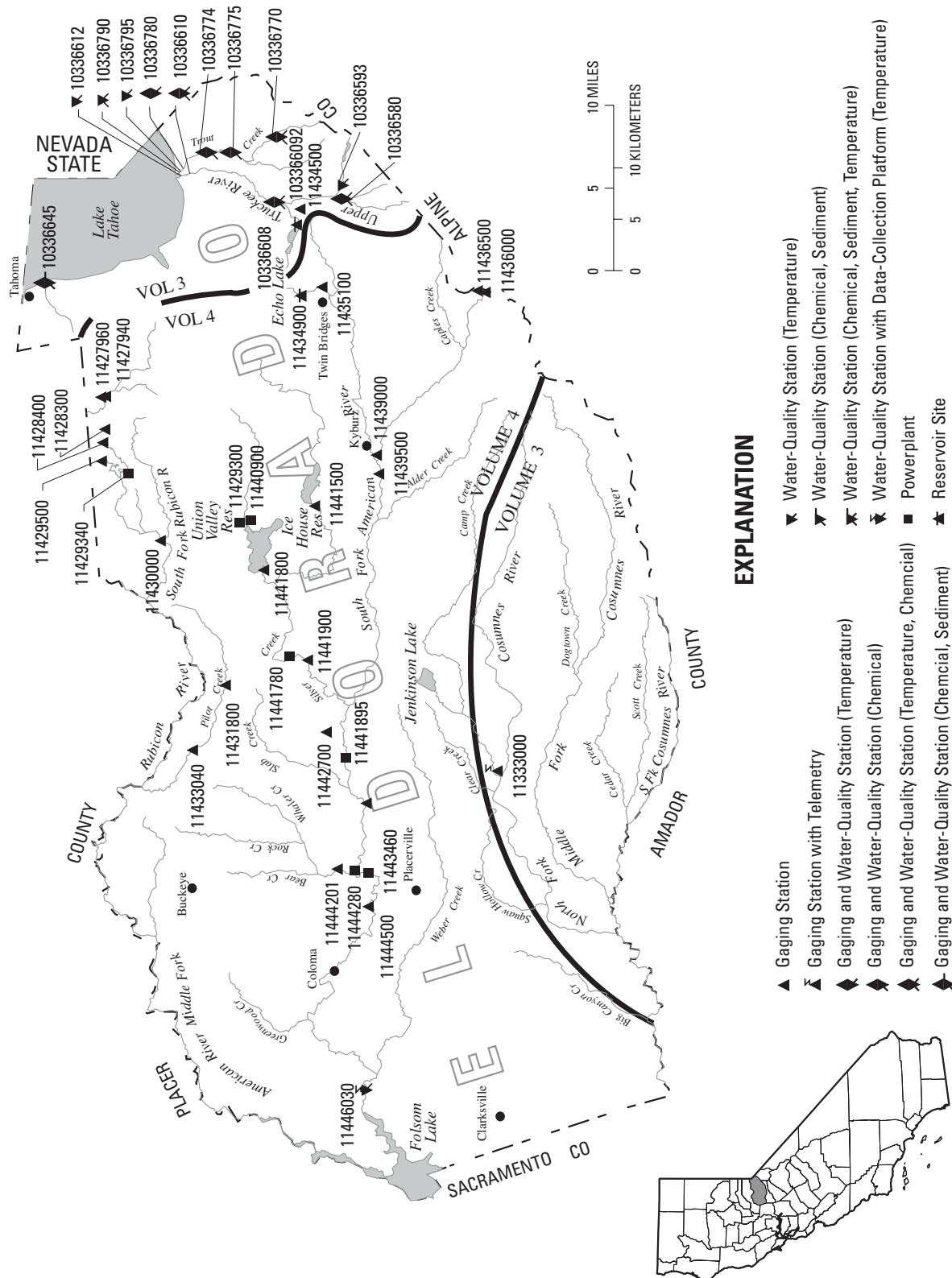

Figure 5. Location of discharge and water-quality stations in Colusa County.





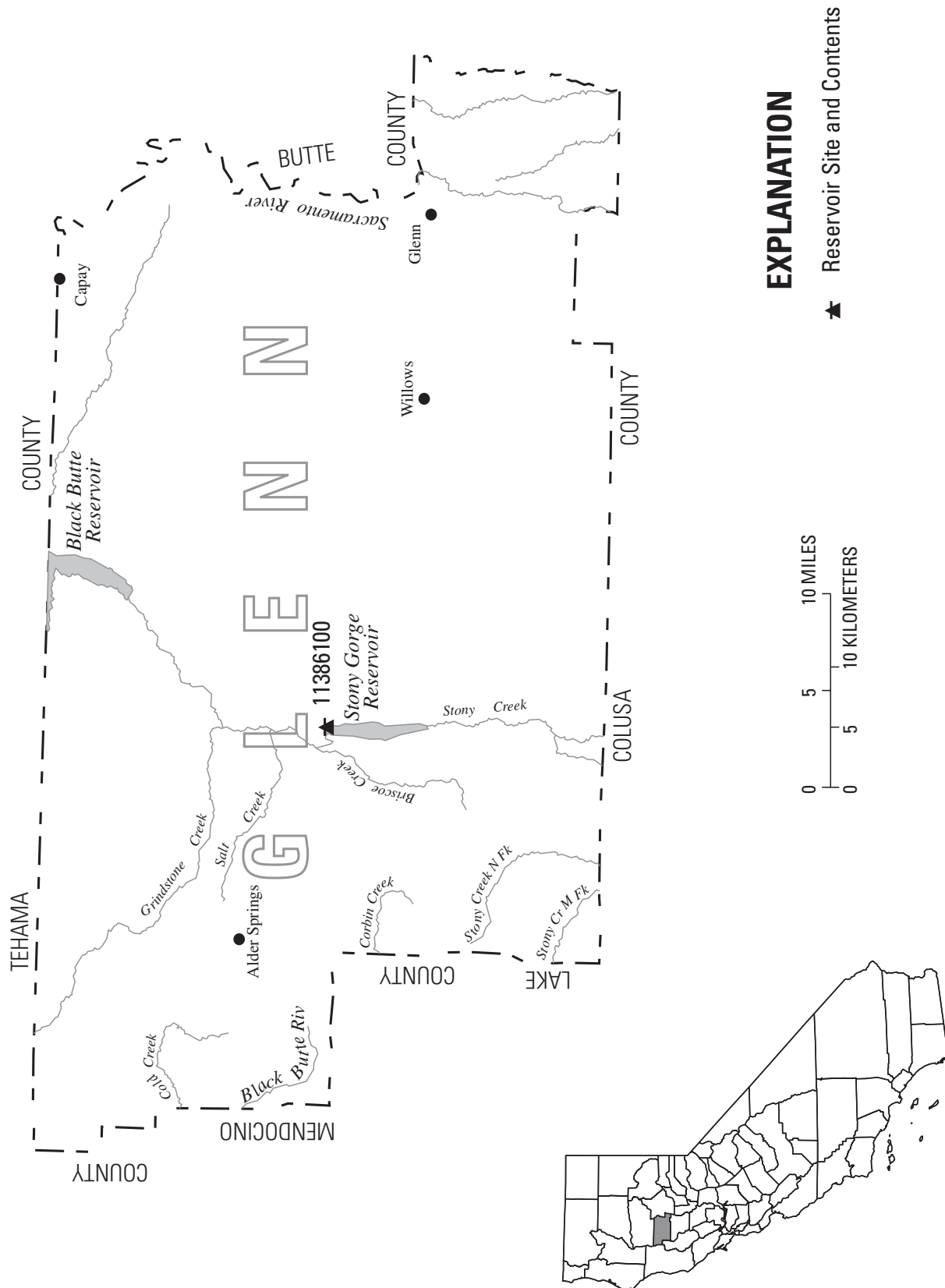
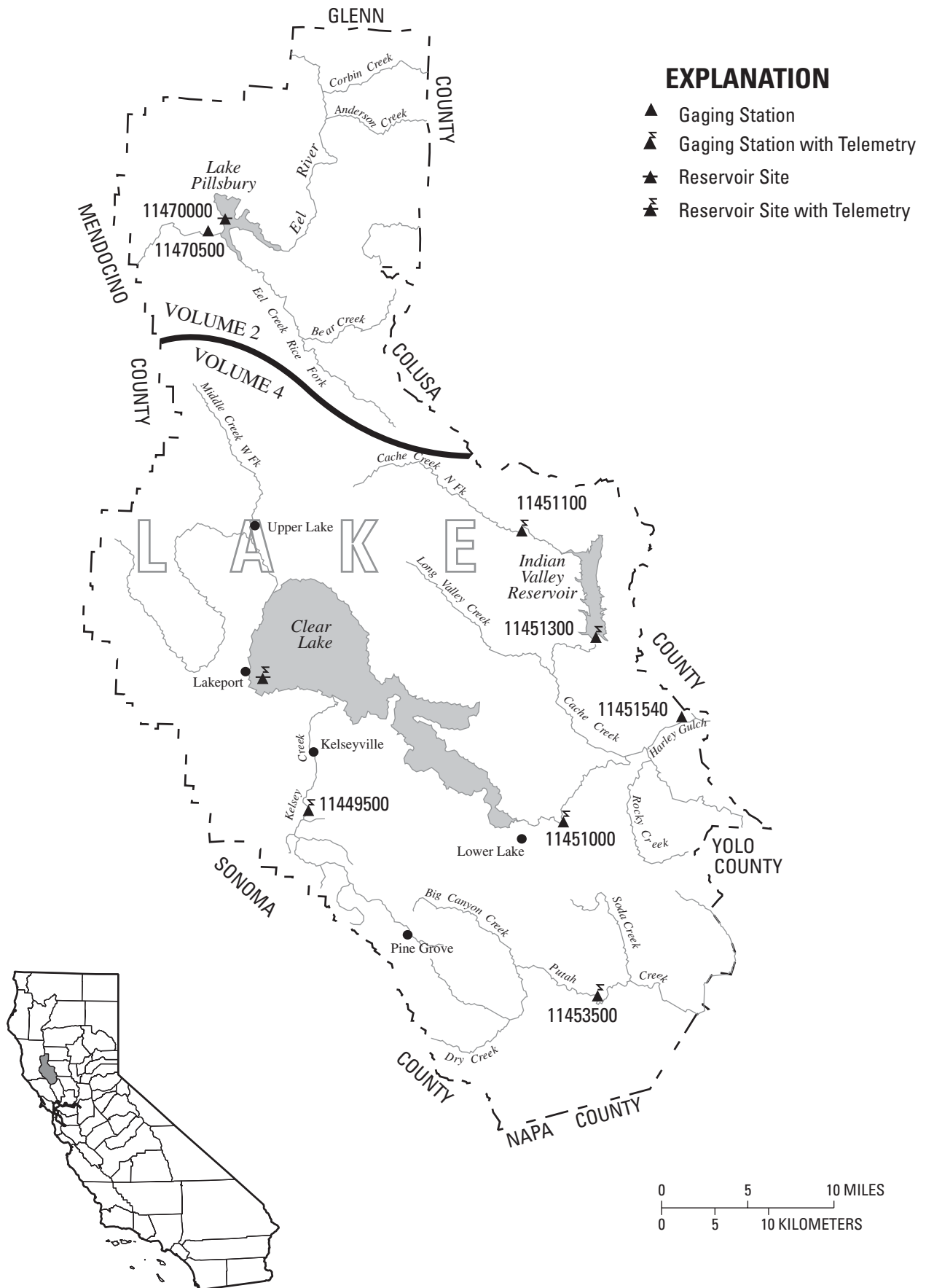

Figure 7. Location of discharge station in Glenn County.



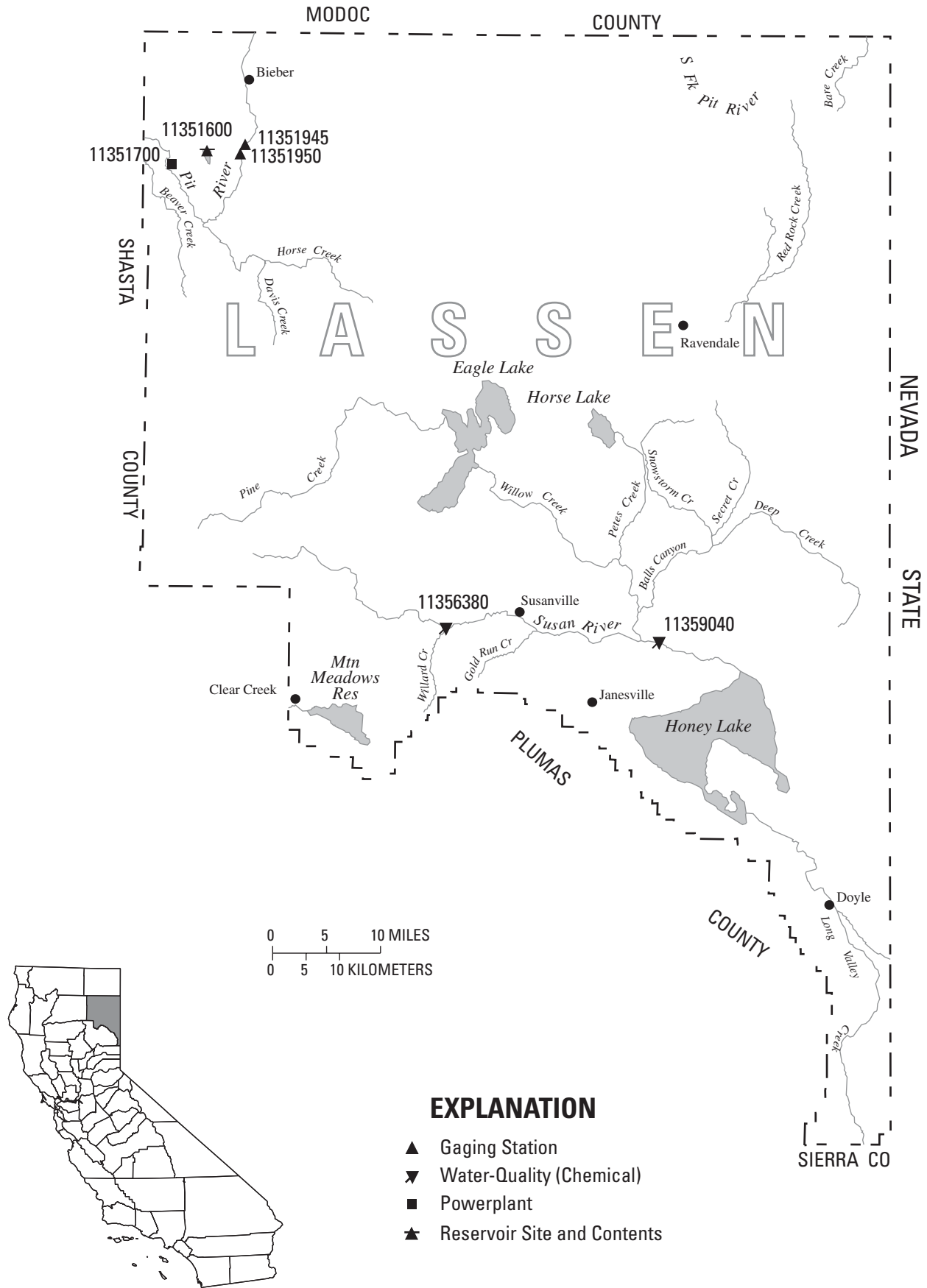
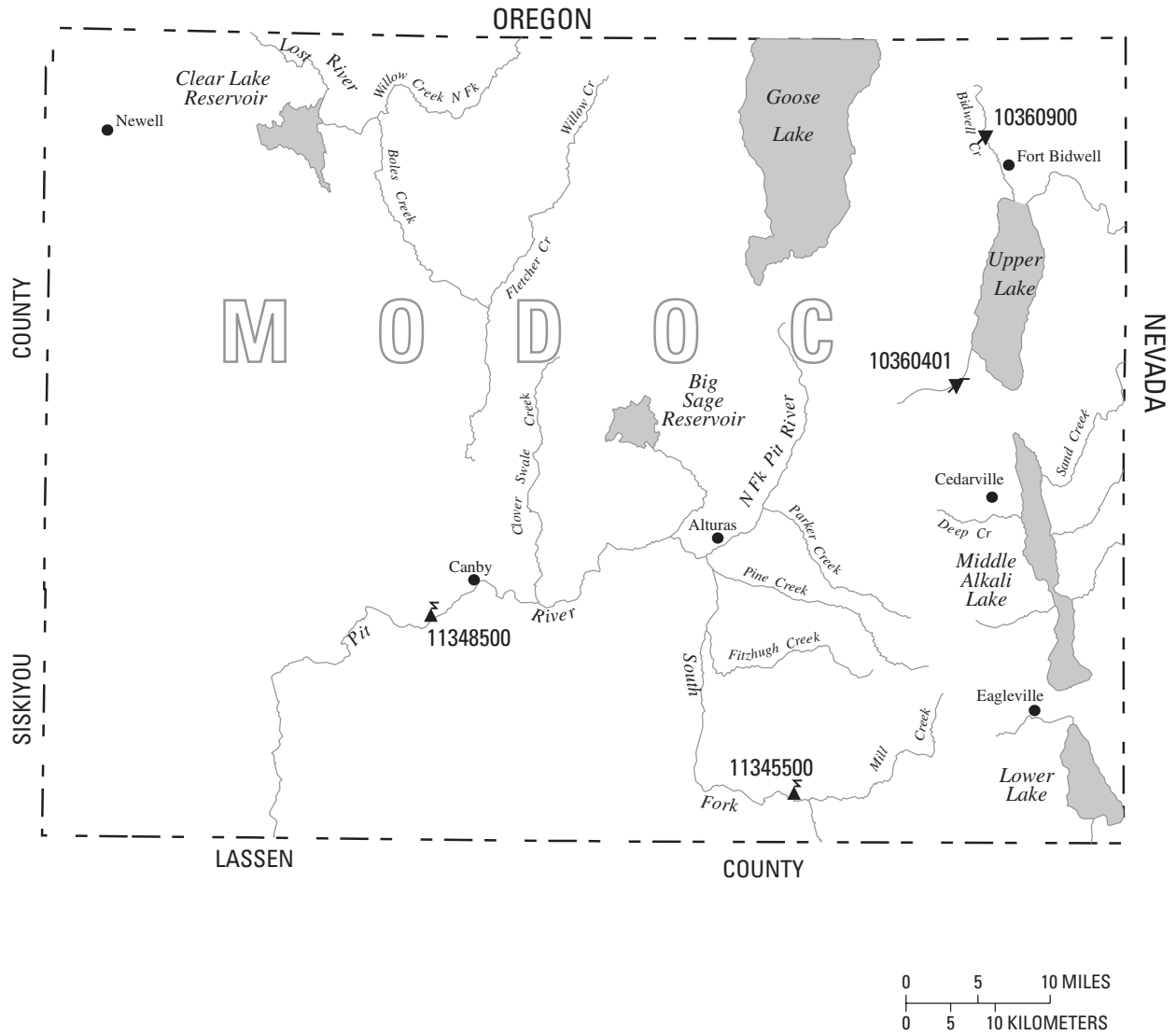

Figure 9. Location of discharge stations in Lassen County.



**EXPLANATION**

- ▲ Gaging Station
- ▲ Gaging Station with Telemetry
- ▼ Water-Quality (Chemical)
- ▼ Water-Quality (Chemical, Sediment)



**Figure 10.** Location of discharge stations in Modoc County.

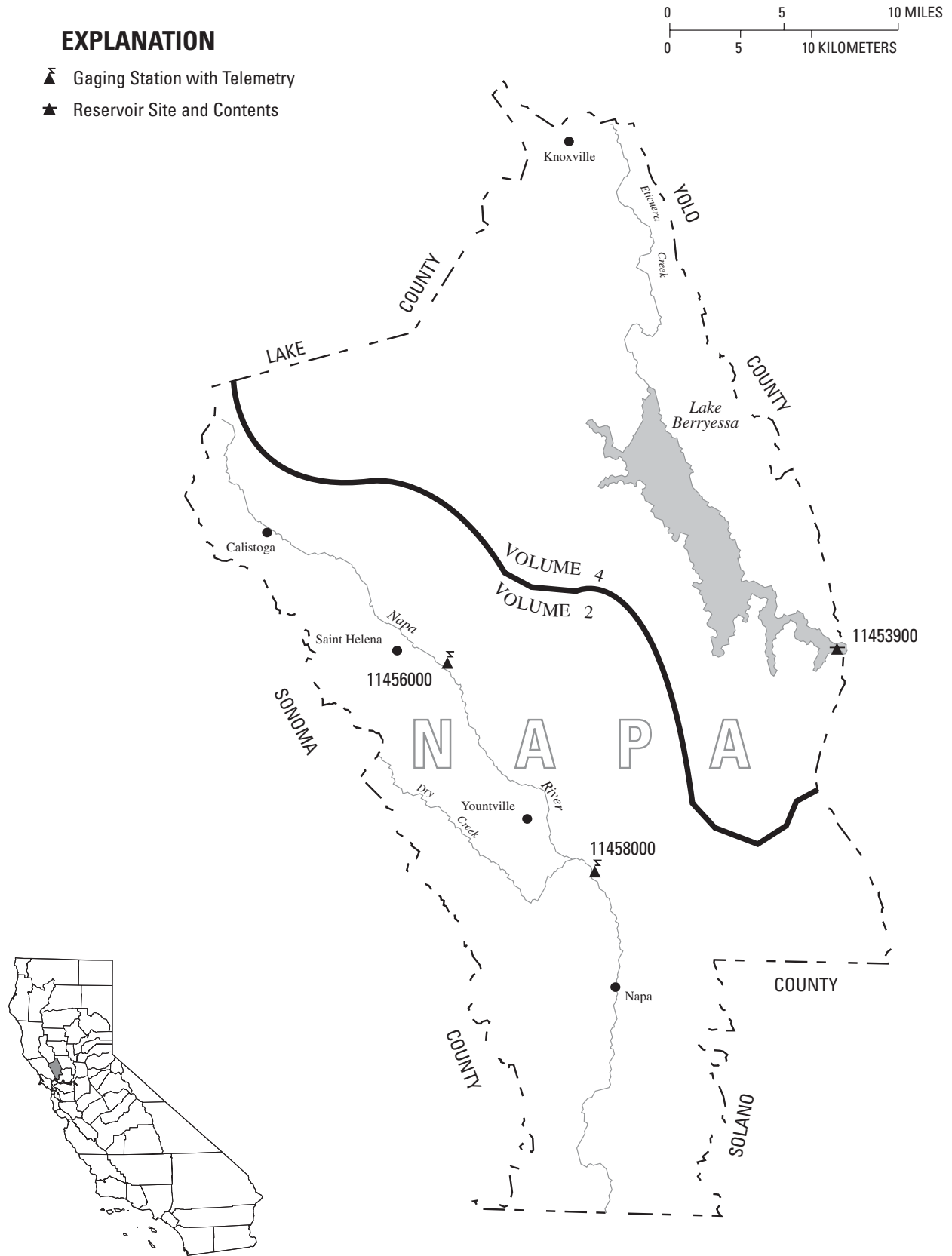

**Figure 11.** Location of discharge stations in Napa County.  
 (NOTE: Records for stations 11456000 and 11458000 published in volume 2.)

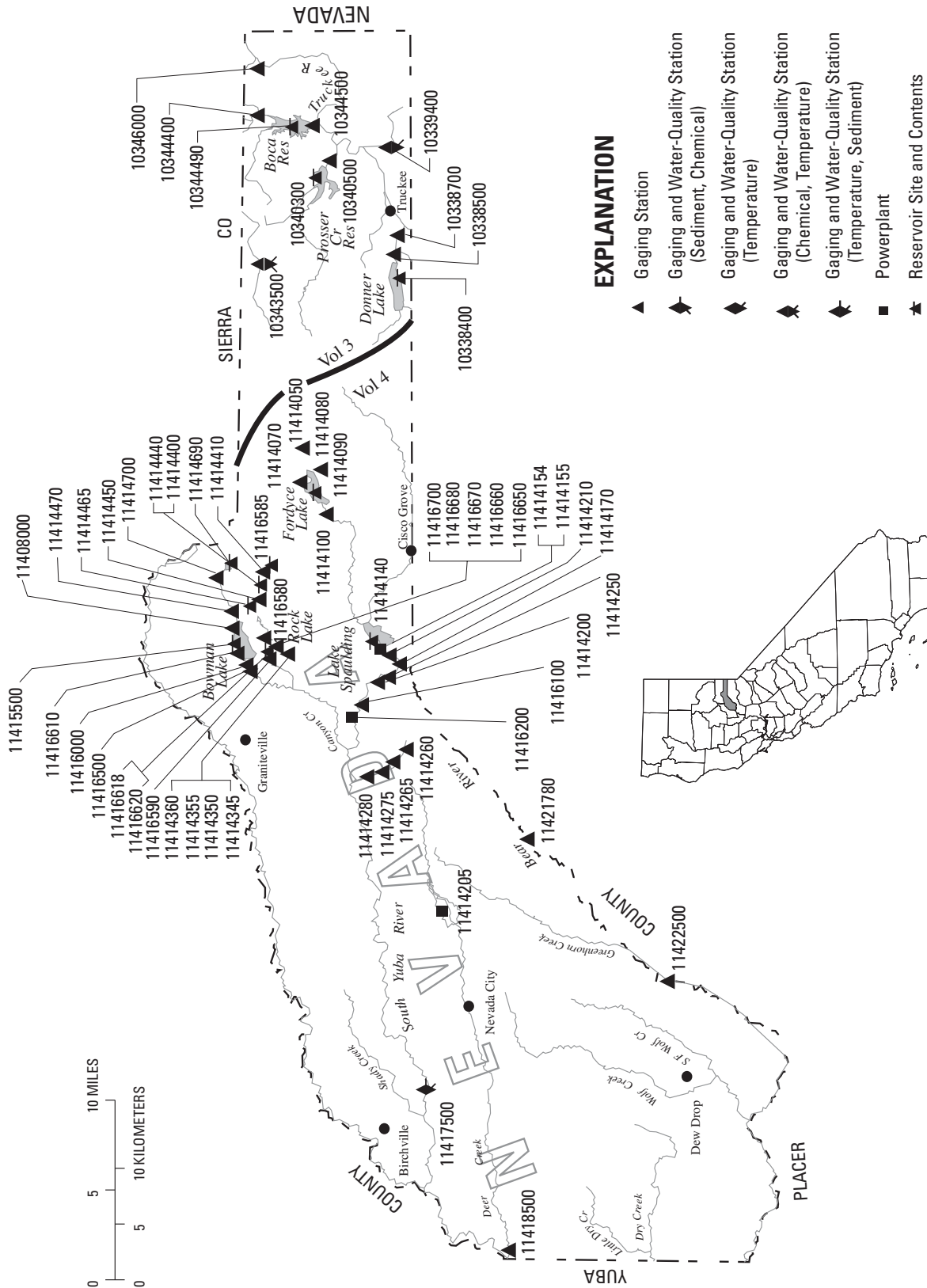

Figure 12. Location of discharge and water-quality stations in Nevada County. (NOTE: Records for stations 10338400 through 10346000 published in volume 3.)

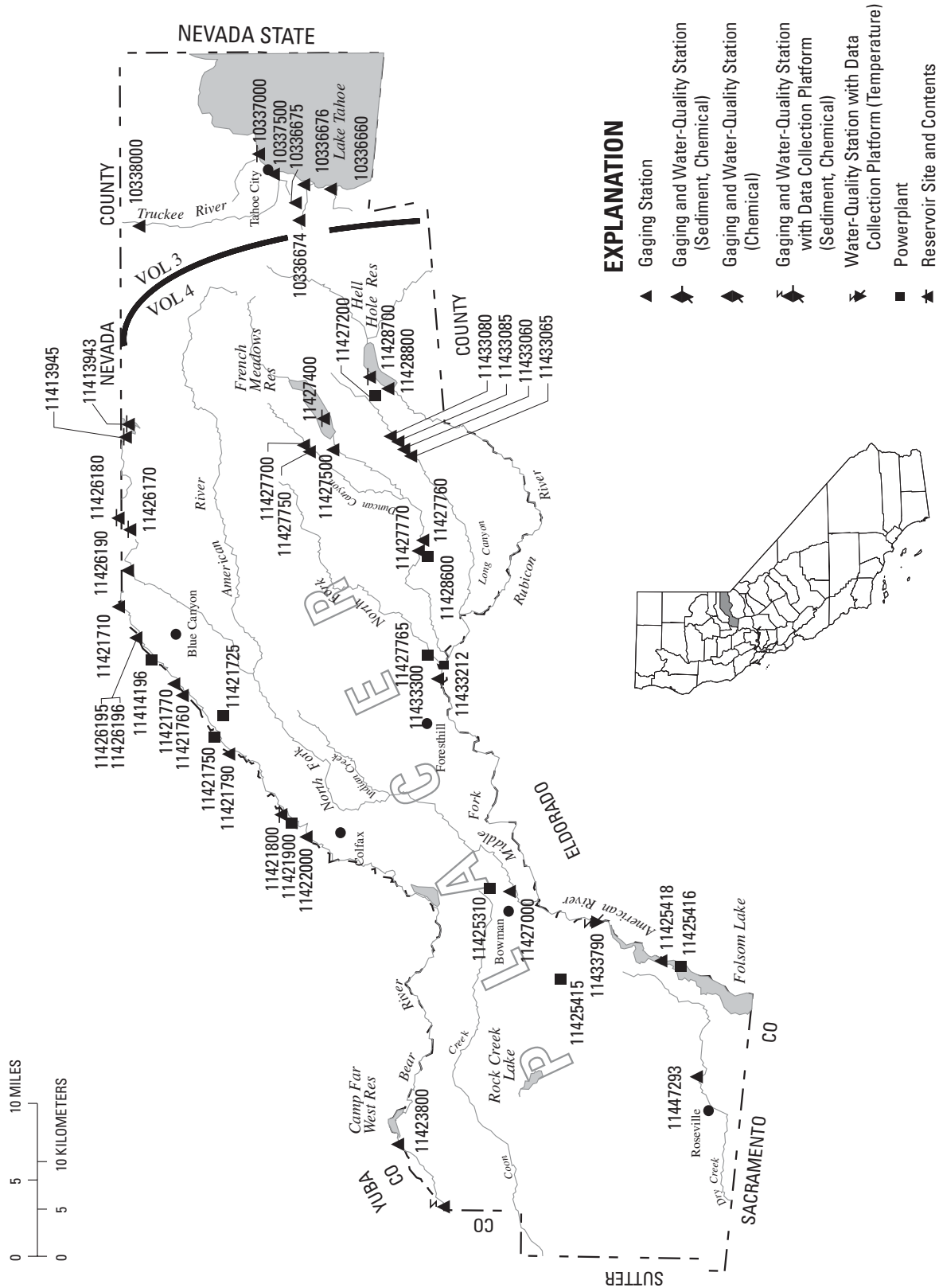

Figure 13. Location of discharge and water-quality stations in Placer County. (NOTE: Records for stations 10336660 through 10338000 published in volume 3.)

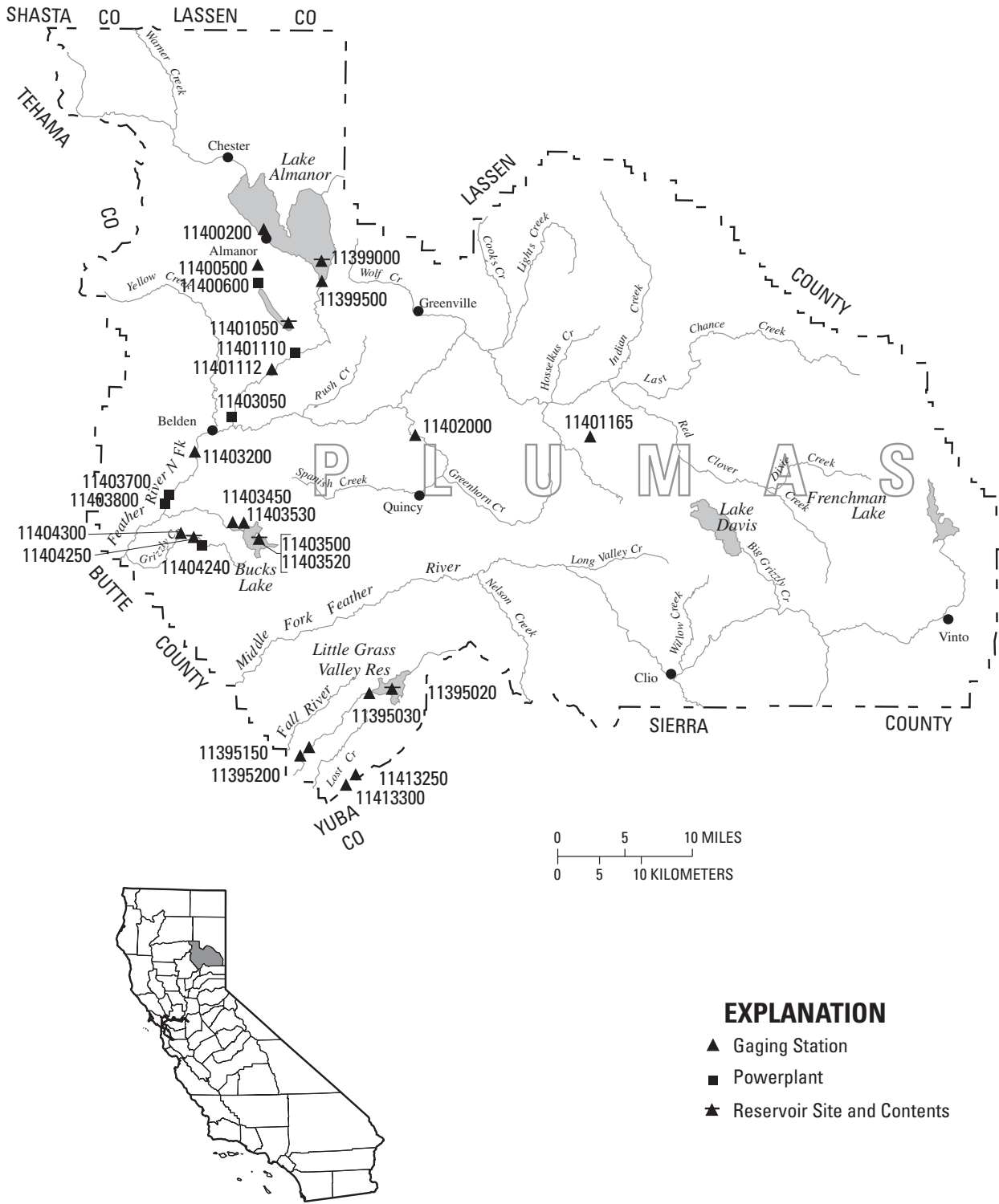
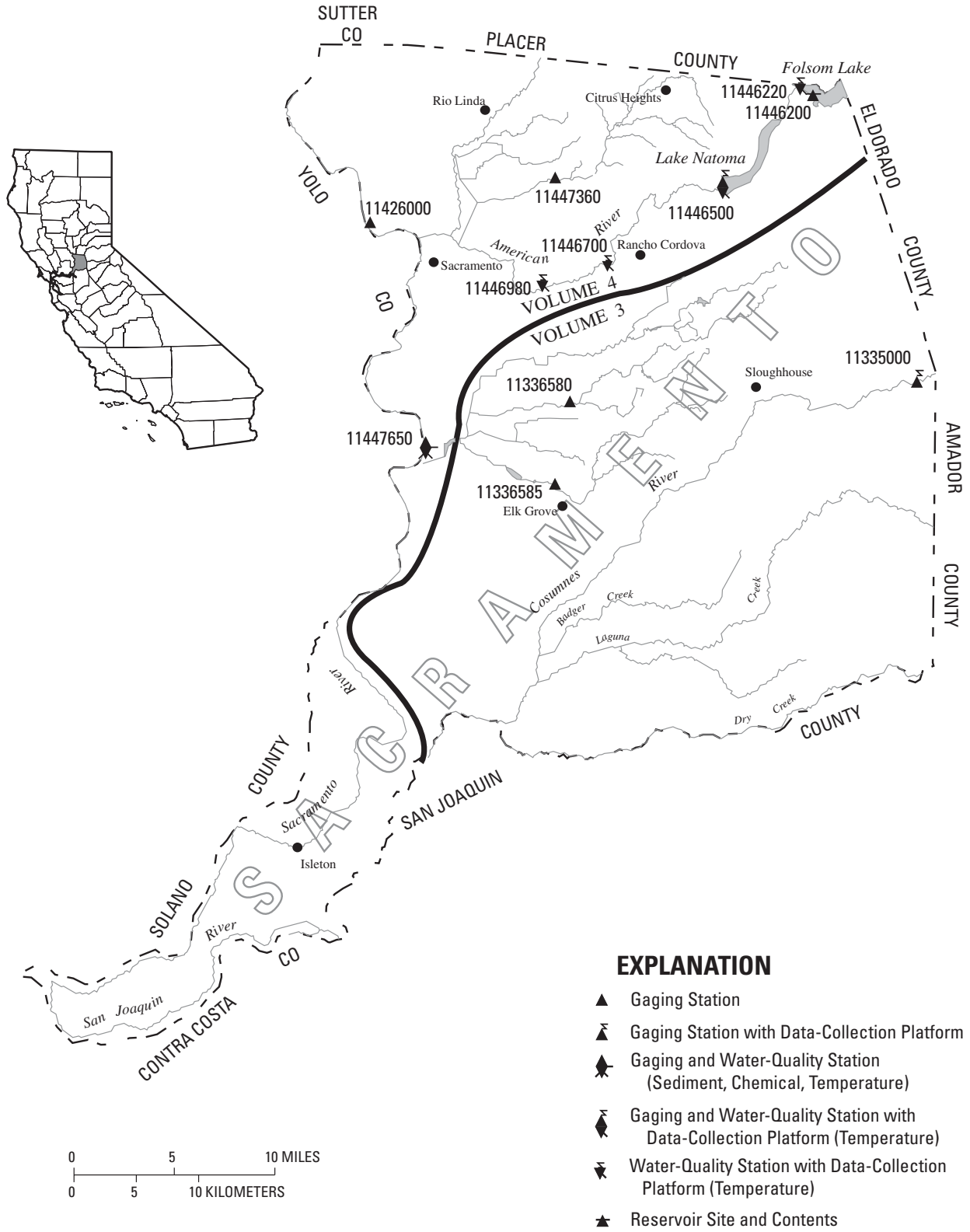

Figure 14. Location of discharge stations in Plumas County.





**Figure 15.** Location of discharge and water-quality stations in Sacramento County. (NOTE: Records for stations 11335000 through 11336585 published in volume 3.)

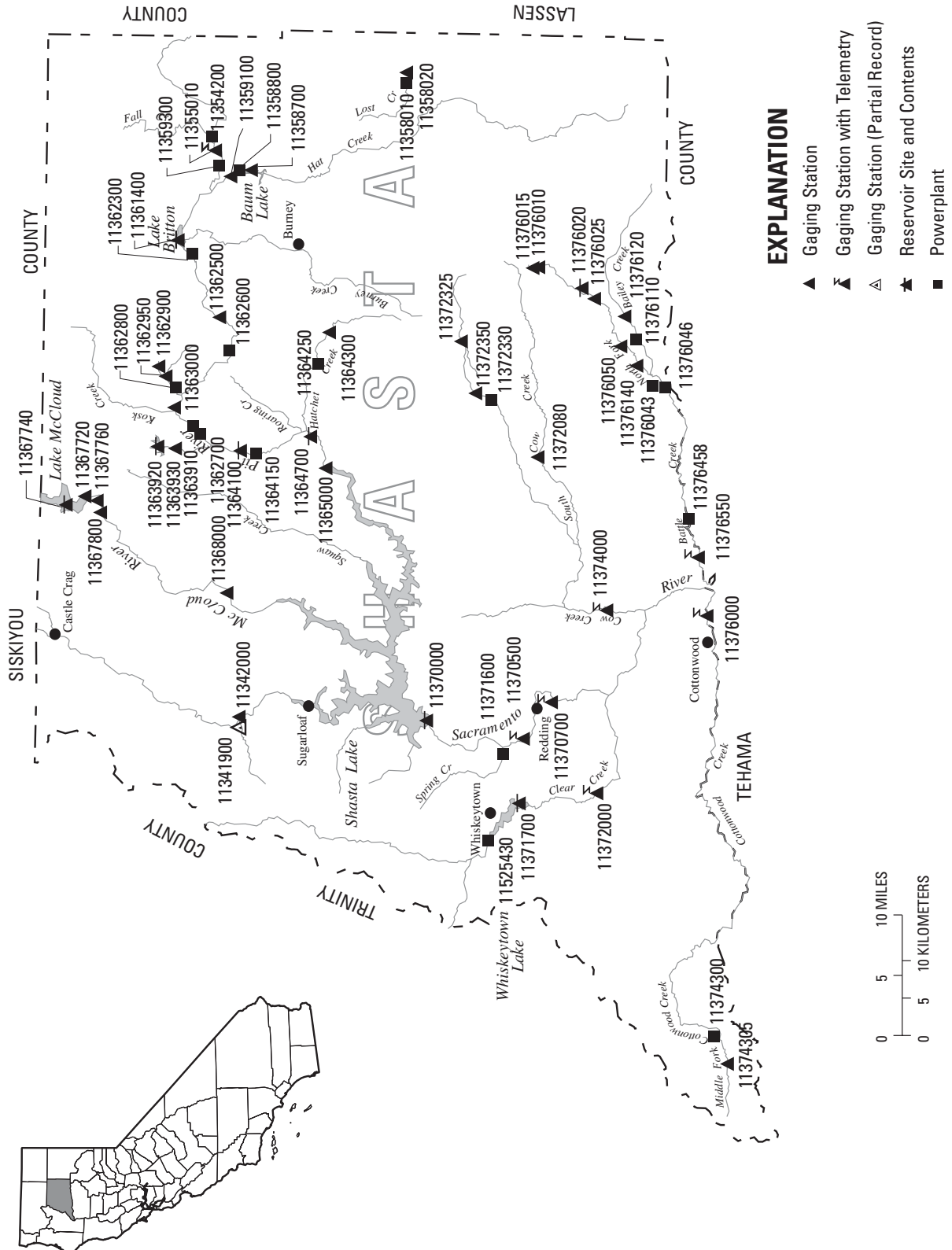
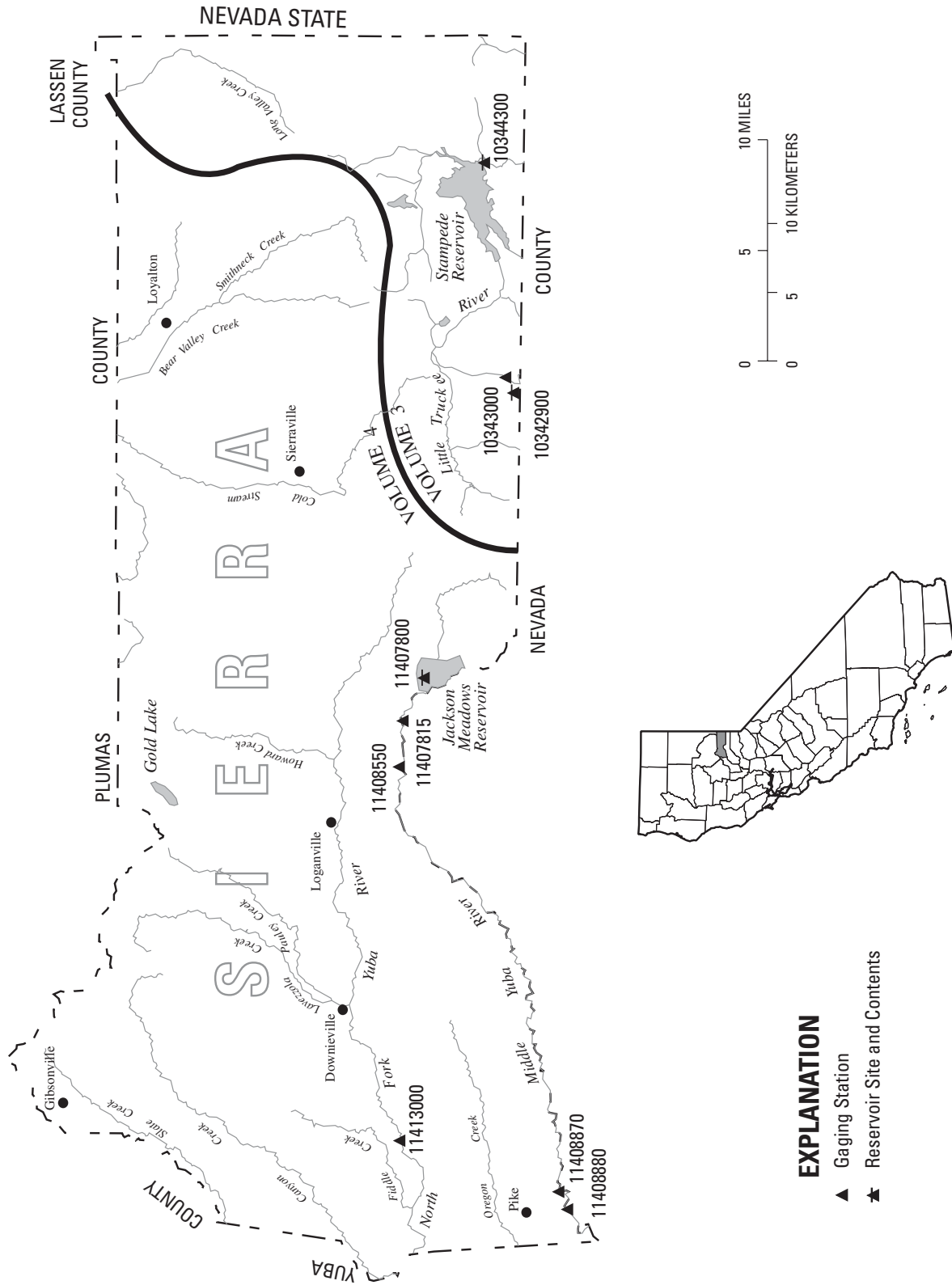
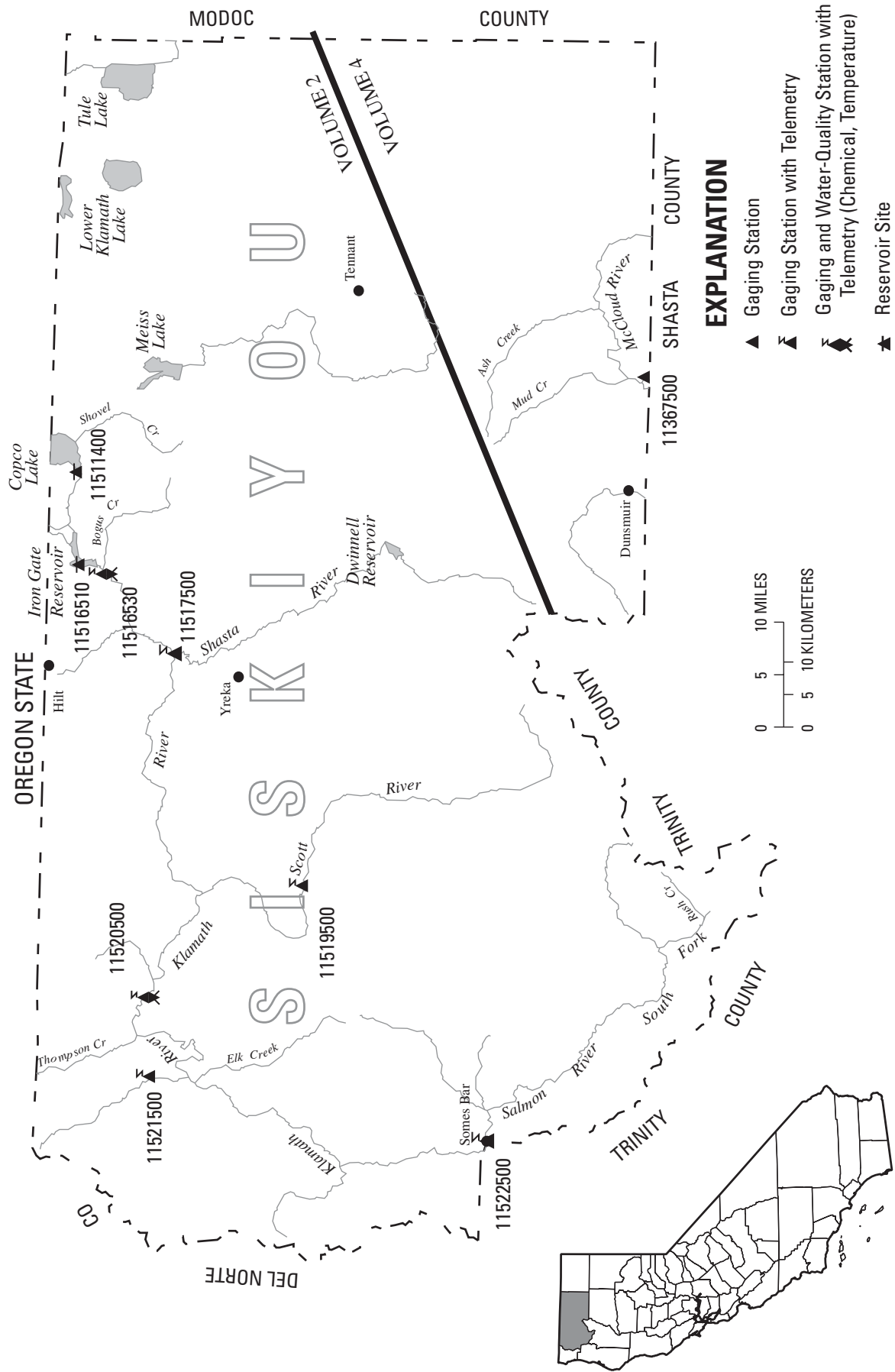

Figure 16. Location of discharge stations in Shasta County.



**Figure 17.** Location of discharge stations in Sierra County.  
 (NOTE: Records for stations 10342900 through 10344300 published in volume 3.)



**Figure 18.** Location of discharge stations in Siskiyou County.  
(NOTE: Records for stations 1151400 through 11522500 published in volume 2.)

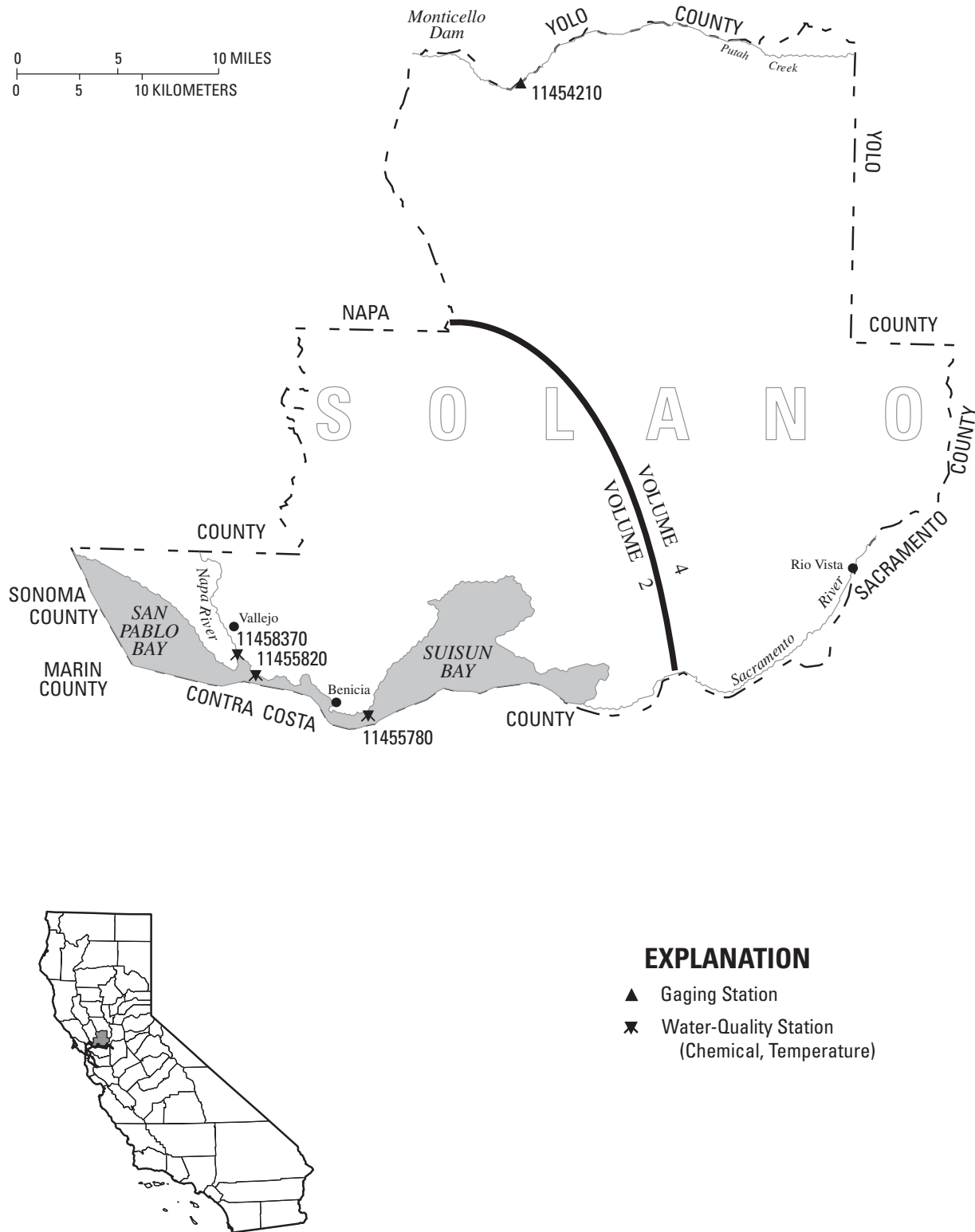

**Figure 19.** Location of discharge and water-quality stations in Solano County.  
 (NOTE: Records for station 11455780 through 11458370 published in volume 2.)

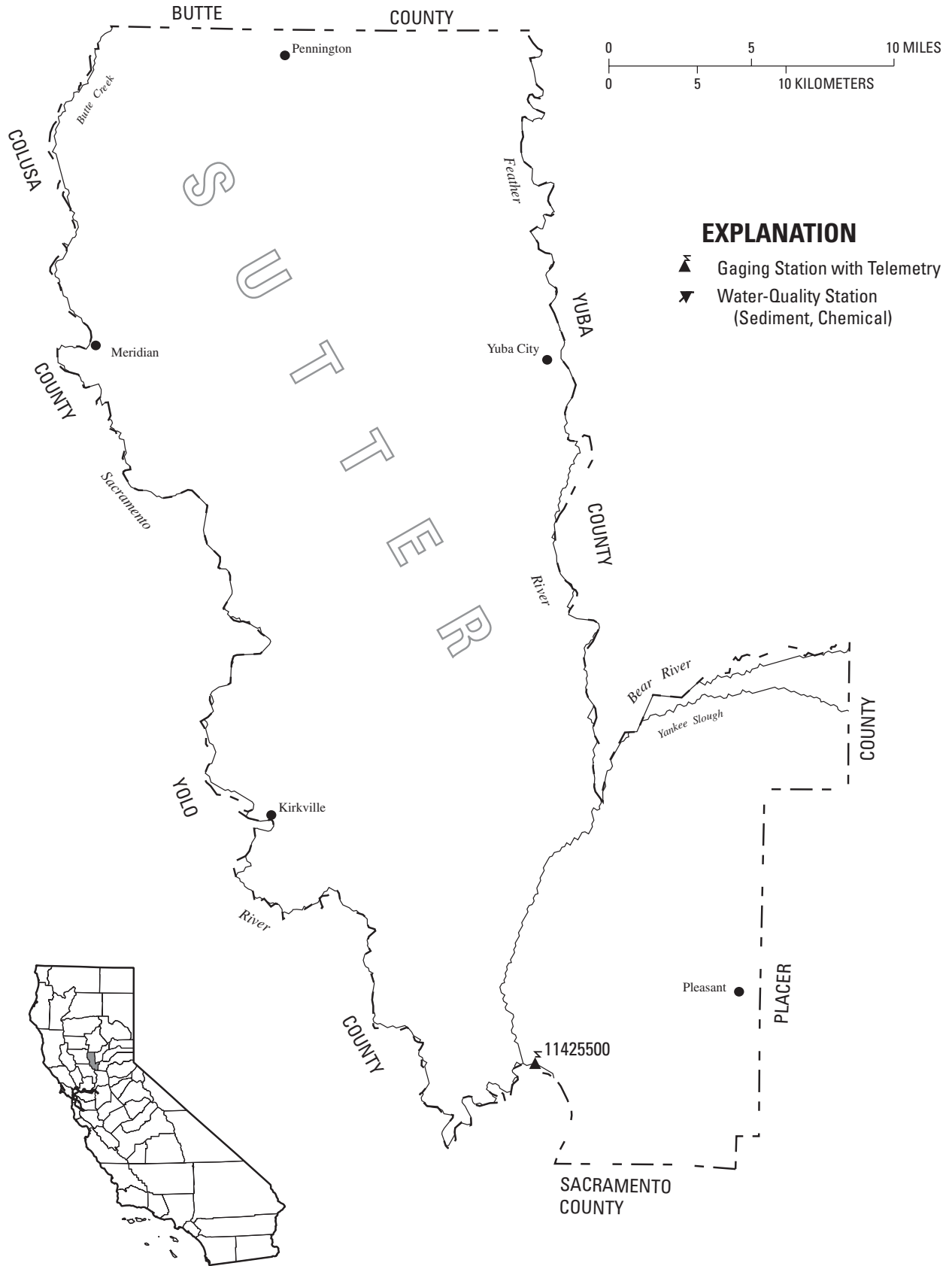

Figure 20. Location of discharge and water-quality stations in Sutter County.

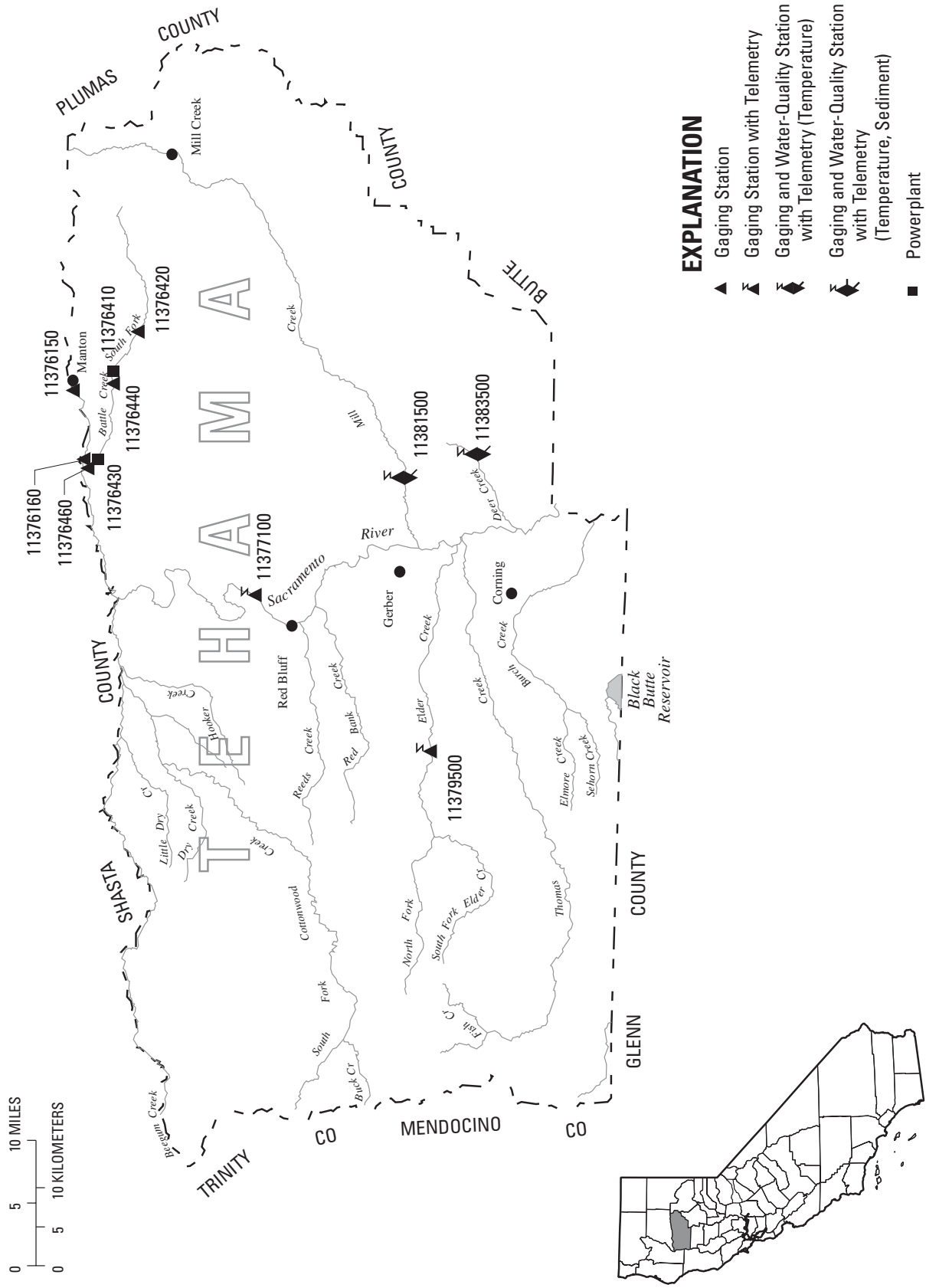
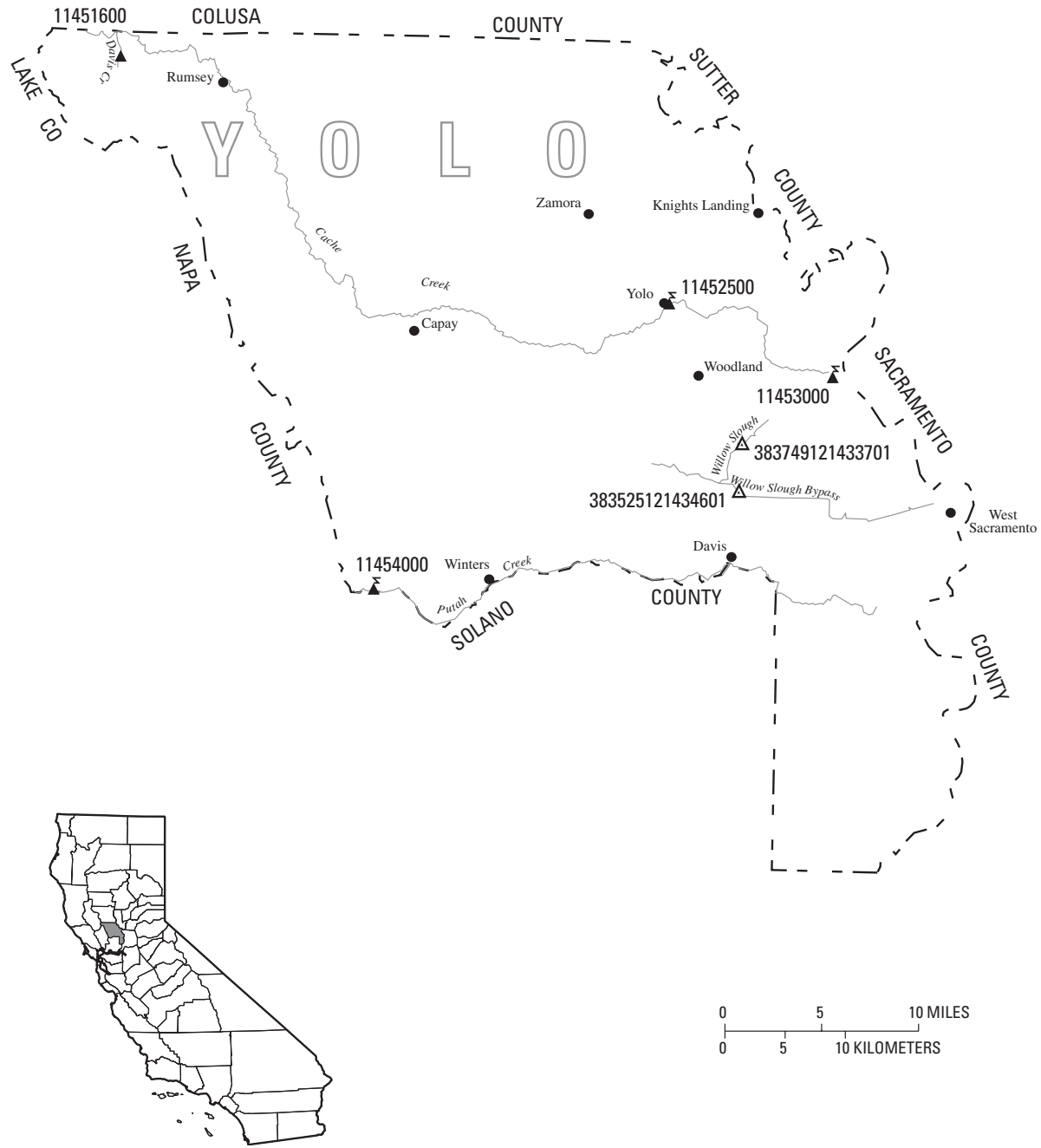

Figure 21. Location of discharge and water-quality stations in Tehama County.

**EXPLANATION**

- △ Gaging Station (Partial Record)
- ▲ Gaging Station
- ▲ Gaging Station with Data-Collection Platform
- ✦ Water-Quality Station (Chemical, Sediment)



**Figure 22.** Location of discharge and water-quality stations in Yolo County.



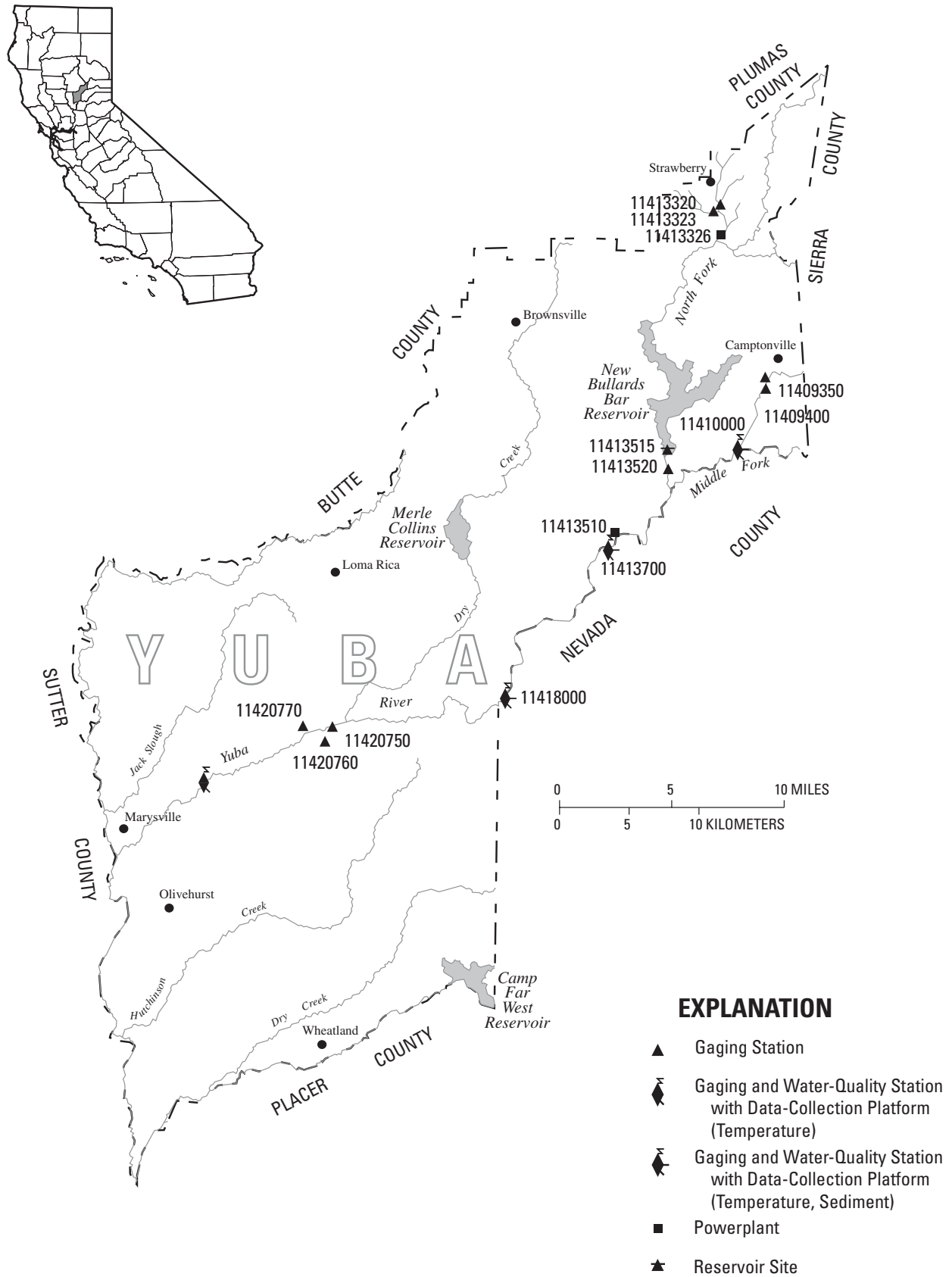

Figure 23. Location of discharge and water-quality stations in Yuba County.

## WATER RESOURCES DATA—CALIFORNIA, WATER YEAR 2001

### SURFACE-WATER-DISCHARGE AND SURFACE-WATER-QUALITY RECORDS

#### Remark Codes

The following remark codes may appear with the water-quality data in this section:

<u>PRINTED OUTPUT</u>	<u>REMARK</u>
e	Value is estimated.
>	Actual value is known to be greater than the value shown.
<	Actual value is known to be less than the value shown.
M	Presence of material verified, but not quantified.
U	Material specifically analyzed for, but not detected.
V	Analyte was detected in both the environmental sample and the associated blanks.
S	Most probable value.
K	Results based on colony count outside the acceptance range (non-ideal colony count).
L	Biological organism count less than 0.5 percent (organism may be observed rather than counted).
D	Biological organism count equal to or greater than 15 percent (dominant).
ND	Not detected.
N	Suspended-sediment data determined from a sample collected and processed according to National Water-Quality Assessment (NAWQA) protocol.
A	Samples collected by another agency.
&	Biological organism estimated as dominant.
*	Instantaneous discharge at the time of cross-sectional measurements.
**	Partial sampled width.
1	Laboratory value.
2	Laboratory fixed-end point titration.
†	Sample collected using an automatic sampler.

#### Dissolved Trace-Element Concentrations

NOTE: Traditionally, dissolved trace-element concentrations have been reported at the microgram per liter ( $\mu\text{g/L}$ ) level. Recent evidence, mostly from large rivers, indicates that actual dissolved-phase concentrations for a number of trace elements are within the range of 10's to 100's of nanograms per liter ( $\text{ng/L}$ ). Data above the  $\mu\text{g/L}$  level should be viewed with caution. Such data may actually represent elevated environmental concentrations from natural or human causes; however, these data could reflect contamination introduced during sampling, processing, or analysis. To confidently produce dissolved trace-element data with insignificant contamination, the U.S. Geological Survey began using new trace-element protocols at some stations in water year 1994.

#### Data Precision

NOTE: Precision varies for different analytical methods used to determine the same constituent. The presence of trailing zeroes after the decimal in values printed in this report does not necessarily indicate that the method used for the determination is as precise as the level implied by the rightmost zero.

#### Change in National Trends Network Procedures

NOTE: Sample handling procedures at all National Trends Network stations were changed substantially on January 11, 1994, in order to reduce contamination from the sample shipping container. The data for samples before and after that date are different and not directly comparable. A tabular summary of the differences based on a special intercomparison study, is available from the NADP/NTN Coordination Office, Colorado State University, Fort Collins, CO 80523 (Telephone: 303-491-5643).

*THIS  
PAGE  
INTENTIONALLY  
LEFT  
BLANK*

SACRAMENTO RIVER BASIN

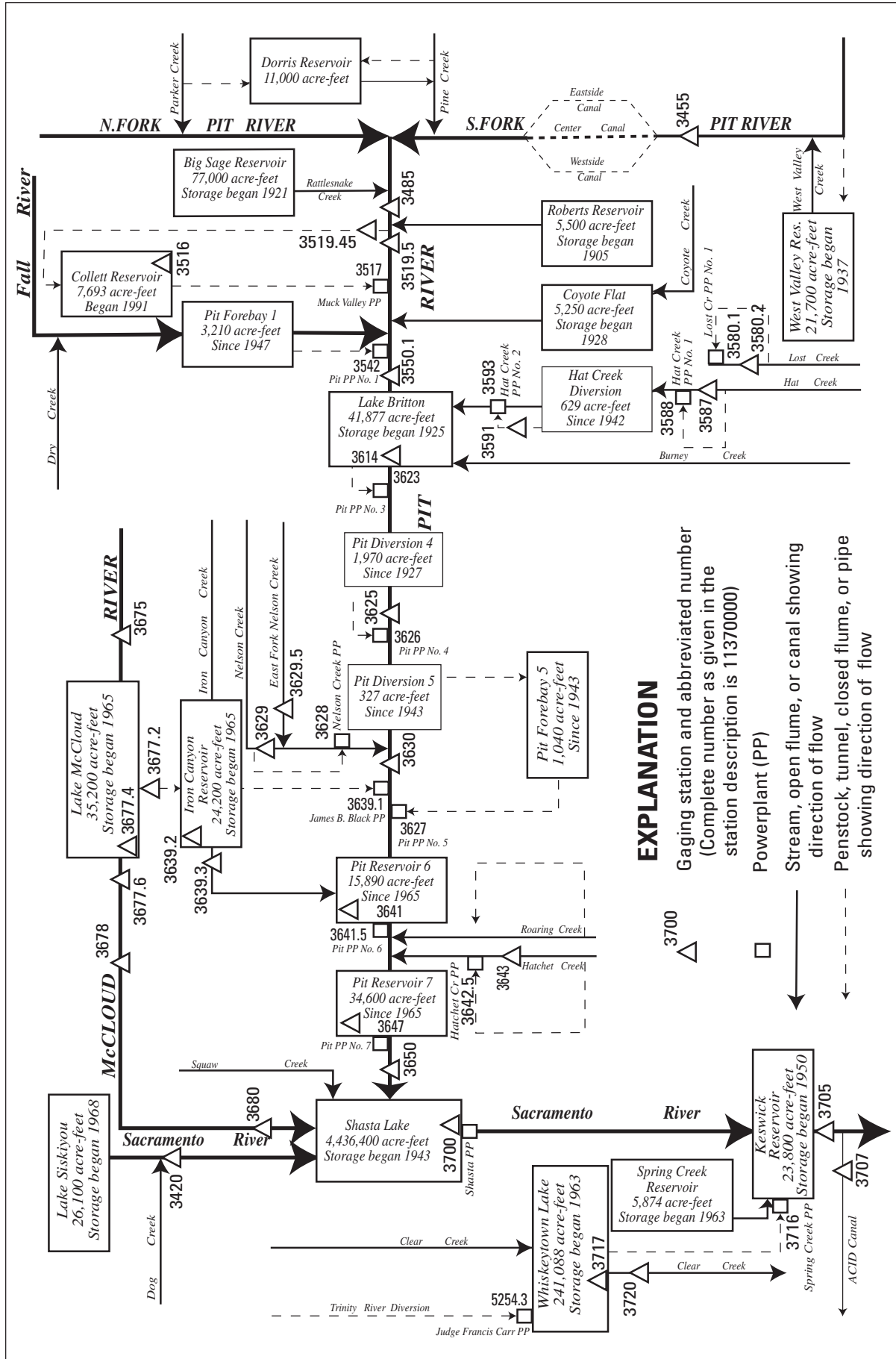

**EXPLANATION**

Gaging station and abbreviated number  
(Complete number as given in the station description is 11370000)

Powerplant (PP)

Stream, open flume, or canal showing direction of flow

Penstock, tunnel, closed flume, or pipe showing direction of flow

Figure 24. Diversions and storage in Pit and McCloud River Basins.

## 11342000 SACRAMENTO RIVER AT DELTA, CA

LOCATION.—Lat 40°56'23", long 122°24'58", in SW 1/4 NW 1/4 sec.35, T.36 N., R.5 W., Shasta County, Hydrologic Unit 18020005, U.S. Bureau of Reclamation property, on left bank, 0.2 mi downstream from Dog Creek, 0.6 mi southeast of Delta, 2.8 mi south of Lamoine, and 29 mi downstream from Lake Siskiyou.

DRAINAGE AREA.—425 mi<sup>2</sup>.

PERIOD OF RECORD.—October 1944 to current year. Monthly discharge only for some periods, published in WSP 1315-A.

CHEMICAL DATA: Water years 1951–81.

WATER TEMPERATURE: Water years 1951, 1954–57, 1963–79.

REVISED RECORDS.—WSP 1395: 1951(M). WDR-CA-94-4: 1993(P).

GAGE.—Water-stage recorder. Datum of gage is 1,075.00 ft above sea level (levels by U.S. Bureau of Reclamation).

REMARKS.—Records good. Some regulation by Lake Siskiyou, capacity, 26,100 acre-ft, since December 1968. Some minor diversions for irrigation upstream from station. See schematic diagram of Pit and McCloud River Basins.

EXTREMES FOR PERIOD OF RECORD.—Maximum discharge, 69,800 ft<sup>3</sup>/s, Jan. 16, 1974, gage height, 27.20 ft in gage well, 28.7 ft from floodmarks, from rating curve extended above 19,000 ft<sup>3</sup>/s on basis of slope-area measurements at gage height 19.50 ft, and of peak flow; minimum daily, 117 ft<sup>3</sup>/s, Aug. 5, 6, 12–15, 1977.

EXTREMES FOR CURRENT YEAR.—Peak discharges greater than base discharge of 8,000 ft<sup>3</sup>/s, or maximum:

Date	Time	Discharge (ft <sup>3</sup> /s)	Gage height (ft)
Mar. 5	0145	9,440	10.52

DISCHARGE, CUBIC FEET PER SECOND, WATER YEAR OCTOBER 2000 TO SEPTEMBER 2001  
DAILY MEAN VALUES

DAY	OCT	NOV	DEC	JAN	FEB	MAR	APR	MAY	JUN	JUL	AUG	SEP
1	264	293	300	270	405	1160	2560	2010	496	358	225	200
2	261	288	279	268	402	1160	2350	1770	494	327	222	200
3	261	282	277	266	422	1090	1970	1580	470	315	219	199
4	261	279	270	263	507	3000	1670	1540	447	311	219	198
5	257	274	268	267	606	6850	1410	1620	437	301	219	192
6	257	269	265	264	568	3710	1400	1610	446	290	216	193
7	258	265	264	267	504	2920	1340	1670	426	285	213	195
8	256	265	262	356	439	2870	1180	1820	400	285	212	194
9	271	265	264	342	495	2530	1090	1920	386	278	210	194
10	291	307	275	516	502	2050	1050	1850	384	274	209	195
11	276	346	274	1050	563	1720	968	1770	381	275	207	197
12	272	348	297	620	536	1530	971	1770	378	271	206	205
13	273	358	360	450	491	1490	944	1650	365	265	205	205
14	270	305	562	409	461	1490	911	1490	378	261	205	203
15	270	318	472	370	551	1380	928	1530	343	262	203	201
16	267	276	370	349	527	1260	964	1510	324	259	204	229
17	253	278	335	334	571	1190	1390	1360	318	259	202	208
18	252	263	303	314	1160	1290	1760	1300	312	258	202	203
19	252	258	293	314	2240	1910	1890	1150	309	253	201	200
20	270	258	300	319	4960	2180	1730	1130	303	249	202	199
21	288	260	292	315	7230	2360	1410	1110	299	251	202	199
22	271	257	331	321	5020	2710	1330	1020	296	247	204	198
23	268	256	333	460	2750	2890	1460	938	294	241	210	197
24	267	255	316	897	2010	3470	1710	781	292	238	211	198
25	292	256	296	744	1810	5400	2050	794	295	235	207	287
26	337	255	289	611	1600	3560	2440	740	352	231	204	235
27	292	256	283	542	1430	2690	2660	696	1230	229	202	219
28	603	255	279	490	1280	2510	2530	644	714	227	198	214
29	399	341	276	477	---	2670	2070	594	453	226	198	210
30	522	375	274	449	---	2620	1930	543	386	225	199	208
31	343	---	273	428	---	2500	---	533	---	226	199	---
TOTAL	9174	8561	9532	13342	40040	76160	48066	40443	12408	8212	6435	6175
MEAN	296	285	307	430	1430	2457	1602	1305	414	265	208	206
MAX	603	375	562	1050	7230	6850	2660	2010	1230	358	225	287
MIN	252	255	262	263	402	1090	911	533	292	225	198	192
AC-FT	18200	16980	18910	26460	79420	151100	95340	80220	24610	16290	12760	12250

## 11342000 SACRAMENTO RIVER AT DELTA, CA—Continued

## STATISTICS OF MONTHLY MEAN DATA FOR WATER YEARS 1945 - 2001, BY WATER YEAR (WY)

	OCT	NOV	DEC	JAN	FEB	MAR	APR	MAY	JUN	JUL	AUG	SEP
MEAN	352	777	1323	1871	2345	2270	2019	1691	820	344	236	233
MAX	1837	6075	5770	7162	9557	7957	4264	4216	3741	1198	462	514
(WY)	1951	1974	1997	1995	1958	1983	1963	1983	1998	1998	1983	1957
MIN	150	187	197	214	226	243	264	410	229	145	122	154
(WY)	1945	1992	1977	1991	1977	1977	1977	1977	1977	1977	1977	1991

SUMMARY STATISTICS	FOR 2000 CALENDAR YEAR		FOR 2001 WATER YEAR		WATER YEARS 1945 - 2001	
ANNUAL TOTAL	569200		278548			
ANNUAL MEAN	1555		763		1184	
HIGHEST ANNUAL MEAN					2715	
LOWEST ANNUAL MEAN					228	
HIGHEST DAILY MEAN	16500	Feb 14	7230	Feb 21	53900	Jan 16 1974
LOWEST DAILY MEAN	252	Oct 18	192	Sep 5	117	Aug 5 1977
ANNUAL SEVEN-DAY MINIMUM	256	Nov 22	194	Sep 5	117	Aug 11 1977
MAXIMUM PEAK FLOW			9440	Mar 5	69800	Jan 16 1974
MAXIMUM PEAK STAGE			10.52	Mar 5	27.20	Jan 16 1974
ANNUAL RUNOFF (AC-FT)	1129000		552500		857800	
10 PERCENT EXCEEDS	3780		1910		2660	
50 PERCENT EXCEEDS	445		318		525	
90 PERCENT EXCEEDS	268		205		200	

## 11345500 SOUTH FORK PIT RIVER NEAR LIKELY, CA

LOCATION.—Lat 41°13'51", long 120°26'10", in NE 1/4 SE 1/4 sec.11, T.39 N., R.13 E., Modoc County, Hydrologic Unit 18020002, on left bank, 250 ft downstream from highway bridge, 1.4 mi downstream from West Valley Creek, and 3.5 mi east of Likely.

DRAINAGE AREA.—247 mi<sup>2</sup>.

PERIOD OF RECORD.—October 1928 to current year. Monthly discharge only for some periods, published in WSP 1315-A.

CHEMICAL DATA: Water years 1951–79.

WATER TEMPERATURE: Water years 1965–79.

SEDIMENT DATA: Water years 1957–61, 1967–70.

REVISED RECORDS.—WSP 1931: Drainage area, 1932(M), 1938(M), 1952(M). WDR CA-88-4: 1983(M).

GAGE.—Water-stage recorder. Datum of gage is 4,507.74 ft above sea level. Prior to Oct. 1, 1931, at site 1,000 ft downstream at different datum.

REMARKS.—Records fair. Considerable regulation by West Valley Reservoir on West Valley Creek beginning in May 1937, usable capacity, 21,700 acre-ft. Diversions for irrigation of about 3,800 acres upstream from station. See schematic diagram of Pit and McCloud River Basins.

EXTREMES FOR PERIOD OF RECORD.—Maximum discharge, 1,620 ft<sup>3</sup>/s, June 2, 1971, gage height, 6.05 ft; minimum, 0.2 ft<sup>3</sup>/s, Feb. 3, 1941.

DISCHARGE, CUBIC FEET PER SECOND, WATER YEAR OCTOBER 2000 TO SEPTEMBER 2001  
DAILY MEAN VALUES

DAY	OCT	NOV	DEC	JAN	FEB	MAR	APR	MAY	JUN	JUL	AUG	SEP
1	40	29	26	e13	e11	e4.8	43	78	121	66	59	34
2	36	29	24	e12	e12	e5.6	34	71	130	69	57	33
3	31	29	24	e12	e11	e6.6	30	63	130	80	63	32
4	31	29	24	e11	e11	e7.8	23	60	116	84	62	32
5	33	29	24	11	e10	e9.5	21	59	102	73	57	31
6	35	29	24	12	e10	11	22	56	102	65	62	30
7	32	26	25	11	e10	12	21	54	101	65	67	29
8	30	22	26	11	e10	14	21	49	107	61	66	27
9	31	29	27	11	e12	13	17	51	112	56	66	25
10	37	25	33	11	e11	10	15	61	112	56	65	23
11	51	24	28	10	e11	10	18	92	102	57	64	23
12	47	26	28	e10	e11	9.8	20	109	98	57	65	25
13	44	34	27	e9.9	e12	10	15	110	92	50	64	25
14	43	32	27	e9.9	e10	11	15	108	94	46	63	23
15	36	28	26	e9.8	e9.2	9.6	14	109	99	42	62	21
16	33	27	24	e9.9	e8.5	10	16	116	96	41	61	20
17	32	37	26	e10	8.0	11	26	110	91	39	55	19
18	30	40	33	e10	7.5	19	32	106	87	47	49	19
19	30	35	49	e11	7.5	21	41	103	85	55	47	19
20	30	31	33	e11	7.3	24	43	101	87	62	53	19
21	35	25	24	e11	6.9	27	36	96	87	65	55	19
22	34	25	15	e10	6.6	33	29	92	87	64	54	19
23	31	20	14	e10	6.7	30	36	91	84	60	53	18
24	29	22	13	e9.6	6.4	22	42	91	73	57	52	18
25	29	24	e13	e9.2	e6.0	33	44	93	68	56	52	21
26	30	26	e13	e9.0	e5.6	25	48	109	68	57	49	23
27	30	26	e14	e8.9	e5.2	18	50	117	71	56	48	21
28	29	27	e14	e10	e4.8	30	52	116	70	58	43	16
29	30	28	e14	e9.2	---	40	63	115	72	60	32	12
30	31	29	e13	e9.0	---	51	75	113	68	60	28	13
31	30	---	e13	e10	---	43	---	113	---	61	30	---
TOTAL	1050	842	718	322.4	248.2	581.7	962	2812	2812	1825	1703	689
MEAN	33.9	28.1	23.2	10.4	8.86	18.8	32.1	90.7	93.7	58.9	54.9	23.0
MAX	51	40	49	13	12	51	75	117	130	84	67	34
MIN	29	20	13	8.9	4.8	4.8	14	49	68	39	28	12
AC-FT	2080	1670	1420	639	492	1150	1910	5580	5580	3620	3380	1370

## STATISTICS OF MONTHLY MEAN DATA FOR WATER YEARS 1929 - 2001, BY WATER YEAR (WY)

MEAN	32.1	28.1	28.5	30.9	34.8	47.8	108	232	179	92.8	116	57.5
MAX	63.4	57.8	107	98.5	101	219	385	570	643	238	236	159
(WY)	1997	1985	1965	1997	1965	1972	1952	1984	1998	1995	1995	1975
MIN	15.7	5.17	3.28	5.99	4.07	4.63	16.9	25.7	12.1	7.70	9.97	10.5
(WY)	1932	1980	1980	1941	1978	1977	1991	1931	1931	1931	1934	1931

SUMMARY STATISTICS	FOR 2000 CALENDAR YEAR		FOR 2001 WATER YEAR		WATER YEARS 1929 - 2001		
ANNUAL TOTAL	21402		14565.3				
ANNUAL MEAN	58.5		39.9		82.5		
HIGHEST ANNUAL MEAN					183		
LOWEST ANNUAL MEAN					27.3		
HIGHEST DAILY MEAN	256		May 17	130	Jun 2	1220	
LOWEST DAILY MEAN	13		Feb 19	4.8	Feb 28	.80	
ANNUAL SEVEN-DAY MINIMUM	13		Dec 24	5.5	Feb 24	1.1	
MAXIMUM PEAK FLOW					130	Jun 1	1620
MAXIMUM PEAK STAGE					2.83	Jun 1	6.05
ANNUAL RUNOFF (AC-FT)	42450		28890		59740		
10 PERCENT EXCEEDS	129		91		189		
50 PERCENT EXCEEDS	35		30		42		
90 PERCENT EXCEEDS	17		10		12		

e Estimated.

## 11348500 PIT RIVER NEAR CANBY, CA

LOCATION.—Lat 41°24'22", long 120°55'36", in NW 1/4 SW 1/4 sec.10, T.41 N., R.9 E., Modoc County, Hydrologic Unit 18020002, on right bank, at lower end of Warm Spring Valley, and 3.9 mi southwest of Canby.

DRAINAGE AREA.—1,431 mi<sup>2</sup>, excluding Goose Lake Basin.

PERIOD OF RECORD.—January 1904 to December 1905, May 1929 to current year (1929–31 incomplete).

CHEMICAL DATA: Water years 1951–79.

WATER TEMPERATURE: Water years 1965–79.

SEDIMENT DATA: Water years 1957–61, 1967–70.

REVISED RECORDS.—WSP 1445: 1904, 1935(M), 1936, 1937(M). WSP 1931: Drainage area.

GAGE.—Water-stage recorder. Datum of gage is 4,266.0 ft above sea level. January 1904 to December 1905, nonrecording gage and May 6, 1929, to Sept. 30, 1931, water-stage recorder, at site 100 ft upstream at different datum.

REMARKS.—Records fair. Low flow regulated by many small reservoirs, total capacity about 144,000 acre-ft. Diversions for irrigation of about 39,000 acres upstream from station. See schematic diagram of [Pit and McCloud River Basins](#).

EXTREMES FOR PERIOD OF RECORD.—Maximum discharge observed, 13,000 ft<sup>3</sup>/s, Mar. 8, 1904, gage height, 15.0 ft, site and datum then in use; no flow July 18, 19, 2000.

EXTREMES FOR CURRENT YEAR.—Peak discharges greater than base discharge of 800 ft<sup>3</sup>/s, or maximum:

Date	Time	Discharge (ft <sup>3</sup> /s)	Gage height (ft)
July 4	0745	268	3.40

DISCHARGE, CUBIC FEET PER SECOND, WATER YEAR OCTOBER 2000 TO SEPTEMBER 2001  
DAILY MEAN VALUES

DAY	OCT	NOV	DEC	JAN	FEB	MAR	APR	MAY	JUN	JUL	AUG	SEP
1	33	99	121	e85	71	61	30	22	2.2	8.4	2.3	2.5
2	115	93	126	e84	84	64	28	21	2.7	9.6	2.1	2.5
3	118	92	118	e82	78	66	55	7.8	2.5	31	2.6	2.5
4	123	90	90	e81	80	68	115	7.4	2.5	115	3.9	2.5
5	191	85	90	e79	79	72	93	7.8	24	28	3.4	2.4
6	140	79	88	77	78	74	64	11	42	8.6	3.2	2.0
7	129	77	87	71	66	74	60	10	31	3.2	4.8	4.4
8	116	78	87	70	55	59	70	10	15	2.6	3.2	3.7
9	122	76	133	71	76	57	85	6.9	6.8	2.5	2.5	4.5
10	125	79	111	72	64	49	98	5.4	15	2.2	2.3	3.2
11	137	80	101	67	70	73	78	16	21	2.1	2.2	2.6
12	165	81	103	66	69	63	83	23	18	1.8	2.5	2.5
13	190	78	104	67	71	61	90	24	8.1	1.2	2.5	2.8
14	189	80	106	66	82	57	115	20	2.5	2.0	2.2	6.4
15	175	81	108	65	89	57	106	16	2.6	1.9	2.4	11
16	147	85	102	64	75	59	101	9.1	3.3	1.8	2.2	11
17	75	93	95	e65	72	63	107	3.1	5.1	2.2	2.1	15
18	52	90	86	e66	81	60	92	4.9	5.6	3.3	2.1	20
19	49	78	84	e68	83	62	78	17	3.5	2.8	2.5	28
20	43	83	84	69	90	75	115	21	12	2.8	2.4	23
21	50	80	99	97	91	79	158	7.4	15	2.5	2.6	23
22	54	83	101	83	82	92	142	6.8	11	2.7	2.8	18
23	52	86	97	82	74	100	80	9.0	2.5	2.6	2.6	12
24	39	95	92	81	72	72	64	10	2.3	7.3	2.5	11
25	53	95	79	81	73	88	80	19	2.9	3.4	2.5	16
26	68	91	63	73	72	93	58	6.5	4.2	2.8	2.5	30
27	68	130	76	62	70	81	27	5.4	7.1	2.4	2.5	33
28	62	96	89	53	66	48	21	2.3	6.7	2.5	2.3	32
29	71	106	e90	60	---	54	19	2.5	5.3	2.3	2.0	32
30	88	109	e88	46	---	55	21	2.5	4.9	2.4	2.5	30
31	98	---	e86	52	---	58	---	2.3	---	2.6	2.5	---
TOTAL	3137	2648	2984	2205	2113	2094	2333	337.1	287.3	266.5	80.7	389.5
MEAN	101	88.3	96.3	71.1	75.5	67.5	77.8	10.9	9.58	8.60	2.60	13.0
MAX	191	130	133	97	91	100	158	24	42	115	4.8	33
MIN	33	76	63	46	55	48	19	2.3	2.2	1.2	2.0	2.0
AC-FT	6220	5250	5920	4370	4190	4150	4630	669	570	529	160	773

e Estimated.



## SACRAMENTO RIVER BASIN

11348500 PIT RIVER NEAR CANBY, CA—Continued

## STATISTICS OF MONTHLY MEAN DATA FOR WATER YEARS 1904 - 2001, BY WATER YEAR (WY)

	OCT	NOV	DEC	JAN	FEB	MAR	APR	MAY	JUN	JUL	AUG	SEP
MEAN	82.0	107	193	313	430	548	467	468	277	65.9	43.9	65.2
MAX	1068	418	1225	1684	2249	1749	2774	2176	1746	312	125	201
(WY)	1963	1982	1938	1970	1986	1972	1952	1995	1971	1971	1983	1998
MIN	.26	12.7	31.0	14.7	19.2	5.83	1.29	2.32	3.53	4.62	.22	.28
(WY)	1935	1935	1937	1937	1937	1934	1934	1992	1992	1931	1934	1934

SUMMARY STATISTICS	FOR 2000 CALENDAR YEAR		FOR 2001 WATER YEAR		WATER YEARS 1904 - 2001	
ANNUAL TOTAL	44515.30		18875.1			
ANNUAL MEAN	122		51.7		253	
HIGHEST ANNUAL MEAN					676	
LOWEST ANNUAL MEAN					22.4	
HIGHEST DAILY MEAN	746	Mar 8	191	Oct 5	8580	Feb 19 1986
LOWEST DAILY MEAN	.00	Jul 18	1.2	Jul 13	.00	Jul 18 2000
ANNUAL SEVEN-DAY MINIMUM	4.0	Jul 14	1.9	Jul 10	.13	Apr 17 1934
MAXIMUM PEAK FLOW			268	Jul 4	13000	Mar 8 1904
MAXIMUM PEAK STAGE			3.40	Jul 4	15.00	Mar 8 1904
ANNUAL RUNOFF (AC-FT)	88300		37440		183300	
10 PERCENT EXCEEDS	254		101		647	
50 PERCENT EXCEEDS	88		59		95	
90 PERCENT EXCEEDS	12		2.5		16	

## 11351600 COLLETT RESERVOIR NEAR LITTLE VALLEY, CA

LOCATION.—Lat 40°58'00", long 121°13'00", unsurveyed, Lassen County, Hydrologic Unit 18020003, on right bank, 1.9 mi east of Muck Valley Powerplant, 5.5 mi northwest of Little Valley, and 9.1 mi southwest of Nubieber.

PERIOD OF RECORD.—October 1991 to September 1992, October 1993 to current year.

GAGE.—Water-stage recorder. Datum of gage is sea level.

REMARKS.—Lake is formed by earth and rockfill dam. Storage began Dec. 31, 1990. Water is diverted from the Pit River through a tunnel to the reservoir. Operating pool from elevation 4,030 ft, capacity 155 acre-ft, to 4,065 ft, capacity 7,693 acre-ft. Crest of spillway is at elevation 4,065 ft. Reservoir is used for power generation. Figures given represent total contents. Data not published below the minimum operating level at elevation 4,030 ft, capacity 155 acre-ft. See schematic diagram of [Pit and McCloud River Basins](#).

COOPERATION.—Records were provided by Malacha Hydro Limited Partnership, under general supervision of the U.S. Geological Survey, in connection with a Federal Energy Regulatory Commission project.

Capacity table (elevation, in feet, and contents, in acre-feet)  
(Based on table provided by Malacha Hydro Limited Partnership, dated November 1991)

4,030	155	4,035	931	4,050	4,052	4,065	7,693
4,032	395	4,040	1,899				

## RESERVOIR STORAGE (ACRE-FEET), WATER YEAR OCTOBER 2000 TO SEPTEMBER 2001

## DAILY OBSERVATION AT 2400 HOURS

DAY	OCT	NOV	DEC	JAN	FEB	MAR	APR	MAY	JUN	JUL	AUG	SEP
1	---	456	176	1516	429	1239	2076	4011	254	---	---	---
2	---	663	---	1437	429	1048	1779	3807	254	---	---	---
3	---	397	---	1340	641	1270	1779	3598	254	---	---	---
4	---	505	---	1279	711	1468	1779	3395	236	---	---	---
5	---	505	---	1279	711	1320	1779	3395	218	---	---	---
6	---	455	---	1491	711	1200	1779	3395	200	---	---	---
7	---	455	---	1701	711	1164	1810	3181	200	---	---	---
8	---	470	---	1635	711	1097	1905	2986	200	---	---	---
9	---	518	---	1590	711	1064	1516	2777	200	---	---	---
10	---	568	---	1526	902	1293	1678	2566	200	---	---	---
11	179	568	180	1471	1101	1496	2233	2359	186	---	---	---
12	363	608	---	1231	1101	1435	2400	2359	186	---	---	---
13	924	603	329	1231	1101	1369	2400	2359	177	---	---	---
14	1256	499	290	1402	1101	1249	2731	2151	---	---	---	---
15	1559	433	224	1544	1101	1171	2731	1939	---	---	---	---
16	1775	376	554	1377	1101	1142	2943	1736	---	---	---	---
17	1766	386	354	1160	1322	1142	2777	1483	---	---	---	---
18	1779	386	173	967	1556	1336	2400	1232	---	---	---	---
19	1868	481	---	1122	1761	1269	2721	1232	---	---	---	---
20	1755	531	---	1299	1688	1220	2763	1229	---	---	---	---
21	1839	566	---	1325	1611	1261	2842	1016	---	---	---	---
22	1916	441	180	1459	1430	1301	3235	846	---	---	---	---
23	1633	329	407	1532	1260	1301	3009	740	---	---	---	---
24	1357	329	644	1642	1524	1351	3231	648	---	---	---	---
25	1252	329	1126	1805	1819	1360	3256	552	---	---	---	---
26	1117	293	976	1778	1709	1296	3315	552	---	---	---	---
27	991	282	976	1797	1536	1416	3493	552	---	---	---	---
28	999	265	976	1507	1432	1748	3684	552	---	---	---	---
29	1002	239	978	969	---	1819	3800	451	---	---	---	---
30	934	201	1167	506	---	2035	4174	383	---	---	---	---
31	715	---	1344	429	---	2076	---	254	---	---	---	---
MAX	---	663	---	1805	1819	2076	4174	4011	---	---	---	---
MIN	---	201	---	429	429	1048	1516	254	---	---	---	---
a	3820	5430	6140	6290	4700	4430	1780	3650	77	0	0	0
b	4370	4970	7000	5370	5700	5190	3870	40	0	0	0	0

a Discharge, in acre-feet, for Muck Valley Powerplant (station 11351700), provided by Malacha Hydro Limited Partnership.

b Discharge, in acre-feet, for Pit River Tunnel Flow (station 11351945), provided by Malacha Hydro Limited Partnership.

## 11351950 PIT RIVER BELOW DIVERSION TO MUCK VALLEY POWERPLANT, NEAR BIEBER, CA

LOCATION.—Lat 41°00'55", long 121°09'13", in NE 1/4 SW 1/4 sec.27, T.37 N., R.7 E., Lassen County, Hydrologic Unit 18020003, on right bank, 1.7 mi upstream from North Gulch, 2.2 mi upstream from Spring Gulch, and 7.4 mi south of Bieber.

DRAINAGE AREA.—2,475 mi<sup>2</sup>, excluding Goose Lake Basin.

PERIOD OF RECORD.—October 1994 to current year.

GAGE.—Acoustic-velocity meter measures minimum bypass flow; water-stage recorder and Ogee weir for spillway. Elevation of gage is 4,120 ft above sea level, from topographic map.

REMARKS.—Flow at this station has two components which are combined for publication: low-flow release (station 11351946) and flow over Ogee weir (station 11351948). Water is diverted upstream of weir through a tunnel to Collett Reservoir (station 11351600), for power generation. During powerplant operation, the minimum release is 50 ft<sup>3</sup>/s. See schematic diagram of [Pit and McCloud River Basins](#).

COOPERATION.—Records were provided by Malacha Hydro Limited Partnership, under general supervision of the U.S. Geological Survey, in connection with a Federal Energy Regulatory commission project.

EXTREMES FOR PERIOD OF RECORD.—Maximum daily discharge, 16,800 ft<sup>3</sup>/s, Jan. 3, 1997; no flow many days during 1995, 1997, and 2000.

DISCHARGE, CUBIC FEET PER SECOND, WATER YEAR OCTOBER 2000 TO SEPTEMBER 2001  
DAILY MEAN VALUES

DAY	OCT	NOV	DEC	JAN	FEB	MAR	APR	MAY	JUN	JUL	AUG	SEP
1	.00	44	32	17	17	21	2.0	13	1.0	.00	.00	.00
2	.00	54	27	26	11	19	2.0	2.0	2.0	.00	.00	.00
3	.00	53	26	21	18	30	2.0	2.0	2.0	.00	.00	.00
4	.00	46	30	16	15	17	2.0	2.0	1.0	.00	.00	.00
5	.00	31	28	19	24	22	1.0	2.0	1.0	.00	.00	.00
6	.00	42	30	23	17	23	1.0	2.0	1.0	.00	.00	.00
7	.00	10	27	20	19	26	4.0	2.0	1.0	.00	.00	.00
8	.00	45	28	24	19	21	10	2.0	1.0	.00	.00	.00
9	.00	35	23	15	21	28	12	2.0	1.0	.00	.00	.00
10	.00	38	21	15	19	31	13	2.0	1.0	.00	.00	.00
11	23	30	27	13	18	21	36	2.0	1.0	.00	.00	.00
12	50	34	31	21	18	23	16	2.0	1.0	.00	.00	.00
13	53	33	22	17	17	24	2.0	2.0	.00	.00	.00	.00
14	54	27	27	17	18	19	21	2.0	.00	.00	.00	.00
15	54	23	26	15	19	18	2.0	1.0	.00	.00	.00	.00
16	53	23	28	15	22	23	22	1.0	.00	.00	.00	.00
17	47	25	19	21	21	2.0	4.0	1.0	.00	.00	.00	.00
18	53	13	18	16	22	25	4.0	1.0	.00	.00	.00	.00
19	53	37	21	17	19	18	23	1.0	.00	.00	.00	.00
20	53	26	23	19	20	6.0	5.0	1.0	.00	.00	.00	.00
21	45	27	24	15	22	10	11	1.0	.00	.00	.00	.00
22	45	16	23	20	21	6.0	46	1.0	.00	.00	.00	.00
23	11	14	25	19	26	30	27	.00	.00	.00	.00	.00
24	15	22	27	19	22	6.0	17	.00	.00	.00	.00	.00
25	32	23	22	22	29	4.0	4.0	.00	.00	.00	.00	.00
26	31	32	22	21	25	25	16	.00	.00	.00	.00	.00
27	29	23	20	19	23	13	25	.00	.00	.00	.00	.00
28	26	25	21	18	25	25	16	.00	.00	.00	.00	.00
29	35	33	17	18	---	8.0	10	.00	.00	.00	.00	.00
30	41	31	28	16	---	20	31	.00	.00	.00	.00	.00
31	47	---	28	15	---	6.0	---	.00	---	.00	.00	---
TOTAL	850.00	915	771	569	567	570.0	387.0	47.00	14.00	0.00	0.00	0.00
MEAN	27.4	30.5	24.9	18.4	20.2	18.4	12.9	1.52	.47	.000	.000	.000
MAX	54	54	32	26	29	31	46	13	2.0	.00	.00	.00
MIN	.00	10	17	13	11	2.0	1.0	.00	.00	.00	.00	.00
AC-FT	1690	1810	1530	1130	1120	1130	768	93	28	.00	.00	.00

## STATISTICS OF MONTHLY MEAN DATA FOR WATER YEARS 1995 - 2001, BY WATER YEAR (WY)

	1995	1996	1997	1998	1999	2000	2001	2002	2003	2004	2005	
MEAN	39.1	87.4	176	974	1130	1303	670	1057	368	21.5	7.16	19.4
MAX	53.0	325	475	3344	3089	3316	1677	3679	1903	69.1	31.4	43.0
(WY)	1995	1999	1999	1997	1996	1995	1995	1995	1998	1998	1998	1998
MIN	21.5	30.5	24.9	18.4	20.2	18.4	12.9	1.52	.47	.000	.000	.000
(WY)	1995	2001	2001	2001	2001	2001	2001	2001	2001	2001	2000	2000

## SUMMARY STATISTICS

	FOR 2000 CALENDAR YEAR		FOR 2001 WATER YEAR		WATER YEARS 1995 - 2001	
ANNUAL TOTAL	36081.00		4690.00			
ANNUAL MEAN	98.6		12.8		485	
HIGHEST ANNUAL MEAN					997	
LOWEST ANNUAL MEAN					12.8	
HIGHEST DAILY MEAN	1610	Feb 16	54	Oct 14	16800	Jan 3 1997
LOWEST DAILY MEAN	.00	Aug 1	.00	Oct 1	.00	Oct 1 1994
ANNUAL SEVEN-DAY MINIMUM	.00	Aug 1	.00	Oct 1	.00	Aug 3 1995
ANNUAL RUNOFF (AC-FT)	71570		9300		351500	
10 PERCENT EXCEEDS	133		31		1490	
50 PERCENT EXCEEDS	28		10		53	
90 PERCENT EXCEEDS	.00		.00		1.0	

## 11354200 PIT NO. 1 POWERPLANT NEAR FALL RIVER MILLS, CA

LOCATION.—Lat 40°59'28", long 121°29'49", in SE 1/4 NE 1/4 sec.10, T.37 N., R.4 E., Shasta County, Hydrologic Unit 18020003, on right bank of Pit River, 2.3 mi downstream from Pit River Falls, and 3.2 mi southwest of Fall River Mills.

PERIOD OF RECORD.—October 1986 to current year. Unpublished records for water years 1973–86 available in files of the U.S. Geological Survey. Fragmentary record for water years 1922–72 available in files of the Pacific Gas & Electric Co.

GAGE.—Discharge computed from powerplant output.

REMARKS.—Water is diverted from Fall River at Pit No. 1 Forebay at NW 1/4 SW 1/4 sec.25, T.37 N., R.4 E., through a tunnel to powerplant and then into Pit River. See schematic diagram of [Pit and McCloud River Basins](#).

COOPERATION.—Records were collected by Pacific Gas & Electric Co., under general supervision of the U.S. Geological Survey, in connection with a Federal Energy Regulatory Commission project.

EXTREMES FOR PERIOD OF RECORD.—Maximum daily discharge, 2,490 ft<sup>3</sup>/s, Mar. 13, 1995; no flow several days most years.

## DISCHARGE, CUBIC FEET PER SECOND, WATER YEAR OCTOBER 2000 TO SEPTEMBER 2001

## DAILY MEAN VALUES

DAY	OCT	NOV	DEC	JAN	FEB	MAR	APR	MAY	JUN	JUL	AUG	SEP
1	1200	1330	1220	1270	1030	1350	1330	1270	1090	1130	1100	1090
2	1190	1310	1370	1340	1170	1190	1300	1270	982	1090	1060	1090
3	1220	1320	1330	1310	1050	1380	1300	1300	1360	1090	1120	1090
4	1270	1330	1300	1310	1220	1110	1310	1210	1140	1110	1150	1100
5	1200	422	1310	1410	1340	1390	1260	1190	1120	1080	1090	1110
6	1330	.00	1290	1260	1320	1290	1370	1280	1090	1060	1110	1060
7	1270	.00	1320	1240	1270	1320	1220	1290	1160	1080	1100	1090
8	1280	.00	1300	1310	1240	1340	1380	1220	1110	1000	1090	1080
9	1270	.00	1300	1370	1200	1320	1300	1200	1140	1160	1090	1120
10	1340	.00	1330	1310	1380	1330	1310	1190	1130	1070	1100	1110
11	1410	.00	1280	1300	1260	1320	1270	1190	1120	1110	1090	1080
12	1310	.00	1330	1340	1320	1180	1260	1120	1110	1120	1120	1090
13	1310	.00	1250	1340	1240	1230	1300	1140	873	1120	1080	1160
14	1320	.00	1450	1320	1320	1300	1520	1180	1120	1130	1100	1170
15	1360	.00	1360	1330	1270	1310	1360	1470	1110	1100	1080	1170
16	1310	.00	1370	1190	1290	1330	1380	1460	1160	1080	1100	1140
17	1330	.00	1270	1280	1140	1230	1530	1300	1030	1030	1100	1120
18	1330	.00	1260	1300	1360	1220	1380	1270	1120	1100	1080	1170
19	1300	.00	1310	1290	1330	1310	1310	1210	1090	1130	1100	1150
20	1290	.00	1290	1420	1260	1310	1410	1190	1090	1100	1090	1160
21	1350	.00	1340	1190	1290	1330	1450	1160	1090	1100	1120	1140
22	1350	676	1290	1250	1320	1320	1300	1150	1030	1140	1100	1270
23	1310	1220	1350	1300	1330	1280	1330	1130	1150	1070	1110	1100
24	1260	1340	1320	1290	1310	1290	1340	1010	1080	1080	1140	1080
25	1280	1350	1340	1350	1300	1290	1340	1220	1080	1110	1130	1170
26	948	1190	1270	1310	1330	1320	1350	1200	1080	1090	1110	1200
27	1310	1360	1300	1310	1330	1380	1330	1110	1170	1080	1100	1180
28	1290	1280	1330	1210	1340	1350	1300	1130	1100	1110	966	1180
29	1350	1280	1280	1310	---	1330	1300	1120	1150	1090	1280	1170
30	1390	1450	1190	1270	---	1260	1290	1170	1140	1080	1130	1140
31	1340	---	1310	866	---	1380	---	1140	---	1110	1040	---
TOTAL	40018	16858.00	40560	39896	35560	40290	40130	37490	33215	33950	34176	33980
MEAN	1291	562	1308	1287	1270	1300	1338	1209	1107	1095	1102	1133
MAX	1410	1450	1450	1420	1380	1390	1530	1470	1360	1160	1280	1270
MIN	948	.00	1190	866	1030	1110	1220	1010	873	1000	966	1060
AC-FT	79380	33440	80450	79130	70530	79920	79600	74360	65880	67340	67790	67400

## STATISTICS OF MONTHLY MEAN DATA FOR WATER YEARS 1987 - 2001, BY WATER YEAR (WY)

MEAN	1160	1136	1180	1268	1321	1467	1456	1358	1197	1105	1087	1108
MAX	1394	1527	1533	1720	1871	1972	1927	1939	1698	1412	1379	1278
(WY)	1999	1999	1999	1998	1998	1995	1995	1998	1998	1998	1998	2000
MIN	941	562	987	996	749	1053	1014	947	914	844	835	900
(WY)	1995	2001	1995	1992	1994	1992	1994	1992	1994	1992	1992	1994

## SUMMARY STATISTICS

## FOR 2000 CALENDAR YEAR

## FOR 2001 WATER YEAR

## WATER YEARS 1987 - 2001

ANNUAL TOTAL	491919.00	426123.00	
ANNUAL MEAN	1344	1167	1236
HIGHEST ANNUAL MEAN			1572
LOWEST ANNUAL MEAN			955
HIGHEST DAILY MEAN	2110	Apr 14	2490
LOWEST DAILY MEAN	.00	Nov 6	.00
ANNUAL SEVEN-DAY MINIMUM	.00	Nov 6	.00
ANNUAL RUNOFF (AC-FT)	975700	845200	895700
10 PERCENT EXCEEDS	1730	1350	1660
50 PERCENT EXCEEDS	1320	1220	1190
90 PERCENT EXCEEDS	1180	1080	955

## 11355010 PIT RIVER BELOW PIT NO. 1 POWERPLANT, NEAR FALL RIVER MILLS, CA

LOCATION.—Lat 40°59'00", long 121°30'39", in NE 1/4 NW 1/4 sec.15, T.36 N., R.4 E., [Shasta County](#), Hydrologic Unit 18020003, on left bank, 0.9 mi downstream from Pit No. 1 Powerplant, and 4 mi southwest of Fall River Mills.

DRAINAGE AREA.—3,761 mi<sup>2</sup>, excluding Goose Lake Basin.

PERIOD OF RECORD.—August 1975 to current year.

GAGE.—Water-stage recorder and crest-stage gage. Elevation of gage is 2,798.21 ft above sea level (levels by Pacific Gas and Electric Co.).

REMARKS.—Records good. Low flow regulated by many small reservoirs (total usable reservoir capacity, 210,000 acre-ft) and Pit No. 1 Powerplant. Many diversions upstream from station for irrigation. See schematic diagram of [Pit and McCloud River Basins](#).

EXTREMES FOR PERIOD OF RECORD.—Maximum discharge, 30,000 ft<sup>3</sup>/s, Feb. 20, 1986, gage height, 17.03 ft; minimum daily, 535 ft<sup>3</sup>/s, Sept. 11, 1994.

EXTREMES OUTSIDE PERIOD OF RECORD.—Flood of January 1974 reached a stage of 14.8 ft, from floodmarks on right bank, discharge 22,600 ft<sup>3</sup>/s.

EXTREMES FOR CURRENT YEAR.—Peak discharges greater than base discharge of 4,000 ft<sup>3</sup>/s, or maximum:

Date	Time	Discharge (ft <sup>3</sup> /s)	Gage height (ft)
Jan. 29	1900	2650	7.09

## DISCHARGE, CUBIC FEET PER SECOND, WATER YEAR OCTOBER 2000 TO SEPTEMBER 2001

## DAILY MEAN VALUES

DAY	OCT	NOV	DEC	JAN	FEB	MAR	APR	MAY	JUN	JUL	AUG	SEP
1	1390	1790	1670	1510	1330	1760	1540	1460	1270	1280	1240	1230
2	1380	1760	1780	1590	1470	1640	1510	1620	1120	1240	1210	1240
3	1410	1640	1710	1700	1340	1760	1600	1570	1490	1250	1290	1240
4	1450	1740	1680	1690	1440	1360	1530	1460	1310	1270	1290	1250
5	1380	1380	1690	1740	1610	1670	1500	1410	1290	1220	1230	1260
6	1510	1640	1660	1560	1650	1690	1550	1430	1270	1230	1250	1270
7	1460	1720	1660	1470	1590	1700	1420	1420	1320	1240	1240	1260
8	1460	1670	1640	1590	1580	1700	1580	1430	1270	1160	1230	1240
9	e1480	1680	1650	1720	1520	1700	1570	1460	1290	1320	1260	1290
10	e1580	1670	1650	1670	1680	1670	1700	1450	1290	1230	1230	1280
11	e1600	1650	1640	1650	1510	1560	1500	1450	1270	1280	1220	1240
12	e1620	1610	1700	1730	1560	1430	1480	1380	1270	1300	1250	1260
13	e1660	1700	1630	1730	1590	1580	1530	1340	1270	1290	1210	1310
14	e1680	1750	1760	1660	1620	1660	1730	1370	1280	1290	1250	1330
15	e1680	1720	1780	1580	1580	1650	1560	1670	1270	e1250	1220	1330
16	e1680	1700	1760	1460	1610	1640	1580	1710	1300	e1230	1230	1310
17	1710	1700	1580	1650	1440	1540	1750	1550	1200	e1170	1240	1280
18	1700	1670	1700	1710	1590	1450	1670	1550	1280	e1250	1210	1320
19	1680	1600	1720	1660	1560	1520	1670	1490	1250	e1290	1230	1300
20	1670	1700	1660	1660	1530	1590	1620	1360	1250	e1250	1220	1310
21	1690	1580	1690	1510	1670	1590	1650	1330	1250	1250	1230	1300
22	1590	1850	1640	1550	1790	1540	1530	1360	1190	1280	1240	1390
23	1570	1580	1690	1560	1790	1500	1570	1360	1300	1210	1250	1250
24	1610	1660	1570	1590	1700	1590	1710	1220	1230	1250	1280	1240
25	1620	1670	1580	1610	1550	1530	1550	1400	1240	1240	1290	1330
26	1680	1500	1550	1600	1620	1550	1540	1380	1240	1230	1270	1360
27	1680	1670	1690	1640	1720	1730	1520	1300	1340	1220	1250	1350
28	1660	1640	1630	1610	1740	1590	1480	1300	1330	1240	1100	1360
29	1600	1700	1590	1810	---	1550	1490	1300	1320	1220	1410	1350
30	1650	1820	1560	1840	---	1600	1480	1350	1300	1220	1280	1320
31	1820	---	1560	1300	---	1600	---	1320	---	1250	1190	---
TOTAL	49350	50160	51470	50350	44380	49640	47110	44200	38300	38650	38540	38800
MEAN	1592	1672	1660	1624	1585	1601	1570	1426	1277	1247	1243	1293
MAX	1820	1850	1780	1840	1790	1760	1750	1710	1490	1320	1410	1390
MIN	1380	1380	1550	1300	1330	1360	1420	1220	1120	1160	1100	1230
AC-FT	97890	99490	102100	99870	88030	98460	93440	87670	75970	76660	76440	76960

e Estimated.

## 11355010 PIT RIVER BELOW PIT NO. 1 POWERPLANT, NEAR FALL RIVER MILLS, CA—Continued

## STATISTICS OF MONTHLY MEAN DATA FOR WATER YEARS 1975 - 2001, BY WATER YEAR (WY)

	OCT	NOV	DEC	JAN	FEB	MAR	APR	MAY	JUN	JUL	AUG	SEP
MEAN	1410	1640	1824	2312	2887	3234	2565	2309	1685	1324	1283	1321
MAX	1776	3181	3834	6060	8539	6539	5614	6883	4582	1809	1618	1628
(WY)	1999	1982	1984	1997	1986	1993	1982	1995	1998	1998	1998	1998
MIN	939	1133	1214	1222	1268	1294	1173	1050	1012	954	828	784
(WY)	1995	1993	1993	1991	1994	1992	1992	1992	1992	1994	1994	1994

SUMMARY STATISTICS	FOR 2000 CALENDAR YEAR		FOR 2001 WATER YEAR		WATER YEARS 1975 - 2001	
ANNUAL TOTAL	691400		540950			
ANNUAL MEAN	1889		1482		1977	
HIGHEST ANNUAL MEAN					2914	
LOWEST ANNUAL MEAN					1149	
HIGHEST DAILY MEAN	4170	Mar 8	1850	Nov 22	28800	Feb 20 1986
LOWEST DAILY MEAN	1200	Aug 10	1100	Aug 28	535	Sep 11 1994
ANNUAL SEVEN-DAY MINIMUM	1360	Jun 28	1230	Aug 15	663	Sep 7 1994
MAXIMUM PEAK FLOW			2650	Jan 29	30000	Feb 20 1986
MAXIMUM PEAK STAGE			7.09	Jan 29	17.03	Feb 20 1986
ANNUAL RUNOFF (AC-FT)	1371000		1073000		1432000	
10 PERCENT EXCEEDS	2680		1700		3310	
50 PERCENT EXCEEDS	1670		1520		1520	
90 PERCENT EXCEEDS	1410		1240		1170	

## 11358020 LOST CREEK BELOW DIVERSION TO LOST CREEK POWERPLANT NO. 1, NEAR OLD STATION, CA

LOCATION.—Lat 40°45'35", long 121°24'46", in NW 1/4 SW 1/4 sec.34, T.34 N., R.5 E., Shasta County, Hydrologic Unit 18020003, on right bank, 0.4 mi downstream from Lost Creek Diversion Dam, 2.5 mi downstream from Porcupine Reservoir, 6.0 mi north of Old Station, and 13.2 mi southeast of Cassel.

DRAINAGE AREA.—7.53 mi<sup>2</sup>.

PERIOD OF RECORD.—October 1989 to September 1997, October 1998 to current year (operated as low-flow station only).

GAGE.—Water-stage recorder and sharp-crested weir. Elevation of gage is 3,900 ft above sea level, from topographic map.

REMARKS.—During times of powerplant operation, the minimum release requirement is 15 ft<sup>3</sup>/s; flow is computed to 80 ft<sup>3</sup>/s. See schematic diagram of Pit and McCloud River Basins.

COOPERATION.—Records were collected by Snow Mountain Hydro, under general supervision of the U.S. Geological Survey, in connection with a Federal Energy Regulatory Commission project.

DISCHARGE, CUBIC FEET PER SECOND, WATER YEAR OCTOBER 2000 TO SEPTEMBER 2001  
DAILY MEAN VALUES

DAY	OCT	NOV	DEC	JAN	FEB	MAR	APR	MAY	JUN	JUL	AUG	SEP
1	17	16	16	15	15	16	16	16	16	16	16	16
2	16	16	16	15	16	20	16	16	16	16	16	16
3	17	17	17	16	16	16	16	16	16	16	16	16
4	16	16	19	16	16	15	16	16	16	16	16	16
5	16	17	16	16	16	16	16	16	16	16	16	18
6	16	17	16	15	15	15	16	16	16	16	16	16
7	16	17	16	16	15	16	16	16	16	31	16	16
8	17	17	17	15	16	15	16	16	16	22	16	16
9	17	16	16	16	15	15	16	16	16	20	16	16
10	16	17	16	15	15	15	16	16	16	22	16	18
11	17	16	17	16	15	16	16	16	16	20	16	16
12	16	16	17	16	16	16	16	16	16	18	16	19
13	17	17	17	16	16	18	16	16	16	16	16	16
14	17	16	16	15	16	15	16	16	16	16	16	16
15	17	16	16	15	15	16	16	16	16	16	16	16
16	17	16	17	16	16	18	16	16	35	16	16	19
17	16	17	17	15	16	16	16	16	16	20	16	16
18	17	17	16	15	16	16	16	16	16	16	16	16
19	17	17	16	15	15	16	16	16	16	16	16	16
20	16	17	16	16	16	16	16	16	16	16	16	16
21	16	16	16	16	29	16	16	16	16	16	16	16
22	17	17	15	15	50	16	16	16	16	16	16	16
23	17	16	15	15	15	16	16	16	16	16	16	16
24	16	17	16	15	16	16	16	16	16	16	16	16
25	16	17	16	15	16	16	16	16	16	16	16	16
26	16	16	15	15	15	16	16	16	16	16	16	21
27	17	16	16	16	16	16	16	16	16	16	16	16
28	21	17	16	16	15	16	16	16	16	16	16	16
29	16	17	15	15	---	16	16	16	16	16	16	16
30	17	16	15	16	---	18	16	16	16	16	16	16
31	17	---	20	16	---	16	---	16	---	16	16	---
TOTAL	517	496	505	480	484	500	480	496	499	537	496	495
MEAN	16.7	16.5	16.3	15.5	17.3	16.1	16.0	16.0	16.6	17.3	16.0	16.5
MAX	21	17	20	16	50	20	16	16	35	31	16	21
MIN	16	16	15	15	15	15	16	16	16	16	16	16
AC-FT	1030	984	1000	952	960	992	952	984	990	1070	984	982
a	3070	2980	3110	3140	2710	3040	2920	2870	2750	2720	2760	2650

a Discharge, in acre-feet, for Lost Creek Powerplant No. 1 (station 11358010), provided by Snow Mountain Hydro.

## 11358700 HAT CREEK BELOW HAT NO. 1 DIVERSION DAM, NEAR BURNEY, CA

LOCATION.—Lat 40°55'08", long 121°33'02", in NW 1/4 SW 1/4 sec.5, T.36 N., R.4 E., Shasta County, Hydrologic Unit 18020003, on right bank, at Hat No. 1 Diversion Dam on Hat Creek, and 6.5 mi northeast of Burney.

DRAINAGE AREA.—347 mi<sup>2</sup>.

PERIOD OF RECORD.—Oct. 1 to Dec. 8, 1987 (fragmentary); Dec. 9, 1987, to current year (operated as a low-flow station only). Unpublished fragmentary records for water years 1980–87 available in files of the U.S. Geological Survey.

GAGE.—Water-stage recorder and Cipolletti weir. Elevation of gage is 3,180 ft above sea level, from topographic map.

REMARKS.—This station records fishwater release only. The minimum release requirement is 2.0 ft<sup>3</sup>/s at all times. Flow is computed to 9.0 ft<sup>3</sup>/s. See schematic diagram of Pit and McCloud River Basins.

COOPERATION.—Records were collected by Pacific Gas & Electric Co., under general supervision of the U.S. Geological Survey, in connection with a Federal Energy Regulatory Commission project.

DISCHARGE, CUBIC FEET PER SECOND, WATER YEAR OCTOBER 2000 TO SEPTEMBER 2001  
DAILY MEAN VALUES

DAY	OCT	NOV	DEC	JAN	FEB	MAR	APR	MAY	JUN	JUL	AUG	SEP
1	3.0	2.9	3.3	3.4	3.4	3.2	3.3	3.2	3.2	3.1	3.3	3.2
2	2.9	3.0	3.4	3.4	3.5	3.2	3.3	3.2	3.2	3.0	3.3	3.2
3	2.9	3.0	3.4	3.4	3.5	3.2	3.3	3.2	3.2	3.0	3.3	3.2
4	2.9	3.0	3.4	3.4	3.5	3.2	3.3	3.2	3.1	3.0	3.3	3.3
5	2.9	3.0	3.3	3.5	3.5	3.2	3.3	4.2	3.2	3.1	3.3	3.3
6	2.8	3.0	3.4	3.5	3.4	3.2	3.3	4.5	3.2	3.0	3.3	3.4
7	2.7	3.0	3.3	3.5	3.5	3.2	3.3	4.5	3.2	3.0	3.3	3.4
8	2.6	3.2	3.4	3.4	3.5	3.2	3.3	3.9	3.2	3.2	3.3	3.3
9	2.7	3.2	3.4	3.4	3.5	3.2	3.3	3.4	3.1	3.4	3.3	3.3
10	2.8	3.2	3.4	3.8	3.4	3.2	3.3	3.3	3.1	3.2	3.3	3.3
11	3.0	3.1	3.4	3.6	3.4	3.2	3.3	3.2	3.1	3.2	3.3	3.3
12	3.2	3.1	3.4	3.6	3.4	3.2	3.3	3.2	3.1	3.2	3.2	3.2
13	3.1	3.1	3.4	3.6	3.4	3.2	3.3	3.2	3.3	3.3	3.2	3.2
14	3.0	3.1	3.4	3.5	3.4	3.2	3.2	3.2	3.4	3.3	3.1	3.2
15	3.0	3.2	3.4	3.5	3.4	3.2	3.2	3.2	3.4	3.2	3.1	3.2
16	3.0	3.2	3.4	3.5	3.4	3.2	3.2	3.2	3.4	3.2	3.1	3.0
17	3.0	3.1	3.4	3.5	3.4	3.2	3.2	3.2	3.4	3.2	3.1	3.0
18	3.0	3.1	3.4	3.5	3.4	3.2	3.2	3.1	3.4	3.3	3.0	3.1
19	3.0	3.1	3.4	3.5	3.4	3.2	3.2	3.1	3.4	3.3	3.1	3.3
20	3.0	3.2	3.4	3.5	3.4	3.2	3.2	3.1	3.3	3.4	3.1	3.1
21	3.0	3.2	3.4	3.5	3.3	3.3	3.1	3.1	3.3	3.4	3.1	3.1
22	3.0	3.2	3.4	3.5	3.2	3.3	3.1	3.1	3.3	3.4	3.1	3.0
23	3.0	3.2	3.5	---	3.2	3.3	3.1	3.1	3.3	3.4	3.2	3.1
24	3.0	3.2	3.5	3.4	3.2	3.3	3.1	3.1	3.3	3.4	3.2	3.0
25	3.0	3.2	3.5	3.4	3.2	3.3	3.1	3.1	3.3	3.5	3.2	3.0
26	3.0	3.2	3.5	3.4	3.2	3.3	3.1	3.2	3.2	3.4	3.2	3.2
27	3.0	3.2	3.4	3.4	3.2	3.3	3.2	3.2	3.2	3.4	3.2	3.3
28	2.9	3.2	3.5	3.4	3.1	3.3	3.2	3.2	3.2	3.2	3.2	3.4
29	2.9	3.3	3.4	3.4	---	3.3	3.3	3.2	3.2	3.2	3.2	3.4
30	2.9	3.3	3.4	3.4	---	3.3	3.2	3.2	3.1	3.2	3.2	3.3
31	2.9	---	3.4	3.4	---	3.3	---	3.2	---	3.2	3.2	---
TOTAL	91.1	94.0	105.6	---	94.3	100.3	96.8	103.0	97.3	100.3	99.3	96.3
MEAN	2.94	3.13	3.41	---	3.37	3.24	3.23	3.32	3.24	3.24	3.20	3.21
MAX	3.2	3.3	3.5	---	3.5	3.3	3.3	4.5	3.4	3.5	3.3	3.4
MIN	2.6	2.9	3.3	---	3.1	3.2	3.1	3.1	3.1	3.0	3.0	3.0
AC-FT	181	186	209	---	187	199	192	204	193	199	197	191



## 11358800 HAT CREEK NO. 1 POWERPLANT NEAR BURNEY, CA

LOCATION.—Lat 40°55'45", long 121°32'37", in SW 1/4 SW 1/4 sec.32, T.36 N., R.4 E., Shasta County, Hydrologic Unit 18020003, on right bank of Hat Creek, at the upper end of Baum Lake, and 7.4 mi northeast of Burney.

PERIOD OF RECORD.—October 1986 to current year. Unpublished records for water years 1981–86 available in files of the U.S. Geological Survey. Fragmentary records for water years 1921–80 available in the files of the Pacific Gas & Electric Co.

GAGE.—Discharge computed from powerplant output.

REMARKS.—Water is diverted from left bank of Hat Creek at NW 1/4 SW 1/4 sec.5, T.36 N., R.8 W., through a canal to powerplant and then into Hat Creek. See schematic diagram of Pit and McCloud River Basins.

COOPERATION.—Records were collected by Pacific Gas & Electric Co., under general supervision of the U.S. Geological Survey, in connection with a Federal Energy Regulatory Commission project.

EXTREMES FOR PERIOD OF RECORD.—Maximum daily discharge, 518 ft<sup>3</sup>/s, Nov. 2, 1998; no flow several days most years.

DISCHARGE, CUBIC FEET PER SECOND, WATER YEAR OCTOBER 2000 TO SEPTEMBER 2001  
DAILY MEAN VALUES

DAY	OCT	NOV	DEC	JAN	FEB	MAR	APR	MAY	JUN	JUL	AUG	SEP
1	331	407	389	392	386	386	334	317	293	296	291	286
2	337	406	404	391	388	374	350	306	292	297	291	286
3	343	408	373	391	387	384	354	305	292	296	293	286
4	341	411	404	391	388	386	351	305	295	289	295	286
5	333	410	387	393	388	390	339	304	295	288	290	286
6	335	384	402	392	388	390	355	304	297	288	288	278
7	335	410	402	393	388	388	368	304	298	291	289	291
8	335	395	401	396	386	388	373	305	298	294	288	290
9	335	393	401	394	389	392	376	310	297	292	292	286
10	335	413	401	395	390	388	369	306	298	289	287	287
11	335	411	399	396	391	385	363	300	297	290	286	289
12	335	408	400	394	388	383	360	289	296	290	285	291
13	335	406	402	394	387	384	352	289	295	290	284	294
14	335	390	405	393	386	382	355	289	293	291	283	294
15	335	410	401	391	386	381	353	295	290	294	285	295
16	335	409	400	391	386	381	344	296	288	295	289	296
17	335	407	399	389	386	378	315	305	286	292	288	297
18	335	404	394	388	388	379	310	309	287	294	285	300
19	335	404	394	388	390	380	314	296	285	296	282	294
20	335	405	397	390	390	379	321	302	283	296	281	294
21	335	405	399	389	375	382	329	303	294	295	277	292
22	335	404	398	389	393	383	328	301	286	296	278	285
23	335	403	396	318	391	379	331	302	288	298	284	285
24	369	403	396	386	392	378	328	301	289	296	288	285
25	407	404	396	388	392	373	321	300	292	294	286	297
26	339	405	395	388	392	369	314	299	296	293	285	294
27	409	404	394	387	389	358	316	298	304	294	286	294
28	397	405	394	386	387	362	313	296	306	293	287	297
29	419	416	393	387	---	361	313	294	303	296	286	297
30	415	411	345	388	---	313	320	293	299	292	284	296
31	412	---	393	387	---	356	---	294	---	289	287	---
TOTAL	10882	12151	12254	12035	10867	11692	10169	9317	8812	9084	8880	8728
MEAN	351	405	395	388	388	377	339	301	294	293	286	291
MAX	419	416	405	396	393	392	376	317	306	298	295	300
MIN	331	384	345	318	375	313	310	289	283	288	277	278
AC-FT	21580	24100	24310	23870	21550	23190	20170	18480	17480	18020	17610	17310
a	31250	31690	32070	31510	28270	30610	27430	25740	24290	24900	24590	23970

## STATISTICS OF MONTHLY MEAN DATA FOR WATER YEARS 1987 - 2001, BY WATER YEAR (WY)

	302	320	342	347	329	344	316	288	297	285	267	271
MEAN	302	320	342	347	329	344	316	288	297	285	267	271
MAX	432	437	433	422	431	408	393	384	430	410	344	349
(WY)	1987	1999	1999	1997	1999	2000	1999	1998	1998	1998	1998	1998
MIN	187	72.5	248	266	69.5	258	203	150	200	195	170	192
(WY)	1993	1990	1995	1993	1996	1992	1992	1991	1994	1994	1992	1994

## SUMMARY STATISTICS

	FOR 2000 CALENDAR YEAR		FOR 2001 WATER YEAR		WATER YEARS 1987 - 2001	
ANNUAL TOTAL	135703		124871			
ANNUAL MEAN	371		342		309	
HIGHEST ANNUAL MEAN					383	
LOWEST ANNUAL MEAN					225	
HIGHEST DAILY MEAN	440		Feb 27		518	
LOWEST DAILY MEAN	282		Aug 3		.00	
ANNUAL SEVEN-DAY MINIMUM	317		Aug 1		.00	
ANNUAL RUNOFF (AC-FT)	269200		247700		223700	
10 PERCENT EXCEEDS	418		402		409	
50 PERCENT EXCEEDS	364		335		303	
90 PERCENT EXCEEDS	325		288		210	

a Discharge, in acre-feet, for Hat Creek No. 2 Powerplant (station 11359300), provided by Pacific Gas & Electric Co.

## 11359100 HAT NO. 2 POWER CANAL DIVERSION TO HAT CREEK, NEAR BURNEY, CA

LOCATION.—Lat 40°57'01", long 121°32'39", in SE 1/4 NW 1/4 sec.29, T.36 N., R.4 E., Shasta County, Hydrologic Unit 18020003, on right bank of Hat No. 2 Power Canal, 75 ft downstream from Hat No. 2 Diversion Dam on Hat Creek, and 7.9 mi northeast of Burney.

PERIOD OF RECORD.—Oct. 1 to Dec. 9, 1987 (fragmentary); Dec. 10, 1987, to current year (operated as a low-flow station only). Unpublished fragmentary records for water years 1979–87 available in files of the U.S. Geological Survey.

GAGE.—Water-stage recorder and Parshall flume. Elevation of gage is 2,980 ft above sea level, from topographic map.

REMARKS.—This station records fishwater release only. The minimum release requirement is 8.0 ft<sup>3</sup>/s at all times. Flow is computed to 15 ft<sup>3</sup>/s. See schematic diagram of Pit and McCloud River Basins.

COOPERATION.—Records were collected by Pacific Gas & Electric Co., under general supervision of the U.S. Geological Survey, in connection with a Federal Energy Regulatory Commission project.

## DISCHARGE, CUBIC FEET PER SECOND, WATER YEAR OCTOBER 2000 TO SEPTEMBER 2001

## DAILY MEAN VALUES

DAY	OCT	NOV	DEC	JAN	FEB	MAR	APR	MAY	JUN	JUL	AUG	SEP
1	9.8	9.6	9.7	9.5	9.2	9.4	9.2	9.6	9.3	9.4	9.2	9.5
2	9.8	9.5	9.6	9.5	9.2	9.4	9.2	9.4	9.3	9.5	9.2	9.4
3	9.9	9.5	9.6	9.4	9.3	9.4	9.2	9.6	9.3	9.5	9.2	9.5
4	9.9	9.6	9.6	9.4	9.3	9.4	9.2	9.4	9.3	9.4	9.3	9.5
5	9.8	9.6	9.5	9.4	9.3	9.4	9.2	9.4	9.3	9.4	9.1	9.5
6	9.9	9.6	9.5	9.4	9.3	9.4	9.2	9.4	9.3	9.4	9.3	9.6
7	9.9	9.7	9.5	9.4	9.3	9.4	9.4	9.4	9.3	9.5	9.7	9.5
8	10	9.7	9.5	9.4	9.4	9.4	9.4	9.5	9.4	9.6	9.8	9.5
9	9.9	9.7	9.6	9.4	9.4	9.5	9.4	9.6	9.4	9.5	9.8	9.5
10	10	9.7	9.6	9.4	9.4	9.5	9.4	9.5	9.4	9.6	9.7	9.5
11	10	9.7	9.6	9.5	9.4	9.5	9.3	9.5	9.3	9.5	9.7	9.5
12	9.8	9.6	9.6	9.4	9.4	9.5	9.3	9.2	9.4	9.5	9.6	9.6
13	9.6	9.6	9.6	9.4	9.4	9.4	9.2	9.2	9.4	9.5	9.5	9.6
14	9.7	9.6	9.7	9.4	9.4	9.4	9.2	9.2	9.4	9.5	9.5	9.7
15	9.7	9.6	9.6	9.4	9.4	9.4	9.2	9.3	9.3	9.6	9.6	9.6
16	9.7	9.6	9.6	9.4	9.4	9.4	9.2	9.4	9.3	9.6	9.7	9.6
17	9.7	9.6	9.5	9.4	9.4	9.4	9.0	9.5	9.3	9.5	9.6	9.6
18	9.6	9.5	9.5	9.3	9.4	9.4	10	9.5	9.4	9.5	9.6	9.5
19	9.6	9.5	9.5	9.3	9.4	9.4	9.8	9.3	9.3	9.6	9.5	9.3
20	9.6	9.5	9.5	9.3	9.4	9.4	9.5	9.2	9.2	9.6	9.5	9.3
21	9.7	9.6	9.6	9.4	9.4	9.4	9.7	9.3	9.3	9.6	9.4	9.3
22	9.7	9.5	9.6	9.4	9.5	9.4	9.6	9.4	9.4	9.6	9.4	9.2
23	9.7	9.5	9.6	9.3	9.5	9.4	9.6	9.4	9.3	9.7	9.5	9.1
24	9.7	9.5	9.6	9.4	9.4	9.4	9.5	9.4	9.5	9.6	9.5	9.2
25	9.6	9.5	9.5	9.3	9.5	9.4	9.5	9.3	9.4	9.3	9.4	9.3
26	9.7	9.5	9.5	9.2	9.5	9.4	9.4	9.2	9.5	9.4	9.5	9.3
27	9.7	9.5	9.5	9.3	9.5	9.3	9.5	9.4	9.6	9.3	9.5	9.3
28	9.7	9.5	9.5	9.3	9.4	9.3	9.6	9.2	9.7	9.1	9.5	9.3
29	9.7	9.6	9.5	9.3	---	9.3	9.7	9.2	9.6	9.1	9.5	9.3
30	9.7	9.7	9.5	9.3	---	9.3	9.8	9.2	9.6	9.1	9.4	9.3
31	9.7	---	9.5	9.3	---	9.2	---	9.3	---	9.2	9.5	---
TOTAL	302.5	287.4	296.3	290.5	262.8	291.2	282.4	290.4	281.5	293.2	294.2	282.9
MEAN	9.76	9.58	9.56	9.37	9.39	9.39	9.41	9.37	9.38	9.46	9.49	9.43
MAX	10	9.7	9.7	9.5	9.5	9.5	10	9.6	9.7	9.7	9.8	9.7
MIN	9.6	9.5	9.5	9.2	9.2	9.2	9.0	9.2	9.2	9.1	9.1	9.1
AC-FT	600	570	588	576	521	578	560	576	558	582	584	561

## RESERVOIRS IN PIT AND McCLOUD RIVER BASINS, CA

- 11361400 LAKE BRITTON NEAR BURNEY.—Lat 41°1'20", long 121°40'32", in SW 1/4 SW 1/4 sec.19, T.37 N., R.3 E., [Shasta County](#), Hydrologic Unit 18020003, Shasta National Forest, at control house on right bank 200 ft upstream from dam on Pit River, 1.1 mi downstream from Clark Creek, 1.3 mi northwest of Burney Falls, and 9 mi north of Burney.
- DRAINAGE AREA.—4,607 mi<sup>2</sup>, excluding Goose Lake Basin.
- PERIOD OF RECORD.—October 1965 to current year (monthend contents only). Fragmentary records for water years 1925–65 in files of the Pacific Gas & Electric Co.
- GAGE.—Remote telemark read once daily. Datum of gage is 19.53 ft above sea level (levels by Pacific Gas & Electric Co.). Monthend contents based on capacity table dated Dec. 1, 1976, provided by Pacific Gas & Electric Co.
- REMARKS.—Reservoir is formed by gravity-type concrete dam. Storage began July 15, 1925. Usable capacity, 41,877 acre-ft between elevations 2,665.0 ft, invert of sluice gate, and 2,758.0 ft, top of flash boards. Dead storage, 30 acre-ft. Normal operating pool is from elevation 2,744.0 ft, capacity, 26,183 acre-ft, to 2,757.0 ft, capacity, 40,626 acre-ft. Figures given represent total contents. Lake is used for power generation and recreation. See schematic diagram of [Pit and McCloud River Basins](#). Records prior to water year 1977 reported usable contents only.
- COOPERATION.—Record of contents collected by Pacific Gas & Electric Co., under general supervision of the U.S. Geological Survey, in connection with a Federal Energy Regulatory Commission project. Contents not rounded to U.S. Geological Survey standards.
- EXTREMES (AT 2400) FOR PERIOD OF RECORD.—Maximum total contents, 47,922 acre-ft, Feb. 20, 1986, elevation, 2,762.50 ft; minimum total contents, 26,755 acre-ft, Oct. 9, 1976, elevation, 2,744.60 ft.
- EXTREMES (AT 2400) FOR CURRENT YEAR.—Maximum contents, 40,224 acre-ft, Nov. 26, elevation, 2,756.68 ft; minimum, 28,998 acre-ft, Mar. 9, elevation, 2,746.86 ft.
- 11363920 IRON CANYON RESERVOIR NEAR BIG BEND.—Lat 41°02'41", long 121°58'52", in SW 1/4 SE 1/4 sec.21, T.37 N., R.1 W., [Shasta County](#), Hydrologic Unit 18020003, Shasta National Forest, in control house on left bank 500 ft upstream from Iron Canyon Dam on Iron Canyon Creek, 3.7 mi northwest of Big Bend.
- DRAINAGE AREA.—11.1 mi<sup>2</sup>.
- PERIOD OF RECORD.—December 1965 to current year (monthend contents only).
- GAGE.—Water-stage recorder. Datum of gage is sea level (levels by Pacific Gas & Electric Co.). Monthend contents based on capacity table dated May 17, 1965, provided by Pacific Gas & Electric Co.
- REMARKS.—Reservoir is formed by a rockfill dam completed in 1965. Usable capacity is 24,197 acre-ft between elevations 2,525.00 ft, invert of sluice pipe, and 2,665.00 ft, crest of spillway. Dead storage, 44 acre-ft. Normal operating pool is from elevation 2,565.0 ft, capacity, 990 acre-ft, to 2,664.0 ft, capacity, 23,738 acre-ft. Water is diverted from Lake McCloud (station 11367740) through a tunnel to Iron Canyon Reservoir and then into the Pit River via James B. Black Powerplant (station 11363910). Figures given represent total contents. Water is used for power generation and recreation. See schematic diagram of [Pit and McCloud River Basins](#).
- COOPERATION.—Record of contents collected by Pacific Gas & Electric Co., under general supervision of the U.S. Geological Survey, in connection with a Federal Energy Regulatory Commission project. Contents not rounded to U.S. Geological Survey standards.
- EXTREMES (AT 2400) FOR PERIOD OF RECORD.—Maximum contents, 23,539 acre-ft, May 16, 22, 1977, elevation, 2,663.60 ft; normal minimum since reservoir first filled, 2,860 acre-ft, May 23, 24, 29, June 2, 7, 9, 14, 23, 24, 1966, elevation, 2,590.00 ft. Contents reduced to 195 acre-ft, elevation, 2,540.00 ft, Feb. 10, 1971, when reservoir was drained for inspection.
- EXTREMES (AT 2400) FOR CURRENT YEAR.—Maximum contents, 20,811 acre-ft, June 3, elevation, 2,657.90 ft; minimum, 5,182 acre-ft, Apr. 6, elevation, 2,607.30 ft.
- 11367740 LAKE McCLOUD NEAR McCLOUD.—Lat 41°08'06", long 122°04'26", in SE 1/4 SW 1/4 sec.22, T.38 N., R.2 W., [Shasta County](#), Hydrologic Unit 18020004, Shasta National Forest, on McCloud Dam near spillway on McCloud River, 200 ft downstream from Panther Creek, and 8.8 mi southeast of McCloud.
- DRAINAGE AREA.—403 mi<sup>2</sup>.
- PERIOD OF RECORD.—October 1965 to current year (monthend contents only).
- GAGE.—Water-stage recorder. Datum of gage is sea level (levels by Pacific Gas & Electric Co.). Monthend contents based on capacity table dated June 29, 1965, provided by Pacific Gas & Electric Co.
- REMARKS.—Reservoir is formed by a rockfill dam completed in 1965. Usable capacity, 35,231 acre-ft between elevations 2,471.30 ft, invert of sluice pipe, and 2,680.00 ft, maximum operational water surface. Dead storage, 3 acre-ft. Normal operating pool is from elevation 2,635.00 ft, capacity, 16,425 acre-ft, to 2,680.00 ft, capacity, 35,234 acre-ft. Water is diverted from Lake McCloud (station 11367740) through a diversion tunnel to Iron Canyon Reservoir (station 11363920) and then into the Pit River via James B. Black Powerplant (station 11363910). Figures given represent total contents. Water is used for power generation and recreation. See schematic diagram of [Pit and McCloud River Basins](#).
- COOPERATION.—Record of contents collected by Pacific Gas & Electric Co., under general supervision of the U.S. Geological Survey, in connection with a Federal Energy Regulatory Commission project. Contents not rounded to U.S. Geological Survey standards.
- EXTREMES (AT 2400) FOR PERIOD OF RECORD.—Maximum contents, 35,967 acre-ft, Jan. 15, 1974, elevation, 2,681.40 ft; minimum since reservoir first filled, 13,017 acre-ft, Oct. 14–22, 1981, elevation, 2,632.50 ft.
- EXTREMES (AT 2400) FOR CURRENT YEAR.—Maximum contents, 32,173 acre-ft, June 19, elevation, 2,673.90 ft; minimum, 17,700 acre-ft, Dec. 16, elevation, 2,638.90 ft.

## RESERVOIRS IN PIT AND McCLOUD RIVER BASINS, CA—Continued

## MONTH-END ELEVATION AND CONTENTS AT 2400 HOURS, WATER YEAR OCTOBER 2000 TO SEPTEMBER 2001

Date	11361400 LAKE BRITTON			11363920 IRON CANYON RESERVOIR			11367740 LAKE McCLOUD		
	Elevation (ft)	Contents (acre- ft)	Change in contents (acre- ft)	Elevation (ft)	Contents (acre- ft)	Change in contents (acre- ft)	Elevation (ft)	Contents acre- ft)	Change in contents (acre- ft)
Sept. 30 . . . . .	2,753.06	35,809	--	2,639.60	13,562	--	2,663.50	27,329	--
Oct. 31 . . . . .	2,755.37	38,593	+2,784	2,628.70	10,207	-3,355	2,651.20	22,179	-5,150
Nov. 30 . . . . .	2,755.62	38,892	+299	2,624.40	9,065	-1,142	2,648.10	20,096	-2,083
Dec. 31 . . . . .	2,754.69	35,756	-3,136	2,629.80	10,532	+1,467	2,646.00	20,228	+132
CAL YR 2000 . . . . .			-1,803			+2,293			+890
Jan. 31 . . . . .	2,753.99	36,917	+1,161	2,626.90	9,718	-814	2,647.80	20,885	+657
Feb. 28 . . . . .	2,752.44	35,087	-1,830	2,613.70	6,517	-3,201	2,646.40	20,382	-503
Mar. 31 . . . . .	2,755.92	39,267	+4,180	2,617.30	7,321	+804	2,658.80	25,298	+4,916
Apr. 30 . . . . .	2,755.90	39,242	-25	2,637.70	12,955	+5,634	2,662.70	26,962	+1,664
May 31 . . . . .	2,754.11	37,059	-2,183	2,650.60	17,654	+4,699	2,670.40	30,480	+3,518
June 30 . . . . .	2,754.28	37,261	+202	2,652.80	18,576	+922	2,673.70	32,035	+1,555
July 31 . . . . .	2,755.22	38,407	+1,146	2,651.70	18,107	-469	2,669.60	30,089	-1,946
Aug. 31 . . . . .	2,753.95	36,869	-1,538	2,643.90	15,063	-3,044	2,665.40	28,158	-1,931
Sept. 30 . . . . .	2,754.53	37,559	+690	2,648.60	16,864	+1,801	2,660.50	26,012	-2,146
WTR YR 2001 . . . . .			+1,750			+3,302			-1,317

## 11362500 PIT RIVER BELOW PIT NO. 4 DAM, CA

LOCATION.—Lat 40°58'25", long 121°46'42", unsurveyed, T.36 N., R.2 E., Shasta County, Hydrologic Unit 18020003, Shasta National Forest, on right bank, 0.6 mi downstream from Ruling Creek, 1.3 mi downstream from Pit No. 4 Dam, and 2.7 mi downstream from Pit No. 3 Powerplant.

DRAINAGE AREA.—4,648 mi<sup>2</sup>, excluding Goose Lake Basin.

PERIOD OF RECORD.—May 1922 to current year. Monthly discharge only for some periods, published in WSP 1315-A. Published as "near Pecks Bridge" April to October 1922, and as "at Lindsay Flat" November 1922 to June 1927.

REVISED RECORDS.—WSP 843: 1935(M). WSP 1315-A: 1928(M). WDR CA-75-4: Drainage area.

GAGE.—Water-stage recorder. Elevation of gage is 2,358 ft above sea level, from river-profile map. Prior to November 1922, water-stage recorder at site at Pecks Bridge 7.4 mi upstream at different datum. November 1922 to June 20, 1927, at site at Lindsay Flat 1.8 mi upstream at different datum. June 20, 1927, to Sept. 5, 1990, at site 200 ft downstream at datum 0.15 ft lower.

REMARKS.—Low flow completely regulated by small reservoirs and powerplants, total usable reservoir capacity, 253,000 acre-ft. Many diversions upstream from station; diversion to Pit No. 4 Powerplant began June 9, 1955. See schematic diagram of [Pit and McCloud River Basins](#).

COOPERATION.—Records were collected by Pacific Gas & Electric Co., under general supervision of the U.S. Geological Survey, in connection with a Federal Energy Regulatory Commission project.

EXTREMES FOR PERIOD OF RECORD.—Maximum discharge, 33,700 ft<sup>3</sup>/s, Feb. 20, 1986, gage height, 18.70 ft; minimum daily, prior to diversion to Pit No. 4 Powerplant in 1955, 234 ft<sup>3</sup>/s, Sept. 13, 1953; minimum daily, since diversion to Pit No. 4 Powerplant, 22 ft<sup>3</sup>/s, Dec. 2–4, 1969.

## DISCHARGE, CUBIC FEET PER SECOND, WATER YEAR OCTOBER 2000 TO SEPTEMBER 2001

## DAILY MEAN VALUES

DAY	OCT	NOV	DEC	JAN	FEB	MAR	APR	MAY	JUN	JUL	AUG	SEP
1	186	183	199	193	192	166	298	185	189	185	185	188
2	186	183	200	192	189	164	189	198	189	189	187	190
3	184	183	199	192	186	161	678	189	189	186	194	190
4	187	183	185	184	185	163	1190	193	187	184	190	191
5	187	183	184	202	188	163	474	194	189	187	186	188
6	189	179	189	193	192	168	197	188	185	188	188	189
7	192	186	188	194	194	175	211	187	191	189	188	190
8	189	186	191	189	192	168	196	188	194	189	189	191
9	187	186	189	191	188	169	192	190	191	188	189	190
10	185	186	188	189	185	166	189	192	189	188	190	189
11	187	186	186	183	185	166	188	191	191	188	188	189
12	191	182	187	186	189	166	189	188	190	188	182	188
13	191	184	190	193	189	166	188	183	188	188	189	190
14	191	190	185	191	189	166	190	190	188	189	189	193
15	194	188	195	192	176	166	188	191	188	220	189	189
16	191	186	195	190	164	166	191	188	187	193	189	192
17	189	200	188	194	166	166	192	193	186	192	188	189
18	184	191	194	194	172	170	195	192	192	190	186	193
19	185	192	197	195	166	1190	198	194	189	189	196	198
20	186	187	205	201	167	1190	195	191	188	188	192	190
21	183	188	199	194	166	930	194	191	192	193	188	189
22	181	191	192	198	168	555	190	194	194	200	190	191
23	186	192	199	191	168	188	189	189	192	194	190	190
24	188	193	188	188	166	190	354	189	191	185	193	189
25	192	192	190	190	166	190	766	183	188	189	193	187
26	191	187	197	191	165	462	768	187	189	187	188	186
27	189	192	194	192	166	488	770	189	189	187	189	184
28	189	208	189	187	166	376	774	190	189	189	188	186
29	186	206	192	184	---	378	654	189	189	189	189	185
30	183	203	189	186	---	378	184	189	188	189	188	187
31	183	---	187	190	---	378	---	189	---	185	189	---
TOTAL	5812	5676	5950	5929	4985	9888	10571	5884	5681	5885	5859	5681
MEAN	187	189	192	191	178	319	352	190	189	190	189	189
MAX	194	208	205	202	194	1190	1190	198	194	220	196	198
MIN	181	179	184	183	164	161	184	183	185	184	182	184
AC-FT	11530	11260	11800	11760	9890	19610	20970	11670	11270	11670	11620	11270
a	117900	120200	124800	119100	108500	121700	115200	108400	92180	93430	97460	95850
b	127200	130500	141200	135200	125800	129700	123500	121900	106900	108600	109400	105800

a Discharge, in acre-feet, for Pit No. 3 Powerplant (station 11362300), provided by Pacific Gas & Electric Co.

b Diversion, in acre-feet, to Pit No. 4 Powerplant (station 11362600), provided by Pacific Gas & Electric Co.

## 11362500 PIT RIVER BELOW PIT NO. 4 DAM, CA—Continued

## STATISTICS OF MONTHLY MEAN DATA FOR WATER YEARS 1927 - 1954, BY WATER YEAR (WY)

	OCT	NOV	DEC	JAN	FEB	MAR	APR	MAY	JUN	JUL	AUG	SEP
MEAN	1945	2102	2458	2700	3338	3799	3766	2877	2307	1925	1833	1865
MAX	2385	2544	5968	5523	6872	8510	11400	5507	4096	2652	2146	2318
(WY)	1954	1954	1938	1953	1942	1938	1952	1938	1953	1952	1954	1953
MIN	1571	1666	1745	1698	1742	1895	1730	1635	1612	1569	1509	1541
(WY)	1935	1934	1935	1937	1933	1934	1934	1934	1934	1934	1934	1934

## SUMMARY STATISTICS

## WATER YEARS 1927 - 1954

ANNUAL MEAN	2572
HIGHEST ANNUAL MEAN	4066 1952
LOWEST ANNUAL MEAN	1703 1934
HIGHEST DAILY MEAN	26200 Dec 12 1937
LOWEST DAILY MEAN	234 Sep 13 1953
ANNUAL SEVEN-DAY MINIMUM	1450 Aug 2 1936
MAXIMUM PEAK FLOW	a30200 Dec 12 1937
MAXIMUM PEAK STAGE	17.90 Dec 12 1937
ANNUAL RUNOFF (AC-FT)	1863000
10 PERCENT EXCEEDS	3810
50 PERCENT EXCEEDS	2170
90 PERCENT EXCEEDS	1630

## STATISTICS OF MONTHLY MEAN DATA FOR WATER YEARS 1955 - 2001, BY WATER YEAR (WY)

MEAN	231	232	439	987	1084	1209	815	544	272	167	165	161
MAX	2189	2436	3791	7250	7657	5545	3416	4770	2788	490	458	268
(WY)	1955	1955	1965	1970	1986	1995	1982	1995	1998	1955	1992	1973
MIN	96.8	66.4	49.8	50.0	49.0	49.7	88.3	128	128	137	120	79.8
(WY)	1962	1957	1979	1981	1981	1981	1961	1961	1961	1964	1955	1955

## SUMMARY STATISTICS

## FOR 2000 CALENDAR YEAR

## FOR 2001 WATER YEAR

## WATER YEARS 1955 - 2001

ANNUAL TOTAL	214696	77801	
ANNUAL MEAN	587	213	523
HIGHEST ANNUAL MEAN			1868 1955
LOWEST ANNUAL MEAN			98.4 1961
HIGHEST DAILY MEAN	3800 Feb 28	1190 Mar 19	31100 Feb 20 1986
LOWEST DAILY MEAN	161 May 4	161 Mar 3	22 Dec 2 1969
ANNUAL SEVEN-DAY MINIMUM	163 Jun 4	164 Feb 27	27 Dec 1 1969
MAXIMUM PEAK FLOW		1940 Mar 19	33700 Feb 20 1986
MAXIMUM PEAK STAGE		6.79 Mar 19	18.70 Feb 20 1986
ANNUAL RUNOFF (AC-FT)	425800	154300	378900
10 PERCENT EXCEEDS	1720	198	1280
50 PERCENT EXCEEDS	198	189	158
90 PERCENT EXCEEDS	174	183	60

a From rating curve extended above 12,000 ft<sup>3</sup>/s on basis of velocity-area studies.

## 11362900 NELSON CREEK BELOW DIVERSION TO NELSON CREEK POWERPLANT, NEAR BIG BEND, CA

LOCATION.—Lat 41°02'32", long 121°52'34", in NE 1/4 NE 1/4 sec.29, T.37 N., R.1 E., [Shasta County](#), Hydrologic Unit 18020003, on right bank, 400 ft upstream from Snowslide Creek, 0.3 mi downstream from Bull Creek, and 2.3 mi northeast of Big Bend.

DRAINAGE AREA.—13.2 mi<sup>2</sup>.

PERIOD OF RECORD.—October 1993 to September 1996, October 1996 to current year (operated as a low-flow station only).

GAGE.—Water-stage recorder and broad-crested weir; water-stage recorder and sharp-crested weir. Elevation of gages is 2,320 ft above sea level, from topographic map.

REMARKS.—Records good. Flow at this station has two components which are combined for publication: flow over a broad-crested weir (station 11362880) and flow over a sharp-crested weir (station 11362890). Water is diverted upstream of weirs through a tunnel to Nelson Creek Powerplant (station 11362800), returning to Nelson Creek at its confluence with the Pit River. Flow is computed to 100 ft<sup>3</sup>/s. See schematic diagram of [Pit and McCloud River Basins](#).

EXTREMES FOR PERIOD OF RECORD.—Maximum discharge, 623 ft<sup>3</sup>/s, Feb. 19, 1996; minimum daily, 7.4 ft<sup>3</sup>/s, Sept. 8, 21, 22, 1994.

## DISCHARGE, CUBIC FEET PER SECOND, WATER YEAR OCTOBER 2000 TO SEPTEMBER 2001

## DAILY MEAN VALUES

DAY	OCT	NOV	DEC	JAN	FEB	MAR	APR	MAY	JUN	JUL	AUG	SEP
1	12	16	16	17	16	17	16	16	15	12	e9.2	8.9
2	12	16	17	17	16	17	17	16	15	12	e9.5	8.9
3	12	16	16	17	16	16	17	16	15	12	e10	8.8
4	12	15	16	16	18	17	17	16	15	12	e9.8	8.7
5	12	15	15	16	19	17	17	16	15	12	e9.6	8.8
6	12	14	15	16	18	17	17	16	15	12	e9.6	8.7
7	12	14	14	16	17	17	17	16	15	12	e9.2	8.8
8	12	14	14	17	17	17	17	16	14	12	e8.8	8.7
9	13	14	15	17	18	17	18	16	14	12	e9.3	8.7
10	16	14	15	18	17	17	16	16	14	12	9.3	8.7
11	15	14	16	19	18	17	16	16	14	12	9.2	8.9
12	14	13	17	18	17	17	16	16	14	11	9.2	9.0
13	14	13	28	18	16	17	16	16	14	10	9.2	9.0
14	13	14	62	17	16	17	16	16	14	11	9.2	8.9
15	13	13	59	17	16	17	17	17	13	12	9.2	8.8
16	13	13	19	16	16	17	17	16	13	11	9.1	8.9
17	13	13	16	16	17	17	16	16	13	10	9.1	8.7
18	13	13	17	16	19	17	16	16	13	10	9.1	8.6
19	13	13	17	16	17	17	17	16	13	10	9.0	8.6
20	13	13	16	16	17	17	17	16	13	10	9.0	8.6
21	13	13	18	16	17	17	16	16	13	10	9.1	8.6
22	13	13	31	16	17	17	16	16	12	10	9.2	8.6
23	13	13	17	17	17	16	16	18	12	9.6	9.4	8.6
24	13	13	16	18	16	17	16	17	12	9.4	9.3	8.6
25	13	13	17	18	17	17	16	17	12	9.4	9.2	11
26	13	13	16	17	17	16	16	17	13	e9.1	9.0	8.8
27	13	13	16	17	17	17	16	17	20	e9.2	8.9	9.5
28	26	13	18	17	17	17	16	16	15	e9.4	8.9	9.6
29	68	18	19	17	---	16	17	16	13	e9.6	8.8	9.6
30	25	17	18	16	---	17	16	16	13	e9.2	8.9	9.4
31	17	---	18	16	---	17	---	15	---	e9.2	8.9	---
TOTAL	486	419	624	521	476	523	494	502	416	331.1	285.2	268.0
MEAN	15.7	14.0	20.1	16.8	17.0	16.9	16.5	16.2	13.9	10.7	9.20	8.93
MAX	68	18	62	19	19	17	18	18	20	12	10	11
MIN	12	13	14	16	16	16	16	15	12	9.1	8.8	8.6
AC-FT	964	831	1240	1030	944	1040	980	996	825	657	566	532
a	62	24	215	0	294	1520	972	327	1.2	0	0	0

e Estimated.

a Discharge, in acre-feet, for Nelson Creek Powerplant (station 11362800), provided by Sierra Pacific Industries.

## 11362950 EAST FORK NELSON CREEK BELOW DIVERSION TO NELSON CREEK, NEAR BIG BEND, CA

LOCATION.—Lat 41°02'25", long 121°52'28", in NE 1/4 NE 1/4 sec.29, T.37 N., R.1 E., Shasta County, Hydrologic Unit 18020003, on right bank, 700 ft upstream from Nelson Creek, and 2.3 mi northeast of Big Bend.

DRAINAGE AREA.—8.18 mi<sup>2</sup>.

PERIOD OF RECORD.—October 1993 to September 1996, October 1996 to current year (operated as a low-flow station only).

GAGE.—Water-stage recorder and broad-crested weir; water-stage recorder and sharp-crested weir. Elevation of gages is 2,360 ft above sea level, from topographic map.

REMARKS.—Records good. Flow at this station has two components which are combined for publication: flow over a broad-crested weir (station 11362940) and flow over a sharp-crested weir (station 11362945). Water is diverted upstream of weirs through a pipe to Nelson Creek (station 11362900). Flows computed to 50 ft<sup>3</sup>/s. See schematic diagram of Pit and McCloud River Basins.

EXTREMES FOR PERIOD OF RECORD.—Maximum discharge, 267 ft<sup>3</sup>/s, Mar. 15, 1995; minimum daily, 0.07 ft<sup>3</sup>/s, Aug. 12 to Sept. 23, 1994, and Oct. 11, 1994.

DISCHARGE, CUBIC FEET PER SECOND, WATER YEAR OCTOBER 2000 TO SEPTEMBER 2001  
DAILY MEAN VALUES

DAY	OCT	NOV	DEC	JAN	FEB	MAR	APR	MAY	JUN	JUL	AUG	SEP
1	2.0	2.3	2.4	2.1	1.8	2.4	5.6	5.0	2.3	1.4	1.0	.83
2	2.0	2.1	2.2	2.0	1.8	2.7	5.5	4.7	2.3	1.4	.99	.82
3	2.0	2.0	2.0	2.0	1.8	2.4	5.2	4.5	2.3	1.3	.99	.82
4	2.0	2.0	2.0	1.9	1.9	3.2	4.9	4.4	2.3	1.4	1.0	.82
5	2.0	2.0	1.9	1.9	1.9	3.6	4.9	4.4	2.3	1.4	.99	.82
6	2.0	2.0	1.9	1.9	1.9	3.5	5.6	4.2	2.3	1.3	.99	.79
7	1.9	2.0	1.9	1.9	1.9	3.7	5.4	4.1	2.1	1.3	.97	.76
8	1.9	2.0	1.9	2.0	1.9	4.3	5.0	4.0	2.0	1.3	.96	.76
9	2.2	2.0	2.1	2.0	2.0	4.6	4.9	3.9	2.0	1.3	.94	.76
10	2.5	2.0	2.0	2.4	1.9	4.4	5.1	3.6	2.1	1.2	.91	.75
11	2.3	1.9	2.2	2.6	2.1	4.2	5.3	3.4	2.1	1.2	.95	.69
12	2.1	1.9	2.3	2.1	1.9	3.9	5.0	3.3	2.1	1.2	.95	.69
13	2.0	1.9	3.9	2.1	1.9	3.9	4.9	3.5	2.0	1.2	.91	.75
14	2.0	1.9	6.0	1.9	1.9	3.9	4.9	3.9	2.0	1.2	.92	.75
15	2.0	1.9	5.7	1.9	1.9	3.9	4.9	4.6	2.0	1.2	.90	.76
16	2.0	1.9	3.8	1.9	1.9	3.9	4.9	4.1	1.9	1.2	.89	.78
17	2.0	1.9	3.1	1.9	1.9	3.9	4.9	3.8	1.9	1.2	.90	.79
18	2.0	1.9	2.7	1.9	2.3	3.9	5.2	3.6	1.8	1.1	.89	.78
19	2.0	1.9	2.5	1.9	2.4	4.4	5.8	3.5	1.7	1.1	.88	.76
20	2.1	1.9	2.4	1.9	3.1	4.9	6.6	3.3	1.7	1.1	.88	.76
21	2.0	1.9	2.5	1.9	4.4	5.4	6.4	3.2	1.6	1.1	.91	.76
22	2.0	1.9	4.5	1.9	4.2	6.1	6.1	3.1	1.7	1.1	.92	.76
23	1.9	1.9	3.7	2.0	3.4	6.6	6.0	3.1	1.6	1.1	.93	.76
24	1.9	1.9	3.3	2.0	3.1	7.2	6.0	3.0	1.4	1.1	.91	.76
25	1.9	1.9	3.0	2.0	3.0	7.8	6.0	2.9	1.5	1.1	.91	.93
26	2.0	1.9	2.7	1.9	2.7	7.3	5.9	2.9	1.7	1.0	.88	.61
27	2.0	1.9	2.6	1.9	2.5	6.6	5.6	2.9	2.5	1.0	.84	.69
28	3.7	1.9	2.4	1.9	2.5	6.2	5.4	2.8	1.7	.96	.82	.69
29	6.3	3.7	2.4	1.9	---	6.0	5.3	2.7	1.5	.97	.82	.66
30	3.8	3.3	2.3	1.8	---	5.8	5.2	2.5	1.4	.96	.82	.62
31	2.6	---	2.2	1.8	---	5.6	---	2.3	---	.99	.84	---
TOTAL	71.1	61.6	86.5	61.2	65.9	146.2	162.4	111.2	57.8	36.38	28.41	22.68
MEAN	2.29	2.05	2.79	1.97	2.35	4.72	5.41	3.59	1.93	1.17	.92	.76
MAX	6.3	3.7	6.0	2.6	4.4	7.8	6.6	5.0	2.5	1.4	1.0	.93
MIN	1.9	1.9	1.9	1.8	1.8	2.4	4.9	2.3	1.4	.96	.82	.61
AC-FT	141	122	172	121	131	290	322	221	115	72	56	45



## 11363000 PIT RIVER AT BIG BEND, CA

LOCATION.—Lat 41°01'10", long 121°54'36", in NW 1/4 SW 1/4 sec.31, T.37 N., R.1 E., [Shasta County](#), Hydrologic Unit 18020003, on left bank at Big Bend, 0.4 mi downstream from Nelson Creek, 1.5 mi upstream from Kosk Creek, and 3.1 mi downstream from Pit No. 5 Dam.

DRAINAGE AREA.—4,711 mi<sup>2</sup>, excluding Goose Lake Basin.

PERIOD OF RECORD.—October 1910 to current year. Monthly discharge only for some periods, published in WSP 1315-A. Published as "at Henderson" 1910–23.

REVISED RECORDS.—WSP 1345: 1911, 1914(M), 1916(M), 1917, 1928, 1935–36(M). WDR CA-75-4: Drainage area.

GAGE.—Water-stage recorder. Datum of gage is 1,674.47 ft above sea level. Prior to Dec. 28, 1912, nonrecording gage; Dec. 28, 1912, to June 21, 1924, water-stage recorder at same site, at datum 7.69 ft higher. June 22, 1924, to Sept. 30, 1988, at site 200 ft downstream at same datum.

REMARKS.—Low flow completely regulated by many reservoirs and powerplants, total usable reservoir capacity, about 253,000 acre-ft. Many diversions upstream from station; diversion to Pit No. 5 Powerplant (station 11362700) began May 1, 1944. See schematic diagram of [Pit and McCloud River Basins](#).

COOPERATION.—Records were collected by Pacific Gas & Electric Co., under general supervision of the U.S. Geological Survey, in connection with a Federal Energy Regulatory Commission project.

EXTREMES FOR PERIOD OF RECORD.—Maximum discharge, 49,000 ft<sup>3</sup>/s, Jan. 25, 1970, gage height, 18.17 ft, in gage well, 19.0 ft, from floodmarks, site then in use, from rating curve extended above 17,000 ft<sup>3</sup>/s; maximum gage height, 18.70 ft, Feb. 20, 1986, site then in use; minimum daily, 692 ft<sup>3</sup>/s, July 9, 1925; since diversion to Pit No. 5 Powerplant, minimum daily, 34 ft<sup>3</sup>/s, Mar. 29, 1955.

EXTREMES FOR CURRENT YEAR.—Peak discharges greater than base discharge of 6,000 ft<sup>3</sup>/s, or maximum:

Date	Time	Discharge (ft <sup>3</sup> /s)	Gage height (ft)
Oct. 26	1030	1,460	8.02

## DISCHARGE, CUBIC FEET PER SECOND, WATER YEAR OCTOBER 2000 TO SEPTEMBER 2001

## DAILY MEAN VALUES

DAY	OCT	NOV	DEC	JAN	FEB	MAR	APR	MAY	JUN	JUL	AUG	SEP
1	172	165	195	179	e165	180	186	192	202	e149	158	155
2	169	164	194	184	e165	198	192	185	181	e151	152	155
3	163	166	193	176	e172	187	185	183	176	154	164	155
4	180	169	194	187	e165	214	172	176	182	152	163	154
5	178	166	191	191	e176	218	169	179	178	150	158	156
6	183	168	185	185	e178	217	188	164	194	160	154	152
7	184	166	187	181	e180	216	180	177	191	159	156	152
8	178	166	177	183	e167	220	180	177	194	155	155	171
9	177	164	180	184	e174	220	179	179	184	157	152	155
10	169	170	181	196	e172	206	171	178	175	153	156	166
11	177	163	187	203	e183	198	183	175	179	153	163	168
12	168	171	172	200	e172	190	181	183	184	165	165	178
13	168	167	209	188	e167	191	187	185	187	157	163	169
14	163	158	227	187	e174	191	197	187	156	154	159	164
15	169	168	216	187	181	189	198	203	155	164	155	159
16	174	172	178	192	175	187	183	185	161	157	156	155
17	189	176	165	185	174	184	175	183	149	153	158	160
18	190	179	168	186	198	188	182	188	154	171	161	156
19	189	185	179	187	197	190	191	184	151	167	153	159
20	200	186	190	176	205	196	206	172	159	161	161	158
21	199	184	187	174	242	200	181	184	154	154	157	159
22	197	168	217	186	231	201	170	174	154	153	161	156
23	186	173	168	187	216	189	181	190	148	161	157	155
24	180	177	178	191	220	187	184	179	e159	163	155	170
25	355	179	179	183	209	199	190	169	e158	154	163	175
26	548	175	197	177	200	193	191	177	e165	151	173	154
27	198	177	195	166	193	192	197	183	e176	153	159	159
28	223	189	188	169	187	187	187	181	e154	162	147	163
29	267	213	170	171	---	179	185	177	e149	155	162	151
30	204	203	164	e168	---	183	192	194	e147	158	155	150
31	167	---	168	e165	---	186	---	201	---	163	161	---
TOTAL	6264	5227	5779	5674	5238	6076	5543	5644	5056	4869	4912	4789
MEAN	202	174	186	183	187	196	185	182	169	157	158	160
MAX	548	213	227	203	242	220	206	203	202	171	173	178
MIN	163	158	164	165	165	179	169	164	147	149	147	150
AC-FT	12420	10370	11460	11250	10390	12050	10990	11190	10030	9660	9740	9500

e Estimated.

## 11363000 PIT RIVER AT BIG BEND, CA—Continued

## STATISTICS OF MONTHLY MEAN DATA FOR WATER YEARS 1911 - 1943, BY WATER YEAR (WY)

	OCT	NOV	DEC	JAN	FEB	MAR	APR	MAY	JUN	JUL	AUG	SEP
MEAN	2206	2373	2676	3000	3927	4449	4446	3229	2520	2214	2100	2107
MAX	3021	3186	6792	7675	7989	9953	11410	6216	3763	3218	2987	2975
(WY)	1912	1912	1938	1914	1942	1938	1917	1938	1911	1911	1911	1911
MIN	1607	1740	1764	1750	1746	2051	1860	1734	1672	1584	1526	1565
(WY)	1935	1934	1935	1937	1933	1931	1934	1934	1934	1934	1934	1934

## SUMMARY STATISTICS

## WATER YEARS 1911 - 1943

ANNUAL MEAN	2931
HIGHEST ANNUAL MEAN	4597 1938
LOWEST ANNUAL MEAN	1787 1934
HIGHEST DAILY MEAN	30300 Dec 12 1937
LOWEST DAILY MEAN	692 Jul 9 1925
ANNUAL SEVEN-DAY MINIMUM	915 Jul 4 1925
MAXIMUM PEAK FLOW	a34200 Dec 12 1937
MAXIMUM PEAK STAGE	16.26 Dec 12 1937
ANNUAL RUNOFF (AC-FT)	2123000
10 PERCENT EXCEEDS	4520
50 PERCENT EXCEEDS	2440
90 PERCENT EXCEEDS	1750

## STATISTICS OF MONTHLY MEAN DATA FOR WATER YEARS 1944 - 2001, BY WATER YEAR (WY)

	1944	1944	1965	1970	1986	1995	1952	1995	1998	1998	1992	1986
MEAN	204	218	488	1055	1237	1417	1101	662	284	135	133	127
MAX	2322	2469	3889	8804	9457	6658	8441	5420	3052	203	448	284
(WY)	1944	1944	1965	1970	1986	1995	1952	1995	1998	1998	1992	1986
MIN	58.8	56.0	45.0	51.4	57.1	52.6	49.9	114	78.5	63.5	60.9	60.1
(WY)	1949	1979	1979	1949	1977	1977	1977	1977	1944	1944	1944	1945

## SUMMARY STATISTICS

## FOR 2000 CALENDAR YEAR

## FOR 2001 WATER YEAR

## WATER YEARS 1944 - 2001

ANNUAL TOTAL	128895	65071	
ANNUAL MEAN	352	178	585
HIGHEST ANNUAL MEAN			1638 1995
LOWEST ANNUAL MEAN			86.5 1977
HIGHEST DAILY MEAN	3320 Feb 16	548 Oct 26	36500 Feb 21 1986
LOWEST DAILY MEAN	158 Nov 14	147 Jun 30	34 Mar 29 1955
ANNUAL SEVEN-DAY MINIMUM	166 Nov 8	150 Jun 29	40 Dec 7 1978
MAXIMUM PEAK FLOW		1460 Oct 26	49000 Jan 25 1970
MAXIMUM PEAK STAGE		8.02 Oct 26	18.70 Feb 20 1986
ANNUAL RUNOFF (AC-FT)	255700	129100	423900
10 PERCENT EXCEEDS	584	198	1590
50 PERCENT EXCEEDS	187	177	141
90 PERCENT EXCEEDS	168	155	75

a From rating extended above 11,000 ft3/s on basis of velocity-area studies.

## 11363910 JAMES B. BLACK POWERPLANT NEAR BIG BEND, CA

LOCATION.—Lat 40°59'12", long 121°58'35", in SW 1/4 SE 1/4 sec.9, T.36 N., R.1 W., Shasta County, Hydrologic Unit 18020003, at powerplant, on right bank of Pit River, and 5.8 mi downstream from Big Bend.

PERIOD OF RECORD.—December 1965 to current year.

GAGE.—Discharge computed from powerplant output.

REMARKS.—Water is diverted from Lake McCloud (station 11367740) at SE 1/4 SW 1/4 sec.22, T.38 N., R.2 W., through McCloud–Iron Canyon Diversion Tunnel (station 11367720) to Iron Canyon Reservoir (station 11363920), then through the penstock for powerplant and into the Pit River. Records are combined flow of diversion from McCloud River at McCloud Dam plus Iron Canyon Creek. See schematic diagram of Pit and McCloud River Basins.

COOPERATION.—Records were collected by Pacific Gas & Electric Co., under general supervision of the U.S. Geological Survey, in connection with a Federal Energy Regulatory Commission project.

EXTREMES FOR PERIOD OF RECORD.—Maximum daily discharge, 2,420 ft<sup>3</sup>/s, July 15, 1966; no flow several days most years.

DISCHARGE, CUBIC FEET PER SECOND, WATER YEAR OCTOBER 2000 TO SEPTEMBER 2001  
DAILY MEAN VALUES

DAY	OCT	NOV	DEC	JAN	FEB	MAR	APR	MAY	JUN	JUL	AUG	SEP
1	946	.00	985	263	1080	524	726	851	492	352	840	588
2	875	941	995	856	864	626	1340	698	.00	1110	869	525
3	1040	1200	1060	938	390	452	1230	902	.00	1040	834	611
4	826	1230	744	1070	229	630	1290	937	1040	892	330	990
5	752	1180	1130	1060	946	940	1390	748	1060	1130	.00	784
6	733	1110	898	416	879	776	1430	483	1020	1110	653	892
7	723	1070	532	.00	838	1200	1010	1000	1110	185	776	954
8	748	833	841	1160	919	1120	1130	1170	985	264	870	574
9	1210	661	552	1100	998	945	1140	1440	200	916	845	452
10	1200	943	344	1200	229	889	1090	1600	52	1010	850	915
11	1310	853	1090	1160	243	1320	838	1260	791	1060	630	683
12	1390	912	1200	983	1130	1480	971	300	759	980	303	875
13	1420	1400	969	286	911	1240	1020	390	1060	1060	931	878
14	596	1090	1100	523	1370	1140	827	834	1640	308	863	963
15	755	975	994	714	977	1200	700	1030	938	188	949	600
16	1080	1210	.00	780	728	1180	799	912	228	926	950	514
17	1210	416	191	980	710	433	781	1100	214	902	943	856
18	1350	5.1	743	1320	1150	590	737	1200	1070	834	862	934
19	1050	382	1130	950	1330	1100	753	257	1150	955	625	846
20	1020	743	1220	600	1240	1120	716	513	998	902	885	795
21	350	258	928	452	1030	1020	581	1110	978	394	898	764
22	232	707	1120	743	930	949	669	1140	1050	115	995	239
23	433	299	.00	546	1420	1030	704	1100	278	1070	902	218
24	846	330	.00	855	776	383	655	1110	.00	1070	854	589
25	918	533	.00	326	591	390	821	863	595	1010	471	512
26	831	348	665	1490	1120	1140	745	109	1020	986	514	518
27	939	810	672	651	1250	1280	550	124	1170	915	824	495
28	1020	941	920	401	994	1330	594	105	1150	184	1100	529
29	976	1100	1210	879	---	1300	536	757	907	.00	914	588
30	1020	1030	259	907	---	1240	893	656	297	892	837	546
31	506	---	460	742	---	702	---	840	---	851	948	---
TOTAL	28305	23510.10	22952.00	24351.00	25272	29669	26666	25539	22252.00	23611.00	24065.00	20227
MEAN	913	784	740	786	903	957	889	824	742	762	776	674
MAX	1420	1400	1220	1490	1420	1480	1430	1600	1640	1130	1100	990
MIN	232	.00	.00	.00	229	383	536	105	.00	.00	.00	218
AC-FT	56140	46630	45530	48300	50130	58850	52890	50660	44140	46830	47730	40120
a	145200	149800	158800	149700	142200	151000	145200	138000	125500	123600	124700	120200

## STATISTICS OF MONTHLY MEAN DATA FOR WATER YEARS 1966 - 2001, BY WATER YEAR (WY)

MEAN	756	756	890	975	1050	1182	1148	1014	898	840	812	788
MAX	1122	1401	1538	1651	1625	1565	1670	1797	1735	1260	1101	1225
(WY)	1976	1974	1974	1970	1998	1995	1966	1967	1967	1966	1983	1983
MIN	505	428	433	500	373	581	421	368	523	533	465	515
(WY)	1993	1992	1992	1992	1978	1991	1990	1977	1987	1994	1992	1992

SUMMARY STATISTICS	FOR 2000 CALENDAR YEAR		FOR 2001 WATER YEAR		WATER YEARS 1966 - 2001	
ANNUAL TOTAL	375061.10		296419.10			
ANNUAL MEAN	1025		812		922	
HIGHEST ANNUAL MEAN					1313	
LOWEST ANNUAL MEAN					547	
HIGHEST DAILY MEAN	1820	Jan 28	1640	Jun 14	2420	Jul 15 1966
LOWEST DAILY MEAN	.00	Nov 1	.00	Nov 1	.00	Jun 2 1966
ANNUAL SEVEN-DAY MINIMUM	389	Jul 12	389	Nov 18	.00	Feb 3 1971
ANNUAL RUNOFF (AC-FT)	743900		587900		668100	
10 PERCENT EXCEEDS	1550		1200		1490	
50 PERCENT EXCEEDS	1040		878		895	
90 PERCENT EXCEEDS	440		283		399	

a Discharge, in acre-feet, for Pit No. 5 Powerplant (station 11362700), provided by Pacific Gas & Electric Co.

## 11363930 IRON CANYON CREEK BELOW IRON CANYON DAM, NEAR BIG BEND, CA

LOCATION.—Lat 41°02'22", long 121°59'03", in NW 1/4 NW 1/4 sec.28, T.37 N., R.1 W., Shasta County, Hydrologic Unit 18020003, on left bank, 0.2 mi downstream from Iron Canyon Dam, and 4.2 mi west of Big Bend.

DRAINAGE AREA.—11.2 mi<sup>2</sup>.

PERIOD OF RECORD.—August 1966 to current year (beginning October 1994, operated as a low-flow station only).

REVISED RECORDS.—WDR CA-95-4: Drainage area.

GAGE.—Water-stage recorder, 60° sharp-crested V-notch weir, and concrete control with flashboards in 2- by 10-ft opening. Datum of gage is 2,461.52 ft above sea level (levels by Pacific Gas & Electric Co.).

REMARKS.—Flow is completely regulated by Iron Canyon Reservoir (station 11363920). There is an interbasin diversion from Lake McCloud (station 11367740) to Iron Canyon Reservoir and then through a tunnel to James B. Black Powerplant on the Pit River (station 11363910). This station records fishwater release only. The minimum release requirement is 3.0 ft<sup>3</sup>/s at all times. Flow is computed to 12.0 ft<sup>3</sup>/s. See schematic diagram of Pit and McCloud River Basins.

COOPERATION.—Records were collected by Pacific Gas & Electric Co., under general supervision of the U.S. Geological Survey, in connection with a Federal Energy Regulatory Commission project.

EXTREMES FOR PERIOD OF RECORD.—Maximum discharge, 650 ft<sup>3</sup>/s, Feb. 5, 1986, gage height unknown (flashboards removed from weir), from equation for a 4- by 4-ft slide gate. Flow was the result of full travel test of slide gate at Iron Canyon Dam; maximum gage height, 3.24 ft, Feb. 25, 1978 (flashboards in weir), was the result of failure of the James B. Black Penstock; no flow, July 15–18, 1967.

## DISCHARGE, CUBIC FEET PER SECOND, WATER YEAR OCTOBER 2000 TO SEPTEMBER 2001

## DAILY MEAN VALUES

DAY	OCT	NOV	DEC	JAN	FEB	MAR	APR	MAY	JUN	JUL	AUG	SEP
1	5.0	4.7	5.6	5.6	5.6	5.0	5.1	6.0	6.4	6.4	6.4	6.4
2	5.0	4.8	5.3	5.6	5.6	5.3	5.3	6.0	6.4	6.4	6.4	6.4
3	5.0	4.7	5.3	5.2	5.3	5.3	5.3	6.0	6.4	6.6	6.4	6.4
4	5.0	4.7	5.3	5.3	5.6	5.9	5.1	6.0	6.4	6.8	6.4	6.4
5	5.0	4.6	5.1	5.3	5.6	6.2	5.1	6.0	6.4	6.6	6.4	6.4
6	5.0	4.4	5.0	5.3	5.6	6.0	5.0	6.0	6.4	6.4	6.4	6.4
7	5.0	4.4	5.0	5.4	5.5	5.8	5.0	6.0	6.4	6.4	6.4	6.4
8	5.0	4.4	5.0	5.6	5.6	5.6	5.0	6.0	6.4	6.4	6.4	6.4
9	5.0	4.4	5.0	5.6	5.6	5.6	4.9	6.0	6.4	6.4	6.4	6.4
10	5.0	4.5	5.2	5.6	5.6	5.6	4.9	5.8	6.4	6.4	6.4	6.4
11	5.0	4.4	5.3	5.5	5.6	5.4	4.9	5.6	6.4	6.4	6.4	6.4
12	4.8	4.4	5.2	5.3	5.6	5.1	4.9	5.6	6.4	6.4	6.4	6.4
13	4.7	4.3	5.4	5.3	5.6	5.0	5.0	5.9	6.6	6.4	6.4	6.4
14	4.6	4.1	5.3	5.3	5.6	5.0	5.0	6.0	6.6	6.4	6.4	6.4
15	4.7	4.5	5.1	5.6	5.6	5.0	5.0	6.0	6.4	6.4	6.4	6.4
16	4.7	4.8	5.0	5.6	5.3	4.9	5.2	6.0	6.4	6.4	6.4	6.4
17	4.6	4.8	5.1	5.6	5.4	4.9	5.3	6.0	6.4	6.4	6.4	6.4
18	4.5	4.9	5.3	5.5	5.6	5.0	5.3	6.0	6.4	6.4	6.4	6.4
19	4.4	5.0	5.3	5.3	5.6	5.0	5.6	6.0	6.4	6.4	6.4	6.4
20	4.4	5.2	5.0	5.3	5.8	4.9	5.8	6.0	6.4	6.4	6.4	6.4
21	4.4	5.3	5.0	5.3	6.3	4.9	5.8	6.0	6.4	6.4	6.4	6.4
22	4.6	5.5	5.2	5.3	6.0	4.9	5.6	6.0	6.4	6.4	6.4	6.4
23	4.7	5.6	5.0	5.4	5.5	4.9	5.6	6.0	6.4	6.4	6.4	6.4
24	4.8	5.6	5.2	5.6	5.3	5.0	5.6	6.0	6.4	6.4	6.4	6.4
25	4.8	5.6	5.3	5.6	5.3	5.3	5.6	6.0	6.4	6.4	6.4	6.8
26	4.8	5.6	5.6	5.6	5.3	5.3	5.6	6.0	6.5	6.4	6.4	6.8
27	4.7	5.6	5.6	5.5	5.2	5.2	5.6	6.0	5.6	6.4	6.4	6.8
28	4.9	5.6	5.6	5.5	5.1	5.1	5.9	6.2	5.5	6.4	6.4	6.8
29	5.2	5.9	5.5	5.6	---	5.0	6.0	6.4	6.4	6.4	6.4	6.8
30	4.8	5.8	5.3	5.6	---	5.0	6.0	6.4	6.4	6.4	6.4	6.8
31	4.7	---	5.4	5.6	---	5.0	---	6.4	---	6.4	6.4	---
TOTAL	148.8	148.1	162.5	169.4	155.3	162.1	160.0	186.3	190.8	199.2	198.4	194.4
MEAN	4.80	4.94	5.24	5.46	5.55	5.23	5.33	6.01	6.36	6.43	6.40	6.48
MAX	5.2	5.9	5.6	5.6	6.3	6.2	6.0	6.4	6.6	6.8	6.4	6.8
MIN	4.4	4.1	5.0	5.2	5.1	4.9	4.9	5.6	5.5	6.4	6.4	6.4
AC-FT	295	294	322	336	308	322	317	370	378	395	394	386

## 11364300 HATCHET CREEK BELOW DIVERSION TO HATCHET CREEK POWERPLANT, NEAR MONTGOMERY CREEK, CA

LOCATION.—Lat 40°52'39", long 121°51'55", in SW 1/4 NE 1/4 sec.21, T.35 N., R.1 E., Shasta County, Hydrologic Unit 18020003, on left bank, 1,100 ft downstream from diversion to powerplant, 1,400 ft downstream from Buffom Creek, and 3.8 mi northeast of Montgomery Creek.

DRAINAGE AREA.—29.6 mi<sup>2</sup>.

PERIOD OF RECORD.—October 1987 to September 1988, October 1990 to September 1996. October 1989 to September 1990, October 1997 to September 1998 and October 1999 to current year (operated as low-flow station only).

GAGE.—Water-stage recorder and sharp-crested weir. Elevation of gage is 3,460 ft above sea level, from topographic map.

REMARKS.—During times of powerplant operation the minimum flow requirement is 15 ft<sup>3</sup>/s. Flows computed to 70 ft<sup>3</sup>/s. See schematic diagram of Pit and McCloud River Basins.

COOPERATION.—Records were collected by Shasta Hydroelectric, under general supervision of the U.S. Geological Survey, in connection with a Federal Energy Regulatory Commission project.

EXTREMES FOR PERIOD OF RECORD.—(Water years 1991–96) Maximum discharge, 1,930 ft<sup>3</sup>/s, Oct. 29, 1992, gage height, 7.06 ft, from outside highwater mark, from rating curve extended above 42 ft<sup>3</sup>/s on basis of theoretical computation of flow over weir; minimum daily, 3.8 ft<sup>3</sup>/s, Aug. 18 to Sept. 8, 1992.

## DISCHARGE, CUBIC FEET PER SECOND, WATER YEAR OCTOBER 2000 TO SEPTEMBER 2001

## DAILY MEAN VALUES

DAY	OCT	NOV	DEC	JAN	FEB	MAR	APR	MAY	JUN	JUL	AUG	SEP
1	14	18	18	18	19	18	18	18	21	14	9.2	8.0
2	14	18	18	18	18	18	18	18	20	14	9.2	8.0
3	14	18	18	18	18	18	18	18	20	14	9.2	8.0
4	13	18	18	18	18	18	19	18	20	14	8.8	7.7
5	14	17	18	18	18	18	18	18	21	14	8.8	7.7
6	13	16	20	18	18	19	18	18	21	14	9.2	7.7
7	13	16	20	18	18	25	18	18	20	14	9.2	7.7
8	13	17	20	18	18	30	18	18	20	14	8.8	7.3
9	14	17	20	18	18	30	18	18	19	13	8.8	7.3
10	23	17	23	18	18	17	18	18	19	13	8.8	7.3
11	22	17	18	18	18	18	18	18	18	13	8.8	7.3
12	20	17	18	18	18	18	18	18	18	13	8.4	8.0
13	17	17	18	18	17	18	18	18	18	12	8.4	8.0
14	17	17	17	17	21	18	18	18	18	12	8.4	8.0
15	16	17	18	18	24	18	18	18	18	12	8.4	8.0
16	16	16	17	18	18	18	18	18	17	12	8.4	8.0
17	15	16	18	18	18	18	18	18	17	12	8.0	7.3
18	15	16	18	18	22	18	18	18	16	12	7.7	8.0
19	15	16	18	18	20	18	18	18	16	12	7.7	7.3
20	16	16	18	18	18	18	18	18	16	11	8.0	7.0
21	16	16	18	18	18	18	18	18	15	11	7.7	7.0
22	15	16	18	18	18	18	18	18	15	11	7.7	7.0
23	15	16	18	18	18	18	18	18	15	11	8.0	7.0
24	15	16	18	18	18	18	18	18	15	11	8.0	7.0
25	15	16	18	18	18	26	18	18	15	10	8.0	14
26	16	16	18	18	18	18	18	18	15	10	7.7	10
27	16	16	18	18	18	18	18	18	15	9.2	7.3	10
28	26	16	18	18	18	18	18	18	15	10	8.0	9.2
29	19	18	18	18	---	18	18	18	15	9.2	8.0	9.2
30	18	18	18	18	---	18	18	21	15	10	7.7	9.2
31	19	---	18	18	---	18	---	21	---	9.2	7.7	---
TOTAL	504	501	569	557	519	597	541	564	523	370.6	258.0	243.2
MEAN	16.3	16.7	18.4	18.0	18.5	19.3	18.0	18.2	17.4	12.0	8.32	8.11
MAX	26	18	23	18	24	30	19	21	21	14	9.2	14
MIN	13	16	17	17	17	17	18	18	15	9.2	7.3	7.0
AC-FT	1000	994	1130	1100	1030	1180	1070	1120	1040	735	512	482
a	111	67	702	270	954	3790	2780	1110	0	0	0	0

a Discharge, in acre-feet, for Hatchet Creek Powerplant (station 11364250), provided by Shasta Hydroelectric.

## 11365000 PIT RIVER NEAR MONTGOMERY CREEK, CA

LOCATION.—Lat 40°50'38", long 122°00'05", in NE 1/4 SW 1/4 sec.32, T.35 N., R.1 W., Shasta County, Hydrologic Unit 18020003, Shasta National Forest, on left bank, 0.7 mi downstream from Pit No. 7 Dam and Powerplant, 1.4 mi upstream from Potem Creek, and 4.1 mi west of town of Montgomery Creek.

DRAINAGE AREA.—4,952 mi<sup>2</sup>, excluding Goose Lake Basin.

PERIOD OF RECORD.—October 1944 to current year (monthly discharge only December 1964 to May 1965). Monthly discharge only for some periods, published in WSP 1315-A.

CHEMICAL DATA: Water years 1951, 1953, 1955–81.

WATER TEMPERATURE: Water years 1951, 1954–57, 1959.

REVISED RECORDS.—WSP 1931: Drainage area. WDR CA-86-4: 1983 (M).

GAGE.—Water-stage recorder and crest-stage gage. Datum of gage is 1,000.00 ft above sea level (levels by Pacific Gas & Electric Co.). October 1944 to Feb. 17, 1963, at site 0.7 mi upstream at different datum. Feb. 17, 1963, to May 21, 1965, at site 1.5 mi upstream at different datum. May 21, 1965, to June 20, 1981, at site 0.9 mi downstream at datum 1,036.00 ft above sea level.

REMARKS.—Low flow completely regulated by many reservoirs and powerplants, total usable reservoir capacity, 337,000 acre-ft. Many diversions upstream from station for irrigation. Diversion from McCloud River to Iron Canyon Reservoir (station 11363920) began December 1965. See schematic diagram of Pit and McCloud River Basins.

COOPERATION.—Records were collected by Pacific Gas & Electric Co., under general supervision of the U.S. Geological Survey, in connection with a Federal Energy Regulatory Commission project.

EXTREMES FOR PERIOD OF RECORD.—Maximum discharge, 73,000 ft<sup>3</sup>/s, Jan. 24, 1970, gage height, 32.36 ft, site and datum then in use; maximum gage height, 74.65 ft, Feb. 19, 1986; minimum daily, 30 ft<sup>3</sup>/s, July 12, 27, 1975, result of construction work below Pit No. 7 Powerplant.

## DISCHARGE, CUBIC FEET PER SECOND, WATER YEAR OCTOBER 2000 TO SEPTEMBER 2001

## DAILY MEAN VALUES

DAY	OCT	NOV	DEC	JAN	FEB	MAR	APR	MAY	JUN	JUL	AUG	SEP
1	2510	4670	4500	2740	4790	4480	e3070	e3690	3300	1540	3310	2380
2	2730	1100	3940	3090	4030	5150	e3970	e3330	1330	3720	3160	1760
3	3290	2690	4240	3850	991	3760	e4810	e4730	1640	4020	3850	2130
4	2830	3450	4270	3640	1530	5230	e5150	e4890	3520	3340	2280	3350
5	3640	4920	4630	3900	4310	5100	e4120	e2930	3880	3910	189	3390
6	3410	4060	4280	2560	3760	4590	e4320	e2610	3440	3410	3190	3430
7	3210	4380	4670	1570	4090	4730	e4560	e4340	3570	1720	3290	3530
8	2400	3880	2770	4100	4060	5600	e4210	e3780	4330	1380	3310	2960
9	3180	3890	2110	4100	4300	4510	e4060	e4990	994	2780	3290	447
10	5260	3920	1590	5180	2920	5290	e3970	e4930	1260	3360	3500	3220
11	4740	2480	4260	4460	2570	4200	e3600	e3210	3840	3290	2760	3370
12	4610	3530	3870	4640	4370	3360	e4990	e1780	3530	3370	984	3400
13	5090	3480	3880	2740	4180	4390	e4910	e2410	3140	3910	3260	3330
14	1880	4030	4270	4110	e5720	4160	e3920	e4070	3290	2310	3400	3470
15	3050	4380	4930	3870	e3940	4430	e4220	e3260	3940	1640	3530	2990
16	4500	5530	3350	3950	e3510	3790	e4690	e3930	1590	3610	3370	3320
17	4080	3730	3190	4000	e2940	3750	e4440	e4530	1790	3090	3310	2570
18	2890	2740	3920	4060	e3920	3460	e5140	e4340	3690	3240	1280	2620
19	3710	3780	5280	4440	e4590	e4510	e4270	e2790	3600	4060	1390	2590
20	2850	3240	4740	3150	e4810	e5290	e3900	e1830	3540	3500	3170	2580
21	3370	3850	3790	2220	5560	e4190	e3230	e4460	3480	758	3600	2490
22	3620	3740	4660	3280	5060	e4720	e2620	e4450	3550	302	3560	2240
23	2960	2540	2680	3060	5600	e7510	e3600	e4600	1490	3290	3350	2490
24	2850	2620	1700	3640	5270	e1560	e3290	e3670	1540	3640	3080	2700
25	2780	2860	1480	3530	4090	e772	e2840	e3440	3270	3820	1780	2690
26	2990	1760	3150	4950	5410	e5250	e3490	e1510	3650	3400	1580	2600
27	4210	3340	4230	2880	5040	e4620	e2800	e1460	3470	3060	3140	2610
28	3540	3550	4760	2520	4550	e4490	e3620	e1810	3730	1670	2870	2360
29	4230	3760	4940	4050	---	e4930	e3980	e3670	3440	398	4020	2840
30	4960	3870	3620	4610	---	e4680	e4600	e3350	1300	3380	3130	2700
31	4580	---	2440	3420	---	e5150	---	3080	---	3360	3520	---
TOTAL	109950	105770	116140	112310	115911	137652	120390	107870	88134	88278	89453	82557
MEAN	3547	3526	3746	3623	4140	4440	4013	3480	2938	2848	2886	2752
MAX	5260	5530	5280	5180	5720	7510	5150	4990	4330	4060	4020	3530
MIN	1880	1100	1480	1570	991	772	2620	1460	994	302	189	447
AC-FT	218100	209800	230400	222800	229900	273000	238800	214000	174800	175100	177400	163800
a	9680	14100	13800	15500	14800	13600	13800	14800	14800	15000	13600	14500
b	224400	211600	229500	222700	224000	252100	230500	212700	178800	182300	190300	172600
c	33223	32466	32218	31101	33731	29510	31950	33435	33393	32861	32693	32707

e Estimated.

a Contents, in acre-feet, at end of month for Pit No. 6 Reservoir (station 11364100), provided by Pacific Gas & Electric Co.

b Discharge, in acre-feet, for Pit No. 6 Powerplant (station 11364150), provided by Pacific Gas & Electric Co.

c Contents, in acre-feet, at end of month for Pit No. 7 Reservoir (station 11364700), provided by Pacific Gas & Electric Co.

## 11365000 PIT RIVER NEAR MONTGOMERY CREEK, CA—Continued

## STATISTICS OF MONTHLY MEAN DATA FOR WATER YEARS 1945 - 1965, BY WATER YEAR (WY)

	OCT	NOV	DEC	JAN	FEB	MAR	APR	MAY	JUN	JUL	AUG	SEP
MEAN	2643	2828	3821	4320	5592	5331	5711	4297	3127	2376	2231	2284
MAX	5999	3710	9541	11240	12970	8212	13350	7380	5044	3037	2651	2744
(WY)	1963	1951	1956	1956	1958	1956	1952	1952	1953	1958	1958	1959
MIN	2112	2232	2219	2137	2500	3225	3404	2299	2353	1935	1971	1899
(WY)	1950	1950	1950	1949	1948	1964	1947	1947	1950	1949	1947	1949

## SUMMARY STATISTICS

## WATER YEARS 1945 - 1965

ANNUAL TOTAL	
ANNUAL MEAN	3704
HIGHEST ANNUAL MEAN	5529 1956
LOWEST ANNUAL MEAN	2658 1947
HIGHEST DAILY MEAN	32100 Dec 23 1955
LOWEST DAILY MEAN	150 Jul 19 1965
ANNUAL SEVEN-DAY MINIMUM	1610 Jul 19 1965
MAXIMUM PEAK FLOW	37100 Dec 23 1955
MAXIMUM PEAK STAGE	14.12 Dec 23 1955
ANNUAL RUNOFF (AC-FT)	2684000
10 PERCENT EXCEEDS	6080
50 PERCENT EXCEEDS	3010
90 PERCENT EXCEEDS	1740

## STATISTICS OF MONTHLY MEAN DATA FOR WATER YEARS 1966 - 2001, BY WATER YEAR (WY)

MEAN	3428	4115	4743	6567	7234	8065	6577	5463	4046	3296	3112	3123
MAX	5865	8683	9814	20890	18670	16030	12920	11900	8911	4633	4187	4257
(WY)	1997	1997	1982	1970	1986	1983	1982	1995	1998	1998	1983	1998
MIN	2286	2533	2408	2632	2784	3241	2626	2404	2268	2291	2049	1428
(WY)	1993	1993	1991	1991	1991	1977	1977	1992	1992	1994	1992	1966

## SUMMARY STATISTICS

## FOR 2000 CALENDAR YEAR

## FOR 2001 WATER YEAR

## WATER YEARS 1966 - 2001

ANNUAL TOTAL	1740209	1274415	
ANNUAL MEAN	4755	3492	4969
HIGHEST ANNUAL MEAN			7693 1974
LOWEST ANNUAL MEAN			2808 1992
HIGHEST DAILY MEAN	16300 Feb 14	7510 Mar 23	53900 Jan 23 1970
LOWEST DAILY MEAN	192 Jul 4	189 Aug 5	30 Jul 12 1975
ANNUAL SEVEN-DAY MINIMUM	2560 Jul 3	2510 Sep 17	939 Sep 5 1966
MAXIMUM PEAK FLOW		7950 Oct 27	73000 Jan 24 1970
MAXIMUM PEAK STAGE		62.98 Oct 27	74.65 Feb 19 1986
ANNUAL RUNOFF (AC-FT)	3452000	2528000	3600000
10 PERCENT EXCEEDS	7840	4800	8510
50 PERCENT EXCEEDS	4060	3530	4040
90 PERCENT EXCEEDS	2610	1780	2120

## 11367500 McCLOUD RIVER NEAR McCLOUD, CA

LOCATION.—Lat 41°11'18", long 122°03'52", in NW 1/4 NE 1/4 sec.34, T.39 N., R.2 W., Siskiyou County, Hydrologic Unit 18020004, on right bank, 0.4 mi downstream from Angel Creek, and 6 mi southeast of McCloud.

DRAINAGE AREA.—358 mi<sup>2</sup>.

PERIOD OF RECORD.—April 1931 to current year.

REVISED RECORDS.—WSP 843: 1936(M). WSP 1445: 1940(M). WSP 1931: Drainage area.

GAGE.—Water-stage recorder. Datum of gage is 2,711.2 ft above sea level, from river-profile map.

REMARKS.—Two small diversions upstream from station for irrigation and one 22-in. pipeline for town of McCloud. See schematic diagram of [Pit and McCloud River Basins](#).

COOPERATION.—Records were collected by Pacific Gas & Electric Co., under general supervision of the U.S. Geological Survey, in connection with a Federal Energy Regulatory Commission project.

EXTREMES FOR PERIOD OF RECORD.—Maximum discharge, 15,400 ft<sup>3</sup>/s, Jan. 1, 1997, gage height, 11.22 ft, from rating curve extended above 8,800 ft<sup>3</sup>/s on basis of slope-area measurement of peak flow; minimum daily, 524 ft<sup>3</sup>/s, Nov. 23, 24, 1932.

EXTREMES FOR CURRENT YEAR.—Peak discharges greater than base discharge of 1,500 ft<sup>3</sup>/s, or maximum:

Date	Time	Discharge (ft <sup>3</sup> /s)	Gage height (ft)
Mar. 25	1415	1,060	2.04

DISCHARGE, CUBIC FEET PER SECOND, WATER YEAR OCTOBER 2000 TO SEPTEMBER 2001  
DAILY MEAN VALUES

DAY	OCT	NOV	DEC	JAN	FEB	MAR	APR	MAY	JUN	JUL	AUG	SEP
1	839	826	804	782	767	772	942	939	770	743	720	705
2	838	822	803	782	766	774	938	914	766	740	718	705
3	836	818	800	782	766	771	913	897	763	738	717	705
4	836	817	798	782	766	791	889	889	760	738	717	705
5	834	815	795	782	767	819	873	892	760	738	716	705
6	833	815	793	782	767	810	873	888	759	736	716	705
7	832	815	793	781	765	804	872	885	757	735	716	705
8	831	815	793	783	765	807	856	893	755	734	716	704
9	835	815	793	783	771	815	843	899	751	733	716	705
10	842	815	793	786	771	806	838	894	749	732	716	705
11	835	811	796	792	771	799	832	886	749	732	716	705
12	832	809	795	783	769	794	827	885	749	732	716	705
13	830	810	804	782	763	794	826	875	747	731	715	705
14	828	810	804	780	762	798	822	867	746	730	714	705
15	828	807	802	776	760	796	820	887	743	729	712	704
16	827	804	798	775	765	793	822	914	742	728	711	703
17	827	804	794	773	766	793	841	875	740	728	711	702
18	827	804	793	772	773	795	891	856	739	727	711	700
19	826	804	793	771	780	809	924	844	738	727	710	700
20	829	804	793	771	794	832	910	835	738	727	710	699
21	827	804	794	771	813	850	889	828	738	727	710	699
22	825	803	801	771	808	878	870	820	737	727	710	699
23	823	800	798	775	796	903	872	812	738	727	711	698
24	823	799	796	780	792	933	887	805	737	726	710	700
25	825	799	793	779	784	1030	911	800	738	725	709	716
26	825	798	793	775	780	988	948	794	745	723	707	705
27	823	798	791	771	776	944	970	790	767	722	706	702
28	847	798	788	771	775	939	977	784	771	721	705	700
29	849	812	787	771	---	953	941	780	756	721	705	699
30	840	811	784	770	---	944	927	775	748	721	705	699
31	830	---	782	768	---	934	---	771	---	721	705	---
TOTAL	25782	24262	24644	24102	21698	26268	26544	26473	22496	22619	22077	21094
MEAN	832	809	795	777	775	847	885	854	750	730	712	703
MAX	849	826	804	792	813	1030	977	939	771	743	720	716
MIN	823	798	782	768	760	771	820	771	737	721	705	698
AC-FT	51140	48120	48880	47810	43040	52100	52650	52510	44620	44860	43790	41840



## SACRAMENTO RIVER BASIN

## 11367500 McCLOUD RIVER NEAR McCLOUD, CA—Continued

## STATISTICS OF MONTHLY MEAN DATA FOR WATER YEARS 1931 - 2001, BY WATER YEAR (WY)

	OCT	NOV	DEC	JAN	FEB	MAR	APR	MAY	JUN	JUL	AUG	SEP
MEAN	767	792	865	909	979	1051	1128	1125	952	837	798	776
MAX	1030	1569	1879	2348	2155	2220	1896	2182	1574	1219	1101	1059
(WY)	1984	1974	1956	1970	1958	1983	1974	1938	1998	1983	1983	1983
MIN	536	537	534	539	549	568	674	606	574	561	556	544
(WY)	1933	1933	1933	1933	1933	1935	1994	1992	1992	1934	1992	1932

SUMMARY STATISTICS	FOR 2000 CALENDAR YEAR		FOR 2001 WATER YEAR		WATER YEARS 1931 - 2001	
ANNUAL TOTAL	365406		288059			
ANNUAL MEAN	998		789		917	
HIGHEST ANNUAL MEAN					1406	
LOWEST ANNUAL MEAN					589	
HIGHEST DAILY MEAN	2150	Feb 14	1030	Mar 25	11900	Jan 1 1997
LOWEST DAILY MEAN	782	Dec 31	698	Sep 23	524	Nov 23 1932
ANNUAL SEVEN-DAY MINIMUM	788	Dec 25	699	Sep 18	528	Nov 20 1932
MAXIMUM PEAK FLOW			1060	Mar 25	15400	Jan 1 1997
MAXIMUM PEAK STAGE			2.04	Mar 25	11.22	Jan 1 1997
ANNUAL RUNOFF (AC-FT)	724800		571400		664300	
10 PERCENT EXCEEDS	1270		885		1260	
50 PERCENT EXCEEDS	908		784		840	
90 PERCENT EXCEEDS	804		710		611	

11367720 McCLOUD-IRON CANYON DIVERSION TUNNEL NEAR McCLOUD, CA

LOCATION.—Lat 41°08'06", long 122°04'26", in SE 1/4 SW 1/4 sec.22, T.38 N., R.2 W., Shasta County, Hydrologic Unit 18020004, Shasta National Forest, on left bank of Lake McCloud, and 8.8 mi southeast of McCloud.

PERIOD OF RECORD.—December 1965 to current year.

REVISED RECORDS.—WDR CA-75-4: 1973.

GAGE.—None. Water-stage recorders on Iron Canyon Reservoir and Lake McCloud (stations 11363920 and 11367740) used to compute record.

REMARKS.—Water is diverted from Lake McCloud (station 11367740) via tunnel to Iron Canyon Reservoir (station 11363920) and then via penstock into James B. Black Powerplant (station 11363910) on the Pit River. Diversion began Dec. 1, 1965. See schematic diagram of Pit and McCloud River Basins.

COOPERATION.—Records were collected by Pacific Gas & Electric Co., under general supervision of the U.S. Geological Survey, in connection with a Federal Energy Regulatory Commission project.

EXTREMES FOR PERIOD OF RECORD.—Maximum daily discharge, 1,890 ft<sup>3</sup>/s, several days during May and June 1967; no flow several days in 1965-68, 1971, 1978, June 8, 10, 2001.

DISCHARGE, CUBIC FEET PER SECOND, WATER YEAR OCTOBER 2000 TO SEPTEMBER 2001  
DAILY MEAN VALUES

DAY	OCT	NOV	DEC	JAN	FEB	MAR	APR	MAY	JUN	JUL	AUG	SEP
1	664	635	728	587	739	806	961	784	667	670	662	690
2	756	677	744	627	742	767	998	781	614	700	673	662
3	767	728	767	665	687	714	1010	794	569	718	680	985
4	762	769	744	709	625	699	1030	806	614	724	644	677
5	747	796	773	742	664	738	1070	802	652	746	584	673
6	732	811	769	690	687	747	1100	775	679	765	592	691
7	722	822	716	600	696	799	1070	795	708	710	610	703
8	714	805	716	671	713	834	1060	830	.00	667	630	677
9	751	766	677	718	738	841	1050	883	677	683	645	643
10	784	778	622	773	665	839	1030	940	.00	703	657	660
11	821	778	680	803	612	883	985	960	641	724	652	648
12	859	786	740	812	673	939	970	898	651	735	614	662
13	898	849	760	732	694	959	960	853	677	751	637	670
14	845	858	787	692	761	965	923	849	716	703	654	685
15	817	849	801	688	772	977	877	860	725	656	671	662
16	825	884	665	691	756	985	855	862	680	674	686	634
17	845	808	591	720	737	886	836	881	639	688	698	646
18	878	666	618	773	776	833	821	899	670	697	701	663
19	874	614	687	779	835	866	809	838	703	708	684	668
20	867	608	754	743	878	898	806	805	719	715	692	666
21	788	546	763	712	868	912	777	827	742	680	700	666
22	711	575	802	693	871	915	764	845	757	627	712	606
23	668	538	670	669	932	929	758	857	711	661	717	553
24	679	518	574	687	889	866	750	866	651	688	719	553
25	696	531	503	707	835	835	764	854	644	707	684	546
26	717	515	549	719	852	884	772	782	671	724	661	537
27	727	562	578	702	888	930	761	723	707	729	666	530
28	748	615	628	659	880	972	759	670	741	683	697	527
29	759	678	700	682	---	1010	746	677	745	612	705	533
30	777	708	638	701	---	1040	768	673	701	634	704	531
31	727	---	618	702	---	989	---	686	---	650	714	---
TOTAL	23925	21073	21362	21848	21465	27257	26840	25355	19071.00	21532	20745	19247
MEAN	772	702	689	705	767	879	895	818	636	695	669	642
MAX	898	884	802	812	932	1040	1100	960	757	765	719	985
MIN	664	515	503	587	612	699	746	670	.00	612	584	527
AC-FT	47460	41800	42370	43340	42580	54060	53240	50290	37830	42710	41150	38180

STATISTICS OF MONTHLY MEAN DATA FOR WATER YEARS 1966 - 2001, BY WATER YEAR (WY)

	1966	1967	1968	1969	1970	1971	1972	1973	1974	1975	1976	1977	1978	1979	1980	1981	1982	1983	1984	1985	1986	1987	1988	1989	1990	1991	1992	1993	1994	1995	1996	1997	1998	1999	2000	2001		
MEAN	666	680	814	881	973	1108	1133	1023	898	789	752	715																										
MAX	1028	1205	1362	1451	1583	1592	1624	1729	1854	1305	1150	1123																										
(WY)	1984	1984	1974	1970	1970	1970	1966	1967	1967	1967	1971	1983																										
MIN	.000	.000	333	383	439	562	445	388	416	409	343	383																										
(WY)	1966	1966	1992	1992	1991	1991	1990	1977	1992	1992	1992	1992																										

SUMMARY STATISTICS

	FOR 2000 CALENDAR YEAR		FOR 2001 WATER YEAR		WATER YEARS 1966 - 2001	
ANNUAL TOTAL	339979		269720.00			
ANNUAL MEAN	929		739		869	
HIGHEST ANNUAL MEAN					1260	
LOWEST ANNUAL MEAN					453	
HIGHEST DAILY MEAN	1390	Apr 13	1100	Apr 6	1890	May 20 1967
LOWEST DAILY MEAN	398	Jan 22	.00	Jun 8	.00	Oct 1 1965
ANNUAL SEVEN-DAY MINIMUM	541	Nov 21	476	Jun 4	.00	Oct 1 1965
ANNUAL RUNOFF (AC-FT)	674300		535000		629300	
10 PERCENT EXCEEDS	1300		888		1390	
50 PERCENT EXCEEDS	850		718		807	
90 PERCENT EXCEEDS	640		615		487	

## 11367760 McCLOUD RIVER BELOW McCLOUD DAM, NEAR McCLOUD, CA

LOCATION.—Lat 41°07'44", long 122°04'08", in SW 1/4 NE 1/4 sec.27, T.38 N., R.2 W., Shasta County, Hydrologic Unit 18020004, Shasta National Forest, on left bank, 0.1 mi downstream from Lizard Creek, 0.6 mi downstream from McCloud Dam, and 9 mi southeast of McCloud.

DRAINAGE AREA.—404 mi<sup>2</sup>.

PERIOD OF RECORD.—April 1966 to current year (operated as a low-flow station only).

GAGE.—Water-stage recorder. Datum of gage is 2,398.76 ft above sea level (levels by Pacific Gas & Electric Co.). Prior to Apr. 7, 1972, at datum 3.00 ft higher.

REMARKS.—Low flow regulated by Lake McCloud (station 11367740) since November 1965. Most of McCloud River runoff is diverted from reservoir through tunnel to Iron Canyon Reservoir (station 11363920) in Pit River Basin. This station records fishwater release. The minimum release requirement is 40 ft<sup>3</sup>/s at all times. Prior to water year 1974, flow was computed up to 400 ft<sup>3</sup>/s. During water years 1975–81, because of channel changes, flow was computed up to 200 ft<sup>3</sup>/s. Currently, because of maximum required release, flow is computed to 220 ft<sup>3</sup>/s. See schematic diagram of [Pit and McCloud River Basins](#).

COOPERATION.—Records were collected by Pacific Gas & Electric Co., under general supervision of the U.S. Geological Survey, in connection with a Federal Energy Regulatory Commission project.

## DISCHARGE, CUBIC FEET PER SECOND, WATER YEAR OCTOBER 2000 TO SEPTEMBER 2001

## DAILY MEAN VALUES

DAY	OCT	NOV	DEC	JAN	FEB	MAR	APR	MAY	JUN	JUL	AUG	SEP
1	201	192	193	138	140	128	63	104	130	133	138	138
2	200	193	193	138	140	128	77	106	130	134	139	137
3	199	193	192	138	142	128	86	109	130	133	139	137
4	199	193	192	138	144	127	91	113	130	134	139	137
5	198	192	192	138	144	66	93	116	130	135	139	137
6	198	192	191	138	144	59	93	117	130	136	139	137
7	198	192	191	138	144	63	94	117	131	137	139	149
8	198	192	191	138	145	63	104	114	131	136	139	156
9	198	191	191	138	145	63	105	111	131	136	139	156
10	198	190	191	139	145	62	106	111	131	136	139	156
11	198	190	191	139	145	74	108	116	131	136	139	156
12	198	191	191	138	145	89	110	115	131	136	139	156
13	197	192	191	138	145	94	112	116	132	136	139	156
14	197	192	191	138	145	94	111	117	133	136	139	156
15	196	191	191	138	145	93	111	117	133	136	139	155
16	196	191	149	138	145	93	111	117	132	136	139	156
17	195	190	139	138	145	95	111	118	132	136	139	156
18	195	190	139	138	146	96	112	121	132	136	139	157
19	194	190	142	138	128	97	112	122	133	136	139	158
20	194	190	142	138	91	69	112	122	135	136	139	158
21	194	191	142	138	63	53	113	122	135	136	139	157
22	194	191	142	138	61	51	111	122	135	136	138	157
23	193	191	142	138	58	51	110	123	135	136	139	157
24	193	192	142	138	69	52	110	124	135	136	138	157
25	193	192	143	138	84	53	107	126	135	137	138	158
26	193	192	143	138	94	51	99	125	135	137	138	157
27	193	192	143	138	99	51	98	126	136	138	138	158
28	193	193	143	138	107	51	100	130	135	138	138	158
29	193	193	144	138	---	51	103	130	133	138	138	158
30	193	193	143	138	---	52	103	130	133	138	138	158
31	192	---	144	138	---	59	---	130	---	139	138	---
TOTAL	6071	5747	5154	4280	3448	2356	3076	3687	3975	4219	4299	4579
MEAN	196	192	166	138	123	76.0	103	119	132	136	139	153
MAX	201	193	193	139	146	128	113	130	136	139	139	158
MIN	192	190	139	138	58	51	63	104	130	133	138	137
AC-FT	12040	11400	10220	8490	6840	4670	6100	7310	7880	8370	8530	9080

## 11367800 McCLOUD RIVER AT AH-DI-NA, NEAR McCLOUD, CA

LOCATION.—Lat 41°06'39", long 122°05'42", in NE 1/4 SW 1/4 sec.33, T.38 N., R.2 W., Shasta County, Hydrologic Unit 18020004, Shasta National Forest, on right bank at Ah-Di-Na, 1.8 mi downstream from Squirrel Creek, 3.9 mi downstream from McCloud Dam, and 9.6 mi south of McCloud.

DRAINAGE AREA.—427 mi<sup>2</sup>.

PERIOD OF RECORD.—October 1964 to current year.

REVISED RECORDS.—WDR CA-98-4: 1997 (m).

GAGE.—Water-stage recorder. Elevation of gage is 2,160 ft above sea level, from topographic map.

REMARKS.—Low flow completely regulated by Lake McCloud (station 11367740) 3.9 mi upstream since November 1965. Diversion to Iron Canyon Reservoir (station 11363920) through McCloud–Iron Canyon diversion tunnel (station 11367720) started Dec. 1, 1965. This station records fishwater release. The minimum release requirements range from 160 to 210 ft<sup>3</sup>/s per schedule outlined in Federal Energy Regulatory Commission License 2106. See schematic diagram of [Pit and McCloud River Basins](#).

COOPERATION.—Records were collected by Pacific Gas & Electric Co., under general supervision of the U.S. Geological Survey, in connection with a Federal Energy Regulatory Commission project.

EXTREMES FOR PERIOD OF RECORD.—Prior to completion of McCloud Dam in 1965, maximum discharge, 9,660 ft<sup>3</sup>/s, Dec. 22, 1964, gage height, 9.43 ft, from rating curve extended above 2,500 ft<sup>3</sup>/s; minimum daily, 86 ft<sup>3</sup>/s, Oct. 1–26, 1964. Since completion of McCloud Dam, maximum discharge, 31,700 ft<sup>3</sup>/s, Jan. 1, 1997, gage height, 14.77 ft, from rating curve extended above 8,000 ft<sup>3</sup>/s on basis of slope-area measurement of peak flow; minimum daily, 41 ft<sup>3</sup>/s, Dec. 18–20, 1971 (caused by valve malfunction at McCloud Dam).

EXTREMES OUTSIDE PERIOD OF RECORD.—Flood of Dec. 21, 1955, reached a stage of 12.5 ft, discharge, 17,800 ft<sup>3</sup>/s, from rating curve extended above 2,500 ft<sup>3</sup>/s.

EXTREMES FOR CURRENT YEAR.—Peak discharges greater than base discharge of 3,000 ft<sup>3</sup>/s, or maximum:

Date	Time	Discharge (ft <sup>3</sup> /s)	Gage height (ft)
Feb. 21	1600	383	1.92

## DISCHARGE, CUBIC FEET PER SECOND, WATER YEAR OCTOBER 2000 TO SEPTEMBER 2001

## DAILY MEAN VALUES

DAY	OCT	NOV	DEC	JAN	FEB	MAR	APR	MAY	JUN	JUL	AUG	SEP
1	251	251	254	185	189	213	206	190	183	181	181	181
2	251	248	251	184	188	211	211	188	183	181	181	181
3	251	248	248	182	190	207	214	189	182	181	181	181
4	251	246	247	181	195	229	199	190	183	181	181	181
5	251	245	245	181	199	257	193	193	183	182	181	181
6	251	245	245	181	201	218	193	191	183	183	181	181
7	250	245	245	181	199	211	188	190	182	183	181	193
8	249	245	245	185	198	229	192	186	181	183	181	203
9	251	245	245	185	200	237	190	179	181	182	181	204
10	252	244	245	190	199	210	188	177	181	181	181	204
11	251	243	245	205	200	199	189	180	181	181	181	204
12	251	243	245	196	196	202	189	179	181	181	181	204
13	251	245	255	191	196	205	190	178	181	181	181	204
14	250	245	266	188	196	207	189	178	182	181	181	204
15	248	245	268	186	196	207	188	182	181	181	180	203
16	248	242	212	186	198	202	189	178	181	181	179	202
17	248	242	192	185	201	200	198	177	181	181	179	201
18	248	242	189	184	223	200	206	179	180	180	179	203
19	245	242	191	184	232	223	210	180	181	179	179	204
20	247	242	191	182	271	233	215	179	183	179	179	204
21	245	242	192	181	364	231	211	178	182	179	179	204
22	245	242	204	181	299	248	207	178	181	179	181	204
23	245	242	204	184	216	260	207	178	181	179	182	204
24	245	242	199	189	188	267	210	178	181	179	181	204
25	247	242	196	191	187	289	210	179	181	180	181	215
26	245	242	195	191	188	251	205	178	188	181	181	205
27	245	245	193	189	187	219	201	179	203	181	181	204
28	269	245	192	187	190	207	199	183	190	181	181	204
29	265	257	191	188	---	206	196	183	183	181	181	204
30	269	264	191	186	---	202	192	184	182	181	181	204
31	254	---	191	186	---	203	---	183	---	181	181	---
TOTAL	7769	7356	6872	5775	5886	6883	5975	5644	5486	5605	5599	5975
MEAN	251	245	222	186	210	222	199	182	183	181	181	199
MAX	269	264	268	205	364	289	215	193	203	183	182	215
MIN	245	242	189	181	187	199	188	177	180	179	179	181
AC-FT	15410	14590	13630	11450	11670	13650	11850	11190	10880	11120	11110	11850

## SACRAMENTO RIVER BASIN

## 11367800 McCLOUD RIVER AT AH-DI-NA, NEAR McCLOUD, CA—Continued

## STATISTICS OF MONTHLY MEAN DATA FOR WATER YEARS 1965 - 2001, BY WATER YEAR (WY)

	OCT	NOV	DEC	JAN	FEB	MAR	APR	MAY	JUN	JUL	AUG	SEP
MEAN	250	282	310	454	417	476	359	349	262	225	223	233
MAX	919	1140	1863	2211	1770	2107	2102	1498	1173	1035	992	954
(WY)	1966	1974	1965	1970	1986	1983	1965	1965	1965	1965	1965	1965
MIN	180	182	93.2	93.4	119	167	166	162	160	159	155	182
(WY)	1978	1978	1972	1972	1972	1977	1968	1977	1977	1977	1977	1977

SUMMARY STATISTICS	FOR 2000 CALENDAR YEAR		FOR 2001 WATER YEAR		WATER YEARS 1965 - 2001	
ANNUAL TOTAL	114732		74825			
ANNUAL MEAN	313		205		320	
HIGHEST ANNUAL MEAN					1326	
LOWEST ANNUAL MEAN					168	
HIGHEST DAILY MEAN	2720	Feb 15	364	Feb 21	25200	Jan 1 1997
LOWEST DAILY MEAN	185	Jan 12	177	May 10	41	Dec 18 1971
ANNUAL SEVEN-DAY MINIMUM	186	Jan 2	178	May 20	42	Dec 15 1971
MAXIMUM PEAK FLOW			383		31700	
MAXIMUM PEAK STAGE			1.92		14.77	
ANNUAL RUNOFF (AC-FT)	227600		148400		231600	
10 PERCENT EXCEEDS	460		248		492	
50 PERCENT EXCEEDS	245		192		208	
90 PERCENT EXCEEDS	206		181		169	

## 11368000 McCLOUD RIVER ABOVE SHASTA LAKE, CA

LOCATION.—Lat 40°57'30", long 122°13'07", unsurveyed, T.36 N., R.3 W., Shasta County, Hydrologic Unit 18020004, on right bank, just upstream from Shasta Lake, 0.2 mi downstream from Big Bollibokka Creek, and 11.3 mi east of Lamoine.

DRAINAGE AREA.—604 mi<sup>2</sup>.

PERIOD OF RECORD.—October 1945 to current year. Prior to 1950, published as "above Shasta Reservoir."

TEMPERATURE: Water years 1956–59.

REVISED RECORDS.—WSP 1445: 1953(M). WSP 1931: Drainage area. WDR CA-94-4: 1993(P).

GAGE.—Water-stage recorder. Datum of gage is 1,100.00 ft above sea level (levels by U.S. Bureau of Reclamation).

REMARKS.—Low flow completely regulated by Lake McCloud (station 11367740) 16.5 mi upstream since Nov. 3, 1965. Diversions to Iron Canyon Reservoir (station 11363920) began Dec. 1, 1965. See schematic diagram of Pit and McCloud River Basins.

COOPERATION.—Records were collected by Pacific Gas & Electric Co., under general supervision of the U.S. Geological Survey, in connection with a Federal Energy Regulatory Commission project.

EXTREMES FOR PERIOD OF RECORD.—Maximum discharge, 51,300 ft<sup>3</sup>/s, Jan. 1, 1997, gage height, 29.00 ft, from rating curve extended above 15,000 ft<sup>3</sup>/s on basis of slope-area measurement of peak flow; minimum daily, 109 ft<sup>3</sup>/s, Dec. 16–20, 1971. Minimum prior to regulation by Lake McCloud, 825 ft<sup>3</sup>/s, Jan. 3, 1950.

EXTREMES FOR CURRENT YEAR.—Peak discharges greater than base discharge of 4,500 ft<sup>3</sup>/s, or maximum:

Date	Time	Discharge (ft <sup>3</sup> /s)	Gage height (ft)
Feb. 21	1800	4,640	14.58

DISCHARGE, CUBIC FEET PER SECOND, WATER YEAR OCTOBER 2000 TO SEPTEMBER 2001  
DAILY MEAN VALUES

DAY	OCT	NOV	DEC	JAN	FEB	MAR	APR	MAY	JUN	JUL	AUG	SEP
1	321	357	373	266	350	806	756	474	309	280	236	220
2	321	345	350	258	341	790	722	454	307	272	235	220
3	318	337	340	255	340	747	704	442	306	267	234	220
4	317	332	333	254	364	1070	635	437	303	268	235	219
5	316	330	328	253	401	2540	604	436	302	265	235	218
6	316	325	325	251	408	1800	620	427	300	264	234	217
7	316	322	324	250	388	1500	616	418	296	264	234	226
8	316	325	321	288	368	1500	569	413	296	263	234	246
9	328	327	324	287	395	1450	544	399	292	261	233	245
10	356	323	323	372	391	1210	522	394	289	260	232	246
11	330	320	332	617	435	1030	512	390	288	259	232	247
12	328	317	354	506	416	930	496	382	285	257	231	254
13	325	323	444	406	397	898	489	375	280	254	231	253
14	322	327	627	363	384	895	479	373	282	253	229	253
15	321	323	602	338	374	858	468	420	278	252	228	252
16	320	322	430	319	392	812	464	396	277	250	228	258
17	317	317	337	305	435	775	499	374	272	250	227	251
18	316	316	303	297	779	771	525	366	268	250	227	250
19	316	316	293	292	1060	867	550	361	266	248	226	250
20	326	316	287	287	2000	998	622	353	268	246	226	251
21	325	316	291	283	3950	1010	610	347	266	245	227	250
22	315	316	353	281	3060	1060	575	342	265	243	228	247
23	312	312	340	306	1750	1090	557	338	264	241	233	248
24	312	313	326	428	1250	1120	553	329	264	238	234	249
25	327	316	310	477	1090	1440	557	329	266	237	230	328
26	335	316	300	472	1030	1150	554	329	289	236	226	272
27	321	316	293	432	926	964	543	327	436	236	225	266
28	484	316	286	402	850	870	527	328	344	236	220	266
29	457	391	282	397	---	842	504	323	297	237	220	265
30	501	430	277	379	---	805	485	315	287	237	219	262
31	391	---	274	362	---	769	---	311	---	236	219	---
TOTAL	10526	9862	10682	10683	24324	33367	16861	11702	8742	7805	7108	7449
MEAN	340	329	345	345	869	1076	562	377	291	252	229	248
MAX	501	430	627	617	3950	2540	756	474	436	280	236	328
MIN	312	312	274	250	340	747	464	311	264	236	219	217
AC-FT	20880	19560	21190	21190	48250	66180	33440	23210	17340	15480	14100	14780

## SACRAMENTO RIVER BASIN

## 11368000 McCLOUD RIVER ABOVE SHASTA LAKE, CA—Continued

## STATISTICS OF MONTHLY MEAN DATA FOR WATER YEARS 1946 - 1965, BY WATER YEAR (WY)

	OCT	NOV	DEC	JAN	FEB	MAR	APR	MAY	JUN	JUL	AUG	SEP
MEAN	1121	1252	2080	2077	2617	2177	2467	1965	1460	1159	1059	1020
MAX	1899	2162	6513	4525	7493	3966	4599	2978	2248	1715	1489	1395
(WY)	1951	1951	1956	1953	1958	1958	1963	1958	1958	1958	1958	1958
MIN	856	870	856	903	1040	1265	1320	1085	1069	901	852	839
(WY)	1950	1950	1950	1949	1948	1964	1964	1947	1949	1950	1950	1950

## SUMMARY STATISTICS

## WATER YEARS 1946 - 1965

ANNUAL MEAN	1699
HIGHEST ANNUAL MEAN	2703 1958
LOWEST ANNUAL MEAN	1213 1950
HIGHEST DAILY MEAN	36100 Dec 21 1955
LOWEST DAILY MEAN	825 Jan 3 1950
ANNUAL SEVEN-DAY MINIMUM	826 Oct 9 1950
MAXIMUM PEAK FLOW	a45200 Dec 22 1955
MAXIMUM PEAK STAGE	28.20 Dec 22 1955
ANNUAL RUNOFF (AC-FT)	1231000
10 PERCENT EXCEEDS	2670
50 PERCENT EXCEEDS	1270
90 PERCENT EXCEEDS	928

## STATISTICS OF MONTHLY MEAN DATA FOR WATER YEARS 1967 - 2001, BY WATER YEAR (WY)

	309	576	837	1455	1536	1633	955	682	436	324	285	291
MEAN	309	576	837	1455	1536	1633	955	682	436	324	285	291
MAX	468	4068	3681	6043	5118	5825	2794	1930	1379	540	409	366
(WY)	1990	1974	1997	1970	1986	1983	1982	1983	1998	1998	1998	1998
MIN	206	227	235	222	232	248	226	232	215	200	192	200
(WY)	1992	1992	1977	1991	1977	1977	1977	1977	1977	1977	1991	1991

## SUMMARY STATISTICS

## FOR 2000 CALENDAR YEAR

## FOR 2001 WATER YEAR

## WATER YEARS 1967 - 2001

ANNUAL TOTAL	326064	159111	
ANNUAL MEAN	891	436	773
HIGHEST ANNUAL MEAN			1720 1974
LOWEST ANNUAL MEAN			230 1977
HIGHEST DAILY MEAN	10900 Feb 14	3950 Feb 21	45000 Jan 1 1997
LOWEST DAILY MEAN	271 Jan 8	217 Sep 6	109 Dec 16 1971
ANNUAL SEVEN-DAY MINIMUM	273 Jan 3	219 Aug 31	113 Dec 15 1971
MAXIMUM PEAK FLOW		4640 Feb 21	51300 Jan 1 1997
MAXIMUM PEAK STAGE		14.58 Feb 21	29.00 Jan 1 1997
ANNUAL RUNOFF (AC-FT)	646700	315600	560100
10 PERCENT EXCEEDS	2160	796	1520
50 PERCENT EXCEEDS	404	322	364
90 PERCENT EXCEEDS	316	235	250

a From rating curve extended above 6,400 ft<sup>3</sup>/s on basis of slope-area measurement of peak flow.

11370000 SHASTA LAKE NEAR REDDING, CA

LOCATION.—Lat 40°43'08", long 122°25'12", in SE 1/4 NW 1/4 sec.15, T.33 N., R.5 W., Shasta County, Hydrologic Unit 18020005, in Shasta Dam on Sacramento River, near right bank, 2 mi downstream from Squaw Creek, and 9.5 mi north of Redding.

DRAINAGE AREA.—6,421 mi<sup>2</sup>, excluding Goose Lake Basin.

PERIOD OF RECORD.—November 1942 to current year. Prior to 1950, published as Shasta Reservoir near Redding.

CHEMICAL DATA: Water years 1978–80.

GAGE.—Water-stage recorder. Datum of gage is sea level (levels by U.S. Bureau of Reclamation). Prior to July 10, 1944, nonrecording gage at various sites near dam at same datum. Contents based on capacity table dated May 8, 1967, provided by U.S. Bureau of Reclamation.

REMARKS.—Lake is formed by concrete gravity-type dam completed in 1949; regulation began Dec. 30, 1943. Usable capacity, 4,436,400 acre-ft, between elevations 737.75 ft, invert of lowest set of river outlets, and 1,067.0 ft, top of flashboard gates on drum-type spillway gates. Operating pool from elevation, 840.0 ft, capacity, 587,127 acre-ft to 1,067.0 ft, capacity, 4,552,090 acre-ft. Dead storage, 115,800 acre-ft. Installation of flashboard gates on top of drum gates completed Nov. 12, 1964. All water passes down the Sacramento River, most of which is through powerplant at dam. Figures given represent total contents at 2400 hours. Lake is used for flood control, power generation, irrigation, and recreation. See schematic diagram of Pit and McCloud River Basins.

COOPERATION.—Records were provided by U.S. Bureau of Reclamation, not rounded to U.S. Geological Survey standards.

EXTREMES (AT 2400 HOURS) FOR PERIOD OF RECORD.—Maximum contents, 4,550,300 acre-ft, May 19, 1967, elevation, 1,066.94 ft; minimum since first filling, 562,600 acre-ft, Sept. 13, 1977, elevation, 836.68 ft.

EXTREMES (AT 2400 HOURS) FOR CURRENT YEAR.—Maximum contents, 4,025,297 acre-ft, Apr. 23, elevation, 1,048.63 ft; minimum, 2,199,643 acre-ft, Sept. 30, elevation, 968.56 ft.

Capacity table (elevation, in feet, and contents, in acre-feet)  
(Based on table provided by U.S. Bureau of Reclamation, dated May 8, 1967)

830	515,543	890	1,051,713	950	1,876,996	1,010	3,051,750
840	587,127	900	1,167,888	960	2,046,829	1,020	3,286,929
850	665,511	910	1,291,854	970	2,226,093	1,030	3,533,478
860	751,027	920	1,424,780	980	2,416,019	1,050	4,063,108
870	843,589	930	1,566,238	990	2,616,622	1,067	4,552,090
880	943,929	940	1,717,255	1,000	2,828,544		

RESERVOIR STORAGE (ACRE-FEET), WATER YEAR OCTOBER 2000 TO SEPTEMBER 2001  
DAILY OBSERVATION AT 2400 HOURS

DAY	OCT	NOV	DEC	JAN	FEB	MAR	APR	MAY	JUN	JUL	AUG	SEP
1	2980848	2943147	2886781	2908440	3041694	3511542	3961521	4018145	3772193	3261665	2702760	2381425
2	2977473	2937114	2886120	2906890	3046493	3530704	3967788	4013470	3758193	3245145	2688663	2372155
3	2975448	2933774	2885019	2906890	3045122	3542600	3972420	4011269	3738695	3231773	2676276	2362908
4	2971849	2931993	2883477	2907997	3044436	3575370	3977324	4010169	3727155	3216765	2662061	2354836
5	2969599	2933107	2884358	2909325	3049922	3624022	3979777	4006327	3716927	3202064	2643328	2348324
6	2966899	2931993	2884138	2908882	3054736	3655239	3987164	4001399	3702815	3183383	2631303	2340854
7	2964649	2931548	2885680	2905340	3059561	3681441	3990723	3997567	3686376	3161956	2618276	2335890
8	2961049	2930658	2881715	2909325	3064845	3708297	3993460	3994555	3672870	3140398	2605518	2329224
9	2959259	2929767	2877751	2912868	3076109	3732925	3995377	3992092	3652137	3121030	2593809	2317807
10	2961949	2927986	2873566	2925092	3086270	3748705	3995650	3990723	3630452	3103620	2581334	2312883
11	2962849	2924202	2874226	2937114	3099210	3761092	3996472	3984974	3614505	3086732	2569131	2309475
12	2964199	2921530	2874887	2944490	3112209	3767689	3997019	3975690	3597591	3068980	2553335	2305877
13	2966449	2917968	2880173	2948070	3123597	3776961	4000852	3968060	3578935	3051064	2541546	2302280
14	2960378	2916855	2887882	2949861	3135031	3783319	4000852	3962339	3561619	3030723	2531421	2298317
15	2955902	2917300	2895598	2952546	3140398	3789676	4001947	3953892	3546401	3008663	2522772	2291915
16	2955007	2918414	2896705	2955455	3146711	3794178	4004684	3945213	3526922	2990784	2512327	2286455
17	2952546	2916410	2896927	2957916	3154451	3800531	4006327	3938705	3506006	2972973	2503326	2279502
18	2948070	2912868	2897812	2959930	3168056	3805296	4012920	3930570	3487689	2954783	2490746	2273324
19	2946280	2910211	2899805	2965099	3187864	3813237	4016495	3919216	3471191	2937559	2478015	2265835
20	2943147	2909547	2902683	2965099	3232726	3824913	4021446	3905454	3454981	2920862	2470086	2257630
21	2940462	2907775	2902019	2963749	3300665	3834224	4022271	3896025	3437594	2899141	2463163	2249626
22	2939567	2906226	2906668	2964424	3349371	3848068	4020896	3889311	3418789	2875988	2457229	2241639
23	2936891	2901133	2907111	2969149	3381371	3865441	4025297	3881253	3397096	2858441	2451907	2234236
24	2933552	2897370	2905340	2977473	3408902	3874539	4021996	3872123	3376477	2844016	2445415	2228499
25	2931993	2894491	2904012	2989880	3436352	3886088	4020346	3864639	3359595	2824636	2434797	2223333
26	2930658	2890526	2905119	3001187	3459957	3902216	4021171	3850474	3344745	2808352	2422669	2217445
27	2930212	2887001	2907997	3008208	3480926	3913550	4020621	3833958	3333071	2789556	2414266	2212476
28	2934442	2885239	2910432	3013209	3495969	3924883	4019796	3819858	3320232	2767838	2407252	2208060
29	2935555	2886341	2913310	3021166	---	3935180	4020346	3808472	3304762	2745813	2402771	2203302
30	2940686	2885680	2913089	3030266	---	3945755	4020071	3808472	3283078	2730708	2395761	2199643
31	2941357	---	2910875	3035294	---	3955799	---	3782524	---	2716074	2389562	---
a	1005.12	1002.61	1003.75	1009.28	1028.51	1046.09	1048.44	1039.62	1019.84	994.76	978.64	968.56
b	-43774	-55677	+25195	+124419	+460675	+459830	+64272	-237547	-499446	-567004	-326512	-189919
MAX	2980848	2943147	2913310	3035294	3495969	3955799	4025297	4018145	3772193	3261665	2702760	2381425
MIN	2930212	2885239	2873566	2905340	3041694	3511542	3961521	3782524	3283078	2716074	2389562	2199643

a Elevation, in feet, at end of month.  
b Change in contents, in acre-feet.



## 11370500 SACRAMENTO RIVER AT KESWICK, CA

LOCATION.—Lat 40°36'04", long 122°26'36", in SW 1/4 NW 1/4 sec.28, T.32 N., R.5 W., Shasta County, Hydrologic Unit 18020101, on right bank, 0.4 mi upstream from Middle Creek, 0.8 mi downstream from Keswick Dam, 1.6 mi downstream from Keswick, and 10 mi downstream from Shasta Dam.

DRAINAGE AREA.—6,468 mi<sup>2</sup>, excluding Goose Lake Basin.

PERIOD OF RECORD.—October 1938 to current year. Monthly discharge only for some periods, published in WSP 1315-A.

CHEMICAL DATA: Water years 1951–94. Published as "near Keswick" in 1951 and 1953, and as "at Keswick Dam, near Keswick" in 1968–69.

BIOLOGICAL DATA: Water years 1979–81.

SPECIFIC CONDUCTANCE: Water years 1978–94.

WATER TEMPERATURE: Water years 1978–94.

SEDIMENT DATA: Water years 1978–94.

REVISED RECORDS.—WSP 1931: Drainage area.

GAGE.—Water-stage recorder. Datum of gage is 479.81 ft above sea level. Prior to Oct. 1, 1939, at site 1.5 mi upstream at datum 20.2 ft higher and Oct. 1, 1939, to Apr. 30, 1942, at site 1.5 mi upstream at datum 15.2 ft higher. Aug. 20, 1960, to July 3, 1973, auxiliary water-stage recorder at city of Redding pumping plant 2.1 mi downstream.

REMARKS.—Records excellent. Flow completely regulated by Shasta Lake (station 11370000) beginning Dec. 30, 1943. Minor regulation by Keswick Reservoir since 1950, total capacity, 23,800 acre-ft, operational capacity, 4,170 acre-ft, between normal operating elevations of 579.0 ft and 586.0 ft. No diversion between Shasta Dam and station at Keswick. Since December 1963, water is released from Whiskeytown Lake (station 11371700), through a tunnel to Spring Creek Powerplant (station 11371600), and then into Keswick Reservoir. See schematic diagrams of upper Sacramento River Basin and Pit and McCloud River Basins.

EXTREMES FOR PERIOD OF RECORD.—Maximum discharge, 186,000 ft<sup>3</sup>/s, Feb. 23, 1940, gage height, 47.2 ft, site and datum then in use, from rating curve extended above 75,000 ft<sup>3</sup>/s on basis of peak discharge at Kennet, plus 4,000 ft<sup>3</sup>/s estimated inflow; minimum observed, 2,730 ft<sup>3</sup>/s, Aug. 22, 1939. Since regulation by Shasta Dam in 1943, maximum discharge, 81,400 ft<sup>3</sup>/s, Apr. 1, 1974, gage height, 31.92 ft; maximum gage height, 32.71 ft, Jan. 4, 1997; minimum discharge, 154 ft<sup>3</sup>/s, May 15, 1948.

## DISCHARGE, CUBIC FEET PER SECOND, WATER YEAR OCTOBER 2000 TO SEPTEMBER 2001

## DAILY MEAN VALUES

DAY	OCT	NOV	DEC	JAN	FEB	MAR	APR	MAY	JUN	JUL	AUG	SEP
1	6520	e5320	6050	4960	3620	3340	4490	8190	11000	14300	13100	9560
2	6510	e5350	5800	4940	3550	3330	4580	8250	11100	14100	13000	9710
3	6440	e5520	5820	4940	3550	3320	6070	8230	11100	14200	12600	9580
4	6590	5660	5830	4760	3560	3610	6290	8260	11100	14400	12500	9430
5	6550	5550	5610	4570	3620	3940	6220	8240	12100	14600	12500	9380
6	6500	5620	5650	4350	3580	3680	6200	8630	13100	15100	12600	9450
7	6440	5870	5510	4320	3460	3430	6190	8700	13000	15200	12600	8860
8	6380	6020	5460	4360	3190	3370	6180	8680	13000	15200	12600	8910
9	6500	5890	5560	4350	3230	3890	6150	8690	13900	14800	12600	8970
10	6400	5920	5470	4460	3500	6740	6180	9170	14100	14800	12600	8520
11	6410	5920	5450	4520	3680	6700	6240	9210	13900	15100	11900	8180
12	6370	5950	5470	4380	3680	6680	6260	9120	13800	15000	11800	8120
13	6380	5900	5300	4350	3580	6150	6240	9090	13700	15100	11900	8120
14	6380	6030	5060	4320	3480	5980	6240	9670	14200	15200	12000	8140
15	6490	5910	4940	4250	3460	5830	6230	10800	14100	15200	11200	8140
16	6390	5970	4870	4290	3380	5670	6220	10200	14500	15200	11100	8140
17	6350	5990	4900	4370	3310	5500	6210	10500	14600	15200	11100	8150
18	6100	5930	4960	4410	3330	5230	6200	10600	14400	15300	10400	8380
19	5830	5970	5000	4380	3430	4900	6230	10600	14300	15100	10400	8590
20	5580	5990	5010	4350	3750	4660	6250	10700	14300	15200	10400	8660
21	5500	5990	4980	4370	3960	4470	5830	10700	15100	15100	9620	8670
22	5400	5890	4970	4330	3760	4450	5820	10700	14900	15100	9440	8660
23	5430	6000	4960	4280	3520	4430	5710	10700	14000	15100	9440	8680
24	5520	5960	4910	4370	3510	4490	6850	10100	14200	15000	9760	8660
25	5440	5960	4910	4280	3890	4470	7340	10300	14300	15200	10100	8700
26	5430	5910	4940	4160	3710	4490	7360	11100	14200	15600	10200	8290
27	5540	6010	4940	4070	3490	4490	7360	11100	14300	15400	10300	7770
28	5550	6060	4930	4030	3420	4450	7360	11100	14500	15200	9500	7720
29	5490	5990	4940	3770	---	4410	7370	11000	14300	14100	9380	7730
30	5420	6020	4990	3640	---	4500	7380	11000	14400	13900	9600	7770
31	e5500	---	4970	3680	---	4470	---	11100	---	13900	9630	---
TOTAL	187330	176070	162160	134610	99200	145070	189250	304430	409500	461900	345870	257640
MEAN	6043	5869	5231	4342	3543	4680	6308	9820	13650	14900	11160	8588
MAX	6590	6060	6050	4960	3960	6740	7380	11100	15100	15600	13100	9710
MIN	5400	5320	4870	3640	3190	3320	4490	8190	11000	13900	9380	7720
AC-FT	371600	349200	321600	267000	196800	287700	375400	603800	812200	916200	686000	511000

e Estimated.

11370500 SACRAMENTO RIVER AT KESWICK, CA—Continued

STATISTICS OF MONTHLY MEAN DATA FOR WATER YEARS 1946 - 1962, BY WATER YEAR (WY)

	OCT	NOV	DEC	JAN	FEB	MAR	APR	MAY	JUN	JUL	AUG	SEP
MEAN	5992	5603	6611	10610	11700	6564	6714	8212	8564	9951	10030	7331
MAX	8572	8970	16680	32870	44170	14490	21180	13400	10300	11810	11870	10030
(WY)	1959	1958	1951	1953	1958	1957	1958	1948	1948	1951	1958	1958
MIN	4785	4064	3726	3234	3060	2546	2830	5247	6437	7480	7057	5239
(WY)	1948	1952	1960	1962	1950	1950	1950	1951	1947	1947	1947	1947

SUMMARY STATISTICS

WATER YEARS 1946 - 1962

ANNUAL MEAN	8141
HIGHEST ANNUAL MEAN	13910 1958
LOWEST ANNUAL MEAN	5364 1950
HIGHEST DAILY MEAN	75800 Feb 21 1958
LOWEST DAILY MEAN	2360 Mar 15 1950
ANNUAL SEVEN-DAY MINIMUM	2440 Mar 9 1950
MAXIMUM PEAK FLOW	78800 Feb 21 1958
MAXIMUM PEAK STAGE	31.55 Feb 21 1958
INSTANTANEOUS LOW FLOW	154 May 15 1948
ANNUAL RUNOFF (AC-FT)	5898000
10 PERCENT EXCEEDS	11600
50 PERCENT EXCEEDS	7000
90 PERCENT EXCEEDS	3720

STATISTICS OF MONTHLY MEAN DATA FOR WATER YEARS 1964 - 2001, BY WATER YEAR (WY)

MEAN	6191	7223	9805	11430	13820	11680	8908	10580	11550	12750	11620	8274
MAX	10290	23430	27340	41600	40420	47170	26840	17410	15590	15070	14700	11800
(WY)	1984	1974	1974	1997	1998	1983	1974	1995	1998	2000	1998	1971
MIN	3431	3182	2847	3258	3268	2869	3096	6953	7342	7754	8070	4564
(WY)	1978	1993	1978	1993	1990	1991	1991	1992	1992	1992	1992	1977

SUMMARY STATISTICS

FOR 2000 CALENDAR YEAR

FOR 2001 WATER YEAR

WATER YEARS 1964 - 2001

ANNUAL TOTAL	4293070	2873030	
ANNUAL MEAN	11730	7871	10310
HIGHEST ANNUAL MEAN			18230 1974
LOWEST ANNUAL MEAN			5390 1992
HIGHEST DAILY MEAN	52700 Mar 3	15600 Jul 26	79700 Mar 31 1974
LOWEST DAILY MEAN	4350 Jan 14	3190 Feb 8	2360 Mar 17 1989
ANNUAL SEVEN-DAY MINIMUM	4470 Jan 13	3420 Feb 13	2460 Mar 12 1989
MAXIMUM PEAK FLOW		15800 Jul 27	81400 Apr 1 1974
MAXIMUM PEAK STAGE		16.76 Jul 27	32.71 Jan 4 1997
INSTANTANEOUS LOW FLOW			154 May 15 1948
ANNUAL RUNOFF (AC-FT)	8515000	5699000	7467000
10 PERCENT EXCEEDS	17400	14300	15000
50 PERCENT EXCEEDS	8740	6250	8580
90 PERCENT EXCEEDS	5300	3840	4070

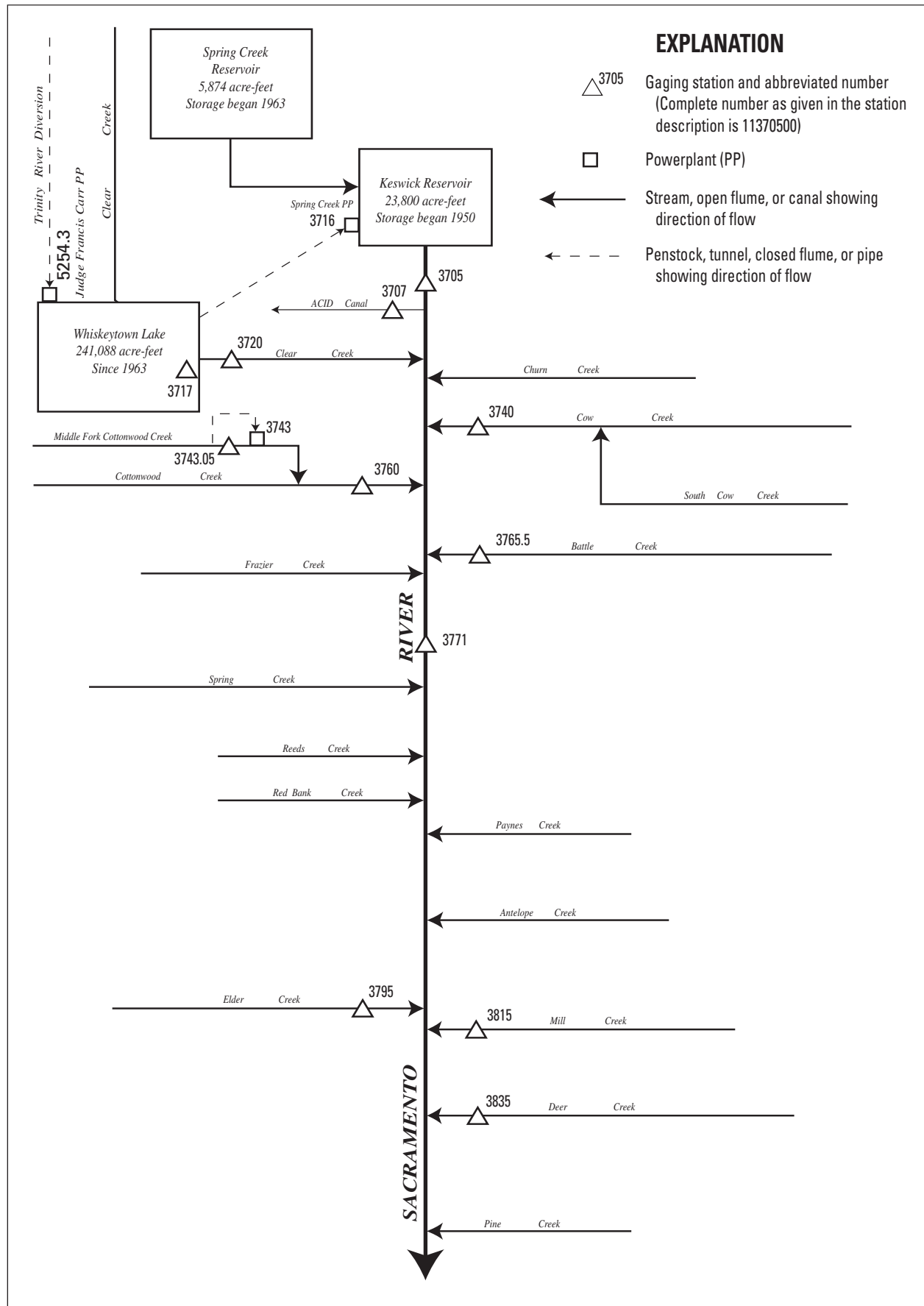

Figure 25. Diversions and storage in upper Sacramento River Basin.

## 11370700 ANDERSON-COTTONWOOD IRRIGATION DISTRICT CANAL AT SHARON STREET, AT REDDING, CA

LOCATION.—Lat 40°34'08", long 122°22'49", unsurveyed, Shasta County, Hydrologic Unit 18020101, on right bank of canal, 10 ft upstream from Sharon Street, 900 ft downstream from Parkview Avenue, and 0.75 mi southwest of Mercy Hospital.

PERIOD OF RECORD.—April to September 1989, April 1991 to current year (beginning October 1994, irrigation season only).

GAGE.—Water-stage recorder. Elevation of gage is 480 ft above sea level, from topographic map.

REMARKS.—Records good. Canal diverts from Sacramento River 0.3 mi downstream from Southern Pacific Railroad bridge and 0.1 mi upstream from Highway 273; water is used for irrigation. See schematic diagrams for upper Sacramento River Basin and Pit and McCloud River Basins.

EXTREMES FOR PERIOD OF RECORD.—Maximum daily discharge, 370 ft<sup>3</sup>/s, June 9, 1989; no flow at times each year.

## DISCHARGE, CUBIC FEET PER SECOND, WATER YEAR OCTOBER 2000 TO SEPTEMBER 2001

## DAILY MEAN VALUES

DAY	OCT	NOV	DEC	JAN	FEB	MAR	APR	MAY	JUN	JUL	AUG	SEP
1	255	23	---	---	---	---	---	305	315	292	248	280
2	256	---	---	---	---	---	---	296	323	294	249	279
3	252	---	---	---	---	---	---	302	323	293	253	284
4	252	---	---	---	---	---	---	304	321	299	256	279
5	251	---	---	---	---	---	---	306	326	296	258	274
6	245	---	---	---	---	---	---	309	311	294	264	274
7	254	---	---	---	---	---	---	309	302	293	266	270
8	258	---	---	---	---	---	---	313	292	292	270	270
9	252	---	---	---	---	---	---	319	296	295	274	273
10	229	---	---	---	---	---	---	320	296	291	279	267
11	227	---	---	---	---	---	---	314	294	288	279	266
12	226	---	---	---	---	---	---	318	266	285	283	268
13	225	---	---	---	---	---	e54	321	245	283	280	265
14	224	---	---	---	---	---	64	322	253	285	283	260
15	226	---	---	---	---	---	63	302	268	289	286	257
16	229	---	---	---	---	---	108	292	285	288	285	255
17	232	---	---	---	---	---	160	306	290	285	281	262
18	233	---	---	---	---	---	160	321	290	284	279	261
19	231	---	---	---	---	---	159	331	291	281	282	260
20	223	---	---	---	---	---	157	338	286	277	291	259
21	221	---	---	---	---	---	154	336	290	275	286	257
22	220	---	---	---	---	---	153	335	289	273	284	257
23	225	---	---	---	---	---	193	335	286	273	288	259
24	229	---	---	---	---	---	221	327	288	268	294	261
25	156	---	---	---	---	---	264	325	234	265	299	269
26	74	---	---	---	---	---	293	335	112	265	300	267
27	59	---	---	---	---	---	305	335	199	262	300	257
28	44	---	---	---	---	---	286	327	291	261	292	248
29	40	---	---	---	---	---	239	313	294	258	286	248
30	43	---	---	---	---	---	299	310	293	254	280	248
31	31	---	---	---	---	---	---	313	---	252	279	---
TOTAL	6122	---	---	---	---	---	---	9839	8449	8690	8634	7934
MEAN	197	---	---	---	---	---	---	317	282	280	279	264
MAX	258	---	---	---	---	---	---	338	326	299	300	284
MIN	31	---	---	---	---	---	---	292	112	252	248	248
AC-FT	12140	---	---	---	---	---	---	19520	16760	17240	17130	15740

e Estimated.

## 11525430 JUDGE FRANCIS CARR POWERPLANT NEAR FRENCH GULCH, CA

LOCATION.—Lat 40°38'49", long 122°37'34", Shasta County, Hydrologic Unit 18010212, at powerplant, 1.6 mi downstream from Mill Creek, and 3.8 mi south of French Gulch.

PERIOD OF RECORD.—April 1963 to current year.

GAGE.—Recorded powerplant output.

REMARKS.—Water is diverted from Trinity River at NW 1/4 SE 1/4 sec.8, T.33 N., R.8 W., through a tunnel to powerplant and then into Whiskeytown Lake (station 11371700). See schematic diagram of [upper Sacramento](#) and [Pit and McCloud River Basins](#).

COOPERATION.—Records were provided by U.S. Bureau of Reclamation, not rounded to U.S. Geological Survey standards.

EXTREMES FOR PERIOD OF RECORD.—Maximum daily discharge, 4,000 ft<sup>3</sup>/s, Oct. 18, 1987; no flow for many days most years.

## DISCHARGE, CUBIC FEET PER SECOND, WATER YEAR OCTOBER 2000 TO SEPTEMBER 2001

## DAILY MEAN VALUES

DAY	OCT	NOV	DEC	JAN	FEB	MAR	APR	MAY	JUN	JUL	AUG	SEP
1	363	0	0	0	4	0	0	376	675	1920	2601	2401
2	242	0	0	242	0	0	964	391	738	2036	2367	1856
3	568	0	0	191	0	0	760	393	750	2271	2357	1979
4	414	0	0	350	0	0	635	0	982	2458	2556	2053
5	0	0	0	254	0	0	313	0	920	2442	2486	1981
6	446	0	0	311	0	0	631	118	941	2633	2584	2060
7	0	0	0	330	257	0	636	636	1181	2652	2617	2144
8	799	0	0	331	0	0	0	483	1233	2608	2343	2318
9	0	0	0	0	760	0	617	260	1188	2684	2580	1929
10	0	0	0	0	1190	0	689	30	1199	2515	2712	2251
11	0	0	0	0	1293	0	691	108	1251	2485	2710	2352
12	0	0	472	574	1324	0	454	839	1193	2352	2794	2017
13	0	0	932	0	1264	0	507	0	1226	2598	2330	2018
14	0	0	1175	744	1207	0	618	0	1937	2437	2302	1726
15	67	0	1542	558	0	0	0	0	1919	2574	2415	1701
16	14	0	1594	0	0	0	1558	0	1947	2556	2845	1210
17	0	0	1574	677	397	0	819	0	1950	2443	2415	767
18	0	0	1577	1224	0	0	804	96	1919	2318	2208	1217
19	0	0	1598	607	0	0	781	0	1983	2492	2370	1159
20	0	371	748	889	0	0	621	0	2098	3084	2904	760
21	0	1638	88	328	0	0	0	737	1950	3398	2720	1210
22	0	1485	858	1258	0	0	0	797	1946	2946	2542	1591
23	0	1660	886	771	0	0	209	792	2017	2943	2501	1191
24	0	1652	930	775	0	0	0	790	1966	3007	2436	1265
25	0	1252	965	1033	0	0	0	885	1957	2996	2487	1196
26	0	0	1123	1313	0	0	0	756	2015	3146	2429	1170
27	0	0	1120	1031	0	0	0	663	1965	3103	2313	1030
28	0	1075	410	0	0	0	311	719	1961	2975	2613	1436
29	0	1099	153	1203	---	0	355	741	1947	2375	2512	1936
30	0	901	0	1188	---	0	0	733	2007	2634	2130	1034
31	0	---	0	1052	---	2	---	1153	---	2561	3119	---
TOTAL	2913	11133	17745	17234	7696	2	12973	12496	46961	81642	78298	48958
MEAN	94.0	371	572	556	275	.065	432	403	1565	2634	2526	1632
MAX	799	1660	1598	1313	1324	2	1558	1153	2098	3398	3119	2401
MIN	0	0	0	0	0	0	0	0	675	1920	2130	760
AC-FT	5780	22080	35200	34180	15270	4.0	25730	24790	93150	161900	155300	97110

## STATISTICS OF MONTHLY MEAN DATA FOR WATER YEARS 1963 - 2001, BY WATER YEAR (WY)

MEAN	1265	821	672	612	783	852	1177	1338	1850	2398	2258	2044
MAX	3363	2158	2891	2755	3223	3111	3220	3513	3662	3589	3236	3504
(WY)	1988	1967	1979	1982	1974	1974	1970	1974	1969	1968	1977	1988
MIN	94.0	18.0	.16	.000	.34	.000	.000	.097	.63	253	507	415
(WY)	2001	1992	1993	1986	1988	1988	1978	1991	1993	1978	1992	1997

## SUMMARY STATISTICS

## FOR 2000 CALENDAR YEAR

## FOR 2001 WATER YEAR

## WATER YEARS 1963 - 2001

ANNUAL TOTAL	537860	338051	
ANNUAL MEAN	1470	926	1353
HIGHEST ANNUAL MEAN			2485
LOWEST ANNUAL MEAN			301
HIGHEST DAILY MEAN	3360	Jul 18	3398
LOWEST DAILY MEAN	0	Jan 6	0
ANNUAL SEVEN-DAY MINIMUM	.00	Feb 27	.00
ANNUAL RUNOFF (AC-FT)	1067000	670500	980200
10 PERCENT EXCEEDS	3070	2490	3110
50 PERCENT EXCEEDS	1370	675	1100
90 PERCENT EXCEEDS	.00	.00	.00

## 11371600 SPRING CREEK POWERPLANT AT KESWICK, CA

LOCATION.—Lat 40°37'41", long 122°27'59", in NE 1/4 SE 1/4 sec.18, T.32 N., R.5 W., Shasta County, Hydrologic Unit 18020112, at powerplant on Spring Creek, 0.4 mi northwest of Keswick, and 4.9 mi northwest of Redding.

PERIOD OF RECORD.—December 1963 to current year.

GAGE.—Discharge computed from powerplant output.

REMARKS.—Water is released from Whiskeytown Lake (station 11371700) through a tunnel to powerplant and then into Keswick Reservoir.

Spring Creek Reservoir releases into Keswick Reservoir at Spring Creek Powerplant. See schematic diagrams of [upper Sacramento River](#) and [Pit and McCloud River Basins](#).

COOPERATION.—Records were provided by U.S. Bureau of Reclamation, not rounded to U.S. Geological Survey standards.

EXTREMES FOR PERIOD OF RECORD.—Maximum daily discharge, 4,800 ft<sup>3</sup>/s, May 2, 1983; no flow for many days most years.

## DISCHARGE, CUBIC FEET PER SECOND, WATER YEAR OCTOBER 2000 TO SEPTEMBER 2001

## DAILY MEAN VALUES

DAY	OCT	NOV	DEC	JAN	FEB	MAR	APR	MAY	JUN	JUL	AUG	SEP
1	1022	0	252	0	244	2488	299	341	1347	1744	2448	2474
2	1025	0	0	0	239	1508	341	291	766	2037	2436	2085
3	1002	0	0	267	249	875	357	275	280	2518	2482	2045
4	1005	0	0	239	269	851	287	299	860	2492	2445	2042
5	1076	0	0	253	259	2458	279	308	1427	2557	2459	2011
6	992	0	0	260	254	2195	260	867	1381	2318	2481	2011
7	1062	0	0	261	252	2182	260	221	954	2480	2725	2070
8	1059	0	0	262	261	2216	252	587	1082	2529	2486	2082
9	1034	0	0	252	635	2356	279	256	1220	2447	2488	2080
10	961	0	0	586	2316	3776	260	645	1148	2479	2475	2040
11	1059	0	0	805	2216	3484	213	252	1168	2472	2478	2065
12	1080	0	0	660	2531	1881	310	452	1066	2471	2498	2063
13	1024	0	0	246	2143	1194	306	271	1052	2468	2481	2081
14	682	0	261	257	1656	534	306	295	1511	2448	2465	1986
15	0	0	420	163	337	161	302	291	2097	2500	2580	1528
16	0	34	446	241	306	162	287	77	2136	2495	2470	1532
17	0	0	449	252	337	806	275	171	1553	2471	2471	1524
18	0	0	73	628	384	154	318	256	1913	2549	2482	1515
19	0	0	0	250	275	1047	318	310	1845	2618	2578	1150
20	0	140	0	247	2464	317	306	264	2137	2944	2556	1393
21	0	250	0	234	1789	246	302	721	1850	2999	2476	1460
22	0	253	1042	251	1763	1126	745	1213	1998	2962	2672	1527
23	0	257	1000	263	2704	559	592	984	1866	2966	2589	1526
24	124	250	1045	1568	2280	377	186	795	1805	2964	2487	1540
25	240	260	1036	1142	2475	1069	275	1030	2063	2980	2472	1468
26	249	265	1121	1591	2162	1228	279	415	1789	2979	2478	1560
27	244	257	1056	1785	2209	806	302	702	1856	2986	2502	1943
28	247	250	252	1322	1705	1024	326	1522	2732	2941	2500	1837
29	265	256	5	1507	---	263	337	1053	2016	2471	2494	1947
30	252	248	0	1536	---	298	245	256	1644	2514	2486	1972
31	238	---	0	1286	---	252	---	711	---	2461	2505	---
TOTAL	15942	2720	8458	18614	34714	37893	9404	16131	46562	80260	77645	54557
MEAN	514	90.7	273	600	1240	1222	313	520	1552	2589	2505	1819
MAX	1080	265	1121	1785	2704	3776	745	1522	2732	2999	2725	2474
MIN	0	0	0	0	239	154	186	77	280	1744	2436	1150
AC-FT	31620	5400	16780	36920	68860	75160	18650	32000	92360	159200	154000	108200
a	61	105	113	712	1030	1930	1060	2620	1870	0	24	169

## STATISTICS OF MONTHLY MEAN DATA FOR WATER YEARS 1964 - 2001, BY WATER YEAR (WY)

MEAN	1542	1237	1067	1353	1662	1657	1399	1570	2011	2457	2342	2191
MAX	3691	3174	4032	4532	4498	4364	4405	4265	3866	3886	3654	3526
(WY)	1989	1967	1974	1974	1974	1983	1983	1983	1969	1968	1977	1988
MIN	265	.87	1.55	2.10	3.36	86.6	5.23	5.45	158	250	467	416
(WY)	1978	1992	1992	1991	1991	1988	1987	1991	1989	1978	1992	1992

## SUMMARY STATISTICS

	FOR 2000 CALENDAR YEAR		FOR 2001 WATER YEAR		WATER YEARS 1964 - 2001	
ANNUAL TOTAL	719659		402900			
ANNUAL MEAN	1966		1104		1707	
HIGHEST ANNUAL MEAN					3389	
LOWEST ANNUAL MEAN					748	
HIGHEST DAILY MEAN	4397	Feb 23	3776	Mar 10	4800	May 2 1983
LOWEST DAILY MEAN	0	Jan 5	0	Oct 15	0	Mar 30 1974
ANNUAL SEVEN-DAY MINIMUM	.00	Oct 15	.00	Oct 15	.00	Mar 26 1976
ANNUAL RUNOFF (AC-FT)	1427000		799200		1237000	
10 PERCENT EXCEEDS	3520		2490		3480	
50 PERCENT EXCEEDS	2320		867		1570	
90 PERCENT EXCEEDS	.00		.00		34	

a Discharge, in acre-feet, from Spring Creek Reservoir, provided by U.S. Bureau of Reclamation.

## 11371700 WHISKEYTOWN LAKE NEAR IGO, CA

LOCATION.—Lat 40°37'03", long 122°31'31", unsurveyed, Shasta County, Hydrologic Unit 18010112, Whiskeytown–Shasta–Trinity National Recreation Area, at outlet works to Spring Creek Powerplant, on Clear Creek, 1.8 mi downstream from Whiskey Creek, and 7.8 mi northeast of Igo.

DRAINAGE AREA.—200 mi<sup>2</sup>.

PERIOD OF RECORD.—May 1963 to current year. Prior to October 1964 published as Whiskeytown Reservoir near Igo.

GAGE.—Water-stage recorder. Datum of gage is sea level (levels by U.S. Bureau of Reclamation). Contents based on capacity table dated April 1962 provided by U.S. Bureau of Reclamation.

REMARKS.—Lake is formed by earth and rockfill dam. Storage began in May 1963. Usable capacity, 241,088 acre-ft, between elevations 972.0 ft, invert of sluice pipe, and 1,210.00 ft, crest of glory hole spillway. Dead storage 8 acre-ft. Normal operating pool is from elevation 1,197.0 ft, capacity, 201,288 acre-ft, to 1,210.0 ft, capacity, 241,096 acre-ft. Transbasin water enters the reservoir through Judge Francis Carr Powerplant (station 11525430) and is released through Spring Creek Tunnel to Spring Creek Powerplant (station 11371600) and Keswick Reservoir. Figures given represent total contents at 2400 hours. Lake is used for power generation and recreation. See schematic diagrams of upper Sacramento River Basin and Pit and McCloud River Basins.

COOPERATION.—Records were provided by U.S. Bureau of Reclamation, not rounded to U.S. Geological Survey standards.

EXTREMES (AT 2400 HOURS) FOR PERIOD OF RECORD.—Maximum contents, 258,600 acre-ft, Mar. 2, 1983, elevation, 1,215.34 ft; minimum since first filling, 145,562 acre-ft, Dec. 27, 1992, elevation, 1,176.05 ft.

EXTREMES (AT 2400 HOURS) FOR CURRENT YEAR.—Maximum contents, 239,207 acre-ft, May 27, elevation, 1,209.41 ft; minimum, 176,538 acre-ft, Nov. 19, elevation, 1,188.17 ft.

Capacity table (elevation, in feet, and contents, in acre-feet)  
(Based on survey by U.S. Bureau of Reclamation in 1962)

1,015	714	1,040	3,055	1,080	15,076	1,140	73,960
1,020	994	1,050	4,898	1,100	27,542	1,180	155,276
1,030	1,797	1,060	7,418	1,120	46,701	1,220	274,389

## RESERVOIR STORAGE (ACRE-FEET), WATER YEAR OCTOBER 2000 TO SEPTEMBER 2001

## DAILY OBSERVATION AT 2400 HOURS

DAY	OCT	NOV	DEC	JAN	FEB	MAR	APR	MAY	JUN	JUL	AUG	SEP
1	211802	181486	190635	205741	210784	207155	205564	236624	237736	238375	238375	237545
2	210036	181186	190381	206065	210365	205476	207957	237355	237482	238311	238183	237132
3	208967	180885	190155	205800	209977	204769	209887	238151	238439	237673	237768	236973
4	207541	180585	189872	205829	209620	209650	211502	238087	238599	237514	237927	236973
5	205181	180258	189592	205711	209293	217443	212430	237800	237641	237164	237895	236973
6	203829	179930	189312	205711	208907	219420	214145	236751	236878	237673	238247	236973
7	201522	179685	189060	205741	209175	219236	215683	237991	237228	237895	237831	236793
8	200767	179439	188808	206242	208759	218203	215864	238119	237387	237959	237514	237259
9	198536	179166	188528	205888	209769	215804	217260	238503	237196	238311	237514	236878
10	196409	178893	188248	205653	207957	210724	218719	237545	237132	238279	237800	237196
11	194179	178622	188108	205387	207274	205859	220155	237641	237228	238215	238055	237609
12	191878	178378	188892	205594	205446	203800	221166	239079	237355	238279	238439	237387
13	189620	178189	190889	205299	204121	202982	222177	238983	237482	238439	238023	237196
14	188080	177945	192811	206301	203566	203303	223379	238887	238375	238311	237545	236560
15	187912	177729	195205	206831	203479	204180	223472	238951	237927	238311	237101	236783
16	187632	177404	197529	206360	203362	204916	226628	238983	237418	238343	237704	235956
17	187352	177106	199724	207008	204504	204297	228400	238951	237959	238311	237641	234307
18	187044	176836	202602	208343	205476	204946	230122	239079	237831	237800	237291	233676
19	186739	176538	205653	209026	208105	204034	231783	238887	237959	237418	237069	233423
20	186544	176673	206978	210215	212580	204680	233676	238663	237673	237641	237704	231972
21	186239	179357	206890	210365	219298	205476	233865	238631	237800	238247	238055	231218
22	186100	181623	206477	212281	221687	204621	233802	238055	237514	238183	238215	231155
23	185850	184212	206212	213964	219696	204887	233581	237895	237641	238087	237927	230404
24	185239	186794	205947	214778	218081	205918	233771	237895	237800	238087	237704	229840
25	184906	188640	205741	215502	216805	205623	233960	237704	237514	238023	237609	229120
26	184378	187940	205741	215623	215080	204563	234149	238439	238183	238247	237545	228182
27	183634	187212	205859	214567	212610	204063	234307	239207	238983	238311	237132	226286
28	183441	188584	206065	212251	210724	203187	235035	237800	237577	238343	237323	225696
29	182807	190268	206212	211981	---	203858	235766	237259	237482	237959	237259	225696
30	182449	191341	206065	211502	---	204474	235861	238311	238119	238087	236656	223657
31	181816	---	205918	211173	---	205034	---	239111	---	238151	237768	---
a	1190.11	1193.53	1196.56	1200.35	1200.20	1198.28	1208.36	1209.38	1209.07	1209.08	1208.96	1204.46
b	-31394	+9525	+14577	+5255	-449	-5690	+30827	+3250	-992	+32	-383	-14111
MAX	211802	191341	206978	215623	221687	219420	235861	239207	238983	238439	238439	237609
MIN	181816	176538	188108	205299	203362	202982	205564	236624	236878	237164	236656	223657

a Elevation, in feet, at end of month.

b Change in contents, in acre-feet.

## 11372000 CLEAR CREEK NEAR IGO, CA

LOCATION.—Lat 40°30'48", long 122°31'23", unsurveyed, Shasta County, Hydrologic Unit 18020112, on left bank, at old highway bridge on Redding-Igo Road, 1.0 mi northeast of Igo, 7.0 mi downstream from Whiskeytown Dam, 8.3 mi southwest of Redding, and 10.4 mi upstream from mouth.

DRAINAGE AREA.—228 mi<sup>2</sup>.

PERIOD OF RECORD.—October 1940 to current year.

CHEMICAL DATA: Water years 1958–79.

WATER TEMPERATURE: Water years 1965–79.

REVISED RECORDS.—WSP 1345: Drainage area. WSP 1395: 1941(M).

GAGE.—Water-stage recorder. Datum of gage is 672.99 ft above sea level.

REMARKS.—Records good. Low flow completely regulated by Whiskeytown Lake (station 11371700) since May 1963. Transbasin diversion from Trinity River through Judge Francis Carr Powerplant (station 11525430) to Whiskeytown Lake began in April 1963. Diversions from Whiskeytown Lake to Spring Creek Powerplant (station 11371600) began in December 1963. See schematic diagrams of upper Sacramento River and Pit and McCloud River Basins.

EXTREMES FOR PERIOD OF RECORD.—Maximum discharge, 24,500 ft<sup>3</sup>/s, Dec. 21, 1955, gage height, 13.75 ft; minimum daily, 9.0 ft<sup>3</sup>/s, Sept. 4–7, 1950. Since completion of Whiskeytown Dam in 1963, maximum discharge, 19,200 ft<sup>3</sup>/s, Mar. 3, 1983, gage height, 12.73 ft, from rating curve extended above 12,000 ft<sup>3</sup>/s on basis of slope-area measurement of peak flow; minimum daily, 30 ft<sup>3</sup>/s, Oct. 10, 11, 1977.

## DISCHARGE, CUBIC FEET PER SECOND, WATER YEAR OCTOBER 2000 TO SEPTEMBER 2001

## DAILY MEAN VALUES

DAY	OCT	NOV	DEC	JAN	FEB	MAR	APR	MAY	JUN	JUL	AUG	SEP
1	102	128	172	159	169	235	163	156	140	140	75	76
2	133	127	170	159	167	261	162	155	141	136	73	76
3	133	125	170	159	165	233	162	154	141	119	74	76
4	132	125	170	160	164	653	161	153	140	103	74	76
5	132	125	170	156	162	733	161	152	140	85	73	76
6	132	115	170	156	160	470	200	151	139	77	73	86
7	132	91	170	156	158	351	183	150	140	77	73	104
8	132	93	168	164	155	304	170	150	140	77	73	104
9	133	94	168	164	193	272	167	149	140	75	73	104
10	136	94	168	272	260	221	165	149	140	75	73	105
11	134	94	171	253	389	176	165	148	140	75	74	106
12	134	94	172	191	309	144	163	147	140	76	74	106
13	133	95	224	172	260	134	161	147	140	75	74	105
14	132	96	213	165	204	126	161	147	139	75	73	112
15	132	96	184	161	176	147	160	149	138	75	73	121
16	132	96	172	158	170	190	159	149	138	75	73	121
17	132	103	168	156	194	186	159	148	137	75	72	121
18	132	123	166	156	256	183	161	147	137	75	73	121
19	132	124	165	155	366	182	161	144	137	75	72	121
20	132	135	163	154	745	181	198	143	136	75	72	121
21	132	149	163	154	871	179	196	143	136	75	71	121
22	132	153	163	154	558	178	177	142	136	75	71	121
23	132	166	163	177	370	177	171	142	136	75	72	121
24	132	167	163	388	383	179	167	141	136	74	75	123
25	131	168	161	324	748	183	165	141	136	75	75	134
26	142	168	161	293	441	174	164	141	139	77	75	132
27	135	168	161	236	308	170	163	141	171	77	75	132
28	122	168	161	202	259	167	160	143	151	76	76	130
29	98	180	159	188	---	166	158	140	142	75	76	130
30	119	174	159	179	---	165	158	140	140	75	76	129
31	118	---	159	173	---	165	---	140	---	75	76	---
TOTAL	4015	3834	5267	5894	8760	7285	5021	4542	4206	2544	2282	3311
MEAN	130	128	170	190	313	235	167	147	140	82.1	73.6	110
MAX	142	180	224	388	871	733	200	156	171	140	76	134
MIN	98	91	159	154	155	126	158	140	136	74	71	76
AC-FT	7960	7600	10450	11690	17380	14450	9960	9010	8340	5050	4530	6570



## SACRAMENTO RIVER BASIN

## 11372000 CLEAR CREEK NEAR IGO, CA—Continued

## STATISTICS OF MONTHLY MEAN DATA FOR WATER YEARS 1941 - 1962, BY WATER YEAR (WY)

	OCT	NOV	DEC	JAN	FEB	MAR	APR	MAY	JUN	JUL	AUG	SEP
MEAN	76.7	150	597	807	1226	834	676	347	161	63.4	35.1	32.8
MAX	373	427	2336	2513	5753	2595	2431	773	289	126	64.6	89.7
(WY)	1951	1951	1956	1941	1958	1941	1941	1957	1953	1941	1941	1957
MIN	25.8	39.0	47.0	65.5	142	168	172	87.6	66.5	24.3	14.3	13.4
(WY)	1950	1960	1950	1947	1948	1955	1944	1947	1950	1950	1950	1944

## SUMMARY STATISTICS

## WATER YEARS 1941 - 1962

ANNUAL MEAN	413
HIGHEST ANNUAL MEAN	1092 1941
LOWEST ANNUAL MEAN	128 1944
HIGHEST DAILY MEAN	15100 Mar 1 1941
LOWEST DAILY MEAN	9.0 Sep 4 1950
ANNUAL SEVEN-DAY MINIMUM	9.5 Sep 1 1950
MAXIMUM PEAK FLOW	24500 Dec 21 1955
MAXIMUM PEAK STAGE	13.75 Dec 21 1955
ANNUAL RUNOFF (AC-FT)	299000
10 PERCENT EXCEEDS	929
50 PERCENT EXCEEDS	133
90 PERCENT EXCEEDS	27

## STATISTICS OF MONTHLY MEAN DATA FOR WATER YEARS 1965 - 2001, BY WATER YEAR (WY)

MEAN	78.2	146	202	300	314	338	167	106	74.8	60.2	57.7	58.5
MAX	317	299	625	1358	1612	3437	668	419	249	150	151	225
(WY)	1993	1974	1965	1970	1998	1983	1974	1982	1993	1999	1999	1999
MIN	38.8	70.7	94.2	54.3	49.8	51.3	50.7	48.6	42.9	39.2	37.9	37.9
(WY)	1978	1969	1977	1977	1977	1977	1977	1966	1966	1966	1966	1977

## SUMMARY STATISTICS

## FOR 2000 CALENDAR YEAR

## FOR 2001 WATER YEAR

## WATER YEARS 1965 - 2001

ANNUAL TOTAL	75896	56961	
ANNUAL MEAN	207	156	159
HIGHEST ANNUAL MEAN			570 1983
LOWEST ANNUAL MEAN			57.9 1977
HIGHEST DAILY MEAN	1600	871	15000 Mar 3 1983
LOWEST DAILY MEAN	54	71	30 Oct 10 1977
ANNUAL SEVEN-DAY MINIMUM	54	72	31 Oct 5 1977
MAXIMUM PEAK FLOW		1220	19200 Mar 3 1983
MAXIMUM PEAK STAGE		5.47	12.73 Mar 3 1983
ANNUAL RUNOFF (AC-FT)	150500	113000	115400
10 PERCENT EXCEEDS	380	199	261
50 PERCENT EXCEEDS	146	143	75
90 PERCENT EXCEEDS	55	75	49

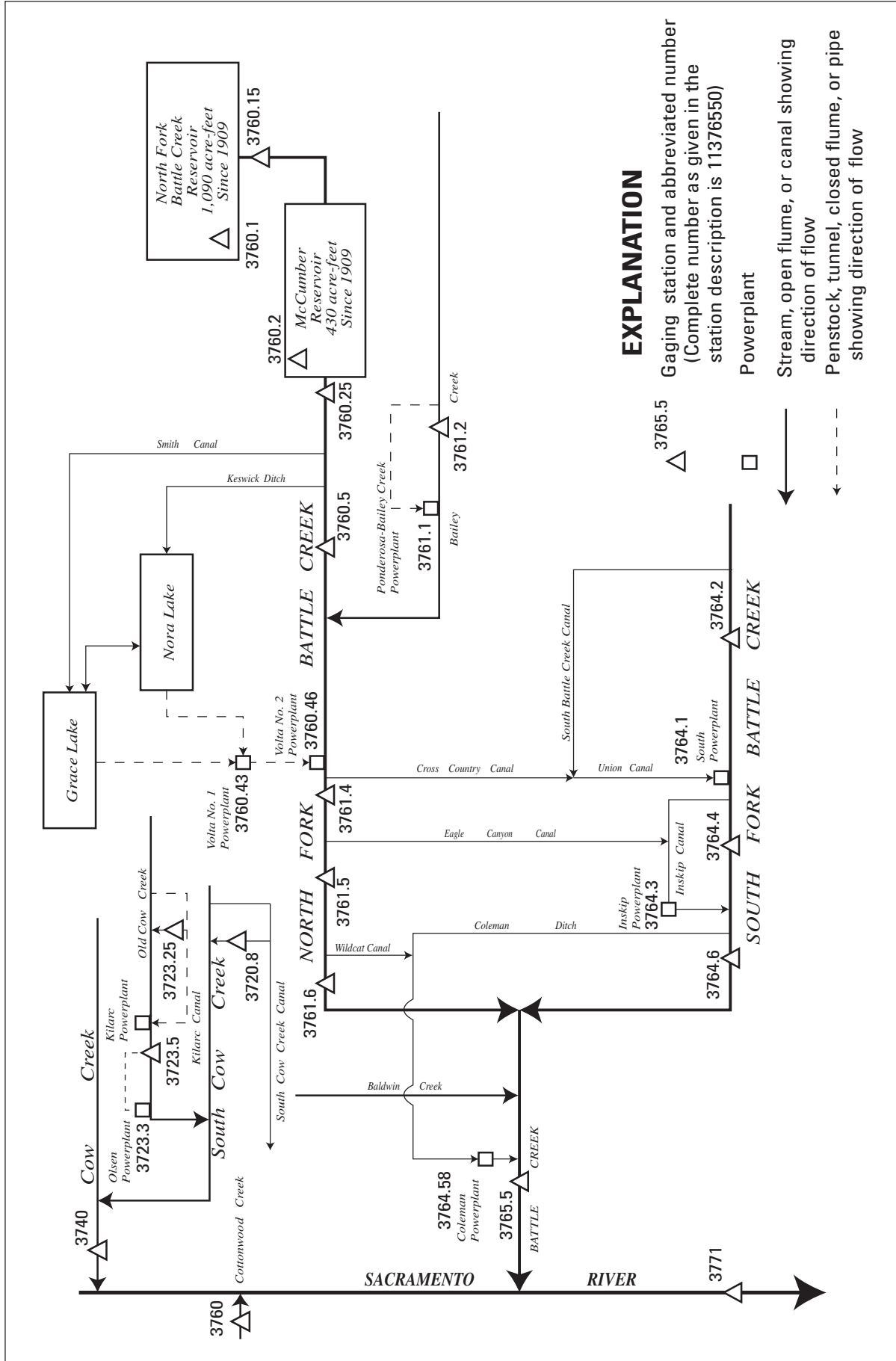

Figure 26. Divisions and storage in Battle Creek and Cow Creek Basins.

## 11372080 SOUTH COW CREEK CANAL DIVERSION TO SOUTH COW CREEK, NEAR WHITMORE, CA

LOCATION.—Lat 40°35'35", long 121°58'53", in NE 1/4 NW 1/4 sec.33, T.32 N., R.1 W., Shasta County, Hydrologic Unit 18020118, on left bank, 2.5 mi northeast of Cow Creek Powerplant, and 4.3 mi southwest of Whitmore.

PERIOD OF RECORD.—October 1986 to current year (operated as a low-flow station only). Unpublished records for water years 1984–86 available in files of the U.S. Geological Survey.

GAGE.—Water-stage recorder. Elevation of gage is 1,560 ft above sea level, from topographic map.

REMARKS.—This station records fishwater release only. The minimum release requirements are 2.0 ft<sup>3</sup>/s during dry years and 4.0 ft<sup>3</sup>/s during normal years. Flow is computed to 7.8 ft<sup>3</sup>/s. See schematic diagram of Battle Creek and Cow Creek Basins.

COOPERATION.—Records were collected by Pacific Gas & Electric Co., under general supervision of the U.S. Geological Survey, in connection with a Federal Energy Regulatory Commission project.

## DISCHARGE, CUBIC FEET PER SECOND, WATER YEAR OCTOBER 2000 TO SEPTEMBER 2001

## DAILY MEAN VALUES

DAY	OCT	NOV	DEC	JAN	FEB	MAR	APR	MAY	JUN	JUL	AUG	SEP
1	5.3	5.3	5.4	5.8	5.4	5.4	6.0	6.1	3.9	3.9	3.9	4.0
2	5.3	5.3	5.3	5.7	5.4	5.4	5.8	5.9	3.9	3.9	3.9	4.0
3	5.3	5.3	5.3	5.7	5.4	5.4	5.6	5.8	3.9	3.9	3.9	4.0
4	5.3	5.3	5.3	5.5	5.4	5.8	5.4	5.5	3.9	3.9	3.9	4.0
5	5.3	5.3	5.3	5.3	5.4	5.8	5.4	5.5	3.9	3.9	3.9	4.0
6	5.3	5.3	5.3	5.3	5.4	6.0	5.6	5.4	3.9	3.9	3.9	4.0
7	5.3	5.3	5.3	5.2	5.4	6.3	6.3	5.5	3.9	3.9	3.9	4.0
8	5.3	5.3	5.3	5.2	5.4	6.4	5.8	5.5	3.9	3.9	3.9	4.0
9	5.3	5.3	5.3	5.3	5.8	6.4	5.7	5.5	3.9	3.9	4.0	4.0
10	5.3	5.3	5.3	6.6	6.3	6.2	5.7	5.5	3.9	3.9	4.0	4.0
11	5.6	5.3	5.3	7.1	6.4	6.0	5.9	5.5	3.9	3.9	4.0	4.0
12	5.3	5.3	5.4	5.4	5.7	5.9	5.7	5.5	3.9	3.9	4.0	4.0
13	5.3	5.3	5.8	5.3	5.5	5.7	5.4	5.5	3.9	3.9	4.0	4.0
14	5.3	5.4	6.7	5.8	5.4	5.6	5.4	5.5	3.9	3.9	4.0	4.0
15	5.3	5.3	5.4	5.2	5.4	5.3	5.4	5.5	3.9	3.9	4.0	4.0
16	5.3	5.7	5.3	5.2	5.4	5.4	5.4	5.1	3.9	4.0	4.0	4.0
17	5.3	5.2	5.3	5.2	5.5	5.4	5.4	4.8	3.9	4.0	4.0	4.0
18	5.3	5.3	5.4	5.2	5.8	5.5	5.9	4.8	3.9	4.0	4.0	4.0
19	5.3	5.3	5.6	5.2	5.7	5.5	6.5	4.8	3.9	4.0	4.0	4.0
20	5.3	5.3	5.6	5.2	5.9	5.6	6.6	4.8	3.9	4.0	4.0	4.0
21	5.3	5.3	5.7	5.2	6.3	5.9	6.4	4.8	3.9	4.0	4.0	4.0
22	5.3	5.3	5.9	5.2	6.4	6.1	6.3	4.7	3.9	4.0	4.0	4.0
23	5.3	5.3	5.7	5.3	5.6	6.4	6.2	4.7	3.9	4.0	4.0	4.0
24	5.3	5.3	5.8	6.2	5.7	6.6	6.2	4.7	3.9	4.0	4.0	4.0
25	5.3	5.3	5.5	6.3	5.8	7.1	6.3	4.7	3.9	4.0	4.0	4.0
26	5.3	5.3	5.5	6.7	5.4	6.6	6.3	4.7	3.9	4.0	4.0	4.0
27	5.3	5.3	5.5	6.0	5.4	6.2	6.3	4.7	3.9	4.0	4.0	4.0
28	5.8	5.3	5.5	5.4	5.4	6.1	6.4	4.6	3.9	4.0	4.0	4.0
29	5.4	6.5	5.5	5.4	---	6.1	6.2	4.6	3.9	4.0	4.0	4.0
30	5.6	5.6	5.5	5.4	---	6.0	6.1	4.2	3.9	4.0	4.0	4.0
31	5.3	---	5.8	5.4	---	6.0	---	3.9	---	3.9	4.0	---
TOTAL	165.5	160.9	170.8	172.9	158.0	184.1	177.6	158.3	117.0	122.4	123.2	120.0
MEAN	5.34	5.36	5.51	5.58	5.64	5.94	5.92	5.11	3.90	3.95	3.97	4.00
MAX	5.8	6.5	6.7	7.1	6.4	7.1	6.6	6.1	3.9	4.0	4.0	4.0
MIN	5.3	5.2	5.3	5.2	5.4	5.3	5.4	3.9	3.9	3.9	3.9	4.0
AC-FT	328	319	339	343	313	365	352	314	232	243	244	238

## 11372325 KILARC CANAL DIVERSION TO OLD COW CREEK, NEAR WHITMORE, CA

LOCATION.—Lat 40°41'13", long 121°48'27", in SW 1/4 NE 1/4 sec.25, T.32 N., R.1 E., Shasta County, Hydrologic Unit 18020118, on right bank of Kilarc Canal, 3.6 mi upstream of Kilarc Powerplant, and 6.9 mi northeast of Whitmore.

PERIOD OF RECORD.—October 1986 to current year (operated as a low-flow station only). Unpublished records for water years 1983–86 available in files of the U.S. Geological Survey.

GAGE.—Water-stage recorder and Cipolletti weir. Elevation of gage is 3,840 ft above sea level, from topographic map.

REMARKS.—This station records fishwater release only. The minimum release requirement is 2.0 ft<sup>3</sup>/s during dry or normal years. Flow is computed to 5.0 ft<sup>3</sup>/s. See schematic diagram of Battle Creek and Cow Creek Basins.

COOPERATION.—Records were collected by Pacific Gas & Electric Co., under general supervision of the U.S. Geological Survey, in connection with a Federal Energy Regulatory Commission project.

## DISCHARGE, CUBIC FEET PER SECOND, WATER YEAR OCTOBER 2000 TO SEPTEMBER 2001

## DAILY MEAN VALUES

DAY	OCT	NOV	DEC	JAN	FEB	MAR	APR	MAY	JUN	JUL	AUG	SEP
1	3.1	3.1	3.2	3.0	2.7	2.7	2.9	2.9	2.8	2.7	2.7	2.6
2	3.1	3.1	3.0	3.0	2.7	2.7	2.7	3.0	2.8	2.7	2.7	2.7
3	3.1	3.1	3.0	3.0	2.7	2.7	2.7	3.0	2.8	2.7	2.7	2.7
4	3.1	3.1	3.0	3.0	2.7	2.7	2.7	3.0	2.6	2.7	2.7	2.7
5	3.1	3.1	3.0	3.0	2.7	2.7	2.7	3.0	2.6	2.7	2.7	2.7
6	3.1	3.1	3.0	3.0	2.7	2.7	2.8	3.0	2.6	2.7	2.7	2.6
7	3.1	3.1	3.0	3.0	2.7	2.7	2.5	2.9	2.6	2.7	2.7	2.6
8	3.1	3.2	3.0	3.0	2.7	2.8	2.8	3.0	2.6	2.7	2.6	2.7
9	3.1	3.0	3.1	3.0	2.7	2.8	2.8	2.9	2.6	2.7	2.6	2.7
10	3.2	3.1	3.3	3.0	2.7	2.7	2.8	2.9	2.6	2.7	2.6	2.7
11	3.2	3.1	3.1	3.6	2.7	2.7	2.8	2.9	2.6	2.7	2.6	2.7
12	3.2	3.1	3.1	3.9	2.7	2.7	2.8	2.8	2.6	2.7	2.6	2.7
13	3.2	3.1	3.1	3.7	2.7	2.7	2.8	2.8	2.6	2.7	2.6	2.7
14	3.2	3.1	3.5	3.5	2.7	2.7	2.8	2.8	2.6	2.7	2.6	2.7
15	3.1	3.1	3.5	3.5	2.7	2.7	2.8	2.9	2.6	2.7	2.6	2.6
16	3.2	3.1	3.2	3.5	2.7	2.7	2.8	2.8	2.6	2.7	2.7	2.6
17	3.2	3.0	3.1	3.5	2.7	2.7	2.8	2.8	2.6	2.7	2.6	2.6
18	3.2	3.0	3.0	3.3	2.7	2.7	3.0	2.8	2.6	2.7	2.7	2.6
19	3.1	3.0	3.0	3.0	2.8	2.8	3.0	2.8	2.6	2.7	2.6	2.6
20	3.1	3.0	3.0	3.0	2.8	2.9	2.8	2.8	2.6	2.7	2.7	2.6
21	3.1	3.0	3.1	3.0	2.8	2.8	2.8	2.8	2.6	2.7	2.7	2.6
22	3.2	3.0	3.2	2.9	2.7	2.8	2.8	2.8	2.6	2.7	2.7	2.6
23	3.2	3.0	3.1	2.8	2.7	2.8	2.8	2.8	2.6	2.7	2.6	2.6
24	3.1	3.0	3.0	2.8	2.7	3.0	2.8	2.8	2.6	2.7	2.6	2.6
25	3.1	3.0	3.0	2.8	2.7	3.3	2.9	2.8	2.6	2.7	2.6	2.7
26	3.1	3.0	3.0	2.8	2.7	3.1	2.9	2.8	2.7	2.7	2.6	2.6
27	3.1	3.1	3.0	2.7	2.7	3.0	2.9	2.8	2.7	2.7	2.7	2.6
28	3.1	3.1	3.0	2.7	2.7	3.1	2.9	2.8	2.7	2.7	2.7	2.6
29	3.1	3.3	3.0	2.7	---	3.1	2.9	2.8	2.7	2.7	2.6	2.6
30	3.1	3.2	3.0	2.7	---	3.0	2.9	2.8	2.7	2.7	2.6	2.6
31	3.1	---	3.0	2.6	---	2.9	---	2.8	---	2.7	2.7	---
TOTAL	97.1	92.3	95.6	95.0	75.9	87.4	84.4	88.6	79.1	83.7	82.1	79.2
MEAN	3.13	3.08	3.08	3.06	2.71	2.82	2.81	2.86	2.64	2.70	2.65	2.64
MAX	3.2	3.3	3.5	3.9	2.8	3.3	3.0	3.0	2.8	2.7	2.7	2.7
MIN	3.1	3.0	3.0	2.6	2.7	2.7	2.5	2.8	2.6	2.7	2.6	2.6
AC-FT	193	183	190	188	151	173	167	176	157	166	163	157

## 11372350 OLD COW CREEK BELOW DIVERSION TO OLSEN POWERPLANT, NEAR WHITMORE, CA

LOCATION.—Lat 40°40'10", long 121°53'27", in NW 1/4 SW 1/4 sec.32, T.33 N., R.1 E., [Shasta County](#), Hydrologic Unit 18020118, on right bank, 1.2 mi downstream from Kilarc Powerhouse, 2.2 mi upstream from Glendenning Creek, and 3.0 mi north of Whitmore.

DRAINAGE AREA.—32.6 mi<sup>2</sup>.

PERIOD OF RECORD.—January 1990 to September 1992 (operated as low-flow station only); October 1996 to September 1997; October 1998 to current year.

GAGE.—Water-stage recorder. Elevation of gage is 2,340 ft above sea level, from topographic map.

REMARKS.—This station records regulated bypass flow or natural flow only. During times of powerplant operation the minimum release requirement is 30 ft<sup>3</sup>/s. See schematic diagram of [Battle Creek and Cow Creek Basins](#).

COOPERATION.—Records were collected by Synergics Incorporated, under general supervision of the U.S. Geological Survey, in connection with a Federal Energy Regulatory Commission project.

EXTREMES FOR PERIOD OF RECORD.—Maximum discharge, 2,280 ft<sup>3</sup>/s, Jan. 1, 1997, gage height, 7.29 ft; minimum daily, 6.9 ft<sup>3</sup>/s, Aug. 7, 9, 1997.

DISCHARGE, CUBIC FEET PER SECOND, WATER YEAR OCTOBER 2000 TO SEPTEMBER 2001  
DAILY MEAN VALUES

DAY	OCT	NOV	DEC	JAN	FEB	MAR	APR	MAY	JUN	JUL	AUG	SEP
1	28	29	31	25	23	19	17	17	17	17	17	24
2	28	28	30	26	23	18	17	16	17	20	18	25
3	28	28	28	25	20	18	17	17	17	19	17	25
4	28	27	27	25	20	19	17	17	17	21	17	25
5	28	27	27	25	20	18	17	17	17	20	17	25
6	28	27	27	25	20	18	18	16	17	21	17	25
7	29	27	27	25	20	17	31	16	17	21	17	25
8	26	27	27	28	20	22	e27	17	17	21	17	25
9	32	27	28	28	20	19	22	16	17	21	16	25
10	38	29	31	31	20	17	16	16	17	23	21	25
11	36	27	30	33	20	17	20	16	17	22	24	25
12	31	27	32	29	20	16	17	16	17	20	22	26
13	29	27	32	31	20	16	19	17	17	19	25	26
14	28	28	36	30	20	17	19	17	17	19	26	25
15	27	27	36	27	20	17	20	17	18	19	26	25
16	27	27	32	27	20	16	17	17	17	20	25	25
17	27	27	30	27	20	16	17	17	17	19	25	25
18	27	27	29	26	20	17	17	17	17	19	25	25
19	26	27	29	26	20	16	17	17	18	19	25	25
20	29	27	29	25	20	17	17	17	17	18	23	25
21	28	26	29	25	20	17	17	17	17	18	23	25
22	27	26	30	25	21	17	17	17	17	18	23	25
23	27	26	29	27	20	18	17	17	18	18	24	26
24	26	26	29	33	21	17	16	17	18	18	24	26
25	28	26	27	29	20	18	17	16	18	18	23	32
26	29	27	27	28	20	17	17	16	17	18	23	28
27	29	28	27	28	21	17	17	17	17	18	23	27
28	33	28	27	27	21	18	17	17	16	17	22	27
29	34	34	27	25	---	17	17	17	17	18	24	27
30	35	33	26	27	---	17	16	17	17	18	23	26
31	31	---	26	21	---	17	---	17	---	18	24	---
TOTAL	907	827	902	839	570	540	547	518	514	595	676	770
MEAN	29.3	27.6	29.1	27.1	20.4	17.4	18.2	16.7	17.1	19.2	21.8	25.7
MAX	38	34	36	33	23	22	31	17	18	23	26	32
MIN	26	26	26	21	20	16	16	16	16	17	16	24
AC-FT	1800	1640	1790	1660	1130	1070	1080	1030	1020	1180	1340	1530
a	0	0	6.0	32	585	1810	2200	1730	387	18	0	0

e Estimated.

a Discharge, in acre-feet, for Olsen Powerplant (station 11372330), provided by Synergics Incorporated.

## 11372350 OLD COW CREEK BELOW DIVERSION TO OLSEN POWERPLANT, NEAR WHITMORE, CA—Continued

## STATISTICS OF MONTHLY MEAN DATA FOR WATER YEARS 1997 - 2001, BY WATER YEAR (WY)

	OCT	NOV	DEC	JAN	FEB	MAR	APR	MAY	JUN	JUL	AUG	SEP
MEAN	33.6	35.4	51.2	71.6	42.3	35.7	37.3	31.4	28.3	26.6	28.4	30.8
MAX	36.8	45.1	97.5	184	52.7	54.9	58.7	49.8	43.8	42.4	41.1	35.9
(WY)	1999	1999	1997	1997	1997	1999	1999	1999	1999	1999	1999	1999
MIN	29.3	27.6	29.1	27.1	20.4	17.4	18.2	16.7	17.1	10.4	19.7	25.7
(WY)	2001	2001	2001	2001	2001	2001	2001	2001	2001	1997	1997	2001

SUMMARY STATISTICS	FOR 2000 CALENDAR YEAR		FOR 2001 WATER YEAR		WATER YEARS 1997 - 2001	
ANNUAL TOTAL	12793		8205			
ANNUAL MEAN	35.0		22.5		37.7	
HIGHEST ANNUAL MEAN					47.2	
LOWEST ANNUAL MEAN					22.5	
HIGHEST DAILY MEAN	125	Feb 14	38	Oct 10	1510	Jan 1 1997
LOWEST DAILY MEAN	26	Oct 8	16	Mar 12	6.9	Aug 7 1997
ANNUAL SEVEN-DAY MINIMUM	26	Nov 19	16	May 6	7.1	Aug 5 1997
MAXIMUM PEAK FLOW			127	Mar 8	2280	Jan 1 1997
MAXIMUM PEAK STAGE			3.68	Mar 8	7.29	Jan 1 1997
ANNUAL RUNOFF (AC-FT)	25370		16270		27340	
10 PERCENT EXCEEDS	39		29		45	
50 PERCENT EXCEEDS	34		21		34	
90 PERCENT EXCEEDS	27		17		17	

## 11374000 COW CREEK NEAR MILLVILLE, CA

LOCATION.—Lat 40°30'19", long 122°13'56", in NE 1/4 NW 1/4 sec.32, T.31 N., R.3 W., Shasta County, Hydrologic Unit 18020101, on right bank, 2.9 mi upstream from mouth, 4.2 mi southwest of Millville, and 4.3 mi downstream from Little Cow Creek.

DRAINAGE AREA.—425 mi<sup>2</sup>.

PERIOD OF RECORD.—October 1949 to current year.

CHEMICAL DATA: Water years 1959–66.

WATER TEMPERATURE: Water years 1966–71, 1973–76, 1978–79.

SEDIMENT DATA: Water year 1978.

REVISED RECORDS.—WSP 1931: Drainage area.

GAGE.—Water-stage recorder and crest-stage gage. Datum of gage is 385.7 ft above sea level. Prior to June 11, 1987, at datum 3.00 ft higher.

REMARKS.—Records good. Numerous small diversions upstream from station for irrigation. See schematic diagrams of [upper Sacramento River Basin](#) and [Battle Creek and Cow Creek Basins](#).

EXTREMES FOR PERIOD OF RECORD.—Maximum discharge, 48,700 ft<sup>3</sup>/s, Nov. 16, 1981, gage height, 24.22 ft, present datum; maximum gage height, 24.55 ft, Dec. 27, 1951, present datum; minimum daily, 0.02 ft<sup>3</sup>/s, July 29, 1977.

EXTREMES OUTSIDE PERIOD OF RECORD.—Flood of 1937 or 1940 reached a stage of 26.8 ft from floodmarks, present datum; probable backwater effect from high flows on the Sacramento River.

EXTREMES FOR CURRENT YEAR.—Peak discharges greater than base discharge of 13,900 ft<sup>3</sup>/s, or maximum:

Date	Time	Discharge (ft <sup>3</sup> /s)	Gage height (ft)
Mar. 4	1430	9,260	11.39

## DISCHARGE, CUBIC FEET PER SECOND, WATER YEAR OCTOBER 2000 TO SEPTEMBER 2001

## DAILY MEAN VALUES

DAY	OCT	NOV	DEC	JAN	FEB	MAR	APR	MAY	JUN	JUL	AUG	SEP
1	52	177	254	164	315	528	297	271	37	36	13	13
2	55	155	205	162	283	1140	258	259	37	32	13	13
3	50	141	183	159	270	943	255	232	36	27	12	12
4	49	135	169	158	255	4080	242	222	37	26	13	13
5	48	132	161	156	240	2860	232	201	39	21	13	12
6	47	128	155	156	229	1490	250	195	33	20	13	12
7	46	125	150	156	224	1010	829	186	34	18	14	13
8	51	124	147	258	212	853	613	177	36	19	12	12
9	57	125	144	348	361	901	412	170	32	20	12	12
10	201	142	151	2440	1690	682	361	171	31	19	12	13
11	326	152	159	2370	1790	524	313	164	32	19	11	14
12	191	135	403	786	1280	441	303	152	36	20	12	18
13	135	134	486	480	825	399	260	148	33	18	13	20
14	119	159	2000	529	578	366	248	147	31	17	13	18
15	111	165	1400	373	463	336	235	151	29	17	10	17
16	107	154	532	299	403	322	234	177	27	19	10	14
17	103	144	354	261	441	297	231	162	26	19	10	16
18	103	138	288	242	1200	281	247	140	26	20	10	16
19	103	133	246	232	1050	261	355	120	26	19	11	17
20	108	132	224	217	1120	292	400	98	26	17	11	18
21	122	129	219	207	1860	298	406	92	26	16	12	18
22	111	128	226	198	3470	302	346	74	24	16	12	18
23	104	126	214	200	2770	302	313	73	24	16	13	18
24	100	126	204	1950	2370	309	299	67	25	15	14	16
25	105	126	197	2060	3680	436	296	63	27	12	14	33
26	134	126	185	2250	1530	378	305	60	30	12	15	43
27	128	125	179	1050	933	313	314	58	67	14	15	29
28	456	130	171	687	693	272	320	61	122	15	14	27
29	692	658	165	596	---	340	308	55	62	15	13	26
30	349	485	167	480	---	325	268	42	42	14	12	25
31	235	---	165	374	---	308	---	39	---	13	13	---
TOTAL	4598	4989	9903	19998	30535	21589	9750	4227	1093	581	385	546
MEAN	148	166	319	645	1091	696	325	136	36.4	18.7	12.4	18.2
MAX	692	658	2000	2440	3680	4080	829	271	122	36	15	43
MIN	46	124	144	156	212	261	231	39	24	12	10	12
AC-FT	9120	9900	19640	39670	60570	42820	19340	8380	2170	1150	764	1080

SACRAMENTO RIVER BASIN

11374000 COW CREEK NEAR MILLVILLE, CA—Continued

STATISTICS OF MONTHLY MEAN DATA FOR WATER YEARS 1950 - 2001, BY WATER YEAR (WY)

	OCT	NOV	DEC	JAN	FEB	MAR	APR	MAY	JUN	JUL	AUG	SEP
MEAN	127	480	1105	1738	1695	1379	851	547	232	64.5	38.3	48.3
MAX	1057	2539	3929	5593	5636	5275	3012	2375	1386	324	148	130
(WY)	1963	1982	1984	1970	1998	1983	1963	1998	1998	1998	1998	1983
MIN	19.4	58.3	76.1	80.7	103	118	63.0	54.1	13.5	.63	.74	3.19
(WY)	1992	1992	1991	1991	1977	1977	1977	1992	1992	1977	1977	1992

SUMMARY STATISTICS FOR 2000 CALENDAR YEAR FOR 2001 WATER YEAR WATER YEARS 1950 - 2001

ANNUAL TOTAL	249736		108194									
ANNUAL MEAN	682		296						688			
HIGHEST ANNUAL MEAN									1634			1998
LOWEST ANNUAL MEAN									66.8			1977
HIGHEST DAILY MEAN	12700	Feb 13	4080	Mar 4					32500	Dec 27	1951	
LOWEST DAILY MEAN	26	Aug 16	10	Aug 15					.02	Jul 29	1977	
ANNUAL SEVEN-DAY MINIMUM	28	Aug 13	11	Aug 15					.09	Jul 23	1977	
MAXIMUM PEAK FLOW			9260	Mar 4					48700	Nov 16	1981	
MAXIMUM PEAK STAGE			11.39	Mar 4					24.55	Dec 27	1951	
ANNUAL RUNOFF (AC-FT)	495400		214600						498200			
10 PERCENT EXCEEDS	1880		668						1640			
50 PERCENT EXCEEDS	164		144						190			
90 PERCENT EXCEEDS	39		13						25			



11374305 MIDDLE FORK COTTONWOOD CREEK BELOW DIVERSION TO ARBUCKLE MOUNTAIN POWERPLANT, NEAR PLATINA, CA

LOCATION.—Lat 40°24'35", long 122°52'52", in NW 1/4 SE 1/4 sec.4, T.29 N., R.9 W., Shasta County, Hydrologic Unit 18020113, on left bank, 1.2 mi downstream from Cow Gulch, 1.0 mi upstream from Knob Gulch, and 2.4 mi northeast of the town of Platina.

DRAINAGE AREA.—46.0 mi<sup>2</sup>.

PERIOD OF RECORD.—October 1997 to current year (low-flow records only, collected only seasonally during period of upstream diversion for power generation).

GAGE.—Water-stage recorder and V-notched weir. Elevation of gage is 2,050 ft above sea level, from topographic map.

REMARKS.—No records computed above 32 ft<sup>3</sup>/s. Record is only collected during the part of the year when flow is generally high enough to allow for upstream diversion of water to Arbutle Mountain Powerplant (station 11374300). This year, record was collected Jan. 11, 2001, to Apr. 12, 2001. Flow was above 32 ft<sup>3</sup>/s for several days during this period. During times of powerplant operation, the minimum release requirement is 5.0 ft<sup>3</sup>/s. See schematic diagram of upper Sacramento River Basin.

COOPERATION.—Records were collected by Arbutle Mountain Hydro, LLC, under general supervision of the U.S. Geological Survey, in connection with a Federal Energy Regulatory Commission Project.

DISCHARGE, CUBIC FEET PER SECOND, WATER YEAR OCTOBER 2000 TO SEPTEMBER 2001  
DAILY MEAN VALUES

DAY	OCT	NOV	DEC	JAN	FEB	MAR	APR	MAY	JUN	JUL	AUG	SEP
1	---	---	---	---	15	6.4	5.7	---	---	---	---	---
2	---	---	---	---	13	5.8	5.8	---	---	---	---	---
3	---	---	---	---	6.7	5.4	9.8	---	---	---	---	---
4	---	---	---	---	5.5	---	5.5	---	---	---	---	---
5	---	---	---	---	11	---	5.5	---	---	---	---	---
6	---	---	---	---	12	---	5.9	---	---	---	---	---
7	---	---	---	---	14	---	11	---	---	---	---	---
8	---	---	---	---	14	---	5.5	---	---	---	---	---
9	---	---	---	---	15	14	7.0	---	---	---	---	---
10	---	---	---	---	14	15	5.5	---	---	---	---	---
11	---	---	---	6.2	12	6.2	5.5	---	---	---	---	---
12	---	---	---	7.4	5.5	5.7	12	---	---	---	---	---
13	---	---	---	5.5	5.7	5.8	---	---	---	---	---	---
14	---	---	---	13	11	5.9	---	---	---	---	---	---
15	---	---	---	12	5.5	5.8	---	---	---	---	---	---
16	---	---	---	12	5.7	5.8	---	---	---	---	---	---
17	---	---	---	9.2	6.2	6.9	---	---	---	---	---	---
18	---	---	---	10	5.4	5.8	---	---	---	---	---	---
19	---	---	---	9.8	---	5.8	---	---	---	---	---	---
20	---	---	---	9.2	---	5.7	---	---	---	---	---	---
21	---	---	---	9.6	---	5.7	---	---	---	---	---	---
22	---	---	---	9.6	28	5.7	---	---	---	---	---	---
23	---	---	---	9.2	20	5.5	---	---	---	---	---	---
24	---	---	---	5.7	6.9	5.7	---	---	---	---	---	---
25	---	---	---	12	7.7	5.8	---	---	---	---	---	---
26	---	---	---	17	7.2	5.7	---	---	---	---	---	---
27	---	---	---	19	9.4	5.9	---	---	---	---	---	---
28	---	---	---	19	5.8	5.9	---	---	---	---	---	---
29	---	---	---	20	---	5.9	---	---	---	---	---	---
30	---	---	---	14	---	5.9	---	---	---	---	---	---
31	---	---	---	16	---	5.9	---	---	---	---	---	---
TOTAL	---	---	---	---	---	---	---	---	---	---	---	---
MEAN	---	---	---	---	---	---	---	---	---	---	---	---
MAX	---	---	---	---	---	---	---	---	---	---	---	---
MIN	---	---	---	---	---	---	---	---	---	---	---	---
AC-FT	---	---	---	---	---	---	---	---	---	---	---	---
a	---	---	---	302	1800	2740	280	---	---	---	---	---

a Discharge, in acre-feet, for Arbutle Mountain Powerplant (station 11374300), provided by Arbutle Mountain Hydro, LLC.

## 11376000 COTTONWOOD CREEK NEAR COTTONWOOD, CA

LOCATION.—Lat 40°23'14", long 122°14'15", in NE 1/4 NE 1/4 sec.7, T.29 N., R.3 W., [Shasta County](#), Hydrologic Unit 18020102, on left bank, 2.2 mi east of Cottonwood, and 2.5 mi upstream from mouth.

DRAINAGE AREA.—927 mi<sup>2</sup>.

PERIOD OF RECORD.—October 1940 to current year.

CHEMICAL DATA: Water years 1982–85.

WATER TEMPERATURE: Water years 1963–67, 1977–85.

SEDIMENT DATA: Water years 1957–67, 1977–85.

REVISED RECORDS.—WSP 1345: 1943, 1944(M), 1946–47, 1949(M), 1951–52. WSP 1931: Drainage area.

GAGE.—Water-stage recorder and crest-stage gage. Datum of gage is 363.80 ft above sea level (levels by U.S. Army Corps of Engineers). Prior to July 26, 1963, on right bank at datum 3.59 ft higher. July 26, 1963, to Sept. 13, 1972, at site 250 ft downstream on right bank at present datum. Sept. 21, 1967, to Jan. 14, 1968, supplementary gage at a site 1,450 ft downstream on right bank at datum 2.35 ft higher.

REMARKS.—Records good. Small diversions for irrigation upstream from station. At times during irrigation season, Cottonwood Creek receives water from the Sacramento River by way of Anderson–Cottonwood Irrigation District Canal. See schematic diagrams of [upper Sacramento River Basin](#) and [Battle Creek and Cow Creek Basins](#).

EXTREMES FOR PERIOD OF RECORD.—Maximum discharge, 86,000 ft<sup>3</sup>/s, Mar. 1, 1983, gage height, 21.59 ft, from rating curve extended above 34,000 ft<sup>3</sup>/s on basis of runoff comparisons with upstream stations then in use; minimum, 15 ft<sup>3</sup>/s, several days during September 1945.

EXTREMES FOR CURRENT YEAR.—Peak discharges greater than base discharge of 11,000 ft<sup>3</sup>/s, or maximum:

Date	Time	Discharge (ft <sup>3</sup> /s)	Gage height (ft)
Mar. 5	0315	30,900	14.83

## DISCHARGE, CUBIC FEET PER SECOND, WATER YEAR OCTOBER 2000 TO SEPTEMBER 2001

## DAILY MEAN VALUES

DAY	OCT	NOV	DEC	JAN	FEB	MAR	APR	MAY	JUN	JUL	AUG	SEP
1	79	167	188	117	349	1170	778	403	153	118	62	70
2	68	139	151	114	318	1480	735	398	149	101	66	73
3	64	121	136	112	299	1210	693	379	141	91	67	68
4	63	113	126	110	300	9960	654	357	134	101	80	65
5	60	108	119	108	366	16900	620	342	137	92	82	84
6	60	105	115	107	368	5740	613	336	136	85	83	80
7	63	99	111	105	325	3340	701	331	132	81	78	66
8	60	95	110	155	291	2580	591	326	141	80	75	55
9	95	95	109	163	432	2140	552	335	164	85	78	53
10	167	98	110	327	1940	1820	526	343	143	109	44	61
11	161	94	110	1090	1310	1590	505	335	128	131	49	62
12	155	94	127	712	1700	1420	483	330	141	90	58	67
13	139	98	138	441	1090	1330	446	330	144	86	55	60
14	127	104	281	323	699	1290	432	321	124	85	49	56
15	122	103	336	268	538	1240	431	340	111	77	56	54
16	131	101	251	233	454	1170	415	358	100	73	84	63
17	133	98	209	204	436	1110	397	336	98	94	94	68
18	137	98	177	186	653	1130	398	300	91	84	84	88
19	137	96	161	178	1800	1190	404	269	82	77	67	73
20	138	95	150	173	5330	1270	417	267	117	74	65	66
21	143	97	143	167	3690	1320	619	255	90	81	75	66
22	145	104	138	163	3140	1310	483	245	84	82	116	65
23	147	101	141	172	2670	1260	434	233	71	74	53	60
24	143	99	145	2590	3120	1200	413	219	69	97	62	62
25	170	98	142	2620	7600	1330	403	203	61	118	61	74
26	193	98	138	2790	3600	1230	418	220	81	91	58	82
27	159	99	134	1430	2000	1050	434	252	103	65	59	83
28	142	98	129	803	1440	979	444	242	198	52	63	67
29	164	110	125	592	---	973	422	216	199	51	74	82
30	185	168	122	471	---	902	400	204	147	65	108	77
31	206	---	120	395	---	822	---	176	---	60	83	---
TOTAL	3956	3193	4692	17419	46258	71456	15261	9201	3669	2650	2188	2050
MEAN	128	106	151	562	1652	2305	509	297	122	85.5	70.6	68.3
MAX	206	168	336	2790	7600	16900	778	403	199	131	116	88
MIN	60	94	109	105	291	822	397	176	61	51	44	53
AC-FT	7850	6330	9310	34550	91750	141700	30270	18250	7280	5260	4340	4070

## SACRAMENTO RIVER BASIN

## 11376000 COTTONWOOD CREEK NEAR COTTONWOOD, CA—Continued

## STATISTICS OF MONTHLY MEAN DATA FOR WATER YEARS 1941 - 2001, BY WATER YEAR (WY)

	OCT	NOV	DEC	JAN	FEB	MAR	APR	MAY	JUN	JUL	AUG	SEP
MEAN	128	353	1184	2136	2486	1983	1186	649	324	120	71.0	77.2
MAX	805	1828	5428	9193	12430	10770	4270	2447	2082	495	178	164
(WY)	1958	1985	1984	1995	1998	1983	1941	1983	1998	1998	1998	1983
MIN	50.6	52.2	49.8	60.3	76.3	146	136	165	74.5	36.8	26.4	30.8
(WY)	1995	1991	1991	1991	1977	1977	1977	1977	1977	1994	1945	1945

SUMMARY STATISTICS	FOR 2000 CALENDAR YEAR		FOR 2001 WATER YEAR		WATER YEARS 1941 - 2001	
ANNUAL TOTAL	373560		181993			
ANNUAL MEAN	1021		499		884	
HIGHEST ANNUAL MEAN					2714	
LOWEST ANNUAL MEAN					94.4	
HIGHEST DAILY MEAN	13600	Feb 14	16900	Mar 5	54300	Jan 16 1974
LOWEST DAILY MEAN	45	Aug 18	44	Aug 10	15	Sep 7 1945
ANNUAL SEVEN-DAY MINIMUM	52	Aug 17	56	Aug 9	16	Sep 4 1945
MAXIMUM PEAK FLOW			30900	Mar 5	86000	Mar 1 1983
MAXIMUM PEAK STAGE			14.83	Mar 5	21.59	Mar 1 1983
ANNUAL RUNOFF (AC-FT)	741000		361000		640300	
10 PERCENT EXCEEDS	2910		1220		2100	
50 PERCENT EXCEEDS	174		141		226	
90 PERCENT EXCEEDS	65		65		58	

## 11376015 NORTH FORK BATTLE CREEK BELOW NORTH BATTLE CREEK DAM, NEAR MANZANITA LAKE, CA

LOCATION.—Lat 40°36'10", long 121°39'17", in SE 1/4 SE 1/4 sec.20, T.32 N., R.3 E., Shasta County, Hydrologic Unit 18020118, Lassen National Forest, on left bank, 300 ft downstream from North Battle Creek Dam, and 6.7 mi northwest of Manzanita Lake.

DRAINAGE AREA.—6.40 mi<sup>2</sup>.

PERIOD OF RECORD.—October 1987 to current year (operated as a low-flow station only). Unpublished records for water years 1978–87 available in files of the U.S. Geological Survey. Fragmentary records for water years 1920–77 in files of the Pacific Gas & Electric Co.

GAGE.—Water-stage recorder and a compound weir consisting of a 5-ft rectangular and V-notch weir. Elevation of gage is 5,560 ft above sea level, from topographic map.

REMARKS.—This station records fishwater release only. The minimum release requirement is 0.30 ft<sup>3</sup>/s Oct. 1–31 and Apr. 1 to Sept. 30. No license requirement Nov. 1 to Mar. 31, records not computed. Each fall, North Fork Battle Creek Reservoir is drafted and flows may exceed the rated limits of the weirs; flow is computed to 60 ft<sup>3</sup>/s. See schematic diagram of Battle Creek and Cow Creek Basins.

COOPERATION.—Records were collected by Pacific Gas & Electric Co., under general supervision of the U.S. Geological Survey, in connection with a Federal Energy Regulatory Commission project.

DISCHARGE, CUBIC FEET PER SECOND, WATER YEAR OCTOBER 2000 TO SEPTEMBER 2001  
DAILY MEAN VALUES

DAY	OCT	NOV	DEC	JAN	FEB	MAR	APR	MAY	JUN	JUL	AUG	SEP
1	6.6	---	---	---	---	---	.79	.55	.58	.39	.95	1.3
2	6.6	---	---	---	---	---	.75	.47	.55	.38	1.2	1.1
3	6.6	---	---	---	---	---	.65	.44	.55	.38	1.2	.93
4	6.6	---	---	---	---	---	.68	.42	.53	.39	1.1	.99
5	5.7	---	---	---	---	---	.72	.42	.56	.39	1.1	.88
6	5.0	---	---	---	---	---	.70	.41	.55	.40	1.2	.82
7	5.0	---	---	---	---	---	.72	.41	.49	.43	1.4	.81
8	5.0	---	---	---	---	---	.72	.43	.50	.43	1.5	.87
9	5.0	---	---	---	---	---	.72	.46	.48	.41	1.4	.87
10	5.0	---	---	---	---	---	.70	.51	.51	.40	1.4	.81
11	5.0	---	---	---	---	---	.72	.47	.51	.82	1.1	.81
12	5.0	---	---	---	---	---	.72	.46	.54	.89	1.1	2.0
13	5.0	---	---	---	---	---	.72	.47	.58	.89	.94	2.4
14	5.0	---	---	---	---	---	.73	.46	.57	.86	1.2	2.3
15	5.0	---	---	---	---	---	.72	.47	.46	.76	1.8	2.1
16	5.0	---	---	---	---	---	.70	.51	.46	.71	2.0	1.9
17	5.0	---	---	---	---	---	.67	.51	.46	.75	2.1	1.7
18	5.0	---	---	---	---	---	.65	.45	.45	.60	2.0	1.5
19	5.0	---	---	---	---	---	.63	.42	.46	.53	2.1	2.3
20	4.8	---	---	---	---	---	.60	.44	.45	.54	2.0	3.0
21	4.8	---	---	---	---	---	.60	.53	.41	.51	2.0	2.9
22	4.8	---	---	---	---	---	.56	.50	.37	.50	1.9	2.9
23	4.8	---	---	---	---	---	.56	.52	.33	.50	1.8	2.8
24	4.8	---	---	---	---	---	.57	.48	.34	.51	1.7	2.8
25	6.3	---	---	---	---	---	.57	.48	.33	.97	1.7	2.6
26	7.5	---	---	---	---	---	.57	.48	.32	1.1	1.6	2.5
27	7.3	---	---	---	---	---	.61	.50	.49	1.1	1.4	2.4
28	7.3	---	---	---	---	---	.59	.53	.54	.94	1.6	2.2
29	7.2	---	---	---	---	---	.60	.58	.51	.85	1.3	2.1
30	7.0	---	---	---	---	---	.60	.60	.44	.84	1.3	2.0
31	7.0	---	---	---	---	---	---	.58	---	.94	1.2	---
TOTAL	175.7	---	---	---	---	---	19.84	14.96	14.32	20.11	46.29	54.59
MEAN	5.67	---	---	---	---	---	.66	.48	.48	.65	1.49	1.82
MAX	7.5	---	---	---	---	---	.79	.60	.58	1.1	2.1	3.0
MIN	4.8	---	---	---	---	---	.56	.41	.32	.38	.94	.81
AC-FT	349	---	---	---	---	---	39	30	28	40	92	108
a	210	167	236	287	336	481	677	759	693	589	449	335

a Contents, in acre-feet, end of month for North Fork Battle Creek Reservoir (station 11376010), provided by Pacific Gas & Electric Co.

## 11376025 NORTH FORK BATTLE CREEK BELOW McCUMBER DAM, NEAR MANZANITA LAKE, CA

LOCATION.—Lat 40°32'15", long 121°43'53", in SW 1/4 SE 1/4 sec.15, T.31 N., R.2 E., Shasta County, Hydrologic Unit 18020118, on right bank, 300 ft downstream from McCumber Dam, 3.0 mi northwest of Viola, and 9.0 mi west of Manzanita Lake.

DRAINAGE AREA.—27.6 mi<sup>2</sup>.

PERIOD OF RECORD.—October 1987 to current year (operated as a low-flow station only). Unpublished records for water years 1978–87 available in files of the U.S. Geological Survey.

GAGE.—Water-stage recorder and V-notch weir. Elevation of gage is 4,080 ft above sea level, from topographic map.

REMARKS.—This station records fishwater release only. Prior to water year 1995 flow computed to 211 ft<sup>3</sup>/s. The minimum release requirement is 0.30 ft<sup>3</sup>/s at all times; flow is computed to 800 ft<sup>3</sup>/s. See schematic diagram of Battle Creek and Cow Creek Basins.

COOPERATION.—Records were collected by Pacific Gas & Electric Co., under general supervision of the U.S. Geological Survey, in connection with a Federal Energy Regulatory Commission project.

## DISCHARGE, CUBIC FEET PER SECOND, WATER YEAR OCTOBER 2000 TO SEPTEMBER 2001

## DAILY MEAN VALUES

DAY	OCT	NOV	DEC	JAN	FEB	MAR	APR	MAY	JUN	JUL	AUG	SEP
1	24	28	16	13	16	17	22	18	6.7	5.1	2.8	2.0
2	24	30	16	12	16	17	22	16	6.7	5.1	2.4	2.0
3	24	30	16	11	16	17	20	12	6.7	4.8	2.0	1.8
4	24	30	16	11	16	17	19	14	6.4	4.9	2.2	1.6
5	24	30	16	11	16	18	18	15	6.9	5.2	2.2	1.6
6	24	30	16	11	14	19	21	15	7.5	4.6	2.2	1.6
7	23	29	16	11	13	22	22	14	7.1	4.1	2.2	1.6
8	20	26	15	11	13	26	18	14	6.6	4.1	2.3	1.5
9	17	25	15	12	13	27	18	14	6.3	4.1	2.5	1.4
10	17	19	15	13	13	27	17	12	6.5	3.9	2.4	1.4
11	23	18	15	14	13	27	18	12	6.9	3.2	2.5	1.4
12	27	17	15	15	13	27	17	12	7.0	2.6	2.5	1.4
13	27	16	15	15	13	24	17	11	6.6	2.5	2.5	1.4
14	27	16	16	15	13	20	17	11	6.1	2.5	2.5	1.5
15	27	16	16	13	13	17	16	13	6.2	2.5	2.2	1.6
16	26	16	16	11	13	17	16	12	5.9	2.5	2.0	1.6
17	24	16	16	11	13	17	17	11	5.9	2.5	2.0	1.8
18	24	16	16	11	13	15	20	11	5.9	2.7	2.2	1.8
19	24	14	16	11	13	14	27	10	5.9	2.7	2.2	1.6
20	24	13	16	11	15	13	26	9.0	5.8	2.8	2.1	1.6
21	25	13	16	11	16	14	22	8.3	5.1	2.8	2.0	1.6
22	23	13	16	11	16	14	20	8.6	5.5	2.8	2.0	1.6
23	19	13	15	14	16	14	22	8.3	5.7	2.8	2.0	1.6
24	19	12	16	14	16	14	24	7.9	5.4	2.8	2.0	1.6
25	23	12	16	14	16	14	24	8.2	5.4	2.8	2.0	5.4
26	27	12	16	15	17	15	24	8.0	6.3	2.8	2.0	7.7
27	27	12	15	15	17	12	23	7.9	11	2.8	2.0	7.7
28	27	12	15	15	17	8.8	22	8.0	8.3	2.8	2.0	7.7
29	27	14	13	16	---	8.7	21	8.3	6.1	2.8	2.0	7.7
30	27	16	13	17	---	21	19	7.2	5.2	2.8	2.0	7.7
31	27	---	13	16	---	22	---	6.6	---	2.8	2.0	---
TOTAL	745	564	478	401	409	555.5	609	343.3	193.6	103.2	67.9	82.5
MEAN	24.0	18.8	15.4	12.9	14.6	17.9	20.3	11.1	6.45	3.33	2.19	2.75
MAX	27	30	16	17	17	27	27	18	11	5.2	2.8	7.7
MIN	17	12	13	11	13	8.7	16	6.6	5.1	2.5	2.0	1.4
AC-FT	1480	1120	948	795	811	1100	1210	681	384	205	135	164
a	e196	156	96	110	147	436	436	428	428	395	356	266

a Contents, in acre-feet, at end of month for McCumber Reservoir (station 11376020), provided by Pacific Gas & Electric Co.  
e Estimated.

## POWERPLANTS IN BATTLE CREEK AND COW CREEK BASINS

- 11376043 VOLTA NO. 1 POWERPLANT NEAR MANTON, CA, in NW 1/4 NE 1/4 sec.16, T.30 N., R.1 E., [Shasta County](#), Hydrologic Unit 18020118, 1.7 mi north of Manton. Powerplant consists of one unit with a total of 8,550 KW normal operating capacity. See schematic diagram of [Battle Creek and Cow Creek Basins](#).
- 11376046 VOLTA NO. 2 POWERPLANT NEAR MANTON, CA, in NE 1/4 SW 1/4 sec.16, T.30 N., R.1 E., [Shasta County](#), Hydrologic Unit 18020118, 1.2 mi northeast of Manton. Powerplant consists of one unit with a total of 956 KW normal operating capacity. See schematic diagram of [Battle Creek and Cow Creek Basins](#).
- 11376410 SOUTH POWERPLANT NEAR MANTON, CA, in NE 1/4 SE 1/4 sec.5, T.29 N., R.1 E., [Tehama County](#), Hydrologic Unit 18020118, 2.7 mi south of Manton. Powerplant consists of one unit with a total of 6,750 KW normal operating capacity. See schematic diagram of [Battle Creek and Cow Creek Basins](#).
- 11376430 INSKIP POWERPLANT NEAR MANTON, CA, in NE 1/4 NW 1/4 sec.3, T.29 N., R.1 W., [Tehama County](#), Hydrologic Unit 18020118, 5.5 mi southwest of Manton. Powerplant consists of one unit with a total of 7,650 KW normal operating capacity. See schematic diagram of [Battle Creek and Cow Creek Basins](#).
- 11376458 COLEMAN POWERPLANT NEAR COTTONWOOD, CA, in SW 1/4 SW 1/4 sec.32, T.30 N., R.2 W., [Shasta County](#), Hydrologic Unit 18020006, 8.5 mi east of Cottonwood. Powerplant consists of one unit with a total of 12,150 KW normal operating capacity. See schematic diagram of [Battle Creek and Cow Creek Basins](#).

## MONTHLY DISCHARGE, IN ACRE-FEET, WATER YEAR OCTOBER 2000 TO SEPTEMBER 2001

Date	Volta No. 1	Volta No. 2	South	Inskip	Coleman
Oct.....	4,250	4,830	11,200	12,460	11,710
Nov.....	3,990	4,450	11,270	12,280	11,590
Dec.....	3,860	4,410	11,140	12,400	11,790
Jan.....	3,670	4,320	11,150	12,520	11,880
Feb.....	3,330	3,930	10,520	12,000	10,790
Mar.....	4,050	4,880	12,880	14,620	12,060
Apr.....	4,180	4,850	12,550	14,010	11,480
May.....	3,910	4,540	12,790	15,430	0
June.....	3,380	3,970	10,030	10,670	0
July.....	3,020	3,400	8,820	9,240	6,340
Aug.....	1,540	3,080	8,120	8,460	10,170
Sept.....	1,600	2,910	7,750	8,030	9,790

Note.—Records were provided by Pacific Gas & Electric Co., in connection with a Federal Energy Regulatory Commission project. Unpublished records for water years 1979–86 available in files of U.S.Geological Survey. Fragmentary records prior to water year 1979 available in files of Pacific Gas & Electric Co.

## 11376050 NORTH FORK BATTLE CREEK BELOW DIVERSION TO KESWICK DITCH, NEAR MANTON, CA

LOCATION.—Lat 40°30'00", long 121°48'29", in NW 1/4 NE 1/4 sec.36, T.31 N., R.1 E., Shasta County, Hydrologic Unit 18020118, on right bank, 4.2 mi east of Shingletown, and 5.5 mi northeast of Manton.

PERIOD OF RECORD.—October 1986 to current year (operated as a low-flow station only). Unpublished records for water years 1978–86 available in files of the U.S. Geological Survey.

GAGE.—Water-stage recorder and Parshall flume. Elevation of gage is 3,600 ft above sea level, from topographic map.

REMARKS.—This station records fishwater release only. The minimum release requirement is 3.0 ft<sup>3</sup>/s at all times; flow is computed to 5.6 ft<sup>3</sup>/s. See schematic diagram of Battle Creek and Cow Creek Basins.

COOPERATION.—Records were collected by Pacific Gas & Electric Co., under general supervision of the U.S. Geological Survey, in connection with a Federal Energy Regulatory Commission project.

DISCHARGE, CUBIC FEET PER SECOND, WATER YEAR OCTOBER 2000 TO SEPTEMBER 2001  
DAILY MEAN VALUES

DAY	OCT	NOV	DEC	JAN	FEB	MAR	APR	MAY	JUN	JUL	AUG	SEP
1	3.4	3.4	3.6	3.5	3.5	3.6	3.5	3.4	3.6	3.5	4.1	3.6
2	3.4	3.6	3.6	3.5	3.5	3.6	3.5	3.4	3.6	3.5	3.8	3.6
3	3.4	3.7	3.7	3.5	3.5	3.6	3.6	3.5	3.6	3.5	3.6	3.6
4	3.4	3.6	3.6	3.5	3.5	3.6	3.5	3.6	3.6	3.5	3.6	3.6
5	3.5	3.6	3.6	3.5	3.5	3.7	3.5	3.6	3.5	3.5	3.6	3.6
6	3.6	3.6	3.6	3.5	3.5	3.7	3.6	3.6	3.5	3.5	3.6	3.6
7	3.5	3.5	3.6	3.5	3.5	3.8	3.6	3.6	3.5	3.5	3.6	3.6
8	3.5	3.5	3.6	3.6	3.5	3.8	3.5	3.6	3.6	3.5	3.6	3.6
9	3.4	3.4	3.6	3.5	3.5	3.8	3.5	3.6	3.6	3.5	3.6	3.6
10	3.5	3.3	3.6	3.6	3.5	3.5	3.5	3.6	3.6	3.5	3.5	3.6
11	3.6	3.3	3.6	3.6	3.5	3.8	3.5	3.6	3.6	3.5	3.5	3.6
12	3.7	3.4	3.6	3.6	3.5	3.5	3.5	3.6	3.6	3.5	3.5	3.6
13	3.7	3.4	3.6	3.6	3.5	3.5	3.6	3.6	3.6	3.6	3.6	3.6
14	3.7	3.4	3.9	3.6	3.5	3.4	3.6	3.5	3.5	3.6	3.5	3.6
15	3.7	3.4	3.8	3.6	3.5	3.4	3.6	3.6	3.5	3.6	3.3	3.6
16	3.7	3.4	3.6	3.5	3.5	3.5	3.6	3.6	3.5	3.6	3.5	3.6
17	3.6	3.4	3.6	3.5	3.5	3.5	3.6	3.6	3.5	3.6	3.5	3.6
18	3.5	3.4	3.6	3.5	3.5	3.5	3.7	3.6	3.5	3.6	3.5	3.5
19	3.5	3.4	3.6	3.5	3.6	3.5	3.6	3.6	3.5	3.6	3.5	3.5
20	3.5	3.4	3.5	3.5	3.6	3.5	3.3	3.5	3.5	3.6	3.5	3.5
21	3.5	3.4	3.5	3.5	3.6	3.6	3.3	3.5	3.5	3.6	3.5	3.5
22	3.4	3.5	3.5	3.5	3.7	3.6	3.4	3.5	3.5	3.6	3.5	3.5
23	3.4	3.5	3.5	3.5	3.7	3.6	3.4	3.5	3.5	3.6	3.5	3.6
24	3.5	3.5	3.5	3.5	3.7	3.6	3.4	3.5	3.5	3.6	3.5	3.6
25	3.4	3.5	3.5	3.5	3.7	3.6	3.5	3.5	3.5	3.6	3.5	3.6
26	3.5	3.6	3.5	3.5	3.7	3.6	3.6	3.5	3.5	3.6	3.6	3.6
27	3.6	3.6	3.5	3.5	3.6	3.5	3.5	3.5	3.7	3.6	3.6	3.6
28	3.6	3.6	3.5	3.5	3.6	3.4	3.5	3.5	3.7	3.6	3.6	3.5
29	3.3	3.8	3.5	3.5	---	3.5	3.5	3.5	3.6	3.6	3.6	3.5
30	3.3	3.7	3.5	3.5	---	3.6	3.5	3.6	3.5	3.5	3.6	3.5
31	3.2	---	3.5	3.5	---	3.6	---	3.6	---	3.6	3.6	---
TOTAL	108.5	104.8	111.0	109.2	99.5	111.0	105.5	110.0	106.5	110.3	110.6	107.2
MEAN	3.50	3.49	3.58	3.52	3.55	3.58	3.52	3.55	3.55	3.56	3.57	3.57
MAX	3.7	3.8	3.9	3.6	3.7	3.8	3.7	3.6	3.7	3.6	4.1	3.6
MIN	3.2	3.3	3.5	3.5	3.5	3.4	3.3	3.4	3.5	3.5	3.3	3.5
AC-FT	215	208	220	217	197	220	209	218	211	219	219	213

## 11376120 BAILEY CREEK BELOW DIVERSION TO PONDEROSA—BAILEY CREEK POWERPLANT, NEAR MANTON, CA

LOCATION.—Lat 40°27'59", long 121°59'20", in NE 1/4 SE 1/4 sec.11, T.30 N., R.1 E., [Shasta County](#), Hydrologic Unit 18020118, on right bank, 250 ft downstream from Spring Creek, 0.4 mi upstream from Ponderosa Way, 3.3 mi northeast of Manton, and 3.9 mi southeast of Shingletown.

DRAINAGE AREA.—29.6 mi<sup>2</sup>.

PERIOD OF RECORD.—January 1990 to current year (operated as a low-flow station only).

GAGE.—Water-stage recorder and V-notch weir. Elevation of gage is 2,650 ft above sea level, from topographic map.

REMARKS.—During times of powerplant operation the minimum release requirement is 17 ft<sup>3</sup>/s; flow is computed to 109 ft<sup>3</sup>/s. See schematic diagram of [Battle Creek and Cow Creek Basins](#).

COOPERATION.—Records were collected by Snow Mountain Hydro, under general supervision of the U.S. Geological Survey, in connection with a Federal Energy Regulatory Commission project.

## DISCHARGE, CUBIC FEET PER SECOND, WATER YEAR OCTOBER 2000 TO SEPTEMBER 2001

## DAILY MEAN VALUES

DAY	OCT	NOV	DEC	JAN	FEB	MAR	APR	MAY	JUN	JUL	AUG	SEP
1	17	17	23	18	19	20	17	22	19	16	e16	16
2	17	17	19	18	19	20	17	24	18	16	e16	16
3	e18	17	19	18	19	20	17	21	18	16	e16	16
4	17	17	19	17	19	21	17	21	18	16	e16	16
5	17	17	19	18	19	24	17	23	20	16	e16	16
6	17	17	18	18	19	24	17	21	23	16	e16	16
7	17	17	19	18	18	24	19	24	22	16	e16	16
8	17	17	19	19	19	23	22	19	21	16	16	16
9	18	17	19	18	20	18	22	18	21	16	16	16
10	18	17	19	19	19	24	23	18	21	16	16	16
11	18	17	19	19	19	24	23	18	21	16	16	16
12	18	17	19	19	19	23	22	18	20	16	16	16
13	18	17	19	19	19	23	21	18	19	16	16	16
14	18	18	22	19	19	22	18	18	17	16	16	16
15	18	19	21	19	19	21	18	18	17	16	16	16
16	18	19	20	18	19	21	17	18	17	16	16	16
17	e17	19	19	18	19	21	17	18	16	16	16	16
18	16	19	19	19	20	21	17	18	16	16	16	16
19	16	19	19	19	21	22	19	18	16	16	16	16
20	16	19	19	18	21	22	24	18	16	16	16	16
21	17	19	19	19	21	18	24	18	16	16	16	16
22	17	19	19	19	22	18	19	18	16	16	16	16
23	17	19	19	19	21	17	18	18	16	16	16	16
24	17	19	19	20	21	17	17	18	16	16	16	16
25	17	19	18	19	21	19	17	18	16	16	16	16
26	17	19	19	19	21	18	18	18	16	16	16	15
27	17	19	19	19	20	17	19	19	16	16	16	15
28	17	19	18	18	20	17	20	18	20	16	16	15
29	17	e22	19	20	---	17	19	18	17	16	16	15
30	17	21	18	18	---	17	18	18	16	e16	16	15
31	17	---	18	19	---	17	---	18	---	e16	16	---
TOTAL	533	548	594	577	552	630	573	590	541	496	496	475
MEAN	17.2	18.3	19.2	18.6	19.7	20.3	19.1	19.0	18.0	16.0	16.0	15.8
MAX	18	22	23	20	22	24	24	24	23	16	16	16
MIN	16	17	18	17	18	17	17	18	16	16	16	15
AC-FT	1060	1090	1180	1140	1090	1250	1140	1170	1070	984	984	942
a	0	0	0	0	0	9.9	0	1420	135	0	0	0

e Estimated.

a Discharge, in acre-feet, for Ponderosa-Bailey Creek Powerplant (station 11376110), provided by Snow Mountain Hydro.





## 11376150 NORTH FORK BATTLE CREEK BELOW DIVERSION TO EAGLE CANYON CANAL, NEAR MANTON, CA

LOCATION.—Lat 40°25'26", long 121°55'09", in NW 1/4 SE 1/4 sec.25, T.30 N., R.1 W., Tehama County, Hydrologic Unit 18020118, on left bank, at diversion dam to Eagle Canyon Canal, and 2.8 mi southwest of Manton.

DRAINAGE AREA.—186 mi<sup>2</sup>.

PERIOD OF RECORD.—October 1987 to current year (operated as a low-flow station only). Unpublished records for water years 1978–87 available in files of the U.S. Geological Survey. Fragmentary records for water year 1977 available in files of Pacific Gas & Electric Co.

GAGE.—Water-stage recorder and metal Alaskan fishladder. Elevation of gage is 1,400 ft above sea level, from topographic map.

REMARKS.—This station records fishwater release only. Prior to water year 1996 flow computed to 7.2 ft<sup>3</sup>/s. The minimum release requirement is 3.0 ft<sup>3</sup>/s at all times; flow is computed to 50 ft<sup>3</sup>/s. See schematic diagram of Battle Creek and Cow Creek Basins.

COOPERATION.—Records were collected by Pacific Gas & Electric Co., under general supervision of the U.S. Geological Survey, in connection with a Federal Energy Regulatory Commission project.

DISCHARGE, CUBIC FEET PER SECOND, WATER YEAR OCTOBER 2000 TO SEPTEMBER 2001  
DAILY MEAN VALUES

DAY	OCT	NOV	DEC	JAN	FEB	MAR	APR	MAY	JUN	JUL	AUG	SEP
1	e36	e32	e33	e31	e32	e34	e35	e33	e38	e34	e33	e33
2	e36	e31	e33	e31	e32	e36	e35	e31	e38	e34	e33	e33
3	e37	e31	e33	e31	e32	e35	e34	e31	e37	e34	e33	e33
4	e36	e31	e32	e31	e32	e42	e33	e32	e36	e34	e33	e33
5	e36	e31	e33	e31	e32	e46	e35	e32	e34	e34	e33	e33
6	e36	e31	e33	e31	e32	e39	e36	e32	e33	e34	e33	e33
7	e36	e31	e33	e31	e32	e37	e36	e32	e33	e34	e33	e33
8	e35	e32	e32	e32	e32	e37	e34	e32	e33	e34	e33	e33
9	e37	e31	e32	e31	e32	e38	e34	e34	e33	e34	e33	e33
10	e38	e33	e32	e35	e33	e48	e35	e36	e33	e34	e33	e33
11	e34	e31	e33	e37	e35	e38	e36	e35	e33	e35	e33	e33
12	e31	e32	e33	e33	e35	e37	e35	e39	e33	e34	e33	e33
13	e32	e32	e32	e32	e33	e36	e36	e40	e32	e34	e33	e33
14	e32	e31	e35	e32	e32	e36	e35	e34	e33	e33	e33	e33
15	e32	e32	e34	e32	e32	e35	e35	e36	e35	e33	e33	e33
16	e32	e32	e33	e32	e32	e35	e35	e40	e35	e33	e33	e33
17	e32	e31	e33	e32	e33	e35	e35	e33	e34	e33	e33	e33
18	e32	e31	e33	e31	e33	e35	e34	e31	e34	e33	e33	e33
19	e32	e31	e33	e32	e34	e35	e37	e33	e34	e33	e33	e33
20	e32	e31	e33	e32	e34	e35	e37	e32	e34	e34	e33	e33
21	e32	e32	e33	e31	e35	e35	e37	e38	e34	e33	e33	e33
22	e31	e34	e32	e32	e45	e34	e36	e41	e34	e33	e33	e33
23	e31	e33	e32	e32	e38	e34	e36	e35	e34	e33	e33	e33
24	e31	e33	e32	e38	e40	e35	e36	e31	e34	e33	e33	e34
25	e31	e33	e32	e36	e41	e36	e35	e31	e34	e33	e33	e35
26	e31	e33	e32	e35	e36	e35	e36	e30	e35	e33	e34	e34
27	e31	e33	e31	e33	e35	e34	e36	e31	e36	e33	e33	e34
28	e31	e33	e31	e32	e34	e33	e36	e31	e35	e32	e33	e33
29	e31	e39	e31	e33	---	e34	e35	e31	e34	e32	e33	e33
30	e38	e35	e31	e32	---	e35	e35	e31	e34	e33	e33	e33
31	e34	---	e31	e32	---	e35	---	e35	---	e33	e33	---
TOTAL	1036	966	1006	1006	958	1129	1060	1043	1029	1036	1024	995
MEAN	33.4	32.2	32.5	32.5	34.2	36.4	35.3	33.6	34.3	33.4	33.0	33.2
MAX	38	39	35	38	45	48	37	41	38	35	34	35
MIN	31	31	31	31	32	33	33	30	32	32	33	33
AC-FT	2050	1920	2000	2000	1900	2240	2100	2070	2040	2050	2030	1970

e Estimated.

## 11376160 NORTH FORK BATTLE CREEK BELOW DIVERSION TO WILDCAT CANAL, NEAR MANTON, CA

LOCATION.—Lat 40°25'14", long 121°57'36", in SE 1/4 SW 1/4 sec.27, T.30 N., R.1 W., Tehama County, Hydrologic Unit 18020118, on left bank, at diversion dam to Wildcat Canal, and 4.9 mi west of Manton.

DRAINAGE AREA.—189 mi<sup>2</sup>.

PERIOD OF RECORD.—October 1987 to current year (operated as a low-flow station only). Unpublished records for water years 1978–87 available in files of the U.S. Geological Survey. Fragmentary records for water year 1977 available in files of Pacific Gas & Electric Co.

GAGE.—Water-stage recorder and metal Alaskan fishladder. Elevation of gage is 1,080 ft above sea level, from topographic map.

REMARKS.—This station records fishwater release only. The minimum release requirement is 3.0 ft<sup>3</sup>/s at all times; flow is computed to 60 ft<sup>3</sup>/s. See schematic diagram of Battle Creek and Cow Creek Basins.

COOPERATION.—Records were collected by Pacific Gas & Electric Co., under general supervision of the U.S. Geological Survey, in connection with a Federal Energy Regulatory Commission project.

DISCHARGE, CUBIC FEET PER SECOND, WATER YEAR OCTOBER 2000 TO SEPTEMBER 2001  
DAILY MEAN VALUES

DAY	OCT	NOV	DEC	JAN	FEB	MAR	APR	MAY	JUN	JUL	AUG	SEP
1	39	35	36	34	35	37	38	36	41	37	36	36
2	39	34	36	34	35	39	38	34	41	37	36	36
3	40	34	36	34	35	38	37	34	40	37	36	36
4	39	34	35	34	35	45	36	35	39	37	36	36
5	39	34	36	34	35	49	38	35	37	37	36	36
6	39	34	36	34	35	42	39	35	36	37	36	36
7	39	34	36	34	35	40	39	35	36	37	36	36
8	38	35	35	35	35	40	37	35	36	37	36	36
9	40	34	35	34	35	41	37	37	36	37	36	36
10	41	36	35	38	36	51	38	39	36	37	36	36
11	37	34	36	40	38	41	39	38	36	38	36	36
12	34	35	36	36	38	40	38	42	36	37	36	36
13	35	35	35	35	36	39	39	43	35	37	36	36
14	35	34	38	35	35	39	38	37	36	36	36	36
15	35	35	37	35	35	38	38	39	38	36	36	36
16	35	35	36	35	35	38	38	43	38	36	36	36
17	35	34	36	35	36	38	38	36	37	36	36	36
18	35	34	36	34	36	38	37	34	37	36	36	36
19	35	34	36	35	37	38	40	36	37	36	36	36
20	35	34	36	35	37	38	40	35	37	37	36	36
21	35	35	36	34	38	38	40	41	37	36	36	36
22	e34	37	36	35	48	37	39	44	37	36	36	36
23	e34	36	35	35	41	37	39	38	37	36	36	36
24	e34	36	35	41	43	38	39	34	37	36	36	37
25	e34	36	35	39	44	39	38	34	37	36	36	38
26	e34	36	35	38	39	38	39	33	38	36	37	37
27	e34	36	34	36	38	37	39	34	39	36	36	37
28	e34	36	34	35	37	36	39	34	38	35	36	36
29	e34	42	34	36	---	37	38	34	37	35	36	36
30	e41	38	34	35	---	38	38	34	37	36	36	36
31	e37	---	34	35	---	38	---	38	---	36	36	---
TOTAL	1129	1056	1100	1099	1042	1222	1150	1136	1119	1129	1117	1085
MEAN	36.4	35.2	35.5	35.5	37.2	39.4	38.3	36.6	37.3	36.4	36.0	36.2
MAX	41	42	38	41	48	51	40	44	41	38	37	38
MIN	34	34	34	34	35	36	36	33	35	35	36	36
AC-FT	2240	2090	2180	2180	2070	2420	2280	2250	2220	2240	2220	2150

e Estimated.

## 11376420 SOUTH FORK BATTLE CREEK BELOW DIVERSION TO SOUTH BATTLE CREEK CANAL, NEAR MANTON, CA

LOCATION.—Lat 40°22'08", long 121°47'48", in SW 1/4 NW 1/4 sec.18, T.29 N., R.2 E., Tehama County, Hydrologic Unit 18020118, on right bank, at diversion dam to South Battle Creek Canal, and 5.9 mi southeast of Manton.

DRAINAGE AREA.—66.7 mi<sup>2</sup>.

PERIOD OF RECORD.—October 1987 to current year (operated as a low-flow station only). Unpublished records for water years 1978–87 available in files of the U.S. Geological Survey. Fragmentary records for water years 1976–77 in files of Pacific Gas & Electric Co.

GAGE.—Water-stage recorder and metal Alaskan fishladder. Elevation of gage is 2,040 ft above sea level, from topographic map.

REMARKS.—This station records fishwater release only. The minimum release requirement is 5.0 ft<sup>3</sup>/s at all times; flow is computed to 8.9 ft<sup>3</sup>/s. See schematic diagram of Battle Creek and Cow Creek Basins.

COOPERATION.—Records were collected by Pacific Gas & Electric Co., under general supervision of the U.S. Geological Survey, in connection with a Federal Energy Regulatory Commission project.

## DISCHARGE, CUBIC FEET PER SECOND, WATER YEAR OCTOBER 2000 TO SEPTEMBER 2001

## DAILY MEAN VALUES

DAY	OCT	NOV	DEC	JAN	FEB	MAR	APR	MAY	JUN	JUL	AUG	SEP
1	6.2	6.5	---	6.8	6.2	6.0	---	---	5.8	5.7	5.7	5.7
2	6.1	6.6	7.9	6.8	6.2	6.0	---	---	5.7	5.7	5.7	5.7
3	6.2	6.6	6.8	6.8	6.2	6.0	---	---	5.8	5.7	5.7	5.7
4	6.1	6.7	6.8	6.9	6.2	6.0	---	---	5.8	5.7	5.7	5.7
5	6.1	6.6	6.8	6.8	6.3	---	---	---	5.8	5.7	5.8	5.7
6	6.2	6.6	6.8	6.9	6.2	6.2	---	---	5.7	5.7	5.7	5.7
7	6.2	6.6	6.7	6.8	6.2	5.9	---	---	5.6	5.7	5.7	5.7
8	6.2	6.6	6.8	6.8	5.6	6.2	---	---	5.7	5.7	5.7	5.7
9	7.6	6.6	6.8	6.8	6.2	7.1	---	---	5.7	5.7	5.8	5.7
10	7.9	6.2	6.8	6.9	6.2	5.5	---	---	5.7	5.7	5.7	5.7
11	6.1	6.0	6.8	5.9	6.2	6.0	---	---	5.7	5.7	5.7	5.7
12	6.1	6.6	6.8	---	6.2	6.0	6.8	---	5.7	5.7	5.7	5.7
13	6.1	6.5	6.8	7.6	6.2	6.0	6.3	---	5.7	5.7	5.7	5.7
14	6.2	6.6	6.8	6.8	6.2	6.4	6.5	---	5.7	5.7	5.7	5.7
15	6.1	6.7	6.8	6.7	6.2	6.1	7.9	---	5.7	5.7	5.7	5.8
16	6.2	6.7	6.8	6.7	6.2	6.0	---	---	5.7	5.6	5.7	5.8
17	6.2	6.8	6.8	6.7	6.2	6.2	---	---	5.7	5.7	5.7	5.7
18	6.2	6.8	6.8	6.7	6.2	7.3	---	---	5.7	5.7	5.8	5.7
19	6.2	6.8	6.8	6.6	6.2	---	---	8.4	5.7	5.7	5.8	5.8
20	6.2	6.8	6.8	6.6	6.1	---	---	7.3	5.7	5.7	5.7	5.7
21	6.2	6.0	6.8	6.6	---	---	---	7.5	5.7	5.7	5.7	5.7
22	6.2	6.3	6.9	6.6	---	---	---	5.8	5.7	5.7	5.7	5.7
23	6.3	6.4	6.9	6.6	6.4	---	---	5.8	5.7	5.7	5.7	5.8
24	6.3	7.1	6.9	6.6	6.9	---	---	5.7	5.7	5.7	5.7	5.7
25	---	7.2	6.9	6.5	6.9	---	---	5.8	5.7	5.8	5.7	5.7
26	8.7	7.2	6.8	6.6	6.9	---	---	5.7	5.7	5.7	5.7	5.7
27	6.5	7.6	6.9	6.5	6.6	---	---	5.7	5.7	5.7	5.8	5.8
28	---	8.0	6.9	5.9	6.0	---	---	5.7	5.6	5.7	5.7	5.7
29	---	6.8	6.9	6.6	---	---	---	5.7	5.6	5.7	5.7	5.7
30	6.5	6.8	6.9	6.6	---	---	---	5.8	5.7	5.7	5.7	5.7
31	6.5	---	6.9	6.3	---	---	---	5.8	---	5.7	5.7	---
TOTAL	---	201.3	---	---	---	---	---	---	171.1	176.7	177.2	171.5
MEAN	---	6.71	---	---	---	---	---	---	5.70	5.70	5.72	5.72
MAX	---	8.0	---	---	---	---	---	---	5.8	5.8	5.8	5.8
MIN	---	6.0	---	---	---	---	---	---	5.6	5.6	5.7	5.7
AC-FT	---	399	---	---	---	---	---	---	339	350	351	340

## 11376440 SOUTH FORK BATTLE CREEK BELOW DIVERSION TO INSKIP CANAL, NEAR MANTON, CA

LOCATION.—Lat 40°23'43", long 121°52'57", in NW 1/4 SE 1/4 sec.5, T.29 N., R.1 E., Tehama County, Hydrologic Unit 18020118, on left bank, at diversion dam to Inskip Canal, and 2.8 mi south of Manton.

DRAINAGE AREA.—88.3 mi<sup>2</sup>.

PERIOD OF RECORD.—October 1987 to current year (operated as a low-flow station only). Unpublished records for water years 1978–87 available in files of the U.S. Geological Survey. Fragmentary records for water year 1977 available in files of Pacific Gas & Electric Co.

GAGE.—Water-stage recorder and metal Alaskan fishladder. Elevation of gage is 1,440 ft above sea level, from topographic map.

REMARKS.—This station records fishwater release only. Prior to Feb. 6, 1998, flow computed to 12 ft<sup>3</sup>/s. The minimum release requirement is 5.0 ft<sup>3</sup>/s at all times; flow computed to 60 ft<sup>3</sup>/s. See schematic diagram of [Battle Creek and Cow Creek Basins](#).

COOPERATION.—Records were collected by Pacific Gas & Electric Co., under general supervision of the U.S. Geological Survey, in connection with a Federal Energy Regulatory Commission project.

DISCHARGE, CUBIC FEET PER SECOND, WATER YEAR OCTOBER 2000 TO SEPTEMBER 2001  
DAILY MEAN VALUES

DAY	OCT	NOV	DEC	JAN	FEB	MAR	APR	MAY	JUN	JUL	AUG	SEP
1	8.1	9.0	22	20	8.2	8.7	---	---	8.6	8.2	8.6	8.9
2	8.0	8.9	21	20	8.4	11	---	59	8.5	8.3	8.6	8.8
3	8.1	8.8	21	20	8.2	9.1	40	35	8.6	8.2	8.6	9.0
4	8.2	8.8	21	20	8.1	18	21	32	8.6	8.2	8.7	9.0
5	8.2	8.7	21	20	8.4	---	13	39	8.6	8.3	8.5	8.9
6	8.2	8.9	21	20	8.2	45	20	39	8.5	8.3	8.5	9.0
7	8.2	8.9	21	20	8.3	30	27	41	8.5	8.4	8.3	8.9
8	8.2	9.1	21	20	8.3	35	14	45	8.4	8.3	8.8	8.9
9	8.5	9.4	21	20	8.2	41	11	54	8.4	8.5	8.8	9.0
10	9.0	9.2	21	12	8.2	18	12	53	8.4	8.4	8.9	8.9
11	9.7	9.1	21	19	9.7	22	14	46	8.3	8.6	8.8	8.6
12	8.3	9.1	21	20	8.2	20	13	46	8.4	8.4	8.9	9.0
13	8.3	9.2	21	20	8.1	20	11	36	8.4	8.5	8.9	9.0
14	8.6	9.2	22	21	8.0	20	10	28	8.4	8.7	8.9	9.1
15	8.5	9.2	21	20	8.0	18	10	29	8.4	8.5	8.7	9.0
16	8.5	9.2	21	20	8.1	14	11	43	8.4	8.7	8.9	9.0
17	8.5	9.1	21	20	8.6	13	19	33	8.4	8.7	8.7	9.0
18	8.5	9.1	21	20	14	16	41	24	8.3	8.6	8.5	9.0
19	8.5	9.2	21	20	12	23	---	19	8.4	8.5	8.6	9.0
20	8.6	9.0	21	20	14	36	---	16	8.4	8.5	8.6	8.8
21	8.7	8.9	20	20	22	44	41	15	8.7	8.5	8.1	9.2
22	8.7	8.9	21	20	57	48	37	12	8.4	8.6	8.1	9.3
23	8.7	9.0	21	20	25	58	36	11	8.4	8.5	8.3	9.1
24	8.7	9.0	20	23	24	---	47	11	8.4	8.5	8.3	9.1
25	8.8	8.9	20	23	35	---	---	9.8	8.4	8.5	8.4	9.1
26	10	9.0	20	22	15	---	---	9.7	8.4	8.6	8.8	9.3
27	8.7	9.0	20	20	11	---	---	9.8	8.5	8.6	9.1	9.3
28	20	9.0	20	20	9.2	---	---	11	8.4	8.6	9.0	9.1
29	29	21	20	21	---	---	---	10	8.3	8.6	8.5	9.3
30	11	15	20	20	---	---	54	9.4	8.2	8.7	9.0	9.1
31	9.4	---	20	20	---	---	---	8.6	---	8.6	9.0	---
TOTAL	300.4	288.8	644	621	379.4	---	---	---	253.0	263.1	268.4	270.7
MEAN	9.69	9.63	20.8	20.0	13.6	---	---	---	8.43	8.49	8.66	9.02
MAX	29	21	22	23	57	---	---	---	8.7	8.7	9.1	9.3
MIN	8.0	8.7	20	12	8.0	---	---	---	8.2	8.2	8.1	8.6
AC-FT	596	573	1280	1230	753	---	---	---	502	522	532	537

## 11376460 SOUTH FORK BATTLE CREEK BELOW DIVERSION TO COLEMAN DITCH, NEAR MANTON, CA

LOCATION.—Lat 40°24'10", long 121°58'02", in NW 1/4 NW 1/4 sec.3, T.29 N., R.1 W., Tehama County, Hydrologic Unit 18020118, on right bank, 7.5 mi southwest of Shingletown, and 5.7 mi southwest of Manton.

DRAINAGE AREA.—102 mi<sup>2</sup>.

PERIOD OF RECORD.—October 1987 to current year (operated as a low-flow station only). Unpublished records for water years 1978–86 available in files of the U.S. Geological Survey. Fragmentary records for water year 1977 available in files of Pacific Gas & Electric Co.

GAGE.—Water-stage recorder and metal Alaskan fishladder. Elevation of gage is 980 ft above sea level, from topographic map.

REMARKS.—This station records fishwater release only. Prior to water year 1996 flow computed to 10 ft<sup>3</sup>/s. The minimum release requirement is 5.0 ft<sup>3</sup>/s at all times; flow is computed to 45 ft<sup>3</sup>/s. See schematic diagram of Battle Creek and Cow Creek Basins.

COOPERATION.—Records were collected by the Pacific Gas & Electric Co., under general supervision of the U.S. Geological Survey, in connection with a Federal Energy Regulatory Commission project.

## DISCHARGE, CUBIC FEET PER SECOND, WATER YEAR OCTOBER 2000 TO SEPTEMBER 2001

## DAILY MEAN VALUES

DAY	OCT	NOV	DEC	JAN	FEB	MAR	APR	MAY	JUN	JUL	AUG	SEP
1	35	32	33	34	33	45	---	---	10	5.9	6.2	5.8
2	35	32	33	34	33	---	---	---	10	5.9	6.3	6.2
3	35	35	33	34	33	---	---	---	9.8	5.8	6.4	6.2
4	36	37	33	34	33	---	---	---	9.3	5.8	6.4	6.0
5	36	36	33	33	33	---	44	---	8.9	5.8	6.4	6.0
6	35	36	33	33	33	---	---	---	8.7	5.8	6.5	6.0
7	35	36	32	33	33	---	---	---	7.0	5.9	6.4	6.0
8	35	36	32	33	32	---	---	---	6.1	6.0	6.2	6.0
9	34	36	32	33	32	---	44	---	6.1	5.9	6.6	5.8
10	34	36	32	42	32	---	44	---	6.2	6.0	6.5	6.2
11	34	36	33	---	---	---	45	---	6.1	6.0	6.3	6.0
12	34	36	31	---	---	---	44	---	6.2	6.0	6.3	5.8
13	34	36	31	44	35	---	43	---	6.1	6.1	6.4	5.8
14	34	35	34	33	31	---	43	---	6.1	6.1	6.3	5.8
15	34	35	35	33	32	---	43	---	6.1	6.2	6.4	5.8
16	34	35	35	32	33	---	43	---	6.0	6.2	6.0	5.8
17	34	35	34	32	34	45	44	---	6.0	6.2	6.3	5.8
18	34	35	34	32	---	45	---	---	6.1	6.2	6.4	5.8
19	31	31	34	32	---	---	---	---	6.1	6.2	6.4	5.8
20	29	32	34	32	---	---	---	---	6.1	6.2	6.2	6.0
21	29	34	33	32	---	---	---	---	6.0	6.2	6.0	6.0
22	29	34	33	32	---	---	---	36	5.9	6.2	6.0	6.0
23	29	34	33	32	---	---	---	23	5.8	6.3	6.0	6.0
24	29	35	33	---	---	---	---	17	6.0	6.7	6.2	5.6
25	29	34	33	---	---	---	---	17	6.0	6.3	6.4	5.8
26	29	34	33	---	---	---	---	17	6.0	6.2	6.2	5.8
27	29	34	34	35	---	---	---	17	6.0	6.2	6.2	5.8
28	39	34	34	33	---	---	---	17	6.0	6.3	6.3	5.6
29	---	36	34	34	---	---	---	16	6.0	6.3	6.2	5.6
30	30	33	33	33	---	---	---	16	5.9	6.3	6.2	5.5
31	39	---	33	33	---	---	---	14	---	6.2	6.0	---
TOTAL	---	1040	1027	---	---	---	---	---	202.6	189.4	194.6	176.3
MEAN	---	34.7	33.1	---	---	---	---	---	6.75	6.11	6.28	5.88
MAX	---	37	35	---	---	---	---	---	10	6.7	6.6	6.2
MIN	---	31	31	---	---	---	---	---	5.8	5.8	6.0	5.5
AC-FT	---	2060	2040	---	---	---	---	---	402	376	386	350

## 11376550 BATTLE CREEK BELOW COLEMAN FISH HATCHERY, NEAR COTTONWOOD, CA

LOCATION.—Lat 40°23'54", long 122°08'43", in SW 1/4 NE 1/4 sec.1, T.29 N., R.3 W., [Shasta County](#), Hydrologic Unit 18020101, U.S. Fish and Wildlife Service land, on right bank, 3.7 mi downstream from Spring Branch, 5.7 mi upstream from mouth, and 7.0 mi east of Cottonwood.

DRAINAGE AREA.—357 mi<sup>2</sup>.

PERIOD OF RECORD.—October 1940 to September 1996, October 1996 to September 1997 (operated as a low-flow station only), October 1997 to current year.

CHEMICAL DATA: Water years 1962–66.

WATER TEMPERATURE: Water years 1966–79.

SEDIMENT DATA: Water years 1962–70.

GAGE.—Water-stage recorder. Elevation of gage is 415 ft above sea level, from topographic map. Prior to Oct. 1, 1961, water-stage recorder at site 0.6 mi upstream at different datum published as "11376500 Battle Creek near Cottonwood"; low-flow records not equivalent owing to Coleman Fish Hatchery diversion, maximum flows considered equivalent.

REMARKS.—Records good. Some regulation at low flows by five small powerplants, several small reservoirs, and Coleman Fish Hatchery. Coleman Fish Hatchery diverts from 50 to 90 ft<sup>3</sup>/s and pumps ground water for temperature control, which is returned above the station. At times, 10 ft<sup>3</sup>/s diverted upstream from station for irrigation. See schematic diagrams of [Battle Creek and Cow Creek Basins](#) and [upper Sacramento River Basin](#).

EXTREMES FOR PERIOD OF RECORD.—Maximum discharge, 24,300 ft<sup>3</sup>/s, Jan. 24, 1970, gage height, 14.75 ft, from rating curve extended above 4,200 ft<sup>3</sup>/s on basis of slope-area measurement of peak flow; minimum, 52 ft<sup>3</sup>/s, Aug. 8, 1962.

EXTREMES OUTSIDE PERIOD OF RECORD.—Maximum stage known, 15.8 ft, Dec. 11, 1937, from floodmarks, site and datum then in use, discharge, 35,000 ft<sup>3</sup>/s, by slope-area measurement.

EXTREMES FOR CURRENT YEAR.—Peak discharges greater than base discharge of 3,100 ft<sup>3</sup>/s, or maximum:

Date	Time	Discharge (ft <sup>3</sup> /s)	Gage height (ft)
Mar. 4	1315	2,640	4.48

## DISCHARGE, CUBIC FEET PER SECOND, WATER YEAR OCTOBER 2000 TO SEPTEMBER 2001

## DAILY MEAN VALUES

DAY	OCT	NOV	DEC	JAN	FEB	MAR	APR	MAY	JUN	JUL	AUG	SEP
1	264	329	342	300	312	379	394	389	294	257	220	211
2	264	316	333	298	312	462	387	383	304	251	210	217
3	265	313	332	293	316	424	359	363	304	232	206	209
4	272	315	326	290	310	1130	339	346	290	247	208	208
5	281	311	330	289	308	1030	323	346	286	247	212	215
6	281	311	330	292	320	595	326	360	280	243	209	212
7	281	310	328	290	314	473	380	366	278	244	211	212
8	284	306	327	324	314	450	338	367	275	241	207	212
9	294	305	320	318	321	559	322	377	278	253	207	210
10	359	308	320	574	347	448	319	387	275	234	209	208
11	352	306	317	629	444	417	323	387	272	245	201	210
12	331	298	339	379	468	400	326	391	271	255	206	216
13	328	302	315	338	393	392	314	389	264	238	215	212
14	316	320	339	338	359	378	310	371	262	239	205	207
15	315	314	332	317	339	373	308	366	259	240	203	205
16	311	311	319	310	333	371	309	415	258	233	206	216
17	313	303	316	295	342	357	317	393	257	226	201	215
18	312	300	317	291	459	350	338	373	255	229	198	213
19	312	302	316	294	459	351	405	365	252	231	198	214
20	313	298	304	293	458	362	405	364	250	230	200	211
21	314	295	304	294	467	362	385	370	251	227	199	213
22	314	297	304	294	983	354	361	370	250	226	202	218
23	315	295	313	303	623	357	351	357	250	222	206	216
24	313	297	313	683	707	372	353	346	251	218	205	214
25	315	298	311	574	1020	476	373	332	255	224	200	237
26	332	296	304	639	540	452	402	324	258	223	204	226
27	329	296	300	389	435	403	415	312	282	221	207	225
28	351	297	302	342	399	393	418	305	287	221	205	227
29	450	355	302	356	---	413	397	307	271	222	210	227
30	390	390	299	344	---	396	371	296	260	224	207	234
31	349	---	300	329	---	393	---	291	---	225	209	---
TOTAL	9820	9294	9854	11299	12402	14072	10668	11108	8079	7268	6386	6470
MEAN	317	310	318	364	443	454	356	358	269	234	206	216
MAX	450	390	342	683	1020	1130	418	415	304	257	220	237
MIN	264	295	299	289	308	350	308	291	250	218	198	205
AC-FT	19480	18430	19550	22410	24600	27910	21160	22030	16020	14420	12670	12830

## 11376550 BATTLE CREEK BELOW COLEMAN FISH HATCHERY, NEAR COTTONWOOD, CA—Continued

## STATISTICS OF MONTHLY MEAN DATA FOR WATER YEARS 1962 - 2001, BY WATER YEAR (WY)

	OCT	NOV	DEC	JAN	FEB	MAR	APR	MAY	JUN	JUL	AUG	SEP
MEAN	299	413	545	756	748	749	648	623	493	336	268	263
MAX	589	1058	1602	2434	1919	1802	1160	1578	1453	817	540	449
(WY)	1963	1982	1984	1970	1986	1983	1995	1998	1998	1998	1998	1998
MIN	139	205	224	234	260	266	231	266	207	168	160	154
(WY)	1993	1993	1992	1991	1977	1977	1977	1977	1992	1992	1992	1992

SUMMARY STATISTICS	FOR 2000 CALENDAR YEAR		FOR 2001 WATER YEAR		WATER YEARS 1962 - 2001	
ANNUAL TOTAL	173416		116720			
ANNUAL MEAN	474		320		511	
HIGHEST ANNUAL MEAN					926	
LOWEST ANNUAL MEAN					238	
HIGHEST DAILY MEAN	2020	Feb 27	1130	Mar 4	10900	Jan 16 1974
LOWEST DAILY MEAN	245	Sep 12	198	Aug 18	102	Oct 27 1992
ANNUAL SEVEN-DAY MINIMUM	256	Aug 18	201	Aug 16	110	Oct 22 1992
MAXIMUM PEAK FLOW			2640	Mar 4	24300	Jan 24 1970
MAXIMUM PEAK STAGE			4.48	Mar 4	14.75	Jan 24 1970
ANNUAL RUNOFF (AC-FT)	344000		231500		370300	
10 PERCENT EXCEEDS	781		404		892	
50 PERCENT EXCEEDS	348		310		369	
90 PERCENT EXCEEDS	265		211		224	



## 11377100 SACRAMENTO RIVER ABOVE BEND BRIDGE, NEAR RED BLUFF, CA

LOCATION.—Lat 40°17'19", long 122°11'08", in NW 1/4 NE 1/4 sec.15, T.28 N., R.3 W., Tehama County, Hydrologic Unit 18020103, on left bank, 2.7 mi upstream from Bend Bridge, and 8.1 mi northeast of Red Bluff.

DRAINAGE AREA.—8,900 mi<sup>2</sup>, excluding Goose Lake Basin.

PERIOD OF RECORD.—1879–88 annual observed maximums only, published in WSP 1315-A. January 1892 to current year. Monthly discharges only for some periods and yearly estimates for some incomplete years, published in WSP 1315-A. Published as "at Red Bluff" 1894–96, as "at Jellys Ferry" 1895–1902, and as "near Red Bluff" 1903–68 (station 11378000).

CHEMICAL DATA: Water years 1955–81, 1996–98.

SPECIFIC CONDUCTANCE: Water years 1955–63.

WATER TEMPERATURE: Water years 1955–80.

SEDIMENT DATA: Water year 1958–70, 1996–98.

REVISED RECORDS.—WSP 861: 1904, 1907, 1909, 1914–15, 1927–28. WSP 1315-A: 1916(M), 1918(M), 1941(M). WSP 1931: Drainage area. WDR CA-69-2: 1965.

GAGE.—Water-stage recorder and crest-stage gage. Datum of gage is 285.77 ft above sea level. See WSP 2131 for history of changes prior to September 1968.

REMARKS.—Records excellent. Flow completely regulated by Shasta Lake (station 11370000), 52 mi upstream, since Dec. 30, 1943. Diversions, in addition to those on tributaries, for irrigation of about 22,000 acres between stations at Keswick and above Bend Bridge. Transbasin diversion from Trinity River to Whiskeytown Lake (station 11371700) via Judge Francis Carr Powerplant (station 11525430) started in April 1963. See schematic diagrams of [upper Sacramento River Basin](#) and [Battle Creek and Cow Creek Basins](#).

EXTREMES FOR PERIOD OF RECORD.—Maximum discharge, 291,000 ft<sup>3</sup>/s, Feb. 28, 1940, gage height, 38.9 ft, site and datum then in use, from rating curve extended above 170,000 ft<sup>3</sup>/s, on basis of velocity-area studies; minimum (water years 1892–2000), 2,000 ft<sup>3</sup>/s, Mar. 29, 1944. Since regulation by Shasta Lake in 1943, maximum discharge, 170,000 ft<sup>3</sup>/s, Dec. 22, 1964, gage height, 28.15 ft, site and datum then in use; maximum gage height, 36.60 ft, Jan. 24, 1970.

## DISCHARGE, CUBIC FEET PER SECOND, WATER YEAR OCTOBER 2000 TO SEPTEMBER 2001

## DAILY MEAN VALUES

DAY	OCT	NOV	DEC	JAN	FEB	MAR	APR	MAY	JUN	JUL	AUG	SEP
1	6950	6730	7090	5970	5620	6890	6660	9060	11500	15000	13800	9870
2	6990	6540	6860	5940	5420	8240	6570	9330	11500	14600	13300	9890
3	6930	6570	6700	5940	5360	7790	7300	9260	11500	14500	13000	9920
4	6980	6480	6700	5850	5300	21700	7950	9200	11500	14900	12800	9780
5	7020	6460	6600	5710	5320	37800	7870	9170	12100	14800	12800	9610
6	6950	6460	6480	5530	5290	16700	7850	9390	13100	15600	12800	9710
7	6940	6550	6530	5440	5170	11100	9140	9590	13400	15600	12900	9430
8	6880	6750	6370	5940	4970	9370	8430	9560	13400	15700	12900	9080
9	6940	6650	6350	5940	5000	9090	7990	9570	14100	15300	12900	9230
10	7310	6630	6390	8130	9030	10100	7880	9840	14400	15200	12800	9010
11	7450	6730	6360	12000	9060	10200	7830	10000	14500	15500	12400	8620
12	7240	6680	6580	7600	9290	9710	7780	9990	14300	15500	12100	8470
13	7160	6640	6520	6540	7570	9140	7650	9940	14200	15600	12100	8500
14	7040	6800	8750	6290	6350	8740	7560	9950	14400	15500	12200	8480
15	7130	6750	7970	5990	5870	8480	7550	11800	14700	15700	11700	8480
16	7130	6720	6670	5810	5620	8280	7490	11100	14700	15600	11400	8510
17	7010	6750	6340	5790	5490	8010	7360	11300	15100	15600	11300	8500
18	6870	6720	6200	5750	6980	7750	7400	11400	14900	15700	11000	8550
19	6700	6650	6170	5730	8040	7580	7560	11300	14700	15600	10700	8900
20	6510	6780	6140	5680	12300	7410	7740	11400	14800	15600	10700	8930
21	6370	6720	6090	5660	11900	7340	8020	11400	15200	15600	10300	8970
22	6310	6710	6110	5630	14200	7260	7730	11400	15400	15500	9790	8960
23	6220	6710	6060	5630	13400	7200	7550	11300	14700	15500	9740	8990
24	6280	6740	6050	11700	11600	7180	7960	11000	14500	15500	9730	8980
25	6350	6720	6000	11100	23400	7540	8540	10700	14800	15500	10400	9170
26	6530	6720	5990	14500	12800	7500	8730	11300	14900	16000	10400	8990
27	6480	6710	6000	8820	8830	7090	8740	11700	15100	15700	10700	8490
28	6780	6840	5960	7100	7590	6880	8760	11700	15200	15800	10100	8220
29	7460	7130	5960	6460	---	6860	8770	11600	15000	15000	9720	8190
30	7050	7530	6000	6060	---	6780	8640	11500	15000	14200	9750	8220
31	6990	---	5990	5780	---	6710	---	11500	---	14300	9900	---
TOTAL	212950	201570	199980	216010	236770	302420	237000	327250	422600	475700	356130	268650
MEAN	6869	6719	6451	6968	8456	9755	7900	10560	14090	15350	11490	8955
MAX	7460	7530	8750	14500	23400	37800	9140	11800	15400	16000	13800	9920
MIN	6220	6460	5960	5440	4970	6710	6570	9060	11500	14200	9720	8190
AC-FT	422400	399800	396700	428500	469600	599900	470100	649100	838200	943600	706400	532900

## 11377100 SACRAMENTO RIVER ABOVE BEND BRIDGE, NEAR RED BLUFF, CA—Continued

## STATISTICS OF MONTHLY MEAN DATA FOR WATER YEARS 1892 - 1943, BY WATER YEAR (WY)

	OCT	NOV	DEC	JAN	FEB	MAR	APR	MAY	JUN	JUL	AUG	SEP
MEAN	4853	7538	11940	18960	24760	22210	18280	12310	7635	5127	4381	4404
MAX	10910	21420	42780	72340	69240	73280	38810	27910	17640	10170	9050	8481
(WY)	1905	1904	1893	1909	1902	1904	1904	1896	1906	1893	1893	1893
MIN	2847	3300	3618	4142	4778	4434	4014	3253	2969	2622	2505	2551
(WY)	1933	1937	1937	1937	1920	1924	1924	1924	1924	1931	1931	1934

## SUMMARY STATISTICS

## WATER YEARS 1892 - 1943

ANNUAL MEAN	11800
HIGHEST ANNUAL MEAN	22180 1904
LOWEST ANNUAL MEAN	4096 1924
HIGHEST DAILY MEAN	261000 Feb 28 1940
LOWEST DAILY MEAN	2400 Aug 13 1931
ANNUAL SEVEN-DAY MINIMUM	2470 Aug 7 1931
MAXIMUM PEAK FLOW	291000 Feb 28 1940
MAXIMUM PEAK STAGE	38.9 Feb 28 1940
ANNUAL RUNOFF (AC-FT)	8545000
10 PERCENT EXCEEDS	24000
50 PERCENT EXCEEDS	6500
90 PERCENT EXCEEDS	3520

## STATISTICS OF MONTHLY MEAN DATA FOR WATER YEARS 1946 - 1962, BY WATER YEAR (WY)

MEAN	6501	6932	11440	16840	19340	11950	10210	10260	9469	10030	10030	7510
MAX	10490	11180	29530	52620	76870	24840	32420	17830	12930	11630	11800	10230
(WY)	1958	1958	1956	1956	1958	1958	1958	1948	1948	1951	1958	1958
MIN	5468	4681	4336	5104	4579	4727	5335	6788	7253	7476	7080	5289
(WY)	1960	1960	1960	1957	1948	1955	1950	1947	1947	1947	1947	1947

## SUMMARY STATISTICS

## WATER YEARS 1946 - 1962

ANNUAL MEAN	10840
HIGHEST ANNUAL MEAN	20330 1958
LOWEST ANNUAL MEAN	6690 1947
HIGHEST DAILY MEAN	125000 Feb 19 1958
LOWEST DAILY MEAN	3640 Jan 31 1949
ANNUAL SEVEN-DAY MINIMUM	3830 Feb 27 1948
MAXIMUM PEAK FLOW	139000 Feb 19 1958
MAXIMUM PEAK STAGE	24.98 Feb 19 1958
ANNUAL RUNOFF (AC-FT)	7852000
10 PERCENT EXCEEDS	16900
50 PERCENT EXCEEDS	8430
90 PERCENT EXCEEDS	5190

## STATISTICS OF MONTHLY MEAN DATA FOR WATER YEARS 1964 - 2001, BY WATER YEAR (WY)

MEAN	6834	9158	13820	18650	20860	18210	12220	12330	12370	13020	11710	8535
MAX	10600	29690	43350	61060	68400	75830	35110	22920	21150	16760	15790	11900
(WY)	1984	1974	1984	1970	1998	1983	1974	1995	1998	1998	1998	1998
MIN	3935	4068	4296	4573	4700	5476	4804	7322	7431	7811	7998	5323
(WY)	1978	1993	1977	1992	1990	1994	1991	1992	1992	1992	1992	1977

## SUMMARY STATISTICS

## FOR 2000 CALENDAR YEAR

## FOR 2001 WATER YEAR

## WATER YEARS 1964 - 2001

ANNUAL TOTAL	5369930	3457030	
ANNUAL MEAN	14670	9471	13110
HIGHEST ANNUAL MEAN			25450 1983
LOWEST ANNUAL MEAN			6494 1991
HIGHEST DAILY MEAN	72600 Mar 5	37800 Mar 5	127000 Jan 27 1970
LOWEST DAILY MEAN	5930 Jan 10	4970 Feb 8	3200 Oct 11 1977
ANNUAL SEVEN-DAY MINIMUM	5990 Dec 25	5200 Feb 3	3210 Oct 10 1977
MAXIMUM PEAK FLOW		53300 Mar 5	170000 Dec 22 1964
MAXIMUM PEAK STAGE		17.86 Mar 5	36.60 Jan 24 1970
ANNUAL RUNOFF (AC-FT)	10650000	6857000	9501000
10 PERCENT EXCEEDS	25900	14900	20600
50 PERCENT EXCEEDS	10800	8480	10100
90 PERCENT EXCEEDS	6470	6000	5570

## 11379500 ELDER CREEK NEAR PASKENTA, CA

LOCATION.—Lat 40°01'29", long 122°30'31", in SE 1/4 NW 1/4 sec.14, T.25 N., R.6 W., Tehama County, Hydrologic Unit 18020103, on left bank, 2.5 mi downstream from South Fork Elder Creek, 8.2 mi northwest of Flournoy, and 10 mi north of Paskenta.

DRAINAGE AREA.—92.4 mi<sup>2</sup>.

PERIOD OF RECORD.—October 1948 to current year. Monthly discharge only for some periods, published in WSP 1315-A.

REVISED RECORDS.—WSP 1515: 1956. WDR CA-70-2: 1967(P). WDR CA-75-4: 1966–67(P), 1969–71(P), 1973(P). WDR CA-78-4: Drainage area. WDR CA-94-4: 1993(P).

GAGE.—Water-stage recorder. Datum of gage is 718.1 ft above sea level. Prior to Aug. 13, 1965, water-stage recorder at site 300 ft downstream at datum 5.13 ft lower.

REMARKS.—Records good. No regulation or large diversion upstream from station. See schematic diagram of upper Sacramento River Basin.

EXTREMES FOR PERIOD OF RECORD.—Maximum discharge, 17,700 ft<sup>3</sup>/s, Feb. 28, 1983, gage height, 12.10 ft, from rating curve extended above 5,200 ft<sup>3</sup>/s on basis of slope-area measurements at gage height 11.34 ft and of peak flow; maximum gage height, 13.90 ft, Feb. 24, 1958, site and datum then in use; no flow at times some years.

EXTREMES FOR CURRENT YEAR.—Peak discharges greater than base discharge of 2,000 ft<sup>3</sup>/s, or maximum:

Date	Time	Discharge (ft <sup>3</sup> /s)	Gage height (ft)
Mar. 4	2045	15,100	11.58

## DISCHARGE, CUBIC FEET PER SECOND, WATER YEAR OCTOBER 2000 TO SEPTEMBER 2001

## DAILY MEAN VALUES

DAY	OCT	NOV	DEC	JAN	FEB	MAR	APR	MAY	JUN	JUL	AUG	SEP
1	3.4	13	13	9.7	31	116	160	83	14	8.6	2.0	.57
2	3.4	11	12	9.6	28	107	143	75	14	7.7	1.8	.57
3	3.5	10	11	9.3	29	95	125	68	14	7.2	1.7	.57
4	3.4	10	11	9.3	35	3860	110	61	14	6.7	1.6	.57
5	3.5	10	10	9.3	41	1920	98	59	13	6.3	1.5	.57
6	3.5	9.6	10	9.3	35	709	96	57	13	5.8	1.5	.57
7	3.4	9.3	10	9.3	29	429	91	56	13	5.6	1.4	.57
8	3.6	9.3	10	12	26	350	81	55	12	5.4	1.4	.54
9	3.9	9.3	11	13	91	282	78	56	11	5.3	1.4	.54
10	5.2	9.3	10	103	103	224	72	53	11	4.9	1.2	.54
11	5.8	9.3	11	151	69	189	68	49	11	4.8	1.2	.54
12	6.1	9.3	13	106	87	167	65	46	10	4.7	1.1	.56
13	6.1	9.5	11	46	70	161	63	44	10	4.6	1.1	.63
14	6.0	9.7	24	32	51	164	62	42	9.6	4.4	1.0	.70
15	5.6	9.7	17	25	42	152	59	41	9.1	4.1	.96	.70
16	5.6	9.7	15	21	38	142	57	40	8.5	3.7	.90	.65
17	5.5	9.7	13	19	63	137	60	36	8.1	3.7	.86	.61
18	5.4	9.7	12	17	102	166	68	32	7.4	3.7	.84	.61
19	5.3	9.5	12	17	344	189	75	30	7.0	3.5	.79	.61
20	5.2	9.3	11	17	1040	233	129	27	6.7	3.3	.73	.61
21	5.5	9.6	11	17	542	247	123	25	6.1	3.4	.70	.61
22	5.2	9.7	12	17	327	251	91	24	5.8	3.4	.71	.61
23	5.1	9.7	12	45	198	240	85	23	5.6	3.3	.74	.61
24	5.2	9.6	11	346	304	228	87	22	5.6	3.0	.72	.59
25	7.1	9.3	11	273	743	263	98	21	5.7	2.7	.74	1.1
26	33	9.3	11	227	264	196	110	20	6.5	2.5	.74	2.4
27	16	9.6	10	119	173	163	112	19	21	2.5	.70	2.3
28	16	9.7	10	73	138	176	104	19	22	2.3	.67	2.1
29	20	17	10	51	---	181	91	18	13	2.1	.62	1.9
30	17	18	9.7	40	---	166	83	16	10	2.0	.58	1.7
31	17	---	9.7	34	---	163	---	15	---	2.0	.57	---
TOTAL	240.5	307.7	364.4	1886.8	5043	12066	2744	1232	317.7	133.2	32.47	25.75
MEAN	7.76	10.3	11.8	60.9	180	389	91.5	39.7	10.6	4.30	1.05	.86
MAX	33	18	24	346	1040	3860	160	83	22	8.6	2.0	2.4
MIN	3.4	9.3	9.7	9.3	26	95	57	15	5.6	2.0	.57	.54
AC-FT	477	610	723	3740	10000	23930	5440	2440	630	264	64	51

## 11379500 ELDER CREEK NEAR PASKENTA, CA—Continued

## STATISTICS OF MONTHLY MEAN DATA FOR WATER YEARS 1949 - 2001, BY WATER YEAR (WY)

	OCT	NOV	DEC	JAN	FEB	MAR	APR	MAY	JUN	JUL	AUG	SEP
MEAN	9.16	47.0	129	248	296	242	152	83.2	31.6	8.96	3.46	3.13
MAX	102	310	649	1208	1636	1176	497	463	262	49.6	17.5	11.3
(WY)	1958	1974	1984	1995	1958	1983	1958	1998	1998	1998	1998	1978
MIN	.66	2.89	4.06	5.38	7.00	22.6	13.8	13.4	2.52	.32	.002	.14
(WY)	1992	1991	1991	1991	1977	1964	1977	1977	1977	1977	1994	1991

SUMMARY STATISTICS	FOR 2000 CALENDAR YEAR		FOR 2001 WATER YEAR		WATER YEARS 1949 - 2001	
ANNUAL TOTAL	41055.4		24393.52			
ANNUAL MEAN	112		66.8		104	
HIGHEST ANNUAL MEAN					303	
LOWEST ANNUAL MEAN					6.69	
HIGHEST DAILY MEAN	2730	Apr 17	3860	Mar 4	7650	Dec 22 1964
LOWEST DAILY MEAN	3.2	Sep 20	.54	Sep 8	.00	Aug 6 1950
ANNUAL SEVEN-DAY MINIMUM	3.4	Oct 1	.55	Sep 6	.00	Aug 14 1950
MAXIMUM PEAK FLOW			15100	Mar 4	17700	Feb 28 1983
MAXIMUM PEAK STAGE			11.58	Mar 4	13.90	Feb 24 1958
ANNUAL RUNOFF (AC-FT)	81430		48380		75060	
10 PERCENT EXCEEDS	286		162		241	
50 PERCENT EXCEEDS	16		11		19	
90 PERCENT EXCEEDS	5.1		.77		1.6	

## 11381500 MILL CREEK NEAR LOS MOLINOS, CA

LOCATION.—Lat 40°03'17", long 122°01'23", in NE 1/4 NW 1/4 sec.6, T.25 N., R.1 W., Tehama County, Hydrologic Unit 18020103, on right bank, 4.5 mi northeast of Los Molinos, and 5.5 mi upstream from mouth.

DRAINAGE AREA.—131 mi<sup>2</sup>.

## WATER-DISCHARGE RECORDS

PERIOD OF RECORD.—September 1909 to August 1913 (fragmentary), October 1928 to current year.

REVISED RECORDS.—WSP 1315-A: 1929(M). WSP 1931: Drainage area. WSP 2131: 1938(M).

GAGE.—Water-stage recorder. Elevation of gage is 385 ft above sea level, from topographic map. Prior to September 1913, nonrecording gage at site 0.3 mi downstream at different datum.

REMARKS.—Records good. No storage or large diversion upstream from station. See schematic diagram of [upper Sacramento River Basin](#).

EXTREMES FOR PERIOD OF RECORD (water years 1929–2001).—Maximum discharge, 36,400 ft<sup>3</sup>/s, Dec. 11, 1937, gage height, 23.4 ft, from floodmarks, from rating curve extended above 14,000 ft<sup>3</sup>/s on basis of step-backwater computation and slope-area measurement of peak flow; minimum, 49 ft<sup>3</sup>/s, Dec. 13, 1932.

EXTREMES FOR CURRENT YEAR.—Peak discharges greater than base discharge of 2,400 ft<sup>3</sup>/s, or maximum:

Date	Time	Discharge (ft <sup>3</sup> /s)	Gage height (ft)
Mar. 5	0445	1,500	4.98

## DISCHARGE, CUBIC FEET PER SECOND, WATER YEAR OCTOBER 2000 TO SEPTEMBER 2001

## DAILY MEAN VALUES

DAY	OCT	NOV	DEC	JAN	FEB	MAR	APR	MAY	JUN	JUL	AUG	SEP
1	112	147	145	120	159	238	335	339	182	134	97	93
2	112	141	139	119	155	269	315	318	180	124	97	95
3	112	131	135	119	153	265	282	284	176	121	96	95
4	112	132	130	119	158	436	250	274	166	121	95	95
5	112	132	124	119	162	1020	230	283	159	120	95	95
6	112	133	122	119	159	532	227	287	156	118	95	95
7	112	131	121	119	155	421	237	297	152	116	95	95
8	110	130	122	140	147	392	214	313	147	116	95	93
9	110	137	121	142	160	412	207	335	144	116	93	92
10	133	131	125	228	205	339	199	339	142	115	92	92
11	135	129	125	519	374	296	202	325	140	114	92	92
12	132	126	132	229	285	268	206	331	139	114	91	92
13	121	128	127	178	223	257	196	318	137	112	92	92
14	121	139	164	170	206	258	193	297	134	112	92	94
15	120	133	173	158	193	254	191	287	134	112	92	95
16	119	131	157	148	193	233	192	336	134	109	92	95
17	117	129	148	132	212	222	199	305	134	109	92	95
18	116	127	141	130	485	231	218	289	132	109	92	95
19	116	126	133	130	439	258	290	279	131	108	92	95
20	116	127	129	128	762	304	330	274	131	106	92	95
21	124	124	128	126	883	334	299	277	129	104	92	95
22	120	124	133	126	906	343	281	266	127	104	92	95
23	117	124	133	132	610	339	267	250	123	104	92	95
24	116	124	130	345	514	344	278	241	121	103	92	95
25	119	124	126	427	711	466	306	227	121	102	92	96
26	143	124	123	333	420	409	341	217	123	102	93	102
27	125	124	121	234	322	340	346	209	138	100	93	102
28	158	126	121	189	275	342	344	199	162	100	93	102
29	242	158	121	191	---	366	304	193	139	100	92	102
30	173	168	121	180	---	345	301	187	136	97	92	101
31	159	---	121	167	---	331	---	183	---	97	92	---
TOTAL	3946	3960	4091	5716	9626	10864	7780	8559	4269	3419	2884	2865
MEAN	127	132	132	184	344	350	259	276	142	110	93.0	95.5
MAX	242	168	173	519	906	1020	346	339	182	134	97	102
MIN	110	124	121	119	147	222	191	183	121	97	91	92
AC-FT	7830	7850	8110	11340	19090	21550	15430	16980	8470	6780	5720	5680

## 11381500 MILL CREEK NEAR LOS MOLINOS, CA—Continued

## STATISTICS OF MONTHLY MEAN DATA FOR WATER YEARS 1929 - 2001, BY WATER YEAR (WY)

	OCT	NOV	DEC	JAN	FEB	MAR	APR	MAY	JUN	JUL	AUG	SEP
MEAN	125	200	346	450	485	452	430	442	330	180	118	107
MAX	684	1039	1365	1837	1744	1278	862	923	790	510	230	168
(WY)	1963	1974	1965	1970	1986	1983	1982	1938	1998	1998	1983	1983
MIN	76.0	75.1	87.4	96.8	98.6	107	112	122	94.9	67.8	61.4	65.4
(WY)	1930	1930	1977	1977	1977	1977	1977	1977	1931	1931	1931	1931

SUMMARY STATISTICS	FOR 2000 CALENDAR YEAR		FOR 2001 WATER YEAR		WATER YEARS 1929 - 2001	
ANNUAL TOTAL	111379		67979			
ANNUAL MEAN	304		186		304	
HIGHEST ANNUAL MEAN					576	
LOWEST ANNUAL MEAN					93.6	
HIGHEST DAILY MEAN	2480	Feb 27	1020	Mar 5	14400	Jan 1 1997
LOWEST DAILY MEAN	110	Oct 8	91	Aug 12	52	Dec 12 1932
ANNUAL SEVEN-DAY MINIMUM	111	Oct 3	92	Aug 10	60	Jul 28 1931
MAXIMUM PEAK FLOW			1500		36400	
MAXIMUM PEAK STAGE			4.98		23.40	
ANNUAL RUNOFF (AC-FT)	220900		134800		220600	
10 PERCENT EXCEEDS	544		335		582	
50 PERCENT EXCEEDS	176		133		180	
90 PERCENT EXCEEDS	119		95		91	

## 11381500 MILL CREEK NEAR LOS MOLINOS, CA—Continued

## WATER-QUALITY RECORDS

PERIOD OF RECORD.—Water year 1999 to current year.

WATER TEMPERATURE: Water year 1999 to current year.

PERIOD OF DAILY RECORD.—

WATER TEMPERATURE: October 1998 to current year.

INSTRUMENTATION.—Temperature recorder since Oct. 5, 1998.

REMARKS.—Records rated excellent except for Oct. 1 to Jan. 12., which are rated good.

EXTREMES FOR PERIOD OF DAILY RECORD.—

WATER TEMPERATURE: Maximum recorded, 26.5°C, July 25, 26, 2001; minimum recorded, 0.5°C, Dec. 23, 1998.

EXTREME FOR CURRENT YEAR.—

WATER TEMPERATURE: Maximum recorded, 26.5°C, July 25, 26; minimum recorded, 3.0°C, Jan. 17, 18.

## TEMPERATURE, WATER (DEG. C), WATER YEAR OCTOBER 2000 TO SEPTEMBER 2001

DAY	MAX	MIN	MAX	MIN	MAX	MIN	MAX	MIN	MAX	MIN	MAX	MIN
	OCTOBER		NOVEMBER		DECEMBER		JANUARY		FEBRUARY		MARCH	
1	19.0	16.5	10.0	9.0	7.5	7.0	6.0	5.5	6.0	4.5	7.5	7.0
2	18.5	16.5	11.0	9.5	7.0	6.5	7.0	5.5	7.0	5.5	8.0	7.5
3	18.0	16.0	12.0	10.0	7.0	6.0	6.5	6.0	8.5	7.0	7.5	6.5
4	17.0	15.0	11.5	10.5	7.5	6.5	6.5	6.0	9.5	8.0	8.5	7.0
5	17.0	14.5	11.5	10.0	7.5	7.0	6.0	5.5	9.5	8.0	9.5	8.0
6	17.0	14.5	10.5	9.5	7.5	7.0	7.0	5.5	8.0	7.0	11.0	8.5
7	17.0	15.0	9.5	8.5	8.5	7.0	7.0	6.0	7.0	5.0	11.5	9.0
8	17.0	15.0	10.5	8.5	8.5	8.0	7.5	6.5	5.0	4.0	11.5	10.0
9	16.0	14.5	9.5	8.0	9.0	8.0	7.5	6.5	5.5	4.5	10.0	9.0
10	14.5	13.5	8.5	7.5	9.5	8.5	7.5	6.5	5.5	5.0	9.0	7.5
11	13.5	12.5	7.5	6.0	9.0	8.0	7.5	7.0	6.0	5.0	10.0	8.5
12	14.0	12.5	6.0	5.0	8.0	7.5	7.0	6.5	6.0	5.0	10.0	8.5
13	14.0	12.5	5.5	4.5	7.5	7.0	7.0	6.0	6.0	5.0	11.0	9.5
14	14.0	12.5	5.5	4.5	8.0	7.5	6.5	5.5	6.0	4.5	11.0	10.0
15	14.0	12.5	6.0	5.0	8.0	7.5	5.5	4.0	6.0	5.0	10.0	9.0
16	14.0	12.5	6.5	5.5	7.5	7.0	4.0	3.5	7.5	5.5	10.0	8.5
17	14.0	12.0	6.0	5.0	7.0	6.0	4.0	3.0	7.5	7.0	11.0	9.5
18	14.0	12.0	6.0	5.0	6.0	5.0	4.5	3.0	8.0	7.0	13.0	11.0
19	14.0	12.0	6.5	5.0	6.0	5.0	6.0	4.5	8.0	8.0	13.0	11.5
20	13.5	12.5	6.5	5.5	7.0	6.0	6.0	5.0	8.0	7.5	13.0	12.0
21	12.5	11.0	6.5	5.5	7.0	6.5	6.5	5.0	9.0	7.5	13.0	11.5
22	11.0	10.0	6.5	5.5	8.5	7.0	7.5	6.0	8.5	7.0	13.0	11.5
23	11.0	9.5	6.5	6.0	8.0	7.0	7.5	6.5	7.5	6.0	13.0	11.5
24	12.0	10.0	7.5	6.0	7.0	6.5	7.5	7.0	7.5	7.0	13.0	11.5
25	12.0	11.0	7.5	6.5	6.5	5.5	7.0	6.0	8.5	7.0	12.0	10.5
26	11.5	11.0	8.0	7.0	6.5	5.5	7.0	6.0	8.5	7.5	10.5	9.0
27	11.5	10.5	9.0	8.0	6.5	5.5	6.5	5.5	8.5	7.5	11.5	9.0
28	11.0	10.5	9.0	8.5	6.0	5.5	6.0	5.0	8.0	7.0	13.5	10.5
29	11.0	10.5	10.0	9.0	6.0	5.5	6.5	5.5	---	---	13.0	11.0
30	11.0	10.0	9.5	7.5	6.5	5.5	6.0	5.0	---	---	13.0	10.5
31	10.5	9.0	---	---	6.0	5.5	5.5	4.5	---	---	13.5	11.0
MONTH	19.0	9.0	12.0	4.5	9.5	5.0	7.5	3.0	9.5	4.0	13.5	6.5

## 11381500 MILL CREEK NEAR LOS MOLINOS, CA—Continued

## TEMPERATURE, WATER (DEG. C), WATER YEAR OCTOBER 2000 TO SEPTEMBER 2001

DAY	MAX	MIN	MAX	MIN	MAX	MIN	MAX	MIN	MAX	MIN	MAX	MIN
	APRIL		MAY		JUNE		JULY		AUGUST		SEPTEMBER	
1	13.5	11.0	16.0	13.5	22.0	20.0	25.5	21.0	25.0	21.5	23.5	21.0
2	12.5	9.5	14.0	12.0	21.0	18.5	26.0	21.5	24.5	21.5	23.5	21.0
3	9.5	8.0	14.0	11.0	19.5	17.5	24.5	22.5	24.0	21.0	23.0	20.5
4	9.0	7.5	15.5	12.5	19.5	16.5	24.5	22.0	24.0	20.5	22.5	20.0
5	10.5	8.5	16.0	13.5	20.0	17.5	26.0	22.5	24.0	21.0	22.0	19.5
6	10.5	9.0	16.5	13.5	21.5	17.5	26.0	23.0	25.0	21.0	21.0	18.5
7	9.5	8.5	18.0	14.5	23.0	19.0	24.5	22.0	25.5	21.5	21.0	18.0
8	9.0	7.0	18.5	15.5	23.0	19.5	25.0	21.0	26.0	22.5	21.0	18.0
9	9.0	7.0	19.0	15.5	23.0	19.5	26.0	22.0	26.0	23.0	20.5	18.5
10	10.0	8.0	18.5	15.5	22.0	19.5	26.0	22.5	25.5	22.5	20.5	18.5
11	12.0	9.5	19.0	15.5	21.0	19.0	25.5	22.5	25.0	22.0	20.0	18.0
12	11.0	9.0	18.5	15.5	21.5	18.0	25.0	22.0	24.5	21.5	19.5	17.0
13	12.0	9.5	17.5	15.0	21.0	17.5	25.5	21.5	24.0	21.0	21.0	18.0
14	12.5	10.0	17.0	14.5	22.0	18.0	25.0	21.5	24.0	20.5	21.5	18.5
15	12.5	10.5	15.0	13.5	23.0	19.0	24.5	21.5	24.0	20.5	21.5	19.5
16	13.5	11.5	16.5	13.5	24.0	20.0	23.5	20.5	23.5	20.5	21.5	19.5
17	14.5	12.5	18.0	15.0	24.5	20.5	23.5	20.5	23.0	20.5	21.5	19.0
18	13.5	12.5	19.0	16.0	24.0	20.5	24.0	20.5	23.5	20.0	21.5	19.0
19	12.5	10.0	19.5	16.5	24.5	20.5	24.0	21.0	23.5	20.5	21.5	19.0
20	10.0	9.0	20.0	17.0	25.0	21.0	24.0	20.5	23.0	20.5	21.5	19.0
21	11.5	8.0	20.5	18.0	26.0	22.0	23.5	20.5	22.0	19.5	21.0	18.5
22	13.0	10.5	21.0	18.0	26.0	22.5	24.0	20.0	22.0	19.5	20.5	18.5
23	15.0	12.5	21.5	19.0	25.0	22.5	24.5	20.5	22.5	19.5	20.0	18.0
24	16.0	14.0	21.0	19.5	23.0	20.5	26.0	21.5	23.0	20.0	19.0	16.5
25	17.0	14.5	21.0	19.0	20.5	19.0	26.5	22.5	23.0	20.0	19.0	17.0
26	17.0	14.5	20.5	18.5	19.0	18.0	26.5	23.0	23.5	20.5	19.0	17.0
27	16.0	13.5	20.0	18.5	18.0	17.0	26.0	23.0	24.0	21.0	19.0	16.5
28	15.0	13.0	19.5	18.0	20.5	16.5	25.5	22.5	24.0	21.0	18.5	16.5
29	14.0	11.5	20.0	18.0	23.5	19.0	25.0	22.0	24.0	21.5	18.5	16.0
30	16.0	12.5	21.5	18.5	24.0	20.5	24.0	21.5	23.5	21.5	19.0	16.5
31	---	---	23.0	20.0	---	---	25.0	21.5	23.5	21.0	---	---
MONTH	17.0	7.0	23.0	11.0	26.0	16.5	26.5	20.0	26.0	19.5	23.5	16.0



## 11383500 DEER CREEK NEAR VINA, CA

LOCATION.—Lat 40°00'51", long 121°56'50", in NW 1/4 NE 1/4 sec.23, T.25 N., R.1 W., Tehama County, Hydrologic Unit 18020103, on left bank, 0.5 mi upstream from irrigation diversion dam, and 7.9 mi northeast of Vina.

DRAINAGE AREA.—208 mi<sup>2</sup>.

## WATER-DISCHARGE RECORDS

PERIOD OF RECORD.—October 1911 to September 1915, March 1920 to current year. December 1937 to January 1939 first published in WDR CA-94-4. Monthly discharge only for some periods, published in WSP 1315-A.

REVISED RECORDS.—WSP 1315-A: 1940–42(M). WSP 1931: Drainage area.

GAGE.—Water-stage recorder. Datum of gage is 479.2 ft above sea level, from river-profile survey. Prior to Oct. 9, 1928, nonrecording gage at site 0.8 mi downstream at different datum. Oct. 9, 1928, to Jan. 19, 1939, water-stage recorder at present site at datum 2.64 ft higher.

REMARKS.—Records good. No storage or large diversions upstream from station. See schematic diagram of upper Sacramento River Basin.

EXTREMES FOR PERIOD OF RECORD.—Maximum discharge, 24,000 ft<sup>3</sup>/s, Jan. 1, 1997, gage height, 15.56 ft, from rating curve extended above 9,200 ft<sup>3</sup>/s; maximum gage height, 19.20 ft, Dec. 10, 1937; minimum, 43 ft<sup>3</sup>/s, Dec. 13, 1932.

EXTREMES FOR CURRENT YEAR.—Peak discharges greater than base discharge of 2,500 ft<sup>3</sup>/s, or maximum:

Date	Time	Discharge (ft <sup>3</sup> /s)	Gage height (ft)
Mar. 5	0230	2,540	6.42

## DISCHARGE, CUBIC FEET PER SECOND, WATER YEAR OCTOBER 2000 TO SEPTEMBER 2001

## DAILY MEAN VALUES

DAY	OCT	NOV	DEC	JAN	FEB	MAR	APR	MAY	JUN	JUL	AUG	SEP
1	95	124	135	109	154	280	275	239	107	100	81	76
2	95	119	125	108	149	284	268	229	107	98	79	76
3	96	116	120	108	147	276	247	213	106	96	76	75
4	95	114	116	107	153	629	231	202	105	95	76	75
5	95	113	116	107	157	1620	213	195	106	95	77	73
6	95	112	114	107	153	726	208	190	107	93	77	74
7	95	111	113	108	148	536	228	184	106	91	76	73
8	95	110	113	134	138	468	209	181	103	90	75	74
9	98	115	113	135	167	456	203	179	102	90	74	75
10	134	115	119	204	242	389	195	176	101	90	74	76
11	145	114	120	467	403	342	194	168	101	89	75	78
12	129	110	126	232	279	305	218	163	100	90	74	81
13	115	112	121	177	218	286	194	159	99	89	74	82
14	109	122	165	162	204	280	189	154	99	87	74	81
15	107	118	178	147	196	270	186	155	98	87	74	80
16	107	116	154	136	205	258	185	158	98	87	74	79
17	105	113	140	129	252	245	186	150	97	88	73	79
18	105	112	130	125	665	252	198	142	96	88	74	79
19	104	112	123	125	607	269	319	138	95	87	74	78
20	105	113	122	124	1320	302	407	131	95	86	74	78
21	123	112	121	121	1230	320	394	127	95	86	74	76
22	110	113	124	120	903	326	346	122	95	86	76	76
23	105	112	128	128	605	317	319	120	93	85	77	77
24	105	111	124	339	516	325	311	118	93	84	77	78
25	112	112	120	408	776	466	307	118	96	84	78	99
26	141	112	115	326	494	416	304	118	104	82	77	106
27	121	112	113	239	386	337	289	115	113	81	76	87
28	152	115	112	204	326	315	273	114	125	80	76	85
29	226	140	111	196	---	327	260	112	110	79	75	84
30	164	177	111	185	---	302	244	110	103	80	76	83
31	137	---	110	165	---	283	---	108	---	82	76	---
TOTAL	3620	3507	3852	5482	11193	12207	7600	4788	3055	2725	2343	2393
MEAN	117	117	124	177	400	394	253	154	102	87.9	75.6	79.8
MAX	226	177	178	467	1320	1620	407	239	125	100	81	106
MIN	95	110	110	107	138	245	185	108	93	79	73	73
AC-FT	7180	6960	7640	10870	22200	24210	15070	9500	6060	5410	4650	4750

## 11383500 DEER CREEK NEAR VINA, CA—Continued

## STATISTICS OF MONTHLY MEAN DATA FOR WATER YEARS 1912 - 2001, BY WATER YEAR (WY)

	OCT	NOV	DEC	JAN	FEB	MAR	APR	MAY	JUN	JUL	AUG	SEP
MEAN	114	195	374	546	645	586	530	391	203	119	98.5	95.5
MAX	775	984	1825	2458	2600	2105	1494	1193	674	267	194	174
(WY)	1963	1974	1956	1970	1986	1983	1982	1995	1998	1983	1983	1983
MIN	63.4	65.2	82.5	87.4	95.3	109	99.5	77.2	66.1	55.8	53.3	55.2
(WY)	1935	1930	1931	1991	1977	1977	1977	1924	1924	1931	1931	1931

SUMMARY STATISTICS	FOR 2000 CALENDAR YEAR		FOR 2001 WATER YEAR		WATER YEARS 1912 - 2001	
ANNUAL TOTAL	110689		62765			
ANNUAL MEAN	302		172		324	
HIGHEST ANNUAL MEAN					700	
LOWEST ANNUAL MEAN					86.2	
HIGHEST DAILY MEAN	3800	Feb 14	1620	Mar 5	20100	Jan 1 1997
LOWEST DAILY MEAN	94	Sep 19	73	Aug 17	52	Aug 25 1931
ANNUAL SEVEN-DAY MINIMUM	95	Oct 1	74	Aug 12	53	Aug 21 1931
MAXIMUM PEAK FLOW			2540		24000	
MAXIMUM PEAK STAGE			6.42		19.20	
ANNUAL RUNOFF (AC-FT)	219600		124500		234400	
10 PERCENT EXCEEDS	643		318		688	
50 PERCENT EXCEEDS	137		115		145	
90 PERCENT EXCEEDS	99		77		80	

11383500 DEER CREEK NEAR VINA, CA—Continued

## WATER-QUALITY RECORDS

PERIOD OF RECORD.—Water year 1999 to current year.

WATER TEMPERATURE: Water year 1999 to current year.

TURBIDITY: January 2001 to current year.

PERIOD OF DAILY RECORD.—

WATER TEMPERATURE: October 1998 to current year.

TURBIDITY: January 2001 to current year.

INSTRUMENTATION.—Temperature recorder since Oct. 5, 1998, and Turbidity recorder since October 2000.

REMARKS.—Temperature record rated excellent except for Oct. 1 to Nov. 7, which is rated good. Turbidity record rated poor. Interruption in record due to malfunction of the recording equipment or data did not meet maximum allowable limits.

EXTREMES FOR PERIOD OF DAILY RECORD.—

WATER TEMPERATURE: Maximum recorded, 27.0°C, June 28, 29, 2000, July 5, 25–27 and Aug. 9, 2001; minimum recorded, 0.5°C, Dec. 23, 24, 1998.

TURBIDITY: Maximum recorded, 43 NTU, Feb. 18, 2001; minimum recorded, &lt;0.5 NTU, many days during 2001.

EXTREME FOR CURRENT YEAR.—

WATER TEMPERATURE: Maximum recorded, 27.0°C, July 5, 25–27, Aug. 9; minimum recorded, 3.0°C, Jan. 17, 18.

TURBIDITY: Maximum recorded, 43 NTU, Feb. 18; minimum recorded, &lt;0.5 NTU, many days during the year.

## CROSS-SECTIONAL DATA, WATER YEAR OCTOBER 2000 TO SEPTEMBER 2001

DATE	TIME	DEPTH BOTTOM AT SAMPLE LOC- ATION, (FEET) (81903)	TURBID- ITY LAB WATER (NTU) (82079)	TEMPER- ATURE WATER (DEG C) (00010)	SEDI- MENT, SUS- PENDE (MG/L) (80154)	SAMPLE LOC- ATION, CROSS SECTION (FT FM L BANK) (00009)
FEB						
20...*	1435	4.00	7.0	--	51	70.0
20...*	1440	4.10	7.0	--	56	57.0
20...*	1445	4.00	8.0	--	57	43.0
20...*	1450	3.80	6.0	--	45	33.0
20...*	1455	3.40	6.0	7.0	47	21.0
MAR						
08...*	1015	2.20	1.0	--	4	65.0
08...*	1020	1.90	1.0	--	5	52.0
08...*	1025	2.30	1.0	--	5	41.0
08...*	1030	2.20	1.0	--	7	31.0
08...*	1035	1.80	1.0	9.5	4	19.0
APR						
11...*	1015	2.40	1.0	--	4	75.0
11...*	1020	2.40	1.0	--	3	65.0
11...*	1025	2.80	1.0	--	2	57.0
11...*	1030	2.80	1.0	--	4	47.0
11...*	1035	1.90	<.5	9.5	4	26.0
MAY						
10...*	1110	2.40	1.0	--	2	68.0
10...*	1115	2.40	1.0	--	3	58.0
10...*	1120	2.90	1.0	--	3	51.0
10...*	1125	2.50	<.5	--	3	42.0
10...*	1130	2.00	1.0	19.0	3	24.0
JUN						
08...*	0935	1.80	1.0	--	4	71.0
08...*	0940	1.80	1.0	--	2	61.0
08...*	0945	2.30	1.0	--	2	53.0
08...*	0950	2.20	1.0	--	2	47.0
08...*	0955	1.80	1.0	21.0	4	32.0

\* Instantaneous discharge at the time of the cross-sectional measurements: Feb. 20, 1,570 ft<sup>3</sup>/s; Mar. 8, 474 ft<sup>3</sup>/s; Apr. 11, 188 ft<sup>3</sup>/s; May 10, 178 ft<sup>3</sup>/s; June 8, 103 ft<sup>3</sup>/s.  
< Actual value is known to be less than the value shown

## 11383500 DEER CREEK NEAR VINA, CA—Continued

## TEMPERATURE, WATER (DEG. C), WATER YEAR OCTOBER 2000 TO SEPTEMBER 2001

DAY	MAX	MIN	MAX	MIN	MAX	MIN	MAX	MIN	MAX	MIN	MAX	MIN
	OCTOBER		NOVEMBER		DECEMBER		JANUARY		FEBRUARY		MARCH	
1	19.0	16.5	9.5	9.0	8.0	7.0	5.5	5.0	5.5	4.5	7.5	6.0
2	18.5	16.5	11.0	9.5	7.0	6.5	6.0	5.0	6.5	5.5	8.0	7.0
3	18.0	16.0	11.5	10.0	6.5	6.0	6.0	5.5	8.0	6.5	7.0	6.0
4	17.5	15.5	11.0	10.0	7.0	6.5	6.0	5.5	8.5	7.5	8.0	7.0
5	17.0	15.0	11.0	10.0	7.5	6.5	5.5	5.0	8.5	7.5	9.0	7.5
6	17.0	15.0	10.5	9.0	7.0	6.5	6.0	5.0	8.0	7.0	10.0	8.0
7	17.0	15.0	9.5	8.5	8.0	7.0	6.0	5.0	7.0	5.0	10.5	8.5
8	17.0	15.0	10.0	8.5	8.5	8.0	7.0	6.0	5.0	4.0	10.0	9.5
9	15.5	14.5	9.5	8.0	9.0	7.5	7.0	6.0	5.0	5.0	9.5	8.5
10	14.5	14.0	8.5	7.5	9.0	8.5	7.0	6.5	5.5	5.0	9.0	7.0
11	14.0	12.5	7.5	6.0	8.5	8.0	7.5	7.0	5.5	5.0	9.5	8.0
12	13.5	12.0	6.5	5.0	8.0	7.5	7.0	6.0	6.0	5.0	9.5	8.0
13	14.0	12.0	5.0	4.5	7.5	7.0	7.0	6.0	6.0	4.5	10.5	8.5
14	14.0	12.5	5.5	5.0	8.0	7.5	6.5	5.0	6.0	4.5	10.5	9.0
15	14.0	12.5	6.0	5.5	8.5	7.5	5.0	4.5	6.0	4.5	9.5	8.5
16	14.0	12.5	6.5	5.5	7.5	7.0	4.5	3.5	7.0	5.5	9.5	8.0
17	13.5	12.0	6.0	5.0	7.0	6.0	3.5	3.0	7.0	6.0	11.0	8.5
18	14.0	12.0	5.5	5.0	6.0	5.0	4.0	3.0	7.5	6.5	12.0	10.0
19	14.0	12.0	6.0	5.0	6.0	5.0	5.5	4.0	7.5	7.0	13.0	11.0
20	13.0	12.0	6.0	5.5	6.5	6.0	5.0	4.5	7.5	7.0	13.0	12.0
21	12.5	11.0	6.0	5.5	7.0	6.0	5.5	4.5	8.0	7.5	13.5	11.5
22	11.5	10.0	6.5	5.5	8.0	7.0	7.0	5.5	8.0	6.0	13.5	11.5
23	11.5	9.5	6.5	5.5	7.5	7.0	7.0	6.0	7.5	6.0	13.0	11.5
24	11.5	10.0	7.0	6.0	7.0	6.0	7.5	6.5	7.0	7.0	12.5	11.5
25	11.5	11.0	7.0	6.0	6.5	5.5	7.0	6.0	8.0	7.0	12.5	10.5
26	11.5	11.0	7.5	6.5	6.5	5.5	6.5	6.0	8.5	7.0	11.0	8.5
27	11.5	10.0	8.5	7.5	6.0	5.5	6.0	5.0	8.0	7.0	11.5	9.0
28	11.0	10.5	8.5	8.0	6.0	5.0	5.5	4.5	7.5	6.5	13.5	11.0
29	11.0	10.5	9.5	8.5	5.5	5.0	6.5	5.5	---	---	13.5	11.5
30	11.0	10.0	9.0	8.0	5.5	5.0	6.0	4.5	---	---	13.0	11.5
31	10.5	9.0	---	---	5.5	5.0	5.5	4.5	---	---	13.5	11.5
MONTH	19.0	9.0	11.5	4.5	9.0	5.0	7.5	3.0	8.5	4.0	13.5	6.0
	APRIL		MAY		JUNE		JULY		AUGUST		SEPTEMBER	
1	14.0	12.0	16.5	14.5	24.0	22.0	25.5	22.5	25.5	23.0	24.0	21.5
2	13.0	10.5	15.5	13.0	23.0	20.0	26.0	23.0	25.5	22.5	24.0	21.5
3	10.5	8.5	15.5	12.5	21.0	19.0	25.0	23.5	24.5	22.0	23.5	21.0
4	10.0	8.0	16.0	13.0	21.0	18.0	25.0	23.5	25.0	22.0	23.5	21.0
5	10.5	7.5	17.0	14.0	21.5	19.0	27.0	23.5	25.0	22.0	22.5	20.5
6	10.5	9.5	17.5	14.5	22.0	19.0	26.5	24.0	25.5	22.5	21.5	19.5
7	10.0	8.5	19.0	15.5	23.5	20.0	25.5	23.0	26.0	22.5	21.5	19.0
8	9.0	7.0	20.0	17.0	23.5	21.0	26.0	22.5	26.5	23.5	21.5	19.5
9	9.0	7.0	20.5	18.0	23.5	21.0	26.5	23.5	27.0	24.5	21.5	19.0
10	10.0	7.0	21.0	18.0	23.0	20.5	26.5	23.5	26.0	23.5	21.0	19.0
11	11.5	9.5	21.0	18.5	22.0	20.5	26.5	23.5	25.5	23.0	19.5	18.0
12	11.0	9.0	21.0	18.5	22.0	19.5	25.5	23.0	25.0	23.0	20.0	17.5
13	11.5	9.0	20.0	18.0	21.5	19.0	26.0	23.0	25.0	22.0	21.5	19.0
14	12.0	9.5	19.5	17.0	22.5	19.5	26.0	23.0	24.5	22.0	22.0	19.5
15	12.5	10.0	17.0	16.5	23.5	20.5	25.0	22.5	24.5	21.5	22.0	20.0
16	13.0	10.5	19.0	16.0	24.0	21.0	24.5	22.0	24.0	21.5	22.0	20.0
17	14.5	12.0	20.0	17.0	24.5	21.5	24.5	21.5	23.5	21.0	22.0	19.5
18	14.0	12.5	21.0	18.0	24.5	21.5	24.5	21.5	24.0	21.0	22.0	19.5
19	13.0	10.5	22.0	19.0	25.0	22.0	25.0	22.0	24.0	21.5	22.0	19.5
20	10.5	8.5	22.5	19.5	25.5	22.5	24.5	22.0	23.5	21.5	22.0	19.5
21	11.5	8.0	23.5	20.5	26.0	23.5	24.0	21.5	23.0	20.5	21.5	19.0
22	12.5	9.5	23.5	21.0	26.5	24.0	24.0	21.5	23.0	20.5	21.0	18.5
23	14.5	11.5	24.5	21.5	26.0	23.5	25.0	22.0	23.0	20.5	19.5	18.0
24	15.5	12.5	24.0	21.5	24.0	21.5	26.0	23.0	23.5	20.5	19.0	17.5
25	17.0	14.0	23.0	21.5	21.5	20.0	27.0	24.0	23.5	21.0	19.5	17.5
26	17.0	14.5	23.0	20.5	20.0	19.0	27.0	24.5	24.0	21.5	19.0	17.0
27	16.5	14.5	22.0	20.0	19.0	18.5	27.0	24.0	24.5	22.0	19.5	17.0
28	15.5	14.0	21.5	19.0	21.5	18.0	26.0	23.5	24.5	22.0	19.0	17.0
29	15.0	12.5	22.0	19.5	23.5	20.0	25.5	23.5	24.5	22.5	18.5	16.5
30	16.5	13.0	23.0	20.0	24.5	21.5	25.0	22.5	24.5	22.0	19.0	16.5
31	---	---	24.5	21.0	---	---	25.5	22.5	24.0	21.5	---	---
MONTH	17.0	7.0	24.5	12.5	26.5	18.0	27.0	21.5	27.0	20.5	24.0	16.5

## SACRAMENTO RIVER BASIN

11383500 DEER CREEK NEAR VINA, CA—Continued

## TURBIDITY (NTU), WATER YEAR OCTOBER 2000 TO SEPTEMBER 2001

DAY	MAX	MIN	MAX	MIN	MAX	MIN	MAX	MIN	MAX	MIN	MAX	MIN
	OCTOBER		NOVEMBER		DECEMBER		JANUARY		FEBRUARY		MARCH	
1	---	---	---	---	---	---	---	---	1.1	<.5	1.8	.6
2	---	---	---	---	---	---	---	---	.7	<.5	1.4	<.5
3	---	---	---	---	---	---	---	---	1.1	<.5	2.0	.6
4	---	---	---	---	---	---	---	---	1.4	<.5	13	<.5
5	---	---	---	---	---	---	---	---	1.6	<.5	30	5.2
6	---	---	---	---	---	---	---	---	1.6	<.5	7.2	2.1
7	---	---	---	---	---	---	---	---	1.2	<.5	3.7	1.6
8	---	---	---	---	---	---	---	---	2.2	<.5	3.6	1.1
9	---	---	---	---	---	---	---	---	4.2	<.5	2.2	1.1
10	---	---	---	---	---	---	---	---	6.0	1.9	1.6	1.1
11	---	---	---	---	---	---	---	---	15	3.8	1.5	.8
12	---	---	---	---	---	---	---	---	5.4	1.5	2.2	.7
13	---	---	---	---	---	---	1.3	<.5	1.7	.9	2.2	.7
14	---	---	---	---	---	---	4.8	<.5	1.2	.7	1.7	<.5
15	---	---	---	---	---	---	---	---	2.4	<.5	2.6	.6
16	---	---	---	---	---	---	---	---	1.1	<.5	2.5	.7
17	---	---	---	---	---	---	---	---	15	<.5	2.0	.6
18	---	---	---	---	---	---	---	---	43	4.1	1.6	.7
19	---	---	---	---	---	---	---	---	9.4	2.7	2.6	.8
20	---	---	---	---	---	---	---	---	27	5.1	3.1	1.0
21	---	---	---	---	---	---	---	---	12	5.1	4.2	1.3
22	---	---	---	---	---	---	---	---	12	3.4	4.2	1.4
23	---	---	---	---	---	---	---	---	4.5	2.1	2.9	1.2
24	---	---	---	---	---	---	16	1.9	3.2	1.8	4.7	1.5
25	---	---	---	---	---	---	10	3.3	6.6	2.0	16	1.9
26	---	---	---	---	---	---	7.9	1.7	4.0	1.4	15	4.2
27	---	---	---	---	---	---	6.2	.7	5.8	1.1	4.9	2.2
28	---	---	---	---	---	---	6.9	<.5	3.5	.6	2.7	1.8
29	---	---	---	---	---	---	3.4	<.5	---	---	6.0	1.8
30	---	---	---	---	---	---	11	<.5	---	---	4.9	1.5
31	---	---	---	---	---	---	8.3	<.5	---	---	4.2	1.5
MONTH	---	---	---	---	---	---	---	---	43	<.5	30	<.5
	APRIL		MAY		JUNE		JULY		AUGUST		SEPTEMBER	
1	2.5	1.4	2.4	1.0	1.2	<.5	---	---	5.0	<.5	1.7	<.5
2	2.3	1.2	3.9	1.1	1.6	<.5	---	---	5.0	<.5	---	---
3	2.0	1.0	2.5	.9	1.5	<.5	---	---	---	---	---	---
4	1.4	.9	1.6	.8	1.7	<.5	---	---	---	---	---	---
5	2.3	.8	1.8	.9	2.1	<.5	---	---	---	---	---	---
6	3.3	.7	2.0	.9	.7	<.5	---	---	---	---	---	---
7	1.6	.7	2.8	.8	1.3	<.5	---	---	---	---	---	---
8	2.7	.7	2.9	.9	1.9	<.5	---	---	---	---	---	---
9	3.3	.6	2.2	.9	2.8	<.5	---	---	---	---	---	---
10	2.5	<.5	2.2	<.5	1.7	<.5	---	---	---	---	---	---
11	1.3	.6	1.1	<.5	2.2	<.5	---	---	---	---	---	---
12	3.7	<.5	3.3	<.5	1.4	<.5	---	---	---	---	---	---
13	2.1	.7	1.1	<.5	2.0	<.5	3.7	<.5	---	---	---	---
14	1.5	.6	1.0	<.5	1.2	<.5	5.0	<.5	---	---	---	---
15	1.2	.6	1.0	<.5	1.9	<.5	5.0	<.5	---	---	---	---
16	1.4	.6	1.8	<.5	1.4	<.5	5.0	<.5	---	---	---	---
17	2.7	.8	1.3	<.5	1.7	<.5	5.0	<.5	---	---	---	---
18	2.0	.8	1.1	<.5	2.1	<.5	5.0	<.5	---	---	---	---
19	6.3	1.6	1.9	<.5	2.8	<.5	5.0	<.5	---	---	---	---
20	6.9	3.1	1.2	<.5	1.6	<.5	5.0	<.5	---	---	---	---
21	4.0	1.5	1.0	<.5	3.4	<.5	5.0	1.0	---	---	---	---
22	5.6	1.2	2.1	<.5	4.1	<.5	5.0	<.5	---	---	---	---
23	2.9	1.3	.9	<.5	---	---	5.0	<.5	---	---	---	---
24	4.9	1.3	1.1	<.5	---	---	5.0	<.5	---	---	---	---
25	2.0	1.2	.8	<.5	---	---	5.0	<.5	---	---	---	---
26	3.0	1.3	1.4	<.5	---	---	5.0	<.5	---	---	---	---
27	2.4	1.1	1.1	<.5	4.1	<.5	5.0	1.0	---	---	---	---
28	3.2	1.1	1.2	<.5	2.5	<.5	5.0	1.0	1.9	<.5	---	---
29	1.7	1.0	1.2	<.5	1.4	<.5	5.0	1.0	2.6	<.5	---	---
30	5.9	1.0	.7	<.5	2.7	<.5	4.6	1.0	1.2	<.5	---	---
31	---	---	.8	<.5	---	---	5.0	<.5	3.8	<.5	---	---
MONTH	6.9	<.5	3.9	<.5	---	---	---	---	---	---	---	---

&lt; Actual value is known to be less than the value shown.

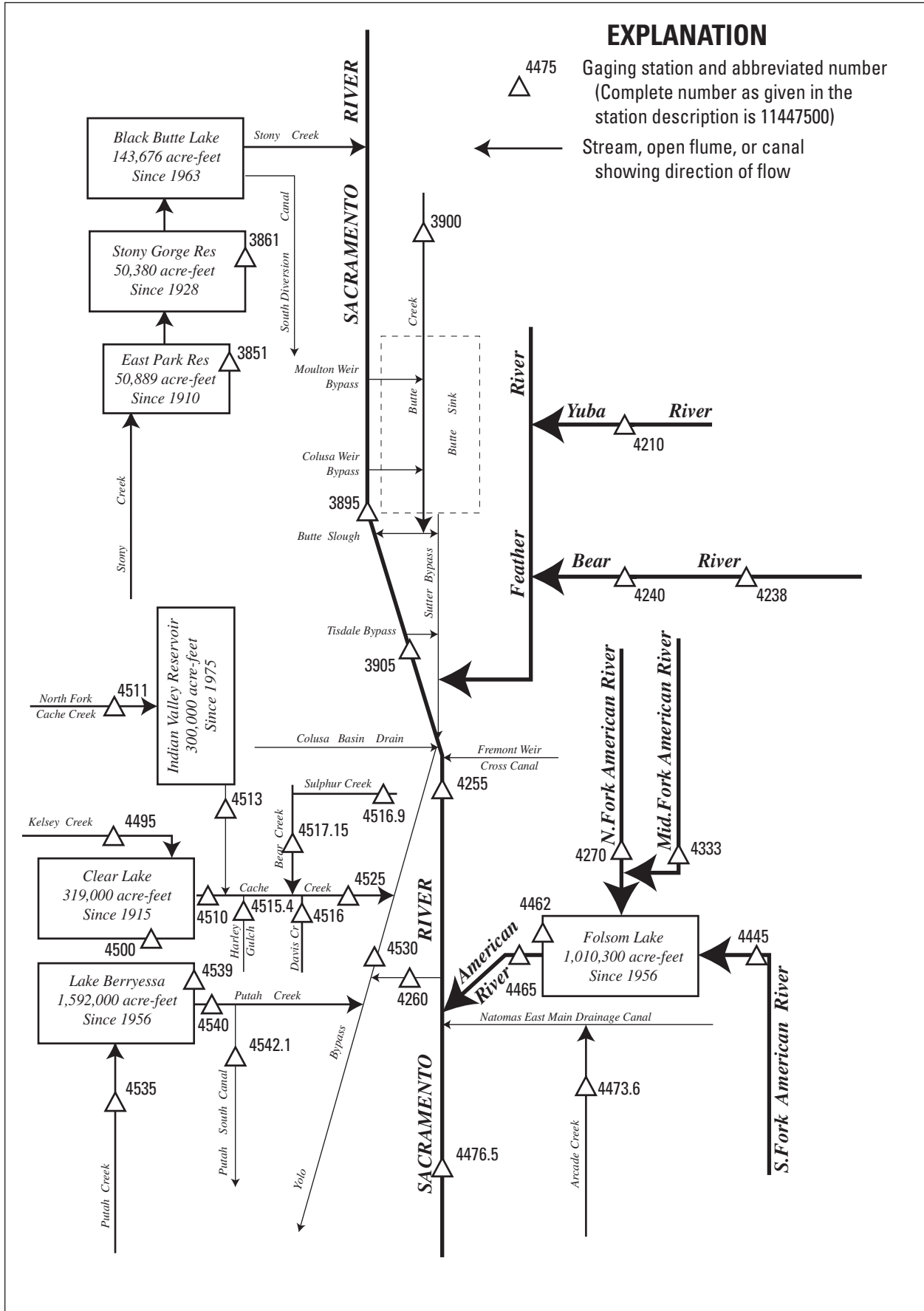

Figure 27. Diversions and storage in lower Sacramento River Basin.

## RESERVOIRS IN STONY CREEK BASIN, CA

## 11385100 EAST PARK RESERVOIR NEAR STONYFORD

LOCATION.—Lat 39°21'24", long 122°30'53", in SW 1/4 NE 1/4 sec.3, T.17 N., R.6 W., Colusa County, Hydrologic Unit 18020115, near south side of spillway section on East Park Dam on Little Stony Creek, 1.9 mi southeast of Stonyford.

DRAINAGE AREA.—98.2 mi<sup>2</sup>.

PERIOD OF RECORD.—October 1969 to current year.

GAGE.—Nonrecording gage read once daily. Datum of gage is sea level (levels by U.S. Bureau of Reclamation).

REMARKS.—Reservoir is formed by a concrete arch-type dam. Storage began in 1910. Capacity, 48,210 acre-ft, between elevations 1,131.68 ft, invert of sluice pipe, and 1,198.18 ft, crest of spillway. Capacity increased to 50,889 acre-ft with the addition of flashboards to an elevation of 1,199.68 ft. Dead storage, 279 acre-ft. Records of contents provided by U.S. Bureau of Reclamation. See schematic diagram of lower Sacramento River Basin.

EXTREMES FOR PERIOD OF RECORD.—Maximum contents, 53,500 acre-ft, Mar. 30, 1974, elevation, 1,201.10 ft; minimum, 280 acre-ft, Aug. 8 to Oct. 31, 1972, Apr. 30 to Nov. 1, 1977, elevation, 1,131.68 ft.

EXTREMES FOR CURRENT YEAR.—Maximum contents, 50,694 acre-ft, Mar. 5, elevation, 1,199.57 ft; minimum, 30,559 acre-ft, Sept. 30, elevation, 1,186.76 ft.

## 11386100 STONY GORGE RESERVOIR NEAR ELK CREEK

LOCATION.—Lat 39°35'09", long 122°31'54", in NE 1/4 SE 1/4 sec.16, T.20 N., R.6 W., Glenn County, Hydrologic Unit 18020115, on south end of Stony Gorge Dam on Stony Creek, 1.3 mi southeast of Elk Creek.

DRAINAGE AREA.—301 mi<sup>2</sup>.

PERIOD OF RECORD.—October 1969 to current year.

GAGE.—Nonrecording gage read once daily. Datum of gage is sea level (levels by U.S. Bureau of Reclamation).

REMARKS.—Reservoir is formed by slab and buttress-type dam. Storage began in 1928. Capacity, 50,380 acre-ft, between elevations 728.0 ft, top of low intake, and 841.0 ft, crest of spillway. No dead storage. Records of contents provided by U.S. Bureau of Reclamation. See schematic diagram of lower Sacramento River Basin.

EXTREMES FOR PERIOD OF RECORD.—Maximum contents, 54,630 acre-ft, Mar. 26, 1971, elevation, 844.20 ft; minimum, 3,810 acre-ft, Nov. 6, 1971, elevation, 779.20 ft.

EXTREMES FOR CURRENT YEAR.—Maximum contents, 50,280 acre-ft, Mar. 30, elevation, 840.92 ft; minimum, 28,578 acre-ft, Sept. 21, 22, 24, elevation, 821.55 ft.

## MONTHEND ELEVATION AND CONTENTS AT 0800 HOURS, WATER YEAR OCTOBER 2000 TO SEPTEMBER 2001

Date	Elevation (ft)	Contents (acre-ft)	Change in contents (acre-ft)	Elevation (ft)	Contents (acre-ft)	Change in contents (acre-ft)
11385100 EAST PARK RESERVOIR				11386100 STONY GORGE RESERVOIR		
Sept. 30 .....	1,194.94	42,713	-1,457	830.00	37,204	-2,232
Oct. 31 .....	1,194.44	41,902	-811	830.30	37,536	332
Nov. 30 .....	1,194.18	41,481	-421	830.92	38,222	686
Dec. 31 .....	1,194.34	41,740	259	831.55	38,930	708
CAL YR 2000 .....	—	—	-97	—	—	-146
Jan. 31 .....	1,196.25	44,892	3,152	831.62	39,009	79
Feb. 28 .....	1,198.49	48,762	3,870	832.97	40,546	1,537
Mar. 31 .....	1,198.34	48,497	-265	840.54	49,790	9,244
Apr. 30 .....	1,198.28	48,391	-106	840.86	50,203	413
May 31 .....	1,197.85	47,635	-756	838.15	46,758	-3,445
June 30 .....	1,193.39	40,222	-7,413	831.36	38,716	-8,042
July 31 .....	1,188.88	33,470	-6,752	822.87	29,839	-8,877
Aug. 31 .....	1,187.84	32,021	-1,449	821.99	28,993	-846
Sept. 30 .....	1,186.76	30,559	-1,462	821.56	28,587	-406
WTR YR 2001 .....	—	—	-12,154	—	—	-8,617

## 11389500 SACRAMENTO RIVER AT COLUSA, CA

LOCATION.—Lat 39°12'51", long 121°59'57", at north end of Jimeno Grant, Colusa County, Hydrologic Unit 18020104, on right bank, 60 ft downstream from highway bridge at Colusa, and at mile 89.4 upstream from Sacramento.

DRAINAGE AREA.—12,090 mi<sup>2</sup>.

## WATER-DISCHARGE RECORDS

PERIOD OF RECORD.—April 1921 to current year (prior to October 1940, low-water periods only).

REVISED RECORDS.—WSP 1345: 1952. WDR CA-77-4: Drainage area.

GAGE.—Water-stage recorder and crest-stage gage. Datum of gage is 2.95 ft below sea level. Prior to December 1930, water-stage recorder in center fender pier 50 ft upstream from bridge at same datum.

REMARKS.—Records good. Natural flow of stream affected by storage reservoirs, including Shasta Lake (station 11370000) since 1943, power development, bypassing for flood control, diversions for irrigation, and return flow from irrigated areas. When discharge exceeds about 30,000 ft<sup>3</sup>/s, flow begins over Colusa Weir, 2.5 mi upstream on left bank, into Butte Sink and Sutter Bypass. See schematic diagram of lower Sacramento River Basin.

EXTREMES FOR PERIOD OF RECORD.—Maximum discharge (water years 1941–2001), 51,800 ft<sup>3</sup>/s, Mar. 4, 1983, gage height, 68.50 ft, maximum gage height, 69.20 ft, Feb. 18, 1942; minimum recorded, 820 ft<sup>3</sup>/s, July 25, 26, 1931, gage height, 34.79 ft.

## DISCHARGE, CUBIC FEET PER SECOND, WATER YEAR OCTOBER 2000 TO SEPTEMBER 2001

## DAILY MEAN VALUES

DAY	OCT	NOV	DEC	JAN	FEB	MAR	APR	MAY	JUN	JUL	AUG	SEP
1	5730	6080	6520	5350	7640	13900	8040	5870	7900	11300	10600	7300
2	5680	5730	6330	5320	7120	12300	7890	5910	7770	11300	10300	7360
3	5640	5450	6100	5320	6720	12000	7640	6510	7650	11000	9780	7450
4	5580	5240	5830	5310	6390	12800	7560	6220	7600	10600	9280	7750
5	5350	5140	5780	5220	6180	24700	8130	5850	7550	10800	9040	7570
6	5250	5150	5750	5120	6090	38800	8200	5700	7640	10900	9110	7530
7	4980	5000	5600	5010	6080	34500	8240	5890	8430	11400	9150	7680
8	4930	5030	5570	5070	5940	27100	8930	6150	9060	11600	9090	7750
9	4890	5140	5430	5530	5800	20800	8860	6170	9070	11700	9020	7290
10	4890	5220	5400	6110	6280	17300	8380	6190	9400	11600	9020	7400
11	5590	5160	5500	8220	10100	15000	7940	6480	9880	11400	8940	7510
12	5700	5230	5470	15200	13900	14500	7730	6800	10200	11400	8780	7160
13	5970	5220	5550	12000	14000	13600	7500	6880	10100	11600	8530	7010
14	5600	5280	5720	9140	12000	12800	7260	6890	9990	11500	8410	7180
15	5500	5320	7080	7860	9630	12100	7050	6930	10000	11500	8570	7250
16	5490	5450	7700	7250	8330	11500	6730	7050	10400	11600	8430	7740
17	5520	5290	6810	6630	7660	11100	6390	7800	10300	11600	7940	7960
18	5390	5330	5950	6290	7480	10600	6070	7900	10600	11600	7800	7620
19	5180	5420	5670	6050	9930	10400	5770	8110	10500	11700	7720	7410
20	4970	5340	5570	5870	12500	10200	5920	8100	10300	11700	7300	7710
21	4930	5380	5510	5760	19200	10200	6480	8160	10200	11600	7420	7790
22	4580	5400	5430	5730	21400	10100	7030	8060	10200	11500	7220	7630
23	4440	5380	5410	5870	22500	9990	6910	7880	10600	11500	6720	e7650
24	4340	5360	5390	6000	22400	9800	6590	7460	10200	11500	6740	e7700
25	4360	5440	5330	12600	20200	9650	6380	7180	9840	11600	6690	e7850
26	4540	5420	5280	17900	31300	10100	6660	e6720	10200	11600	7200	e8020
27	4870	5430	5380	22100	25500	10100	6750	e7150	10500	12000	7490	e8100
28	5010	5450	5330	15800	17500	9340	6660	7760	11200	11800	7710	e7700
29	5360	5560	5400	11600	---	8920	6440	7920	11500	11700	7490	e7300
30	6530	5720	5380	9560	---	8660	6140	7960	11600	11300	6980	e7000
31	6150	---	5350	8500	---	8280	---	7890	---	10600	6930	---
TOTAL	162940	160760	178520	259290	349770	441140	216270	217540	290380	354500	255400	226370
MEAN	5256	5359	5759	8364	12490	14230	7209	7017	9679	11440	8239	7546
MAX	6530	6080	7700	22100	31300	38800	8930	8160	11600	12000	10600	8100
MIN	4340	5000	5280	5010	5800	8280	5770	5700	7550	10600	6690	7000
AC-FT	323200	318900	354100	514300	693800	875000	429000	431500	576000	703200	506600	449000

e Estimated.



## SACRAMENTO RIVER BASIN

## 11389500 SACRAMENTO RIVER AT COLUSA, CA—Continued

## STATISTICS OF MONTHLY MEAN DATA FOR WATER YEARS 1946 - 2001, BY WATER YEAR (WY)

	OCT	NOV	DEC	JAN	FEB	MAR	APR	MAY	JUN	JUL	AUG	SEP
MEAN	6504	8726	13560	17600	20000	17490	12610	10620	9072	8731	8293	7237
MAX	12040	27000	38000	39720	45500	44450	31490	26680	24590	13890	12320	10850
(WY)	1958	1974	1984	1997	1998	1983	1982	1983	1998	1998	1998	1998
MIN	3219	3860	4141	5193	5147	5852	4966	5015	4852	5073	5081	4322
(WY)	1978	1993	1977	1991	1991	1977	1994	1947	1992	1992	1947	1977

SUMMARY STATISTICS	FOR 2000 CALENDAR YEAR		FOR 2001 WATER YEAR		WATER YEARS 1946 - 2001	
ANNUAL TOTAL	4543330		3112880			
ANNUAL MEAN	12410		8528		11670	
HIGHEST ANNUAL MEAN					21790	
LOWEST ANNUAL MEAN					5671	
HIGHEST DAILY MEAN	42600	Mar 7	38800	Mar 6	51300	Mar 4 1983
LOWEST DAILY MEAN	4340	Oct 24	4340	Oct 24	2620	Oct 16 1977
ANNUAL SEVEN-DAY MINIMUM	4580	Oct 21	4580	Oct 21	2690	Oct 12 1977
MAXIMUM PEAK FLOW			39600	Mar 6	51800	Mar 4 1983
MAXIMUM PEAK STAGE			64.18	Mar 6	68.83	Jan 3 1997
ANNUAL RUNOFF (AC-FT)	9012000		6174000		8451000	
10 PERCENT EXCEEDS	28100		11700		24600	
50 PERCENT EXCEEDS	9520		7530		8340	
90 PERCENT EXCEEDS	5360		5330		5350	

## 11389500 SACRAMENTO RIVER AT COLUSA, CA—Continued

## WATER-QUALITY RECORDS

PERIOD OF RECORD.—Water years 1959–66, 1973–80, 1996 to September 1999, October 2000 to September 2001.

CHEMICAL DATA: Water years 1959–66, 1996 to September 1999, October 2000 to September 2001.

SPECIFIC CONDUCTANCE: Water years 1995–98.

WATER TEMPERATURE: Water years 1975, 1977–80, 1995–98.

SEDIMENT: Water years 1973–80, 1996 to September 1999.

PERIOD OF DAILY RECORD.—

SPECIFIC CONDUCTANCE: Water years 1995–98.

WATER TEMPERATURE: Water years 1995–98.

INSTRUMENTATION.—Water-quality monitor since October 1995.

REMARKS.—Chemical Data for water year 2000 available in the files of the U.S. Geological Survey.

## WATER-QUALITY DATA, WATER YEAR OCTOBER 2000 TO SEPTEMBER 2001

DATE	TIME	DIS- CHARGE, CUBIC FEET PER SECOND (00061)	2,6-DI- ETHYL WAT FLT 0.7 U GF, REC (82660)	ACETO- CHLOR, WATER FLTRD (49260)	ALA- CHLOR, WATER, DISS, REC, (46342)	ALPHA BHC DIS - SOLVED (34253)	ATRA- ZINE, WATER, DISS, REC (39632)	BEN- FLUR- ALIN WAT FLD 0.7 U GF, REC (82673)	BUTYL- ATE, WATER, DISS, REC (04028)	CAR- BARYL WATER FLTRD 0.7 U GF, REC (82680)	CARBO- FURAN WATER FLTRD 0.7 U GF, REC (82674)	CHLOR- PYRIFOS DIS- SOLVED (38933)	CYANA- ZINE, WATER, DISS, REC (04041)
		JAN											
24...	0940	5940	<.002	<.004	<.002	<.005	<.007	<.010	<.002	<.041	<.020	<.005	<.018
25...	1020	12800	<.002	<.004	<.002	<.005	<.007	<.010	<.002	<.041	<.020	<.005	<.018
26...	0940	15700	<.002	<.004	<.002	<.005	<.007	<.010	<.002	<.041	<.020	<.005	<.018
27...	1040	22900	<.002	<.004	<.002	<.005	e.003	<.010	<.002	<.041	<.020	<.005	<.018
28...	0940	16200	<.002	<.004	<.002	<.005	<.007	<.010	<.002	<.041	<.020	<.005	<.018
FEB													
10...	0930	5870	<.002	<.004	<.002	<.005	<.007	<.010	<.002	<.041	<.020	<.005	<.018
11...	1040	9690	<.002	<.004	<.002	<.005	<.007	<.010	<.002	<.041	<.020	<.005	<.018
12...	1040	14100	<.002	<.004	<.002	<.005	<.007	<.010	<.002	<.041	<.020	<.005	<.018
13...	0930	14200	<.002	<.004	<.002	<.005	<.007	<.010	<.002	<.041	<.020	<.005	<.018
14...	1000	1010	<.002	<.004	<.002	<.005	<.007	<.010	<.002	<.041	<.020	<.005	<.018

DATE	TIME	DCPA WATER FLTRD 0.7 U GF, REC (82682)	DEETHYL ATRA- ZINE, DI- WATER, AZINON, DISS, SOLVED (04040)	DI- ELDRIN DI- SOLVED (39572)	DISUL- FOTON WATER FLTRD 0.7 U GF, REC (82677)	EPTC WATER FLTRD 0.7 U GF, REC (82668)	ETHAL- FLUR- ALIN WAT FLT 0.7 U GF, REC (82663)	ETHO- PROP WATER FLTRD 0.7 U GF, REC (82672)	FONOFOS WATER DISS (04095)	LIN- URON WATER FLTRD 0.7 U GF, REC (82666)	MALA- THION, DISS (39532)	METHYL AZIN- PHOS WAT FLT 0.7 U GF, REC (82686)	
		JAN											
24...	<.003	<.006	.012	<.005	<.021	<.002	<.009	<.005	<.003	<.004	<.035	<.027	<.050
25...	<.003	<.006	.016	<.005	<.021	<.002	<.009	<.005	<.003	<.004	<.035	<.027	<.050
26...	<.003	<.006	.036	<.005	<.021	<.002	<.009	<.005	<.003	<.004	<.035	<.027	<.050
27...	<.003	<.006	.053	<.005	<.021	<.002	<.009	<.005	<.003	<.004	<.035	<.027	<.050
28...	<.003	<.006	.027	<.005	<.021	<.002	<.009	<.005	<.003	<.004	<.035	<.027	<.050
FEB													
10...	<.003	<.006	<.005	<.005	<.021	<.002	<.009	<.005	<.003	<.004	<.035	<.027	<.050
11...	<.003	<.006	.007	<.005	<.021	<.002	<.009	<.005	<.003	<.004	<.035	<.027	<.050
12...	<.003	<.006	.015	<.005	<.021	<.002	<.009	<.005	<.003	<.004	<.035	<.027	<.050
13...	<.003	<.006	.009	<.005	<.021	<.002	<.009	<.005	<.003	<.004	<.035	<.027	<.050
14...	<.003	<.006	.010	<.005	<.021	<.002	<.009	<.005	<.003	<.004	<.035	<.027	<.050

< Actual value is known to be less than value shown.  
e Estimated.

## 11389500 SACRAMENTO RIVER AT COLUSA, CA—Continued

## WATER-QUALITY DATA, WATER YEAR OCTOBER 2000 TO SEPTEMBER 2001

DATE	METHYL PARA- THION	METO- LACHLOR	METRI- BUZIN	MOL- INATE WATER	NAPROP- AMIDE WATER	P, P' DDE	PARA- THION,	PEB- ULATE WATER	PENDI- METH- ALIN	PER- METHRIN CIS	PHORATE WATER	PRO- METON, WATER	PRON- AMIDE WATER
	WAT FLT 0.7 U	WATER DISSOLV	WATER DISSOLV	FLTRD 0.7 U	FLTRD 0.7 U		SOLVED	DIS-	FILTRD 0.7 U	WAT FLT 0.7 U	WAT FLT 0.7 U	FLTRD 0.7 U	REC DISS,
	(UG/L) (82667)	(UG/L) (39415)	(UG/L) (82630)	(UG/L) (82671)	(UG/L) (82684)	(UG/L) (34653)	(UG/L) (39542)	(UG/L) (82669)	(UG/L) (82683)	(UG/L) (82687)	(UG/L) (82664)	(UG/L) (04037)	(UG/L) (82676)
JAN													
24...	<.006	<.013	<.006	<.002	<.007	<.003	<.007	<.002	<.010	<.006	<.011	<.015	<.004
25...	<.006	<.013	<.006	<.002	<.007	<.003	<.007	<.002	<.010	<.006	<.011	<.015	<.004
26...	<.006	e.004	<.006	<.002	<.007	<.003	<.007	<.002	<.010	<.006	<.011	<.015	<.004
27...	<.006	<.013	<.006	<.002	<.007	<.003	<.007	<.002	<.010	<.006	<.011	<.015	<.004
28...	<.006	<.013	<.006	<.002	<.007	<.003	<.007	<.002	<.010	<.006	<.011	<.015	<.004
FEB													
10...	<.006	<.013	<.006	<.002	<.007	<.003	<.007	<.002	<.010	<.006	<.011	<.015	<.004
11...	<.006	<.013	<.006	<.002	<.007	<.003	<.007	<.002	<.010	<.006	<.011	<.015	<.004
12...	<.006	<.013	<.006	<.002	<.007	<.003	<.007	<.002	<.010	<.006	<.011	<.015	<.004
13...	<.006	<.013	<.006	<.002	<.007	<.003	<.007	<.002	<.010	<.006	<.011	<.015	<.004
14...	<.006	<.013	<.006	<.002	<.007	<.003	<.007	<.002	<.010	<.006	<.011	<.015	<.004
DATE	PROPA- CHLOR, WATER,	PRO- PANIL WATER	PRO- PARGITE WATER	SI- MAZINE, WATER,	TEBU- THIURON WATER	TER- BACIL WATER	TER- BUFOS WATER	THIO- BENCARB WATER	TRIAL- LATE WATER	TRI- FLUR- ALIN			
	DISS, REC	0.7 U GF, REC	0.7 U GF, REC	DISS, REC	0.7 U GF, REC	0.7 U GF, REC	0.7 U GF, REC	0.7 U GF, REC	0.7 U GF, REC	0.7 U GF, REC			
	(UG/L) (04024)	(UG/L) (82679)	(UG/L) (82685)	(UG/L) (04035)	(UG/L) (82670)	(UG/L) (82665)	(UG/L) (82675)	(UG/L) (82681)	(UG/L) (82678)	(UG/L) (82661)			
JAN													
24...	<.010	<.011	<.023	<.011	.036	<.034	<.017	<.005	<.002	<.009			
25...	<.010	<.011	<.023	<.011	<.016	<.034	<.017	<.005	<.002	<.009			
26...	<.010	<.011	<.023	.021	<.016	<.034	<.017	<.005	<.002	<.009			
27...	<.010	<.011	<.023	.064	<.016	<.034	<.017	<.005	<.002	<.009			
28...	<.010	<.011	<.023	.034	<.016	<.034	<.017	<.005	<.002	<.009			
FEB													
10...	<.010	<.011	<.023	<.011	<.016	<.034	<.017	<.005	<.002	<.009			
11...	<.010	<.011	<.023	.012	<.016	<.034	<.017	<.005	<.002	<.009			
12...	<.010	<.011	<.023	.022	<.016	<.034	<.017	<.005	<.002	<.009			
13...	<.010	<.011	<.023	.015	<.016	<.034	<.017	<.005	<.002	<.009			
14...	<.010	<.011	<.023	.021	<.016	<.034	<.017	<.005	<.002	<.009			

< Actual value is known to be less than value shown.  
e Estimated.

## 11389720 BUTTE CREEK BELOW DIVERSION DAM, NEAR STIRLING CITY, CA

LOCATION.—Lat 39°58'53", long 121°35'15", unsurveyed, T.25 N., R.3 E., Butte County, Hydrologic Unit 18020120, on left bank, 400 ft downstream from diversion dam, 0.1 mi upstream from Haw Creek, and 6.2 mi northwest of Stirling City.

DRAINAGE AREA.—61.3 mi<sup>2</sup>.

PERIOD OF RECORD.—January to February 1986, June 1986 to current year (low-flow records only).

GAGE.—Water-stage recorder. Elevation of gage is 2,840 ft above sea level, from topographic map.

REMARKS.—Flow regulated by diversion dam 400 ft upstream. Flows computed to 100 ft<sup>3</sup>/s. Most of the water is diverted at diversion dam to Butte Creek Canal and then to De Sabla Powerplant (station 11389750).

COOPERATION.—Records were collected by Pacific Gas & Electric Co., under general supervision of the U.S. Geological Survey, in connection with a Federal Energy Regulatory Commission project.

## DISCHARGE, CUBIC FEET PER SECOND, WATER YEAR OCTOBER 2000 TO SEPTEMBER 2001

## DAILY MEAN VALUES

DAY	OCT	NOV	DEC	JAN	FEB	MAR	APR	MAY	JUN	JUL	AUG	SEP
1	18	19	21	18	20	---	---	---	19	9.8	10	8.8
2	18	19	21	18	20	---	---	---	19	9.8	9.9	8.8
3	18	19	21	18	20	---	---	---	19	9.8	9.9	8.8
4	18	19	21	18	24	---	---	---	14	9.8	10	8.8
5	18	19	21	18	26	---	---	---	12	9.8	9.9	8.8
6	18	19	20	18	21	---	---	---	11	9.8	9.9	8.8
7	18	19	20	18	20	---	---	---	11	9.8	9.9	8.8
8	18	27	20	21	26	---	---	---	9.8	9.8	9.9	8.8
9	19	25	21	51	43	---	---	---	9.9	9.8	9.7	8.8
10	42	24	21	58	---	---	---	---	10	9.8	10	8.8
11	29	23	21	44	---	---	---	---	10	9.8	10	8.8
12	20	22	21	29	---	---	---	---	9.9	9.8	10	8.7
13	19	22	25	26	---	---	---	---	9.8	9.8	10	8.7
14	19	22	55	23	---	---	---	---	9.8	9.8	10	8.7
15	19	21	39	20	---	---	---	---	9.7	9.8	9.0	8.7
16	19	21	27	18	---	---	---	---	9.6	9.8	8.6	8.7
17	19	21	22	20	---	---	---	---	9.6	9.8	8.8	8.7
18	19	21	20	21	---	---	---	---	9.5	9.8	8.8	8.7
19	19	21	20	21	---	---	---	---	9.3	9.8	8.8	8.7
20	19	21	19	21	---	---	---	---	9.3	9.8	8.8	8.8
21	19	21	19	21	---	---	---	---	9.9	9.8	8.8	8.8
22	19	21	22	20	---	---	---	---	9.9	9.9	8.8	8.8
23	19	20	19	23	---	---	---	---	9.8	9.8	8.8	8.8
24	19	20	19	32	---	---	---	---	9.8	9.8	8.8	8.8
25	23	20	19	29	---	---	---	---	9.9	9.9	8.8	9.2
26	25	20	18	22	---	---	---	---	10	9.9	8.8	8.8
27	19	20	19	42	---	---	---	---	10	9.9	8.8	8.8
28	46	20	18	---	---	---	---	---	10	10	8.8	8.8
29	50	45	18	---	---	---	---	---	9.9	10	8.8	8.8
30	31	27	19	---	---	---	---	---	9.8	10	8.8	8.8
31	21	---	18	47	---	---	---	52	---	10	8.8	---
TOTAL	697	658	684	---	---	---	---	---	330.2	305.0	288.7	263.6
MEAN	22.5	21.9	22.1	---	---	---	---	---	11.0	9.84	9.31	8.79
MAX	50	45	55	---	---	---	---	---	19	10	10	9.2
MIN	18	19	18	---	---	---	---	---	9.3	9.8	8.6	8.7
AC-FT	1380	1310	1360	---	---	---	---	---	655	605	573	523

## 11389740 BUTTE CREEK BELOW FORKS OF BUTTE DIVERSION DAM, NEAR DE SABLA, CA

LOCATION.—Lat 39°54'05", long 121°37'24", in NW 1/4 NE 1/4 sec.34, T.24 N., R.3 E., Butte County, Hydrologic Unit 18020120, on left bank, 30 ft downstream from diversion dam, 0.2 mi upstream from American Ravine, and 2.0 mi north of De Sabla.

DRAINAGE AREA.—96.4 mi<sup>2</sup>.

PERIOD OF RECORD.—April 1992 to current year (low-flow records only).

GAGE.—Water-stage recorder and concrete control. Elevation of gage is 1,900 ft above sea level, from topographic map.

REMARKS.—No records computed above 60 ft<sup>3</sup>/s. Flow regulated by Forks of Butte Diversion Dam 30 ft upstream. Water is diverted out of creek to Butte Canal 7.4 mi upstream by Pacific Gas and Electric Co. Water is diverted 30 ft upstream to Forks of Butte Powerplant (station 11389747).

COOPERATION.—Records were collected by Energy Growth Partnership I, under general supervision of the U.S. Geological Survey, in connection with a Federal Energy Regulatory Commission project.

DISCHARGE, CUBIC FEET PER SECOND, WATER YEAR OCTOBER 2000 TO SEPTEMBER 2001  
DAILY MEAN VALUES

DAY	OCT	NOV	DEC	JAN	FEB	MAR	APR	MAY	JUN	JUL	AUG	SEP
1	34	40	45	39	54	---	---	---	51	31	25	22
2	34	39	43	39	54	---	---	---	49	30	25	22
3	34	38	42	39	54	---	---	---	47	30	24	22
4	34	37	41	38	---	---	---	---	44	30	25	22
5	34	37	40	38	---	---	---	---	39	29	25	21
6	34	36	40	38	---	---	---	---	39	29	24	22
7	34	36	40	37	58	---	---	---	38	28	24	21
8	34	49	40	51	57	---	---	---	37	28	24	21
9	36	44	40	---	---	---	---	---	36	28	24	21
10	---	43	42	---	---	---	---	---	36	28	24	21
11	---	41	43	---	---	---	---	---	36	28	25	21
12	43	40	47	---	---	---	---	---	36	28	24	22
13	38	40	59	---	---	---	---	---	35	28	25	22
14	37	43	---	---	---	---	---	---	34	27	25	22
15	37	41	---	56	---	---	---	---	34	27	24	22
16	36	40	---	49	---	---	---	---	33	27	22	22
17	36	39	56	48	---	---	---	---	32	27	22	22
18	36	39	49	49	---	---	---	---	32	27	22	22
19	35	39	46	48	---	---	---	---	32	27	22	22
20	37	39	44	47	---	---	---	---	32	27	22	22
21	37	39	43	47	---	---	---	---	32	26	22	22
22	35	39	46	46	---	---	---	---	32	26	23	22
23	35	38	43	53	---	---	---	---	31	26	23	22
24	35	38	42	---	---	---	---	---	31	26	23	22
25	42	38	41	---	---	---	---	---	31	26	22	28
26	---	38	40	---	---	---	---	---	33	26	22	24
27	40	38	40	---	---	---	---	---	38	25	22	23
28	---	44	40	---	---	---	---	---	37	25	22	23
29	---	---	40	---	---	---	---	---	33	25	22	23
30	---	---	39	---	---	---	---	---	32	25	21	22
31	46	---	39	---	---	---	---	---	---	26	22	---
TOTAL	---	---	---	---	---	---	---	---	1082	846	721	665
MEAN	---	---	---	---	---	---	---	---	36.1	27.3	23.3	22.2
MAX	---	---	---	---	---	---	---	---	51	31	25	28
MIN	---	---	---	---	---	---	---	---	31	25	21	21
AC-FT	---	---	---	---	---	---	---	---	2150	1680	1430	1320
a	286	105	319	1280	6090	12350	9390	9020	0	0	0	0

a Diversion, in acre-feet, to Forks of Butte Powerplant, provided by Energy Growth Partnership I.

## 11389780 BUTTE CREEK BELOW CENTERVILLE DIVERSION DAM, NEAR PARADISE, CA

LOCATION.—Lat 39°52'01", long 121°37'58", in SW 1/4 NW 1/4 sec.10, T.23 N., R.3 E., Butte County, Hydrologic Unit 18020120, on left bank, 400 ft downstream from Centerville Diversion Dam, 0.2 mi downstream from De Sabla Powerplant, and 6.8 mi north of Paradise.

DRAINAGE AREA.—101 mi<sup>2</sup>.

PERIOD OF RECORD.—November 1985 to February 1986, June 1986 to current year (low-flow records only).

GAGE.—Water-stage recorder. Elevation of gage is 1,130 ft above sea level, from topographic map.

REMARKS.—Flow regulated by several reservoirs and diversions upstream. Flows computed to 60 ft<sup>3</sup>/s. Most of the water is diverted at Centerville Diversion Dam to the Centerville Powerplant (station 11389775).

COOPERATION.—Records were collected by Pacific Gas & Electric Co., under general supervision of the U.S. Geological Survey, in connection with a Federal Energy Regulatory Commission project.

## DISCHARGE, CUBIC FEET PER SECOND, WATER YEAR OCTOBER 2000 TO SEPTEMBER 2001

## DAILY MEAN VALUES

DAY	OCT	NOV	DEC	JAN	FEB	MAR	APR	MAY	JUN	JUL	AUG	SEP
1	46	50	---	---	---	---	---	---	48	47	46	46
2	46	51	---	---	---	---	---	---	49	50	46	46
3	46	51	---	---	---	---	---	---	50	50	45	45
4	46	51	---	---	---	---	---	---	53	46	45	52
5	46	50	---	---	---	---	---	---	54	47	46	46
6	46	55	---	---	44	---	---	---	52	47	45	47
7	46	56	---	---	44	---	---	---	52	47	46	48
8	46	57	---	---	---	---	---	---	50	46	47	48
9	46	57	---	---	---	---	---	---	48	46	48	45
10	48	57	---	---	---	---	---	---	52	44	49	49
11	51	57	---	---	---	---	---	---	48	49	49	47
12	45	57	---	---	---	---	---	---	52	51	49	45
13	45	56	---	45	---	---	---	---	49	51	47	46
14	45	58	---	45	---	---	---	---	48	51	46	46
15	45	58	---	45	---	---	---	---	51	51	46	46
16	45	58	46	---	---	---	---	---	50	50	47	47
17	45	58	---	---	---	---	45	60	52	48	46	46
18	45	57	---	---	---	---	---	50	50	47	47	45
19	45	57	---	---	---	---	---	49	48	47	47	46
20	45	57	---	---	---	---	---	49	50	47	46	47
21	45	---	---	---	---	---	---	47	47	48	46	46
22	45	---	---	---	---	---	---	46	47	47	47	47
23	45	57	---	---	---	---	---	46	47	48	46	51
24	---	57	---	---	---	---	---	46	47	50	47	50
25	47	57	---	---	---	---	---	47	47	47	48	46
26	57	57	---	---	---	---	---	46	47	47	46	46
27	49	57	---	47	---	---	---	47	47	47	47	46
28	---	58	---	45	---	---	---	48	48	46	46	45
29	---	---	---	46	---	---	---	47	49	46	46	45
30	---	---	---	47	---	---	---	60	50	46	50	49
31	51	---	---	45	---	---	---	57	---	46	49	---
TOTAL	---	---	---	---	---	---	---	---	1482	1480	1451	1404
MEAN	---	---	---	---	---	---	---	---	49.4	47.7	46.8	46.8
MAX	---	---	---	---	---	---	---	---	54	51	50	52
MIN	---	---	---	---	---	---	---	---	47	44	45	45
AC-FT	---	---	---	---	---	---	---	---	2940	2940	2880	2780
a	3370	2940	3390	4550	4060	7780	7440	8130	7330	6160	4080	3880

a Discharge, in acre-feet, from Centerville Powerplant (station 11389775), provided by Pacific Gas & Electric Co.

## 11389800 TOADTOWN CANAL ABOVE BUTTE CANAL, NEAR STIRLING CITY, CA

LOCATION.—Lat 39°53'09", long 121°36'35", in NE 1/4 NW 1/4 sec.2, T.23 N., R.3 E., Butte County, Hydrologic Unit 18020120, on right bank, 600 ft upstream from Butte Canal, and 4.6 mi west of Stirling City.

PERIOD OF RECORD.—October 1986 to current year. Monthly discharges for water years 1931–86 are published as a line item to Butte Creek near Chico (station 11390000).

GAGE.—Water-stage recorder and Parshall flume. Elevation of gage is 2,790 ft above sea level, from topographic map.

REMARKS.—Canal diverts from right bank of West Branch Feather River, in sec.16, T.24 N., R.4 E. at Hendricks Diversion Dam to Hendricks Canal, flows through tunnel down Long Ravine to Toadtown Canal, and discharges into Butte Canal. Butte Canal flows to De Sabla Powerplant (station 11389750) on Butte Creek.

COOPERATION.—Records were collected by Pacific Gas & Electric Co., under general supervision of the U.S. Geological Survey, in connection with a Federal Energy Regulatory Commission project.

EXTREMES FOR PERIOD OF RECORD.—Maximum daily discharge, 127 ft<sup>3</sup>/s, Feb. 12, May 20, 1995, no flow at times in most years.

## DISCHARGE, CUBIC FEET PER SECOND, WATER YEAR OCTOBER 2000 TO SEPTEMBER 2001

## DAILY MEAN VALUES

DAY	OCT	NOV	DEC	JAN	FEB	MAR	APR	MAY	JUN	JUL	AUG	SEP
1	27	29	30	26	31	44	124	.31	91	58	58	43
2	27	27	28	25	32	47	123	46	92	56	57	43
3	27	27	27	25	32	44	121	104	90	57	58	42
4	28	24	26	25	38	56	118	104	92	62	57	42
5	28	22	25	25	41	68	114	108	98	62	57	42
6	28	21	25	25	40	74	106	113	94	60	57	42
7	28	20	25	25	40	81	106	115	89	59	57	41
8	29	21	24	31	41	80	105	118	84	57	49	41
9	34	23	25	29	44	90	105	118	81	53	49	41
10	52	23	30	40	43	89	105	117	79	51	49	41
11	48	22	28	49	30	81	106	117	77	57	48	42
12	38	21	29	40	6.6	76	107	116	75	57	48	42
13	37	24	31	38	2.0	77	112	116	74	56	48	41
14	38	32	51	36	.63	81	110	47	74	57	48	41
15	38	31	46	34	.02	81	111	5.7	72	64	45	42
16	39	30	37	33	.01	76	38	4.1	70	64	45	41
17	31	28	34	32	.06	75	.47	4.0	66	64	45	41
18	29	28	31	33	.10	83	.03	3.8	64	63	44	40
19	29	28	30	33	.36	94	.15	3.8	64	61	44	40
20	30	28	29	33	1.5	98	.06	3.9	62	60	44	40
21	32	28	30	32	.55	107	.03	4.0	60	60	44	32
22	29	27	35	32	16	108	.03	4.1	57	60	44	27
23	29	27	32	35	53	108	.01	4.0	56	59	44	26
24	29	27	30	44	53	105	.01	3.6	55	59	44	26
25	35	28	29	39	56	96	.01	3.3	56	63	44	36
26	45	28	28	39	51	103	.01	2.9	64	61	43	30
27	34	30	27	35	48	113	.01	5.2	73	59	43	28
28	54	32	27	34	47	116	.01	6.6	70	59	43	27
29	73	57	27	34	---	122	.01	19	63	59	43	27
30	47	43	26	32	---	124	.05	77	60	59	43	26
31	36	---	26	30	---	123	---	96	---	59	43	---
TOTAL	1108	836	928	1023	747.83	2720	1711.89	1590.31	2202	1835	1485	1113
MEAN	35.7	27.9	29.9	33.0	26.7	87.7	57.1	51.3	73.4	59.2	47.9	37.1
MAX	73	57	51	49	56	124	124	118	98	64	58	43
MIN	27	20	24	25	.01	44	.01	.31	55	51	43	26
AC-FT	2200	1660	1840	2030	1480	5400	3400	3150	4370	3640	2950	2210
a	4590	4170	4920	4500	2250	7940	7000	4560	7640	6280	5190	4350

a Discharge, in acre-feet, from De Sabla Powerplant (station 11389750), provided by Pacific Gas & Electric Co.

## 11390000 BUTTE CREEK NEAR CHICO, CA

LOCATION.—Lat 39°43'34", long 121°42'28", in NW 1/4 NW 1/4 sec.36, T.22 N., R.2 E., Butte County, Hydrologic Unit 18020105, on right bank, 0.7 mi downstream from Little Butte Creek, and 7.5 mi east of Chico.

DRAINAGE AREA.—147 mi<sup>2</sup>.

## WATER-DISCHARGE RECORDS

PERIOD OF RECORD.—October 1930 to current year. Monthly discharge only for some periods, published in WSP 1315-A.

REVISED RECORDS.—WSP 1445: 1953(M). WSP 1931: Drainage area.

GAGE.—Water-stage recorder and crest-stage gage. Elevation of gage is 320 ft above sea level, from topographic map. Prior to Aug. 13, 1944, water-stage recorder at site 0.4 mi upstream at different datum. Aug. 13, 1944, to June 5, 1986, at datum 3.00 ft higher.

REMARKS.—Records good. Flow slightly regulated by storage in Magalia Reservoir, usable capacity, 2,640 acre-ft, and since 1957 by Paradise Reservoir, usable capacity, 11,500 acre-ft. Diversions upstream from station for irrigation and domestic use of about 7,000 acre-ft annually. Butte Creek receives water above station from West Branch Feather River by way of Toadtown Canal (11389800).

EXTREMES FOR PERIOD OF RECORD.—Maximum discharge, 35,600 ft<sup>3</sup>/s, Jan. 1, 1997, gage height, 15.06 ft, in gage well, 15.7 ft from floodmarks, on basis of slope-area measurement of peak flow; maximum gage height, 17.52 ft, Feb. 17, 1986, present datum; minimum discharge, 10 ft<sup>3</sup>/s, Nov. 29, 1952.

EXTREMES FOR CURRENT YEAR.—Peak discharges greater than base discharge of 2,700 ft<sup>3</sup>/s, or maximum:

Date	Time	Discharge (ft <sup>3</sup> /s)	Gage height (ft)
Mar. 5	0830	1,690	3.06

DISCHARGE, CUBIC FEET PER SECOND, WATER YEAR OCTOBER 2000 TO SEPTEMBER 2001  
DAILY MEAN VALUES

DAY	OCT	NOV	DEC	JAN	FEB	MAR	APR	MAY	JUN	JUL	AUG	SEP
1	115	134	154	110	169	360	492	378	222	151	128	109
2	115	126	141	109	167	377	486	382	225	145	123	109
3	116	122	135	108	166	369	449	441	224	141	122	105
4	117	117	130	108	176	545	415	422	225	148	122	105
5	117	114	129	108	193	1370	394	426	230	145	122	107
6	116	111	126	108	183	933	391	431	228	143	124	109
7	115	109	125	108	178	730	418	429	221	139	122	108
8	114	108	125	151	164	648	375	440	211	137	117	106
9	123	113	124	157	222	645	363	444	207	132	117	106
10	209	125	137	204	365	594	358	438	201	126	117	106
11	214	114	135	439	545	531	361	427	200	133	117	109
12	166	110	167	283	368	465	357	417	199	134	116	112
13	138	115	155	188	254	428	351	405	197	134	118	111
14	132	140	269	166	210	432	343	345	196	131	118	110
15	129	132	229	149	189	420	340	251	192	138	115	108
16	127	127	175	137	179	395	296	256	189	141	114	107
17	125	124	147	130	188	378	228	240	185	142	114	107
18	124	123	137	133	349	396	242	223	178	139	114	106
19	122	122	129	125	486	434	419	212	178	134	113	103
20	125	123	125	122	1100	478	513	201	175	131	113	104
21	140	122	123	120	1280	502	544	196	167	130	111	97
22	128	123	130	115	924	522	460	189	159	130	111	87
23	126	121	128	131	741	522	410	182	154	127	115	87
24	126	121	123	265	681	520	390	173	151	124	113	88
25	148	122	119	295	886	778	399	166	152	128	110	120
26	222	122	116	323	622	632	410	162	168	127	109	107
27	150	123	114	251	481	544	408	153	191	123	107	94
28	245	125	114	207	412	519	407	149	196	124	109	91
29	296	196	113	199	---	530	374	151	170	120	109	89
30	215	205	112	190	---	505	362	194	157	120	110	87
31	160	---	111	184	---	493	---	236	---	127	109	---
TOTAL	4615	3789	4297	5423	11878	16995	11755	9159	5748	4144	3579	3094
MEAN	149	126	139	175	424	548	392	295	192	134	115	103
MAX	296	205	269	439	1280	1370	544	444	230	151	128	120
MIN	114	108	111	108	164	360	228	149	151	120	107	87
AC-FT	9150	7520	8520	10760	23560	33710	23320	18170	11400	8220	7100	6140



## SACRAMENTO RIVER BASIN

## 11390000 BUTTE CREEK NEAR CHICO, CA—Continued

## STATISTICS OF MONTHLY MEAN DATA FOR WATER YEARS 1931 - 2001, BY WATER YEAR (WY)

	OCT	NOV	DEC	JAN	FEB	MAR	APR	MAY	JUN	JUL	AUG	SEP
MEAN	138	225	453	687	821	768	676	501	286	166	133	119
MAX	775	1269	2061	2847	2925	2601	1848	1314	773	356	223	183
(WY)	1963	1974	1956	1997	1986	1995	1982	1995	1998	1998	1975	1998
MIN	65.8	77.8	89.5	91.0	114	123	114	134	79.4	54.4	46.1	51.9
(WY)	1992	1992	1991	1991	1977	1977	1977	1977	1977	1977	1931	1992

SUMMARY STATISTICS	FOR 2000 CALENDAR YEAR		FOR 2001 WATER YEAR		WATER YEARS 1931 - 2001	
ANNUAL TOTAL	156167		84476			
ANNUAL MEAN	427		231		412	
HIGHEST ANNUAL MEAN					834	
LOWEST ANNUAL MEAN					94.0	
HIGHEST DAILY MEAN	5090	Feb 14	1370	Mar 5	26600	Jan 1 1997
LOWEST DAILY MEAN	108	Nov 8	87	Sep 22	44	Aug 23 1931
ANNUAL SEVEN-DAY MINIMUM	113	Sep 25	96	Sep 18	44	Aug 23 1931
MAXIMUM PEAK FLOW			1690		35600	
MAXIMUM PEAK STAGE			3.06		17.52	
ANNUAL RUNOFF (AC-FT)	309800		167600		298800	
10 PERCENT EXCEEDS	942		453		858	
50 PERCENT EXCEEDS	204		149		208	
90 PERCENT EXCEEDS	121		109		102	

## 11390000 BUTTE CREEK NEAR CHICO, CA—Continued

## WATER-QUALITY RECORDS

PERIOD OF RECORD.—Water years 1953–79, 1999 to current year.

CHEMICAL DATA: Water years 1953–79.

WATER TEMPERATURE: Water years 1962–79, 1999 to current year.

TURBIDITY: January 2000 to current year.

PERIOD OF DAILY RECORD.—

WATER TEMPERATURE: November 1961 to January 1979, October 1998 to current year.

TURBIDITY: January 2000 to current year.

INSTRUMENTATION.—Temperature recorder since October 1998 and Turbidity recorder since October 2000.

REMARKS.—Temperature record rated excellent except for Nov. 8 to Jan. 12, which is rated good. Turbidity record rated poor. Interruption in record due to malfunction of the recording equipment or data does not meet maximum allowable limits.

EXTREMES FOR PERIOD OF DAILY RECORD.—

WATER TEMPERATURE: Maximum recorded, 26.0°C, July 21, 22, 1966, on several days in 1977, and Aug. 8, 2001; minimum recorded, 0.5°C, Dec. 8, 31, 1978, Jan. 1, 1979.

TURBIDITY: Maximum recorded, 110 NTU, Feb. 11, 2001; minimum recorded, <0.5 NTU, many days during 2001.

EXTREME FOR CURRENT YEAR.—

WATER TEMPERATURE: Maximum recorded, 26.0°C, Aug. 8; minimum recorded, 2.0°C, Jan. 17.

TURBIDITY: Maximum record, 110 NTU, Feb. 11; minimum recorded, <0.5 NTU, many days during the year.

## CROSS-SECTIONAL DATA, WATER YEAR OCTOBER 2000 TO SEPTEMBER 2001

DATE	TIME	DEPTH BOTTOM AT SAMPLE LOC- ATION, (FEET) (81903)	TUR- BID- ITY LAB (NTU) (82079)	TEMPER- ATURE WATER (DEG C) (00010)	SEDI- MENT, SUS- PENDE (MG/L) (80154)	SAMPLE LOC- ATION, CROSS SECTION (FT FM L BANK) (00009)
FEB						
20...	1115	1.50	21	7.5	81	20.0
20...	1120	2.40	11	--	94	57.0
20...	1125	2.40	23	--	102	79.0
20...	1130	2.55	21	--	94	100
20...	1135	2.65	12	--	83	120
MAR						
07...	1515	1.04	2.0	10.0	5	34.0
07...	1520	1.82	1.0	--	4	68.0
07...	1525	2.12	1.0	--	8	87.0
07...	1530	2.10	2.0	--	4	105
07...	1535	2.00	1.0	--	4	121
APR						
10...	1550	1.00	1.0	9.5	3	49.0
10...	1555	1.48	<.5	--	3	75.0
10...	1600	1.78	1.0	--	4	92.0
10...	1605	1.80	1.0	--	3	107
10...	1610	1.90	1.0	--	3	119
MAY						
09...	1445	1.00	1.0	17.0	--	47.0
09...	1450	1.60	1.0	--	2	80.0
09...	1455	1.70	1.0	--	5	93.0
09...	1500	1.90	2.0	--	5	109
09...	1505	2.10	1.0	--	3	121
JUN						
07...	1400	.96	1.0	20.0	2	43.0
07...	1405	1.22	1.0	--	3	64.0
07...	1410	1.44	1.0	--	3	77.0
07...	1415	1.54	<.5	--	1	90.0
07...	1420	1.32	<.5	--	2	101

\* Instantaneous discharge at the time of the cross-sectional measurements: Feb. 20, 1300 ft<sup>3</sup>/s; Mar. 7, 704 ft<sup>3</sup>/s; Apr. 10, 349 ft<sup>3</sup>/s; May 9, 449 ft<sup>3</sup>/s; June 7, 225 ft<sup>3</sup>/s.

< Actual value is known to be less than the value shown.

## 11390000 BUTTE CREEK NEAR CHICO, CA—Continued

## TEMPERATURE, WATER (DEG. C), WATER YEAR OCTOBER 2000 TO SEPTEMBER 2001

DAY	MAX	MIN	MAX	MIN	MAX	MIN	MAX	MIN	MAX	MIN	MAX	MIN
	OCTOBER		NOVEMBER		DECEMBER		JANUARY		FEBRUARY		MARCH	
1	19.5	15.5	10.0	8.0	8.0	6.0	6.0	4.0	6.0	3.5	8.0	5.5
2	19.5	15.5	11.5	8.5	7.5	5.5	6.5	4.0	7.0	5.0	7.5	6.5
3	19.0	15.0	12.0	9.0	7.5	5.0	6.5	4.0	8.0	5.0	7.5	5.5
4	18.5	14.5	11.5	8.5	7.5	5.5	6.0	4.0	9.0	6.0	7.5	7.0
5	18.5	14.5	11.5	9.0	7.5	5.0	6.0	4.0	9.0	6.0	8.5	7.5
6	18.5	14.5	11.0	8.5	7.0	5.5	6.5	4.0	8.0	6.0	10.5	7.5
7	18.0	14.5	10.5	7.5	8.0	6.0	6.0	4.5	7.0	4.5	10.5	7.5
8	18.0	14.0	10.5	8.5	8.0	6.5	7.0	6.0	6.5	3.0	10.0	8.5
9	16.0	14.5	9.5	7.5	8.0	6.5	6.5	5.0	5.5	4.5	10.5	7.5
10	15.0	13.0	8.5	7.0	8.5	7.0	7.0	6.5	6.0	5.0	9.5	6.5
11	13.0	12.0	8.0	6.0	7.5	6.5	7.0	6.5	7.0	5.5	10.0	7.0
12	14.5	11.0	7.5	5.0	8.0	6.5	7.0	5.5	7.0	5.0	10.5	7.0
13	14.5	11.5	5.5	4.5	7.0	6.5	7.5	5.5	8.0	4.5	11.0	7.0
14	14.5	11.0	7.0	5.0	7.0	7.0	7.0	5.0	7.5	4.5	10.5	7.5
15	15.0	11.5	6.0	4.5	8.0	6.5	6.0	4.0	7.5	4.5	9.0	7.5
16	15.0	11.5	6.5	4.0	8.0	5.5	5.5	2.5	8.5	5.5	10.0	7.0
17	14.5	11.0	6.5	4.0	7.5	5.5	5.0	2.0	7.0	5.5	11.0	7.5
18	14.5	11.5	6.0	3.5	6.5	4.5	4.5	2.5	7.0	6.5	12.0	8.5
19	14.5	11.5	6.5	4.5	6.5	4.5	6.0	4.0	7.5	6.5	12.5	9.0
20	13.0	11.5	6.5	4.0	7.0	5.0	5.5	3.5	8.0	7.5	12.0	9.5
21	13.5	10.5	6.0	4.5	6.5	5.0	6.0	3.5	9.0	7.5	13.0	9.5
22	12.5	9.5	6.5	5.0	8.0	6.5	7.5	5.0	8.5	7.0	12.5	9.5
23	12.5	9.0	6.0	4.5	6.5	5.5	6.5	5.5	8.0	6.0	12.5	9.5
24	13.0	9.5	7.0	5.0	7.0	5.5	8.0	6.0	7.5	6.5	12.0	9.5
25	11.5	10.5	7.5	5.5	7.0	4.5	6.0	5.5	9.0	7.5	11.5	9.0
26	11.5	10.0	7.5	6.0	6.5	4.5	6.5	5.0	9.5	6.5	11.0	8.0
27	12.0	9.0	7.5	6.5	6.0	4.5	6.5	4.0	9.5	6.5	11.0	8.0
28	11.0	10.5	8.0	7.0	6.0	4.0	6.5	4.0	9.0	6.0	13.0	9.0
29	11.0	9.5	9.5	7.5	6.0	4.0	7.5	5.0	---	---	13.0	9.5
30	11.0	9.0	9.0	6.5	6.0	4.0	6.0	3.5	---	---	12.5	9.0
31	10.5	8.0	---	---	6.0	4.0	6.5	3.0	---	---	13.0	9.0
MONTH	19.5	8.0	12.0	3.5	8.5	4.0	8.0	2.0	9.5	3.0	13.0	5.5
	APRIL		MAY		JUNE		JULY		AUGUST		SEPTEMBER	
1	13.0	9.5	16.0	11.5	21.0	17.5	24.0	18.0	24.5	18.5	23.5	18.5
2	11.5	8.5	15.0	10.5	21.0	16.5	24.5	18.0	24.5	18.5	23.5	18.5
3	10.0	6.5	13.5	9.5	20.0	15.5	24.0	19.0	24.0	18.0	23.5	18.0
4	9.5	5.5	14.5	9.5	19.5	14.0	24.0	19.5	24.0	18.5	23.0	18.0
5	10.5	6.0	15.0	10.5	18.5	15.0	25.5	20.0	24.0	18.0	22.5	17.5
6	8.0	7.5	15.5	10.5	20.0	14.5	25.0	19.5	24.5	18.5	21.5	17.0
7	9.0	6.0	16.5	11.0	21.5	15.5	24.5	19.0	25.0	19.0	21.5	16.0
8	8.5	5.0	17.0	12.5	21.5	16.0	25.0	18.5	26.0	19.5	21.5	16.5
9	8.5	5.0	17.0	13.0	21.5	16.0	25.5	19.5	25.5	20.5	21.0	16.5
10	10.0	5.0	17.5	13.0	21.5	16.0	25.5	19.5	25.0	19.5	21.0	16.5
11	10.0	7.5	17.5	13.0	19.5	16.0	25.0	20.0	25.0	19.0	19.0	17.0
12	10.0	6.0	17.0	13.0	21.5	16.0	25.0	19.0	24.5	19.0	20.5	16.0
13	11.0	7.0	17.0	12.5	21.0	15.0	25.0	19.0	24.0	18.5	21.0	16.5
14	11.5	7.0	15.5	12.5	21.5	15.5	25.0	19.0	24.0	18.0	21.5	16.5
15	12.0	7.5	15.5	13.0	22.0	16.0	24.0	18.5	24.0	18.0	21.5	17.0
16	13.0	8.0	17.5	13.0	22.5	16.5	23.0	18.5	24.0	18.0	21.5	17.0
17	14.5	10.0	18.5	13.0	23.0	17.0	23.0	17.5	23.0	18.0	21.5	17.0
18	13.0	10.5	19.5	14.0	23.5	17.5	23.5	17.5	23.5	18.0	21.5	17.0
19	11.0	9.0	20.0	15.0	23.5	18.0	23.5	18.0	23.5	18.0	22.0	17.0
20	9.0	8.0	21.0	15.0	24.0	18.0	23.0	17.5	23.0	18.0	21.5	17.0
21	12.0	7.5	21.5	16.5	25.0	19.0	23.0	17.0	22.5	17.5	21.0	16.5
22	13.0	8.5	22.0	16.5	25.5	19.5	23.5	17.0	22.5	17.5	20.5	16.5
23	14.0	9.5	23.0	17.0	24.0	19.0	24.0	17.5	22.0	17.5	20.0	16.5
24	15.5	10.5	23.0	17.0	21.5	17.5	25.0	18.5	23.0	17.5	18.5	15.5
25	16.5	11.5	21.5	17.5	19.5	17.5	25.5	19.5	23.0	17.5	20.0	16.5
26	16.0	12.0	22.5	17.0	19.0	16.5	25.5	20.0	23.5	18.0	19.5	15.0
27	15.5	11.5	21.0	16.0	17.0	15.5	25.5	19.5	24.0	18.0	19.5	15.5
28	14.5	11.5	21.0	15.5	21.0	14.5	24.5	18.5	24.0	18.5	19.0	15.0
29	14.5	10.5	22.0	16.0	22.5	16.0	24.5	18.5	24.0	19.0	19.0	14.5
30	16.0	10.5	22.5	16.5	23.0	17.0	24.0	19.0	23.5	18.5	19.5	15.0
31	---	---	22.5	17.0	---	---	24.5	18.5	23.5	18.5	---	---
MONTH	16.5	5.0	23.0	9.5	25.5	14.0	25.5	17.0	26.0	17.5	23.5	14.5

## 11390000 BUTTE CREEK NEAR CHICO, CA—Continued

## TURBIDITY (NTU), WATER YEAR OCTOBER 2000 TO SEPTEMBER 2001

DAY	MAX	MIN	MAX	MIN	MAX	MIN	MAX	MIN	MAX	MIN	MAX	MIN
	OCTOBER		NOVEMBER		DECEMBER		JANUARY		FEBRUARY		MARCH	
1	---	---	---	---	---	---	---	---	3.1	.6	5.1	1.3
2	---	---	---	---	---	---	---	---	1.9	.7	4.5	1.6
3	---	---	---	---	---	---	---	---	4.3	.7	4.2	1.4
4	---	---	---	---	---	---	---	---	7.3	.8	14	2.0
5	---	---	---	---	---	---	---	---	3.4	.8	51	12
6	---	---	---	---	---	---	---	---	2.0	.8	15	4.3
7	---	---	---	---	---	---	---	---	5.2	.6	8.1	3.0
8	---	---	---	---	---	---	---	---	2.7	<.5	4.5	2.4
9	---	---	---	---	---	---	---	---	17	.7	9.0	2.7
10	---	---	---	---	---	---	---	---	21	9.5	4.1	2.3
11	---	---	---	---	---	---	---	---	110	7.6	4.4	1.8
12	---	---	---	---	---	---	---	---	20	5.3	4.4	1.5
13	---	---	---	---	---	---	---	---	5.4	2.8	4.4	1.5
14	---	---	---	---	---	---	---	---	4.8	1.7	4.4	1.4
15	---	---	---	---	---	---	---	---	4.1	1.4	7.0	1.3
16	---	---	---	---	---	---	---	---	7.4	1.1	9.0	1.1
17	---	---	---	---	---	---	---	---	2.8	.9	6.7	1.3
18	---	---	---	---	---	---	---	---	8.7	2.8	14	1.0
19	---	---	---	---	---	---	---	---	34	4.1	8.3	1.1
20	---	---	---	---	---	---	---	---	64	17	7.2	1.3
21	---	---	---	---	---	---	---	---	54	12	3.4	1.3
22	---	---	---	---	---	---	---	---	43	7.7	3.9	1.3
23	---	---	---	---	---	---	---	---	12	4.8	3.9	1.4
24	---	---	---	---	---	---	---	---	25	4.7	5.2	1.3
25	---	---	---	---	---	---	---	---	16	4.2	13	3.1
26	---	---	---	---	---	---	---	---	6.5	3.0	12	2.1
27	---	---	---	---	---	---	---	---	8.7	2.2	6.6	2.1
28	---	---	---	---	---	---	---	---	3.9	1.8	6.0	1.0
29	---	---	---	---	---	---	---	---	---	---	9.1	1.6
30	---	---	---	---	---	---	---	---	---	---	---	---
31	---	---	---	---	---	---	3.0	.6	---	---	---	---
MONTH	---	---	---	---	---	---	---	---	110	<.5	---	---
	APRIL		MAY		JUNE		JULY		AUGUST		SEPTEMBER	
1	---	---	12	.6	3.1	1.3	4.9	1.5	---	---	<.5	<.5
2	---	---	---	---	3.8	1.1	4.9	2.1	1.5	<.5	.8	<.5
3	---	---	5.4	1.1	2.3	.9	4.8	2.0	2.1	<.5	1.4	<.5
4	---	---	2.3	.7	2.0	.7	5.0	1.5	2.4	<.5	.8	<.5
5	7.5	2.3	9.2	.8	1.7	.6	4.8	1.3	2.8	<.5	<.5	<.5
6	12	2.4	5.6	.7	---	---	5.0	1.2	2.4	<.5	<.5	<.5
7	11	3.1	2.2	.9	4.0	.8	5.0	1.6	2.5	<.5	1.0	<.5
8	11	1.3	5.3	1.0	4.0	.6	4.8	1.7	2.0	<.5	1.0	<.5
9	7.7	1.5	5.5	1.0	5.0	1.9	5.0	1.5	1.1	<.5	.7	<.5
10	6.4	.6	4.4	1.5	5.0	1.4	---	---	3.9	<.5	1.1	<.5
11	2.8	.7	2.4	1.4	4.9	1.5	4.9	1.2	3.6	<.5	2.6	<.5
12	2.4	.9	2.5	1.1	4.9	1.8	5.0	1.1	1.4	<.5	1.5	<.5
13	2.3	.6	3.6	1.1	4.7	1.8	4.2	<.5	2.9	<.5	1.4	<.5
14	2.2	<.5	1.9	.7	5.0	2.3	3.7	1.0	2.3	<.5	.6	<.5
15	2.2	<.5	1.7	<.5	---	---	5.0	1.5	4.9	<.5	.6	<.5
16	1.6	<.5	1.5	.7	---	---	---	---	1.5	<.5	1.9	<.5
17	3.1	<.5	3.0	.7	---	---	---	---	1.5	<.5	<.5	<.5
18	3.4	<.5	2.2	<.5	---	---	---	---	1.4	<.5	1.2	<.5
19	17	.7	3.2	<.5	---	---	---	---	.8	<.5	5.0	<.5
20	9.7	2.2	3.0	.8	---	---	---	---	.7	<.5	4.6	<.5
21	8.3	1.5	3.5	.6	---	---	---	---	1.2	<.5	---	---
22	2.5	1.2	1.9	<.5	---	---	---	---	1.4	<.5	---	---
23	3.9	.8	1.9	<.5	5.0	2.2	4.9	.9	<.5	<.5	---	---
24	1.9	.6	2.0	<.5	4.5	1.7	3.9	.9	1.8	<.5	---	---
25	2.8	.6	2.4	<.5	4.9	1.2	4.2	.9	<.5	<.5	1.8	<.5
26	7.9	.9	4.1	<.5	5.0	<.5	3.6	.9	1.2	<.5	2.2	<.5
27	7.8	.9	1.3	<.5	4.1	1.1	3.6	.9	.7	<.5	2.2	<.5
28	7.6	<.5	1.2	<.5	4.8	1.0	4.7	1.3	<.5	<.5	2.2	<.5
29	12	.9	2.6	<.5	4.2	.8	---	---	.6	<.5	.7	<.5
30	12	<.5	2.9	.7	5.0	1.3	---	---	4.6	<.5	3.0	<.5
31	---	---	4.0	1.0	---	---	---	---	2.5	<.5	---	---
MONTH	---	---	---	---	---	---	---	---	---	---	---	---

&lt; Actual value is known to be less than the value shown.

## 11390500 SACRAMENTO RIVER BELOW WILKINS SLOUGH, NEAR GRIMES, CA

LOCATION.—Lat 39°00'36", long 121°49'25", in NW 1/4 NE 1/4 sec.2, T.13 N., R.1 E., Colusa County, Hydrologic Unit 18020104, on right bank, 1,200 ft downstream from Wilkins Slough, 5.8 mi southeast of Grimes, and at mile 62.9 upstream from Sacramento.

DRAINAGE AREA.—12,926 mi<sup>2</sup>.

## WATER-DISCHARGE RECORDS

PERIOD OF RECORD.—August 1931 to current year (prior to October 1938, low-water periods only). Monthly discharge only for some periods, published in WSP 1315-A. Prior to October 1965, published as "below Wilkins Slough."

GAGE.—Water-stage recorder and crest-stage gage. Datum of gage is 3.00 ft below sea level.

REMARKS.—Records good. Natural flow of stream affected by storage reservoirs, power development, bypassing for flood control, diversions for irrigation, and return flow from irrigated areas. When discharge exceeds about 23,000 ft<sup>3</sup>/s, flow begins over Tisdale Weir, 1.0 mi upstream on left bank, into Sutter Bypass. Records tabulated below do not include flow over Tisdale Weir. See schematic diagram of lower Sacramento River Basin.

EXTREMES FOR PERIOD OF RECORD.—Maximum discharge (water years 1939–2001), 32,700 ft<sup>3</sup>/s, Feb. 20, 1986, gage height, 52.50 ft, maximum gage height, 52.75 ft, Mar. 1, 1940; minimum daily, 645 ft<sup>3</sup>/s, Aug. 9, 1939.

## DISCHARGE, CUBIC FEET PER SECOND, WATER YEAR OCTOBER 2000 TO SEPTEMBER 2001

## DAILY MEAN VALUES

DAY	OCT	NOV	DEC	JAN	FEB	MAR	APR	MAY	JUN	JUL	AUG	SEP
1	6230	6680	6730	6140	8840	15300	8790	5400	6810	9820	9020	6790
2	6200	6440	6990	6120	8310	13200	8570	5250	6860	9720	8900	6940
3	6150	6100	6810	6100	7950	12300	8180	5630	6730	9530	8530	7080
4	6110	5770	6580	6140	7640	13000	7960	5490	6680	9220	8120	7330
5	5930	5600	6440	6090	7400	17800	8260	4940	6530	9140	7800	7370
6	5770	5500	6420	6000	7170	27400	8470	4730	6530	9250	7800	7290
7	5540	5360	6330	5900	7100	27000	8550	4770	6980	9420	7830	7390
8	5370	5220	6230	5910	6980	24700	8890	4950	7650	9830	7760	7550
9	5330	5300	6150	6350	6860	22100	9300	5000	7890	9920	7710	7340
10	5280	5490	6060	7150	6930	19100	8950	4880	8040	9970	7670	7280
11	5720	5420	6130	7860	8730	16600	8430	5040	8460	9670	7690	7460
12	6110	5410	6190	13600	12700	15800	8140	5360	8700	9660	7630	7340
13	6220	5470	6220	13600	13900	15000	7930	5510	8700	9830	7420	7150
14	6130	5560	6420	11000	13000	14100	7710	5530	8570	9800	7300	7200
15	6030	5650	6870	9460	10900	13300	7460	5510	8500	e9780	7360	7390
16	5990	5800	8060	8770	9410	12700	7130	5730	8770	e9830	7420	7510
17	6110	5730	7810	8230	8660	12000	6690	6350	8720	9830	7060	7890
18	6060	5660	6970	7850	8290	11600	6310	6630	8880	9800	6860	7790
19	5880	5830	6550	7570	9220	11300	5840	6880	8910	9880	6860	7580
20	5630	5900	6360	7360	11300	11100	5810	7090	8760	9880	6530	7630
21	5560	5890	6260	7180	16300	10900	6340	6990	8590	9830	6480	7810
22	5320	5950	6230	7080	19900	10900	6960	6810	8510	9800	6500	7780
23	4990	5960	6300	7090	20800	10700	7110	6620	8840	9830	6110	7740
24	4780	5960	6300	7270	22100	10500	6860	6390	8790	9860	6040	7790
25	4710	5970	6240	9880	19200	10300	6440	6210	8360	9890	6060	7890
26	4780	6020	6160	15700	24600	10500	6420	5850	8480	9930	6290	8010
27	5090	5990	6210	20700	24100	10900	6420	5890	8790	10100	6680	8080
28	5500	6000	6160	17600	19200	10300	6250	6450	9270	10200	6920	7930
29	5680	6130	6200	13200	---	9760	6050	6840	9830	10100	7090	7580
30	6580	6280	6190	10900	---	9450	5640	6860	10000	10000	6660	7320
31	6870	---	6130	9690	---	9110	---	6840	---	9330	6510	---
TOTAL	177650	174040	200700	283490	347490	438720	221860	182420	247130	302650	224610	225230
MEAN	5731	5801	6474	9145	12410	14150	7395	5885	8238	9763	7245	7508
MAX	6870	6680	8060	20700	24600	27400	9300	7090	10000	10200	9020	8080
MIN	4710	5220	6060	5900	6860	9110	5640	4730	6530	9140	6040	6790
AC-FT	352400	345200	398100	562300	689200	870200	440100	361800	490200	600300	445500	446700

## STATISTICS OF MONTHLY MEAN DATA FOR WATER YEARS 1946 - 2001, BY WATER YEAR (WY)

MEAN	6525	8468	12280	14940	16940	15570	11480	9391	7901	7478	7308	7242
MAX	11800	20510	27430	27310	29090	29490	24920	23110	20670	12500	10940	10620
(WY)	1958	1974	1984	1997	1998	1983	1982	1983	1998	1998	1998	1967
MIN	3330	3839	4103	5281	5012	5152	4201	3397	3451	3784	4086	4065
(WY)	1978	1993	1977	1991	1991	1977	1994	1992	1992	1992	1947	1977

## SUMMARY STATISTICS

	FOR 2000 CALENDAR YEAR		FOR 2001 WATER YEAR		WATER YEARS 1946 - 2001	
ANNUAL TOTAL	4082330		3025990			
ANNUAL MEAN	11150		8290		10430	
HIGHEST ANNUAL MEAN					17980	
LOWEST ANNUAL MEAN					5109	
HIGHEST DAILY MEAN	29200	Feb 16	27400	Mar 6	32600	Feb 20 1986
LOWEST DAILY MEAN	4710	Oct 25	4710	Oct 25	2720	May 7 1992
ANNUAL SEVEN-DAY MINIMUM	5020	Oct 22	4900	May 5	2880	Oct 12 1977
MAXIMUM PEAK FLOW			28000	Mar 6	32700	Feb 20 1986
MAXIMUM PEAK STAGE			48.76	Mar 6	52.68	Jan 4 1997
ANNUAL RUNOFF (AC-FT)	8097000		6002000		7556000	
10 PERCENT EXCEEDS	24600		11300		22100	
50 PERCENT EXCEEDS	8410		7280		8010	
90 PERCENT EXCEEDS	5940		5620		5050	

e Estimated.

## 11390500 SACRAMENTO RIVER BELOW WILKINS SLOUGH, NEAR GRIMES, CA—Continued

## WATER-QUALITY RECORDS

PERIOD OF RECORD.—October 1966 to current year.

WATER TEMPERATURE: October 1966 to current year.

PERIOD OF DAILY RECORD.—

WATER TEMPERATURE: October 1966 to current year.

INSTRUMENTATION.—Water-temperature recorder since October 1966.

REMARKS.—Water-temperature records rated excellent except for Oct. 1 to Nov. 11, Jan. 21–28, June 11–24, which are rated good; and June 25 to Sept. 30, which are rated fair. Temperature recorder located at gaging station on right bank. Water temperature is affected by regulation from dams upstream.

EXTREMES FOR PERIOD OF DAILY RECORD.—

WATER TEMPERATURE: Maximum recorded, 25.5°C, Sept. 6–8, 1977, June 3–5, 1992; minimum recorded, 3.5°C, Dec. 23–25, 1990.

EXTREMES FOR CURRENT YEAR.—

WATER TEMPERATURE: Maximum recorded, 21.5°C, May 23–26, Aug. 8; minimum recorded, 6.0°C, Jan. 28.

## CROSS-SECTIONAL DATA, WATER YEAR OCTOBER 2000 TO SEPTEMBER 2001

DATE	TIME	DEPTH BOTTOM AT SAMPLE LOC- TION, (FEET) (81903)	TEMPER- ATURE WATER (DEG C) (00010)	SAMPLE LOC- TION, CROSS SECTION (FT FM L BANK) (00009)
AUG				
27...*	1256	16.0	20.5	252
27...*	1259	15.0	20.5	226
27...*	1301	15.0	20.5	200
27...*	1303	14.0	20.5	174
27...*	1304	13.5	20.5	148
27...*	1306	13.5	20.5	122
27...*	1308	12.5	20.5	96.0
27...*	1309	12.0	20.5	70.0
27...*	1311	10.5	20.5	44.0
27...*	1312	7.50	20.5	18.0

## TEMPERATURE, WATER (DEG. C), WATER YEAR OCTOBER 2000 TO SEPTEMBER 2001

DAY	MAX	MIN	MAX	MIN	MAX	MIN	MAX	MIN	MAX	MIN	MAX	MIN
	OCTOBER		NOVEMBER		DECEMBER		JANUARY		FEBRUARY		MARCH	
1	19.5	18.5	13.0	12.5	11.5	11.0	9.0	8.5	8.0	8.0	11.0	10.0
2	19.5	19.0	13.5	13.0	11.5	11.0	9.0	8.5	8.5	8.0	10.5	10.0
3	19.5	19.0	14.0	13.5	11.0	11.0	9.0	8.5	9.0	8.5	10.5	10.0
4	19.5	19.0	14.5	13.5	11.0	10.5	9.0	9.0	10.5	9.0	10.0	9.5
5	19.0	18.5	14.5	14.0	11.0	10.5	9.5	9.0	11.0	10.0	10.0	9.5
6	19.0	18.0	14.5	14.0	10.5	10.5	9.5	9.0	11.5	11.0	10.0	9.5
7	18.5	18.0	14.0	13.5	10.5	10.0	9.5	9.0	11.0	10.0	11.0	10.0
8	18.0	17.5	13.5	13.0	11.0	10.5	9.0	9.0	10.0	9.0	12.0	11.0
9	18.0	17.0	13.0	12.5	11.0	11.0	9.0	8.5	9.0	8.5	12.5	12.0
10	17.0	16.0	13.0	12.5	11.5	11.0	9.0	8.0	8.5	8.0	12.5	12.0
11	16.0	15.5	12.5	12.0	11.5	11.5	8.5	8.5	8.5	8.0	12.5	12.0
12	15.5	15.0	12.0	11.5	11.5	11.0	9.0	8.5	8.0	7.0	13.0	12.0
13	15.5	14.5	11.5	10.5	11.5	11.0	8.5	8.5	7.5	7.0	13.0	12.0
14	16.0	15.0	10.5	9.5	11.0	10.5	8.5	8.0	8.0	7.5	14.0	12.5
15	16.5	15.5	10.0	9.5	11.0	10.5	8.5	8.0	8.5	8.0	13.5	13.0
16	16.5	15.5	10.0	9.5	11.0	10.5	8.0	7.5	9.5	8.5	13.5	12.5
17	16.5	16.0	10.0	9.5	11.0	10.5	7.5	7.0	9.5	9.0	13.5	13.0
18	16.5	16.0	10.0	9.5	10.5	10.0	7.5	7.0	9.5	9.0	14.0	13.0
19	16.5	15.5	10.5	9.5	10.0	9.5	8.0	7.0	10.0	9.5	15.0	14.0
20	16.5	16.0	10.5	10.0	10.0	9.5	8.0	7.5	10.0	9.5	16.0	15.0
21	16.0	15.0	10.5	9.5	10.0	9.5	8.0	7.5	10.0	9.5	16.5	16.0
22	15.0	13.5	10.5	9.5	10.0	9.5	8.5	8.0	10.0	10.0	16.7	16.5
23	13.5	12.5	10.5	10.0	10.0	10.0	9.0	8.5	10.5	10.0	17.0	16.5
24	14.0	13.0	10.5	10.0	10.0	10.0	9.5	8.5	10.0	9.0	17.0	16.5
25	14.0	13.5	10.5	10.5	10.0	9.5	9.0	9.0	9.5	9.0	16.5	16.0
26	14.0	13.5	10.5	10.5	9.5	9.0	9.0	7.5	9.5	9.0	16.0	16.0
27	14.0	13.0	11.0	10.5	9.0	9.0	7.5	6.5	10.0	9.0	16.0	15.5
28	14.0	13.5	11.0	10.5	9.0	8.5	7.0	6.0	10.5	10.0	16.0	15.0
29	13.5	13.0	11.5	11.0	9.0	8.5	8.0	6.5	---	---	16.5	15.5
30	13.5	12.5	11.5	11.0	9.0	8.5	8.0	7.5	---	---	17.0	16.0
31	13.0	12.5	---	---	9.0	8.5	8.0	8.0	---	---	17.0	16.5
MONTH	19.5	12.5	14.5	9.5	11.5	8.5	9.5	6.0	11.5	7.0	17.0	9.5

\* Instantaneous discharge at time of cross-section measurement: 6,710 ft<sup>3</sup>/s.

## SACRAMENTO RIVER BASIN

11390500 SACRAMENTO RIVER BELOW WILKINS SLOUGH, NEAR GRIMES, CA—Continued

TEMPERATURE, WATER (DEG. C), WATER YEAR OCTOBER 2000 TO SEPTEMBER 2001

DAY	MAX	MIN	MAX	MIN	MAX	MIN	MAX	MIN	MAX	MIN	MAX	MIN
	APRIL		MAY		JUNE		JULY		AUGUST		SEPTEMBER	
1	17.7	16.9	19.0	18.5	21.0	20.0	20.5	18.5	20.5	19.0	21.0	20.5
2	17.4	16.9	18.5	17.0	21.0	20.5	21.0	19.5	20.5	19.0	21.0	20.5
3	17.0	16.0	17.0	16.0	20.5	20.0	21.0	20.0	20.5	19.0	21.0	20.5
4	16.0	15.5	17.0	16.0	20.0	19.0	20.0	18.5	20.5	19.0	20.5	20.0
5	15.5	14.5	18.0	17.0	19.5	18.5	19.5	18.5	21.0	19.5	20.5	19.5
6	15.0	13.5	18.5	18.0	19.5	18.5	19.5	18.0	21.0	19.5	20.0	19.5
7	13.5	12.5	19.0	18.5	20.0	19.0	20.0	19.0	21.0	19.5	19.5	19.0
8	13.0	12.5	20.0	19.0	20.5	19.5	20.0	19.0	21.5	20.0	19.0	18.0
9	13.0	12.5	20.5	19.5	20.5	18.0	20.0	18.6	21.0	20.0	19.0	18.5
10	13.0	12.0	20.5	18.0	20.0	19.0	20.0	19.0	21.0	19.5	19.0	18.5
11	14.0	13.0	20.5	20.0	20.0	19.0	20.0	19.0	20.5	19.5	19.0	18.5
12	14.5	14.0	20.5	20.0	19.5	18.5	20.0	19.0	20.5	19.0	18.5	18.0
13	15.0	14.5	20.0	19.5	19.0	18.0	20.5	19.0	20.0	19.0	18.0	17.5
14	15.0	14.5	19.5	19.0	19.0	17.5	20.5	19.0	20.0	19.0	19.0	18.0
15	15.5	14.5	19.0	19.0	19.5	18.0	20.0	18.5	20.0	19.0	19.5	17.5
16	16.5	15.0	19.0	18.5	20.0	18.5	20.0	18.5	20.0	19.0	19.5	19.0
17	17.0	15.5	19.0	18.5	20.0	19.0	19.5	18.0	20.0	19.0	19.5	19.0
18	17.0	16.0	19.0	18.5	20.5	19.0	20.0	18.5	20.0	19.0	19.5	17.5
19	17.0	16.0	19.5	18.5	20.0	18.0	20.0	18.5	20.0	19.5	20.0	17.5
20	16.0	15.0	20.0	19.5	20.5	18.0	20.0	18.5	20.0	19.0	20.0	19.5
21	15.0	14.0	21.0	20.0	20.5	20.5	19.5	18.5	19.5	19.0	20.0	19.5
22	15.3	14.1	21.0	20.5	21.0	19.5	20.0	18.5	19.5	19.0	19.5	19.0
23	16.5	15.0	21.5	21.0	21.0	20.0	20.0	18.5	19.5	19.0	19.5	19.0
24	17.5	16.0	21.5	21.0	20.5	19.0	20.5	18.5	20.0	19.5	19.0	18.5
25	19.5	17.5	21.5	21.5	19.0	18.0	21.0	19.0	20.5	20.0	18.5	18.0
26	20.0	18.5	21.5	21.0	18.0	17.0	21.0	19.5	21.0	20.5	18.0	18.0
27	19.5	19.0	21.0	20.5	17.5	16.5	20.5	19.0	21.0	20.5	18.5	18.0
28	19.5	19.0	20.5	20.0	17.0	16.0	20.0	18.5	21.0	20.5	18.5	18.0
29	19.0	18.5	20.0	19.5	17.5	16.5	20.0	18.5	21.0	20.5	18.5	18.0
30	19.0	18.5	20.0	19.5	18.5	17.5	20.0	18.5	21.0	20.0	18.5	18.0
31	---	---	20.5	20.0	---	---	20.0	18.5	20.5	20.0	---	---
MONTH	20.0	12.0	21.5	16.0	21.0	16.0	21.0	18.0	21.5	19.0	21.0	17.5

11391100 SACRAMENTO SLOUGH NEAR KNIGHTS LANDING, CA

LOCATION.—Lat 38°47'06", long 121°39'12", in SE 1/4 NE 1/4, sec.20, T.11 S, R.3 E, Sutter County, Hydrologic Unit 18020104, on right bank, 200 ft upstream of Karnak Pumping Plant, and 3.6 mi east of Knights Landing.

DRAINAGE AREA.—Not determined.

PERIOD OF RECORD.—Water years 1996 to 1998, January 2001 to September 2001.

CHEMICAL DATA: February 1996 to September 1998, January 2001 to September 2001.

SPECIFIC CONDUCTANCE: October 1995 to September 1996.

WATER TEMPERATURE: October 1995 to September 1996.

SEDIMENT DATA: February 1996 to September 1998, January 2001 to September 2001.

PERIOD OF DAILY RECORD.—

SPECIFIC CONDUCTANCE: October 1995 to September 1996.

WATER TEMPERATURE: October 1995 to September 1996.

WATER-QUALITY DATA, WATER YEAR OCTOBER 2000 TO SEPTEMBER 2001

DATE	TIME	DIS-CHARGE, INST CUBIC FEET PER SECOND (00061)	BARO-METRIC PRES-SURE (MM OF HG) (00025)	OXYGEN, (PER-CENT SATUR-ATION) (MG/L) (00300)	PH (STAND-ARD UNITS) (00400)	SPE-CIFIC CON-DUCT-ANCE (US/CM) (00095)	TEMPER-ATURE WATER (DEG C) (00010)	HARD-NESS NONCARB DISSOLV FLD AS CACO3 (MG/L) (00904)	HARD-NESS TOTAL (MG/L CACO3) (00900)	CALCIUM DIS-SOLVED (MG/L AS CA) (00915)	MAGNE-SIUM, DIS-SOLVED (MG/L AS MG) (00925)	POTAS-SIUM, DIS-SOLVED (MG/L AS K) (00935)	
JAN													
18...	1040	15	769	6.5	57.7	8.0	265	10.5	--	106	19.8	13.8	3.29
FEB													
27...	1100	25	760	8.7	79.1	7.8	233	11.0	--	90.7	17.2	11.6	2.36
MAR													
20...	1030	16	760	7.8	83.7	7.8	764	18.5	9.1	232	41.2	31.4	1.68
APR													
12...	1100	13	764	7.8	77.2	8.2	422	15.0	4.3	157	29.1	20.5	1.35
MAY													
17...	1000	12	758	6.3	73.3	7.8	465	22.5	12	158	30.1	20.1	1.52
JUN													
11...	1030	13	760	6.3	74.5	7.9	485	23.5	8.7	170	31.4	22.2	1.44
JUL													
30...	1130	15	761	6.3	77.2	8.0	348	25.5	--	139	25.5	18.4	1.48
AUG													
28...	0930	14	755	6.2	73.1	7.6	417	23.0	--	157	29.3	20.2	1.50
SEP													
17...	1000	14	759	7.3	84.0	7.9	358	22.0	--	134	24.7	17.5	1.78
DATE	RATIO	SODIUM AD-SORP-TION (MG/L AS NA) (00931)	SODIUM, DIS-SOLVED (MG/L AS NA) (00930)	ALKA-LINITY WAT.DIS GRAN T. CACO3 (MG/L) (29802)	CHLO-RIDE, DIS-SOLVED (MG/L AS CL) (00940)	FLUO-RIDE, DIS-SOLVED (MG/L AS F) (00950)	SILICA, DIS-SOLVED (MG/L AS SIO2) (00955)	SULFATE DIS-SOLVED (MG/L AS SO4) (00945)	SOLIDS, DIS-SOLVED (TONS PER AC-FT) (70303)	SOLIDS, RESIDUE AT 180 DEG. C DIS-SOLVED (MG/L) (70300)	SOLIDS, SUM OF CONSTI-TUENTS, DIS-SOLVED (MG/L) (70301)	NITRO-GEN, AM-MONIA + ORGANIC DIS. (MG/L AS N) (00608)	NITRO-GEN, AM-MONIA + ORGANIC DIS. (MG/L AS N) (00623)
JAN													
18...	.585	13.9	21.4	120	6.8	<.2	23.3	8.2	.2	168	161	e.023	.32
FEB													
27...	.538	11.8	21.5	100	7.1	<.2	20.9	8.4	.2	145	141	e.022	.41
MAR													
20...	1.70	59.5	35.6	220	91.8	e.1	25.4	25.6	.6	440	413	<.041	.26
APR													
12...	.970	28.0	27.7	150	30.6	<.2	23.1	10.9	.3	257	236	<.041	.16
MAY													
17...	1.16	33.5	31.3	150	43.5	.2	24.1	13.6	.3	257	256	<.040	.27
JUN													
11...	1.21	36.3	31.6	160	45.9	.2	27.9	14.4	.4	288	278	.202	.46
JUL													
30...	.670	18.2	21.9	160	9.3	e.1	24.3	9.0	.3	208	204	<.040	.25
AUG													
28...	.983	28.3	28.0	--	26.9	e.1	27.3	9.3	--	253	--	<.040	.22
SEP													
17...	.848	22.5	26.5	150	19.0	e.1	25.6	6.8	.3	201	206	<.040	.28

< Actual value is known to be less than value shown.  
e Estimated.



## 11391100 SACRAMENTO SLOUGH NEAR KNIGHTS LANDING, CA—Continued

## WATER-QUALITY DATA, WATER YEAR OCTOBER 2000 TO SEPTEMBER 2001

DATE	NITRO- GEN, AM- MONIA + ORGANIC TOTAL (MG/L AS N) (00625)	NITRO- GEN, NO2+NO3 DIS- SOLVED (MG/L AS N) (00631)	NITRO- GEN, NITRITE DIS- SOLVED (MG/L AS N) (00613)	PHOS- PHORUS ORTHO, DIS- SOLVED (MG/L AS P) (00666)	PHOS- PHORUS ORTHOPHOS- SOLVED (MG/L AS P) (00671)	PHOS- PHORUS TOTAL (MG/L AS P) (00665)	IRON, DIS- SOLVED (UG/L AS FE) (01046)	MANGA- NESE, DIS- SOLVED (UG/L AS MN) (01056)	2,6-DI- ETHYL ANILINE WAT FLT 0.7 U GF, REC (UG/L) (82660)	ACETO- CHLOR, WATER FLTRD REC (UG/L) (49260)	ALA- CHLOR, WATER, DISS, REC, (UG/L) (46342)	ALPHA BHC DIS- SOLVED (UG/L) (34253)	ATRA- ZINE, WATER, DISS, REC (UG/L) (39632)
JAN													
18...	.55	.158	e.005	.097	.074	.163	30	14.1	<.002	<.004	<.002	<.005	<.007
FEB													
27...	.45	.236	.006	.087	.077	.177	30	9.1	<.002	<.004	<.002	<.005	<.007
MAR													
20...	.53	.576	.011	.142	.125	.216	10	108	<.002	<.004	<.002	<.005	<.007
APR													
12...	.45	.075	e.005	.096	.086	.161	M	26.2	<.002	<.004	<.002	<.005	<.007
MAY													
17...	.49	.231	.012	.150	.126	.204	<10	46.3	<.002	<.004	<.002	<.005	<.007
JUN													
11...	.80	.331	.025	.157	.140	.215	<10	25.6	<.002	<.004	<.002	<.005	<.007
JUL													
30...	.45	<.050	<.006	.107	.094	.153	<10	e2.8	<.002	<.004	<.002	<.005	<.007
AUG													
28...	.19	<.050	<.006	.116	e.079	.171	M	13.1	<.002	<.004	<.002	<.005	<.007
SEP													
17...	.43	<.050	e.003	.114	.076	.185	M	5.3	<.002	<.004	<.002	<.005	<.007
DATE	BEN- FLUR- ALIN WAT FLT 0.7 U GF, REC (UG/L) (82673)	BUTYL- ATE, WATER, DISS, REC (UG/L) (04028)	CAR- BARYL WATER FLTRD 0.7 U GF, REC (UG/L) (82680)	CARBO- FURAN WATER FLTRD 0.7 U GF, REC (UG/L) (82674)	CHLOR- PYRIFOS DIS- SOLVED (UG/L) (38933)	CYANA- ZINE, WATER, DISS, REC (UG/L) (04041)	DCPA WATER FLTRD 0.7 U GF, REC (UG/L) (82682)	DEETHYL ATRA- ZINE, WATER, DISS, REC (UG/L) (04040)	DI- AZINON, DIS- SOLVED (UG/L) (39572)	DI- ELDRIN DIS- SOLVED (UG/L) (39381)	DISUL- FOTON WATER FLTRD 0.7 U GF, REC (UG/L) (82677)	EPTC WATER FLTRD 0.7 U GF, REC (UG/L) (82668)	ETHAL- FLUR- ALIN WAT FLT 0.7 U GF, REC (UG/L) (82663)
JAN													
18...	<.010	<.002	e.017	e.034	e.002	<.018	<.003	<.006	.033	<.005	<.021	<.002	<.009
FEB													
27...	<.010	<.002	<.041	<.020	<.005	<.018	e.002	<.006	.106	<.005	<.021	<.002	<.009
MAR													
20...	<.010	<.002	<.041	<.020	<.005	<.018	<.003	<.006	.010	<.005	<.021	<.002	<.009
APR													
12...	<.010	<.002	<.041	<.020	<.005	<.018	<.003	<.006	<.005	<.005	<.021	.004	<.009
MAY													
17...	<.010	<.002	<.041	<.020	<.005	<.018	<.003	<.006	e.002	<.005	<.021	e.002	<.009
JUN													
11...	<.010	<.002	e.003	<.020	<.005	<.018	e.001	<.006	<.005	<.005	<.021	<.002	<.009
JUL													
30...	<.010	<.002	e.086	e.007	<.005	<.018	<.003	<.006	<.005	<.005	<.021	<.002	<.009
AUG													
28...	<.010	<.002	e.045	<.020	<.005	<.018	<.003	<.006	<.005	<.005	<.021	<.002	<.009
SEP													
17...	<.010	<.002	e.005	<.020	<.005	<.018	<.003	<.006	<.005	<.005	<.021	<.002	<.009

e Estimated.

&lt; Actual value is known to be less than value shown.

M Presence of material verified, but not quantified.

## 11391100 SACRAMENTO SLOUGH NEAR KNIGHTS LANDING, CA—Continued

## WATER-QUALITY DATA, WATER YEAR OCTOBER 2000 TO SEPTEMBER 2001

DATE	ETHO- PROP WATER	FONOFOS WATER	LINDANE DIS-	LIN- URON WATER	MALA- THION, DIS-	METHYL AZIN- PHOS WAT FLT	METHYL PARA- THION WAT FLT	METO- LACHLOR WATER	METRI- BUZIN WATER	MOL- INATE WATER	NAPROP- AMIDE WATER	P,P' DDE	PARA- THION, DIS-	
	FLTRD 0.7 U GF, REC (82672)	FLTRD DISS REC (04095)	SOLVED DIS- (39341)	FLTRD 0.7 U GF, REC (82666)	SOLVED DIS- (39532)	GF, REC 0.7 U (82686)	GF, REC 0.7 U (82667)	DISSOLV WATER (39415)	DISSOLV WATER (82630)	GF, REC (82671)	GF, REC (82684)	DISSOLV (34653)	SOLVED (39542)	
JAN	18...	<.005	<.003	<.004	<.035	<.027	<.050	<.006	.025	<.006	.090	<.007	<.003	<.007
FEB	27...	<.005	<.003	<.004	<.035	<.027	<.050	<.006	.017	<.006	.034	<.007	<.003	<.007
MAR	20...	<.005	<.003	<.004	<.035	<.027	<.050	<.006	e.007	<.006	.081	<.007	<.003	<.007
APR	12...	<.005	<.003	<.004	<.035	<.027	<.050	<.006	e.005	<.006	.037	<.007	<.003	<.007
MAY	17...	<.005	<.003	<.004	<.035	<.027	<.050	<.006	.386	e.004	5.66	<.007	<.003	<.007
JUN	11...	<.005	<.003	<.004	<.035	<.027	<.050	<.006	.068	<.006	6.88	<.007	<.003	<.007
JUL	30...	<.005	<.003	<.004	<.035	e.008	<.050	<.006	e.003	<.006	.417	<.007	<.003	<.007
AUG	28...	<.005	<.003	<.004	<.035	e.005	<.050	<.006	e.005	<.006	.289	<.007	<.003	<.007
SEP	17...	<.005	<.003	<.004	<.035	.088	<.050	<.006	e.006	<.006	.162	<.007	<.003	<.007
	PEB- ULATE WATER	PENDI- METH- ALIN WAT FLT	PER- METHRIN CIS WAT FLT	PHORATE WATER	PRO- METON, DISS, REC	PRON- AMIDE WATER FLTRD	PROPA- CHLOR, WATER, FLTRD	PRO- PANIL WATER FLTRD	PRO- PARGITE WATER FLTRD	SI- MAZINE, WATER, DISS, REC	TEBU- THIURON WATER FLTRD	TER- BACIL WATER FLTRD	TER- BUFOS WATER FLTRD	
DATE	GF, REC (82669)	GF, REC (82683)	GF, REC (82687)	GF, REC (82664)	REC (04037)	GF, REC (82676)	REC (04024)	GF, REC (82679)	GF, REC (82685)	REC (04035)	GF, REC (82670)	GF, REC (82665)	GF, REC (82675)	
JAN	18...	<.002	<.010	<.006	<.011	<.015	e.003	<.010	<.011	<.023	.036	e.014	<.034	<.017
FEB	27...	<.002	<.010	<.006	<.011	<.015	<.004	<.010	<.011	<.023	.058	<.016	<.034	<.017
MAR	20...	<.002	<.010	<.006	<.011	<.015	<.004	<.010	<.011	<.023	.017	<.016	<.034	<.017
APR	12...	<.002	<.010	<.006	<.011	<.015	<.004	<.010	<.011	<.023	<.011	<.016	<.034	<.017
MAY	17...	.003	<.010	<.006	<.011	<.015	<.004	<.010	<.011	<.023	<.011	<.016	<.034	<.017
JUN	11...	<.002	<.010	<.006	<.011	<.015	<.004	<.010	.318	<.023	<.011	<.016	<.034	<.017
JUL	30...	<.002	<.010	<.006	<.011	<.015	<.004	<.010	<.011	<.023	<.011	<.016	<.034	<.017
AUG	28...	<.002	<.010	<.006	<.011	<.015	<.004	<.010	<.011	<.023	<.011	<.016	<.034	<.017
SEP	17...	<.002	<.010	<.006	<.011	<.015	<.004	<.010	<.011	<.023	<.011	<.016	<.034	<.017

&lt; Actual value is known to be less than value shown.

e Estimated.

## SACRAMENTO RIVER BASIN

11391100 SACRAMENTO SLOUGH NEAR KNIGHTS LANDING, CA—Continued

WATER-QUALITY DATA, WATER YEAR OCTOBER 2000 TO SEPTEMBER 2001

DATE	THIO- BENCARB WATER FLTRD 0.7 U GF, REC (UG/L) (82681)	TRIAL- LATE WATER FLTRD 0.7 U GF, REC (UG/L) (82678)	TRI- FLUR- ALIN WAT FLT 0.7 U GF, REC (UG/L) (82661)
JAN			
18...	.030	<.002	e.004
FEB			
27...	.009	<.002	e.004
MAR			
20...	.010	<.002	e.003
APR			
12...	.007	<.002	<.009
MAY			
17...	.194	<.002	e.005
JUN			
11...	.172	<.002	<.009
JUL			
30...	.027	<.002	<.009
AUG			
28...	.023	<.002	<.009
SEP			
17...	.019	<.002	<.009

PARTICLE-SIZE DISTRIBUTION OF SUSPENDED SEDIMENT, WATER YEAR OCTOBER 2000 TO SEPTEMBER 2001

DATE	TIME	DIS- CHARGE, INST. CUBIC FEET PER SECOND (00061)	TEMPER- ATURE WATER (DEG C) (00010)	SEDI- MENT, DIS- CHARGE, SUS- PENDED (MG/L) (80154)	SEDI- MENT, DIS- CHARGE, SUS- PENDED (T/DAY) (80155)	SED. SUSP. SIEVE DIAM. % FINER THAN .062 MM (70331)
JAN						
18..N	1040	15	10.5	38	1.5	92
FEB						
27..N	1100	25	11.0	41	2.8	92
MAR						
20..N	1030	16	18.5	60	2.6	93
APR						
12..N	1100	13	15.0	49	1.7	95
MAY						
17..N	1000	12	22.5	63	2.0	94
JUN						
11..N	1030	13	23.5	80	2.8	99
JUL						
30..N	1130	15	25.5	30	1.2	94
AUG						
28..N	0930	14	23.0	49	1.9	84
SEP						
17..N	1000	14	22.0	54	2.0	95

&lt; Actual value is known to be less than value shown.

e Estimated.

N Suspended-sediment data determined from a sample collected and processed according to National Water-Quality Assessment (NAWQA) protocol.

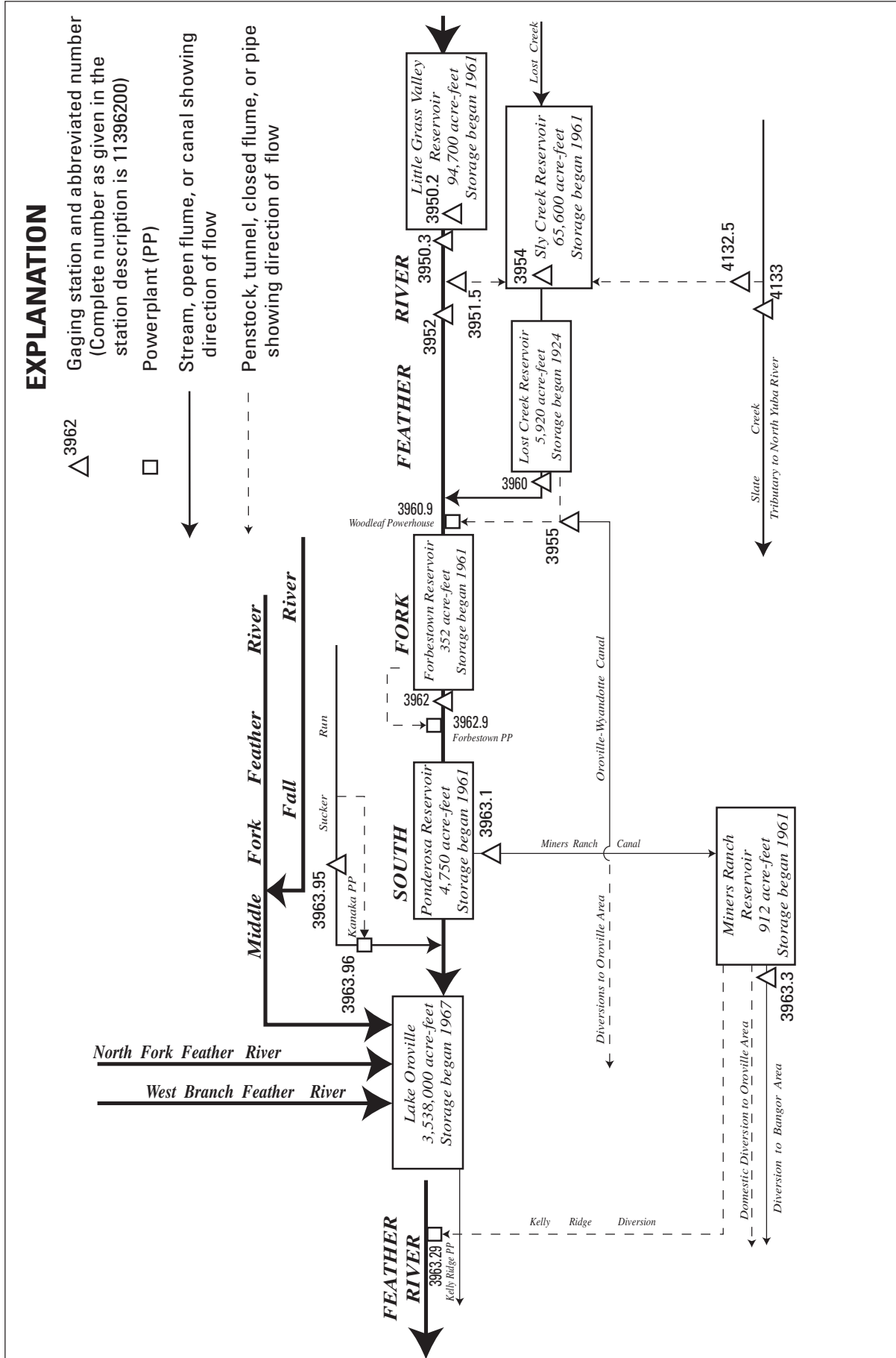

Figure 28. Diversions and storage in South Fork Feather River Basin.

## 11395020 LITTLE GRASS VALLEY RESERVOIR NEAR LA PORTE, CA

LOCATION.—Lat 39°43'25", long 121°01'10", in SE 1/4 NW 1/4 sec.31, T.22 N., R.9 E., [Plumas County](#), Hydrologic Unit 18020123, Plumas National Forest, on right bank, 300 ft upstream from dam on South Fork Feather River, and 3.3 mi northwest of La Porte.

DRAINAGE AREA.—25.8 mi<sup>2</sup>.

PERIOD OF RECORD.—October 1961 to current year. Monthend elevation and contents only, October 1961 to October 1962.

GAGE.—Water-stage recorder. Datum of gage is sea level (levels by Oroville–Wyandotte Irrigation District). Prior to Nov. 1, 1962, in valve chamber in dam at same datum.

REMARKS.—Reservoir is formed by rockfill dam. Storage began in October 1961. Total capacity, 94,700 acre-ft, between elevations 4,876 ft, invert of release valve, and 5,047 ft, top of spillway gates, all of which is available for release. Water is released down South Fork Feather River for power development and irrigation. Records represent total contents at 2400 hours. See schematic diagram of [South Fork Feather River Basin](#).

COOPERATION.—Records provided by Oroville–Wyandotte Irrigation District, under general supervision of the U.S. Geological Survey, in connection with a Federal Energy Regulatory Commission project.

EXTREMES FOR PERIOD OF RECORD.—Maximum contents, 98,000 acre-ft, May 1, 1995, and May 17, 1996, elevation, 5,049.0 ft; minimum since reservoir first filled, 30,300 acre-ft, many days during 1977, elevation, 4,994.8 ft.

EXTREMES FOR CURRENT YEAR.—Maximum contents, 66,400 acre-ft, May 30, 31, elevation, 5,028.1 ft; minimum, 40,300 acre-ft, Feb. 5–8, elevation, 5,005.8 ft.

Capacity table (elevation, in feet, and contents, in acre-feet)  
(Based on survey by Pacific Gas & Electric Co. in 1963)

4,990	26,300	5,010	44,400	5,030	68,900	5,048	96,300
5,000	34,600	5,020	55,900	5,040	83,500	5,049	98,000

## RESERVOIR STORAGE (ACRE-FEET), WATER YEAR OCTOBER 2000 TO SEPTEMBER 2001

## DAILY OBSERVATION AT 2400 HOURS

DAY	OCT	NOV	DEC	JAN	FEB	MAR	APR	MAY	JUN	JUL	AUG	SEP
1	59100	50600	43100	40700	40400	41100	46600	56100	66300	65900	65000	64200
2	58900	50000	42700	40700	40400	41100	47000	56800	66300	65900	65000	64100
3	58600	49500	42400	40600	40400	41100	47400	57300	66300	65900	65000	64100
4	58400	48900	42000	40600	40400	41200	47600	58000	66300	65900	65000	64100
5	58100	48300	41700	40600	40300	41300	47900	58400	66300	65900	65000	64100
6	57800	48100	41300	40600	40300	41300	48100	59000	66300	65900	64900	63900
7	57700	48100	41000	40500	40300	41400	48400	59500	66300	65900	64900	63700
8	57400	48100	40800	40500	40300	41400	48700	60200	66200	65800	64900	63400
9	57300	48100	40800	40600	40400	41500	48800	60800	66200	65800	64900	63200
10	57200	48100	40800	40700	40500	41500	48900	61500	66200	65800	64900	63000
11	57200	48000	40800	40700	40700	41500	49100	62000	66200	65800	64900	62800
12	57200	48000	40800	40700	40700	41500	49200	62600	66000	65600	64700	62600
13	57100	48000	40900	40700	40700	41500	49400	63200	66000	65600	64700	62400
14	56800	48000	41000	40700	40700	41600	49500	63400	66000	65600	64700	62100
15	56400	48000	41000	40700	40600	41600	49600	63900	66000	65600	64600	61900
16	56100	47900	41000	40600	40600	41600	49700	64300	66000	65500	64600	61700
17	55700	47900	40900	40600	40600	41600	49900	64700	66000	65500	64600	61500
18	55300	47900	40900	40600	40600	41700	50300	65000	66000	65500	64600	61200
19	55100	47900	40900	40500	40700	41700	50600	65200	66000	65400	64500	61000
20	54600	47900	40900	40500	40800	41800	51000	65500	65900	65400	64500	60800
21	54300	47500	40900	40500	41000	42000	51200	65600	65900	65400	64500	60600
22	53900	47100	40900	40500	41100	42200	51400	65800	65900	65200	64500	60300
23	53600	46600	40900	40500	41100	42400	51800	65900	65900	65200	64300	60000
24	53200	46200	40900	40500	41100	42700	52100	66000	65900	65200	64300	59700
25	52900	45700	40900	40600	41100	43400	52600	66200	65900	65200	64300	59500
26	52600	45200	40800	40600	41100	43800	53100	66200	65900	65200	64300	59300
27	52200	44800	40800	40600	41100	44100	53700	66300	65900	65200	64300	59000
28	52100	44300	40800	40500	41100	44800	54400	66300	65900	65200	64300	58900
29	51900	43900	40800	40500	---	45200	55000	66300	65900	65100	64200	58600
30	51500	43500	40800	40500	---	45600	55500	66400	65900	65100	64200	58400
31	51200	---	40700	40500	---	46000	---	66400	---	65100	64200	---
MAX	59100	50600	43100	40700	41100	46000	55500	66400	66300	65900	65000	64200
MIN	51200	43500	40700	40500	40300	41100	46600	56100	65900	65100	64200	58400
a	5015.9	5009.0	5006.2	5006.0	5006.6	5011.4	5019.7	5028.1	5027.7	5027.1	5026.4	5021.9
b	-8100	-7700	-2800	-200	+600	+4900	+9500	+10900	-500	-800	-900	-5800

CAL YR 2000 b -3400

WTR YR 2001 b -900

a Elevation, in feet, at end of month.

b Change in contents, in acre-feet.

## 11395030 SOUTH FORK FEATHER RIVER BELOW LITTLE GRASS VALLEY DAM, CA

LOCATION.—Lat 39°43'26", long 121°01'16", in SW 1/4 NW 1/4 sec.31, T.22 N., R.9 E., Plumas County, Hydrologic Unit 18020123, Plumas National Forest, on left bank, 0.1 mi downstream from Little Grass Valley Dam, and 3.5 mi northwest of La Porte.

DRAINAGE AREA.—25.9 mi<sup>2</sup>.

PERIOD OF RECORD.—October 1927 to September 1933 (published as "near La Porte"), October 1960 to current year.

REVISED RECORDS.—WSP 1931: Drainage area.

GAGE.—Water-stage recorder. Datum of gage is 4,809.0 ft above sea level. Prior to Oct. 1, 1960, at site 0.4 mi upstream at different datum. Oct. 1, 1960, to Oct. 30, 1962, at present site and datum. Nov. 1, 1962, to May 31, 1966, at site on outlet works at base of Little Grass Valley Dam 0.1 mi upstream at datum 4,850.00 ft above sea level.

REMARKS.—Flow regulated by Little Grass Valley Reservoir (station 11395020) beginning in October 1961. No diversion upstream from station. See schematic diagram of [South Fork Feather River Basin](#).

COOPERATION.—Records provided by Oroville–Wyandotte Irrigation District, under general supervision of the U.S. Geological Survey, in connection with a Federal Energy Regulatory Commission project.

EXTREMES FOR PERIOD OF RECORD.—Maximum discharge, 7,370 ft<sup>3</sup>/s, Jan. 1, 1997, gage height, 14.80 ft; minimum daily, 0.2 ft<sup>3</sup>/s, Oct. 28–31, Nov. 2, 1961, during initial operation of Little Grass Valley Reservoir; since operation stabilized in 1964, 1.4 ft<sup>3</sup>/s, Jan. 27, 1964.

## DISCHARGE, CUBIC FEET PER SECOND, WATER YEAR OCTOBER 2000 TO SEPTEMBER 2001

## DAILY MEAN VALUES

DAY	OCT	NOV	DEC	JAN	FEB	MAR	APR	MAY	JUN	JUL	AUG	SEP
1	117	304	234	20	20	20	24	25	22	5.5	5.5	5.7
2	117	317	232	20	20	20	24	24	22	5.5	5.4	5.8
3	117	316	233	20	20	20	22	23	22	5.5	5.4	5.8
4	117	315	232	20	20	20	22	23	22	5.5	5.4	5.7
5	117	314	232	20	20	20	22	24	22	5.5	5.4	5.7
6	117	174	231	20	20	20	22	24	22	5.5	5.4	75
7	116	15	231	20	20	20	21	25	21	5.5	5.4	114
8	116	15	135	19	20	20	21	26	22	5.5	5.4	113
9	116	15	20	19	20	20	21	25	22	5.5	5.2	113
10	55	15	21	19	20	20	21	25	21	5.4	5.2	113
11	17	15	21	19	20	20	21	25	21	5.4	5.2	113
12	17	15	21	19	20	20	21	24	21	5.4	5.2	112
13	87	15	21	19	20	20	21	23	21	5.4	5.2	113
14	154	15	21	19	20	21	21	23	21	5.4	5.2	112
15	154	15	21	19	20	21	21	24	11	5.4	5.2	112
16	181	15	21	19	20	21	21	24	5.7	5.4	5.2	112
17	197	15	20	19	20	21	22	23	5.7	5.4	5.2	112
18	197	15	20	19	20	20	22	23	5.7	5.4	5.4	112
19	196	15	20	19	20	21	23	23	5.7	5.5	5.4	112
20	196	15	20	19	20	21	22	23	5.7	5.5	5.4	112
21	196	146	20	19	20	22	21	22	5.7	5.5	5.4	e113
22	195	236	21	19	20	22	21	22	5.7	5.5	5.3	e113
23	195	236	21	19	20	23	22	22	5.7	5.5	5.5	e113
24	194	236	20	19	20	23	23	22	5.7	5.5	5.7	e113
25	194	235	20	19	20	29	25	22	5.6	5.5	5.7	e114
26	194	235	20	19	20	24	25	22	5.6	5.5	5.7	e112
27	194	235	20	19	20	23	25	22	5.6	5.5	5.7	e112
28	194	234	20	19	20	24	25	22	5.6	5.5	5.7	e111
29	193	235	20	19	---	24	24	22	5.6	5.5	5.7	e111
30	193	234	20	20	---	24	24	22	5.5	5.5	5.7	e111
31	244	---	20	20	---	24	---	22	---	5.5	5.7	---
TOTAL	4687	4212	2229	598	560	668	670	721	397.8	169.6	168.1	2801.7
MEAN	151	140	71.9	19.3	20.0	21.5	22.3	23.3	13.3	5.47	5.42	93.4
MAX	244	317	234	20	20	29	25	26	22	5.5	5.7	114
MIN	17	15	20	19	20	20	21	22	5.5	5.4	5.2	5.7
AC-FT	9300	8350	4420	1190	1110	1320	1330	1430	789	336	333	5560

e Estimated.

## SACRAMENTO RIVER BASIN

## 11395030 SOUTH FORK FEATHER RIVER BELOW LITTLE GRASS VALLEY DAM, CA—Continued

## STATISTICS OF MONTHLY MEAN DATA FOR WATER YEARS 1928 - 1933, BY WATER YEAR (WY)

	OCT	NOV	DEC	JAN	FEB	MAR	APR	MAY	JUN	JUL	AUG	SEP
MEAN	2.56	19.5	47.6	26.3	45.2	134	181	201	78.8	7.70	1.74	1.35
MAX	6.62	94.5	206	51.3	94.7	386	301	384	169	13.7	2.54	1.72
(WY)	1932	1928	1930	1928	1930	1928	1930	1932	1933	1932	1932	1930
MIN	1.43	1.67	2.65	3.60	3.55	14.5	106	48.9	13.8	2.38	1.06	1.04
(WY)	1929	1930	1933	1933	1933	1933	1933	1931	1931	1931	1931	1931

## SUMMARY STATISTICS

## WATER YEARS 1928 - 1933

ANNUAL MEAN	62.3
HIGHEST ANNUAL MEAN	85.6 1932
LOWEST ANNUAL MEAN	28.0 1931
HIGHEST DAILY MEAN	1800 Mar 25 1928
LOWEST DAILY MEAN	.90 Aug 25 1931
ANNUAL SEVEN-DAY MINIMUM	.90 Sep 1 1931
MAXIMUM PEAK FLOW	2600 Mar 26 1928
MAXIMUM PEAK STAGE	7.00 Mar 26 1928
ANNUAL RUNOFF (AC-FT)	45140
10 PERCENT EXCEEDS	202
50 PERCENT EXCEEDS	10
90 PERCENT EXCEEDS	1.4

## STATISTICS OF MONTHLY MEAN DATA FOR WATER YEARS 1964 - 2001, BY WATER YEAR (WY)

MEAN	104	75.9	69.9	99.8	97.0	107	83.1	133	104	114	141	160
MAX	305	404	420	725	694	586	317	489	403	350	344	389
(WY)	1970	1982	1982	1997	1986	1995	1989	1995	1998	1983	1968	1984
MIN	13.0	2.94	4.01	2.36	2.25	3.70	4.31	4.38	3.99	3.71	5.42	10.0
(WY)	1986	1976	1979	1964	1976	1964	1964	1977	1977	1977	2001	1981

## SUMMARY STATISTICS

## FOR 2000 CALENDAR YEAR

## FOR 2001 WATER YEAR

## WATER YEARS 1964 - 2001

ANNUAL TOTAL	41277	17882.2	
ANNUAL MEAN	113	49.0	107
HIGHEST ANNUAL MEAN			250 1982
LOWEST ANNUAL MEAN			29.5 1981
HIGHEST DAILY MEAN	339 May 9	317 Nov 2	5420 Jan 1 1997
LOWEST DAILY MEAN	15 Jan 1	5.2 Aug 9	1.4 Jan 27 1964
ANNUAL SEVEN-DAY MINIMUM	15 Jan 1	5.2 Aug 9	1.4 Jan 27 1964
MAXIMUM PEAK FLOW		329 Nov 1	7370 Jan 1 1997
MAXIMUM PEAK STAGE		9.24 Nov 1	14.80 Jan 1 1997
ANNUAL RUNOFF (AC-FT)	81870	35470	77870
10 PERCENT EXCEEDS	232	186	248
50 PERCENT EXCEEDS	116	20	49
90 PERCENT EXCEEDS	17	5.5	5.4

## 11395150 SOUTH FORK TUNNEL NEAR STRAWBERRY VALLEY, CA

LOCATION.—Lat 39°38'55", long 120°07'00", in NW 1/4 SW 1/4 sec.29, T.21 N., R.8 E., Plumas County, Hydrologic Unit 18020123, Plumas National Forest, 3.2 mi upstream from Rock Creek, and 5.8 mi north of Strawberry Valley.

PERIOD OF RECORD.—October 1973 to current year. Records of daily discharge for November 1961 to September 1973 are in files of the U.S. Geological Survey. Monthly diversion used to adjust South Fork Feather River below diversion dam near Strawberry Valley (station 11395200) since October 1961.

GAGE.—Water-stage recorder. Datum of gage is sea level.

REMARKS.—Tunnel diverts water from South Fork Feather River to Sly Creek Reservoir (station 11395400) for power development. See schematic diagram of [South Fork Feather River Basin](#).

COOPERATION.—Records provided by Oroville–Wyandotte Irrigation District, under general supervision of the U.S. Geological Survey, in connection with a Federal Energy Regulatory Commission project.

EXTREMES FOR PERIOD OF RECORD.—Maximum daily discharge, 570 ft<sup>3</sup>/s, Mar. 13, May 25–29, June 3, 1983; no flow at times in several years.

DISCHARGE, CUBIC FEET PER SECOND, WATER YEAR OCTOBER 2000 TO SEPTEMBER 2001  
DAILY MEAN VALUES

DAY	OCT	NOV	DEC	JAN	FEB	MAR	APR	MAY	JUN	JUL	AUG	SEP
1	107	287	240	24	24	33	195	139	28	4.5	2.5	.00
2	108	303	239	24	24	34	181	128	28	4.4	2.5	.00
3	107	302	239	24	24	32	150	110	27	4.1	2.5	.00
4	107	301	238	24	29	58	124	102	27	4.1	2.4	.00
5	107	301	237	24	33	102	108	99	26	3.9	2.4	.00
6	106	186	237	24	33	85	103	97	26	3.8	2.3	57
7	106	15	236	24	31	82	95	95	26	3.9	2.3	113
8	106	15	185	26	30	89	84	95	25	3.9	2.3	114
9	111	14	23	25	31	93	78	91	25	3.7	2.1	113
10	94	14	28	30	31	85	74	83	25	3.7	2.1	113
11	17	14	24	32	27	79	76	77	24	3.5	1.9	113
12	5.6	14	26	26	33	76	72	71	24	3.5	1.9	112
13	33	14	27	26	29	79	70	65	24	3.5	1.8	114
14	132	15	39	25	28	84	68	60	23	3.3	.54	114
15	132	14	37	24	27	83	68	60	21	3.2	.58	113
16	154	14	32	23	27	79	71	57	7.3	3.1	1.3	112
17	184	14	30	23	27	80	82	53	6.4	3.1	1.5	111
18	184	14	27	22	31	94	93	49	6.1	3.1	1.5	110
19	184	14	26	23	39	119	115	46	5.9	3.1	1.6	110
20	185	13	25	23	41	156	111	44	5.7	3.1	.70	111
21	183	96	27	22	49	177	102	41	5.5	3.1	.49	113
22	181	238	38	23	56	189	99	39	5.3	3.0	.22	113
23	182	238	32	25	41	192	101	37	5.0	3.0	.98	113
24	182	239	29	28	39	196	121	36	4.7	2.9	.50	113
25	185	239	28	26	36	336	153	34	4.9	2.8	.00	115
26	183	238	26	26	35	261	167	33	6.7	2.8	.00	110
27	186	239	26	24	35	208	167	32	5.8	2.8	.00	110
28	212	238	25	24	35	201	157	31	5.9	2.7	.00	110
29	217	252	25	25	---	207	141	31	5.2	2.6	.00	109
30	204	242	25	24	---	198	136	30	4.9	2.5	5.4	110
31	230	---	25	24	---	195	---	29	---	2.5	2.2	---
TOTAL	4414.6	4137	2501	767	925	3982	3362	1994	464.3	103.2	46.51	2746.00
MEAN	142	138	80.7	24.7	33.0	128	112	64.3	15.5	3.33	1.50	91.5
MAX	230	303	240	32	56	336	195	139	28	4.5	5.4	115
MIN	5.6	13	23	22	24	32	68	29	4.7	2.5	.00	.00
AC-FT	8760	8210	4960	1520	1830	7900	6670	3960	921	205	92	5450

## STATISTICS OF MONTHLY MEAN DATA FOR WATER YEARS 1974 - 2001, BY WATER YEAR (WY)

	1974	1975	1976	1977	1978	1979	1980	1981	1982	1983	1984	1985	1986	1987	1988	1989	1990	1991	1992	1993	1994	1995	1996	1997	1998	1999	2000	2001
MEAN	93.4	100	105	124	149	178	153	168	113	113	125	145																
MAX	202	377	462	381	406	454	429	520	421	363	327	390																
(WY)	1999	1982	1982	1974	1996	1983	1989	1993	1983	1983	1983	1978																
MIN	6.21	4.14	3.36	5.99	8.49	9.71	8.68	16.4	7.22	3.33	1.50	.000																
(WY)	1986	1977	1977	1977	1977	1977	1977	1977	1977	2001	2001	1981																

SUMMARY STATISTICS	FOR 2000 CALENDAR YEAR		FOR 2001 WATER YEAR		WATER YEARS 1974 - 2001	
ANNUAL TOTAL	55539.6		25442.61			
ANNUAL MEAN	152		69.7		131	
HIGHEST ANNUAL MEAN					294	
LOWEST ANNUAL MEAN					35.0	
HIGHEST DAILY MEAN	510	Feb 14	336	Mar 25	570	Mar 13 1983
LOWEST DAILY MEAN	5.6	Oct 12	.00	Aug 25	.00	Jan 16 1980
ANNUAL SEVEN-DAY MINIMUM	14	Nov 14	.21	Aug 23	.00	Jan 16 1980
ANNUAL RUNOFF (AC-FT)	110200		50470		94550	
10 PERCENT EXCEEDS	261		187		316	
50 PERCENT EXCEEDS	122		32		91	
90 PERCENT EXCEEDS	26		2.5		8.5	



## 11395200 SOUTH FORK FEATHER RIVER BELOW DIVERSION DAM, NEAR STRAWBERRY VALLEY, CA

LOCATION.—Lat 39°38'51", long 121°07'04", in NE 1/4 SE 1/4 sec.30, T.21 N., R.8 E., [Plumas County](#), Hydrologic Unit 18020123, Plumas National Forest, on left bank, 0.1 mi downstream from diversion dam, 3.1 mi upstream from Rock Creek, and 5.8 mi north of Strawberry Valley.

DRAINAGE AREA.—37.7 mi<sup>2</sup>.

PERIOD OF RECORD.—October 1960 to current year.

REVISED RECORDS.—WDR CA-80-4: 1976(M).

GAGE.—Water-stage recorder and since May 8, 1987, sharp-crested rectangular weir. Datum of gage is 3,535.02 ft above sea level (levels by Oroville–Wyandotte Irrigation District).

REMARKS.—Flow regulated by Little Grass Valley Reservoir (station 11395020) since October 1961. South Fork Diversion Tunnel, maximum capacity, about 600 ft<sup>3</sup>/s, 500 ft upstream, diverts to Sly Creek Reservoir (station 11395400); diversion began in November 1961. See schematic diagram of [South Fork Feather River Basin](#).

COOPERATION.—Records provided by Oroville–Wyandotte Irrigation District, under general supervision of the U.S. Geological Survey, in connection with a Federal Energy Regulatory Commission project.

EXTREMES FOR PERIOD OF RECORD.—Maximum discharge, 11,300 ft<sup>3</sup>/s, Jan. 1, 1997, gage height unknown, from computation of peak flow over diversion dam; minimum daily, 0.30 ft<sup>3</sup>/s, Dec. 25, 1962, to Jan. 2, 1963, Mar. 1–3, 1963, during initial operation of Little Grass Valley Reservoir; since operation stabilized in 1964, 0.70 ft<sup>3</sup>/s, Jan. 18, 1968.

DISCHARGE, CUBIC FEET PER SECOND, WATER YEAR OCTOBER 2000 TO SEPTEMBER 2001  
DAILY MEAN VALUES

DAY	OCT	NOV	DEC	JAN	FEB	MAR	APR	MAY	JUN	JUL	AUG	SEP
1	11	8.3	6.0	5.6	5.6	5.5	5.6	5.6	5.5	5.5	5.4	5.1
2	11	6.0	6.0	5.6	5.6	5.5	5.6	5.6	5.5	5.4	5.5	5.4
3	11	5.8	6.0	5.5	5.6	5.5	5.6	5.6	5.5	5.3	5.3	5.4
4	11	5.6	6.0	5.5	5.6	5.6	5.6	5.6	5.5	5.3	5.3	7.2
5	11	5.6	6.0	5.5	5.5	5.8	5.6	5.6	5.5	5.3	5.3	9.4
6	11	5.6	5.9	5.5	5.5	5.8	5.6	5.6	5.5	5.3	5.3	7.7
7	11	5.4	5.8	5.5	5.5	5.6	5.6	5.6	5.5	5.3	5.3	6.9
8	11	5.3	5.8	5.6	5.5	5.6	5.6	5.6	5.5	5.3	5.3	6.9
9	11	5.3	5.4	5.6	5.5	5.7	5.6	5.6	5.5	5.3	5.3	6.9
10	11	5.3	5.5	5.5	5.7	5.6	5.6	5.6	5.5	5.3	5.3	6.9
11	11	5.3	5.5	5.6	5.9	5.6	5.6	5.6	5.5	5.3	5.3	6.9
12	24	5.3	5.5	5.6	5.7	5.6	5.6	5.6	5.5	5.3	5.3	6.9
13	31	5.3	5.5	5.6	5.6	5.6	5.6	5.6	5.5	5.3	5.3	6.0
14	32	5.3	5.6	5.6	5.6	5.6	5.6	5.6	5.5	5.3	11	5.3
15	32	5.3	5.6	5.6	5.6	5.6	5.6	5.6	5.5	5.3	6.3	5.3
16	32	5.3	5.6	5.6	5.6	5.6	5.6	5.6	5.3	5.3	5.5	5.3
17	33	5.3	5.6	5.6	5.6	5.6	5.6	5.6	5.3	5.3	5.4	5.4
18	33	5.3	5.6	5.6	5.6	5.6	5.6	5.6	5.3	5.3	5.5	5.5
19	33	5.3	5.6	5.6	5.6	5.6	5.6	5.6	5.3	5.3	5.5	5.4
20	33	5.3	5.6	5.6	5.6	5.6	5.6	5.6	5.4	5.3	7.2	5.5
21	33	5.4	5.6	5.6	5.8	5.6	5.6	5.6	5.5	5.3	7.3	5.5
22	34	5.6	5.6	5.6	5.8	5.7	5.6	5.6	5.5	5.3	7.0	5.5
23	35	5.6	5.6	5.6	5.6	5.8	5.6	5.6	5.5	5.3	6.2	5.5
24	35	5.6	5.6	5.6	5.8	5.9	5.6	5.6	5.5	5.3	5.7	5.5
25	35	5.6	5.6	5.6	5.6	6.2	5.6	5.6	5.5	5.3	5.6	5.6
26	35	5.6	5.6	5.6	5.5	6.0	5.6	5.6	5.5	5.3	5.6	5.6
27	22	5.6	5.6	5.6	5.5	6.0	5.6	5.6	5.5	5.3	5.6	5.6
28	11	5.6	5.6	5.6	5.5	5.8	5.6	5.6	5.5	5.3	5.5	5.6
29	11	5.9	5.6	5.6	---	5.8	5.6	5.6	5.5	5.3	5.5	5.6
30	11	6.0	5.6	5.6	---	5.8	5.6	5.6	5.5	5.4	6.8	5.6
31	11	---	5.6	5.6	---	5.6	---	5.6	---	5.4	5.4	---
TOTAL	677	167.7	175.7	173.0	157.1	176.4	168.0	173.6	164.1	164.8	181.8	180.9
MEAN	21.8	5.59	5.67	5.58	5.61	5.69	5.60	5.60	5.47	5.32	5.86	6.03
MAX	35	8.3	6.0	5.6	5.9	6.2	5.6	5.6	5.5	5.5	11	9.4
MIN	11	5.3	5.4	5.5	5.5	5.5	5.6	5.6	5.3	5.3	5.3	5.1
AC-FT	1340	333	349	343	312	350	333	344	325	327	361	359

## 11395200 SOUTH FORK FEATHER RIVER BELOW DIVERSION DAM, NEAR STRAWBERRY VALLEY, CA—Continued

## STATISTICS OF MONTHLY MEAN DATA FOR WATER YEARS 1964 - 2001, BY WATER YEAR (WY)

	OCT	NOV	DEC	JAN	FEB	MAR	APR	MAY	JUN	JUL	AUG	SEP
MEAN	10.6	13.0	41.4	80.2	53.4	47.5	24.3	44.1	21.0	9.55	10.1	10.4
MAX	21.8	226	808	885	1113	741	317	417	230	13.3	18.5	18.8
(WY)	2001	1982	1965	1970	1986	1995	1982	1995	1998	1968	1973	1973
MIN	2.92	2.62	2.41	3.94	2.73	3.79	3.68	3.61	2.20	2.57	3.32	3.45
(WY)	1978	1978	1980	1976	1978	1980	1970	1977	1977	1977	1977	1977

SUMMARY STATISTICS	FOR 2000 CALENDAR YEAR		FOR 2001 WATER YEAR		WATER YEARS 1964 - 2001	
ANNUAL TOTAL	3843.9		2560.1			
ANNUAL MEAN	10.5		7.01		30.4	
HIGHEST ANNUAL MEAN					120	
LOWEST ANNUAL MEAN					3.72	
HIGHEST DAILY MEAN	308	Feb 14	35	Oct 23	9020	Jan 1 1997
LOWEST DAILY MEAN	5.3	Nov 8	5.1	Sep 1	.70	Jan 18 1968
ANNUAL SEVEN-DAY MINIMUM	5.3	Nov 8	5.3	Nov 8	1.1	Jan 18 1968
MAXIMUM PEAK FLOW			534	Oct 27	11300	Jan 1 1997
MAXIMUM PEAK STAGE			7.82	Oct 27	unknown	Jan 1 1997
ANNUAL RUNOFF (AC-FT)	7620		5080		22060	
10 PERCENT EXCEEDS	11		7.2		12	
50 PERCENT EXCEEDS	10		5.6		7.8	
90 PERCENT EXCEEDS	5.6		5.3		4.6	

## 11395400 SLY CREEK RESERVOIR NEAR STRAWBERRY VALLEY, CA

LOCATION.—Lat 39°35'01", long 121°06'59", in NE 1/4 NE 1/4 sec.19, T.20 N., R.8 E., Butte County, Hydrologic Unit 18020123, Plumas National Forest, on right bank, 100 ft upstream from dam on Lost Creek, and 1.4 mi northwest of Strawberry Valley.

DRAINAGE AREA.—24.0 mi<sup>2</sup>.

PERIOD OF RECORD.—November 1961 to current year (fragmentary prior to Mar. 14, 1962).

GAGE.—Water-stage recorder. Datum of gage is sea level (levels by Oroville–Wyandotte Irrigation District). Prior to Sept. 30, 1966, water-stage recorder in valve chamber inside dam at same datum. Oct. 1, 1966, to December 1974, nonrecording gage read once daily.

REMARKS.—Reservoir is formed by earthfill dam. Storage began in November 1961. Total capacity, 65,600 acre-ft, between elevations 3,285 ft, invert of outlet, and 3,531 ft, top of spillway gate, all of which is available for release. Water is diverted into reservoir from South Fork Feather River through South Fork Diversion Tunnel and from North Yuba River Basin through Slate Creek Tunnel (station 11413250). Records represent total contents at 2400 hours. See schematic diagram of [South Fork Feather River Basin](#).

COOPERATION.—Records provided by Oroville–Wyandotte Irrigation District, under general supervision of the U.S. Geological Survey, in connection with a Federal Energy Regulatory Commission project.

EXTREMES FOR PERIOD OF RECORD.—Maximum contents, 65,600 acre-ft, June 22, 1978, elevation, 3,530.9 ft; minimum observed under normal operating conditions since reservoir first filled, 860 acre-ft, Feb. 11, 1976, elevation, 3,320.0 ft. Reservoir completely drained for powerplant construction, Sept. 12 to Oct. 17, 1981.

EXTREMES FOR CURRENT YEAR.—Maximum contents, 63,900 acre-ft, May 17, elevation, 3,528.0 ft; minimum, 9,010 acre-ft, Jan. 26, 27, elevation, unknown.

Capacity table (elevation, in feet, and contents, in acre-feet)  
(Based on survey by Pacific Gas & Electric Co. in 1946)

3,310	450	3,340	2,150	3,400	11,500	3,480	38,500
3,315	655	3,360	4,300	3,420	16,600	3,510	53,400
3,320	860	3,380	7,360	3,450	26,300	3,531	65,600

RESERVOIR STORAGE (ACRE-FEET), WATER YEAR OCTOBER 2000 TO SEPTEMBER 2001  
DAILY OBSERVATION AT 2400 HOURS

DAY	OCT	NOV	DEC	JAN	FEB	MAR	APR	MAY	JUN	JUL	AUG	SEP
1	21800	11700	15400	e9390	e9630	11600	33900	e56600	e61900	e52100	34300	18800
2	21300	11300	15900	e9500	e9700	11600	34900	57600	e61500	e51800	33800	18600
3	20600	11300	16400	e9610	e9920	11800	35700	58400	e61600	e50900	33200	18400
4	20100	11600	16600	e9720	e9850	12300	36100	59100	e61700	e50200	33000	17900
5	19600	12200	16900	e9830	e9960	12900	36400	59800	e61600	e49600	32800	17400
6	19100	12600	17200	e9920	e10100	13500	36900	e59800	e61300	48000	32200	16900
7	18700	12600	17500	e10000	e10300	13800	37500	e60700	e60900	47800	31500	16600
8	18300	12700	17700	e10200	e10800	14300	38100	e61500	e60300	47500	30800	16600
9	17900	12800	17700	e10400	e10900	14700	38500	e61500	e59800	46700	30200	16600
10	17500	12700	17400	e10500	e11000	15300	39000	61400	e59800	46000	29700	16300
11	e17500	12000	17000	e10600	e11100	15800	39300	61600	e59700	45400	29500	15900
12	17200	11200	16600	e10800	e11200	16000	39800	62300	e59500	44600	29300	15500
13	16600	11300	16200	10900	e11300	16200	40200	e63000	e59300	44000	28800	15100
14	16400	e11000	15700	11100	e11000	16400	40600	63100	e58700	43700	28300	14800
15	16300	e10300	15400	11200	e10700	16500	41100	63300	e58200	43400	27600	14600
16	15900	e9850	14900	11200	e10600	16600	41400	63600	e57800	42700	26900	14900
17	15400	e9720	14300	e11000	e10700	17000	41900	63600	e57500	42000	26300	15100
18	14900	e9890	13700	e10400	e10800	17500	42400	63600	e57200	41300	25900	15300
19	14100	e10100	13300	e10200	e11000	17900	43400	63800	e56600	40700	25600	15500
20	13500	e10300	12900	e10100	e11000	18600	44400	e63700	e55900	40000	24900	15700
21	13200	e10500	12400	e9590	e11200	19300	45300	e63800	e55600	39800	24200	15900
22	13000	e11000	12100	e9260	e11200	20300	46200	e63400	e55000	39500	23600	16100
23	12500	11400	11600	e9260	11500	21400	47000	e63300	e54600	38800	22900	16300
24	11800	e11900	11200	e9200	11400	22800	47600	e63100	e54300	38200	22300	16500
25	11300	e12300	e10800	e9110	11600	25200	48900	e63100	e54100	37500	22100	16700
26	11000	12800	e10100	e9010	11600	26900	50500	e62800	e53800	37000	22000	16900
27	10900	13200	e9320	e9010	11700	28100	e51900	e63000	e53300	36400	21300	17100
28	11100	13700	e9160	e9110	11600	29400	53200	e63300	e53100	36200	20700	17000
29	11500	14300	e9110	e9410	---	30200	54400	e63400	e52800	35900	20100	17200
30	11600	14900	e9110	e9520	---	31000	55600	e63000	e52400	35400	19500	17400
31	11800	---	e9240	e9520	---	33000	---	e62500	---	34800	19000	---
MAX	21800	14900	17700	11200	11700	33000	55600	63800	61900	52100	34300	18800
MIN	10900	9720	9110	9010	9630	11600	33900	56600	52400	34800	19000	14600
a	3401.2	3413.7	---	---	3400.5	3467.1	3513.8	---	---	3471.5	3428.2	3422.9
b	-10400	+3100	-5660	+280	+2080	+21400	+22600	+6900	-10100	-17600	-15800	-1600

CAL YR 2000 b -8960

WTR YR 2001 b -4800

e Estimated.

a Elevation, in feet, at end of month.

b Change in contents, in acre-feet.

## 11395500 OROVILLE-WYANDOTTE CANAL NEAR CLIPPER MILLS, CA

LOCATION.—Lat 39°33'15", long 121°11'31", in NW 1/4 NE 1/4 sec.33, T.20 N., R.7 E., Butte County, Hydrologic Unit 18020123, in concrete valve house at head of canal, and 2.5 mi north of Clipper Mills.

PERIOD OF RECORD.—October 1927 to September 1941 (published as Forbestown Ditch), October 1953 to current year. Monthly discharge only for October 1953 to September 1961, published with records for Lost Creek near Clipper Mills.

GAGE.—Water-stage recorder and Parshall flume. Datum of gage is 3,166.0 ft above sea level (levels by Oroville–Wyandotte Irrigation District). Prior to Sept. 30, 1941, nonrecording gages and Oct. 1, 1941, to Nov. 16, 1962, water-stage recorder at sites at different datums 4 mi upstream in abandoned part of canal, 0.3 mi downstream from Lost Creek Dam.

REMARKS.—Water is discharged to canal through valve in Woodleaf Penstock. Prior to Nov. 16, 1962, canal diverted from Lost Creek Dam. Water is used for irrigation and domestic supply. Demand for water reduced when a large lumber mill closed at Woodleaf in 1962. See schematic diagram of [South Fork Feather River Basin](#).

COOPERATION.—Records provided by Oroville–Wyandotte Irrigation District, under general supervision of the U.S. Geological Survey, in connection with a Federal Energy Regulatory Commission project.

EXTREMES FOR PERIOD OF RECORD.—Maximum daily discharge, 43 ft<sup>3</sup>/s, Aug. 9 to Sept. 9, 1937, Aug. 13–15, 1977; no flow at times in many years.

DISCHARGE, CUBIC FEET PER SECOND, WATER YEAR OCTOBER 2000 TO SEPTEMBER 2001  
DAILY MEAN VALUES

DAY	OCT	NOV	DEC	JAN	FEB	MAR	APR	MAY	JUN	JUL	AUG	SEP
1	21	.00	.00	.00	.00	11	.00	2.0	24	24	23	23
2	18	.00	.00	.00	.00	4.3	.00	.00	24	24	23	23
3	16	.00	.00	.00	.00	.00	.00	.00	24	24	23	23
4	12	.00	6.9	.00	.00	.00	.00	.00	23	24	23	23
5	.00	.00	11	.00	.00	.00	.00	.00	23	24	23	23
6	13	.00	5.1	.00	5.9	.00	.00	.00	22	24	23	23
7	20	.00	.00	.00	10	.00	.00	.00	24	24	23	23
8	20	.00	.00	.00	6.5	.00	.00	.00	24	24	23	23
9	20	.00	.00	.00	.00	.00	.00	9.7	24	24	23	23
10	10	.00	.00	.00	.00	.00	.00	15	24	24	23	23
11	.00	.00	.00	.00	.00	.00	.00	15	24	24	23	23
12	.00	.00	.00	.00	.00	.00	.00	15	24	23	23	23
13	.00	.00	.00	.00	.00	.00	.00	15	24	23	23	23
14	.00	.00	.00	.00	.00	3.9	.00	15	24	23	23	23
15	.00	7.2	.00	.00	.00	7.3	.00	15	24	23	23	23
16	9.7	11	.00	.00	.00	6.3	.00	13	24	23	23	23
17	14	11	.00	.00	.00	6.3	7.1	13	24	23	23	23
18	14	11	.00	6.7	.00	6.3	11	13	24	23	23	23
19	14	11	.00	11	.00	2.2	11	13	24	23	23	23
20	14	3.5	.00	5.5	.00	.00	3.5	14	24	23	23	23
21	14	.00	.00	.00	.00	.00	.00	17	24	23	23	23
22	14	.00	.00	.00	.00	.00	.00	20	24	23	23	23
23	14	.00	.00	.00	.00	.00	.00	20	24	23	23	23
24	14	.00	.00	.00	.00	.00	.00	20	24	23	23	23
25	7.0	.00	.00	.00	.00	.00	.00	20	24	23	23	23
26	.00	.00	.00	.00	.00	.00	3.5	20	24	23	23	23
27	.00	.00	6.2	.00	.00	.00	6.3	22	24	23	23	23
28	.00	.00	11	.00	7.2	.00	6.2	24	24	23	23	23
29	.00	.00	11	.00	---	.00	6.3	23	24	23	23	23
30	.00	.00	3.5	.00	---	.00	6.2	24	24	23	23	23
31	.00	---	.00	.00	---	.00	---	24	---	23	23	---
TOTAL	278.70	54.70	54.70	23.20	29.60	47.60	61.10	401.70	716	724	713	690
MEAN	8.99	1.82	1.76	.75	1.06	1.54	2.04	13.0	23.9	23.4	23.0	23.0
MAX	21	11	11	11	10	11	11	24	24	24	23	23
MIN	.00	.00	.00	.00	.00	.00	.00	.00	22	23	23	23
AC-FT	553	108	108	46	59	94	121	797	1420	1440	1410	1370

## STATISTICS OF MONTHLY MEAN DATA FOR WATER YEARS 1963 - 2001, BY WATER YEAR (WY)

MEAN	12.4	5.37	2.23	1.28	.75	.95	1.73	5.83	12.3	17.5	20.7	19.9
MAX	20.2	16.5	8.64	6.89	5.34	6.70	11.4	20.2	29.3	26.4	37.4	30.9
(WY)	1967	1968	1977	1968	1977	1964	1977	1977	1963	1976	1977	1977
MIN	3.75	.84	.000	.000	.000	.000	.000	.000	.88	7.60	9.47	9.29
(WY)	1990	1992	1982	1980	1963	1963	1963	1975	1998	1998	1965	1965

SUMMARY STATISTICS	FOR 2000 CALENDAR YEAR		FOR 2001 WATER YEAR		WATER YEARS 1963 - 2001	
ANNUAL TOTAL	3040.10		3794.30			
ANNUAL MEAN	8.31		10.4		8.45	
HIGHEST ANNUAL MEAN					16.7	
LOWEST ANNUAL MEAN					4.33	
HIGHEST DAILY MEAN	24	Aug 2	24	May 28	43	Aug 13 1977
LOWEST DAILY MEAN	.00	Jan 1	.00	Oct 5	.00	Dec 12 1962
ANNUAL SEVEN-DAY MINIMUM	.00	Jan 1	.00	Oct 26	.00	Dec 15 1962
ANNUAL RUNOFF (AC-FT)	6030		7530		6120	
10 PERCENT EXCEEDS	23		24		23	
50 PERCENT EXCEEDS	5.1		6.5		5.5	
90 PERCENT EXCEEDS	.00		.00		.00	

## 11396000 LOST CREEK NEAR CLIPPER MILLS, CA

LOCATION.—Lat 39°34'25", long 121°08'26", in SE 1/4 SW 1/4 sec.24, T.20 N., R.7 E., Butte County, Hydrologic Unit 18020123, Plumas National Forest, on left bank, 0.3 mi downstream from Lost Creek Reservoir, and 2.8 mi north of Clipper Mills.

DRAINAGE AREA.—30.0 mi<sup>2</sup>.

PERIOD OF RECORD.—October 1927 to September 1941, October 1948 to current year. Records for Woodleaf Powerplant from February 1963 to September 1966 in files of the U.S. Geological Survey.

REVISED RECORDS.—WSP 1395: 1954. WSP 1931: Drainage area.

GAGE.—Water-stage recorder. Sharp-crested weir for low-water control since June 20, 1987. Elevation of gage is 3,170 ft above sea level, from topographic map. Prior to June 20, 1987, at site 100 ft downstream at same datum.

REMARKS.—Flow regulated by Sly Creek Reservoir (station 11395400) 1.5 mi upstream and Lost Creek Reservoir 0.3 mi upstream, usable capacity, 5,920 acre-ft with flashboards. Water is diverted into Sly Creek Reservoir through South Fork Diversion Tunnel from South Fork Feather River and through Slate Creek Tunnel (station 11413250) from North Yuba River Basin. Woodleaf Tunnel diverts from Lost Creek Reservoir to Woodleaf Powerhouse. Oroville–Wyandotte Canal (station 11395500) diverts from Woodleaf Penstock for irrigation and domestic use. Records represent seepage, release, and spill from Lost Creek Reservoir to Lost Creek. See schematic diagram of South Fork Feather River Basin.

COOPERATION.—Records provided by Oroville–Wyandotte Irrigation District, under general supervision of the U.S. Geological Survey, in connection with a Federal Energy Regulatory Commission project.

EXTREMES FOR PERIOD OF RECORD.—Maximum discharge, 5,760 ft<sup>3</sup>/s, Jan. 1, 1997, gage height, 13.50 ft; no flow at times in some years.

## DISCHARGE, CUBIC FEET PER SECOND, WATER YEAR OCTOBER 2000 TO SEPTEMBER 2001

## DAILY MEAN VALUES

DAY	OCT	NOV	DEC	JAN	FEB	MAR	APR	MAY	JUN	JUL	AUG	SEP
1	8.9	6.7	6.2	5.8	5.9	6.1	8.6	9.1	8.4	8.4	8.4	8.4
2	9.1	5.8	5.9	5.8	5.9	6.1	8.4	9.3	8.4	8.4	8.4	8.3
3	9.1	6.0	5.9	5.7	5.9	6.1	8.4	9.3	8.4	8.4	8.4	8.2
4	9.0	6.2	5.7	5.7	5.9	7.3	8.4	9.3	8.4	8.4	8.4	8.2
5	9.1	5.8	5.7	5.8	5.9	8.3	8.4	9.3	8.4	8.6	8.4	8.3
6	9.4	5.5	5.7	5.9	5.9	7.2	8.5	9.3	8.4	8.5	8.4	8.4
7	10	5.5	5.7	5.9	5.9	6.8	8.6	9.2	8.4	8.5	8.4	8.4
8	9.8	5.5	5.7	5.9	5.9	6.7	8.5	8.6	8.5	8.6	8.6	8.4
9	9.7	5.5	5.7	6.0	5.9	6.7	8.5	8.6	8.5	8.6	8.7	8.3
10	10	5.6	5.7	6.3	5.9	6.6	8.4	9.3	8.4	8.9	8.8	8.4
11	11	5.5	5.6	6.5	5.9	6.3	8.5	10	8.4	8.9	8.7	8.4
12	10	5.5	5.9	6.1	5.9	6.3	8.4	10	8.4	8.9	8.6	8.5
13	9.9	5.5	6.0	5.9	5.9	6.3	8.4	9.8	8.4	8.8	8.6	8.7
14	9.3	5.6	6.1	5.9	5.9	6.3	8.4	9.4	8.4	8.7	8.7	8.8
15	8.9	5.7	6.0	5.9	5.9	6.3	8.4	9.0	8.4	8.4	8.5	8.8
16	8.7	6.2	17	5.9	5.9	6.3	8.4	9.3	8.4	8.4	8.4	8.8
17	8.6	7.0	5.9	5.9	5.9	6.3	8.4	9.0	8.4	8.4	8.4	8.6
18	8.6	7.2	5.9	5.9	5.9	6.3	8.4	8.9	8.5	8.6	8.4	8.5
19	8.6	7.2	8.0	5.9	6.3	6.3	8.5	8.8	8.8	8.7	8.4	8.4
20	8.7	7.0	5.9	5.9	7.4	6.3	8.6	8.7	8.7	8.9	8.4	8.3
21	8.7	6.4	5.9	5.9	8.3	6.3	8.6	8.4	8.5	8.8	8.4	8.2
22	8.6	6.3	5.9	5.9	7.3	6.1	8.6	8.9	8.6	8.8	8.4	8.2
23	8.6	6.3	5.9	6.0	6.5	6.1	12	9.0	8.6	8.8	8.4	8.2
24	9.2	6.3	5.9	6.1	6.4	6.1	25	8.5	8.7	8.8	8.4	8.2
25	11	6.3	5.9	6.1	6.3	6.2	26	8.2	8.5	8.8	8.4	8.2
26	10	6.3	5.9	6.0	6.3	6.1	17	8.1	8.6	8.8	8.4	8.2
27	10	6.3	5.8	5.9	6.3	6.1	9.5	8.0	8.6	8.8	8.4	8.2
28	10	6.3	5.7	5.9	6.2	6.0	9.5	8.0	8.4	8.8	8.4	8.2
29	9.7	6.4	5.7	5.9	---	5.9	9.5	8.2	8.6	8.6	8.4	8.2
30	9.3	6.3	5.7	5.9	---	7.1	9.2	8.3	8.5	8.4	8.4	8.2
31	8.8	---	5.8	5.9	---	8.5	---	8.3	---	8.4	8.4	---
TOTAL	290.3	183.7	194.3	184.1	173.5	201.4	304.0	276.1	254.6	267.8	262.4	251.1
MEAN	9.36	6.12	6.27	5.94	6.20	6.50	10.1	8.91	8.49	8.64	8.46	8.37
MAX	11	7.2	17	6.5	8.3	8.5	26	10	8.8	8.9	8.8	8.8
MIN	8.6	5.5	5.6	5.7	5.9	5.9	8.4	8.0	8.4	8.4	8.4	8.2
AC-FT	576	364	385	365	344	399	603	548	505	531	520	498
a	20180	3930	14080	4110	4940	10620	5610	11340	12550	17110	15390	6750

a Diversion, acre-feet, through Woodleaf Powerhouse (station 11396090), provided by Oroville–Wyandotte Irrigation District.

## 11396000 LOST CREEK NEAR CLIPPER MILLS, CA—Continued

## STATISTICS OF MONTHLY MEAN DATA FOR WATER YEARS 1928 - 1961, BY WATER YEAR (WY)

	OCT	NOV	DEC	JAN	FEB	MAR	APR	MAY	JUN	JUL	AUG	SEP
MEAN	3.78	8.61	66.0	93.4	170	175	191	129	29.9	6.42	4.23	5.13
MAX	13.4	121	544	485	562	467	423	441	153	34.7	10.2	15.3
(WY)	1928	1951	1956	1956	1958	1938	1938	1952	1952	1952	1961	1960
MIN	.20	.000	.000	.15	.50	25.7	4.68	1.21	1.33	.20	.10	.10
(WY)	1935	1960	1960	1960	1937	1933	1931	1931	1934	1939	1934	1934

## SUMMARY STATISTICS

## WATER YEARS 1928 - 1961

ANNUAL MEAN	73.0
HIGHEST ANNUAL MEAN	167 1938
LOWEST ANNUAL MEAN	6.78 1931
HIGHEST DAILY MEAN	3840 Dec 22 1955
LOWEST DAILY MEAN	.00 Jul 30 1940
ANNUAL SEVEN-DAY MINIMUM	.00 Nov 1 1959
MAXIMUM PEAK FLOW	5000 Dec 22 1955
MAXIMUM PEAK STAGE	a6.90 Dec 22 1955
ANNUAL RUNOFF (AC-FT)	52890
10 PERCENT EXCEEDS	212
50 PERCENT EXCEEDS	8.4
90 PERCENT EXCEEDS	.30

## STATISTICS OF MONTHLY MEAN DATA FOR WATER YEARS 1962 - 2001, BY WATER YEAR (WY)

	OCT	NOV	DEC	JAN	FEB	MAR	APR	MAY	JUN	JUL	AUG	SEP
MEAN	12.9	6.83	42.0	54.7	75.8	82.3	54.2	46.1	39.8	4.24	3.77	4.06
MAX	392	179	417	674	512	573	410	454	750	16.0	22.2	34.4
(WY)	1963	1963	1998	1997	1986	1983	1993	1995	1995	1962	1966	1997
MIN	.006	.029	.094	.10	.35	.33	.22	.13	.097	.10	.000	.000
(WY)	1965	1975	1975	1962	1964	1964	1968	1968	1966	1963	1964	1963

## SUMMARY STATISTICS

## FOR 2000 CALENDAR YEAR

## FOR 2001 WATER YEAR

## WATER YEARS 1962 - 2001

ANNUAL TOTAL	13462.0	2843.3	
ANNUAL MEAN	36.8	7.79	35.4
HIGHEST ANNUAL MEAN			200 1995
LOWEST ANNUAL MEAN			.49 1964
HIGHEST DAILY MEAN	700 Mar 2	26 Apr 25	4490 Jan 1 1997
LOWEST DAILY MEAN	5.5 Nov 6	5.5 Nov 6	.00 Oct 21 1961
ANNUAL SEVEN-DAY MINIMUM	5.5 Nov 6	5.5 Nov 6	.00 Oct 21 1961
MAXIMUM PEAK FLOW		166 Dec 16	5760 Jan 1 1997
MAXIMUM PEAK STAGE		6.42 Dec 16	13.50 Jan 1 1997
ANNUAL RUNOFF (AC-FT)	26700	5640	25610
TOTAL DIVERSION (AC-FT) b	231500	126600	209900
10 PERCENT EXCEEDS	12	9.2	15
50 PERCENT EXCEEDS	8.8	8.4	1.8
90 PERCENT EXCEEDS	5.8	5.9	.18

a Site then in use.

b Diversion, in acre-feet, through Woodleaf Powerhouse (station 11396090), provided by Oroville-Wyandotte Irrigation District.

## 11396200 SOUTH FORK FEATHER RIVER BELOW FORBESTOWN DAM, CA

LOCATION.—Lat 39°33'05", long 121°12'30", in SE 1/4 NE 1/4 sec.32, T.20 N., R.7 E., Butte County, Hydrologic Unit 18020123, Plumas National Forest, on right bank, 500 ft downstream from Forbestown Dam, 0.4 mi upstream from Oroleve Creek, and 4.0 mi northeast of Forbestown.

DRAINAGE AREA.—87.5 mi<sup>2</sup>.

PERIOD OF RECORD.—July 1962 to current year. Records for Forbestown Powerplant from February 1963 to September 1966 in files of the U.S. Geological Survey.

GAGE.—Water-stage recorder. Elevation of gage is 1,690 ft above sea level, from topographic map.

REMARKS.—Flow regulated by Little Grass Valley Reservoir (station 11395020), Sly Creek Reservoir (station 11395400), and smaller reservoirs. Water from North Yuba River Basin is imported through Slate Creek Tunnel (station 11413250) to Sly Creek Reservoir. Oroville–Wyandotte Canal (station 11395500) diverts upstream from station. Tunnel 600 ft upstream from station diverts most flow through Forbestown Powerplant (station 11396290) except fishwater releases and uncontrolled spill over Forbestown Dam. See schematic diagram of South Fork Feather River Basin.

COOPERATION.—Records provided by Oroville–Wyandotte Irrigation District, under general supervision of the U.S. Geological Survey, in connection with a Federal Energy Regulatory Commission project.

EXTREMES FOR PERIOD OF RECORD.—Maximum discharge, 21,800 ft<sup>3</sup>/s, Jan. 1, 1997, gage height, 17.64 ft, from rating curve extended above 5,400 ft<sup>3</sup>/s on basis of flow-over-dam measurement of peak flow; minimum daily, 0.60 ft<sup>3</sup>/s, Apr. 4, 1963, during initial operation of Little Grass Valley Reservoir; since operation stabilized in 1964, 1.3 ft<sup>3</sup>/s, Mar. 15, 1980.

## DISCHARGE, CUBIC FEET PER SECOND, WATER YEAR OCTOBER 2000 TO SEPTEMBER 2001

## DAILY MEAN VALUES

DAY	OCT	NOV	DEC	JAN	FEB	MAR	APR	MAY	JUN	JUL	AUG	SEP
1	10	7.9	6.3	6.1	6.1	5.4	5.3	5.2	5.8	5.8	5.7	5.7
2	10	6.5	6.3	6.1	6.2	5.4	5.3	5.2	5.7	5.7	5.7	5.7
3	10	6.5	6.3	6.0	6.3	5.4	5.3	5.2	5.8	5.8	5.7	5.7
4	10	6.5	7.0	6.2	6.3	5.6	5.3	5.6	5.8	5.9	5.7	5.7
5	10	6.5	7.2	6.1	5.9	5.6	5.3	5.8	5.8	5.8	5.7	5.6
6	10	6.3	6.1	6.1	5.5	5.4	5.3	5.8	5.7	5.8	5.7	5.6
7	10	6.3	6.1	6.1	5.5	5.4	5.3	5.8	5.7	5.8	5.7	5.6
8	10	6.3	6.1	6.1	5.5	5.4	5.3	5.8	5.7	5.8	5.7	5.7
9	10	6.3	6.1	6.1	5.4	5.3	5.3	5.9	5.7	5.8	5.7	5.7
10	10	6.4	6.1	6.4	5.4	5.4	5.3	5.9	5.7	5.7	5.7	5.7
11	10	6.5	6.1	6.2	5.5	5.4	5.2	5.9	5.7	5.8	5.7	5.7
12	10	6.5	6.1	6.2	5.4	5.4	5.2	5.8	5.8	5.7	5.7	5.7
13	10	6.6	6.1	6.2	5.3	5.3	5.3	5.8	5.8	5.8	5.7	5.5
14	10	18	6.3	6.1	5.3	5.3	5.3	5.8	5.7	5.8	5.7	5.6
15	10	18	6.3	6.1	5.3	5.3	5.3	5.8	5.8	5.8	5.7	5.5
16	10	6.6	6.3	6.2	5.3	5.3	5.3	5.8	5.7	5.7	5.7	5.5
17	10	6.5	6.2	6.1	5.4	5.3	5.3	5.8	5.7	5.7	5.7	5.5
18	10	6.5	6.1	6.1	5.4	5.4	5.2	5.7	5.8	5.7	5.7	5.4
19	10	6.6	6.1	6.2	5.5	5.3	5.3	5.8	5.8	5.7	5.7	5.3
20	10	6.6	6.1	6.1	5.6	5.3	5.3	5.8	5.8	5.7	5.7	5.3
21	10	6.6	6.1	6.1	5.7	5.3	5.2	5.7	5.7	5.8	5.7	5.4
22	10	6.6	6.2	6.2	5.6	5.3	5.3	5.8	5.8	5.7	5.7	5.5
23	10	6.6	6.2	6.2	5.4	5.3	5.2	5.8	5.9	5.7	5.7	5.5
24	10	6.6	6.2	6.3	5.5	5.4	5.3	5.8	5.9	5.7	5.7	5.5
25	10	6.6	6.2	6.3	5.5	5.4	5.2	5.8	5.8	5.7	5.7	5.5
26	10	6.6	6.1	6.3	5.4	5.3	5.2	5.8	5.8	5.7	5.7	5.5
27	10	6.3	6.2	6.3	5.4	5.3	5.2	5.7	5.8	5.7	5.7	5.5
28	10	6.3	6.2	6.3	5.3	5.3	5.3	5.7	5.8	5.7	5.7	5.5
29	11	6.3	6.1	6.3	---	5.3	5.2	5.9	5.9	5.7	5.7	5.5
30	10	6.3	6.1	6.3	---	5.3	5.2	5.8	5.8	5.7	5.7	5.5
31	10	---	6.1	6.2	---	5.3	---	5.8	---	5.7	5.7	---
TOTAL	311	218.7	193.0	191.6	155.9	166.1	158.0	177.8	173.2	178.1	176.7	166.6
MEAN	10.0	7.29	6.23	6.18	5.57	5.36	5.27	5.74	5.77	5.75	5.70	5.55
MAX	11	18	7.2	6.4	6.3	5.6	5.3	5.9	5.9	5.9	5.7	5.7
MIN	10	6.3	6.1	6.0	5.3	5.3	5.2	5.2	5.7	5.7	5.7	5.3
AC-FT	617	434	383	380	309	329	313	353	344	353	350	330
a	20330	3620	13480	3860	5590	13520	6500	12140	12010	16320	14140	5790

a Diversion, in acre-feet, to Forbestown Powerplant (station 11396290), provided by Oroville–Wyandotte Irrigation District.

## 11396200 SOUTH FORK FEATHER RIVER BELOW FORBESTOWN DAM, CA—Continued

## STATISTICS OF MONTHLY MEAN DATA FOR WATER YEARS 1964 - 2001, BY WATER YEAR (WY)

	OCT	NOV	DEC	JAN	FEB	MAR	APR	MAY	JUN	JUL	AUG	SEP
MEAN	15.2	18.0	90.8	169	173	168	90.6	97.9	44.4	11.7	10.7	13.8
MAX	76.1	240	1262	2059	2000	1472	718	990	617	30.6	27.3	120
(WY)	1966	1982	1997	1997	1986	1995	1982	1996	1998	1986	1986	1996
MIN	4.21	3.68	3.37	4.06	4.46	4.47	4.06	4.02	2.90	4.04	3.37	3.84
(WY)	1978	1976	1976	1976	1972	1972	1964	1977	1977	1977	1977	1977

SUMMARY STATISTICS	FOR 2000 CALENDAR YEAR		FOR 2001 WATER YEAR		WATER YEARS 1964 - 2001	
ANNUAL TOTAL	10458.5		2266.7			
ANNUAL MEAN	28.6		6.21		74.9	
HIGHEST ANNUAL MEAN					325	
LOWEST ANNUAL MEAN					4.36	
HIGHEST DAILY MEAN	673	Feb 14	18	Nov 14	17300	Jan 1 1997
LOWEST DAILY MEAN	5.7	Jan 1	5.2	Apr 11	1.3	Mar 15 1980
ANNUAL SEVEN-DAY MINIMUM	5.7	Jan 1	5.2	Apr 25	1.7	Mar 25 1980
MAXIMUM PEAK FLOW			30	Nov 14	21800	Jan 1 1997
MAXIMUM PEAK STAGE			5.23	Nov 14	17.64	Jan 1 1997
ANNUAL RUNOFF (AC-FT)	20740		4500		54230	
TOTAL DIVERSION (AC-FT) a	267400		127300		229500	
10 PERCENT EXCEEDS	35		6.8		117	
50 PERCENT EXCEEDS	10		5.8		10	
90 PERCENT EXCEEDS	5.8		5.3		5.0	

a Diversion, in acre-feet, to Forbestown Powerplant (station 11396290), provided by Oroville-Wyandotte Irrigation District.



11396310 MINERS RANCH CANAL BELOW PONDEROSA DAM, NEAR FORBESTOWN, CA

LOCATION.—Lat 39°33'00", long 121°18'20", in SE 1/4 NW 1/4 sec.33, T.20 N., R.6 E., Butte County, Hydrologic Unit 18020123, on right bank, 800 ft downstream from Ponderosa Dam, and 3 mi northwest of Forbestown.

PERIOD OF RECORD.—October 1962 to current year.

REVISED RECORDS.—WDR CA-88-4: diversion only.

GAGE.—Water-stage recorder and concrete control. Elevation of gage is 975 ft above sea level, from topographic map.

REMARKS.—Canal diverts from South Fork Feather River at Ponderosa Dam. Water is used for power development and irrigation. See schematic diagram of [South Fork Feather River Basin](#).

COOPERATION.—Records provided by Oroville–Wyandotte Irrigation District, under general supervision of the U.S. Geological Survey, in connection with a Federal Energy Regulatory Commission project.

EXTREMES FOR PERIOD OF RECORD.—Maximum daily discharge, 314 ft<sup>3</sup>/s, May 13, 1984; no flow at times in most years.

DISCHARGE, CUBIC FEET PER SECOND, WATER YEAR OCTOBER 2000 TO SEPTEMBER 2001  
DAILY MEAN VALUES

DAY	OCT	NOV	DEC	JAN	FEB	MAR	APR	MAY	JUN	JUL	AUG	SEP
1	.00	271	.00	.00	64	268	262	151	252	251	286	199
2	.00	275	.00	.00	.00	268	262	163	251	268	273	203
3	.00	269	.00	182	.00	268	263	162	251	281	281	199
4	.00	259	140	55	.00	267	269	162	251	283	284	200
5	.00	264	89	83	77	264	270	163	240	283	269	199
6	113	265	161	119	.00	264	269	200	247	285	267	254
7	285	235	249	80	.00	264	266	258	251	286	283	286
8	285	220	152	82	.00	264	264	276	252	286	284	286
9	285	155	.00	3.3	80	264	266	283	252	286	284	286
10	284	124	.00	49	.00	264	265	286	252	286	266	286
11	281	189	.00	206	119	264	260	286	252	257	250	286
12	277	260	.00	56	234	263	213	286	238	289	249	286
13	273	237	.00	119	248	264	151	282	243	289	249	286
14	273	215	.00	104	246	265	151	211	253	289	249	283
15	270	173	5.5	.00	251	265	151	176	252	289	272	280
16	268	117	43	59	259	265	33	188	253	290	284	85
17	270	82	.00	270	258	265	.00	201	253	290	284	12
18	270	40	43	268	206	265	81	241	253	290	283	24
19	250	.00	.00	255	206	265	152	281	253	290	283	24
20	268	.00	.00	223	254	265	161	281	253	288	283	52
21	279	.00	62	265	261	264	67	283	252	286	283	77
22	276	.00	.00	250	261	263	272	286	254	286	283	81
23	277	.00	.00	181	261	266	185	286	285	286	284	18
24	276	.00	.00	216	261	267	50	286	285	288	287	.00
25	240	.00	.00	187	261	267	37	286	285	289	283	.00
26	268	29	.00	178	262	265	127	237	285	288	272	.00
27	262	35	171	47	267	265	127	201	284	290	243	.00
28	258	77	261	.00	268	263	127	196	279	289	287	.00
29	259	40	269	120	---	262	127	219	277	287	287	.00
30	265	63	273	182	---	262	127	258	269	286	287	104
31	272	---	12	.00	---	262	---	251	---	286	241	---
TOTAL	6884.00	3894.00	1930.50	3839.30	4604.00	8207	5255.00	7326	7757	8817	8500	4296.00
MEAN	222	130	62.3	124	164	265	175	236	259	284	274	143
MAX	285	275	273	270	268	268	272	286	285	290	287	286
MIN	.00	.00	.00	.00	.00	262	.00	151	238	251	241	.00
AC-FT	13650	7720	3830	7620	9130	16280	10420	14530	15390	17490	16860	8520
a	12160	7480	2980	6790	8060	15710	9730	12580	13510	15430	14990	7070

STATISTICS OF MONTHLY MEAN DATA FOR WATER YEARS 1963 - 2001, BY WATER YEAR (WY)

MEAN	173	187	192	196	212	216	211	219	236	247	247	186
MAX	263	269	264	264	262	269	276	280	285	284	289	270
(WY)	1980	1992	1999	1999	2000	1998	1987	1999	2000	2001	1986	1980
MIN	26.6	20.9	18.1	16.6	10.5	16.8	14.5	22.2	51.9	49.3	43.0	25.0
(WY)	1987	1978	1977	1977	1977	1977	1977	1977	1977	1977	1977	1992

SUMMARY STATISTICS FOR 2000 CALENDAR YEAR FOR 2001 WATER YEAR WATER YEARS 1963 - 2001

ANNUAL TOTAL	83849.00	71309.80	
ANNUAL MEAN	229	195	211
HIGHEST ANNUAL MEAN			257
LOWEST ANNUAL MEAN			52.2
HIGHEST DAILY MEAN	288	Jun 1	290
LOWEST DAILY MEAN	.00	Sep 30	.00
ANNUAL SEVEN-DAY MINIMUM	.00	Nov 19	.00
ANNUAL RUNOFF (AC-FT)	166300	141400	152600
TOTAL DIVERSION (AC-FT) a	150100	126500	131400
10 PERCENT EXCEEDS	286	286	279
50 PERCENT EXCEEDS	271	253	247
90 PERCENT EXCEEDS	27	.00	47

a Discharge, in acre-feet, through Kelly Ridge Powerplant (station 11396329), provided by Oroville–Wyandotte Irrigation District.

## 11396330 BANGOR CANAL BELOW MINERS RANCH RESERVOIR, NEAR OROVILLE, CA

LOCATION.—Lat 39°30'15", long 121°27'16", in NE 1/4 SW 1/4 sec.18, T.19 N., R.5 E., Butte County, Hydrologic Unit 18020124, on left bank, 400 ft downstream from outlet at Miners Ranch Dam, and 5 mi east of Oroville.

PERIOD OF RECORD.—January 1963 to current year.

GAGE.—Water-stage recorder and Parshall flume. Elevation of gage is 815 ft above sea level, from topographic map.

REMARKS.—Flow regulated by Miners Ranch Reservoir, capacity, 912 acre-ft. Canal completed in November 1962. Water is used for irrigation. See schematic diagram of [South Fork Feather River Basin](#).

COOPERATION.—Records provided by Oroville–Wyandotte Irrigation District, under general supervision of the U.S. Geological Survey, in connection with a Federal Energy Regulatory Commission project.

EXTREMES FOR PERIOD OF RECORD.—Maximum daily discharge, 65 ft<sup>3</sup>/s, Aug. 17–20, 1963; no flow for several days in 1965, 1969.

## DISCHARGE, CUBIC FEET PER SECOND, WATER YEAR OCTOBER 2000 TO SEPTEMBER 2001

## DAILY MEAN VALUES

DAY	OCT	NOV	DEC	JAN	FEB	MAR	APR	MAY	JUN	JUL	AUG	SEP
1	15	9.3	6.7	7.9	6.2	6.2	6.2	8.2	16	16	16	16
2	15	9.1	6.6	7.7	6.2	6.2	6.2	9.5	16	16	16	16
3	15	8.9	6.2	7.1	6.2	6.2	6.2	10	16	16	16	16
4	15	8.0	6.0	6.5	6.1	6.2	7.3	10	16	16	16	16
5	15	7.7	6.2	6.4	6.1	6.3	8.2	10	16	16	16	16
6	15	7.4	6.0	6.5	6.2	6.2	8.2	10	16	16	16	16
7	15	7.9	8.1	6.4	6.2	6.2	8.2	11	16	16	16	16
8	15	8.2	9.2	6.2	6.2	6.2	8.2	12	16	16	16	16
9	16	8.1	8.8	6.2	6.1	6.2	8.2	12	16	16	16	16
10	14	8.0	8.5	6.2	6.2	6.2	8.0	13	16	16	16	16
11	12	8.3	8.1	6.4	6.2	6.2	8.0	15	16	16	16	16
12	12	9.0	7.7	6.5	6.1	6.2	8.0	15	16	16	16	16
13	12	9.1	7.5	6.3	6.2	6.2	8.0	15	16	16	16	16
14	12	8.9	7.5	6.7	6.2	6.2	8.0	16	16	16	16	16
15	12	8.7	7.4	6.4	6.1	6.2	8.0	16	16	16	16	16
16	10	8.3	7.3	6.2	6.1	6.2	8.0	16	16	16	16	16
17	8.8	7.5	7.5	6.5	6.2	6.4	8.0	16	16	16	16	16
18	8.8	7.0	7.5	6.5	6.1	6.4	8.3	16	16	16	16	15
19	8.8	7.0	7.5	6.5	6.1	6.5	8.5	16	16	16	16	16
20	8.6	7.0	7.4	6.4	6.2	6.5	8.3	16	16	16	16	16
21	8.8	7.0	7.4	6.2	6.2	6.5	8.0	16	16	16	16	16
22	9.1	6.9	7.7	6.2	6.2	6.5	8.0	16	16	16	16	16
23	9.3	6.7	7.5	6.2	6.2	6.5	8.1	16	16	16	16	16
24	9.4	6.6	7.3	6.5	6.2	6.5	8.2	16	16	16	16	15
25	9.2	6.5	7.2	6.3	6.2	6.5	8.2	16	16	16	16	16
26	9.1	6.5	7.0	6.4	6.2	6.5	8.1	16	16	16	16	16
27	9.1	6.3	7.2	6.5	6.2	6.5	8.0	16	16	16	16	15
28	9.5	6.5	7.7	6.5	6.2	6.5	8.0	16	16	16	16	16
29	8.8	6.7	7.9	6.3	---	6.5	8.4	16	16	16	16	15
30	8.8	6.7	8.0	6.3	---	6.2	8.4	16	16	16	16	16
31	8.9	---	8.0	6.2	---	6.4	---	16	---	16	16	---
TOTAL	355.0	229.8	230.6	201.1	172.8	196.2	237.4	438.7	480	496	496	476
MEAN	11.5	7.66	7.44	6.49	6.17	6.33	7.91	14.2	16.0	16.0	16.0	15.9
MAX	16	9.3	9.2	7.9	6.2	6.5	8.5	16	16	16	16	16
MIN	8.6	6.3	6.0	6.2	6.1	6.2	6.2	8.2	16	16	16	15
AC-FT	704	456	457	399	343	389	471	870	952	984	984	944

## STATISTICS OF MONTHLY MEAN DATA FOR WATER YEARS 1963 - 2001, BY WATER YEAR (WY)

MEAN	16.7	7.93	5.67	4.70	4.30	4.70	8.71	16.0	21.4	23.9	24.0	21.8
MAX	29.7	14.3	11.2	12.0	7.68	8.27	20.3	27.8	42.0	56.4	53.4	36.2
(WY)	1965	1972	1975	1963	1980	1988	1970	1970	1963	1963	1963	1963
MIN	5.42	1.47	.035	.30	.25	.20	2.65	6.41	11.0	16.0	16.0	14.4
(WY)	1985	1969	1966	1966	1966	1966	1983	1995	1998	1982	2001	1993

SUMMARY STATISTICS	FOR 2000 CALENDAR YEAR		FOR 2001 WATER YEAR		WATER YEARS 1963 - 2001	
ANNUAL TOTAL	4245.5		4009.6			
ANNUAL MEAN	11.6		11.0		13.2	
HIGHEST ANNUAL MEAN					18.0	
LOWEST ANNUAL MEAN					8.95	
HIGHEST DAILY MEAN	19	Jul 1	16	Oct 9	65	Aug 17 1963
LOWEST DAILY MEAN	5.3	Feb 20	6.0	Dec 4	.00	Jan 7 1965
ANNUAL SEVEN-DAY MINIMUM	5.5	Feb 15	6.1	Feb 12	.00	Jan 7 1965
ANNUAL RUNOFF (AC-FT)	8420		7950		9530	
10 PERCENT EXCEEDS	18		16		27	
50 PERCENT EXCEEDS	10		8.9		11	
90 PERCENT EXCEEDS	6.0		6.2		3.0	

## 11396395 SUCKER RUN AT KANAKA DIVERSION, NEAR FEATHER FALLS, CA

LOCATION.—Lat 39°33'44", long 121°16'46", in SE 1/4 NE 1/4 sec.27, T.20 N., R.6 E., Butte County, Hydrologic Unit 18020123, on left bank, at Kanaka Diversion Measuring Weir, 2.5 mi upstream from confluence with South Fork Feather River, and 2.5 mi southwest of Feather Falls.

DRAINAGE AREA.—15.5 mi<sup>2</sup>.

PERIOD OF RECORD.—March 1989 to September 1998, October 1999 to current year.

GAGE.—Water-stage recorder and 120° V-notch weir. Elevation of gage is 1,660 ft above sea level, from topographic map.

REMARKS.—Water from creek is diverted upstream from gage to Kanaka Powerplant (station 11396396). See schematic diagram of South Fork Feather River Basin.

COOPERATION.—Records provided by STS Hydro Power Ltd., under general supervision of the U.S. Geological Survey, in connection with a Federal Energy Regulatory Commission project.

EXTREMES FOR PERIOD OF RECORD.—Maximum discharge, 1,500 ft<sup>3</sup>/s, Jan. 1, 1997, gage height, 4.40 ft; minimum daily, 1.2 ft<sup>3</sup>/s, Aug. 21, 22, 27, 1992, Aug. 13, 1994.

DISCHARGE, CUBIC FEET PER SECOND, WATER YEAR OCTOBER 2000 TO SEPTEMBER 2001  
DAILY MEAN VALUES

DAY	OCT	NOV	DEC	JAN	FEB	MAR	APR	MAY	JUN	JUL	AUG	SEP
1	3.8	6.7	7.2	6.4	8.3	14	12	9.7	5.9	4.3	2.9	e2.0
2	3.7	6.2	6.9	6.4	8.2	14	11	9.4	5.9	4.2	2.8	e2.0
3	3.8	5.5	6.8	6.3	8.2	14	11	9.3	6.0	4.1	2.7	e2.0
4	3.8	5.4	6.6	6.3	8.3	33	11	9.1	5.9	4.0	2.7	e2.0
5	3.8	5.5	6.4	6.3	8.5	57	11	9.0	5.8	3.9	2.9	e2.0
6	3.7	5.7	6.3	6.3	8.3	15	12	8.9	5.7	3.7	2.8	e2.0
7	3.6	5.8	6.3	6.2	8.1	13	15	8.7	5.6	3.7	2.7	e1.9
8	3.7	5.6	6.3	6.0	7.9	13	14	8.5	5.5	3.7	2.6	e1.9
9	4.5	5.8	6.3	6.6	9.3	13	13	8.4	5.4	3.7	2.5	e1.9
10	9.7	6.4	7.0	5.4	11	13	13	8.2	5.4	3.6	2.6	e1.9
11	9.9	6.1	6.6	5.4	12	13	13	8.1	5.4	3.6	2.6	e1.9
12	6.9	5.9	5.2	5.2	10	13	14	7.9	5.5	3.5	2.5	e1.9
13	5.9	6.4	5.5	5.1	10	13	12	7.8	5.2	3.6	2.5	e1.9
14	5.7	7.7	5.3	5.3	9.8	13	12	7.8	5.0	3.5	2.5	e1.9
15	5.7	7.3	5.3	6.1	9.5	13	12	8.0	4.9	3.4	2.5	e1.9
16	5.7	7.0	5.1	8.1	9.4	14	11	8.2	4.8	3.4	2.5	e1.9
17	5.7	6.8	6.1	7.8	9.7	14	11	7.9	4.8	3.4	2.5	e1.9
18	5.7	6.7	7.7	7.6	14	16	11	7.7	4.8	3.5	2.4	e1.9
19	5.7	6.7	7.4	7.5	18	16	12	7.3	4.6	3.4	2.4	e1.9
20	5.4	6.8	7.3	7.3	28	15	14	7.1	4.5	3.3	2.5	e1.9
21	5.8	6.7	7.2	7.2	63	15	14	6.9	4.4	3.2	2.4	e1.9
22	5.2	6.8	7.5	7.0	32	14	14	6.8	4.3	3.2	2.5	e1.9
23	5.4	6.7	7.1	6.6	16	14	13	6.8	4.2	3.2	2.6	e1.8
24	5.4	6.7	7.0	5.3	16	14	12	6.7	4.1	3.1	2.6	e1.8
25	6.3	6.6	6.8	6.0	17	14	11	6.7	4.4	3.0	2.6	e3.0
26	6.5	6.5	6.7	5.4	14	15	11	6.6	5.4	3.0	e2.2	e2.8
27	6.0	6.5	6.7	5.2	15	14	11	6.4	5.5	2.9	e2.1	e2.7
28	9.9	6.5	6.6	5.3	15	13	10	6.4	5.5	2.8	e2.1	e2.7
29	14	6.2	6.6	5.3	---	13	10	6.4	4.8	2.8	e2.1	e2.7
30	8.6	7.3	6.5	5.3	---	12	9.9	6.1	4.6	2.9	e2.1	e2.7
31	7.4	---	6.5	5.4	---	12	---	6.0	---	3.0	e2.1	---
TOTAL	186.9	192.5	202.8	191.6	404.5	489	360.9	238.8	153.8	106.6	77.5	62.6
MEAN	6.03	6.42	6.54	6.18	14.4	15.8	12.0	7.70	5.13	3.44	2.50	2.09
MAX	14	7.7	7.7	8.1	63	57	15	9.7	6.0	4.3	2.9	3.0
MIN	3.6	5.4	5.1	5.1	7.9	12	9.9	6.0	4.1	2.8	2.1	1.8
AC-FT	371	382	402	380	802	970	716	474	305	211	154	124

STATISTICS OF MONTHLY MEAN DATA FOR WATER YEARS 1989 - 2001, BY WATER YEAR (WY)

	1989	1990	1991	1992	1993	1994	1995	1996	1997	1998	1999	2000	2001
MEAN	4.58	5.53	11.0	32.1	29.6	25.7	16.6	13.0	7.73	6.44	4.40	3.99	
MAX	7.19	7.32	51.7	128	91.7	92.0	37.5	45.5	10.4	13.7	8.09	7.58	
(WY)	1990	1990	1997	1997	1998	1995	1995	1995	1998	1995	1995	1998	
MIN	2.36	3.44	4.34	4.44	5.11	12.1	9.83	6.40	4.24	2.85	1.55	1.33	
(WY)	1995	1993	1991	1991	1991	1994	1994	1992	1992	1994	1994	1992	

SUMMARY STATISTICS	FOR 2000 CALENDAR YEAR		FOR 2001 WATER YEAR		WATER YEARS 1989 - 2001	
ANNUAL TOTAL	4811.6		2667.5			
ANNUAL MEAN	13.1		7.31		13.4	
HIGHEST ANNUAL MEAN					28.2	
LOWEST ANNUAL MEAN					6.29	
HIGHEST DAILY MEAN	311	Feb 14	63	Feb 21	1100	Jan 1 1997
LOWEST DAILY MEAN	3.6	Oct 7	1.8	Sep 23	1.2	Aug 21 1992
ANNUAL SEVEN-DAY MINIMUM	3.7	Oct 2	1.9	Sep 18	1.3	Aug 21 1992
MAXIMUM PEAK FLOW			85		1500	
MAXIMUM PEAK STAGE			2.37		4.40	
ANNUAL RUNOFF (AC-FT)	9540		5290		9700	
10 PERCENT EXCEEDS	16		13		18	
50 PERCENT EXCEEDS	7.6		6.3		7.0	
90 PERCENT EXCEEDS	4.8		2.5		2.7	

e Estimated.

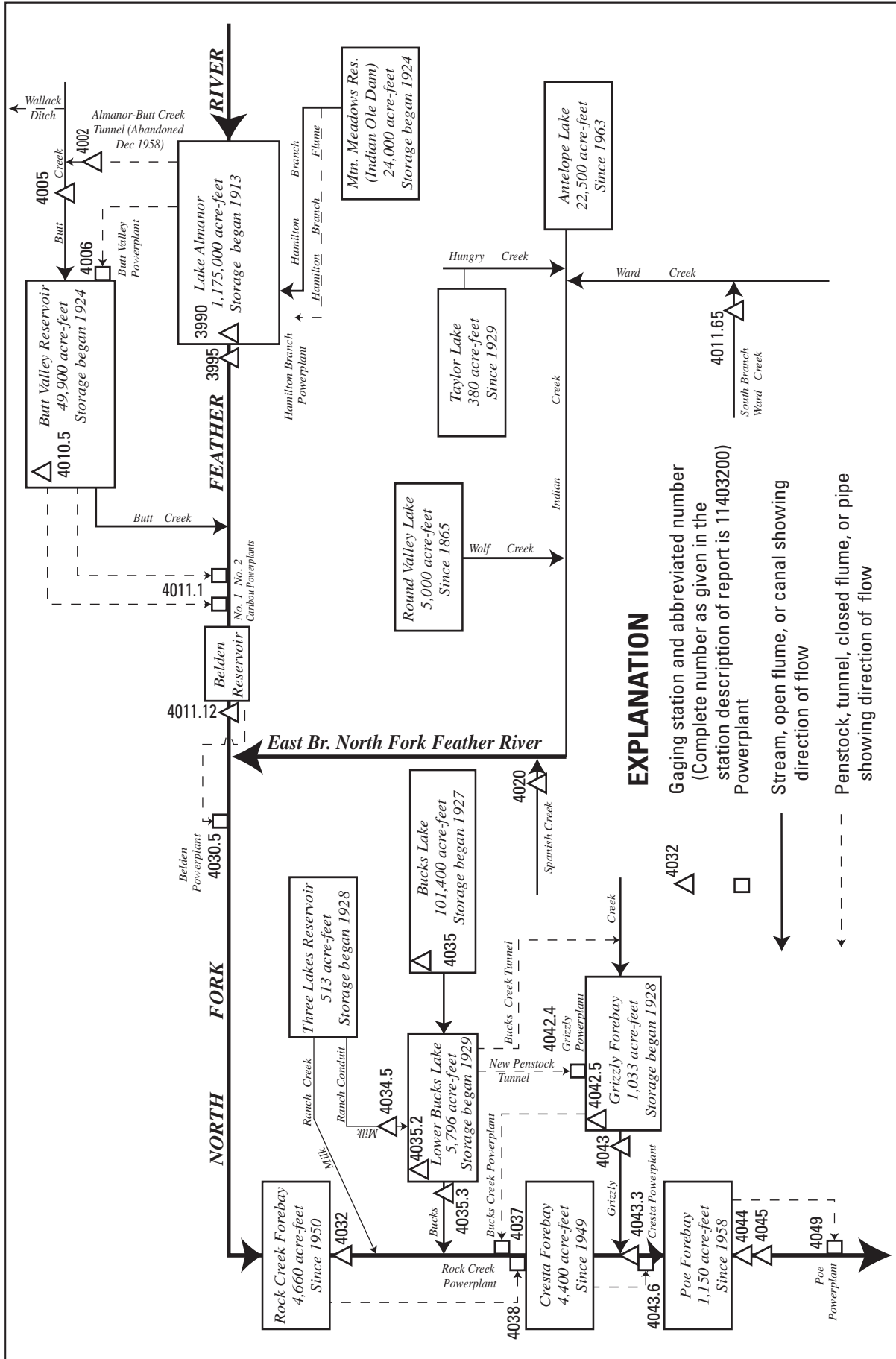

Figure 29. Diversions and storage in North Fork Feather River Basin.

## 11399000 LAKE ALMANOR AT PRATTVILLE, CA

LOCATION.—Lat 40°12'46", long 121°09'43", in SW 1/4 NE 1/4 sec.11, T.27 N., R.7 E., Plumas County, Hydrologic Unit 18020121, Lassen National Forest, at intake tower to Butt Valley Tunnel at Prattville, 4.7 mi northwest of Lake Almanor Dam, and 5.6 mi northwest of Canyondam.

DRAINAGE AREA.—491 mi<sup>2</sup>.

PERIOD OF RECORD.—July 1913 to current year. Monthly contents only for some periods, published in WSP 1315-A. Published as "near Prattville" 1937–60. Prior to October 1964, records published as usable contents.

REVISED RECORDS.—WSP 1931: Drainage area.

GAGE.—Nonrecording gage read once daily. Datum of gage is 10.23 ft below sea level (levels by Pacific Gas & Electric Co.). Prior to June 1, 1965, nonrecording gage at site 4.7 mi southeast at same datum.

REMARKS.—Lake is formed by earthfill dam; storage began in July 1913; dam raised to gage height 4,455 ft in 1917 and 4,515 ft in 1927. Usable capacity, 1,175,000 acre-ft, between gage heights 4,422 ft, invert of outlet, and 4,495.5 ft, maximum storage limit. Dead storage, 8,948 acre-ft. Water is diverted by tunnel and penstock to Butt Valley Powerplant (station 11400600) and then is used for power development in the North Fork Feather River. Figures given, including extremes, represent total contents at 2400 hours. See schematic diagram of North Fork Feather River Basin.

COOPERATION.—Records were collected by Pacific Gas & Electric Co., under general supervision of the U.S. Geological Survey, in connection with a Federal Energy Regulatory Commission project. Contents not rounded to U.S. Geological Survey standards.

EXTREMES FOR PERIOD OF RECORD.—Maximum contents, 1,142,960 acre-ft, June 8, 1982, gage height, 4,494.00 ft; minimum, 5,230 acre-ft, Feb. 5, 1918, gage height, 4,416.1 ft.

EXTREMES FOR CURRENT YEAR.—Maximum contents, 839,813 acre-ft, Oct. 1, 2, gage height, 4,482.20 ft; minimum, 662,618 acre-ft, Sept. 30, gage height, 4,474.55 ft.

Capacity table (gage height, in feet, and contents, in acre-feet)  
(Based on surveys by Pacific Gas & Electric Co. in 1924 and 1926)

4,422	8,948	4,432	34,173	4,445	156,414	4,470	565,519
4,424	10,067	4,434	49,510	4,450	220,848	4,480	787,304
4,426	11,260	4,437	74,189	4,455	94,531	4,490	1,036,269
4,428	13,480	4,440	101,869	4,460	376,686	4,495.5	1,183,835
4,430	21,200						

## RESERVOIR STORAGE (ACRE-FEET), WATER YEAR OCTOBER 2000 TO SEPTEMBER 2001

## DAILY OBSERVATION AT 2400 HOURS

DAY	OCT	NOV	DEC	JAN	FEB	MAR	APR	MAY	JUN	JUL	AUG	SEP
1	839813	796688	749829	724501	686041	690549	729101	768463	791961	766119	719918	679380
2	839813	794322	752144	722207	686041	690549	731407	768463	791961	763780	717633	679745
3	837399	791961	752144	719918	686041	692783	733718	770811	791961	763780	717633	680156
4	834989	789604	752144	719918	686041	692783	733718	773164	791961	761444	717633	680492
5	832584	789604	752144	717633	683788	697262	736030	773164	789604	759113	717633	680763
6	830182	787252	752144	715353	683788	699509	736030	775520	789604	756786	715353	680913
7	830182	787252	752144	713076	683788	699509	738319	775520	787252	756786	713076	681166
8	827784	784903	747519	713076	683788	699509	738319	777881	787252	756786	710804	681446
9	827784	784903	745213	710804	686041	699509	740613	780218	787252	754463	710804	681605
10	825388	782558	742911	710804	686041	701759	740613	780218	787252	752144	710710	682055
11	825388	782558	740613	710804	688298	704014	742911	782558	787252	752144	709462	682485
12	822974	780218	740613	708537	688298	704014	742911	782558	784903	749829	709132	683104
13	820564	775520	740613	706273	688298	706273	745213	782558	782558	747519	708612	683741
14	818158	770811	740613	706273	688298	706273	745213	784903	782558	747519	706763	684266
15	815756	768463	738319	704014	686041	708537	745213	784903	782558	745213	704598	684857
16	813358	766119	738319	701759	686041	708537	747519	787252	782558	742911	702558	685496
17	810964	763780	736030	701759	688298	710804	747519	787252	784903	742911	700212	685524
18	810964	761444	733718	699509	688298	713076	749829	787252	782558	742911	698348	684154
19	808574	761444	733718	697262	690549	713076	752144	787252	780218	740613	696861	683048
20	808574	761444	733718	697262	690549	713076	754463	789604	780218	738319	694657	681587
21	808574	761444	733718	695020	690549	715353	754463	789604	777881	738319	692448	679679
22	806189	759113	731407	692783	692783	715353	756786	791961	775520	736030	690352	677477
23	806189	759113	731407	692783	692783	717633	756786	791961	775520	736030	688232	674720
24	803807	759113	731407	692783	692783	719918	759113	791961	775520	733718	686407	672341
25	803807	759113	731407	692783	692783	722207	759113	794322	773164	731407	685045	671293
26	801430	759113	729101	692783	690549	724501	761444	794322	773164	731407	684294	669708
27	799057	756786	729101	692783	690549	724501	763780	794322	770811	729101	683207	667368
28	799057	754463	729101	690549	690549	724501	763780	794322	770811	726799	681615	665770
29	801430	754463	726799	690549	---	726799	766119	796688	768463	724501	679960	664193
30	799057	752144	726799	688298	---	726799	768463	794322	768463	724501	678960	662618
31	799057	---	724501	688298	---	729101	---	794322	---	722207	679007	---
MAX	839813	796688	752144	724501	692783	729101	768463	796688	791961	766119	719918	685524
MIN	799057	752144	724501	688298	683788	690549	729101	768463	768463	722207	678960	662618
a	4480.50	4478.50	4477.30	4475.70	4475.80	4477.50	4479.20	4480.30	4479.20	4470.20	4475.31	4474.57
b	-43657	-46913	-27643	-36203	+2251	+38552	+39362	+25859	-25859	-46256	-43200	-16389
CAL YR 2000	MAX 1090522	MIN 724501	b -104242									
WTR YR 2001	MAX 839813	MIN 662618	b -180096									

a Gage height, in feet, at end of month.  
b Change in contents, in acre-feet.

## 11399500 NORTH FORK FEATHER RIVER NEAR PRATTVILLE, CA

LOCATION.—Lat 40°10'06", long 121°05'31", in NE 1/4 SW 1/4 sec.28, T.27 N., R.8 E., [Plumas County](#), Hydrologic Unit 18020121, Plumas National Forest, on left bank, 0.4 mi downstream from Almanor Dam, 4.5 mi southeast of Prattville, and 9 mi upstream from Butt Creek.

DRAINAGE AREA.—493 mi<sup>2</sup>.

PERIOD OF RECORD.—June 1905 to current year. Published as "below Prattville" prior to 1911. No record for January, February, or March 1911. Estimated mean discharge for water year 1911 published in WSP 1315-A.

REVISED RECORDS.—WSP 1245: 1951 (yearly summaries). WSP 1285: 1952 (yearly summaries). WDR CA-88-4: 1987 (monthly and yearly totals for Butt Valley Powerplant).

GAGE.—Water-stage recorder and broad-crested weir. Datum of gage is 4,379.86 ft above sea level. Prior to Oct. 1, 1936, nonrecording gages or water-stage recorders at several sites within 0.5 mi of present site at various datums.

REMARKS.—Flow regulated since 1913 by Lake Almanor (station 11399000) 0.5 mi upstream and since 1924 by Mountain Meadows Reservoir, capacity, 24,000 acre-ft, 12 mi upstream on Hamilton Branch. Water diverted from Lake Almanor to Butt Valley Reservoir (station 11401050) through old Almanor–Butt Creek Tunnel from May 1921 to December 1958, for use at Caribou Powerplant. Old tunnel closed Dec. 30, 1958, and diversion began Dec. 31, 1958, to Butt Valley Powerplant (station 11400600) at upstream end of Butt Valley Reservoir. See schematic diagram of [North Fork Feather River Basin](#).

COOPERATION.—Records were collected by Pacific Gas & Electric Co., under general supervision of the U.S. Geological Survey, in connection with a Federal Energy Regulatory Commission project.

EXTREMES FOR PERIOD OF RECORD.—Maximum discharge, 10,000 ft<sup>3</sup>/s, Mar. 19, 1907, before construction of dam, gage height, 16.2 ft, at former site, from rating curve extended above 3,700 ft<sup>3</sup>/s; no flow at times during 1914, 1919, 1923.

## DISCHARGE, CUBIC FEET PER SECOND, WATER YEAR OCTOBER 2000 TO SEPTEMBER 2001

## DAILY MEAN VALUES

DAY	OCT	NOV	DEC	JAN	FEB	MAR	APR	MAY	JUN	JUL	AUG	SEP
1	36	40	40	36	36	36	37	37	39	38	37	36
2	187	40	40	36	36	36	37	37	39	38	37	36
3	364	40	40	36	36	36	37	37	39	38	37	36
4	265	40	40	35	36	36	37	37	39	38	37	36
5	42	40	38	35	36	36	37	37	39	38	37	36
6	41	40	36	35	36	36	37	37	39	38	37	36
7	41	40	36	35	36	36	37	37	39	38	37	36
8	41	40	36	35	36	36	37	37	39	38	37	36
9	41	40	36	36	36	36	37	37	39	38	37	36
10	41	40	36	37	36	36	37	37	39	38	37	36
11	41	40	36	37	36	36	37	46	39	38	37	36
12	41	40	36	37	36	36	37	498	39	38	37	36
13	41	40	36	37	36	36	37	271	39	38	37	36
14	40	40	36	37	36	36	37	92	39	38	37	36
15	40	40	36	37	36	36	37	85	39	37	37	36
16	40	40	36	37	36	36	37	40	39	37	37	36
17	40	40	36	37	36	36	37	40	39	37	36	36
18	40	40	36	37	36	36	37	40	39	37	36	36
19	40	40	36	37	36	36	37	40	39	37	36	36
20	40	40	36	37	36	36	37	39	38	37	36	36
21	40	40	36	37	36	36	37	39	38	37	36	36
22	40	40	36	37	36	36	37	39	38	37	36	36
23	40	40	36	37	36	36	37	39	38	37	36	36
24	40	40	36	37	36	36	37	39	38	37	36	36
25	40	40	36	37	36	37	37	39	38	37	36	36
26	40	40	36	37	36	37	37	39	38	37	36	36
27	40	40	36	36	36	37	37	39	38	37	36	36
28	40	40	36	36	36	37	37	39	38	37	36	36
29	40	40	36	36	---	37	37	39	38	37	36	36
30	40	40	36	36	---	37	37	39	38	37	36	36
31	40	---	36	36	---	37	---	39	---	37	36	---
TOTAL	1942	1200	1134	1128	1008	1123	1110	1990	1159	1161	1132	1080
MEAN	62.6	40.0	36.6	36.4	36.0	36.2	37.0	64.2	38.6	37.5	36.5	36.0
MAX	364	40	40	37	36	37	37	498	39	38	37	36
MIN	36	40	36	35	36	36	37	37	38	37	36	36
AC-FT	3850	2380	2250	2240	2000	2230	2200	3950	2300	2300	2250	2140
a	78860	76770	62590	81150	34620	7240	1670	3270	45680	66480	62550	35680

a Diversion, in acre-feet, to Butt Valley Powerplant (station 11400600), provided by Pacific Gas & Electric Co.

## 11399500 NORTH FORK FEATHER RIVER NEAR PRATTVILLE, CA—Continued

## STATISTICS OF MONTHLY MEAN DATA FOR WATER YEARS 1925 - 1958, BY WATER YEAR (WY)

	OCT	NOV	DEC	JAN	FEB	MAR	APR	MAY	JUN	JUL	AUG	SEP
MEAN	498	393	371	282	349	272	318	327	349	479	602	569
MAX	1607	1414	1418	1489	2124	1609	1852	2206	1065	1280	1755	1762
(WY)	1931	1931	1938	1946	1938	1929	1938	1938	1935	1929	1929	1929
MIN	3.80	3.32	3.41	3.20	3.20	3.61	2.63	2.02	2.11	8.02	3.72	3.16
(WY)	1942	1940	1937	1944	1944	1944	1939	1939	1939	1943	1937	1937

## SUMMARY STATISTICS

## WATER YEARS 1925 - 1958

ANNUAL TOTAL		
ANNUAL MEAN	401	
HIGHEST ANNUAL MEAN	1061	1929
LOWEST ANNUAL MEAN	27.1	1937
HIGHEST DAILY MEAN	2670	May 17 1942
LOWEST DAILY MEAN	.50	Apr 28 1949
ANNUAL SEVEN-DAY MINIMUM	.87	Apr 25 1949
MAXIMUM PEAK FLOW	2710	May 22 1941
MAXIMUM PEAK STAGE	6.95	May 22 1941
ANNUAL RUNOFF (AC-FT)	290600	
10 PERCENT EXCEEDS	1060	
50 PERCENT EXCEEDS	60	
90 PERCENT EXCEEDS	4.4	

## STATISTICS OF MONTHLY MEAN DATA FOR WATER YEARS 1960 - 2001, BY WATER YEAR (WY)

MEAN	47.4	44.6	33.2	78.1	76.7	37.4	41.8	50.0	66.7	62.0	58.6	44.4
MAX	510	546	59.6	1901	1800	163	293	352	660	688	596	415
(WY)	1997	1997	1997	1997	1997	1997	1983	1996	1996	1996	1996	1996
MIN	17.3	8.65	7.47	8.67	10.0	9.90	10.1	15.7	16.0	15.4	14.9	15.0
(WY)	1978	1960	1960	1960	1962	1964	1964	1977	1977	1977	1977	1977

## SUMMARY STATISTICS

## FOR 2000 CALENDAR YEAR

## FOR 2001 WATER YEAR

## WATER YEARS 1960 - 2001

ANNUAL TOTAL	14446	15167	
ANNUAL MEAN	39.5	41.6	53.3
HIGHEST ANNUAL MEAN			459
LOWEST ANNUAL MEAN			22.3
HIGHEST DAILY MEAN	364	Oct 3	498
LOWEST DAILY MEAN	36	Jan 1	35
ANNUAL SEVEN-DAY MINIMUM	36	Jan 1	35
MAXIMUM PEAK FLOW			714
MAXIMUM PEAK STAGE			4.77
ANNUAL RUNOFF (AC-FT)	28650	30080	38590
ANNUAL DIVERSION (AC-FT) a	693000	556600	
10 PERCENT EXCEEDS	40	40	40
50 PERCENT EXCEEDS	37	37	36
90 PERCENT EXCEEDS	36	36	33

a Diversion, in acre-feet, to Butt Valley Powerplant (station 11400600), provided by Pacific Gas & Electric Co.

## 11400500 BUTT CREEK BELOW ALMANOR–BUTT CREEK TUNNEL, NEAR PRATTVILLE, CA

LOCATION.—Lat 40°11'14", long 121°11'13", in NE 1/4 NW 1/4 sec.22, T.27 N., R.7 E., [Plumas County](#), Hydrologic Unit 18020121, on right bank, 500 ft downstream from outlet of old Almanor–Butt Creek Tunnel, and 2.2 mi southwest of Prattville.

DRAINAGE AREA.—69.3 mi<sup>2</sup>.

PERIOD OF RECORD.—October 1936 to September 1959, October 1964 to current year. Published as "below tunnel No. 1" 1938–40. Records for water years 1937–38 published in WSP 1515. Records prior to 1964 not equivalent owing to inflow from Almanor–Butt Creek Tunnel.

GAGE.—Water-stage recorder and concrete control. Elevation of gage is 4,300 ft above sea level, from topographic map. Prior to Oct. 5, 1937, at site 200 ft downstream at datum 4 ft lower.

REMARKS.—No regulation upstream from station. Howell–Bunger valve in conduit from Lake Almanor (station 11399000) to Butt Valley Powerplant (station 11400600) is opened for short periods several times a year, causing sharp peaks. Wallack Ditch upstream from station diverts about 3 ft<sup>3</sup>/s during each irrigation season into Yellow Creek Basin. Some inflow 500 ft upstream that is the leakage from the abandoned Almanor–Butt Creek Tunnel at Outlet (station 11400200) is included in the table below. See schematic diagram of [North Fork Feather River Basin](#).

COOPERATION.—Records were collected by Pacific Gas & Electric Co., under general supervision of the U.S. Geological Survey, in connection with a Federal Energy Regulatory Commission project.

EXTREMES FOR PERIOD OF RECORD.—Maximum discharge, 4,080 ft<sup>3</sup>/s, Jan. 1, 1997, gage height, 6.22 ft, from rating curve extended above 1,400 ft<sup>3</sup>/s; minimum daily, 26 ft<sup>3</sup>/s, several days during May and June 1976.

## DISCHARGE, CUBIC FEET PER SECOND, WATER YEAR OCTOBER 2000 TO SEPTEMBER 2001

## DAILY MEAN VALUES

DAY	OCT	NOV	DEC	JAN	FEB	MAR	APR	MAY	JUN	JUL	AUG	SEP
1	45	52	51	48	55	51	152	126	52	43	40	36
2	46	51	50	48	53	52	141	116	51	43	39	36
3	46	52	49	47	49	51	117	104	50	42	39	36
4	49	52	49	48	50	51	101	100	50	42	39	36
5	48	52	49	48	50	59	96	101	49	42	39	36
6	48	51	48	48	51	60	97	100	49	42	39	36
7	48	50	49	48	50	62	92	100	48	42	38	36
8	48	51	49	49	52	63	82	103	48	42	38	36
9	50	49	49	49	50	64	81	105	48	42	37	36
10	60	48	49	49	48	61	79	102	47	45	37	36
11	57	47	49	50	50	61	85	97	47	43	37	37
12	54	46	49	49	52	61	81	93	47	42	37	37
13	51	46	49	49	54	64	79	87	46	41	37	38
14	50	48	53	48	57	66	80	82	47	42	37	37
15	50	48	52	49	57	65	82	83	46	41	37	37
16	50	48	50	51	56	63	85	81	46	40	37	38
17	49	48	49	44	55	64	91	76	46	40	37	37
18	49	47	48	50	54	74	108	72	45	40	37	37
19	48	48	48	52	53	84	138	69	45	40	37	36
20	49	48	48	49	53	96	114	67	45	40	37	35
21	50	47	49	49	53	104	98	65	44	e40	37	35
22	48	48	52	49	53	115	95	63	44	e40	37	35
23	48	47	50	49	52	116	104	61	44	e40	37	35
24	48	48	49	49	52	129	118	60	43	e40	37	35
25	50	48	48	48	52	228	131	58	44	e40	37	43
26	53	48	48	49	51	168	137	57	46	e40	37	37
27	50	48	48	49	51	144	133	56	47	e40	37	36
28	59	49	48	48	51	167	128	55	46	e40	37	36
29	64	65	49	49	---	173	117	54	44	e40	36	36
30	56	55	48	47	---	157	120	54	43	e40	36	36
31	53	---	48	52	---	154	---	53	---	e40	36	---
TOTAL	1574	1485	1524	1511	1464	2927	3162	2500	1397	1274	1159	1093
MEAN	50.8	49.5	49.2	48.7	52.3	94.4	105	80.6	46.6	41.1	37.4	36.4
MAX	64	65	53	52	57	228	152	126	52	45	40	43
MIN	45	46	48	44	48	51	79	53	43	40	36	35
AC–FT	3120	2950	3020	3000	2900	5810	6270	4960	2770	2530	2300	2170
a	492	471	495	491	443	479	449	453	434	437	425	418

e Estimated.

a Inflow, in acre-feet, from Almanor–Butt Creek Tunnel at Outlet (station 11400200), provided by Pacific Gas & Electric Co.



## 11400500 BUTT CREEK BELOW ALMANOR-BUTT CREEK TUNNEL, NEAR PRATTVILLE, CA—Continued

## STATISTICS OF MONTHLY MEAN DATA FOR WATER YEARS 1937 - 2001, BY WATER YEAR (WY)

	OCT	NOV	DEC	JAN	FEB	MAR	APR	MAY	JUN	JUL	AUG	SEP
MEAN	362	335	347	295	293	327	335	370	361	379	371	367
MAX	995	1073	1419	1098	1025	1050	1178	1176	1092	1038	1019	990
(WY)	1943	1938	1959	1953	1941	1953	1952	1956	1958	1953	1953	1953
MIN	32.3	39.2	39.3	39.4	38.0	47.8	47.5	42.7	32.9	28.7	27.8	29.4
(WY)	1989	1992	1991	1992	1937	1977	1977	1976	1976	1977	1977	1992

SUMMARY STATISTICS	FOR 2000 CALENDAR YEAR		FOR 2001 WATER YEAR		WATER YEARS 1937 - 2001	
ANNUAL TOTAL	32711		21070			
ANNUAL MEAN	89.4		57.7		345	
HIGHEST ANNUAL MEAN					974	
LOWEST ANNUAL MEAN					40.1	
HIGHEST DAILY MEAN	370	Feb 14	228	Mar 25	2830	Feb 17 1986
LOWEST DAILY MEAN	45	Sep 19	35	Sep 20	26	May 26 1976
ANNUAL SEVEN-DAY MINIMUM	45	Sep 25	35	Sep 18	26	May 30 1976
MAXIMUM PEAK FLOW			245	Mar 25	4080	Jan 1 1997
MAXIMUM PEAK STAGE			1.42	Mar 25	6.22	Jan 1 1997
ANNUAL RUNOFF (AC-FT)	64880		41790		250300	
ANNUAL INFLOW (AC-FT) a	6120		5490			
10 PERCENT EXCEEDS	178		99		989	
50 PERCENT EXCEEDS	60		49		97	
90 PERCENT EXCEEDS	48		37		42	

a Inflow, in acre-feet, from Almanor-Butt Creek Tunnel at Outlet (station 11400200), provided by Pacific Gas & Electric Co.

## 11401050 BUTT VALLEY RESERVOIR NEAR CARIBOU, CA

LOCATION.—Lat 40°06'59", long 121°08'42", in SE 1/4 SW 1/4 sec.12, T.26 N., R.7 E., Plumas County, Hydrologic Unit 18020121, on center intake tower in Butt Valley Reservoir, 2.5 mi north of Caribou, and 5.4 mi southwest of Canyon Dam.

DRAINAGE AREA.—83.5 mi<sup>2</sup>.

PERIOD OF RECORD.—October 1985 to current year. Unpublished records for water years 1983–85 available in files of the U.S. Geological Survey.

GAGE.—Water-stage recorder. Datum of gage is 10.23 ft below sea level (levels by Great Western Power Co.).

REMARKS.—Lake is formed by earthfill dam. Storage began in 1924. Usable capacity, 49,900 acre-ft, between elevations 4,075.9 ft, invert of outlet tunnel, and 4,132.1 ft, crest of spillway. Water is diverted by tunnel and penstock to Caribou Powerplants (station 11401110). Figures given, including extremes, represent total contents at 2400 hours. See schematic diagram of North Fork Feather River Basin.

REVISED RECORDS.—WDR CA-00-4 (discharge through Caribou Powerplants).

COOPERATION.—Records were collected by Pacific Gas & Electric Co., under general supervision of the U.S. Geological Survey, in connection with a Federal Energy Regulatory Commission project. Contents not rounded to U.S. Geological Survey standards.

EXTREMES FOR PERIOD OF RECORD.—Maximum contents, 52,667 acre-ft, Feb. 18, 19, 1986, elevation, 4,133.80 ft; minimum, 4,284 acre-ft, Mar. 3, 1997, elevation, 4,094.95 ft.

EXTREMES FOR CURRENT YEAR.—Maximum contents, 49,414 acre-ft, Sept. 13, elevation, 4,131.78 ft; minimum, 29,219 acre-ft, Jan. 1, elevation, 4,118.30 ft.

Capacity table (elevation, in feet, and contents, in acre-feet)  
(Based on surveys by Great Western Power Co. in 1923 and 1924)

4,090	1,754	4,110	18,395	4,130	46,591	4,137	57,891
4,100	8,024	4,120	31,592				

## RESERVOIR STORAGE (ACRE-FEET), WATER YEAR OCTOBER 2000 TO SEPTEMBER 2001

## DAILY OBSERVATION AT 2400 HOURS

DAY	OCT	NOV	DEC	JAN	FEB	MAR	APR	MAY	JUN	JUL	AUG	SEP
1	39348	41166	46277	29219	31463	32875	40257	41720	41226	43288	45702	48790
2	38893	41621	44710	30044	31463	32029	40257	41832	41749	44047	45893	48688
3	39348	41621	42849	29769	31605	32311	40257	41850	42183	44179	45302	48613
4	39803	41926	41166	29769	31746	31746	40409	41947	42978	44280	44228	48619
5	39499	41166	41015	29907	31463	32452	40560	42052	44691	44388	43787	48682
6	39044	41166	38593	30186	31322	33166	40712	42164	46102	44460	43526	48745
7	38445	40257	37556	30896	31605	34182	40560	42182	46667	44723	44071	48832
8	38149	39954	38297	31322	31322	34906	40712	42148	47031	45439	43532	48909
9	37407	39954	39348	31746	31180	35196	40712	42213	47002	45861	43614	48989
10	37556	40409	41015	32170	31180	35340	40712	42347	46847	45715	43407	49079
11	37852	41621	41621	32593	31038	35630	40863	42496	46578	45680	43098	49177
12	38893	41166	41469	32734	30755	35340	40853	42458	45836	45693	42556	49296
13	39044	41926	41166	33166	30755	35196	40829	42548	45834	45617	41681	49414
14	39348	43157	40257	32875	30471	35340	40706	42444	45863	45774	41726	49289
15	39196	44710	39499	32875	30471	35051	40756	42321	45596	45944	42537	48838
16	39499	45336	39499	33166	30613	35196	40615	42287	45050	46197	42852	48502
17	39803	46592	38593	32734	30613	35340	40512	42152	44481	46389	43081	48072
18	39651	48175	39044	32452	30613	35630	40508	42000	44120	46241	43375	47580
19	39348	46434	38000	32875	30186	35051	40396	41821	43960	46173	43689	47191
20	39499	44554	37259	32875	30186	35051	40436	41717	43795	46188	44437	46847
21	40560	42542	37111	32452	30186	35340	40642	41349	43494	46204	44789	47059
22	41469	42080	37407	33311	31322	35630	40811	40810	43174	46368	44929	47040
23	41772	42080	36517	33020	32029	35923	40998	40164	42523	46132	45377	47435
24	41772	43003	35196	33166	34037	36368	41161	39494	41835	45723	45458	47452
25	41469	42234	33747	33311	33602	36962	41220	39334	42161	45422	45374	47933
26	43157	41469	33602	33311	34037	37407	41335	39252	42177	45374	45350	48139
27	43003	42849	33456	32875	34037	37704	41534	39149	42008	45393	45068	48602
28	43003	44243	31180	32593	33602	38445	41553	39035	41593	45594	45312	48194
29	40712	45963	31605	32170	---	38893	41576	38910	41573	46103	47198	47486
30	41015	46120	31463	32029	---	39499	41547	38859	42094	46064	48652	46731
31	40560	---	31463	31888	---	39803	---	39975	---	45786	48876	---
MAX	43157	48175	46277	33311	34037	39803	41576	42548	47031	46389	48876	49414
MIN	37407	39954	31180	29219	30186	31746	40257	38859	41226	43288	41681	46731
a	4126.10	4129.70	4119.90	4120.20	4121.40	4125.60	4126.79	4126.28	4127.63	4129.63	4131.49	4130.51
b	+1127	+5560	-14657	+425	+1714	+6201	+1744	-1572	+2119	+3692	+3090	-2145
c	75180	70230	69610	72720	35100	8310	4470	8300	40210	58520	55130	37680

CAL YR 2000 MAX 48175 MIN 24991 b +466 c 720700  
WTR YR 2001 MAX 49414 MIN 29219 b +7294 c 535500

a Elevation, in feet, at end of month.

b Change in contents, in acre-feet.

c Discharge, in acre-feet, through Caribou Powerplants (station 11401110), provided by Pacific Gas & Electric Co.

## 11401112 NORTH FORK FEATHER RIVER BELOW BELDEN DAM, CA

LOCATION.—Lat 40°04'17", long 121°09'49", in NE 1/4 NW 1/4 sec.35, T.26 N., R.7 E., Plumas County, Hydrologic Unit 18020121, Plumas National Forest, on left bank, 0.4 mi downstream from Belden Dam, 0.5 mi upstream from Deadwood Canyon, and 6.4 mi northeast of Belden.

DRAINAGE AREA.—612 mi<sup>2</sup>.

PERIOD OF RECORD.—October 1969 to current year. July 1959 to September 1969 in files of Pacific Gas & Electric Co.

REVISED RECORDS.—WDR CA-78-4: 1977 (monthly and yearly summaries).

GAGE.—Water-stage recorder. Datum of gage is 2,800.77 ft above sea level (levels by Pacific Gas & Electric Co.).

REMARKS.—Flow regulated by Butt Valley Reservoir (station 11401050), Lake Almanor (station 11399000), Belden Reservoir, and Mountain Meadows Reservoir, combined capacity, 1,267,000 acre-ft. Diversion to Belden Powerplant (station 11403050) began on Aug. 27, 1969. See schematic diagram of North Fork Feather River Basin.

COOPERATION.—Records were collected by Pacific Gas & Electric Co., under general supervision of the U.S. Geological Survey, in connection with a Federal Energy Regulatory Commission project.

EXTREMES FOR PERIOD OF RECORD.—Maximum discharge, 3,460 ft<sup>3</sup>/s, Jan. 1, 1997, gage height, 9.17 ft; minimum daily, 2.3 ft<sup>3</sup>/s, Oct. 25, 1981.

DISCHARGE, CUBIC FEET PER SECOND, WATER YEAR OCTOBER 2000 TO SEPTEMBER 2001  
DAILY MEAN VALUES

DAY	OCT	NOV	DEC	JAN	FEB	MAR	APR	MAY	JUN	JUL	AUG	SEP
1	481	64	66	66	67	67	64	146	146	148	146	148
2	65	64	66	66	67	67	64	135	147	147	147	148
3	64	64	66	66	67	66	64	108	147	148	146	124
4	64	64	66	67	66	66	64	103	147	148	147	65
5	64	64	66	66	67	66	64	103	146	148	147	65
6	64	64	66	66	67	66	64	103	146	147	148	65
7	64	64	67	66	66	66	64	104	147	148	148	65
8	64	64	66	66	64	66	64	105	148	148	147	65
9	64	62	66	67	64	66	64	104	147	148	147	65
10	64	63	66	66	73	66	64	103	148	147	148	65
11	64	64	66	66	85	65	65	107	148	147	147	65
12	64	66	65	66	64	65	66	521	148	146	147	65
13	64	65	66	65	65	65	66	302	148	148	147	82
14	64	64	66	65	65	65	66	272	147	148	147	123
15	64	64	66	66	66	66	65	140	147	147	146	66
16	64	64	66	65	65	65	65	140	148	147	146	65
17	64	65	66	67	65	65	65	141	147	146	147	65
18	63	64	66	67	65	65	66	140	146	147	148	68
19	64	63	66	67	65	66	96	141	148	146	148	67
20	64	63	67	67	65	66	65	140	149	147	148	67
21	64	64	66	66	65	66	65	140	146	148	148	67
22	63	65	65	66	67	66	64	141	148	148	147	68
23	64	64	65	66	65	66	64	142	148	149	147	68
24	64	64	66	67	65	66	66	143	148	146	147	68
25	64	65	66	66	66	66	67	144	148	147	148	67
26	64	65	66	66	66	66	74	143	148	147	147	68
27	64	65	66	66	66	64	104	143	147	146	147	67
28	64	65	66	65	66	63	105	143	148	146	151	67
29	65	66	66	66	---	64	105	144	148	147	147	68
30	64	66	66	67	---	65	112	145	147	147	147	68
31	64	---	66	67	---	65	---	145	---	146	147	---
TOTAL	2401	1928	2045	2051	1864	2032	2151	4731	4421	4563	4565	2284
MEAN	77.5	64.3	66.0	66.2	66.6	65.5	71.7	153	147	147	147	76.1
MAX	481	66	67	67	85	67	112	521	149	149	151	148
MIN	63	62	65	65	64	63	64	103	146	146	146	65
AC-FT	4760	3820	4060	4070	3700	4030	4270	9380	8770	9050	9050	4530
a	76470	72730	78390	75750	34330	8650	2900	3260	34600	52600	50250	36610

a Diversion, in acre-feet, to Belden Powerplant (station 11403050), provided by Pacific Gas & Electric Co.

## 11401112 NORTH FORK FEATHER RIVER BELOW BELDEN DAM, CA—Continued

## STATISTICS OF MONTHLY MEAN DATA FOR WATER YEARS 1970 - 2001, BY WATER YEAR (WY)

	OCT	NOV	DEC	JAN	FEB	MAR	APR	MAY	JUN	JUL	AUG	SEP
MEAN	131	138	119	133	110	107	174	169	147	140	136	121
MAX	1414	2487	1664	1200	616	591	743	549	374	199	173	1134
(WY)	1975	1975	1975	1997	1997	1975	1983	1995	1995	1970	1970	1987
MIN	57.8	38.4	45.2	51.6	51.2	50.0	63.1	62.2	56.5	64.2	89.0	61.9
(WY)	1985	1981	1976	1976	1976	1976	1972	1971	1971	1971	1972	1976

SUMMARY STATISTICS	FOR 2000 CALENDAR YEAR		FOR 2001 WATER YEAR		WATER YEARS 1970 - 2001	
ANNUAL TOTAL	46810		35036			
ANNUAL MEAN	128		96.0		135	
HIGHEST ANNUAL MEAN					745	
LOWEST ANNUAL MEAN					76.3	
HIGHEST DAILY MEAN	803	Apr 26	521	May 12	2800	Nov 20 1974
LOWEST DAILY MEAN	58	Sep 29	62	Nov 9	2.3	Oct 25 1981
ANNUAL SEVEN-DAY MINIMUM	59	Sep 23	64	Nov 4	3.5	Oct 25 1981
MAXIMUM PEAK FLOW			878	Oct 1	3460	Jan 1 1997
MAXIMUM PEAK STAGE			5.97	Oct 1	9.17	Jan 1 1997
ANNUAL RUNOFF (AC-FT)	92850		69490		98140	
ANNUAL DIVERSION (AC-FT) a	704800		526500			
10 PERCENT EXCEEDS	144		148		150	
50 PERCENT EXCEEDS	66		66		68	
90 PERCENT EXCEEDS	63		64		60	

a Diversion, in acre-feet, to Belden Powerplant (station 11403050), provided by Pacific Gas & Electric Co.

## 11401165 SOUTH BRANCH WARD CREEK BELOW DIVERSION DAM, NEAR GENESEE, CA

LOCATION.—Lat 40°00'07", long 120°42'07", in SE 1/4 NE 1/4 sec.26, T.25 N., R.11 E., Plumas County, Hydrologic Unit 18020122, on left bank, 20 ft downstream from diversion dam, 30 ft downstream from Nye Creek, 3.5 mi upstream from Indian Creek, and 3.8 mi southeast of Genesee.

DRAINAGE AREA.—6.74 mi<sup>2</sup>.

PERIOD OF RECORD.—October 1990 to current year (low-flow records only).

GAGE.—Water-stage recorder and V-notch sharp-crested weir in concrete control. Elevation of gage is 5,300 ft above sea level, from topographic map.

REMARKS.—No records computed above 12 ft<sup>3</sup>/s. Flow regulated at diversion dam 20 ft upstream. Some water is diverted to Five Bears Powerplant and bypasses this gage. See schematic diagram of North Fork Feather River Basin.

COOPERATION.—Records were collected by Five Bears Hydro, Inc., under general supervision of the U.S. Geological Survey, in connection with a Federal Energy Regulatory Commission project.

DISCHARGE, CUBIC FEET PER SECOND, WATER YEAR OCTOBER 2000 TO SEPTEMBER 2001  
DAILY MEAN VALUES

DAY	OCT	NOV	DEC	JAN	FEB	MAR	APR	MAY	JUN	JUL	AUG	SEP
1	3.1	3.4	3.5	3.3	4.0	6.1	10	7.9	e3.6	3.4	3.3	3.6
2	3.1	3.5	3.5	3.4	4.0	6.6	10	8.2	e3.6	3.2	3.4	3.8
3	3.1	3.4	3.5	3.4	4.4	6.8	10	7.6	e3.5	3.2	3.4	4.0
4	3.1	3.4	3.5	3.4	4.6	7.6	12	7.0	e3.5	3.2	3.4	3.9
5	3.1	3.4	3.4	3.3	4.7	7.7	11	7.0	e3.5	3.2	3.4	3.8
6	3.2	3.4	3.5	3.4	4.4	7.6	11	7.0	e3.5	3.2	3.4	3.8
7	3.2	3.4	3.5	3.5	4.8	9.3	11	6.9	e3.4	3.2	3.4	3.7
8	3.2	3.4	3.4	3.4	4.4	11	11	7.0	e3.4	3.2	3.4	3.6
9	3.2	3.6	3.2	3.5	4.6	11	11	7.0	3.4	3.2	3.5	3.4
10	3.2	3.5	3.4	3.5	5.0	11	10	7.0	3.3	3.2	3.4	3.4
11	3.3	3.4	3.4	3.4	5.4	12	10	6.9	3.3	3.3	3.4	3.2
12	3.3	3.5	3.5	3.5	5.3	11	10	6.8	3.4	3.4	3.4	3.3
13	3.3	3.5	4.3	3.9	4.8	11	10	6.7	3.6	3.3	3.4	3.3
14	3.4	3.5	3.4	4.4	4.7	11	10	6.5	3.8	3.3	3.4	3.3
15	3.5	3.5	3.4	4.1	4.7	12	10	e6.3	3.8	3.3	3.4	3.2
16	3.4	3.4	3.4	3.9	4.7	---	10	e6.0	3.5	3.2	3.4	3.0
17	3.5	3.4	3.3	4.1	4.8	---	10	e5.5	3.4	3.2	3.4	3.2
18	3.5	3.5	3.3	3.9	4.8	---	10	e5.0	3.5	3.2	3.5	3.2
19	3.5	3.6	3.1	3.9	4.7	---	10	e4.7	3.5	3.3	3.6	3.1
20	3.6	3.4	3.1	3.9	4.7	---	10	e4.4	3.4	3.3	3.5	3.2
21	3.6	3.4	3.1	4.0	4.6	---	9.6	e4.1	3.5	3.3	3.6	3.3
22	3.6	3.6	3.1	4.0	4.7	---	9.5	e3.8	3.2	3.3	3.6	3.3
23	3.7	3.5	3.1	4.0	4.7	---	9.5	e3.8	3.1	3.3	3.5	3.2
24	3.7	3.6	3.1	3.8	4.8	12	9.6	e3.8	3.1	3.3	3.5	3.2
25	3.8	3.5	3.1	4.0	4.8	11	9.4	e3.8	3.1	3.2	3.5	3.2
26	3.9	3.5	3.1	4.0	4.9	10	9.4	e3.8	3.1	3.3	3.5	3.2
27	3.5	3.4	3.1	4.0	4.9	10	9.5	e3.7	3.3	3.3	3.6	3.2
28	3.5	3.4	3.1	3.8	5.4	10	9.4	e3.7	3.3	3.3	3.6	3.3
29	3.6	3.7	3.1	3.9	---	11	8.5	e3.7	3.3	3.3	3.6	3.3
30	3.4	3.4	3.1	4.0	---	10	8.4	e3.7	3.3	3.3	3.6	3.3
31	3.4	---	3.2	4.1	---	10	---	e3.6	---	3.3	3.7	---
TOTAL	105.5	104.1	102.8	116.7	132.3	---	299.8	172.9	102.2	101.2	107.7	101.5
MEAN	3.40	3.47	3.32	3.76	4.72	---	9.99	5.58	3.41	3.26	3.47	3.38
MAX	3.9	3.7	4.3	4.4	5.4	---	12	8.2	3.8	3.4	3.7	4.0
MIN	3.1	3.4	3.1	3.3	4.0	---	8.4	3.6	3.1	3.2	3.3	3.0
AC-FT	209	206	204	231	262	---	595	343	203	201	214	201

e Estimated.

## 11402000 SPANISH CREEK ABOVE BLACKHAWK CREEK, AT KEDDIE, CA

LOCATION.—Lat 40°00'11", long 120°57'12", in SE 1/4 NE 1/4 sec.27, T.25 N., R.9 E., Plumas County, Hydrologic Unit 18020122, on right bank, 200 ft upstream from Blackhawk Creek, and 0.9 mi southeast of Keddies.

DRAINAGE AREA.—184 mi<sup>2</sup>.

PERIOD OF RECORD.—October 1933 to current year.

REVISED RECORDS.—WSP 1041: 1938(M).

GAGE.—Water-stage recorder. Datum of gage is 3,129.86 ft above sea level.

REMARKS.—Records good. Low flow regulated by five small reservoirs having a combined capacity of 800 acre-ft. Approximately 4,600 acres irrigated upstream from station (from information provided by U.S. Forest Service). City of Quincy diverts about 450 acre-ft annually for municipal supply. See schematic diagram of North Fork Feather River Basin.

EXTREMES FOR PERIOD OF RECORD.—Maximum discharge, 22,100 ft<sup>3</sup>/s, Jan. 2, 1997, gage height, 15.68 ft, from rating curve extended above 5,200 ft<sup>3</sup>/s on basis of slope-area measurement of peak flow; minimum daily, 3.0 ft<sup>3</sup>/s, Sept. 4, 5, 1988.

EXTREMES FOR CURRENT YEAR.—Peak discharges greater than base discharge of 1,700 ft<sup>3</sup>/s, or maximum:

Date	Time	Discharge (ft <sup>3</sup> /s)	Gage height (ft)
Mar. 25	0800	1110	4.17

## DISCHARGE, CUBIC FEET PER SECOND, WATER YEAR OCTOBER 2000 TO SEPTEMBER 2001

## DAILY MEAN VALUES

DAY	OCT	NOV	DEC	JAN	FEB	MAR	APR	MAY	JUN	JUL	AUG	SEP
1	34	56	65	56	61	125	328	235	45	23	16	11
2	33	55	60	54	64	126	315	220	44	28	16	11
3	32	53	58	53	62	125	246	184	46	19	15	11
4	36	51	59	53	65	203	209	161	37	24	15	13
5	33	51	56	53	67	580	185	151	41	30	22	15
6	34	52	55	55	69	390	174	160	39	22	21	15
7	37	51	55	54	69	314	181	160	34	24	17	14
8	34	51	55	56	61	294	166	158	41	22	16	13
9	37	51	55	58	71	354	157	159	40	21	15	12
10	56	52	63	66	69	287	152	153	37	19	15	18
11	52	52	61	99	70	240	155	139	41	20	19	17
12	49	51	63	82	69	217	155	135	33	22	16	18
13	42	52	60	74	67	215	149	133	32	28	16	17
14	46	52	87	71	66	223	145	121	34	16	15	16
15	44	54	81	65	67	216	146	112	40	22	11	17
16	41	52	71	63	71	194	150	119	34	16	9.8	23
17	45	51	66	56	73	188	169	111	27	13	8.8	21
18	43	51	62	61	89	221	190	92	27	13	10	17
19	36	53	59	63	123	276	237	87	24	13	10	14
20	44	51	59	60	163	361	221	90	25	19	17	14
21	44	52	59	59	223	408	198	81	24	20	10	14
22	41	52	68	59	289	436	189	66	24	15	12	16
23	43	50	66	61	205	452	192	66	33	22	11	16
24	44	51	63	78	172	420	211	63	30	17	12	20
25	45	51	60	74	164	847	251	69	23	19	12	27
26	50	51	58	72	156	553	289	69	33	12	12	30
27	49	52	57	68	145	377	282	62	36	17	12	30
28	51	53	56	64	135	371	257	53	32	16	12	24
29	109	80	54	67	---	414	227	57	34	12	15	20
30	75	84	50	62	---	362	218	53	33	16	11	26
31	62	---	56	59	---	328	---	45	---	16	11	---
TOTAL	1421	1618	1897	1975	3005	10117	6144	3564	1023	596	430.6	530
MEAN	45.8	53.9	61.2	63.7	107	326	205	115	34.1	19.2	13.9	17.7
MAX	109	84	87	99	289	847	328	235	46	30	22	30
MIN	32	50	50	53	61	125	145	45	23	12	8.8	11
AC-FT	2820	3210	3760	3920	5960	20070	12190	7070	2030	1180	854	1050

## SACRAMENTO RIVER BASIN

## 11402000 SPANISH CREEK ABOVE BLACKHAWK CREEK, AT KEDDIE, CA—Continued

## STATISTICS OF MONTHLY MEAN DATA FOR WATER YEARS 1934 - 2001, BY WATER YEAR (WY)

	OCT	NOV	DEC	JAN	FEB	MAR	APR	MAY	JUN	JUL	AUG	SEP
MEAN	58.4	130	282	441	528	565	560	426	172	52.6	29.0	30.8
MAX	702	1015	1498	2657	2843	2043	1715	1301	755	187	74.6	63.8
(WY)	1963	1982	1956	1997	1986	1995	1952	1938	1983	1983	1983	1983
MIN	18.4	34.9	35.3	37.5	50.5	56.1	44.3	50.6	18.6	10.8	5.10	7.57
(WY)	1989	1991	1977	1937	1991	1977	1977	1977	1977	1934	1934	1934

SUMMARY STATISTICS	FOR 2000 CALENDAR YEAR		FOR 2001 WATER YEAR		WATER YEARS 1934 - 2001	
ANNUAL TOTAL	91335		32320.6			
ANNUAL MEAN	250		88.5		271	
HIGHEST ANNUAL MEAN					641	
LOWEST ANNUAL MEAN					34.1	
HIGHEST DAILY MEAN	4850	Feb 14	847	Mar 25	18000	Jan 2 1997
LOWEST DAILY MEAN	22	Aug 27	8.8	Aug 17	3.0	Sep 4 1988
ANNUAL SEVEN-DAY MINIMUM	25	Aug 25	11	Aug 15	4.4	Aug 18 1934
MAXIMUM PEAK FLOW			1110	Mar 25	22100	Jan 2 1997
MAXIMUM PEAK STAGE			4.17	Mar 25	15.68	Jan 2 1997
ANNUAL RUNOFF (AC-FT)	181200		64110		196600	
10 PERCENT EXCEEDS	588		219		649	
50 PERCENT EXCEEDS	63		54		89	
90 PERCENT EXCEEDS	33		15		24	

## 11403200 NORTH FORK FEATHER RIVER BELOW ROCK CREEK DIVERSION DAM, CA

LOCATION.—Lat 39°58'49", long 121°16'33", in SW 1/4 NW 1/4 sec.35, T.25 N., R.6 E., Plumas County, Hydrologic Unit 18020121, Plumas National Forest, on left bank, 0.7 mi downstream from Rock Creek Diversion Dam, and 5.0 mi northeast of Storrie.

DRAINAGE AREA.—1,773 mi<sup>2</sup>.

PERIOD OF RECORD.—October 1985 to February 1986, October 1986 to current year. Unpublished records for water years 1982–85 available in files of the U.S. Geological Survey.

GAGE.—Water-stage recorder. Elevation of gage is 2,120 ft above sea level, from topographic map.

REMARKS.—Low and medium flow regulated by Rock Creek Forebay 0.7 mi upstream. Most of the flow is diverted to Rock Creek Powerplant (station 11403800). Diversion to Rock Creek Powerplant began Feb. 28, 1950. See schematic diagram of North Fork Feather River Basin.

COOPERATION.—Records were collected by Pacific Gas & Electric Co., under general supervision of the U.S. Geological Survey, in connection with a Federal Energy Regulatory Commission project.

EXTREMES FOR PERIOD OF RECORD.—Maximum discharge, 91,600 ft<sup>3</sup>/s, Jan. 2, 1997, gage height, 31.85 ft; minimum daily, 50 ft<sup>3</sup>/s, Feb. 7, 1989.

DISCHARGE, CUBIC FEET PER SECOND, WATER YEAR OCTOBER 2000 TO SEPTEMBER 2001  
DAILY MEAN VALUES

DAY	OCT	NOV	DEC	JAN	FEB	MAR	APR	MAY	JUN	JUL	AUG	SEP
1	114	84	59	60	53	56	58	121	110	112	113	114
2	113	60	59	61	52	57	57	114	113	112	113	114
3	112	59	59	61	52	56	57	111	113	113	113	114
4	113	57	59	60	53	61	57	112	113	113	113	114
5	112	59	59	61	53	65	56	112	113	113	113	114
6	112	59	59	60	53	62	57	112	112	113	113	114
7	111	59	59	61	53	61	57	112	111	113	113	114
8	111	59	59	61	53	61	57	112	111	113	113	114
9	113	59	60	61	53	61	56	112	111	113	113	114
10	114	59	59	62	441	60	56	112	111	113	113	114
11	113	59	59	63	1010	59	57	111	111	113	113	114
12	112	59	59	62	898	58	57	110	111	113	113	114
13	112	59	61	62	61	58	57	110	111	113	113	115
14	112	60	63	61	55	58	56	110	111	113	114	115
15	112	59	61	61	55	57	56	110	110	113	113	115
16	112	59	60	61	55	57	56	110	111	113	113	115
17	110	59	59	61	57	57	56	110	111	113	113	115
18	107	59	59	61	59	57	57	109	111	113	113	115
19	107	59	61	61	59	302	57	109	111	113	113	115
20	107	59	61	61	62	531	56	109	110	113	113	115
21	106	59	61	61	65	115	56	108	110	113	113	115
22	115	59	61	56	65	61	56	108	110	113	114	115
23	120	59	61	54	62	60	56	108	110	113	113	115
24	120	59	61	53	60	61	57	108	110	113	114	116
25	121	59	61	53	59	879	57	108	110	113	113	117
26	176	59	61	53	58	586	57	108	110	113	113	116
27	122	59	61	53	57	101	56	108	110	113	113	116
28	123	59	61	53	57	61	56	107	110	113	113	116
29	124	61	61	53	---	103	56	107	110	113	114	116
30	122	60	61	53	---	59	82	107	110	113	114	115
31	121	---	61	53	---	58	---	107	---	113	114	---
TOTAL	3599	1798	1865	1817	3770	4038	1722	3412	3326	3501	3509	3445
MEAN	116	59.9	60.2	58.6	135	130	57.4	110	111	113	113	115
MAX	176	84	63	63	1010	879	82	121	113	113	114	117
MIN	106	57	59	53	52	56	56	107	110	112	113	114
AC-FT	7140	3570	3700	3600	7480	8010	3420	6770	6600	6940	6960	6830
a	100200	105100	109900	108000	66940	94860	69650	62910	56530	70140	64080	46480

## STATISTICS OF MONTHLY MEAN DATA FOR WATER YEARS 1987 - 2001, BY WATER YEAR (WY)

	1987	1988	1989	1990	1991	1992	1993	1994	1995	1996	1997	1998	1999	2000	2001
MEAN	123	89.9	305	1153	815	1359	803	835	429	121	117	133			
MAX	211	226	3012	12700	3378	8612	5384	7371	2684	169	178	313			
(WY)	2000	1999	1997	1997	1996	1995	1995	1995	1995	2000	1997	1997			
MIN	52.7	53.2	52.4	52.0	52.9	52.9	54.2	55.3	55.7	55.3	53.0	53.0			
(WY)	1988	1988	1995	1992	1994	1994	1990	1987	1987	1987	1987	1987			

SUMMARY STATISTICS	FOR 2000 CALENDAR YEAR		FOR 2001 WATER YEAR		WATER YEARS 1987 - 2001	
ANNUAL TOTAL	94041		35802			
ANNUAL MEAN	257		98.1		523	
HIGHEST ANNUAL MEAN					2333	
LOWEST ANNUAL MEAN					77.7	
HIGHEST DAILY MEAN	11500	Feb 14	1010	Feb 11	74400	Jan 2 1997
LOWEST DAILY MEAN	53	Apr 24	52	Feb 2	50	Feb 7 1989
ANNUAL SEVEN-DAY MINIMUM	53	Apr 23	53	Jan 28	51	Dec 22 1993
MAXIMUM PEAK FLOW			2120		91600	
MAXIMUM PEAK STAGE			8.63		31.85	
ANNUAL RUNOFF (AC-FT)	186500		71010		379000	
ANNUAL DIVERSION (AC-FT) a	1496000		954800			
10 PERCENT EXCEEDS	384		115		710	
50 PERCENT EXCEEDS	114		108		108	
90 PERCENT EXCEEDS	58		56		53	

a Diversion, in acre-feet, to Rock Creek Powerplant (station 11403800), provided by Pacific Gas & Electric Co.



## 11403450 MILK RANCH CONDUIT AT OUTLET, NEAR BUCKS LODGE, CA

LOCATION.—Lat 39°54'09", long 121°13'36", in SW 1/4 SW 1/4 sec.29, T.24 N., R.7 E., Plumas County, Hydrologic Unit 18020121, Plumas National Forest, on left bank, 150 ft upstream from right abutment of Lower Bucks Lake Dam, 200 ft upstream from outlet, and 3.4 mi northwest of Bucks Lodge.

PERIOD OF RECORD.—October 1986 to current year. Unpublished records for water years 1981–84 available in files of the U.S. Geological Survey.

GAGE.—Water-stage recorder in 3-ft steel pipe. Elevation of gage is 5,050 ft above sea level.

REMARKS.—Conduit diverts from channel below Three Lakes Reservoir, capacity, 513 acre-ft, and from 12 additional diversions along the conduit. Water is used for power at Bucks Creek Powerplant (station 11403700) and Grizzly Powerplant (station 11404240). See schematic diagram of North Fork Feather River Basin.

COOPERATION.—Records were collected by Pacific Gas & Electric Co., under general supervision of the U.S. Geological Survey, in connection with a Federal Energy Regulatory Commission project.

EXTREMES FOR PERIOD OF RECORD.—Maximum daily discharge, 71 ft<sup>3</sup>/s, Apr. 29, 1995, May 17, 1996; minimum daily, no flow for many days in water years 1997–2000, and several days in May 2001.

## DISCHARGE, CUBIC FEET PER SECOND, WATER YEAR OCTOBER 2000 TO SEPTEMBER 2001

## DAILY MEAN VALUES

DAY	OCT	NOV	DEC	JAN	FEB	MAR	APR	MAY	JUN	JUL	AUG	SEP
1	7.0	2.3	2.6	1.9	1.9	2.3	25	9.6	9.7	2.4	6.6	5.1
2	6.8	2.5	2.3	1.9	1.9	2.3	23	6.3	9.1	2.2	6.5	4.7
3	6.5	2.6	2.1	1.8	2.1	2.3	12	6.2	8.2	2.1	6.4	4.2
4	6.2	2.3	1.9	1.8	3.0	2.6	2.2	6.1	7.6	1.9	6.4	3.8
5	5.7	2.1	1.9	1.8	3.2	3.4	1.8	4.9	7.2	1.8	6.4	3.3
6	5.1	2.0	1.9	1.8	3.0	3.9	1.7	4.7	6.8	1.6	6.3	1.7
7	4.4	1.7	1.8	1.8	2.3	5.1	1.5	4.4	6.3	1.6	6.1	.60
8	3.2	1.6	1.8	1.9	2.1	5.7	1.3	4.0	5.9	1.5	6.7	.43
9	1.9	1.6	2.2	2.0	2.3	5.4	1.2	2.0	5.5	1.4	7.9	.36
10	3.3	1.6	3.6	2.1	2.7	4.5	1.1	.05	5.2	1.4	7.8	.33
11	2.5	1.6	2.6	2.3	3.1	4.4	1.0	.04	5.1	1.4	7.8	.30
12	2.0	1.6	2.5	2.6	3.4	4.6	.94	.04	4.8	1.3	7.7	.29
13	1.5	1.5	2.3	2.6	3.4	5.5	.93	.04	4.6	1.2	7.6	.27
14	1.2	1.7	2.7	2.4	3.1	6.0	.89	.04	4.1	1.2	7.4	.27
15	1.1	1.7	2.8	2.2	2.8	5.7	.87	.03	3.9	1.1	7.2	.27
16	.98	1.6	2.7	2.0	2.5	5.0	1.2	.01	3.8	1.1	7.2	.27
17	.93	1.5	2.6	1.9	2.4	5.6	1.9	.00	3.6	1.1	7.0	.27
18	.93	1.5	2.3	1.9	2.5	7.9	2.9	.00	3.4	1.1	7.0	.23
19	.90	1.5	2.2	1.9	2.6	11	2.5	.00	3.2	1.0	6.9	.23
20	1.2	1.5	2.2	2.0	2.8	15	1.6	.00	3.0	1.0	6.8	.23
21	1.3	1.5	2.4	1.9	3.1	19	1.3	.00	2.7	.95	6.6	.21
22	1.0	1.4	2.8	1.9	3.4	21	1.2	.00	2.5	.93	6.6	.20
23	.91	1.4	2.5	2.0	3.3	23	2.1	1.0	2.3	.87	6.5	.20
24	.85	1.4	2.3	2.2	3.1	27	6.9	14	2.2	4.3	6.3	.20
25	1.1	1.5	1.9	2.4	3.0	47	13	20	2.6	7.1	6.1	.94
26	1.8	1.5	1.8	2.5	2.8	25	13	18	3.6	7.0	6.0	.45
27	1.6	1.6	1.8	2.3	2.6	20	13	15	4.5	7.0	5.9	.34
28	4.2	1.8	2.0	2.3	2.5	27	13	14	3.7	6.8	5.7	.32
29	4.6	3.9	2.1	2.2	---	26	12	14	3.1	6.7	5.6	.31
30	2.8	3.2	2.1	2.1	---	24	13	12	2.7	6.6	5.5	.27
31	2.1	---	1.9	2.0	---	25	---	11	---	6.7	5.4	---
TOTAL	85.60	55.2	70.6	64.4	76.9	392.2	174.03	167.45	140.9	84.35	205.9	30.59
MEAN	2.76	1.84	2.28	2.08	2.75	12.7	5.80	5.40	4.70	2.72	6.64	1.02
MAX	7.0	3.9	3.6	2.6	3.4	47	25	20	9.7	7.1	7.9	5.1
MIN	.85	1.4	1.8	1.8	1.9	2.3	.87	.00	2.2	.87	5.4	.20
AC-FT	170	109	140	128	153	778	345	332	279	167	408	61

## STATISTICS OF MONTHLY MEAN DATA FOR WATER YEARS 1987 - 2001, BY WATER YEAR (WY)

	1987	1988	1989	1990	1991	1992	1993	1994	1995	1996	1997	1998	1999	2000	2001
MEAN	3.47	3.90	5.71	5.62	8.47	15.8	25.5	25.2	12.8	5.64	3.08	3.18			
MAX	9.22	8.15	27.5	19.2	38.7	42.7	59.6	66.6	57.3	30.5	7.35	8.22			
(WY)	2000	1990	1997	1995	1996	1989	1989	1993	1993	1995	1992	2000			
MIN	.000	.000	.000	.000	.000	.000	.000	.000	.000	.000	.000	.000			
(WY)	1998	1998	1998	1998	1997	1997	1997	1997	1997	1997	1997	1997			

SUMMARY STATISTICS	FOR 2000 CALENDAR YEAR		FOR 2001 WATER YEAR		WATER YEARS 1987 - 2001	
ANNUAL TOTAL	2409.56		1548.12			
ANNUAL MEAN	6.58		4.24		9.86	
HIGHEST ANNUAL MEAN					21.6	
LOWEST ANNUAL MEAN					.000	
HIGHEST DAILY MEAN	48	Apr 13	47	Mar 25	71	Apr 29 1995
LOWEST DAILY MEAN	.00	May 26	.00	May 17	.00	Jan 2 1997
ANNUAL SEVEN-DAY MINIMUM	.00	May 26	.00	May 16	.00	Jan 2 1997
ANNUAL RUNOFF (AC-FT)	4780		3070		7140	
10 PERCENT EXCEEDS	21		7.8		30	
50 PERCENT EXCEEDS	2.5		2.4		4.2	
90 PERCENT EXCEEDS	.12		.75		.00	

## 11403500 BUCKS LAKE NEAR BUCKS LODGE, CA

LOCATION.—Lat 39°53'45", long 121°12'08", in SE 1/4 NW 1/4 sec.33, T.24 N., R.7 E., **Plumas County**, Hydrologic Unit 18020121, Plumas National Forest, in outlet structure, 100 ft upstream from dam on Bucks Creek, 2.0 mi northwest of Bucks Lodge, and 15 mi west of Quincy.

DRAINAGE AREA.—28.6 mi<sup>2</sup>.

PERIOD OF RECORD.—Water years 1927–28 (year-end contents only, published in WSP 1315-A), October 1928 to current year. Prior to October 1954, published as Bucks Creek Reservoir near Bucks Ranch.

GAGE.—Water-stage recorder. Datum of gage is 3.50 ft below sea level (levels by Feather River Power Co.).

REMARKS.—Reservoir is formed by concrete-faced, rockfill dam, completed in 1927; storage began in May 1927. Capacity, 101,400 acre-ft, between elevations 5,064.75 ft, sill of outlet gate, and 5,154.85 ft, spillway crest. Storage of 274 acre-ft is not available for release. Released water flows down Bucks Creek to Lower Bucks Lake (station 11403520), where most of the water is diverted to Bucks Creek Tunnel or Grizzly Powerplant (station 11404240), which discharges into Grizzly Creek. Figures given, including extremes, represent total contents at 2400 hours. See schematic diagram of [North Fork Feather River Basin](#).

COOPERATION.—Records were collected by Pacific Gas & Electric Co., under general supervision of the U.S. Geological Survey, in connection with a Federal Energy Regulatory Commission project. Contents not rounded to U.S. Geological Survey standards.

EXTREMES FOR PERIOD OF RECORD.—Maximum contents, 107,278 acre-ft, May 17, 1996, elevation, 5,157.9 ft; minimum, 12,330 acre-ft, Feb. 27, 1929, elevation, 5,090.7 ft.

EXTREMES FOR CURRENT YEAR.—Maximum contents, 71,391 acre-ft, many days in July, elevation, 5,136.70 ft; minimum, 44,668 acre-ft, Jan. 21, 22, elevation, 5,119.40 ft.

Capacity table (elevation, in feet, and contents, in acre-feet)  
(Based on survey by Feather River Power Co. in 1927)

5,090	11,742	5,110	32,519	5,130	59,997	5,150	92,950
5,095	16,183	5,120	45,472	5,140	75,894	5,160	111,220
5,100	21,180						

## RESERVOIR STORAGE (ACRE-FEET), WATER YEAR OCTOBER 2000 TO SEPTEMBER 2001

## DAILY OBSERVATION AT 2400 HOURS

DAY	OCT	NOV	DEC	JAN	FEB	MAR	APR	MAY	JUN	JUL	AUG	SEP
1	70197	60150	47983	45896	45071	46738	51699	59249	70038	71220	71220	71033
2	69720	59813	47570	46037	45205	46738	51998	59588	70038	71391	71220	70999
3	69402	59475	47294	46037	45205	46877	52295	59813	70038	71391	71220	70999
4	69242	59135	47294	46037	45205	47155	52444	60038	70197	71391	71220	70709
5	68923	58908	46877	46178	44937	47294	52444	60537	70197	71391	71220	70402
6	68444	58566	46598	46178	45071	47432	52444	61117	70197	71391	71220	70385
7	68285	58222	46598	46178	45071	47432	52741	61696	70368	71391	71220	70368
8	67805	57876	46318	46318	45071	47570	52889	62469	70368	71391	71186	70334
9	67805	57496	46178	46458	45339	47708	52889	63048	70368	71391	71186	70334
10	67645	56926	46178	46598	45472	47846	52889	63820	70538	71391	71220	70316
11	67164	56355	46178	46738	45755	47846	53036	64464	70538	71391	71186	70316
12	66855	55784	45896	46738	45896	47846	53036	64915	70538	71391	71186	70316
13	66409	55403	45896	46738	45896	47983	53184	65364	70709	71391	71135	70316
14	65962	54831	45755	46318	45896	47983	53184	65663	70709	71391	71135	70316
15	65514	54258	45339	46178	46037	48120	53479	66260	70709	71391	71135	70316
16	65065	53773	45339	46178	45614	48120	53626	66557	70709	71391	71135	70316
17	64615	53479	45339	46037	45755	48257	53920	67003	70709	71391	71135	70316
18	64164	53036	45339	45614	45755	48401	54258	67324	70879	71391	71118	70316
19	63820	52741	45339	45339	46037	48401	54640	67645	70879	71391	71118	70070
20	63627	52295	45472	44937	46318	48401	55021	67965	70879	71391	71084	69815
21	63627	51699	45472	44668	46458	48401	55212	68285	70879	71391	71084	69815
22	63627	51250	45614	44668	46738	48545	55593	68604	70879	71391	71067	69800
23	63627	50819	45614	44803	46598	48689	55784	68764	70879	71391	71067	69784
24	63434	50538	45755	44803	46598	48976	56165	68923	70879	71391	71067	69831
25	62855	50115	45755	45071	46738	49547	56736	69083	70879	71391	71067	69895
26	62469	49689	45755	44937	46738	49831	57306	69242	71050	71391	71067	69895
27	61889	49404	45755	44937	46738	50115	57876	69402	71220	71391	71067	69895
28	61696	48832	45755	44937	46738	50397	58222	69561	71220	71220	71033	69895
29	61503	48689	45896	45071	---	50819	58566	69720	71220	71220	71033	69863
30	60923	48257	45896	45071	---	51100	58908	69720	71220	71220	71033	69784
31	60730	---	45896	45071	---	51400	---	69879	---	71220	71033	---
MAX	70197	60150	47983	46738	46738	51400	58908	69879	71220	71391	71220	71033
MIN	60730	48257	45339	44668	44937	46738	51699	59249	70038	71220	71033	69784
a	5130.30	5122.00	5120.30	5119.70	5120.90	5124.20	5128.90	5135.80	5136.60	5136.60	5136.49	5135.74
b	-8691	-12473	-2361	-825	+1667	+4662	+7508	+10971	+1341	0	-187	-1249

CAL YR 2000 MAX 100329 MIN 45339 b -2247

WTR YR 2001 MAX 71391 MIN 44668 b +363

a Elevation, in feet, at end of month.

b Change in contents, in acre-feet.

## 11403520 LOWER BUCKS LAKE NEAR BUCKS LODGE, CA

LOCATION.—Lat 39°53'59", long 121°13'32", in NE 1/4 NW 1/4 sec.32, T.24 N., R.7 E., Plumas County, Hydrologic Unit 18020121, Plumas National Forest, in outlet tower for Bucks Creek Tunnel, 900 ft upstream from Buck Diversion Dam, 1.3 mi downstream from Bucks Lake Dam, and 3.2 mi northwest of Bucks Lodge.

DRAINAGE AREA.—31.3 mi<sup>2</sup>.

PERIOD OF RECORD.—October 1985 to current year. Unpublished records for water years 1981–85 available in files of the U.S. Geological Survey.

GAGE.—Water-stage recorder. Datum of gage is 3.50 ft below sea level (levels by Pacific Gas & Electric Co.).

REMARKS.—Lake is formed by concrete dam. Storage began in October 1929. Usable capacity, 5,796 acre-ft, between elevations 4,952 ft, point of lowest drawdown, and 5,021.95 ft, crest of spillway. Water is received from Bucks Lake (station 11403500) and from Milk Ranch Conduit (station 11403450). Most of the water is diverted through Bucks Creek Tunnel or Grizzly Powerplant (station 11404240) and discharges into Grizzly Creek for power development downstream. Figures given, including extremes, represent total contents at 2400 hours. See schematic diagram of North Fork Feather River Basin.

COOPERATION.—Records were collected by Pacific Gas & Electric Co., under general supervision of the U.S. Geological Survey, in connection with a Federal Energy Regulatory Commission project. Contents not rounded to U.S. Geological Survey standards.

EXTREMES FOR PERIOD OF RECORD.—Maximum contents, 6,203 acre-ft, May 18, 1996, elevation, 5,024.6 ft; minimum, 99 acre-ft, Sept. 9, 1993, elevation, 4,956.1 ft.

EXTREMES FOR CURRENT YEAR.—Maximum contents, 5,573 acre-ft, Feb. 5, 16, 24, elevation, 5,020.00 ft; minimum, 3,572 acre-ft, Sept. 4, elevation, 5,003.60 ft.

Capacity table (elevation, in feet, and contents, in acre-feet)  
(Based on survey by Feather River Power Co. in 1928)

4,950	24	4,980	1,314	5,000	3,175	5,020	5,573
4,960	194	4,990	2,171	5,010	4,307	5,030	6,981
4,970	624						

## RESERVOIR STORAGE (ACRE-FEET), WATER YEAR OCTOBER 2000 TO SEPTEMBER 2001

## DAILY OBSERVATION AT 2400 HOURS

DAY	OCT	NOV	DEC	JAN	FEB	MAR	APR	MAY	JUN	JUL	AUG	SEP
1	5196	5021	4993	5183	5364	5351	5439	5439	4857	4951	4363	3621
2	5300	4868	5274	5169	5351	5463	5401	5439	4846	4951	4349	3606
3	5235	4755	5313	5143	5338	5451	5338	5426	4846	4923	4335	3589
4	5183	4812	5209	5129	5313	5463	5287	5426	4835	4901	4321	3572
5	5183	4857	5143	5116	5573	5463	5500	5426	4824	4879	4307	3817
6	5401	4868	5451	5103	5561	5451	5500	5426	4835	4868	4298	4074
7	5222	4835	5235	5076	5537	5513	5463	5326	4846	4846	4242	4048
8	5313	4801	5196	4890	5525	5513	5439	5248	4857	4824	4223	4020
9	5287	4767	5451	4732	5525	5500	5451	5183	4857	4801	4220	3993
10	5183	4684	5439	4732	5488	5500	5561	5169	4868	4790	4213	3965
11	5103	4648	5183	4523	5439	5488	5549	5156	4879	4767	4204	3936
12	4912	4624	5274	4391	5451	5414	5525	5143	4879	4743	4194	3907
13	4923	4523	5248	4242	5463	5414	5513	5116	4890	4720	4183	3875
14	5089	4549	5222	4574	5451	5401	5500	5103	4890	4696	4180	3842
15	5196	4536	5364	4684	5313	5401	5476	5089	4901	4672	4170	3810
16	5326	4497	5439	4660	5573	5389	5463	5062	4901	4648	4159	3776
17	5248	4536	5426	4648	5561	5389	5451	5035	4901	4624	4148	3743
18	5235	4561	5401	4767	5561	5389	5451	5021	4912	4611	4135	3713
19	5338	4523	5389	5035	5549	5338	5451	5007	4912	4586	4124	3686
20	5439	4431	5376	5183	5561	5376	5451	4979	4912	4561	4112	3956
21	5414	4561	5364	5451	5326	5513	5439	4951	4912	4536	4099	4155
22	5414	4755	5351	5439	5326	5549	5426	4937	4912	4510	4085	4129
23	5351	4743	5338	5426	5513	5513	5414	4912	4912	4484	4075	4105
24	5048	4743	5326	5389	5573	5463	5351	4923	4912	4471	4061	4078
25	4901	4778	5313	5389	5561	5488	5338	4937	4923	4458	4047	4059
26	5021	4824	5287	5401	5364	5500	5364	4951	4923	4444	4034	4043
27	5007	4846	5274	5439	5351	5451	5376	4965	4937	4431	4020	4016
28	5156	4923	5248	5426	5338	5414	5389	4965	4937	4418	4006	3990
29	5313	4965	5235	5414	---	5439	5414	4965	4951	4404	3663	3964
30	5274	4979	5222	5401	---	5389	5426	4890	4951	4391	3651	3936
31	5169	---	5209	5376	---	5401	---	4857	---	4377	3637	---
MAX	5439	5021	5451	5451	5573	5549	5561	5439	4951	4951	4363	4155
MIN	4901	4431	4993	4242	5313	5338	5287	4857	4824	4377	3637	3572
a	5016.80	5015.40	5017.10	5018.40	5018.10	5018.60	5018.80	5014.40	5015.20	5010.50	5004.19	5006.50
b	-205	-190	+230	+167	-38	+63	+25	-569	+94	-574	-740	+299
CAL YR 2000	MAX 5748	MIN 3960	b +80									
WTR YR 2001	MAX 5573	MIN 3572	b -1438									

a Elevation, in feet, at end of month.  
b Change in contents, in acre-feet.

## 11403530 BUCKS CREEK BELOW DIVERSION DAM, NEAR BUCKS LODGE, CA

LOCATION.—Lat 39°54'16", long 121°13'47", in NW 1/4 SW 1/4 sec.29, T.24 N., R.7 E., Plumas County, Hydrologic Unit 18020121, Plumas National Forest, on left bank, 20 ft upstream from unnamed tributary, 0.2 mi downstream from diversion dam, and 3.6 mi northwest of Bucks Lodge.

DRAINAGE AREA.—31.5 mi<sup>2</sup>.

PERIOD OF RECORD.—October 1990 to current year. Unpublished records for water years 1981–90 available in files of the U.S. Geological Survey.

GAGE.—Water-stage recorder and concrete control with V-notch sharp-crested weir Sept. 19, 1990, to Sept. 24, 1998. Ultrasonic-velocity meter since Sept. 24, 1998. Elevation of gage is 4,850 ft above sea level, from topographic map.

REMARKS.—Flow regulated by diversion dam at Lower Bucks Lake 0.2 mi upstream, where most of the flow is diverted to Grizzly Creek via Bucks Creek Tunnel outlet or Grizzly Powerplant (station 11404240). Low flows regulated by fixed-plate orifice at outlet of diversion dam. See schematic diagram of [North Fork Feather River Basin](#).

COOPERATION.—Records were collected by Pacific Gas & Electric Co., under general supervision of the U.S. Geological Survey, in connection with a Federal Energy Regulatory Commission project.

EXTREMES FOR PERIOD OF RECORD.—Maximum discharge recorded, 5,870 ft<sup>3</sup>/s, Feb. 17, 1986, gage height, 9.54 ft; minimum recorded, no flow on several days in February 1986.

## DISCHARGE, CUBIC FEET PER SECOND, WATER YEAR OCTOBER 2000 TO SEPTEMBER 2001

## DAILY MEAN VALUES

DAY	OCT	NOV	DEC	JAN	FEB	MAR	APR	MAY	JUN	JUL	AUG	SEP
1	4.0	3.9	3.9	1.5	1.5	1.6	e3.9	e3.9	e3.9	3.9	3.8	3.6
2	4.0	3.9	3.9	1.5	1.5	1.6	e3.9	e3.9	e3.9	3.9	3.8	3.6
3	4.0	3.9	4.0	1.5	1.5	1.6	e3.9	e3.9	e3.9	3.9	3.8	3.6
4	3.9	3.9	2.6	1.5	1.5	1.6	e3.9	e3.9	e3.9	3.9	3.8	3.6
5	3.9	3.9	1.5	1.5	1.5	1.6	e3.9	e3.9	e3.9	3.9	3.8	3.7
6	4.0	3.9	1.5	1.5	1.5	1.6	e3.9	e3.9	e3.9	3.9	3.8	3.7
7	4.0	3.9	1.6	1.5	1.5	1.5	e3.9	e3.9	e3.9	3.9	3.8	3.7
8	3.9	3.9	1.5	1.5	1.5	1.5	e3.9	e3.9	e3.9	3.9	3.8	3.7
9	4.0	3.9	1.5	1.5	1.5	1.5	e3.9	e3.9	e3.9	3.9	3.8	3.7
10	4.0	3.8	1.6	1.5	1.5	1.5	e3.9	e3.9	e3.9	3.9	3.7	3.7
11	3.9	3.8	1.6	1.5	1.5	1.5	e3.9	e3.9	e3.9	3.9	3.7	3.7
12	3.9	3.8	1.6	1.5	1.5	e1.5	e3.9	e3.9	e3.9	3.9	3.7	3.7
13	3.9	3.8	1.5	1.5	1.5	e1.5	e3.9	e3.9	e3.9	3.9	3.7	3.7
14	3.9	3.8	1.5	1.5	1.5	e1.5	e3.9	e3.9	e3.9	3.9	3.7	3.7
15	3.9	3.8	1.6	1.5	1.5	e1.5	e3.9	e3.9	e3.9	3.9	3.7	3.6
16	4.0	3.8	1.6	1.5	1.5	e1.5	e3.9	e3.9	3.9	3.8	3.7	3.6
17	3.9	3.8	1.6	1.5	1.6	e1.5	e3.9	e3.9	3.9	3.8	3.7	3.6
18	3.9	3.8	1.6	1.5	1.5	e1.5	e3.9	e3.9	3.9	3.8	3.7	3.6
19	3.9	3.8	1.6	1.5	1.5	e1.5	e3.9	e3.9	3.9	3.8	3.7	3.6
20	4.0	3.8	1.6	1.5	1.6	e1.5	e3.9	e3.9	3.9	3.8	3.7	3.7
21	4.0	3.8	1.6	1.5	1.6	e1.5	e3.9	e3.9	3.9	3.8	3.7	3.7
22	4.0	3.8	1.6	1.5	1.6	e1.5	e3.9	e3.9	3.9	3.8	3.7	3.7
23	4.0	3.9	1.6	1.5	1.5	e1.5	e3.9	e3.9	3.9	3.8	3.7	3.7
24	3.9	3.8	1.6	1.5	1.5	e1.5	e3.9	e3.9	3.9	3.8	3.7	3.7
25	3.9	3.9	1.5	1.5	1.6	e1.5	e3.9	e3.9	3.9	3.8	3.7	3.7
26	3.9	3.9	1.5	1.5	1.6	e1.5	e3.9	e3.9	3.9	3.8	3.7	3.7
27	3.9	3.9	1.5	1.5	1.6	e1.5	e3.9	e3.9	3.9	3.8	3.7	3.7
28	3.9	3.9	1.5	1.5	1.6	e1.5	e3.9	e3.9	3.9	3.8	3.7	3.7
29	4.0	3.9	1.5	1.5	---	e2.7	e3.9	e3.9	3.9	3.8	3.6	3.7
30	4.0	3.9	1.5	1.5	---	e3.9	e3.9	e3.9	3.9	3.8	3.6	3.7
31	4.0	---	1.5	1.5	---	e3.9	---	e3.9	---	3.8	3.6	---
TOTAL	122.4	115.6	56.3	46.5	42.8	53.1	117.0	120.9	117.0	119.3	115.3	110.1
MEAN	3.95	3.85	1.82	1.50	1.53	1.71	3.90	3.90	3.90	3.85	3.72	3.67
MAX	4.0	3.9	4.0	1.5	1.6	3.9	3.9	3.9	3.9	3.9	3.8	3.7
MIN	3.9	3.8	1.5	1.5	1.5	1.5	3.9	3.9	3.9	3.8	3.6	3.6
AC-FT	243	229	112	92	85	105	232	240	232	237	229	218
a	11730	12100	5230	956	1110	3690	2560	9380	4720	10610	7440	7870

e Estimated.

a Diversion, in acre-feet, to Grizzly Powerplant (station 11404240), provided by Pacific Gas & Electric Co.

## 11403530 BUCKS CREEK BELOW DIVERSION DAM, NEAR BUCKS LODGE, CA—Continued

## STATISTICS OF MONTHLY MEAN DATA FOR WATER YEARS 1986 - 2001, BY WATER YEAR (WY)

	OCT	NOV	DEC	JAN	FEB	MAR	APR	MAY	JUN	JUL	AUG	SEP
MEAN	3.23	2.83	1.68	1.50	15.5	1.62	3.51	26.2	29.0	3.54	3.93	4.19
MAX	4.30	3.85	1.82	1.50	57.9	1.71	3.93	187	167	4.70	9.06	11.6
(WY)	1994	2001	2001	1999	1986	2001	2000	1995	1995	1991	1993	1993
MIN	1.54	1.64	1.54	1.50	1.50	1.52	2.70	1.78	1.47	1.45	1.45	1.51
(WY)	1995	1996	1999	1999	1999	1999	1999	1994	1994	1994	1994	1994

SUMMARY STATISTICS	FOR 2000 CALENDAR YEAR	FOR 2001 WATER YEAR	WATER YEARS 1986 - 2001
ANNUAL TOTAL	1147.5	1136.3	
ANNUAL MEAN	3.14	3.11	3.03
HIGHEST ANNUAL MEAN			3.11 2001
LOWEST ANNUAL MEAN			2.87 1999
HIGHEST DAILY MEAN	4.0 Apr 13	4.0 Oct 1	1340 May 18 1996
LOWEST DAILY MEAN	1.5 Jan 1	1.5 Dec 5	.00 Feb 1 1986
ANNUAL SEVEN-DAY MINIMUM	1.5 Jan 1	1.5 Dec 25	.00 Feb 1 1986
MAXIMUM PEAK FLOW		4.4 Oct 1	5870 Feb 17 1986
MAXIMUM PEAK STAGE		.08 Oct 1	9.54 Feb 17 1986
ANNUAL RUNOFF (AC-FT)	2280	2250	2200
ANNUAL DIVERSION (AC-FT) a	80750	77400	
10 PERCENT EXCEEDS	4.0	3.9	4.5
50 PERCENT EXCEEDS	3.8	3.8	3.7
90 PERCENT EXCEEDS	1.5	1.5	1.5

a Diversion, in acre-feet, to Grizzly Powerplant (station 11404240), provided by Pacific Gas & Electric Co.

## 11404250 GRIZZLY FOREBAY NEAR STORRIE, .CA

LOCATION.—Lat 39°53'32", long 121°17'25", in SW 1/4 NE 1/4 sec.34, T.24 N., R.6 E., Plumas County, Hydrologic Unit 18020121, Plumas National Forest, in outlet tower for Bucks Creek Powerplant, 100 ft upstream from Grizzly Diversion Dam, 2.4 mi southeast of Storrie, and 6.2 mi west of Bucks Lodge.

DRAINAGE AREA.—14.4 mi<sup>2</sup>.

PERIOD OF RECORD.—October 1986 to current year. Unpublished records for water years 1981–86 available in files of the U.S. Geological Survey.

GAGE.—Water-stage recorder. Datum of gage is 3.50 ft below sea level (levels by Pacific Gas & Electric Co.).

REMARKS.—Lake is formed by concrete dam. Storage began in July 1928. Usable capacity, 1,033 acre-ft, between elevations 4,271 ft, bottom of diversion tunnel, and 4,316.0 ft, crest of spillway. Water is received from Bucks Creek via Bucks Creek Tunnel and Grizzly Powerplant (station 11404240) which enter Grizzly Creek upstream. Most of the water is diverted through tunnel to Bucks Creek Powerplant (station 11403700) for power development downstream on North Fork Feather River. Figures given, including extremes, represent total contents at 2400 hours. See schematic diagram of [North Fork Feather River Basin](#).

COOPERATION.—Records were collected by Pacific Gas & Electric Co., under general supervision of the U.S. Geological Survey, in connection with a Federal Energy Regulatory Commission project. Contents not rounded to U.S. Geological Survey standards.

EXTREMES FOR PERIOD OF RECORD.—Maximum contents, 1,329 acre-ft, Dec. 30, 1996, elevation, 4,321.5 ft; minimum, 216 acre-ft, Sept. 20, 1991, elevation, 4,282.8 ft.

EXTREMES FOR CURRENT YEAR.—Maximum contents, 1,090 acre-ft, Mar. 24, elevation, 4,315.40 ft; minimum, 746 acre-ft, Oct. 23, Jan. 10, Mar. 27, elevation, 4,305.30 ft.

Capacity table (elevation, in feet, and contents, in acre-feet)  
(Based on survey by Feather River Power Co. in 1928)

4,290	350	4,300	592	4,310	898	4,320	1,268
4,295	464	4,305	736				

## RESERVOIR STORAGE (ACRE-FEET), WATER YEAR OCTOBER 2000 TO SEPTEMBER 2001

## DAILY OBSERVATION AT 2400 HOURS

DAY	OCT	NOV	DEC	JAN	FEB	MAR	APR	MAY	JUN	JUL	AUG	SEP
1	874	871	971	903	815	880	1024	883	921	848	988	1000
2	896	874	918	896	809	900	957	880	914	851	1006	1012
3	851	946	1002	890	822	918	841	783	900	841	1020	1025
4	825	957	1009	880	838	928	831	812	887	858	1031	1040
5	822	921	1031	883	838	995	770	914	871	874	1042	1053
6	877	867	967	877	851	1049	841	995	867	887	1057	1056
7	960	880	936	874	851	1046	854	1064	861	900	1082	1051
8	995	858	1034	890	854	1042	787	1071	851	921	978	1044
9	918	831	1046	864	858	1057	834	1020	874	907	967	1025
10	774	799	861	746	921	1064	783	883	890	928	981	1003
11	796	819	918	764	981	1002	855	854	896	946	992	995
12	932	812	939	755	946	939	887	851	903	946	1004	983
13	867	783	995	858	964	903	887	796	907	918	1005	974
14	799	822	1034	914	974	960	793	783	911	932	992	983
15	802	896	1020	911	1068	974	777	867	900	946	966	997
16	809	903	867	971	911	992	799	964	907	950	967	1010
17	928	896	838	1049	925	1027	887	890	914	967	987	1023
18	981	900	838	950	900	1057	1006	838	890	960	1001	1038
19	854	932	819	974	858	943	992	819	834	943	1013	1018
20	825	971	802	1038	752	1017	932	854	828	953	968	1029
21	858	900	841	1031	903	1064	960	887	787	971	984	999
22	802	828	877	1042	799	1034	960	911	767	988	990	1014
23	746	911	914	1046	838	1082	971	918	774	978	1003	1031
24	806	1002	925	1049	796	1090	1079	918	780	967	959	1050
25	936	999	939	1006	780	1057	1049	867	790	957	944	1043
26	992	1013	925	957	900	799	1020	864	806	921	954	1027
27	964	981	918	896	851	746	1006	845	825	925	959	1038
28	1006	978	914	838	864	900	918	838	831	939	988	1055
29	1034	960	900	845	---	988	841	822	834	953	966	1035
30	988	957	896	834	---	921	834	887	845	967	981	1009
31	871	---	896	828	---	995	---	918	---	981	988	---
MAX	1034	1013	1046	1049	1068	1090	1079	1071	921	988	1082	1056
MIN	746	783	802	746	752	746	770	783	767	841	944	974
a	4309.20	4311.70	4310.00	4307.90	4309.00	4312.80	4308.10	4310.60	4308.40	4312.40	4312.60	4313.20
b	-34	+86	-61	-68	+36	+131	-161	+84	-73	+136	+7	+21

CAL YR 2000 MAX 1135 MIN 744 b +16  
WTR YR 2001 MAX 1090 MIN 746 b +104

a Elevation, in feet, at end of month.  
b Change in contents, in acre-feet.

## 11404300 GRIZZLY CREEK BELOW DIVERSION DAM, NEAR STORRIE, CA

LOCATION.—Lat 39°53'29", long 121°17'35", in SW 1/4 NE 1/4 sec.34, T.24 N., R.6 E., Plumas County, Hydrologic Unit 18020121, Plumas National Forest, on right bank, 0.2 mi downstream from diversion dam, and 2.4 mi southeast of Storrie.

DRAINAGE AREA.—14.4 mi<sup>2</sup>.

PERIOD OF RECORD.—October 1985 to current year. Unpublished records for water years 1976–85 available in files of the U.S. Geological Survey.

GAGE.—Water-stage recorder and concrete control with V-notch sharp-crested weir, since Oct. 8, 1987. Elevation of gage is 4,320 ft above sea level, from topographic map. Prior to Oct. 8, 1987, at datum 1.79 ft higher.

REMARKS.—Flow regulated by diversion dam 0.2 mi upstream. There is considerable inflow upstream from the diversion dam from Bucks Creek Tunnel outlet and Grizzly Powerplant (station 11404240). Most of the flow is diverted to Bucks Creek Powerplant (station 11403700) on North Fork Feather River. See schematic diagram of [North Fork Feather River Basin](#).

COOPERATION.—Records were collected by Pacific Gas & Electric Co., under general supervision of the U.S. Geological Survey, in connection with a Federal Energy Regulatory Commission project.

EXTREMES FOR PERIOD OF RECORD.—Maximum discharge, 6,300 ft<sup>3</sup>/s, Jan. 1, 1997, gage height, 7.33 ft, from rating curve extended above 260 ft<sup>3</sup>/s on basis of computation of peak flow over dam; maximum gage height, 9.54 ft, Feb. 17, 1986, datum then in use; minimum daily, 1.9 ft<sup>3</sup>/s, June 14, 1988.

## DISCHARGE, CUBIC FEET PER SECOND, WATER YEAR OCTOBER 2000 TO SEPTEMBER 2001

## DAILY MEAN VALUES

DAY	OCT	NOV	DEC	JAN	FEB	MAR	APR	MAY	JUN	JUL	AUG	SEP
1	4.4	4.4	4.6	2.3	2.3	2.4	5.2	4.5	4.6	4.4	4.5	4.5
2	4.4	4.4	4.6	2.3	2.3	2.4	5.0	4.6	4.6	4.4	4.5	4.5
3	4.4	4.4	4.5	2.3	2.3	2.4	4.9	4.5	4.6	4.4	4.5	4.5
4	4.4	4.5	3.6	2.3	2.3	2.7	4.8	4.4	4.6	4.4	4.5	4.5
5	4.4	4.5	2.4	2.3	2.3	2.8	4.7	4.5	4.6	4.4	4.6	4.5
6	4.4	4.4	2.4	2.3	2.3	2.7	4.7	4.6	4.5	4.4	4.6	4.5
7	4.5	4.4	2.3	2.3	2.3	2.7	4.8	4.6	4.4	4.4	4.6	4.6
8	4.5	4.4	2.3	2.3	2.3	2.7	4.7	4.6	4.4	4.4	4.6	4.6
9	4.6	4.4	2.4	2.3	2.4	2.7	4.7	4.6	4.4	4.4	4.5	4.6
10	4.4	4.4	2.4	2.3	2.4	2.7	4.7	4.5	4.4	4.4	4.5	4.5
11	4.3	4.4	2.3	2.3	2.4	2.7	4.7	4.5	4.4	4.4	4.5	4.5
12	4.4	4.3	2.3	2.3	2.4	2.6	4.7	4.5	4.4	4.4	4.5	4.5
13	4.4	4.4	2.4	2.3	2.4	2.6	4.8	4.4	4.4	4.4	4.5	4.5
14	4.4	4.4	2.5	2.3	2.4	2.6	4.7	4.4	4.4	4.4	4.5	4.5
15	4.4	4.4	2.4	2.3	2.4	2.6	4.6	4.4	4.4	4.4	4.5	4.5
16	4.4	4.4	2.3	2.3	2.4	2.6	4.6	4.6	4.4	4.5	4.5	4.5
17	4.4	4.4	2.3	2.3	2.4	2.6	4.7	4.7	4.4	4.5	4.5	4.5
18	4.5	4.4	2.3	2.4	2.4	2.7	4.9	4.6	4.4	4.5	4.5	4.5
19	4.5	4.4	2.3	2.4	2.4	2.7	4.9	4.6	4.4	4.5	4.5	4.5
20	4.4	4.5	2.3	2.4	2.4	2.7	4.8	4.6	4.4	4.5	4.5	4.5
21	4.4	4.5	2.3	2.4	2.4	2.7	4.8	4.6	4.4	4.5	4.5	4.5
22	4.4	4.4	2.3	2.4	2.5	2.8	4.8	4.6	4.3	4.5	4.5	4.5
23	4.3	4.4	2.3	2.4	2.4	2.8	4.8	4.6	4.3	4.5	4.5	4.5
24	4.3	4.5	2.3	2.4	2.4	2.9	4.7	4.6	4.3	4.5	4.5	4.6
25	4.5	4.5	2.3	2.4	2.4	3.6	4.8	4.6	4.3	4.5	4.5	4.6
26	4.5	4.5	2.3	2.4	2.3	3.0	4.7	4.6	4.4	4.5	4.5	4.6
27	4.5	4.5	2.3	2.4	2.4	2.8	4.7	4.6	4.4	4.4	4.5	4.7
28	4.7	4.6	2.3	2.3	2.4	2.8	4.7	4.5	4.4	4.5	4.5	4.8
29	4.7	4.7	2.3	2.3	---	3.9	4.6	4.5	4.4	4.5	4.5	4.8
30	4.6	4.6	2.3	2.3	---	5.1	4.5	4.5	4.4	4.5	4.5	4.8
31	4.4	---	2.3	2.3	---	5.0	---	4.6	---	4.5	4.5	---
TOTAL	137.8	133.4	80.2	72.3	66.4	90.0	142.7	141.0	132.7	137.9	139.9	136.7
MEAN	4.45	4.45	2.59	2.33	2.37	2.90	4.76	4.55	4.42	4.45	4.51	4.56
MAX	4.7	4.7	4.6	2.4	2.5	5.1	5.2	4.7	4.6	4.5	4.6	4.8
MIN	4.3	4.3	2.3	2.3	2.3	2.4	4.5	4.4	4.3	4.4	4.5	4.5
AC-FT	273	265	159	143	132	179	283	280	263	274	277	271
a	12310	13630	6650	7320	9350	10030	13790	16130	6670	10670	7120	8280

a Diversion, in acre-feet, to Bucks Creek Powerplant (station 11403700), provided by Pacific Gas & Electric Co.

## 11404300 GRIZZLY CREEK BELOW DIVERSION DAM, NEAR STORRIE, CA—Continued

## STATISTICS OF MONTHLY MEAN DATA FOR WATER YEARS 1986 - 2001, BY WATER YEAR (WY)

	OCT	NOV	DEC	JAN	FEB	MAR	APR	MAY	JUN	JUL	AUG	SEP
MEAN	4.62	4.99	22.3	51.4	60.7	43.7	19.4	32.6	32.7	9.11	3.92	3.85
MAX	11.8	19.7	284	650	396	174	215	277	286	61.0	5.49	5.57
(WY)	1996	1999	1997	1997	1997	1995	1995	1995	1998	1998	1991	1999
MIN	2.01	2.01	2.09	2.11	2.17	2.20	2.10	2.03	2.01	2.08	2.03	2.00
(WY)	1995	1988	1994	1994	1994	1988	1987	1987	1992	1992	1992	1992

SUMMARY STATISTICS	FOR 2000 CALENDAR YEAR		FOR 2001 WATER YEAR		WATER YEARS 1986 - 2001	
ANNUAL TOTAL	2035.8		1411.0			
ANNUAL MEAN	5.56		3.87		23.9	
HIGHEST ANNUAL MEAN					125	
LOWEST ANNUAL MEAN					2.58	
HIGHEST DAILY MEAN	478	Feb 14	5.2	Apr 1	4810	Jan 1 1997
LOWEST DAILY MEAN	2.2	Jan 3	2.3	Dec 7	1.9	Jun 14 1988
ANNUAL SEVEN-DAY MINIMUM	2.2	Jan 2	2.3	Dec 16	2.0	May 2 1987
MAXIMUM PEAK FLOW			7.1	Mar 25	6300	Jan 1 1997
MAXIMUM PEAK STAGE			1.37	Mar 25	9.54	Feb 17 1986
ANNUAL RUNOFF (AC-FT)	4040		2800		17340	
ANNUAL DIVERSION (AC-FT) a	127500		121900			
10 PERCENT EXCEEDS	4.9		4.6		5.1	
50 PERCENT EXCEEDS	4.5		4.4		2.9	
90 PERCENT EXCEEDS	2.4		2.3		2.1	

a Diversion, in acre-feet, to Bucks Creek Powerplant (station 11403700), provided by Pacific Gas & Electric Co.



## 11404330 NORTH FORK FEATHER RIVER BELOW GRIZZLY CREEK, CA

LOCATION.—Lat 39°51'09", long 121°23'29", in NE 1/4 NW 1/4 sec.14, T.23 N., R.5 E., Butte County, Hydrologic Unit 18020121, Lassen National Forest, on left bank, 0.7 mi upstream from Bear Ranch Creek, 1.6 mi downstream from Grizzly Creek, and 2.1 mi downstream from Cresta Dam.

DRAINAGE AREA.—1,914 mi<sup>2</sup>.

PERIOD OF RECORD.—October 1985 to February 1986, October 1986 to current year. Unpublished records for water years 1982–85 available in files of the U.S. Geological Survey.

GAGE.—Water-stage recorder. Elevation of gage is 1,480 ft above sea level, from topographic map.

REMARKS.—Flow regulated by numerous reservoirs upstream, combined capacity, 1,386,000 acre-ft. Most of the flow bypasses this station through Cresta Powerplant (station 11404360). Diversion through Cresta Powerplant began in 1949. See schematic diagram of North Fork Feather River Basin.

COOPERATION.—Records were collected by Pacific Gas & Electric Co., under general supervision of the U.S. Geological Survey, in connection with a Federal Energy Regulatory Commission project.

EXTREMES FOR PERIOD OF RECORD.—Maximum discharge, 115,000 ft<sup>3</sup>/s, Jan. 1, 1997, gage height, 29.97 ft; minimum daily, 37 ft<sup>3</sup>/s, July 25, 1994.

## DISCHARGE, CUBIC FEET PER SECOND, WATER YEAR OCTOBER 2000 TO SEPTEMBER 2001

## DAILY MEAN VALUES

DAY	OCT	NOV	DEC	JAN	FEB	MAR	APR	MAY	JUN	JUL	AUG	SEP
1	56	65	65	60	64	101	189	164	73	57	54	55
2	56	63	63	60	64	104	181	155	72	56	53	56
3	55	62	62	60	66	97	163	144	71	56	52	56
4	55	61	61	60	72	209	151	142	69	55	53	56
5	55	61	60	60	71	328	143	143	68	54	53	55
6	55	60	59	60	69	212	145	141	68	54	52	54
7	55	59	59	60	66	198	149	142	67	53	52	96
8	55	60	59	66	65	193	135	144	66	53	52	243
9	60	60	60	65	68	217	130	142	66	53	51	147
10	69	60	63	84	69	170	125	136	65	53	51	162
11	65	60	62	97	76	152	128	131	64	53	55	106
12	60	59	66	78	74	140	122	125	64	53	56	58
13	58	59	70	73	71	137	118	119	64	54	56	58
14	58	63	114	72	69	135	115	114	63	55	56	58
15	57	61	92	69	68	130	114	111	62	54	56	57
16	57	61	77	67	71	126	115	108	61	54	55	58
17	58	60	72	66	78	124	119	104	61	56	55	57
18	57	60	67	66	119	132	131	101	60	56	55	57
19	57	60	66	65	145	146	144	97	60	56	56	56
20	56	60	64	64	207	166	148	94	60	56	56	56
21	58	59	65	64	261	177	138	91	59	54	55	56
22	57	59	68	64	207	181	131	89	58	54	56	56
23	57	59	65	70	148	180	132	86	58	54	56	56
24	57	60	65	81	137	193	142	84	57	55	56	56
25	61	60	63	74	136	461	159	82	57	54	56	63
26	66	59	63	74	119	256	166	81	60	54	55	57
27	60	60	62	69	113	195	167	79	63	53	56	57
28	120	60	62	67	106	196	165	77	61	54	55	57
29	100	89	61	69	---	197	158	76	59	53	56	57
30	77	70	62	66	---	189	159	74	58	53	56	57
31	67	---	61	65	---	187	---	73	---	54	56	---
TOTAL	1934	1849	2058	2115	2879	5629	4282	3449	1894	1683	1692	2173
MEAN	62.4	61.6	66.4	68.2	103	182	143	111	63.1	54.3	54.6	72.4
MAX	120	89	114	97	261	461	189	164	73	57	56	243
MIN	55	59	59	60	64	97	114	73	57	53	51	54
AC-FT	3840	3670	4080	4200	5710	11170	8490	6840	3760	3340	3360	4310
a	112000	116800	114400	109900	78790	125000	94200	93290	66460	78970	73700	51690

a Diversion, in acre-feet, to Cresta Powerplant (station 11404360), provided by Pacific Gas & Electric Co.

## 11404330 NORTH FORK FEATHER RIVER BELOW GRIZZLY CREEK, CA—Continued

## STATISTICS OF MONTHLY MEAN DATA FOR WATER YEARS 1986 - 2001, BY WATER YEAR (WY)

	OCT	NOV	DEC	JAN	FEB	MAR	APR	MAY	JUN	JUL	AUG	SEP
MEAN	96.9	133	487	1620	1373	2051	1131	1174	571	95.1	76.9	76.6
MAX	302	588	5071	16310	6576	10220	6777	9322	3842	221	205	235
(WY)	2000	1999	1997	1997	1997	1995	1995	1995	1995	1995	1997	1999
MIN	57.4	57.8	59.0	55.7	61.5	86.0	78.0	67.7	55.6	54.3	54.6	56.0
(WY)	1992	1993	1990	1991	1991	1988	1988	1992	1988	2001	2001	1991

SUMMARY STATISTICS	FOR 2000 CALENDAR YEAR		FOR 2001 WATER YEAR		WATER YEARS 1986 - 2001	
ANNUAL TOTAL	122114		31637			
ANNUAL MEAN	334		86.7		745	
HIGHEST ANNUAL MEAN					3115	
LOWEST ANNUAL MEAN					75.2	
HIGHEST DAILY MEAN	15200	Feb 14	461	Mar 25	96900	Jan 1 1997
LOWEST DAILY MEAN	54	Jan 3	51	Aug 9	37	Jul 25 1994
ANNUAL SEVEN-DAY MINIMUM	55	Jan 1	52	Aug 4	52	Dec 10 1989
MAXIMUM PEAK FLOW			1150	Mar 25	115000	Jan 1 1997
MAXIMUM PEAK STAGE			5.60	Mar 25	29.97	Jan 1 1997
ANNUAL RUNOFF (AC-FT)	242200		62750		539900	
ANNUAL DIVERSION (AC-FT) a	1772000		1115000			
10 PERCENT EXCEEDS	590		151		1470	
50 PERCENT EXCEEDS	95		64		83	
90 PERCENT EXCEEDS	56		55		56	

a Diversion, in acre-feet, to Cresta Powerplant (station 11404360), provided by Pacific Gas & Electric Co.



## 11404400 NORTH FORK FEATHER RIVER BELOW POE DAM, CA

LOCATION.—Lat 39°48'32", long 121°26'04", in SW 1/4 NE 1/4 sec.32, T.23 N., R.5 E., [Butte County](#), Hydrologic Unit 18020121, Plumas National Forest, on right bank, 900 ft downstream from Poe Dam, 0.4 mi upstream from Mill Creek, and 0.8 mi northeast of Pulga.

DRAINAGE AREA.—1,942 mi<sup>2</sup>.

PERIOD OF RECORD.—October 1999 to current year (low-flow records only). Records for water years 1980–99 available in the files of the U.S. Geological Survey.

GAGE.—Non-recording gage read daily. Elevation of gage is 1,350 ft above sea level, from topographic map.

REMARKS.—Records not computed above 137 ft<sup>3</sup>/s. See schematic diagram of [North Fork Feather River Basin](#).

COOPERATION.—Records were collected by Pacific Gas & Electric Co., under general supervision of the U.S. Geological Survey, in connection with a Federal Energy Regulatory Commission project.

## DISCHARGE, CUBIC FEET PER SECOND, WATER YEAR OCTOBER 2000 TO SEPTEMBER 2001

## DAILY INSTANTANEOUS VALUES

DAY	OCT	NOV	DEC	JAN	FEB	MAR	APR	MAY	JUN	JUL	AUG	SEP
1	105	109	113	116	109	113	113	105	109	102	105	99
2	105	113	116	116	109	113	120	105	116	102	102	105
3	105	109	116	113	113	113	116	105	113	102	102	113
4	105	128	113	128	113	105	116	113	109	113	102	105
5	105	113	113	113	109	109	113	113	109	109	102	109
6	105	128	113	120	113	109	116	113	102	105	102	105
7	105	113	120	116	109	109	109	109	102	105	102	105
8	105	116	120	120	113	109	109	109	109	109	102	109
9	105	109	113	120	113	109	109	113	109	109	102	---
10	105	109	116	116	113	113	116	109	105	109	102	---
11	102	116	124	124	116	113	109	113	109	105	102	---
12	102	133	124	116	116	102	113	113	102	109	102	---
13	105	133	116	116	109	113	113	105	102	109	102	---
14	109	133	116	116	105	102	113	102	105	109	102	124
15	109	113	120	116	113	105	113	109	102	113	113	113
16	99	128	116	116	113	105	109	102	102	105	109	116
17	105	120	116	102	113	105	109	109	102	99	105	116
18	102	109	105	113	113	109	109	105	109	113	113	113
19	102	113	116	113	113	105	113	105	102	113	105	109
20	99	109	102	113	116	102	109	109	113	105	109	102
21	99	113	116	113	116	99	109	105	113	102	113	124
22	105	109	120	116	116	109	109	105	109	105	113	116
23	102	116	116	109	109	109	113	109	109	99	105	116
24	99	109	116	113	109	109	109	105	109	102	113	116
25	99	113	116	109	109	116	113	109	105	102	113	113
26	105	113	113	113	113	133	109	109	113	102	113	113
27	105	109	113	113	109	102	109	102	109	102	113	113
28	113	116	116	113	113	109	113	109	102	102	113	120
29	109	109	113	113	---	116	109	105	102	105	109	120
30	102	109	116	113	---	116	109	102	102	102	109	120
31	113	---	116	116	---	120	---	95	---	102	113	---
TOTAL	3235	3470	3579	3564	3135	3401	3349	3321	3204	3270	3312	---
MEAN	104	116	115	115	112	110	112	107	107	105	107	---
MAX	113	133	124	128	116	133	120	113	116	113	113	---
MIN	99	109	102	102	105	99	109	95	102	99	102	---
AC-FT	6420	6880	7100	7070	6220	6750	6640	6590	6360	6490	6570	---

## 11404500 NORTH FORK FEATHER RIVER AT PULGA, CA

LOCATION.—Lat 39°47'40", long 121°27'02", in SE 1/4 NE 1/4 sec.6, T.22 N., R.5 E., Butte County, Hydrologic Unit 18020121, Plumas National Forest, on left bank, between railroad and highway bridges, 0.6 mi downstream from Flea Valley Creek and Pulga, and 1.6 mi downstream from Poe Dam.

DRAINAGE AREA.—1,953 mi<sup>2</sup>.

PERIOD OF RECORD.—October 1910 to current year. Monthly discharge only for some periods and yearly estimates for water years 1911 and 1938, published in WSP 1315-A. Prior to October 1960, published as "at Big Bar."

CHEMICAL DATA: Water years 1963–66, 1972, 1977.

WATER TEMPERATURE: Water years 1963–83.

REVISED RECORDS.—WSP 931: 1938(M), 1940. WSP 1515: 1935. WDR CA-77-4: 1976 (yearly summaries).

GAGE.—Water-stage recorder. Datum of gage is 1,305.62 ft above sea level. Prior to Oct. 1, 1937, at site 1.1 mi upstream at different datum. Oct. 1, 1937, to Sept. 30, 1958, at present site at datum 5.00 ft higher.

REMARKS.—Flow regulated by Lake Almanor, Bucks Lake, Butt Valley Reservoir (stations 11399000, 11403500, 11401050), Mountain Meadows Reservoir, and five forebays, combined capacity, 1,386,000 acre-ft. Diversion through Poe Powerplant (station 11404900) began on May 29, 1958. See schematic diagram of [North Fork Feather River Basin](#).

COOPERATION.—Records were collected by Pacific Gas & Electric Co., under general supervision of the U.S. Geological Survey, in connection with a Federal Energy Regulatory Commission project.

EXTREMES FOR PERIOD OF RECORD.—Maximum discharge, 105,400 ft<sup>3</sup>/s, Jan. 1, 1997, gage height, 41.65 ft, from rating curve extended above 32,000 ft<sup>3</sup>/s on basis of slope area measurement of peak discharge; minimum daily, 5.4 ft<sup>3</sup>/s, Sept. 18, 1977.

## DISCHARGE, CUBIC FEET PER SECOND, WATER YEAR OCTOBER 2000 TO SEPTEMBER 2001

## DAILY MEAN VALUES

DAY	OCT	NOV	DEC	JAN	FEB	MAR	APR	MAY	JUN	JUL	AUG	SEP
1	106	127	120	122	120	137	133	131	124	117	101	106
2	106	121	122	120	118	144	138	133	125	112	105	108
3	105	117	119	121	117	137	133	128	119	111	104	110
4	104	117	120	121	116	161	129	129	118	114	106	106
5	103	117	119	119	121	254	128	135	112	117	106	113
6	105	115	118	121	120	201	136	136	110	116	102	114
7	106	115	119	117	118	176	137	134	115	115	108	110
8	102	116	122	128	119	167	132	132	116	116	107	119
9	105	117	119	125	122	177	132	134	113	115	109	231
10	109	119	121	135	123	158	134	130	110	113	108	259
11	106	120	126	144	134	149	132	132	113	118	114	318
12	101	125	130	133	125	139	133	132	117	115	114	224
13	104	122	131	124	116	142	134	129	117	110	108	183
14	106	129	142	122	117	137	133	127	117	116	108	117
15	104	125	132	122	118	133	133	126	115	116	110	112
16	100	126	124	121	122	133	132	125	111	112	105	112
17	110	123	121	120	127	134	129	136	115	111	108	114
18	105	125	118	123	139	135	133	126	115	118	112	114
19	104	125	120	118	154	131	138	123	118	112	110	115
20	101	124	115	121	235	135	143	126	126	112	111	119
21	98	123	122	119	280	134	142	121	125	110	110	119
22	104	126	122	123	212	134	139	126	117	115	107	107
23	104	121	121	123	172	134	136	125	113	114	112	109
24	103	118	116	128	165	136	136	123	116	112	111	111
25	107	121	117	126	164	232	139	123	124	115	110	119
26	112	120	117	126	152	216	136	118	121	123	107	111
27	108	117	121	122	146	140	135	116	123	122	106	116
28	125	122	123	120	141	140	132	123	118	111	107	113
29	117	123	125	123	---	141	133	120	119	103	109	114
30	109	121	118	122	---	139	131	115	124	107	107	113
31	108	---	125	122	---	135	---	116	---	109	111	---
TOTAL	3287	3637	3785	3831	4013	4761	4031	3930	3526	3527	3353	4036
MEAN	106	121	122	124	143	154	134	127	118	114	108	135
MAX	125	129	142	144	280	254	143	136	126	123	114	318
MIN	98	115	115	117	116	131	128	115	110	103	101	106
AC-FT	6520	7210	7510	7600	7960	9440	8000	7800	6990	7000	6650	8010
a	101400	101000	100200	96890	72810	120600	90060	85400	58660	67200	62280	42480

a Diversion, in acre-feet, to Poe Powerplant (station 11404900), provided by Pacific Gas & Electric Co.

## 11404500 NORTH FORK FEATHER RIVER AT PULGA, CA—Continued

## STATISTICS OF MONTHLY MEAN DATA FOR WATER YEARS 1911 - 2001, BY WATER YEAR (WY)

	OCT	NOV	DEC	JAN	FEB	MAR	APR	MAY	JUN	JUL	AUG	SEP
MEAN	932	1127	1669	2218	2746	2857	3441	2982	1585	942	885	843
MAX	2943	4594	10690	14120	14320	11960	13580	12460	7689	2771	2441	2430
(WY)	1963	1951	1956	1997	1986	1995	1952	1922	1911	1952	1952	1952
MIN	16.4	26.4	50.7	52.6	56.0	58.2	54.9	41.7	34.0	32.6	13.3	14.2
(WY)	1978	1978	1977	1977	1990	1977	1990	1977	1977	1977	1977	1977

SUMMARY STATISTICS	FOR 2000 CALENDAR YEAR		FOR 2001 WATER YEAR		WATER YEARS 1911 - 2001	
ANNUAL TOTAL	143946		45717			
ANNUAL MEAN	393		125		1823	
HIGHEST ANNUAL MEAN					5320	
LOWEST ANNUAL MEAN					42.7	
HIGHEST DAILY MEAN	17700	Feb 14	318	Sep 11	101000	Jan 1 1997
LOWEST DAILY MEAN	84	Jan 5	98	Oct 21	5.4	Sep 18 1977
ANNUAL SEVEN-DAY MINIMUM	87	Jan 1	103	Oct 18	12	Aug 10 1977
MAXIMUM PEAK FLOW			1190	Mar 25	105400	Jan 1 1997
MAXIMUM PEAK STAGE			6.74	Mar 25	41.65	Jan 1 1997
ANNUAL RUNOFF (AC-FT)	285500		90680		1321000	
ANNUAL DIVERSION (AC-FT) a	1667000		999000			
10 PERCENT EXCEEDS	709		139		4570	
50 PERCENT EXCEEDS	117		120		1270	
90 PERCENT EXCEEDS	103		107		55	

a Diversion, in acre-feet, to Poe Powerplant (station 11404900), provided by Pacific Gas & Electric Co.

## 11405120 PHILBROOK CREEK BELOW PHILBROOK DAM, NEAR BUTTE MEADOWS, CA

LOCATION.—Lat 40°01'48", long 121°28'36", unsurveyed, T.25 N., R.4 E., Butte County, Hydrologic Unit 18020121, Lassen National Forest, on right bank, 500 ft downstream from outlet structure on Philbrook Dam, and 5.4 mi southeast of Butte Meadows.

DRAINAGE AREA.—5.05 mi<sup>2</sup>.

PERIOD OF RECORD.—July 1989 to current year (no winter records). Unpublished records for water years 1986–89 available in files of the U.S. Geological Survey.

GAGE.—Water-stage recorder, Parshall flume, and V-notch sharp-crested weir. Elevation of gage is 5,490 ft above sea level, from topographic map. October 1985 to July 1989, nonrecording gage at same site and datum. In June 1989, V-notch sharp-crested weir installed in flume to be used at low flows.

REMARKS.—Records not computed for winter months. Flow completely regulated by Philbrook Reservoir, usable capacity, 5,370 acre-ft, 500 ft upstream. Spillwater from Philbrook Reservoir bypasses this station.

COOPERATION.—Records were collected by Pacific Gas & Electric Co., under general supervision of the U.S. Geological Survey, in connection with a Federal Energy Regulatory Commission project.

DISCHARGE, CUBIC FEET PER SECOND, WATER YEAR OCTOBER 2000 TO SEPTEMBER 2001  
DAILY MEAN VALUES

DAY	OCT	NOV	DEC	JAN	FEB	MAR	APR	MAY	JUN	JUL	AUG	SEP
1	3.4	2.8	---	---	---	---	---	4.2	4.6	6.7	40	20
2	3.4	2.8	---	---	---	---	---	4.2	4.7	6.7	37	20
3	3.3	2.9	---	---	---	---	---	4.2	4.6	13	34	20
4	3.0	2.8	---	---	---	---	---	4.2	4.3	16	34	20
5	3.0	2.8	---	---	---	---	---	4.3	4.3	16	34	20
6	3.0	2.8	---	---	---	---	---	4.3	4.3	16	34	20
7	3.0	2.8	---	---	---	---	---	4.4	4.3	16	29	20
8	3.0	2.8	---	---	---	---	---	4.4	4.4	16	24	20
9	3.0	2.8	---	---	---	---	---	4.4	4.4	16	24	20
10	3.0	2.8	---	---	---	---	---	4.5	4.4	21	24	20
11	3.0	2.8	---	---	---	---	---	4.6	3.5	25	24	20
12	3.0	2.8	---	---	---	---	---	4.6	2.7	25	24	20
13	3.0	2.8	---	---	---	---	---	4.6	2.6	25	24	19
14	3.0	2.8	---	---	---	---	---	4.6	2.7	30	23	19
15	3.0	2.8	---	---	---	---	---	4.6	2.6	36	22	19
16	3.0	2.8	---	---	---	---	---	4.6	2.6	36	22	19
17	3.0	2.8	---	---	---	---	---	4.6	2.6	36	21	19
18	2.9	2.8	---	---	---	---	3.8	4.6	2.6	36	21	19
19	2.9	2.8	---	---	---	---	3.9	4.6	2.6	36	21	19
20	2.9	2.8	---	---	---	---	3.9	4.6	2.6	35	21	17
21	2.9	2.8	---	---	---	---	3.9	4.6	7.6	35	21	2.8
22	2.8	2.8	---	---	---	---	3.9	4.6	13	35	21	2.8
23	2.8	2.8	---	---	---	---	3.9	4.4	13	35	21	2.8
24	2.8	2.8	---	---	---	---	3.9	4.4	13	38	21	2.8
25	2.8	2.8	---	---	---	---	3.9	4.4	9.2	41	21	2.6
26	2.8	2.7	---	---	---	---	4.0	4.4	6.7	41	21	2.3
27	2.8	2.7	---	---	---	---	4.1	4.4	6.7	41	21	2.3
28	2.8	2.7	---	---	---	---	4.2	4.4	6.7	41	21	2.3
29	2.8	2.7	---	---	---	---	4.2	4.4	6.7	41	21	2.3
30	2.8	---	---	---	---	---	4.2	4.4	6.7	40	20	2.3
31	2.8	---	---	---	---	---	---	4.4	---	40	20	---
TOTAL	91.7	---	---	---	---	---	---	137.9	160.7	891.4	766	415.3
MEAN	2.96	---	---	---	---	---	---	4.45	5.36	28.8	24.7	13.8
MAX	3.4	---	---	---	---	---	---	4.6	13	41	40	20
MIN	2.8	---	---	---	---	---	---	4.2	2.6	6.7	20	2.3
AC-FT	182	---	---	---	---	---	---	274	319	1770	1520	824
a	572	516	498	490	517	1517	3245	4870	4879	3178	1673	828

a Contents, in acre-feet, from Philbrook Reservoir (station 11405100), provided by Pacific Gas & Electric Co.

## 11405200 WEST BRANCH FEATHER RIVER BELOW HENDRICKS DIVERSION DAM, NEAR STIRLING CITY, CA

LOCATION.—Lat 39°56'03", long 121°31'43", in NW 1/4 SE 1/4 sec.16, T.24 N., R.4 E., Butte County, Hydrologic Unit 18020121, on right bank, 200 ft upstream from road bridge, 1,800 ft downstream from Hendricks Diversion Dam, and 1.9 mi north of Stirling City.

DRAINAGE AREA.—46.1 mi<sup>2</sup>.

PERIOD OF RECORD.—August 1986 to current year (low-flow records only).

GAGE.—Water-stage recorder. Elevation of gage is 3,210 ft above sea level, from topographic map.

REMARKS.—Flows computed to 100 ft<sup>3</sup>/s. Most of the water is diverted at Hendricks Diversion Dam to the Hendricks Canal and Toadtown Canal (station 11389800) and then to De Sabla Powerplant (station 11389750) on Butte Creek.

COOPERATION.—Records were collected by Pacific Gas & Electric Co., under general supervision of the U.S. Geological Survey, in connection with a Federal Energy Regulatory Commission project.

## DISCHARGE, CUBIC FEET PER SECOND, WATER YEAR OCTOBER 2000 TO SEPTEMBER 2001

## DAILY MEAN VALUES

DAY	OCT	NOV	DEC	JAN	FEB	MAR	APR	MAY	JUN	JUL	AUG	SEP
1	17	18	19	18	18	19	---	---	18	9.3	14	8.5
2	17	18	19	18	18	19	---	---	18	9.3	13	8.3
3	17	18	18	18	18	19	89	---	17	9.3	8.8	8.5
4	17	18	18	18	18	36	61	---	e8.1	9.5	9.7	8.5
5	17	18	18	18	18	---	47	---	e8.1	9.7	9.7	8.5
6	17	18	18	18	18	65	45	---	e8.1	9.7	9.0	8.2
7	17	18	18	18	18	44	36	---	e8.1	9.7	8.0	8.5
8	17	18	18	18	18	34	26	---	14	9.7	8.4	8.7
9	18	18	18	18	19	24	22	---	14	9.4	8.0	8.7
10	18	18	18	19	20	21	19	---	14	9.3	7.7	8.6
11	18	18	18	19	24	20	19	---	13	9.3	7.7	8.6
12	18	18	18	19	19	20	19	---	13	9.0	7.3	8.6
13	18	18	19	18	18	20	18	---	12	9.0	7.3	8.6
14	17	18	19	18	18	20	18	---	8.2	9.0	8.0	8.6
15	17	18	19	18	18	20	18	---	8.7	9.1	8.8	8.6
16	17	18	19	18	18	20	74	---	8.0	9.0	8.7	8.6
17	17	18	19	18	18	20	---	---	10	9.0	8.6	8.6
18	17	18	19	18	19	20	---	---	9.4	11	8.3	8.6
19	17	18	18	18	33	28	---	---	8.7	12	8.3	8.6
20	17	18	18	18	46	47	---	---	8.7	12	8.3	8.6
21	17	18	18	18	50	54	---	---	8.7	12	8.3	8.6
22	17	18	19	18	42	58	---	---	8.7	12	8.3	8.6
23	18	18	18	18	19	66	---	---	8.7	12	8.3	8.6
24	18	18	18	19	19	87	---	---	8.7	12	8.3	8.6
25	18	18	18	18	19	---	---	---	8.7	12	8.3	8.8
26	19	18	18	18	19	---	---	---	8.9	13	8.3	8.6
27	18	18	18	18	19	---	---	---	9.3	14	8.3	8.6
28	25	18	18	18	19	---	---	---	9.3	14	8.3	8.6
29	20	20	18	18	---	---	---	95	9.3	14	8.3	8.6
30	19	19	18	18	---	---	---	40	9.0	14	8.3	8.6
31	19	---	18	18	---	---	---	18	---	14	8.3	---
TOTAL	553	543	567	562	620	---	---	---	316.4	336.3	268.9	257.2
MEAN	17.8	18.1	18.3	18.1	22.1	---	---	---	10.5	10.8	8.67	8.57
MAX	25	20	19	19	50	---	---	---	18	14	14	8.8
MIN	17	18	18	18	18	---	---	---	8.0	9.0	7.3	8.2
AC-FT	1100	1080	1120	1110	1230	---	---	---	628	667	533	510

e Estimated.



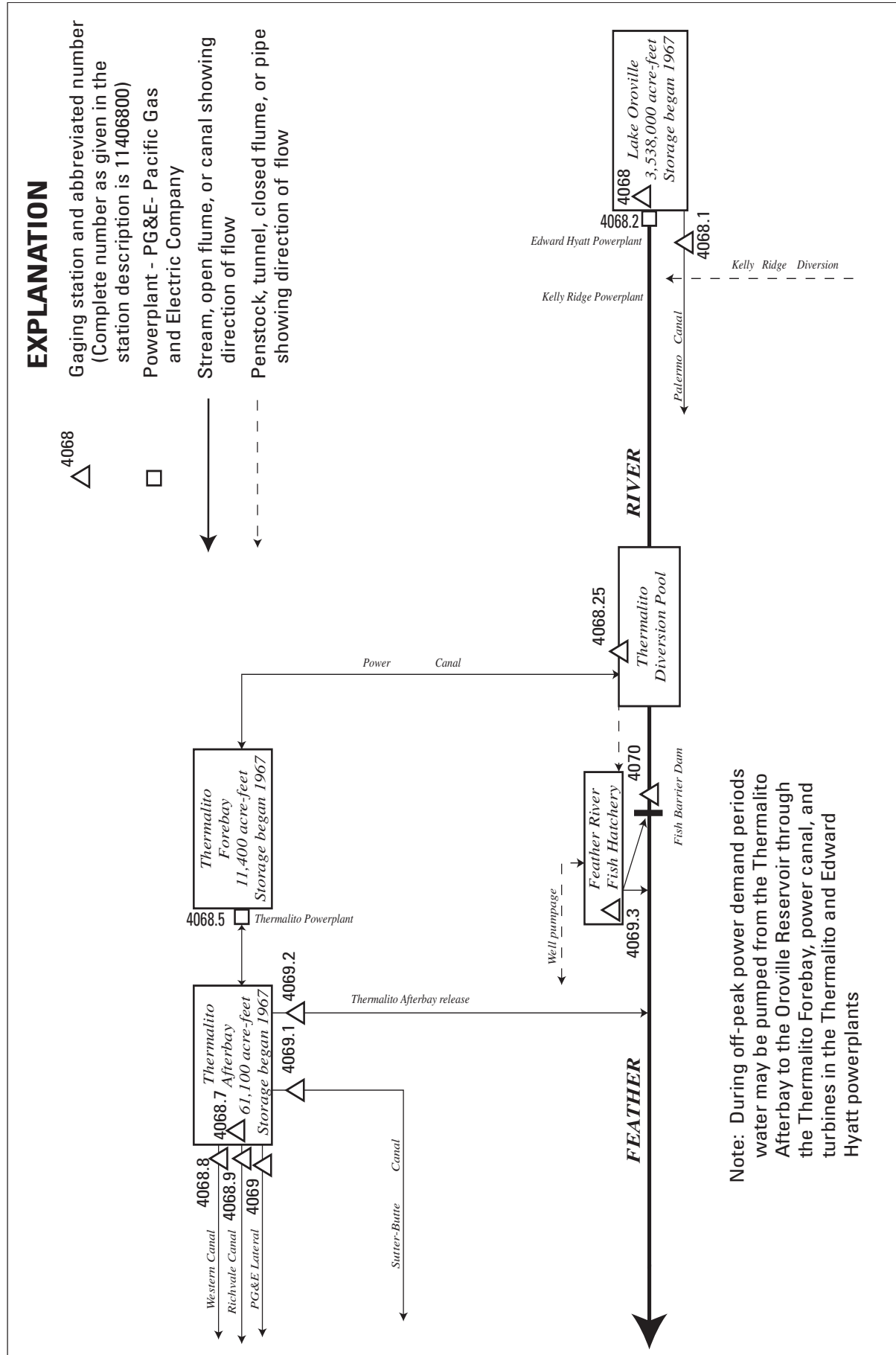

Figure 30. Diversions and storage from Feather River at Lake Oroville.

## 11406800 LAKE OROVILLE NEAR OROVILLE, CA

LOCATION.—Lat 39°32'06", long 121°28'25", in NE 1/4 SW 1/4 sec.1, T.19 N., R.4 E., Butte County, Hydrologic Unit 18020123, near intake structure, at left end of Oroville Dam on Feather River, 1.0 mi downstream from North Fork Feather River, and 4.2 mi east of Oroville.

DRAINAGE AREA.—3,607 mi<sup>2</sup>.

PERIOD OF RECORD.—November 1967 to current year.

GAGE.—Water-stage recorder. Datum of gage is 0.47 ft above sea level (levels by California Department of Water Resources). Contents based on capacity table in use since Sept. 21, 1967.

REMARKS.—Reservoir is formed by an earthfill dam with concrete chute-type sidehill spillway completed May 13, 1968; storage began Nov. 14, 1967. Usable capacity, 2,685,385 acre-ft, between elevations 640.0 ft, minimum power pool, and 900.0 ft, normal maximum pool. Dead storage, 852,192 acre-ft. Total capacity at normal maximum pool, 3,537,577 acre-ft; temporary detention storage occurred at times during construction; maximum was 155,200 acre-ft, Dec. 23, 1964. Water is released to Edward Hyatt Powerplant (station 11406820) through penstock in left abutment of dam and to Palermo Canal (station 11406810) through concrete tunnel also in left abutment of dam. Three of the total of six turbines in the Edward Hyatt Powerplant are reversible and during periods of low power demand water is pumped at times from the river back into Lake Oroville. Records, including extremes, represent total contents at 2400 hours. Maximum inflow of 266,000 ft<sup>3</sup>/s during a 2-hour period Feb. 17, 1986. See schematic diagram showing diversions and storage from Feather River at Lake Oroville.

COOPERATION.—Records were collected by California Department of Water Resources, under general supervision of the U.S. Geological Survey, in connection with a Federal Energy Regulatory Commission project. Contents not rounded to U.S. Geological Survey standards.

EXTREMES FOR PERIOD OF RECORD.—Maximum contents, 3,536,000 acre-ft, June 4, 1973, gage height, 899.88 ft; minimum since initial storage began, 882,395 acre-ft, Sept. 7, 1977, gage height, 645.11 ft.

EXTREMES FOR CURRENT YEAR.—Maximum contents, 2,203,836 acre-ft, May 6, gage height, 801.07 ft; minimum, 1,483,999 acre-ft, Sept. 29, gage height, 728.35 ft.

Capacity table (gage height, in feet, and contents, in acre-feet)  
(Based on table provided by California Department of Water Resources, dated Sept. 21, 1967)

640	852,192	710	1,332,547	780	1,974,240	850	2,808,349
650	911,975	720	1,413,685	790	2,080,969	860	2,944,741
660	974,560	730	1,498,175	800	2,191,742	870	3,085,747
670	1,040,003	740	1,586,086	810	2,306,597	880	3,231,454
680	1,108,406	750	1,677,554	820	2,425,571	890	3,382,038
690	1,179,915	760	1,772,690	830	2,548,850	900	3,537,577
700	1,254,634	770	1,871,511	840	2,676,446		

## 11406800 LAKE OROVILLE NEAR OROVILLE, CA—Continued

RESERVOIR STORAGE (ACRE-FEET), WATER YEAR OCTOBER 2000 TO SEPTEMBER 2001  
DAILY OBSERVATION AT 2400 HOURS

DAY	OCT	NOV	DEC	JAN	FEB	MAR	APR	MAY	JUN	JUL	AUG	SEP
1	1924024	1828345	1752691	1725133	1736196	1842952	2062866	2190501	2109271	1917659	1719620	1537919
2	1918479	1821024	1752980	1719620	1735622	1841060	2060598	2192757	2105650	1912741	1711280	1542751
3	1915302	1816780	1758569	1714594	1736482	1840462	2065894	2190839	2102690	1904872	1702026	1540026
4	1912946	1821913	1749902	1705138	1750672	1858244	2070441	2189035	2095360	1899368	1702403	1532048
5	1909570	1831121	1747116	1697225	1749422	1868288	2075430	2188021	2084452	1888901	1701837	1526105
6	1903342	1827355	1732280	1696566	1748461	1869295	2080209	2203836	2077058	1879587	1692526	1518003
7	1900182	1823198	1731135	1700707	1748173	1875850	2089246	2197726	2062542	1876355	1682410	1510189
8	1904974	1814610	1729514	1700425	1748941	1879688	2102690	2196483	2049712	1876456	1674384	1508889
9	1900896	1806445	1730562	1699765	1751441	1885657	2105869	2192983	2036617	1868490	1663324	1510709
10	1896213	1803598	1742800	1699012	1752499	1888596	2105430	2192080	2033728	1864467	1656103	1506984
11	1891945	1799774	1737438	1696849	1758858	1904464	2107953	2191065	2027103	1859347	1656011	1497829
12	1889306	1809983	1735048	1697131	1759437	1904362	2108612	2190501	2025182	1851836	1655548	1493869
13	1885252	1804677	1730086	1700048	1758569	1903342	2109710	2203722	2017407	1846342	1645497	1491118
14	1884441	1796055	1726561	1702592	1757990	1903342	2113775	2199083	2007427	1846342	1635121	1490173
15	1887785	1786487	1726465	1700802	1756351	1903240	2124019	2195580	1998539	1845744	1626709	1489744
16	1881204	1783663	1730563	1693278	1752692	1905893	2124570	2192080	1993578	1836881	1619236	1491462
17	1872421	1783663	1742608	1688025	1754232	1910491	2124681	2185993	1991575	1829237	1608163	1490517
18	1865472	1781231	1743087	1685122	1769493	1925772	2125674	2183180	1986837	1819148	1603820	1490774
19	1860150	1795077	1741554	1687088	1774337	1926183	2127220	2183293	1986311	1807526	1603459	1491290
20	1853837	1793415	1729704	1693184	1782690	1933188	2130978	2185881	1980112	1800068	1595792	1490344
21	1848938	1786390	1725989	1703912	1798404	1942280	2138064	2182843	1969115	1794588	1588868	1489915
22	1857042	1782203	1725133	1705799	1808803	1949120	2154069	2176550	1957953	1795663	1581966	1492750
23	1849738	1790973	1724942	1707498	1814216	1957225	2155629	2168702	1950988	1787072	1580445	1495676
24	1843052	1785902	1731039	1707215	1819246	1965563	2154514	2159981	1949846	1782203	1569292	1492665
25	1839766	1783274	1732757	1706554	1836781	1993472	2155518	2149058	1944247	1773465	1562982	1489228
26	1836881	1789705	1733139	1703158	1839367	2002662	2157526	2146278	1939798	1762623	1566446	1488113
27	1831319	1783176	1730085	1710902	1841458	2009442	2163780	2154292	1936697	1752499	1560499	1484427
28	1831121	1775501	1727227	1730181	1842155	2018046	2171167	2153846	1934323	1752210	1551916	1484684
29	1845345	1767652	1724942	1738491	---	2027743	2188698	2144500	1924435	1751248	1547858	1483999
30	1838671	1761850	1724086	1738682	---	2036652	2188360	2131863	1918274	1746156	1541432	1487684
31	1834794	---	1724942	1737247	---	2048313	---	2118838	---	1730944	1539411	---
MAX	1924024	1831121	1758569	1738682	1842155	2048313	2188698	2203836	2109271	1917659	1719620	1542751
MIN	1831121	1761850	1724086	1685122	1735622	1840462	2060598	2118838	1918274	1730944	1539411	1483999
a	766.33	758.88	755.03	756.32	767.07	786.90	799.70	793.46	774.60	755.66	734.74	728.78
b	-85019	-72944	-36908	+12305	+104908	+206158	+140047	-69522	-200564	-187330	-191533	-51727
c	3601	1430	773	944	1252	2573	3365	7567	7542	7795	7305	5048
d	232200	212500	203200	146100	76740	90950	92100	282200	284300	272000	264700	112800

CAL YR 2000 b -461390

WTR YR 2001 b -432129

ANNUAL DIVERSION (AC-FT) CAL YR 2000 d 4334000

ANNUAL DIVERSION (AC-FT) WTR YR 2001 d 2270000

a Gage height, in feet, at end of month.

b Change in contents, in acre-feet.

c Total evaporation, in acre-feet, provided by California Department of Water Resources; not reviewed by the U.S. Geological Survey.

d Diversion, in acre-feet, to Edward Hyatt Powerplant (station 11406820), provided by California Department of Water Resources.

11406810 PALERMO CANAL NEAR OROVILLE, CA

LOCATION.—Lat 39°31'59", long 121°28'54", in SW 1/4 SW 1/4 sec.1, T.19 N., R.4 E., Butte County, Hydrologic Unit 18020106, on right bank, 50 ft downstream from Oroville Dam, and 4.4 mi east of Oroville.

PERIOD OF RECORD.—April 1965 to current year. Daily discharge records of diversion from Kelly Ridge Penstock for period April 1965 to October 1968, when Kelly Ridge Penstock supplied the entire flow of Palermo Canal, are in files of the U.S. Geological Survey.

GAGE.—Water-stage recorder and Parshall flume. Datum of gage is 547.67 ft above sea level (levels by California Department of Water Resources). April 1965 to October 1968, water-stage recorder and Parshall flume at site of diversion from Kelly Ridge Penstock, 0.4 mi downstream at different datum.

REMARKS.—Canal diverts from left end of Oroville Dam. Water is used for irrigation near Oroville. During period of construction of Oroville Dam, water was released from Kelly Ridge Penstock to meet irrigation requirements. See schematic diagram showing diversions and storage from Feather River at Lake Oroville.

COOPERATION.—Records were provided by California Department of Water Resources, under general supervision of the U.S. Geological Survey, in connection with a Federal Energy Regulatory Commission project.

EXTREMES FOR PERIOD OF RECORD.—Maximum daily discharge, 28 ft<sup>3</sup>/s, several days during July to September 1967; no flow at times in some years.

DISCHARGE, CUBIC FEET PER SECOND, WATER YEAR OCTOBER 2000 TO SEPTEMBER 2001  
DAILY MEAN VALUES

DAY	OCT	NOV	DEC	JAN	FEB	MAR	APR	MAY	JUN	JUL	AUG	SEP
1	18	2.8	3.0	2.9	.00	.00	4.2	10	17	17	17	17
2	18	2.8	2.9	2.8	.00	.00	4.2	10	17	17	17	17
3	18	2.8	2.9	2.8	.00	.00	4.2	14	17	17	17	17
4	18	2.8	2.9	2.8	.00	.00	4.2	18	17	17	17	17
5	18	2.8	2.9	2.8	.00	.00	4.2	18	17	17	17	17
6	18	2.9	2.9	2.9	.00	.00	4.2	18	17	17	17	17
7	18	2.9	4.2	2.9	.00	.00	4.2	17	17	17	17	17
8	18	2.9	4.9	2.9	.00	2.4	4.2	16	17	17	17	17
9	18	2.9	4.9	2.9	.00	.00	4.2	17	17	17	17	17
10	14	2.9	4.9	2.9	.00	.00	4.2	17	17	17	17	17
11	8.4	2.9	4.9	2.9	.00	.00	4.3	17	17	17	17	17
12	5.1	2.9	4.9	2.7	.00	.00	4.3	17	17	17	17	17
13	6.1	2.9	3.6	2.7	.00	.00	4.3	17	17	17	17	17
14	7.1	2.9	2.9	2.7	.00	.00	4.2	17	17	17	17	17
15	7.1	2.9	2.9	2.7	.00	.00	4.0	17	17	17	17	17
16	7.1	3.0	3.0	2.7	.00	.00	4.1	17	17	17	17	17
17	7.1	3.0	2.9	.94	.00	.00	4.1	17	17	17	17	17
18	7.1	3.0	3.2	.00	.00	.00	4.2	17	17	17	17	17
19	7.1	2.9	3.3	.00	.00	.00	4.2	17	17	17	17	17
20	7.1	2.8	2.8	.00	.00	.00	4.3	17	17	17	17	17
21	7.1	2.7	3.0	.00	.00	.00	4.3	17	17	17	17	17
22	6.2	2.7	3.0	.00	.00	.00	4.3	17	17	17	17	17
23	1.7	2.7	2.9	.00	.00	.00	8.1	17	17	17	17	17
24	1.1	2.7	2.9	.00	.00	.00	10	17	17	17	17	17
25	1.1	2.8	2.9	.00	.00	.00	10	17	17	17	17	17
26	1.1	3.0	2.9	.00	.00	.00	10	17	17	17	17	17
27	3.0	3.0	2.9	.00	.00	.00	10	17	17	17	17	17
28	3.8	3.0	2.9	.00	.00	2.7	10	17	17	17	17	17
29	3.8	3.0	2.9	.00	---	4.1	10	17	17	17	17	17
30	3.2	3.0	2.9	.00	---	4.1	10	17	17	17	17	17
31	2.8	---	2.9	.00	---	4.1	---	17	---	17	17	---
TOTAL	280.2	86.3	102.9	45.94	0.00	17.40	170.7	512	510	527	527	510
MEAN	9.04	2.88	3.32	1.48	.000	.56	5.69	16.5	17.0	17.0	17.0	17.0
MAX	18	3.0	4.9	2.9	.00	4.1	10	18	17	17	17	17
MIN	1.1	2.7	2.8	.00	.00	.00	4.0	10	17	17	17	17
AC-FT	556	171	204	91	.00	35	339	1020	1010	1050	1050	1010

STATISTICS OF MONTHLY MEAN DATA FOR WATER YEARS 1969 - 2001, BY WATER YEAR (WY)

	1969	1970	1971	1972	1973	1974	1975	1976	1977	1978	1979	1980	1981	1982	1983	1984	1985	1986	1987	1988	1989	1990	1991	1992	1993	1994	1995	1996	1997	1998	1999	2000	2001			
MEAN	12.4	5.11	3.26	2.65	2.19	2.65	6.01	14.3	18.6	19.4	19.7	18.8																								
MAX	18.0	8.56	5.94	5.12	5.33	6.22	19.1	22.3	24.5	24.5	24.5	22.8																								
(WY)	1979	1994	1975	1971	1974	1988	1970	1976	1976	1975	1978	1975																								
MIN	6.85	2.04	.000	.21	.000	.000	.000	3.21	11.3	16.0	16.2	13.8																								
(WY)	1973	1983	1982	1995	1975	1979	1991	1995	1998	1991	1991	1985																								

SUMMARY STATISTICS	FOR 2000 CALENDAR YEAR		FOR 2001 WATER YEAR		WATER YEARS 1969 - 2001	
ANNUAL TOTAL	3335.88		3289.44			
ANNUAL MEAN	9.11		9.01		10.5	
HIGHEST ANNUAL MEAN					13.3	
LOWEST ANNUAL MEAN					7.54	
HIGHEST DAILY MEAN	19	Aug 16	18	Oct 1	26	Jul 2 1975
LOWEST DAILY MEAN	.00	Feb 12	.00	Jan 18	.00	Jan 15 1970
ANNUAL SEVEN-DAY MINIMUM	.00	Feb 12	.00	Jan 18	.00	Jan 15 1970
ANNUAL RUNOFF (AC-FT)	6620		6520		7580	
10 PERCENT EXCEEDS	18		17		20	
50 PERCENT EXCEEDS	4.9		5.1		8.2	
90 PERCENT EXCEEDS	1.1		.00		1.3	

## 11406870 THERMALITO AFTERBAY NEAR OROVILLE, CA

LOCATION.—Lat 39°27'30", long 121°38'17", in NE 1/4 SE 1/4 sec.33, T.19 N., R.3 E., Butte County, Hydrologic Unit 18020106, at dam, 195 ft northeast of centerline of outlet structure, and 5.7 mi southwest of Oroville.

PERIOD OF RECORD.—October 1967 to current year.

GAGE.—Water-stage recorder. Datum of gage is 100.47 ft above sea level (levels by California Department of Water Resources). Auxiliary water-stage recorder 90 ft southwest of centerline of Western Canal outlet and 7.2 mi west of Oroville.

REMARKS.—Reservoir is formed by an earthfill dam completed in 1967. Diversion from the reservoir began Oct. 12, 1967. Usable capacity, 61,144 acre-ft, between gage heights 120.0 and 139.0 ft, extreme operating levels. Normal operating range is from 123 to 136.5 ft. Water is released to four canals (stations 11406880, 11406890, 11406900, and 11406910) and to the Feather River (station 11406920) from the reservoir. Total maximum release to the four canals is approximately 4,000 ft<sup>3</sup>/s. Water is pumped, at times, from Thermalito Afterbay back into Thermalito Forebay (station 11406840) during off-peak periods to be re-released through Thermalito Powerplant (station 11406850) for power generation during peak-demand periods. Records, including extremes, represent total contents at 2400 hours. See schematic diagram showing diversions and storage from Feather River at Lake Oroville.

COOPERATION.—Records were collected by California Department of Water Resources, under general supervision of the U.S. Geological Survey, in connection with a Federal Energy Regulatory Commission project. Contents not rounded to U.S. Geological Survey standards.

EXTREMES FOR PERIOD OF RECORD.—Maximum contents, 57,300 acre-ft, May 24, 1969, gage height, 136.56 ft; minimum since initial operation began, 5,590 acre-ft, Mar. 1, 1968, gage height, 119.09 ft.

EXTREMES FOR CURRENT YEAR.—Maximum contents, 55,713 acre-ft, Nov. 16, gage height, 136.19 ft; minimum, 17,132 acre-ft, Feb. 4, gage height, 124.82 ft.

Capacity table (gage height, in feet, and contents, in acre-feet)  
(Based on table provided by California Department of Water Resources, dated Oct. 10, 1968)

119	5,465	124	15,157	128	25,832	134	46,719
120	7,054	126	20,171	130	32,150	139	68,198
122	10,792						

## RESERVOIR STORAGE (ACRE-FEET), WATER YEAR OCTOBER 2000 TO SEPTEMBER 2001

## DAILY OBSERVATION AT 2400 HOURS

DAY	OCT	NOV	DEC	JAN	FEB	MAR	APR	MAY	JUN	JUL	AUG	SEP
1	26191	45463	44491	22104	29769	29131	22551	24969	34552	27751	34312	34793
2	28751	50780	42312	23401	31359	34621	30283	26011	28941	28000	35870	28531
3	29226	52638	33223	26951	30025	37854	32518	29258	22636	30802	38106	26041
4	30026	46918	38322	34038	17132	37854	32351	31688	21169	30187	30672	28406
5	30445	36467	38938	39120	17808	27104	31886	31096	21332	35590	24822	29833
6	33392	36361	51602	38467	19535	30251	31523	17232	22077	39852	27042	32987
7	31359	39047	50657	33596	20466	38647	28594	21993	28280	36361	30251	32185
8	24704	43567	52140	33528	19588	41073	20600	25621	34483	29609	32685	32618
9	25951	49964	48070	34552	21552	42804	20789	29961	38756	31293	35173	29290
10	27751	51149	35173	36538	22411	46208	23861	31260	34758	28594	36185	29577
11	28124	52264	38430	40924	22244	34380	25981	33629	36256	28909	27782	36045
12	29897	40331	40516	42349	24441	39558	28249	34827	34106	30251	21634	36080
13	29865	42880	45112	38394	28155	44452	29417	21114	35625	31227	25771	35312
14	29577	48310	49396	35730	30219	48270	28972	23688	40257	23430	30510	35243
15	23774	54567	48030	36891	34690	52016	21689	25681	43759	18213	32418	32285
16	29449	55713	44801	43185	39741	52098	23544	26828	41859	19220	34931	29449
17	35208	53599	33562	47791	39631	50862	26071	29417	36432	21196	39229	26889
18	41222	53599	30802	52596	25264	37675	28062	29258	36467	24266	37069	26920
19	44220	37639	30998	52389	26951	41934	31820	26071	30933	29704	32152	26252
20	45151	36502	40109	47751	28500	42198	33122	20951	31326	31293	33970	24616
21	44259	40257	42160	38503	28563	41784	29641	22551	37783	29417	34827	23145
22	31457	43032	42274	38575	28783	42766	18315	26585	42274	22833	35975	21305
23	35069	29705	41110	37926	30640	41372	20119	29577	41185	23717	33936	18752
24	38792	30380	32585	41185	32318	41521	24704	35905	37765	24851	40516	19826
25	40850	29481	29481	44723	20924	28972	29332	40627	35765	27319	40590	21689
26	40368	19720	27012	51396	22777	32719	34242	38503	36856	30705	35835	22104
27	45385	23116	28625	45034	25205	34140	34621	25741	33190	35312	37926	26433
28	45228	26981	28000	27349	27257	33731	33190	19194	30640	29194	41260	25742
29	32551	33902	29226	22383	---	32351	19853	20978	34655	23173	40553	24587
30	38720	37818	27937	22861	---	30802	23717	27751	33629	24005	41409	21799
31	40627	---	24441	26767	---	28720	---	33562	---	29865	38938	---
MAX	45385	55713	52140	52596	39741	52098	34621	40627	43759	39852	41409	36080
MIN	23774	19720	24441	22104	17132	27104	18315	17232	21169	18213	21634	18752
a	132.41	131.64	127.53	128.31	128.47	128.94	127.28	130.42	130.44	129.30	131.95	126.60
b	+8972	-2809	-13377	+2326	+490	+1463	-5003	+9845	+67	-3764	+9073	-17139
c	1083	530	268	393	411	875	941	2180	2318	2296	2395	1581
d	213200	187500	171600	118800	56870	71970	68520	262600	261200	246400	243800	83550

CAL YR 2000 b -24874

WTR YR 2001 b -9856

ANNUAL DIVERSION (AC-FT) 2000 d 4109000

ANNUAL DIVERSION (AC-FT) 2001 d 1986000

a Gage height, in feet, at end of month.

b Change in contents, in acre-feet.

c Total evaporation, in acre-feet, provided by California Department of Water Resources; not reviewed by the U.S. Geological Survey.

d Diversion, in acre-feet, to Thermalito Powerplant (station 11406850), provided by California Department of Water Resources.

## 11406880 WESTERN CANAL AT INTAKE, NEAR OROVILLE, CA

LOCATION.—Lat 39°30'19", long 121°41'06", in SW 1/4 NW 1/4 sec.18, T.19 N., R.3 E., Butte County, Hydrologic Unit 18020105, on left bank, 500 ft downstream from Thermalito Afterbay Dam, and 7.3 mi west of Oroville.

PERIOD OF RECORD.—October 1967 to current year.

GAGE.—Water-stage recorder. Datum of gage is 100.47 ft above sea level (levels by California Department of Water Resources).

REMARKS.—Water is diverted from Thermalito Afterbay (station 11406870) and is used for irrigation. See schematic diagram showing diversions and storage from Feather River at Lake Oroville.

COOPERATION.—Records collected by California Department of Water Resources, under general supervision of the U.S. Geological Survey, in connection with a Federal Energy Regulatory Commission project.

EXTREMES FOR PERIOD OF RECORD.—Maximum daily discharge, 1,230 ft<sup>3</sup>/s, May 11, 12, 2001; no flow at times each year.

## DISCHARGE, CUBIC FEET PER SECOND, WATER YEAR OCTOBER 2000 TO SEPTEMBER 2001

## DAILY MEAN VALUES

DAY	OCT	NOV	DEC	JAN	FEB	MAR	APR	MAY	JUN	JUL	AUG	SEP
1	272	448	378	308	.00	.00	.00	559	693	772	797	322
2	318	448	377	297	.00	.00	.00	592	732	784	785	306
3	362	474	377	288	.00	.00	.00	663	747	814	772	292
4	397	497	378	289	.00	.00	.00	802	763	822	772	269
5	436	497	370	288	.00	.00	.00	927	800	810	772	257
6	477	529	366	288	.00	.00	.00	1000	836	797	773	239
7	498	548	373	287	.00	.00	.00	1060	847	797	772	197
8	496	547	373	273	.00	.00	.00	1120	838	798	763	147
9	497	558	372	246	.00	.00	.00	1170	822	814	748	125
10	497	573	373	214	.00	.00	.00	1200	810	851	748	108
11	497	573	373	140	.00	.00	.00	1230	798	893	742	98
12	497	572	358	35	.00	.00	.00	1230	768	899	722	98
13	512	589	314	.00	.00	.00	.00	1200	732	913	713	96
14	522	545	288	.00	.00	.00	.00	1170	723	910	712	97
15	508	484	288	.00	.00	.00	.00	1090	738	899	730	96
16	497	473	288	.00	.00	.00	52	987	790	869	737	97
17	497	432	287	.00	.00	.00	98	947	822	850	737	97
18	498	397	288	.00	.00	.00	151	904	838	850	737	96
19	498	397	298	.00	.00	.00	198	872	875	850	724	125
20	513	397	319	.00	.00	.00	198	828	909	852	693	179
21	522	398	328	.00	.00	.00	198	797	922	840	646	221
22	522	398	328	.00	.00	.00	197	807	922	830	611	247
23	523	397	328	.00	.00	.00	171	811	911	839	583	247
24	549	397	328	.00	.00	.00	147	797	897	860	547	263
25	637	398	327	.00	.00	.00	179	797	897	875	510	272
26	577	397	317	.00	.00	.00	226	797	853	861	497	289
27	539	398	308	.00	.00	.00	272	746	805	840	484	298
28	548	398	308	.00	.00	.00	372	675	781	825	461	297
29	517	398	308	.00	---	.00	435	647	772	826	422	304
30	469	385	307	.00	---	.00	508	648	772	812	386	307
31	448	---	307	.00	---	.00	---	647	---	798	360	---
TOTAL	15140	13942	10332	2953.00	0.00	0.00	3402.00	27720	24413	26050	20456	6086
MEAN	488	465	333	95.3	.000	.000	113	894	814	840	660	203
MAX	637	589	378	308	.00	.00	508	1230	922	913	797	322
MIN	272	385	287	.00	.00	.00	.00	559	693	772	360	96
AC-FT	30030	27650	20490	5860	.00	.00	6750	54980	48420	51670	40570	12070

## STATISTICS OF MONTHLY MEAN DATA FOR WATER YEARS 1968 - 2001, BY WATER YEAR (WY)

MEAN	278	254	126	31.8	.000	.39	142	698	698	793	659	169
MAX	539	607	403	155	.000	12.4	566	947	959	1032	890	305
(WY)	1975	1975	2000	1977	1968	1972	1977	1999	1981	1981	1981	1995
MIN	95.2	38.9	.000	.000	.000	.000	1.00	271	477	504	456	49.9
(WY)	1990	1974	1971	1969	1968	1968	1982	1995	1983	1970	1970	1977

SUMMARY STATISTICS	FOR 2000 CALENDAR YEAR		FOR 2001 WATER YEAR		WATER YEARS 1968 - 2001	
ANNUAL TOTAL	156045.00		150494.00			
ANNUAL MEAN	426		412		323	
HIGHEST ANNUAL MEAN					443	
LOWEST ANNUAL MEAN					217	
HIGHEST DAILY MEAN	1190	May 14	1230	May 11	1230	May 11 2001
LOWEST DAILY MEAN	.00	Jan 11	.00	Jan 13	.00	Dec 4 1967
ANNUAL SEVEN-DAY MINIMUM	.00	Jan 11	.00	Jan 13	.00	Jan 5 1968
ANNUAL RUNOFF (AC-FT)	309500		298500		234100	
10 PERCENT EXCEEDS	977		850		842	
50 PERCENT EXCEEDS	378		378		216	
90 PERCENT EXCEEDS	.00		.00		.00	

## 11406890 RICHVALE CANAL AT INTAKE, NEAR OROVILLE, CA

LOCATION.—Lat 39°30'19", long 121°41'06", in SW 1/4 NW 1/4 sec.18, T.19 N., R.3 E., Butte County, Hydrologic Unit 18020105, on right bank, 500 ft downstream from axis of Thermalito Afterbay Dam, and 7.3 mi west of Oroville.

PERIOD OF RECORD.—April 1968 to current year.

REVISED RECORDS.—WDR CA-91-4: 1990.

GAGE.—Water-stage recorder. Datum of gage is 100.47 ft above sea level (levels by California Department of Water Resources).

REMARKS.—Canal diverts from Thermalito Afterbay (station 11406870); water is used for irrigation. See schematic diagram showing diversions and storage from Feather River at Lake Oroville.

COOPERATION.—Records collected by California Department of Water Resources, under general supervision of the U.S. Geological Survey, in connection with a Federal Energy Regulatory Commission project.

EXTREMES FOR PERIOD OF RECORD.—Maximum daily discharge, 511 ft<sup>3</sup>/s, May 16, 1974; no flow for many days each year.

## DISCHARGE, CUBIC FEET PER SECOND, WATER YEAR OCTOBER 2000 TO SEPTEMBER 2001

## DAILY MEAN VALUES

DAY	OCT	NOV	DEC	JAN	FEB	MAR	APR	MAY	JUN	JUL	AUG	SEP
1	41	280	330	269	.00	.00	.00	349	321	403	337	136
2	42	279	329	270	.00	.00	.00	386	324	403	334	128
3	68	296	329	269	.00	.00	.00	431	323	404	333	129
4	106	304	329	270	.00	.00	.00	444	324	414	333	113
5	156	303	336	260	.00	.00	.00	454	334	420	333	92
6	187	304	326	253	.00	.00	.00	457	338	419	334	71
7	194	304	319	254	.00	.00	.00	459	360	419	333	66
8	193	304	331	254	.00	.00	.00	452	359	419	334	66
9	218	305	329	248	.00	.00	.00	449	354	413	320	65
10	265	304	329	243	.00	.00	.00	449	353	410	314	53
11	280	304	323	244	.00	.00	.00	449	361	410	306	42
12	279	303	315	245	.00	.00	.00	449	364	410	303	48
13	259	304	307	243	.00	.00	.00	448	378	410	305	52
14	250	304	304	243	.00	.00	.00	449	385	409	304	44
15	248	304	296	239	.00	.00	.00	449	385	409	304	37
16	250	311	289	234	.00	.00	54	432	394	409	294	36
17	256	314	289	235	.00	.00	123	424	398	410	282	39
18	259	314	289	234	.00	.00	173	377	399	410	279	44
19	270	313	276	80	.00	.00	189	334	409	410	279	34
20	274	315	270	.00	.00	.00	189	323	414	410	279	e27
21	274	302	268	.00	.00	.00	171	324	421	410	262	e23
22	273	288	268	.00	.00	.00	113	338	411	410	247	e13
23	274	283	269	.00	.00	.00	95	344	397	410	243	.00
24	275	285	268	.00	.00	.00	95	345	393	410	244	.00
25	296	285	269	.00	.00	.00	123	345	393	410	233	.00
26	304	284	270	.00	.00	.00	199	344	404	411	198	.00
27	304	284	269	.00	.00	.00	224	323	408	404	184	e16
28	305	301	270	.00	.00	.00	270	313	408	400	185	e27
29	304	323	270	.00	---	.00	320	314	400	393	174	e27
30	305	330	270	.00	---	.00	348	315	401	365	159	e27
31	292	---	270	.00	---	.00	---	314	---	347	152	---
TOTAL	7301	9034	9206	4587.00	0.00	0.00	2686.00	12083	11313	12591	8521	1455.00
MEAN	236	301	297	148	.000	.000	89.5	390	377	406	275	48.5
MAX	305	330	336	270	.00	.00	348	459	421	420	337	136
MIN	41	279	268	.00	.00	.00	.00	313	321	347	152	.00
AC-FT	14480	17920	18260	9100	.00	.00	5330	23970	22440	24970	16900	2890

## STATISTICS OF MONTHLY MEAN DATA FOR WATER YEARS 1968 - 2001, BY WATER YEAR (WY)

	MEAN	MAX	MIN	(WY)	(WY)	(WY)	(WY)	(WY)	(WY)	(WY)	(WY)	(WY)
MEAN	41.2	73.8	65.3	24.0	.000	.23	69.0	286	294	323	278	74.6
MAX	236	328	297	185	.000	6.32	201	436	400	444	397	154
MIN	.000	.000	.000	.000	.000	.000	.000	104	129	140	130	8.43
(WY)	2001	2000	2001	2000	1969	1972	1972	1974	1979	1999	1999	1995
(WY)	1972	1969	1969	1969	1969	1969	1983	1991	1991	1991	1991	1977

## SUMMARY STATISTICS

## FOR 2000 CALENDAR YEAR

## FOR 2001 WATER YEAR

## WATER YEARS 1968 - 2001

ANNUAL TOTAL	81047.00	78777.00	
ANNUAL MEAN	221	216	129
HIGHEST ANNUAL MEAN			216
LOWEST ANNUAL MEAN			66.4
HIGHEST DAILY MEAN	454	Jul 1	511
LOWEST DAILY MEAN	.00	Jan 22	.00
ANNUAL SEVEN-DAY MINIMUM	.00	Jan 22	.00
ANNUAL RUNOFF (AC-FT)	160800	156300	93650
10 PERCENT EXCEEDS	429	410	360
50 PERCENT EXCEEDS	276	270	59
90 PERCENT EXCEEDS	.00	.00	.00

e Estimated.

## 11406900 PACIFIC GAS &amp; ELECTRIC CO. LATERAL AT INTAKE, NEAR OROVILLE, CA

LOCATION.—Lat 39°29'22", long 121°41'12", in SE 1/4 NW 1/4 sec.19, T.19 N., R.3 E., Butte County, Hydrologic Unit 18020106, on right bank, 82 ft downstream from axis of Thermalito Afterbay Dam, and 7.2 mi west of Oroville.

PERIOD OF RECORD.—April 1968 to current year.

GAGE.—Water-stage recorder. Datum of gage is 113.47 ft above sea level (levels by California Department of Water Resources).

REMARKS.—Flow regulated at outlet works from Thermalito Afterbay (station 11406870); water is used for irrigation. See schematic diagram showing diversions and storage from Feather River at Lake Oroville.

COOPERATION.—Records collected by California Department of Water Resources, under general supervision of the U.S. Geological Survey, in connection with a Federal Energy Regulatory Commission project.

EXTREMES FOR PERIOD OF RECORD.—Maximum daily discharge, 46 ft<sup>3</sup>/s, Apr. 24, 1977, May 16, 1978; no flow for many days each year.

## DISCHARGE, CUBIC FEET PER SECOND, WATER YEAR OCTOBER 2000 TO SEPTEMBER 2001

## DAILY MEAN VALUES

DAY	OCT	NOV	DEC	JAN	FEB	MAR	APR	MAY	JUN	JUL	AUG	SEP
1	.00	11	3.3	1.8	.00	.00	.00	6.6	9.6	16	15	2.6
2	.00	3.9	4.1	1.8	.00	.00	.00	15	11	16	15	1.9
3	.00	3.2	3.9	1.8	.00	.00	.00	24	14	16	15	1.7
4	.00	2.2	4.0	1.9	.00	.00	.00	25	16	16	15	1.5
5	.00	2.0	3.3	2.1	.00	.00	.00	26	17	16	15	2.0
6	.00	1.8	1.9	2.1	.00	.00	.00	26	16	16	15	2.4
7	.00	1.8	2.0	2.0	.00	.00	.00	20	17	17	16	2.3
8	.00	1.9	2.0	2.0	.00	.00	.00	15	21	17	16	.68
9	.00	1.9	2.0	2.1	.00	.00	.00	9.3	20	16	16	.00
10	.00	2.0	1.9	1.4	.00	.00	.00	6.3	19	15	16	.00
11	.00	2.0	1.8	.00	.00	.00	.00	6.3	20	15	16	.00
12	.00	2.0	1.8	.00	.00	.00	.00	6.2	18	15	16	.00
13	.00	1.9	1.9	.00	.00	.00	.00	14	15	15	16	.00
14	.00	1.9	1.9	.00	.00	.00	.00	19	14	15	16	.00
15	.00	2.0	2.0	.00	.00	.00	.00	17	13	15	16	.00
16	.00	3.3	1.9	.00	.00	.00	.00	15	14	15	16	.00
17	.00	3.2	2.0	.00	.00	.00	.00	15	16	15	16	.00
18	.00	1.9	1.9	.00	.00	.00	.00	9.7	16	15	15	.00
19	.00	1.8	1.8	.00	.00	.00	.00	7.2	16	15	15	.00
20	.00	1.9	1.9	.00	.00	.00	.00	4.5	17	15	15	.00
21	.00	2.1	1.9	.00	.00	.00	.00	4.1	17	14	15	.00
22	.00	2.2	1.9	.00	.00	.00	.00	4.8	17	14	15	.00
23	.00	2.1	1.9	.00	.00	.00	.00	5.0	17	14	15	.00
24	7.7	2.0	2.0	.00	.00	.00	.00	6.8	17	15	15	.00
25	17	2.0	1.9	.00	.00	.00	2.9	10	16	15	11	.00
26	19	1.8	1.8	.00	.00	.00	16	12	16	15	8.1	.00
27	19	1.7	1.7	.00	.00	.00	21	11	16	15	6.1	.00
28	19	1.8	1.8	.00	.00	.00	23	6.4	16	15	4.9	.00
29	19	1.9	1.8	.00	---	.00	23	4.7	16	15	4.9	.00
30	19	2.0	1.8	.00	---	.00	16	5.0	16	15	4.1	.00
31	19	---	1.8	.00	---	.00	---	7.7	---	15	3.4	---
TOTAL	138.70	73.2	67.6	19.00	0.00	0.00	101.90	364.6	483.6	473	413.5	15.08
MEAN	4.47	2.44	2.18	.61	.000	.000	3.40	11.8	16.1	15.3	13.3	.50
MAX	19	11	4.1	2.1	.00	.00	23	26	21	17	16	2.6
MIN	.00	1.7	1.7	.00	.00	.00	.00	4.1	9.6	14	3.4	.00
AC-FT	275	145	134	38	.00	.00	202	723	959	938	820	30

## STATISTICS OF MONTHLY MEAN DATA FOR WATER YEARS 1968 - 2001, BY WATER YEAR (WY)

MEAN	.44	1.93	.88	.12	.000	.000	3.52	12.6	12.6	13.6	10.9	1.23
MAX	4.47	6.58	5.74	1.00	.000	.000	14.8	23.2	18.3	17.1	15.1	2.62
(WY)	2001	1996	2000	2000	1969	1969	1977	1975	1981	1981	1999	1972
MIN	.000	.000	.000	.000	.000	.000	.000	6.55	8.40	9.37	7.12	.000
(WY)	1969	1969	1969	1969	1969	1969	1974	1994	1998	1970	1988	1994

## SUMMARY STATISTICS

## FOR 2000 CALENDAR YEAR

## FOR 2001 WATER YEAR

## WATER YEARS 1968 - 2001

ANNUAL TOTAL	1964.37	2150.18		
ANNUAL MEAN	5.37	5.89	4.89	
HIGHEST ANNUAL MEAN			5.94	1999
LOWEST ANNUAL MEAN			3.67	1983
HIGHEST DAILY MEAN	30	May 3	46	Apr 24 1977
LOWEST DAILY MEAN	.00	Jan 11	.00	Sep 9 1968
ANNUAL SEVEN-DAY MINIMUM	.00	Jan 11	.00	Sep 9 1968
ANNUAL RUNOFF (AC-FT)	3900	4260	3540	
10 PERCENT EXCEEDS	16	16	15	
50 PERCENT EXCEEDS	1.9	1.9	.00	
90 PERCENT EXCEEDS	.00	.00	.00	



## 11406910 SUTTER-BUTTE CANAL AT INTAKE, NEAR OROVILLE, CA

LOCATION.—Lat 39°27'01", long 121°39'27", in NW corner of Boga Fernandez Grant, T.18 N., R.3 E., Butte County, Hydrologic Unit 18020105, on left bank, 675 ft downstream from Thermalito Afterbay Dam, and 6.8 mi southwest of Oroville.

PERIOD OF RECORD.—November 1967 to current year.

GAGE.—Water-stage recorder. Datum of gage is 109.97 ft above sea level (levels by California Department of Water Resources). Prior to May 1, 1970, at datum 109.50 ft lower.

REMARKS.—Water is diverted from Thermalito Afterbay and is used for irrigation. See schematic diagram showing diversions and storage from Feather River at Lake Oroville.

COOPERATION.—Records collected by California Department of Water Resources, under general supervision of the U.S. Geological Survey, in connection with a Federal Energy Regulatory Commission project.

EXTREMES FOR PERIOD OF RECORD.—Maximum daily discharge, 2,110 ft<sup>3</sup>/s, Apr. 22–24, 1968; no flow for many days each year.

DISCHARGE, CUBIC FEET PER SECOND, WATER YEAR OCTOBER 2000 TO SEPTEMBER 2001  
DAILY MEAN VALUES

DAY	OCT	NOV	DEC	JAN	FEB	MAR	APR	MAY	JUN	JUL	AUG	SEP
1	566	550	630	586	.00	.00	.00	1230	1370	1440	1450	1210
2	564	626	624	593	.00	.00	.00	1400	1400	1440	1450	1190
3	564	664	624	591	.00	.00	.00	1480	1430	1440	1430	1160
4	566	670	626	594	.00	.00	.00	1520	1460	1430	1390	1150
5	566	668	630	574	.00	.00	.00	1540	1480	1440	1390	1110
6	565	650	628	572	.00	.00	.00	1580	1500	1460	1390	1070
7	572	652	626	563	.00	.00	.00	1600	1510	1470	1410	1040
8	607	680	627	566	.00	.00	.00	1600	1510	1460	1420	1040
9	644	680	629	570	.00	.00	105	1640	1510	1470	1420	1000
10	669	665	625	564	.00	.00	218	1710	1490	1470	1430	953
11	650	661	629	566	.00	.00	202	1730	1480	1470	1440	893
12	637	659	616	554	.00	.00	233	1720	1480	1470	1430	873
13	606	686	611	550	.00	.00	304	1700	1490	1470	1410	838
14	591	655	610	550	.00	.00	315	1670	1490	1480	1400	779
15	591	642	610	553	.00	.00	308	1660	1490	1460	1400	758
16	581	643	606	541	.00	.00	333	1640	1500	1430	1400	734
17	577	643	608	526	.00	.00	428	1600	1490	1450	1400	685
18	599	645	611	323	.00	.00	489	1580	1510	1450	1380	603
19	600	638	609	215	.00	.00	561	1590	1550	1450	1360	592
20	591	643	612	194	.00	.00	600	1560	1560	1450	1370	602
21	583	631	614	197	.00	.00	514	1510	1570	1450	1370	604
22	579	627	601	196	.00	.00	498	1500	1560	1450	1340	582
23	594	623	601	189	.00	.00	485	1510	1530	1450	1320	564
24	599	629	598	192	.00	.00	516	1520	1510	1460	1320	580
25	601	630	597	184	.00	.00	606	1520	1500	1470	1320	586
26	584	624	596	183	.00	.00	739	1490	1500	1470	1280	586
27	546	626	608	184	.00	.00	851	1430	1490	1470	1280	589
28	543	627	591	179	.00	.00	946	1390	1460	1460	1270	576
29	540	630	591	52	---	.00	1040	1360	1420	1460	1250	571
30	438	625	590	.00	---	.00	1080	1380	1430	1450	1200	574
31	472	---	592	.00	---	.00	---	1380	---	1450	1190	---
TOTAL	17985	19292	18970	11901.00	0.00	0.00	11371.00	47740	44670	45140	42310	24092
MEAN	580	643	612	384	.000	.000	379	1540	1489	1456	1365	803
MAX	669	686	630	594	.00	.00	1080	1730	1570	1480	1450	1210
MIN	438	550	590	.00	.00	.00	.00	1230	1370	1430	1190	564
AC-FT	35670	38270	37630	23610	.00	.00	22550	94690	88600	89540	83920	47790

## STATISTICS OF MONTHLY MEAN DATA FOR WATER YEARS 1968 - 2001, BY WATER YEAR (WY)

MEAN	395	175	136	49.6	22.1	89.4	528	1403	1386	1479	1360	731
MAX	661	643	612	384	374	571	1294	1815	1643	1709	1608	893
(WY)	1975	2001	2001	2001	1977	1976	1968	1975	1975	1981	1982	1995
MIN	77.2	.000	.000	.000	.000	.000	.000	519	826	834	776	283
(WY)	1978	1975	1971	1969	1969	1978	1983	1977	1992	1991	1991	1977

SUMMARY STATISTICS	FOR 2000 CALENDAR YEAR		FOR 2001 WATER YEAR		WATER YEARS 1968 - 2001	
ANNUAL TOTAL	283296.00		283471.00			
ANNUAL MEAN	774		777		648	
HIGHEST ANNUAL MEAN					777	
LOWEST ANNUAL MEAN					401	
HIGHEST DAILY MEAN	1690	May 5	1730	May 11	2110	Apr 22 1968
LOWEST DAILY MEAN	.00	Jan 29	.00	Jan 30	.00	Jan 8 1968
ANNUAL SEVEN-DAY MINIMUM	.00	Jan 29	.00	Jan 30	.00	Jan 8 1968
ANNUAL RUNOFF (AC-FT)	561900		562300		469300	
10 PERCENT EXCEEDS	1550		1490		1560	
50 PERCENT EXCEEDS	626		626		448	
90 PERCENT EXCEEDS	.00		.00		.00	

## 11406920 THERMALITO AFTERBAY RELEASE TO FEATHER RIVER, NEAR OROVILLE, CA

LOCATION.—Lat 39°27'23", long 121°38'10", in NW 1/4 SE 1/4 sec.33, T.19 N., R.3 E., Butte County, Hydrologic Unit 18020106, on left bank of outlet channel, 955 ft downstream from centerline of Thermalito Afterbay Dam, and 5.7 mi southwest of Oroville.

PERIOD OF RECORD.—November 1967 to current year.

WATER TEMPERATURE: Water years 1969–92.

GAGE.—Water-stage recorder. Datum of gage is 113.47 ft above sea level (levels by California Department of Water Resources). Prior to May 1, 1970, at datum 13.00 ft lower.

REMARKS.—Flow regulated by gates of Thermalito Afterbay outlet 955 ft upstream. See schematic diagram showing diversions and storage from Feather River at Lake Oroville.

COOPERATION.—Records collected by California Department of Water Resources, under general supervision of the U.S. Geological Survey, in connection with a Federal Energy Regulatory Commission project.

EXTREMES FOR PERIOD OF RECORD.—Maximum discharge, 21,600 ft<sup>3</sup>/s, Jan. 28, 1970, gage height, 23.30 ft, datum then in use, 21,600 ft<sup>3</sup>/s, Jan. 2, 1997, gage height, 11.45 ft; no flow for many days during 1968.

DISCHARGE, CUBIC FEET PER SECOND, WATER YEAR OCTOBER 2000 TO SEPTEMBER 2001  
DAILY MEAN VALUES

DAY	OCT	NOV	DEC	JAN	FEB	MAR	APR	MAY	JUN	JUL	AUG	SEP
1	2280	1700	1700	1690	1010	1010	1130	634	2400	1280	1790	580
2	2280	1700	1690	1690	1010	1010	1140	534	2900	1290	1790	577
3	2280	1690	1700	1690	1010	1010	1140	534	2910	1220	1790	580
4	2280	1690	1690	1540	1010	1010	1140	535	2900	1180	1790	580
5	2280	1690	1700	1370	1010	1010	933	684	2770	1180	1790	580
6	2280	1690	1700	1370	1010	1010	732	682	2270	1180	1790	581
7	2280	1700	1700	1370	1010	1010	533	687	1890	1180	1730	581
8	2280	1690	1700	1370	1010	1000	432	690	1690	1180	1690	581
9	2280	1700	1690	1370	1010	1010	428	683	1490	1180	1690	579
10	2290	1700	1690	1380	1010	1010	429	685	1290	1180	1740	587
11	2290	1700	1700	1380	1010	1010	429	684	1290	1180	1740	582
12	2290	1700	1700	1370	1010	1010	433	885	1180	1190	1740	582
13	2070	1700	1700	1370	1010	1010	436	888	1180	1180	1640	580
14	1850	1700	1700	1370	1010	1010	433	885	1180	1180	1440	576
15	1690	1700	1700	1380	1010	1060	430	1390	1180	1180	1340	578
16	1690	1700	1700	1330	1020	1140	431	1390	1280	1180	1340	580
17	1690	1700	1690	1150	1020	1140	429	1390	1290	1180	1340	578
18	1690	1700	1690	1010	1010	1140	428	1390	1290	1180	1340	578
19	1700	1690	1700	1020	1010	1140	432	1390	1290	1250	1340	576
20	1690	1700	1700	1010	1010	1140	632	1390	1290	1290	1370	578
21	1690	1700	1700	1010	1010	1140	633	1390	1290	1290	1390	577
22	1700	1700	1700	1010	1010	1140	630	1390	1280	1280	1390	578
23	1690	1700	1700	1020	1020	1140	631	1390	1290	1290	1180	576
24	1690	1700	1700	1010	1010	1140	629	1390	1280	1180	981	581
25	1690	1700	1690	1010	1010	1130	630	1390	1290	1180	763	583
26	1700	1700	1700	1010	1010	1140	628	1390	1290	1180	530	583
27	1700	1700	1700	1010	1010	1130	629	1450	1290	1180	565	581
28	1700	1700	1700	1010	1010	1130	633	1930	1290	1180	591	579
29	1700	1700	1700	1010	---	1140	631	2150	1290	1180	579	582
30	1700	1700	1690	1010	---	1130	633	2400	1290	1180	583	582
31	1700	---	1700	1010	---	1130	---	2400	---	1610	587	---
TOTAL	60120	50940	52620	38350	28310	33380	18857	36700	47840	37770	41359	17396
MEAN	1939	1698	1697	1237	1011	1077	629	1184	1595	1218	1334	580
MAX	2290	1700	1700	1690	1020	1140	1140	2400	2910	1610	1790	587
MIN	1690	1690	1690	1010	1010	1000	428	534	1180	1180	530	576
AC-FT	119200	101000	104400	76070	56150	66210	37400	72790	94890	74920	82040	34500

## STATISTICS OF MONTHLY MEAN DATA FOR WATER YEARS 1968 - 2001, BY WATER YEAR (WY)

	1962	2315	4114	4532	5398	5737	4512	3512	3156	3877	3473	2847
MEAN	1962	2315	4114	4532	5398	5737	4512	3512	3156	3877	3473	2847
MAX	5867	11020	15120	14700	14600	16890	15410	12340	9717	8232	7043	7085
(NY)	1975	1974	1984	1997	1983	1983	1983	1983	1983	1999	1974	1974
MIN	145	336	56.7	391	345	239	207	549	337	.13	116	398
(WY)	1978	1978	1968	1993	1968	1992	1992	1977	1990	1968	1968	1968

SUMMARY STATISTICS	FOR 2000 CALENDAR YEAR		FOR 2001 WATER YEAR		WATER YEARS 1968 - 2001	
ANNUAL TOTAL	1534450		463642			
ANNUAL MEAN	4192		1270		3871	
HIGHEST ANNUAL MEAN					9352	
LOWEST ANNUAL MEAN					970	
HIGHEST DAILY MEAN	16500	Mar 10	2910	Jun 3	21200	Jan 28 1970
LOWEST DAILY MEAN	1000	Jan 25	428	Apr 9	.00	Nov 16 1967
ANNUAL SEVEN-DAY MINIMUM	1000	Jan 25	431	Apr 9	.00	Nov 16 1967
MAXIMUM PEAK FLOW			3090	Jun 5	21600	Jan 28 1970
MAXIMUM PEAK STAGE			3.69	Jun 5	23.30	Jan 28 1970
ANNUAL RUNOFF (AC-FT)	3044000		919600		2805000	
10 PERCENT EXCEEDS	7780		1700		9440	
50 PERCENT EXCEEDS	2840		1190		2250	
90 PERCENT EXCEEDS	1340		580		567	

## 11407000 FEATHER RIVER AT OROVILLE, CA

LOCATION.—Lat 39°31'18", long 121°32'48", in Boga Fernandez Grant, T.19 N., R.4 E., [Butte County](#), Hydrologic Unit 18020106, on right bank, 300 ft upstream from fish barrier dam on Feather River, 0.4 mi downstream from Thermalito Diversion Dam, 0.8 mi northeast of Oroville Post Office, and 4.8 mi downstream from Oroville Dam.

DRAINAGE AREA.—3,624 mi<sup>2</sup>.

PERIOD OF RECORD.—October 1901 to current year. Monthly discharge only for some periods, published in WSP 1315-A. October 1934 to September 1961 published as "near Oroville."

CHEMICAL DATA: Water years 1906–07, 1951–77.

SPECIFIC CONDUCTANCE: Water years 1972–78.

WATER TEMPERATURE: Water years 1954–92.

SEDIMENT DATA: Water years 1957–79.

REVISED RECORDS.—WSP 843: 1907(M), 1909(M), 1914–15(M), 1919(M), 1927–28(M). WSP 881: 1913–28 (yearly summaries). WSP 1515: 1906–8. WSP 1931: Drainage area. WDR CA-74-2: 1968–70, adjusted monthly discharge.

GAGE.—Water-stage recorder. Datum of gage is 148.97 ft above sea level (levels by California Department of Water Resources). See WSP 1931 for history of changes prior to Oct. 1, 1964.

REMARKS.—Flow completely regulated by Lake Oroville (station 11406800), beginning November 1967, and Thermalito Diversion Pool (station 11406825), capacity 13,500 acre-ft. Diversions upstream from station for power and irrigation. Feather River Fish Hatchery (station 11406930) diverts up to 120 ft<sup>3</sup>/s at Thermalito Diversion Dam 0.4 mi upstream from gage. Daily figures shown are combined figures of river flow and diversion to fish hatchery. See schematic diagram showing diversions and storage from [Feather River at Lake Oroville](#).

COOPERATION.—Records were collected by California Department of Water Resources, under general supervision of the U.S. Geological Survey, in connection with a Federal Energy Regulatory Commission project.

EXTREMES FOR PERIOD OF RECORD.—Prior to completion of Oroville Dam: Maximum discharge observed, 230,000 ft<sup>3</sup>/s Mar. 19, 1907, elevation, 167.5 ft, above sea level, site and datum then in use, maximum discharge (since completion of Oroville Dam), 161,000 ft<sup>3</sup>/s, Jan. 2, 1997, gage height, 25.45 ft; minimum, 300 ft<sup>3</sup>/s, estimated, Nov. 9, 1931.

Combined flow (since completion of Oroville Dam): Maximum daily discharge, 132,000 ft<sup>3</sup>/s, Feb. 18, 1986; minimum daily, 222 ft<sup>3</sup>/s, Sept. 19, 1972.

EXTREMES FOR CURRENT YEAR.—River only: Maximum discharge, 1,110 ft<sup>3</sup>/s, Aug. 29, gage height, 1.28 ft; minimum daily, 508 ft<sup>3</sup>/s, May 19, 21.

Combined flow: Maximum daily discharge, 746 ft<sup>3</sup>/s, July 30; minimum daily, 614 ft<sup>3</sup>/s, May 19, 21.

## DISCHARGE, CUBIC FEET PER SECOND, WATER YEAR OCTOBER 2000 TO SEPTEMBER 2001

## DAILY MEAN VALUES

DAY	OCT	NOV	DEC	JAN	FEB	MAR	APR	MAY	JUN	JUL	AUG	SEP
1	624	638	626	631	629	626	620	622	627	628	645	637
2	622	640	627	630	630	631	618	622	624	627	649	634
3	625	640	627	630	630	632	631	620	623	693	645	633
4	631	637	627	631	629	630	632	620	626	730	647	637
5	627	639	630	630	628	638	641	620	620	731	650	639
6	627	637	632	631	630	630	639	621	624	724	648	639
7	627	638	630	632	629	628	637	621	624	729	709	640
8	634	639	630	636	629	630	635	622	624	731	745	643
9	631	640	630	633	637	632	632	621	622	729	742	645
10	635	642	631	634	638	629	634	622	623	730	693	643
11	630	641	631	637	642	627	631	625	624	729	690	638
12	625	642	631	631	637	629	631	626	624	731	696	631
13	632	643	630	630	630	630	632	625	624	730	691	622
14	631	638	630	632	630	627	631	626	622	733	691	624
15	628	637	627	626	631	630	630	628	618	735	691	620
16	628	635	626	629	631	634	631	623	618	733	693	624
17	626	632	627	630	632	639	629	616	621	733	691	627
18	630	632	623	630	632	652	631	615	621	733	692	638
19	626	643	624	630	635	628	633	614	625	669	690	636
20	632	627	623	630	642	630	634	615	628	626	663	635
21	632	640	624	630	642	629	632	614	628	634	643	633
22	629	628	627	631	641	631	633	619	630	642	642	635
23	630	629	629	630	638	631	631	619	630	643	642	633
24	633	629	626	631	644	631	632	618	630	743	645	631
25	635	630	626	634	637	629	632	617	631	743	666	631
26	634	630	627	632	636	628	632	617	631	745	690	633
27	630	629	629	630	637	628	633	619	630	744	658	631
28	636	630	627	628	635	624	633	618	631	739	637	630
29	633	629	628	631	---	622	634	619	629	744	667	629
30	634	626	628	631	---	623	633	616	627	746	633	632
31	632	---	631	629	---	620	---	615	---	694	636	---
TOTAL	19529	19060	19464	19560	17761	19528	18957	19215	18759	22021	20820	19003
MEAN	630	635	628	631	634	630	632	620	625	710	672	633
MAX	636	643	632	637	644	652	641	628	631	746	745	645
MIN	622	626	623	626	628	620	618	614	618	626	633	620
AC-FT	38740	37810	38610	38800	35230	38730	37600	38110	37210	43680	41300	37690
MEAN <sup>a</sup>	2737	2519	2787	2763	3588	5165	4188	3875	1781	1751	1563	1253
AC-FT <sup>a</sup>	168300	149900	171400	169900	199200	317600	249200	238200	106000	107700	96100	74500

<sup>a</sup> Adjusted for unreviewed evaporation, change in contents, and diversions in and out of Lake Oroville, Thermalito Diversion Pool, Thermalito Forebay, and Thermalito Afterbay (station 11406870).

## 11407000 FEATHER RIVER AT OROVILLE, CA—Continued

## STATISTICS OF MONTHLY MEAN DATA FOR WATER YEARS 1902 - 1967, BY WATER YEAR (WY)

	OCT	NOV	DEC	JAN	FEB	MAR	APR	MAY	JUN	JUL	AUG	SEP
MEAN	2085	3069	5296	6790	9463	10080	12120	9930	5176	2505	1980	1792
MAX	12370	19710	28410	39860	28030	39760	30100	25150	15650	5999	3265	2883
(WY)	1963	1904	1956	1909	1904	1904	1911	1938	1911	1907	1967	1967
MIN	745	853	1102	1350	1714	1564	2146	1246	924	852	956	992
(WY)	1933	1933	1950	1947	1933	1924	1924	1924	1924	1924	1924	1924

## SUMMARY STATISTICS

## WATER YEARS 1902 - 1967

ANNUAL MEAN	5834
HIGHEST ANNUAL MEAN	12860
LOWEST ANNUAL MEAN	1623
HIGHEST DAILY MEAN	187000
LOWEST DAILY MEAN	577
ANNUAL SEVEN-DAY MINIMUM	652
MAXIMUM PEAK FLOW	230000
MAXIMUM PEAK STAGE	167.5
ANNUAL RUNOFF (AC-FT)	4226000
10 PERCENT EXCEEDS	13300
50 PERCENT EXCEEDS	2870
90 PERCENT EXCEEDS	1470

## STATISTICS OF MONTHLY MEAN DATA FOR WATER YEARS 1969 - 2001, BY WATER YEAR (WY)

	MEAN	MAX	(WY)	MIN	(WY)
	564	1580	1996	399	1969
	747	3313	1982	397	1979
	1181	7728	1997	392	1979
	3009	26750	1997	401	1976
	2261	25180	1986	399	1978
	2038	18870	1995	404	1978
	988	7064	1982	401	1977
	762	7916	1995	387	1969
	517	998	1989	405	1974
	516	775	1992	404	1981
	503	672	2001	393	1979
	504	659	1999	389	1972

## SUMMARY STATISTICS

## FOR 2000 CALENDAR YEAR

## FOR 2001 WATER YEAR

## WATER YEARS 1969 - 2001

ANNUAL TOTAL	230062	233677	
ANNUAL MEAN	629	640	1129
ANNUAL MEAN ADJUSTED a	5713	2829	b 6182
HIGHEST ANNUAL MEAN			3936
LOWEST ANNUAL MEAN			404
HIGHEST DAILY MEAN	683	Jun 15	746
LOWEST DAILY MEAN	605	Apr 21	614
ANNUAL SEVEN-DAY MINIMUM	609	Apr 19	616
MAXIMUM PEAK FLOW			161000
MAXIMUM PEAK STAGE			25.45
ANNUAL RUNOFF (AC-FT)	456300	463500	817700
ANNUAL RUNOFF (AC-FT) ADJUSTED a	4148000	2048000	b 4479000
10 PERCENT EXCEEDS	643	690	650
50 PERCENT EXCEEDS	627	631	431
90 PERCENT EXCEEDS	615	622	402

a Adjusted for unreviewed evaporation, change in contents, and diversions in and out of Lake Oroville, Thermalito Diversion Pool, Thermalito Forebay, and Thermalito Afterbay (station 11406870).

b Includes water year 1968.

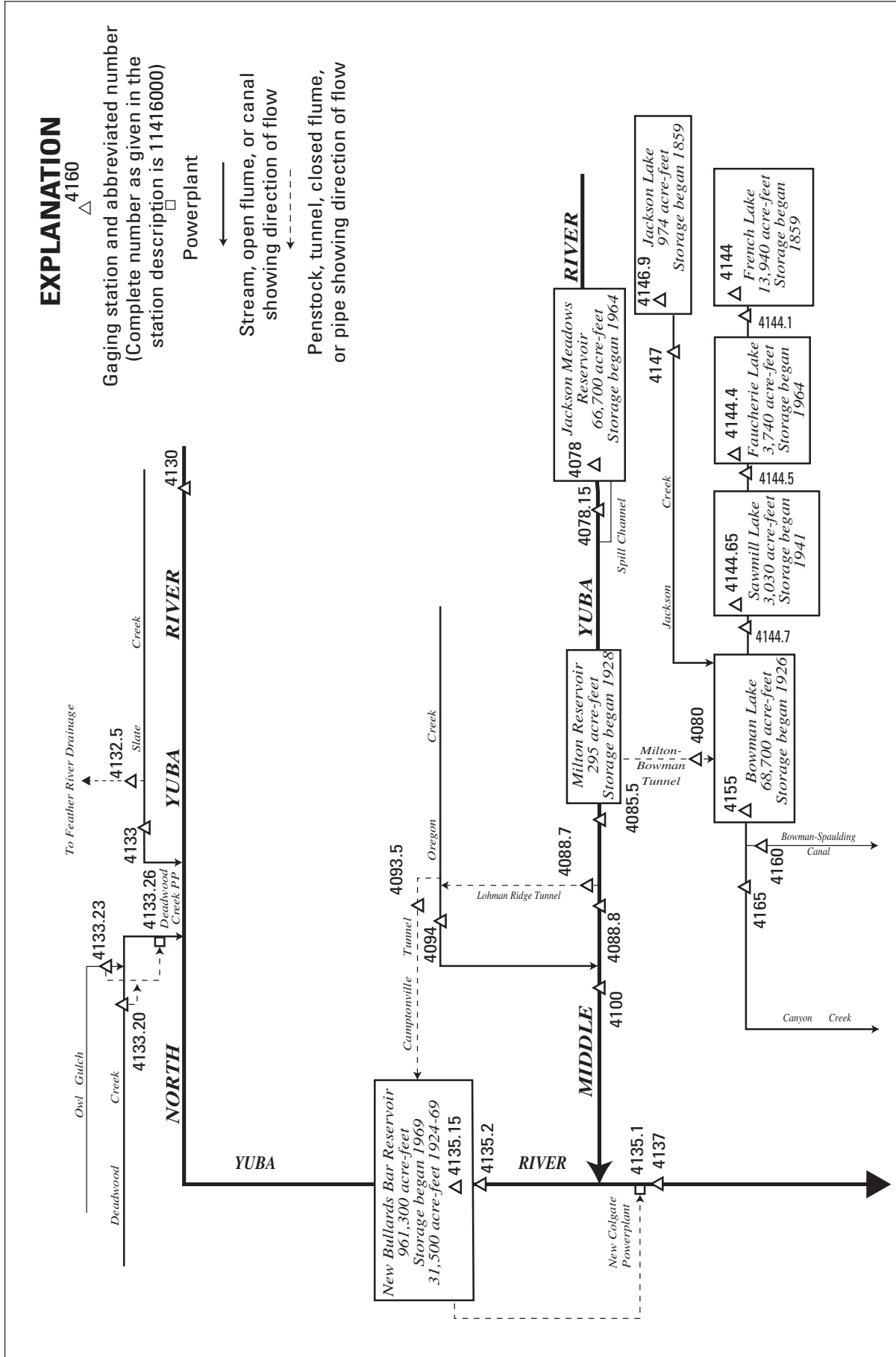

Figure 31. Diversions and storage in North and Middle Yuba River Basins.

## 11407800 JACKSON MEADOWS RESERVOIR NEAR SIERRA CITY, CA

LOCATION.—Lat 39°30'33", long 120°33'08", in NW 1/4 SE 1/4 sec.18, T.19 N., R.13 E., [Sierra County](#), Hydrologic Unit 18020125, Tahoe National Forest, on right bank, at Jackson Meadows Dam on Middle Yuba River, 0.7 mi downstream from Pass Creek, and 5.7 mi southeast of Sierra City.

DRAINAGE AREA.—37.6 mi<sup>2</sup>.

PERIOD OF RECORD.—November 1964 to current year.

GAGE.—Water-stage recorder. Datum of gage is sea level (levels by Nevada Irrigation District).

REMARKS.—Reservoir is formed by an earthfill dam. Storage began Nov. 9, 1964. Usable capacity, 66,700 acre-ft, between elevations 5,933.0 ft, bottom of intake tower, and 6,036.0 ft, top of radial spillway gates. Dead contents, 2,500 acre-ft. Records, including extremes, represent total contents. See schematic diagram of [North Yuba River Basin](#).

COOPERATION.—Records were collected by Nevada Irrigation District, under general supervision of the U.S. Geological Survey, in connection with a Federal Energy Regulatory Commission project.

EXTREMES FOR PERIOD OF RECORD.—Maximum contents, 71,100 acre-ft, May 31 and June 1, 1993, elevation, 6,037.78 ft; minimum since reservoir first filled, 2,500 acre-ft, Sept. 27–29, 1976, elevation, 5,933.1 ft.

EXTREMES FOR CURRENT YEAR.—Maximum contents, 46,800 acre-ft, June 3–6, elevation, 6,013.15 ft; minimum, 29,600 acre-ft, Mar. 24, elevation, 5992.70 ft.

Capacity table (elevation, in feet, and contents, in acre-feet)  
(Based on table provided by Nevada Irrigation District, dated February 1965)

5,930	2,000	5,960	10,600	5,990	27,600	6,020	53,200
5,940	3,920	5,970	15,400	6,000	35,300	6,030	63,000
5,950	6,760	5,980	21,000	6,010	43,900	6,040	73,500

## RESERVOIR STORAGE (ACRE-FEET), WATER YEAR OCTOBER 2000 TO SEPTEMBER 2001

## DAILY OBSERVATION AT 2400 HOURS

DAY	OCT	NOV	DEC	JAN	FEB	MAR	APR	MAY	JUN	JUL	AUG	SEP
1	42100	35200	34900	34700	34700	34800	30600	35100	46700	44900	38100	35100
2	41800	35200	34900	34700	34700	34600	30700	36000	46700	44700	38000	35000
3	41500	35200	34900	34700	34700	34300	30800	36300	46800	44400	37800	35000
4	41200	35200	34900	34700	34700	34100	30800	36500	46800	44200	37700	34900
5	40800	35100	34800	34700	34700	33900	30900	36700	46800	44000	37500	34800
6	40500	35100	34800	34700	34700	33700	30900	37000	46800	43800	37400	34800
7	40200	35100	34800	34700	34700	33400	31000	37700	46700	43600	37300	34700
8	39900	35100	34800	34700	34700	33100	31000	38500	46700	43400	37300	34600
9	39700	35100	34800	34700	34700	32900	31000	39200	46700	43200	37200	34500
10	39400	35100	34900	34700	34800	32600	31000	39800	46700	42900	37100	34400
11	39100	35100	34900	34800	34900	32400	31000	40600	46700	42600	37000	34400
12	38800	35100	34800	34800	34900	32100	31000	41500	46600	42300	36900	34300
13	38500	35100	34900	34800	34900	31800	30900	42000	46600	42200	36800	34200
14	38200	35000	34900	34800	34800	31600	30900	42600	46600	42000	36700	34100
15	37900	35000	34900	34800	34800	31300	30900	43300	46600	41800	36600	34000
16	37600	35000	34900	34700	34800	31100	30900	43700	46500	41600	36500	33900
17	37300	35000	34900	34700	34800	30800	31000	44100	46500	41300	36400	33800
18	37000	35000	34900	34700	34800	30600	31100	44400	46500	41100	36400	33700
19	36700	35000	34900	34700	34900	30400	31300	44700	46500	40900	36300	33600
20	36400	34900	34900	34700	34900	30200	31500	45300	46400	40700	36200	33600
21	36100	34900	34900	34700	35000	30000	31500	45300	46400	40500	36100	33500
22	35800	34900	34900	34700	35000	29800	31600	45700	46300	40300	36000	33400
23	35500	34900	34900	34700	35000	29700	31700	46000	46300	40000	35900	33300
24	35200	34900	34900	34700	35100	29600	32000	46200	46200	39800	35700	33200
25	35100	34900	34800	34700	35100	29800	32400	46300	46100	39500	35600	33100
26	35100	34800	34800	34700	35100	29800	32800	46400	45900	39200	35500	33000
27	35100	34800	34800	34700	35000	29700	33500	46500	45700	39000	35600	32900
28	35200	34800	34800	34700	35000	29700	33900	46600	45500	38800	35300	32900
29	35200	34900	34800	34700	---	29900	34300	46600	45300	38700	35400	32800
30	35200	34900	34800	34700	---	30100	34800	46700	45100	38500	35300	32700
31	35200	---	34800	34700	---	30300	---	46700	---	38100	35200	---
MAX	42100	35200	34900	34800	35100	34800	34800	46700	46800	44900	38100	35100
MIN	35100	34800	34800	34700	34700	29600	30600	35100	45100	38100	35200	32700
a	5999.83	5999.46	5999.29	5999.23	5999.58	5993.65	5999.24	6013.10	6011.29	6003.28	5999.71	5996.71
b	-7200	-300	-100	-100	+300	-4700	+4500	+11900	-1600	-7000	-2900	-2500
CAL YR 2000	MAX 69900	MIN 34800	b -4100									
WTR YR 2001	MAX 46800	MIN 29600	b -9700									

a Elevation, in feet, at end of month.

b Change in contents, in acre-feet.

## 11407815 MIDDLE YUBA RIVER CONTROLLED RELEASE AT JACKSON MEADOWS DAM, NEAR SIERRA CITY, CA

LOCATION.—Lat 39°30'36", long 120°33'15", in NW 1/4 SE 1/4 sec.18, T.19 N., R.13 E., *Sierra County*, Hydrologic Unit 18020125, Tahoe National Forest, in outlet structure, near right bank, below Jackson Meadows Dam on Middle Yuba River, 0.7 mi downstream from Pass Creek, and 5.7 mi southeast of Sierra City.

DRAINAGE AREA.—37.6 mi<sup>2</sup>.

PERIOD OF RECORD.—July 1994 to current year.

GAGE.—Ultrasonic meter measures flow in two outlet pipes. Elevation of gage is 5,910 ft above sea level, from topographic map.

REMARKS.—Flow regulated by Jackson Meadows Reservoir (station 11407800). Flow over the spillway bypasses this station. See schematic diagram of *North Yuba River Basin*.

COOPERATION.—Records were collected by Nevada Irrigation District, under general supervision of the U.S. Geological Survey, in connection with a Federal Energy Regulatory Commission project.

EXTREMES FOR PERIOD OF RECORD.—Maximum daily discharge, 415 ft<sup>3</sup>/s, May 23, 28, 1996; minimum daily, 7.9 ft<sup>3</sup>/s, several days November 1994.

## DISCHARGE, CUBIC FEET PER SECOND, WATER YEAR OCTOBER 2000 TO SEPTEMBER 2001

## DAILY MEAN VALUES

DAY	OCT	NOV	DEC	JAN	FEB	MAR	APR	MAY	JUN	JUL	AUG	SEP
1	e146	9.9	9.3	9.3	9.2	e69	e58	e58	e19	e109	89	41
2	e145	9.3	9.3	9.3	9.3	e135	e58	e58	e19	e108	68	41
3	e145	9.3	9.3	9.3	9.3	e135	e58	e58	e19	e108	68	41
4	e145	9.3	9.3	9.2	9.2	e135	e58	e58	e19	e108	68	28
5	e145	9.3	9.3	9.3	9.3	e135	e58	e58	e19	e108	68	15
6	e144	9.3	9.3	9.2	9.3	e135	e58	e58	e19	e108	54	15
7	e144	9.3	9.3	9.2	9.3	e135	e58	e58	e19	e109	41	32
8	e144	9.2	9.3	9.3	9.3	e135	e58	e58	e19	e109	41	44
9	e144	9.2	9.3	9.3	9.3	e135	e58	e58	e19	e109	41	44
10	e143	9.2	9.3	9.2	9.3	e135	e58	e38	e19	e109	41	44
11	e143	9.2	9.3	9.2	9.3	e135	e58	e19	e20	e109	41	44
12	e143	9.2	9.3	9.3	9.2	e135	e58	e19	e20	e108	41	44
13	e143	9.2	9.3	9.3	9.2	e135	e58	e19	e20	e108	41	44
14	e143	9.2	9.3	9.3	9.3	e135	e58	e19	e20	e108	41	44
15	e142	9.2	9.3	9.2	9.3	e135	e58	e19	e20	e108	41	44
16	e142	9.2	9.3	9.3	9.3	e135	e58	e19	e20	e108	41	44
17	e142	9.2	9.3	9.2	9.2	e135	e58	e19	e20	e108	41	44
18	e140	9.2	9.3	9.3	9.2	e135	e58	e19	e20	e108	41	44
19	e140	9.2	9.3	9.2	9.3	e135	e58	e19	e20	e108	41	44
20	141	9.2	9.2	9.2	9.3	e135	e58	e19	e20	e107	41	44
21	140	9.2	9.2	9.3	9.3	e135	e58	e19	e20	107	41	44
22	140	9.2	9.3	9.3	9.4	e135	e58	e19	e20	107	41	44
23	140	9.2	9.2	9.2	9.3	e135	e58	e19	e20	107	41	44
24	140	9.2	9.3	9.2	9.3	e135	e58	e19	e20	107	41	44
25	67	9.2	9.3	9.2	9.3	e135	e58	e19	e40	107	41	44
26	10	9.2	9.2	9.3	9.3	e135	e58	e19	e109	106	41	44
27	11	9.2	9.3	9.3	e9.4	e135	e58	e19	e109	106	41	44
28	11	9.3	9.3	9.3	e19	e135	e58	e19	e109	106	41	44
29	11	9.3	9.3	9.3	---	e86	e58	e19	e109	106	41	44
30	11	9.3	9.2	9.2	---	e58	e58	e19	e109	106	41	44
31	11	---	9.2	9.3	---	e58	---	e19	---	106	41	---
TOTAL	3556	277.6	287.7	287.0	269.7	3916	1740	959	1055	3336	1440	1225
MEAN	115	9.25	9.28	9.26	9.63	126	58.0	30.9	35.2	108	46.5	40.8
MAX	146	9.9	9.3	9.3	19	135	58	58	109	109	89	44
MIN	10	9.2	9.2	9.2	9.2	58	58	19	19	106	41	15
AC-FT	7050	551	571	569	535	7770	3450	1900	2090	6620	2860	2430

CAL YR 2000 TOTAL 34157.3 MEAN 93.3 MAX 179 MIN 9.2 AC-FT 67750  
WTR YR 2001 TOTAL 18349.0 MEAN 50.3 MAX 146 MIN 9.2 AC-FT 36400

e Estimated.

## 11408000 MILTON-BOWMAN TUNNEL OUTLET NEAR GRANITEVILLE, CA

LOCATION.—Lat 39°27'37", long 120°36'37", in NW 1/4 NE 1/4 sec.3, T.18 N., R.12 E., Nevada County, Hydrologic Unit 18020125, on right bank, 100 ft downstream from tunnel outlet, near upper end of Bowman Lake, and 6.9 mi east of Graniteville.

PERIOD OF RECORD.—May 1928 to September 1930, February 1931 to current year. Monthly discharge only for some periods, published in WSP 1315-A. Prior to October 1962, published as "Milton-Bowman tunnel at outlet."

GAGE.—Water-stage recorder and Parshall flume. Datum of gage is 5,592.51 ft above sea level. Prior to Sept. 22, 1964, at datum 0.56 ft higher.

REMARKS.—Tunnel diverts from Middle Yuba River at Milton Reservoir, in sec.12, T.19 N., R.12 E., and discharges into Bowman Lake. Nearly the entire flow of Middle Yuba River is diverted during low and medium flows. Middle Yuba River is regulated by Jackson Meadows Reservoir (station 11407800) since November 1964. See schematic diagram of [North Yuba River Basin](#).

COOPERATION.—Records were collected by Nevada Irrigation District, under general supervision of the U.S. Geological Survey, in connection with a Federal Energy Regulatory Commission project.

EXTREMES FOR PERIOD OF RECORD.—Maximum daily discharge, 492 ft<sup>3</sup>/s, Feb. 11, 1941; minimum daily, 0.4 ft<sup>3</sup>/s, Oct. 7, 1944.

## DISCHARGE, CUBIC FEET PER SECOND, WATER YEAR OCTOBER 2000 TO SEPTEMBER 2001

## DAILY MEAN VALUES

DAY	OCT	NOV	DEC	JAN	FEB	MAR	APR	MAY	JUN	JUL	AUG	SEP
1	151	10	7.5	6.9	6.5	64	78	87	19	106	94	35
2	151	10	7.3	6.7	6.5	136	75	83	19	106	64	35
3	151	10	7.3	6.7	6.8	136	70	77	19	106	64	34
4	150	10	7.3	6.7	7.0	141	68	77	19	106	64	30
5	150	9.7	7.3	6.7	7.1	140	66	78	19	106	64	13
6	150	9.5	7.2	6.7	7.1	137	66	79	19	105	57	12
7	149	9.0	7.3	6.7	7.0	137	67	80	20	106	36	17
8	149	7.8	7.3	6.9	6.7	137	64	83	18	105	36	38
9	151	7.7	7.5	6.8	7.6	137	63	83	18	105	36	38
10	153	7.5	9.6	7.5	8.3	136	62	70	18	105	36	38
11	150	7.4	8.2	8.5	8.2	136	63	39	18	105	35	39
12	149	7.1	8.1	7.0	7.1	135	62	36	18	105	35	39
13	149	7.2	7.7	6.8	6.8	136	62	34	18	104	36	39
14	148	7.6	9.4	6.7	6.7	136	62	32	18	104	36	39
15	148	7.3	8.0	6.7	6.7	136	63	34	18	104	35	38
16	147	7.3	7.6	6.7	6.7	135	64	34	18	104	35	38
17	147	7.0	7.5	6.5	6.7	136	66	31	18	104	35	38
18	147	7.0	7.3	6.5	7.1	137	70	29	18	104	35	38
19	147	7.0	7.3	6.7	7.2	138	75	27	18	104	35	38
20	147	7.0	7.3	6.6	7.5	140	70	26	18	104	35	38
21	147	7.0	7.4	6.6	7.8	141	68	24	18	103	35	38
22	146	7.0	7.5	6.7	8.2	141	68	23	18	103	35	38
23	146	7.0	7.3	6.7	7.1	142	71	23	18	103	35	38
24	146	7.0	7.3	7.5	7.4	143	76	22	18	103	35	38
25	103	7.0	7.1	7.2	7.4	168	82	22	39	103	35	40
26	14	7.0	7.0	7.3	7.0	154	87	21	106	103	35	39
27	11	7.2	7.0	6.7	6.8	150	87	21	107	102	35	38
28	13	7.3	7.0	6.6	12	154	83	20	107	102	35	38
29	16	8.9	7.0	6.9	---	137	80	20	107	102	35	38
30	11	8.1	7.0	6.6	---	78	83	20	106	102	35	38
31	10	---	7.0	6.5	---	78	---	19	---	102	35	---
TOTAL	3747	236.6	232.6	212.3	205.0	4152	2121	1354	1012	3226	1288	1057
MEAN	121	7.89	7.50	6.85	7.32	134	70.7	43.7	33.7	104	41.5	35.2
MAX	153	10	9.6	8.5	12	168	87	87	107	106	94	40
MIN	10	7.0	7.0	6.5	6.5	64	62	19	18	102	35	12
AC-FT	7430	469	461	421	407	8240	4210	2690	2010	6400	2550	2100



## SACRAMENTO RIVER BASIN

## 11408000 MILTON-BOWMAN TUNNEL OUTLET NEAR GRANITEVILLE, CA—Continued

## STATISTICS OF MONTHLY MEAN DATA FOR WATER YEARS 1928 - 1964, BY WATER YEAR (WY)

	OCT	NOV	DEC	JAN	FEB	MAR	APR	MAY	JUN	JUL	AUG	SEP
MEAN	8.00	14.6	31.4	35.3	51.6	72.9	176	242	142	28.6	6.77	3.88
MAX	101	65.4	118	124	143	213	294	414	272	90.9	26.8	10.1
(WY)	1963	1951	1956	1942	1963	1940	1936	1937	1933	1938	1952	1952
MIN	.50	.50	.70	1.00	4.28	9.19	19.7	45.6	24.8	4.21	2.06	1.00
(WY)	1931	1931	1931	1931	1931	1933	1938	1936	1934	1939	1964	1931

## SUMMARY STATISTICS

## WATER YEARS 1928 - 1964

ANNUAL MEAN	67.9
HIGHEST ANNUAL MEAN	97.2 1930
LOWEST ANNUAL MEAN	33.5 1949
HIGHEST DAILY MEAN	492 Feb 11 1941
LOWEST DAILY MEAN	.40 Oct 7 1944
ANNUAL SEVEN-DAY MINIMUM	.50 Oct 1 1930
ANNUAL RUNOFF (AC-FT)	49180
10 PERCENT EXCEEDS	220
50 PERCENT EXCEEDS	20
90 PERCENT EXCEEDS	3.0

## STATISTICS OF MONTHLY MEAN DATA FOR WATER YEARS 1966 - 2001, BY WATER YEAR (WY)

MEAN	151	123	56.2	36.2	38.9	61.1	59.6	97.6	81.4	66.8	88.8	151
MAX	310	368	357	211	197	265	225	333	280	174	253	300
(WY)	1981	1973	1973	1985	1985	1986	1999	1969	1998	1976	1968	1974
MIN	1.52	1.34	1.25	1.17	1.20	1.68	5.38	7.69	5.23	3.95	2.20	1.72
(WY)	1977	1977	1977	1977	1977	1977	1977	1986	1976	1977	1993	1981

## SUMMARY STATISTICS

## FOR 2000 CALENDAR YEAR

## FOR 2001 WATER YEAR

## WATER YEARS 1966 - 2001

ANNUAL TOTAL	38474.5	18843.5	
ANNUAL MEAN	105	51.6	84.4
HIGHEST ANNUAL MEAN			133 1998
LOWEST ANNUAL MEAN			14.5 1977
HIGHEST DAILY MEAN	295 Feb 14	168 Mar 25	438 Nov 4 1972
LOWEST DAILY MEAN	7.0 Nov 17	6.5 Jan 17	1.1 Dec 11 1976
ANNUAL SEVEN-DAY MINIMUM	7.0 Nov 17	6.6 Jan 15	1.1 Dec 26 1976
ANNUAL RUNOFF (AC-FT)	76310	37380	61180
10 PERCENT EXCEEDS	180	137	254
50 PERCENT EXCEEDS	116	35	27
90 PERCENT EXCEEDS	7.4	7.0	5.5

## 11408550 MIDDLE YUBA RIVER BELOW MILTON DAM, NEAR SIERRA CITY, CA

LOCATION.—Lat 39°31'19", long 120°34'57", in SW 1/4 SW 1/4 sec.12, T.19 N., R.12 E., Sierra County, Hydrologic Unit 18020125, Tahoe National Forest, on right bank, 350 ft downstream from Milton Dam, and 4.1 mi southeast of Sierra City.

DRAINAGE AREA.—39.9 mi<sup>2</sup>.

PERIOD OF RECORD.—October 1987 to current year. Unpublished records for water years 1965–87 available in files of the U.S. Geological Survey.

REVISED RECORDS.—WDR CA-88-4: Drainage area.

GAGE.—Water-stage recorder, sharp-crested weir, and crest-stage gage. Elevation of gage is 5,690 ft above sea level, from topographic map. Prior to October 1987, nonrecording gage 450 ft downstream at different datum.

REMARKS.—Middle Yuba River is regulated by Jackson Meadows Reservoir (station 11407800) since November 1964 and Milton Reservoir. Tunnel diverts from Middle Yuba River at Milton Dam, in sec.12, T.19 N., R.12 E., and discharges into Bowman Lake via Milton–Bowman Tunnel (station 11408000). Practically the entire flow of Middle Yuba River is diverted during low and medium flows. See schematic diagram of North Yuba River Basin.

COOPERATION.—Records were collected by Nevada Irrigation District, under general supervision of the U.S. Geological Survey, in connection with a Federal Energy Regulatory Commission project.

EXTREMES FOR PERIOD OF RECORD.—Maximum discharge, 8,610 ft<sup>3</sup>/s, Jan. 2, 1997, gage height, 17.1 ft, from floodmarks; minimum daily, 0.77 ft<sup>3</sup>/s, Nov. 3, 1990.

## DISCHARGE, CUBIC FEET PER SECOND, WATER YEAR OCTOBER 2000 TO SEPTEMBER 2001

## DAILY MEAN VALUES

DAY	OCT	NOV	DEC	JAN	FEB	MAR	APR	MAY	JUN	JUL	AUG	SEP
1	3.5	2.9	4.2	4.4	4.5	4.7	4.8	4.7	4.5	4.0	4.1	3.8
2	3.5	2.8	4.2	4.4	4.5	4.9	4.8	4.7	4.5	4.0	4.0	3.8
3	3.5	2.8	4.2	4.4	4.5	4.9	4.7	4.7	4.5	3.9	3.9	3.8
4	3.5	2.7	4.2	4.4	4.5	5.0	4.8	4.7	4.5	3.9	3.9	3.7
5	3.5	2.9	4.2	4.5	4.5	4.9	4.8	4.7	4.5	3.9	3.8	3.7
6	3.5	3.0	4.2	4.5	4.5	4.9	4.8	4.7	4.5	3.9	3.8	3.7
7	3.5	3.5	4.2	4.5	4.5	4.9	4.8	4.7	4.5	3.9	3.8	3.7
8	3.5	4.2	4.2	4.5	4.5	4.9	4.7	4.7	4.4	3.9	3.8	3.8
9	3.5	4.2	4.2	4.5	4.5	4.9	4.8	4.7	4.4	3.9	3.9	3.8
10	3.5	4.2	4.2	4.5	4.5	4.9	4.8	4.6	4.4	3.9	3.9	3.8
11	3.5	4.2	4.2	4.5	4.5	4.9	4.7	4.5	4.4	3.9	3.9	3.8
12	3.5	4.2	4.2	4.5	4.5	4.9	4.8	4.5	4.4	3.9	3.9	3.8
13	3.5	4.2	4.2	4.5	4.5	4.9	4.7	4.5	4.1	3.9	3.9	3.8
14	3.5	4.2	4.2	4.5	4.5	4.9	4.7	4.5	3.8	3.9	3.8	3.8
15	3.5	4.2	4.2	4.5	4.5	4.9	4.7	4.6	3.8	3.9	3.8	3.8
16	3.5	4.2	4.2	4.5	4.5	4.9	4.7	4.5	3.8	3.9	3.8	3.8
17	3.5	4.2	4.2	4.5	4.5	4.9	4.7	4.5	3.8	3.9	3.8	3.8
18	3.5	4.2	4.2	4.5	4.5	4.9	4.7	4.5	3.8	3.9	3.8	3.8
19	3.5	4.2	4.3	4.5	4.5	4.9	4.7	4.5	4.0	3.9	3.8	3.8
20	3.5	4.2	4.3	4.5	4.5	5.0	4.7	4.5	3.8	3.9	3.8	3.8
21	3.4	4.2	4.3	4.5	4.5	5.0	4.7	4.5	3.8	3.9	3.8	3.8
22	3.4	4.2	4.3	4.5	4.5	5.0	4.7	4.5	3.8	4.0	3.8	3.8
23	3.3	4.2	4.3	4.5	4.5	5.0	4.7	4.5	3.8	4.0	3.8	3.8
24	3.3	4.2	4.3	4.5	4.5	5.0	4.7	4.5	3.8	4.1	3.8	3.8
25	3.3	4.2	4.3	4.5	4.5	5.1	4.7	4.5	3.8	4.1	3.8	3.8
26	3.1	4.2	4.3	4.5	4.5	5.0	4.7	4.5	4.0	4.1	3.8	3.7
27	3.0	4.2	4.3	4.5	4.5	5.0	4.6	4.5	4.0	4.1	3.8	3.8
28	3.1	4.2	4.3	4.5	4.6	5.0	4.6	4.5	4.0	4.1	3.8	3.8
29	3.1	4.2	4.3	4.5	---	4.9	4.7	4.5	4.0	4.1	3.8	3.8
30	3.0	4.2	4.3	4.5	---	4.8	4.7	4.5	4.0	4.1	3.8	3.8
31	3.0	---	4.3	4.5	---	4.8	---	4.5	---	4.1	3.8	---
TOTAL	105.0	117.2	131.5	139.1	126.1	152.6	141.7	141.5	123.4	122.9	119.0	113.5
MEAN	3.39	3.91	4.24	4.49	4.50	4.92	4.72	4.56	4.11	3.96	3.84	3.78
MAX	3.5	4.2	4.3	4.5	4.6	5.1	4.8	4.7	4.5	4.1	4.1	3.8
MIN	3.0	2.7	4.2	4.4	4.5	4.7	4.6	4.5	3.8	3.9	3.8	3.7
AC-FT	208	232	261	276	250	303	281	281	245	244	236	225

## SACRAMENTO RIVER BASIN

## 11408550 MIDDLE YUBA RIVER BELOW MILTON DAM, NEAR SIERRA CITY, CA—Continued

## STATISTICS OF MONTHLY MEAN DATA FOR WATER YEARS 1988 - 2001, BY WATER YEAR (WY)

	OCT	NOV	DEC	JAN	FEB	MAR	APR	MAY	JUN	JUL	AUG	SEP
MEAN	4.04	3.77	3.60	47.9	23.5	9.72	36.6	110	92.0	19.0	3.90	3.87
MAX	7.02	4.94	4.24	620	195	61.3	213	723	631	119	5.36	4.68
(WY)	1994	1994	2001	1997	1993	1995	1996	1995	1995	1995	1993	1993
MIN	3.39	3.21	3.26	3.24	3.19	3.45	3.09	3.16	3.38	3.37	3.39	3.42
(WY)	2001	1996	1989	1996	1989	1990	1994	2000	1990	1988	1995	1990

SUMMARY STATISTICS	FOR 2000 CALENDAR YEAR		FOR 2001 WATER YEAR		WATER YEARS 1988 - 2001	
ANNUAL TOTAL	1316.3		1533.5			
ANNUAL MEAN	3.60		4.20		29.8	
HIGHEST ANNUAL MEAN					146	
LOWEST ANNUAL MEAN					3.53	
HIGHEST DAILY MEAN	4.3	Dec 19	5.1	Mar 25	6860	Jan 2 1997
LOWEST DAILY MEAN	2.7	Nov 4	2.7	Nov 4	.77	Nov 3 1990
ANNUAL SEVEN-DAY MINIMUM	2.9	Oct 30	2.9	Oct 30	1.8	Apr 9 1994
MAXIMUM PEAK FLOW			19	Jun 19	8610	Jan 2 1997
MAXIMUM PEAK STAGE			5.44	Jun 19	17.10	Jan 2 1997
ANNUAL RUNOFF (AC-FT)	2610		3040		21590	
10 PERCENT EXCEEDS	4.2		4.8		6.1	
50 PERCENT EXCEEDS	3.5		4.2		3.8	
90 PERCENT EXCEEDS	3.2		3.5		3.3	

## 11408870 LOHMAN RIDGE TUNNEL AT INTAKE, NEAR CAMPTONVILLE, CA

LOCATION.—Lat 39°24'25", long 120°59'43", in SW 1/4 NE 1/4 sec.20, T.18 N., R.8 E., Sierra County, Hydrologic Unit 18020125, Tahoe National Forest, at tunnel intake at Our House Dam, and 4.0 mi southeast of Camptonville.

PERIOD OF RECORD.—October 1988 to current year. Records of monthly diversion published with "Middle Yuba River below Our House Dam, near Camptonville" (station 11408880), for water years 1969–88.

GAGE.—Water-stage recorder. Datum of gage is 2,014.77 ft above sea level.

REMARKS.—Records good. Tunnel diverts water from Middle Yuba River to New Bullards Bar Reservoir (station 11413515) for power development. See schematic diagram of North Yuba River Basin.

EXTREMES FOR PERIOD OF RECORD.—Maximum daily discharge, 839 ft<sup>3</sup>/s, Mar. 25, 1989; no flow for many days in most years.

## DISCHARGE, CUBIC FEET PER SECOND, WATER YEAR OCTOBER 2000 TO SEPTEMBER 2001

## DAILY MEAN VALUES

DAY	OCT	NOV	DEC	JAN	FEB	MAR	APR	MAY	JUN	JUL	AUG	SEP
1	.23	17	20	15	35	100	326	316	22	2.8	.00	.00
2	.22	13	16	14	36	107	313	316	20	1.5	.00	.00
3	.21	11	13	14	40	104	254	252	18	1.0	.00	.00
4	.25	11	11	13	55	213	207	217	16	.60	.00	.00
5	.25	9.1	10	12	72	485	186	214	14	.30	.00	.00
6	.24	7.7	8.6	12	65	368	180	216	13	.17	.00	.00
7	.20	6.6	8.2	11	55	298	198	219	11	.15	.00	.00
8	.14	5.9	7.2	16	44	299	174	246	7.0	.17	.00	.00
9	3.7	6.8	8.1	18	49	274	156	269	4.2	.14	.00	.00
10	24	10	25	43	56	208	150	255	2.5	.05	.00	.00
11	25	9.9	28	120	58	183	161	238	1.6	.00	.00	.00
12	21	7.6	45	73	52	169	162	221	1.5	.00	.00	.00
13	8.3	7.7	34	53	52	169	152	196	.55	.00	.00	.00
14	5.1	15	135	44	56	177	136	181	.18	.00	.00	.00
15	3.7	13	130	35	52	176	128	173	.14	.00	.00	.00
16	2.8	10	65	29	53	168	138	185	4.7	.00	.00	.00
17	2.3	8.7	46	24	60	161	165	164	10	.00	.00	.00
18	1.7	7.6	35	23	73	180	185	139	11	.00	.00	.00
19	1.2	7.3	28	23	135	213	278	119	10	.00	.00	.00
20	1.7	7.5	26	24	198	279	287	107	9.4	.00	.00	.00
21	3.4	7.3	26	22	292	307	263	96	8.3	.00	.00	.00
22	1.1	7.5	35	22	351	312	255	86	6.9	.00	.00	.00
23	.60	6.6	32	27	213	313	248	79	5.7	.00	.00	.00
24	.94	6.4	26	63	161	315	281	70	4.4	.00	.00	.00
25	3.3	6.5	23	60	165	635	323	60	4.7	.00	.00	.21
26	13	6.4	20	55	150	501	365	52	10	.00	.00	.11
27	10	6.2	18	51	130	385	368	45	12	.00	.00	.05
28	18	7.6	17	45	115	354	341	39	12	.00	.00	.00
29	124	35	16	49	---	374	305	35	8.3	.00	.00	.00
30	49	41	16	47	---	346	289	31	5.0	.00	.00	.00
31	24	---	15	40	---	327	---	26	---	.00	.00	---
TOTAL	349.58	322.9	943.1	1097	2873	8500	6974	4862	254.07	6.88	0.00	0.37
MEAN	11.3	10.8	30.4	35.4	103	274	232	157	8.47	.22	.000	.012
MAX	124	41	135	120	351	635	368	316	22	2.8	.00	.21
MIN	.14	5.9	7.2	11	35	100	128	26	.14	.00	.00	.00
AC-FT	693	640	1870	2180	5700	16860	13830	9640	504	14	.00	.7

## STATISTICS OF MONTHLY MEAN DATA FOR WATER YEARS 1989 - 2001, BY WATER YEAR (WY)

	1989	1990	1991	1992	1993	1994	1995	1996	1997	1998	1999	2000	2001
MEAN	10.9	37.6	114	205	315	392	431	319	177	59.5	10.7	5.27	
MAX	51.4	112	486	509	649	644	688	701	503	269	41.4	23.6	
(WY)	1990	1997	1997	1995	1998	1993	1995	1996	1993	1995	1998	1998	
MIN	.000	1.42	1.36	.66	16.6	206	182	38.0	8.47	.22	.000	.000	
(WY)	1989	1991	1991	1997	1991	1997	1994	1995	2001	2001	1992	1992	

## SUMMARY STATISTICS

## FOR 2000 CALENDAR YEAR

## FOR 2001 WATER YEAR

## WATER YEARS 1989 - 2001

ANNUAL TOTAL	68591.66	26182.90		
ANNUAL MEAN	187	71.7	172	
HIGHEST ANNUAL MEAN			305	1998
LOWEST ANNUAL MEAN			71.7	2001
HIGHEST DAILY MEAN	765	Jan 24	635	Mar 25
LOWEST DAILY MEAN	.00	Sep 29	.00	Jul 11
ANNUAL SEVEN-DAY MINIMUM	.12	Sep 24	.00	Jul 11
ANNUAL RUNOFF (AC-FT)	136100	51930	124700	
10 PERCENT EXCEEDS	544	254	555	
50 PERCENT EXCEEDS	34	15	48	
90 PERCENT EXCEEDS	.75	.00	.00	

## 11408880 MIDDLE YUBA RIVER BELOW OUR HOUSE DAM, NEAR CAMPTONVILLE, CA

LOCATION.—Lat 39°24'42", long 120°59'49", in SW 1/4 NW 1/4 sec.20, T.18 N., R.9 E., Sierra County, Hydrologic Unit 18020125, Tahoe National Forest, on right bank, 300 ft downstream from Our House Dam, and 4.0 mi southeast of Camptonville.

DRAINAGE AREA.—145 mi<sup>2</sup>.

PERIOD OF RECORD.—October 1968 to current year.

GAGE.—Water-stage recorder, sharp-crested weir since Oct. 16, 1990, and crest-stage gage. Datum of gage is 1,957.51 ft above sea level. Prior to Nov. 4, 1970, water-stage recorder at datum 10 ft higher. Prior to Oct. 1, 1987, at site 75 ft downstream.

REMARKS.—Records good. Natural flow of stream affected by Jackson Meadows Reservoir (station 11407800), Milton–Bowman Tunnel (station 11408000), which diverts upstream from station to Bowman Lake (station 11415500), and Lohman Ridge Tunnel (station 11408870), which diverts 300 ft upstream to Oregon Creek and then to New Bullards Bar Reservoir (station 11413515) via Camptonville Tunnel (station 11409350). Other small diversions upstream from station. See schematic diagram of North Yuba River Basin.

EXTREMES FOR PERIOD OF RECORD.—Maximum discharge, 27,500 ft<sup>3</sup>/s, Jan. 2, 1997, gage height, 30.7 ft, from floodmark, present datum, from rating curve extended above 8,600 ft<sup>3</sup>/s, on basis of theoretical rating of Our House Dam spillway; minimum daily, 2.1 ft<sup>3</sup>/s, Jan. 10, 1982.

DISCHARGE, CUBIC FEET PER SECOND, WATER YEAR OCTOBER 2000 TO SEPTEMBER 2001  
DAILY MEAN VALUES

DAY	OCT	NOV	DEC	JAN	FEB	MAR	APR	MAY	JUN	JUL	AUG	SEP
1	33	37	37	36	37	38	40	55	53	38	29	25
2	34	37	37	36	37	38	40	56	53	38	28	25
3	34	37	37	36	37	38	40	55	54	38	28	24
4	35	37	36	36	37	39	40	54	54	38	27	24
5	34	37	36	36	37	43	39	54	53	38	27	24
6	34	37	36	36	37	42	39	55	53	37	27	24
7	34	37	37	36	37	41	39	55	53	36	27	24
8	33	37	37	36	37	41	39	56	54	36	26	24
9	34	37	36	36	37	40	39	56	54	35	26	24
10	36	37	37	37	37	40	39	56	54	35	26	24
11	36	37	37	38	37	39	39	56	54	34	26	24
12	37	37	37	37	37	39	39	55	54	34	25	25
13	37	37	37	37	37	39	39	55	54	34	25	25
14	37	37	38	37	37	39	47	54	53	33	25	25
15	37	37	38	37	37	39	55	54	52	32	25	24
16	37	37	37	37	37	39	55	54	45	32	25	24
17	37	37	37	37	37	39	56	54	40	32	25	24
18	37	37	36	37	37	39	56	54	38	33	25	24
19	37	37	36	37	39	40	56	54	38	32	24	24
20	37	37	36	36	40	40	57	53	38	32	24	24
21	37	37	36	37	42	40	57	54	38	31	24	23
22	37	37	37	37	44	40	56	54	38	31	25	24
23	37	37	37	37	42	40	56	54	38	30	25	23
24	37	37	36	37	41	40	57	53	38	31	26	23
25	37	37	36	37	41	77	57	54	38	30	26	31
26	37	37	36	37	39	43	58	54	38	30	25	30
27	37	37	36	37	38	41	57	54	37	29	25	28
28	37	37	36	37	38	41	56	54	37	28	23	27
29	40	38	37	37	---	41	55	54	37	27	24	26
30	38	38	37	37	---	41	55	54	38	28	24	25
31	37	---	36	37	---	40	---	53	---	29	24	---
TOTAL	1121	1112	1135	1138	1070	1276	1457	1687	1378	1021	791	745
MEAN	36.2	37.1	36.6	36.7	38.2	41.2	48.6	54.4	45.9	32.9	25.5	24.8
MAX	40	38	38	38	44	77	58	56	54	38	29	31
MIN	33	37	36	36	37	38	39	53	37	27	23	23
AC-FT	2220	2210	2250	2260	2120	2530	2890	3350	2730	2030	1570	1480

## STATISTICS OF MONTHLY MEAN DATA FOR WATER YEARS 1969 - 2001, BY WATER YEAR (WY)

MEAN	31.2	74.5	158	364	238	233	154	214	116	33.7	30.2	29.9
MAX	52.7	462	1040	2973	1521	1228	1368	1697	994	49.6	42.1	39.6
(WY)	1983	1982	1982	1997	1986	1995	1982	1995	1995	1983	1984	1986
MIN	16.6	20.4	20.7	7.10	28.0	31.3	33.9	32.5	28.8	17.5	13.0	14.3
(WY)	1978	1978	1987	1987	1977	1976	1970	1970	1977	1977	1977	1977

## SUMMARY STATISTICS

## FOR 2000 CALENDAR YEAR

## FOR 2001 WATER YEAR

## WATER YEARS 1969 - 2001

ANNUAL TOTAL	26704	13931										
ANNUAL MEAN	73.0	38.2							139			
HIGHEST ANNUAL MEAN									481		1969	
LOWEST ANNUAL MEAN									26.3		1977	
HIGHEST DAILY MEAN	5200	Feb 14				77	Mar 25		21000		Jan 2	1997
LOWEST DAILY MEAN	33	Sep 29				23	Aug 28		2.1		Jan 10	1982
ANNUAL SEVEN-DAY MINIMUM	34	Sep 27				24	Sep 18		3.2		Oct 21	1970
MAXIMUM PEAK FLOW						193	Mar 25		27500		Jan 2	1997
MAXIMUM PEAK STAGE						19.00	Mar 25		30.70		Jan 2	1997
ANNUAL RUNOFF (AC-FT)	52970					27630			101000			
10 PERCENT EXCEEDS		55				54			151			
50 PERCENT EXCEEDS		37				37			35			
90 PERCENT EXCEEDS		36				25			26			

## 11409350 CAMPTONVILLE TUNNEL AT INTAKE, NEAR CAMPTONVILLE, CA

LOCATION.—Lat 39°26'25", long 121°03'30", in NW 1/4 SW 1/4 sec.11, T.18 N., R.8 E., Yuba County, Hydrologic Unit 18020125, Tahoe National Forest, at tunnel intake, at Log Cabin Dam, 1.0 mi southwest of town of Camptonville.

PERIOD OF RECORD.—October 1988 to current year. Records of monthly diversion published with Oregon Creek below Log Cabin Dam near Camptonville (station 11409400) for water years 1969–88.

GAGE.—Water-stage recorder. Datum of gage is 1,952.00 ft above sea level (from contractor's drawings).

REMARKS.—Records good. Water is diverted to Oregon Creek from the Middle Yuba River through Lohman Ridge Tunnel (station 11408870) 1,000 ft upstream. Camptonville Tunnel diverts water from Oregon Creek to New Bullards Bar Reservoir (station 11413515) for power development. See schematic diagram of North Yuba River Basin.

EXTREMES FOR PERIOD OF RECORD.—Maximum daily discharge, 1,090 ft<sup>3</sup>/s, Mar. 25, 1989, Feb. 3, 1998; no flow for many days each year.

## DISCHARGE, CUBIC FEET PER SECOND, WATER YEAR OCTOBER 2000 TO SEPTEMBER 2001

## DAILY MEAN VALUES

DAY	OCT	NOV	DEC	JAN	FEB	MAR	APR	MAY	JUN	JUL	AUG	SEP
1	.00	15	20	15	41	124	402	384	18	.00	.00	.00
2	.00	9.9	14	14	41	132	387	382	16	.00	.00	.00
3	.00	7.5	10	13	45	130	322	315	14	.00	.00	.00
4	.00	6.7	8.0	12	61	269	266	275	12	.00	.00	.00
5	.00	5.1	6.9	11	82	639	223	266	10	.00	.00	.00
6	.00	3.8	5.5	12	77	511	207	264	8.2	.00	.00	.00
7	.00	2.6	5.0	11	68	422	245	265	6.3	.00	.00	.00
8	.00	2.1	4.2	18	54	422	196	290	3.2	.00	.00	.00
9	.00	2.5	4.7	23	57	396	172	312	.47	.00	.00	.00
10	22	5.3	23	46	65	328	166	296	.00	.00	.00	.00
11	22	5.9	27	156	67	272	182	278	.00	.00	.00	.00
12	20	3.6	48	92	62	233	194	256	.00	.00	.00	.00
13	4.6	3.2	37	68	60	227	173	223	.00	.00	.00	.00
14	.99	11	168	56	63	244	160	195	.00	.00	.00	.00
15	.07	9.5	185	44	59	248	151	176	.00	.00	.00	.00
16	.00	5.9	83	36	59	223	160	204	.01	.00	.00	.00
17	.00	4.7	57	29	68	209	186	168	3.1	.00	.00	.00
18	.00	3.8	43	28	81	244	219	142	3.6	.00	.00	.00
19	.00	3.8	34	26	166	307	343	123	3.2	.00	.00	.00
20	.00	3.7	31	27	294	373	372	107	2.3	.00	.00	.00
21	.00	3.6	29	25	450	406	363	95	1.4	.00	.00	.00
22	.00	3.8	40	24	519	409	354	84	.30	.00	.00	.00
23	.00	3.1	39	28	325	408	341	76	.00	.00	.00	.00
24	.00	2.8	32	72	230	405	363	67	.00	.00	.00	.00
25	.00	3.1	27	71	231	709	405	58	.00	.00	.00	.00
26	6.7	2.9	23	66	200	615	450	49	2.6	.00	.00	.00
27	6.1	2.8	21	60	170	486	455	41	5.4	.00	.00	.00
28	10	4.0	19	52	146	443	425	35	6.1	.00	.00	.00
29	132	30	17	56	---	459	382	31	2.1	.00	.00	.00
30	53	45	17	55	---	430	359	27	.18	.00	.00	.00
31	24	---	16	46	---	404	---	22	---	.00	.00	---
TOTAL	301.46	216.7	1094.3	1292	3841	11127	8623	5506	118.46	0.00	0.00	0.00
MEAN	9.72	7.22	35.3	41.7	137	359	287	178	3.95	.000	.000	.000
MAX	132	45	185	156	519	709	455	384	18	.00	.00	.00
MIN	.00	2.1	4.2	11	41	124	151	22	.00	.00	.00	.00
AC-FT	598	430	2170	2560	7620	22070	17100	10920	235	.00	.00	.00

## STATISTICS OF MONTHLY MEAN DATA FOR WATER YEARS 1989 - 2001, BY WATER YEAR (WY)

	1989	1990	1991	1992	1993	1994	1995	1996	1997	1998	1999	2000	2001
MEAN	10.4	43.8	136	284	423	545	521	373	192	66.9	8.27	3.30	
MAX	54.9	127	628	695	865	793	867	820	542	347	37.8	19.8	
(WY)	1990	1999	1997	1995	1998	1993	1995	1996	1993	1995	1998	1998	
MIN	.000	1.28	.83	1.16	16.7	308	173	53.2	3.95	.000	.000	.000	
(WY)	1989	1991	1991	1991	1991	1994	1994	1992	2001	2001	1992	1991	

## SUMMARY STATISTICS FOR 2000 CALENDAR YEAR FOR 2001 WATER YEAR WATER YEARS 1989 - 2001

ANNUAL TOTAL	86504.62	32119.92	
ANNUAL MEAN	236	88.0	216
HIGHEST ANNUAL MEAN			364
LOWEST ANNUAL MEAN			75.7
HIGHEST DAILY MEAN	964	Feb 13	709
LOWEST DAILY MEAN	.00	Aug 7	.00
ANNUAL SEVEN-DAY MINIMUM	.00	Aug 7	.00
ANNUAL RUNOFF (AC-FT)	171600	63710	156500
10 PERCENT EXCEEDS	723	326	719
50 PERCENT EXCEEDS	36	13	56
90 PERCENT EXCEEDS	.00	.00	.00

## 11409400 OREGON CREEK BELOW LOG CABIN DAM, NEAR CAMPTONVILLE, CA

LOCATION.—Lat 39°26'22", long 121°03'29", in SW 1/4 SW 1/4 sec.11, T.18 N., R.8 E., Yuba County, Hydrologic Unit 18020125, Tahoe National Forest, on left bank, 500 ft downstream from Log Cabin Dam, 670 ft upstream from High Point Ravine, and 1.1 mi southwest of Camptonville.

DRAINAGE AREA.—29.1 mi<sup>2</sup>.

PERIOD OF RECORD.—August 1968 to current year.

WATER TEMPERATURE: Water years 1972–79.

REVISED RECORDS.—WDR CA-81-4: 1980(M).

GAGE.—Water-stage recorder, sharp-crested weir since Nov. 13, 1990, and crest-stage gage. Datum of gage is 1,912.73 ft above sea level (levels by Yuba County Water Agency). Prior to July 24, 1973, at site 470 ft downstream at datum 8.40 ft lower. July 24, 1973, to Sept. 30, 1986, at site on right bank. Oct. 1, 1986, to Nov. 13, 1990, a sharp-crested weir was put in at same location and gage house located on left bank. The weir was deemed too shallow so a new sharp-crested weir was put in 70 ft downstream at a datum 7.24 ft lower.

REMARKS.—Records good. Lohman Ridge Tunnel (station 11408870) diverts water into the basin from the Middle Yuba River. Camptonville Tunnel (station 11409350), maximum capacity, about 1,000 ft<sup>3</sup>/s, 520 ft upstream, diverts water out of the basin to New Bullards Bar Reservoir (station 11413515); diversion began October 1968. See schematic diagram of [North Yuba River Basin](#).

EXTREMES FOR PERIOD OF RECORD.—Maximum discharge, 6,400 ft<sup>3</sup>/s, Feb. 17, 1986, gage height, 11.24 ft, datum then in use, from rating curve extended above 50 ft<sup>3</sup>/s, based on flow-over-dam computation, maximum gage height, 15.70 ft (from floodmark), Jan. 1, 1997; minimum daily, 0.34 ft<sup>3</sup>/s, Sept. 18, 1972.

DISCHARGE, CUBIC FEET PER SECOND, WATER YEAR OCTOBER 2000 TO SEPTEMBER 2001  
DAILY MEAN VALUES

DAY	OCT	NOV	DEC	JAN	FEB	MAR	APR	MAY	JUN	JUL	AUG	SEP
1	3.8	9.9	9.9	9.6	10	13	14	15	12	7.8	2.3	1.8
2	3.8	9.6	9.7	9.4	10	13	14	15	12	5.9	2.3	1.7
3	3.8	9.5	9.6	9.4	10	13	14	14	12	4.8	2.2	1.8
4	3.8	9.5	9.5	9.4	10	15	13	14	12	4.2	2.0	1.7
5	3.8	9.4	9.5	9.4	10	18	13	14	12	3.8	1.8	1.7
6	3.8	9.3	9.4	9.4	10	17	13	14	12	3.4	1.8	1.7
7	3.7	9.3	9.4	9.3	10	17	13	14	12	3.2	1.8	1.7
8	3.6	9.3	9.4	9.6	10	17	13	14	11	3.1	1.7	1.7
9	4.4	9.3	9.4	9.7	10	16	12	15	11	3.2	1.6	1.7
10	11	9.5	9.9	10	10	16	12	14	9.8	3.1	1.6	1.7
11	11	9.6	10	12	10	15	13	14	8.6	3.0	1.7	1.7
12	11	9.4	11	11	10	15	13	14	8.1	2.9	1.7	1.9
13	10	9.4	10	11	10	15	12	14	7.1	2.9	1.7	1.9
14	9.9	9.7	12	10	10	15	13	14	6.0	2.9	1.8	2.0
15	9.4	9.6	12	10	10	14	14	14	5.6	2.8	1.8	2.0
16	8.5	9.5	11	10	10	12	14	14	6.6	2.8	1.7	2.0
17	7.8	9.4	11	9.9	10	12	14	14	11	2.8	1.7	1.9
18	7.1	9.4	10	9.9	10	13	15	13	11	2.8	1.7	1.9
19	6.4	9.4	10	9.8	12	13	16	13	11	2.8	1.7	1.9
20	6.1	9.4	10	9.8	13	14	16	13	11	2.8	1.7	1.9
21	7.9	9.4	10	9.8	15	14	16	13	11	2.7	1.7	1.9
22	7.2	9.4	10	9.8	16	14	16	13	11	2.7	1.7	1.9
23	5.1	9.4	10	9.8	15	14	15	13	10	2.6	1.8	1.9
24	5.3	9.4	10	11	14	14	16	13	8.9	2.5	1.9	1.9
25	6.2	9.3	10	11	14	17	16	13	8.1	2.5	1.9	2.7
26	10	9.3	9.9	10	14	16	16	13	11	2.4	1.9	3.4
27	10	9.3	9.8	10	13	15	16	13	12	2.3	1.8	3.0
28	11	9.4	9.8	10	13	15	15	12	12	2.2	1.7	2.7
29	14	10	9.7	10	---	15	15	12	11	2.1	1.7	2.5
30	12	10	9.7	10	---	15	14	12	10	2.1	1.7	2.4
31	10	---	9.7	10	---	14	---	12	---	2.2	1.7	---
TOTAL	231.4	284.3	311.3	310.0	319	456	426	419	306.8	97.3	55.8	60.6
MEAN	7.46	9.48	10.0	10.0	11.4	14.7	14.2	13.5	10.2	3.14	1.80	2.02
MAX	14	10	12	12	16	18	16	15	12	7.8	2.3	3.4
MIN	3.6	9.3	9.4	9.3	10	12	12	12	5.6	2.1	1.6	1.7
AC-FT	459	564	617	615	633	904	845	831	609	193	111	120

## 11409400 OREGON CREEK BELOW LOG CABIN DAM, NEAR CAMPTONVILLE, CA—Continued

## STATISTICS OF MONTHLY MEAN DATA FOR WATER YEARS 1968 - 2001, BY WATER YEAR (WY)

	OCT	NOV	DEC	JAN	FEB	MAR	APR	MAY	JUN	JUL	AUG	SEP
MEAN	6.61	16.0	47.5	97.5	63.6	44.7	28.4	19.1	23.1	8.33	6.50	5.81
MAX	12.8	72.5	273	604	617	189	268	111	394	15.2	13.1	14.3
(WY)	1972	1982	1982	1969	1986	1969	1969	1969	1998	1983	1983	1984
MIN	1.95	2.27	1.97	4.57	3.39	7.14	8.11	8.00	4.89	1.82	1.32	1.37
(WY)	1989	1977	1977	1977	1977	1977	1986	1986	1987	1977	1977	1988

SUMMARY STATISTICS	FOR 2000 CALENDAR YEAR		FOR 2001 WATER YEAR		WATER YEARS 1968 - 2001	
ANNUAL TOTAL	6831.7		3277.5			
ANNUAL MEAN	18.7		8.98		30.5	
HIGHEST ANNUAL MEAN					128	
LOWEST ANNUAL MEAN					4.20	
HIGHEST DAILY MEAN	1060	Feb 14	18	Mar 5	5340	Feb 17 1986
LOWEST DAILY MEAN	3.6	Oct 8	1.6	Aug 9	.34	Sep 18 1972
ANNUAL SEVEN-DAY MINIMUM	3.8	Oct 2	1.7	Aug 7	.74	Sep 18 1972
MAXIMUM PEAK FLOW			20		6400	Feb 17 1986
MAXIMUM PEAK STAGE			7.36		15.70	Jan 1 1997
ANNUAL RUNOFF (AC-FT)	13550		6500		22090	
10 PERCENT EXCEEDS	16		14		18	
50 PERCENT EXCEEDS	10		10		10	
90 PERCENT EXCEEDS	4.9		1.9		3.4	



## 11410000 MIDDLE YUBA RIVER NEAR NORTH SAN JUAN, CA

LOCATION.—Lat 39°23'39", long 121°05'02", in NW 1/4 SE 1/4 sec.28, T.18 N., R.8 E., Yuba County, Hydrologic Unit 18020125, Tahoe National Forest, on right bank, 100 ft downstream of State Highway 49 bridge, 400 ft downstream from Oregon Creek, and 2 mi northeast of North San Juan.

DRAINAGE AREA.—198 mi<sup>2</sup>.

## WATER-DISCHARGE RECORDS

PERIOD OF RECORD.—July to September 1900 (monthly discharge only, September 1900), August 1911 to March 1941, October 2000 to September 2001.

GAGE.—Water-stage recorder and crest-stage gage. Elevation of gage is 1,450 ft above sea level, from topographic map. July 1 to Sept. 30, 1900, and Aug. 1, 1911, to Oct. 7, 1930, nonrecording gage at site 0.5 mi downstream at different datum. Oct. 8, 1930, to Mar. 31, 1941, water-stage recorder 0.9 mi downstream at datum 1,400.62 ft above sea level.

REMARKS.—Records good. Natural flow of stream affected by storage in Milton Reservoir beginning 1928 and Jackson Meadows Reservoir (station 11407800) beginning November 1964. Milton–Bowman Tunnel (station 11408000) diverts water from Milton Reservoir to Bowman Lake (station 11415500) beginning May 1928, and Lohman Ridge Tunnel (station 11408870) diverts water to Oregon Creek and then to New Bullards Bar Reservoir (station 11413515) via Camptonville Tunnel (station 11409350) beginning October 1968. Other small diversions upstream from station. See schematic diagram of North Yuba River Basin.

EXTREMES FOR PERIOD OF RECORD.—Maximum discharge 26,000 ft<sup>3</sup>/s, Mar. 25, 1928, gage height, 15.3 ft, site and datum then in use, from floodmarks, from rating curve extended above 1,200 ft<sup>3</sup>/s; minimum daily, 14 ft<sup>3</sup>/s, Aug. 27, 28, 1931.

## DISCHARGE, CUBIC FEET PER SECOND, WATER YEAR OCTOBER 2000 TO SEPTEMBER 2001

## DAILY MEAN VALUES

DAY	OCT	NOV	DEC	JAN	FEB	MAR	APR	MAY	JUN	JUL	AUG	SEP
1	36	49	51	50	54	66	63	76	66	46	35	28
2	36	48	50	50	53	76	63	76	66	44	34	30
3	36	48	49	50	53	71	61	76	66	43	33	29
4	36	48	49	50	53	89	60	74	66	42	32	28
5	36	48	49	50	54	124	59	74	66	41	32	28
6	35	48	49	50	54	104	61	74	66	40	32	28
7	35	49	49	50	53	89	71	74	66	40	32	28
8	35	49	49	56	52	83	64	74	66	40	31	28
9	41	49	50	53	56	81	61	76	70	39	31	28
10	49	52	51	64	68	75	60	75	75	39	30	27
11	52	51	53	98	82	71	61	74	76	38	30	28
12	48	50	63	66	71	69	61	74	75	38	29	28
13	48	51	56	59	64	68	60	73	74	37	29	29
14	47	53	98	56	63	67	63	72	71	37	29	29
15	46	51	91	54	60	66	77	72	69	37	30	29
16	45	50	63	53	59	65	77	73	63	35	29	29
17	44	49	58	52	60	64	78	71	59	36	29	29
18	44	49	56	52	63	64	81	69	57	37	29	28
19	42	49	55	52	84	64	82	68	56	37	29	29
20	42	49	54	52	109	65	92	66	53	37	29	29
21	44	49	55	51	149	66	90	67	46	37	29	28
22	45	49	55	51	150	65	84	68	46	37	29	28
23	44	49	53	56	111	65	82	68	46	36	29	28
24	43	49	52	72	100	65	83	67	45	36	30	28
25	47	49	52	65	95	125	82	67	45	36	30	34
26	51	49	51	67	82	73	83	68	48	35	29	37
27	51	49	51	61	74	67	82	68	49	34	29	34
28	60	49	51	57	69	66	79	68	49	33	28	33
29	70	59	51	60	---	65	77	67	48	32	27	32
30	57	53	51	57	---	65	76	67	47	33	28	31
31	50	---	51	55	---	64	---	66	---	34	28	---
TOTAL	1395	1494	1716	1769	2095	2307	2173	2202	1795	1166	930	882
MEAN	45.0	49.8	55.4	57.1	74.8	74.4	72.4	71.0	59.8	37.6	30.0	29.4
MAX	70	59	98	98	150	125	92	76	76	46	35	37
MIN	35	48	49	50	52	64	59	66	45	32	27	27
AC-FT	2770	2960	3400	3510	4160	4580	4310	4370	3560	2310	1840	1750

## 11410000 MIDDLE YUBA RIVER NEAR NORTH SAN JUAN, CA—Continued

## STATISTICS OF MONTHLY MEAN DATA FOR WATER YEARS 1912 - 1927, BY WATER YEAR (WY)

	OCT	NOV	DEC	JAN	FEB	MAR	APR	MAY	JUN	JUL	AUG	SEP
MEAN	65.9	180	276	458	898	690	1132	1247	610	129	51.7	47.2
MAX	101	779	758	2286	2942	1643	1647	2673	1850	239	70.0	73.7
(WY)	1919	1927	1923	1914	1927	1916	1927	1915	1922	1922	1916	1918
MIN	42.1	54.5	78.4	77.4	104	116	315	180	45.3	25.7	23.5	24.9
(WY)	1914	1924	1924	1918	1920	1924	1924	1924	1924	1924	1924	1924

## SUMMARY STATISTICS

## WATER YEARS 1912 - 1927

ANNUAL MEAN	479
HIGHEST ANNUAL MEAN	830 1927
LOWEST ANNUAL MEAN	111 1924
HIGHEST DAILY MEAN	15300 Feb 21 1927
LOWEST DAILY MEAN	21 Aug 12 1924
ANNUAL SEVEN-DAY MINIMUM	22 Aug 8 1924
MAXIMUM PEAK FLOW	21900 Feb 21 1927
MAXIMUM PEAK STAGE	14.00 Feb 21 1927
ANNUAL RUNOFF (AC-FT)	346900
10 PERCENT EXCEEDS	1270
50 PERCENT EXCEEDS	156
90 PERCENT EXCEEDS	44

## STATISTICS OF MONTHLY MEAN DATA FOR WATER YEARS 1929 - 1940, BY WATER YEAR (WY)

MEAN	41.7	70.9	246	334	609	744	828	763	316	60.9	33.2	29.0
MAX	63.2	174	1152	941	1629	1937	1832	2215	1053	135	61.6	48.3
(WY)	1939	1938	1938	1936	1940	1940	1935	1938	1938	1938	1938	1938
MIN	31.9	26.0	39.3	56.3	111	269	164	107	52.8	20.7	15.5	16.2
(WY)	1935	1930	1931	1937	1933	1931	1931	1931	1931	1931	1931	1931

## SUMMARY STATISTICS

## WATER YEARS 1929 - 1940

ANNUAL MEAN	338
HIGHEST ANNUAL MEAN	818 1938
LOWEST ANNUAL MEAN	90.5 1931
HIGHEST DAILY MEAN	16100 Dec 11 1937
LOWEST DAILY MEAN	14 Aug 27 1931
ANNUAL SEVEN-DAY MINIMUM	15 Aug 22 1931
MAXIMUM PEAK FLOW	26000 Mar 25 1928
MAXIMUM PEAK STAGE	15.30 Mar 25 1928
ANNUAL RUNOFF (AC-FT)	244800
10 PERCENT EXCEEDS	905
50 PERCENT EXCEEDS	90
90 PERCENT EXCEEDS	27

## STATISTICS OF MONTHLY MEAN DATA FOR WATER YEARS 2001 - 2001, BY WATER YEAR (WY)

MEAN	45.0	49.8	55.4	57.1	74.8	74.4	72.4	71.0	59.8	37.6	30.0	29.4
MAX	45.0	49.8	55.4	57.1	74.8	74.4	72.4	71.0	59.8	37.6	30.0	29.4
(WY)	2001	2001	2001	2001	2001	2001	2001	2001	2001	2001	2001	2001
MIN	45.0	49.8	55.4	57.1	74.8	74.4	72.4	71.0	59.8	37.6	30.0	29.4
(WY)	2001	2001	2001	2001	2001	2001	2001	2001	2001	2001	2001	2001

## SUMMARY STATISTICS

## FOR 2001 WATER YEAR

ANNUAL TOTAL	19924
ANNUAL MEAN	54.6
HIGHEST DAILY MEAN	150 Feb 22
LOWEST DAILY MEAN	27 Aug 29
ANNUAL SEVEN-DAY MINIMUM	28 Sep 4
MAXIMUM PEAK FLOW	310 Mar 25
MAXIMUM PEAK STAGE	8.19 Mar 25
ANNUAL RUNOFF (AC-FT)	39520
10 PERCENT EXCEEDS	76
50 PERCENT EXCEEDS	52
90 PERCENT EXCEEDS	29

## 11410000 MIDDLE YUBA RIVER NEAR NORTH SAN JUAN, CA—Continued

## WATER-QUALITY RECORDS

PERIOD OF RECORD.—Water years 1975–77, October 2000 to September 2001.

WATER TEMPERATURE: Water years 1975–77, October 2000 to September 2001.

SEDIMENT DATA: November 2000 to September 2001.

PERIOD OF DAILY RECORD.—October 1974 to September 1977, October 2000 to September 2001.

WATER TEMPERATURE: October 1974 to September 1977, October 2000 to September 2001.

SUSPENDED-SEDIMENT DISCHARGE: November 2000 to September 2001.

INSTRUMENTATION.—Water-temperature recorder September 1974–77 and since October 2000.

REMARKS.—Water-temperature records rated excellent except for Oct. 1–15, Jan. 23, 24, Apr. 17 to June 13, Aug. 17 to Sept. 10, which are rated good; and Sept. 11–30, which are rated fair.

EXTREMES FOR PERIOD OF DAILY RECORD.—

WATER TEMPERATURE: Maximum recorded, 30.5°C, June 25, 29, 1977; minimum recorded, 0.0°C, Dec. 24, 1974, Jan. 2, 3, 1975, Jan. 17, 1977.

SEDIMENT CONCENTRATION: Maximum daily mean, 27mg/L, Dec. 14, 2000, Jan. 11, 2001; minimum daily mean, 0 mg/L, several days during the 2001 water year.

SEDIMENT LOAD: Maximum daily, 8.8 tons, Feb. 21, 2001; minimum daily, 0 ton, several days in 2001.

EXTREMES FOR CURRENT YEAR.—

WATER TEMPERATURE: Maximum recorded, 28.0°C, July 5, 26; minimum recorded, 0.5°C Jan. 17, 18.

SEDIMENT CONCENTRATION: Maximum daily mean, 27 mg/L, Dec. 14, Jan. 11; minimum daily mean, 0 mg/L, many days during the year.

SEDIMENT LOAD: Maximum daily, 8.8 tons, Feb. 21; minimum daily, 0 ton, several days during the year.

## CROSS-SECTIONAL DATA, WATER YEAR OCTOBER 2000 TO SEPTEMBER 2001

DATE	TIME	TEMPER- ATURE WATER (DEG C) (00010)	SAMPLE LOC- ATION, CROSS SECTION (FT FM L BANK) (00009)
JUL			
03...*	1400	24.5	61.0
03...*	1401	24.5	55.0
03...*	1402	24.5	49.0
03...*	1403	24.5	43.0
03...*	1404	24.5	37.0
03...*	1405	24.5	31.0
03...*	1406	24.5	25.0
03...*	1407	24.5	19.0
03...*	1408	24.5	13.0
03...*	1409	25.0	7.00

## SUSPENDED-SEDIMENT DISCHARGE, WATER YEAR OCTOBER 2000 TO SEPTEMBER 2001

DATE	TIME	DIS- CHARGE, INST. CUBIC FEET PER SECOND (00061)	TEMPER- ATURE WATER (DEG C) (00010)	SEDI- MENT, DIS- CHARGE, SUS- PENDED (MG/L) (80154)	SEDI- MENT, DIS- CHARGE, SUS- PENDED (T/DAY) (80155)
DEC					
06...	1330	49	4.5	1	.13
JAN					
11...	1500	93	5.0	28	7.0
29...	1300	65	3.5	2	.35
APR					
09...	1345	61	8.0	2	.33
MAY					
07...	1515	74	18.0	3	.60
JUN					
07...	1345	66	22.0	4	.71

\* Instantaneous discharge at time of cross-sectional measurement: 43 ft<sup>3</sup>/s.

## 11410000 MIDDLE YUBA RIVER NEAR NORTH SAN JUAN, CA—Continued

## TEMPERATURE, WATER (DEG. C), WATER YEAR OCTOBER 2000 TO SEPTEMBER 2001

DAY	MAX		MIN		MAX		MIN		MAX		MIN	
	OCTOBER	NOVEMBER	DECEMBER	JANUARY	FEBRUARY	MARCH	APRIL	MAY	JUNE	JULY	AUGUST	SEPTEMBER
1	18.0	15.5	9.0	7.5	6.5	5.0	3.5	2.5	3.5	1.5	6.0	3.5
2	17.5	15.5	9.5	8.0	6.0	4.5	3.5	2.0	4.5	2.5	6.0	5.5
3	16.5	14.5	9.5	8.0	5.5	4.0	3.5	2.5	5.5	3.5	6.5	4.5
4	16.5	14.5	9.0	7.5	5.5	4.5	3.0	2.0	6.0	4.5	7.0	6.0
5	16.5	14.0	9.0	7.5	5.5	4.5	3.0	1.5	6.0	4.5	7.5	6.5
6	16.0	14.0	9.0	7.5	5.0	4.0	3.5	2.0	5.5	4.0	8.5	6.0
7	16.0	14.0	8.5	6.5	6.0	5.0	4.0	2.0	4.5	3.0	9.5	6.5
8	16.0	14.0	8.5	7.0	6.5	6.0	5.0	3.5	3.5	1.5	9.5	8.0
9	15.5	14.0	8.5	7.0	6.5	5.5	4.5	3.5	3.5	2.0	9.5	8.0
10	14.5	12.5	7.5	5.5	7.5	6.5	5.0	4.0	2.5	1.5	9.0	6.0
11	13.0	12.0	6.5	5.5	7.5	6.0	5.5	4.5	2.5	1.0	8.5	6.0
12	12.5	11.0	5.5	4.0	7.0	6.0	5.5	4.5	3.5	2.0	9.0	5.5
13	12.5	10.5	5.0	3.5	6.5	5.5	5.5	4.0	4.0	2.0	9.5	6.0
14	12.5	10.5	6.0	4.5	7.0	6.0	5.0	4.0	3.5	2.0	9.5	7.0
15	12.5	10.5	6.0	5.0	7.5	6.5	4.0	2.5	4.0	1.5	9.0	7.0
16	12.5	10.5	5.5	4.0	7.0	5.5	2.5	1.5	5.0	3.0	9.5	6.5
17	12.0	10.5	4.5	3.5	6.0	4.5	2.0	.5	5.0	3.5	10.5	7.5
18	12.5	11.0	4.0	3.0	4.5	3.5	2.5	.5	5.5	4.5	11.5	8.5
19	12.5	10.5	4.5	3.0	4.5	3.0	3.5	2.5	6.0	5.0	12.0	9.0
20	12.0	10.5	4.5	3.5	5.0	3.5	3.5	2.5	6.5	5.0	13.0	10.0
21	12.5	11.5	5.0	3.5	5.0	3.5	4.0	2.5	7.0	5.5	13.0	10.5
22	11.5	9.5	5.5	4.5	6.0	4.5	5.0	3.5	7.0	6.0	13.5	10.5
23	11.0	9.0	5.0	3.5	5.5	4.5	5.0	3.5	6.5	5.0	13.5	10.5
24	11.0	9.0	5.5	4.5	5.5	4.5	5.5	4.5	6.0	5.0	13.0	10.5
25	10.5	9.5	5.5	4.0	5.0	3.5	5.0	3.0	7.0	5.0	13.0	10.5
26	10.5	9.5	6.0	4.5	4.0	3.0	4.0	3.0	7.5	5.0	11.5	8.5
27	10.5	9.0	7.0	5.5	4.0	3.0	3.5	2.5	7.0	4.5	12.0	8.5
28	10.5	9.5	7.0	6.0	4.0	2.5	3.0	1.5	6.0	4.0	13.5	10.5
29	11.0	9.5	7.5	6.0	4.0	2.5	4.0	2.5	---	---	14.0	11.0
30	10.5	9.0	7.0	6.0	3.5	2.5	3.5	2.0	---	---	13.5	10.5
31	9.5	8.0	---	---	3.5	2.5	3.0	1.5	---	---	14.0	10.5
MONTH	18.0	8.0	9.5	3.0	7.5	2.5	5.5	.5	7.5	1.0	14.0	3.5
1	14.0	11.0	17.5	13.0	23.5	19.5	25.5	20.5	25.5	20.5	24.5	20.0
2	13.5	10.0	16.0	12.0	23.0	18.5	26.0	21.0	26.0	21.0	24.0	20.0
3	11.0	8.5	15.5	11.0	22.0	17.5	26.5	22.0	25.5	21.0	24.5	20.0
4	9.5	6.5	16.0	11.0	21.5	16.5	26.5	23.0	25.0	20.5	24.0	20.0
5	10.5	6.5	17.0	12.0	21.0	17.0	28.0	23.0	25.5	20.5	23.5	19.5
6	10.0	8.0	17.5	12.5	22.5	17.0	26.5	22.5	26.0	20.5	23.0	19.0
7	8.5	7.0	19.0	13.5	23.5	17.5	25.5	22.5	26.5	21.5	22.5	18.0
8	7.5	6.0	20.0	15.0	23.5	18.0	26.5	21.5	27.5	22.5	22.0	18.0
9	9.0	5.0	20.0	15.5	23.0	18.0	27.0	22.5	27.5	23.0	22.0	18.0
10	10.0	5.5	20.5	15.5	23.0	18.0	27.5	23.0	27.0	22.0	22.0	18.5
11	10.0	8.0	20.5	16.0	22.5	18.5	27.0	22.5	26.5	21.5	20.5	19.0
12	10.0	6.5	19.5	16.0	23.0	18.5	26.5	21.5	26.5	21.5	21.5	18.0
13	10.0	7.0	19.5	15.5	23.0	17.5	26.5	21.5	26.0	21.0	22.0	18.0
14	11.0	7.5	18.0	15.0	23.0	17.5	26.0	21.0	26.0	20.5	22.0	18.5
15	12.0	7.5	17.5	15.5	24.0	18.5	25.5	21.0	25.5	20.5	22.0	18.5
16	13.0	8.5	19.5	15.0	24.5	19.0	24.5	20.5	25.5	20.5	22.0	18.5
17	14.0	9.5	20.0	15.0	24.0	19.5	25.0	20.0	25.5	20.5	22.0	18.0
18	13.0	10.5	21.0	16.0	24.5	19.5	25.5	20.5	25.5	20.5	22.0	18.5
19	12.5	10.0	21.5	16.5	25.0	20.0	25.0	20.5	25.0	20.5	22.0	18.5
20	10.5	8.0	22.5	17.0	25.5	20.5	25.0	20.5	24.5	20.0	22.0	18.5
21	11.0	7.5	23.0	17.5	26.0	21.0	24.5	19.5	24.0	19.5	21.0	17.5
22	13.0	8.0	23.0	18.0	26.5	21.5	25.0	19.5	24.0	19.5	20.5	17.5
23	14.5	9.5	24.0	18.5	24.0	21.0	25.5	20.5	23.5	19.5	20.0	17.5
24	16.0	11.0	23.5	18.5	22.5	19.0	26.5	21.5	24.0	19.0	19.5	17.0
25	17.0	12.5	22.5	18.5	20.5	19.0	27.5	22.5	24.5	20.0	20.5	18.0
26	17.5	13.0	22.5	18.0	21.0	18.5	28.0	23.0	25.0	20.0	19.5	17.0
27	16.5	12.5	21.5	17.0	20.0	18.5	27.0	22.5	25.5	20.0	19.5	17.0
28	15.0	12.5	21.0	16.5	23.0	17.5	26.5	21.5	25.5	21.0	19.0	16.0
29	15.0	10.5	22.0	17.0	24.0	19.0	26.0	21.5	25.0	20.5	18.5	15.5
30	16.5	11.5	23.5	18.0	25.0	20.0	25.0	21.0	24.5	20.5	19.0	16.0
31	---	---	24.5	19.0	---	---	25.5	20.0	24.5	20.5	---	---
MONTH	17.5	5.0	24.5	11.0	26.5	16.5	28.0	19.5	27.5	19.0	24.5	15.5

## 11410000 MIDDLE YUBA RIVER NEAR NORTH SAN JUAN, CA—Continued

## SEDIMENT DISCHARGE, SUSPENDED (TONS/DAY), WATER YEAR OCTOBER 2000 TO SEPTEMBER 2001

DAY	MEAN	MEAN	SEDIMENT	MEAN	MEAN	SEDIMENT	MEAN	MEAN	SEDIMENT
	DISCHARGE (CFS)	CONCEN- TRATION (MG/L)	DISCHARGE (TONS/DAY)	DISCHARGE (CFS)	CONCEN- TRATION (MG/L)	DISCHARGE (TONS/DAY)	DISCHARGE (CFS)	CONCEN- TRATION (MG/L)	DISCHARGE (TONS/DAY)
	OCTOBER			NOVEMBER			DECEMBER		
1	36	---	---	49	---	---	51	1	.16
2	36	---	---	48	---	---	50	2	.23
3	36	---	---	48	---	---	49	2	.31
4	36	---	---	48	---	---	49	3	.35
5	36	---	---	48	---	---	49	1	.18
6	35	---	---	48	---	---	49	2	.20
7	35	---	---	49	---	---	49	2	.25
8	35	---	---	49	0	.00	49	2	.30
9	41	---	---	49	0	.00	50	3	.34
10	49	---	---	52	0	.00	51	3	.38
11	52	---	---	51	0	.00	53	3	.40
12	48	---	---	50	0	.00	63	2	.38
13	48	---	---	51	0	.05	56	6	.90
14	47	---	---	53	1	.21	98	27	7.4
15	46	---	---	51	0	.02	91	17	4.3
16	45	---	---	50	0	.02	63	12	2.0
17	44	---	---	49	1	.11	58	9	1.4
18	44	---	---	49	1	.13	56	6	.84
19	42	---	---	49	1	.13	55	2	.29
20	42	---	---	49	1	.13	54	3	.47
21	44	---	---	49	1	.13	55	1	.19
22	45	---	---	49	1	.13	55	1	.17
23	44	---	---	49	1	.13	53	1	.19
24	43	---	---	49	1	.14	52	2	.21
25	47	---	---	49	1	.18	52	2	.23
26	51	---	---	49	2	.22	51	2	.25
27	51	---	---	49	2	.26	51	2	.25
28	60	---	---	49	2	.26	51	1	.15
29	70	---	---	59	2	.32	51	1	.14
30	57	---	---	53	2	.27	51	1	.14
31	50	---	---	---	---	---	51	1	.14
TOTAL	1395	---	---	1494	---	---	1716	---	23.14
	JANUARY			FEBRUARY			MARCH		
1	50	1	.14	54	1	.21	66	2	.28
2	50	1	.14	53	1	.17	76	3	.63
3	50	1	.14	53	2	.25	71	4	.85
4	50	1	.08	53	2	.34	89	6	1.4
5	50	2	.25	54	3	.38	124	6	2.1
6	50	2	.27	54	1	.18	104	3	.93
7	50	2	.27	53	1	.12	89	2	.47
8	56	2	.28	52	0	.04	83	1	.28
9	53	1	.16	56	1	.14	81	2	.42
10	64	8	1.7	68	1	.21	75	2	.41
11	98	27	7.4	82	2	.42	71	2	.39
12	66	5	.93	71	2	.38	69	2	.37
13	59	3	.55	64	2	.33	68	1	.24
14	56	3	.45	63	1	.25	67	2	.45
15	54	2	.36	60	1	.17	66	2	.35
16	53	2	.28	59	1	.16	65	1	.20
17	52	1	.21	60	1	.19	64	1	.23
18	52	1	.15	63	1	.25	64	2	.29
19	52	1	.14	84	9	2.5	64	2	.37
20	52	1	.14	109	16	4.8	65	3	.52
21	51	1	.14	149	20	8.8	66	4	.63
22	51	1	.16	150	12	4.9	65	4	.70
23	56	5	.91	111	4	1.1	65	4	.71
24	72	13	2.7	100	3	.71	65	4	.74
25	65	5	.97	95	2	.60	125	7	2.9
26	67	5	.87	82	2	.42	73	8	1.5
27	61	4	.65	74	1	.19	67	4	.79
28	57	3	.45	69	0	.06	66	4	.66
29	60	2	.26	---	---	---	65	2	.41
30	57	2	.23	---	---	---	65	3	.49
31	55	2	.28	---	---	---	64	2	.40
TOTAL	1769	---	21.66	2095	---	28.27	2307	---	21.11

## 11410000 MIDDLE YUBA RIVER NEAR NORTH SAN JUAN, CA—Continued

## SEDIMENT DISCHARGE, SUSPENDED (TONS/DAY), WATER YEAR OCTOBER 2000 TO SEPTEMBER 2001

DAY	MEAN	MEAN	SEDIMENT	MEAN	MEAN	SEDIMENT	MEAN	MEAN	SEDIMENT
	DISCHARGE (CFS)	CONCEN- TRATION (MG/L)	DISCHARGE (TONS/DAY)	DISCHARGE (CFS)	CONCEN- TRATION (MG/L)	DISCHARGE (TONS/DAY)	DISCHARGE (CFS)	CONCEN- TRATION (MG/L)	DISCHARGE (TONS/DAY)
	APRIL			MAY			JUNE		
1	63	2	.28	76	4	.80	66	3	.52
2	63	1	.19	76	4	.82	66	3	.54
3	61	2	.25	76	4	.78	66	3	.54
4	60	2	.29	74	3	.63	66	3	.57
5	59	1	.18	74	3	.67	66	4	.67
6	61	1	.17	74	4	.74	66	3	.53
7	71	1	.19	74	3	.66	66	2	.43
8	64	1	.17	74	4	.90	66	1	.23
9	61	1	.18	76	4	.80	70	1	.25
10	60	1	.16	75	3	.63	75	2	.34
11	61	1	.18	74	3	.59	76	2	.43
12	61	2	.25	74	3	.53	75	3	.53
13	60	2	.32	73	2	.46	74	1	.27
14	63	2	.40	72	2	.42	71	2	.37
15	77	3	.56	72	3	.55	69	2	.42
16	77	3	.59	73	2	.49	63	3	.42
17	78	2	.41	71	2	.39	59	3	.44
18	81	1	.26	69	2	.37	57	3	.44
19	82	2	.34	68	2	.37	56	2	.32
20	92	2	.47	66	2	.36	53	2	.26
21	90	2	.40	67	2	.42	46	1	.14
22	84	1	.30	68	3	.64	46	1	.12
23	82	1	.25	68	3	.46	46	1	.12
24	83	2	.34	67	3	.64	45	1	.12
25	82	2	.43	67	2	.40	45	1	.16
26	83	2	.46	68	2	.41	48	3	.34
27	82	2	.50	68	3	.46	49	2	.26
28	79	3	.53	68	3	.51	49	1	.14
29	77	3	.58	67	3	.54	48	1	.14
30	76	3	.65	67	3	.51	47	1	.17
31	---	---	---	66	2	.40	---	---	---
TOTAL	2173	---	10.28	2202	---	17.35	1795	---	10.23
	JULY			AUGUST			SEPTEMBER		
1	46	2	.21	35	2	.20	28	1	.08
2	44	2	.25	34	3	.24	30	1	.08
3	43	3	.32	33	1	.11	29	1	.08
4	42	2	.22	32	1	.12	28	1	.08
5	41	1	.12	32	2	.15	28	1	.08
6	40	1	.11	32	2	.17	28	1	.10
7	40	1	.11	32	2	.17	28	2	.13
8	40	1	.11	31	2	.15	28	2	.15
9	39	1	.11	31	1	.12	28	2	.18
10	39	1	.12	30	1	.10	27	3	.20
11	38	2	.19	30	1	.08	28	3	.22
12	38	2	.19	29	1	.06	28	3	.21
13	37	1	.11	29	0	.04	29	2	.18
14	37	1	.10	29	0	.02	29	2	.16
15	37	1	.10	30	0	.00	29	2	.14
16	35	1	.12	29	0	.01	29	1	.11
17	36	3	.26	29	0	.03	29	1	.09
18	37	2	.23	29	1	.04	28	1	.07
19	37	3	.26	29	1	.05	29	1	.05
20	37	1	.12	29	1	.07	29	0	.02
21	37	1	.10	29	1	.08	28	0	.00
22	37	1	.10	29	1	.08	28	0	.03
23	36	1	.10	29	1	.08	28	1	.05
24	36	1	.10	30	1	.08	28	1	.08
25	36	1	.08	30	1	.08	34	1	.12
26	35	0	.02	29	1	.08	37	2	.17
27	34	1	.08	29	1	.08	34	2	.17
28	33	1	.09	28	1	.08	33	2	.15
29	32	1	.09	27	1	.07	32	1	.12
30	33	1	.10	28	1	.08	31	1	.09
31	34	2	.17	28	1	.08	---	---	---
TOTAL	1166	---	4.39	930	---	2.80	882	---	3.39
YEAR	19924		145.46						

## 11413000 NORTH YUBA RIVER BELOW GOODYEARS BAR, CA

LOCATION.—Lat 39°31'30", long 120°56'13", in NE 1/4 SW 1/4 sec.11, T.19 N., R.9 E., Sierra County, Hydrologic Unit 18020125, Tahoe National Forest, on right bank, 200 ft downstream from St. Catherine Creek, 3.1 mi southwest of Goodyears Bar, and 6.4 mi southwest of Downieville.

DRAINAGE AREA.—250 mi<sup>2</sup>.

PERIOD OF RECORD.—October 1930 to current year. Prior to October 1949, published as North Fork Yuba River below Goodyears Bar. Monthly and yearly discharge only for some periods, published in WSP 1315-A.

REVISED RECORDS.—WSP 1041: 1944. WSP 1931: Drainage area.

GAGE.—Water-stage recorder. Datum of gage is 2,453 ft above sea level (river-profile survey).

REMARKS.—Records good. Several small diversions upstream from station for irrigation and mining. See schematic diagram of [North Yuba River Basin](#).

EXTREMES FOR PERIOD OF RECORD.—Maximum discharge, 45,500 ft<sup>3</sup>/s, Jan. 2, 1997, gage height, 25.65 ft, from rating curve extended above 11,900 ft<sup>3</sup>/s on basis of one float measurement at 17,900 ft<sup>3</sup>/s and slope-area measurements at gage heights 19.15 and 23.8 ft; minimum daily, 60 ft<sup>3</sup>/s, Sept. 7–14, 1977.

EXTREMES FOR CURRENT YEAR.—Peak discharges greater than base discharge of 3,200 ft<sup>3</sup>/s, or maximum:

Date	Time	Discharge (ft <sup>3</sup> /s)	Gage height (ft)
Mar. 25	0815	2,240	6.77

## DISCHARGE, CUBIC FEET PER SECOND, WATER YEAR OCTOBER 2000 TO SEPTEMBER 2001

## DAILY MEAN VALUES

DAY	OCT	NOV	DEC	JAN	FEB	MAR	APR	MAY	JUN	JUL	AUG	SEP
1	144	177	179	163	169	244	1020	1330	297	160	119	104
2	144	174	170	160	169	255	962	1260	285	156	118	104
3	143	177	165	160	173	243	764	1000	278	153	116	103
4	143	173	162	159	191	418	653	953	269	151	114	103
5	143	168	159	158	219	739	583	1000	259	150	115	103
6	141	166	157	158	210	589	574	1030	255	148	114	101
7	141	161	156	157	197	512	582	1110	247	147	112	100
8	140	158	156	166	184	534	514	1260	239	148	111	100
9	150	160	161	165	199	517	470	1330	231	145	110	99
10	199	161	218	203	202	441	447	1280	224	144	109	100
11	187	159	194	250	205	391	479	1240	220	143	110	101
12	177	153	202	209	193	360	454	1200	218	142	110	103
13	163	155	194	192	191	364	441	1110	212	138	110	103
14	160	167	327	184	184	393	430	996	207	136	110	103
15	157	160	274	174	182	393	442	1030	201	135	109	102
16	155	155	217	168	184	371	483	1130	197	133	108	101
17	153	153	199	161	186	368	564	951	193	133	107	101
18	151	153	183	165	204	436	671	842	188	134	106	100
19	149	154	180	165	260	530	846	764	185	132	106	100
20	150	154	177	164	340	679	760	703	181	131	105	100
21	155	153	178	162	500	770	717	662	178	130	105	99
22	149	152	199	162	561	814	702	609	174	128	108	98
23	147	151	186	171	397	828	736	571	171	128	108	98
24	148	151	179	210	334	873	875	526	167	126	108	98
25	153	152	172	195	323	1740	1090	479	167	123	107	122
26	166	151	167	193	301	1220	1280	441	182	122	105	112
27	167	152	166	184	280	950	1290	405	184	120	104	105
28	222	159	164	177	262	991	1210	373	181	118	103	104
29	363	236	164	183	---	1090	1070	353	172	117	103	103
30	215	203	165	176	---	1010	1130	334	165	118	103	101
31	187	---	163	171	---	986	---	311	---	121	104	---
TOTAL	5162	4898	5733	5465	7000	20049	22239	26583	6327	4210	3377	3071
MEAN	167	163	185	176	250	647	741	858	211	136	109	102
MAX	363	236	327	250	561	1740	1290	1330	297	160	119	122
MIN	140	151	156	157	169	243	430	311	165	117	103	98
AC-FT	10240	9720	11370	10840	13880	39770	44110	52730	12550	8350	6700	6090

## 11413000 NORTH YUBA RIVER BELOW GOODYEARS BAR, CA—Continued

## STATISTICS OF MONTHLY MEAN DATA FOR WATER YEARS 1931 - 2001, BY WATER YEAR (WY)

	OCT	NOV	DEC	JAN	FEB	MAR	APR	MAY	JUN	JUL	AUG	SEP
MEAN	186	352	643	880	963	1073	1376	1792	1116	370	187	152
MAX	1407	2380	3830	4526	4367	3074	2822	3894	3627	1384	417	256
(WY)	1963	1951	1965	1997	1986	1995	1982	1952	1983	1983	1983	1983
MIN	71.8	107	97.3	117	138	151	241	335	170	82.7	66.8	71.0
(WY)	1978	1978	1977	1991	1977	1977	1977	1977	1992	1977	1977	1977

SUMMARY STATISTICS	FOR 2000 CALENDAR YEAR		FOR 2001 WATER YEAR		WATER YEARS 1931 - 2001	
ANNUAL TOTAL	260722		114114			
ANNUAL MEAN	712		313		756	
HIGHEST ANNUAL MEAN					1566	
LOWEST ANNUAL MEAN					141	
HIGHEST DAILY MEAN	7160	Feb 14	1740	Mar 25	29600	Jan 2 1997
LOWEST DAILY MEAN	140	Oct 8	98	Sep 22	60	Sep 7 1977
ANNUAL SEVEN-DAY MINIMUM	142	Oct 2	99	Sep 18	60	Sep 7 1977
MAXIMUM PEAK FLOW			2240	Mar 25	45500	Jan 2 1997
MAXIMUM PEAK STAGE			6.77	Mar 25	25.65	Jan 2 1997
ANNUAL RUNOFF (AC-FT)	517100		226300		547800	
10 PERCENT EXCEEDS	1710		834		1870	
50 PERCENT EXCEEDS	275		174		329	
90 PERCENT EXCEEDS	153		106		127	



## 11413250 SLATE CREEK TUNNEL NEAR STRAWBERRY VALLEY, CA

LOCATION.—Lat 39°36'57", long 121°03'03", in SE 1/4 SW 1/4 sec.2, T.20 N., R.8 E., [Plumas County](#), Hydrologic Unit 18020125, Plumas National Forest, on right bank, 30 ft upstream from diversion dam on Slate Creek, 0.3 mi upstream from Feny Ravine, and 4.5 mi northeast of town of Strawberry Valley.

PERIOD OF RECORD.—February 1962 to current year. Monthly discharge only published as adjustment to Slate Creek below diversion dam near Strawberry Valley (station 11413300) February 1962 to September 1966; records of daily discharge are in files of the U.S. Geological Survey.

GAGE.—Water-stage recorder. Datum of gage is sea level.

REMARKS.—Tunnel diverts water from Slate Creek to Sly Creek Reservoir (station 11395400) for power development. See schematic diagrams of [South Fork Feather River](#) and [North Yuba River Basins](#).

COOPERATION.—Records provided by Oroville–Wyandotte Irrigation District, under general supervision of the U.S. Geological Survey, in connection with a Federal Energy Regulatory Commission project.

EXTREMES FOR PERIOD OF RECORD.—Maximum daily discharge, 863 ft<sup>3</sup>/s, Apr. 6, 1963; no flow for many days in each year.

DISCHARGE, CUBIC FEET PER SECOND, WATER YEAR OCTOBER 2000 TO SEPTEMBER 2001  
DAILY MEAN VALUES

DAY	OCT	NOV	DEC	JAN	FEB	MAR	APR	MAY	JUN	JUL	AUG	SEP
1	.00	2.5	17	11	13	41	475	426	35	4.9	.00	.00
2	.00	4.5	11	11	14	40	436	381	33	4.3	.00	.00
3	.00	6.5	8.7	10	14	36	319	301	31	3.9	.00	.00
4	.00	4.8	7.0	10	22	59	254	278	29	3.5	.00	.00
5	.00	3.4	5.8	9.9	37	155	215	282	27	3.0	.00	.00
6	.00	2.5	4.7	10	38	154	201	280	26	.94	.00	.00
7	.00	1.9	4.3	10	33	147	182	293	24	.00	.00	.00
8	.00	1.4	4.0	14	28	166	153	321	21	.00	.00	.00
9	.00	.47	4.3	14	26	156	137	316	20	.00	.00	.00
10	9.1	.00	29	20	17	136	129	292	18	.00	.00	.00
11	8.4	.00	18	24	17	124	136	272	17	.00	.00	.00
12	5.5	.00	17	22	22	116	123	247	17	.00	.00	.00
13	.21	.00	16	19	27	127	123	214	15	.00	.00	.00
14	.00	.00	33	16	23	140	121	184	14	.00	.00	.00
15	.00	.00	38	12	21	137	131	180	13	.00	.00	.00
16	.00	.00	29	11	21	122	152	181	12	.00	.00	.00
17	.00	.00	25	10	21	123	196	153	11	.00	.00	.00
18	.00	.00	19	13	24	160	255	135	10	.00	.00	.00
19	.00	.00	16	13	38	218	374	121	9.4	.00	.00	.00
20	.00	.00	14	12	47	305	297	109	8.7	.00	.00	.00
21	.00	.00	16	11	70	366	258	101	7.9	.00	.00	.00
22	.00	.00	50	12	100	399	263	90	7.2	.00	.00	.00
23	.00	.00	38	16	71	421	278	82	6.3	.00	.00	.00
24	.00	.00	28	23	57	434	355	74	5.6	.00	.00	.00
25	.00	.00	22	17	49	786	472	67	5.9	.00	.00	.00
26	.00	.00	17	19	46	680	533	60	11	.00	.00	.00
27	.00	.00	14	16	44	463	499	56	9.9	.00	.00	.00
28	.00	.00	12	15	44	452	450	50	10	.00	.00	.00
29	13	42	12	17	---	507	388	46	7.9	.00	.00	.00
30	17	34	12	13	---	468	393	42	6.0	.00	.00	.00
31	7.3	---	11	13	---	459	---	38	---	.00	.00	---
TOTAL	60.51	103.97	552.8	443.9	984	8097	8298	5672	468.8	20.54	0.00	0.00
MEAN	1.95	3.47	17.8	14.3	35.1	261	277	183	15.6	.66	.000	.000
MAX	17	42	50	24	100	786	533	426	35	4.9	.00	.00
MIN	.00	.00	4.0	9.9	13	36	121	38	5.6	.00	.00	.00
AC-FT	120	206	1100	880	1950	16060	16460	11250	930	41	.00	.00

## STATISTICS OF MONTHLY MEAN DATA FOR WATER YEARS 1963 - 2001, BY WATER YEAR (WY)

MEAN	7.98	62.0	90.1	129	149	215	224	210	109	22.9	3.05	1.45
MAX	43.5	321	302	408	595	588	690	638	470	144	24.2	21.1
(WY)	1983	1984	1967	1995	1996	1993	1993	1973	1998	1983	1983	1986
MIN	.000	.000	.000	.000	.000	.000	.000	.000	.028	.000	.000	.000
(WY)	1963	1963	1974	1965	1965	1969	1969	1977	1977	1966	1963	1963

## SUMMARY STATISTICS FOR 2000 CALENDAR YEAR FOR 2001 WATER YEAR WATER YEARS 1963 - 2001

ANNUAL TOTAL	40279.88	24701.52	
ANNUAL MEAN	110	67.7	102
HIGHEST ANNUAL MEAN			209
LOWEST ANNUAL MEAN			.002
HIGHEST DAILY MEAN	779	Jan 25	786
LOWEST DAILY MEAN	.00	Feb 16	.00
ANNUAL SEVEN-DAY MINIMUM	.00	Feb 16	.00
ANNUAL RUNOFF (AC-FT)	79900	49000	73620
10 PERCENT EXCEEDS	361	267	336
50 PERCENT EXCEEDS	11	12	15
90 PERCENT EXCEEDS	.00	.00	.00



## 11413320 DEADWOOD CREEK NEAR STRAWBERRY VALLEY, CA

LOCATION.—Lat 39°33'00", long 121°05'36", in SW 1/4 SW 1/4 sec.33, T.20 N., R.8 E., Yuba County, Hydrologic Unit 18020125, Plumas National Forest, on right bank, 250 ft upstream of confluence with Owl Gulch, and 1.3 mi southeast of Strawberry Valley.

DRAINAGE AREA.—3.16 mi<sup>2</sup>.

PERIOD OF RECORD.—October 1994 to current year.

GAGE.—Water-stage recorder and 120° V-notch weir. Elevation of gage is 3,275 ft above sea level, from topographic map.

REMARKS.—Water from creek is diverted at gage to Deadwood Creek Powerplant (station 11413326). See schematic diagram of North Yuba River Basin.

COOPERATION.—Records provided by Yuba County Water Agency, under general supervision of the U.S. Geological Survey, in connection with a Federal Energy Regulatory Commission project.

EXTREMES FOR PERIOD OF RECORD.—Maximum daily discharge, 400 ft<sup>3</sup>/s, Jan. 1, 1997; minimum daily, 1.7 ft<sup>3</sup>/s, several days in February and March 1997.

## DISCHARGE, CUBIC FEET PER SECOND, WATER YEAR OCTOBER 2000 TO SEPTEMBER 2001

## DAILY MEAN VALUES

DAY	OCT	NOV	DEC	JAN	FEB	MAR	APR	MAY	JUN	JUL	AUG	SEP
1	3.3	4.1	4.1	3.8	4.0	3.4	2.6	2.8	4.1	3.2	2.4	2.0
2	3.3	4.0	3.9	3.7	4.0	4.9	2.6	2.8	4.1	3.1	2.3	2.0
3	3.3	3.8	3.8	3.7	4.1	2.6	2.6	2.8	4.1	3.1	2.3	2.0
4	3.3	3.7	3.7	3.7	4.2	2.7	2.6	2.8	4.0	3.0	2.3	2.0
5	3.2	3.6	3.6	3.6	4.4	3.0	2.6	2.8	4.0	3.1	2.3	2.0
6	3.2	3.6	3.5	3.6	3.7	2.8	2.6	2.8	3.9	3.1	2.3	2.0
7	3.2	3.5	3.6	3.6	3.9	2.8	2.6	2.8	3.9	3.1	2.3	1.9
8	3.2	3.5	3.6	3.5	4.1	2.8	2.6	2.8	3.8	3.2	2.3	1.9
9	4.3	3.5	3.8	3.9	4.3	2.8	2.6	2.8	3.8	3.1	2.2	1.9
10	7.0	3.7	3.9	2.8	4.6	2.8	2.6	2.8	3.7	3.1	2.2	1.9
11	5.4	3.6	4.0	2.9	4.6	2.8	2.7	2.8	3.7	2.8	2.2	1.9
12	4.3	3.6	4.9	2.9	4.6	2.7	2.8	2.8	3.7	2.7	2.2	1.9
13	4.0	3.6	5.8	2.9	4.2	2.6	2.7	2.8	3.6	2.7	2.2	1.9
14	3.8	3.8	14	2.8	4.1	2.6	2.6	2.8	3.6	2.7	2.2	1.9
15	3.7	3.7	5.4	2.8	4.0	2.6	2.6	2.8	3.6	2.6	2.2	1.9
16	3.7	3.7	2.8	3.3	3.6	2.6	2.6	2.8	3.5	2.7	2.2	1.9
17	3.2	3.6	2.8	4.3	3.9	2.6	2.6	2.8	3.5	2.7	2.1	1.9
18	3.6	3.6	3.7	4.1	4.4	2.6	2.6	2.8	3.4	2.6	2.1	1.9
19	3.6	3.5	4.4	4.0	3.9	2.6	2.6	2.8	3.4	2.6	2.1	1.9
20	3.6	3.5	4.3	3.9	2.7	2.6	2.8	2.8	3.3	2.6	2.1	1.9
21	3.7	3.5	4.4	3.9	3.7	2.6	2.9	2.8	3.3	2.6	2.1	1.9
22	3.5	3.6	2.9	3.9	16	2.6	2.9	2.8	3.3	2.6	2.1	1.9
23	3.5	3.5	4.3	3.6	11	2.6	2.8	2.8	3.3	2.6	2.1	1.9
24	3.5	3.6	4.4	2.6	9.6	2.6	2.8	3.2	3.2	2.6	2.1	1.9
25	4.1	3.6	4.2	2.6	9.9	2.7	2.8	4.4	3.4	2.6	2.1	2.6
26	4.1	3.6	4.1	2.6	8.8	2.6	2.8	4.4	3.7	2.5	2.1	2.1
27	3.9	3.7	4.0	2.6	8.1	2.8	2.8	4.4	3.7	2.5	2.1	2.1
28	5.9	3.7	4.0	3.9	5.4	2.8	2.8	4.4	3.2	2.4	2.0	2.0
29	9.2	5.9	3.9	3.3	---	2.8	2.8	4.3	3.3	2.4	2.0	2.0
30	5.6	4.9	3.9	3.9	---	2.7	2.8	4.2	3.2	2.4	2.0	1.9
31	4.6	---	3.9	4.1	---	2.6	---	4.1	---	2.5	2.0	---
TOTAL	127.8	112.8	133.6	106.8	153.8	86.3	80.8	97.8	108.3	85.5	67.2	58.9
MEAN	4.12	3.76	4.31	3.45	5.49	2.78	2.69	3.15	3.61	2.76	2.17	1.96
MAX	9.2	5.9	14	4.3	16	4.9	2.9	4.4	4.1	3.2	2.4	2.6
MIN	3.2	3.5	2.8	2.6	2.7	2.6	2.6	2.8	3.2	2.4	2.0	1.9
AC-FT	253	224	265	212	305	171	160	194	215	170	133	117
a	.00	.00	23	74	48	895	474	145	.00	2.4	.00	.00

## STATISTICS OF MONTHLY MEAN DATA FOR WATER YEARS 1995 - 2001, BY WATER YEAR (WY)

	1995	1996	1997	1998	1999	2000	2001	1995	1996	1997	1998	1999	2000	2001
MEAN	3.90	3.86	5.74	12.3	11.0	7.01	4.13	4.15	3.02	3.12	3.25	3.43		
MAX	4.75	4.73	17.7	42.4	20.3	22.8	10.7	10.7	3.61	4.16	4.13	4.35		
(WY)	1999	1997	1997	1997	1998	1995	1995	1995	2001	1997	1997	1996		
MIN	2.04	3.09	2.75	3.34	4.64	2.78	2.69	2.63	2.54	2.57	2.17	1.96		
(WY)	1995	1995	1998	2000	1997	2001	2001	1999	1999	1999	2001	2001		

SUMMARY STATISTICS	FOR 2000 CALENDAR YEAR		FOR 2001 WATER YEAR		WATER YEARS 1995 - 2001	
ANNUAL TOTAL	1495.4		1219.6			
ANNUAL MEAN	4.09		3.34		5.38	
HIGHEST ANNUAL MEAN					8.23	
LOWEST ANNUAL MEAN					3.34	
HIGHEST DAILY MEAN	68	Feb 14	16	Feb 22	400	Jan 1 1997
LOWEST DAILY MEAN	2.4	Jan 22	1.9	Sep 7	1.7	Feb 24 1997
ANNUAL SEVEN-DAY MINIMUM	2.5	Mar 30	1.9	Sep 7	1.7	Feb 23 1997
ANNUAL RUNOFF (AC-FT)	2970		2420		3900	
TOTAL DIVERSION (AC-FT) a	5680		1660		8750	
10 PERCENT EXCEEDS	4.7		4.3		6.4	
50 PERCENT EXCEEDS	3.5		3.1		3.0	
90 PERCENT EXCEEDS	2.6		2.1		2.6	

a Diversion, in acre-feet, to Deadwood Creek Powerplant (station 11413326), provided by Yuba County Water Agency.

## 11413323 OWL GULCH NEAR STRAWBERRY VALLEY, CA

LOCATION.—Lat 39°32'44", long 121°05'39", in SW 1/4 SW 1/4 sec.33, T.20 N., R.8 E., Yuba County, Hydrologic Unit 18020125, Plumas National Forest, on left bank, 250 ft upstream from Deadwood Creek, and 1.3 mi southeast of Strawberry Valley.

DRAINAGE AREA.—2.07 mi<sup>2</sup>.

PERIOD OF RECORD.—October 1994 to current year.

GAGE.—Water-stage recorder and 120° V-notch weir. Elevation of gage is 3,050 ft above sea level, from topographic map.

REMARKS.—Water from creek is diverted at gage to Deadwood Creek Powerplant (station 11413326). See schematic diagram of [North Yuba River Basin](#).

COOPERATION.—Records provided by Yuba County Water Agency, under general supervision of the U.S. Geological Survey, in connection with a Federal Energy Regulatory Commission project.

EXTREMES FOR PERIOD OF RECORD.—Maximum daily discharge, 346 ft<sup>3</sup>/s, Jan. 1, 1997; minimum daily, 0.58 ft<sup>3</sup>/s, Sept. 17–22, 1997.

## DISCHARGE, CUBIC FEET PER SECOND, WATER YEAR OCTOBER 2000 TO SEPTEMBER 2001

## DAILY MEAN VALUES

DAY	OCT	NOV	DEC	JAN	FEB	MAR	APR	MAY	JUN	JUL	AUG	SEP
1	1.2	1.5	1.7	1.6	1.9	2.4	1.8	1.7	2.1	1.6	1.1	.80
2	1.2	1.5	1.5	1.6	1.9	3.7	1.8	1.7	2.0	1.6	1.0	.80
3	1.2	1.5	1.5	1.6	1.9	1.8	1.8	1.8	2.0	1.5	1.0	.77
4	1.1	1.4	1.4	1.6	2.0	2.1	1.8	1.7	2.0	1.5	1.0	.77
5	1.1	1.4	1.4	1.5	2.0	2.6	1.7	1.7	1.8	1.5	1.0	.77
6	1.1	1.4	1.4	1.5	2.0	1.8	1.8	1.7	1.9	1.4	.97	.77
7	1.1	1.4	1.4	1.5	2.0	1.7	1.8	1.7	1.8	1.4	.97	.77
8	1.1	1.4	1.4	1.7	2.0	1.7	1.8	1.6	1.8	1.4	.97	.77
9	1.4	1.4	1.5	1.8	2.0	1.7	1.7	1.7	1.7	1.4	.93	.77
10	2.5	1.4	1.5	1.8	2.2	1.7	1.8	1.7	1.7	1.4	.93	.77
11	2.0	1.4	1.6	1.8	2.1	1.7	1.7	1.6	1.7	1.4	.93	.80
12	1.5	1.4	2.0	1.8	2.1	1.8	1.8	1.6	1.7	1.3	.93	.77
13	1.4	1.4	2.5	1.8	1.9	1.8	1.8	1.6	1.6	1.3	.93	.77
14	1.4	1.5	6.0	1.8	1.9	1.8	1.8	1.6	1.6	1.3	.89	.77
15	1.3	1.4	3.2	1.8	1.8	1.8	1.8	1.6	1.7	1.3	.89	.77
16	1.3	1.4	1.8	1.8	1.8	1.8	1.8	1.6	1.6	1.3	.89	.77
17	1.3	1.4	1.8	2.0	1.8	1.8	1.8	1.6	1.6	1.3	.89	.77
18	1.3	1.4	1.8	1.9	2.0	1.8	1.8	1.7	1.6	1.3	.84	.77
19	1.3	1.4	1.8	1.9	2.6	1.8	1.8	1.7	1.6	1.3	.84	.77
20	1.3	1.4	1.8	1.8	2.3	1.8	2.6	1.7	1.6	1.2	.84	.73
21	1.3	1.4	1.8	1.8	3.6	1.8	2.4	1.6	1.7	1.2	.84	.73
22	1.2	1.4	1.8	1.8	4.1	1.8	1.9	1.6	1.7	1.2	.84	.73
23	1.2	1.4	1.8	1.8	4.1	1.8	1.8	1.6	1.7	1.1	.89	.73
24	1.3	1.4	1.8	1.8	4.1	1.8	1.8	1.8	1.7	1.2	.84	.73
25	1.5	1.4	1.7	1.8	4.1	2.0	1.8	2.4	1.7	1.1	.84	1.0
26	1.5	1.4	1.7	1.8	4.2	1.8	1.8	2.3	1.8	1.1	.84	.84
27	1.5	1.4	1.7	1.7	4.3	1.8	1.8	2.3	1.8	1.1	.84	.84
28	2.3	1.4	1.7	2.0	3.6	1.8	1.8	2.3	1.8	1.1	.80	.80
29	3.2	2.4	1.6	1.9	---	1.7	1.8	2.3	1.8	1.1	.80	.80
30	2.2	2.0	1.6	2.0	---	1.8	1.7	2.2	1.7	1.1	.80	.77
31	1.7	---	1.6	1.9	---	1.8	---	2.1	---	1.1	.80	---
TOTAL	46.0	44.0	57.8	54.9	72.3	59.0	55.1	55.8	52.5	40.1	27.87	23.42
MEAN	1.48	1.47	1.86	1.77	2.58	1.90	1.84	1.80	1.75	1.29	.90	.78
MAX	3.2	2.4	6.0	2.0	4.3	3.7	2.6	2.4	2.1	1.6	1.1	1.0
MIN	1.1	1.4	1.4	1.5	1.8	1.7	1.7	1.6	1.6	1.1	.80	.73
AC-FT	91	87	115	109	143	117	109	111	104	80	55	46

## STATISTICS OF MONTHLY MEAN DATA FOR WATER YEARS 1995 - 2001, BY WATER YEAR (WY)

	1995	1996	1997	1998	1999	2000	2001	2002	2003	2004	2005	2006
MEAN	1.69	1.79	3.65	10.2	9.62	6.44	3.44	3.54	2.06	1.80	1.48	1.41
MAX	2.85	2.17	14.2	35.3	23.7	16.3	8.74	10.6	2.87	2.06	1.90	2.09
(WY)	1999	1999	1997	1997	1998	1995	1995	1995	1998	1997	1998	1998
MIN	.99	1.47	1.70	1.77	2.58	1.90	1.84	1.80	1.75	1.29	.77	.78
(WY)	1995	2001	2000	2001	2001	2001	2001	2001	2001	2001	1997	2001

## SUMMARY STATISTICS FOR 2000 CALENDAR YEAR FOR 2001 WATER YEAR WATER YEARS 1995 - 2001

	2000 CALENDAR YEAR	2001 WATER YEAR	1995 - 2001
ANNUAL TOTAL	972.1	588.79	
ANNUAL MEAN	2.66	1.61	3.91
HIGHEST ANNUAL MEAN			6.02 1997
LOWEST ANNUAL MEAN			1.61 2001
HIGHEST DAILY MEAN	46 Feb 14	6.0 Dec 14	346 Jan 1 1997
LOWEST DAILY MEAN	1.1 Oct 4	.73 Sep 20	.58 Sep 17 1997
ANNUAL SEVEN-DAY MINIMUM	1.1 Oct 2	.74 Sep 18	.58 Sep 16 1997
ANNUAL RUNOFF (AC-FT)	1930	1170	2830
10 PERCENT EXCEEDS	3.2	2.0	7.5
50 PERCENT EXCEEDS	1.8	1.6	1.8
90 PERCENT EXCEEDS	1.3	.84	1.3

## 11413510 NEW COLGATE POWERPLANT NEAR FRENCH CORRAL, CA

LOCATION.—Lat 39°19'51", long 121°11'23", in NE 1/4 SE 1/4 sec.16, T.17 N., R.7 E., Yuba County, Hydrologic Unit 18020125, at powerplant, on right bank of Yuba River, 0.3 mi upstream from Dobbins Creek, and 2.3 mi northwest of French Corral.

PERIOD OF RECORD.—October 1966 to current year. Prior to October 1969, published as "Colgate Powerplant."

GAGE.—Recorded output from powerplant turbines.

REMARKS.—Water is diverted from North Yuba River at New Bullards Bar Reservoir (station 11413515). Colgate Powerplant was rebuilt during the 1970 water year with an increased capacity. Prior to Oct. 31, 1973, Browns Valley Ditch diverted up to 10 ft<sup>3</sup>/s at times from the head of the penstock for use in irrigation. See schematic diagram of North Yuba River Basin.

COOPERATION.—Records provided by Yuba County Water Agency, under general supervision of the U.S. Geological Survey, in connection with a Federal Energy Regulatory Commission project.

## DISCHARGE, CUBIC FEET PER SECOND, WATER YEAR OCTOBER 2000 TO SEPTEMBER 2001

## DAILY MEAN VALUES

DAY	OCT	NOV	DEC	JAN	FEB	MAR	APR	MAY	JUN	JUL	AUG	SEP
1	1320	1260	901	438	524	550	.00	728	929	.00	2480	.00
2	1390	1280	898	1300	498	129	824	304	.00	1550	2420	.00
3	1430	1040	897	1230	.00	.00	746	1120	.00	1600	2370	.00
4	522	101	934	962	64	.00	417	768	886	680	968	1220
5	889	.00	968	708	507	.00	825	.00	1040	2020	414	821
6	814	976	961	.00	643	127	47	.00	1310	2010	2160	795
7	452	1250	841	.00	814	276	.00	884	1120	1470	2360	954
8	608	1220	510	430	798	.00	.00	1280	1380	1290	2410	.00
9	1040	1250	480	1090	713	.00	108	1740	.00	2660	2230	.00
10	1180	1400	793	1000	.00	.00	615	1590	.00	2930	2390	1010
11	1180	3.0	922	764	.00	.00	806	1560	1060	2820	800	900
12	1240	.00	925	775	202	158	615	.00	1360	2600	949	2040
13	1360	990	860	.00	374	.00	1020	.00	1280	1290	2160	1040
14	.00	1330	380	.00	233	.00	1270	1370	1340	1060	2230	578
15	.00	1400	580	1360	316	252	1.0	1420	1220	1110	2250	.00
16	1040	1550	305	1480	126	.00	851	1110	.00	2260	2400	.00
17	1370	1300	379	1280	.00	.00	1030	1180	.00	2410	2290	738
18	1390	3.0	902	1440	.00	.00	573	1180	1410	2660	1130	781
19	1380	334	1100	1300	.00	1360	701	.00	1260	2720	1100	789
20	1360	1080	1070	.00	188	276	1180	.00	1280	2680	2070	642
21	134	897	1130	.00	94	336	608	995	1250	1090	2320	700
22	.00	1480	1160	833	.00	297	17	1160	1240	822	1790	.00
23	1080	1770	328	755	54	371	435	701	.00	2350	2400	.00
24	1320	1740	386	1190	.00	.00	339	624	.00	2490	1990	965
25	1470	846	770	1700	.00	.00	850	803	1220	2520	.00	860
26	1480	825	394	359	204	330	290	.00	1330	2610	.00	765
27	1530	972	1010	30	221	580	214	.00	1320	2410	1360	672
28	12	1030	1150	.00	1120	736	320	.00	1310	997	1450	693
29	.00	850	1260	937	---	683	341	1360	1400	1020	1340	.00
30	984	994	586	821	---	741	942	1210	.00	2610	1100	.00
31	1180	---	455	515	---	28	---	1380	---	2790	1250	---
TOTAL	29155.00	29171.00	24235	22697.00	7693.00	7230.00	15985.00	24467.00	25945.00	59529.00	52581.00	16963.00
MEAN	940	972	782	732	275	233	533	789	865	1920	1696	565
MAX	1530	1770	1260	1700	1120	1360	1270	1740	1410	2930	2480	2040
MIN	.00	.00	305	.00	.00	.00	.00	.00	.00	.00	.00	.00
AC-FT	57830	57860	48070	45020	15260	14340	31710	48530	51460	118100	104300	33650

## STATISTICS OF MONTHLY MEAN DATA FOR WATER YEARS 1971 - 2001, BY WATER YEAR (WY)

	1971	1972	1973	1974	1975	1976	1977	1978	1979	1980	1981	1982	1983	1984	1985	1986	1987	1988	1989	1990	1991	1992	1993	1994	1995	1996	1997	1998	1999	2000	2001
MEAN	1200	1129	1377	1517	1692	1713	1712	1505	1648	1774	1935	1350																			
MAX	2497	2433	3262	3496	3525	3519	3508	3565	3629	3057	3130	2995																			
(WY)	1976	1976	1975	1984	1998	1980	1993	1982	1983	1983	1984	1980																			
MIN	.000	302	96.6	152	54.6	39.3	103	206	404	386	319	.000																			
(WY)	1975	1978	1978	1977	1977	1977	1979	1977	1977	1977	1977	1974																			

SUMMARY STATISTICS	FOR 2000 CALENDAR YEAR	FOR 2001 WATER YEAR	WATER YEARS 1971 - 2001
ANNUAL TOTAL	532471.70	315651.00	
ANNUAL MEAN	1455	865	1546
HIGHEST ANNUAL MEAN			2686
LOWEST ANNUAL MEAN			316
HIGHEST DAILY MEAN	3570	Mar 10	2930
LOWEST DAILY MEAN	.00	Jan 19	.00
ANNUAL SEVEN-DAY MINIMUM	.00	Jan 19	23
ANNUAL RUNOFF (AC-FT)	1056000	626100	1120000
10 PERCENT EXCEEDS	3050	1870	3390
50 PERCENT EXCEEDS	1360	846	1280
90 PERCENT EXCEEDS	124	.00	148

## 11413515 NEW BULLARDS BAR RESERVOIR NEAR NORTH SAN JUAN, CA

LOCATION.—Lat 39°23'34", long 121°08'25", in SE 1/4 NW 1/4 sec.25, T.18 N., R.7 E., Yuba County, Hydrologic Unit 18020125, Plumas National Forest, in center of dam on North Yuba River, 2.2 mi upstream from Middle Yuba River, and 2.4 mi northwest of North San Juan.

DRAINAGE AREA.—489 mi<sup>2</sup>.

PERIOD OF RECORD.—January 1969 to current year.

GAGE.—Water-stage recorder. Datum of gage is sea level (levels by Yuba County Water Agency).

REMARKS.—Reservoir is formed by concrete-arch dam with a concrete-sidehill spillway. Spill controlled by three 30-ft by 53-ft radial gates. Storage began in January 1969. Usable capacity, 727,380 acre-ft, between elevations 1,732.0 ft, minimum power pool and 1,955.0 ft, normal gross pool. Dead storage, 233,920 acre-ft. Total capacity at normal gross pool, 961,300 acre-ft, elevation, 1,955.0 ft. Water is released to New Colgate Powerplant (station 11413510) through a tunnel at the dam. Water is diverted into the reservoir from Middle Yuba River via Lohman Ridge Tunnel to Oregon Creek then via Camptonville Tunnel (stations 11408870 and 11409350). Records, including extremes, represent total contents at 2400 hours. See schematic diagram of [North Yuba River Basin](#).

COOPERATION.—Records provided by Yuba County Water Agency, under general supervision of the U.S. Geological Survey, in connection with a Federal Energy Regulatory Commission project. Contents not rounded to U.S. Geological Survey standards.

EXTREMES FOR PERIOD OF RECORD.—Maximum contents, 972,224 acre-ft, June 27, 1995, elevation, 1,957.27 ft; minimum since reservoir first filled, 178,230 acre-ft, Dec. 29, 1980, elevation, 1,700.00 ft.

EXTREMES FOR CURRENT YEAR.—Maximum contents, 803,732 acre-ft, May 28, elevation, 1,920.11 ft; minimum, 537,967 acre-ft, Sept. 28, elevation, 1,849.46 ft.

Capacity table (elevation, in feet, and contents, in acre-feet)  
(Based on survey by Yuba County Water Agency in 1969)

1,600	64,900	1,690	162,983	1,800	389,977	1,900	721,130
1,630	90,570	1,720	211,768	1,850	539,748	1,960	985,471
1,660	122,993	1,750	270,110				

## RESERVOIR STORAGE (ACRE-FEET), WATER YEAR OCTOBER 2000 TO SEPTEMBER 2001

## DAILY OBSERVATION AT 2400 HOURS

DAY	OCT	NOV	DEC	JAN	FEB	MAR	APR	MAY	JUN	JUL	AUG	SEP
1	700737	661971	622114	601011	581920	613203	705888	765390	798387	766297	655051	563212
2	698403	660058	620996	599141	581678	614743	708198	769104	799149	763825	650588	563450
3	696036	658373	619771	597310	582405	616284	709963	770386	799911	761113	646146	563654
4	695377	658523	618511	595973	583132	619015	711771	772913	799022	760005	644484	561518
5	693906	659048	617110	595166	583132	624029	712597	775819	797794	756605	643968	560097
6	692553	657739	615710	595587	582924	627652	715316	780524	796102	753012	640067	558679
7	691780	655685	614564	596149	582232	630413	718002	782195	794583	750487	635704	556947
8	690969	653747	614062	596219	581505	633731	720297	782988	792558	748252	631288	557161
9	689659	651739	613704	594990	581367	636948	722042	783951	793064	743511	627144	557364
10	688541	649772	612846	594323	582681	639589	722916	785039	793697	738145	622764	555646
11	687156	650106	611987	594604	584103	642015	723392	786003	792263	733006	621356	554101
12	685313	650551	611095	594288	584693	643820	724226	789949	790159	728208	619735	552323
13	683242	649402	610774	595201	584762	645924	724346	793528	788268	725977	615781	550516
14	683511	647328	612274	596043	585109	648068	723868	794076	786129	724226	611595	549546
15	683970	645222	613561	594218	585318	649809	725618	794540	784243	722360	607425	549780
16	682515	642641	614348	592116	585943	651925	725937	795849	784662	718279	602956	550015
17	680220	640581	614528	590019	586812	653971	726176	796525	785249	713936	598682	548812
18	677969	640912	613489	588275	587927	656244	727809	796652	783030	708982	596711	547511
19	675685	640765	612095	586361	590019	656356	730045	799022	781109	703934	594709	546146
20	673405	639259	610667	586778	592571	659235	731524	801269	779023	699025	590893	545115
21	673481	637938	609277	587439	597626	662308	733687	801226	777066	697161	586534	543920
22	673861	635595	607924	586499	602496	665645	736818	800463	775071	695842	582994	544119
23	672267	632636	608102	585943	605366	668823	739072	800590	775362	691587	578224	544318
24	670033	629795	608031	584589	607995	673102	742016	801014	775736	686964	574303	542693
25	667804	628560	607248	582578	610239	681329	744522	800251	773992	682362	574303	541434
26	665525	627507	607070	582578	611952	686273	748658	801524	771877	677550	574509	540244
27	663059	626128	605649	583548	613274	689312	753053	802627	769848	673102	572212	539121
28	664074	624716	604018	584311	612810	692089	756851	803732	767782	671358	569646	537967
29	666295	624246	602177	583583	---	695377	760169	802288	765555	669579	567190	538165
30	665525	623198	601683	582751	---	698209	762304	800929	765926	664827	565216	538363
31	663886	---	601363	582232	---	702022	---	799276	---	659646	563042	---
MAX	700737	661971	622114	601011	613274	702022	762304	803732	799911	766297	655051	563654
MIN	663059	623198	601363	582232	581367	613203	705888	765390	765555	659646	563042	537967
a	1885.18	1874.14	1868.03	1862.56	1871.25	1895.14	1910.20	1919.06	1911.08	1884.05	1856.96	1849.58
b	-38994	-40688	-21835	-19131	+30578	+89212	+60282	+36972	-33350	-106280	-96604	-24679

CAL YR 2000 b +91330

WTR YR 2001 b -164517

a Elevation, in feet, at end of month.

b Change in contents, in acre-feet.

## 11413520 NORTH YUBA RIVER BELOW NEW BULLARDS BAR DAM, NEAR NORTH SAN JUAN, CA

LOCATION.—Lat 39°23'26", long 121°08'36", in SE 1/4 NW 1/4 sec.25, T.18 N., R.7 E., Yuba County, Hydrologic Unit 18020125, Plumas National Forest, on right bank, at old Colgate Dam, 0.2 mi downstream from New Bullards Bar Dam, and 2.5 mi northwest of North San Juan.

DRAINAGE AREA.—490 mi<sup>2</sup>.

PERIOD OF RECORD.—August 1966 to current year.

GAGE.—Water-stage recorder, and sharp-crested low-water control since Oct. 1, 1986. Elevation of gage is 1,350 ft above sea level, from topographic map. Auxiliary water-stage recorder for high flow 0.9 mi downstream at different datum.

REMARKS.—Records good except for estimated daily discharges, which are fair. Flow regulated by New Bullards Bar Reservoir (station 11413515) since 1969. Prior to 1969, flow regulated by Bullards Bar Reservoir (usable capacity, 31,500 acre-ft). New Colgate Powerplant (station 11413510) diverts at New Bullards Bar Dam 0.2 mi upstream. Water is diverted to Feather River Basin through Slate Creek Tunnel (station 11413250). Camptonville Tunnel (station 11409350) diverts water from Middle Yuba River to New Bullards Bar Reservoir. Records include flow over New Bullards Bar Reservoir spillway. See schematic diagram of [North Yuba River Basin](#).

EXTREMES FOR PERIOD OF RECORD.—Maximum discharge, 56,200 ft<sup>3</sup>/s, Jan. 22, 1970, gage height, 35.29 ft, at auxiliary gage, from rating curve extended above 40,000 ft<sup>3</sup>/s, on basis of computation of flow over old Colgate Dam; minimum daily, 0.42 ft<sup>3</sup>/s, Nov. 5, 1966.

EXTREMES OUTSIDE PERIOD OF RECORD.—Flood of Dec. 22, 1964, reached a stage of 49.8 ft, from floodmarks, discharge, 91,600 ft<sup>3</sup>/s, at auxiliary gage, from computation of flow over old Colgate Dam.

## DISCHARGE, CUBIC FEET PER SECOND, WATER YEAR OCTOBER 2000 TO SEPTEMBER 2001

## DAILY MEAN VALUES

DAY	OCT	NOV	DEC	JAN	FEB	MAR	APR	MAY	JUN	JUL	AUG	SEP
1	7.2	6.8	6.4	6.4	6.4	6.4	6.4	e7.0	e6.8	6.6	6.6	6.5
2	7.2	6.8	6.4	6.4	6.4	6.4	6.4	e7.2	e6.8	6.6	6.6	6.6
3	7.2	6.8	6.4	6.4	6.4	6.4	6.4	e7.2	e6.6	6.6	6.6	6.6
4	7.2	6.7	6.4	6.4	6.4	6.4	6.4	e7.4	e6.8	6.5	6.6	6.6
5	7.2	6.6	6.4	6.4	6.4	6.4	6.4	e7.6	e6.8	6.5	6.6	6.6
6	7.2	6.6	6.4	6.4	6.4	6.4	6.4	e6.8	e6.8	6.4	6.6	6.6
7	7.2	6.6	6.4	6.4	6.4	6.4	6.4	6.4	e6.8	6.4	6.6	6.6
8	7.2	6.6	6.4	6.4	6.4	6.4	6.4	6.4	e6.8	6.4	6.6	6.6
9	7.1	6.6	6.4	6.4	6.4	6.4	6.4	6.4	e6.8	6.4	6.6	6.6
10	7.0	6.6	6.4	6.4	6.4	6.4	6.4	6.4	e6.8	6.4	6.6	6.6
11	7.0	6.6	6.4	6.4	6.4	6.4	e6.6	6.4	e6.6	6.5	6.6	6.9
12	7.0	6.6	6.4	6.4	6.4	6.4	6.4	6.4	e6.8	6.6	6.5	5.6
13	7.0	6.6	6.4	6.4	6.4	6.4	6.4	e7.2	e6.8	6.6	6.4	6.0
14	7.0	6.6	6.4	6.4	6.4	6.4	e6.8	e7.4	e6.8	6.6	6.4	6.4
15	6.9	6.6	6.4	6.4	6.4	6.4	e7.0	e7.4	e6.8	6.6	6.5	6.4
16	6.8	6.6	6.4	6.4	6.4	6.4	e7.0	e7.6	e6.8	6.6	6.6	6.4
17	6.8	6.6	6.4	6.4	6.4	6.4	e7.0	e7.6	e6.8	6.6	6.6	6.4
18	6.8	6.6	6.4	6.4	6.4	6.4	e7.0	e7.6	e6.8	8.5	6.6	6.6
19	6.8	6.6	6.4	6.4	6.4	6.4	e7.0	e7.6	e6.6	6.6	6.6	6.8
20	6.8	6.6	6.4	6.4	6.4	6.4	e7.0	e7.6	e6.6	6.6	6.6	6.8
21	6.8	6.6	6.4	6.4	6.4	6.4	e6.6	e7.0	6.6	6.6	6.5	6.8
22	6.8	6.6	6.4	6.4	6.4	6.4	e6.8	e6.4	6.6	6.6	6.4	6.8
23	6.8	6.6	6.4	6.4	6.4	6.4	e6.8	e6.6	6.6	6.6	6.4	6.8
24	6.8	6.5	6.4	6.4	6.4	6.4	e6.8	e6.8	6.6	6.6	6.4	6.8
25	6.8	6.4	6.4	6.4	6.4	6.4	e7.0	e6.8	6.6	6.6	6.4	6.8
26	6.8	6.4	6.4	6.4	6.4	6.4	e7.0	e6.6	6.6	6.6	6.4	6.8
27	6.8	6.4	6.4	6.4	6.4	6.4	e7.0	e6.6	6.6	6.6	6.4	6.8
28	6.8	6.4	6.4	6.4	6.4	6.4	e7.0	e6.8	6.6	6.6	6.5	6.8
29	6.8	6.4	6.4	6.4	---	6.4	e7.0	e6.8	6.6	6.6	6.6	6.8
30	6.8	6.4	6.4	6.4	---	6.4	e7.2	e6.8	6.6	6.6	6.5	6.8
31	6.8	---	6.4	6.4	---	6.4	---	e6.6	---	6.6	6.4	---
TOTAL	215.4	197.4	198.4	198.4	179.2	198.4	201.4	215.4	201.2	205.2	202.3	198.2
MEAN	6.95	6.58	6.40	6.40	6.40	6.40	6.71	6.95	6.71	6.62	6.53	6.61
MAX	7.2	6.8	6.4	6.4	6.4	6.4	7.2	7.6	6.8	8.5	6.6	6.9
MIN	6.8	6.4	6.4	6.4	6.4	6.4	6.4	6.4	6.6	6.4	6.4	5.6
AC-FT	427	392	394	394	355	394	399	427	399	407	401	393

e Estimated.

## 11413520 NORTH YUBA RIVER BELOW NEW BULLARDS BAR DAM, NEAR NORTH SAN JUAN, CA—Continued

## STATISTICS OF MONTHLY MEAN DATA FOR WATER YEARS 1966 - 2001, BY WATER YEAR (WY)

	OCT	NOV	DEC	JAN	FEB	MAR	APR	MAY	JUN	JUL	AUG	SEP
MEAN	17.8	34.6	275	777	850	670	372	489	253	35.9	7.56	8.01
MAX	381	404	3570	8990	7457	4648	4144	4289	3759	759	25.4	45.9
(WY)	1975	1967	1984	1970	1986	1995	1982	1967	1967	1967	1967	1969
MIN	2.60	3.41	4.97	4.65	2.10	5.32	3.09	4.12	1.92	3.48	3.21	2.89
(WY)	1971	1971	1978	1981	1971	1976	1970	1970	1970	1977	1977	1966

SUMMARY STATISTICS	FOR 2000 CALENDAR YEAR		FOR 2001 WATER YEAR		WATER YEARS 1966 - 2001	
ANNUAL TOTAL	15934.7		2410.9			
ANNUAL MEAN	43.5		6.61		313	
HIGHEST ANNUAL MEAN					1560	
LOWEST ANNUAL MEAN					4.62	
HIGHEST DAILY MEAN	3300	Mar 15	8.5	Jul 18	48200	Feb 19 1986
LOWEST DAILY MEAN	6.4	Feb 20	5.6	Sep 12	.42	Nov 5 1966
ANNUAL SEVEN-DAY MINIMUM	6.4	Nov 25	6.3	Sep 12	.68	Nov 1 1966
MAXIMUM PEAK FLOW			49	Jul 18	56200	Jan 22 1970
MAXIMUM PEAK STAGE			4.45	Jul 18	35.29	Jan 22 1970
ANNUAL RUNOFF (AC-FT)	31610		4780		227100	
10 PERCENT EXCEEDS	8.2		7.0		39	
50 PERCENT EXCEEDS	7.3		6.6		6.7	
90 PERCENT EXCEEDS	6.4		6.4		5.0	



## 11413700 YUBA RIVER BELOW NEW COLGATE POWERPLANT, NEAR FRENCH CORRAL, CA

LOCATION.—Lat 39°19'50", long 121°11'34", in NW 1/4 SE 1/4 sec.16, T.17 N., R.7 E., Yuba County, Hydrologic Unit 18020125, on right bank, 0.1 mi upstream of Dobbins Creek, 0.2 mi downstream of New Colgate Powerplant, and 2.3 mi northwest of French Corral.

DRAINAGE AREA.—717 mi<sup>2</sup>.

## WATER-DISCHARGE RECORDS

PERIOD OF RECORD.—October 2000 to September 2001.

GAGE.—Water-stage recorder, and crest-stage gage. Elevation of gage is 550 ft above sea level, from topographic map.

REMARKS.—Records fair. Flow regulated by New Bullards Bar Reservoir (station 11413515) since January 1969, and several other reservoirs.

Flow through New Colgate Powerplant (station 11413510) is diverted from New Bullards Bar Reservoir. See schematic diagram of [North Yuba River Basin](#).

EXTREMES FOR PERIOD OF RECORD.—Maximum discharge, 3,720 ft<sup>3</sup>/s, May 24, 2001, gage height, 11.61 ft; minimum daily, 41 ft<sup>3</sup>/s, Sept. 9, 22, 23, 2001.

## DISCHARGE, CUBIC FEET PER SECOND, WATER YEAR OCTOBER 2000 TO SEPTEMBER 2001

## DAILY MEAN VALUES

DAY	OCT	NOV	DEC	JAN	FEB	MAR	APR	MAY	JUN	JUL	AUG	SEP
1	1320	1330	958	514	601	649	104	807	1040	73	2640	42
2	1390	1340	949	1350	586	284	886	406	99	1700	2600	44
3	1420	1210	948	1300	86	148	819	1190	99	1740	2510	45
4	572	276	975	1010	150	175	534	819	986	781	1060	1340
5	1000	101	997	760	584	241	885	117	1120	2150	481	919
6	930	1110	985	75	718	319	156	116	1390	2150	2320	931
7	632	1420	876	75	882	437	146	930	1280	1580	2520	1060
8	666	1400	583	506	872	147	124	1310	1530	1420	2560	42
9	1080	1400	553	1130	798	148	252	1810	98	2830	2390	41
10	1210	1520	872	1100	171	137	684	1620	98	3080	2540	1110
11	1220	111	984	949	246	128	876	1600	1220	2960	906	1000
12	1260	98	1010	892	370	293	715	113	1520	2760	1050	1130
13	1390	1100	928	103	494	117	1120	113	1440	1410	2300	1150
14	84	1440	564	91	342	194	1260	1380	1480	1170	2390	664
15	80	1490	472	1410	404	349	126	1420	1370	1210	2400	42
16	1080	1650	265	1530	223	108	932	1160	86	2420	2570	42
17	1420	1450	456	1370	107	105	1130	1200	77	2560	2450	844
18	1440	98	959	1560	110	105	668	1210	1540	2830	1250	890
19	1410	423	1170	1400	160	1440	800	106	1390	2880	1210	890
20	1390	1160	1140	79	450	366	1250	104	1410	2840	2220	738
21	222	991	1190	78	485	427	772	1010	1390	1190	2490	807
22	72	1560	1210	914	378	388	163	1170	1370	909	2440	41
23	1090	1820	383	853	301	454	588	760	71	2510	2580	41
24	1360	1790	464	1350	217	103	500	729	70	2650	2170	1070
25	1480	935	822	1870	211	157	956	891	1360	2680	50	979
26	1500	882	475	500	355	581	442	103	1460	2780	45	884
27	1550	1020	1080	150	348	759	365	102	1450	2570	1470	783
28	124	1080	1190	102	1220	817	432	102	1450	1100	1560	814
29	127	937	1310	1010	---	756	445	1440	1530	1100	1460	48
30	1050	1040	653	912	---	814	1010	1300	74	2760	1220	46
31	1220	---	514	750	---	135	---	1450	---	2960	1350	---
TOTAL	30789	32182	25935	25693	11869	11281	19140	26588	29498	63753	57202	18477
MEAN	993	1073	837	829	424	364	638	858	983	2057	1845	616
MAX	1550	1820	1310	1870	1220	1440	1260	1810	1540	3080	2640	1340
MIN	72	98	265	75	86	103	104	102	70	73	45	41
AC-FT	61070	63830	51440	50960	23540	22380	37960	52740	58510	126500	113500	36650

## STATISTICS OF MONTHLY MEAN DATA FOR WATER YEARS 2001 - 2001, BY WATER YEAR (WY)

MEAN	993	1073	837	829	424	364	638	858	983	2057	1845	616
MAX	993	1073	837	829	424	364	638	858	983	2057	1845	616
(WY)	2001	2001	2001	2001	2001	2001	2001	2001	2001	2001	2001	2001
MIN	993	1073	837	829	424	364	638	858	983	2057	1845	616
(WY)	2001	2001	2001	2001	2001	2001	2001	2001	2001	2001	2001	2001

## SUMMARY STATISTICS

## FOR 2001 WATER YEAR

ANNUAL TOTAL	352407
ANNUAL MEAN	965
HIGHEST DAILY MEAN	3080 Jul 10
LOWEST DAILY MEAN	41 Sep 9
ANNUAL SEVEN-DAY MINIMUM	166 Mar 8
MAXIMUM PEAK FLOW	3720 May 24
MAXIMUM PEAK STAGE	11.61 May 24
ANNUAL RUNOFF (AC-FT)	699000
10 PERCENT EXCEEDS	1980
50 PERCENT EXCEEDS	931
90 PERCENT EXCEEDS	102

## 11413700 YUBA RIVER BELOW NEW COLGATE POWERPLANT, NEAR FRENCH CORRAL, CA—Continued

## WATER-QUALITY RECORDS

PERIOD OF RECORD.—Water years 1975–78, January to September 2001.

WATER TEMPERATURE: Water years 1975–78, January to September 2001.

SEDIMENT DATA: January to September 2001.

PERIOD OF DAILY RECORD.—

WATER TEMPERATURE: Water years 1975–78, January to September 2001.

SUSPENDED-SEDIMENT DISCHARGE: January to September 2001.

INSTRUMENTATION.—Water-temperature recorder October 1974 to September 1978, and since January 19, 2001.

REMARKS.—Water-temperature records rated excellent except for Feb. 21 to Mar. 18, and May 2 to June 28, which are rated good. Water temperature is affected by regulation from New Colgate Powerplant.

EXTREMES FOR PERIOD OF DAILY RECORD.—

WATER TEMPERATURE: Maximum recorded, 27.0°C, July 25, 1976; minimum recorded, 1.0°C, Jan. 9, 1977.

SEDIMENT CONCENTRATION: Maximum daily mean, 25 mg/L, Feb. 20, 2001; minimum daily mean, 1 mg/L, many days January to August 2001.

SEDIMENT LOAD: Maximum daily, 56 tons, July 20, 2001; minimum daily, 0.26 ton, June 23, 2001.

EXTREMES FOR CURRENT YEAR.—

WATER TEMPERATURE: Maximum recorded, 25.5°C, July 1, Aug. 5; minimum recorded, 3.5°C Jan. 20, 21.

SEDIMENT CONCENTRATION: Maximum daily mean, 25 mg/L, Feb. 20; minimum daily mean, 1 mg/L, many days January to August.

SEDIMENT LOAD: Maximum daily, 56 tons, July 20; minimum daily, 0.26 ton, June 23.

## CROSS-SECTIONAL DATA, WATER YEAR OCTOBER 2000 TO SEPTEMBER 2001

DATE	TIME	TEMPER- ATURE WATER (DEG C) (00010)	SAMPLE LOC- ATION, CROSS SECTION (FT FM L BANK) (00009)
JUL			
03...*	1156	8.5	152
03...*	1157	8.5	136
03...*	1159	8.5	120
03...*	1200	8.5	104
03...*	1201	8.5	88.0
03...*	1203	8.5	72.0
03...*	1205	8.5	56.0
03...*	1207	9.0	40.0
03...*	1208	9.0	24.0
03...*	1210	9.0	8.00

## SUSPENDED-SEDIMENT DISCHARGE, WATER YEAR OCTOBER 2000 TO SEPTEMBER 2001

DATE	TIME	DIS- CHARGE, INST. CUBIC FEET PER SECOND (00061)	TEMPER- ATURE WATER (DEG C) (00010)	SEDI- MENT, DIS- CHARGE, SUS- PENDE (MG/L) (80154)	SEDI- MENT, DIS- CHARGE, SUS- PENDE (T/DAY) (80155)
JAN					
31...	1630	93	5.0	2	.50
APR					
10...	1500	104	11.5	1	.28
MAY					
11...	1330	851	10.0	2	4.6
JUN					
22...	1100	2700	8.5	1	7.3
JUL					
11...	1345	3480	8.5	1	9.4

\* Instantaneous discharge at time of cross-sectional measurement: 2,130 ft<sup>3</sup>/s.

## 11413700 YUBA RIVER BELOW NEW COLGATE POWERPLANT, NEAR FRENCH CORRAL, CA—Continued

## TEMPERATURE, WATER (DEG. C), WATER YEAR OCTOBER 2000 TO SEPTEMBER 2001

DAY	MAX	MIN	MAX	MIN	MAX	MIN	MAX	MIN	MAX	MIN	MAX	MIN	
	OCTOBER		NOVEMBER		DECEMBER		JANUARY		FEBRUARY		MARCH		
1	---	---	---	---	---	---	---	---	9.0	4.5	8.5	7.0	
2	---	---	---	---	---	---	---	---	9.0	5.0	8.5	7.0	
3	---	---	---	---	---	---	---	---	6.5	4.5	8.0	6.5	
4	---	---	---	---	---	---	---	---	9.0	5.5	8.5	7.5	
5	---	---	---	---	---	---	---	---	9.0	6.0	9.0	8.0	
6	---	---	---	---	---	---	---	---	9.0	7.0	10.0	8.5	
7	---	---	---	---	---	---	---	---	9.0	6.0	10.5	8.5	
8	---	---	---	---	---	---	---	---	9.0	5.0	11.0	9.5	
9	---	---	---	---	---	---	---	---	9.0	5.0	11.0	10.0	
10	---	---	---	---	---	---	---	---	5.0	4.5	11.0	9.0	
11	---	---	---	---	---	---	---	---	4.5	4.0	11.0	9.0	
12	---	---	---	---	---	---	---	---	9.0	4.0	10.5	8.5	
13	---	---	---	---	---	---	---	---	8.5	4.0	11.0	9.0	
14	---	---	---	---	---	---	---	---	9.0	5.0	11.0	8.5	
15	---	---	---	---	---	---	---	---	8.5	4.5	11.0	8.0	
16	---	---	---	---	---	---	---	---	8.5	5.0	11.5	9.5	
17	---	---	---	---	---	---	---	---	6.0	5.5	12.0	10.0	
18	---	---	---	---	---	---	---	---	6.5	6.0	13.0	10.5	
19	---	---	---	---	---	---	---	9.5	5.0	7.0	6.5	12.5	8.0
20	---	---	---	---	---	---	---	5.5	3.5	9.0	7.0	14.5	8.0
21	---	---	---	---	---	---	4.5	3.5	8.5	7.5	15.5	8.0	
22	---	---	---	---	---	---	9.0	4.0	8.5	7.5	16.0	8.0	
23	---	---	---	---	---	---	9.0	5.0	9.0	7.0	16.0	8.0	
24	---	---	---	---	---	---	9.0	5.5	7.5	7.0	15.5	14.5	
25	---	---	---	---	---	---	9.0	6.0	8.0	7.0	16.0	14.5	
26	---	---	---	---	---	---	9.0	5.0	9.0	7.0	14.5	8.0	
27	---	---	---	---	---	---	8.5	4.0	9.5	7.5	13.0	8.0	
28	---	---	---	---	---	---	5.0	4.0	8.5	7.0	9.5	8.0	
29	---	---	---	---	---	---	9.0	4.0	---	---	10.0	8.0	
30	---	---	---	---	---	---	9.0	4.5	---	---	9.5	8.0	
31	---	---	---	---	---	---	9.0	4.5	---	---	16.0	8.5	
MONTH	---	---	---	---	---	---	---	---	9.5	4.0	16.0	6.5	
	APRIL		MAY		JUNE		JULY		AUGUST		SEPTEMBER		
1	16.5	14.5	17.0	8.5	22.0	8.5	25.5	22.5	9.0	8.5	24.5	18.5	
2	15.0	8.0	18.5	8.5	24.0	19.0	24.0	8.5	9.0	8.5	24.5	21.5	
3	9.5	8.0	16.0	8.5	23.5	21.0	22.5	8.5	9.0	8.5	25.0	21.5	
4	9.0	8.0	16.0	8.5	21.5	8.5	24.5	8.5	24.5	8.5	23.0	8.5	
5	9.0	8.0	18.5	16.0	20.0	8.5	23.5	8.5	25.5	8.5	21.0	8.5	
6	11.0	8.0	19.0	16.5	19.5	8.5	22.5	8.5	10.0	8.5	20.5	8.5	
7	11.0	9.5	18.0	8.5	20.5	8.5	22.5	8.0	9.0	8.5	19.0	8.5	
8	10.0	8.5	18.5	8.5	21.0	8.5	23.0	8.5	9.5	8.5	21.5	17.0	
9	11.0	8.0	19.5	8.5	23.5	18.0	14.5	8.0	9.0	8.5	22.0	19.0	
10	11.5	8.0	20.0	8.5	23.5	21.0	8.5	8.5	9.0	8.5	20.5	8.5	
11	10.5	7.5	20.5	8.5	22.0	8.5	8.5	8.5	23.5	8.5	19.0	8.5	
12	9.0	7.5	22.0	16.0	21.0	8.5	9.0	8.5	23.5	8.5	18.5	8.5	
13	9.0	7.5	22.0	19.5	20.0	8.5	22.5	8.5	17.5	8.5	18.5	8.5	
14	9.0	8.0	20.5	8.5	20.0	8.5	23.0	8.5	9.5	8.5	19.5	8.5	
15	13.0	8.0	19.0	8.5	20.5	8.5	23.0	8.5	9.0	8.5	22.5	18.5	
16	12.0	8.0	19.0	8.5	24.0	18.0	17.0	8.5	9.0	8.5	22.5	19.5	
17	9.0	8.0	19.5	8.5	24.5	22.0	9.0	8.5	9.5	8.5	20.5	8.5	
18	14.0	8.0	19.5	8.5	23.0	8.5	9.0	8.5	21.0	8.5	19.0	8.5	
19	9.5	8.0	22.5	19.0	22.0	8.5	9.0	8.5	21.0	8.5	19.0	8.5	
20	8.5	8.0	24.0	20.5	22.0	8.5	9.0	8.5	9.5	8.5	19.5	8.5	
21	9.0	8.0	22.0	8.5	22.5	8.5	21.5	8.5	9.0	8.5	19.0	8.5	
22	14.5	8.5	21.5	8.5	23.5	8.5	23.0	8.5	9.5	8.5	21.5	16.5	
23	13.5	8.0	22.5	8.5	25.0	21.5	18.5	8.5	9.5	8.5	21.0	18.5	
24	11.0	8.5	23.5	8.5	23.5	21.5	9.0	8.5	9.0	8.5	19.0	8.5	
25	15.5	8.5	23.0	8.5	22.0	8.5	9.0	8.5	24.0	9.0	18.0	8.5	
26	17.5	8.5	23.5	21.5	19.5	8.5	9.0	8.5	24.5	21.0	17.0	8.5	
27	17.5	9.0	23.0	21.0	20.0	8.5	9.0	8.5	22.5	8.5	17.5	8.5	
28	18.0	8.5	22.5	20.5	19.5	8.5	23.5	8.5	21.0	8.5	16.5	8.5	
29	17.5	8.0	21.0	8.5	21.0	8.5	23.5	8.5	20.5	8.5	20.0	15.5	
30	16.0	8.0	21.0	8.5	24.5	17.5	19.0	8.5	20.5	8.5	20.0	16.5	
31	---	---	21.5	8.5	---	---	9.0	8.5	20.5	8.5	---	---	
MONTH	18.0	7.5	24.0	8.5	25.0	8.5	25.5	8.0	25.5	8.5	25.0	8.5	

11413700 YUBA RIVER BELOW NEW COLGATE POWERPLANT, NEAR FRENCH CORRAL, CA—Continued

SEDIMENT DISCHARGE, SUSPENDED (TONS/DAY), WATER YEAR OCTOBER 2000 TO SEPTEMBER 2001

DAY	MEAN	MEAN	SEDIMENT	MEAN	MEAN	SEDIMENT	MEAN	MEAN	SEDIMENT
	DISCHARGE (CFS)	CONCEN- TRATION (MG/L)	DISCHARGE (TONS/DAY)	DISCHARGE (CFS)	CONCEN- TRATION (MG/L)	DISCHARGE (TONS/DAY)	DISCHARGE (CFS)	CONCEN- TRATION (MG/L)	DISCHARGE (TONS/DAY)
	OCTOBER			NOVEMBER			DECEMBER		
1	1320	---	---	1330	---	---	958	---	---
2	1390	---	---	1340	---	---	949	---	---
3	1420	---	---	1210	---	---	948	---	---
4	572	---	---	276	---	---	975	---	---
5	1000	---	---	101	---	---	997	---	---
6	930	---	---	1110	---	---	985	---	---
7	632	---	---	1420	---	---	876	---	---
8	666	---	---	1400	---	---	583	---	---
9	1080	---	---	1400	---	---	553	---	---
10	1210	---	---	1520	---	---	872	---	---
11	1220	---	---	111	---	---	984	---	---
12	1260	---	---	98	---	---	1010	---	---
13	1390	---	---	1100	---	---	928	---	---
14	84	---	---	1440	---	---	564	---	---
15	80	---	---	1490	---	---	472	---	---
16	1080	---	---	1650	---	---	265	---	---
17	1420	---	---	1450	---	---	456	---	---
18	1440	---	---	98	---	---	959	---	---
19	1410	---	---	423	---	---	1170	---	---
20	1390	---	---	1160	---	---	1140	---	---
21	222	---	---	991	---	---	1190	---	---
22	72	---	---	1560	---	---	1210	---	---
23	1090	---	---	1820	---	---	383	---	---
24	1360	---	---	1790	---	---	464	---	---
25	1480	---	---	935	---	---	822	---	---
26	1500	---	---	882	---	---	475	---	---
27	1550	---	---	1020	---	---	1080	---	---
28	124	---	---	1080	---	---	1190	---	---
29	127	---	---	937	---	---	1310	---	---
30	1050	---	---	1040	---	---	653	---	---
31	1220	---	---	---	---	---	514	---	---
TOTAL	30789	---	---	32182	---	---	25935	---	---
	JANUARY			FEBRUARY			MARCH		
1	514	---	---	601	2	2.8	649	5	8.8
2	1350	---	---	586	1	1.9	284	6	4.7
3	1300	---	---	86	2	.37	148	7	2.7
4	1010	---	---	150	2	.92	175	8	3.6
5	760	---	---	584	3	3.5	241	9	6.2
6	75	---	---	718	3	3.7	319	8	7.2
7	75	---	---	882	3	4.6	437	7	8.3
8	506	---	---	872	2	5.2	147	5	1.8
9	1130	---	---	798	3	6.5	148	2	.99
10	1100	4	11	171	4	1.9	137	3	1.2
11	949	8	15	246	5	3.3	128	5	1.6
12	892	7	14	370	6	6.1	293	6	4.6
13	103	5	1.3	494	7	8.7	117	6	1.8
14	91	4	.99	342	4	4.2	194	5	2.8
15	1410	4	14	404	2	2.3	349	5	5.1
16	1530	4	15	223	1	.74	108	6	1.9
17	1370	3	13	107	2	.60	105	5	1.5
18	1560	3	14	110	4	1.1	105	4	1.0
19	1400	3	12	160	15	7.6	1440	2	8.4
20	79	3	.66	450	25	23	366	3	3.2
21	78	3	.63	485	24	32	427	4	4.5
22	914	3	7.4	378	16	17	388	4	3.8
23	853	4	8.6	301	8	6.5	454	3	4.1
24	1350	7	24	217	7	3.9	103	3	.87
25	1870	8	40	211	6	3.6	157	3	1.2
26	500	4	6.5	355	6	5.6	581	3	4.0
27	150	3	1.3	348	5	4.6	759	2	4.6
28	102	3	.74	1220	4	14	817	2	4.6
29	1010	2	5.4	---	---	---	756	2	5.2
30	912	2	3.8	---	---	---	814	3	6.4
31	750	1	2.3	---	---	---	135	3	.97
TOTAL	25693	---	---	11869	---	176.23	11281	---	117.63

## SACRAMENTO RIVER BASIN

11413700 YUBA RIVER BELOW NEW COLGATE POWERPLANT, NEAR FRENCH CORRAL, CA—Continued

SEDIMENT DISCHARGE, SUSPENDED (TONS/DAY), WATER YEAR OCTOBER 2000 TO SEPTEMBER 2001

DAY	MEAN	MEAN	SEDIMENT	MEAN	MEAN	SEDIMENT	MEAN	MEAN	SEDIMENT
	DISCHARGE (CFS)	CONCEN- TRATION (MG/L)	DISCHARGE (TONS/DAY)	DISCHARGE (CFS)	CONCEN- TRATION (MG/L)	DISCHARGE (TONS/DAY)	DISCHARGE (CFS)	CONCEN- TRATION (MG/L)	DISCHARGE (TONS/DAY)
	APRIL			MAY			JUNE		
1	104	2	.66	807	2	4.4	1040	2	5.6
2	886	2	5.1	406	2	2.2	99	2	.53
3	819	2	5.5	1190	2	6.4	99	2	.54
4	534	3	4.1	819	2	4.3	986	2	5.3
5	885	2	4.8	117	2	.53	1120	2	6.0
6	156	1	.53	116	1	.42	1390	2	7.5
7	146	1	.39	930	1	2.5	1280	2	6.9
8	124	1	.34	1310	1	3.5	1530	2	8.1
9	252	1	.68	1810	1	5.2	98	2	.44
10	684	1	2.2	1620	2	6.8	98	1	.35
11	876	2	4.3	1600	2	8.4	1220	1	3.3
12	715	2	2.8	113	2	.52	1520	1	4.1
13	1120	1	3.3	113	1	.41	1440	1	3.9
14	1260	1	4.5	1380	1	3.9	1480	1	4.3
15	126	2	.56	1420	1	4.9	1370	2	5.7
16	932	2	4.8	1160	2	4.8	86	2	.46
17	1130	2	4.7	1200	2	5.8	77	2	.52
18	668	1	1.9	1210	2	6.3	1540	3	12
19	800	1	2.2	106	2	.48	1390	3	11
20	1250	1	3.4	104	1	.37	1410	3	11
21	772	1	2.1	1010	1	3.1	1390	2	6.9
22	163	1	.44	1170	2	5.8	1370	1	3.9
23	588	1	1.7	760	1	2.5	71	1	.26
24	500	2	2.1	729	2	5.3	70	2	.32
25	956	2	5.1	891	4	9.5	1360	2	7.0
26	442	2	2.4	103	4	1.0	1460	2	5.7
27	365	2	2.0	102	4	.96	1450	1	4.0
28	432	2	2.3	102	3	.90	1450	1	3.9
29	445	2	2.4	1440	3	11	1530	1	4.6
30	1010	2	5.4	1300	2	8.6	74	2	.33
31	---	---	---	1450	2	7.9	---	---	---
TOTAL	19140	---	82.70	26588	---	128.69	29498	---	134.45
	JULY			AUGUST			SEPTEMBER		
1	73	2	.46	2640	2	13	42	4	.51
2	1700	6	33	2600	1	8.1	44	4	.52
3	1740	7	32	2510	2	10	45	4	.52
4	781	6	12	1060	2	6.1	1340	4	15
5	2150	5	29	481	2	3.5	919	4	10
6	2150	4	23	2320	3	19	931	4	10
7	1580	3	12	2520	4	24	1060	4	11
8	1420	2	7.1	2560	4	28	42	4	.44
9	2830	1	8.6	2390	5	30	41	4	.43
10	3080	1	8.3	2540	5	36	1110	4	11
11	2960	1	8.2	906	6	14	1000	4	10
12	2760	1	9.7	1050	6	18	1130	4	11
13	1410	3	17	2300	7	43	1150	4	11
14	1170	4	13	2390	7	48	664	4	6.3
15	1210	3	11	2400	8	51	42	3	.39
16	2420	3	17	2570	7	48	42	3	.38
17	2560	2	12	2450	6	38	844	3	7.5
18	2830	2	12	1250	5	15	890	3	7.7
19	2880	4	35	1210	3	10	890	3	7.5
20	2840	7	56	2220	2	13	738	3	6.1
21	1190	6	18	2490	1	7.9	807	3	6.5
22	909	4	9.0	2440	2	9.8	41	3	.33
23	2510	2	15	2580	2	14	41	3	.33
24	2650	2	11	2170	2	14	1070	3	8.7
25	2680	1	8.1	50	3	.38	979	3	7.9
26	2780	2	11	45	3	.40	884	3	7.2
27	2570	2	13	1470	4	15	783	3	6.3
28	1100	2	5.9	1560	6	31	814	3	6.6
29	1100	2	5.9	1460	11	45	48	3	.39
30	2760	2	15	1220	9	28	46	3	.37
31	2960	2	16	1350	6	20	---	---	---
TOTAL	63753	---	484.26	57202	---	661.18	18477	---	171.91
YEAR	352407		2168.67						



## 11413945 LOWER CASCADE LAKE NEAR SODA SPRINGS, CA

LOCATION.—Lat 39°18'12", long 120°26'19", in SE 1/4 SE 1/4 sec.30, T.17 N., R.14 E., Placer County, Hydrologic Unit 18020125, Tahoe National Forest, on outlet structure, on Lower Cascade Lake Dam, and 3.6 mi southwest of Soda Springs.

DRAINAGE AREA.—1.02 mi<sup>2</sup>.

PERIOD OF RECORD.—July 1991 to current year. Unpublished records for water years 1966–90 available in files of the U.S. Geological Survey.

GAGE.—Water-stage recorder. Datum of gage is 6,560.4 ft above sea level (levels by Pacific Gas & Electric Co.). Prior to July 1991, nonrecording gage at same site and datum.

REMARKS.—No records computed during the winter months. Reservoir is formed on natural lake by rock-fill dam completed in 1860. Usable capacity, 484 acre-ft, between gage heights 0.0 ft, invert of outlet, and 21.5 ft, crest of spillway. Water is used for power development downstream.

COOPERATION.—Records were collected by Pacific Gas & Electric Co., under general supervision of the U.S. Geological Survey, in connection with a Federal Energy Regulatory Commission project.

Capacity table (gage height, in feet, and contents, in acre-feet)  
(Based on survey by Pacific Gas & Electric Co., dated April 1965)

0	0	8	133	16	318	22	500
4	62	12	218	20	435	23	530

## RESERVOIR STORAGE (ACRE-FEET), WATER YEAR OCTOBER 2000 TO SEPTEMBER 2001

## DAILY OBSERVATION AT 2400 HOURS

DAY	OCT	NOV	DEC	JAN	FEB	MAR	APR	MAY	JUN	JUL	AUG	SEP
1	378	169	---	---	---	---	---	---	475	452	424	402
2	370	145	---	---	---	---	---	---	474	451	423	402
3	363	118	---	---	---	---	---	---	473	450	422	401
4	355	33	---	---	---	---	---	---	472	449	421	377
5	348	---	---	---	---	---	---	---	472	448	421	357
6	341	---	---	---	---	---	---	---	471	448	420	335
7	334	---	---	---	---	---	---	---	471	447	420	320
8	331	---	---	---	---	---	---	---	470	446	419	315
9	336	---	---	---	---	---	---	---	469	445	418	304
10	339	---	---	---	---	---	---	---	468	445	417	293
11	339	---	---	---	---	---	---	---	467	444	417	283
12	339	---	---	---	---	---	---	---	467	443	416	274
13	336	---	---	---	---	---	---	---	465	441	415	269
14	333	---	---	---	---	---	---	---	465	440	415	268
15	330	---	---	---	---	---	---	---	464	439	414	267
16	325	---	---	---	---	---	---	---	463	437	413	266
17	320	---	---	---	---	---	---	---	463	436	413	265
18	315	---	---	---	---	---	---	---	462	435	412	263
19	309	---	---	---	---	---	---	---	461	434	411	262
20	303	---	---	---	---	---	---	---	460	434	410	259
21	296	---	---	---	---	---	---	---	459	433	409	267
22	288	---	---	---	---	---	---	---	459	432	409	287
23	280	---	---	---	---	---	---	---	457	432	408	303
24	271	---	---	---	---	---	---	---	456	431	407	316
25	263	---	---	---	---	---	---	---	456	430	407	328
26	252	---	---	---	---	---	---	---	455	429	406	336
27	239	---	---	---	---	---	---	---	455	428	405	342
28	230	---	---	---	---	---	---	---	454	427	404	346
29	217	---	---	---	---	---	---	---	453	426	403	348
30	203	---	---	---	---	---	---	476	453	425	403	347
31	187	---	---	---	---	---	---	476	---	425	403	---
MAX	378	---	---	---	---	---	---	---	475	452	424	402
MIN	187	---	---	---	---	---	---	---	453	425	403	259
a	10.58	---	---	---	---	---	---	21.24	20.54	19.65	18.92	17.05
b	-198	---	---	---	---	---	---	---	-23	-28	-22	-56

WTR YR 2001 b -38

a Gage height, in feet, at end of month.  
b Change in contents, in acre-feet.

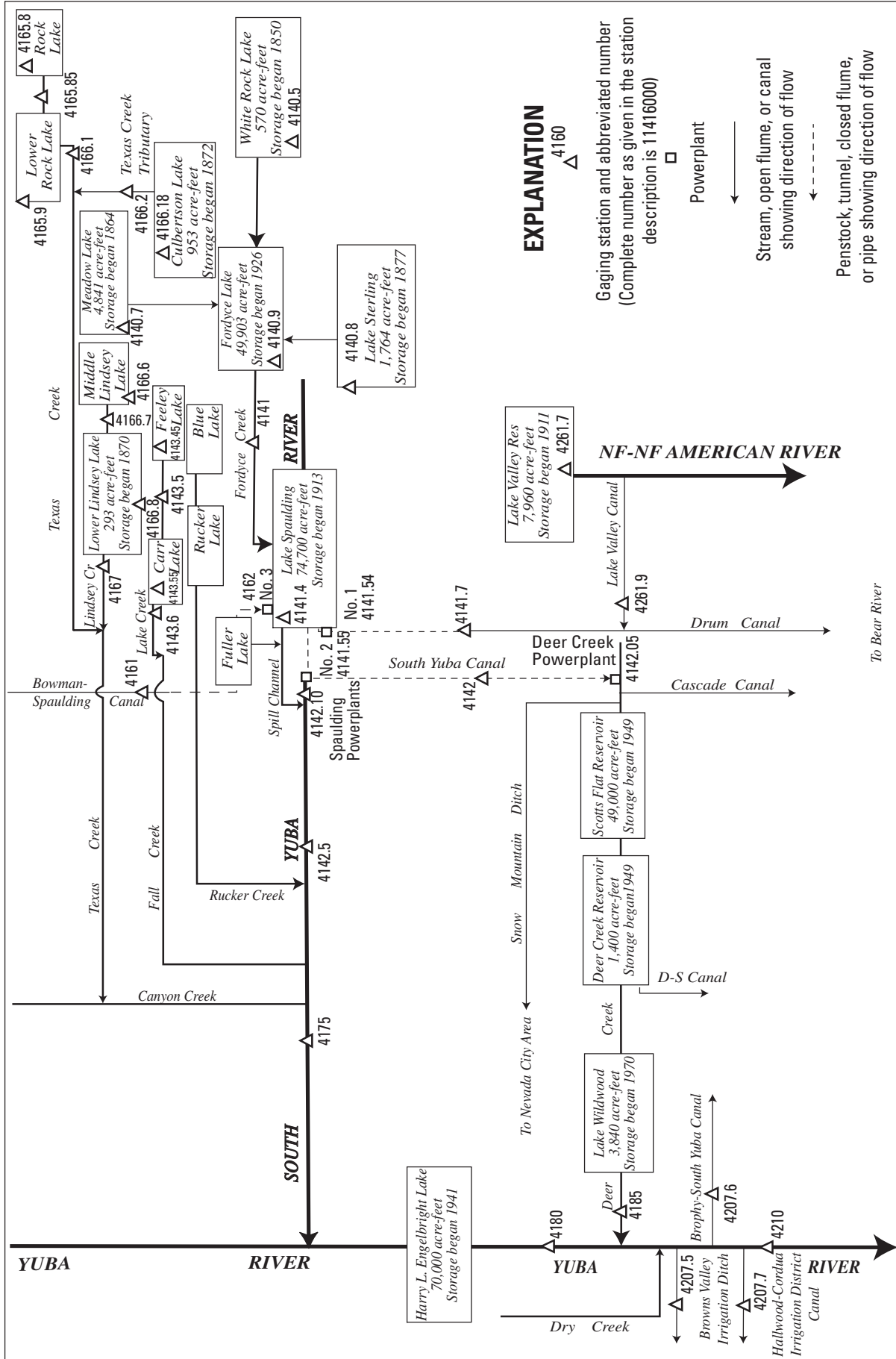

Figure 32. Diversions and storage in South Yuba River Basin.









## 11414090 FORDYCE LAKE NEAR CISCO, CA

LOCATION.—Lat 39°22'44", long 120°29'40", in NE 1/4 SE 1/4 sec.34, T.18 N., R.12 E., Nevada County, Hydrologic Unit 18020125, near left abutment of Fordyce Dam, on Fordyce Creek, and 5.3 mi northeast of Cisco.

DRAINAGE AREA.—31.7 mi<sup>2</sup>.

PERIOD OF RECORD.—October 1977 to current year. Periodic gage heights only for October 1965 to September 1976 and daily contents for water year 1977 are in the files of the U.S. Geological Survey.

GAGE.—Water-stage recorder. Datum of gage is 6,290.5 ft above sea level (levels by Pacific Gas & Electric Co.). Prior to Nov. 29, 1976, nonrecording gage on upstream side of dam at same datum.

REMARKS.—Lake is formed by a rockfill dam; storage began in 1926. In 1980 the capacity of Fordyce Lake was increased by the addition of 3 ft of flashboards. Capacity, 49,903 acre-ft, between gage heights 0.85 ft, bottom of outlet valve, and 114.6 ft, top of flashboards in spillway. Released water flows down Fordyce Creek (station 11414100) to Lake Spaulding (station 11414140) for use in a power and irrigation system. See schematic diagram of [South Yuba River Basin](#).

COOPERATION.—Records were collected by Pacific Gas & Electric Co., under general supervision of the U.S. Geological Survey, in connection with a Federal Energy Regulatory Commission project.

EXTREMES FOR PERIOD OF RECORD.—Maximum contents, 50,100 acre-ft, June 4, 2000, gage height, 114.88 ft; minimum, 250 acre-ft, Oct. 31 to Nov. 7, 1979.

EXTREMES FOR CURRENT YEAR.—Maximum contents, 39,600 acre-ft, June 2–7, maximum gage height, 100.37 ft, June 3, 4; minimum, 5,910 acre-ft, Jan. 7, 9, minimum gage height, 32.57 ft, Jan. 7.

Capacity table (gage height, in feet, and contents, in acre-feet)  
(Based on table provided by Pacific Gas & Electric Co., dated May 1981)

4	219	20	2,608	40	8,183	80	26,770
5	278	25	3,827	50	11,797	90	32,820
10	774	30	5,170	60	16,174	100	39,342
15	1,570	35	6,628	70	21,196	114.6	49,903

## RESERVOIR STORAGE (ACRE-FEET), WATER YEAR OCTOBER 2000 TO SEPTEMBER 2001

## DAILY OBSERVATION AT 2400 HOURS

DAY	OCT	NOV	DEC	JAN	FEB	MAR	APR	MAY	JUN	JUL	AUG	SEP
1	30200	16400	7390	5950	5990	6390	11900	21400	39500	35800	28500	22200
2	30100	16000	7290	5940	5980	6410	12300	22100	39600	35600	28300	22000
3	29700	15600	7200	5940	5980	6410	12500	22600	39600	35400	28000	21700
4	29200	15200	7110	5930	5990	6460	12700	23100	39600	35100	27800	21500
5	28700	14800	7020	5920	6000	6480	12800	23800	39600	34900	27600	21300
6	28200	14400	6930	5920	6020	6490	13000	24600	39600	34600	27500	21000
7	27700	13900	6840	5910	6020	6490	13100	25600	39600	34400	27400	20800
8	27200	13500	6750	5920	6030	6510	13200	26800	39500	34200	27400	20500
9	26800	13100	6670	5910	6070	6530	13300	27900	39500	33900	27300	20300
10	26300	12700	6600	5950	6100	6540	13400	28800	39500	33700	27300	20100
11	25800	12300	6520	5970	6140	6550	13500	29900	39400	33400	27200	19900
12	25400	11900	6440	5960	6150	6560	13500	30800	39400	33200	27200	19600
13	24900	11500	6360	5960	6160	6580	13600	31700	39400	33000	27000	19500
14	24400	11200	6310	5970	6170	6600	13700	32300	39300	32700	26700	19300
15	23900	10800	6240	5960	6180	6620	13700	33500	39300	32500	26500	19100
16	23500	10400	6150	5960	6190	6650	13900	34500	39200	32200	26200	19000
17	23000	9940	6070	5950	6190	6680	14200	35200	39200	32000	26000	18800
18	22500	9540	6020	5940	6200	6740	14500	35800	39000	31800	25700	18700
19	22000	9130	6020	5950	6230	6840	14800	36300	38700	31500	25400	18500
20	21600	8740	6010	5940	6250	7010	15000	36900	38500	31300	25200	18300
21	21100	8360	6010	5940	6290	7210	15200	37300	38300	31100	24900	18200
22	20700	e8150	6010	5940	6320	7420	15300	37800	38000	30800	24700	18000
23	20200	e8060	6010	5950	6330	7640	15600	38200	37800	30600	24400	17900
24	19700	e7980	6010	5970	6360	7960	16000	38500	37500	30400	24200	17700
25	19300	e7890	5990	5990	6370	8530	16800	38800	37300	30100	23900	17600
26	18900	e7810	5990	5990	6380	8900	17600	39000	37000	29900	23700	17400
27	18400	e7730	5980	5980	6380	9240	18400	39100	36800	29700	23400	17300
28	18100	e7640	5970	5990	6390	9740	19100	39200	36600	29400	23200	17100
29	17700	e7560	5970	5990	---	10300	19600	39300	36300	29200	23000	16900
30	17300	7480	5960	5990	---	10800	20500	39400	36100	29000	22700	16800
31	16900	---	5950	5990	---	11400	---	39500	---	28700	22500	---
MAX	30200	16400	7390	5990	6390	11400	20500	39500	39600	35800	28500	22200
MIN	16900	7480	5950	5910	5980	6390	11900	21400	36100	28700	22500	16800
a	61.45	37.79	32.72	32.84	34.19	48.92	68.59	100.22	95.10	83.32	72.37	61.25
b	-13500	-9420	-1530	+40	+400	+5010	+9100	+19000	-3400	-7400	-6200	-5700

CAL YR 2000 MAX 50100 MIN 4800 b +860

WTR YR 2001 MAX 39600 MIN 5910 b -13600

e Estimated.

a Gage height, in feet, at end of month.

b Change in contents, in acre-feet.

## 11414100 FORDYCE CREEK BELOW FORDYCE DAM, NEAR CISCO, CA

LOCATION.—Lat 39°22'48", long 120°29'54", in NW 1/4 SE 1/4 sec.34, T.18 N., R.13 E., Nevada County, Hydrologic Unit 18020125, Tahoe National Forest, on right bank, 850 ft downstream from Fordyce Dam, and 5.3 mi northeast of Cisco.

DRAINAGE AREA.—31.7 mi<sup>2</sup>.

PERIOD OF RECORD.—June 1966 to current year.

GAGE.—Water-stage recorder. Elevation of gage is 6,250 ft above sea level, from topographic map.

REMARKS.—Flow regulated by Fordyce Lake (station 11414090). See schematic diagram of South Yuba River Basin.

COOPERATION.—Records were collected by Pacific Gas & Electric Co., under general supervision of the U.S. Geological Survey, in connection with a Federal Energy Regulatory Commission project.

EXTREMES FOR PERIOD OF RECORD.—Maximum discharge, 4,660 ft<sup>3</sup>/s, July 9, 1974, gage height, 7.90 ft, in gage well, 6.82 ft, from high-water marks, from rating curve extended above 1,000 ft<sup>3</sup>/s, on basis of slope-area measurement of peak flow; minimum daily, 3.5 ft<sup>3</sup>/s, Jan. 2–9, 1979.

## DISCHARGE, CUBIC FEET PER SECOND, WATER YEAR OCTOBER 2000 TO SEPTEMBER 2001

## DAILY MEAN VALUES

DAY	OCT	NOV	DEC	JAN	FEB	MAR	APR	MAY	JUN	JUL	AUG	SEP
1	101	270	55	8.6	8.7	8.6	14	19	28	119	112	114
2	101	269	54	8.6	8.8	8.6	14	19	28	119	112	114
3	226	268	54	8.6	8.6	8.6	14	19	28	119	111	113
4	314	265	54	8.6	8.8	8.6	14	20	28	118	111	113
5	313	263	54	8.6	8.7	8.6	14	20	28	118	111	113
6	312	261	53	8.6	8.6	8.6	14	21	28	118	54	112
7	310	258	53	8.6	8.6	8.7	14	21	28	118	22	112
8	309	256	53	8.6	8.6	9.0	14	22	28	117	22	112
9	308	254	53	8.6	8.6	8.9	14	23	28	117	22	112
10	307	252	53	8.6	8.6	8.8	14	23	28	117	22	111
11	305	249	52	8.3	8.6	8.8	14	24	28	117	22	109
12	303	248	52	8.4	8.6	9.0	14	24	28	117	22	108
13	301	246	52	8.6	8.6	9.3	14	24	28	116	84	108
14	300	243	52	8.6	8.6	9.2	14	25	28	116	123	108
15	299	241	51	8.6	8.6	9.1	15	26	27	116	122	108
16	297	239	51	8.6	8.6	9.1	15	26	27	116	121	108
17	295	236	51	8.6	8.6	9.5	15	27	27	116	121	108
18	294	234	34	8.6	8.5	9.8	16	27	85	115	121	107
19	292	232	8.8	8.6	8.3	10	15	27	121	115	120	107
20	290	229	8.8	8.6	8.3	10	15	27	121	115	120	107
21	288	227	8.8	8.6	8.5	10	15	27	121	115	120	107
22	287	119	8.8	8.6	8.6	11	15	27	121	114	119	106
23	285	50	8.8	8.6	8.6	11	16	28	120	115	118	106
24	283	50	8.8	8.6	8.6	11	16	28	120	114	118	106
25	281	50	8.8	8.4	8.6	13	17	28	120	114	117	106
26	279	50	8.7	8.4	8.6	12	17	28	119	114	116	105
27	278	50	8.6	8.6	8.6	12	17	28	119	114	116	105
28	277	50	8.6	8.6	8.6	13	17	29	119	114	116	105
29	276	49	8.6	8.6	---	13	18	28	119	113	115	105
30	274	52	8.6	8.6	---	13	18	28	119	113	115	105
31	272	---	8.6	8.6	---	14	---	27	---	113	114	---
TOTAL	8657	5760	1044.3	265.7	240.6	313.8	453	770	1997	3592	2959	3260
MEAN	279	192	33.7	8.57	8.59	10.1	15.1	24.8	66.6	116	95.5	109
MAX	314	270	55	8.6	8.8	14	18	29	121	119	123	114
MIN	101	49	8.6	8.3	8.3	8.6	14	19	27	113	22	105
AC-FT	17170	11420	2070	527	477	622	899	1530	3960	7120	5870	6470

## STATISTICS OF MONTHLY MEAN DATA FOR WATER YEARS 1966 - 2001, BY WATER YEAR (WY)

	87.1	46.5	28.4	35.9	54.7	70.2	66.6	186	356	283	210	141
MEAN	87.1	46.5	28.4	35.9	54.7	70.2	66.6	186	356	283	210	141
MAX	428	236	173	278	328	353	315	727	957	542	403	497
(WY)	1976	1977	1982	1997	1984	1984	1986	1996	1995	1995	1983	1980
MIN	4.35	3.90	3.75	4.76	4.78	5.07	9.21	17.0	36.4	21.7	11.4	4.84
(WY)	1978	1979	1979	1981	1977	1977	1977	1977	1976	1981	1987	1977

## SUMMARY STATISTICS

## FOR 2000 CALENDAR YEAR

## FOR 2001 WATER YEAR

## WATER YEARS 1966 - 2001

ANNUAL TOTAL	42164.3	29312.4	
ANNUAL MEAN	115	80.3	131
HIGHEST ANNUAL MEAN			288
LOWEST ANNUAL MEAN			49.3
HIGHEST DAILY MEAN	819	May 25	314
LOWEST DAILY MEAN	8.6	Dec 27	8.3
ANNUAL SEVEN-DAY MINIMUM	8.6	Dec 25	8.5
MAXIMUM PEAK FLOW			322
MAXIMUM PEAK STAGE			3.51
ANNUAL RUNOFF (AC-FT)	83630	58140	94960
10 PERCENT EXCEEDS	291	255	404
50 PERCENT EXCEEDS	53	28	34
90 PERCENT EXCEEDS	18	8.6	6.9

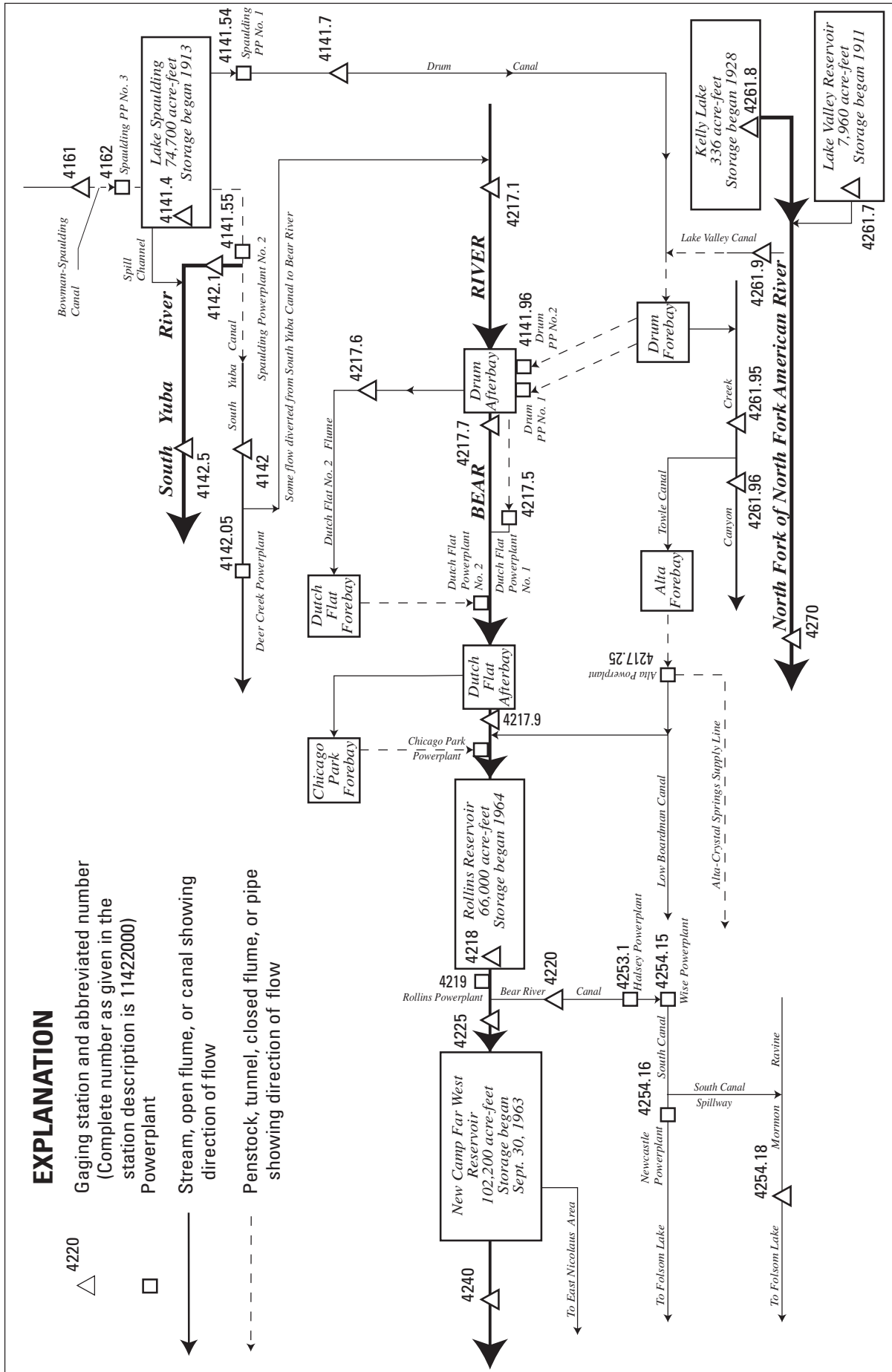

Figure 33. Diversions and storage in Bear River Basin.

## 11414140 LAKE SPAULDING NEAR EMIGRANT GAP, CA

LOCATION.—Lat 39°19'35", long 120°38'32", in SE 1/4 NE 1/4 sec.20, T.17 N., R.12 E., Nevada County, Hydrologic Unit 18020125, near center of Spaulding Dam, on South Yuba River, and 2.5 mi northeast of Emigrant Gap.

DRAINAGE AREA.—118 mi<sup>2</sup>.

PERIOD OF RECORD.—October 1964 to current year.

GAGE.—Water-stage recorder. Datum of gage is 4,809.6 ft above sea level (levels by Pacific Gas & Electric Co.). Prior to July 1968, nonrecording gage at same site and datum.

REMARKS.—Lake is formed by three concrete-arch dams with spillway on the middle arch. Storage began in 1913. Capacity, 74,700 acre-ft, between gage heights 0.6 ft, bottom of outlet, and 205.0 ft, top of radial gates. Released water flows through Spaulding Powerplants Nos. 1 and 2 (stations 11414154 and 11414155). Flow through Powerplant No. 1 is transported out of Yuba River Basin by Drum Canal to Bear River Basin. See schematic diagrams of *South Yuba and Bear River Basins*.

COOPERATION.—Records were collected by Pacific Gas & Electric Co., under general supervision of the U.S. Geological Survey, in connection with a Federal Energy Regulatory Commission project. Contents not rounded to U.S. Geological Survey standards.

EXTREMES FOR PERIOD OF RECORD.—Maximum contents, 75,100 acre-ft, July 13, 1967, gage height, 205.5 ft; minimum, 914 acre-ft, Feb. 28, 1976, gage height, 25.5 ft.

EXTREMES FOR CURRENT YEAR.—Maximum contents, 73,200 acre-ft, May 16, 17, maximum gage height, 202.70 ft, May 16; minimum, 16,400 acre-ft, Mar. 2, gage height, 91.27 ft.

Capacity table (gage height, in feet, and contents, in acre-feet)  
(Based on survey by Pacific Gas & Electric Co., dated Apr. 23, 1965)

20	566	40	2,742	100	19,541	200	71,329
25	874	50	4,578	150	41,545	206	75,473
30	1,352	70	9,632				

## RESERVOIR STORAGE (ACRE-FEET), WATER YEAR OCTOBER 2000 TO SEPTEMBER 2001

## DAILY OBSERVATION AT 2400 HOURS

DAY	OCT	NOV	DEC	JAN	FEB	MAR	APR	MAY	JUN	JUL	AUG	SEP
1	17000	25700	22300	22200	18300	16600	34900	58900	67800	54000	34300	20900
2	17600	25600	22300	22000	18200	16400	35800	59800	67600	53700	33700	20500
3	18400	25400	22400	21600	18200	16500	36200	59800	67500	53300	33300	20200
4	19400	25500	22400	21300	18200	16500	36300	60000	66700	52900	33400	20000
5	20100	25500	22400	21000	18300	16800	36400	60900	65900	52500	33300	19700
6	20900	25000	22400	20800	18300	17200	36400	62000	65100	52100	32900	19400
7	21600	24500	22400	20700	18300	17700	36700	63600	64300	51600	32200	19200
8	22400	24200	22400	20600	18200	18300	37000	65400	63800	50700	31600	19000
9	23100	24000	22600	20500	18100	18700	37000	66900	63800	49800	30900	18900
10	23900	23800	22900	20400	17900	18900	36900	68300	63700	48800	30300	18700
11	24800	24100	22800	20000	17700	19200	36800	69500	63700	47700	29600	18500
12	25500	24200	22700	19800	17500	19400	36700	70700	63600	46800	29000	18400
13	25500	23900	22500	19800	17600	19800	36700	71500	63000	45800	28700	18200
14	25500	23600	22400	19800	17600	20200	37000	71600	62300	44800	28300	18000
15	25500	23600	22300	19700	17600	20500	37400	72300	61700	43800	27900	17900
16	25200	23700	22400	19700	17500	20800	37700	73200	61100	43100	27500	18400
17	25000	23600	22600	19300	17400	20900	38400	73200	60500	42400	27000	18700
18	24700	23900	22600	19200	17200	21300	39400	72800	59900	41800	26600	18700
19	24500	23900	22500	19100	17100	21400	40800	72800	59500	41300	26200	18800
20	24400	23600	22200	19000	17000	21800	41700	72800	59000	40700	25800	18900
21	25000	23300	22100	19000	16900	22300	42500	72700	58500	40200	25300	18900
22	25500	23000	22100	19000	16800	22800	43400	72700	58100	39600	24900	19000
23	25300	23000	22200	19000	16700	23200	44300	72600	57600	39100	24500	19000
24	25100	23100	22300	18800	16600	24500	45800	72500	57200	38500	24100	19100
25	24900	23000	22400	18700	16600	27500	48000	72200	56600	37900	23700	19200
26	24700	23000	22300	18600	16600	28500	50300	71800	56100	37400	23200	19300
27	24600	22900	22200	18600	16600	29000	52400	71400	55700	36800	22800	19400
28	25400	22700	22100	18600	16600	30000	54400	71000	55200	36400	22300	19600
29	26200	22700	22100	18500	---	31100	55900	70200	54800	36000	22000	19800
30	26100	22500	22100	18400	---	32100	57200	69400	54300	35400	21600	20100
31	25900	---	22200	18400	---	33500	---	68500	---	34900	21300	---
MAX	26200	25700	22900	22200	18300	33500	57200	73200	67800	54000	34300	20900
MIN	17000	22500	22100	18400	16600	16400	34900	58900	54300	34900	21300	17900
a	116.37	107.87	107.06	96.76	91.77	133.62	178.02	195.82	173.07	136.56	104.59	101.39
b	+9400	-3400	-300	-3800	-1800	+16900	+23700	+11300	-14200	-19400	-13600	-1200
c	15660	18960	10960	8520	6180	12510	14590	33700	31450	22700	24110	9700
d	3750	3140	4440	3260	2610	3280	3890	3740	502	5570	5550	5630

CAL YR 2000 MAX 74900 MIN 11100 b -300 c 300100 d 57230  
WTR YR 2001 MAX 73200 MIN 16400 b +3600 c 209000 d 45370

a Gage height, in feet, at end of month.

b Change in contents, in acre-feet.

c Diversion, in acre-feet, to Spaulding No. 1 Powerplant (station 11414154), provided by Pacific Gas & Electric Co.

d Diversion, in acre-feet, to Spaulding No. 2 Powerplant (station 11414154), provided by Pacific Gas & Electric Co.

## 11414170 DRUM CANAL AT TUNNEL OUTLET, NEAR EMIGRANT GAP, CA

LOCATION.—Lat 39°19'03", long 120°39'08", in SE 1/4 SW 1/4 sec.20, T.17 N., R.12 E., Nevada County, Hydrologic Unit 18020125, Tahoe National Forest, 100 ft downstream from tunnel outlet, 1.0 mi downstream from Spaulding No. 1 Powerplant, and 1.7 mi northeast of Emigrant Gap.

PERIOD OF RECORD.—October 1964 to current year. Prior to October 1972, published as "Drum Canal at intake."

GAGE.—Water-stage recorder. Elevation of gage is 4,880 ft above sea level, from topographic map. Prior to Oct. 1, 1968, in powerplant 0.7 mi upstream at different datum.

REMARKS.—Canal diverts from Spaulding No. 1 Powerplant (station 11414154) at Lake Spaulding Dam. Most of the water from Drum Canal enters the Bear River via Drum No. 1 and 2 Powerplants (station 11414196) at Drum Afterbay. Some of the water is diverted out of Drum Forebay to Alta Powerplant (station 11421725). See schematic diagrams of [South Yuba](#) and [Bear River Basins](#).

COOPERATION.—Records were collected by Pacific Gas & Electric Co., under general supervision of the U.S. Geological Survey, in connection with a Federal Energy Regulatory Commission project.

EXTREMES FOR PERIOD OF RECORD.—Maximum daily discharge, 864 ft<sup>3</sup>/s, May 1, 1998; no flow for several days in most years.

DISCHARGE, CUBIC FEET PER SECOND, WATER YEAR OCTOBER 2000 TO SEPTEMBER 2001  
DAILY MEAN VALUES

DAY	OCT	NOV	DEC	JAN	FEB	MAR	APR	MAY	JUN	JUL	AUG	SEP
1	.00	594	313	123	100	107	233	495	631	551	412	521
2	.00	589	220	224	99	209	302	641	247	531	417	527
3	.00	564	219	223	103	116	303	733	284	529	414	484
4	.00	214	219	221	103	217	303	712	674	557	315	480
5	60	209	219	212	117	140	303	488	686	562	331	478
6	132	488	213	119	124	112	296	477	684	561	551	475
7	136	484	202	117	124	105	193	355	681	559	567	471
8	137	481	209	181	131	106	116	480	534	557	582	436
9	181	505	113	165	259	107	306	488	274	566	588	434
10	129	485	126	190	259	108	305	496	262	610	585	432
11	129	204	305	320	256	109	305	499	262	604	580	431
12	160	248	305	221	221	109	304	502	270	564	585	429
13	528	521	304	107	105	110	292	513	582	560	460	427
14	527	519	304	107	105	111	111	790	554	570	519	430
15	527	517	303	106	105	112	132	810	552	577	579	399
16	634	515	135	104	105	116	307	829	550	419	582	81
17	630	506	122	222	186	200	279	821	555	408	578	.00
18	626	225	220	119	241	264	260	793	565	381	575	.00
19	624	356	219	119	195	502	263	475	562	345	580	.00
20	591	514	219	111	222	502	241	480	561	417	579	.00
21	201	512	218	110	220	506	110	480	560	422	576	.00
22	239	490	210	110	220	510	116	479	558	426	579	.00
23	623	208	110	124	220	494	244	480	557	424	564	.00
24	621	223	109	203	201	204	246	482	556	435	552	.00
25	619	223	127	174	141	224	249	492	555	435	558	.00
26	617	228	217	180	107	504	252	492	554	411	590	.00
27	579	306	218	118	107	525	243	491	553	402	582	.00
28	201	305	218	117	107	521	103	493	552	314	571	.00
29	204	305	209	154	---	503	123	665	550	329	525	.00
30	584	305	114	109	---	497	491	668	549	414	520	.00
31	596	---	114	101	---	225	---	667	---	412	518	---
TOTAL	10835.00	11843	6353	4811	4483	8175	7331	17766	15514	14852	16514	6935.00
MEAN	350	395	205	155	160	264	244	573	517	479	533	231
MAX	634	594	313	320	259	525	491	829	686	610	590	527
MIN	.00	204	109	101	99	105	103	355	247	314	315	.00
AC-FT	21490	23490	12600	9540	8890	16220	14540	35240	30770	29460	32760	13760
a	20770	22290	12090	8730	8320	17220	15290	34250	28680	26470	30120	12300
b	899	1040	607	574	646	284	411	282	1220	1320	1140	578

a Discharge, in acre-feet, to Drum No. 1 and 2 Powerplants (station 11414196), provided by Pacific Gas & Electric Co.

b Discharge, in acre-feet, to Alta Powerplant (station 11421725), provided by Pacific Gas & Electric Co.



## SACRAMENTO RIVER BASIN

## 11414170 DRUM CANAL AT TUNNEL OUTLET, NEAR EMIGRANT GAP, CA—Continued

## STATISTICS OF MONTHLY MEAN DATA FOR WATER YEARS 1965 - 2001, BY WATER YEAR (WY)

	OCT	NOV	DEC	JAN	FEB	MAR	APR	MAY	JUN	JUL	AUG	SEP
MEAN	405	422	457	438	468	524	605	651	640	616	580	366
MAX	817	824	835	837	833	838	839	855	851	820	820	661
(WY)	1983	1984	1984	1984	1984	1984	1996	1998	1999	1983	1998	1986
MIN	.000	29.5	31.1	30.2	.000	22.6	22.9	5.77	166	178	.000	.000
(WY)	1966	1987	1977	1997	1991	1988	1988	1976	1977	1977	1965	1965

SUMMARY STATISTICS	FOR 2000 CALENDAR YEAR	FOR 2001 WATER YEAR	WATER YEARS 1965 - 2001
ANNUAL TOTAL	200655.00	125412.00	
ANNUAL MEAN	548	344	515
HIGHEST ANNUAL MEAN			796 1984
LOWEST ANNUAL MEAN			101 1977
HIGHEST DAILY MEAN	846 Jun 9	829 May 16	864 May 1 1998
LOWEST DAILY MEAN	.00 Sep 22	.00 Oct 1	.00 Jul 31 1965
ANNUAL SEVEN-DAY MINIMUM	.00 Sep 22	.00 Sep 17	.00 Jul 31 1965
ANNUAL RUNOFF (AC-FT)	398000	248800	372800
ANNUAL DISCHARGE (AC-FT) a	382500	236500	
ANNUAL DISCHARGE (AC-FT) b	9570	9000	
10 PERCENT EXCEEDS	838	582	827
50 PERCENT EXCEEDS	613	305	567
90 PERCENT EXCEEDS	205	107	40

a Discharge, in acre-feet, to Drum No. 1 and 2 Powerplants (station 11414196), provided by Pacific Gas & Electric Co.

b Discharge, in acre-feet, to Alta Powerplant (station 11421725), provided by Pacific Gas & Electric Co.

## 11414200 SOUTH YUBA CANAL NEAR EMIGRANT GAP, CA

LOCATION.—Lat 39°18'49", long 120°39'43", in SE 1/4 NE 1/4 sec.30, T.17 N., R.12 E., Nevada County, Hydrologic Unit 18020125, on left bank of concrete flume, 400 ft downstream from Bowman Lake Road, and 2.5 mi northeast of Emigrant Gap.

PERIOD OF RECORD.—October 1964 to current year.

GAGE.—Water-stage recorder and concrete control. Elevation of gage is 4,590 ft above sea level, from topographic map.

REMARKS.—Canal diverts from Spaulding No. 2 Powerplant (station 11414155) at Lake Spaulding Dam. Downstream from the gage, some flow is diverted to Bear River. The remainder of the water enters Deer Creek at Deer Creek Powerplant (station 11414205). See schematic diagrams of South Yuba and Bear River Basins.

COOPERATION.—Records were collected by Pacific Gas & Electric Co., under general supervision of the U.S. Geological Survey, in connection with a Federal Energy Regulatory Commission project.

EXTREMES FOR PERIOD OF RECORD.—Maximum daily discharge, 165 ft<sup>3</sup>/s, Aug. 3, 1965; no flow at times in some years.

DISCHARGE, CUBIC FEET PER SECOND, WATER YEAR OCTOBER 2000 TO SEPTEMBER 2001  
DAILY MEAN VALUES

DAY	OCT	NOV	DEC	JAN	FEB	MAR	APR	MAY	JUN	JUL	AUG	SEP
1	61	51	63	67	42	42	58	67	73	34	89	89
2	62	51	66	53	44	42	60	66	74	64	89	88
3	62	52	67	45	46	42	60	65	31	86	91	89
4	63	54	67	45	43	42	62	65	2.0	85	90	89
5	57	52	67	45	34	42	65	66	1.3	85	91	89
6	61	53	67	45	29	40	71	66	.14	83	89	89
7	60	53	67	45	43	40	67	66	.14	81	89	89
8	64	50	67	45	43	40	66	65	.21	81	89	89
9	62	46	67	45	43	40	66	66	.00	80	88	89
10	64	46	67	45	43	41	65	67	.00	80	88	90
11	62	47	67	45	43	41	67	66	.00	79	87	90
12	63	47	67	45	42	40	66	66	.00	79	86	90
13	63	45	67	45	42	40	66	66	.00	78	58	92
14	63	45	64	45	42	55	63	66	.00	78	34	94
15	63	45	63	45	42	66	66	56	.00	77	58	94
16	58	44	63	46	42	65	65	61	.00	78	89	91
17	53	44	65	48	42	61	65	64	.00	84	89	91
18	57	44	64	49	42	60	66	61	.00	85	89	91
19	55	45	64	49	43	60	68	70	.00	85	88	91
20	52	45	65	47	44	61	69	70	.10	85	88	91
21	52	45	65	47	43	61	68	70	.27	87	70	89
22	52	45	65	46	42	61	66	70	.27	89	89	93
23	53	45	65	46	42	60	66	72	.28	90	87	91
24	53	45	64	43	42	60	65	73	.27	90	87	93
25	52	47	63	43	43	62	66	70	.26	89	88	93
26	51	47	65	43	43	61	67	68	.17	89	90	94
27	52	47	67	43	43	58	67	71	.14	89	90	91
28	48	47	67	43	43	57	67	71	.14	89	91	91
29	45	44	67	43	---	61	66	68	21	91	92	89
30	51	56	67	43	---	62	66	68	33	90	91	89
31	52	---	67	42	---	62	---	71	---	90	90	---
TOTAL	1766	1427	2036	1426	1175	1625	1965	2077	237.69	2550	2624	2718
MEAN	57.0	47.6	65.7	46.0	42.0	52.4	65.5	67.0	7.92	82.3	84.6	90.6
MAX	64	56	67	67	46	66	71	73	74	91	92	94
MIN	45	44	63	42	29	40	58	56	.00	34	34	88
AC-FT	3500	2830	4040	2830	2330	3220	3900	4120	471	5060	5200	5390
a	3090	2450	3700	2530	1870	3140	3830	3840	333	4240	4070	4650

## STATISTICS OF MONTHLY MEAN DATA FOR WATER YEARS 1965 - 2001, BY WATER YEAR (WY)

MEAN	77.7	66.6	70.3	72.6	76.4	83.7	76.8	108	108	96.5	91.2	87.8
MAX	158	157	157	155	151	147	146	156	163	160	155	152
(WY)	1966	1966	1966	1984	1984	1980	1967	1980	1965	1965	1965	1965
MIN	35.9	14.7	33.4	18.2	11.4	15.6	11.3	27.2	7.92	46.1	41.7	38.0
(WY)	1978	1995	1978	1997	1997	1997	1979	1977	2001	1977	1977	1977

SUMMARY STATISTICS	FOR 2000 CALENDAR YEAR	FOR 2001 WATER YEAR	WATER YEARS 1965 - 2001
ANNUAL TOTAL	28042.90	21626.69	
ANNUAL MEAN	76.6	59.3	84.7
HIGHEST ANNUAL MEAN			124
LOWEST ANNUAL MEAN			47.2
HIGHEST DAILY MEAN	143	94	165
LOWEST DAILY MEAN	.00	.00	.00
ANNUAL SEVEN-DAY MINIMUM	.14	.00	.00
ANNUAL RUNOFF (AC-FT)	55620	42900	61340
ANNUAL DISCHARGE (AC-FT) a	29290	37740	
10 PERCENT EXCEEDS	139	89	141
50 PERCENT EXCEEDS	67	63	77
90 PERCENT EXCEEDS	36	40	39

a Discharge, in acre-feet, to Deer Creek Powerplant (station 11414205), provided by Pacific Gas & Electric Co.

## 11414210 SOUTH YUBA RIVER CONTROLLED RELEASE AT LAKE SPAULDING, NEAR EMIGRANT GAP, CA

LOCATION.—Lat 39°19'28", long 120°38'42", in NE 1/4 SE 1/4 sec.20, T.17 N., R.12 E., Nevada County, Hydrologic Unit 18020125, on left bank, 200 ft downstream from Spaulding No. 2 Powerplant, 0.2 mi downstream from Spaulding Dam, and 2.3 mi northeast of Emigrant Gap.

DRAINAGE AREA.—118 mi<sup>2</sup>.

PERIOD OF RECORD.—October 1985 to current year. Unpublished records for water years 1965–85 in files of the U.S. Geological Survey. Prior to October 2000, published as South Yuba River below Spaulding No. 2 Powerplant, near Emigrant Gap.

GAGE.—Water-stage recorder, V-notch sharp-crested weir, and steel-lipped rectangular weir. Elevation of gage is 4,670 ft above sea level, from topographic map. Prior to June 1988, at same site and different datum.

REMARKS.—Flow regulated by Lake Spaulding (station 11414140) 0.2 mi upstream. Water is released at the intake to South Yuba Canal (station 11414200) 100 ft upstream. Flow over Lake Spaulding spillway bypasses this station. See schematic diagrams of [South Yuba](#) and [Bear River Basins](#).

COOPERATION.—Records were collected by Pacific Gas & Electric Co., under general supervision of the U.S. Geological Survey, in connection with a Federal Energy Regulatory Commission project.

EXTREMES FOR PERIOD OF RECORD.—Maximum discharge, 194 ft<sup>3</sup>/s, Apr. 14, June 8, 1986, gage height, 3.37 ft, from rating curve extended above 45 ft<sup>3</sup>/s, on basis of weir formula; minimum daily, 0.09 ft<sup>3</sup>/s, Nov. 5–7, 1985.

## DISCHARGE, CUBIC FEET PER SECOND, WATER YEAR OCTOBER 2000 TO SEPTEMBER 2001

## DAILY MEAN VALUES

DAY	OCT	NOV	DEC	JAN	FEB	MAR	APR	MAY	JUN	JUL	AUG	SEP
1	6.9	4.5	5.3	3.5	1.9	1.3	1.1	1.6	3.5	4.4	5.9	6.5
2	6.3	4.5	5.0	3.6	1.9	1.5	1.3	1.4	2.4	4.6	5.7	6.5
3	5.4	4.5	4.8	3.5	1.9	1.4	1.3	1.4	1.2	4.5	5.6	6.5
4	4.0	4.5	4.8	3.5	1.8	2.5	2.3	1.5	1.3	4.5	5.6	6.5
5	5.0	4.8	4.8	3.5	1.5	2.4	3.6	1.5	1.4	4.5	5.6	6.4
6	5.7	4.8	4.8	3.5	1.4	2.3	2.2	1.6	1.3	4.5	5.6	6.3
7	5.6	4.8	4.8	3.5	1.4	2.2	1.2	2.3	1.3	4.5	5.6	6.2
8	5.6	4.8	4.8	3.5	1.4	2.0	1.1	3.4	1.3	4.5	5.6	6.2
9	4.8	4.8	4.8	3.5	1.5	1.6	1.2	2.5	1.1	4.5	5.6	6.2
10	4.4	4.8	4.8	3.7	1.6	1.5	.95	2.4	1.1	4.6	5.6	6.2
11	4.0	4.6	4.8	4.0	1.6	1.5	.98	2.4	1.1	4.8	5.6	6.2
12	3.8	4.5	4.8	3.3	1.6	1.8	.90	2.4	1.1	4.8	5.6	6.5
13	3.8	4.8	4.8	2.4	1.4	2.3	.90	2.4	1.3	4.8	3.9	6.8
14	3.8	4.8	4.8	2.2	1.4	2.2	.94	2.8	1.2	4.8	5.0	6.8
15	3.8	4.8	5.0	2.2	1.4	2.1	.94	1.7	1.2	4.8	5.0	6.8
16	3.8	4.8	4.8	2.2	1.4	2.1	1.1	1.2	1.2	4.8	5.5	6.8
17	4.2	4.8	4.7	2.8	1.5	2.0	.94	1.9	1.2	4.8	5.9	6.7
18	4.8	4.5	4.5	3.1	1.7	2.2	1.2	2.2	1.2	4.8	5.9	6.5
19	4.8	4.5	4.5	3.1	1.6	3.0	1.7	1.9	1.1	4.8	5.9	6.4
20	4.8	4.5	4.5	3.1	1.6	3.1	1.1	1.9	1.1	4.8	5.9	6.2
21	4.6	4.5	4.5	3.1	1.8	2.7	.93	1.8	1.1	5.2	5.2	6.0
22	4.3	4.5	3.3	3.1	1.8	2.7	.95	1.7	1.1	5.4	5.1	6.2
23	4.5	4.5	1.8	3.1	1.6	2.5	1.4	1.6	1.1	5.3	6.7	6.3
24	4.5	4.5	2.4	3.3	1.5	1.8	1.4	1.6	1.1	5.9	7.1	6.1
25	4.5	4.8	2.8	3.1	1.5	3.0	1.3	1.6	1.5	6.2	6.5	5.9
26	4.5	5.0	2.8	2.9	1.4	2.5	1.3	1.6	1.5	6.2	6.5	5.9
27	4.5	5.0	2.8	2.3	1.4	2.3	1.4	1.6	1.5	6.2	6.5	5.9
28	5.0	5.0	3.1	2.0	1.4	2.0	1.2	2.2	5.8	6.0	5.9	5.8
29	4.8	5.5	3.5	2.0	---	1.8	1.1	3.2	5.0	5.9	5.3	7.0
30	4.5	5.4	3.4	1.9	---	1.7	1.6	3.4	4.5	5.9	5.4	7.5
31	4.5	---	3.5	1.9	---	1.2	---	3.5	---	5.9	6.0	---
TOTAL	145.5	142.1	129.8	92.4	43.9	65.2	39.53	64.2	51.8	157.2	176.8	191.8
MEAN	4.69	4.74	4.19	2.98	1.57	2.10	1.32	2.07	1.73	5.07	5.70	6.39
MAX	6.9	5.5	5.3	4.0	1.9	3.1	3.6	3.5	5.8	6.2	7.1	7.5
MIN	3.8	4.5	1.8	1.9	1.4	1.2	.90	1.2	1.1	4.4	3.9	5.8
AC-FT	289	282	257	183	87	129	78	127	103	312	351	380

## STATISTICS OF MONTHLY MEAN DATA FOR WATER YEARS 1986 - 2001, BY WATER YEAR (WY)

	1986	1987	1988	1989	2000	2001	1986	1987	1988	1989	2000	2001
MEAN	4.58	4.42	4.43	4.16	9.40	15.2	21.6	24.0	23.6	6.65	4.84	4.92
MAX	7.45	6.63	21.2	17.7	61.4	111	118	85.8	111	29.1	8.84	8.22
(WY)	2000	1999	1997	1995	1986	1986	1986	1986	1986	1998	1997	1997
MIN	1.50	1.52	1.72	1.70	1.57	1.95	1.32	1.75	1.71	1.71	1.55	1.58
(WY)	1986	1986	1987	1989	2001	1988	2001	1987	1987	1986	1986	1987

## SUMMARY STATISTICS FOR 2000 CALENDAR YEAR FOR 2001 WATER YEAR WATER YEARS 1986 - 2001

ANNUAL TOTAL	2915.9	1300.23	
ANNUAL MEAN	7.97	3.56	10.6
HIGHEST ANNUAL MEAN			41.3
LOWEST ANNUAL MEAN			2.05
HIGHEST DAILY MEAN	45	May 12	7.5
LOWEST DAILY MEAN	1.5	Jan 22	.90
ANNUAL SEVEN-DAY MINIMUM	1.7	Jun 13	.96
MAXIMUM PEAK FLOW			35
MAXIMUM PEAK STAGE			1.75
ANNUAL RUNOFF (AC-FT)	5780	2580	7700
10 PERCENT EXCEEDS	29	6.0	32
50 PERCENT EXCEEDS	4.8	3.5	4.6
90 PERCENT EXCEEDS	1.9	1.3	1.7

## 11414250 SOUTH YUBA RIVER AT LANGS CROSSING, NEAR EMIGRANT GAP, CA

LOCATION.—Lat 39°19'07", long 120°39'24", in SW 1/4 SW 1/4 sec.20, T.17 N., R.12 E., Nevada County, Hydrologic Unit 18020125, on right bank, 50 ft downstream from road bridge, 0.8 mi downstream from Spaulding Nos. 1 and 2 Powerplants, and 1.6 mi northeast of Emigrant Gap.

DRAINAGE AREA.—120 mi<sup>2</sup>.

PERIOD OF RECORD.—December 1965 to current year.

GAGE.—Water-stage recorder. Datum of gage is 4,432.44 ft above sea level (levels by Pacific Gas & Electric Co.).

REMARKS.—Flow regulated by Lake Spaulding (station 11414140) 0.8 mi upstream. Lake Spaulding receives water from Canyon Creek via the Bowman–Spaulding Canal (station 11416100). Most of the water is diverted out of the Yuba River just downstream from Spaulding Dam via Drum Canal (station 11414170) and South Yuba Canal (station 11414200). See schematic diagrams of South Yuba and Bear River Basins.

COOPERATION.—Records were collected by Pacific Gas & Electric Co., under general supervision of the U.S. Geological Survey, in connection with a Federal Energy Regulatory Commission project.

EXTREMES FOR PERIOD OF RECORD.—Maximum discharge, about 34,200 ft<sup>3</sup>/s, Jan. 1, 1997, gage height, 23.60 ft, from rating curve extended above 8,800 ft<sup>3</sup>/s, on basis of spillway rating at Spaulding Dam; minimum daily, 2.1 ft<sup>3</sup>/s, on several days during July and September 1977.

## DISCHARGE, CUBIC FEET PER SECOND, WATER YEAR OCTOBER 2000 TO SEPTEMBER 2001

## DAILY MEAN VALUES

DAY	OCT	NOV	DEC	JAN	FEB	MAR	APR	MAY	JUN	JUL	AUG	SEP
1	10	8.2	9.3	6.2	5.8	8.8	8.2	7.0	7.5	7.2	7.5	8.4
2	9.7	7.5	8.4	6.0	6.2	9.2	7.7	6.3	13	7.1	7.3	8.2
3	8.5	7.1	7.6	5.7	7.8	8.4	7.2	5.9	12	7.1	7.3	8.2
4	6.2	11	7.3	5.6	9.8	24	7.7	5.7	11	7.6	7.0	8.2
5	7.5	8.9	7.2	5.5	8.7	38	9.6	5.3	9.1	7.1	7.0	8.0
6	8.6	7.7	7.0	5.4	7.5	32	8.4	5.2	7.7	6.9	7.2	7.9
7	8.4	7.1	6.9	5.3	6.4	30	7.7	5.1	7.4	6.8	7.0	7.9
8	8.5	6.9	6.8	5.9	5.7	29	7.3	7.5	7.8	6.6	6.7	7.8
9	8.6	6.7	6.8	5.9	6.3	25	7.8	6.2	7.5	6.4	6.7	7.7
10	8.1	6.7	8.5	7.7	6.4	19	7.9	6.8	7.3	8.1	6.7	7.7
11	8.4	6.2	8.1	8.6	6.6	18	9.9	7.9	7.3	29	6.7	7.8
12	7.3	6.1	9.0	7.6	6.0	17	10	9.0	7.3	38	6.5	8.1
13	7.1	6.8	9.0	5.9	5.8	19	11	12	7.3	32	4.5	8.7
14	6.9	7.0	15	5.6	5.9	20	11	13	7.2	17	5.3	8.8
15	6.8	6.8	17	5.1	5.7	18	11	10	7.2	10	6.2	8.8
16	6.7	6.7	14	5.1	6.1	17	11	13	7.0	8.0	7.7	10
17	7.0	6.7	12	5.6	6.4	18	10	14	7.0	7.4	8.5	8.7
18	7.9	6.2	11	6.4	8.7	21	12	12	7.3	7.2	8.4	8.3
19	6.9	6.3	9.6	7.3	11	23	24	9.5	7.8	6.7	8.2	8.0
20	5.8	6.6	9.0	7.3	11	24	23	8.7	7.3	6.5	7.8	7.7
21	5.4	6.5	9.2	7.2	16	22	22	8.9	7.4	6.8	7.0	7.4
22	9.6	6.4	8.2	7.2	21	20	19	7.8	7.3	6.8	6.7	7.7
23	7.7	6.0	5.2	7.9	15	18	16	7.4	7.7	6.7	9.5	7.7
24	6.4	6.2	5.4	9.3	13	16	14	7.1	7.9	7.8	11	7.5
25	6.6	6.7	6.0	8.6	12	49	12	7.0	8.5	8.4	9.2	7.7
26	6.5	7.2	5.8	8.2	11	34	11	7.3	8.9	8.1	9.2	7.3
27	6.2	7.4	5.6	6.9	10	17	9.3	6.6	9.0	8.0	9.0	7.2
28	16	7.4	5.7	6.3	9.4	14	8.3	5.5	15	7.8	8.1	7.0
29	17	13	6.4	6.6	---	15	7.4	7.0	15	7.5	7.0	8.9
30	12	10	6.2	6.1	---	15	7.4	6.8	8.5	7.7	6.9	10
31	9.3	---	6.1	5.8	---	9.7	---	6.9	---	7.6	7.6	---
TOTAL	257.6	220.0	259.3	203.8	251.2	648.1	338.8	248.4	258.2	315.9	231.4	243.3
MEAN	8.31	7.33	8.36	6.57	8.97	20.9	11.3	8.01	8.61	10.2	7.46	8.11
MAX	17	13	17	9.3	21	49	24	14	15	38	11	10
MIN	5.4	6.0	5.2	5.1	5.7	8.4	7.2	5.1	7.0	6.4	4.5	7.0
AC-FT	511	436	514	404	498	1290	672	493	512	627	459	483

## STATISTICS OF MONTHLY MEAN DATA FOR WATER YEARS 1966 - 2001, BY WATER YEAR (WY)

MEAN	7.17	40.4	47.3	117	91.1	87.0	83.1	324	419	67.9	6.19	6.47
MAX	18.8	683	685	2465	1626	1304	620	1734	2613	822	9.44	10.3
(WY)	1972	1984	1982	1997	1986	1986	1982	1996	1983	1983	1971	1986
MIN	2.68	4.51	5.44	4.51	5.58	5.10	3.41	5.29	3.05	2.34	2.43	2.73
(WY)	1978	1978	1977	1976	1977	1977	1977	1977	1977	1977	1977	1977

## SUMMARY STATISTICS

## FOR 2000 CALENDAR YEAR

## FOR 2001 WATER YEAR

## WATER YEARS 1966 - 2001

ANNUAL TOTAL	20750.9	3476.0		
ANNUAL MEAN	56.7	9.52	111	
HIGHEST ANNUAL MEAN			448	1997
LOWEST ANNUAL MEAN			4.35	1977
HIGHEST DAILY MEAN	1650	May 24	49	Mar 25
LOWEST DAILY MEAN	5.0	Aug 14	4.5	Aug 13
ANNUAL SEVEN-DAY MINIMUM	5.7	Dec 23	5.6	Jan 3
MAXIMUM PEAK FLOW			60	Mar 25
MAXIMUM PEAK STAGE			2.99	Mar 25
ANNUAL RUNOFF (AC-FT)	41160	6890	80060	23.60
10 PERCENT EXCEEDS	89	16	88	
50 PERCENT EXCEEDS	8.1	7.7	7.6	
90 PERCENT EXCEEDS	6.0	6.0	5.3	



## 11414265 RUCKER CREEK BELOW BLUE LAKE, NEAR EMIGRANT GAP, CA

LOCATION.—Lat 39°21'32", long 120°38'09", in NE 1/4 NW 1/4 sec.9, T.17 N., R.12 E., Nevada County, Hydrologic Unit 18020125, Tahoe National Forest, on left bank, 300 ft downstream from outlet structure on Blue Lake Dam, and 4.6 mi northeast of Emigrant Gap.

DRAINAGE AREA.—0.27 mi<sup>2</sup>.

PERIOD OF RECORD.—October 1999 to current year. Unpublished records for water years 1965–99 available in the files of the U.S. Geological Survey.

GAGE.—Nonrecording gage observed intermittently during the summer months. Datum of gage is 5,910 ft above sea level (from topographic map).

REMARKS.—Flow regulated by Blue Lake (station 11414260) 300 ft upstream. There are no diversions upstream of station.

COOPERATION.—Records were collected by Pacific Gas & Electric Co., under general supervision of the U.S. Geological Survey, in connection with a Federal Energy Regulatory Commission project.

## DISCHARGE, CUBIC FEET PER SECOND, WATER YEAR OCTOBER 2000 TO SEPTEMBER 2001

## DAILY INSTANTANEOUS VALUES

DAY	OCT	NOV	DEC	JAN	FEB	MAR	APR	MAY	JUN	JUL	AUG	SEP
1	---	---	---	---	---	---	---	---	---	e.20	e.20	---
2	---	---	---	---	---	---	---	---	---	---	---	e.20
3	---	---	---	---	---	---	---	---	---	---	---	---
4	---	---	---	---	---	---	---	---	---	---	---	---
5	---	---	---	---	---	---	---	---	---	---	e.20	e.20
6	---	---	---	---	---	---	---	---	e.20	---	---	---
7	---	---	---	---	---	---	---	---	.23	e.20	---	---
8	---	---	---	---	---	---	---	---	---	---	e.20	---
9	---	---	---	---	---	---	---	---	---	---	---	e.20
10	---	---	---	---	---	---	---	---	---	---	e.20	---
11	---	---	---	---	---	---	---	---	e.20	e.20	---	---
12	---	---	---	---	---	---	---	---	---	---	---	e.20
13	---	---	---	---	---	---	---	---	e.20	---	---	---
14	---	---	---	---	---	---	---	---	---	e.20	---	---
15	---	---	---	---	---	---	---	---	---	---	e.20	---
16	---	---	---	---	---	---	---	---	---	---	---	e.20
17	---	---	---	---	---	---	---	---	---	---	---	---
18	---	---	---	---	---	---	---	---	---	e.20	---	---
19	---	---	---	---	---	---	---	---	e.20	---	e.20	e.20
20	---	---	---	---	---	---	---	---	e.20	e.20	---	---
21	---	---	---	---	---	---	---	---	---	---	e.20	---
22	---	---	---	---	---	---	---	---	---	---	---	---
23	---	---	---	---	---	---	---	---	e.20	---	---	e.20
24	.32	---	---	---	---	---	---	---	---	---	---	.23
25	---	---	---	---	---	---	---	---	---	e.20	e.20	.21
26	---	---	---	---	---	---	---	---	---	---	---	e.20
27	---	---	---	---	---	---	---	e.25	e.20	---	.24	---
28	---	---	---	---	---	---	---	---	---	---	---	---
29	---	---	---	---	---	---	---	---	---	e.20	---	---
30	---	---	---	---	---	---	---	---	---	---	e.20	e.20
31	---	---	---	---	---	---	---	---	---	---	---	---
TOTAL	---	---	---	---	---	---	---	---	---	---	---	---
MEAN	---	---	---	---	---	---	---	---	---	---	---	---
MAX	---	---	---	---	---	---	---	---	---	---	---	---
MIN	---	---	---	---	---	---	---	---	---	---	---	---
AC-FT	---	---	---	---	---	---	---	---	---	---	---	---

e Estimated.













## 11414360 LAKE CREEK BELOW CARR LAKE, NEAR GRANITEVILLE, CA

LOCATION.—Lat 39°23'57", long 120°38'31", in SE 1/4 NE 1/4 sec.29, T.18 N., R.12 E., Nevada County, Hydrologic Unit 18020125, Tahoe National Forest, on right bank, 65 ft downstream from Carr Lake, 2.0 mi upstream from Fall Creek, and 5.8 mi southeast of Graniteville.

DRAINAGE AREA.—0.48 mi<sup>2</sup>.

PERIOD OF RECORD.—October 1995 to current year. Unpublished records for water years 1965–95 available in files of the U.S. Geological Survey.

GAGE.—Water-stage recorder and compound rectangular weir. Elevation of gage is 6,650 ft above sea level (levels by Pacific Gas & Electric Co.). August 1965 to November 1975, nonrecording gage at site 65 ft upstream at different datum. November 1975 to July 1984, nonrecording gage at same site but different datum. July 1984 to September 1995, nonrecording gage at same site and datum.

REMARKS.—Records not computed for winter months. Flow regulated by Carr Lake. See schematic diagram of [South Yuba River Basin](#).

COOPERATION.—Records were collected by Pacific Gas & Electric Co., under general supervision of the U.S. Geological Survey, in connection with a Federal Energy Regulatory Commission project.

## DISCHARGE, CUBIC FEET PER SECOND, WATER YEAR OCTOBER 2000 TO SEPTEMBER 2001

## DAILY MEAN VALUES

DAY	OCT	NOV	DEC	JAN	FEB	MAR	APR	MAY	JUN	JUL	AUG	SEP
1	4.7	2.9	---	---	---	---	---	---	.57	.86	.56	e.94
2	4.7	5.3	---	---	---	---	---	---	.56	.83	e.58	e1.0
3	4.7	7.1	---	---	---	---	---	---	.46	.83	e.60	1.1
4	4.7	6.8	---	---	---	---	---	---	.24	.83	e.62	1.1
5	4.7	6.6	---	---	---	---	---	---	.24	.83	e.64	.76
6	4.7	6.0	---	---	---	---	---	---	.39	.83	e.67	.56
7	4.3	3.4	---	---	---	---	---	---	.64	.83	e.70	.54
8	4.3	2.9	---	---	---	---	---	---	.64	.83	e.73	.41
9	6.0	4.7	---	---	---	---	---	---	.64	.83	e.83	.49
10	7.1	6.2	---	---	---	---	---	---	.64	.83	e.94	.64
11	7.1	6.1	---	---	---	---	---	---	.72	.83	e.94	1.1
12	7.1	5.8	---	---	---	---	---	---	.73	.83	e.94	1.0
13	7.0	5.8	---	---	---	---	---	---	.62	.54	e.94	.94
14	6.6	5.8	---	---	---	---	---	---	.40	.25	e.94	.94
15	5.7	5.5	---	---	---	---	---	---	.29	.24	e.94	.90
16	4.7	---	---	---	---	---	---	---	.28	.24	e.91	1.1
17	4.7	---	---	---	---	---	---	---	.27	.24	e.88	1.5
18	3.9	---	---	---	---	---	---	---	.27	.30	e.85	1.5
19	3.4	---	---	---	---	---	---	---	.27	.35	e.83	1.4
20	3.4	---	---	---	---	---	---	---	.26	.35	e.83	1.3
21	3.2	---	---	---	---	---	---	---	.61	.35	e.83	1.3
22	2.6	---	---	---	---	---	---	---	.94	.67	e.79	1.3
23	2.2	---	---	---	---	---	---	---	.94	.94	e.75	1.2
24	2.6	---	---	---	---	---	---	---	.94	.94	e.71	1.2
25	3.4	---	---	---	---	---	---	---	.94	.88	e.68	1.2
26	3.4	---	---	---	---	---	---	---	.94	.49	e.64	1.2
27	3.4	---	---	---	---	---	---	---	.94	.48	e.64	1.3
28	2.9	---	---	---	---	---	---	---	.94	.48	e.64	1.3
29	2.9	---	---	---	---	---	---	---	.94	.55	e.64	1.3
30	2.9	---	---	---	---	---	---	---	.94	.64	e.74	1.3
31	2.9	---	---	---	---	---	---	---	---	.62	e.84	---
TOTAL	135.9	---	---	---	---	---	---	---	18.20	19.54	23.77	31.82
MEAN	4.38	---	---	---	---	---	---	---	.61	.63	.77	1.06
MAX	7.1	---	---	---	---	---	---	---	.94	.94	.94	1.5
MIN	2.2	---	---	---	---	---	---	---	.24	.24	.56	.41
AC-FT	270	---	---	---	---	---	---	---	36	39	47	63

e Estimated.

## 11414400 FRENCH LAKE NEAR CISCO, CA

LOCATION.—Lat 39°25'16", long 120°32'28", in SE 1/4 SW 1/4 sec.17, T.18 N., R.13 E., Nevada County, Hydrologic Unit 18020125, Tahoe National Forest, on right bank, near French Lake Dam on Canyon Creek, 0.5 mi upstream from Weil Lake, and 8.2 mi north of Cisco.

DRAINAGE AREA.—4.60 mi<sup>2</sup>.

PERIOD OF RECORD.—October 1986 to current year. Unpublished records for water years 1966–86 available in the files of the U.S. Geological Survey.

GAGE.—Water-stage recorder. Datum of gage is sea level (levels by Nevada Irrigation District).

REMARKS.—Reservoir is formed on natural lake by rock-filled dam completed in 1859. Usable capacity, 13,940 acre-ft, between elevations 6,594.90 ft, invert of outlet gate, and 6,660.28 ft, crest of spillway. Figures given represent usable contents. Released water is used for hydroelectric power and irrigation downstream. See schematic diagram of North Yuba River Basin.

COOPERATION.—Records were collected by Nevada Irrigation District, under general supervision of the U.S. Geological Survey, in connection with a Federal Energy Regulatory Commission project.

EXTREMES FOR PERIOD OF RECORD.—Maximum contents, 14,300 acre-ft, June 19, 1998, May 8, 23, 24, 2000, maximum elevation, 6661.34 ft, May 8, 2000; minimum, 6140 acre-ft, Nov. 16, 1998, elevation, 6632.07 ft.

EXTREMES FOR CURRENT YEAR.—Maximum contents, 13,200 acre-ft, several days in May and June, maximum elevation, 6657.98, June 1; minimum, 6,840 acre-ft, Oct. 26, 27, Nov. 25–27, minimum elevation, 6635.13 ft, Oct. 27.

Capacity table (elevation, in feet, and contents, in acre-feet)  
(Based on survey by Nevada Irrigation District in 1964)

6,610	1,805	6,630	5,677	6,650	10,701	6,662	14,542
6,620	3,636	6,640	8,006				

## RESERVOIR STORAGE (ACRE-FEET), WATER YEAR OCTOBER 2000 TO SEPTEMBER 2001

## DAILY OBSERVATION AT 2400 HOURS

DAY	OCT	NOV	DEC	JAN	FEB	MAR	APR	MAY	JUN	JUL	AUG	SEP
1	7220	6900	6880	6960	7040	7280	8640	10400	13200	12900	12400	12000
2	7200	6910	6880	6960	7040	7290	8710	10500	13200	12800	12400	12000
3	7170	6910	6880	6960	7040	7300	8730	10500	13200	12800	12400	12000
4	7170	6910	6880	6950	7060	7340	8750	10600	13200	12800	12400	12000
5	7150	6910	6880	6950	7070	7350	8770	10700	13200	12800	12400	12000
6	7130	6910	6880	6950	7080	7350	8810	10900	13100	12800	12300	11900
7	7110	6900	6880	6960	7080	7350	8850	11000	13100	12800	12300	11800
8	7100	6900	6880	6960	7080	7360	8860	11200	13100	12800	12300	11700
9	7090	6900	6900	6970	7110	7370	8870	11400	13100	12800	12300	11500
10	7090	6900	6910	7000	7140	7380	8880	11500	13100	12700	12300	11400
11	7080	6900	6910	7010	7170	7370	8910	11700	13100	12700	12300	11200
12	7060	6890	6920	7010	7170	7380	8920	11800	13100	12700	12300	11100
13	7040	6890	6940	7010	7160	7390	8930	11900	13100	12700	12200	11000
14	7030	6890	6980	7010	7160	7400	8930	12000	13100	12700	12200	10800
15	7010	6890	6970	7010	7160	7410	8950	12300	13100	12700	12200	10700
16	6990	6880	6970	7010	7160	7410	8990	12500	13000	12700	12200	10700
17	6980	6890	6960	7010	7160	7430	9050	12600	13000	12600	12200	10700
18	6960	6870	6970	7010	7170	7450	9130	12700	13000	12600	12200	10700
19	6940	6870	6970	7010	7180	7490	9200	12700	13000	12600	12200	10700
20	6930	6870	6970	7010	7200	7550	9250	12800	13000	12600	12200	10700
21	6920	6860	6970	7000	7240	7610	9270	12900	13000	12600	12100	10700
22	6900	6860	6970	7010	7260	7670	9300	13000	13000	12600	12100	10700
23	6870	6850	6970	7010	7260	7730	9360	13000	12900	12500	12100	10700
24	6860	6850	6970	7030	7280	7820	9470	13100	12900	12500	12100	10700
25	6850	6840	6970	7040	7280	8000	9630	13100	12900	12500	12100	10700
26	6840	6840	6960	7040	7280	8090	9800	13100	12900	12500	12100	10600
27	6840	6840	6960	7040	7290	8160	9930	13100	12900	12500	12100	10600
28	6890	6850	6960	7040	7280	8280	10000	13200	12900	12500	12100	10600
29	6910	6870	6960	7050	---	8380	10100	13200	12900	12500	12100	10600
30	6910	6880	6960	7050	---	8470	10300	13200	12900	12400	12000	10600
31	6900	---	6960	7050	---	8560	---	13200	---	12400	12000	---
MAX	7220	6910	6980	7050	7290	8560	10300	13200	13200	12900	12400	12000
MIN	6840	6840	6880	6950	7040	7280	8640	10400	12900	12400	12000	10600
a	6635.40	6635.29	6635.63	6636.00	6636.98	6642.15	6648.45	6657.94	6657.02	6655.70	6654.44	6649.61
b	-340	-20	+80	+90	+230	+1280	+1740	+2900	-300	-500	-400	-1400
CAL YR 2000	MAX 14300	MIN 6840	b -560									
WTR YR 2001	MAX 13200	MIN 6840	b +3360									

a Elevation, in feet, at end of month.

b Change in contents, in acre-feet.

## 11414410 CANYON CREEK BELOW FRENCH LAKE, NEAR CISCO, CA

LOCATION.—Lat 39°25'16", long 120°32'30", in SE 1/4 SW 1/4 sec.17, T.18 N., R.13 E., Nevada County, Hydrologic Unit 18020125, Tahoe National Forest, on left bank, 10 ft downstream from outlet at French Lake Dam on Canyon Creek, 0.5 mi upstream from Weil Lake, and 8.2 mi north of Cisco.

DRAINAGE AREA.—4.60 mi<sup>2</sup>.

PERIOD OF RECORD.—January 1989 to current year (low-flow records only). Unpublished records for water years 1967–88 available in files of the U.S. Geological Survey.

GAGE.—Water-stage recorder and V-notch sharp-crested weir. Elevation of gage is 6,590 ft above sea level, from topographic map. Prior to January 1989, nonrecording gages at three sites and datums.

REMARKS.—No records computed above 3.2 ft<sup>3</sup>/s. Flow regulated by French Lake (station 11414400). Flow over the spillway bypasses this station. See schematic diagram of [North Yuba River Basin](#).

COOPERATION.—Records were collected by Nevada Irrigation District, under general supervision of the U.S. Geological Survey, in connection with a Federal Energy Regulatory Commission project.

DISCHARGE, CUBIC FEET PER SECOND, WATER YEAR OCTOBER 2000 TO SEPTEMBER 2001  
DAILY MEAN VALUES

DAY	OCT	NOV	DEC	JAN	FEB	MAR	APR	MAY	JUN	JUL	AUG	SEP
1	---	---	---	3.1	3.0	3.0	3.0	---	---	---	---	---
2	---	---	3.1	3.1	2.9	3.0	3.1	---	---	---	---	---
3	---	---	3.0	3.1	3.0	3.0	3.1	---	---	---	---	---
4	---	---	3.0	2.9	3.0	3.0	---	---	---	---	---	---
5	---	---	3.0	3.0	3.0	3.0	---	---	---	---	---	---
6	---	---	3.0	3.0	3.0	2.9	3.1	---	---	---	---	---
7	---	---	3.0	3.0	3.0	2.9	---	---	---	---	---	---
8	---	---	3.1	3.0	3.0	2.9	---	---	---	---	---	---
9	---	---	3.1	3.0	3.0	3.0	---	---	---	---	---	---
10	---	---	---	2.9	3.0	3.0	---	---	---	---	---	---
11	---	---	3.1	3.0	---	3.0	---	---	---	---	---	---
12	---	---	---	2.9	3.0	3.0	---	---	---	---	---	---
13	---	---	3.1	2.9	3.0	3.0	---	---	---	---	---	---
14	---	---	3.1	3.0	3.0	3.0	---	---	---	---	---	---
15	---	---	---	3.0	3.0	3.0	---	---	---	---	---	---
16	---	---	3.1	3.0	3.0	3.0	---	---	---	---	---	---
17	---	---	---	2.9	2.9	3.0	---	---	---	---	---	2.9
18	---	---	3.1	2.9	2.9	3.0	---	---	---	---	---	2.7
19	---	---	3.1	2.9	2.9	3.0	---	---	---	---	---	2.7
20	---	---	3.1	3.0	2.9	3.0	---	---	---	---	---	2.7
21	---	---	---	2.9	2.9	3.0	---	---	---	---	---	2.7
22	---	---	3.1	2.9	2.9	3.0	---	---	---	---	---	2.7
23	---	---	3.1	3.0	2.9	3.0	---	---	---	---	---	2.7
24	---	---	---	3.0	3.0	3.0	---	---	---	---	---	2.7
25	---	---	---	3.0	2.9	3.1	---	---	---	---	---	2.7
26	---	---	3.1	3.0	2.9	3.1	---	---	---	---	---	---
27	---	---	3.1	3.0	2.9	3.1	---	---	---	---	---	---
28	---	---	3.1	3.0	3.0	3.0	---	---	---	---	---	---
29	---	---	3.1	3.0	---	3.0	---	---	---	---	2.8	---
30	---	---	---	3.0	---	3.0	---	---	---	---	2.8	---
31	---	---	3.1	3.0	---	3.0	---	---	---	---	---	---
TOTAL	---	---	---	92.4	---	93.0	---	---	---	---	---	---
MEAN	---	---	---	2.98	---	3.00	---	---	---	---	---	---
MAX	---	---	---	3.1	---	3.1	---	---	---	---	---	---
MIN	---	---	---	2.9	---	2.9	---	---	---	---	---	---
AC-FT	---	---	---	183	---	184	---	---	---	---	---	---

## 11414440 FAUCHERIE LAKE NEAR CISCO, CA

LOCATION.—Lat 39°25'45", long 120°34'04", in SE 1/4 NE 1/4 sec.13, T.18 N., R.12 E., Nevada County, Hydrologic Unit 18020125, Tahoe National Forest, near right bank end of Faucherie Dam, on Canyon Creek, 8.5 mi north of Cisco.

DRAINAGE AREA.—8.97 mi<sup>2</sup>.

PERIOD OF RECORD.—October 1986 to current year. Unpublished records for water years 1965–86 available in files of the U.S. Geological Survey.

GAGE.—Water-stage recorder installed Dec. 8, 1999. Records prior to Dec. 8 are instantaneous values. Datum of gage is sea level (levels by Nevada Irrigation District).

REMARKS.—Reservoir is formed on natural lake by earth-filled dam initially constructed prior to 1880 and enlarged in 1964. Usable capacity, 3,740 acre-ft, between elevations 6,090.00 ft, invert of outlet gate, and 6,123.00 ft, crest of spillway. Dead storage, below elevation 6,090 ft, 240 acre-ft. Figures given represent total contents. Released water is used for hydroelectric power and irrigation downstream. See schematic diagram of North Yuba River Basin.

COOPERATION.—Records were collected by Nevada Irrigation District, under general supervision of the U.S. Geological Survey, in connection with a Federal Energy Regulatory Commission project.

EXTREMES FOR PERIOD OF RECORD.—Maximum contents recorded, 4,110 acre-ft, May 8, 2000, elevation, 6,123.85 ft; minimum recorded, 2,500 acre-ft, Dec. 8, 1999, elevation, 6112.24 ft.

EXTREMES FOR CURRENT YEAR.—Maximum contents, 4,050 acre-ft, Apr. 25, May 8, 15, maximum elevation, 6,123.46 ft, May 15; minimum, 3,910 acre-ft, Sept. 1–5, minimum elevation, 6,122.52 ft, Sept. 5.

Capacity table (elevation, in feet, and contents, in acre-feet)  
(Based on survey by Nevada Irrigation District in 1964)

6,090	240	6,100	1,095	6,110	2,216	6,120	3,540
6,095	628	6,105	1,629	6,115	2,854	6,125	4,280

## RESERVOIR STORAGE (ACRE-FEET), WATER YEAR OCTOBER 2000 TO SEPTEMBER 2001

## DAILY OBSERVATION AT 2400 HOURS

DAY	OCT	NOV	DEC	JAN	FEB	MAR	APR	MAY	JUN	JUL	AUG	SEP
1	3980	3990	3990	3980	3980	3990	4020	4040	3990	3970	3960	3910
2	3980	3990	3990	3980	3980	3990	4000	4010	3990	3970	3960	3910
3	3980	3990	3990	3980	3990	3990	4000	4010	3990	3970	3960	3910
4	3980	3990	3990	3980	3990	3990	3990	4020	3990	3970	3950	3910
5	3980	3990	3990	3980	3990	3990	3990	4030	3990	3970	3950	3910
6	3980	3980	3980	3980	3990	3990	4000	4030	3990	3970	3950	3930
7	3980	3980	3980	3980	3990	3990	4000	4040	3990	3970	3950	4010
8	3980	3980	3990	3990	3990	4000	3990	4050	3990	3970	3960	4020
9	3990	3980	4000	3990	4000	3990	3990	4040	3980	3970	3960	4020
10	3990	3980	3990	4000	4000	3990	3990	4040	3980	3970	3960	4020
11	3990	3980	3990	3990	3990	3990	3990	4040	3980	3970	3950	4020
12	3990	3980	3990	3990	3990	3990	3990	4030	3980	3970	3960	4020
13	3990	3980	3990	3990	3990	4000	3990	4030	3980	3970	3950	4020
14	3990	3980	3990	3990	3990	3990	3990	4020	3980	3970	3950	4020
15	3990	3980	3990	3980	3980	3990	4000	4050	3980	3970	3950	3990
16	3990	3980	3990	3980	3990	3990	4010	4030	3980	3970	3950	3980
17	3990	3980	3990	3990	3990	4000	4020	4020	3980	3970	3950	3970
18	3990	3980	3990	3980	3990	4000	4020	4020	3980	3970	3940	3970
19	3990	3980	3990	3990	3990	4010	4010	4010	3980	3970	3940	3960
20	3990	3980	3990	3990	3990	4020	4000	4020	3980	3960	3940	3960
21	3990	3980	3990	3990	3990	4020	4000	4020	3980	3960	3940	3960
22	3980	3980	3990	3990	3990	4010	4000	4010	3980	3960	3930	3950
23	3990	3980	3990	3990	3990	4020	4020	4010	3970	3960	3930	3950
24	3990	3980	3990	3990	4000	4030	4030	4010	3970	3960	3930	3950
25	3990	3980	3980	3990	3990	4030	4050	4000	3970	3960	3930	3950
26	3990	3980	3980	3990	3990	4010	4040	4000	3970	3960	3930	3940
27	3980	3980	3980	3980	3990	4010	4030	4000	3970	3960	3930	3940
28	4010	3980	3980	3990	3990	4030	4020	3990	3970	3960	3920	3950
29	3990	3990	3990	3990	---	4020	4020	3990	3970	3960	3920	3950
30	3990	3990	3990	3990	---	4020	4040	3990	3970	3960	3920	3950
31	3990	---	3990	3980	---	4020	---	3990	---	3960	3920	---
MAX	4010	3990	4000	4000	4000	4030	4050	4050	3990	3970	3960	4020
MIN	3980	3980	3980	3980	3980	3990	3990	3990	3970	3960	3920	3910
a	6123.04	6123.06	6123.04	6123.03	6123.04	6123.29	6123.40	6123.10	6122.95	6122.84	6122.57	6122.77
b	+10	0	0	-10	+10	+30	+20	-50	-20	-10	-40	+30
CAL YR 2000	MAX 4110	MIN 2740	b +1260									
WTR YR 2001	MAX 4050	MIN 3910	b -30									

a Elevation, in feet, at end of month.

b Change in contents, in acre-feet.

## 11414450 CANYON CREEK BELOW FAUCHERIE LAKE, NEAR CISCO, CA

LOCATION.—Lat 39°25'46", long 120°34'06", in SE 1/4 NE 1/4 sec.13, T.18 N., R.12 E., Nevada County, Hydrologic Unit 18020125, Tahoe National Forest, on left bank, 80 ft downstream from Faucherie Dam, on Canyon Creek, 8.5 mi north of Cisco.

DRAINAGE AREA.—8.97 mi<sup>2</sup>.

PERIOD OF RECORD.—January 1989 to current year (low-flow records only). Unpublished records for water years 1965–88 available in files of the U.S. Geological Survey.

GAGE.—Water-stage recorder and V-notch sharp-crested weir. Elevation of gage is 6,080 ft above sea level, from topographic map. October 1964 to July 1988, nonrecording gage at site 10 ft downstream at different datum. July 1988 to January 1989, nonrecording gage at same site and datum.

REMARKS.—No records computed above 3.3 ft<sup>3</sup>/s. Flow regulated by Faucherie Lake (station 11414440). Flow over the spillway bypasses this station. See schematic diagram of [North Yuba River Basin](#).

COOPERATION.—Records were collected by Nevada Irrigation District, under general supervision of the U.S. Geological Survey, in connection with a Federal Energy Regulatory Commission project.

DISCHARGE, CUBIC FEET PER SECOND, WATER YEAR OCTOBER 2000 TO SEPTEMBER 2001  
DAILY MEAN VALUES

DAY	OCT	NOV	DEC	JAN	FEB	MAR	APR	MAY	JUN	JUL	AUG	SEP
1	3.0	2.9	2.9	2.9	2.9	2.9	3.0	3.0	3.0	3.1	3.1	3.1
2	3.0	2.9	2.9	2.9	2.9	3.0	3.0	3.0	3.0	3.1	3.0	3.1
3	2.9	2.9	2.9	2.9	2.9	3.0	3.0	3.0	3.0	3.1	3.0	3.1
4	2.9	2.9	2.9	2.9	2.9	3.0	3.0	3.0	3.0	3.1	3.0	3.1
5	2.9	2.9	2.9	2.9	2.9	2.9	3.0	3.0	3.0	3.1	3.0	3.1
6	2.9	2.9	2.9	2.9	3.0	2.9	3.0	3.0	3.0	3.1	3.0	3.1
7	2.9	2.9	2.9	2.9	3.0	2.9	3.0	3.0	3.0	3.1	3.0	3.1
8	2.9	2.9	2.9	3.0	2.9	2.9	3.0	3.0	3.0	3.1	3.0	3.1
9	2.9	3.0	2.9	3.0	3.0	3.0	2.9	3.0	3.0	3.1	3.0	3.1
10	3.0	2.9	3.0	3.0	3.0	2.9	2.9	3.0	3.0	3.0	2.9	3.1
11	3.0	2.9	2.9	3.0	3.0	2.9	3.0	3.0	3.0	3.0	2.9	3.1
12	3.0	2.9	3.0	2.9	3.0	2.9	2.9	3.0	3.1	3.0	2.9	3.1
13	3.0	2.9	3.0	3.0	2.9	2.9	3.0	3.0	3.1	3.0	2.9	3.1
14	3.0	2.9	3.0	2.9	2.9	3.0	3.0	3.0	3.1	3.0	2.9	3.1
15	3.0	2.9	2.9	2.9	2.9	3.0	3.0	3.0	3.1	3.0	2.9	3.1
16	3.0	2.9	2.9	2.9	3.0	2.9	3.0	3.0	3.1	3.0	2.9	3.1
17	3.0	2.9	2.9	2.9	3.0	3.0	3.0	3.0	3.1	3.0	2.9	3.1
18	3.0	2.9	2.9	2.9	3.0	2.9	3.0	3.0	3.1	3.0	2.9	3.1
19	3.0	2.9	2.9	2.9	3.0	2.9	3.0	3.0	3.1	3.0	2.8	3.1
20	3.0	2.9	2.9	2.9	3.0	3.0	3.0	3.0	3.1	3.0	2.8	3.1
21	2.9	3.0	2.9	2.9	3.0	3.0	3.0	3.0	---	3.0	2.8	3.1
22	2.9	2.9	2.9	2.9	3.0	3.0	3.0	3.0	3.3	3.0	3.0	3.1
23	2.9	2.9	2.9	3.0	3.0	3.0	3.0	3.0	3.3	3.0	3.1	3.1
24	2.9	2.9	2.9	3.0	2.9	3.0	3.0	2.9	3.3	3.0	3.1	3.1
25	3.0	2.9	2.9	3.0	3.0	3.0	3.0	2.9	3.3	3.0	3.1	3.1
26	3.0	2.9	2.9	3.0	2.9	3.0	3.0	3.0	3.2	3.0	3.1	3.1
27	3.0	2.9	2.9	3.0	2.9	3.0	3.0	3.0	3.1	3.0	3.1	3.1
28	3.0	2.9	2.9	2.9	2.9	3.0	3.0	3.0	3.1	3.0	3.1	3.1
29	3.0	3.0	2.9	3.0	---	3.0	3.0	3.0	3.1	3.0	3.1	3.1
30	3.0	2.9	3.0	2.9	---	3.0	3.0	3.0	3.1	3.0	3.1	3.1
31	3.0	---	2.9	2.9	---	3.0	---	3.0	---	3.0	3.1	---
TOTAL	91.9	87.3	90.4	91.0	82.7	91.8	89.7	92.8	---	93.9	92.5	93.0
MEAN	2.96	2.91	2.92	2.94	2.95	2.96	2.99	2.99	---	3.03	2.98	3.10
MAX	3.0	3.0	3.0	3.0	3.0	3.0	3.0	3.0	---	3.1	3.1	3.1
MIN	2.9	2.9	2.9	2.9	2.9	2.9	2.9	2.9	---	3.0	2.8	3.1
AC-FT	182	173	179	180	164	182	178	184	---	186	183	184



## 11414465 SAWMILL LAKE NEAR GRANITEVILLE, CA

LOCATION.—Lat 39°26'44", long 120°36'02", in NW 1/4 NW 1/4 sec.11, T.18 N., R.12 E., Nevada County, Hydrologic Unit 18020125, Tahoe National Forest, near right bank end of Sawmill Lake Dam, on Canyon Creek, 0.8 mi upstream from Bowman Lake, and 7.2 mi east of Graniteville.

DRAINAGE AREA.—16.4 mi<sup>2</sup>.

PERIOD OF RECORD.—October 1986 to current year. Unpublished records for water years 1966–86 available in files of the U.S. Geological Survey.

GAGE.—Water-stage recorder, installed Nov. 22, 1999. Records prior to Nov. 22 are instantaneous values. Datum of gage is sea level (levels by Nevada Irrigation District).

REMARKS.—Reservoir is formed by a rock-filled dam initially constructed prior to 1880 and enlarged in 1941. Usable capacity, 3,030 acre-ft, between elevations 5,805 ft, base of dam, and 5,860 ft, crest of spillway. Figures given represent usable contents. Released water is used for hydroelectric power and irrigation downstream. See schematic diagram of [North Yuba River Basin](#).

COOPERATION.—Records were collected by Nevada Irrigation District, under general supervision of the U.S. Geological Survey, in connection with a Federal Energy Regulatory Commission project.

EXTREMES FOR PERIOD OF RECORD.—Maximum storage recorded, 3,180 acre-ft, May 8, 2000, elevation, 5,861.31 ft; minimum recorded, 1,400 acre-ft, Nov. 22, 1999, elevation, 5,843.15 ft.

EXTREMES FOR CURRENT YEAR.—Maximum contents, 3,140 acre-ft, May 8, elevation, 5,860.92 ft; minimum, 2,430 acre-ft, Oct. 4, elevation, 5,854.22 ft.

Capacity table (elevation, in feet, and contents, in acre-feet)  
(Based on survey by Nevada Irrigation District in 1964)

5,805	0	5,830	430	5,850	2,000	5,863	3,375
5,820	110	5,840	1,130	5,860	3,030		

## RESERVOIR STORAGE (ACRE-FEET), WATER YEAR OCTOBER 2000 TO SEPTEMBER 2001

## DAILY OBSERVATION AT 2400 HOURS

DAY	OCT	NOV	DEC	JAN	FEB	MAR	APR	MAY	JUN	JUL	AUG	SEP
1	2650	2870	3040	3060	3060	3060	3100	3120	3070	3040	2940	2810
2	2560	2880	3050	3060	3060	3060	3090	3100	3070	3040	2940	2810
3	2470	2890	3060	3060	3060	3060	3080	3090	3060	3040	2930	2810
4	2430	2910	3060	3060	3070	3070	3080	3100	3060	3040	2930	2800
5	2440	2910	3060	3060	3070	3070	3070	3110	3060	3040	2920	2800
6	2450	2920	3060	3060	3070	3060	3080	3110	3060	3030	2920	2790
7	2470	2930	3060	3060	3070	3070	3080	3130	3060	3030	2920	2800
8	2470	2930	3060	3060	3060	3070	3070	3140	3060	3030	2910	2920
9	2500	2940	3070	3060	3070	3070	3070	3130	3050	3030	2910	3050
10	2520	2940	3070	3070	3070	3070	3070	3130	3050	3020	2900	3080
11	2540	2950	3070	3070	3070	3070	3070	3130	3040	3020	2900	3080
12	2560	2950	3070	3060	3070	3070	3070	3120	3040	3020	2890	3080
13	2570	2950	3070	3060	3060	3070	3070	3110	3050	3020	2890	3080
14	2580	2960	3070	3060	3060	3070	3070	3100	3050	3010	2890	3080
15	2590	2960	3070	3060	3060	3070	3070	3130	3050	3010	2880	3070
16	2600	2960	3060	3060	3060	3070	3090	3110	3050	3010	2880	3060
17	2610	2960	3060	3060	3060	3070	3100	3100	3050	3000	2870	3050
18	2620	2960	3060	3060	3060	3080	3100	3100	3050	3000	2870	3050
19	2630	2960	3060	3060	3070	3090	3090	3090	3050	2990	2860	3050
20	2650	2960	3060	3060	3070	3100	3080	3100	3050	2990	2860	3040
21	2660	2960	3060	3060	3070	3100	3080	3090	3050	2990	2850	3040
22	2670	2960	3060	3060	3070	3100	3080	3090	3050	2980	2850	3030
23	2670	2960	3060	3070	3060	3100	3100	3090	3050	2980	2850	3030
24	2680	2960	3060	3060	3070	3110	3120	3080	3050	2980	2840	3020
25	2700	2960	3060	3070	3070	3130	3130	3080	3050	2970	2840	3020
26	2720	2960	3060	3060	3060	3100	3130	3080	3050	2970	2840	3020
27	2730	2960	3060	3060	3060	3100	3110	3070	3050	2960	2830	3020
28	2780	2970	3060	3060	3060	3120	3100	3070	3050	2960	2830	3010
29	2830	3000	3060	3060	---	3110	3100	3070	3050	2950	2830	3010
30	2850	3020	3060	3060	---	3100	3120	3070	3050	2950	2820	3000
31	2860	---	3060	3060	---	3110	---	3070	---	2940	2820	---
MAX	2860	3020	3070	3070	3070	3130	3130	3140	3070	3040	2940	3080
MIN	2430	2870	3040	3060	3060	3060	3070	3070	3040	2940	2820	2790
a	5858.35	5859.94	5860.27	5860.27	5860.28	5860.68	5860.82	5860.33	5860.14	5859.17	5857.94	5859.75
b	+110	+160	+40	0	0	+50	+10	-50	-20	-110	-120	+180
CAL YR 2000	MAX 3180	MIN 1760	b +1310									
WTR YR 2001	MAX 3140	MIN 2430	b +250									

a Elevation, in feet, at end of month.

b Change in contents, in acre-feet.

## 11414470 CANYON CREEK BELOW SAWMILL LAKE, NEAR GRANITEVILLE, CA

LOCATION.—Lat 39°26'44", long 120°36'05", in NW 1/4 NW 1/4 sec.11, T.18 N., R.12 E., Nevada County, Hydrologic Unit 18020125, Tahoe National Forest, on right bank, 130 ft downstream from outlet at Sawmill Lake Dam, on Canyon Creek, 0.8 mi upstream from Bowman Lake, and 7.2 mi east of Graniteville.

DRAINAGE AREA.—16.4 mi<sup>2</sup>.

PERIOD OF RECORD.—October 1989 to current year. Unpublished records for water years 1965–89 available in files of the U.S. Geological Survey.

GAGE.—Water-stage recorder and V-notch sharp-crested weir in concrete control. Elevation of gage is 5,790 ft above sea level, from topographic map. September 1964 to July 6, 1988, nonrecording gage at two sites 470 ft downstream at different datum. July 7, 1988, to January 1989, nonrecording gage at same site and datum.

REMARKS.—No records computed above 2.6 ft<sup>3</sup>/s. Flow completely regulated by Sawmill Lake (station 11414465). Flow over the spillway bypasses this station. See schematic diagram of [North Yuba River Basin](#).

COOPERATION.—Records were collected by Nevada Irrigation District, under general supervision of the U.S. Geological Survey, in connection with a Federal Energy Regulatory Commission project.

EXTREMES FOR CURRENT YEAR.—No flow below 2.6 ft<sup>3</sup>/s.

## 11414690 JACKSON LAKE NEAR SIERRA CITY, CA

LOCATION.—Lat 39°27'52", long 120°33'44", in SW 1/4 SW 1/4 sec.31, T.19 N., R.13 E., Nevada County, Hydrologic Unit 18020125, Tahoe National Forest, on outlet structure on Jackson Lake Dam, on Jackson Creek, 3.0 mi upstream from Bowman Lake, and 8.0 mi southeast of Sierra City.

DRAINAGE AREA.—0.65 mi<sup>2</sup>.

PERIOD OF RECORD.—October 1986 to current year. Unpublished records for water years 1965–86 available in files of U.S. Geological Survey.

GAGE.—Water-stage recorder. Datum of gage is 6,570 ft above sea level (levels by Nevada Irrigation District).

REMARKS.—Reservoir is formed on natural lake by earth-filled dam completed in 1859. Usable capacity, 974 acre-ft, between gage height 0.0 ft, invert of outlet, and 22.67 ft, crest of spillway. Dead storage below gage height 0.0 ft, 360 acre-ft. Figures given represent total contents. Released water is used for hydroelectric power and irrigation downstream. See schematic diagram of [North Yuba River Basin](#).

COOPERATION.—Records were collected by Nevada Irrigation District, under general supervision of the U.S. Geological Survey, in connection with a Federal Energy Regulatory Commission project.

EXTREMES FOR PERIOD OF RECORD.—Maximum contents recorded, 1,370 acre-ft, May 21–25, 2000, maximum elevation, 6,593.33 ft, May 24, 2000; minimum recorded, 428 acre-ft, Nov. 21, 22, 1998, elevation, 6571.80 ft.

EXTREMES FOR CURRENT YEAR.—Maximum contents, 1,350 acre-ft, May 22, 23, elevation, 6,592.88 ft; minimum, 805 acre-ft, Mar. 17, elevation, 6581.65 ft.

Capacity table (gage height, in feet, and contents, in acre-feet)  
(Based on survey by Nevada Irrigation District in 1964)

0	360	10	730	20	1,185	24	1,407
5	545	15	958				

## RESERVOIR STORAGE (ACRE-FEET), WATER YEAR OCTOBER 2000 TO SEPTEMBER 2001

## DAILY OBSERVATION AT 2400 HOURS

DAY	OCT	NOV	DEC	JAN	FEB	MAR	APR	MAY	JUN	JUL	AUG	SEP
1	1040	981	921	863	818	813	910	1090	1330	1250	1160	1070
2	1030	978	919	861	817	813	917	1100	1330	1250	1160	1070
3	1030	977	916	858	815	812	921	1110	1330	1250	1160	1070
4	1030	976	914	856	814	817	923	1110	1330	1250	1150	1070
5	1020	975	912	853	813	819	925	1120	1330	1240	1150	1060
6	1020	975	909	851	812	817	930	1130	1320	1240	1150	1060
7	1020	972	908	849	811	816	936	1150	1320	1240	1150	1060
8	1010	970	905	847	809	815	939	1170	1320	1240	1140	1050
9	1020	968	905	846	813	814	940	1190	1320	1230	1140	1050
10	1010	966	904	849	817	813	941	1210	1310	1230	1140	1050
11	1010	963	904	850	821	812	944	1230	1310	1230	1130	1040
12	1010	961	902	847	819	811	945	1250	1310	1230	1130	1040
13	1010	960	900	845	818	809	946	1260	1310	1220	1130	1040
14	1000	957	906	843	816	809	946	1270	1300	1220	1130	1040
15	1000	954	902	840	814	808	947	1290	1300	1220	1120	1030
16	1000	951	900	838	813	806	949	1310	1300	1210	1120	1030
17	998	948	898	834	811	805	953	1320	1290	1210	1120	1030
18	995	946	896	833	812	806	961	1320	1290	1210	1110	1030
19	993	944	893	831	813	808	968	1330	1290	1200	1110	1020
20	991	941	890	829	813	811	975	1340	1290	1200	1110	1020
21	988	938	890	827	818	815	977	1340	1280	1190	1100	1020
22	986	936	887	826	820	819	979	1350	1280	1190	1100	1020
23	983	933	885	827	818	824	983	1350	1280	1190	1100	1010
24	981	931	884	827	821	832	994	1340	1270	1180	1100	1010
25	980	928	879	829	820	852	1010	1340	1270	1180	1090	1010
26	980	926	878	828	818	857	1030	1340	1270	1180	1090	1010
27	978	924	875	825	817	862	1040	1340	1270	1180	1090	1000
28	986	922	872	823	815	875	1050	1340	1260	1170	1080	1000
29	986	925	870	824	---	885	1060	1340	1260	1170	1080	997
30	985	923	868	821	---	893	1070	1340	1260	1170	1080	995
31	982	---	866	820	---	901	---	1340	---	1160	1080	---
MAX	1040	981	921	863	821	901	1070	1350	1330	1250	1160	1070
MIN	978	922	866	820	809	805	910	1090	1260	1160	1080	995
a	6585.54	6584.24	6582.97	6581.98	6581.87	6583.76	6587.54	6592.74	6591.30	6589.54	6587.61	6585.81
b	-58	-59	-57	-46	-5	+86	+169	+270	-80	-100	-80	-85
CAL YR 2000	MAX 1370	MIN 829	b +16									
WTR YR 2001	MAX 1350	MIN 805	b -45									

a Elevation, in feet, at end of month.

b Change in contents, in acre-feet.

## 11414700 JACKSON CREEK BELOW JACKSON LAKE, NEAR SIERRA CITY, CA

LOCATION.—Lat 39°27'53", long 120°33'46", in SW 1/4 SW 1/4 sec.31, T.19 N., R.13 E., Nevada County, Hydrologic Unit 18020125, Tahoe National Forest, on left bank, 75 ft downstream from Jackson Lake Dam, on Jackson Creek, 3.0 mi upstream from Bowman Lake, and 8.0 mi southeast of Sierra City.

DRAINAGE AREA.—0.65 mi<sup>2</sup>.

PERIOD OF RECORD.—January 1989 to September 1992, April 1993 to current year (low-flow records only). Unpublished records for water years 1965–88 available in files of the U.S. Geological Survey.

GAGE.—Water-stage recorder and V-notch sharp-crested weir. Elevation of gage is 6,570 ft above sea level, from topographic map. October 1964 to October 1986, nonrecording gage at site 25 ft downstream at different datum. October 1986 to January 1989, nonrecording gage at same site and datum.

REMARKS.—No records computed above 2.9 ft<sup>3</sup>/s. Flow regulated by Jackson Lake (station 11414690). Flow over the spillway bypasses this station. See schematic diagram of North Yuba River Basin.

COOPERATION.—Records were collected by Nevada Irrigation District, under general supervision of the U.S. Geological Survey, in connection with a Federal Energy Regulatory Commission project.

## DISCHARGE, CUBIC FEET PER SECOND, WATER YEAR OCTOBER 2000 TO SEPTEMBER 2001

## DAILY MEAN VALUES

DAY	OCT	NOV	DEC	JAN	FEB	MAR	APR	MAY	JUN	JUL	AUG	SEP
1	1.1	1.2	1.2	1.3	.96	.92	.49	.93	1.0	.99	1.0	1.2
2	1.1	1.2	1.4	1.3	.96	.92	.48	.95	1.0	.99	1.1	1.2
3	1.2	1.1	1.5	1.3	.96	.92	.48	.94	1.0	.99	1.1	1.2
4	1.6	.90	1.4	1.3	.96	.91	.48	.95	1.0	.97	1.1	1.2
5	1.4	.82	1.4	1.3	.95	.92	.47	.95	1.0	.96	1.1	1.1
6	1.4	.82	1.4	1.3	.94	.92	.46	.96	.98	.73	1.1	1.2
7	1.3	.95	1.4	1.3	.94	.93	.45	.96	.97	.62	1.1	1.2
8	1.3	1.3	1.4	1.3	.93	.92	.45	.98	.96	.61	1.1	1.2
9	1.2	1.4	1.4	1.3	.95	.92	.45	.99	.96	---	1.1	1.2
10	1.3	1.4	1.4	1.3	.94	.92	.45	1.0	.96	1.0	1.1	1.2
11	1.2	1.4	1.4	1.3	.95	.92	.45	1.0	.96	1.0	1.1	1.2
12	1.2	1.4	1.4	1.4	.94	.91	.45	1.0	.96	1.0	1.0	1.2
13	1.2	1.4	1.4	1.4	.94	.92	.44	1.0	1.0	1.0	1.0	---
14	1.2	1.4	1.4	1.4	.94	.92	.44	1.0	1.0	.99	1.0	1.2
15	1.2	1.4	1.4	1.5	.93	.92	.44	1.1	1.0	.99	---	1.2
16	1.2	1.4	1.4	1.5	.93	.92	.44	1.1	1.0	.99	1.1	1.2
17	1.2	1.4	1.4	1.4	.93	.92	.43	1.1	1.0	1.0	1.1	1.2
18	1.2	1.4	1.4	1.1	.93	.91	.44	1.1	1.0	1.0	1.1	1.1
19	1.2	1.4	1.4	.97	.92	.89	.44	1.1	1.0	---	1.1	1.1
20	1.2	1.4	1.3	.98	.92	.89	.44	1.0	1.0	1.1	1.1	1.1
21	1.2	1.4	1.4	.97	.92	.88	.44	1.0	1.0	1.1	1.2	1.1
22	1.2	1.4	1.4	.98	.93	.87	.44	1.0	.97	1.1	1.2	1.1
23	1.2	1.4	1.4	.97	.93	.87	.44	1.0	.95	1.1	1.2	1.1
24	1.2	1.4	1.4	.97	.93	.87	.71	1.0	.98	1.1	1.2	1.1
25	1.2	1.4	1.4	.98	.93	.90	.90	1.0	1.0	1.1	1.2	1.2
26	1.2	1.4	1.4	.97	.92	.87	.89	1.0	.99	1.1	1.2	1.2
27	1.2	1.4	1.4	.98	.93	.83	.90	1.0	1.0	1.1	1.2	1.1
28	1.2	1.4	1.3	.97	.93	.77	.91	1.0	1.0	1.1	1.2	1.2
29	1.2	1.2	1.3	.96	---	.71	.91	1.0	1.0	1.1	1.2	1.2
30	1.2	1.2	1.3	.97	---	.62	.92	1.0	.99	1.1	1.2	1.2
31	1.2	---	1.3	.96	---	.53	---	1.0	---	1.1	1.2	---
TOTAL	38.1	38.69	42.8	36.63	26.24	27.04	16.53	31.11	29.63	---	---	---
MEAN	1.23	1.29	1.38	1.18	.94	.87	.55	1.00	.99	---	---	---
MAX	1.6	1.4	1.5	1.5	.96	.93	.92	1.1	1.0	---	---	---
MIN	1.1	.82	1.2	.96	.92	.53	.43	.93	.95	---	---	---
AC-FT	76	77	85	73	52	54	33	62	59	---	---	---

## 11415500 BOWMAN LAKE NEAR GRANITEVILLE, CA

LOCATION.—Lat 39°27'01", long 120°39'09", in SE 1/4 SW 1/4 sec.5, T.18 N., R.12 E., Nevada County, Hydrologic Unit 18020125, on right bank, near rockfill portion of Bowman Dam on Canyon Creek, 4.6 mi east of Graniteville, and 8 mi south of Sierra City.

DRAINAGE AREA.—27.1 mi<sup>2</sup>.

PERIOD OF RECORD.—December 1926 to current year.

REVISED RECORDS.—WSP 1931: Drainage area.

GAGE.—Water-stage recorder. Datum of gage is sea level (levels by Nevada Irrigation District). Prior to Oct. 8, 1964, nonrecording gage at same site and datum.

REMARKS.—Lake is formed by one rockfill and one concrete-arch dam; storage began in November 1926. Total capacity, 68,700 acre-ft, between elevations 5,400 ft, bottom of outlet tunnel, and 5,563.6 ft, top of radial spillway gates and crest of concrete-arch dam. Flashboards are occasionally added, increasing elevation to 5,565.8 ft and capacity to 70,400 acre-ft, all of which is available for release. Lake receives water from Middle Yuba River via Milton–Bowman Tunnel (station 11408000), and releases it through Bowman–Spaulding Canal (station 11416000) which conveys it to reservoirs of Pacific Gas & Electric Co. Water is eventually used for irrigation by Nevada Irrigation District. Records, including extremes, represent total contents. See schematic diagram of North Yuba River Basin.

COOPERATION.—Records were collected by Nevada Irrigation District, under general supervision of the U.S. Geological Survey, in connection with a Federal Energy Regulatory Commission project.

EXTREMES FOR PERIOD OF RECORD.—Maximum contents, 71,000 acre-ft, May 30, 1965, elevation, 5,566.5 ft; lake completely drained for inspection and repair Nov. 25 to Dec. 9, 1949, Oct. 1–20, 1966, Oct. 4–29, 1972, and Sept. 21–30, 1981.

EXTREMES FOR CURRENT YEAR.—Maximum contents, 56,300 acre-ft, Oct. 1, elevation, 5548.38 ft; minimum, 19,400 acre-ft, estimated, Sept. 17.

Capacity table (elevation, in feet, and contents, in acre-feet)  
(Based on table dated Nov. 24, 1926)

5,419.6	0	5,450	4,100	5,480	14,200	5,540	49,800
5,430	900	5,460	6,900	5,510	30,000	5,570	73,800
5,440	2,100	5,470	10,200				

## RESERVOIR STORAGE (ACRE-FEET), WATER YEAR OCTOBER 2000 TO SEPTEMBER 2001

## DAILY OBSERVATION AT 2400 HOURS

DAY	OCT	NOV	DEC	JAN	FEB	MAR	APR	MAY	JUN	JUL	AUG	SEP
1	56300	47600	38200	28400	25000	22900	34600	43600	49200	41000	41400	26600
2	56200	47100	37800	28200	24900	23100	35100	44100	49000	40600	41300	26100
3	56100	46800	37400	28200	24900	23200	35400	44400	48700	40200	41100	25600
4	56000	46800	37000	28200	24800	23400	35600	44700	48400	39900	40600	25100
5	55800	46800	36700	28100	24800	23600	35800	45000	48100	39500	40200	24500
6	55600	46800	36300	28000	24700	23600	36000	45500	47900	39200	39800	23900
7	55300	46800	36000	27900	24600	23600	36300	45900	47600	39200	39300	23400
8	55100	46600	35600	27800	24500	23700	36400	46500	47300	39400	38800	22900
9	54900	46200	35300	27600	24500	23800	36600	47100	47000	39600	38300	22300
10	54700	45800	35000	27600	24400	23900	36700	47500	46700	39800	37700	e21900
11	54500	45500	34700	27500	24300	24100	36800	48000	46400	40000	37200	e21500
12	54300	45100	34400	27300	24100	24200	37000	48300	46100	40200	36700	e21100
13	54100	44700	34100	27200	24000	24300	37100	48600	45800	40400	36300	e20800
14	53800	44400	33900	27000	23900	24400	37200	48800	45500	40600	36000	e20400
15	53600	44000	33700	26900	23900	24600	37300	49200	45200	40800	35500	e20000
16	53400	43600	33300	26800	23800	24900	37500	49500	44900	41000	35000	e19600
17	53100	43300	33000	26700	23700	25100	37800	49800	44600	41100	34400	e19400
18	52900	42900	32700	26400	23600	25400	38200	50200	44200	41100	33900	e19500
19	52600	42500	32400	26600	23600	25800	38600	50400	43900	41100	33300	e19600
20	52300	42200	32300	26400	23500	26300	38900	50700	43600	41100	32900	e19700
21	52100	41800	32000	26300	23500	26800	39000	50800	43300	41100	32300	e19700
22	51800	41400	31700	26100	23400	27200	39100	50900	43000	41100	31800	e19700
23	51500	41100	31300	26000	23300	27800	39300	50800	42700	41100	31200	e19700
24	51300	40700	31000	25900	23300	28400	39700	50700	42400	41100	30600	e19700
25	51000	40300	30700	25800	23100	29800	40300	50600	42200	41100	30100	e19700
26	50400	40000	30300	25700	23000	30400	40800	50500	42100	41200	29500	e19700
27	49900	39600	29900	25600	22900	31200	41600	50200	41900	41200	29000	e19700
28	49600	39200	29600	25400	22800	31900	42100	50100	41800	41200	28500	e19700
29	49100	38900	29300	25300	---	32800	42500	49800	41700	41300	28000	e19700
30	48700	38600	29000	25200	---	33300	42900	49600	41400	41300	27600	e19700
31	48100	---	28700	25100	---	33800	---	49400	---	41400	27100	---
MAX	56300	47600	38200	28400	25000	33800	42900	50900	49200	41400	41400	26600
MIN	48100	38600	28700	25100	22800	22900	34600	43600	41400	39200	27100	19400
a	5537.41	5523.72	5508.24	5501.90	5497.83	5516.35	5530.26	5539.16	5527.92	5527.90	5505.38	
b	-8200	-9500	-9900	-3600	-2300	+11000	+9100	+6500	-8000	0	-14300	-7400
CAL YR 2000	MAX 68000	MIN 23900	b +900									
WTR YR 2001	MAX 56300	MIN 19400	b -36600									

e Estimated.

a Elevation, in feet, at end of month.

b Change in contents, in acre-feet.

## 11416100 BOWMAN-SPAULDING CANAL AT JORDAN CREEK SIPHON VENTURI, NEAR EMIGRANT GAP, CA

LOCATION.—Lat 39°20'32", long 120°38'26", in SW 1/4 NW 1/4 sec.16, T.17 N., R.12 E., Nevada County, Hydrologic Unit 18020125, at outlet of Jordan Creek Siphon, 0.6 mi downstream from Fuller Lake, and 3.5 mi northeast of Emigrant Gap.

PERIOD OF RECORD.—October 1964 to current year.

GAGE.—Water-stage recorder and Venturi section. Elevation of gage is 5,340 ft above sea level, from topographic map.

REMARKS.—Records show water diverted from Bowman Lake (station 11415500) plus numerous small tributaries before it enters Lake Spaulding (station 11414140). Most of the water at this gage flows downstream through Spaulding No. 3 Powerplant (station 11416200). See schematic diagrams of South Yuba and Bear River Basins.

COOPERATION.—Records were collected by Pacific Gas & Electric Co., under general supervision of the U.S. Geological Survey, in connection with a Federal Energy Regulatory Commission project.

EXTREMES FOR PERIOD OF RECORD.—Maximum daily discharge, 335 ft<sup>3</sup>/s, Dec. 25, 1983; no flow at times in most years.

DISCHARGE, CUBIC FEET PER SECOND, WATER YEAR OCTOBER 2000 TO SEPTEMBER 2001  
DAILY MEAN VALUES

DAY	OCT	NOV	DEC	JAN	FEB	MAR	APR	MAY	JUN	JUL	AUG	SEP
1	215	275	192	172	e72	e72	103	197	181	273	85	286
2	223	274	201	97	e72	95	106	203	144	290	85	286
3	254	200	209	e57	e72	109	102	189	154	299	164	285
4	263	e41	206	e54	e72	110	104	175	197	295	282	286
5	226	e43	195	e69	e72	111	102	177	196	291	284	289
6	262	e43	210	e67	e72	136	103	183	190	290	284	292
7	272	e43	209	79	e72	190	105	185	185	216	285	290
8	274	128	202	102	89	184	104	193	181	e61	277	288
9	273	215	198	102	111	131	102	201	182	e30	283	287
10	280	205	200	103	111	111	101	200	182	e5.8	291	286
11	283	204	195	105	111	111	99	196	178	.00	294	285
12	281	199	194	104	111	113	99	192	176	.00	296	287
13	281	207	192	104	111	116	97	185	174	.00	289	286
14	279	208	190	104	111	115	97	178	172	.00	180	284
15	281	202	178	104	111	87	97	184	177	.00	255	282
16	270	198	176	104	111	82	97	196	179	.00	288	281
17	262	189	181	86	111	81	102	138	180	.00	292	127
18	272	191	182	e64	111	78	109	83	180	.00	294	e15
19	274	201	174	e64	111	81	171	e64	178	e38	299	e15
20	275	190	76	86	111	96	189	e62	177	82	284	e15
21	257	203	177	102	111	104	181	84	177	83	280	e15
22	283	205	191	102	111	138	177	174	177	84	293	e15
23	284	203	184	102	111	126	176	198	177	87	297	e15
24	277	203	182	102	111	107	188	184	179	90	294	e15
25	278	201	174	102	111	164	206	181	119	91	294	e15
26	279	201	188	102	111	193	223	178	186	89	297	e15
27	272	201	188	102	85	153	221	181	189	85	296	e46
28	283	201	181	102	e72	113	209	181	181	85	294	94
29	295	203	180	101	---	111	191	184	179	85	293	84
30	284	192	178	100	---	153	184	182	201	85	278	82
31	279	---	177	85	---	119	---	180	---	85	282	---
TOTAL	8371	5469	5760	2929	2748	3690	4145	5288	5328	3119.80	8289	5148
MEAN	270	182	186	94.5	98.1	119	138	171	178	101	267	172
MAX	295	275	210	172	111	193	223	203	201	299	299	292
MIN	215	41	76	54	72	72	97	62	119	.00	85	15
AC-FT	16600	10850	11420	5810	5450	7320	8220	10490	10570	6190	16440	10210
a	16970	9470	11730	179	0	4120	8350	10590	10920	3760	15440	10030

## STATISTICS OF MONTHLY MEAN DATA FOR WATER YEARS 1965 - 2001, BY WATER YEAR (WY)

	1965	1966	1967	1968	1969	1970	1971	1972	1973	1974	1975	1976	1977	1978	1979	1980	1981	1982	1983	1984	1985	1986	1987	1988	1989	1990	1991	1992	1993	1994	1995	1996	1997	1998	1999	2000	2001			
MEAN	198	200	202	195	187	211	224	235	236	204	253	257																												
MAX	306	308	312	313	311	311	311	319	315	305	316	311																												
(WY)	1983	1984	1984	1984	1995	1983	1980	1983	1983	1983	1993	1983																												
MIN	29.5	.000	41.9	37.8	21.4	26.3	19.3	33.9	.000	45.6	40.2	143																												
(WY)	1973	1965	1978	1977	1991	1977	1977	1965	1965	1991	1988	1977																												

SUMMARY STATISTICS	FOR 2000 CALENDAR YEAR	FOR 2001 WATER YEAR	WATER YEARS 1965 - 2001
ANNUAL TOTAL	85981.70	60284.80	
ANNUAL MEAN	235	165	217
HIGHEST ANNUAL MEAN			304
LOWEST ANNUAL MEAN			77.9
HIGHEST DAILY MEAN	322	May 8	299
LOWEST DAILY MEAN	.00	Jul 10	.00
ANNUAL SEVEN-DAY MINIMUM	.00	Jul 14	.00
ANNUAL RUNOFF (AC-FT)	170500	119600	157100
ANNUAL DISCHARGE (AC-FT) a	168900	101600	
10 PERCENT EXCEEDS	306	284	306
50 PERCENT EXCEEDS	260	178	251
90 PERCENT EXCEEDS	168	72	67

e Estimated.

a Discharge, in acre-feet, through Spaulding No. 3 Powerplant (station 11416200), provided by Pacific Gas & Electric Co.

## 11416500 CANYON CREEK BELOW BOWMAN LAKE, CA

LOCATION.—Lat 39°26'23", long 120°39'37", in NE 1/4 SE 1/4 sec.7, T.18 N., R.12 E., Nevada County, Hydrologic Unit 18020125, on left bank, 1 mi downstream from Bowman Dam, 3.5 mi upstream from Texas Creek, and 8.8 mi south of Sierra City.

DRAINAGE AREA.—28.3 mi<sup>2</sup>.

PERIOD OF RECORD.—January 1927 to current year.

REVISED RECORDS.—WSP 1315-A: 1930(M). WSP 1931: Drainage area.

GAGE.—Water-stage recorder. Elevation of gage is 5,300 ft above sea level, from topographic map.

REMARKS.—Flow regulated by Bowman Lake (station 11415500), several smaller reservoirs, and diversion into Bowman–Spaulding Canal (station 11416000). See schematic diagram of [North Yuba River Basin](#).

COOPERATION.—Records were collected by Nevada Irrigation District, under general supervision of the U.S. Geological Survey, in connection with a Federal Energy Regulatory Commission project.

EXTREMES FOR PERIOD OF RECORD.—Maximum discharge, about 5,500 ft<sup>3</sup>/s, Jan. 2, 1997, gage height, 13.01 ft, from floodmarks (backwater from debris), from rating curve extended above 1,500 ft<sup>3</sup>/s, on basis of computation of flow over Bowman Dam; no flow at times in some years.

## DISCHARGE, CUBIC FEET PER SECOND, WATER YEAR OCTOBER 2000 TO SEPTEMBER 2001

## DAILY MEAN VALUES

DAY	OCT	NOV	DEC	JAN	FEB	MAR	APR	MAY	JUN	JUL	AUG	SEP
1	5.5	6.8	7.0	5.3	3.6	3.8	5.5	4.3	4.7	4.5	4.1	e4.5
2	5.7	6.8	5.5	5.5	3.7	3.9	5.1	4.2	4.6	4.5	4.1	e4.6
3	5.8	6.5	3.3	5.0	3.8	4.0	4.6	4.1	4.7	4.4	4.4	e4.7
4	5.8	6.3	3.3	4.8	4.2	4.9	4.3	4.0	4.7	4.3	5.0	e4.7
5	5.7	8.3	6.4	5.1	4.3	5.7	4.2	4.0	4.7	4.3	5.1	e4.9
6	5.9	8.5	4.9	5.1	4.0	5.9	4.3	4.0	4.7	4.3	5.0	e4.9
7	5.7	8.4	4.9	5.2	3.8	6.8	4.4	3.9	4.6	7.1	4.9	e5.1
8	5.5	7.3	4.9	5.4	3.8	6.9	4.2	3.9	4.6	7.9	4.8	e5.1
9	6.0	6.4	5.0	5.5	4.0	6.0	4.2	3.9	4.6	6.3	5.0	e5.2
10	6.0	6.7	5.3	5.5	4.1	5.1	4.3	3.9	4.6	4.9	4.9	e5.3
11	5.9	6.7	5.1	5.4	4.1	5.0	4.4	3.9	4.5	4.3	4.9	e5.3
12	5.6	6.7	5.2	5.4	11	5.0	4.4	4.0	4.6	4.1	5.0	e5.5
13	5.6	6.7	5.2	5.4	4.4	5.4	4.7	4.0	4.5	4.1	5.0	e5.5
14	5.7	6.8	5.3	5.4	3.9	5.7	4.8	4.0	4.5	3.7	4.6	e5.6
15	5.7	6.7	5.5	5.5	3.6	5.4	4.9	4.3	4.5	3.8	e5.1	e5.7
16	5.6	6.7	5.8	5.3	3.6	5.1	4.9	4.2	4.5	3.8	e5.1	e5.8
17	5.7	6.7	5.5	4.9	3.6	5.6	5.2	5.4	4.5	4.0	e5.1	e6.0
18	5.7	6.8	5.4	4.5	3.8	6.9	5.3	8.4	4.5	4.4	e5.1	e6.0
19	5.9	6.8	5.2	4.4	4.0	7.8	5.3	8.4	4.5	4.4	e4.9	e6.1
20	6.1	6.8	4.7	4.6	4.0	8.9	5.5	7.3	4.5	4.3	e4.9	e6.2
21	6.1	6.8	5.4	4.7	4.1	8.2	5.5	6.5	4.4	4.2	e4.9	e6.2
22	6.0	7.0	5.4	4.4	4.1	8.3	5.5	6.4	4.3	4.2	e4.7	e6.1
23	6.2	7.0	5.3	4.1	4.0	7.8	5.7	6.3	4.3	4.2	e4.7	e6.0
24	6.3	7.0	5.3	4.2	4.0	8.3	5.9	5.5	4.4	4.1	e4.7	e6.0
25	6.6	7.0	5.1	4.1	4.1	20	5.8	4.8	4.3	3.9	e4.5	e6.0
26	6.4	6.9	5.1	4.1	4.0	7.5	5.5	4.7	4.5	3.9	e4.5	e5.9
27	6.4	7.0	5.1	4.0	3.9	6.5	5.1	4.8	4.5	3.9	e4.5	e5.7
28	8.9	6.9	5.2	4.0	3.8	6.9	4.9	4.8	4.4	3.8	e4.3	e5.7
29	8.6	7.8	5.3	4.0	---	6.6	4.5	4.8	4.4	3.8	e4.3	e5.7
30	7.3	7.5	5.3	4.1	---	5.9	4.3	4.7	4.6	3.9	e4.3	e5.6
31	7.0	---	5.3	3.7	---	5.7	---	4.7	---	4.0	e4.5	---
TOTAL	190.9	210.3	161.2	148.6	117.3	205.5	147.2	152.1	135.7	137.3	146.9	165.6
MEAN	6.16	7.01	5.20	4.79	4.19	6.63	4.91	4.91	4.52	4.43	4.74	5.52
MAX	8.9	8.5	7.0	5.5	11	20	5.9	8.4	4.7	7.9	5.1	6.2
MIN	5.5	6.3	3.3	3.7	3.6	3.8	4.2	3.9	4.3	3.7	4.1	4.5
AC-FT	379	417	320	295	233	408	292	302	269	272	291	328
a	16990	9900	10900	5160	4680	4660	3930	6200	10380	6030	16760	9910

e Estimated.

a Diversion, in acre-feet, to Bowman–Spaulding Canal (station 11416000), provided by Nevada Irrigation District.

## 11416500 CANYON CREEK BELOW BOWMAN LAKE, CA—Continued

## STATISTICS OF MONTHLY MEAN DATA FOR WATER YEARS 1927 - 2001, BY WATER YEAR (WY)

	OCT	NOV	DEC	JAN	FEB	MAR	APR	MAY	JUN	JUL	AUG	SEP
MEAN	3.09	6.22	16.9	22.9	17.9	27.6	43.0	124	142	13.9	2.72	2.60
MAX	24.1	195	360	453	198	629	325	773	542	314	37.3	17.0
(WY)	1973	1984	1965	1997	1965	1986	1940	1963	1952	1952	1952	1952
MIN	.13	.19	.20	.20	.50	.58	.46	.43	.30	.029	.000	.000
(WY)	1935	1940	1937	1937	1933	1935	1934	1947	1977	1935	1934	1963

SUMMARY STATISTICS	FOR 2000 CALENDAR YEAR		FOR 2001 WATER YEAR		WATER YEARS 1927 - 2001	
ANNUAL TOTAL	5207.9		1918.6			
ANNUAL MEAN	14.2		5.26		34.8	
HIGHEST ANNUAL MEAN					165	
LOWEST ANNUAL MEAN					.81	
HIGHEST DAILY MEAN	144	May 7	20	Mar 25	5520	Jan 2 1997
LOWEST DAILY MEAN	2.3	Jul 10	3.3	Dec 3	.00	Apr 16 1934
ANNUAL SEVEN-DAY MINIMUM	3.3	Jul 5	3.8	Feb 14	.00	Apr 16 1934
MAXIMUM PEAK FLOW			48	Mar 25	5500	Jan 2 1997
MAXIMUM PEAK STAGE			4.14	Mar 25	13.01	Jan 2 1997
ANNUAL RUNOFF (AC-FT)	10330		3810		25240	
ANNUAL DIVERSION (AC-FT) a	145200		105500			
10 PERCENT EXCEEDS	24		6.8		62	
50 PERCENT EXCEEDS	6.1		5.0		3.2	
90 PERCENT EXCEEDS	4.0		4.0		.30	

a Diversion, in acre-feet, to Bowman-Spaulding Canal (station 11416000), provided by Nevada Irrigation District.









## 11416610 TEXAS CREEK BELOW LOWER ROCK LAKE, NEAR GRANITEVILLE, CA

LOCATION.—Lat 39°25'42", long 120°37'19", in SW 1/4 NW 1/4 sec.15, T.18 N., R.12 E., Nevada County, Hydrologic Unit 18020125, Tahoe National Forest, on right bank, 200 ft downstream from outlet structure on Lower Rock Lake Dam, and 6.4 mi east of Graniteville.

DRAINAGE AREA.—0.36 mi<sup>2</sup>.

PERIOD OF RECORD.—October 1995 to current year (low-flow records only). Unpublished records for water years 1974 and 1979–95 available in files of the U.S. Geological Survey.

GAGE.—Water-stage recorder and Parshall flume. Elevation of gage is 6,615 ft above sea level, from topographic map. August 1965 to August 1995, nonrecording gage at same site and datum.

REMARKS.—Records not computed for winter months or above 1.2 ft<sup>3</sup>/s. Oct. 1 to Nov. 15 missing due to equipment failure. Flow regulated by Lower Rock Lake. See schematic diagram of [South Yuba River Basin](#).

COOPERATION.—Records were collected by Pacific Gas & Electric Co., under general supervision of the U.S. Geological Survey, in connection with a Federal Energy Regulatory Commission project.

DISCHARGE, CUBIC FEET PER SECOND, WATER YEAR OCTOBER 2000 TO SEPTEMBER 2001  
DAILY MEAN VALUES

DAY	OCT	NOV	DEC	JAN	FEB	MAR	APR	MAY	JUN	JUL	AUG	SEP
1	---	---	---	---	---	---	---	---	.12	.19	.87	.31
2	---	---	---	---	---	---	---	---	.11	.21	.67	.29
3	---	---	---	---	---	---	---	---	.10	.23	.62	.29
4	---	---	---	---	---	---	---	---	.11	.20	.59	.29
5	---	---	---	---	---	---	---	---	.62	.15	.54	.30
6	---	---	---	---	---	---	---	---	.58	.18	.47	.31
7	---	---	---	---	---	---	---	---	.58	.20	.46	.30
8	---	---	---	---	---	---	---	---	.49	.19	.45	.29
9	---	---	---	---	---	---	---	---	.43	.19	.40	.29
10	---	---	---	---	---	---	---	---	.81	.19	.33	.29
11	---	---	---	---	---	---	---	---	.76	.23	.33	.65
12	---	---	---	---	---	---	---	---	.51	.23	.31	1.1
13	---	---	---	---	---	---	---	---	.46	.20	.31	1.1
14	---	---	---	---	---	---	---	---	.40	.25	.29	1.1
15	---	---	---	---	---	---	---	---	.39	.22	.27	1.1
16	---	---	---	---	---	---	---	---	.38	.17	.24	1.1
17	---	---	---	---	---	---	---	---	.35	.14	.23	1.1
18	---	---	---	---	---	---	---	---	.33	.24	.21	1.1
19	---	---	---	---	---	---	---	---	.29	.41	.19	1.1
20	---	---	---	---	---	---	---	---	.25	.38	.19	1.0
21	---	---	---	---	---	---	---	---	.24	.34	.29	1.0
22	---	---	---	---	---	---	---	---	.22	.35	.38	1.0
23	---	---	---	---	---	---	---	---	.20	.34	.37	1.0
24	---	---	---	---	---	---	---	---	.16	.30	.35	.98
25	---	---	---	---	---	---	---	---	.19	.29	.34	.97
26	---	---	---	---	---	---	---	---	.18	.28	.34	1.1
27	---	---	---	---	---	---	---	---	.18	.26	.34	1.2
28	---	---	---	---	---	---	---	---	.21	.43	.34	1.2
29	---	---	---	---	---	---	---	---	.19	.60	.34	1.1
30	---	---	---	---	---	---	---	---	.17	.83	.34	1.1
31	---	---	---	---	---	---	---	---	---	.96	.33	---
TOTAL	---	---	---	---	---	---	---	---	10.01	9.38	11.73	24.06
MEAN	---	---	---	---	---	---	---	---	.33	.30	.38	.80
MAX	---	---	---	---	---	---	---	---	.81	.96	.87	1.2
MIN	---	---	---	---	---	---	---	---	.10	.14	.19	.29
AC-FT	---	---	---	---	---	---	---	---	20	19	23	48



## 11416620 TEXAS CREEK TRIBUTARY BELOW CULBERTSON LAKE, NEAR GRANITEVILLE, CA

LOCATION.—Lat 39°25'17", long 120°37'21", in SW 1/4 SW 1/4 sec.15, T.18 N., R.12 E., Nevada County, Hydrologic Unit 18020125, Tahoe National Forest, on right bank, 150 ft downstream from outlet structure, on Culbertson Lake Dam, 0.15 mi upstream from Texas Creek, and 6.4 mi east of Graniteville.

DRAINAGE AREA.—0.44 mi<sup>2</sup>.

PERIOD OF RECORD.—October 1988 to current year (low-flow records only). Unpublished records for water years 1965–88 available in files of the U.S. Geological Survey.

GAGE.—Water-stage recorder and V-notch sharp-crested weir. Elevation of gage is 6,420 ft above sea level. October 1965 to August 1988, nonrecording gage at site 10 ft downstream at different datum. August to September 1988, nonrecording gage at same site and datum.

REMARKS.—Records not computed for winter months or above 1.2 ft<sup>3</sup>/s. Low and medium flow regulated by Culbertson Lake (capacity, 953 acre-ft). See schematic diagram of [South Yuba River Basin](#).

COOPERATION.—Records were collected by Pacific Gas & Electric Co., under general supervision of the U.S. Geological Survey, in connection with a Federal Energy Regulatory Commission project.

DISCHARGE, CUBIC FEET PER SECOND, WATER YEAR OCTOBER 2000 TO SEPTEMBER 2001  
DAILY MEAN VALUES

DAY	OCT	NOV	DEC	JAN	FEB	MAR	APR	MAY	JUN	JUL	AUG	SEP
1	---	---	---	---	---	---	---	---	.99	.84	.97	1.1
2	---	---	---	---	---	---	---	---	.97	.84	.69	.90
3	---	---	---	---	---	---	---	---	.96	.85	.66	.72
4	---	---	---	---	---	---	---	---	.96	.85	.64	.70
5	---	---	---	---	---	---	---	---	.93	.85	.74	.73
6	---	---	---	---	---	---	---	---	.92	.82	.84	.74
7	---	---	---	---	---	---	---	---	.92	.82	.82	.73
8	---	---	---	---	---	---	---	---	.90	.79	.79	.73
9	---	---	---	---	---	---	---	---	1.0	.80	.79	.70
10	---	---	---	---	---	---	---	---	1.1	.89	.78	.58
11	---	---	---	---	---	---	---	---	1.1	.87	.75	---
12	---	---	---	---	---	---	---	---	1.1	.85	.73	---
13	---	---	---	---	---	---	---	---	.89	.83	.73	---
14	---	---	---	---	---	---	---	---	.80	.80	.73	1.2
15	---	---	---	---	---	---	---	---	.78	.79	.73	1.2
16	---	---	---	---	---	---	---	---	.77	.79	.71	---
17	---	---	---	---	---	---	---	---	.76	.77	.70	---
18	---	---	---	---	---	---	---	---	.76	.76	.70	---
19	---	---	---	---	---	---	---	---	.73	.76	.70	---
20	---	---	---	---	---	---	---	---	.72	.76	.69	---
21	---	---	---	---	---	---	---	---	.80	.73	.69	---
22	---	---	---	---	---	---	---	---	.78	.73	.70	---
23	---	---	---	---	---	---	---	---	.75	.73	.70	---
24	---	---	---	---	---	---	---	---	.72	.73	.70	---
25	---	---	---	---	---	---	---	---	.70	.71	.70	---
26	---	---	---	---	---	---	---	---	.68	.70	.70	---
27	---	---	---	---	---	---	---	---	.76	.70	.68	---
28	---	---	---	---	---	---	---	---	.81	.67	.86	---
29	---	---	---	---	---	---	---	---	.81	.87	1.1	---
30	---	---	---	---	---	---	---	---	.84	1.2	1.1	---
31	---	---	---	---	---	---	---	---	---	1.1	1.1	---
TOTAL	---	---	---	---	---	---	---	---	25.71	25.20	23.92	---
MEAN	---	---	---	---	---	---	---	---	.86	.81	.77	---
MAX	---	---	---	---	---	---	---	---	1.1	1.2	1.1	---
MIN	---	---	---	---	---	---	---	---	.68	.67	.64	---
AC-FT	---	---	---	---	---	---	---	---	51	50	47	---











## 11416700 LINDSEY CREEK BELOW LOWER LINDSEY LAKE, NEAR GRANITEVILLE, CA

LOCATION.—Lat 39°24'43", long 120°38'35", in NE 1/4 SE 1/4 sec.20, T.18 N., R.12 E., Nevada County, Hydrologic Unit 18020125, Tahoe National Forest, on left bank, 10 ft downstream from outlet structure on Lower Lindsey Lake Dam, and 5.5 mi east of Graniteville.

DRAINAGE AREA.—0.91 mi<sup>2</sup>.

PERIOD OF RECORD.—October 1988 to current year (low-flow records only). Unpublished records for water years 1965–88 available in files of the U.S. Geological Survey.

GAGE.—Water-stage recorder and V-notch sharp-crested weir. Elevation of gage is 6,225 ft above sea level, from topographic map. October 1965 to July 1984, nonrecording gage at same site and different datum. July 1984 to August 1988, nonrecording gage at same site and different datum.

REMARKS.—Records not computed for winter months or above 1.2 ft<sup>3</sup>/s. Low and medium flow regulated by Lower Lindsey Lake, capacity, 293 acre-ft. Spillway flows bypass this station. See schematic diagram of [South Yuba River Basin](#).

COOPERATION.—Records were collected by Pacific Gas & Electric Co., under general supervision of the U.S. Geological Survey, in connection with a Federal Energy Regulatory Commission project.

DISCHARGE, CUBIC FEET PER SECOND, WATER YEAR OCTOBER 2000 TO SEPTEMBER 2001  
DAILY MEAN VALUES

DAY	OCT	NOV	DEC	JAN	FEB	MAR	APR	MAY	JUN	JUL	AUG	SEP
1	1.1	.21	---	---	---	---	---	---	.32	.55	.71	1.1
2	1.0	---	---	---	---	---	---	---	.32	.66	.71	.85
3	1.0	---	---	---	---	---	---	---	.25	.77	.70	.64
4	1.0	---	---	---	---	---	---	---	---	.77	.70	.64
5	1.0	---	---	---	---	---	---	---	.89	.77	.70	.63
6	1.0	---	---	---	---	---	---	---	.87	.76	.70	.62
7	---	---	---	---	---	---	---	---	.87	.76	.70	.56
8	---	---	---	---	---	---	---	---	.86	.75	.70	.51
9	---	---	---	---	---	---	---	---	.85	.75	.70	.73
10	---	---	---	---	---	---	---	---	.85	.78	.70	1.1
11	---	---	---	---	---	---	---	---	.65	.79	.70	.94
12	---	---	---	---	---	---	---	---	.66	.82	.70	.77
13	---	---	---	---	---	---	---	---	.66	.82	.70	.77
14	---	---	---	---	---	---	---	---	.53	.79	.68	.76
15	---	---	---	---	---	---	---	---	.49	.79	.68	.82
16	---	---	---	---	---	---	---	---	.54	.79	.70	.89
17	---	---	---	---	---	---	---	---	.48	.79	.69	.88
18	---	---	---	---	---	---	---	---	.44	.77	.67	.85
19	---	---	---	---	---	---	---	---	.45	.76	.67	.85
20	---	---	---	---	---	---	---	---	.59	.76	.67	.84
21	---	---	---	---	---	---	---	---	.75	.76	.64	.82
22	.54	---	---	---	---	---	---	---	.77	.76	.64	.82
23	.29	---	---	---	---	---	---	---	.70	.76	.64	---
24	.26	---	---	---	---	---	---	---	.69	.76	.64	---
25	.22	---	---	---	---	---	---	---	.61	.76	.64	---
26	.22	---	---	---	---	---	---	---	.55	.76	.64	---
27	.21	---	---	---	---	---	---	---	.58	.76	.64	.89
28	.21	---	---	---	---	---	---	---	.55	.75	.72	.87
29	.21	---	---	---	---	---	---	---	.50	.73	.87	.81
30	.21	---	---	---	---	---	---	---	.54	.72	.89	.76
31	.21	---	---	---	---	---	---	---	---	.71	.94	---
TOTAL	---	---	---	---	---	---	---	---	---	23.43	21.78	---
MEAN	---	---	---	---	---	---	---	---	---	.76	.70	---
MAX	---	---	---	---	---	---	---	---	---	.82	.94	---
MIN	---	---	---	---	---	---	---	---	---	.55	.64	---
AC-FT	---	---	---	---	---	---	---	---	---	46	43	---

## 11417500 SOUTH YUBA RIVER AT JONES BAR, NEAR GRASS VALLEY, CA

LOCATION.—Lat 39°17'32", long 121°06'13", in NW 1/4 SE 1/4 sec.32, T.17 N., R.8 E., Nevada County, Hydrologic Unit 18020125, on left bank at Jones Bar, 100 ft upstream from Rush Creek, 0.9 mi downstream from bridge on State Highway 49, and 5 mi northwest of Grass Valley.

DRAINAGE AREA.—308 mi<sup>2</sup>.

## WATER-DISCHARGE RECORDS

PERIOD OF RECORD.—October 1940 to September 1948, April 1959 to current year. Published as South Fork Yuba River at Jones Bar 1940–48, and as South Yuba River at Jones Bar 1959–63. Yearly discharge for the 1947 water year published in WSP 1315-A.

REVISED RECORDS.—WSP 1315-A: 1942–43(M), drainage area at former site. WSP 1931: Drainage area.

GAGE.—Water-stage recorder and crest-stage gage. Elevation of gage is 1,060 ft above sea level, from river-profile map. Oct. 1, 1940, to Sept. 30, 1948, at site 150 ft upstream at datum 2.00 ft higher.

REMARKS.—Records good. Flow regulated by Lake Spaulding, Fordyce Lake, and Bowman Lake (stations 11414140, 11414090, and 11415500) and many smaller reservoirs. Diversions into and out of basin for several powerplants and for irrigation. See schematic diagram of [South Yuba River Basin](#).

EXTREMES FOR PERIOD OF RECORD.—Maximum discharge, 53,600 ft<sup>3</sup>/s, Dec. 22, 1964, gage height, 25.0 ft, from floodmarks, from rating curve extended above 23,000 ft<sup>3</sup>/s on basis of slope-area measurement of peak flow; minimum daily, 1.0 ft<sup>3</sup>/s, Sept. 10–13, 1944.

EXTREMES OUTSIDE PERIOD OF RECORD.—Flood of Dec. 23, 1955, reached a stage of 30.7 ft, from floodmarks, present datum, at site 100 ft upstream.

## DISCHARGE, CUBIC FEET PER SECOND, WATER YEAR OCTOBER 2000 TO SEPTEMBER 2001

## DAILY MEAN VALUES

DAY	OCT	NOV	DEC	JAN	FEB	MAR	APR	MAY	JUN	JUL	AUG	SEP
1	42	88	91	68	98	218	259	235	61	46	33	31
2	44	75	79	67	95	232	249	229	59	43	33	31
3	44	71	74	66	98	240	226	209	61	41	32	32
4	44	68	68	66	109	435	207	196	62	40	32	31
5	44	72	65	65	126	1020	191	192	59	39	32	31
6	42	68	63	65	125	654	185	187	58	38	33	31
7	42	67	65	64	117	495	242	182	57	38	33	30
8	43	65	63	70	102	449	218	181	55	38	32	30
9	48	62	63	75	108	411	194	181	53	45	31	31
10	88	63	70	102	169	348	189	173	51	44	31	32
11	85	65	87	274	202	300	198	165	50	41	31	32
12	79	62	112	173	179	272	239	159	50	45	31	33
13	63	61	102	126	159	259	207	151	50	63	31	33
14	56	67	168	110	138	260	202	144	49	61	31	33
15	55	69	240	100	128	256	199	141	48	46	31	33
16	53	64	159	91	128	244	200	148	46	42	29	33
17	52	62	123	85	137	233	208	137	46	39	31	32
18	50	61	107	81	155	243	216	127	e46	39	31	35
19	50	61	95	80	293	268	277	120	e47	37	31	33
20	51	61	89	80	443	296	349	109	47	35	31	32
21	53	61	85	79	631	309	345	101	47	34	31	33
22	52	62	90	77	738	301	321	93	46	34	31	32
23	49	61	89	85	469	292	297	90	45	34	31	33
24	51	61	82	162	371	285	294	85	44	35	32	32
25	53	60	78	150	393	623	296	82	43	34	33	38
26	64	61	75	160	325	468	295	77	47	33	33	42
27	67	61	73	135	279	335	284	72	50	33	32	36
28	72	61	71	117	247	298	266	70	55	32	32	35
29	267	83	70	117	---	300	249	69	52	32	32	34
30	150	127	70	119	---	283	234	68	55	32	31	34
31	140	---	69	105	---	267	---	65	---	32	31	---
TOTAL	2093	2030	2835	3214	6562	10894	7336	4238	1539	1225	979	988
MEAN	67.5	67.7	91.5	104	234	351	245	137	51.3	39.5	31.6	32.9
MAX	267	127	240	274	738	1020	349	235	62	63	33	42
MIN	42	60	63	64	95	218	185	65	43	32	29	30
AC-FT	4150	4030	5620	6370	13020	21610	14550	8410	3050	2430	1940	1960

e Estimated.

## SACRAMENTO RIVER BASIN

## 11417500 SOUTH YUBA RIVER AT JONES BAR, NEAR GRASS VALLEY, CA—Continued

## STATISTICS OF MONTHLY MEAN DATA FOR WATER YEARS 1941 - 2001, BY WATER YEAR (WY)

	OCT	NOV	DEC	JAN	FEB	MAR	APR	MAY	JUN	JUL	AUG	SEP
MEAN	80.1	199	469	774	802	767	682	887	671	123	39.5	39.4
MAX	1197	1350	3756	4865	4078	3029	2804	3323	3618	996	84.9	132
(WY)	1963	1984	1965	1997	1986	1986	1982	1963	1967	1983	1983	1965
MIN	11.7	24.2	37.4	45.0	64.0	67.2	51.1	68.3	31.8	11.6	3.05	1.42
(WY)	1945	1960	1960	1991	1977	1977	1977	1992	1977	1947	1947	1947

SUMMARY STATISTICS	FOR 2000 CALENDAR YEAR		FOR 2001 WATER YEAR		WATER YEARS 1941 - 2001	
ANNUAL TOTAL	134879		43933			
ANNUAL MEAN	369		120		465	
HIGHEST ANNUAL MEAN					1135	
LOWEST ANNUAL MEAN					42.6	
HIGHEST DAILY MEAN	6380	Feb 14	1020	Mar 5	30300	Jan 1 1997
LOWEST DAILY MEAN	41	Aug 26	29	Aug 16	1.0	Sep 10 1944
ANNUAL SEVEN-DAY MINIMUM	41	Aug 23	31	Aug 10	1.0	Sep 9 1944
MAXIMUM PEAK FLOW			1290	Mar 5	53600	Dec 22 1964
MAXIMUM PEAK STAGE			7.13	Mar 5	25.00	Dec 22 1964
ANNUAL RUNOFF (AC-FT)	267500		87140		337100	
10 PERCENT EXCEEDS	963		278		1140	
50 PERCENT EXCEEDS	84		68		122	
90 PERCENT EXCEEDS	44		32		30	

## 11417500 SOUTH YUBA RIVER AT JONES BAR, NEAR GRASS VALLEY, CA—Continued

## WATER-QUALITY RECORDS

PERIOD OF RECORD.—Water years 1965–79, November 2000 to September 2001.

WATER TEMPERATURE: Water years 1965–79, November 2000 to September 2001.

SEDIMENT DATA: Water years 1967–74, November 2000 to September 2001.

PERIOD OF DAILY RECORD.—

WATER TEMPERATURE: Water years 1965–79, November 2000 to September 2001.

SUSPENDED-SEDIMENT DISCHARGE: November 2000 to September 2001.

INSTRUMENTATION.—Water-temperature recorder from February 1965 to April 1979, November 2000 to September 2001.

REMARKS.—Water-temperature records rated excellent except for Feb. 19 to Mar. 6, and May 3 to July 13, which are rated good. Water-quality and suspended-sediment samples taken at site 100 yards downstream of continuous water-quality monitor.

EXTREMES FOR PERIOD OF DAILY RECORD.—

WATER TEMPERATURE: Maximum recorded, 28.5°C, Aug. 7, 8, 1978; minimum recorded, 0.0°C, several days in most years.

SEDIMENT CONCENTRATION: Maximum daily mean, 129 mg/L, Mar. 5, 2001; minimum daily mean, 0 mg/L, many days during the 2001 water year.

SEDIMENT LOAD: Maximum daily, 363 tons, Mar. 5, 2001; minimum daily, 0 ton, Nov. 15–20, 2000, Jan. 5–7, Aug. 21, 2001.

EXTREMES FOR CURRENT YEAR.—

WATER TEMPERATURE: Maximum recorded, 27.0°C, July 5; minimum recorded, 0.5°C, Jan. 18.

SEDIMENT CONCENTRATION: Maximum daily mean, 129 mg/L, Mar. 5; minimum daily mean, 0 mg/L, many days during year.

SEDIMENT LOAD: Maximum daily, 363 tons, Mar. 5; minimum daily, 0 ton, several days during year.

## CROSS-SECTIONAL DATA, WATER YEAR OCTOBER 2000 TO SEPTEMBER 2001

DATE	TIME	TEMPER- ATURE WATER (DEG C) (00010)	SAMPLE LOC- ATION, CROSS SECTION (FT FM L BANK) (00009)
JUL			
03...*	1650	26.0	17.5
03...*	1651	26.0	22.5
03...*	1652	26.0	27.5
03...*	1653	26.0	32.5
03...*	1654	26.0	37.5
03...*	1655	26.0	42.5
03...*	1656	26.0	47.5
03...*	1657	26.0	52.5
03...*	1658	26.0	57.5
03...*	1659	26.0	62.5

## SUSPENDED-SEDIMENT DISCHARGE, WATER YEAR OCTOBER 2000 TO SEPTEMBER 2001

DATE	TIME	DIS- CHARGE, INST. CUBIC FEET PER SECOND (00061)	TEMPER- ATURE WATER (DEG C) (00010)	SEDI- MENT, DIS- CHARGE, SUS- PENDE (MG/L) (80154)	SEDI- MENT, DIS- CHARGE, SUS- PENDE (T/DAY) (80155)
JAN					
08...	1600	71	4.0	<.5	<.01
30...	1330	120	3.0	4	1.3
APR					
12...	1315	246	8.0	4	2.7
MAY					
17...	1430	137	19.5	2	.74
JUN					
18...	1500	46	24.0	1	.12

\* Instantaneous discharge at time of cross-sectional measurement: 41 ft<sup>3</sup>/s.

< Actual value is known to be less than the value shown.

## 11417500 SOUTH YUBA RIVER AT JONES BAR, NEAR GRASS VALLEY, CA—Continued

## TEMPERATURE, WATER (DEG. C), WATER YEAR OCTOBER 2000 TO SEPTEMBER 2001

DAY	MAX	MIN	MAX	MIN	MAX	MIN	MAX	MIN	MAX	MIN	MAX	MIN
	OCTOBER		NOVEMBER		DECEMBER		JANUARY		FEBRUARY		MARCH	
1	---	---	---	---	6.5	5.5	3.5	3.0	3.0	2.0	6.0	4.5
2	---	---	9.5	8.5	6.0	5.0	3.5	2.5	4.0	3.0	6.5	6.0
3	---	---	9.5	8.5	5.5	4.5	3.0	2.5	5.0	4.0	7.0	5.5
4	---	---	9.0	8.0	6.0	5.0	3.0	2.5	6.0	4.5	7.5	6.5
5	---	---	9.0	8.0	5.5	5.0	3.0	2.0	6.0	5.0	7.5	7.0
6	---	---	9.0	8.0	5.5	4.5	3.0	2.0	5.5	5.0	8.0	6.5
7	---	---	8.0	7.0	6.0	5.0	3.5	2.5	5.0	3.5	9.0	7.0
8	---	---	8.0	7.0	6.5	6.0	4.5	3.5	4.0	2.5	9.0	8.5
9	---	---	7.5	7.0	6.5	6.0	4.5	3.5	3.5	3.5	9.0	8.0
10	---	---	7.0	5.5	7.5	6.5	5.0	4.5	3.5	2.5	9.0	6.5
11	---	---	6.0	5.0	7.0	6.5	5.5	5.0	3.0	2.5	9.0	6.5
12	---	---	5.5	4.5	7.0	6.5	5.5	4.5	3.5	2.0	9.0	6.5
13	---	---	4.5	4.0	6.5	6.0	5.0	4.5	4.0	2.5	9.5	7.0
14	---	---	5.0	4.5	7.0	6.5	5.0	4.0	3.5	2.0	10.0	7.5
15	---	---	5.5	4.5	7.5	7.0	4.0	3.0	4.0	2.0	9.0	8.0
16	---	---	5.0	4.0	7.0	6.0	3.0	2.0	5.0	3.0	10.0	7.5
17	---	---	4.0	3.0	6.0	5.0	2.0	1.0	5.5	3.5	10.5	8.0
18	---	---	3.5	2.5	5.0	4.0	2.0	.5	6.0	5.0	12.0	9.0
19	---	---	4.0	3.0	4.5	3.5	3.5	2.0	6.0	5.5	12.5	10.0
20	---	---	4.0	3.0	4.5	4.0	3.0	2.0	6.0	5.0	13.0	11.0
21	---	---	4.0	3.0	4.5	4.0	3.5	2.5	7.0	6.0	13.5	11.0
22	---	---	4.5	3.5	5.5	4.5	4.5	3.5	6.5	5.5	13.5	11.0
23	---	---	4.5	3.5	5.5	4.5	4.5	3.5	6.0	5.0	13.5	11.0
24	---	---	5.0	4.0	5.5	5.0	5.5	4.5	6.0	5.5	13.0	11.5
25	---	---	5.0	4.0	5.0	4.0	5.0	4.0	6.5	5.5	12.5	10.0
26	---	---	5.5	5.0	4.0	3.5	4.5	3.5	7.5	5.5	11.0	8.5
27	---	---	6.5	5.5	4.0	3.0	3.5	2.5	7.0	5.5	11.5	9.0
28	---	---	6.5	6.0	4.0	3.0	3.0	2.0	6.5	5.0	13.5	10.5
29	---	---	7.5	6.5	4.0	3.0	3.5	2.5	---	---	14.0	11.0
30	---	---	7.0	6.0	3.5	3.0	3.5	2.5	---	---	14.0	11.0
31	---	---	---	---	3.5	2.5	3.0	2.0	---	---	14.0	11.0
MONTH	---	---	---	---	7.5	2.5	5.5	.5	7.5	2.0	14.0	4.5
	APRIL		MAY		JUNE		JULY		AUGUST		SEPTEMBER	
1	14.0	11.5	17.0	14.0	24.5	22.0	25.5	22.0	25.0	21.5	24.0	21.0
2	13.0	10.5	16.0	13.5	23.5	21.0	26.0	22.5	25.5	22.0	23.5	21.0
3	10.5	9.0	16.0	12.5	22.5	20.0	26.0	23.0	25.0	22.0	24.0	21.0
4	10.0	7.0	16.0	12.5	22.0	19.0	26.0	23.5	24.5	21.5	23.5	21.0
5	10.0	7.0	17.0	13.5	22.0	19.0	27.0	24.0	24.5	21.5	23.0	20.5
6	9.5	8.5	17.5	14.0	22.5	19.0	26.0	24.0	25.0	21.5	22.0	19.5
7	8.5	7.0	19.0	15.0	23.5	20.0	26.0	23.5	25.5	22.0	21.5	18.5
8	7.5	5.5	20.0	16.5	23.5	20.5	26.0	23.0	26.0	23.0	21.0	18.5
9	9.0	5.5	20.5	17.5	23.5	20.5	26.5	23.0	26.0	23.5	21.0	18.5
10	9.5	6.0	21.0	18.0	23.0	20.5	26.5	23.5	26.0	23.0	21.5	18.5
11	9.5	8.0	21.5	18.0	22.5	20.5	26.0	23.5	25.5	22.5	20.0	19.0
12	9.5	6.5	20.5	18.5	23.0	20.0	25.5	23.0	25.0	22.0	21.0	18.5
13	10.5	7.5	20.5	17.5	22.5	19.5	25.5	22.5	24.5	22.0	21.5	19.0
14	11.0	8.0	19.5	17.0	23.0	19.5	25.0	22.0	24.5	21.5	21.5	19.0
15	11.5	8.5	19.0	18.0	23.5	20.0	24.5	21.5	24.5	21.5	21.5	19.0
16	13.0	9.5	20.5	17.5	24.0	21.0	24.0	21.5	24.5	21.0	21.5	19.0
17	13.5	10.5	20.5	17.5	24.5	21.5	24.0	21.0	24.0	21.0	21.5	19.0
18	13.0	11.0	21.5	18.0	24.5	21.5	24.5	21.5	24.5	21.0	21.5	19.0
19	12.0	10.5	22.0	19.0	25.0	21.5	24.5	21.5	24.0	21.0	21.5	19.0
20	10.5	8.5	22.5	19.5	25.5	22.0	24.0	21.0	23.5	20.5	21.5	19.0
21	11.0	7.5	23.5	20.5	26.0	22.5	24.0	21.0	23.0	20.5	21.0	18.5
22	12.5	9.0	24.0	21.0	26.0	23.0	24.0	20.5	23.0	20.0	20.5	18.0
23	14.0	10.0	24.5	21.5	24.5	22.5	24.5	21.0	22.5	20.0	19.5	18.0
24	15.5	11.5	24.5	21.5	23.0	21.0	25.5	22.0	23.0	20.0	19.0	17.5
25	17.0	13.5	23.5	21.5	21.5	20.5	26.0	23.0	23.5	20.5	20.0	18.0
26	17.0	14.0	23.0	20.5	21.5	20.0	26.5	23.5	24.0	20.5	19.0	17.5
27	16.0	13.5	22.5	20.0	21.0	20.0	26.0	23.0	24.0	21.0	19.0	17.0
28	15.0	13.5	22.0	19.0	23.0	19.5	25.5	22.0	24.5	21.5	18.5	16.5
29	15.0	12.0	23.0	19.0	24.5	21.0	25.0	22.0	24.0	21.5	18.5	16.0
30	16.5	12.5	24.0	20.0	25.0	21.5	25.0	22.0	23.5	21.0	18.5	16.0
31	---	---	25.0	21.0	---	---	25.0	21.5	24.0	21.0	---	---
MONTH	17.0	5.5	25.0	12.5	26.0	19.0	27.0	20.5	26.0	20.0	24.0	16.0

## 11417500 SOUTH YUBA RIVER AT JONES BAR, NEAR GRASS VALLEY, CA—Continued

## SEDIMENT DISCHARGE, SUSPENDED (TONS/DAY), WATER YEAR OCTOBER 2000 TO SEPTEMBER 2001

DAY	MEAN DISCHARGE (CFS)	MEAN CONCEN- TRATION (MG/L)	SEDIMENT DISCHARGE (TONS/DAY)	MEAN DISCHARGE (CFS)	MEAN CONCEN- TRATION (MG/L)	SEDIMENT DISCHARGE (TONS/DAY)	MEAN DISCHARGE (CFS)	MEAN CONCEN- TRATION (MG/L)	SEDIMENT DISCHARGE (TONS/DAY)
	OCTOBER			NOVEMBER			DECEMBER		
1	42	---	---	88	---	---	91	6	1.5
2	44	---	---	75	---	---	79	4	.81
3	44	---	---	71	---	---	74	2	.46
4	44	---	---	68	---	---	68	1	.17
5	44	---	---	72	---	---	65	0	.07
6	42	---	---	68	---	---	63	2	.28
7	42	---	---	67	---	---	65	2	.26
8	43	---	---	65	0	.02	63	1	.19
9	48	---	---	62	1	.15	63	1	.18
10	88	---	---	63	1	.17	70	1	.26
11	85	---	---	65	1	.18	87	2	.40
12	79	---	---	62	1	.17	112	2	.77
13	63	---	---	61	1	.14	102	5	1.4
14	56	---	---	67	0	.02	168	11	5.2
15	55	---	---	69	0	.00	240	24	15
16	53	---	---	64	0	.00	159	12	5.4
17	52	---	---	62	0	.00	123	6	1.9
18	50	---	---	61	0	.00	107	2	.68
19	50	---	---	61	0	.00	95	2	.51
20	51	---	---	61	0	.00	89	2	.46
21	53	---	---	61	0	.03	85	1	.33
22	52	---	---	62	1	.15	90	1	.24
23	49	---	---	61	1	.16	89	1	.17
24	51	---	---	61	1	.17	82	0	.11
25	53	---	---	60	1	.22	78	0	.05
26	64	---	---	61	2	.28	75	1	.11
27	67	---	---	61	2	.27	73	3	.58
28	72	---	---	61	1	.08	71	3	.61
29	267	---	---	83	3	.77	70	0	.07
30	150	---	---	127	8	2.7	70	0	.05
31	140	---	---	---	---	---	69	1	.10
TOTAL	2093	---	---	2030	---	---	2835	---	38.32
	JANUARY			FEBRUARY			MARCH		
1	68	1	.14	98	2	.61	218	3	1.9
2	67	1	.21	95	1	.31	232	5	2.9
3	66	2	.28	98	2	.46	240	6	3.9
4	66	0	.03	109	2	.71	435	40	65
5	65	0	.00	126	3	1.0	1020	129	363
6	65	0	.00	125	3	.96	654	29	55
7	64	0	.00	117	2	.66	495	10	13
8	70	0	.01	102	2	.55	449	5	6.6
9	75	1	.18	108	5	1.5	411	5	5.4
10	102	7	2.4	169	15	6.7	348	4	4.0
11	274	28	21	202	7	3.6	300	4	2.9
12	173	18	8.8	179	4	1.8	272	3	2.1
13	126	7	2.5	159	2	.93	259	2	1.5
14	110	3	.82	138	2	.75	260	2	1.3
15	100	2	.50	128	2	.76	256	1	.75
16	91	1	.26	128	3	1.1	244	1	.69
17	85	1	.23	137	4	1.4	233	1	.80
18	81	1	.18	155	6	2.5	243	2	1.0
19	80	0	.03	293	31	28	268	2	1.3
20	80	0	.08	443	73	86	296	2	1.7
21	79	1	.14	631	80	137	309	4	2.9
22	77	1	.22	738	73	146	301	6	4.6
23	85	3	.83	469	29	38	292	5	4.2
24	162	10	4.2	371	17	17	285	7	5.4
25	150	11	4.3	393	11	12	623	96	192
26	160	6	2.8	325	6	5.4	468	87	114
27	135	5	2.0	279	4	2.8	335	14	13
28	117	5	1.6	247	3	2.0	298	2	1.5
29	117	4	1.4	---	---	---	300	1	1.2
30	119	4	1.2	---	---	---	283	2	1.3
31	105	6	1.8	---	---	---	267	1	.72
TOTAL	3214	---	58.14	6562	---	500.50	10894	---	875.56



## 11417500 SOUTH YUBA RIVER AT JONES BAR, NEAR GRASS VALLEY, CA—Continued

## SEDIMENT DISCHARGE, SUSPENDED (TONS/DAY), WATER YEAR OCTOBER 2000 TO SEPTEMBER 2001

DAY	MEAN	MEAN	SEDIMENT	MEAN	MEAN	SEDIMENT	MEAN	MEAN	SEDIMENT
	DISCHARGE (CFS)	CONCEN- TRATION (MG/L)	DISCHARGE (TONS/DAY)	DISCHARGE (CFS)	CONCEN- TRATION (MG/L)	DISCHARGE (TONS/DAY)	DISCHARGE (CFS)	CONCEN- TRATION (MG/L)	DISCHARGE (TONS/DAY)
	APRIL			MAY			JUNE		
1	259	1	.70	235	4	2.9	61	4	.62
2	249	1	.67	229	3	2.0	59	3	.52
3	226	1	.61	209	3	1.8	61	3	.42
4	207	1	.56	196	4	2.0	62	2	.34
5	191	1	.52	192	3	1.7	59	2	.32
6	185	1	.55	187	3	1.3	58	2	.28
7	242	2	1.3	182	2	1.2	57	1	.14
8	218	2	1.2	181	4	1.9	55	0	.02
9	194	2	.96	181	4	2.0	53	0	.05
10	189	1	.64	173	4	1.7	51	1	.10
11	198	2	1.4	165	2	.93	50	1	.16
12	239	4	2.7	159	2	.70	50	2	.21
13	207	3	1.7	151	1	.53	50	0	.05
14	202	2	1.2	144	1	.40	49	1	.17
15	199	2	.86	141	1	.45	48	3	.36
16	200	1	.57	148	2	.70	46	3	.37
17	208	1	.56	137	2	.55	46	3	.37
18	216	1	.48	127	1	.40	e46	2	e.31
19	277	4	3.0	120	1	.44	e47	1	e.14
20	349	8	7.5	109	2	.50	47	1	.13
21	345	7	6.5	101	2	.59	47	1	.15
22	321	4	3.4	93	3	.73	46	2	.25
23	297	2	1.7	90	3	.64	45	2	.29
24	294	2	1.6	85	2	.35	44	3	.32
25	296	2	1.6	82	3	.63	43	3	.33
26	295	2	1.6	77	3	.62	47	2	.24
27	284	2	1.7	72	3	.59	50	1	.17
28	266	2	1.8	70	3	.57	55	2	.26
29	249	3	1.9	69	3	.56	52	1	.16
30	234	3	2.1	68	3	.52	55	1	.20
31	---	---	---	65	2	.42	---	---	---
TOTAL	7336	---	51.58	4238	---	30.32	1539	---	7.45
	JULY			AUGUST			SEPTEMBER		
1	46	2	.21	33	2	.17	31	2	.17
2	43	2	.23	33	1	.13	31	2	.17
3	41	2	.22	32	1	.09	32	2	.17
4	40	2	.22	32	1	.09	31	2	.17
5	39	2	.21	32	1	.09	31	2	.17
6	38	2	.21	33	1	.09	31	2	.17
7	38	2	.21	33	1	.09	30	2	.16
8	38	2	.20	32	1	.09	30	2	.16
9	45	2	.30	31	1	.08	31	2	.17
10	44	1	.14	31	1	.08	32	2	.17
11	41	1	.11	31	1	.08	32	2	.17
12	45	1	.16	31	1	.08	33	2	.18
13	63	2	.33	31	1	.08	33	2	.18
14	61	2	.32	31	1	.08	33	2	.18
15	46	2	.19	31	1	.08	33	2	.18
16	42	1	.16	29	1	.06	33	2	.18
17	39	2	.26	31	1	.05	32	2	.17
18	39	1	.12	31	0	.04	35	2	.19
19	37	2	.17	31	0	.03	33	2	.18
20	35	4	.39	31	0	.01	32	2	.17
21	34	3	.26	31	0	.00	33	2	.18
22	34	2	.22	31	0	.02	32	2	.18
23	34	2	.19	31	1	.04	33	2	.18
24	35	2	.17	32	1	.07	32	2	.17
25	34	1	.10	33	1	.09	38	2	.21
26	33	1	.07	33	1	.11	42	2	.22
27	33	0	.02	32	2	.13	36	2	.19
28	32	1	.06	32	2	.15	35	2	.16
29	32	1	.12	32	2	.17	34	1	.13
30	32	2	.17	31	2	.17	34	1	.10
31	32	2	.18	31	2	.17	---	---	---
TOTAL	1225	---	5.92	979	---	2.71	988	---	5.18
YEAR	43933		1581.36						

e Estimated.

## 11418000 YUBA RIVER BELOW ENGLEBRIGHT DAM, NEAR SMARTVILLE, CA

LOCATION.—Lat 39°14'07", long 121°16'23", in NW 1/4 NW 1/4 sec.23, T.16 N., R.6 E., Yuba County, Hydrologic Unit 18020125, on right bank, 2,000 ft downstream from Englebright Dam, 0.5 mi upstream from Deer Creek, and 2.3 mi northeast of Smartville.

DRAINAGE AREA.—1,108 mi<sup>2</sup>.

## WATER-DISCHARGE RECORDS

PERIOD OF RECORD.—October 1941 to current year. Prior to October 1953, published as "at Narrows Dam". October 1953 to September 1969, published as "at Englebright Dam". If records for Deer Creek near Smartville (station 11418500) since 1941 are added to records at this station, records equivalent to those published from 1903 to 1941 as "Yuba River at Smartville" (station 11419000) can be obtained.

REVISED RECORDS.—WSP 1931: Drainage area. WDR CA-97-4: 1999(M).

GAGE.—Water-stage recorder. Datum of gage is 278.68 ft above sea level (levels by International Engineering Co.). Prior to Sept. 19, 1958, at site 2,000 ft upstream at datum 248.31 ft higher, and Sept. 19, 1958, to Sept. 30, 1969, at datum 278.68 ft lower. Supplementary gage 2,000 ft upstream since Oct. 1, 1969, at Englebright Dam at datum 248.31 ft higher.

REMARKS.—Diversions up to 1,800 ft<sup>3</sup>/s (see stations 11413250, 11414190, and 11414200) out of basin for power and irrigation upstream from station. Flow regulation by Lake Spaulding (station 11414140), Jackson Meadows and New Bullards Bar Reservoirs (stations 11407800 and 11413515), Englebright Reservoir beginning in 1941, capacity, 70,000 acre-ft, Bowman and Fordyce Lakes (stations 11415500 and 11414090), and many smaller reservoirs. See schematic diagram of South Yuba River Basin.

EXTREMES FOR PERIOD OF RECORD.—Maximum discharge, 171,000 ft<sup>3</sup>/s, Dec. 22, 1964, gage height, 546.14 ft, site and datum then in use, from rating curve extended above 25,000 ft<sup>3</sup>/s, on basis of computation of peak flow over spillway of dam at gage heights 544.72 and 546.14 ft; no flow at times in 1942, 1949, 1956, 1958–61, 1968–69.

## DISCHARGE, CUBIC FEET PER SECOND, WATER YEAR OCTOBER 2000 TO SEPTEMBER 2001

## DAILY MEAN VALUES

DAY	OCT	NOV	DEC	JAN	FEB	MAR	APR	MAY	JUN	JUL	AUG	SEP
1	e1090	e1080	1090	936	724	699	1090	874	940	909	2110	752
2	e1080	e1080	1070	936	694	695	1080	907	911	915	2100	742
3	e1080	e1090	1060	939	629	695	1080	998	906	1010	2000	714
4	e1090	e1090	1070	942	630	698	1080	1090	915	1500	1960	733
5	e1080	e1080	1110	939	632	738	1080	1120	963	1950	1940	789
6	e1080	e1080	1100	938	632	737	1080	1140	978	2280	1940	773
7	e1080	e1080	1110	930	632	738	1080	1160	963	2210	1930	736
8	e1080	e1080	1040	927	641	735	1070	1170	955	2120	1920	705
9	e1080	e1050	1000	936	656	727	1070	1180	954	2110	1890	643
10	e1080	e1090	985	939	656	729	1070	1140	954	2090	1870	609
11	e1080	e1090	969	941	658	717	1070	1110	959	2090	1900	600
12	e1080	e1080	972	941	656	698	1050	1080	955	2110	1900	616
13	e1080	e1080	972	939	652	715	956	1070	945	2120	1900	598
14	e1080	e1050	1060	937	652	717	885	1020	948	2120	1900	600
15	e1070	e1070	1110	938	650	716	865	911	970	2130	1910	599
16	e1070	e1070	1090	939	650	711	860	850	972	2110	1960	623
17	e1080	e1060	1060	943	646	708	865	841	995	2110	2020	643
18	e1080	e1050	1040	948	655	712	865	851	1010	2120	2010	669
19	e1090	e1030	1010	955	679	714	870	856	1020	2120	1990	680
20	e1090	e1000	988	945	663	717	880	833	1030	2130	1980	673
21	e1090	e1010	988	936	653	716	877	841	1030	2130	1880	671
22	e1050	e1000	991	933	1210	723	876	887	1030	2120	1690	669
23	e1080	996	990	933	1500	729	874	896	1010	2130	1560	666
24	e1080	986	987	935	1250	729	876	895	1010	2120	1430	665
25	e1080	982	983	941	1140	727	878	897	1020	2120	1320	639
26	e1080	969	984	946	1150	724	877	908	1000	2120	1200	617
27	e1090	956	982	937	1150	726	875	926	947	2110	1110	622
28	e1060	957	970	876	941	743	872	914	902	2110	931	637
29	e1080	990	947	835	---	755	871	933	877	2090	830	658
30	e1070	1090	941	777	---	753	872	971	903	2090	810	675
31	e1080	---	938	729	---	880	---	960	---	2110	782	---
TOTAL	33460	31316	31607	28566	22081	22521	28694	30229	28972	61504	52673	20016
MEAN	1079	1044	1020	921	789	726	956	975	966	1984	1699	667
MAX	1090	1090	1110	955	1500	880	1090	1180	1030	2280	2110	789
MIN	1050	956	938	729	629	695	860	833	877	909	782	598
AC-FT	66370	62120	62690	56660	43800	44670	56910	59960	57470	122000	104500	39700
a	22980	22340	5420	4220	1210	681	10100	38850	40530	43300	36750	14290

e Estimated.

a Combined flow, in acre-feet, from Browns Valley Irrigation Ditch (station 11420750), Brophy-South Canal (station 11420760), and Hallwood-Cordua Irrigation District Canal (station 11420770).

## SACRAMENTO RIVER BASIN

## 11418000 YUBA RIVER BELOW ENGLEBRIGHT DAM, NEAR SMARTVILLE, CA—Continued

## STATISTICS OF MONTHLY MEAN DATA FOR WATER YEARS 1942 - 2001, BY WATER YEAR (WY)

	OCT	NOV	DEC	JAN	FEB	MAR	APR	MAY	JUN	JUL	AUG	SEP
MEAN	970	1229	2651	3533	3929	3596	3700	3940	2666	1388	1302	1004
MAX	5206	8964	18100	22350	17330	13060	11950	13330	9017	4034	3140	3144
(WY)	1963	1951	1965	1997	1986	1995	1982	1952	1983	1983	1980	1980
MIN	207	41.3	175	283	211	199	437	367	501	430	326	202
(WY)	1960	1942	1960	1977	1977	1977	1976	1977	1977	1977	1944	1977

SUMMARY STATISTICS	FOR 2000 CALENDAR YEAR		FOR 2001 WATER YEAR		WATER YEARS 1942 - 2001	
ANNUAL TOTAL	756539		391639			
ANNUAL MEAN	2067		1073		2485	
HIGHEST ANNUAL MEAN					5251	
LOWEST ANNUAL MEAN					414	
HIGHEST DAILY MEAN	15700	Feb 14	2280	Jul 6	134000	Jan 2 1997
LOWEST DAILY MEAN	869	Sep 7	598	Sep 13	.00	Nov 8 1941
ANNUAL SEVEN-DAY MINIMUM	964	Dec 25	606	Sep 10	.00	Nov 8 1941
MAXIMUM PEAK FLOW			2340	Jul 6	171000	Dec 22 1964
MAXIMUM PEAK STAGE			9.32	Jul 6	546.14	Dec 22 1964
ANNUAL RUNOFF (AC-FT)	1501000		776800		1800000	
ANNUAL DISCHARGE (AC-FT) a	276400		240700			
10 PERCENT EXCEEDS	4090		1940		5210	
50 PERCENT EXCEEDS	1590		971		1300	
90 PERCENT EXCEEDS	1020		670		450	

a Combined flow, in acre-feet, from Browns Valley Irrigation Ditch (station 11420750), Brophy-South Canal (station 11420760), and Hallwood-Cordua Irrigation District Canal (station 11420770).

## 11418000 YUBA RIVER BELOW ENGLEBRIGHT DAM, NEAR SMARTVILLE, CA—Continued

## WATER-QUALITY RECORDS

PERIOD OF RECORD.—Water years 1973–78, January to September 2001.

WATER TEMPERATURE: Water years 1973–78, March to September 2001.

SEDIMENT DATA: January to September 2001.

PERIOD OF DAILY RECORD.—

WATER TEMPERATURE: Water years 1973–78, March to September 2001.

SUSPENDED-SEDIMENT DISCHARGE: January to September 2001.

INSTRUMENTATION.—Water-temperature recorder October 1972–78 and since March 23, 2001.

REMARKS.—Water-temperature records rated excellent except for Mar. 23–28, June 15–21, and July 27 to Aug. 18, which are rated good. Water temperatures can be affected by releases from Englebright Reservoir.

EXTREMES FOR PERIOD OF DAILY RECORD.—

WATER TEMPERATURE: Maximum recorded, 20.0°C, Oct. 1, 3, 5, 7, 11, 1974; minimum recorded, 3.0°C, Dec. 19, 20, 1973.

SEDIMENT CONCENTRATION: Maximum daily mean, 5 mg/L, May 7, 8, 2001; minimum daily mean, 1 mg/L, many days during 2001 water year.

SEDIMENT LOAD: Maximum daily, 17 tons, July 24, 2001; minimum daily, 1.7 tons, Sept. 11, 2001.

EXTREMES FOR CURRENT YEAR.—

WATER TEMPERATURE: Maximum recorded, 14.5°C, several days in June; minimum recorded, 9.0°C Mar. 23, 24.

SEDIMENT CONCENTRATION: Maximum daily mean, 5 mg/L, May 7, 8; minimum daily mean, 1 mg/L, many days during water year.

SEDIMENT LOAD: Maximum daily, 17 tons, July 24; minimum daily, 1.7 tons, Sept. 11.

## CROSS-SECTIONAL DATA, WATER YEAR OCTOBER 2000 TO SEPTEMBER 2001

DATE	TIME	TEMPER- ATURE WATER (DEG C) (00010)	SAMPLE LOC- ATION, CROSS SECTION (FT FM L BANK) (00009)
JUL			
03...*	0920	13.0	133
03...*	0922	13.0	119
03...*	0923	13.0	105
03...*	0925	13.0	91.0
03...*	0926	13.0	77.0
03...*	0928	13.0	63.0
03...*	0929	13.0	49.0
03...*	0931	13.0	35.0
03...*	0932	13.0	21.0
03...*	0934	13.0	7.00

## SUSPENDED-SEDIMENT DISCHARGE, WATER YEAR OCTOBER 2000 TO SEPTEMBER 2001

DATE	TIME	DIS- CHARGE, INST. CUBIC FEET PER SECOND (00061)	TEMPER- ATURE WATER (DEG C) (00010)	SEDI- MENT, DIS- CHARGE, SUS- PENDE (MG/L) (80154)	SEDI- MENT, DIS- CHARGE, SUS- PENDE (T/DAY) (80155)
FEB					
14...	1445	656	8.0	2	3.5
APR					
11...	1545	1070	11.5	2	5.8
JUN					
19...	1415	1020	14.0	2	5.5

\* Instantaneous discharge at time of cross-sectional measurement: 956 ft<sup>3</sup>/s.

## 11418000 YUBA RIVER BELOW ENGLEBRIGHT DAM, NEAR SMARTVILLE, CA—Continued

## TEMPERATURE, WATER (DEG. C), WATER YEAR OCTOBER 2000 TO SEPTEMBER 2001

DAY	MAX	MIN	MAX	MIN	MAX	MIN	MAX	MIN	MAX	MIN	MAX	MIN
	OCTOBER		NOVEMBER		DECEMBER		JANUARY		FEBRUARY		MARCH	
1	---	---	---	---	---	---	---	---	---	---	---	---
2	---	---	---	---	---	---	---	---	---	---	---	---
3	---	---	---	---	---	---	---	---	---	---	---	---
4	---	---	---	---	---	---	---	---	---	---	---	---
5	---	---	---	---	---	---	---	---	---	---	---	---
6	---	---	---	---	---	---	---	---	---	---	---	---
7	---	---	---	---	---	---	---	---	---	---	---	---
8	---	---	---	---	---	---	---	---	---	---	---	---
9	---	---	---	---	---	---	---	---	---	---	---	---
10	---	---	---	---	---	---	---	---	---	---	---	---
11	---	---	---	---	---	---	---	---	---	---	---	---
12	---	---	---	---	---	---	---	---	---	---	---	---
13	---	---	---	---	---	---	---	---	---	---	---	---
14	---	---	---	---	---	---	---	---	---	---	---	---
15	---	---	---	---	---	---	---	---	---	---	---	---
16	---	---	---	---	---	---	---	---	---	---	---	---
17	---	---	---	---	---	---	---	---	---	---	---	---
18	---	---	---	---	---	---	---	---	---	---	---	---
19	---	---	---	---	---	---	---	---	---	---	---	---
20	---	---	---	---	---	---	---	---	---	---	---	---
21	---	---	---	---	---	---	---	---	---	---	---	---
22	---	---	---	---	---	---	---	---	---	---	---	---
23	---	---	---	---	---	---	---	---	---	---	10.0	9.0
24	---	---	---	---	---	---	---	---	---	---	10.0	9.0
25	---	---	---	---	---	---	---	---	---	---	10.0	9.5
26	---	---	---	---	---	---	---	---	---	---	10.0	9.5
27	---	---	---	---	---	---	---	---	---	---	10.5	9.5
28	---	---	---	---	---	---	---	---	---	---	11.0	10.0
29	---	---	---	---	---	---	---	---	---	---	11.5	10.5
30	---	---	---	---	---	---	---	---	---	---	11.5	10.5
31	---	---	---	---	---	---	---	---	---	---	11.5	11.0
MONTH	---	---	---	---	---	---	---	---	---	---	---	---
	APRIL		MAY		JUNE		JULY		AUGUST		SEPTEMBER	
1	11.5	11.0	12.0	11.5	14.0	13.5	13.5	12.5	12.0	11.5	12.0	11.5
2	11.5	11.0	13.0	11.5	14.0	13.0	13.5	12.5	12.0	11.5	12.0	11.5
3	11.5	11.0	12.5	11.5	14.5	13.0	13.5	12.5	12.0	11.5	12.0	11.5
4	11.5	11.0	13.0	12.0	14.5	13.0	13.5	13.0	12.0	11.5	12.0	11.5
5	11.5	11.0	12.5	12.0	14.5	13.5	13.5	13.0	12.0	11.5	12.0	11.5
6	11.5	11.0	13.0	12.0	14.5	13.5	13.5	13.0	12.0	12.0	12.0	11.5
7	11.5	11.0	13.0	12.5	14.5	13.5	13.5	13.0	12.0	12.0	12.0	11.5
8	11.5	11.0	13.0	12.5	14.0	13.5	13.5	13.0	12.0	11.5	12.0	11.5
9	12.0	11.5	13.0	12.5	14.0	13.5	13.5	13.0	12.0	11.5	12.5	11.5
10	12.0	11.0	13.0	12.5	14.0	13.5	13.0	12.5	12.0	11.5	12.5	11.5
11	---	---	12.5	12.0	14.0	13.5	12.5	12.5	12.0	11.5	12.0	12.0
12	---	---	13.0	12.0	14.5	13.5	12.5	12.0	12.0	11.5	12.0	11.5
13	---	---	13.0	12.0	14.5	13.0	12.0	12.0	12.0	12.0	12.0	11.0
14	---	---	12.5	12.0	14.0	13.0	12.5	12.0	12.0	12.0	12.0	11.0
15	---	---	13.0	12.0	14.0	13.5	12.5	12.0	12.0	11.5	12.0	11.5
16	---	---	13.0	12.0	14.0	13.5	13.0	12.5	12.0	11.5	12.0	11.5
17	---	---	13.0	12.0	14.0	13.5	12.5	12.5	12.0	11.5	12.0	11.5
18	---	---	13.0	12.0	14.0	13.5	12.5	12.0	11.5	11.5	12.0	11.5
19	---	---	13.0	12.0	14.5	13.5	12.0	12.0	12.0	11.5	12.5	11.5
20	---	---	13.0	12.0	14.0	13.5	12.0	11.5	12.0	11.5	12.5	11.5
21	11.5	10.5	13.0	12.0	14.0	13.0	12.0	11.5	12.0	11.5	12.5	11.5
22	11.0	10.5	13.0	12.5	14.0	13.0	12.0	12.0	12.0	11.5	12.5	11.5
23	11.5	10.5	13.5	12.5	14.0	13.0	12.5	12.0	12.0	11.5	12.5	12.0
24	11.5	10.5	13.5	12.5	14.0	13.0	12.0	12.0	12.0	11.0	12.5	12.0
25	11.5	10.5	13.5	12.5	14.0	13.0	12.0	11.5	11.5	11.5	13.0	12.0
26	11.5	11.0	13.5	12.5	14.0	13.0	12.0	11.5	12.0	11.0	13.0	12.0
27	12.0	11.0	13.5	13.0	13.5	13.0	12.0	11.5	12.0	11.0	13.0	12.0
28	12.0	11.0	14.0	13.0	13.5	13.0	12.0	11.5	12.0	11.0	13.0	12.0
29	12.0	11.5	14.0	13.0	13.5	13.0	12.0	12.0	12.0	11.5	13.0	12.0
30	12.0	11.5	14.0	13.0	13.5	12.5	12.5	12.0	12.0	11.5	13.0	12.0
31	---	---	14.0	13.0	---	---	12.0	12.0	12.0	11.5	---	---
MONTH	---	---	14.0	11.5	14.5	12.5	13.5	11.5	12.0	11.0	13.0	11.0

## 11418000 YUBA RIVER BELOW ENGLEBRIGHT DAM, NEAR SMARTVILLE, CA—Continued

## SEDIMENT DISCHARGE, SUSPENDED (TONS/DAY), WATER YEAR OCTOBER 2000 TO SEPTEMBER 2001

DAY	MEAN	MEAN	SEDIMENT	MEAN	MEAN	SEDIMENT	MEAN	MEAN	SEDIMENT
	DISCHARGE (CFS)	CONCEN- TRATION (MG/L)	DISCHARGE (TONS/DAY)	DISCHARGE (CFS)	CONCEN- TRATION (MG/L)	DISCHARGE (TONS/DAY)	DISCHARGE (CFS)	CONCEN- TRATION (MG/L)	DISCHARGE (TONS/DAY)
OCTOBER			NOVEMBER			DECEMBER			
1	e1090	---	---	e1080	---	---	1090	---	---
2	e1080	---	---	e1080	---	---	1070	---	---
3	e1080	---	---	e1090	---	---	1060	---	---
4	e1090	---	---	e1090	---	---	1070	---	---
5	e1080	---	---	e1080	---	---	1110	---	---
6	e1080	---	---	e1080	---	---	1100	---	---
7	e1080	---	---	e1080	---	---	1110	---	---
8	e1080	---	---	e1080	---	---	1040	---	---
9	e1080	---	---	e1050	---	---	1000	---	---
10	e1080	---	---	e1090	---	---	985	---	---
11	e1080	---	---	e1090	---	---	969	---	---
12	e1080	---	---	e1080	---	---	972	---	---
13	e1080	---	---	e1080	---	---	972	---	---
14	e1080	---	---	e1050	---	---	1060	---	---
15	e1070	---	---	e1070	---	---	1110	---	---
16	e1070	---	---	e1070	---	---	1090	---	---
17	e1080	---	---	e1060	---	---	1060	---	---
18	e1080	---	---	e1050	---	---	1040	---	---
19	e1090	---	---	e1030	---	---	1010	---	---
20	e1090	---	---	e1000	---	---	988	---	---
21	e1090	---	---	e1010	---	---	988	---	---
22	e1050	---	---	e1000	---	---	991	---	---
23	e1080	---	---	996	---	---	990	---	---
24	e1080	---	---	986	---	---	987	---	---
25	e1080	---	---	982	---	---	983	---	---
26	e1080	---	---	969	---	---	984	---	---
27	e1090	---	---	956	---	---	982	---	---
28	e1060	---	---	957	---	---	970	---	---
29	e1080	---	---	990	---	---	947	---	---
30	e1070	---	---	1090	---	---	941	---	---
31	e1080	---	---	---	---	---	938	---	---
TOTAL	33460	---	---	31316	---	---	31607	---	---
JANUARY			FEBRUARY			MARCH			
1	936	---	---	724	2	3.9	699	1	2.7
2	936	---	---	694	2	3.7	695	2	3.1
3	939	---	---	629	2	3.0	695	2	3.5
4	942	---	---	630	2	2.6	698	2	4.0
5	939	---	---	632	1	2.1	738	2	4.6
6	938	---	---	632	1	1.8	737	2	5.1
7	930	---	---	632	1	2.0	738	3	5.5
8	927	---	---	641	1	2.3	735	3	5.9
9	936	---	---	656	2	2.7	727	3	5.9
10	939	---	---	656	2	2.9	729	3	5.9
11	941	---	---	658	2	3.2	717	3	5.8
12	941	---	---	656	2	3.5	698	3	5.7
13	939	2	5.1	652	2	3.7	715	3	5.8
14	937	2	5.1	652	3	4.8	717	3	5.6
15	938	2	5.1	650	2	3.8	716	2	4.2
16	939	2	5.1	650	2	3.5	711	2	4.2
17	943	2	5.1	646	2	3.9	708	2	4.5
18	948	2	5.1	655	2	4.4	712	2	4.8
19	955	2	5.2	679	3	5.0	714	3	5.1
20	945	2	5.1	663	3	5.1	717	3	5.5
21	936	2	5.1	653	2	3.7	716	3	5.8
22	933	2	5.0	1210	1	3.6	723	3	6.2
23	933	2	5.0	1500	1	4.1	729	3	6.6
24	935	2	5.0	1250	1	3.4	729	4	6.9
25	941	2	5.1	1140	1	3.1	727	4	7.2
26	946	2	5.1	1150	1	3.1	724	4	7.5
27	937	2	5.1	1150	1	3.2	726	4	7.8
28	876	2	4.7	941	1	3.1	743	4	8.0
29	835	2	4.5	---	---	---	755	4	8.2
30	777	2	4.2	---	---	---	753	4	8.1
31	729	2	3.9	---	---	---	880	4	9.5
TOTAL	28566	---	---	22081	---	95.2	22521	---	179.2

e Estimated.

## 11418000 YUBA RIVER BELOW ENGLEBRIGHT DAM, NEAR SMARTVILLE, CA—Continued

## SEDIMENT DISCHARGE, SUSPENDED (TONS/DAY), WATER YEAR OCTOBER 2000 TO SEPTEMBER 2001

DAY	MEAN	MEAN	SEDIMENT	MEAN	MEAN	SEDIMENT	MEAN	MEAN	SEDIMENT
	DISCHARGE (CFS)	CONCEN- TRATION (MG/L)	DISCHARGE (TONS/DAY)	DISCHARGE (CFS)	CONCEN- TRATION (MG/L)	DISCHARGE (TONS/DAY)	DISCHARGE (CFS)	CONCEN- TRATION (MG/L)	DISCHARGE (TONS/DAY)
	APRIL			MAY			JUNE		
1	1090	4	12	874	3	6.9	940	1	3.0
2	1080	4	12	907	3	7.3	911	1	3.1
3	1080	4	11	998	3	8.2	906	2	3.7
4	1080	3	8.9	1090	3	9.9	915	2	4.3
5	1080	2	6.2	1120	4	11	963	2	5.4
6	1080	2	5.3	1140	4	13	978	3	7.8
7	1080	2	4.7	1160	5	14	963	4	9.9
8	1070	1	4.1	1170	5	15	955	4	9.5
9	1070	1	3.5	1180	4	11	954	3	8.6
10	1070	1	3.0	1140	2	6.9	954	3	7.8
11	1070	1	3.3	1110	2	6.6	959	3	6.9
12	1050	3	7.5	1080	2	7.0	955	2	6.1
13	956	3	7.3	1070	3	7.5	945	2	5.4
14	885	3	6.2	1020	3	7.7	948	2	6.4
15	865	2	5.6	911	3	7.2	970	3	7.6
16	860	2	5.1	850	2	5.8	972	3	7.2
17	865	2	4.6	841	2	4.7	995	2	6.7
18	865	2	3.6	851	2	4.3	1010	2	6.1
19	870	1	2.5	856	2	4.0	1020	2	4.5
20	880	1	2.4	833	2	3.5	1030	1	2.8
21	877	1	2.4	841	1	3.3	1030	1	2.9
22	876	1	2.4	887	1	3.1	1030	1	3.9
23	874	1	2.4	896	1	2.8	1010	2	4.9
24	876	1	2.4	895	1	2.6	1010	2	6.0
25	878	1	2.4	897	1	3.2	1020	3	7.1
26	877	1	2.5	908	2	4.1	1000	3	7.7
27	875	1	3.3	926	2	5.0	947	2	5.2
28	872	2	4.2	914	2	5.7	902	1	2.8
29	871	2	5.1	933	3	6.7	877	1	2.4
30	872	3	6.1	971	3	7.5	903	1	2.4
31	---	---	---	960	2	5.3	---	---	---
TOTAL	28694	---	152.0	30229	---	210.8	28972	---	168.1
	JULY			AUGUST			SEPTEMBER		
1	909	1	2.5	2110	1	5.7	752	1	2.9
2	915	1	2.5	2100	1	5.7	742	2	3.1
3	1010	1	2.8	2000	1	5.4	714	2	3.3
4	1500	1	4.6	1960	1	5.3	733	2	3.7
5	1950	1	6.8	1940	1	5.2	789	2	4.2
6	2280	1	8.8	1940	1	5.2	773	2	3.8
7	2210	2	9.3	1930	1	5.3	736	2	3.3
8	2120	2	9.8	1920	1	5.8	705	2	2.9
9	2110	2	11	1890	1	6.4	643	1	2.3
10	2090	2	11	1870	1	6.9	609	1	1.9
11	2090	2	8.6	1900	2	7.7	600	1	1.7
12	2110	1	6.1	1900	2	8.3	616	1	1.8
13	2120	1	5.7	1900	2	8.9	598	1	1.8
14	2120	1	5.7	1900	2	9.6	600	1	1.9
15	2130	1	5.8	1910	2	10	599	1	2.0
16	2110	1	5.7	1960	2	9.7	623	1	2.2
17	2110	1	5.7	2020	2	9.1	643	1	2.4
18	2120	1	5.7	2010	2	8.2	669	1	2.6
19	2120	1	6.0	1990	1	7.2	680	2	2.7
20	2130	1	8.0	1980	1	6.3	673	2	2.8
21	2130	2	10	1880	1	5.2	671	2	2.9
22	2120	2	12	1690	1	4.6	669	2	3.0
23	2130	3	15	1560	1	4.2	666	2	3.1
24	2120	3	17	1430	1	3.9	665	2	3.2
25	2120	2	14	1320	1	3.6	639	2	3.2
26	2120	2	12	1200	1	3.2	617	2	3.2
27	2110	2	10	1110	1	3.0	622	2	3.3
28	2110	2	9.1	931	1	2.5	637	2	3.4
29	2090	1	7.9	830	1	2.3	658	2	3.6
30	2090	1	6.8	810	1	2.5	675	2	3.6
31	2110	1	5.8	782	1	2.7	---	---	---
TOTAL	61504	---	251.7	52673	---	179.6	20016	---	85.8
YEAR	391639		1416.0						

## 11418500 DEER CREEK NEAR SMARTVILLE, CA

LOCATION.—Lat 39°13'28", long 121°16'03", in SW 1/4 SE 1/4 sec.23, T.16 N., R.6 E., Nevada County, Hydrologic Unit 18020125, on left bank, 400 ft upstream from county road bridge, 0.9 mi upstream from mouth, and 2 mi northeast of Smartville.

DRAINAGE AREA.—84.6 mi<sup>2</sup>.

PERIOD OF RECORD.—June 1935 to current year.

WATER TEMPERATURE: Water years 1974–79.

SEDIMENT DATA: Water years 1974–79.

REVISED RECORDS.—WSP 1395: Drainage area.

GAGE.—Water-stage recorder. Elevation of gage is 630 ft above sea level, from river-profile map. June 21, 1935, to Nov. 30, 1938, nonrecording gage at same site and datum.

REMARKS.—Records good. Natural flow of stream is affected by Scotts Flat Reservoir beginning in 1949, usable capacity, 26,300 acre-ft, increased to 49,000 acre-ft in July 1964; Deer Creek Reservoir, capacity, 1,400 acre-ft beginning 1949; Lake Wildwood, capacity, 3,840 acre-ft beginning in 1970, power developments, and diversion for irrigation. At times water from South Yuba River is diverted to Deer Creek and water from Deer Creek is diverted to Bear River. See schematic diagram of [South Yuba River Basin](#).

EXTREMES FOR PERIOD OF RECORD.—Maximum discharge, 12,100 ft<sup>3</sup>/s, Feb. 17, 1986, gage height, 14.05 ft, from rating curve extended above 5,200 ft<sup>3</sup>/s; minimum daily, 0.06 ft<sup>3</sup>/s, Aug. 5, 1977.

EXTREMES OUTSIDE PERIOD OF RECORD.—Flood of March 1928 reached a stage of 14.5 ft from floodmarks, discharge, 14,000 ft<sup>3</sup>/s.

## DISCHARGE, CUBIC FEET PER SECOND, WATER YEAR OCTOBER 2000 TO SEPTEMBER 2001

## DAILY MEAN VALUES

DAY	OCT	NOV	DEC	JAN	FEB	MAR	APR	MAY	JUN	JUL	AUG	SEP
1	5.8	2.6	4.8	4.3	33	56	16	13	7.1	6.9	3.5	6.9
2	4.0	1.7	4.2	4.0	29	112	14	16	6.0	5.4	4.6	6.9
3	5.0	1.7	4.0	3.9	28	117	14	8.6	6.2	5.2	5.0	5.0
4	4.0	1.6	3.5	3.8	28	206	15	7.3	5.3	6.3	5.6	3.0
5	4.2	1.7	3.3	4.0	27	399	15	8.9	4.8	5.1	6.5	1.9
6	4.3	1.7	3.4	4.1	25	164	17	10	6.4	3.9	5.2	2.0
7	4.3	1.6	3.2	4.3	26	97	52	8.9	8.0	3.8	4.4	1.9
8	4.4	1.6	3.6	8.4	23	76	47	8.9	7.6	3.6	4.5	2.5
9	6.0	1.6	3.4	8.9	37	68	33	10	5.9	3.1	4.1	2.9
10	34	2.4	4.1	15	288	61	23	11	6.3	3.9	4.0	3.5
11	50	3.3	4.3	90	534	52	21	10	4.5	3.4	4.8	5.8
12	31	2.2	8.2	29	199	49	25	11	4.2	2.9	5.0	6.0
13	13	1.9	6.4	13	98	46	21	10	5.0	4.2	4.4	5.7
14	8.8	2.2	13	15	88	43	18	8.7	3.9	4.9	3.5	5.4
15	47	2.4	14	28	67	41	16	9.8	4.6	4.3	3.8	5.0
16	278	1.9	9.0	19	57	38	15	9.8	6.7	3.3	3.3	4.6
17	257	1.9	6.9	19	58	36	15	9.5	7.0	3.1	3.7	2.9
18	233	1.7	5.8	18	61	36	13	9.5	5.6	2.8	4.7	3.1
19	199	1.7	5.3	19	174	34	17	11	5.3	3.3	4.8	5.1
20	156	1.8	5.2	18	367	31	39	8.9	5.0	3.0	4.2	4.3
21	66	1.8	5.3	17	578	29	111	6.8	5.5	4.6	3.3	3.4
22	32	2.0	5.4	17	414	30	47	5.5	5.2	4.6	3.3	4.0
23	14	2.1	5.2	24	213	28	32	7.1	5.5	3.2	3.7	3.5
24	2.3	2.1	4.8	185	200	27	25	8.6	5.1	2.6	5.2	2.5
25	2.5	2.1	4.5	122	204	57	21	9.9	4.7	2.6	7.0	11
26	5.4	2.1	4.5	190	106	43	17	12	8.5	3.0	7.1	9.7
27	5.5	2.2	4.4	95	77	34	13	11	12	2.9	4.2	7.1
28	7.0	2.0	4.3	58	64	31	11	11	14	3.6	3.6	5.8
29	22	6.9	4.4	54	---	28	12	7.7	11	4.1	3.3	6.6
30	8.1	7.4	4.2	53	---	25	12	9.6	8.9	4.3	2.9	5.5
31	5.6	---	4.3	40	---	21	---	7.7	---	3.7	3.6	---
TOTAL	1519.2	69.9	166.9	1183.7	4103	2115	747	297.7	195.8	121.6	136.8	143.5
MEAN	49.0	2.33	5.38	38.2	147	68.2	24.9	9.60	6.53	3.92	4.41	4.78
MAX	278	7.4	14	190	578	399	111	16	14	6.9	7.1	11
MIN	2.3	1.6	3.2	3.8	23	21	11	5.5	3.9	2.6	2.9	1.9
AC-FT	3010	139	331	2350	8140	4200	1480	590	388	241	271	285



## SACRAMENTO RIVER BASIN

## 11418500 DEER CREEK NEAR SMARTVILLE, CA—Continued

## STATISTICS OF MONTHLY MEAN DATA FOR WATER YEARS 1936 - 2001, BY WATER YEAR (WY)

	OCT	NOV	DEC	JAN	FEB	MAR	APR	MAY	JUN	JUL	AUG	SEP
MEAN	28.3	60.3	163	302	380	323	182	70.8	20.8	6.58	5.03	5.96
MAX	373	388	960	1418	1399	1162	888	301	129	23.2	14.2	19.1
(WY)	1963	1951	1956	1997	1986	1938	1982	1995	1998	1974	1969	1980
MIN	1.07	2.25	2.89	5.25	14.5	10.5	3.91	3.58	.48	.36	.33	.27
(WY)	1989	1940	1977	1991	1991	1977	1977	1981	1977	1940	1940	1937

SUMMARY STATISTICS	FOR 2000 CALENDAR YEAR		FOR 2001 WATER YEAR		WATER YEARS 1936 - 2001	
ANNUAL TOTAL	42769.1		10800.1			
ANNUAL MEAN	117		29.6		128	
HIGHEST ANNUAL MEAN					327	
LOWEST ANNUAL MEAN					5.48	
HIGHEST DAILY MEAN	3010	Feb 27	578	Feb 21	10200	Feb 17 1986
LOWEST DAILY MEAN	1.6	Nov 4	1.6	Nov 4	.06	Aug 5 1977
ANNUAL SEVEN-DAY MINIMUM	1.6	Nov 3	1.6	Nov 3	.16	Aug 3 1940
MAXIMUM PEAK FLOW			1100	Feb 21	12100	Feb 17 1986
MAXIMUM PEAK STAGE			6.02	Feb 21	14.05	Feb 17 1986
ANNUAL RUNOFF (AC-FT)	84830		21420		92530	
10 PERCENT EXCEEDS	281		62		314	
50 PERCENT EXCEEDS	9.1		6.9		17	
90 PERCENT EXCEEDS	3.3		2.7		2.7	

## 11421000 YUBA RIVER NEAR MARYSVILLE, CA

LOCATION.—Lat 39°10'33", long 121°31'26", in New Helvetia Grant, Yuba County, Hydrologic Unit 18020107, on left bank, 4.2 mi northeast of Marysville, and 5 mi downstream from Dry Creek.

DRAINAGE AREA.—1,339 mi<sup>2</sup>.

## WATER-DISCHARGE RECORDS

PERIOD OF RECORD.—October 1940 to current year (prior to October 1943, low-water periods only). Published as "at Marysville" October 1940 to September 1957. Separate records published for two sites August 1954 to September 1955. Yearly discharge for the water year 1945 published in WSP 1315-A.

REVISED RECORDS.—WSP 1715: 1956(M). WSP 1931: Drainage area. WDR CA-99-4: 1997(M).

GAGE.—Water-stage recorder and crest-stage gage. Datum of gage is 2.95 ft below sea level. Prior to August 1954, and Oct. 1, 1956, to Sept. 30, 1957, at Simpson Lane Bridge in Marysville, 4.2 mi downstream, at same datum. Sept. 3, 1963, to Sept. 23, 1968, auxiliary water-stage recorder at Simpson Lane Bridge at same datum.

REMARKS.—Records good. Flow regulated by New Bullards Bar Reservoir since January 1969, and several other reservoirs. Many diversions upstream from station for power and for irrigation. See schematic diagrams of [South Yuba River](#) and [lower Sacramento River Basins](#).

EXTREMES FOR PERIOD OF RECORD.—Maximum discharge (water years 1944, 1947–99), 180,000 ft<sup>3</sup>/s, Dec. 22, 1964, gage height, 90.15 ft, from floodmarks, from rating curve extended above 91,000 ft<sup>3</sup>/s, on basis of U.S. Army Corps of Engineers flood-routing study, maximum gage height, 91.64 ft, from floodmarks, Jan. 2, 1997; minimum recorded, 10 ft<sup>3</sup>/s, July 2, 1959.

## DISCHARGE, CUBIC FEET PER SECOND, WATER YEAR OCTOBER 2000 TO SEPTEMBER 2001

## DAILY MEAN VALUES

DAY	OCT	NOV	DEC	JAN	FEB	MAR	APR	MAY	JUN	JUL	AUG	SEP
1	890	e714	726	647	757	928	1000	303	301	253	1580	525
2	850	704	713	639	729	881	1050	255	291	242	1560	510
3	817	683	697	641	676	968	1050	259	276	281	1450	500
4	786	656	683	661	654	976	1040	321	268	579	1410	495
5	726	646	714	652	651	1520	1040	318	287	1110	1390	539
6	696	646	729	640	651	1210	1070	302	301	1550	1390	584
7	674	660	739	630	651	1030	1110	297	294	1620	1410	551
8	674	665	716	689	648	957	1120	291	283	1540	1420	511
9	687	679	674	724	671	904	1080	e300	274	1530	1410	533
10	709	e693	662	737	895	877	1050	308	264	1510	1420	512
11	746	e669	645	883	1430	848	1030	297	268	1520	1440	505
12	768	653	652	846	1150	797	1010	307	277	1520	1460	515
13	739	649	651	797	875	795	899	302	265	1530	1450	525
14	726	669	684	783	810	795	803	316	258	1520	1460	529
15	722	672	767	817	770	785	754	332	262	1520	1470	531
16	931	652	759	797	739	776	717	301	258	1500	1500	526
17	985	634	725	784	727	768	644	294	259	1500	1580	524
18	974	631	703	781	728	763	616	297	245	1520	1590	515
19	941	622	703	858	794	761	617	314	243	1540	1570	524
20	907	609	690	932	1270	824	648	305	247	1550	1550	522
21	828	608	694	915	1370	810	770	287	251	1540	1490	525
22	e772	616	700	908	1810	810	696	307	256	1540	1320	533
23	752	609	707	919	1970	810	676	315	243	1550	1180	537
24	735	600	707	1090	1710	770	667	320	243	1580	1060	531
25	736	604	702	1040	1680	769	670	310	247	1550	949	541
26	747	598	697	1250	1440	769	641	290	260	1550	826	503
27	739	577	705	1090	1350	751	503	308	270	1550	748	497
28	742	572	682	966	1170	750	395	302	264	1540	635	498
29	763	611	653	905	---	764	377	299	239	1520	573	507
30	743	654	647	852	---	750	355	311	234	1520	532	506
31	741	---	651	783	---	781	---	309	---	1550	544	---
TOTAL	24246	19255	21577	25656	28776	26697	24098	9377	7928	42425	39367	15654
MEAN	782	642	696	828	1028	861	803	302	264	1369	1270	522
MAX	985	714	767	1250	1970	1520	1120	332	301	1620	1590	584
MIN	674	572	645	630	648	750	355	255	234	242	532	495
AC-FT	48090	38190	42800	50890	57080	52950	47800	18600	15730	84150	78080	31050

e Estimated.

## SACRAMENTO RIVER BASIN

## 11421000 YUBA RIVER NEAR MARYSVILLE, CA—Continued

## STATISTICS OF MONTHLY MEAN DATA FOR WATER YEARS 1944 - 1968, BY WATER YEAR (WY)

	OCT	NOV	DEC	JAN	FEB	MAR	APR	MAY	JUN	JUL	AUG	SEP
MEAN	507	846	3323	3574	4555	3928	4965	5064	2610	514	218	240
MAX	6222	8586	18650	13160	12470	7321	10400	13750	8712	2669	551	458
(WY)	1963	1951	1965	1956	1958	1958	1952	1952	1952	1952	1967	1952
MIN	50.5	116	157	573	965	1360	2139	1264	265	30.5	35.3	47.9
(WY)	1962	1960	1960	1960	1948	1964	1961	1947	1959	1959	1959	1961

## SUMMARY STATISTICS

## WATER YEARS 1944 - 1968

ANNUAL MEAN	2518
HIGHEST ANNUAL MEAN	5393 1952
LOWEST ANNUAL MEAN	882 1961
HIGHEST DAILY MEAN	136000 Dec 23 1955
LOWEST DAILY MEAN	15 Nov 7 1959
ANNUAL SEVEN-DAY MINIMUM	15 Nov 5 1959
MAXIMUM PEAK FLOW	180000 Dec 22 1964
MAXIMUM PEAK STAGE	90.15 Dec 22 1964
ANNUAL RUNOFF (AC-FT)	1824000
10 PERCENT EXCEEDS	6450
50 PERCENT EXCEEDS	822
90 PERCENT EXCEEDS	108

## STATISTICS OF MONTHLY MEAN DATA FOR WATER YEARS 1970 - 2001, BY WATER YEAR (WY)

MEAN	1123	1403	2419	4304	4575	4453	2921	2283	1918	1276	1457	1310
MAX	2731	4475	11430	26180	20970	15100	14280	9721	8633	3735	2829	2900
(WY)	1976	1984	1984	1997	1986	1983	1982	1995	1983	1983	1984	1980
MIN	132	182	371	230	211	188	173	166	155	88.4	71.7	85.8
(WY)	1970	1970	1977	1977	1977	1977	1977	1977	1977	1977	1977	1977

## SUMMARY STATISTICS

## FOR 2000 CALENDAR YEAR

## FOR 2001 WATER YEAR

## WATER YEARS 1970 - 2001

ANNUAL TOTAL	720041	285056	
ANNUAL MEAN	1967	781	2444
HIGHEST ANNUAL MEAN			5818 1982
LOWEST ANNUAL MEAN			229 1977
HIGHEST DAILY MEAN	21500 Feb 14	1970 Feb 23	140000 Jan 2 1997
LOWEST DAILY MEAN	572 Nov 28	234 Jun 30	62 Jul 19 1977
ANNUAL SEVEN-DAY MINIMUM	596 Nov 23	247 Jun 18	65 Jul 31 1977
MAXIMUM PEAK FLOW		2230 Feb 22	161000 Jan 2 1997
MAXIMUM PEAK STAGE		63.63 Feb 22	91.64 Jan 2 1997
ANNUAL RUNOFF (AC-FT)	1428000	565400	1770000
10 PERCENT EXCEEDS	4640	1500	5110
50 PERCENT EXCEEDS	947	709	1290
90 PERCENT EXCEEDS	681	294	320

## 11421000 YUBA RIVER NEAR MARYSVILLE, CA—Continued

## WATER-QUALITY RECORDS

PERIOD OF RECORD.—Water years 1951–52, 1973–80, 1990 to current year. Published as Yuba River at Marysville (station 11421500) during water years 1966, 1973–76.

CHEMICAL DATA: Water years 1951–52, 1973–80. Published as Yuba River at Marysville (station 11421500) water years 1966, 1973–76.  
WATER TEMPERATURE: Water years 1973–78, 1990 to current year.

PERIOD OF DAILY RECORD.—

WATER TEMPERATURE: November 1972 to September 1978, October 1989 to current year.

INSTRUMENTATION.—Water-temperature recorder November 1972 to September 1978, October 1989 to current year.

REMARKS.—Water-temperature records are rated excellent except Nov. 4 to Jan. 21, May 11–14, Aug. 21 to Sept. 1 which are rated good; Sept. 2–6, 11–30 which are rated fair; and Sept. 7–10 which are rated poor. Water temperatures can be affected by releases from Englebright Reservoir located approximately 13 mi upstream from station. Interruption in record was due to malfunction of the recording instrument.

EXTREMES FOR PERIOD OF DAILY RECORD.—

WATER TEMPERATURE: Maximum recorded, 28.5°C, July 16, 30, 1977, Aug. 11, 1992; minimum recorded, 4.5°C, Dec. 22, 23, 29–31, 1990.

EXTREMES FOR CURRENT YEAR.—

WATER TEMPERATURE: Maximum recorded, 24.5°C, June 20, 22, 30, July 1, 2; minimum recorded, 6.0°C, Feb. 8.

## CROSS-SECTIONAL DATA, WATER YEAR OCTOBER 2000 TO SEPTEMBER 2001

DATE	TIME	DEPTH BOTTOM AT SAMPLE LOC- TION, (FEET) (81903)	TEMPER- ATURE WATER (DEG C) (00010)	SAMPLE LOC- ATION, CROSS SECTION (FT FM L BANK) (00009)
JUL				
02...*	1111	e2.00	20.0	7.50
02...*	1110	e2.00	20.0	22.5
02...*	1109	e2.00	20.0	37.5
02...*	1108	e2.50	20.0	52.5
02...*	1107	e2.50	20.0	67.5
02...*	1106	e2.50	20.0	82.5
02...*	1105	e3.00	20.0	97.5
02...*	1104	e3.00	20.0	112
02...*	1103	e3.00	20.0	128

## TEMPERATURE, WATER (DEG. C), WATER YEAR OCTOBER 2000 TO SEPTEMBER 2001

DAY	MAX	MIN	MAX	MIN	MAX	MIN	MAX	MIN	MAX	MIN	MAX	MIN
	OCTOBER		NOVEMBER		DECEMBER		JANUARY		FEBRUARY		MARCH	
1	18.0	13.5	13.0	11.0	11.0	9.0	10.0	7.5	9.0	6.5	10.0	7.5
2	18.0	13.5	14.0	11.0	11.0	8.5	10.0	7.5	9.0	7.5	9.5	8.0
3	17.5	13.5	14.5	11.0	10.5	8.5	10.0	7.5	10.5	7.5	10.0	7.5
4	17.5	13.5	14.0	11.0	10.0	9.0	10.0	7.5	11.0	7.5	9.5	8.5
5	18.0	13.5	14.0	11.0	10.0	9.0	10.0	7.5	11.0	7.5	10.0	8.5
6	17.5	13.5	13.5	11.0	9.5	9.0	10.0	7.5	10.0	8.0	11.5	8.5
7	17.5	13.5	13.5	10.0	10.0	9.0	9.0	7.5	9.5	6.5	12.5	8.5
8	17.5	13.5	13.5	10.5	11.0	9.0	9.0	8.5	9.5	6.0	11.0	9.0
9	15.5	13.5	13.0	10.0	10.0	9.0	9.0	8.5	8.0	7.5	12.0	9.0
10	14.5	13.0	11.5	10.5	10.5	10.0	8.5	8.5	8.5	7.0	12.0	8.0
11	14.5	13.0	12.5	9.5	10.0	9.5	9.0	8.5	8.0	7.0	12.5	8.5
12	16.0	13.0	12.0	9.0	11.0	9.5	10.0	8.0	8.0	7.0	13.0	8.5
13	16.5	12.5	10.5	9.0	10.0	9.0	9.5	8.0	9.5	6.5	13.0	9.0
14	16.5	12.5	12.0	10.0	10.0	9.0	9.5	8.0	10.0	6.5	13.0	9.0
15	16.0	12.5	11.5	9.5	10.5	9.5	9.0	7.0	9.5	6.5	12.0	9.0
16	16.5	12.5	11.5	9.0	10.5	8.5	9.0	6.5	10.5	7.5	13.0	9.0
17	16.5	13.0	11.5	8.5	10.5	8.5	9.0	6.5	8.5	7.5	13.0	9.5
18	16.0	13.0	11.5	8.5	10.0	8.0	9.0	6.5	9.0	8.0	14.0	9.5
19	16.0	13.0	11.5	9.0	10.0	8.0	9.5	7.5	9.5	8.0	14.5	10.0
20	15.0	13.0	11.5	9.0	10.0	8.5	9.0	7.0	9.0	8.0	14.5	11.0
21	15.0	12.5	10.0	9.0	9.5	8.0	9.0	7.0	9.5	8.5	15.0	11.0
22	14.5	11.5	10.5	9.5	10.5	9.0	10.0	7.5	9.5	8.0	15.0	11.5
23	15.5	11.5	10.5	9.0	9.5	8.0	8.5	7.5	10.0	7.5	15.5	11.0
24	15.0	12.0	11.0	9.5	10.0	8.5	9.0	8.0	8.0	8.0	15.0	11.0
25	13.5	12.5	10.5	9.0	9.5	7.5	8.0	7.5	10.5	8.0	15.0	11.5
26	13.0	12.5	10.5	10.0	10.0	7.5	9.0	7.5	11.0	7.5	15.0	10.5
27	15.0	11.5	10.0	9.5	10.0	8.0	9.5	6.5	11.0	7.5	15.0	10.5
28	13.0	12.0	10.5	9.5	10.0	7.5	9.0	6.5	11.0	7.5	16.0	11.5
29	13.5	11.5	11.5	9.5	10.0	7.5	9.5	7.5	---	---	16.5	11.5
30	13.0	11.5	11.0	9.0	10.0	7.5	9.0	6.5	---	---	16.5	11.5
31	14.0	10.5	---	---	9.5	7.5	9.5	6.5	---	---	16.5	11.5
MONTH	18.0	10.5	14.5	8.5	11.0	7.5	10.0	6.5	11.0	6.0	16.5	7.5

\* Instantaneous discharge at time of cross-sectional measurement: 251 ft<sup>3</sup>/s.  
e Estimated.

## SACRAMENTO RIVER BASIN

11421000 YUBA RIVER NEAR MARYSVILLE, CA—Continued

TEMPERATURE, WATER (DEG. C), WATER YEAR OCTOBER 2000 TO SEPTEMBER 2001

DAY	MAX	MIN	MAX	MIN	MAX	MIN	MAX	MIN	MAX	MIN	MAX	MIN
	APRIL		MAY		JUNE		JULY		AUGUST		SEPTEMBER	
1	16.0	11.5	20.0	14.0	22.0	17.5	24.5	18.0	18.0	13.5	21.0	16.0
2	14.0	11.0	19.0	12.0	22.5	16.5	24.5	18.0	18.0	13.0	21.5	16.0
3	15.0	10.5	---	12.5	21.5	16.0	23.5	18.5	18.5	13.0	21.5	16.0
4	15.0	10.5	20.0	---	22.0	16.0	21.0	16.5	18.5	13.5	21.5	16.5
5	15.5	10.5	20.5	14.0	21.5	16.0	20.0	15.0	18.5	13.0	21.0	16.0
6	13.0	11.0	21.0	14.0	22.5	16.0	19.5	14.5	19.0	13.0	20.0	15.5
7	13.5	11.0	21.5	14.5	23.5	17.0	19.0	14.5	18.5	13.5	20.5	15.5
8	14.0	10.5	22.0	15.0	23.0	17.0	19.5	14.5	19.0	13.5	20.5	16.0
9	15.0	10.5	22.0	15.5	23.0	16.5	19.5	14.5	18.5	14.0	20.5	16.0
10	15.0	10.5	22.0	15.5	22.5	16.5	19.0	14.5	18.5	13.5	21.0	16.0
11	14.0	11.5	22.5	16.0	21.5	17.0	18.5	14.0	18.5	13.0	18.5	16.5
12	15.5	10.5	20.5	15.5	22.5	17.0	18.5	13.5	18.5	13.0	20.5	15.5
13	15.0	11.0	21.5	15.0	22.0	16.5	18.5	13.5	18.5	13.0	20.5	16.0
14	15.5	10.5	19.5	14.5	23.0	17.0	18.5	13.5	18.5	13.5	21.0	16.5
15	16.0	11.0	19.5	15.0	23.5	17.0	18.5	13.5	18.0	13.0	21.0	16.5
16	16.0	11.5	21.0	15.5	23.5	17.5	18.0	13.5	18.0	13.0	21.0	16.5
17	17.0	12.0	21.5	15.5	23.5	17.5	18.5	13.5	17.5	13.0	20.5	16.0
18	16.0	12.0	21.5	16.0	24.0	17.5	18.5	13.5	18.0	13.0	20.5	16.0
19	14.0	11.5	22.0	16.0	24.0	17.5	18.5	13.5	18.0	13.0	20.5	16.0
20	12.5	11.0	22.0	16.0	24.5	18.0	18.0	13.0	18.0	13.0	20.5	16.0
21	15.5	10.5	22.5	16.5	24.0	18.0	18.0	13.0	17.5	13.0	20.5	16.0
22	16.5	11.5	22.5	16.5	24.5	18.0	18.5	13.0	18.5	13.0	20.0	16.0
23	17.5	11.5	23.0	16.5	22.5	17.5	18.5	13.0	18.0	13.5	19.5	16.0
24	18.0	12.5	23.0	17.0	22.0	16.5	18.5	13.5	19.0	13.5	18.5	15.5
25	18.5	13.0	21.5	17.0	19.5	17.0	18.5	13.5	19.0	13.5	20.0	16.0
26	18.5	13.0	22.5	16.5	20.5	16.5	18.5	13.5	19.5	14.0	20.0	15.5
27	19.0	12.5	21.0	16.0	18.5	17.0	18.5	13.0	20.0	14.5	20.0	16.0
28	18.0	13.5	21.5	15.5	23.0	16.5	18.0	13.0	20.5	15.0	19.5	15.5
29	19.0	13.0	22.5	16.5	24.0	17.5	18.5	13.0	21.0	15.5	20.0	15.5
30	20.0	13.5	23.0	16.5	24.5	18.0	18.0	13.0	20.5	15.5	20.0	15.5
31	---	---	23.5	17.0	---	---	18.0	13.0	21.0	15.5	---	---
MONTH	20.0	10.5	---	---	24.5	16.0	24.5	13.0	21.0	13.0	21.5	15.5

## 11421710 BEAR RIVER NEAR EMIGRANT GAP, CA

LOCATION.—Lat 39°18'23", long 120°40'41", in NW 1/4 SW 1/4 sec.30, T.17 N., R.12 E., Placer County, Hydrologic Unit 18020126, on left bank, 20 ft upstream from Highway 20 Bridge, and 0.7 mi northwest of Emigrant Gap.

DRAINAGE AREA.—0.76 mi<sup>2</sup>.

PERIOD OF RECORD.—October 1987 to current year (low-flow records only). Unpublished records for water years 1981–87 available in files of the U.S. Geological Survey.

GAGE.—Water-stage recorder and concrete culvert. Elevation of gage is 4,550 ft above sea level, from topographic map. Prior to October 1987, nonrecording gage at same site and datum.

REMARKS.—No records computed above 160 ft<sup>3</sup>/s. Some water is diverted into stream from South Yuba Canal (station 11414200). See schematic diagram of [Bear River Basin](#).

COOPERATION.—Records were collected by Pacific Gas & Electric Co., under general supervision of the U.S. Geological Survey, in connection with a Federal Energy Regulatory Commission project.

## DISCHARGE, CUBIC FEET PER SECOND, WATER YEAR OCTOBER 2000 TO SEPTEMBER 2001

## DAILY MEAN VALUES

DAY	OCT	NOV	DEC	JAN	FEB	MAR	APR	MAY	JUN	JUL	AUG	SEP
1	5.3	7.3	6.2	6.3	6.9	5.3	11	7.1	5.9	5.4	6.7	7.1
2	5.5	7.3	5.4	5.6	6.9	5.3	9.8	7.2	6.0	6.5	6.7	7.1
3	5.3	7.3	5.1	6.6	6.2	5.3	8.8	7.2	8.8	6.4	6.6	7.1
4	5.3	7.1	5.2	6.9	5.0	9.1	8.2	6.7	7.7	6.4	6.6	7.1
5	5.0	6.8	5.7	6.9	25	13	7.9	6.3	5.4	6.4	7.2	7.6
6	5.2	6.5	5.7	6.9	18	13	7.8	5.9	7.0	6.3	7.0	8.5
7	5.2	6.4	5.7	6.9	6.3	14	8.3	5.6	9.0	6.4	7.0	8.5
8	5.3	6.1	5.7	6.9	5.5	14	7.8	5.4	12	6.4	7.1	8.5
9	5.9	6.1	5.8	7.1	6.6	12	7.6	5.1	9.0	6.4	7.0	8.3
10	5.8	6.1	6.2	7.3	6.9	9.1	7.9	5.0	8.3	6.5	7.5	8.3
11	8.6	6.1	5.8	7.9	6.5	8.9	8.6	4.7	7.9	6.5	7.5	8.9
12	11	6.5	5.7	7.4	5.9	9.0	8.7	4.6	7.4	6.3	7.7	8.9
13	11	6.5	5.8	7.2	5.5	9.4	9.4	4.3	6.3	6.1	7.0	9.0
14	12	6.5	7.9	6.9	5.5	9.9	9.8	6.0	7.0	6.1	6.7	9.0
15	10	6.5	8.2	6.9	5.7	9.3	10	7.6	7.7	6.1	6.9	9.0
16	9.1	6.5	6.7	6.9	5.7	9.4	11	6.4	7.0	5.9	7.0	8.9
17	9.5	6.5	6.3	6.9	5.7	11	10	5.8	7.7	5.5	7.1	9.3
18	9.5	6.5	6.1	6.9	6.0	12	12	6.1	8.7	5.5	6.9	9.6
19	8.2	6.1	5.8	6.9	6.6	13	22	6.4	7.4	5.8	6.8	10
20	6.6	6.5	5.5	6.9	6.2	14	16	6.4	8.4	5.9	7.0	11
21	5.3	6.5	5.5	6.9	7.7	16	14	7.1	6.9	6.1	6.9	10
22	5.2	6.5	5.7	6.9	9.6	15	14	6.5	5.5	6.2	7.2	10
23	6.9	6.5	5.7	7.1	7.4	15	13	6.3	7.8	6.3	7.7	10
24	6.1	6.5	5.6	6.2	6.5	15	12	6.4	8.2	6.1	7.6	9.8
25	6.2	6.5	6.7	5.7	6.1	21	11	6.1	6.5	5.9	7.6	9.9
26	5.9	6.5	8.1	5.4	5.7	16	10	5.8	5.9	6.0	7.6	9.0
27	5.7	6.2	7.7	5.0	5.4	14	9.4	5.7	5.2	6.6	7.6	8.9
28	8.9	6.3	7.3	5.0	5.3	14	8.6	6.2	5.1	7.4	7.7	9.3
29	7.0	8.3	7.0	5.0	---	13	8.0	6.9	5.2	7.3	7.4	9.7
30	6.0	7.5	6.5	5.8	---	12	7.3	5.9	5.3	7.3	7.3	9.5
31	7.4	---	6.5	6.9	---	12	---	6.1	---	7.0	7.1	---
TOTAL	219.9	198.5	192.8	204.1	206.3	369.0	309.9	188.8	216.2	195.0	221.7	267.8
MEAN	7.09	6.62	6.22	6.58	7.37	11.9	10.3	6.09	7.21	6.29	7.15	8.93
MAX	12	8.3	8.2	7.9	25	21	22	7.6	12	7.4	7.7	11
MIN	5.0	6.1	5.1	5.0	5.0	5.3	7.3	4.3	5.1	5.4	6.6	7.1
AC-FT	436	394	382	405	409	732	615	374	429	387	440	531

WTR YR 2001 TOTAL 2790.0 MEAN 7.64 MAX 25 MIN 4.3 AC-FT 5530

## 11421770 BEAR RIVER BELOW DRUM AFTERBAY, NEAR BLUE CANYON, CA

LOCATION.—Lat 39°15'16", long 120°46'26", in SW 1/4 NW 1/4 sec.17, T.16 N., R.11 E., Placer County, Hydrologic Unit 18020126, on left bank, 60 ft downstream from Drum Afterbay Dam, and 3.5 mi west of Blue Canyon.

DRAINAGE AREA.—12.3 mi<sup>2</sup>.

PERIOD OF RECORD.—April 1966 to current year, low flows only April to September 1966 and since October 1998.

GAGE.—Water-stage recorder and 4-ft steel Cipolletti weir set in a concrete broad-crested weir. Elevation of gage is 3,300 ft above sea level, from topographic map. April 1966 to May 25, 1967, water-stage recorder at present site at different datum. May 26, 1967, to Feb. 11, 1968, water-stage recorder at site 1,000 ft downstream at different datum.

REMARKS.—Records not computed above 13.5 ft<sup>3</sup>/s. Water for Dutch Flat No. 1 Powerplant (station 11421750) and Dutch Flat No. 2 Flume (station 11421760) is diverted from Drum Afterbay just upstream from station. See schematic diagram of [Bear River Basin](#).

COOPERATION.—Records were collected by Pacific Gas & Electric Co., under general supervision of the U.S. Geological Survey, in connection with a Federal Energy Regulatory Commission project.

## DISCHARGE, CUBIC FEET PER SECOND, WATER YEAR OCTOBER 2000 TO SEPTEMBER 2001

## DAILY MEAN VALUES

DAY	OCT	NOV	DEC	JAN	FEB	MAR	APR	MAY	JUN	JUL	AUG	SEP
1	7.6	6.2	6.3	6.1	6.4	---	6.3	6.2	6.2	6.2	6.3	6.3
2	6.2	6.2	6.3	6.1	6.3	11	6.3	6.2	6.2	6.2	6.2	6.3
3	6.2	6.3	6.3	6.1	6.3	11	6.3	6.3	6.2	6.2	6.2	6.3
4	6.3	6.2	6.3	6.1	6.3	11	6.3	6.3	6.2	6.1	6.2	6.4
5	6.2	6.2	6.2	6.1	6.3	7.7	6.3	6.2	6.2	6.2	6.3	6.3
6	6.2	6.2	6.3	6.1	6.3	6.3	6.3	6.2	6.2	6.1	6.3	6.4
7	6.2	6.2	6.3	6.1	6.3	6.3	6.3	6.2	6.2	6.2	6.3	6.2
8	6.2	6.2	6.3	6.1	6.3	6.3	6.3	6.2	6.2	6.2	6.3	6.3
9	6.2	6.2	6.3	6.1	6.3	6.3	6.3	6.2	6.2	6.2	6.3	6.3
10	6.2	6.3	6.3	6.1	6.3	6.3	6.3	6.2	6.2	6.2	6.3	6.3
11	6.2	6.3	6.3	6.1	6.3	6.3	6.3	6.2	6.2	6.2	6.3	6.3
12	6.2	6.3	6.3	6.1	6.3	6.3	6.3	6.2	6.2	6.2	6.3	6.3
13	6.3	6.3	6.3	6.1	6.3	6.3	6.3	6.2	6.2	6.2	6.3	6.3
14	6.2	6.3	6.3	6.1	6.3	6.3	6.4	6.2	6.2	6.2	6.3	6.3
15	6.2	6.3	6.3	6.1	6.3	6.3	6.3	6.2	6.2	6.2	6.3	6.3
16	6.2	6.3	6.3	6.2	6.3	6.3	6.3	6.2	6.1	6.2	6.3	6.3
17	6.2	6.3	6.3	6.2	6.3	6.3	6.3	6.2	6.2	6.2	6.3	6.3
18	6.2	6.3	6.3	6.1	6.3	6.3	6.3	6.2	6.2	6.2	6.2	6.3
19	6.2	6.2	6.3	6.1	6.3	6.3	6.3	6.2	6.1	6.2	6.2	6.4
20	6.2	6.3	6.3	6.1	6.3	6.3	6.3	6.2	6.2	6.2	6.2	6.2
21	6.2	6.3	6.3	6.2	6.3	6.3	6.3	6.2	6.2	6.2	6.2	6.2
22	6.2	6.3	6.3	6.1	6.3	6.3	6.4	6.2	6.1	6.1	6.3	6.2
23	6.2	6.3	6.3	6.1	6.4	6.2	---	6.2	6.1	6.2	6.3	6.4
24	6.2	6.2	6.3	6.1	6.3	6.3	6.3	6.1	6.2	6.1	6.3	6.3
25	6.2	6.2	6.3	6.1	6.3	6.3	6.3	6.2	6.1	6.1	6.3	6.2
26	6.2	6.2	6.3	6.1	6.3	6.3	6.3	6.2	6.2	6.2	6.3	6.2
27	6.2	6.2	6.2	6.1	6.3	6.3	6.3	6.2	6.2	6.2	6.3	6.3
28	6.3	6.2	6.1	6.1	6.3	6.3	6.3	6.2	6.2	6.3	6.3	6.4
29	6.3	6.2	6.1	6.2	---	6.3	6.3	6.2	6.2	6.3	6.4	6.4
30	6.2	6.3	6.1	6.4	---	6.3	6.3	6.2	6.2	6.3	6.3	6.4
31	6.3	---	6.1	6.4	---	6.3	---	6.2	---	6.3	6.4	---
TOTAL	194.1	187.5	194.3	190.1	176.6	---	---	192.3	185.5	192.1	194.8	189.1
MEAN	6.26	6.25	6.27	6.13	6.31	---	---	6.20	6.18	6.20	6.28	6.30
MAX	7.6	6.3	6.3	6.4	6.4	---	---	6.3	6.2	6.3	6.4	6.4
MIN	6.2	6.2	6.1	6.1	6.3	---	---	6.1	6.1	6.1	6.2	6.2
AC-FT	385	372	385	377	350	---	---	381	368	381	386	375
a	9890	5840	1930	1360	2930	11090	7490	18550	15470	14580	15500	7050
b	9640	15690	9810	6760	5850	9450	9000	15570	12800	12040	13440	4560

CAL YR 2000 a 209400 b 221900

WTR YR 2001 a 111700 b 124600

a Diversion, in acre-feet, to Dutch Flat No. 2 Flume (station 11421750), provided by Nevada Irrigation District.

b Diversion, in acre-feet, to Dutch Flat No. 1 Powerplant (station 11421760), provided by Pacific Gas & Electric Co.

## 11421790 BEAR RIVER BELOW DUTCH FLAT AFTERBAY, NEAR DUTCH FLAT, CA

LOCATION (REVISED).—Lat 39°12'49", long 120°50'39", in NE 1/4 NW 1/4 sec.34, T.16 N., R.10 E., Placer County, Hydrologic Unit 18020126, at left bank downstream end of spillway, on Dutch Flat Afterbay Dam, and 0.6 mi north of Dutch Flat.

DRAINAGE AREA.—21.5 mi<sup>2</sup>.

PERIOD OF RECORD.—December 1965 to current year.

REVISED RECORDS.—WDR CA-82-4: 1978, 1979(M), 1980.

GAGE.—Water-stage recorder and concrete control. Elevation of gage is 2,600 ft above sea level, from topographic map.

REMARKS.—Water is imported from South Yuba River Basin via Drum Canal above forebay. Chicago Park Flume (station 11421780) diverts upstream from station to Chicago Park Powerplant. Records include spill over Dutch Flat Afterbay Dam. See schematic diagram of Bear River Basin.

COOPERATION.—Records were collected by Nevada Irrigation District, under general supervision of the U.S. Geological Survey, in connection with a Federal Energy Regulatory Commission project.

EXTREMES FOR PERIOD OF RECORD.—Maximum discharge, 4,240 ft<sup>3</sup>/s, Feb. 17, 1986; minimum daily, 0.08 ft<sup>3</sup>/s, Mar. 8–19, 1968.

## DISCHARGE, CUBIC FEET PER SECOND, WATER YEAR OCTOBER 2000 TO SEPTEMBER 2001

## DAILY MEAN VALUES

DAY	OCT	NOV	DEC	JAN	FEB	MAR	APR	MAY	JUN	JUL	AUG	SEP
1	12	9.8	7.6	7.3	7.3	7.5	7.5	11	11	11	11	11
2	12	8.2	7.5	7.3	7.4	7.5	7.6	11	11	11	11	11
3	12	7.5	7.3	7.4	7.3	7.5	7.6	11	11	11	11	11
4	12	7.6	7.5	7.3	7.3	7.5	7.5	11	11	11	11	11
5	12	7.6	7.5	7.4	7.4	7.3	7.5	11	11	11	11	11
6	12	7.5	7.2	7.3	7.4	7.2	7.6	11	11	11	11	11
7	12	7.6	7.2	7.3	7.3	7.3	7.6	11	11	11	11	11
8	13	7.6	7.3	7.4	7.3	7.4	7.6	11	11	11	11	11
9	13	7.4	7.4	7.3	7.3	7.5	7.6	11	11	11	11	11
10	17	7.5	7.5	7.3	7.3	7.5	7.6	11	11	11	11	11
11	99	7.5	7.4	7.4	7.5	7.6	7.6	11	11	11	11	11
12	14	7.5	7.4	7.5	7.4	7.5	7.6	11	11	11	11	11
13	13	7.5	7.4	7.5	7.4	7.6	7.6	11	11	11	11	11
14	14	7.6	7.4	7.5	7.3	7.6	7.6	11	11	11	11	11
15	14	7.6	7.4	7.4	7.3	7.6	7.5	11	11	11	11	36
16	14	7.4	7.4	7.3	7.3	7.6	7.4	11	11	11	11	83
17	14	7.5	7.5	7.3	7.3	7.5	7.6	11	11	11	11	97
18	13	7.4	7.5	7.1	7.3	7.6	7.6	11	11	11	11	65
19	13	7.5	7.5	7.2	7.3	7.5	7.6	11	11	11	11	31
20	13	7.4	7.5	86	7.3	7.5	7.6	11	11	11	11	21
21	13	7.4	7.4	108	7.3	7.6	7.6	11	11	11	11	21
22	13	7.4	7.5	64	7.5	7.6	7.6	11	11	11	11	21
23	13	7.6	7.6	7.3	7.4	7.5	7.4	11	11	11	11	21
24	13	7.5	7.6	7.3	7.3	7.6	7.6	11	11	11	11	18
25	13	7.5	7.5	7.3	7.4	7.6	7.6	11	11	11	11	14
26	12	7.4	7.5	7.4	7.3	7.6	7.6	11	11	11	11	14
27	11	7.5	7.4	7.5	7.3	7.5	7.6	11	11	11	11	13
28	11	7.5	7.4	7.3	7.4	7.6	7.6	11	11	11	11	12
29	11	7.4	7.4	7.3	---	7.5	7.6	11	11	11	11	12
30	11	7.4	7.4	7.3	---	7.6	8.8	11	11	11	11	12
31	11	---	7.3	7.3	---	7.5	---	11	---	11	11	---
TOTAL	480	227.8	230.4	463.5	205.6	233.0	228.4	341	330	341	341	645
MEAN	15.5	7.59	7.43	15.0	7.34	7.52	7.61	11.0	11.0	11.0	11.0	21.5
MAX	99	9.8	7.6	108	7.5	7.6	8.8	11	11	11	11	97
MIN	11	7.4	7.2	7.1	7.3	7.2	7.4	11	11	11	11	11
AC-FT	952	452	457	919	408	462	453	676	655	676	676	1280
a	20470	23510	14100	9950	10630	21850	18540	36730	28750	26060	31420	13180

a Diversion, in acre-feet, to Chicago Park Flume.



## SACRAMENTO RIVER BASIN

## 11421790 BEAR RIVER BELOW DUTCH FLAT AFTERBAY, NEAR DUTCH FLAT, CA—Continued

## STATISTICS OF MONTHLY MEAN DATA FOR WATER YEARS 1966 - 2001, BY WATER YEAR (WY)

	OCT	NOV	DEC	JAN	FEB	MAR	APR	MAY	JUN	JUL	AUG	SEP
MEAN	18.6	11.7	41.9	50.8	56.7	63.0	59.5	25.1	13.9	10.9	10.6	14.6
MAX	266	71.1	350	531	380	395	602	142	63.5	22.0	13.1	21.5
(WY)	1968	1984	1997	1997	1986	1966	1969	1998	1998	1970	1969	2001
MIN	4.81	2.65	2.42	4.94	4.10	4.26	3.94	5.30	5.13	5.00	5.00	5.00
(WY)	1978	1968	1968	1975	1974	1973	1973	1977	1977	1977	1977	1977

SUMMARY STATISTICS	FOR 2000 CALENDAR YEAR		FOR 2001 WATER YEAR		WATER YEARS 1966 - 2001	
ANNUAL TOTAL	11404.2		4066.7			
ANNUAL MEAN	31.2		11.1		28.4	
HIGHEST ANNUAL MEAN					80.1	
LOWEST ANNUAL MEAN					5.53	
HIGHEST DAILY MEAN	853	Feb 14	108	Jan 21	3400	Feb 17 1986
LOWEST DAILY MEAN	1.6	Feb 2	7.1	Jan 18	.08	Mar 8 1968
ANNUAL SEVEN-DAY MINIMUM	6.2	Feb 2	7.3	Feb 14	.08	Mar 8 1968
MAXIMUM PEAK FLOW			520	Jan 21	4240	Feb 17 1986
ANNUAL RUNOFF (AC-FT)	22620		8070		20550	
ANNUAL DIVERSION (AC-FT) a	432600		255200			
10 PERCENT EXCEEDS	75		12		29	
50 PERCENT EXCEEDS	11		11		9.6	
90 PERCENT EXCEEDS	7.5		7.3		5.0	

a Diversion, in acre-feet, to Chicago Park Flume.

## 11421800 ROLLINS RESERVOIR NEAR COLFAX, CA

LOCATION.—Lat 39°08'08", long 120°56'57", in NE 1/4 SE 1/4 sec.22, T.15 N., R.9 E., Placer County, Hydrologic Unit 18020126, on left bank, 300 ft upstream from Rollins Dam on Bear River, and 2.3 mi north of Colfax.

DRAINAGE AREA.—104 mi<sup>2</sup>.

PERIOD OF RECORD.—December 1964 to current year.

REVISED RECORDS.—WDR CA-01-4: Oct. 10, 1977, contents; 1978–2000, minimum contents for period of record.

GAGE.—Water-stage recorder. Datum of gage is sea level (levels by Nevada Irrigation District).

REMARKS.—Reservoir is formed by an earthfill dam. Storage began Dec. 15, 1964. Usable capacity, 66,000 acre-ft, between elevations 1,970.0 ft, invert of outlet tunnel, and 2,171.0 ft, spillway crest. Dead storage, 270 acre-ft. Several diversions into and out of basin upstream for power development and irrigation. Water is normally released through Rollins Powerplant (station 11421900). Part of the water then is diverted to Bear River Canal (station 11422000) for power development. Water is later used for irrigation. See schematic diagram of [Bear River Basin](#).

COOPERATION.—Records were collected by Nevada Irrigation District, under general supervision of the U.S. Geological Survey, in connection with a Federal Energy Regulatory Commission project.

EXTREMES FOR PERIOD OF RECORD.—Maximum contents, 71,700 acre-ft, Feb. 17, 1986, elevation, 2,177.7 ft; minimum since reservoir first filled, 4,550 acre-ft, Oct. 13, 1977, elevation, 2,204.7 ft.

EXTREMES FOR CURRENT YEAR.—Maximum contents, 66,100 acre-ft, Apr. 23, elevation, 2,171.15 ft; minimum, 29,400 acre-ft, Oct. 12, 13, minimum elevation, 2,112.87 ft, Oct. 13.

REVISIONS.—The contents for Oct. 10, 1977, have been revised to 4,950 acre-ft, estimated. The minimum contents for water year 1978 and the period of record have been revised to 4,550 acre-ft, Oct. 13, 1977, gage height, 2,204.7 ft.

Capacity table (elevation, in feet, and contents, in acre-feet)  
(Based on table provided by Nevada Irrigation District in 1964)

2,020	3,920	2,050	8,940	2,100	23,900	2,160	57,300
2,030	5,320	2,060	11,200	2,120	32,700	2,178	72,000
2,040	6,990	2,080	16,800	2,140	43,800		

## RESERVOIR STORAGE (ACRE-FEET), WATER YEAR OCTOBER 2000 TO SEPTEMBER 2001

## DAILY OBSERVATION AT 2400 HOURS

DAY	OCT	NOV	DEC	JAN	FEB	MAR	APR	MAY	JUN	JUL	AUG	SEP
1	40500	45600	55400	53300	56200	60300	65500	65500	65600	62700	56100	54800
2	39100	46800	55300	53200	56200	60400	65400	65200	65000	62600	55800	54800
3	37900	47900	55100	53300	56200	60300	65300	65300	64500	62500	55500	54800
4	36800	48300	54800	53400	56200	60900	65400	65300	64700	62300	55000	54900
5	35700	48800	54800	53500	56300	62100	65400	65500	64900	62100	54500	54900
6	34500	49700	55000	53500	56300	62700	65100	65500	65200	62100	54400	54700
7	33400	50600	54400	53500	56400	62800	64600	65300	65500	62100	54400	54600
8	32300	51700	54000	53500	56400	63000	65300	65300	65600	62100	54400	54500
9	31300	52800	53600	53600	56600	63100	65600	65300	65000	62000	54400	54500
10	30300	53800	53300	53800	56900	63100	65900	65400	64500	62100	54400	54400
11	29800	54100	53500	54300	57200	62900	65900	65500	63900	62100	54300	54300
12	29400	54000	53700	54700	57400	62800	65900	65500	63300	62200	54300	54400
13	29400	54300	53600	54800	57600	62600	65900	65600	63200	62200	54300	54400
14	29600	54500	54000	54900	57700	62200	65800	65700	63200	62100	54000	54400
15	30500	54800	54400	54900	57700	61900	65800	65600	63200	62200	54100	54600
16	31700	55000	54100	55100	57100	61600	65800	65600	63200	61800	53900	54000
17	32900	55400	53800	55400	56700	61500	65600	65500	63200	61600	54300	53400
18	34000	55200	54000	55300	56500	61400	65500	65500	63200	61300	54100	52800
19	35300	55300	53800	55100	57000	62000	65500	65300	63100	60700	54100	52100
20	36300	55800	53700	54900	57400	62500	65900	65100	63000	60400	54100	51400
21	36400	56000	53700	54800	58500	63000	65900	64900	63000	60100	54100	50800
22	36500	56400	53800	55100	59500	63400	65800	64800	63000	59800	54200	50100
23	37400	56200	53600	55300	59900	64200	66100	64700	63000	59500	54400	49300
24	38400	56000	53400	55500	60400	64300	65900	64700	62800	59300	54500	48600
25	39200	55800	53300	55700	60800	64700	66000	64700	62700	58900	54400	47900
26	40200	55600	53500	55800	60800	65300	66000	64600	62500	58500	54400	47100
27	41300	55500	53500	56100	60700	65800	65800	64500	62500	58200	54500	46400
28	41700	55500	53600	56000	60600	65600	65500	64500	62500	57700	54600	45600
29	42300	55700	53600	56100	---	65300	65100	64800	62500	57100	54700	44900
30	43200	55700	53600	56000	---	65400	65400	65000	62700	56900	54600	44100
31	44400	---	53500	56100	---	65600	---	65200	---	56600	54800	---
MAX	44400	56400	55400	56100	60800	65800	66100	65700	65600	62700	56100	54900
MIN	29400	45600	53300	53200	56200	60300	64600	64500	62500	56600	53900	44100
a	2140.95	2157.77	2154.77	2158.34	2164.24	2170.52	2170.30	2170.01	2166.96	2158.98	2156.60	2140.54
b	+2200	+11300	-2200	+2600	+4500	+5000	-200	-200	-2500	-6100	-1800	-10700
c	17850	13800	18820	10680	15110	28940	25890	41770	34140	35120	33300	24900

CAL YR 2000 MAX 68200 MIN 29400

WTR YR 2001 MAX 66100 MIN 29400

a Elevation, in feet, at end of month.

b Change in contents, in acre-feet.

c Discharge, in acre-feet, through Rollins Powerplant (station 11421900), provided by Pacific Gas & Electric Co.

## 11422000 BEAR RIVER CANAL INTAKE NEAR COLFAX, CA

LOCATION.—Lat 39°07'58", long 120°57'12", in SW 1/4 SE 1/4 sec.22, T.15 N., R.9 E., Placer County, Hydrologic Unit 18020126, on right bank, 400 ft downstream from canal inlet, 0.2 mi downstream from Rollins Dam, and 2.2 mi north of Colfax.

PERIOD OF RECORD.—January 1912 to September 1953, October 1964 to current year. Monthly discharge only for some periods published in WSP 1315-A. Prior to October 1912, published as "Pacific Gas & Electric Co.'s Canal near Colfax"; October 1912 to September 1953, published as "Bear River Canal near Colfax".

GAGE.—Water-stage recorder. Elevation of gage is 1,950 ft above sea level, from topographic map. Prior to Mar. 25, 1946, water-stage recorder at site 1.5 mi downstream at different datum.

REMARKS.—Canal diverts from left bank of Bear River. Water is used to develop power at Halsey and Wise Powerplants (stations 11425310 and 11425415). Part of the water is distributed for irrigation, and the remainder is eventually spilled into North Fork American River. Capacity of canal is believed to have been increased in 1917 and 1931. See schematic diagram of [Bear River Basin](#).

COOPERATION.—Records were collected by Pacific Gas & Electric Co., under general supervision of the U.S. Geological Survey, in connection with a Federal Energy Regulatory Commission project.

EXTREMES FOR PERIOD OF RECORD.—Maximum daily discharge, 531 ft<sup>3</sup>/s, Oct. 5, 6, 1980; no flow at times in most years.

## DISCHARGE, CUBIC FEET PER SECOND, WATER YEAR OCTOBER 2000 TO SEPTEMBER 2001

## DAILY MEAN VALUES

DAY	OCT	NOV	DEC	JAN	FEB	MAR	APR	MAY	JUN	JUL	AUG	SEP
1	477	.00	307	205	154	327	423	436	433	387	424	336
2	473	.00	307	205	154	327	431	444	432	444	423	332
3	469	.00	306	205	154	327	436	444	432	450	422	330
4	470	.00	306	170	154	327	436	444	431	451	421	329
5	473	.00	306	152	154	329	381	442	431	451	419	360
6	473	.00	307	152	154	330	301	442	431	434	418	365
7	478	.00	306	152	151	330	300	440	436	424	417	363
8	476	.00	306	153	150	330	294	440	443	425	418	364
9	456	.00	305	153	150	331	294	440	442	414	417	359
10	438	.00	305	153	162	331	295	440	441	390	426	340
11	442	16	305	154	185	331	365	440	441	399	433	331
12	439	282	306	154	141	335	429	439	441	416	433	324
13	437	337	306	154	141	417	421	439	440	416	424	325
14	435	337	306	154	141	446	353	443	440	423	407	323
15	48	402	307	154	228	453	320	442	441	429	397	313
16	43	437	308	154	406	435	373	442	442	429	388	313
17	44	306	307	154	412	428	425	441	442	442	388	304
18	45	306	307	155	360	429	427	441	444	447	388	289
19	45	306	307	155	338	429	412	440	445	435	388	276
20	46	306	306	154	329	431	366	439	446	426	388	268
21	82	307	242	154	329	432	382	439	442	421	375	268
22	103	307	204	155	330	433	403	438	438	404	370	269
23	104	308	204	156	330	435	419	437	439	406	371	296
24	109	307	205	156	330	436	427	436	439	420	372	306
25	107	307	204	157	330	437	426	435	440	428	373	305
26	91	307	204	116	329	343	426	435	440	427	373	304
27	79	306	205	154	329	428	426	435	441	427	374	303
28	80	307	205	154	328	433	426	434	441	414	376	303
29	81	307	205	155	---	433	425	434	367	417	372	299
30	78	307	205	155	---	428	425	433	233	426	361	282
31	65	---	205	154	---	424	---	433	---	425	350	---
TOTAL	7686	6105.00	8414	4908	6853	12085	11667	13607	12894	13147	12306	9479
MEAN	248	204	271	158	245	390	389	439	430	424	397	316
MAX	478	437	308	205	412	453	436	444	446	451	433	365
MIN	43	.00	204	116	141	327	294	433	233	387	350	268
AC-FT	15250	12110	16690	9740	13590	23970	23140	26990	25580	26080	24410	18800
a	11090	9530	14730	8570	12190	21210	20410	23240	22000	21980	20700	15380
b	9880	9410	14970	10390	13650	19880	18210	19940	18280	17490	19470	14320

a Discharge, in acre-feet, to Halsey Powerplant (station 11425310), provided by Pacific Gas & Electric Co.

b Discharge, in acre-feet, to Wise Powerplant (station 11425415), provided by Pacific Gas & Electric Co.

## 11422000 BEAR RIVER CANAL INTAKE NEAR COLFAX, CA—Continued

## STATISTICS OF MONTHLY MEAN DATA FOR WATER YEARS 1918 - 1931, BY WATER YEAR (WY)

	OCT	NOV	DEC	JAN	FEB	MAR	APR	MAY	JUN	JUL	AUG	SEP
MEAN	184	158	156	124	139	154	200	253	253	250	251	235
MAX	300	285	281	257	265	257	286	278	300	317	300	300
(WY)	1929	1929	1925	1925	1925	1922	1925	1925	1927	1931	1926	1927
MIN	.000	.000	.000	.000	.000	.000	53.2	158	190	162	167	93.7
(WY)	1930	1930	1930	1930	1930	1930	1931	1931	1931	1918	1918	1924

## SUMMARY STATISTICS

## WATER YEARS 1918 - 1931

ANNUAL MEAN	197
HIGHEST ANNUAL MEAN	245 1929
LOWEST ANNUAL MEAN	121 1931
HIGHEST DAILY MEAN	345 Aug 2 1931
LOWEST DAILY MEAN	.00 Nov 12 1917
ANNUAL SEVEN-DAY MINIMUM	.00 Mar 17 1918
ANNUAL RUNOFF (AC-FT)	142400
10 PERCENT EXCEEDS	300
50 PERCENT EXCEEDS	232
90 PERCENT EXCEEDS	.00

## STATISTICS OF MONTHLY MEAN DATA FOR WATER YEARS 1932 - 2001, BY WATER YEAR (WY)

	1932	1933	1934	1935	1936	1937	1938	1939	1940	1941	1942	1943	1944	1945	1946	1947	1948	1949	1950	1951	1952	1953	1954	1955	1956	1957	1958	1959	1960	1961	1962	1963	1964	1965	1966	1967	1968	1969	1970	1971	1972	1973	1974	1975	1976	1977	1978	1979	1980	1981	1982	1983	1984	1985	1986	1987	1988	1989	1990	1991	1992	1993	1994	1995	1996	1997	1998	1999	2000	2001
MEAN	331	309	371	352	344	322	315	390	402	410	410	396																																																										
MAX	492	495	488	479	478	485	490	498	499	493	497	496																																																										
(WY)	1968	1968	1976	1979	1980	1980	1978	1978	1978	1967	1967	1967																																																										
MIN	69.8	27.9	52.7	8.65	27.8	18.5	18.4	106	139	143	136	114																																																										
(WY)	1978	1978	1977	1946	1946	1977	1940	1977	1977	1977	1977	1977																																																										

## SUMMARY STATISTICS

## FOR 2000 CALENDAR YEAR

## FOR 2001 WATER YEAR

## WATER YEARS 1932 - 2001

ANNUAL TOTAL	126412.00	119151.00	
ANNUAL MEAN	345	326	363
HIGHEST ANNUAL MEAN			462 1980
LOWEST ANNUAL MEAN			118 1977
HIGHEST DAILY MEAN	478 Oct 7	478 Oct 7	531 Oct 5 1980
LOWEST DAILY MEAN	.00 Nov 1	.00 Nov 1	.00 Mar 12 1932
ANNUAL SEVEN-DAY MINIMUM	.00 Nov 1	.00 Nov 1	.00 Mar 12 1932
ANNUAL RUNOFF (AC-FT)	250700	236300	262900
ANNUAL DISCHARGE (AC-FT) a	176100	201000	
ANNUAL DISCHARGE (AC-FT) b	195400	185900	
10 PERCENT EXCEEDS	465	441	475
50 PERCENT EXCEEDS	398	361	423
90 PERCENT EXCEEDS	202	152	140

## 11422500 BEAR RIVER BELOW ROLLINS DAM, NEAR COLFAX, CA

LOCATION.—Lat 39°07'53", long 120°57'29", in SE 1/4 SW 1/4 sec.22, T.15 N., R.9 E., Nevada County, Hydrologic Unit 18020126, on right bank, 20 ft upstream from new highway bridge, 0.5 mi downstream from Rollins Dam, and 2.2 mi north of Colfax.

DRAINAGE AREA.—105 mi<sup>2</sup>.

PERIOD OF RECORD.—January 1912 to September 1913, October 1913 to July 1915 (gage heights and discharge measurements only), August 1915 to June 1917, November 1949 to September 1953, August 1964 to current year. Monthly discharge only for some periods, published in WSP 1315-A. Prior to August 1964, published as Bear River near Colfax. Records for November and December 1911 include diversion to Bear River Canal and are not equivalent.

GAGE.—Water-stage recorder and concrete control. Datum of gage is 1,927.41 ft above sea level. Prior to Aug. 8, 1915, nonrecording gages at several sites above diversion dam 0.3 mi upstream at different datums. Aug. 8, 1915, to June 30, 1917, nonrecording gage 0.7 mi downstream at different datum. Nov. 1, 1949, to Sept. 30, 1953, at site 0.2 mi downstream at different datum. Aug. 17, 1964, to Feb. 4, 1986, at present site and datum. Feb. 5, 1986, to Mar. 19, 1987, at site 160 ft downstream at datum 8.00 ft lower.

REMARKS.—Flow regulated by Rollins Reservoir (station 11421800) beginning Dec. 15, 1964. Bear River Canal (station 11422000) diverts upstream from station. See schematic diagram of [Bear River Basin](#).

COOPERATION.—Records were collected by Nevada Irrigation District, under general supervision of the U.S. Geological Survey, in connection with a Federal Energy Regulatory Commission project.

EXTREMES FOR PERIOD OF RECORD.—Maximum discharge (prior to construction of Rollins Dam in 1964), 9,620 ft<sup>3</sup>/s, Nov. 20, 1950, gage height, 21.40 ft, site and datum then in use, from rating curve extended above 3,600 ft<sup>3</sup>/s on basis of slope-area measurement of peak flow; no flow at times in 1912, 1952. Maximum discharge since construction of Rollins Dam, 34,300 ft<sup>3</sup>/s, Jan. 2, 1997, gage height, 18.01 ft, maximum gage height, 20.62 ft, Feb. 17, 1986, site and datum then in use, from rating curve extended above 11,600 ft<sup>3</sup>/s; minimum daily, 0.5 ft<sup>3</sup>/s, Nov. 17, 1964.

## DISCHARGE, CUBIC FEET PER SECOND, WATER YEAR OCTOBER 2000 TO SEPTEMBER 2001

## DAILY MEAN VALUES

DAY	OCT	NOV	DEC	JAN	FEB	MAR	APR	MAY	JUN	JUL	AUG	SEP
1	318	85	23	23	25	28	25	139	114	157	129	125
2	177	20	23	23	25	29	93	303	114	151	130	123
3	81	21	23	23	25	28	24	414	113	144	129	124
4	81	22	23	23	25	31	24	406	113	144	129	127
5	81	24	23	22	25	34	25	156	114	138	130	129
6	81	23	22	22	25	30	27	152	115	135	130	113
7	81	24	22	22	25	29	28	116	113	134	130	103
8	81	24	22	22	25	29	27	91	110	135	129	102
9	81	40	22	22	25	29	26	91	109	134	129	103
10	81	27	22	23	27	29	26	91	107	133	129	102
11	80	27	23	25	29	28	52	91	112	134	130	94
12	81	26	23	23	27	28	83	93	119	134	132	90
13	80	24	22	23	27	30	30	95	118	132	131	90
14	80	23	23	22	27	30	27	392	117	128	129	88
15	77	24	23	22	27	28	26	425	117	129	132	87
16	78	25	23	22	28	24	27	425	117	130	135	86
17	78	23	22	22	28	24	31	425	117	131	135	86
18	78	23	22	22	29	24	30	413	126	131	135	85
19	78	23	22	22	33	24	28	196	137	130	135	85
20	78	23	22	22	32	24	29	184	137	130	136	85
21	82	23	23	22	33	24	28	184	140	130	134	86
22	85	23	23	23	32	24	27	184	143	128	134	86
23	85	23	23	25	30	24	37	132	149	129	134	87
24	85	22	23	26	31	24	31	104	147	129	134	87
25	85	23	23	25	30	26	27	104	147	129	134	87
26	84	23	23	34	29	27	27	105	144	129	134	87
27	83	23	23	26	28	129	27	104	141	129	131	87
28	84	23	23	26	28	377	26	105	140	129	128	87
29	84	23	23	26	---	422	26	106	139	129	129	86
30	83	23	23	26	---	117	56	107	144	130	125	86
31	91	---	23	25	---	24	---	110	---	129	127	---
TOTAL	2862	780	703	734	780	1778	1000	6043	3773	4134	4068	2893
MEAN	92.3	26.0	22.7	23.7	27.9	57.4	33.3	195	126	133	131	96.4
MAX	318	85	23	34	33	422	93	425	149	157	136	129
MIN	77	20	22	22	25	24	24	91	107	128	125	85
AC-FT	5680	1550	1390	1460	1550	3530	1980	11990	7480	8200	8070	5740

11422500 BEAR RIVER BELOW ROLLINS DAM, NEAR COLFAX, CA—Continued

STATISTICS OF MONTHLY MEAN DATA FOR WATER YEARS 1912 - 1953, BY WATER YEAR (WY)

	OCT	NOV	DEC	JAN	FEB	MAR	APR	MAY	JUN	JUL	AUG	SEP
MEAN	46.0	300	474	804	778	635	586	314	133	46.2	36.3	47.0
MAX	73.8	1016	1372	1103	1354	1110	1126	578	226	109	102	89.7
(WY)	1951	1951	1951	1951	1916	1916	1952	1952	1953	1916	1916	1916
MIN	12.7	19.8	58.4	287	201	127	151	165	35.1	.000	.000	.000
(WY)	1913	1953	1953	1913	1913	1913	1912	1916	1913	1913	1913	1913

SUMMARY STATISTICS

WATER YEARS 1912 - 1953

ANNUAL MEAN	356
HIGHEST ANNUAL MEAN	534 1951
LOWEST ANNUAL MEAN	126 1913
HIGHEST DAILY MEAN	5760 Nov 20 1950
LOWEST DAILY MEAN	.00 Jul 5 1912
ANNUAL SEVEN-DAY MINIMUM	.00 Sep 11 1912
MAXIMUM PEAK FLOW	9620 Nov 20 1950
MAXIMUM PEAK STAGE	21.40 Nov 20 1950
ANNUAL RUNOFF (AC-FT)	258000
10 PERCENT EXCEEDS	879
50 PERCENT EXCEEDS	138
90 PERCENT EXCEEDS	1.0

STATISTICS OF MONTHLY MEAN DATA FOR WATER YEARS 1966 - 2001, BY WATER YEAR (WY)

	1966	1967	1968	1969	1970	1971	1972	1973	1974	1975	1976	1977	1978	1979	1980	1981	1982	1983	1984	1985	1986	1987	1988	1989	1990	1991	1992	1993	1994	1995	1996	1997	1998	1999	2000	2001			
MEAN	116	190	350	621	725	742	640	505	352	250	200	158																											
MAX	330	1267	1957	2973	2889	2324	2516	1211	757	538	420	383																											
(WY)	1999	1984	1997	1997	1986	1983	1982	1995	1998	1983	1995	1983																											
MIN	21.3	10.3	6.53	6.67	5.14	4.56	16.6	21.8	15.2	22.8	34.3	34.4																											
(WY)	1978	1978	1978	1977	1977	1977	1976	1977	1977	1977	1977	1977																											

SUMMARY STATISTICS

FOR 2000 CALENDAR YEAR

FOR 2001 WATER YEAR

WATER YEARS 1966 - 2001

ANNUAL TOTAL	184224	29548	
ANNUAL MEAN	503	81.0	402
HIGHEST ANNUAL MEAN			972 1983
LOWEST ANNUAL MEAN			19.0 1977
HIGHEST DAILY MEAN	6260 Feb 14	425 May 15	22800 Jan 2 1997
LOWEST DAILY MEAN	20 Nov 2	20 Nov 2	3.6 Dec 26 1977
ANNUAL SEVEN-DAY MINIMUM	22 Dec 4	22 Jan 14	4.4 Mar 23 1977
MAXIMUM PEAK FLOW		438 May 17	34300 Jan 2 1997
MAXIMUM PEAK STAGE		2.12 May 17	20.62 Feb 17 1986
ANNUAL RUNOFF (AC-FT)	365400	58610	291600
10 PERCENT EXCEEDS	1150	136	964
50 PERCENT EXCEEDS	318	80	157
90 PERCENT EXCEEDS	23	23	22

## 11423800 BEAR RIVER FISH RELEASE BELOW NEW CAMP FAR WEST RESERVOIR, NEAR WHEATLAND, CA

LOCATION.—Lat 39°02'30", long 121°19'52", in NE 1/4 NW 1/4 sec.29, T.14 N., R.6 E., Placer County, Hydrologic Unit 18020108, on left bank, 5.4 mi northeast of Wheatland, and 1.2 mi downstream from New Camp Far West Reservoir.

DRAINAGE AREA.—Not determined.

PERIOD OF RECORD.—October 1989 to current year.

GAGE.—Water-stage recorder. Elevation of gage is 120 ft above sea level, from topographic map.

REMARKS.—The gage measures required fish-release flow and is entirely regulated by New Camp Far West Reservoir. See schematic diagrams of lower Sacramento River and Bear River Basins.

COOPERATION.—Records provided by South Sutter Water District, under general supervision of the U.S. Geological Survey, in connection with a Federal Energy Regulatory Commission project.

EXTREMES FOR PERIOD OF RECORD.—Maximum daily discharge, 43 ft<sup>3</sup>/s, Dec. 4, 1994; minimum daily, 8.0 ft<sup>3</sup>/s, July 2, 1995.

## DISCHARGE, CUBIC FEET PER SECOND, WATER YEAR OCTOBER 2000 TO SEPTEMBER 2001

## DAILY MEAN VALUES

DAY	OCT	NOV	DEC	JAN	FEB	MAR	APR	MAY	JUN	JUL	AUG	SEP
1	11	12	12	15	13	12	26	26	25	15	10	11
2	11	12	12	14	13	12	27	26	25	10	10	11
3	11	12	12	11	12	12	26	25	25	10	10	11
4	11	11	12	12	12	12	27	25	26	10	10	11
5	11	11	12	12	12	13	27	26	27	10	10	11
6	11	11	12	13	12	13	27	26	26	10	10	11
7	11	11	12	13	12	13	27	26	26	10	10	11
8	11	11	12	13	12	13	27	26	26	10	10	11
9	11	11	12	13	12	13	27	26	26	10	10	11
10	11	12	12	12	12	13	27	26	26	10	10	11
11	11	12	12	12	12	12	27	26	26	10	10	11
12	11	12	14	12	12	12	26	26	26	10	10	11
13	11	12	15	12	12	12	26	26	26	10	10	11
14	11	12	15	12	12	13	26	27	26	10	10	11
15	11	12	15	12	12	13	26	27	26	10	10	11
16	11	12	15	12	12	13	28	26	26	10	10	11
17	12	12	15	12	12	13	28	26	26	10	10	11
18	11	12	14	12	12	13	27	26	26	10	10	11
19	12	12	14	12	12	13	27	26	26	10	10	11
20	12	12	14	12	12	13	26	26	26	10	10	11
21	12	12	16	12	12	13	26	26	26	10	10	11
22	11	12	17	12	12	13	26	26	26	10	10	11
23	11	12	17	12	12	13	26	26	26	10	10	11
24	11	12	16	12	12	13	26	26	26	10	10	11
25	11	12	16	13	12	13	25	26	26	10	10	11
26	11	12	16	13	12	13	26	26	26	10	10	11
27	12	12	15	13	12	13	26	26	26	10	10	11
28	12	12	15	13	12	13	26	26	26	10	10	11
29	12	12	15	13	---	13	26	26	27	10	11	11
30	12	12	15	13	---	20	26	26	26	10	11	11
31	12	---	15	13	---	27	---	25	---	10	11	---
TOTAL	350	354	436	387	338	417	794	805	779	315	313	330
MEAN	11.3	11.8	14.1	12.5	12.1	13.5	26.5	26.0	26.0	10.2	10.1	11.0
MAX	12	12	17	15	13	27	28	27	27	15	11	11
MIN	11	11	12	11	12	12	25	25	25	10	10	11
AC-FT	694	702	865	768	670	827	1570	1600	1550	625	621	655

## STATISTICS OF MONTHLY MEAN DATA FOR WATER YEARS 1990 - 2001, BY WATER YEAR (WY)

	1990	1991	1992	1993	1994	1995	1996	1997	1998	1999	2000	2001
MEAN	12.6	12.9	13.0	13.5	13.5	14.0	27.4	27.8	27.6	11.2	11.2	11.4
MAX	14.5	18.0	16.4	21.7	18.7	21.7	32.0	30.5	30.1	12.9	13.0	13.0
(WY)	1998	1996	1996	1995	1995	1995	1995	1995	1995	1995	1995	1995
MIN	11.0	11.0	11.0	10.9	11.0	11.2	23.7	25.9	25.8	10.2	10.1	10.8
(WY)	1991	1991	1991	1991	1991	1991	1999	1990	1990	2001	2001	1990

SUMMARY STATISTICS	FOR 2000 CALENDAR YEAR		FOR 2001 WATER YEAR		WATER YEARS 1990 - 2001	
ANNUAL TOTAL	6020		5618			
ANNUAL MEAN	16.4		15.4		16.3	
HIGHEST ANNUAL MEAN					19.5	
LOWEST ANNUAL MEAN					15.0	
HIGHEST DAILY MEAN	29	May 2	28	Apr 16	43	Dec 4 1994
LOWEST DAILY MEAN	11	Jul 7	10	Jul 2	8.0	Jul 2 1995
ANNUAL SEVEN-DAY MINIMUM	11	Jul 9	10	Jul 2	10	Jul 2 2001
ANNUAL RUNOFF (AC-FT)	11940		11140		11840	
10 PERCENT EXCEEDS	28		26		28	
50 PERCENT EXCEEDS	14		12		13	
90 PERCENT EXCEEDS	11		10		11	

## 11424000 BEAR RIVER NEAR WHEATLAND, CA

LOCATION.—Lat 39°00'00", long 121°24'20", in SE 1/4 SW 1/4 sec.3, T.13 N., R.5 E., Placer County, Hydrologic Unit 18020108, on right bank, 200 ft downstream from bridge on State Highway 65, 1 mi southeast of Wheatland, and 6.5 mi downstream from New Camp Far West Reservoir.

DRAINAGE AREA.—292 mi<sup>2</sup>.

PERIOD OF RECORD.—October 1928 to current year.

CHEMICAL DATA: Water years 1953 to July 1980, June 1999 to September 1999.

SEDIMENT DATA: June 1999 to September 1999.

REVISED RECORDS.—WSP 1931: Drainage area.

GAGE.—Water-stage recorder. Datum of gage is 71.92 ft above sea level. See WSP 2131 for history of changes prior to May 28, 1970.

REMARKS.—Records good. Natural flow of stream affected by inflow from Yuba and American River Basins. Flow regulated by Lake Combie, usable capacity, 7,840 acre-ft, since 1928; Rollins Reservoir (station 11421800), since December 1964; and New Camp Far West Reservoir, usable capacity, 102,200 acre-ft, since October 1963. Many diversions for irrigation and power. See schematic diagrams of Bear River and lower Sacramento River Basins.

EXTREMES FOR PERIOD OF RECORD.—Maximum discharge, 48,000 ft<sup>3</sup>/s, Feb. 17, 1986, gage height, 21.60 ft, maximum gage height, 23.72 ft, Jan. 2, 1997; no flow at times.

## DISCHARGE, CUBIC FEET PER SECOND, WATER YEAR OCTOBER 2000 TO SEPTEMBER 2001

## DAILY MEAN VALUES

DAY	OCT	NOV	DEC	JAN	FEB	MAR	APR	MAY	JUN	JUL	AUG	SEP
1	12	16	11	14	15	16	25	26	39	27	55	17
2	12	24	12	14	15	18	24	26	33	22	58	17
3	12	19	13	e14	15	17	26	29	33	58	59	16
4	12	13	13	e12	14	21	28	28	34	57	60	15
5	12	13	13	12	12	54	26	28	31	54	60	15
6	13	12	13	13	11	21	26	28	31	55	57	13
7	12	11	8.0	13	8.3	17	26	30	31	54	57	13
8	12	11	9.5	17	9.0	15	26	33	30	55	58	13
9	15	12	13	13	9.5	15	25	34	29	57	57	14
10	11	12	13	15	14	14	25	32	30	56	58	13
11	14	14	13	13	19	14	25	34	31	54	59	14
12	e15	15	e14	9.4	15	14	25	34	31	54	61	14
13	e17	16	e15	11	15	14	25	35	30	57	60	14
14	18	e16	15	13	14	14	25	36	29	58	61	13
15	17	e15	15	13	14	14	26	34	31	56	60	13
16	17	e15	15	13	14	14	27	34	31	57	63	12
17	18	14	15	13	14	13	30	36	30	56	64	12
18	18	14	13	14	15	e14	29	37	30	48	63	10
19	16	14	12	11	17	e14	29	35	30	57	63	10
20	17	14	14	12	19	e13	32	33	28	56	61	10
21	22	14	14	14	19	e13	30	32	28	55	61	10
22	23	14	16	14	20	e13	28	33	28	55	57	10
23	23	13	16	15	23	e13	27	32	27	55	60	10
24	18	13	16	16	29	13	27	32	28	54	61	10
25	17	13	15	21	21	13	26	31	29	53	61	11
26	23	13	15	18	15	12	26	31	30	54	63	10
27	20	13	15	16	14	12	26	33	32	52	64	10
28	21	13	15	15	14	12	26	31	32	53	53	10
29	21	15	14	17	---	12	26	30	31	52	20	9.7
30	20	11	15	16	---	13	26	31	32	55	18	9.9
31	19	---	15	15	---	25	---	36	---	57	17	---
TOTAL	517	422	425.5	436.4	433.8	497	798	994	919	1643	1729	368.6
MEAN	16.7	14.1	13.7	14.1	15.5	16.0	26.6	32.1	30.6	53.0	55.8	12.3
MAX	23	24	16	21	29	54	32	37	39	58	64	17
MIN	11	11	8.0	9.4	8.3	12	24	26	27	22	17	9.7
AC-FT	1030	837	844	866	860	986	1580	1970	1820	3260	3430	731

e Estimated.



## SACRAMENTO RIVER BASIN

## 11424000 BEAR RIVER NEAR WHEATLAND, CA—Continued

## STATISTICS OF MONTHLY MEAN DATA FOR WATER YEARS 1930 - 1963, BY WATER YEAR (WY)

	OCT	NOV	DEC	JAN	FEB	MAR	APR	MAY	JUN	JUL	AUG	SEP
MEAN	92.8	184	565	826	1240	1033	770	306	79.0	12.6	16.7	18.4
MAX	1348	1980	3501	3004	3360	2918	2553	939	245	55.4	148	215
(WY)	1963	1951	1956	1956	1936	1938	1958	1942	1932	1952	1935	1935
MIN	2.05	9.14	21.3	68.0	156	192	11.3	.57	.71	.53	.65	.30
(WY)	1961	1960	1960	1947	1933	1933	1959	1959	1959	1959	1939	1939

## SUMMARY STATISTICS

## WATER YEARS 1930 - 1963

ANNUAL MEAN	424	
HIGHEST ANNUAL MEAN	891	1951
LOWEST ANNUAL MEAN	70.0	1933
HIGHEST DAILY MEAN	22100	Dec 23 1955
LOWEST DAILY MEAN	.00	Sep 18 1939
ANNUAL SEVEN-DAY MINIMUM	.00	Sep 18 1939
MAXIMUM PEAK FLOW	33000	Dec 22 1955
MAXIMUM PEAK STAGE	20.83	Nov 21 1950
ANNUAL RUNOFF (AC-FT)	307500	
10 PERCENT EXCEEDS	1060	
50 PERCENT EXCEEDS	77	
90 PERCENT EXCEEDS	3.6	

## STATISTICS OF MONTHLY MEAN DATA FOR WATER YEARS 1966 - 2001, BY WATER YEAR (WY)

	OCT	NOV	DEC	JAN	FEB	MAR	APR	MAY	JUN	JUL	AUG	SEP
MEAN	22.8	140	444	960	1267	1151	720	245	71.6	20.6	16.8	16.1
MAX	263	1606	2668	3954	5201	3845	3796	1035	484	72.6	55.8	73.2
(WY)	1999	1984	1984	1997	1986	1983	1982	1983	1998	1995	2001	1998
MIN	.002	.056	.000	.14	.62	1.07	.60	4.05	3.17	2.95	4.72	1.31
(WY)	1978	1977	1977	1977	1977	1977	1977	1977	1977	1977	1977	1977

## SUMMARY STATISTICS

## FOR 2000 CALENDAR YEAR

## FOR 2001 WATER YEAR

## WATER YEARS 1966 - 2001

ANNUAL TOTAL	177573.5		9183.3	
ANNUAL MEAN	485		25.2	419
HIGHEST ANNUAL MEAN				1191
LOWEST ANNUAL MEAN				3.42
HIGHEST DAILY MEAN	13300	Feb 14	64	Aug 17
LOWEST DAILY MEAN	8.0	Dec 7	8.0	Dec 7
ANNUAL SEVEN-DAY MINIMUM	12	Dec 2	10	Sep 18
MAXIMUM PEAK FLOW			100	Mar 5
MAXIMUM PEAK STAGE			1.56	Mar 5
ANNUAL RUNOFF (AC-FT)	352200		18220	303300
10 PERCENT EXCEEDS	1360		56	1220
50 PERCENT EXCEEDS	20		17	23
90 PERCENT EXCEEDS	13		12	8.4

## 11425418 MORMON RAVINE NEAR NEWCASTLE, CA

LOCATION.—Lat 38°50'12", long 121°05'36", in SE 1/4 NW 1/4 sec.4, T.11 N., R.8 E., [Placer County](#), Hydrologic Unit 18020128, on right bank, 200 ft upstream from Folsom Lake, 700 ft north of Newcastle Powerplant, and 3.3 mi southeast of Newcastle.

DRAINAGE AREA.—3.84 mi<sup>2</sup>.

PERIOD OF RECORD.—October 1989 to current year (low-flow records only).

GAGE.—Water-stage recorder and V-notch sharp-crested weir. Elevation of gage is 500 ft above sea level, from topographic map.

REMARKS.—Records not computed above 8.5 ft<sup>3</sup>/s. Low flow augmented by release from end of South Canal. Most of the water in South Canal is diverted to Newcastle Powerplant (station 11425416). See schematic diagram of [Bear River Basin](#).

COOPERATION.—Records were collected by Pacific Gas & Electric Co., under general supervision of the U.S. Geological Survey, in connection with a Federal Energy Regulatory Commission project.

## DISCHARGE, CUBIC FEET PER SECOND, WATER YEAR OCTOBER 2000 TO SEPTEMBER 2001

## DAILY MEAN VALUES

DAY	OCT	NOV	DEC	JAN	FEB	MAR	APR	MAY	JUN	JUL	AUG	SEP
1	---	---	---	8.2	---	---	---	---	7.6	---	---	---
2	---	---	---	---	---	---	---	8.1	7.8	8.1	---	---
3	7.8	---	8.2	8.3	---	---	---	7.6	8.0	---	---	---
4	7.6	---	8.2	8.3	---	---	---	7.6	---	---	---	---
5	7.6	---	---	8.2	---	---	---	7.5	---	---	---	---
6	7.7	---	---	8.3	---	---	---	7.1	---	---	---	---
7	7.6	---	---	8.5	---	---	---	7.4	8.1	---	---	---
8	7.8	---	---	---	---	---	---	---	7.7	---	---	---
9	---	---	---	---	---	---	---	---	8.0	---	---	---
10	---	---	---	---	---	---	---	---	---	---	---	---
11	---	---	---	---	---	---	---	---	---	---	---	---
12	---	---	---	---	---	---	---	---	---	---	---	---
13	---	---	---	---	---	---	---	---	7.9	---	---	---
14	---	---	---	---	---	---	---	---	---	---	---	---
15	---	---	---	---	---	---	---	---	---	---	---	---
16	---	---	---	---	---	---	---	---	---	---	---	---
17	---	8.2	---	---	---	---	---	---	---	---	---	---
18	---	8.2	---	7.8	---	---	---	8.0	---	---	---	---
19	---	8.0	---	7.7	---	---	---	7.5	---	---	---	---
20	---	8.3	8.2	---	---	---	---	6.5	---	---	---	---
21	---	---	8.2	---	---	---	---	6.0	---	---	---	---
22	---	---	8.1	---	---	---	---	---	---	---	---	---
23	---	---	8.1	---	---	---	---	---	---	---	---	---
24	1.6	---	8.2	---	---	---	---	---	---	---	---	---
25	---	---	8.2	---	---	---	---	---	---	---	---	---
26	3.0	---	8.2	---	---	---	---	---	---	---	---	---
27	2.2	---	8.2	---	---	---	---	---	---	---	---	---
28	---	---	8.2	---	---	---	---	---	---	---	---	---
29	---	---	8.3	---	---	---	---	---	---	---	---	---
30	4.9	---	8.3	---	---	---	---	---	---	---	---	---
31	3.1	---	8.3	---	---	---	---	7.9	---	---	---	---
TOTAL	---	---	---	---	---	---	---	---	---	---	---	---
MEAN	---	---	---	---	---	---	---	---	---	---	---	---
MAX	---	---	---	---	---	---	---	---	---	---	---	---
MIN	---	---	---	---	---	---	---	---	---	---	---	---
AC-FT	---	---	---	---	---	---	---	---	---	---	---	---
a	6450	8860	13200	5930	10910	15740	12800	7850	4830	309	3.0	0

CAL YR 2000 a 95030

WTR YR 2001 a 86890

a Diversion, in acre-feet, to Newcastle Powerplant (station 11425416), provided by Pacific Gas & Electric Co.

## 11425500 SACRAMENTO RIVER AT VERONA, CA

LOCATION.—Lat 38°46'28", long 121°35'50", in SW 1/4 NW 1/4 sec.25, T.11 N., R.3 E., [Sutter County](#), Hydrologic Unit 18020109, on left bank, 1.3 mi southeast of Verona, 1.5 mi downstream from Feather River, 6.2 mi east of Knights Landing, and at mile 19.1 upstream from Sacramento.

DRAINAGE AREA.—21,251 mi<sup>2</sup>.

PERIOD OF RECORD.—May 1926 to September 1929 (low-water periods only), October 1929 to current year.

CHEMICAL DATA: Water years 1952, 1969–70, 1996–98.

SPECIFIC CONDUCTANCE: Water years 1995–98.

WATER TEMPERATURE: Water years 1980, 1995–98.

SEDIMENT: Water years 1980, 1996–98.

REVISED RECORDS.—WDR CA-77-4: Drainage area.

GAGE.—Water-stage recorder and crest-stage gage. Datum of gage is 3.00 ft below sea level. May 1926 to Sept. 30, 1987, at site 0.5 mi upstream at same datum.

REMARKS.—Records good. Natural flow of stream affected by storage reservoirs, power developments, diversions for irrigation, return flow from irrigated areas, and bypassing for flood control. When discharge exceeds about 55,000 ft<sup>3</sup>/s, flow begins over Fremont Weir, 3.5 mi upstream on right bank, into Yolo Bypass (station 11453000). See schematic diagram of [lower Sacramento River Basin](#).

EXTREMES FOR PERIOD OF RECORD.—Maximum discharge, 94,000 ft<sup>3</sup>/s, Jan. 2, 1997, gage height, 42.09 ft; maximum gage height, 42.11 ft, Feb. 20, 1986, site then in use; minimum daily, 304 ft<sup>3</sup>/s, July 23, 24, 1931.

## DISCHARGE, CUBIC FEET PER SECOND, WATER YEAR OCTOBER 2000 TO SEPTEMBER 2001

## DAILY MEAN VALUES

DAY	OCT	NOV	DEC	JAN	FEB	MAR	APR	MAY	JUN	JUL	AUG	SEP
1	10800	12200	11400	11100	15300	28100	12500	e7100	10100	13300	13700	11100
2	10700	11800	11900	11000	14100	25000	12400	7070	10100	13100	13800	11200
3	10500	11300	11900	11000	13200	22800	11800	7080	10100	12800	13600	11300
4	10300	10600	11800	11100	12400	21800	11400	7060	10200	12400	13200	11300
5	10100	10200	11600	11100	11900	25100	11200	6270	10100	12200	12700	11600
6	9760	10100	11500	10900	11700	34500	11600	5790	9730	12600	12500	11600
7	9700	10000	11400	10800	11300	38100	12000	5650	9390	12900	12500	11600
8	9450	9760	11300	11200	11000	41400	12000	5970	9740	13300	12600	11700
9	9390	9540	11200	12200	11100	41200	12300	6370	10200	13400	12700	11700
10	9470	9300	11100	13300	11600	36300	12100	6340	10100	13400	12700	11600
11	9740	9550	11200	15200	13200	31100	11600	6310	10100	13200	12800	11600
12	10300	9530	11300	19000	18600	28300	11200	6550	10400	13000	12700	11800
13	10500	9640	11400	23200	21900	26100	11000	6760	10700	12900	12600	11800
14	10400	9840	11600	21500	21100	23800	10700	6910	10500	13000	12400	11600
15	10200	9880	11900	18700	18400	21400	10300	6760	10200	13000	12200	11500
16	10100	10100	13000	16800	15600	19500	9940	7090	10100	13100	12500	11400
17	10500	10300	13600	15600	14100	17900	9410	7940	10400	13100	12500	11500
18	10400	10100	12900	14500	13300	16800	8920	8650	10500	13200	12500	11500
19	10100	10000	12300	13600	13200	15800	8540	8960	10500	13200	12300	11300
20	9890	10200	11800	12900	15800	15400	8440	9470	10400	13400	12100	10900
21	9760	10400	11600	12500	20800	15400	9500	9460	10300	13500	11800	10900
22	9400	10600	11500	12200	27100	15200	10700	9050	10200	13600	11800	10900
23	9070	10900	11500	12200	30300	14700	11000	8580	10200	13800	11700	10700
24	8890	10900	11500	12800	31600	14400	10900	8220	10300	13900	11200	10600
25	8700	10800	11500	13500	31500	14200	10500	8180	10200	13900	11000	10700
26	8770	10900	11500	19400	31900	14000	9950	8190	10100	13900	10700	10800
27	9310	10800	11300	25200	33600	14200	e9500	8120	10700	14000	10900	10900
28	10100	10700	11300	26100	31800	14400	e9200	8700	11500	14300	11000	10800
29	10900	11000	11200	22800	---	13800	e8800	9670	12500	14400	11400	10500
30	11600	11300	11200	19500	---	13300	e7900	10300	13200	14500	11400	10100
31	12300	---	11200	17000	---	12800	---	10300	---	14200	11200	---
TOTAL	311100	312240	361400	477900	527400	686800	317300	238870	312760	414500	378700	336500
MEAN	10040	10410	11660	15420	18840	22150	10580	7705	10430	13370	12220	11220
MAX	12300	12200	13600	26100	33600	41400	12500	10300	13200	14500	13800	11800
MIN	8700	9300	11100	10800	11000	12800	7900	5650	9390	12200	10700	10100
AC-FT	617100	619300	716800	947900	1046000	1362000	629400	473800	620400	822200	751200	667400

e Estimated.

## 11425500 SACRAMENTO RIVER AT VERONA, CA—Continued

## STATISTICS OF MONTHLY MEAN DATA FOR WATER YEARS 1930 - 1943, BY WATER YEAR (WY)

	OCT	NOV	DEC	JAN	FEB	MAR	APR	MAY	JUN	JUL	AUG	SEP
MEAN	5623	8493	17140	28130	33500	35320	34370	24600	12750	3943	2603	4242
MAX	7816	23510	41690	56930	57860	57700	55330	53730	33480	9176	5036	5895
(WY)	1939	1938	1938	1941	1942	1938	1938	1938	1938	1938	1938	1938
MIN	3462	3923	5968	7819	11730	13860	5932	3103	1872	497	846	2960
(WY)	1933	1933	1937	1937	1933	1931	1931	1931	1931	1931	1931	1934

## SUMMARY STATISTICS

## WATER YEARS 1930 - 1943

ANNUAL MEAN	17470
HIGHEST ANNUAL MEAN	31300 1938
LOWEST ANNUAL MEAN	6286 1931
HIGHEST DAILY MEAN	76900 Feb 8 1942
LOWEST DAILY MEAN	304 Jul 23 1931
ANNUAL SEVEN-DAY MINIMUM	313 Jul 18 1931
MAXIMUM PEAK FLOW	79200 Mar 1 1940
MAXIMUM PEAK STAGE	41.20 Mar 1 1940
ANNUAL RUNOFF (AC-FT)	12650000
10 PERCENT EXCEEDS	50700
50 PERCENT EXCEEDS	8620
90 PERCENT EXCEEDS	2680

## STATISTICS OF MONTHLY MEAN DATA FOR WATER YEARS 1946 - 2001, BY WATER YEAR (WY)

MEAN	10610	13880	22510	29670	34940	32350	24880	19990	14530	11850	12190	12810
MAX	24920	43300	64470	71040	70030	71340	62140	51600	45560	24550	21400	22110
(WY)	1963	1974	1984	1997	1998	1983	1982	1952	1998	1983	1983	1971
MIN	4725	5987	6586	8561	7591	6731	6188	5118	4858	4848	5385	6300
(WY)	1978	1993	1960	1991	1991	1977	1977	1992	1992	1947	1947	1977

## SUMMARY STATISTICS

## FOR 2000 CALENDAR YEAR

## FOR 2001 WATER YEAR

## WATER YEARS 1946 - 2001

ANNUAL TOTAL	7794440	4675470	
ANNUAL MEAN	21300	12810	19940
HIGHEST ANNUAL MEAN			39150 1983
LOWEST ANNUAL MEAN			7178 1977
HIGHEST DAILY MEAN	66600 Feb 28	41400 Mar 8	92300 Feb 20 1986
LOWEST DAILY MEAN	8700 Oct 25	5650 May 7	3590 Jun 24 1992
ANNUAL SEVEN-DAY MINIMUM	9130 Oct 21	6100 May 5	3960 Jun 22 1992
MAXIMUM PEAK FLOW		42400 Mar 9	94000 Jan 2 1997
MAXIMUM PEAK STAGE		26.43 Mar 9	42.11 Feb 20 1986
ANNUAL RUNOFF (AC-FT)	15460000	9274000	14450000
10 PERCENT EXCEEDS	46300	18500	47200
50 PERCENT EXCEEDS	15900	11400	13500
90 PERCENT EXCEEDS	10300	9260	7540

## 11426000 SACRAMENTO WEIR SPILL TO YOLO BYPASS, NEAR SACRAMENTO, CA

LOCATION.—Lat 38°36'25", long 121°33'15", unsurveyed, Sacramento County, Hydrologic Unit 18020109, on right bank, 100 ft upstream from weir, 3.2 mi upstream from American River, 4 mi northwest of Sacramento, and 4.2 mi upstream from Sacramento.

PERIOD OF RECORD.—October 1939 to current year. Monthly discharge only for water years 1940–51, published in WSP 1735. Published as Sacramento Weir near Sacramento 1939–61. Gage-height records collected at same site February 1926 to September 1934 and major flood flows only October 1934 to September 1939 are contained in reports of California Department of Water Resources.

GAGE.—Water-stage recorder and concrete weir crest. Datum of gage is 3.00 ft below sea level. October 1939 to September 1942, October 1959 to September 1963, water-stage recorder or nonrecording gage at downstream end of weir. October 1942 to September 1959, water-stage recorder on left bank of Sacramento River opposite center of weir. February 1963 to September 1985, water-stage recorder on right bank of Sacramento River 100 ft downstream from end of weir.

REMARKS.—Crest of weir is at gage height 20.2 ft and top of movable gates are at 28.0 ft. Weir consists of 48 gates each 38.1 ft long. Flow over weir enters Yolo Bypass by way of Sacramento Bypass. Flow regulated by weir gates. February 1963 to September 1985, stage was obtained by averaging the stage obtained at sites on the Sacramento River above and below the weir. See schematic diagram of lower Sacramento River Basin.

COOPERATION.—Records provided by California Department of Water Resources; not reviewed by the U.S. Geological Survey.

EXTREMES FOR PERIOD OF RECORD.—Maximum discharge, 128,000 ft<sup>3</sup>/s, Feb. 20, 1986, gage height, 30.84 ft; maximum gage height, 33.01 ft, Dec. 23, 1955; no flow all or most of each year.

EXTREMES FOR CURRENT YEAR.—No flow for 2001 water year.

## STATISTICS OF MONTHLY MEAN DATA FOR WATER YEARS 1943 – 2001, BY WATER YEAR (WY)

	OCT	NOV	DEC	JAN	FEB	MAR	APR	MAY	JUN	JUL	AUG	SEP
MEAN	1.25	125	533	788	768	527	86.4	2.16	.22	.000	.000	.000
MAX	72.6	7014	12470	19700	23920	17830	2042	79.1	12.7	.000	.000	.000
(WY)	1963	1951	1965	1997	1986	1983	1982	1983	1998	1943	1943	1943
MIN	.000	.000	.000	.000	.000	.000	.000	.000	.000	.000	.000	.000
(WY)	1944	1944	1944	1944	1944	1944	1944	1943	1943	1943	1943	1943

SUMMARY STATISTICS	FOR 2000 CALENDAR YEAR	FOR 2001 WATER YEAR	WATER YEARS 1943 – 2001
ANNUAL MEAN			231
HIGHEST ANNUAL MEAN			2075
LOWEST ANNUAL MEAN			.000
HIGHEST DAILY MEAN			123000
LOWEST DAILY MEAN	.00 Jan 1	.00 Oct 1	.00 Jan 1 1943
ANNUAL SEVEN-DAY MINIMUM	.00 Jan 1	.00 Oct 1	.00 Jan 1 1943
MAXIMUM PEAK FLOW			128000
MAXIMUM PEAK STAGE			33.01
ANNUAL RUNOFF (AC-FT)			167400
10 PERCENT EXCEEDS	.00	.00	.00
50 PERCENT EXCEEDS	.00	.00	.00
90 PERCENT EXCEEDS	.00	.00	.00

## 11426170 LAKE VALLEY RESERVOIR NEAR CISCO, CA

LOCATION.—Lat 39°18'01", long 120°35'46", in NE 1/4 NW 1/4 sec.35, T.17 N., R.12 E., Placer County, Hydrologic Unit 18020128, on dam near left abutment, on North Fork of North Fork American River, and 1.3 mi west of Cisco.

DRAINAGE AREA.—4.54 mi<sup>2</sup>.

PERIOD OF RECORD.—July 1987 to current year. Unpublished records for water years 1980–86 available in files of the U.S. Geological Survey.

GAGE.—Water-stage recorder. Datum of gage is 5,727.4 ft above sea level (levels by Pacific Gas & Electric Co.). Prior to July 1987, nonrecording gage at same site and datum.

REMARKS.—Lake is formed by an earthfill dam; storage began in 1911. Usable capacity, 7,960 acre-ft, between gage heights 6.2 ft, natural rim of lake, and 57.5 ft, top of flashboards. Released water is diverted downstream to Lake Valley Canal (station 11426190) and then to several powerplants. Records, including extremes, represent usable contents at 2400 hours. See schematic diagrams of Bear River and South Yuba River Basins.

COOPERATION.—Records were collected by Pacific Gas & Electric Co., under general supervision of the U.S. Geological Survey, in connection with a Federal Energy Regulatory Commission project.

EXTREMES FOR PERIOD OF RECORD.—Maximum contents, 8,225 acre-ft, Jan. 1, 1997, gage height, 58.35 ft; minimum, 1,153 acre-ft, Feb. 28, 1990, gage height, 25.01 ft.

EXTREMES FOR CURRENT YEAR.—Maximum contents, 5,060 acre-ft, May 24–27, maximum gage height, 46.99 ft, May 25, 26; minimum, 1,160 acre-ft, Mar. 18, gage height, 25.13 ft.

Capacity table (gage height, in feet, and contents, in acre-feet)  
(Based on survey by Pacific Gas & Electric Co., dated June 18, 1965)

8	41	14	304	25	1,152	50	5,810
10	102	17	476	30	1,830	59	8,411
12	189	20	693	40	3,455		

## RESERVOIR STORAGE (ACRE-FEET), WATER YEAR OCTOBER 2000 TO SEPTEMBER 2001

## DAILY OBSERVATION AT 2400 HOURS

DAY	OCT	NOV	DEC	JAN	FEB	MAR	APR	MAY	JUN	JUL	AUG	SEP
1	4890	4540	4340	3360	2680	1750	2210	3560	5020	4720	4380	3990
2	4880	4530	4330	3350	2650	1690	2290	3660	5020	4710	4370	3980
3	4870	4520	4320	3320	2630	1630	2330	3720	5010	4700	4350	3970
4	4860	4520	4310	3270	2610	1590	2360	3780	4990	4690	4340	3950
5	4840	4520	4300	3270	2590	1540	2380	3860	4980	4680	4330	3940
6	4820	4490	4290	3200	2570	1470	2400	3950	4970	4680	4320	3930
7	4800	4490	4260	3180	2540	1420	2420	4060	4960	4670	4310	3920
8	4780	4470	4220	3160	2520	1360	2430	4180	4950	4650	4300	3910
9	4790	4460	4160	3140	2510	1310	2430	4300	4940	4650	4280	3890
10	4780	4460	4130	3130	2510	1260	2440	4400	4930	4640	4270	3880
11	4770	4460	4070	3130	2500	1240	2460	4500	4920	4630	4260	3880
12	4740	4440	4040	3100	2470	1220	2470	4590	4910	4620	4250	3870
13	4710	4430	4000	3080	2450	1210	2470	4650	4890	4600	4230	3860
14	4680	4430	3970	3050	2420	1200	2480	4710	4880	4590	4220	3850
15	4650	4430	3970	3030	2400	1190	2490	4790	4860	4580	4200	3840
16	4620	4420	3970	3010	2370	1180	2520	4850	4850	4570	4190	3830
17	4610	4410	3860	2980	2340	1170	2550	4900	4840	4560	4180	3820
18	4600	4410	3810	2960	2290	1160	2600	4940	4830	4550	4160	3810
19	4590	4400	3810	2940	2260	1170	2670	4970	4830	4540	4150	3800
20	4580	4400	3730	2910	2220	1180	2710	5000	4820	4520	4140	3790
21	4580	4390	3710	2890	2190	1200	2730	5020	4810	4510	4120	3780
22	4560	4390	3680	2870	2160	1220	2760	5040	4800	4500	4110	3770
23	4540	4390	3650	2850	2110	1250	2800	5050	4790	4490	4090	3750
24	4530	4380	3620	2840	2070	1310	2870	5060	4770	4480	4080	3730
25	4530	4370	3590	2820	2010	1510	2960	5060	4770	4470	4070	3720
26	4530	4370	3590	2810	1950	1620	3070	5060	4760	4460	4060	3710
27	4510	4340	3510	2790	1880	1710	3160	5060	4760	4440	4050	3700
28	4560	4340	3500	2770	1820	1810	3240	5050	4750	4430	4040	3690
29	4570	4350	3470	2740	---	1920	3330	5050	4740	4420	4020	3670
30	4550	4340	3420	2720	---	2020	3440	5040	4730	4410	4010	3660
31	4550	---	3380	2700	---	2120	---	5040	---	4390	4000	---
MAX	4890	4540	4340	3360	2680	2120	3440	5060	5020	4720	4380	3990
MIN	4510	4340	3380	2700	1820	1160	2210	3560	4730	4390	4000	3660
a	44.76	43.88	39.70	35.83	29.93	31.94	39.95	46.89	45.56	44.09	42.38	40.88
b	-350	-210	-960	-680	-880	+300	+1320	+1600	-310	-340	-390	-340
c	398	141	1030	948	817	1470	1290	923	128	0	0	0

CAL YR 2000 MAX 7960 MIN 2430 b +800 c 12620

WTR YR 2001 MAX 5060 MIN 1160 b -1240 c 7150

a Gage height, in feet, at end of month.

b Change in contents, in acre-feet.

c Diversion, in acre-feet, to Lake Valley Canal (station 11426190), provided by Pacific Gas & Electric Co.

## 11426180 KELLY LAKE NEAR CISCO, CA

LOCATION.—Lat 39°18'40", long 120°34'49", in SE 1/4 NW 1/4 sec.25, T.17 N., R.12 E., Placer County, Hydrologic Unit 18020128, Tahoe National Forest, on outlet structure on Kelly Lake Dam, on unnamed tributary to North Fork of North Fork American River, and 2.2 mi west of Cisco.

DRAINAGE AREA.—0.58 mi<sup>2</sup>.

PERIOD OF RECORD.—October 1991 to current year. Unpublished records for water years 1965–91 available in files of the U.S. Geological Survey.

GAGE.—Water-stage recorder. Datum of gage is 5,888.9 ft above sea level (levels by Pacific Gas & Electric Co.). Prior to October 1991, nonrecording gage at same site and datum.

REMARKS.—No records computed during the winter months. Reservoir is formed on natural lake by rock-fill dam completed in 1928. Usable capacity, 336 acre-ft, between gage heights 0.0 ft, invert of outlet, and 17.1 ft, top of flashboards. Water is used for power development downstream. Records, including extremes, represent usable contents at 2400 hours. See schematic diagram of [Bear River Basin](#).

COOPERATION.—Records were collected by Pacific Gas & Electric Co., under general supervision of the U.S. Geological Survey, in connection with a Federal Energy Regulatory Commission project.

Capacity table (gage height, in feet, and contents, in acre-feet)  
(Based on survey by Pacific Gas & Electric Co., dated December 1933)

0	0	8	130	16	308	19	387
4	61	12	213				

## RESERVOIR STORAGE (ACRE-FEET), WATER YEAR OCTOBER 2000 TO SEPTEMBER 2001

## DAILY OBSERVATION AT 2400 HOURS

DAY	OCT	NOV	DEC	JAN	FEB	MAR	APR	MAY	JUN	JUL	AUG	SEP
1	266	141	---	---	---	---	---	---	332	314	290	266
2	266	135	---	---	---	---	---	---	331	314	288	264
3	265	128	---	---	---	---	---	---	331	313	288	264
4	265	122	---	---	---	---	---	---	331	312	287	264
5	264	116	---	---	---	---	---	---	330	311	287	262
6	264	109	---	---	---	---	---	---	330	311	286	262
7	264	104	---	---	---	---	---	---	329	311	286	262
8	263	99	---	---	---	---	---	---	328	310	285	261
9	264	94	---	---	---	---	---	---	328	308	285	261
10	264	89	---	---	---	---	---	---	327	307	283	260
11	262	84	---	---	---	---	---	---	327	306	282	259
12	256	80	---	---	---	---	---	---	326	306	281	259
13	251	75	---	---	---	---	---	---	325	305	281	257
14	245	71	---	---	---	---	---	---	325	304	280	256
15	239	66	---	---	---	---	---	---	324	303	280	254
16	232	63	---	---	---	---	---	---	323	302	279	253
17	226	59	---	---	---	---	---	---	322	302	277	253
18	220	53	---	---	---	---	---	---	322	301	275	252
19	214	49	---	---	---	---	---	---	322	300	274	252
20	209	45	---	---	---	---	---	---	321	299	272	250
21	203	42	---	---	---	---	---	---	321	299	272	249
22	197	39	---	---	---	---	---	---	319	299	272	249
23	190	37	---	---	---	---	---	---	318	297	271	249
24	185	33	---	---	---	---	---	---	318	296	270	249
25	181	31	---	---	---	---	---	---	317	295	270	251
26	177	31	---	---	---	---	---	---	317	294	269	250
27	170	31	---	---	---	---	---	---	317	294	268	250
28	167	31	---	---	---	---	---	---	316	294	268	250
29	161	33	---	---	---	---	---	---	334	315	293	268
30	156	---	---	---	---	---	---	---	334	315	291	267
31	148	---	---	---	---	---	---	---	333	---	290	267
MAX	266	---	---	---	---	---	---	---	332	314	290	266
MIN	148	---	---	---	---	---	---	---	315	290	267	249
a	8.91							16.95	16.26	15.28	14.35	13.64
b	-120								-18	-25	-23	-17

WTR YR 2001 b -18

a Gage height, in feet, at end of month.  
b Change in contents, in acre-feet.

## 11426195 CANYON CREEK NEAR BLUE CANYON, CA

LOCATION.—Lat 39°15'27", long 120°43'57", in NW 1/4 NW 1/4 sec.15, T.16 N., R.11 E., [Placer County](#), Hydrologic Unit 18020128, on left bank, 200 ft upstream from culvert, and 1.2 mi west of Blue Canyon.

DRAINAGE AREA.—0.51 mi<sup>2</sup>.

PERIOD OF RECORD.—October 1999 to current year (low-flow records only). Unpublished records for water years 1981–99 available in files of the U.S. Geological Survey.

GAGE.—Nonrecording gage read most days. Datum of gage is 4,660 ft above sea level (from topographic map).

REMARKS.—No records computed above 1.2 ft<sup>3</sup>/s. No regulation or diversion upstream from station. See schematic diagram of [Bear River Basin](#).

COOPERATION.—Records were collected by Pacific Gas & Electric Co., under general supervision of the U.S. Geological Survey, in connection with a Federal Energy Regulatory Commission project.

## DISCHARGE, CUBIC FEET PER SECOND, WATER YEAR OCTOBER 2000 TO SEPTEMBER 2001

## DAILY INSTANTANEOUS VALUES

DAY	OCT	NOV	DEC	JAN	FEB	MAR	APR	MAY	JUN	JUL	AUG	SEP
1	.01	.10	.08	.08	.21	---	---	---	.21	.11	.04	.03
2	.01	.10	.07	.08	.12	.40	---	1.1	.21	.11	.05	.03
3	.02	.19	.07	---	.12	.34	---	1.1	.22	.08	---	.02
4	.01	.09	.06	---	.18	1.0	---	1.1	.22	.09	.04	.02
5	---	.07	.06	.06	.24	---	---	.96	.21	.08	.05	.02
6	.01	.07	.06	.06	.19	1.0	---	.85	.21	.08	.03	.02
7	.02	.06	.06	.06	.16	.96	---	.70	.19	.07	---	.02
8	.02	.06	.06	.06	.16	.96	1.0	.67	.19	.06	.03	.03
9	.02	.06	.06	.08	---	.96	.96	.64	.17	.06	.03	.02
10	.25	.06	.06	.12	---	.96	.96	.64	.17	.09	.04	.03
11	.40	.06	.06	.12	---	.70	---	.64	.14	.09	.04	.02
12	.05	.06	.13	.12	---	.70	---	.56	.22	.06	.05	.02
13	.04	.06	.14	.25	---	.76	1.0	.54	.17	.09	.04	.02
14	.04	.06	.44	.10	---	---	1.0	.49	.16	.08	.03	.02
15	.04	.06	.32	.10	---	---	1.0	.49	---	.08	.04	.02
16	.04	.06	.18	---	---	.76	1.1	.49	.12	.06	.04	.02
17	.04	.10	.14	.09	.25	.76	1.0	.44	.12	.06	.03	---
18	.02	.07	---	.09	.16	.96	1.0	.42	.12	.06	.03	.02
19	.02	.06	.12	.09	.18	1.1	---	.44	.14	.06	.03	.02
20	.07	---	.12	.09	---	1.1	---	.38	.12	.06	.03	.02
21	.03	.06	.12	.09	---	---	---	.38	---	.06	.03	.02
22	.03	.06	.17	.12	.36	---	---	---	.12	.05	.04	.02
23	.03	.06	.17	---	.30	---	---	.27	.13	.05	.03	.02
24	.03	.06	.18	.18	.29	---	---	.30	.10	.05	.09	.02
25	---	.06	---	.16	.25	---	---	.30	.10	.05	.03	.04
26	.05	.06	---	---	.46	---	---	.30	.12	.04	.03	---
27	.05	---	.10	.16	.40	---	---	.25	.13	.04	---	.02
28	.05	.07	.10	.16	.29	---	---	.27	---	.06	.03	.02
29	.44	---	.10	---	---	---	---	.25	.12	.04	.03	.02
30	.14	---	.10	.16	---	---	---	.22	.08	.04	---	.02
31	.12	---	.08	---	---	---	---	.24	---	.04	.03	---
TOTAL	---	---	---	---	---	---	---	---	---	2.05	---	---
MEAN	---	---	---	---	---	---	---	---	---	.066	---	---
MAX	---	---	---	---	---	---	---	---	---	.11	---	---
MIN	---	---	---	---	---	---	---	---	---	.04	---	---
AC-FT	---	---	---	---	---	---	---	---	---	4.1	---	---



## 11426196 CANYON CREEK BELOW TOWLE DIVERSION DAM, NEAR BLUE CANYON, CA

LOCATION.—Lat 39°14'31", long 120°45'03", in SE 1/4 NW 1/4 sec.21, T.16 N., R.11 E., [Placer County](#), Hydrologic Unit 18020128, on left bank, 4 ft downstream from Towle Diversion Dam, and 2.4 mi southwest of Blue Canyon.

DRAINAGE AREA.—1.35 mi<sup>2</sup>.

PERIOD OF RECORD.—October 1999 to current year (low-flow records only). Unpublished records for water years 1981–99 available in files of the U.S. Geological Survey.

GAGE.—Nonrecording gage read most days. Datum of gage is 4,320 ft above sea level (from topographic map).

REMARKS.—No records computed above 1.2 ft<sup>3</sup>/s. Flow regulated by Towle Diversion Dam. Water from the Drum Canal is diverted out of Drum Forebay to Canyon Creek upstream. Most of this water is diverted at the Towle Diversion Dam. See schematic diagram of [Bear River Basin](#).

COOPERATION.—Records were collected by Pacific Gas & Electric Co., under general supervision of the U.S. Geological Survey, in connection with a Federal Energy Regulatory Commission project.

DISCHARGE, CUBIC FEET PER SECOND, WATER YEAR OCTOBER 2000 TO SEPTEMBER 2001  
DAILY INSTANTANEOUS VALUES

DAY	OCT	NOV	DEC	JAN	FEB	MAR	APR	MAY	JUN	JUL	AUG	SEP
1	.06	.25	1.1	.79	.61	---	1.0	1.0	1.1	.18	.06	---
2	.06	.25	1.0	.82	.25	.85	---	1.0	---	.18	.05	---
3	.03	.25	1.2	---	.25	.70	1.0	1.0	---	.34	---	---
4	.02	.29	1.2	---	.25	1.0	1.0	1.0	1.1	.18	.06	---
5	---	.29	1.0	.25	.34	---	1.0	1.0	1.0	.14	.05	---
6	---	.25	.25	.25	.34	1.0	1.1	1.0	1.2	.16	.04	---
7	.12	.25	.32	.25	.40	1.0	1.2	1.0	1.0	.14	---	---
8	.07	.25	.25	.25	.70	1.0	1.0	1.0	1.0	.12	.05	---
9	.10	.25	.25	.25	---	1.0	1.1	1.0	1.0	.12	.08	---
10	.32	.25	.25	.25	---	1.0	1.1	.85	1.1	.13	.12	---
11	.44	.25	.25	.25	---	.85	---	1.0	---	.12	.19	---
12	.06	.25	1.0	.44	---	.76	1.0	.76	1.1	.25	.07	---
13	.25	.25	1.0	1.0	---	.85	1.0	.82	1.1	.19	.05	---
14	.25	.25	1.0	.70	---	---	1.0	---	1.1	.17	.04	.04
15	.25	.25	.92	.70	---	---	1.0	---	---	.17	.05	.10
16	.25	.25	.82	---	---	.85	1.1	---	.44	.12	.08	.07
17	.25	.22	.76	.25	.70	.85	1.1	---	.44	.12	.05	.05
18	.25	.22	---	.25	.70	1.0	1.1	---	.38	.11	.05	.05
19	.25	.25	.76	.25	.70	1.0	1.1	---	.34	.11	.04	.08
20	.25	---	.76	.25	---	1.0	1.1	---	.14	.07	.04	.02
21	.25	.25	.76	.34	---	1.0	1.1	---	---	.06	.12	.03
22	.25	.25	.82	.25	.70	1.0	1.1	---	.14	.07	.10	.02
23	.25	.25	.82	---	.64	1.0	1.1	---	.29	.07	.10	.05
24	.25	.25	.76	.25	.70	1.0	1.1	---	.25	.05	.09	.04
25	---	.25	---	.25	.56	1.0	1.1	---	.22	.05	.09	.08
26	.07	.32	---	---	.76	1.0	---	---	.18	.06	.08	---
27	.25	---	.85	.70	.70	1.0	1.0	---	.19	.08	.08	.54
28	.25	1.0	.85	.70	.70	1.0	1.0	---	---	.08	---	.18
29	.70	---	.85	---	---	1.0	1.0	---	.29	.08	---	.02
30	.64	---	.79	.70	---	1.0	1.0	1.0	.25	.07	---	.00
31	.25	---	.79	---	---	1.0	---	1.1	---	.06	---	---
TOTAL	---	---	---	---	---	---	---	---	---	3.85	---	---
MEAN	---	---	---	---	---	---	---	---	---	.12	---	---
MAX	---	---	---	---	---	---	---	---	---	.34	---	---
MIN	---	---	---	---	---	---	---	---	---	.05	---	---
AC-FT	---	---	---	---	---	---	---	---	---	7.6	---	---

## 11427000 NORTH FORK AMERICAN RIVER AT NORTH FORK DAM, CA

LOCATION.—Lat 38°56'10", long 121°01'22", in SW 1/4 NW 1/4 sec.31, T.13 N., R.9 E., Placer County, Hydrologic Unit 18020128, on left bank, 50 ft upstream from crest of North Fork Dam, 2 mi upstream from Middle Fork, and 4 mi northeast of Auburn.

DRAINAGE AREA.—342 mi<sup>2</sup>.

PERIOD OF RECORD.—October 1941 to current year.

CHEMICAL DATA: Water years 1977–80.

WATER TEMPERATURE: Water years 1959–83.

SEDIMENT DATA: Water year 1980 (periodic record).

REVISED RECORDS.—WSP 1931: Drainage area.

GAGE.—Water-stage recorder and ogee section of concrete debris dam. Datum of gage is 715.0 ft above sea level (levels by U.S. Army Corps of Engineers).

REMARKS.—Records fair. Minor regulation by Lake Clementine, usable capacity, 12,800 acre-ft, formed by North Fork Dam. Storage in Big Reservoir and Lake Valley Reservoir (station 11426170), combined capacity, 10,300 acre-ft, upstream from station. Lake Valley Canal (station 11426190) diverts from North Fork of North Fork American River into Bear River Basin for power development in powerplants of Pacific Gas & Electric Co. Combined storage and diversion have small effect on natural flow. See schematic diagrams of [Bear River](#) and [lower Sacramento River Basins](#).

EXTREMES FOR PERIOD OF RECORD.—Maximum discharge, 65,400 ft<sup>3</sup>/s, Dec. 23, 1964, gage height, 11.87 ft, from rating curve extended above 24,000 ft<sup>3</sup>/s, on basis of computed flow over crest of dam at gage height 10.22 ft; no flow, Aug. 27–30, Sept. 2–11, 1944; Oct. 5, 6, 1963; Nov. 7–10, 1965, caused by operation of valve in North Fork Dam.

EXTREMES FOR CURRENT YEAR.—Peak discharges greater than base discharge of 4,300 ft<sup>3</sup>/s, or maximum:

Date	Time	Discharge (ft <sup>3</sup> /s)	Gage height (ft)
Mar. 25	1445	2,530	2.72

## DISCHARGE, CUBIC FEET PER SECOND, WATER YEAR OCTOBER 2000 TO SEPTEMBER 2001

## DAILY MEAN VALUES

DAY	OCT	NOV	DEC	JAN	FEB	MAR	APR	MAY	JUN	JUL	AUG	SEP
1	56	115	174	96	150	432	1190	1440	228	71	46	32
2	55	99	149	94	142	435	1120	1420	220	68	45	32
3	55	91	139	92	141	440	859	1060	210	67	43	31
4	54	92	135	90	149	526	694	930	197	65	42	31
5	55	88	131	90	189	1180	603	972	187	64	39	31
6	55	84	129	90	222	1220	562	1060	179	61	39	30
7	54	81	124	89	193	995	677	1090	175	61	39	29
8	53	80	119	96	170	969	618	1250	169	60	38	28
9	57	86	113	103	177	937	542	1370	156	60	37	28
10	96	90	114	113	287	827	513	1230	147	59	36	28
11	119	101	134	394	481	695	502	1170	142	57	36	29
12	100	88	187	296	425	623	559	1160	135	57	35	30
13	80	86	184	186	321	591	508	1020	129	57	37	31
14	67	94	230	158	307	611	504	920	129	55	36	32
15	61	93	406	142	266	619	514	794	123	54	35	32
16	59	87	302	129	240	582	559	1140	117	52	35	31
17	57	84	232	119	236	555	687	917	112	52	34	32
18	57	87	202	115	239	623	798	749	108	53	33	31
19	58	100	173	114	389	778	1130	659	100	52	33	31
20	58	105	151	115	705	985	1230	598	97	51	33	32
21	58	107	135	111	797	1150	1170	554	95	50	33	31
22	56	109	131	106	1120	1120	1060	515	84	50	31	31
23	54	108	130	113	959	1090	1040	480	81	49	32	29
24	55	107	124	218	734	1120	1240	448	76	48	33	28
25	59	107	114	205	812	1880	1510	397	75	48	33	34
26	70	107	108	252	689	1680	1720	358	77	47	32	39
27	77	107	101	234	563	1200	1680	323	79	45	33	36
28	82	108	99	190	486	1110	1470	292	79	44	32	33
29	350	142	98	176	---	1380	1240	272	79	43	32	33
30	250	205	97	178	---	1250	1200	254	74	43	32	34
31	149	---	97	162	---	1150	---	241	---	44	32	---
TOTAL	2566	3038	4762	4666	11589	28753	27699	25083	3859	1687	1106	939
MEAN	82.8	101	154	151	414	928	923	809	129	54.4	35.7	31.3
MAX	350	205	406	394	1120	1880	1720	1440	228	71	46	39
MIN	53	80	97	89	141	432	502	241	74	43	31	28
AC-FT	5090	6030	9450	9260	22990	57030	54940	49750	7650	3350	2190	1860

## SACRAMENTO RIVER BASIN

## 11427000 NORTH FORK AMERICAN RIVER AT NORTH FORK DAM, CA—Continued

## STATISTICS OF MONTHLY MEAN DATA FOR WATER YEARS 1942 - 2001, BY WATER YEAR (WY)

	OCT	NOV	DEC	JAN	FEB	MAR	APR	MAY	JUN	JUL	AUG	SEP
MEAN	103	365	887	1362	1461	1497	1565	1614	788	194	66.6	50.4
MAX	1749	3307	5781	7303	8403	5187	4490	3688	2855	928	214	121
(WY)	1963	1951	1965	1997	1986	1995	1982	1952	1983	1983	1983	1982
MIN	18.3	35.6	33.9	44.6	70.5	114	207	273	71.7	25.8	13.4	14.9
(WY)	1978	1960	1977	1991	1991	1977	1977	1992	1992	1977	1977	1977

SUMMARY STATISTICS	FOR 2000 CALENDAR YEAR		FOR 2001 WATER YEAR		WATER YEARS 1942 - 2001	
ANNUAL TOTAL	270495		115747			
ANNUAL MEAN	739		317		826	
HIGHEST ANNUAL MEAN					1843	
LOWEST ANNUAL MEAN					88.5	
HIGHEST DAILY MEAN	14300	Feb 14	1880	Mar 25	50100	Jan 2 1997
LOWEST DAILY MEAN	53	Aug 28	28	Sep 8	.00	Aug 27 1944
ANNUAL SEVEN-DAY MINIMUM	54	Aug 25	29	Sep 6	.00	Sep 2 1944
MAXIMUM PEAK FLOW			2530	Mar 25	65400	Dec 23 1964
MAXIMUM PEAK STAGE			2.72	Mar 25	11.87	Dec 23 1964
ANNUAL RUNOFF (AC-FT)	536500		229600		598500	
10 PERCENT EXCEEDS	1730		1060		2050	
50 PERCENT EXCEEDS	154		114		270	
90 PERCENT EXCEEDS	58		33		43	

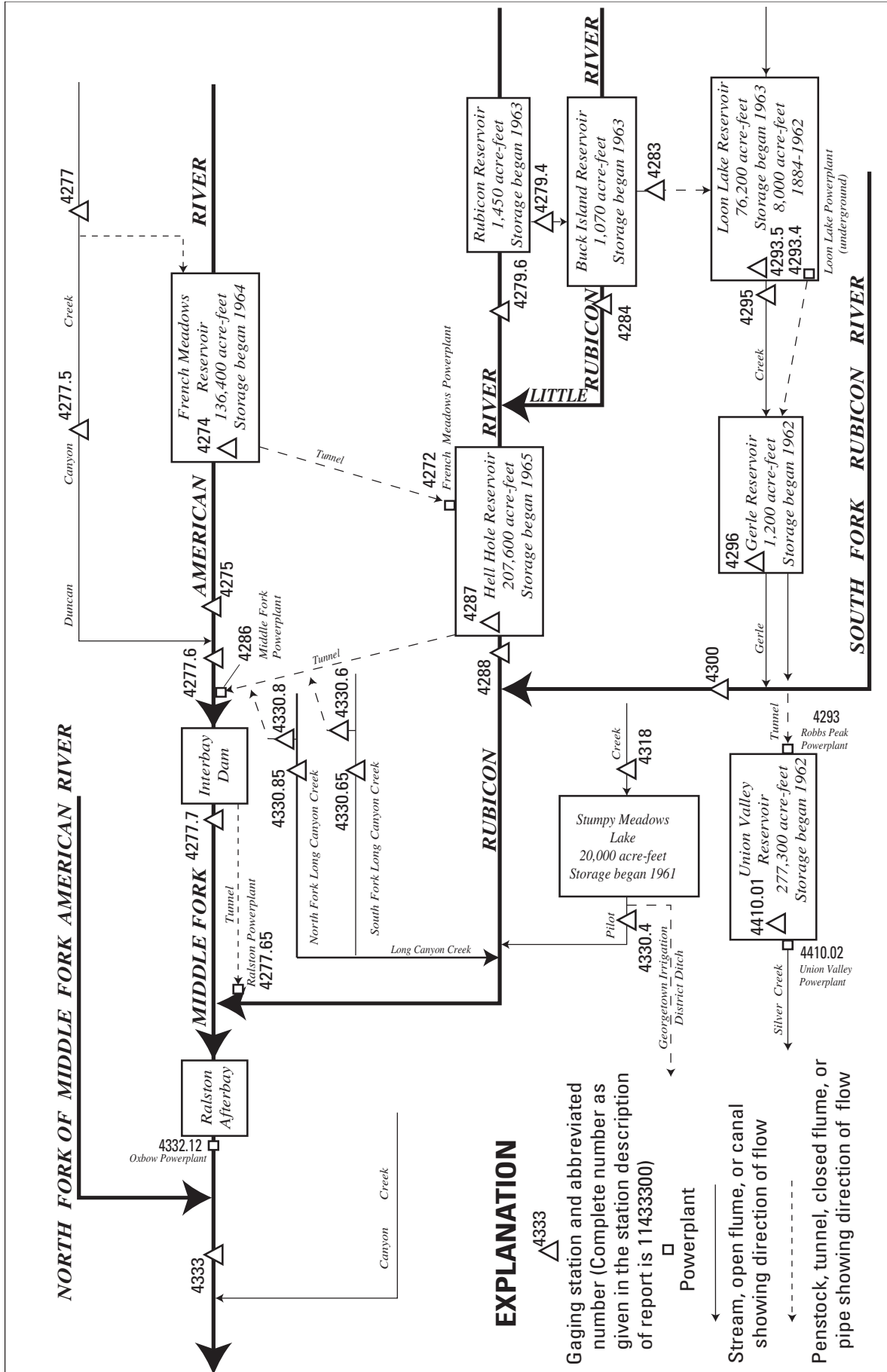

Figure 34. Diversions and storage in Middle Fork American and Rubicon River Basins.

## 11427400 FRENCH MEADOWS RESERVOIR NEAR FORESTHILL, CA

LOCATION.—Lat 39°06'32", long 120°25'49", in SW 1/4 NE 1/4 sec.32, T.15 N., R.14 E., Placer County, Hydrologic Unit 18020128, Tahoe National Forest, on left bank, 2.2 mi upstream from dam, on Middle Fork American River, 6.9 mi upstream from Chipmunk Creek, and 21 mi northeast of Foresthill.

DRAINAGE AREA.—47.0 mi<sup>2</sup>.

PERIOD OF RECORD.—December 1964 to current year.

GAGE.—Water-stage recorder. Datum of gage is sea level (levels by Placer County Water Agency).

REMARKS.—Reservoir is formed by rockfill dam with earth core. Storage began Dec. 21, 1964. Usable capacity, 125,601 acre-ft, between elevations 5,125 ft, minimum operating level, and 5,263 ft, top of radial gates. Dead storage, 10,804 acre-ft. Reservoir is used to store water for hydroelectric power. Up to 400 ft<sup>3</sup>/s diverted from Duncan Creek through a tunnel to reservoir. Water is released through a tunnel to French Meadows Powerplant (station 11427200) at Hell Hole Reservoir (station 11428700) on the Rubicon River; releases began Dec. 13, 1965. See schematic diagram of [Middle Fork American and Rubicon River Basins](#).

COOPERATION.—Records provided by Placer County Water Agency, under general supervision of the U.S. Geological Survey, in connection with a Federal Energy Regulatory Commission project.

EXTREMES FOR PERIOD OF RECORD.—Maximum contents, 137,700 acre-ft, May 19, 1966, elevation, 5,263.9 ft; minimum since reservoir first filled, 28,500 acre-ft, Oct. 21–24, 1991, elevation, 5,157.6 ft.

EXTREMES FOR CURRENT YEAR.—Maximum contents, 94,700 acre-ft, May 29, elevation, 5,230.5 ft; minimum, 44,500 acre-ft, Sept. 29, 30, elevation, 5,179.6 ft.

Capacity table (elevation, in feet, and contents, in acre-feet)  
(Based on a survey by Placer County Water Agency in 1965)

5,125	10,800	5,150	23,700	5,200	62,400	5,270	146,500
5,130	13,100	5,170	37,100	5,230	94,100		

## RESERVOIR STORAGE (ACRE-FEET), WATER YEAR OCTOBER 2000 TO SEPTEMBER 2001

## DAILY OBSERVATION AT 2400 HOURS

DAY	OCT	NOV	DEC	JAN	FEB	MAR	APR	MAY	JUN	JUL	AUG	SEP
1	79000	68100	51300	51000	50800	50800	62300	79500	94100	85400	74900	59500
2	79000	67600	50800	51000	50800	50900	63000	80500	94200	84900	74400	59100
3	79000	67200	50600	51000	50800	50900	63400	81200	94300	84400	73800	58600
4	78900	66700	50600	51000	50800	51100	63800	82000	94100	84000	73700	58100
5	78900	66400	50600	51000	50900	51200	64100	82700	93700	83700	73700	57400
6	78900	65900	50600	51000	51000	51200	64500	e83500	93400	83300	73200	56900
7	78800	65400	50600	51000	51000	51300	64800	84300	93000	83300	72700	56300
8	78400	64900	50600	51000	51000	51400	65000	85300	92700	83300	72100	55900
9	78000	64400	50600	51100	50900	51500	65200	86100	92500	82800	71600	55400
10	77600	63900	50600	51200	51000	51600	65400	87000	92200	82400	71000	54900
11	77200	63200	50700	51100	51200	51600	65700	87800	91900	82000	70900	54300
12	76600	62600	50700	51100	51000	51700	65900	88700	91900	81500	70900	53800
13	76400	61900	50800	51100	50800	51800	66100	89600	91800	81000	70300	53400
14	76300	61200	50800	51100	50800	52000	66300	90200	91300	81000	69800	52800
15	76200	60500	50800	51100	50700	52100	66500	91000	90900	81000	69200	52400
16	76100	59700	50800	51100	50600	52100	66900	91700	90900	80700	68600	52000
17	75200	58900	50800	50600	50600	52300	67400	92200	90600	80400	68000	51400
18	74800	58200	50900	50500	50600	52600	68000	92600	90200	79800	67500	50900
19	74100	57600	50900	50500	50800	52800	68800	93200	89800	79400	67000	50300
20	73500	56900	50900	50500	50800	53000	69400	93600	89600	78900	66400	49800
21	73000	56100	50900	50600	50800	53600	69800	93700	89000	78900	65700	49200
22	72600	55500	50900	50600	50900	54200	70200	94000	88500	78900	65100	48600
23	72000	55200	50900	50700	51000	54700	70800	94000	88300	78300	64600	48200
24	71500	54800	50900	50700	51100	55400	71700	94000	88100	77900	63900	47500
25	71000	54300	50900	50800	51100	56700	72900	94100	87700	77400	63500	46800
26	70500	53800	50900	50800	51100	57500	74200	94200	87100	77000	63000	46000
27	69600	53200	50900	50800	51100	58100	75500	94400	86700	76500	62400	45300
28	69800	52700	50900	50800	50800	59000	76400	94500	86300	76400	61800	44600
29	69500	52200	50900	50800	---	59800	77300	94500	85800	76400	61200	44500
30	69000	51800	50900	50800	---	60600	78300	94300	85600	75900	60700	44500
31	68600	---	50900	50800	---	61400	---	94200	---	75400	60000	---
MAX	79000	68100	51300	51200	51200	61400	78300	94500	94300	85400	74900	59500
MIN	68600	51800	50600	50500	50600	50800	62300	79500	85600	75400	60000	44500
a	5206.3	5188.3	5187.3	5187.2	5187.2	5198.9	5215.8	5230.1	5222.5	5213.0	5197.4	5179.6
b	-10500	-16800	-900	-100	0	+10600	+16900	+15900	-8600	-10200	-15400	-15500

CAL YR 2000 b -20700

WTR YR 2001 b -34600

e Estimated.

a Elevation, in feet, at end of month.

b Change in contents, in acre-feet.

## 11427500 MIDDLE FORK AMERICAN RIVER AT FRENCH MEADOWS, CA

LOCATION.—Lat 39°06'35", long 120°28'49", in SW 1/4 NW 1/4 sec.36, T.15 N., R.13 E., Placer County, Hydrologic Unit 18020128, Tahoe National Forest, on left bank, 0.6 mi downstream from French Meadows Dam, 4.1 mi upstream from Chipmunk Creek, and 14 mi south of Cisco.

DRAINAGE AREA.—47.9 mi<sup>2</sup>.

PERIOD OF RECORD.—October 1951 to current year.

REVISED RECORDS.—WSP 1445: 1953–54. WSP 1931: Drainage area.

GAGE.—Water-stage recorder. Elevation of gage is 4,920 ft above sea level, from topographic map. Prior to Oct. 1, 1962, at site 0.8 mi upstream at different datum.

REMARKS.—Considerable regulation by French Meadows Reservoir (station 11427400) 0.6 mi upstream beginning December 1964. Water diverted into basin from Duncan Creek to French Meadows Reservoir since December 1964. Water diverted out of basin from French Meadows Reservoir through French Meadows Powerplant (station 11427200) to Hell Hole Reservoir (station 11428700) since December 1965. See schematic diagram of [Middle Fork American and Rubicon River Basins](#).

COOPERATION.—Records provided by Placer County Water Agency, under general supervision of the U.S. Geological Survey, in connection with a Federal Energy Regulatory Commission project.

EXTREMES FOR PERIOD OF RECORD.—Maximum discharge, 21,500 ft<sup>3</sup>/s, Jan. 31, 1963, gage height, 14.20 ft, from rating curve extended above 1,100 ft<sup>3</sup>/s on basis of peak flow at former site; minimum, 0.3 ft<sup>3</sup>/s, Oct. 4, 5, 21–25, 1960, Oct. 5, 6, 1961. Maximum discharge since construction of French Meadows Dam in 1964, 6,050 ft<sup>3</sup>/s, May 16, 1996, gage height, 11.61 ft, from flow over spillway of French Meadows Reservoir; minimum daily, 0.8 ft<sup>3</sup>/s, Oct. 22–25, 1964.

## DISCHARGE, CUBIC FEET PER SECOND, WATER YEAR OCTOBER 2000 TO SEPTEMBER 2001

## DAILY MEAN VALUES

DAY	OCT	NOV	DEC	JAN	FEB	MAR	APR	MAY	JUN	JUL	AUG	SEP
1	9.8	10	11	9.7	10	10	13	12	10	9.9	9.3	9.5
2	9.9	9.9	11	9.7	9.9	10	13	11	10	9.9	9.4	9.5
3	9.9	9.9	11	9.9	10	10	12	11	10	9.9	9.5	9.5
4	9.9	9.9	11	9.9	10	11	11	10	10	9.9	9.5	9.5
5	9.9	9.9	10	9.9	10	12	11	10	10	9.9	9.5	9.5
6	9.9	11	9.7	9.9	10	11	11	10	10	9.7	9.5	9.4
7	9.9	13	9.7	9.9	10	11	11	10	10	9.7	9.5	9.3
8	9.9	13	9.7	9.9	9.9	11	11	9.9	10	9.7	9.5	9.3
9	10	11	9.7	9.9	10	11	10	9.9	10	9.7	9.5	9.3
10	10	11	9.8	10	10	11	10	9.8	10	9.7	9.5	9.3
11	10	11	9.7	10	10	11	10	9.7	10	9.7	9.5	9.3
12	10	11	10	10	10	11	10	9.7	10	9.7	9.5	9.3
13	9.9	10	9.8	9.9	10	11	10	9.6	10	9.7	9.5	9.3
14	9.9	10	10	9.9	10	11	10	9.5	10	9.7	9.5	9.3
15	9.9	10	10	9.9	10	11	10	9.7	10	9.6	9.6	9.3
16	9.9	10	9.9	9.9	10	11	11	9.6	10	9.5	9.7	9.3
17	10	10	9.9	9.9	10	12	11	9.5	10	9.5	9.7	9.3
18	11	10	9.7	9.9	10	12	12	9.5	10	9.5	9.7	9.3
19	11	10	9.7	9.9	10	12	15	9.6	10	9.5	9.7	9.3
20	9.9	10	9.7	9.9	10	13	13	9.7	10	9.5	9.7	9.3
21	13	10	9.8	9.9	10	14	13	9.7	10	9.5	9.7	9.3
22	12	10	9.9	9.9	11	14	12	9.7	10	9.5	9.7	9.3
23	12	10	9.7	10	10	14	13	9.7	9.9	9.5	9.7	9.3
24	12	10	9.7	10	10	14	14	9.7	9.9	9.5	9.7	9.3
25	12	10	9.7	10	10	18	14	9.5	9.9	9.5	9.7	9.4
26	12	10	9.7	10	10	16	14	9.5	9.9	9.5	9.7	9.2
27	12	10	9.7	10	10	14	13	9.5	9.9	9.5	9.6	9.1
28	12	11	9.7	10	10	14	13	9.5	9.9	9.5	9.5	9.1
29	12	11	9.7	10	---	14	12	9.5	9.9	9.5	9.5	9.1
30	12	11	9.7	10	---	14	12	9.5	9.9	9.5	9.5	9.1
31	11	---	9.7	10	---	13	---	9.8	---	9.4	9.5	---
TOTAL	332.6	313.6	308.0	307.7	280.8	382	355	305.3	299.2	298.3	296.6	279.3
MEAN	10.7	10.5	9.94	9.93	10.0	12.3	11.8	9.85	9.97	9.62	9.57	9.31
MAX	13	13	11	10	11	18	15	12	10	9.9	9.7	9.5
MIN	9.8	9.9	9.7	9.7	9.9	10	10	9.5	9.9	9.4	9.3	9.1
AC-FT	660	622	611	610	557	758	704	606	593	592	588	554
a	9580	15350	1120	599	962	327	.00	3560	9080	9290	14200	13850

a Diversion, in acre-feet, from French Meadows Reservoir to Hell Hole Reservoir through French Meadows Powerplant (station 11427200), provided by Placer County Water Agency.

## 11427500 MIDDLE FORK AMERICAN RIVER AT FRENCH MEADOWS, CA—Continued

## STATISTICS OF MONTHLY MEAN DATA FOR WATER YEARS 1952 - 1964, BY WATER YEAR (WY)

	OCT	NOV	DEC	JAN	FEB	MAR	APR	MAY	JUN	JUL	AUG	SEP
MEAN	19.8	20.3	101	92.5	143	151	356	550	297	52.4	6.04	2.10
MAX	222	106	882	377	561	367	537	1110	775	232	25.3	5.06
(WY)	1963	1964	1956	1956	1963	1960	1962	1958	1952	1952	1952	1952
MIN	.40	1.60	1.76	5.57	40.1	55.2	187	210	69.7	6.22	1.57	.64
(WY)	1961	1960	1960	1960	1955	1962	1955	1959	1959	1959	1959	1961

## SUMMARY STATISTICS

## WATER YEARS 1952 - 1964

ANNUAL MEAN	149
HIGHEST ANNUAL MEAN	265 1956
LOWEST ANNUAL MEAN	68.7 1961
HIGHEST DAILY MEAN	11300 Dec 23 1955
LOWEST DAILY MEAN	.30 Oct 22 1960
ANNUAL SEVEN-DAY MINIMUM	.34 Oct 19 1960
MAXIMUM PEAK FLOW	21500 Jan 31 1963
MAXIMUM PEAK STAGE	14.20 Jan 31 1963
ANNUAL RUNOFF (AC-FT)	108000
10 PERCENT EXCEEDS	446
50 PERCENT EXCEEDS	38
90 PERCENT EXCEEDS	1.5

## STATISTICS OF MONTHLY MEAN DATA FOR WATER YEARS 1965 - 2001, BY WATER YEAR (WY)

MEAN	15.0	10.3	12.7	19.6	18.1	22.4	23.3	59.0	42.1	16.2	8.59	11.7
MAX	266	42.7	83.3	249	200	375	248	518	272	136	15.0	136
(WY)	1966	1966	1965	1997	1982	1986	1965	1965	1995	1983	1965	1965
MIN	1.67	3.16	3.91	4.37	4.53	4.40	4.47	3.95	3.68	2.98	2.76	2.70
(WY)	1965	1978	1977	1977	1977	1977	1977	1976	1977	1977	1977	1977

## SUMMARY STATISTICS

## FOR 2000 CALENDAR YEAR

## FOR 2001 WATER YEAR

## WATER YEARS 1965 - 2001

ANNUAL TOTAL	4203.0	3758.4	
ANNUAL MEAN	11.5	10.3	21.6
HIGHEST ANNUAL MEAN			97.3 1965
LOWEST ANNUAL MEAN			3.90 1977
HIGHEST DAILY MEAN	60 Feb 14	18 Mar 25	3430 May 16 1996
LOWEST DAILY MEAN	9.1 May 4	9.1 Sep 27	.80 Oct 22 1964
ANNUAL SEVEN-DAY MINIMUM	9.3 Jul 18	9.2 Sep 24	.84 Oct 21 1964
MAXIMUM PEAK FLOW		29 Dec 12	6050 May 16 1996
MAXIMUM PEAK STAGE		5.80 Dec 12	11.61 May 16 1996
ANNUAL RUNOFF (AC-FT)	8340	7450	15640
TOTAL DIVERSION (AC-FT) a	132600	77920	
10 PERCENT EXCEEDS	15	12	15
50 PERCENT EXCEEDS	10	9.9	9.7
90 PERCENT EXCEEDS	9.6	9.5	5.8

a Diversion, in acre-feet, from French Meadows Reservoir to Hell Hole Reservoir through French Meadows Powerplant (station 11427200), provided by Placer County Water Agency.

## 11427700 DUNCAN CANYON CREEK NEAR FRENCH MEADOWS, CA

LOCATION.—Lat 39°08'09", long 120°28'39", in NE 1/4 NW 1/4 sec.24, T.15 N., R.13 E., Placer County, Hydrologic Unit 18020128, Tahoe National Forest, on left bank, 0.2 mi upstream from diversion dam, 0.5 mi downstream from Little Duncan Creek, 2 mi northwest of French Meadows, and 20 mi northeast of Foresthill.

DRAINAGE AREA.—9.94 mi<sup>2</sup>.

PERIOD OF RECORD.—August 1960 to current year. Published as Duncan Creek near French Meadows 1961–2000.

GAGE.—Water-stage recorder. Elevation of gage is 5,270 ft above sea level, from topographic map. Prior to Sept. 3, 1965, at site 150 ft upstream at datum 9.56 ft higher.

REMARKS.—No regulation or diversion upstream from station. See schematic diagram of Middle Fork American and Rubicon River Basins.

COOPERATION.—Records provided by Placer County Water Agency, under general supervision of the U.S. Geological Survey, in connection with a Federal Energy Regulatory Commission project.

EXTREMES FOR PERIOD OF RECORD.—Maximum discharge, 3,650 ft<sup>3</sup>/s, Dec. 22, 1964, gage height, 10.6 ft, from floodmarks, from rating curve extended above 400 ft<sup>3</sup>/s, on basis of computation of flow over diversion dam; maximum gage height, 10.95, Jan. 1, 1997 (backwater from debris dam); minimum daily, 0.10 ft<sup>3</sup>/s, several days during July and August 1977.

EXTREMES FOR CURRENT YEAR.—Peak discharges greater than base discharge of 250 ft<sup>3</sup>/s, or maximum:

Date	Time	Discharge (ft <sup>3</sup> /s)	Gage height (ft)
Apr. 26	1800	199	7.09

## DISCHARGE, CUBIC FEET PER SECOND, WATER YEAR OCTOBER 2000 TO SEPTEMBER 2001

## DAILY MEAN VALUES

DAY	OCT	NOV	DEC	JAN	FEB	MAR	APR	MAY	JUN	JUL	AUG	SEP
1	.70	3.7	4.2	4.1	4.7	5.0	102	147	11	1.8	.59	.41
2	.70	4.7	4.0	4.0	4.9	5.1	84	127	9.7	1.7	.57	.41
3	.70	4.5	3.8	3.8	5.9	4.8	59	101	8.9	1.6	.52	.41
4	.65	3.6	3.7	4.1	10	5.8	45	94	8.2	1.5	.50	.41
5	.58	3.3	3.4	4.1	11	7.3	38	102	7.6	1.5	.50	.41
6	.57	3.1	3.1	3.9	8.6	8.2	34	108	7.1	1.4	e.48	.40
7	.57	2.6	3.1	3.7	6.7	11	30	125	6.4	1.4	e.47	.41
8	.57	2.8	3.1	3.9	6.7	13	26	151	5.9	1.4	.44	.39
9	1.0	3.3	3.2	4.0	5.8	13	24	149	5.4	1.2	.43	.36
10	3.6	3.0	6.7	3.9	6.6	10	23	138	5.1	1.2	.41	.36
11	3.0	2.6	4.8	5.0	e6.6	11	22	135	4.8	1.1	.40	.41
12	2.0	2.5	4.6	5.2	e6.6	12	21	122	4.7	1.1	.42	.41
13	1.7	2.5	4.0	4.6	e6.5	15	21	106	4.4	1.0	.41	.41
14	1.7	2.7	e4.3	4.1	6.3	16	22	86	4.1	.96	.41	.41
15	1.5	2.5	e5.3	4.0	5.8	16	25	98	3.8	.94	.40	.41
16	1.4	2.5	5.0	4.1	5.6	15	32	97	3.6	.94	.38	.41
17	1.3	2.5	5.7	e4.8	5.5	19	40	76	3.3	.95	.37	.44
18	1.2	2.6	5.5	e5.1	5.4	26	45	63	3.1	.94	.35	.47
19	1.1	2.8	5.5	e5.0	5.3	36	55	54	2.9	.91	.34	.47
20	1.2	2.7	5.2	e4.9	5.2	49	41	47	2.8	.86	.38	.47
21	1.3	2.7	5.3	4.9	5.2	52	38	41	2.6	.82	.40	.47
22	1.0	2.5	5.3	4.9	5.3	56	42	36	2.4	.78	.41	.47
23	1.0	2.4	4.7	5.1	5.0	59	53	31	2.3	.76	.41	.47
24	1.0	2.5	4.3	e5.2	5.0	72	81	27	2.2	.74	.41	.47
25	1.3	2.6	4.1	5.0	5.0	143	124	23	2.2	.66	.41	.82
26	2.6	2.6	3.8	e5.0	5.0	89	150	20	2.5	.63	.41	.77
27	2.3	2.8	3.8	4.8	5.0	73	146	17	2.7	.58	.41	.66
28	8.6	3.2	3.8	4.8	5.2	92	124	15	2.5	.56	.41	.60
29	8.3	4.5	4.2	4.9	---	100	110	14	2.2	.53	.41	.60
30	4.4	4.2	4.4	4.7	---	93	130	13	2.0	.57	.41	.59
31	3.6	---	4.4	4.6	---	100	---	12	---	.68	.41	---
TOTAL	61.14	90.5	136.3	140.2	170.4	1227.2	1787	2375	136.4	31.71	13.27	14.20
MEAN	1.97	3.02	4.40	4.52	6.09	39.6	59.6	76.6	4.55	1.02	.43	.47
MAX	8.6	4.7	6.7	5.2	11	143	150	151	11	1.8	.59	.82
MIN	.57	2.4	3.1	3.7	4.7	4.8	21	12	2.0	.53	.34	.36
AC-FT	121	180	270	278	338	2430	3540	4710	271	63	26	28

e Estimated.



## SACRAMENTO RIVER BASIN

## 11427700 DUNCAN CANYON CREEK NEAR FRENCH MEADOWS, CA—Continued

## STATISTICS OF MONTHLY MEAN DATA FOR WATER YEARS 1960 - 2001, BY WATER YEAR (WY)

	OCT	NOV	DEC	JAN	FEB	MAR	APR	MAY	JUN	JUL	AUG	SEP
MEAN	3.95	17.2	33.3	43.5	41.0	51.2	76.8	120	59.8	9.09	1.56	1.11
MAX	51.1	172	256	213	291	161	162	245	316	100	10.4	4.51
(WY)	1963	1984	1965	1997	1986	1986	1989	1993	1983	1983	1983	1982
MIN	.22	1.09	.76	1.76	3.24	5.75	12.7	12.9	2.71	.51	.19	.34
(WY)	1978	1977	1977	1991	1977	1977	1977	1992	1992	1977	1977	1960

SUMMARY STATISTICS	FOR 2000 CALENDAR YEAR		FOR 2001 WATER YEAR		WATER YEARS 1960 - 2001	
ANNUAL TOTAL	12861.63		6183.32			
ANNUAL MEAN	35.1		16.9		38.2	
HIGHEST ANNUAL MEAN					86.8	
LOWEST ANNUAL MEAN					4.27	
HIGHEST DAILY MEAN	431	Feb 14	151	May 8	2800	Jan 1 1997
LOWEST DAILY MEAN	.57	Oct 6	.34	Aug 19	.10	Jul 31 1977
ANNUAL SEVEN-DAY MINIMUM	.62	Oct 2	.37	Aug 15	.11	Aug 8 1977
MAXIMUM PEAK FLOW			199	Apr 26	3650	Dec 22 1964
MAXIMUM PEAK STAGE			7.09	Apr 26	10.95	Jan 1 1997
ANNUAL RUNOFF (AC-FT)	25510		12260		27670	
10 PERCENT EXCEEDS	121		59		107	
50 PERCENT EXCEEDS	4.6		4.1		8.9	
90 PERCENT EXCEEDS	.87		.41		.75	

a Backwater from debris dam.

## 11427750 DUNCAN CANYON CREEK BELOW DIVERSION DAM, NEAR FRENCH MEADOWS, CA

LOCATION.—Lat 39°07'59", long 120°28'58", in NE 1/4 SE 1/4 sec.23, T.15 N., R.13 E., Placer County, Hydrologic Unit 18020128, Tahoe National Forest, on right bank, 800 ft downstream from unnamed right bank tributary, 1,000 ft downstream from Duncan Canyon Creek Diversion Dam, and 20 mi northeast of Foresthill.

DRAINAGE AREA.—10.5 mi<sup>2</sup>.

PERIOD OF RECORD.—October 1964 to current year. Published as "Duncan Creek below Diversion Dam, near French Meadows" 1965–2000.

GAGE.—Water-stage recorder. Elevation of gage is 5,210 ft above sea level, from topographic map.

REMARKS.—Natural flow affected by transmountain diversion through Duncan Canyon Creek Diversion Tunnel to French Meadows Reservoir (station 11427400). Maximum design flow of tunnel is 400 ft<sup>3</sup>/s. See schematic diagram of Middle Fork American and Rubicon River Basins.

COOPERATION.—Records provided by Placer County Water Agency, under general supervision of the U.S. Geological Survey, in connection with a Federal Energy Regulatory Commission project.

EXTREMES FOR PERIOD OF RECORD.—Maximum discharge, 3,640 ft<sup>3</sup>/s, Dec. 22, 1964, gage height, 8.74 ft, in gage well, 10.0 ft, from floodmarks, from rating curve extended above 400 ft<sup>3</sup>/s, on basis of computation of peak flow over diversion dam; no flow at times in 1965–66.

DISCHARGE, CUBIC FEET PER SECOND, WATER YEAR OCTOBER 2000 TO SEPTEMBER 2001  
DAILY MEAN VALUES

DAY	OCT	NOV	DEC	JAN	FEB	MAR	APR	MAY	JUN	JUL	AUG	SEP
1	.75	3.8	4.3	4.1	4.9	5.8	17	15	10	1.9	.73	.19
2	.75	4.6	4.0	4.0	5.2	5.9	16	14	9.4	1.7	.67	.24
3	.75	4.7	3.9	3.9	6.0	5.7	15	14	8.8	1.6	.58	.30
4	.75	3.8	3.7	4.1	9.7	6.7	14	13	8.2	1.5	.56	.32
5	.75	3.3	3.4	4.1	12	8.3	14	13	7.6	1.5	.56	.26
6	.69	3.2	3.2	4.0	9.7	9.2	14	13	7.3	1.4	.54	.10
7	.69	2.6	3.1	3.9	7.7	11	14	13	6.7	1.4	.54	.16
8	.69	2.7	3.1	4.1	7.2	13	13	12	6.2	1.4	.49	.31
9	.94	3.5	3.1	4.0	e7.0	13	13	12	5.8	1.3	.46	.24
10	3.8	3.0	6.5	4.3	e6.7	12	13	12	5.4	1.2	.44	.30
11	3.3	2.7	5.0	5.4	e6.7	12	13	11	5.1	1.2	.43	.34
12	2.3	2.4	4.7	5.4	e6.5	13	13	11	4.9	1.2	.41	.38
13	1.7	2.4	4.1	4.8	e6.5	14	13	11	4.6	1.1	.40	.40
14	1.7	2.6	4.4	4.3	e6.3	14	13	10	4.3	1.0	.40	.42
15	1.6	2.4	5.4	4.2	e6.2	15	14	9.5	4.0	1.0	.40	.44
16	1.5	2.4	5.1	4.2	6.2	14	15	8.5	3.7	.99	.40	.44
17	1.4	2.4	5.8	4.6	6.2	15	16	9.6	3.5	1.0	.40	.44
18	1.3	2.5	5.6	5.1	e5.8	18	16	12	3.2	1.0	.40	.47
19	1.2	2.7	5.5	5.1	e5.4	20	17	12	3.1	.95	.40	.49
20	1.3	2.7	5.3	4.9	e5.4	22	16	12	2.9	.95	.39	.49
21	1.4	2.6	5.3	4.9	e5.4	21	15	12	2.7	.93	.38	.49
22	1.2	2.6	5.4	5.0	e5.4	22	16	12	2.5	.88	.40	.49
23	1.2	2.5	4.9	e5.4	e5.3	21	17	12	2.4	.88	.40	.49
24	1.2	2.6	4.4	e5.2	e5.4	21	20	12	2.2	.86	.40	.49
25	1.4	2.6	4.1	e5.0	5.8	27	19	12	2.2	.80	.40	.77
26	2.7	2.7	3.8	e5.0	5.9	22	18	11	2.5	.74	.37	.72
27	2.5	2.8	3.8	e5.0	5.7	19	17	11	2.7	.68	.38	.64
28	5.1	3.2	3.8	5.2	5.9	19	16	11	2.7	.63	.28	.64
29	8.7	4.6	4.2	5.3	---	18	15	11	2.2	.60	.23	.62
30	4.7	4.3	4.4	4.9	---	18	15	11	2.0	.62	.28	.59
31	3.8	---	4.3	4.9	---	17	---	11	---	.76	.27	---
TOTAL	61.76	90.9	137.6	144.3	182.1	472.6	457	363.6	138.8	33.67	13.39	12.67
MEAN	1.99	3.03	4.44	4.65	6.50	15.2	15.2	11.7	4.63	1.09	.43	.42
MAX	8.7	4.7	6.5	5.4	12	27	20	15	10	1.9	.73	.77
MIN	.69	2.4	3.1	3.9	4.9	5.7	13	8.5	2.0	.60	.23	.10
AC-FT	123	180	273	286	361	937	906	721	275	67	27	25

## STATISTICS OF MONTHLY MEAN DATA FOR WATER YEARS 1965 - 2001, BY WATER YEAR (WY)

MEAN	2.12	8.39	21.3	29.9	21.6	19.2	15.7	28.3	13.4	3.92	1.40	1.08
MAX	17.3	76.1	244	225	237	80.3	91.7	149	107	21.9	5.87	3.61
(WY)	1983	1982	1965	1997	1986	1986	1982	1967	1998	1983	1983	1983
MIN	.061	1.15	.76	1.69	2.02	2.63	4.80	3.88	2.15	.44	.28	.090
(WY)	1966	1991	1977	1991	1974	1965	1974	1976	1965	1965	1977	1965

SUMMARY STATISTICS	FOR 2000 CALENDAR YEAR		FOR 2001 WATER YEAR		WATER YEARS 1965 - 2001	
ANNUAL TOTAL	3375.57		2108.39			
ANNUAL MEAN	9.22		5.78		13.8	
HIGHEST ANNUAL MEAN					43.1	
LOWEST ANNUAL MEAN					2.16	
HIGHEST DAILY MEAN	247	Feb 14	27	Mar 25	2560	Jan 1 1997
LOWEST DAILY MEAN	.69	Oct 6	.10	Sep 6	.00	Sep 10 1965
ANNUAL SEVEN-DAY MINIMUM	.72	Oct 2	.22	Sep 1	.00	Sep 10 1965
MAXIMUM PEAK FLOW			32	Mar 25	3640	Dec 22 1964
MAXIMUM PEAK STAGE			a2.09	Feb 11	8.74	Dec 22 1964
ANNUAL RUNOFF (AC-FT)	6700		4180		10030	
10 PERCENT EXCEEDS	18		14		16	
50 PERCENT EXCEEDS	4.8		4.1		5.4	
90 PERCENT EXCEEDS	.93		.44		.73	

e Estimated.  
a Ice jam.

## 11427760 MIDDLE FORK AMERICAN RIVER ABOVE MIDDLE FORK POWERPLANT, NEAR FORESTHILL, CA

LOCATION.—Lat 39°01'31", long 120°35'40", in NW 1/4 NW 1/4 sec.36, T.14 N., R.12 E., Placer County, Hydrologic Unit 18020128, Tahoe National Forest, on right bank, 300 ft upstream from Middle Fork Powerplant, 3.7 mi upstream from Big Mosquito Creek, and 11 mi east of Foresthill.

DRAINAGE AREA.—87.8 mi<sup>2</sup>.

PERIOD OF RECORD.—August 1965 to current year.

GAGE.—Water-stage recorder. Elevation of gage is 2,540 ft above sea level, from topographic map. Prior to May 15, 1980, at datum 5.00 ft higher. May 15, 1980, to Oct. 11, 1984, at datum 4.00 ft higher.

REMARKS.—Considerable regulation by French Meadows Reservoir (station 11427400) 11 mi upstream. Transbasin diversions from French Meadows Reservoir to Hell Hole Reservoir (station 11428700) through French Meadows Powerplant (station 11427200). See schematic diagram of [Middle Fork American and Rubicon River Basins](#).

COOPERATION.—Records provided by Placer County Water Agency, under general supervision of the U.S. Geological Survey, in connection with a Federal Energy Regulatory Commission project.

EXTREMES FOR PERIOD OF RECORD.—Maximum discharge, 13,900 ft<sup>3</sup>/s, Jan. 2, 1997, gage height, 14.6 ft, from floodmark, from rating curve extended above 4,200 ft<sup>3</sup>/s; minimum daily, 5.3 ft<sup>3</sup>/s, Sept. 11, 1977.

## DISCHARGE, CUBIC FEET PER SECOND, WATER YEAR OCTOBER 2000 TO SEPTEMBER 2001

## DAILY MEAN VALUES

DAY	OCT	NOV	DEC	JAN	FEB	MAR	APR	MAY	JUN	JUL	AUG	SEP
1	15	23	26	22	26	45	131	120	38	17	12	11
2	15	22	24	22	26	48	123	114	36	17	12	11
3	15	23	23	22	28	44	108	104	35	16	12	11
4	16	22	23	21	35	63	99	98	34	16	12	11
5	15	21	22	21	45	93	92	95	33	16	12	11
6	15	20	21	21	42	96	89	91	32	15	12	11
7	15	22	20	21	37	90	96	87	31	15	12	11
8	15	24	20	23	31	98	84	84	29	15	12	10
9	17	30	20	22	36	100	79	81	28	15	11	11
10	29	25	24	28	35	88	77	76	28	15	11	11
11	25	23	25	38	34	82	82	71	27	14	11	11
12	22	21	28	28	34	77	78	68	26	14	11	11
13	19	21	24	26	35	79	77	64	26	14	11	11
14	18	23	44	25	33	83	77	61	25	14	11	11
15	18	21	53	23	32	86	78	61	24	14	11	11
16	17	20	36	22	32	83	83	59	23	14	11	11
17	17	20	31	22	33	85	90	54	23	14	11	11
18	17	20	29	23	36	97	97	55	22	14	11	11
19	17	20	28	23	45	113	142	53	22	13	11	11
20	18	20	26	24	56	131	140	52	21	13	11	11
21	18	20	27	23	66	140	131	50	20	13	11	11
22	19	20	28	23	86	145	132	48	19	13	11	11
23	19	19	26	25	63	145	135	47	19	13	11	11
24	19	20	25	36	59	146	154	45	18	13	11	10
25	22	20	24	31	60	214	165	44	18	13	11	12
26	25	20	23	30	56	181	163	43	20	13	11	11
27	22	20	23	28	51	153	153	42	20	12	10	11
28	27	21	22	27	48	148	140	41	20	12	11	11
29	65	36	22	28	---	150	128	40	19	12	11	11
30	34	32	22	26	---	140	122	39	18	12	11	10
31	27	---	22	26	---	134	---	38	---	13	11	---
TOTAL	652	669	811	780	1200	3377	3345	2025	754	434	348	328
MEAN	21.0	22.3	26.2	25.2	42.9	109	112	65.3	25.1	14.0	11.2	10.9
MAX	65	36	53	38	86	214	165	120	38	17	12	12
MIN	15	19	20	21	26	44	77	38	18	12	10	10
AC-FT	1290	1330	1610	1550	2380	6700	6630	4020	1500	861	690	651

## STATISTICS OF MONTHLY MEAN DATA FOR WATER YEARS 1966 - 2001, BY WATER YEAR (WY)

MEAN	27.2	45.9	87.8	174	173	209	178	180	96.5	36.2	19.3	17.2
MAX	270	262	446	781	969	696	601	600	451	184	33.2	29.5
(WY)	1966	1984	1997	1997	1986	1986	1982	1982	1995	1983	1983	1982
MIN	7.43	12.9	12.2	15.7	18.4	21.7	19.3	21.5	15.4	8.64	6.35	6.59
(WY)	1978	1978	1977	1977	1977	1977	1977	1977	1977	1977	1977	1977

## SUMMARY STATISTICS

## FOR 2000 CALENDAR YEAR

## FOR 2001 WATER YEAR

## WATER YEARS 1966 - 2001

ANNUAL TOTAL	28063	14723		
ANNUAL MEAN	76.7	40.3		103
HIGHEST ANNUAL MEAN				271
LOWEST ANNUAL MEAN				14.3
HIGHEST DAILY MEAN	990	Feb 14	214	Mar 25
LOWEST DAILY MEAN	15	Aug 24	10	Aug 27
ANNUAL SEVEN-DAY MINIMUM	15	Sep 27	11	Aug 21
MAXIMUM PEAK FLOW			251	Mar 25
MAXIMUM PEAK STAGE			5.76	Mar 25
ANNUAL RUNOFF (AC-FT)	55660	29200	74910	14.60
10 PERCENT EXCEEDS	188	97	247	
50 PERCENT EXCEEDS	29	23	38	
90 PERCENT EXCEEDS	16	11	15	

## 11427770 MIDDLE FORK AMERICAN RIVER BELOW INTERBAY DAM, NEAR FORESTHILL, CA

LOCATION.—Lat 39°01'35", long 120°36'09", in SW 1/4 SE 1/4 sec.26, T.14 N., R.12 E., Placer County, Hydrologic Unit 18020128, Tahoe National Forest, on left bank, at Interbay Dam, 3.3 mi upstream from Big Mosquito Creek, and 10.6 mi east of Foresthill.

DRAINAGE AREA.—89.1 mi<sup>2</sup>.

PERIOD OF RECORD.—October 1965 to current year (since October 1985, operated as low-flow station only).

GAGE.—Acoustic-velocity meter system. Elevation of gage is 2,470 ft above sea level, from topographic map. Prior to February 1986, water-stage recorder at same site. March 1986 to September 1987, nonrecording gage and V-notch sharp-crested weir at same site and datum as previous gage.

REMARKS.—Flow regulated by French Meadows Reservoir (station 11427400) and after Aug. 22, 1966, by Interbay Reservoir (usable capacity, 130 acre-ft, between normal operating limits) 500 ft upstream. Water is diverted out of the basin from French Meadows Reservoir to Hell Hole Reservoir (station 11428700) and from Interbay Reservoir to Ralston Powerplant (station 11427765). Water is diverted into the basin from Hell Hole Reservoir to Middle Fork Powerplant (station 11428600) and through South Fork and North Fork Long Canyon Creek Diversion Tunnels (stations 11433060 and 11433080). See schematic diagram of Middle Fork American and Rubicon River Basins. Beginning October 1985, only flows less than 35 ft<sup>3</sup>/s are computed.

COOPERATION.—Records provided by Placer County Water Agency, under general supervision of the U.S. Geological Survey, in connection with a Federal Energy Regulatory Commission project.

EXTREMES FOR PERIOD OF RECORD.—Maximum discharge (water years 1966–85), 9,900 ft<sup>3</sup>/s, Jan. 13, 1980, gage height, 7.95 ft; minimum daily, 1.0 ft<sup>3</sup>/s, Oct. 25–30, 1966, Jan. 19, 1967.

## DISCHARGE, CUBIC FEET PER SECOND, WATER YEAR OCTOBER 2000 TO SEPTEMBER 2001

## DAILY MEAN VALUES

DAY	OCT	NOV	DEC	JAN	FEB	MAR	APR	MAY	JUN	JUL	AUG	SEP
1	e15	23	23	23	23	23	23	23	23	20	15	13
2	e15	23	23	23	23	23	23	23	23	20	15	13
3	e15	23	23	23	23	23	23	23	23	20	15	13
4	e16	23	23	23	23	23	23	23	23	20	15	13
5	e15	23	23	23	23	23	23	23	23	20	15	13
6	e15	23	23	23	23	23	23	23	23	20	14	12
7	e15	23	23	23	23	23	23	23	23	20	14	13
8	e15	23	23	23	23	23	23	23	23	20	13	12
9	e17	23	23	23	23	23	23	23	23	19	13	12
10	e29	23	23	23	23	23	23	23	23	18	13	13
11	e25	23	23	23	23	23	23	23	23	17	13	13
12	e22	23	23	23	23	23	23	23	23	16	13	13
13	e19	23	23	23	23	23	23	23	23	16	13	13
14	e18	23	23	23	23	23	23	23	23	16	13	13
15	e18	23	23	23	23	23	23	23	23	16	13	13
16	e17	23	23	23	23	23	23	23	23	16	13	13
17	22	23	23	23	23	23	23	23	23	16	13	12
18	22	23	23	23	23	23	23	23	23	16	13	12
19	20	23	23	23	23	23	23	23	23	16	13	12
20	20	23	23	23	23	23	23	23	23	16	13	12
21	23	23	23	23	23	23	23	23	23	16	13	12
22	23	23	23	23	23	23	23	23	23	16	13	12
23	23	23	23	23	23	23	23	23	23	16	13	12
24	23	23	23	23	23	23	23	23	21	16	13	12
25	23	23	23	23	23	23	23	23	19	16	13	14
26	23	23	23	23	23	23	23	23	22	16	13	13
27	23	23	23	23	23	23	23	23	24	16	12	12
28	23	23	23	23	23	23	23	23	23	16	13	12
29	23	23	23	23	---	23	23	23	22	16	13	12
30	23	23	23	23	---	23	23	23	21	16	13	13
31	23	---	23	23	---	23	---	23	---	16	13	---
TOTAL	623	690	713	713	644	713	690	713	681	534	414	377
MEAN	20.1	23.0	23.0	23.0	23.0	23.0	23.0	23.0	22.7	17.2	13.4	12.6
MAX	29	23	23	23	23	23	23	23	24	20	15	14
MIN	15	23	23	23	23	23	23	23	19	16	12	12
AC-FT	1240	1370	1410	1410	1280	1410	1370	1410	1350	1060	821	748
a	11550	34130	23270	21280	14660	12920	10160	18130	22550	30240	37480	27500

e Estimated.

a Diversion, in acre-feet, through Ralston Powerplant (station 11427765), provided by Placer County Water Agency.

## SACRAMENTO RIVER BASIN

## 11427770 MIDDLE FORK AMERICAN RIVER BELOW INTERBAY DAM, NEAR FORESTHILL, CA—Continued

## STATISTICS OF MONTHLY MEAN DATA FOR WATER YEARS 1966 - 1985, BY WATER YEAR (WY)

	OCT	NOV	DEC	JAN	FEB	MAR	APR	MAY	JUN	JUL	AUG	SEP
MEAN	30.5	27.4	73.8	93.7	86.6	101	117	118	78.2	29.4	18.8	18.3
MAX	270	140	548	398	928	508	868	857	313	152	23.7	24.7
(WY)	1966	1984	1984	1980	1982	1983	1982	1982	1967	1983	1983	1983
MIN	5.84	6.38	6.22	6.15	9.32	7.61	11.6	11.1	11.3	7.52	5.86	5.68
(WY)	1978	1968	1968	1968	1968	1968	1977	1977	1977	1977	1977	1977

SUMMARY STATISTICS	WATER YEARS 1966 - 1985	FOR 2000 CALENDAR YEAR	FOR 2001 WATER YEAR
ANNUAL MEAN	66.0		
HIGHEST ANNUAL MEAN	347	1982	
LOWEST ANNUAL MEAN	10.0	1968	
HIGHEST DAILY MEAN	8090	Feb 16 1982	
LOWEST DAILY MEAN	1.0	Oct 25 1966	
ANNUAL SEVEN-DAY MINIMUM	1.3	Oct 25 1966	
INSTANTANEOUS PEAK FLOW	9900	Jan 13 1980	
INSTANTANEOUS PEAK STAGE	7.95	Jan 13 1980	
ANNUAL RUNOFF (AC-FT)	47810		
TOTAL DIVERSION (AC-FT) a		365200	26390
10 PERCENT EXCEEDS	141		
50 PERCENT EXCEEDS	22		
90 PERCENT EXCEEDS	11		

a Diversion, in acre-feet, through Ralston Powerplant (station 11427765), provided by Placer County Water Agency.

## 11427940 RUBICON-ROCKBOUND TUNNEL NEAR MEEKS BAY, CA

LOCATION.—Lat 38°59'16", long 120°13'29", in NE 1/4 SE 1/4 sec.8, T.13 N., R.16 E., El Dorado County, Hydrologic Unit 18020128, Eldorado National Forest, on right bank at tunnel intake, 100 ft upstream from diversion dam on Rubicon River, 3.5 mi upstream from Rubicon Springs, and 6.4 mi southwest of Meeks Bay.

PERIOD OF RECORD.—December 1963 to current year.

GAGE.—Water-stage recorder. Datum of gage is 6,533.23 ft above sea level (levels by Sacramento Municipal Utility District). Auxiliary water-stage recorder since Aug. 26, 1966, 220 ft downstream from tunnel outlet at different datum.

REMARKS.—Tunnel diverts water from Rubicon River to Rockbound Lake which flows into Buck Island Lake. Water is then diverted via Buck-Loon Tunnel (station 11428300) to Loon Lake (station 11429350) for power development. See schematic diagram of [Middle Fork American and Rubicon River Basins](#).

COOPERATION.—Records were collected by Sacramento Municipal Utility District, under general supervision of the U.S. Geological Survey, in connection with a Federal Energy Regulatory Commission project.

DISCHARGE, CUBIC FEET PER SECOND, WATER YEAR OCTOBER 2000 TO SEPTEMBER 2001  
DAILY MEAN VALUES

DAY	OCT	NOV	DEC	JAN	FEB	MAR	APR	MAY	JUN	JUL	AUG	SEP
1	.00	14	15	4.2	3.7	6.4	215	370	109	e.10	.00	.00
2	.00	14	13	3.7	3.5	6.2	174	331	103	e.10	.00	.00
3	.00	18	11	3.2	5.7	6.2	99	183	72	e.10	.00	.00
4	.00	16	10	2.5	13	7.2	63	152	54	e.10	.00	.00
5	.00	13	7.4	2.6	23	8.7	48	209	44	e.10	.00	.00
6	.00	13	6.1	2.9	20	8.9	43	273	25	e.10	.00	.00
7	.00	10	5.4	3.2	15	9.9	41	318	e.20	e.10	.00	.00
8	.00	6.1	5.2	3.6	11	17	40	405	e.20	e.10	.00	.00
9	.00	7.1	5.3	4.0	10	24	36	440	e.20	e.10	.00	.00
10	.00	9.0	5.7	3.9	9.8	19	32	392	e.20	e.10	.00	.00
11	.00	8.3	5.6	4.5	9.8	16	31	392	e.20	e.10	.00	.00
12	.00	6.6	6.0	5.0	10	14	29	423	e.20	e.10	.00	.00
13	.00	5.5	6.0	5.2	10	17	30	378	e.20	e.10	.00	.00
14	.00	5.2	7.1	4.9	9.6	24	31	331	e.20	.00	.00	.00
15	.00	4.6	8.5	4.6	7.6	27	42	390	e.20	.00	.00	.00
16	.00	4.3	9.8	4.1	6.6	24	72	516	e.20	.00	.00	.00
17	.00	3.7	10	3.5	6.1	27	116	356	e.20	.00	.00	.00
18	.00	2.5	9.9	3.1	6.0	45	140	274	e.20	.00	.00	.00
19	.00	2.5	9.3	3.1	5.9	62	121	245	e.20	.00	.00	.00
20	.00	2.4	8.6	3.3	6.3	93	82	231	e.20	.00	.00	.00
21	.00	2.4	8.0	3.4	6.9	120	61	236	e.20	.00	.00	.00
22	.00	2.3	7.8	3.5	7.6	134	57	231	e.20	.00	.00	.00
23	.00	1.9	7.1	3.9	8.7	124	86	243	e.20	.00	.00	.00
24	.00	1.5	6.0	4.5	8.8	139	154	220	e.20	.00	.00	.00
25	.00	1.6	5.1	4.7	8.5	185	244	183	e.20	.00	.00	.00
26	.00	1.8	4.4	5.2	8.4	163	324	156	e.20	.00	.00	.00
27	73	2.2	3.8	5.3	7.6	124	335	135	e.20	.00	.00	.00
28	51	6.5	3.5	5.2	7.1	165	296	116	e.20	.00	.00	.00
29	27	12	3.6	5.0	---	218	223	99	e.20	.00	.00	.00
30	20	14	4.1	4.7	---	189	267	98	e.20	.00	.00	.00
31	16	---	4.3	4.1	---	192	---	101	---	.00	.00	---
TOTAL	187.00	212.0	222.6	124.6	256.2	2215.5	3532	8427	411.80	1.30	0.00	0.00
MEAN	6.03	7.07	7.18	4.02	9.15	71.5	118	272	13.7	.042	.000	.000
MAX	73	18	15	5.3	23	218	335	516	109	.10	.00	.00
MIN	.00	1.5	3.5	2.5	3.5	6.2	29	98	.20	.00	.00	.00
AC-FT	371	421	442	247	508	4390	7010	16710	817	2.6	.00	.00

## STATISTICS OF MONTHLY MEAN DATA FOR WATER YEARS 1964 - 2001, BY WATER YEAR (WY)

MEAN	15.7	47.1	44.1	48.9	42.8	67.2	155	358	316	113	17.9	10.2
MAX	149	277	204	222	187	196	295	655	789	519	168	91.0
(WY)	1983	1984	1965	1970	1986	1986	1989	1969	1983	1983	1983	1982
MIN	.000	.000	.000	.000	3.44	13.5	24.6	110	13.7	.042	.000	.000
(WY)	1964	1964	1977	1977	1991	1977	1975	1977	2001	2001	1964	1964

## SUMMARY STATISTICS

## FOR 2000 CALENDAR YEAR

## FOR 2001 WATER YEAR

## WATER YEARS 1964 - 2001

ANNUAL TOTAL	32466.96	15590.00		
ANNUAL MEAN	88.7	42.7	103	
HIGHEST ANNUAL MEAN			197	1982
LOWEST ANNUAL MEAN			30.5	1977
HIGHEST DAILY MEAN	899	May 24	516	May 16
LOWEST DAILY MEAN	.00	Aug 11	.00	Oct 1
ANNUAL SEVEN-DAY MINIMUM	.00	Aug 11	.00	Oct 1
ANNUAL RUNOFF (AC-FT)	64400	30920	74720	
10 PERCENT EXCEEDS	280	169	335	
50 PERCENT EXCEEDS	22	4.5	26	
90 PERCENT EXCEEDS	.00	.00	.00	

e Estimated.

## 11427960 RUBICON RIVER BELOW RUBICON DAM, NEAR MEEKS BAY, CA

LOCATION.—Lat 38°59'20", long 120°13'20", in NW 1/4 SW 1/4 sec.9, T.13 N., R.16 E., El Dorado County, Hydrologic Unit 18020128, Eldorado National Forest, at outlet structure, on diversion dam on Rubicon River, 3.3 mi upstream from Rubicon Springs, and 6.2 mi southwest of Meeks Bay.

PERIOD OF RECORD.—October 1991 to current year (low-flow records only). Unpublished records for water years 1964–91 available in files of the U.S. Geological Survey.

GAGE.—Differential-pressure gage and orifice control in outlet pipes. Auxiliary nonrecording gage 1,300 ft downstream at different datum. Datum of gage is 6,520 ft above sea level from topographic map. Prior to Sept. 4, 1991, nonrecording gage at site 1,300 ft downstream at different datum.

REMARKS.—Records not computed above 10 ft<sup>3</sup>/s. Flow regulated by Rubicon Reservoir. Flow over the spillway bypasses this station. Most of the water is diverted through Rubicon–Rockbound Tunnel (station 11427940) to Rockbound Lake, which flows into Buck Island Lake. Water is then diverted via Buck–Loon Tunnel (station 11428300) to Loon Lake (station 11429350) for power development. See schematic diagram of [Middle Fork American and Rubicon River Basins](#).

COOPERATION.—Records were collected by Sacramento Municipal Utility District, under general supervision of the U.S. Geological Survey, in connection with a Federal Energy Regulatory Commission project.

DISCHARGE, CUBIC FEET PER SECOND, WATER YEAR OCTOBER 2000 TO SEPTEMBER 2001  
DAILY MEAN VALUES

DAY	OCT	NOV	DEC	JAN	FEB	MAR	APR	MAY	JUN	JUL	AUG	SEP
1	1.4	6.4	6.3	6.2	6.2	6.1	7.1	7.9	6.8	6.4	.75	.23
2	1.4	6.4	6.3	6.2	6.1	6.1	7.1	7.8	6.9	6.4	.75	.22
3	1.4	6.4	6.3	6.2	6.3	6.3	6.9	7.3	6.8	6.4	.72	.21
4	1.3	6.4	6.4	6.2	6.3	6.1	6.7	7.1	6.6	6.4	.71	.23
5	1.3	6.4	6.3	6.2	6.3	6.2	6.6	7.4	6.5	6.4	.71	.23
6	1.3	6.4	6.3	6.2	6.3	6.2	6.4	7.6	6.1	6.4	.70	.24
7	1.3	6.4	6.3	6.1	6.3	6.1	6.4	7.7	5.7	6.3	.69	.22
8	1.3	6.4	6.3	6.1	6.3	6.3	6.4	8.0	6.0	6.3	.68	.24
9	1.3	6.4	6.3	6.2	6.2	6.3	6.4	8.1	6.1	6.3	.50	.24
10	1.3	6.4	6.3	6.1	6.2	6.3	6.4	8.1	6.3	6.1	.30	.24
11	1.3	6.4	6.3	6.1	6.2	6.3	6.4	8.1	6.3	4.8	.29	.24
12	1.3	6.4	6.3	6.2	6.2	6.1	6.4	8.1	6.3	4.8	.28	.26
13	1.3	6.4	6.3	6.2	6.3	6.3	6.4	8.0	6.4	4.6	.29	.27
14	1.3	6.4	6.3	6.2	6.2	6.3	6.4	7.9	6.4	4.6	.28	.27
15	1.3	6.4	6.3	6.2	6.3	6.3	6.4	8.0	6.5	4.6	.28	.27
16	1.3	6.4	6.3	6.1	6.3	6.3	6.7	8.4	6.4	4.6	.27	.25
17	1.3	6.4	6.3	6.1	6.2	6.3	6.9	8.0	6.5	4.6	.26	.24
18	1.3	6.4	6.3	6.1	6.1	6.4	7.0	7.7	6.5	4.6	.25	.23
19	1.3	6.3	6.3	6.1	6.1	6.6	6.9	7.6	6.5	4.5	.28	.22
20	1.2	6.3	6.4	6.1	6.2	6.7	6.7	7.6	6.5	4.5	.30	.21
21	1.2	6.3	6.4	6.1	6.2	6.8	6.6	7.5	6.5	4.5	.30	.20
22	1.2	6.3	6.4	6.1	6.2	6.9	6.5	7.6	6.5	4.5	.32	.20
23	1.2	6.3	6.4	6.2	6.2	6.9	6.7	7.6	6.5	4.5	.31	.19
24	1.2	6.2	6.4	6.2	6.2	6.9	7.0	7.4	6.6	4.4	.30	.20
25	1.1	6.2	6.3	6.2	6.2	7.1	7.4	7.4	6.6	4.4	.30	.18
26	1.1	6.2	6.2	6.2	6.3	6.9	7.6	7.2	6.6	3.3	.28	.14
27	4.5	6.3	6.2	6.2	6.3	6.8	7.8	7.1	6.6	.76	.27	.14
28	6.7	6.3	6.2	6.3	6.3	6.9	7.6	7.1	6.6	.75	.26	.15
29	6.6	6.3	6.2	6.3	---	7.2	7.3	7.0	6.6	.76	.25	.16
30	6.5	6.3	6.2	6.2	---	7.1	7.6	6.8	6.5	.77	.25	.16
31	6.5	---	6.2	6.2	---	7.1	---	6.8	---	.76	.25	---
TOTAL	64.0	190.5	195.3	191.3	174.5	202.2	204.7	235.9	193.7	139.00	12.38	6.48
MEAN	2.06	6.35	6.30	6.17	6.23	6.52	6.82	7.61	6.46	4.48	.40	.22
MAX	6.7	6.4	6.4	6.3	6.3	7.2	7.8	8.4	6.9	6.4	.75	.27
MIN	1.1	6.2	6.2	6.1	6.1	6.1	6.4	6.8	5.7	.75	.25	.14
AC-FT	127	378	387	379	346	401	406	468	384	276	25	13

CAL YR 2000 TOTAL 2224.45 MEAN 6.08 MAX 8.6 MIN .95 AC-FT 4410  
WTR YR 2001 TOTAL 1809.96 MEAN 4.96 MAX 8.4 MIN .14 AC-FT 3590

## 11428300 BUCK-LOON TUNNEL NEAR MEEKS BAY, CA

LOCATION.—Lat 39°00'17", long 120°15'21", in SE 1/4 NW 1/4 sec.6, T.13 N., R.16 E., El Dorado County, Hydrologic Unit 18020128, Eldorado National Forest, on right bank, at tunnel intake near left abutment of diversion dam, and 7.4 mi southwest of Meeks Bay.

PERIOD OF RECORD.—November 1963 to current year.

GAGE.—Water-stage recorder. Datum of gage is 6,425.0 ft above sea level (levels by Sacramento Municipal Utility District).

REMARKS.—Tunnel diverts water from Buck Island Lake and discharges into Loon Lake (station 11429350). Buck Island Lake receives water from Rubicon River via Rubicon-Rockbound Tunnel (station 11427940). Gates are closed at the tunnel entrance during the summer to raise the level of Buck Island Lake for recreational purposes. See schematic diagram of [Middle Fork American and Rubicon River Basins](#).

COOPERATION.—Records were collected by Sacramento Municipal Utility District, under general supervision of the U.S. Geological Survey, in connection with a Federal Energy Regulatory Commission project.

## DISCHARGE, CUBIC FEET PER SECOND, WATER YEAR OCTOBER 2000 TO SEPTEMBER 2001

## DAILY MEAN VALUES

DAY	OCT	NOV	DEC	JAN	FEB	MAR	APR	MAY	JUN	JUL	AUG	SEP
1	.00	21	14	2.5	5.3	8.5	302	490	134	4.8	.00	.00
2	.00	19	14	2.5	4.8	8.8	276	496	137	3.9	.00	.00
3	.00	21	12	2.3	4.8	8.6	185	307	109	3.2	.00	.00
4	.00	22	10	2.6	6.8	10	115	221	44	2.5	.00	.00
5	.00	20	8.6	3.5	15	12	78	262	.45	2.1	.00	.00
6	.00	18	7.0	3.5	23	12	64	354	.55	1.7	.00	.00
7	.00	15	5.8	3.5	23	11	65	419	2.3	1.3	.00	.00
8	.00	9.9	5.1	4.0	17	14	59	521	6.3	1.0	.00	.00
9	.00	8.8	4.7	4.7	15	21	51	598	6.3	.41	.00	.00
10	.00	9.4	5.4	5.5	17	25	44	546	5.9	.00	.00	.00
11	.00	8.8	5.6	8.9	18	22	41	524	12	.00	.00	.00
12	.00	7.4	7.0	8.1	16	19	40	561	20	.00	.00	.00
13	.00	6.1	6.5	7.0	13	18	38	515	25	.00	.00	.00
14	.00	5.8	8.7	6.6	11	24	38	468	26	.00	.00	.00
15	.00	4.8	9.4	6.2	10	30	44	454	23	.00	.00	.00
16	.00	4.0	8.4	5.8	9.0	32	74	673	21	.00	.00	.00
17	.00	3.3	8.3	5.2	8.1	32	143	531	20	.00	.00	.00
18	.00	2.7	8.4	4.6	8.0	48	204	392	18	.00	.00	.00
19	.00	2.3	8.1	4.3	8.4	75	206	331	17	.00	.00	.00
20	.00	2.1	7.7	4.3	11	116	154	306	15	.00	.00	.00
21	.00	1.9	7.3	4.0	12	179	107	297	14	.00	.00	.00
22	.00	2.0	7.2	4.0	12	200	82	295	13	.00	.00	.00
23	.00	1.8	6.8	4.1	12	198	97	299	12	.00	.00	.00
24	.00	1.6	6.2	6.2	12	203	179	290	11	.00	.00	.00
25	.00	1.4	5.4	6.7	13	262	304	250	9.5	.00	.00	.00
26	.00	1.3	4.2	8.4	12	268	428	214	8.2	.00	.00	.00
27	137	1.4	3.5	7.8	10	204	471	185	7.2	.00	.00	.00
28	64	2.7	3.0	6.9	9.0	223	438	160	6.6	.00	.00	.00
29	56	8.3	2.6	6.7	---	308	343	139	6.2	.00	.00	.00
30	39	13	2.3	6.5	---	289	344	127	5.7	.00	.00	.00
31	28	---	2.5	5.8	---	274	---	128	---	.00	.00	---
TOTAL	324.00	246.8	215.7	162.7	336.2	3154.9	5014	11353	736.20	20.91	0.00	0.00
MEAN	10.5	8.23	6.96	5.25	12.0	102	167	366	24.5	.67	.000	.000
MAX	137	22	14	8.9	23	308	471	673	137	4.8	.00	.00
MIN	.00	1.3	2.3	2.3	4.8	8.5	38	127	.45	.00	.00	.00
AC-FT	643	490	428	323	667	6260	9950	22520	1460	41	.00	.00

## STATISTICS OF MONTHLY MEAN DATA FOR WATER YEARS 1964 - 2001, BY WATER YEAR (WY)

	MEAN	20.4	64.1	60.4	67.3	57.4	88.0	199	458	395	134	19.6	12.4
MAX	182	405	264	297	254	239	356	861	994	643	197	116	
(WY)	1983	1984	1965	1970	1986	1989	1989	1969	1983	1995	1983	1982	
MIN	.000	.000	.000	.25	5.46	19.1	36.8	145	24.5	.67	.000	.000	
(WY)	1964	1964	1977	1991	1991	1977	1967	1977	2001	2001	1964	1964	

SUMMARY STATISTICS	FOR 2000 CALENDAR YEAR		FOR 2001 WATER YEAR		WATER YEARS 1964 - 2001	
ANNUAL TOTAL	40954.05		21564.41			
ANNUAL MEAN	112		59.1		131	
HIGHEST ANNUAL MEAN					245	
LOWEST ANNUAL MEAN					39.2	
HIGHEST DAILY MEAN	949	May 8	673	May 16	1240	Dec 23 1964
LOWEST DAILY MEAN	.00	Oct 1	.00	Oct 1	.00	Oct 1 1963
ANNUAL SEVEN-DAY MINIMUM	.00	Oct 1	.00	Oct 1	.00	Oct 1 1963
ANNUAL RUNOFF (AC-FT)	81230		42770		95250	
10 PERCENT EXCEEDS	355		255		422	
50 PERCENT EXCEEDS	20		6.6		34	
90 PERCENT EXCEEDS	.03		.00		.04	



## 11428400 LITTLE RUBICON RIVER BELOW BUCK ISLAND DAM, NEAR MEEKS BAY, CA

LOCATION.—Lat 39°00'18", long 120°15'19", in SW 1/4 NW 1/4 sec.6, T.13 N., R.16 E., El Dorado County, Hydrologic Unit 18020128, Eldorado National Forest, at outlet structure on Buck Island Diversion Dam, and 7.4 mi southwest of Meeks Bay.

DRAINAGE AREA.—6.00 mi<sup>2</sup>.

PERIOD OF RECORD.—October 1990 to current year (low-flow records only). Unpublished records for water years 1964–90 available in files of the U.S. Geological Survey.

GAGE.—Water-stage recorder and V-notch sharp-crested weir. Elevation of gage is 6,420 ft above sea level, from topographic map. Aug. 14, 1964, to Oct. 4, 1973, nonrecording gage at site 60 ft downstream at different datum. Nonrecording gage at present site Oct. 4, 1973, to Aug. 26, 1986, at different datum and Aug. 27, 1986, to Sept. 30, 1990, at same datum.

REMARKS.—No records computed above 2 ft<sup>3</sup>/s. Flow regulated by Buck Island Reservoir. Flow over the spillway bypasses this station. Most of the water is diverted at Buck Island Reservoir via Buck–Loon Tunnel (station 11428300) to Loon Lake (station 11429350). Buck Island Lake receives water from Rubicon River via Rubicon–Rockbound Tunnel (station 11427940). See schematic diagram of [Middle Fork American and Rubicon River Basins](#).

COOPERATION.—Records were collected by Sacramento Municipal Utility District, under general supervision of the U.S. Geological Survey, in connection with a Federal Energy Regulatory Commission project.

## DISCHARGE, CUBIC FEET PER SECOND, WATER YEAR OCTOBER 2000 TO SEPTEMBER 2001

## DAILY MEAN VALUES

DAY	OCT	NOV	DEC	JAN	FEB	MAR	APR	MAY	JUN	JUL	AUG	SEP
1	1.3	1.4	1.3	1.3	1.3	1.3	1.5	1.3	1.1	1.2	1.3	1.2
2	1.3	1.3	1.3	1.3	1.3	1.3	1.5	1.4	1.1	1.2	1.3	1.2
3	1.3	1.3	1.3	1.3	1.3	1.3	1.5	1.3	1.0	1.3	1.3	1.2
4	1.3	1.3	1.3	1.3	1.3	1.3	1.4	1.2	1.1	1.3	1.3	1.2
5	1.3	1.3	1.3	1.3	1.3	1.3	1.4	1.2	1.2	1.3	1.2	1.2
6	1.3	1.3	1.3	1.3	1.3	1.3	1.3	1.2	1.3	1.3	1.2	1.3
7	1.3	1.3	1.3	1.3	1.3	1.3	1.3	1.3	1.4	1.3	1.2	1.3
8	1.3	1.3	1.3	1.3	1.3	1.3	1.3	1.3	1.4	1.3	1.2	1.3
9	1.3	1.3	1.3	1.3	1.3	1.3	1.3	1.4	1.5	1.4	1.2	1.3
10	1.3	1.3	1.3	1.3	1.3	1.3	1.3	1.3	1.5	1.4	1.3	1.3
11	1.3	1.3	1.3	1.3	1.3	1.3	1.3	1.3	1.5	1.3	1.3	1.3
12	1.3	1.3	1.3	1.3	1.3	1.3	1.3	1.4	1.6	1.3	1.2	1.3
13	1.3	1.3	1.3	1.3	1.3	1.3	1.3	1.3	1.6	1.3	1.2	1.3
14	1.3	1.3	1.3	1.3	1.3	1.3	1.3	1.3	1.6	1.2	1.2	1.3
15	1.3	1.3	1.3	1.3	1.3	1.3	1.3	1.3	1.6	1.2	1.2	1.3
16	1.3	1.3	1.3	1.3	1.3	1.3	1.4	1.4	1.6	1.2	1.3	1.3
17	1.3	1.3	1.3	1.3	1.3	1.3	1.4	1.4	1.6	1.1	1.3	1.3
18	1.3	1.3	1.3	1.3	1.3	1.3	1.5	1.3	1.6	1.3	1.3	1.3
19	1.3	1.3	1.3	1.3	1.3	1.3	1.4	1.5	1.3	1.6	1.3	1.2
20	1.3	1.3	1.3	1.3	1.3	1.3	1.4	1.4	e1.3	1.6	1.3	1.2
21	1.3	1.3	1.3	1.3	1.3	1.5	1.4	e1.3	1.5	1.3	1.2	1.2
22	1.3	1.3	1.3	1.3	1.3	1.5	1.4	1.3	1.2	1.2	1.2	1.2
23	1.3	1.3	1.3	1.3	1.3	1.5	1.4	1.3	1.3	1.2	1.3	1.2
24	1.3	1.3	1.3	1.3	1.3	1.5	1.4	1.3	1.2	1.2	1.3	1.2
25	1.3	1.3	1.3	1.3	1.3	1.5	1.5	1.5	1.2	1.2	1.3	1.2
26	1.3	1.3	1.3	1.3	1.3	1.5	1.6	1.2	1.2	1.2	1.2	1.2
27	1.4	1.3	1.3	1.3	1.3	1.5	1.7	1.1	1.2	1.3	1.2	1.3
28	1.4	1.3	1.3	1.3	1.3	1.5	1.6	1.1	1.2	1.3	1.2	1.3
29	1.4	1.3	1.3	1.3	---	1.6	1.6	1.1	1.2	1.3	1.2	1.3
30	1.4	1.3	1.3	1.3	---	1.5	1.4	1.1	1.2	1.3	1.2	1.3
31	1.4	---	1.3	1.3	---	1.5	---	1.1	---	1.3	1.2	---
TOTAL	40.8	39.1	40.3	40.3	36.4	42.8	42.5	39.3	40.9	39.3	38.4	37.8
MEAN	1.32	1.30	1.30	1.30	1.30	1.38	1.42	1.27	1.36	1.27	1.24	1.26
MAX	1.4	1.4	1.3	1.3	1.3	1.6	1.7	1.4	1.6	1.4	1.3	1.3
MIN	1.3	1.3	1.3	1.3	1.3	1.3	1.3	1.1	1.0	1.1	1.2	1.2
AC-FT	81	78	80	80	72	85	84	78	81	78	76	75

e Estimated.

## 11428700 HELL HOLE RESERVOIR NEAR MEEKS BAY, CA

LOCATION.—Lat 39°03'54", long 120°24'50", in SE 1/4 NW 1/4 sec.16, T.14 N., R.14 E., Placer County, Hydrologic Unit 18020128, Eldorado National Forest, on right bank, 0.3 mi upstream from Hell Hole Dam, on Rubicon River, and 15.6 mi west of Meeks Bay.

DRAINAGE AREA.—114 mi<sup>2</sup>.

PERIOD OF RECORD.—December 1965 to current year.

GAGE.—Water-stage recorder. Datum of gage is sea level (levels by Placer County Water Agency).

REMARKS.—Reservoir is formed by rockfill dam with earth core. Storage began Dec. 6, 1965. Usable capacity, 207,342 acre-ft, between elevations 4,287.65 ft, invert of river outlet, and 4,630.0 ft, crest of ogee spillway. Dead storage, 248 acre-ft. Reservoir is used to store water for hydroelectric power. Water is diverted into reservoir from French Meadows Reservoir (station 11427400) on the Middle Fork American River through French Meadows Powerplant (station 11427200). Water is diverted out of reservoir to the Middle Fork American River through Middle Fork Powerplant. See schematic diagram of [Middle Fork American and Rubicon River Basins](#).

COOPERATION.—Records provided by Placer County Water Agency, under general supervision of the U.S. Geological Survey, in connection with a Federal Energy Regulatory Commission project.

EXTREMES FOR PERIOD OF RECORD.—Maximum contents, 217,400 acre-ft, Jan. 2, 1997, elevation, 4,637.7 ft; minimum since reservoir first filled, 37,499 acre-ft, Mar. 23, 1973, elevation, 4,428.28 ft.

EXTREMES FOR CURRENT YEAR.—Maximum contents, 126,100 acre-ft, Oct. 22, elevation, 4,553.9 ft; minimum, 37,600 acre-ft, Sept. 28–30, elevation, 4,428.4 ft.

Capacity table (elevation, in feet, and contents, in acre-feet)  
(Based on survey by Placer County Water Agency in 1966)

4,340	5,220	4,400	24,200	4,500	83,000	4,600	171,900
4,360	9,840	4,450	49,600	4,550	122,700	4,650	233,400
4,380	16,200						

## RESERVOIR STORAGE (ACRE-FEET), WATER YEAR OCTOBER 2000 TO SEPTEMBER 2001

## DAILY OBSERVATION AT 2400 HOURS

DAY	OCT	NOV	DEC	JAN	FEB	MAR	APR	MAY	JUN	JUL	AUG	SEP
1	121900	119700	102900	82900	65500	56300	71200	92200	107800	96800	74400	50600
2	121800	119200	102500	82400	65500	55800	71900	93200	108000	95900	73500	50100
3	121700	118400	101900	81900	65400	55200	72300	93900	108100	95100	72800	49700
4	121700	117900	100700	81400	65400	54800	72300	94400	107600	94600	72300	49000
5	121600	117300	99500	81000	65200	54700	72500	95600	107400	93600	71600	48600
6	121600	116600	98300	80500	65100	54500	72600	96800	106900	93500	70800	47900
7	121500	116000	97100	80000	64900	54400	73100	97600	106100	92100	70000	47100
8	121800	115300	96500	79600	64500	54700	73500	98500	105700	92100	69200	46700
9	122300	114700	95600	79100	64100	54900	73600	99500	105900	91400	68400	46200
10	122800	114100	94800	78600	64100	55200	73600	100200	106100	90700	67600	45500
11	123300	113900	93900	78000	64100	55400	74000	101000	105500	90200	67000	44700
12	123700	113600	93100	77600	63400	55300	74200	102500	104500	89700	66200	44100
13	123900	113100	92200	77000	62900	55500	74400	103700	103600	88800	65400	43500
14	123900	112600	91400	76500	62400	55700	74800	104300	102900	88200	64500	42700
15	123900	112000	90800	75800	61600	55900	75300	105300	102800	87800	64100	42300
16	124000	111400	90400	75200	61000	56100	75600	106500	102900	87000	63200	42000
17	124600	110600	90000	74900	60500	56500	76100	107200	103000	86500	62200	41200
18	125200	110000	89400	74200	60100	57100	76900	108200	102400	85800	61400	40500
19	125600	109400	88900	73600	59700	57800	78000	109000	101400	84800	61000	39800
20	125600	108900	88500	72400	59200	58900	78600	109700	100500	83800	60100	39100
21	125700	108300	88000	70900	59000	59700	79400	109800	99800	83200	59100	38600
22	126100	107800	87400	69800	58900	60700	80200	109700	99100	82600	58300	38600
23	125600	107200	87000	69400	58700	61600	81200	109500	99200	81600	57800	38600
24	125600	106600	86500	68500	58600	62800	82400	109500	99400	80700	56800	38300
25	124000	106300	86300	67800	58300	64700	83900	109200	99100	80100	56100	38300
26	123200	105800	85800	67400	57900	65500	85500	109500	98400	79200	55500	38200
27	122400	105300	85300	67000	57400	66200	86800	109900	97900	78200	54600	37800
28	121800	104600	84800	66800	56800	67000	88200	110200	97300	77600	54000	37600
29	121800	104200	84400	66200	---	68100	89400	109700	96600	76900	53000	37600
30	121200	103600	83800	66000	---	68900	90700	109100	96600	76100	52000	37600
31	120400	---	83400	65800	---	70000	---	108600	---	75200	51100	---
MAX	126100	119700	102900	82900	65500	70000	90700	110200	108100	96800	74400	50600
MIN	120400	103600	83400	65800	56800	54400	71200	92200	96600	75200	51100	37600
a	4547.3	4526.8	4500.5	4475.6	4461.8	4481.8	4510.3	4533.0	4518.0	4489.1	4452.5	4428.4
b	-1500	-16800	-20200	-17600	-9000	+13200	+20700	+17900	-12000	-21400	-24100	-13500

CAL YR 2000 b -6900

WTR YR 2001 b -84300

a Elevation, in feet, at end of month.

b Change in contents, in acre-feet.

## 11428800 RUBICON RIVER BELOW HELL HOLE DAM, NEAR MEEKS BAY, CA

LOCATION.—Lat 39°03'24", long 120°24'25", in NE 1/4 NE 1/4 sec.21, T.14 N., R.14 E., Placer County, Hydrologic Unit 18020128, Eldorado National Forest, on right bank, 600 ft downstream from outlet of dam, and 15.3 mi west of Meeks Bay.

DRAINAGE AREA.—114 mi<sup>2</sup>.

PERIOD OF RECORD.—November 1965 to current year.

GAGE.—Water-stage recorder and V-notch sharp-crested weir. Datum of gage is 4,231.52 ft above sea level (levels by Placer County Water Agency).

REMARKS.—Flow completely regulated by Hell Hole Reservoir (station 11428700) 600 ft upstream from station. During years when Hell Hole Dam spills, records include flow which bypasses the station. Transbasin diversions upstream from station through Buck-Loon Tunnel (station 11428300) to Loon Lake Reservoir (station 11429350); from Middle Fork American River Basin through tunnel from French Meadows Reservoir (station 11427400) to Hell Hole Reservoir; from Hell Hole Reservoir through tunnel to Middle Fork Powerplant (station 11428600). Diversion began Sept. 8, 1966. See schematic diagram of [Middle Fork American and Rubicon River Basins](#).

COOPERATION.—Records provided by Placer County Water Agency, under general supervision of the U.S. Geological Survey, in connection with a Federal Energy Regulatory Commission project.

EXTREMES FOR PERIOD OF RECORD.—Maximum discharge, 28,800 ft<sup>3</sup>/s, Jan. 2, 1997, including flow over spillway; no flow Aug. 25 to Sept. 11, 1966.

## DISCHARGE, CUBIC FEET PER SECOND, WATER YEAR OCTOBER 2000 TO SEPTEMBER 2001

## DAILY MEAN VALUES

DAY	OCT	NOV	DEC	JAN	FEB	MAR	APR	MAY	JUN	JUL	AUG	SEP
1	25	22	22	12	12	12	12	15	21	22	21	21
2	25	22	21	12	12	12	12	14	21	22	22	21
3	25	22	21	12	12	12	12	13	21	21	23	21
4	25	22	21	12	13	14	12	12	21	22	23	22
5	25	22	21	12	12	15	12	12	21	22	23	22
6	25	22	21	12	13	14	12	12	21	22	22	22
7	25	22	22	12	13	13	13	12	21	22	22	22
8	23	22	25	12	13	13	13	13	21	22	22	21
9	22	22	28	12	13	12	13	12	21	21	22	21
10	22	22	28	12	13	12	13	12	21	22	21	21
11	22	22	28	12	13	12	13	12	21	22	21	21
12	22	22	28	12	13	12	13	12	22	22	21	21
13	22	22	28	12	13	12	13	12	22	22	21	21
14	22	22	28	12	13	12	13	17	21	22	21	21
15	22	22	18	12	13	12	13	26	21	22	21	21
16	22	22	11	12	13	12	12	25	22	22	21	21
17	22	22	12	12	13	12	12	24	22	22	21	21
18	22	22	12	12	13	12	12	23	22	22	21	21
19	22	22	12	12	13	12	14	22	22	22	21	21
20	22	22	12	12	13	12	12	21	22	22	21	21
21	22	22	14	12	13	13	13	21	22	22	21	21
22	22	22	13	12	14	13	13	21	22	22	21	21
23	22	22	13	12	13	12	12	21	22	22	22	21
24	22	22	13	12	13	13	13	21	22	22	21	21
25	22	22	13	12	13	13	13	21	22	22	21	21
26	22	22	13	12	13	13	14	21	22	22	21	21
27	22	22	13	11	13	12	13	21	22	22	21	21
28	22	22	12	12	12	12	13	21	22	22	21	21
29	22	22	12	12	---	13	12	21	22	22	21	21
30	22	22	12	12	---	12	14	21	22	21	21	21
31	22	---	12	12	---	12	---	21	---	21	21	---
TOTAL	704	660	559	371	360	387	381	552	647	678	663	634
MEAN	22.7	22.0	18.0	12.0	12.9	12.5	12.7	17.8	21.6	21.9	21.4	21.1
MAX	25	22	28	12	14	15	14	26	22	22	23	22
MIN	22	22	11	11	12	12	12	12	21	21	21	21
AC-FT	1400	1310	1110	736	714	768	756	1090	1280	1340	1320	1260
a	11310	33270	22260	19970	12850	7510	5060	15680	21760	29110	35390	25230

a Diversion, in acre-feet, from Hell Hole Reservoir through Middle Fork Powerplant (station 11428600), provided by Placer County Water Agency.

## 11428800 RUBICON RIVER BELOW HELL HOLE DAM, NEAR MEEKS BAY, CA—Continued

## STATISTICS OF MONTHLY MEAN DATA FOR WATER YEARS 1966 - 2001, BY WATER YEAR (WY)

	OCT	NOV	DEC	JAN	FEB	MAR	APR	MAY	JUN	JUL	AUG	SEP
MEAN	18.6	17.7	24.6	60.4	21.6	30.3	21.6	65.7	107	44.9	15.7	17.2
MAX	40.6	25.8	318	1615	172	478	129	1053	1007	303	23.6	36.7
(WY)	1989	1984	1982	1997	1982	1986	1982	1996	1995	1983	1995	1989
MIN	7.14	7.51	7.57	6.24	6.34	6.33	7.78	7.92	7.74	6.93	6.50	6.43
(WY)	1974	1977	1989	1977	1977	1977	1977	1977	1977	1977	1977	1977

SUMMARY STATISTICS	FOR 2000 CALENDAR YEAR		FOR 2001 WATER YEAR		WATER YEARS 1966 - 2001	
ANNUAL TOTAL	7023		6596			
ANNUAL MEAN	19.2		18.1		37.7	
HIGHEST ANNUAL MEAN					158	
LOWEST ANNUAL MEAN					7.11	
HIGHEST DAILY MEAN	47	Sep 22	28	Dec 9	17100	Jan 2 1997
LOWEST DAILY MEAN	11	Jan 1	11	Dec 16	.00	Aug 25 1966
ANNUAL SEVEN-DAY MINIMUM	12	Jan 1	12	Jan 21	.00	Aug 25 1966
MAXIMUM PEAK FLOW			35		28800	
ANNUAL RUNOFF (AC-FT)	13930		13080		27320	
TOTAL DIVERSION (AC-FT) a	328900		239400			
10 PERCENT EXCEEDS	23		22		27	
50 PERCENT EXCEEDS	22		21		18	
90 PERCENT EXCEEDS	12		12		9.1	

a Diversion, in acre-feet, from Hell Hole Reservoir through Middle Fork Powerplant (station 11428600), provided by Placer County Water Agency.

## 11429500 GERLE CREEK BELOW LOON LAKE DAM, NEAR MEEKS BAY, CA

LOCATION.—Lat 39°00'20", long 120°18'52", in NE 1/4 NE 1/4 sec.5, T.13 N., R.15 E., El Dorado County, Hydrologic Unit 18020128, Eldorado National Forest, on right bank, 0.3 mi downstream from Loon Lake Dam, and 11 mi southwest of Meeks Bay.

DRAINAGE AREA.—8.01 mi<sup>2</sup>.

PERIOD OF RECORD.—July 1910 to April 1914 (fragmentary), August 1962 to current year. Prior to August 1962, published as "near Rubicon Springs."

GAGE.—Water-stage recorder and V-notch sharp-crested weir. Elevation of gage is 6,250 ft above sea level, from topographic map. Prior to August 1962, nonrecording gage at site 1,400 ft upstream at different datum.

REMARKS.—Beginning in 1884, flow regulated by Loon Lake (station 11429350). Original dam was dismantled during September and October 1962 to permit construction of a new earthfill dam, which was completed Dec. 27, 1963. Loon Lake receives water from Rubicon River via Buck-Loon Tunnel (station 11428300). Since August 1971, most of the water is diverted past the station via Loon Lake Powerplant (station 11429340) and returns to Gerle Creek at Gerle Creek Dam. See schematic diagram of [Middle Fork American and Rubicon River Basins](#).

COOPERATION.—Records were collected by Sacramento Municipal Utility District, under general supervision of the U.S. Geological Survey, in connection with a Federal Energy Regulatory Commission project.

EXTREMES FOR PERIOD OF RECORD.—Maximum discharge, 3,240 ft<sup>3</sup>/s, unregulated, Feb. 1, 1963, gage height, 12.65 ft, from rating curve extended above 970 ft<sup>3</sup>/s, on basis of slope-area measurement of peak flow; no flow Oct. 15, 1913. Maximum discharge since construction of Loon Lake Dam in 1963, 1,050 ft<sup>3</sup>/s, June 5, 1969, gage height, 9.03 ft; minimum daily, 3.6 ft<sup>3</sup>/s, Sept. 27, 28, Nov. 3, 1977.

DISCHARGE, CUBIC FEET PER SECOND, WATER YEAR OCTOBER 2000 TO SEPTEMBER 2001  
DAILY MEAN VALUES

DAY	OCT	NOV	DEC	JAN	FEB	MAR	APR	MAY	JUN	JUL	AUG	SEP
1	8.6	8.7	8.9	9.7	11	9.8	12	12	8.9	9.2	9.5	11
2	8.6	8.9	8.9	9.8	11	10	11	8.6	8.9	9.2	9.3	11
3	8.6	8.6	9.0	10	9.6	10	10	8.8	8.9	9.2	9.4	11
4	8.6	8.6	9.4	10	9.9	11	10	8.9	8.9	9.2	9.3	11
5	8.6	8.6	9.0	10	9.3	11	11	8.9	8.9	9.2	9.4	11
6	8.6	8.6	8.9	10	9.2	11	10	9.0	8.9	9.2	9.2	11
7	8.6	8.6	9.6	10	9.2	12	10	9.1	8.9	9.2	9.2	11
8	8.6	8.6	9.8	10	8.9	11	10	9.1	8.9	9.2	9.2	11
9	8.7	8.8	9.2	10	9.0	10	10	9.0	8.9	9.2	9.2	11
10	8.8	8.6	9.5	11	9.2	9.6	11	8.9	8.9	9.2	9.2	11
11	8.6	8.9	8.3	11	9.2	9.5	10	8.9	8.9	9.2	9.2	11
12	8.5	8.8	8.5	11	9.2	9.8	10	8.9	8.8	9.2	9.2	11
13	8.3	8.7	9.2	11	9.2	11	11	8.9	8.7	9.4	9.2	11
14	8.3	9.0	9.2	11	9.2	11	11	8.9	8.6	9.5	11	11
15	8.3	9.1	9.2	12	9.2	9.9	12	9.3	8.6	9.5	9.5	11
16	8.3	9.0	9.2	11	9.2	11	13	8.9	8.6	9.5	9.5	10
17	8.4	9.0	9.1	11	9.2	12	13	8.9	8.6	9.5	9.2	10
18	8.6	9.0	8.9	12	9.2	11	13	8.9	8.7	9.5	9.2	10
19	8.6	9.0	8.9	12	9.2	12	11	8.9	8.6	9.5	9.2	10
20	8.6	9.0	8.9	12	9.2	12	11	8.9	8.6	9.5	9.8	10
21	8.6	9.2	9.0	12	9.2	12	11	8.9	8.6	9.5	11	10
22	8.6	9.2	9.2	12	9.4	12	12	8.9	8.6	9.5	11	10
23	8.6	9.2	9.2	9.6	9.5	12	13	8.9	8.6	9.5	11	10
24	8.6	9.4	9.2	10	9.5	13	14	8.9	8.6	9.5	11	10
25	11	9.3	9.1	10	9.5	16	15	8.9	8.6	9.5	11	11
26	8.8	9.3	9.1	10	9.5	11	15	8.9	8.6	9.5	11	11
27	8.6	9.2	9.2	11	9.5	12	14	8.9	8.6	9.5	11	10
28	9.4	8.7	9.2	11	9.6	13	13	8.9	8.6	9.5	11	10
29	9.1	8.8	9.3	11	---	12	13	8.9	8.6	9.5	11	10
30	8.8	9.1	9.5	11	---	12	14	8.9	8.6	9.5	11	10
31	8.6	---	9.5	11	---	13	---	8.9	---	9.5	11	---
TOTAL	269.5	267.5	283.1	333.1	264.0	352.6	354	279.6	261.7	290.8	308.9	317
MEAN	8.69	8.92	9.13	10.7	9.43	11.4	11.8	9.02	8.72	9.38	9.96	10.6
MAX	11	9.4	9.8	12	11	16	15	12	8.9	9.5	11	11
MIN	8.3	8.6	8.3	9.6	8.9	9.5	10	8.6	8.6	9.2	9.2	10
AC-FT	535	531	562	661	524	699	702	555	519	577	613	629
a	5260	344	7610	66	0	0	0	769	240	419	2880	1460

a Diversion, in acre-feet, to Loon Lake Powerplant (station 11429340), provided by Sacramento Municipal Utility District.

## 11429500 GERLE CREEK BELOW LOON LAKE DAM, NEAR MEEKS BAY, CA—Continued

## STATISTICS OF MONTHLY MEAN DATA FOR WATER YEARS 1965 - 1970, BY WATER YEAR (WY)

	OCT	NOV	DEC	JAN	FEB	MAR	APR	MAY	JUN	JUL	AUG	SEP
MEAN	112	132	165	74.7	103	192	133	63.0	390	341	232	115
MAX	190	356	343	134	261	347	244	209	721	493	351	338
(WY)	1970	1966	1966	1968	1970	1970	1967	1969	1969	1967	1969	1967
MIN	7.53	7.93	8.95	8.41	9.13	9.57	8.75	10.5	185	196	50.8	8.20
(WY)	1965	1968	1969	1965	1968	1968	1965	1968	1966	1965	1965	1970

## SUMMARY STATISTICS

## WATER YEARS 1965 - 1970

ANNUAL MEAN	171
HIGHEST ANNUAL MEAN	217 1970
LOWEST ANNUAL MEAN	127 1965
HIGHEST DAILY MEAN	1030 Jun 5 1969
LOWEST DAILY MEAN	6.0 Dec 2 1969
ANNUAL SEVEN-DAY MINIMUM	6.4 Dec 10 1969
MAXIMUM PEAK FLOW	1050 Jun 5 1969
MAXIMUM PEAK STAGE	9.03 Jun 5 1969
ANNUAL RUNOFF (AC-FT)	124100
10 PERCENT EXCEEDS	394
50 PERCENT EXCEEDS	28
90 PERCENT EXCEEDS	8.1

## STATISTICS OF MONTHLY MEAN DATA FOR WATER YEARS 1972 - 2001, BY WATER YEAR (WY)

MEAN	9.06	8.92	9.51	9.34	9.21	9.33	9.35	11.0	9.22	9.17	8.79	8.83
MAX	13.3	11.8	23.9	13.0	12.8	11.6	13.6	48.7	13.6	15.7	12.0	12.0
(WY)	1993	2000	1984	1997	1996	1996	2000	1996	1999	1995	1999	1998
MIN	3.93	4.00	4.45	4.61	5.12	4.67	4.27	4.64	4.13	4.30	4.09	3.99
(WY)	1978	1978	1978	1978	1978	1977	1977	1977	1977	1977	1977	1977

## SUMMARY STATISTICS

## FOR 2000 CALENDAR YEAR

## FOR 2001 WATER YEAR

## WATER YEARS 1972 - 2001

ANNUAL TOTAL	3944.8	3581.8	
ANNUAL MEAN	10.8	9.81	9.32
HIGHEST ANNUAL MEAN			13.5 1996
LOWEST ANNUAL MEAN			6.06 1977
HIGHEST DAILY MEAN	17 Feb 14	16 Mar 25	403 May 17 1996
LOWEST DAILY MEAN	8.3 Oct 13	8.3 Oct 13	3.6 Sep 27 1977
ANNUAL SEVEN-DAY MINIMUM	8.4 Oct 11	8.4 Oct 11	3.7 Sep 23 1977
MAXIMUM PEAK FLOW		94 Aug 4	510 May 18 1996
MAXIMUM PEAK STAGE		3.47 Aug 4	6.65 May 18 1996
ANNUAL RUNOFF (AC-FT)	7820	7100	6750
ANNUAL DIVERSION (AC-FT) a	106000	19040	
10 PERCENT EXCEEDS	13	11	11
50 PERCENT EXCEEDS	11	9.3	8.9
90 PERCENT EXCEEDS	8.6	8.6	8.0

a Diversion, in acre-feet, to Loon Lake Powerplant (station 11429340), provided by Sacramento Municipal Utility District.

## 11430000 SOUTH FORK RUBICON RIVER BELOW GERLE CREEK, NEAR GEORGETOWN, CA

LOCATION.—Lat 38°57'17", long 120°24'02", in SW 1/4 SW 1/4 sec.22, T.13 N., R.14 E., El Dorado County, Hydrologic Unit 18020128, Eldorado National Forest, on left bank, 600 ft downstream from Gerle Creek, 1.2 mi downstream from South Fork Rubicon River Diversion Dam, and 18 mi east of Georgetown.

DRAINAGE AREA.—47.6 mi<sup>2</sup>.

PERIOD OF RECORD.—February 1910 to June 1914 (published as "Little South Fork Rubicon River below Gerle Creek, near Quintette"), August 1961 to current year.

REVISED RECORDS.—WSP 1931: Drainage area.

GAGE.—Water-stage recorder. Elevation of gage is 4,970 ft above sea level, from topographic map. Feb. 1, 1910, to June 21, 1914, nonrecording gage at site about 700 ft downstream at different datum.

REMARKS.—Beginning in 1884, flow regulated by Loon Lake (station 11429350). Original dam was dismantled during September and October 1962 to permit construction of a new earthfill dam completed Dec. 27, 1963. Loon Lake receives water from Rubicon River via Rubicon-Rockbound Tunnel (station 11427940) to Buck Island Lake and from Buck Island Lake to Loon Lake via Buck-Loon Tunnel (station 11428300). Prior to Dec. 3, 1961, water was diverted out of the basin in Georgetown Divide Ditch. Water is diverted 1.2 mi upstream at South Fork Rubicon River Diversion Dam to Robbs Peak Powerplant (station 11429300). Diversion of up to 1,440 ft<sup>3</sup>/s to Silver Creek Basin began in October 1962. See schematic diagram of [Middle Fork American and Rubicon River Basins](#).

COOPERATION.—Records were collected by Sacramento Municipal Utility District, under general supervision of the U.S. Geological Survey, in connection with a Federal Energy Regulatory Commission project.

EXTREMES FOR PERIOD OF RECORD.—Maximum discharge, 12,600 ft<sup>3</sup>/s, Jan. 1, 1997, gage height, 12.65 ft, from rating curve extended above 2,500 ft<sup>3</sup>/s, on basis of slope-area measurement of peak flow; minimum, 0.8 ft<sup>3</sup>/s, Sept. 21, 1962.

DISCHARGE, CUBIC FEET PER SECOND, WATER YEAR OCTOBER 2000 TO SEPTEMBER 2001  
DAILY MEAN VALUES

DAY	OCT	NOV	DEC	JAN	FEB	MAR	APR	MAY	JUN	JUL	AUG	SEP
1	12	11	7.3	6.7	6.6	7.6	11	9.9	7.5	9.1	8.1	8.0
2	12	7.0	7.0	6.7	6.8	7.8	10	6.8	8.2	8.8	8.1	7.9
3	12	7.0	7.1	6.9	7.3	7.4	9.3	5.5	9.1	7.5	8.1	8.0
4	12	6.9	6.6	6.9	7.0	9.1	8.7	5.7	8.6	6.4	8.1	8.1
5	12	6.8	6.9	7.1	7.0	9.8	8.6	5.8	7.9	6.3	8.2	8.1
6	12	6.5	7.0	7.5	7.2	9.9	8.8	5.7	8.4	6.4	8.3	8.1
7	12	6.4	7.2	7.2	6.9	10	8.6	5.4	9.1	6.3	8.0	8.1
8	12	6.5	6.9	7.3	7.1	10	8.0	5.7	9.4	6.8	7.9	7.9
9	12	6.7	7.2	7.4	7.2	10	8.0	5.6	8.8	6.8	7.7	7.4
10	12	6.8	7.8	7.5	7.1	9.8	8.2	5.6	8.5	6.5	7.7	7.4
11	12	6.6	7.5	7.8	7.1	9.9	8.5	5.3	9.0	6.7	7.8	7.4
12	12	6.6	7.5	7.4	6.9	10	8.6	7.4	8.5	6.9	7.7	7.4
13	12	6.6	7.4	7.4	6.9	10	9.0	6.9	6.8	7.1	6.7	7.4
14	11	6.5	8.5	7.4	7.2	11	9.5	6.8	5.3	7.1	6.3	7.4
15	12	6.4	9.4	7.4	7.0	11	9.9	7.1	5.1	7.3	6.3	7.1
16	12	6.4	7.7	7.1	7.1	10	10	7.1	5.3	7.4	6.2	6.9
17	12	6.4	7.7	6.6	6.8	11	10	6.9	5.5	7.5	5.6	7.0
18	12	6.4	7.3	6.8	7.2	11	11	6.7	5.9	7.2	5.7	7.0
19	12	6.5	7.2	7.1	7.5	10	14	6.7	6.2	7.3	5.5	7.0
20	12	6.6	7.2	6.4	7.9	11	12	6.4	6.5	7.4	5.6	7.1
21	12	6.6	7.3	6.4	8.1	11	12	6.3	7.1	7.4	5.5	7.1
22	12	6.6	7.6	6.5	8.5	12	12	6.3	9.9	7.4	5.5	7.2
23	12	6.4	7.5	6.8	7.7	11	12	6.8	6.3	7.4	5.6	7.2
24	12	6.5	7.4	7.4	7.5	12	12	7.1	7.2	7.6	5.6	7.3
25	12	6.5	7.5	6.8	7.7	15	12	8.8	7.5	7.8	5.6	8.6
26	12	6.6	7.0	6.8	7.6	13	12	10	7.7	7.8	5.7	7.5
27	12	6.9	6.9	6.6	7.8	12	11	9.5	8.3	7.8	6.0	7.1
28	13	7.1	6.9	6.6	7.5	12	11	10	8.6	7.8	9.0	7.7
29	14	8.8	6.9	6.9	---	12	10	9.1	8.8	7.9	6.5	8.0
30	13	7.7	7.1	7.0	---	11	10	8.7	8.9	8.0	5.8	8.1
31	13	---	7.3	6.6	---	11	---	7.8	---	8.1	7.0	---
TOTAL	376	206.3	227.8	217.0	204.2	328.3	305.7	219.4	229.9	227.8	211.4	226.5
MEAN	12.1	6.88	7.35	7.00	7.29	10.6	10.2	7.08	7.66	7.35	6.82	7.55
MAX	14	11	9.4	7.8	8.5	15	14	10	9.9	9.1	9.0	8.6
MIN	11	6.4	6.6	6.4	6.6	7.4	8.0	5.3	5.1	6.3	5.5	6.9
AC-FT	746	409	452	430	405	651	606	435	456	452	419	449
a	5410	1060	8700	1110	1470	10420	13180	9850	841	546	3090	1490

a Diversion, in acre-feet, to Robbs Peak Powerplant (station 11429300), provided by Sacramento Municipal Utility District.

## 11430000 SOUTH FORK RUBICON RIVER BELOW GERLE CREEK, NEAR GEORGETOWN, CA—Continued

## STATISTICS OF MONTHLY MEAN DATA FOR WATER YEARS 1963 - 2001, BY WATER YEAR (WY)

	OCT	NOV	DEC	JAN	FEB	MAR	APR	MAY	JUN	JUL	AUG	SEP
MEAN	10.8	18.8	35.4	57.7	35.4	20.1	13.1	26.1	20.0	12.8	9.22	9.40
MAX	52.2	268	396	530	524	130	141	276	249	92.5	12.5	22.3
(WY)	1963	1984	1965	1997	1986	1986	1982	1996	1983	1967	1983	1982
MIN	2.40	2.75	4.79	4.86	5.03	3.11	2.35	2.42	2.29	2.36	2.03	1.99
(WY)	1978	1978	1968	1968	1966	1977	1977	1977	1977	1977	1977	1977

SUMMARY STATISTICS	FOR 2000 CALENDAR YEAR		FOR 2001 WATER YEAR		WATER YEARS 1963 - 2001	
ANNUAL TOTAL	5060.8		2980.3			
ANNUAL MEAN	13.8		8.17		22.4	
HIGHEST ANNUAL MEAN					67.1 1997	
LOWEST ANNUAL MEAN					3.59 1977	
HIGHEST DAILY MEAN	554	Feb 14	15	Mar 25	8050	Jan 1 1997
LOWEST DAILY MEAN	5.5	Apr 8	5.1	Jun 15	1.3	Sep 29 1963
ANNUAL SEVEN-DAY MINIMUM	6.1	Apr 2	5.6	Aug 19	1.5	Sep 28 1963
MAXIMUM PEAK FLOW			50	Jun 22	12600	Jan 1 1997
MAXIMUM PEAK STAGE			2.55	Jun 22	12.65	Jan 1 1997
ANNUAL RUNOFF (AC-FT)	10040		5910		16220	
ANNUAL DIVERSION (AC-FT) a	184300		57160			
10 PERCENT EXCEEDS	13		12		13	
50 PERCENT EXCEEDS	11		7.4		8.4	
90 PERCENT EXCEEDS	6.6		6.4		5.3	

a Diversion, in acre-feet, to Robbs Peak Powerplant (station 11429300), provided by Sacramento Municipal Utility District.



## 11431800 PILOT CREEK ABOVE STUMPY MEADOWS LAKE, CA

LOCATION.—Lat 38°53'41", long 120°34'02", in NE 1/4 NW 1/4 sec.18, T.12 N., R.13 E., El Dorado County, Hydrologic Unit 18020128, on right bank, 2.1 mi upstream from Stumpy Meadows Dam, and 12.5 mi east of Georgetown.

DRAINAGE AREA.—11.7 mi<sup>2</sup>.

PERIOD OF RECORD.—October 1960 to current year. Prior to October 1971, published as "above Stumpy Meadows Reservoir."

GAGE.—Water-stage recorder. Elevation of gage is 4,280 ft above sea level, from topographic map.

REMARKS.—Records good except July and August, which are poor. No regulation or diversion upstream from station. See schematic diagram of [Middle Fork American and Rubicon River Basins](#).

EXTREMES FOR PERIOD OF RECORD.—Maximum discharge, 3,510 ft<sup>3</sup>/s, Feb. 17, 1986, gage height, 7.15 ft, from rating curve extended above 540 ft<sup>3</sup>/s, on basis of slope-area measurement at gage height 6.31 ft, maximum gage height, 8.05 ft, Jan. 31, 1963; minimum daily, 0.14 ft<sup>3</sup>/s, Aug. 16, 1977.

EXTREMES FOR CURRENT YEAR.—Peak discharges greater than base discharge of 140 ft<sup>3</sup>/s, or maximum:

Date	Time	Discharge (ft <sup>3</sup> /s)	Gage height (ft)	Date	Time	Discharge (ft <sup>3</sup> /s)	Gage height (ft)
Feb. 12	0700	Unknown	a1.71	Mar. 25	0715	54	1.49

a Backwater from ice.

DISCHARGE, CUBIC FEET PER SECOND, WATER YEAR OCTOBER 2000 TO SEPTEMBER 2001  
DAILY MEAN VALUES

DAY	OCT	NOV	DEC	JAN	FEB	MAR	APR	MAY	JUN	JUL	AUG	SEP
1	4.9	7.8	8.7	7.1	e7.0	11	24	22	7.3	5.1	2.8	2.0
2	4.9	7.7	8.0	6.8	7.0	11	23	21	7.4	4.9	2.6	1.8
3	4.8	7.6	7.4	6.8	7.2	11	20	19	7.3	4.6	2.6	1.8
4	4.8	7.3	7.2	6.8	7.5	16	19	18	7.1	4.5	2.7	1.7
5	4.7	7.2	7.1	7.1	7.9	20	18	18	7.1	4.5	2.9	1.7
6	4.7	7.3	6.9	7.1	8.0	21	18	17	7.2	4.3	2.6	1.5
7	4.9	7.3	6.9	7.1	7.7	19	18	17	6.9	4.6	2.0	1.6
8	4.9	7.7	6.9	7.7	e7.8	19	16	16	6.6	4.7	1.7	1.7
9	5.6	7.7	6.9	7.7	7.9	20	16	16	6.6	4.2	1.7	1.7
10	8.9	8.2	7.6	8.8	e8.0	18	16	15	6.7	4.0	1.8	1.5
11	7.5	7.7	7.3	9.5	e8.0	18	17	15	6.4	4.2	1.9	1.8
12	6.9	7.6	8.1	8.0	e8.0	17	16	14	6.2	4.2	2.1	2.1
13	6.4	e7.4	7.7	7.8	e8.0	17	17	14	6.1	4.1	1.8	2.0
14	6.6	7.3	11	7.7	e8.0	18	17	13	5.9	4.0	1.8	1.9
15	6.5	7.2	12	7.8	e8.0	18	17	13	5.8	4.0	1.8	1.9
16	6.5	7.1	9.8	e7.7	8.1	18	18	13	5.8	3.8	1.6	1.9
17	6.5	e7.1	8.8	e7.5	7.9	18	19	12	5.7	3.8	1.5	1.8
18	6.6	e7.2	8.2	e7.5	8.6	20	22	12	5.5	3.8	1.5	1.9
19	6.6	7.2	8.0	e7.3	9.6	22	35	11	5.4	3.5	1.7	1.8
20	6.6	7.2	7.8	7.3	12	25	32	11	5.3	3.4	1.5	1.7
21	6.9	7.2	7.8	7.3	12	27	30	11	5.2	3.6	1.5	1.8
22	6.8	7.1	8.4	7.1	13	29	30	10	5.1	3.5	1.7	1.8
23	6.8	7.1	8.3	7.1	12	30	31	9.8	5.2	3.3	2.0	1.8
24	6.8	7.2	8.0	e7.1	12	31	33	9.5	5.3	2.9	1.9	1.8
25	7.9	7.2	7.8	e7.2	12	46	34	9.3	5.3	2.7	2.0	4.3
26	9.9	7.2	7.5	e7.1	12	35	32	8.8	5.6	2.6	1.9	3.8
27	8.6	7.3	7.6	e7.1	11	29	30	8.7	6.1	2.5	1.5	3.0
28	11	7.3	7.5	e7.1	11	28	27	8.5	6.0	2.4	1.4	3.0
29	18	11	7.5	7.1	---	28	25	8.3	5.5	2.6	1.4	2.8
30	12	10	7.5	e7.0	---	26	23	7.7	5.2	2.7	1.5	2.3
31	9.3	---	7.5	e7.0	---	25	---	7.4	---	3.3	1.7	---
TOTAL	223.8	227.4	247.7	229.3	257.2	691	693	406.0	182.8	116.3	59.1	62.2
MEAN	7.22	7.58	7.99	7.40	9.19	22.3	23.1	13.1	6.09	3.75	1.91	2.07
MAX	18	11	12	9.5	13	46	35	22	7.4	5.1	2.9	4.3
MIN	4.7	7.1	6.9	6.8	7.0	11	16	7.4	5.1	2.4	1.4	1.5
AC-FT	444	451	491	455	510	1370	1370	805	363	231	117	123

e Estimated.

## 11431800 PILOT CREEK ABOVE STUMPY MEADOWS LAKE, CA—Continued

## STATISTICS OF MONTHLY MEAN DATA FOR WATER YEARS 1961 - 2001, BY WATER YEAR (WY)

	OCT	NOV	DEC	JAN	FEB	MAR	APR	MAY	JUN	JUL	AUG	SEP
MEAN	6.56	12.6	25.4	47.3	50.0	53.7	47.1	35.8	15.4	8.39	5.37	4.83
MAX	24.8	74.1	159	268	373	195	139	118	50.4	17.8	16.2	16.3
(WY)	1963	1984	1965	1997	1986	1983	1982	1967	1967	1998	1961	1961
MIN	.87	2.79	3.35	4.55	4.64	4.82	3.38	4.06	1.93	.64	.18	.50
(WY)	1978	1977	1977	1991	1977	1977	1977	1977	1977	1977	1977	1977

SUMMARY STATISTICS	FOR 2000 CALENDAR YEAR		FOR 2001 WATER YEAR		WATER YEARS 1961 - 2001	
ANNUAL TOTAL	9570.6		3395.8			
ANNUAL MEAN	26.1		9.30		25.9	
HIGHEST ANNUAL MEAN					64.8	
LOWEST ANNUAL MEAN					2.96	
HIGHEST DAILY MEAN	480	Feb 14	46	Mar 25	2840	Feb 17 1986
LOWEST DAILY MEAN	4.7	Oct 5	1.4	Aug 28	.14	Aug 16 1977
ANNUAL SEVEN-DAY MINIMUM	4.8	Sep 30	1.6	Aug 16	.15	Aug 12 1977
MAXIMUM PEAK FLOW			54	Mar 25	3510	Feb 17 1986
MAXIMUM PEAK STAGE			a1.71	Feb 12	8.05	Jan 31 1963
ANNUAL RUNOFF (AC-FT)	18980		6740		18770	
10 PERCENT EXCEEDS	57		19		59	
50 PERCENT EXCEEDS	9.6		7.3		10	
90 PERCENT EXCEEDS	5.8		1.9		3.4	

a Backwater from ice.

## 11433040 PILOT CREEK BELOW MUTTON CANYON, NEAR GEORGETOWN, CA

LOCATION.—Lat 38°55'25", long 120°38'27", in NE 1/4 NW 1/4 sec.4, T.12 N., R.12 E., El Dorado County, Hydrologic Unit 18020128, Eldorado National Forest, on left bank, 450 ft downstream from Mutton Canyon, 500 ft downstream from Georgetown Divide Diversion Dam, 2.5 mi downstream from Stumpy Meadows Dam, and 10 mi east of Georgetown.

DRAINAGE AREA.—21.1 mi<sup>2</sup>.

PERIOD OF RECORD.—June 1961 to current year.

GAGE.—Water-stage recorder. Elevation of gage is 3,760 ft above sea level, from topographic map.

REMARKS.—Records good. Flow regulated by Stumpy Meadows Lake 2.5 mi upstream, usable capacity, 20,000 acre-ft, completed in November 1961. Georgetown Irrigation District Ditch, capacity, about 60 ft<sup>3</sup>/s, diverts water out of Pilot Creek, 500 ft upstream from station. See schematic diagram of [Middle Fork American and Rubicon River Basins](#).

EXTREMES FOR PERIOD OF RECORD.—Maximum discharge, 7,830 ft<sup>3</sup>/s, Jan. 2, 1997, gage height, 10.95 ft, from rating curve extended above 970 ft<sup>3</sup>/s, on basis of slope-area measurement at gage height 10.06 ft; minimum daily, 0.20 ft<sup>3</sup>/s, Sept. 24, Nov. 1–5, 1966.

## DISCHARGE, CUBIC FEET PER SECOND, WATER YEAR OCTOBER 2000 TO SEPTEMBER 2001

## DAILY MEAN VALUES

DAY	OCT	NOV	DEC	JAN	FEB	MAR	APR	MAY	JUN	JUL	AUG	SEP
1	4.4	4.9	5.0	4.9	5.1	6.2	8.0	19	2.8	2.5	2.7	2.7
2	4.4	4.7	4.8	4.8	5.1	6.3	7.8	18	2.8	2.4	2.7	2.8
3	4.8	4.7	4.7	4.7	5.1	6.4	7.6	16	2.8	2.7	2.7	2.7
4	4.7	4.5	4.7	4.7	5.1	8.7	7.5	8.4	2.8	3.0	2.7	2.7
5	4.7	4.5	4.6	4.7	5.3	11	7.3	4.9	2.7	3.0	2.7	2.7
6	4.7	4.5	4.5	4.7	5.3	9.7	7.3	3.6	2.7	2.9	2.6	2.7
7	4.7	4.5	4.5	4.7	5.3	9.0	8.0	3.5	2.6	2.9	2.6	2.7
8	4.6	4.4	4.5	5.0	5.3	9.1	7.4	3.4	2.6	3.0	2.6	2.7
9	5.1	4.5	4.5	5.0	5.3	9.1	7.4	3.3	2.5	2.9	2.5	2.7
10	6.7	4.5	4.5	6.0	5.3	8.5	7.5	3.2	2.5	2.8	2.5	2.7
11	5.6	4.5	4.5	7.1	5.6	8.4	8.2	4.2	2.5	2.7	2.5	2.7
12	5.4	4.5	5.1	5.9	5.5	8.1	8.3	3.3	2.6	2.7	2.5	2.7
13	5.1	4.5	4.9	5.7	5.2	8.1	7.9	3.1	2.6	2.7	2.5	2.7
14	5.1	4.5	8.9	5.5	5.1	8.3	7.7	3.1	2.6	2.7	2.5	2.7
15	5.0	4.5	8.5	5.4	5.1	8.4	7.6	3.0	2.6	2.7	2.4	2.6
16	4.9	4.5	6.0	5.2	5.1	8.3	7.6	3.0	2.6	2.7	2.4	2.6
17	4.9	4.5	5.6	5.1	5.1	8.3	7.4	2.9	2.6	2.9	2.4	2.7
18	4.9	4.5	5.4	5.1	5.1	8.6	7.2	2.8	2.5	3.0	2.4	3.0
19	4.8	4.5	5.3	5.1	5.6	9.1	8.5	2.8	2.5	3.0	2.4	3.1
20	4.7	4.5	5.2	5.1	6.6	9.5	6.8	2.7	2.5	3.0	2.4	3.1
21	4.7	4.5	5.2	5.1	8.8	9.6	7.6	2.6	2.4	3.0	2.7	3.1
22	4.7	4.5	5.4	5.1	9.7	9.7	17	2.6	2.3	3.0	2.7	3.1
23	4.7	4.5	5.3	5.2	7.3	9.6	26	2.5	2.3	2.9	2.7	3.1
24	4.7	4.5	5.1	5.8	6.8	9.4	32	2.5	2.3	2.9	2.7	3.1
25	5.3	4.5	5.1	5.4	7.2	17	35	2.4	2.4	3.0	2.7	3.4
26	5.6	4.5	5.0	5.3	6.9	11	36	2.4	2.8	2.9	2.7	2.9
27	5.1	4.5	4.9	5.3	6.6	9.5	34	2.4	2.8	2.8	2.7	2.8
28	5.6	4.5	4.9	5.3	6.4	9.1	28	2.5	2.8	2.7	2.7	2.8
29	8.5	6.3	4.9	5.3	---	8.9	24	2.6	2.7	2.7	2.7	2.8
30	6.0	5.5	4.9	5.2	---	8.5	21	2.9	2.6	2.7	2.7	2.7
31	5.3	---	4.9	5.1	---	8.2	---	2.8	---	2.7	2.7	---
TOTAL	159.4	138.5	161.3	162.5	165.9	279.6	413.6	142.4	77.8	87.5	80.4	84.8
MEAN	5.14	4.62	5.20	5.24	5.92	9.02	13.8	4.59	2.59	2.82	2.59	2.83
MAX	8.5	6.3	8.9	7.1	9.7	17	36	19	2.8	3.0	2.7	3.4
MIN	4.4	4.4	4.5	4.7	5.1	6.2	6.8	2.4	2.3	2.4	2.4	2.6
AC-FT	316	275	320	322	329	555	820	282	154	174	159	168

## STATISTICS OF MONTHLY MEAN DATA FOR WATER YEARS 1961 - 2001, BY WATER YEAR (WY)

MEAN	2.98	5.74	29.2	62.1	80.8	76.5	67.0	37.8	9.57	4.26	3.33	2.91
MAX	7.19	28.6	340	621	585	370	289	171	54.4	15.6	13.4	8.54
(WY)	1963	1984	1965	1997	1986	1983	1982	1995	1967	1983	1983	1983
MIN	.46	.46	.54	.53	.89	1.21	.98	1.12	.66	.45	.38	.37
(WY)	1962	1962	1962	1962	1991	1977	1977	1977	1977	1977	1977	1977

SUMMARY STATISTICS	FOR 2000 CALENDAR YEAR	FOR 2001 WATER YEAR	WATER YEARS 1961 - 2001
ANNUAL TOTAL	10432.8	1953.7	
ANNUAL MEAN	28.5	5.35	31.6
HIGHEST ANNUAL MEAN			109
LOWEST ANNUAL MEAN			.84
HIGHEST DAILY MEAN	687	Feb 14	5210
LOWEST DAILY MEAN	3.9	May 29	.20
ANNUAL SEVEN-DAY MINIMUM	4.2	Aug 8	.23
MAXIMUM PEAK FLOW		39	Apr 26
MAXIMUM PEAK STAGE		4.17	Apr 26
ANNUAL RUNOFF (AC-FT)	20690	3880	22900
10 PERCENT EXCEEDS	80	8.5	86
50 PERCENT EXCEEDS	5.0	4.6	4.3
90 PERCENT EXCEEDS	4.4	2.6	1.2

## 11433060 SOUTH FORK LONG CANYON CREEK DIVERSION TUNNEL NEAR VOLCANOVILLE, CA

LOCATION.—Lat 39°03'04", long 120°28'14", in SW 1/4 NE 1/4 sec.24, T.14 N., R.13 E., Placer County, Hydrologic Unit 18020128, Eldorado National Forest, on right bank at diversion dam, 3.3 mi upstream from confluence with North and South Forks Long Canyon Creek, and 17.2 mi east of Volcanoville.

PERIOD OF RECORD.—October 1965 to current year.

GAGE.—Water-stage recorder and sharp-crested weir. Elevation of gage is 4,630 ft above sea level, from topographic map.

REMARKS.—Tunnel completed in September 1965; diversion began in February 1966. Flow is diverted from South Fork Long Canyon Creek to a tunnel from Hell Hole Reservoir to Middle Fork Powerplant on the Middle Fork American River. See schematic diagram of [Middle Fork American and Rubicon River Basins](#).

COOPERATION.—Records provided by Placer County Water Agency, under general supervision of the U.S. Geological Survey, in connection with a Federal Energy Regulatory Commission project.

EXTREMES FOR PERIOD OF RECORD.—Maximum daily discharge, 251 ft<sup>3</sup>/s, Nov. 12, 1973; no flow for part of each year.

## DISCHARGE, CUBIC FEET PER SECOND, WATER YEAR OCTOBER 2000 TO SEPTEMBER 2001

## DAILY MEAN VALUES

DAY	OCT	NOV	DEC	JAN	FEB	MAR	APR	MAY	JUN	JUL	AUG	SEP
1	.00	.00	.00	.00	.00	.00	26	32	.00	.00	.00	.00
2	.00	.00	.00	.00	.00	.00	23	29	.00	.00	.00	.00
3	.00	.00	.00	.00	.00	.00	18	26	.00	.00	.00	.00
4	.00	.00	.00	.00	.00	.00	15	23	.00	.00	.00	.00
5	.00	.00	.00	.00	.00	.00	13	23	.00	.00	.00	.00
6	.00	.00	.00	.00	.00	.00	12	16	.00	.00	.00	.00
7	.00	.00	.00	.00	.00	.00	12	21	.00	.00	.00	.00
8	.00	.00	.00	.00	.00	.00	10	22	.00	.00	.00	.00
9	.00	.00	.00	.00	.00	3.8	9.4	21	.00	.00	.00	.00
10	.00	.00	.00	.00	.00	6.2	9.1	19	.00	.00	.00	.00
11	.00	.00	.00	.00	.00	5.6	9.1	17	.00	.00	.00	.00
12	.00	.00	.00	.00	.00	5.3	8.3	16	.00	.00	.00	.00
13	.00	.00	.00	.00	.00	6.5	9.8	14	.00	.00	.00	.00
14	.00	.00	.00	.00	.00	8.3	11	12	.00	.00	.00	.00
15	.00	.00	.00	.00	.00	8.7	13	13	.00	.00	.00	.00
16	.00	.00	.00	.00	.00	7.6	16	13	.00	.00	.00	.00
17	.00	.00	.00	.00	.00	9.4	19	9.8	.00	.00	.00	.00
18	.00	.00	.00	.00	.00	7.9	27	8.7	.00	.00	.00	.00
19	.00	.00	.00	.00	.00	7.8	42	7.2	.00	.00	.00	.00
20	.00	.00	.00	.00	.00	22	29	6.5	.00	.00	.00	.00
21	.00	.00	.00	.00	.00	23	27	5.6	.00	.00	.00	.00
22	.00	.00	.00	.00	.00	26	30	4.8	.00	.00	.00	.00
23	.00	.00	.00	.00	.00	28	36	4.0	.00	.00	.00	.00
24	.00	.00	.00	.00	.00	28	43	3.5	.00	.00	.00	.00
25	.00	.00	.00	.00	.00	53	44	2.5	.00	.00	.00	.00
26	.00	.00	.00	.00	.00	35	42	2.1	.00	.00	.00	.00
27	.00	.00	.00	.00	.00	28	39	1.6	.00	.00	.00	.00
28	.00	.00	.00	.00	.00	31	35	.90	.00	.00	.00	.00
29	.00	.00	.00	.00	---	31	32	.57	.00	.00	.00	.00
30	.00	.00	.00	.00	---	27	32	.11	.00	.00	.00	.00
31	.00	---	.00	.00	---	27	---	.00	---	.00	.00	---
TOTAL	0.00	0.00	0.00	0.00	0.00	436.10	691.7	374.88	0.00	0.00	0.00	0.00
MEAN	.000	.000	.000	.000	.000	14.1	23.1	12.1	.000	.000	.000	.000
MAX	.00	.00	.00	.00	.00	53	44	32	.00	.00	.00	.00
MIN	.00	.00	.00	.00	.00	.00	8.3	.00	.00	.00	.00	.00
AC-FT	.00	.00	.00	.00	.00	865	1370	744	.00	.00	.00	.00

## STATISTICS OF MONTHLY MEAN DATA FOR WATER YEARS 1966 - 2001, BY WATER YEAR (WY)

	1966	1966	1966	1966	1991	1974	1974	1974	1966	1966	1966	1966
MEAN	.002	3.15	5.17	10.3	13.6	22.1	27.9	25.1	8.40	.31	.002	.000
MAX	.034	37.2	38.6	42.1	77.3	77.7	67.8	80.6	54.0	4.54	.067	.001
(WY)	1980	1974	1984	1974	1996	1989	1980	1975	1998	1983	1983	1972
MIN	.000	.000	.000	.000	.000	.000	.000	.000	.000	.000	.000	.000
(WY)	1966	1966	1966	1966	1991	1974	1974	1974	1966	1966	1966	1966

## SUMMARY STATISTICS FOR 2000 CALENDAR YEAR FOR 2001 WATER YEAR WATER YEARS 1966 - 2001

ANNUAL TOTAL	4223.10	1502.68	
ANNUAL MEAN	11.5	4.12	9.64
HIGHEST ANNUAL MEAN			24.1
LOWEST ANNUAL MEAN			.43
HIGHEST DAILY MEAN	92	53	251
LOWEST DAILY MEAN	.00	.00	.00
ANNUAL SEVEN-DAY MINIMUM	.00	.00	.00
ANNUAL RUNOFF (AC-FT)	8380	2980	6980
10 PERCENT EXCEEDS	40	19	33
50 PERCENT EXCEEDS	.00	.00	.00
90 PERCENT EXCEEDS	.00	.00	.00

## 11433065 SOUTH FORK LONG CANYON CREEK BELOW DIVERSION DAM, NEAR VOLCANOVILLE, CA

LOCATION.—Lat 39°03'04", long 120°28'14", in SW 1/4 NE 1/4 sec.24, T.14 N., R.13 E., Placer County, Hydrologic Unit 18020128, Eldorado National Forest, on right bank, 21 ft below diversion dam, 3.3 mi upstream from confluence of North and South Forks Long Canyon Creek, and 17.2 mi east of Volcanoville.

PERIOD OF RECORD.—October 1988 to current year.

GAGE.—Water-stage recorder. Elevation of gage is 4,630 ft above sea level, from topographic map.

REMARKS.—Discharge is computed only during periods of operation of South Fork Long Canyon Creek Diversion Tunnel (station 11433060). See schematic diagram of Middle Fork American and Rubicon River Basins.

COOPERATION.—Records provided by Placer County Water Agency, under general supervision of the U.S. Geological Survey, in connection with a Federal Energy Regulatory Commission project.

## DISCHARGE, CUBIC FEET PER SECOND, WATER YEAR OCTOBER 2000 TO SEPTEMBER 2001

## DAILY MEAN VALUES

DAY	OCT	NOV	DEC	JAN	FEB	MAR	APR	MAY	JUN	JUL	AUG	SEP
1	---	---	---	---	---	---	6.0	6.0	---	---	---	---
2	---	---	---	---	---	---	5.9	6.0	---	---	---	---
3	---	---	---	---	---	---	5.9	6.0	---	---	---	---
4	---	---	---	---	---	---	6.0	6.0	---	---	---	---
5	---	---	---	---	---	---	6.0	6.0	---	---	---	---
6	---	---	---	---	---	---	6.0	6.7	---	---	---	---
7	---	---	---	---	---	---	6.0	6.0	---	---	---	---
8	---	---	---	---	---	---	5.9	6.0	---	---	---	---
9	---	---	---	---	---	6.2	5.9	6.0	---	---	---	---
10	---	---	---	---	---	5.7	5.8	6.0	---	---	---	---
11	---	---	---	---	---	5.7	5.8	6.0	---	---	---	---
12	---	---	---	---	---	5.7	5.8	6.0	---	---	---	---
13	---	---	---	---	---	5.7	5.9	6.0	---	---	---	---
14	---	---	---	---	---	5.8	5.9	5.9	---	---	---	---
15	---	---	---	---	---	5.8	5.9	5.9	---	---	---	---
16	---	---	---	---	---	5.8	5.9	5.9	---	---	---	---
17	---	---	---	---	---	5.8	5.9	5.9	---	---	---	---
18	---	---	---	---	---	6.6	6.0	5.8	---	---	---	---
19	---	---	---	---	---	7.2	6.0	5.8	---	---	---	---
20	---	---	---	---	---	6.0	5.9	5.8	---	---	---	---
21	---	---	---	---	---	5.9	5.9	5.7	---	---	---	---
22	---	---	---	---	---	6.0	5.9	5.7	---	---	---	---
23	---	---	---	---	---	6.0	6.0	5.7	---	---	---	---
24	---	---	---	---	---	6.0	6.0	5.6	---	---	---	---
25	---	---	---	---	---	6.2	6.2	5.6	---	---	---	---
26	---	---	---	---	---	6.0	6.0	5.5	---	---	---	---
27	---	---	---	---	---	5.9	6.0	5.5	---	---	---	---
28	---	---	---	---	---	5.9	6.0	5.3	---	---	---	---
29	---	---	---	---	---	6.0	6.0	5.3	---	---	---	---
30	---	---	---	---	---	5.9	6.0	5.3	---	---	---	---
31	---	---	---	---	---	5.9	---	5.0	---	---	---	---
TOTAL	---	---	---	---	---	---	178.4	179.9	---	---	---	---
MEAN	---	---	---	---	---	---	5.95	5.80	---	---	---	---
MAX	---	---	---	---	---	---	6.2	6.7	---	---	---	---
MIN	---	---	---	---	---	---	5.8	5.0	---	---	---	---
AC-FT	---	---	---	---	---	---	354	357	---	---	---	---

## 11433080 NORTH FORK LONG CANYON CREEK DIVERSION TUNNEL NEAR VOLCANOVILLE, CA

LOCATION.—Lat 39°02'57", long 120°28'56", in SW 1/4 NW 1/4 sec.24, T.14 N., R.13 E., Placer County, Hydrologic Unit 18020128, Eldorado National Forest, on left bank at diversion dam, 3.2 mi upstream from confluence of North and South Forks Long Canyon Creek, and 16.9 mi east of Volcanoville.

PERIOD OF RECORD.—October 1965 to current year.

GAGE.—Water-stage recorder and Parshall flume. Elevation of gage is 4,700 ft above sea level, from topographic map.

REMARKS.—Tunnel completed in September 1965 and diversions began in February 1966. Flow is diverted from North Fork Long Canyon Creek to a tunnel from Hell Hole Reservoir to Middle Fork Powerplant (stations 11428700 and 11428600) on the Middle Fork American River. See schematic diagram of Middle Fork American and Rubicon River Basins.

COOPERATION.—Records provided by Placer County Water Agency, under general supervision of the U.S. Geological Survey, in connection with a Federal Energy Regulatory Commission project.

EXTREMES FOR PERIOD OF RECORD.—Maximum daily discharge, 100 ft<sup>3</sup>/s, Jan. 15, 1998; no flow for part of each year.

## DISCHARGE, CUBIC FEET PER SECOND, WATER YEAR OCTOBER 2000 TO SEPTEMBER 2001

## DAILY MEAN VALUES

DAY	OCT	NOV	DEC	JAN	FEB	MAR	APR	MAY	JUN	JUL	AUG	SEP
1	.00	.00	.00	.00	.00	.00	17	17	.00	.00	.00	.00
2	.00	.00	.00	.00	.00	.00	14	14	.00	.00	.00	.00
3	.00	.00	.00	.00	.00	.00	9.3	12	.00	.00	.00	.00
4	.00	.00	.00	.00	.00	.00	6.7	10	.00	.00	.00	.00
5	.00	.00	.00	.00	.00	.00	5.9	10	.00	.00	.00	.00
6	.00	.00	.00	.00	.00	.00	5.4	6.9	.00	.00	.00	.00
7	.00	.00	.00	.00	.00	.00	5.0	9.3	.00	.00	.00	.00
8	.00	.00	.00	.00	.00	.00	4.1	9.1	.00	.00	.00	.00
9	.00	.00	.00	.00	.00	.00	3.5	7.7	.00	.00	.00	.00
10	.00	.00	.00	.00	.00	.00	3.6	6.7	.00	.00	.00	.00
11	.00	.00	.00	.00	.00	.00	4.0	5.9	.00	.00	.00	.00
12	.00	.00	.00	.00	.00	.00	3.6	4.6	.00	.00	.00	.00
13	.00	.00	.00	.00	.00	5.1	5.2	4.0	.00	.00	.00	.00
14	.00	.00	.00	.00	.00	9.3	6.7	3.2	.00	.00	.00	.00
15	.00	.00	.00	.00	.00	8.4	6.1	3.6	.00	.00	.00	.00
16	.00	.00	.00	.00	.00	7.5	10	3.5	.00	.00	.00	.00
17	.00	.00	.00	.00	.00	10	11	2.5	.00	.00	.00	.00
18	.00	.00	.00	.00	.00	6.7	14	1.8	.00	.00	.00	.00
19	.00	.00	.00	.00	.00	10	24	1.3	.00	.00	.00	.00
20	.00	.00	.00	.00	.00	23	16	.92	.00	.00	.00	.00
21	.00	.00	.00	.00	.00	22	15	.52	.00	.00	.00	.00
22	.00	.00	.00	.00	.00	22	19	.09	.00	.00	.00	.00
23	.00	.00	.00	.00	.00	21	24	.00	.00	.00	.00	.00
24	.00	.00	.00	.00	.00	22	28	.00	.00	.00	.00	.00
25	.00	.00	.00	.00	.00	46	28	.00	.00	.00	.00	.00
26	.00	.00	.00	.00	.00	24	26	.00	.00	.00	.00	.00
27	.00	.00	.00	.00	.00	21	22	.00	.00	.00	.00	.00
28	.00	.00	.00	.00	.00	22	19	.00	.00	.00	.00	.00
29	.00	.00	.00	.00	---	21	17	.00	.00	.00	.00	.00
30	.00	.00	.00	.00	---	19	18	.00	.00	.00	.00	.00
31	.00	---	.00	.00	---	18	---	.00	---	.00	.00	---
TOTAL	0.00	0.00	0.00	0.00	0.00	338.00	391.1	134.63	0.00	0.00	0.00	0.00
MEAN	.000	.000	.000	.000	.000	10.9	13.0	4.34	.000	.000	.000	.000
MAX	.00	.00	.00	.00	.00	46	28	17	.00	.00	.00	.00
MIN	.00	.00	.00	.00	.00	.00	3.5	.00	.00	.00	.00	.00
AC-FT	.00	.00	.00	.00	.00	670	776	267	.00	.00	.00	.00

## STATISTICS OF MONTHLY MEAN DATA FOR WATER YEARS 1966 - 2001, BY WATER YEAR (WY)

	1966	1966	1966	1966	1974	1974	1974	1974	1966	1966	1966	1966
MEAN	.043	.76	1.78	3.89	6.39	11.0	13.3	10.8	2.52	.017	.003	.004
MAX	.74	13.2	12.7	18.5	35.6	35.5	33.0	39.9	22.5	.20	.093	.077
(WY)	1980	1982	1997	1998	1996	1993	1993	1998	1998	1973	1973	1973
MIN	.000	.000	.000	.000	.000	.000	.000	.000	.000	.000	.000	.000
(WY)	1966	1966	1966	1966	1974	1974	1974	1974	1966	1966	1966	1966

## SUMMARY STATISTICS FOR 2000 CALENDAR YEAR FOR 2001 WATER YEAR WATER YEARS 1966 - 2001

ANNUAL TOTAL	2032.08	863.73	
ANNUAL MEAN	5.55	2.37	4.20
HIGHEST ANNUAL MEAN			12.7 1998
LOWEST ANNUAL MEAN			.007 1977
HIGHEST DAILY MEAN	55 May 8	46 Mar 25	100 Jan 15 1998
LOWEST DAILY MEAN	.00 Jan 1	.00 Oct 1	.00 Oct 1 1965
ANNUAL SEVEN-DAY MINIMUM	.00 Jan 1	.00 Oct 1	.00 Oct 1 1965
ANNUAL RUNOFF (AC-FT)	4030	1710	3040
10 PERCENT EXCEEDS	20	9.6	15
50 PERCENT EXCEEDS	.00	.00	.00
90 PERCENT EXCEEDS	.00	.00	.00

## 11433085 NORTH FORK LONG CANYON CREEK BELOW DIVERSION DAM, NEAR VOLCANOVILLE, CA

LOCATION.—Lat 39°02'57", long 120°28'56", in SW 1/4 NW 1/4 sec.24, T.14 N., R.13 E., Placer County, Hydrologic Unit 18020128, Eldorado National Forest, on right bank, 26 ft below diversion dam, 3.2 mi upstream from confluence of North and South Forks Long Canyon Creek, and 16.9 mi east of Volcanoville.

PERIOD OF RECORD.—October 1988 to current year.

GAGE.—Water-stage recorder. Elevation of gage is 4,700 ft above sea level, from topographic map.

REMARKS.—Discharge is computed only during periods of operation of North Fork Long Canyon Creek Diversion Tunnel (station 11433080). See schematic diagram of [Middle Fork American and Rubicon River Basins](#).

COOPERATION.—Records provided by Placer County Water Agency, under general supervision of the U.S. Geological Survey, in connection with a Federal Energy Regulatory Commission project.

## DISCHARGE, CUBIC FEET PER SECOND, WATER YEAR OCTOBER 2000 TO SEPTEMBER 2001

## DAILY MEAN VALUES

DAY	OCT	NOV	DEC	JAN	FEB	MAR	APR	MAY	JUN	JUL	AUG	SEP
1	---	---	---	---	---	---	2.4	3.7	---	---	---	---
2	---	---	---	---	---	---	2.4	3.6	---	---	---	---
3	---	---	---	---	---	---	2.9	3.5	---	---	---	---
4	---	---	---	---	---	---	3.3	3.5	---	---	---	---
5	---	---	---	---	---	---	3.3	3.5	---	---	---	---
6	---	---	---	---	---	---	3.3	4.0	---	---	---	---
7	---	---	---	---	---	---	3.4	3.4	---	---	---	---
8	---	---	---	---	---	---	3.4	3.4	---	---	---	---
9	---	---	---	---	---	---	3.4	3.4	---	---	---	---
10	---	---	---	---	---	---	3.4	3.3	---	---	---	---
11	---	---	---	---	---	---	3.4	3.3	---	---	---	---
12	---	---	---	---	---	---	3.4	3.3	---	---	---	---
13	---	---	---	---	---	---	3.7	3.2	---	---	---	---
14	---	---	---	---	---	---	2.9	3.2	---	---	---	---
15	---	---	---	---	---	---	2.8	3.1	---	---	---	---
16	---	---	---	---	---	---	2.8	3.2	---	---	---	---
17	---	---	---	---	---	---	2.9	3.1	---	---	---	---
18	---	---	---	---	---	---	3.8	3.1	---	---	---	---
19	---	---	---	---	---	---	4.6	3.0	---	---	---	---
20	---	---	---	---	---	---	3.2	2.9	---	---	---	---
21	---	---	---	---	---	---	3.1	2.9	---	---	---	---
22	---	---	---	---	---	---	3.1	2.9	---	---	---	---
23	---	---	---	---	---	---	3.1	3.9	---	---	---	---
24	---	---	---	---	---	---	3.2	4.0	---	---	---	---
25	---	---	---	---	---	---	2.7	3.9	---	---	---	---
26	---	---	---	---	---	---	2.7	3.8	---	---	---	---
27	---	---	---	---	---	---	2.5	3.7	---	---	---	---
28	---	---	---	---	---	---	2.5	3.7	---	---	---	---
29	---	---	---	---	---	---	2.5	3.6	---	---	---	---
30	---	---	---	---	---	---	2.4	3.6	---	---	---	---
31	---	---	---	---	---	---	2.4	---	---	---	---	---
TOTAL	---	---	---	---	---	---	105.2	---	---	---	---	---
MEAN	---	---	---	---	---	---	3.51	---	---	---	---	---
MAX	---	---	---	---	---	---	4.1	---	---	---	---	---
MIN	---	---	---	---	---	---	2.4	---	---	---	---	---
AC-FT	---	---	---	---	---	---	209	---	---	---	---	---

## 11433300 MIDDLE FORK AMERICAN RIVER NEAR FORESTHILL, CA

LOCATION.—Lat 39°00'22", long 120°45'35", in NW 1/4 NW 1/4 sec.4, T.13 N., R.11 E., Placer County, Hydrologic Unit 18020128, Tahoe National Forest, on right bank, 1.6 mi downstream from Oxbow Powerplant, and 3.3 mi east of Foresthill.

DRAINAGE AREA.—524 mi<sup>2</sup>.

PERIOD OF RECORD.—October 1958 to current year.

CHEMICAL DATA: Water year 1979.

BIOLOGICAL DATA: Water year 1979.

GAGE.—Water-stage recorder. Elevation of gage is 1,070 ft above sea level, from topographic map. Prior to Oct. 22, 1965, at site 3.2 mi downstream at different datum. Oct. 22, 1965, to Aug. 28, 1985, at site 400 ft downstream at different datum.

REMARKS.—Flow regulated by French Meadows Reservoir, Hell Hole Reservoir, Loon Lake (stations 11427400, 11428700, and 11429350), Stumpy Meadows Lake, usable capacity, 17,500 acre-ft, several smaller reservoirs, and Oxbow Powerplant (station 11433212). Robbs Peak Powerplant (station 11429300) and Georgetown Divide Ditch, capacity about 60 ft<sup>3</sup>/s, divert water out of basin upstream from station. See schematic diagrams of lower Sacramento River Basin and Middle Fork American and Rubicon River Basins.

COOPERATION.—Records provided by Placer County Water Agency, under general supervision of the U.S. Geological Survey, in connection with a Federal Energy Regulatory Commission project.

EXTREMES FOR PERIOD OF RECORD.—Maximum discharge, 310,000 ft<sup>3</sup>/s, Dec. 23, 1964, gage height, 69.0 ft, from floodmarks, site and datum then in use, caused by overtopping of the partly constructed Hell Hole Dam on the Rubicon River, from rating curve extended above 28,000 ft<sup>3</sup>/s on basis of slope-area measurement at gage height 38.0 ft and slope-conveyance study at gage height 69.0 ft, at site and datum then in use; next highest peak, 123,000 ft<sup>3</sup>/s, Jan. 2, 1997, gage height, 29.56 ft, from rating curve extended above 37,000 ft<sup>3</sup>/s; minimum, 35 ft<sup>3</sup>/s, Oct. 10–20, 1961.

## DISCHARGE, CUBIC FEET PER SECOND, WATER YEAR OCTOBER 2000 TO SEPTEMBER 2001

## DAILY MEAN VALUES

DAY	OCT	NOV	DEC	JAN	FEB	MAR	APR	MAY	JUN	JUL	AUG	SEP
1	110	637	727	369	244	604	713	798	608	100	717	525
2	106	714	565	459	247	726	750	843	379	561	732	525
3	106	800	599	263	295	618	680	727	143	820	735	481
4	109	508	750	470	301	814	662	769	626	530	303	668
5	108	606	743	415	386	1030	724	554	497	698	389	576
6	108	741	821	407	371	1190	644	512	629	763	693	592
7	108	751	804	304	449	1090	546	843	733	428	679	673
8	106	736	491	400	410	790	483	990	638	99	768	499
9	106	734	560	410	567	862	409	776	350	743	751	485
10	184	743	554	566	421	724	539	838	130	565	765	676
11	178	562	642	649	231	611	394	793	591	617	396	699
12	160	599	587	483	698	745	578	495	631	507	410	583
13	146	760	688	617	688	696	453	382	715	691	677	618
14	134	785	787	411	529	553	500	584	720	363	717	658
15	126	765	776	580	799	640	465	605	434	356	643	489
16	113	781	425	487	642	570	488	561	310	519	792	440
17	106	915	563	576	523	526	613	636	123	522	735	699
18	111	786	560	541	522	532	592	438	539	687	684	659
19	134	743	464	442	635	751	854	277	748	747	486	683
20	180	805	329	781	779	834	1050	265	788	756	772	648
21	90	835	493	767	793	843	892	800	742	446	835	552
22	92	746	395	753	894	880	866	666	660	390	791	349
23	479	592	446	450	830	991	862	773	306	718	663	321
24	722	528	447	648	633	715	1020	694	101	797	751	421
25	804	585	273	702	828	1210	1280	567	433	601	599	509
26	837	558	441	691	672	1080	1120	479	685	694	641	561
27	841	748	316	341	820	1010	914	153	682	743	769	533
28	667	720	439	332	842	988	868	244	621	387	665	527
29	910	711	401	475	---	973	679	639	700	408	812	292
30	894	914	422	284	---	943	768	634	313	720	804	236
31	832	---	453	370	---	689	---	700	---	771	816	---
TOTAL	9707	21408	16961	15443	16049	25228	21406	19035	15575	17747	20990	16177
MEAN	313	714	547	498	573	814	714	614	519	572	677	539
MAX	910	915	821	781	894	1210	1280	990	788	820	835	699
MIN	90	508	273	263	231	526	394	153	101	99	303	236
AC-FT	19250	42460	33640	30630	31830	50040	42460	37760	30890	35200	41630	32090
a	12190	37710	26270	23330	21770	26320	22280	24520	25570	32120	39450	29020

a Diversion, in acre-feet, through Oxbow Powerplant (station 11433212), provided by Placer County Water Agency.



## SACRAMENTO RIVER BASIN

## 11433300 MIDDLE FORK AMERICAN RIVER NEAR FORESTHILL, CA—Continued

## STATISTICS OF MONTHLY MEAN DATA FOR WATER YEARS 1959 - 2001, BY WATER YEAR (WY)

	OCT	NOV	DEC	JAN	FEB	MAR	APR	MAY	JUN	JUL	AUG	SEP
MEAN	446	657	1145	1642	1871	1847	1747	1546	1022	668	628	523
MAX	1634	2952	7172	8778	8815	5076	5572	4642	3300	1836	1142	1084
(WY)	1963	1984	1965	1997	1986	1983	1982	1963	1983	1983	1983	1983
MIN	54.3	47.1	64.8	85.2	111	240	110	120	124	99.2	47.2	42.8
(WY)	1961	1960	1960	1991	1991	1977	1977	1977	1977	1966	1959	1962

SUMMARY STATISTICS	FOR 2000 CALENDAR YEAR		FOR 2001 WATER YEAR		WATER YEARS 1959 - 2001	
ANNUAL TOTAL	377219		215726			
ANNUAL MEAN	1031		591		1142	
HIGHEST ANNUAL MEAN					2723	
LOWEST ANNUAL MEAN					179	
HIGHEST DAILY MEAN	11800	Feb 14	1280	Apr 25	65000	Dec 23 1964
LOWEST DAILY MEAN	90	Oct 21	90	Oct 21	35	Oct 19 1961
ANNUAL SEVEN-DAY MINIMUM	107	Oct 2	107	Oct 2	38	Oct 14 1961
MAXIMUM PEAK FLOW			1710	Mar 25	310000	Dec 23 1964
MAXIMUM PEAK STAGE			13.40	Mar 25	69.00	Dec 23 1964
ANNUAL RUNOFF (AC-FT)	748200		427900		827000	
TOTAL DIVERSION (AC-FT) a	482000		320500			
10 PERCENT EXCEEDS	1930		835		2390	
50 PERCENT EXCEEDS	821		618		756	
90 PERCENT EXCEEDS	287		270		100	

a Diversion, in acre-feet, through Oxbow Powerplant (station 11433212), provided by Placer County Water Agency.

## 11433790 NORTH FORK AMERICAN RIVER AT AUBURN DAM SITE, NEAR AUBURN, CA

LOCATION.—Lat 39°51'06", long 121°03'26", in SW 1/4 NW 1/4 sec.23, T.12 N., R.8 E., Placer County, Hydrologic Unit 18020128, on the right bank upstream side of the Auburn Dam Site diversion tunnel, 0.7 mi upstream from Knickerbocker Creek, and 1.3 mi southeast of Auburn.

DRAINAGE AREA.— 972 mi<sup>2</sup>.

PERIOD OF RECORD.—Water year 1999 to current year.

WATER TEMPERATURE.—Water year 1999 to current year.

PERIOD OF DAILY RECORD.—

WATER TEMPERATURE.—June 1999 to current year.

INSTRUMENTATION.—Water-temperature recorder since June 4, 1999.

REMARKS.—Water-temperature records rated excellent except for Nov. 13–19, Dec. 8–17, Dec. 24 to Jan. 13 which are rated good; and Dec. 18–25 which are rated fair. Water temperature can be affected by upstream releases.

EXTREMES FOR PERIOD OF DAILY RECORD.—

WATER TEMPERATURE: Maximum recorded, 25.0°C, July 2, 2001; minimum recorded, 4.5°C, Jan. 6, 2000 and Jan. 17, 18, 31, Feb. 1, 2001.

EXTREMES FOR CURRENT YEAR.—

WATER TEMPERATURE: Maximum recorded, 25.0°C, July 2; minimum recorded, 4.5°C, Jan. 17, 18, 31, Feb. 1.

## CROSS-SECTIONAL DATA, WATER YEAR OCTOBER 2000 TO SEPTEMBER 2001

DATE	TIME	TEMPER- ATURE WATER (DEG C) (00010)	SAMPLE LOC- ATION, CROSS SECTION (FT FM L BANK) (00009)
AUG			
13...*	1428	21.0	50.5
13...*	1429	21.0	45.5
13...*	1430	21.0	40.5
13...*	1431	21.0	35.5
13...*	1432	21.0	30.5
13...*	1433	21.0	25.5
13...*	1434	21.0	20.5
13...*	1435	21.0	15.5
13...*	1436	21.0	10.5
13...*	1437	21.0	5.50

## TEMPERATURE, WATER (DEG. C), WATER YEAR OCTOBER 2000 TO SEPTEMBER 2001

DAY	MAX	MIN	MAX	MIN	MAX	MIN	MAX	MIN	MAX	MIN	MAX	MIN
	OCTOBER		NOVEMBER		DECEMBER		JANUARY		FEBRUARY		MARCH	
1	21.5	19.0	13.0	11.5	10.0	9.5	7.5	6.5	6.0	4.5	8.0	6.0
2	21.5	19.5	14.0	12.0	10.0	9.0	7.5	6.0	6.5	5.5	8.0	7.0
3	21.0	18.5	14.0	12.0	9.5	8.5	7.5	6.0	7.5	6.0	8.0	6.0
4	21.0	18.5	13.0	12.0	10.0	8.5	7.0	6.5	8.0	6.0	8.0	7.0
5	20.5	18.5	13.5	11.5	10.0	9.0	7.0	5.5	8.0	6.5	8.0	7.0
6	20.5	18.5	13.5	11.5	9.5	8.5	7.0	5.5	8.0	6.5	9.0	7.5
7	21.0	18.5	12.5	11.0	10.5	9.0	7.0	6.0	7.5	6.0	9.5	7.5
8	20.5	18.0	12.5	11.0	10.5	9.5	8.0	7.0	6.5	5.0	10.0	8.5
9	19.0	17.5	12.5	11.0	10.5	9.5	8.0	7.0	6.5	5.5	10.0	9.0
10	18.0	17.0	12.0	10.0	11.0	10.0	8.0	7.5	6.0	5.5	10.5	8.5
11	17.5	16.0	11.5	10.0	10.5	10.0	8.0	7.5	6.0	5.5	10.5	8.0
12	16.5	15.0	10.5	9.0	10.5	9.5	8.0	7.5	6.0	5.0	10.5	8.5
13	17.0	14.5	9.5	8.5	10.0	9.5	8.0	7.0	6.5	5.0	10.5	8.5
14	17.5	15.0	10.5	9.0	10.5	9.5	8.0	7.0	7.0	5.0	11.0	9.0
15	17.5	15.0	10.5	9.0	11.0	9.5	7.0	6.0	7.0	5.0	10.5	9.0
16	17.5	15.0	10.5	8.5	10.0	9.0	6.5	5.5	7.0	5.0	11.0	9.0
17	17.5	15.0	10.0	8.5	9.5	8.5	6.0	4.5	7.0	5.5	11.5	9.0
18	17.5	15.5	10.0	8.5	9.0	8.0	6.0	4.5	7.0	6.5	12.5	9.5
19	17.5	15.0	10.0	8.5	9.0	7.5	7.0	6.0	7.0	6.5	13.0	10.5
20	16.0	15.0	10.0	9.0	8.5	7.5	7.0	5.5	7.0	6.5	13.0	11.0
21	17.0	15.0	10.0	8.5	8.5	7.5	7.0	5.5	7.5	6.5	13.5	11.0
22	16.5	14.0	10.5	9.0	9.0	8.0	7.5	6.5	7.5	7.0	13.0	11.5
23	16.0	13.5	10.0	9.5	9.0	7.5	7.5	6.5	8.0	6.5	13.0	11.0
24	14.5	12.5	10.5	9.0	8.5	8.0	7.5	7.0	7.5	7.0	13.5	11.5
25	14.0	12.5	10.0	9.0	8.0	7.5	7.0	6.5	8.0	7.0	12.5	11.5
26	14.0	13.0	10.5	9.5	7.5	7.0	7.0	6.0	8.5	7.0	12.0	10.5
27	15.0	13.0	10.5	9.5	7.5	6.5	6.5	5.5	9.0	7.0	12.5	10.0
28	14.0	13.0	10.5	10.0	7.5	6.5	6.5	5.0	8.5	6.5	13.0	10.5
29	15.0	13.0	10.5	9.5	7.5	6.5	6.5	5.5	---	---	13.0	11.0
30	14.0	12.5	10.5	9.5	7.5	6.5	6.0	5.0	---	---	13.5	11.5
31	13.5	11.5	---	---	7.5	6.0	6.0	4.5	---	---	14.0	11.5
MONTH	21.5	11.5	14.0	8.5	11.0	6.0	8.0	4.5	9.0	4.5	14.0	6.0

\* Instantaneous discharge at time of cross-sectional measurement: Unknown.

## 11433790 NORTH FORK AMERICAN RIVER AT AUBURN DAM SITE, NEAR AUBURN, CA—Continued

## TEMPERATURE, WATER (DEG. C), WATER YEAR OCTOBER 2000 TO SEPTEMBER 2001

DAY	MAX	MIN	MAX	MIN	MAX	MIN	MAX	MIN	MAX	MIN	MAX	MIN
	APRIL		MAY		JUNE		JULY		AUGUST		SEPTEMBER	
1	14.0	11.5	15.5	13.5	22.0	18.0	23.0	18.0	21.0	16.5	22.0	19.0
2	13.0	11.5	15.5	13.5	21.5	18.0	25.0	21.5	20.5	17.0	23.0	19.5
3	12.5	10.5	15.5	13.0	22.0	17.5	24.0	19.5	20.0	16.5	23.0	20.0
4	12.0	10.0	15.5	12.5	22.0	19.0	20.5	18.0	20.0	16.5	23.0	20.5
5	12.0	9.5	16.0	13.0	21.5	17.5	22.5	18.0	22.0	17.0	22.0	19.5
6	10.5	10.0	16.5	13.5	22.0	18.0	20.5	17.5	23.0	19.0	22.0	19.5
7	10.0	9.0	17.0	14.0	22.0	18.0	20.0	16.5	22.0	18.0	21.5	18.5
8	10.5	8.5	17.5	15.0	21.0	16.5	22.0	17.0	22.0	18.0	21.5	18.5
9	11.0	8.0	17.5	15.5	20.5	17.0	24.5	21.0	21.0	17.5	21.5	19.0
10	11.5	8.5	18.0	16.0	22.0	17.5	22.0	18.5	21.0	17.5	22.0	19.0
11	11.0	9.5	18.5	15.5	22.5	20.0	21.5	18.5	20.5	17.0	21.0	19.0
12	11.0	8.5	17.5	15.5	22.0	18.5	21.5	17.5	21.5	18.0	21.5	18.5
13	11.5	9.0	18.5	15.5	20.5	17.0	22.0	18.0	22.0	18.5	21.5	19.0
14	12.0	9.0	18.0	15.5	20.5	16.0	21.0	17.0	21.5	18.0	22.0	19.0
15	13.0	9.5	18.0	16.5	20.5	16.0	22.0	17.5	21.0	17.5	21.5	19.0
16	13.5	10.5	18.5	16.0	22.5	17.5	22.0	18.5	21.0	17.5	22.0	19.5
17	14.5	11.0	19.0	16.0	23.0	18.5	21.5	17.5	21.0	17.5	22.0	19.5
18	14.5	11.5	19.5	16.5	24.5	21.0	22.0	17.5	21.0	17.5	21.5	19.0
19	13.0	11.5	20.5	17.0	23.5	20.5	20.5	17.0	20.5	17.5	22.0	19.0
20	11.5	10.0	21.5	17.5	21.5	17.5	20.0	16.5	20.5	18.0	21.5	19.0
21	11.0	9.5	22.0	19.0	21.5	17.0	19.5	16.0	20.5	17.5	21.0	18.5
22	12.0	9.5	22.5	19.5	21.5	17.0	21.0	16.5	20.5	17.5	21.0	18.5
23	13.0	10.5	22.5	18.5	20.0	17.5	22.0	17.5	20.5	18.0	21.0	18.5
24	14.5	11.5	22.0	18.0	20.5	17.0	21.0	17.0	21.0	18.0	21.0	18.5
25	15.0	12.5	22.0	18.0	21.5	19.5	21.0	16.5	21.0	18.0	21.5	19.0
26	15.0	13.0	22.0	18.5	21.5	19.0	22.0	17.5	22.0	19.0	21.0	18.5
27	14.5	13.5	21.5	18.0	19.5	16.5	21.0	17.0	22.0	19.0	21.0	18.5
28	14.0	12.5	22.0	18.5	20.5	15.0	20.5	16.5	22.0	19.0	20.5	18.0
29	14.5	12.5	22.5	19.0	21.0	17.0	22.0	17.5	22.0	19.5	20.5	17.5
30	15.0	12.5	23.0	19.5	21.0	16.5	22.0	18.5	21.5	19.0	21.0	17.5
31	---	---	22.5	19.0	---	---	21.0	17.0	21.5	19.0	---	---
MONTH	15.0	8.0	23.0	12.5	24.5	15.0	25.0	16.0	23.0	16.5	23.0	17.5

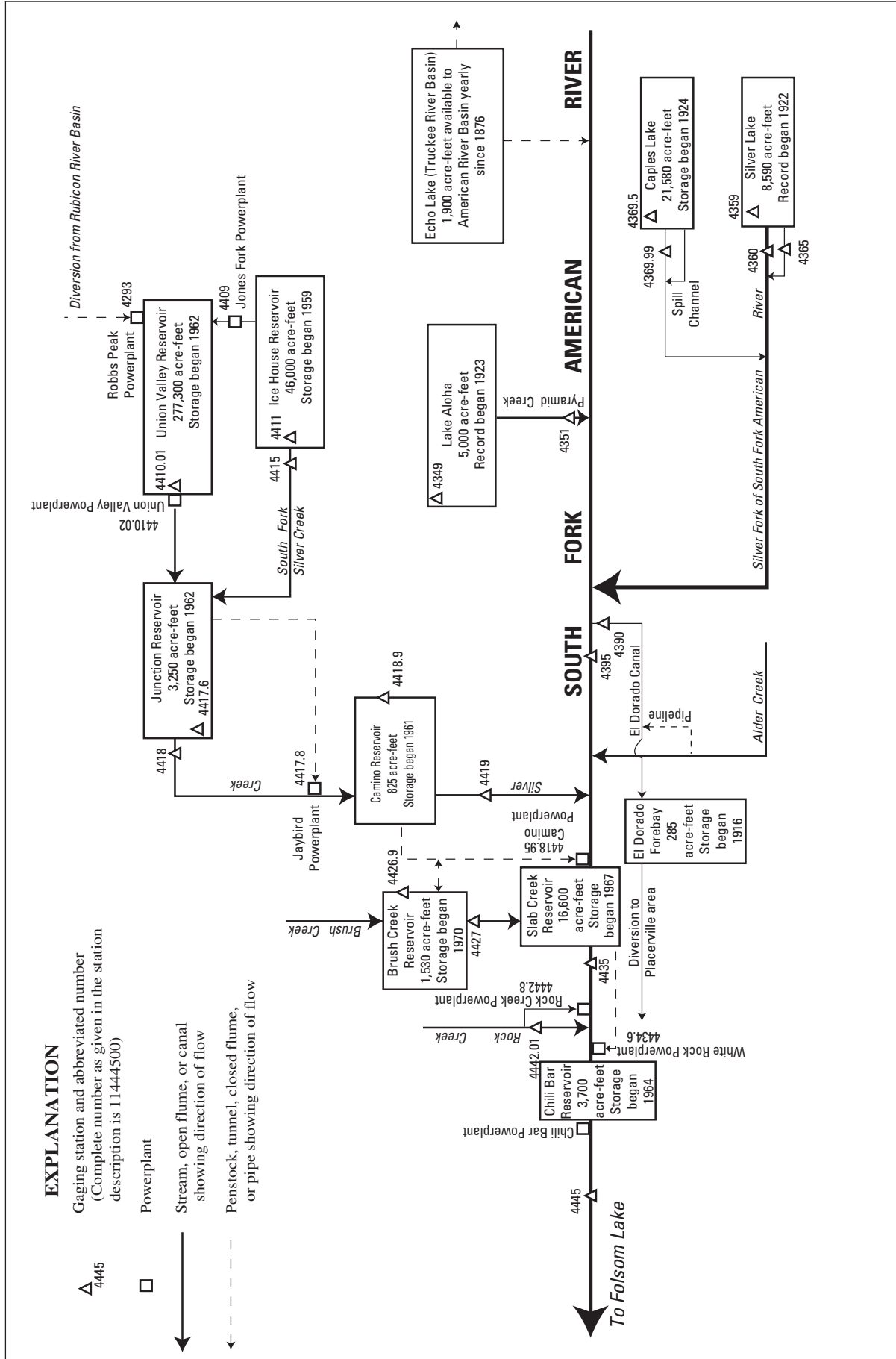



## 11435100 PYRAMID CREEK AT TWIN BRIDGES, CA

LOCATION.—Lat 38°48'57", long 120°06'58", in NW 1/4 SW 1/4 sec.9, T.11 N., R.17 E., El Dorado County, Hydrologic Unit 18020129, Eldorado National Forest, on right bank, 0.5 mi northeast of Twin Bridges, 2.2 mi west of Phillips, and 3.6 mi downstream from Lake Aloha.

DRAINAGE AREA.—8.76 mi<sup>2</sup>.

PERIOD OF RECORD.—October 1970 to current year.

GAGE.—Water-stage recorder. Elevation of gage is 6,320 ft above sea level, from topographic map. Prior to October 1987, at datum 1.00 ft higher.

REMARKS.—Flow regulated by Lake Aloha, capacity, 5,060 acre-ft. Lake of the Woods, Ropi Lake, and Toem Lake (unknown capacities) also regulate at times. See schematic diagram of [South Fork American River Basin](#).

COOPERATION.—Records were collected by the El Dorado Irrigation District, under general supervision of the U.S. Geological Survey, in connection with a Federal Energy Regulatory Commission project.

EXTREMES FOR PERIOD OF RECORD.—Maximum discharge, 2,920 ft<sup>3</sup>/s, Jan. 2, 1997, gage height, 7.22 ft, from rating curve extended above 300 ft<sup>3</sup>/s; minimum daily, 0.03 ft<sup>3</sup>/s, Oct. 26–28, 1992.

DISCHARGE, CUBIC FEET PER SECOND, WATER YEAR OCTOBER 2000 TO SEPTEMBER 2001  
DAILY MEAN VALUES

DAY	OCT	NOV	DEC	JAN	FEB	MAR	APR	MAY	JUN	JUL	AUG	SEP
1	7.2	15	11	7.4	8.0	e8.5	52	66	29	8.6	19	46
2	7.0	16	10	7.0	7.5	8.5	52	65	26	8.4	18	45
3	6.9	16	9.5	6.8	e7.5	e9.0	36	39	22	8.6	18	40
4	6.9	15	9.0	7.1	e7.5	9.4	26	44	20	19	18	13
5	6.7	14	8.2	7.3	e7.5	e9.8	21	73	19	22	18	5.7
6	6.6	13	7.9	7.4	e7.5	10	19	84	18	22	18	4.5
7	6.7	11	7.4	7.3	e7.5	12	18	95	19	22	18	4.2
8	6.7	9.2	7.5	7.3	e7.5	16	22	111	18	22	18	4.1
9	6.9	9.4	7.3	7.5	e7.5	16	20	104	18	21	18	4.0
10	9.0	9.6	8.4	7.9	e7.5	13	18	100	17	21	17	4.0
11	8.7	9.4	8.0	14	e7.5	11	16	103	15	21	17	4.0
12	8.7	11	9.3	12	e7.5	12	16	106	15	21	17	4.1
13	8.8	9.1	8.5	9.6	e7.5	14	17	99	15	21	17	4.0
14	8.9	7.6	e8.5	8.0	e7.5	16	16	95	14	20	17	3.9
15	8.5	8.0	e8.8	7.9	e7.5	16	16	108	13	20	16	3.9
16	8.0	7.3	e9.1	8.3	e7.5	14	21	125	13	20	16	3.8
17	7.7	8.9	e9.4	8.6	e7.5	19	24	98	13	20	16	3.8
18	7.5	6.9	e9.4	8.4	e7.5	26	39	85	13	20	16	3.8
19	7.3	7.1	9.8	8.3	7.7	34	36	79	12	20	16	3.7
20	7.3	6.8	9.4	8.0	e7.7	45	29	76	12	20	19	3.6
21	7.8	6.7	9.0	7.5	e7.8	45	28	74	12	19	51	3.5
22	7.4	6.4	8.8	7.5	e7.9	41	28	73	11	19	53	3.4
23	6.9	6.3	8.3	7.3	e8.0	38	36	72	11	19	53	3.2
24	6.7	6.3	7.8	8.9	e8.0	45	50	71	9.8	19	52	2.9
25	7.1	6.6	8.1	8.8	e8.1	50	69	67	9.3	19	51	4.9
26	9.5	6.9	7.8	10	e8.2	37	85	53	9.4	19	51	4.0
27	12	7.3	7.4	9.2	e8.3	36	80	43	9.5	19	50	3.5
28	15	11	7.0	9.2	e8.4	49	65	40	9.3	18	49	3.2
29	20	13	7.6	8.5	---	51	57	32	9.0	18	48	3.1
30	17	13	7.9	9.2	---	42	70	29	8.9	19	48	3.0
31	15	---	7.8	8.6	---	38	---	28	---	19	47	---
TOTAL	276.4	293.8	263.9	260.8	215.6	791.2	1082	2337	440.2	584.6	900	243.8
MEAN	8.92	9.79	8.51	8.41	7.70	25.5	36.1	75.4	14.7	18.9	29.0	8.13
MAX	20	16	11	14	8.4	51	85	125	29	22	53	46
MIN	6.6	6.3	7.0	6.8	7.5	8.5	16	28	8.9	8.4	16	2.9
AC-FT	548	583	523	517	428	1570	2150	4640	873	1160	1790	484

## STATISTICS OF MONTHLY MEAN DATA FOR WATER YEARS 1971 - 2001, BY WATER YEAR (WY)

	1971	1972	1973	1974	1975	1976	1977	1978	1979	1980	1981	1982
MEAN	12.1	17.6	16.0	19.8	17.7	24.6	40.9	96.6	101	68.5	44.1	18.2
MAX	35.8	57.1	53.2	133	55.6	63.2	70.2	160	249	198	90.2	77.4
(WY)	1996	1997	1997	1997	1982	1982	1997	1974	1998	1995	1974	1983
MIN	.18	.74	1.93	2.25	3.54	7.13	14.7	29.5	14.7	18.9	2.52	.28
(WY)	1991	1991	1991	1991	1991	1977	1975	1977	2001	2001	1981	1981

SUMMARY STATISTICS	FOR 2000 CALENDAR YEAR		FOR 2001 WATER YEAR		WATER YEARS 1971 - 2001	
ANNUAL TOTAL	13591.1		7689.3			
ANNUAL MEAN	37.1		21.1		39.8	
HIGHEST ANNUAL MEAN					65.1	
LOWEST ANNUAL MEAN					15.3	
HIGHEST DAILY MEAN	281	May 8	125	May 16	1570	Jan 2 1997
LOWEST DAILY MEAN	5.1	Jan 6	2.9	Sep 24	.03	Oct 26 1992
ANNUAL SEVEN-DAY MINIMUM	5.2	Jan 4	3.4	Sep 18	.04	Oct 22 1992
MAXIMUM PEAK FLOW			149		2920	
MAXIMUM PEAK STAGE			3.41		7.22	
ANNUAL RUNOFF (AC-FT)	26960		15250		28860	
10 PERCENT EXCEEDS	104		51		99	
50 PERCENT EXCEEDS	20		12		20	
90 PERCENT EXCEEDS	7.2		6.8		3.5	

e Estimated.

## 11435900 SILVER LAKE NEAR KIRKWOOD, CA

LOCATION.—Lat 38°40'07", long 120°07'14", in NW 1/4 SE 1/4 sec.32, T.10 N., R.17 E., Amador County, Hydrologic Unit 18020129, Eldorado National Forest, on outlet structure, 3.5 mi southwest of Kirkwood.

DRAINAGE AREA.—15.2 mi<sup>2</sup>.

PERIOD OF RECORD.—October 1985 to current year. Unpublished records for water years 1981–85 available in files of U.S. Geological Survey.

GAGE.—Water-stage recorder. Datum of gage is 7,184.3 ft above sea level (levels by Pacific Gas & Electric Co.). October 1985 to Mar. 5, 1991, nonrecording gage at same site and datum.

REMARKS.—Lake is formed by earthfill and rock masonry dam initially constructed in 1876 and enlarged in 1929. Capacity, 8,590 acre-ft, between gage heights 0.0 ft, invert of outlet, and 22.7 ft, top of radial gates and flashboards. Released water is used for power development on South Fork American River. See schematic diagram of [South Fork American River Basin](#).

COOPERATION.—Records were collected by El Dorado Irrigation District, under general supervision of the U.S. Geological Survey, in connection with a Federal Energy Regulatory Commission project. Contents not rounded to U.S. Geological Survey standards.

EXTREMES FOR PERIOD OF RECORD.—Maximum contents, 8,791 acre-ft, June 3, 1996, gage height, 23.10 ft; minimum, 0 acre-ft, Feb. 13, 15, 20, 22, 27, 1991, gage height, 0 ft.

EXTREMES FOR CURRENT YEAR.—Maximum contents, 8,615 acre-ft, June 1, gage height, 22.65 ft; minimum, 1,099 acre-ft, Mar. 11, gage height, 4.08 ft.

Capacity table (gage height, in feet, and contents, in acre-feet)  
(Based on table provided by El Dorado Irrigation District, dated Sept. 30, 1999)

0.0	0	6.0	1,671	15.0	5,003	21.0	7,799
2.0	519	9.0	2,646	18.0	6,364	24.0	8,792
4.0	1,076	12.0	3,756				

## RESERVOIR STORAGE (ACRE-FEET), WATER YEAR OCTOBER 2000 TO SEPTEMBER 2001

## DAILY OBSERVATION AT 2400 HOURS

DAY	OCT	NOV	DEC	JAN	FEB	MAR	APR	MAY	JUN	JUL	AUG	SEP
1	5228	3088	2044	1574	1239	1175	3299	4657	8615	7589	6500	5558
2	5179	3055	2028	1553	1222	1137	3435	4739	8605	7550	6476	5531
3	5109	2982	2009	1537	1213	1123	3504	4929	8600	7511	6457	5508
4	5003	2932	1996	1522	1204	1120	3566	5074	8590	7477	6457	5481
5	4903	2886	1996	1507	1198	1128	3597	5329	8565	7443	6457	5445
6	4799	2829	1980	1489	1201	1123	3655	5635	8545	7400	6313	5400
7	4691	2776	1961	1471	1196	1114	3713	6006	8520	7371	6289	5329
8	4588	2723	1948	1465	1175	1108	3744	6443	8490	7337	6261	5250
9	4500	2681	1930	1447	1204	1117	3760	6801	8461	7299	6229	5170
10	4421	2674	1914	1480	1216	1117	3756	7073	8426	7265	6196	5078
11	4338	2639	1895	1477	1239	1099	3776	7356	8386	7231	6168	4986
12	4267	2557	1895	1465	1213	1105	3776	7579	8356	7193	6131	4903
13	4197	2544	1879	1450	1213	1114	3760	7774	8317	7154	6103	4829
14	4132	2452	1879	1441	1207	1123	3737	7848	8277	7111	6075	4752
15	4063	2405	1876	1420	1190	1131	3737	7931	8237	7073	6048	4687
16	3995	2357	1848	1405	1187	1137	3764	8000	8198	7039	6015	4614
17	3927	2317	1829	1390	1175	1146	3823	8005	8158	6992	5983	4542
18	3859	2294	1811	1378	1181	1169	3915	8025	8114	6963	5951	4466
19	3792	2265	1798	1366	1196	1216	3991	8064	8074	6925	5919	4404
20	3729	2238	1780	1351	1184	1298	4015	8114	8040	6892	5882	4333
21	3678	2209	1761	1337	1204	1414	3995	8173	8000	6863	5854	4267
22	3577	2190	1748	1322	1207	1528	3979	8262	7951	6830	5822	4197
23	3520	2173	1727	1325	1198	1638	4019	8351	7907	6792	5795	4124
24	3458	2154	1714	1334	1207	1780	4055	8391	7853	6754	5767	4055
25	3404	2131	1699	1334	1201	1945	4197	8411	7809	6726	5735	4027
26	3359	2112	1671	1331	1193	2073	4346	8431	7774	6693	5712	3959
27	3303	2093	1656	1313	1175	2209	4429	8466	7730	6659	5685	3895
28	3280	2080	1641	1289	1175	2405	4429	8505	7696	6626	5658	3831
29	3254	2089	1622	1266	---	2632	4408	8530	7662	6589	5631	3764
30	3195	2063	1607	1263	---	2840	4529	8580	7623	6561	5608	3705
31	3140	---	1589	1248	---	3070	---	8595	---	6532	5585	---
MAX	5228	3088	2044	1574	1239	3070	4529	8595	8615	7589	6500	5558
MIN	3140	2063	1589	1248	1175	1099	3299	4657	7623	6532	5585	3705
a	10.38	7.25	5.73	4.59	4.34	10.19	13.90	22.61	20.64	18.36	16.31	11.87
b	-2144	-1077	-474	-341	-73	+1895	+1459	+4066	-972	-1091	-947	-1880

CAL YR 2000 MAX 8669 MIN 1589 b -198  
WTR YR 2001 MAX 8615 MIN 1099 b -1579

a Gage height, in feet, at end of month.  
b Change in contents, in acre-feet.

## 11436000 SILVER LAKE OUTLET NEAR KIRKWOOD, CA

LOCATION.—Lat 38°40'18", long 120°07'19", in NE 1/4 SW 1/4 sec.32, T.10 N., R.17 E., El Dorado County, Hydrologic Unit 18020129, Eldorado National Forest, on right bank, 1,000 ft downstream from Silver Lake Dam, and 3.5 mi southwest of Kirkwood.

DRAINAGE AREA.—15.2 mi<sup>2</sup>.

PERIOD OF RECORD.—September 1922 to current year. Records for water year 1923 incomplete, yearly estimate published in WSP 1315-A.

REVISED RECORDS.—WDR CA-75-4: 1927(M), 1929(M), 1932(M), 1937–38(M), 1940–45(M), 1950–53(M), 1955–58(M), 1963(M), 1965(M), 1967(M), 1969–70(M), 1973(M).

GAGE.—Water-stage recorder. Concrete control since Sept. 8, 1986. Datum of gage is 7,198.0 ft above sea level (levels by Pacific Gas & Electric Co.).

REMARKS.—Low and medium flow regulated by Silver Lake (station 11435900) 1,000 ft upstream. Some water, in addition to that released through dam and over spillway, escapes from Silver Lake through porous rock formation and is measured at staff gage (station 11436500) 0.25 mi east of station. For leakage from Silver Lake, refer to monthly figures below. See schematic diagram of [South Fork American River Basin](#).

COOPERATION.—Records were collected by El Dorado Irrigation District, under general supervision of the U.S. Geological Survey, in connection with a Federal Energy Regulatory Commission project.

EXTREMES FOR PERIOD OF RECORD.—Maximum discharge, 2,170 ft<sup>3</sup>/s, Jan. 2, 1997, gage height, 7.79 ft, from rating curve extended above 430 ft<sup>3</sup>/s; no flow many days in February and March 1948, Jan. 13, 14, 1954, and Nov. 3, 1959, to Feb. 5, 1960.

## DISCHARGE, CUBIC FEET PER SECOND, WATER YEAR OCTOBER 2000 TO SEPTEMBER 2001

## DAILY MEAN VALUES

DAY	OCT	NOV	DEC	JAN	FEB	MAR	APR	MAY	JUN	JUL	AUG	SEP
1	11	26	9.8	8.7	7.9	11	7.2	127	3.5	2.9	3.0	3.1
2	14	26	9.9	8.3	7.5	11	7.2	70	3.3	2.9	3.3	3.2
3	30	26	10	7.9	7.5	11	7.3	24	2.9	2.9	3.4	3.1
4	49	25	10	7.9	7.5	11	7.3	25	2.7	3.0	3.3	3.0
5	48	25	10	7.9	7.4	8.8	7.4	25	2.9	2.8	3.3	2.7
6	49	25	9.8	7.9	7.5	6.5	7.2	26	2.9	2.8	3.3	12
7	49	25	9.8	7.9	7.3	6.5	7.1	47	2.9	2.7	3.2	26
8	48	24	9.8	7.9	7.3	6.5	7.1	78	2.9	2.7	3.2	30
9	48	24	9.8	7.9	7.5	6.5	12	78	2.9	2.7	3.2	29
10	48	24	9.8	7.9	7.5	6.5	15	79	2.9	2.7	3.2	35
11	39	24	9.7	7.9	7.5	5.8	15	87	3.2	2.5	3.3	38
12	30	24	9.7	7.9	7.5	5.0	15	101	2.6	2.8	3.3	33
13	30	23	9.6	7.9	7.5	5.0	21	104	3.0	3.1	3.2	29
14	30	23	9.6	7.8	7.5	5.0	25	113	3.9	2.9	2.9	29
15	30	23	9.6	7.7	7.0	5.0	25	117	3.7	2.8	2.8	29
16	29	23	9.6	7.7	6.7	5.1	25	106	3.6	2.8	2.6	29
17	29	22	9.5	7.7	6.7	5.1	25	87	3.5	2.7	2.8	28
18	29	14	9.3	7.7	6.7	5.2	28	87	3.3	2.7	3.2	28
19	29	13	9.3	7.7	6.7	5.1	31	88	3.1	2.7	3.2	28
20	28	11	9.3	7.7	6.7	5.0	38	53	3.1	2.8	3.2	28
21	28	10	9.2	7.7	6.7	5.1	44	50	3.0	2.8	3.2	28
22	28	10	9.1	7.7	6.2	5.3	44	50	2.7	2.8	3.2	28
23	28	10	9.1	7.7	5.6	5.5	50	50	2.7	2.7	3.2	27
24	27	10	9.1	7.7	5.6	5.9	74	50	2.5	3.1	3.1	27
25	27	10	9.0	7.7	5.6	6.0	96	41	2.6	3.0	3.1	27
26	27	10	8.9	8.1	5.6	6.1	114	10	2.6	3.0	3.0	27
27	27	10	8.9	8.4	7.3	6.3	126	4.6	2.6	2.8	3.0	27
28	27	9.9	8.9	8.5	11	6.5	131	3.6	3.2	2.7	3.0	26
29	27	9.9	8.9	8.5	---	6.5	129	3.4	3.1	2.7	3.0	26
30	27	9.9	8.9	8.4	---	6.6	136	3.5	2.9	2.7	2.7	26
31	26	---	8.9	8.3	---	6.9	---	3.5	---	2.8	2.9	---
TOTAL	996	549.7	292.8	246.6	199.0	203.3	1276.8	1791.6	90.7	87.0	96.3	715.1
MEAN	32.1	18.3	9.45	7.95	7.11	6.56	42.6	57.8	3.02	2.81	3.11	23.8
MAX	49	26	10	8.7	11	11	136	127	3.9	3.1	3.4	38
MIN	11	9.9	8.9	7.7	5.6	5.0	7.1	3.4	2.5	2.5	2.6	2.7
AC-FT	1980	1090	581	489	395	403	2530	3550	180	173	191	1420
a	19	0	0	0	0	0	0	493	780	400	188	37

a Leakage (station 11436500), in acre-feet, from Silver Lake, provided by El Dorado Irrigation District.



## SACRAMENTO RIVER BASIN

## 11436000 SILVER LAKE OUTLET NEAR KIRKWOOD, CA—Continued

## STATISTICS OF MONTHLY MEAN DATA FOR WATER YEARS 1923 - 2001, BY WATER YEAR (WY)

	OCT	NOV	DEC	JAN	FEB	MAR	APR	MAY	JUN	JUL	AUG	SEP
MEAN	25.3	18.5	15.9	15.0	13.6	15.6	44.0	127	87.4	19.6	8.32	36.9
MAX	54.3	110	116	188	93.2	98.2	133	306	353	186	50.5	74.6
(WY)	1953	1951	1951	1997	1963	1986	1943	1969	1983	1983	1987	1983
MIN	.11	.15	.000	.000	.093	.013	.20	1.37	1.43	.91	.44	.16
(WY)	1930	1929	1960	1960	1948	1948	1924	1977	1977	1959	1925	1923

SUMMARY STATISTICS	FOR 2000 CALENDAR YEAR		FOR 2001 WATER YEAR		WATER YEARS 1923 - 2001	
ANNUAL TOTAL	11476.1		6544.9			
ANNUAL MEAN	31.4		17.9		35.6	
HIGHEST ANNUAL MEAN					85.4 1983	
LOWEST ANNUAL MEAN					8.76 1976	
HIGHEST DAILY MEAN	403	May 25	136	Apr 30	1940	Jan 2 1997
LOWEST DAILY MEAN	2.1	Jul 27	2.5	Jun 24	.00	Feb 24 1948
ANNUAL SEVEN-DAY MINIMUM	2.4	Jul 22	2.7	Jun 21	.00	Feb 28 1948
MAXIMUM PEAK FLOW			157	May 1	2170	Jan 2 1997
MAXIMUM PEAK STAGE			4.49	May 1	7.79	Jan 2 1997
ANNUAL RUNOFF (AC-FT)	22760		12980		25790	
ANNUAL LEAKAGE (AC-FT) a	2410		1920			
10 PERCENT EXCEEDS	107		44		95	
50 PERCENT EXCEEDS	9.6		7.9		11	
90 PERCENT EXCEEDS	2.6		2.9		.80	

a Leakage (station 11436500), in acre-feet, from Silver Lake, provided by El Dorado Irrigation District.

## 11436950 CAPLES LAKE NEAR KIRKWOOD, CA

LOCATION.—Lat 38°42'27", long 120°02'55", in SW 1/4 SW 1/4 sec.18, T.10 N., R.18 E., [Alpine County](#), Hydrologic Unit 18020129, Eldorado National Forest, on Caples Lake Dam, near the center of the earthfill portion, and 1.3 mi east of Kirkwood.

DRAINAGE AREA.—13.5 mi<sup>2</sup>.

PERIOD OF RECORD.—October 1985 to current year. Unpublished records for water years 1981–85 available in files of the U.S. Geological Survey.

GAGE.—Water-stage recorder since Oct. 1, 1991. Datum of gage is 7,894.0 ft above sea level (levels by Pacific Gas & Electric Co.). Prior to Oct. 1, 1991, nonrecording gage read periodically except for the periods Oct. 16, 1986, to Sept. 30, 1987, Dec. 18, 1990, to May 26, 1991, and July 30 to Sept. 16, 1991, when there was a water-stage recorder at same site and datum.

REMARKS.—Lake is formed by one earthfill and one concrete dam at spillway; dam was completed and storage began in 1924. Capacity, 21,581 acre-ft, between gage heights 6.0 and 62.0 ft, top of 3 ft of flashboards; capacity, 19,751 acre-ft, at spillway level. Released water is measured at Caples Creek Release (station 11436999). When gage height is above spillway crest of 59.0 ft, there is leakage or spill which is not measured. Released water is used for power development on South Fork American River. See schematic diagram of [South Fork American River Basin](#).

COOPERATION.—Records were collected by El Dorado Irrigation District, under general supervision of the U.S. Geological Survey, in connection with a Federal Energy Regulatory Commission project. Contents not rounded to U.S. Geological Survey standards.

EXTREMES FOR PERIOD OF RECORD.—Maximum contents, 22,319 acre-ft, July 12, 2000, gage height, 61.97 ft, maximum gage height, 62.19 ft, July 9, 10, 1997, capacity table then in use; minimum, 2,427 acre-ft, Mar. 30, 31, 1987, gage height, 20.7 ft.

EXTREMES FOR CURRENT YEAR.—Maximum contents, 21,841 acre-ft, June 24, 25, gage height, 61.20 ft; minimum, 9,778 acre-ft, Mar 16–19, gage height, 38.75 ft.

Capacity table (gage height, in feet, and contents, in acre-feet)  
(Based on survey by El Dorado Irrigation District, dated Sept. 30, 1999)

15.0	1,347	30.0	6,086	45.0	12,743	60.0	21,103
20.0	2,665	35.0	8,129	50.0	15,331	63.0	22,338
25.0	4,254	40.0	10,349	55.0	18,122		

## RESERVOIR STORAGE (ACRE-FEET), WATER YEAR OCTOBER 2000 TO SEPTEMBER 2001

## DAILY OBSERVATION AT 2400 HOURS

DAY	OCT	NOV	DEC	JAN	FEB	MAR	APR	MAY	JUN	JUL	AUG	SEP
1	18716	17995	14602	12452	10660	9864	10386	12491	20956	21810	21274	19783
2	18664	17995	14565	12403	10600	9859	10433	12698	21066	21810	21244	19747
3	18646	17948	14512	12344	10539	9836	10474	12813	21140	21810	21201	19675
4	18646	17718	14449	12280	10484	9877	10511	12913	21274	21810	21164	19544
5	18611	17432	14418	12197	10446	9877	10530	13114	21323	21810	21134	19425
6	18611	17150	14355	12134	10396	9882	10572	13342	21391	21773	21085	19324
7	18570	17093	14235	12076	10335	9864	10632	13632	21465	21773	21072	19258
8	18547	17206	14183	12022	10294	9836	10660	14033	21526	21779	21048	19176
9	18512	17082	14121	11969	10262	9832	10684	14381	21569	21730	21005	19111
10	18436	16953	14090	11930	10243	9832	10684	14745	21606	21730	20981	19069
11	18412	16785	14023	11930	10243	9809	10698	15154	21649	21730	20919	19040
12	18389	16617	13966	11882	10206	9809	10735	15562	21680	21699	20877	18963
13	18389	16467	13904	11828	10161	9787	10744	15964	21705	21699	20840	18904
14	18360	16328	13873	11770	10106	9782	10740	16295	21717	21674	20797	18857
15	18331	16423	13817	11689	10051	9782	10740	16718	21742	21668	20767	18793
16	18325	15992	13786	11612	10023	9778	10763	17155	21767	21643	20663	18716
17	18302	15795	13724	11535	10000	9778	10782	17415	21785	21637	20524	18675
18	18302	15660	13039	11449	9968	9778	10848	17695	21810	21600	20391	18599
19	18250	15487	12983	11392	9941	9778	10909	17983	21804	21600	20233	18564
20	18250	15331	12923	11306	9937	9800	10975	18250	21822	21563	20137	18500
21	18226	15202	12893	11220	9937	9796	11017	18500	21816	21532	20083	18442
22	18197	15138	12823	11164	9927	9832	11041	18928	21835	21520	20047	18378
23	18000	15074	12763	11064	9905	9877	11074	19341	21822	21489	20011	18308
24	18000	15005	12783	11064	9905	9909	11154	19621	21841	21477	20005	18267
25	18000	14968	12743	11031	9905	9955	11292	19866	21841	21471	19968	18232
26	17995	14904	12684	10979	9905	9991	11492	20083	21829	21434	19950	18163
27	17995	14835	12654	10923	9886	10032	11684	20251	21829	21403	19920	18093
28	17995	14766	12624	10866	9886	10073	11853	20384	21816	21385	19890	18024
29	17995	14739	12565	10815	---	10156	12012	20536	21816	21348	19854	17995
30	17995	14665	12540	10763	---	10211	12227	20663	21810	21311	19854	17925
31	18000	---	12481	10716	---	10294	---	20797	---	21299	19789	---
MAX	18716	17995	14602	12452	10660	10294	12227	20797	21841	21810	21274	19783
MIN	17995	14665	12481	10716	9886	9778	10386	12491	20956	21299	19789	17925
a	54.79	48.75	44.47	40.79	38.99	39.88	43.95	59.50	61.15	60.32	57.83	54.66
b	-734	-3335	-2184	-1765	-830	+408	+1933	+8570	+1013	-511	-1510	-1864
CAL YR 2000	MAX 22319	MIN 11282	b -770									
WTR YR 2001	MAX 21841	MIN 9778	b -809									

a Gage height, in feet, at end of month.  
b Change in contents, in acre-feet.

## 11436999 CAPLES CREEK RELEASE BELOW CAPLES DAM, NEAR KIRKWOOD, CA

LOCATION.—Lat 38°42'31", long 120°03'02", in NW 1/4 SW 1/4 sec.18, T.10 N., R.18 E., [Alpine County](#), Hydrologic Unit 18020129, Eldorado National Forest, on right bank, 500 ft downstream from main dam and outlet gate of Caples Lake, and 1.3 mi east of Kirkwood.

DRAINAGE AREA.—13.5 mi<sup>2</sup>.

PERIOD OF RECORD.—October 1992 to current year. Records for September 1922 to September 1992 were published as station 11437000, Caples Lake Outlet. This record combined the spillway discharge. Records for water year 1945 incomplete, yearly estimate published in WSP 1315-A. Prior to October 1969, published as Twin Lakes Outlet near Kirkwood.

REVISED RECORDS.—WSP 1931: Drainage area.

GAGE.—Water-stage recorder and concrete control. Elevation of gage is 7,730 ft above sea level, from topographic map.

REMARKS.—Flow regulated by Caples Lake (station 11436950) 500 ft upstream. Flow over Caples Lake Spillway bypasses this gage. No diversion upstream from station. See schematic diagram of [South Fork American River Basin](#).

COOPERATION.—Records were collected by El Dorado Irrigation District, under general supervision of the U.S. Geological Survey, in connection with a Federal Energy Regulatory Commission project.

EXTREMES FOR PERIOD OF RECORD.—Maximum discharge, 292 ft<sup>3</sup>/s, May 28, 1999, gage height, 3.21 ft; minimum daily, 5.5 ft<sup>3</sup>/s, Sept. 10, 1996.

## DISCHARGE, CUBIC FEET PER SECOND, WATER YEAR OCTOBER 2000 TO SEPTEMBER 2001

## DAILY MEAN VALUES

DAY	OCT	NOV	DEC	JAN	FEB	MAR	APR	MAY	JUN	JUL	AUG	SEP
1	8.3	19	37	30	28	11	7.8	8.2	5.9	5.9	11	11
2	8.3	39	37	30	28	13	7.5	7.9	5.9	5.9	11	11
3	8.2	50	37	30	28	13	7.3	7.8	5.9	5.9	11	36
4	8.2	50	36	30	28	13	7.3	7.9	5.9	5.9	11	55
5	8.1	50	36	30	28	13	7.3	8.0	5.9	5.9	11	55
6	14	60	36	30	28	13	7.3	8.0	5.9	5.9	12	45
7	19	72	36	30	28	13	7.0	8.1	5.9	5.9	14	29
8	19	72	36	29	27	13	6.8	8.4	5.9	5.9	14	24
9	19	78	36	29	27	9.4	7.1	8.3	5.9	5.9	14	24
10	19	82	36	30	27	7.3	7.2	8.4	5.9	5.9	14	19
11	15	82	36	29	27	7.3	7.2	8.4	5.9	5.9	14	15
12	11	82	36	29	27	7.3	7.3	8.4	5.9	5.9	14	21
13	11	82	36	29	27	7.3	7.3	8.3	5.9	5.9	14	25
14	11	82	36	29	27	7.3	7.3	8.6	5.9	5.9	14	25
15	11	81	36	35	22	7.3	7.4	8.6	5.9	5.9	21	25
16	11	81	36	40	18	7.3	7.5	8.8	5.9	5.9	45	25
17	11	81	36	40	18	7.3	7.5	8.8	5.9	5.9	69	25
18	11	81	36	40	18	7.5	7.5	9.0	5.9	5.9	69	25
19	11	81	36	40	18	7.8	7.6	9.0	5.9	5.9	61	25
20	11	80	36	40	17	8.2	7.5	9.0	5.9	5.9	35	25
21	11	51	36	39	16	7.4	7.5	8.4	5.9	5.9	20	25
22	11	32	36	39	16	6.1	7.7	7.7	5.9	5.9	7.7	25
23	11	32	36	32	11	6.0	7.8	7.7	5.9	5.9	7.7	25
24	11	32	35	28	7.9	6.0	7.8	7.9	5.9	5.9	7.6	24
25	11	32	35	28	7.9	5.9	8.0	7.9	5.9	5.9	7.6	24
26	11	32	35	28	7.4	5.8	8.1	8.0	5.9	5.9	7.5	24
27	10	29	33	28	7.9	6.4	8.0	7.9	5.9	5.9	7.5	24
28	11	26	30	28	7.9	7.6	8.0	8.1	5.9	5.9	7.5	24
29	11	32	30	28	---	7.6	8.0	7.9	5.9	5.9	9.7	24
30	11	37	30	28	---	7.7	8.1	7.6	5.9	5.9	11	24
31	10	---	30	28	---	7.8	---	6.5	---	8.8	11	---
TOTAL	364.1	1720	1089	983	578.0	267.6	225.7	253.5	177.0	185.8	583.8	788
MEAN	11.7	57.3	35.1	31.7	20.6	8.63	7.52	8.18	5.90	5.99	18.8	26.3
MAX	19	82	37	40	28	13	8.1	9.0	5.9	8.8	69	55
MIN	8.1	19	30	28	7.4	5.8	6.8	6.5	5.9	5.9	7.5	11
AC-FT	722	3410	2160	1950	1150	531	448	503	351	369	1160	1560

## STATISTICS OF MONTHLY MEAN DATA FOR WATER YEARS 1993 - 2001, BY WATER YEAR (WY)

MEAN	26.9	23.3	19.7	33.7	28.5	21.1	28.7	58.4	103	57.9	26.7	30.9
MAX	54.5	57.3	35.1	116	92.4	40.0	83.5	134	203	183	64.5	55.3
(WY)	1996	2001	2001	1997	1997	1997	1995	1999	1995	1995	1995	1995
MIN	6.72	6.75	6.60	13.0	9.54	8.63	7.52	8.18	5.90	5.99	10.1	17.0
(WY)	1998	1998	1998	1999	1996	2001	2001	2001	2001	2001	1999	1994

SUMMARY STATISTICS	FOR 2000 CALENDAR YEAR		FOR 2001 WATER YEAR		WATER YEARS 1993 - 2001	
ANNUAL TOTAL	11864.9		7215.5			
ANNUAL MEAN	32.4		19.8		38.2	
HIGHEST ANNUAL MEAN					63.1	
LOWEST ANNUAL MEAN					19.8	
HIGHEST DAILY MEAN	156	Jun 16	82	Nov 10	290	May 28 1999
LOWEST DAILY MEAN	7.0	Jul 28	5.8	Mar 26	5.5	Sep 10 1996
ANNUAL SEVEN-DAY MINIMUM	7.0	Jul 28	5.9	Jun 1	5.9	Jun 1 2001
MAXIMUM PEAK FLOW			88		292	
MAXIMUM PEAK STAGE			2.34		3.21	
ANNUAL RUNOFF (AC-FT)	23530		14310		27690	
10 PERCENT EXCEEDS	81		37		87	
50 PERCENT EXCEEDS	19		11		23	
90 PERCENT EXCEEDS	8.2		5.9		7.9	

## 11439500 SOUTH FORK AMERICAN RIVER NEAR KYBURZ, CA

LOCATION.—Lat 38°45'49", long 120°19'39", in SW 1/4 SW 1/4 sec.29, T.11 N., R.15 E., El Dorado County, Hydrologic Unit 18020129, Eldorado National Forest, on right bank, 0.8 mi downstream from Silver Fork American River, and 1.9 mi southwest of Kyburz.

DRAINAGE AREA.—193 mi<sup>2</sup>.

PERIOD OF RECORD.—August to December 1907, October 1922 to current year. Prior to October 1956, records for river and El Dorado Canal published separately; combined flow only, October 1956 to September 1960.

CHEMICAL DATA: Water years 1979, 1980.

BIOLOGICAL DATA: Water years 1979, 1980.

SUSPENDED SEDIMENT: Water year 1980.

WATER TEMPERATURE: Water years 1966–79.

REVISED RECORDS.—WSP 1445: 1923(M), 1925(M), 1927(M), 1928 (river only), 1935–37(M). WSP 1515: 1928 (combined). WSP 1931: Drainage area.

GAGE.—Water-stage recorder on river; water-stage recorder for canal diversion (station 11439000). Elevation of gage is 3,840 ft above sea level, from topographic map. Prior to Oct. 1, 1962, at datum 1.00 ft higher.

REMARKS.—Low and medium flows regulated by Echo Lake, Silver Lake, Caples Lake (stations 10336608, 11435900, and 11436950), and Lake Aloha, total capacity, 37,100 acre-ft. Some water is diverted out of river 0.6 mi upstream at diversion dam to El Dorado Canal (station 11439000). Part of this water is used for irrigation and domestic use and the remainder is returned to river at El Dorado Powerplant. See schematic diagram of South Fork American River Basin.

COOPERATION.—Records were collected by El Dorado Irrigation District, under general supervision of the U.S. Geological Survey, in connection with a Federal Energy Regulatory Commission project.

EXTREMES FOR PERIOD OF RECORD.—River only: Maximum discharge, 25,000 ft<sup>3</sup>/s, Jan. 2, 1997, gage height, 14.26 ft (from floodmarks), from rating curve extended above 6,300 ft<sup>3</sup>/s on basis of contracted-opening measurement at gage height 10.40 ft; minimum daily, 0.13 ft<sup>3</sup>/s, Nov. 26, 1977.

Combined flow: Maximum discharge, 25,000 ft<sup>3</sup>/s, Jan. 2, 1997; minimum daily, 10 ft<sup>3</sup>/s, Oct. 17, 19, 1929.

## DISCHARGE, CUBIC FEET PER SECOND, WATER YEAR OCTOBER 2000 TO SEPTEMBER 2001

## DAILY MEAN VALUES

DAY	OCT	NOV	DEC	JAN	FEB	MAR	APR	MAY	JUN	JUL	AUG	SEP
1	49	79	78	64	75	65	547	1050	173	22	24	20
2	48	88	75	65	76	76	459	869	158	19	24	19
3	51	116	74	66	77	70	305	572	137	23	22	17
4	60	115	80	66	87	91	246	562	124	32	21	29
5	51	110	82	66	97	106	215	701	113	36	21	18
6	53	109	80	66	93	103	199	785	107	33	22	14
7	70	120	79	68	86	103	197	867	99	32	25	26
8	73	120	80	74	74	125	190	1030	92	31	26	28
9	75	121	80	73	94	135	176	998	86	29	24	24
10	90	134	82	76	86	114	177	938	81	28	23	24
11	90	129	82	76	85	103	183	984	77	26	21	20
12	72	123	85	79	82	99	169	978	74	24	21	16
13	56	126	83	78	88	105	169	912	70	24	22	19
14	55	128	90	76	81	123	180	826	65	24	23	17
15	55	120	98	69	80	131	204	880	61	22	22	16
16	59	121	88	72	74	119	270	923	58	22	26	17
17	60	117	88	78	72	127	347	796	54	23	32	16
18	54	117	85	95	72	176	393	701	51	25	30	15
19	56	118	86	89	75	215	445	616	49	23	30	15
20	57	118	84	85	77	292	362	587	47	21	41	15
21	58	115	84	84	78	330	336	564	44	20	51	14
22	62	82	84	79	79	347	349	502	41	31	42	14
23	62	74	82	75	73	326	424	516	38	55	23	14
24	58	74	81	78	71	367	606	454	34	53	25	15
25	60	74	79	78	69	502	828	401	32	53	24	37
26	68	74	72	78	68	420	982	346	34	52	22	17
27	71	74	67	75	64	355	968	274	35	36	21	16
28	81	70	64	74	60	447	904	239	36	24	21	15
29	114	84	64	78	---	535	795	215	30	23	21	17
30	87	84	63	72	---	475	933	199	26	23	23	19
31	79	---	63	73	---	502	---	187	---	25	23	---
TOTAL	2034	3134	2462	2325	2193	7084	12558	20472	2126	914	796	563
MEAN	65.6	104	79.4	75.0	78.3	229	419	660	70.9	29.5	25.7	18.8
MAX	114	134	98	95	97	535	982	1050	173	55	51	37
MIN	48	70	63	64	60	65	169	187	26	19	21	14
AC-FT	4030	6220	4880	4610	4350	14050	24910	40610	4220	1810	1580	1120

## SACRAMENTO RIVER BASIN

## 11439500 SOUTH FORK AMERICAN RIVER NEAR KYBURZ, CA—Continued

## STATISTICS OF MONTHLY MEAN DATA FOR WATER YEARS 1923 - 2001, BY WATER YEAR (WY)

	OCT	NOV	DEC	JAN	FEB	MAR	APR	MAY	JUN	JUL	AUG	SEP
MEAN	37.2	78.6	129	155	176	277	637	1202	842	184	27.0	25.7
MAX	223	1283	1587	1964	1333	1252	1497	2765	3551	1628	343	417
(WY)	1984	1951	1951	1997	1986	1986	1982	1969	1983	1995	1983	1983
MIN	.77	.49	.69	.57	.76	2.42	38.9	56.8	.76	.62	.58	.54
(WY)	1929	1929	1931	1929	1931	1933	1977	1977	1924	1924	1926	1924

SUMMARY STATISTICS	FOR 2000 CALENDAR YEAR		FOR 2001 WATER YEAR		WATER YEARS 1923 - 2001	
ANNUAL TOTAL	129686		56661			
ANNUAL MEAN	354		155		314	
HIGHEST ANNUAL MEAN					907	
LOWEST ANNUAL MEAN					19.4	
HIGHEST DAILY MEAN	2660	May 8	1050	May 1	18000	Jan 2 1997
LOWEST DAILY MEAN	43	Sep 25	14	Sep 6	.13	Nov 26 1977
ANNUAL SEVEN-DAY MINIMUM	46	Sep 23	15	Sep 18	.36	Nov 5 1928
MAXIMUM PEAK FLOW			1420	May 8	25000	Jan 2 1997
MAXIMUM PEAK STAGE			4.68	May 8	14.26	Jan 2 1997
ANNUAL RUNOFF (AC-FT)	257200		112400		227800	
10 PERCENT EXCEEDS	1030		456		1030	
50 PERCENT EXCEEDS	117		76		53	
90 PERCENT EXCEEDS	54		22		2.9	

## 11439501 SOUTH FORK AMERICAN RIVER NEAR KYBURZ, CA—Continued

## SOUTH FORK AMERICAN RIVER AND EL DORADO CANAL NEAR KYBURZ, CA

## DISCHARGE, CUBIC FEET PER SECOND, WATER YEAR OCTOBER 2000 TO SEPTEMBER 2001

## DAILY MEAN VALUES

DAY	OCT	NOV	DEC	JAN	FEB	MAR	APR	MAY	JUN	JUL	AUG	SEP
1	50	89	90	76	75	65	547	1060	206	57	49	74
2	49	97	86	73	76	76	459	873	194	54	50	73
3	52	125	85	72	77	70	305	572	173	53	48	71
4	76	124	84	72	87	91	246	562	160	58	47	86
5	81	120	82	72	104	106	215	701	149	68	47	80
6	84	118	80	72	98	103	199	785	143	67	47	73
7	102	128	79	72	86	103	197	875	135	66	49	88
8	105	128	80	74	74	125	190	1040	128	65	52	96
9	105	128	80	73	94	135	176	1020	122	63	50	92
10	121	140	82	76	88	114	177	960	117	63	49	96
11	120	136	82	76	88	103	183	1010	113	61	47	95
12	95	129	85	79	84	99	176	1000	110	59	47	87
13	75	132	83	78	93	105	184	935	106	58	47	93
14	74	135	90	76	89	123	196	849	101	57	47	91
15	74	128	98	69	84	131	220	903	97	55	46	89
16	70	129	88	72	75	119	282	947	94	54	56	90
17	72	125	88	78	73	127	358	820	90	54	90	89
18	72	119	85	101	73	176	410	725	87	55	101	87
19	75	118	86	93	76	215	456	640	85	53	101	87
20	75	118	84	85	78	292	362	610	82	52	81	86
21	78	115	84	84	79	330	336	587	79	51	90	85
22	82	82	84	86	79	347	349	525	76	50	96	84
23	82	74	82	87	73	326	427	542	73	55	82	82
24	78	74	81	82	71	367	614	482	69	53	82	81
25	81	74	79	78	69	502	836	430	67	53	80	105
26	91	75	79	78	68	420	990	375	69	52	78	84
27	85	76	79	75	64	355	976	302	70	49	76	79
28	87	75	76	74	60	447	912	267	72	46	74	77
29	121	84	76	78	---	535	803	243	65	45	73	80
30	96	92	75	72	---	475	941	227	61	44	75	79
31	90	---	75	73	---	502	---	215	---	48	76	---
TOTAL	2598	3287	2567	2406	2235	7084	12722	21082	3193	1718	2033	2559
MEAN	83.8	110	82.8	77.6	79.8	229	424	680	106	55.4	65.6	85.3
MAX	121	140	98	101	104	535	990	1060	206	68	101	105
MIN	49	74	75	69	60	65	176	215	61	44	46	71
AC-FT	5150	6520	5090	4770	4430	14050	25230	41820	6330	3410	4030	5080
a	1120	302	209	174	84	1.0	325	1210	2120	1590	2450	3960

## STATISTICS OF MONTHLY MEAN DATA FOR WATER YEARS 1923 - 2001, BY WATER YEAR (WY)

MEAN	110	160	217	240	270	380	739	1321	970	308	147	133
MAX	365	1301	1698	1964	1412	1344	1533	2905	3561	1637	357	424
(WY)	1983	1951	1951	1997	1986	1986	1982	1969	1983	1995	1983	1983
MIN	20.8	25.1	44.2	35.9	38.4	53.7	178	207	99.7	55.4	65.6	46.4
(WY)	1978	1930	1960	1929	1977	1977	1977	1977	1924	2001	2001	1987

SUMMARY STATISTICS	FOR 2000 CALENDAR YEAR		FOR 2001 WATER YEAR		WATER YEARS 1923 - 2001	
ANNUAL TOTAL	135121		63484			
ANNUAL MEAN	369		174		416	
HIGHEST ANNUAL MEAN					980	
LOWEST ANNUAL MEAN					104	
HIGHEST DAILY MEAN	2660	May 8	1060	May 1	18000	Jan 2 1997
LOWEST DAILY MEAN	48	Sep 30	44	Jul 30	10	Oct 17 1929
ANNUAL SEVEN-DAY MINIMUM	49	Sep 26	47	Jul 28	13	Oct 6 1929
MAXIMUM PEAK FLOW			1440		25000	
ANNUAL RUNOFF (AC-FT)	268000		125900		301700	
ANNUAL DIVERSION (AC-FT) a	10850		13540			
10 PERCENT EXCEEDS	1030		465		1140	
50 PERCENT EXCEEDS	128		85		166	
90 PERCENT EXCEEDS	76		55		74	

a Diversion, in acre-feet, to El Dorado Canal (station 11439000), provided by El Dorado Irrigation District.

## 11441500 SOUTH FORK SILVER CREEK NEAR ICE HOUSE, CA

LOCATION.—Lat 38°49'08", long 120°21'51", in NW 1/4 NW 1/4 sec.12, T.11 N., R.14 E., El Dorado County, Hydrologic Unit 18020129, Eldorado National Forest, on right bank, 300 ft upstream from Peavine Creek, 0.4 mi downstream from Ice House Dam, and 4.8 mi northwest of Kyburz.

DRAINAGE AREA.—27.5 mi<sup>2</sup>.

PERIOD OF RECORD.—October 1924 to current year.

REVISED RECORDS.—WSP 1395: 1928, 1938. WSP 1635: Drainage area at former site.

GAGE.—Water-stage recorder and concrete control. Elevation of gage is 5,290 ft above sea level, from topographic map. Prior to Oct. 1, 1959, at site 0.3 mi upstream at different datum.

REMARKS.—Flow regulated by Ice House Reservoir (station 11441100) beginning in December 1959. Diversion to Jones Fork Powerplant (station 11440900) starting April 1985 bypasses station and returns to Silver Creek at Union Valley Reservoir (station 11441001). See schematic diagram of [South Fork American River Basin](#).

COOPERATION.—Records were collected by Sacramento Municipal Utility District, under general supervision of the U.S. Geological Survey, in connection with a Federal Energy Regulatory Commission project.

EXTREMES FOR PERIOD OF RECORD.—Maximum discharge prior to construction of Ice House Dam in 1959, 3,940 ft<sup>3</sup>/s, Dec. 23, 1955, gage height, 6.71 ft, site and datum then in use, from rating curve extended above 540 ft<sup>3</sup>/s, on basis of slope-area measurement at gage height 6.69 ft; no flow Oct. 31 to Nov. 9, 1958. Maximum discharge since construction of the dam, 7,530 ft<sup>3</sup>/s, May 16, 1996, gage height, 7.64 ft, from rating curve extended above 730 ft<sup>3</sup>/s, on basis of computation of flow over dam at gage height 5.66 ft; minimum daily, 1.2 ft<sup>3</sup>/s, Mar. 17–19, 1960.

## DISCHARGE, CUBIC FEET PER SECOND, WATER YEAR OCTOBER 2000 TO SEPTEMBER 2001

## DAILY MEAN VALUES

DAY	OCT	NOV	DEC	JAN	FEB	MAR	APR	MAY	JUN	JUL	AUG	SEP
1	15	12	5.1	4.8	4.4	4.4	4.9	5.8	6.2	5.9	5.9	5.9
2	14	11	5.1	4.3	4.4	4.4	4.9	5.9	6.5	5.9	5.9	5.9
3	14	11	5.1	4.2	4.5	4.4	4.9	5.9	6.5	5.9	5.8	5.9
4	14	11	5.1	4.0	4.4	4.5	4.9	5.9	6.7	5.9	5.8	6.2
5	14	11	5.1	4.0	4.4	4.7	5.0	5.9	6.5	5.9	5.9	6.2
6	14	11	5.0	4.0	4.3	4.8	5.2	5.9	6.3	5.9	5.8	6.2
7	14	11	4.9	3.9	4.3	4.8	5.3	5.9	6.2	5.9	5.6	6.2
8	14	11	4.9	3.9	4.2	4.9	5.1	5.9	6.2	5.9	5.8	6.1
9	14	11	5.0	3.9	4.3	4.8	4.9	5.9	6.2	5.9	5.9	5.9
10	14	11	4.9	3.9	4.4	4.7	4.9	5.9	6.2	5.9	5.9	6.0
11	14	11	4.9	4.0	4.4	4.6	4.9	6.0	6.2	5.9	5.9	6.5
12	14	11	5.2	4.0	4.4	4.7	4.9	6.0	6.2	6.0	5.9	6.5
13	14	11	4.9	4.0	4.2	4.9	5.0	6.0	6.2	6.1	5.9	6.5
14	13	11	4.9	4.0	4.2	5.0	5.2	6.0	6.2	5.9	10	6.3
15	13	11	5.2	4.0	4.3	4.9	5.5	6.1	6.2	5.9	6.1	5.8
16	13	8.3	4.9	4.0	4.3	4.8	5.4	6.2	6.2	6.0	5.9	5.6
17	13	4.5	4.9	3.9	4.3	4.8	5.0	6.2	6.5	5.9	5.9	5.6
18	13	4.9	4.9	4.0	4.3	4.9	5.0	6.2	6.2	6.1	6.0	5.6
19	13	4.9	4.9	4.0	4.4	5.0	5.8	6.2	6.2	6.1	6.2	6.2
20	13	4.9	4.9	4.0	4.4	5.2	5.4	6.2	6.2	5.9	6.1	6.8
21	13	4.9	4.9	4.0	4.3	5.3	5.6	6.2	6.2	6.4	5.9	6.9
22	13	4.9	4.9	4.0	4.3	5.3	5.8	6.2	6.2	6.2	5.9	7.0
23	13	4.9	4.9	4.1	4.4	5.4	5.9	6.2	6.2	6.2	6.1	7.1
24	13	4.9	4.9	4.4	4.4	5.5	5.2	6.2	6.2	6.2	6.2	7.1
25	15	4.9	5.0	4.4	4.4	5.6	5.0	6.2	6.2	6.2	6.1	7.2
26	13	5.0	5.1	4.4	4.4	5.1	4.9	6.2	6.2	6.2	5.9	7.1
27	13	4.9	5.1	4.4	4.4	5.0	4.9	6.2	6.2	6.2	5.9	7.2
28	13	4.9	5.1	4.4	4.4	4.9	5.0	6.2	6.2	6.2	5.9	7.4
29	13	5.3	5.1	4.4	---	4.9	5.1	6.2	6.2	6.2	5.9	7.4
30	13	5.1	5.2	4.4	---	4.9	5.3	6.2	6.1	6.0	5.9	7.4
31	13	---	5.1	4.4	---	4.9	---	6.2	---	5.9	5.9	---
TOTAL	419	243.2	155.1	128.1	121.8	152.0	154.8	188.2	187.7	186.7	187.8	193.7
MEAN	13.5	8.11	5.00	4.13	4.35	4.90	5.16	6.07	6.26	6.02	6.06	6.46
MAX	15	12	5.2	4.8	4.5	5.6	5.9	6.2	6.7	6.4	10	7.4
MIN	13	4.5	4.9	3.9	4.2	4.4	4.9	5.8	6.1	5.9	5.6	5.6
AC-FT	831	482	308	254	242	301	307	373	372	370	373	384
a	4090	1260	3800	1330	571	421	31	279	1260	1760	1010	577

a Diversion, in acre-feet, to Jones Fork Powerplant (station 11440900), provided by Sacramento Municipal Utility District.

## 11441500 SOUTH FORK SILVER CREEK NEAR ICE HOUSE, CA—Continued

## STATISTICS OF MONTHLY MEAN DATA FOR WATER YEARS 1925 - 1959, BY WATER YEAR (WY)

	OCT	NOV	DEC	JAN	FEB	MAR	APR	MAY	JUN	JUL	AUG	SEP
MEAN	4.98	24.1	36.6	31.3	35.8	61.6	155	296	197	42.7	5.82	2.03
MAX	28.0	326	305	163	91.7	191	280	531	418	132	22.8	7.62
(WY)	1948	1951	1951	1956	1925	1928	1943	1952	1952	1952	1952	1952
MIN	.65	.64	2.34	3.00	3.00	6.92	54.9	66.2	35.0	2.92	.22	.18
(WY)	1933	1930	1933	1933	1933	1933	1944	1934	1931	1934	1931	1931

## SUMMARY STATISTICS

## WATER YEARS 1925 - 1959

ANNUAL MEAN	74.5
HIGHEST ANNUAL MEAN	123 1956
LOWEST ANNUAL MEAN	25.3 1931
HIGHEST DAILY MEAN	2780 Dec 23 1955
LOWEST DAILY MEAN	.00 Oct 31 1958
ANNUAL SEVEN-DAY MINIMUM	.00 Oct 31 1958
MAXIMUM PEAK FLOW	3940 Dec 23 1955
MAXIMUM PEAK STAGE	6.71 Dec 23 1955
ANNUAL RUNOFF (AC-FT)	53970
10 PERCENT EXCEEDS	237
50 PERCENT EXCEEDS	20
90 PERCENT EXCEEDS	1.4

## STATISTICS OF MONTHLY MEAN DATA FOR WATER YEARS 1961 - 1984, BY WATER YEAR (WY)

MEAN	112	87.6	49.4	57.1	71.2	43.6	56.0	125	157	78.1	80.9	90.1
MAX	330	332	171	216	316	199	348	449	382	363	378	360
(WY)	1970	1966	1980	1982	1971	1969	1983	1982	1983	1983	1983	1983
MIN	5.64	5.05	5.21	4.76	5.48	3.67	2.94	4.17	3.80	4.02	3.79	3.97
(WY)	1965	1963	1963	1967	1973	1984	1977	1977	1977	1977	1977	1977

## SUMMARY STATISTICS

## WATER YEARS 1961 - 1984

ANNUAL MEAN	84.0
HIGHEST ANNUAL MEAN	226 1983
LOWEST ANNUAL MEAN	24.8 1977
HIGHEST DAILY MEAN	1560 Jan 22 1970
LOWEST DAILY MEAN	1.3 Jan 26 1984
ANNUAL SEVEN-DAY MINIMUM	1.4 Jan 24 1984
MAXIMUM PEAK FLOW	1930 May 26 1982
MAXIMUM PEAK STAGE	5.74 May 26 1982
ANNUAL RUNOFF (AC-FT)	60830
10 PERCENT EXCEEDS	256
50 PERCENT EXCEEDS	12
90 PERCENT EXCEEDS	5.3

## STATISTICS OF MONTHLY MEAN DATA FOR WATER YEARS 1986 - 2001, BY WATER YEAR (WY)

MEAN	10.4	7.67	5.46	16.3	5.49	8.81	5.29	13.1	23.1	15.2	11.8	11.8
MAX	14.3	11.2	6.12	184	7.03	55.0	6.13	87.9	168	61.9	18.2	17.6
(WY)	1998	1997	1993	1997	1986	1986	1990	1996	1995	1995	1997	1996
MIN	5.32	5.65	4.78	3.65	3.97	4.13	4.01	5.49	5.54	5.46	5.21	5.29
(WY)	1989	1993	1990	1987	1987	1987	1986	1988	1988	1987	1992	1992

## SUMMARY STATISTICS

## FOR 2000 CALENDAR YEAR

## FOR 2001 WATER YEAR

## WATER YEARS 1986 - 2001

ANNUAL TOTAL	3530.0	2318.1	
ANNUAL MEAN	9.64	6.35	11.2
HIGHEST ANNUAL MEAN			26.2 1995
LOWEST ANNUAL MEAN			5.68 1988
HIGHEST DAILY MEAN	18 Jul 1	15 Oct 1	2840 Jan 2 1997
LOWEST DAILY MEAN	3.7 Jan 6	3.9 Jan 7	2.8 Jan 3 1986
ANNUAL SEVEN-DAY MINIMUM	3.8 Jan 6	3.9 Jan 4	3.0 Apr 11 1989
MAXIMUM PEAK FLOW		296 Aug 14	7530 May 16 1996
MAXIMUM PEAK STAGE		4.08 Aug 14	7.64 May 16 1996
ANNUAL RUNOFF (AC-FT)	7000	4600	8140
ANNUAL DIVERSION (AC-FT) a	49570	16400	
10 PERCENT EXCEEDS	17	11	16
50 PERCENT EXCEEDS	9.6	5.9	6.0
90 PERCENT EXCEEDS	4.5	4.4	4.6

a Diversion, in acre-feet, to Jones Fork Powerplant (station 11440900), provided by Sacramento Municipal Utility District.



## 11441800 SILVER CREEK BELOW JUNCTION DAM, NEAR POLLOCK PINES, CA

LOCATION.—Lat 38°51'08", long 120°27'22", in SW 1/4 SW 1/4 sec.30, T.12 N., R.14 E., El Dorado County, Hydrologic Unit 18020129, Eldorado National Forest, at outlet structure, on Junction Dam, and 9 mi northeast of Pollock Pines.

DRAINAGE AREA.—147 mi<sup>2</sup>.

PERIOD OF RECORD.—October 1987 to current year (low-flow records only). Unpublished records for water years 1965–87 available in files of the U.S. Geological Survey.

GAGE.—Differential-pressure gage and orifice control in outlet pipe. Auxiliary nonrecording gage 550 ft downstream at different datum. Elevation of gage is 4,280 ft above sea level, from topographic map. August 1964 to December 1986, nonrecording gage at site 500 ft downstream at different datum. December 1986 to September 1987, nonrecording gage at site 550 ft downstream.

REMARKS.—Records not computed above 30 ft<sup>3</sup>/s. Flow completely regulated by Junction Dam. Flow over the spillway bypasses this station. Diversion through Jaybird Powerplant (station 11441780) since 1962 bypasses this station. See schematic diagram of [South Fork American River Basin](#).

COOPERATION.—Records were collected by Sacramento Municipal Utility District, under general supervision of the U.S. Geological Survey, in connection with a Federal Energy Regulatory Commission project.

## DISCHARGE, CUBIC FEET PER SECOND, WATER YEAR OCTOBER 2000 TO SEPTEMBER 2001

## DAILY MEAN VALUES

DAY	OCT	NOV	DEC	JAN	FEB	MAR	APR	MAY	JUN	JUL	AUG	SEP
1	20	15	11	11	11	11	11	11	11	11	11	11
2	20	11	10	11	11	11	11	10	11	11	11	11
3	20	10	11	10	11	11	10	10	11	11	11	11
4	20	11	11	10	11	11	11	11	10	11	11	11
5	20	11	11	11	11	11	11	e11	10	11	11	11
6	20	10	11	11	11	11	11	e11	11	11	11	11
7	13	10	11	11	11	10	11	e11	11	11	11	11
8	5.7	11	11	10	11	11	11	11	11	11	11	11
9	5.7	11	11	11	11	10	11	11	11	11	11	11
10	5.6	11	10	11	11	11	11	11	11	11	11	11
11	5.5	11	11	10	11	11	11	10	11	11	11	11
12	5.6	11	11	10	11	10	10	11	11	11	11	11
13	5.6	11	10	11	11	10	10	11	11	11	11	11
14	5.7	11	11	11	11	10	10	11	11	11	11	11
15	5.7	11	10	11	11	10	11	11	11	11	11	11
16	5.6	10	10	11	10	10	11	11	11	11	11	11
17	5.6	10	11	11	11	10	11	10	11	11	11	11
18	5.6	11	11	11	11	11	10	11	11	11	11	11
19	5.7	11	11	11	11	11	10	10	11	11	11	11
20	5.7	11	11	10	11	11	10	11	11	11	11	11
21	5.6	10	11	10	11	11	10	11	11	11	11	11
22	5.6	11	11	11	11	11	11	11	11	11	11	11
23	5.7	11	11	11	10	10	11	10	11	11	11	11
24	5.7	10	10	11	11	11	10	11	11	11	11	11
25	5.7	11	11	11	11	11	10	10	11	11	11	11
26	5.6	10	11	11	11	10	11	10	11	11	11	11
27	5.6	11	11	10	10	10	10	10	11	11	11	11
28	12	10	11	10	11	11	10	10	11	11	11	11
29	21	11	11	11	---	10	11	11	11	11	11	11
30	21	11	11	11	---	11	10	11	11	11	11	11
31	21	---	11	10	---	11	---	11	---	11	11	---
TOTAL	320.8	325	335	331	305	329	317	331	328	341	341	330
MEAN	10.3	10.8	10.8	10.7	10.9	10.6	10.6	10.7	10.9	11.0	11.0	11.0
MAX	21	15	11	11	11	11	11	11	11	11	11	11
MIN	5.5	10	10	10	10	10	10	10	10	11	11	11
AC-FT	636	645	664	657	605	653	629	657	651	676	676	655
a	8510	49560	59070	17360	3050	6110	6050	8690	10380	12710	14410	4980

CAL YR 2000 a 482200

WTR YR 2001 a 201300

e Estimated.

a Diversion, in acre-feet, to Jaybird Powerplant (station 11441780), provided by Sacramento Municipal Utility District.

## 11441900 SILVER CREEK BELOW CAMINO DIVERSION DAM, CA

LOCATION.—Lat 38°49'26", long 120°32'18", on line between secs.4 and 5, T.11 N., R.13 E., El Dorado County, Hydrologic Unit 18020129, Eldorado National Forest, on right bank, 300 ft downstream from Round Tent Canyon, 0.4 mi downstream from diversion dam, and 5 mi northeast of Pollock Pines.

DRAINAGE AREA.—171 mi<sup>2</sup>.

PERIOD OF RECORD.—October 1960 to current year.

GAGE.—Water-stage recorder. Datum of gage is 2,754.06 ft above sea level (Sacramento Municipal Utility District benchmark).

REMARKS.—Flow is regulated by Ice House Reservoir (station 11441100) since 1959, Union Valley Reservoir (station 11441001) since 1962, and Junction and Camino Reservoirs (stations 11441760 and 11441890). Diversion to Camino Powerplant (station 11441895) since 1961 bypasses this station. See schematic diagram of [South Fork American River Basin](#).

COOPERATION.—Records were collected by Sacramento Municipal Utility District, under general supervision of the U.S. Geological Survey, in connection with a Federal Energy Regulatory Commission project.

EXTREMES FOR PERIOD OF RECORD.—Maximum discharge, about 47,700 ft<sup>3</sup>/s, Jan. 2, 1997, gage height, 15.72 ft, backwater from log jam, from rating curve extended above 4,700 ft<sup>3</sup>/s, on basis of slope-area measurement at gage height 11.28 ft; minimum daily, 1.0 ft<sup>3</sup>/s, Nov. 1, 1980.

## DISCHARGE, CUBIC FEET PER SECOND, WATER YEAR OCTOBER 2000 TO SEPTEMBER 2001

## DAILY MEAN VALUES

DAY	OCT	NOV	DEC	JAN	FEB	MAR	APR	MAY	JUN	JUL	AUG	SEP
1	23	20	13	13	14	14	14	14	14	13	14	14
2	23	14	13	14	14	14	14	13	14	14	14	13
3	23	14	14	13	14	14	14	13	14	13	14	14
4	23	14	13	13	14	14	13	13	14	14	14	14
5	22	14	14	14	14	15	13	14	14	14	14	14
6	22	14	13	14	14	16	13	13	14	14	14	13
7	22	14	13	14	14	17	13	14	14	14	14	14
8	19	14	14	13	14	18	13	14	14	14	14	13
9	25	14	14	14	14	18	13	14	14	14	14	13
10	28	14	13	14	14	16	13	14	14	14	14	14
11	19	14	14	13	14	15	14	14	14	14	14	14
12	29	14	13	14	14	14	13	14	14	14	14	14
13	25	14	14	14	14	14	13	14	14	14	14	14
14	21	14	13	14	14	14	13	14	14	14	14	14
15	20	14	13	13	13	14	14	14	14	14	14	14
16	20	14	13	13	13	14	13	14	14	14	14	14
17	20	14	13	14	14	14	13	14	14	14	14	15
18	19	13	13	14	14	14	19	14	14	14	14	13
19	20	13	14	13	14	14	53	14	14	14	14	13
20	19	13	13	14	14	14	57	14	14	14	14	13
21	20	13	14	14	14	14	56	14	14	14	14	13
22	19	13	14	14	13	15	56	14	14	14	14	13
23	16	13	14	14	13	14	41	14	14	14	14	13
24	9.5	13	14	13	14	14	22	14	15	14	14	13
25	9.9	13	13	14	13	16	19	14	14	14	14	14
26	8.4	13	13	14	14	14	17	14	14	14	14	13
27	6.7	13	14	14	14	14	14	14	14	14	14	13
28	15	13	14	14	13	14	13	14	14	14	14	13
29	27	13	14	14	---	14	14	14	14	13	14	13
30	26	13	14	14	---	14	13	14	14	14	14	13
31	26	---	13	14	---	14	---	14	---	14	13	---
TOTAL	625.5	413	418	425	386	454	620	430	421	431	433	405
MEAN	20.2	13.8	13.5	13.7	13.8	14.6	20.7	13.9	14.0	13.9	14.0	13.5
MAX	29	20	14	14	14	18	57	14	15	14	14	15
MIN	6.7	13	13	13	13	14	13	13	14	13	13	13
AC-FT	1240	819	829	843	766	901	1230	853	835	855	859	803
a	9430	50970	60980	18900	5800	11090	10810	11510	11510	13620	15340	5790

a Diversion, in acre-feet, to Camino Powerplant (station 11441895), provided by Sacramento Municipal Utility District.

## SACRAMENTO RIVER BASIN

## 11441900 SILVER CREEK BELOW CAMINO DIVERSION DAM, CA—Continued

## STATISTICS OF MONTHLY MEAN DATA FOR WATER YEARS 1961 - 2001, BY WATER YEAR (WY)

	OCT	NOV	DEC	JAN	FEB	MAR	APR	MAY	JUN	JUL	AUG	SEP
MEAN	27.7	43.5	70.2	196	125	113	113	182	142	64.3	31.9	26.0
MAX	138	1088	856	4122	1168	1207	956	1505	1019	503	364	188
(WY)	1995	1984	1965	1997	1986	1986	1962	1995	1995	1995	1962	1962
MIN	3.12	3.44	5.39	5.21	5.45	3.56	3.14	3.30	3.29	2.98	3.11	3.18
(WY)	1978	1978	1977	1977	1977	1977	1977	1977	1977	1977	1977	1977

SUMMARY STATISTICS	FOR 2000 CALENDAR YEAR		FOR 2001 WATER YEAR		WATER YEARS 1961 - 2001	
ANNUAL TOTAL	8167.5		5461.5			
ANNUAL MEAN	22.3		15.0		94.5	
HIGHEST ANNUAL MEAN					461 1997	
LOWEST ANNUAL MEAN					4.16 1977	
HIGHEST DAILY MEAN	323	Feb 14	57	Apr 20	32900	Jan 2 1997
LOWEST DAILY MEAN	6.7	Oct 27	6.7	Oct 27	1.0	Nov 1 1980
ANNUAL SEVEN-DAY MINIMUM	11	Mar 25	12	Oct 22	2.7	Mar 2 1977
MAXIMUM PEAK FLOW			70	Oct 9	47700	Jan 2 1997
MAXIMUM PEAK STAGE			2.95	Oct 9	15.72	Jan 2 1997
ANNUAL RUNOFF (AC-FT)	16200		10830		68440	
ANNUAL DIVERSION (AC-FT) a	537100		225800			
10 PERCENT EXCEEDS	26		17		129	
50 PERCENT EXCEEDS	22		14		19	
90 PERCENT EXCEEDS	11		13		7.1	

a Diversion, in acre-feet, to Camino Powerplant (station 11441895), provided by Sacramento Municipal Utility District.

## 11442700 BRUSH CREEK BELOW BRUSH CREEK DAM, NEAR POLLOCK PINES, CA

LOCATION.—Lat 38°48'41", long 120°37'20", in NW 1/4 SE 1/4 sec.10, T.11 N., R.12 E., El Dorado County, Hydrologic Unit 18020129, Eldorado National Forest, at outlet structure on Brush Creek Dam, and 4.0 mi northwest of Pollock Pines.

DRAINAGE AREA.—7.99 mi<sup>2</sup>.

PERIOD OF RECORD.—October 1987 to current year. Unpublished records for water years 1971–87 available in files of the U.S. Geological Survey.

GAGE.—Differential-pressure gage and orifice control in outlet pipe. Auxiliary water-stage recorder 200 ft downstream at different datum. Elevation of gage is 2,700 ft above sea level, from topographic map. Prior to October 1987, nonrecording gage 400 ft downstream at different datum.

REMARKS.—Flow completely regulated by Brush Creek Reservoir (station 11442690). See schematic diagram of [South Fork American River Basin](#).

COOPERATION.—Records were collected by Sacramento Municipal Utility District, under general supervision of the U.S. Geological Survey, in connection with a Federal Energy Regulatory Commission project.

EXTREMES FOR PERIOD OF RECORD.—Maximum daily discharge, 620 ft<sup>3</sup>/s, Jan. 2, 1997; minimum daily, 2.1 ft<sup>3</sup>/s, many days in 1988.

## DISCHARGE, CUBIC FEET PER SECOND, WATER YEAR OCTOBER 2000 TO SEPTEMBER 2001

## DAILY MEAN VALUES

DAY	OCT	NOV	DEC	JAN	FEB	MAR	APR	MAY	JUN	JUL	AUG	SEP
1	3.3	7.1	6.7	6.7	6.7	6.7	4.5	4.5	3.7	2.6	2.7	2.8
2	3.3	7.1	6.7	6.8	6.7	6.7	4.5	4.5	2.7	2.6	2.7	2.8
3	3.3	7.1	6.7	6.8	6.7	6.8	4.5	4.5	2.7	2.6	2.7	2.8
4	3.4	7.1	6.7	6.8	6.8	6.8	4.5	4.5	2.6	2.6	2.8	2.8
5	3.3	7.1	6.7	6.8	6.8	6.9	4.5	4.5	2.7	2.6	2.8	2.8
6	3.3	7.1	6.7	6.8	6.7	6.9	4.5	4.5	2.6	2.6	2.8	2.8
7	3.4	7.2	6.7	6.7	6.7	6.9	4.5	4.4	2.6	2.7	2.7	2.8
8	3.4	7.2	6.6	6.7	6.7	6.8	4.4	4.4	2.6	2.7	2.7	2.8
9	3.4	7.1	6.7	6.7	6.7	6.8	4.5	4.4	2.6	2.6	2.7	2.8
10	3.4	7.2	6.7	6.8	6.7	6.9	4.5	4.5	2.5	2.7	2.8	2.8
11	3.4	7.2	6.7	6.8	6.8	6.9	4.5	4.5	2.5	2.7	2.8	2.8
12	3.4	7.2	6.7	6.7	6.7	6.8	4.5	4.5	2.5	2.7	2.7	2.8
13	3.4	7.2	6.7	6.7	6.7	5.4	4.5	4.5	2.4	2.7	2.7	2.8
14	3.4	7.1	6.7	6.7	6.8	4.4	4.5	4.5	2.4	2.7	2.8	2.8
15	3.4	7.2	6.7	6.7	6.7	4.5	4.5	4.5	2.7	2.7	2.8	2.8
16	3.4	7.0	6.8	6.7	6.8	4.5	4.5	4.5	2.7	2.7	2.8	2.8
17	3.4	7.0	6.7	6.8	6.9	4.5	4.5	4.5	2.7	2.7	2.9	2.8
18	3.4	7.0	6.7	6.8	6.9	4.5	4.5	4.5	2.7	2.7	2.9	2.8
19	3.4	6.9	6.8	6.8	6.9	4.5	4.4	4.5	2.7	2.7	2.9	2.8
20	3.4	6.9	6.8	6.8	6.8	4.5	4.5	4.5	2.6	2.7	2.9	2.8
21	3.4	6.7	6.7	6.7	6.8	4.5	4.5	4.4	2.6	2.7	2.8	2.8
22	3.4	6.7	6.7	6.7	6.8	4.5	4.5	4.4	2.6	2.6	2.9	2.8
23	3.4	6.7	6.7	6.8	6.9	4.5	4.5	4.4	2.6	2.6	2.9	2.8
24	3.4	6.7	6.7	6.8	6.9	4.5	4.5	4.4	2.6	2.6	2.9	2.8
25	3.3	6.7	6.7	6.8	6.8	4.5	4.4	4.4	2.6	2.6	2.8	2.8
26	3.3	6.7	6.7	6.8	6.7	4.5	4.4	4.4	2.7	2.6	2.8	2.8
27	3.3	6.7	6.7	6.8	6.8	4.5	4.4	4.4	2.7	2.7	2.8	2.8
28	3.3	6.7	6.7	6.7	6.8	4.5	4.4	4.4	2.7	2.7	2.8	2.7
29	3.4	6.7	6.7	6.7	---	4.5	4.4	4.4	2.7	2.7	2.8	2.8
30	3.4	6.7	6.7	6.7	---	4.5	4.5	4.4	2.6	2.7	2.8	2.8
31	5.3	---	6.7	6.7	---	4.5	---	4.4	---	2.7	2.8	---
TOTAL	106.4	209.0	207.9	209.3	189.7	168.2	134.3	138.1	79.6	82.5	86.7	83.9
MEAN	3.43	6.97	6.71	6.75	6.78	5.43	4.48	4.45	2.65	2.66	2.80	2.80
MAX	5.3	7.2	6.8	6.8	6.9	6.9	4.5	4.5	3.7	2.7	2.9	2.8
MIN	3.3	6.7	6.6	6.7	6.7	4.4	4.4	4.4	2.4	2.6	2.7	2.7
AC-FT	211	415	412	415	376	334	266	274	158	164	172	166

## STATISTICS OF MONTHLY MEAN DATA FOR WATER YEARS 1988 - 2001, BY WATER YEAR (WY)

	1988	1989	1990	1991	1992	1993	1994	1995	1996	1997	1998	1999	2000	2001
MEAN	3.12	5.87	5.84	9.47	5.91	5.97	6.05	5.86	3.18	3.09	3.06	3.07		
MAX	3.86	8.06	7.81	58.0	7.76	8.95	10.4	9.09	4.43	4.26	3.87	3.81		
(WY)	1994	1990	1990	1997	1997	1997	1997	1997	1995	1995	1995	1993		
MIN	2.44	4.16	4.09	4.10	4.12	4.39	4.23	4.28	2.24	2.18	2.14	2.14		
(WY)	1993	1991	1988	1988	1988	1992	1988	1988	1988	1988	1988	1988		

SUMMARY STATISTICS	FOR 2000 CALENDAR YEAR		FOR 2001 WATER YEAR		WATER YEARS 1988 - 2001	
ANNUAL TOTAL	2011.0		1695.6			
ANNUAL MEAN	5.49		4.65		5.04	
HIGHEST ANNUAL MEAN					10.5	
LOWEST ANNUAL MEAN					3.39	
HIGHEST DAILY MEAN	7.6	Sep 19	7.2	Nov 7	620	Jan 2 1997
LOWEST DAILY MEAN	3.1	Jun 2	2.4	Jun 13	2.1	Jul 4 1988
ANNUAL SEVEN-DAY MINIMUM	3.2	Jun 2	2.5	Jun 8	2.1	Aug 15 1988
ANNUAL RUNOFF (AC-FT)	3990		3360		3650	
10 PERCENT EXCEEDS	7.1		6.8		7.0	
50 PERCENT EXCEEDS	6.7		4.5		4.4	
90 PERCENT EXCEEDS	3.3		2.7		2.5	

## 11443500 SOUTH FORK AMERICAN RIVER NEAR CAMINO, CA

LOCATION.—Lat 38°46'23", long 120°42'02", in SW 1/4 NE 1/4 sec.25, T.11 N., R.11 E., El Dorado County, Hydrologic Unit 18020129, on right bank, 500 ft upstream from Iowa Canyon Creek, and 2.8 mi northwest of Camino.

DRAINAGE AREA.—493 mi<sup>2</sup>.

PERIOD OF RECORD.—October 1922 to current year. Monthly discharge only for October 1922, WSP 1315-A. Records for river and American River Flume, published separately October 1922 to September 1956 and October 1962 to December 1964, when flume was destroyed. Records of river and flume combined October 1956 to September 1962.

REVISED RECORDS.—WSP 931: 1928, 1938, 1940(M). WSP 1931: Drainage area at former site.

GAGE.—Acoustic-velocity meter. Elevation of gage is 1,625 ft above sea level, from topographic map. Prior to May 26, 1987, water-stage recorder at different datum at site 1,000 ft downstream. Auxiliary water-stage recorder on Slab Creek Dam records spill discharges which are combined with release discharges. See WSP 2131 for history of changes prior to Oct. 12, 1966.

REMARKS.—Flow regulated by several reservoirs. Since 1967 diversion from Slab Creek Dam to White Rock Powerplant (station 11443460) bypasses this station. Echo Lake Conduit (station 11434500) imports up to 1,900 acre-ft each year from Truckee River Basin. Variable amounts of El Dorado Canal water, up to 40 ft<sup>3</sup>/s May to October, and about 7 ft<sup>3</sup>/s remainder of the year, diverted for irrigation and domestic use between Pollock Pines and Placerville. Water from Jenkinson Lake in North Fork Cosumnes River Basin diverted to Camino and substituted for flow from El Dorado Canal in some years. Since October 1962, water is imported from the Upper Rubicon River Basin by way of Robbs Peak Powerplant (station 11429300). See schematic diagram of [South Fork American River Basin](#).

COOPERATION.—Records were collected by Sacramento Municipal Utility District, under general supervision of the U.S. Geological Survey, in connection with a Federal Energy Regulatory Commission project.

EXTREMES FOR PERIOD OF RECORD.—Maximum discharge, 62,300 ft<sup>3</sup>/s, Jan. 2, 1997, from rating curve extended above 24,000 ft<sup>3</sup>/s, on basis of computation of peak flow over dam; minimum daily, 1.3 ft<sup>3</sup>/s, Aug. 24, 1931.

## DISCHARGE, CUBIC FEET PER SECOND, WATER YEAR OCTOBER 2000 TO SEPTEMBER 2001

## DAILY MEAN VALUES

DAY	OCT	NOV	DEC	JAN	FEB	MAR	APR	MAY	JUN	JUL	AUG	SEP
1	40	38	38	40	40	39	13	11	37	38	37	38
2	40	37	38	40	40	39	13	11	37	38	38	e38
3	40	37	38	39	40	39	13	11	36	38	38	e38
4	40	37	38	39	40	39	12	11	36	38	38	38
5	40	38	38	39	40	38	12	11	36	e38	37	38
6	39	38	38	39	40	39	12	11	37	e38	38	38
7	39	39	38	39	40	39	12	11	36	e38	38	38
8	39	39	38	39	40	40	12	11	37	e38	38	38
9	39	38	39	39	40	40	12	11	38	37	38	38
10	39	39	40	39	39	40	12	11	38	37	38	38
11	39	38	40	39	40	40	12	11	38	37	38	e38
12	39	39	39	38	40	39	12	11	38	37	38	38
13	39	39	38	39	39	24	12	11	38	37	38	38
14	39	38	39	39	39	13	12	11	38	e37	38	38
15	39	38	39	39	39	13	12	11	38	e37	38	38
16	39	38	39	39	39	13	12	11	38	e37	38	38
17	39	38	40	39	39	13	12	11	38	37	38	e38
18	39	37	40	39	39	13	12	10	38	37	38	38
19	39	37	39	39	39	13	12	10	38	37	38	38
20	39	37	39	40	39	13	12	10	38	37	38	38
21	39	37	39	40	39	13	12	10	38	37	38	38
22	39	37	39	39	40	13	12	10	38	36	38	38
23	39	37	40	40	40	13	12	10	37	37	39	38
24	39	38	40	40	39	13	12	10	37	37	39	38
25	39	38	40	40	39	13	12	11	37	37	38	38
26	39	38	40	40	39	13	12	11	37	37	39	38
27	39	38	40	40	39	13	12	11	37	37	39	38
28	38	38	40	39	39	13	12	11	37	e37	39	38
29	38	38	39	40	---	12	12	11	37	e37	38	38
30	38	38	39	40	---	13	11	11	38	e37	38	38
31	38	---	40	40	---	12	---	25	---	37	38	---
TOTAL	1210	1136	1211	1220	1105	727	362	348	1121	1154	1181	1140
MEAN	39.0	37.9	39.1	39.4	39.5	23.5	12.1	11.2	37.4	37.2	38.1	38.0
MAX	40	39	40	40	40	40	13	25	38	38	39	38
MIN	38	37	38	38	39	12	11	10	36	36	37	38
AC-FT	2400	2250	2400	2420	2190	1440	718	690	2220	2290	2340	2260
a	18410	57680	65540	25720	14760	34780	48580	60100	16070	15900	14620	8430

e Estimated.

a Diversion, in acre-feet, to White Rock Powerplant (station 11443460), provided by Sacramento Municipal Utility District.

## 11443500 SOUTH FORK AMERICAN RIVER NEAR CAMINO, CA—Continued

## STATISTICS OF MONTHLY MEAN DATA FOR WATER YEARS 1923 - 1957, BY WATER YEAR (WY)

	OCT	NOV	DEC	JAN	FEB	MAR	APR	MAY	JUN	JUL	AUG	SEP
MEAN	54.8	254	569	601	855	1171	2069	2681	1557	285	39.7	31.1
MAX	221	3951	4780	3422	2125	3367	4015	6382	4031	1310	168	150
(WY)	1952	1951	1951	1956	1927	1943	1952	1952	1952	1952	1951	1951
MIN	4.43	5.46	12.9	43.0	116	146	620	418	13.8	1.97	2.01	6.97
(WY)	1930	1930	1950	1929	1929	1924	1924	1934	1924	1931	1931	1955

## SUMMARY STATISTICS

## WATER YEARS 1923 - 1957

ANNUAL MEAN	846
HIGHEST ANNUAL MEAN	1760 1951
LOWEST ANNUAL MEAN	161 1924
HIGHEST DAILY MEAN	40000 Dec 23 1955
LOWEST DAILY MEAN	1.3 Aug 24 1931
ANNUAL SEVEN-DAY MINIMUM	1.5 Jul 29 1931
MAXIMUM PEAK FLOW	49800 Dec 23 1955
MAXIMUM PEAK STAGE	32.6 Dec 23 1955
ANNUAL RUNOFF (AC-FT)	612700
10 PERCENT EXCEEDS	2520
50 PERCENT EXCEEDS	230
90 PERCENT EXCEEDS	13

## STATISTICS OF MONTHLY MEAN DATA FOR WATER YEARS 1923 - 1957, COMBINED RIVER PLUS FLUME, BY WATER YEAR (WY)

MEAN	167	364	684	713	959	1259	2176	2815	1695	413	154	142
MAX	288	4051	4780	3422	2229	3490	4181	6552	4201	1474	324	227
(WY)	1948	1951	1951	1956	1927	1943	1952	1952	1952	1952	1952	1952
MIN	44.1	49.8	134	141	212	252	727	533	97.3	50.2	35.5	53.4
(WY)	1930	1930	1924	1929	1933	1924	1924	1934	1924	1931	1931	1924

## SUMMARY STATISTICS

## WATER YEARS 1923 - 1957

ANNUAL MEAN	960
HIGHEST ANNUAL MEAN	1860 1952
LOWEST ANNUAL MEAN	249 1924
HIGHEST DAILY MEAN	40000 Dec 23 1955
LOWEST DAILY MEAN	20 Aug 24 1931
ANNUAL SEVEN-DAY MINIMUM	30 Aug 19 1931
ANNUAL RUNOFF (AC-FT)	695700
10 PERCENT EXCEEDS	2660
50 PERCENT EXCEEDS	350
90 PERCENT EXCEEDS	120

## STATISTICS OF MONTHLY MEAN DATA FOR WATER YEARS 1968 - 2001, BY WATER YEAR (WY)

MEAN	47.2	84.9	129	330	221	124	123	324	289	80.9	35.0	34.9
MAX	453	1093	1112	4836	2709	1090	1402	2434	2619	936	45.1	48.2
(WY)	1968	1968	1984	1997	1986	1986	1971	1995	1995	1995	1980	1980
MIN	9.97	10.2	10.0	10.0	5.62	10.9	10.0	9.73	9.98	9.93	10.4	10.1
(WY)	1978	1978	1988	1988	1970	1992	1988	1977	1977	1977	1977	1977

## SUMMARY STATISTICS

## FOR 2000 CALENDAR YEAR

## FOR 2001 WATER YEAR

## WATER YEARS 1968 - 2001

ANNUAL TOTAL	15012	11915	
ANNUAL MEAN	41.0	32.6	152
HIGHEST ANNUAL MEAN			608 1995
LOWEST ANNUAL MEAN			13.3 1977
HIGHEST DAILY MEAN	469 Feb 13	40 Oct 1	48900 Jan 2 1997
LOWEST DAILY MEAN	37 Nov 2	10 May 18	2.4 Feb 12 1970
ANNUAL SEVEN-DAY MINIMUM	37 Nov 17	10 May 18	2.6 Feb 9 1970
MAXIMUM PEAK FLOW		41 Oct 3	62300 Jan 2 1997
ANNUAL RUNOFF (AC-FT)	29780	23630	109900
ANNUAL DIVERSION (AC-FT) a	902800	380600	
10 PERCENT EXCEEDS	40	40	72
50 PERCENT EXCEEDS	39	38	36
90 PERCENT EXCEEDS	38	12	11

a Diversion, in acre-feet, to White Rock Powerplant (station 11443460), provided by Sacramento Municipal Utility District.

## 11444201 ROCK CREEK NEAR PLACERVILLE, CA

LOCATION.—Lat 38°47'39", long 120°46'28", in NE 1/4 NW 1/4 sec.20, T.11 N., R.11 E., El Dorado County, Hydrologic Unit 18020129, on left bank, 500 ft downstream from Rock Creek Road, and 4.0 mi north of Placerville.

DRAINAGE AREA.—73.0 mi<sup>2</sup>.

PERIOD OF RECORD.—October 1986 to current year.

GAGE.—Water-stage recorder and broad-crested weir; water-stage recorder and sharp-crested weir. Elevation of gages is 1,305 ft above sea level, from topographic map.

REMARKS.—Flow at this station has two components which are combined for publication: flow over a broad-crested weir (station 11444200) and flow over a sharp-crested weir (station 11444260). Water is diverted upstream from weirs through a tunnel to Rock Creek Powerplant (station 11444280), returning to Rock Creek at its confluence with the South Fork American River. Extremes also represent combined flows. See schematic diagram of *South Fork American River Basin*.

COOPERATION.—Records provided by Sithe Energies, Inc., under general supervision of the U.S. Geological Survey, in connection with a Federal Energy Regulatory Commission project.

EXTREMES FOR PERIOD OF RECORD.—Maximum discharge, 6,690 ft<sup>3</sup>/s, Jan. 2, 1997; no flow Sept. 29 to Oct. 3, 1987.

## DISCHARGE, CUBIC FEET PER SECOND, WATER YEAR OCTOBER 2000 TO SEPTEMBER 2001

## DAILY MEAN VALUES

DAY	OCT	NOV	DEC	JAN	FEB	MAR	APR	MAY	JUN	JUL	AUG	SEP
1	16	27	27	21	36	23	29	37	19	14	8.8	7.3
2	16	25	24	21	33	25	29	37	19	13	8.6	6.6
3	16	24	23	21	32	25	28	35	19	13	8.4	6.6
4	16	23	22	21	32	25	28	34	20	12	8.3	6.6
5	17	22	22	21	32	64	29	34	19	11	8.5	5.7
6	17	21	22	20	32	37	29	33	19	11	8.1	5.7
7	16	21	21	20	33	29	25	32	18	11	7.3	5.7
8	17	21	21	24	31	27	23	31	18	12	7.3	5.5
9	18	22	21	25	28	23	22	31	17	11	7.3	5.5
10	61	26	22	25	24	23	22	30	17	11	7.3	5.5
11	26	26	22	54	39	23	34	29	17	11	7.3	5.5
12	29	24	28	23	31	23	24	29	17	11	7.3	6.6
13	29	25	29	26	31	23	23	28	17	11	7.3	6.6
14	20	28	26	33	24	23	23	28	16	11	7.3	5.5
15	22	27	38	31	23	23	23	27	16	11	7.3	5.5
16	22	25	22	29	23	23	37	28	16	11	7.3	6.4
17	22	23	32	27	23	23	37	26	16	11	7.3	6.4
18	22	23	30	26	22	23	36	26	15	11	7.3	6.4
19	22	22	28	25	30	22	33	25	15	11	6.6	6.4
20	22	22	25	25	152	24	46	24	15	11	6.6	6.4
21	21	22	25	24	146	37	87	23	15	11	6.6	6.4
22	22	23	27	24	163	36	25	23	14	11	7.3	5.5
23	21	24	24	24	130	35	23	22	14	9.4	7.3	5.5
24	22	22	23	37	79	34	23	22	14	9.1	7.3	5.5
25	26	22	23	23	116	36	22	22	14	9.0	7.3	9.9
26	29	22	23	23	57	33	23	21	15	9.0	7.3	9.0
27	25	22	22	23	30	36	22	21	16	9.0	6.6	7.3
28	27	21	22	23	23	33	23	21	16	8.6	6.6	7.3
29	76	27	22	23	---	31	23	21	15	8.3	6.6	12
30	26	28	22	23	---	31	23	21	14	8.5	6.6	18
31	33	---	21	26	---	31	---	20	---	9.1	6.6	---
TOTAL	774	710	759	791	1455	904	874	841	492	331.0	227.6	208.8
MEAN	25.0	23.7	24.5	25.5	52.0	29.2	29.1	27.1	16.4	10.7	7.34	6.96
MAX	76	28	38	54	163	64	87	37	20	14	8.8	18
MIN	16	21	21	20	22	22	22	20	14	8.3	6.6	5.5
AC-FT	1540	1410	1510	1570	2890	1790	1730	1670	976	657	451	414
a	180	34	278	892	1810	2100	1590	18	.00	.00	.00	.00

a Discharge, in acre-feet, through Rock Creek Powerplant (station 11444280) near Placerville, provided by Sithe Energies U.S.A., Inc.

## 11444201 ROCK CREEK NEAR PLACERVILLE, CA—Continued

## STATISTICS OF MONTHLY MEAN DATA FOR WATER YEARS 1987 - 2001, BY WATER YEAR (WY)

	OCT	NOV	DEC	JAN	FEB	MAR	APR	MAY	JUN	JUL	AUG	SEP
MEAN	13.9	21.2	55.4	142	116	92.3	39.3	32.2	19.2	14.4	12.2	10.6
MAX	25.0	36.6	403	737	326	454	99.6	127	31.5	35.2	39.2	25.7
(WY)	2001	1999	1997	1997	1998	1995	1995	1995	1995	1999	1999	1998
MIN	4.60	6.15	9.97	11.4	12.5	16.4	16.6	11.3	6.35	3.18	1.97	1.86
(WY)	1993	1993	1990	1991	1991	1988	1994	1992	1992	1988	1994	1992

SUMMARY STATISTICS	FOR 2000 CALENDAR YEAR		FOR 2001 WATER YEAR		WATER YEARS 1987 - 2001	
ANNUAL TOTAL	18021		8367.4			
ANNUAL MEAN	49.2		22.9		47.2	
ANNUAL MEAN a	74.9		32.5			
HIGHEST ANNUAL MEAN					118	1997
LOWEST ANNUAL MEAN					14.3	1988
HIGHEST DAILY MEAN	1620	Feb 14	163	Feb 22	4660	Jan 2 1997
LOWEST DAILY MEAN	16	Aug 17	5.5	Sep 8	.00	Sep 29 1987
ANNUAL SEVEN-DAY MINIMUM	16	Aug 22	5.6	Sep 5	.35	Sep 28 1987
MAXIMUM PEAK FLOW			250	Feb 20	6690	Jan 2 1997
ANNUAL RUNOFF (AC-FT)	35740		16600		34170	
TOTAL DIVERSION (AC-FT) b	18610		6900		10940	
ANNUAL RUNOFF (AC-FT) a	54350		23500			
10 PERCENT EXCEEDS	45		33		68	
50 PERCENT EXCEEDS	23		22		21	
90 PERCENT EXCEEDS	17		7.3		5.0	

a Adjusted for Rock Creek Powerplant near Placerville.

b Discharge, in acre-feet, through Rock Creek Powerplant (station 11444280) near Placerville, provided by Sithe Energies U.S.A., Inc.





## 11446030 SOUTH FORK AMERICAN RIVER NEAR PILOT HILL, CA

LOCATION.—Lat 38°45'47", long 121°00'26", in SE 1/4 NE 1/4 sec.31, T.11 N., R.9 E., El Dorado County, Hydrologic Unit 18020128, on left bank, 0.1 mi downstream from Weber Creek, and 5.0 mi south of Pilot Hill.

DRAINAGE AREA.—801 mi<sup>2</sup>.

PERIOD OF RECORD.—Water year 1999 to current year.

WATER TEMPERATURE: Water year 1999 to current year.

PERIOD OF DAILY RECORD.—

WATER TEMPERATURE: August 1999 to current year.

INSTRUMENTATION.—Water-temperature recorder since Aug. 4, 1999.

REMARKS.—Water-temperature records rated excellent except for Oct. 4–15, Dec. 10–30, Feb. 5–23, and Apr. 29 to June 1, which are rated good. Periods of missing record due to repeated vandalism at site. Water temperature can be affected by upstream powerplant releases.

EXTREMES FOR PERIOD OF DAILY RECORD.—

WATER TEMPERATURE: Maximum recorded, 25.5°C, Aug. 17, 2001, but may have been higher during periods of missing record; minimum recorded, 3.5°C, Jan. 17, 2001.

EXTREMES FOR CURRENT YEAR.—

WATER TEMPERATURE: Maximum recorded, 25.5°C, Aug. 17, but may have been higher during periods of missing record; minimum recorded, 3.5°C, Jan. 17.

## CROSS-SECTIONAL DATA, WATER YEAR OCTOBER 2000 TO SEPTEMBER 2001

DATE	TIME	TEMPER- ATURE WATER (DEG C) (00010)	SAMPLE LOC- ATION, CROSS SECTION (FT FM L BANK) (00009)
JUL			
30...*	1054	21.5	3.00
30...*	1055	21.5	9.00
30...*	1058	21.5	15.0
30...*	1059	21.5	21.0
30...*	1100	21.5	27.0
30...*	1101	21.5	33.0
30...*	1102	21.5	39.0
30...*	1103	21.5	45.0
30...*	1104	21.5	51.0
30...*	1105	21.5	57.0

\* Instantaneous discharge at time of cross-sectional measurement: Unknown.

## 11446030 SOUTH FORK AMERICAN RIVER NEAR PILOT HILL, CA—Continued

## TEMPERATURE, WATER (DEG. C), WATER YEAR OCTOBER 2000 TO SEPTEMBER 2001

DAY	MAX	MIN	MAX	MIN	MAX	MIN	MAX	MIN	MAX	MIN	MAX	MIN
	OCTOBER		NOVEMBER		DECEMBER		JANUARY		FEBRUARY		MARCH	
1	19.5	17.5	13.0	11.5	10.0	8.5	7.5	6.0	5.5	4.0	---	---
2	19.0	16.5	13.0	11.5	10.0	8.5	7.0	5.5	6.5	4.5	---	---
3	18.5	16.0	13.0	10.5	10.0	8.5	7.0	5.5	7.5	5.0	---	---
4	18.5	17.0	12.5	10.5	10.0	8.5	7.0	5.5	8.0	6.0	---	---
5	19.5	17.0	12.5	11.5	10.0	8.5	7.0	5.0	8.0	6.0	---	---
6	18.5	16.0	13.0	11.0	10.0	8.0	7.0	5.5	8.0	6.5	---	---
7	18.5	16.5	12.5	10.5	10.0	9.0	6.5	5.5	7.0	5.0	---	---
8	18.5	16.5	12.0	10.5	10.0	9.0	7.5	6.0	6.5	4.5	---	---
9	18.5	16.5	12.0	10.5	10.0	8.5	7.5	6.5	6.5	5.5	---	---
10	17.0	15.5	11.5	10.5	11.0	9.5	7.0	6.5	6.0	5.0	---	---
11	15.5	14.5	12.0	10.0	10.0	9.0	7.0	6.5	6.0	5.5	---	---
12	15.0	14.0	11.0	9.0	10.5	9.0	7.5	6.5	6.0	5.0	---	---
13	15.0	13.5	11.0	9.0	10.0	8.5	7.0	6.0	6.5	4.0	---	---
14	16.0	14.0	11.0	10.0	10.0	9.5	7.5	6.0	7.0	5.5	---	---
15	16.0	14.5	10.5	9.5	10.5	9.5	7.0	5.0	7.0	5.0	---	---
16	16.5	15.0	10.5	9.0	10.0	8.5	5.5	4.0	6.5	5.0	---	---
17	16.5	15.0	10.5	8.5	9.5	8.0	5.0	3.5	7.5	6.0	---	---
18	16.5	15.5	10.5	8.5	9.0	7.5	5.5	4.0	8.0	6.5	---	---
19	16.5	15.0	10.5	8.5	9.0	7.5	6.5	5.5	8.0	7.0	---	---
20	16.0	15.0	10.5	8.5	9.0	7.5	6.0	5.0	8.0	7.0	---	---
21	16.5	15.0	10.0	8.5	8.5	7.0	6.0	4.5	8.5	7.5	---	---
22	15.5	14.0	10.0	9.0	8.5	7.5	7.0	5.5	8.5	7.5	---	---
23	14.5	13.0	9.5	8.5	8.5	7.0	6.5	5.5	9.0	6.5	---	---
24	14.5	13.0	10.0	8.5	8.0	7.0	7.0	6.0	---	---	13.0	10.5
25	14.5	13.5	10.0	8.5	8.0	6.5	6.5	5.5	---	---	12.5	9.0
26	14.0	13.0	10.0	9.0	8.0	6.5	6.5	5.5	---	---	11.5	8.0
27	15.0	12.5	10.5	9.5	8.0	6.5	6.5	5.0	---	---	11.5	8.5
28	14.5	13.5	10.0	9.0	8.0	6.0	6.0	4.5	---	---	13.0	9.0
29	13.5	12.5	10.5	9.0	8.0	6.5	6.0	5.0	---	---	13.0	9.5
30	13.0	12.0	10.0	8.5	7.5	6.0	6.0	4.5	---	---	13.5	9.0
31	13.5	11.5	---	---	7.0	5.5	5.5	4.0	---	---	13.5	10.0
MONTH	19.5	11.5	13.0	8.5	11.0	5.5	7.5	3.5	---	---	---	---
DAY	MAX	MIN	MAX	MIN	MAX	MIN	MAX	MIN	MAX	MIN	MAX	MIN
	APRIL		MAY		JUNE		JULY		AUGUST		SEPTEMBER	
1	13.5	9.5	14.5	11.5	---	---	---	---	---	---	25.0	22.0
2	12.5	10.5	14.5	10.5	---	---	---	---	---	---	23.5	20.0
3	12.0	9.0	14.5	11.0	---	---	---	---	---	---	23.5	20.0
4	11.5	8.5	15.0	11.0	---	---	---	---	---	---	22.5	20.0
5	12.5	10.0	16.0	12.0	---	---	---	---	---	---	23.0	21.0
6	12.0	9.5	16.0	13.0	---	---	---	---	---	---	23.0	21.0
7	10.0	9.0	17.0	11.5	---	---	---	---	---	---	21.5	19.0
8	11.0	8.0	17.5	13.0	---	---	---	---	---	---	21.5	19.5
9	10.5	8.0	16.5	12.5	---	---	---	---	23.9	20.6	22.0	20.0
10	12.0	8.5	17.5	12.5	---	---	---	---	24.5	20.5	22.0	20.5
11	11.0	10.0	18.5	13.5	---	---	---	---	24.0	20.5	22.0	20.5
12	11.5	8.5	17.5	14.5	---	---	---	---	24.0	20.0	21.0	19.0
13	12.0	10.0	17.0	13.5	---	---	---	---	23.0	20.0	22.0	20.0
14	12.0	9.5	17.5	13.5	---	---	---	---	24.0	21.5	22.5	20.5
15	14.5	10.0	17.5	14.5	---	---	---	---	24.5	22.0	22.5	20.5
16	15.0	11.5	18.0	14.5	---	---	---	---	24.5	22.5	22.0	20.5
17	12.5	10.5	18.0	14.5	---	---	---	---	25.5	22.5	22.0	20.5
18	13.0	9.5	19.0	14.5	---	---	---	---	23.5	21.0	21.5	19.5
19	12.5	9.5	18.5	15.0	---	---	---	---	23.5	20.0	22.0	19.5
20	10.0	9.0	19.0	14.5	---	---	---	---	22.0	19.5	22.5	20.5
21	12.5	8.5	19.5	16.5	---	---	---	---	23.0	20.5	21.5	20.0
22	13.0	9.0	20.5	15.0	---	---	---	---	23.5	21.0	20.5	19.0
23	13.0	9.0	21.0	16.5	---	---	---	---	23.0	21.5	21.0	19.5
24	15.0	10.0	20.5	15.5	---	---	---	---	23.5	21.5	21.0	19.5
25	14.5	10.0	20.0	15.5	---	---	---	---	24.5	21.5	22.0	20.0
26	15.0	10.5	20.0	16.5	---	---	---	---	24.0	20.0	21.5	19.5
27	13.5	9.5	21.5	17.5	---	---	---	---	23.5	20.5	21.0	19.5
28	13.5	10.5	21.0	17.5	---	---	---	---	23.5	18.5	21.0	19.0
29	15.0	10.5	22.0	18.0	---	---	---	---	22.5	20.0	20.5	18.5
30	15.5	13.0	21.0	19.0	---	---	---	---	23.0	21.0	21.0	19.0
31	---	---	21.0	17.0	---	---	---	---	24.0	21.5	---	---
MONTH	15.5	8.0	22.0	10.5	---	---	---	---	---	---	25.0	18.5

## 11446200 FOLSOM LAKE NEAR FOLSOM, CA

LOCATION.—Lat 38°42'29", long 121°09'22", in NW 1/4 NE 1/4 sec.24, T.10 N., R.7 E., Sacramento County, Hydrologic Unit 18020128, near center of dam on American River, 0.7 mi downstream from South Fork American River, and 2.3 mi northeast of Folsom.

DRAINAGE AREA.—1,861 mi<sup>2</sup>.

PERIOD OF RECORD.—February 1955 to current year. Prior to October 1959, published as Folsom Reservoir near Folsom.

REVISED RECORDS.—WSP 1931: Drainage area.

GAGE.—Water-stage recorder. Datum of gage is sea level (levels by U.S. Bureau of Reclamation).

REMARKS.—Reservoir is formed by concrete gravity-type dam with rolled-earth-wing dams, auxiliary dams, and dikes, completed May 14, 1956; storage began Feb. 25, 1955. Total capacity, 1,010,300 acre-ft, between elevations 205.5 ft, invert of lower tier of river outlets, and 466.0 ft gross pool elevation, all of which are available for release. Spillway design flood pool elevation, 475.4 ft, capacity, 1,120,200 acre-ft. Records, including extremes, represent usable contents at 2400 hours. See schematic diagram of lower Sacramento River Basin.

COOPERATION.—Records provided by U.S. Bureau of Reclamation.

EXTREMES FOR PERIOD OF RECORD.—Maximum contents, 1,024,400 acre-ft, June 15, 1963, elevation, 467.23 ft; minimum since storage pool first filled, 140,600 acre-ft, Nov. 20, 21, 1977, elevation, 347.57 ft.

EXTREMES FOR CURRENT YEAR.—Maximum contents, 709,300 acre-ft, May 24, elevation, 440.30 ft; minimum, 367,600 acre-ft, Sept. 30, elevation, 398.20 ft.

Capacity table (elevation, in feet, and contents, in acre-feet)  
(Based on survey by U.S. Bureau of Reclamation in 1992)

345	123,600	370	210,500	400	376,900	460	908,400
350	137,900	380	258,600	420	525,500	479	1,125,000
360	170,600	390	314,100	440	703,800		

## RESERVOIR STORAGE (ACRE-FEET), WATER YEAR OCTOBER 2000 TO SEPTEMBER 2001

## DAILY OBSERVATION AT 2400 HOURS

DAY	OCT	NOV	DEC	JAN	FEB	MAR	APR	MAY	JUN	JUL	AUG	SEP
1	659300	577900	560400	531000	490900	524800	604400	672900	694100	582700	486700	428900
2	658100	577600	559900	528200	488800	526000	606500	677400	689800	579500	484200	426900
3	656200	577300	559100	526200	487200	528400	608500	681400	684800	577800	482300	425000
4	653400	576400	557900	523600	485800	531400	608800	683300	678900	575900	480200	422600
5	651000	574800	557500	522100	484300	537800	608500	684800	674400	573000	477800	420300
6	650300	573500	557500	520200	483700	542700	609200	686600	669800	570200	475600	418300
7	647600	573500	557800	518100	482400	545600	610600	688000	665000	567700	473500	416400
8	644300	572500	557000	515100	481600	547900	611600	691600	660400	564800	472600	413900
9	641700	572300	555200	511300	481000	550400	612500	696100	656600	560500	471500	411400
10	639000	572100	553100	508800	482800	552400	612400	699200	652100	557400	469700	409000
11	637200	572800	552700	507800	486800	554800	612900	701300	648200	554300	468000	407100
12	635100	571400	554800	505600	489100	556900	613100	703300	645300	550600	465800	405100
13	632700	572500	555400	502700	491100	556900	613100	704600	642200	546900	463500	402500
14	628900	574200	555400	500100	491300	557600	613600	705100	639900	543900	461800	401400
15	625100	575000	556000	498000	491900	559300	613400	706100	637700	540000	459300	399800
16	620500	574900	555500	496000	492400	561100	613200	707200	634900	535900	457400	397600
17	616100	575100	553500	493600	492200	561400	614500	708200	631400	532500	455900	395100
18	612000	575700	553600	492400	492100	561500	616300	709200	627900	529100	454500	393700
19	608400	575400	554300	491600	493400	562100	618400	709200	626500	526000	452500	392400
20	604000	574500	553400	491200	496800	564200	622900	708900	624600	523100	449900	390500
21	599500	573800	552400	489700	499800	567300	627600	708700	621300	520200	448300	389000
22	595100	573500	550600	489800	503900	570300	631300	709100	618200	517200	447200	386400
23	590500	572100	548500	490200	509200	572400	635100	708800	614800	513600	444500	383400
24	587000	569100	547100	491500	514400	575100	638800	709300	610000	510600	442600	381100
25	584700	566100	546000	492800	519000	580100	644100	708700	604900	507600	440700	378800
26	582700	563600	543700	494900	522300	585500	650000	708600	600800	504200	438800	376900
27	580800	561800	541500	495900	523900	588500	656700	706600	596900	501400	437100	374900
28	580200	561500	540200	494400	524600	592400	661400	702300	593000	498400	436000	372700
29	581100	561500	539600	493900	---	596300	664400	698400	589000	494700	434100	370300
30	580800	560900	536000	492800	---	599400	667500	697000	586100	491500	432700	367600
31	579500	---	532900	491800	---	602200	---	695800	---	488900	430500	---
MAX	659300	577900	560400	531000	524600	602200	667500	709300	694100	582700	486700	428900
MIN	579500	560900	532900	489700	481000	524800	604400	672900	586100	488900	430500	367600
a	426.12	423.94	420.60	415.49	415.58	428.71	435.90	438.90	426.87	415.12	407.37	398.20
b	-81200	-18600	-28000	-41100	+32800	+77600	+65300	+28300	-109700	-97200	-58400	-62900
c	434	655	837	1099	684	1704	1902	4590	4598	4594	3562	2725

CAL YR 2000 b +2700

WTR YR 2001 b -293100

a Elevation, in feet, at end of month.

b Change in contents, in acre-feet.

c Total evaporation, in acre-feet, provided by U.S. Bureau of Reclamation; not reviewed by U.S. Geological Survey.

## 11446220 AMERICAN RIVER BELOW FOLSOM DAM, NEAR FOLSOM, CA

LOCATION.—Lat 38°42'14", long 121°09'48", in NE 1/4 SE 1/4 sec.24, T.10 N., R.7 E., Sacramento County, Hydrologic Unit 18020111, on left bank, 0.3 mi downstream from Folsom Dam, and 1.5 mi north of Folsom.

DRAINAGE AREA.—1,863 mi<sup>2</sup>.

PERIOD OF RECORD.—October 1998 to current year.

WATER TEMPERATURE.—October 1998 to current year.

PERIOD OF DAILY RECORD.—

WATER TEMPERATURE.—October 1998 to current year.

INSTRUMENTATION.—Water-temperature recorder since Oct. 23, 1998.

REMARKS.—Water-temperature records rated excellent except Nov. 12 to Dec. 20, which are rated good. Interruption in record due to malfunction of the recording instrument. Water temperature is affected by upstream releases from Folsom Dam.

EXTREMES FOR PERIOD OF DAILY RECORD.—

WATER TEMPERATURE: Maximum recorded, 20.5°C, Sept. 29, 30, 2001; minimum recorded, 7.0°C, Feb. 6, 15–17, 1999.

EXTREMES FOR CURRENT YEAR.—

WATER TEMPERATURE: Maximum recorded, 20.5°C, Sept. 29, 30; minimum recorded, 7.5°C, Feb. 17.

## TEMPERATURE, WATER (DEG. C), WATER YEAR OCTOBER 2000 TO SEPTEMBER 2001

DAY	MAX	MIN	MAX	MIN	MAX	MIN	MAX	MIN	MAX	MIN	MAX	MIN
	OCTOBER		NOVEMBER		DECEMBER		JANUARY		FEBRUARY		MARCH	
1	17.5	14.0	17.0	16.5	12.5	11.5	10.0	9.5	9.5	8.0	9.5	8.0
2	17.5	14.0	16.5	16.0	12.0	11.5	10.0	9.0	9.5	8.0	9.0	8.0
3	17.5	15.0	16.5	15.0	12.0	11.0	10.0	9.0	9.0	8.0	9.0	8.0
4	17.5	15.0	16.0	15.0	12.0	11.5	10.0	9.0	9.5	8.0	9.0	8.0
5	17.5	15.0	15.5	14.5	12.0	11.0	10.0	9.0	9.5	8.0	9.5	8.5
6	17.5	15.0	16.0	14.5	12.0	11.0	10.0	9.5	9.0	8.0	10.0	8.5
7	17.5	14.5	15.5	14.5	11.5	11.0	9.5	9.0	9.0	8.0	10.0	8.5
8	17.5	15.0	15.5	14.5	11.5	11.0	10.0	9.0	9.5	8.5	10.0	8.0
9	17.5	15.0	15.5	14.0	11.5	11.0	9.5	9.0	8.5	8.0	9.5	8.0
10	17.5	14.5	15.5	14.0	11.5	11.0	9.5	8.5	9.0	8.0	9.5	8.0
11	17.5	15.5	15.0	14.0	11.5	11.0	10.0	9.0	8.5	8.0	9.5	8.5
12	18.0	15.0	15.0	14.0	11.5	11.0	9.5	9.0	8.5	8.0	9.5	8.0
13	18.0	14.5	15.0	14.0	11.5	11.0	9.5	9.0	8.5	8.0	9.0	8.5
14	17.5	15.0	14.5	13.5	11.5	10.5	9.5	9.0	9.0	8.0	9.0	8.5
15	18.0	16.5	14.0	13.0	11.5	11.0	9.5	9.0	9.0	8.0	9.5	8.5
16	17.5	15.5	14.0	12.5	11.5	10.5	9.5	9.0	9.0	8.0	9.5	8.5
17	18.0	16.0	13.5	12.5	11.5	10.5	9.5	9.0	8.5	7.5	9.5	8.5
18	17.5	16.0	13.5	12.5	11.5	10.5	9.5	9.0	8.5	8.0	9.5	8.5
19	18.0	15.0	13.5	12.5	11.0	10.5	9.5	9.0	8.5	8.0	10.0	9.0
20	18.0	15.5	13.5	12.0	11.5	10.5	9.5	8.5	9.0	8.0	10.0	8.5
21	18.0	15.5	13.0	12.0	11.0	10.5	9.5	8.5	8.5	8.0	9.5	8.5
22	18.5	15.5	13.0	12.0	11.0	10.5	9.5	8.5	9.0	8.0	9.5	9.0
23	18.0	15.5	13.0	11.5	11.0	10.0	9.5	8.5	9.0	8.0	10.0	8.5
24	18.0	15.5	12.5	12.0	11.0	10.0	9.0	8.5	8.5	8.0	9.5	9.0
25	18.0	16.0	12.5	11.5	10.5	10.0	9.0	8.5	9.5	8.0	9.5	9.0
26	17.5	16.0	12.5	11.5	10.5	9.5	9.5	8.5	9.0	8.0	9.5	8.5
27	17.5	16.0	12.5	12.0	11.0	10.0	9.0	8.5	9.5	8.0	10.0	8.5
28	17.5	16.0	12.5	11.5	10.5	9.5	9.0	8.5	9.5	8.0	9.5	8.5
29	17.0	15.5	12.5	11.5	10.5	9.5	8.5	8.5	---	---	9.5	8.5
30	17.0	16.5	12.5	11.5	10.5	9.5	8.5	8.0	---	---	12.0	9.0
31	17.0	16.5	---	---	10.0	9.5	9.0	8.0	---	---	12.5	9.5
MONTH	18.5	14.0	17.0	11.5	12.5	9.5	10.0	8.0	9.5	7.5	12.5	8.0

## 11446220 AMERICAN RIVER BELOW FOLSOM DAM, NEAR FOLSOM, CA—Continued

## TEMPERATURE, WATER (DEG. C), WATER YEAR OCTOBER 2000 TO SEPTEMBER 2001

DAY	MAX	MIN	MAX	MIN	MAX	MIN	MAX	MIN	MAX	MIN	MAX	MIN
	APRIL		MAY		JUNE		JULY		AUGUST		SEPTEMBER	
1	12.0	9.5	14.0	10.5	12.5	10.5	16.0	12.0	16.5	12.5	17.0	13.0
2	12.5	9.0	14.5	10.5	12.5	11.0	16.0	12.0	16.5	13.0	17.5	14.0
3	12.0	9.5	14.0	10.5	12.5	11.0	16.5	12.0	16.5	13.0	17.5	14.0
4	12.0	9.0	14.0	11.0	12.5	10.5	16.5	12.5	17.0	13.0	17.5	14.0
5	12.5	9.5	14.5	11.0	13.0	11.0	16.5	13.0	17.5	13.5	18.0	14.5
6	11.0	9.5	15.5	10.5	13.0	11.5	17.0	14.0	17.0	13.0	18.5	14.5
7	11.5	9.5	15.0	10.5	13.0	11.5	17.0	12.5	17.5	13.0	18.0	15.0
8	11.5	9.0	15.0	11.5	13.0	11.5	17.0	13.0	17.5	13.0	18.5	16.0
9	11.5	9.0	14.5	11.5	13.5	11.0	17.0	12.5	17.5	14.0	18.5	15.5
10	12.5	9.0	14.5	11.0	13.5	11.5	17.0	11.5	18.0	13.5	18.5	16.0
11	11.5	9.5	14.5	11.0	13.5	11.0	17.5	12.5	18.0	14.0	18.5	16.0
12	12.5	9.0	14.5	11.0	13.5	11.5	17.5	13.0	18.0	14.0	19.0	16.5
13	11.0	9.5	14.5	11.5	14.0	11.0	17.5	13.0	18.5	14.5	19.0	16.5
14	11.5	9.5	14.5	10.5	14.0	12.0	17.5	12.5	18.5	14.0	19.0	16.5
15	12.5	9.5	14.5	11.0	14.0	11.5	18.0	12.0	18.5	15.5	17.5	16.5
16	11.5	9.5	15.0	11.0	14.0	11.5	18.0	12.5	18.5	13.5	17.5	16.5
17	12.5	9.5	15.0	10.5	14.0	12.0	18.0	13.5	18.5	14.5	17.5	16.5
18	12.5	9.5	15.0	11.0	14.5	12.0	18.5	14.0	19.0	15.0	18.0	17.0
19	11.5	9.5	15.0	11.0	14.5	12.0	18.0	13.0	19.0	15.0	18.5	17.5
20	11.5	9.5	15.0	11.5	14.5	11.5	18.5	13.0	19.0	15.0	18.5	18.0
21	12.5	10.0	15.0	11.0	14.5	11.5	18.5	13.0	19.5	14.5	18.5	18.0
22	12.0	10.0	12.0	10.5	14.5	12.5	18.5	13.0	19.0	14.0	19.0	18.0
23	12.5	9.5	12.0	10.5	15.0	11.5	18.5	13.0	19.5	13.0	19.5	18.5
24	13.0	10.0	12.0	10.5	15.0	11.5	18.5	13.0	19.5	13.0	19.5	18.5
25	13.5	10.5	12.0	10.5	15.5	12.0	15.5	12.5	16.0	13.0	20.0	18.5
26	13.0	10.5	12.0	10.5	15.5	12.0	16.0	13.0	17.0	12.5	20.0	18.5
27	13.5	10.5	12.0	10.5	15.5	11.5	---	---	17.0	13.0	20.0	18.5
28	13.0	11.0	12.0	11.0	15.5	12.0	---	---	17.5	14.0	20.0	19.0
29	14.0	10.5	14.0	10.5	16.0	12.5	---	---	17.0	14.5	20.5	19.0
30	13.5	11.0	14.0	11.0	16.0	12.5	16.0	15.5	17.0	14.0	20.5	19.0
31	---	---	12.5	11.0	---	---	16.0	12.5	17.0	13.5	---	---
MONTH	14.0	9.0	15.5	10.5	16.0	10.5	---	---	19.5	12.5	20.5	13.0

## 11446500 AMERICAN RIVER AT FAIR OAKS, CA

LOCATION.—Lat 38°38'08", long 121°13'36", in SE 1/4 NE 1/4 sec.17, T.9 N., R.7 E., Sacramento County, Hydrologic Unit 18020111, on right bank, 2,100 ft downstream from Nimbus Dam, 2.4 mi east of Fair Oaks, 8.1 mi downstream from South Fork, and at mile 22.2.

DRAINAGE AREA.—1,888 mi<sup>2</sup>.

## WATER-DISCHARGE RECORDS

PERIOD OF RECORD.—November 1904 to current year. Monthly discharge only for some periods, published in WSP 1315-A.

REVISED RECORDS.—WSP 1181: 1928(M). WSP 1515: 1907(M), 1910, 1931(M), 1943(M). WSP 1931: Drainage area.

GAGE.—Water-stage recorder. Datum of gage is 71.53 ft above sea level. See WSP 2131 for history of changes prior to July 15, 1970.

REMARKS.—Records good. Flow regulated by Folsom Lake beginning Feb. 25, 1955 (station 11446200). Some minor regulation of high flows by temporary pondage during period of construction January 1953 to February 1955. Diurnal fluctuations from Folsom Powerplant re-regulated by Nimbus Reservoir, capacity, 2,800 acre-ft, between normal operating elevations 118.5 and 125.0 ft, and by Nimbus Powerplant. Many diversions upstream from station for irrigation, municipal, and domestic water supply. Diversions for San Juan Suburban Water District, city of Folsom, city of Roseville, and State of California are made at Folsom Dam. Diversion to Folsom South Canal from Nimbus Reservoir started in June 1973. Some inflow from Bear and Yuba River Basins. See schematic diagram of [lower Sacramento River Basin](#).

EXTREMES FOR PERIOD OF RECORD.—Maximum discharge, 180,000 ft<sup>3</sup>/s, Nov. 21, 1950, gage height, 31.85 ft, site and datum then in use; minimum, 3.6 ft<sup>3</sup>/s, Aug. 16, 1924. Maximum discharge since regulation by Folsom Lake in 1955, 134,000 ft<sup>3</sup>/s, Feb. 19, 1986, gage height, 27.96 ft; minimum daily, 160 ft<sup>3</sup>/s, Apr. 17, 1955.

## DISCHARGE, CUBIC FEET PER SECOND, WATER YEAR OCTOBER 2000 TO SEPTEMBER 2001

## DAILY MEAN VALUES

DAY	OCT	NOV	DEC	JAN	FEB	MAR	APR	MAY	JUN	JUL	AUG	SEP
1	1410	2010	2390	2400	1520	1530	1470	1490	2420	2140	1740	1560
2	1680	2030	2370	2380	1510	1510	1480	1500	e3110	2100	1720	1530
3	1690	1720	2360	2390	1520	1520	1580	1470	e3050	2110	1600	1520
4	1700	1650	2370	2360	1490	1490	1960	1470	e3040	2150	1530	1550
5	1670	1650	2350	2210	1490	1510	1990	1500	e3030	2090	1540	1550
6	1720	1660	2300	1960	1480	1520	2000	1480	3020	2110	1530	1540
7	1710	1640	2300	1900	1480	1490	1640	1490	3010	2140	1580	1540
8	1660	1680	2310	2250	1530	1490	1480	1500	3000	2090	1570	1520
9	1680	1660	2300	2940	1510	1520	1510	1480	3020	2140	1540	1520
10	1690	1630	2290	3030	1500	1520	1520	1490	2570	2120	1530	1530
11	1710	1680	2310	2990	1550	1510	1510	1490	2090	2130	1600	1540
12	1680	1680	2310	3030	1570	1470	1500	1790	2000	2110	1550	1530
13	1670	1690	2340	2510	1550	1510	1500	1820	2000	2130	1540	1520
14	2150	1900	2330	2130	1510	1540	1520	1820	1980	2120	1550	1540
15	2190	1940	2320	2040	1490	1520	1490	1820	1970	2130	1540	1510
16	2130	2150	2340	2020	1470	1540	1520	1810	1980	2160	1560	1520
17	2100	2360	2370	2020	1490	1500	1490	1810	1970	2150	1530	1530
18	2140	2380	2410	1970	1480	1490	1480	1800	1990	2150	1570	1520
19	2150	2430	2370	1780	1490	1520	1480	1820	1990	2130	1540	1310
20	2130	2400	2390	1580	1500	1540	2200	1810	2150	2140	1570	1530
21	2130	2360	2400	1520	1510	1520	2080	1810	2580	2130	1560	1530
22	2120	2360	2380	1500	1510	1540	1610	1820	2620	2130	1550	1540
23	2140	2390	2390	1480	1520	1520	1460	1830	2620	2130	1580	1540
24	2140	2390	2400	1490	1510	1540	1470	1820	2590	2130	1550	1510
25	2100	2420	2390	1490	1520	1500	1480	1810	2620	2130	1540	1520
26	2120	2380	2320	1550	1520	1540	1470	1810	2600	2150	1540	1530
27	2140	2390	2310	1550	1470	1500	1470	1820	2600	2130	1540	1500
28	2130	2360	2340	1530	1500	1470	1470	2400	2600	2130	1530	1520
29	2190	2370	2310	1540	---	1460	1480	2410	2600	2160	1530	1530
30	2130	2380	2350	1540	---	1470	1480	2410	2240	2160	1580	1510
31	2110	---	2360	1560	---	1470	---	2410	---	1890	1550	---
TOTAL	60110	61740	72780	62640	42190	46770	47790	55010	75060	65810	48480	45640
MEAN	1939	2058	2348	2021	1507	1509	1593	1775	2502	2123	1564	1521
MAX	2190	2430	2410	3030	1570	1540	2200	2410	3110	2160	1740	1560
MIN	1410	1630	2290	1480	1470	1460	1460	1470	1970	1890	1530	1310
AC-FT	119200	122500	144400	124200	83680	92770	94790	109100	148900	130500	96160	90530

e Estimated.

## 11446500 AMERICAN RIVER AT FAIR OAKS, CA—Continued

## STATISTICS OF MONTHLY MEAN DATA FOR WATER YEARS 1905 - 1954, BY WATER YEAR (WY)

	OCT	NOV	DEC	JAN	FEB	MAR	APR	MAY	JUN	JUL	AUG	SEP
MEAN	455	1327	2504	4483	5831	6647	8258	8656	5149	1293	342	269
MAX	1430	16450	17360	24290	15540	24710	15640	18200	17720	6336	1497	813
(WY)	1905	1951	1951	1909	1909	1907	1907	1952	1911	1906	1907	1907
MIN	100	85.0	254	284	650	879	1998	1488	206	26.8	15.8	24.4
(WY)	1930	1930	1906	1918	1920	1924	1924	1924	1924	1924	1924	1924

## SUMMARY STATISTICS

## WATER YEARS 1905 - 1954

ANNUAL MEAN	3752
HIGHEST ANNUAL MEAN	7896 1907
LOWEST ANNUAL MEAN	731 1924
HIGHEST DAILY MEAN	132000 Nov 21 1950
LOWEST DAILY MEAN	4.6 Jul 29 1924
ANNUAL SEVEN-DAY MINIMUM	4.8 Jul 29 1924
MAXIMUM PEAK FLOW	180000 Nov 21 1950
MAXIMUM PEAK STAGE	31.85 Nov 21 1950
ANNUAL RUNOFF (AC-FT)	2718000
10 PERCENT EXCEEDS	9980
50 PERCENT EXCEEDS	1420
90 PERCENT EXCEEDS	216

## STATISTICS OF MONTHLY MEAN DATA FOR WATER YEARS 1956 - 2001, BY WATER YEAR (WY)

MEAN	1940	2422	3900	5472	5798	5147	4240	4287	3769	3626	2739	2252
MAX	4102	11700	19360	31780	31140	19340	17760	14270	9828	10710	4500	4014
(WY)	1970	1984	1965	1997	1986	1983	1982	1995	1983	1995	1983	1998
MIN	284	272	252	350	408	273	258	520	1135	869	855	602
(WY)	1978	1978	1978	1962	1991	1977	1977	1977	1977	1977	1977	1977

## SUMMARY STATISTICS

## FOR 2000 CALENDAR YEAR

## FOR 2001 WATER YEAR

## WATER YEARS 1956 - 2001

ANNUAL TOTAL	1299190	684020	
ANNUAL MEAN	3550	1874	3791
HIGHEST ANNUAL MEAN			8854 1983
LOWEST ANNUAL MEAN			778 1977
HIGHEST DAILY MEAN	24100 Feb 15	3110 Jun 2	131000 Feb 19 1986
LOWEST DAILY MEAN	1410 Oct 1	1310 Sep 19	215 Apr 20 1977
ANNUAL SEVEN-DAY MINIMUM	1440 Sep 7	1470 Apr 23	237 Jan 7 1978
MAXIMUM PEAK FLOW		3360 Jun 8	134000 Feb 19 1986
MAXIMUM PEAK STAGE		6.15 Jun 8	27.96 Feb 19 1986
ANNUAL RUNOFF (AC-FT)	2577000	1357000	2747000
10 PERCENT EXCEEDS	5950	2390	7610
50 PERCENT EXCEEDS	2410	1690	2500
90 PERCENT EXCEEDS	1480	1490	937



## 11446500 AMERICAN RIVER AT FAIR OAKS, CA—Continued

## WATER-QUALITY RECORDS

PERIOD OF RECORD.—Water years 1960–65, October 1998 to current year.

WATER TEMPERATURE: Water years 1961–65, October 1998 to current year.

CHEMICAL DATA: Water years 1960–62.

PERIOD OF DAILY RECORD.—

WATER TEMPERATURE: Water years 1961–65, October 1998 to current year.

INSTRUMENTATION.—Water-temperature recorder since Oct. 29, 1998. Water-temperature probe was relocated 300 ft upstream on May 10, 2001, to obtain more representative stream temperatures.

REMARKS.—Water-temperature records rated excellent except for Oct. 1–12, Jan. 4 to Apr. 3, June 29, 30, which are rated good. Water temperature is affected by upstream releases from Nimbus Dam. Interruptions in record were due to malfunction of the recording instrument.

EXTREMES FOR PERIOD OF DAILY RECORD.—

WATER TEMPERATURE: Maximum recorded, 20.5°C, Sept. 30, 2001; minimum recorded, 7.5°C, Jan. 10, 1999.

EXTREMES FOR CURRENT YEAR.—

WATER TEMPERATURE: Maximum recorded, 20.5°C, Sept. 30, but may have been higher during periods of missing record; minimum recorded, 8.0°C, several days in January and February.

## CROSS-SECTIONAL DATA, WATER YEAR OCTOBER 2000 TO SEPTEMBER 2001

DATE	TIME	TEMPER- ATURE WATER (DEG C) (00010)	SAMPLE LOC- ATION, CROSS SECTION (FT FM L BANK) (00009)
JUN			
18...*	1015	17.0	17.5
18...*	1017	16.5	52.5
18...*	1019	16.0	87.5
18...*	1020	16.0	122
18...*	1022	16.0	158
18...*	1025	16.0	192
18...*	1027	15.5	228
18...*	1030	15.5	262
18...*	1032	15.5	298
18...*	1034	16.0	332

DATE	TIME	DEPTH BOTTOM AT SAMPLE LOC- ATION, (FEET) (81903)	TEMPER- ATURE WATER (DEG C) (00010)	SAMPLE LOC- ATION, CROSS SECTION (FT FM L BANK) (00009)
AUG				
24...*	0812	11.0	20.0	228
24...*	0815	12.0	20.0	204
24...*	0819	11.0	20.0	180
24...*	0825	11.0	20.0	156
24...*	0830	12.5	20.0	132
24...*	0832	13.2	20.0	108
24...*	0835	13.6	20.0	84.0
24...*	0838	15.7	20.0	60.0
24...*	0842	14.8	20.0	36.0
24...*	0845	9.30	20.0	12.0

\* Instantaneous discharge at time of cross-sectional measurement: 2,000 ft<sup>3</sup>/s, June 18, 2001; 1,520 ft<sup>3</sup>/s, Aug. 24, 2001 (at upstream site).

## 11446500 AMERICAN RIVER AT FAIR OAKS, CA—Continued

## TEMPERATURE, WATER (DEG. C), WATER YEAR OCTOBER 2000 TO SEPTEMBER 2001

DAY	OCTOBER		NOVEMBER		DECEMBER		JANUARY		FEBRUARY		MARCH	
	MAX	MIN	MAX	MIN	MAX	MIN	MAX	MIN	MAX	MIN	MAX	MIN
1	19.5	18.0	17.5	16.5	13.0	12.0	11.0	10.0	10.0	8.0	10.5	8.5
2	19.0	17.5	17.5	16.5	13.0	12.0	10.5	10.0	10.0	8.5	10.0	9.0
3	19.0	18.0	17.5	16.5	13.0	12.0	10.5	9.5	10.5	8.5	10.5	8.5
4	19.0	17.5	17.5	16.5	12.5	12.0	10.5	9.5	11.0	9.0	9.5	9.0
5	19.5	17.5	17.5	16.0	12.5	12.0	10.5	10.0	11.0	9.0	10.5	9.0
6	19.0	17.5	17.0	15.5	12.5	12.0	10.5	9.5	10.5	9.0	10.5	9.0
7	19.0	17.5	16.5	15.5	12.5	12.0	10.5	9.5	10.5	8.5	11.0	9.5
8	19.0	17.5	16.0	15.5	12.5	12.0	10.5	9.5	10.5	8.0	11.0	9.5
9	18.5	17.5	16.5	15.0	12.5	12.0	10.0	9.5	9.0	8.0	11.0	9.5
10	18.0	17.5	15.5	14.5	12.5	12.0	10.0	9.5	9.5	8.0	11.5	9.5
11	17.5	17.0	15.5	14.5	12.0	11.5	10.0	9.5	9.5	8.0	11.5	9.5
12	18.0	17.0	15.5	14.0	12.5	11.5	10.0	9.5	9.0	8.0	11.5	9.5
13	18.5	17.0	15.0	14.0	12.0	11.5	10.0	9.5	9.5	8.0	11.5	9.5
14	18.0	17.0	15.0	14.0	12.0	11.5	10.5	9.5	10.0	8.0	12.0	10.0
15	18.5	17.0	15.0	14.0	12.0	11.5	10.5	9.5	10.0	8.0	11.0	10.0
16	18.5	17.5	14.5	14.0	12.0	11.5	10.0	9.0	10.5	8.5	12.0	10.0
17	18.5	17.5	14.5	14.0	12.0	11.0	10.0	9.0	10.0	8.5	12.0	10.0
18	18.5	17.5	14.5	13.5	12.0	11.0	10.0	8.5	10.0	9.0	12.0	10.0
19	18.5	17.5	14.0	13.5	12.0	11.0	10.5	9.0	10.0	9.0	12.0	10.5
20	18.5	17.5	14.0	13.5	12.0	11.0	10.5	9.0	9.5	9.0	12.5	10.5
21	18.5	17.5	14.0	13.5	11.5	11.0	10.5	8.5	9.5	9.0	12.5	10.5
22	18.0	17.0	13.5	13.0	11.5	11.0	11.0	9.0	10.0	9.0	12.5	10.5
23	18.0	17.0	13.5	13.0	11.5	11.0	10.0	8.5	11.0	8.5	12.5	10.5
24	18.0	17.5	13.5	13.0	11.5	11.0	10.5	9.0	9.5	8.5	12.5	11.0
25	18.0	17.5	13.5	12.5	11.0	10.5	9.5	8.5	10.5	8.5	13.0	11.0
26	18.0	17.0	13.0	12.5	11.0	10.5	10.5	8.5	10.5	8.5	13.0	11.0
27	18.0	17.0	13.0	12.5	11.0	10.5	10.5	8.0	11.0	8.5	13.0	11.0
28	18.0	17.0	13.0	12.5	11.0	10.5	10.5	8.0	11.0	9.0	13.0	11.5
29	17.5	17.0	13.5	12.5	11.0	10.5	10.0	8.5	---	---	13.0	11.5
30	17.5	16.5	13.0	12.5	11.0	10.0	10.0	8.5	---	---	13.5	11.5
31	17.5	16.5	---	---	11.0	10.0	10.5	8.0	---	---	13.0	11.5
MONTH	19.5	16.5	17.5	12.5	13.0	10.0	11.0	8.0	11.0	8.0	13.5	8.5
DAY	APRIL		MAY		JUNE		JULY		AUGUST		SEPTEMBER	
	MAX	MIN	MAX	MIN	MAX	MIN	MAX	MIN	MAX	MIN	MAX	MIN
1	14.0	11.5	16.0	14.0	14.0	13.0	18.0	16.5	17.5	17.0	19.0	18.5
2	13.5	11.5	16.5	14.5	14.5	14.0	18.0	17.0	18.0	17.0	19.0	18.5
3	13.0	12.0	16.5	14.5	14.0	13.5	18.0	17.0	18.0	17.5	19.0	18.5
4	13.5	12.0	16.5	14.5	14.0	13.0	18.0	16.5	18.0	17.5	19.0	18.5
5	13.5	12.0	16.5	14.5	14.0	13.0	17.5	16.5	18.5	18.0	19.0	18.0
6	13.0	12.5	17.0	15.0	14.5	13.5	18.0	17.0	19.0	17.0	19.5	18.5
7	13.0	12.0	17.0	15.0	14.5	14.0	18.5	17.5	19.0	18.5	19.0	18.5
8	13.0	11.5	17.0	15.0	14.5	13.5	18.0	17.0	18.5	18.0	19.0	18.5
9	13.5	11.0	17.0	15.0	14.5	14.0	18.0	17.5	19.0	18.0	19.0	18.5
10	13.5	11.5	16.5	15.0	14.5	14.0	18.5	17.5	19.5	19.0	19.5	19.0
11	13.0	12.0	15.5	15.0	14.5	14.0	18.5	18.0	19.5	19.0	19.5	19.0
12	14.0	12.0	16.0	15.0	15.5	14.5	18.5	18.0	19.0	18.5	19.5	19.0
13	13.5	12.0	16.0	15.5	15.5	14.5	19.0	18.0	19.5	19.0	19.5	19.0
14	14.0	12.0	16.0	15.0	15.5	14.5	18.5	18.0	19.5	19.0	19.5	19.0
15	14.0	12.0	15.5	15.0	15.5	15.0	19.0	18.5	19.5	19.0	19.5	19.0
16	14.0	12.5	16.5	15.0	15.5	15.0	19.0	18.5	20.0	19.0	19.5	19.0
17	14.5	12.5	16.5	15.5	16.0	15.0	19.0	18.0	---	---	20.0	19.0
18	14.5	12.5	17.5	15.5	16.0	15.5	19.0	18.5	---	---	19.0	18.5
19	14.5	13.0	17.5	16.0	16.0	15.5	19.0	18.5	---	---	19.0	18.5
20	13.5	12.5	17.5	16.0	16.0	15.5	19.0	19.0	---	---	19.0	18.5
21	13.5	12.5	17.0	16.0	16.0	15.5	19.5	19.0	---	---	19.5	19.0
22	14.0	12.5	17.0	14.5	16.0	15.5	19.5	19.0	---	---	19.5	19.0
23	14.5	12.5	16.0	14.5	---	---	19.5	19.0	---	---	19.0	19.0
24	15.0	13.5	15.0	14.0	---	---	19.5	19.0	20.0	19.0	19.0	19.0
25	15.0	13.5	14.5	13.0	---	---	19.5	17.5	19.5	18.0	19.5	19.0
26	15.5	14.0	14.0	13.0	---	---	18.0	17.0	18.5	18.0	20.0	19.5
27	15.5	13.5	14.5	13.0	---	---	17.5	17.0	18.5	18.0	20.0	19.0
28	15.5	14.0	14.5	13.5	16.5	---	17.5	16.5	18.5	18.0	19.5	19.5
29	16.0	13.5	14.5	13.5	17.0	16.5	17.5	16.5	18.0	17.5	20.0	19.5
30	16.0	14.5	14.5	13.5	17.0	16.5	17.5	16.5	18.5	17.5	20.5	19.5
31	---	---	14.5	13.0	---	---	17.5	17.0	19.0	18.5	---	---
MONTH	16.0	11.0	17.5	13.0	---	---	19.5	16.5	---	---	20.5	18.0

## 11446700 AMERICAN RIVER AT WILLIAM B. POND PARK, AT CARMICHAEL, CA

LOCATION.—Lat 38°35'29", long 121°19'54", in T.9 N., R.6.E., Rio De Los Americanos Grant, Sacramento County, Hydrologic Unit 18020111, on right bank, 20 ft downstream of the pedestrian bridge at William B. Pond Park on the American River Parkway, and 15.8 mi downstream of Folsom Dam.

DRAINAGE AREA.— 1,932 mi<sup>2</sup>.

PERIOD OF RECORD.—October 2000 to September 2001.

WATER TEMPERATURE: October 2000 to September 2001.

PERIOD OF DAILY RECORD.—

WATER TEMPERATURE: October 2000 to September 2001.

INSTRUMENTATION.—Water-temperature recorder since October 10, 2000.

REMARKS.—Water-temperature records rated excellent except for Nov. 17, 18, Dec. 7 to Jan. 19, May 3 to June 13, July 7–11, and July 23 to Aug. 1 which are rated good; and July 12, 13, Aug. 2–6 which are rated fair.

EXREMES FOR PERIOD OF DAILY RECORD.—

WATER TEMPERATURE: Maximum recorded, 23.5°C, Aug. 24, 2001; minimum recorded, 7.5°C, Feb. 13–15, 2001.

EXREMES FOR CURRENT YEAR.—

WATER TEMPERATURE: Maximum recorded, 23.5°C, Aug. 24; minimum recorded, 7.5°C, Feb. 13–15.

## CROSS-SECTIONAL DATA, WATER YEAR OCTOBER 2000 TO SEPTEMBER 2001

DATE	TIME	DEPTH BOTTOM AT SAMPLE LOC- ATION, (FEET) (81903)	TEMPER- ATURE WATER (DEG C) (00010)	SAMPLE LOC- ATION, CROSS SECTION (FT FM L BANK) (00009)
JUL				
13...*	1050	9.00	18.5	361
13...*	1057	6.00	18.5	323
13...*	1102	6.00	18.5	285
13...*	1106	6.00	18.5	247
13...*	1112	4.00	19.0	209
13...*	1120	4.00	19.0	171
13...*	1128	2.00	19.5	133
13...*	1131	2.00	19.5	95.0
13...*	1133	3.00	19.0	57.0
13...*	1135	2.00	19.0	19.0

\* Estimated discharge at time of cross-sectional measurement: 2,090 ft<sup>3</sup>/s.

## 11446700 AMERICAN RIVER AT WILLIAM B. POND PARK, AT CARMICHAEL, CA—Continued

## TEMPERATURE, WATER (DEG. C), WATER YEAR OCTOBER 2000 TO SEPTEMBER 2001

DAY	MAX		MIN		MAX		MIN		MAX		MIN	
	OCTOBER	NOVEMBER	DECEMBER	JANUARY	FEBRUARY	MARCH	APRIL	MAY	JUNE	JULY	AUGUST	SEPTEMBER
1	---	---	17.0	15.5	12.5	11.5	10.5	9.5	10.0	8.0	10.5	8.5
2	---	---	17.5	15.5	12.5	11.5	10.5	9.0	10.0	8.0	9.5	9.0
3	---	---	17.5	15.5	12.5	11.5	10.5	9.0	10.5	8.0	10.5	8.5
4	---	---	17.5	15.5	12.0	11.5	10.5	9.0	10.5	8.5	9.5	9.0
5	---	---	17.0	15.5	12.0	11.5	10.5	9.0	10.5	8.5	10.0	9.5
6	---	---	16.5	15.0	12.0	11.0	10.5	9.0	9.5	8.5	11.0	9.0
7	---	---	16.5	14.5	12.0	11.0	10.0	9.0	10.0	8.0	12.0	9.0
8	---	---	16.0	14.5	12.5	11.0	10.0	9.5	9.5	8.0	11.5	9.5
9	---	---	15.5	14.0	12.0	11.0	10.5	10.0	8.5	8.0	11.0	9.0
10	---	---	15.0	14.0	12.0	11.5	10.5	10.5	9.0	8.0	12.0	9.0
11	16.5	16.0	15.0	13.5	11.5	11.5	10.5	10.0	9.0	8.0	12.0	9.0
12	18.0	16.0	14.5	13.0	11.5	11.0	10.5	9.5	8.5	8.0	12.5	9.0
13	18.0	16.0	14.0	13.0	11.5	11.0	10.5	9.5	9.0	7.5	12.5	9.0
14	18.5	16.5	14.0	13.0	11.0	11.0	10.5	9.5	10.0	7.5	13.0	9.5
15	19.0	16.5	14.0	12.5	12.0	11.0	11.0	9.5	10.0	7.5	11.5	9.5
16	19.0	16.5	14.0	12.5	11.5	10.5	11.5	10.0	10.5	8.0	12.5	9.5
17	19.0	17.0	14.0	12.5	11.5	10.5	11.5	10.0	9.5	8.5	13.0	9.5
18	19.0	17.0	14.0	12.5	11.5	10.0	11.5	10.0	10.0	9.0	13.0	10.0
19	19.0	17.0	14.0	12.5	11.5	10.5	11.0	9.0	10.0	8.5	13.5	10.0
20	18.5	17.0	14.0	12.5	11.5	10.5	9.5	8.5	9.5	9.0	13.5	10.5
21	18.0	16.5	12.5	12.5	11.0	10.0	9.5	8.5	10.0	9.0	13.5	10.5
22	17.5	15.5	13.0	12.0	11.5	10.5	10.5	8.5	10.0	8.5	13.5	10.0
23	18.0	15.5	12.5	12.0	11.0	10.0	9.5	8.5	10.5	8.5	14.0	10.0
24	18.5	16.5	13.0	12.0	11.0	10.0	10.0	9.0	9.5	8.5	13.5	10.5
25	17.5	16.5	12.5	12.0	10.5	9.5	9.0	8.5	11.0	8.5	13.5	11.0
26	17.0	16.5	12.0	12.0	10.5	9.5	10.0	8.5	10.0	8.5	14.0	10.5
27	18.0	16.5	12.0	12.0	10.5	9.5	10.0	8.0	11.0	8.0	14.0	11.0
28	17.0	16.0	12.0	12.0	10.5	9.5	10.0	8.0	11.0	8.5	14.5	11.0
29	17.5	16.0	12.5	11.5	10.5	9.5	10.0	8.5	---	---	14.5	10.5
30	17.0	16.0	13.0	11.5	10.5	9.5	9.5	8.0	---	---	14.5	11.0
31	17.5	15.5	---	---	10.5	9.5	10.0	8.0	---	---	14.5	11.0
MONTH	---	---	17.5	11.5	12.5	9.5	11.5	8.0	11.0	7.5	14.5	8.5
1	15.0	11.0	17.5	14.0	16.5	13.5	20.0	16.0	21.0	17.5	22.0	18.5
2	14.0	11.0	17.0	14.0	17.0	13.5	20.5	16.5	21.0	17.0	22.0	18.5
3	14.0	11.5	17.5	14.0	16.5	13.5	20.5	17.0	21.5	17.5	22.0	18.5
4	14.5	11.5	18.0	14.0	16.5	13.5	19.0	17.0	21.5	17.5	22.0	18.5
5	15.0	11.5	18.5	14.5	16.5	13.0	20.5	17.0	22.0	18.0	21.5	18.5
6	13.0	11.5	18.5	14.5	17.0	13.0	20.5	16.5	22.0	18.0	21.5	18.5
7	13.0	12.0	19.5	14.5	17.0	14.0	21.0	17.0	22.5	18.5	21.5	18.5
8	13.5	11.0	19.5	15.0	17.0	14.0	21.0	17.5	22.5	18.5	21.5	18.0
9	14.0	10.5	19.5	15.0	17.0	13.5	21.0	17.0	22.0	18.0	21.5	18.0
10	14.5	11.0	19.5	15.0	17.5	13.5	21.0	17.5	22.5	18.0	22.0	18.5
11	13.5	11.0	19.0	15.5	17.5	14.0	21.0	17.5	22.5	18.5	21.0	18.5
12	14.5	11.5	18.5	15.0	18.5	14.0	21.5	17.5	22.0	18.5	22.0	19.0
13	14.0	11.5	18.5	15.0	18.0	14.5	22.0	18.0	22.5	18.0	22.0	18.5
14	15.0	11.0	18.5	15.0	18.5	14.5	21.5	18.0	22.5	18.5	22.5	19.0
15	15.0	11.5	18.5	15.0	18.5	14.5	22.0	18.0	23.0	19.0	22.0	19.0
16	15.0	11.5	19.0	15.0	19.0	14.5	21.5	18.0	23.0	18.5	22.0	19.0
17	16.0	12.0	19.5	15.5	19.0	15.0	22.0	18.5	23.0	19.0	22.0	18.5
18	15.0	12.0	19.5	15.5	19.5	15.0	22.0	18.0	23.0	19.0	21.5	18.5
19	14.5	12.0	20.0	16.5	19.5	15.5	22.0	18.5	23.0	19.0	21.5	18.5
20	13.0	12.0	20.0	16.5	19.5	15.0	22.0	18.5	22.5	19.0	21.5	18.5
21	14.0	11.5	20.5	17.0	19.0	15.5	21.5	18.0	23.0	18.5	21.5	18.5
22	15.5	11.5	20.5	16.0	19.0	15.0	22.0	18.0	22.5	19.0	21.5	18.5
23	16.0	11.5	19.0	15.0	18.0	15.0	22.0	18.5	23.0	19.0	21.0	18.5
24	17.0	13.0	18.0	15.0	18.5	15.5	22.5	18.5	23.5	20.0	20.5	18.5
25	17.5	13.0	17.5	14.0	17.5	15.5	22.0	18.5	22.5	19.0	21.5	19.0
26	17.5	13.5	17.5	13.0	18.0	15.5	21.0	17.0	22.0	18.5	22.0	18.5
27	17.0	13.0	17.0	13.0	16.5	15.0	20.5	17.0	22.0	18.0	21.5	19.0
28	16.5	13.5	17.5	13.5	18.5	15.0	20.5	17.0	22.0	18.5	21.5	18.5
29	17.0	13.5	17.0	13.5	19.0	15.5	20.5	17.0	21.5	18.0	22.0	18.5
30	18.0	14.0	17.0	14.0	20.0	16.0	20.0	16.5	21.0	18.0	22.5	19.0
31	---	---	17.5	13.5	---	---	21.0	17.0	22.0	18.0	---	---
MONTH	18.0	10.5	20.5	13.0	20.0	13.0	22.5	16.0	23.5	17.0	22.5	18.0

## 11446980 AMERICAN RIVER BELOW WATT AVENUE BRIDGE, NEAR CARMICHAEL, CA

LOCATION.—Lat 38°34'32", long 121°23'14", in SE 1/4 NW 1/4 sec.12, T.8 N., R.5 E., Sacramento County, Hydrologic Unit 18020111, on right bank, 19.8 mi downstream from Folsom Dam, and 5 mi southwest of Carmichael.

DRAINAGE AREA.—1,938 mi<sup>2</sup>.

PERIOD OF RECORD.—November 1998 to current year.

WATER TEMPERATURE.—November 1998 to current year.

PERIOD OF DAILY RECORD.—

WATER TEMPERATURE.—November 1998 to current year.

INSTRUMENTATION.—Water-temperature recorder since Nov. 13, 1998.

REMARKS.—Water-temperature records rated excellent except for Oct. 1–10, Dec. 7 to Jan. 10, Feb. 12–26, June 15–28, July 23 to Aug. 4 which are rated good; Oct. 11–19, Jan. 11–15, Aug. 5, 6 which are rated fair; and Jan. 16 which is rated poor. Water temperature can be affected by releases from Folsom and Nimbus Dams.

EXTREMES FOR PERIOD OF DAILY RECORD.—

WATER TEMPERATURE: Maximum recorded, 24.0°C, Aug. 24, 2001; minimum recorded, 7.5°C, several days in January and February 1999, Jan. 17, 18, 31, Feb. 8, 13, 2001.

EXTREMES FOR CURRENT YEAR.—

WATER TEMPERATURE: Maximum recorded, 24.0°C, Aug. 24; minimum recorded, 7.5°C, Jan. 17, 18, 31, Feb. 8, 13.

## CROSS-SECTIONAL DATA, WATER YEAR OCTOBER 2000 TO SEPTEMBER 2001

DATE	TIME	TEMPER- ATURE WATER (DEG C) (00010)	SAMPLE LOC- ATION, CROSS SECTION (FT FM L BANK) (00009)
JUL			
13...*	1623	21.5	25.0
13...*	1637	21.5	33.0
13...*	1643	21.5	56.0
13...*	1650	21.5	71.0
13...*	1657	21.5	86.0
13...*	1705	21.5	101
13...*	1715	21.5	116
13...*	1730	21.5	123
13...*	1738	21.5	148
13...*	1745	21.5	173

\* Estimated discharge at time of cross-sectional measurement: 2,100 ft<sup>3</sup>/s.

## 11446980 AMERICAN RIVER BELOW WATT AVENUE BRIDGE, NEAR CARMICHAEL, CA—Continued

## TEMPERATURE, WATER (DEG. C), WATER YEAR OCTOBER 2000 TO SEPTEMBER 2001

DAY	MAX	MIN	MAX	MIN	MAX	MIN	MAX	MIN	MAX	MIN	MAX	MIN
	OCTOBER		NOVEMBER		DECEMBER		JANUARY		FEBRUARY		MARCH	
1	20.0	18.0	16.5	15.0	12.0	11.0	10.0	8.5	9.5	8.0	10.5	9.0
2	20.0	18.0	17.0	15.0	12.0	10.5	10.0	8.5	9.5	8.5	10.5	9.5
3	19.5	17.0	17.0	15.0	12.0	11.0	10.0	8.5	10.5	8.5	10.5	8.5
4	19.0	17.5	17.0	15.0	11.5	11.0	10.0	8.5	11.0	9.0	10.5	9.5
5	19.5	17.0	16.5	15.0	12.0	11.0	10.0	8.5	10.5	9.0	10.5	9.5
6	19.5	17.5	16.0	14.5	11.5	10.5	9.5	8.5	10.5	9.0	11.5	9.5
7	19.0	17.0	15.5	13.5	11.5	10.5	9.5	8.0	9.5	8.0	12.0	9.5
8	19.0	17.0	15.5	14.0	12.0	11.0	10.0	9.0	9.5	7.5	12.0	10.0
9	19.0	17.0	15.0	13.5	12.0	10.5	9.5	9.0	9.0	8.0	11.5	10.0
10	17.5	16.5	14.5	13.0	12.0	11.0	9.5	9.0	9.0	8.0	12.0	9.0
11	17.0	16.5	14.0	12.5	11.5	11.0	9.0	9.0	9.0	8.0	12.0	9.5
12	17.5	16.0	14.0	12.0	11.0	10.5	10.0	8.5	8.5	8.0	12.5	9.5
13	18.0	16.0	13.5	12.0	11.0	10.5	10.0	9.0	9.0	7.5	12.5	10.0
14	18.5	16.5	13.5	12.0	11.0	10.5	10.0	9.0	10.0	8.0	13.0	10.5
15	18.5	16.5	13.5	12.0	11.5	10.5	9.5	8.0	9.5	8.0	12.5	10.5
16	19.0	16.5	13.5	12.0	11.0	10.0	9.0	8.0	10.5	8.5	12.5	10.0
17	19.0	17.0	13.5	11.5	11.0	10.0	9.0	7.5	10.0	9.0	13.0	10.0
18	19.0	17.0	13.5	11.5	11.0	9.5	9.5	7.5	10.0	9.0	13.5	10.5
19	19.0	17.0	13.5	11.5	11.0	9.5	10.0	8.5	10.5	9.0	13.5	11.0
20	18.5	17.0	13.5	11.5	11.0	9.5	9.0	8.0	10.0	9.0	14.0	11.5
21	18.0	16.5	12.5	11.5	11.0	9.5	9.5	8.0	10.0	9.0	14.0	11.5
22	17.0	15.0	13.0	12.0	11.0	10.0	10.0	8.5	10.5	9.0	13.5	11.5
23	17.5	15.5	12.5	11.5	10.5	9.5	9.5	9.0	11.0	8.5	14.0	11.0
24	18.5	16.0	13.0	11.5	10.5	9.5	10.0	9.0	10.5	8.5	14.0	11.5
25	18.0	16.5	12.0	11.0	10.0	9.0	9.0	8.5	11.0	8.5	14.0	12.0
26	17.0	16.5	12.0	11.5	10.5	9.0	9.5	8.0	10.5	9.0	14.0	11.5
27	18.0	16.0	12.0	11.5	10.0	8.5	9.5	8.0	11.0	8.5	14.5	11.0
28	17.5	16.0	12.0	11.5	10.0	9.0	9.5	8.0	11.0	8.5	15.0	11.5
29	17.0	15.5	12.0	11.0	10.0	8.5	10.0	8.5	---	---	15.0	12.0
30	16.5	15.5	12.5	11.0	10.0	9.0	9.5	8.0	---	---	15.0	12.0
31	17.0	15.0	---	---	10.0	8.5	9.5	7.5	---	---	15.0	12.0
MONTH	20.0	15.0	17.0	11.0	12.0	8.5	10.0	7.5	11.0	7.5	15.0	8.5
DAY	MAX	MIN	MAX	MIN	MAX	MIN	MAX	MIN	MAX	MIN	MAX	MIN
APRIL		MAY		JUNE		JULY		AUGUST		SEPTEMBER		
1	15.0	12.0	18.0	15.0	17.5	14.0	21.0	17.0	21.5	18.0	22.0	19.5
2	14.5	12.0	17.5	14.0	17.5	13.5	21.5	17.5	21.5	17.5	22.5	19.5
3	14.0	11.5	17.5	14.0	17.5	13.5	21.5	18.0	21.5	18.0	22.5	19.5
4	14.5	11.0	18.5	15.0	17.5	13.5	20.5	18.0	21.5	18.5	22.0	19.5
5	15.0	12.0	18.5	15.5	17.0	13.0	21.5	17.0	22.0	19.0	22.0	19.0
6	14.5	12.0	19.0	15.5	18.0	13.0	21.0	17.0	22.5	19.0	21.5	19.0
7	13.5	11.5	20.0	16.0	18.0	14.0	21.5	17.5	23.0	19.5	21.5	19.0
8	13.5	11.0	19.5	16.5	18.0	14.0	21.5	18.0	23.0	19.5	21.5	19.0
9	14.0	11.0	19.5	16.5	18.5	13.5	21.0	17.5	22.5	19.5	21.0	18.5
10	14.5	11.0	19.5	16.5	18.5	14.0	21.0	17.5	22.5	19.0	21.5	18.5
11	14.0	12.0	19.5	16.5	18.5	14.5	21.0	17.5	23.0	19.0	21.5	19.0
12	14.5	11.0	19.0	16.0	19.0	15.0	21.5	17.0	22.0	19.0	22.0	19.0
13	14.0	12.0	18.5	15.0	18.5	15.0	21.5	18.0	22.5	18.5	22.0	19.0
14	14.5	11.5	18.5	15.0	19.5	15.5	21.5	18.0	23.0	19.5	22.5	20.0
15	15.0	12.0	18.5	15.5	20.0	15.5	21.5	17.5	23.0	20.0	22.0	20.0
16	15.0	12.5	19.5	15.5	20.0	15.5	21.0	17.5	23.0	20.0	22.0	19.5
17	16.0	12.5	19.5	16.0	20.0	16.0	21.5	17.5	23.5	20.0	22.0	19.0
18	15.5	13.5	20.0	16.0	20.5	16.0	22.0	18.0	23.0	20.0	21.5	19.5
19	14.5	12.5	20.5	16.5	21.0	16.5	21.5	18.0	23.5	20.0	22.0	18.5
20	13.5	12.0	21.0	17.0	20.5	16.5	22.0	18.0	22.5	19.5	21.5	19.0
21	14.5	11.5	21.0	17.5	20.0	16.0	22.0	18.0	23.0	19.0	21.5	18.5
22	15.5	11.5	21.0	17.0	20.5	16.0	22.5	18.5	23.0	20.0	21.5	19.0
23	16.0	12.5	20.0	16.5	19.0	15.5	23.0	19.0	23.0	20.0	21.0	19.0
24	17.5	13.5	19.0	16.0	19.5	15.5	23.0	19.0	24.0	20.5	20.5	18.5
25	17.5	14.5	18.5	15.0	18.5	16.0	22.5	19.0	23.0	20.0	21.5	19.0
26	17.5	14.5	18.0	14.0	18.5	15.5	21.5	18.0	22.5	19.5	22.0	19.0
27	17.0	14.0	17.5	14.0	17.5	15.5	21.5	17.5	22.5	19.0	21.5	19.5
28	16.5	14.5	18.0	13.5	19.5	16.0	21.5	17.0	22.5	19.0	21.5	18.5
29	17.0	14.0	18.0	14.0	20.5	16.0	21.0	17.0	22.0	19.0	21.5	19.0
30	18.5	14.5	18.5	14.0	21.0	16.5	20.5	16.5	21.5	18.5	22.5	19.5
31	---	---	18.5	14.0	---	---	21.5	17.5	22.0	19.0	---	---
MONTH	18.5	11.0	21.0	13.5	21.0	13.0	23.0	16.5	24.0	17.5	22.5	18.5

## 11447293 DRY CREEK AT VERNON STREET BRIDGE, AT ROSEVILLE, CA

LOCATION.—Lat 38°44'00", long 121°18'03", SE 1/4 SE 1/4 sec.10, T.10 N, R.6 E, Placer County, Hydrologic Unit 18021111, on left bank downstream side of bridge, and 0.5 mi below confluence of Cirby Creek at Roseville.

DRAINAGE AREA.—80.08 mi<sup>2</sup>.

PERIOD OF RECORD.—October 1996 to September 1999 (no low-flow records), October 1999 to current year.

GAGE.—Water-stage recorder and crest-stage gage. Datum of gage is 99.86 ft above sea level (levels by City of Roseville). Prior to Nov. 10, 1999, at site 30 ft upstream at same datum.

REMARKS.—Records good except for estimated daily discharges, which are poor. Low summer flow sustained by ground-water seepage and residential and industrial wastewater.

EXTREMES FOR PERIOD OF RECORD.—Maximum discharge, 7,950 ft<sup>3</sup>/s, Jan. 22, 1997, gage height, 24.39 ft; minimum daily, excluding no-flow records, 7.8 ft<sup>3</sup>/s, June 22, 2001.

EXTREMES FOR CURRENT YEAR.—Peak discharges greater than a base discharge of 1,500 ft<sup>3</sup>/s, or maximum:

Date	Time	Discharge (ft <sup>3</sup> /s)	Gage height (ft)
Feb. 11	1015	983	13.32

## DISCHARGE, CUBIC FEET PER SECOND, WATER YEAR OCTOBER 2000 TO SEPTEMBER 2001

## DAILY MEAN VALUES

DAY	OCT	NOV	DEC	JAN	FEB	MAR	APR	MAY	JUN	JUL	AUG	SEP
1	e24	35	30	22	50	83	48	66	13	24	11	14
2	e22	34	28	23	45	171	52	63	15	17	9.8	15
3	e20	28	25	22	41	128	51	59	16	15	9.1	15
4	e24	25	25	22	43	336	54	53	16	9.6	8.8	13
5	e26	24	25	25	42	506	53	53	16	13	11	13
6	e24	25	24	24	46	198	70	56	13	9.4	12	12
7	e26	22	24	27	48	140	201	55	15	10	12	13
8	e28	22	25	237	38	113	97	66	16	11	10	15
9	e33	21	26	68	85	108	69	53	13	11	13	14
10	e53	37	25	259	312	102	60	24	12	11	14	16
11	e154	23	32	259	636	95	79	26	13	10	15	20
12	114	20	54	125	286	86	118	25	15	10	11	22
13	65	29	34	60	154	81	73	26	14	12	11	27
14	51	40	43	55	98	83	66	30	12	10	19	27
15	46	36	35	43	81	76	67	30	13	13	21	24
16	32	30	29	38	74	74	58	29	14	15	14	21
17	34	25	26	34	68	85	64	27	12	15	10	24
18	29	24	25	35	63	92	65	23	12	15	10	22
19	23	24	24	34	202	85	91	21	14	12	11	21
20	19	22	25	32	260	76	387	17	10	13	9.7	21
21	17	25	26	33	222	61	407	15	12	14	10	20
22	14	27	25	34	214	52	186	13	7.8	14	15	20
23	12	24	26	77	441	e44	156	12	10	11	19	19
24	13	23	25	145	450	e48	140	16	17	10	16	20
25	17	23	24	297	257	138	122	38	27	8.9	14	85
26	100	23	24	336	140	48	108	34	43	13	14	45
27	53	24	25	98	112	46	110	23	58	12	12	38
28	149	25	23	68	91	55	110	22	60	10	13	29
29	307	51	24	87	---	51	109	22	43	10	10	30
30	101	40	23	64	---	47	89	18	35	9.4	11	23
31	51	---	23	52	---	44	---	15	---	11	13	---
TOTAL	1681	831	852	2735	4599	3352	3360	1030	586.8	379.3	389.4	698
MEAN	54.2	27.7	27.5	88.2	164	108	112	33.2	19.6	12.2	12.6	23.3
MAX	307	51	54	336	636	506	407	66	60	24	21	85
MIN	12	20	23	22	38	44	48	12	7.8	8.9	8.8	12
AC-FT	3330	1650	1690	5420	9120	6650	6660	2040	1160	752	772	1380

e Estimated.

## 11447293 DRY CREEK AT VERNON STREET BRIDGE, AT ROSEVILLE, CA—Continued

## STATISTICS OF MONTHLY MEAN DATA FOR WATER YEARS 2000 - 2001, BY WATER YEAR (WY)

	OCT	NOV	DEC	JAN	FEB	MAR	APR	MAY	JUN	JUL	AUG	SEP
MEAN	38.4	30.3	27.1	180	382	141	98.3	45.1	21.9	14.7	14.3	26.5
MAX	54.2	32.8	27.5	272	591	173	112	56.9	24.3	17.1	16.0	29.8
(WY)	2001	2000	2001	2000	2000	2000	2001	2000	2000	2000	2000	2000
MIN	22.6	27.7	26.7	88.2	164	108	84.7	33.2	19.6	12.2	12.6	23.3
(WY)	2000	2001	2000	2001	2001	2001	2000	2001	2001	2001	2001	2001

SUMMARY STATISTICS	FOR 2000 CALENDAR YEAR		FOR 2001 WATER YEAR		WATER YEARS 2000 - 2001	
ANNUAL TOTAL	41281		20493.5			
ANNUAL MEAN	113		56.1		83.3	
HIGHEST ANNUAL MEAN					110	
LOWEST ANNUAL MEAN					56.1	
HIGHEST DAILY MEAN	3020	Jan 24	636	Feb 11	3020	Jan 24 2000
LOWEST DAILY MEAN	12	Jul 25	7.8	Jun 22	7.8	Jun 22 2001
ANNUAL SEVEN-DAY MINIMUM	13	Jul 21	9.9	Jul 29	9.9	Jul 29 2001
MAXIMUM PEAK FLOW			983	Feb 11	4010	Jan 24 2000
MAXIMUM PEAK STAGE			13.32	Feb 11	19.04	Jan 24 2000
ANNUAL RUNOFF (AC-FT)	81880		40650		60380	
10 PERCENT EXCEEDS	244		120		185	
50 PERCENT EXCEEDS	29		26		26	
90 PERCENT EXCEEDS	16		12		13	



## 11447360 ARCADE CREEK NEAR DEL PASO HEIGHTS, CA

LOCATION.—Lat 38°38'01", long 121°22'54", in Del Paso Grant, Sacramento County, Hydrologic Unit 18021111, on right bank, 500 ft upstream from bridge on Watt Avenue, at intersection with Longview Drive, and 1.3 mi east of Del Paso Heights.

DRAINAGE AREA.—31.5 mi<sup>2</sup>.

## WATER-DISCHARGE RECORDS

PERIOD OF RECORD.—July 1963 to June 1978, December 1995 to current year.

GAGE.—Water-stage recorder. Elevation of gage is 50 ft above sea level, from topographic map. Prior to December 1995, at site 0.3 mi upstream at different datum.

REMARKS.—Records fair except for estimated daily discharges and discharges below 1 ft<sup>3</sup>/s, which are poor. Low summer flow sustained by residential and industrial wastewater. See schematic diagram of lower Sacramento River Basin.

EXTREMES FOR PERIOD OF RECORD.—Maximum discharge, 3,320 ft<sup>3</sup>/s, Feb. 3, 1998, gage height, 15.63; no flow for many days in most years.

EXTREMES FOR CURRENT YEAR.—Peak discharges greater than a base discharge of 500 ft<sup>3</sup>/s, or maximum:

Date	Time	Discharge (ft <sup>3</sup> /s)	Gage height (ft)	Date	Time	Discharge (ft <sup>3</sup> /s)	Gage height (ft)
Oct. 28	2200	519	9.46	Feb. 11	1100	623	10.10
Jan. 10	2100	1,030	11.77	Feb. 23	0530	629	10.14
Jan. 25	2230	958	11.54	Mar. 5	0615	687	10.46

## DISCHARGE, CUBIC FEET PER SECOND, WATER YEAR OCTOBER 2000 TO SEPTEMBER 2001

## DAILY MEAN VALUES

DAY	OCT	NOV	DEC	JAN	FEB	MAR	APR	MAY	JUN	JUL	AUG	SEP
1	1.7	3.2	.70	.00	7.7	2.6	e1.5	1.3	e1.8	1.8	1.8	1.7
2	1.4	1.7	.25	.00	7.3	47	e1.3	.89	e1.9	1.8	1.9	1.7
3	1.3	1.2	.04	.00	6.4	6.9	e1.1	1.4	e2.0	1.7	1.9	1.5
4	1.6	.81	.00	.00	7.3	126	e1.1	1.8	e1.9	1.9	1.9	1.4
5	1.4	.58	.15	.00	7.2	273	e1.1	2.4	e1.9	2.2	2.0	1.3
6	1.4	.55	.14	.00	11	14	e10	1.9	e2.1	1.7	2.0	1.2
7	1.4	.37	.37	.00	16	5.7	e45	2.7	e1.8	1.7	1.8	1.3
8	1.3	.12	.56	249	7.7	3.7	e7.3	2.4	e1.6	1.7	1.9	1.4
9	4.4	.00	.36	15	44	2.9	e2.1	1.9	e1.6	1.7	1.8	1.6
10	9.4	.00	.14	281	105	2.8	e1.2	2.0	e1.5	1.8	1.8	1.7
11	39	.50	3.1	125	259	2.4	e.95	1.9	e1.5	1.5	1.8	1.7
12	11	.55	29	35	89	1.9	e3.5	2.0	e1.8	1.6	1.8	1.6
13	3.6	1.8	4.3	10	e30	2.0	e2.1	1.8	e1.6	1.8	2.0	1.6
14	2.4	6.1	16	7.0	e10	1.8	e2.1	1.7	e1.7	1.9	2.4	1.7
15	2.3	.97	9.1	5.9	e6.7	1.5	e2.0	1.7	e1.5	2.0	2.1	1.6
16	2.1	.47	3.4	5.0	e3.8	1.4	e2.0	2.1	e1.6	1.7	1.8	1.7
17	1.8	.40	1.6	4.7	e3.6	1.4	e1.9	1.8	e1.5	1.6	2.0	1.9
18	2.1	.18	1.3	4.0	e5.4	1.5	e1.9	1.8	e1.7	1.7	2.0	1.7
19	1.6	.11	.97	3.9	e108	1.6	e10	1.9	e1.6	1.7	1.7	1.6
20	1.4	.01	.74	3.9	59	1.8	e170	1.8	e1.8	1.7	1.8	1.4
21	.86	3.1	.54	3.9	46	e1.9	e10	2.0	2.1	1.7	1.5	1.5
22	.45	4.4	1.0	3.8	43	e1.6	e4.0	2.0	1.7	1.8	1.7	1.6
23	.03	.84	1.1	47	221	e1.3	e1.9	1.8	1.7	1.9	1.7	1.3
24	.65	.30	.76	49	196	3.2	e2.0	2.2	1.6	2.0	2.0	1.7
25	3.7	.08	.51	222	20	64	2.0	2.3	2.3	1.8	2.1	35
26	47	.00	.25	161	6.8	3.6	1.7	1.6	8.3	2.0	2.1	3.1
27	13	.00	.02	16	4.0	2.1	1.5	1.8	2.5	2.0	2.3	1.6
28	116	.00	.00	12	3.2	1.7	1.2	1.6	2.3	1.9	1.9	.90
29	209	19	.00	41	---	1.7	1.3	1.4	2.0	1.7	1.7	.97
30	34	2.8	.00	13	---	e1.4	1.1	1.4	2.1	1.5	1.5	.79
31	6.3	---	.00	9.4	---	e1.5	---	e1.7	---	1.4	1.4	---
TOTAL	523.59	50.14	76.40	1327.50	1334.1	585.9	294.85	56.99	61.0	54.9	58.1	79.76
MEAN	16.9	1.67	2.46	42.8	47.6	18.9	9.83	1.84	2.03	1.77	1.87	2.66
MAX	209	19	29	281	259	273	170	2.7	8.3	2.2	2.4	35
MIN	.03	.00	.00	.00	3.2	1.3	.95	.89	1.5	1.4	1.4	.79
AC-FT	1040	99	152	2630	2650	1160	585	113	121	109	115	158

e Estimated.

## 11447360 ARCADE CREEK NEAR DEL PASO HEIGHTS, CA—Continued

## STATISTICS OF MONTHLY MEAN DATA FOR WATER YEARS 1963 - 2001, BY WATER YEAR (WY)

	OCT	NOV	DEC	JAN	FEB	MAR	APR	MAY	JUN	JUL	AUG	SEP
MEAN	5.30	21.9	31.1	68.9	55.2	18.7	12.0	5.62	3.17	3.36	2.98	3.41
MAX	16.9	76.0	92.4	227	232	64.0	34.7	27.6	5.90	10.0	5.53	14.0
(WY)	2001	1974	1997	1969	1998	1975	1996	1998	1975	1974	1975	1965
MIN	.65	1.67	.40	3.15	.93	.85	.12	.64	.000	.000	.001	1.02
(WY)	1966	2001	2000	1976	1971	1966	1977	1965	1977	1977	1977	1996

SUMMARY STATISTICS	FOR 2000 CALENDAR YEAR		FOR 2001 WATER YEAR		WATER YEARS 1963 - 2001	
ANNUAL TOTAL	11199.10		4503.23			
ANNUAL MEAN	30.6		12.3		18.2	
HIGHEST ANNUAL MEAN					38.2	
LOWEST ANNUAL MEAN					2.64	
HIGHEST DAILY MEAN	1790	Jan 24	281	Jan 10	1910	Feb 3 1998
LOWEST DAILY MEAN	.00	Jan 1	.00	Nov 9	.00	Oct 27 1963
ANNUAL SEVEN-DAY MINIMUM	.00	Jan 1	.00	Dec 28	.00	Dec 31 1963
MAXIMUM PEAK FLOW			1030	Jan 10	3320	Feb 3 1998
MAXIMUM PEAK STAGE			11.77	Jan 10	15.63	Feb 3 1998
ANNUAL RUNOFF (AC-FT)	22210		8930		13210	
10 PERCENT EXCEEDS	36		16		25	
50 PERCENT EXCEEDS	2.4		1.8		2.4	
90 PERCENT EXCEEDS	.37		.46		.40	

11447360 ARCADE CREEK NEAR DEL PASO HEIGHTS, CA—Continued

## WATER-QUALITY RECORDS

PERIOD OF RECORD.—Water years 1996 to April 1999, January 2001 to September 2001.

CHEMICAL DATA: Water years 1996 to April 1999, January 2001 to September 2001.

SPECIFIC CONDUCTANCE: Water years 1996 to April 1999, January 2001 to September 2001.

WATER TEMPERATURE: Water years 1996 to April 1999, January 2001 to September 2001.

SEDIMENT DATA: Water years 1996 to April 1999, January 2001 to September 2001.

PERIOD OF DAILY RECORD.—

SPECIFIC CONDUCTANCE: July 1997 to September 1999.

WATER TEMPERATURE: July 1997 to September 1999.

INSTRUMENTATION.—Water-quality monitor July 1997 to September 1999.

REMARKS.—National Water-Quality Assessment (NAWQA) Program urban runoff study. Variability of chemical concentration result from fluctuations in discharge and storm-drain runoff.

## WATER-QUALITY DATA, WATER YEAR OCTOBER 2000 TO SEPTEMBER 2001

DATE	TIME	DIS- CHARGE, INST CUBIC FEET PER SECOND (00061)	BARO- METRIC PRES- SURE OF HG (00025)	OXYGEN, DIS- SOLVED OXYGEN, (PER- CENT SOLVED MG/L) (00300)	OXYGEN, DIS- SOLVED (PER- CENT SATUR- ATION) (00301)	PH WATER WHOLE FIELD (STAND- ARD UNITS) (00400)	SPE- CIFIC CON- DUCT- ANCE (US/CM) (00095)	TEMPER- ATURE WATER (DEG C) (00010)	HARD- NESS NONCARB DISSOLV FLD AS CACO3 (MG/L) (00904)	HARD- NESS TOTAL AS CACO3 (MG/L) (00900)	CALCIUM DIS- SOLVED (MG/L AS CA) (00915)	MAGNE- SIUM, DIS- SOLVED (MG/L AS MG) (00925)	POTAS- SIUM, DIS- SOLVED (MG/L AS K) (00935)	
JAN														
	17...1130	4.9	769	10.0	77.6	7.6	174	5.0	11	57.5	15.9	4.30	2.76	
FEB														
	16...1000	e3.8	764	11.0	94.9	7.5	195	9.0	9.3	67.3	18.0	5.42	2.98	
MAR														
	13...1140	2.0	764	9.0	86.2	7.3	315	13.5	15	105	29.3	7.76	3.62	
APR														
	10...1130	e1.2	758	7.7	72.6	7.5	152	12.5	8.9	50.9	14.3	3.71	3.07	
MAY														
	15...1240	1.4	762	9.8	107	7.5	346	19.5	--	88.8	23.7	7.18	4.61	
JUN														
	18...1010	e1.5	758	5.8	68.7	7.5	261	23.5	14	89.0	22.8	7.79	4.00	
JUL														
	12...1010	1.3	765	7.2	77.4	7.9	235	19.0	5.2	88.2	22.1	8.03	3.97	
AUG														
	20...0930	1.6	757	6.4	71.6	7.8	293	20.5	1.9	96.9	24.1	8.89	4.15	
SEP														
	18...0900	1.8	757	7.0	76.0	7.7	215	19.0	9.3	84.3	21.2	7.59	3.86	
DATE		SODIUM AD- SORP- TION RATIO (00931)	SODIUM, DIS- SOLVED AS NA (00930)	SODIUM PERCENT (00932)	ALKA- LINITY WAT.DIS GRAN T. FIELD CACO3 (MG/L) (29802)	CHLO- RIDE, DIS- SOLVED AS CL (00940)	FLUO- RIDE, DIS- SOLVED AS F (00950)	SILICA, DIS- SOLVED AS SIO2 (00955)	SULFATE DIS- SOLVED AS SO4 (00945)	SOLIDS, RESIDUE PER AC-FT (70303)	SOLIDS, SUM OF AT 180 DEG. C SOLVED (MG/L) (70300)	SOLIDS, SUM OF CONSTI- TUENTS, DIS- SOLVED (MG/L) (70301)	NITRO- GEN, DIS- SOLVED AS N (00608)	NITRO- GEN,AM- MONIA + ORGANIC DIS SOLVED AS N (00623)
JAN														
	17... .544	9.5	25.3	46	13.2	<.2	14.7	10.5	.2	123	103	e.032	.47	
FEB														
	16... .566	10.7	24.6	58	13.3	<.2	19.3	10.7	.2	146	120	.042	.59	
MAR														
	13... .843	19.9	28.3	90	24.2	<.2	17.9	18.3	.3	205	178	e.022	.76	
APR														
	10... .478	7.8	23.7	42	9.6	<.2	12.9	6.9	.2	114	86.0	e.023	.59	
MAY														
	15... .978	21.2	32.8	--	2.6	e.1	28.0	1.2	--	210	--	<.041	.65	
JUN														
	18... .764	16.6	27.7	75	25.2	e.1	29.2	9.6	.2	183	162	<.040	.60	
JUL														
	12... .819	17.7	29.2	83	21.5	e.1	31.8	7.6	.2	182	164	e.022	.46	
AUG														
	20... .830	18.8	28.6	95	26.7	e.1	37.5	11.9	.3	204	192	e.035	.56	
SEP														
	18... .827	17.4	29.9	75	22.8	e.1	33.0	8.4	.2	180	161	<.040	.57	

&lt; Actual value is known to be less than value shown.

e Estimated.

## 11447360 ARCADE CREEK NEAR DEL PASO HEIGHTS, CA—Continued

## WATER-QUALITY DATA, WATER YEAR OCTOBER 2000 TO SEPTEMBER 2001

DATE	NITRO- GEN, AM- MONIA + ORGANIC TOTAL (MG/L AS N) (00625)	NITRO- GEN, NO2+NO3 DIS- SOLVED (MG/L AS N) (00631)	NITRO- GEN, NITRITE DIS- SOLVED (MG/L AS N) (00613)	NITRO- GEN, PAR TICULATE WAT FLT SUSP (MG/L AS N) (49570)	PHOS- PHORUS DIS- SOLVED (MG/L AS P) (00666)	PHOS- PHORUS ORTHO, DIS- SOLVED (MG/L AS P) (00671)	PHOS- PHORUS PHOS- TOTAL (MG/L AS P) (00665)	CARBON, INORG + ORGANIC PARTIC TOTAL (MG/L AS C) (00694)	CARBON, INOR- GANIC, PARTIC TOTAL (MG/L AS C) (00688)	CARBON, ORGANIC DIS- SOLVED (MG/L AS C) (00681)	CARBON, ORGANIC PARTIC- ULATE TOTAL (MG/L AS C) (00689)	IRON, DIS- SOLVED (UG/L AS FE) (01046)	MANGA- NESE, DIS- SOLVED (UG/L AS MN) (01056)
JAN													
17...	M	.900	.013	--	.061	.047	.128	--	--	--	--	70	19.2
FEB													
16...	.65	1.05	.015	--	.086	.070	.161	--	--	--	--	50	15.6
MAR													
13...	.91	.752	.010	--	.073	.059	.132	--	--	--	--	50	22.3
APR													
10...	.70	.465	.011	--	.107	.089	.156	--	--	--	--	150	22.7
MAY													
15...	.77	.369	.020	--	.213	.182	.258	--	--	--	--	120	29.4
JUN													
18...	.68	.322	.014	--	.229	.191	.271	--	--	--	--	100	21.3
JUL													
12...	.57	.196	.007	--	.232	.199	.255	--	--	--	--	130	23.5
AUG													
20...	.71	.458	.009	--	.221	.203	.243	--	--	--	--	80	17.1
SEP													
18...	.62	.361	.010	<.022	.177	.137	.188	.7	<.1	6.2	.7	80	11.6

DATE	2,6-DI- ETHYL ANILINE WAT FLT 0.7 U GF, REC (UG/L) (82660)	ACETO- CHLOR, WATER FLTRD REC (UG/L) (49260)	ALA- CHLOR, WATER, DISS, REC, (UG/L) (46342)	ALPHA BHC DIS- SOLVED (UG/L) (34253)	ATRA- ZINE, WATER, DISS, REC (UG/L) (39632)	BEN- FLUR- ALIN WAT FLD 0.7 U GF, REC (UG/L) (82673)	BUTYL- ATE, WATER, DISS, REC (UG/L) (04028)	CAR- BARYL WATER FLTRD 0.7 U GF, REC (UG/L) (82680)	CARBO- FURAN WATER FLTRD 0.7 U GF, REC (UG/L) (82674)	CHLOR- PYRIFOS DIS- SOLVED (UG/L) (38933)	CYANA- ZINE, WATER, DISS, REC (UG/L) (04041)	DCPA WATER FLTRD 0.7 U GF, REC (UG/L) (82682)	DEETHYL ATRA- ZINE, WATER, DISS, REC (UG/L) (04040)
JAN													
17...	<.002	<.004	<.002	<.005	e.007	<.010	<.002	e.113	<.020	e.006	<.018	e.002	<.006
FEB													
16...	<.002	<.004	<.002	<.005	e.007	<.010	<.002	e.021	<.020	.007	<.018	e.003	<.006
MAR													
13...	<.002	<.004	<.002	<.005	e.004	e.003	<.002	e.015	<.020	e.004	<.018	e.002	e.002
APR													
10...	<.002	<.004	<.002	<.005	e.007	<.010	<.002	e.397	<.020	.009	<.018	e.003	<.006
MAY													
15...	<.002	<.004	<.002	<.005	e.004	<.010	<.002	e.236	<.020	<.005	<.018	<.003	<.006
JUN													
18...	<.002	<.004	<.002	<.005	<.007	<.010	<.002	e.029	<.020	<.005	<.018	<.003	<.006
JUL													
12...	<.002	<.004	<.002	<.005	e.004	<.010	<.002	e.012	<.020	<.005	<.018	<.003	<.006
AUG													
20...	<.002	<.004	<.002	<.005	<.007	<.010	<.002	e.011	<.020	<.005	<.018	<.003	<.006
SEP													
18...	<.002	<.004	<.002	<.005	<.007	<.010	<.002	e.025	<.020	e.004	<.018	<.003	<.006

&lt; Actual value is known to be less than value shown.

e Estimated.

M Presence of material verified, but not quantified.

## 11447360 ARCADE CREEK NEAR DEL PASO HEIGHTS, CA—Continued

## WATER-QUALITY DATA, WATER YEAR OCTOBER 2000 TO SEPTEMBER 2001

DATE	DI- AZINON, DIS- SOLVED (UG/L) (39572)	DI- ELDRIN DIS- SOLVED (UG/L) (39381)	DISUL- FOTON WATER FLTRD 0.7 U GF, REC (UG/L) (82677)	EPTC WATER FLTRD 0.7 U GF, REC (UG/L) (82668)	ETHAL- FLUR- ALIN WAT FLT 0.7 U GF, REC (UG/L) (82663)	ETHO- PROP WATER FLTRD 0.7 U GF, REC (UG/L) (82672)	FONOFOS WATER LINDANE DISS REC (UG/L) (04095)	DIS- SOLVED (UG/L) (39341)	LIN- URON WATER FLTRD 0.7 U GF, REC (UG/L) (82666)	MALA- THION, WAT FLT DIS- GF, REC (UG/L) (39532)	METHYL AZIN- PHOS WAT FLT 0.7 U GF, REC (UG/L) (82686)	METHYL PARA- THION WAT FLT 0.7 U GF, REC (UG/L) (82667)	METO- LACHLOR WATER DISSOLV (UG/L) (39415)	
	JAN	17...	.268	<.005	<.021	<.002	<.009	<.005	<.003	<.004	<.035	e.026	<.050	<.006
FEB	16...	.177	<.005	<.021	e.002	<.009	<.005	<.003	<.004	<.035	e.009	<.050	<.006	e.006
MAR	13...	.072	<.005	<.021	<.002	<.009	<.005	<.003	<.004	<.035	<.027	<.050	<.006	e.001
APR	10...	.590	<.005	<.021	.009	<.009	<.005	<.003	<.004	<.035	.036	e.099	<.006	.015
MAY	15...	.208	<.005	<.021	<.005	<.009	<.005	<.003	<.004	<.035	e.008	<.050	<.006	.014
JUN	18...	.386	<.005	<.021	<.002	<.009	<.005	<.003	<.004	<.035	e.007	<.050	<.006	e.006
JUL	12...	.214	<.005	<.021	.002	<.009	<.005	<.003	<.004	<.035	<.027	<.050	<.006	e.006
AUG	20...	.127	<.005	<.021	<.002	<.009	<.005	<.003	<.004	<.035	<.027	<.050	<.006	e.007
SEP	18...	.364	<.005	<.021	<.002	<.009	<.005	<.003	<.004	<.035	<.027	<.050	<.006	e.005
DATE	METRI- BUZIN SENCOR WATER DISSOLV (UG/L) (82630)	MOL- INATE WATER FLTRD 0.7 U GF, REC (UG/L) (82671)	NAPROP- AMIDE WATER FLTRD 0.7 U GF, REC (UG/L) (82684)	P,P' DDE DISSOLV (UG/L) (34653)	PARA- THION, DIS- SOLVED (UG/L) (39542)	PEB- ULATE WATER FILTRD 0.7 U GF, REC (UG/L) (82669)	PENDI- METH- ALIN WAT FLT 0.7 U GF, REC (UG/L) (82683)	PER- METHRIN CIS WAT FLT 0.7 U GF, REC (UG/L) (82687)	PHORATE WATER FLTRD 0.7 U GF, REC (UG/L) (82664)	PRO- METON, WATER DISS, REC (UG/L) (04037)	PRON- AMIDE WATER FLTRD 0.7 U GF, REC (UG/L) (82676)	PRO- CHLOR, WATER DISS, REC (UG/L) (04024)	PANIL WATER FLTRD 0.7 U GF, REC (UG/L) (82679)	
JAN	17...	<.006	<.002	<.007	<.003	<.007	<.002	e.009	<.006	<.011	.097	<.004	<.010	<.011
FEB	16...	<.006	<.002	<.007	<.003	<.007	<.002	.022	<.006	<.011	.041	<.004	<.010	<.011
MAR	13...	<.006	<.002	<.007	<.003	<.007	<.002	<.020	<.006	<.011	.034	<.004	<.010	<.011
APR	10...	<.006	<.002	<.007	<.003	<.007	<.002	.020	<.006	<.011	.187	<.004	<.010	<.011
MAY	15...	<.006	<.005	<.007	<.003	<.007	<.002	<.010	<.006	<.011	.058	<.004	<.010	<.011
JUN	18...	<.006	<.002	<.007	<.003	<.007	<.002	<.010	<.006	<.011	.042	<.004	<.010	<.011
JUL	12...	<.006	<.002	<.007	<.003	<.007	<.002	<.010	<.006	<.011	.043	<.004	<.010	<.011
AUG	20...	<.006	<.002	<.007	<.003	<.007	<.002	<.010	<.006	<.011	.058	<.004	<.010	<.011
SEP	18...	<.006	<.002	<.007	<.003	<.007	<.002	<.010	<.006	<.011	.026	<.011	<.010	<.011

< Actual value is known to be less than value shown.  
e Estimated.

## 11447360 ARCADE CREEK NEAR DEL PASO HEIGHTS, CA—Continued

## WATER-QUALITY DATA, WATER YEAR OCTOBER 2000 TO SEPTEMBER 2001

DATE	PRO-PARGITE WATER FLTRD 0.7 U GF, REC (UG/L) (82685)	SI-MAZINE, WATER, DISS, REC (UG/L) (04035)	TEBU-THIURON WATER FLTRD 0.7 U GF, REC (UG/L) (82670)	TER-BACIL WATER FLTRD 0.7 U GF, REC (UG/L) (82665)	TER-BUFOS WATER FLTRD 0.7 U GF, REC (UG/L) (82675)	THIO-BENCARB WATER FLTRD 0.7 U GF, REC (UG/L) (82681)	TRIAL-LATE WATER FLTRD 0.7 U GF, REC (UG/L) (82678)	TRI-FLUR-ALIN WAT FLT 0.7 U GF, REC (UG/L) (82661)
JAN 17...	<.023	.013	.035	<.034	<.017	<.005	<.002	e.001
FEB 16...	<.023	e.008	e.014	<.034	<.017	<.005	<.002	e.001
MAR 13...	<.023	<.011	<.016	<.034	<.017	<.005	<.002	e.003
APR 10...	<.023	e.009	.017	<.034	<.017	<.005	<.002	<.009
MAY 15...	<.023	e.009	e.012	<.034	<.017	<.005	<.002	<.009
JUN 18...	<.023	<.011	<.016	<.034	<.017	<.005	<.002	<.009
JUL 12...	<.023	.014	e.009	<.034	<.017	<.005	<.002	<.009
AUG 20...	<.023	<.011	<.016	<.034	<.017	<.005	<.002	<.009
SEP 18...	<.023	<.011	<.016	<.034	<.017	<.005	<.002	<.009

## PARTICLE-SIZE DISTRIBUTION OF SUSPENDED SEDIMENT, WATER YEAR OCTOBER 2000 TO SEPTEMBER 2001

DATE	TIME	DIS-CHARGE, INST. CUBIC FEET PER SECOND (00061)	TEMPER-ATURE WATER (DEG C) (00010)	SEDI-MENT, SUS-PENDED (MG/L) (80154)	SEDI-MENT, DIS-CHARGE, SUS-PENDED (T/DAY) (80155)	SED. SUSP. SIEVE DIAM. % FINER THAN .062 MM (70331)
JAN 17..N	1130	4.9	5.0	17	.22	85
MAR 13..N	1140	2.0	13.5	14	.08	87
APR 10..N	1130	e1.2	12.5	12	e.04	92
MAY 15..N	1240	1.4	19.5	10	.04	75
JUL 12..N	1010	1.3	19.0	16	.06	52
AUG 20..N	0930	1.6	20.5	11	.05	67
SEP 18..N	0900	1.8	19.0	13	.06	83

< Actual value is known to be less than value shown.

e Estimated.

N Suspended-sediment data determined from a sample collected and processed according to National Water-Quality Assessment (NAWQA) protocol.

## 11447650 SACRAMENTO RIVER AT FREEPORT, CA

LOCATION.—Lat 38°27'15", long 121°29'54", in SW 1/4 SW 1/4 sec.13, T.7 N., R.4 E., Sacramento County, Hydrologic Unit 18020109, on left bank, 630 ft downstream from drawbridge at Freeport, and 11 mi south of Sacramento.

DRAINAGE AREA.—Indeterminate.

## WATER-DISCHARGE RECORDS

PERIOD OF RECORD.—January 1904 to July 1905 (gage heights only), June to November 1921, October 1948 to current year. Prior to October 1979, published as Sacramento River at Sacramento (station 11447500).

REVISED RECORD.—WDR CA-96-4: 1994–1995 (P).

GAGE.—Water-stage recorder and acoustic-velocity system. Datum of gage is sea level. Prior to Nov. 16, 1956, nonrecording gage and water-stage recorder at various sites in vicinity of I Street Bridge in Sacramento, 13 mi upstream at datum of low-water mark of Oct. 23, 1856, 0.12 ft above sea level. Nov. 17, 1956, to Sept. 20, 1979, at site 1,000 ft upstream from I Street Bridge.

REMARKS.—Records good. Natural flow of stream affected by storage reservoirs, power development, diversions for irrigation, return flow from irrigated areas, and tide. Floodflows bypass station through Sacramento Weir Spill to Yolo Bypass (stations 11426000 and 11453000). See schematic diagram of lower Sacramento River Basin.

EXTREMES FOR PERIOD OF RECORD (since 1949).—Maximum discharge, 117,000 ft<sup>3</sup>/s, Feb. 19, 1986, elevation, 25.00 ft; minimum daily, 3,970 ft<sup>3</sup>/s, Oct. 15, 1977.

EXTREMES OUTSIDE PERIOD OF RECORD.—Maximum discharge known prior to Nov. 21, 1950, 103,000 ft<sup>3</sup>/s, Jan. 17, 1909, elevation, 29.6 ft, site then in use at present datum, from reports of California Department of Water Resources.

## DISCHARGE, CUBIC FEET PER SECOND, WATER YEAR OCTOBER 2000 TO SEPTEMBER 2001

## DAILY MEAN VALUES

DAY	OCT	NOV	DEC	JAN	FEB	MAR	APR	MAY	JUN	JUL	AUG	SEP
1	11900	14400	13500	13000	17800	31900	13900	9270	11600	15200	14800	12100
2	12000	13900	14100	13100	16200	28500	14100	9400	12200	14900	14900	12100
3	12000	13500	14300	12900	15000	25900	13700	8380	12600	14400	14500	12200
4	11900	12400	14100	12700	14000	24000	13300	8190	12400	14100	14200	12200
5	11900	12100	14000	12500	13200	27300	12700	7780	12300	13600	13900	12600
6	11200	12100	13700	12000	12600	35400	13300	7010	12300	13900	13600	12700
7	11200	11700	13300	11600	13100	41400	14100	6790	11800	14600	13300	12600
8	11200	11100	13200	12600	12100	45100	13900	6930	11800	14600	13200	12600
9	10600	11100	13100	14200	12300	46200	13800	7150	12900	14700	13200	12600
10	10900	10700	12900	15000	13000	41500	13600	7500	12600	14800	13600	13100
11	11200	11000	13000	17700	14400	35300	13100	7240	11700	14700	14000	12900
12	11800	11000	13100	20400	19700	31400	13200	7260	12200	15000	13200	13000
13	11800	10900	13200	25100	23600	28900	12600	8470	12400	14700	14000	13500
14	11800	11300	13800	24200	23700	26400	12600	8520	12400	14500	13600	13000
15	11900	11400	14200	21400	21600	24200	12200	8600	11800	14400	13400	12300
16	11800	11600	14900	19300	18400	22200	11600	8570	11600	14600	13500	12200
17	12000	12500	15900	18000	16100	20400	11300	9100	11600	14900	13400	12400
18	12000	12500	15600	16600	15200	19000	10100	9790	11800	14800	13300	12300
19	12100	12400	14600	15300	14700	18000	9860	9980	11700	14300	13200	12100
20	11500	12500	13900	14300	17100	17300	10400	10500	11700	14700	12800	11800
21	12300	12400	13500	13600	21400	16900	12200	10500	12100	15000	13000	12000
22	11700	12600	13300	13100	27400	16800	12700	10200	11900	15200	12600	12100
23	10600	12900	13300	13100	33500	16700	12700	9860	11800	15300	12900	11700
24	10500	12900	13300	14000	35000	16100	12400	9460	12400	15200	12500	12100
25	10200	12800	13400	14700	35700	16200	12000	9120	12600	15300	12000	12600
26	10400	13000	13400	19800	34500	15900	11200	e9140	12400	15700	12200	12100
27	10900	12900	13200	25400	36800	15800	11000	9150	13100	15800	12300	12000
28	11400	12700	13100	28900	36200	16000	11200	10600	13800	16000	12000	e12300
29	13400	12600	13000	26300	---	15500	10600	11700	14700	15900	12000	e12000
30	13900	13600	12900	22400	---	15000	9820	12400	15300	16200	12400	e11600
31	14200	---	13000	19700	---	14400	---	12300	---	16000	12300	---
TOTAL	362200	368500	423800	532900	584300	765600	369180	280860	371500	463000	409800	370800
MEAN	11680	12280	13670	17190	20870	24700	12310	9060	12380	14940	13220	12360
MAX	14200	14400	15900	28900	36800	46200	14100	12400	15300	16200	14900	13500
MIN	10200	10700	12900	11600	12100	14400	9820	6790	11600	13600	12000	11600
AC-FT	718400	730900	840600	1057000	1159000	1519000	732300	557100	736900	918400	812800	735500

e Estimated.

## 11447650 SACRAMENTO RIVER AT FREEPORT, CA—Continued

STATISTICS OF MONTHLY MEAN DATA FOR WATER YEARS 1949 - 2001, BY WATER YEAR (WY)

	OCT	NOV	DEC	JAN	FEB	MAR	APR	MAY	JUN	JUL	AUG	SEP
MEAN	12460	16340	26390	34830	41470	38300	29760	24620	18280	15080	14540	14880
MAX	28690	48820	74510	87110	81370	78290	76580	69820	55690	31000	25180	25320
(WY)	1963	1984	1984	1997	1998	1983	1982	1952	1998	1983	1998	1998
MIN	4494	6380	7208	8984	8003	6573	5961	6414	6865	6345	7061	6838
(WY)	1978	1993	1960	1991	1977	1977	1977	1992	1977	1949	1949	1977

SUMMARY STATISTICS	FOR 2000 CALENDAR YEAR		FOR 2001 WATER YEAR		WATER YEARS 1949 - 2001	
ANNUAL TOTAL	9098700		5302440			
ANNUAL MEAN	24860		14530		23830	
HIGHEST ANNUAL MEAN					46900	
LOWEST ANNUAL MEAN					7608	
HIGHEST DAILY MEAN	87700	Feb 15	46200	Mar 9	115000	Feb 19 1986
LOWEST DAILY MEAN	10200	Oct 25	6790	May 7	3970	Oct 15 1977
ANNUAL SEVEN-DAY MINIMUM	10800	Oct 22	7130	May 6	4060	Oct 13 1977
MAXIMUM PEAK FLOW			48800	Mar 9	117000	Feb 19 1986
MAXIMUM PEAK STAGE			9.88	Mar 9	25.00	Feb 19 1986
ANNUAL RUNOFF (AC-FT)	18050000		10520000		17260000	
10 PERCENT EXCEEDS	54800		20000		56400	
50 PERCENT EXCEEDS	17000		13000		16000	
90 PERCENT EXCEEDS	12100		10600		9010	



## 11447650 SACRAMENTO RIVER AT FREEPORT, CA—Continued

## WATER-QUALITY RECORDS

PERIOD OF RECORD.—Water years 1957 to current year.

CHEMICAL DATA: Water years 1959 to September 1999, October 2000 to September 2001.

BIOLOGICAL DATA: Water years 1974–81.

SPECIFIC CONDUCTANCE: Water years 1974–75, 1989–98.

WATER TEMPERATURE: Water year 1960 to current year.

SEDIMENT DATA: Water year 1957 to current year (prior to water year 1980, published as 11447500 Sacramento River at Sacramento).

PERIOD OF DAILY RECORD.—October 1956 to current year.

CHEMICAL DATA: June 1960 to June 1963.

SPECIFIC CONDUCTANCE: Water years 1974–75, 1989–94, 1996–98.

WATER TEMPERATURE: June 1960 to current year.

SUSPENDED SEDIMENT: October 1956 to current year.

INSTRUMENTATION.—Temperature recorder June 1960 to November 1988. Water-quality monitor since November 1988.

REMARKS.—Water-temperature records rated excellent except for Oct. 13 to Nov. 22, Feb. 6–22, Apr. 22 to May 11, May 30 to July 31, and

Aug. 3–10, which are rated good. Records of sediment discharge from 1957 to 1979 were obtained at Sacramento and are considered equivalent. Additional specific-conductance, monthly chemical, and trace-element data are available in files of the U.S. Geological Survey. Chemical Data for water year 2000 available in the files of the U.S. Geological Survey.

EXTREMES FOR PERIOD OF DAILY RECORD.—

SPECIFIC CONDUCTANCE: Maximum recorded, 318 microsiemens, Nov. 22, 1974; minimum recorded, 32 microsiemens, Apr. 6, 1974.

WATER TEMPERATURE: Maximum recorded, 27.0°C, Sept. 8, 1977; minimum recorded, 3.0°C, Dec. 25–27, 1990.

SEDIMENT CONCENTRATION: Maximum daily mean, 1,960 mg/L, Dec. 24, 1964; minimum daily, 2 mg/L, Jan. 27, 31, Nov. 21, 1991.

SEDIMENT LOAD: Maximum daily, 525,000 tons, Dec. 24, 1964; minimum daily, 35 tons, Jan. 31, 1991.

EXTREMES FOR CURRENT YEAR.—

WATER TEMPERATURE: Maximum recorded, 25.0°C, July 3, 4; minimum recorded, 7.0°C, Jan. 18, 29, Feb. 14.

SEDIMENT CONCENTRATION: Maximum daily mean, 376 mg/L, Mar. 8; minimum daily mean, 6 mg/L, Apr. 17.

SEDIMENT LOAD: Maximum daily, 45,700 tons, Mar. 8; minimum daily, 193 tons, Apr. 17.

## WATER-QUALITY DATA, WATER YEAR OCTOBER 2000 TO SEPTEMBER 2001

DATE	TIME	DIS-CHARGE,	BARO-	OXYGEN,		PH	SPE-	TEMPER-	HARD-	HARD-	MAGNE-	POTAS-	
		INST.	METRIC	SOLVED	DIS-	WATER			NESS			SIUM,	
		CUBIC	SURE	OXYGEN,	(PER-	FIELD	CON-	ATURE	DISSOLV	TOTAL	DIS-	DIS-	
		FEET	(MM	DIS-	CENT	(STAND-	DUCT-	WATER	FLD. AS	(MG/L	SOLVED	SOLVED	
		PER	OF	SOLVED	SATUR-	ARD	ANCE	WATER	CACO3	AS	(MG/L	(MG/L	
		SECOND	HG)	(MG/L)	ATION)	UNITS)	(US/CM	(DEG C)	(MG/L)	CACO3)	AS CA)	AS MG)	
		(00061)	(00025)	(00300)	(00301)	(00400)	(00095)	(00010)	(00904)	(00900)	(00915)	(00925)	
												(00935)	
OCT													
24...	1100	14600	764	9.4	92.0	7.9	142	14.5	--	52.5	11.4	5.87	1.18
NOV													
17...	1000	9430	768	10.4	93.6	7.6	159	11.0	--	57.8	12.3	6.57	1.46
DEC													
20...	1130	10600	764	10.1	88.2	7.7	173	9.5	--	61.3	12.9	7.06	1.61
JAN													
19...	1050	14000	769	10.7	88.4	8.0	196	7.5	--	68.1	13.8	8.16	1.73
FEB													
27...	1330	37600	760	10.2	90.6	7.8	126	10.0	--	48.7	10.4	5.50	1.28
MAR													
20...	1400	13600	760	9.5	95.5	7.5	192	15.5	--	68.2	14.3	7.91	1.31
APR													
12...	1400	16100	766	10.0	97.6	8.1	160	14.5	4.8	59.8	12.9	6.72	1.14
MAY													
17...	1300	6820	758	8.2	94.4	7.9	182	22.0	6.7	62.7	13.2	7.21	1.17
JUN													
11...	1220	14300	760	8.4	95.5	8.1	143	21.5	--	52.5	11.0	6.10	1.11
JUL													
31...	1030	20600	759	8.1	92.2	7.9	152	21.5	--	53.9	11.1	6.34	.96
AUG													
28...	1220	15200	755	7.7	92.4	7.9	171	24.0	--	69.0	13.8	8.36	1.20
SEP													
17...	1320	17500	759	8.5	96.7	7.9	176	21.5	--	69.3	14.0	8.34	1.17

11447650 SACRAMENTO RIVER AT FREEPORT, CA—Continued

WATER-QUALITY DATA, WATER YEAR OCTOBER 2000 TO SEPTEMBER 2001

DATE	SODIUM AD-SORPTION RATIO (00931)	SODIUM, DIS-SOLVED (MG/L) (00930)	SODIUM PERCENT (00932)	ALKA-LINITY WAT.DIS GRAN T. FIELD CACO3 (MG/L) (29802)	CHLO-RIDE, DIS-SOLVED (MG/L) (00940)	FLUO-RIDE, DIS-SOLVED (MG/L) (00950)	SILICA, DIS-SOLVED (MG/L) (00955)	SULFATE DIS-SOLVED (MG/L) (00945)	SOLIDS, DIS-SOLVED (TONS PER AC-FT) (70303)	SOLIDS, RESIDUE AT 180 DEG. C DIS-SOLVED (MG/L) (70300)	SOLIDS, SUM OF CONSTITUENTS, DIS-SOLVED (MG/L) (70301)	NITRO-GEN, AMMONIA DIS-SOLVED (MG/L) (00608)	NITRO-GEN, AMMONIA + ORGANIC DIS. (MG/L) (00623)
OCT													
24...	.532	8.9	26.3	66	5.0	e.1	16.6	6.1	.1	92	95.0	e.025	<.10
NOV													
17...	.577	10.1	26.9	64	5.5	<.2	17.8	6.9	.1	103	99.5	<.041	e.09
DEC													
20...	.623	11.2	27.8	65	6.5	<.2	18.6	8.2	.2	116	106	<.041	.18
JAN													
19...	.683	12.9	28.6	75	7.8	<.2	18.5	10.6	.2	126	120	<.041	.13
FEB													
27...	.398	6.4	21.6	50	4.4	<.2	17.7	5.9	.1	85	82.4	<.041	.36
MAR													
20...	.520	9.9	23.5	77	6.1	<.2	18.1	8.9	.2	126	114	<.041	.13
APR													
12...	.470	8.4	22.9	55	6.2	<.2	18.1	6.2	.2	116	93.2	<.041	e.06
MAY													
17...	.641	11.7	28.3	56	7.3	e.1	17.6	9.7	.1	105	102	<.040	e.10
JUN													
11...	.531	8.8	26.3	60	5.3	e.1	18.5	6.7	.1	94	93.9	<.040	.12
JUL													
31...	.553	9.3	26.9	--	5.0	<.2	18.3	5.6	--	96	--	<.040	e.07
AUG													
28...	.715	13.6	29.6	75	7.6	<.2	18.1	7.3	.2	129	115	<.040	.10
SEP													
17...	.567	10.8	25.0	73	7.1	e.1	19.3	6.1	.2	111	111	<.040	.12

DATE	NITRO-GEN, AMMONIA + ORGANIC TOTAL (MG/L) (00625)	NITRO-GEN, NO2+NO3 DIS-SOLVED (MG/L) (00631)	NITRO-GEN, NITRITE DIS-SOLVED (MG/L) (00613)	NITRO-GEN, PAR TICULTE WAT FLT SUSP (MG/L) (49570)	PHOS-PHORUS DIS-SOLVED (MG/L) (00666)	PHOS-PHORUS ORTHO, DIS-SOLVED (MG/L) (00671)	PHOS-PHORUS TOTAL (MG/L) (00665)	CARBON, INORG + ORGANIC PARTIC. TOTAL (MG/L) (00694)	CARBON, INOR-GANIC, ORGANIC PARTIC. TOTAL (MG/L) (00688)	CARBON, ORGANIC DIS-SOLVED (MG/L) (00681)	CARBON, ORGANIC PARTIC-ULATE TOTAL (MG/L) (00689)	IRON, DIS-SOLVED (UG/L) (01046)	MANGA-NESE, DIS-SOLVED (UG/L) (01056)
OCT													
24...	.67	.096	<.006	--	.032	.027	.061	--	--	1.6	.4	30	e3.1
NOV													
17...	.18	.107	<.006	--	.032	.027	.046	--	--	1.9	.5	30	4.2
DEC													
20...	.23	.149	.013	--	.039	.021	.070	--	--	2.3	.5	20	e1.7
JAN													
19...	.32	.190	e.003	--	.048	.033	.080	--	--	2.9	.5	20	4.5
FEB													
27...	.51	.187	<.006	--	.040	.031	.265	--	--	--	--	20	5.9
MAR													
20...	.21	.192	<.006	--	.034	.026	.067	--	--	--	--	20	4.9
APR													
12...	.12	.127	e.004	.076	.026	e.017	.044	.4	--	1.4	--	10	4.1
MAY													
17...	.15	.106	e.005	--	.041	--	.059	--	--	--	--	M	3.7
JUN													
11...	.12	.076	e.004	--	.033	.024	.052	--	--	--	--	M	3.9
JUL													
31...	.16	.057	<.006	.073	.031	.026	.061	.6	<.1	1.3	.6	M	e2.8
AUG													
28...	.66	<.050	e.008	.099	.040	e.019	.067	.8	<.1	2.0	.8	20	4.7
SEP													
17...	.20	.054	<.006	--	.039	.026	.065	--	--	1.5	--	10	4.5

e Estimated.  
 < Actual value is known to be less than value shown.  
 M Presence of material verified, but not quantified.

## 11447650 SACRAMENTO RIVER AT FREEPORT, CA—Continued

## WATER-QUALITY DATA, WATER YEAR OCTOBER 2000 TO SEPTEMBER 2001

DATE	2,6-DI-ETHYL ANILINE WAT FLT 0.7 U GF, REC (UG/L) (82660)	ACETO-CHLOR, WATER FLTRD REC (UG/L) (49260)	ALA-CHLOR, WATER DISS, REC, (UG/L) (46342)	ALPHA BHC DIS- SOLVED (UG/L) (34253)	ATRA-ZINE, WATER DISS, REC (UG/L) (39632)	BEN-FLUR-ALIN WAT FLD GF, REC (UG/L) (82673)	BUTYL-ATE, WATER DISS, REC (UG/L) (04028)	CAR-BARYL WATER FLTRD GF, REC (UG/L) (82680)	CARBO-FURAN FLTRD GF, REC (UG/L) (82674)	CHLOR-PYRIFOS DIS- SOLVED (UG/L) (38933)	CYANA-ZINE, WATER DISS, REC (UG/L) (04041)	DCPA WATER FLTRD GF, REC (UG/L) (82682)	DEETHYL ATRA-ZINE, WATER DISS, REC (UG/L) (04040)
OCT													
24...	<.002	<.004	<.002	<.005	e.002	<.010	<.002	e.003	<.020	<.005	<.018	<.003	<.006
NOV													
17...	<.002	<.004	<.002	<.005	<.007	<.010	<.002	e.006	<.020	<.005	<.018	<.003	<.006
DEC													
20...	<.002	<.004	<.002	<.005	<.007	<.010	<.002	<.041	<.020	<.005	<.018	<.003	<.006
JAN													
19...	<.002	<.004	<.002	<.005	<.007	<.010	<.002	e.005	<.020	<.005	<.018	<.003	<.006
FEB													
27...	<.002	<.004	<.002	<.005	<.007	<.010	<.002	<.041	<.020	<.005	<.018	<.003	<.006
MAR													
20...	<.002	<.004	<.002	<.005	<.007	<.010	<.002	<.041	<.020	<.005	<.018	<.003	<.006
APR													
12...	<.002	<.004	<.002	<.005	e.002	<.010	<.002	e.013	<.020	<.005	<.018	<.003	<.006
MAY													
17...	<.002	<.004	<.002	<.005	<.007	<.010	<.002	<.041	<.020	<.005	<.018	<.003	<.006
JUN													
11...	<.002	<.004	<.002	<.005	e.003	<.010	<.002	<.041	<.020	<.005	<.018	<.003	<.006
JUL													
31...	<.002	<.004	<.002	<.005	<.007	<.010	<.002	<.041	<.020	<.005	<.018	<.003	<.006
AUG													
28...	<.002	<.004	<.002	<.005	<.007	<.010	<.002	<.041	<.020	<.005	<.018	<.003	<.006
SEP													
17...	<.002	<.004	<.002	<.005	<.007	<.010	<.002	<.041	<.020	<.005	<.018	<.003	<.006
DATE	DI-AZINON, DIS-SOLVED (UG/L) (39572)	DI-ELDRIN DIS-SOLVED (UG/L) (39381)	DISUL-FOTON WATER FLTRD GF, REC (UG/L) (82677)	EPTC WATER FLTRD GF, REC (UG/L) (82668)	ETHAL-ALIN WAT FLT GF, REC (UG/L) (82663)	ETHO-PROP WATER FLTRD GF, REC (UG/L) (82672)	FONOFOS WATER DISS REC (UG/L) (04095)	LINDANE DIS-SOLVED (UG/L) (39341)	LIN-URON WATER FLTRD GF, REC (UG/L) (82666)	MALA-THION, DIS-SOLVED (UG/L) (39532)	METHYL-AZIN-PHOS WAT FLT GF, REC (UG/L) (82686)	METHYL-PARA-THION WAT FLT GF, REC (UG/L) (82667)	METO-LACHLOR WATER DISSOLV (UG/L) (39415)
OCT													
24...	<.005	<.005	<.021	<.002	<.009	<.005	<.003	<.004	<.035	<.027	<.050	<.006	e.003
NOV													
17...	<.005	<.005	<.021	<.002	<.009	<.005	<.003	<.004	<.035	<.027	<.050	<.006	<.013
DEC													
20...	e.003	<.005	<.021	<.002	<.009	<.005	<.003	<.004	<.035	<.027	<.050	<.006	<.013
JAN													
19...	.015	<.005	<.021	<.002	<.009	<.005	<.003	<.004	<.035	<.027	<.050	<.006	e.003
FEB													
27...	.015	<.005	<.021	<.002	<.009	<.005	<.003	<.004	<.035	<.027	<.050	<.006	e.002
MAR													
20...	e.004	<.005	<.021	<.002	<.009	<.005	<.003	<.004	<.035	<.027	<.050	<.006	e.001
APR													
12...	e.004	<.005	<.021	e.002	<.009	<.005	<.003	<.004	<.035	<.027	<.050	<.006	<.013
MAY													
17...	e.001	<.005	<.021	<.002	<.009	<.005	<.003	<.004	<.035	<.027	<.050	<.006	.050
JUN													
11...	<.005	<.005	<.021	<.002	<.009	<.005	<.003	<.004	<.035	<.027	<.050	<.006	.030
JUL													
31...	<.005	<.005	<.021	<.002	<.009	<.005	<.003	<.004	<.035	<.027	<.050	<.006	e.007
AUG													
28...	<.005	<.005	<.021	<.002	<.009	<.005	<.003	<.004	<.035	<.027	<.050	<.006	e.003
SEP													
17...	<.005	<.005	<.021	<.002	<.009	<.005	<.003	<.004	<.035	e.011	<.050	<.006	e.005

< Actual value is known to be less than value shown.  
e Estimated.

11447650 SACRAMENTO RIVER AT FREEPORT, CA—Continued

WATER-QUALITY DATA, WATER YEAR OCTOBER 2000 TO SEPTEMBER 2001

DATE	METRI- BUZIN SENCOR WATER (UG/L) (82630)	MOL- INATE WATER FLTRD 0.7 U (UG/L) (82671)	NAPROP- AMIDE WATER FLTRD 0.7 U (UG/L) (82684)	P,P' DDE DISSOLV (UG/L) (34653)	PARA- THION, DIS- SOLVED (UG/L) (39542)	FEB- ULATE WATER FILTRD 0.7 U (UG/L) (82669)	PENDI- METH- ALIN WAT FLT 0.7 U (UG/L) (82683)	PER- METHRIN CIS WAT FLT 0.7 U (UG/L) (82687)	PHORATE WATER FLTRD 0.7 U (UG/L) (82664)	PRO- METON, WATER FLTRD DISS, REC (UG/L) (04037)	PRON- AMIDE WATER FLTRD 0.7 U (UG/L) (82676)	PRO- PROPA- CHLOR, WATER FLTRD DISS, REC (UG/L) (04024)	PANIL WATER FLTRD 0.7 U (UG/L) (82679)
OCT													
24...	<.006	.010	<.007	<.003	<.007	<.002	<.010	<.006	<.011	<.015	<.004	<.010	<.011
NOV													
17...	<.006	.015	<.007	<.003	<.007	<.002	<.010	<.006	<.011	<.015	<.004	<.010	<.011
DEC													
20...	<.006	.015	<.007	<.003	<.007	<.002	<.010	<.006	<.011	<.015	<.004	<.010	<.011
JAN													
19...	<.006	.024	<.007	<.003	<.007	<.002	<.010	<.006	<.011	<.015	<.004	<.010	<.011
FEB													
27...	<.006	.005	<.007	<.003	<.007	<.002	<.010	<.006	<.011	<.015	.004	<.010	<.011
MAR													
20...	<.006	e.003	<.007	<.003	<.007	<.002	<.010	<.006	<.011	<.015	<.004	<.010	<.011
APR													
12...	<.006	<.002	<.007	e.001	<.007	<.002	<.010	<.006	<.011	e.002	<.004	<.010	<.011
MAY													
17...	<.006	.817	<.007	<.003	<.007	<.002	<.010	<.006	<.011	<.015	<.004	<.010	<.011
JUN													
11...	<.006	.517	<.007	<.003	<.007	<.002	<.010	<.006	<.011	<.015	<.004	<.010	.029
JUL													
31...	<.006	.030	<.007	<.003	<.007	<.002	<.010	<.006	<.011	<.015	<.004	<.010	<.011
AUG													
28...	<.006	.039	<.007	<.003	<.007	<.002	<.010	<.006	<.011	<.015	<.004	<.010	<.011
SEP													
17...	<.006	.023	<.007	<.003	<.007	<.002	<.010	<.006	<.011	<.015	<.004	<.010	<.011

DATE	PRO- PARGITE WATER FLTRD 0.7 U (UG/L) (82685)	SI- MAZINE, WATER DISS, (UG/L) (04035)	TEBU- THIURON WATER FLTRD 0.7 U (UG/L) (82670)	TER- BACIL WATER FLTRD 0.7 U (UG/L) (82665)	TER- BUFOS WATER FLTRD 0.7 U (UG/L) (82675)	THIO- BENCARB WATER FLTRD 0.7 U (UG/L) (82681)	TRIAL- LATE WATER FLTRD 0.7 U (UG/L) (82678)	TRI- FLUR- ALIN WAT FLT 0.7 U (UG/L) (82661)
OCT								
24...	<.023	<.011	<.016	<.034	<.017	e.004	<.002	<.009
NOV								
17...	<.023	<.011	<.016	<.034	<.017	<.005	<.002	<.009
DEC								
20...	<.023	<.011	<.016	<.034	<.017	.005	<.002	<.009
JAN								
19...	<.023	.015	<.016	<.034	<.017	.012	<.002	<.009
FEB								
27...	<.023	.034	<.016	<.034	<.017	<.005	<.002	<.009
MAR								
20...	<.023	e.006	<.016	<.034	<.017	e.001	<.002	<.009
APR								
12...	<.023	e.004	<.016	<.034	<.017	<.005	<.002	<.009
MAY								
17...	<.023	<.011	<.016	<.034	<.017	.144	<.002	e.003
JUN								
11...	<.023	.011	<.016	<.034	<.017	.084	<.002	<.009
JUL								
31...	<.023	<.011	<.016	<.034	<.017	.009	<.002	<.009
AUG								
28...	<.023	<.011	<.016	<.034	<.017	.017	<.002	<.009
SEP								
17...	<.023	<.011	<.016	<.034	<.017	.012	<.002	<.009

< Actual value is known to be less than value shown.  
e Estimated.

## SACRAMENTO RIVER BASIN

11447650 SACRAMENTO RIVER AT FREEPORT, CA—Continued

## CROSS-SECTIONAL DATA, WATER YEAR OCTOBER 2000 TO SEPTEMBER 2001

DATE	TIME	DEPTH BOTTOM AT SAMPLE LOC- ATION, (FEET) (81903)	TEMPER- ATURE WATER (DEG C) (00010)	SAMPLE LOC- ATION, CROSS SECTION (FT FM L BANK) (00009)
JUL				
06...*	1228	20.0	22.5	547
06...*	1230	20.0	22.5	462
06...*	1238	20.0	22.5	377
06...*	1240	15.0	22.5	274
06...*	1244	15.0	22.5	172

## PARTICLE-SIZE DISTRIBUTION OF SUSPENDED SEDIMENT, WATER YEAR OCTOBER 2000 TO SEPTEMBER 2001

DATE	TIME	DIS- CHARGE, INST. CUBIC FEET PER SECOND (00061)	TEMPER- ATURE WATER (DEG C) (00010)	SED. SUSP. SIEVE DIAM. % FINER THAN .062 MM (70331)	SEDI- MENT, SUS- PENDED (MG/L) (80154)	SEDI- MENT, DIS- CHARGE, SUS- PENDED (T/DAY) (80155)
OCT						
16...	1150	11800	17.0	70	13	414
24...N	1100	14600	14.5	89	15	591
NOV						
17...N	1000	9430	11.0	91	10	255
28...	1041	12200	11.0	82	17	560
DEC						
20...N	1130	10600	9.5	44	20	572
JAN						
09...	1117	16100	9.0	81	24	1040
19...N	1050	14000	7.5	75	23	869
FEB						
22...	1128	28100	9.5	93	48	3640
MAR						
20...N	1400	13600	15.5	86	27	991
APR						
03...	1050	14800	17.0	88	22	879
12...N	1400	16100	14.5	90	17	739
MAY						
16...	1112	8880	21.0	86	19	456
17...N	1300	6820	22.0	72	17	313
JUN						
11...N	1220	14300	21.5	86	19	734
JUL						
06...	1114	18400	23.0	84	32	1590
31...N	1030	20600	21.5	92	33	1840
AUG						
20...	1319	17900	22.5	80	20	967
28...N	1220	15200	24.0	91	27	1110
SEP						
17...N	1320	17500	21.5	97	22	1040
28...	0941	e12300	19.5	93	22	e731

\* Measured discharge at time of cross-sectional measurement: 19,500 ft<sup>3</sup>/s.

N Suspended-sediment data determined from a sample collected and processed according to National Water-Quality Assessment (NAWQA) protocol.

e Estimated.

## 11447650 SACRAMENTO RIVER AT FREEPORT, CA—Continued

## PARTICLE-SIZE DISTRIBUTION OF SURFACE BED MATERIAL, WATER YEAR OCTOBER 2000 TO SEPTEMBER 2001

DATE	TIME	DIS- CHARGE, INST. CUBIC FEET PER SECOND (00061)	TEMPER- ATURE WATER (DEG C) (00010)	BED	BED	BED	BED	BED	BED	BED	BED	NUMBER OF SAM- PLING POINTS (COUNT) (00063)
				MAT. SIEVE DIAM. % FINER THAN (80164)	MAT. SIEVE DIAM. % FINER THAN (80165)	MAT. SIEVE DIAM. % FINER THAN (80166)	MAT. SIEVE DIAM. % FINER THAN (80167)	MAT. SIEVE DIAM. % FINER THAN (80168)	MAT. SIEVE DIAM. % FINER THAN (80169)	MAT. SIEVE DIAM. % FINER THAN (80170)	MAT. SIEVE DIAM. % FINER THAN (80171)	
MAY												
16...	1210	6520	21.0	7	15	22	36	73	90	99	100	1
16...	1215	6520	21.0	1	2	4	40	88	97	99	100	1
16...	1220	6520	21.0	4	6	15	71	88	91	93	100	1
16...	1222	6520	21.0	4	10	20	78	96	99	100	--	1
16...	1225	6520	21.0	2	5	22	97	99	100	--	--	1
SEP												
28...	1210	e12300	19.5	8	18	37	92	96	98	100	--	1
28...	1215	e12300	19.5	--	--	11	85	100	--	--	--	1
28...	1220	e12300	19.5	--	--	--	--	--	--	--	--	1
28...	1225	e12300	19.5	6	13	17	40	85	92	95	100	1
28...	1230	e12300	19.5	2	6	9	49	88	94	98	100	1

e Estimated.

## SACRAMENTO RIVER BASIN

11447650 SACRAMENTO RIVER AT FREEPORT, CA—Continued

TEMPERATURE, WATER (DEG. C), WATER YEAR OCTOBER 2000 TO SEPTEMBER 2001

DAY	MAX		MIN		MAX		MIN		MAX		MIN		MAX		MIN	
	OCTOBER		NOVEMBER		DECEMBER		JANUARY		FEBRUARY		MARCH					
1	20.0	19.5	14.0	14.0	11.0	10.5	8.5	8.0	8.0	8.0	11.0	10.0				
2	20.5	20.0	14.0	14.0	11.0	10.5	8.5	8.0	8.5	8.0	11.0	10.5				
3	20.5	19.5	14.5	14.0	11.0	10.5	8.5	8.5	9.0	8.0	11.0	11.0				
4	20.0	19.5	14.5	14.0	10.5	10.5	8.5	8.5	9.5	8.5	11.0	10.5				
5	20.5	19.5	15.0	14.5	10.5	10.5	8.5	8.5	10.0	9.5	11.0	10.5				
6	20.5	19.5	15.0	14.5	10.5	10.5	9.0	8.5	10.5	10.0	11.0	10.5				
7	20.0	19.0	14.5	14.0	10.5	10.0	8.5	8.5	10.0	9.5	11.0	10.5				
8	19.5	19.0	14.5	14.0	10.5	10.0	9.0	8.5	9.5	9.0	12.0	11.0				
9	19.0	18.5	14.0	13.5	10.5	10.5	9.0	9.0	9.0	9.0	12.5	12.0				
10	18.5	17.5	14.0	13.0	11.0	10.5	9.0	9.0	9.0	8.5	12.5	12.5				
11	17.5	16.5	13.0	12.5	11.0	11.0	9.0	9.0	8.5	8.0	13.0	12.5				
12	16.5	16.0	13.0	12.5	11.0	11.0	9.0	8.5	8.5	8.0	13.5	13.0				
13	16.5	16.0	12.5	11.5	11.0	10.5	9.0	8.5	8.0	7.5	14.0	13.0				
14	16.5	16.0	11.5	11.0	10.5	10.5	9.0	9.0	7.5	7.0	14.0	13.5				
15	17.0	16.5	11.0	11.0	10.5	10.5	9.0	8.5	8.0	7.5	14.0	14.0				
16	17.0	16.5	11.0	10.5	10.5	10.5	8.5	8.0	8.5	8.0	14.5	14.0				
17	17.5	17.0	11.0	10.5	10.5	10.0	8.0	7.5	9.0	8.5	14.5	14.0				
18	17.5	17.0	11.0	10.5	10.0	10.0	7.5	7.0	9.5	9.0	15.0	14.0				
19	18.0	17.5	11.0	10.5	10.0	9.5	7.5	7.5	9.5	9.0	15.0	14.5				
20	18.0	17.5	11.0	10.5	9.5	9.5	8.0	7.5	10.0	9.5	16.0	15.0				
21	17.5	16.5	11.0	10.5	9.5	9.5	8.0	7.5	10.0	9.5	17.0	16.0				
22	16.5	15.0	11.0	10.5	9.5	9.5	8.5	7.5	10.0	9.5	18.0	16.5				
23	15.0	14.5	11.0	10.5	10.0	9.5	8.5	8.0	10.5	10.0	17.5	17.0				
24	15.0	14.5	11.0	10.5	9.5	9.5	9.0	8.5	10.5	10.0	17.5	17.0				
25	15.0	15.0	11.0	10.5	9.5	9.5	8.5	8.5	10.0	9.5	17.5	17.0				
26	15.0	15.0	10.5	10.5	9.5	9.0	8.5	8.5	10.0	9.5	17.5	17.0				
27	15.0	14.5	10.5	10.5	9.0	8.5	8.5	8.0	10.5	9.5	17.0	16.5				
28	15.0	14.5	10.5	10.5	8.5	8.5	8.0	7.5	10.5	9.5	17.0	16.5				
29	15.0	14.5	11.0	10.5	8.5	8.5	7.5	7.0	---	---	17.0	16.5				
30	14.5	14.0	11.0	10.5	8.5	8.5	7.5	7.5	---	---	17.0	16.5				
31	14.5	14.0	---	---	8.5	8.0	8.0	7.5	---	---	17.5	17.0				
MONTH	20.5	14.0	15.0	10.5	11.0	8.0	9.0	7.0	10.5	7.0	18.0	10.0				
	APRIL		MAY		JUNE		JULY		AUGUST		SEPTEMBER					
1	18.0	17.0	21.0	20.5	23.5	22.5	22.0	21.0	22.0	21.5	23.0	22.5				
2	17.5	16.5	20.5	19.0	23.0	22.0	23.5	22.0	22.0	21.5	23.5	22.5				
3	17.0	16.0	19.0	18.5	22.0	21.5	25.0	23.0	21.5	21.5	23.5	22.5				
4	16.5	16.0	20.0	18.0	21.5	21.0	25.0	24.0	21.5	21.5	23.5	22.5				
5	16.5	16.0	20.0	18.0	21.0	20.5	24.5	23.5	22.0	21.5	23.0	22.5				
6	16.0	15.0	20.5	19.0	21.0	20.5	23.5	23.0	22.0	21.5	22.5	22.0				
7	15.0	13.5	21.5	20.0	21.5	20.5	23.0	22.5	22.5	22.0	22.5	21.5				
8	14.0	13.5	22.5	20.5	22.0	21.0	23.0	22.5	23.5	22.5	22.0	21.5				
9	14.0	13.5	23.5	21.5	22.0	21.5	23.0	22.5	23.5	23.0	21.5	21.0				
10	14.0	13.0	24.0	22.5	22.0	21.0	22.5	22.0	23.0	22.5	21.0	20.5				
11	14.0	13.5	24.0	23.0	22.0	21.5	22.0	21.5	22.5	22.5	21.0	20.5				
12	14.5	13.5	23.5	23.0	22.0	21.5	22.0	21.5	22.5	22.0	21.0	20.5				
13	15.0	14.0	23.0	21.5	22.0	21.5	22.5	21.5	22.0	22.0	21.0	20.0				
14	15.5	14.5	22.0	21.0	22.0	21.0	22.5	22.0	22.0	21.5	21.0	20.5				
15	16.0	15.0	21.5	20.5	22.0	21.0	22.5	21.5	22.5	22.0	21.0	20.5				
16	16.5	15.5	22.0	20.5	22.5	21.5	21.5	21.0	22.5	22.0	21.0	20.5				
17	17.0	15.5	22.0	20.5	23.0	22.0	21.5	21.0	23.0	22.5	21.5	20.5				
18	18.0	16.5	22.0	21.0	23.5	22.5	22.0	21.0	23.0	22.5	21.5	21.0				
19	17.5	17.0	23.0	21.5	24.0	23.0	22.0	21.5	23.0	22.5	21.5	21.0				
20	17.0	16.0	22.5	22.0	24.0	23.5	22.0	21.5	22.5	21.5	21.5	21.0				
21	16.0	15.0	23.0	22.0	24.0	23.5	21.5	21.0	22.0	21.5	21.5	21.0				
22	16.0	15.0	23.5	22.5	24.0	23.0	22.0	21.0	22.0	21.0	21.5	21.0				
23	17.0	16.0	24.0	22.5	24.0	23.0	22.5	21.5	22.0	21.0	21.5	21.0				
24	18.0	16.5	24.5	23.0	23.0	22.0	22.5	22.0	22.5	21.5	21.0	20.5				
25	19.0	17.5	24.5	23.0	22.0	21.5	23.0	22.0	23.0	22.0	20.5	20.0				
26	20.5	19.0	23.5	23.0	21.5	20.5	23.0	22.0	23.5	22.5	20.5	20.0				
27	21.0	19.5	23.0	22.0	20.5	20.0	23.0	22.5	24.0	23.0	20.5	20.0				
28	20.5	20.0	22.0	21.5	20.0	19.5	23.0	22.5	24.5	23.0	20.0	19.5				
29	20.5	19.5	22.0	21.0	21.0	19.5	23.0	22.0	24.5	23.5	20.0	19.0				
30	21.0	20.0	22.5	21.5	21.5	20.5	22.0	21.5	23.5	23.0	20.5	19.5				
31	---	---	23.5	22.0	---	---	22.0	21.5	23.0	22.5	---	---				
MONTH	21.0	13.0	24.5	18.0	24.0	19.5	25.0	21.0	24.5	21.0	23.5	19.0				

## 11447650 SACRAMENTO RIVER AT FREEPORT, CA—Continued

## SEDIMENT DISCHARGE, SUSPENDED (TONS/DAY), WATER YEAR OCTOBER 2000 TO SEPTEMBER 2001

DAY	MEAN	MEAN	SEDIMENT	MEAN	MEAN	SEDIMENT	MEAN	MEAN	SEDIMENT
	DISCHARGE (CFS)	CONCEN- TRATION (MG/L)	DISCHARGE (TONS/DAY)	DISCHARGE (CFS)	CONCEN- TRATION (MG/L)	DISCHARGE (TONS/DAY)	DISCHARGE (CFS)	CONCEN- TRATION (MG/L)	DISCHARGE (TONS/DAY)
	OCTOBER			NOVEMBER			DECEMBER		
1	11900	10	321	14400	13	490	13500	9	335
2	12000	10	324	13900	11	409	14100	9	357
3	12000	10	324	13500	9	340	14300	10	370
4	11900	10	323	12400	8	283	14100	10	372
5	11900	10	333	12100	10	342	14000	10	377
6	11200	11	323	12100	14	444	13700	10	370
7	11200	11	334	11700	16	514	13300	10	363
8	11200	12	348	11100	15	438	13200	11	390
9	10600	12	344	11100	13	385	13100	12	426
10	10900	13	369	10700	12	334	12900	13	460
11	11200	13	383	11000	10	310	13000	15	509
12	11800	11	362	11000	9	280	13100	16	554
13	11800	10	320	10900	8	250	13200	15	535
14	11800	9	299	11300	8	234	13800	14	527
15	11900	11	352	11400	7	223	14200	14	537
16	11800	13	407	11600	8	253	14900	14	563
17	12000	13	421	12500	9	299	15900	14	601
18	12000	13	429	12500	9	291	15600	14	590
19	12100	14	470	12400	8	278	14600	14	547
20	11500	16	490	12500	8	275	13900	13	488
21	12300	16	546	12400	9	303	13500	12	442
22	11700	15	461	12600	10	350	13300	12	431
23	10600	13	366	12900	12	406	13300	12	431
24	10500	11	318	12900	13	461	13300	12	431
25	10200	10	283	12800	15	515	13400	12	434
26	10400	11	310	13000	16	561	13400	12	430
27	10900	12	355	12900	17	593	13200	11	392
28	11400	13	398	12700	16	536	13100	10	355
29	13400	13	470	12600	12	404	13000	9	327
30	13900	13	488	13600	9	345	12900	9	302
31	14200	13	498	---	---	---	13000	8	284
TOTAL	362200	---	11769	368500	---	11146	423800	---	13530
	JANUARY			FEBRUARY			MARCH		
1	13000	8	264	17800	47	2250	31900	136	11800
2	13100	7	250	16200	41	1790	28500	116	8960
3	12900	7	244	15000	38	1530	25900	98	6840
4	12700	7	247	14000	35	1310	24000	92	5960
5	12500	9	309	13200	32	1140	27300	119	8800
6	12000	12	391	12600	30	1000	35400	162	15500
7	11600	16	498	13100	27	962	41400	273	30500
8	12600	21	713	12100	26	849	45100	376	45700
9	14200	23	878	12300	32	1050	46200	300	37500
10	15000	19	770	13000	41	1420	41500	225	25200
11	17700	33	1590	14400	52	2010	35300	169	16100
12	20400	62	3440	19700	66	3520	31400	127	10800
13	25100	69	4660	23600	72	4600	28900	95	7420
14	24200	64	4180	23700	65	4180	26400	72	5140
15	21400	59	3430	21600	46	2660	24200	61	3980
16	19300	53	2760	18400	31	1520	22200	53	3150
17	18000	35	1700	16100	31	1330	20400	43	2370
18	16600	22	1000	15200	34	1380	19000	35	1780
19	15300	19	792	14700	37	1470	18000	28	1360
20	14300	17	673	17100	41	1880	17300	23	1070
21	13600	16	583	21400	45	2590	16900	23	1040
22	13100	14	511	27400	64	4730	16800	24	1090
23	13100	14	490	33500	145	13100	16700	26	1160
24	14000	22	828	35000	166	15700	16100	28	1200
25	14700	38	1500	35700	165	15900	16200	30	1310
26	19800	55	2940	34500	164	15300	15900	32	1380
27	25400	77	5310	36800	162	16100	15800	34	1460
28	28900	103	8060	36200	150	14700	16000	32	1400
29	26300	101	7180	---	---	---	15500	30	1240
30	22400	92	5530	---	---	---	15000	27	1110
31	19700	67	3550	---	---	---	14400	27	1070
TOTAL	532900	---	65271	584300	---	135971	765600	---	263390





## 11449500 KELSEY CREEK NEAR KELSEYVILLE, CA

LOCATION.—Lat 38°55'39", long 122°50'33", in SE 1/4 SE 1/4 sec.34, T.13 N., R.9 W., Lake County, Hydrologic Unit 18020116, on left bank, 1.6 mi downstream from Widow Creek, and 3.5 mi south of Kelseyville.

DRAINAGE AREA.—36.6 mi<sup>2</sup>.

PERIOD OF RECORD.—October 1946 to current year.

REVISED RECORDS.—WSP 1285: 1947–48(M), 1950–52(P). WSP 1931: Drainage area. WDR CA-96-4: 1956–93(P).

GAGE.—Water-stage recorder. Datum of gage is 1,475.44 ft above sea level. Prior to July 16, 1955, at site 600 ft upstream at different datum.

REMARKS.—Records good except for estimated discharges, which are fair. Some minor diversions upstream from station. See schematic diagram of lower Sacramento River Basin.

EXTREMES FOR PERIOD OF RECORD.—Maximum discharge, 8,600 ft<sup>3</sup>/s, Mar. 9, 1995, gage height, 13.80 ft; minimum daily, 0.13 ft<sup>3</sup>/s, Sept. 6–11, 1992.

EXTREMES FOR CURRENT YEAR.—Peak discharges greater than base discharge of 2,400 ft<sup>3</sup>/s, or maximum:

Date	Time	Discharge (ft <sup>3</sup> /s)	Gage height (ft)
Mar. 4	2015	2,470	9.16

DISCHARGE, CUBIC FEET PER SECOND, WATER YEAR OCTOBER 2000 TO SEPTEMBER 2001  
DAILY MEAN VALUES

DAY	OCT	NOV	DEC	JAN	FEB	MAR	APR	MAY	JUN	JUL	AUG	SEP
1	3.0	11	13	10	e27	104	29	17	5.2	3.4	1.2	1.0
2	2.9	10	11	10	e25	89	28	15	5.2	3.0	1.2	1.0
3	3.0	9.7	11	10	e24	76	26	15	4.8	2.8	1.2	1.0
4	3.0	9.7	10	10	e22	931	26	15	5.2	2.6	1.2	1.0
5	3.3	9.5	10	10	e21	529	25	15	5.0	2.4	1.2	1.0
6	3.0	9.3	10	10	e19	240	27	14	5.1	2.3	1.2	1.0
7	2.7	9.1	10	10	e18	160	28	14	4.7	2.3	1.2	1.0
8	2.9	8.7	9.9	17	17	124	25	13	4.4	2.3	1.2	1.0
9	3.2	9.0	10	18	43	104	25	13	4.3	2.2	1.2	1.0
10	4.1	9.3	10	155	97	88	23	12	4.3	2.1	1.2	1.0
11	5.1	9.5	10	248	122	76	23	12	4.3	2.3	1.2	1.0
12	5.7	9.6	12	138	89	67	22	11	4.1	2.3	1.1	1.0
13	5.5	10	11	58	67	61	22	11	4.1	2.2	1.1	1.0
14	5.2	11	17	38	62	56	20	11	3.8	2.2	1.1	1.0
15	4.8	9.9	17	29	56	53	20	11	3.7	2.1	1.1	1.0
16	4.7	9.9	15	24	55	50	20	12	3.5	2.1	1.1	1.0
17	4.6	9.5	13	21	176	48	22	11	3.4	2.3	1.1	1.0
18	4.7	9.5	12	19	176	46	21	9.9	3.3	2.3	1.1	1.0
19	4.7	9.5	12	18	468	43	21	9.2	3.1	2.2	1.1	1.0
20	4.9	9.4	11	17	928	42	25	8.6	3.1	2.1	1.1	1.0
21	5.3	10	12	16	523	40	32	8.0	2.9	2.1	1.1	1.0
22	5.1	12	12	15	545	38	25	7.3	2.8	2.2	1.1	1.0
23	4.7	10	12	38	321	37	22	7.2	2.7	2.0	1.1	1.0
24	5.1	9.9	11	100	337	38	21	6.7	2.7	1.9	1.1	1.0
25	7.4	9.6	11	e200	894	47	20	6.7	3.0	1.6	1.1	1.0
26	16	9.1	11	e240	317	37	20	6.6	3.4	1.5	1.1	1.9
27	14	9.2	11	e75	187	35	19	6.7	4.9	1.4	1.1	2.1
28	15	9.3	11	e50	135	33	19	6.6	5.7	1.3	1.1	2.1
29	25	20	11	e42	---	32	17	6.5	4.5	1.3	1.1	2.0
30	17	18	10	e35	---	31	18	6.0	3.8	1.3	1.1	1.9
31	13	---	10	e31	---	30	---	5.6	---	1.2	1.1	---
TOTAL	208.6	310.2	356.9	1712	5771	3385	691	323.6	121.0	65.3	35.2	35.0
MEAN	6.73	10.3	11.5	55.2	206	109	23.0	10.4	4.03	2.11	1.14	1.17
MAX	25	20	17	248	928	931	32	17	5.7	3.4	1.2	2.1
MIN	2.7	8.7	9.9	10	17	30	17	5.6	2.7	1.2	1.1	1.0
AC-FT	414	615	708	3400	11450	6710	1370	642	240	130	70	69

e Estimated.

## SACRAMENTO RIVER BASIN

11449500 KELSEY CREEK NEAR KELSEYVILLE, CA—Continued

## STATISTICS OF MONTHLY MEAN DATA FOR WATER YEARS 1947 - 2001, BY WATER YEAR (WY)

	OCT	NOV	DEC	JAN	FEB	MAR	APR	MAY	JUN	JUL	AUG	SEP
MEAN	11.2	45.4	123	205	216	151	77.2	31.5	13.1	5.73	3.57	3.75
MAX	154	334	688	929	919	640	429	163	64.1	19.2	9.40	16.3
(WY)	1963	1974	1956	1995	1986	1983	1982	1983	1998	1998	1998	1957
MIN	1.22	3.55	4.19	4.83	8.97	11.4	5.67	6.12	1.98	.46	.20	.16
(WY)	1992	1991	1991	1991	1977	1977	1977	1977	1977	1977	1977	1992

SUMMARY STATISTICS	FOR 2000 CALENDAR YEAR		FOR 2001 WATER YEAR		WATER YEARS 1947 - 2001	
ANNUAL TOTAL	20940.7		13014.8			
ANNUAL MEAN	57.2		35.7		73.1	
HIGHEST ANNUAL MEAN					206	
LOWEST ANNUAL MEAN					4.78	
HIGHEST DAILY MEAN	1580	Feb 14	931	Mar 4	6020	Feb 17 1986
LOWEST DAILY MEAN	2.7	Aug 26	1.0	Sep 1	.13	Sep 6 1992
ANNUAL SEVEN-DAY MINIMUM	2.8	Aug 14	1.0	Sep 1	.13	Sep 5 1992
MAXIMUM PEAK FLOW			2470	Mar 4	8600	Mar 9 1995
MAXIMUM PEAK STAGE			9.16	Mar 4	13.80	Mar 9 1995
ANNUAL RUNOFF (AC-FT)	41540		25810		52990	
10 PERCENT EXCEEDS	166		61		154	
50 PERCENT EXCEEDS	12		9.9		13	
90 PERCENT EXCEEDS	3.2		1.1		2.6	

## 11450000 CLEAR LAKE AT LAKEPORT, CA

LOCATION.—Lat 39°02'21", long 122°54'44", in NE 1/4 NE 1/4 sec.25, T.14 N., R.10 W., Lake County, Hydrologic Unit 18020116, on pier behind 410 Esplanade Street in Lakeport.

DRAINAGE AREA.—528 mi<sup>2</sup>.

PERIOD OF RECORD.—1874–1900 (incomplete), January 1913 to April 1982, October 1984 to current year.

GAGE.—Water-stage recorder. Datum of gage is 1,318.26 ft above sea level (California State Land Commission Benchmark). Prior to July 8, 1947, nonrecording gage, and July 8, 1947, to Mar. 17, 1949, at municipal wharf at foot of Third Street in Lakeport at datum 0.33 ft higher. Mar. 18, 1949, to Sept. 30, 1967, at private pier at foot of Fourth Street at datum 0.33 ft higher. Gage relocated at same datum, Apr. 20, 1982, and published as "at Clearlake" for 1982–84.

REMARKS.—This natural lake is regulated by gates on a dam at outlet, completed in 1915. Capacity between gage heights 0.00 and 7.56 ft, limits stipulated by court decree of 1920, about 319,000 acre-ft. Water is released down natural channel of Cache Creek (station 11451000), from which it is diverted for irrigation. See schematic diagram of [lower Sacramento River Basin](#).

EXTREMES FOR PERIOD OF RECORD.—Maximum gage height, 11.44 ft, Feb. 24, 1998, minimum observed, -3.50 ft, Sept. 24–27, 1920.

EXTREMES OUTSIDE PERIOD OF RECORD.—Flood of Mar. 4, 1983, reached a stage of 11.24 ft, present datum, from floodmarks.

## GAGE HEIGHT, FEET, WATER YEAR OCTOBER 2000 TO SEPTEMBER 2001

## DAILY MEAN VALUES

DAY	OCT	NOV	DEC	JAN	FEB	MAR	APR	MAY	JUN	JUL	AUG	SEP
1	1.65	1.22	1.15	1.17	1.68	3.89	5.20	5.11	4.45	3.59	2.70	1.66
2	1.62	1.23	1.15	1.17	1.68	3.94	5.15	5.12	4.40	3.58	2.67	1.65
3	1.60	1.23	1.15	1.17	1.69	4.00	5.17	5.10	4.37	3.57	2.62	1.63
4	1.58	1.21	1.14	1.17	1.70	4.22	5.18	5.08	4.34	3.55	2.58	1.60
5	1.56	1.20	1.14	1.16	1.69	4.54	5.16	5.07	4.28	3.51	2.55	1.56
6	1.54	1.19	1.13	1.17	1.61	4.71	5.17	5.07	4.27	3.48	2.53	1.56
7	1.51	1.19	1.13	1.18	1.67	4.81	5.15	5.07	4.25	3.45	2.52	1.55
8	1.48	1.14	1.13	1.19	1.66	4.88	5.17	5.06	4.21	3.41	2.50	1.52
9	1.42	1.14	1.13	1.22	1.72	4.92	5.19	5.03	4.18	3.37	2.47	1.50
10	1.40	1.15	1.13	1.32	1.78	4.98	5.16	5.03	4.14	3.34	2.43	1.48
11	1.39	1.14	1.15	1.37	1.84	5.02	5.15	5.01	4.09	3.31	2.39	1.46
12	1.36	1.13	1.15	1.39	1.90	5.05	5.16	4.98	4.06	3.28	2.35	1.43
13	1.34	1.13	1.16	1.40	1.91	5.06	5.15	4.95	4.05	3.24	2.31	1.43
14	1.32	1.13	1.19	1.41	1.93	5.08	5.16	4.91	4.03	3.21	2.28	1.42
15	1.31	1.13	1.20	1.41	1.95	5.06	5.17	4.89	4.01	3.18	2.25	1.40
16	1.31	1.14	1.21	1.40	1.96	5.08	5.16	4.87	3.99	3.14	2.21	1.39
17	1.30	1.12	1.24	1.40	2.02	5.10	5.16	4.86	3.95	3.10	2.16	1.37
18	1.29	1.12	1.20	1.41	2.09	5.12	5.15	4.84	3.93	3.07	2.11	1.36
19	1.29	1.12	1.18	1.41	2.20	5.14	5.13	4.83	3.90	3.03	2.08	1.35
20	1.27	1.12	1.18	1.41	2.43	5.16	5.15	4.82	3.88	3.00	2.05	1.34
21	1.25	1.13	1.18	1.41	2.65	5.17	5.17	4.80	3.86	2.97	2.01	1.32
22	1.23	1.12	1.18	1.41	2.86	5.17	5.17	4.77	3.83	2.95	1.96	1.31
23	1.18	1.13	1.18	1.44	3.04	5.19	5.18	4.74	3.78	2.93	1.92	1.30
24	1.16	1.13	1.19	1.47	3.23	5.20	5.18	4.70	3.72	2.90	1.90	1.28
25	1.20	1.12	1.18	1.54	3.50	5.20	5.18	4.67	3.69	2.87	1.86	1.29
26	1.23	1.12	1.18	1.62	3.69	5.20	5.17	4.63	3.66	2.86	1.83	1.25
27	1.20	1.13	1.18	1.64	3.78	5.21	5.14	4.59	3.65	2.84	1.79	1.22
28	1.21	1.13	1.17	1.65	3.85	5.21	5.12	4.55	3.64	2.81	1.75	1.21
29	1.23	1.13	1.17	1.65	---	5.22	5.13	4.54	3.63	2.77	1.73	1.21
30	1.25	1.15	1.17	1.67	---	5.22	5.12	4.52	3.61	2.72	1.71	1.21
31	1.23	---	1.17	1.68	---	5.22	---	4.51	---	2.72	1.69	---
MEAN	1.35	1.15	1.17	1.39	2.28	4.93	5.16	4.86	3.99	3.15	2.19	1.41
MAX	1.65	1.23	1.24	1.68	3.85	5.22	5.20	5.12	4.45	3.59	2.70	1.66
MIN	1.16	1.12	1.13	1.16	1.61	3.89	5.12	4.51	3.61	2.72	1.69	1.21

## 11451000 CACHE CREEK NEAR LOWER LAKE, CA

LOCATION.—Lat 38°55'27", long 122°33'53", in sec.6, T.12 N., R.6 W., Lake County, Hydrologic Unit 18020116, on left bank, 500 ft downstream from Cache Creek Dam, 1.9 mi downstream from Copsy Creek, and 2.5 mi northeast of Lower Lake.

DRAINAGE AREA.—528 mi<sup>2</sup>.

PERIOD OF RECORD.—May 1944 to current year.

GAGE.—Water-stage recorder and rain gage (station 385525122335501). Datum of gage is 1,279.64 ft above sea level. Prior to Oct. 2, 1987, at datum 1.00 ft higher.

REMARKS.—Records fair including periods of estimated daily discharges. Flow regulated by Clear Lake (station 11450000) from Cache Creek Dam, 500 ft upstream. See schematic diagram of lower Sacramento River Basin.

EXTREMES FOR PERIOD OF RECORD.—Maximum discharge, 10,200 ft<sup>3</sup>/s, Feb. 17, 1998, gage height, 11.01 ft, present datum; no flow Nov. 8–20, 1977, Apr. 5, 6, 1987.

DISCHARGE, CUBIC FEET PER SECOND, WATER YEAR OCTOBER 2000 TO SEPTEMBER 2001  
DAILY MEAN VALUES

DAY	OCT	NOV	DEC	JAN	FEB	MAR	APR	MAY	JUN	JUL	AUG	SEP
1	270	4.2	e3.9	e3.8	3.3	5.9	11	11	188	188	134	110
2	268	4.5	e3.7	e3.9	3.4	6.0	11	11	216	185	199	6.1
3	270	4.6	e3.5	e4.2	3.4	6.2	11	11	239	186	203	5.7
4	269	4.7	e3.7	e4.1	3.6	e6.0	11	12	211	191	199	5.6
5	270	4.8	3.8	e4.5	3.6	e6.1	11	12	196	191	197	5.0
6	272	4.7	3.7	e4.7	3.8	e5.8	11	12	197	191	195	4.9
7	276	4.5	3.7	4.7	3.7	e5.7	11	116	195	197	161	4.9
8	280	4.4	3.8	4.8	3.7	5.4	11	190	197	199	14	4.9
9	282	4.5	3.9	4.8	3.8	7.5	11	195	193	198	285	5.4
10	279	4.6	3.9	4.8	3.9	6.1	11	195	194	197	385	5.6
11	272	4.6	3.9	4.8	3.9	6.1	11	184	194	194	369	5.7
12	271	4.6	4.0	4.4	4.0	6.2	11	201	194	194	346	5.8
13	271	4.4	4.1	4.1	3.7	6.2	11	206	189	192	341	6.2
14	112	4.2	4.1	3.9	3.6	6.3	11	197	187	190	411	6.3
15	10	4.0	4.4	3.9	3.7	6.3	11	199	188	189	486	6.3
16	9.8	e4.0	4.4	3.7	3.8	6.3	11	202	188	187	507	5.9
17	9.5	e4.2	4.3	3.7	4.0	6.5	11	206	189	187	491	5.6
18	9.5	e4.0	4.2	3.6	4.2	6.5	11	208	193	187	282	5.2
19	9.5	e3.8	4.2	3.6	4.4	6.5	12	208	188	186	73	5.1
20	9.2	e3.7	4.3	3.6	4.7	6.5	13	207	197	183	7.2	5.0
21	8.8	e4.0	e4.3	3.8	4.8	6.5	12	205	214	192	130	5.1
22	6.8	e3.9	e4.2	3.8	4.8	6.7	11	250	241	200	304	5.0
23	5.6	e3.7	e4.1	4.0	4.9	6.5	11	289	218	200	399	4.9
24	5.4	e3.6	e4.1	4.1	5.2	7.6	11	303	188	200	461	4.7
25	5.3	e3.7	e4.3	4.2	5.7	6.7	11	307	188	112	412	4.6
26	5.0	e3.7	e4.5	3.9	6.5	8.8	11	274	99	13	300	4.8
27	4.5	e3.9	e4.2	3.6	5.6	10	11	241	12	11	234	4.8
28	4.4	e4.0	e4.3	3.6	5.8	11	11	204	11	11	169	4.9
29	4.4	e4.1	e4.0	3.6	---	11	11	186	109	11	179	5.1
30	4.0	e3.8	e3.9	3.5	---	11	11	186	189	11	191	5.2
31	4.0	---	e3.7	3.3	---	11	---	187	---	10	182	---
TOTAL	3777.7	125.4	125.1	125.0	119.5	220.9	334	5415	5402	4783	8246.2	264.3
MEAN	122	4.18	4.04	4.03	4.27	7.13	11.1	175	180	154	266	8.81
MAX	282	4.8	4.5	4.8	6.5	11	13	307	241	200	507	110
MIN	4.0	3.6	3.5	3.3	3.3	5.4	11	11	11	10	7.2	4.6
AC-FT	7490	249	248	248	237	438	662	10740	10710	9490	16360	524
a	2.03	1.85	0.72	6.21	8.39	3.80	0.62	0.00	0.00	0.00	0.00	0.25

STATISTICS OF MONTHLY MEAN DATA FOR WATER YEARS 1945 - 2001, BY WATER YEAR (WY)

MEAN	33.4	15.8	109	613	839	825	535	329	378	398	320	166
MAX	191	683	2584	3047	4988	4919	3538	951	702	651	514	325
(WY)	1996	1984	1984	1997	1998	1983	1958	1983	2000	1998	1999	1995
MIN	.40	.17	.14	.18	.17	.32	.42	.40	.29	.41	.71	.55
(WY)	1978	1978	1991	1991	1991	1955	1990	1990	1991	1977	1977	1977

SUMMARY STATISTICS	FOR 2000 CALENDAR YEAR		FOR 2001 WATER YEAR		WATER YEARS 1945 - 2001	
ANNUAL TOTAL	116529.8		28938.1			
ANNUAL MEAN	318		79.3		378	
HIGHEST ANNUAL MEAN					1342	
LOWEST ANNUAL MEAN					.67	
HIGHEST DAILY MEAN	2200	Mar 5	507	Aug 16	7200	Feb 18 1998
LOWEST DAILY MEAN	3.5	Jan 10	3.3	Jan 31	.00	Nov 8 1977
ANNUAL SEVEN-DAY MINIMUM	3.6	Jan 6	3.4	Jan 28	.00	Nov 8 1977
MAXIMUM PEAK FLOW			538	Aug 16	10200	Feb 17 1998
MAXIMUM PEAK STAGE			4.74	Aug 16	11.01	Feb 17 1998
ANNUAL RUNOFF (AC-FT)	231100		57400		273800	
10 PERCENT EXCEEDS	721		236		631	
50 PERCENT EXCEEDS	256		7.2		58	
90 PERCENT EXCEEDS	3.9		3.8		1.1	

e Estimated.

a Precipitation in inches.

## 11451100 NORTH FORK CACHE CREEK AT HOUGH SPRINGS, NEAR CLEARLAKE OAKS, CA

LOCATION.—Lat 39°09'56", long 122°37'08", in SE 1/4 NW 1/4 sec.10, T.15 N., R.7 W., Lake County, Hydrologic Unit 18020116, on right bank, 0.5 mi upstream from Spanish Creek, 0.9 mi upstream from Hough Springs, and 10 mi northeast of Clearlake Oaks.

DRAINAGE AREA.—60.2 mi<sup>2</sup>.

PERIOD OF RECORD.—October 1971 to current year.

GAGE.—Water-stage recorder and crest-stage gage. Elevation of gage is 1,534.13 ft above sea level. Prior to Jan. 13, 1980, at datum 2.0 ft higher. Recording rain gage (station 391056122420801) 4.7 mi northwest of gage. Elevation of rain gage is 2,050 ft above sea level, from topographic map.

REMARKS.—Records good except for estimated daily discharges, which are fair. No regulation or diversion upstream from station. See schematic diagram of lower Sacramento River Basin.

EXTREMES FOR PERIOD OF RECORD.—Maximum discharge, 13,200 ft<sup>3</sup>/s, Jan. 1, 1997, gage height, 14.14 ft, from rating curve extended above 3,900 ft<sup>3</sup>/s, on basis of slope-area measurement at gage height 11.23 ft; no flow at times in 1972, 1976–77, 1987–88, 1990–92, 1994.

EXTREMES FOR CURRENT YEAR.—Peak discharges greater than base discharge of 1,500 ft<sup>3</sup>/s, or maximum:

Date	Time	Discharge (ft <sup>3</sup> /s)	Gage height (ft)
Mar. 4	2100	4,100	9.57

## DISCHARGE, CUBIC FEET PER SECOND, WATER YEAR OCTOBER 2000 TO SEPTEMBER 2001

## DAILY MEAN VALUES

DAY	OCT	NOV	DEC	JAN	FEB	MAR	APR	MAY	JUN	JUL	AUG	SEP
1	1.5	6.2	8.1	6.8	32	173	73	31	8.4	4.5	1.8	.57
2	1.5	5.2	6.7	6.5	30	164	70	30	8.4	4.1	1.6	.58
3	1.5	4.9	6.2	6.4	33	155	67	29	8.4	3.7	1.4	.54
4	1.5	4.5	e5.9	6.4	37	1590	65	29	8.4	3.4	1.4	.46
5	1.5	4.4	e5.3	6.8	37	1500	62	28	8.2	3.1	1.4	.43
6	1.4	4.4	e5.6	6.9	34	682	63	27	8.5	2.7	1.4	.42
7	1.4	4.4	e5.3	6.9	31	489	63	26	8.4	2.6	1.2	.38
8	1.3	4.5	5.3	12	28	404	59	24	8.0	2.6	1.2	.33
9	1.4	4.6	5.2	14	37	339	55	24	7.9	2.4	.96	.37
10	1.9	4.8	5.2	92	44	279	52	23	7.7	2.3	.80	.46
11	2.4	4.6	5.8	124	57	234	51	21	7.6	2.2	.73	.74
12	e2.6	4.4	6.6	68	54	201	49	21	7.7	2.2	.72	1.0
13	2.4	4.8	6.6	42	50	180	47	20	7.4	2.2	.68	1.1
14	2.2	5.2	20	33	51	168	46	20	7.2	2.1	.70	.93
15	2.2	5.2	14	27	49	156	45	20	6.6	2.1	.84	.89
16	2.2	5.2	12	24	50	143	44	21	6.2	2.1	.86	.81
17	e2.1	5.2	9.9	22	136	133	44	19	5.6	2.2	.81	.74
18	2.2	4.9	8.7	21	220	132	43	18	5.1	2.2	.86	.73
19	2.2	4.8	7.9	20	333	124	42	17	5.1	2.1	.72	.62
20	2.2	4.8	7.9	19	806	134	47	16	4.9	2.0	.57	.58
21	2.2	5.1	7.9	18	775	171	49	14	4.6	2.0	.57	.58
22	2.3	5.2	8.0	18	539	126	44	13	4.6	1.9	.89	.61
23	2.2	5.2	8.1	30	334	112	41	13	4.4	2.1	1.4	.63
24	e2.3	5.2	7.9	75	278	e120	40	12	4.3	1.9	1.5	.72
25	e2.5	4.9	7.8	61	533	142	39	12	4.7	1.7	1.5	1.3
26	e3.6	4.8	7.6	65	372	117	37	11	5.3	1.5	1.1	1.4
27	5.3	4.8	7.4	58	276	104	36	11	7.9	1.5	.78	1.4
28	6.9	5.2	7.2	48	220	96	36	11	7.1	1.4	.57	1.3
29	8.7	14	7.0	43	---	88	35	11	5.6	1.3	.46	1.2
30	9.2	12	6.9	40	---	82	33	9.5	5.0	1.5	.43	1.1
31	9.0	---	6.9	35	---	76	---	9.0	---	1.8	.50	---
TOTAL	91.8	163.4	240.9	1055.7	5476	8614	1477	590.5	199.2	71.4	30.35	22.92
MEAN	2.96	5.45	7.77	34.1	196	278	49.2	19.0	6.64	2.30	.98	.76
MAX	9.2	14	20	124	806	1590	73	31	8.5	4.5	1.8	1.4
MIN	1.3	4.4	5.2	6.4	28	76	33	9.0	4.3	1.3	.43	.33
AC-FT	182	324	478	2090	10860	17090	2930	1170	395	142	60	45
a	3.46	3.45	1.19	7.35	12.27	6.48	1.04	0.00	0.00	0.00	0.00	0.42

e Estimated.

a Precipitation, in inches.

## SACRAMENTO RIVER BASIN

11451100 NORTH FORK CACHE CREEK AT HOUGH SPRINGS, NEAR CLEARLAKE OAKS, CA—Continued

STATISTICS OF MONTHLY MEAN DATA FOR WATER YEARS 1972 - 2001, BY WATER YEAR (WY)

	OCT	NOV	DEC	JAN	FEB	MAR	APR	MAY	JUN	JUL	AUG	SEP
MEAN	3.20	54.3	135	306	352	284	116	46.8	16.1	4.76	1.67	1.29
MAX	12.4	405	738	1750	1382	1258	631	242	90.9	26.7	10.8	6.75
(WY)	1980	1982	1997	1995	1998	1995	1982	1995	1998	1998	1998	1998
MIN	.19	1.11	1.17	4.74	9.59	9.88	5.13	3.93	1.69	.19	.000	.000
(WY)	1992	1977	1977	1991	1991	1977	1977	1977	1977	1977	1977	1994

SUMMARY STATISTICS	FOR 2000 CALENDAR YEAR		FOR 2001 WATER YEAR		WATER YEARS 1972 - 2001	
ANNUAL TOTAL	35262.3		18033.17			
ANNUAL MEAN	96.3		49.4		109	
HIGHEST ANNUAL MEAN					335	
LOWEST ANNUAL MEAN					3.67	
HIGHEST DAILY MEAN	2640	Feb 14	1590	Mar 4	8340	Feb 17 1986
LOWEST DAILY MEAN	1.1	Sep 20	.33	Sep 8	.00	Aug 27 1972
ANNUAL SEVEN-DAY MINIMUM	1.4	Sep 16	.41	Sep 4	.00	Aug 27 1972
MAXIMUM PEAK FLOW			4100	Mar 4	13200	Jan 1 1997
MAXIMUM PEAK STAGE			9.57	Mar 4	14.14	Jan 1 1997
ANNUAL RUNOFF (AC-FT)	69940		35770		78950	
10 PERCENT EXCEEDS	313		122		263	
50 PERCENT EXCEEDS	9.9		6.9		11	
90 PERCENT EXCEEDS	1.7		.86		.54	

## 11451300 NORTH FORK CACHE CREEK NEAR CLEARLAKE OAKS, CA

LOCATION.—Lat 39°04'32", long 122°31'59", in SE 1/4 SW 1/4 sec.9, T.14 N., R.6 W., Lake County, Hydrologic Unit 18020116, on right bank, 1,900 ft downstream from Indian Valley Dam, and 8 mi northeast of Clearlake Oaks.

DRAINAGE AREA.—121 mi<sup>2</sup>.

PERIOD OF RECORD.—October 1983 to September 1985 (operated as a low-flow station only), October 1985 to current year.

GAGE.—Water-stage recorder and crest-stage gage. Elevation of gage is 1,320 ft above sea level, from topographic map. Recording rain gage (station 390500122321601) located on top of Indian Valley Dam.

REMARKS.—Records good. Flow completely regulated by Indian Valley Reservoir, capacity 300,000 acre-ft. See schematic diagram of lower Sacramento River Basin.

EXTREMES FOR PERIOD OF RECORD.—Maximum discharge, 7,950 ft<sup>3</sup>/s, Feb. 11, 1998, gage height 10.61, maximum gage height, 10.62 ft, Jan. 2, 1997; minimum daily, 0.37 ft<sup>3</sup>/s, Oct. 15, 1994.

EXTREMES OUTSIDE PERIOD OF RECORD.—Flood of Jan. 26, 1983, reached a stage of 12.74 ft, present datum, discharge about 9,500 ft<sup>3</sup>/s.

DISCHARGE, CUBIC FEET PER SECOND, WATER YEAR OCTOBER 2000 TO SEPTEMBER 2001  
DAILY MEAN VALUES

DAY	OCT	NOV	DEC	JAN	FEB	MAR	APR	MAY	JUN	JUL	AUG	SEP
1	9.3	11	12	10	8.8	12	16	e635	672	e557	569	290
2	9.3	11	12	10	8.8	12	125	e685	695	e554	586	367
3	9.3	11	12	10	8.8	12	260	e740	693	e562	539	367
4	9.3	e11	12	9.9	8.8	14	260	e770	691	e570	448	345
5	9.3	e11	12	9.8	8.7	14	223	e745	691	e581	378	324
6	9.3	11	12	9.8	8.8	13	101	e770	689	e560	327	324
7	9.3	11	12	9.8	8.8	14	11	e735	675	e600	360	301
8	9.3	11	12	e9.6	8.9	14	70	e740	634	e620	482	268
9	9.4	11	12	9.6	9.1	15	92	e750	610	e655	317	297
10	9.4	11	12	e10	9.1	14	143	e740	642	e645	236	336
11	9.4	11	12	e9.8	9.3	15	241	e720	658	e610	236	325
12	9.4	11	12	e9.5	9.3	14	289	e655	634	e580	236	313
13	9.4	12	12	9.5	9.4	15	334	e620	e655	e540	236	333
14	145	12	12	9.5	9.3	16	368	e540	e640	e560	133	351
15	183	12	12	9.3	9.5	16	372	e475	e629	e510	9.8	347
16	176	11	12	e9.4	9.4	16	380	e467	e621	e475	9.3	311
17	170	12	12	e9.3	9.8	16	393	464	e670	e390	43	283
18	160	12	11	e9.2	9.9	16	410	499	e670	e400	220	304
19	141	12	11	e9.3	10	16	e430	532	e665	e430	357	322
20	129	12	11	e9.3	11	16	e440	557	e675	e427	419	337
21	125	12	11	e9.3	11	16	e400	578	e690	e449	350	362
22	125	12	11	e9.1	12	16	e420	578	e690	e460	194	372
23	116	12	11	e9.2	11	16	e435	577	e695	e480	111	372
24	109	12	11	e9.1	12	16	e460	577	e690	e520	74	355
25	109	12	11	e9.1	12	16	e470	589	e620	e590	132	e350
26	52	12	11	e9.2	12	16	e445	616	e650	e708	191	e345
27	11	12	11	e9.1	11	16	e415	681	e660	e700	206	e300
28	11	12	11	e9.1	12	16	e400	727	e660	e650	281	e240
29	11	12	11	e9.0	---	16	e450	714	e613	e610	322	e210
30	11	12	11	e9.0	---	16	e515	645	e580	e645	289	e65
31	11	---	10	e8.9	---	16	---	629	---	e680	257	---
TOTAL	1916.4	347	357	292.7	278.5	466	9368	19750	19757	17318	8548.1	9416
MEAN	61.8	11.6	11.5	9.44	9.95	15.0	312	637	659	559	276	314
MAX	183	12	12	10	12	16	515	770	695	708	586	372
MIN	9.3	11	10	8.9	8.7	12	11	464	580	390	9.3	65
AC-FT	3800	688	708	581	552	924	18580	39170	39190	34350	16960	18680
a	1.59	0.87	1.37	4.46	4.50	0.62	0.84	0.04	0.00	0.00	0.00	0.25

e Estimated.

a Precipitation, in inches.



## SACRAMENTO RIVER BASIN

## 11451300 NORTH FORK CACHE CREEK NEAR CLEARLAKE OAKS, CA—Continued

## STATISTICS OF MONTHLY MEAN DATA FOR WATER YEARS 1986 - 2001, BY WATER YEAR (WY)

	OCT	NOV	DEC	JAN	FEB	MAR	APR	MAY	JUN	JUL	AUG	SEP
MEAN	36.2	14.0	22.6	146	336	205	201	207	243	223	135	92.5
MAX	172	35.5	187	1675	1964	849	557	717	659	559	342	348
(WY)	1998	1997	1999	1997	1998	1986	1987	1987	2001	2001	1996	1996
MIN	6.65	6.96	7.21	7.02	4.62	1.90	8.26	6.98	8.10	8.16	8.17	9.10
(WY)	1994	1995	1994	1994	1994	1994	1993	1993	1993	1993	1990	1990

SUMMARY STATISTICS	FOR 2000 CALENDAR YEAR		FOR 2001 WATER YEAR		WATER YEARS 1986 - 2001	
ANNUAL TOTAL	51393.9		87814.7			
ANNUAL MEAN	140		241		154	
HIGHEST ANNUAL MEAN					326	
LOWEST ANNUAL MEAN					8.54	
HIGHEST DAILY MEAN	2310	Feb 29	770	May 4	6690	Feb 11 1998
LOWEST DAILY MEAN	8.5	Sep 10	8.7	Feb 5	.37	Oct 15 1994
ANNUAL SEVEN-DAY MINIMUM	8.6	Sep 9	8.8	Feb 1	1.8	Mar 9 1994
MAXIMUM PEAK FLOW			799	May 4	7950	Feb 11 1998
MAXIMUM PEAK STAGE			4.74	May 4	10.62	Jan 2 1997
ANNUAL RUNOFF (AC-FT)	101900		174200		111500	
10 PERCENT EXCEEDS	341		655		400	
50 PERCENT EXCEEDS	12		111		12	
90 PERCENT EXCEEDS	9.4		9.3		7.5	

## 11451540 HARLEY GULCH NEAR WILBUR SPRINGS, CA

LOCATION.—Lat 39°00'33", long 122°26'04", in sec.5, T.13 N., R.5 W., Lake County, Hydrologic Unit 18020116, on right bank, 500 ft downstream of Highway 20, and 2.2 mi southwest of Wilbur Hot Springs Resort.

DRAINAGE AREA.—2.90 mi<sup>2</sup>.

PERIOD OF RECORD.—December 1999 to current year.

GAGE.—Water-stage recorder. Elevation of gage is 1,530 ft above sea level, from topographic map.

REMARKS.—Records poor. No regulation or diversion upstream from station. See schematic diagram of lower Sacramento River Basin.

EXTREMES FOR CURRENT YEAR.—Peak discharges greater than base discharge of 60 ft<sup>3</sup>/s, or maximum:

Date	Time	Discharge (ft <sup>3</sup> /s)	Gage height (ft)
Mar. 4	unknown	unknown	unknown

## DISCHARGE, CUBIC FEET PER SECOND, WATER YEAR OCTOBER 2000 TO SEPTEMBER 2001

## DAILY MEAN VALUES

DAY	OCT	NOV	DEC	JAN	FEB	MAR	APR	MAY	JUN	JUL	AUG	SEP
1	e.03	.11	.12	.15	e.26	e.45	.22	.15	.05	.01	.00	.00
2	e.03	.10	.10	.15	e.28	e.42	.20	.14	.04	.01	.00	.00
3	e.03	e.10	.11	.15	e.31	e.40	.21	.13	.04	.01	.00	.00
4	e.04	e.10	.10	.15	e.33	e27	.21	.13	.04	.01	.00	.00
5	e.04	e.10	.11	.15	e.33	e13	.21	.13	.04	.01	.00	.00
6	e.04	.10	.11	.15	e.30	e5.0	.18	.12	.04	.01	.00	.00
7	e.04	e.10	.12	.15	e.30	e2.7	.19	.13	.03	.01	.00	.00
8	e.05	e.10	.16	e.30	e.50	e2.0	.19	.13	.02	.01	.00	.00
9	e.05	.10	.15	e.67	e.73	e1.6	.21	.12	.02	.01	.00	.00
10	.05	.11	.15	e.67	e.91	e1.3	.21	.11	.02	.01	.00	.00
11	.05	e.22	.15	e3.5	e.97	e1.0	.21	.10	.02	.01	.00	.00
12	.05	e.17	.15	e4.7	e1.9	e.88	.22	.10	.01	.00	.00	.00
13	.05	e.20	.15	e1.5	e1.5	e.71	.22	.10	.01	.00	.00	.00
14	.05	e.20	.16	e.79	e1.1	e.52	.21	.09	.01	.00	.00	.00
15	.05	e.18	.16	e.62	e.79	e.45	.21	.09	.01	.00	.00	.00
16	e.05	e.19	.15	e.53	e.67	e.35	.19	.09	.01	.00	.00	.00
17	.06	e.17	.15	e.50	e.64	e.24	.20	.09	.01	.00	.00	.00
18	e.06	e.17	.15	e.44	e1.0	.18	.19	.08	.01	.00	.00	.00
19	.06	e.18	.15	e.44	e2.5	.21	.18	.08	.02	.00	.00	.00
20	e.06	e.18	.14	e.41	e6.2	.18	.16	.08	.02	.00	.00	.00
21	.06	e.23	.14	e.38	e5.6	.17	.18	.08	.02	.00	.00	.00
22	.06	e.24	.14	e.35	e5.6	.17	.19	.07	.02	.00	.00	.00
23	e.07	e.19	.14	e.56	e5.0	.17	.19	.07	.01	.00	.00	.00
24	e.10	e.18	.14	e1.5	e7.3	.17	.19	.07	.01	.00	.00	.00
25	e.10	e.18	.14	e2.8	e16	.17	.18	.07	.01	.00	.00	.00
26	e.22	e.18	.14	e4.1	e4.4	.17	.18	.06	.01	.00	.00	.00
27	.11	e.19	.14	e2.3	e1.5	.18	.16	.06	.01	.00	.00	.00
28	.13	e.19	.14	e1.3	e.48	.19	.15	.06	.01	.00	.00	.00
29	.14	.23	.15	e.81	---	.19	.15	.06	.01	.00	.00	.00
30	.12	.12	.15	e.40	---	.19	.15	.05	.01	.00	.00	.00
31	.11	---	.15	e.20	---	.18	---	.05	---	.00	.00	---
TOTAL	2.16	4.81	4.31	30.82	67.40	60.54	5.74	2.89	0.59	0.11	0.00	0.00
MEAN	.070	.16	.14	.99	2.41	1.95	.19	.093	.020	.004	.000	.000
MAX	.22	.24	.16	4.7	16	27	.22	.15	.05	.01	.00	.00
MIN	.03	.10	.10	.15	.26	.17	.15	.05	.01	.00	.00	.00
AC-FT	4.3	9.5	8.5	61	134	120	11	5.7	1.2	.2	.00	.00

## STATISTICS OF MONTHLY MEAN DATA FOR WATER YEARS 2000 - 2001, BY WATER YEAR (WY)

MEAN	.070	.16	.10	.81	2.80	1.46	.26	.12	.033	.010	.010	.011
MAX	.070	.16	.14	.99	3.19	1.95	.33	.15	.046	.017	.021	.022
(WY)	2001	2001	2001	2001	2000	2001	2000	2000	2000	2000	2000	2000
MIN	.070	.16	.065	.63	2.41	.97	.19	.093	.020	.004	.000	.000
(WY)	2001	2001	2000	2000	2001	2000	2001	2001	2001	2001	2001	2001

## SUMMARY STATISTICS

## FOR 2000 CALENDAR YEAR

## FOR 2001 WATER YEAR

## WATER YEARS 2000 - 2001

ANNUAL TOTAL	171.11	179.37	
ANNUAL MEAN	.47	.49	.49
HIGHEST ANNUAL MEAN			.49
LOWEST ANNUAL MEAN			.49
HIGHEST DAILY MEAN	19	Feb 13	27
LOWEST DAILY MEAN	.01	Jul 14	.00
ANNUAL SEVEN-DAY MINIMUM	.01	Jul 14	.00
MAXIMUM PEAK FLOW			62
MAXIMUM PEAK STAGE			2.37
ANNUAL RUNOFF (AC-FT)	339	356	356
10 PERCENT EXCEEDS	.86	.72	.88
50 PERCENT EXCEEDS	.11	.11	.09
90 PERCENT EXCEEDS	.02	.00	.00

e Estimated.

## 11451600 DAVIS CREEK AT KNOXVILLE, CA

LOCATION.—Lat 38°51'51", long 122°21'11", in sec.30, T.12 N., R.6 W., Yolo County, Hydrologic Unit 18020116, on left bank of Davis Creek Dam spillway, and 2.5 mi northwest of Knoxville.

DRAINAGE AREA.—10.2 mi<sup>2</sup>.

PERIOD OF RECORD.—December 8, 1999, to current year.

GAGE.—Water-stage recorder. Datum of gage is 1,480 ft above sea level, from topographic map.

REMARKS.—Records poor. Flow is completely regulated by Davis Creek Reservoir. See schematic diagram of lower Sacramento River Basin.

EXTREMES FOR PERIOD OF RECORD.—Maximum discharge, 201 ft<sup>3</sup>/s, Feb. 27, 2000, gage height, 27.87 ft; no flow for many days in each year.

EXTREMES FOR CURRENT YEAR.—Maximum discharge, unknown, gage height, unknown; no flow for many days.

DISCHARGE, CUBIC FEET PER SECOND, WATER YEAR OCTOBER 2000 TO SEPTEMBER 2001  
DAILY MEAN VALUES

DAY	OCT	NOV	DEC	JAN	FEB	MAR	APR	MAY	JUN	JUL	AUG	SEP
1	.00	.00	.00	e.00	e.00	8.7	e.60	e.00	.00	.00	.00	.00
2	.00	.00	.00	e.00	e.00	8.4	e.54	e.00	.00	.00	.00	.00
3	.00	.00	.00	e.00	e.00	8.4	e.49	.00	.00	.00	.00	.00
4	.00	.00	.00	e.00	e.00	8.2	e.44	.00	.00	.00	.00	.00
5	.00	.00	.00	e.00	e.00	8.2	e.32	.00	.00	.00	.00	.00
6	.00	.00	.00	e.00	e.00	9.0	e.29	.00	.00	.00	.00	.00
7	.00	.00	.00	e.00	e.00	9.7	1.1	.00	.00	.00	.00	.00
8	.00	.00	.00	e.00	.00	10	2.3	.00	.00	.00	.00	.00
9	.00	.00	.00	e.00	.00	9.7	.99	.00	.00	.00	.00	.00
10	.00	.00	.00	e.00	.00	9.3	e.60	.00	.00	.00	.00	.00
11	.00	.00	.00	e.00	.00	9.7	e.43	.00	.00	e.00	.00	.00
12	.00	.00	.00	e.00	.00	6.9	e.36	.00	.00	e.00	.00	.00
13	.00	.00	.00	e.00	.00	3.4	e.30	.00	.00	e.00	.00	.00
14	.00	.00	.00	e.00	.00	3.2	e.26	.00	.00	e.00	.00	.00
15	.00	.00	.00	e.00	.00	2.9	e.24	.00	.00	e.00	.00	.00
16	.00	.00	.00	e.00	.00	3.1	e.22	.00	.00	e.00	.00	.00
17	.00	.00	.00	e.00	.00	3.3	e.18	.00	.00	e.00	.00	.00
18	.00	.00	e.00	e.00	.00	3.4	e.60	.00	.00	e.00	.00	.00
19	.00	.00	e.00	e.00	.00	3.7	e5.0	.00	.00	e.00	.00	.00
20	.00	.00	e.00	e.00	.00	3.7	e5.0	.00	.00	e.00	.00	.00
21	.00	.00	e.00	e.00	.00	3.8	e17	.00	.00	e.00	.00	.00
22	.00	.00	e.00	e.00	.00	3.1	e10	.00	.00	e.00	.00	.00
23	.00	.00	e.00	e.00	.00	3.2	e6.0	.00	.00	e.00	.00	.00
24	.00	.00	e.00	e.00	.00	3.1	e1.3	.00	.00	e.00	.00	.00
25	.00	.00	e.00	e.00	.00	2.8	e.25	.00	.00	e.00	.00	.00
26	.00	.00	e.00	e.00	.04	2.8	e.12	.00	.00	e.00	.00	.00
27	.00	.00	e.00	e.00	.85	3.2	e.05	.00	.00	e.00	.00	.00
28	.00	.00	e.00	e.00	3.8	e4.0	e.03	.00	.00	e.00	.00	.00
29	.00	.00	e.00	e.00	---	e2.4	e.01	.00	.00	.00	.00	.00
30	.00	.00	e.00	e.00	---	e1.3	e.01	.00	.00	.00	.00	.00
31	.00	---	e.00	e.00	---	e.82	---	.00	---	.00	.00	---
TOTAL	0.00	0.00	0.00	0.00	4.69	163.42	55.03	0.00	0.00	0.00	0.00	0.00
MEAN	.000	.000	.000	.000	.17	5.27	1.83	.000	.000	.000	.000	.000
MAX	.00	.00	.00	.00	3.8	10	17	.00	.00	.00	.00	.00
MIN	.00	.00	.00	.00	.00	.82	.01	.00	.00	.00	.00	.00
AC-FT	.00	.00	.00	.00	9.3	324	109	.00	.00	.00	.00	.00

## STATISTICS OF MONTHLY MEAN DATA FOR WATER YEARS 2000 - 2001, BY WATER YEAR (WY)

	2000	2001	2000	2001	2000	2001	2000	2001	2000	2001	2000	2001
MEAN	.000	.000	.000	.000	15.1	12.1	2.63	.34	.000	.000	.000	.000
MAX	.000	.000	.000	.000	29.6	18.9	3.43	.69	.000	.000	.000	.000
(WY)	2001	2001	2001	2000	2000	2000	2000	2000	2000	2000	2000	2000
MIN	.000	.000	.000	.000	.17	5.27	1.83	.000	.000	.000	.000	.000
(WY)	2001	2001	2001	2000	2001	2001	2001	2001	2000	2000	2000	2000

SUMMARY STATISTICS	FOR 2000 CALENDAR YEAR		FOR 2001 WATER YEAR		WATER YEARS 2000 - 2001	
ANNUAL TOTAL	1568.44		223.14			
ANNUAL MEAN	4.29		.61		.61	
HIGHEST ANNUAL MEAN					.61	
LOWEST ANNUAL MEAN					.61	
HIGHEST DAILY MEAN	166	Feb 27	17	Apr 21	166	Feb 27 2000
LOWEST DAILY MEAN	.00	Jan 1	.00	Oct 1	.00	Dec 8 1999
ANNUAL SEVEN-DAY MINIMUM	.00	Jan 1	.00	Oct 1	.00	Dec 8 1999
MAXIMUM PEAK FLOW					201	Feb 27 2000
MAXIMUM PEAK STAGE					27.87	Feb 27 2000
ANNUAL RUNOFF (AC-FT)	3110		443		443	
10 PERCENT EXCEEDS	9.9		1.7		4.3	
50 PERCENT EXCEEDS	.00		.00		.00	
90 PERCENT EXCEEDS	.00		.00		.00	

e Estimated.

## 11451690 SULPHUR CREEK AT WILBUR SPRINGS, CA

LOCATION.—Lat 39°02'19", long 122°25'08", in sec.28, T.14 N., R.5 W., Colusa County, Hydrologic Unit 18020116, on right bank, 0.85 mi upstream from mouth at Bear Creek, and at Wilbur Springs.

DRAINAGE AREA.—9.87 mi<sup>2</sup>.

PERIOD OF RECORD.—October 29, 1999, to current year.

GAGE.—Water-stage recorder. Datum of gage is 1,315 ft above sea level, from topographic map.

REMARKS.—Records fair except for estimated daily discharges, which are poor. No regulation or diversion upstream from station. See schematic diagram of lower Sacramento River Basin.

EXTREMES FOR PERIOD OF RECORD.—Maximum discharge, 282 ft<sup>3</sup>/s, Mar. 4, 2001, gage height, 4.86 ft; minimum daily, 0.05 ft<sup>3</sup>/s, Aug. 14, 15, 2001.

EXTREMES FOR CURRENT YEAR.—Peak discharges greater than base discharge of 180 ft<sup>3</sup>/s, or maximum.

Date	Time	Discharge (ft <sup>3</sup> /s)	Gage height (ft)
Mar. 4	2000	282	4.86

## DISCHARGE, CUBIC FEET PER SECOND, WATER YEAR OCTOBER 2000 TO SEPTEMBER 2001

## DAILY MEAN VALUES

DAY	OCT	NOV	DEC	JAN	FEB	MAR	APR	MAY	JUN	JUL	AUG	SEP
1	.18	e.51	.80	.42	1.8	4.2	1.5	1.0	.35	.21	.14	e.21
2	.18	e.51	.74	.40	1.7	4.1	1.4	.94	.36	.25	.14	e.21
3	.18	e.48	.71	.39	1.7	3.5	1.5	.90	.57	.28	.11	e.21
4	.18	e.45	.68	.38	1.6	93	1.5	.90	.40	.29	.11	e.20
5	.19	e.46	.62	.40	1.6	46	1.4	.88	.39	.28	.26	e.21
6	.19	e.48	.62	.43	1.6	17	1.7	.83	.33	.23	.16	e.21
7	.19	e.41	.64	.45	1.4	9.2	1.8	.80	.39	.26	.11	e.23
8	.21	e.45	.63	.86	1.4	6.7	1.7	.76	.41	.16	.09	e.22
9	.19	e.47	.62	.61	2.5	5.4	1.7	.72	.24	.18	.07	e.23
10	.27	e.51	.62	2.3	3.1	4.5	1.5	.68	.34	.18	.07	e.24
11	.25	e.74	.76	12	3.3	3.9	1.4	.64	.35	.18	.09	e.23
12	.18	e.57	.97	16	6.5	3.4	1.3	.62	.33	.23	.08	e.23
13	.18	e.68	.75	5.2	5.0	3.1	1.3	.64	.25	.16	.08	e.25
14	.19	e.69	1.2	2.7	3.9	2.9	1.3	.75	.26	.16	.05	e.24
15	.19	e.63	1.1	2.1	2.7	2.7	1.3	.75	.26	.13	.05	.22
16	.18	e.64	.83	1.8	2.3	2.5	1.3	.78	.29	.20	e.06	.23
17	.19	e.58	.69	1.7	2.2	2.4	1.2	.73	.29	.29	e.07	.23
18	.18	e.59	.60	1.5	3.4	2.3	1.3	.66	.28	.27	.11	.23
19	.18	e.61	.61	1.5	8.4	2.2	1.3	.57	.29	.36	e.13	.23
20	.19	e.62	.62	1.4	21	2.2	1.8	.63	.30	.29	e.13	.23
21	.23	e.80	.62	1.3	19	2.2	2.0	.62	.30	.28	e.16	.23
22	.24	e.83	.65	1.2	19	2.0	1.4	.68	.31	.23	e.19	.23
23	.26	e.65	.59	1.9	17	1.9	1.3	.74	.31	.20	e.21	.23
24	.25	e.63	.57	5.0	25	2.0	1.2	.57	.33	.22	e.22	.32
25	.33	e.62	.53	9.6	54	2.0	1.2	.51	.32	.24	e.21	.30
26	.70	e.62	.49	14	16	1.8	1.1	.51	.35	.23	e.21	.27
27	1.1	e.62	.49	8.0	7.5	1.7	1.1	.56	.37	.19	.19	.28
28	.76	e.64	.49	4.3	5.1	1.7	1.1	.53	.35	.25	e.20	.29
29	.93	e.90	.49	2.8	---	1.6	1.1	.51	.38	.18	e.22	.27
30	e.72	e.87	.49	2.3	---	1.6	1.1	.46	.33	.18	e.21	.28
31	e.59	---	.47	2.0	---	1.5	---	.52	---	.18	e.23	---
TOTAL	9.98	18.26	20.69	104.94	239.7	241.2	41.8	21.39	10.03	6.97	4.36	7.19
MEAN	.32	.61	.67	3.39	8.56	7.78	1.39	.69	.33	.22	.14	.24
MAX	1.1	.90	1.2	16	54	93	2.0	1.0	.57	.36	.26	.32
MIN	.18	.41	.47	.38	1.4	1.5	1.1	.46	.24	.13	.05	.20
AC-FT	20	36	41	208	475	478	83	42	20	14	8.6	14

e Estimated.

## SACRAMENTO RIVER BASIN

## 11451690 SULPHUR CREEK AT WILBUR SPRINGS, CA—Continued

## STATISTICS OF MONTHLY MEAN DATA FOR WATER YEARS 2000 - 2001, BY WATER YEAR (WY)

	OCT	NOV	DEC	JAN	FEB	MAR	APR	MAY	JUN	JUL	AUG	SEP
MEAN	.32	.60	.65	3.56	13.9	8.44	2.00	1.02	.39	.19	.16	.20
MAX	.32	.61	.67	3.73	19.1	9.10	2.60	1.36	.44	.22	.18	.24
(WY)	2001	2001	2001	2000	2000	2000	2000	2000	2000	2001	2000	2001
MIN	.32	.59	.63	3.39	8.56	7.78	1.39	.69	.33	.16	.14	.15
(WY)	2001	2000	2000	2001	2001	2001	2001	2001	2001	2000	2001	2000

SUMMARY STATISTICS	FOR 2000 CALENDAR YEAR		FOR 2001 WATER YEAR		WATER YEARS 2000 - 2001	
ANNUAL TOTAL	1148.70		726.51			
ANNUAL MEAN	3.14		1.99		1.99	
HIGHEST ANNUAL MEAN					1.99	
LOWEST ANNUAL MEAN					1.99	
HIGHEST DAILY MEAN	76	Feb 13	93	Mar 4	93	Mar 4 2001
LOWEST DAILY MEAN	.06	Jul 21	.05	Aug 14	.05	Aug 14 2001
ANNUAL SEVEN-DAY MINIMUM	.10	Jul 20	.07	Aug 10	.07	Aug 10 2001
MAXIMUM PEAK FLOW			282	Mar 4	282	Mar 4 2001
MAXIMUM PEAK STAGE			4.86	Mar 4	4.86	Mar 4 2001
ANNUAL RUNOFF (AC-FT)	2280		1440		1440	
10 PERCENT EXCEEDS	8.0		3.1		5.0	
50 PERCENT EXCEEDS	.62		.58		.59	
90 PERCENT EXCEEDS	.14		.18		.15	

## 11451715 BEAR CREEK ABOVE HOLSTEN CHIMNEY CANYON, NEAR RUMSEY, CA

LOCATION.—Lat 38°57'28", long 122°20'30", in NW 1/4 SE 1/4 sec.19, T.13 N., R.4 W., Colusa County, Hydrologic Unit 18020116, on the left bank downstream side of Highway 16 bridge, 2.9 mi upstream from confluence with Cache Creek, and 7.4 mi northwest of Rumsey.

DRAINAGE AREA.—94.90 mi<sup>2</sup>.

PERIOD OF RECORD.—November 1997 to current year.

GAGE.—Water-stage recorder and crest-stage gage. Elevation of gage is 920 ft above sea level, from topographic map.

REMARKS.—Records fair except for estimated daily discharges, which are poor. Some minor diversions upstream from station. See schematic diagram of lower Sacramento River Basin.

EXTREMES FOR PERIOD OF RECORD.—Maximum discharge, 8,510 ft<sup>3</sup>/s, Feb. 2, 1998, gage height, 13.57 ft, from rating curve extended above 3,000 ft<sup>3</sup>/s; minimum daily, 1.1 ft<sup>3</sup>/s, Aug. 10, 11, 2001.

EXTREMES OUTSIDE PERIOD OF RECORD.—Maximum discharge, 9,200 ft<sup>3</sup>/s, Jan. 5, 1965.

EXTREMES FOR CURRENT YEAR.—Peak discharges greater than base discharge of 2,000 ft<sup>3</sup>/s, or maximum:

Date	Time	Discharge (ft <sup>3</sup> /s)	Gage height (ft)
Mar. 4	2130	2,860	10.41

## DISCHARGE, CUBIC FEET PER SECOND, WATER YEAR OCTOBER 2000 TO SEPTEMBER 2001

## DAILY MEAN VALUES

DAY	OCT	NOV	DEC	JAN	FEB	MAR	APR	MAY	JUN	JUL	AUG	SEP
1	1.6	3.2	3.5	3.0	11	48	19	7.9	3.0	2.3	1.5	1.3
2	1.6	3.0	3.3	3.0	10	45	18	7.3	3.0	2.1	1.4	1.3
3	1.6	2.9	3.2	2.9	9.7	42	18	6.5	3.1	2.1	1.3	1.3
4	1.6	2.8	3.1	2.9	9.3	944	18	6.5	e3.2	2.2	1.3	1.2
5	1.7	2.8	3.0	2.9	9.0	730	17	6.4	e2.9	2.1	1.3	1.2
6	1.7	2.8	3.0	3.0	9.0	205	17	6.3	3.0	1.9	1.4	1.2
7	1.7	2.7	3.0	3.1	8.6	113	20	6.2	3.2	1.8	1.3	1.2
8	1.7	2.6	3.1	4.5	8.1	87	19	6.2	3.1	1.8	1.3	1.2
9	1.7	2.7	3.0	4.4	11	78	18	5.9	2.7	1.8	1.2	1.3
10	2.0	3.0	3.1	9.8	18	66	16	5.7	2.8	1.7	1.1	1.3
11	2.9	3.2	3.3	81	19	59	15	5.4	2.8	1.7	1.1	1.5
12	2.8	3.0	4.1	136	50	53	15	4.9	2.8	1.7	1.2	1.7
13	2.3	2.9	3.8	36	47	48	14	4.7	2.7	1.7	1.2	1.7
14	2.1	3.3	4.7	18	23	46	14	4.9	2.6	1.7	1.3	1.6
15	2.1	3.2	4.6	13	18	43	14	5.3	2.6	1.6	1.3	1.5
16	2.1	3.1	4.0	10	16	e40	12	4.9	2.5	1.7	1.3	1.5
17	2.1	2.9	3.6	8.4	16	e38	11	4.8	2.4	1.7	1.3	1.5
18	2.1	2.8	3.3	7.4	26	e37	11	4.7	2.4	1.9	1.3	1.5
19	2.1	2.8	3.1	7.0	44	e36	11	4.3	2.3	1.8	1.3	1.5
20	2.1	2.8	3.2	6.6	177	e37	13	3.9	2.3	1.7	1.3	1.5
21	2.1	3.3	3.2	6.4	161	e41	18	3.7	2.3	1.7	1.3	1.5
22	1.9	3.8	3.3	6.3	184	e34	14	3.9	2.2	1.7	1.3	1.5
23	1.8	3.3	3.3	7.0	204	29	12	3.8	2.1	1.6	1.4	1.5
24	1.9	3.1	3.2	16	246	29	11	3.5	2.0	1.5	1.4	1.8
25	2.4	3.0	3.1	98	435	29	11	3.6	2.2	1.5	1.5	3.4
26	6.1	3.0	3.0	95	189	26	9.9	3.8	2.7	1.4	1.4	2.7
27	7.2	3.0	3.0	44	85	24	9.2	3.7	2.8	1.4	1.3	2.0
28	4.5	3.1	3.0	25	60	23	8.6	3.9	3.0	1.4	1.3	1.8
29	4.5	3.7	3.0	19	---	22	8.4	3.9	2.8	1.3	1.2	1.7
30	3.9	4.1	3.0	15	---	21	8.2	3.4	2.5	1.4	1.2	1.7
31	3.7	---	3.0	13	---	20	---	3.0	---	1.5	1.3	---
TOTAL	79.6	91.9	103.1	707.6	2103.7	3093	420.3	152.9	80.0	53.4	40.3	47.6
MEAN	2.57	3.06	3.33	22.8	75.1	99.8	14.0	4.93	2.67	1.72	1.30	1.59
MAX	7.2	4.1	4.7	136	435	944	20	7.9	3.2	2.3	1.5	3.4
MIN	1.6	2.6	3.0	2.9	8.1	20	8.2	3.0	2.0	1.3	1.1	1.2
AC-FT	158	182	204	1400	4170	6130	834	303	159	106	80	94

e Estimated

## SACRAMENTO RIVER BASIN

## 11451715 BEAR CREEK ABOVE HOLSTEN CHIMNEY CANYON, NEAR RUMSEY, CA—Continued

## STATISTICS OF MONTHLY MEAN DATA FOR WATER YEARS 1998 - 2001, BY WATER YEAR (WY)

	OCT	NOV	DEC	JAN	FEB	MAR	APR	MAY	JUN	JUL	AUG	SEP
MEAN	3.55	7.03	14.9	79.1	379	122	58.1	40.7	18.2	5.52	2.99	2.69
MAX	5.48	14.0	34.9	252	1029	180	126	124	56.6	14.2	5.97	5.34
(WY)	1999	1999	1998	1998	1998	1998	1998	1998	1998	1998	1998	1998
MIN	2.57	3.06	3.33	13.6	75.1	95.5	14.0	4.93	2.67	1.72	1.30	1.59
(WY)	2001	2001	2001	1999	2001	1999	2001	2001	2001	2001	2001	2001

SUMMARY STATISTICS	FOR 2000 CALENDAR YEAR		FOR 2001 WATER YEAR		WATER YEARS 1998 - 2001	
ANNUAL TOTAL	13547.5		6973.4			
ANNUAL MEAN	37.0		19.1		29.9	
HIGHEST ANNUAL MEAN					37.2	
LOWEST ANNUAL MEAN					19.1	
HIGHEST DAILY MEAN	995	Feb 14	944	Mar 4	2660	Feb 3 1998
LOWEST DAILY MEAN	1.3	Aug 17	1.1	Aug 10	1.1	Aug 10 2001
ANNUAL SEVEN-DAY MINIMUM	1.3	Aug 23	1.2	Aug 7	1.2	Aug 7 2001
MAXIMUM PEAK FLOW			2860	Mar 4	8510	Feb 2 1998
MAXIMUM PEAK STAGE			10.41	Mar 4	13.57	Feb 2 1998
ANNUAL RUNOFF (AC-FT)	26870		13830		21650	
10 PERCENT EXCEEDS	94		37		140	
50 PERCENT EXCEEDS	3.7		3.1		7.4	
90 PERCENT EXCEEDS	1.6		1.4		1.7	

11452500 CACHE CREEK AT YOLO, CA

LOCATION.—Lat 38°43'38", long 121°48'22", in Rio Jesus Maria Grant, Yolo County, Hydrologic Unit 18020129, on left bank, 35 ft upstream from Interstate Highway 5 bridge, 0.5 mi south of Yolo, and 7.3 mi downstream from Moore Dam.

DRAINAGE AREA.—1,139 mi<sup>2</sup>.

PERIOD OF RECORD.—January 1903 to current year. Records for water year 1903 incomplete; yearly estimate published in WSP 1315-A.

WATER TEMPERATURE: Water years 1959–65, November 1966 to February 1967.

SEDIMENT DATA: Water years 1959–65, November 1966 to February 1967 (daily record), 1986 (periodic record).

REVISED RECORDS.—WSP 1315-A: 1914(M). WSP 1345: 1906. WSP 1445: 1955. WSP 1931: Drainage area.

GAGE.—Water-stage recorder. Datum of gage is sea level. See WSP 2131 for history of changes prior to Apr. 25, 1969. Apr. 25, 1969, to July 1976, at site 765 ft upstream at same datum.

REMARKS.—Records fair. Some regulation by Clear Lake (station 11450000) beginning in 1915 and Indian Valley Reservoir beginning in 1974, capacity, 300,000 acre-ft. Diversions for irrigation of about 30,000 acres between Capay and Yolo, from data furnished by Clear Lake Water Co. See schematic diagram of lower Sacramento River Basin.

EXTREMES FOR PERIOD OF RECORD.—Maximum discharge, 41,400 ft<sup>3</sup>/s, Feb. 25, 1958, gage height, 85.35 ft, present datum, maximum stage observed, 86.4 ft (corrected), present datum, Mar. 10, 1904; no flow at times in most years.

DISCHARGE, CUBIC FEET PER SECOND, WATER YEAR OCTOBER 2000 TO SEPTEMBER 2001

DAILY MEAN VALUES

DAY	OCT	NOV	DEC	JAN	FEB	MAR	APR	MAY	JUN	JUL	AUG	SEP
1	52	39	16	18	61	366	32	21	.03	.39	.00	1.4
2	54	36	17	17	55	313	20	24	.00	3.5	.00	9.5
3	50	30	17	16	51	273	16	49	5.5	1.6	12	8.4
4	47	25	16	16	48	546	56	28	17	.00	54	2.5
5	52	22	15	15	43	5920	75	8.4	7.8	.00	67	.31
6	52	20	14	15	43	1890	82	16	.29	.00	61	2.0
7	55	17	14	16	38	1030	98	12	2.0	.00	22	.00
8	61	15	13	26	37	718	62	9.8	8.5	.00	16	.00
9	68	13	12	23	44	576	36	6.4	6.7	.00	1.4	.35
10	71	13	12	35	63	495	16	4.5	.46	.00	.00	1.7
11	79	13	13	72	124	426	19	6.9	3.4	.00	.00	.00
12	82	14	23	465	210	370	38	19	1.6	.00	.08	.00
13	80	16	16	283	257	327	47	33	.02	.00	28	.00
14	83	18	18	139	168	292	35	90	.00	.00	22	.00
15	85	16	19	98	119	263	33	77	.00	1.7	11	.00
16	69	15	19	73	101	246	45	35	.00	39	26	.00
17	69	14	22	61	90	226	32	40	6.6	41	.80	.00
18	59	13	23	54	89	212	18	10	20	53	13	.00
19	58	13	21	48	140	199	21	12	6.2	16	12	.00
20	50	13	20	43	789	184	45	11	.01	.27	23	.00
21	49	13	18	41	970	188	89	4.7	.00	.00	5.9	.00
22	47	16	17	39	816	200	73	2.1	.00	3.7	.00	.00
23	51	19	18	35	1460	177	56	2.0	.00	7.8	6.8	.00
24	55	18	18	37	1140	163	54	.00	.00	2.0	21	.00
25	48	18	19	51	2170	155	62	.00	.00	.00	.86	.00
26	59	16	19	230	1550	155	42	.00	9.8	.00	.00	.00
27	103	15	18	236	725	145	20	1.2	26	.00	17	12
28	117	13	17	152	477	134	16	4.4	18	.00	34	14
29	75	15	17	104	---	109	28	41	.70	.00	10	3.0
30	55	17	17	81	---	68	33	34	.00	2.5	6.5	.00
31	47	---	18	68	---	38	---	8.1	---	2.2	.83	---
TOTAL	1982	535	536	2607	11878	16404	1299	610.50	140.61	174.66	472.17	55.16
MEAN	63.9	17.8	17.3	84.1	424	529	43.3	19.7	4.69	5.63	15.2	1.84
MAX	117	39	23	465	2170	5920	98	90	26	53	67	14
MIN	47	13	12	15	37	38	16	.00	.00	.00	.00	.00
AC-FT	3930	1060	1060	5170	23560	32540	2580	1210	279	346	937	109

STATISTICS OF MONTHLY MEAN DATA FOR WATER YEARS 1903 - 2001, BY WATER YEAR (WY)

MEAN	13.7	60.8	423	1381	2010	1530	865	197	63.1	27.0	12.9	7.95
MAX	335	1593	5644	7446	12750	10930	6353	1655	784	421	189	105
(WY)	1963	1984	1984	1914	1998	1983	1958	1904	1906	1907	1907	1998
MIN	.000	.000	.000	.000	.000	.000	.000	.000	.000	.000	.000	.000
(WY)	1904	1906	1906	1920	1920	1920	1924	1919	1913	1912	1910	1903

SUMMARY STATISTICS

FOR 2000 CALENDAR YEAR

FOR 2001 WATER YEAR

WATER YEARS 1903 - 2001

ANNUAL TOTAL	108873.5	36694.10	
ANNUAL MEAN	297	101	541
HIGHEST ANNUAL MEAN			2449
LOWEST ANNUAL MEAN			.000
HIGHEST DAILY MEAN	4910	Mar 1	5920
LOWEST DAILY MEAN	6.5	Jul 22	.00
ANNUAL SEVEN-DAY MINIMUM	13	Dec 5	.00
MAXIMUM PEAK FLOW			9270
MAXIMUM PEAK STAGE			63.98
ANNUAL RUNOFF (AC-FT)	216000	72780	391600
10 PERCENT EXCEEDS	806	186	1400
50 PERCENT EXCEEDS	52	19	3.1
90 PERCENT EXCEEDS	14	.00	.00



## 11453000 YOLO BYPASS NEAR WOODLAND, CA

LOCATION.—Lat 38°40'40", long 121°38'35", unsurveyed, Yolo County, Hydrologic Unit 18020109, on left bank, 300 ft upstream from Sacramento and Woodland Railroad Bridge, 6 mi upstream from Sacramento Bypass, 6 mi downstream from Fremont Weir, and 7 mi east of Woodland.

PERIOD OF RECORD.—October 1939 to current year (since October 1977, high-flow records only). Monthly discharge only for some periods, published in WSP 1315-A.

SEDIMENT DATA: Water years 1957–61, 1980.

REVISED RECORDS.—WDR CA-96-4: 1995(M).

GAGE.—Water-stage recorder. Datum of gage is 3.41 ft below sea level. Prior to Dec. 17, 1941, nonrecording gage, and Dec. 18–31, 1941, water-stage recorder, at datum 0.73 ft higher. Prior to Sept. 30, 1977, a supplementary water-stage recorder 6 mi downstream at different datum recorded low flow.

REMARKS.—Flow is from Cache Creek and Knights Landing Ridge Cut plus floodwater passing over Fremont Weir. Beginning October 1977, only flows above 1,000 ft<sup>3</sup>/s are computed. See schematic diagram of lower Sacramento River Basin.

EXTREMES FOR PERIOD OF RECORD.—Maximum discharge, 374,000 ft<sup>3</sup>/s, Feb. 20, 1986, gage height, 34.87 ft; no flow at times in several years.

EXTREMES FOR CURRENT YEAR.—Maximum discharge, 5,220 ft<sup>3</sup>/s, Mar. 6, gage height, 20.79 ft.

## DISCHARGE, CUBIC FEET PER SECOND, WATER YEAR OCTOBER 2000 TO SEPTEMBER 2001

## DAILY MEAN VALUES

DAY	OCT	NOV	DEC	JAN	FEB	MAR	APR	MAY	JUN	JUL	AUG	SEP
1	---	---	---	---	---	3660	---	---	---	---	---	---
2	---	---	---	---	---	3050	---	---	---	---	---	---
3	---	---	---	---	---	2320	---	---	---	---	---	---
4	---	---	---	---	---	1860	---	---	---	---	---	---
5	---	---	---	---	---	3180	---	---	---	---	---	---
6	---	---	---	---	---	5110	---	---	---	---	---	---
7	---	---	---	---	---	4750	---	---	---	---	---	---
8	---	---	---	---	---	4490	---	---	---	---	---	---
9	---	---	---	---	---	4370	---	---	---	---	---	---
10	---	---	---	---	---	4330	---	---	---	---	---	---
11	---	---	---	---	---	4250	---	---	---	---	---	---
12	---	---	---	---	---	3950	---	---	---	---	---	---
13	---	---	---	---	---	3510	---	---	---	---	---	---
14	---	---	---	---	---	2900	---	---	---	---	---	---
15	---	---	---	---	---	2130	---	---	---	---	---	---
16	---	---	---	---	---	1440	---	---	---	---	---	---
17	---	---	---	---	---	1120	---	---	---	---	---	---
18	---	---	---	---	---	---	---	---	---	---	---	---
19	---	---	---	---	---	---	---	---	---	---	---	---
20	---	---	---	---	---	---	---	---	---	---	---	---
21	---	---	---	---	---	---	---	---	---	---	---	---
22	---	---	---	---	1420	---	---	---	---	---	---	---
23	---	---	---	---	2260	---	---	---	---	---	---	---
24	---	---	---	---	3000	---	---	---	---	---	---	---
25	---	---	---	---	3670	---	---	---	---	---	---	---
26	---	---	---	---	4360	---	---	---	---	---	---	---
27	---	---	---	1020	4300	---	---	---	---	---	---	---
28	---	---	---	1940	3990	---	---	---	---	---	---	---
29	---	---	---	1740	---	---	---	---	---	---	---	---
30	---	---	---	1080	---	---	---	---	---	---	---	---
31	---	---	---	---	---	---	---	---	---	---	---	---
TOTAL	---	---	---	---	---	---	---	---	---	---	---	---
MEAN	---	---	---	---	---	---	---	---	---	---	---	---
MAX	---	---	---	---	---	---	---	---	---	---	---	---
MIN	---	---	---	---	---	---	---	---	---	---	---	---
AC-FT	---	---	---	---	---	---	---	---	---	---	---	---

## STATISTICS OF MONTHLY MEAN DATA FOR WATER YEARS 1946 - 1977, BY WATER YEAR (WY)

MEAN	441	738	5638	13230	11240	3398	3849	430	144	20.7	26.1	51.0
MAX	13420	10890	48790	86470	92890	27910	37310	4546	1420	107	84.9	155
(WY)	1963	1951	1956	1970	1958	1958	1958	1952	1967	1958	1958	1954
MIN	1.01	2.19	.92	2.43	.88	3.55	.083	.55	.53	.000	.000	.63
(WY)	1977	1960	1977	1977	1977	1977	1976	1977	1977	1966	1966	1977

## SUMMARY STATISTICS

## WATER YEARS 1946 - 1977

ANNUAL MEAN	3230
HIGHEST ANNUAL MEAN	13020
LOWEST ANNUAL MEAN	1.53
HIGHEST DAILY MEAN	259000
LOWEST DAILY MEAN	.00
ANNUAL SEVEN-DAY MINIMUM	.00
MAXIMUM PEAK FLOW	265000
MAXIMUM PEAK STAGE	32.48
ANNUAL RUNOFF (AC-FT)	2340000
10 PERCENT EXCEEDS	3080
50 PERCENT EXCEEDS	35
90 PERCENT EXCEEDS	1.9

## 11453500 PUTAH CREEK NEAR GUENOC, CA

LOCATION.—Lat 38°46'44", long 122°30'59", in Guenoc Grant, Lake County, on right bank just upstream from Coyote Valley damsite, 2.8 mi upstream from Soda Creek, and 3.2 mi downstream from highway bridge at Guenoc.

DRAINAGE AREA.—113 mi<sup>2</sup>.

PERIOD OF RECORD.—February 1904 to September 1906, July 1930 to September 1976, and April 1998 to current year. Monthly discharge only for some periods, published in WSP 1315-A.

REVISED RECORDS.—WSP 1285: 1937(M), 1938, 1940, 1943(M), 1951(M).

GAGE.—Water-stage recorder. Datum of gage is 911.18 ft above sea level. February 1904 to September 1906, nonrecording gage 0.2 mi upstream at different datum, July 1930 to September 1976, at datum 3.00 ft higher.

REMARKS.—Records good. Some regulation by Hartmann Dam on Coyote Creek since 1969, capacity, 3,000 acre-ft; diversions and ground-water withdrawals for domestic use and irrigation of about 1,600 acres above station. See schematic diagram of lower Sacramento River Basin.

EXTREMES FOR PERIOD OF RECORD.—Maximum discharge, 32,000 ft<sup>3</sup>/s, Dec. 11, 1937, gage height, 22.7 ft, from rating curve extended above 13,000 ft<sup>3</sup>/s; no flow many days in 1964, 1970, 1974–76.

EXTREMES FOR CURRENT YEAR.—Peak discharges greater than base discharge of 5,000 ft<sup>3</sup>/s, or maximum:

Date	Time	Discharge (ft <sup>3</sup> /s)	Gage height (ft)
Mar. 4	2230	4,450	12.24

## DISCHARGE, CUBIC FEET PER SECOND, WATER YEAR OCTOBER 2000 TO SEPTEMBER 2001

## DAILY MEAN VALUES

DAY	OCT	NOV	DEC	JAN	FEB	MAR	APR	MAY	JUN	JUL	AUG	SEP
1	.62	12	26	e16	77	335	73	34	12	.00	.79	.10
2	.74	8.9	20	e15	70	291	71	32	12	.01	.36	.02
3	.41	7.2	18	e15	65	249	69	32	11	.02	.34	.03
4	.59	5.9	17	15	60	1710	65	32	9.1	.02	.12	.01
5	.82	6.0	15	15	56	1610	63	29	8.4	.02	.56	.01
6	.55	5.7	14	14	52	788	63	28	8.0	.02	.77	.00
7	.74	5.6	13	14	49	536	69	27	7.7	.02	1.4	.00
8	.83	5.9	14	21	46	408	64	26	6.7	.02	1.1	.00
9	.83	6.1	13	24	102	332	61	24	5.9	.02	.73	.01
10	.86	6.6	14	123	312	279	58	25	5.8	.02	1.2	.13
11	.88	7.1	14	685	482	236	55	23	5.6	.01	.00	.22
12	.89	7.1	16	584	443	202	53	23	5.1	.01	.30	.22
13	.88	8.0	16	178	323	180	51	23	4.7	.00	.81	.13
14	.88	9.6	25	108	229	164	50	23	4.8	.00	.70	.03
15	.88	9.0	52	82	181	152	48	22	4.8	.00	.61	.19
16	.86	9.3	41	67	160	142	46	22	3.7	.02	.24	.48
17	.79	9.1	32	58	251	133	48	20	3.0	.38	.37	.31
18	.77	9.0	27	51	509	124	46	17	2.6	.19	.28	.10
19	.74	9.1	24	46	707	117	45	16	2.2	.24	.22	.17
20	.77	9.2	23	43	1430	111	50	16	1.9	.72	.17	.30
21	.80	11	22	40	1580	106	77	14	1.6	1.8	.31	.27
22	.67	12	22	37	1200	101	60	13	1.4	1.8	.26	.15
23	.60	11	20	41	1160	96	52	13	1.3	1.7	.00	.23
24	.71	11	19	208	1230	97	48	12	1.2	1.3	.00	.47
25	.95	11	19	388	2130	132	44	12	1.1	1.5	.00	.96
26	1.6	11	18	481	997	106	42	13	.82	.75	.00	1.1
27	1.1	11	18	280	620	96	41	13	.69	.00	.00	.90
28	1.6	8.2	e18	160	439	89	40	13	1.4	.64	.00	1.1
29	54	13	e17	124	---	83	39	12	1.7	2.2	.00	1.2
30	30	34	e18	104	---	80	36	10	.62	1.8	.14	1.3
31	15	---	e17	88	---	76	---	11	---	.97	.19	---
TOTAL	122.36	289.6	642	4125	14960	9161	1627	630	136.83	16.20	11.97	10.14
MEAN	3.95	9.65	20.7	133	534	296	54.2	20.3	4.56	.52	.39	.34
MAX	54	34	52	685	2130	1710	77	34	12	2.2	1.4	1.3
MIN	.41	5.6	13	14	46	76	36	10	.62	.00	.00	.00
AC-FT	243	574	1270	8180	29670	18170	3230	1250	271	32	24	20

e Estimated.

## SACRAMENTO RIVER BASIN

## 11453500 PUTAH CREEK NEAR GUENOC, CA—Continued

## STATISTICS OF MONTHLY MEAN DATA FOR WATER YEARS 1905 - 2001, BY WATER YEAR (WY)

	OCT	NOV	DEC	JAN	FEB	MAR	APR	MAY	JUN	JUL	AUG	SEP
MEAN	15.8	88.9	374	621	673	405	220	68.8	27.1	7.87	3.74	2.68
MAX	329	1005	1684	2288	2107	1326	906	264	165	36.8	12.0	10.0
(WY)	1963	1974	1956	1970	1958	1938	1958	1998	1906	1998	1906	1905
MIN	.27	1.35	2.34	15.2	36.7	55.9	26.6	9.48	1.57	.47	.000	.000
(WY)	1965	1932	1937	1976	1976	1976	1931	1976	1976	1976	1976	1976

SUMMARY STATISTICS	FOR 2000 CALENDAR YEAR		FOR 2001 WATER YEAR		WATER YEARS 1905 - 2001	
ANNUAL TOTAL	69083.64		31732.10			
ANNUAL MEAN	189		86.9		206	
HIGHEST ANNUAL MEAN					467	
LOWEST ANNUAL MEAN					21.8	
HIGHEST DAILY MEAN	5500	Feb 14	2130	Feb 25	16500	Dec 10 1937
LOWEST DAILY MEAN	.00	Aug 10	.00	Jul 1	.00	Aug 20 1964
ANNUAL SEVEN-DAY MINIMUM	.45	Sep 9	.00	Aug 23	.00	Jul 26 1976
MAXIMUM PEAK FLOW			4450	Mar 4	32000	Dec 11 1937
MAXIMUM PEAK STAGE			12.24	Mar 4	22.70	Dec 11 1937
ANNUAL RUNOFF (AC-FT)	137000		62940		149400	
10 PERCENT EXCEEDS	596		180		446	
50 PERCENT EXCEEDS	18		12		25	
90 PERCENT EXCEEDS	.70		.11		1.5	

## 11453900 LAKE BERRYESSA NEAR WINTERS, CA

LOCATION.—Lat 38°30'48", long 122°06'13", in SE 1/4 NW 1/4 sec.29, T.8 N., R.2 W., Napa County, Hydrologic Unit 18020117, near center of Monticello Dam on Putah Creek, and 7.4 mi west of Winters.

DRAINAGE AREA.—566 mi<sup>2</sup>.

PERIOD OF RECORD.—January 1957 to current year.

REVISED RECORDS.—WSP 1735: 1958–60. WSP 1931: Drainage area.

GAGE.—Water-stage recorder. Datum of gage is sea level (levels by U.S. Bureau of Reclamation).

REMARKS.—Reservoir is formed by concrete arch-gravity dam completed November 1956. Usable capacity, 1,592,000 acre-ft, between elevations 253.25 ft, invert of outlet valves, and 440 ft, crest of glory-hole spillway. Dead storage, 10,340 acre-ft. Water is released down Putah Creek and is diverted into Putah South Canal for irrigation of about 46,000 acres in the lower Sacramento Valley. Total diverted during current year was 196,400 acre-ft. Releases for irrigation began in May 1959. Records, including extremes, show total contents at 2400 hours. See schematic diagram of lower Sacramento River Basin.

COOPERATION.—Records provided by U.S. Bureau of Reclamation.

EXTREMES FOR PERIOD OF RECORD.—Maximum contents, 1,733,500 acre-ft, Mar. 2, 1983, elevation, 446.67 ft; minimum since irrigation pool first filled, 422,130 acre-ft, Dec. 1, 1992, elevation, 361.73 ft.

EXTREMES FOR CURRENT YEAR.—Maximum contents, 1,490,500 acre-ft, Mar. 24, elevation, 434.12 ft; minimum, 1,264,300 acre-ft, Sept. 30, elevation, 421.63 ft.

Capacity table (elevation, in feet, and contents, in acre-feet)  
(Based on survey by U.S. Bureau of Reclamation in 1956)

360	404,550	390	765,730	410	1,068,100	430	1,414,200
370	511,760	400	911,200	420	1,236,000	450	1,799,900
380	632,360						

## RESERVOIR STORAGE (ACRE-FEET), WATER YEAR OCTOBER 2000 TO SEPTEMBER 2001

## DAILY OBSERVATION AT 2400 HOURS

DAY	OCT	NOV	DEC	JAN	FEB	MAR	APR	MAY	JUN	JUL	AUG	SEP
1	1389500	1375400	1368300	1363300	1377200	1451800	1488600	1471800	1428300	1381900	1335200	1294000
2	1388600	1375400	1368000	1363100	1377200	1453100	1487700	1469800	1426500	1380100	1333800	1293000
3	1387900	1375400	1368000	1362900	1377200	1454200	1487100	1468300	1424600	1378800	1332200	1291400
4	1387400	1374600	1367800	1362700	1377400	1466100	1486800	1467500	1422800	1377400	1330900	1290100
5	1386400	1374100	1367600	1362500	1377000	1476300	1486200	1466400	1421200	1375900	1329900	1288900
6	1385900	1373600	1367200	1362200	1377200	1479700	1486000	1465500	1419700	1374600	1328100	1287500
7	1385000	1373000	1367200	1362200	1376600	1481500	1485600	1464200	1418000	1372700	1326800	1286400
8	1384300	1372300	1367200	1362700	1376500	1483800	1485300	1463100	1416600	1371200	1325600	1285500
9	1383500	1371900	1367200	1362400	1377900	1485100	1485100	1462000	1415100	1369200	1324000	1284000
10	1383000	1371400	1367100	1364500	1379700	1485600	1484900	1460500	1413600	1368000	1322400	1283100
11	1382600	1371000	1367100	1368500	1382600	1486200	1484300	1459400	1412200	1366200	1321000	1281900
12	1382100	1370500	1366900	1370800	1385700	1487100	1483800	1457900	1410500	1364900	1319400	1280800
13	1381900	1370700	1367100	1371200	1387000	1487700	1483000	1456400	1408300	1363300	1318500	1279700
14	1381200	1370300	1367100	1371800	1387900	1488100	1482500	1454500	1407200	1361800	1316700	1278700
15	1380800	1370100	1367100	1371400	1388400	1488800	1481900	1453600	1405800	1360200	1315300	1277500
16	1380300	1369800	1366900	1371000	1389000	1489200	1481300	1451900	1404300	1358600	1313800	1276800
17	1380100	1370100	1366900	1371000	1390100	1489600	1480800	1450800	1402100	1356900	1312400	1275900
18	1379500	1369200	1366500	1370500	1391900	1489900	1480200	1449400	1401600	1355900	1311400	1274700
19	1379200	1369200	1366000	1370700	1395700	1489600	1479300	1448100	1399700	1354100	1309800	1273800
20	1378600	1368700	1366200	1370300	1405200	1489600	1479500	1446600	1398300	1352600	1308300	1272400
21	1377700	1368900	1365800	1370100	1412300	1489900	1479100	1444900	1396600	1351200	1306900	1271500
22	1377400	1368700	1365800	1370100	1418900	1489900	1478200	1443800	1395000	1349900	1305800	1270300
23	1376800	1368500	1365600	1370700	1426100	1489900	1478200	1442100	1393000	1348700	1304400	1269600
24	1375000	1368700	1365400	1371400	1431300	1490500	1477600	1440500	1391300	1347200	1303400	1269200
25	1375000	1368300	1364700	1374100	1422500	1490300	1477000	1439000	1389500	1345400	1302100	1268300
26	1376100	1368000	1364300	1375700	1446600	1490300	1476300	1437500	1388400	1344000	1301100	1267500
27	1375700	1367600	1364300	1376300	1449000	1490100	1475600	1435700	1386600	1342700	1300200	1266400
28	1376300	1367600	1364200	1376300	1450500	1490100	1474400	1434000	1385000	1341100	1299000	1265700
29	1376300	1368000	1364000	1377000	---	1489800	1473300	1432500	1384100	1339700	1297700	1264800
30	1375900	1368300	1363800	1377200	---	1489400	1472400	1431300	1382800	1338800	1296500	1264300
31	1375500	---	1363800	1377200	---	1489000	---	1430000	---	1336500	1295100	---
MAX	1389500	1375400	1368300	1377200	1450500	1490500	1488600	1471800	1428300	1381900	1335200	1294000
MIN	1375000	1367600	1363800	1362200	1376500	1451800	1472400	1430000	1382800	1336500	1295100	1264300
a	427.88	427.48	427.23	427.97	431.97	434.04	433.15	430.86	428.28	425.71	423.38	421.63
b	-14600	-7200	-4500	+13400	+73300	+38500	-16600	-42400	-47200	-46300	-41400	-30800
c	3961	1541	1012	1297	1664	4080	5125	10409	10247	10025	9600	7002

CAL YR 2000 b +1300

WTR YR 2001 b -125800

a Elevation, in feet, at end of month.

b Change in contents, in acre-feet.

c Total evaporation, in acre-feet, provided by U.S. Bureau of Reclamation, not reviewed by U.S. Geological Survey.

## 11454000 PUTAH CREEK NEAR WINTERS, CA

LOCATION.—Lat 38°30'55", long 122°04'51", in NE 1/4 NE 1/4 sec.28, T.8 N., R.2 W., Yolo County, Hydrologic Unit 18020109, on left bank, 1 mi downstream from Cold Canyon, 1.3 mi downstream from Monticello Dam, and 6 mi west of Winters.

DRAINAGE AREA.—574 mi<sup>2</sup>.

PERIOD OF RECORD.—July 1930 to current year.

CHEMICAL DATA: Water years 1951–66, 1973–81.

WATER TEMPERATURE: Water years 1966–81.

REVISED RECORDS.—WSP 901: 1937–38(M). WSP 1285: 1932(M), 1935–36(M), 1940(M), 1942–43(M), 1951, 1952(M). WSP 1565: 1957. WSP 1931: Drainage area.

GAGE.—Water-stage recorder. Datum of gage is 160.75 ft above sea level (river-profile survey). June 28, 1930, to Feb. 29, 1940, at datum about 1 ft higher.

REMARKS.—Records fair except for estimated daily discharges, which are poor. Flow completely regulated by Lake Berryessa (station 11453900) beginning January 1957. See schematic diagram of [lower Sacramento River Basin](#).

EXTREMES FOR PERIOD OF RECORD.—Maximum discharge, 81,000 ft<sup>3</sup>/s, Feb. 27, 1940, gage height, 30.5 ft, present datum, from rating curve extended above 30,000 ft<sup>3</sup>/s; no flow, Sept. 6–15, 1950, July 26 to Sept. 1, Sept. 6–9, 1955. Since completion of Monticello Dam in 1957, maximum discharge, 18,700 ft<sup>3</sup>/s, Mar. 2, 1983, gage height, 19.55 ft; minimum daily, 6.1 ft<sup>3</sup>/s, Dec. 19, 1967.

EXTREMES OUTSIDE PERIOD OF RECORD.—Maximum stage known since at least 1905, that of Feb. 27, 1940, on basis of records for station at Winters.

## DISCHARGE, CUBIC FEET PER SECOND, WATER YEAR OCTOBER 2000 TO SEPTEMBER 2001

## DAILY MEAN VALUES

DAY	OCT	NOV	DEC	JAN	FEB	MAR	APR	MAY	JUN	JUL	AUG	SEP
1	248	156	e45	98	73	64	e260	531	679	513	599	497
2	248	156	e45	98	92	67	e264	547	695	555	579	496
3	254	e96	e45	86	92	80	284	535	673	596	556	503
4	266	e96	e45	72	92	237	298	509	662	593	568	471
5	266	e120	e58	78	91	196	317	528	655	586	553	452
6	262	e144	e68	92	91	125	268	556	642	614	540	429
7	234	e155	70	95	91	110	206	576	635	628	549	433
8	219	e155	74	97	75	104	185	577	620	621	574	427
9	219	e155	75	96	59	100	185	593	632	620	587	404
10	198	e130	75	81	59	97	199	607	610	596	605	385
11	160	e110	75	78	72	94	241	622	602	596	593	405
12	144	e78	75	98	67	92	279	635	609	614	570	431
13	149	e59	75	80	61	91	314	646	591	614	565	412
14	146	e57	75	78	59	89	339	638	609	604	570	409
15	142	e66	75	77	58	89	355	599	610	582	575	416
16	136	e73	75	87	57	88	364	584	624	574	567	413
17	131	e73	74	98	57	88	358	616	604	574	577	429
18	141	e73	73	78	59	88	415	633	623	581	559	421
19	142	e73	83	92	60	87	433	632	665	565	540	362
20	143	e73	95	136	115	140	377	636	663	559	501	337
21	143	e74	97	81	79	186	305	621	675	549	457	378
22	144	e72	98	56	69	180	289	618	707	534	464	377
23	e145	e61	98	56	83	181	289	679	711	562	489	324
24	e130	e47	107	54	115	183	336	710	681	617	523	315
25	e130	e47	98	82	92	183	380	682	659	621	539	308
26	e89	e47	98	145	73	183	406	648	634	592	511	291
27	91	e62	98	118	66	192	462	632	604	581	497	289
28	106	e75	99	56	64	213	464	631	586	588	497	259
29	124	e60	99	55	---	e215	439	607	540	573	502	245
30	141	e47	99	55	---	e320	488	589	521	565	494	244
31	156	---	98	55	---	e285	---	607	---	600	508	---
TOTAL	5247	2690	2464	2608	2121	4447	9799	18824	19021	18167	16808	11562
MEAN	169	89.7	79.5	84.1	75.8	143	327	607	634	586	542	385
MAX	266	156	107	145	115	320	488	710	711	628	605	503
MIN	89	47	45	54	57	64	185	509	521	513	457	244
AC-FT	10410	5340	4890	5170	4210	8820	19440	37340	37730	36030	33340	22930

e Estimated.

## 11454000 PUTAH CREEK NEAR WINTERS, CA—Continued

## STATISTICS OF MONTHLY MEAN DATA FOR WATER YEARS 1931 - 1956, BY WATER YEAR (WY)

	OCT	NOV	DEC	JAN	FEB	MAR	APR	MAY	JUN	JUL	AUG	SEP
MEAN	8.62	96.0	993	1284	1716	976	514	137	42.1	12.5	6.94	5.84
MAX	45.4	807	5110	3957	6468	3506	2729	452	156	63.7	31.7	20.8
(WY)	1951	1951	1956	1952	1938	1938	1941	1941	1942	1941	1941	1941
MIN	.89	3.17	7.16	44.6	66.7	118	40.8	12.3	6.72	2.39	.000	1.47
(WY)	1956	1956	1931	1947	1948	1932	1931	1931	1931	1955	1955	1931

## SUMMARY STATISTICS

## WATER YEARS 1931 - 1956

ANNUAL MEAN	477
HIGHEST ANNUAL MEAN	1387 1941
LOWEST ANNUAL MEAN	48.1 1931
HIGHEST DAILY MEAN	54500 Feb 27 1940
LOWEST DAILY MEAN	.00 Sep 6 1950
ANNUAL SEVEN-DAY MINIMUM	.00 Sep 6 1950
MAXIMUM PEAK FLOW	81000 Feb 27 1940
MAXIMUM PEAK STAGE	30.5 Feb 27 1940
ANNUAL RUNOFF (AC-FT)	345500
10 PERCENT EXCEEDS	924
50 PERCENT EXCEEDS	38
90 PERCENT EXCEEDS	3.0

## STATISTICS OF MONTHLY MEAN DATA FOR WATER YEARS 1960 - 2001, BY WATER YEAR (WY)

MEAN	224	89.1	108	485	682	757	640	546	599	627	547	400
MAX	476	263	1625	4406	6271	7791	5023	1018	773	802	681	610
(WY)	1972	1987	1984	1970	1998	1983	1982	1983	1981	1984	1975	1968
MIN	13.3	14.9	11.6	11.6	21.6	40.9	110	155	328	338	298	175
(WY)	1960	1963	1961	1960	1960	1962	1960	1960	1960	1960	1960	1960

## SUMMARY STATISTICS

## FOR 2000 CALENDAR YEAR

## FOR 2001 WATER YEAR

## WATER YEARS 1960 - 2001

ANNUAL TOTAL	129299	113758	
ANNUAL MEAN	353	312	474
HIGHEST ANNUAL MEAN			1580 1983
LOWEST ANNUAL MEAN			132 1960
HIGHEST DAILY MEAN	859 Mar 16	711 Jun 23	17700 Mar 2 1983
LOWEST DAILY MEAN	44 Feb 4	45 Dec 1	6.1 Dec 19 1967
ANNUAL SEVEN-DAY MINIMUM	49 Nov 29	49 Nov 29	8.3 Nov 7 1963
MAXIMUM PEAK FLOW		825 Jun 22	18700 Mar 2 1983
MAXIMUM PEAK STAGE		8.80 Jun 22	19.55 Mar 2 1983
ANNUAL RUNOFF (AC-FT)	256500	225600	343600
10 PERCENT EXCEEDS	703	620	718
50 PERCENT EXCEEDS	345	248	354
90 PERCENT EXCEEDS	61	68	53

## 11454210 PUTAH SOUTH CANAL NEAR WINTERS, CA

LOCATION.—Lat 38°29'34", long 122°00'07", in Rio De Los Putos Grant, T.8 N., R.1 W., Solano County, Hydrologic Unit 18020109, on left bank, 500 ft downstream from diversion headgate structure on Lake Solano, and 2.7 mi southwest of Winters.

PERIOD OF RECORD.—October 1994 to September 1997, October 1998 to current year. Monthly and yearly totals were published during water years 1972–93.

GAGE.—Water-stage recorder. Elevation of gage is 160 ft above sea level, from topographic map.

REMARKS.—Water from canal is diverted for irrigation, municipal, and industrial use. See schematic diagram of lower Sacramento River Basin.

COOPERATION.—Records provided by U.S. Bureau of Reclamation.

EXTREMES FOR PERIOD OF RECORD.—Maximum daily discharge, 784 ft<sup>3</sup>/s, June 21, 2000; no flow on some days during most years.

## DISCHARGE, CUBIC FEET PER SECOND, WATER YEAR OCTOBER 2000 TO SEPTEMBER 2001

## DAILY MEAN VALUES

DAY	OCT	NOV	DEC	JAN	FEB	MAR	APR	MAY	JUN	JUL	AUG	SEP
1	218	61	29	59	48	53	238	465	626	462	547	451
2	226	60	32	56	60	59	253	490	652	496	533	454
3	235	69	13	46	60	64	253	487	638	535	507	463
4	237	82	14	50	50	64	261	467	622	538	519	427
5	236	85	30	50	40	64	265	481	609	536	508	407
6	235	81	35	56	51	58	233	507	596	562	497	397
7	207	80	35	60	58	53	165	524	587	571	505	405
8	195	75	41	60	58	54	154	534	580	576	517	400
9	174	45	39	60	52	53	142	544	594	562	523	369
10	156	40	35	60	49	54	155	553	570	546	550	365
11	138	40	35	60	48	54	189	575	558	544	543	381
12	130	40	35	60	43	53	228	589	561	561	522	381
13	123	40	30	60	38	55	274	597	551	561	519	372
14	116	40	32	60	39	65	305	596	550	550	525	377
15	115	46	35	60	43	70	317	576	564	533	518	376
16	104	50	35	57	48	70	319	530	579	521	521	387
17	107	46	35	56	48	69	334	564	562	518	525	404
18	110	40	42	55	48	63	345	589	566	530	506	394
19	110	40	51	49	48	59	358	586	604	511	487	356
20	110	40	60	47	43	101	352	596	606	503	461	327
21	110	40	60	50	38	135	284	576	627	494	421	353
22	110	40	60	50	40	144	240	577	654	481	417	362
23	103	36	60	50	43	156	236	607	665	496	433	322
24	100	10	60	55	43	160	280	652	643	561	461	307
25	94	.00	60	59	43	158	320	654	616	562	483	296
26	70	18	53	60	46	155	350	618	593	536	468	285
27	44	34	51	57	54	167	398	595	567	533	446	264
28	40	25	60	55	54	183	408	581	531	539	447	251
29	61	.00	60	55	---	202	409	562	497	513	455	249
30	70	.00	60	46	---	210	438	548	476	516	438	246
31	66	---	60	30	---	217	---	558	---	540	456	---
TOTAL	4150	1303.00	1337	1688	1333	3122	8503	17378	17644	16487	15258	10828
MEAN	134	43.4	43.1	54.5	47.6	101	283	561	588	532	492	361
MAX	237	85	60	60	60	217	438	654	665	576	550	463
MIN	40	.00	13	30	38	53	142	465	476	462	417	246
AC-FT	8230	2580	2650	3350	2640	6190	16870	34470	35000	32700	30260	21480

## STATISTICS OF MONTHLY MEAN DATA FOR WATER YEARS 1995 - 2001, BY WATER YEAR (WY)

	1995	1996	1997	1998	1999	2000	2001
MEAN	191	58.4	44.9	43.7	46.9	84.8	259
MAX	219	79.0	55.5	54.5	55.1	182	450
(WY)	1996	1996	1999	2001	1997	1997	1999
MIN	134	43.4	33.6	34.5	42.2	37.8	168
(WY)	2001	2001	2000	1995	1999	1996	1995

## SUMMARY STATISTICS

## FOR 2000 CALENDAR YEAR

## FOR 2001 WATER YEAR

## WATER YEARS 1995 - 2001

ANNUAL TOTAL	101020.00	99031.00	
ANNUAL MEAN	276	271	274
HIGHEST ANNUAL MEAN			299
LOWEST ANNUAL MEAN			246
HIGHEST DAILY MEAN	784	Jun 21	784
LOWEST DAILY MEAN	.00	Nov 25	.00
ANNUAL SEVEN-DAY MINIMUM	12	Nov 24	12
ANNUAL RUNOFF (AC-FT)	200400	196400	198200
10 PERCENT EXCEEDS	643	570	597
50 PERCENT EXCEEDS	226	226	210
90 PERCENT EXCEEDS	35	40	40

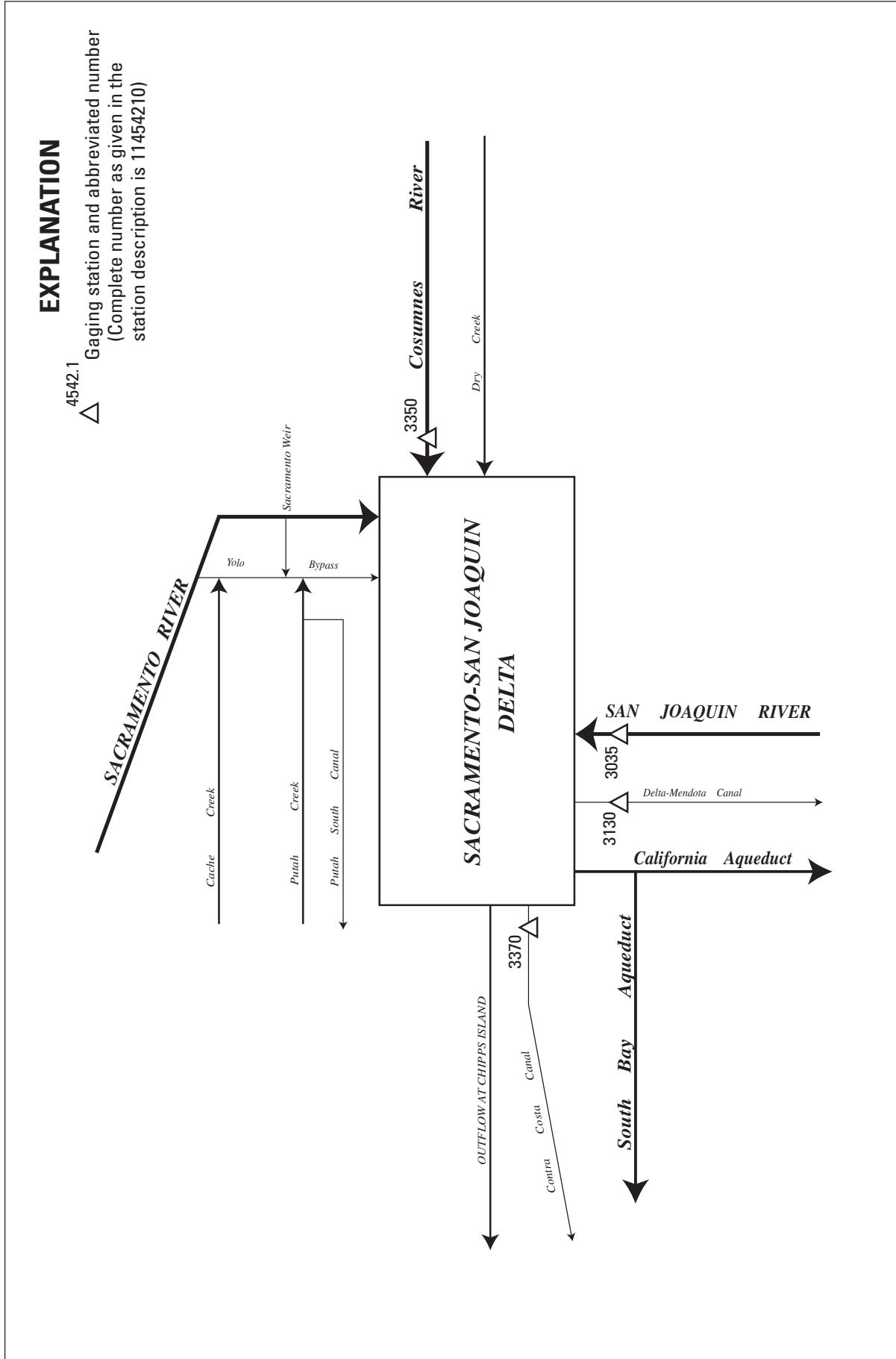

Figure 36. Principal inflows and diversions, Sacramento-San Joaquin Delta.



As the number of streams on which streamflow information is likely to be desired far exceeds the number of stream-gaging stations feasible to operate at one time, the U.S. Geological Survey collects limited streamflow data at sites other than stream-gaging stations. When limited streamflow data are collected on a systematic basis over a period of years for use in hydrologic analyses, the site at which the data are collected is called a partial-record station. Data collected at these partial-record stations are usable in low- or flood-flow analyses, depending on the type of data collected.

Discharge measurements made at miscellaneous sites during water year 2001

Station no.	Station name	Location	Drainage area (mi <sup>2</sup> )	Period of record	Measurements	
					Date	Discharge (ft <sup>3</sup> /s)
SACRAMENTO RIVER BASIN						
11341900	Dog Creek at Delta, CA	Lat 40°56'17", long 122°25'13", in SE 1/4 NE 1/4 sec.34, T.36 N., R.5 W., Shasta County, Hydrologic Unit 18020005, 0.1 mi upstream from mouth, 0.5 mi southwest of Delta, and 25 mi north of Redding.	17.3	a1975,	02-21-01	969
				1976–84,	03-09-01	395
				1986–2001	08-02-01	b5.32

a Published as a miscellaneous measurement.

b Base flow.

Station No.	Station name	Location	Drainage area (mi <sup>2</sup> )	Period of Record	Measurements		
					Date	Gage Height	Discharge (ft <sup>3</sup> /s)
SACRAMENTO RIVER BASIN							
38352512143 4601	Willow Slough Bypass near Davis, CA	Lat 38°35'25", long 121°43'46", in SE 1/4 SE 1/4 sec.27, T.9 N., R.2 E., <a href="#">Yolo</a> <a href="#">County</a> , Hydrologic Unit 18020109, at County Road 102, and 3.5 mi northeast of Davis.	—	1999–2001	10-02-00	5.29	21
					10-11-00	6.16	61
					10-16-00	5.49	36
					10-23-00	5.34	24
					10-30-00	4.98	16
					11-06-00	4.90	4.7
					11-13-00	4.78	1.3
					04-26-01	5.36	30
					05-03-01	7.70	52
					05-11-01	4.97	8.0
					05-17-01	5.12	16
					05-25-01	5.07	12
					05-30-01	5.31	29
					06-07-01	5.20	19
					06-15-01	5.18	15
					06-21-01	5.27	18
					06-28-01	5.63	39
					07-05-01	5.28	23
					07-12-01	5.23	20
					07-19-01	2.70	1.2
					07-26-01	2.00	1.1
					08-02-01	5.00	8.0
					08-08-01	5.06	11
08-14-01	5.08	12					
08-22-01	5.15	14					
08-28-01	5.44	34					
09-06-01	5.04	8.4					
09-13-01	4.98	8.0					
09-20-01	5.30	24					
09-28-01	5.12	13					
38374912143 3701	Willow Slough near Woodland, CA	Lat 38°37'49", long 121°43'37", in NW 1/4 NW 1/4 sec.14, T.9 N., R.2 E., <a href="#">Yolo</a> <a href="#">County</a> , Hydrologic Unit 18020109, 1,000 ft downstream of County Road 102, and 3.8 miles southeast of Woodland.	—	1999–2001	10-02-00	5.08	14
					10-11-00	5.06	9.4
					10-16-00	5.18	9.4
					10-23-00	5.34	9.7
					10-30-00	5.49	9.6
					11-06-00	5.09	.00
					11-13-00	4.30	0.17
					04-26-01	6.62	11
					05-03-01	6.52	24
					05-11-01	6.25	6.0
					05-17-01	6.19	2.0
					05-25-01	---	2.7
					05-30-01	6.92	3.1
					06-07-01	7.17	4.3
					06-15-01	6.73	20
					06-21-01	6.46	7.9
					06-28-01	6.50	6.5
					07-05-01	6.28	7.8
					07-12-01	6.48	3.3
					07-19-01	4.92	4.2
					07-26-01	6.32	12
					08-02-01	6.62	28
					08-08-01	5.98	26
08-14-01	5.70	6.0					
08-22-01	5.84	21					
08-28-01	5.53	16					
09-06-01	6.25	31					
09-13-01	5.98	27					
09-20-01	5.37	14					
09-28-01	5.49	9.9					

Water-quality partial-record stations are particular sites where chemical-quality, biological, and (or) sediment data are collected systematically over a period of years for use in hydrologic analyses. The data are collected usually less than quarterly. Samples collected at sites other than gaging stations and partial-record stations to give better areal coverage in a river basin are referred to as miscellaneous sites.

## SACRAMENTO RIVER BASIN

383430121302001 SACRAMENTO RIVER AT TOWER BRIDGE, AT SACRAMENTO, CA

LOCATION.—Lat 38°34'30", long 121°30'20", T.9 N, R.4 E, Sacramento County, Hydrologic Unit 18020109, at I Street Bridge, in city of Sacramento, and 0.5 mi downstream from American River.

DRAINAGE AREA.—23,502 mi<sup>2</sup>.

PERIOD OF RECORD.—January 2001 to February 2001.

CHEMICAL DATA: January 2001 to February 2001.

REMARKS.—Water-stage recorder operated by Department of Water Resources since October 1995; currently not maintained for accurate discharge values. U.S. Geological Survey maintained gage prior to October 1995 as station 11447500, Sacramento River at Sacramento. Water-stage recorder. Datum of gage is sea level. Prior to Oct. 15, 1912, nonrecording gage in vicinity of I Street Bridge. Oct. 15, 1912 to Nov. 15, 1956, datum of gages at low-water mark of Oct. 23, 1856, 0.12 ft above sea level. Chemical Data for water year 2000 available in the files of the U.S. Geological Survey.

## WATER-QUALITY DATA, WATER YEAR OCTOBER 2000 TO SEPTEMBER 2001

DATE	TIME	2,6-DI-	ACETO-	ALA-	ALPHA	BEN-	CAR-	CARBO-	CHLOR-	CYANA-	DCPA	
		ETHYL	CHLOR,	CHLOR,	ALPHA	FLUR-	BARYL	FURAN				ZINE,
		WAT FLT	WATER	WATER,	BHC	ZINE,	ATE,	WATER	PYRIFOS	ZINE,	WATER	
		0.7 U	FLTRD	DISS,	DIS-	WATER,	WATER,	FLTRD	0.7 U	DIS-	0.7 U	
		GF, REC	REC	REC,	SOLVED	REC	GF, REC	REC	GF, REC	SOLVED	REC	
		(UG/L)	(UG/L)	(UG/L)	(UG/L)	(UG/L)	(UG/L)	(UG/L)	(UG/L)	(UG/L)	(UG/L)	
		(82660)	(49260)	(46342)	(34253)	(39632)	(82673)	(04028)	(82680)	(82674)	(38933)	
		(04041)	(04041)	(04041)	(04041)	(04041)	(04041)	(04041)	(04041)	(04041)	(04041)	
JAN												
25...	0900	<.002	<.004	<.002	<.005	<.007	<.010	<.002	e.004	e.007	<.005	<.018
26...	1100	<.002	<.004	<.002	<.005	<.007	<.010	<.002	e.004	<.020	<.005	<.018
27...	1100	<.002	<.004	<.002	<.005	<.007	<.010	<.002	<.041	<.020	<.005	<.018
28...	0800	<.002	<.004	<.002	<.005	<.007	<.010	<.002	<.041	<.020	<.005	<.018
29...	1100	<.002	<.004	<.002	<.005	<.007	<.010	<.002	<.041	<.020	<.005	<.018
31...	1130	<.002	<.004	<.002	<.005	<.007	<.010	<.002	<.041	<.020	<.005	<.018
FEB												
10...	1600	<.002	<.004	<.002	<.005	<.007	<.010	<.002	<.041	<.020	<.005	<.018
11...	1300	<.002	<.004	<.002	<.005	<.007	<.010	<.002	<.041	<.020	<.005	<.018
12...	1300	<.002	<.004	<.002	<.005	<.007	<.010	<.002	<.041	<.020	<.005	<.018
13...	1330	<.002	<.004	<.002	<.005	<.007	<.010	<.002	<.041	<.020	<.005	<.018
14...	1400	<.002	<.004	<.002	<.005	<.007	<.010	<.002	<.041	<.020	<.005	<.018
16...	1230	<.002	<.004	<.002	<.005	<.007	<.010	<.002	e.004	<.020	<.005	<.018
DEETHYL												
ATRA-												
ZINE, DI-												
WATER, AZINON, DI-												
DISS, DIS-												
DATE REC SOLVED SOLVED GF, REC GF, REC GF, REC GF, REC												
(UG/L) (UG/L) (UG/L) (UG/L) (UG/L) (UG/L) (UG/L) (UG/L)												
(04040) (39572) (39381) (82677) (82668) (82663) (82672) (04095)												
(39341) (82666) (39532) (82686) (82667)												
JAN												
25...	<.006	.018	<.005	<.021	<.002	<.009	<.005	<.003	<.004	<.035	<.027	<.050
26...	<.006	.020	<.005	<.021	<.002	<.009	<.005	<.003	<.004	<.035	<.027	<.050
27...	<.006	.045	<.005	<.021	<.002	<.009	<.005	<.003	<.004	<.035	<.027	<.050
28...	<.006	.096	<.005	<.021	<.002	<.009	<.005	<.003	<.004	<.035	<.027	<.050
29...	<.006	.061	<.005	<.021	<.002	<.009	<.005	<.003	<.004	<.035	<.027	<.050
31...	<.006	.030	<.005	<.021	<.002	<.009	<.005	<.003	<.004	<.035	<.027	<.050
FEB												
10...	<.006	.009	<.005	<.021	<.002	<.009	<.005	<.003	<.004	<.035	<.027	<.050
11...	<.006	.011	<.005	<.021	<.002	<.009	<.005	<.003	<.004	<.035	<.027	<.050
12...	<.006	.014	<.005	<.021	<.002	<.009	<.005	<.003	<.004	<.035	<.027	<.050
13...	<.006	.016	<.005	<.021	<.002	<.009	<.005	<.003	<.004	<.035	<.027	<.050
14...	<.006	.028	<.005	<.021	<.002	<.009	<.005	<.003	<.004	<.035	<.027	<.050
16...	<.006	.018	<.005	<.021	<.002	<.009	<.005	<.003	<.004	<.035	<.027	<.050

< Actual value is known to be less than value shown.  
e Estimated.

## SACRAMENTO RIVER BASIN

383430121302001 SACRAMENTO RIVER AT TOWER BRIDGE, AT SACRAMENTO, CA—Continued

## WATER-QUALITY DATA, WATER YEAR OCTOBER 2000 TO SEPTEMBER 2001

DATE	METO- LACHLOR WATER DISSOLV (UG/L) (39415)	METRI- BUZIN WATER DISSOLV (UG/L) (82630)	MOL- INATE WATER FLTRD 0.7 U GF, REC (82671)	NAPROP- AMIDE WATER FLTRD 0.7 U GF, REC (82684)	P, P' DDE DISSOLV (UG/L) (34653)	PARA- THION, DIS- SOLVED (UG/L) (39542)	PEB- ULATE WATER FILTRD 0.7 U GF, REC (82669)	PENDI- METH- ALIN WAT FLT 0.7 U GF, REC (82683)	PER- METHRIN CIS WAT FLT 0.7 U GF, REC (82687)	PHORATE WATER FLTRD 0.7 U GF, REC (82664)	PRO- AMIDE WATER FLTRD 0.7 U DISS, REC (82676)	PROPA- CHLOR, WATER, DISS, REC (04024)	
JAN													
25...	e.001	<.006	.021	<.007	<.003	<.007	<.002	<.010	<.006	<.011	<.015	e.004	<.010
26...	e.002	<.006	.025	<.007	<.003	<.007	<.002	<.010	<.006	<.011	<.015	<.004	<.010
27...	<.013	<.006	.014	e.007	<.003	<.007	<.002	<.010	<.006	<.011	<.015	<.004	<.010
28...	<.013	<.006	<.002	<.007	<.003	<.007	<.002	<.010	<.006	<.011	<.015	<.004	<.010
29...	<.013	<.006	.011	<.007	<.003	<.007	<.002	<.010	<.006	<.011	<.015	.021	<.010
31...	e.005	<.006	.021	e.006	<.003	<.007	<.002	<.010	<.006	<.011	<.015	.017	<.010
FEB													
10...	<.013	<.006	.019	<.007	<.003	<.007	<.002	<.010	<.006	<.011	<.015	<.004	<.010
11...	<.013	<.006	.022	<.007	<.003	<.007	<.002	<.010	<.006	<.011	<.015	.007	<.010
12...	<.013	<.006	.019	<.007	<.003	<.007	<.002	<.010	<.006	<.011	<.015	<.004	<.010
13...	e.003	<.006	.016	<.007	<.003	<.007	<.002	<.010	<.006	<.011	<.015	<.004	<.010
14...	e.005	.016	.016	<.007	<.003	<.007	<.002	<.010	<.006	<.011	<.015	<.004	<.010
16...	e.001	<.006	.012	<.007	<.003	<.007	<.002	<.010	<.006	<.011	<.015	.010	<.010
DATE	PRO- PANIL WATER FLTRD 0.7 U GF, REC (82679)	PRO- PARGITE WATER FLTRD 0.7 U GF, REC (82685)	SI- MAZINE, WATER, DISS, REC (04035)	TEBU- THIURON WATER FLTRD 0.7 U GF, REC (82670)	TER- BACIL WATER FLTRD 0.7 U GF, REC (82665)	TER- BUFOS WATER FLTRD 0.7 U GF, REC (82675)	THIO- BENCARB WATER FLTRD 0.7 U GF, REC (82681)	TRIAL- LATE WATER FLTRD 0.7 U GF, REC (82678)	TRI- FLUR- ALIN WAT FLT 0.7 U GF, REC (82661)				
JAN													
25...	<.011	<.023	e.006	e.005	<.034	<.017	.010	<.002	<.009				
26...	<.011	<.023	e.006	<.016	<.034	<.017	.009	<.002	e.003				
27...	<.011	<.023	.020	<.016	<.034	<.017	<.005	<.002	<.009				
28...	<.011	<.023	.070	<.016	<.034	<.017	<.005	<.002	<.009				
29...	<.011	<.023	.078	<.016	<.034	<.017	<.005	<.002	<.009				
31...	<.011	<.023	.026	e.009	<.034	<.017	.008	<.002	<.009				
FEB													
10...	<.011	<.023	<.011	<.016	<.034	<.017	.005	<.002	<.009				
11...	<.011	<.023	<.011	<.016	<.034	<.017	.008	<.002	<.009				
12...	<.011	<.023	.015	<.016	<.034	<.017	.005	<.002	<.009				
13...	<.011	<.023	.033	<.016	<.034	<.017	.007	<.002	<.009				
14...	<.011	<.023	.030	<.016	<.034	<.017	.006	<.002	<.009				
16...	<.011	<.023	.022	e.006	<.034	<.017	<.006	<.002	<.009				

e Estimated.

&lt; Actual value is known to be less than value shown.

## SACRAMENTO RIVER BASIN

384030121373601 SACRAMENTO RIVER AT ALAMAR, CA

LOCATION.—Lat 38°40'30", long 121°37'36", in NW 1/4 SW 1/4 sec.35, T.10 N, R.3 E, Sacramento County, Hydrologic Unit Code 18020109, at end of pier of left bank, approximately 0.75 mi south of Elkhorn Rodad, on Garden Highway.

DRAINAGE AREA.—Not determined.

PERIOD OF RECORD.—January 2001 to February 2001.

CHEMICAL DATA: January 2001 to February 2001.

REMARKS.—Discharge values calculated from U.S. Geological Survey gaging station 11425500 with appropriate travel times taken into account.

## WATER-QUALITY DATA, WATER YEAR OCTOBER 2000 TO SEPTEMBER 2001

DATE	TIME	DIS- CHARGE, INST. CUBIC FEET PER SECOND (00061)	2,6-DI- ETHYL ANILINE WAT FLT 0.7 U GF, REC (82660)	ACETO- CHLOR, WATER FLTRD REC (49260)	ALA- CHLOR, WATER, DISS, REC, (46342)	ALPHA BHC DISS- SOLVED (34253)	ATRA- ZINE, WATER, DISS, REC (39632)	BEN- FLUR- ALIN WAT FLD 0.7 U GF, REC (82673)	BUTYL- ATE, WATER, DISS, REC (04028)	CAR- BARYL WATER FLTRD 0.7 U GF, REC (82680)
JAN										
24...	1010	e12600	<.002	<.004	<.002	<.005	<.007	<.010	<.002	e.004
25...	1110	e13100	<.002	<.004	<.002	<.005	<.007	<.010	<.002	e.004
26...	0840	e17800	<.002	<.004	<.002	<.005	e.001	<.010	<.002	e.021
27...	1100	e24800	<.002	<.004	<.002	<.005	<.007	<.010	<.002	e.034
28...	1050	e26600	<.002	<.004	<.002	<.005	<.007	<.010	<.002	e.004
FEB										
09...	0930	e11000	<.002	<.004	<.002	<.005	<.007	<.010	<.002	<.041
10...	1050	e11500	<.002	<.004	<.002	<.005	<.007	<.010	<.002	<.041
11...	1030	e12500	<.002	<.004	<.002	<.005	<.007	<.010	<.002	e.003
12...	1040	e17800	<.002	<.004	<.002	<.005	<.007	<.010	<.002	<.041
13...	1110	e22000	<.002	<.004	<.002	<.005	<.007	<.010	<.002	e.003
14...	1010	e21600	<.002	<.004	<.002	<.005	<.007	<.010	<.002	e.003

DATE	CARBO- FURAN WATER FLTRD 0.7 U GF, REC (82674)	CHLOR- PYRIFOS DISS- SOLVED (38933)	CYANA- ZINE, WATER, DISS, REC (04041)	DCPA WATER FLTRD 0.7 U GF, REC (82682)	DEETHYL ATRA- ZINE, WATER, DISS, REC (04040)	DI- AZINON, DISS- SOLVED (39572)	DI- ELDRIN DISS- SOLVED (39381)	DISUL- FOTON WATER FLTRD 0.7 U GF, REC (82677)	EPTC WATER FLTRD 0.7 U GF, REC (82668)	ETHAL- FLUR- ALIN WAT FLT 0.7 U GF, REC (82663)
JAN										
24...	e.006	<.005	<.018	<.003	<.006	.020	<.005	<.021	<.002	<.009
25...	e.006	<.005	<.018	<.003	<.006	.024	<.005	<.021	<.002	<.009
26...	e.031	e.002	<.018	<.003	<.006	.016	<.005	<.021	<.002	<.009
27...	<.040	e.002	<.018	e.001	<.006	.037	<.005	<.021	<.002	<.009
28...	<.020	<.005	<.018	<.003	<.006	.084	<.005	<.021	<.002	<.009
FEB										
09...	<.020	<.005	<.018	<.003	<.006	.013	<.005	<.021	<.002	<.009
10...	<.020	<.005	<.018	<.003	<.006	.013	<.005	<.021	<.002	<.009
11...	e.007	<.005	<.018	<.003	<.006	.017	<.005	<.021	<.002	<.009
12...	<.020	<.005	<.018	<.003	<.006	.021	<.005	<.021	<.002	<.009
13...	<.020	<.005	<.018	<.003	<.006	.021	<.005	<.021	<.002	<.009
14...	e.005	<.005	<.018	<.003	<.006	.027	<.005	<.021	<.002	<.009

DATE	ETHO- PROP WATER FLTRD 0.7 U GF, REC (82672)	FONOFOS WATER DISS REC (04095)	LINDANE DIS- SOLVED (39341)	LIN- URON WATER FLTRD 0.7 U GF, REC (82666)	METHYL AZIN- PHOS THION, WAT FLT DISS- SOLVED (39532)	METHYL PARA- PHOS THION, WAT FLT 0.7 U GF, REC (82686)	METHYL THION, WAT FLT 0.7 U GF, REC (82667)	METO- LACHLOR WATER DISSOLV (39415)	METRI- BUZIN WATER DISSOLV (82630)	MOL- INATE WATER FLTRD 0.7 U GF, REC (82671)
JAN										
24...	<.005	<.003	<.004	<.035	<.027	<.050	<.006	e.001	<.006	.018
25...	e.005	<.003	<.004	<.035	<.027	<.050	<.006	e.001	<.006	.023
26...	<.005	<.003	<.004	<.035	<.027	<.050	<.006	e.005	<.006	.026
27...	<.005	<.003	<.004	<.035	<.027	<.050	<.006	e.005	e.005	.015
28...	<.005	<.003	<.004	<.035	<.027	<.050	<.006	e.003	<.006	.014
FEB										
09...	<.005	<.003	<.004	<.035	<.027	<.050	<.006	<.013	<.006	.019
10...	<.005	<.003	<.004	<.035	<.027	<.050	<.006	<.013	<.006	.018
11...	<.005	<.003	<.004	<.035	<.027	<.050	<.006	e.002	<.006	.020
12...	<.005	<.003	<.004	<.035	<.027	<.050	<.006	<.013	<.006	.021
13...	<.005	<.003	<.004	<.035	<.027	<.050	<.006	e.005	.006	.019
14...	<.005	<.003	<.004	<.035	<.027	<.050	<.006	e.006	.010	.018

< Actual value is known to be less than the value shown.  
e Estimated.

## SACRAMENTO RIVER BASIN

384030121373601 SACRAMENTO RIVER AT ALAMAR, CA—Continued

## WATER-QUALITY DATA, WATER YEAR OCTOBER 2000 TO SEPTEMBER 2001

DATE	NAPROP- AMIDE WATER FLTRD 0.7 U	P,P' DDE DISSOLV (UG/L)	PARA- THION, DIS- SOLVED (UG/L)	PEB- ULATE WATER FILTRD 0.7 U	PENDI- METH- ALIN WAT FLT 0.7 U	PER- METHRIN CIS WAT FLT 0.7 U	PHORATE WATER FLTRD 0.7 U	PRO- METON, WATER, DISS, REC (UG/L)	PRON- AMIDE WATER FLTRD 0.7 U	PROPA- CHLOR, WATER, DISS, REC (UG/L)
	(82684)	(34653)	(39542)	(82669)	(82683)	(82687)	(82664)	(04037)	(82676)	(04024)
JAN										
24...	<.007	<.003	<.007	<.002	<.010	<.006	<.011	<.015	.004	<.010
25...	<.007	<.003	<.007	<.002	<.010	<.006	<.011	<.015	<.004	<.010
26...	e.003	<.003	<.007	<.002	<.010	<.006	<.011	<.015	<.004	<.010
27...	e.005	<.003	<.007	<.002	<.010	<.006	<.011	<.015	e.003	<.010
28...	<.007	<.003	<.007	<.002	<.010	<.006	<.011	<.015	<.004	<.010
FEB										
09...	<.007	<.003	<.007	<.002	<.010	<.006	<.011	<.015	<.004	<.010
10...	<.007	<.003	<.007	<.002	<.010	<.006	<.011	<.015	.007	<.010
11...	<.007	<.003	<.007	<.002	<.010	<.006	<.011	<.015	.010	<.010
12...	<.007	<.003	<.007	<.002	<.010	<.006	<.011	<.015	.005	<.010
13...	.009	<.003	<.007	<.002	<.010	<.006	<.011	<.015	.006	<.010
14...	<.007	<.003	<.007	<.002	<.010	<.006	<.011	<.015	.009	<.010

DATE	PRO- PANIL WATER FLTRD 0.7 U	PRO- PARGITE WATER FLTRD 0.7 U	SI- MAZINE, WATER, DISS, REC (UG/L)	TEBU- THIURON WATER FLTRD 0.7 U	TER- BACIL WATER FLTRD 0.7 U	TER- BUFOS WATER FLTRD 0.7 U	THIO- BENCARB WATER FLTRD 0.7 U	TRIAL- LATE WATER FLTRD 0.7 U	TRI- FLUR- ALIN WAT FLT 0.7 U
	(82679)	(82685)	(04035)	(82670)	(82665)	(82675)	(82681)	(82678)	(82661)
JAN									
24...	<.011	<.023	e.007	e.007	<.034	<.017	.007	<.002	<.009
25...	<.011	<.023	e.011	e.007	<.034	<.017	.009	<.002	<.009
26...	e.002	<.023	e.007	e.006	<.034	<.017	.007	<.002	<.009
27...	e.002	<.023	.019	e.007	<.034	<.017	.006	<.002	<.009
28...	<.011	<.023	.073	<.016	<.034	<.017	<.005	<.002	<.009
FEB									
09...	<.011	<.023	<.011	<.016	<.034	<.017	.006	<.002	<.009
10...	<.011	<.023	<.011	<.016	<.034	<.017	.006	<.002	<.009
11...	<.011	<.023	e.009	<.016	<.034	<.017	.008	<.002	<.009
12...	<.011	<.023	.031	<.016	<.034	<.017	.006	<.002	<.009
13...	<.011	<.023	.037	<.016	<.034	<.017	.007	<.002	<.009
14...	<.011	<.023	.025	<.016	<.034	<.017	.007	<.002	<.009

< Actual value is known to be less than the value shown.  
e Estimated.

## SACRAMENTO RIVER BASIN

390020121344201 FEATHER RIVER BELOW STAR BEND, NEAR NICOLAUS, CA

LOCATION.—Lat 39°00'20", long 121°34'42", in SE 1/4 NE 1/4 sec.1, T.13 N, R.3 E, Yuba County, Hydrologic Unit 18020106, on Feather River, and 8 mi upstream of Highway 99 bridge.

DRAINAGE AREA.—Not determined.

PERIOD OF RECORD.—January 2001 to February 2001.

CHEMICAL DATA: January 2001 to February 2001.

REMARKS.—Discharge values were ADCP measured.

## WATER-QUALITY DATA, WATER YEAR OCTOBER 2000 TO SEPTEMBER 2001

DATE	TIME	DIS- CHARGE, CUBIC FEET	2,6-DI- ETHYL WAT FLT	ACETO- CHLOR, WATER	ALA- CHLOR, WATER, DISS,	ALA- CHLOR, WATER, DISS,	ALPHA BHC	ALPHA DIS- SOLVED	ATRA- ZINE, WATER, DISS,	BEN- FLUR- ALIN WAT FLD	BUTYL- ATE, WATER, DISS,	CAR- BARYL FLTRD	CARBO- FURAN WATER FLTRD	CHLOR- PYRIFOS DIS- SOLVED	CYANA- ZINE, WATER, DISS, REC
		(00061)	(82660)	(49260)	(46342)	(34253)	(39632)	(82673)	(04028)	(82680)	(82674)	(38933)	(04041)		
JAN															
24...	1520	3130	<.002	<.004	<.002	<.005	<.007	<.010	<.002	<.041	<.020	<.005	<.018		
25...	1300	3120	<.002	<.004	<.002	<.005	<.007	<.010	<.002	e.004	<.020	<.005	<.018		
26...	1400	3870	<.002	<.004	<.002	<.005	<.007	<.010	<.002	<.040	<.020	e.002	<.018		
27...	1330	3630	<.002	<.004	<.002	<.005	e.003	<.010	<.002	<.041	--	e.002	<.018		
28...	1230	3170	<.002	<.004	<.002	<.005	e.002	<.010	<.002	<.041	<.060	<.005	<.018		
FEB															
10...	1300	3140	<.002	<.004	<.002	<.005	<.007	<.010	<.002	<.041	<.020	<.005	<.018		
11...	1330	4250	<.002	<.004	<.002	<.005	<.007	<.010	<.002	<.041	<.020	<.005	<.018		
12...	1300	5520	<.002	<.004	<.002	<.005	<.007	<.010	<.002	<.041	<.020	<.005	<.018		
13...	1130	4470	<.002	<.004	<.002	<.005	<.007	<.010	<.002	<.041	<.020	<.005	<.018		
14...	1040	3570	<.002	<.004	<.002	<.005	<.007	<.010	<.002	<.041	e.009	<.005	<.018		
DATE	GF, REC	DEETHYL ATRA- ZINE, FLTRD	DI- AZINON, DIS- SOLVED	DI- ELDRIN DIS- SOLVED	DISUL- FOTON WATER FLTRD	EPTC WATER FLTRD	ETHAL- FLUR- ALIN WAT FLT	ETHO- PROP WATER FLTRD	FONOFOFOS WATER DISS	LINDANE DIS- SOLVED	LIN- URON WATER FLTRD	MALA- THION, DIS- SOLVED	METHYL AZIN- PHOS WAT FLT		
		(82682)	(04040)	(39572)	(39381)	(82677)	(82668)	(82663)	(82672)	(04095)	(39341)	(82666)	(39532)	(82686)	
JAN															
24...	<.003	<.006	.031	<.005	<.021	<.002	<.009	<.005	<.003	<.004	<.035	<.027	<.050		
25...	<.003	<.006	.015	<.005	<.021	<.002	<.009	<.005	<.003	<.004	<.035	<.027	<.050		
26...	<.003	<.006	.026	<.005	<.021	<.002	<.009	<.005	<.003	<.004	<.035	<.027	<.050		
27...	<.003	<.006	.015	<.005	<.021	<.002	<.009	<.005	<.003	<.004	<.035	<.027	<.050		
28...	<.003	<.006	.009	<.005	<.021	<.002	<.009	<.005	<.003	<.004	<.035	<.027	<.050		
FEB															
10...	<.003	<.006	.015	<.005	<.021	<.002	<.009	<.005	<.003	<.004	<.035	<.027	<.050		
11...	<.003	<.006	.012	<.005	<.021	<.002	<.009	<.005	<.003	<.004	<.035	<.027	<.050		
12...	<.003	<.006	.013	<.005	<.021	<.002	<.009	<.005	<.003	<.004	<.035	<.027	<.050		
13...	<.003	<.006	.013	<.005	<.021	<.002	<.009	<.005	<.003	<.004	<.035	<.027	<.050		
14...	<.003	<.006	.024	<.005	<.021	<.002	<.009	<.005	<.003	<.004	<.035	<.027	<.050		
DATE	GF, REC	METHYL PARA- THION	METRI- BUZIN WATER	MOL- INATE WATER FLTRD	NAPROP- AMIDE WATER FLTRD	P, P' DDE	PARA- THION, DIS- SOLVED	PEB- ULATE WATER FILTRD	PENDI- METH- ALIN WAT FLT	PER- METHRIN CIS WAT FLT	PHORATE WATER FLTRD	PRO- METON, WATER, DISS,	PRON- AMIDE WATER FLTRD		
		(82667)	(39415)	(82630)	(82671)	(82684)	(34653)	(39542)	(82669)	(82683)	(82687)	(82664)	(04037)	(82676)	
JAN															
24...	<.006	<.013	<.006	.027	<.007	<.003	<.007	<.002	<.010	<.006	<.011	<.015	<.004		
25...	<.006	<.013	<.006	.020	<.007	<.003	<.007	<.002	<.010	<.006	<.011	<.015	<.004		
26...	<.006	<.013	<.006	.025	<.007	<.003	<.007	<.002	<.010	<.006	<.011	<.015	<.004		
27...	<.006	<.013	<.006	.014	<.007	<.003	<.007	<.002	<.010	<.006	<.011	<.015	<.004		
28...	<.006	<.013	<.006	.011	<.007	<.003	<.007	<.002	<.010	<.006	<.011	<.015	<.004		
FEB															
10...	<.006	<.013	<.006	.016	<.007	<.003	<.007	<.002	<.010	<.006	<.011	<.015	<.004		
11...	<.006	<.013	<.006	.015	<.007	<.003	<.007	<.002	<.010	<.006	<.011	<.015	<.004		
12...	<.006	<.013	<.006	.011	.010	<.003	<.007	<.002	<.010	<.006	<.011	<.015	<.004		
13...	<.006	<.013	<.006	.011	<.007	<.003	<.007	<.002	<.010	<.006	<.011	<.015	<.004		
14...	<.006	<.013	<.006	.007	<.007	<.003	<.007	<.002	<.010	<.006	<.011	<.015	<.004		

< Actual value is known to be less than value shown.  
e Estimated.

## SACRAMENTO RIVER BASIN

390020121344201 FEATHER RIVER BELOW STAR BEND, NEAR NICOLAUS, CA—Continued

## WATER-QUALITY DATA, WATER YEAR OCTOBER 2000 TO SEPTEMBER 2001

DATE	PROPA- CHLOR, WATER, DISS, REC (UG/L) (04024)	PRO- PANIL WATER FLTRD GF, REC (UG/L) (82679)	PRO- PARGITE WATER FLTRD GF, REC (UG/L) (82685)	SI- MAZINE, WATER, DISS, REC (UG/L) (04035)	TEBU- THIURON WATER FLTRD GF, REC (UG/L) (82670)	TER- BACIL WATER FLTRD GF, REC (UG/L) (82665)	TER- BUFOS WATER FLTRD GF, REC (UG/L) (82675)	THIO- BENCARB WATER FLTRD GF, REC (UG/L) (82681)	TRIAL- LATE WATER FLTRD GF, REC (UG/L) (82678)	TRI- FLUR- ALIN WAT FLT GF, REC (UG/L) (82661)
JAN										
24...	<.010	<.011	<.023	e.009	e.010	<.034	<.017	.008	<.002	<.009
25...	<.010	<.011	<.023	e.010	e.009	<.034	<.017	.007	<.002	<.009
26...	<.010	<.011	<.023	.025	e.008	<.034	<.017	.007	<.002	<.009
27...	<.010	e.003	<.023	.019	e.008	<.034	<.017	e.005	<.002	<.009
28...	<.010	e.002	<.023	.017	e.009	<.034	<.017	e.004	<.002	<.009
FEB										
10...	<.010	<.011	<.023	<.011	<.016	<.034	<.017	<.005	<.002	<.009
11...	<.010	<.011	<.023	e.005	<.016	<.034	<.017	.006	<.002	<.009
12...	<.010	<.011	<.023	.012	<.016	<.034	<.017	<.005	<.002	<.009
13...	<.010	<.011	<.023	.017	<.016	<.034	<.017	e.004	<.002	<.009
14...	<.010	<.011	<.023	.023	<.016	<.034	<.017	.005	<.002	<.009

< Actual value is known to be less than value shown.  
e Estimated.



*THIS  
PAGE  
INTENTIONALLY  
LEFT  
BLANK*

	Page		Page
<b>A</b>			
ACCESS TO USGS WATER DATA .....	11	BEAR RIVER BELOW DRUM AFTERBAY, NEAR BLUE CANYON .....	312
Accuracy of the Records .....	7	BEAR RIVER BELOW DUTCH FLAT AFTERBAY, NEAR DUTCH FLAT .....	313
Acid neutralizing capacity, definition of .....	13	BEAR RIVER BELOW ROLLINS DAM, NEAR COLFAX .....	318
Acre-foot, definition of .....	13	BEAR RIVER CANAL INTAKE NEAR COLFAX .....	316
Adenosine triphosphate, definition of .....	13	BEAR RIVER FISH RELEASE BELOW NEW CAMP FAR WEST RESERVOIR, NEAR WHEATLAND .....	320
Algae		BEAR RIVER NEAR EMIGRANT GAP .....	311
Blue-green, definition of .....	14	BEAR RIVER NEAR WHEATLAND .....	321
Euglenoids, definition of .....	16	Bed material, definition of .....	13
Fire, definition of .....	16	Bedload discharge, definition of .....	13
Green, definition of .....	16	Bedload, definition of .....	13
Algal growth potential, definition of .....	13	Belden Powerplant .....	180
Alkalinity, definition of .....	13	Benthic organisms, definition of .....	14
Almanor–Butt Creek Tunnel at Outlet .....	177	Biochemical oxygen demand (BOD), definition of .....	14
Alpine County, location of discharge stations in .....	29	Biomass	
Alta Powerplant .....	257	Pigment ratio, definition of .....	14
Amador County, location of discharge stations in .....	30	Biomass, definition of .....	14
Ambient blank .....	10	Biovolume, definition of .....	14
AMERICAN RIVER AT FAIR OAKS .....	392	Blank Samples .....	10
AMERICAN RIVER AT WILLIAM B. POND PARK, AT CARMICHAEL .....	396	BLUE LAKE NEAR EMIGRANT GAP .....	262
American River Basin, Middle Fork, diversions and storage in .....	333	Blue-green algae, definition of .....	14
American River Basin, South Fork, diversions and storage in .....	365	BOD (See "Biochemical oxygen demand") .....	14
AMERICAN RIVER BELOW FOLSOM DAM, NEAR FOLSOM .....	390	Bottom material (See "Bed material") .....	14
AMERICAN RIVER BELOW WATT AVENUE BRIDGE, NEAR CARMICHAEL .....	398	BOWMAN LAKE NEAR GRANITEVILLE .....	278
ANALYSES OF SAMPLES COLLECTED		Bowman–Spaulding Canal .....	280
AT WATER-QUALITY PARTIAL-RECORD SITES .....	444	BOWMAN–SPAULDING CANAL AT JORDAN CREEK SIPHON VENTURI, NEAR EMIGRANT GAP .....	279
ANDERSON–COTTONWOOD IRRIGATION DISTRICT CANAL AT SHARON STREET, AT REDDING .....	93	Brophy South Canal .....	299
Annual 7-day minimum, definition of .....	13	Browns Valley Irrigation Ditch .....	299
Annual mean, explanation of .....	6	BRUSH CREEK BELOW BRUSH CREEK DAM, NEAR POLLOCK PINES .....	381
Annual runoff, definition of .....	13	BUCK–LOON TUNNEL NEAR MEEKS BAY .....	345
Annual runoff, explanation of .....	7	BUCKS CREEK BELOW DIVERSION DAM, NEAR BUCKS LODGE .....	189
Annual total, explanation of .....	6	Bucks Creek Powerplant .....	192
Aquifer, water table, definition of .....	24	BUCKS LAKE NEAR BUCKS LODGE .....	187
Arbuckle Mountain Powerplant .....	106	BUTT CREEK BELOW ALMANOR–BUTT CREEK TUNNEL, NEAR PRATTVILLE .....	177
ARCADE CREEK NEAR DEL PASO HEIGHTS .....	402	Butt Valley Powerplant .....	175
Aroclor, definition of .....	13	BUTT VALLEY RESERVOIR NEAR CARIBOU .....	179
Arrangement of Records .....	8	Butte County, location of discharge and water-quality stations .....	31
Artificial substrate, definition of .....	13	BUTTE CREEK BELOW CENTERVILLE DIVERSION DAM, NEAR PARADISE .....	143
Ash mass, definition of .....	13	BUTTE CREEK BELOW DIVERSION DAM, NEAR STIRLING CITY .....	141
<b>B</b>			
Bacteria		BUTTE CREEK BELOW FORKS OF BUTTE DIVERSION DAM, NEAR DE SABLE .....	142
Enterococcus, definition of .....	15	BUTTE CREEK NEAR CHICO .....	145
Escherichia coli (E. Coli), definition of .....	16	Butte Powerplant .....	142
Fecal coliform, definition of .....	16	<b>C</b>	
Fecal streptococcal, definition of .....	16	C. perfringens, definitions of .....	14
Total coliform, definition of .....	23	CACHE CREEK AT YOLO .....	433
Bacteria, definition of .....	13	CACHE CREEK NEAR LOWER LAKE .....	422
BAILEY CREEK BELOW DIVERSION TO PONDEROSA–BAILEY CREEK POWERPLANT, NEAR MANTON .....	113	Camino Powerplant .....	379
BANGOR CANAL BELOW MINERS RANCH RESERVOIR, NEAR OROVILLE .....	171	CAMP CREEK NEAR PULGA .....	196
Base discharge (for peak discharge), definition of .....	13	CAMPTONVILLE TUNNEL AT INTAKE, NEAR CAMPTONVILLE .....	223
Base flow, definition of .....	13	Canister blank .....	10
Battle Creek and Cow Creek Basins, diversions and storage in .....	99	CANYON CREEK BELOW BOWMAN LAKE .....	280
BATTLE CREEK BELOW COLEMAN FISH HATCHERY, NEAR COTTONWOOD .....	120	CANYON CREEK BELOW FAUCHERIE LAKE, NEAR CISCO .....	273
BEAR CREEK ABOVE HOLSTEN CHIMNEY CANYON, NEAR RUMSEY .....	431	CANYON CREEK BELOW FRENCH LAKE, NEAR CISCO .....	271
Bear River Basin, diversions and storage in .....	255		

	Page		Page
CANYON CREEK BELOW SAWMILL LAKE, NEAR GRANITEVILLE .....	275	DEADWOOD CREEK NEAR STRAWBERRY VALLEY .....	236
CANYON CREEK BELOW TOWLE DIVERSION DAM, NEAR BLUE CANYON .....	330	Deadwood Creek Powerplant .....	236
CANYON CREEK NEAR BLUE CANYON .....	329	DEER CREEK NEAR SMARTVILLE .....	305
CAPLES CREEK RELEASE BELOW CAPLES DAM, NEAR KIRKWOOD .....	372	DEER CREEK NEAR VINA .....	130
CAPLES LAKE NEAR KIRKWOOD .....	371	Deer Creek Powerplant .....	259
Caribou Powerplants .....	179	DEFINITION OF TERMS .....	13
CARR LAKE NEAR GRANITEVILLE .....	268	Diatoms, definition of .....	15
Cells volume (biovolume), definition of .....	14	Diel, definition of .....	15
Cells/volume, definition of .....	14	Discharge	
Centerville Powerplant .....	143	Base, definition of .....	13
Cfs-day (See "Cubic foot per second-day") .....	14	Bedload, definition of .....	13
Change in National Trends Network Procedures .....	51	Instantaneous, definition of .....	17
Chemical oxygen demand (COD), definition of .....	14	Mean, definition of .....	17
Chicago Park Flume .....	313	Peak, definition of .....	13
Classification of Records .....	8	Total sediment, definition of .....	23
Clay, definition of .....	19	Total, definition of .....	23
CLEAR CREEK NEAR IGO .....	97	Discharge measurements made at miscellaneous sites during water year 2001 .....	442
CLEAR LAKE AT LAKEPORT .....	421	Discharge, definition of .....	15
Clostridium perfringens, definition of .....	14	DISCONTINUED CONTINUOUS WATER-QUALITY STATIONS .....	xix
COD (See "Chemical oxygen demand") .....	14	DISCONTINUED LAKES AND RESERVOIRS .....	xix
COLEMAN POWERPLANT NEAR COTTONWOOD .....	111	Dissolved oxygen, definition of .....	15
Coliphages, definition of .....	14	Dissolved Trace-Element Concentrations .....	51
COLLETT RESERVOIR NEAR LITTLE VALLEY .....	59	Dissolved, definition of .....	15
Color unit, definition of .....	14	Dissolved-solids concentration, definition of .....	15
Colusa County, location of discharge and water-quality stations .....	32	Diversions and storage	
Conductivity, definition of .....	21	American River Basin, Middle Fork .....	333
Confined aquifer, definition of .....	14	American River Basin, South Fork .....	365
Contents, definition of .....	14	Battle Creek and Cow Creek Basins .....	99
Continuing-record station .....	8	Bear River Basin .....	255
Continuous-record station, definition of .....	14	Cow Creek and Battle Creek Basins .....	99
Control structure, definition of .....	14	Feather River at Lake Oroville .....	202
Control, definition of .....	14	Feather River Basin, North Fork .....	173
COOPERATION .....	1	Feather River Basin, South Fork .....	157
Cooperation paragraph .....	5	Lower Sacramento River Basin .....	135
COTTONWOOD CREEK NEAR COTTONWOOD .....	107	Middle and North Yuba River Basins .....	214
Cow Creek and Battle Creek Basins, diversions and storage in .....	99	Middle Fork American and Rubicon River Basins .....	333
COW CREEK NEAR MILLVILLE .....	104	North and Middle Yuba River Basins .....	214
Cresta Powerplant .....	194	North Fork Feather River Basin .....	173
Cross-Sectional Data .....	9	Pit and McCloud River Basins .....	53
Cubic foot per second per day, definition of .....	14	Rubicon River Basin .....	333
Cubic foot per second per square mile, definition of .....	14	Sacramento River Basin, lower .....	135
Cubic foot per second, definition of .....	14	Sacramento River Basin, upper .....	92
CULBERTSON LAKE NEAR GRANITEVILLE .....	286	South Fork American River Basin .....	365
		South Fork Feather River Basin .....	157
		South Yuba River Basin .....	249
		Upper Sacramento River Basin .....	92
		Yuba River Basin, south .....	249
		Yuba River Basins, north and middle .....	214
D		Diversity index, definition of .....	15
Daily mean suspended-sediment concentration, definition of .....	15	Dog Creek at Delta .....	442
Daily mean values, data table of .....	6	Downstream Order System .....	3
Daily-record station, definition of .....	15	Drainage area paragraph .....	5
Data Collection and Computation .....	4	Drainage area, definition of .....	15
Data Collection Platform, definition of .....	15	Drainage basin, definition of .....	15
Data logger, definition of .....	15	DRUM CANAL AT TUNNEL OUTLET, NEAR EMIGRANT GAP .....	257
Data Precision .....	51	Drum No. 1 and 2 Powerplants .....	257
Data Presentation .....	5, 11	DRY CREEK AT VERNON STREET BRIDGE, AT ROSEVILLE .....	400
Datum		Dry mass, definition of .....	15
Gage, definition of .....	16	Dry weight, definition of .....	15
Land-surface, definition of .....	17	DUNCAN CANYON CREEK BELOW DIVERSION DAM, NEAR FRENCH MEADOWS .....	339
NAVD of 1988, definition of .....	18	DUNCAN CANYON CREEK NEAR FRENCH MEADOWS .....	337
NGVD of 1929, definition of .....	18	Dutch Flat No. 1 Powerplant .....	312
Datum, definition of .....	15	Dutch Flat No. 2 Flume .....	312
DAVIS CREEK AT KNOXVILLE .....	428		
De Sabla Powerplant .....	144		

Page	Page
E	
EAST FORK NELSON CREEK BELOW DIVERSION TO NELSON CREEK, NEAR BIG BEND .....	73
EAST PARK RESERVOIR NEAR STONYFORD .....	136
Edward Hyatt Powerplant .....	203
EL DORADO CANAL AND SOUTH FORK AMERICAN RIVER	
NEAR KYBURZ (combined) .....	375
ELDER CREEK NEAR PASKENTA .....	124
Enterococcus bacteria, definition of .....	15
EPT Index, definition of .....	16
Equipment blank .....	10
Escherichia coli (E. coli), definition of .....	16
Estimated (E) value, definition of .....	16
Euglenoids, definition of .....	16
EXPLANATION OF THE RECORDS .....	3
Extractable organic halides, definition of .....	16
Extremes for current year paragraph .....	5
Extremes for period of record paragraph .....	5
Extremes outside period of record paragraph .....	5
F	
FAUCHERIE LAKE NEAR CISCO .....	272
Feather River at Lake Oroville, diversions and storage from .....	202
FEATHER RIVER AT OROVILLE .....	212
Feather River Basin, North Fork, diversions and storage in .....	173
Feather River Basin, South Fork, diversions and storage in .....	157
FEATHER RIVER BELOW STAR BEND, NEAR NICOLAUS .....	448
Feather River Fish Hatchery .....	212
Fecal coliform bacteria, definition of .....	16
Fecal streptococcal bacteria, definition of .....	16
FEELEY LAKE NEAR GRANITEVILLE .....	266
Field blank .....	10
Filer feeder, definition of .....	23
Filter blank .....	10
Fire algae, definition of .....	16
Flow	
Annual 7-day minimum, definition of .....	13
Base, definition of .....	13
Peak, definition of .....	19
Seven-day 10-year low flow, definition of .....	21
Streamflow, definition of .....	21
Flow-duration percentiles, definition of .....	16
FOLSOM LAKE NEAR FOLSOM .....	389
Forbestown Powerplant .....	168
FORDYCE CREEK BELOW FORDYCE DAM, NEAR CISCO .....	254
FORDYCE LAKE NEAR CISCO .....	253
FRENCH LAKE NEAR CISCO .....	270
French Meadows Powerplant .....	335
FRENCH MEADOWS RESERVOIR NEAR FORESTHILL .....	334
G	
Gage datum, definition of .....	16
Gage height, definition of .....	16
Gage paragraph .....	5
Gage values, definition of .....	16
Gaging station, definition of .....	16
GAGING STATIONS, DISCONTINUED .....	xiv
Gas chromatography/flame ionization detector, definition of .....	16
GERLE CREEK BELOW LOON LAKE DAM, NEAR MEEKS BAY .....	350
Glenn County, location of discharge stations in .....	34
Gravel, definition of .....	19
Green algae, definition of .....	16
GRIZZLY CREEK BELOW DIVERSION DAM, NEAR STORRIE .....	192
GRIZZLY FOREBAY NEAR STORRIE .....	191
Grizzly Powerplant .....	189
H	
Habitat quality index, definition of .....	16
Hallwood-Cordova Irrigation Ditch .....	299
Halsey Powerplant .....	316
Hardness, definition of .....	16
HARLEY GULCH NEAR WILBUR SPRINGS .....	427
HAT CREEK BELOW HAT NO. 1 DIVERSION DAM, NEAR BURNEY .....	65
HAT CREEK NO. 1 POWERPLANT NEAR BURNEY .....	66
Hat Creek No. 2 Powerplant .....	66
HAT NO. 2 POWER CANAL DIVERSION TO HAT CREEK, NEAR BURNEY .....	67
HATCHET CREEK BELOW DIVERSION TO HATCHET CREEK POWERPLANT, NEAR MONTGOMERY CREEK .....	78
Hatchet Creek Powerplant .....	78
HELL HOLE RESERVOIR NEAR MEEKS BAY .....	347
Herbivore, definition of .....	23
High tide, definition of .....	16
Highest annual mean, explanation of .....	6
Highest daily mean, explanation of .....	7
Hilsenhoff's Biotic Index, definition of .....	17
Horizontal datum (See "Datum") .....	17
Hydrologic Benchmark Network .....	2
Hydrologic benchmark station, definition of .....	17
Hydrologic index stations, definition of .....	17
Hydrologic unit, definition of .....	17
I	
Identifying Estimated Daily Discharge .....	7
Inch, definition of .....	17
INSKIP POWERPLANT NEAR MANTON .....	111
Instantaneous discharge, definition of .....	17
Instantaneous low flow, explanation of .....	7
Instantaneous peak flow, explanation of .....	7
Instantaneous peak stage, explanation of .....	7
INTRODUCTION .....	1
Invertivore, definition of .....	23
IRON CANYON CREEK BELOW IRON CANYON DAM, NEAR BIG BEND .....	77
IRON CANYON RESERVOIR NEAR BIG BEND .....	68
J	
JACKSON CREEK BELOW JACKSON LAKE, NEAR SIERRA CITY .....	277
JACKSON LAKE NEAR SIERRA CITY .....	276
JACKSON MEADOWS RESERVOIR NEAR SIERRA CITY .....	215
JAMES B. BLACK POWERPLANT NEAR BIG BEND .....	76
Jaybird Powerplant .....	378
Jones Fork Powerplant .....	376
JUDGE FRANCIS CARR POWERPLANT NEAR FRENCH GULCH .....	94
K	
KELLY LAKE NEAR CISCO .....	328
Kelly Ridge Powerplant .....	170
KELSEY CREEK NEAR KELSEYVILLE .....	419

	Page		Page
KILARC CANAL DIVERSION TO OLD COW CREEK, NEAR WHITMORE .....	101	Lakes and reservoirs—Continued	
L		SILVER LAKE NEAR KIRKWOOD .....	368
Laboratory Measurements .....	9	SLY CREEK RESERVOIR NEAR STRAWBERRY VALLEY .....	164
Laboratory Reporting Level, definition of .....	17	STONY GORGE RESERVOIR NEAR ELK CREEK .....	136
LAKE ALMANOR AT PRATTVILLE .....	174	THERMALITO AFTERBAY NEAR OROVILLE .....	206
LAKE ALOHA NEAR PHILLIPS .....	366	UPPER CASCADE LAKE NEAR SODA SPRINGS .....	247
LAKE BERRYESSA NEAR WINTERS .....	437	UPPER LINDSEY LAKE NEAR GRANITEVILLE .....	288
LAKE BRITTON NEAR BURNEY .....	68	WHISKEYTOWN LAKE NEAR IGO .....	96
Lake County, location of discharge stations .....	35	WHITE ROCK LAKE NEAR SODA SPRINGS .....	250
LAKE CREEK BELOW CARR LAKE, NEAR GRANITEVILLE .....	269	Land-surface datum, definition of .....	17
LAKE CREEK BELOW FEELEY LAKE, NEAR GRANITEVILLE .....	267	Lassen County, location of discharge and water-quality stations .....	36
LAKE McCLOUD NEAR McCLOUD .....	68	Latitude-Longitude System .....	3
LAKE OROVILLE NEAR OROVILLE .....	203	Light-attenuation coefficient, definition of .....	17
LAKE SPAULDING NEAR EMIGRANT GAP .....	256	LINDSEY CREEK BELOW LOWER LINDSEY LAKE, NEAR GRANITEVILLE .....	292
LAKE STERLING NEAR CISCO .....	252	LINDSEY CREEK BELOW MIDDLE LINDSEY LAKE .....	290
Lake Valley Canal .....	327	Lipid, definition of .....	17
LAKE VALLEY RESERVOIR NEAR CISCO .....	327	LITTLE GRASS VALLEY RESERVOIR NEAR LA PORTE .....	158
Lakes and reservoirs:		LITTLE RUBICON RIVER BELOW BUCK ISLAND DAM, NEAR MEEKS BAY .....	346
BLUE LAKE NEAR EMIGRANT GAP .....	262	Location paragraph .....	5
BOWMAN LAKE NEAR GRANITEVILLE .....	278	LOHMAN RIDGE TUNNEL AT INTAKE, NEAR CAMPTONVILLE .....	221
BUCKS LAKE NEAR BUCKS LODGE .....	187	Long-Term Method Detection Level, definition of .....	17
BUTT VALLEY RESERVOIR NEAR CARIBOU .....	179	Loon Lake Powerplant .....	350
CAPLES LAKE NEAR KIRKWOOD .....	371	LOST CREEK BELOW DIVERSION TO LOST CREEK POWERPLANT NO. 1, NEAR OLD STATION .....	64
CARR LAKE NEAR GRANITEVILLE .....	268	LOST CREEK NEAR CLIPPER MILLS .....	166
CLEAR LAKE AT LAKEPORT .....	421	LOST CREEK POWERPLANT NO. 1 .....	64
COLLETT RESERVOIR NEAR LITTLE VALLEY .....	59	Low flow, 7-day 10-year, definition of .....	21
CULBERTSON LAKE NEAR GRANITEVILLE .....	286	Low tide, definition of .....	17
EAST PARK RESERVOIR NEAR STONYFORD .....	136	LOWER BUCKS LAKE NEAR BUCKS LODGE .....	188
FAUCHERIE LAKE NEAR CISCO .....	272	LOWER CASCADE LAKE NEAR SODA SPRINGS .....	248
FEELEY LAKE NEAR GRANITEVILLE .....	266	LOWER LINDSEY LAKE NEAR GRANITEVILLE .....	291
FOLSOM LAKE NEAR FOLSOM .....	389	LOWER ROCK LAKE NEAR GRANITEVILLE .....	284
FORDYCE LAKE NEAR CISCO .....	253	Lower Sacramento River Basin, diversions and storage in .....	135
FRENCH LAKE NEAR CISCO .....	270	Lowest annual mean, explanation of .....	7
FRENCH MEADOWS RESERVOIR NEAR FORESTHILL .....	334	Lowest daily mean, explanation of .....	7
GRIZZLY FOREBAY NEAR STORRIE .....	191		
HELL HOLE RESERVOIR NEAR MEEKS BAY .....	347	M	
IRON CANYON RESERVOIR NEAR BIG BEND .....	68	Macrophytes, definition of .....	17
JACKSON LAKE NEAR SIERRA CITY .....	276	Mass	
JACKSON MEADOWS RESERVOIR NEAR SIERRA CITY .....	215	Ash, definition of .....	13
KELLY LAKE NEAR CISCO .....	328	Biomass, definition of .....	14
LAKE ALMANOR AT PRATTVILLE .....	174	Dry, definition of .....	15
LAKE ALOHA NEAR PHILLIPS .....	366	Organic, definition of .....	19
LAKE BERRYESSA NEAR WINTERS .....	437	Wet, definition of .....	24
LAKE BRITTON NEAR BURNEY .....	68	McCLOUD RIVER ABOVE SHASTA LAKE .....	87
LAKE McCLOUD NEAR McCLOUD .....	68	McCloud River and Pit Basins, diversions and storage in .....	53
LAKE OROVILLE NEAR OROVILLE .....	203	McCLOUD RIVER AT AH-DI-NA, NEAR McCLOUD .....	85
LAKE SPAULDING NEAR EMIGRANT GAP .....	256	McCLOUD RIVER BELOW McCLOUD DAM, NEAR McCLOUD .....	84
LAKE STERLING NEAR CISCO .....	252	McCLOUD RIVER NEAR McCLOUD .....	81
LAKE VALLEY RESERVOIR NEAR CISCO .....	327	McCLOUD-IRON CANYON DIVERSION TUNNEL NEAR McCLOUD .....	83
LITTLE GRASS VALLEY RESERVOIR NEAR LA PORTE .....	158	McCumber Reservoir .....	110
LOWER BUCKS LAKE NEAR BUCKS LODGE .....	188	MEADOW LAKE NEAR CISCO .....	251
LOWER CASCADE LAKE NEAR SODA SPRINGS .....	248	Mean concentration of suspended sediment, definition of .....	17
LOWER LINDSEY LAKE NEAR GRANITEVILLE .....	291	Mean discharge, definition of .....	17
LOWER ROCK LAKE NEAR GRANITEVILLE .....	284	Mean high tide, definition of .....	18
MEADOW LAKE NEAR CISCO .....	251	Mean low tide, definition of .....	18
MIDDLE LINDSEY LAKE NEAR GRANITEVILLE .....	289	Mean sea level, definition of .....	18
NEW BULLARDS BAR RESERVOIR NEAR NORTH SAN JUAN .....	239	Measuring point, definition of .....	18
ROCK LAKE NEAR GRANITEVILLE .....	282	Membrane filter, definition of .....	18
ROLLINS RESERVOIR NEAR COLFAX .....	315	Metamorphic stage, definition of .....	18
RUCKER LAKE NEAR EMIGRANT GAP .....	264		
SAWMILL LAKE NEAR GRANITEVILLE .....	274		
SHASTA LAKE NEAR REDDING .....	89		

	Page
Method Detection Limit, definition of .....	18
Methylene blue active substance, definition of .....	18
Micrograms per gram, definition of .....	18
Micrograms per kilogram, definition of .....	18
Micrograms per liter, definition of .....	18
Microsiemens per centimeter, definition of .....	18
Middle and North Yuba River Basins, diversions and storage in .....	214
Middle Fork American and Rubicon River Basins, diversions and storage in .....	333
MIDDLE FORK AMERICAN RIVER ABOVE MIDDLE FORK POWERPLANT, NEAR FORESTHILL .....	340
MIDDLE FORK AMERICAN RIVER AT FRENCH MEADOWS .....	335
MIDDLE FORK AMERICAN RIVER BELOW INTERBAY DAM, NEAR FORESTHILL .....	341
MIDDLE FORK AMERICAN RIVER NEAR FORESTHILL .....	361
MIDDLE FORK COTTONWOOD CREEK BELOW DIVERSION TO ARBUCKLE MOUNTAIN POWERPLANT, NEAR PLATINA .....	106
Middle Fork Powerplant .....	348
MIDDLE LINDSEY LAKE NEAR GRANITEVILLE .....	289
MIDDLE YUBA RIVER BELOW MILTON DAM, NEAR SIERRA CITY .....	219
MIDDLE YUBA RIVER BELOW OUR HOUSE DAM, NEAR CAMPTONVILLE .....	222
MIDDLE YUBA RIVER CONTROLLED RELEASE AT JACKSON MEADOWS DAM, NEAR SIERRA CITY .....	216
MIDDLE YUBA RIVER NEAR NORTH SAN JUAN .....	226
MILK RANCH CONDUIT AT OUTLET, NEAR BUCKS LODGE .....	186
MILL CREEK NEAR LOS MOLINOS .....	126
Milligrams per liter, definition of .....	18
MILTON-BOWMAN TUNNEL OUTLET NEAR GRANITEVILLE .....	217
MINERS RANCH CANAL BELOW PONDEROSA DAM, NEAR FORBESTOWN .....	170
Minimum Reporting Level, definition of .....	18
Miscellaneous sampling site .....	8
Miscellaneous site, definition of .....	18
Miscellaneous sites, discharge measurements made at .....	442
Modoc County, location of discharge stations .....	37
Monthly mean data, statistics of .....	6
MORMON RAVINE NEAR NEWCASTLE .....	323
Most probable number (MPN), definition of .....	18
Muck Valley Powerplant .....	59
Multiple-plate samplers, definition of .....	18

N

Nanograms per liter, definition of .....	18
Napa County, location of discharge and water-quality stations .....	38
National Atmospheric Deposition Program .....	2
National Geodetic Vertical Datum of 1929, definition of .....	18
National Stream-Quality Accounting Network .....	2
National Trends Network .....	2
National Trends Network, change in procedures .....	8
National Water Data Exchange .....	7
National Water Information System (NWIS) .....	11
National Water-Quality Assessment Program .....	2
Natural substrate, definition of .....	18
NAVD of 1988 (See "National American Vertical Datum of 1988) .....	18
Nekton, definition of .....	18
NELSON CREEK BELOW DIVERSION TO NELSON CREEK POWERPLANT, NEAR BIG BEND .....	72
Nelson Creek Powerplant .....	72
Nephelometric turbidity unit, definition of .....	18
Nevada County, location of discharge and water-quality stations .....	39

NEW BULLARDS BAR RESERVOIR NEAR NORTH SAN JUAN ....	239
NEW COLGATE POWERPLANT NEAR FRENCH CORRAL .....	238
Newcastle Powerplant .....	323
NGVD of 1929 (See "National Geodetic Vertical Datum of 1929) .....	18
North American Vertical Datum of 1988, definition of .....	18
North and Middle Yuba River Basins, diversions and storage in .....	214
NORTH FORK AMERICAN RIVER AT AUBURN DAM SITE, NEAR AUBURN .....	363
NORTH FORK AMERICAN RIVER AT NORTH FORK DAM .....	331
NORTH FORK BATTLE CREEK BELOW DIVERSION TO CROSS COUNTRY CANAL, NEAR MANTON .....	114
NORTH FORK BATTLE CREEK BELOW DIVERSION TO EAGLE CANYON CANAL, NEAR MANTON .....	115
NORTH FORK BATTLE CREEK BELOW DIVERSION TO KESWICK DITCH, NEAR MANTON .....	112
NORTH FORK BATTLE CREEK BELOW DIVERSION TO WILDCAT CANAL, NEAR MANTON .....	116
NORTH FORK BATTLE CREEK BELOW McCUMBER DAM, NEAR MANZANITA LAKE .....	110
NORTH FORK BATTLE CREEK BELOW NORTH BATTLE CREEK DAM, NEAR MANZANITA LAKE .....	109
North Fork Battle Creek Reservoir .....	109
NORTH FORK CACHE CREEK AT HOUGH SPRINGS, NEAR CLEARLAKE OAKS .....	423
NORTH FORK CACHE CREEK NEAR CLEARLAKE OAKS .....	425
NORTH FORK FEATHER RIVER AT PULGA .....	198
North Fork Feather River Basin, diversions and storage in .....	173
NORTH FORK FEATHER RIVER BELOW BELDEN DAM .....	180
NORTH FORK FEATHER RIVER BELOW GRIZZLY CREEK .....	194
NORTH FORK FEATHER RIVER BELOW POE DAM .....	197
NORTH FORK FEATHER RIVER BELOW ROCK CREEK DIVERSION DAM .....	185
NORTH FORK FEATHER RIVER NEAR PRATTVILLE .....	175
NORTH FORK LONG CANYON CREEK BELOW DIVERSION DAM, NEAR VOLCANOVILLE .....	360
NORTH FORK LONG CANYON CREEK DIVERSION TUNNEL NEAR VOLCANOVILLE .....	359
NORTH YUBA RIVER BELOW GOODYEARS BAR .....	232
NORTH YUBA RIVER BELOW NEW BULLARDS BAR DAM, NEAR NORTH SAN JUAN .....	240

O

OLD COW CREEK BELOW DIVERSION TO OLSEN POWERPLANT, NEAR WHITMORE .....	102
Olsen Powerplant .....	102
Omnivore, definition of .....	23
Onsite Measurements and Sample Collection .....	8
Open or screened interval, definition of .....	18
OREGON CREEK BELOW LOG CABIN DAM, NEAR CAMPTONVILLE .....	224
Organic carbon, definition of .....	19
Organic mass, definition of .....	19
Organism count/area, definition of .....	19
Organism count/volume, definition of .....	19
Organisms Benthic, definition of .....	14
Organochlorine compounds, definition of .....	19
OROVILLE-WYANDOTTE CANAL NEAR CLIPPER MILLS .....	165
Other Records Available .....	7
OWL GULCH NEAR STRAWBERRY VALLEY .....	237
Oxbow Powerplant .....	361

	Page		Page
P			
PACIFIC GAS & ELECTRIC CO. LATERAL AT INTAKE, NEAR OROVILLE .....	209	Primary productivity	
PALERMO CANAL NEAR OROVILLE .....	205	Carbon method, definition of .....	20
Parameter Code, definition of .....	19	Oxygen method, definition of .....	20
Partial-record station .....	8	Primary productivity, definition of .....	20
Partial-record station, definition of .....	19	Principal inflows and diversions, Sacramento–San Joaquin Delta .....	441
Partial-record stations, discharge measurements made at .....	442	Pump blank .....	10
Particle size, definition of .....	19	PUTAH CREEK NEAR GUENOC .....	435
Particle-size classification		PUTAH CREEK NEAR WINTERS .....	438
Clay, definition of .....	19	PUTAH SOUTH CANAL NEAR WINTERS .....	440
Gravel, definition of .....	19	PYRAMID CREEK AT TWIN BRIDGES .....	367
Sand, definition of .....	19		
Silt, definition of .....	19	Q	
Particle-size classification, definition of .....	19	Quality-Control Data .....	10
PCBs (See Polychlorinated biphenyls) .....	20		
PCNs (See "Polychlorinated naphthalenes") .....	20	R	
Peak flow (peak stage), definition of .....	19	Radioisotopes, definition of .....	20
Peak stage, definition of .....	19	Ralston Powerplant .....	341
Percent composition (percent of total), definition of .....	19	Records of Stage and Water Discharge .....	3
Percent shading, definition of .....	19	Records of Surface-Water Quality .....	8
Period of record paragraph .....	5	Recoverable from bed (bottom) material, definition of .....	20
Periodic-record station, definition of .....	19	Recurrence interval, definition of .....	20
Periphyton, definition of .....	19	Reference Samples .....	10
Pesticides, definition of .....	19	Remarks Codes .....	51
pH, definition of .....	19	Remarks paragraph .....	5
PHILBROOK CREEK BELOW PHILBROOK DAM, NEAR BUTTE MEADOWS .....	200	Replicate Samples .....	10
Phytoplankton, definition of .....	20	Concurrent sample .....	10
Picocurie, definition of .....	20	Sequential samples .....	10
PILOT CREEK ABOVE STUMPY MEADOWS LAKE .....	354	Split sample .....	10
PILOT CREEK BELOW MUTTON CANYON, NEAR GEORGETOWN .....	356	Replicate samples, definition of .....	20
Piscivore, definition of .....	23	RESERVOIRS IN PIT AND McCLOUD RIVER BASINS .....	68
Pit and McCloud River Basins, diversions and storage in .....	53	RESERVOIRS IN STONY CREEK BASIN .....	136
PIT NO. 1 POWERPLANT NEAR FALL RIVER MILLS .....	61	Return period (See "Recurrence interval") .....	20
Pit No. 3 Powerplant .....	70	Revised record paragraph .....	5
Pit No. 4 Powerplant .....	70	Revisions paragraph .....	6
Pit No. 5 Powerplant .....	76	RICHVALE CANAL AT INTAKE, NEAR OROVILLE .....	208
Pit No. 6 Powerplant .....	79	River mileage, definition of .....	20
Pit No. 6 Reservoir .....	79	Robbs Peak Powerplant .....	352
Pit No. 7 Reservoir .....	79	ROCK CREEK NEAR PLACERVILLE .....	384
PIT RIVER AT BIG BEND .....	74	Rock Creek Powerplant .....	384
PIT RIVER BELOW DIVERSION TO MUCK VALLEY POWERPLANT, NEAR BIEBER .....	60	ROCK LAKE NEAR GRANITEVILLE .....	282
PIT RIVER BELOW PIT NO. 1 POWERPLANT, NEAR FALL RIVER MILLS .....	62	Rollins Powerplant .....	315
PIT RIVER BELOW PIT NO. 4 DAM .....	70	ROLLINS RESERVOIR NEAR COLFAX .....	315
PIT RIVER NEAR CANBY .....	57	Rubicon River Basin, diversions and storage in .....	333
PIT RIVER NEAR MONTGOMERY CREEK .....	79	RUBICON RIVER BELOW HELL HOLE DAM, NEAR MEEKS BAY .....	348
Pit River Tunnel Flow .....	59	RUBICON RIVER BELOW RUBICON DAM, NEAR MEEKS BAY .....	344
Placer County, location of discharge and water-quality stations .....	40	RUBICON–ROCKBOUND TUNNEL NEAR MEEKS BAY .....	343
Plankton		RUCKER CREEK BELOW BLUE LAKE, NEAR EMIGRANT GAP .....	263
Phytoplankton, definition of .....	20	RUCKER CREEK BELOW RUCKER LAKE, NEAR EMIGRANT GAP .....	265
Zooplankton, definition of .....	24	RUCKER LAKE NEAR EMIGRANT GAP .....	264
Plankton, definition of .....	20	Runoff	
Plumas County, location of discharge stations .....	41	Annual, definition of .....	13
Poe Powerplant .....	198	Runoff, definition of .....	20
Polychlorinated biphenyls (PCBs), definition of .....	20		
Polychlorinated naphthalenes (PCNs), definition of .....	20	S	
PONDEROSA–BAILEY CREEK POWERPLANT .....	113	Sacramento County, location of discharge and water-quality stations .....	42
POWERPLANTS IN BATTLE CREEK AND COW CREEK BASIN .....	111	SACRAMENTO RIVER ABOVE BEND BRIDGE, NEAR RED BLUFF .....	122
Preservation blank .....	10	SACRAMENTO RIVER AT ALAMAR .....	446
		SACRAMENTO RIVER AT COLUSA .....	137

Page	Page		
SACRAMENTO RIVER AT DELTA .....	54	SOUTH FORK LONG CANYON CREEK DIVERSION TUNNEL	
SACRAMENTO RIVER AT FREEPORT .....	408	NEAR VOLCANOVILLE .....	357
SACRAMENTO RIVER AT KESWICK .....	90	SOUTH FORK PIT RIVER NEAR LIKELY .....	56
SACRAMENTO RIVER AT TOWER BRIDGE,		SOUTH FORK RUBICON RIVER BELOW GERLE CREEK,	
AT SACRAMENTO .....	444	NEAR GEORGETOWN .....	352
SACRAMENTO RIVER AT VERONA .....	324	SOUTH FORK SILVER CREEK NEAR ICE HOUSE .....	376
Sacramento River Basin, lower, diversions and storage in .....	135	SOUTH FORK TUNNEL NEAR STRAWBERRY VALLEY .....	161
Sacramento River Basin, upper, diversions and storage in .....	92	SOUTH POWERPLANT NEAR MANTON .....	111
SACRAMENTO RIVER BELOW WILKINS SLOUGH,		SOUTH YUBA CANAL NEAR EMIGRANT GAP .....	259
NEAR GRIMES .....	150	SOUTH YUBA RIVER AT JONES BAR, NEAR GRASS VALLEY .....	293
SACRAMENTO SLOUGH NEAR KNIGHTS LANDING .....	153	SOUTH YUBA RIVER AT LANGS CROSSING,	
SACRAMENTO WEIR SPILL TO YOLO BYPASS,		NEAR EMIGRANT GAP .....	261
NEAR SACRAMENTO .....	326	South Yuba River Basin, diversions and storage in .....	249
Sacramento–San Joaquin Delta, principal inflows and diversions .....	441	SOUTH YUBA RIVER CONTROLLED RELEASE AT LAKE	
Sampler blank .....	10	SPAULDING, NEAR EMIGRANT GAP .....	260
Sand, definition of .....	19	SPANISH CREEK ABOVE BLACKHAWK CREEK, AT KEDDIE .....	183
SAWMILL LAKE NEAR GRANITEVILLE .....	274	Spaulding No. 3 Powerplant .....	279
Sea level, definition of .....	21	Spaulding Powerplants Nos. 1 and 2 .....	256
Sediment .....	9	SPECIAL NETWORKS AND PROGRAMS .....	2
Sediment, definition of .....	21	Specific electrical conductance (conductivity), definition of .....	21
Seven-day 10-year low flow, definition of .....	21	Spike Samples .....	10
Shasta County, location of discharge and water-quality stations .....	43	Concurrent sample .....	11
SHASTA LAKE NEAR REDDING .....	89	Split sample .....	11
Sierra County, location of discharge stations .....	44	Splitter blank .....	10
Silt, definition of .....	19	SPRING CREEK POWERPLANT AT KESWICK .....	95
SILVER CREEK BELOW CAMINO DIVERSION DAM .....	379	Stable isotope ratio, definition of .....	21
SILVER CREEK BELOW JUNCTION DAM,		Stage	
NEAR POLLOCK PINES .....	378	Peak, definition of .....	19
Silver Lake Leakage .....	369	Stage (See "Gage height" ) .....	21
SILVER LAKE NEAR KIRKWOOD .....	368	Stage-discharge relation, definition of .....	21
SILVER LAKE OUTLET NEAR KIRKWOOD .....	369	Standpipe blank .....	10
Siskiyou County, location of discharge and water-quality stations .....	45	Station manuscript, explanation of .....	5
SLATE CREEK BELOW DIVERSION DAM,		Station-Identification Numbers .....	3
NEAR STRAWBERRY VALLEY .....	235	Stations	
SLATE CREEK TUNNEL NEAR STRAWBERRY VALLEY .....	234	Continuous-record, definition of .....	14
SLY CREEK RESERVOIR NEAR STRAWBERRY VALLEY .....	164	Daily record, definition of .....	15
Sodium adsorption ratio, definition of .....	21	Gaging, definition of .....	16
Solano County, location of discharge and water-quality stations in .....	46	Hydrologic benchmark, definition of .....	17
Source solution blank .....	10	Hydrologic index, definition of .....	17
SOUTH BRANCH WARD CREEK BELOW DIVERSION DAM,		Miscellaneous site, definition of .....	18
NEAR GENESEE .....	182	Partial-record, definition of .....	19
SOUTH COW CREEK CANAL DIVERSION TO		Periodic-record, definition of .....	19
SOUTH COW CREEK, NEAR WHITMORE .....	100	STONY GORGE RESERVOIR NEAR ELK CREEK .....	136
SOUTH FORK AMERICAN RIVER AND EL DORADO CANAL		Streamflow, definition of .....	21
NEAR KYBURZ (combined) .....	375	Substrate	
South Fork American River Basin, diversions and storage in .....	365	Artificial, definition of .....	13
SOUTH FORK AMERICAN RIVER NEAR CAMINO .....	382	Embeddedness Class, definition of .....	21
SOUTH FORK AMERICAN RIVER NEAR KYBURZ .....	373	Natural, definition of .....	18
SOUTH FORK AMERICAN RIVER NEAR PILOT HILL .....	387	Substrate, definition of .....	21
SOUTH FORK AMERICAN RIVER NEAR PLACERVILLE .....	386	SUCKER RUN AT KANAKA DIVERSION,	
SOUTH FORK BATTLE CREEK BELOW DIVERSION TO		NEAR FEATHER FALLS .....	172
COLEMAN DITCH, NEAR MANTON .....	119	SULPHUR CREEK AT WILBUR SPRINGS .....	429
SOUTH FORK BATTLE CREEK BELOW DIVERSION TO		Summary statistics, explanation of .....	6
INSKIP CANAL, NEAR MANTON .....	118	Surface area of a lake, definition of .....	21
SOUTH FORK BATTLE CREEK BELOW DIVERSION TO		Surficial bed material, definition of .....	21
SOUTH BATTLE CREEK CANAL, NEAR MANTON .....	117	Suspended	
South Fork Feather River Basin, diversions and storage in .....	157	Recoverable, definition of .....	21
SOUTH FORK FEATHER RIVER BELOW DIVERSION DAM,		Total, definition of .....	22
NEAR STRAWBERRY VALLEY .....	162	Suspended sediment	
SOUTH FORK FEATHER RIVER		Concentration, definition of .....	22
BELOW FORBESTOWN DAM .....	168	Discharge, definition of .....	22
SOUTH FORK FEATHER RIVER		Load, definition of .....	22
BELOW LITTLE GRASS VALLEY DAM .....	159	Suspended sediment, definition of .....	21
SOUTH FORK LONG CANYON CREEK		Suspended solids, total residue, definition of .....	22
BELOW DIVERSION DAM, NEAR VOLCANOVILLE .....	358	Suspended, definition of .....	21



	Page		Page
Sutter County, location of discharge and water-quality stations .....	47		
SUTTER-BUTTE CANAL AT INTAKE, NEAR OROVILLE .....	210		
Synoptic studies, definition of .....	22		
System for numbering miscellaneous sites (latitude and longitude) .....	3		
T			
Taxa richness, definition of .....	22		
Taxonomy, definition of .....	22		
TECHNIQUES OF WATER-RESOURCES INVESTIGATIONS OF THE U.S. GEOLOGICAL SURVEY .....	25		
Tehama County, location of discharge and water-quality stations .....	48		
Temperature preferences			
Cold, definition of .....	22		
Cool, definition of .....	22		
Warm, definition of .....	22		
TEXAS CREEK BELOW LOWER ROCK LAKE, NEAR GRANITEVILLE .....	285		
TEXAS CREEK BELOW ROCK LAKE .....	283		
TEXAS CREEK TRIBUTARY BELOW CULBERTSON LAKE, NEAR GRANITEVILLE .....	287		
THERMALITO AFTERBAY NEAR OROVILLE .....	206		
THERMALITO AFTERBAY RELEASE TO FEATHER RIVER, NEAR OROVILLE .....	211		
Thermalito Powerplant .....	206		
Thermograph, definition of .....	22		
Time-weighted average, definition of .....	22		
TOADTOWN CANAL ABOVE BUTTE CANAL, NEAR STIRLING CITY .....	144		
Tons per acre-foot, definition of .....	22		
Tons per day, definition of .....	22		
Total coliform bacteria, definition of .....	23		
Total discharge, definition of .....	23		
Total in bottom material, definition of .....	23		
Total length, definition of .....	23		
Total load, definition of .....	23		
Total organism count, definition of .....	23		
Total recoverable, definition of .....	23		
Total sediment discharge, definition of .....	23		
Total sediment load, definition of .....	23		
Total, definition of .....	22		
Trip blank .....	10		
Trophic groups			
Filter feeder, definition of .....	23		
Herbivore, definition of .....	23		
Invertivore, definition of .....	23		
Omnivore, definition of .....	23		
Piscivore, definition of .....	23		
Turbidity, definition of .....	23		
		U	
		Ultraviolet (UV) absorption, definition of .....	23
		UPPER CASCADE LAKE NEAR SODA SPRINGS .....	247
		UPPER LINDSEY LAKE NEAR GRANITEVILLE .....	288
		Upper Sacramento River Basin, diversions and storage in .....	92
		V	
		Vertical datum (See "Datum") .....	23
		VOCs (See "Volatile organic compounds") .....	23
		Volatile organic compounds (VOCs), definition of .....	23
		VOLTA NO. 1 POWERPLANT NEAR MANTON .....	111
		VOLTA NO. 2 POWERPLANT NEAR MANTON .....	111
		W	
		Water table, definition of .....	24
		Water Temperature .....	9
		Water year, definition of .....	24
		Water-Data Report (See "WDR") .....	24
		Water-Supply Paper (See "WSP") .....	24
		Water-table aquifer, definition of .....	24
		WDR, definition of .....	24
		Weighted average, definition of .....	24
		WEST BRANCH FEATHER RIVER BELOW HENDRICKS DIVERSION DAM, NEAR STIRLING CITY .....	201
		WESTERN CANAL AT INTAKE, NEAR OROVILLE .....	207
		Wet mass, definition of .....	24
		Wet weight, definition of .....	24
		WHISKEYTOWN LAKE NEAR IGO .....	96
		WHITE ROCK LAKE NEAR SODA SPRINGS .....	250
		White Rock Powerplant .....	382
		Willow Slough Bypass near Davis .....	443
		Willow Slough near Woodland .....	443
		Wise Powerplant .....	316
		Woodleaf Powerhouse .....	166
		WSP, definition of .....	24
		Y	
		YOLO BYPASS NEAR WOODLAND .....	434
		Yolo County, location of discharge and water-quality stations .....	49
		Yuba County, location of discharge stations .....	50
		Yuba River Basin, South, diversions and storage in .....	249
		Yuba River Basins, North and Middle, diversions and storage in .....	214
		YUBA RIVER BELOW ENGLEBRIGHT DAM, NEAR SMARTVILLE .....	299
		YUBA RIVER BELOW NEW COLGATE POWERPLANT, NEAR FRENCH CORRAL .....	242
		YUBA RIVER NEAR MARYSVILLE .....	307
		Z	
		Zooplankton, definition of .....	24

## CONVERSION FACTORS AND VERTICAL DATUM

Multiply	By	To obtain
<i>Length</i>		
inch (in.)	$2.54 \times 10^1$	millimeter
	$2.54 \times 10^{-2}$	meter
foot (ft)	$3.048 \times 10^{-1}$	meter
mile (mi)	$1.609 \times 10^0$	kilometer
<i>Area</i>		
acre	$4.047 \times 10^3$	square meter
	$4.047 \times 10^{-1}$	square hectometer
	$4.047 \times 10^{-3}$	square kilometer
square mile (mi <sup>2</sup> )	$2.590 \times 10^0$	square kilometer
<i>Volume</i>		
gallon (gal)	$3.785 \times 10^0$	liter
	$3.785 \times 10^0$	cubic decimeter
	$3.785 \times 10^{-3}$	cubic meter
million gallons (Mgal)	$3.785 \times 10^3$	cubic meter
	$3.785 \times 10^{-3}$	cubic hectometer
cubic foot (ft <sup>3</sup> )	$2.832 \times 10^1$	cubic decimeter
	$2.832 \times 10^{-2}$	cubic meter
cubic-foot-per-second day [(ft <sup>3</sup> /s) d]	$2.447 \times 10^3$	cubic meter
	$2.447 \times 10^{-3}$	cubic hectometer
acre-foot (acre-ft)	$1.233 \times 10^3$	cubic meter
	$1.233 \times 10^{-3}$	cubic hectometer
	$1.233 \times 10^{-6}$	cubic kilometer
<i>Flow</i>		
cubic foot per second (ft <sup>3</sup> /s)	$2.832 \times 10^1$	liter per second
	$2.832 \times 10^1$	cubic decimeter per second
	$2.832 \times 10^{-2}$	cubic meter per second
gallon per minute (gal/min)	$6.309 \times 10^{-2}$	liter per second
	$6.309 \times 10^{-2}$	cubic decimeter per second
	$6.309 \times 10^{-5}$	cubic meter per second
million gallons per day (Mgal/d)	$4.381 \times 10^1$	cubic decimeter per second
	$4.381 \times 10^{-2}$	cubic meter per second
<i>Mass</i>		
ton (short)	$9.072 \times 10^{-1}$	megagram or metric ton

*Sea level:* In this report "sea level" refers to the National Geodetic Vertical Datum of 1929 (NGVD of 1929)—a geodetic datum derived from a general adjustment for the first-order level nets of both the United States and Canada, formerly called Sea Level Datum of 1929.