



Astrobiology in your classroom



Life on Earth ...and elsewhere?

Hands-on activities for grades 5–10

EDUCATOR RESOURCE GUIDE

Life on Earth ...and elsewhere?

Students come to class filled with questions about life on other worlds. They have seen fantastic scenarios presented on television and in films. They have read and heard about exploring and colonizing space. They have followed the drama of manned and robotic space missions. The answers to the questions that arise out of these experiences are often complex and multidimensional. How can teachers meaningfully address such questions?

The hands-on activities in this Educator Resource Guide lay the conceptual groundwork for understanding questions fundamental to the field of astrobiology. They enable students to examine the nature of life, what it requires, its limits, and where it might be found. Through these experiences, students learn important ideas related to the search for extraterrestrial life.

After completing the activities in this guide, students will understand more about the nature of life, the habitability of planets, how astrobiologists gain insight into the possibility of extraterrestrial life, the interdisciplinary nature of astrobiology, and the difficulties and subtleties of the search for life. Not only will students have a better grasp of the concepts, but they will also deepen their appreciation for the many things that are necessary in order for life to arise and persist. Ultimately, the ambition of the guide is to inspire students to stay abreast of developments — and perhaps even to become involved — in the search for life on other worlds.

This Educator Resource Guide was written by Chris Randall (TERC) with help from TERC's *Astrobiology: The Search For Life* curriculum project staff (NSF #ESI-9730728). It is in the Public Domain and is not protected by copyright. Permission is not required for duplication. Illustration and design by Michelle Hlubinka.

Cover images courtesy of NASA and the Hubble Heritage Team:
heritage.stsci.edu/public/gallery/galindex.html#gallery

Activity Overview

ACTIVITY **1** **What is life?**5

Defining Life

- Compare real and fake or live and dead objects and brainstorm ideas about what life is
- Refine the definition by playing 20 Questions to identify an object or organism
- Test the definition by comparing “mystery” samples

2-3 DAYS*

ACTIVITY **2** **What does life need to live?**11

Understanding that Life Needs Water, Nutrients, and Energy

- Grow organisms in one of 12 classroom environments and identify common requirements (e.g., water, nutrients, and energy)
- Design a mission to identify habitable places by searching for water, nutrients, and energy
- **The Math Connection** – Measuring Calories

2 DAYS*

ACTIVITY **3** **What makes a world habitable?**23

Assessing Planets As Candidates for Life

- Examine *Habitability Cards*, which discuss each planet and the six large moons in terms of water temperature, atmosphere, energy, and nutrients, and identify the top candidates for life in the solar system
- **The Math Connection** – Inverse Square Law

1-2 DAYS*

ACTIVITY **4** **What can life tolerate?**37

Identifying the Range of Terrestrial Life

- Meet some extremophiles. What conditions do they tolerate?
- Play a card game similar to Rummy. Students create a set by matching an extremophile, an extreme habitat on Earth, and an extraterrestrial habitat that may be similar to an Earth habitat.
- Assemble a crew of extremophiles and target them to specific locations on a planet or moon
- Debate the ethics of sending Earth life to other worlds

2-4 DAYS*

ACTIVITY **5** **Is there life on other worlds?**49

Determining the Chances of Extraterrestrial Life

- Discuss the question, “What is the chance that we are the only life in the universe?”
- Determine what we need to know to predict the chances of extraterrestrial life
- Make estimates for each Drake Equation term and discuss the range of predictions in the class
- **The Math Connection** – Estimation

1-2 DAYS*

* For time estimates, one day equals a 50-minute class period

Using This Guide

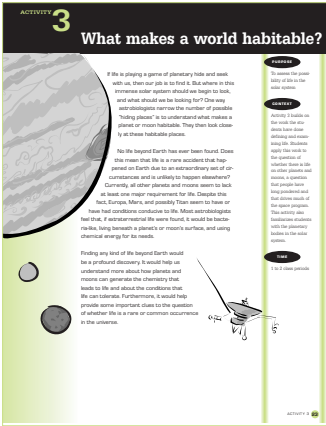

A **Background Reading** starts the investigation and informs teachers about the topic.

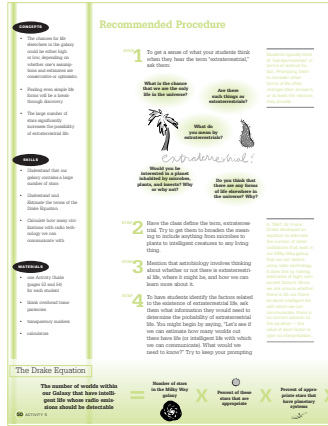

The **Recommended Procedure** details how to implement the activity.

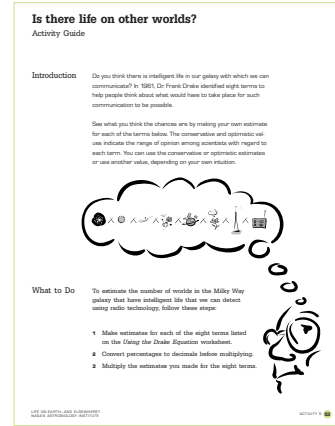

The **Activity Guide** leads students through an activity step-by-step.

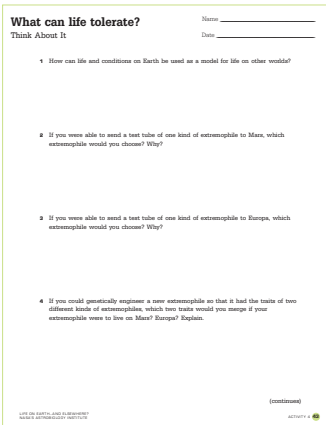

The **Think About It** questions help students reflect on what they have learned. They can be used as the basis for a class discussion, as homework, or as an assessment.

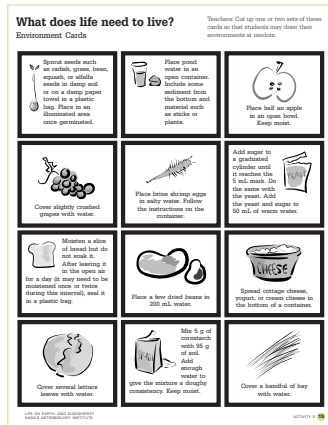

Blackline Masters of any required printed materials are placed at the end of an activity.

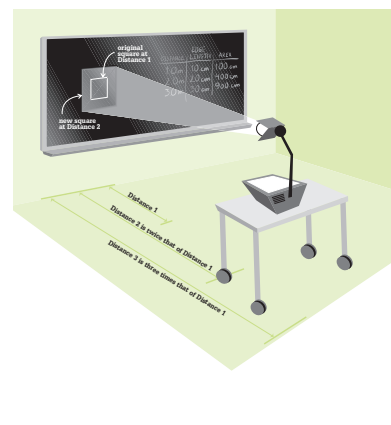

The **Math Extension** explores a mathematical concept related to the activity.

What is life?

We think that we can recognize something as being alive or not alive. But when scientists study very small samples or very old fossilized materials, the signs of life or past life are not easy to recognize. Furthermore, dormant and slow-growing organisms appear to be non-living unless observed under the right conditions or over long periods of time.

Surprisingly, there is no firm scientific definition of life. There is no single test that can establish the presence or absence of life nor single characteristic that applies to all living things. However, one can begin to define life by listing the characteristics that almost all living creatures share. For example, Earth's life forms all:

- have carbon-based chemistry
- have a membrane or wall that creates an internal environment
- use energy to maintain an internal state
- require liquid water
- are able to extract energy from the environment
- carry out metabolic processes resulting in the exchange of gases and solid materials (i.e., consuming raw materials and producing wastes)
- exhibit some type of growth, cell division, reproduction, or replication
- are able to have a population evolve and adapt to the environment.

Some non-living objects, such as fire, possess many of these characteristics and some arguably living organisms, such as viruses, possess only a few. Are some characteristics more fundamental than others?

There are two characteristics that are particularly useful in helping distinguish living from non-living entities — the ability to **reproduce** and the ability to produce and perpetuate **genetic variation** among offspring. Put another way, one could say that life is a self-contained chemi-

PURPOSE

To develop a working definition of life

CONTEXT

Activity 1 takes a close look at what characterizes life and sets the stage for subsequent activities that examine what life requires, what physical limits it can tolerate, and where it might be found in the solar system.

TIME

2 to 3 class periods

CONCEPTS

- There is no firm scientific definition of life, no single test that can establish the presence or absence of life, and no single characteristic that applies to all living things.
- There are characteristics that almost all living creatures share.
- Two characteristics useful in helping distinguish life from non-life are the ability to reproduce and the ability to produce and perpetuate genetic variation among offspring.

SKILLS

- *Observe* carefully and *Record* data
- *Define* life operationally
- *Apply* definitions and *Draw* conclusions
- *Contribute* thoughtfully to group and class discussions

MATERIALS

- one Activity Guide (page 9) for each student
- pairs of objects (see Step 1)
- for each group:
 - two hand lenses
 - three jars
 - hot tap water in a container
 - 150 mg sand
 - 15 mg sugar
 - half a packet of active dry yeast
 - one fizzing-style antacid tablet

cal system capable of undergoing Darwinian evolution. This large-scale, long-term view of life acknowledges that individual organisms must still carry out many of the small-scale, short-term functions listed above. In fact, many of the tests that scientists design to detect life on other worlds look for byproducts related to these short-term functions. So, while detecting life depends on many immediately recognizable characteristics, for life to persist in the grander scheme of things, it must evolve and adapt to changing conditions.

Few of the characteristics on this list lend themselves to quick, one-time tests, and many require multiple observations over a period of time. Some characteristics leave traces after an organism has died. One way astrobiologists search for extraterrestrial life is to search for **biosignatures**, large-scale, telltale signs of life such as oxygen and methane in the atmosphere (these reactive gases are quickly removed by natural processes).

Recommended Procedure

STEP 1 Distribute a hand lens and one pair of objects to each student. Have students examine the objects and create a list of characteristics associated with life. What tells them that something is alive? After five minutes, have students trade objects and examine a second pair. Have them complete Questions 1 and 2 on the Activity Guide. With the following pairs, students will immediately know which one is alive, yet articulating how they know this can be very challenging.

- live ant in a container and a plastic ant (available at toy and joke shops)
- live flower and a similar kind of silk, paper, or plastic flower
- live leaf and a similar kind of silk, paper, or plastic leaf
- live tree leaf and a dead tree leaf of the same kind
- live grass and dead grass of the same kind
- a dead house fly and a plastic fly (available at toy and joke shops)
- live cricket (from a pet shop) and a plastic cricket
- live earthworm (from the yard or a bait shop) and a gummy worm candy

STEP 2 Form groups of four students and have them develop a common set of characteristics that can be used to identify life. Have each student record this list under Question 3 on the Activity Guide.

In Steps 2, 4, and 11, the class creates working definitions for life. However, to avoid too much repetition, groups should proceed on their own in Steps 2 and 4, without reviewing and processing the lists of characteristics as a class. By Step 11 all groups should have refined their thinking and be able to contribute meaningfully to a class discussion.

STEP 3 Have the students test their working definitions of life by playing an abbreviated version of the familiar game, 20 Questions. Have each group think of something either living or non-living. When it is their turn, the class can ask the group ten (or five, depending on time) yes-no questions to determine whether the mystery object is alive or not. The class may not ask direct questions such as “Is it alive?” but, instead, should ask about what the mystery object looks like, does (or does not do), and uses or produces.

Before beginning, model an example that uses an ambiguous mystery object to demonstrate the need for clear questioning. Have the class ask you five to ten questions to determine whether your object is living or non-living. Any time a student asks you a poorly phrased question, challenge the student to clarify his or her actual meaning.

An icicle is a good choice because it shows many of the attributes of life. For instance, it grows, requires water, consumes raw materials, has a complex internal structure made up of ice crystals, divides in two when it breaks, responds to its environment, and produces waste products when it drips and when the water evaporates or sublimates. Fire is another good example because it takes in nutrients (fuel and oxygen), gives off energy (light and heat), grows, expands its geographical coverage, moves, reproduces, and produces waste products (heat, carbon dioxide, and smoke). So, how can scientists justify that icicles and fire are not alive? Icicles and fire do not have cell membranes or walls, do not use energy to maintain an internal state, and do not have heritable traits that can be transferred. Consequently, they may meet a limited definition for life, yet they do not meet certain fundamental criteria.

STEP 4 After each group has challenged the class to identify its mystery object, have each group answer Questions 4 to 6 on the Activity Guide and create a list of some fundamental characteristics of life. For a characteristic to qualify for the list, there can be no exceptions. For example, if “moving independently” were suggested, one would counter that plants are unable to move independently. Therefore, moving independently could not be considered a fundamental characteristic. This step can be begun in class and completed as homework.

STEP 5 For each group, prepare the set of three jars described below. Distribute one set to each group.

Jar	Sand	Sugar	Other
1	50 mg sand (3 tablespoons)	5 mg sugar (1 teaspoon)	
2	50 mg sand (3 tablespoons)	5 mg sugar (1 teaspoon)	5 mg active dry yeast (heaping teaspoon or half of a 1/4 oz packet)
3	50 mg sand (3 tablespoons)	5 mg sugar (1 teaspoon)	1 fizzing antacid tablet, crushed

The intention of Step 3 is to hone in on the key attributes of life. Poorly phrased questions can be answered truthfully and still be misleading. Encourage students to word their questions carefully and try to identify characteristics that are fundamental to life.

Other ambiguous mystery objects include mules (which are sterile), clouds, lights, streams, crystals, televisions, viruses, and cars. Only go through a second example if absolutely necessary. Mentioning these examples will reduce the number of ambiguous mystery objects students will have available.

Steps 5 to 10 are adapted with permission from Lesson 5 of Johnson Space Center's Destination Mars activity packet. sn-io.jsc.nasa.gov/sn/outreach/activities/destmars/destmars.htm

STEP 6 Explain that it is difficult to tell whether or not there is anything alive in the jars. Ask students to observe all three samples and write their observations under Question 7 on the Activity Guide. They can smell and touch the samples but not taste them. Encourage them to take some material out and examine it with the hand lens, returning the material to the correct jar each time.

STEP 7 Give each group a small cup of hot tap water (50–55°C). Ask students to pour the water so that each sample is just covered. Have students record their observations under Question 8 on the Activity Guide. Students should look for and record differences caused by adding water.

Jar 1 will show no activity. Jar 2 will begin to show activity after about 5 minutes. Jar 3 will immediately fizz vigorously.

STEP 8 Ask groups to look for signs of life. Have them use their lists of fundamental characteristics to determine whether there is something alive in any of the jars. Have them write their conclusions and reasoning under Questions 9 and 10 on the Activity Guide.

STEP 9 Reassemble as a class and create a class chart showing each group's conclusions for whether there is something alive in the three jars. Probe their thinking by asking:

Which criteria were most important in helping you draw your conclusions?

What conclusions did you draw about the rapid fizzing of Jar 3?

What kinds of follow-up tests might provide you pertinent information?

Does no change mean that a sample contains nothing that is alive?

STEP 10 After students have engaged with the questions sufficiently, tell them the contents of the three jars. Ask them how one might distinguish between a living and a non-living chemical change. What tests can they suggest to show that the yeast is indeed alive – what can yeast do that the fizzing antacid cannot do?

STEP 11 Have the class create a working definition for life, drawing on their lists of fundamental criteria, experimental work, and discussion. Have them write this definition under Question 11 on the Activity Guide.

STEP 12 Use the *Think About It* questions as a basis for a class discussion, as homework, or as an assessment.

Our senses are of limited use in detecting microscopic life. However, we can cause changes that help us understand what is contained in a sample. For example, we can encourage microbes to grow and become visible by culturing them, or we can cause chemical changes to occur and infer what is in the sample based on the byproducts.

Students can continue to feed the yeast, and the reaction should continue for several days. They can also observe them under the microscope and see internal structures and cells dividing in two.

What is life?

Activity Guide

Name _____

Date _____

- 1** From your teacher, obtain a pair of objects. Examine them and create a list of characteristics associated with life. What tells you that something is alive?
- 2** Repeat Step 1 with a new pair of objects
- 3** In your group develop a common set of characteristics that can be used to identify life.
- 4** After you have finished playing 20 Questions, write down an example of a carefully worded question that helped identify characteristics that are fundamental to life.
- 5** Write down an example of a poorly worded question that led to a misleading answer which really did not help identify characteristics that are fundamental to life.
- 6** In your group develop a common set of characteristics that can be used to identify life. This task is similar to what you did in Question 3, but since then, you have thought more about what it means to be alive, and your list could be quite different.
- 7** Obtain three jars containing mystery samples from your teacher. Describe and compare the contents of the three jars. If your teacher gave you a small sample of material from one of the jars, how would you know in which jar it belongs? Look carefully.
- 8** Describe and compare the three samples after you added water.
- 9** Use your list of fundamental characteristics to determine whether there is something alive in any of the jars. Write your conclusions and reasoning below.
- 10** Which of your criteria were most important in helping you draw your conclusions?
- 11** In the space below, write the working definition for life you developed with your class.

What is life?

Name _____

Think About It

Date _____

- 1 Why is defining life difficult?
- 2 When you compared the pair of objects, which characteristics were most useful to you in distinguishing the real one from the manufactured one or the live one from the dead one?
- 3 When playing 20 Questions, what was the most challenging mystery object or organism? What made it so difficult to determine whether it was living or non-living?
- 4 Since our senses are of limited use in terms of helping determine what is in each sample jar, what are some other ways that we can use to figure out what is in each jar?
- 5 What would you tell someone to help them distinguish between a one-time chemical reaction and a chemical reaction associated with life?
- 6 Describe some follow-up tests that could provide additional information and help you decide whether or not the jars contained something alive.
- 7 Does no change in a jar mean that a sample contains nothing that is alive? Explain.

What does life need to live?

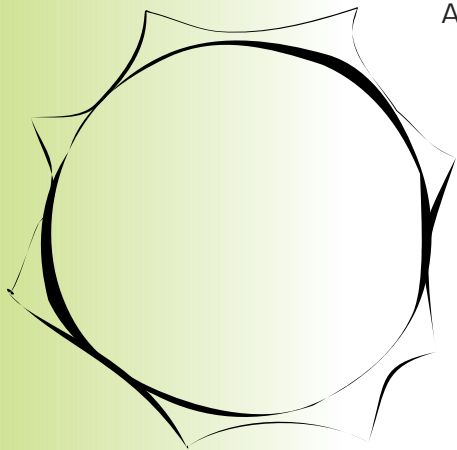

Astrobiologists begin their assessment of whether a planet or moon is a promising candidate for life by seeing if any liquid water, energy sources, and nutrients are present.

Many astrobiologists use the availability of **liquid water** as the primary criterion for judging whether a planet is a candidate for life. While other liquids do exist (e.g., ammonia, methane, or ethane), they exist at temperatures far below the level conducive for life.

The life discovered to date seems to be limited to a temperature range of about minus 15°C to 115°C. Under the right conditions, water can be liquid over this entire range. Furthermore, water is an important vehicle for transporting and delivering dissolved chemicals as well as being an important chemical reactant in its own right. Therefore, planets and moons with a way to cycle liquid water such as geothermal or atmospheric cycles have a mechanism for delivering the chemicals required by living organisms.

All life requires energy. Organisms use either light energy or chemical energy to run their life processes. **Light energy** is available only to organisms that live on or close to a planet or moon's surface. For life to exist there, the surface must be within a temperature range conducive for life and be protected from harmful ultraviolet radiation and charged solar particles. Strong magnetic fields and thick atmospheres around some planets and moons provide just this kind of protection. At some point, light energy from the sun becomes too dim to be a viable energy source. Thus, on planets that are unprotected or too distant from the sun, the only option for organisms is to live beneath the ground and to depend on **chemical energy** for their needs. Some microbes on Earth obtain energy from organic (carbon containing) compounds. Others rely on inorganic (without carbon) compounds such as sulfide and manganese compounds. There are even microbes that can use both organic and inorganic compounds as a source of energy. In each case, microbes break complex compounds into simpler ones to obtain a small amount of energy from

PURPOSE

To establish the fact that all life requires water, nutrients, and energy to live

CONTEXT

After developing a working definition for life in Activity 1, students now take a broader look at life by considering the kinds of things all living organisms require. Because organisms need to obtain certain essentials from their environment, this activity places life within a planetary context and lays the foundation for discussing habitability in Activity 3.

TIME

2 class periods and brief observation times over the following week.



CONCEPTS

- All known life requires liquid water, nutrients, and energy to live.
- Organisms use either light energy or chemical energy to run their life processes.
- Habitable planets are able to provide organisms a dependable supply of liquid water, nutrients, and energy.

SKILLS

- *Plan* how to maintain a setup to promote the growth of organisms
- *Create and Maintain* their environments
- *Make Predictions* based on a model (the environment)
- *Generalize and Extrapolate* from a model
- *Design* an instrument package that can detect conditions favorable to life
- *Contribute* thoughtfully to group and class discussions

MATERIALS

- one Activity Guide (pages 16 and 17) for each student
- *How to tell what's growing in your environment* (page 19) key for each group
- 1 to 2 sets of environment cards (page 15)
- materials for the twelve environments (see page 14, *Teacher notes on the 12 environments for growing organisms*)

this chemical change. This energy is sufficient to power microbial life. For life to arise and persist for billions of years, organisms need a constant supply of these compounds. Processes such as volcanic activity, weathering, lightning, and even the activity of life itself make these energy-supplying compounds available.

Nutrients are the raw materials organisms need to construct and maintain their bodies. While the solid planets and moons in our solar system all have the same general composition, local conditions and processes have led to variations in the concentrations and availability of different chemical compounds. As a result, nutrients required by life are more available on some planets and moons than on others. Atmospheres can also serve as a source of nutrients. For example, nitrogen from nitrogen gas can be used to make proteins and carbon from carbon dioxide or methane can be used to make carbohydrates and fats.

Once students understand life's common requirements, they are ready to think about how a planet might provide those essentials. Habitable planets are ones that are able to provide organisms a dependable supply of liquid water, nutrients, and energy. Since chemistry works by the same rules throughout the universe, most scientists think that extraterrestrial life will use the same things for their life processes as life on Earth does. Consequently, when searching for extraterrestrial life, astrobiologists search both for direct evidence of life and for habitable conditions.

Recommended Procedure

STEP 1 Distribute the Activity Guide. Ask each student to answer Question 1 about what one must provide any organism in order to have it live a long time. Lead a class discussion and create a list of students' ideas.

STEP 2 Cut up one or two sets of *Environment Cards* have students pick one from a hat. On the Activity Guide, have them answer Questions 3 to 5.

STEP 3 To make sure their setup is safe and has the necessary elements (see *Teacher notes on the 12 environments for growing organisms*), check the instructions that students wrote in Question 5 for maintaining conditions in their environment. After approving their approach, have them create the environment according to their instructions.

The list should include requirements such as water; an energy source (e.g., light, food, carbohydrates, fats, or sugar), nutrients (e.g., chemicals, substances in soil and fertilizers, and vitamins and minerals), and a suitable habitat (e.g., suitable temperature range, protection).

You may want to tell students to loosely cover their containers with plastic wrap with a few holes poked in it, and to keep Environments 3 to 12 out of direct sunlight.

STEP 4 Have students complete Activity Guide Questions 7 to 10. This could be done in class or as homework. Over the next week or two, ask students to observe their environments and identify what is growing by using the *How to Tell What Is Growing in Your Environment* key. Have them write their observations under Question 11 of the Activity Guide.

STEP 5 To help students understand that all life has certain basic requirements in common, conduct a class discussion based on their answers to Questions 9 and 10, which examine what all life requires. Using the categories identified in Step 1 such as energy, raw materials (i.e., nutrients), and water, have students identify how each environment provides these essentials. The class list might look like the following.

Energy Source	Source of Raw Materials	Source for Water
<ul style="list-style-type: none"> • Sunlight • Carbohydrates (e.g., sugar, starch, and cellulose) • Other organisms 	<ul style="list-style-type: none"> • Soil • Nitrogen and carbon dioxide in the air • Chemicals contained in food • Other organisms 	<ul style="list-style-type: none"> • Rain • Groundwater • Moisture in food • Other organisms

STEP 6 Assuming that all life requires energy, raw materials, and water, ask students how they would go about looking for life in the solar system. Instead of searching for actual life forms, could one make a plausible argument for searching for extraterrestrial life by searching for water, nutrients, and energy? Have them list the tools and instruments they would include on a robotic spacecraft that was sent to look for life on another planet. Have them articulate their reasons for including each tool or instrument.













STEP 7 Use the *Think About It* questions as a basis for a class discussion, as homework, or as an assessment.

Astrobiologists look for planets and moons that are or were habitable. A critical aspect of being habitable means having a dependable supply of energy, raw materials, and water. In Step 6, students can design instrument packages that either look for habitable conditions or that look for direct evidence of life.

Extension

While students may be comfortable with the idea that chemical compounds such as sugar can be an energy source for organisms, this may well be the first time that they have heard that inorganic compounds also contain energy. When microbes absorb such compounds and break them down into simpler compounds, they obtain enough energy to satisfy their energy needs. One vivid way to reveal the energy contained in the inorganic substance iron is to ignite some fine steel wool. Hold a small wad with some tongs and ignite it with a match. It will spark and flare. As the Fe^0 oxidizes to Fe^{+3} , light and heat energy are given off. Iron-oxidizing bacteria oxidize iron to satisfy their energy needs. Since only a small amount of energy is available, they need to oxidize a lot of iron to satisfy their needs. Other everyday examples of the energy contained in inorganic compounds include match heads, which contain sulfur and phosphorous, and many explosives, which contain nitrogen compounds. While microbes do not absorb match heads and explosives, these substances demonstrate the energy available from sulfur, phosphorous, iron, and nitrogen-based compounds.

Teacher notes on the 12 environments for growing organisms

	ENVIRONMENTS	CULTURING TIPS	HOW TO TELL WHAT'S GROWING
	1 Seeds	Sprout seeds such as radish, grass, bean, squash, or alfalfa seeds in damp soil or on a damp towel in a plastic bag. Place in an illuminated area once germinated.	Plants Watch for the development of a root, stem, and leaves.
	2 Pond water	Place in an open container. Include some sediment from the bottom and material such as sticks or plants. Notice how the numbers and kinds of organisms change as the water ages.	Protists Single-celled organisms visible under the microscope. Insects May be attached to floating materials and in bottom sediments. Algae Gives water a greenish color. Plants May be rooted in the sediment.
	3 Apple	Place half an apple in an open bowl. Moisten occasionally.	Molds Many molds look cottony. As the molds age, look for sporangia, spore-filled spheres on top of a stalk. Bacteria Bacterial colonies are masses of millions of bacteria and appear as shiny discs.
	4 Grapes	Crush slightly and cover with water.	Molds See description in #3. Bacteria Water becomes cloudy. Bacterial colonies may appear on pieces of grape that are above the waterline.
	5 Brine shrimp	Brine shrimp eggs are available at pet stores. Follow the instructions on the container.	Crustacean Brine shrimp will emerge from dormancy and swim about the container, visible to the naked eye. Technically, the "eggs" are cysts, produced when conditions become unfavorable to adult brine shrimp.
	6 Yeast	Place 5 g of yeast in 50 mL of warm water. Add 5 g of sugar. Replenish the sugar every other day. Eventually, alcohol, a waste product, builds up to toxic levels. At this point yeast form thick walls and become dormant.	Fungi Yeast is a single-celled fungus. It will convert the sugar to carbon dioxide and alcohol, producing bubbles and a sweet, bread-like odor. It can be seen to bud into two cells under a microscope's low power.
	7 Bread	Moisten a slice but do not soak it. Leave it in the open air for a day without letting it dry out. Then seal it in a plastic bag.	Mold White molds (<i>Rhizopus nigricans</i>), pinkish molds (<i>Neurospora</i>), and green molds (<i>Aspergillus</i>) are common bread molds. Bacteria See description in #3.
	8 Dried beans	Place a few dried beans in 200 mL water. After they soften, crush them slightly.	Mold See description in #3. Green molds such as <i>Aspergillus</i> and <i>Penicillium</i> are common. Bacteria Water becomes cloudy. Bacterial colonies may appear on any bean parts that are above the waterline.
	9 Cottage cheese, yogurt or cream cheese	Spread cottage cheese, yogurt, or cream cheese in the bottom of a container. Keep the surface moist.	Mold See description in #3. Green and white molds are common. Bacteria Colonies may appear as shiny discs. <i>Lactobacillus acidophilus</i> breaks down the lactose sugar in milk and gives yogurt its consistency. Certain molds are utilized to age cheeses.
	10 Lettuce	Cover several lettuce leaves with water. Keep very moist.	Bacteria Bacteria quickly break down lettuce leaves, turning them to runny mush.
	11 Cornstarch and rich soil	Mix 5g of cornstarch with 95g of soil. Add enough water to give the mixture a doughy consistence. Many soil organisms will feed on the starch. Keep moist.	Mold See description in #3. Bacteria Colonies may appear as shiny discs.
	12 Hay	Cover a handful of hay with water. Keep covered with water.	Bacteria The water becomes cloudy. Protists Single-celled organisms visible under the microscope. Mold Mold may appear on any hay above the waterline.

What does life need to live?

Environment Cards

Teachers: Cut up one or two sets of these cards so that students may draw their environments at random.



Sprout seeds such as radish, grass, bean, squash, or alfalfa seeds in damp soil or on a damp paper towel in a plastic bag. Place in an illuminated area once germinated.



Place pond water in an open container. Include some sediment from the bottom and material such as sticks or plants.

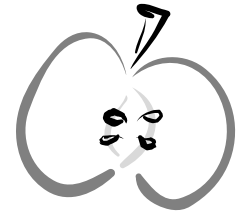

Place half an apple in an open bowl. Keep moist.

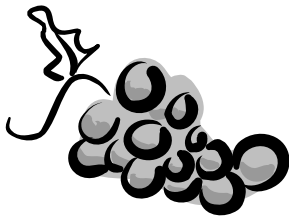

Cover slightly crushed grapes with water.



Place brine shrimp eggs in salty water. Follow the instructions on the container.

Add sugar to a graduated cylinder until it reaches the 5 mL mark. Do the same with the yeast. Add the yeast and sugar to 50 mL of warm water.



Moisten a slice of bread but do not soak it. After leaving it in the open air for a day (it may need to be moistened once or twice during this interval), seal it in a plastic bag.

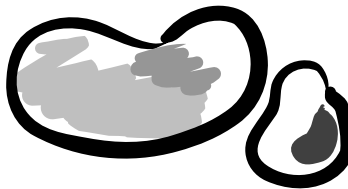

Place a few dried beans in 200 mL water.



Spread cottage cheese, yogurt, or cream cheese in the bottom of a container.



Cover several lettuce leaves with water.



Mix 5 g of cornstarch with 95 g of soil. Add enough water to give the mixture a doughy consistency. Keep moist.

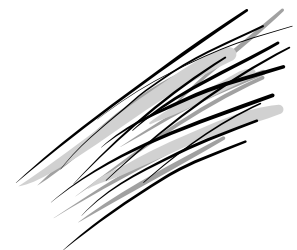

Cover a handful of hay with water.

What does life need to live?

Name _____

Activity Guide

Date _____

- 1 List some things one must provide an organism in order to have it live a long time.
- 2 From your teacher, obtain a description of an environment for growing organisms.
- 3 What essential materials does the initial environment provide to organisms living in it?
- 4 Which of these essential materials may run out in less than ten days?
- 5 What must you provide in order for the organisms living in your environment to live a long time? Below, write a brief set of instructions (five to ten steps long) for how to maintain your environment over the next ten days so that organisms will have what they need to live.
- 6 After your teacher approves your plan, create the growing environment.

(continues)

What does life need to live?

Activity Guide (continued)

- 7 Predict what will be growing in your environment in ten days.

- 8 How will you tell that the organisms inhabiting your environment are alive?

- 9 What are some things each environment in the class has in common with the others?

- 10 Based on the class's environments, list the things you think are essential for life to exist.

- 11 Observe your environment for ten days. Use the *How to tell what's growing in your environment* key to identify what is growing in it

What does life need to live?

Name _____

How to tell what's growing in your environment

Date _____



Algae

Look for grass-green patches, green water, floating clumps, or green films on the surface of the water, sediments, or container. Algae can range in size from microscopic to many meters in length. All algae lack roots, stems, and leaves.



Bacteria

Bacterial colonies are masses of millions of bacteria. Look for shiny discs up to 50 mm in diameter growing on moist (but not submerged) solid surfaces. Bacteria often make water look cloudy. Bacteria quickly soften and break down soft materials such as lettuce leaves.



Crustaceans

Look for organisms that have a hard outer shell, segmented body parts like a crab, and more than six legs (such as a pill bug).



Fungi

Look for a spreading growth that sends thread-like strands throughout the material on which it is growing. Yeast is a microscopic single-celled fungus. It converts sugar to carbon dioxide and alcohol, producing bubbles and a sweet, bread-like odor. Yeast colonies can appear yellow or pink. Molds (see below) are also fungi.



Plants

Look for roots, stems, and leaves. The green color of chlorophyll is a common indicator of plants.

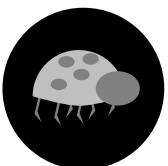

Insects

Look for organisms with six legs. They can be found in soils, in bottom sediments, and attached to floating materials.



Molds (a type of fungus)

Look for fuzzy growth on moist, solid surfaces. Many molds look cottony. As the molds age, look for sporangia, black, spore-filled spheres on top of a stalk. White molds (*Rhizopus nigricans*), pinkish molds (*Neurospora*), and green molds (*Aspergillus* and *Penicillium*) are common bread molds.



Protists

Look for microscopic, single-celled organisms that move about, usually in an aquatic or very moist environment. There are three general shapes: those having a long tail (flagellates), those covered with short hairs (ciliates), and those that have a blobby appearance and move by changing the shape of their body (amoebae). Make microscope slides and view them under the microscope.

What does life need to live?

Math Extension

One domain of mathematics, and one especially important in science, is **measurement**. While certain kinds of measurement are logically obvious, other kinds, such as measuring the energy content of food, are not. Food energy is measured in **calories**, a standard unit of heat energy. Calculating calories is a two-step process that involves transforming food energy into heat, something that is more easily measured.

Scientists determine the number of calories in a food sample by burning it and measuring the heat energy that is given off. One **calorie** is the amount of energy needed to raise the temperature of one gram of water one degree Celsius. (See Step 10 for a discussion of the difference between a nutritionist's Calorie and a physicist's or biologist's calorie.)

The accuracy and validity of an experiment or measurement depend on one's ability to eliminate potential **sources of error**. In fact, an important research skill is developing sensitivity to sources of error. The setup suggested below is intentionally skeletal. Keeping it basic helps students see clearly how one measures the energy content of food. The spare setup also invites a great deal of error and provides opportunities to identify sources of error and reduce them by refining the setup and by controlling variables.

The joule is the SI unit of energy, replacing the calorie as a unit of heat energy. A joule is defined as (a) the amount of work done by moving one newton one meter, or (b) the work done by one ampere flowing through the resistance of one ohm for one second. To convert calories to joules, multiply the calories by 4.19.

Recommended Procedure

- STEP 1** Write the definition for calorie on the board. Ask the class how many calories are required to raise the temperature of 1 gram of water 10 degrees Celsius and 100 grams of water 5 degrees Celsius (10 and 500 calories, respectively). Then, ask how they can determine the number of calories in a sample of food using this information. Challenge them to express it in an equation to measure calories in food.
- STEP 2** As a class, develop a procedure to measure calories in food similar to Steps 4 to 7. Make sure to instruct students to wear safety goggles at all times and not to eat the food or touch the fire or hot can.
- STEP 3** Give each group a sample of one of the foods, and instruct them to use the class procedure to measure the calories in their sample. To ensure having multiple data points, make sure at least two groups test each kind of food.

MATERIALS

- can (soup or soda can size)
- ring stand with clamp
- thermometer
- matches
- food sample holder (stick a pin into a cork)
- sample of food (marshmallows, peanuts, taco chips)
- 50 mL of water at room temperature
- glove or forceps to grasp hot materials

- STEP 4** Set up a calorie-measuring device similar to the figure at the right.
- STEP 5** Pour 50 ml of water into the can and measure its initial temperature. Make sure the thermometer is not touching the bottom of the can.
- STEP 6** Ignite the food sample with a match. When the food sample has burned completely, record the final temperature of the water.
- STEP 7** Calculate the calories in the food sample.

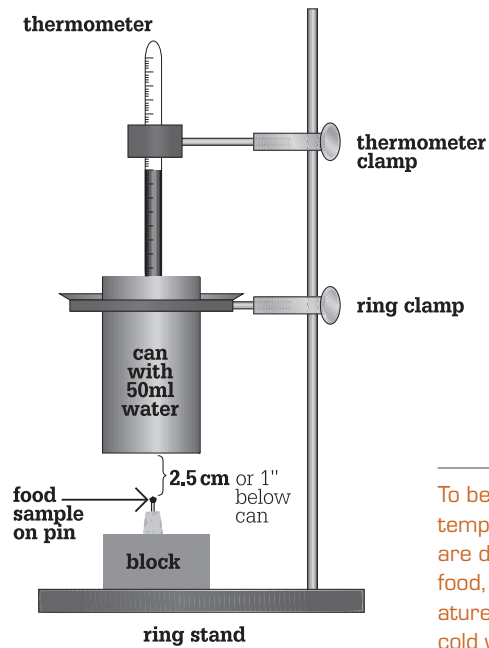

$$\text{calories} = \text{Mass of Water (grams)} \times \left(\text{Final Temperature } ^\circ\text{C} - \text{Starting Temperature } ^\circ\text{C} \right)$$

- STEP 8** Create a data table on the board showing the calories measured by each group. Based on the table, determine which food contains the most energy.
- STEP 9** Ask if this experiment is a fair way to compare the energy content of foods. Ask how one could fairly compare the energy content of different foods.

This experiment is *not* a fair way to compare the energy content of foods because the food samples are of different sizes. Use the table from Step 8 to show students that, for each food type, there is a range in the number of calories they measured. Note that this setup has many sources of error. Have students research bomb calorimeters to see how scientists try to reduce experimental error when measuring the energy content of foods.

- STEP 10** Have students compare the caloric values they measured for each type of food with the nutrition labels on the food containers. Ask them why their values differ from those on the labels. Ask how fats, carbohydrates, and proteins compare in energy value.

One reason for the difference is considerable experimental error. For example, the apparatus is inefficient and uninsulated, so heat that should warm the water is lost to the room. Another difference stems from the fact that nutritionists measure food energy in Calories (capital C), not calories. The difference between a nutritionist's Calorie and a physicist's or biologist's calorie is that a Calorie equals 1000 calories, or one kilocalorie. To calculate the Calories in the above experiment, multiply calories by 1000.

To be confident that all temperature changes are due to the burning food, use room temperature water. If hot or cold water is used, the water will lose or gain heat independently of the heat contributed by the burning food.

Since a gram of water equals one milliliter of water, one can calculate the number of calories by multiplying the change in temperature in degrees Celsius by either the water's mass in grams **or** its volume in milliliters.

To be fair, one must determine the calories on a per-gram basis. Only when one compares the caloric value of equal amounts of food can one determine which kind of food contains more energy. If you have the inclination, consider having students determine the per-gram caloric value by massing the food sample before and after burning and divide the total number of calories by this difference in weight.

What does life need to live?

Math Extension Activity Guide

Name _____

Date _____

- 1 Write the name of your food sample below.
- 2 What was the initial temperature of the water?
- 3 What was the final temperature of the water?
- 4 How many calories did your food sample contain?
calories = (mass of water) × (change in temperature)
- 5 What happened to the heat energy that did not go into raising the temperature of the water?

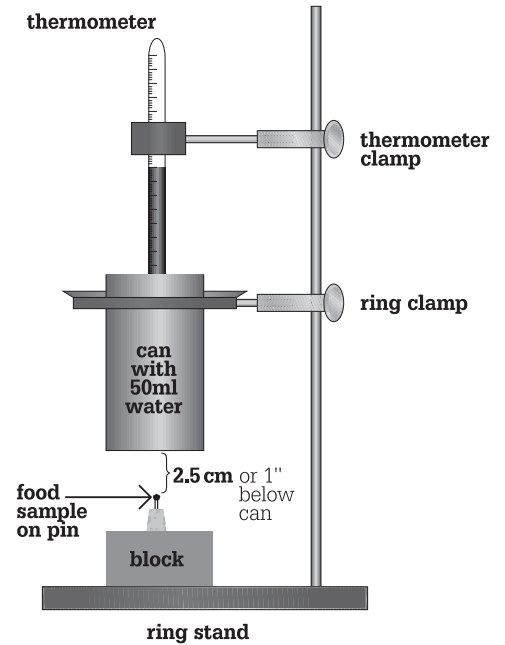

- 6 Suggest some improvements to the setup to reduce experimental error and to increase the accuracy of your energy measurement.
- 7 Is this experiment a fair way to compare the energy content of foods? Explain.
- 8 How can you fairly compare the energy content of different foods?
- 9 Why were the calorie values on the nutrition labels so different from the calorie values you measured in each type of food?
- 10 How do fats, carbohydrates, and proteins compare in energy value?

What makes a world habitable?

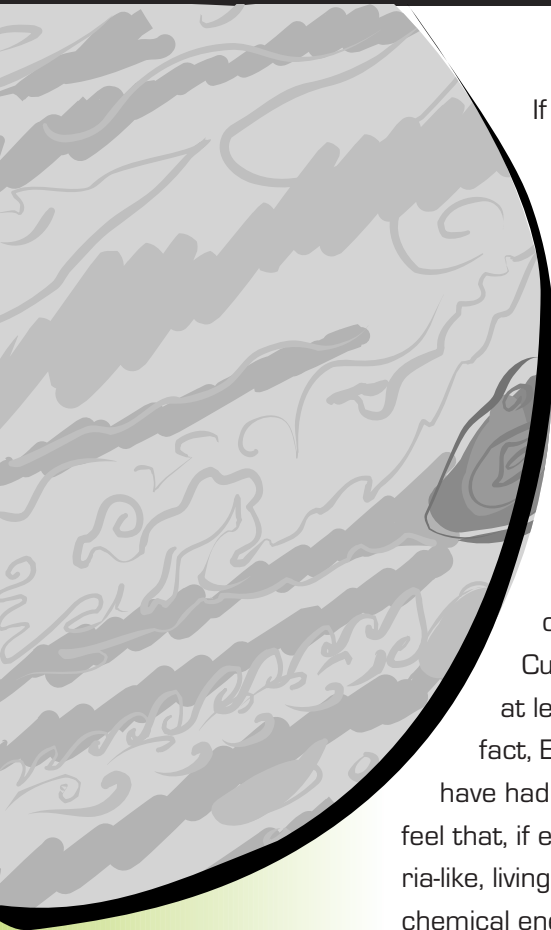

If life is playing a game of planetary hide and seek with us, then our job is to find it. But where in this immense solar system should we begin to look, and what should we be looking for? One way astrobiologists narrow the number of possible “hiding places” is to understand what makes a planet or moon habitable. They then look closely at these habitable places.

No life beyond Earth has ever been found. Does this mean that life is a rare accident that happened on Earth due to an extraordinary set of circumstances and is unlikely to happen elsewhere? Currently, all other planets and moons seem to lack at least one major requirement for life. Despite this fact, Europa, Mars, and possibly Titan seem to have or have had conditions conducive to life. Most astrobiologists feel that, if extraterrestrial life were found, it would be bacteria-like, living beneath a planet’s or moon’s surface, and using chemical energy for its needs.

Finding any kind of life beyond Earth would be a profound discovery. It would help us understand more about how planets and moons can generate the chemistry that leads to life and about the conditions that life can tolerate. Furthermore, it would help provide some important clues to the question of whether life is a rare or common occurrence in the universe.

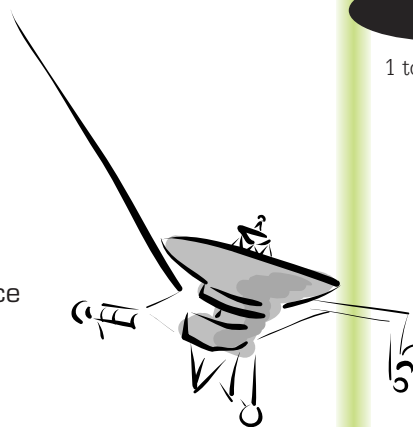

PURPOSE

To assess the possibility of life in the solar system

CONTEXT

Activity 3 builds on the work the students have done defining and examining life. Students apply this work to the question of whether there is life on other planets and moons, a question that people have long pondered and that drives much of the space program. This activity also familiarizes students with the planetary bodies in the solar system.

TIME

1 to 2 class periods

Recommended Procedure

CONCEPTS

- Except for Earth, each planet or moon currently has major limitations for life as we know it.
- Looking for habitable conditions is easier than looking for actual organisms.
- If extraterrestrial organisms exist in our solar system, they probably live underground and, thus, are very small.
- Europa, Mars, and Titan may have or have had habitable conditions.
- Sunlight intensity influences surface temperatures and whether organisms can use light as an energy source.
- Sunlight intensity on a planet or moon diminishes as the square of its distance from the sun.

SKILLS

- *Interpret* images and data and *Compare, Sort,* and *Categorize* that data
- *Generalize* and *Infer* from observations and *Draw* conclusions
- *Summarize* information, *Synthesize* understanding, and *Present* it clearly
- *Contribute* thoughtfully to group and class discussions

MATERIALS

- three to four sets of *Habitability Cards* (pages 29 to 34; laminate, if possible)
- one Activity Guide (page 36) and *Key to Habitability Factors* (page 35) for each student (copy back-to-back, if possible)

STEP 1 To get a sense of student understanding about habitability, ask students, “What makes a planet or moon a good home for living things?” Have each student write down an answer.

STEP 2 If you feel that students need a quick review of the key habitability factors, conduct a class discussion to develop a set of basic criteria. You might ask:

In general terms what does life need?

Answer: Life needs food, water, and conducive habitats (e.g., protection from radiation and suitable temperatures). Food is both a source of energy and raw materials for construction. Students will be able to make better use of the *Habitability Cards* if they are aware of food’s dual roles.

What kinds of things might limit life?

Answer: Extreme temperatures, high levels of radiation such as ultraviolet radiation, and lack of food and water can limit life.

STEP 3 To investigate the possibility of life in our solar system, have students use the *Habitability Cards* and the accompanying key to assess the habitability of each planet and moon in our solar system. [To make a set of cards, photocopy pages 29 to 34, double-sided if possible. Cut them into individual cards. To make them last longer, copy them onto card stock or laminate them.] On the Activity Guide, have each student rank each planet or moon as a likely, unlikely, or possible candidate for life and articulate the reasoning behind his or her determination.

STEP 4 If students have been working on their own, organize them in groups. Have each group select its top three candidates for life. Conduct a class discussion and record each group’s analyses on a class chart. Have them state the reasoning behind their choices.

Students should come away from this discussion with a clearer (it does not have to be perfect!) sense of what makes a planet conducive for life. What they need before going on is a rudimentary set of criteria for judging the possibility of life on a planet.

Since students typically take several minutes with each card, there is no need to prepare a large number of sets. Students can share cards, exchanging ones they have used for new ones. Alternatively, if you feel that trading will cause too much disruption in your class, organize the class in groups of six students and provide each group a complete set of *Habitability Cards*.

Photocopied versions of the *Habitability Cards* are usually lackluster and uninspiring. You can download a full-color version of the *Habitability Cards* at astrobio.terc.edu or astrobiology.arc.nasa.gov.



Math Extension

In the *Habitability Cards*, students read that, at certain distances from the sun, sunlight is too dim to be a viable energy source. The intensity of light diminishes as one moves further from the source. Students know this intuitively from observing how the brightness of a flashlight changes as one moves toward or away from a surface. Interestingly, the light changes in a predictable, measurable way that can be described by a mathematical formula called the **Inverse Square Law**. Any student comfortable with fractions and multiplying and dividing can calculate differences in light intensities.

The Inverse Square Law applies to fields that radiate evenly in all directions (e.g., light and magnetic and gravitational fields). Objects that generate such fields are called **point sources**. The diagram below shows the sun serving as a point source of light because it is in the center of a sphere of light traveling evenly in all directions.

As the light spreads out, its intensity per unit area decreases. To calculate the light intensity, one needs to know the light intensity at some reference point. For our solar system, astronomers use Earth as a reference point because they have measured the intensity of light reaching Earth from the sun to be 1370 watts per square meter (W/m^2).

To calculate the light intensity at any position in the solar system, one needs to have a reference intensity and to know the distance from the light source. A convenient unit for talking about distances

in the solar system is the **astronomical unit** (AU.) One AU equals 149,597,870 kilometers (about 93 million miles), the distance from Earth to the sun.

A sphere's surface area grows as the square of its radius. Therefore, light intensity depends on the square of the distance from the center of the sphere.

Mathematically:

$$\text{difference in light intensity} = \frac{1}{\text{distance}^2}$$

For example, Mars is 1.5 AU from the sun. We can use the Inverse

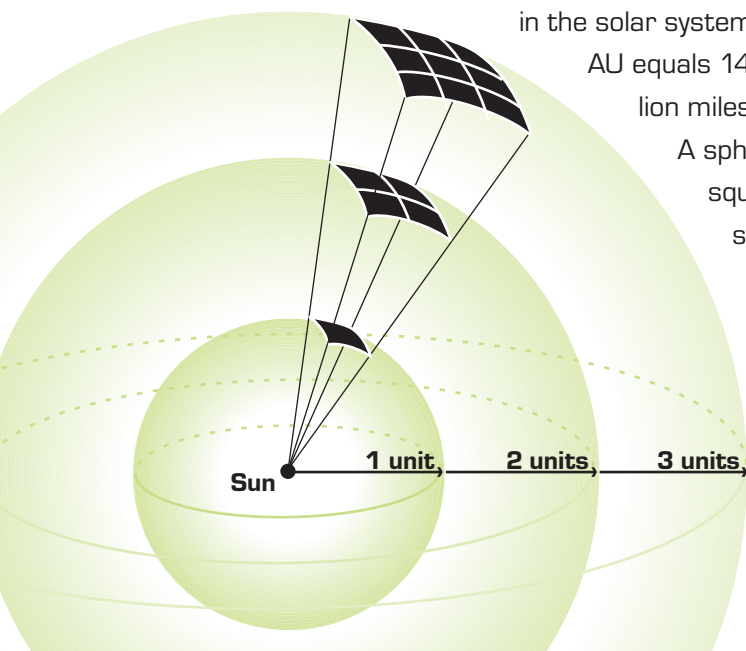

Square Law to see how the light intensity on Mars compares with the light intensity on Earth.

$$1/\text{distance}^2 = 1 / 1.5^2 = 1/ 2.25 = 0.44$$

The light intensity on Mars is 44% that of Earth's. Since the intensity on Earth is 1370 W/m^2 , then the intensity on Mars is

$$0.44 \times 1370 \text{ W/m}^2 = 603 \text{ W/m}^2$$

By increasing the distance from the sun by just one-half an AU, the light intensity drops by more than half, relative to Earth.

Unlike the sun or a light bulb, both of which are point sources of light, overhead and slide projectors use mirrors and lenses to focus light. Consequently, the light from these projectors does not radiate evenly in all directions, and they are not point sources of light. Nonetheless, the model described in this Math Extension successfully approximates the Inverse Square Law, and light intensity does diminish with distance in close accordance with the $1/\text{distance}^2$ relationship.

As with most models, this one has its limitations — it illustrates certain aspects of the Inverse Square Law well while misrepresenting others. With any model, students must be made aware of its strengths and limitations. So, even though the Inverse Square Law applies only to point sources, this model with its focused beam still demonstrates the inverse square relationship fairly well. For a truly accurate inverse square demonstration, use a light meter to measure the drop off in intensity around a 40 Watt (or less) light bulb.

Recommended Procedure

- STEP 1** Set a slide or overhead projector either ten centimeters or one meter from a wall or board. Either of these distances will make the inverse square relationship readily apparent. (This distance can vary. It is really a function of how much space you have and the size of your screen.) Note the distance between the board and the bulb or lens.
- STEP 2** Project light onto the board and outline the illuminated square. Use a three-column table to keep track of the distance from the board, the length of the illuminated square's edge, and the area of the illuminated square.
- STEP 3** Have students predict what will happen to the illuminated square when you move the projector further from the board. (It increases in size.) Ask them how the light intensity changes when you move the projector further from the board. (It decreases.)

MATERIALS

- overhead projector

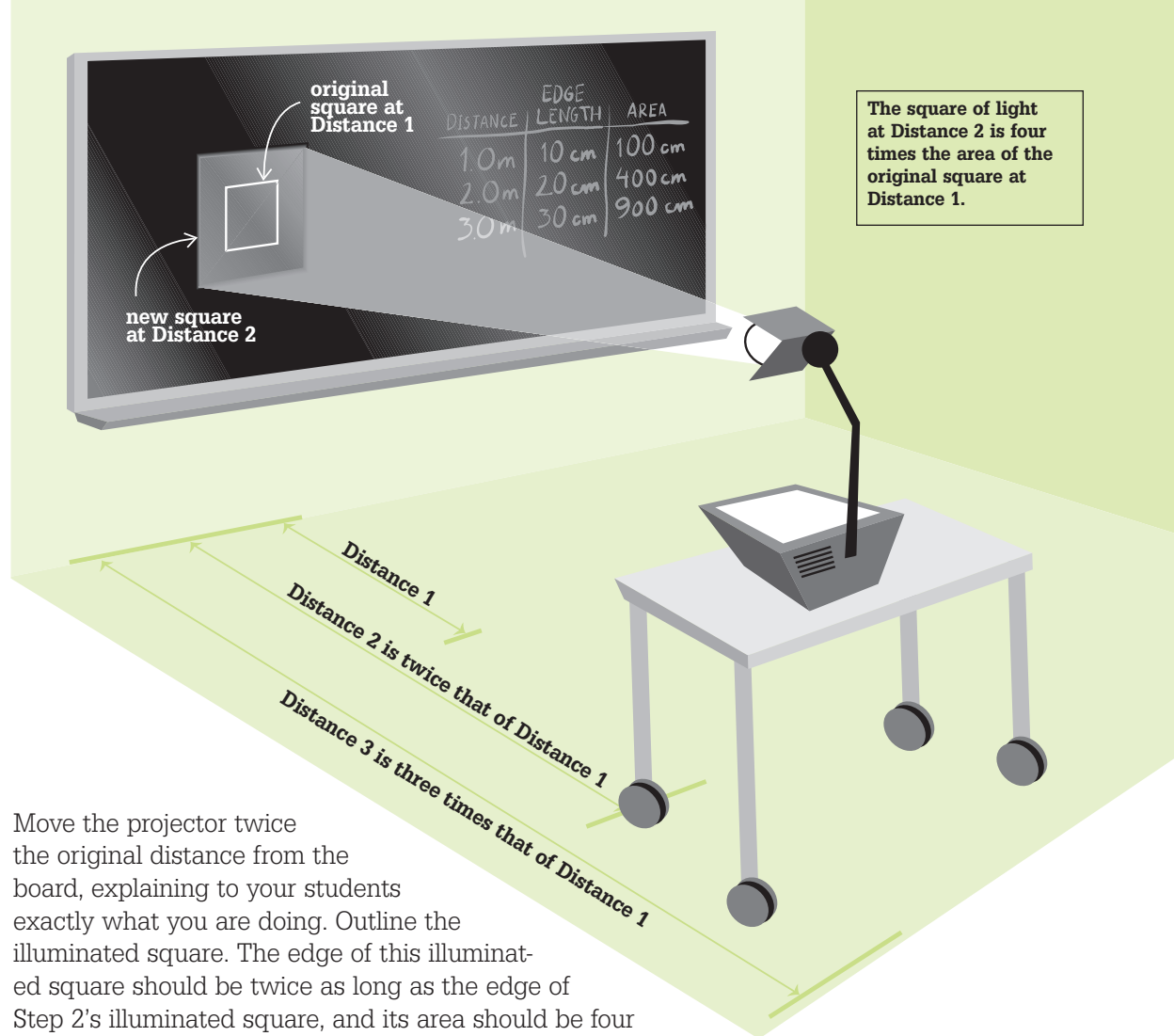

The square of light at Distance 2 is four times the area of the original square at Distance 1.

STEP 4 Move the projector twice the original distance from the board, explaining to your students exactly what you are doing. Outline the illuminated square. The edge of this illuminated square should be twice as long as the edge of Step 2's illuminated square, and its area should be four times the area of Step 2's square. Ask students how the light intensity has changed, now that the same amount of light has to cover four times the area. They should say that the light intensity within the square is one fourth of the original light intensity.

STEP 5 Ask students to predict what the intensity will be if you move the projector three times the original distance from the wall. When you move the projector this distance, the edge of this illuminated square should be three times as long as the edge of Step 2's illuminated square, and its area should be nine times the area of Step 2's square. Consequently, the amount of light hitting each unit area in Step 5 is about one ninth of the amount hitting each unit area in Step 2.

STEP 6 Have students create a graph comparing the projector's distance from the board with the area of the illuminated square. Then, introduce your students to the math of the Inverse Square Law. Refer to the distance, length, and area data from the table you created:

$\frac{1}{(\text{Distance } 1)^2} = \frac{1}{1^2} = 1$	Define the intensity at Distance 1 as the reference intensity
$\frac{1}{(\text{Distance } 2)^2} = \frac{1}{2^2} = \frac{1}{4}$	A value of 1/4 means that the intensity per unit area at Distance 2 is 1/4 of the reference intensity
$\frac{1}{(\text{Distance } 3)^2} = \frac{1}{3^2} = \frac{1}{9}$	A value of 1/9 means that the intensity per unit area at Distance 3 is 1/9 of the reference intensity

STEP 7 Using the graph or applying the Inverse Square formula, ask students to predict the size of the illuminated area if the projector were moved four times the original distance. Try it, if possible. (Compared with the illuminated square in Step 2, the edge of Step 6's square will be four times as long and its area will be 16 times as large.)

STEP 8 The Inverse Square Law enables you to calculate light intensities relative to a known light intensity. Step 8 uses the light intensity of Earth (1370 W/m²) as the known light intensity. Have your students calculate the light intensity for planets and moons in our solar system relative to Earth. Then have them create a graph of their calculated values against their distances from the sun.

Begin by using Mercury as an example. On average, Mercury is 0.39 A.U. from the sun. According to the Inverse Square Law, the amount of light reaching Mercury is inversely proportional to Mercury's distance from the sun, so:

$$1/(0.39)^2 = 6.575$$

Thus, the amount of light reaching Mercury is more than six and a half times (657.5%) of the amount of light reaching Earth. To determine the light intensity on Mercury, use Earth's intensity, 1370 W/m², as a reference intensity

$$6.575 \times 1370 \text{ W/m}^2 = 9,008 \text{ W/m}^2$$

Planet or Moon	Distance from Sun (AU)	Light Intensity (relative to Earth)	Watts per Square Meter
Mercury	0.39	6.575	9008
Venus	0.72	1.929	2643
Earth & Moon	1.0	1.000	1370
Mars	1.5	0.444	603
Jupiter & its moons	5.2	0.037	51
Saturn & its moons	9.5	0.011	15
Uranus	19.2	0.0027	3.7
Neptune	30.1	0.0011	1.5
Pluto	39.5	0.0006	0.8

STEP 9 Briefly discuss the pattern students found and the idea of a **Habitable Zone** – the zone between the point where there is too much and too little sunlight. Beyond the inner edge of the Habitable Zone, it is too hot for life and surface water boils away. Beyond the outer edge of the Habitable Zone, liquid water freezes. Also, at some point beyond the outer edge of the Habitable Zone, sunlight becomes too dim to be a viable energy source for organisms living on or near the surface. Within the Habitable Zone, water can exist as a liquid, given the right atmospheric conditions.

THE GAS GIANTS

JUPITER
SATURN
URANUS
NEPTUNE



The temperature at the cloud tops is -200°C while the interior temperatures reach tens of thousands of degrees. The churning of the atmosphere causes temperatures of the circulating gasses to change greatly over short distances and periods of time.



The gas giants are made almost entirely of hydrogen and helium, with very small amounts of water.



Gas giants release large amounts of their own energy, keeping internal temperatures high and causing their atmospheres to circulate constantly. The violent storms created by this circulation would subject life to rapid and extreme changes in temperature and pressure.



Sunlight is dim but may be a viable energy source. Obtaining sufficient amounts of chemicals in a gaseous environment is difficult, making chemical energy an unlikely energy source.



A gas environment is too diffuse to concentrate nutrients and make them available in a predictable, reliable way. Having life arise or survive in such a constantly changing environment is highly unlikely.

VENUS



Venus has a thick carbon dioxide atmosphere that traps heat efficiently. The average surface temperature is 464°C .



There is no surface water. The atmosphere has trace amounts of water vapor (30 parts per million or 0.0000003%).



Venus's atmosphere is 92 times that of Earth's. It is 97% carbon dioxide.



The thick clouds prevent much sunlight from reaching the surface, so any life would have to depend on chemical energy. Sulfuric acid clouds provide a potential source of chemical energy.



In general, Venus and Earth have the same chemical composition, and Venus is volcanically active, giving it a way to cycle chemicals important to life.

EARTH



The average surface temperature is 15°C . Earth's maximum temperature is 51°C (Libya) and its minimum is -89°C (Antarctica).



On Earth, water exists in all three states. The water cycle delivers water to nearly every part of Earth.



Earth's atmosphere shields the surface from harmful ultraviolet radiation and most meteorites, insulates the Earth, and serves as a source of nutrients such as nitrogen and carbon.



Plants capture sunlight and make possible the food chain. High oxygen levels in the atmosphere enable life to use high-energy, carbon-based energy sources (e.g., sugar). Many microbes live off the chemical energy in inorganic compounds such as iron and sulfur.



Everything organisms need to build and maintain their bodies is already on Earth. Earth has processes such as plate tectonics to cycle chemicals important to life.

MARS



Even though the surface temperature can reach room temperature for a few minutes at mid latitudes, the average surface temperature is -63°C .



Though there is no surface water, features suggest that Mars once had flowing surface water. There are also indications of thick layers of permafrost, soil locked in water ice. The Northern and Southern ice caps contain water ice.



The Martian atmosphere is 95% carbon dioxide. The atmospheric pressure is so low (one-thousandth that of Earth's) that surface water quickly boils away. The atmosphere is too thin to protect or insulate the surface of Mars significantly.



Mars is on the edge of the Habitable Zone, making sunlight a possible energy source. Chemicals made available by volcanic activity early in Mars's history may once have been a possible energy source.



Mars and Earth have the same general chemical composition. Mars was volcanically active for its first two to three billion years, giving it a way to cycle chemicals important to life.

VENUS



lava disks



The surface is so hot, it melts in places, causing depressions and lava channels. High temperatures caused these depressions and lava channels (left).



volcano and ash plume

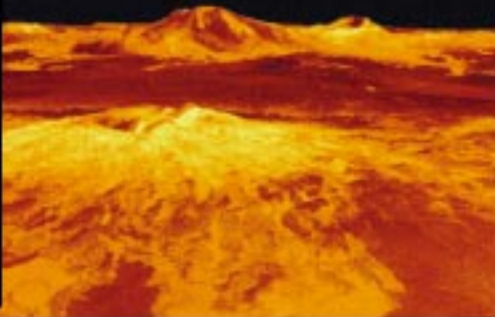

Jupiter

Saturn



Uranus



Neptune



GAS GIANTS

These two features indicate flowing water.

Frame width 100km

Biggest volcano in the solar system (800 km in diameter)

Frame width 10km



Pathfinder landing site



North Pole

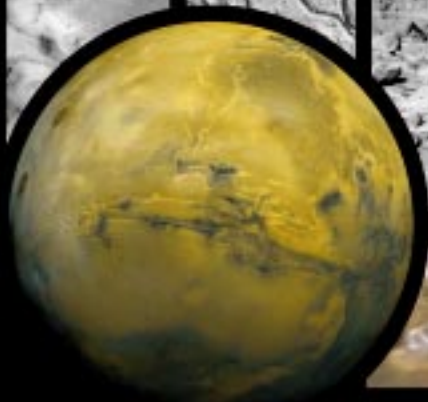

MARS

Ophir Canyon
Frame width is 300 km

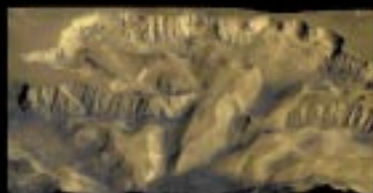

Mangrove Delta in Bangladesh



Middle East



Deforestation in Brazil



South Pole



Buenos Aires (left side of bay)

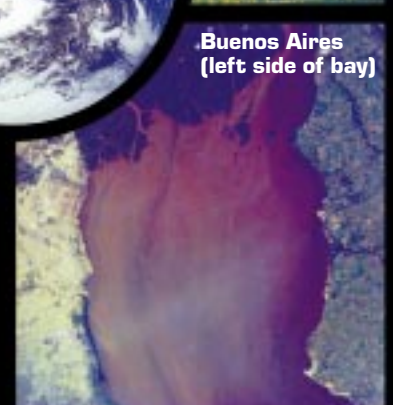

Eroded volcano in Hawaii



EARTH

The bright patches are a highly reflective material such as ice that oozed from the interior. Ganymede is Jupiter's largest moon.



GANYMEDE

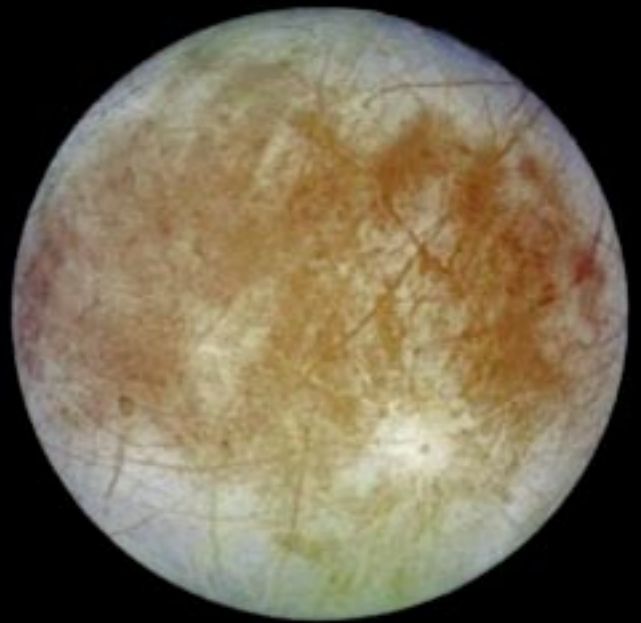

EUROPA



Surface close-up. Frame width is 50 km.

IO

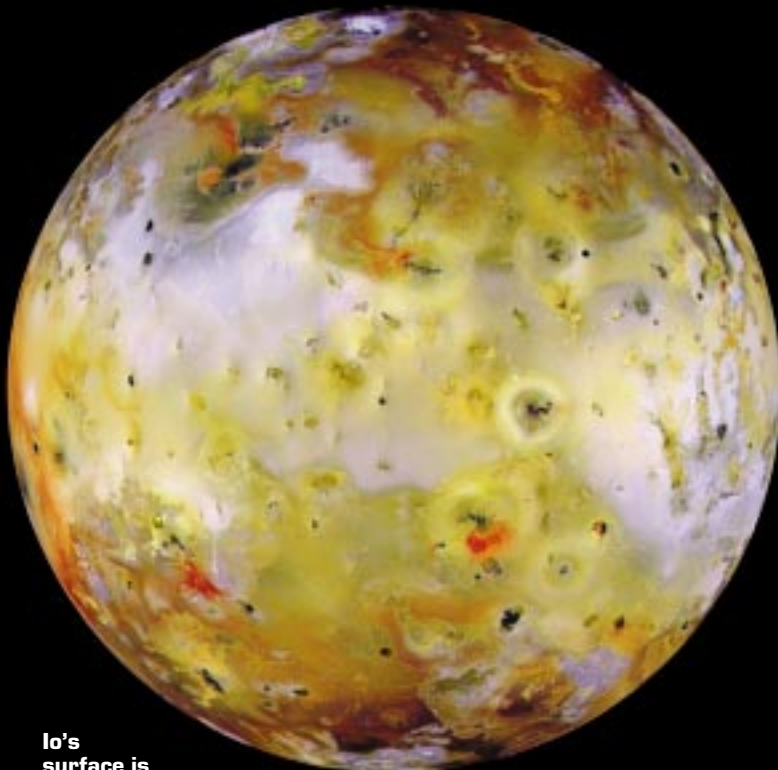

Io's surface is discolored by sulfur compounds from volcanic eruptions.

Computer-generated surface view.



CALLISTO



Callisto is the most heavily cratered object in the solar system.



At noon on the equator, the average surface temperature is -145°C .



Europa is covered with a one- to ten-kilometer-thick crust of water ice. There is strong evidence that this crust may cover a 60–100-km deep ocean of water. An ocean of this size would hold more water than there is on Earth!



There is no atmosphere.



Sunlight may be a viable energy source. Scientists think Europa's core is hot enough to have volcanic activity beneath its ocean. Such activity might make energy-rich compounds such as sulfur compounds available. Europa's ice crust is also thickly dusted with another potential energy source, sulfur compounds from Io's eruptions.



Europa is a solid body and the materials for life are likely to be present. Possible volcanic activity and a large ocean provide several ways to cycle chemicals important to life.



At noon on the equator, the average surface temperature is -121°C .



Ganymede's surface and upper layers are an even mixture of rock and water ice. There is no known source of heat to melt the ice.



There is virtually no atmosphere.



Sunlight may be a viable energy source. There are no known geologic processes to make chemicals available to organisms that rely on chemical energy.



Ganymede is a solid body and probably has the necessary materials for life. However, Ganymede seems to lack any processes that are necessary to cycle chemicals important to life.



At noon on the equator, the average surface temperature is -108°C .



Callisto appears to be an ice-rock mix through and through. Its low density suggests that it contains large amounts of water ice. Some scientists think there is a salt-water layer beneath the surface.



There is virtually no atmosphere.



Sunlight may be a viable energy source. If there is a salt-water layer beneath the surface, organisms may be able to rely on chemical energy.



Callisto is a solid body and probably has the necessary materials for life. However, Callisto seems to lack any processes that are necessary to cycle chemicals important to life.



At noon on the equator, the average surface temperature is -150°C . In areas with volcanic activity, the lava flowing across the surface can reach $1,250^{\circ}\text{C}$.



Io experiences almost constant volcanic activity, making it the most active volcanic body in the solar system. This activity and the hot interior drive out any water, and there is no known liquid water or water ice on Io.



There is essentially no atmosphere. A thin cloud of sulfur compounds from Io's constant volcanic activity surrounds Io.



Sunlight may be a viable energy source. Volcanic activity has coated Io's surface with compounds such as sulfur and sulfur dioxide. On Earth, many microbes use such compounds as an energy source.



Io is a solid body and the materials for life are likely to be present. Volcanic activity could cycle chemicals important to life.

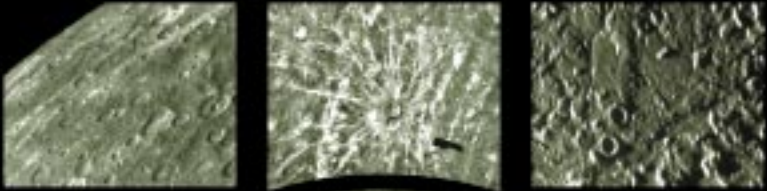

With no atmosphere, meteors of all sizes hit the planet.

There are no processes to remove the craters.



MERCURY

Because no spacecraft has ever visited Pluto, this computer-generated image based on telescopic observations is among the most accurate depictions we have of Pluto.



PLUTO



EARTH'S MOON



TITAN

A thick, hazy atmosphere envelops Titan. The closest a spacecraft has come to Titan is about 400,000 km.

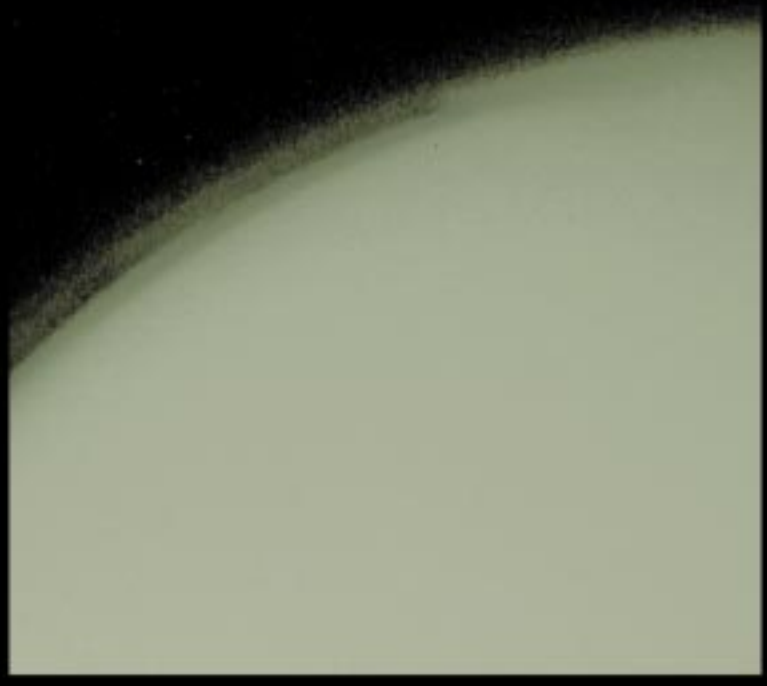

fast facts **PLUTO**



The average surface temperature is -225°C .



All water is permanently frozen as ice.



There is essentially no atmosphere.



At this distance from the sun, sunlight is too dim to be a viable energy source. Organisms would need to rely on chemical energy.



Pluto and Earth have the same general chemical composition, but Pluto lacks any processes that are necessary to cycle chemicals important to life.

fast facts **MERCURY**



The temperature on the side facing the sun is 252°C . On the dark side, it is -183°C .



There is no surface water or water in the atmosphere.



There is essentially no atmosphere.



Living on or near the surface is impossible, so life would have to live underground and depend on chemical energy.



Mercury and Earth have the same general chemical composition, but Mercury lacks the processes that are necessary to cycle chemicals important to life.

fast facts **TITAN SATURN'S MOON**



The average surface temperature is -179°C .



Water-ice icebergs might float in an ocean of ethane-methane liquid or slush. There is virtually no water in the atmosphere.



Titan has an atmospheric pressure 1.5 times that of Earth. It is 90–97% nitrogen and 3–10% methane, a composition more like Earth's than the carbon dioxide atmospheres of Mars and Venus.



At this distance from the sun, sunlight is too dim to be a viable energy source. Organisms would need to rely on chemical energy.



Sunlight-driven reactions can turn methane into amino acids, the building blocks of life. They could join into large, complex molecules and rain down on the surface. There, they could accumulate, covering the surface with thick, gooey deposits of hydrocarbons. These conditions may be similar to those on early Earth.

fast facts **EARTH'S MOON**



There is no atmosphere to moderate temperatures, and temperature depends entirely on how much sunlight falls on the surface. While the overall average surface temperature is -23°C , the daytime average is 107°C and the nighttime average is -153°C .



There is no known liquid water on the moon. In 1998, NASA's Lunar Prospector spacecraft detected water ice at each of the moon's poles.



There is no atmosphere. Without an atmosphere, the surface experiences large and rapid temperature swings, which are hard for organisms to cope with.



The moon receives the same amount of sunlight as Earth, making the sun a viable energy source. Chemicals made available by volcanic activity early in the moon's history may once have been a possible energy source.



The moon and Earth have the same general chemical composition, but the moon lacks any processes that are necessary to cycle chemicals important to life.

What makes a world habitable?

Name _____

A key of habitability factors

Date _____

Temperature

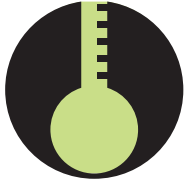

At about 125°C, protein and carbohydrate molecules and genetic material (e.g., DNA and RNA) start to break down. Cold temperatures cause chemicals in a living cell to react too slowly to support the reactions necessary for life. Thus, life seems to be limited to a temperature range of about minus 15°C to 115°C.

Water

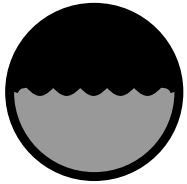

Life as we know it requires liquid water. It can be available on an irregular basis with organisms going dormant until it becomes available, but, eventually, it needs to be available. On a cold planet or moon, there must be internal heat to melt ice or permafrost. On a hot planet or moon, the water will boil away or evaporate unless it is far beneath the surface.

Atmosphere



Atmospheres can insulate a planet or moon and protect life from harmful ultraviolet radiation and small- and medium-sized meteorite impacts. In addition, atmospheres can serve as an important source of biochemicals. For example, nitrogen from nitrogen gas can be used for proteins, and carbon from carbon dioxide and methane can be used for carbohydrates and fats. Atmospheres also moderate day-night and seasonal temperature swings. However, to serve as an effective shield or insulator, the atmosphere has to be fairly substantial, as it is on Earth, Venus, and Titan. A planet or moon depends on its gravity to hold an atmosphere. A small-sized body such as Pluto or Earth's moon has too little gravity to hold onto an atmosphere, making life on or near the surface difficult.

Energy

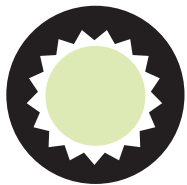

Organisms use either light or chemical energy to run their life processes. At some point, light energy from the sun becomes too dim to be a viable energy source. On Earth, many microbes obtain energy from the sulfur, iron, and manganese compounds present in the Earth's crust and surface layers. When they absorb such compounds and break them down, they obtain a small amount of energy from this chemical change. This energy is sufficient to power microbial life.

Nutrients



The solid planets and moons in our solar system have the same general chemical composition. As a result, the necessary raw materials to construct and maintain an organism's body are in place. However, a planet or moon needs to have processes such as plate tectonics or volcanic activity to make these chemicals constantly available. In addition, liquid water is a powerful solvent and is an important vehicle for transporting and delivering dissolved chemicals. Therefore, planets or moons with volcanic activity, plate tectonics, or a way to cycle liquid water have a way to supply the chemicals required by living organisms.

What makes a world habitable?

Name _____

Searching for a habitable world

Date _____

Planet/Moon	LIFE IS LIKELY	LIFE IS POSSIBLE	LIFE IS UNLIKELY	Rationale
MERCURY				
VENUS				
EARTH				
Earth's MOON				
MARS				
JUPITER				
Jupiter's Moon IO				
Jupiter's Moon EUROPA				
Jupiter's Moon GANYMEDE				
Jupiter's Moon CALLISTO				
SATURN				
Saturn's Moon TITAN				
URANUS				
NEPTUNE				
PLUTO				

What can life tolerate?

Cold-loving bacteria

COURTESY OF DR. HENRY ALDRICH, UNIVERSITY OF FLORIDA



Collecting cold-loving extremophiles by coring into the Antarctic ice sheet.

COURTESY OF THE NATIONAL SCIENCE FOUNDATION

Our solar system has nine planets and over 60 moons. Of all these worlds, only Earth is known to have life.

Consequently, we must base any search for extraterrestrial life on what we know about life here.

Thanks to advancing technology, the past decade has seen the discovery of organisms living under conditions we consider extreme and uninhabitable. These bacteria and bacteria-like organisms are called **extremophiles**. They are **prokaryotes**, a type of very small, single-celled organism that lacks a nucleus. The fact that no one expected to find organisms living under extreme conditions underscores how much we still have to learn about life!

Collecting acid-loving extremophiles in Carlsbad Caverns, New Mexico.

COURTESY OF VAL HILDRETH-WALKER

Collecting heat-loving extremophiles from a hot spring in Yellowstone National Park.

COURTESY OF MICHAEL MILSTEIN, BILLINGS GAZETTE



Two views of heat-loving bacteria.

COURTESY OF DR. HENRY ALDRICH, UNIVERSITY OF FLORIDA



Extremophiles adapted to cave conditions (e.g., dark, acidic, and low levels of oxygen and nutrients)

COURTESY OF SPILDE, NORTHUP, AND BOSTON

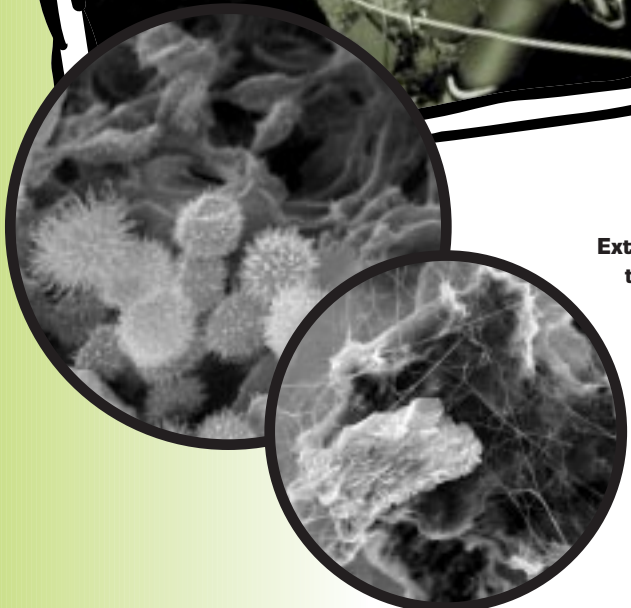

PURPOSE

To show that organisms living under extreme conditions on Earth can serve as analogs for extraterrestrial life

CONTEXT

Activity 4 explores some of the reasons to think that extraterrestrial life is possible. In doing so, it draws on concepts developed earlier in the module such as understanding what life is, what it requires, and what makes a planet habitable.

TIME

2 to 4 class periods

CONCEPTS

- We must base any search for extraterrestrial life on what we know about life on Earth.
- Extremophiles live at the limits of what life's chemistry is able to tolerate.
- Any place that mirrors Earth's life-sustaining environments may harbor life.
- As we explore the solar system, we find evidence for conditions that may support life.
- If extraterrestrial life is found in our solar system, it will most likely be microbial and inhabit environments considered extreme on Earth.

SKILLS

- *Extract* key information from a reading
- *Contribute* thoughtfully to discussions
- *Draw* conclusions and *Make* inferences when creating sets
- *Understand* extremophiles as analogs for extraterrestrial life
- *Conceive* of a plausible mission
- *Debate* the ethics of sending Earth life to another world

MATERIALS

- one Activity Guide (pp. 41–42) for each student
- one set of *Life on the Edge* cards (pp. 46–48) per four students (laminated or copy onto cardstock, if possible)
- poster materials

These bacteria extract energy from inorganic chemical sources. They live inside tubeworms by the millions.

COURTESY OF DR. COLLEEN CAVANAUGH, HARVARD UNIVERSITY

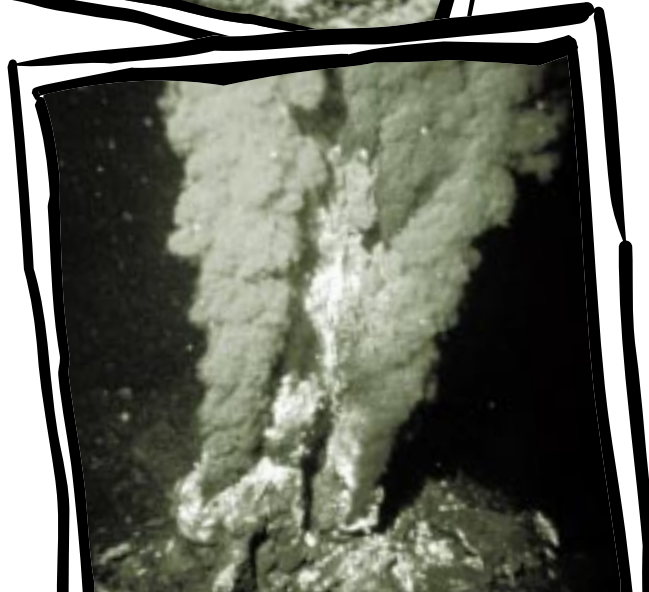
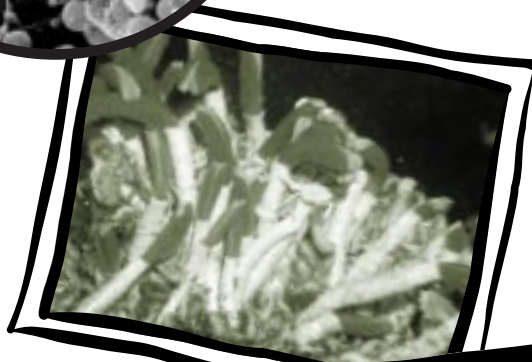
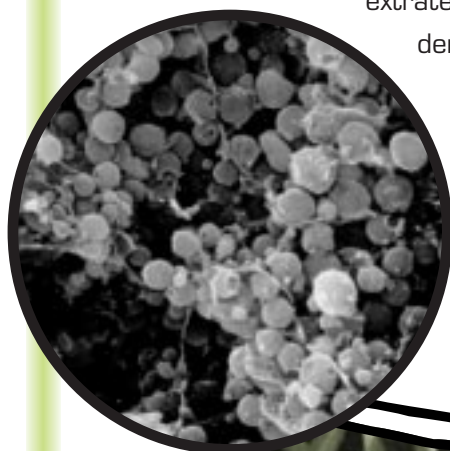

Extremophiles live at the limits of what life's chemistry is able to tolerate. If organisms on Earth can thrive under such conditions, then one might reasonably expect that similar conditions on other worlds might support life, as well. In fact, as we explore our solar system, we find mounting evidence for extraterrestrial conditions that may support extremophiles.

The logic at work, both in the search for extraterrestrial life and in this activity, is that Earth's extremophiles can serve as models for life elsewhere. It is plausible to think that we may find evidence of life in any place that mirrors Earth's life-sustaining environments.

In this activity, students play a card game that models the logic driving much of the search for extraterrestrial life. In the game, students start with an extreme habitat on Earth, find an extremophile that might live under those conditions, and finally identify a similar extraterrestrial habitat. By grouping these three elements, students realize that promising extraterrestrial habitats, and maybe extraterrestrial life itself, do indeed exist.

Additionally, they realize that if extraterrestrial life *is* found in our solar system, it will most likely resemble one of Earth's extremophilic microbes.

We are in the infancy of being able to detect extraterrestrial life. But daily, we learn more about the limits of life and about extraterrestrial environments and are moving our search forward.

These tubeworms are about one meter long. They lack a mouth or gut but are able to absorb chemical-rich seawater to feed the bacteria living in their bodies. The bacteria break down the chemicals, providing energy for themselves and for their tubeworm hosts.

© WOODS HOLE OCEANOGRAPHIC INSTITUTION

Along mid-oceanic ridges, hydrothermal vents spew clouds of chemicals and minerals into the seawater. Bacteria can metabolize these chemicals, forming the base of an entire ecosystem that functions in the absence of sunlight.

COURTESY OF P. RONA OAR/NATIONAL UNDERSEA RESEARCH PROGRAM

Recommended Procedure

STEP 1 Read the Activity Guide (pages 41 to 42) so you are familiar with the information that the students have available.

STEP 2 Have students read the information about extremophiles in the Activity Guide (page 41).

STEP 3 In groups, have students discuss and answer the four questions that follow the reading. Conduct a brief class discussion to make sure students understand:

- **why extremophiles are either bacteria or bacteria-like organisms.**
- **that extremophiles require the extreme conditions to be ongoing and continuous. With extremophiles, we are talking about long-term conditions, not short-term, one-time exposures.**
- **the range of conditions that life can tolerate.**

STEP 4 Teach students the *Life on the Edge* card game. You can do this by having students read the directions on the Activity Guide (page 45) themselves, read and discuss the directions as a class, or demonstrate the game for the class. Make sure they understand:

- **what constitutes a set.**
- **that there are duplicates of the organism cards. A table showing how many of each card are available is printed on the *Life on the Edge* rules sheet.**
- **that the three kinds of cards are linked by a particular environmental condition.**

STEP 5 Have students play two or three rounds of the *Life on the Edge* card game.

The table below shows the make up of the 48 cards in the deck. This table is reproduced on the *Life on the Edge* rule sheet.

Environmental Condition	Number of Organism Cards	Number of Earth Habitat Cards	Number of Possible Extraterrestrial Habitat Cards
Hot	4	4	4
Cold	4	4	4
Acid	2	2	2
Salt	3	3	3
Radiation	3	3	3

Emphasize that the habitats described on the *Possible Extraterrestrial Habitat* cards are speculations based on current data. Confirming the existence of most of the features described on these cards requires further exploration.

To date, no extraterrestrial life has been found in the solar system. Linking specific Earth organisms to extraterrestrial habitats is an exercise in imagining what type of extraterrestrial life might be found based on adaptations that are successful in similar Earth environments.

STEP 6 Base a class discussion on *Think About It* Questions 1 to 7. Students can answer these questions on their own, in groups, as homework, or as a class.

STEP 7 Challenge groups to select a “crew” of extremophiles to send to Mars, Europa, or one of the other top candidates they identified in Activity 3. To have the organisms survive once they reach their destination, groups must select a specific habitat on their target planet or moon and describe a plausible way to deliver the extremophiles to that habitat. Have groups create and then present a poster explaining their mission.

STEP 8 Discuss the ethical issues involved with sending Earth life to another planet or moon and have students debate different positions.

Some would say that sending Earth life to another world contaminates it and seriously compromises learning about how life arises, evolves, and persists on other worlds. They also might say that Earth life might out-compete extraterrestrial life forms and drive them into extinction before we understand them or even know they are there. Merely sending a spacecraft to another world might be enough to damage a sensitive environment with rocket exhaust, physical impact, and Earth materials. Even though NASA takes great pains to sterilize its spacecraft, it is still possible for microbes to “hitchhike” a ride to another world.

Others say that if humans are ever to inhabit other worlds, we need to send microbes now to provide raw materials and change the environment in ways that will support serious colonization. This is called **terraforming**. For example, microbes could help create an atmosphere, add oxygen to the environment, detoxify harmful compounds, extract useful materials from the planet’s or moon’s crust, and establish a food supply.

The *Life on the Edge* game follows the rules for Rummy. Students can also use the cards to play any card game in which the cards are grouped to make sets. *Concentration* and *Go Fish* are examples of this kind of game.

What can life tolerate?

Activity Guide

Name _____

Date _____

Introduction

Our solar system has nine planets and over 60 moons. Of all these worlds, only Earth is known to have life. Consequently, we must base any search for extraterrestrial life on what we know about life here. Over the past ten years, we have discovered organisms living in places once considered extreme and uninhabitable. These bacteria and bacteria-like organisms are called **extremophiles** (*philia* is Greek for “love”). No one expected to find organisms living under such extreme conditions, which shows how much we still have to learn about life!

If organisms on Earth can thrive under extreme conditions, then couldn't organisms live under similar conditions on other worlds? As we explore the worlds in our solar system, we find evidence for conditions that may support extremophiles. As a result, Earth's extremophiles can serve as models for life elsewhere.

Meet the Champions

Let's meet some extremophiles. Extremophiles not only tolerate extreme conditions (extreme by human standards, anyway), but they require them! If you put most of them in the kinds of conditions we like, they would die.

This list is posted on NASA's Astrobiology Institute web site: astrobiology.arc.nasa.gov/overview.html

Hottest	113°C	<i>Pyrolobus fumarii</i> (Vulcano Island, Italy). Earth's average surface temperature is 15°C
Coldest	-15°C	<i>Cryptotendoliths</i> (Antarctica)
Deepest underground	3.2 km underground	These bacteria live in the spaces between rock grains in the Earth's crust and are exposed to high levels of pressure, heat, and radiation.
Most acidic	pH 0.0	These bacteria grow in caves. The acid-base scale is called the pH scale where 0 is the most acidic and 14 is the most basic. Most life lives within a pH range of 5 to 8.
Most basic	pH 11	Alkaliphilic bacteria are found in areas where large bodies of water have evaporated and left behind layers of alkaline (i.e., basic) minerals.
Highest radiation dose	5 million rads	<i>Deinococcus radiodurans</i> is a common soil organism. A dose of 1000 rads will kill a person. Less than 1 rad per year is normal, and zero rads is ideal.
Longest period in space	6 years	<i>Bacillus subtilis</i> living in a NASA satellite that exposed test organisms to the extreme conditions of outer space.
Highest pressure	1200 times atmospheric pressure	This was a bacillus living at the bottom of the Marianas Trench, the deepest point beneath Earth's oceans. Typically, atmospheric pressure at sea level is 1013 millibar (14.7 pounds per sq. inch.)
Saltiest	30% salt	Halophilic bacteria live in water with a 30% salt content. By comparison, seawater and human blood are about 3.5% salt. Fresh water has very little salt.

What can life tolerate?

Activity Guide (continued)

Why are all these extremophiles bacteria or bacteria-like organisms, rather than being more like cockroaches, plants, or us? Mostly because extremophiles are very simple organisms compared with multicellular life. With fewer parts and fewer internal processes to coordinate, less can go wrong. When something does go wrong, it is easier to repair the damage and keep the organism living.

Some people will only be happy when we find a Hollywood-style alien. However, astrobiologists would be ecstatic if we found evidence of even a simple microbe anywhere beyond Earth. That would suggest that life occurs whenever the conditions are right. Also, once microbes inhabit a world, it opens up possibilities for the development of more advanced life. The first life on Earth was microbial and look at us now!

Before starting today's activity, answer the following questions.

- 1 What is an extremophile?
- 2 Why are extremophiles either bacteria or bacteria-like?
- 3 Could humans be considered extremophiles? Explain.
- 4 Complete this table with information on the conditions that life can tolerate.

Environmental Condition	Maximum Level Tolerated by Life	Minimum Level Tolerated by Life	Typical Level for Humans
Temperature			
Acid-Base Levels			
Salt Levels			
Radiation Levels			

What can life tolerate?

Name _____

Think About It

Date _____

- 1 How can life and conditions on Earth be used as a model for life on other worlds?
- 2 If you were able to send a test tube of one kind of extremophile to Mars, which extremophile would you choose? Why?
- 3 If you were able to send a test tube of one kind of extremophile to Europa, which extremophile would you choose? Why?
- 4 If you could genetically engineer a new extremophile so that it had the traits of two different kinds of extremophiles, which two traits would you merge if your extremophile were to live on Mars? Europa? Explain.

(continues)

What can life tolerate?

Think About It (continued)

- 5 Describe the kind of extraterrestrial life that we are most likely to find in our solar system. Why do you think it is the most likely kind?
- 6 What will finding evidence of microbial life on another world teach us about life in general?
- 7 Draw two pictures: one of the kind of extraterrestrial life we might reasonably expect to find in our solar system and the other of what you think most people think is out there. If they are different, explain why you think they are different.

What can life tolerate?

Rules for *Life on the Edge* Card Game



LIFE ON THE EDGE

Today you will play a card game that shows how life and conditions on Earth can be used as a model for life on other worlds. The rules are similar to Rummy, and the game is best played with two to four students.

- Deal five cards to each player and place the remainder face down between the players. This will be the *draw deck*. Turn one card face up next to the draw deck.
- The first player takes either the upturned card or the top card of the draw deck.
- The player sees if he or she has a set (one card from each category). To be a valid set, the organism must be able to live in the Earth and possible extraterrestrial habitats.

Organism Card	Earth Habitat Card	Possible Extraterrestrial Habitat Card
 <p>describes a specific type of extremophile</p>	 <p>describes a specific habitat on Earth where this extremophile might be found</p>	 <p>describes an extraterrestrial habitat with similar characteristics to the Earth habitat that could be home to extremophiles or extremophile-like life</p>

- If the player has a valid set, he or she must lay it down, read the three cards aloud, and explain why it is reasonable to think that an organism might exist on this other world. Other players can challenge the set if they disagree.
- The player discards a card and play continues in a clockwise rotation.
- The next player may take the discarded card or select the top card of the draw deck.
- Play continues until the first person goes out. If all the cards from the draw deck have been drawn, shuffle the discarded cards and use them as a new draw deck.

The Makeup of the 48 Cards in the Deck			
Condition			
Hot	4	4	4
Cold	4	4	4
Acid	2	2	2
Salt	3	3	3
Radiation	3	3	3



**Organism Card
Cold-Loving Bacteria**

Little Known Fact:
Scientists have found
Cryptotendoliths living at
minus 15°C. Earth's average
surface temperature is
15°C.



**Organism Card
Cold-Loving Bacteria**

Little Known Fact:
Scientists have found
Cryptotendoliths living at
minus 15°C. Earth's average
surface temperature is
15°C.



**Organism Card
Cold-Loving Bacteria**

Little Known Fact:
Scientists have found
Cryptotendoliths living at
minus 15°C. Earth's average
surface temperature is
15°C.



**Organism Card
Cold-Loving Bacteria**

Little Known Fact:
Scientists have found
Cryptotendoliths living at
minus 15°C. Earth's average
surface temperature is
15°C.



**Organism Card
Heat-Loving Bacteria**

Little Known Fact:
Scientists have found
Pyrolobus fumarii living in
113°C water.



**Organism Card
Heat-Loving Bacteria**

Little Known Fact:
Scientists have found
Pyrolobus fumarii living in
113°C water.



**Organism Card
Heat-Loving Bacteria**

Little Known Fact:
Scientists have found
Pyrolobus fumarii living in
113°C water.



**Organism Card
Heat-Loving Bacteria**

Little Known Fact:
Scientists have found
Pyrolobus fumarii living in
113°C water.



**Organism Card
Radiation-Tolerant Bacteria**

Little Known Fact: Scientists have
found *Deinococcus radiodurans*
living after being exposed to radia-
tion levels of five million rads. It
can tolerate high levels of both
ultraviolet radiation and radioac-
tive decay. The lethal dose for
humans is 1000 rads.



**Organism Card
Radiation-Tolerant Bacteria**

Little Known Fact: Scientists have
found *Deinococcus radiodurans*
living after being exposed to radia-
tion levels of five million rads. It
can tolerate high levels of both
ultraviolet radiation and radioac-
tive decay. The lethal dose for
humans is 1000 rads.



**Organism Card
Radiation-Tolerant Bacteria**

Little Known Fact: Scientists have
found *Deinococcus radiodurans*
living after being exposed to radia-
tion levels of five million rads. It
can tolerate high levels of both
ultraviolet radiation and radioac-
tive decay. The lethal dose for
humans is 1000 rads.



**Organism Card
Acid-loving Bacteria**

Little Known Fact:
Scientists have found
bacteria growing on the
walls of caves living at 0.0
pH. Most organisms live
within a pH range of 5 to 8.



**Organism Card
Salt-Loving Bacteria**

Little Known Fact:
Scientists have found
halophilic bacteria living
in water that is 30% salt.
By comparison seawater
and human blood are about
3.5% salt.



**Organism Card
Salt-Loving Bacteria**

Little Known Fact:
Scientists have found
halophilic bacteria living
in water that is 30% salt.
By comparison seawater
and human blood are about
3.5% salt.



**Organism Card
Salt-Loving Bacteria**

Little Known Fact:
Scientists have found
halophilic bacteria living
in water that is 30% salt.
By comparison seawater
and human blood are about
3.5% salt.



**Organism Card
Acid-loving Bacteria**

Little Known Fact:
Scientists have found
bacteria growing on the
walls of caves living at 0.0
pH. Most organisms live
within a pH range of 5 to 8.



Earth Habitat Card

Salt domes and brine are often found in association with petroleum deposits.



Earth Habitat Card

The Arctic ice cap is made of water ice.



Earth Habitat Card

Water ice over two kilometers thick covers Antarctica. The coldest temperature on Earth, minus 89°C, was recorded in Antarctica.



Earth Habitat Card

Greenland is covered with a two-kilometer-thick sheet of water ice.



Earth Habitat Card

The evaporation of large bodies of salt water has covered large areas of land with thick layers of salt.



Earth Habitat Card

Volcanic vents occur all along the 17,000 miles of Earth's mid-oceanic ridges. The water injected into the ocean environment is extremely hot.



Earth Habitat Card

Hot springs occur when groundwater is heated and rises to the surface.



Earth Habitat Card

Processes in the Earth's crust produce extremely hot groundwater.



Earth Habitat Card

Contact between volcanic magma and underground water produce pockets of hot water.



Earth Habitat Card

The Arctic tundra has a layer of permafrost beneath it. Permafrost is soil locked in water ice.



Earth Habitat Card

Natural deposits of uranium can produce areas with high levels of radiation.



Earth Habitat Card

When our atmosphere's ozone layer gets thin, Earth's surface can receive dangerous levels of harmful ultraviolet radiation.



Earth Habitat Card

Acidic groundwater is found beneath much of the Earth's crust.



Earth Habitat Card

Acidic groundwater dissolves certain kinds of rocks, forming caves and producing an acidic environment for life.



Earth Habitat Card

Salt occurs in Earth's ocean water. The salt concentration can rise dramatically as water evaporates from enclosed bodies of sea water such as tide pools and enclosed bays.



Earth Habitat Card

Radiation in the Earth's crust comes from the decay of radioactive elements such as uranium.



Possible Extraterrestrial Habitat

Just beneath Europa's surface, there may be large pockets of salty brine.



Possible Extraterrestrial Habitat

During its first two to three billion years, Mars had water and volcanic activity. This combination would likely produce hot springs and underground pockets of hot water.



Possible Extraterrestrial Habitat

Europa's ocean is probably very salty.



Possible Extraterrestrial Habitat

The decay of radioactive elements such as uranium in the Martian crust would create high levels of radiation.



Possible Extraterrestrial Habitat

Mars may have a layer of water beneath its surface. On Earth, such groundwater is often acidic.



Possible Extraterrestrial Habitat

Acidic groundwater dissolves certain kinds of rocks, forming caves. Mars may have these kinds of rocks, resulting in an acidic environment for life.



Possible Extraterrestrial Habitat

Ultraviolet radiation and charged particles from the sun bombard the surface of Mars, which is completely unprotected from these kinds of harmful radiation.



Possible Extraterrestrial Habitat

Salt layers form when large bodies of salty water evaporate. Mars may have had large bodies of water that have since evaporated, possibly leaving layers of salt.



Possible Extraterrestrial Habitat

Ultraviolet radiation bombards the surface of Europa, which is completely unprotected from this kind of harmful radiation.



Possible Extraterrestrial Habitat

Processes in the Martian crust may heat water below the surface, producing pockets of hot groundwater.



Possible Extraterrestrial Habitat

The Northern Polar ice cap on Mars is made of water ice.



Possible Extraterrestrial Habitat

The core of the Southern Polar ice cap on Mars seems to be made of water ice.



Possible Extraterrestrial Habitat

Most of the Martian surface has a layer of permafrost beneath it. Permafrost is soil locked in water ice.



Possible Extraterrestrial Habitat

Europa is completely covered by a one- to ten-kilometer-thick shell of water ice.



Possible Extraterrestrial Habitat

Evidence suggests that Europa may have considerable volcanic activity beneath its ocean. This volcanic activity would provide Europa's ocean with large amounts of hot water.



Possible Extraterrestrial Habitat

The Martian surface has deposits of a kind of iron oxide called hematite. Hematite is often associated with organisms living in hot springs.

Is there life on other worlds?

Is there life on other worlds? People have pondered this question since ancient times. But now, for the first time in human history, advances in the biological sciences, space exploration, and space technology may finally make it possible to answer it.

At first, “Is there life on other worlds?” seems a simple question to answer. However, it quickly becomes a complex web of issues. What is life, anyway? How does it begin and evolve? What conditions can life tolerate? What makes a planet or moon habitable? How do we look for and identify extraterrestrial life? To attempt to resolve these kinds of questions, astrobiologists draw on many branches of science and employ many research strategies such as fieldwork, laboratory research, telescopic observation, and exploration with spacecraft.

Though we have not found any examples of extraterrestrial life, comparisons with certain kinds of life on Earth suggest that potential habitats for extraterrestrial life, and maybe life itself, do indeed exist. However, contrary to popular notions, if extraterrestrial life is found in our solar system, it will most likely be bacteria-like.

In 1961, the astronomer Dr. Frank Drake suggested an organized framework for thinking about life in the galaxy. Known as the Drake Equation, it provides a way to estimate the number of worlds within our Milky Way galaxy that have intelligent life and whose radio transmissions should be detectable. Drake identified a sequence of eight terms to help people think about what must occur before a world can be inhabited by a civilization with radio technology. This activity uses Dr. Drake’s framework to have students consider the implications of each term and make their own estimates of life in the Milky Way galaxy.

PURPOSE

To estimate the number of worlds in the Milky Way galaxy that have life

CONTEXT

By asking students to consider the possibility of life – simple to technological – in our galaxy, Activity 5 builds on the previous investigations of life and habitability and gets students to think about the size and composition of the galaxy.

TIME

1 to 2 class periods

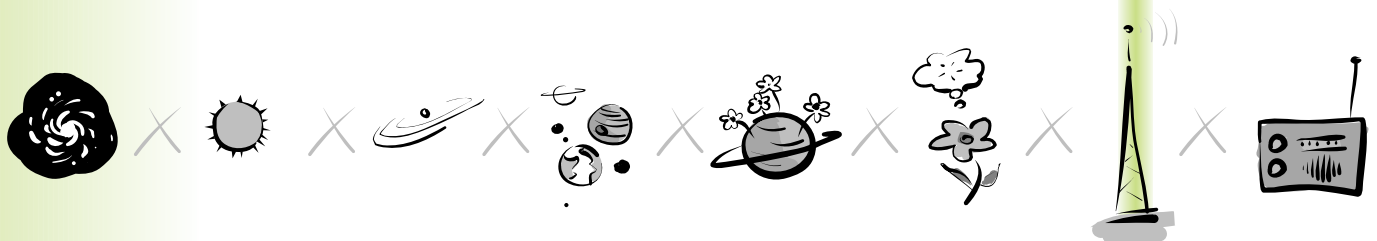

CONCEPTS

- The chances for life elsewhere in the galaxy could be either high or low, depending on whether one's assumptions and estimates are conservative or optimistic.
- Finding even simple life forms will be a breakthrough discovery.
- The large number of stars significantly increases the possibility of extraterrestrial life.

SKILLS

- *Understand* that our galaxy contains a large number of stars
- *Understand* and *Estimate* the terms of the Drake Equation
- *Calculate* how many civilizations with radio technology we can communicate with

MATERIALS

- one Activity Guide (pages 53 and 54) for each student
- blank overhead transparencies
- transparency markers
- calculators

Recommended Procedure

STEP 1 To get a sense of what your students think when they hear the term “extraterrestrial,” ask them:

What is the chance that we are the only life in the universe?

Are there such things as extraterrestrials?



What do you mean by extraterrestrials?



extraterrestrial?

Would you be interested in a planet inhabited by microbes, plants, and insects? Why or why not?

Do you think that there are any forms of life elsewhere in the universe? Why?

Students typically think of “extraterrestrials” in terms of science fiction. Prompting them to consider other forms of life often changes their answers, or at least the reasons they provide.

STEP 2 Have the class define the term, extraterrestrial. Try to get them to broaden the meaning to include anything from microbes to plants to intelligent creatures to any living thing.

STEP 3 Mention that astrobiology involves thinking about whether or not there is extraterrestrial life, where it might be, and how we can learn more about it.

STEP 4 To have students identify the factors related to the existence of extraterrestrial life, ask them what information they would need to determine the probability of extraterrestrial life. You might begin by saying, “Let’s see if we can estimate how many worlds out there have life (or intelligent life with which we can communicate). What would we need to know?” Try to keep your prompting

In 1961, Dr. Frank Drake developed an equation to estimate the number of other civilizations that exist in our Milky Way galaxy that we can detect using radio technology. It does this by making estimates of eight component factors. Since we are unsure whether there is life out there, let alone intelligent life with which we can communicate, there is no correct solution to the equation — the value of each factor is open to interpretation.

The Drake Equation

The number of worlds within our Galaxy that have intelligent life whose radio emissions should be detectable

=

Number of stars in the Milky Way galaxy



X

Percent of these stars that are appropriate



X

Percent of appropriate stars that have planetary systems



to a minimum. It is more important to have students think about the terms than it is to get a complete set. Record their terms on the board or overhead projector.

With minimal prompting, students can determine many of the factors needed to estimate the number of worlds with intelligent, technology-using civilizations. Note that one can begin this list from any term and work out from there to the rest of the terms. Some prompts you might find helpful include:

- What does _____ depend on?
- What might the next step be?
- Are you saying we'll find life on any _____ ?

STEP 5 Introduce the Drake Equation as one scientist's effort to identify the factors in the same way students did in Step 4. Have students complete the worksheet and estimate values for each term. Make sure they understand that there are no right answers. The Drake Equation simply helps us think about the factors involved in determining the probability of communicating with civilizations that have radio technology.

STEP 6 After making estimates for each term, have students multiply the eight terms and determine their estimate of the number of other civilizations that exist in our Milky Way galaxy that we can detect using radio technology (Question 1 on the Activity Guide). The percentages should be treated as decimals. (For example, 30% = 0.30; 5% = 0.05; 0.01% = 0.0001).

STEP 7 Have students report their estimates and discuss the range and their implications. The Drake Equation can provide radically different answers from 1 (we will never hear from intelligent extraterrestrials) to billions (we will almost undoubtedly hear from them).

STEP 8 Use the *Think About It* questions to guide a class discussion on the implications of the numbers that the students estimated. There is a Teacher Answer Guide to the *Think About It* questions on pages 57 and 58.

Students can succeed in the next part of the activity after naming five or six factors in this brainstorm.

Don't worry about creating a usable equation. The goal is to have students think about each factor. Students should be able to identify factors such as the number of stars, planets, habitable planets, planets with life, planets with intelligent life, and planets with radio technology.

Explore an online version of the Drake Equation at astrobio.terc.edu. Since the computer recalculates whenever you change a value, this online version may be the best way for students to manipulate the terms easily and obtain different results quickly.

Average number of habitable planets within a system



X

Percent of habitable planets that develops life



X

Percent of planets with life that develops intelligent life



X

Percent of intelligent life that develops radio technology



X

Percent of radio technologies that are "current"



Math Extension

Calculating a number using the Drake Equation is an exercise in **estimation**. When estimating, we provide definite numbers to terms for which we have no actual values. However, we use whatever pertinent information is available to make an estimate as accurate as possible. An estimate is different from a sheer guess because, with an estimate, one constrains the possibilities by extrapolating from what one does know.

Probabilities are different than estimates. Probabilities focus on how often an event will occur out of a certain number of trials (e.g., one chance in a hundred or in a million). As a result, they are expressed as percentages. Estimates are expressed as numbers. Since the Drake Equation results in a number rather than in a percentage, it is an estimate.

Enrico Fermi, a Nobel Prize-winning physicist, often challenged his students with similar kinds of problems, such as estimating the number of corn flakes in the United States. Known as Fermi Problems, they rely on the same process — extrapolating from what you know. Astrobiologists use the Earth in this fashion. By studying our planet and its inhabitants, scientists have learned a great deal about life and habitability. Using what we know enables us to make predictions about life in distant places.

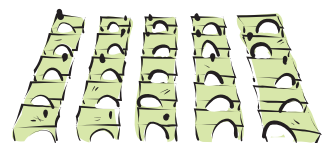

Recommended Procedure

- STEP 1** Ask students how they would estimate the number of pens and pencils in the school. To give their estimate some basis, they might count the actual number of pens and pencils in the classroom. This number together with the number of classrooms in the school can provide a rough estimate of the total number of pens and pencils.
- STEP 2** As students think more deeply about the question, they will realize that there are offices, teacher's desks, and supply rooms that have pens and pencils, too. Including these in their estimate makes it increasingly accurate.
- STEP 3** One could expand this exercise by estimating the number of pens and pencils nationwide.

Is there life on other worlds?

Activity Guide

Introduction

Do you think there is intelligent life in our galaxy with which we can communicate? In 1961, Dr. Frank Drake identified eight terms to help people think about what would have to take place for such communication to be possible.

See what you think the chances are by making your own estimate for each of the terms below. The conservative and optimistic values indicate the range of opinion among scientists with regard to each term. You can use the conservative or optimistic estimates or use another value, depending on your own intuition.

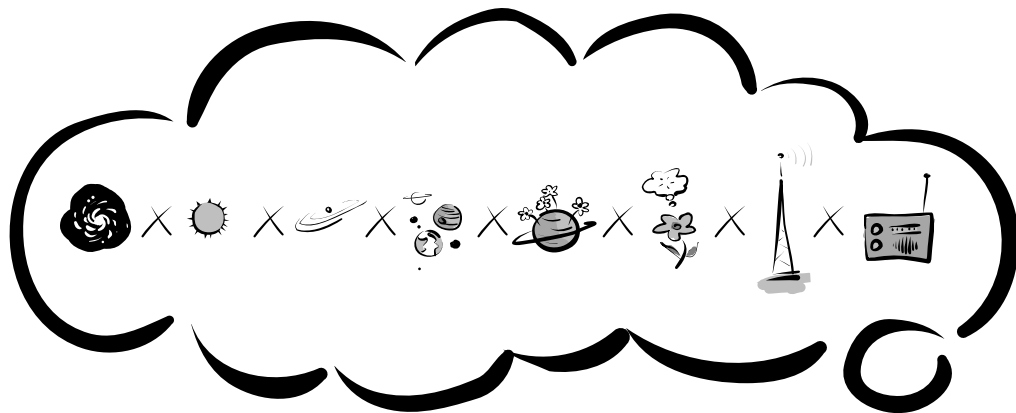

What to Do

To estimate the number of worlds in the Milky Way galaxy that have intelligent life that we can detect using radio technology, follow these steps:

- 1 Make estimates for each of the eight terms listed on the *Using the Drake Equation* worksheet.
- 2 Convert percentages to decimals before multiplying.
- 3 Multiply the estimates you made for the eight terms.











Is there life on other worlds?

Name _____

Using the Drake Equation

Date _____

	TERM	BACKGROUND	CONSERVATIVE ESTIMATE	OPTIMISTIC ESTIMATE	YOUR ESTIMATE
	1 The total number of stars in the Milky Way galaxy	These numbers are based on observations of the stars in our galaxy, the Milky Way galaxy, and of other galaxies we believe to be like our own. Most scientists believe the number of stars to be 400 billion.	100 billion	600 billion	
	2 The percent of stars that are appropriate	Many scientists believe that a star has to be like our sun, which is a Main Sequence, G-type star. Only about 5% of the stars in our galaxy are G-type stars, though about 10% are the closely related F- and K-type stars. About 50% of stars exist in binary or multiple systems, which many scientists feel make them inappropriate.	5%	15–45%	
	3 The percent of these appropriate stars that have planetary systems	Appropriate stars may not have planets circling them. We have only just begun detecting extra-solar planets, so we don't really know how common they are.	5%	50–100%	
	4 The average number of habitable planets or moons within a solar system	Our only example of this term is our own solar system. Could Earth be the only habitable place in our solar system? Is our system typical? Remember that if one system has no habitable planets or moons and another has four, the average would be two per system.	0.1 On average, there is one habitable planet in every ten systems	4 On average, there are four habitable planets in every system	
	5 The percent of habitable planets or moons that develop life	Having a planet or moon that is appropriate for life doesn't necessarily mean that life will arise. No real data are available to help us estimate this term. Earth is the only planet on which we know there is life. However, bacterial life existed on Earth shortly (geologically speaking) after its formation, possibly indicating that the development of life is easy. Many scientists believe that whether or not life arises depends on many factors.	0.000001% Life is a rare accident that is unlikely to happen elsewhere	100% Life will arise if conditions are appropriate	
	6 The percent of planets with life that develop intelligent life	On Earth, humans developed intelligence, apparently as an evolutionary advantage. However, this term depends on how you define intelligence. Are dolphins, gorillas, octopus, and ants intelligent? Furthermore, single-celled life existed on Earth very early, and multicellular life took 2.5 billion years to form (a very long time, geologically speaking). Maybe the development of complex life, let alone intelligent life, is unusual.	0.0001% or less Only one in a million planets with life will develop intelligent life	100% Any planet with life will develop intelligent life	
	7 The percent of intelligent life that develops radio technology	Communication with intelligent extraterrestrials requires that we hear from them. Given the vast distances of space, they would probably send signals which travel at the speed of light, such as radio waves. On Earth, humans have only just developed radio technology, so possibly this term should have a low value. But, we did eventually develop radio technology, so maybe this is true of all intelligent beings.	0.0001% or less Only one in a million planets with intelligent civilizations will develop radio technology	100% All intelligent life will develop radio technology	
	8 The percent of "current" civilizations having radio technologies	Will an extraterrestrial's signals overlap with the lifespan of the receiving civilization? Extraterrestrials that <i>sent</i> signals a million years ago from a world a million light years away would still overlap with us, even if they died out long ago. So, how long do civilizations with radio technology last? A high level of technological development could bring with it conditions that ultimately threaten the species. Or maybe, once a society has radio technology, it may survive for a long time. Finally, radio signals may give way to more advanced, less noisy technologies such as optical fiber. No one would hear us then!	0.0001% or less One in a million civilizations with radio technology will develop it in time to detect signals from another civilization	10% One in a ten civilizations with radio technology will develop it in time to detect signals from another civilization	

Is there life on other worlds?

Name _____

Think About It

Date _____

- 1 To find out your estimate of the number of worlds in the Milky Way galaxy that have intelligent life that we can detect using radio technology, fill out the *Drake Equation* worksheet and multiply the eight terms together. Write your answer here:
- 2 Based on your estimates, how good are our chances of hearing from intelligent extraterrestrials?
- 3 How does your answer to Question 2 compare to what you thought before you began the activity?
- 4 Can your answer to Question 1 be less than one? Why or why not?
- 5 When making estimates, in which terms did you have the most confidence? The least? Why?
- 6 Are you more optimistic or conservative when it comes to thinking about extraterrestrial life with radio technology in the Milky Way galaxy? Why?
- 7 How could you adjust the estimates in the equation to have it come out so that Earth is the only planet in the Milky Way galaxy with radio technology?

(continues)

Is there life on other worlds?

Think About It (continued)

- 8 If tomorrow's newspaper headline read, "*Message Received from Outer Space*" what would it mean to you?

- 9 What would your reaction be if we discovered microbes on another planet? Plants? Insects? Mammals? Intelligent life?

- 10 If microbial life were discovered on another planet, what implications might such a discovery have?

- 11 How would you define extraterrestrial now? How does your current definition differ from the one that the class developed earlier in the activity?

- 12 What do you think is the most abundant life form on Earth?

- 13 If life exists elsewhere, what do you think it will look like?

Is there life on other worlds?

Teacher Answer Guide to the *Think About It* Questions

These background notes provide answers to some of the questions on the Student Activity Guide and can be used to help guide a class discussion based on those questions. Questions 2, 3, 7, 8, 9, and 11 ask students to reflect on their own feelings, perceptions, or idea, and therefore have no background notes.

1 Based on the eight terms, what is your estimate?

While Terms 5 to 8 are percentages, the final number that students obtain is a discrete number rather than a percentage or a probability. This number represents a student's estimate of the number of civilizations with radio technology that we can detect.

4 Can your answer to Question 1 be less than one?

While there is no right answer, there are wrong answers. Because Earth exists, the final answer *cannot* be zero and probably should not be less than one. If students choose low probabilities for Terms 5 to 8, they may need more than the 400 billion stars in the Milky Way galaxy to obtain a final answer of one. This would require considering additional galaxies to account for the existence of Earth.

5 In which terms did you have the most or least confidence?

Estimating numbers for the eight terms becomes increasingly a matter of conjecture as one goes from Term 1 to Term 8. There is widespread agreement only for the first two terms.

6 Are you more optimistic or conservative?

An answer of one states that Earth is the only place with intelligent life that has radio technology. There may still be life or even intelligent extraterrestrials out there, but we cannot communicate with them because they do not have radio technology. Any number larger than one implies that we may receive signals from intelligent extraterrestrials someday. However, make the distinction between detection and communication, which is a two-way exchange. With a small final number, actual communication is less likely. With a large final number, actual communication becomes increasingly likely.

(continues)

Is there life on other worlds?

Teacher Answer Guide to the *Think About It* Questions (continued)

10 What are the implications of discovering microbial life?

Many students express disinterest in discovering anything less than a bona fide, Hollywood-style extraterrestrial. However, no life beyond Earth has ever been found, which implies that life may be a rare accident that happened on Earth due to an extraordinary convergence of circumstances and that it is unlikely to happen elsewhere. In this context, discovering microbial life would help us understand more about how life arises and what conditions it can tolerate. Furthermore, it would help answer the question of whether life is a common process in the universe. In short, discovering microbial life beyond Earth would be a profound discovery. By multiplying Terms 1 to 5, students can make their own estimate of how many worlds in our galaxy have life of any sort.

12 What is the most abundant life form on Earth?

We live in the age of bacteria. For the past three and a half billion years, bacteria have been the dominant life form in terms of numbers and biomass. They are key to many biological, geological, and chemical processes, and many scientists think that multicellular organisms became possible only after single-celled bacteria began living symbiotically within a cell membrane.

13 If life exists elsewhere, what do you think it will look like?

Astrobiologists feel that most extraterrestrial life will be bacteria-like, living beneath a planet's or moon's surface and using chemical energy for their needs. Animal life, and especially intelligent animal life, is probably much rarer.

National Standards

Science Standards

Unifying Concepts and Processes

	1 What is life?	2 What does life need to live?	3 What makes a world habitable?	4 What can life tolerate?	5 Is there life on other worlds?
Systems, Order, and Organization	•	•	•		•
Evidence, Models, and Explanation	•	•	•	•	•
Constancy, Change, and Measurement		•	•		•
Evolution and Equilibrium	•			•	•
Form and Function	•			•	

Science as Inquiry

Abilities Necessary to do Scientific Inquiry	•	•	•	•	•
Understandings about Scientific Inquiry	•	•	•	•	•

Physical Science

Structure & Properties of Matter, Objects, & Materials	•	•	•		
Chemical Reactions	•	•			
Interactions of Energy and Matter		•			

Life Science

Biological Evolution	•				
Matter, Energy, & Organization in Living Systems	•	•	•		
Behavior of Organisms				•	

Earth and Space Science

Energy in the Earth System		•	•	•	
Origin and Evolution of Planetary Systems			•		•
Planetary Characteristics			•		
Organization of the Solar System			•		

Science and Technology

Abilities of Technological Design		•		•	•
Understanding Science and Technology		•	•	•	•

Science in Personal and Social Perspectives

Natural Resources		•	•	•	
Risks and Benefits				•	

History and Nature of Science

Science as a Human Endeavor				•	•
-----------------------------	--	--	--	---	---

Mathematics Standards

	1 What is life?	2 What does life need to live?	3 What makes a world habitable?	4 What can life tolerate?	5 Is there life on other worlds?
Problem Solving		•	•		•
Communication	•	•	•	•	•
Reasoning				•	•
Connections		•	•		•
Computation and Estimation		•	•		•
Patterns and Functions			•		
Probability					•
Measurement		•	•		

Science Process Skills

Observing	•	•			
Measuring		•			
Communicating	•	•	•	•	•
Collecting Data	•	•			
Inferring	•	•	•	•	
Predicting	•	•	•	•	•
Making Models		•		•	
Hypothesizing	•	•	•	•	
Interpreting Data	•	•	•		
Controlling Variables	•	•			
Defining Operationally	•	•			
Investigating	•	•			
Extrapolating		•			•
Synthesizing	•	•	•	•	•

“The search for life-sustaining worlds could be a new unifying goal for space research”

Daniel Goldin, NASA Administrator

Astrobiology is an interdisciplinary field. It provides a relevant, meaningful context for students to explore key concepts in biology, chemistry, physics, mathematics, and Earth and space science. This Educator Resource Guide provides opportunities for students in grades 5–10 to master fundamental science concepts and develop inquiry skills.

The Guide’s hands-on activities introduce students to core ideas in astrobiology by examining five key questions:

What is life?

What does life require?

Which planets and moons might be habitable?

How do Earth’s extremophiles support the idea of extraterrestrial life?

What are the possibilities for life elsewhere in our solar system?

The Science and Mathematics Standards met by the activities are listed inside this cover.

Visit nai.arc.nasa.gov for further information on NASA’s Astrobiology Institute.

Visit astrobiology.arc.nasa.gov for further information on the science of astrobiology.

Visit astrobio.terc.edu for more information on TERC’s yearlong astrobiology curriculum.



This curriculum guide was sponsored by the NASA Astrobiology Institute (NAI), with funds from the NAI Lead Teams at NASA Ames Research Center and NASA Jet Propulsion Laboratory, and TERC’s Astrobiology Curriculum Project.

Version 1.2 Fall 2000