

SUSY Searches at the TEVATRON

- Why Supersymmetry?
- Why Colliders?
- Example 1: jets + MET search for squarks and gluinos
- Example 2: tri-lepton searches for charginos and neutralinos
- Example 3: rare B_s decays
- After the TEVATRON - the LHC
- Summary & Conclusions

Michael Schmitt
Northwestern University / CDF

SLAC Summer Institute, August 2, 2005

Why Supersymmetry?

The Standard Model (SM) of particle physics is theoretically incomplete – there are many questions it cannot answer, and many aspects which are *ad hoc*.

We believe there is a better theory which rectifies at least some of the deficiencies of the SM, and which will also predict phenomena beyond the SM (BSM).

Probably the best candidate for the correct theory BSM is Supersymmetry (SUSY), though other very different theories are interesting and deserve attention. Today, however, SUSY!

There are many motivations for the theory of Supersymmetry, and there are reasons why it is so popular among speculations.

Motivation 1: Extend the Poincaré Group

We would like to unify all the forces of Nature, including gravity.

Spin-1 (gauge) bosons and spin-2 bosons (gravity) cannot be placed in the same representation, in general.

The only exception is: **SUPERSYMMETRY.**

If Q is a generator of SUSY algebra, then by definition

$$Q |fermion\rangle = |boson\rangle \quad \text{and} \quad Q |boson\rangle = |fermion\rangle$$

This allows the sequence

$$spin\ 2 \rightarrow spin\ 3/2 \rightarrow spin\ 1 \rightarrow spin\ 1/2 \rightarrow spin\ 0$$

which shows that unification with gravity implies boson/fermion symmetry.

Taking infinitesimal transformations based on Q_α , and demanding that they be local, requires a theory like General Relativity.

This makes Supersymmetry mathematically unique, and valuable.

Finally, one should note that String Theories require Supersymmetry.

The particle mirror

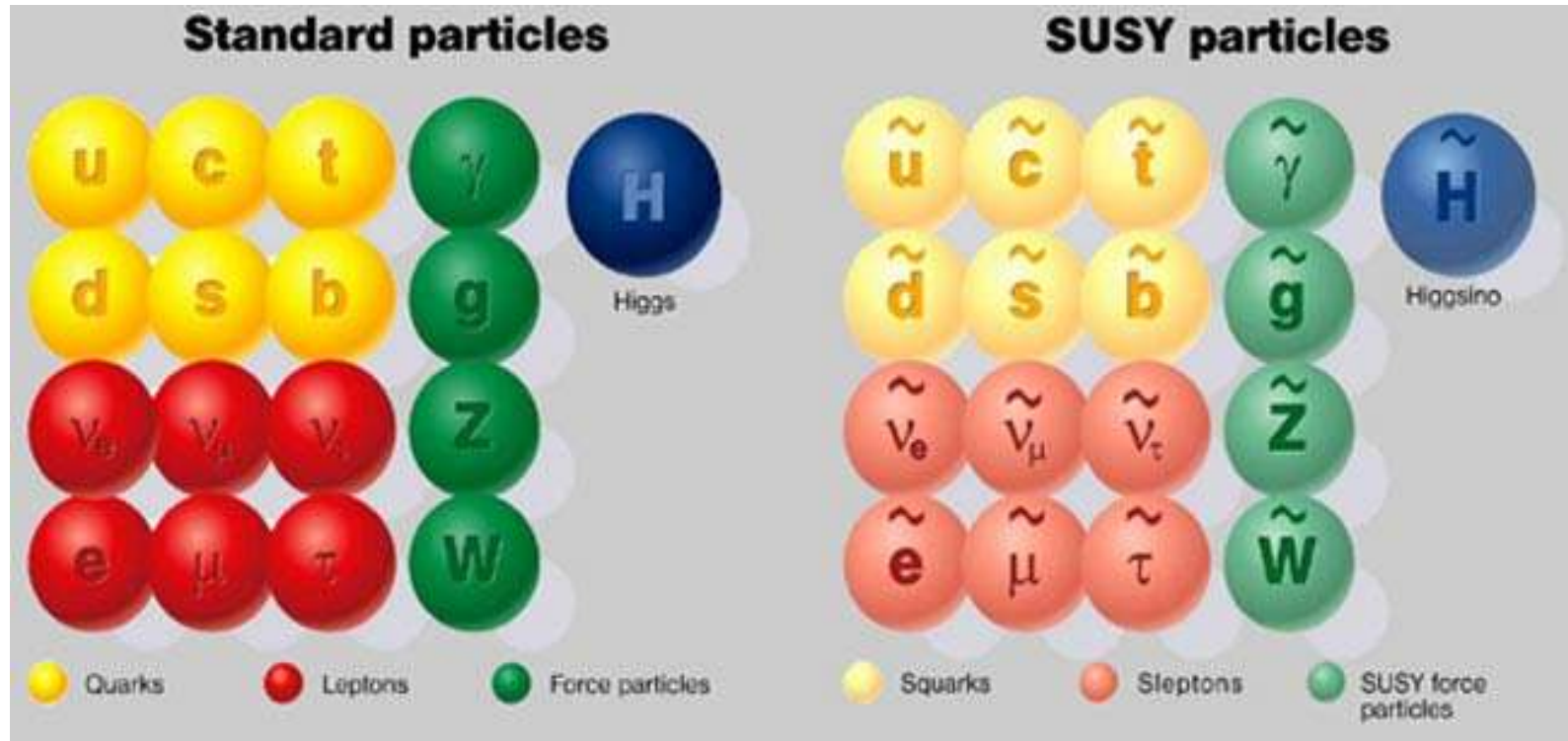

For every SM fermion (the matter particles), there is a SUSY boson (spin-0).

For every SM boson (the force carriers), there is a SUSY fermion (spin-1/2).

Note, also, that particles mix to form mass states, when not forbidden by some symmetry (conservation rule).

Motivation 2: Dark Matter Candidate

The lightest supersymmetric particle (LSP), typically is neutral and interacts only weakly with matter. Of course it has mass, too...

If this LSP is stable (which has to be postulated) then there will be relic particles left over from the big bang.

It turns out that the density and mass of the LSP today easily matches that of dark matter!

There are a number of scenarios which have been carefully explored and calculated, which lead to a variety of related observations in colliders – should SUSY be the correct theory BSM!

Motivation 3: Unification of Forces

Unifying the known four forces has always been a goal – a paradigm – of particle physics. (These are the famous “GUTs”)

“Unifying” means that there is a mass scale (or interaction energy) at which the electromagnetic, weak, and strong interactions have the same strength.

(Gravity is left out of the picture most of the time.)

The way the forces change with interaction energy is well known from precision measurements. One can extrapolate to high energies.

In the SM, the three forces do not unify at a common point.

In SUSY, they do!

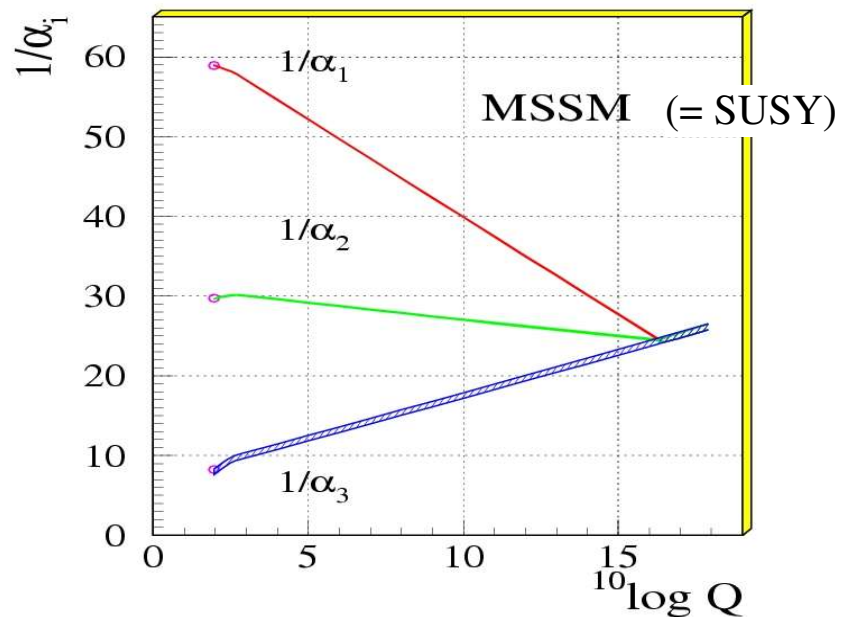
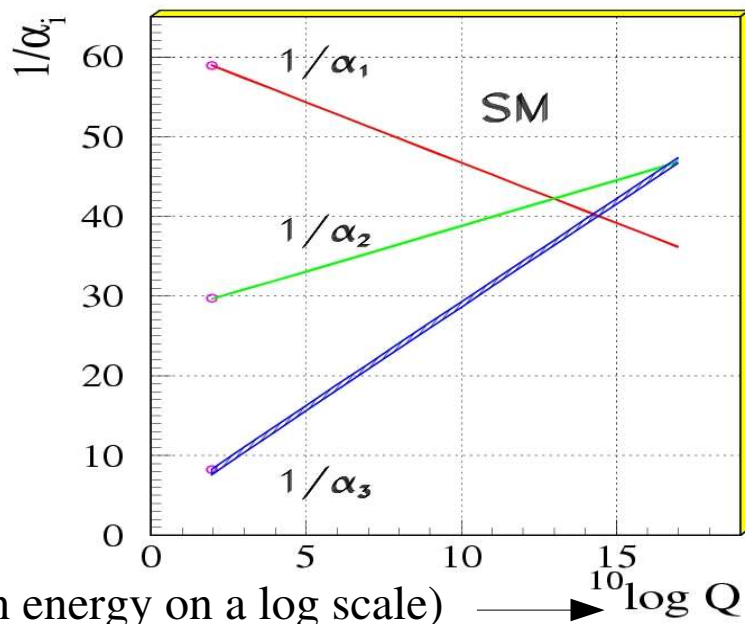

(interaction energy on a log scale) $\longrightarrow 10 \log Q$

Motivation 4: Taming Higgs UV Divergence (also known as the “Hierarchy Problem”)

The Higgs mechanism provides an explanation for the masses of the gauge bosons (via “Electroweak Symmetry Breaking” - EWSB), and hence is a fundamental feature – and success – of the SM.

hep-ph/0012288

Unfortunately, if you calculate radiative corrections to the Higgs mass, you obtain divergent contributions which are many orders of magnitude larger (e.g., 10^{17} GeV) than the mass needed to provide EWSB (around 10^2 GeV), and in the SM there is no good way to cure this.

It turns out that SUSY naturally solves this problem, since the boson contributions have opposite sign to the fermion contributions. Due to the symmetry between bosons and fermions, the sum of all contributions is strictly limited!

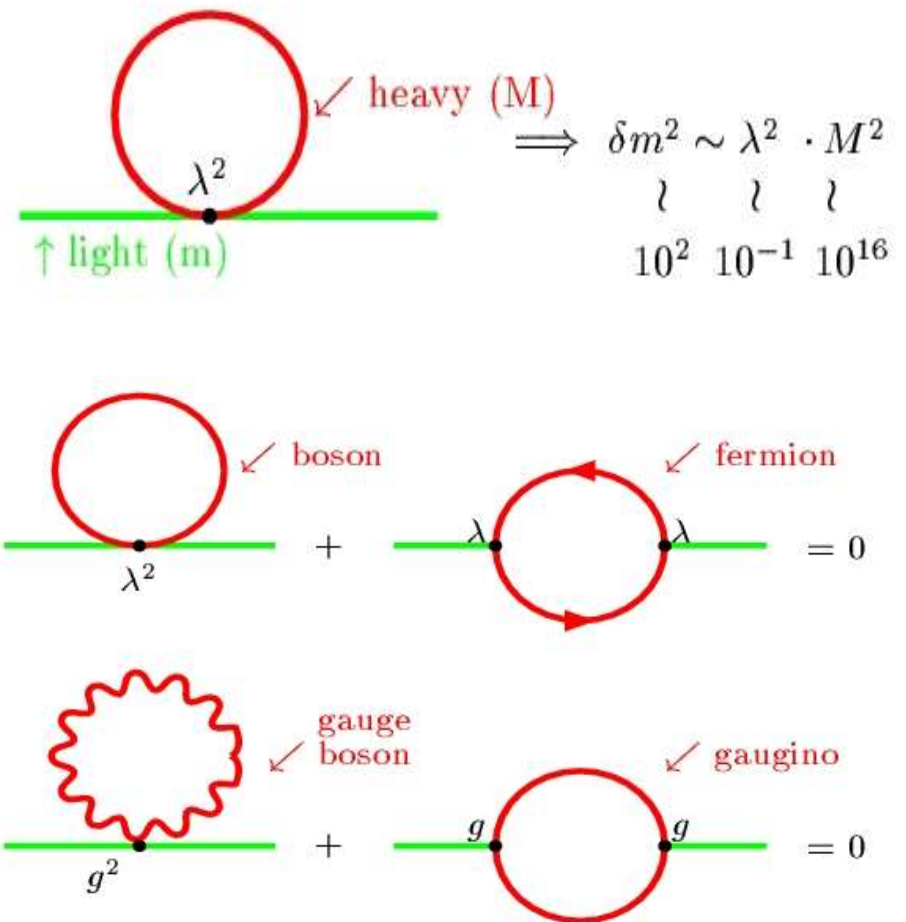

Why Colliders?

The symmetry between SM particles and their SUSY partners clearly is not maintained (otherwise we would have a light selectron, *etc. etc.*)

It is fair to assume that sparticles must be heavy.

So, in order to observe and study them, we need high energy collisions.

Hadron colliders provide the highest C.M. energies anywhere on earth. The **TEVATRON** collides proton and anti-proton beams of energy nearly $1 \text{ TeV} = 1000 \text{ GeV}$ (about 1000 x proton mass).

(The LHC will be seven times more energetic – more, later...)

Electron colliders have been limited by the power needed to accelerate electrons (which radiate away their energy too quickly).

Keep in mind that only the quarks and gluons inside the proton actually collide, so only a small fraction of the TeV energy is available for any given interaction, or “event.”

Experimenter's Toolkit

Any sparticle except the LSP will decay.

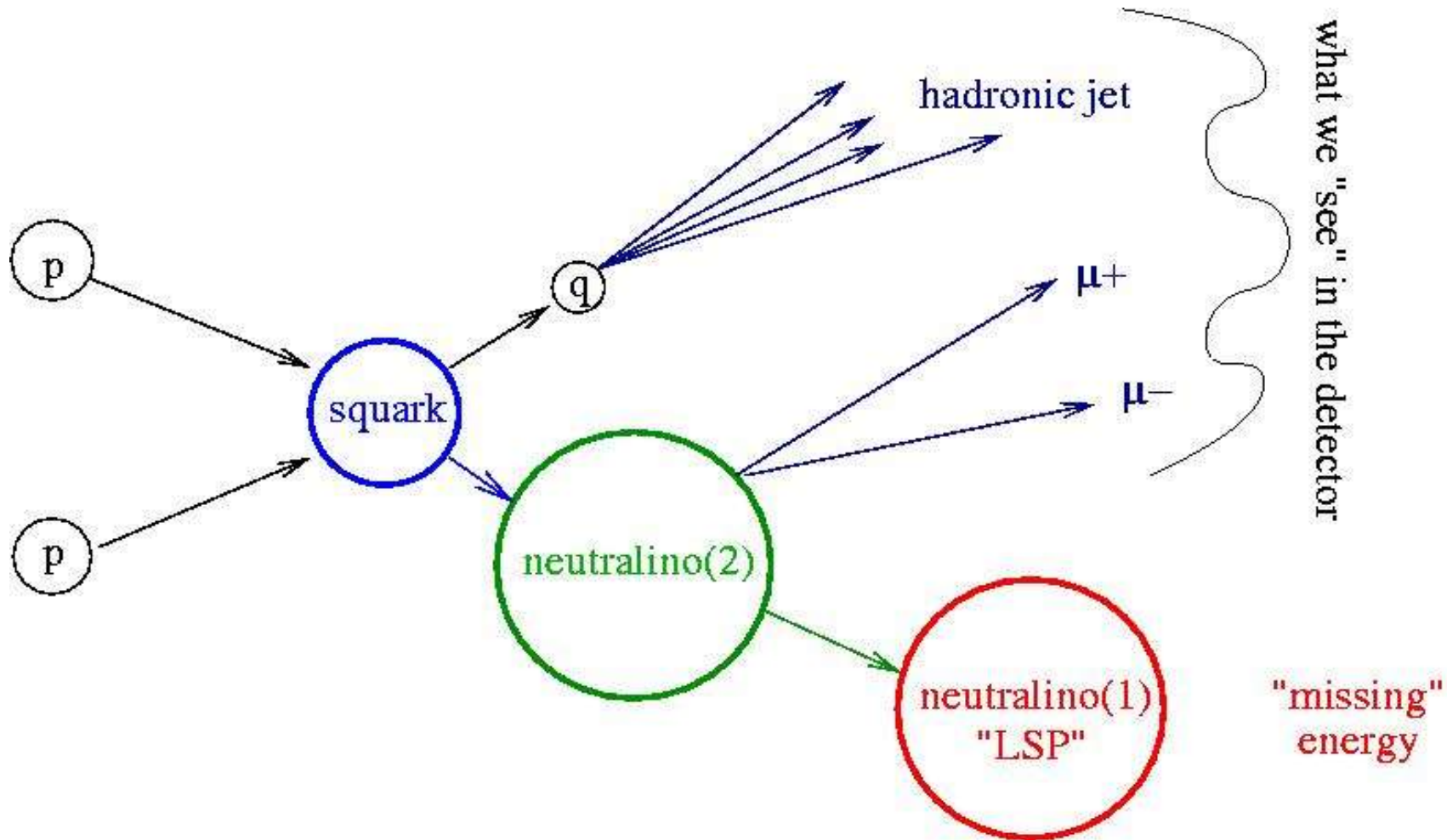

By and large, the decay products will be SM particles, which we need to detect, measure and correlate in order to reconstruct the sparticle that decayed.

The (quasi-)stable SM particles are the relevant ones: e , γ , μ and hadrons.

Collider Detectors

Collider detectors are like a set of nested Russian dolls, each of which tells us something useful.

With all that information, we decide what kind of particles we are detecting, and whether they might come from the decay of one or more SUSY particles.

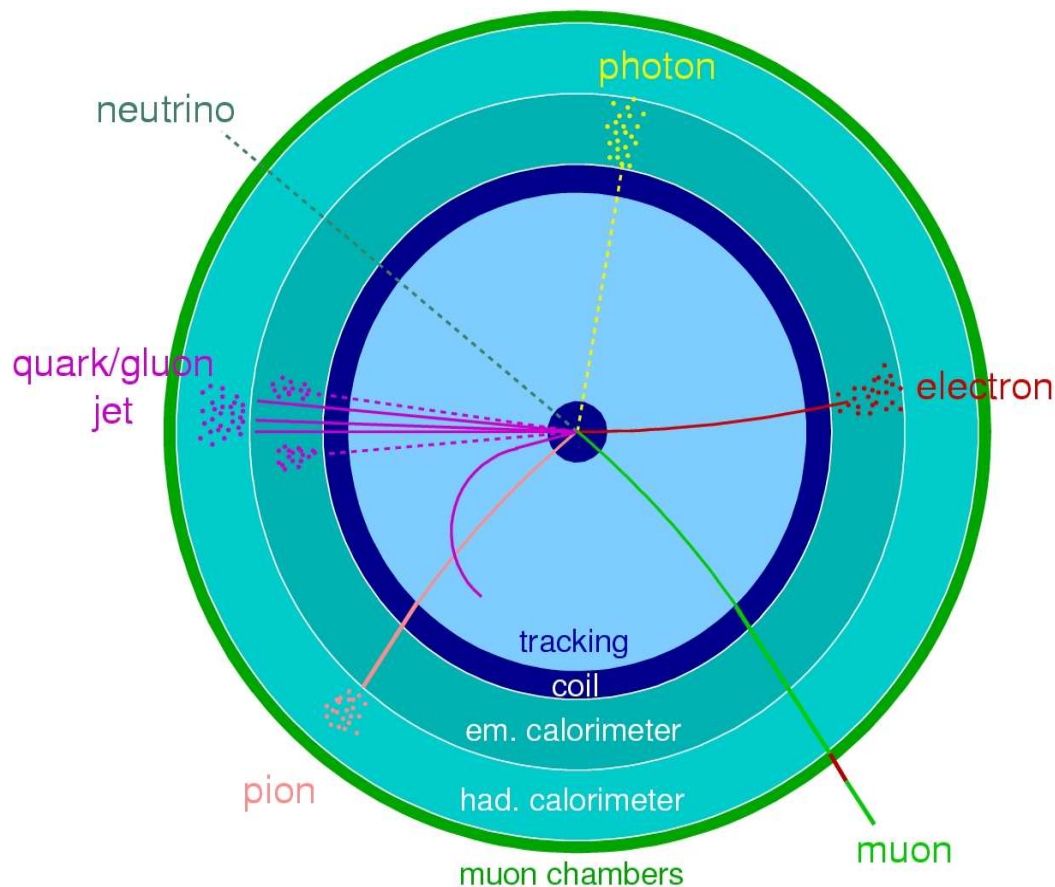

- charged particles leave tracks
- curvature (B-field) tells us p_T
- e & γ shower in the EM-CAL
- hadrons shower in the H-CAL
- μ don't shower and reach μ -det
- ν (and LSP's) are undetected

The D0 Detector

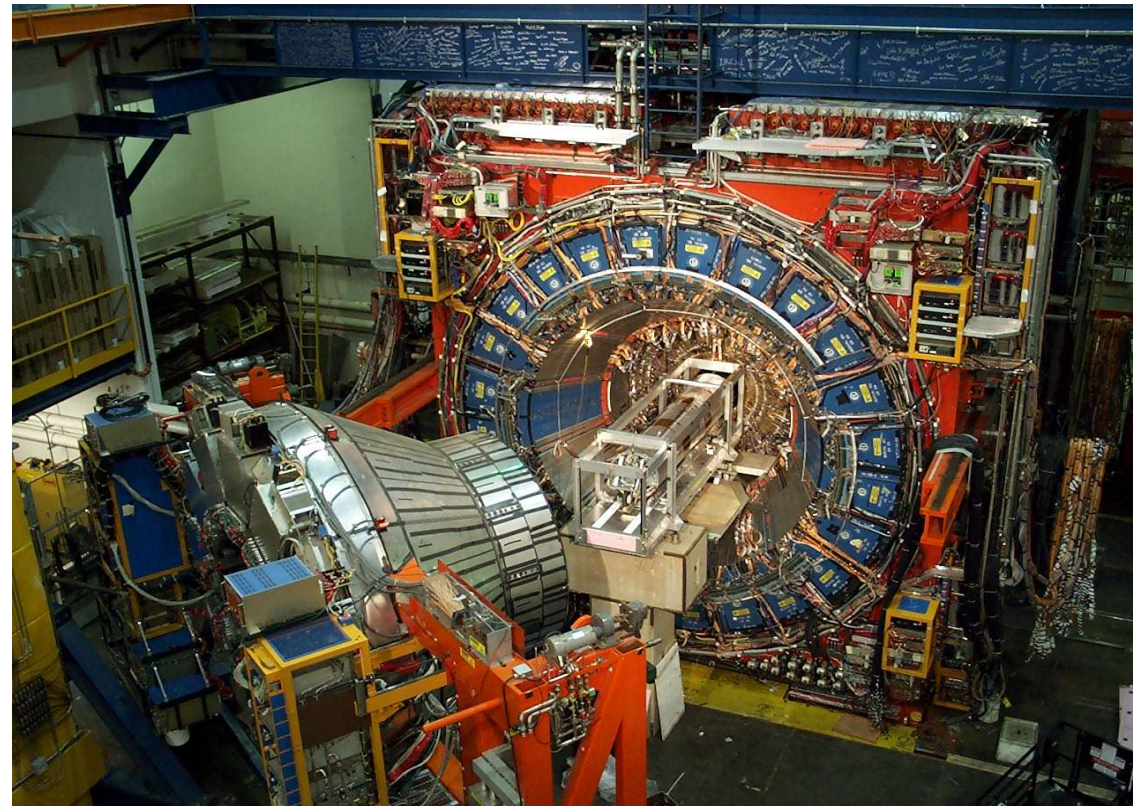
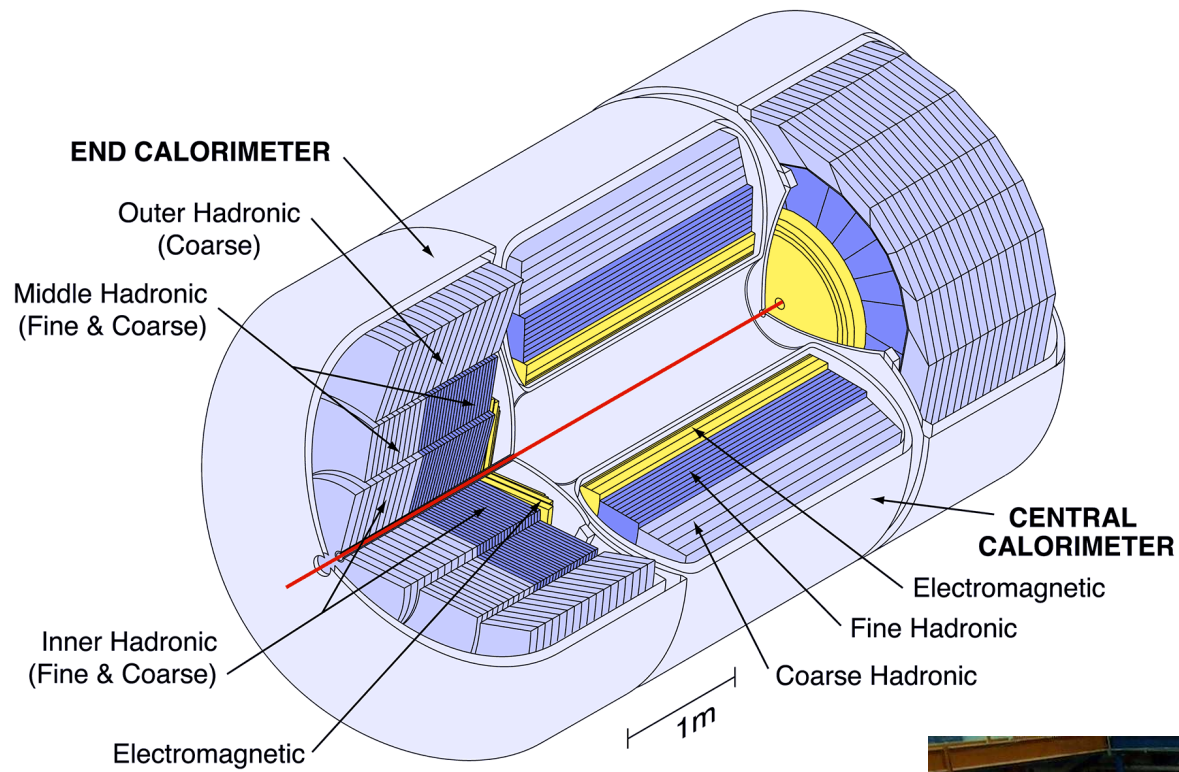

The CDF Detector

The SM is in the way!

Unfortunately (?!?), there are many SM processes which also produce e , γ , μ , and jets, and they obscure any SUSY process that might be present!

- the biggest source of events is q-q or q-g scattering, which leads to jets of hadrons with quite high energies sometimes.
- more interesting are the W and Z events which yield energetic (and isolated) electrons and muons, and sometimes neutrinos
- the top quark (discovered with the TEVATRON in 1995) has a non-trivial decay pattern to b-quark jets, leptons and neutrinos
- boson pairs (such as WW, WZ & ZZ) are produced at very low levels, but are “interesting” because they mimic some of the most distinctive signals for SUSY particles.

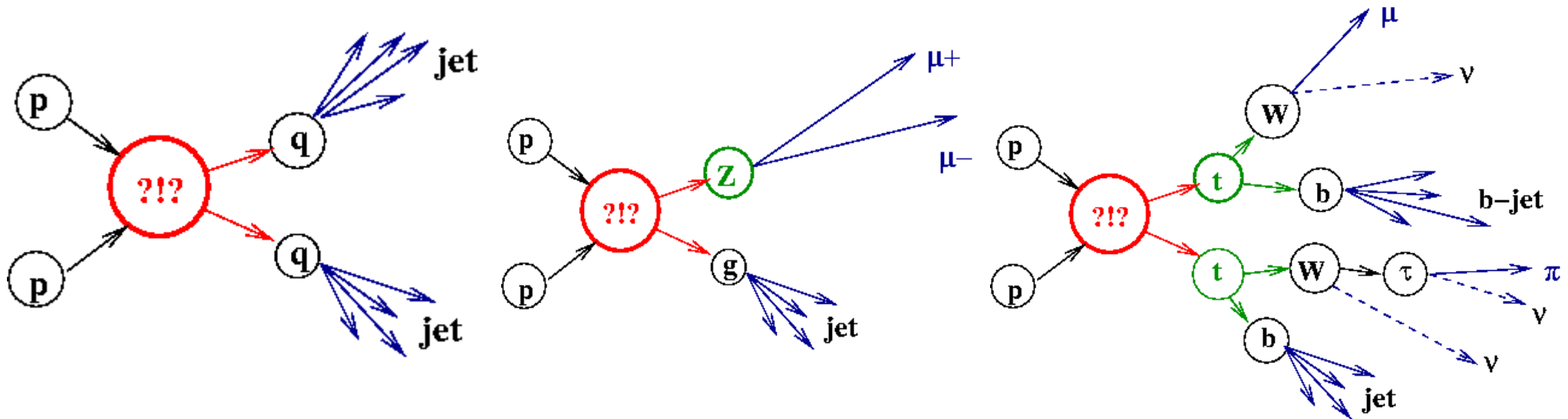

Examples of real events:

CDF

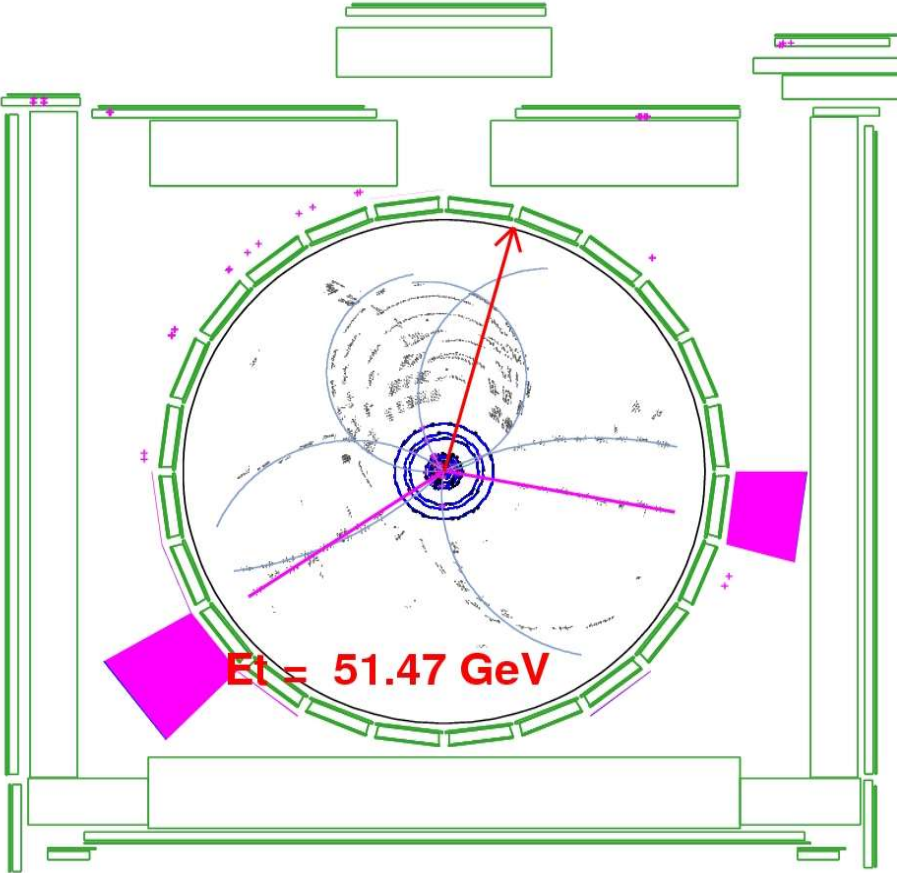

*two electrons and
"missing" energy*

(from search for di-boson production)

D0

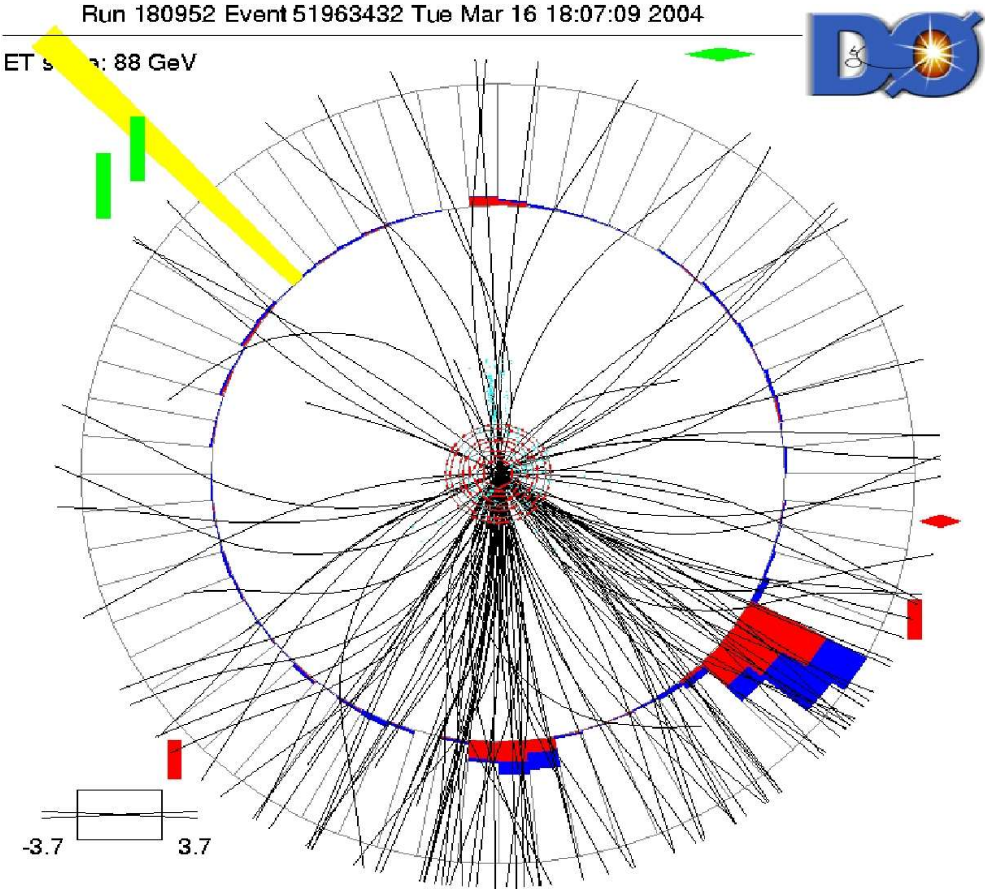

*two hadronic jets
and "missing" energy*

(from search for SUSY)

Example 1: Jets and Missing Energy

Since the TEVATRON collides protons and anti-protons, which are made of quarks, anti-quarks and gluons, it makes a lot of sense to look for squarks and gluinos (the SUSY partners of quarks and gluons).

The task is to separate events with squarks and gluinos from ordinary SM events (which we call “QCD events” since they are characterized by strong-interaction processes).

The typical TEVATRON event consists of 2 or 3 energetic jets.

What would be different about an event with squarks or gluinos?

→ *missing transverse energy (MET)* \cancel{E}_T

What is MET?

The calorimeters are segmented, so we know what energy is recorded where.

Since the incoming quark/gluon energy is not known event-by-event, we focus on kinematic quantities transverse to the beam direction.

The vector sum of all transverse momenta must be zero!

If something invisible is produced (such as the LSP or a ν), then the sum of all transverse momenta will not be zero: it will be the opposite of the transverse momentum of the undetected particle(s).

This “missing transverse energy” (MET) is absent for most SM processes, but is the hallmark of most SUSY particles.

exploit this distinction!

Example of a real event with large MET, from D0

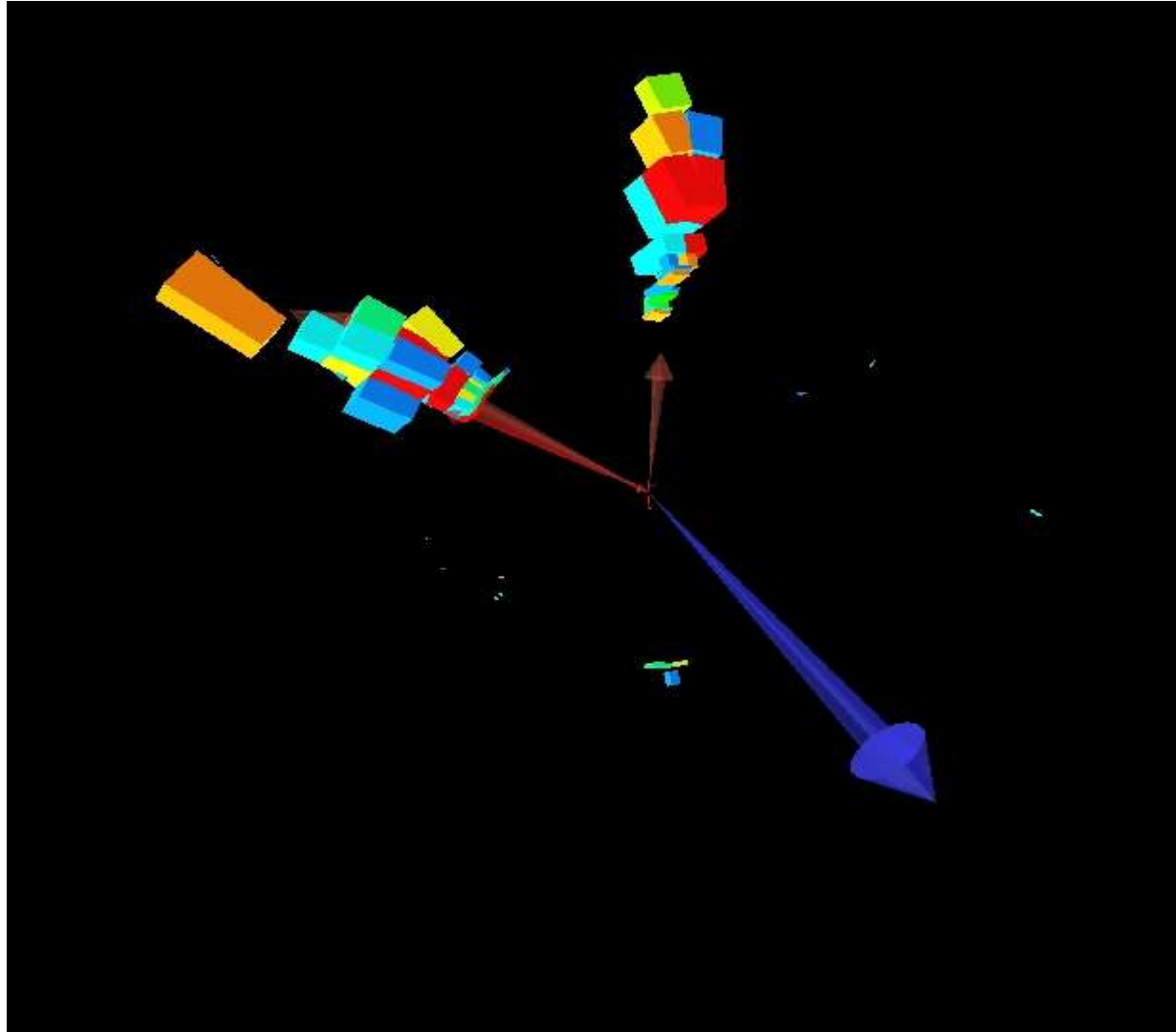

The colored boxes indicate energy deposits in the calorimeter.

The blue arrow shows the direction & magnitude of MET.

It is not so easy to “measure” the missing energy, due to difficult limitations in our instruments.

What are the sources of MET?

- calorimeter resolution on the jet energies
- losses of energy in uninstrumented regions (“cracks”)
- additional energy unrelated to the primary interaction
- neutrinos and also long-lived neutral kaons plus neutrons
- real LSP's, we hope....

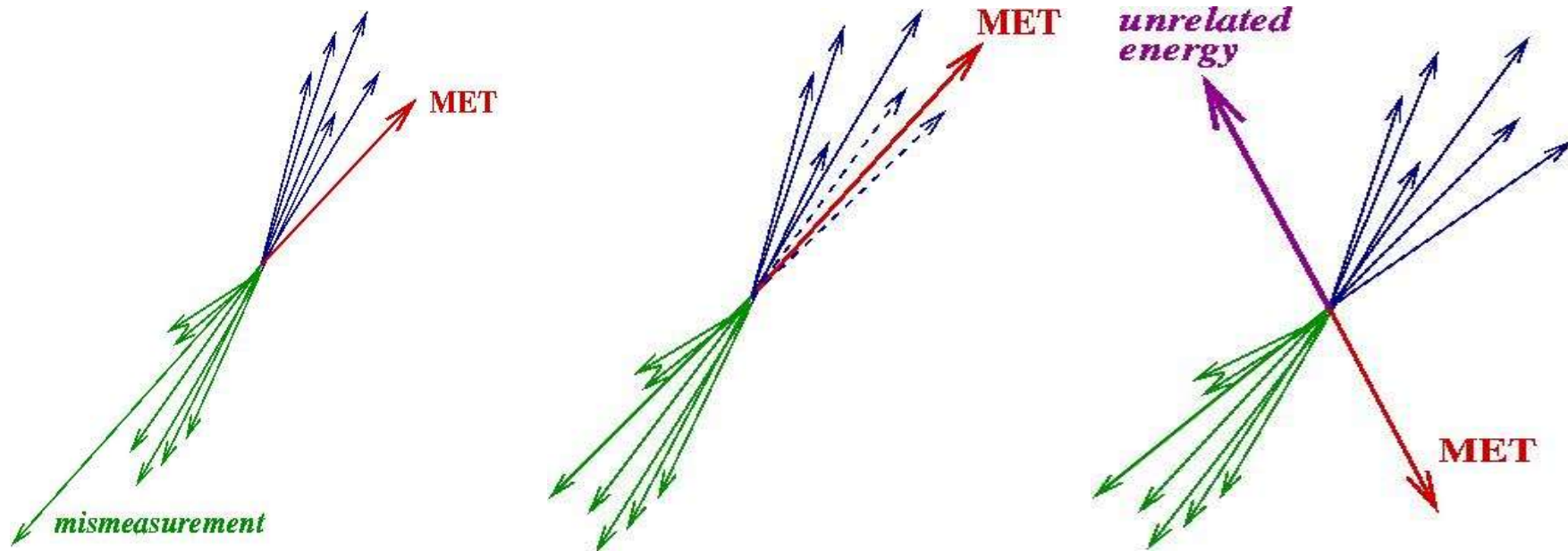

MET “clean-up”

After a lot of work, we learn how to remove “junk” from our data sample.

- *cosmic rays,*
- *beam halo,*
- *beam-gas events,*
- *calorimeter noise,*
- *etc.*

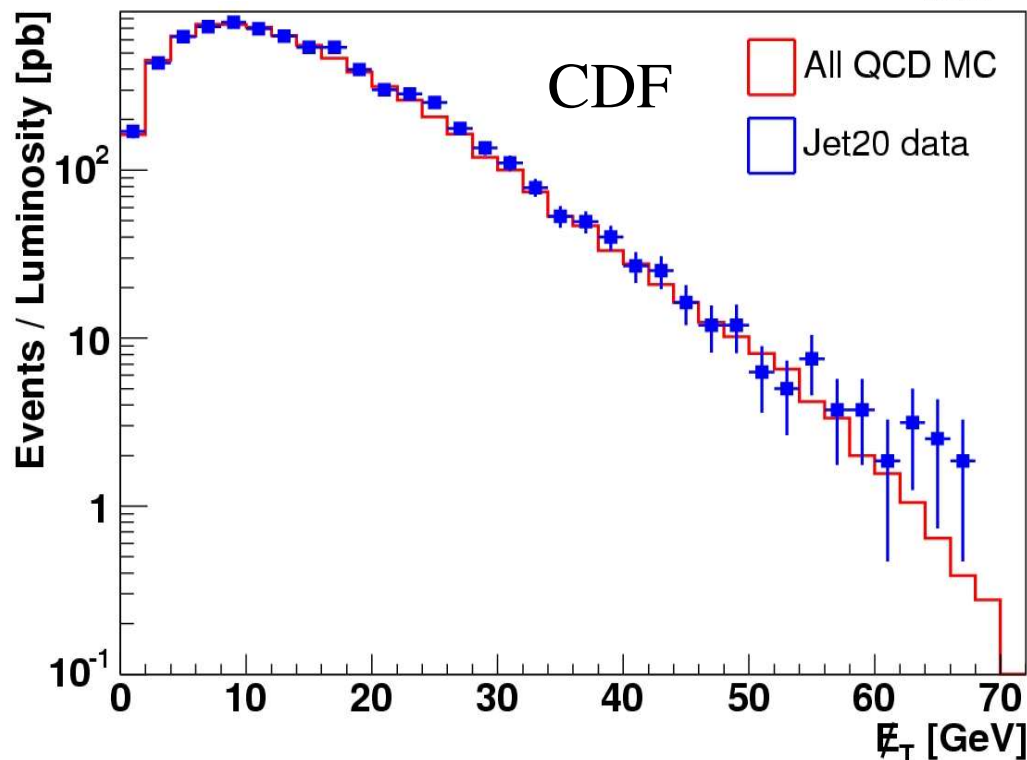
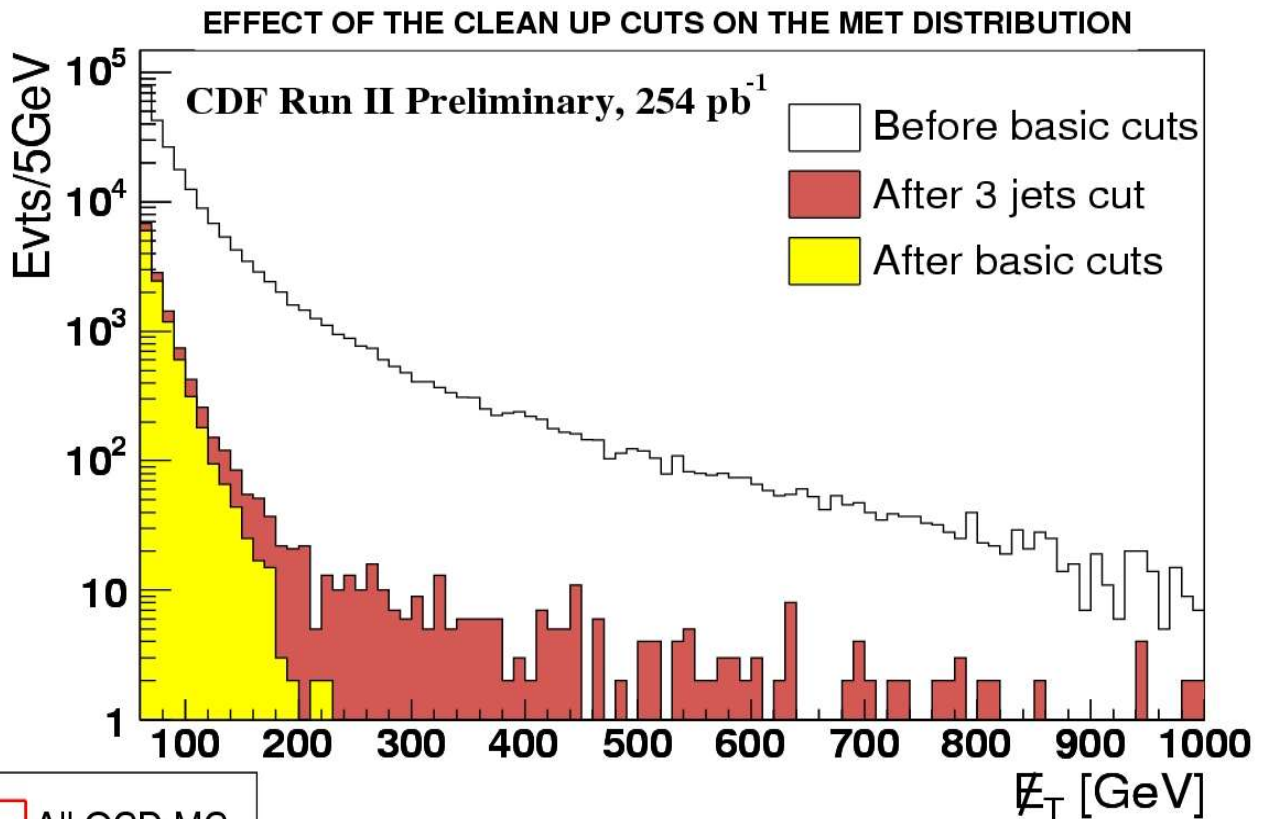

It is now possible to model the QCD backgrounds from simulation.

This is important as the QCD background is the most severe for this kind of search.

After you have your best measurement of MET, what then?

We need to think about the kinematic features of the SUSY events, and see how they might differ from ordinary QCD events.

- if $M(\text{squarks}) < M(\text{gluinos})$ then
 - squarks decay to quarks and LSP's
 - gluinos decay to squarks and gluons
- if $M(\text{squarks}) > M(\text{gluinos})$ then
 - gluinos decay to a pair of quarks and an LSP
 - squarks decay to a quark and a gluino

Note that we expect $M(\text{squarks}), M(\text{gluinos})$ to be > 300 GeV or so (mainly because they have not been found for masses less than that).

The JETS that come from the SUSY decays will always be **energetic**, in distinction to ordinary jets which tend to have less energy.

→ Require high energies for the jets, and require the sum of jet energies (H_T) to be high.

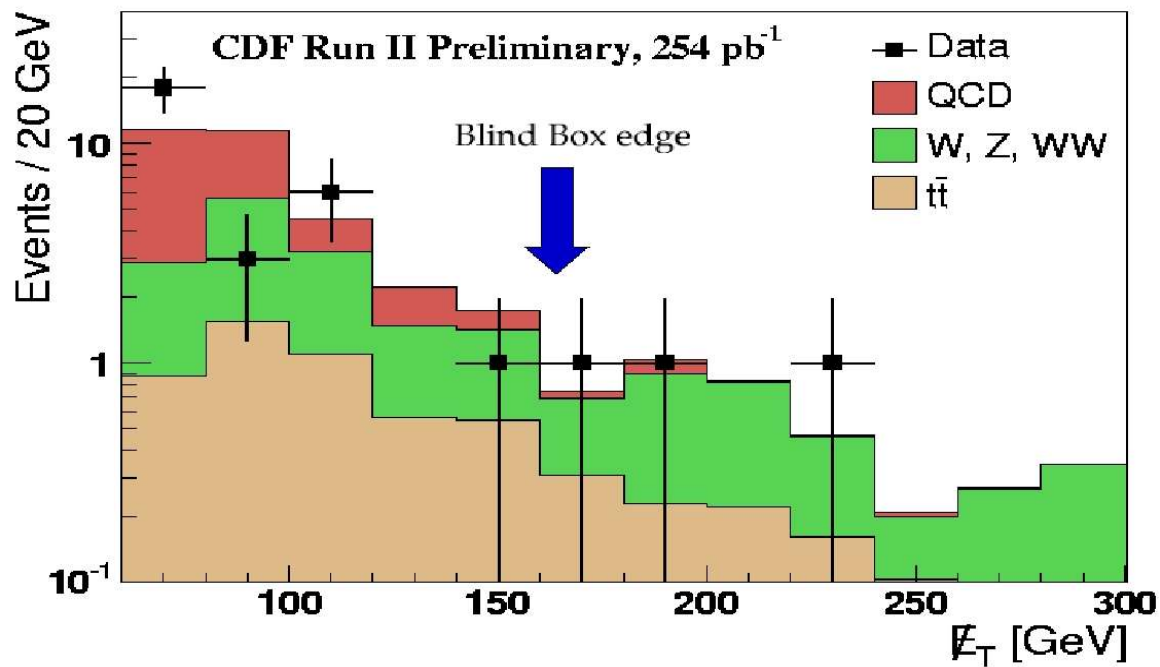

After lots of hard work, one can examine the last few events in the MET distribution.

We see no evidence for any excess of events above those expected from SM processes...

CDF preliminary

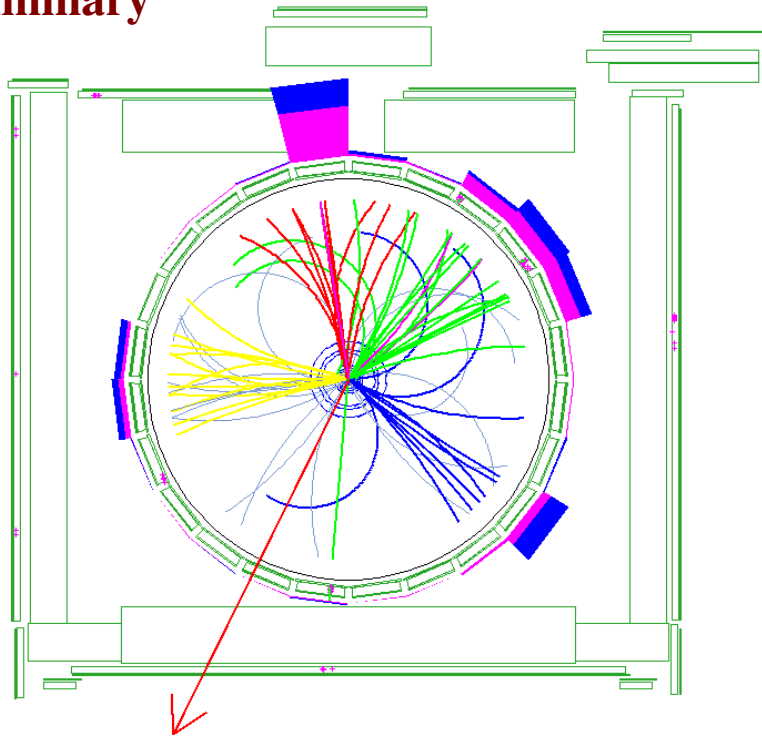

Here is the event with the highest missing energy.

One clearly sees four energetic jets, and a large MET (red arrow).

No evidence for squarks or gluinos.

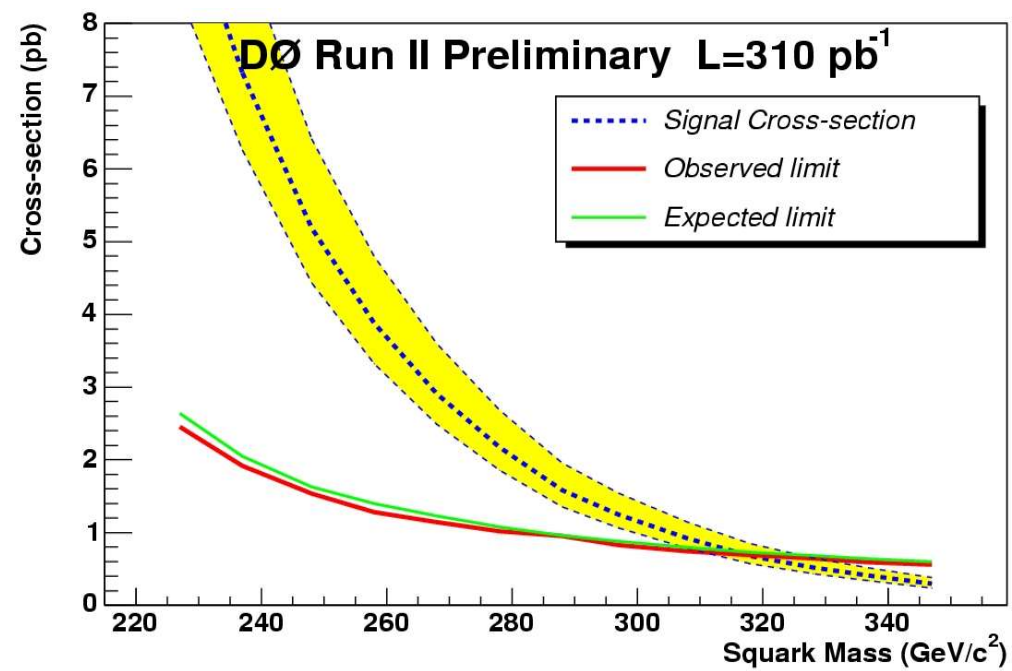
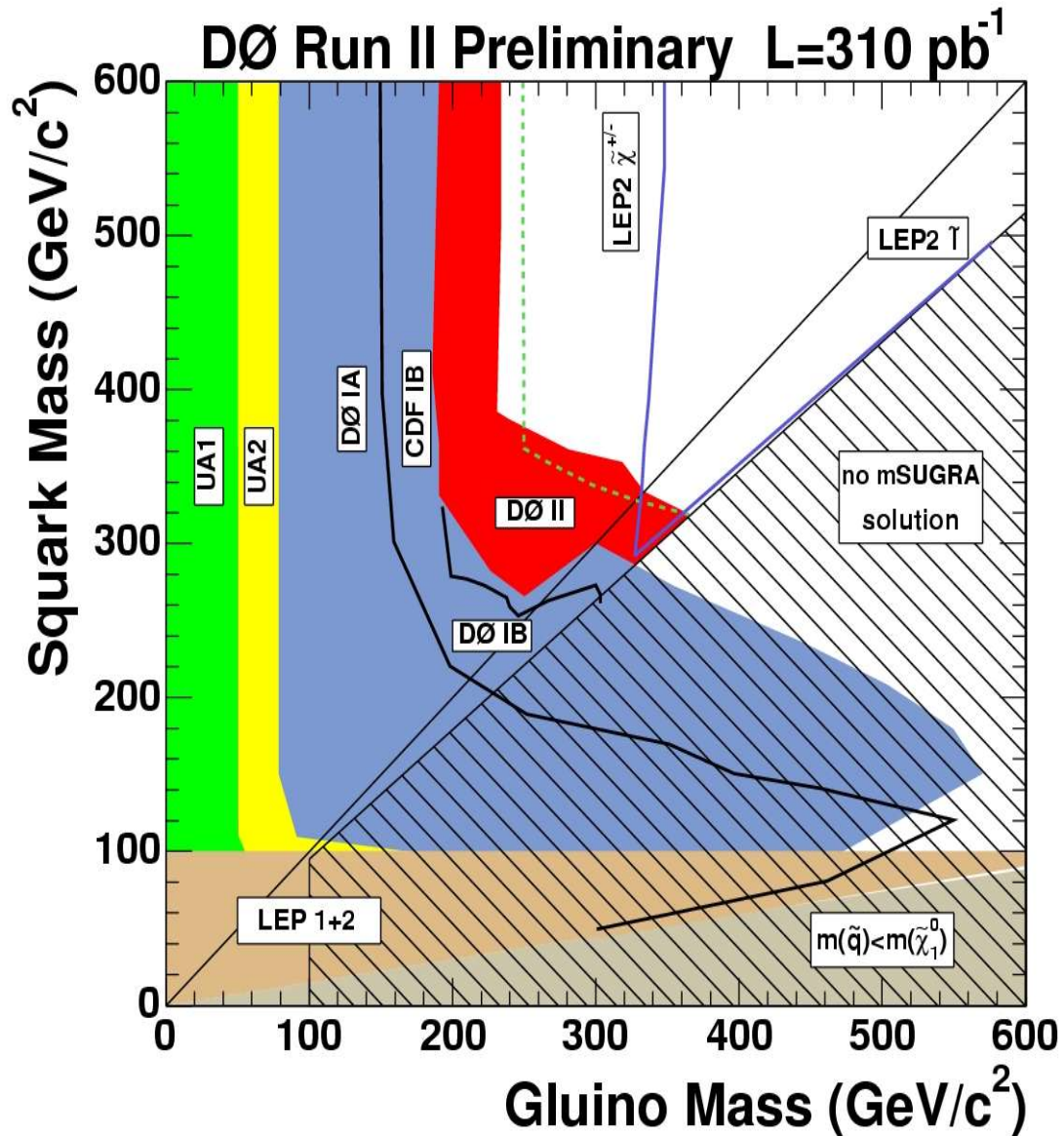

In view of the negative results of these searches, one can only say that squarks and gluinos do not exist, provided they would have been produced at a rate which would have been visible...

In practice this is translated into excluded ranges for the squark and gluino masses.

Example 2: The “tri-Lepton” Search

Perhaps the problem is that Jets+MET is not distinctive enough. Rare SM processes can be identified by the presence of leptons, so let's try that strategy with SUSY processes, too.

Charginos and neutralinos are the spin-1/2 SUSY partners of (W and charged Higgs), and (γ , Z and neutral Higgs bosons).

Schematically speaking, their decays will resemble those of their SM partners, except for the “extra” LSP at the end of the decay chain.

e.g., charginos decay to 2 fermions + LSP

- Single-lepton events come from inclusive W production and $t\bar{t}$.
- Double-lepton events come from inclusive Z (Drell-Yan) and $t\bar{t}$.
- So, *look for triple-lepton events...*

The tri-lepton Search

To be more specific, this is what we are after:

production:

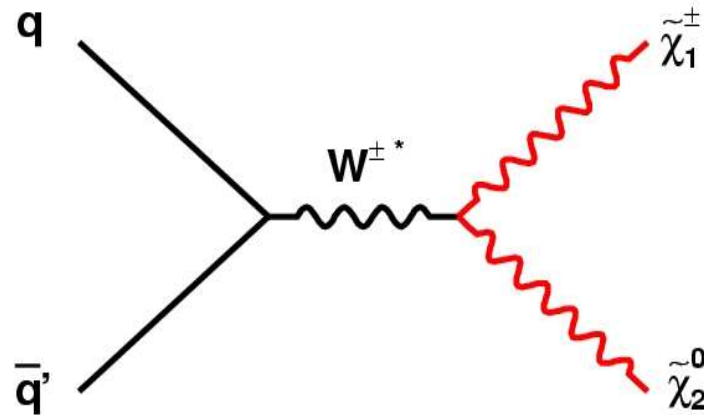

decay:

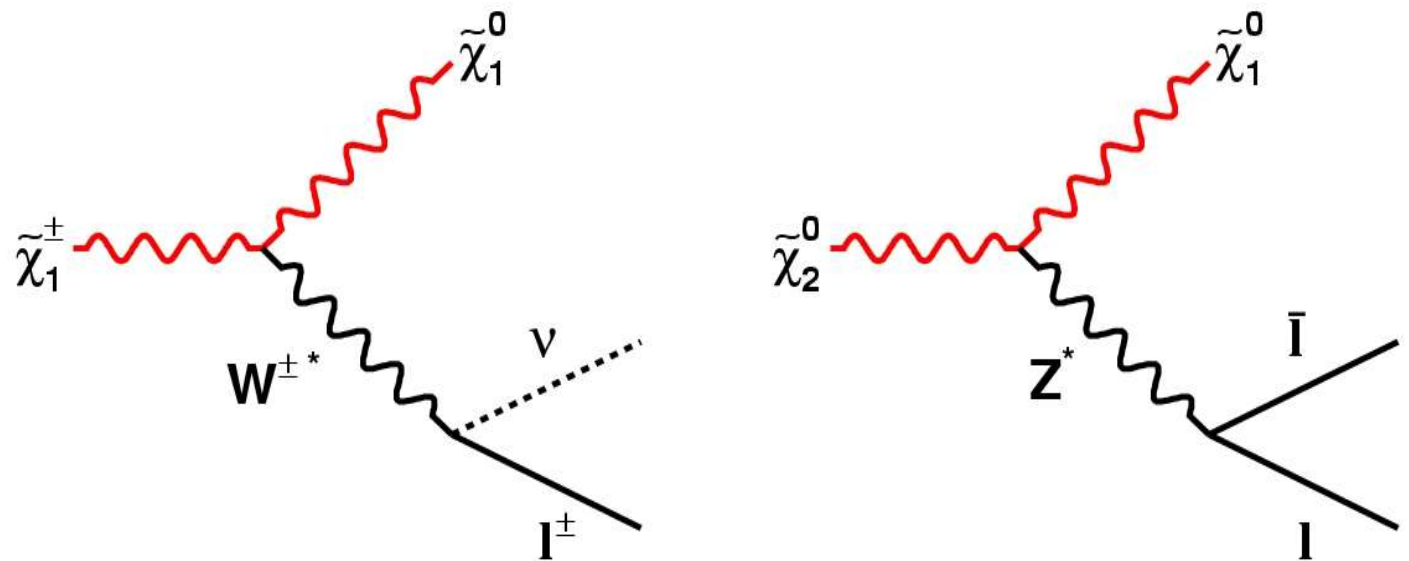

One lepton comes from the chargino, and two leptons come from the neutralino.
There is lots of missing transverse energy, too!

Again, we know that charginos and neutralinos are heavy (> 100 GeV).

This ensures that the leptons will be **energetic**.

They will also tend to be **isolated** in the sense that they will not be part of a jet.

(A troublesome source of leptons are jets with b-hadrons or c-hadrons, which sometimes decay semileptonically, giving us a lepton and a neutrino (=MET). The key point is that the leptons from b- or c-decays come associated with hadrons that are produced with the b- or c-quarks, and also in the b- and c-decays. So, we veto any leptons which have hadrons near by.)

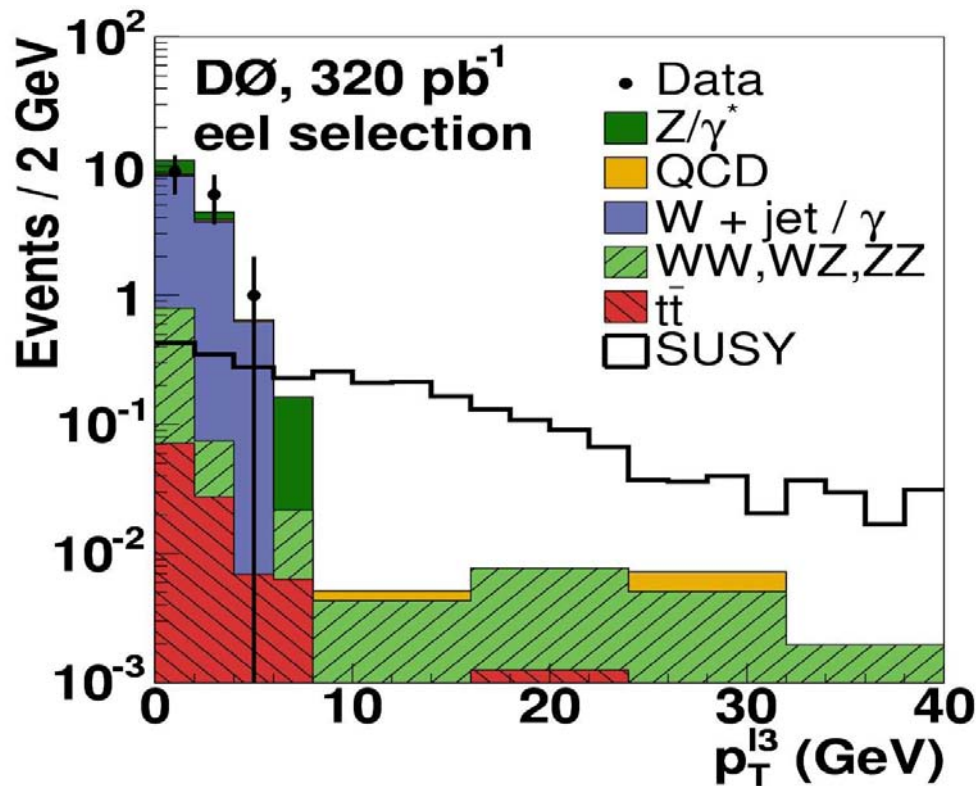

This plot shows the discriminating power of the energy cuts (p_T) on the third lepton.

The SUSY curve corresponds to an optimistic but not crazy scenario.

These plots show the power of the other cuts.

Overall di-electron mass spectrum.

MET distribution after cutting out the Z-peak.

MET distribution after all cuts.

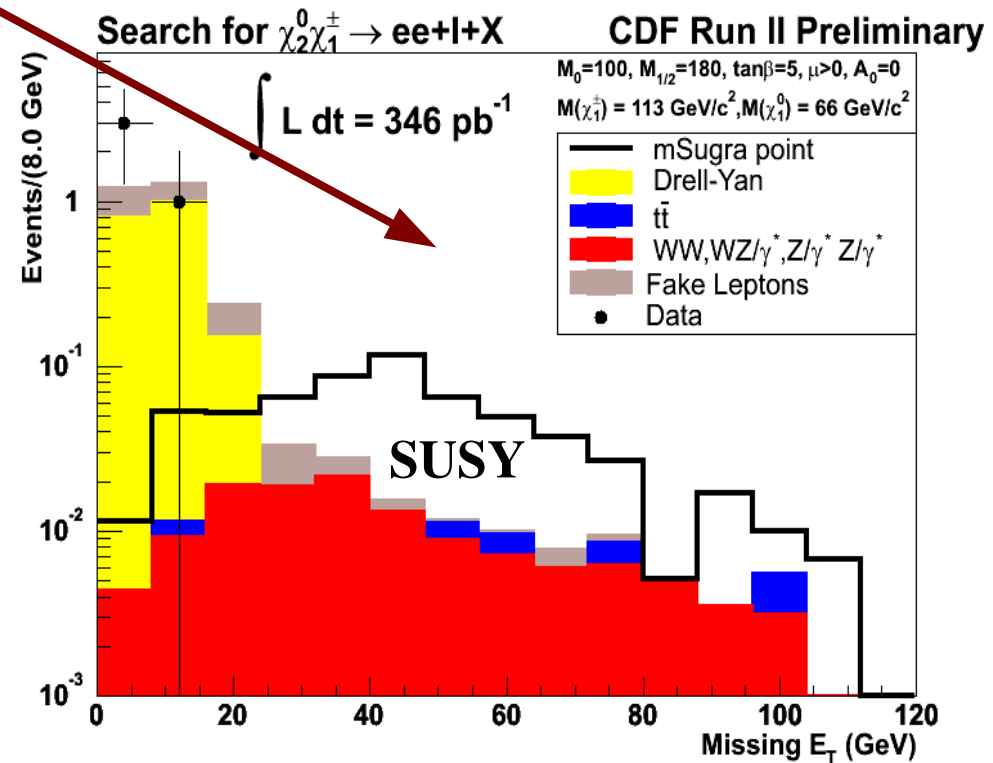
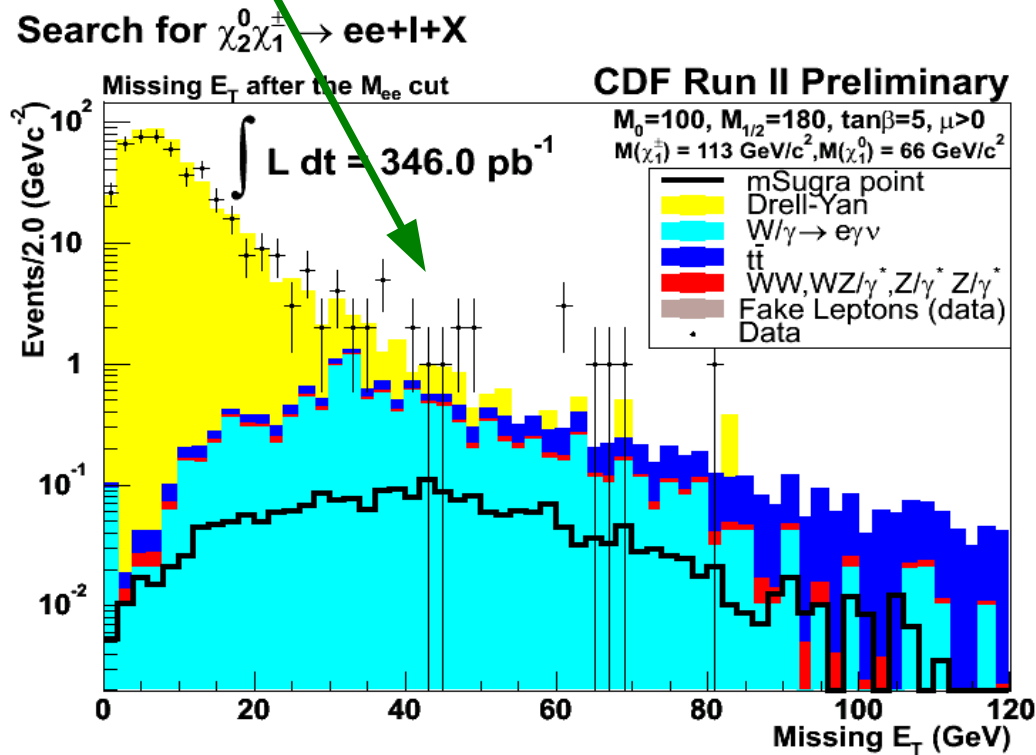
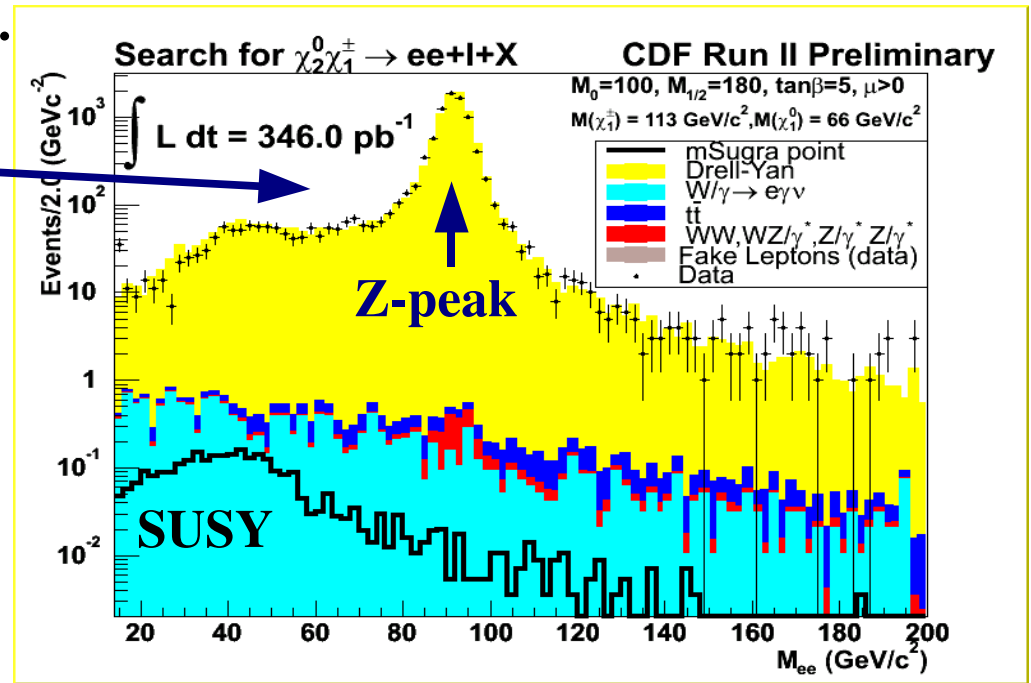

Limits from the tri-Lepton Search

Again, no evidence for any excess, so we can only place limits on SUSY cross sections, equiv., masses.

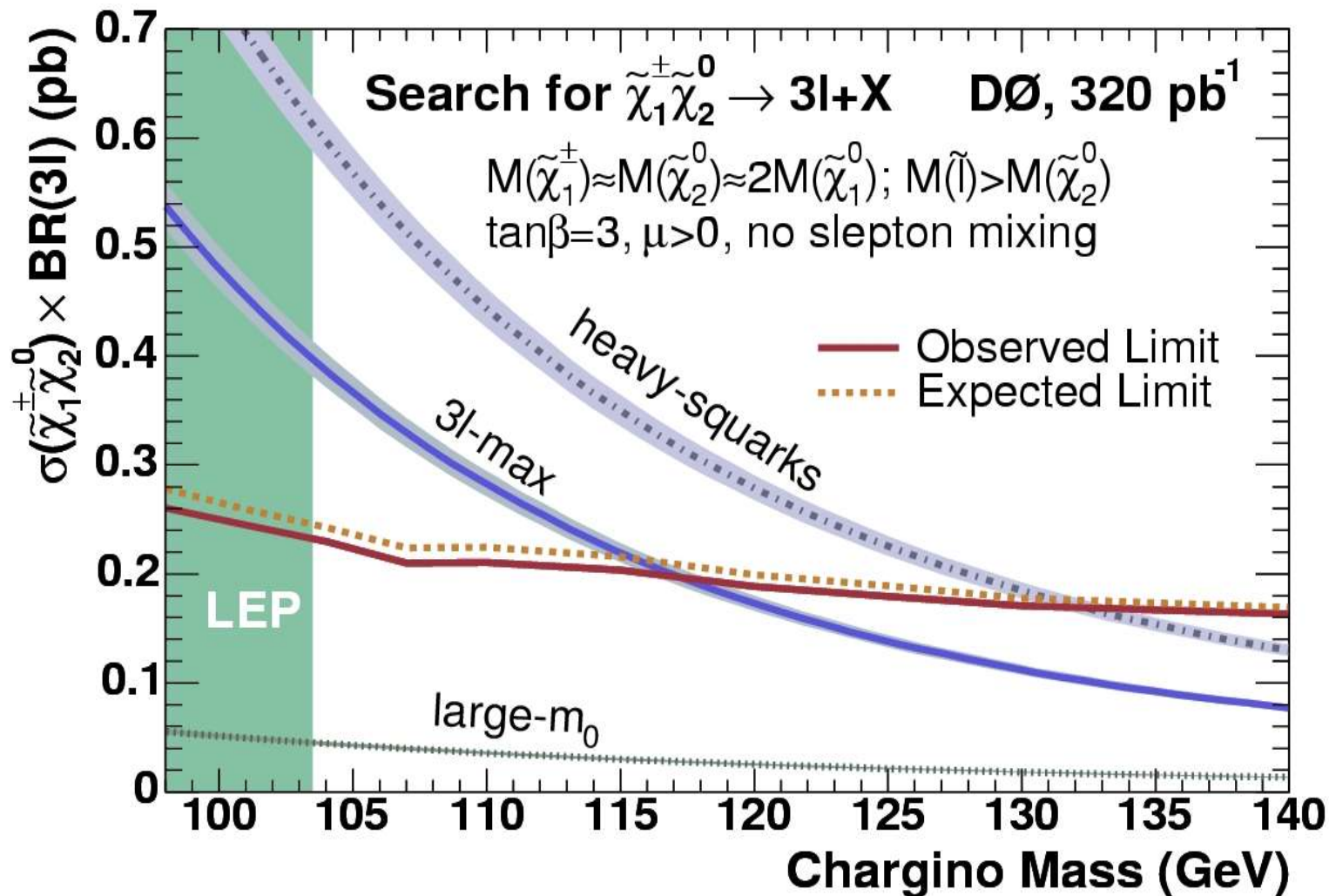

hep-ex/0504032

Example 3: Rare B_s Decays

Let's switch gears and look into the possibility of
virtual effects from Supersymmetry...

Particle physicists are expert in looking for and utilizing virtual effects from heavy particles.

For example, our knowledge of the Higgs boson comes mainly from the analysis of “precision electroweak observables” which are influenced by virtual Higgs bosons circulating in loops.

There have been many analyses of the possible impact of virtual SUSY particles, and there are several excellent examples:

- the Higgs boson mass itself (remember the “Hierarchy Problem”)
- the same precision EWO are preserved by the structure of SUSY corrections
- the anomalous magnetic moment of the muon $(g-2)_\mu$
- enhancements to the rate of the $b \rightarrow s + \gamma$ transition (a FCNC)
- huge enhancements to the rate of $B_s \rightarrow \mu^+ \mu^-$

The influence of SUSY particles on the $B_s \rightarrow \mu^+\mu^-$ decay rate comes through a complicated loop diagram as shown here:

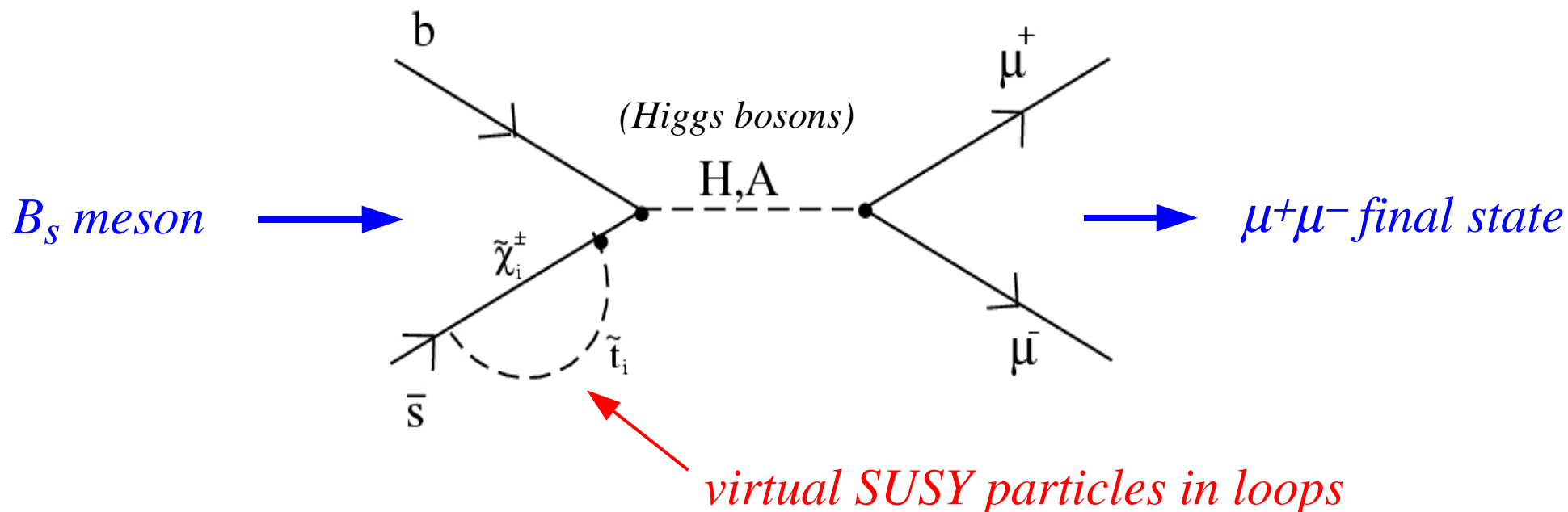

This is extremely rare in the SM, since it constitutes a “flavor-changing neutral current” (FCNC) – which are forbidden at lowest order.

Hence, there is a special “window” onto virtual SUSY effects...

In the end, one sees that for *some* SUSY parameter choices (large $\tan\beta$), there is a **huge** enhancement for this decay. In fact, this enhancement occurs in regions where the tri-lepton searches tend to be weaker, so *the two searches are complementary*.

Once again we are using muons, but this time in a very direct and restricted way
– we are looking for a bump in the $\mu^+\mu^-$ invariant mass spectrum.

The signal is really tiny compared to SM production of $\mu^+\mu^-$ pairs, so one needs to be clever in isolating any possible signal.

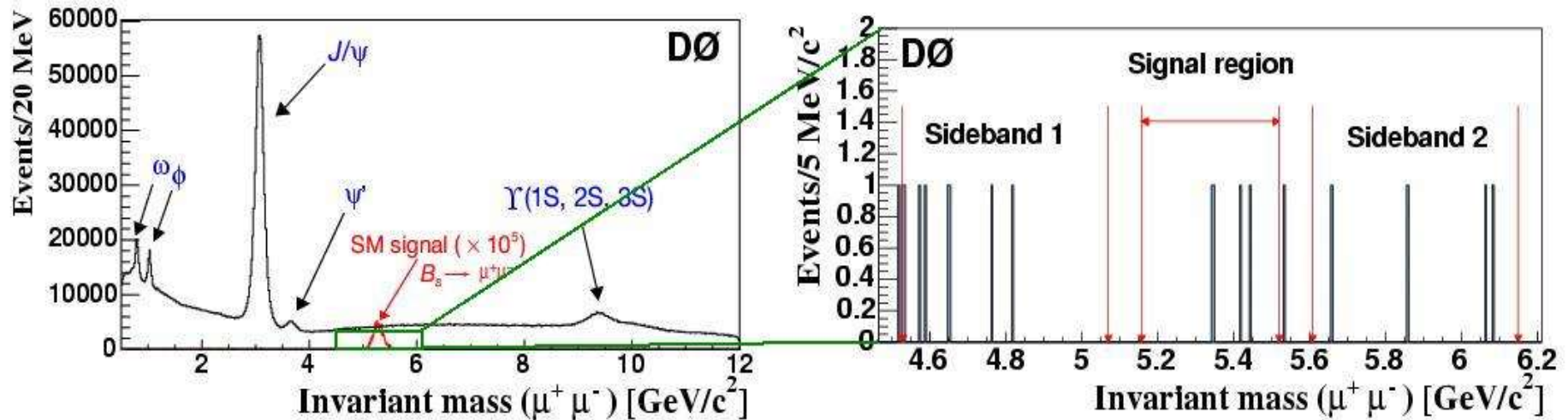

Clearly, having the narrowest possible mass peak is imperative.

And more...

Some of the “handles” we can use to isolate any signal include:

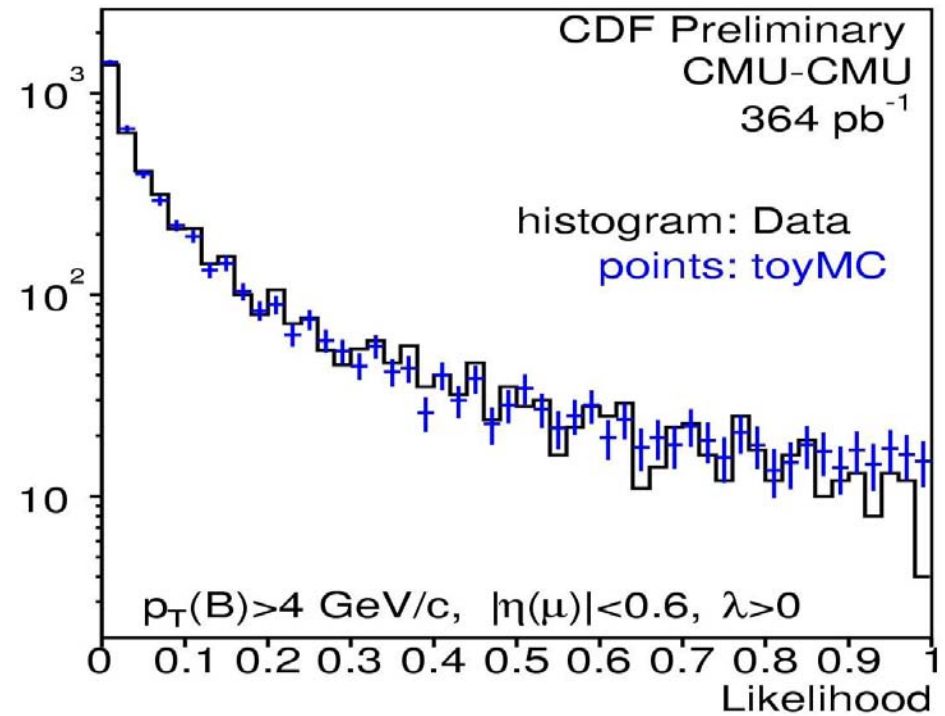
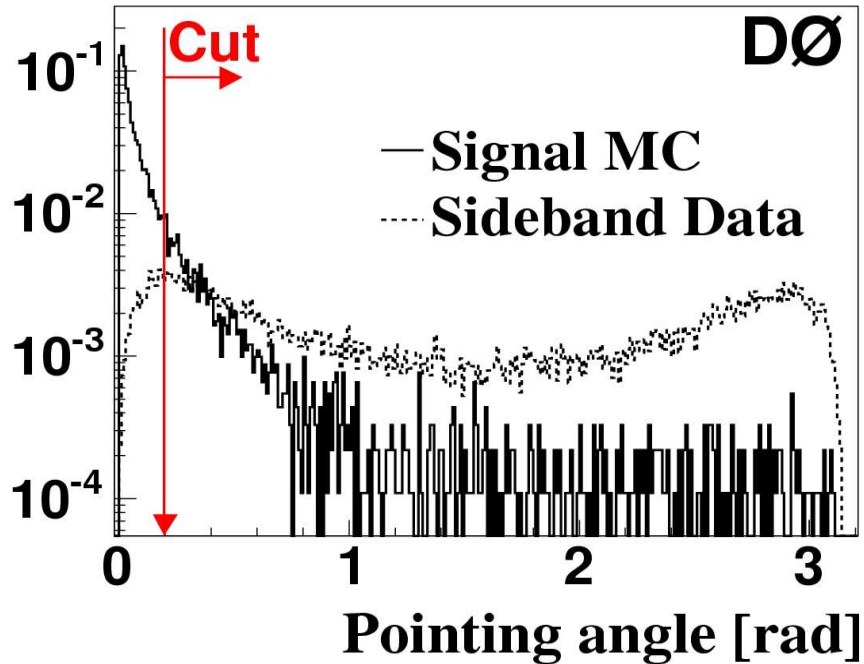
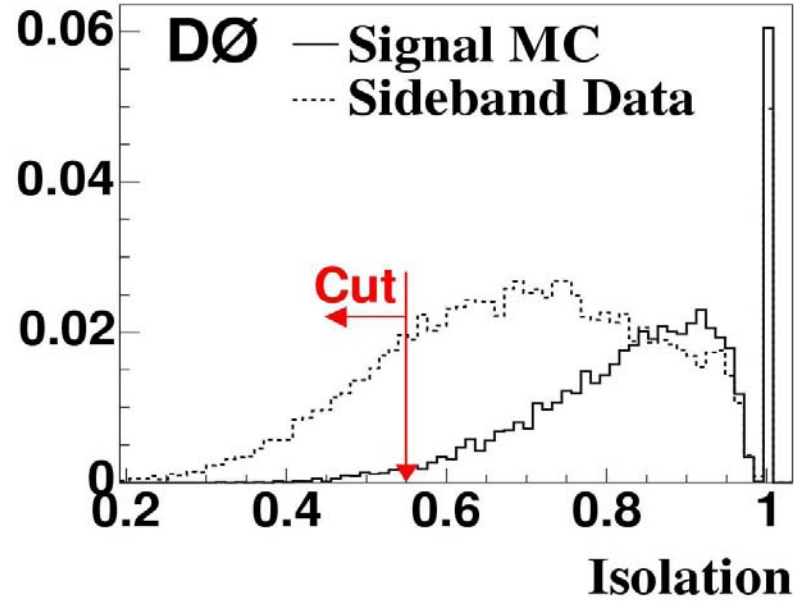
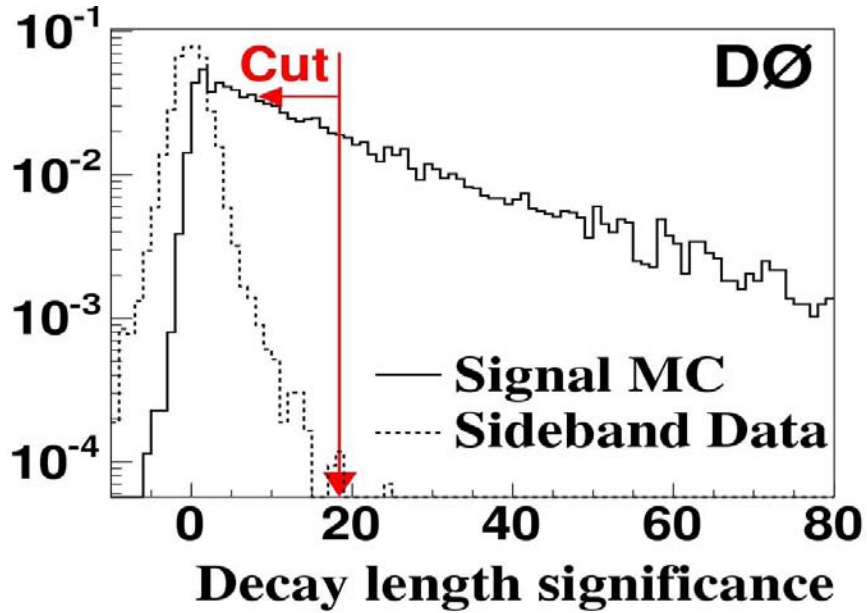

D0 and CDF results for $B_s \rightarrow \mu^+\mu^-$:

D0: $Br(B_s \rightarrow \mu^+\mu^-) < 3.7 \times 10^{-7}$

CDF: $Br(B_s \rightarrow \mu^+\mu^-) < 2.0 \times 10^{-7}$

SUSY predictions range up to $5 * 10^{-8}$.

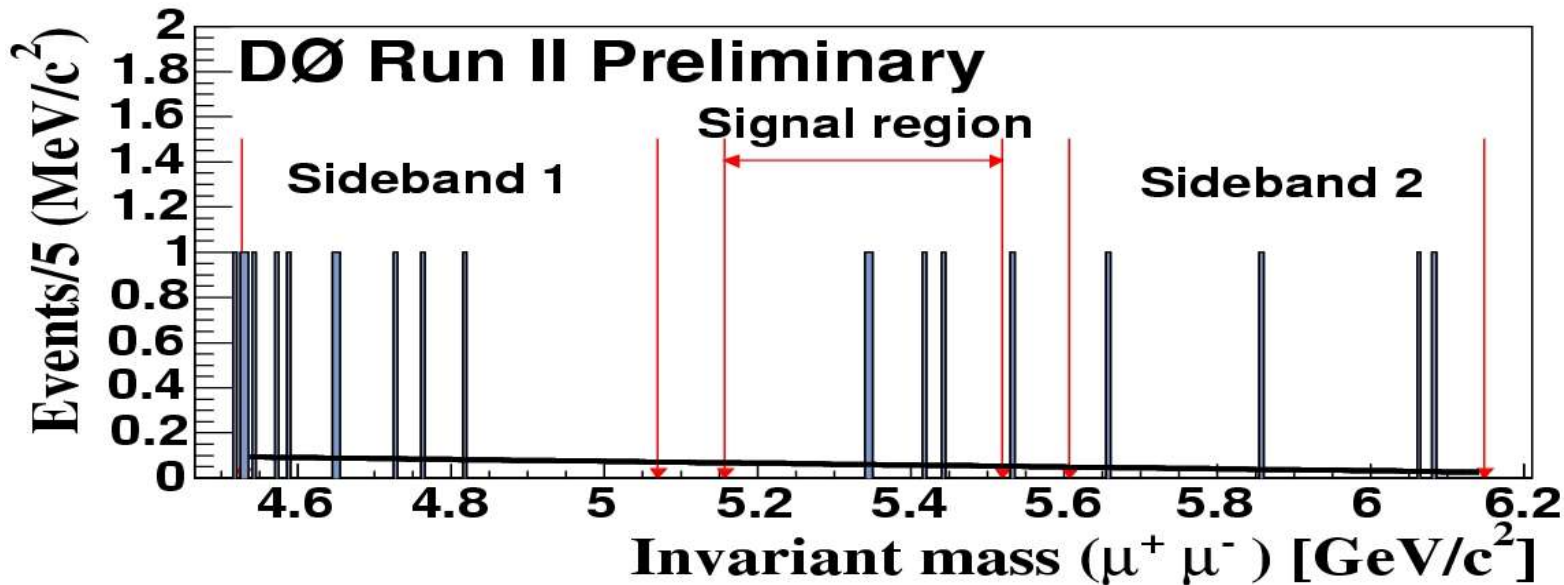
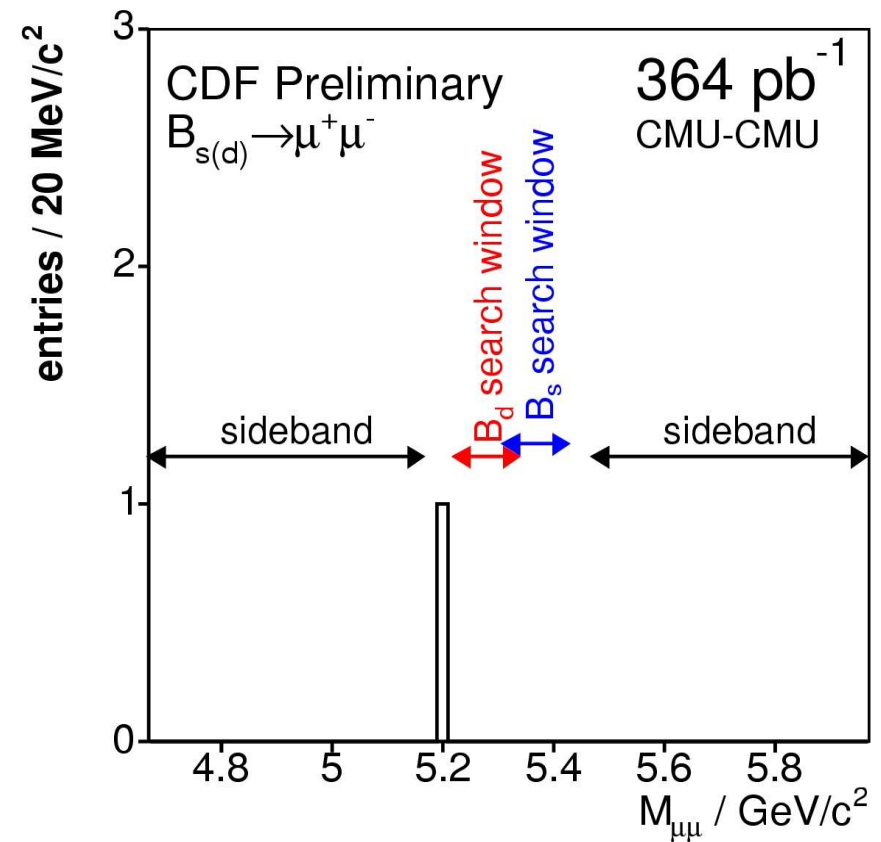

After the TEVATRON: The LHC

We hope the TEVATRON will find the first evidence for SUSY.

However, it does not have the capability to study all SUSY particles in detail.

The **Large Hadron Collider (LHC)** will begin data taking in 2 – 3 years, at CERN in Geneva, Switzerland.

- collide protons and protons at **14 TeV** (Tevatron is 2 TeV)
- two experiments called **ATLAS** and **CMS**
- nominally “must” discover SUSY if it exists at “low” energy

As before, the *Experimenter's Toolkit* consists of leptons, jets, MET and photons, plus a bag of kinematic magic tricks.

We will consider two examples quickly to illustrate the promise of the LHC.

m_0 and $M_{1/2}$ are fundamental SUSY parameters (in the CMSSM version). They control the masses of squarks and gluinos, and other particles.

This plot shows the reach of CMS as more and more data are collected.

Once the LHC is up and running, it will log a luminosity 10 fb^{-1} in one year.

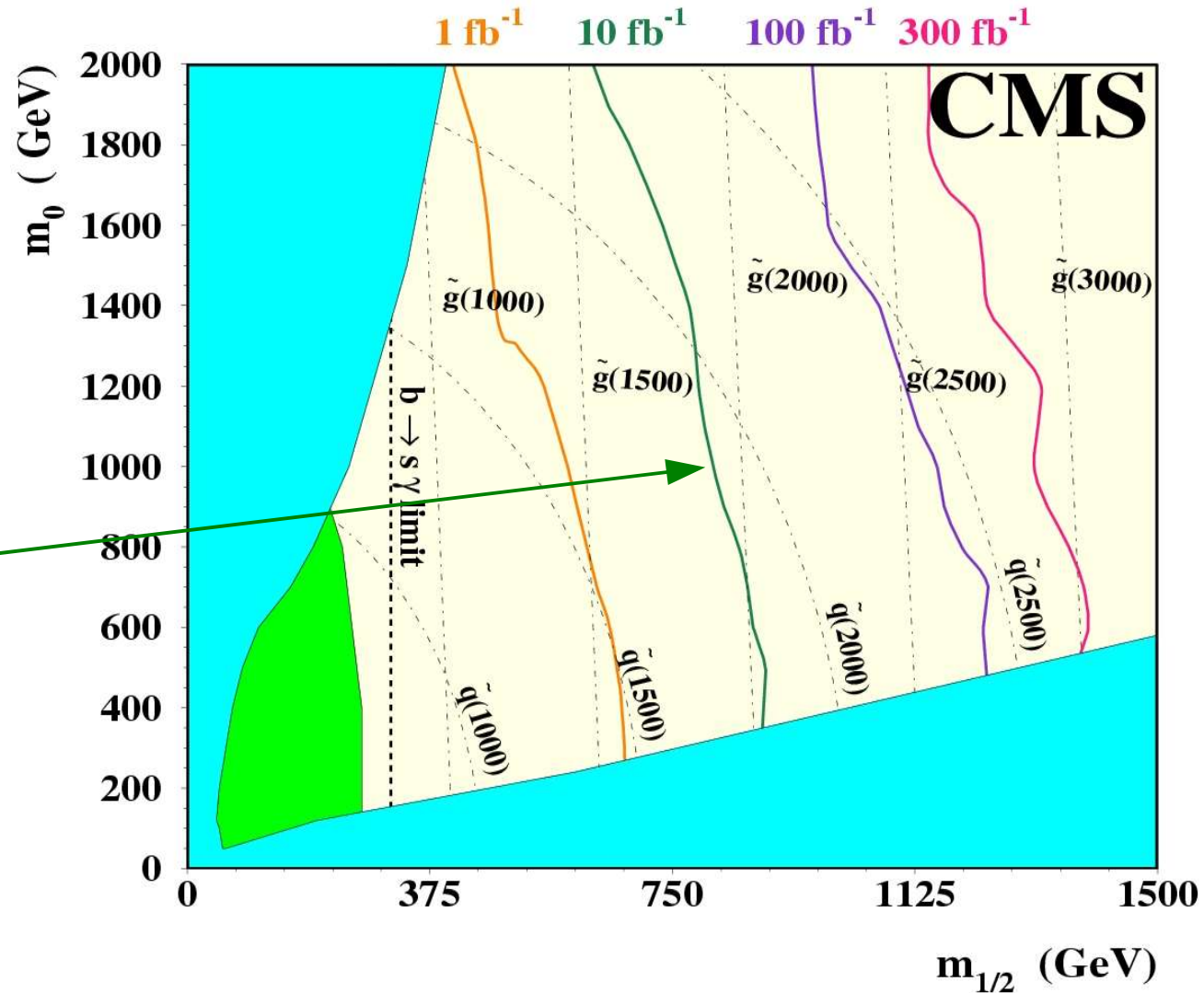

(ATLAS has a very similar capability.)

Jets + MET at the LHC

Since the LHC has so much energy, one expects it will produce **all** squarks and gluinos.

In our usual scenario, the decays of SUSY particles eventually yield two LSP's which results in large MET, and a number of energetic jets.

The production of squarks and gluons should be so copious that the simplest possible measure of “lots of energetic jets + MET” will already reveal SUSY beyond the SM.

$$M_{\text{eff}} = E_{T1} + E_{T2} + E_{T3} + E_{T4} + MET \quad \text{correlates with SUSY mass scale!}$$

hep-ph/9610544

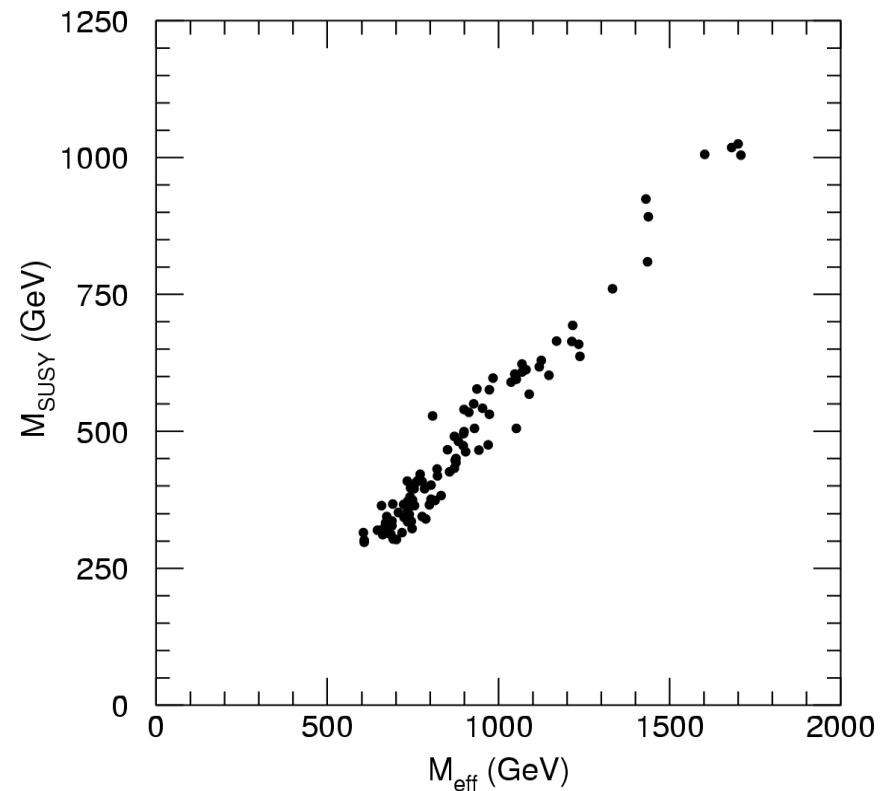
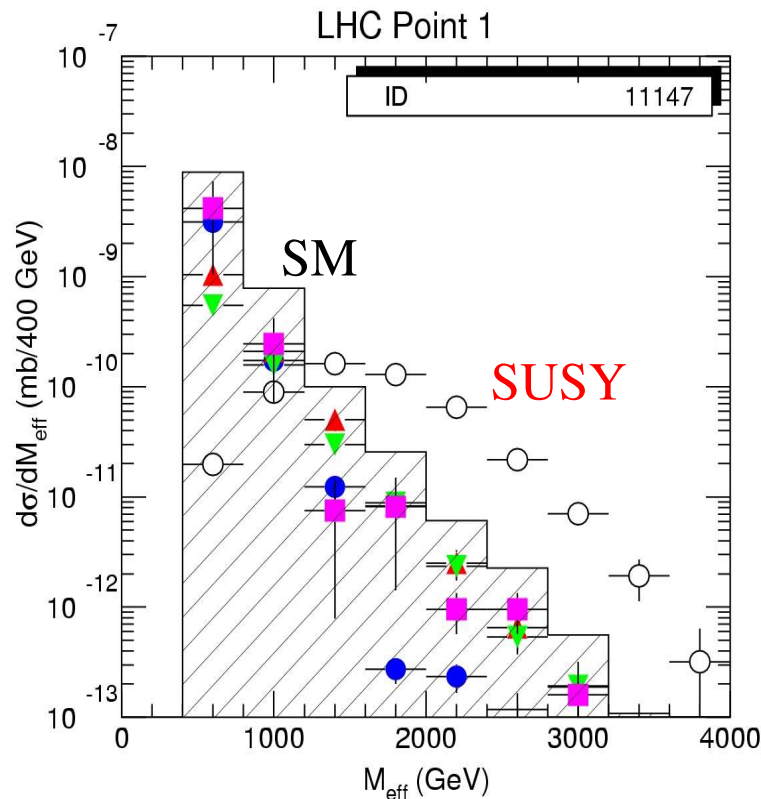

Lepton-based Searches at the LHC

Lepton-based signals could also be very impressive –
even the di-lepton + MET signature might be background-free!

With large distinctive signatures, we will be able to infer masses of SUSY particles
(or combinations of SUSY particles).

Here is an example of a neutralino signal: Neutralino(2) \rightarrow $\mu^+\mu^-$ + Neutralino(1)

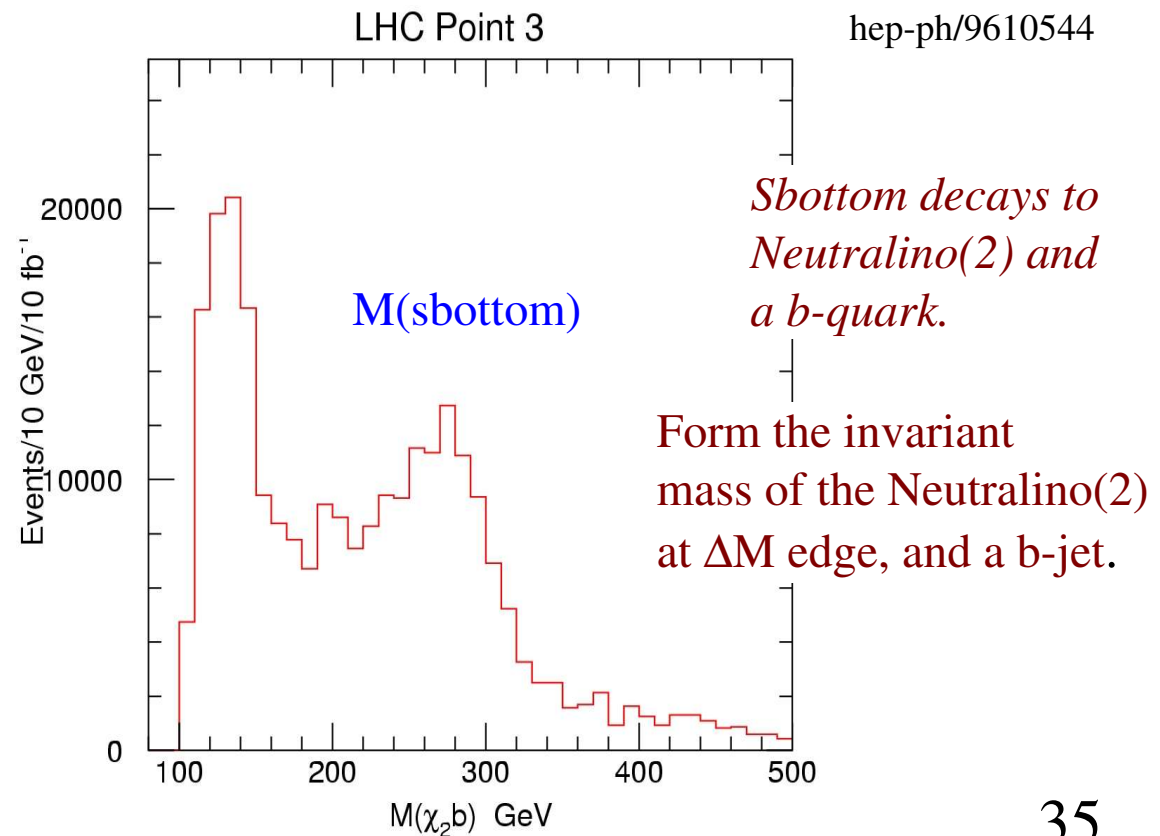
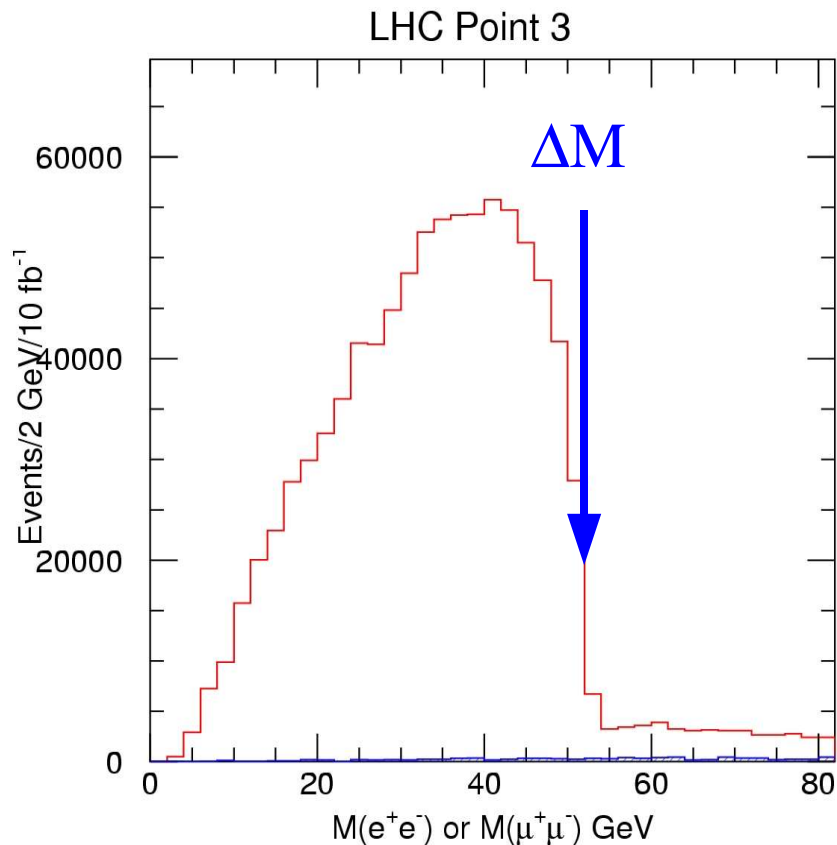

“Observation” of Dark Matter at the LHC

If SUSY is discovered and elucidated at the LHC,

can we confirm that it explains **Dark Matter**?

Yes!

The fundamental SUSY parameters can be inferred with fairly good precision, and then used to calculate the DM relic density.

Finally, check the result against astrophysical observations:

hep-ph/0406147

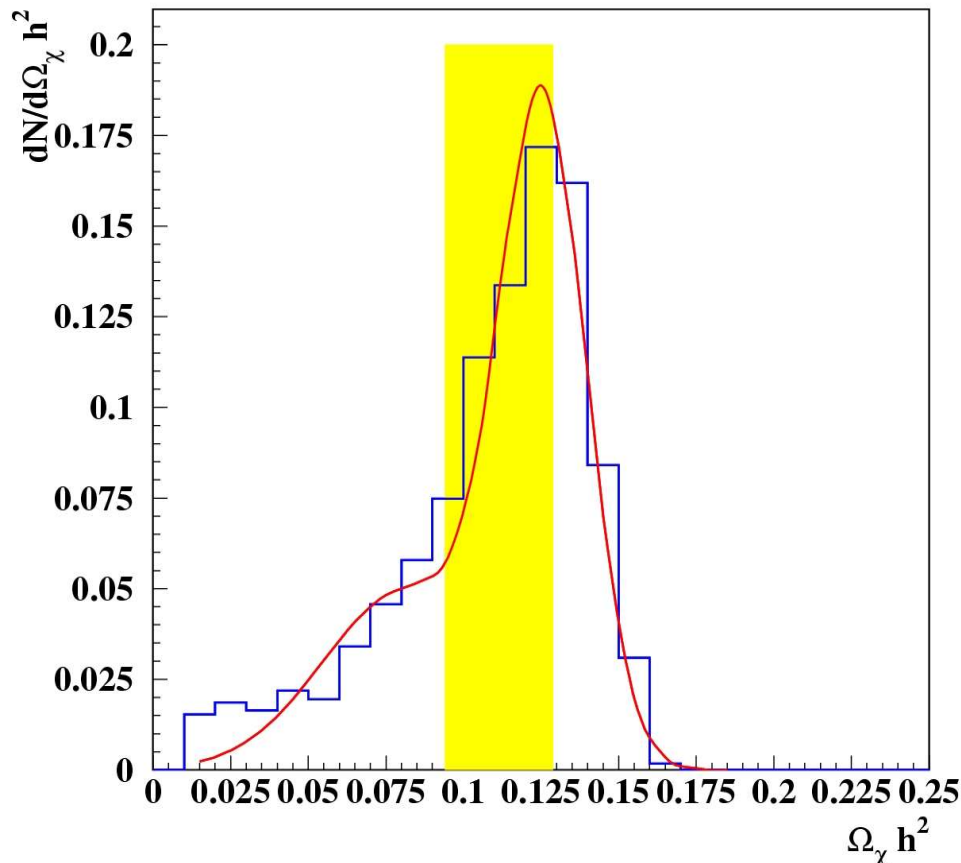

hep-ph/0507214

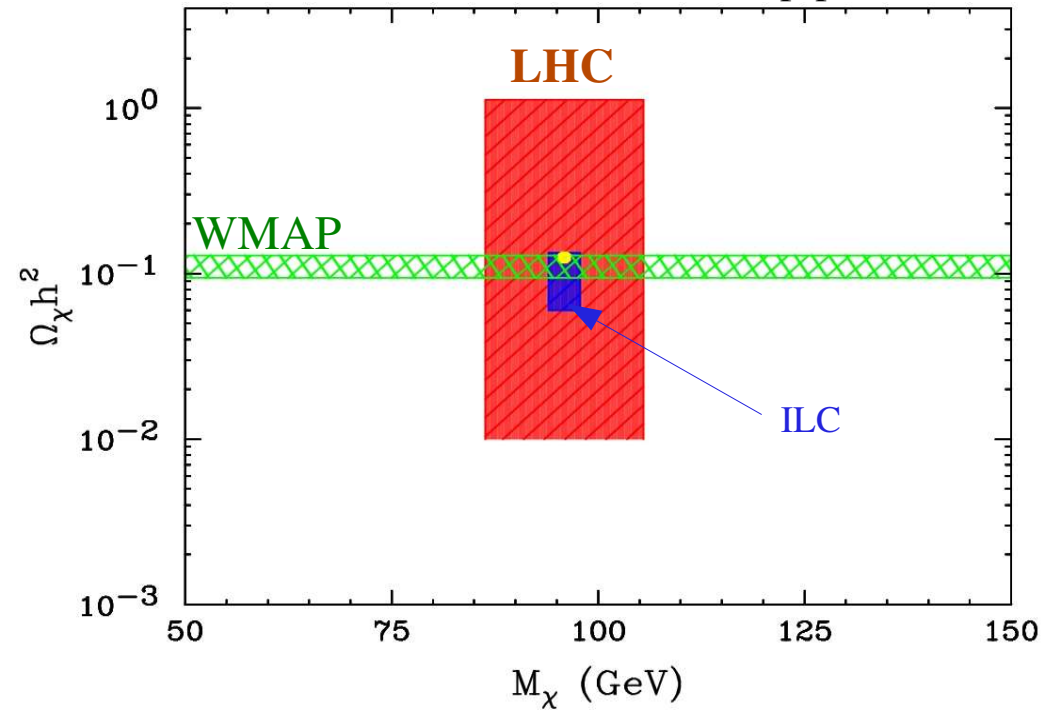

(Assumed 10% measurements of some masses.)

Summary and Conclusions

- SUSY is a well-motivated theory, on theoretical grounds.
- SUSY predicts a variety of distinctive phenomena beyond the SM.
- Searches at the TEVATRON are under way, exploiting as much as possible the information coming from reconstructed jets, leptons and missing energy (MET).
- The LHC promises to be a SUSY factory, leaving a variety of signals to be studied.
- If so, we will begin to discern the correct form of SUSY and to fix fundamental parameters from judicious analyses of the data.

Of course, SUSY might not be the “right” theory, in which case we hope to discover whatever Nature has in store for us...

SUSY Review Articles

There are many excellent reviews of SUSY with a variety of perspectives. Here is a limited list (no particular order) to get you started:

- D.I. Kazakov, *In Search of Supersymmetry*, hep-ph/0012288
- J. Ellis, *Supersymmetry for Alp Hikers*, hep-ph/0203114
- S. Dawson, *SUSY and Such*, hep-ph/9612229
- G. Kane, *Weak Scale Supersymmetry – a Top-motivated, Bottom-up Approach*, hep-ph/0202185
- S. Martin, *A Supersymmetry Primer*, hep-ph/9709356
- M. Carena et al., *Search for Supersymmetry at the Tevatron Collider*, hep-ex/9712022
- H. Murayama, *Supersymmetry Phenomenology*, hep-ph/0002232
- etc.