

ATTACHMENT 3



U.S. Department of Energy
Office of Civilian Radioactive Waste Management



Background - Waste Package Design

Presented to:
DOE/NRC Technical Exchange on Waste Package Design

Presented by:
Neil R. Brown, Ph.D.
Analysis and Component Design

June 4, 2003
Las Vegas, Nevada

Outline

- **Background - Waste Package and Drip Shield Design**
- **Design Detail for License Application (LA)**
- **Application of ASME Code**
- **Key Technical Issue (KTI) Status**
- **Methodology for Waste Package Seismic Response**



Meeting Purpose and Scope

- **Purpose: To discuss waste package and drip shield design approach including:**
 - Preclosure design
 - Postclosure design
 - Fabrication and closure methods
- **Scope: Limited to design issues. In order to focus meeting, certain items are outside the scope of this meeting, including:**
 - Validity of design inputs (e.g., corrosion rates, seismic spectra etc.)
 - Modeling approach to using design outputs (e.g., waste package damage as result of rockfall, etc.)



Background - Waste Package Design

- Discussion topics include design approach that will address portions of the following Yucca Mountain Review Plan (YMRP) sections:
 - §2.1.1.2, Description of Structures, Systems, Components, Equipment, and Operational Process Activities
 - § 2.1.1.7, Design of Structures, Systems, and Components to Safety and Safety Controls
 - § 2.2.1.1, System Description and Demonstration of Multiple Barriers
 - § 2.2.1.3.2, Mechanical Disruption of Engineered Barriers
 - § 2.2.1.3.4, Radionuclide Release Rates and Solubility Limits
 - § 2.5.1, Quality Assurance Program



Background - Waste Package and Drip Shield Design

- **Waste Package and Drip Shield Functions**
- **Waste Package and Drip Shield Design Process**
- **Changes to Waste Package Design since Site Recommendation (SR)**
- **Changes to Drip Shield Design since SR**
- **Approach to Accounting for Material Degradation and Drift Temperatures**
- **Waste Package Prototypes**



Waste Package

Functional and Operational Requirements

- **Waste package must:**
 - **Facilitate safe and efficient loading of spent nuclear fuel and high-level waste**
 - **Be transportable within surface facilities and to emplacement drifts**
 - **Be safely and efficiently sealed remotely**
 - **Be retrievable**
 - **Meet preclosure safety requirements**
 - ◆ **No breach for identified event sequences**
 - ◆ **Preclude criticality**
 - **Meet postclosure needs**
 - ◆ **Long-term dose performance requirements**



Drip Shield

Functional and Operational Requirements

- **Drip shield designed to:**
 - **Provide additional protection for the waste package from rock fall**
 - **Divert potential seepage away from waste package**



Waste Package and Drip Shield Design Process

**Fundamental Design Strategy:
Design for Preclosure and Analyze for Postclosure**

- **Preclosure**
 - Analyze against identified and postulated event sequences to support Preclosure Safety Analysis (PSA)
 - ◆ Waste package is designed to not breach
 - ◆ Preclosure event sequences and design evolution is discussed in Design for License Application portion of the meeting



Waste Package and Drip Shield Design Process

(Continued)

Fundamental Design Strategy: Design for Preclosure and Analyze for Postclosure

- **Postclosure**
 - **Analyze postulated events (drip shield installed) and provide information to support Total System Performance Assessment (TSPA)**
 - ◆ **Damage from rock fall, seismic, etc.**
 - ◆ **Weld flaw distribution**
 - ◆ **Weld stress state**



Waste Package Configurations

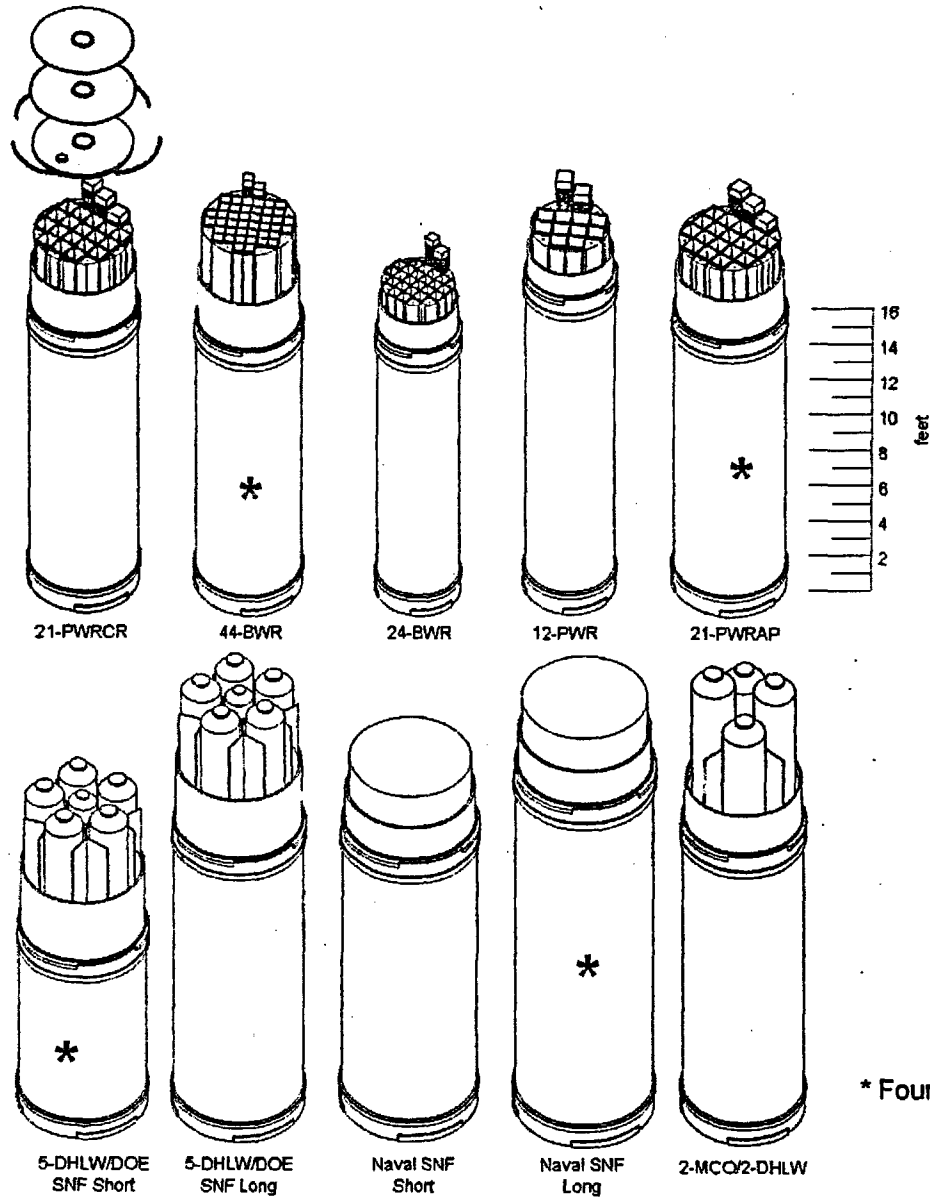

* Four Representative Configurations for LA



Waste Package Closure Details

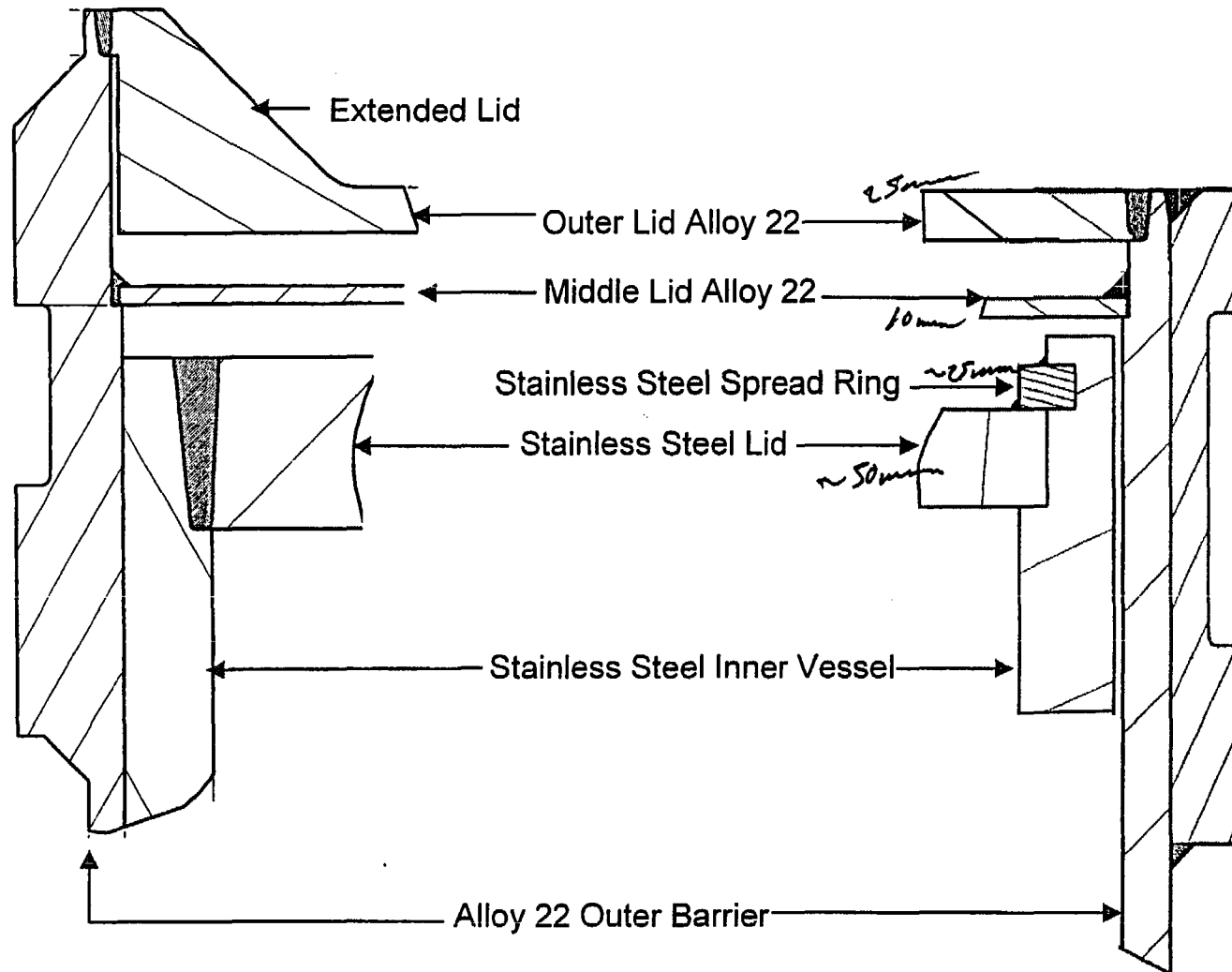

Site Recommendation Design

License Application Design



Waste Package Bottom Details

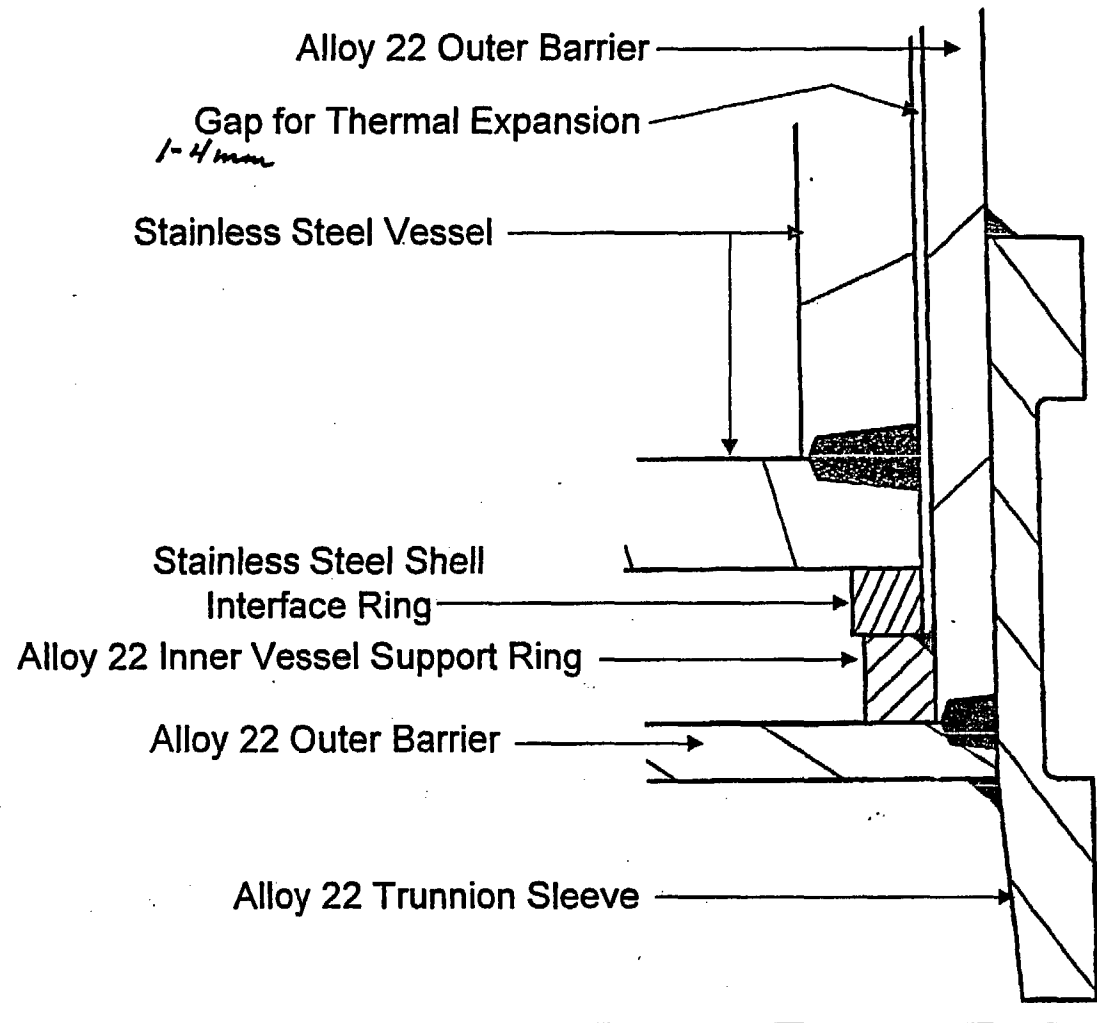

License Application Design



License Application Trunnion Design

- **One piece trunnion collar design**
 - Changed to improve operability

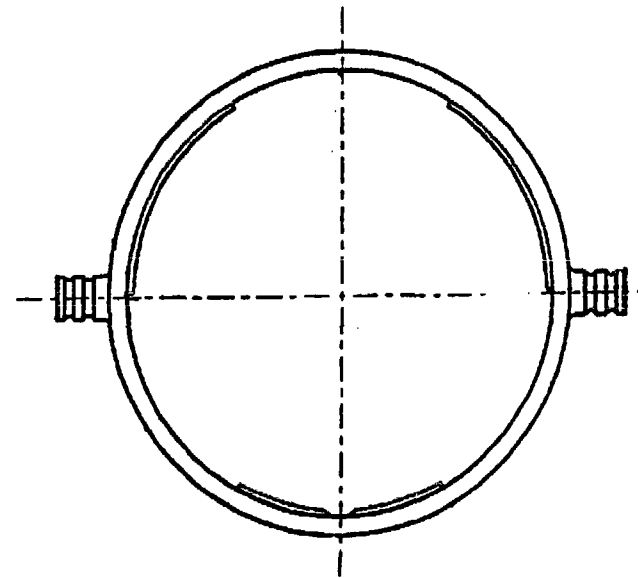
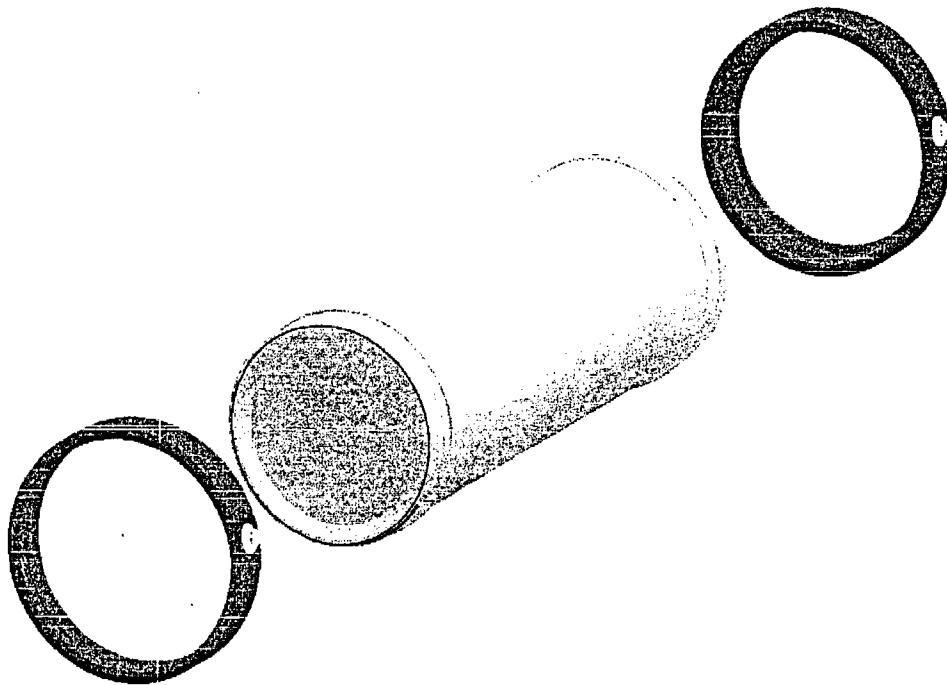

Drip Shield Illustration

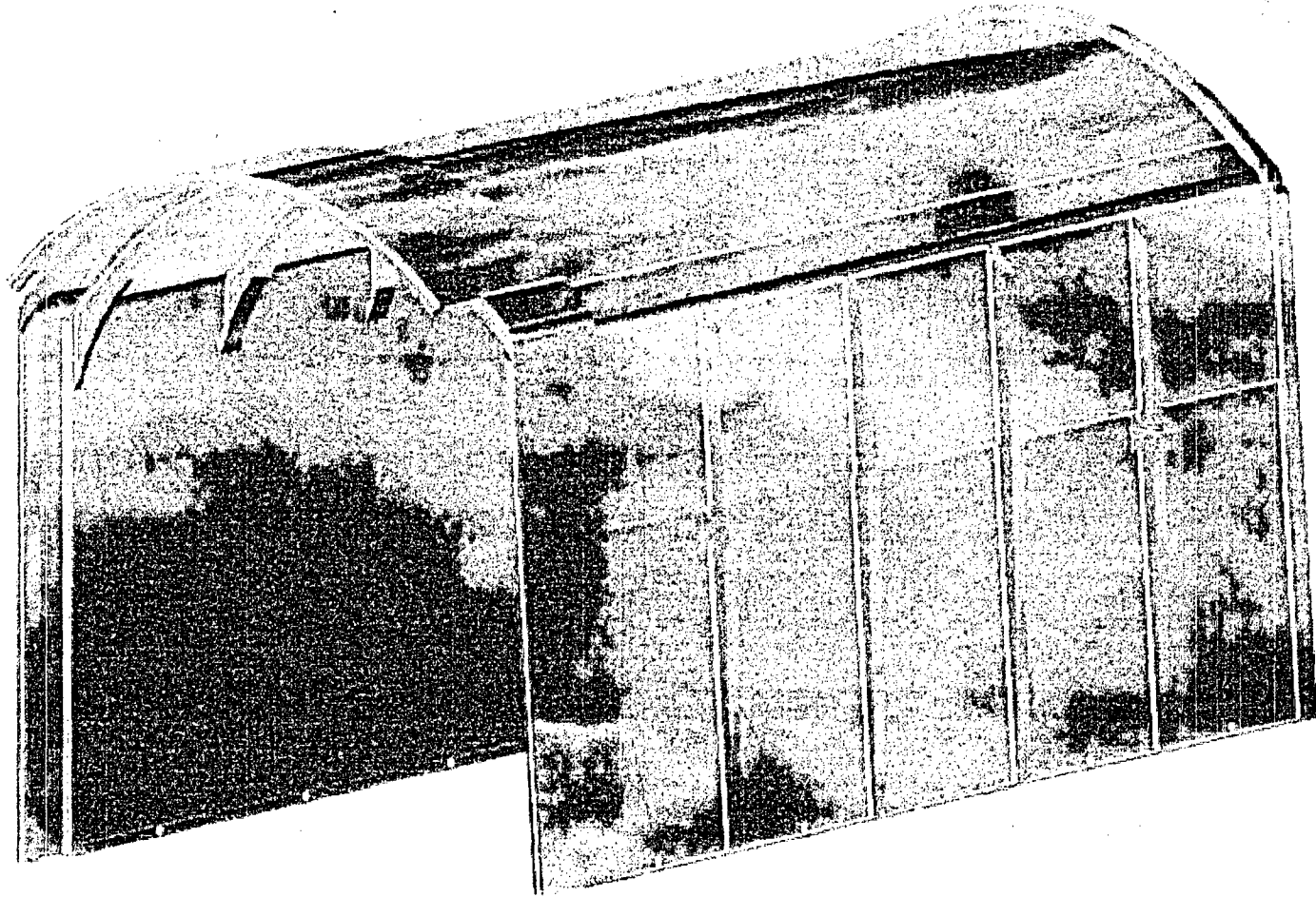

Changes to Drip Shield Design Since Site Recommendation

- **Material selection remains unchanged from SR**
- **LA design will increase stiffness for bending loads and stresses along the bulkheads:**
 - **SR design included four bulkheads (90 mm high, 38 mm wide) under drip shield top plate**
 - **LA design will add flanges (20 mm high, 50 mm wide) to the bottom of each side of the four bulkheads thereby forming reverse T-section**
- **LA design will provide for three longitudinal stiffener beams (70 mm high 38 mm wide) between the bulkheads along the axial direction. Beams will provide additional strength for bending loads along axial length**



Changes to Drip Shield Design Since Site Recommendation

(Continued)

- **LA design will provide additional distance from drip shield to waste package to prevent drip shield contact with the waste package in the event of rock fall**
 - **LA design will be 38 cm compared to SR design of 8 cm**
- **Handling and interlocking mechanism will be simplified**



YUCCA MOUNTAIN PROJECT

Approach for Elevated Temperatures and Corrosion Allowance

- **Postclosure structural calculations have been based on:**
 - Assumed postclosure temperature of 150°C
 - Assumed reduction in wall thickness of 2 mm to account for general corrosion
- **A literature survey is underway to determine appropriate method to account for material properties related to possible hydrogen embrittlement of titanium**

Design Approach and Waste Package Prototypes

- **Prototyping is an integral part of design**
 - **First-of-a-kind fabrication**
 - **Ensure waste packages can be manufactured using conventional techniques**
 - **Develop cadre of qualified vendors**
 - **Ensure proper and effective closure at YMP**



Design Approach and Waste Package Prototypes

(Continued)

- **Planned prototype strategy**
 - **15 waste package prototypes by calendar year 2009**
 - **1st waste package prototype procurement is underway**
 - ◆ **21 pressurized-water reactor (PWR) waste package with absorber plates full scale, includes all internals**
 - ◆ **Consistent with specified design requirements and codes and standards**
 - ◆ **Multiple vendors in process of prequalifying to bid on the request for proposal (RFP)**
 - ◆ **Assembly drawings in check process**
 - ◆ **Delivery expected by February 2005**



Design Approach and Waste Package Prototypes

(Continued)

- **Planned prototype strategy (Continued)**
 - **Waste package prototypes will be used as follows:**
 - ◆ **To verify the closure processes and systems**
 - ◆ **For future destructive and nondestructive testing. These tests could include:**
 - » **Ring core tests to determine compressive stress depth and uniformity of the stress mitigation layer**
 - » **Metallography**
 - » **Other tests as deemed necessary**
 - ◆ **Used in the proposed training facility to demonstrate waste package handling processes**
 - ◆ **Prototypes will be necessary in the Operational Readiness Review (ORR) process**
 - ◆ **Prototypes will be used in the training facility to train operators for ORR, start-up, and actual operations**



Design Approach and Waste Package Prototypes

(Continued)

- **Planned prototype strategy** (Continued)
 - **5 drip shield prototypes**
 - ◆ **Procurement expected CY2006 - CY2010**
 - **8 emplacement pallet prototypes**
 - ◆ **Procurement expected CY2004 - CY2009**



Summary

- **Presented the waste package and drip shield design approach**
 - **Preclosure**
 - **Postclosure**
- **Outlined the major design changes since the Site Recommendation**
- **Discussed the approach to account for postclosure conditions**
- **Summarized plan for development and use of prototypes**





U.S. Department of Energy
Office of Civilian Radioactive Waste Management



Design for License Application

Presented to:
**DOE/NRC Technical Exchange on Waste Package
Design**

Presented by:
Neil R. Brown, Ph.D.
Analysis and Component Design

June 4, 2003
Las Vegas, Nevada

Design Detail for License Application

- **Background and Rationale**
- **Currently Assumed Event Sequences**
- **Approach to Long-term Performance**



YUCCA MOUNTAIN PROJECT

Waste Package Level of Design for License Application

- **1 waste package design for License Application (LA)**
 - **Long-term performance components are the same for waste packages including:**
 - ◆ **Materials**
 - ◆ **Shell thickness**
 - ◆ **Lid design, closure, and stress mitigation**
 - **Design methodology is the same for waste packages**
 - **Licensing the waste package design methodology and design bases in order to:**
 - ◆ **Control and facilitate design evolution**
 - ◆ **Consistently manage changes, specifically from the Preclosure Safety Analysis**
 - ◆ **Facilitate project integration**



Waste Package Level of Design for License Application

(Continued)

- **10 waste package configurations**
 - Aligned with the various waste forms
 - One design with varying diameters, lengths, weights, and internal basket configurations
 - Outline drawings will be submitted at LA for 10 configurations and include:
 - ◆ Components, materials, and nominal dimensions
 - ◆ Lid and closure details
 - ◆ Internals configuration without assembly details



Waste Package Level of Design for License Application

(Continued)

- **Details of 4 representative configurations for the LA**
 - **4 representative configurations correspond to:**
 - ◆ ~75% of the waste packages to be emplaced
 - ◆ ~90% of metric tons of heavy metal (MTHM) to be received
 - **Representative configurations are:**
 - ◆ 21 PWR Absorber Plate
 - ◆ 44 BWR
 - ◆ 5 DHLW/DOE SNF Co-Disposal Short
 - ◆ Navy Canistered SNF Long

PWR - pressurized-water reactor

BWR - boiling-water reactor

DHLW - defense high-level radioactive waste

DOE - U.S. Department of Energy

SNF - spent nuclear fuel



YUCCA MOUNTAIN PROJECT

Waste Package Level of Design for License Application

(Continued)

- **Details of 4 representative configurations for the LA**
(Continued)
 - **Postulated accident analysis will be completed for the 4 representative configurations including drop calculations for:**
 - ◆ **The heaviest waste package**
 - ◆ **The longest waste package**
 - ◆ **The shortest waste package**
 - ◆ **The largest diameter waste package**
 - **Assembly drawings (suitable for procurement) for the 4 representative configurations will be provided with the LA**



YUCCA MOUNTAIN PROJECT

Level of Design Detail

Design and Analysis Feature	License Application	Prior to Use
4 Representative Configurations		
Postclosure Design Features	✓	✓
Drawings		
• Configuration Drawings	✓	✓
• Assembly Drawings (Suitable for Procurement)	✓	✓
✗ Preclosure Design Bases		
• Assumed (will verify)	✓	
• Preliminary Hazards Analysis	✓	
• Final Hazards Analysis		✓
Fabrication Specification		✓
Operational Specifications		✓
Remaining 6 Configurations		
Postclosure Design Features	✓	✓
Drawings		
• Configuration Drawings	✓	✓
• Assembly Drawings (Suitable for Procurement)		✓
Preclosure Design Bases		
• Assumed (will verify)		
• Preliminary Hazards Analysis		✓
• Final Hazards Analysis		✓
Fabrication Specification		✓
Operational Specifications		✓



Assumed Preclosure Event Sequences

- For preclosure safety purposes the waste package is being designed to not breach for event sequences
- The following event sequences will be analyzed:
 - Normal handling
 - 2.3 metric ton object falling 2.0 meters onto end of the waste package (inner vessel lid installed)
 - 2.0 meter vertical orientation drop
 - 2.4 meter corner drop
 - 2.4 meter horizontal drop
 - 1.9 meter horizontal drop onto steel support, 2.4 meter onto concrete pier
 - Swingdown



Assumed Preclosure Event Sequences

(Continued)

- **Event sequences** (Continued)

- 10 degree oblique drop from 2.4 meter with slap down
- Withstand $\leq 10^{-4}$ annual frequency earthquake (includes surface facility features)
- Missile impact (0.5 kg, 5.7 m/s), arising from an internal pressurized system (compressed air, etc.)
- Tipover from elevated platform (1.5 meter for shortest WP, shorter for longer WP)
- Parametric 10 CFR 71 Fire
- Preclosure rock fall
- Transporter run-away (includes waste package transporter features)



Assumed Preclosure Event Sequences

(Continued)

- **Event Sequences subject to change as facility design matures. Changes may require:**
 - **Additional waste package analysis**
 - **Changes to waste package design (e.g., wall thickness)**
 - **Changes to facility design (e.g., impact absorbers, lift heights)**



Design Details for Postclosure Analysis

- **Level of Design Detail provided for Total System Performance Assessment at LA**
 - Not configuration specific
 - Materials including waste package internals
 - Shell thickness
 - Lid and closure design details
 - Necessary information for performance assessment calculations



Summary

- **Described approach for design detail for LA and beyond**
 - 1 waste package design
 - 10 different configurations
 - Same design methodology and design bases
- **At LA we will:**
 - Commit to waste package design bases
 - Establish and demonstrate the design methodology
 - Provide outline drawings for the 10 waste package configurations
 - Provide detailed assembly drawings for 4 of the waste package configurations



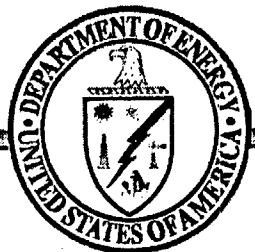

U.S. Department of Energy
Office of Civilian Radioactive Waste Management



Application of the ASME Code for Waste Package Fabrication

Presented to:
**DOE/NRC Technical Exchange on Waste Package
Design**

Presented by:
Neil R. Brown, Ph.D.
Analysis and Component Design

June 4, 2003
Las Vegas, Nevada

Application of ASME Code

- **Selected Code and Rationale**
- **Application of Code at Fabricator**
- **Application of Code at the Repository Facility**



Selection of ASME Code for Waste Package Construction

- **Why the American Society of Mechanical Engineers (ASME) Code?**
 - The ASME Code is the industry standard for construction of spent nuclear fuel storage containers
 - ♦ NRC licenses for commercial spent nuclear fuel storage containers have been issued based on compliance with the technical requirements of the ASME Code
 - *Yucca Mountain Review Plan* (NUREG-1804) provides guidance regarding the use of the ASME Boiler and Pressure Vessel Code for waste package design



Selection of ASME Code for Waste Package Construction

(Continued)

- **Why the ASME Code?** (Continued)
 - To ensure fabrication consistency amongst vendors, ASME Code provides administrative requirements including:
 - ◆ ASME Certificates of Authorization and Authorized Nuclear Inspection
 - ◆ ASME Code Stamps
 - ◆ ASME-accredited Quality Assurance Programs
 - ◆ Manufacturer's Data Reports



Selection of ASME Code for Waste Package Construction

(Continued)

- **The ASME Code, Section III, Division 1, Subsection NC (for Class 2 Components) will be used for the construction of the Yucca Mountain waste packages**
 - **Construction within the context of the ASME Code includes:**
 - ◆ **Materials**
 - ◆ **Design**
 - ◆ **Fabrication**
 - ◆ **Examination**
 - ◆ **Testing**



Selection of ASME Code for Waste Package Construction

(Continued)

- **Why Section III?**
 - **Section III rules are intended for the design and fabrication of nuclear vessels**
 - **Section III rules pertain to unfired pressure vessels**
 - **The NRC has licensed many components under Section III in nuclear applications**
 - **Common industry practice is to use Section III for new nuclear safety-related applications**



Selection of ASME Code for Waste Package Construction

(Continued)

- **Why Division 1, Subsection NC?**
 - Subsection NC has the appropriate combination of lower allowable design stresses and the level of nondestructive examination for construction of the Yucca Mountain waste packages
 - Subsection NC is most appropriate since:
 - ◆ Waste package wall thickness is driven by preclosure safety event sequences (accident loads)
 - ◆ The ASME Code design for design pressure and loaded dead weight, accident loads will be evaluated by the Project and will not be part of the ASME Code design
 - Substantial number of Subsection NC fabricators available within the United States



Application of ASME Code at the Fabricator

- **Stainless steel inner vessel**
 - The inner vessel material will be 316 stainless steel (UNS S31600) with additional restrictions on carbon and nitrogen
 - The Project will prepare the ASME Code Design Specification
 - The inner vessel will be designed to the requirements of ASME Code, Section III, Division 1, Subsection NC (for Class 2 components)
 - The ASME Code Design Report for design pressure and loaded dead weight will be prepared by the fabricator
 - The accident loads will be evaluated by the Project and will not be part of the ASME Code Design Report



Application of ASME Code at the Fabricator

(Continued)

- **Stainless steel inner vessel** (Continued)
 - The inner vessel will be fabricated to the requirements of ASME Code, Section III, Division 1, Subsection NC (for Class 2 components) and the Project fabrication specification and drawings
 - The fabricator will possess an ASME Certificate of Authorization for ASME Code, Section III, Division 1, Subsection NC (for Class 2 Components)
 - The fabricator will comply with all the administrative requirements of ASME Code, Section III, Subsection NCA including affixing the N stamp to the inner vessel
 - At this time it is not anticipated that any existing or new ASME Code Cases will be required for the construction of the inner vessel



Application of ASME Code at the Fabricator

(Continued)

- **Stainless steel inner vessel** (Continued)
 - **Nondestructive examination**
 - ◆ **Welds will be nondestructively examined by radiographic examination (RT) and liquid penetrant examination (PT)**
 - **With stainless steel closure lid temporarily installed**
 - ◆ **The inner vessel will be pressure tested**
 - ◆ **The inner vessel will be helium leak tested at the fabricator's facilities (not required by the ASME Code)**
 - » **A helium leak test will be performed to verify the leak tightness of the inner vessel at the fabricator's facilities prior to shipment to the Repository Facility**



Application of ASME Code at the Fabricator

(Continued)

- **Alloy 22 Corrosion Barrier**
 - The corrosion barrier material will be Alloy 22 (UNS N06022)
 - The corrosion barrier design will be prepared by the Project
 - All accident loads will be evaluated by the Project
 - The outer corrosion barrier will be fabricated to the requirements of ASME Code, Section III, Division 1, Subsection NC (for Class 2 components) for materials, fabrication, and examination
 - The fabricator will possess an ASME Certificate of Authorization for ASME Code, Section III, Division 1, Subsection NC (for Class 2 Components). The corrosion resistant outer barrier will be fabricated by the stainless steel inner vessel fabricator



Application of ASME Code at the Fabricator

(Continued)

- **Alloy 22 corrosion barrier (Continued)**
 - The fabricator will use ASME NCA-3800 for Alloy 22 base metal procurement
 - Inspection by an Authorized Nuclear Inspector (ANI) will be performed
 - An alternative (non-Code) Data Report, as specified by the Project, will be prepared by the fabricator and certified by the fabricator and the ANI



Application of ASME Code at the Fabricator

(Continued)

- **Alloy 22 corrosion barrier (Continued)**
 - **Nondestructive examination**
 - ◆ The corrosion barrier base material will be examined by ultrasonic examination (UT) in accordance with ASME Code, Section III, NB-2532.2 to provide additional confidence for long-term waste package performance
 - ◆ Welds will be nondestructively examined by radiographic examination (RT), ultrasonic examination (UT), and liquid penetrant examination (PT)
 - **Assuring proper surface condition**
 - ◆ Alloy 22 will be solution annealed and quenched in a controlled manner to assure appropriate stress state
 - ◆ Surface finish will be controlled to specifications
 - ◆ Discussed in Key Technical Issue PRE.7.05 portion of the meeting



Application of ASME Code at the Repository Facility

- **After loading the waste package with spent nuclear fuel or high-level waste, the waste package will be sealed as described below:**
- **Stainless steel inner vessel lid**
 - **The inner vessel will be closed by placing the stainless steel inner lid on the waste package, engaging the spread ring, and seal welding the spread ring to ensure leak tightness**
 - **Seal weld will be performed to ASME Section IX welding requirements**
 - **Seal weld will be visually inspected (VT) and inner vessel will be helium leak tested**



Application of ASME Code at the Repository Facility

(Continued)

- **Stainless steel inner vessel lid (Continued)**
 - Inner vessel will be inerted to NUREG-1536
 - ◆ Evacuated, checked to confirm no off-gassing, backfilled with helium
 - ◆ Evacuated a second time then backfilled
 - ◆ Inerting plug will be sealed
- **Alloy 22 corrosion barrier middle lid**
 - The middle Alloy 22 lid provides additional margin for corrosion protection and will be closed with a fillet weld
 - Fillet weld will be performed to ASME Section IX welding requirements
 - ◆ Weld will be visually inspected (VT) and eddy current tested (ET)



Application of ASME Code at the Repository Facility

(Continued)

- **Alloy 22 corrosion barrier outer lid**
 - The outer Alloy 22 lid will be closed with a full penetration structural weld
 - Full penetration weld will be performed to ASME Section IX welding requirements
 - Weld will be visually inspected (VT), eddy current (ET), and ultrasonically tested (UT) before and after stress mitigation



Summary

- **Presented the Project position on application of the ASME Code**
 - **At the Fabricator**
 - **At the Repository Facility**
- **Discussed planned nondestructive examination**



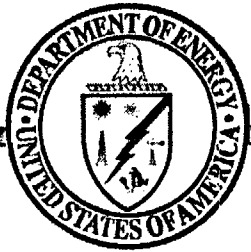

U.S. Department of Energy
Office of Civilian Radioactive Waste Management



Key Technical Issue Status

Presented to:
**DOE/NRC Technical Exchange on Waste Package
Design**

Presented by:
Neil R. Brown, Ph.D.
Analysis and Component Design

June 4, 2003
Las Vegas, Nevada

Key Technical Agreements Related to Waste Package Design

- **Container Life and Source Term (CLST) Agreements**
 - CLST.2.01
 - CLST.2.02
 - CLST.2.03
 - CLST.2.06
 - CLST.2.08
 - CLST.2.09



Key Technical Agreements Related to Waste Package Design

(Continued)

- **Preclosure (PRE) Agreements**
 - PRE.7.02
 - PRE.7.03
 - PRE.7.04
 - PRE.7.05



YUCCA MOUNTAIN PROJECT

CLST.2.01

AGREEMENT—“Either provide documentation using solid element formulation, or provide justification for not using it, for the drip shield - rockfall analysis. DOE stated that shell elements include normal stresses and transverse stresses in the calculations and provide more accurate results for thin plates and use far fewer elements. Therefore, shell elements will be used instead of solid elements. This justification will be documented in the next revision of AMR ANL-XCS-ME-000001, Design Analysis for the Ex-Container Components, prior to LA.”



CLST.2.01

(Continued)

- **NRC Status - Closed-Pending**
 - Due January 2004
- **DOE Status**
 - In Process
- **Path Forward**
 - Calculations will be performed that consist of rock fall analyses on the drip shield that use combinations of shell element and solid element formulation



CLST.2.01

(Continued)

- **Calculations will consist of:**
 - **Four different drip shield finite element representations are being used to evaluate shell versus solid element formulations**
 1. **All components of the drip shield are composed of solid elements**
 2. **The top and side plates of the drip shield are composed of shell elements while all other components are solid elements**
 3. **The top and side plates, and the internal and external support plates are composed of shell elements while all other components are solid elements**
 4. **All components are composed of shell elements**
 - **Geometry of the finite element representation is a point-loaded rock falling directly in the center of a drip shield**
 - **Rock shape in the evaluation is a rectangular prism**
 - **Maximum stress intensities and levels of deformation will be compared**



CLST.2.02

AGREEMENT—“Provide the documentation for the point loading rockfall analysis. DOE stated that point loading rock fall calculations will be documented in the next revisions of AMRs ANL-XCS-ME-000001, Design Analysis for the Ex-Container Components, and ANL-UDC-MD-000001, Design Analysis for UCF Waste Packages, both to be completed prior to LA.”



CLST.2.02

(Continued)

- **NRC Status - Closed-Pending**

- Due January 2004

- **DOE Status**

- In Process

- **Path Forward**

- Rock fall calculations addressing point-loading on the drip shield and the waste package have been performed
- Results of calculations will be discussed as part of the waste package seismic response portion of the meeting



CLST.2.03

AGREEMENT—“Demonstrate how the Tresca failure criterion bounds a fracture mechanics approach to calculating the mechanical failure of the drip shield. DOE stated that it believes its current approach of using ASME Code is appropriate for this application. Additional justification for this conclusion will be included in the next revision of AMR ANL-XCS-ME-000001, Design Analysis for the Ex-Container Components, to be completed prior to LA.”



CLST.2.03

(Continued)

- **NRC Status - Closed-Pending**
 - Received, Needs Additional Information
- **DOE Status**
 - Need for additional information received March 2003, preparing response
- **Submitted information included:**
 - Analysis demonstrates that failure of Ti-7 and Alloy 22 is dominated by plastic collapse and not by brittle fracture
 - Ultimate failure conditions for these materials were determined using a failure assessment diagram (FAD)
 - Based on the FADs, it is shown that the strength of materials approach (Tresca failure criterion) is appropriate for both materials



CLST.2.03

(Continued)

- **NRC—Needs Additional Information**

- Approach used to establish governing failure mechanism for the drip shield and waste package materials, using failure assessment diagrams, is appropriate
- Failed to adequately establish the appropriate failure mechanisms for the drip shield and waste package materials because the various material properties used in the analyses have yet to be satisfactorily justified

- **Path Forward**

- Finalizing path forward, which includes fracture toughness testing, literature surveys, and corresponding analyses to establish appropriate failure mechanisms for Ti-7, Ti-24, and Alloy 22



CLST.2.03

(Continued)

Examples of FADs

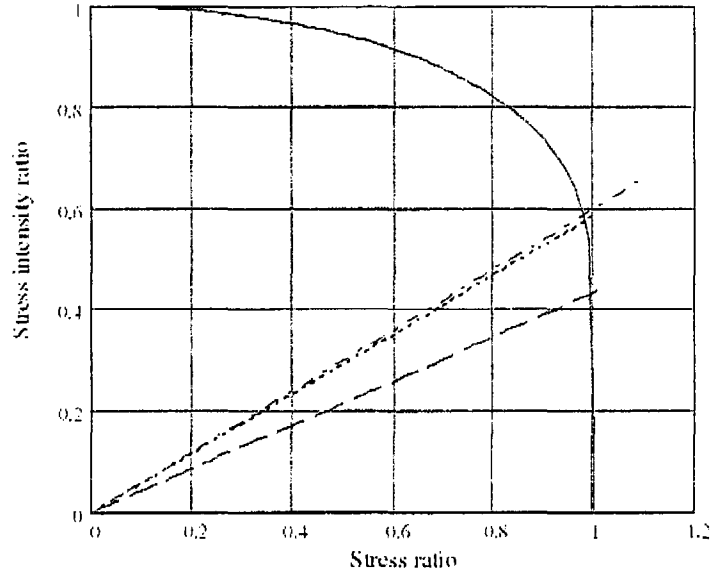

Figure 1. Failure assessment diagram for Ti-7 (compact specimen)

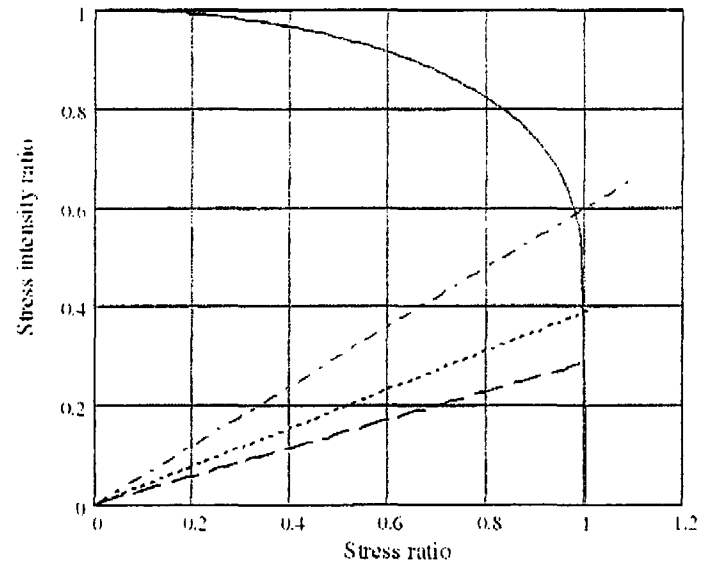

Figure 4. Failure assessment diagram for Alloy C-22 (compact specimen)



CLST.2.06

- **AGREEMENT—“Provide the technical basis for the mechanical integrity of the inner overpack closure weld. DOE will provide the documentation in AMR, ANL-UDC-MD-000001, Rev. 00, Design Analysis for UFC Waste Packages in the next revision, prior to LA.”**

- **NRC Status**
 - Complete

- **DOE Status**
 - Complete

- **Path Forward**
 - None required



CLST.2.08

AGREEMENT—“Provide documentation of the path forward items in the "Subissue 2: Effects of Phase Instability of Materials and Initial Defects on the Mechanical Failure and Lifetime of the Containers" presentation, slide 16. [future rockfall evaluations will address (1) effects of potential embrittlement of WP closure material after stress annealing due to aging, (2) effects of drip shield wall thinning due to corrosion; (3) effects of hydrogen embrittlement on titanium drip shield; and (4) effects of multiple rock blocks falling on WP and drip shield; future seismic evaluations will address the effects of static loads from fallen rock on drip shield during seismic events]

(Continued on next slide)



CLST.2.08

(Continued)

DOE stated that the rockfall calculations addressing potential embrittlement of the waste package closure weld and rock falls of multiple rock blocks will be included in the next revision of the AMR ANL-UDC-MD-000001, Design Analysis for UCF Waste Packages, to be completed prior to LA. Rock fall calculations addressing drip shield wall thinning due to corrosion, hydrogen embrittlement of titanium, and rock falls of multiple rock blocks will be included in the next revision of the AMR ANL-XCS-ME-000001, Design Analysis for the Ex-Container Components, to be completed prior to LA.

(Continued on next slide)



CLST.2.08

(Continued)

Seismic calculations addressing the load of fallen rock on the drip shield will be included in the next revision of the AMR ANL-XCS-ME-000001, Design Analysis for the Ex-Container Components, to be completed prior to LA.”

- **NRC Status - Closed-Pending**
 - Due January 2004
- **DOE Status**
 - In Process



CLST.2.08

(Continued)

- **Path Forward**

- **Rock fall on waste package calculations**

- ◆ **Rock fall calculations addressing waste package wall thinning due to corrosion and rock falls of multiple rock blocks will be performed**
 - ◆ **Embrittlement of the waste package closure material after induction annealing is no longer an issue with the new waste package closure design**

- **Rock fall on drip shield calculations**

- ◆ **Rock fall calculations addressing drip shield wall thinning due to corrosion, hydrogen embrittlement of titanium, and rock falls of multiple rock blocks will be performed**
 - ◆ **Literature search is being conducted to determine the effects of hydrogen embrittlement on titanium and select appropriate material properties to perform rock fall calculations**



CLST.2.08

(Continued)

- **Path Forward** (Continued)

- **Seismic calculations addressing the load of fallen rock on the drip shield will be developed**
 - ◆ **Results of calculations will be discussed as part of the waste package seismic response portion of the meeting**



CLST.2.08 Path Forward

- **Rock fall on waste package**
 - **Calculation basis**
 - ◆ **Calculations are being conducted to evaluate multiple rock falls on the waste package during the preclosure period**
 - ◆ **Various rock sizes are used in the evaluation**
 - » **0.1, 1.0, and 6.0 metric ton**
 - ◆ **Rock shape in the evaluation is pyramidal**
 - ◆ **Thickness of the waste package corrosion barrier is reduced to account for degradation due to general corrosion**



CLST.2.08 Path Forward

(Continued)

• **Rock fall on waste package** (Continued)

– **Results to date**

- ◆ **Critical distance between impact locations for multiple rock fall on the waste package is within the range of 0.25 to 0.50 meter**
 - » **Critical distance is defined as the one for which the maximum effective plastic strain in the first (primary) impact region on the waste package outer corrosion barrier is negligibly affected by the second rock fall**

– **Additional Work Needed**

- ◆ **In the process of updating the analyses to focus on stress state and failure rather than critical distance between multiple rock falls**
- ◆ **Moving from a probabilistic to a consequence based approach**
- ◆ **Critical distance will be used to provide a limit to the size, mass, and kinetic energy of the multiple rocks**



CLST.2.08 Path Forward

(Continued)

- **Rock fall on drip shield**

- **Calculation basis**

- ◆ **Calculations are being conducted to evaluate multiple rock falls on the drip shield in the postclosure period**
 - ◆ **Various rock sizes are used in the evaluation**
 - » **0.1, 1.0, and 6.0 metric ton**
 - ◆ **Rock shape in the evaluation is a rectangular prism**
 - ◆ **Rock angles of inclination are adjusted such that the rock's center of gravity lies directly above the point of contact**
 - ◆ **Thickness of the drip shield is reduced to account for degradation due to general corrosion**
 - ◆ **The drip shield is represented by solid elements**



CLST.2.08 Path Forward

(Continued)

• Rock fall on drip shield (Continued)

— Results to date

- Rock fall vertical impact velocity of 9.0 m/s
- Critical distance between impact locations for multiple rock fall on the drip shield is 0.50 meter
 - » Critical distance defined as the one for which the maximum effective plastic strain in the first (primary) impact region of the drip shield top plate is negligibly affected by the second rock fall

— Additional work needed

- In the process of updating the analyses to focus on stress state rather than critical distance between multiple rock falls
- Moving from a probabilistic to a consequence based approach
- Critical distance will be used to provide a limit to the size, mass, and kinetic energy of the multiple rocks



YUCCA MOUNTAIN PROJECT

CLST.2.09

AGREEMENT—“Demonstrate the drip shield and waste package mechanical analysis addressing seismic excitation is consistent with the design basis earthquake covered in the SDS KTI. DOE stated that the same seismic evaluations of waste packages and drip shield (revision of AMRs ANL-UDC-MD-000001 and ANL-XCS-ME-000001) will support both the SDS KTI and the CLST KTI, therefore consistency is ensured. These revisions will be completed prior to LA.”



CLST.2.09

(Continued)

- **NRC Status - Closed-Pending**
 - Due January 2004
- **DOE Status**
 - In Process
- **Path Forward**
 - Results of calculations will be discussed as part of the waste package seismic response portion of the meeting



PRE.7.02

AGREEMENT—“Provide documentation demonstrating that a sufficient finite element model mesh discretization has been used and the failure criterion adequately bounds the uncertainties associated with effects not explicitly considered in the analysis. These uncertainties include but are not limited to: (1) residual and differential thermal expansion stresses, (2) strain rate effects, (3) dimensional and material variability, (4) seismic effects on ground motion, (5) initial tip-over velocities, and (6) sliding and inertial effects of the waste package contents, etc.

(Continued on next slide)



PRE.7.02

(Continued)

In addition, document the loads and boundary conditions used in the models and provide the technical bases and or rationale for them. DOE agreed to provide the information. The information will be available in FY03 and documented in Waste Package Design Methodology Report.”

- **NRC Status - Closed-Pending**
 - Due November 2003
- **DOE Status**
 - In Process



PRE.7.02

(Continued)

- **Path Forward**

- **Will provide relative magnitudes of factors in finite element analysis not generally considered in such calculations. The specific factors addressed will be:**
 - ◆ **Residual and thermal expansion stresses**
 - ◆ **Strain-rate effects**
 - ◆ **Dimensional and material variability**
 - ◆ **Initial tip-over velocities**
 - ◆ **Sliding and inertial effects of waste package contents**
- **Will include the process used to ensure that the mesh-discretization is adequate and the relative conservatism in the failure criterion used**



PRE.7.02 Path Forward

- **Residual and differential thermal expansion stresses**
 - Components are sized to provide tolerance to accommodate such expansion
 - Expansion and resulting stresses are expected to be non-existent or very low
 - A probable through-wall residual stress profile will be provided to assess the effect of residual stress distribution
 - Information from the FY2000 Mockup will be required to determine actual stress profiles (discussed in Pre.7.05)



PRE.7.02 Path Forward

(Continued)

- **Strain-rate effects**
 - Investigations into strain-rate effects are pending
- **Dimensional and material variability**
 - Dimensional minimums are used for event sequence structural calculations to maintain conservatism
 - ASME Boiler and Pressure Vessel Code minimums for important structural parameters are used resulting in conservative calculations
 - The effect of variability in metal constituent on gross structural properties will be determined in PRE.7.03



PRE.7.02 Path Forward

(Continued)

- **Seismic effect on ground motion**
 - Analyses have been performed for the $5 \cdot 10^{-4}$ ground motions for waste packages within the emplacement drift during preclosure and show neither immediate breach nor appreciable damage to the waste package
 - Calculations to evaluate the performance of a waste package on the emplacement pallet within the surface facility is pending
 - Restraint of the waste package during other surface and subsurface operations precludes immediate breach and appreciable damage



PRE.7.02 Path Forward

(Continued)

- **Initial tip-over velocities**
 - A parametric study of initial tip-over velocities will be performed
- **Sliding and inertial effects of waste package contents**
 - Waste package internals and waste forms are generally combined as a single mass in event sequence calculations
 - Resulting maximum energy being delivered at the time of impact is considered conservative



PRE.7.03

AGREEMENT—“Demonstrate that the allowed microstructural and compositional variations of alloy 22 base metal and the allowed compositional variations in the weld filler metals used in the fabrication of the waste packages do not result in unacceptable waste package mechanical properties. DOE will provide justification that the ASME code case for alloy 22 results in acceptable waste package mechanical properties considering allowed microstructural and compositional variations of alloy 22 base metal and the allowed compositional variations in the weld filler metals used in the fabrication of the waste packages. DOE agrees to provide the information in FY03 and document the information in the Waste Package Design Methodology Report.”



PRE.7.03

(Continued)

- **NRC Status - Closed-Pending**
 - Due November 2003 (date is subject to replan)
- **DOE Status**
 - In Process
- **Path Forward**
 - Tests are being performed to study the microstructural and compositional variations of Alloy 22 for both base and weld filler materials
 - Several compositional variations within the scope of the ASME code case will be fabricated for the study



PRE.7.03

(Continued)

- **Material variability study**
 - 7 base material compositions (see following slides)
 - 7 weld wire compositions (see following slides)
 - Resulting in 49 combinations
 - Testing in as welded and annealed condition
 - ◆ Tensile and Impact testing in accordance with ASME/ASTM SA-370
 - ◆ Metallography of base material, weld, and heat affected zones



PRE.7.03

(Continued)

• Base material composition range

Element	Composition % (Nominal)	Test Compositions Desired						
		Base Material Set A	Base Material Set B	Base Material Set C	Base Material Set D	Base Material Set E	Base Material Set F	Base Material Set G
Nickel	Balance	Bal	Bal	Bal	Bal	Bal	Bal	Bal
Chromium	20.5 - 22.5	20.0	20.5	20.9	21.2	21.6	22.0	22.5
Molybdenum	12.5 -14.5	12.5	12.8	13.1	13.4	13.7	14.0	14.5
Iron	2 - 6	2.0	2.7	3.4	4.1	4.8	5.5	6
Tungsten	2.5 -3.5	2.5	2.65	2.75	2.85	2.95	3.25	3.5
Cobalt	2.5 max	Note 1	As required by specification ASME SB-575	Note 2	As required by specification ASME SB-575			
Vanadium	0.35 max							
Carbon	0.015 max							
Phosphorous	0.02 max							
Sulfur	0.02 max							
Manganese	0.5 max							
Silicon	0.08 max							

Note 1: The chemistry of these seven elements shall be picked to select a material with minimum elemental content (e.g., the lowest possible, within the limits set by ASME SB-575. Carbon shall be as near 0% as achievable).

Note 2: The chemistry of these seven elements shall be picked to select a material with maximum elemental content (e.g., the maximum possible, within the limits set by ASME SB-575). Carbon may be any value between 0.01% and 0.015%.



PRE.7.03

(Continued)

- Weld wire composition range

Element	Composition % (Nominal) - ERNiCrMo-14	Test Composition Requirements in Percentages						
		Filler Set 1	Filler Set 2	Filler Set 3	Filler Set 4	Filler Set 5	Filler Set 6	Filler Set 7
Nickel	Balance	Bal	Bal	Bal	Bal	Bal	Bal	Bal
Chromium	19-23	19	19.7	20.3	21.0	21.7	22.3	23
Molybdenum	15-17	15	15.3	15.7	16.0	16.3	16.7	17
Tungsten	3-4.4	3.0	3.2	3.5	3.7	3.9	4.2	4.4
Iron	5.0 max	Note 1	Composition meeting the requirements of ASME SFA 5.14, type ERNiCrMo-14.	Note 2	Composition meeting the requirements of ASME SFA 5.14, type ERNiCrMo-14			
Aluminum	0.5 max							
Manganese	1.0 max							
Copper	0.5 max							
Vanadium	0.35 max							
Carbon	0.01 max							
Manganese	1.0 max							
Sulfur	0.02 max							
Silicon	0.08 max							
Titanium	0.25 max							
Phosphorus	0.02 max							
Other elements	0.50 max							

Note 1: The chemistry of these elements shall be picked to select a material with minimum elemental content (e.g., the lowest achievable within the limits set by ASME SFA 5.14).

Note 2: The chemistry of these elements shall be picked to select a material with maximum elemental content (e.g., the maximum achievable within the limits set by ASME SFA 5.14).



PRE.7.04

AGREEMENT—“Demonstrate that the non-destructive evaluation methods used to inspect the alloy 22 and 316 nuclear grade plate material and closure welds are sufficient and are capable of detecting all defects that may alter waste package mechanical properties. DOE will provide justification that the non-destructive evaluation methods used to inspect the alloy 22 and 316 nuclear grade plate material and welds are sufficient and are capable of detecting defects that may adversely affect waste package pre-closure structural performance. DOE agrees to provide the information in FY03 and document the information in the Waste Package Operations Fabrication Process Report.”



PRE.7.04

(Continued)

- **NRC Status - Closed-Pending**
 - Due March 2003, expected delivery in June 2003
- **DOE Status**
 - In Process
- **Path Forward**
 - Development program completed
 - Document is currently undergoing DOE review
 - Conducted on Alloy 22 only
 - ◆ Significant body of NDE information for Stainless Steel
 - 16 rings welded by Auto Gas Tungsten Cold Wire Process



PRE.7.04

(Continued)

- **Path Forward** (Continued)
 - **Compared ultrasonic and radiographic examination techniques for volumetric inspection**
 - ◆ **Strong correlation between the two methods**
 - ◆ **Detected flaws down to 1 millimeter**
 - **Compared eddy current and liquid penetrant examinations for surface inspection**
 - ◆ **Comparable results for the two methods**
 - **Gas bubbles under one millimeter (most significantly smaller) were observed by metallographic examination but not detected by volumetric NDE**
 - ◆ **Smaller than ASME acceptance criteria**
 - ◆ **Spherical, will not affect mechanical properties**
 - ◆ **Can control through welding gas composition**



PRE.7.05

AGREEMENT—“Provide justification that the mechanical properties of the disposal container fabrication and waste package closure welds are adequately represented considering the (1) range of welding methods used to construct the disposal containers, (2) post weld annealing and stress mitigation processes, and (3) post weld repairs. DOE agrees to provide the information in FY03 and document the information in the Waste Package Operations Fabrication Process Report.”



PRE.7.05

(Continued)

- **NRC Status - Closed-Pending**
 - Due November 2003 (date is subject to replan)
- **DOE Status**
 - In Process
- **Path Forward**
 - **Fabrication and Closure Welds**
 - ◆ FY2000 Mockup was welded using Gas Tungsten Arc Welding (GTAW) process
 - ◆ Additional information regarding GTAW of Alloy 22 was discussed in PRE.7.04



PRE.7.05

(Continued)

- **Path Forward** (Continued)

- **FY2000 Mockup was solution annealed and quenched**
 - ◆ **Is undergoing residual stress measurements at Lambda Research**
 - ◆ **Checking 34 different areas for residual stress**
 - ◆ **Mock up will be shipped to LLNL for sectioning and further testing**
 - ◆ **Completion of Lambda testing expected Summer 2003**
 - ◆ **Results will be compared to finite element model predictions**



PRE.7.05

(Continued)

- **Path Forward** (Continued)
 - **Studies underway on closure weld stress mitigation**
 - ◆ **Laser Peening**
 - ◆ **Controlled Plasticity Burnishing**
 - ◆ **Will determine depth of compressive stress**

 - **Mechanical testing of Alloy 22 welds is planned**
 - ◆ **As welded - discussed in PRE.7.03**
 - ◆ **After stress mitigation**
 - ◆ **After weld repair**



Summary

- **Presented status and path forward for all KTIs that affect waste package and drip shield designs**
- **Results involving seismic ground motions, including rock fall will be discussed in the waste package seismic response portion of the meeting**
- **In the process of replanning work activities, the replan will affect some of these KTI agreement due dates**





U.S. Department of Energy
Office of Civilian Radioactive Waste Management



Waste Package Seismic Response

Presented to:
**DOE/NRC Technical Exchange on Waste Package
Design**

Presented by:
Michael J. Anderson
Analysis and Component Design

June 5, 2003
Las Vegas, Nevada

Analysis Methodology

Waste Package Seismic Response

- **Postclosure vibratory ground motion**
 - Assumptions, analysis inputs and methodology
 - Problem domain division
 - Finite element analysis (FEA) representations
 - Results to date
- **Postclosure rock fall impact on the drip shield**
 - Assumptions, analysis inputs and methodology
 - FEA representations
 - Results to date
- **Information to support closure of Key Technical Issues**
 - CLST.2.02, CLST.2.08, and CLST.2.09



Assumptions for Vibratory Ground Motion

- **Strong-motion duration and wave phasing is represented by the use of acceleration time histories**
 - Inputs from Disruptive Events and sourced through the Technical Data Management System
 - Duration captures 5% - 95% of total energy content
 - Deformation process is adequately represented
 - Durations of ground motion time histories are approximately 15 - 30 seconds
- **Deformation is localized within contact region**
 - In some analyses, some portions of the problem may be represented as rigid, as appropriate



Vibratory Ground Motion Inputs and Methodology

- **Uncertain parameters**
 - **Acceleration time histories for a given peak ground velocity (PGV)**
 - ♦ **15 time histories per annual frequency level**
 - **Friction coefficients**
 - ♦ **Sampling from uniform probability distribution**
 - ♦ **Separate sampling for metal-to-metal and metal-to-rock friction coefficients**



Vibratory Ground Motion Inputs and Methodology

(Continued)

- **Typical mechanical properties**
 - **Uncertainties assumed negligible compared to acceleration time history and friction coefficients**
- **Corrosion resistant barrier thickness**
 - **Assumed reduction in wall thickness of 2 mm to account for general corrosion**



Vibratory Ground Motion Inputs and Methodology

(Continued)

- **Temperature is assumed to be 150°C for temperature-dependent properties**
- **No system damping**
 - **Regulatory fractions are allowed for elastic analyses**
 - **Analyses of unanchored structures require a defensible definition of critical damping**



Problem Domain Division

- **Structural response differs based on magnitude of ground motion and component interactions**
 - **Lower ground accelerations, ≤ 3 g peak ground acceleration (PGA)**
 - ♦ **Waste package-emplacment pallet interaction is “hammer and anvil” effect**
 - ♦ **Little effect for drip shield**
 - **Higher ground accelerations, > 3 g PGA**
 - ♦ **Waste package-emplacment pallet “hammer and anvil” effect is reduced due to increased rigid-body motion**
 - ♦ **Multiple interactions among waste package, emplacment pallet, drip shield and drift wall assessed in kinematic simulations**
 - ♦ **Interactions represented as localized impacts**



Finite Element Analysis Representation of Waste Package

Time - 0

Upper half:ELASTIC-PLASTIC

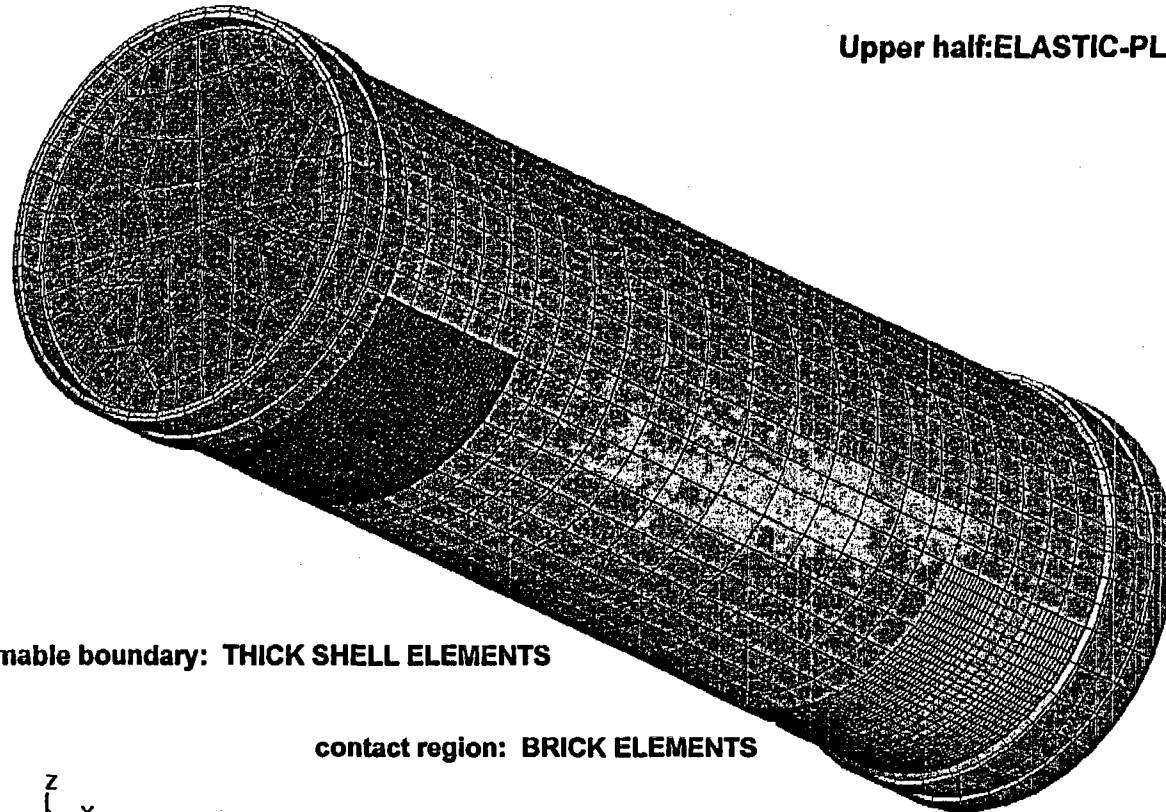

deformable boundary: THICK SHELL ELEMENTS

contact region: BRICK ELEMENTS



lower half: ELASTIC-PLASTIC

Preliminary



YUCCA MOUNTAIN PROJECT

Finite Element Analysis Representation of Drip Shields

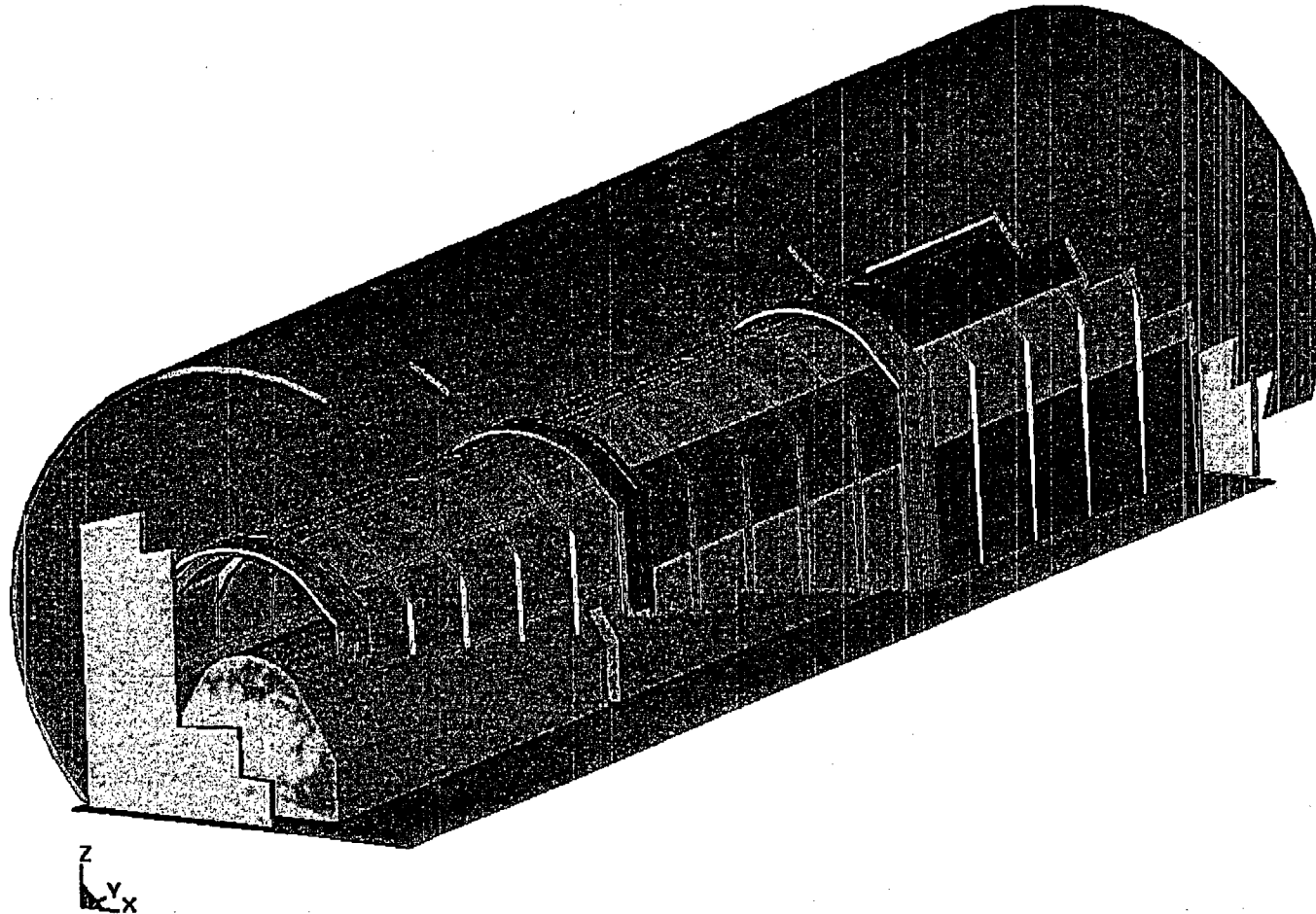

Preliminary



YUCCA MOUNTAIN PROJECT

Finite Element Analysis Representation of Drift Segment

- FEA representation of drift segment for seismic evaluations

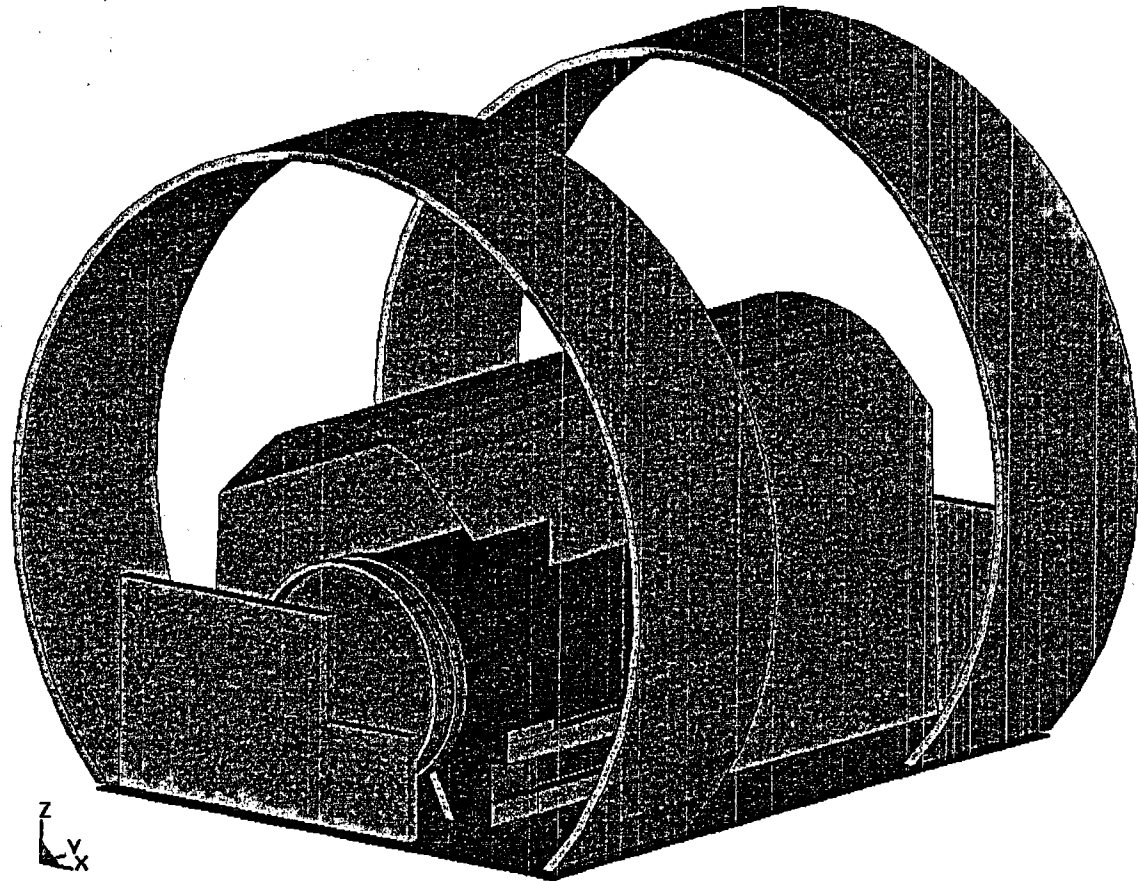

Preliminary

Results from 10^{-6} Seismic Evaluations

Realization Number	Ground Motion Number	Damaged Area (m ² ; % of total outer surface area)					
		WP-Pallet Interaction		WP-WP Interaction		Cumulative	
		80% Yield Strength	90% Yield Strength	80% Yield Strength	90% Yield Strength	80% Yield Strength	90% Yield Strength
1	7	0.0029; 0.010%	0.0014; 0.0050%	0.023; 0.082%	0.012; 0.043%	0.026; 0.092%	0.013; 0.046%
2	16	0; 0	0; 0	0.017; 0.060%	0.0089; 0.032%	0.017; 0.060%	0.0089; 0.032%
3	4	0.0050; 0.018%	0; 0	0.19; 0.67%	0.083; 0.29%	0.20; 0.71%	0.083; 0.29%
4	8	0.030; 0.11%	0.0064; 0.023%	0.12; 0.43%	0.061; 0.22%	0.15; 0.53%	0.067; 0.24%
5	11	0.0015; 0.0053	0; 0	0.15; 0.53%	0.066; 0.23%	0.15; 0.53%	0.066; 0.23%
6	1	0.025; 0.089%	0.0028; 0.0099%	0.15; 0.53%	0.063; 0.22%	0.18; 0.64%	0.066; 0.23%
7	2	0.017; 0.060%	0; 0	0.11; 0.39%	0.057; 0.20%	0.13; 0.46%	0.057; 0.20%
9	10	0.0035; 0.012%	0; 0	0.12; 0.43%	0.062; 0.22%	0.12; 0.43%	0.062; 0.22%
10	9	0; 0	0; 0	0.014; 0.050%	0.0071; 0.025%	0.014; 0.050%	0.0071; 0.025%
11	5	0.012; 0.043%	0.0037; 0.013%	0.074; 0.26%	0.032; 0.11%	0.086; 0.30%	0.036; 0.13%
12	6	0.0039; 0.014%	0; 0	0.073; 0.26%	0.036; 0.13%	0.077; 0.27%	0.036; 0.13%
13	12	0; 0	0; 0	0.032; 0.11%	0.016; 0.057%	0.032; 0.11%	0.016; 0.057%
14	14	0.010; 0.035%	0.0043; 0.015%	0.0056; 0.020%	0.0029; 0.010%	0.016; 0.057%	0.0072; 0.026%
15	3	0.0078; 0.028%	0.0015; 0.0053%	0.020; 0.071%	0.010; 0.035%	0.028; 0.099%	0.012; 0.043%

Preliminary



Results from 10⁻⁷ Seismic Evaluations

Realization Number	Ground Motion Number	Damaged Area (m ² ; % of total outer surface area)					
		WP-Pallet Interaction		WP-WP Interaction		Cumulative	
		80% Yield Strength	90% Yield Strength	80% Yield Strength	90% Yield Strength	80% Yield Strength	90% Yield Strength
1	7	0.20; 0.71%	0.17; 0.60%	0.16; 0.57%	0.086; 0.30%	0.36; 1.28%	0.26; 0.92%
3	4	0.096; 0.34%	0.083; 0.29%	0.42; 1.49%	0.17; 0.60%	0.52; 1.84%	0.25; 0.89%
4	8	0.12; 0.43%	0.096; 0.34%	0.11; 0.39%	0.050; 0.18%	0.23; 0.78%	0.15; 0.53%
5	11	0.093; 0.33%	0.071; 0.25%	0.18; 0.64%	0.080; 0.28%	0.27; 0.96%	0.15; 0.53%
6	1	0.046; 0.16%	0.024; 0.085%	0.42; 1.49%	0.15; 0.53%	0.47; 1.67%	0.17; 0.60%
7	2	0.038; 0.13%	0.028; 0.099%	0.32; 1.13%	0.14; 0.50%	0.36; 1.28%	0.17; 0.60%
8	13	0.095; 0.34%	0.068; 0.24%	0.32; 1.13%	0.14; 0.50%	0.42; 1.49%	0.21; 0.74%
9	10	0.0052; 0.018%	0.0035; 0.012%	0.034; 0.12%	0.017; 0.060%	0.039; 0.14%	0.021; 0.074%
10	9	0.16; 0.57%	0.14; 0.50%	0.33; 1.17%	0.15; 0.53%	0.49; 1.74%	0.29; 1.03%
11	5	0.0016; 0.0057%	0; 0	0.30; 1.06%	0.11; 0.39%	0.30; 1.06%	0.11; 0.39%
12	6	0.062; 0.22%	0.041; 0.15%	0.10; 0.35%	0.044; 0.16%	0.16; 0.57%	0.085; 0.30%
13	12	0.027; 0.096%	0.018; 0.064%	0.12; 0.43%	0.053; 0.19%	0.15; 0.53%	0.071; 0.25%
14	14	0.020; 0.071%	0.016; 0.057%	0.0077; 0.027%	0.0040; 0.014%	0.028; 0.099%	0.020; 0.071%
15	3	0.0045; 0.016%	0; 0	0.29; 1.03%	0.14; 0.50%	0.29; 1.03%	0.14; 0.50%

Preliminary



Observations about Seismic Results

- **Package-to-package impacts dominate creation of residual tensile stress fields over package-to-pallet impacts**
 - Package-to-pallet impacts are responsible for ~10% of area above threshold for 10^{-6}
 - Package-to-pallet impacts may be responsible for ~1% of area above threshold for 10^{-7}
 - Package-to-drip shield impacts are assumed to be negligible due to the large mass difference between the components
- **Friction coefficients are not as important as previously thought**



Observations about Seismic Results

(Continued)

- **No tensile stresses above threshold for single analysis run for $5 \cdot 10^{-4}$ exceedence frequency**
- **Will perform 10^{-5} exceedence frequency analyses next**
 - **TSPA model requires the zero damage exceedence frequency**
- **Cumulative damage effects will be investigated**



Rock Fall Impact Assumptions

- **The rock shape in non-lithophysal rock units is assumed to be a rectangular prism.**
 - Rock center-of-gravity is located directly above the point of impact
 - Transfers the maximum linear momentum to the drip shield
 - The sharp edge of the prism results in maximum strain on the drip shield plate
- **Drip shield walls free to move in lateral direction**
 - Friction coefficient is specified between the drip shield and invert



Rock Fall Impact Assumptions

(Continued)

- **150°C used to determine material properties**
- **Maximum rock unconfined compressive strength used in an elastic-plastic rock stress-strain curve**
 - **A conservative assumption since the significance of variation in rock strength is negligibly small compared to variation in rock kinetic energy**
- **Titanium thickness**
 - **Assumed reduction in Ti-7 and Ti-24 thickness of 2 mm to account for general corrosion**



Rock Fall Impact Inputs and Methodology

- **Rock characteristics**
 - Obtained from 3DEC simulations (described in last Repository Design Thermal-Mechanical Effects (RDTME) Technical Exchange)
- **Drip shield representation**
 - 3-D finite element analysis representation developed to evaluate the drip shield structural response to rock fall
 - Parametric calculations performed to prepare a catalog of 15 results
 - ♦ Five values for kinetic energy (i.e., mass and velocity)
 - ♦ Three impact locations (vertical, corner, and side-wall)
 - The results are provided in terms of areas that exceed 50% of the titanium yield strength



Finite Element Analysis Representation of Rock Fall Impact

- FEA geometry (half-symmetry) for rock fall impact on drip shield (14.5 metric ton rock shown)

Time - 0

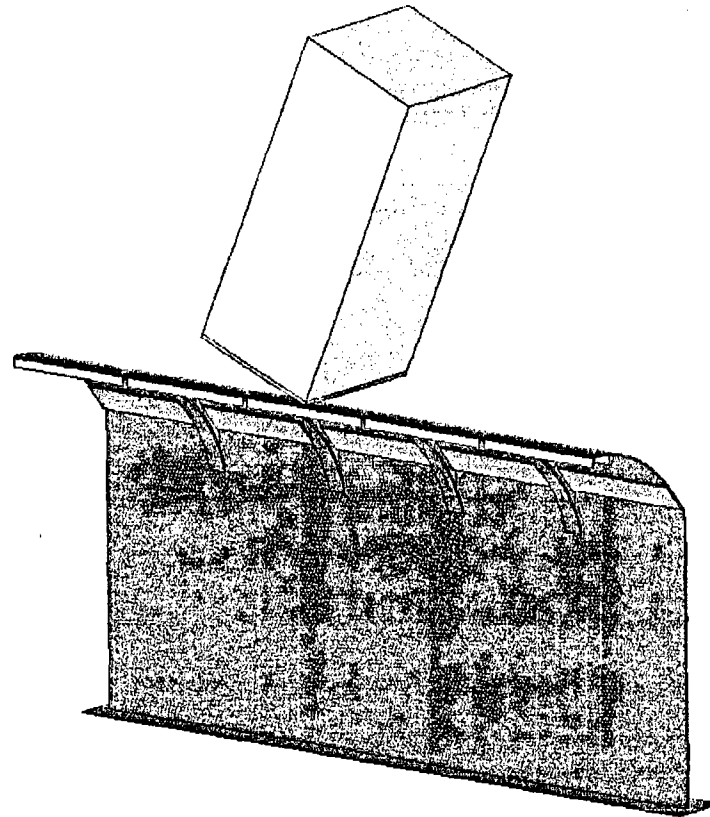

Preliminary



Finite Element Analysis Representation of Rock Fall Impact

(Continued)

- FEA representation of drip shield

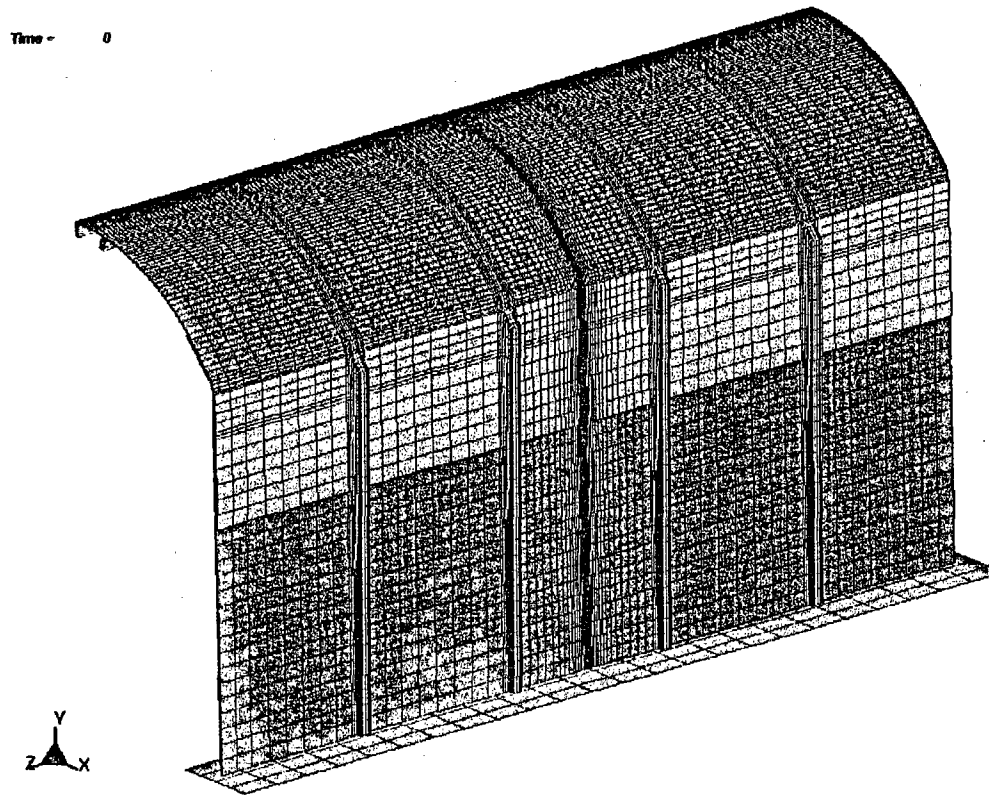

Preliminary

Results from Seismically Induced Rock Fall Evaluations

Rock Mass and Kinetic Energy	Patch Area (m ²) and Ratio of Patch Area to Total Drip Shield Surface Area		
	Vertical Rock Fall (90° from horizontal)	Rock Fall onto Drip Shield Corner (60° from horizontal)	Rock Fall onto Drip Shield Side-wall (40° from horizontal)
11.5 MT Rock (348174 J)	4.304 (11.25%)	2.835 (7.41%)	1.126 (2.94%)
14.5 MT Rock (163083 J)	3.508 (9.17%)	0.612 (1.60%)	0.079 (0.21%)
3.3 MT Rock (24712 J)	0.548 (1.43%)	0.416 (1.09%)	0.0 (0.00%)
0.15 MT Rock (902 J)	0.0015 (0.00%)	0.0091 (0.02%)	0.0 (0.00%)
0.11 MT Rock (42 J)	0.0 (0.00%)	0.0 (0.00%)	0.0 (0.00%)
0.25 MT Rock (~0 J)	0.0 (0.00%)	0.0 (0.00%)	0.0 (0.00%)

MT: metric tons (1 MT = 1000 kg)

Areas are based on principal residual stress that exceeds 50% of Ti-7 yield strength at 150°C.

Preliminary



YUCCA MOUNTAIN PROJECT

Observations about Rock Fall Evaluations

- **Calculation performed parametrically**
 - Rock kinetic energy
 - Location of impact
- **Drip shield sustains all rock impacts without rupture**
- **Actual distribution of tensile stress dependent upon distribution of key blocks**
- **Results indicate a clear threshold**
 - ~10% of the repository is in the non-lithophysal region
 - Rock fall in the lithophysal region is analyzed as small rocks
 - Static load calculations have shown that rupture is not expected for dead load of lithophysal rock fall



Summary

- **Analytical approach for addressing vibratory ground motion effects and seismically induced rock fall impacts in the postclosure period**
 - **Ground motion and rock fall appropriately de-coupled in analysis**
 - **Impacts properly treated in accordance with predominate features and corresponding damage accrued**
- **Results to date show no waste package breach**
- **Results to date show no drip shield rupture**

