

Preliminary Screening — Technical and Economic Assessment of Synthesis Gas to Fuels and Chemicals with Emphasis on the Potential for Biomass-Derived Syngas

P.L. Spath and D.C. Dayton



NREL

National Renewable Energy Laboratory

1617 Cole Boulevard
Golden, Colorado 80401-3393

NREL is a U.S. Department of Energy Laboratory
Operated by Midwest Research Institute • Battelle

Contract No. DE-AC36-99-GO10337

Preliminary Screening — Technical and Economic Assessment of Synthesis Gas to Fuels and Chemicals with Emphasis on the Potential for Biomass-Derived Syngas

P.L. Spath and D.C. Dayton

Prepared under Task No. BBB3.4210



NREL

National Renewable Energy Laboratory

1617 Cole Boulevard
Golden, Colorado 80401-3393

NREL is a U.S. Department of Energy Laboratory
Operated by Midwest Research Institute • Battelle

Contract No. DE-AC36-99-GO10337

NOTICE

This report was prepared as an account of work sponsored by an agency of the United States government. Neither the United States government nor any agency thereof, nor any of their employees, makes any warranty, express or implied, or assumes any legal liability or responsibility for the accuracy, completeness, or usefulness of any information, apparatus, product, or process disclosed, or represents that its use would not infringe privately owned rights. Reference herein to any specific commercial product, process, or service by trade name, trademark, manufacturer, or otherwise does not necessarily constitute or imply its endorsement, recommendation, or favoring by the United States government or any agency thereof. The views and opinions of authors expressed herein do not necessarily state or reflect those of the United States government or any agency thereof.

Available electronically at <http://www.osti.gov/bridge>

Available for a processing fee to U.S. Department of Energy
and its contractors, in paper, from:

U.S. Department of Energy
Office of Scientific and Technical Information
P.O. Box 62
Oak Ridge, TN 37831-0062
phone: 865.576.8401
fax: 865.576.5728
email: reports@adonis.osti.gov

Available for sale to the public, in paper, from:

U.S. Department of Commerce
National Technical Information Service
5285 Port Royal Road
Springfield, VA 22161
phone: 800.553.6847
fax: 703.605.6900
email: orders@ntis.fedworld.gov
online ordering: <http://www.ntis.gov/ordering.htm>



Executive Summary/Conclusions

In principle, syngas (primarily consisting of CO and H₂) can be produced from any hydrocarbon feedstock, including: natural gas, naphtha, residual oil, petroleum coke, coal, and biomass. The lowest cost routes for syngas production, however, are based on natural gas, the cheapest option being remote or stranded reserves. Economic considerations dictate that the current production of liquid fuels from syngas translates into the use of natural gas as the hydrocarbon source. Nevertheless, the syngas production operation in a gas-to-liquids plant amounts to greater than half of the capital cost of the plant. The choice of technology for syngas production also depends on the scale of the synthesis operation. Syngas production from solid fuels can require an even greater capital investment with the addition of feedstock handling and more complex syngas purification operations. The greatest impact on improving the economics of gas-to-liquids plants is through 1) decreasing capital costs associated with syngas production and 2) improving the thermal efficiency with better heat integration and utilization. Improved thermal efficiency can be obtained by combining the gas-to-liquids plant with a power generation plant to take advantage of the availability of low-pressure steam.

The extensive research and development efforts devoted to syngas conversion to fuels and chemicals are documented in a vast amount of literature that tracks the scientific and technological advancements in syngas chemistry. The purpose of this report is to review the many syngas to products processes and summarize the salient points regarding the technology status and description, chemistry, catalysts, reactors, gas cleanliness requirements, process and environmental performances, and economics. Table 1 lists the products examined in this study and gives some facts about the technology as well as advantages and disadvantages. Table 2 summarizes the catalysts, process conditions, conversions, and selectivities for the various syngas to products processes. Table 3 presents catalyst poisons for the various products.

For all of the products examined in the economic analysis section (H₂, MeOH, FTL, EtOH, mixed alcohols, olefins), syngas production accounts for at least 50% of the product cost and in many cases it is more like 75%. Overall, steps should be made to optimize the biomass-to-fuels process in order to obtain the highest yield, least cost configuration. To reduce costs, efforts should be focused on minimizing the cost of clean syngas production. The state of biomass gasifiers varies from the research and development stage to commercially available gasifiers. Research has been performed for various steps involved in cold and hot gas clean up and should be focused on demonstrating successful integrated low cost concepts. With the exception of mixed alcohols and ethanol, downstream syngas conversion technologies have all been demonstrated at the commercial scale.

Overall, the information gathered in this report indicates that the best products to pursue are hydrogen and methanol. Ethanol from biomass-derived syngas could potentially be cost competitive. However, the state of this technology is still at the lab scale and the amount of data available is limited. Therefore, the ethanol analysis has a higher level of uncertainty than the other products examined. Additionally, because of the limited

amount of design data, more analysis should be performed for mixed alcohols synthesis to examine biomass-optimized configurations including recycle for maximum conversion and the resulting economics.

All biomass fuels have potential to significantly reduce the import of petroleum products. Additionally, economies of scale can play a large factor in lowering the product cost. Therefore, opportunities to co-feed with coal or natural gas systems may be one way to get renewable fuels into the marketplace, just as co-firing biomass with coal is being done in the power generation industry.

The impetus for this extensive literature review is the recent re-organization of the U.S. Department of Energy's Office of Energy Efficiency and Renewable Energy (EERE) into eleven new Program Offices. EERE's mission is to strengthen US energy security, environmental quality, and economic health. The Office of Biomass Program is one of these newly created offices. Its goal is developing technologies to transform our abundant biomass resources into clean, affordable, and domestically-produced biofuels, biopower, and high-value bioproducts resulting in economic development, energy supply options, and energy security. In this context, commercially available and near-commercial syngas conversion processes were evaluated on technological, environmental, and economic bases. This report serves as a first step. Additional, more detailed analyses are required to identify promising, cost-effective fuel synthesis technologies where biomass thermochemical conversion could make an impact.

Table 1: Summary of Product Information – Facts, Advantages, & Disadvantages

Product	Facts	Advantages	Disadvantages
H ₂	<ul style="list-style-type: none"> ▪ Largest use of syngas ▪ Predominately made via SMR 	<ul style="list-style-type: none"> ▪ Appears to be the most cost competitive option for biomass ▪ Automakers working on H₂ fueled vehicles ▪ H₂ itself is a clean fuel ▪ Concentrated CO₂ stream ▪ Mature technology ▪ High yields 	<ul style="list-style-type: none"> ▪ Delivered price can be significantly greater than plant gate price
FTL	<ul style="list-style-type: none"> ▪ Existing plants in South Africa, Malaysia, and New Zealand ▪ Predominately made from coal but South Africa switching some operating plants to natural gas ▪ Many companies are examining FTL for stranded natural gas 	<ul style="list-style-type: none"> ▪ Yields petroleum products consistent with today's fuel supply ▪ Successful operation of slurry phase reactor ▪ No sulfur and low aromatic products ▪ Reduced tailpipe emissions compared to conventional diesel 	<ul style="list-style-type: none"> ▪ Low yields ▪ Unavoidable broad range of products; poor selectivity ▪ Need to use all streams to be economical making it complex (South Africa makes more than 200 fuel and chemical products) ▪ Currently, only economical in areas where petroleum is not prevalent
NH ₃	<ul style="list-style-type: none"> ▪ Largest consumer of H₂ ▪ 2nd largest synthetic chemical product 	<ul style="list-style-type: none"> ▪ Mature technology 	<ul style="list-style-type: none"> ▪ Toxic
MeOH	<ul style="list-style-type: none"> ▪ Predominately from syngas made via SMR ▪ Several automakers have developed prototype direct MeOH fuel cell vehicles ▪ Commodity chemical 	<ul style="list-style-type: none"> ▪ Mature technology ▪ Many uses for MeOH (formaldehyde, acetic acid, DME, MTBE, MTG, MTO, MOGD) ▪ Fuel used as M100 and M85 ▪ Possible source of H₂ & MeOH reforming is a practiced technology 	<ul style="list-style-type: none"> ▪ Have to compete with mega methanol plants ▪ LPMeOH still in development stage ▪ Poor solubility in gasoline and phase separation problems ▪ More corrosive than gasoline ▪ M85 has not developed on a large scale
DME	<ul style="list-style-type: none"> ▪ Many potential uses (diesel or cooking fuel, refrigerant, chemical feedstock) 	<ul style="list-style-type: none"> ▪ In situ dehydration of MeOH to DME increases MeOH yields 	
Acetic acid	<ul style="list-style-type: none"> ▪ Half of worldwide production comes from MeOH carbonylation 		
Formaldehyde	<ul style="list-style-type: none"> ▪ Largest consumer of MeOH ▪ Demand driven by construction industry 		
MTBE	<ul style="list-style-type: none"> ▪ 95% used in gasoline pool ▪ North America consumes 65% of worldwide production 		<ul style="list-style-type: none"> ▪ Environmental concern with groundwater contamination

Product	Facts	Advantages	Disadvantages
MTO and MOGD		<ul style="list-style-type: none"> Low aromatic content in MOGD gasoline Selectivity of olefins to gasoline & diesel > 95% for MOGD 	<ul style="list-style-type: none"> No commercial MTO or MOGD plants but UOP and HYDRO does license a process that produces ethylene and propylene
MTG	<ul style="list-style-type: none"> One plant in New Zealand built in 1985 but currently it produces only MeOH 	<ul style="list-style-type: none"> High quality, high octane gasoline 	<ul style="list-style-type: none"> High amount of aromatics in gasoline High decalene concentrations
TIGAS	<ul style="list-style-type: none"> MeOH to gasoline 		<ul style="list-style-type: none"> No commercial plants TIGAS yields a lower quality gasoline than MTG
Ethanol	<ul style="list-style-type: none"> Currently produced primarily via direct fermentation of carbohydrates 	<ul style="list-style-type: none"> Is currently a fuel additive Currently, has a tax credit Compared to direct fermentation, able to process nearly any biomass resource 	<ul style="list-style-type: none"> No commercial plants from syngas Many universities have worked on fermentor designs but present status of work for most is unknown
Mixed alcohols	<ul style="list-style-type: none"> Alcohol fuels developed by many Some tested in Europe 	<ul style="list-style-type: none"> More attractive blending stock than MeOH Lower H₂:CO ratio required 	<ul style="list-style-type: none"> No stand alone commercial plants Low yields Poor selectivity Currently, there is little activity in mixed alcohol synthesis
Oxosynthesis products	<ul style="list-style-type: none"> Hydroformylation of olefins with syngas Produces C₃-C₁₅ aldehydes which are typically converted to alcohols and acids 	<ul style="list-style-type: none"> Lower H₂:CO ratio required Very versatile process Commercial process 	<ul style="list-style-type: none"> Product/catalyst separation is an issue Limited to high value commercial products
Isosynthesis products	<ul style="list-style-type: none"> Converts syngas to isobutene and isobutane 	<ul style="list-style-type: none"> Lower H₂:CO ratio required 	<ul style="list-style-type: none"> No commercial plants Low catalyst activity Must compete with isomerization of butanes

Table 2: Summary of Syngas Conversion Processes and Conditions

Process	Catalyst	Process Conditions			% conv (CO basis)	Product	Selectivity
		T (°C)	P (bar)	H ₂ :CO			
Fischer-Tropsch Synthesis	Fe	300-350	10-40	1.7:1	50-90% with recycle	α-olefins gasoline	ASF -48% (max) 15-40% actual
	Co	200-240	7-12	2.15:1		Waxes diesel	ASF - 40% (max)
	Ru					Waxes	
Methanol Synthesis	ZnO/Cr ₂ O ₃	350	250-350	3:1	99% (25% max/pass – 4-7% actual/pass)	Methanol	> 99% with recycle
	Cu/ZnO/Al ₂ O ₃	220-275	50-100				
Ammonia	Fe/FeO + additives	430-480 (550 max)	100-500	2-3:1 H ₂ :N ₂	10-35%/pass	Ammonia	> 99% with recycle
	Alkali/ZnO/Cr ₂ O ₃	300-425	125-300	1:1	5-20%	Branched primary alcohols	
	Alkali/Cu/ZnO(Al ₂ O ₃)	275-310	50-100	2-3:1	20-30%	Primary alcohols	30-45% C ₂₊ 17-25% CO ₂
	Alkali/CuO/CoO	260-340	60-200	0.5-4:1	5-30%	Linear primary alcohols	ASF
	Alkali/MoS ₂	260-350	30-175	1:1	10%	Linear alcohols	75-90% C ₂₊ in liquid product
Oxosynthesis	Co carbonyl	110-200	200-300	1:1 + olefin			
	Co – P modified	160-200	50-100	1:1 + olefin		C ₁₁ -C ₁₄ alcohols	
	Rh – P modified	60-120	7-25	1:1 + propylene		C ₄ aldehydes	> 90%
Isosynthesis	ThO ₂	400-450	100-1000 (300)	0.85:1	40-50%	<i>i</i> -C ₄	
	ZrO ₂	300-425	350	1:1	30%		15
Steam Methane Reforming	Ni	850	15-30	na	100% CH ₄ conversion	Syngas/ hydrogen	

Table 3: Summary of Poisons

Process	Contaminant	Level	Source/comments
Fischer-Tropsch Synthesis	Sulfur	0.2 ppm 1 ppmv 60 ppb	Dry, 1981 Boerrigter, et al, 2002 Turk, et al, 2001
	Halides	10 ppb	Boerrigter, et al, 2002
	Nitrogen	10 ppmv NH ₃ 0.2 ppmv NO _x 10 ppb HCN	Turk, et al, 2001
Methanol Synthesis	Sulfur (not COS)	<0.5 ppmv (<0.1 ppmv preferred)	Kung, 1992
	Halides	0.001 ppmv	Twigg and Spencer 2001
	Fe and Ni	0.005 ppmv	Kung, 1992
LPMeOH Synthesis	Sulfur (including OCS)	0.1 ppmv	Novem (2002)
	Total halides	0.01 ppmv	
	Acetylene	5 ppmv	
	Total unsaturates	300 ppmv	
	NH ₃	10 ppmv	
	HCN	0.01 ppmv	
	Fe and Ni	0.01 ppmv	
Ammonia Synthesis	H ₂ O	200 ppm	Revsible
	CO	200 ppm	Revsible
	CO ₂	100 ppm	Revsible
	O ₂	100 ppm	Revsible
	Sulfur (H ₂ S)	0.1 ppm	Irreversible
	Chlorine	0.1 ppm	Irreversible
	As, P, Sb	---	Irreversible
Ethanol Synthesis	Very little work has been published on the effects of syngas impurities		
Higher Alcohol Synthesis	- modified FT catalysts are the same as those for FT catalyst - modified methanol synthesis catalysts are the same as those for meOH catalysts		
Oxosynthesis	Strong acids, HCN, organosulfur, H ₂ S, COS, O ₂ , and dienes (Bahrmann and Bach 2000)		
Isosynthesis	Thoria catalysts are not poisoned by sulfur and have high resistance to other poisons as well		
Steam Methane Reforming	<0.5 ppm for reformer catalyst life of 3 years		

Acknowledgements

The authors acknowledge the following colleagues from the National Renewable Energy Laboratory who contributed information and assisted in the economic assessment: Matthew B. Ringer, John L. Jechura, and Margaret K. Mann. Additionally, we acknowledge Tim Eggeman from Neoterics International who contributed the ethanol section of this report.

Table of Contents

Executive Summary/Conclusions	i
Acknowledgements	vii
1 Introduction.....	1
2 Hydrogen	5
2.1 Summary.....	5
2.2 Introduction	7
2.3 Technology Description	7
2.4 Hydrogen From Other Compounds	8
2.5 Chemistry	8
2.6 Catalysts	9
2.7 Reactors	10
2.8 Gas Cleanliness Requirements	10
2.9 Status/Technology Developers.....	11
2.10 Process Performance	12
2.11 Environmental Performance.....	12
2.12 Cost.....	13
2.13 R&D Needs	14
2.14 References	14
3 Ammonia.....	16
3.1 Summary.....	16
3.2 Introduction	18
3.3 Technology Description	19
3.4 Chemistry	20
3.5 Catalysts	21
3.6 Reactors	23
3.7 Gas Cleanliness Requirements	25
3.8 Status/Technology Developers.....	26
3.9 Environmental Performance.....	27
3.10 Cost.....	27
3.11 R&D Needs	28
3.12 References	28

4 Methanol and Methanol Derivative (including formaldehyde, acetic acid, MTG, MTO, MOGD, TIGAS, and DME)	29
4.1 Summary.....	29
4.2 Introduction	31
4.3 Technology Description	31
4.4 Reactors	32
4.5 Chemistry	34
4.6 Catalysts	35
4.7 Gas Cleanliness Requirements	36
4.8 Status/Technology Developers.....	38
4.9 Process Performance	39
4.10 Uses	40
4.11 Environmental Performance	47
4.12 Cost of Methanol	47
4.13 R&D Needs	51
4.14 References	52
5 Ethanol	58
5.1 Summary.....	58
5.2 Introduction	60
5.3 Technology Description	61
5.4 Chemistry And Microbiology.....	63
5.5 Fermentor Design	65
5.6 Gas Cleanliness Requirements	65
5.7 Status/Technology Developers.....	65
5.8 Environmental Performance	66
5.9 Cost.....	67
5.10 R&D Needs	68
5.11 References	69
6 Mixed Higher Alcohols	70
6.1 Summary.....	70
6.2 Introduction	72
6.3 Technology Description	73
6.4 Chemistry	73

6.5 Catalysts	76
6.6 Reactors	79
6.7 Gas Cleanliness Requirements	79
6.8 Status/Technology Developers	79
6.9 Environmental Performance	83
6.10 Cost.....	83
6.11 R&D Needs	83
6.12 References	85
7 Fischer-Tropsch Synthesis	90
7.1 Summary.....	90
7.2 Introduction	92
7.3 Technology Description	93
7.4 Chemistry	94
7.5 Catalysts	96
7.6 Reactors	97
7.7 Gas Cleanliness Requirements	99
7.8 Status/Technology Developers	101
7.9 Process Performance	102
7.10 Environmental Performance	102
7.11 Cost.....	103
7.12 R&D Needs	106
7.13 References	107
8 Oxosynthesis	111
8.1 Summary.....	111
8.2 Introduction	113
8.3 Technology Description	113
8.4 Chemistry	114
8.5 Catalysts	115
8.6 Gas Cleanliness Requirements	116
8.7 Status/Technology Developers	116
8.8 Cost.....	119
8.9 R&D Needs	119
8.10 References	120

9 Isosynthesis	121
9.1 Summary	121
9.2 Introduction	123
9.3 Technology Description	123
9.4 Chemistry	123
9.5 Catalysts	124
9.6 Gas Cleanliness Requirements	125
9.7 Status/Technology Developers	125
9.8 R&D Needs	125
9.9 References	125
10 Yields, Energy, and Economics	127
10.1 Summary.....	127
10.2 Product Yields	129
10.3 Life Cycle Energy Ratios	131
10.4 Petroleum Product Replacement	133
10.5 Economics	135
10.6 References	141

List of Figures

Figure 1: Diagram of Syngas Conversion Processes Covered in This Report	3
Figure 2: Block Flow Diagram of Hydrogen via Steam Methane Reforming.....	8
Figure 3: Generic Ammonia Synthesis Process Flow Diagram.....	19
Figure 4: Various Ammonia Converter Designs	24
Figure 5: Simplified Methanol Synthesis Process Flow Diagram.....	31
Figure 6: Syngas to Ethanol Simplified Block Flow Diagram	61
Figure 7: FTS General Process Flow Diagram.....	93
Figure 8: Anderson-Shulz-Flory Distribution.....	95
Figure 9: Types of Fischer-Tropsch Synthesis Reactors	98
Figure 10: Schematic Flow Diagram of the LP Oxo Process	117
Figure 11: Product Yields from Fossil and Biomass Resources.....	130
Figure 12: Life Cycle Fossil Energy Ratio	132
Figure 13: Life Cycle Primary Energy Ratio.....	132
Figure 14: Potential Replacement of Petroleum Products with Biomass Fuels (Energy Basis).....	134
Figure 15: Product Price in \$/GJ (LHV).....	139
Figure 16: Capital Cost Breakdown for Biomass to MeOH Systems.....	140

List of Tables

Table 1: Summary of Product Information – Facts, Advantages, & Disadvantages	iii
Table 2: Summary of Syngas Conversion Processes and Conditions.....	v
Table 3: Summary of Poisons	vi
Table 4: Catalytic Steam Reforming Licensors*	11
Table 5: Commercial Suppliers of PSA Units**	12
Table 6: Comparison of Biomass Based Hydrogen Studies	13
Table 7: Hydrogen Cost Data From other Sources.....	14
Table 8: Summary of Commercial Ammonia Synthesis Catalyst Compositions	23
Table 9: Summary of Ammonia Synthesis Catalyst Poisons	26
Table 10: Comparison of Ammonia Economics.....	27
Table 11: Commercial Methanol Synthesis Catalyst Formulations	36
Table 12: MeOH Gaseous Contaminant Constraints.....	38
Table 13: Methanol Technology Suppliers.....	39
Table 14: Conversions for Methanol, Methanol/DME, and DME	45
Table 15: Comparison of Coal Based Methanol Economic Studies.....	48
Table 16: Comparison of Biomass Based Methanol Studies.....	49
Table 17: Comparison of Formaldehyde Production Costs.....	50
Table 18: Comparison of Coal Based MTG Economic Studies	51
Table 19: Ethanol Yields on a Common Basis	63
Table 20: Summary of USDA Survey Result (Cash Costs in \$/gal of ethanol)	68
Table 21: Companies and Information Regarding Mixed Alcohols Research	82
Table 22: Ecalene TM Composition.....	83
Table 23: Comparison of Mixed Higher Alcohol Economics From Natural Gas	84
Table 24: Syngas Impurities and Tolerances for Fischer-Tropsch	100
Table 25: Price Ranges for Natural Gas, Gasoline, and Diesel	104
Table 26: Comparison of Biomass Based Fischer Tropsch Studies	106
Table 27: Summary of U.S. Oxo Chemical Producers	118
Table 28: U.S. Prices for Oxo Chemicals.....	119
Table 29: Feedstock to Product Material Balance Information.....	129
Table 30: Life Cycle Energy Ratios (LHV basis).....	131

Table 31: Economic Parameters for Discounted Cash Flow Analysis	136
Table 32: Summary of Cases Examined	137
Table 33: Base Case Minimum Product Selling Price	138
Table 34: Price of Commercial Products	138
Table 35: Sensitivity – Minimum Product Selling Price	139

1 Introduction

In its simplest form, syngas is composed of two diatomic molecules, CO and H₂ that provide the building blocks upon which an entire field of fuel science and technology is based. Over the years, the gaseous mixture of CO and H₂ has had many names depending on how it was formed; producer gas, town gas, blue water gas, synthesis gas, and syngas, to name a few. In the 1800s coal gasification was used to provide much of the syngas used for lighting and heating. The beginning of the 20th century saw the dawn of fuels and chemicals synthesis from syngas.

The synthesis of hydrocarbons from CO hydrogenation was discovered in 1902 by Sabatier and Sanderens who produced methane by passing CO and H₂ over Ni, Fe, and Co catalysts. At about the same time, the first commercial hydrogen from syngas produced from steam methane reforming was commercialized. Haber and Bosch discovered the synthesis of ammonia from H₂ and N₂ in 1910 and the first industrial ammonia synthesis plant was commissioned in 1913. The production of liquid hydrocarbons and oxygenates from syngas conversion over iron catalysts was discovered in 1923 by Fischer and Tropsch. Variations on this synthesis pathway were soon to follow for the selective production of methanol, mixed alcohols, and isosynthesis products. Another outgrowth of Fischer-Tropsch Synthesis (FTS) was the hydroformylation of olefins discovered in 1938.

Many of the syngas conversion processes were developed in Germany during the first and second world wars at a time when natural resources were becoming scarce and alternative routes for hydrogen production, ammonia synthesis, and transportation fuels were a necessity. Thus the poor economics of some of these syngas conversion processes were of little consequence. With the development of the petroleum industry in the 1940s and beyond, the unattractive economics of many of these syngas routes became an issue and were replaced by petroleum-based processes. Methanol and ammonia continue to be produced from syngas using similar processes. Apart from hydrogen production, these processes constitute the major uses of syngas.

While petroleum-derived transportation fuels and chemicals were taking center stage in the worldwide market, certain political and environmental drivers were helping to develop improved commercial syngas conversion processes. The political situation in South Africa and the abundance of local coal reserves in that country helped bring about the most successful commercial FTS industry in the world based on syngas production from coal gasification. Sasol currently supplies diesel, gasoline, and other high-value hydrocarbons to local and global markets. The Arab oil embargo in the 1970s also highlighted the US dependence on foreign oil imports and helped renew interest in syngas conversion technologies.

Increasing environmental concerns and tighter regulations surrounding fossil fuel use also provided impetus for syngas conversion technologies to produce cleaner (virtually no sulfur) fuels and chemicals. The use of methanol and isobutene for the production of methyl tert-butyl ether (MTBE), an octane enhancing oxygenated component in reformulated gasoline, also increased demand for syngas conversion technologies.

MTBE itself, however, is becoming an environmental concern as a watershed pollutant and the future use of this oxygenate is uncertain. The latest environmental driver to likely increase demand for syngas even more is the goal of establishing a hydrogen economy. The vision is that hydrogen will be the fuel of choice for transportation and electricity generation via high efficiency, environmentally benign fuel cells.

In principle, syngas can be produced from any hydrocarbon feedstock. These include: natural gas, naphtha, residual oil, petroleum coke, coal, and biomass. The lowest cost routes for syngas production, however, are based on natural gas. The cheapest option is remote or stranded reserves. Current economic considerations dictate that the production of liquid fuels from syngas translates into using natural gas as the hydrocarbon source. Nevertheless, the syngas production operation in a gas-to-liquids plant amounts to greater than half of the capital cost of the plant. The choice of technology for syngas production also depends on the scale of the synthesis operation. Syngas production from solid fuels can require an even greater capital investment with the addition of feedstock handling and more complex syngas purification operations. The greatest impact on improving gas-to-liquids plant economics is to decrease capital costs associated with syngas production and improve thermal efficiency through better heat integration and utilization. Improved thermal efficiency can be obtained by combining the gas-to-liquids plant with a power generation plant to take advantage of the availability of low-pressure steam.

The syngas composition, most importantly the H_2/CO ratio, varies as a function of production technology and feedstock. Steam methane reforming yields H_2/CO ratios of 3/1 while coal gasification yields ratios closer to unity or lower. Conversely, the required properties of the syngas are a function of the synthesis process. Fewer moles of product almost always occur when H_2 and CO are converted to fuels and chemicals. Consequently, syngas conversion processes are more thermodynamically favorable at higher H_2 and CO partial pressures. The optimum pressures depend on the specific synthesis process.

With the exception of methane steam reforming, catalytic syngas conversion processes are exothermic reactions generating large excesses of heat. This highlights the specific need for removing this heat of reaction to carefully control reaction temperatures and maintain optimized process conditions. Maximizing product yields, minimizing side or competing reactions, and maintaining catalyst integrity dictate optimum synthesis reaction temperatures.

Catalysts play a pivotal role in syngas conversion reactions. In fact, fuels and chemicals synthesis from syngas does not occur in the absence of appropriate catalysts. The basic concept of a catalytic reaction is that reactants adsorb onto the catalyst surface and rearrange and combine into products that desorb from the surface. One of the fundamental functional differences between syngas synthesis catalysts is whether or not the adsorbed CO molecule dissociates on the catalyst surface. For FTS and higher alcohol synthesis, CO dissociation is a necessary reaction condition. For methanol synthesis, the CO bond remains intact. Hydrogen has two roles in catalytic syngas synthesis reactions. In addition to being a reactant needed for CO hydrogenation, it is commonly used to reduce the metalized synthesis catalysts and activate the metal surface.

Since the genesis of syngas conversion to fuels and chemicals, a tremendous amount of research and development has been devoted to optimizing product yields and process efficiencies. This includes the discovery of catalysts with optimized formulations containing the most active metals in combination with appropriate additives to improve activity and selectivity in a given process. Mechanistic studies have been conducted to interpret the fundamentals of specific conversion processes and measure the kinetic rates of key chemical reactions. Reactor design and engineering is another active research and development area of syngas conversion technology. Temperature control and stability in conversion reactors is a critical process parameter because of the large excess heat of reaction. Detailed process engineering and integration with respect to heat integration and syngas recycle to improve conversion efficiencies is used to optimize commercial synthesis processes.

Given the rich history of syngas conversion and the extensive research and development efforts devoted to this field of study, it is not surprising that a vast amount of literature is available that tracks the scientific and technological advancements in syngas chemistry. The purpose of this report is to review the many syngas to products processes and summarize the salient points regarding the technology status and description, chemistry, catalysts, reactors, gas cleanliness requirements, process and environmental performances, and economics. A diagram highlighting the specific processes reviewed in this report is shown in Figure 1.

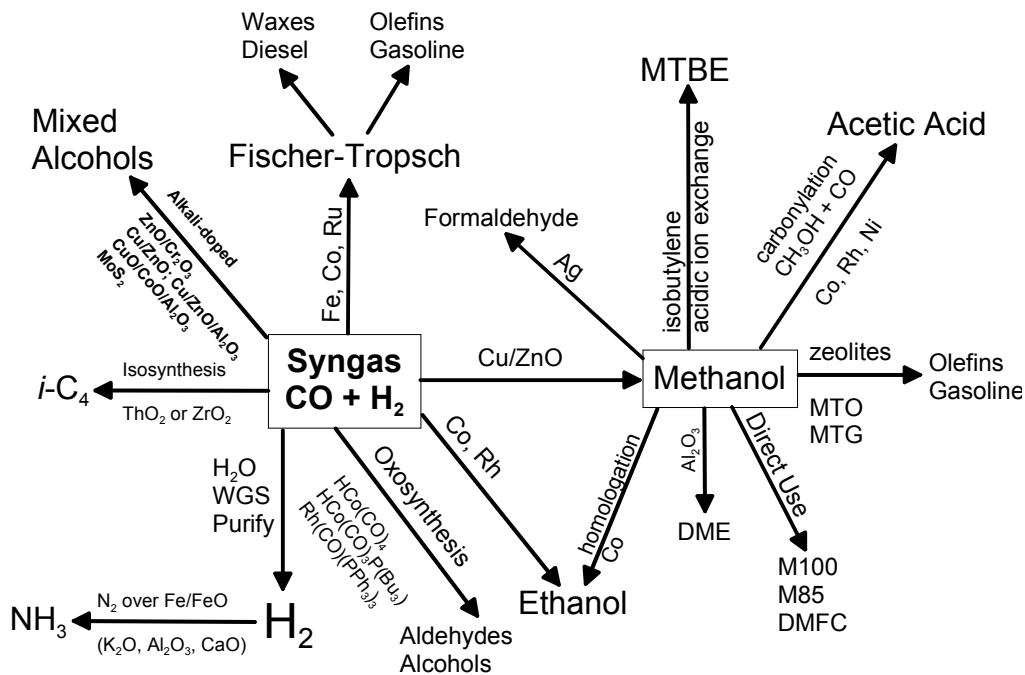

Figure 1: Diagram of Syngas Conversion Processes Covered in This Report

The impetus for this extensive literature review is the recent re-organization of the U.S. Department of Energy's Office of Energy Efficiency and Renewable Energy (EERE) into eleven new Program Offices. EERE's mission is to strengthen US energy security, environmental quality, and economic health. The Office of Biomass Program is one of these newly created offices. Its goal is developing technologies to transform our abundant biomass resources into clean, affordable, and domestically produced biofuels, biopower, and high-value bioproducts resulting in economic development, energy supply options, and energy security. In this context, commercially available and near-commercial syngas conversion processes were evaluated on technological, environmental, and economic bases. This report serves as a first step. Additional, more detailed analyses are required to identify promising, cost-effective fuel synthesis technologies where biomass thermochemical conversion could make an impact.

2 Hydrogen

2.1 Summary

Hydrogen production is the largest use of syngas. Hydrogen is mainly consumed for ammonia production, followed by refining and methanol production. Hydrogen is primarily produced from methane.

The dominant technology for hydrogen production is steam methane reforming. The process can be divided into the following four steps: feed pretreatment, steam reforming, CO shift conversion, and hydrogen purification. Reforming ($C_nH_m + nH_2O \rightarrow (n+m/2)H_2 + nCO$) and shift ($CO + H_2O \rightarrow CO_2 + H_2$) are the main reactions. If the feedstock is methane then 50% of the hydrogen comes from the steam. The reforming reaction is highly endothermic and is favored by high temperatures and low pressures. The shift reaction is exothermic and favors low temperatures. In industrial reformers, the reforming and shift reactions result in a product composition that closely approaches equilibrium. Presently, most plants use pressure swing adsorption (PSA) after the shift conversion step, to purify the hydrogen. Using PSA, a hydrogen purity greater than 99.99% can be achieved.

BASF was the first company to develop steam methane reforming in the early 1900s (Nirula, 1995). Today there are many licensors for the various components of the steam reforming process. A wide variety of reformer designs exist and can be used in various process configurations. The reformer steam to carbon ratio is usually between 2-6 depending on the feedstock and process conditions. Excess steam is used to prevent coking in the reformer tubes. Conventional steam reforming catalysts are 10-33 wt% NiO on a mineral support (alumina, cement, or magnesia). The high temperature shift (HTS) catalyst has an iron oxide, chromium oxide basis while the major component in the low temperature shift (LTS) catalyst is copper oxide, usually in a mixture with zinc oxide.

Sulfur compounds are the main poison of reforming catalyst. Even at a concentration of 0.1 ppm the catalyst can begin to deactivate. The LTS catalyst is also very sensitive to sulfur. Additionally, chloride is a LTS catalyst poison. HTS catalysts can tolerate sulfur concentrations up to several hundred ppm, although the activity will decline. Other HTS catalyst poisons include phosphorus, silicon and unsaturated hydrocarbons in the presence of NO_x (Häussinger, 2000). Prior to the PSA unit, entrained liquids (water and condensed hydrocarbons) must be removed because they will permanently damage the adsorbents.

Hydrogen itself is a clean burning fuel. However, depending upon the feedstock used, its production can generate a considerable amount of CO_2 . Additionally, steam reformers produce NO_x from fuel combustion. Generally, as the feedstock goes from natural gas to light hydrocarbons to heavy hydrocarbons and then to solid feedstocks, there is an increase in processing difficulty and capital costs. Merchant hydrogen prices vary considerably depending on the volume and form of delivery. For large volume users, pipeline delivery is the most economical followed by bulk liquid hydrogen delivery.

Section Contents

<u>2.1 Summary</u>	5
<u>2.2 Introduction</u>	7
<u>2.3 Technology Description</u>	7
<u>2.4 Hydrogen From Other Compounds</u>	8
<u>2.5 Chemistry</u>	8
<u>2.6 Catalysts</u>	9
<u>2.7 Reactors</u>	10
<u>2.8 Gas Cleanliness Requirements</u>	10
<u>2.9 Status/Technology Developers</u>	11
<u>2.10 Process Performance</u>	12
<u>2.11 Environmental Performance</u>	12
<u>2.12 Cost</u>	13
<u>2.13 R&D Needs</u>	14
<u>2.14 References</u>	14

List of Figures

<u>Figure 2: Block Flow Diagram of Hydrogen via Steam Methane Reforming</u>	8
---	---

List of Tables

<u>Table 4: Catalytic Steam Reforming Licensors*</u>	11
<u>Table 5: Commercial Suppliers of PSA Units**</u>	12
<u>Table 6: Comparison of Biomass Based Hydrogen Studies</u>	13
<u>Table 7: Hydrogen Cost Data From other Sources</u>	14

2.2 Introduction

The largest use of syngas is for hydrogen production (Wender, 1996). Hydrogen is produced as both a main product and as a by-product. Hydrogen producers often consume the product captively (e.g., ammonia producers, oil refineries, and methanol producers). The total amount of hydrogen consumed worldwide in 1999 was 15,864 billion ft³; 20% of this was consumed in the U.S. (Suresh, et al, 2001). The majority of the worldwide hydrogen consumption (about 60%) was for ammonia production. This was followed by refining at 23% and methanol production at 9%, leaving only 8% as merchant hydrogen.

Currently, hydrogen is primarily produced from methane. However, other hydrocarbon feedstocks include naphtha, heavy residues from petrochemical processes, coke oven gas, and coal. Electrolysis has also been used to produce hydrogen primarily where there is cheap electricity from hydropower stations. Presently, 77% of the worldwide hydrogen production comes from petrochemicals, 18 % from coal, 4 % from water electrolysis, and 1% from other sources (Häussinger, et al, 2000). The flexibility of hydrogen to be produced from any resource enables production from locally available, lowest-cost resources.

2.3 Technology Description

The dominant technology for hydrogen production is currently steam methane reforming. The process can be divided into the following four steps: feed pretreatment, steam reforming, CO shift conversion, and hydrogen purification. For natural gas, the only pretreatment required is desulfurization, which usually consists of a hydrogenator followed by a zinc oxide bed. After desulfurization, natural gas is fed to a reformer reactor, where it reacts with steam to produce CO, CO₂, and H₂ through the reforming ($\text{CH}_4 + \text{H}_2\text{O} \rightarrow \text{CO} + 3\text{H}_2$) and water gas shift ($\text{CO} + \text{H}_2\text{O} \rightarrow \text{CO}_2 + \text{H}_2$) reactions. The reformer reactor is comprised of catalyst-filled tubes, surrounded by a firebox that provides the heat necessary for the endothermic reforming reaction which operates at about 850°C and between 1.5-3 MPa. The gas exiting the reformer is cooled to about 350°C then undergoes the water gas shift (WGS) reaction in a high temperature shift (HTS) converter.

In the “classical process”, the gas is further cooled to about 220°C and undergoes WGS in a low temperature shift (LTS) converter followed by CO₂ scrubbing (e.g., monoethanolamine or hot potash). Finally, to remove trace amounts of CO and CO₂ a methanation reactor is used ($\text{CO} + 3\text{H}_2 \rightarrow \text{CH}_4 + \text{H}_2\text{O}$). The product hydrogen has a purity of 97-99%.

Currently, after the shift conversion step, hydrogen is purified using a pressure swing adsorption (PSA) unit to obtain purity greater than 99.99%. Since the PSA unit can easily remove CO and other components to produce a high purity hydrogen stream, most of today’s hydrogen plants use only the HTS reactor (Leiby, 1994). However, the LTS reactor can increase the hydrogen yield slightly. The PSA off-gas, which contains

unreacted CH₄, CO, and CO₂, plus unrecovered hydrogen, is used to fuel the reformer. This stream usually supplies 80-90% of the reformer heat duty supplemented by natural gas to fulfill the remaining heat requirement (Leiby, 1994). Figure 2 depicts this process.

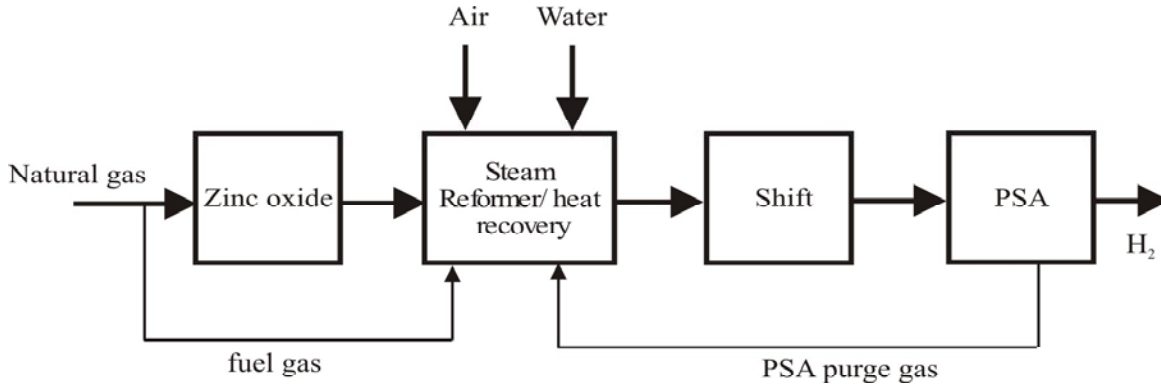

Figure 2: Block Flow Diagram of Hydrogen via Steam Methane Reforming

2.4 Hydrogen From Other Compounds

In addition to the direct production of hydrogen from gaseous hydrocarbon feedstocks, hydrogen can be produced from liquid energy carriers such as ethanol and methanol as well as from ammonia. Methanol reforming ($\text{CH}_3\text{OH} + \text{H}_2\text{O} \rightarrow \text{CO}_2 + 3\text{H}_2$) is practiced in Japan and, to a lesser degree, in Europe where there are no economical sources of syngas (Suresh, et al, 2001). Currently, there are about a dozen companies that are involved in building plants to produce hydrogen from methanol or ammonia.

2.5 Chemistry

Steam reforming of hydrocarbons involves the catalytic conversion of a hydrocarbon feedstock and steam to hydrogen and carbon oxides. Generally speaking, the chemical process for steam reforming of hydrocarbons is described by the following equation (Häussinger, et al, 2000):

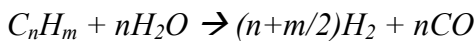

Water gas shift is another important reaction that occurs in the reformer. For steam methane reforming the following two reactions occur in the reformer (Leiby, 1994):

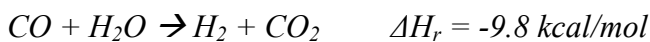

Therefore, in this case, 50% of the hydrogen comes from the steam. The reforming reaction is highly endothermic and is favored by high temperatures and low pressures.

Higher pressures tend to lower the methane conversion. In industrial reformers the reforming and shift reactions result in a product composition that closely approaches equilibrium.

The following side reactions produce carbon in the steam reformer:



The reformer molar steam to carbon ratio is usually between 2-6, depending on the feedstock and process conditions. Excess steam is used to prevent coking in the reformer tubes. The shift reaction is exothermic and favors low temperatures. Since it does not approach completion in the reformer (usually there is 10-15 vol% CO, dry basis, in the reformer effluent), further conversion of CO is performed using shift conversion catalysts.

2.6 Catalysts

Conventional steam reforming catalysts are 10-33 wt% NiO on a mineral support (alumina, cement, or magnesia). Reforming catalyst suppliers include, BASF, Dycat International, Haldor Topsoe, ICI Katalco and United Catalysts (Leiby, 1994). Heavy feedstocks tend to coke the reforming catalyst but promoters (potassium, lanthanum, ruthenium, and cerium) may be used to help avoid this problem. These promoters increase steam gasification of solid carbon reducing coke formation but they also reduce the reforming activity of the catalyst (Leiby, 1994). For feedstocks heavier than naphtha, nickel-free catalysts containing primarily strontium, aluminum, and calcium oxides, have been successfully tested (Häussinger, et al, 2000). However, the methane content in the exiting gas is high, requiring a secondary reformer.

HTS catalyst has an iron oxide, chromium oxide basis while the major component in the LTS catalyst is copper oxide, most often in a mixture with zinc oxide (Häussinger, et al, 2000). The HTS reactor operates in the temperature range of 300-450 °C while the LTS is in the range of 180-270 °C. Often the LTS reactor operates near condensation conditions. This catalyst is sensitive to changes in operating conditions. Typical catalyst lifetimes for both HTS and LTS catalysts are 3-5 years.

Sulfur tolerant or “dirty shift” catalysts have also been developed. These catalysts can handle larger amounts of sulfur. ICI Katalco makes dirty shift conversion catalysts that consist of cobalt and molybdenum oxides. They operate over a temperature range of 230-500 °C. The controlling factors are the ratio of steam to sulfur in the feed gas and the catalyst temperature.

For the methanation catalyst, nickel oxide is used, often in combination with chromium oxide.

2.7 Reactors

A wide variety of reformer designs exist and can be used in various process configurations. The main components of the reformer furnace include an air/fuel combustion system, a radiant heat transfer section, and a convection section. The radiant section supplies heat to the catalyst tubes by combustion of the air/fuel mixture and the convection section recovers heat by cooling down the flue gases. Reformer furnaces are not very efficient and only about half of the heat in the radiant section is absorbed by the furnace tubes.

Generally, the feed gas flows up through the catalyst tubes. However, the reformer furnace can be side-, terrace-, top-, or bottom-fired (Johansen, 1992). Top-fired reformers are generally suited for larger production units. For small units of < 24 tubes, side-fired units are more economical. The terrace-fired reformer, developed in the 1960s, is a variation of the side-wall design. Bottom-fired reformers are the least common of the four designs (Leiby, 1994).

The shift converters and methanation reactor are fixed bed reactors.

2.8 Gas Cleanliness Requirements

Sulfur compounds are the main poison of reforming catalysts. Even at a concentration of 0.1 ppm the catalyst can begin to deactivate. To maintain a 3-year catalyst lifetime the sulfur concentration in the reformer feed gas should be less than 0.5 ppm (Leiby, 1994). Uranium oxide and chromium oxide are used as a promoter in certain reforming catalysts resulting in a higher tolerance to sulfur poisoning (Häussinger, 2000). Natural gas usually contains only small amounts of sulfur compounds generally in the form of H₂S. In most SMR plants, prior to the steam reformer, there is a hydrogenator where sulfur compounds are converted to H₂S. A desulfurizer follows this where the H₂S in the feed gas is absorbed on a ZnO bed. Any remaining organic sulfur compounds and carbonyl sulfide are partially cracked and absorbed on the zinc oxide bed (Häussinger, et al, 2000). If the sulfur concentration in the feed gas is greater than 1% then the sulfur must be removed by chemical or physical scrubbing.

The LTS catalyst is also very sensitive to sulfur. Additionally, chloride is a LTS catalyst poison. HTS catalyst can tolerate sulfur concentrations up to several hundred ppm, although the activity will decline. Other HTS catalyst poisons include phosphorus, silicon and unsaturated hydrocarbons in the presence of NO_x (Häussinger, 2000).

Prior to the PSA unit, entrained liquids (water and condensed hydrocarbons) must be removed because they will permanently damage the adsorbent, which is a mixture of activated carbon and zeolites. Cooling the product and installing a knock out drum with a mist eliminator prior to the PSA unit is usually sufficient.

2.9 Status/Technology Developers

BASF was the first company to develop steam methane reforming in the early 1900s (Nirula, 1995). In the mid-1930s to 1950s steam reforming was developed for heavier hydrocarbon feedstocks. Thereafter, energy efficiency improvements were made in this mature technology by the 1980s. There are many licensors for the various components of the steam reforming process. Table 4 is a list of licensors for steam reforming technology and Table 5 is a list of current commercial suppliers of PSA units.

Table 4: Catalytic Steam Reforming Licensors*

Company	Headquarters Location
ABB Lummus Global Inc.	Bloomfield, NJ, U.S.A.
Air Products and Chemicals	Allentown, PA, U.S.A.
BOC Gases	Murray Hill, NJ, U.S.A.
Brown & Root, Inc.	Alhambra, CA, U.S.A.
John Brown Engineers & Constructors Ltd.	London, England
Caloric	Gräfelfing, Germany
Exxon Research & Engineering Co.	Florham Park, NJ, U.S.A.
Haldor Topsoe A/S	Copenhagen, Denmark
Howe-Baker Engineers	Tyler, TX, U.S.A.
International Fuel Cells	South Windsor, CT, U.S.A.
JGC Corporation	Tokyo, Japan
KTI Group BV	Zoetermeer, Netherlands
Koch Process Technology Incorporated	Roswell, GA, U.S.A.
Linde AG	Munich, Germany
Lurgi AG	Frankfurt, Germany
Mahler AGS	Stuttgart, Germany
Messer Griesheim GmbH	Krefeld, Germany
The MW Kellogg Company	Houston, TX, U.S.A.
PETROBRAS – Petróleo Brasileiro S/A	Ro de Janeiro, Brazil
Uhde GmbH	Dortmund, Germany

* Source: (Suresh, et al, 2001 and Leiby, 1994)

Table 5: Commercial Suppliers of PSA Units**

Company	Headquarters Location
L'Air Liquide SA	Paris, France
Air Products and Chemicals	St. Louis, MO, U.S.A.
Bergbau AG	Herne, Germany
The BOC Group PLC	Windlesham, United Kingdom
Caloric Analgenbau	Munich, Germany
Howmar	United Kingdom
Linde AG	Munich, Germany
Questor Industries, Inc.	Vancouver, BC, Canada
Toyo Engineering	Tokyo, Japan
UOP, LLC	Des Plaines, IL, U.S.A.

**Source: (Suresh, et al, 2001)

2.10 Process Performance

About 65-75% of the CO and steam in the feed stream to the HTS reactor are converted to additional hydrogen and CO₂ (Leiby, 1994). When a LTS reactor is used to convert additional CO to hydrogen about 80-90% of the remaining CO is converted to hydrogen resulting in an improvement in the hydrogen yield of about 5% (Leiby, 1994).

For the PSA unit, the minimum pressure ratio between the feed and purge gas is about 4:1 and the purge gas pressure is typically between 17-20 psi to obtain a high recovery of hydrogen. Hydrogen recovery is usually 85-90% at these conditions and drops to 60-80% at high purge gas pressures (55-95 psi) (Leiby, 1994). The PSA efficiency is also affected by adsorption temperature. Fewer impurities are adsorbed at higher temperatures because the equilibrium capacity of the molecular sieves decreases with increasing temperature. Additionally, nitrogen is weakly adsorbed onto the adsorbent bed in the PSA unit, reducing the hydrogen recovery rate for the same purity. The hydrogen recovery may be reduced by as much as 2.5% for a 10-ppm nitrogen concentration in the PSA feed stream.

2.11 Environmental Performance

Hydrogen itself is a clean burning fuel. However, depending upon the feedstock used, its production can generate a considerable amount of CO₂. Additionally, steam reformers produce NO_x from fuel combustion. In California, selective catalytic reduction units are used in combination with low NO_x burners to meet the state's strict air regulations (Baade, et al, 2001). Controlling the emissions from less hydrogen-rich feedstocks is more difficult as the feedstock goes from natural gas to heavy fuel oil, coke, or coal. These feedstocks also contain other impurities such as sulfur and heavy metals.

2.12 Cost

Merchant hydrogen prices vary considerably depending on the volume and form of delivery. For large volume users, pipeline is the most economical followed by bulk liquid hydrogen delivery. For gaseous hydrogen produced from natural gas at a large-scale, central production facility at a pressure of around 400 psi, the plant gate price is about \$5-\$8/GJ. In general, contract prices for delivered hydrogen are not publicly available and they vary a great deal depending on the type of delivery, quantity required, and delivery distance. SRI states that liquid hydrogen list prices have been around \$45/GJ, but that the average transaction prices are considerably below this (Suresh, et al, 2001). A typical price range for large-volume, bulk liquid consumers is \$18-\$24/GJ (Suresh, et al, 2001).

Generally, as the feedstock goes from natural gas to light hydrocarbons to heavy hydrocarbons and then to solid feedstocks, there is an increase in processing difficulty and capital costs. Table 6 is a comparison of detailed biomass to hydrogen studies. Table 8 gives some costs for hydrogen from natural gas, coal, and biomass from other sources containing little or no details. All of these numbers are plant gate costs.

Table 6: Comparison of Biomass Based Hydrogen Studies

Study	Hamelinck (2001) (a), (b)	Larson (1992) (a)	Spath (2000) (a)
Cost year	2001	1991	2000
Biomass feed rate (BD tonne/day)	1,920	1,650	about 300-1,500 (3 plant sizes)
Biomass cost	\$2/GJ \$34/dry tonne	\$2/GJ \$34/dry tonne	\$2.7/GJ \$46.2/dry tonne
Electricity selling price	\$0.03/kWh	\$0.05/kWh (purchased)	\$0.05/kWh (purchased)
Net power (MW)	ranges from no excess to about 85 MW (@ 91% production cap)	no excess	no excess (excess steam is produced and sold)
H ₂ produced (tonne/day)	91 – 184 (@ 91% production cap)	134 - 188	23 – 114
Price of H ₂ (HHV basis, plant gate)	\$8-11/GJ	\$7-12/GJ	\$14-21/GJ (for 15% IRR; gasification only)
Level of detail	Very detailed - Gives costs of individual equipment, operating costs, and other economic parameters and assumptions	Somewhat detailed – Gives capital and operating costs	Somewhat detailed - Gives total installed capital costs, and other economic parameters and assumptions

Notes: (a) Examined direct & indirect gasifiers and atmospheric and pressurized gasifiers.
 (b) Several configurations examined (varied type of gas cleaning, and H₂ separation)

Table 7: Hydrogen Cost Data From other Sources

Resource	IEA (1999)	IEA (2001)	McKinley, et al (1990)	British Government Panel (1999)	Grégoire Padró (1999)	Amick (2003)
Natural gas	\$5.6/GJ (nat gas @ \$3/GJ) \$7/GJ (w/CO ₂ seq)	\$5.4-7.5/GJ	\$7/GJ (1987\$)	\$5.7/GJ (nat gas @ \$3/GJ) \$7/GJ (w/CO ₂ seq)	\$5.97-7.46/GJ	-----
Coal	\$10/GJ (coal @ \$2/GJ) \$13/GJ (w/CO ₂ seq)	\$10-12/GJ	\$15/GJ (1987\$)	\$10.3/GJ (coal @ \$2/GJ) \$13.2/GJ (w/CO ₂ seq)	\$9.87-19.3/GJ	\$9-10/GJ
Biomass	-----	\$12-13/GJ	\$7/GJ (Biomass @ \$15/ton - 1987\$)	-----	\$8.69-17.1/GJ	-----

2.13 R&D Needs

Although steam reforming has been around for many years, improvements in reforming and shift catalyst continue to be made. Additionally, more efficient engineering designs have aided in cost reductions.

2.14 References

Amick, P. Geosits, R., Kramer, S. (2003). 225th ACS National Meeting. New Orleans, Louisiana. March 23-27. Fuel Chemistry Preprints. 48 (1) pg. 199-204.

Baade, W.F.; Parekh, U.N.; Raman, V.S. (2001). "Hydrogen." Kirk-Othmer Encyclopedia of Chemical Technology, John Wiley & Sons, Inc.

British Government Panel on Sustainable Development. July 1999.

Grégoire Padró, C.E.; Putsche, V. (1999). Survey of the Economics of Hydrogen Technologies. 57 pp.; NREL Report No. TP-570-27079.

Häussinger, P.; Lohmüller, R.; Watson, A.M. (2000). "Hydrogen." Ullmann's Encyclopedia of Industrial. Wiley-VCH Verlag GmbH & Co.KGaA.

IEA Greenhouse Gas R&D Programme (1999). Hydrogen – Today and Tomorrow.

IEA Bioenergy Task 33: Thermal Gasification of Biomass, Spring 2001, Task Meeting.

Johansen, T.; Raghuraman, K.S.; Hackett, L.A. (1992). "Trends in hydrogen plant design". *Hydrocarbon Processing*.

Leiby, S.M. (1994). *Options for Refinery Hydrogen*. SRI Report No. 212. Menlo Park, CA.

McKinley, K.R., Browne, S.H., Neill, D.R., Seki, A., Takahashi, P.K. (1990). "Hydrogen Fuel from Renewable Resources". *Energy Sources*. Vol 12. pp. 105-110.

Nirula, S.C. (1995). *Synthesis Gas*. SRI Report No. 148A. Menlo Park, CA.

Suresh, B.; Gubler, R.; Sasano, T. (2001). "Hydrogen." *Chemical Economics Handbook Product Review*, SRI International, Menlo Park, CA. Reprint number 743.5000.

Spath, P.L.; Lane, J.M.; Mann, M.K.; Amos, W.A. (April 2000). Update of Hydrogen from Biomass - Determination of the Delivered Cost of Hydrogen. NREL Milestone report.

Wender, I. (1996). "Reactions of synthesis gas." *Fuel Processing Technology* 48(3): 189-297.

3 Ammonia

3.1 Summary

Ammonia is the second largest synthetic chemical product. Most of the ammonia produced is used to make fertilizers in the form of urea or ammonium salts. The basic process steps for industrial production are: synthesis gas production, gas conditioning, compression, and ammonia synthesis. The goal of the synthesis gas production and gas conditioning steps is to provide a pure H₂ stream for input into the ammonia converter.

Ammonia synthesis is achieved in catalytic converters at pressures ranging from 15-35 MPa at a minimum temperature of 430-480°C. Ammonia synthesis occurs via the following exothermic chemical reaction: $N_2 + 3H_2 \rightarrow 2 NH_3$ and is typically performed over promoted Fe catalysts. The optimum H₂/N₂ ratio is near 2 at high space velocities and approaches 3 at low space velocities as equilibrium becomes more dominant.

Commercial ammonia synthesis catalysts are basically the same Fe-promoted catalysts first developed by Mittasch in 1910. However, the search for catalysts with high activity and long lifetimes at lower synthesis temperatures and lower pressures continues. Other catalysts are being developed such as promoted Ru on high surface area graphite supports. These recently developed commercial catalysts offer the possibility of greatly reducing synthesis temperatures and pressures with improved activity at high ammonia concentrations.

The basic design of an ammonia synthesis reactor is a pressure vessel with sections for catalyst beds and heat exchangers. Ammonia converters are classified by flow type (radial, axial, or cross flow) and cooling method (quench or indirect) used. Removing the heat generated from the exothermic synthesis reaction to maintain control of the reaction temperature is the main design challenge.

Gas phase impurities can be separated into temporary and irreversible catalyst poisons. Oxygenated compounds like CO, CO₂, H₂O, and O₂ are temporary, reversible ammonia catalyst poisons at low process temperatures. Removal of these oxygenates from the feed gas stream followed by re-reduction of the catalyst with pure H₂ and N₂ will restore catalyst activity. Sulfur, Chlorine, and As, P, Sb are irreversible poisons.

In the early days the ammonia industry was based on coal as the feedstock but as cheap petroleum feedstocks became available the industry moved toward natural gas. The cost of ammonia is highly dependent on the feedstock price. In general, the price of ammonia has fluctuated between \$100-\$250/tonne since 1986. Improved catalysts and process optimization are part of the continuing efforts to improve the economics of ammonia production by reducing process energy consumption.

Section Contents

<u>3.1 Summary</u>	16
<u>3.2 Introduction</u>	18
<u>3.3 Technology Description</u>	19
<u>3.4 Chemistry</u>	20
<u>3.5 Catalysts</u>	21
<u>3.6 Reactors</u>	23
<u>3.7 Gas Cleanliness Requirements</u>	25
<u>3.8 Status/Technology Developers</u>	26
<u>3.9 Environmental Performance</u>	27
<u>3.10 Cost</u>	27
<u>3.11 R&D Needs</u>	28
<u>3.12 References</u>	28

List of Figures

<u>Figure 3: Generic Ammonia Synthesis Process Flow Diagram</u>	19
<u>Figure 4: Various Ammonia Converter Designs</u>	24

List of Tables

<u>Table 8: Summary of Commercial Ammonia Synthesis Catalyst Compositions</u>	23
<u>Table 9: Summary of Ammonia Synthesis Catalyst Poisons</u>	26
<u>Table 10: Comparison of Ammonia Economics</u>	27

3.2 Introduction

Ammonia is the second largest synthetic chemical product. In 1996, worldwide ammonia production totaled 143 million tonnes (Appl 2003). Most of the ammonia produced is used to make fertilizers in the form of urea or ammonium salts (nitrate, phosphate, and sulfate). A small fraction of ammonia is used for the manufacture of organic chemical feedstocks for the plastics industry; polyamides, caprolactam, and others, and for the production of explosives (hydrazine, nitriles, etc.). Ammonia is also converted to nitric acid and cyanides. Ammonia is manufactured from nitrogen, fixed from the atmosphere, and hydrogen, produced mainly by steam methane reforming, in the catalytic process developed in the early 1900s by Fritz Haber and Carl Bosch using a promoted iron catalyst discovered by Alwin Mittasch (Satterfield 1991). The onset of World War I brought concerns about diminished worldwide nitrate supplies caused by an increase in the production of explosives. This led to the first industrial plant constructed at Oppau, Germany, and commissioned in 1913. About 50% of the hydrogen produced from syngas processes is used for ammonia production (Wender 1996).

The vast amount of literature on ammonia synthesis over the past 100 years details process improvements, reactor engineering, catalyst developments, and mechanistic interpretation of the conversion of N_2 and H_2 to NH_3 over Fe catalysts at high temperature and high pressure. Several reviews on ammonia production were consulted in writing this technology description (Kirth-Othmer)(Appl 2003; Jennings and Ward 1989; Satterfield 1991) and individual references to previous work can be found therein. For example, the “Ammonia” article in Ullmann’s Encyclopedia of Industrial Chemistry contains over 1000 cited references (Appl 2003). Numerous books and entire journals such as *Nitrogen* and *Ammonia Plant Safety* are can be found that are dedicated to all aspects of ammonia synthesis.

Commercial ammonia synthesis catalysts are basically the same Fe promoted catalysts first developed by Mittasch. The search for catalysts with high activity and long lifetimes at lower synthesis temperatures and lower pressures continues. Recent developments in ammonia synthesis catalysts include Ru-based formulations that are showing promise for commercial applications.

Improved catalysts and process optimization are part of the continuing efforts to improve the economics of ammonia production by reducing process energy consumption. Energy consumption in ammonia plants has decreased nearly an order of magnitude since the early plants; from ~100 GJ/tonne NH_3 to ~30 GJ/tonne NH_3 (Jennings and Ward 1989). Part of this is a result of improved efficiencies in syngas (hydrogen) production by switching fuels, from coal to natural gas. Improved reactor design and optimized heat integration in the ammonia plant also contributes significantly to reducing energy consumption. One objective is to optimize heat recovery and minimize the capital and operating costs of the ammonia synthesis loop.

3.3 Technology Description

The basic process steps for industrial ammonia production are synthesis gas production, gas conditioning, compression, and ammonia synthesis. The goal of the synthesis gas production and gas conditioning operations is to provide a pure H₂ stream for input into the ammonia converter. This requires a number of unit operations including feedstock pretreatment, syngas generation, CO conversion, and gas purification. These individual operations are summarized in the generic block flow diagram in Figure 3.

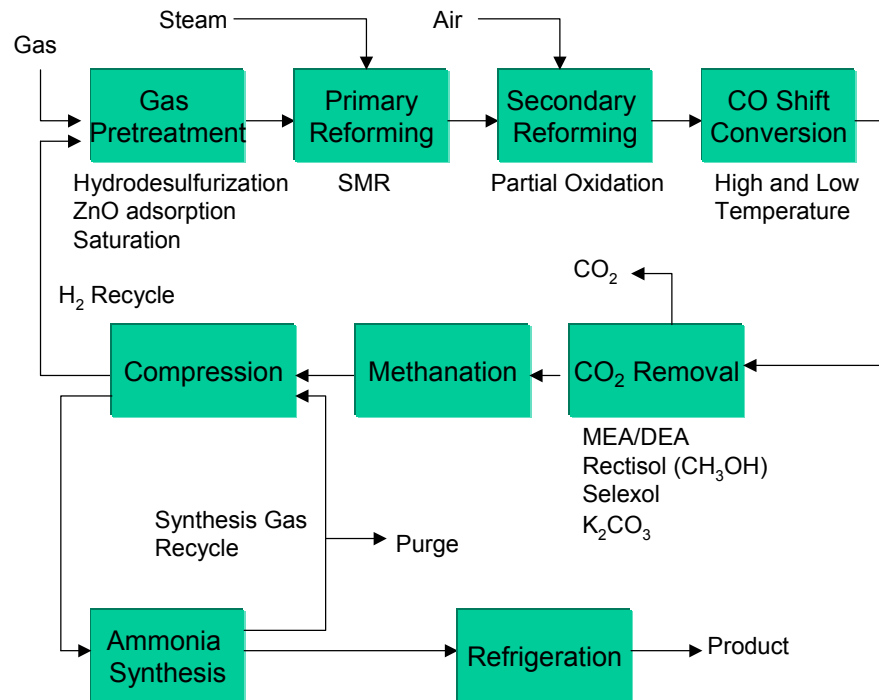

Figure 3: Generic Ammonia Synthesis Process Flow Diagram

For natural gas plants, feedstock pretreatment is essentially desulfurization prior to steam methane reforming. Feedstock preparation and handling is more complicated for solid fuel based systems. Secondary reformers are also used to further decrease the hydrocarbon content in the syngas. Following the reforming section, the syngas is cleaned and conditioned. Syngas cleaning is more involved for solid fuel based processes. Conditioning the cleaned syngas is required to increase the yield and purity of the hydrogen that is produced. CO is converted to H₂ via the water gas shift reaction in high and low temperature shift reactors. Water is removed by cooling the syngas and CO₂ is removed in an absorber-stripper process. Residual CO and CO₂ in the product H₂ is reduced to lower levels by what amounts to the reverse steam methane reforming process. A fraction the H₂ is consumed in a methanation reactor to convert residual CO and CO₂ to CH₄. Purified H₂ is then compressed and fed to the ammonia synthesis loop. Another configuration would be to replace the following process steps: low temperature shift, CO₂ removal, methanation and possibly the secondary reformer with pressure

swing adsorption. It is also possible to replace the reforming section with an autothermal reformer. However, currently the majority of ammonia plants follow the process scheme shown in Figure 3.

Ammonia synthesis is achieved in catalytic converters at pressures ranging from 15-35 MPa at a minimum temperature of 430-480°C. A maximum temperature of ~550°C results from the balance between increasing reaction kinetics and decreasing the equilibrium NH₃ concentration as the temperature increases. Thermodynamics suggests that low process temperatures are favorable, however, the kinetics of the reactions dictates that high temperatures are required. The most effective catalysts from a process perspective are those that have the highest rate of conversion at the lowest temperatures (Jennings and Ward 1989). With effective gas cleanup and conditioning, catalyst lifetimes of 5-8 years can be achieved in commercial practice and up to 14 years in certain cases. Ammonia formation increases as the process pressure is increased. The optimum H₂/N₂ ratio is near 2 at high space velocities and approaches 3 at low space velocities as equilibrium becomes more dominant. Space velocities in commercial ammonia synthesis vary from 12,000/hr at 15 MPa to 35,000/hr at 80MPa (Appl 2003).

Per-pass conversion on the order of 10-35% is typically achieved. Ammonia is recovered from the synthesis loop by cooling the synthesis gas at process pressures to condense the ammonia. The liquid ammonia is separated from the gas, which is recycled back through the converter. Earlier plant designs used air or water-cooling for ammonia recovery. Modern synthesis plants use refrigeration to condense out the ammonia.

The ammonia recovery is not extremely efficient so the recycled gas typically contains 4% NH₃ plus any inert gases (Ar, He, CH₄, etc.) that may be in the process stream. Purging some of the gas in the recycle loop before it is recycled minimizes inert gas concentrations. This purged gas also contains some product NH₃ that is recovered, unconverted N₂ and H₂, plus the inert gases. The purged H₂ is recovered and recycled back to the converter or used as a fuel in the process. Some of the inert gases also end up dissolved in the condensed NH₃ product. Flashing the liquid ammonia in a pressure letdown step releases any dissolved gases that are separated from the product.

Clearly, the ammonia synthesis process consists of many complex unit operations apart from the actual synthesis loop. The way in which these process components are combined with respect to mass and energy flow has a major influence on efficiency and reliability. Apart from the feedstock, many of the differences between various commercial ammonia processes lie in the way in which the process elements are integrated.

3.4 Chemistry

Ammonia synthesis occurs via the following exothermic chemical reaction:

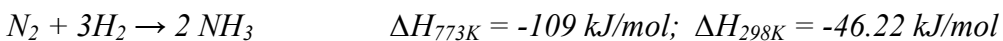

Since the reaction is exothermic, maximum conversion at equilibrium occurs at high pressure and low temperature. Early attempts at ammonia production were hampered by a lack of understanding of thermodynamic equilibrium and the temperatures and pressures chosen for ammonia synthesis were unfavorable for reaction.

Ammonia synthesis is typically performed over promoted Fe catalysts. Numerous mechanistic studies based on the measurement of surface adsorbed species have determined that the rate-limiting step is the dissociative chemisorption of N₂ on the catalyst surface to form N atoms. Surface concentration of N atoms is governed by the equilibrium with gas phase H₂ and NH₃.

The following rate expression for ammonia synthesis was developed by Temkin and Pyzhev in 1940 and has been widely applied to ammonia converter design and development (Jennings and Ward 1989) and references therein):

$$r = k_1 P_{N_2} \left(\frac{P_{H_2}^3}{P_{NH_3}^2} \right)^\alpha - k_2 \left(\frac{P_{NH_3}^2}{P_{H_2}^3} \right)^\beta \quad \alpha + \beta = 1 \quad \alpha, \beta > 0$$

where the first term is the rate of ammonia formation and the second term is the rate of ammonia decomposition. This rate expression is valid over a very wide pressure range with fugacities substituted for pressures at very high pressure. The value for α ranges between 0.4-0.75 for commercial processes where ammonia is recycled back to the reactor. Clearly, this expression is not valid for zero ammonia concentrations that are often encountered in the laboratory. For process using only pure reactants without ammonia recycle, the following rate equation applies:

$$r = k P_{H_2}^\alpha P_{N_2}^{1-\alpha} \quad \alpha = 0.5$$

3.5 Catalysts

Mittasch screened more than 2000 catalyst compositions before developing a promoted Fe catalyst that is, in principle, still commercially used today. Catalysts usually contain multiple promoters to improve the effectiveness and stability of the catalysts for long periods of time.

Ammonia synthesis catalysts are made by cooling, casting, crushing, and sieving a fused melt of magnetite ore (Fe₃O₄) and promoter precursors. Promoters include Al₂O₃, K₂O, CaO, MgO, etc. One of the functions of the promoters is to minimize Fe sintering during reduction and reaction. K₂O is a structural promoter. Typical ammonia synthesis catalysts contain: 2.5-4% Al₂O₃, 0.5-1.2% K₂O, 2.0-3.5% CaO, 0-1.0% MgO, and 0.2-0.5% SiO₂ (naturally occurring in the magnetite ore). Commercial catalyst formulations are listed in Table 8.

Finely divided iron is pyrophoric so Fe catalysts are reduced to metallic form in situ in ammonia converters. Porosity is developed as the catalysts are reduced. During reduction, oxygen is removed from the magnetite crystal lattice without shrinkage. Metallic Fe is formed with essentially the same porous structure as the magnetite precursor (Jennings and Ward 1989). The production and preservation of this highly porous structure during reduction of the ammonia synthesis catalysts leads to highly active catalysts. The additions of structural promoters like Al_2O_3 , MgO , and Cr_2O_3 facilitates the formation of highly porous metallic iron. Surface areas of freshly reduced promoted iron ammonia synthesis catalysts can be as high as 15-20 m^2/g .

Catalyst activity is not directly associated with Fe surface area but is also related to the complex interactions of the promoters. Alkali metal promoters in ammonia synthesis catalysts are needed to attain high activity. Potassium is the most cost effective alkali promoter. Cs and Rb are effective promoters but more costly than K. Li and Na are poor promoters and not used commercially. Potassium is thought to interact with the Fe crystallites by increasing the dissociative sticking probability of N_2 on the Fe sites and increasing catalytic activity. Dissociative adsorption of H_2 on the Fe sites occurs rapidly at relatively low temperatures. Equilibrium is, therefore, attained for H_2 adsorption/desorption at ammonia synthesis temperatures.

Other catalysts are being developed such as promoted Ru on high surface area graphite supports. These recently commercial catalysts offer the possibility of greatly reducing synthesis temperatures and pressures with improved activity at high ammonia concentrations. The Kellogg Advanced Ammonia Process is based on a Ru catalyst that is claimed to be 40% more active than Fe catalysts.

Table 8: Summary of Commercial Ammonia Synthesis Catalyst Compositions

Catalyst		Composition (wt%)						Operating Ranges		
Vendor	Name	Fe oxides [#]	K ₂ O	Al ₂ O ₃	CaO	SiO ₂	Other	T (°C)	P (bar)	
Haldor Topsoe	KM1	91-95	5-9						340-550	88-588
	KM1R*	89-93	7-11							
Katalco (ICI)	35-4	93.9	0.7	3.0	2.4			350-530	100-600	
	35-8*	92.1	0.9	3.8	3.2					
	S6-10	93.9	0.7	3.0	2.4		BASF catalyst			
	S6-10R*	92.1	0.9	3.8	3.2					
	74-1	95.8	0.6	2.1	1.5				≥60	
	74-1R*	94.7	0.8	2.6	1.9					
Sud Chemie	AS-4	92	promoters							
	As-4R*	78%Fe 10% FeO	promoters							

* pre-reduced catalysts

For unreduced catalysts, Fe is in the form of magnetite (Fe₃O₄). In pre-reduced catalysts the Fe is present as metallic Fe and FeO.

3.6 Reactors

The basic design of an ammonia synthesis reactor is a pressure vessel with sections for catalyst beds and heat exchangers. Ammonia converters are classified by flow type (radial, axial, or cross flow) and cooling method (quench or indirect) used.

Axial flow reactors are essentially top-to-bottom flow reactors. The design is comparatively simple, however, a fairly large pressure drop develops across the catalyst bed. A radial flow configuration feeds gas into an annular region between the reactor wall and the outer surface of the catalyst bed. Gas flows through the bed and exits out a central collection tube. This design minimizes pressure drop across a shallow bed with a large surface area. Radial flow converters tend to be tall vessels with relatively small diameter. The cross-flow configuration has a similar principle in that gas is introduced along one side of the reactor and is collected radially across the reactor by a collector on the other side.

Removing the heat generated from the exothermic synthesis reaction to maintain control of the reaction temperature is another design challenge. Quench converters are designed to introduce cool reactant gas at various points along the length of the catalyst bed. Interbed heat exchangers can also be used to remove heat at specific intervals along the bed, effectively separating the bed into multiple synthesis zones, or continuously along the bed with cooling tubes. These indirectly cooled designs allow for efficient reaction

heat recovery that can be used in other parts of the process. Reactant gas can be circulated through the heat exchangers to preheat the ammonia synthesis gas or water is used to produce steam.

A number of ammonia converters are commercially available. Seventeen different designs for ammonia converters are described by Zardi (Zardi 1982). The article in Ullmann's also contains figures and descriptions of several different ammonia converters (Appl 2003). Many designs are based on quench converters that have multiple catalyst beds in series and cold gas is introduced between the beds for temperature control. Early designs based on axial flow were easier to build but not as efficient as the more complex radial flow converters that have more recently been designed. A small subset of ammonia converters are depicted in Figure 4 and described below.

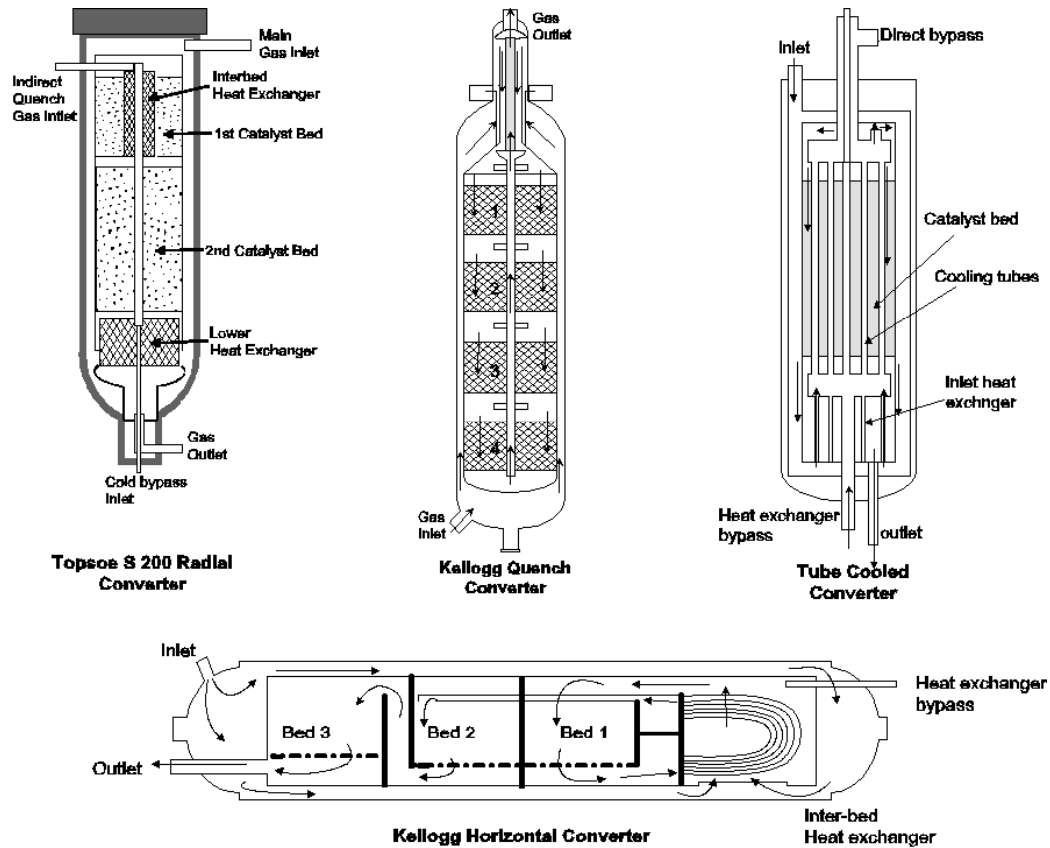

Figure 4: Various Ammonia Converter Designs

3.6.1 *Topsoe radial-flow converter*

One design uses 2 radial beds with quench gas injection between them. A similar radial flow design uses an inter-bed heat exchanger in the first catalyst bed. Cold ammonia synthesis gas is introduced from the bottom of the converter through the second catalyst bed then through the heat exchanger in the first catalyst bed. The cold gas flow through the second bed also provides indirect heat exchange. An additional heat exchanger is located at the bottom of the reactor to cool the reacted gases.

3.6.2 *Kellogg 4-bed axial flow quench converter*

This reactor consists of 4 catalyst beds held on separate grids. Quench gas is introduced in the spaces between the beds. A heat exchanger is located at the top of the vessel.

3.6.3 *Kellogg horizontal converter*

This reactor is a cross-flow converter design where gas flows through the catalyst bed perpendicular to the axis of the vessel. It is available in both quench and indirectly cooled versions.

3.6.4 *Tube Cooled Converter*

There are many variations in this design. Figure 4 shows a generic reactor.

3.6.5 *ICI Lozenge Quench Converter*

This is an additional reactor which is not shown in Figure 4. An axial flow, continuous catalyst bed is divided by lozenge distributors for quench gas addition.

3.7 Gas Cleanliness Requirements

In a carefully controlled ammonia synthesis processes, 10-year catalyst lifetimes are not uncommon. Loss of activity, however, does still occur by common deactivation mechanisms. Deactivation by sintering is a slow, gradual process that leads to loss of active area by Fe crystallization and oxidation. The activity of ammonia synthesis catalysts can also be reduced by trace impurities in the feed gas stream or solid impurities introduced during catalyst manufacture. Careful manufacturing processes are required to avoid the solid catalyst poisons, although, some are unavoidable because they are present as impurities in the natural magnetite starting material. Extensive purification of H₂ and N₂ is required to minimize gas phase catalyst poisons.

Gas phase impurities can be separated into temporary and irreversible catalyst poisons. Oxygenated compounds like CO, CO₂, H₂O, and O₂ are temporary, reversible ammonia catalyst poisons at low process temperatures. Removal of these oxygenates from the feed gas stream followed by re-reduction of the catalyst with pure H₂ and N₂ will restore

catalyst activity. A typical maximum specification allowed for all oxygen containing compounds in the ammonia synthesis reactor feed is 10 ppm (total oxygen compounds). As temperatures increase above 520°C water vapor can become an irreversible poison as Fe crystallites form.

Very low levels of gaseous sulfur and chlorine irreversibly poison catalysts. The sulfur is removed from the process gas stream before the primary reformer by a hydrodesulfurization unit containing Co-Mo catalysts followed by a fixed bed ZnO absorber. Syngas from coal gasification can contain high levels of H₂S and COS that must be removed.

Chlorine attacks the alkali promoters to form volatile alkali chlorides that can vaporize at process temperatures. Chlorine also attacks the active metallic Fe sites converting them to Fe-chlorides. Trace levels of arsenic and phosphorous are also strong catalyst poisons. Table 9 summarizes the various catalyst poisons.

Table 9: Summary of Ammonia Synthesis Catalyst Poisons

Poison	Type	Maximum concentration (ppm)
H ₂ O	Rev	200
CO	Rev	200
CO ₂	Rev	100
O ₂	Rev	100
Sulfur (H ₂ S)	Irrev	0.1
Chlorine	irrev	0.1
As, P, Sb	Irrev	---

3.8 Status/Technology Developers

In the early days the entire ammonia industry was based on coal as the feedstock. Today coal or coke (including coke oven gas) is no longer of major economic importance. In 1990, for example, only 13.5 % of the world ammonia capacity was based on this raw material. Apart from a few plants operating in India and South Africa, today, the majority of coal-based ammonia plants are found in China. As cheap petroleum feedstocks became available the industry moved toward natural gas as the main feedstock.

More than 20 commercial ammonia synthesis processes are described in the article on “Ammonia” in Ullmann’s Encyclopedia of Industrial Chemistry (Appl 2003). Commercial vendors include:

ICI – (<http://www.syntex.com/ammonia/index.htm>)
 Linde (Ilg and Kandziora 1997) - (<http://www.linde-process-engineering.com/en/p0001/p0017/p0020/p0020.jsp>),
 Kellogg, Brown, and Root - (http://www.mwkl.co.uk/pdf/Ammonia_brochure_1.pdf and <http://www.mwkl.co.uk/pdf/KAAPplus.pdf>)
 Haldor Topsoe (<http://www.topsoe.com/tempfiles/267.asp>)
 Ammonia Casale (<http://www.casale.ch/ammonia/>)
 Krupp-Uhde - (<http://www.uhde.biz/kompetenzen/technologien/duengemittel.en.html>)

3.9 Environmental Performance

There are safety aspects in handling and storing liquid ammonia because it is toxic. The release of CO₂ is an environmental concern related to ammonia production. Often times the CO₂ is captured and sold, otherwise it is vented to the atmosphere.

3.10 Cost

The cost of ammonia is highly dependent on the feedstock price. In general, the price of ammonia has fluctuated between \$100-\$250/tonne since 1986 (Appl 2003). It is interesting to note that in 1969 the majority of the ammonia was produced in North America and Europe (54% of total worldwide production) and now Asia produces the largest fraction of ammonia (38% of the total in 1996). Table 10 gives the cost of ammonia from a few sources for different feedstocks.

Table 10: Comparison of Ammonia Economics

Study	Dietz et al 1978				Appl 2003			Eggeman 2001
	1981	1980	1980	1980	1996			
Cost year	1981	1980	1980	1980	1996			1990
Feedstock	Brava cane	Natural gas	Resid	Coal	Natural gas	Vacuum resid	Coal	Natural gas
Feedstock cost	\$9.77/dry ton	na	na	na	\$2.8/GJ	\$2.0/GJ	\$1.8/GJ	\$1.9/GJ
Ammonia (tonne/day)	91-363	900	900	900	na	na	na	1,000
Price of ammonia (\$/tonne)	\$213-314	\$215	\$271	\$314	\$206	\$248	\$362	\$161
Level of detail	Some details				Minimal details			Minimal details

3.11 R&D Needs

One way to improve the economics of ammonia synthesis is by improved heat integration and more efficient H₂ production. Additionally, advances in better low temperature ammonia synthesis catalysts with high activity and long lifetime need to be made.

3.12 References

Appl, M. (2003). "Ammonia." Ullmann's Encyclopedia of Industrial Chemistry Release 2003, 6th Edition, Wiley-VCH Verlag GmbH & Co.KGaA.

Dietz, C.K., Lutz, I.H., Roman, A. (1978) Ammonia Production from Brava Cane. *Energy From Biomass and Wastes Symposium*, August 14-18, Washington, D.C., 575-604.

Eggeman, T. (2001). "Ammonia." Kirk-Othmer Encyclopedia of Chemical Technology, John Wiley & Sons, Inc.

Ilg, J., and Kandziora, B. (1997). "Linde ammonia concept." *Ammonia Plant Safety & Related Facilities*, 37, 341-352.

Jennings, J. R., and Ward, S. A. (1989). "Ammonia Synthesis." Catalyst Handbook, M. V. Twigg, ed., Wolfe Publishing, Ltd., London, England, 384-440.

Lauriente, D.H. (2001). "Ammonia." *Chemical Economics Handbook Marketing Research Report*, SRI International, Menlo Park, CA. Report number 756.6000.

Satterfield, C. N. (1991). *Heterogeneous Catalysis in Industrial Practice*, Krieger Publishing Company, Malabar, FL.

Zardi, U. (1982). "Review These Developments in Ammonia and Methanol Reactors." *Hydrocarbon Processing*, 61(8), 129-133.

4 Methanol and Methanol Derivative (including formaldehyde, acetic acid, MTG, MTO, MOGD, TIGAS, and DME)

4.1 Summary

Currently, the majority of methanol is synthesized from syngas that is produced via steam reforming of natural gas. Catalytic methanol synthesis from syngas is a classic high-temperature, high-pressure, exothermic, equilibrium limited synthesis reaction with overall conversion efficiency of over 99%. Removing the large excess heat of reaction and overcoming the thermodynamic constraint are challenges to overcome in commercial methanol synthesis. Numerous methanol converter designs have been commercialized over the years and these can be roughly separated into two categories - adiabatic or isothermal reactors. Examples of commercially available methanol converters are described.

The first high-temperature, high-pressure methanol synthesis catalysts were ZnO/Cr₂O₃ and were operated at 350°C and 250-350 bar. Over the years, as gas purification technologies improved (i.e., removal of impurities such as sulfur, chlorine, and metals) interest in the easily poisoned Cu catalysts for methanol synthesis was renewed. In 1966, ICI introduced a new, more active Cu/ZnO/Al₂O₃ catalyst that began a new generation of methanol production by a low temperature (220-275°C), low pressure process (50-100 bar). Under normal commercial operating conditions, CuO/ZnO methanol catalysts have quite long lifetimes, up to 2-5 years. Copper catalysts are extremely sensitive to site-blocking poisons such as reduced sulfur. To retain the long-term activity of Cu catalysts, it has been found empirically that the gas-phase sulfur concentration needs to be kept below 1 ppm and preferably below 0.1 ppm. If reactor temperatures are not properly controlled, the highly exothermic methanol synthesis reactions can also rapidly cause catalyst deactivation by sintering of the Cu crystallites. Reactor temperatures are maintained below 300°C to minimize sintering. The presence of Cl in syngas has also been correlated with a greatly enhanced rate of sintering of copper crystallites most likely due to the formation of volatile copper chloride compounds. The limits on HCl content to avoid catalyst poisoning are on the order of 1 ppb.

Methanol is a commodity chemical, one of the top ten chemicals produced globally. A summary of the literature regarding the economics of methanol produced from syngas is presented. The many uses of methanol are also described. Methanol can be used directly or blended with other petroleum products as a clean burning transportation fuel. Methanol is also an important chemical intermediate used to produce a number of chemicals, including: formaldehyde, dimethyl ether, methyl tert-butyl ether, acetic acid, and olefins, to name a few. A description of the processes associated with these secondary products is presented with a summary of the available economics for each process.

Section Contents

<u>4.1 Summary</u>	29
<u>4.2 Introduction</u>	31
<u>4.3 Technology Description</u>	31
<u>4.4 Reactors</u>	32
<u>4.5 Chemistry</u>	34
<u>4.6 Catalysts</u>	35
<u>4.7 Gas Cleanliness Requirements</u>	36
<u>4.8 Status/Technology Developers</u>	38
<u>4.9 Process Performance</u>	39
<u>4.10 Uses</u>	40
<u>4.11 Environmental Performance</u>	47
<u>4.12 Cost of Methanol</u>	47
<u>4.13 R&D Needs</u>	51
<u>4.14 References</u>	52

List of Figures

<u>Figure 5: Simplified Methanol Synthesis Process Flow Diagram</u>	31
---	----

List of Tables

<u>Table 11: Commercial Methanol Synthesis Catalyst Formulations</u>	36
<u>Table 12: MeOH Gaseous Contaminant Constraints</u>	38
<u>Table 13: Methanol Technology Suppliers</u>	39
<u>Table 14: Conversions for Methanol, Methanol/DME, and DME</u>	45
<u>Table 15: Comparison of Coal Based Methanol Economic Studies</u>	48
<u>Table 16: Comparison of Biomass Based Methanol Studies</u>	49
<u>Table 17: Comparison of Formaldehyde Production Costs</u>	50
<u>Table 18: Comparison of Coal Based MTG Economic Studies</u>	51

4.2 Introduction

Methanol synthesis actually began in the 1800s with the isolation of “wood” alcohol from the dry distillation (pyrolysis) of wood. Research and development efforts at the beginning of the 20th century involving the conversion of syngas to liquid fuels and chemicals led to the discovery of a methanol synthesis process concurrently with the development of the Fischer-Tropsch synthesis. In fact, methanol is a byproduct of Fischer-Tropsch synthesis when alkali metal promoted catalysts are used. Methanol synthesis is now a well-developed commercial catalytic process with high activity and very high selectivity (>99%). For economic reasons, methanol is almost exclusively produced via reforming of natural gas (90% of the worldwide methanol, Davenport 2002). However, a variety of feedstocks other than natural gas can be used.

The long time interest in methanol is due to its potential fuel and chemical uses. In particular, methanol can be used directly or blended with other petroleum products as a clean burning transportation fuel. Methanol is also an important chemical intermediate used to produce: formaldehyde, dimethyl ether (DME), methyl tert-butyl ether (MTBE), acetic acid, olefins, methyl amines, and methyl halides, to name a few.

4.3 Technology Description

Currently, the majority of methanol is synthesized from syngas that is produced via steam reforming of natural gas. It can also be reformed using autothermal reforming (ATR) or a combination of steam methane reforming (SMR) and ATR. Once the natural gas is reformed the resulting synthesis gas is fed to a reactor vessel in the presence of a catalyst to produce methanol and water vapor. This crude methanol, which usually contains up to 18% water, plus ethanol, higher alcohols, ketones, and ethers, is fed to a distillation plant that consists of a unit that removes the volatiles and a unit that removes the water and higher alcohols. The unreacted syngas is recirculated back to the methanol converter resulting in an overall conversion efficiency of 99%. A generic methanol synthesis process flow diagram is shown in Figure 5.

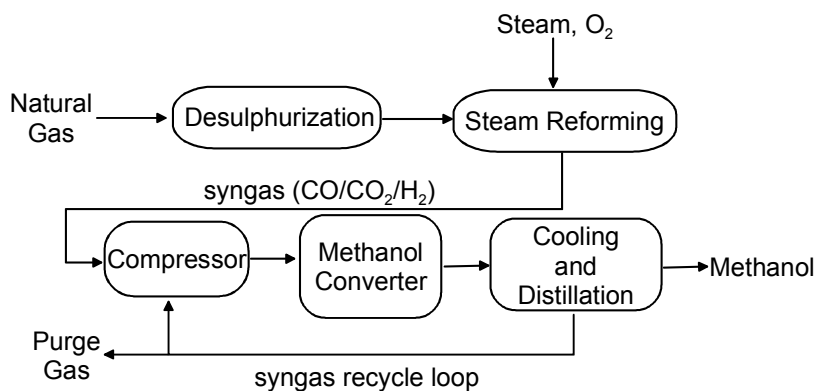

Figure 5: Simplified Methanol Synthesis Process Flow Diagram

As is the case with Fischer-Tropsch synthesis, one of the challenges associated with commercial methanol synthesis is removing the large excess heat of reaction. Methanol synthesis catalyst activity increases at higher temperatures but so does the chance for competing side reactions (Supp and Quinkler 1984). Byproducts of methanol formation are: CH₄, DME, methyl formate, higher alcohols and acetone. Catalyst lifetimes are also reduced by continuous high temperature operation and typically process temperatures are maintained below 300°C to minimize catalyst sintering.

Overcoming the thermodynamic constraint is another challenge in commercial methanol synthesis. The maximum per-pass conversion efficiency of syngas to methanol is limited to about 25% (Wender 1996). Higher conversion efficiencies per-pass can be realized at lower temperatures where the methanol equilibrium is shifted towards products; however, catalyst activities generally decrease as the temperature is lowered. Removing the methanol as it is produced is another strategy used for overcoming the thermodynamic limitations and improving the per pass conversion process efficiencies. Methanol is either physically removed (condensed out or physisorbed onto a solid) or converted to another product like dimethyl ether, methyl formate, or acetic acid.

Controlling and dissipating the heat of reaction and overcoming the equilibrium constraint to maximize the per-pass conversion efficiency are the two main process features that are considered when designing a methanol synthesis reactor, commonly referred to as a methanol converter. Numerous methanol converter designs have been commercialized over the years and these can be roughly separated into two categories - adiabatic or isothermal reactors. Adiabatic reactors often contain multiple catalyst beds separated by gas cooling devices, either direct heat exchange or injection of cooled, fresh or recycled, syngas. Axial temperature profiles often have a sawtooth pattern that is low at the point of heat removal and increases linearly between the heat exchange sections. The isothermal reactors are designed to continuously remove the heat of reaction so they operate essentially like a heat exchanger with an isothermal axial temperature profile. The following section describes some of the many methanol converter designs found in the literature.

4.4 Reactors

One of the more widely used commercial isothermal methanol converters is the Lurgi Methanol Converter (Haid and Koss 2001; Supp and Quinkler 1984). It is a shell and tube design similar to their Fischer Tropsch (FT) reactor. The tubes contain a proprietary Lurgi methanol catalyst (Cu/ZnO/Cr₂O₃ + promoters) and are surrounded by boiling water for reaction heat removal. These units operate at 50-100 bar and 230-265°C. Varying the pressure of the boiling water controls the reactor temperature. Byproduct steam is produced at 40-50 bar and can be used to run the compressor or to provide heat for the distillation process.

The ICI Low pressure Quench Converter (Pinto and Rogerson 1977; Rogerson 1971; Rogerson 1984) is the most widely used adiabatic methanol converter. It is operated at 50-100 bar and 270°C. The Cu/ZnO/Al₂O₃ catalyst is contained in a single bed supported

by an inert material. Adding cold fresh and recycled syngas quenches the synthesis reaction and controls the reaction temperature. The gas is injected at appropriate depths within the reactor through spargers called lozenges. There are horizontal layers of these lozenges that run across the converter from side to side and each has an outer surface covered with wire mesh and a central pipe that delivers the cold gas. ICI has an improved version of this reactor known as an ARC converter. The main technical difference is that instead of a single continuous catalyst bed, the bed is separated by distribution plates to form multiple consecutive catalyst domains.

Kellogg, Brown, and Root (now Halliburton) has developed an adiabatic methanol converter that has multiple fixed bed reactors arranged in series and separated by heat exchangers. All of the recycled syngas is fed directly into the first reactor stage. The reactors have a spherical geometry to reduce construction costs and they also use less catalyst compared to the ICI Quench Converter. The Haldor-Topsoe Collect, Mix, Distribute (CMD) converter operates on a similar principle. Vertical support beams separate catalyst beds. The gas inlet at the bottom of the reactor provides fresh syngas that flows radially up through the first catalyst bed. At the top of the reactor, this first pass through gas is mixed with quench gas and distributed evenly so that it flows radially down through the second catalyst bed (Dybkjaer 1981). The cited benefit of this design is an increase in per-pass conversion. Toyo Engineering Corporation has designed another version of a multistage radial flow methanol converter (MRF-Z™) that uses bayonet boiler tubes for intermediate cooling. The tubes divide the catalyst into concentric beds.

The Tube Cooled Converter is a reactor design that is simple to operate. The syngas enters at the bottom of the reactor where a manifold distributes the gas through tubes that act as a heat exchanger prior to the gas entering the catalyst bed. The Linde isothermal reactor, known as the Variobar converter, has the unique design feature of using coiled helical tubes embedded in the catalyst bed for heat removal. Spacers separate the multi-layer coils and boiling water is circulated through the tubes. Mitsubishi Gas Chemical in collaboration with Mitsubishi Heavy Industry has developed an isothermal reactor known as the MGC/MHI Superconverter (Takase and Niwa 1985). This reactor design uses double-walled tubes that are filled with catalyst in the annular space between the inner and outer tubes. The feed syngas enters the inner tubes and is heated as it progresses through the tube. The gas then passes downward through the catalyst bed in the annular space. Heat is removed on both sides of the catalyst bed by the boiling water surrounding the tubes as well as by the feed gas introduced into the inner tube (Tijm et al. 2001). A high conversion rate (about 14 % methanol in the reactor outlet) is cited for this reactor (Fiedler et al. 2003).

Additional methanol converter designs include technologies using three phase systems similar in principle to the slurry reactors used for Fischer Tropsch synthesis (FTS). These technologies are collectively known as Liquid Phase Methanol Synthesis. ChemSystems, Inc. and Air Products and Chemicals, Inc. with Department of Energy funding developed a liquid-entrained catalytic reactor for converting low $H_2/(CO + CO_2)$ ratio syngas into methanol known as LPMEOH™ (Bhatt et al. 1999; DOE 1992). The ability to convert low stoichiometric ratio (CO rich) syngas lends itself to using syngas

from coal or biomass gasification for methanol production. The three-phase slurry reactor provides better temperature control by uniformly dissipating the heat of reaction into the high heat capacity liquid. The LPMEOH™ process uses a supported Cu/ZnO catalyst (20-45 wt%) dispersed in circulating mineral oil with reactor temperatures of 225-265°C and a pressure of 50 bar. Brookhaven National Laboratory has also developed a liquid phase methanol synthesis process that can be operated at lower pressures (< 5 atm) with up to 90% conversion without syngas recycling (Tijm et al. 2001). This work has been done in collaboration with Amoco and in 1998 a 50 ml mini-pilot plant was successfully operated.

Two other methanol conversion processes are based on systems in which the product methanol is continuously removed from the gas phase by selective adsorption on a solid or in a liquid. The Gas-Solid-Solid Trickle Flow Reactor (GSSTFR) utilizes an adsorbent such as SiO₂/Al₂O₃ to trap the product methanol (Herman 1991; Pass et al. 1990). The solid adsorbent is collected in holding tanks and the methanol is desorbed. In the Reactor System with Interstage Product Removal (RSIPR), a liquid solvent is used to adsorb the product methanol (Herman 1991).

4.5 Chemistry

Catalytic methanol synthesis from syngas is a classic high-temperature, high-pressure exothermic equilibrium limited synthesis reaction. The chemistry of methanol synthesis is as follows (Rostrup-Nielsen 2000):



For methanol synthesis, a stoichiometric ratio, defined as (H₂ – CO₂)/(CO + CO₂), of about 2 is preferred. This means that there will be just the stoichiometric amount of hydrogen needed for methanol synthesis. For kinetic reasons and in order to control by-products, a value slightly above 2 is normally preferred (Dybkjaer and Christensen 2001).

Although methanol is made from mixtures of H₂ and CO, the reaction is about 100 times slower than when CO₂ is present (Wender 1996). Until as recently as the 1990s the role of CO₂ in methanol synthesis was not clear. The water gas shift (WGS) activity of Cu catalysts is so high that it was difficult to deconvolute the role of CO and CO₂ in methanol synthesis. Isotopic labeling studies have unequivocally proved that CO₂ is the source of C in methanol (Ladebeck 1993; Wender 1996). CO is involved in the reverse WGS reaction to make H₂ and CO₂. CO₂ is also thought to keep the catalyst in an intermediate oxidation state Cu⁰/Cu⁺ preventing ZnO reduction followed by brass formation (Ladebeck 1993). The proposed mechanism for catalytic methanol synthesis is believed to proceed through a long-lived formate intermediate. CO₂ is adsorbed on a partially oxidized metal surface as a carbonate and hydrogenated. This intermediate is

then hydrogenated in the rate-limiting step. The copper catalyst sites have high activity for splitting the first C-O bond in CO₂ that helps maintain the oxidation state of the active copper sites. At high concentrations, however, CO₂ actually reduces catalyst activity by inhibiting methanol synthesis. The feed gas composition for methanol synthesis is typically adjusted to contain 4-8% CO₂ for maximum activity and selectivity. Even though Cu has WGS activity, excessive amounts of H₂O also leads to active site blocking that is poor for activity but improves selectivity by reducing byproduct formation by 50% (Chinchen et al. 1990).

4.6 Catalysts

The first high-temperature, high-pressure methanol synthesis catalysts were ZnO/Cr₂O₃ and were operated at 350°C and 250-350 bar. Catalyst compositions contained 20-75 atom% Zn. These catalysts demonstrated high activity and selectivity for methanol synthesis and proved robust enough to resist sulfur poisoning which is inherent when generating syngas from coal gasification. Over the years, as gas purification technologies improved (i.e., removal of impurities such as sulfur, chlorine, and metals), interest in the easily poisoned Cu catalysts for methanol synthesis was renewed. In 1966, ICI introduced a new, more active Cu/ZnO/Al₂O₃ catalyst that began a new generation of methanol production by using a low temperature (220-275°C), low pressure process (50-100 bar). The last high temperature methanol synthesis plant closed in the mid-1980s (Fiedler et al. 2003) and, at present, low temperature low pressure processes based on Cu catalysts are used for all commercial production of methanol from syngas. The synthesis process has been optimized to point that modern methanol plants yield 1 kg of MeOH /liter of catalyst/hr with >99.5% selectivity for methanol. Commercial methanol synthesis catalysts have lifetimes on the order of 3-5 years under normal operating conditions.

The Cu crystallites in methanol synthesis catalysts have been identified as the active catalytic sites although the actual state (oxide, metallic, etc.) of the active Cu site is still being debated. The most active catalysts all have high Cu content, optimum ~60% Cu that is limited by the need to have enough refractory oxide to prevent sintering of the Cu crystallites. The ZnO in the catalyst formulation creates a high Cu metal surface area; it is suitably refractory at methanol synthesis temperatures and hinders the agglomeration of Cu particles. ZnO also interacts with Al₂O₃ to form a spinel that provides a robust catalyst support. Acidic materials like alumina, are known to catalyze methanol dehydration reactions to produce DME. By interacting with the Al₂O₃ support material, the ZnO effectively improves methanol selectivity by reducing the potential for DME formation.

Catalysts are typically prepared by the co-precipitation of metal salts (such as nitrates or sulfates) with a variety of precipitating agents. It is important to avoid contaminating methanol catalysts with metals that have FT activity (Fe or Ni) during synthesis. Incorporation of alkali metals in catalyst formulations should also be avoided because they catalyze the increased production of higher alcohols. Table 11 shows catalyst formulations for the many commercial manufacturers.

Table 11: Commercial Methanol Synthesis Catalyst Formulations

Manufacturer	Cu at%	Zn at%	Al at%	Other	Patent date
IFP	45-70	15-35	4-20	Zr – 2-18	1987
ICI	20-35	15-50	4-20	Mg	1965
BASF	38.5	48.8	12.9		1978
Shell	71	24		Rare Earth oxide –5	1973
Sud Chemie	65	22	12		1987
Dupont	50	19	31		none found
United Catalysts	62	21	17		none found
Haldor Topsoe MK-121	> 55	21-25	8-10		none found

Additional catalyst formulations have been presented in the literature with the purpose of improving per-pass methanol yields (Klier 1982). The addition of Cs to Cu/ZnO mixtures has shown improved methanol synthesis yields. This only holds true for the heavier alkali metals, as the addition of K to methanol synthesis catalysts tends to enhance higher alcohol yields. Cu/ThO₂ intermetallic catalysts have also been investigated for methanol synthesis (Klier 1982). These catalysts have demonstrated high activity for forming methanol from CO₂-free syngas. Thoria based methanol catalysts deactivate very rapidly in the presence of CO₂. Cu/Zr catalysts have proven active for methanol synthesis in CO-free syngas at 5 atm and 160-300°C (Herman 1991). Supported Pd catalysts have also demonstrated methanol synthesis activity in CO₂-free syngas a 5 -110 atm at 260-350°C.

4.7 Gas Cleanliness Requirements

Through the years, methanol catalysts have been optimized for maximum selectivity, spacetime yields, and long service life, but they still deactivate (Wender 1996). Nevertheless, under normal commercial operating conditions, CuO/ZnO methanol catalysts have quite long lifetimes, up to 2-5 years. Increasing the process operating temperature to maintain activity and yield compensates for progressive catalyst deactivation.

Copper has a very low activity for breaking C-O bonds or forming C-C bonds. As a result, in methanol synthesis, wax formation is not usually a major problem nor is formation of coke from hydrocarbons (Twigg and Spencer 2001). Cu catalysts also do not have a strong tendency to catalyze FT reactions, or processes involving carbonium ion chemistry. Therefore, the major causes of methanol catalyst deactivation are poisoning and Cu sintering that results in loss of Cu surface area.

Copper catalysts are extremely sensitive to site-blocking poisons such as reduced sulfur. To retain the long-term activity of Cu catalysts, it has been found empirically that the gas-phase sulfur concentration needs to be kept below 1 ppm and preferably below 0.1

ppm. High partial pressures of water vapor also inhibit the reaction, presumably by competitive adsorption on active sites.

Interestingly enough, the catalyst's formulation itself tends to reduce the effects of sulfur poisoning. The ZnO in the catalyst is very effective in limiting poisoning of copper catalysts because it acts as a poison sink, diverting the poisons away from the active Cu sites and scavenging the sulfur out of the gas stream by forming ZnS and ZnSO₄. Commercial Cu-ZnO catalysts can absorb 0.4 wt% sulfur and still maintain 70% of their activity (Kung 1992). This helps to extend the catalyst lifetime.

As it turns out, COS is not a gas phase methanol catalyst poison. Studies have shown that COS does not cause any deactivation over a concentration range of 0.6-9 ppm. The Cu/ZnO catalysts have no activity for COS adsorption or dissociation and at methanol synthesis conditions, COS does not react with H₂ to form H₂S (Kung 1992). Gas phase COS does not pose a catalyst poisoning problem, however, it becomes a serious catalyst poison in the liquid phase methanol synthesis process.

If reactor temperatures are not properly controlled, the highly exothermic methanol synthesis reactions can rapidly cause catalyst deactivation by sintering of the Cu crystallites. Reactor temperatures are maintained below 300°C to minimize sintering.

The presence of Cl in syngas has also been correlated with a greatly enhanced rate of sintering of copper crystallites most likely due to the formation of volatile copper chloride compounds. The mechanism of Cl poisoning can be explained by adsorbed Cl atoms that block or modify active catalyst sites. The Cl interacts with the Cu by forming CuCl₂ that has a low melting point and high surface mobility that accelerates catalysts sintering. The presence of trace amounts of chlorine also causes enhanced sulfur poisoning, probably because Zn chlorides also form removing these sites as possible sinks for sulfur capture. The limits on HCl content to avoid catalyst poisoning are more severe than for H₂S poisoning, on the order of 1 ppb (Twigg and Spencer 2001).

Other gas phase poisons in syngas that need to be avoided are metal carbonyls, particularly Ni and Fe carbonyls. Trace amounts of metal carbonyl compounds could be present in feed streams, especially in laboratory experiments where stainless steel tubing is used. Volatile metal carbonyl compounds deposit on the catalyst surface and block active sites. The deposition of Fe and Ni carbonyls affects the selectivity of the methanol catalysts. Ni increases the production of CH₄ and Fe increases the production of FT products. Metal carbonyl concentrations should be below 5 ppb (Wender 1996).

The purity of catalyst formulations is also critical to insure optimum activity and selectivity of methanol synthesis catalysts. It is very important to eliminate Ni and Fe impurities in catalyst precursors during catalyst formulation. These impurities in methanol synthesis catalysts reduce the selectivity and increase the yield of CH₄ and FT hydrocarbon products. Alkali metals should also be avoided because these reduce overall catalyst activity and increase the production of higher alcohols. Unwanted SiO₂ in the catalyst promotes wax formation and unreacted (non-spinel) alumina enhances DME formation. Other poisons to be avoided are As and P.

Maintaining low levels of sulfur in the syngas used to produce methanol is typically not a problem. Most syngas used for methanol synthesis is produced from steam reforming of methane over Ni catalysts that are very intolerant of sulfur. Therefore, sulfur compounds in the feedstock will normally be reduced to below 0.1 ppm by desulfurization prior to the primary reformer in hydrogen, ammonia, and methanol plants. Poisoning by chlorine or other compounds is also negligible in normal plant operation, because these are removed by the earlier stages of generation of synthesis gas. A summary of the gas cleanliness requirements for gas phase and liquid phase methanol production are in Table 12.

Table 12: MeOH Gaseous Contaminant Constraints

Gas phase	ppmv	Reference	LPMeOH (Novem 2000)	ppmv
Sulfur (not COS)	<0.5 (<0.1 preferred)	Kung, 1992	Sulfur (including OCS)	0.1
Halides	0.001	Twigg and Spencer 2001	Total halides	0.01
Fe and Ni	0.005	Kung, 1992	Acetylene	5
			Total unsaturates	300
			NH ₃	10
			HCN	0.01
			Fe and Ni	0.01

4.8 Status/Technology Developers

BASF of Germany introduced the first commercial methanol synthesis route in 1923 at pressures of 250-350 atm (3,675-5,145 psi). Plants operated at high pressures until low-pressure routes were developed and by the early 1980s the majority of the producers had switched from the high-pressure process to a low pressure one. This was done because the low-pressure process is more efficient, has a lower capital cost, and is less expensive to operate. ICI and Lurgi offer the two most widely used low-pressure processes (Davenport 2002). Low-pressure technologies are also offered by Mitsubishi Gas Chemical Company, Inc. of Japan, jointly by Haldor-Topsoe of Denmark and Nihon Suiso Kogyo of Japan, and by Halliburton. Table 13 presents the process conditions for each supplier.

Table 13: Methanol Technology Suppliers

Technology supplier	T (C)	P (atm)	Notes
ICI (Syntex)	210-290	50-100	Currently licenses 4 types of reactors: ARC, Tubular Cooled, Isothermal Linde, and Toyo (see reactor section for details)
Lurgi	230-265	50-100	Tubular, isothermal reactor
Mitsubishi	240	77-97	Tubular, isothermal reactor
Haldor-Topsoe & Nihon	260	48-300	To date, no commercial plants based on this process.
Halliburton (Kellogg, Brown & Root)	not found	not found	Spherical reactor geometry

Source: (Davenport 2002; Dybkjaer and Christensen 2001; Fiedler et al. 2003; Lee 1990; Takase and Niwa 1985; Tijm et al. 2001)

The world's largest producer of methanol is Methanex; they account for 17% of the total global capacity (Davenport 2002). The next largest producer is SABIC which accounts for 6.5% of the total global capacity (Davenport 2002). As of January 1, 2002, worldwide annual capacity of methanol was 12.8 billion gallons (38 million tonnes, 9 million GJ) (Davenport 2002). In 2001, the U.S. consumed 28% of the total world methanol while North America produced 20% of the world supply (Davenport 2002). There are 18 methanol production plants in the U.S. (Lidderdale 2001).

Recently, Lurgi won a contract to build a methanol plant for National Petrochemical's subsidiary Zagros Petrochemical in Bandar Assaluye, Iran. The capacity will be 1.8 million tonnes/yr., making it the largest methanol unit in the world. It is expected to begin operation in 2004 [<http://www.qipc.net/news/june/jun0051.htm>].

Liquid phase methanol synthesis (LPMeOH) was invented in late 1970s (Hamelinck and Faaij 2001) and developed in the 1980s (Bhatt et al. 1999). In the 1980s, Air Products and Chemicals, Inc. tested this technology at a pilot-scale facility with an output of 8 tpd of methanol in LaPorte, TX. Later, a 260 TDP LPMeOH demonstration plant was built in Kingsport, TN and began operation in 1997 (Bhatt et al. 1999). It was a joint venture between Eastman Chemical Company and Air Products and Chemicals, Inc. (Wender 1996).

4.9 Process Performance

Converting syngas to methanol in commercial units is limited by thermodynamic considerations to about 25% per-pass (Wender 1996). Lurgi's multitubular reactor produces close to 1 kg of methanol per liter of catalyst per hour. The actual per-pass conversion of methanol is only 4-7 vol% (Wender 1996). Removal of methanol would increase per-pass conversions. Another way to increase the conversion is in situ dehydration of methanol to DME. Generally, 100 tons of methanol is converted to nearly 44 tons of hydrocarbons and 56 tons of water (Maiden 1983; Wender 1996).

4.10 Uses

Globally, formaldehyde production is the largest consumer of methanol (35% of worldwide methanol) (Davenport 2002). This is followed by MTBE at 25%. The third largest consumer is acetic acid at 9% (Davenport 2002). The following sections discuss the uses of methanol.

4.10.1 Formaldehyde

Formaldehyde was first commercially produced in 1890 in Germany by the catalytic partial oxidation of methanol with air over an unsupported Cu catalyst at atmospheric pressure (Satterfield 1991). By the beginning of the 20th century, Cu was replaced by Ag as the catalyst of choice because yields were better. Use of Iron molybdate catalysts began in the 1940s (Satterfield 1991).

Formaldehyde produced over Ag catalysts proceeds via methanol dehydrogenation and partial oxidation according to the following reactions: (Chen and Masel 1995; Ruf and Emig 1999):

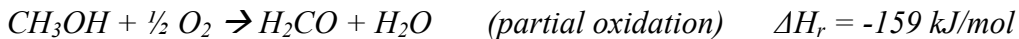
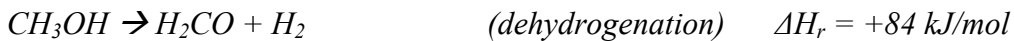

For the Ag catalyst process, a 50% methanol mixture in air is passed through a thin, fixed bed at 600°C and slightly above atmospheric pressure. Metallic Ag is not active for methanol decomposition. The active Ag site requires chemisorbed oxygen, which provides a site for methanol adsorption.

For the iron molybdate $[\text{Fe}_2(\text{MoO}_4)_3]$ process, a lean methanol-air mixture is used. This reaction is more exothermic than the Ag process so heat removal is required (Satterfield 1991). The catalyst temperature is about 340-380°C. Excessive reactor temperatures cause volatilization of molybdenum oxide, which reduces the selectivity of the process. A high oxygen partial pressure is required to maintain catalyst activity and in the presence of excess methanol catalyst activity is lost.

Formaldehyde is produced commercially from methanol by three industrial processes (Reuss et al. 2003):

1. Partial oxidation and dehydrogenation with air in the presence of silver crystals, steam, and excess methanol at a temperature of 680-720 °C, otherwise known as the BASF process. The methanol conversion for this process is 97-98%.
2. The same as process 1 except in the presence of crystalline silver or silver gauze at a temperature of 600-650 °C. Then, the product is distilled and the unreacted methanol is recycled. The primary methanol conversion for this process is 77-87%.

3. Oxidation with only excess air in the presence of a modified iron/molybdenum/vanadium oxide catalyst at a temperature of 250-400 °C, also known as the Formox process. The methanol conversion for this process is 98-99%.

Formaldehyde is used to make resins with phenol, urea, or melamine for the manufacture of various construction board products. The demand for formaldehyde is driven by the construction industry.

4.10.2 MTBE (Methyl Tertiary-Butyl Ether)

In general, greater than 95% of the MTBE produced is used in the gasoline pool. MTBE is also used in the petrochemical industry for the production of isobutene. Additionally, it can be used in a number of chemical reactions including methacrolein, methacrylic acid, or isoprene production. One other use is solvent dewaxing of hydrocarbon oils (Peters et al. 2003).

MTBE is produced by reacting isobutene with methanol in the presence of an acidic catalyst according to the following slightly exothermic reaction:



The reaction temperature and pressure are 30-100°C and 7-14 atm (100-200 psig), respectively (Schädlich et al. 2003), so that the reaction occurs in the liquid phase. Catalysts used are solid acids, zeolites (H-ZSM-5), and macroporous sulfonic acid ion-exchange resins such as Amberlyst-15 (Collignon et al. 1999). A molar excess of methanol is used to increase isobutene conversion and inhibit the dimerization and oligomerization of isobutene. At optimum reaction conditions, MTBE yields approaching 90% can be achieved.

In general, most commercially available processes are similar, consisting of a reaction and a refining section. In addition to the Snamprogetti and Hüls (now Oxeno) processes, processes have been developed by Arco, IFP, CDTECH (ABB Lummus Crest and Chemical Research Licensing), DEA (formerly Deutsche Texaco), Shell (Netherlands), Phillips Petroleum, and Sumitomo (Peters et al. 2003). Currently, there are over 140 MTBE plants with a total installed capacity of about 20 million tonnes/yr.

The largest demand for MTBE has [primarily] been in the U.S., with North America consuming roughly 65% of the worldwide production of MTBE. U.S. consumption increased substantially with the Clean Air Act Amendments of 1990. Recently, however, MTBE has come under environmental attack because of leaky tanks and groundwater contamination. In fact, California planned to ban MTBE from gasoline by January 1, 2003 but the ban has been pushed back a year. Recently, Alberta Envirofuels closed its 800,000 tonne/yr MTBE plant located in Edmonton, Canada (2002). They plan to convert the plant into an iso-octane facility (a gasoline additive that is an alternative to MTBE) at a cost of \$50 million. With the reduction and possibly elimination of MTBE in gasoline, a worldwide decline in the demand for MTBE of about 3-5% is predicted (Davenport 2002).

4.10.3 Acetic Acid

The third most abundant chemical synthesized from methanol is acetic acid ($\text{CH}_3\text{OH} + \text{CO} \rightarrow \text{CH}_3\text{COOH}$). Vinyl acetate, acetic anhydride and terephthalic acid are all manufactured from acetic acid. Latex emulsion resins for paints, adhesives, paper coatings, and textile finishing agents are made from vinyl acetate. Acetic anhydride is used in making cellulose acetate fibers and cellulosic plastics. In terms of world production of acetic acid, approximately one-half comes from methanol carbonylation and about one-third from acetaldehyde oxidation (Wagner 2002). Cheung et al. 2003 states that there is little doubt that the technology of the future is methanol carbonylation. In 1999, the worldwide demand for acetic acid was 2.8 million tonnes (6.17×10^9 lb) (Wagner 2002).

Acetic acid is produced by the carbonylation of methanol with CO in the liquid phase using Co, Rh, or Ni catalysts promoted by iodine. The synthesis of acetic acid by carbonylation of methanol is one of the most important industrial applications of homogeneous catalysis (Roper 1991). Two processes have been developed based on this homogeneous catalytic synthesis. One is the BASF process (which is the older of the two) which uses a Co/iodine catalyst at process conditions of 250°C and 500-700 atm (3,000-10,000 psig) with 90% selectivity to acetic acid (from methanol). The second is the Monsanto process, which uses an Rh/iodine catalyst at process conditions of 180°C and 30-40 atm with over 99% selectivity. This liquid phase process is initiated by the reaction of methanol with HI to yield methyl iodide. The active catalyst in the process is the metal carbonyl $[\text{RhI}_2(\text{CO})_2]^-$ into which methyl iodide is inserted in the rate-limiting step. Acetic acid is formed by the hydrolysis of the eliminated acetyl iodide species CH_3COI that also regenerates HI (King and Grate 1985).

The second, less severe Monsanto process has displaced the BASF process and all new installed capacity since 1973 is based on the Monsanto process (SRI 1994). The catalytic system is very corrosive and requires expensive steels for materials of construction. Complete recovery of the expensive Rh catalyst ($\sim 10^{-3}$ M) and recycle of HI (~ 0.1 M) is paramount to maintain favorable process economics. The high cost of Rh has led to the search for other, lower cost, metals that could be used as acetic acid catalysts with similar performance.

4.10.4 Methanol to Gasoline (MTG)

The methanol to gasoline (MTG) process developed by Mobil Oil Corporation involves the conversion of methanol to hydrocarbons over zeolite catalysts. The MTG process, although considered the first major new synthetic fuel development since FTS, was discovered by accident in the 1970s by two independent groups of Mobil scientists trying to convert methanol to ethylene oxide and attempting to methylate isobutene with methanol over a ZSM-5 zeolite catalyst (Keil 1999).

The MTG process occurs in two steps. First, crude methanol (17% water) is super-heated to 300°C and partially dehydrated over an alumina catalyst at 27 atm to yield an equilibrium mixture of methanol, dimethyl ether, and water (75% of the methanol is

converted). This effluent is then mixed with heated recycled syngas and introduced into a reactor containing ZSM-5 zeolite catalyst at 350-366°C and 19-23 atm to produce hydrocarbons (44%) and water (56%) (Hancock 1985). The overall MTG process usually contains multiple gasoline conversion reactors in parallel because the zeolites have to be regenerated frequently to burn off the coke formed during the reaction. The reactors are then cycled so that individual reactors can be regenerated without stopping the process, usually every 2-6 weeks (Kam et al. 1984).

The MTG reactions may be summarized as follows (Wender 1996):

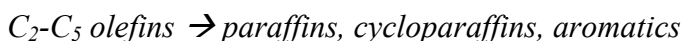
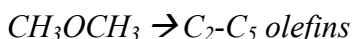

The selectivity to gasoline range hydrocarbons is greater than 85% with the remainder of the product being primarily LPG (Wender 1996). Nearly 40% of the gasoline produced from the MTG process is aromatic hydrocarbons with the following distribution: 4% benzene, 26% toluene, 2% ethylbenzene, 43% xylenes, 14% trimethyl substituted benzenes, plus 12% other aromatics (Wender 1996). The shape selectivity of the zeolite catalyst results in a relatively high durene (1,2,4,5-tetramethylbenzene) concentration, 3-5% of the gasoline produced (MacDougall 1991). Therefore, MTG gasoline is usually distilled and the heavy fraction is processed in the heavy gasoline treating unit to reduce the durene concentration to below 2%. This results in a high quality gasoline with a high octane number. The MTG process may no longer be a good option for gasoline production because the 1990 Clean Air Act Amendments limits the amount of aromatics in reformulated gasoline in order to reduce air toxics. In California, the amount of total aromatics is limited to 25 vol% (Owen and Coley 1995).

The first commercial MTG plant came onstream in 1985 in New Zealand (Mobil's Motunui plant), producing both methanol and high octane gasoline from natural gas. Plant production averaged 14,500 BPD of gasoline until 1997, at which time gasoline manufacturing was abandoned and the plant produced only methanol. No information could be found regarding the reason for abandoning the manufacture of gasoline, but it is most likely due to economic factors such as the cost of oil and the market price of methanol. Presently this plant, along with a nearby methanol plant at Waitara produces, 2.43 million tonnes per year of chemical grade methanol for export [<http://www.techhistory.co.nz/pages/Petrochemical%20Decisions.htm>].

A fluid bed MTG plant was jointly designed and operated near Cologne, Germany by Mobil Research and Development Corp., Union Rheinische Braunkohlen Kraftstoff AG and Uhde Gmb (Keil 1999). A demonstration plant (15.9 m³/day) operated from 1982 to 1985. Although, no commercial plants have been built, the fluid bed technology is ready for commercialization.

4.10.5 Methanol to Olefins (MTO) and Methanol to Gasoline and Diesel (MOGD)

Along with the MTG process, Mobil developed several other processes for converting methanol to hydrocarbons based on zeolite catalysts. Since light olefins are intermediates in the MTG process, it is possible to optimize the methanol to olefins (MTO) synthesis. Higher reaction temperatures ($\sim 500^{\circ}\text{C}$), lower pressures, and lower catalyst (acidity) activity favors light olefin production (Keil 1999). The rate of olefin production could be modified so that 80% of the product consists of C_2 to C_5 olefins rich in propylene (32%) and butenes (20%) with an aromatic rich C_5+ gasoline fraction (36%) (MacDougall 1991; Wender 1996). The process can also be modified for high ethylene and propylene yield ($>60\%$).

Mobil also developed a methanol to gasoline and diesel (MOGD) process. Oligomerization, disproportionation and aromatization of the olefins produced in the MTO synthesis are the basis for the MOGD process. In the MOGD process, the selectivity of gasoline and distillate from olefins is greater than 95% (Keil 1999). One source gives the gasoline product from MOGD to be: 3 wt% paraffins, 94 wt% olefins, 1 wt% naphthenes, and 2 wt% aromatics (Tabak and Yurchak 1990). A large-scale test run was performed at a Mobil refinery in 1981.

Neither the MTO nor the MOGD process is currently in commercial practice (Wender 1996). However, UOP and HYDRO of Norway, does license their own methanol to olefins process where the primary products are ethylene and propylene [http://www.uop.com/petrochemicals/processes_products/mto_intro.htm and (Keil 1999)]. They use a fluidized bed reactor at $400 - 450^{\circ}\text{C}$ and achieve roughly 80% carbon selectivity to olefins at nearly complete methanol conversion (Apanel and Netzer 2002). The operating parameters can be adjusted so that either more ethylene is produced (48 wt% ethylene, 31 wt% propylene, 9 wt% butenes and 1.5 wt% other olefins) or else more propylene (45 wt% propylene, 34 wt% ethylene, 12 wt% butenes and 0.75 wt% other olefins).

4.10.6 TIGAS (Topsoe Integrated Gasoline Synthesis)

The Topsoe Integrated Gasoline Synthesis (TIGAS) process was developed by Haldor Topsoe with the intent of minimizing capital and energy costs by integrating methanol synthesis with the MTG step into a single loop, without isolation of methanol as an intermediate (Keil 1999; Topp-Jorgensen 1987; Topp-Jorgensen 1988). This process was developed with the idea that future plants would be constructed in remote areas for recovery of low cost natural gas. In Mobil's MTG process, different pressures are preferred for syngas production, methanol synthesis, and the fixed bed MTG step. These pressures are 15-20 atm (221-294 psi), 50-100 atm (735-1470 psi), and 15-25 atm (221-368 psi), respectively (Wender 1996). The TIGAS process involves modified catalysts and conditions so that the system pressure levels out and separate compression steps are not required. In order to do this, a mixture of methanol and DME is made prior to gasoline synthesis. This approach results in only one recycle loop which goes from the gasoline synthesis step back to the MeOH/DME synthesis step. A 1 MTPD demonstration plant was built in Houston, Texas in 1984 and operated for 3 years (Topp-

Jorgensen 1988). The gasoline yield for the TIGAS process, defined as the amount of gasoline produced divided by the amount of natural gas feed and fuel, was shown to be 56.5 wt% (Topp-Jorgensen 1988). Because of a reduced selectivity to gasoline range aromatics, the TIGAS process, however, yields a lower quality gasoline with a lower octane number, compared to MTG (MacDougall 1991).

4.10.7 DME (Dimethyl Ether)

DME is industrially important as the starting material in the production of the methylating agent dimethyl sulfate. It is also used as an aerosol propellant. DME has the potential to be used as a diesel or cooking fuel, a refrigerant, or a chemical feedstock (Gunda et al. 1995; Peng et al. 1999b; Shikada et al. 1999). Commercial production of DME originated as a byproduct of high-pressure methanol production.

DME is formed in a two-step process where first, methanol is synthesized, then it is dehydrated over an acid catalyst such as γ -alumina at methanol synthesis conditions. The DME reaction scheme is as follows (Hansen and Joensen 1991; Peng et al. 1999a):

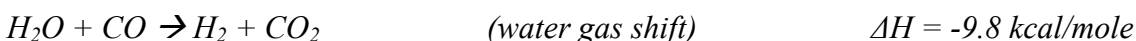

Note that one product in each reaction is consumed by another reaction. Because of the synergy between these reactions, syngas conversion to DME gives higher conversions than syngas conversion to methanol. Shikada et al. 1999 gives the per-pass and total conversion for the synthesis of methanol, methanol/DME and DME to be:

Table 14: Conversions for Methanol, Methanol/DME, and DME

Conversion	MeOH	MeOH/DME	DME
Per-pass (%)	14	18	50
Total (%)	77	85	95

The optimum $H_2:CO$ ratio for DME synthesis is lower than that for methanol synthesis and, ideally, should be around one (Peng et al. 1999a; Peng et al. 1999b; Shikada et al. 1999). Recent improvements to the DME synthesis process involve the development of bifunctional catalysts to produce DME in a single gas phase step (i.e., one reactor) (Ge et al. 1998; Peng et al. 1999b) or the use of a slurry reactor for liquid phase dimethyl ether (LPDME) synthesis (Brown et al. 1991; Sardesai and Lee 1998).

4.10.8 M100 and M85

Neat methanol (M100) has many desirable properties that make it an attractive alternative to petroleum gasoline. It has a high heat of vaporization and relatively low heating value (about half of gasoline) that leads to a lower flame temperature compared to gasoline. This results in lower CO, NO_x, and hydrocarbons emissions, but higher formaldehyde emissions. In general, neat methanol has only found use as a motor fuel in high-performance racing engines and in airplanes that have been fully modified and adapted to operate on methanol (Fiedler et al. 2003). This includes replacing plastic components in the fuel system, modifying the carburetor or fuel injection system, and preheating the fuel mixture.

Methanol is miscible in water and in low concentration methanol mixtures, phase separation can occur. Methanol is also more corrosive than gasoline, however, it is less toxic and is not carcinogenic. Methanol was used as a gasoline blending agent prior to the mid-1980s. After that time, the EPA prohibited use of methanol in unleaded gasoline without the use of a cosolvent alcohol (Davenport et al. 2002). This was done, primarily, because methanol exhibits poor solubility in gasoline and has phase separation problems. However, there has been some success with M85, a mixture of methanol and gasoline (85 vol%/15 vol%, respectively). Methanol is most commonly used in a mixture with 15% gasoline. This is done for two reasons: (1) a methanol flame is colorless, so gasoline is added to give the flame some color so that a fire can be detected in the event of a vehicle crash and (2) neat methanol can cause cold-start problems in the winter, or vapor lock in the summer [<http://www.altfuels.org/m85.html>]. Although automobiles have been manufactured to operate on M85, and some fleets continue to use M85, this fuel has failed to develop on a large-scale. Contributing factors include adverse consumer perceptions coupled with a lack of sufficient infrastructure, even though only small changes are required at gasoline fueling station (e.g., linings and seals in tanks, pumps, and dispensers) in order to handle M85 (Davenport et al. 2002).

M100 is also being targeted for use in direct methanol fuel cells (DMFC), for fuel cell vehicle applications. DMFCs allow the use of methanol as fuel without requiring a fuel processor to extract hydrogen from the methanol. Significant progress has been made on finding better electrolyte material to prevent methanol crossover through the membrane. Operating temperatures of direct methanol fuel cells has increased to nearly 100°C. Improved anode catalysts have facilitated methanol oxidation and eliminated the need for an on-board hydrogen reformer. Several automakers have developed methanol powered fuel cell vehicles and currently, DaimlerChrysler and Honda both have two prototype direct methanol fuel cell vehicles. In fact, in 2002 one of DaimlerChrysler's vehicles (NECAR 5) completed a 3,000 miles cross-country trip across the U.S.

4.11 Environmental Performance

Methanol is stable under normal storage conditions. It is not subject to hazardous polymerization reactions, but can react violently with strong oxidizing agents. The greatest hazard involved in handling methanol is the danger of fire or explosion (English et al. 1995).

When used in spark engines, the higher the concentration of methanol in a methanol/gasoline blend, the lower the amount of CO, HC, and NO_x in the exhaust emissions (Letcher 1983). In fact, the addition of tertiary butyl alcohol (TBA) and methanol may reduce the CO emissions up to 40 % and the hydrocarbon emissions up to 20 % in comparison with conventional gasoline (Schädlich et al. 2003).

As far as emissions are concerned, the MTG product has nearly the same emissions as gasoline from oil unless the methanol for the process is formed from biomass (Vermillion et al. 2001).

4.12 Cost of Methanol

From January 1993 to October 2001, U.S. spot prices for methanol ranged from a low of about \$0.20/gallon to a high of about \$1.50/gallon (Davenport 2002). In general, the price tended to be between \$0.30/gallon (\$5/GJ, LHV) and \$0.70/gallon (\$12/GJ LHV). Price fluctuations are often a result of oversupply, but the price is also highly dependent on the availability of imports and the price of natural gas. The current price of methanol listed in Chemical Marketing Reporter (2003) for January 28th is \$0.40/gallon (\$7/GJ, LHV) given as a contract price at the point of production. However, on January 6th, the price was listed as \$0.62/gallon (\$10/GJ, LHV) (2003).

In producing methanol from natural gas, the majority of the capital cost comes from the reforming and gas-conditioning steps. A capital cost breakdown for the ICI process is given as: desulfurization (2%), reforming/gas cooling (32%), steam production (14%), compression (24%), methanol synthesis (22%), and distillation (6%) (Wender 1996). Using a slurry reactor instead of tubular one reduces the capital cost and decreases the compression cost (i.e. lower pressure drop across the reactor). In fact, LPMEOH investment costs are expected to be 5-23% less than the gas phase process of the same capacity (Hamelinck and Faaij 2001).

Vermillion et al. 2001, claims that if methanol is formed from biomass, the cost would be \$0.30/gallon to \$0.55/gallon higher than if it were produced from natural gas. Table 15 gives cost information from several coal based methanol studies and Table 16 gives the cost for several biomass-to-methanol studies.

Table 15: Comparison of Coal Based Methanol Economic Studies

Study	(ChemSystems 1990)	(Salmon 1986)	Synthetic Fuels Associates, Inc. (1983)		(Wham and Forrester III 1980)	(Michaels 1979)	(Bailey 1979)
			max MeOH	once through			
Cost year	1987	1984	1982	1982	1979	1979	1979
Coal feed rate (tonne/day)	unclear	22,000-30,000 (as received)	23,054 (as received)	9,662 (as received)	18,331 (MAF)	4,100 (as received)	15,767 (as received)
Coal cost	\$1.48/GJ \$38.6/tonne	\$0.95/GJ and \$1.42/GJ	\$46.47/tonne	\$50.99/tonne	\$0.95/GJ	\$16.5/tonne (mine mouth)	\$22/tonne
Methanol produced (tonne/day)	886 plus 833 MWe	5,000-10,000	14,439	2,231 plus 870 MWe	5,067	1,995	6,395
Price of methanol (HHV basis)	\$6.6/GJ \$0.45/gallon electricity sold at \$0.37/kWh	\$7.2-\$8.8/GJ \$0.49-\$0.60/gal	\$6.16/GJ \$0.42/gallon (price was set and IRR calculated to be marginal at 7%)	\$5.87-\$9.43/GJ \$0.40-\$0.64/gal electricity sold at \$0.42/kWh	\$8.2/GJ \$0.56/gallon	\$5/GJ \$0.34/gal 1980\$ and \$8/GJ \$0.53/gal 1984\$	\$8.2/GJ \$0.56/gallon
Level of detail	Some details – Gives total capital investment and operating costs, and other economic assumptions	Somewhat detailed – puts previous studies on same cost basis	Some details – Gives total capital investment and operating costs, and other economic assumptions		Somewhat detailed – Gives total capital investment, operating costs, and other economic assumptions	Some details – Gives total capital investment and operating costs, and other economic assumptions	Somewhat detailed – Gives capital cost by plant sections, operating costs, and other economic assumptions

Table 16: Comparison of Biomass Based Methanol Studies

Study	(Hamelinck and Faaij 2001) (a), (b)	(Novem 2000) (a), (c)	(Larson 1992) (a)	(Wyman et al. 1993) (a)	(1990)	(Mudge et al. 1981)
Cost year	2001	1999	1991	1989	1987	1980
Biomass feed rate (BD tonne/day)	1,920	1,358	1,650	1,814	1,814 - 9,841	1,800
Biomass cost	\$2/GJ \$38/dry tonne	\$3/GJ \$55/dry tonne	\$2/GJ \$38/dry tonne	\$2.45/GJ \$46/dry tonne	\$2.45/GJ \$46/dry tonne (\$0-2.4/GJ sensitivity)	\$1.2/GJ \$22/dry tonne (\$0-154/dry tonne sensitivity)
Electricity selling price	\$0.03/kWh	\$0.067/kWh	\$0.05/kWh (purchased)	not given	\$0.041/kWh	\$0.03/kWh (purchased)
Net power (MW)	no excess to about 100 MW (@ 91% production cap)	about 150	no excess	no excess	no excess	no excess
Other fuels	none	co-fires nat gas in gas turbine	none	none	none	none
MeOH produced (tonne/day)	613-970 (@ 91% production cap)	57-196	705-1,004	790-1,110	717 – 4,577	900
Price of MeOH (HHV basis)	\$9-\$12/GJ \$0.58-\$0.83/gallon	\$10.6-\$13.6/GJ \$0.72-\$0.93/gallon	\$9.62-\$15.4/GJ \$0.66-\$1.05/gallon	\$10.01-\$19.60/GJ \$0.68-\$1.34/gallon (@ 12% discount rate)	\$10-\$18.9/GJ \$0.68-\$1.29/gal (for 20% capital recovery factor)	\$8.2-\$10.3/GJ \$0.56-\$0.70/gallon (sensitivity: \$5.9-\$22.7/GJ \$0.40-\$1.55/gal)
Level of detail	Very detailed - Gives costs of individual equipment, operating costs, and other economic parameters and assumptions	Some details - Gives costs of major plant sections, and assumptions used to determine installed costs	Somewhat detailed - Gives capital and operating costs	Somewhat detailed - Gives capital and operating costs and cash flow sheet	Somewhat detailed - Gives capital cost by section and operating costs	Somewhat detailed - Gives capital cost by section, operating costs, and other economic parameters

Notes: (a) Examined direct & indirect gasifiers and atmospheric and pressurized gasifiers.

(b) Several configurations examined (varied type of gas cleaning, reforming, and gas or LPMeOH with and without recycle)

(c) Examined once through LPMeOH with combined heat and power.

4.12.1 Cost of Formaldehyde

A study by others was performed to examine the three industrial routes for producing formaldehyde. The cost of production for each process is presented in Table 17 (Reuss et al. 2003). The BASF process is the most economical, followed by the Formox process. The key feature in the BASF process design is a liquid recirculation system that produces excess steam while simultaneous savings cooling water. For comparison, the price of formaldehyde given in Chemical Marketing Reporter for January 28th 2003 is \$463/tonne (\$0.21/lb).

Table 17: Comparison of Formaldehyde Production Costs

Process	BASF	Incomplete conversion & MeOH recovery	Formox
Cost of production (\$/tonne)	345	364	339
Return of capital investment (\$/tonne)	33	43	48
Cost of production with ROI (\$/tonne)	378	407	387

4.12.2 Cost of MTBE

From 1980 to 2001, the average U.S. Gulf Coast price for MTBE fluctuated between \$0.63/gallon (1998) and \$1.27/gallon (1981) (Davenport et al. 2002). MTBE is produced in three different manners: (1) refinery/petrochemical plants using by-product isobutylene, (2) merchant plants which isomerize n- and iso-butane and dehydrogenate isobutane to isobutylene, and (3) tertiary butyl alcohol (TBA) plants which react by-product TBA from propylene oxide production with methanol (Lidderdale 2001). The first is the cheapest way to produce MTBE at a cost of \$6,000 - \$10,000/BPD of capacity. The second is the most expensive at a cost of \$20,000 - \$28,000/BPD of capacity. Only 2 plants in the U.S. use the third manner to produce MTBE.

4.12.3 Cost of Acetic Acid

Chemical Marketing Reporter gives the current cost (January 28th 2003) of acetic acid to be \$992/tonne (\$0.45/lb).

4.12.4 Cost of MTG

The capital cost of the New Zealand MTG plant (14,450 BPD) was estimated to be \$767 million dollars (mid-1980) with a total project cost of \$1,475 million dollars (1985) (Bem 1985; Maiden 1983). The production cost, including return on investment, was estimated to be \$0.96/gallon. The New Zealand government planned to sell the gasoline for \$1.31/gallon (Bem 1985). Initial studies performed prior to design and construction of the plant came up with a gasoline cost of \$0.74/gallon (Bem 1985). Table 18 is a comparison of three other studies.

Table 18: Comparison of Coal Based MTG Economic Studies

Study	(Lee et al. 1980)	(Wham and Forrester III 1980)	(Edwards et al. 1979)
Cost year	1977	1979	1978
Coal feed rate (tonne/day)	24,762 (as received)	18,431 (MAF)	18,118 (as received)
Coal cost	\$7.7/tonne	\$0.95/GJ	\$5.5/tonne
Gasoline produced (BPD)	23,065	21,921	15,000
Price of gasoline	\$0.67-\$0.87/gallon \$5.1-\$6.6/GJ (HHV) \$5.5-\$7.2/GJ (LHV)	\$1.25/gallon \$9.5/GJ (HHV) \$10.3/GJ (LHV)	\$0.90/gallon \$6.8/GJ (HHV) \$7.4/GJ (LHV)
Level of detail	Not very detailed – but refers to a more detailed report (Schreiner 1978) which gives overall capital costs and other details	Some details – Gives total capital investment, breakdown of operating costs, and other economic assumptions	Somewhat detailed – Gives capital cost by plant sections, operating costs, and other economic assumptions

4.12.5 Cost of MTO

One study gives the cost of methanol, olefins via MTO, and gasoline via MTG to be \$0.45/gal (\$0.68/lb), \$0.16/lb, and \$0.59/gal (\$0.99/lb), respectively (Gradassi 1998) for a natural gas price of \$0.47/GJ. Overall, there are not many economic details given in the report.

4.12.6 Cost of DME

At a natural gas cost of \$0.6/MMBTU, DME can be produced for \$0.67/gallon (Chaumette et al. 1999). In comparison, their estimate for methanol production at this natural gas price is \$0.35/gallon.

4.13 R&D Needs

Recent research has been aimed at one-step methanol production where oxygen is reacted with methane to form methanol without the intermediate formation of syngas. Commercialization of this is believed to be at least 10 years away.

4.14 References

(1983). "Coal Gasification Systems: A Guide to Status, Application, and Economics." *EPRI/AP-3109*, Synthetic Fuels Associates, Inc.

(1990). "Assessment of Costs and Benefits of Flexible and Alternative Fuel Use in the U.S. Transportation Sector. Technical Report 5: Costs of Methanol Production from Biomass." U.S. Department of Energy.

(2002). "MTBE Prices Rise on Shortages in California." *Chemical Market Reporter*.

(2003). "Price Quote of Methanol, Formaldehyde, and Acetic Acid." *Chemical Market Reporter*.

Apanel, G.; Netzer, D. (2002). Methanol to Polyethylene by the Lurgi MTP Process. PEP Review no. 98-13. SRI Consulting.

Bailey, E. (1979). "The coal to methanol alternative." *Coal Technol. (Houston)*, 2nd(3), 149-61.

Bem, J. (1985). "New Zealand Synthetic Gasoline Plant." *Proceedings of the Intersociety Energy Conversion Engineering Conference*, 20th(Vol. 1), 1.517-1.522.

Bhatt, B. L., Heydorn, E. C., Tihm, P. J. A., Street, B. T., and Kornosky, R. M. (1999). "Liquid phase methanol (LPMEOH) process development." *Preprints - American Chemical Society, Division of Petroleum Chemistry*, 44(1), 25-27.

Brown, D. M., Bhatt, B. L., Hsiung, T. H., Lewnard, J. J., and Waller, F. J. (1991). "Novel technology for the synthesis of dimethyl ether from syngas." *Catalysis Today*, 8(3), 279-304.

Chaumette, P., Courty, P. R., and Raimbault, C. (1999). "Synthetic or reformulated fuels: A challenge for catalysis." *Studies in Surface Science and Catalysis*, 121(Science and Technology in Catalysis 1998), 41-50.

ChemSystems. (1990). "Optimization of Electricity-Methanol Coproduction. Configurations of Integrated-Gasification-Combined-Cycle/Once-Through." *EPRI/GS-6869*.

Chen, A. K., and Masel, R. (1995). "Direct Conversion of Methanol to Formaldehyde in the Absence of Oxygen on Cu(210)." 343(1-2), 17-23.

Cheung, H., Tanke, R. S., and Torrence, G. P. (2003). "Acetic Acid." *Ullmann's Encyclopedia of Industrial Chemistry Release 2003*, 6th Edition, Wiley-VCH Verlag GmbH & Co.KGaA.

Chinchen, G. C., Mansfield, K., and Spencer, M. S. (1990). "The Methanol Synthesis - How Does It Work." *Chemtech*, 20(11), 692-699.

- Collignon, F., Loenders, R., Martens, J. A., Jacobs, P. A., and Poncelet, G. (1999). "Liquid phase synthesis of MTBE from methanol and isobutene over acid zeolites and amberlyst-15." *Journal of Catalysis*, 182(2), 302-312.
- Davenport, B. (2002). "Methanol." *Chemical Economics Handbook Marketing Research Report*, SRI International, Menlo Park, CA. Report number 674.5000.
- Davenport, B., Gubler, R., and Yoneyama, M. (2002). "Gasoline Octane Improvers." *Chemical Economics Handbook Marketing Research Report*, SRI International, Menlo Park, CA. Report number 543.7500.
- DOE, U. S. (1992). "Commercial-Scale Demonstration of the Liquid Phase Methanol (LPMEOHTM) Process." *DOE/FE-0243P*, U.S. Department of Energy.
- Dybkjaer, I. (1981). "Topsoe methanol technology." *CEER, Chem. Econ. Eng. Rev.*, 13(6), 17-25.
- Dybkjaer, I., and Christensen, T. S. (2001). "Syngas for large scale conversion of natural gas to liquid fuels." *Studies in Surface Science and Catalysis*, 136(Natural Gas Conversion VI), 435-440.
- Edwards, M. S., Ulrich, W. C., and Salmon, R. (1979). "Economics of producing gasoline from underground coal gasification synthesis gas." *Urja*, 6(7), 163-78.
- English, A., Rovner, J., Brown, J., and Davies, S. (1995). "Methanol." Kirk-Othmer Encyclopedia of Chemical Technology, John Wiley & Sons, Inc.
- Fiedler, E., Grossmann, G., Kersebohm, D. B., Weiss, G., and Witte, C. (2003). "Methanol." Ullmann's Encyclopedia of Industrial Chemistry Release 2003, 6th Edition, Wiley-VCH Verlag GmbH & Co.KGaA.
- Ge, Q., Huang, Y., Qiu, F., and Li, S. (1998). "Bifunctional catalysts for conversion of synthesis gas to dimethyl ether." *Applied Catalysis, A: General*, 167(1), 23-30.
- Gradassi, M. J. (1998). "Economics of gas to liquids manufacture." *Studies in Surface Science and Catalysis*, 119(Natural Gas Conversion V), 35-44.
- Gunda, A., Tartamella, T., Gogate, M., and Lee, S. (1995). "Dimethyl ether synthesis from CO₂-rich syngas in the LPDME process." *Proceedings - Annual International Pittsburgh Coal Conference*, 12th, 710-715.
- Haid, J., and Koss, U. (2001). "Lurgi's Mega-Methanol technology opens the door for a new era in down-stream applications." *Studies in Surface Science and Catalysis*, 136(Natural Gas Conversion VI), 399-404.
- Hamelinck, C. N., and Faaij, A. P. C. (2001). "Future prospects for production of methanol and hydrogen from biomass." *NWS-E-2001-49; ISBN 90-73958-84-9*, Utrecht University.

- Hancock, E. G. (1985). "The manufacture of gasoline and the chemistry of its components." *Critical Reports on Applied Chemistry*, 10(Technol. Gasoline), 20-56.
- Hansen, J. B., and Joensen, F. (1991). "High conversion of synthesis gas into oxygenates." *Studies in Surface Science and Catalysis*, 61(Nat. Gas Convers.), 457-67.
- Herman, R. G. (1991). "Chapter 7 - Classical and Non-Classical Route for Alcohol Synthesis." *New Trends in CO Activation*, L. Guzzi, ed., Elsevier, Amsterdam, 281-285.
- Kam, A. Y., Schreiner, M., and Yurchak, S. (1984). "Chapter 2-3: Mobil Methanol-to-Gasoline (MTG) Process." *Handbook of Synfuels Technology*, R. A. Meyers, ed., McGraw-Hill Book Company, New York.
- Keil, F. J. (1999). "Methanol-to-hydrocarbons: process technology." *Microporous and Mesoporous Materials*(29), 49-66.
- King, D. L., and Grate, J. H. (1985). "Look what you can make from methanol." *Chemtech*, 15(4), 244-51.
- Klier, K. (1982). "Methanol Synthesis." *Advances in Catalysis*, 31, 243-313.
- Kung, H. H. (1992). "Deactivation of Methanol Synthesis Catalysts - a Review." *Catalysis Today*, 11(4), 443-453.
- Ladebeck, J. (1993). "Improve methanol synthesis." *Hydrocarbon Processing, International Edition*, 72(3), 89-91.
- Larson, E. D. a. K., R.E. (1992). "Production of Methanol and Hydrogen from Biomass." *Report No. 271*, Princeton University, Center for Energy and Environmental Studies, Princeton, NJ.
- Lee, S. (1990). *Methanol Synthesis Technology*, CRC Press, Boca Raton, Fla.
- Lee, W., Maziuk, J., Weekman, V. W., and Yurchak, S. "Catalytic Conversion of Alcohols to Gasoline by the Mobil Process." *Energy from Biomass and Wastes IV*, Lake Buena Vista, FL, 834.
- Letcher, T. M. (1983). "Methanol blends - an alternative fuel for the spark ignition gasoline engine." *Chemsa*, 9(1), 13-14, 16.
- Lidderdale, T. C. M. (2001). "MTBE Production Economics." Energy Information Agency.
- MacDougall, L. V. (1991). "Methanol to fuels routes - the achievements and remaining problems." *Catalysis Today*, 8, 337-369.
- Maiden, C. J. (1983). "New Zealand gas to gasoline plant." *Apea J.*, 23(1), 33-43.

- Michaels, H. J. (1979). "Methanol from coal using the Koppers-Totzek process." *Coal Technol. (Houston)*, 2nd(3), 163-78.
- Mudge, L. K., Robertus, R. J., Mitchell, D. H., Sealock, L. J., Jr., and Weber, S. L. (1981). "Economics of methanol and SNG production from biomass via catalytic gasification." *Energy Biomass Wastes*, 5th, 687-722.
- Novem. (2000). "Technical and Economic Databases - Biomass Energy Conversion Systems for the Production of Gaseous and/or Liquid Energy Carriers." *Report No. GAVE-9915*.
- Owen, K., and Coley, T. (1995). *Automotive fuels reference book*, Society of Automotive Engineers, Warrendale, PA.
- Pass, G., Holzhauser, C., Akgerman, A., and Anthony, R. G. (1990). "Methanol synthesis in a trickle-bed reactor." *AIChE Journal*, 36(7), 1054-60.
- Peng, X. D., Toseland, B. A., and Tijm, P. J. A. (1999a). "Kinetic understanding of the chemical synergy under LPDME conditions-once-through applications." *Chemical Engineering Science*, 54(13-14), 2787-2792.
- Peng, X. D., Wang, A. W., Toseland, B. A., and Tijm, P. J. A. (1999b). "Single-step syngas-to-dimethyl ether processes for optimal productivity, minimal emissions, and natural gas-derived syngas." *Industrial & Engineering Chemistry Research*, 38(11), 4381-4388.
- Peters, U., Nierlich, F., Schulte-Körne, E., Sakuth, M., Deeb, R., Laugier, M., Suominen, M., and Kavanaugh, M. (2003). "Methyl tert-Butyl Ethyl." Ullmann's Encyclopedia of Industrial Chemistry Release 2003, 6th Edition, Wiley-VCH Verlag GmbH & Co.KGAA.
- Pinto, A., and Rogerson, P. L. (1977). "Optimizing the ICI low-pressure methanol process." *Chem. Eng. (N. Y.)*, 84(14), 102-8.
- Reuss, G., Disteldorf, W., Gamer, A. O., and Hilt, A. (2003). "Formaldehyde." Ullmann's Encyclopedia of Industrial Chemistry Release 2003, 6th Edition, Wiley-VCH Verlag GmbH & Co.KGAA.
- Rogerson, P. L. (1971). "The ICI [Imperial Chemical Industries] low pressure methanol process." *Ingenieursblad*, 40(21), 657-63.
- Rogerson, P. L. (1984). "Chapter 2-2: The ICI Low-Pressure Methanol Process." *Handbook of Synfuels Technology*, R. A. Meyers, ed., McGraw-Hill Book Company, New York.
- Roper, M. (1991). "Chapter 9 - CO Activation by Homogeneous Catalysts." *New Trends in CO Activation*, L. Guzzi, ed., Elsevier, Amsterdam, 381-424.

- Rostrup-Nielsen, J. R. (2000). "New aspects of syngas production and use." *Catalysis Today*, 63(2-4), 159-164.
- Ruf, S., and Emig, G. (1999). "Homogeneous catalysis by evaporated solids." 146(1-2), 271-278.
- Salmon, R. (1986). "Economics of Methanol Production from Coal and Natural Gas." *ORNL-6091*, Oak Ridge National Laboratory.
- Sardesai, A., and Lee, S. (1998). "Liquid phase dimethyl ether (DME) synthesis: A review." *Reviews in Process Chemistry and Engineering*, 1(2), 141-178.
- Satterfield, C. N. (1991). *Heterogeneous Catalysis in Industrial Practice*, Krieger Publishing Company, Malabar, FL.
- Schädlich, K., Schug, P., Fabri, J., Dabelstein, W., and Reglitzky, A. (2003). "Octane Enhancers." *Ullmann's Encyclopedia of Industrial Chemistry Release 2003*, 6th Edition, Wiley-VCH Verlag GmbH & Co.KGAA.
- Schreiner, M. (1978). "Research Guidance Studies to Assess Gasoline from Coal by Methanol-To-Gasoline and Sasol-Type Fischer-Tropsch Technologies." *DOE Contract No. EF-76-C-01-2447*, Mobil Research and Development Corp, Princeton, NJ.
- Shikada, T., Ohno, Y., Ogawa, T., Ono, M., Mizuguchi, M., Tomura, K., and Fujimoto, K. (1999). "Synthesis of dimethyl ether from natural gas via synthesis gas." *Kinetics and Catalysis (Translation of Kinetika i Kataliz)*, 40(3), 395-400.
- SRI. (1994). "Acetic Acid and Acetic Anhydride." *PEP 37B*, SRI International, Menlo Park, CA.
- Supp, E., and Quinkler, R. F. (1984). "The Lurgi Low-Pressure Methanol Process." *Handbook of synfuels technology.*, R. A. Meyers, ed., McGraw-Hill, 113 - 131.
- Tabak, S.A., Yurchak, S. (1990). "Conversion of Methanol over ZSM-5 to Fuels and Chemicals." *Catalysis Today*, 6 (3), 307-327.
- Takase, I., and Niwa, K. (1985). "Mitsubishi (MGC/MHI) methanol process." *CEER, Chemical Economy & Engineering Review*, 17(5), 24-30.
- Tijm, P. J. A., Waller, F. J., and Brown, D. M. (2001). "Methanol technology developments for the new millennium." *Applied Catalysis A*, 221, 275-282.
- Topp-Jorgensen, J. (1987). "The Topsoe Integrated Gasoline Synthesis." *Petrole et Techniques*, 333, 11-17.
- Topp-Jorgensen, J. (1988). "Topsoe Integrated Gasoline Synthesis - The TIGAS Process." *Methane conversion: proceedings of a symposium on the production of fuels*

and chemicals from natural gas, Auckland, April 27-30, 1987, D. M. Bibby, ed., Elsevier, Amsterdam ; New York, 293-305.

Twigg, M. V., and Spencer, M. S. (2001). "Deactivation of supported copper metal catalysts for hydrogenation reactions." *Applied Catalysis, A: General*, 212(1-2), 161-174.

Vermillion, B., Nguyen, P., and Tsan, E. Q. (2001). "Feasibility Study of Methanol as Transportation Fuel." University of California, San Diego - Methanol Conversion Group, San Diego, CA.

Wagner, J., Frank S. (2002). "Acetic Acid." Kirk-Othmer Encyclopedia of Chemical Technology, John Wiley & Sons, Inc.

Wender, I. (1996). "Reactions of synthesis gas." *Fuel Processing Technology*, 48(3), 189-297.

Wham, R. M., and Forrester III, R. C. "Available Technology for Indirect Conversion of Coal to Methanol and Gasoline: A Technology and Economics Assessment." *Alternative energy sources III*, Miami Beach, FL, 3-18.

Wyman, C. E., Hinman, N. D., Bain, R. L., and Stevens, D. J. (1993). "Chapter 21 - Ethanol and Methanol from Cellulosic Materials." *Renewable energy: sources for fuels and electricity*, T. B. Johansson and L. Burnham, eds., Island Press, Washington, D.C., 865-923.

5 Ethanol

5.1 Summary

Syngas fermentation is an indirect method for producing ethanol from biomass feedstocks. The first step in the process is to convert biomass into a gaseous intermediate rich in carbon monoxide and hydrogen using gasification or other means. This gaseous intermediate, also known as synthesis gas, or syngas, is then converted to ethanol using fermentation.

A distinct advantage of the syngas fermentation route is its ability to process nearly any biomass resource. Today's corn-based ethanol industry is restricted to processing grain starches. Direct fermentation of biomass, as exemplified by the NREL technology, can handle a wider variety of biomass feedstocks, but more recalcitrant materials lead to high costs. Difficult-to-handle materials, softwoods for example, may best be handled with the syngas fermentation approach.

Expected yields from a grassroots biomass syngas-to-ethanol facility with no external fuel source provided to the gasifier, are 70-105 gallons of ethanol per ton of dry biomass fed. The economics of this route appear to be competitive with today's corn-based ethanol and projections for direct fermentation of biomass. One report states projected cash costs on the order of \$0.70 per gallon, with feedstock available at \$25 per ton. Capital costs are projected at about \$3.00 per gallon of annual capacity. The rational price, defined as the ethanol sales price required for a zero net present value of a project with 100% equity financing and 10% real after-tax discounting, is projected to be \$1.33 per gallon. These economics would support a successful commercial project at the current ethanol sales price of \$1.00-\$1.50 per gallon.

The syngas fermentation approach has received very modest levels of support in the past. Currently, there are only a handful of academic groups working in this area. More people, time, and dollars are needed if the pace of progress is to increase.

Section Contents

<u>5.1 Summary</u>	58
<u>5.2 Introduction</u>	60
<u>5.3 Technology Description</u>	61
<u>5.4 Chemistry And Microbiology</u>	63
<u>5.5 Fermentor Design</u>	65
<u>5.6 Gas Cleanliness Requirements</u>	65
<u>5.7 Status/Technology Developers</u>	65
<u>5.8 Environmental Performance</u>	66
<u>5.9 Cost</u>	67
<u>5.10 R&D Needs</u>	68
<u>5.11 References</u>	69

List of Figures

<u>Figure 6: Syngas to Ethanol Simplified Block Flow Diagram</u>	61
--	----

List of Tables

<u>Table 19: Ethanol Yields on a Common Basis</u>	63
<u>Table 20: Summary of USDA Survey Result (Cash Costs in \$/gal of ethanol)</u>	68

5.2 Introduction

Today, ethanol is the only renewable liquid fuel made in commercial quantities, with U.S. production in 2002 running at about 2.13 billion gal/yr, up from 1.7 billion gal/yr in 2001 (Renewable Fuels Association 2003). According to the Energy Information Administration, the total U.S. demand for motor gasoline is about 8.36 million barrels per day, or about 1.7 GJ per year. Adjusting the figures for heating values, ethanol is responsible for providing only about 1% of our nation's energy needs for gasoline type transportation fuels. Significant expansion of the industry is needed if ethanol is to make a meaningful contribution to our nation's energy supply. The likelihood of this expansion is, in part, contingent on improvements in the technology used for ethanol production.

Commercial production is currently by direct fermentation of carbohydrates or by hydration of ethylene. Direct fermentation accounts for over 95% of global capacity (Davenport et. al. 2002). The U.S. fermentation capacity is 2.9 billion gal/yr; non-idled U.S. synthetic production capacity is only 50 million gal/yr. Cornstarch hydrolyzate, derived from either wet milling or dry milling of corn kernels, is the major source of carbohydrate in the U.S. The other major ethanol producing country, Brazil - with over 4.0 billion gal/yr of capacity, uses sugarcane juices/molasses as the major source of carbohydrate.

Demand for ethanol is driven primarily by its use as a blending ingredient for gasoline. Non-fuel consumption in the U.S. was only 269 million gal/yr in 2001 (Davenport et. al. 2002). Ethanol has a high octane rating, but (in many cases) meeting legislated requirements on gasoline oxygenate content is the market driver behind its use. The price of fuel ethanol traditionally tracks prices for gasoline and MTBE. MTBE is an alternative high-octane, gasoline-blending component made from non-renewable resources that can also be used to satisfy gasoline oxygenate requirements (see section 4.10.2 for information on MTBE).

Feedstock availability is one constraint on the ability of the existing corn-based industry to make a meaningful impact on our Nation's energy supply. U.S. corn production reached 9.5 billion bushels in 2001 (National Corn Growers Association 2002). Fuel ethanol production was responsible for consuming 680 million bushels, or about 7% of the crop for that year. The largest consuming application for corn is direct use as animal feed, accounting for 5.85 billion bushels of consumption in 2001. Even if suitable replacements could be found for animal feed and all other uses of corn, only about 11% of the U.S. energy needs for gasoline type transportation fuels could be met at current corn production levels.

Biomass is an abundant and low cost source of carbohydrate that often does not compete with animal feed or other important uses. Putsche and Sander (in Wyman 1996) estimate the U.S. could produce as much as 1×10^{12} l/yr (264 billion gal/yr) of ethanol from cellulosic biomasses derived from energy crops planted on idle cropland, crop residues such as corn stover and rice straw, municipal solid wastes, etc.

One approach to utilizing this biomass resource is to modify the direct fermentation process so that, rather than fermenting the sugars present in starch, the sugars present in the cellulose and hemicellulose fractions of biomass are converted to ethanol by direct fermentation. Unfortunately, the cellulose and hemicellulose sugars are difficult to liberate and also differ in composition from the sugars present in starch. Both issues lead to significant differences between the two direct fermentation approaches.

5.3 Technology Description

For purposes of discussion in this report, the syngas intermediate required for ethanol production is assumed to be generated from gasification of biomass resources such as wood chips derived from forestry operations and other similar “low-cost” materials. It should be clear that other means of syngas generation could also be considered. Examples of these are: steam reforming of natural gas and other light hydrocarbons, reforming of anaerobic digester biogas, and gasification of other carbonaceous feedstocks such as coal, petroleum resid, coke, municipal solid waste, biomass derived fast pyrolysis oils, etc.

Figure 6 is a simplified block flow diagram for a biomass syngas fermentation facility. The feed is first received and placed in temporary storage on-site. It is then sent to the gasifier where it is converted into a raw syngas mixture rich in CO and hydrogen. Biomass gasification has been an area of R&D interest by governments and private industry for many years, so several technological options exist. The syngas intermediate is then converted to ethanol via fermentation. Again, this approach could be applied to a wide variety of feedstocks.

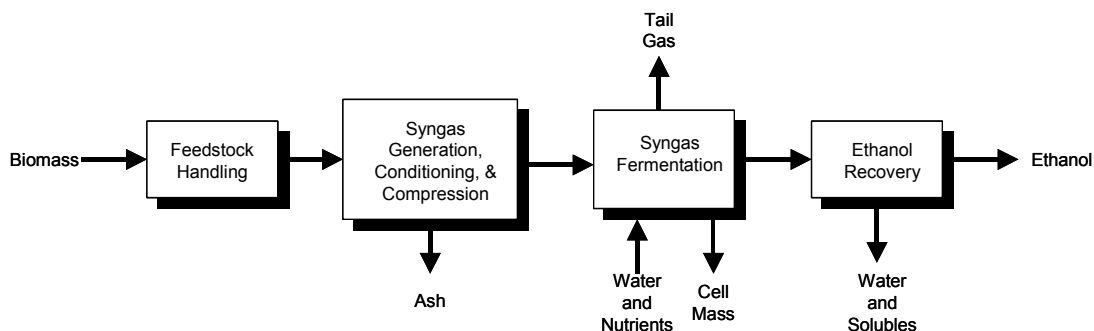

Figure 6: Syngas to Ethanol Simplified Block Flow Diagram

This report only briefly discusses the indirect BCL/FERCO process since it was used in the design of the economic study discussed in the cost section. The BCL/FERCO gasifier is an indirectly heated gasifier that operates at near ambient pressure. The design produces a medium BTU syngas, without the need for an oxygen plant. The biomass feed is dried and then fed to a fast fluidized bed where it is converted into a raw syngas.

Circulating sand provides heat for the gasification in this bed. The sand is disengaged along with char using a cyclone. The resulting syngas is sent downstream for further conditioning and compression. The disengaged sand and char is fed to a second fluidized bed where it is mixed with air and the char is combusted. The heat released in the combustor is used to heat the circulating sand. Heat is also recovered in the combustor offgas and used either for drying or for steam generation.

This particular gasifier needs to operate at temperatures that are low enough that no slagging of the ash occurs. Typical operating temperatures and pressures are 700-850 °C at pressures only slightly greater than atmospheric. At these conditions, the resulting syngas contains significant amounts of methane, ethylene and other light hydrocarbons, plus tars. These species are not converted in the downstream fermentation step. Depending upon the design assumptions, these species can be removed in the gas conditioning steps, converted to additional syngas in the gas-conditioning step, or allowed to pass through the fermentation for eventual incineration with the fermentation tail gas as a fuel trim to the combustion section of the gasifier.

The conditioned syngas is then fed to fermentation where it is converted to ethanol using the bacteria described in the next section. The resulting fermentation broth is quite dilute, typically containing 2% or less of ethanol. The ethanol can be recovered from the broth using recovery schemes patterned after those used in the existing corn ethanol industry (i.e. an ethanol-water mixture close to the azeotropic composition is distilled overhead and an adsorption unit is used to further dry the ethanol product to meet fuel grade specification on water content). The cell mass produced from the fermentation is not currently approved for animal feed use. A reasonable assumption for its disposal is to recycle it as a portion of the feed to the gasifier.

One advantage of the syngas fermentation route is that the chemical energy stored in all parts of the biomass, including the lignin fraction, contributes to the yield of ethanol. The following equation:

$$P = \frac{F \text{ HHV}_F \eta_{\text{Gas+Cond}} X_{\text{CO+H}_2/\text{EtOH}}}{1.5 \times 10^5} \quad \text{Eq. 6.1}$$

where

P = Production of ethanol, million gal/yr

F = Feed rate, tons/day (dry basis)

HHV_F = Higher heating value of the feed in Btu/lb (dry)

η_{Gas+Cond} = Cold gas efficiency of gasifier+conditioning steps (a fraction less than 1)

X_{CO+H₂/EtOH} = Average conversion of CO and H₂ to ethanol, as a fraction of theoretical

is a simple way to generate a ballpark estimate of annual ethanol production for syngas fermentation. For example, assume 2,204 tons/day of dry biomass are converted with a higher heating value of 7,317 Btu/lb (dry), the cold gas efficiency of gasification and conditioning is 70%, and the average conversion of CO and H₂ to ethanol is 80% of theoretical, then:

$$P = \frac{(2204)(7317)(.7)(.8)}{1.5 \times 10^5} = 60.2 \text{ MM gal/yr of Ethanol Production}$$

This equation is based on the assumption that the gasifier/condition steps converts all of the methane and higher hydrocarbons down to syngas and the assumption that the heating value of the ethanol produced is equal to the heating value of the biomass feed less conversion losses. It is important to include any external auxiliary fuel input to the gasifier (e.g. a natural gas trim to the combustor to improve control) in the $F \cdot \text{HHV}_F$ term in equation 6.1 because it is based on a rough energy balance.

Table 19 compares ethanol yields for the corn-based direct fermentation as reported in the USDA survey (Shapouri et. al. 2002), the biomass-based direct ferment process projected by NREL, and projected yields for a syngas fermentation process. It is somewhat surprising that yields from the syngas fermentation process are not projected to be higher since lignin and other components not utilized by direct methods are converted by the syngas fermentation route. However, this benefit appears to be largely offset by conversion losses in gasification, conditioning and fermentation.

Table 19: Ethanol Yields on a Common Basis

	Wet Mill	Dry Mill Large	Dry Mill Medium	Dry Mill Small	Direct Fermentation of Biomass	Syngas Fermentation
Yield, gal/bushel	2.682	2.688	2.606	2.588	-	-
Yield, gal/ton (dry)	112.7	112.9	109.5	108.7	89.7	70-105

5.4 Chemistry And Microbiology

The micro-organisms used for ethanol production from syngas mixtures are obligate anaerobes that use a heterofermentative version of the acetyl-CoA pathway for acetogenesis. Acetyl-CoA is produced from CO or H₂/CO₂ mixtures in this pathway. The acetyl-CoA intermediate is then converted into either acetic acid or ethanol as a primary metabolic product. The details of the biochemistry of acetogenesis are reviewed in Drake (Drake 1994). The relevant overall reactions are (ignoring cell mass production):

Ethanol Production:	ΔG° , <u>kcal/mol</u>	$\frac{\text{HHV}_{\text{Products}}}{\text{HHV}_{\text{Feeds}}}$
$6 \text{ CO} + 3 \text{ H}_2\text{O} \rightarrow \text{CH}_3\text{CH}_2\text{OH} + 4 \text{ CO}_2$	-48.7	0.81
$2 \text{ CO}_2 + 6 \text{ H}_2 \rightarrow \text{CH}_3\text{CH}_2\text{OH} + 3 \text{ H}_2\text{O}$	28.7	0.80

Acetic Acid Production:

$4 \text{ CO} + 2 \text{ H}_2\text{O} \rightarrow \text{CH}_3\text{COOH} + 2 \text{ CO}_2$	-39.2	0.77
$2 \text{ CO}_2 + 4 \text{ H}_2 \rightarrow \text{CH}_3\text{COOH} + 2 \text{ H}_2\text{O}$	-25.8	0.77

The free energy changes are computed from the values listed in Table 3.7 of Roels (Roels 1983) assuming CO_2 present in the form of bicarbonate ion, liquid water and $\text{pH}=7$. Carbon monoxide is actually a preferred substrate over H_2+CO_2 , since the change in free energy is more favorable. Typical CO conversions reported in the literature for laboratory scale fermentations are about 90%, while H_2 conversions are about 70%. Other issues such as mass transfer between the gas and liquid phases may also contribute to the observed differences.

The ratio of the heats of combustion for the products and feeds are also taken from Table 3.7 of Roels. These values represent “cold gas efficiencies” for the fermentation step and are already incorporated into the denominator of Equation 6.1. It is worth noting that these values are rather low for an anaerobic fermentation. By comparison, the same ratio for production of ethanol by direct fermentation of glucose is 0.98.

The ratio of ethanol to acetate produced is dependent upon the strain and the fermentation conditions. The organisms are inhibited by low pH and acetate ion concentration. When acetic acid is formed, the pH drops and the acetate ion concentration rises, so the organism switches to ethanol production to alleviate further inhibition. Typically, pH is kept around 4.5 in ethanol production mode.

Many of the organisms are either mesophiles or thermophiles with temperature optimums ranging from room temperature to 90°C . A fairly rich media is typically, required, but high operating temperatures, low carbohydrate levels, low pH and high CO levels (which are inhibitory to methanogens) reduce the risk of contamination.

5.5 Fermentor Design

A simple gas-sparged tank reactor, operating in batch or continuous mode, can be used for the fermentation. While simple, this design suffers from low volumetric productivity, low gas conversion, and produces very dilute ethanol streams.

Dr. Gaddy at University of Arkansas/Bioengineering Resources Inc. has studied the issue of fermentor design in detail. He suggests a two-stage fermentation system with cell recycle as a better alternative (Klasson et. al. 1991). Conditions in the first stage are selected to encourage cell growth, while conditions in the second stage are selected to encourage ethanol production. Cells are recycled in the second stage to improve volumetric productivity and increase conversion.

Mass transfer between the gas and liquid phases can limit performance of syngas fermentation designs. Dr. Worden at Michigan State University has studied this issue in great detail (Bredwell et. al. 1999).

5.6 Gas Cleanliness Requirements

In contrast to many other syngas based processes, syngas fermentation performance is not tied to a specific ratio of H₂ to CO. While the organisms generally prefer CO to H₂, both CO and H₂/CO₂ mixtures can be simultaneously converted.

Very little work has been published on the effects of syngas impurities. One would expect some tolerance to sulfur compounds, tars and other impurities, but not enough work has been published to make general statements.

5.7 Status/Technology Developers

University of Arkansas/Bioengineering Resources Inc. - Dr. Gaddy and his associates began work on syngas fermentation in the late 1980s. This group has published far more than any other. They discovered and patented the strain *Clostridium ljungdahlii* (Gaddy and Clausen 1992), characterized its performance and developed it with the two stage fermentor design to the point where it was ready for scale-up from their laboratory/pilot plant work. Their work was supported by a U.S. DOE grant in the early 1990s under the concept of converting CO and H₂ present from coal gasification or industrial offgases (i.e. refinery fuel gas, coke oven gases, offgas from carbon black manufacture, etc.) rather than from biomass-derived gases. Support from U.S. DOE was discontinued because of budget constraints in the mid 1990s. The current state of activities for this group is unknown, however some U.S. patents have recently been issued that include Celanese International Corporation as an assignee (Gaddy et. al. 2002).

Mississippi Ethanol LLC - This company has a partially completed sawdust gasifier installed in Winona, MS. The facility was originally designed for methanol production, but market changes made these plans obsolete. The company obtained a contract with U.S. DOE to evaluate conversion of the existing facility to a syngas fermentation facility.

The report (Mississippi Ethanol LLC 2002) discussed what would be needed for this conversion. The present status is unknown.

Mississippi State University - This group, along with several other Mississippi based universities, is currently working under a U.S. DOE grant. Few publications have appeared since the work has only recently started. Dr. French presented a poster at the May 2003 Symposium on Biotechnology for Fuels and Chemicals in Breckenridge, CO titled "Isolation and Performance Optimization of Cultures Capable of Converting Syngas to Ethanol". Dr. Zappi will be chairing a session on syngas fermentation at the November 2003 AIChE Annual Meeting.

Oklahoma State University - This group has been working on syngas fermentation since the mid 1990s. Their present work is aimed at lab/pilot scale integration of gasification and fermentation.

Michigan Biotechnology Institute (MBI) - Researchers from this institution published several articles on this subject in the early 1990s, but have since been silent. The present status of this work is unknown.

Michigan State University - Dr. Mark Worden and his associates published several articles on mass transfer issues for syngas fermentation in the late 1990s and early 2000s. Much of the work has focused on the influence of bubble size on gas-liquid mass transfer.

Iowa State University - This group presented a poster at the May 2003 Symposium on Biotechnology for Fuels and Chemicals. Their focus is on production of polyhydroxyalkanoic acids by syngas fermentation rather than ethanol production.

5.8 Environmental Performance

The major driver for use of ethanol in the gasoline blending pool is as a source of oxygenate, in order to meet current legislative mandates. These mandates were originally imposed in the 1990s as a means to reduce air pollution caused by automobiles, with a particular target of reducing CO emissions. Opponents of the oxygenate mandate argue that today's engines burn fuels more cleanly than engines of 10-15 years ago and that the presence of oxygenates in gasoline is no longer needed to meet CO emission targets.

There is also some controversy over the issue of fugitive emissions from ethanol-blended gasolines. When ethanol is combined with other hydrocarbon blend stocks, the resulting blend has a vapor pressure higher than expected from only a linear combination because ethanol tends to form minimum boiling azeotropes with aromatics and paraffins. In the past, ethanol blends have received waivers on meeting vapor pressure specifications.

MTBE is beginning to show-up as a contaminate in ground water. Leaking underground gasoline storage tanks is often the source. MTBE is quite mobile and persistent in the aquifers. Ethanol blends can leak from the same storage tanks, but ethanol is not as persistent, or as toxic. The foul odors, foul taste, and toxicity of MTBE have lead many states to propose bans on its use in gasoline. While one could argue that eliminating

leaks from underground storage tanks might be a better policy direction, the need for oxygenate mandates has been questioned because of this issue.

It is likely that the oxygenate mandate will be replaced with a renewable fuels standard. The environmental aims for this type of legislation would be to decrease net CO₂ emissions by increasing the renewable fuel content of gasoline. Ethanol, the major renewable fuel component in today's blend pool, will probably be used in larger volumes if this type of legislation were enacted. From a policy perspective, it is important to remember that CO₂ emissions from fossil fuel consumption during the production of ethanol differ widely depending upon how the steam and electricity needed for the production process is generated. At present, the majority of corn ethanol plants consume fossil fuels to generate these utilities; a design that uses biomass to generate these utilities will result in lower overall CO₂ emissions on a life cycle basis. It is unclear whether the upcoming renewable fuels standard will produce legislative advantages for producing these utilities from renewables.

5.9 Cost

Prices for fuel ethanol have varied between \$1.00-\$1.50 per gallon over the 1999-2001 period (Davenport et. al. 2002). This price does not include excise tax exemptions.

Table 20 presents a comparison of typical U.S. cash costs for production of ethanol from corn as recently reported by a USDA survey of existing plants (Shapouri et. al. 2002). Current corn dry mills have capital requirements of \$1.50-2.00 per annual gallon of capacity. Cash costs vary with the type of technology used and the scale of the facility. Small dry mill facilities have the highest costs. These cash costs do not include interest expense, depreciation, income taxes or return on capital. The reported gap between ethanol sales price and the cash costs covers these items. Producer credits are also not included. The U.S. Federal government subsidizes small producers with a \$0.10 per gallon income tax credit on up to 15 million gal/yr of production. Various states also have producer credit programs.

The market price of ethanol does not reflect the actual value of ethanol in the gasoline blending pool. This is because of the impact of the Federal excise tax exemption. The Federal excise tax exemption is a benefit provided to the gasoline blender rather than the ethanol producer. In 2003, the excise tax exemption reduced the cost incurred by the gasoline blender by \$0.52 per gallon of ethanol blended. This excise tax exemption will be reduced to \$0.51 per gallon in 2005. The supporting legislation expires in 2007. The effect of this legislation is to lower the effective price of ethanol so that it can compete in the gasoline blending pool based on its usability value. The value of ethanol as a gasoline-blending ingredient can be estimated from its market price less the excise tax exemption and some corrections for logistics and blender profit margin. Under many market conditions, the value of ethanol is below the current cash cost of production. Research directed at introducing new process technologies with lower production costs is one means that can be pursued to remedy this situation.

Table 20: Summary of USDA Survey Result (Cash Costs in \$/gal of ethanol)

	Wet Mill	Dry Mill Large	Dry Mill Medium	Dry Mill Small
Net Corn	0.4795	0.5284	0.5285	0.5952
Fuel+Power	0.1117	0.1078	0.1403	0.1786
Other Variable	0.1861	0.1025	0.1328	0.1304
Labor	0.0763	0.0712	0.0707	0.0962
Other Fixed	0.0856	0.0801	0.1021	0.0877
Total Cash Costs	0.9392	0.8900	0.9744	1.0881

Source: Shapouri, et al. 2002

Few studies have been published regarding ethanol production from syngas. Putsche (Putsche 1999) constructed an ASPEN model and estimated capital plus operating costs for a grassroots syngas fermentation facility that used a BCL/FERCO type of gasifier. Her work would best be classified as a conceptual study. Results are summarized in the following paragraph.

A facility processing 2,000 tonne (dry) per day of wood would produce 48.5 million gal/yr of ethanol based on an ethanol yield of 71 gallons per ton. Fixed capital was estimated at \$153.6 million, or \$3.17 per annual gallon of capacity. Cash costs are \$0.697 per gallon with feedstock cost at \$25 per ton. Rational price, defined as the price required for a zero net present value for the project with 100% financing and 10% real after-tax discounting, was \$1.33 per gallon.

The Putsche results are based a reasonable set of assumptions using the current state of the technology. More aggressive assumptions based on future expected improvements in yield, reductions in capital costs, etc. would lead to more favorable economics. In any case, the syngas fermentation technology appears to be competitive with today's corn-based facilities. Low cash costs are projected for the syngas fermentation facility, but this is offset by high capital cost.

One of the clear advantages of the syngas fermentation approach is that just about any biomass resource imaginable could be processed. Present-day corn-based facilities are restricted to processing grain starches. Direct fermentation of biomass can handle a wider variety of biomass feedstocks, but more recalcitrant materials lead to much higher costs than the easy to process corn stover feedstock. Difficult to handle materials, softwoods for example, may be best handled with the syngas fermentation approach.

5.10 R&D Needs

The syngas fermentation approach for converting biomass resources into ethanol has received very modest levels of support in the past. More people, time and dollars are needed if the pace of progress is to increase.

5.11 References

Bredwell, M.D., Srivastava, P., Worden, R.M., "Reactor Design Issues for Synthesis-Gas Fermentations", *Biotechnology Progress*, Vol. 15, p. 834-844, 1999.

Davenport, R.E., Gubler, R., Yoneyama, M., *Chemical Economics Handbook Marketing Research Report - Ethyl Alcohol*, SRI International, May 2002.

Drake, H.L. (editor), *Acetogenesis*, Chapman and Hall, 1994.

Energy Information Administration, "2000 Annual Energy Review", www.eia.doe.gov

Gaddy, J.L., Clausen, E.C., "*Clostridium ljungdahlii*, An Anaerobic Ethanol And Acetate Producing Microorganism", US Patent 5173429, December 22, 1992.

Gaddy, J.L., Clausen, E.C., Ko, C.W., Wade, L.E., Wikstrom, C.V., "Microbial Process For The Preparation Of Acetic Acid As Well As Solvent For Its Extraction From The Fermentation Broth", US Patent 6368819 B1, April 9, 2002

Klasson, K.T., Ackerson, M.D., Clausen, E.C., Gaddy, J.L., "Bioreactor Design for Synthesis Gas Fermentations", *Fuel*, Vol. 70, p. 605-614, May 1991.

Mississippi Ethanol LLC, "Final Report from Mississippi Ethanol LLC to the National Renewable Energy Laboratory", NREL/SR-510-31720, March 2002.

National Corn Growers Association, "The World of Corn 2002", www.ncga.com

Paisely, M.A., Overend, R.P., "The SilvaGas® Process From Future Energy Resources - A Commercialization Success", 12th European Conference and Technology Exhibition on Biomass for Energy, Industry and Climate Protection, Amsterdam, Netherlands, June 2002, future-energy.np.def6.com/Resource.asp

Putsche, V., "Complete Process and Economic Model of Syngas Fermentation to Ethanol", C Milestone Completion Report, National Renewable Energy Laboratory, August 31, 1999

Renewable Fuels Association, www.ethanolrfa.org, see Ethanol Plants tab updated April 2003.

Roels, J.A., *Energetics and Kinetics in Biotechnology*, Elsevier Biomedical, 1983.

Shapouri, H., Gallagher, P., Graboski, M.S., USDA's 1998 Ethanol Cost-of-Production Survey, U.S. Department of Agriculture, Office of the Chief Economist, Office of Energy Policy and New Uses, Agricultural Economic Report Number 808, January 2002, www.usda.gov/agency/oce/oeplu/aer-808.pdf.

Wyman, C.E. (Editor), *Handbook on Bioethanol: Production and Utilization*, Taylor and Francis, 1996.

6 Mixed Higher Alcohols

6.1 Summary

Mixed alcohols are a more attractive gasoline blending stock for octane enhancement compared to methanol. Compared to methanol mixed alcohols have a lower vapor pressure, better solubility with hydrocarbon components, improved water tolerance, and higher overall heating value. There are several processes that can be used to make mixed alcohols from CO and H₂; including isosynthesis, variants of FTS, oxosynthesis involving the hydroformylation of olefins, and homologation of methanol and lower molecular weight alcohols to make higher alcohols.

Depending on the process conditions and catalysts used, the most abundant products are typically methanol and CO₂. The first step in higher alcohol synthesis (HAS) is the formation of a C-C bond by CO insertion into CH₃OH. Linear alcohols are produced in a stepwise fashion involving the synthesis of methanol followed by its successive homologation to ethanol, propanol, butanol, etc. The mechanism for HAS involves a complex set of numerous reactions with multiple pathways leading to a variety of products that are impacted by kinetic and thermodynamic constraints. The general HAS reaction mechanism has the following overall stoichiometry: $n\text{CO} + 2n\text{H}_2 \rightarrow \text{C}_n\text{H}_{2n+1}\text{OH} + (n-1)\text{H}_2\text{O}$ with n typically ranging from 1 to 8 (Forzatti et al. 1991). The reaction stoichiometry suggests that the optimum CO/H₂ = 2, however, the simultaneous occurrence of the WGS reaction means that the optimum ratio is closer to 1.

Similar to other syngas conversion processes, one of the most important aspects of HAS is removing the large excess heat of reaction to maintain control of process temperatures, maximize yields, and minimize catalyst deactivation by sintering. HAS is performed in reactors that are similar to methanol and FT synthesis processes. In fact, to date modified methanol and modified FT catalysts have been the most effective in the production of mixed alcohols. Other catalyst types that have been researched for higher alcohol synthesis include sulfide-based, oxide-based, and rhodium (Rh) based.

While other syngas-to-liquids processes have been commercialized, the commercial success of HAS has been limited by poor selectivity and low product yields. In general, advances need to be made which result in increased productivity and improved selectivity in higher alcohol formation. Some possible ideas include injection of lower alcohols in the syngas, using catalyst beds in series, and using a slurry phase reactor.

Several studies have been performed to evaluate the economics of higher alcohol synthesis from natural gas. Depending of the cost of the natural gas and the economic assumptions used, the results of these studies varies from roughly \$0.50/gallon to \$1.20/gallon.

Section Contents

<u>6.1 Summary</u>	70
<u>6.2 Introduction</u>	72
<u>6.3 Technology Description</u>	73
<u>6.4 Chemistry</u>	73
<u>6.5 Catalysts</u>	76
<u>6.6 Reactors</u>	79
<u>6.7 Gas Cleanliness Requirements</u>	79
<u>6.8 Status/Technology Developers</u>	79
<u>6.9 Environmental Performance</u>	83
<u>6.10 Cost</u>	83
<u>6.11 R&D Needs</u>	83
<u>6.12 References</u>	85

List of Tables

<u>Table 21: Companies and Information Regarding Mixed Alcohols Research</u>	82
<u>Table 22: EcaleneTM Composition</u>	83
<u>Table 23: Comparison of Mixed Higher Alcohol Economics From Natural Gas</u>	84

6.2 Introduction

The production of higher alcohols from syngas has been known since the beginning of the last century. There are several processes that can be used to make mixed alcohols from CO and H₂; including isosynthesis, variants of FTS, oxosynthesis involving the hydroformylation of olefins, and homologation of methanol and lower molecular weight alcohols to make higher alcohols. With the development of various gas-to-liquids processes (such as Fischer-Tropsch and methanol synthesis) it was recognized that higher alcohols were by-products of these processes when catalysts or conditions were not optimized. Modified FT or methanol synthesis catalysts can be promoted with alkali metals to shift the products towards higher alcohols. Higher alcohol synthesis (HAS) is also optimized at higher temperatures and lower space velocities compared to methanol synthesis and with H₂/CO \approx 1 instead of 2 or greater.

While other syngas-to-liquids processes were being commercialized, the commercial success of HAS has been limited by poor selectivity and low product yields. Single pass yields of HAS are on the order of 10% syngas conversion to alcohols with methanol typically being the most abundant alcohol produced (Herman 2000; Wender 1996). Methanol can be recycled to produce more higher alcohols or removed and sold separately. Despite these shortcomings, in 1913 BASF patented a process to synthesize a mixture of alcohols, aldehydes, ketones, and other organic compounds from CO and H₂ over an alkalized Co oxide catalyst at 10-20 MPa and 300-400°C (Herman 1991). Fischer and Tropsch developed the “Synthol” process for alcohol production in 1923. They used an alkalized Fe catalyst to convert syngas to alcohols at >10 MPa and 400-450°C. Between 1935 and 1945 commercial mixed alcohol synthesis was performed with alkalized ZnO/Cr₂O₃ catalysts. The demand for mixed alcohol production from syngas decreased after 1945 with the increasing availability of petroleum and the desire for neat alcohols for manufacturing chemicals (Forzatti et al. 1991). Much of this early work on HAS is detailed in the review by Natta, Colombo, and Pasquon (Natta et al. 1957).

The oil embargo of the 1970s provided incentive for renewed interest in the synthesis and utilization of higher alcohols as a transportation fuel to be blended with gasoline. Mixed alcohols are a more attractive gasoline blending stock for octane enhancement compared to methanol. The octane rating is a measure of the fuel’s resistance to uncontrolled ignition by spurious sources such as hot spots in the combustion chamber (Mills and Ecklund 1989). The higher the octane number the less likelihood that a spurious ignition will occur. The undesirable properties of using neat methanol as a gasoline additive include high volatility, phase separation tendency when water is present, and incompatibility with certain engine fuel system components. Using mixed alcohols, containing methanol and higher alcohols, avoids these problems. Mixed alcohols have lower vapor pressure, better solubility with hydrocarbon components, improved water tolerance, and higher overall heating value compared to methanol. Also, when used as a diesel substitute at levels of 20-30 wt% higher alcohols, the calorific value, lubrication properties, and ignition properties are improved compared to pure methanol (Höhlein et

al. 1991). Another important aspect is that it may be possible to use the existing fuel infrastructure.

The environmental impact of oxygenates in gasoline is another driver which increased the interest in HAS. The 1990 Clean Air Act mandated the seasonal use of oxygenated compounds in gasoline in specific regions of the U.S. to improve air quality by reducing volatile organic hydrocarbon emissions that lead to increased ground level ozone concentrations. Until recently, the oxygenate of choice as a gasoline additive was methyl tert-butyl ether (MTBE). The rapid increase in demand for MTBE led to concerns about shortages of petroleum-derived isobutene (Verkerk et al. 1999). Commercial synthesis of MTBE involves the etherification of isobutene with methanol over an acidic ion exchange catalyst.

Recognizing an opportunity, research efforts increased to optimize the HAS process and catalysts to yield mixtures of methanol and isobutanol that could be combined in a dehydrative coupling reaction to produce MTBE from non-petroleum sources (Burcham et al. 1998; Verkerk et al. 1999). The optimum molar ratio of methanol to isobutanol for MTBE production is one. The isobutanol is dehydrated to yield isobutene that is then combined with methanol in the commercial MTBE synthesis process. These activities may not be important in the future, considering the current environmental concerns being encountered with MTBE leaking into watersheds.

6.3 Technology Description

Currently there are no commercial plants that produce mixed alcohols in the C₂ to C₆ range. From a commercial viewpoint, the selectivity of HAS catalysts has not advanced to the point of commercial feasibility. However, the main process steps include synthesis gas production followed by gas clean up and conditioning, alcohol synthesis, and product purification.

6.4 Chemistry

The mechanism for HAS involves a complex set of numerous reactions with multiple pathways leading to a variety of products that are impacted by kinetic and thermodynamic constraints. No kinetic analysis of HAS has been published that is capable of globally predicting product compositions over ranges of operating conditions (Beretta et al. 1996). Depending on the process conditions and catalysts used, the most abundant products are typically methanol and CO₂. The first step in HAS is the formation of a C-C bond by CO insertion into CH₃OH. Linear alcohols are produced in a stepwise fashion involving the synthesis of methanol followed by its successive homologation to ethanol, propanol, butanol, etc. (Quarderer 1986). Therefore, the HAS catalyst should have methanol synthesis activity because methanol can be considered a recurrent C₁ reactant. Branched higher alcohols are typically formed from modified methanol synthesis and modified FTS catalysts and straight chain alcohols are formed when alkalized MoS₂ catalysts are used.

The mechanism for HAS over modified high temperature methanol synthesis catalysts has been described as a unique carbon-chain growth mechanism that is referred to as oxygen retention reversal (ORR) aldol condensation with β -carbon (adjacent to the alcohol oxygen) addition (Herman 2000). Individual reactions in HAS can be grouped into several distinct reaction types (Nunan et al. 1989):

- Linear chain growth by C_1 addition at the end of the chain to yield primary linear alcohols.
- Beta addition between the C_1 and C_n ($n \geq 2$) to yield, for example, 1-propanol and branched primary alcohols such as 2-methyl-1-propanol (isobutanol) for $n = 2$
- Beta addition between C_m ($m = 2$ or 3) and C_n ($n \geq 2$).
- Methyl ester formation via carboxylic acids formed from synthesized alcohols
- Carbonylation of methanol to yield methyl formate

Linear alcohols can proceed along the reaction path but branched alcohols are terminal products of the aldol condensation pathways because they lack the 2 α -hydrogens required for chain growth (Hilmen et al. 1998).

The general HAS reaction mechanism has the following overall stoichiometry (Hutchings et al. 1988; Wong et al. 1986):

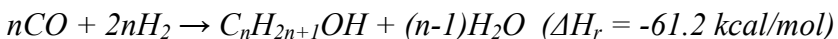

with n typically ranging from 1 to 8 (Forzatti et al. 1991). The reaction stoichiometry suggests that the optimum $CO/H_2 = 2$, however, the simultaneous occurrence of the WGS reaction means that the optimum ratio is closer to 1. The major reactions in HAS are: methanol synthesis, FT reactions, higher alcohol synthesis reactions, and the water-gas shift (WGS) reaction (Xiaoding et al. 1987). The following is a list of some of these more important reactions described above that are associated with HAS.

$CO + 2H_2 \leftrightarrow CH_3OH$	<i>Methanol synthesis</i>
$CO + H_2O \leftrightarrow CO_2 + H_2$	<i>Water-Gas Shift</i>
$CH_3OH + CO \leftrightarrow CH_3CHO + H_2O$	<i>CO beta addition - aldehydes</i>
$CH_3OH + CO + 2H_2 \leftrightarrow CH_3CH_2OH + H_2O$	<i>Ethanol Homologation</i>
$C_nH_{2n-1}OH + CO + 2H_2 \leftrightarrow CH_3(CH_2)_nOH + H_2O$	<i>HAS Homologation</i>
$2 CH_3OH \leftrightarrow CH_3CH_2OH + H_2O$	<i>Condensation/dehydration</i>
$2 CH_3OH \leftrightarrow (CH_3)_2CO + H_2O$	<i>DME formation</i>
$(CH_3)_2CO + H_2 \leftrightarrow (CH_3)_2CHOH$	<i>Branched iso-alcohols</i>
$2 CH_3CHO \leftrightarrow CH_3COOCH_2CH_3$	<i>Methyl ester synthesis</i>

Competing reactions:

$nCO + 2nH_2 \rightarrow C_nH_{2n} + nH_2O$	<i>Olefins</i>
$nCO + (2n+1)H_2 \rightarrow C_nH_{2n+2} + nH_2O$	<i>Paraffins</i>

Methanol formation is favored at low temperatures and high pressures (Courty et al. 1990). At high pressures, HAS increases as the temperature is increased at the expense of methanol formation and minimizing hydrocarbon formation. To maximize higher alcohols, the H_2/CO ratio should be close to the usage ratio, which is about 1. Lower H_2/CO ratios favor CO insertion and C-C chain growth. In general, the reaction conditions for HAS are more severe than those for methanol production. To increase the yield of higher alcohols, methanol can be recycled for subsequent homologation provided the catalyst shows good hydrocarbonylation activity (Courty et al. 1990; Quarderer 1986). Unavoidably, the main reactions stated above produce H_2O and CO_2 as by-products. WGS plays a major role and, depending on the catalyst's shift activity, some chemical dehydration of alcohols can be undertaken in-situ to produce higher alcohols, esters, and ethers (Courty et al. 1990). Secondary reactions also produce hydrocarbons (HCs) including aldehydes and ketones (Courty et al. 1984; Courty et al. 1990). Also, frequently, substantial quantities of methane are formed (Roberts et al. 1992). Thermodynamic constraints limit the theoretical yield of HAS, and as in other syngas-to-liquids processes, one of the most important limitations to HAS is removing the considerable heat of reaction to maintain control of process temperatures (Courty et al. 1984). Compared to methanol, less alcohol product is made per mole of CO, more byproduct is made per mole of alcohol product, and the heat release is greater.

6.5 Catalysts

HAS catalysts are essentially bifunctional base-hydrogenation catalysts and are typically categorized into several groups based on their composition. Common to all HAS catalysts is the addition of alkali metals to the formulation. The activating character of alkali metal promoters is a function of their basicity. Alkali metals provide a basic site to catalyze the aldol condensation reaction by activating surface adsorbed CO and enhancing the formation of the formate intermediate. For the following, 4 groups of catalysts will be discussed (Herman 1991):

1. Modified high pressure methanol synthesis catalysts – alkali-doped ZnO/Cr₂O₃
2. Modified low pressure methanol synthesis catalysts – alkali-doped Cu/ZnO and Cu/ZnO/Al₂O₃
3. Modified Fischer-Tropsch catalysts – alkali-doped CuO/CoO/Al₂O₃
4. Alkali-doped sulfides, mainly MoS₂

One of the major hurdles to overcome before HAS becomes an economic commercial process is improved catalysts that increase the productivity and selectivity to higher alcohols (Fierro 1993).

To date modified methanol and modified FT catalysts have been more effective in the production of mixed alcohols; the sulfide-based catalysts tend to be less active than the oxide-based catalysts (Herman 2000). Rhodium (Rh) based catalysts are another group of catalysts that are not specifically used for HAS but have been developed for selective ethanol synthesis. Other C₂ oxygenates (i.e., acetaldehyde and acetic acid) as well as increased levels of methane production are also synthesized over Rh-based catalysts (Nirula 1994). The high cost and limited availability of rhodium for ethanol synthesis catalysts will impact any commercialization of these synthetic processes for converting syngas to ethanol (Xiaoding et al. 1987).

6.5.1 Modified high pressure/high temperature methanol synthesis catalysts

Alkali/ZnO/Cr₂O₃ - process conditions: 300-425°C and 12.5-30 MPa - major product: branched primary alcohols

For non-alkalized catalysts containing Cu-Zn-Cr oxides, HAS yields were optimized for low Cr levels (15-21 wt% Cr). Chromia does not provide an active catalytic site but it is beneficial in small amounts because it acts as a structural promoter that increases the surface area of the catalyst and helps inhibit Cu sintering (Campos-Martin et al. 1995).

Methanol synthesis is fast compared to HAS over a 3% K₂O/ZnCr catalyst, but is still equilibrium limited, even at high space velocities. CO₂-rich feeds have been shown to inhibit HAS; a 3-fold decrease in C₂₊ alcohol production was measured for HAS at 400°C with 6% CO₂ (Tronconi et al. 1989). The productivity of primary alcohols was maximized over these alkali metal promoted high-temperature methanol synthesis catalysts with a CO₂-free feed with H₂/CO = 1 and CO conversion of ~ 5-20%.

Nunan, et al. (Nunan et al. 1989) studied the effect of Cs-doping on Cu/ZnO catalysts. They determined that HAS product yields were maximized at 0.3-0.5 mol% Cs which translated to a surface concentration of 15-25%. The role of Cs-addition is to increase the ethanol synthesis rate that enhances the formation of higher alcohols. HAS conditions were 310°C at 7.6 MPa with $H_2/CO = 0.45$. Numerous papers by Hoflund and his group systematically describe the properties and effectiveness of promoted Zn/Cr HAS catalysts (Epling et al. 1997; Epling et al. 1998; Epling et al. 1999; Hoflund et al. 1997; Hoflund et al. 1999; Minahan et al. 1998a; Minahan et al. 1998b).

6.5.2 Modified low pressure/low temperature methanol synthesis catalysts

Alkali/Cu/ZnO(Al_2O_3) - process conditions: 275-310°C and 5-10 MPa - major product: primary alcohols (Upper temperature of processes using copper catalysts is limited because of sintering)

Many of the early commercial processes for HAS were based on alkali-promoted, low temperature methanol synthesis catalysts. Lurgi developed the Octamix process in collaboration with Süd Chemie, who provided the catalyst for the process. The Octamix catalyst contained 25-40 wt% CuO, 10-18 wt% Al_2O_3 , 30-45 wt% ZnO, and 1.7-2.5 wt% K_2O with a Cu:Zn ratio of 0.4-1.9 with 3-18 wt% of a variety of oxidic promoters (Cr, Ce, La, Mn, or Th) (Xiaoding et al. 1987). With a starting gas composition of 25-30% CO, 0-8% N_2 , 0-5% CO_2 , 0-5% CH_4 , in a balance of H_2 ; CO conversions were between 21-29% with 29-45% selectivity for C_{2+} alcohols and 17-25% CO_2 selectivity at process conditions of 250-400°C, 10 MPa, and a gas hourly space velocity of 1000-10,000/h (Xiaoding et al. 1987). Methanol is the most abundant oxygenated product (~ 80%). The average carbon number of the oxygenated products is lower compared to products from modified high temperature methanol catalysts (Forzatti et al. 1991). The effectiveness of modified low temperature methanol synthesis catalysts has been detailed in the literature (Elliott and Pennella 1988; Nunan et al. 1989; Smith and Anderson 1984; Smith and Klier 1992).

6.5.3 Modified Fischer-Tropsch catalysts

Alkali/CuO/CoO-based catalysts - process conditions: 260-340°C and 6-20 MPa - major product: Linear primary alcohols that follow ASF distribution

The commercial HAS process sought and developed by the Institut Français du Pétrole (IFP) and collaborators was based on modified Fischer-Tropsch catalysts. The IFP catalyst was a homogeneous mixed-oxide formulation containing Cu and Co on an alumina support as the active components for HAS modified with Zn and alkali metals. The catalysts were designed for HAS process conditions similar to low temperature methanol synthesis process conditions (5-15 MPa, $T = 220-350^\circ C$, $H_2/CO = 0.5-4$ with CO_2 also as a reactant) (Xiaoding et al. 1987). Patented IFP catalyst formulations have the following composition, on an element basis: 10-50% Cu; 5-25% Co; 5-30% Al; 10-70% Zn; alkali/Al = 0-0.2; Zn/Al = 0.4-2.0; Co/Al = 0.2-0.75; Cu/Al = 0.1-3.0 (Xiaoding et al. 1987). The homogeneity of the catalyst correlates with good catalyst performance.

The IFP process yields mainly saturated, straight-chained terminal alcohols that follow an Anderson-Shultz-Flory-type (ASF) distribution for chain growth. At optimal conditions, carbon conversion efficiency of CO and CO₂ is between 5 and 30% and produces a liquid product containing 30-50% higher alcohols with hydrocarbons being the primary byproducts. The lack of long-term stability and low activity of these catalysts hinders the commercial application of this HAS process. Catalyst lifetimes have been quoted as long as 8000 h at the pilot-scale with little deactivation, caused mainly by coke formation and sintering that decreases the homogeneity of the catalyst (Xiaoding et al. 1987). Additional discussions of IFP-type catalyst studies have been presented in the literature (Courty et al. 1984; Courty et al. 1990; Courty et al. 1982; Dai et al. 1989; Dalmon et al. 1992).

6.5.4 Alkali-doped sulfides, mainly MoS₂

Alkali/MoS₂ - process conditions: 260-350°C and 3-17.5 MPa - major product: linear alcohols

In 1984, the Dow Chemical Company and Union Carbide Corporation independently disclosed a new catalyst system for converting syngas to linear alcohols. The catalysts were either supported or unsupported alkali-promoted MoS₂ or Co/MoS₂ (Herman 1991). Sulfide catalysts, such as MoS₂, are well-known hydrogenation catalysts, however, adding alkali metals as dopants shifts the products to alcohols rather than hydrocarbons. The role of the alkali metal is two-fold. 1) to suppress the hydrogenation activity of the Mo active site and 2) to provide additional active sites for alcohol formation. Cesium is the most effective alkali promoter (Herman 2000), although K-addition has been extensively studied. The catalysts have 75-90% selectivity to higher alcohols from syngas with H₂/CO = 1 with ~ 10% CO conversion efficiency (Herman 1991). Both higher alcohols and hydrocarbons formed over sulfide catalysts follow a similar ASF molecular weight distribution.

These catalysts have the unique property of being extremely resistant to sulfur poisoning. In fact, the process requires 50-100 ppm sulfur in the feed gas to maintain the sulfidity of the catalyst (Courty et al. 1990). //modified to achieve a more active voice// H₂S in the feed gas is also thought to moderate the hydrogenation properties of the catalyst and improve selectivity of higher alcohols by reducing methanol production (Forzatti et al. 1991).

Sulfide catalysts are also less sensitive to CO₂ in the syngas but the presence of large amounts (>30%) of CO₂ have been shown to retard the catalyst activity (Herman 1991). Moderate to low (7%) CO₂ concentration in the syngas does not significantly impact CO conversion. The selectivity to higher alcohols versus methanol is reduced by the presence of even low levels of CO₂ (Herman 1991) so CO₂ removal is recommended for processes using sulfide catalysts.

Adding Co to alkalinized MoS₂ catalysts increases the production of ethanol and other higher alcohols because Co promotes the homologation of methanol to ethanol (Forzatti et al. 1991). Activity of the sulfide catalysts can also depend on the catalyst support

material (Avila et al. 1995; Bian et al. 1998; Iranmahboob and Hill 2002; Iranmahboob et al. 2002; Li et al. 1998).

6.6 Reactors

Similar to other syngas conversion processes, one of the most important aspects of HAS is removing the large excess heat of reaction to maintain control of process temperatures, maximize yields, and minimize catalyst deactivation by sintering. HAS is performed in reactors that are similar to methanol and FT synthesis processes. Research and development is being conducted to investigate the use of slurry phase reactors for HAS. ChemSystems has conducted a pilot-scale study of isobutanol synthesis in a slurry reactor using a Cs-promoted Cu/Zn/Al₂O₃ catalyst in hydrocarbon oil (40 wt% slurry) at 12.5 MPa and 350°C (ChemSystems 1990; Herman 2000). Other HAS processes based on a “double bed” configuration have been explored. The idea is to optimize methanol production from syngas in the first reactor using a Cu-based catalyst at a lower temperature. The second reactor usually operates at a slightly higher temperature with a non-Cu Zn-chromite based catalyst to increase the yield of higher alcohols, particularly isobutanol by maximizing the C-C forming steps (Verkerk et al. 1999).

6.7 Gas Cleanliness Requirements

Gas cleanliness requirements for the modified FT and modified methanol synthesis catalysts are the same as those for the unmodified catalysts (see the gas cleanliness requirements section in the FT chapter and in the methanol chapter). Because the catalyst that Dow uses is already sulfided, it is extremely resistant to poisoning by sulfur in the syngas (1984).

6.8 Status/Technology Developers

As stated previously, currently there are no commercial plants that produce mixed alcohols in the C₂ to C₆ range. Table 21 gives information regarding companies that have actively pursued mixed alcohols research. Generally, the H₂/CO ratio is 1-1.4 except for the Snamprogetti, which has a range of 0.5-3. In terms of commercialization, Dow, IFP and Snamprogetti are the most advanced in their process development (Nirula 1994).

6.8.1 Snamprogetti (also referred to as SEHT - Snamprogetti, Enichem, and Haldor Topsoe)

Snamprogetti and Haldor Topsoe developed this process jointly. A 12,000 tonne/yr pilot plant was started-up in 1982 in Pisticci, Italy (Olayan 1987). It was operated from 1982-1987 (Courty et al. 1990; Mills and Ecklund 1989; Nirula 1994). The process is similar to that for methanol production with a different catalyst and a higher operating temperature. In the proposed process, syngas is produced via partial oxidation of natural gas. Mixed alcohols are then synthesized in fixed bed adiabatic reactors. The crude alcohol mixture contains 20% water. The product is purified using 3 distillation columns.

The first removes methanol and ethanol, the second is a stripping column to remove water, and the third recovers the C₃₊ alcohols using azeotropic distillation with cyclohexane (El Sawy 1990; Fox 1993). The final water content is below 0.1 wt% (Ricci et al. 1984).

The alcohol mixture was called MAS (Metanolo piu Alcoli Superiori – methanol plus higher alcohols) (Mills and Ecklund 1989). It was blended into gasoline at about 5 vol% and marketed successfully as a premium gasoline known as SUPER E (El Sawy 1990; Mills and Ecklund 1989). Blends of 10 vol% were also tested in 13 different types of European cars and compared with conventional gasoline for driveability, acceleration, octane, exhaust emissions, and fuel economy (Ricci et al. 1984). For all of these categories except emissions, the alcohol/gasoline fuel blend was shown to be similar to conventional gasoline. The emissions varied depending on the type of car but in general there was a reduction in CO (as much as 40%) and unburned HC (roughly 18%), with slightly higher NO_x emissions (Ricci et al. 1984). Extensive research was largely discontinued because of the availability of large amounts of cheap petroleum.

6.8.2 Dow

Dow's process was first announced in 1984. They tested 2 high pressure reactors. One was a fluid bed and the other was a fixed bed (Nirula 1994). Dow's catalyst has shown high productivity and a resistance to sulfur. The patented Dow Chemical catalysts contain free or combined Mo, W, or Re, a free or combined alkali or alkaline-earth metal, and, optionally, a support. A catalyst containing 21% Mo and 1.5% K on a carbon support demonstrated 23.4% CO conversion when a H₂/CO mixture equal to 0.84 was passed over the catalyst at 262°C and 7.2 MPa. The product distribution of the alcohols was: 25 mol% MeOH, 12.4 mol% EtOH, 6.8 mol% 1-propanol, 2 mol% 1-butanol, and 0.3 mol% C₅ alcohols (Quarderer and Cochran 1984). However, in addition to the mixed alcohols, a substantial amount of CO₂, methanol, and HCs were produced (Xiaoding et al. 1987). The amount of methanol formed can be varied by adjusting the process conditions. The higher alcohols are predominantly straight chain C₂-C₅ alcohols. The water content is low (2-3 wt% given in (Quarderer 1986), and stated to be as low as 0.2% in 1984 - Dow).

6.8.3 Lurgi (also referred to as Octamix)

While developing a low pressure methanol synthesis catalyst, a catalyst was discovered that had tendencies to yield higher alcohols. A 2 TPD demonstration plant was built in May 1990 at the Institute of Energy Process Engineering at the Research Centre Julich in cooperation with Lurgi (Goehna and Koenig 1989; Höhlelein et al. 1991). This process differs from methanol synthesis only in the addition of CO₂ removal and product purification. In Lurgi's process scheme, syngas is produced via a combination of steam reforming and autothermal reforming then a tubular reactor is used for mixed alcohol synthesis. The water content of the crude mixture is only 1-2%. Thus a stabilizer column could be used instead of distillation or else molecular sieves to dry the product unless recovery of the methanol was desired (El Sawy 1990; Fox 1993). The final water content

is low, 0.1-0.3 wt% (Goehna and Koenig 1989). The Octamix product was granted an EPA waiver to be used as a gasoline additive on February 1, 1988 (El Sawy 1990).

6.8.4 *IFP (also referred to as Substifuel)*

IFP's process is in the laboratory stage. They have built a 20 BPD unit in Chiba, Japan (Courty et al. 1990; El Sawy 1990). The IFP process scheme uses steam reforming followed by multibed quench synthesis reactors and distillation. The distillation section consists of 3 distillation columns: methanol distillation, extractive distillation with diethylene glycol (DEG), and distillation to recover the DEG (El Sawy 1990; Fox 1993). The final product contains about 0.2 wt% water.

Table 21: Companies and Information Regarding Mixed Alcohols Research

Company	Country	Catalyst type	T (C)	P (psi)	H ₂ /CO ratio	Products	Conversion and Selectivity Information
Lurgi	Germany	Modified MeOH	250-420	725-1,450	1-1.2	53.5 wt% MeOH 41.9 wt% C2-C6	CO conversion = 20-60%
Union Carbide	U.S.	Rhodium	300-350	1,000-2,500	not found	not found	CO selectivity to etoh = 60%
Sagami Research Center	Japan	Rhodium	200-300	735	1.4	Mainly MeOH, EtOH, & CH ₄	CO conversion = 14% Selectivity to etoh up to 61% Selectivity to alcohols = 90%
IFP	France	Modified MeOH	260-320	850-1,450	1-2	30-50 wt% C2-C4	CO conversion = 12-18% Selectivity to alcohols = 70-75%
Hoechst	Germany	Rhodium	275	1,455	not found	not found	CO selectivity to etoh = 74.5%
Snamprogetti	Italy	Modified MeOH	260-420	2,610-3,822	0.5-3	20-40 wt% C2-C4	CO conversion = 17% Selectivity to alcohols = 71%
Texaco (liquid phase system)	U.S.	Modified FT	220-240	6,615	not found	12-39 wt% non-alcohol oxygenates	Syngas conversion = 40% Selectivity to products = 75%
Dow	U.S.	Modified FT	299-310	1,500-2,000	1.1-1.2	30-70 wt% MeOH	CO conversion = 10-40% Selectivity to alcohols = 85%

Source: (Courty et al. 1990; Goehna and Koenig 1989; Herman 1991; Nirula 1994; Wender 1996).

6.8.5 Ecalene™

Another mixed alcohol process, termed Ecalene™, is currently at the bench scale but is being scaled up to a 500 gallon/day pilot plant. This is a collaborative project between Western Research Institute (WRI) and Power Energy Fuels, Inc. (PEFI), who developed the technology. Table 22 gives the composition of their alcohol mixture which can vary depending on the process parameters. The main alcohol constituent is ethanol. The synthesis reactor operates at 290-360°C and 145-1,595 psi (Lucero et al. 2001).

Table 22: Ecalene™ Composition

Constituent	Current range (wt%) (Taylor 2002)	Target composition (wt%) (Lucero et al. 2001)
Methanol	5-30	0
Ethanol	45-75	75
Propanol	15	9
Butanol	5	7
Pentanol	3	5
Hexanol & higher	2	4

6.9 Environmental Performance

The evaporative emissions from fuel blends containing mixed alcohols (particularly methanol and ethanol) are typically much higher than emissions from straight gasoline. As a fuel additive, mixed alcohols have been shown to exhibit a reduction in CO, HCs, and nitric oxide emissions (Höhlein et al. 1991).

6.10 Cost

Table 23 summarizes the economics of higher alcohol synthesis from several studies which examine natural gas as the feedstock. Another source states a breakdown of the capital cost to be 50% for syngas production, 29% for alcohol synthesis, 17% for CO₂ removal, and 4% for alcohols fractionation (Courty et al. 1990). Economies of scale would improve the economics of mixed alcohol synthesis but it is also extremely important to reduce energy losses as well as overall heat and momentum transfer duty (Lange and Tijm 1996).

6.11 R&D Needs

In general, advances need to be made which result in increased productivity and improved selectivity in higher alcohol formation. Some possible ideas include injection of lower alcohols in the syngas, using catalyst beds in series, and using a slurry phase reactor (Herman, 2000).

Table 23: Comparison of Mixed Higher Alcohol Economics From Natural Gas

Study	(ChemSystems 1990)	(Salmon 1986)	(Courty et al. 1984)	(Ricci et al. 1984)	(El Sawy 1990)	(Bechtel 1998)
Cost year	1986	1989	1983	1982	1986	Not given
Natural gas cost (\$/GJ)	\$1.9/GJ and \$0.47/GJ	\$1.9/GJ and \$0.47/GJ	\$4.3/GJ	\$0.8-\$6.6/GJ	\$2.8/GJ, \$2.6/GJ and \$0.47/GJ	\$1/GJ
Methanol/higher alcohol mixture (wt%)	50/50	65/35 for 70-90% selectivity	(60-70)/(30-40)	70/30	70/30 and 50/50	70/30
Mixed alcohols produced (tonne/yr)	550,000	386,000	600,000	730,000	635,000 – 730,000	about 1,700,000
Price of mixed alcohols	\$167.7/tonne \$0.505/gallon \$105.6/tonne \$0.318/gallon	<u>Production cost:</u> (\$1.9/GJ nat gas) \$198-\$255/tonne \$0.60-\$0.77/gallon (\$0.47/GJ nat gas) \$162-\$199/tonne \$0.49-\$0.60/gallon	<u>Production cost:</u> \$313.9/tonne \$0.95/gallon <u>With 15% return:</u> \$400/tonne \$1.21/gallon <u>Production cost:</u> For \$1/GJ nat gas \$150/tonne \$0.45/gallon	\$110-\$395/tonne \$0.33-\$1.19/gallon	<u>Production cost:</u> (\$2.8/GJ nat gas) \$282/tonne \$0.774/gallon (\$0.47/GJ nat gas) \$205/tonne \$0.562/gallon (\$2.6/GJ nat gas) \$0.90-\$1.04/gallon	\$225-\$265/tonne \$0.68-\$0.80/gallon (\$2.11/GJ nat gas) \$279-\$318/tonne \$0.84-\$0.96/gallon
Level of detail	Few details	Few details	Few details	Few details	Few details	Some details

Note: Production cost = no return on investment for these references.

6.12 References

(1984). "Dow Develops Catalytic Method To Produce Higher Mixed Alcohols." *Chemical and Engineering News*, 29-30.

Avila, Y., Kappenstein, C., Pronier, S., and Barrault, J. (1995). "Alcohol synthesis from syngas over supported molybdenum catalysts." *Applied Catalysis, A: General*, 132(1), 97-109.

Bechtel Corporation. (1998). "Task 4.2 Commercial Applications - Economics of MTBE via Mixed Alcohol." *Subcontract No. PT5781-B*, Prepared for Air Products and Chemicals.

Beretta, A., Tronconi, E., Forzatti, P., Pasquon, I., Micheli, E., Tagliabue, L., and Antonelli, G. B. (1996). "Development of a mechanistic kinetic model of the higher alcohol synthesis over a Cs-doped Zn/Cr/O catalyst .1. Model derivation and data fitting." *Industrial & Engineering Chemistry Research*, 35(7), 2144-2153.

Bian, G.-z., Fan, L., Fu, Y.-l., and Fujimoto, K. (1998). "Mixed Alcohol Synthesis from Syngas on Sulfided K-Mo-Based Catalysts: Influence of Support Acidity." *Industrial & Engineering Chemistry Research*, 37(5), 1736-1743.

Burcham, M. M., Herman, R. G., and Klier, K. (1998). "Higher alcohol synthesis over double bed Cs-Cu/ZnO/Cr₂O₃ catalysts: Optimizing the yields of 2-methyl-1-propanol (isobutanol)." *Industrial & Engineering Chemistry Research*, 37(12), 4657-4668.

Campos-Martin, J. M., Guerrerorruiz, A., and Fierro, J. L. G. (1995). "Structural and Surface Properties of CuO-ZnO-Cr₂O₃ Catalysts and Their Relationship with Selectivity to Higher Alcohol Synthesis." *Journal of Catalysis*, 156(2), 208 - 218.

ChemSystems. (1990). "Optimization of Electricity-Methanol Coproduction. Configurations of Integrated-Gasification-Combined-Cycle/Once-Through." *EPRI/GS-6869*.

Courty, P., Arlie, J. P., Convers, A., Mikitenko, P., and Sugier, A. (1984). "C1-C6 Alcohols from Syngas." *Hydrocarbon Processing*, 63(11), 105-108.

Courty, P., Chaumette, P., Raimbault, C., and Travers, P. (1990). "Production of methanol-higher alcohol mixtures from natural gas via syngas chemistry." *Revue de l'Institut Francais du Petrole*, 45(4), 561-78.

Courty, P., Durand, D., Freund, E., and Sugier, A. (1982). "C1-C6 alcohols from synthesis gas on copper-cobalt catalysts." *J. Mol. Catal.*, 17(2-3), 241-54.

Dai, L., Chen, Z., Li, G., Li, Y., and Liu, X. (1989). "Synthesis of C1-C5 alcohols from coal-based syngas." *Proceedings - Annual International Pittsburgh Coal Conference*, 6th(2), 739-46.

- Dalmon, J. A., Chaumette, P., and Mirodatos, C. (1992). "Higher alcohols synthesis on cobalt based model catalysts." *Catalysis Today*, 15(1), 101-127.
- Elliott, D. J., and Pennella, F. (1988). "Mechanism of ethanol formation from synthesis gas over copper oxide/zinc oxide/alumina." *Journal of Catalysis*, 114(1), 90-9.
- El Sawy, A. H. (1990). "Evaluation of Mixed Alcohol Production Processes and Catalysts." NTIS. DE90010325. SAND89-7151, Mitre Corporation.
- Epling, W. S., Hoflund, G. B., Hart, W. M., and Minahan, D. M. (1997). "Reaction and surface characterization study of higher alcohol synthesis catalysts, II. Cs-promoted commercial Zn/Cr spinel." *Journal of Catalysis*, 172(1), 13-23.
- Epling, W. S., Hoflund, G. B., and Minahan, D. M. (1998). "Reaction and surface characterization study of higher alcohol synthesis catalysts. VII. Cs- and Pd-promoted 1:1 Zn/Cr spinel." *Journal of Catalysis*, 175(2), 175-184.
- Epling, W. S., Hoflund, G. B., and Minahan, D. M. (1999). "Higher alcohol synthesis reaction study. VI: effect of Cr replacement by Mn on the performance of Cs- and Cs, Pd-promoted Zn/Cr spinel catalysts." *Applied Catalysis, A: General*, 183(2), 335-343.
- Fierro, J. L. G. (1993). "Catalysis in C1 chemistry: future and prospect." *Catalysis Letters*, 22(1-2), 67-91.
- Forzatti, P., Tronconi, E., and Pasquon, I. (1991). "Higher Alcohol Synthesis." *Catalysis Reviews-Science and Engineering*, 33(1-2), 109-168.
- Fox, J. M., III. (1993). "The different catalytic routes for methane valorization: an assessment of processes for liquid fuels." *Catalysis Reviews - Science and Engineering*, 35(2), 169-212.
- Goehna, H., and Koenig, P. (1989). "The Octamix process." *Indirect Liquefaction, Proc., Contract. Rev. Meet.*(CONF-891131--DE90 008422), 59-83.
- Herman, R. G. (1991). "Chapter 7 - Classical and Non-Classical Routes for Alcohol Synthesis." *New Trends in CO Activation*, L. Guzzi, ed., Elsevier, New York, 265-349.
- Herman, R. G. (2000). "Advances in catalytic synthesis and utilization of higher alcohols." *Catalysis Today*, 55(3), 233-245.
- Hilmen, A. M., Xu, M., Gines, M. J. L., and Iglesia, E. (1998). "Synthesis of higher alcohols on copper catalysts supported on alkali-promoted basic oxides." *Applied Catalysis A: General*, 169(2), 355-372.
- Hoflund, G. B., Epling, W. S., and Minahan, D. M. (1997). "Higher alcohol synthesis reaction study using K-promoted ZnO catalysts. III." *Catalysis Letters*, 45(1,2), 135-138.

- Hoflund, G. B., Epling, W. S., and Minahan, D. M. (1999). "An efficient catalyst for the production of isobutanol and methanol from syngas. XI. K- and Pd-promoted Zn/Cr/Mn spinel (excess ZnO)." *Catalysis Letters*, 62(2-4), 169-173.
- Höhlein, B., Mausbeck, D., Supp, E., and König, P. "Selective Catalysis for the Synthesis of Energy Alcohols Status and Outlook." *International Symposium on Alcohol Fuels*, Florence, Italy, 43-48.
- Hutchings, G. J., Copperthwaite, R. G., and Coville, N. J. (1988). "Catalysis for hydrocarbon formation and transformations." *South African Journal of Science*, 84(1), 12-16.
- Iranmahboob, J., and Hill, D. O. (2002). "Alcohol synthesis from syngas over K₂CO₃/CoS/MoS₂ on activated carbon." *Catalysis Letters*, 78(1-4), 49-55.
- Iranmahboob, J., Toghiani, H., Hill, D. O., and Nadim, F. (2002). "The influence of clay on K₂CO₃/Co-MoS₂ catalyst in the production of higher alcohol fuel." *Fuel Processing Technology*, 79(1), 71-75.
- Lange, J. P., and Tijm, P. J. A. (1996). "Processes for converting methane to liquid fuels: economic screening through energy management." *Chemical Engineering Science*, 51(10), 2379-2387.
- Li, X., Feng, L., Liu, Z., Zhong, B., Dadyburjor, D. B., and Kugler, E. L. (1998). "Higher Alcohols from Synthesis Gas Using Carbon-Supported Doped Molybdenum-Based Catalysts." *Industrial & Engineering Chemistry Research*, 37(10), 3853-3863.
- Lucero, A. J., Klepper, R. E., O'Keefe, W. M., and Sethi, V. K. (2001). "Development of a process for production of mixed alcohols from synthesis gas." *Preprints of Symposia - American Chemical Society, Division of Fuel Chemistry*, 46(2), 413-419.
- Mills, G. A., and Ecklund, E. E. (1989). "Alternative Fuels - Progress and Prospects .2." *Chemtech*, 19(10), 626-631.
- Minahan, D. M., Epling, W. S., and Hoflund, G. B. (1998a). "An efficient catalyst for the production of isobutanol and methanol from syngas. VIII: Cs- and Pd-promoted Zn/Cr spinel (excess ZnO)." *Catalysis Letters*, 50(3,4), 199-203.
- Minahan, D. M., Epling, W. S., and Hoflund, G. B. (1998b). "Higher-alcohol synthesis reaction study. V. Effect of excess ZnO on catalyst performance." *Applied Catalysis, A: General*, 166(2), 375-385.
- Natta, G., Colombo, U., and Pasquon, I. (1957). "Direct Catalytic Synthesis of Higher Alcohols from Carbon Monoxide and Hydrogen." *Catalysis*, P. H. Emmett, ed., Reinhold, New York, 131-174.
- Nirula, S. C. (1994). "Dow/Union Carbide Process for Mixed Alcohols from Syngas." *PEP Review no. 85-1-4*, SRI International, Menlo Park, CA.

- Nunan, J. G., Bogdan, C. E., Klier, K., Smith, K. J., Young, C. W., and Herman, R. G. (1989). "Higher alcohol and oxygenate synthesis over cesium-doped copper/zinc oxide catalysts." *Journal of Catalysis*, 116(1), 195-221.
- Olayan, H. B. M. (1987). "Selection of technology for synthesis gas based products in Saudi Arabia." *Energy Progress*, 7(1), 9-17.
- Quarderer, G. J. "Mixed Alcohols from Synthesis Gas." *78th National AIChE Meeting*, New Orleans, Louisiana.
- Quarderer, G. J., and Cochran, G. A. (1984). "Catalytic process for producing mixed alcohols from hydrogen and carbon monoxide." PCT Int. Appl., (Dow Chemical Co., USA). Wo, 40 pp.
- Ricci, R., Paggini, A., Fattore, V., Ancillotti, F., and Sposini, M. (1984). "Production of methanol and higher alcohols from synthesis gas." *Chemia Stosowana*, 28(1), 155-68.
- Roberts, G. W., Lim, P. K., McCutchen, M. S., and Mawson, S. (1992). "The thermodynamics of higher alcohol synthesis." *Preprints - American Chemical Society, Division of Petroleum Chemistry*, 37(1), 225-33.
- Salmon, R. (1986). "Economics of Methanol Production from Coal and Natural Gas." *ORNL-6091*, Oak Ridge National Laboratory.
- Smith, K. J., and Anderson, R. B. (1984). "A chain growth scheme for the higher alcohols synthesis." *J. Catal.*, 85(2), 428-36.
- Smith, K. J., and Klier, K. (1992). "An Overview of the Higher Alcohol Synthesis." *Abstracts of Papers of the American Chemical Society*, 203, 82-PETR.
- Taylor, D. G. (2002). "A process to produce Ecalene™ DE ® Denatured Ethanol form synthesis gas Utilizing Catalytic Thermal Reforming (CTR) and the "Power Energy Process".
- Tronconi, E., Lietti, L., Forzatti, P., and Pasquon, I. (1989). "Synthesis of Alcohols from Carbon Oxides and Hydrogen .17. - Higher Alcohol Synthesis over Alkali Metal-Promoted High- Temperature Methanol Catalysts." *Applied Catalysis*, 47(2), 317-333.
- Verkerk, K. A. N., Jaeger, B., Finkeldei, C. H., and Keim, W. (1999). "Recent developments in isobutanol synthesis from synthesis gas." *Applied Catalysis, A: General*, 186(1,2), 407-431.
- Wender, I. (1996). "Reactions of synthesis gas." *Fuel Processing Technology*, 48(3), 189-297.
- Wong, S. F., Patel, M. S., and Storm, D. A. "Retrofitting Methanol Plants For Higher Alcohols." *78th American Institute of Chemical Engineers, National Meeting*, New Orleans, LA.

Xiaoding, X., Doesburg, E. B. M., and Scholten, J. J. F. (1987). "Synthesis of higher alcohols from syngas - recently patented catalysts and tentative ideas on the mechanism." *Catalysis Today*, 2(1), 125-170.

7 Fischer-Tropsch Synthesis

7.1 Summary

Two main characteristics of Fischer-Tropsch synthesis (FTS) are the unavoidable production of a wide range of hydrocarbon products (olefins, paraffins, and oxygenated products) and the liberation of a large amount of heat from the highly exothermic synthesis reactions. Product distributions are influenced by temperature, feed gas composition (H_2/CO), pressure, catalyst type, and catalyst composition. FT products are produced in four main steps: syngas generation, gas purification, FT synthesis, and product upgrading. Depending on the types and quantities of FT products desired, either low (200–240°C) or high temperature (300–350°C) synthesis is used with either an iron (Fe) or cobalt catalyst (Co).

FTS catalysts can lose activity as a result of 1) conversion of the active metal site to an inactive oxide site, 2) sintering, 3) loss of active area by carbon deposition, and 4) chemical poisoning. Some of these mechanisms are unavoidable and others can be prevented or minimized by controlling the impurity levels in the syngas. By far the most abundant, important, and most studied FTS catalyst poison is sulfur. Other catalyst poisons include halides and nitrogen compounds (e.g., NH_3 , NO_x and HCN).

Over the years, four types of FT reactors have been designed and used commercially. The fixed bed tubular reactor known as the ARGE reactor operates at 220–260°C and 20–30 bar. High temperature circulating fluidized bed reactors, known as Synthol reactors, have been developed for gasoline and light olefin production. They operate at 350°C and 25 bar. Recently, the Sasol Advanced Synthol reactor has been developed. It is a fixed fluidized bed reactor with similar operating conditions as the Synthol reactor at half the capital cost and size for the same capacity. The fourth reactor design is the low temperature slurry reactor which is a 3-phase reactor consisting of a solid catalyst suspended and dispersed in a high thermal capacity liquid (often the FT wax product). Syngas is bubbled through the liquid phase achieving excellent contact with the catalyst while keeping the catalyst particles dispersed. Slurry reactors are optimized at low temperatures for FT high wax production with low methane production.

The first FT plants began operation in Germany in 1938 but closed down after the second world war. Then in 1955, Sasol, a world-leader in the commercial production of liquid fuels and chemicals from coal and crude oil, started Sasol I in Sasolburg, South Africa. Following the success of Sasol I, Sasol II and III came on line in 1980 and 1982, respectively. The syngas at these three plants as well as at several other plants abroad is converted to more than 200 fuel and chemical products. In the early 1990s, two other FT plants came on line. The Moss gas plant which converts natural gas to FT products using a high temperature process and an iron catalyst started up in South Africa in 1992. Additionally, Shell commissioned a plant in Bintuli, Malaysia using the Shell Middle Distillate Synthesis process, which is essentially enhanced FT synthesis. Currently, Syntroleum is building a 10,000 BPD specialty chemicals and lube oil plant located in Northwestern Australia.

Section Contents

<u>7.1 Summary</u>	90
<u>7.2 Introduction</u>	92
<u>7.3 Technology Description</u>	93
<u>7.4 Chemistry</u>	94
<u>7.5 Catalysts</u>	96
<u>7.6 Reactors</u>	97
<u>7.7 Gas Cleanliness Requirements</u>	99
<u>7.8 Status/Technology Developers</u>	101
<u>7.9 Process Performance</u>	102
<u>7.10 Environmental Performance</u>	102
<u>7.11 Cost</u>	103
<u>7.12 R&D Needs</u>	106
<u>7.13 References</u>	107

List of Figures

<u>Figure 7: FTS General Process Flow Diagram</u>	93
<u>Figure 8: Anderson-Shulz-Flory Distribution</u>	95
<u>Figure 9: Types of Fischer-Tropsch Synthesis Reactors</u>	98

List of Tables

<u>Table 24: Syngas Impurities and Tolerances for Fischer-Tropsch</u>	100
<u>Table 25: Price Ranges for Natural Gas, Gasoline, and Diesel</u>	104
<u>Table 26: Comparison of Biomass Based Fischer Tropsch Studies</u>	106

7.2 Introduction

The synthesis of hydrocarbons from CO hydrogenation over transition metal catalysts was discovered in 1902 when Sabatier and Sanderens produced CH₄ from H₂ and CO mixtures passed over Ni, Fe, and Co catalysts. In 1923, Fischer and Tropsch reported the use of alkalized Fe catalysts to produce liquid hydrocarbons rich in oxygenated compounds — termed the Synthol process. Succeeding these initial discoveries, considerable effort went into developing catalysts for this process. A precipitated Co catalyst with 100 parts by weight Co, 5 parts by weight ThO₂, 8 parts by weight MgO, and 200 parts by weight kieselguhr (silicious diatomaceous earth) became known as the “standard” atmospheric pressure process catalyst. In 1936, Fischer and Pilcher developed the medium pressure (10-15 bar) FTS process. Following this development, alkalized Fe catalysts were implemented into the medium pressure FTS process. Collectively, the process of converting CO and H₂ mixtures to liquid hydrocarbons over a transition metal catalyst has become known as the Fischer-Tropsch synthesis.

Two main characteristics of Fischer-Tropsch synthesis (FTS) are the unavoidable production of a wide range of hydrocarbon products and the liberation of a large amount of heat from the highly exothermic synthesis reactions. Consequently, reactor design and process development has focused heavily on heat removal and temperature control. The focus of catalyst development is on improved catalyst lifetimes, activity, and selectivity. Single pass FTS always produces a wide range of olefins, paraffins, and oxygenated products such as alcohols, aldehydes, acids and ketones with water as a byproduct. Product distributions are influenced by temperature, feed gas composition (H₂/CO), pressure, catalyst type, and catalyst composition. Product selectivity can also be improved using multiple step processes to upgrade the FTS products.

In a review by Frohning, et al. (1954), it was cited that upwards of 4000 publications and a similar number of patents dealing with FTS could be found in the literature. Since then FTS has attracted an enormous amount of research and development effort. A comprehensive bibliography of FTS literature, including journal and conference articles, books, government reports and patents can be found in the Fischer-Tropsch Archive at www.fischer-tropsch.org. This website is sponsored by Syntroleum Corporation in cooperation with Dr. Anthony Stranges, Professor of History at Texas A&M University and contains more than 7500 references and citations. This site has collected a bibliography of the large body of documents from the 1920's through the 1970s, which are important for researching the history and development of FTS and related processes as well as an up-to-date listing of the latest publications in this field. Many excellent reviews of FTS have been drawn upon for this report (Mills, 1993; Dry, 2002; and Dry, 1981) in an attempt to summarize, the chemistry (Frohning, *et al*, 1982), catalyst development (Bartholemew, 1991; Oukaci, *et al*, 1999; and Raje, *et al*, 1997), commercial processes (Dry, 2002, 1999, 1982; Senden, *et al*, 1992; Haid, *et al*, 2002, Van Nierop *et al*, 2000), reactor development (Adesini, 1986; Dry, 1988; and Dry and Hoogendoorn, 1981), and economics of FTS.

7.3 Technology Description

There are four main steps to producing FT products: syngas generation, gas purification, FT synthesis, and product upgrading. Figure 7 depicts a generic process flow diagram. When using natural gas as the feedstock, many authors (Abbott and Crewdson, 2002; Rostrup-Nielsen, 2000; Vosloo, 2001; and Wilhelm, *et al*, 2001) have recommended autothermal reforming or autothermal reforming in combination with steam reforming as the best option for syngas generation. This is primarily attributed to the resulting H₂/CO ratio and the fact that there is a more favorable economy of scale for air separation units than for tubular reactors (steam methane reforming - SMR). If the feedstock is coal, the syngas is produced via high temperature gasification in the presence of oxygen and steam. Depending on the types and quantities of FT products desired, either low (200–240°C) or high temperature (300–350°C) synthesis is used with either an iron or cobalt catalyst. FTS temperatures are usually kept below 400°C to minimize CH₄ production. Generally, cobalt catalysts are only used at low temperatures. This is because at higher temperatures, a significant amount of methane is produced. Low temperatures yield high molecular mass linear waxes while high temperatures produce gasoline and low molecular weight olefins. If maximizing the gasoline product fraction, it is best to use an iron catalyst at a high temperature in a fixed fluid bed reactor. If maximizing the diesel product fraction, a slurry reactor with a cobalt catalyst is the best choice. The FT reactors are operated at pressures ranging from 10-40 bar (145–580 psi). Upgrading usually means a combination of hydrotreating, hydrocracking, and hydroisomerization in addition to product separation.

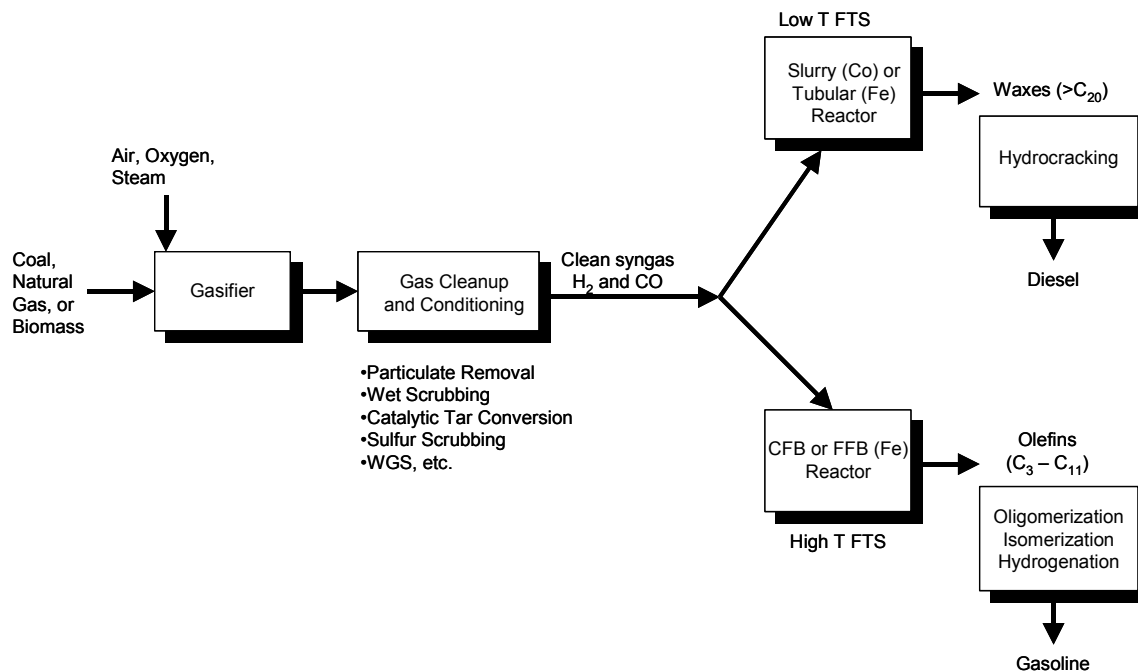

Figure 7: FTS General Process Flow Diagram

7.4 Chemistry

FTS has long been recognized as a polymerization reaction with the basic steps of:

1. reactant (CO) adsorption on the catalyst surface
2. chain initiation by CO dissociation followed by hydrogenation
3. chain growth by insertion of additional CO molecules followed by hydrogenation
4. chain termination
5. product desorption from the catalyst surface

Chemisorbed methyl species are formed by dissociation of absorbed CO molecules and stepwise addition of hydrogen atoms. These methyl species can further hydrogenate to form methane or act as initiators for chain growth. Chain growth occurs via sequential addition of CH₂ groups while the growing alkyl chain remains chemisorbed to the metal surface at the terminal methylene group. Chain termination can occur at any time during the chain growth process to yield either an α -olefin or an n-paraffin once the product desorbs.

The following is the FTS reaction:

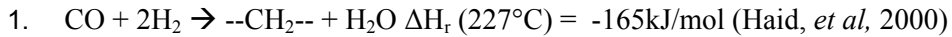

The water-gas shift (WGS) reaction is a secondary reaction that readily occurs when Fe catalysts are used. Combining reaction one (above) with reaction two (below) gives the net reaction for Fe catalyzed FTS (reaction 3).

2. $\text{CO} + \text{H}_2\text{O} \rightarrow \text{H}_2 + \text{CO}_2$ (Water-Gas Shift)
3. $2\text{CO} + \text{H}_2 \rightarrow \text{--CH}_2\text{--} + \text{CO}_2$ (net overall FTS)

The required H₂ to CO ratio for the cobalt catalyst is 2.15 but since the iron catalyst performs WGS in addition to the FT reaction, the H₂ to CO ratio can be slightly lower for the iron catalyst, 1.7 (Dry, 2002).

Specific FTS products are synthesized according to the following reactions.

4. $\text{CO} + 3\text{H}_2 \rightarrow \text{CH}_4 + \text{H}_2\text{O}$ (Methanation)
5. $n\text{CO} + (2n+1)\text{H}_2 \rightarrow \text{C}_n\text{H}_{2n+2} + n\text{H}_2\text{O}$ (Paraffins)
6. $n\text{CO} + 2n\text{H}_2 \rightarrow \text{C}_n\text{H}_{2n} + n\text{H}_2\text{O}$ (Olefins)
7. $n\text{CO} + 2n\text{H}_2 \rightarrow \text{C}_n\text{H}_{2n+1}\text{OH} + (n-1)\text{H}_2\text{O}$ (Alcohols)

Another competing reaction that becomes important in FTS is the Boudouard reaction:



Carbon deposition on the catalyst surface causes catalyst deactivation.

FTS is kinetically controlled and the intrinsic kinetics is stepwise chain growth, in effect the polymerization of CH_2 groups on a catalyst surface. FTS product selectivities are determined by the ability of a catalyst to catalyze chain propagation versus chain termination reactions. The polymerization rates, and therefore kinetics, are independent of the products formed. The probability of chain growth and chain termination is independent of chain length. Therefore, selectivities of various hydrocarbons can be predicted based on simple statistical distributions calculated from chain growth probability and carbon number. The chain polymerization kinetics model known as the Anderson-Shulz-Flory (ASF) model is represented by the following equation:

$$W_n = n(1-\alpha)^2 \alpha^{n-1}$$

W_n is the weight percent of a product containing n carbon atoms and α is the chain growth probability. This equation is graphically represented in Figure 8. It clearly displays the predicted distributions for several products and product ranges of particular interest.

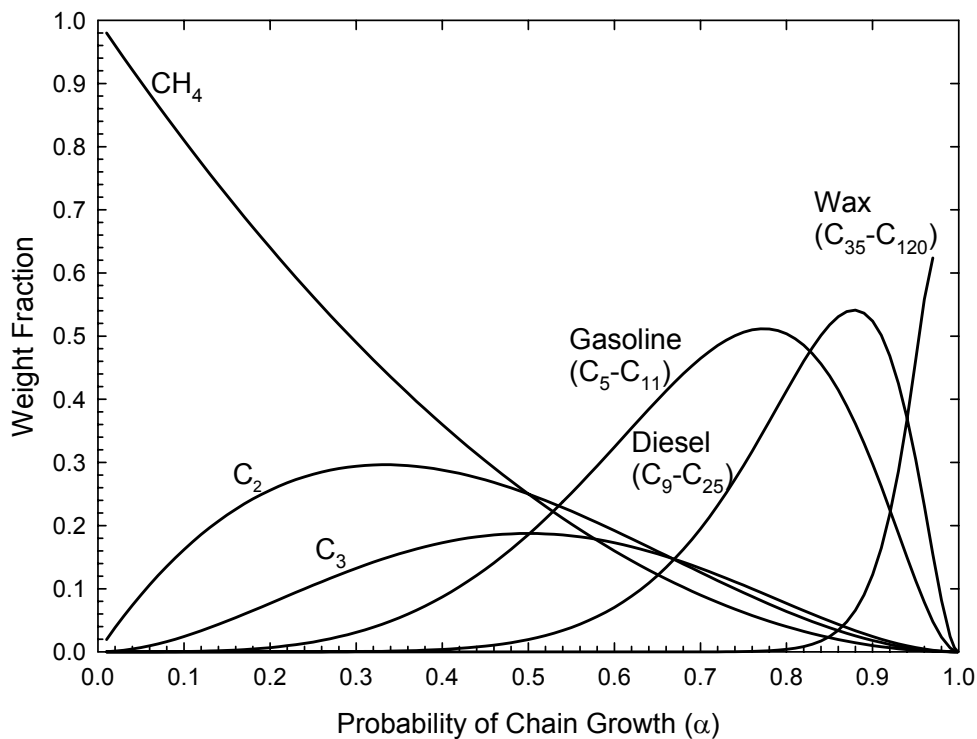

Figure 8: Anderson-Shulz-Flory Distribution

Irrespective of operating conditions, the FT reaction always produces a range of olefins, paraffins, and oxygenated compounds (alcohols, aldehydes, acids, and ketones). There are several unique aspects of FT products. Regardless of the product type, they are predominantly linear with high olefinicity. In fact, the paraffin-to-olefin ratio is lower than thermodynamically predicted. The olefins that do form are predominantly terminal (alpha). A considerable amount of monomethyl chain branches form and the degree of branching decreases as the chain length increases. Theoretically, only methane can be produced with 100% selectivity (Senden, *et al*, 1992). The only other product that can be produced with high selectivity is heavy paraffin wax. The gasoline product fraction has a maximum selectivity of 48%. The maximum diesel product fraction selectivity is closer to 40% and varies depending on the range of carbon numbers in the product cut. The variables that influence the product distribution are: reactor temperature, pressure, feed gas composition, catalyst type, and promoters.

7.5 Catalysts

Group VIII transition metal oxides are generally regarded as good CO hydrogenation catalysts. The earliest catalysts used for FTS were Fe and Co. Vannice has reported a relative activity of these metals for FTS (Adesina, 1996). In decreasing order of activity: Ru > Fe > Ni > Co > Rh > Pd > Pt. Ni is basically a methanation catalyst and does not have the broad selectivity of other FT catalysts. Ru has very high activity and quite high selectivity for producing high molecular weight products at low temperatures. Fe is also very active and has WGS activity. Fe readily forms carbides, nitrides, and carbonitrides with metallic character that also have FTS activity. Fe also has a stronger tendency than Ni or Co to produce carbon that deposits on the surface and deactivates the catalyst. Co tends to have a longer lifetime than Fe catalysts and does not have WGS activity, which leads to improved carbon conversion to products because CO₂ is not formed. Co catalysts in FTS yield mainly straight chain hydrocarbons (no oxygenates like Fe). Although Ru is the most active FTS catalyst it is 3x10⁵ times more expensive than Fe. Iron is by far the least expensive FTS catalyst of all of these metals. Co catalysts are 230 times more expensive than Fe but are still an alternative to Fe catalysts for FTS because they demonstrate activity at lower synthesis pressures, so higher catalyst costs can be offset by lower operating costs.

The three key properties of FT catalysts are lifetime, activity, and product selectivity. Optimizing these properties for desired commercial application has been the focus of FT catalyst research and development since the processes were first discovered. Each one of these properties can be affected by a variety of strategies including;

- use of promoters (chemical and structural)
- catalyst preparation and formulation
- pretreatment and reduction
- selective poisoning
- shape selectivity with zeolites

The performance of Co catalysts is not very sensitive to the addition of promoters. Early work demonstrated that the addition of ThO₂ improved wax production at atmospheric pressure, but had little effect at higher pressures. With Fe catalysts, however, promoters and supports are essential catalyst components. Since the discovery of FTS, potassium has been used as a promoter for Fe catalysts to effectively increase the basicity of the catalyst surface. The objective is to increase the adsorption of CO to the metal surface, which tends to withdraw electrons from the metal, by providing an electron donor. Adding Potassium oxide to Fe catalysts also tends to decrease hydrogenation of adsorbed carbon species, so chain growth is enhanced, resulting in a higher molecular weight product distribution that is more olefinic. Potassium promotion also tends to increase WGS activity leading to a faster rate of catalyst deactivation because of the increased rate of carbon deposition of the surface of the catalyst.

Copper has also been successfully used as a promoter in Fe FTS catalysts. It increases the rate of FTS more effectively than potassium, but decreases the rate of the WGS reaction. Copper has been shown to facilitate iron reduction. The average molecular weight of the products increases in the presence of copper, but not as much as when potassium is used. Potassium promotion is not effective for Co catalysts.

Catalyst preparation impacts the performance of Fe and Co catalysts. Fe catalysts can be prepared by precipitation onto catalyst supports such as SiO₂ or Al₂O₃, or as fused iron where formulations are prepared in molten iron, then cooled and crushed. The role of supports in Co catalysts is also important. Since Co is more expensive than Fe, precipitating the ideal concentration of metal onto a support can help reduce catalyst costs while maximizing activity and durability.

The combination of light transition metal oxides such as MnO with Fe increases the selectivity of light olefins in FTS. Fe/Mn/K catalysts have shown selectivity for C₂-C₄ olefins as high as 85-90%. Noble metal addition to Co catalysts increases FTS activity but not selectivity.

7.6 Reactors

One of the challenges with FTS, mentioned above, is the removal of the large amount of excess heat generated by the exothermic synthesis reactions. Insufficient heat removal leads to localized overheating which results in high carbon deposition leading to catalyst deactivation. Methane formation also dominates at higher temperatures at the expense of desired FTS products. For large-scale commercial FTS reactors heat removal and temperature control are the most important design features to obtain optimum product selectivity and long catalyst lifetimes. Over the years, basically four FTS reactor designs have been used commercially. Figure 9 depicts the types of Fischer-Tropsch synthesis reactors.

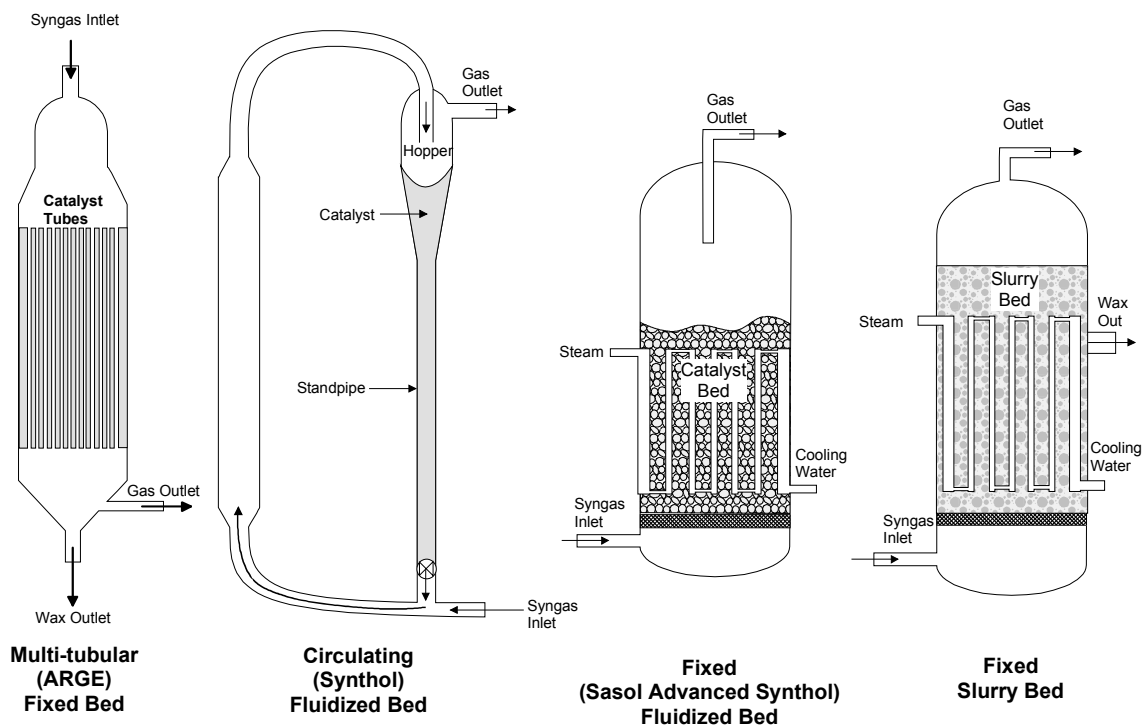

Figure 9: Types of Fischer-Tropsch Synthesis Reactors

One of the earliest FTS reactor designs was the fixed-bed tubular reactor. After many years of development, Ruhrchemie and Lurgi have refined this concept into what is known as the ARGE high capacity FT reactor. This has been used since the inception of Sasol I. The reactors contain 2,000 tubes filled with Fe catalyst immersed in boiling water for heat removal. The water bath temperature is maintained in the reactor by controlling the pressure. Syngas is introduced into the top of the reactor, flows through the tubes, and the products exit at the bottom of the reactor. Wax accounts for 50% of the products. Conversion efficiencies are on the order of 70%. The reactor is operated at 20-30 bar at an operating temperature of 220-260°C. Additional temperature control is obtained by using high gas velocities and gas recycling. Recycled gas is typically 2.5 times the amount of fresh syngas introduced into the reactor. Catalyst lifetimes are around 70-100 days (Wender, 1996) and catalysts removal can be quite difficult.

High-temperature circulating fluidized-bed reactors have been developed for gasoline and light olefin production. These reactors are known as Synthol reactors and operate at 350°C and 25 bar. The combined gas feed (fresh and recycled) enters at the bottom of the reactor and entrains catalyst that is flowing down the standpipe and through the slide valve. The high gas velocity carries the entrained catalyst into the reaction zone where heat is removed through heat exchangers. Product gases and catalyst are then transported into a large diameter catalyst hopper where the catalyst settles out and the product gases exit through a cyclone. These Synthol reactors have been successfully used for many years, however, they have a number of limitations. They are physically very complex reactors that involve circulation of large amounts of catalyst that leads to considerable erosion in particular regions of the reactor. Synthol reactors have also reached their design limit in terms of capacity and throughput (7,500 BPD capacity, (Lutz, 2001)).

The fixed fluidized bed Sasol Advanced Synthol reactor has replaced the circulating fluidized bed Synthol reactor. Gas is introduced through a distributor and bubbles up through the catalyst bed. Heat is removed by an internal heat exchanger immersed in the catalyst bed. These new reactors are half the cost and size of the circulating reactors for the same capacity. They also have better thermal efficiency with a less severe temperature gradient and a lower pressure drop across the reactor. Operating costs are considerably lower and there is greater process flexibility (in terms of product distribution) and the possibility for scale-up to 20,000 BPD (Lutz, 2001). Process conditions in the fixed fluidized bed reactors are similar to those established in the Synthol reactors.

Another reactor design is the low-temperature slurry reactor, which is a design that has been considered since Kolbel's pioneering work in the 1950s (Dry, 1996; and Dry, 2002). These 3-phase reactors consist of a solid catalyst suspended and dispersed in a high thermal capacity liquid (often the FT wax product). Syngas is bubbled through the liquid phase achieving excellent contact with catalyst while keeping the catalyst particles dispersed. Slurry reactors are optimized at low temperatures for high FT wax production with low methane production. Compared to the fluidized bed reactors, the liquid slurry bed offers the advantages of better temperature control, lower catalyst loading, and significantly lower catalyst attrition rates. The improved isothermal conditions in slurry bed reactors allows for higher average reactor temperatures leading to higher conversions to products. Slurry bed reactors also cost 75% less than the much more complex multitubular fixed bed reactors. These reactors have only recently been put into commercial FT production primarily because one of the technical barriers, which required considerable development, was reliable catalyst separation from the FT waxes.

7.7 Gas Cleanliness Requirements

FTS catalysts can lose activity as a result of 1) conversion of the active metal site to an inactive oxide site, 2) sintering, 3) loss of active area by carbon deposition, and 4) chemical poisoning. Some of these mechanisms are unavoidable and others can be prevented or minimized by insuring that the impurity levels in the incident syngas are acceptable for the given process.

Carbon deposition is the most important mode of catalyst deactivation that can be impacted by addition of promoters to catalysts and reaction temperature and pressure. This mode of catalyst deactivation is largely unavoidable and FTS processes must be operated in a manner that the decreasing output from coke deposition is balanced with the economic considerations of catalyst regeneration or replacement. In general, because of its high activity, the coke deposition rate is higher for Fe catalyst than Co catalyst. Consequently, Co catalysts have longer lifetimes.

One of the more controllable modes of catalyst deactivation is that induced by poisoning of the active sites by impurities in the syngas. By far the most abundant, important, and most studied FTS catalyst poison is sulfur. Sulfur is present in both natural gas and coal and during steam reforming or gasification gets converted primarily to H₂S plus other

organic sulfur compounds. Sulfur compounds rapidly deactivate both iron and cobalt catalysts, presumably by forming surface metal sulfides that do not have FTS activity. Ideally, there should be no sulfur in the syngas. There is, however, always a small amount that gets through to the catalyst. There is really no safe sulfur level in FTS. Again, the level of gas cleaning required is based on economic considerations; namely how long the catalyst remains active versus the investment in gas cleaning.

In the beginning, Fischer recommended 4 ppm as the maximum sulfur content in the FTS feedgas. Dry (1981) recommends a maximum sulfur content of 0.2 ppm based on commercial experience in the Sasol plants. Co catalysts are more sensitive to sulfur poisoning than Fe catalysts. Given the relative cost of Co versus Fe, more efficient sulfur removal should be expected for FTS with Co catalysts. Several more recent references cite even lower sulfur tolerances. Boerrigter, *et al*, (2002) state that sulfur levels in syngas for FTS should be below 1 ppmv and Turk, *et al*, (2001) claim that the total sulfur content in syngas should be 60 ppb. In general, for a fixed bed reactor design, any catalyst poison will have the most pronounced affect near the gas inlet and propagate through the reactor towards the outlet, whereas in a fluidized bed design the poison will have a uniform affect throughout the reactor.

Other syngas impurities are also known to poison FTS catalysts. Halide levels in syngas should be less than 10 ppb (Boerrigter, *et al*, 2002) and referenced nitrogen levels are 10 ppmv NH₃, 0.1 ppmv NO_x and 10 ppb HCN (Turk, *et al*, 2001). Additionally, water oxidizes FT catalysts (both Fe & Co) but the rate of oxidation is higher for the iron catalyst. Plus water has an inhibiting effect on the iron catalyst because of its WGS activity (Espinoza, *et al*, 2000). Table 24 summarizes the syngas impurities and tolerances.

Table 24: Syngas Impurities and Tolerances for Fischer-Tropsch

Impurity	Tolerance Level	Source
Sulfur	0.2 ppm 1 ppmv 60 ppb	Dry, 1981 Boerrigter, <i>et al</i> , 2002 Turk, <i>et al</i> , 2001
Halides	10 ppb	Boerrigter, <i>et al</i> , 2002
Nitrogen	10 ppmv NH ₃ 0.2 ppmv NO _x 10 ppb HCN	Turk, <i>et al</i> , 2001

Note: There are differing points of view regarding sulfur level but in general, the sulfur content of the syngas should be minimized according to economics.

Commercial processes are available to clean syngas to meet these stringent contaminant requirements. The Rectisol process uses chilled methanol to scrub the raw syngas. NH₃, H₂S, tars, and CO₂ are removed from syngas to required levels. Other chemical absorption processes include potassium carbonate or alkanolamine (MEA–monoethanolamine or DEA–diethanolamine) for wet scrubbing. Fixed bed reactors containing ZnO are also used for sulfur polishing. Whether or not these gas-cleaning processes are economical will depend on the scale of the FTS process.

7.8 Status/Technology Developers

The first FT plants began operation in Germany in 1938. There were nine plants with a total capacity of 660,000 tonnes/yr of FT products. These plants closed down after the second world war (Dry, 2002). In 1955, Sasol, a world-leader in the commercial production of liquid fuels and chemicals from coal and crude oil, started up its first FT plant (Sasol I) in Sasolburg, South Africa. The plant's capacity is 6 million tonnes/yr of FT products from coal. There are five tubular fixed bed (ARGE) reactors for wax production that are still operational today and three circulating fluid bed (CFB) reactors (Synthol reactors), which operated until 1993 (Dry, 1982). In 1993, a slurry reactor that matches the production of the five ARGE reactors began operation. Following the success of Sasol I, Sasol II and III came on line in 1980 and 1982, respectively. These plants are located in Secunda, South Africa. Sasol II and III all have circulating fluid bed (CFB) reactors (Synthol reactors) but with improved heat exchange. Thus, they get a three-fold increase in capacity compared to the synthol reactors at Sasol I. From 1995 to 1999, these second generation CFB reactors (Synthol reactors; 16 of them) were replaced with eight fixed fluid bed (FFB) reactors known as Sasol Advanced Synthol reactors (Dry, 2002). This was done for economic reasons and although the plant capacity did not increase, the operating cost was projected to decrease by \$1/BBL. In general, these reactors are advantageous because of lower capital costs, higher efficiency, lower operating costs, and less downtime for maintenance. CFB reactors suffered, initially, from enormous scale-up problems (mechanical, operational, & catalyst point of view).

Sasol's South Africa plants use both low and high temperature FT synthesis. The coal consumption at Sasol's three commercial plants is 36 million tons/year and that generates, on average, 1.5 million Nm³/hr of syngas from 97 pressurized Lurgi coal gasifiers (Van Nierop, *et al*, 2000). The syngas is converted to "more than 200 fuel and chemical products at its plants in Sasolburg and Secunda in South Africa, as well as at several other plants abroad." (<http://www.gasandoil.com/goc/company/cna02527.htm>) Its products; including gasoline, diesel, candle waxes, hard waxes, hydrocarbon lubricants, methane, phenol and cresol, tar and pitch, ammonia, detergents, etc., are exported to more than 70 countries around the world. Sasol also supplies 41% of South Africa's liquid transportation fuel requirements. The company has developed world-leading technology for the commercial production of synthetic fuels and chemicals from low-grade coal as well as the conversion of natural gas to environment-friendly diesel and chemicals.

In the early 1990s, two other FT plants came on line. The Moss gas plant, which converts natural gas to FT products using a high temperature process and an iron catalyst, started up in South Africa in 1992 (Dry, 2002). This plant produces 1 million tonnes/yr of FT products including motor gasoline, distillates, kerosene, alcohols and LPG. Additionally, Shell commissioned a plant in Bintuli, Malaysia, using the Shell Middle Distillate Synthesis process, which is essentially enhanced FT synthesis. This plant produces 500,000 tonnes/yr (12,000 BPD) of FT products from 100 MMSCFD of natural gas using a cobalt catalyst (Senden, *et al*, 1992). The plant produces automotive fuels, specialty chemicals, and waxes.

Currently, Syntroleum is building a 10,000 BPD plant (specialty chemicals and lube oil) in the Burrup Peninsula in Northwestern Australia (Haid, *et al*, 2000). The engineering began in 1999. Construction started in 2001 and operation is expected to begin in 2003. The plant will convert natural gas in the gas-to-liquids and specialty products plant using their proprietary process and a cobalt catalyst.

In early 2000, Sasol studied the feasibility of replacing coal with recently discovered offshore natural gas. They decided that switching to natural gas would reduce expenditures in its coal mining operations, as well as the high costs of compliance with environmental regulations associated with coal. Therefore, they are beginning to build a network of natural gas pipelines, which are expected to deliver gas to their facilities in 2004. Sasol plans to use the natural gas as a supplementary feedstock at Secunda and as a replacement feedstock for the coal in Sasolburg (http://www.oil-barrel.com/archives/features_archive/2002/jan-2002/sasol310102.htm and <http://www.eia.doe.gov/emeu/cabs/safrica.html>).

7.9 Process Performance

In reforming methane, about 20% of the carbon is converted to CO₂ while, for coal, this number is 50% due to the lower hydrogen content of coal (Dry, 2002). Coal gasification produces a syngas with a H₂:CO ratio of about 0.67. For this ratio, the maximum obtainable conversion of CO to FT products without WGS is 33% (Raje, *et al*, 1997). The theoretical max conversion of methane to paraffins is 78% on a LHV basis. The conversion at the Bintuli plant in Malaysia is about 63% (Senden, *et al*, 1992). In a slurry reactor, very small catalyst particles are suspended in a liquid medium allowing effective heat removal and good temperature control. Sasol's slurry phase process has a thermal efficiency of about 60% and a carbon conversion efficiency of about 75% (Lutz, 2001).

The slurry reactor has several advantages over the multitubular design. For example, the capital cost is 25% less for the same capacity, the pressure difference across the reactor is less (making the gas compression cost lower), there is a four fold lower catalyst consumption rate, and the reactor can operate at higher temperatures and thus higher conversions (Dry, 1982). One disadvantage is that any poison will poison the entire amount of catalyst, whereas, in the fixed tube design, only the top portion of the catalyst will be poisoned.

7.10 Environmental Performance

Compared to conventional fuels, FT fuels contain no sulfur and low aromatics. These properties, along with a high cetane number, result in superior combustion characteristics (Jager, 1998 and Alleman and McCormick, 2003). Tests performed on heavy duty trucks showed decreases in vehicle emissions of HC, CO, NO_x, and PM when using a FT fuel (Haid, *et al*, 2000; Lutz, 2001). FT diesel has been tested in a variety of light- and heavy-duty vehicles and engines. The paper by Alleman and McCormick (2003) summarizes FT diesel fuel property and emission information found in the literature. Overall, FT

diesel showed a reduction in regulated as well as some unregulated emissions compared to conventional diesel.

Several life cycle assessments (LCA) have been performed on a variety of transportation fuels including FT diesel and gasoline. Most of the studies have examined only greenhouse gas emissions and energy consumption (General Motors, 2001; Marano and Cierferno, 2001; and MIT, 2000) with the exception of General Motors. They also examined five criteria pollutants (VOCs, CO, NO_x, PM₁₀, and SO_x). These analyses have examined the emissions and energy consumption from resource extraction to end use. The results of the studies vary based on the feedstock procurement, technology conversion, and vehicle assumptions. However, in general, there is not a big advantage to FT liquids from fossil fuels in terms of energy consumption and green house gas emissions. This will not be the case for biomass systems. Because of the improved combustion characteristics of the FT liquids, performing a complete LCA including criteria pollutants will mostly likely show the overall benefits of FT liquids compared to conventional transportation fuels.

7.11 Cost

Table 25 presents information about the price of natural gas, gasoline, and diesel fuel, prior to giving cost information about FT synthesis. Over the years the price of each of these has fluctuated significantly.

Table 25: Price Ranges for Natural Gas, Gasoline, and Diesel

Fuel	Average U.S. price (1996-2002)	High		Low		Current price (Nov 02 avg)
		yearly avg	monthly avg	yearly avg	monthly avg	
Natural gas	\$2.76/Mscf (national wellhead)	\$4.12/Mscf \$3.8/GJ (2001)	\$8.06/Mscf \$7.4/GJ (Jan 01)	\$1.96/Mscf \$1.8/GJ (1998)	\$2.35/Mscf \$2.2/GJ (Jan 02)	\$3.64/Mscf \$3.4/GJ
Gasoline	\$1.33/gallon (includes taxes)	\$1.82/gallon \$14/GJ (HHV) \$15/GJ (LHV) (May 2001)		\$0.97/gallon \$7/GJ (HHV) \$8/GJ (LHV) (Feb. 1999)		\$1.42/gallon (\$11/GJ, HHV; \$12/GJ, LHV) <u>Excluding dist., marketing & taxes:</u> \$0.74/gallon (\$5.6/GJ, HHV; \$6.1, LHV)
Diesel	\$1.25/gallon (includes taxes)	\$1.67/gallon \$11/GJ (HHV) \$12/GJ (LHV) (Oct. 2000)		\$0.95/gallon \$6/GJ (HHV) \$7/GJ (LHV) (Feb. 1999)		\$1.42/gallon (\$9.7/GJ, HHV; \$10.5, LHV) <u>Excluding dist., marketing & taxes:</u> \$0.75/gallon (\$5.1/GJ, HHV, \$5.5, LHV)

Data from EIA:

- (1) U.S. Natural Gas Prices and Natural Gas Summary from the Short-Term Energy Outlook (http://www.eia.doe.gov/oil_gas/natural_gas/info_glance/prices.html) (Note: For natural gas, \$/Mscf is essential equivalent to \$/MMBtu). Note: Mscf=1,000 standard cubic feet
- (2) Gasoline and Diesel Fuel Update (<http://tonto.eia.doe.gov/oog/info/gdu/gasdiesel.asp>)

The following is cost information specific to the existing commercial plants and studies by others for fossil fuel feedstocks. In general, the publications give facts without a lot of details.

- The capital cost of the Bintuli, Malaysia plant was about \$660 million. (Senden, et al, 1992)
- The capital cost of replacing Sasol’s 16 CFB reactors with 8 FFB reactors was \$225 million. There was no increase in capacity but the reduction in the operating cost was projected to be \$1/BBL. (Chang, 2000)
- Studies by Sasol indicate that a two train GTL plant made up of slurry phase reactors producing 30,000 BPD of liquid transport fuels can be constructed at a capital cost of about \$25,000/BPD capacity including utilities, offsite facilities, and infrastructure. (Lutz, 2001 and Vosloo, 2001)
- Sasol examined the economics of a grass root plant using slurry phase reactors feeding 100 MMSCFD of natural gas and producing 10,000 BBL/day (425,000

ton/yr) of transportation fuel. The capital investment was around \$300 million resulting in an investment of \$30,000/daily BBL. (Jager, 1998)

- At a natural gas price of \$0.50/MMBtu (inexpensive), the feedstock accounts for \$5/BBL of the product price and the operating cost (fixed and variable) is estimated to contribute an additional \$5/BBL to the product price. (Gradassi, 1998; Jager, 1998; Lutz, 2001; and Vosloo, 2001)
- Using literature information, an economic analysis was performed for a 50,000 BPD plant using a feedstock cost of roughly \$0.50/MMBtu (inexpensive). The resulting cost of the FT liquids at an internal rate of return of 15% was \$26/BBL (\$0.83/gallon). This means that in order for the natural gas to FT liquids process to be competitive at this low feedstock cost, the price of crude oil needs to be at least \$18/BBL. (Gradassi, 1998)
- FT liquids from both coal and natural gas were examined for a plant that produces roughly 50,000 BPD of FT liquids. At a natural gas cost of \$0.5/MMBtu (inexpensive) the cost of the FT liquids is \$24/BBL (\$0.76/gallon) and at \$4/MMBtu this cost increases to \$52/BBL (\$1.7/gallon). Using Illinois #6 coal, the cost of the FT liquids is \$46/BBL (\$1.5/gallon). For a once-through plant that co-produces electricity which is sold at \$0.05/kWh, the cost of the FT is reduced to \$35/BBL (\$1.1/gallon). (Gray and Tomlinson, 1997)

The majority of the capital cost for FT production, greater than 50%, comes from syngas generation (Dry 2002; Senden, *et al*, 1992, and Vosloo, 2001). Additionally, the cost of syngas production from methane is 30% lower than that from coal and it is a more efficient process (Dry 2002). Any cost reduction in syngas generation will have a large impact on the economics.

Three studies that have examined the production of FT liquids from biomass are summarized in Table 26.

Table 26: Comparison of Biomass Based Fischer Tropsch Studies

Study	Tijmensen (2000) (a), (b)	Mitre (1996) (a), (b)	Novem (2000) (a), (c)
Biomass feed rate (BD tonne/day)	1,920	2,000	1,358
Biomass cost	\$2/GJ \$38/dry tonne	\$2.45/GJ \$46/dry tonne	\$3/GJ \$55/dry tonne
Electricity selling price	\$0.057/kWh	\$0.05/kWh	\$0.067/kWh
Net power (MW)	80 – 100 from biomass (150 MW gas turbine)	110 – 120	about 150
Other fuels	co-fires nat gas in gas turbine	None	co-fires nat gas in gas turbine
Raw or finished products	raw	Finished	finished
FT fuels produced	1,216 - 2,026 BBL/day	1,357 - 1,715 BBL/day	486 - 1,378 BBL/day
Cost year	1999	1993	1999
Price of products (without distribution costs and taxes)	\$13 - \$30/GJ \$1.8 - \$4.1/gallon base case = \$15 - 16/GJ	\$8 - \$14/GJ \$1.1 - \$1.9/gallon	\$9 - \$13/GJ \$1.2 - \$1.8/gallon
Level of detail	Very detailed - Gives costs of individual equipment, operating costs, and other economic parameters and assumptions	Somewhat detailed - Gives costs of major plant sections, operating costs, and lists other economic assumptions	Some details - Gives costs of major plant sections, and assumptions used to determine installed costs

Notes: (a) Examined direct & indirect gasifiers and atmospheric and pressurized gasifiers.
 (b) Examined both maximum liquids (recycle of unconverted syngas) and once through with power generated from unconverted syngas.
 (c) Only examined once through with combined heat and power.

7.12 R&D Needs

In as much as syngas generation accounts for the largest capital cost, efficient least-cost biomass gasification is essential for the conversion of biomass to FT products. It will be important to develop gas clean up that is economical at various scales of biomass to FT conversion. Additionally, selectivity and catalyst lifetime will play a role in the success of FT products from biomass.

7.13 References

Abbott, J. and Crewdson, B. (2002). "Gas heated reforming improves Fischer-Tropsch process." Oil & Gas Journal 100(16): 64-66, 68, 70.

Adesina, A.A. (1996). "Hydrocarbon synthesis via Fischer-Tropsch reaction: travails and triumphs", Appl. Catal. A, 13: 345-367.

Alleman, T.L. and McCormick, R.L. (2003). "Fischer-Tropsch Diesel Fuels - Properties and Exhaust Emissions: A Literature Review". 2003 SAE World Congress, CI Engine Combustion Processes & Performance with Alternative Fuels (SP-1737), Detroit, Michigan, March 3-6.

Bartholomew, C. H. (1991). "Recent Developments in Fischer-Tropsch Catalysis," Chapter 5 in "New Trends in CO Activation", (L. Guzzi ed.), Stud. Surf. Sci. Catal., 64: 158.

Boerrigter, H., den Uil, H., and Calis, H.-P. (2002). "Green Diesel from Biomass via Fischer-Tropsch Synthesis: New Insights in Gas Cleaning and Process Design." Paper presented a Pyrolysis and Gasification of Biomass and waste, Expert Meeting, 30 September, 2002, Strasbourg, FR.

Chang, T. (2000). "South African company commercializes new F-T process." Oil & Gas Journal 98(2): 42-45.

Davis, B. H. (2001). "Fischer-Tropsch synthesis: current mechanism and futuristic needs," Fuel Proc. Tech., 71(1-3): 157-166.

Dry, M. E. (2002). "The Fischer-Tropsch process: 1950-2000." Catalysis Today 71(3-4): 227-241.

Dry, M. E. (1999). "Fischer-Tropsch reactions and the environment", Appl. Catal. A, 189(2): 185-190.

Dry, M.E. (1996). "Practical and Theoretical Aspects of the Catalytic Fischer-Tropsch Process," Appl. Catal. A, 138: 319

Dry, M. E. (1990). "The Fischer-Tropsch process-commercial aspects", Cat. Today, 6: 183.

Dry, M. E. (1988). "The Sasol route to chemicals and fuels." Studies in Surface Science and Catalysis 36(Methane Convers.): 447-56.

Dry, M. E. (1982). "Catalytic Aspects of Industrial Fischer-Tropsch Sunthesis." Journal of Molecular Catalysis 71: 133-144.

Dry, M.E. (1981). "The Fischer-Tropsch Synthesis," in Catalysis, Science and Technology, (J.R. Anderson, M. Boudart, eds.), Springer-Verlag, Vol. 1, pp. 159-256.

Dry, M. E. and Hoogendoorn, J.C. (1981). "Technology of the Fischer-Tropsch process." Catal. Rev. - Sci. Eng. 23(2): 265-78.

Espinoza, R. L., Du Toit, E., Santamaria, J., Menendez, M., Coronas, J. and Irusta, S. (2000). "Use of membranes in Fischer-Tropsch reactors." Studies in Surface Science and Catalysis 130A(International Congress on Catalysis, 2000, Pt. A): 389-394.

Espinoza, R. L., Steynberg, A. P., Jager, B., and Vosloo, A. C. (1999). "Low temperature Fischer-Tropsch synthesis from a Sasol perspective", Appl. Catal. A, 186(1-2): 13-26.

Frohning, C., Kolbel, H., Ralek, M., Rottig, W., Schnur, F., and Schulz, H. (1982). "Fischer-tropsch process", Chapter 8 in Chemical feedstocks from coal, J. Falbe, ed., John Wiley and Sons, NY, pp. 309-432.

General Motors, Argonne National Laboratory, ExxonMobil, Shell. (2001). "Well-to-Wheel energy Use and Greenhouse Gas emissions of Advanced Fuel/Vehicle Systems - North American Analysis."

Gradassi, M. J. (1998). "Economics of gas to liquids manufacture." Studies in Surface Science and Catalysis 119(Natural Gas Conversion V): 35-44.

Gray, D. and Tomlinson, G. (1997). "A technical and economic comparison of natural gas and coal feedstocks for Fischer-Tropsch synthesis." Studies in Surface Science and Catalysis 107(Natural Gas Conversion IV): 145-150.

Haid, M. O., Schubert, P. F. and Bayens, C. A. (2000). "Synthetic fuel and lubricants production using gas-to-liquids technology." DGMK Tagungsbericht 2000-3: 205-212.

<http://www.eia.doe.gov/emeu/cabs/safrica.html>

http://www.oil-barrel.com/archives/features_archive/2002/jan-2002/sasol310102.htm

Jager, B. (1998). "Developments in Fischer-Tropsch technology." Studies in Surface Science and Catalysis 119(Natural Gas Conversion V): 25-34.

Jager, B., and Espinoza, R. L. (1995). "Advances in low temperature Fischer-Tropsch synthesis", Cat. Today, 23: 17.

Jess, A., Popp, R., and Hedden, K. (1999). "Fischer-Tropsch-synthesis with nitrogen-rich syngas: Fundamentals and reactor design aspects", Appl. Catal. A, 186(1-2): 321-342.

Kolbel, H., Ralek, M. (1980). "Fischer-Tropsch synthesis in the liquid phase", Catal. Rev. - Sci. Eng., 21(2): 225-274.

Lutz, B. (2001). "New age gas-to-liquids processing." Hydrocarbon Engineering 6(11): 23-26,28.

Marano, J. J., and Ciferno, J. P. (2001). "Life-Cycle Greenhouse-Gas Emissions Inventory For Fischer-Tropsch Fuels". U.S. DOE. National Energy Technology Laboratory.

Massachusetts Institute of Technology Energy Laboratory. (2000). "On the Road in 2020: A Life-Cycle Analysis of New Automobile Technologies". MIT EL 00-003.

Mills, G. (1993) Status and future Opportunities for Conversion of Synthesis Gas to Liquid Energy Fuels: Final Report. National Renewable Energy Laboratory, Golden, CO, TP-421-5150.

MITRE Corporation. (1996). Techno-Economic Assessment of Biomass Gasification Technologies for Fuels and Power.

Novem. (2000). "Technical and Economic Data Biomass-Bases Energy Conversion Systems for the Production of Gaseous and/or Liquid Energy Carriers". Report No. GAVE-9915.

Oukaci, R., Singleton, A. H., and Goodwin, J. G. (1999). "Comparison of Patented Co F-T Catalysts using Fixed-Bed and Slurry Bubble Column Reactors", Appl. Catal. A, 186: 129-144.

Patzlaff, J., Liu, Y., Graffmann, C., and Gaube, J. (1999). "Studies on product distributions of iron and cobalt catalyzed Fischer-Tropsch synthesis", Appl. Catal. A, 186(1-2): 109-119.

Raje, A., Inga, J. R. and Davis, B. H. (1997). "Fischer-Tropsch synthesis: process considerations based on performance of iron-based catalysts." Fuel 76(3): 273-280.

Rao, V. U. S, Stiegel, G. J., Cinquegrane, G. J., and Srivastave, R. D. (1992). "Iron based catalysts for slurry phase Fischer-Tropsch process: Technology Review", Fuel Proc. Tech., 30: 83-107.

Rostrup-Nielsen, J. R. (2000). "New Aspects of Syngas Production and Use." Catalysis Today 63: 159-167.

Schulz, H. (1999). "Short history and present trends of Fischer-Tropsch synthesis", Appl. Catal. A, 186(1-2): 3-12.

Schulz, H. (1985). "Selectivity and mechanism of the Fischer-Tropsch CO-hydrogenation", C1 Mol. Chem., 1: 231

Senden, M. M. G., Sie, S. T., Post, M. F. M. and Ansoorge, J. (1992). "Engineering aspects of the conversion of natural gas into middle distillates." NATO ASI Series, Series E: Applied Sciences 225(Chemical Reactor Technology for Environmentally Safe Reactors and Products): 227-47.

Steynberg, A. P., Espinoza, R. L., Jager, B., and Vosloo, A. C. (1999). "High temperature Fischer-Tropsch synthesis in commercial practice", Appl. Catal. A, 186(1-2): 41-54.

Tijmensen, M. J. A., Faaij, A. P. C., Hamelinck, C. N. and van Hardeveld, M. R. M. (2002). "Exploration of the possibilities for production of Fischer Tropsch liquids and power via biomass gasification." Biomass & Bioenergy 23(2): 129-152.

Tijmensen, M. J. A., Faaij, A. P. C., Hamelinck, C. N. and van Hardeveld, M. R. M. (2000) "The production of Fischer Tropsch liquids and power through biomass gasification", M. Sc. Thesis, Utrecht University/Science, Technology and Society, Utrecht. Report No. NWS-E-2000-29.

Turk, B.S., Merkel, T., Lopez-Ortiz, A., Gupta, R.P. Portzer, J.W., Kishnam, G., Freeman, B.D., and Fleming, G.K. (2001). "Novel TEchnologies for Gaseous Contaminants Control." Final Reprot for DOE Contract No. DE-AC26-99FT40675, September 2001.

Van Nierop, P., Erasmus, H.H., and van Zyl, J.J., (2000). "Sasol's Achievements if the 20th Century as a Building Block for the 21st." Presented at the 2000 Gasification Technologies Council, October 8-11, 2000. San Francisco, CA

Vannice, M. A. (1976). "The Catalytic Synthesis of Hydrocarbons from Carbon Monoxide and Hydrogen", Catal. Rev.-Sci. Eng., 14(2): 153-191.

Wender, I. (1996). "Reactions of synthesis gas." Fuel Processing Technology 48(3): 189-297.

8 Oxosynthesis

8.1 Summary

The oxosynthesis process is also known as hydroformylation. It involves the reaction of CO and H₂ with olefinic hydrocarbons to form an isomeric mixture of normal- and iso-aldehydes. It is an industrial synthetic route for the conversion of olefins (in the C₃-C₁₅ range) to produce solvents, synthetic detergents, flavorings, perfumes and other healthcare products, and other high value commodity chemicals. Worldwide production of oxo-aldehydes and alcohols was 6.5 million tons per year in 1997.

Oxosynthesis is a rapid reaction catalyzed by soluble cobalt or rhodium complexes. Three complimentary catalytic hydroformylation processes have been developed and commercialized. Phosphine-modified rhodium catalysts are best to produce 2-ethylhexanol, a plasticizer alcohol used to make flexible PVC, from propylene and syngas. This is the highest volume oxosynthesis process. Unmodified cobalt catalysts are versatile enough to be used for hydroformylation of high carbon number mixed olefins. Phosphine-modified cobalt catalysts are used for the production of higher, detergent range alcohols rather than aldehydes. The LP Oxo™ Low Pressure Oxo Process is the world's leading process for the production of oxo alcohols from olefins.

Section Contents

<u>8.1 Summary</u>	111
<u>8.2 Introduction</u>	113
<u>8.3 Technology Description</u>	113
<u>8.4 Chemistry</u>	114
<u>8.5 Catalysts</u>	115
<u>8.6 Gas Cleanliness Requirements</u>	116
<u>8.7 Status/Technology Developers</u>	116
<u>8.8 Cost</u>	119
<u>8.9 R&D Needs</u>	119
<u>8.10 References</u>	120

List of Figures

<u>Figure 10: Schematic Flow Diagram of the LP Oxo Process</u>	117
--	-----

List of Tables

<u>Table 27: Summary of U.S. Oxo Chemical Producers</u>	118
<u>Table 28: U.S. Prices for Oxo Chemicals</u>	119

8.2 Introduction

The oxosynthesis process is the hydroformylation of olefins with synthesis gas (CO and H₂). It is the principal chemical route to C₃-C₁₅ aldehydes that are typically converted into alcohols, acids, or other derivatives. Worldwide production of oxo-aldehydes and alcohols was 6.5 million tons per year in 1997 (Bahrmann and Bach 2000). The announced planned capacity additions for oxo chemicals in the next 5 years would add almost an additional 1 million tons (Bitzzari et al. 2002).

Hydroformylation is an industrial synthetic route for the conversion of a large number of olefins. It is used to produce solvents, synthetic detergents, flavorings, perfumes, other healthcare products, and other high value commodity chemicals. Oxo aldehyde products range from C₃-C₁₅. The higher end of this range (C₁₁-C₁₄) is often referred to as the detergent range because these aldehydes are typically used as intermediates in the synthesis of alcohols with the desired surfactancy and lack of crystallinity appropriate for detergents.

The hydroformylation of olefins was discovered in 1938 by Roelen of Ruhrchemie as an outgrowth of Fischer-Tropsch Synthesis (FTS). Oxosynthesis conducted in Germany was thought to be a heterogeneously catalyzed reaction because of its association with FTS. Continuous addition of cobalt, however, was required for early oxosynthesis processes. This prompted additional investigation that identified soluble cobalt carbonyls as the active catalyst for the reaction making the oxosynthesis process one of the first significant homogeneously catalyzed industrial processes. Reactants, catalyst, and products are all present in the same phase, usually as liquids. Today, hydroformylation processes are the fourth largest commercial use of syngas (Wender 1996).

Cobalt hydrocarbonyl was the first oxosynthesis catalyst commercially used. However, in the mid-1970s more active and selective ligand-modified rhodium-based catalysts were introduced for hydroformylation of lower olefins. For example, n-butanal from propylene is the highest volume oxo product. It can be converted to n-butanols (used as solvents) or 2-ethylhexanol, a plasticizer alcohol.

8.3 Technology Description

Oxosynthesis processes are very versatile and are used to commercially produce a wide range of products. The highest volume oxosynthesis process is the hydroformylation of propylene to butyraldehyde, which in turn, is converted to 2-ethylhexanol, a plasticizer alcohol used to make flexible PVC. Hydroformylation is a key step in the commercial production of Vitamin A. Hydroformylation of allyl alcohol is used to commercially produce butanediol.

8.4 Chemistry

The oxosynthesis process is also known as hydroformylation and involves the reaction of CO and H₂ with olefinic hydrocarbons to form an isomeric mixture of normal- and iso-aldehydes. The basic oxosynthesis reaction is highly exothermic and is thermodynamically favorable at ambient pressures and low temperatures (Whyman 1985). The reaction proceeds only in the presence of homogeneous metal carbonyl catalysts.

One of the more important factors in oxosynthesis is the normal-to-branched isomeric ratio (n/i). The normal, or straight chain isomer is the desired product.



Usually a 1:1 H₂:CO syngas mixture is required for oxosynthesis. The overall reaction rate has first-order dependence on the hydrogen partial pressure and inverse-first order dependence on CO partial pressure making the reaction rate essentially independent of total pressure (Pruett 1979). Higher CO partial pressures are usually required, however, to maintain the stability of the metal carbonyl catalysts. The reaction is also first order in olefin and metal concentration at the higher CO partial pressures.

The mechanism for the homogeneously catalyzed hydroformylation reaction is a function of the catalyst system used in the process. However, the general steps in the reaction paths are similar. The first step is to remove CO from the catalyst organometallic complex to give a coordinatively electron deficient species. The olefin attaches to the vacated d-orbital at this site in the catalyst complex. The double bond in the olefin attaches to the metal atom yielding an alkyl metal carbonyl complex. The olefin inserts into the M-H bond. CO then inserts into the complex at the C-M bond followed by hydrogen insertion at the same point to yield the aldehyde product. A generalized reaction mechanism taken from Whyman (1985) follows:

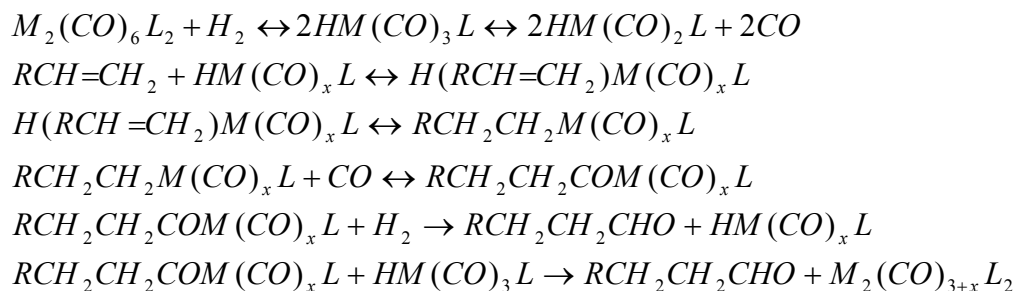

M = metal (Co or Rh)

L = ligand (CO, PR₃, or PPh₃)

x = 2 or 3

8.5 Catalysts

Oxosynthesis is a rapid reaction catalyzed by soluble cobalt or rhodium complexes. The advances made in organometallic chemistry in the 1950s and 1960s led to improved hydroformylation synthesis catalysts with higher thermal stability and greater selectivity. Three complimentary catalytic hydroformylation processes have been developed and commercialized. The choice of catalyst depends on the particular starting olefin or desired product. Phosphine-modified rhodium catalysts are best to produce 2-ethylhexanol from propylene and syngas. Unmodified cobalt catalysts are versatile enough to be used for hydroformylation of high carbon number mixed olefins. Phosphine-modified cobalt catalysts are used for the production of higher, detergent range, alcohols rather than aldehydes. Each of these catalyst systems will be discussed.

8.5.1 Cobalt Carbonyl

The first hydroformylation catalysts were cobalt carbonyls, the specific active catalyst was found to be $\text{HCo}(\text{CO})_4$ in equilibrium with $\text{Co}_2(\text{CO})_8$ based on the following reaction:

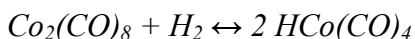

Cobalt metals and most cobalt salts will form cobalt carbonyl under hydroformylation conditions. The cobalt catalyzes both double bond isomerization and oxosynthesis. Undesired competing side reactions, such as the direct hydrogenation of the starting olefin and the condensation of product aldehydes to high boiling products, are generally avoided in the Co-catalyzed process.

For cobalt carbonyl catalysts, a *n/i* ratio of 4:1 can be achieved with catalyst concentrations of 0.1-1% metal/olefin at 200-300 atm and 110-200°C with a 1:1 H_2/CO ratio. Lower process temperatures and higher CO partial pressures favor the formation of the straight chain isomer, however, the overall conversion efficiency decreases. The cobalt carbonyl catalysts are also not very stable at the higher process temperatures. Catalyst tends to deposit on reactor walls decreasing catalyst activity and reducing catalyst recovery at elevated process temperatures.

8.5.2 Phosphine-Modified Cobalt

In the early 1960s Shell Oil Company commercialized a new cobalt-based hydroformylation process. The addition of a phosphine ligand to Co resulted in a trialkylphosphine-substituted cobalt carbonyl catalyst $[\text{HCo}(\text{CO})_3\text{P}(\text{n-C}_4\text{H}_9)_3]$. This new catalyst had higher selectivity to straight-chain aldehydes (*n/i* = 7:1) with improved thermal stability compared to the unsubstituted cobalt catalysts. The improved thermal stability allows for lower process pressures but higher process temperatures. The Shell process conditions are 50-100 atm and 160-200°C with $\text{H}_2:\text{CO} = 1$. Even though this catalyst has improved thermal stability, it has a lower hydroformylation activity than

cobalt carbonyl catalysts, hence the higher reaction temperature. The higher temperatures also increase the competing olefin hydrogenation reaction.

Shell has optimized this process to produce detergent range alcohols (C₁₁-C₁₄) in a single step by capitalizing on the conversion of terminal olefins to alcohols by hydrogenation of the aldehyde hydroformylation products. A high n/i ratio results from increased isomerization rates concurrently with hydroformylation with the phosphine-modified cobalt catalyst.

8.5.3 Phosphine-Modified Rhodium

Significantly lower operating pressures and temperatures and increased selectivity to linear products was demonstrated with the introduction of phosphine-modified rhodium catalysts. In 1976, Union Carbide and Davy Process Technology commercialized the LP Oxo process based on a triphenylphosphine-modified rhodium catalyst. With a HRh(CO)(PPh₃)₃ catalyst, the process is maintained at 7-25 atm and 60-120°C and a n/i ratio of 8-12:1 is possible. Low temperatures, high carbon monoxide partial pressure, and high ligand concentration on the Rh catalysts favors the formation of the straight-chain isomers. Rh-based catalysts are mainly used for the hydroformylation of lower olefins (propylene to butyraldehyde, for example) but have limited use for higher olefins because of thermal instability of the catalyst at the high temperatures required for distillation to separate product and catalyst. Another important factor when selecting Rh-based hydroformylation catalysts is the high cost and low availability of rhodium. This makes catalyst separation and recycle an economically important process consideration. The high cost of rhodium, however, is offset by lower equipment costs, increased activity, and higher selectivity and efficiency. The development of water-soluble Rh-based catalysts avoids some of these issues. Rhone-Poulenc commercialized an oxo process based on a water-soluble Rh catalyst in 1984 (Billig and Bryant 2000).

8.6 Gas Cleanliness Requirements

Catalyst lifetimes are significantly reduced by poisoning from strong acids, HCN, organosulfur, H₂S, COS, O₂, and dienes (Bahrman and Bach 2000).

8.7 Status/Technology Developers

The LP Oxo™ Low Pressure Oxo Process is the result of a collaboration between Davy Process Technology (DPT) and Union Carbide Corporation that began in 1971. It is the world's leading process for the production of oxo alcohols from olefins. It represents most of the world's oxo alcohols capacity licensed during the last 20 years. A schematic of the LP Oxo Process is shown in Figure 10.

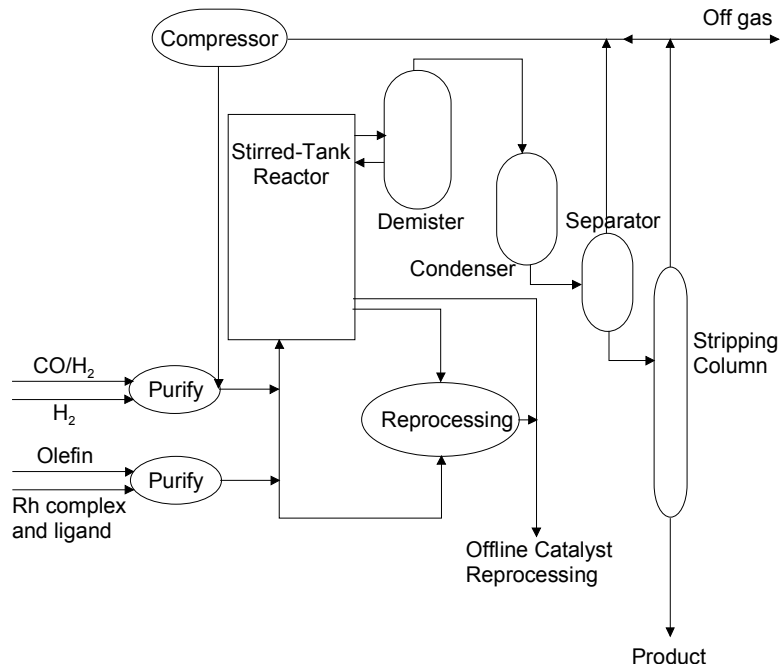

Figure 10: Schematic Flow Diagram of the LP Oxo Process

In the LP Oxo Process, propylene is reacted with synthesis gas to produce butyraldehydes ($n/i = 10-20:1$), which are in turn converted to 2-ethylhexanol. Normal or iso-butyraldehydes are also converted to normal and iso-butanols and other derivatives. Propylene to mixed butyraldehyde efficiencies as high as 97.5% have been demonstrated at commercial scale. The efficiency is a function of feedstock purity with a higher purity feed resulting in a higher efficiency because of lower purge losses.

The Shell Process is another commercial oxo synthesis process based on a phosphine - modified cobalt catalyst to produce alcohols directly from olefins. The conversion of product oxo aldehydes to alcohols occurs in a single step in the Shell process because of the high hydrogenation activity of the modified catalyst. This process yields detergent range alcohols from a range of higher olefins.

A summary of oxochemical producers in the U.S. as cited in the Chemical Economics Handbook (CEH) (Bitzzari et al. 2002) is presented in Table 27.

Table 27: Summary of U.S. Oxo Chemical Producers

Company	Plant Location	Annual Capacity as of 9/01/02 (tonnes x10 ³ /yr)	Oxo Products	Catalyst	Final Products
BASF Corporation, Chemicals Division Industrial Organics	Freeport, TX	270 30	n-butyraldehyde isobutyraldehyde	Rh	n-butanol 2-ethylhexanol neopentyl glycol; isobutanol
Celanese Ltd. Chemicals Division	Bay City, TX	45 250 27	propionaldehyde n-butyraldehyde isobutyraldehyde	Rh	n-propanol n-butanol isobutanol
Dow Chemical	Taft, LA	272 15	n-butyraldehyde isobutyraldehyde	Rh	n-butanol iso-butanol
Dow Chemical	Texas City, TX	100 45 335 33	propionaldehyde valeraldehyde n-butyraldehyde isobutyraldehyde	Rh	n-propanol; propionic acid valeric acid; amyl alcohol n-butanol; 2-ethylhexanol; 2-ethylhexanoic acid isobutanol
Eastman Chemical Company, Eastman Division	Longview, TX	118 424 184	propionaldehyde n-butyraldehyde isobutyraldehyde	Rh	n-propanol; propionic acid n-butanol; 2-ethylhexanol, 2-ethylhexanoic acid; n-butyric acid; methyl amyl ketone neopentyl glycol; methyl isoamyl ketone; isobutyl acetate
ExxonMobil Chemical Company	Baton Rouge, LA	408	Alcohols: C ₆ -C ₁₃ branched C ₉ -C ₁₁ linear	Co	phthalate and trimellitate plasticizers
Shell Chemical Company	Geismar, LA	340	C ₉ -C ₁₅ linear alcohols	Co-PR ₃	Neodol® alcohols
Sterling Chemicals, Inc.	Texas City, TX	102	C ₇ , C ₉ , C ₁₁ linear alcohols	Co	Phthalate plasticizers
Sunoco, Inc.	Pasadena, TX	140 12	n-butyraldehyde isobutyraldehyde	Rh	2-ethylhexanol sold without conversion

Source: (Bitzzari et al. 2002)

8.8 Cost

The cost of oxo products are dependent on the initial costs of the olefin feedstocks, primarily propylene and ethylene. The oxo aldehydes are effectively intermediates for the production of alcohols, acids, and other chemical products. The market price for these products also varies with the cost of the feedstocks and intermediates. Chemical Economics Handbook (Bitzzari et al. 2002) contains estimated costs for a variety of oxo end products. The price of major oxochemical products listed above in Table 27 are presented in Table 28. Although not shown, the highest priced oxo chemical in the CEH list is pelargonic acid (\$1.33/lb). The majority of the oxo products listed in CEH fall in the range of 50-70¢/lb.

Table 28: U.S. Prices for Oxo Chemicals

Product	2002 Price (¢/lb)
n-butyraldehyde	52
n-butanol	55
2-ethylhexanol	63
2-ethyl hexanoic acid	68
isobutyraldehyde	52
Isobutanol	50
n-propanol	55
propionic acid	44
amyl alcohol	63

Source: (Bitzzari et al. 2002)

8.9 R&D Needs

Continuing advances in improving the activity of hydroformylation catalysts are being made and should continue in the future. Thermal stability of future catalysts should be improved to continue the trend of reducing the oxosynthesis reaction severity. Optimizing the organometallic chemistry of these catalysts to increase activity and ease of catalyst separation from products is an area that would have a significant economic benefit to the overall oxosynthesis process. This is especially important for the Rh-based processes. Another area of interest is the development of heterogeneous hydroformylation catalysts, which would eliminate the challenges of catalyst separation and loss.

8.10 References

Bahrman, H., and Bach, H. (2000). "Oxo Synthesis." Ullman's Encyclopedia of Industrial Chemistry, Wiley - VCH Verlag GmbH & Co.

Billig, E., and Bryant, D. R. (2000). "Oxo Process." Kirk-Othmer Encyclopedia of Chemical Technology, John Wiley & Sons.

Bitzari, S. N., Gubler, R., and Kishi, A. (2002). "Oxo Chemicals." Chemical Economics Handbook, SRI International, 1-121. Report number 682.7000.

Pruett, R. L. (1979). "Hydroformylation." *Advances in Organometallic Chemistry*, 17, 1-60.

Wender, I. (1996). "Reactions of synthesis gas." *Fuel Processing Technology*, 48(3), 189-297.

Whyman, R. (1985). "Industrial Applications of Homogeneous Catalysts." Selected Developments in Catalysis, J. R. Jennings, ed., Blackwell Scientific Publications, Oxford, 128.

9 Isosynthesis

9.1 Summary

The isosynthesis reaction converts syngas over a thorium or zirconium-based catalyst at relatively extreme (150-1000 atm and 450°C) conditions to isobutene and isobutane. Demand for MTBE as a gasoline additive increased in the early 1990s to the point that supply shortages of petrochemical isobutene were becoming a concern. This provided renewed interest in the conversion of syngas to *i*-C₄ hydrocarbons, however, the isosynthesis process is not currently commercially practiced. Research and development efforts are being focused on finding isosynthesis catalysts that have high activity and high selectivity to isobutene at less severe process conditions, especially at lower pressure (~50 atm).

Section Contents

<u>9.1 Summary</u>	121
<u>9.2 Introduction</u>	123
<u>9.3 Technology Description</u>	123
<u>9.4 Chemistry</u>	123
<u>9.5 Catalysts</u>	124
<u>9.6 Gas Cleanliness Requirements</u>	125
<u>9.7 Status/Technology Developers</u>	125
<u>9.8 R&D Needs</u>	125
<u>9.9 References</u>	125

9.2 Introduction

The isosynthesis reaction converts syngas over a thorium or zirconium-based catalyst at relatively extreme conditions to isobutene and isobutane. This reaction has often been considered a variation of Fischer-Tropsch Synthesis, however, there are major differences between the two synthetic processes (Feng et al. 1994). Isosynthesis is selective to *i*-C₄ hydrocarbons whereas FTS forms a range of olefins according to the ASF distribution. Only trace amounts of oxygenates (water, methanol, isobutanol, DME, etc.) are formed under isosynthesis reaction conditions. Selective formation of branched hydrocarbons also occurs in isosynthesis.

The isosynthesis reaction was first studied by Pilcher and Ziesecke in the early 1940s using ThO₂-based catalysts and severe reaction conditions of 150-1000 atm and 450°C (Sofianos 1992). The goal was to optimize isobutane production for use in high-octane gasoline. The development of the petroleum industry led to waning interest in commercial isosynthesis processes and since these initial studies, isosynthesis has not received a lot of industrial attention.

Demand for MTBE as a gasoline additive increased in the early 1990s to the point that supply shortages of petrochemical isobutene were becoming a concern (Sofianos 1992). This led to renewed interest in the isosynthesis reaction to convert syngas to branched hydrocarbons, particularly isobutene, which is a reactant in the synthesis of MTBE. Catalyst development has been focused on ZrO₂-based catalysts for increased activity and selectivity to *i*-C₄ products.

9.3 Technology Description

No commercial isosynthesis processes have been developed. Most laboratory studies have been conducted in gas-solid fixed bed reactors. Slurry reactors are also being investigated for isosynthesis, in fact, selectivities to C₄ products are reported to be higher in slurry reactors compared to fixed bed reactors (Erkey et al. 1995).

There is always a large amount of CO₂ produced in the isosynthesis reaction, likely by the reaction of H₂O and CO in the water-gas shift (Su et al. 2000a; Su et al. 2000b). CO₂ recycle and reuse should be investigated to improve conversion efficiency to products.

9.4 Chemistry

Isosynthesis conditions are optimized for isobutene/isobutane production. At lower temperatures, alcohols and other oxygenates are formed. At higher temperatures, methane and aromatics are formed.

The isosynthesis mechanism is related to that of higher alcohol synthesis. It involves two chain growth mechanisms — a step-wise CO insertion reaction and a condensation reaction mechanism involving surface adsorbed oxygenates. The precursor to the

oxygenate products has been identified as a surface adsorbed methoxide species (Maruya et al. 1996). The oxygenates, alcohols and ethers, are more than likely the primary reaction products that undergo dehydration and hydrogenation to form the iso-alkenes and branched alkanes. These two competing chain growth mechanisms result in a discontinuity in the ASF distribution at C₄ that explains the relatively high selectivity of the isosynthesis reaction to C₄ products.

9.5 Catalysts

The first catalysts used by Pilcher and Ziesecke were ThO₂-based. Unpromoted thoria catalysts have demonstrated 46% CO conversion at 150 atm and 450°C, but only 10% isobutene in the C₄ fraction that is mostly isobutane (Sofianos 1992). DME was the main product at higher pressures. Thorium-based catalysts are good alcohol dehydration catalysts and, in turn, are the most active isosynthesis catalysts. They have long lifetimes because they can be regenerated by oxidizing the accumulated coke that deposits on the surface and, they are not poisoned by sulfur. Unfortunately, they are radioactive precluding their commercial use.

Zirconium-based catalysts also have high activity for isosynthesis. Unpromoted zirconium catalysts have demonstrated 32% CO conversion at 150 atm and 450°C with much higher selectivity to isobutene (Sofianos 1992) compared to the thorium-based catalysts. The overall activity of ZrO₂-based catalysts for isosynthesis is lower than ThO₂-based catalysts.

Various promoters have been investigated to improve the activity and selectivity of ThO₂ and ZrO₂ catalysts (Jackson and Ekerdt 1990a; Jackson and Ekerdt 1990b). The most active isosynthesis catalyst is 20% Al₂O₃/ThO₂. Other promoters such as Zn, Cr and alkali metals have also been tested. The addition of alkali metals to zirconium catalysts had a negative effect on catalyst performance (Jackson and Ekerdt 1990b; Li et al. 2001a).

Doped zirconium-based catalysts possess oxygen vacancies in the oxide lattice. The most active catalysts tend to have maximum ionic conductivity suggesting that vacancies in the crystal lattice play an important role in the isosynthesis reaction (Li et al. 2001b; Li et al. 2002). These oxygen vacancy sites are required for methoxide formation on the catalyst surface that contributes to the condensation reaction (Jackson and Ekerdt 1990a).

The selectivity of the isosynthesis reaction depends on the nature of the active catalyst sites, including oxygen vacancies on the surface, and the number of acidic and basic sites. The balance between acidic and basic catalyst sites dictates overall activity and selectivity (Li et al. 2002). Enhancing the number of acidic sites on the ZrO₂ catalyst increased activity and selectivity to linear C₄ hydrocarbons. Increasing the number of basic sites on the catalyst increased the yield of iso-C₄ hydrocarbons (Li et al. 2001b). The acidic catalyst sites are thought to promote condensation and dehydration reactions. The basic sites are known to catalyze CO insertion reactions. The activity of promoted isosynthesis catalyst systems is related to the acid/base ratio, which can be altered and

controlled by varying the preparation procedure for mixed oxide catalysts (Feng et al. 1995; Feng et al. 1994).

9.6 Gas Cleanliness Requirements

Thoria catalysts are not poisoned by sulfur and have high resistance to other poisons as well.

9.7 Status/Technology Developers

The isosynthesis process is not currently commercially practiced.

9.8 R&D Needs

Research and development efforts are focused on finding isosynthesis catalysts that have high activity and high selectivity to isobutylene at less severe process conditions, especially at lower pressure. Research catalysts are being developed for operation at 50 atm compared to the original studies at 300 atm.

9.9 References

Erkey, C., Wang, J. H., Postula, W., Feng, Z. T., Philip, C. V., Akgerman, A., and Anthony, R. G. (1995). "Isobutylene Production from Synthesis Gas over Zirconia in a Slurry Reactor." *Industrial & Engineering Chemistry Research*, 34(4), 1021-1026.

Feng, Z. T., Postula, W. S., Akgerman, A., and Anthony, R. G. (1995). "Characterization of Zirconia-Based Catalysts Prepared by Precipitation, Calcination, and Modified Sol-Gel Methods." *Industrial & Engineering Chemistry Research*, 34(1), 78-82.

Feng, Z. T., Postula, W. S., Erkey, C., Philip, C. V., Akgerman, A., and Anthong, R. G. (1994). "Selective Formation of Isobutane and Isobutene from Synthesis Gas over Zirconia Catalysts Prepared by a Modified Sol-Gel Method." *Journal of Catalysis*, 148(1), 84-90.

Jackson, N. B., and Ekerdt, J. G. (1990a). "Isotope Studies of the Effect of Acid Sites on the Reactions of C-3 Intermediates During Isosynthesis over Zirconium Dioxide and Modified Zirconium Dioxide." *Journal of Catalysis*, 126(1), 46-56.

Jackson, N. B., and Ekerdt, J. G. (1990b). "The Surface Characteristics Required for Isosynthesis over Zirconium Dioxide and Modified Zirconium Dioxide." *Journal of Catalysis*, 126(1), 31-45.

Li, Y. W., He, D. H., Cheng, Z. X., Su, C. L., Li, J. R., and Zhu, Q. M. (2001a). "Effect of calcium salts on isosynthesis over ZrO₂ catalysts." *Journal of Molecular Catalysis a-Chemical*, 175(1-2), 267-275.

Li, Y. W., He, D. H., Yuan, Y. B., Cheng, Z. X., and Zhu, Q. M. (2001b). "Selective formation of isobutene from CO hydrogenation over zirconium dioxide based catalysts." *Energy & Fuels*, 15(6), 1434-1440.

Li, Y. W., He, D. H., Yuan, Y. B., Cheng, Z. X., and Zhu, Q. M. (2002). "Influence of acidic and basic properties of ZrO₂ based catalysts on isosynthesis." *Fuel*, 81(11-12), 1611-1617.

Maruya, K., Takasawa, A., Haraoka, T., Domen, K., and Onishi, T. (1996). "Role of methoxide species in isobutene formation from CO and H₂ over oxide catalysts - Methoxide species in isobutene formation." *Journal of Molecular Catalysis a-Chemical*, 112(1), 143-151.

Sofianos, A. (1992). "Production of Branched-Chain Hydrocarbons Via Isosynthesis." *Catalysis Today*, 15(1), 149-175.

Su, C. L., He, D. H., Li, J. R., Chen, Z. X., and Zhu, Q. M. (2000a). "Influences of preparation parameters on the structural and catalytic performance of zirconia in isosynthesis." *Journal of Molecular Catalysis a-Chemical*, 153(1-2), 139-146.

Su, C. L., Li, J. R., He, D. H., Cheng, Z. X., and Zhu, Q. M. (2000b). "Synthesis of isobutene from synthesis gas over nanosize zirconia catalysts." *Applied Catalysis a-General*, 202(1), 81-89.

10 Yields, Energy, and Economics

10.1 Summary

This section examines the yields, energy consumption, and economics for six of the products discussed in this report: hydrogen, methanol, fischer tropsch liquids, mixed alcohols, olefins and ethanol. The main focus of this section is on products from biomass. However, the yield data and energy consumption compares biomass to fossil based systems. The economics takes information from various biomass studies and puts it on a common basis so that a side-by-side economic comparison can be made.

Overall, hydrogen has the highest yield from biomass followed by methanol. However, as expected, in general, the product yields from biomass resources are lower than if the product were produced from natural gas. The energy ratios were determined using a life cycle approach. Two energy ratios were calculated: a fossil energy ratio and a primary energy ratio. The fossil energy ratio is defined as (the energy in the fuel product)/(the fossil energy consumed by the system). The primary energy ratio includes the renewable energy consumption, and thus, is defined as (the energy in the fuel product)/(the fossil energy + the biomass energy consumed by the system). The fossil energy ratios for the biomass systems are considerably higher than those for the fossil systems (the fossil systems' energy ratios are all less than one). Although biomass is renewable, when the biomass energy is included, the results show that the primary energy ratio is similar for the biomass and fossil systems. All biomass fuels have potential to significantly reduce the import of petroleum products.

For all of the products examined in the economic analysis section (H₂, MeOH, FTL, EtOH, mixed alcohols, olefins), syngas production accounts for at least 50% of the product cost and in many cases it is more like 75%. The economics show hydrogen and methanol to be the most cost competitive products from biomass. Ethanol from biomass-derived syngas could potentially be cost competitive. However, the state of this technology is still at the lab scale and the amount of data available is limited. Therefore, the ethanol analysis has a higher level of uncertainty than the other products examined. Additionally, because of the limited amount of design data, more analysis should be performed for mixed alcohols synthesis to examine biomass-optimized configurations including recycle for maximum conversion and the resulting economics.

Section Contents

<u>10.1 Summary</u>	127
<u>10.2 Product Yields</u>	129
<u>10.3 Life Cycle Energy Ratios</u>	131
<u>10.4 Petroleum Product Replacement</u>	133
<u>10.5 Economics</u>	135
<u>10.6 References</u>	141

List of Figures

<u>Figure 11: Product Yields from Fossil and Biomass Resources</u>	130
<u>Figure 12: Life Cycle Fossil Energy Ratio</u>	132
<u>Figure 13: Life Cycle Primary Energy Ratio</u>	132
<u>Figure 14: Potential Replacement of Petroleum Products with Biomass Fuels (Energy Basis)</u>	134
<u>Figure 15: Product Price in \$/GJ (LHV)</u>	139
<u>Figure 16: Capital Cost Breakdown for Biomass to MeOH Systems</u>	140

List of Tables

<u>Table 29: Feedstock to Product Material Balance Information</u>	129
<u>Table 30: Life Cycle Energy Ratios (LHV basis)</u>	131
<u>Table 31: Economic Parameters for Discounted Cash Flow Analysis</u>	136
<u>Table 32: Summary of Cases Examined</u>	137
<u>Table 33: Base Case Minimum Product Selling Price</u>	138
<u>Table 34: Price of Commercial Products</u>	138
<u>Table 35: Sensitivity – Minimum Product Selling Price</u>	139

10.2 Product Yields

Product yields vary, depending on the process configuration (e.g. once through or recycling to maximize yields), technology used (e.g., gas versus liquid phase), and type of feedstock. Table 29 gives the product yields from both fossil and biomass resources along with the references used to calculate the yields. In some instances, material balance data from NREL's gasifier models (Spath, et al, 2000) were used in conjunction with material balance information from fossil technologies in order to come up with a biomass-to-fuels process. To compare the magnitude of the numbers, Figure 11: Product Yields from Fossil and Biomass Resources, is a graph of the GJ of product/GJ of feed (column 4 of Table 29). As expected, generally, the yield of any product from biomass is lower than that product derived from natural gas. Overall, hydrogen has the highest yield from biomass followed by methanol while mixed alcohols have the lowest product yield from biomass. It should be noted, however, that there was a limited amount of data from which to derive the material balance for the ethanol and mixed alcohols products from biomass and that these processes are not optimized.

Table 29: Feedstock to Product Material Balance Information

System (BD = bone dry)	kg of product/Mg of BD feed	GJ of product/Mg of BD feed	GJ of product/GJ of feed (LHV)	Reference
Natural gas to H ₂	337	40	0.83	Leiby, 1994
Coal to H ₂	96	12	0.44	Spath and Amos (2000)
Biomass to H ₂	52-105	6-13	0.36-0.73	Spath, et al. (2000); Hamelinck, et al. (2001)
Natural gas to MeOH	1,445	29	0.61	SRI (2002)
Coal to MeOH	518-666	11-14	0.40-0.52	Bailey (1979); Michaels (1979); SRI (2002)
Biomass to MeOH	246-554	5-11	0.29-0.65	Hamelinck, et al. (2001)
Natural gas to FT	570-666	26-31	0.54-0.63	Navqvi (2000)
Biomass to FT	60-159	3-7	0.16-0.43	Tijmensen, et al. (2000); Hamelinck, et al, 2003; NREL gasification material balance info (Spath, et al, 2000) with Apanel (Dec. 2002)
Natural gas to mixed alcohols	1,210	31	0.63	Nirula (1994)
Biomass to mixed alcohols	135-223	3-6	0.18-0.30	NREL gasification material balance info (Spath, et al, 2000) with Nirula (1994)
Natural gas to olefins	453	21	0.43	Apanel (2002)
Biomass to MeOH then olefins	77-174	4-8	0.21-0.46	MeOH material balances with Apanel (2002)
Biomass to syngas then ethanol	228	7	0.35	Putsche (1999)

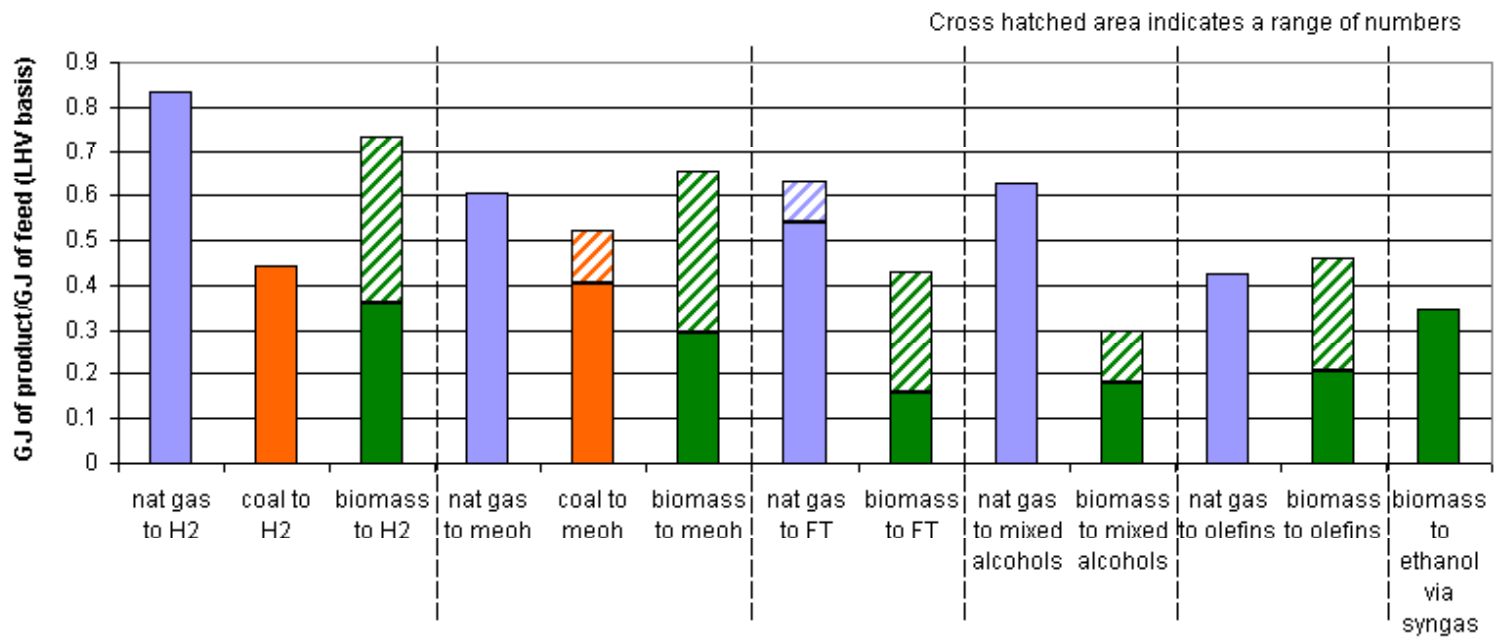

Figure 11: Product Yields from Fossil and Biomass Resources

10.3 Life Cycle Energy Ratios

The energy balance of a system can be examined in a number of ways. This study looked at the energy balance of each system using a life cycle approach. Two energy ratios were calculated: 1) the fossil energy ratio which is defined as the energy in the product divided by the total fossil energy consumed from feedstock procurement through product generation and 2) the primary energy ratio which includes the energy in the biomass feedstock even though it is renewable. Table 30 gives the fossil and primary energy ratios for several products. Most of these ratios (except as noted) were derived using the material balance information in Table 29 along with the life cycle information contained in Mann and Spath (1997) for producing and transporting a dedicated biomass feedstock, specifically poplar. Figure 12 and Figure 13 are graphical representations of the numbers in Table 30. Note that Figure 12 is a log scale so that the lifecycle energy ratio for the fossil systems, which are all less than one, could be seen. Obviously, the energy ratios will follow the same general pattern as the product yields given in the previous section (e.g., hydrogen from biomass has the highest energy ratio followed by methanol).

The fossil energy ratios for the biomass systems are considerably higher than those for the fossil systems because in the fossil systems, the main source of energy consumption is the feedstock itself. Thus, there is a considerable savings in fossil energy consumption by using fuels from biomass-derived syngas. Although biomass is a renewable resource, when the energy content of the biomass is included in the energy ratio, the magnitude of the number is similar to that for the fossil based system.

Table 30: Life Cycle Energy Ratios (LHV basis)

System	Fossil Energy Ratio ($E_{\text{fuel product}}/E_{\text{fossil energy consumed}}$)	Primary Energy Ratio ($E_{\text{fuel product}}/(E_{\text{fossil}} + E_{\text{biomass energy consumed}})$)
Natural gas to H ₂ (a)	0.66	0.66
Coal to H ₂	0.39	0.39
Biomass to H ₂	14-29	0.35-0.71
Natural gas to methanol	0.44	0.44
Coal to methanol	0.34-0.44	0.34-0.44
Biomass to methanol	12-26	0.29-0.64
Natural gas to FT	0.39-0.46	0.39-0.46
Biomass to FT	6-17	0.16-0.42
Biomass to ethanol via syngas	16	0.35
Natural gas to mixed alcohols	0.46	0.46
Biomass to mixed alcohols	8-13	0.18-0.29
Natural gas to olefins	0.31	0.31
Biomass to methanol then olefins	8-19	0.20-0.45
Gasoline/diesel (b)	0.83	0.83

Source: (a) Spath and Mann (2000);

(b) General Motors Corporation, Argonne National Laboratory. (2001)

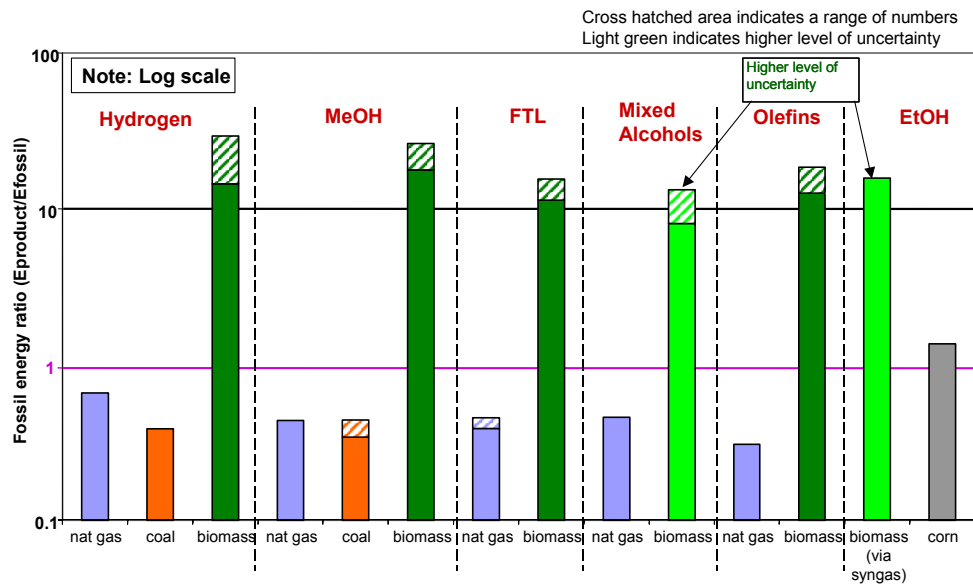

Figure 12: Life Cycle Fossil Energy Ratio

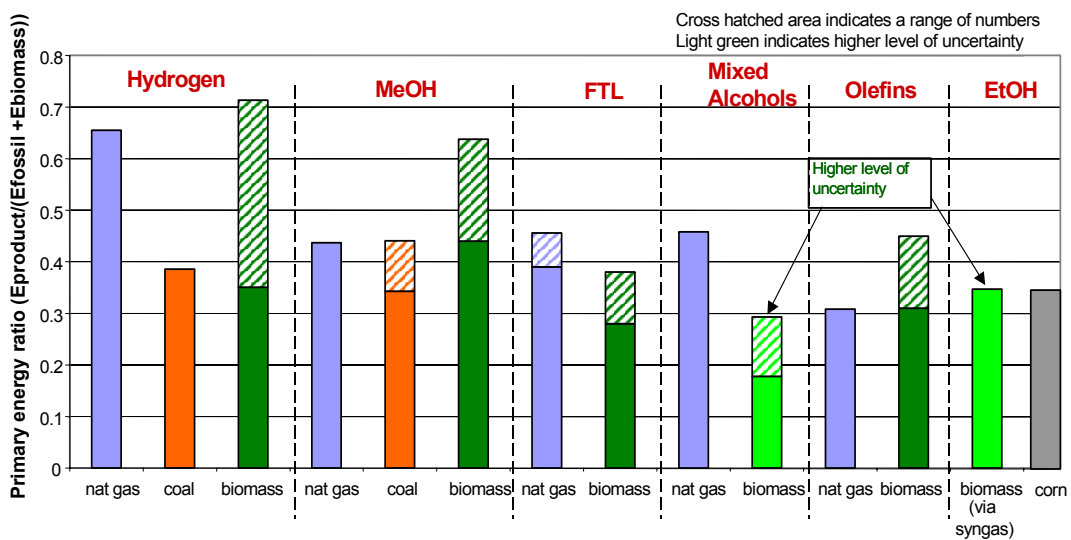

Figure 13: Life Cycle Primary Energy Ratio

10.4 Petroleum Product Replacement

Using the material balance information in Table 29 (specifically, the highest yield for each product), calculations were made to examine the potential petroleum product replacement from biomass-derived fuels. Calculations were made using the current amount of biomass available in the U.S. that is less than \$50/dry ton delivered. This amount of biomass is predicted to be 512 million tons/yr, from Oakridge National Laboratory, (http://bioenergy.esd.ornl.gov/papers/misc/resource_estimates.html). It is estimated that this could potentially be increased to 800 million tons/yr in the next two decades. Note that each product shown in Figure 14 assumes that all of the biomass (512 million tons/yr) is used to produce that one product (i.e., 512 million tons converted to H₂ or 512 million tons converted to MeOH).

The columns shown for each product in Figure 14 are:

- % of total petroleum products consumed in 2000 that the biomass-derived product could replace
- % of yearly net petroleum imports in 2000 that the biomass-derived product could account
- % of the increase in petroleum products consumed in 2020 compared to 2000 that the biomass-derived product could replace
- % of the increase in yearly net imports in 2020 compared to 2000 that the biomass-derived product could account for.

For example, the figure shows that if all of the biomass was converted to hydrogen, this is equivalent to 17% of the petroleum products consumed in 2000 or 30% of the net imports in that year. Additionally, this amount of hydrogen is equivalent to 47% of the predicted increase in petroleum products in 2020 compared to 2000. This also means that this quantity of hydrogen could account for 44% of the increase in predicted net imports in 2020 compared to 2000.

Figure 14 also shows that hydrogen has the greatest potential to replace petroleum products followed by methanol, with mixed alcohols being the smallest. Note however, that the comparison was made on an energy equivalent basis and does not take into account vehicle energy efficiency or fuel economy. In some cases, this could be a significant advantage. For example, although highly debated, hydrogen fuel cell vehicles are expected to be two to three times as energy efficient as current combustion engine vehicles. Thus, on a per vehicle mile traveled basis, hydrogen from biomass would replace a greater amount of petroleum products than the amount shown in Figure 14.

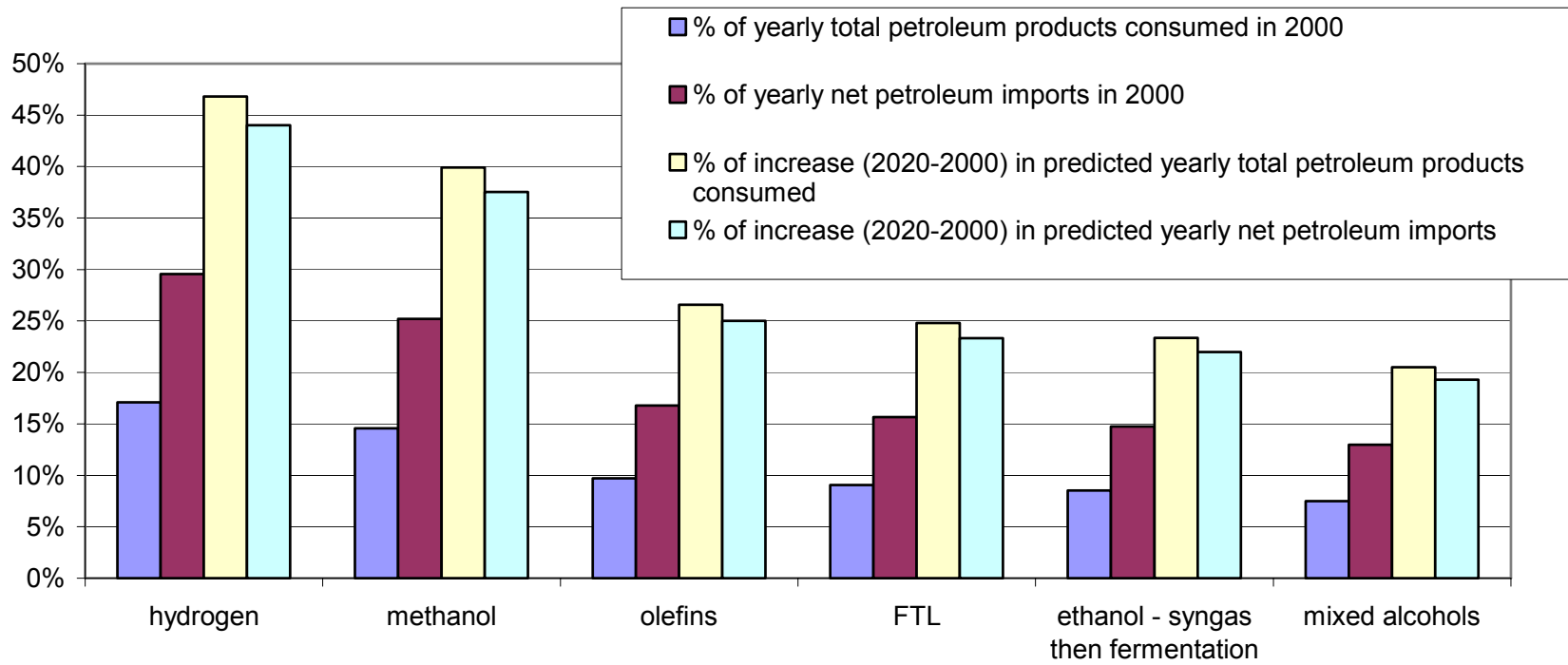

(Assumes 512 MM tons/yr of available biomass which goes to one product)

Figure 14: Potential Replacement of Petroleum Products with Biomass Fuels (Energy Basis)

10.5 Economics

Many other groups have done economic analyses for the various products discussed in this report. However, these analyses are not all on the same basis. They use different plant sizes, different feedstock costs, varying economic parameters, and different methods for determining product price. As a result, a side-by-side economic comparison of the different products is difficult. In this study, an attempt was made to examine several products using the same approach with consistent economic parameters.

In general, when enough detailed information existed, material and energy balances, along with capital and operating cost data, were extracted from studies by others. This information was input into a discounted cash flow rate of return spreadsheet in which the same plant sizes and economic parameters were used to determine the minimum product selling price required to obtain a specific after-tax rate of return. In some instances, energy and material balance data from NREL's gasifier models (Spath, et al, 2000) were used in conjunction with energy and material balance information from fossil technologies to come up with a biomass-to-fuels process. The specific parameters used in this analysis are given in Table 31. In general, these are the same parameters as those used in NREL's design report "Lignocellulosic Biomass to Ethanol Process Design and Economic Utilizing Co-Current Dilute Acid Prehydrolysis and Enzymatic Hydrolysis for Corn Stover" (Aden, et al., 2002). Additionally, the gasifier costs were kept consistent from product to product, using the costs for the Battelle/Fercos low-pressure indirectly heated gasifier and for the Institute of Gas Technology high-pressure gasifier used in NREL's previous analyses (Spath, et al. 2000).

Spreadsheets were set up for 5 hydrogen cases, 4 methanol cases, 8 fischer tropsh cases, 1 ethanol case, 2 mixed alcohol cases, and 4 olefin cases. Table 32 briefly outlines the process configurations examined using the references given in Table 29.

For the base case assumptions outlined in Table 31, the resulting minimal selling price for hydrogen, methanol, FTL, ethanol, mixed higher alcohols, and olefins via biomass derived syngas are shown in Table 33.

Table 31: Economic Parameters for Discounted Cash Flow Analysis

Parameter	Base Case	Sensitivity Values
Plant life	20 years	---
Plant size/biomass feed rate	91.9 BD ton/hr	23 & 60 BD ton/hr
Discount rate	10%	15% & 20%
Financing	100% equity	50% & 75% equity
Plant depreciation	200% DB	---
Plant recovery period	7 years	---
Federal tax rate	39%	---
Construction period	2.5 years	---
Start-up time	6 months	---
Feedstock cost	\$30/dry ton	\$15 & \$42/dry ton
On stream time	8380 hours	---
Loan interest	7.5%	---
Loan term	10 years	---
Reference year	2001	---
Electricity price	4.1¢/kWh	---
Direct costs (including equip installation, instruments and controls, piping, electrical and misc buildings)	61% of total purchased equipment costs (TPEC)	---
Total installed equipment cost (TIEC)	TPEC + direct costs	---
Warehouse	1.5% of TIEC	---
Site development	4.5% of TIEC	---
Total installed cost (TIC)	TIEC + warehouse + site development	---
Indirect Field Costs		---
- field expenses	20% of TIC	
- home office & construction fee	25% of TIC	
- project contingency	3% of TIC	
- prorateable costs	10% of TIC	
Total capital investment (TCI)	TIC + indirect costs	---
Other costs (startup, permits, etc.)	10% of TCI	---
Total Project Investment (TPI)	TCI + other costs	---

Note: This is the same basis as that used in Aden, et al., (2002).

Table 32: Summary of Cases Examined

Product	Cases
H ₂	<ul style="list-style-type: none"> - IGT, HGCU, shift, PSA, combined cycle - BCL, wet gas cleaning, stm reformer, shift, PSA - BCL, wet gas cleaning but no tar cracker, stm reformer, shift, PSA - BCL, wet gas cleaning, shift, PSA, combined cycle - IGT, HGCU, reforming, shift, PSA
MeOH	<ul style="list-style-type: none"> - IGT, HGCU, ATR, LPMeOH, combined cycle - BCL, wet gas cleaning, stm reformer, LPMeOH, stm cycle - IGT, HGCU, ATR, shift, conventional MeOH, stm turbine - BCL, wet gas cleaning, stm reformer, shift, conv. MeOH, stm turbine
FTL	<ul style="list-style-type: none"> - BCL, wet gas cleaning, ATR, CO₂ removal, slurry phase FT, hydrocracker, distillation - IGT, HGCU, ATR, CO₂ removal, slurry phase FT, hydrocracker, distillation - IGT, wet gas cleaning, shift, slurry phase FT, product recovery and upgrading via distillation and hydrocracking, combined cycle (once thru) - IGT, wet gas cleaning, shift, solid bed FT, product recovery and upgrading via distillation and hydrocracking, combined cycle (once thru) (same process @70% conversion and 3 different alphas; which is the probability of chain growth) - IGT, wet gas cleaning, solid bed FT reactor, ATR & shift on recycle stream, product recovery and upgrading via distillation and hydrocracking, combined cycle - IGT, wet gas cleaning, solid bed FT reactor, shift on recycle stream, product recovery and upgrading via distillation and hydrocracking, combined cycle
Ethanol via syngas fermentation	<ul style="list-style-type: none"> - BCL, wet gas cleaning, fermentation, distillation, etoh dehydration
Mixed higher alcohols	<ul style="list-style-type: none"> - BCL, wet gas cleaning, CO₂ separation, alcohol synthesis, product purification, CO₂ separation, CO recovery - IGT, HGCU, CO₂ separation, alcohol synthesis, product purification, CO₂ separation, CO recovery
Olefins (propylene)	<ul style="list-style-type: none"> - MeOH via the 4 schemes listed above followed by MeOH conversion and propylene recovery via distillation

Notes:

- (1) HGCU = granular beds, candle filter, alkali removal, halogen absorption, sulfur absorption
- (2) wet gas cleaning = tar cracker, cyclone, gas cooling, bag filter, COS hydrolysis, scrubbers, ZnO bed

Table 33: Base Case Minimum Product Selling Price

Product	\$/GJ (HHV)	\$/GJ (LHV)	\$/gallon or \$/kg	Reference where data was obtained
H ₂	8-14	9-17	1.1-2.0/kg	Spath, et al, 2000 Hamelinck and Faaji, 2001
MeOH	12-13	13-14	0.80-0.91/gal	Hamelinck and Faaji, 2001
FTL	19-25	20-27	2.7-3.6/gal	Tijmensen, et al, 2000 Hamelinck, et al, 2003 NREL gasification material balance info (Spath, et al, 2000) with Apanel (Dec. 2002)
Ethanol via syngas fermentation	14	16	1.3/gal	Putsche, 1999
Mixed higher alcohols	27-31	31-36	2.4-2.8/gal	NREL gasification material balance info (Spath, et al, 2000) with Nirula (1994)
Olefins (propylene)	17-19	18-20	0.81-0.92/kg	MeOH material balances with Apanel (2002)

Table 34 presents the price of many of today's commercial products. Figure 15 plots the base case ranges (from Table 33) and the commercial product prices in terms of \$/GJ, LHV basis. Although, in general, the biomass-derived product prices are higher than the commercial prices, several of the products appear to be cost competitive: hydrogen, methanol, and ethanol. However, the ethanol analysis was based on a limited amount of data, so the level of uncertainty is higher than it is for the other products examined, thus the results should be viewed with caution.

Table 34: Price of Commercial Products

System	\$/GJ (HHV)	\$/GJ (LHV)	\$/gallon (except for H ₂)	Comments
Natural gas	3.4	3.8	N/A	Average Nov. 2002 price
Gasoline	5.6	6.1	0.74	Excluding distribution, marketing, and taxes (Nov. 2002)
Diesel	5.1	5.5	0.75	
Hydrogen	5-10	6-12	0.7-1.4/kg	Plant gate price of SMR
Methanol	4-10	5-12	0.3-0.7	General range of spot prices from 1993-2001
Ethanol	11-16	12-17	1.00-1.40	Price range from 1989-2000
Ethanol Excise Tax Exemption	6	7	0.53	Currently expected to expire in 2007
Propylene	6-10	6-11	0.29-0.50/kg	Apanel 2002 and website listed below*

*<http://www.the-innovation-group.com/ChemProfiles/Propylene.htm>

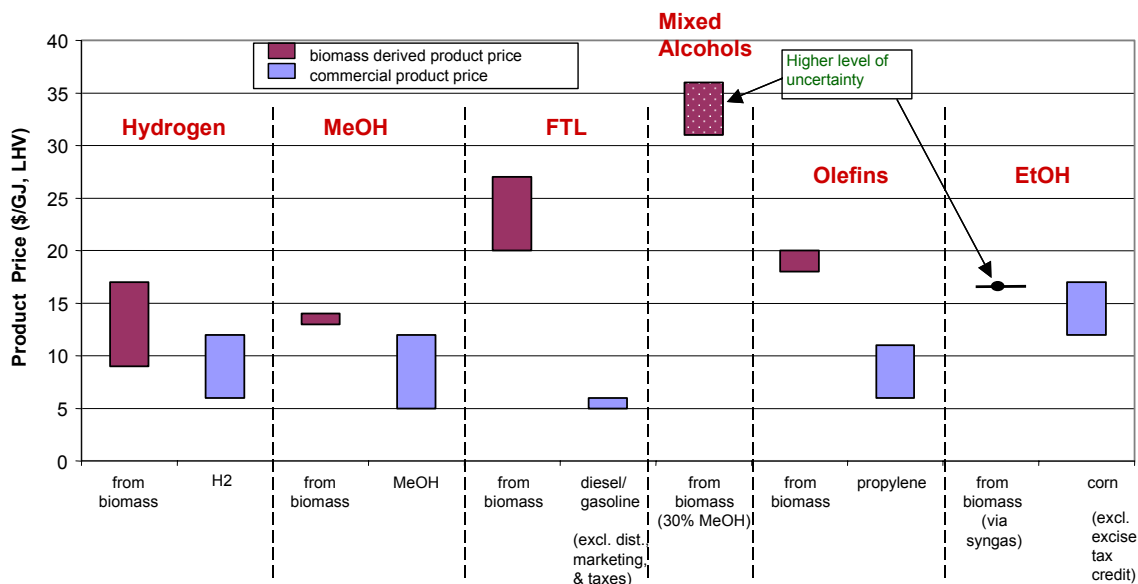
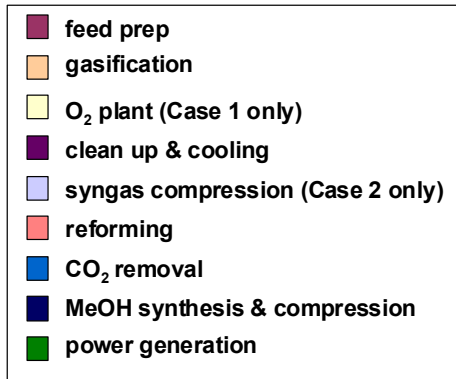

Figure 15: Product Price in \$/GJ (LHV)

Sensitivity runs were performed by making changes to the base case values regarding plant size, feedstock cost, internal rate of return, and financing (debt/equity). A combination of options were examined. For each plant size, the spreadsheet was evaluated 27 times (using macros) to account for the combination of changes in the feedstock cost (\$15, \$30, and \$42/dry ton), internal rate of return (10%, 15%, and 20%), and financing (50%, 75%, and 100% equity). Table 35 gives the range of results for each product and all of the cases examined. Smaller plant sizes, higher rates of return, and higher feedstock costs will contribute to a higher product price compared to the base case. Conversely, a higher amount of debt and lower feedstock costs will result in a product price that is lower than the base case.

Table 35: Sensitivity – Minimum Product Selling Price

Product	\$/GJ (HHV)	\$/GJ (LHV)	\$/gallon or \$/kg
H ₂	6-42	7-48	0.84-5.9/kg
MeOH	9-47	10-51	0.62-3.2/gal
FTL	15-63	16-69	2.2-9.3/gal
Ethanol via syngas fermentation	12-32	13-35	1.0-2.8/gal
Mixed higher alcohols	22-80	25-30	2.2-9.3/gal
Olefins (propylene)	13-70	13-75	1.9-7.1/kg



Direct system: GTI, HGCU, ATR, shift, conv MeOH, stm turbine

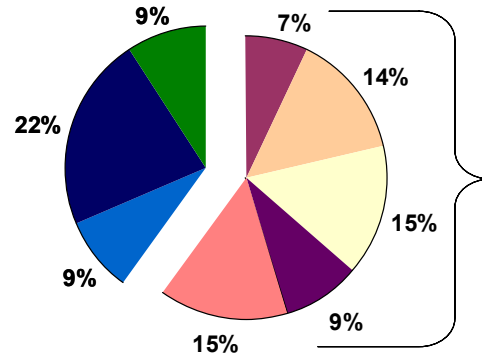

Indirect system: BCL, scrubbing, stm reformer, shift, conv MeOH, stm turbine

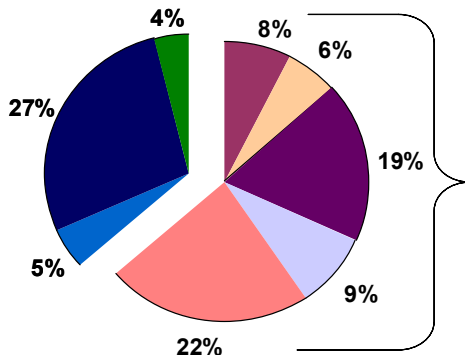

Clean conditioned syngas generation = 60-64% of total capital

Figure 16: Capital Cost Breakdown for Biomass to MeOH Systems

For all of the products examined in the economic analysis (H₂, MeOH, FTL, EtOH, mixed alcohols, olefins), syngas production accounts for at least 50% of the product cost and in many cases, it is almost 75%. Figure 16 shows a breakdown of the capital cost for methanol production from biomass for both a direct and an indirect gasification system (Taken from costs in Hamelinck and Faaij, 2001). Clean conditioned syngas (a combination of feed preparation, gasification, oxygen production, gas clean up and cooling, syngas compression and reforming) accounts for 60-64% of the total capital. Overall, steps should be made to optimize the biomass-to-fuels process in order to obtain the highest yield, least cost configuration. To reduce costs, efforts should be focused on minimizing the cost of clean syngas production. Economies of scale can play a large factor in lowering the product cost, therefore, opportunities to co-feed with coal or natural gas systems may be one way to get renewable fuels into the marketplace, just as co-firing biomass with coal is being done in the power generation industry.

10.6 References

- Aden, A.; Ruth, M.; Ibsen, K.; Jechura, J.; Neeves, K.; Sheehan, J.; Wallace, B.; Montague, L.; Slayton, A.; Lucas, J. (2002). "Lignocellulosic Biomass to Ethanol Process Design and Economics Utilizing Co-Current Dilute Acid Prehydrolysis and Enzymatic Hydrolysis for Corn Stover." National Renewable Energy Laboratory report NREL/TP-510-32438.
- Apanel, G.; Netzer, D. (2002). "Methanol to Propylene by the Lurgi MTP Process". PEP Review 98-13, SRI International, Menlo Park, CA.
- Apanel, G.J. (Dec. 2002). "Gas to Liquids Update". PEP Review, Report No. 247, SRI International, Menlo Park, CA.
- Bailey, E. (1979). "The coal to methanol alternative." *Coal Technol. (Houston)*, 2nd(3), 149-61.
- Fuel Ethanol Terminal Market Price - 18-month History. OXY-FUEL News Price Report. 1995-2003 Hart Publications.
- Gasoline and Diesel Fuel Update (<http://tonto.eia.doe.gov/oog/info/gdu/gasdiesel.asp>)
- General Motors Corporation, Argonne National Laboratory. (2001). "Well-to-Wheel Energy Use and Greenhouse Gas Emissions of Advanced Fuel/Vehicle Systems"
- Gray, D. and Tomlinson, G. (1997). "A technical and economic comparison of natural gas and coal feedstocks for Fischer-Tropsch synthesis." Studies in Surface Science and Catalysis 107(Natural Gas Conversion IV): 145-150.
- Hamelinck, C. N., and Faaij, A. P. C. (2001). "Future prospects for production of methanol and hydrogen from biomass." *NWS-E-2001-49; ISBN 90-73958-84-9*, Utrecht University.
- Hamelinck, C. N.; Faaij, A. P. C.; Uil, H.; Boerrigter, H. (2003). "Production of FT transportation fuels from biomass; technical options, process analysis and optimization, and development potential." *NWS-E-2003-08; ISBN 90-393-3342-4*, Utrecht University.
- Leiby, S.M. (1994). *Options for Refinery Hydrogen*. SRI Report No. 212. Menlo Park, CA.
- Mann, M.K.; Spath, P.L. (1997). *Life Cycle Assessment of a Biomass Gasification Combined-Cycle Power System*. National Renewable Energy Laboratory, Golden, CO, TP-430-23076.
- Mann, M.; Spath, P. (2002). "Life Cycle Assessment Comparisons of Electricity From Biomass, Coal, and Natural Gas." *AICHE 2002 Annual Meeting*, Indianapolis, IN, November 3-8.
- Michaels, H. J. (1979). "Methanol from coal using the Koppers-Totzek process." *Coal Technol. (Houston)*, 2nd(3), 163-78.

Navqvi, S.N. (2000). "Opportunities for Gas-to-Liquid Technologies" Supplement C. Process Economics Program. Menlo Park, California.

Nirula, S. C. (1994). "Dow/Union Carbide Process for Mixed Alcohols from Syngas." *PEP Review no. 85-1-4*, SRI International, Menlo Park, CA.

Putsche, V. (1999). "Complete Process and Economic Model of Syngas Fermentation to Ethanol." NREL Milestone Report.

Spath, P.L.; Mann, M.K. (November 2000). *Life Cycle Assessment of Hydrogen Production via Natural Gas Steam Reforming*. National Renewable Energy Laboratory, Golden, CO, TP-570-27637.

Spath, P.L.; Lane, J.M.; Mann, M.K.; Amos, W.A. (April 2000). Update of Hydrogen from Biomass - Determination of the Delivered Cost of Hydrogen. NREL Milestone report.

Spath, P.L.; Amos, W.A. (2000). "Hydrogen Production from Western Coal Including CO₂ Sequestration and Coalbed Methane Recovery: Economics, CO₂ Emissions, and Energy Balance". *Advances in Hydrogen Energy*. New York: Plenum Publishers, pp. 17-30.

SRI International. (1994). *Options for Refinery Hydrogen*. Report No. 212. Menlo Park, CA.

Suresh, B.; Gubler, R.; Sasano, T. (2001). "Hydrogen." *Chemical Economics Handbook Product Review*, SRI International, Menlo Park, CA. Reprint number 743.5000.

Tijmensen, M. J. A., Faaij, A. P. C., Hamelinck, C. N. and van Hardeveld, M. R. M. (2000) "The production of Fischer Tropsch liquids and power through biomass gasification", M. Sc. Thesis, Utrecht University/Science, Technology and Society, Utrecht. Report No. NWS-E-2000-29.

U.S. Natural Gas Prices and Natural Gas Summary from the Short-Term Energy Outlook (http://www.eia.doe.gov/oil_gas/natural_gas/info_glance/prices.html)

Wham, R. M., and Forrester III, R. C. "Available Technology for Indirect Conversion of Coal to Methanol and Gasoline: A Technology and Economics Assessment." *Alternative energy sources III*, Miami Beach, FL, 3-18.

REPORT DOCUMENTATION PAGE			Form Approved OMB NO. 0704-0188	
Public reporting burden for this collection of information is estimated to average 1 hour per response, including the time for reviewing instructions, searching existing data sources, gathering and maintaining the data needed, and completing and reviewing the collection of information. Send comments regarding this burden estimate or any other aspect of this collection of information, including suggestions for reducing this burden, to Washington Headquarters Services, Directorate for Information Operations and Reports, 1215 Jefferson Davis Highway, Suite 1204, Arlington, VA 22202-4302, and to the Office of Management and Budget, Paperwork Reduction Project (0704-0188), Washington, DC 20503.				
1. AGENCY USE ONLY (Leave blank)	2. REPORT DATE December 2003	3. REPORT TYPE AND DATES COVERED Technical Report		
4. TITLE AND SUBTITLE Preliminary Screening – Technical and Economic Assessment of Synthesis Gas to Fuels and Chemicals with Emphasis on the Potential for Biomass-Derived Syngas			5. FUNDING NUMBERS BBB3.4210	
6. AUTHOR(S) P.L. Spath and D.C. Dayton				
7. PERFORMING ORGANIZATION NAME(S) AND ADDRESS(ES) National Renewable Energy Laboratory 1617 Cole Blvd. Golden, CO 80401-3393			8. PERFORMING ORGANIZATION REPORT NUMBER NREL/TP-510-34929	
9. SPONSORING/MONITORING AGENCY NAME(S) AND ADDRESS(ES)			10. SPONSORING/MONITORING AGENCY REPORT NUMBER	
11. SUPPLEMENTARY NOTES				
12a. DISTRIBUTION/AVAILABILITY STATEMENT National Technical Information Service U.S. Department of Commerce 5285 Port Royal Road Springfield, VA 22161			12b. DISTRIBUTION CODE	
13. ABSTRACT (<i>Maximum 200 words</i>) In principle, syngas (primarily consisting of CO and H ₂) can be produced from any hydrocarbon feedstock, including: natural gas, naphtha, residual oil, petroleum coke, coal, and biomass. The lowest cost routes for syngas production, however, are based on natural gas, the cheapest option being remote or stranded reserves. Economic considerations dictate that the current production of liquid fuels from syngas translates into the use of natural gas as the hydrocarbon source. Nevertheless, the syngas production operation in a gas-to-liquids plant amounts to greater than half of the capital cost of the plant. The choice of technology for syngas production also depends on the scale of the synthesis operation. Syngas production from solid fuels can require an even greater capital investment with the addition of feedstock handling and more complex syngas purification operations. The greatest impact on improving the economics of gas-to liquids plants is through 1) decreasing capital costs associated with syngas production and 2) improving the thermal efficiency with better heat integration and utilization. Improved thermal efficiency can be obtained by combining the gas-to-liquids plant with a power generation plant to take advantage of the availability of low-pressure steam. The extensive research and development efforts devoted to syngas conversion to fuels and chemicals are documented in a vast amount of literature that tracks the scientific and technological advancements in syngas chemistry. The purpose of this report is to review the many syngas to products processes and summarize the salient points regarding the technology status and description, chemistry, catalysts, reactors, gas cleanliness requirements, process and environmental performances, and economics. Table 1 lists the products examined in this study and gives some facts about the technology as well as advantages and disadvantages. Table 2 summarizes the catalysts, process conditions, conversions, and selectivities for the various syngas to products processes. Table 3 presents catalyst poisons for the various products.				
14. SUBJECT TERMS biofuels; ethanol; fuels; chemicals; synthesis gas; syngas; economic assessment; technical assessment; technoeconomic assessment; biomass			15. NUMBER OF PAGES	
			16. PRICE CODE	
17. SECURITY CLASSIFICATION OF REPORT Unclassified	18. SECURITY CLASSIFICATION OF THIS PAGE Unclassified	19. SECURITY CLASSIFICATION OF ABSTRACT Unclassified	20. LIMITATION OF ABSTRACT UL	