

ARM-95-002

Platforms for Ocean Measurements

An ARM Notebook of Buoys, Vessels, and Rigs

December 1993

COMMENT DRAFT

Prepared by Battelle Marine Sciences Laboratory

CONTENTS

1.0	Introduction	1
1.1	Notebook Origin.....	1
1.2	Organization	1
1.3	How to Use this Notebook.....	1
2.0	ARM Ocean Site	3
2.1	Planned Sites.....	3
2.2	Measurement Strategies.....	3
3.0	Measurement and Instrument Requirements	5
3.1	Introduction	5
3.2	Surface Meteorological Observations	5
3.3	Surface Fluxes.....	5
3.4	Vertical Profiling	5
3.5	Solar Irradiance	6
3.6	Integrated Liquid and Water Vapor	7
3.7	Broadband Solar and Infrared Radiation	8
3.8	Radiance Spectrum	10
3.9	Vertical Winds and Virtual Temperature and Profiles.....	11
3.10	Whole Sky Imaging.....	12
3.11	Cloud Base Height and Cloud Characteristics	13
4.0	Platforms	15
4.1	Vessels	15
4.1.1	Research Fleet	15
4.1.2	Commercial Fleet	15
4.1.3	Military Fleet.....	15
4.2	Buoys.....	16
4.2.1	Moored Buoys	16
4.2.2	Drifting Buoys.....	17
4.2.3	Experimental Buoys.....	17
4.3	Oil Platforms.....	18
4.3.1	Drilling Platforms	18
4.3.2	Production Platforms	18
4.3.3	Arctic Exploration and Production Platforms	19
4.4	Fixed Platforms	19
4.4.1	Sea Mounts, Atolls, and Artificial Islands	19
4.4.2	Navigational Aids	19
4.4.3	NDBC Fixed Platform Programs	20
4.5	Special-Purpose Platforms	20
4.5.1	FLIP	20
4.5.2	Plant Barge.....	21
4.5.3	Specialized Vessels	21
4.5.4	Autonomous Undersea Vehicles.....	21
4.5.5	Remotely-Piloted Surface Craft	21
4.5.6	Tethered Balloon System on Ships	21

5.0	Power, Data-Logging, and Telemetry Systems	25
5.1	Batteries	25
5.1.1	Alkaline Batteries	25
5.1.2	Nickel-Cadmium Batteries	25
5.1.3	Lithium Batteries	25
5.1.4	Sealed Lead-Acid Batteries	25
5.1.5	Seawater Cells	26
5.1.6	Fuel Cells	26
5.2	Alternative Power Systems.....	26
5.2.1	Wave-Powered Buoys	26
5.2.2	Compact Wave-Powered Generator	26
5.2.3	Thermal-Electric Generators.....	26
5.3	Data Loggers	26
5.3.1	CR10 Measurement and Control System	27
5.3.2	DL1000	27
5.3.3	Model 7000 Macro Data Logger	27
5.3.4	Model 555 Data Logger	27
5.3.5	Model 211 Field Computer	27
5.3.6	DATApod II Electronic Data Logger	28
5.3.7	HERMIT 2000	28
5.3.8	Model 1167 Data Logger	28
5.3.9	Datataker 5 Single Channel Data Loggers	28
5.3.10	Tattletale Data Logger	28
5.3.11	Squirrel Meter/Loggers	28
5.3.12	IMET Data Logger	28
5.4	Telemetry and Ground Positioning Systems.....	29
5.4.1	ARGOS.....	28
5.4.2	Geosynchronous Orbit Environmental Satellite	29
5.4.3	Meteor-Burst Communication	30
5.4.4	UHF/VHF Transmitter for Data Telemetry.....	30
5.4.5	Global Positioning Systems	31
5.4.6	Loran-C.....	31
5.4.7	SAILOR Radiotelex Systems	31
5.4.8	COMSAT.....	32
5.4.9	Spread-Spectrum RF	32
5.4.10	Submarine Communication Cables	32
5.5	Platform and Sensor Stabilization	34
5.5.1	Electromechanical Stabilization	35
5.5.2	Gravitationally Stabilized Platforms.....	35
5.5.3	Gyroscopic Stabilization	35
5.5.4	Electronic Stabilization	35
5.5.5	Stabilized Instrument Platforms for Ships	35
6.0	Platform/System Compatilby	39
7.0	Platform Fact Sheets	41

List of Figures

2.1	CART Site Concept	4
4.1	WESTPAC AMOS Network	20
4.2	Test of 97 m ² Balloon from NOAA Ship Discovery, 1973	22
4.3	7.3 m ³ Balloon Being Launched for the Seahunt Experiment, 1991	22
5.1	Stabilized Platform for NOAA Profiler during ASTEX	36

List of Tables

4.1	Lightweight Instrumentation for Tethered Balloons	23
5.1	Merit Figures for Commercially Available Batteries	25
5.2	Submarine Communication Cable Information Sources	33
5.3	Summary of Submarine Telecommunication Cables in Service and Planned for Operation in the Near Future and Terminating in the TWP Box	37
6.1	Platform and Observation System Compatibility Matrix	40

1.0 INTRODUCTION

1.1 NOTEBOOK ORIGIN

The Atmospheric Radiation Measurement (ARM) program addresses two basic, scientific problems associated with developing models of the earth's climate. These problems are 1) radiative energy transport in the atmosphere and 2) cloud formation and dissipation. ARM research is focused on phenomena at the smallest-physical and shortest-time scales represented in general circulation models (GCM) of the climate system. This research includes long-term observations at representative locations world wide and complex modeling, data assimilation and analysis efforts to be conducted over the next decade.

In 1990, the ARM Science Team concluded that oceanic Clouds and Radiation Testbed (CART) sites would present unique technical and logistical problems. It also became clear that many ARM scientists working at oceanic sites would be unfamiliar with the problems they would encounter there. In particular, questions arose about the compatibility of ARM instrumentation with oceanic-based platforms.

For this reason, the Ocean Measurements Working Group (OMWOG) was formed at a meeting in Salt Lake City, Utah, in July 1992 to identify and begin solving these problems. The idea for starting a notebook like this one evolved at that meeting.

1.2 ORGANIZATION

The notebook presents basic information about platforms that might be useful at ARM oceanic sites and on general measurement requirements and instrumentation being considered for them. Chapter 2 describes the science strategies for the ARM oceanic sites. Chapter 3 reviews the current measurement needs and instrumentation requirements. Chapter 4 describes vessels, buoys,

drilling equipment, and special-purpose structures that could potentially serve as platforms for ARM measurements at sea. Chapter 5 describes ancillary equipment, such as power-supplies, data-recording equipment, and telemetry systems. Chapter 7 contains fact sheets to facilitate the selection of platforms. In conclusion, an assessment of the compatibility of existing ARM instrumentation with currently available platforms is provided in Chapter 6.

1.3 HOW TO USE THIS NOTEBOOK

This notebook has been designed to be easy to use and to modify as program needs and priorities and measurement technologies evolve throughout the ARM program. Most of the illustrations and supporting information in this notebook are maintained by Michael Reynolds at Brookhaven National Laboratory.

2.0 ARM OCEAN SITES

2.1 PLANNED SITES

To accomplish the program goal of improving climate models, ARM facilities will be established at several key sites around the world. These facilities will be used to test and refine climate-model components by the complete characterization of radiation transfer in the atmosphere. The 1992 ARM science plan calls for two, primary land sites (U.S. Southern Great Plains, SGP, and the north slope of Alaska) and three ocean sites in the western tropical Pacific Ocean (TWP), near the Gulf Stream, and in the eastern-north Pacific or Atlantic Ocean. On March 15, 1992, the SGP site at Norman, Oklahoma, began limited operation. Since then, work has been underway to design and construct the first oceanic site in the western tropical Pacific Ocean. The location of the second oceanic site is currently being evaluated by the ARM Science Team.

2.2 MEASUREMENT STRATEGIES

There are four general scientific strategies that guide operations at CART sites. These include: 1) observing the instantaneous radiative flux, 2) single-column modeling, 3) data-assimilation modeling, and 4) hierarchical diagnostic modeling. By these strategies, observations are corrected to become measurements that can be used for calculations in single-column models of radiation transfer, or that can be further refined by assimilation into diagnostic models. The process of doing this is fundamentally the same on land and at sea, but not all instruments that work on land will function at sea. For example, several types of radiometers and some sounding equipment (shown conceptually in Figure 2.1 for a land site) will be very difficult to operate in a stable orientation at sea.

Planning for measurements at oceanic sites is in a preliminary stage. It was recognized in the early stages of the ARM Program development that establishing a CART (Figure 2.1) in the ocean would not be feasible without substantial modification to land-based hardware and operational procedures. As indicated in the site location reports for the ocean sites, instrumentation, logistics, and communications must be tailored to the conditions at individual sites.

Planning and instrument development for the Gulf Stream and north eastern Atlantic/Pacific sites are temporarily on hold pending funding by the ARM Management Team. Planning for the TWP site, however, is well advanced; and to a lesser degree, so is preparation for the site on the North Slope of Alaska which will involve measurements over sea ice. Because it is not clear now (December 1993) what direction the measurement program will take beyond the TWP, this section focuses on the measurement design for that location.

Scientific rationale explained by Ackerman et al. (1993), led to the following strategy for the TWP site: 1) simultaneous observations of cloud properties, water vapor column, and the surface radiation budget; 2) multi-year radiation measurements; and 3) measurements at several locations to determine mean gradients and variability. The current strategy calls for the establishment of atmospheric radiation and cloud stations (ARCS), the first of which will be on Manus Island, PNG. As many as four more ARCS are planned for the tropical region from about 130° E to 150° W. Initially, ARCS will provide detailed observations of the radiation budget and cloud forcing to meet the first of the ARM Programs' three primary scientific goals. Additional systems may be required for single-column GCM modeling, and at the TWP site, instruments may have to be operated on buoys, ships, or fixed platforms to provide coverage over open water. The measurements currently envisioned for the implementation of this strategy are summarized below:

- o Broad-band, spectral, and direct surface fluxes
- o Location, coverage, structure, phase, optical depth, and emissivity of clouds
- o Profile and amount of water vapor
- o Profile and optical depth of aerosols
- o Boundary-layer structure, including:
temperature, wind, and humidity profiles
- o Wind velocity, temperature, pressure,
humidity, and rain rate.

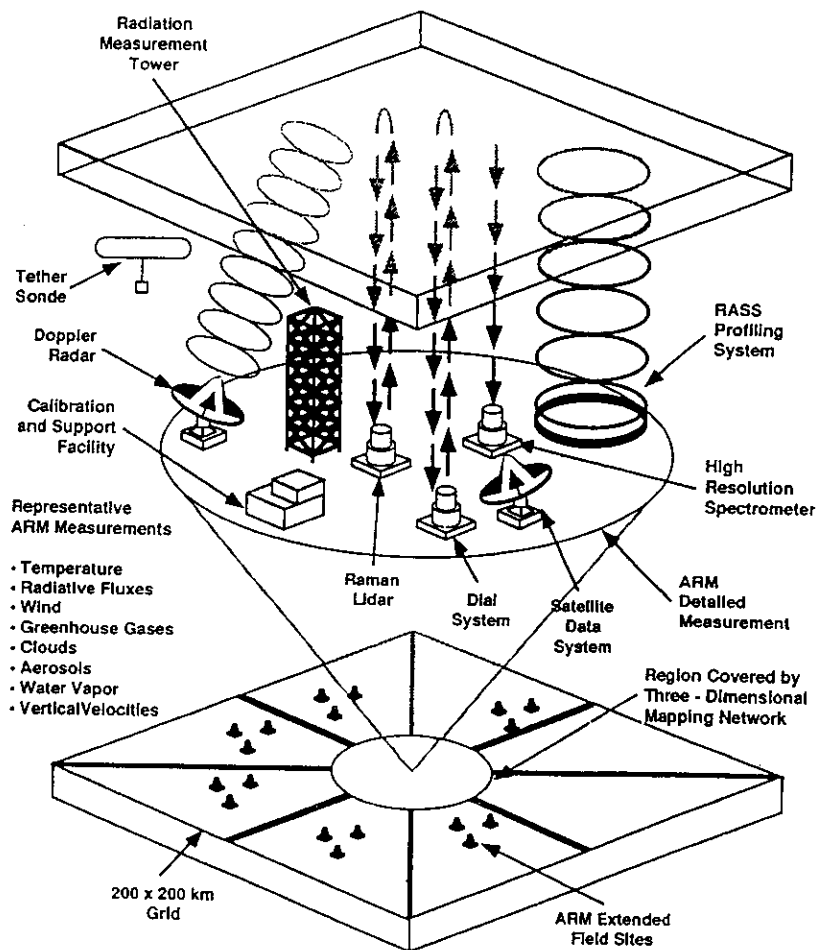

Figure 2.1 Conceptual Schematic of CART Site (circa 1990)

3.0 MEASUREMENT AND INSTRUMENT REQUIREMENTS

3.1 INTRODUCTION

The primary observations taken at ARM field sites consist of radiative fluxes, cloud properties, water vapor and liquid content (profiles and column-integrated amount), wind speed and direction, temperatures, and aerosol properties. Ideally, the quantities will be observed continuously over extensive areas, but practical considerations will surely limit actual coverage. Considerable effort will be made to provide ground-based remote sensing observations of spatial atmospheric properties that affect radiative transfer.

This chapter presents summary descriptions of instruments that are typically used on land. We anticipate that installation on coasts, islands, and at sea will require considerable modification of packaging, enclosures, and mounting systems.

3.2 SURFACE METEOROLOGICAL OBSERVATIONS

Description and Purpose: Surface meteorological observation stations (SMOS) measure basic meteorological variables, wind speed and direction, air temperature and humidity, precipitation, and barometric pressure. These measurements are usually reported as 30- to 60-min averages.

3.3 SURFACE FLUXES

Instrumentation: Tower-supported meteorological and velocity sensors

Description and Purpose: Surface heat and momentum fluxes will be monitored using two systems. The Energy Balance Bowen Ratio (EBBR) Surface Flux Station has instrumenta-

tion for measurement of latent and sensible heat fluxes at the bottom of the atmosphere. EBBR stations produce data in the form of half-hour averages of net radiation, sensible heat flux, water vapor flux, ground heat flux, soil temperature, and moisture content in the uppermost few centimeters. They also record the means of temperature, humidity, wind speed, and wind direction at various heights. Eddy Correlation Systems (ECS) will be used in conjunction with EBBR stations for measuring surface flux. A 60-meter tower (positioned by elevators) will be provided for measuring turbulent fluxes at heights of 25 and 60 meters and for measuring the mean temperature, humidity, and wind speed at 60 meters. Observations of solar and upwelling infrared irradiances are planned for the 25-meter level.

3.4 VERTICAL PROFILING

Instrumentation: Tethered Balloon Instrumentation/Radiosondes

Description and Purpose: Various systems, employing tethered balloons—(also called a Balloon-Borne Sounding System (BBSS))—are used for observing vertical profiles of atmospheric quantities such as mean wind velocity, temperature, and humidity of the lower atmosphere. The description here pertains to the Tethersonde system made by A.I.R. Company. An alternative approach is the kite-balloon (kytoon) which carries an instrument package, consisting of an anemometer, temperature sensor, humidity sensor, and pressure sensor, to heights of 1 to 3 kilometers, depending on weather conditions. An ozone sonde can also be deployed this way. Wind direction is indicated by a vane attached to the balloon. Alternatively, a vane is attached to the instrument package, which is suspended in a harness attached to the tether line.

According to A.I.R., new balloons have just become available for collecting data in winds up to 95 meters/second. Kites of various sizes are also available for lifting tethersondes.

Dimensions: Inflated kytoons range in size from 3.25 to 7.5 cubic meters, with free lifts ranging from 1.8 to 5.7 kg. The lengths and diameters of inflated kytoons range from 4.9 to 6.6 meters and from 1.2 to 1.8 meters. The winch is a 1-cubic-meter box, 1 meter on a side; the receiver measures about 0.2 x 0.1 x 0.3 meters.

Weight: The total weight of the whole system, including receiver, computer, antenna, winch, line, balloon, tethersonde, etc. in carrying cases, is about 90 kg. The weight of uninflated kytoons ranges from 1.6 to 2.2 kg. The weight of the standard tethersone is 270 kg. The tether line weighs 0.65 kg per kilometer, and there is typically 2 kilometers of line on the winch. Each helium cylinder (for inflating the balloon) weighs about 40 kg.

Stabilization and Vibration: Vibration is normally not a problem. The tethered balloon system can be operated with no stabilization from a ship in moderate seas. Stabilization systems have been developed for balloon-borne instrumentation to decouple balloons and tether motions from the sensor platform.

Power Requirements: The system requires both a direct-current source (12 Vdc, 2A) and an alternating-current source (110 Vac, 0.3A). The winch can draw several amps (direct-current) under load.

Output: Digital 20 to 40 kilobytes per flight depending on the length of time the sonde is transmitting. The sonde can cycle through all parameters about every 10 seconds. The tethersonde ground station is usually programmed to calculate a number of secondary quantities, such as potential temperature and mixing ratio.

Maintenance Requirements:

1. **Calibration.** Each sensor must be calibrated in the laboratory as required by the manufacturer.
2. **Cleaning.** The sonde does not normally require cleaning. The winch must be kept clean.
3. **Service.** The winch requires regular lubrication. The inflated balloon can be stored in a shed between flights. The shed must not have any sharp projections that can puncture the balloon. The shed opening must be tall enough (3 m, minimum) that the operator can walk the balloon into the shed, handling it from below. The minimum size of the shed will depend on the size of the kytoons used, but it could be as large as 3 m wide by 10 m long. The sonde batteries need to be replaced or recharged after 2 hours of operation. An adequate supply of helium is needed: nominally, a single 1-A cylinder is needed for each inflation, depending on the size of the balloon.

3.5 SOLAR IRRADIANCE

Instrumentation: Multifilter Rotating Shadowband Radiometer (MFRSR)

Description and Purpose: The MFRSR is a microprocessor-controlled device that measures total and diffuse hemispherical-centered irradiance and direct solar beam irradiance. Measurements are made in seven wavelength bands simultaneously, with standard detectors at 415, 500, 610, 665, 862, and 940 nm, and one broadband shortwave detector (350 to 1150 nm). This selection of wavelengths is used at the Southern Great Plains CART site.

Dimensions: The band/detector assembly is 0.28 m in each dimensions, including the sweep for the shadowband. The electronics assembly box is 0.4 m long, 0.34 m wide, and 0.18 m deep for the 156-channel data loggers, slightly larger for the 32-channel loggers.

Weight: The total weight, including all components, is about 15 kg.

Stabilization and Vibration: The MFRSR is not particularly susceptible to vibration. To achieve the desired observations with this device, it must be kept horizontal to within 0.5 degree.

Power Requirements: This unit requires a direct-current source for internal use (15 Vdc adjustable to 13.8 Vdc, 3A) and an alternating current source for external use (115 Vac, 60 Hz, 0.5A).

Output: Output signal voltage may range from -5 to +5 V, and is measured by a built-in data logger. Digital: 33 bytes per record (once per 10 seconds) for the MFRSR, plus 1.5 bytes per auxiliary channel (maximum of 32 available), averaged or unaveraged. Communications are accomplished through an RS-232 connection.

Maintenance Requirements:

1. **Calibration:** Requires laboratory calibration. Calibration frequency is a function of the desired accuracy of measurements.
2. **Cleaning (optics, etc).** Clean with stream of distilled water or 90-percent-pure ethyl alcohol; with frequency being dependant on ambient conditions (dirty or salty air versus clean dry air). Use room temperature distilled water to remove ice from the white diffuser on the detector.
3. **Service.** Inspect the azimuthal alignment of the band/detector assembly monthly; the white diffuser must be shaded from direct solar radiation during the mid-point of the shadowband sampling interval. Also, make sure the detector canister is level. Monthly to semi-annually, depending on animal traffic and air quality inspect the connectors and circuits.
4. The backup battery is continuously recharged when the unit is connected to an AC-power

source and typically has a 4-year lifetime. The battery may be a small rechargeable 12-Vdc battery that fits inside the electronics assembly box, or it may be an external automotive or marine 12-Vdc battery.

3.6 INTEGRATED LIQUID AND WATER VAPOR

Instrumentation: Raman Lidar and Microwave Water Radiometer (MWR)

Description and Purpose: The primary purpose of a Raman lidar and MWR is to observe vertical profiles of water vapor content. Observations of aerosol backscatter and of liquid-versus vapor-water in clouds can also be made with Raman lidar. System specifications have not yet been finalized. Attributes can vary a great deal depending on the functional requirements of the system. The Microwave Water Radiometer (MWR) is a passive microwave sensor used to observe emissions from the atmosphere at selected wavelengths between 20 and 35 GHz. This measurement is used to infer the total amount of water vapor and liquid water in a narrow, vertical atmospheric column above the instrument.

Dimensions: Approximately 2 x 2 x 6 m.

Weight: 900 kg.

Stabilization and Vibration: Stabilization might be necessary, because the system is not configured for operation with strong vibration or ground motion.

Power Requirements: The instrument requires an alternating-current power source (220 Vac, 50A; and 110 Vac, 100A)

Output: Digital: 1 kilobyte/second.

Maintenance Requirements:

1. **Calibration.** Periodically done by comparison with balloon-borne instrumentation.
2. **Cleaning.** Clean window on top of instrument housing.
3. **Service.** Occasional servicing of laser, mainly to change flashlamps every 30 million shots; frequency depends on duty cycle of lidar.

3.7 BROADBAND SOLAR AND INFRARED RADIATION

The instruments used during the Plot Radiation Observation Experiment (PROBE) included a pyranometer, a pyrheliometer on a tracking system, a pyrgeometer with a tracking disc, and a pyranometer with a tracking disk. Direct, diffuse, and total solar irradiances, plus total downwelling infrared irradiances, were observed at the PROBE site (Kavieng, N.G.). The sensors were calibrated by the National Renewable Energy Laboratory (NREL). Detailed descriptions of other instrumentation follow.

Instrumentation: Low-Resolution Thermal Infrared Sensor (e.g., Heimann KT19.85 Infrared Thermometer)

Description and Purpose: This device observes the brightness temperature associated with radiation received in a narrow cone, about 1 degree, at a selected wavelength interval, 9.6 to 11.5 micrometers, with an accuracy of better than 1°K when viewing a cold scene (-50°C).

Dimensions: 0.2 x 0.07 x 0.14 meters

Weight: 1.2 kg

Stabilization and Vibration: Not highly sensitive to vibration. If the purpose is to observe surface temperature, stabilization might not be desirable. If the purpose is to observe zenith sky

temperature, stabilization is needed only to the extent that the view angle must be coincident with the orientation of other remote sensing systems.

Power Requirements: Vdc: 22 to 30 Vdc; DC current: 80 mA (at 24 Vdc); Vac: 24 Vac; AC current: spec not available; AC power is supplied by a switching power supply, which converts 110 or 220 Vac to 24 Vac, up to 400 mA. It is enclosed in a NEMA 4 equivalent housing.

Output: Analog: 0 to 20 mA, 4 to 20 mV, 0 to 1 V, or 0 to 10 V; Digital: RS232C bidirectional; selectable rate, 1200 to 19200 baud.

Maintenance Requirements:

1. **Calibration.** Not normally needed with the internal reference, but should be checked with a portable blackbody every 3 months.
2. **Cleaning.** Optical windows need to be kept clean.
3. **Service.** None in addition to calibration and visual inspection of optics.

Instrumentation: Solar Spectroradiometer

Description and Purpose: This device provides data on the spectral composition of solar radiation. The LI-COR LI-1800 is described. The spectrum from 300 to 1000 nm is measured, at 6-nm resolution, with programmable wavelength steps of 1, 2, 5, or 10 nm. Normal operation is to measure total (global horizontal, or downwelling hemispherical) irradiance. The solar direct beam could be measured by adding a custom direct-beam tube module (NREL design). Such radiometers are also used in various calibration activities in support of Southern Great Plains CART site. An underwater version is available, Model LI-1800UW, which would be appropriate for using moorings.

Accuracy: The overall accuracy for global, horizontal outdoor measurements is about $\pm 10\%$ to $\pm 20\%$, depending upon wavelength, time, temperature, and leveling. The error sources identified by the manufacturer and NREL include:

1. Calibration Inaccuracy With Respect to Standards: 300 nm = ± 10 percent; 450 nm = ± 5 percent; 550 nm = ± 4 percent; 650 to 800 nm = ± 3 percent; 1100 nm = ± 5 percent (under controlled conditions—see detector TC information below)
2. Calibration Instability: Typically $< \pm 5$ percent change per year; recommended recalibration interval is 6 months.
3. Detector Temperature Coefficient: -0.1 percent/ $^{\circ}\text{C}$ at 350 nm; 0.05 percent/ $^{\circ}\text{C}$ between 400 and 950 nm; 0.5 percent/ $^{\circ}\text{C}$ at 1000 nm; 1 percent to 2 percent/ $^{\circ}\text{C}$ at 1100 nm; factory calibration is at approximately 25°C .
4. Deviation of response from an ideal cosine response of the 180-degree Teflon cosine receptor is generally within ± 2 percent from about 500 to 1000 nm.

Operating Conditions: 0° to 45°C ; 0 to 100 percent RH (enclosed in weatherproof, O-ring-sealed enclosure with sealed recessed connectors)

Dimensions: 0.16 x 0.20 x 0.36 meters (not including accessories or terminal)

Weight: 6.4 kg (not including accessories)

Stabilization and Vibration: Designed for use outside, but is unlikely to withstand prolonged vibration and jarring. Stabilization in the horizontal plane (to a minimum of ± 1 degree) is necessary for interpretable results of global horizontal data. The solar direct beam measurement requires a solar tracker. Shipboard operation would be difficult.

Power Requirements: External DC Source: 12 Vdc; Vac: 100 to 128/200 to 256; Vac: 48 to 66 Hz.

Internal rechargeable 6-Vdc NiCad battery, (4 Ah rating) provides 4 to 8 hours of operation at 25°C (dependent upon number of scans). Requires 14-hour recharging time with instrument non-operating. The internal battery can be recharged from either AC or DC sources.

Output: Analog: 0 to 100 mV, for a strip-chart recorder; Digital RS-232C: programmable from 300 to 4800 baud. Requires about 30 seconds to download to a computer an ASCII data file containing a 300 to 1100 nm spectrum taken at 2 nm steps. Binary data dumps are much faster.

Maintenance Requirements:

1. **Calibration.** Factory calibration sets the instrument for use in a laboratory environment. Using the instrument outdoors results in an attendant increase in uncertainty. Recalibration is recommended at 6-month intervals. It can be done at the factory and requires a NIST-traceable spectral irradiance source (lamp standard with precision source and optical bench). ALI-COR LI-1800-02 Optical Radiation Calibrator provides a 14-percent accuracy source from 350 to 1000 nm, with a stray-light factor of < 0.5 percent and an aging factor of typically $< \pm 1$ percent for the 50-hour lamp life.
2. **Cleaning.** Normal maintenance of sensing head (e.g., cleaning with distilled water and pure ethanol). If unit is not kept sealed when in a marine environment, factory cleaning may be necessary.
3. **Service.** Return to factory when service is needed.
4. Operates on 6-Vdc NiCad batteries, providing 4 to 8 hours of operation, depending on scanning rate. Can operate on AC or DC external power source. Replacing the battery breaks the environmental seal of the instrument.

Instrumentation: Pyrogeometer (PIR)

Description and Purpose: This sensor measures the broadband hemispheric irradiance from 4 to 50 micrometers. It can be pointed upward or downward. When pointed upward, a ventilator and a solar-tracking disc should be attached to achieve accuracies within 20 W/m². In addition, the temperature of the dome and the sensor body should be monitored to achieve such accuracy. The documentation for the Eppley pyrogeometer was the source of information for this description.

Dimensions: 0.15 m in diameter and 0.09 m high without the ventilator. Adding a ventilator adds about 0.1 m in height. An assembly for a solar-tracking disc can be quite large, requiring a clearance of about 0.5 m above and below the sensor.

Weight: 6 kg

Stabilization and Vibration: No inherent problems associated with vibration, but pyrogeometers must be stabilized to within a fraction of a degree if a solar-tracking disk is used. If one is not used, errors can still be substantial if the sensor is not kept horizontal.

Power Requirements: 110 Vac is needed for the tracking disk; AC current: depends on motor, usually around 0.15 A.

Output: Analog: 0 to 5 mV for sensor output; a simple bridge circuit is needed for the two thermistors. Digital: 1 byte of data every 10 seconds is a practical maximum sample rate.

Maintenance Requirements:

1. **Calibration.** Calibration procedures for pyrogeometers are not well established. A standard laboratory calibration procedure is being investigated by NOAA/ARL and NREL. Calibration checks should be done approxi-

mately every six months. Without standard laboratory calibration and frequent recalibration checks, disagreements of 30 to 40 W/m² among different sensors are possible.

2. **Cleaning.** The dome should be kept clean. Daily cleaning with distilled water and 50-percent-pure ethanol and water may be necessary in a marine environment.
3. **Service.** Service is mostly limited to cleaning, calibration checks, and inspections of electronic connections.

3.8 RADIANCE SPECTRUM

The Atmospheric Emitted Radiance Interferometer (AERI) provides a calibrated radiance spectrum of 2000 points from 500 to 2500 cm⁻¹. A UV spectral radiometer is being developed as part of another program and it will be installed initially at the SGP site for test and evaluation in a radiometrically characterized environment. The AERI is designed to produce one-wave number spectrally resolved data for application to studies of the radiative properties of both clear air and cloudy skies. The remote sensing capabilities of the AERI can also provide temperature and moisture profiling.

Instrumentation: Infrared interferometer

Description and Purpose: The AERI is an infrared interferometer that accurately measures radiances from 3.3 to 18.2 micrometers at one-wavenumber resolution with a 1.3-degree field of view. One calibrated sky radiance spectrum is produced approximately every 10 minutes. The AERI also produces spectra of the radiance standard deviation during the sky dwell time. The AERI real-time output, which is accessible through a network connection, consists of radiometric and spectral radiances on a standard wavenumber scale. The AERI system consists of a data acquisition module and a front-end data processor.

The AERI consists of an optics bench with a rigidly mounted interferometer, front-end optics, and calibration blackbodies that mounts to the field facility structures and an electronics module, including the control and logging computer, which is connected to the optics bench with a 20-ft cable. The interferometer and optics bench assembly protrudes through a thermally insulated sidewall, exposing the front-end optics and calibration blackbodies to ambient temperature and allowing the interferometer to operate at room temperature. This portion of the AERI is enclosed in a weatherproof enclosure with a hatch in the "roof." This enclosure attaches to the side of the building that houses the AERI and is designed to operate at outside ambient temperature.

Dimensions: Interferometer and optics bench assembly: 0.9 x 0.7 x 0.5 meters. Electronics Support Equipment 0.8 x 0.6 x 0.8 meters (generally needs a space 1.5 x 2.5 x 2.5 meters).

Weight: Interferometer and optics bench assembly: 40 kg. Electronics support equipment: 30 kg

Stabilization and Vibration: The interferometer and optics bench assembly requires rigidly mounted four mechanical isolators. These isolators are sufficient to prevent normal building motions and vibrations from contaminating AERI data.

Power Requirements: Not applicable; Vac: 115 Vac; AC current: two 20-A dedicated circuits needed.

Output: Digital: TCIP networking with ftp and bootp functions; total data rate is 2425 kbytes/hr. This is broken down as follows:

Raw Data:	2200 kbytes/hr
Calibrated data:	220 kbytes/hr
Summary product:	5 kbytes/hr

Maintenance Requirements:

1. **Calibration.** Self-calibrating system.
2. **Cleaning.** Little cleaning is required because the calibration scheme compensates for window and optical degradation. The instrument is normally operated in a shelter with a hatch in the roof that closes during precipitation. Periodic cleaning of exposed optical surfaces will extend optical throughput; however, this should not be a problem. Future designs might have mirrors on the shelter walls, that obviate the need for a hatch in the roof.
3. **Service.** May require a skilled operator on a weekly basis.
4. Currently, liquid nitrogen is required for cooling the AERI detector dewar. No liquid nitrogen is required for the reference blackbodies. Current estimates of the usage of liquid nitrogen for the AERI is 160 liters every two weeks. This could probably be extended to three weeks with appropriate design modification.

3.9 VERTICAL WINDS AND VIRTUAL TEMPERATURE AND PROFILES

A 915-MHz Radar Wind Profiler-Radio Acoustic Sounding System (RASS) observes mean wind velocities and backscatter in the atmospheric boundary layer to heights of 2 km and temperatures to heights of 0.5 to 1.5 km, depending on atmospheric conditions. At the SGP, the electronics for the system are housed in a trailer approximately 50 m from the antenna and 1 km from the operations center.

A 50-MHz Radar Wind Profiler-RASS covering an area of approximately 70 x 70 m will measure wind profiles from 2 to 12 kts at 500-meter resolution. Temperature profiles will typically be determined to heights of 6 km.

Both of the RASS systems must be isolated from the central facility by terrain, to attenuate RF noise radiated to other instruments.

Instrumentation: 915-MHz Radar Wind Profiler and Radio Acoustic Sounding System

Description and Purpose: This system can observe the means of wind velocity components, backscatter, and mean temperature in the lower atmosphere. The current CART system observes the winds between approximately 0.1 and 3 km and the temperature between 0.1 and 1 km with 0.1-km resolution.

Dimensions: (Note, many of these dimensions could be modified for oceanic operation.)

Antenna: (4 panel) = 2 x 2 x 0.4 m (not including clutter screen); including clutter screen = 3 x 3 x 2 m. (9 panel) = 3 x 3 x 0.4 m; including clutter screen = 4 x 4 x 2 m.

electronics	= 0.48 x 0.56 x 0.3 m
terminal	= 0.36 x 0.36 x 0.4 m
Audio Amp	= 0.48 x 0.51 x 0.2 m
Computer	= 0.48 x 0.51 x 0.2 m
Printer	= 0.48 x 0.51 x 0.2 m
UPS	= 0.3 x 0.30 x 0.2 m

Weight: (Note, many of these weights could be modified for ocean-type operation.). Antenna: (4 panel) = 115 kg; Including Clutter Screen = 160 kg. (9 panel) = 275 kg; Including Clutter Screen = 340 kg

electronics	= 27 kg
terminal	= 18 kg
Audio Amp	= 6 kg
Computer	= 12 kg
Printer	= 9 kg
UPS	= 45 kg

Stabilization and Vibration: Tolerates moderate vibration, operates either from a stabilized platform or performs coordinate rotations in real time.

Power Requirements: 110 Vac, 10A.

Output: Digital: 250 bytes/s (assumes spectra every 30 seconds).

Maintenance Requirements:

1. **Calibration.** Checked by comparison to other observation systems, e.g., a balloon-borne sounding system.
2. **Cleaning.** Antennas must be kept clear of ice and snow. Salt is undoubtedly a problem for electronics and antennas.
3. **Service.** Very little maintenance required.

3.10 WHOLE SKY IMAGING

The whole sky imaging system initially will be a single sky imager, but ultimately will be replaced by an array of imagers to record the 3-D cloud field over the central facility.

Instrumentation: Whole-Sky Imager (WSI)

Description and Purpose: A WSI is used to produce digitized images of the sky from zenith to near the horizon.

Dimensions: Sensor = 0.2 x 0.2 x 1.7 m; Controller = 0.75 x 0.55 x 0.70 m (a 30-m, 16-gauge cable connects the two)

Weight: Sensor = 90 kg; Controller = 45 kg

Stabilization and Vibration: Reasonably tolerant of vibration. Must be mounted on a rigid platform.

Power Requirements: Sensor requires 110 Vac, 60 Hz, 5.9 A; controller requires 1.7 A

Output: Digital: 20 kilobytes/s maximum; 260 kbytes every 15 minutes is more practical. (512 x

512 bytes per scan, 4 per minutes maximum; perhaps once per 15 minutes)

Maintenance Requirements:

1. **Calibration:** Completed by supplier on setup.
2. **Cleaning:** Once per day with water and soft cloth; raindrops are not a problem.
3. **Service:** Change tape once per week.

3.11 CLOUD BASE HEIGHT AND CLOUD CHARACTERISTICS

A ceilometer, similar to systems used by the National Weather Service (NWS) but more powerful, will be used to record cloud-base height up to cirrus altitudes.

Instrumentation: Cloud Radar

Description and Purpose: Vertical profiling of cloud characteristics, i.e., cloud dimensions in the vertical, radial wind speeds from doppler signals, and discrimination of water liquid from ice. For these purposes, either a 35-GHz or a 95-GHz system could be used, but the final specifications are not available. Sample specifications for a 35-GHz system are presented here.

Dimensions: Radar Box = 0.63 x 0.63 x 0.4 m; Modulator = 0.5 x 0.5 x 0.6 m; Antenna - approximately 1 x 1 x 1 m.

Weight: Radar Box = 40 kg; Modulator = 56 kg; Antenna = 18 kg

Stabilization and Vibration: Can tolerate moderate vibration. Stabilization may be necessary.

Power Requirements: 120 Vac, 60 Hz, 20 A.

Output: Digital: 2.5 Mbytes/s of unprocessed data; maximum.

Specific Maintenance Requirements:

1. **Calibration.** Calibration is performed by comparison to traceable independent sensing systems.
2. **Cleaning.** None.
3. **Service.** Replace transmit tube as needed, 5,000 to 10,000 hours.

Instrumentation: Optical Particle Counter (Knollenberg Probe)

Description and Purpose: A PMS model PCASP-X-SP is used as an example for this description. It uses a patented passive-cavity, laser-illumination technique to size particles in the interval from 0.1 to 10 μm . There are 31 channels of information. The last channel is for particles $>10 \mu\text{m}$. The unit has a maximum count rate of 10,000 sec^{-1} with an adjustable flow rate of 1 to 3 $\text{cm}^2 \text{sec}^{-1}$.

Dimensions: 0.6 x 0.4 x 0.2 m

Weight: Less than 21 kg

Stabilization and Vibration: This in situ sensor does not require a stabilized platform and tolerated moderate vibration, but the laser should be inspected frequently when subjected to vibration.

Power Requirements: 115 Vac, 50 to 60 Hz, 2A

Output: Digital: Approximately 40 bytes/s average output, at an adjustable rate. Internally, parallel, differential line drivers (RS-422) are employed to output a 5-bit code, with strobe signal for each particle counted. TTL line drivers/receivers. External read and reset signals can be accommodated. Intrinsic data rate logging must be faster than 100 bytes/s, but a smart probe can be purchased that outputs averages of scans via RS232C. The PCASP-X can be connected to IBM PC for handling the data.

Maintenance Requirements:

1. **Calibration:** An aerosol generator and SEM are required to calibrate this instrument.
2. **Cleaning:** Details for cleaning the optics and changing filters are provided in the manual. Cleaning can be performed by any competent technician. The laser voltage can be monitored to indicate when to clean the optics.
3. **Service:** Normal maintenance should keep the unit working for extended periods, however, most operating experience has been gained during short-term experiments.

4.0 PLATFORMS

4.1 VESSELS

Vessels, as defined here, include boats and ships that are self-propelled, have crew accommodations, and auxiliary power. The ones discussed in the notebook are used for a variety of purposes, including: transportation, oil-field logistics, research, and military operations. Brief descriptions of major fleets that could be utilized for ARM oceanic operations are provided in the following sections; fact sheets about a representative sample of vessels are in Chapter 6.

4.1.1 Research Fleet

Most large research vessels in the U.S. are managed by the University National Oceanographic Laboratory Systems (UNOLS), private research institutions, and NOAA. The UNOLS fleet is maintained to support the diverse research needs of the member universities. Vessels operated by several of these institutions are represented in Section 6.0.

In the past, research programs have used commercial, military, and fishing vessels as ships-of-opportunity for making scientific observations. Scientific equipment can be mounted aboard a vessel to make observations automatically, or it can be operated by ships crew at specified locations. Volunteer observing programs produce little impact on vessel operations, crew time, safety, and schedule.

One disadvantage of using ships-of-opportunity is identified in the following excerpt from Sea Technology Magazine: "The initial TOGA array was built using ships-of-opportunity, but after one year it became obvious that many regions that are critically void of marine traffic would require another means to deploy buoys" (R.M. Partridge "Drifting Buoys Support TOGA Effort," Sea Technology Magazine, September 1986).

Another negative account from a WMO report is paraphrased as follows. For more than two decades, weather observations from ships have been used as ground truth for remotely sensed observations of the ocean. Ships in the Voluntary Observing Program (VOP) of the World Meteorological Organization (WMO) have been a principal source of large quantities of low-cost global data on a daily basis. A major concern of many data users, however, has been uncertainty about accuracy. Substantial differences exist between coincident observations from VOP ships and from NOAA moored buoys, even when they are in close proximity to one another. The report concluded that observations of wind and waves from the VOP are unsuitable for remote sensing validation applications, because the errors in the data exceed specified system accuracies.

4.1.2 Commercial Fleet

The commercial fleet is catalogued by the American Bureau of Shipping (ABS) and Lloyds Casualty and Fire. Their listings contain the vessel specifications, year built, and ownership. Examples of smaller working vessels, not listed by the ABS or Lloyds, are included in Chapter 6.0. The smaller vessels are the work boats of the oil industry and range in length from about 70 feet to 250 feet. Large work boats accommodate crews of about 30, have lots of deck space for cargo transfer and supply, and are equipped with positioning thrusters and satellite navigation systems.

4.1.3 Military Fleet

Only United States Navy ships are considered in the notebook. The Navy funds several of the vessels within the UNOLS fleet via the Office of Naval Research (ONR). Other military vessels may become available for scientific missions in the future, as evidenced by the appropriation of \$3 million in 1993 for a 42-day unclassified

scientific mission aboard a fast-attack nuclear submarine. This suggests that it may be possible in the future to use other stable navy ships, such as aircraft carriers, for scientific purposes. The Navy has well-trained crews aboard vessels, both on and under the water, that could be an asset to the ARM program.

4.2 BUOYS

Buoys are used for navigation, scientific and data collection platforms, and a wide variety of other purposes. Electrical equipment and instrumentation are commonly powered by batteries, charged by solar cells, and in some cases, by diesel-powered generators. Buoy weights range from several pounds for drifters and aircraft-deployed buoys, to nearly one hundred tons. A comprehensive study of navigation buoys was recently completed by the Coast Guard Research and Development Center and representative examples are included in Section 6.0.

Some of the environmental considerations for the design of buoys are: waterdepth, wave and current conditional, weather, and corrosion. Other design considerations include the magnetic characteristics of the hull, dynamic stability, hydrodynamic drag, and vandalism [the National Data Buoy Center (NDBC) stated that some of their buoys have been used for target practice].

4.2.1 Moored Buoys

Moored buoys are anchored to the bottom. Those maintained by the NDBC have standard instrument packages that include anemometers, barometers, air- and sea-surface temperature sensors, and vertically integrative accelerometers to measure wave height. NDBC buoys can remain at sea for two to three years without maintenance in water depths ranging from 10 to 5300 meters. Synthetic mooring lines have extended mooring life to eight years and longer at some locations.

The normal reporting period for NDBC buoys is once every hour via Geosynchronous Orbit Environmental Satellite (GOES).

4.2.1.1 Discus Buoys

4.2.1.1.1 Twelve-Meter Discus Buoys

The 12-meter-diameter discus buoy, also known as the Monster Buoy (weighing nearly 200,000 pounds), was developed to prevent capsizing by the Office of Naval Research (ONR) during the 1960's. The NDBC currently operates three monster buoys, but in the near future, the fleet will be reduced to two buoys. The Coast Guard uses the 12-meter hull in its large navigational buoy. Instrumentation on these buoys is mounted on a 10-meter mast. Monster buoys are deployed with a tugboat.

4.2.1.1.2 Ten-Meter Discus Buoys

The high cost of the 12-meter buoy led to the development of the less-expensive, 10-meter discus buoy (weighing 114,000 pounds). Weather instruments are mounted on a 10-meter mast. The 10-meter buoys are used extensively by Japan. Unfortunately, the smaller hull is less stable and more difficult to board by service personnel. Many instances of capsizing, involving the 10-meter hull, have been reported by the NDBC and Japanese users.

4.2.1.1.3 Three-Meter Discus Buoys

The 3-meter discus buoy was developed by Woods Hole Oceanographic Institution (WHOI) and the NDBC. The deployment weight of the 3-meter discus buoy is 3,500 lb. Its small size allows the buoy to be deployed and retrieved by a ship and transported by truck. The aluminum hull resists corrosion and produces no magnetic field to interference with instrumentation. Meteorological sensors are typically mounted at a height of 5 m on this buoy. The NDBC-estimated purchase price for a 3-meter buoy is \$25,000 (in 1993 dollars).

4.2.1.2 Hull-Shaped Buoys – NOMAD

The Naval Oceanographic and Meteorological Automatic Device (NOMAD) is a six-meter, aluminum, boat-hull-design buoy. As with the 3-meter discus buoy, aluminum increases the corrosion resistance. NOMADs typically weigh about 14,000 lb when rigged for deployment (small enough for deployment and recovery from a large work boat). The instrumentation is typically mounted 5 meters above water level. The boat hull design gives the buoy improved stability and boarding characteristics at the expense of directional-wave measurement capabilities. The NDBC cost estimate for a NOMAD hull is \$140,000 (in 1993 dollars).

4.2.1.3 COLOS

The Coastal Ocean Line of Sight (COLOS) buoy has a foam hull. Its size ranges from 1.6 to 2.3 meters, and it is hemispherical in shape. A cage under the buoy hull acts like a bell and clapper. When the buoy begins to roll, the cage hits the mooring line which provides a moment to right the buoy.

4.2.1.4 Spar Buoys

The Coast Guard uses spar buoys in exposed locations because they are more stable than most other designs. Spar buoys are slender, long and have a low center of gravity and a high center of buoyancy, and thereby resist roll and pitch. Instrumentation packages mounted in the hull, however, are susceptible to damage during deployment and recovery operations because there is no superstructure to protect them.

4.2.1.5 Semi-Submersible Buoys

Semi-submersible buoys utilize hull technology similar to that used on oil-drilling platforms. The hulls are deballasted during deployment to reduce hydrodynamic drag. The WMO report "Guide to Moored Buoys and Other Ocean Data Acquisition Systems" describes tests showing

that a semi-submersible spar buoy of 75,000 kg displacement would roll less than 6 degrees in 4-meter seas and could survive 18-meter waves without capsizing.

4.2.1.6 Toroidal Buoys

The toroidal buoy was developed at the WHOI during the late 1950's. Toroidal buoys are 2.4 to 3.7 meters in diameter and require a stiff bridle under the buoy to prevent capsizing. They can be deployed and retrieved from ships.

Toroidal-hull construction is used in the ATLAS mooring system. The ATLAS moorings were developed by NOAA's Pacific Marine Environmental Laboratory (PMEL) to provide inexpensive meteorological and upper-ocean observing platforms, requiring little maintenance during one-year deployments. The 2.3-meter toroidal buoy has a tower for mounting anemometers and other sensors up to 3.8 meters above water level. The ATLAS buoy has RAM for logging data and transmits data via Service ARGOS.

4.2.2 Drifting Buoys

Recent advances in GPS and electronics have increased the utilization of drifting buoys deployed from ships and aircraft. The Tropical Ocean Global Atmosphere (TOGA) Program demonstrated the reliability of drifting buoys by achieving a mean time to failure of more than 400 days. This major scientific program successfully established an efficient logistics program requiring sizable drifting buoy arrays and networks. Air deployment was performed by C-130s and C-141s.

4.2.3 Experimental Buoys

4.2.3.1 SWADE

SWADE was an ONR experiment which added a wing to a 3-meter discus buoy to improve its directional wind measurement capability. The SWADE design performs well except during

calm periods when aerodynamic forces are insufficient to overcome hydrodynamic drag and friction in mooring hardware.

4.3 OIL PLATFORMS

Oil platforms are separated into a class for drilling and a class for production. Drilling platforms are mobile and are deployed to a site just long enough to prepare a field for production, whereas production platforms are established at fixed locations for the producing life of a field (10 to 25 years). In either case, the operating companies may be open to the placement of instrumentation onboard, provided that it does not interfere with operations. A third category of platforms for arctic exploration and production is also discussed because of potential applications at the ARM site on the North Slope of Alaska. Companies that can assist with the identification of oil platforms for scientific use are the Offshore Data Service, the American Bureau of Shipping, and the Oilfield Publications Service.

4.3.1 Drilling Platforms

Nearly all drilling platforms are contracted for petroleum exploration and development by companies owning or leasing the rights to develop a field. Drilling platforms typically stay on location for about six months. In the sections that follow, platforms are described in three main categories: semi-submersibles, drillships and barges, and jackups.

4.3.1.1 *Semi-Submersibles*

Semi-submersible drilling platforms have pontoon-style ballast tanks so they can be towed or self-propelled to the drill site and then flooded for stability. These platforms typically carry a crew of about 60, have as much as 2500 square meters of deck space, and are equipped with a heliport, complete crew accommodations, and support facilities. Some semi-submersibles are designed to rest on the bottom for shallow-water drilling.

Deep water (1800 meters) semi-submersibles are dynamically moored and held on location with thrusters controlled by satellite positioning systems. The submersible Zane Barnes exemplifies the stability of this type of platform. The Zane Barnes was drilling in the Gulf of Mexico during Hurricane Andrew. Some of the mooring cables parted under dynamic loads of about 4×10^6 kips produced by high seas and wind gusts exceeding 180 knots. The thrusters and surviving cables held the rig in position, while in the galley, juice cans could be stacked three high before toppling over. Slip joints for semi-submersibles are normally designed to compensate for 7 to 8 feet of heave. In normal weather and sea conditions, maximum heave is considerable less than this amount.

4.3.1.2 *Drillships and Barges*

Drillships are vessels equipped with a derrick and a moonpool. They are designed for drilling in water depths ranging from about 200 to 6000 meters, and are held in position by dynamic mooring cables and thrusters. Some drillships are self-propelled and equipped with propulsion systems for dynamic positioning. They normally have a crew of 90, are equipped with a heliport, and remain on location long enough to drill several wells, about six months.

4.3.1.3 *Jackups*

A jackup platform is supported by steel legs that are floated to the drill site and lowered to the bottom in water depths from 15 to 60 meters. Once positioned, the whole platform is "jacked" out of the water high enough to allow extreme waves to pass safely under the work deck. Jackups have accommodations for about 60 people, about 2500 square meters of deck area, and helipads for crew changes, logistics, and emergency transport.

4.3.2 Production Platforms

Production platforms pump, handle, and process crude oil for end use and distribute it to pipelines

and tankers. There are three basic configurations: jacket-leg, tension-leg, and semi-submersibles. A typical production platform has a crew of 200 and nearly all the comforts of home. Semi-submersible production platforms are the same as their drilling counterparts, but have more endurance.

4.3.2.1 Jacket-Leg Platforms

Jacket-leg platforms are the most common. These rigs are constructed of large-diameter steel pipes, called jackets, and usually have four legs, interconnected with cross members. Compliant-tower platforms are an offshoot of the jacket-leg version. Tall, compliant structures of this type can sustain forces from long-period waves because of increased their natural frequency associated with decreased stiffness and added mass. The three styles of compliant structures are flexing towers, buoyant towers, and guyed towers. Compliant towers are used for drilling and production operations in deepwater (~1000 meters).

4.3.2.2 Tension-Leg Platforms

Tension-leg platforms are production facilities similar to semi-submersibles. The facility is floated into position, then moorings are set to pull the rig down against its own buoyancy.

4.3.3 Arctic Exploration and Production Platforms

Operations in the arctic and ice pack zones require ice-hardened facilities and vessels. The Canadian Marine Drilling Company offers a representative variety of facilities and vessels for arctic operations. They have a unique drilling platform called the SSDC/MAT which is an ice-strengthened, bottom-founded, mobile drilling unit that can drill in water as deep as 80 meters.

4.4 FIXED PLATFORMS

Fixed platforms are structures to which instrumentation can be rigidly fixed to the ground and be unaffected by wave motion. Some examples

of fixed platforms are the NDBC C-Man sites (placed on headlands, piers, piles, and docks) as well as lighthouses, seamounts, atolls, and artificial islands. Westpac C-Man sites are shown on Figure 4.1.

4.4.1 Sea Mounts, Atolls, and Artificial Islands

Sea mounts are submarine volcanoes that occur individually, or in groups or chains, such as the Hawaiian or Easter Islands. Atoll are islands on coral reefs formed around a subsiding volcano. Artificial islands are made from landfill and dredged materials, or aggregate. Because construction costs are proportional to water depth, artificial islands are limited to coastal locations.

4.4.2 Navigational Aids

Navigational aids (excluding buoys) are fixed to prominent points or the bottom to assist mariners in locating channels, hazards, or themselves. They can be visible (lighthouses), audible (horns), or electronic (radio beacon).

4.4.2.1 Day Beacons

Day beacons mark channels, identify hazards, and guide vessel traffic. Day beacons are rigidly fixed to the bottom, pilings, breakwaters, or piers. They can be equipped with lights, bells, whistles, and radio transmitters and other devices that can interfere with the operation of some sensors.

4.4.2.2 Lighthouses

Lighthouses are constructed on prominent points and remote islands to provide visible and audible warnings to ships passing through hazardous waters. A few lighthouses are still manned (two in the U.S.), but most are automated. Because lighthouses require power for lights, fog horns, and auxiliary equipment, they have been natural candidates for scientific installations. Many lighthouses acquire periodic meteorologi-

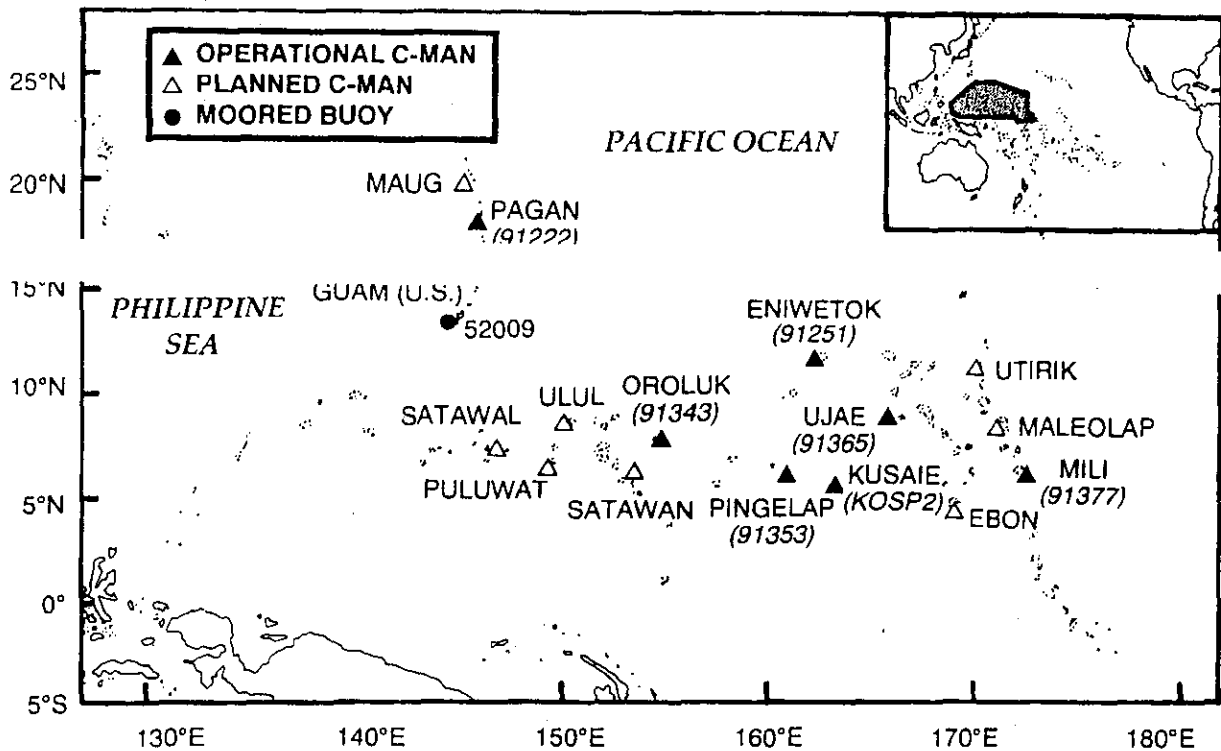

Figure 4.1. WESTPAC AMOS Network

cal readings and transmit them to a central collection facility. The NDBC has begun to use lighthouses in the C-Man program. The International Association of Lighthouse Authorities maintains standards for marine navigation, marine radio beacons, and GPS corrections.

4.4.3. NDBC Fixed Platform Programs

In October, 1988, the NDBC began using the Western Pacific Atmospheric Meteorological Observation Stations (WESTPAC-AMOS) located on strategic islands in the western Pacific Ocean. The National Weather Service (NWS) identified 20 islands in the Pacific Ocean as WESTPAC-AMOS sites. NDBC was involved in the planning and implementation of this network. The current network consists of seven sites (Figure 4.1). NDBC closely coordinates its activities with the NWS, which has overall responsibility for WESTPAC and operates the NOAA GOES and polar-orbiting satellites TIROS satellites. The GOES and TIROS systems used for the WESTPAC-AMOS sites are similar to

those used for the C-MAN and drifting buoys programs.

4.5 SPECIAL-PURPOSE PLATFORMS

Special-purpose platforms include vessels or structures that do not fall into any of the previous categories, but are potentially useful. They include the Floating Instrument Platform (FLIP), tethered balloon systems on ships, plant vessels, Autonomous Underwater Vehicles (AUV), and other specialized vessels such as the SWATH, hydrofoils, and air-cushion boats.

4.5.1 FLIP

FLIP is a 110-meter ship that can operate in either a horizontal or vertical attitude because all its equipment and facilities are hinged or gimbal mounted, allowing work surfaces in laboratories to remain level during maneuvers. The ship is towed horizontally to an operating area, then the

ballast tanks are flooded, and the vessel rotates or flips to a vertical position. When vertical most of the hull (90 meters) is stably submerged (10-meter waves produce less than one meter of heave). FLIP can operate offshore for 35 days, with a five-man crew and a scientific complement of 11. FLIP is operated and maintained by Scripps Institution of Oceanography and is owned by the Office of Naval Research.

4.5.2 Plant Barge

A plant barge is a barge with a factory on it. Plant barges are equipped with power generation capacity to meet factory needs and may be stationed at one location for several years. Plant barges are used by the fishing, logging, agricultural, pulp and processing, desalination, and mining industries.

4.5.3. Specialized Vessels

One of the specialized vessels of potential interest to ARM has a new small-water-plane-area Twin Hull (SWATH). SWATH vessels are built on two submerged submarine-shaped hulls. The superstructure is supported by stilts in catamaran fashion. By controlling ballast and articulation of sub-hull surfaces, the vessel can travel through the water with very little roll, pitch, and heave. SWATH vessels are currently in operation as ferries, fishing vessels, and survey vessels throughout the world. The characteristics of the hull allow Swath vessels operate stably in higher seas than conventional ships. Other specialized vessels that may provide service to the ARM program are hydrofoils and air-cushion vehicles.

4.5.4 Autonomous Undersea Vehicles

Autonomous Undersea Vehicles are self-powered, operate without being connected to an operator, and maneuver in three-dimensions. They can operate according to a preprogrammed schedule, or receive maneuver commands from the surface via an acoustic link. Vehicle weights range from 20 pounds to 140 tons depending on

mission duration. AUVs are usually powered by batteries or fuel cells. The principal mode of propulsion for AUVs is electric thrusters, although underwater "gliders" with water wings have also undergone limited testing. Mission durations of about 8 hours are common for these AUVs. A variety of sensor and navigation systems have been developed sampling programs for AUV. Potential missions for AUVs include water column, benthic, and under-ice surveys, inspection and servicing of underwater structures, and a military operations.

AUVs may be useful for atmospheric radiation monitoring in remote ocean regions infrequently travelled by merchant or research vessels. For example, AUVs could periodically surface for data collection and battery charging via solar arrays or wave-operated generators.

4.5.5 Remotely Piloted Surface Craft

Small, remotely-piloted surface craft have been developed for various applications ranging from surveillance to environmental monitoring. These craft operate like an AUV, but on the surface. As with AUVs, programmed routes can be followed, or maneuvers can be controlled via RF link to a remote operator. RF data transmission rates are much higher than can be achieved with an acoustic link, allowing better control.

4.5.6 Tethered Balloon System on Ships

Tethered-balloons, deployed from ships for over-the-horizon surveillance, date back to 1890. For research, tethered balloons have the advantage that the marine boundary layer is relatively thin, and ocean winds are often less turbulent than those over land. Also, in high winds, the mobility of the host ship can reduce the relative wind. A disadvantage is the difficulty of launching large balloons from confined, and often cluttered, ship decks. Figure 4.2 illustrates how this was done during GATE in 1973 using a 97 cubic meters balloon. Figure 4.3 shows the application of a

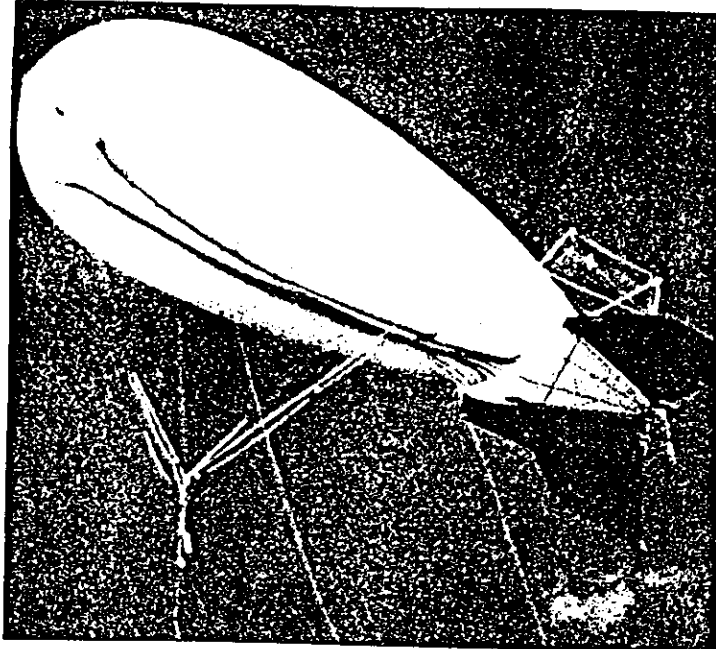

Figure 4.2. Tests of 97 m³ Balloon from NOAA Ship Discovery, 1973

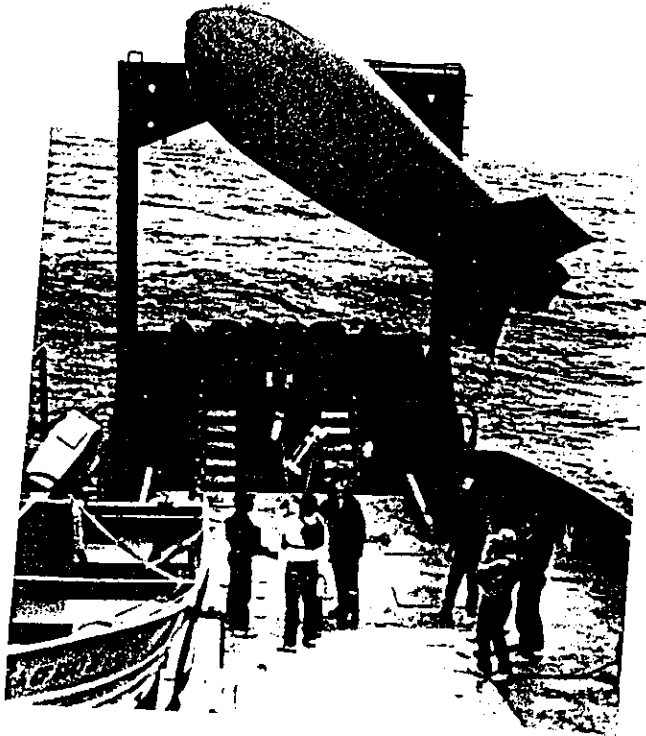

Figure 4.3. 7.3 m³ Balloon Being Launched for the Seahunt Experiment, 1991

smaller (7.25 cubic meters) commercial tethered balloon system in 1991 during the DOE SEAHUNT experiment in the Pacific Ocean southwest of San Diego, California.

The balloon system shown in Figure 4.3 can reach altitudes of about 1 km, but has difficulty climbing when the relative wind exceeds about 10 knots. Launching balloon is often not feasible due to brisk winds offshore. A new balloon design, with a fixed wing for greater lift in high winds has recently become available. Also, the winds are often steady enough that parafoil kites can be considered for airborne platforms. The instrument packages designed for light-weight systems suitable for tethered balloon or kite systems include in Table 4.1.

Table 4.1. Lightweight Instrumentation for Tethered Balloons

Instrument	Measurements	Manufacturer (Example)
Meteorological Package	Wind speed, direction Temperature and RH Ozone	Air Boulder, Boulder, CO
Ozone Sensor	Ozone	Air Boulder, Boulder, CO
Nephelometer	Light scattering coefficient	Radiance Research, Seattle, WA
Aerosol Sampler	Aerosol Collection	OMNI Environmental Services Beaverton, OR
Pyranometer	Downward solar	Radiation Research Instrument Battelle, Pacific Northwest Lab Richland, WA
Cloud Droplet Video Monitor	CloudDrop Spectra Research	Desert Research Inst. Reno, NV
Grab Sampler	Aerosol and gas for surface detectors	Los Alamos National Lab Los Alamos, NM

5.0 POWER, DATA-LOGGING, AND TELEMETRY SYSTEMS

5.1 BATTERIES

5.1.1 Alkaline Batteries

Alkaline batteries are the most common, readily available, use-and-discard power source. They have the second highest energy density (see Table 5.1) and lowest cost per watt-hour (W-h) of all the batteries considered. They come in a wide variety of packages and the only disadvantage is that they are not rechargeable.

5.1.2 Nickel-Cadmium Batteries

Nickel-Cadmium (nicad) batteries are sealed, rechargeable power sources that can withstand high shock and vibration loads. The primary, open-circuit cell potential is 1.3V. They are available from several manufacturers in a wide variety of packages with voltages ranging from 1.3 to 90V. Nicad batteries feature high discharge and charge rates, stable performance over a wide temperature range, and moderate energy density (35 W-h/kg). Low cell impedance allows them to deliver nearly constant voltage over 90% of the discharge cycle, resulting in stable power over a broad range of loads. The life expectancy of a nicad battery is 500 to 1000 charge/discharge cycles, or five years when used in standby mode, at room temperature. Their operation range is -20° to +50°C (-4° to 122°F) for standard cells and

-20° to +70°C (-4° to +158°F) for high-temperature cells. Nicad batteries produce small amounts of gas during charging and should not be charged in sealed containers.

5.1.3 Lithium Batteries

Lithium batteries provide the highest energy density (240 W-h/kg) of all primary cells as well as high open-circuit voltage (1.5V) and long shelf life (>5 years). They are commercially available in use-and-discard and rechargeable packages. The rechargeable ones have lower energy density than comparable use-and-discard versions. Typical applications include computer clocks, high-powered flashlight sources, and memory backup power for industrial controllers. The high performance of lithium batteries comes with high cost per Ah.

5.1.4 Sealed Lead-Acid Batteries

Sealed lead-acid batteries are economical, have service lives of about five years in standby applications and between 200 and 1000 charge/discharge cycles, and low internal resistance allowing small batteries to produce high peak currents. Charged batteries can be stored for up to one year at room temperature prior to use. Wide-operating temperature ranges -76° to +140°F (-60° to +60°C) along with their other attributes have

Table 5.1 Merit Figures for Commercially Available Batteries

	Cell Voltage (Open-circuit, Volts)	Energy Density		Cost (\$/Ah)
		W-h/kg	W-h/l	
Lead-Acid	2.1	35	80	1.75
Alkaline	1.5	90	200	0.05
Lithium	1.5	240	700	0.40
NiCad	1.3	35	100	2.05

made sealed lead-acid batteries the power source of choice for instruments, remote data-gathering devices, UPS systems, emergency lighting, and solar-powered systems. Lead-acid cells produce gas during charging.

5.1.5 Seawater Cells

Alupower, Inc., has developed a seawater battery based on the emf potential between aluminum and seawater. It consists of an aluminum alloy anode, an inert cathode and a seawater electrolyte. When immersed in seawater, an open-circuit emf of 1.5 V develops. The Alupower prototype produced 2 watts for 3 months with a current of 2 amps at 1.1 V.

5.1.6 Fuel Cells

Fuel cells generate electricity from the direct conversion of chemical energy to current. They cannot store energy but continue to supply it as long as fuel is available. A hydrogen-oxygen fuel cell operates by the transfer of electrons produced when gaseous hydrogen combines with an anode. The positive features of fuel cells are: 1) availability, 2) non-polluting, 3) lightweight, 4) high energy density, and 5) relatively low cost. The negative features are the explosive hazards of hydrogen and oxygen storage, as well as the requirements for refueling.

5.2 ALTERNATIVE POWER SYSTEMS

In addition to conventional power sources described above, remote data-collection stations can use solar and wave power, and thermal-electric generators for power.

5.2.1 Wave-Powered Buoys

Takaha Kagaku Kogyo Co, Ltd., has developed a wave-powered generator for buoys. Their device uses a flyweight that is excited by wave motions. It is three times more efficient than

conventional generators that utilizes only heave-induced wave movements. It is 90 cm in diameter, weighs 45 kg, and generates 35 W of electrical power in a 0.40-meter sea.

5.2.2 Compact Wave-Powered Generator

Mechanical Planet Co, Ltd., developed a compact, L-shaped, wave-powered generator that generates 11 W of electrical power. Because power can be generated with small waves, the buoy can be used not only as a navigation beacon but also for meteorological observations.

5.2.3 Thermal-Electric Generators

Thermoelectric generators produce electrical current by heating a thermo-couple and conducting the current to a load. Thermal energy is provided by a gas burner. Generators are self-contained with the exception of the fuel supply, and perform very well in arctic environments. Because of their solid-state construction, they dependably deliver electrical power with minimal maintenance. Waste heat from these generators is commonly used for heating instrument shelters. The output from such generators is conditioned to produce 12, 24, or 48 Vdc by means of dc/dc converters. Teledyne Energy Systems manufacture the TELAN and DECAP series thermoelectric generators. Propane consumption ranges are from 0.07 lb/h for the 10-watt unit to 5 lb/h for the large 90-watt unit.

5.3 DATA LOGGERS

Data loggers:

- Control sensors
- Condition sensor outputs
- Record sensor outputs

A relevant sample of commercially available data loggers is described in the following sections.

5.3.1 CR10 Measurement and Control System (Campbell Scientific, Inc.)

A CR10 is a micropower, logger/controller housed in a weather-resistant enclosure for data collection in harsh environments. The CR10 will operate for as long as one year on an 12-volt, 7 Ah battery, depending on the scan rate, number of sensors scanned, and external temperature.

5.3.2 DL1000 (Interface Instrument Corp)

The DL1000 is a portable, stand-alone data acquisition system that can log data from most industrial and scientific sensors, including accelerometers, anemometers, flowmeters, hygrometers, load cells, radiometers, strain gauges, thermistors, and thermocouples. The 24 analog inputs are capable of measuring temperature, dc voltage, current, and resistance with 16-bit resolution. In the calculation mode, the DL1000 can process the measured data before recording it. User-defined equations can be programmed in the logger to perform arithmetic, exponential, logarithmic, and trigonometric operations on measured data. This capability can be used for sensor linearization, temperature compensation, or to compute quantities dependent on more than one measured value.

5.3.3 Model 7000 Macro Data Logger (Unidata, Ltd.)

Unidata data loggers are fully programmable, battery-operated, and portable units for remote data-collection systems. They include the 32K Portable Data Logger and the 128 K MACRO Data Logger. Because of their low power consumption Unidata systems are particularly well suited for automatic data collection at unmanned sites. The logger is compatible with many types of instruments for environmental monitoring and can be connected to a PC serial port for downloading data. Interfaces for remote access to loggers are also available for various computers.

5.3.4 Model 555 Data Logger (Handar, Inc.)

The Handar 555 has sensor interfaces, 16 single-ended or 8 differential individually programmable analog inputs, eight programmable digital inputs for detecting switch positions or transitions, and can be interfaced to an extensive inventory of meteorological, environmental, and industrial sensors. These loggers can be used to initiate measurements, trigger alarms, or to activate digital outputs.

The scan rates of each channel can be individually programmed (once every 45 days) sample from 1 μ to 0.003 Hz. The Handar 555 can store up to 128 kilobytes of data. These data can be downloaded to a PC, and accessed remotely in a variety of ways, including: GOES UHF/VHF radio, telephone modem, cellular phone. The Handar 555 operates on a 12-V battery (with or without a solar panel), comes in a NEMA-4 enclosure to withstand harsh environmental conditions, and will operate in temperatures ranging from -40° to 55°C.

5.3.5 Model 211 Field Computer (SoMat Corporation)

The SoMat Model 2100 Field Computer is a microprocessor-based digital data acquisition and analysis system. Designed for easy data collection in rugged environments, the SoMat Model 2100 consists of stackable modules arranged in a bus-like architecture and packaged in an aluminum enclosure. The system can be easily configured for a variety of tests by stacking the appropriate modules. The user can configure a system from the following modules: 1) Processor, 2) Power/communications, 3) Strain gauge signal conditioning, 4) Analog transducer, 5) Pulse counter, 6) Digital input/output, 7) Programmable filter, 8) Extended memory as testing needs grow and change. Three internal 9-Vdc batteries power the system for more than a day, and the system has power-fail circuitry for external power.

5.3.6 DATApod II Electronic Data Logger (Omnidata, Ltd.)

Omnidata provides a complete system, including sensors, signal conditioning, data storage, software, and computer cables. The DATApod II takes field measurements, stores the desired information, then formats the output for printed reports. Sensors and signal conditioning are factory matched to provide calibrations, data conversion, and standard data collection schemes. Recording intervals and data formats, are preset, but can be changed as needed.

5.3.7 HERMIT 2000 (In-Situ Inc.)

The HERMIT 2000 is a multi-channel data logger that can be used with an extensive array of hydrologic and environmental sensors in extreme field environments. The Hermit 2000 is portable, waterproof, self contained, and requires no external programmer or PC. It is powered by a lithium battery and will operate over a wide temperature range.

5.3.8 Model 1167 Data Logger (Weather Measure Weathertronics, Inc.)

The Model 1167 data logger is battery powered and well suited for a wide variety of long and short-term environmental monitoring applications. Standard on-board data processing includes wind vector averaging, time-weighted averages, maxima and minima, variance, vapor pressure from wet/dry bulb temperatures, saturation vapor pressure, and histograms.

5.3.9 Datataker 5 Single Channel Data Loggers (Science Electronics Inc.)

The Datataker 5 is a single-channel, battery-powered data logger for recording temperature, events, or voltage. The recording interval can be set from 1 second to 18 hours, and up to 200 records can be logged. The Datataker 5 is controlled by a microprocessor and clock calendar.

Records are logged into nonvolatile solid-state memory.

5.3.10 Tattletale Data Loggers (Onset Computer Corp.)

The Tattletale is a programmable data logger designed for portable, battery-powered operation that comes complete with programming and plotting software.

5.3.11 Squirrel Meter/Loggers (Science Electronics Inc.)

The Squirrel Meter/Logger can be used as a signal-display meter, as a data logger, or as both. As a meter, readings are taken from each input every second, and the selected input displayed on an LCD. As a logger, readings are taken either at user-set intervals, or when user-specified events occur. Readings are stored in memory for downloading to PC, plotting, and analysis. No special interface is required; the Squirrel can be connected directly to a PC for serial data communication.

5.3.12 IMET Data Logger

The IMET (Improved METeorological Measurements) data logger/controller is compatible with PC hardware and software, runs DOS, and requires 0.5 watt of power. Hardware and software can be developed and tested with a PC and later installed in the system. Data are stored on a 120-MB optical disk cartridge. The IMET system records raw meteorological data as one minute averages. The logger is capable of high-speed data sampling and can record directly into the mass storage; for example, buoy motion data could be sampled and stored at rates of up to 4 Hz. The system is capable of computing and telemetering meteorological and flux data via the Service ARGOS.

5.4 TELEMETRY AND GROUND POSITIONING SYSTEMS

This section addresses methods for transferring data from a remote field location to the main data collection facility. These methods include RF data links (UHF and VHF), meteor-burst systems, and satellite transmission. The discussions include an example of typical hardware for each method.

5.4.1 ARGOS

The ARGOS system consists of platform transmit terminals (PTTs), receivers for the uplink aboard the TIROS/N and NOAA/A satellites, and land-based receivers for the downlink. The system provides telemetry between data acquisition platforms in remote areas and data users, who can access their data via telephone, and other methods. A unique feature of the system is its ability to provide the ground positions of PTTs.

PTTs transmit on 401.65 MHz for 360 to 920 ms (depending on the number of sensors) at 40- to 200-second intervals. When the satellite is in view, it measures the carrier frequency, logs the time of message receipt, and acquires the platform I.D. and sensor data. ARGOS satellites can acquire data from as many as 400 platforms in its field of view. The downlinked data are processed in Toulouse, France, and disseminated to users via mail, TELEX, or telephone.

The ARGOS format allows one to eight data frames to be sent per transmission. Each data frame can have up to 256 bits. During a typical satellite pass, 10 transmissions are received by the satellite and 2560 bits of data are transmitted. Some PTTs are programmable and can collect data at regular intervals as well as key the transmitter during user-selected periods. This latter feature reduces power requirements, and in some cases, ARGOS processing costs as well. With the addition of a sensor interface module, PTTs

can support a suite of 16 to 32 analog sensors and operate over a temperature range of -50° to +40°C.

Typical PTT specifications are as follows:

ENVIRONMENTAL - Operating temperature range -20° to +40°C; Maximum temperature change - 0.5°C/20 minutes ; Frequency 401.65 MHz (± 1.25 kHz)

RF POWER OUTPUT - 33 dBm (typical); 31.8 dBm (minimum)

MODULATION - Phase nominally ± 1.1 radians, Bit rate 400 Hz \pm Hz

DATA FORMAT - Unmodulated carrier duration 160 msec \pm 2.5 msec; Bit synch 15 bits; Frame synch 8 bits; Initialization 1 bit; No. of data frames 4 bits (N = 1 to 8); Platform I.D. 20 bits; Sensor data N x 4 x 8 bits; Transmission rep. rate 40 to 200 sec., selectable

DC POWER REQUIREMENTS - Voltage 12 to 20 Vdc; Quiescent Current 7 mA with serial digital interface; Peak nominally 500 mA; Average depends on number of data frames actually sent.

Mechanical (size/weight)

Transmitter box 0.2 x 0.1 x 0.03 m, 0.6 kg
Digital Encoder box 0.2 x 0.1 x 0.03 m, 0.6 kg
Oscillator box (uninsulated) 0.1 x 0.06 x 0.04 m, 1.0 kg
Regulator card 0.14 x 0.1 x 0.02 m, 0.1 kg

5.4.2 Geosynchronous Orbit Environmental Satellite (GOES)

The GOES orbits over equatorial regions and provide data telemetry as well as video images of weather systems. GOES is used by the NDBC for data acquisition in its buoy program.

5.4.3 Meteor-Burst Communication

Meteor-burst communication works by reflecting RF signals off the ionized trails left by micrometers as they burn up in the atmosphere. Billions of meteors produce usable trails in the atmosphere every day. Average throughput of up to several hundred words per minute can be achieved with relatively simple equipment.

The waiting time required to transfer a message between two stations is the primary performance metric of a meteor-burst link. Operating frequency, data rate, transmitter power, antenna gain, and receiver threshold are the main factors that influence waiting time. For extended ranges (> 2000 km), relay stations have been employed using data store- and forward-techniques. Meteor-burst systems are fully automated and simple to operate. Their rapid deployment capability makes them ideal for emergency communications. For both point-to-point service and multi-station networks, meteor-burst systems provide dependable communication without leased circuit costs.

The operational principle is as follows. The master station transmits a continuous, coded signal in the 40 to 50 MHz band that reflects from meteor trails to a remote receiving station. The remote station decodes the signal and retransmits it back to the master station. Information can be sent in either direction up to a maximum length of about 2000 kms. Meteor trails persist for a few hundred milliseconds and waiting times between suitably located trails can range from a few seconds to minutes. Hence, the transmission consists of "bursts" of high-data rate transmissions of tens to hundreds of characters, separated by periods of silence. One important characteristic of this system is that many links can share a common transmission frequency.

MCC-560 Communication System (METEOR COMMUNICATIONS CORP)

Complete meteor-burst communication systems for remote observation sites require: transmitter,

receiver, controller/logger, a dipole antenna, solar panel/battery, and sensors. Typical specifications of this system are:

TRANSMITTER - Power 100 watts

RECEIVER - Sensitivity 121 dBm

MICROCOMPUTER CONTROLLER - Type CMOS; Input/output RS-232 C; Software Data acquisition, message communications; Data processing Min/max/ave; Data reporting- Hourly or as required.

DATA ACQUISITION - Analog inputs, Range 0 to +5 volts; Resolution 12 bits; Digital inputs Serial 12-bit resolution; Parallel 16-bit resolution; Channel capacity
1 Parallel digital
8 Analog (direct)
16 Analog/digital SNOTEL bus
1 Frequency (even accumulator)
1 RS-232C

Data storage;512, 12-bit words

POWER REQUIREMENTS - Standby 12 Vdc, 20 mA; Sensor update 12 Vdc, 40 mA; Transmit 12 Vdc, 20 amps.

GENERAL - Operating temperature (std). - 30° to +60°C; Size 0.3 x 0.33 x 0.1 m; Weight 3.5 kg

OPTIONAL EQUIPMENT - Antenna 3 db YAGI; Enclosure NEMA 4, aluminum; Battery pack 12 volts, 20 A-H; Additional memory 12,000 data samples; Solar panel 10 watts

5.4.4 UHF/VHF Transmitter for Data Telemetry

Telemetry via UHF/VHF transmitters is a simple way communicate with remote data acquisition systems at line-of-site distances (1 to 100 km). This technique makes use of UHF radio modems

capable of providing a simplex or semi-duplex link between computers and instrumentation. The main problems with this method of telemetry are licensing and interference from other transmitters.

MEASUREMENT DEVICES LIMITED, M-TEL

The "M-Tel" is a field-proven, offshore ship-to-ship, ship-to-rig data link.

The characteristics of the M-Tel are as follows:

TRANSMITTER - Size 140 x 215 x 58 millimeters; Weight 1.5 kg; Supply voltage 12 Vdc \pm 5%; Power consumption: Enabled - 250 mA max at 12 Vdc; Disabled - 20 mA max at 12 Vdc; Operating temp - -30° to +55°C; RF power output 0.5 W \pm 1 dB at 12 Vdc; Modulation - Frequency modulation +/- 3 kHz deviation; Data input - RS232 or 5v TTL levels; Baud rate - Up to 1200 baud maximum.

RECEIVER - Size (excl antenna) - 140 x 215 x 58 millimeters; Weight - 1.5 kg; Supply voltage - 12 Vdc \pm 5%; Power consumption - 220 mA (max) at 12 Vdc; Operating temp - 30° to +55°C; Sensitivity - 0.5 μ m for 12 dB SINAD (1 kHz mod); IF frequencies 75 MHz, 10.7 MHz, 455 KHz; Data input - RS232 or 5v TTL levels; Baud rate - Up to 1200 baud maximum

5.4.5 Global Positioning Systems (GPS)

The Global Positioning Systems (GPS) was developed from the Department of Defense's NAVSTAR Global Positioning System. Companies such as COMSAT, Trimble Navigation, and Leica Inc. produce GPS hardware utilizing the 24-satellite system. This system, when used in the differential mode, is the most accurate (+ 5 meters, + 0.1 knots) and reliable commercially available, non-line-of-sight navigation technology. Differential GPS relies on corrections transmitted from a reference station placed at a known location. The reference station calculates the

error in the GPS signals and broadcasts corrections to mobile receivers in the vicinity.

Trimble navigation offers several GPS receivers with DGPS capability. The Wild System 200 is a hand-held 386-based controller with automated post processing software. The system is designed for surveying applications and allows for tracking a roving vehicle from a tracking station. Accuracy is about \pm 2 cm. One shortfall associated with GPS is the sensitivity of the processors to radio communications interference.

5.4.6 Loran-C

Loran-C is a pulse system with a common carrier frequency in the 90-110 kHz band. The accuracy of Loran-C fixes accuracy ranges from 120 to 500 meters feet, depending on the distance to the master station. The low carrier frequency and high-power transmitters result in coverage extending greater than 1,000 nautical miles offshore. Fixes are obtained by measuring the time delay between pulses from a master and two or more slave stations. The delays give lines of position that cross at the mobile platforms location. Loran C is still used extensively for aircraft and ship navigation.

5.4.7 SAILOR RadioTelex Systems

Telex systems relay subscriber data and messages over a worldwide network of automated radio stations. Data transmission by Telex is slow (50 to 100 baud) and large error rates can occur during bad weather. The Sailor Radiotelex specifications are given below.

Communication Protocol: CCCIR REc. 476-3

Local signal: 5 level, 7.5 unit serial start-stop data ITA-2 Code, 40-2400 Baudot or 7-level, serial start-stop data ITA-5 Code, 75-9600 baud (ASCII)

Line signal: Two-tone keyed with 7-unit code constant 4B/3Y ratio in accordance with CCIR

Rec. 476-3. 100 Baud synchronous. Optional: Four-tone keyed 200 Baud Synchronous.

INTERFACE

Tone frequencies: Mark and space frequencies adjustable from 1 kHz to 3 kHz.

Modulation: Phase-continuous AFSK keying.

Keyboard programming: Full EEPROM programming of installation set-up, 105 operator-frequency pairs and scanning tables.

Storage capacity: 64,000 characters (32 A4-size pages)

GENERAL - Power source: 115/127/220/240 Vac (+10/-15%) 50 to 400 Hz and 24 Vdc (-10/+30%); Power consumption: 25 VA; Ambient temperature: 0° to 55°C operation - 20° to 70°C storage; Relative humidity: 95% non-condensing; Vibration: IEC, CEPT and MPT 1204

5.4.8 COMSAT

COMSAT offers telephone, data, and Telex services for ship-to-ship and ship-to-shore telemetry in a full duplex, to and from domestic and international telephone networks. Data speeds of up to 9.6 kb/s can be achieved. Data may also be sent at 56 kb/s via simplex High Speed Data service. INMARSAT-A provides telephone (analog FM voice channel), data up to 9.6 kb/s (56 kb/s service is available over the packet data networks), and Telex communications. INMARSAT-A is primarily for large vessels. INMARSAT-B provides about the same service as the INMARSAT-A, except the INMARSAT-B utilizes digital technology. INMARSAT-M (Mobil Link) provides digitized voice (4.8 kbps), fax (up to 2.4 kbps), and data (up to 2.4 kbps) through smaller, less-expensive INMARSAT-A terminals designed for small ships. INMARSAT-C (C-Link) uses a compact, inexpensive SES for

cost-effective store-and-forward data messaging, position reporting, and remote monitoring. This service is ideal for smaller boats.

5.4.9 Spread-Spectrum RF

Spread-spectrum RF communications were developed by the military to overcome the problems associated with narrowband communications. Spread-spectrum systems do not require an FCC license; data rates are from 100 kb/s to 10 Mb/s; and they offer greater mobility. The John Fluke Manufacturing Company Model 2625A RF Hydra Wireless Logger utilizes spread spectrum communication technology. The Hydra Logger is a combined data logger and RF modem that sells for less than \$6000. It has 21, programmable input channels for several sensor, including: thermocouples, RTDs, ac or dc voltage and current, resistance, and frequency. Spread-spectrum modems running at 500 mW over a 902 to 928 MHz range can transmit information up to 1/4 mile outdoors.

5.4.10 Submarine Communication Cables

A survey was conducted to determine the feasibility of using abandoned submarine communication cables for the transmission of data from oceanic CART sites. In the initial stage of the survey, several individuals, active in the cable business, were questioned about cables in the vicinity of the TWP CART site. These initial enquiries focused on the geographical area bounded by: N 20°, 120° E, N 20°, 120° E, N 20°, 120° E, N 20°, 120° E. These individuals were asked to provide the location (origin and termination points), present condition, and ownership of cables in their jurisdiction. Table 5.2 lists the names of individuals who provided useful information.

In the course of the phone campaign, a U.S. Department of Commerce report, entitled "1990 World's Submarine Telephone Cable Systems," was obtained for the detailed phase of the survey. This report (the "cable book" hereafter) was first published in 1975 and updated three

times since then. It is the most comprehensive summary of the specifications, history, ownership, and current condition of submarine cables we are aware of. In addition to obtaining the cable book, we contacted the International Cable Protection Committee (ICPC) to obtain the names of individuals responsible for cable protection in the vicinity of the TWP site. The responsible parties were contacted for additional information; they are also listed in Table 5.2.

The cable book only lists cables that have in-line repeaters or other signal regeneration circuits. This was done to exclude short cables across channels and inter-island passages which number in the thousands worldwide. Although there are many abandoned telegraph cables, they were not considered useful for ARM because: 1) bandwidth is only 50 bits/s, 2) there are only a few at convenient locations in the TWP box, and 3) the operators are either retired or dead.

Both analog (coaxial) and digital (fiberoptic) telecommunications cables are in use today. The older, analog technology uses a copper coaxial cable to transmit voice signals. The service life of analog cables is 20 to 30 years. Multichannel

operation in analog cables is achieved by frequency multiplexing. This technique divides the total bandwidth of the cable into intermediate bands, or channels, that carry the conversation signals. Because signal attenuation increases roughly as the square root of frequency and linearly with cable length, there is a limit to cable length and the number of channels that can be sent through coaxial cable without inline amplification. Even with amplification, modern cables installed in the early 1980s transmit fewer than 8000 full-duplex telephone conversations, along with power for submerged electronics. Amplification is accomplished by repeaters inserted into the cable every 2 to 40 nm during the laying operation. Transoceanic cables can have as many as 350 repeaters, the cost of which is about 30 percent of the total cost of a cable installation.

Using abandoned analog cables for transmitting digital data is unlikely to be feasible for two reasons. First, cables are usually abandoned because: 1) the cable has been damaged so severely that repair is not economical, 2) submerged electronics have become too costly to maintain, or 3) the cable bandwidth is no longer competitive with faster analog or fiberoptic cables serving the same telecommunication circuits.

Table 5.2. Submarine Communication Cable Information Sources

Contact	Organization	Telephone
Mr. G. Parr Mr. J. Gedisa	OTC Australia Post & Telecommunications Corporation	61 2 287 4894 675 274147
Mr. R. C. Gendrano	Philippine Long Distance Telephone Company	63 2 817 6018
Mr. Allan Wong	Telecommunication Authority of Singapore	63 345 7713
Mr. C. L. Chen	International Telecommunication Development Corporation	886 2 344 3701
Mr. P. Yu	Hong Kong Telecom International	852 8291111
Mr. B. Sulistyo	PT INDOSAT	62 21 363215
Dr. Y. Niiro	Transmission Systems Engineering HQ	81 33 347 7353
Mr. H. Read	Syarikat Telekom Malaysia Berhad	60 3 2329494

Second, analog cables and their submerged electronics are not designed for digital transmissions. They contain frequency discrimination filters to attenuate the high frequencies associated with square waves. Thus, using an analog cable for digital transmissions would require costly engineering and modifications to the terminations to get digital information through the repeaters. If it could be done, there would likely be a significant penalty in bandwidth as well.

With the advent of fiber optics, the bandwidth of telecommunication cables increased dramatically from 1 to more than 50 MHz. Recently installed fiberoptic cables transmit up to 80,000 telephone conversations simultaneously, more than a ten-fold increase over the fastest coaxial cable. As with their coaxial predecessors, signal attenuation is a problem, and about 0.5 dB of signal loss occurs per km in a high-quality fiber cable. The circuits for regenerating light signals in the fiberoptic cables operate differently than in their analog counterparts. But their purpose is fundamentally the same: to maintain an acceptable signal quality and data error rate from origin to terminus. The average spacing of regenerators in fiberoptic cables is about 35 km, and they represent about 35 percent of the installed system cost.

The first long fiberoptic cable placed in operation is seven years old and most of the ones in service have design lives of 25 years. Given that the costs of digital and coax cables are comparable (tens to hundreds of thousands of dollars) and given the youth of the digital cables in service, it seems unlikely that a digital cable would be abandoned and be available in time for the ARM Program to use.

The results of the survey are summarized in Table 5.3. In the table, each cable with a termination point inside the TWP box is identified by its name and, in parentheses, the numeric designation given to it in the cable book. The table entries include: 1) cable type (analog or digital), 2) year placed in service, 3) total bandwidth

(MHz for analog cables and Mbits/s for digital cables), 4) number of repeaters (analog) or regenerators (digital), 5) installed cost, 6) termination points (origin and terminus are not distinguished), and 7) ownership.

We draw the following five conclusions from the survey relevant to the installation of a CART site in the tropical western Pacific Ocean:

- Six analog and five digital submarine telecommunication cables terminate in the TWP box
- Unresolved technical problems and bandwidth limitation are associated with coaxial cables and analog repeaters exist.
- The cost to modify an analog cable for data transmission is unknown, but it is likely to be a sizeable percentage of the installed cost of the cable.
- The oldest digital cable has at least 17 years of service life remaining and is unlikely to be available at an affordable cost for ARM to use in the near future.
- Technical issues notwithstanding, the costs of rehabilitating an abandoned analog cable and of leasing a dedicated channel in a fiberoptic cable is probably beyond the budget of ARM.

5.5 PLATFORM AND SENSOR STABILIZATION

Many of the instruments discussed in Section 3 require positioning within a certain tolerance to maintain accuracy. For example, the Pyrogeometer discussed in Section 3.7 must be stabilized within a fraction of a degree when the solar-tracking disk is used. Because ocean platforms are influenced by wind, wave, and current forces, instrument stabilization is an important consideration. The following sections describe common stabilization techniques.

5.5.1 Electromechanical Stabilization

Electromechanical stabilization of a sensor or platform is accomplished by monitoring the output of position, velocity, and/or acceleration sensors, and using this information to drive a positioning device such as a motor or actuating cylinder. System design is influenced by accuracy requirements, sensor/platform weight and size, and cost. Gun mounts, remotely operated vehicles, and manned submersibles are examples of systems that are often electromechanically stabilized.

The Tethered, Balloon-Borne Instrument Stabilized Platform is suspended on the tether line of a balloon. Two solid state, linear accelerometers are used for sensing level. These accelerometers are interfaced with control circuitry and a DC motor which acts to drive the platform to a level position on the balloon tether line. This system can keep instruments within one degree of horizontal.

5.5.2 Gravitationally Stabilized Platforms

Gravity can be used to provide low-cost platform stabilization. A magnetic boat compass is an example of a gravitationally stabilized device. Magnetic boat compasses are either gimballed or floated inside a water-filled sphere. The weight distribution of the compass relative to the supporting medium causes the compass to maintain its vertical orientation. Ship and buoy stability is improved by increasing the separation between the center of gravity and center of buoyancy. The righting moment increases directly in proportion to the separation of these two points.

5.5.3 Gyroscopic Stabilization

Gyroscopes can provide effective stabilization, but some operational constraints exist. Gyroscopes drift due to the presence of unwanted torque generated, thermal effects, and the orientation of the gyro with respect to the earth's axis of rotation. Some drift can be compensated for by calibration, but random drift will always be

present. Random drift necessitates periodic correction/alignment of the gyroscope.

5.5.4 Electronic Stabilization

Electronic stabilization uses digital processing techniques to place information in a stable position with respect to a fixed reference point. Position information is obtained from a moving platform using position, rate, and/or acceleration sensors. This information is then used to perform polar coordinate transforms on received data to artificially stabilize them. Electronic techniques have been used to stabilize sonar images acquired from ships that move randomly with respect to their sonar target.

5.5.5 Stabilized Instrument Platforms for Ships

Stabilized platforms that either eliminate or reduce the effect of ship motion are important to many atmospheric measurements on ships. This is true for point sensors, as well as passive and active remote sensors. Without stabilization, three of accelerometry, as well as rotation, are required to process ship motion from point turbulence measurements. This requires a sizable post-processing effort and often ship effects are still observed in the spectral analysis. Therefore, a combination of stabilization and accelerometry and rotation sensing is required. Ideally, radiation sensing instruments such as pyranometers need to be stabilized to within 1 degree. Active remote sensing systems, especially Doppler acoustic, radar, and lidar systems also should be stabilized so that ship rotation is not interpreted as horizontal winds and feature altitudes such as boundary layer heights are not confused. Since vertical velocities as small as a few cm/s can be important for cloud formation, stabilization and accelerometry need to be combined as most stabilization systems do not compensate for vertical motion.

Unfortunately, off-the-shelf stabilization systems are usually not available. The three companies and contacts listed below make stabilized plat-

forms for satellite communication and other custom designed applications.

Costs for relatively lightweight (less than about 25 kg) systems usually exceed about \$10K. A system designed to stabilize a shipboard radio-acoustic profiler developed at National Oceanic and Atmospheric Administration, Boulder, Colorado, for the ASTEX costs about \$135K (Figure 5.1). These systems can maintain vertical pointing stability to 1 degree. Most systems are actively stabilized with motors but also partially pendulum based. No systems were found that compensates for vertical ship motion.

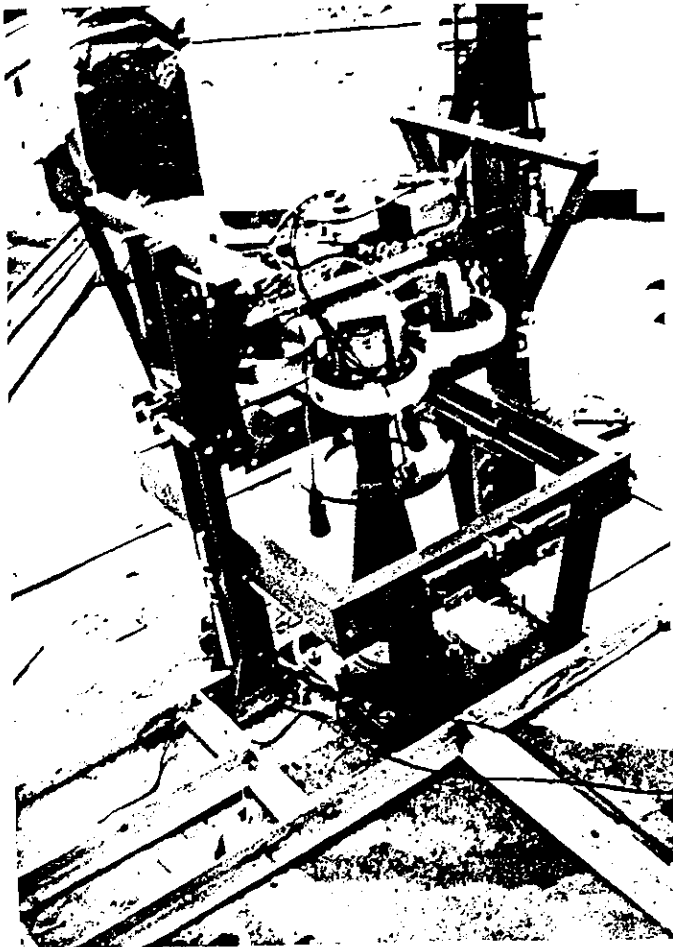

Figure 5.1 Stabilized platform for NOAA Profiler during ASTEX

Table 5.3. Summary of Submarine Telecommunication Cables in Service and Planned for Operation in the Near Future and Terminating in the TWP Box (N 20°, 120° E, N 20°, 120° E, N 20°, 120° E, N 20°, 120° E)

Name	(No.)	Type(1)	Year	Terminations	Bandwidth (mHz)	No. Repeat./ Regen.(2)	Cost (\$m)	Owner
COMPAC	(059)	COAX	1962(3)	Fiji/N.Z.	0.6 mHz	322	\$ 73 m	GOTC, C&W, N.Z.P.O.
TPC1	(068)	COAX	1964(4)	Wake/Guam	1.0 mHz	274	\$ 68 m	AT&T, H. Tel.
TPC1	(070)	COAX	1964	Guam/P.I.	1.0 mHz	76	\$ 23 m	AT&T, P.I.L.D.
SEACOM	(073)	COAX	1967(5)	Mal./H.K./Aus.	0.6-1.1 mHz	353	\$ 67 m	OTCA, C&W, et al.
A-PNG	(173)	COAX	1976	Aust./P.N.G.	4.7 mHz	65	\$ 12 m	OTCA, P.N.G.
ANZCAN	(263)	COAX	1984	Fiji/Aust.	5.0 mHz	1,126	\$ 406 m	Brit. Tel., et al.
NONAME	(341)	FO	1991(6)	Aust.	140 mb/s	N.D.	\$ 5 m	N.D.
NONAME	(348)	FO	1991(6)	Mal.	280 mb/s	6	\$ 40 m	Indo. Postal
NONAME	(357)	FO	1992(6)	Mal./P.I.	560 mb/s	9	N.D.	N.D.
PACRIM-E	(371)	FO	1993(6)	N.Z./H.I.	N.D.	N.D.	\$ 249 m	AT&T/OTC & 32 others
PACRIM-W	(392)	FO	1996(6)	Aust./Guam	560 mb/s	53	\$ 285 m	AT&T/OTC

- 1) COAX: coaxial cable for analog transmissions. FO: fiber-optic cable for digital transmission.
- 2) Entire cable.
- 3) Retired in 1984.
- 4) Retired in 1990.
- 5) Retired in 1984.
- 6) Not installed when cable book was published in 1991.

6.0 SYSTEM COMPATIBILITY

Table 6.1 is a matrix that shows the compatibility of some measurement systems that are operating at the SGP CART site and are being considered for ARM oceanic sites, with platforms described in the notebook. The matrix entries indicate whether a system can (yes) or can not (no) be used on a particular platform. In cases when there was insufficient information to determine compatibility, a "?" was entered. Table 6.1 was not the result of detailed analysis and should be updated and revised as more information becomes available.

In the process of developing the matrix, it was clear that there is a broad class of instruments that only operate properly in a fixed, accurately known orientation with respect to vertical or horizontal references. These instruments will have to be fixed to the sea floor or operated from ultra-stable platforms to be useful over open water. Some navy ships, particularly aircraft carriers, and many drilling platforms are stable enough most of the time to serve as platforms for measurement systems that must remain level or vertical. The attitude of offshore operators in both the military and private sectors is becoming more positive toward the conduct of science aboard their platforms (see the *Journal of the Marine Technology Society*, Volume 27, No. 2, 1993). Assuming the ARM program will eventually recognize the need for measurements over water and sea ice, it seems that the AMT could begin pursuing platform opportunities with the military and the petroleum industry. As a first step, the AMT could identify operators in the TWP, inform them about the ARM program, and enquire about future schedules and equipment deployments in the region.

For instruments requiring limited stability, spar buoys appear to be a good option because they resist near-surface pitch and roll motions and provide satisfactory gross stabilization for instruments tolerant to heaving motions. With secondary stabilization, some instruments could perform well on a spar buoy. The disadvantages of spar buoys are that they can be difficult to deploy and do not physically protect onboard sensors as well as buoys with wide hulls. SWATH vessels also appear to have potential for short-term measurement

campaigns. The SWATH design features low pitch and roll which in many sea states might be sufficiently smooth for the operation of systems requiring a stable platform.

In the data telemetry and logging section, several systems were identified that appear to be potentially useful for ARM oceanic sites. The GPS system, for example, could be used at remote sites for surveying accurate base lines and reference points for the alignment of instrumentation. In the differential mode, GPS could be used to establish a true-north azimuth to $\pm 0.1^\circ$ over a 1-km line of sight (LOS). Portable GPS systems now sell for less than \$ 750. The DOD is considering a proposal to relax the deliberate randomization of geodetic reference information normally supplied to military users of GPS. When this is done, the accuracy of GPS fixes will increase to the sub-decimeter range.

Temporary, Non-LOS, point-to-point, or network communication of digital data can be established using commercially available, meteor-burst systems. Although throughput is only about two hundred words per minute, meteor-burst systems might be useful during mobilization of remote-sites, campaigns, and inter-calibration exercises, when full operational band width is not essential. For global communications, the Inmarsat-C systems has been selected for proof-of-concept tests and potential use at the TWP site. Inmarsat-C features: 1) two-way throughput approaching 600 baud, 2) global operation between 70° N and 70° S, and 3) user access via commercial leased lines such as COMSAT, and very soon, Internet.

At ARCS sites, spread-spectrum, LOS radio-frequency digital communication systems may be an attractive alternative to LAN systems with hard-wired nodes. The HYDRA Wireless Data Logger (John Fluke Company), for example, costs about \$6000, telemeters up to 10 Mb/s between nodes 400m apart, and operates reliably in EMI-prone industrial environments. Because of the low cost of this system, it might be useful as a backup system that could automatically switch on if the primary network at a remote site failed for some reason.

Table 7.1 Platform/Instrumentation Matrix										
Type/Class	Anemometer	Rain Gauge	Hygrometer	Radiometer	Eddy Correlation	Sky Camera	Doppler RADAR	LIDAR	DIAL	RASS
Research Vessels										
Alliance	yes	?	yes	?	?	?	?	?	?	?
Discoverer Seven Seas	yes	?	yes	no	no	no	no	no	no	no
Alaskan Star	yes	?	yes	no	no	no	no	no	no	no
114' Utility Vessel	yes	no	yes	no	no	no	no	no	no	no
Maurice Ewing	yes	yes	yes	?	?	?	?	?	?	?
Morning Watch	yes	?	yes	?	no	?	no	no	no	no
Aqua Truck	yes	no	yes	no	no	no	no	no	no	no
Cape Henlopen	yes	yes	yes	?	no	?	no	no	no	no
Point Sur	yes	yes	yes	?	no	?	no	no	no	no
Alpha Helix	yes	?	yes	?	no	?	?	?	?	?
Buoys										
XM25	yes	no	yes	no	no	no	no	no	no	no
Minimet Data Buoy	yes	no	yes	no	no	no	no	no	no	no
Satellite Located Drifting	no	no	no	no	no	no	no	no	no	no
Fjord Monitoring 3227	yes	no	yes	no	no	no	no	no	no	no
Articulated Beacon Buoy	yes	no	yes	?	no	no	no	no	no	no
Coastal Discus Buoy	yes	no	yes	no	no	no	no	no	no	no
Atlas Buoy	yes	no	yes	no	no	no	no	no	no	no
Johns Hopkins Spar Buoy	yes	?	yes	?	?	no	no	no	no	no
Mentor Buoy	yes	?	yes	?	?	no	no	no	no	no
3-Meter Discus Buoy	yes	no	yes	no	no	no	no	no	no	no
Brookhaven Spar Buoy	yes	?	yes	?	?	?	no	no	no	no
Nomad Buoy	yes	no	yes	no	no	no	no	no	no	no
Esom Buoy	yes	no	yes	no	no	no	no	no	no	no
Wavescan Buoy	yes	no	yes	no	no	no	no	no	no	no
Drilling Platforms										
Snorre TLP	yes	yes	yes	yes	yes	yes	yes	yes	yes	yes
Ocean Alliance	yes	yes	yes	yes	yes	yes	yes	yes	yes	yes
Zane Barnes	yes	yes	yes	yes	yes	yes	yes	yes	yes	yes
Rowan Midland	yes	yes	yes	yes	yes	yes	yes	yes	yes	yes
Western Triton 4	yes	yes	yes	yes	yes	yes	yes	yes	yes	yes
Zapata Scotian	yes	yes	yes	yes	yes	yes	yes	yes	yes	yes
Leman 'H' Platform	yes	yes	yes	yes	yes	yes	yes	yes	yes	yes
North-West Hutton Platform	yes	yes	yes	yes	yes	yes	yes	yes	yes	yes
Ninian Central Platform	yes	yes	yes	yes	yes	yes	yes	yes	yes	yes
Gullfaks 'C' Platform	yes	yes	yes	yes	yes	yes	yes	yes	yes	yes
Ivanhoe/Rob Roy Floating										
Production Facility	yes	yes	yes	yes	yes	yes	yes	yes	yes	yes
Canmar SSDC/MAT	yes	yes	yes	yes	yes	yes	yes	yes	yes	yes
Frigg Field Control Station	yes	yes	yes	yes	yes	yes	yes	yes	yes	yes
Horizon	yes	yes	yes	yes	yes	yes	yes	yes	yes	yes
Neddrill Workshop 1	yes	yes	yes	yes	yes	yes	yes	yes	yes	yes
Special Platforms										
LaLand Marine Terminal	yes	yes	yes	yes	yes	yes	yes	yes	yes	yes
FLIP	yes	yes	yes	yes	?	?	?	?	?	?
Moss	yes	yes	yes	yes	yes	yes	yes	yes	yes	yes
yes = compatible										
no = incompatible										
? = maybe										

7.0 PLATFORM FACT SHEETS

ENGINEERING SURFACE OCEANOGRAPHIC MOORING (ESOM) BUOY

General Description

Type:	
Diameter:	2.74 m
Buoy Material:	Softlite foam with density of 4.5 lbs/ft ³
Tower Material:	Aluminum 6061-T6
Weight:	1360 kg including 400 kg ballast
Displacement:	9080 kg fully submerged
Maximum Buoyancy:	7720 kg
Frequency to Roll:	3.5 sec
Metacentric Height:	0.40 m

Capabilities

The ESOM buoy design satisfies the need of the oceanographic community for a platform with augmented mooring and payload capacity. It has a 3180 kg (7000 lbs) net increase in buoyancy and a larger instrument well (by 12 ft³) over the 3-m discus.

Costs and Contacts

Cost:	\$40,000 approx.
Contact:	Dr. Henri Berteaux CDMS (Cable Dynamics and Mooring Systems) P.O. Box 182 Woods Hole, MA 02543 (tel) 508-548-3872

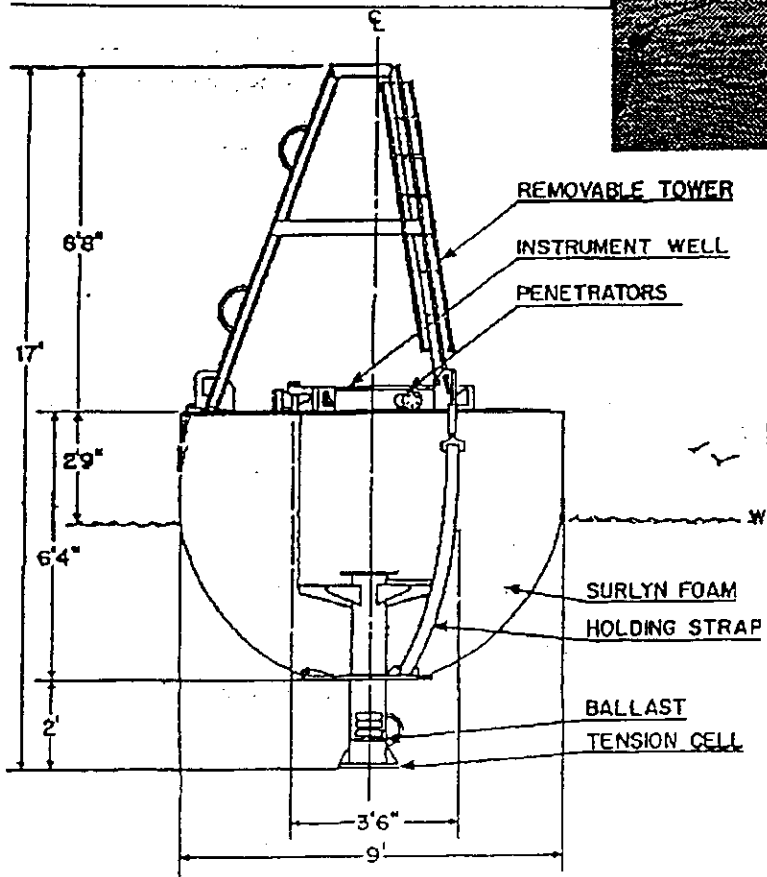
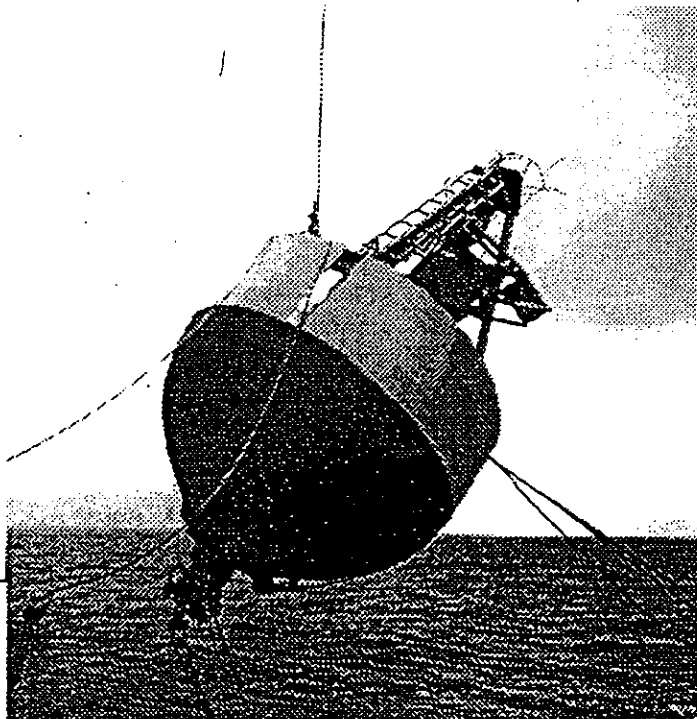

9' WHOI HEMISPHERICAL BUOY

DRAFT - DO NOT REPRODUCE OR DISTRIBUTE

COASTAL DISCUS BUOY

General Description

Type:	Wave Following
Hull Diameter:	7.5 feet
Weight:	1175 lbs
Hull Material:	6061-T6 Aluminum
Buoyancy/Weight Ratio:	4.11:1

Capabilities

Data telemetry/logging:

Power Systems:

Instrumentation:

Dynamics:

Applications: **Long term mooring in bays, estuaries, and continental shelf**

Costs and Contacts

Cost: \$
Contact:

COASTAL DISCUS BUOY

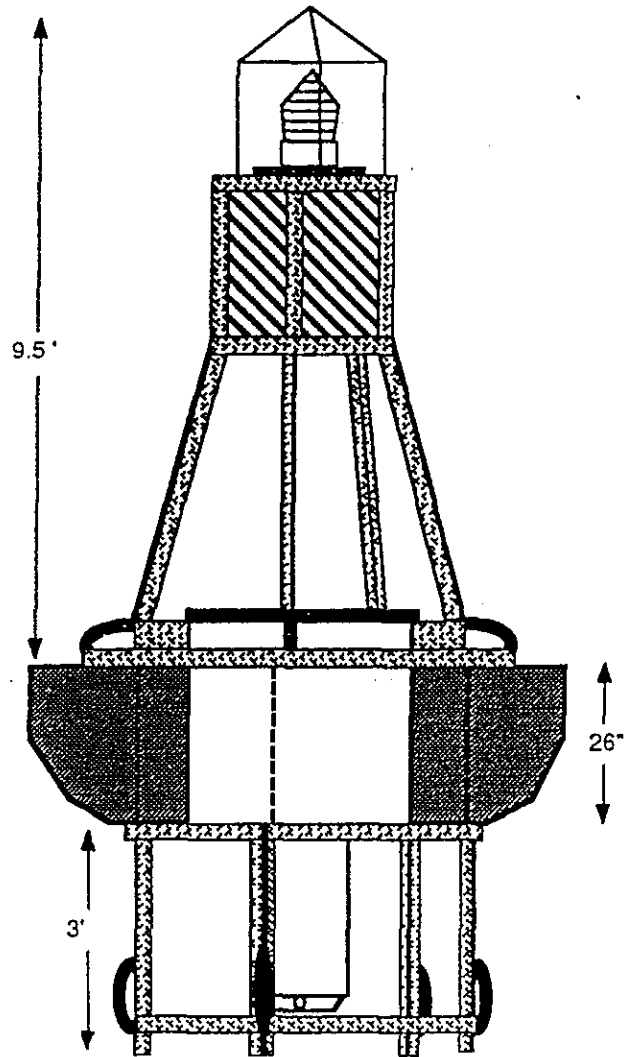

DRAFT - DO NOT REPRODUCE OR DISTRIBUTE

MENTOR BUOY

General Description

Type:	Balance, Semi-Spar
Hull Length:	5 m
Hull Width:	3 m
Mast Height:	10 m
Keel Depth:	10.4 m
Displacement:	8200 Kg
Heave Period:	2.1 sec
Pitch Period:	7.0 sec

Capabilities

The Mentor buoy was designed for air-sea interaction investigations where a minimum of tilt is desired. The buoy is comprised between a spar, which is very long has small residual buoyancy, and a surface following buoy, which has considerable tilt. The keel is raised while the buoy is off site by filling the ballast tanks with air from a surface nozzle. By flooding the tanks, the keel lowers and the buoy stabilizes during measurements.

Recent measurements during ASTEX will provide actual motion measurements. It is expected that typical tilts will be less than ten degrees.

Costs and Contacts

Cost:	\$50,000
Contact:	Dr. K. Katsaros AK-40 University of Washington 1012 NE 40th Street Seattle, WA 98105 (tel) 206-543-1203 (fax) 206-524-8184

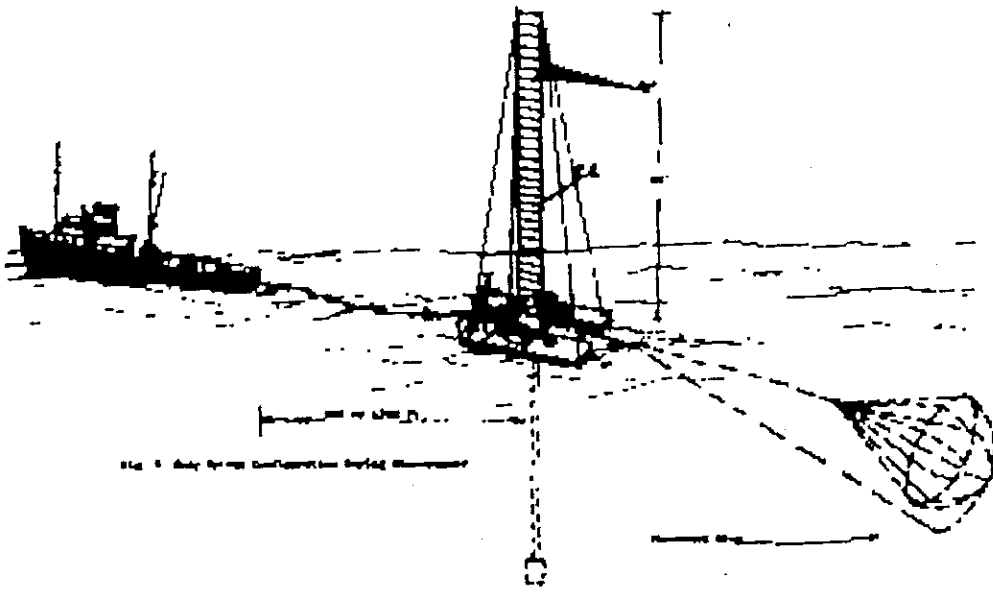
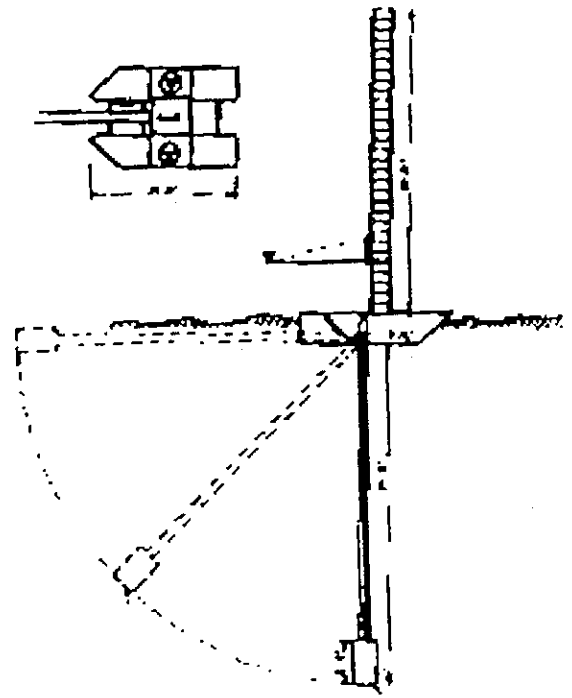

Fig. 1. Ship's Deck Crane with Net



DRAFT - DO NOT REPRODUCE OR DISTRIBUTE

ATLAS BUOY

General Description

Type:	Toroid Surface Following
Hull Diameter:	2.3 m
Winds Height:	3.8 m
Air Temperature Height:	2 m
Hull Material:	
Weight:	
Overall Height:	

Capabilities

Subsurface Temperature:	Water temperatures are measured at ten locations, 20 to 500 m depth. Accuracy = 0.1 decC, resolution = 0.002 degC.
Telemetry:	Argos transmissions, data placed onto the GTS.
Standard Sampling:	Hourly six-minute averages of wind speed and direction based on half-second vector samples. Temperatures sampled each ten minutes and averaged for an hour. Subsurface temperatures sampled each ten minutes, daily averages.

Costs and Contacts

Cost:	Sensors:	\$25,000 (sensors, data logger, telemetry)
	Buoy:	\$15,000 (complete w/light, batteries)
	Mooring:	\$25,000 (anchor, backup recovery, hardware for 4000 m)
Owner/Operator:	Hugh Milburn NOAA PMEL 7600 Sand Point Way NE Seattle, WA 98195 (tel) 206-526-6169 (fax) 206-526-6744	

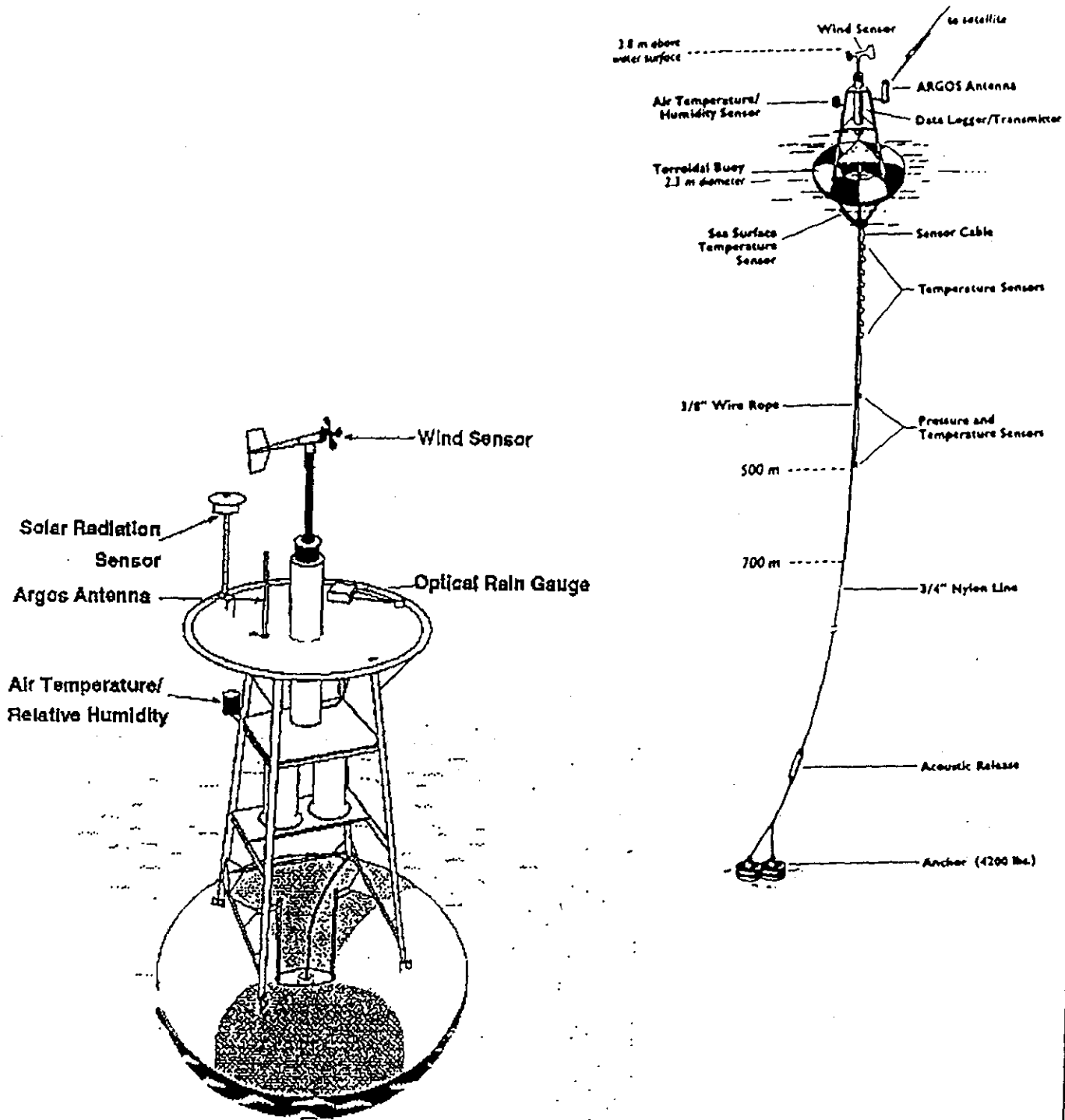

DRAFT - DO NOT REPRODUCE OR DISTRIBUTE

BROOKHAVEN SPAR BUOY

General Description

Type:	Spar
Length Overall:	25 m, 31 m with met tower
Hull Material:	Steel
Weight:	8,200 Kg in air without instrumentation
Displacement:	11,350 Kg

Capabilities

Sensor Height:	-20 m to 10 m
Instrumentation Payload:	1044 Kg
Instrumentation:	The last deployment supported 55 channels of analog and digital data.
Applications:	Meteorology, sky and sea radiation, air/sea interaction, ocean mixed layer dynamics

Costs and Contacts

Cost:	Replacement Cost	\$50,000
	Instrumentation:	Varies with experiment goals
	Basic set of ASI:	\$100,000 (approx)
	Deployment Cost:	varies on location

Contact:	Dr. Charles Flagg Bldg. 318 Brookhaven National Laboratory Upton, NY 11973 (tel) 516-282-3128 (fax) 516-282-3246
----------	---

JOHNS HOPKINS HELICOPTER DEPLOYABLE SPAR BUOY

General Description

Type:	Spar
Hull Length:	20 m
Weight in Air:	1900 Kg
Sensor Height:	+6 m

Capabilities

Sea State: Operates to states 3+

Meteorological Sensors Used: Winds, air temperature, net radiation, RH, surface water temperature, ocean surface layer structure

Costs and Contacts

Cost:	Buoy Cost:	\$50,000
	Standard Met Instrumentation:	\$50,000

Contact: Dr. Carl Nelson
John Hopkins University/APL
John Hopkins Road
Laurel, MD 20707
(tel) 301-953-5000 ext: 7765

This buoy is a stable spar for meteorological and ocean surface layer measurements. It is small enough to be deployed by helicopter yet maintains good stability in 3+ sea state.

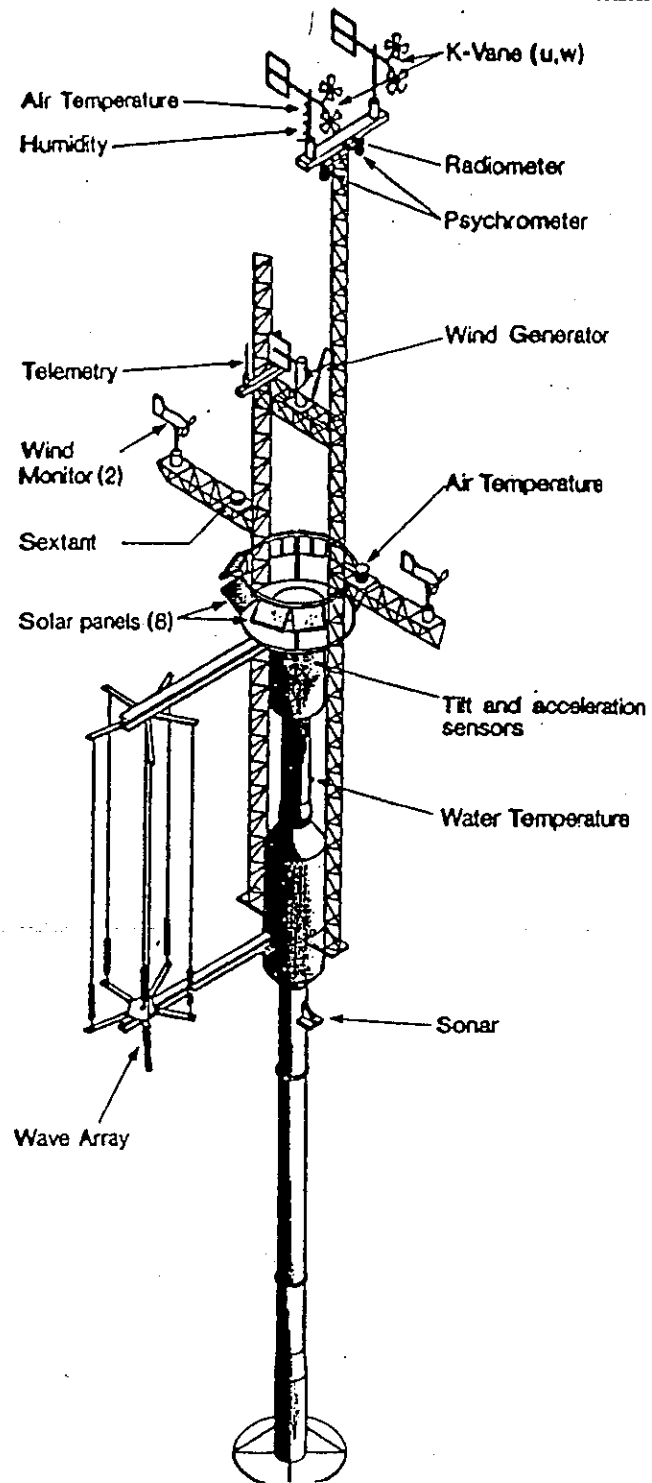

DRAFT - DO NOT REPRODUCE OR DISTRIBUTE



DRAFT - DO NOT REPRODUCE OR DISTRIBUTE

NOMAD BUOY

General Description

Type:	
Length Overall:	6.1 m
Beam Max:	3.3 m
Weight in Air:	9080 kg
Roll Period:	3.8 sec
Pitch Period:	2.4 sec
Sensor Height:	5 m

Capabilities

This buoy was used by the NDBC as a replacement for the monster discus buoys (10 m diameter) in deep ocean moorings. It has ample internal volume for batteries and electronics. Solar panels can easily be mounted on the large deck space.

Costs and Contacts

Cost:	Buoy:	\$150,000 (Hull and hardware)
	Data Package	\$ 70,000

Contact:	Ray Canada
	National Data Buoy Center
	NSTL
	Bay St. Louis, MS 39529
	(tel) 601-688-2800
	(fax) 601-656-4511

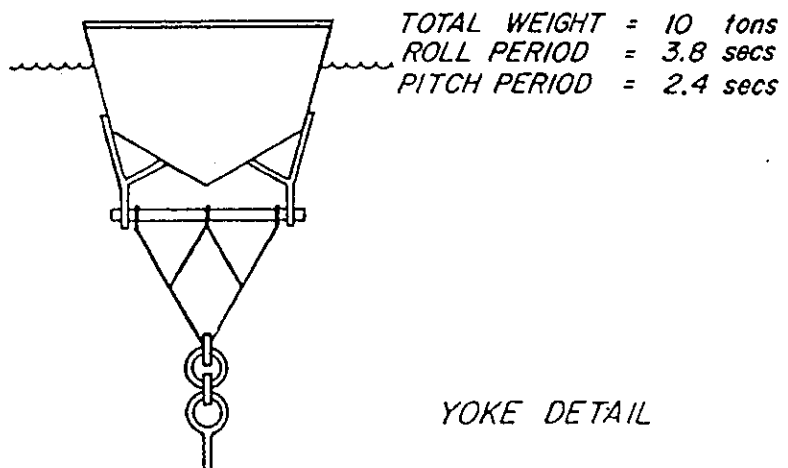
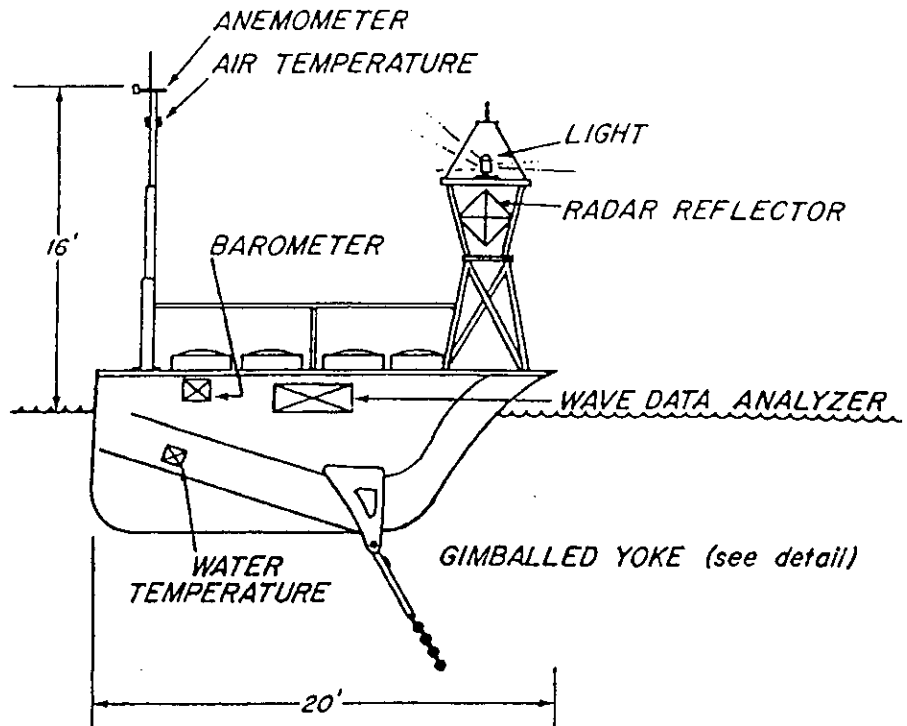

9 Typical Nomad Buoy.

DRAFT - DO NOT REPRODUCE OR DISTRIBUTE

Satellite Located Drifting Buoy (BDL)

General Description

Type:	Drifting Buoy
Hull Diameter:	.46 m
Hull Material:	Steel
Weight:	13 to 15 kg
Overall Height:	1.0 m
Buoyancy	30 to 35 kg

Capabilities

Data Telemetry/Logging:	ARGOS System, Transmitted Power
Power System:	Alkaline-managanese Battery
Applications:	Adapted both to the scientific applications for measuring water mass displacement and to the markings of the surface equipments that have to be retrieved.

Costs and Contacts

Base Rate:	\$
Owner/Operator:	Orca 5, rue Pierre Rivoallon ZI du Vernis 29200 BREST FRANCE +33 98 05 29 05/FAX +33 98 05 52 41

The small draught of the Satellite Located Drifting Buoy in air and in water optimizes its use as a follower of sea current. It is composed of a painted steel body and buoyancy. Operational campaigns have shown the reliability of the BDL and the quality of the locations which are obtained.

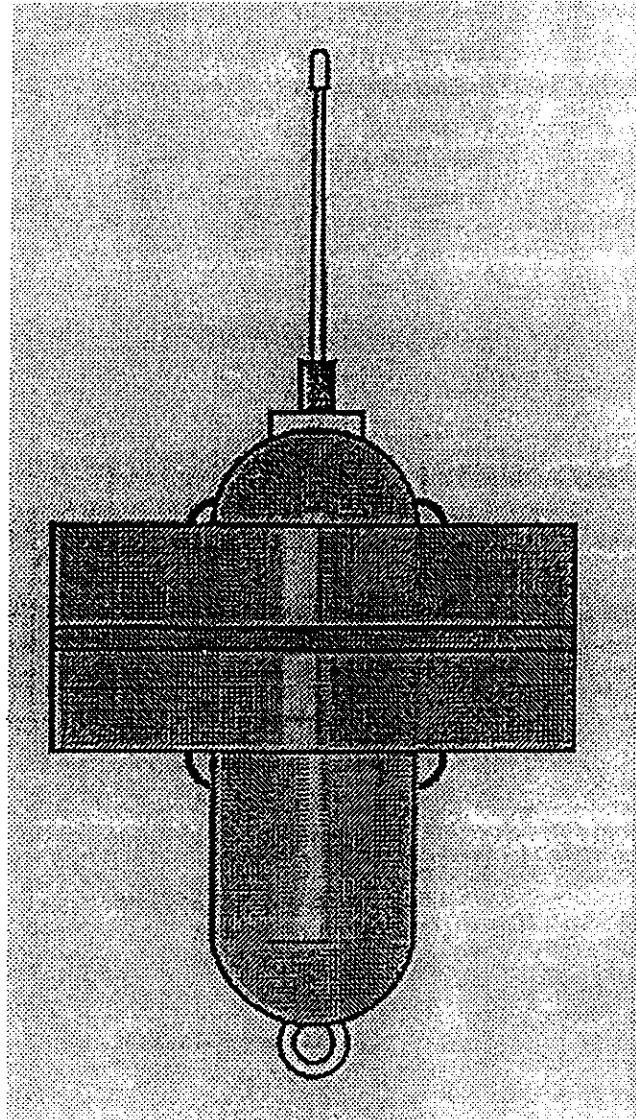

DRAFT - DO NOT REPRODUCE OR DISTRIBUTE

MINIMET DATA BUOY

General Description

Type:	Surface-following
Hull diameter:	0.94 m
Hull material:	6061-T6 Aluminium w/stainless steel fittings
Weight:	120 kg
Overall Height:	3.0 m

Capabilities

Data telemetry/logging:	Antenna for RF Telemetry incl. UHF, VHF, and Satellite (GOES, ARGOS, CMS, etc)
Power Systems:	Battery
Instrumentation:	Anemometer Location, Air Temperature Sensor or Other Environmental Sensor
Dynamics	
Roll:	~10° on vertical axis
Applications:	Environmental data collection and computational needs.

Costs and Contacts

Cost:	\$
Contact:	Coastal Climate Company 316 2nd Avenue S. Seattle, WA 98104 (206) 682-6048/FAX (206) 682-5658

The MINIMET buoy has become the choice of many weather watchers and Oceanographers where a small, easily deployed and relatively inexpensive, moored data buoy is required. The MINIMET, fully loaded, can be deployed from small boats (as small as 20 feet in calm waters) and can contain battery power sufficient for a year and more depending on the sensor configuration.

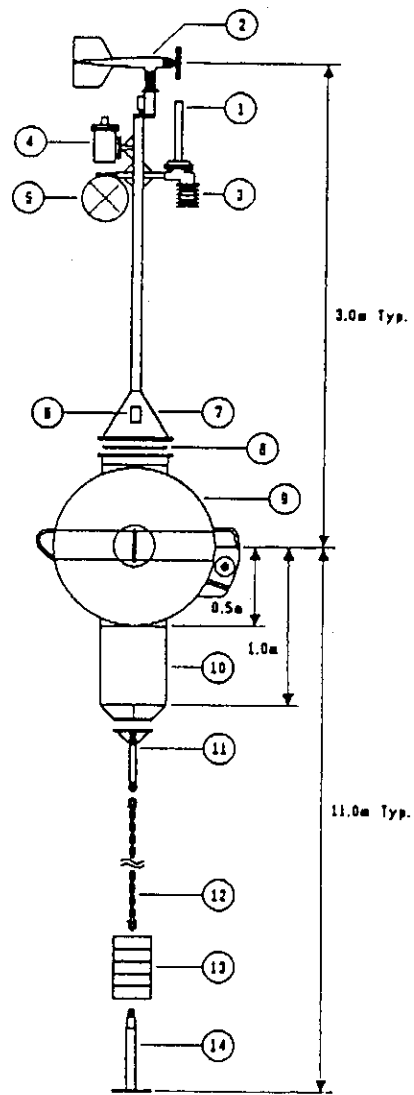
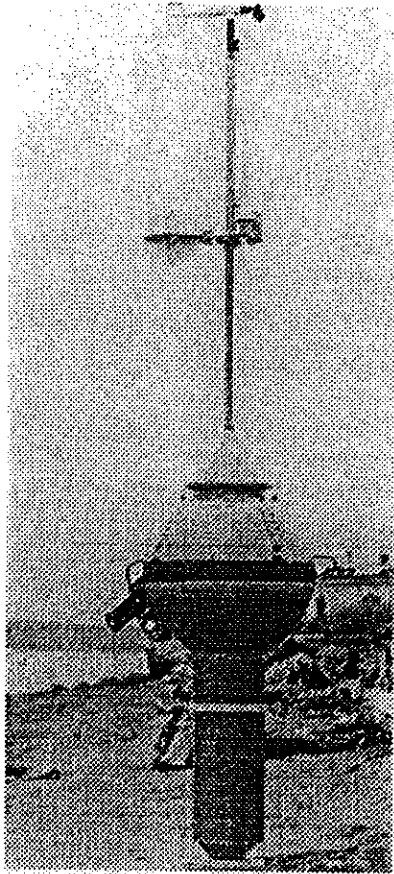

FJORD MONITORING BUOY 3227

General Description

Type:	Surface-following
Hull material:	Inflatable Polyform
Weight:	90 kg
Overall Height:	4.6 m

Capabilities

Data telemetry/logging:	Computing Unit, Voice Generator, Data Storing Unit, VHF Transmitter
Power Systems:	Solar Cell Power Module w/Rechargeable Batteries
Instrumentation:	Sensor Scanning Unit, Wind Speed, Wind Direction and Air Temperature Sensors, Internal Quartz Clock
Dynamics:	
Applications:	Monitor the stratification of the water in fjords and coastal waters

Costs and Contacts

Cost:	\$
Contact:	Aanderaa Instruments Fanaveien 13B 5051 Bergen, Norway 47 5 1 132500/FAX 47 5 137950

A moored buoy for monitoring wind speed, wind direction, and air temperature as well as water temperature at 11 depths or salinity and temperature at 6 depths. Data is conveyed ashore in real-time by a VHF transmitter. Computing unit converts PDC-4 raw data input to engineering units and display the result successively on an LCD. Voice generator converts the latest measured data from the unit to speech, and when connected to a telephone, reads them off as a voice message.

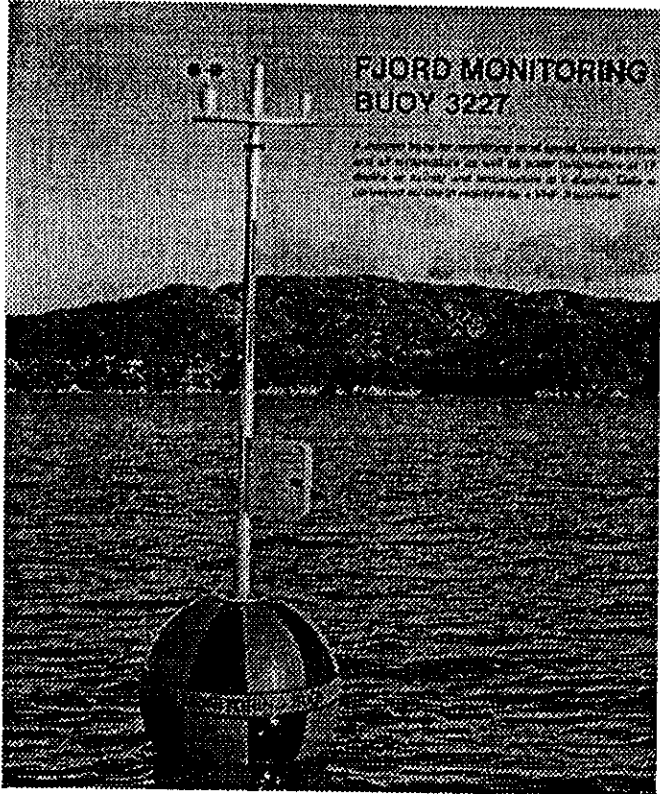

ARTICULATED BEACON BUOY

General Description

Type:	Surface-following
Hull diameter:	2.7 m
Hull material:	6061-T6 Aluminum
Weight:	1,365 kg
Overall Height:	2.0 m
Buoyancy/weight ratio:	5.63:1 (w/o ballast)

Capabilities

Data telemetry/logging:

Power Systems: Solar Panels

Instrumentation:

Applications: The mooring was designed to transmit real-time data to shore via ARGOS satellite. The system provides continuous data on near-surface currents, water temperature, winds and waves, system battery voltage, and buoy position.

Reference: Sea Technology Magazine

Costs and Contacts

Cost:	\$
Owner/Operator:	The Gilman Corporation Gilman, CT 1-800-622-3626/FAX (203) 886-5402

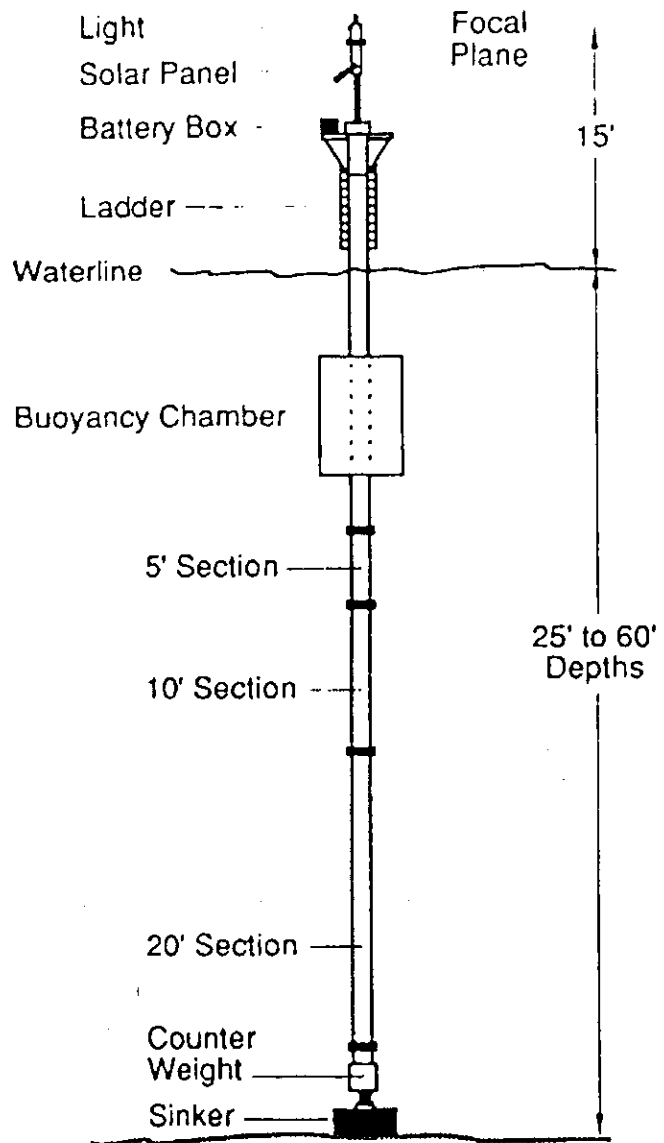

Figure 2. Articulated Beacon

DISCOVERER SEVEN SEAS

General Description

Type:	Offshore Discoverer Class
Built:	1976
Deck Area:	Not available
Maximum Working Depth:	7620 m
Heliport:	S-61, 2,000 gal refueling system

Capabilities

Communications:

Instrumentation:

Equipment: Pyramid 1,330,000 lb and 665 ton Derrick, 2 x Hydrill GL Annular, 2 x Vetco H-4 hydraulic, and 2 x Camercon U Double Ram B.O.P Systems, Drilling Equipment, Continental Emsco Drawworks

Berthing: 128 persons

Propulsion: 6 x EMD MD 20E9 Diesels Each Driving 2,500 kW Generator; EMD MD 12E8-6 Diesel Driving 1,050 kW Generator

Dynamics:

Heave:	7 seconds
Roll:	12 seconds
Pitch:	6 seconds

Operating Area: Panama
Status: Drilling

Costs and Contacts

Base Rate:	\$
Owner/Operator:	Sonat Offshore Drilling Inc.

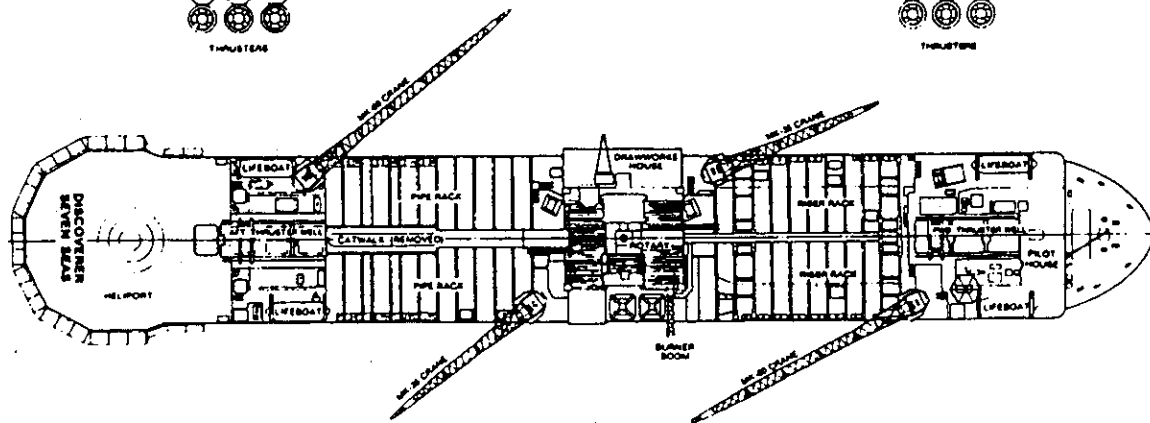
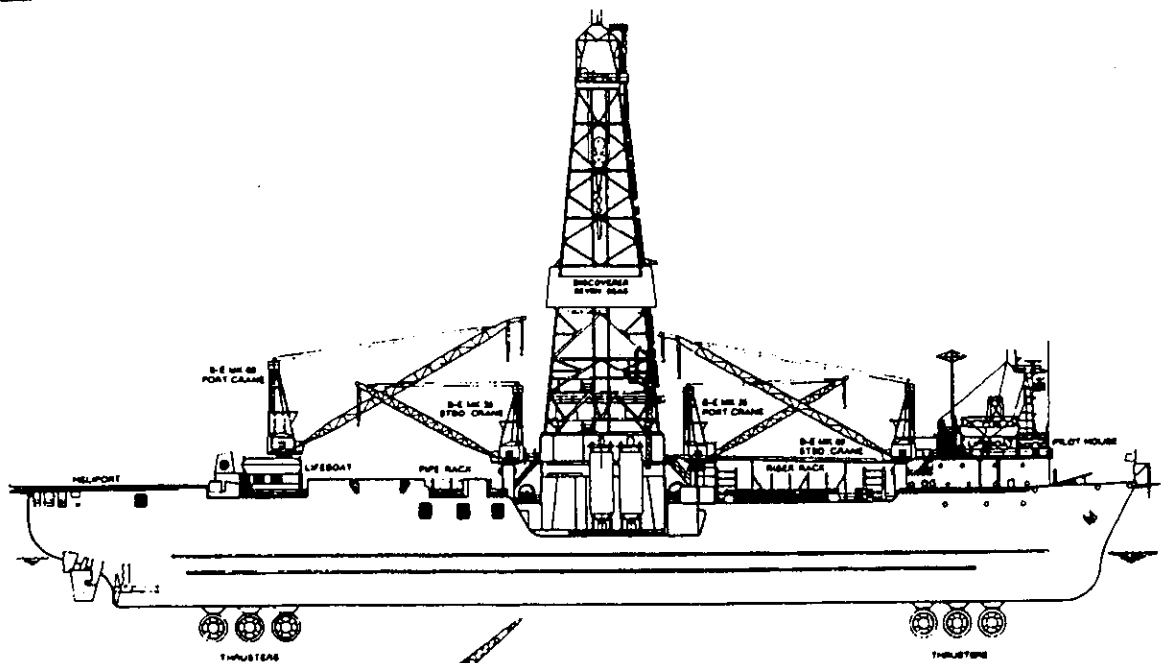

ALASKAN STAR

General Description

Type:	Pacesetter
Built:	1976
Deck Area:	Not available
Maximum Working Depth:	7620 m
Heliport:	S-61

Capabilities

Communications:

Instrumentation: Special teels provide ABS class for -23°C air and 0°C water temperature

Equipment: Continental Emsco 1,000,000 lb Derrick, Manitowoc SC150, 50 tons and 54.5 ton Crane, Drilling Equipment, (2) 15,000 psi Koomey Double Ram

Berthing: 95 persons

Propulsion: 4 x Pielstick 12 PC2V Mk5 Diesel Engines Driving 5,600 kW Alternator

Drilling Conditions:

Wind Speed	50 kts
Wave Max	13.7 m
Current	1.5 kts

Dynamics:

Roll	42.7 sec
Heave	19.6 sec
Pitch	40.5 sec

Operating Area:	USA
Status:	Drilling

Costs and Contacts

Base Rate:	\$
Owner/Operator:	Western Oceanic Inc.

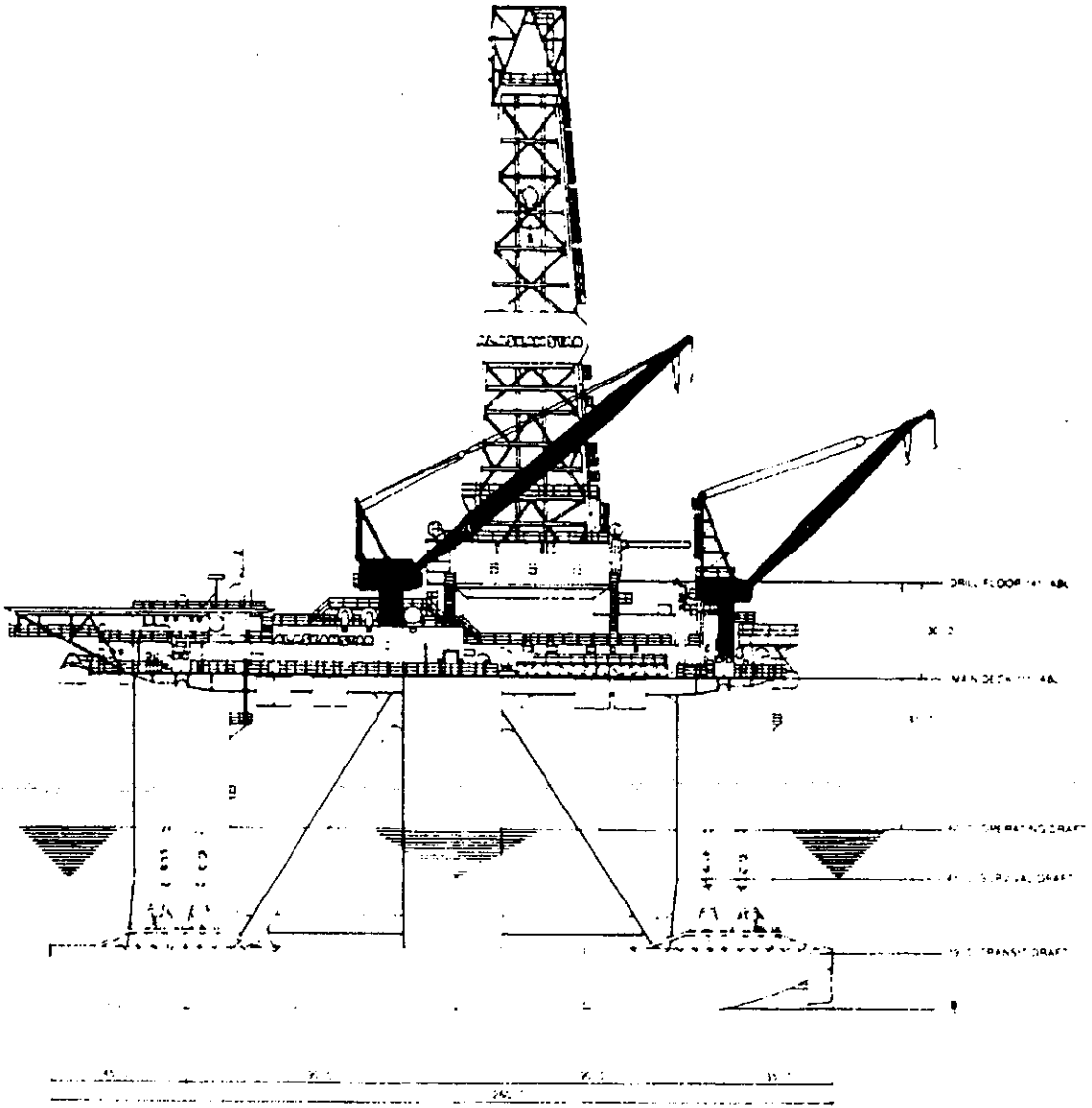

NEDDRILL WORKSHIP 1

General Description

Type:	I.H.C. Gusto Pelican Class
Built:	1981
Deck Area:	Not available
Maximum Working Depth:	6096 m
Heliport:	S-61

Capabilities

Communications:

Instrumentation:

Equipment: Pyramid 1,000,000 lb Derrick, 1 HC Gustos 40 ton and 60 ton Crane, National 1625 Drawworks, Drilling Equipment, B.O.P System

Berthing: 97 persons

Main Power: (5) SACM Diesel Driving 3,000 kVA Generators

Dynamics: Dynamic positioning tends to be used for water depths in excess of 200 m.

Operating Area: USA
Status: Drilling

Costs and Contacts

Base Rate: \$
Owner/Operator: Western Oceanic Inc.

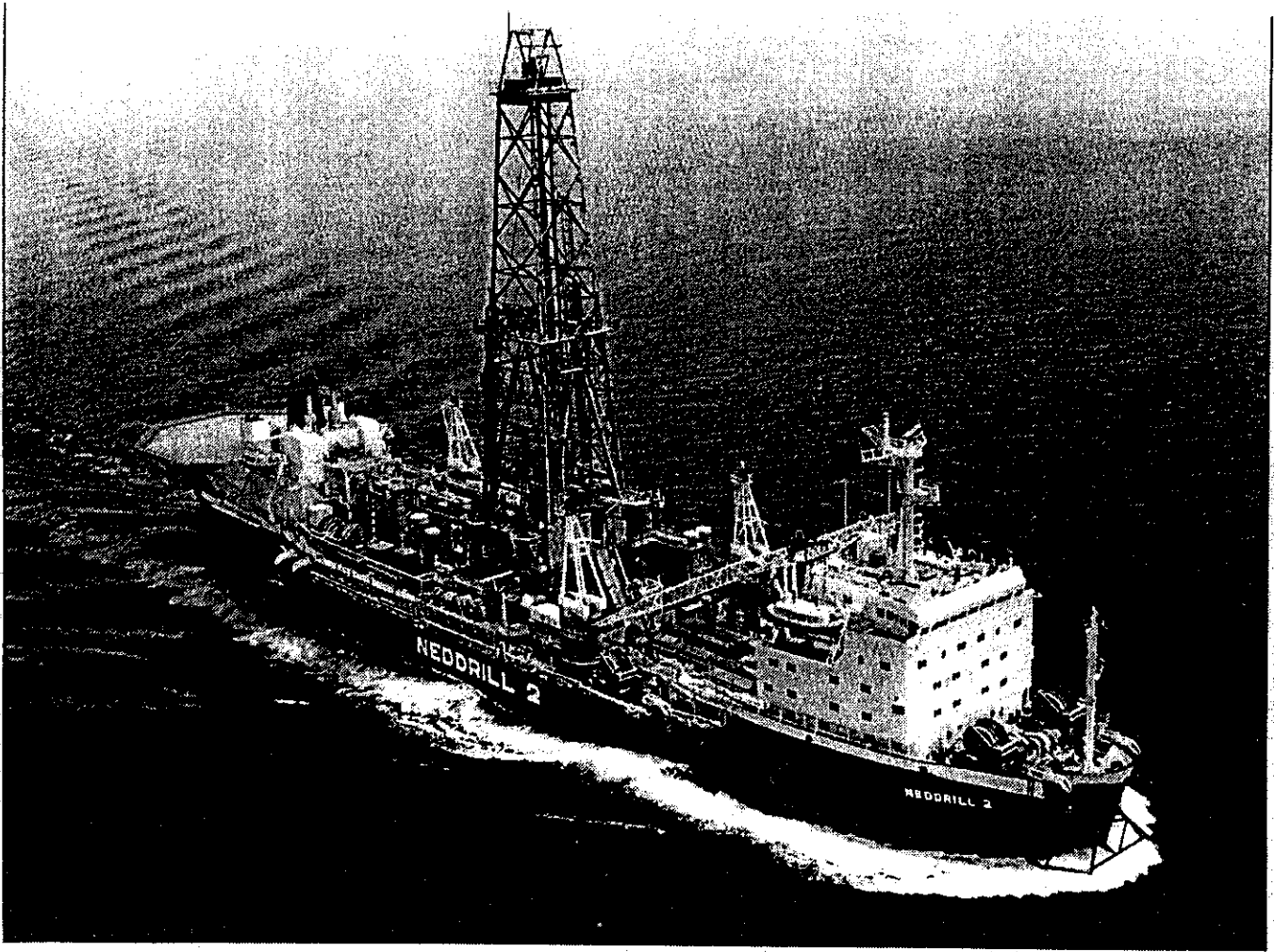

114' UTILITY VESSEL

General Description

Built:
Length: 34.8 m
Beam: 8.5 m
Laboratory Space: Available
Deck Space: 124 m²

Capabilities

Scientific Equipment:
Communications: 3 Station Sound Powered Telephone
Navigation: Global Positioning System, Loran, Depth Sounder,
Doppler Speed Log., Gyro Compass System
Winches & Support
Equipment:
Scientific Berthing: 10
Cruising Speed: 12 knots
Range:
Endurance:
Applications: Utility Vessel

Costs and Contacts

Base Rate: \$
Owner/Operator: Bender Shipbuilding and Repair Co. Inc.
P.O. Box 42
Mobile, Alabama 36601-0042
(205) 431-8000/FAX (205) 432-2260

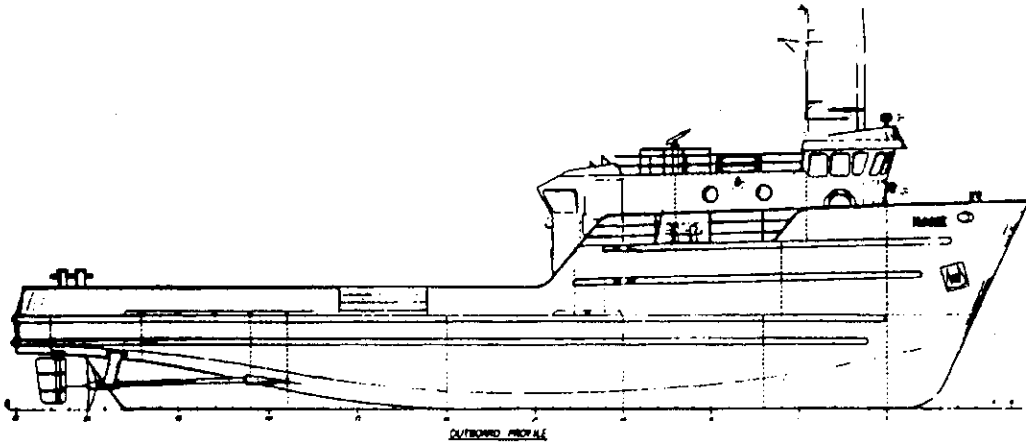

CATINORDO PROF. ALI

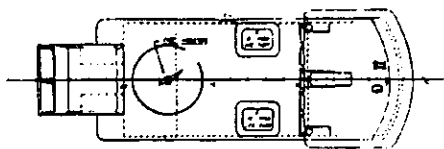

PORT HOUSE DECK

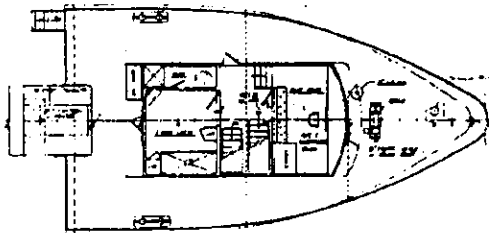

MISSILE DECK

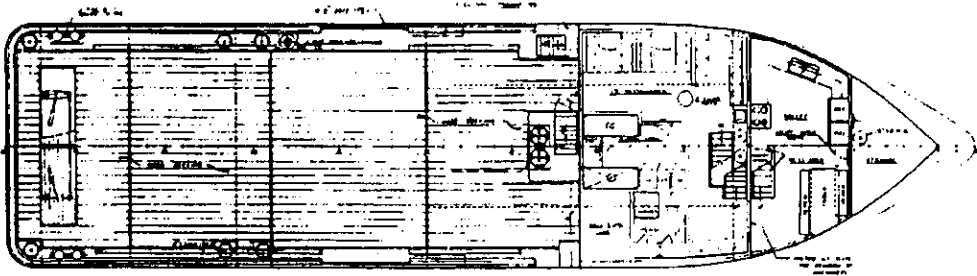

MAIN DECK

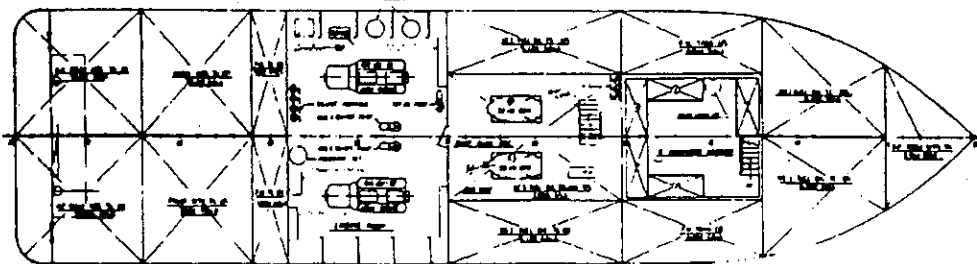

HOLD PLAN

R/V ALLIANCE

General Description

Built:	1988
Length:	93 M
Beam:	15.2 M
Draft:	5.1 m (loaded)

Capabilities

Scientific Berthing:	20
Cruising Speed:	16.3 knots
Range:	8000 nm (12 kts)

"Alliance," one of the most capable undersea research vessels in operation today, is probably the quietest motor ship afloat. She is, moreover, unique in being the only ship owned jointly by all the nations of the North Atlantic Treaty Organization. The ship is operated by the Undersea Research Center of the Supreme Applied Commander Atlantic, located at La Spezia, Italy. "Alliance" enables scientists from the Center to conduct a wide range of experiments in all the oceans of importance to NATO. Particular care has been taken to reduce the noise output of the ship to the lowest possible level in order to minimize interference with the environmental acoustic experiments.

The ship is extensively equipped with winches and other deck handling gear for deploying and towing the systems and instrumentation needed for acoustic and oceanographic research. Sophisticated navigation, recording and computer equipment ensure that the ship position known and logged with great precision and that research data can be accurately recorded and analyzed while trials are progress.

"Alliance" was constructed at La Spezia Fincantieri--Cantieri Navai Italiani and delivered in 1988. For practical operation purposes, "Alliance" has been given the status of a public vessel of the Federal Republic of Germany and flies the German flag.

Costs and Contacts

Base Rate:	\$
Owner/Operator:	

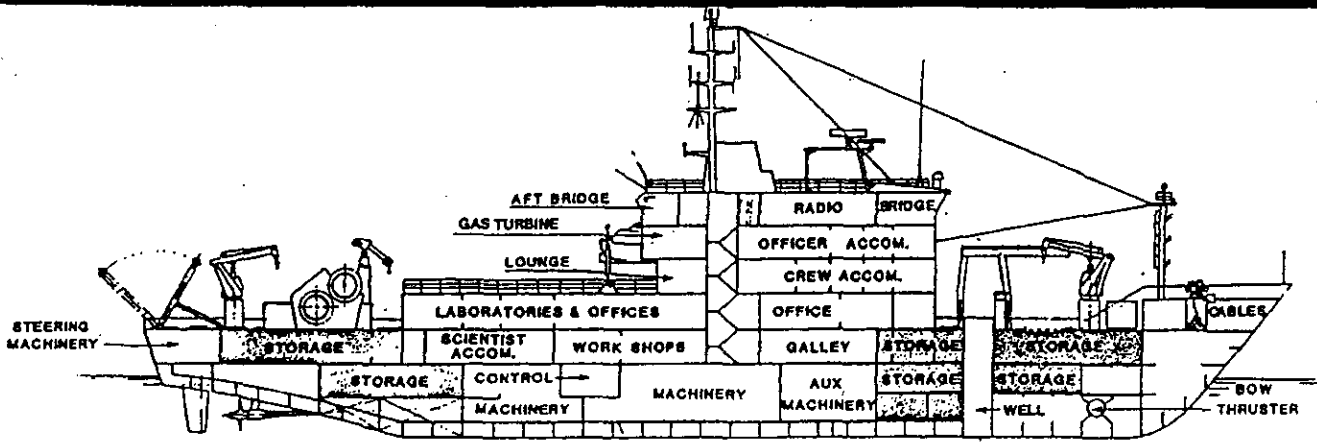

DRAFT - DO NOT REPRODUCE OR DISTRIBUTE

M/V RECOVERY ONE

General Description

Built:	1984
Length:	46.0 m
Beam:	10.7 m
Laboratory Space:	Available
Deck Space:	225.8 m ²

Capabilities

Scientific Equipment:	Echo Sounder, Radar, Positioning
Communications:	SSB Marine Transceiver, VHF, SATCOM, Cellular Phone, FAX
Navigation:	Radar, RP Plotter, Loran, Satnav, Weather Fax, Gyro Convertor, Autopilot
Winches & Support Equipment:	Towing Machines, Deck Tugger Winches, Stern Roller, 5 Ton Hydraulic Deck Crane
Scientific Berthing:	15
Cruising Speed:	11 kts
Range:	
Endurance:	
Applications:	Anchor Handling, Supply Vessel, Scientific Research

Costs and Contacts

Base Rate:	\$
Contact:	Coast Enterprises 505 W. Harbor Drive San Diego, CA 92101 (619) 233-3805/FAX (619) 234-9735

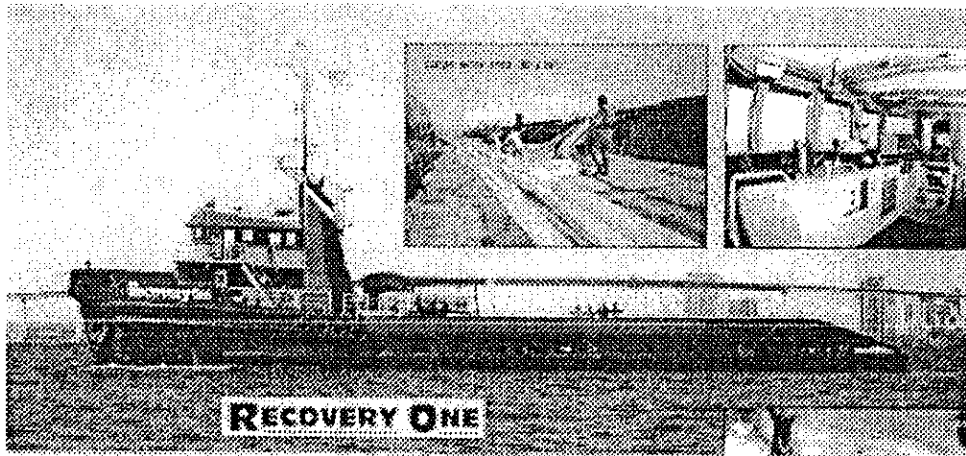

RECOVERY ONE

RECOVERY ONE

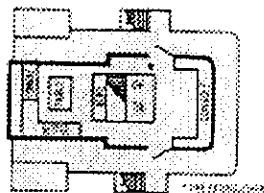

BRIDGE DECK

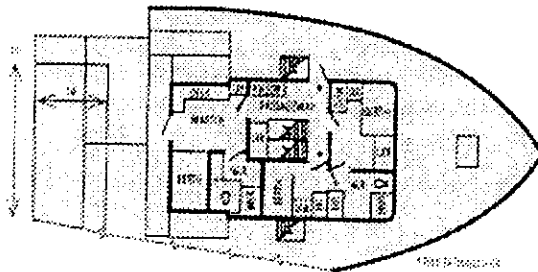

FORECASTLE DECK

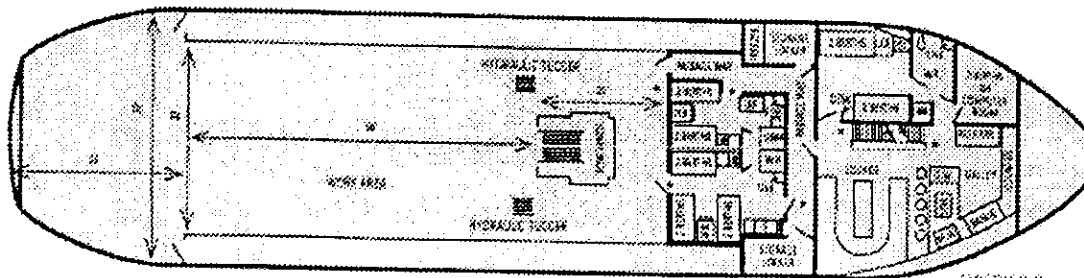

MAIN DECK PLAN

210' OIL SPILL RECOVERY VESSEL

General Description

Built:
Length: 64 m
Beam: 13.7 m
Laboratory Space: Available
Deck Space: 372 m²

Capabilities

Scientific Equipment:
Communications: 12 Station Hose McCann Sound Powered Telephone
Navigation: Global Positioning System; Loran, Depth Sounder, Doppler Speed Log, Gyro Compass System
Winches & Support Equipment:
Scientific Berthing: 38
Cruising Speed: 12 knots
Range:
Endurance:
Applications: Oil Spill Recovery

Costs and Contacts

Base Rate: \$
Owner/Operator: Bender Shipbuilding and Repair Co. Inc.
P.O. Box 42
Mobile, Alabama 36601-0042
(205) 431-8000/FAX (205) 432-2260

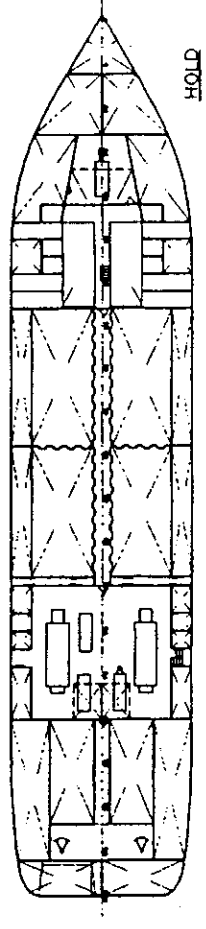
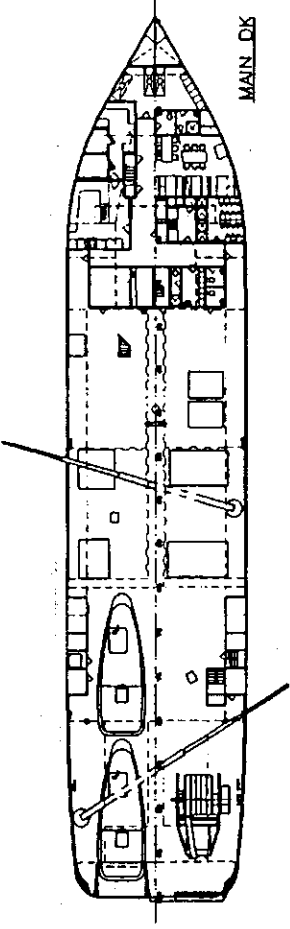
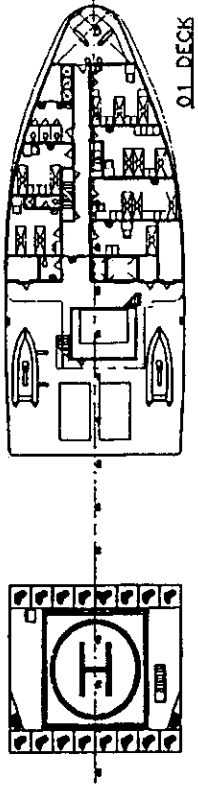
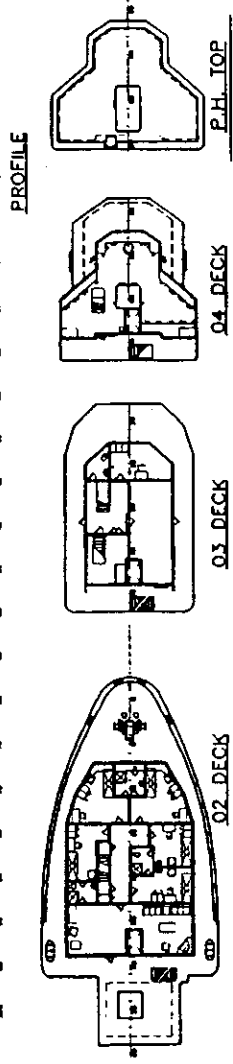
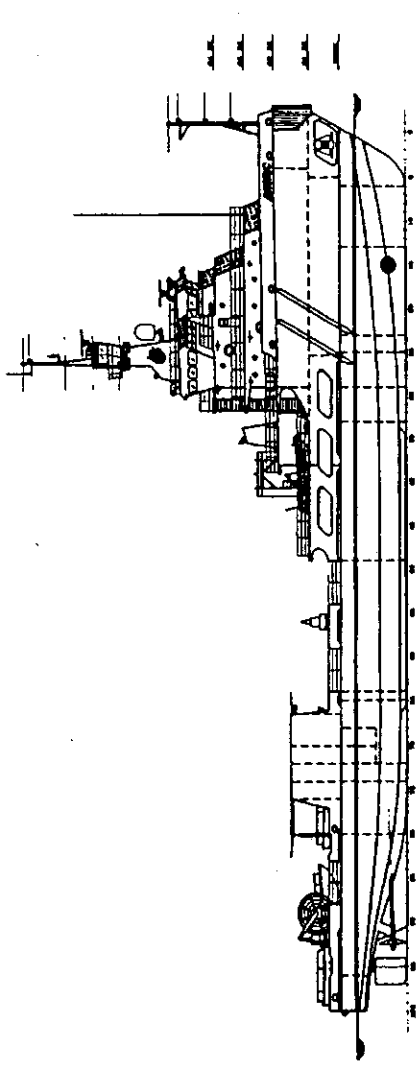

R/V MAURICE EWING

General Description

Built: 1983
Length: 70 m
Beam: 14.1 m
Deck Space:
Laboratory Space:

Capabilities

Scientific Equipment: Dark Room

Communications:

Navigation:

Winches & Support
Equipment:

Scientific Berthing: 28
Cruising Speed: 12 kts
Range: 17,000 N. mi.
Endurance: 60 days

Applications:

Costs and Contacts

Base Rate: \$
Owner/Operator: Columbia University
Contact: Mr. Michael Rawson
Marine Science Coordinator
Lamont-Doherty Geological Observatory
(914) 359-2900 x367/FAX (914) 359-6817



R/V MORNING WATCH

General Description

Built:	1987
Length:	27 m
Beam:	6.8 m
Laboratory Space:	Available
Deck Space:	18.6 m ²

Capabilities

Scientific Equipment:	Echo Sounder, Radar, Positioning
Communications:	Satellite Comm., SSB Transceiver, VHF Transceiver, Navtec Receiver, Weather Fax, Int. & Land Telephone, EPIRB
Navigation:	Radar, Loran C, Satnav, Auto Pilot, Video Platter, Gyro Compass, Magnetic Compass, Digital Echo Sounder, Color Echo Sounder, Log and Speedometer
Winches & Support Equipment:	1270 kg @ 5.5 m Extension, Windlass
Scientific Berthing:	10
Cruising Speed:	10.5 kts
Range:	3,000 N. mi.
Endurance:	30 days
Applications:	Bathymetric Surveys, Side Scan and Magnetometer Searches

Costs and Contacts

Base Rate:	\$1,500/day
Owner/Operator:	Morning Watch, Inc.
Contact:	Sumner Gerard (407) 460-1580/FAX(407) 465-2446

Morning Watch was built in 1987 in England for all-oceans, all-weather operations. She supplies most scientific equipment for bathymetric surveys, side scan sonar or magnetometer searches, and has air-conditioned labs, a dark room etc.

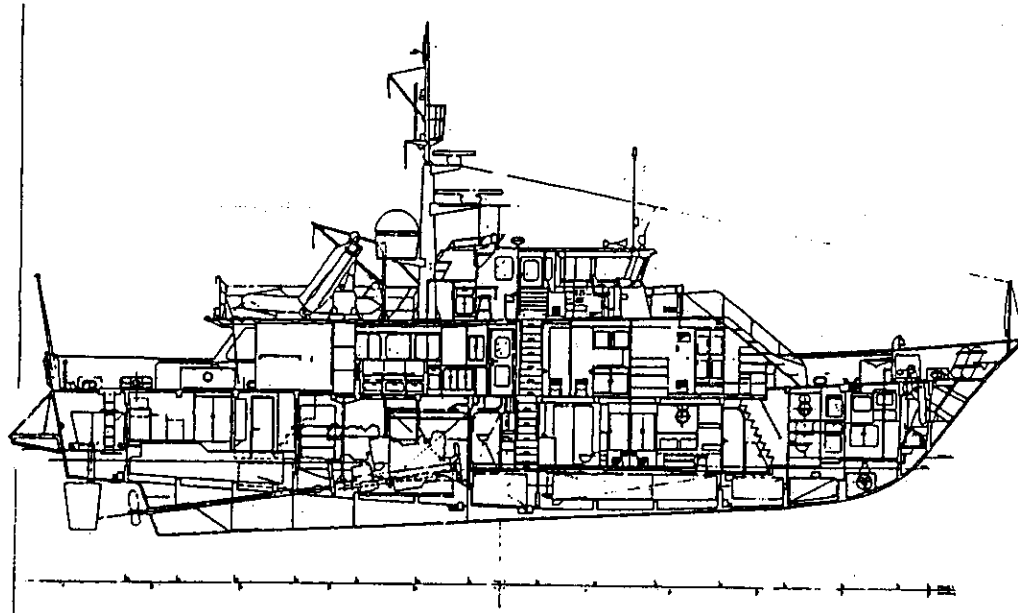
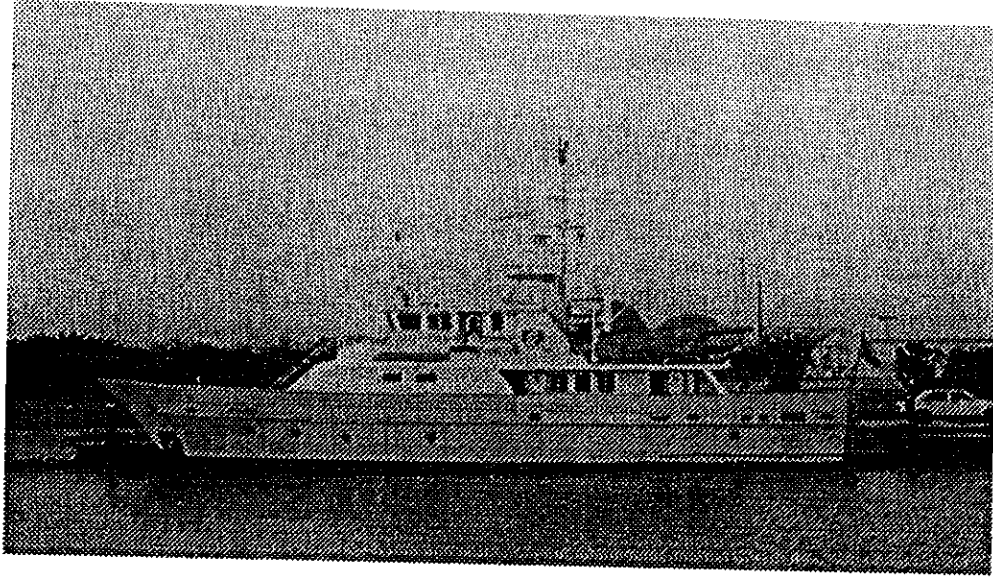

"MORNING WATCH"
DS-1, GENERAL PURPOSE RESEARCH VESSEL

R/V AQUA TRUCK

SPECIFICATIONS

General Description

Built:	New
Length:	15 m
Beam:	6.1 m
Draft:	1.6 m
Laboratory Space:	Custom
Deck Space:	74 m ²

Capabilities

Scientific Equipment:	Custom
Communications:	Custom
Navigation:	Custom
Environmental Limitations:	High Seas
Winches & Support Equipment:	Articulated Cranes (Custom)
Electrical Power Available:	Generator
Applications:	Aquaculture, bridge maintenance, buoy tender, cargo carrier, dredging support, fire fighting, marine construction, research, work platform

Costs and Contacts

Base Rate:	
Contact:	Bud LaVance Atlantic Aqua Marine, Inc. (207) 761-1773/FAX (207) 828-0804

Aqua Trucks are available in sizes from 24' to 150' with outboard, I/O diesel, or jet drive power. They are rugged welded steel or aluminum plate construction and can be supplied with any configuration. There is also a version for semi-offshore use.

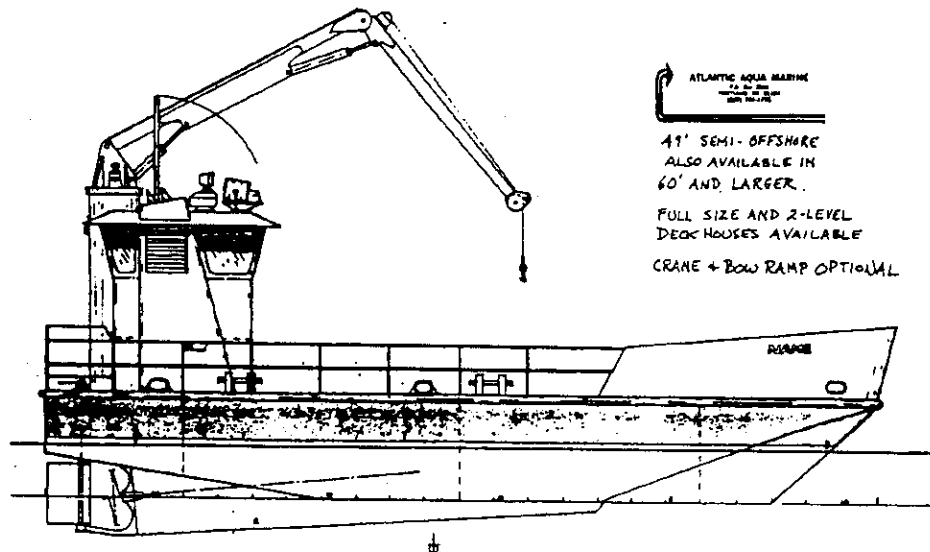
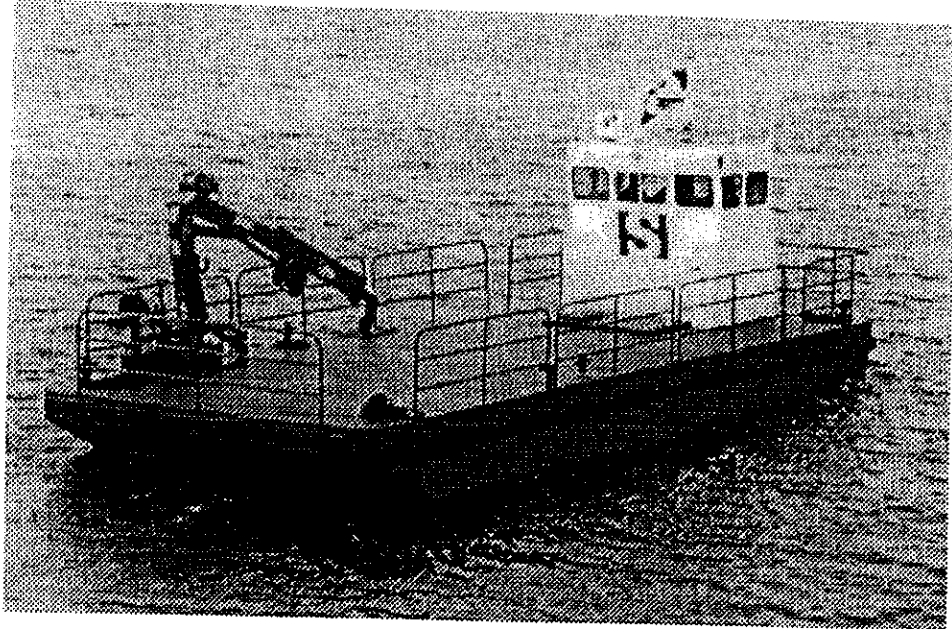

R/V CAPE HENLOPEN

SPECIFICATIONS

General Description

Built:	
Length:	37 m
Beam:	7 m
Draft:	2.8 m
Laboratory Space:	21 m ² (wet) 17 m ² (dry)
Deck Space:	788 m ²

Capabilities

Scientific Equipment:

Communications: Single Side Band, Loran (3)

Navigation: Radar (2), Depth Sounders (3), Gyro Compass

Electrical Power Available: Generator

Winches & Support Equipment: Marine Hydraulic Crane, Capstans, Trawling and Hydrographic Winch

Scientific Berthing: 14

Cruising Speed: 12 to 15 kts

Range: 2368 N. mi

Costs and Contacts

Base Rate: ?

Contact:

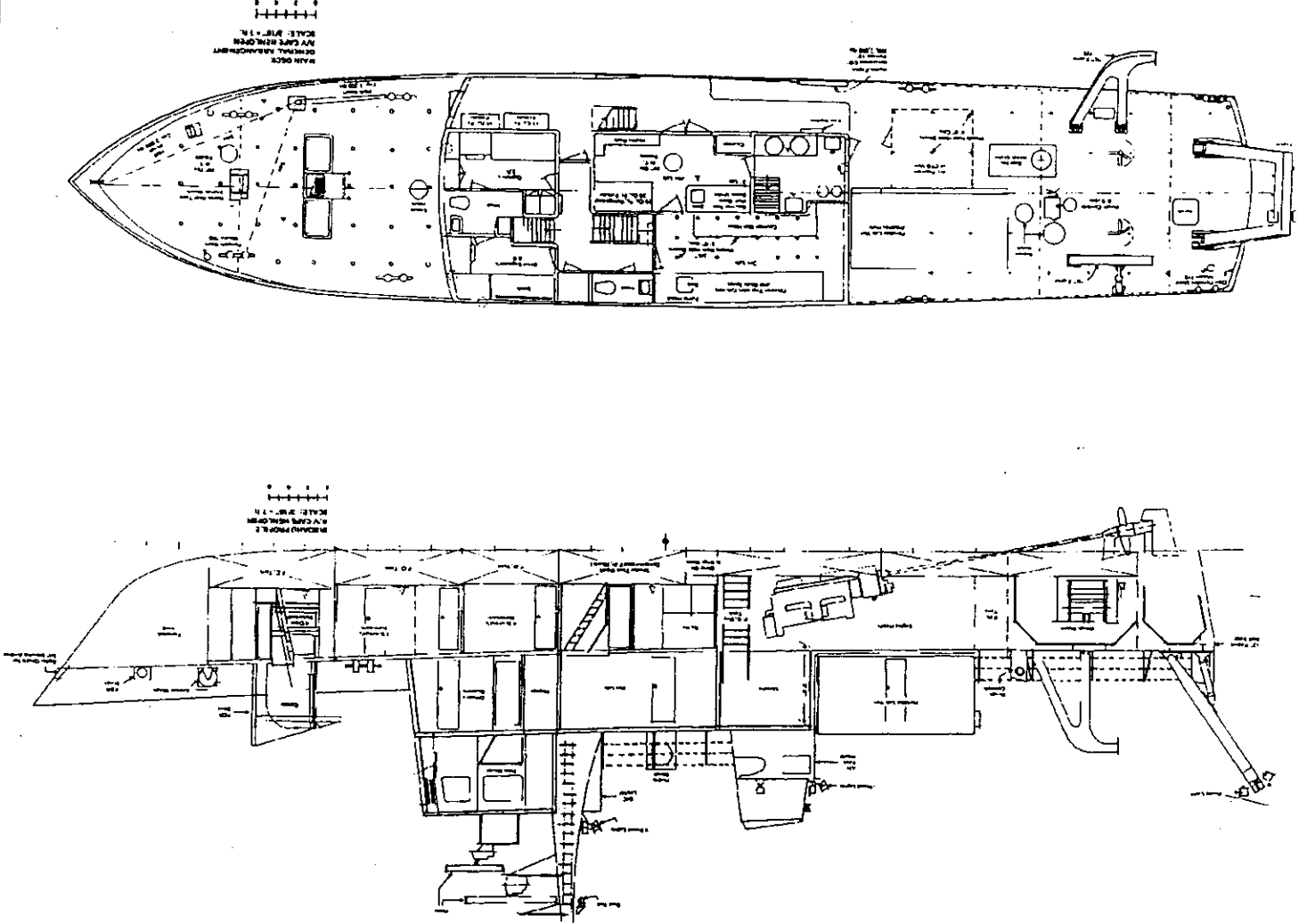

R/V POINT SUR

General Description

Built:	1980
Length:	41 m
Beam:	10 m
Laboratory Space:	65 m ²
Deck Space:	102 m ²

Capabilities

Scientific Equipment:	Seismic/Bathymetry, SBT System, Acoustic Doppler Current Profiler, Color Video Sounder, SAIL System, Hull Mounted Transducers
Communications:	
Navigation:	GPS Satellite Navigator, Loran C, Gyrocompass (2), Speed Log, Auto Pilot, Radar, Weather Fax, Wind Speed and Direction, Bridge Depth Sounder
Winches & Support Equipment:	Gallows Frame, A-Frame, Trawl Winch, CTD Winch, Oceanographic Winch, Portable Winch, Capstan
Scientific Berthing:	12
Cruising Speed:	11.5 kts
Range:	5,000 N. mi.
Endurance:	21 days
Applications:	Biological, Geological, Chemical, and Physical Oceanographic Research

Costs and Contacts

Base Rate:	\$
Owner/Operator:	Mike Prince, Marine Supt.
Contact:	Moss Landing Marine Laboratories (404) 633-3534/FAX(408) 633-4580

The R/V Point Sur was built in 1980 by Atlantic Marine Inc., and is especially suited for short to medium-length cruises. The R/V Point Sur is well equipped with all the necessary navigational, laboratory, and mechanical facilities that support biological, geological, chemical, and physical oceanographic research.

POINT SUR
RESEARCH VESSEL.....
135 ft.

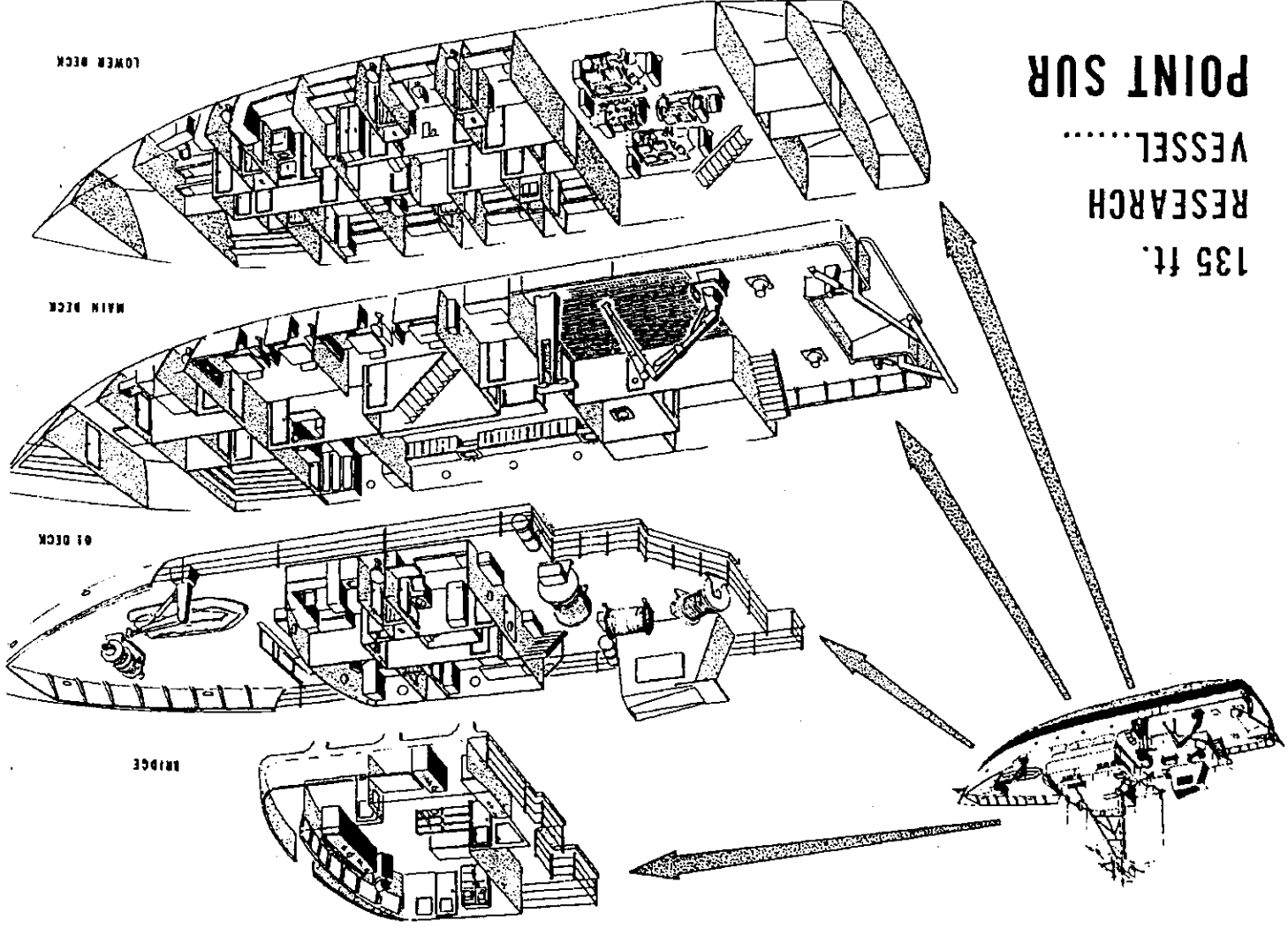

R/V ALPHA HELIX

General Description

Built:	1966
Length:	41 m
Beam:	9.4 m
Laboratory Space:	7.5 m ² (wet) 42.5 m ² (dry)
Deck Space:	118.9 m ²

Capabilities

Scientific Equipment:	Seismic/Bathymetry
Communications:	Single Side Band, VHF, CB, Weather FAX, Satellite Communicator, Inmarsat Satellite Communications
Navigation:	Satellite Navigator w/Global Positions Systems, Loran C, Radars (2), Gyrocompass, Depth Recorders, Wind Speed and Direction Indicator, Radio Direction Finder, Course Plotter, Barometers, Auto Pilot
Winches & Support Equipment:	Hydrowinch/J-Frame, Deep Sea (Trawl) Winch/Stern U-Frame
Scientific Berthing:	15
Cruising Speed:	10 kts
Range:	6500 N. mi.
Endurance:	30 days
Applications:	Bathymetric Surveys

Costs and Contacts

Base Rate:	
Contact:	Seward Marine Center (907) 224-5261/FAX (907) 224-3392

R/V Alpha Helix is owned by the National Science Foundation (NSF) and is operated by the University of Alaska Fairbanks, Institute of Marine Science. It has proven to be well-suited for operation in the rigorous conditions of the North Pacific and Bering Sea, as well as the fjords and near shore areas of the Alaska coast.

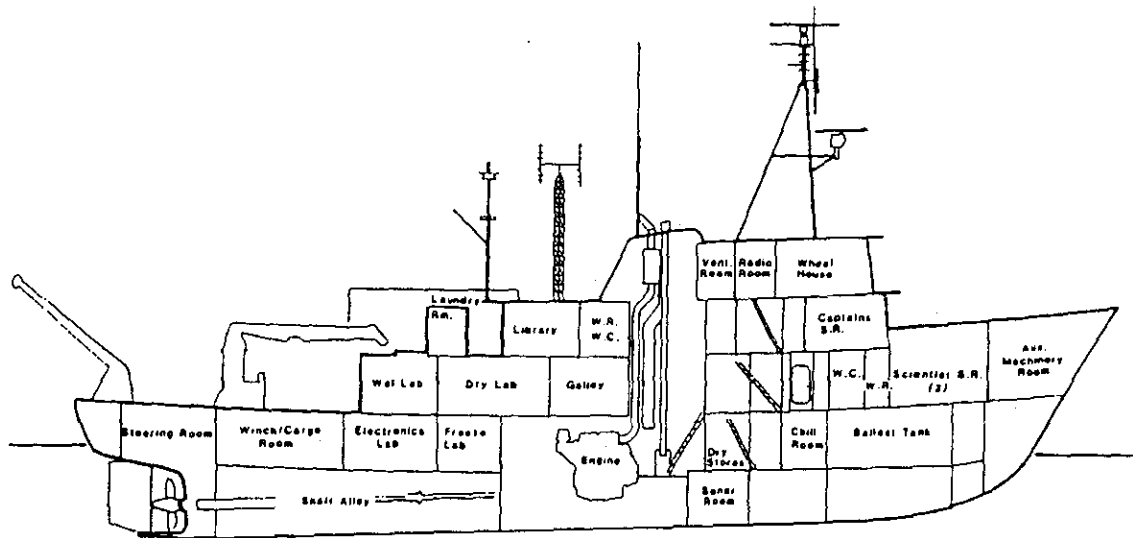

R/V ALPHA HELIX INBOARD PROFILE

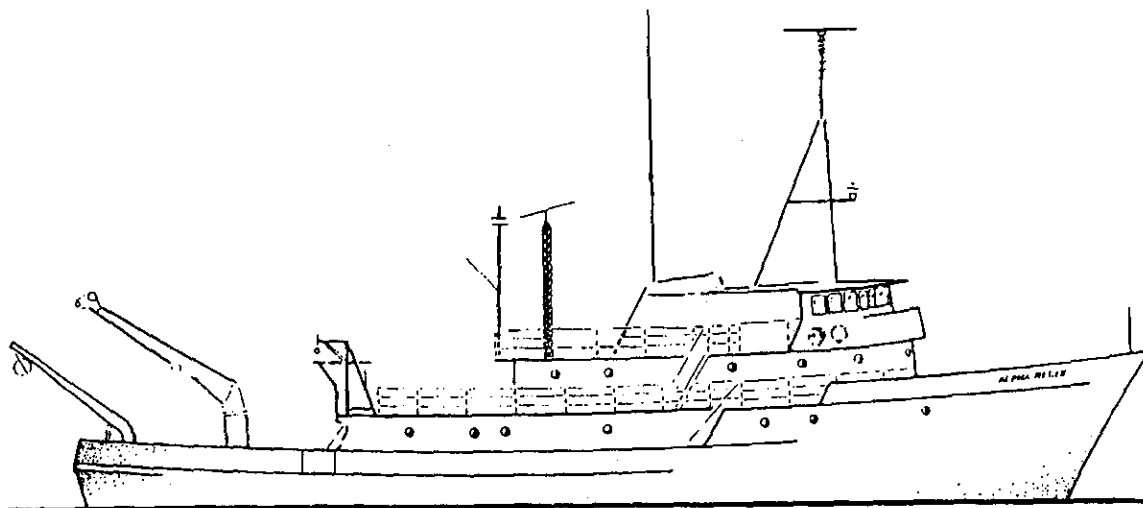

R/V ALPHA HELIX OUTBOARD PROFILE

LALAND MARINE TERMINAL

General Description

Type:	Single Point Offshore Loading System
Built:	1983
Water Depth:	23 m
Deck Area:	8.015 x 7.993 x 7.995 m
Height:	35.7 m

Capabilities

Operating Area:	Indonesia
-----------------	-----------

Costs and Contacts

Base Rate:	
Operator:	Hudbay Oil Ltd.
Contact:	

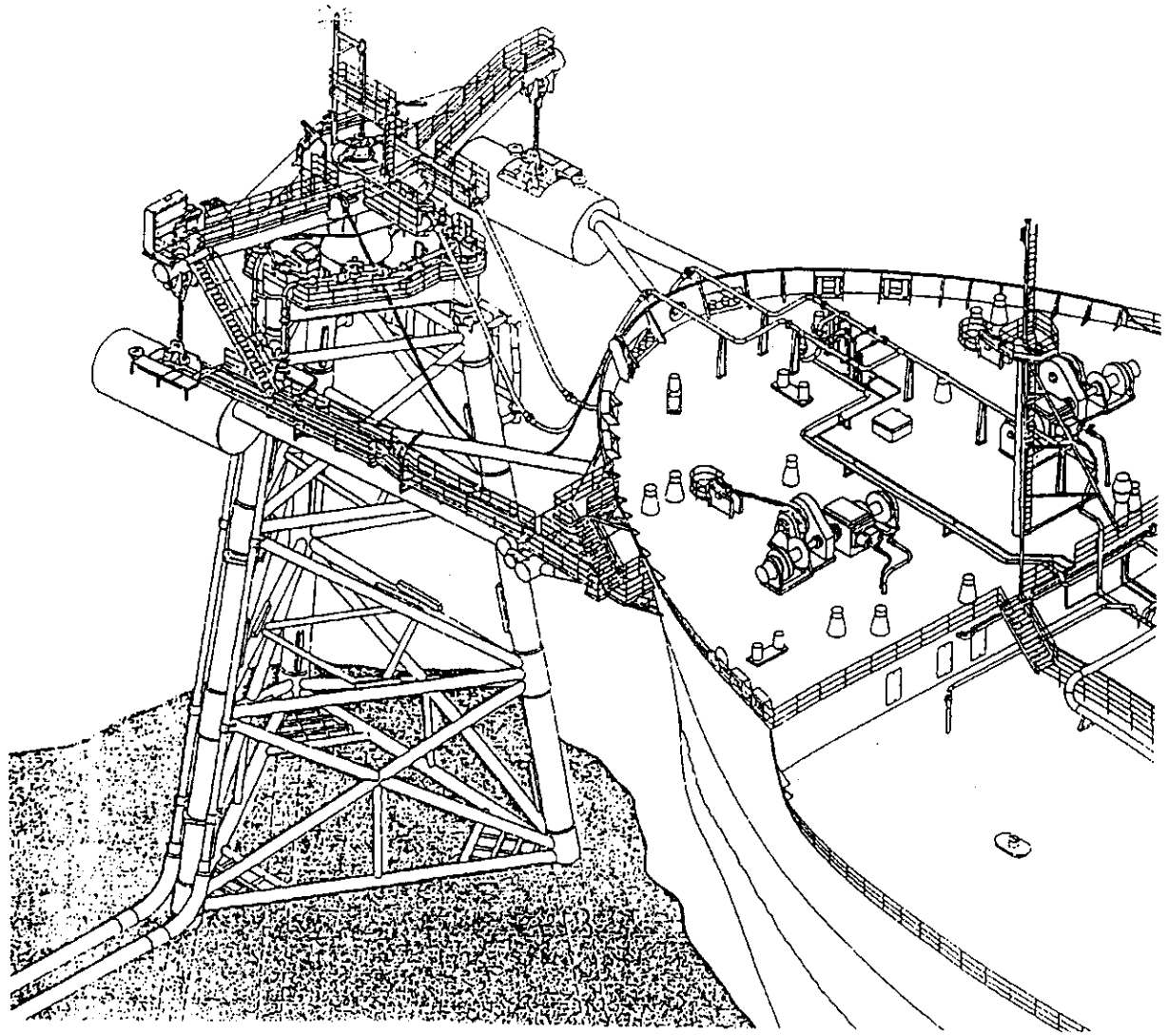

SNORRE TLP

General Description

Type:	Tension Leg Platform (TLP)
Built:	Under Construction
Deck Area:	138 m x 92 m x 15 m
Maximum Working Depth:	310 m
Heliport:	Aluminum helideck

Capabilities

Communications:

Instrumentation:

Equipment: 2 x Liebherr BOS Pedestal Cranes, Drilling Equipment

Berthing: 220 persons

Propulsion: 3 x Gas Turbine Packages, Total Capacity 60 MW

Dynamics:

Heave:

Roll:

Pitch:

Operating Area: Northern North Sea

Status: Producing

Costs and Contacts

Base Rate: \$

Owner/Operator: Saga Petroleum A/S

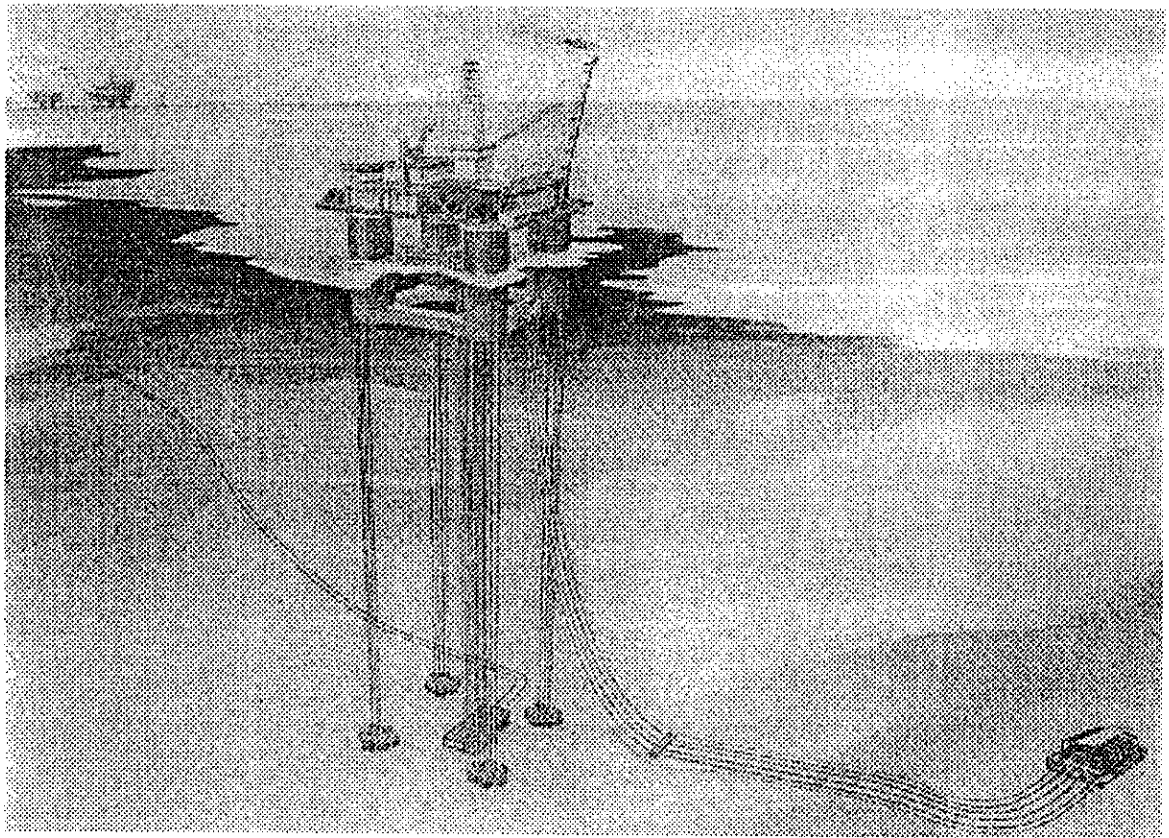

OCEAN ALLIANCE

General Description

Type:	Semi-submersible
Built:	1988
Deck Area:	1881 m ²
Maximum Working Depth:	7620 m
Heliport:	Boeing Chinook

Capabilities

Communications:

Instrumentation:

Equipment: Cantilever Beam Leg Mast 1,000,000 lb Derrick,
35 ton and 75 ton Crane, Drilling Equipment, 2
Cameron "D" BOP Systems

Berthing: 110 persons

Propulsion: 4 x Pielstick 12 PC2V Mk5 Diesel Engines Driving 5,600 kW
Alternator

Dynamics:

Roll	45.6 sec
Heave	21 sec
Pitch	41.8 sec

Operating Area:	USA
Status:	Drilling

Costs and Contacts

Base Rate:	\$
Owner:	Lloyds Leasing Limited
Manager:	Diamond M/OPDECO

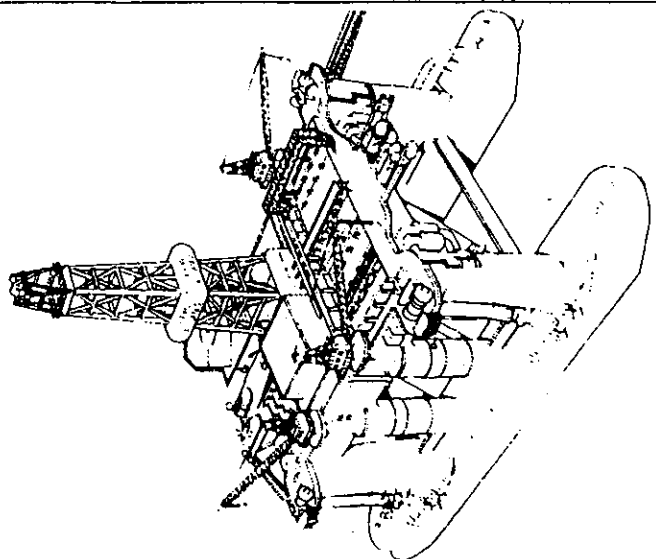
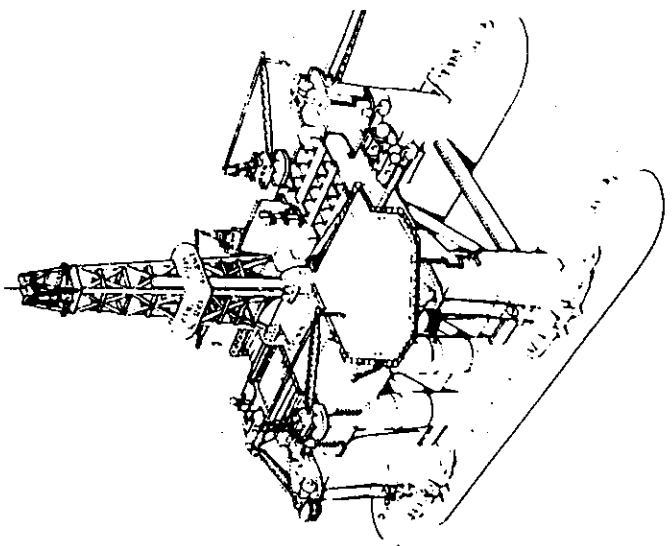

ZANE BARNES

General Description

Type:	Semi-submersible
Built:	1988
Deck Area:	8365 m ²
Maximum Working Depth:	915 m
Heliport:	S-61N

Capabilities

Communications:	VHF, HF(CW), SSB, ATS, Inmarsat
Navigation:	Satnav, GPS, Loran C, 3-cm and 10-cm Radar, and Doppler Log
Instrumentation:	
Equipment:	56-m Branham Derrick, 3 National Cranes w/ 37-m Booms, Drilling Equipment, 2 Cameron "D" BOP Systems
Berthing:	122
Main Power:	2 Wartsilla 12 V 32 D Diesels Driving 6,900v AC Motors, 4,500 kW Each; 2 Wartsilla 8R 32D Diesels Driving 6,900v AC Motors, 3,000 kW Each
Dynamics:	
Heave	0.5 m (wave height, H _w 5.5 m and period of 9 s)
Pitch	<4° (wave height, H _w 5.5 m and period of 9 s)
Roll	<4° (wave height, H _w 5.5 m and period of 9 s)
Operating Area:	China
Status:	Drilling

Costs and Contacts

Base Rate:	\$
Owner/Operator:	Reading & Bates Drilling Co. 901 Threadneedle Suite 200 Houston, TX 77279-2902 (713) 496-5000/FAX (713) 496-9560

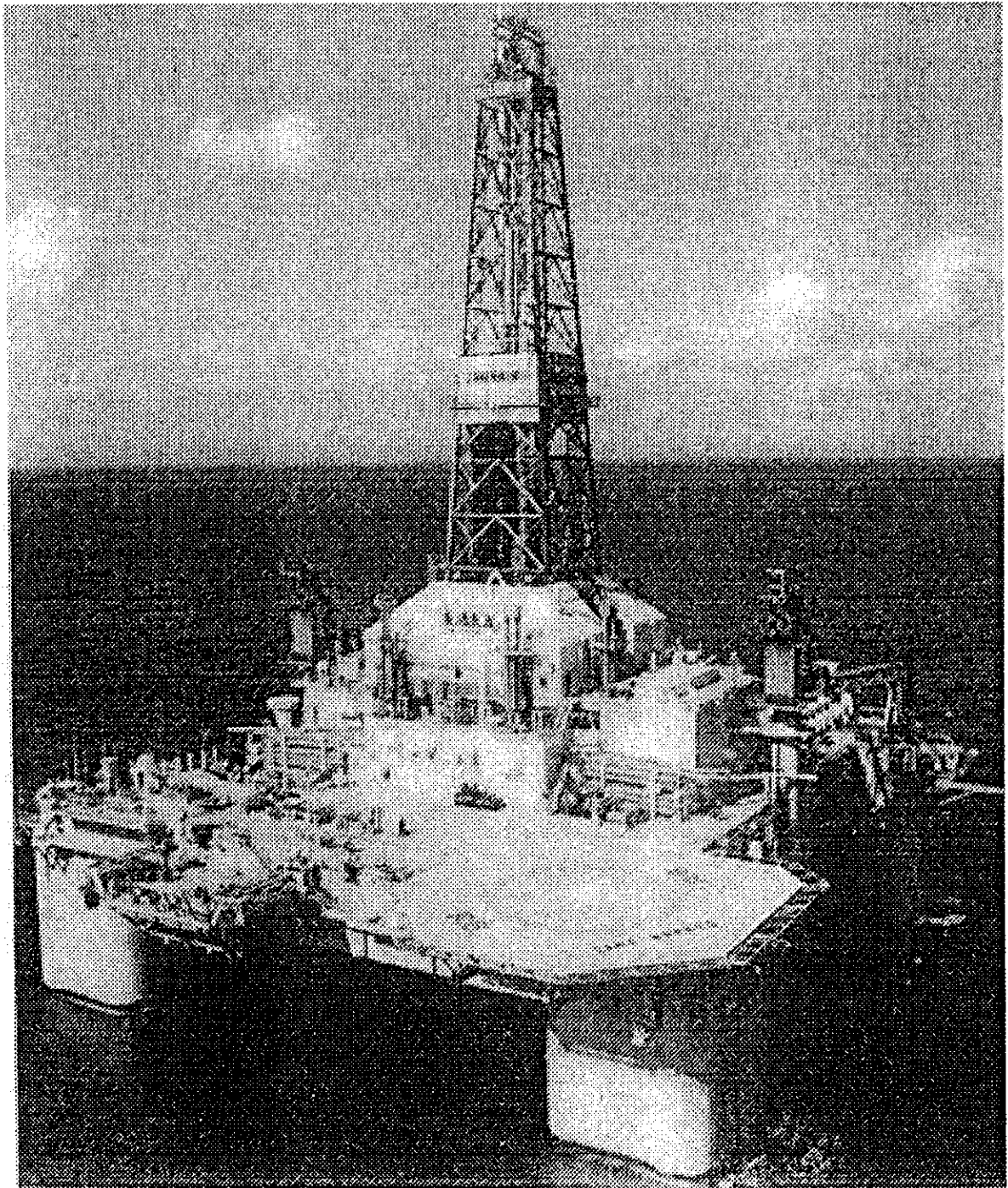

ROWAN MIDLAND

General Description

Type:	Semi-submersible
Built:	1976
Deck Area:	817 m ²
Maximum Working Depth:	7620 m
Heliport:	25 m diameter rated for S-61

Capabilities

Communications:

Instrumentation:

Equipment: Cantilever Beam Leg Mast 1,000,000 lb Derrick,
35 ton and 75 ton Crane, Drilling Equipment, 2
Cameron "D" BOP Systems

Berthing: 94 persons

Propulsion: None

Dynamics:

Heave:	19.2 sec
Roll:	42.0 sec
Pitch:	29.8 sec

Operating Area: USA

Status: Drilling

Costs and Contacts

Base Rate:	\$
Owner/Operator:	Rowan Companies Inc.

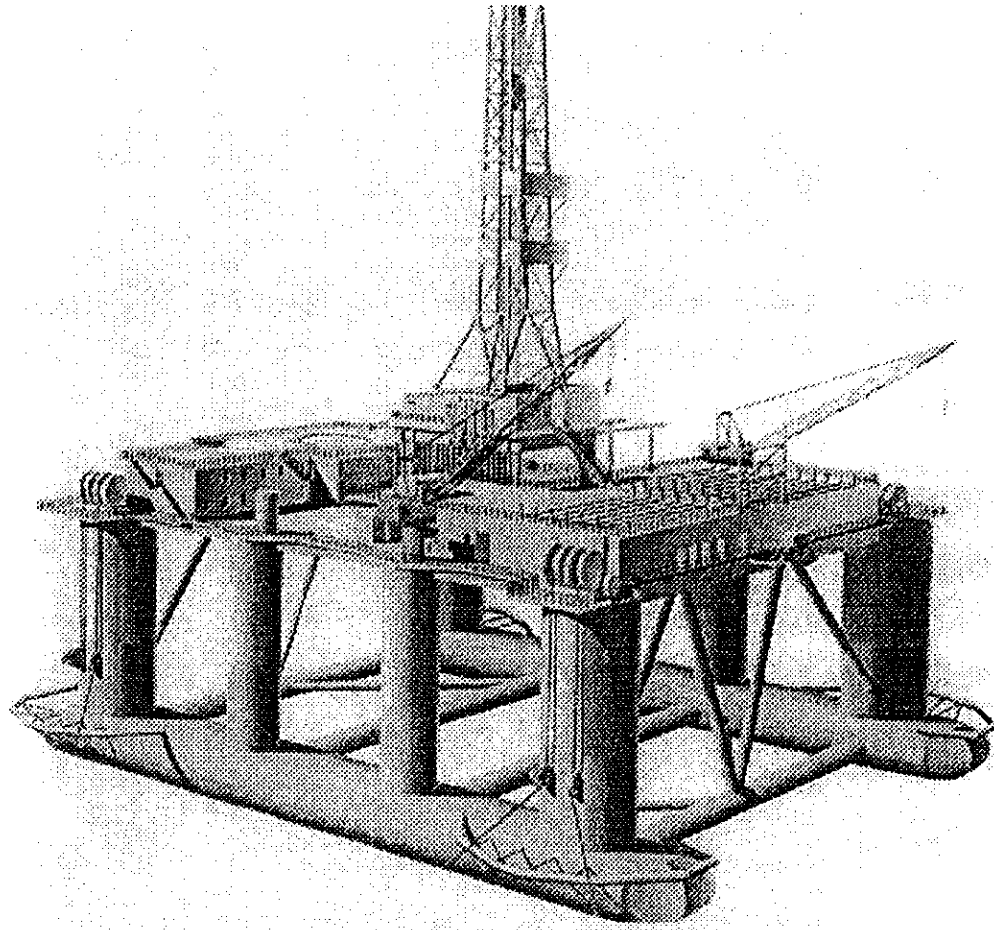

WESTERN TRITON 4

General Description

Type:	Jackup
Built:	1979
Deck Area:	3389 m ²
Maximum Working Depth:	6096 m
Helideck:	S-61N

Capabilities

Communications:

Navigation:

Instrumentation:

Equipment: Derrick w/ 1,000,000 lbs static load, (2) 800 hp Drawworks,
(3) 100 ft Booms w/50 Ton Cranes

Berthing: 90 persons

Main Power: 3 x EMD 16-645-E8 Diesels Each Driving (2) 100 kW
Generators

Dynamics: None

Operating Area: USA
Status: Drilling

Costs and Contacts

Base Rate:	\$
Owner/Operator:	Western Oceanics Inc.

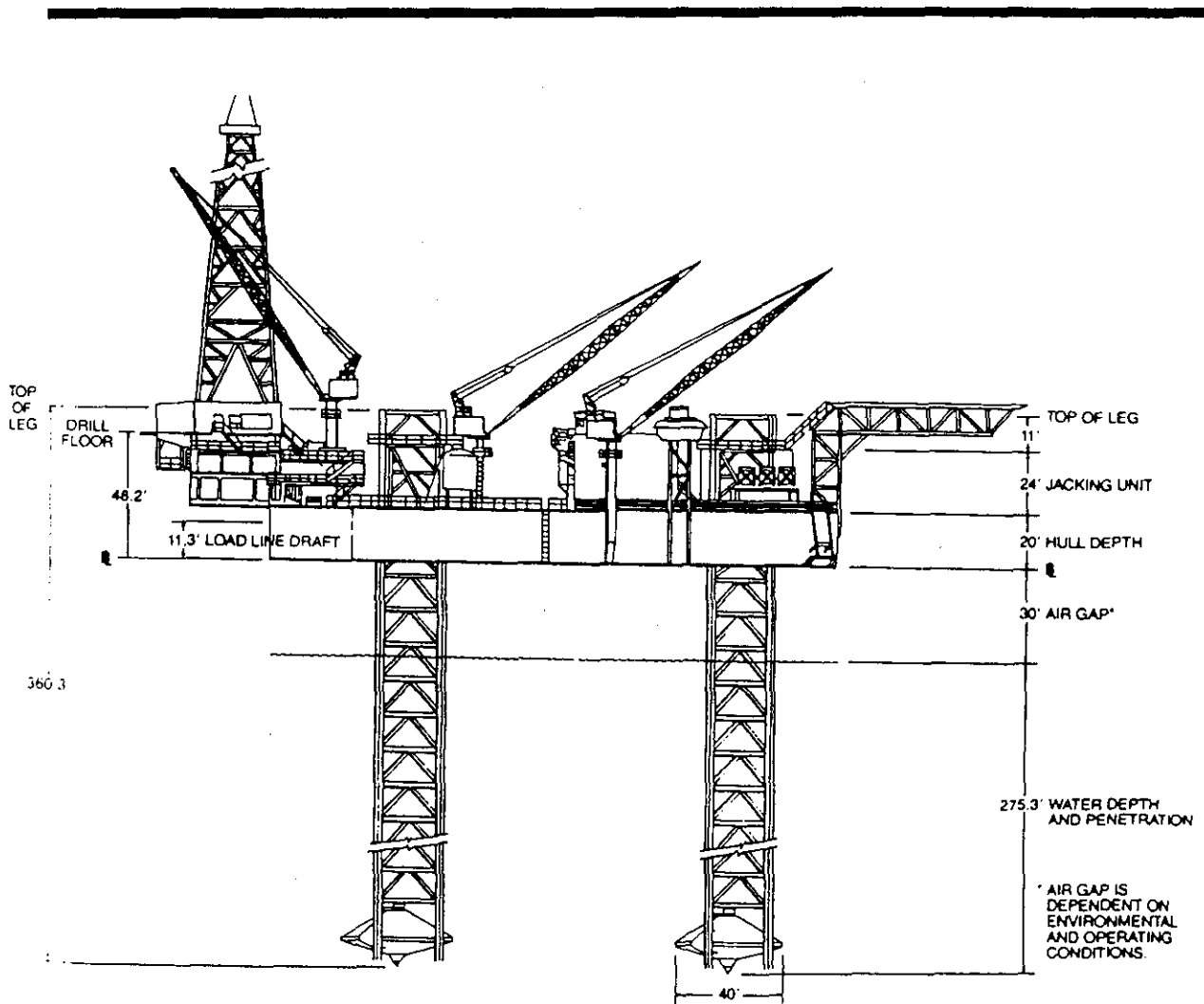

ZAPATA SCOTIAN

General Description

Type:	Jackup
Built:	1981
Deck Area:	4700 m ²
Maximum Working Depth:	7620 m
Helideck:	S-61N

Capabilities

Communications:	VHF, HF(CW), SSB, ATS, Inmarsat
Navigation:	
Instrumentation:	
Equipment:	1,600,000 lb Static Hook Load Derrick, Drawworks, 3 Cranes, B.O.P. System (3)
Berthing:	94
Main Power:	5 Caterpillar D-399 B Engines, 1,050 kW AC Generators
Dynamics:	None
Operating Area:	Panama
Status:	Drilling

Costs and Contacts

Base Rate:	\$
Owner/Operator:	Zapata Off-Shore Co.

NORTH-WEST HUTTON PLATFORM

General Description

Type:	Steel Jacket, Barge Launched
Built:	
Deck Area:	1872 m ²
Maximum Working Depth:	144.3 m
Heliport:	20-seat Tiger Helicopter

Capabilities

Communications: Microwave radio network to shore and Cormorant platform via two tropospheric scatter links; design, installation, commissioning Costain Process

Instrumentation:

Equipment: NEI Favco: 2 x 100 mt. pedestal cranes, diesel/hydraulic

Berthing: 224

Propulsion: 3 x Rolls-Royce Avon Gas Turbine Power Cooper Bessemer RG48 Turbines Driving Parsons Peebles 13 MVA Generators; 2 x Ruston TB Gas Turbines, Total 9800 bhp, Driving Compressors

Dynamics:

Operating Area: Northern North Sea

Status: In production

Costs and Contacts

Base Rate:	\$
Owner/Operator:	Amoco Exploration Company

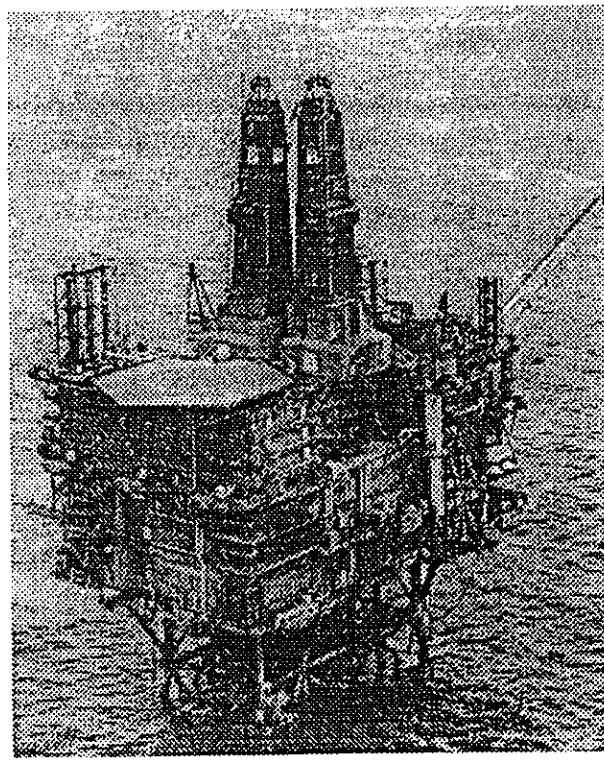
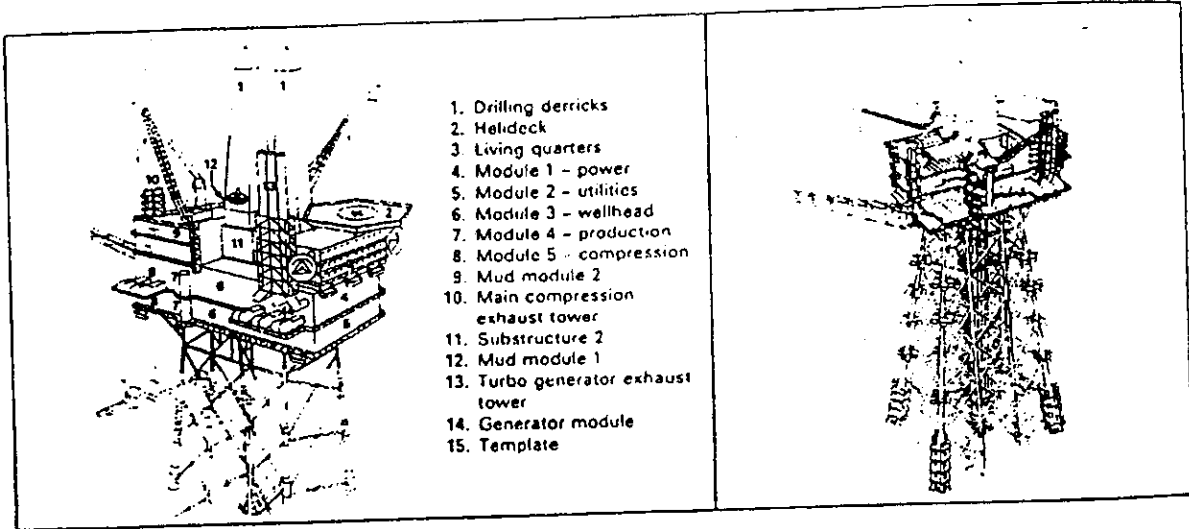

DRAFT - DO NOT REPRODUCE OR DISTRIBUTE

GULLFAKS 'C' PLATFORM

General Description

Type:	Gravity Platform
Built:	
Deck Area:	147 m x 63 m x 60 m high
Maximum Working Depth:	217 mm
Heliport:	Boeing Chinook

Capabilities

Communications:	All normal communications including satellite systems
Instrumentation:	
Equipment:	4 Pedestal Mount Deck Cranes
Berthing:	330 persons
Propulsion:	3 x 20 MW Gas Turbine Generation Packages, (2) MTU 396 TC33 16-cyl. Diesels for Emergency Gensets
Dynamics:	
Heave:	
Roll:	
Pitch:	
Operating Area:	Norwegian North Sea
Status:	Producing

Costs and Contacts

Base Rate:	\$
Owner/Operator:	

Gullfaks 'C' is to date the largest gravity base structure ever built and the heaviest man-made object ever moved. At approximately 1.5 million tons, the concrete gravity base structure is twice the weight of Statfjord 'B' platform.

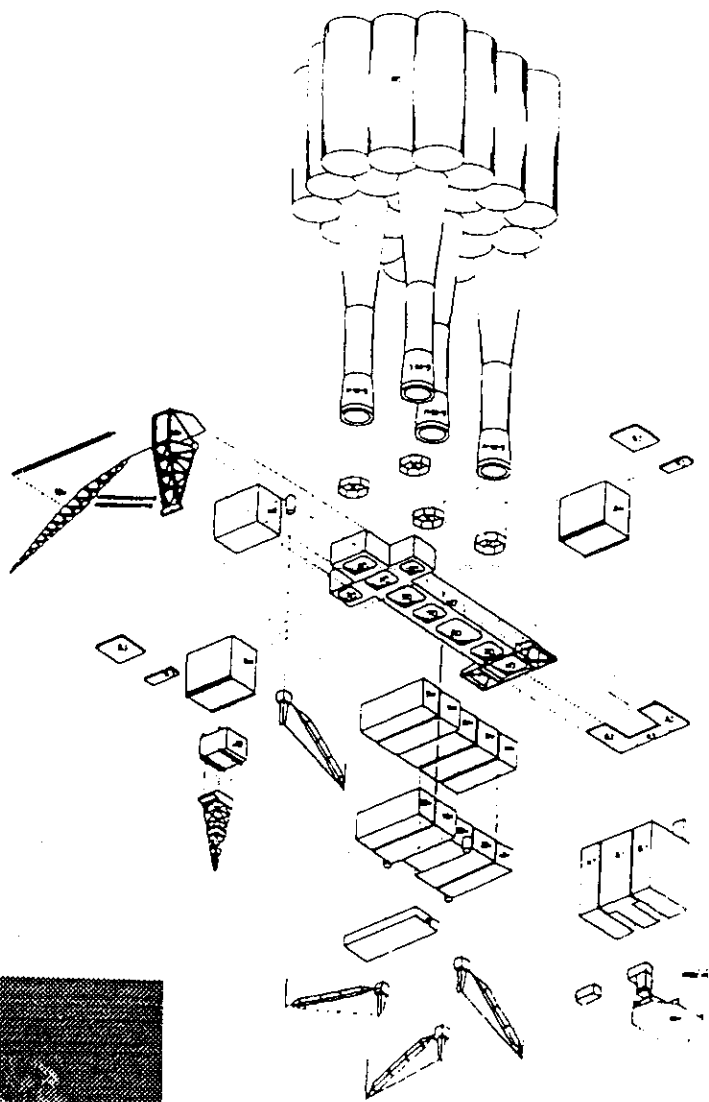

LEMAN 'H' PLATFORM

General Description

Type:	Steel Jacket, Crane Lift
Built:	
Deck Area:	576 m ²
Maximum Working Depth:	38 m
Heliport:	Helideck; starter unit; emergency equipment

Capabilities

Communications:	Line of sight, tied into existing route by Inspectorate EAE
Instrumentation:	
Equipment:	"Mardair" M200 Vent Array; National OS-45, 80 ft Boom 28 ton at 20 ft, CAT 3306 Motor
Berthing:	4-person cabin
Main Power:	Gas Driven Generation Units; Main Supply 415 V 3-Phase, 50 Hz
Dynamics:	
Operating Area:	Southern North Sea
Status:	In production

Costs and Contacts

Base Rate:	\$
Owner/Operator:	Amoco

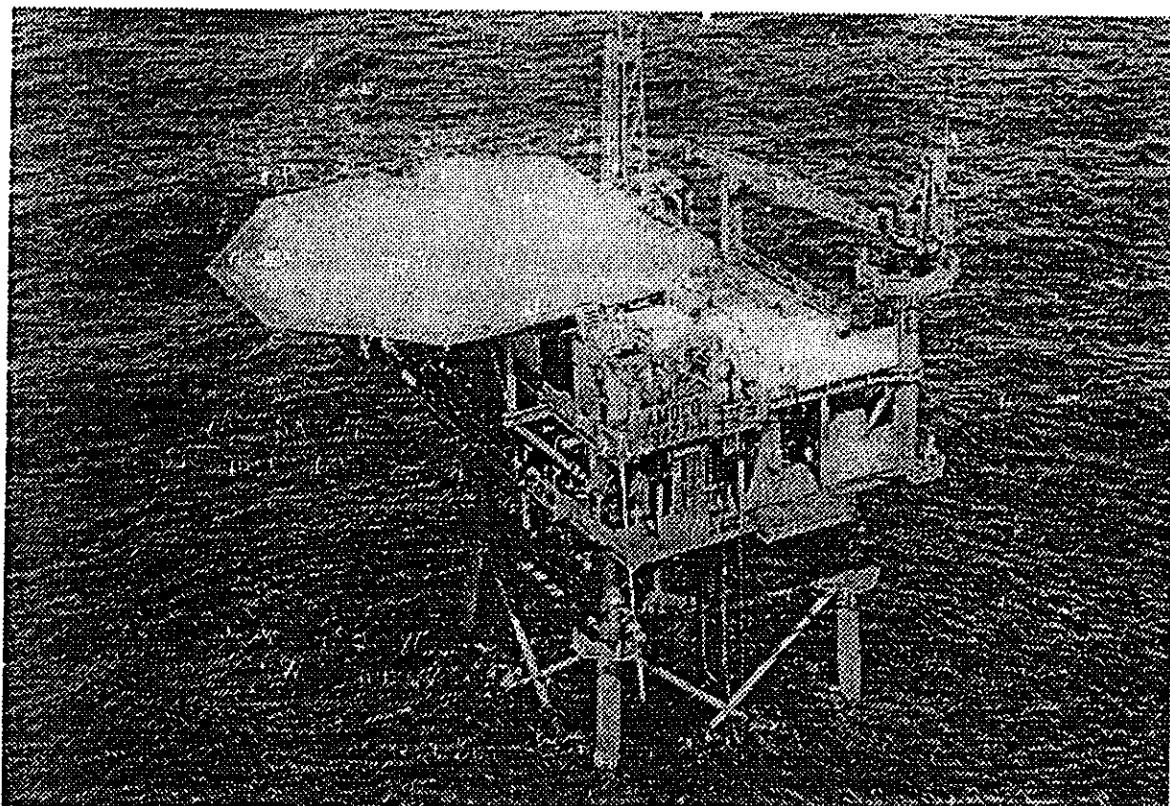

DRAFT - DO NOT REPRODUCE OR DISTRIBUTE

IVANHOE/ROB ROY FLOATING PRODUCTION FACILITY

General Description

Type:	Semi-submersible
Built:	
Deck Area:	6000 m ²
Maximum Working Depth:	140 m
Heliport:	S61N or Super Puma

Capabilities

Communications:	Microwave link to Tartan 'A' platform; message switching system, inspectorate EaE
Instrumentation:	
Equipment:	2 x 70 t Pedestal Cranes, Global Maritime Advisory Computer System (GMACS); Honeywell TDC 3000; Multiplexed Electro-Hydraulic-Control System
Berthing:	100
Operating Parameters:	100 Year Extremes: Maximum Wave 216.6 m High, Maximum Wind (3 sec gust) 57.0 m/sec; Maximum Water Depth 140 m
Propulsion:	3 x Ruston Tornado Gas Turbines, 5.7 MW Each; 2 x Diesel Driven MTU Emergency Generators, 1.4 MW Each at 6.6 kV
Dynamics:	
Operating Area:	Central North Sea
Status:	In production

Costs and Contacts

Base Rate:	\$
Owner/Operator:	Amerada Hess Limited

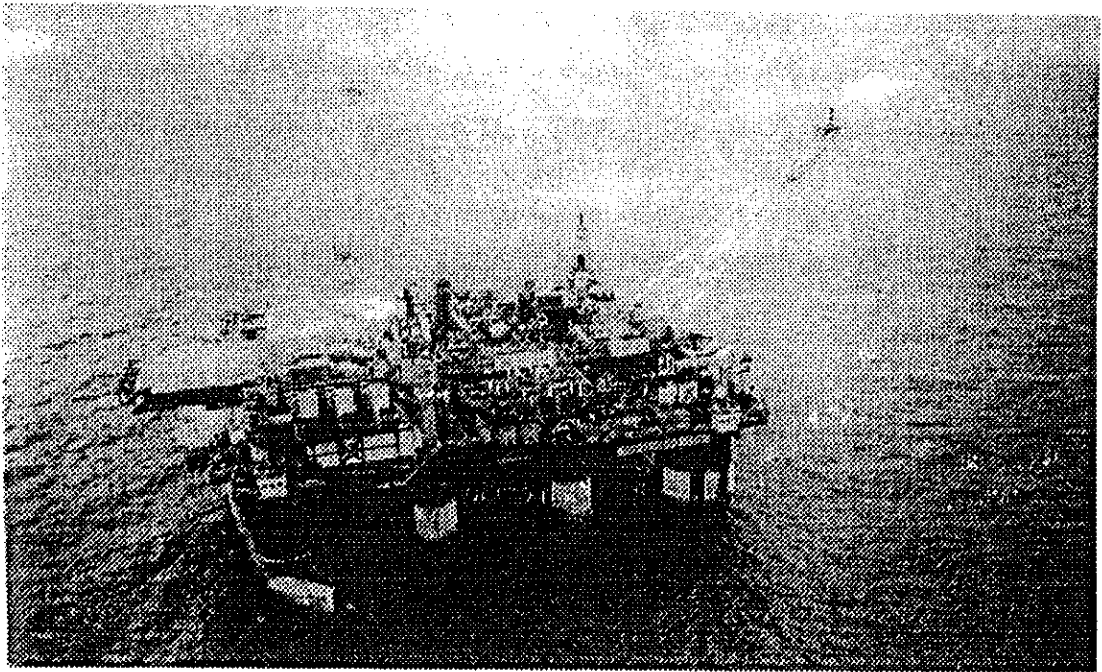
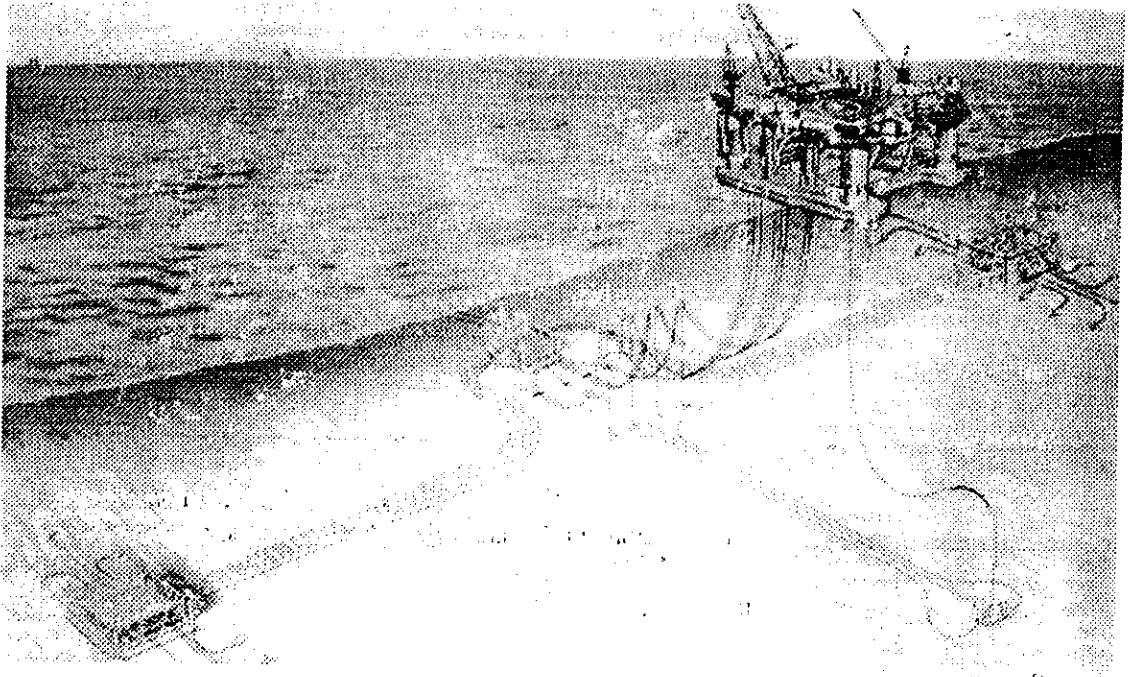

HORIZON

General Description

Type:	Jackup
Built:	1976
Deck Area:	2035 m ²
Maximum Water Depth:	76 m
Minimum Drilling Depth:	7620 m
Heliport:	390 m ²

Capabilities

Communications:

Instrumentation:

Equipment: Pyramid 1,000,000 lb Derrick, 2 Bucyrus Eyrie 50 Ton Cranes, Drilling Equipment, 2 Cameron "D" BOP Systems

Berthing: 56 persons

Propulsion: None

Dynamics: None

Operating Area: USA

Status: Drilling

Costs and Contacts

Base Rate:	\$
Owner/Operator:	Chiles Offshore Corporation

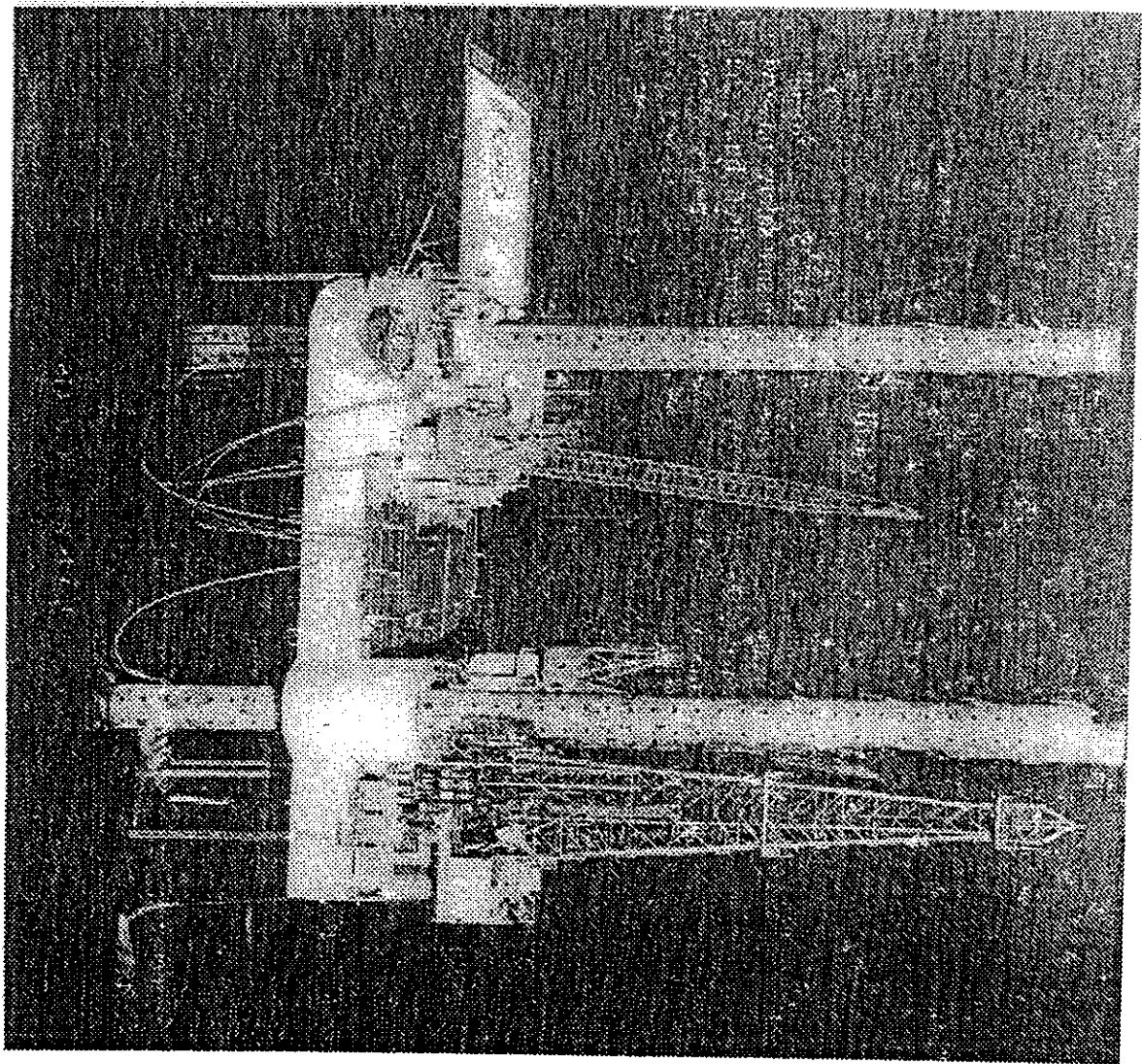

NORTH-EAST FRIGG FIELD CONTROL STATION

General Description

Type:	Articulated Steel Column, Gravity Base
Built:	Under Construction
Deck Area:	
Maximum Working Depth:	102.5 M
Heliport:	OIS "Safedek" for S61N

Capabilities

Communications: Teletransmission system from TCP2 to FCS to monitor all automatic equipment of FCS, and transmit safety and service commands from TCP2 such as shutdowns, firefighting, etc; additional communication systems include a radio link between FCS and Frigg and a slowscan TV system for remote observation of FCS plus an intercom linked by radio to Frigg QP, by Stentor A/S

Instrumentation:

Equipment: Methanol injection system

Berthing: 6; up to 12 during heavy maintenance; normally unmanned

Main Power: Power supplied from Frigg field via a subsea cable; diesel generators are installed on FCS for emergency power

Dynamics:

Operating Area: Northern North Sea

Status:

Costs and Contacts

Base Rate:	\$
Owner/Operator:	Elf Aquitaine Norge A/S

The FCS has four major components: 1) a concrete gravity base, 2) a universal joint connecting the base to the lower part of the column, 3) a cylindrical steel column (the largest component) and 4) a head incorporating the control systems, a helideck, living quarters, main deck holding machinery, and the methanol injection system and storage tanks.

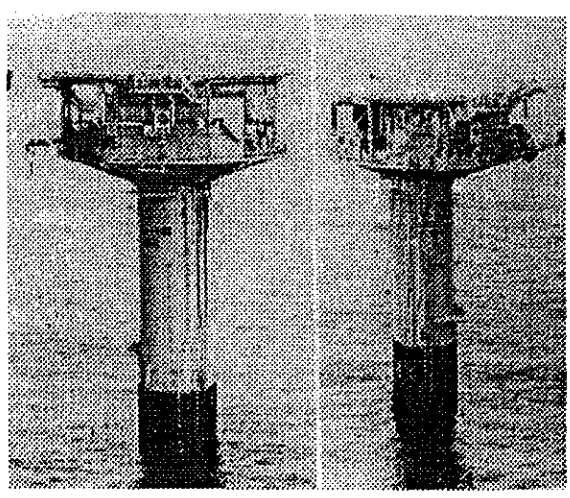
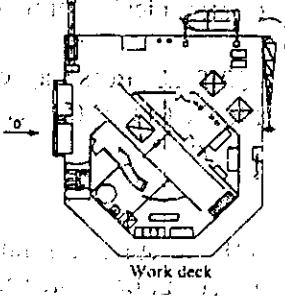
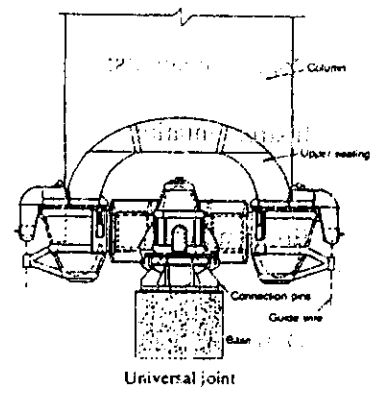
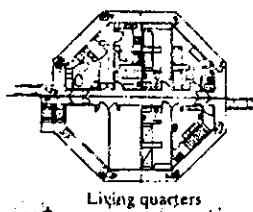
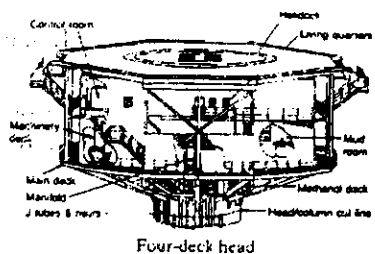
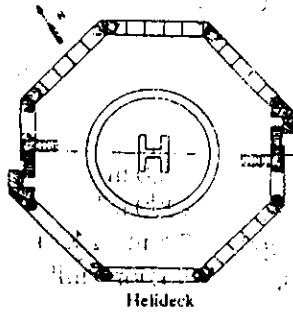
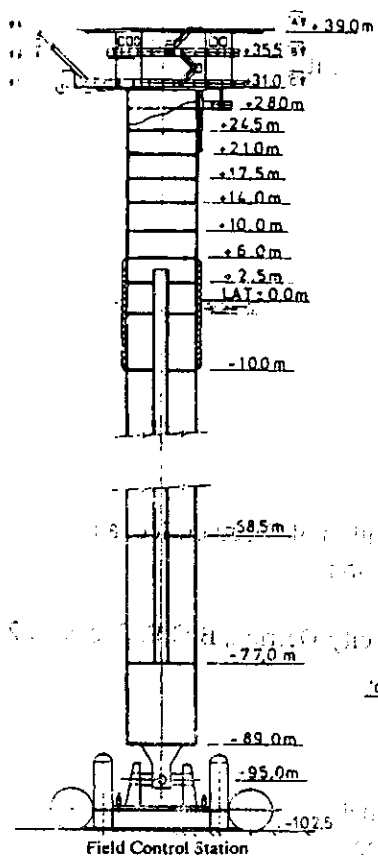

CANMAR SSSDC/MAT

General Description

Type: Offshore Drilling Unit
Built: 1986
Length: 202.4 m
Beam: 53.0 m
Deck Area: 9290 m²
Water Depth: 7.6 m - 24.4 m
Helideck: S61 or similar

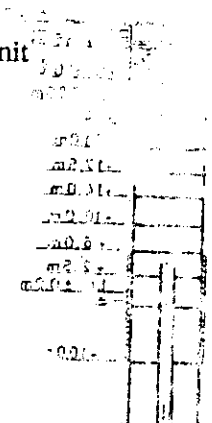
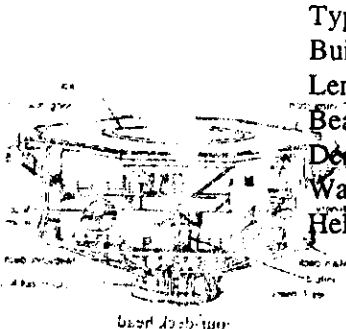

Capabilities

- Communications:
- Instrumentation:
- Equipment:
- Dynamics:
- Berthing:
- Operating Area:

- Complete instrumentation of Weather, Ice, and Geotechnical Information
- 650 Tonne Gross Capacity Derrick, B.O.P. Systems; 2 62 Mobile Cranes (5)
- 118 operating personnel
- Canadian Beaufort Sea

Costs and Contacts

Base Rate:
Owner: Canadian Marine Drilling Limited
Contact: Capt. Alex Hotchkiss
Calgary, Alberta, CANADA
(403) 298-2875/FAX (403) 298-2883

