

Rev CTL Map

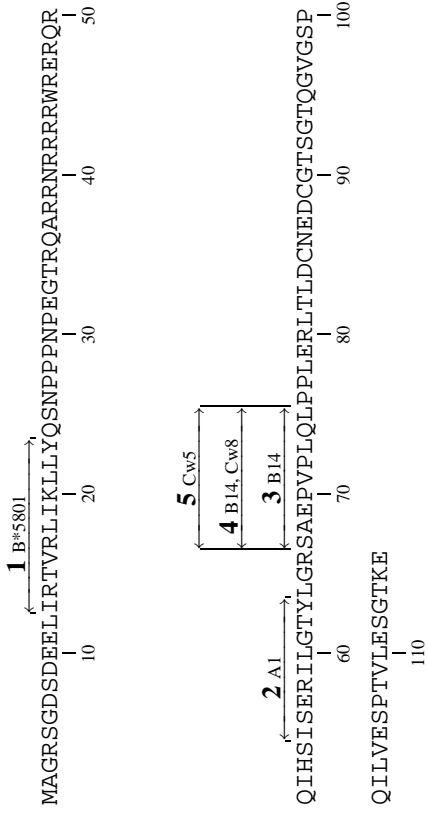

gp160 CTL Map

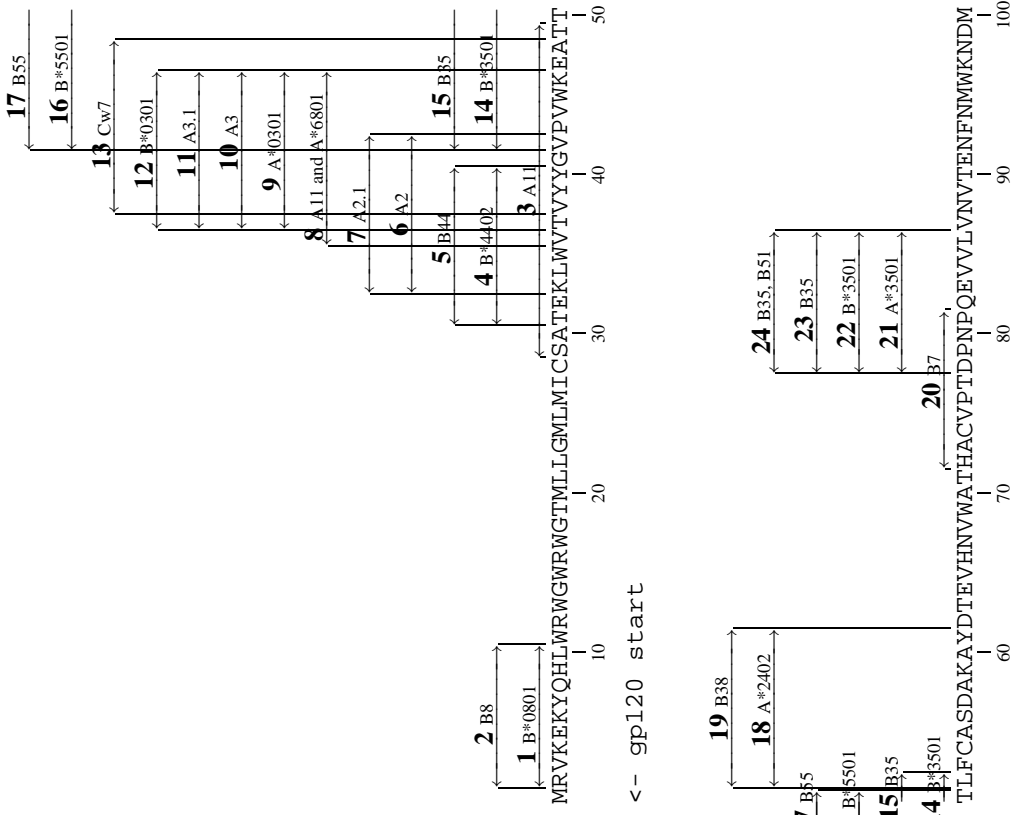

HIV CTL Protein Maps

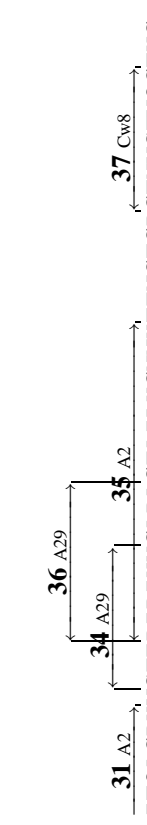
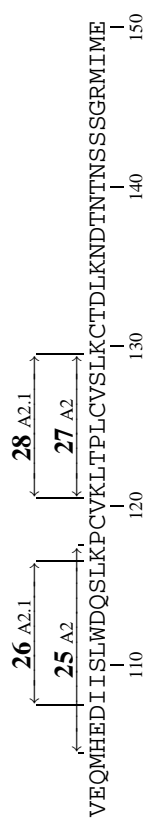
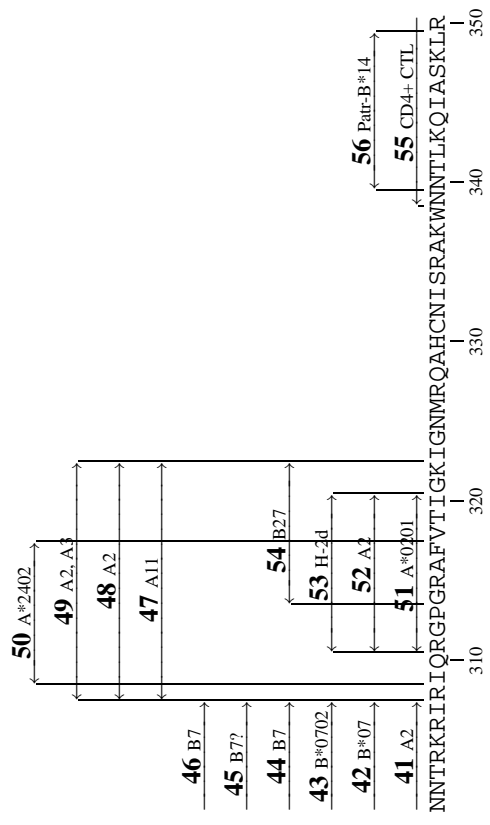

HIV CTL Protein Maps

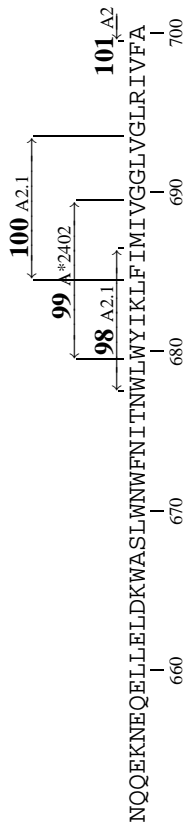
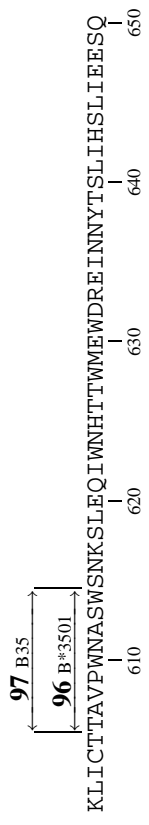
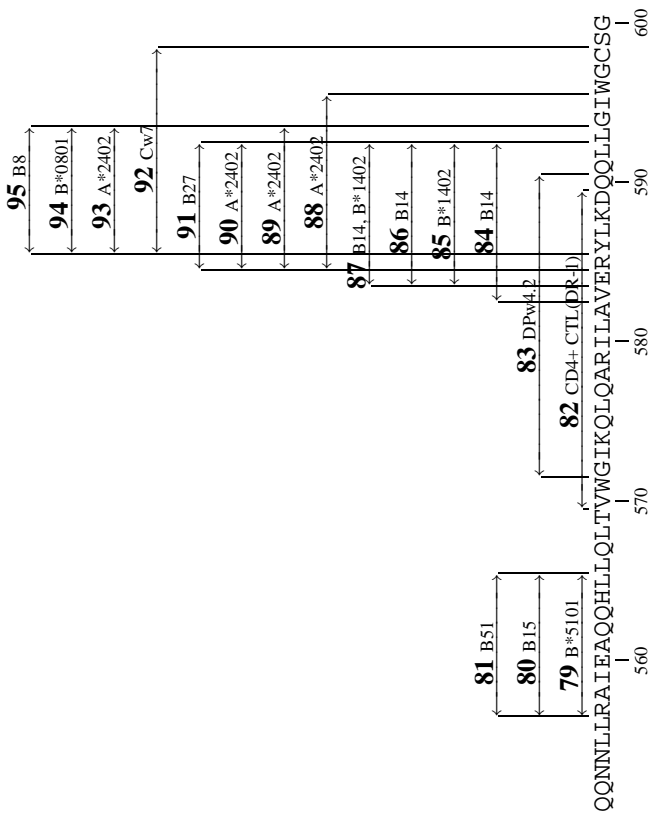
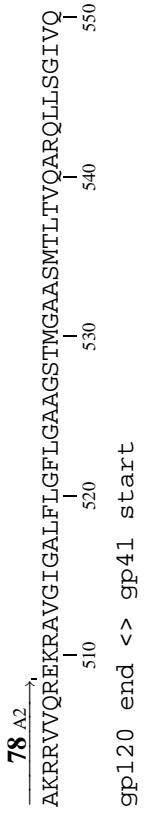
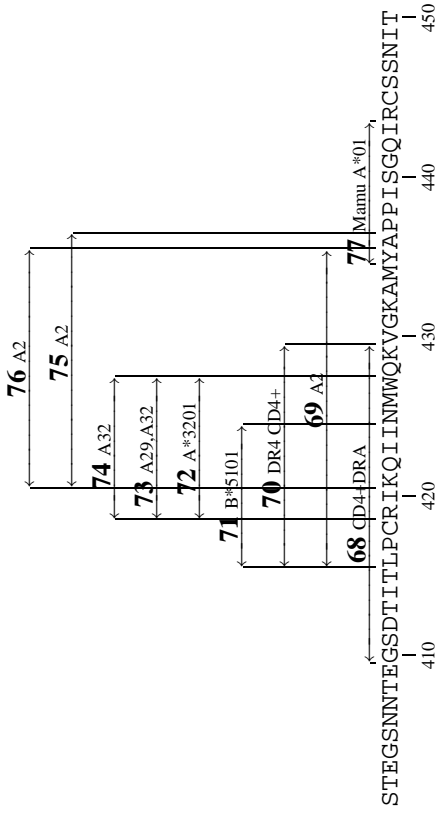

CTL

HIV CTL Protein Maps

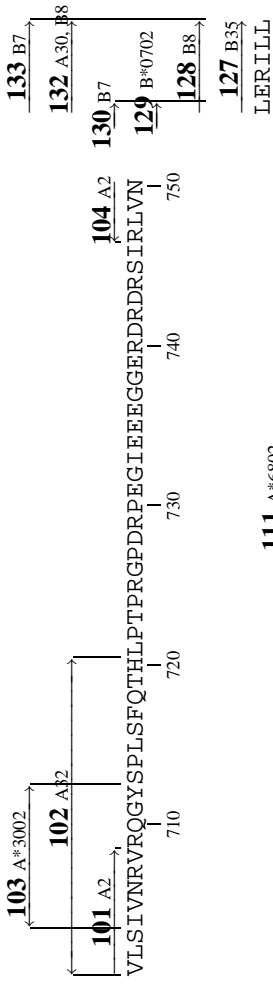

-> gp41 end

