

**SAND2003-0719
Unlimited Release
Printed May 2003**

Blade Manufacturing Improvements Remote Blade Manufacturing Demonstration

TPI Composites, Inc.
373 Market Street
Warren, RI 02885

ABSTRACT

The objective of this program was to investigate manufacturing improvements for wind turbine blades. The program included a series of test activities to evaluate the strength, deflection, performance, and loading characteristics of the prototype blades. The original contract was extended in order to continue development of several key blade technologies identified in the project. The objective of the remote build task was to demonstrate the concept of manufacturing wind turbine blades at a temporary manufacturing facility in a rural environment. TPI Composites successfully completed a remote manufacturing demonstration in which four blades were fabricated. The remote demonstration used a manufacturing approach which relied upon material "kits" that were organized in the factory and shipped to the site. Manufacturing blades at the wind plant site presents serious logistics difficulties and does not appear to be the best approach. A better method appears to be regional manufacturing facilities, which will eliminate most of the transportation cost, without incurring the logistical problems associated with fabrication directly onsite. With this approach the remote facilities would use commonly available industrial infrastructure such as enclosed workbays, overhead cranes, and paved staging areas. Additional fatigue testing of the M20 root stud design was completed with good results. This design provides adhesive bond strength under fatigue loading that exceeds that of the fastener. A new thru-stud bonding concept was developed for the M30 stud design. This approach offers several manufacturing advantages; however, the test results were inconclusive.

ACKNOWLEDGEMENTS

TPI Staff: Derek Berry and Steve Lockard
Dynamic Design: Kevin Jackson
MDZ Consulting: Mike Zuteck

Sandia Technical Monitor: Tom Ashwill

This is a Contractor Report for Sandia National Laboratories that partially fulfills the deliverables under Contract #AX-2111A.

TABLE OF CONTENTS

LIST OF TABLES	6
LIST OF FIGURES	7
1.0 BLADE DESIGN	9
1.1 Project Overview	9
1.2 Blade Design Development	10
1.2.1 Mold Configuration	10
1.2.2 Root Attachment	11
1.2.3 Blade Qualification Testing	13
1.2.4 Blade Operational Testing	15
1.2.5 Blade Design Improvements	17
2.0 BLADE MANUFACTURING	18
2.1 Manufacturing Process Review	18
2.2 Remote Manufacturing Facility	21
2.3 Preparation of Blade Construction Materials	24
2.3.1 Material Cutting	24
2.3.2 Insertion of Dry Materials	25
2.3.3 Mixing of Resin	27
2.3.4 Blade Shell and Shear Web Infusion	28
2.3.5 Root Stud Bonding	28
2.3.6 Blade Shell Demolding	29
2.3.7 Finished Blade Assembly	29
2.3.8 Blade Finishing	32
2.3.9 Weight and Balance Measurement	32
2.4 Blade Qualification Testing	33
3.0 ROOT IMPROVEMENT	36
3.1 Root Stud Design	36
3.2 Root Stud Bonding	37
3.2.1 Manual Bonding	37
3.2.2 Direct Embedment	38
3.2.3 Thru-Stud Bonding	38
3.3 M20 Root Stud Testing	39
3.4 M30 Root Stud Testing	43
3.4.1 Review of M30 Stud Test Results	45
4.0 PROJECT SUMMARY	47
4.1 Blade Remote Manufacturing Demonstration	47
4.2 Blade Root Improvement	47
5.0 REFERENCES	48

LIST OF TABLES

Table 3.1	Summary of M20 Root Stud Test Results.....	42
Table 3.2	Comparison of M20 and M30 Root Stud Test Results.....	45

LIST OF FIGURES

Figure 1.1	Schematic of Candidate Mold Configurations.....	10
Figure 1.2	Typical Blade Cross-Section.....	11
Figure 1.3	Illustration of Blade Root Stud Design.....	12
Figure 1.4	Photograph of the Blade Root Cavities.....	12
Figure 1.5	NWTC Static Test Load Application System.....	13
Figure 1.6	Photograph of the ERS-100 Blade After Static Failure.....	14
Figure 1.7	Photograph of the ERS-100 Panel Buckling Location.....	14
Figure 1.8	Operational Test Turbines.....	15
Figure 1.9	Performance Test Comparison.....	16
Figure 1.10	Gelcoat Cracking at the Bond Line.....	16
Figure 1.11	Cross-Section of Root Laminate Showing Fiber Folding.....	17
Figure 2.1	Blade Manufacturing Process Schematic.....	21
Figure 2.2	Remote Manufacturing Demonstration Building Exterior.....	22
Figure 2.3	Remote Manufacturing Demonstration Building Interior.....	22
Figure 2.4	Portable Propane Heater and Gasoline Generator.....	22
Figure 2.5	Portable Vacuum Generator.....	23
Figure 2.6	Delivery of the Bond Assembly Fixture.....	23
Figure 2.7	Delivery of the Blade Skin Molds.....	23
Figure 2.8	Movement of Blade Skin Molds Into the Structure.....	24
Figure 2.9	Automated Fabric Marking and Cutting.....	24
Figure 2.10	Material Weight Measurement Equipment.....	25
Figure 2.11	Blade Material Kits Prepared for Shipment.....	25
Figure 2.12	Placement of Dry Fabric in the Shear Web Mold.....	26
Figure 2.13	Placement of Balsa Coring in a Blade Skin Mold.....	26
Figure 2.14	Inspecting for Vacuum Leaks Before Skin Infusion.....	27
Figure 2.15	Mixing Resin Prior to Infusion.....	27
Figure 2.16	Partially Infused Shear Web.....	28
Figure 2.17	Blade Skin and Shear Web in the Bond Assembly Fixture.....	29
Figure 2.18	Blade Skin and Shear Web Preparation for Bonding.....	30
Figure 2.19	Closure of the Bond Assembly Fixture.....	31
Figure 2.20	Final NPS-100 Blade Assembly.....	32
Figure 2.21	Static Balance Measurement Locations.....	32
Figure 2.22	TPI Composites Static Blade Test Stand.....	33
Figure 2.23	Static Failure Moment on 15 February 2002 Test.....	34

Figure 2.24	NPS-100 Static Failure on 15 February 2002 Test	34
Figure 2.25	Static Failure Moment on 5 March 2002 Test.....	34
Figure 2.26	Static Failure Moment on 11 March 2002 Test.....	35
Figure 3.1	Illustration of the M20 Blade Root Stud	36
Figure 3.2	Illustration of the M30 Blade Root Stud	37
Figure 3.3	Root Stud Preparation for Direct Embedment	38
Figure 3.4	Thru-Stud Bonding	39
Figure 3.5	M20 Stud Test Specimen Cross-Sections.....	40
Figure 3.6	M20 Blade Root Stud Specimen Sheets	41
Figure 3.7	M20 Blade Root Stud Specimens.....	41
Figure 3.8	Summary of M20 Root Stud Test Results	42
Figure 3.9	Root Stud Fatigue Test Equipment.....	43
Figure 3.10	Failed M30 Stud From Specimen #1.....	44
Figure 3.11	Failed M30 Stud From Specimen #6.....	44
Figure 3.12	Comparison of M20 and M30 Root Stud Test Results	45

1.0 BLADE DESIGN

1.1 Project Overview

The goal of the Sandia National Laboratories Blade Manufacturing Improvements (BMI) program was to improve composite manufacturing processes such that costs were reduced and reliability was enhanced. TPI Composites wind turbine manufacturing development efforts were funded under a BMI contract from Sandia (contract AX-2111) and organized into two phases. The objective of the first phase was to investigate manufacturing improvements for wind turbine blades utilizing TPI Composites, Inc. (TPI) patented Seemann Composites Resin Infusion Molding Process (SCRIMP™), reusable silicone bags, and internally heated molds.

Implementation of the project began in July of 1998, and the first prototype blades, denoted as ERS-100, were completed in July of 1999. The ERS-100 blade was intended as a replacement blade for USW 56-100 turbine. The program included a series of test activities to evaluate the strength, deflection, performance, and loading characteristics of the prototype blades. The tests were broadly categorized as either qualification tests, which occurred in a laboratory environment, or operational tests, which took place on a wind turbine producing electricity in a commercial wind plant environment. Testing of the proof-of-concept blades was completed in the fourth quarter of 1999. The results of the initial effort are documented in the BMI Final Report [1].

After successful completion of the original BMI effort, TPI Composites began a contract extension (second phase) to further develop its blade manufacturing system. Work under the BMI Extension was focused on developing revisions in both design and manufacturing to transition the prototype blade into a commercial blade. Another primary goal was to investigate the feasibility and issues associated with fabricating wind turbine blades away from the normal manufacturing setting.

The BMI Extension began in August 2000 and consisted of two separate but interdependent tasks: 1) a remote manufacturing demonstration to evaluate the concept of manufacturing wind turbine blades at a temporary manufacturing facility, and 2) a root improvement effort to further develop and test the manufacturing techniques for blade root studs. The remote manufacturing demonstration was completed in the fourth quarter of 2001, while root stud development and testing continued into first quarter of 2002.

The original ERS-100 blade design and tooling were modified for use on the North Wind 100 wind turbine under a contract with Northern Power Systems (NPS). The root region for the NPS-100 was extended in length and the stud pattern was changed to match the design requirements of the North Wind 100 turbine. The NPS-100 design was used as the basis for blade fabrication in the remote manufacturing effort and in subsequent testing during the BMI Extension.

1.2 Blade Design Development

1.2.1 Mold Configuration

During the original BMI contract (first phase), TPI Composites considered a number of different mold configurations (Figure 1.1). The concepts ranged from a conventional, low risk clamshell design to a high risk one-piece construction method. Each of the molding methods showed merit, but our goal was to select the most cost-effective mold configuration and produce a finished blade that met the design criteria for structure and airfoil shape.

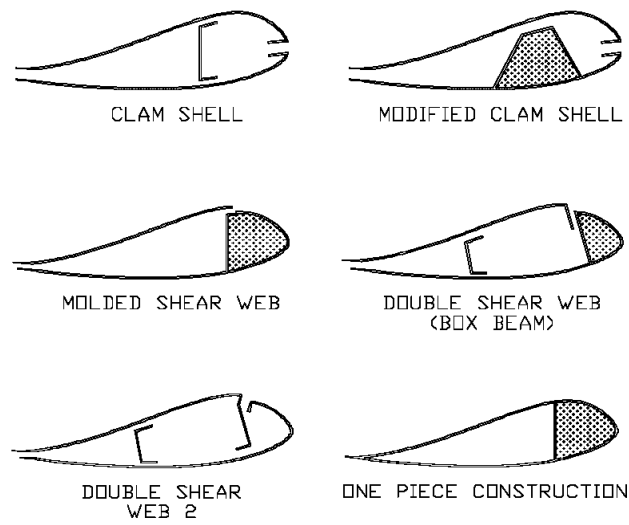

Figure 1.1 Schematic of Candidate Mold Configurations

Several configurations included a double shear web in the blade design. These designs were removed from consideration because the structure of the blade did not warrant an additional shear web. The material cost of this additional web made these methods less than ideal in a small blade; however, these molding methods may have merit in larger blades where a second web is necessary to offset panel buckling.

Integrally molded shear webs and one piece construction were also studied. Each of these concepts was found to have merit, but were considered to have significant technical and manufacturing risk. However these concepts should be reviewed in the context of large blades, which should have less space restrictions.

TPI Composites performed detailed studies of the standard clamshell and modified clamshell approaches. The modified clamshell approach was attractive because it eliminated one bond line. Further study and experimentation proved that the method was not as efficient as it first appeared.

The addition of foam to form the web proved expensive, and labor savings were not expected to offset the increased material cost. This method may prove to be more cost effective in larger blades where a separate mold could be used to form the web.

The clamshell design proved to be the most cost effective method for building the blades, but presented significant challenges in maintaining leading edge profile tolerances. To overcome these challenges, the mold parting line was modified to move the bond line to an area with less aerodynamic significance (Figure 1.2, assembly bond #3).

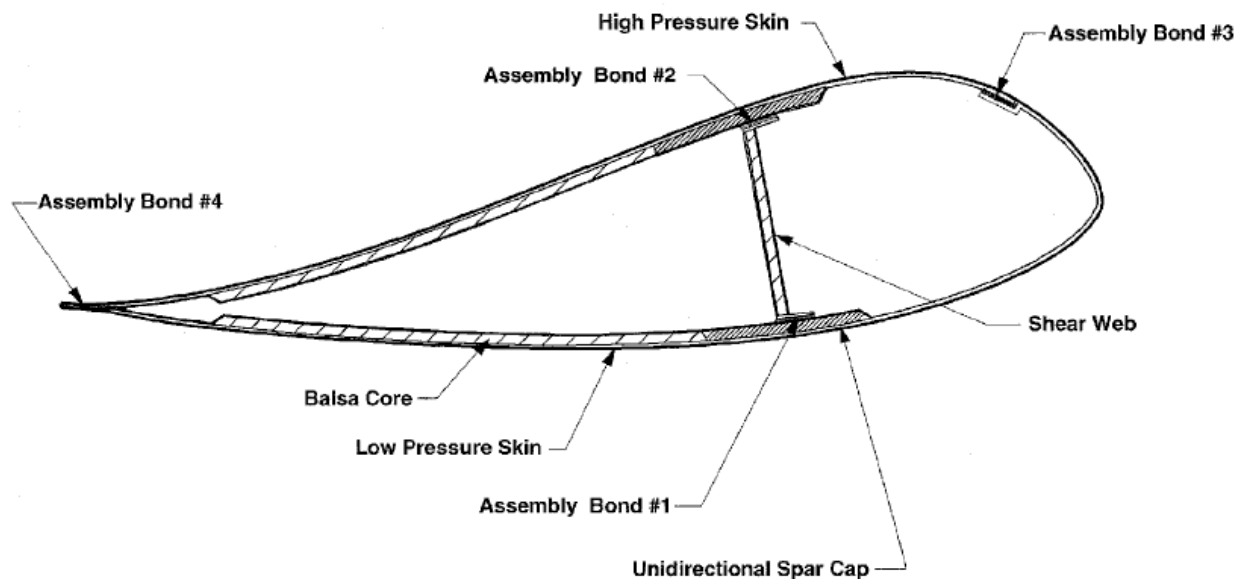

Figure 1.2 Typical Blade Cross-Section

This configuration offered material and labor savings in addition to quality assurance improvements. By offsetting the mold split line, the design maintained the leading edge profile as a molded surface. After resin infusion, the blade shells and web can be easily inspected for flaws prior to bonding. The bond assembly fixture provided precise alignment of the blade skin and placement of the shear web.

1.2.2 Root Attachment

Two root connection methods were reviewed and evaluated for the blade design. The baseline USW 56-100 blade utilized a one-piece, flanged steel root fitting that was attached to the blade root laminate interior surface with an epoxy bond. This approach was not strain compatible and generated large stress concentrations in the root bond. During manufacturing it was also difficult to assure proper bond thickness, which was critical for proper performance of the joint. Although this approach had been applied with some level of success, historical data showed a large number of bond failures associated with this method.

Blade root studs have been a reliable method for attaching the blade to the hub. Root studs have been used by LM Glasfiber, Mitsubishi Heavy Industries, and others with good success. TPI Composites elected to adapt a strain compatible root stud technology originally developed for wood-epoxy blades manufactured by Gougeon Brothers, which had a long and successful history in wind turbine blades dating to the early 1980's. These studs have undergone considerable engineering development and fatigue testing [2]. The approach provides smooth, strain compatible load transfer between the composite blade root and the steel hub (Figure 1.3). The steel root studs were bonded using an epoxy adhesive into cavities (Figure 1.4) molded into the blade laminate. The laminate design approach and the processes for molding the cavities were developed as part of the BMI effort.

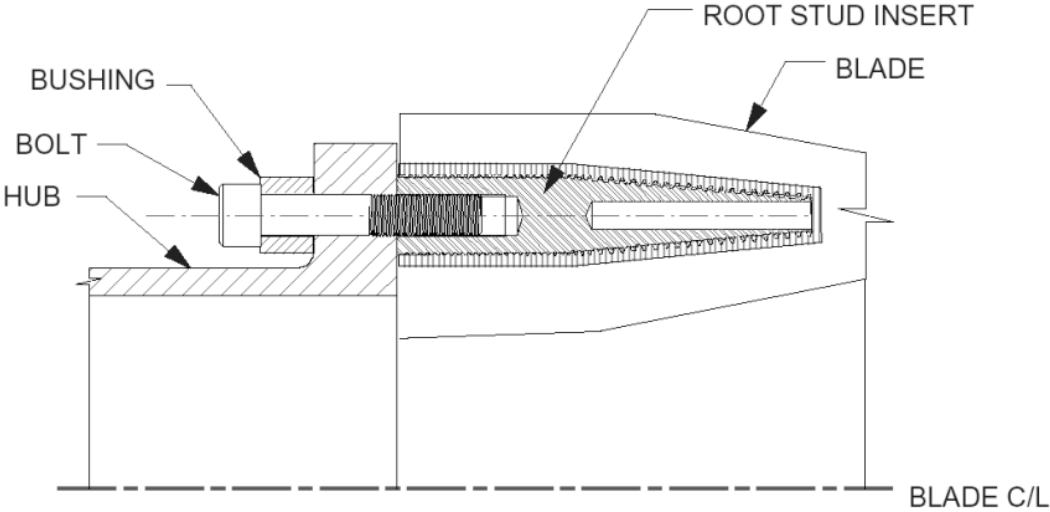

Figure 1.3 Illustration of Blade Root Stud Design

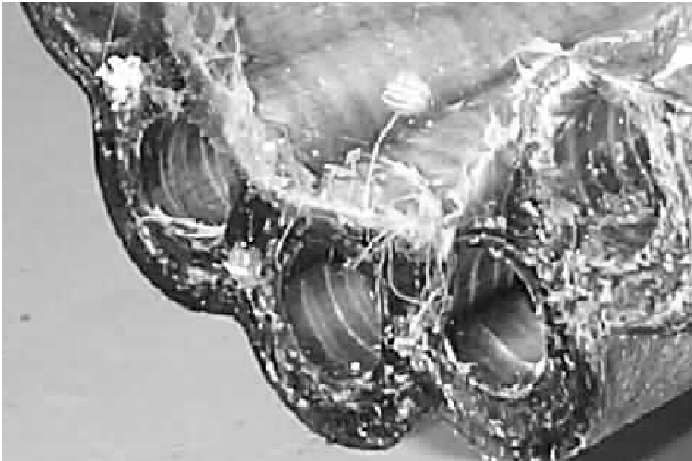

Figure 1.4 Photograph of the Blade Root Cavities

1.2.3 Blade Qualification Testing

Static load testing of the first ERS-100 prototype blade was conducted at the National Wind Technology Center (NWTC) and the test results [3] were used to assure the accuracy of engineering models and identify areas for additional design effort. Test loads were applied using a 5-ton hydraulic gantry crane and loading was distributed with a four-point load application system, or “whiffle tree”. The whiffle tree was composed of three spreader-bars, which distributed the crane load to each of four saddles (Figure 1.5). The spreader bars were made from two opposing C-channels to form an I-beam. Linkages between spreader bars and saddles were constructed as short as possible to maximize overhead clearance. The whiffle tree assembly was statically balanced by attaching ballast weight. This eliminated bending moments in the blade caused by the whiffle tree apparatus.

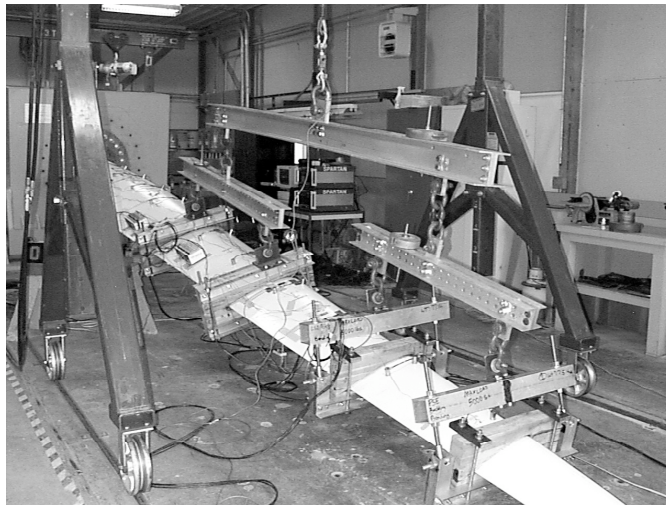

Figure 1.5 NWTC Static Test Load Application System

Airfoil shaped saddles were used to introduce the test loads into the blade shells. The two outboard saddles incorporated a pivoting mechanism to allow the load to be applied at or near the blade chord line. This pivoting yoke design reduced the moment that would be introduced due the large deflection angles. For these blades, only the outer saddles required the pivoting design. Deflections were measured using linear scales at each saddle (load introduction) location and at the blade tip.

The procedure for static testing consisted of monotonically increasing the applied load until the blade failed. The applied load was slowly increased to 4.5 kN (1000 lbf), then held at that position so that the displacement measurements could be read and recorded. This procedure was repeated, in 2.3 kN (500 lbf) increments, until an obvious failure occurred. The blade failure was characterized by catastrophic buckling and was preceded by local dimpling of the forward panel near the point of failure (Figure 1.6). The ERS-100 blade failed at a root flange moment of 123 kNm (90,601 ft-lbf).

The ERS-100 blade failure region was characterized by a slanted chordwise crease that extended from about 1.73 m at the leading edge to 2.16 m at the trailing edge which is approximately at 31% span (Figure 1.7). The location was on the leading edge side of the shear web. Also noted from the video and observed during the test was that at least one other buckling zone, at about 40% span, was oil canning or dimpling at the time of failure.

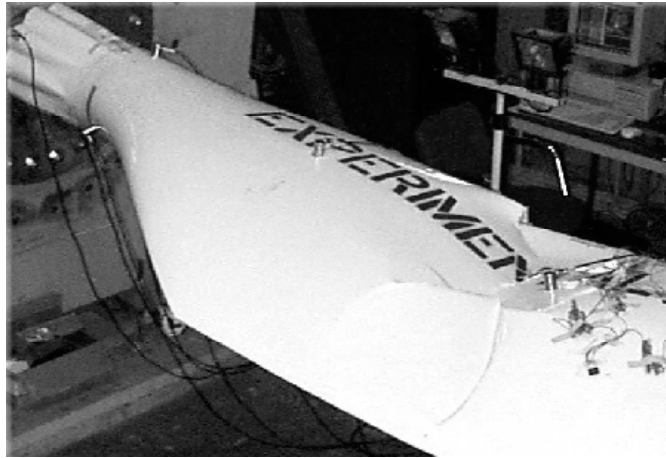

Figure 1.6 Photograph of the ERS-100 Blade After Static Failure



Figure 1.7 Photograph of the ERS-100 Panel Buckling Location

The buckling strength of the ERS-100 blade was improved during the BMI Extension effort by modifying the laminate design in the failure region and by changing the shear web design. Failure investigations conducted after the static blade test suggested that the leading edge panel stiffness could be easily improved by the addition of coring in the leading edge panels forward of the shear web. The root end of the shear web was modified to include a “half moon” that reduced localized stiffness and stress gradients. Additional design improvements included modification of the laminate schedule to smooth load transitions in the root region and reduce stress concentrations.

1.2.4 Blade Operational Testing

Operational testing of the original ERS-100 prototype blades was conducted within a large commercial wind plant comprising more than 600 turbines. The test site was located in Solano County, California in a region of low rolling hills. Field testing was used to compare performance (power) and blade loads between the baseline USW 56-100 blade and the ERS-100 replacement blades. Two turbines were instrumented for testing, as shown in Figure 1.8. Turbine A (located in the foreground) had the ERS-100 replacement blades installed, while Turbine B (in the background) was equipped with newly constructed LS(1) baseline blades.



Figure 1.8 Operational Test Turbines

The operational test results provided good confidence in the performance of the ERS-100 blade design (Figure 1.9). The measured loads were also found to be in agreement with design expectations. The ERS blades remained operating in a normal commercial production mode after the completion of the field test effort in October 1999. Normal operation continued for approximately 9000 hours, until July 2001, when one of the test blades failed and cracks were identified in the root region of the two remaining blades.

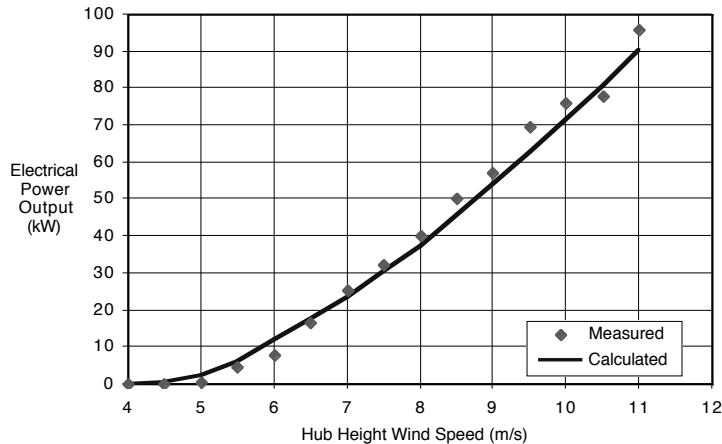

Figure 1.9 Performance Test Comparison

The prototype blades were removed from the test turbine and returned to the NWTC for detailed inspection. Cracks in the gelcoat were found along the bond line between the blade shells (Figure 1.10). These cracks were believed to result from the high elasticity of the bonding adhesive relative to the protective gelcoat coating. Although these cracks were not structurally significant, they provide a break in the protective coating and degrade its moisture and UV protection. In addition, the presence of visually observable cracks on the blade surface creates a maintenance problem, since technicians will not generally know if the cracks are structural or not.

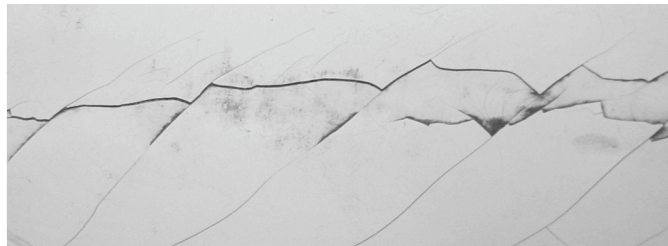

Figure 1.10 Gelcoat Cracking at the Bond Line

Other cracks found in the root region were determined to be structural in nature. These cracks occurred approximately 400 mm outboard of the blade mounting flange. The failure investigation showed that there was significant folding of the fiber in the region of the external root cracks (Figure 1.11). These folds were believed to have been produced during the manufacturing process as the vacuum pressure compacted the glass layers. The root region contains a large build-up of laminate thickness, which is necessary to provide geometric (strain) compatibility between the e-glass composite and the steel root studs. The rapid change in thickness created a slope angle and resulted in movement of the glass fabric under vacuum pressure. The root laminate design was subsequently

modified to provide smoother transition of the root laminate and a much-reduced tendency for the fabric to move axially during infusion. The original 3:1 slope angle of the root laminate was modified by staging the thickness change in two separate steps. In the low strain region closest to the root, the slope was reduced to 4:1 and in the higher strain region outboard of this the slope was adjusted to 12:1.

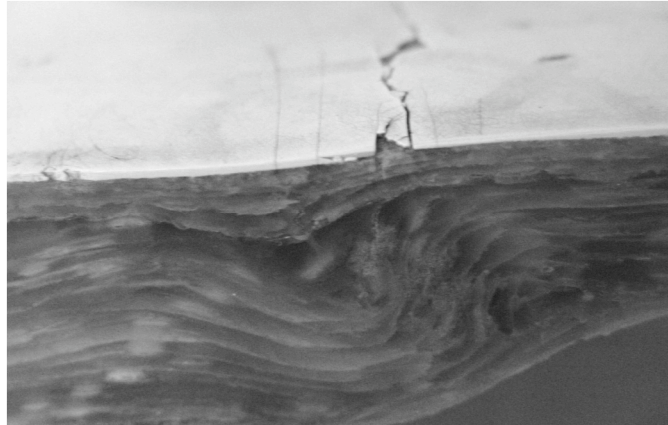

Figure 1.11 Cross-Section of Root Laminate Showing Fiber Folding

1.2.5 Blade Design Improvements

The ERS-100 laminate design was revised to address the issues identified in testing. A few of the key changes made to the laminate during this design iteration were:

- The laminate design was modified to reduce the stress concentration in the root region and minimize fiber folding during infusion.
- Balsa coring was added to the forward panel of both skins to improve the buckling strength.
- The quantity of adhesive used to bond the blade was more carefully controlled.
- The shear web was modified to reduce its stiffness at the root termination. A half-moon shape was cut from the web to minimize the local stiffness change and reduce the stress concentration.
- The shear web termination was extended further towards the root away from the root build-up.

2.0 BLADE MANUFACTURING

2.1 Manufacturing Process Review

The expense of shipping wind turbine blades can be a significant cost item, especially for today's large diameter turbines. Remote manufacturing can overcome many of the problems associated with transport of large blades and reduce cost. The combination of resin infusion technology, integrally heated mold surfaces, reusable vacuum bags, and pre-formed materials can streamline and increase robustness of the manufacturing process. The remote fabrication system is a natural extension of these earlier manufacturing advancements and offers a practical, reliable, and cost effective means for wind turbine blade construction on location anywhere in the world.

Remote manufacturing technology offers potential cost savings for fabricating blades in the 40 meter to 70 meter length range where transportation issues pose significant problems and freight costs become a significant portion of total blade cost. TPI Composites remote manufacturing approach employs factory prepared material kits that are shipped in standard containers. The increased density and standard format of these shipments reduces freight costs and the potential for damage during shipment. In addition, import duties in foreign countries are levied on the value of the kits, not the final value of the blades.

The TPI Composites remote manufacturing process is managed by a few permanent staff that travel to each location, but the majority of labor is provided by local workers at the site. Temporary facilities and mobile tooling are located at the site prior to commencement of fabrication. A further advantage of this approach is that it automatically provides domestic labor content to the blades. This can be advantageous because requirements for domestic content are common in many countries.

After preliminary review of many possible improvements, three were chosen as possessing the possibility to improve both the quality and the ease of remotely manufacturing wind turbine blades. These improvements, pre-form technology, silicon bags and heated molds, were implemented during the original BMI contract. The results of these improvements have been analyzed and utilized during the decisions of how to proceed with the BMI Extension. Following is a brief summary for each of the three improvements, including the knowledge gained and the proposed paths as we move forward.

Structural fiberglass lay-up, as it has evolved over the past half century is performed in a “layer by layer” approach. That is, each distinct layer of fiberglass (or other component, such as carbon, balsa or foam) has been laid into the mold one layer at a time, whether already wet with resin (traditional hand lay-up) or dry with the intention of being infused with resin later (SCRIMP). As composite

structures continue to grow in size and complexity, and thus in the number of distinct layers needed in a laminate, this process has become progressively more labor intensive.

The recent advent of pre-form technology has lightened the burden somewhat, as well as improved the overall quality of the laminate. Using a resin soluble adhesive, layers in a particularly thick or a complex shaped area of a structure can be put together off line. The resulting pre-laid-up and pre-shaped area of laminate can be placed into the mold quickly and accurately during the actual lay-up procedure. This reduces cycle times and increases the compaction and thus the quality of the structural laminate.

The root section of blade can particularly benefit from the advantages that pre-form technology offers. Even in a small nine-meter blade, such as the ERS-100, there can be more than one hundred layers of composite present in the root area. It is also an area of the blade, unlike the spar cap and aft skin, that can have detailed and complex geometry. Using pre-forms during the manufacturing of the ERS-100 greatly reduced the cycle time of the blade in the mold. Pre-forms of the root section were molded off-line and were ready to be placed in the mold at the proper location of the laminate during lay-up.

The advent of vacuum assisted resin transfer molding also brought the necessity to enclose the entire system in a vacuum tight layer. One side of this layer has traditionally been the mold itself. The other side has been a flexible bag, which must be able to conform to the geometry of the mold. For many years a nylon bag has been the standard material for this purpose. A nylon bag holds vacuum well, but can be cumbersome to apply to the mold and can be used only once. Also, when using a nylon bag, two additional layers have to be applied to the laminate before affixing the bag: peel-ply, in order to allow for the release of the nylon bag, and flow medium, a material that provides some loft and allows resin to flow throughout the laminate under vacuum conditions. Like the nylon bag, the peel-ply and the flow medium are not reusable.

Teflon-coated silicone bag technology allows for the vacuum bagging of parts without a peel-ply and flow medium layer. The Teflon allows for the easy release of the bag from the part after cure. The flow medium pattern can be manufactured directly into the silicon bag. Most importantly, the silicone bag is reusable. Instead of discarding three layers of material with every blade built, the silicone bag can be used for several hundred parts.

Heated mold technology has been used recently to augment the cure time of composite structures. Typically, the chemical reaction produced by the reagents in the resin produce the elevated temperature necessary to cure the composite part. Applying heat to the surface of the mold just after resin infusion can accelerate this process. During the initial stages of the BMI contract, several

methods of providing heat to the mold surface were looked at, including hot water and electric heating. The process ultimately chosen involved using carbon resistors embedded within the laminate of the mold surface. An electric controller allows for the distribution of heat over the surface of the mold immediately after infusion.

After reviewing the results of the manufacturing exercise during the original BMI contract, we were able to ascertain which of the manufacturing improvements indeed accelerated the cycle time or improved the quality of the blades. One of the improvements, the use of a silicon bag, was successful enough to warrant its use for all structural composite parts to be manufactured in quantity. Not only did the use of a silicon bag reduce material costs by eliminating throw away material, it also cut labor out of the process due to fewer layers being placed in the mold and an easier interface between the mold and the silicon bag. Using a silicon bag for blade production would be a logical choice whether manufacturing at a dedicated facility or at a remote site.

Pre-form technology also proved to augment cycle times and improve the overall quality of the blade. As mentioned above, a pre-form for the root section of the blade cuts down on labor during the lay-up process and pre-defines geometry in the root stud area. Pre-forms for the root section of the blade will be assembled at the main blade facility and shipped to a remote site to be used during the lay-up process.

The final process improvement implemented during the first phase of the BMI contract, heated molds, had varying results. More tests will have to be conducted to determine the exact correlation between heated surfaces on the mold face and cycle time. There is no doubt that heat applied to the composite structure can aid in the cure process. It is, however, an expensive process to build a mold with heating elements in the laminate. It also may be expensive to supply the amount of electricity needed to heat the mold. These costs will have to be weighed against the benefits provided by a heated mold surface.

In addition to incorporating the above mentioned manufacturing improvements, several other steps were used to ensure a robust process capable of producing a large number of blades away from a main blade facility. The general steps of the SCRIMP process, such as resin mixing, general material lay-up and part release from the mold, have to be reviewed and formulated to be independent of local labor skill and practices. The laminate design of the blade also plays a large part in how robust the entire manufacturing process is. It is helpful for a structure to have few simple layers, and this philosophy was used during the redesign of the blade laminate.

The basic manufacturing process for building blades is the same whether they are fabricated in a factory setting or in a remote location (Figure 2.1) The key to successful implementation of the

remote manufacturing approach is designing the individual process steps so that they can be controlled and monitored properly under field conditions.

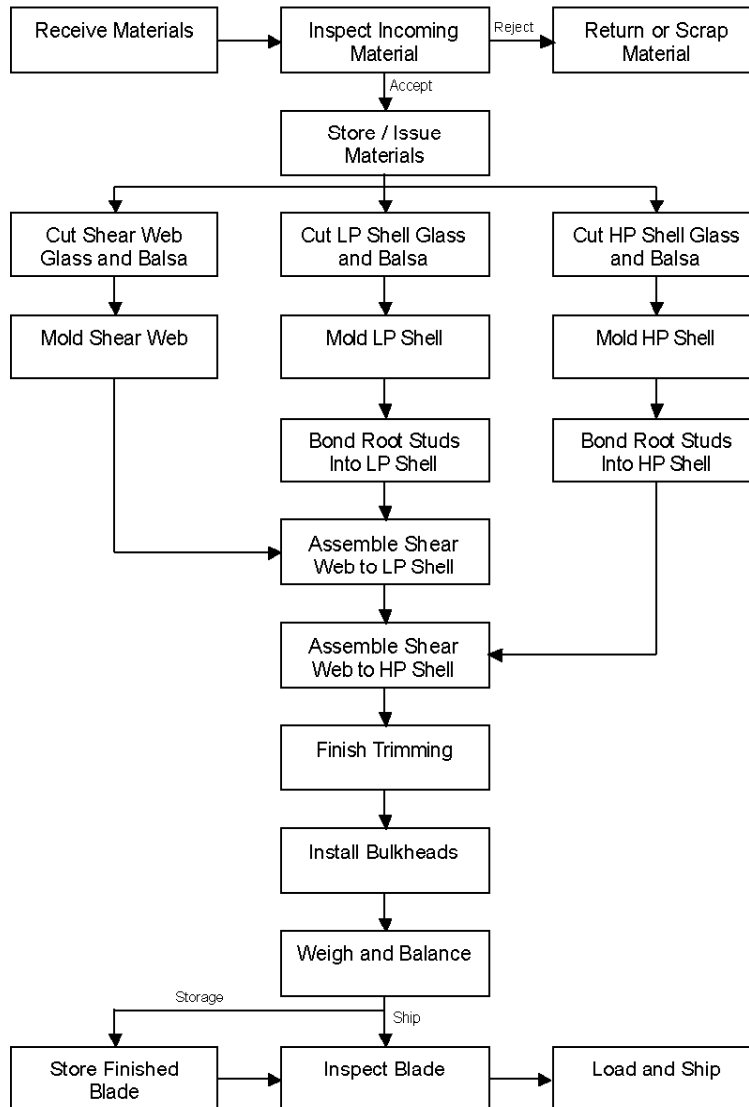

Figure 2.1 Blade Manufacturing Process Schematic

2.2 Remote Manufacturing Facility

A site near TPI Composites’ main plant in Warren, Rhode Island was used for the remote manufacturing demonstration. This site was selected because it eliminated the need to obtain environmental permits associated with the release of volatile organics into the atmosphere. This was a considerable cost saving and also saved calendar time, since application and approval for an operating permit normally requires a minimum of six months.

The remote manufacturing demonstration was conducted in a simple greenhouse structure such as might be available near wind plant sites (Figure 2.2). The interior work space of the remote manufacturing demonstration building measured 14.6 m (48 ft) long by 9.4 m (31 ft) wide, with an overhead clearance of 3.4 m (11 ft) (Figure 2.3).



Figure 2.2 Remote Manufacturing Demonstration Building Exterior



Figure 2.3 Remote Manufacturing Demonstration Building Interior

The building had an asphalt floor and was heated by a portable propane heater (Figure 2.4), which maintained the temperature of the work area between 65° to 70° F. Weather conditions during the manufacturing demonstration period included rain, sleet, and snow. A portable gasoline powered generator (Figure 2.4) provided electricity for lighting and tools. Suction to operate the infusion process was provided by a portable vacuum generator (Figure 2.5).

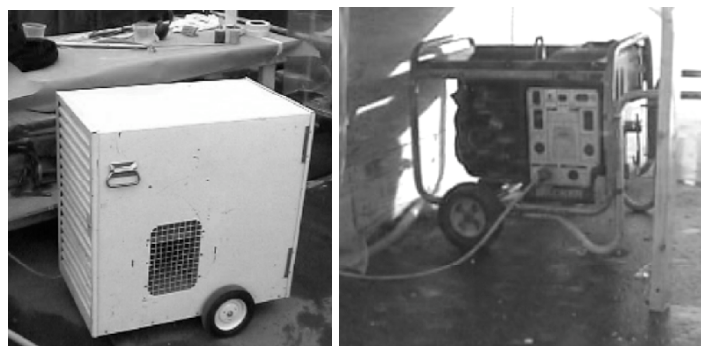

Figure 2.4 Portable Propane Heater and Gasoline Generator



Figure 2.5 Portable Vacuum Generator

The tooling and fixtures were delivered to the remote demonstration site by truck and unloaded with a small forklift (Figures 2.6, 2.7, and 2.8). The tools and equipment used were typical of those available at locations where wind turbines are installed and operated.



Figure 2.6 Delivery of the Bond Assembly Fixture



Figure 2.7 Delivery of the Blade Skin Molds



Figure 2.8 Movement of Blade Skin Molds Into the Structure

2.3 Preparation of Blade Construction Materials

TPI Composites blade manufacturing process begins with receiving materials, including vinylester resin, glass fabric, balsa coring, gel coat, and other chemicals and supplies. All materials utilized in the remote demonstration were checked against a written specification and transported to an appropriate storage location depending on the status of the material. Paper documents were used to record issues of all raw materials and included material cutting data sheets, scrap reports, resin issue sheets and shop supply slips. These documents provide for both inventory control and tracking of materials used. TPI used a separate account number sequence to help differentiate the raw materials and supplies for each blade.

2.3.1 Material Cutting

All fiberglass, peel-ply and balsa were cut and organized into kits during a separate manufacturing operation prior to shipment to the remote manufacturing demonstration site. Material was cut and numbered using an automated cutting machine (Figure 2.9) and then organized into “blade kits”.



Figure 2.9 Automated Fabric Marking and Cutting

This automated cutting machine numbered each layer in the blade construction and printed markings for proper placement of the glass material. Once numbered, the materials were placed on a cardboard roll and loaded onto a material transport truck. Materials were weighed (Figure 2.10) prior to organizing them into the blade kits (Figure 2.11).



Figure 2.10 Material Weight Measurement Equipment



Figure 2.11 Blade Material Kits Prepared for Shipment

2.3.2 *Insertion of Dry Materials*

A unique blade identification number was attached to the mold at the start of fabrication. Normally the first layer in the mold is gel coat, applied to a thickness of 0.020”-0.025” wet and allowed to cure for 15-20 minutes before the placement of dry materials. This step was omitted in the remote demonstration, because a clear surface was desired to facilitate inspection and testing.

Glass materials were positioned in the mold so they lie flat and are free of wrinkles, folds, bumps or air pockets. Material alignment is critical inside the root and along the shear web axis (Figure 2.12). Orientation of the fabric in each layer was specified by the locating marks placed by the automated cutting machine. All layers contained complete lengths of glass, and no splices were used in the skin laminate. At locations where filler pieces were necessary, they were neatly butt jointed, not overlapped. All loose strands and balsa chips were removed from the lay-up surface before the next layer was unrolled. The pre-cut balsa sheets were inserted in a numbered sequence (Figure 2.13), and any gaps were filled with balsa slivers or 0.25" chopped fibers. After the last layer of glass was inserted into the mold, a layer of peel-ply was applied as the last layer.



Figure 2.12 Placement of Dry Fabric in the Shear Web Mold



Figure 2.13 Placement of Balsa Coring in a Blade Skin Mold

Next, the SCRIMPTM distribution materials were placed over the mold; including the feed and vacuum lines and nylon bag. Prior to infusion, the mold was inspected for vacuum leaks (Figure 2.14) and any leaks were repaired before the process continued.



Figure 2.14 Inspecting for Vacuum Leaks Before Skin Infusion

2.3.3 *Mixing of Resin*

The group leader or other trained personnel prepared the resin batches required to infuse the parts (Figure 2.15). Standard manufacturing recipes were used in conjunction with appropriate adjustments for atmospheric conditions (temperature, humidity and resin activity). Extra attention was given to measuring amounts precisely and mixing the ingredients uniformly to reduce unexpected variations in gel times. Once the decision was made to infuse the part, the resin batches, one after another, were mixed with catalyst. Test samples from each resin batch were taken and placed on the process control timer.



Figure 2.15 Mixing Resin Prior to Infusion

2.3.4 Blade Shell and Shear Web Infusion

The resin batches were placed near the feed lines and opened in sequence once the resin reached its respective feed line. Resin was then infused into the mold via the pressure differential between resin feed ports and vacuum (Figure 2.16).

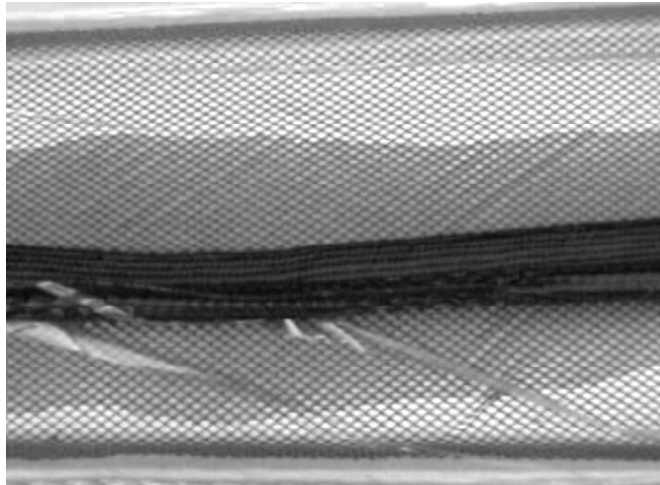

Figure 2.16 Partially Infused Shear Web

To insure the part had attained an adequate green strength to de-mold, a barcol hardness reading of 30 or higher must be measured. This value was collected and noted in the manufacturing record. The vacuum bag, feed lines, vacuum lines, and peel-ply were removed from the part and mold surfaces cleaned of debris.

2.3.5 Root Stud Bonding

Cavities for root stud bonding were prepared by sanding the interior of each cavity using a conical sanding tip. Once this was complete, six root studs were placed inside the root stud assembly fixture. The fixture was moved forward to perform a dry check and assure that each stud was properly centered in the cavity with a 3 mm gap. The studs were cleaned with a solvent to remove debris, grease and oil and provide a clean bonding surface. Each stud was coated with a thin layer of thickened epoxy adhesive. Epoxy was then pumped into each cavity until approximately half full. The fixture assembly was translated into the root and locked into place. Excess epoxy from the root stud area was removed and the cure proceeded. A portion of the epoxy mix was kept and a barcol reading made and recorded.

2.3.6 Blade Shell Demolding

De-molding started by lifting the tip skin from the mold by hand and sliding a strap under the skin. The sling was attached to a crane and the skin was lifted approximately 600 mm (2 ft). Another longer sling was used to raise the skin out of the mold and to the bond assembly area.

2.3.7 Finished Blade Assembly

The finished blade was assembled and bonded in a specialized bond assembly fixture. The low pressure blade shell and shear web were bonded together first, followed by bonding of the high pressure shell.

2.3.7.1 Low-Pressure Shell and Shear Web Bonding

The low pressure (LP) shell was moved to the bond assembly area. The shells (skins) were inspected inside and outside for any flaws that might adversely affect the bond assembly process or finished blade quality. Barcol hardness readings were checked at the root, near the leading edge, at the tip and along the trailing edge. All hardness readings must be 30 or higher before demolding, and the test results were recorded on the process quality sheet.

The LP shell of the blade was placed on a stationary saddle which is part of the bond assembly fixture (Figure 2.17). The shell location was adjusted until correct and secured in position using clamps along the leading edge. A bonding surface was prepared (with 100 grit sandpaper) along the leading edge, trailing edge, and lower shear web bond area. All dust was removed with a vacuum.



Figure 2.17 Blade Skin and Shear Web in the Bond Assembly Fixture

The shear web was then moved to a preparation area and placed in trimming saddles. Again, all the surfaces were inspected for flaws that might adversely affect bonding or finished blade quality. Barcol hardness readings were obtained in four locations along the length of the shear web.

The trimming jig was placed on the lower leg of the shear web and clamped into place. The shear web was trimmed using a diamond cutter, which is guided by the jig. The process was repeated for the shear web upper leg. Again, the bonding surfaces along the outside of both shear web legs were sanded using 100 grit paper. Any bumps along the edge of the shear web legs were sanded smooth and the dust removed with a vacuum. The shear web was checked for length, which was recorded on the process quality form. Once the shear web was properly sanded and trimmed, it was moved to the bond assembly fixture or the shear web storage rack.

The low-pressure shell was placed in the bond assembly fixture and the shear web lowered until it was properly seated on the LP shell (Figure 2.18). A tip alignment guide was used to aid in positioning the shear web along the length of the skin. One by one, the shear web positioning arms were set up. Once all the arms were tightly clamped into place, the shear web was properly positioned along the blade axis, and the position recorded.



Figure 2.18 Blade Skin and Shear Web Preparation for Bonding

The shear web was then lifted about 300 mm (12") above the blade skin. A 6 mm (0.25") bead of adhesive was applied to the bonding surface. A sample portion was retained to insure that minimum durometer reading was achieved. The excess adhesive was removed and the bond allowed to cure for 90 minutes.

2.3.7.2 High-Pressure Shell Assembly

The assembly of the high-pressure (HP) shell to the low-pressure shell/shear web was similar. The HP shell was moved to the bond assembly area and inspected inside and outside for any surface flaws. A Barcol hardness reading was obtained in the root, near the leading edge, at the tip and along the

trailing edge. As before, all readings must exceed a Barcol value of 30 before demolding and were recorded on the process quality sheet.

The high-pressure shell was placed on the movable saddle of the bond assembly fixture. The shell was adjusted until the location in the fixture was correct. Using metal safety clamps along the leading edge and tip locator, the high-pressure shell was secured into position. Bonding surfaces were sanded with 100 grit sandpaper along the leading edge, trailing edge and upper shear web area. All bumps were sanded smooth, and dust and debris were removed via a vacuum.

A hoist was attached to the middle arm of the HP shell moveable saddle. Suction cups were used on the HP shell, and visual feedback was provided to the operator to insure that vacuum was maintained in each cup. The HP shell saddle was lifted and rotated toward the LP shell/shear web. Once the HP shell pivoted past the vertical position, it was slowly lowered onto the LP shell/shear web (Figure 2.19). Any gaps or areas of misalignment were noted and corrected. After the HP shell was properly aligned, it was rotated back into the original resting place. A 6 mm (0.25") bead of a adhesive was applied to the three bonding surfaces. The HP shell was rotated back into place verifying proper alignment of the leading edge. Excess adhesive was wiped and allowed to cure for 90 minutes.



Figure 2.19 Closure of the Bond Assembly Fixture

After curing the blade was removed from the bond assembly fixture (Figure 2.20) and prepared for finishing. As noted earlier, the remote demonstration blades were fabricated without the gelcoat surface coating to facilitate inspection and testing.



Figure 2.20 Final NPS-100 Blade Assembly

2.3.8 Blade Finishing

After the adhesive had cured, the bonded blade was moved to a cradle with the LP shell facing up. Any excess adhesive or flashing that would interfere with the trimming process was removed. A diamond wheel cutter cut the trailing edge down the center of the trim line. Finally, flash from the blade tip was trimmed and/or sanded. The entire outside area was inspected for any flaws and the findings were recorded on the process quality data sheet.

2.3.9 Weight and Balance Measurement

TPI Composites performed weight and balance tests on the prototype blades after fabrication (Figure 2.21). The blade was moved to the balancing and weighing area and placed in holding saddles with the leading edge up. The balance scale used to weigh the blades was set to zero. Then blade root and tip jigs were secured and the blade was raised off the saddles and leveled with an aluminum leveling pole. In the horizontal position the blade root, tip, and total weight were recorded on the process quality information sheets.

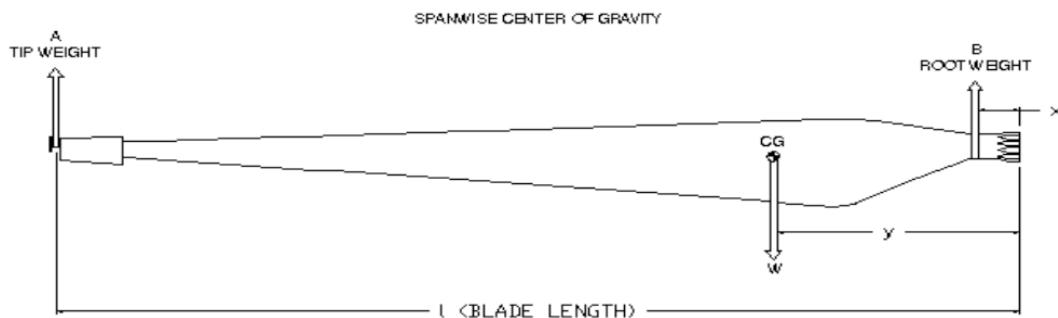

Figure 2.21 Static Balance Measurement Locations

The length between the scales was determined by measuring the distance between the delineation marks on the root and tip jigs. The tip weight, root weight and length between the scales were entered into a computer spreadsheet to determine the blade's center of gravity, static balance and static balance category. Once the final static balance had been determined, an aluminum identification tag was attached to the blade. The tag included the part number, blade serial number, total weight, center of gravity and static balance category.

2.4 Blade Qualification Testing

One of the remote demonstration blades was cut into sections shortly after fabrication. Each of the blade sections was inspected to verify construction details. After reviewing the blade sections, TPI Composites conducted static load testing of three NPS-100 blades at its blade test facility (Figures 2.22). The procedure for static testing consisted of monotonically increasing the applied load in 892 N (200 lbf) increments until the blade failed. Blade loads were applied using a hydraulic winch mounted to a gantry crane and transmitted through a two-point load application system used to approximate the blade design loading distribution.

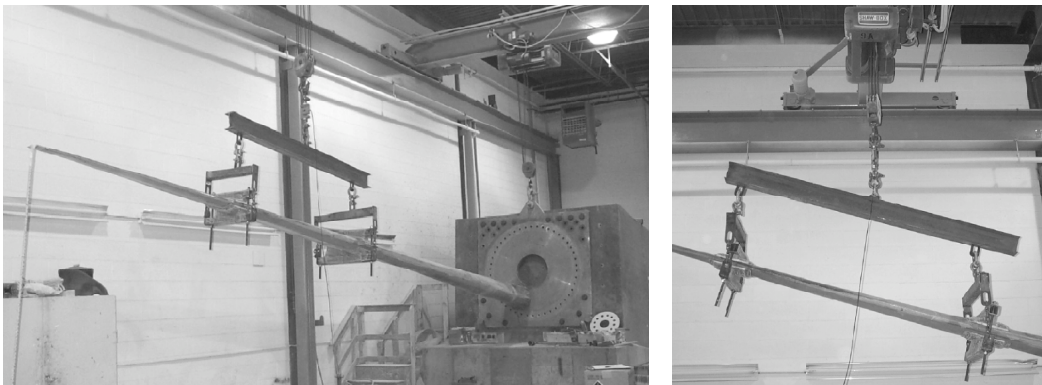

Figure 2.22 TPI Composites Static Blade Test Stand

TPI Composites performed the blade static tests on 15 February, 5 March, and 11 March 2002. The NPS-100 blade design bending moments included partial load factors and test load factors in accordance with the IEC blade test standards [4]. Each of the blades was successful in meeting the ultimate static test loads (Figures 2.23, 2.24, 2.25, and 2.26) and the maximum bending moments at the root flange were 15% to 30% greater than measured on the original ERS-100 prototype. Prior testing had identified buckling as the static failure mode and it remained the primary static failure mode in all three tests. At the failure location the two point loading system generated bending moments that were 30% to 50% greater than the required static test loads.

Static testing showed that the epoxy selected for final bonding of the shells had some undesirable characteristics. In tests #1 and #2 the adhesive bond between the blade shells released by peeling

from the skin surfaces. This failure mode was not anticipated and suggested the epoxy adhesive did not have sufficient peel strength. Another NPS-100 blade was fabricated using a methylacrylate adhesive with higher peel strength and tested statically (test #3). The failure load for the third was somewhat higher than either of the two prior tests and peeling of the adhesive was not observed.

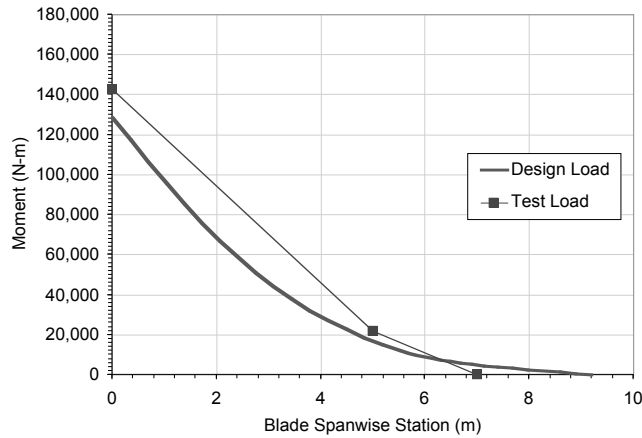

Figure 2.23 Static Failure Moment on 15 February 2002 Test



Figure 2.24 NPS-100 Static Failure on 15 February 2002 Test

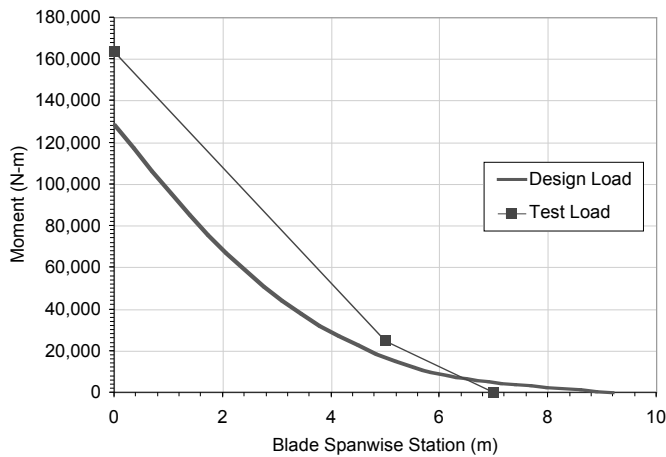

Figure 2.25 Static Failure Moment on 5 March 2002 Test

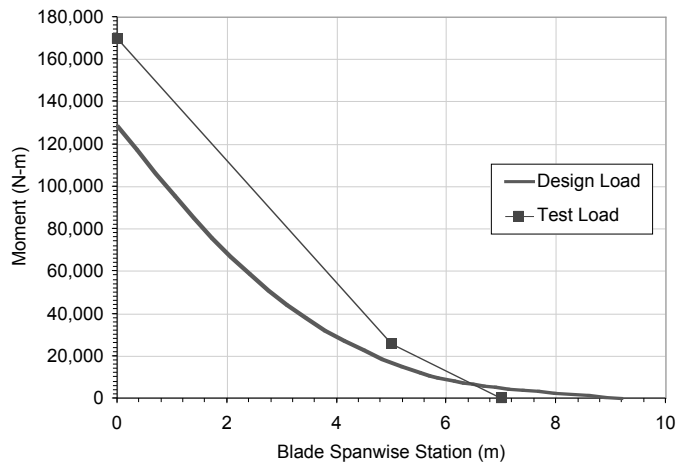

Figure 2.26 Static Failure Moment on 11 March 2002 Test

3.0 ROOT IMPROVEMENT

3.1 Root Stud Design

The ERS-100 and NPS-100 blades both used a root stud design which was sized for M20 (3/4") fasteners (Figure 3.1). This design is appropriate for small to medium sized blades in the range from 8 to 24 m length. A larger M30 (1-1/8") design was developed for blades in the size range from 20 m to 40 m in length (Figure 3.2). The studs were fabricated from high strength AISC 4140 steel bar stock using a numerically controlled lathe. Machining required that the components retain a certain level of stiffness, which limited the minimum thickness of the stud at its tip.

Casting the studs has the potential to eliminate some of the design constraints and may offer cost advantages as well. The primary technical difficulty with the use of steel castings is the increased potential for material defects. Reducing the cost of the cast studs also requires somewhat larger manufacturing quantities than machined parts. Overall our preliminary evaluations suggest that casting could likely be the preferred approach for volume production of root studs.

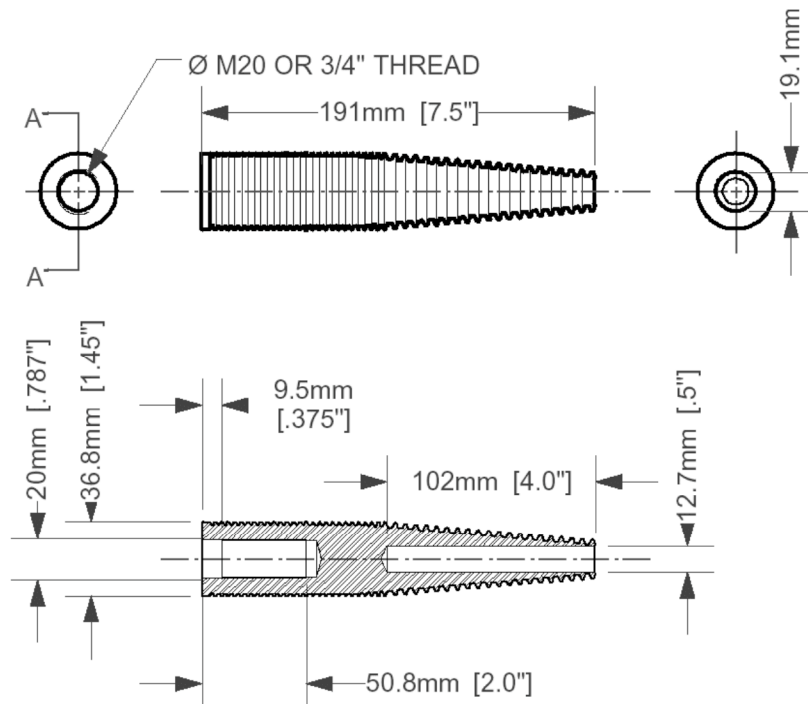

Figure 3.1 Illustration of the M20 Blade Root Stud

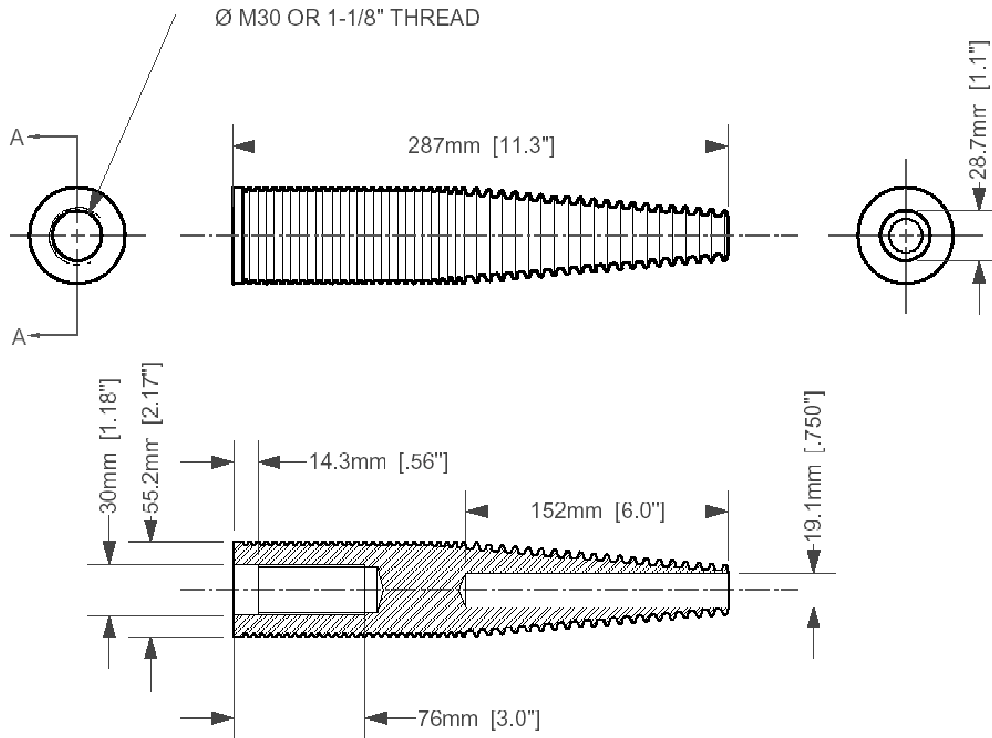

Figure 3.2 Illustration of the M30 Blade Root Stud

3.2 Root Stud Bonding

3.2.1 Manual Bonding

The root stud bonding approach selected for the original ERS-100 blades was based upon earlier experience with wood-epoxy blades, in which cavities were drilled into the end grain of the wood-epoxy blades to accept the root studs. However, drilling in fiberglass composite significantly increases the manufacturing cost, therefore that approach was modified so that cavities were formed during fabrication (Figure 1.4). This approach was simple and provided cavities of known size and location within the root laminate with a minimal amount of a manufacturing effort.

Root studs were then bonded into the cavities with a thickened epoxy adhesive after the blade shell had cured. A fixture was used to accurately locate the position of the studs in the blade root. This procedure required each stud and cavity to be manually coated with adhesive. This process is effective for small blades, but becomes increasingly difficult as the number of studs increases. During the BMI project, two alternative approaches were investigated to improve the root stud manufacturing process: 1) direct embedment and 2) thru-stud bonding.

3.2.2 Direct Embedment

An alternative method for installing the root studs in the blade is to directly embed them within the laminate. This approach has been widely applied by LM Glasfiber and offers several advantages. The primary improvement offered by direct embedment is a reduction in the number of manufacturing process steps and tooling requirements. Generally this tends to simplify production and reduce labor cost. TPI Composites investigated the use of direct embedment and developed a methodology for preparing the root studs for resin infusion. Dry fabric was rolled around each stud and folded material was placed between studs (Figure 3.3).

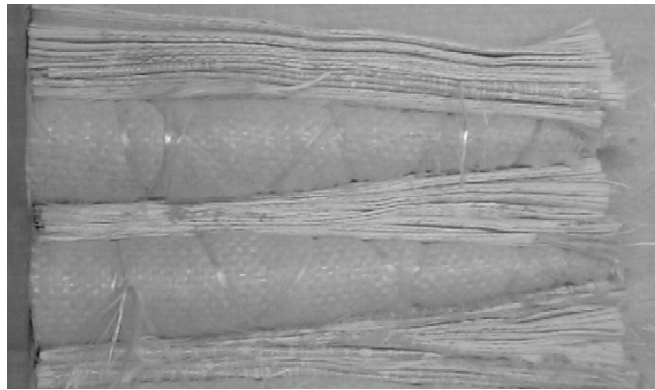

Figure 3.3 Root Stud Preparation for Direct Embedment

3.2.3 Thru-Stud Bonding

The basic stud design was modified to allow flow of the bonding adhesive through the center of the stud. There are several advantages to this process including: 1) excellent potential for process automation, 2) ability to bond all studs simultaneously, and 3) outstanding control of individual stud placement in the root ring. Several test specimens were built using the thru-stud bonding process (Figure 3.4), and the method showed good promise.

The main advantage of the thru-stud approach is that it can accurately locate a sizable number of individual studs to a high tolerance on large bolt circles. The studs are bonded after the blade shells are assembled and installed as a unit while attached to the alignment fixture. This contrasts with direct embedment, in which the studs are infused with each of the two blade shells and aligned during final assembly. Directly embedded studs are subjected to movements due to thermal stresses and resin shrinkage. Developing this process proved more difficult than anticipated and many of the test articles contained voids or areas of poor bonding adhesion. It is believed that those defects could be eliminated with additional manufacturing development effort.

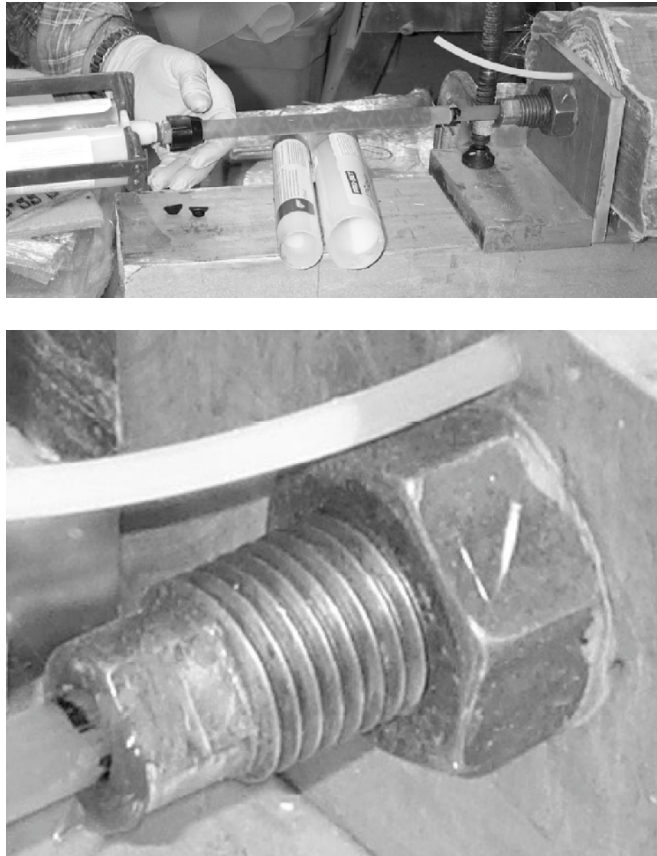

Figure 3.4 Thru-Stud Bonding

3.3 M20 Root Stud Testing

The ERS-100 blade was designed to employ an efficient and cost-effective root stud system adapted from U.S. designed wood/epoxy blades. Bonded studs also dominate the blade root designs of European turbines, and this approach has achieved wide acceptance in the industry. Qualification testing was used to begin development of the information required for successful adaptation of the wood/epoxy stud design to fiberglass blades.

The database for the static and fatigue strength of studs in wood/epoxy laminate is quite extensive, and the correlation to design methodology is well established. However, there is currently not a comparable database and correlation for use with fiberglass laminates. Notable differences exist between the two laminate types, including a shear failure mode which limits static and low-cycle strength for wood/epoxy laminate and is absent for fiberglass laminates. This allows the use of a single fatigue curve slope over the entire cycle range, rather than the dual mode curve for wood/epoxy design.

The original 191 mm (7.5”) long stud for a 3/4-16 UNF (or M20) bolt was dimensioned to be machined from 38 mm (1.5”) steel bar stock. The first use of this stud by TPI Composites was for the ERS-100 blade, which used 10 studs on a 251 mm (9.9”) diameter bolt circle. The nominal stud spacing for this blade was thus $(\pi * 251) / 10 = 79 \text{ mm (3.1”)}$. The second use of this stud was on the NPS-100 blade, which used 12 studs on a 300 mm (11.8”) bolt circle, so the stud to stud spacing was very similar $(\pi * 300) / 12 = 78.5 \text{ mm (3.09”)}$. Since the bolt spacing was nearly equal for both blade variants, only one root stud test specimen size was used. An illustration of the cross-section of the M20 root stud test specimens is provided in Figure 3.5.

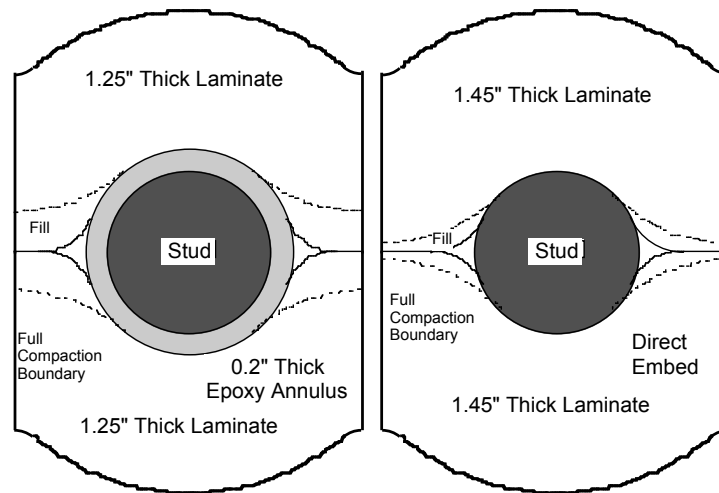

Figure 3.5 M20 Stud Test Specimen Cross-Sections

Root stud testing concentrated on axial tensile tests, since this was historically the most demanding loading mode. Specimens with a single stud in each end, suitable for use in a typical materials test load frame were the baseline. Whole root fatigue tests were not conducted.

The root stud test specimens were tested in axial loading, rather than the cantilever bending mode that loads the blade root. This difference in loading mode means that the laminate had to be balanced differently for the axial test specimens than for the blade root. In the blade root, more laminate was put to the inside of the studs, to compensate for the lower strain values which exist there, in order to obtain relatively uniform load flow into the stud around its perimeter. For the axial loading, this unbalanced strain distribution did not occur, so a symmetrical material layout was used to provide the desired load flow distribution.

Special tooling was created by TPI to produce double ended specimens with a stud in each end. The M20 specimens were fabricated in sheets that contained four specimens each (Figure 3.6). Individual root stud test specimens were then cut from the sheet (Figure 3.7) and prepared for testing.

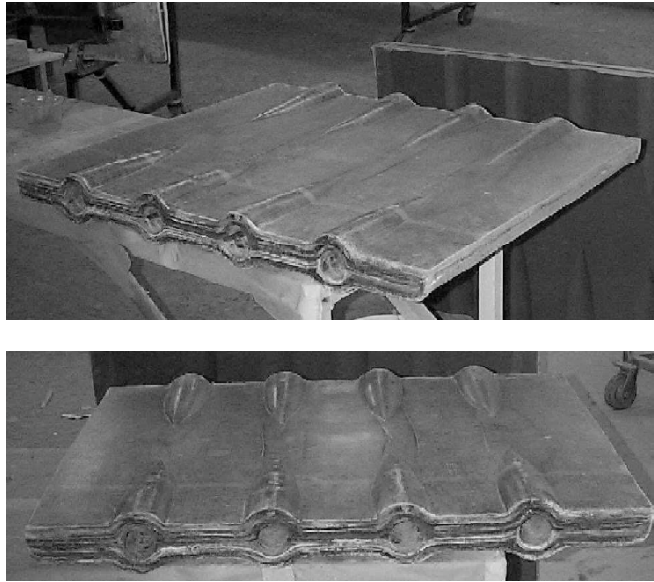

Figure 3.6 M20 Blade Root Stud Specimen Sheets



Figure 3.7 M20 Blade Root Stud Specimens

The stud testing evaluated two bond line thicknesses as shown in Figure 3.5. The 0.2” thick epoxy bond line was the standard that has been studied extensively in previous stud performance test work. The zero bondline thickness case represents direct embedment.

A specimen of each root attachment type was tested to failure in static tension. The 0.2” epoxy annulus design failed under a static load of 301 kN (67.6 kip), while the directly embedded stud failed at 318 kN (71.5 kip). These results were in good agreement with predicted strength values, thereby generating confidence that the design methodology had been accurately transferred to the new design.

The static results were reviewed prior to fatigue testing of the two root stud approaches. For each root attachment type, an R = 0.1 tension load fatigue test at 65% of the static load result was used to provide an initial fatigue test at intermediate cycle levels. A summary of the M20 root stud test results is provided in Table 3.1 and Figure 3.7. Tests of the root stud documented strength at room temperature (20°C) and under low temperature conditions (-50°C). The measured static and fatigue strength of the root studs exceeded the design values and strength was improved at low temperatures. The results also showed that the direct embedment approach could achieve necessary performance levels under fatigue loading.

Table 3.1 Summary of M20 Root Stud Test Results

Load Range (kN) ----- No. of Cycles	Design Line / 0.2" Epoxy Annulus / 20° C / 2.5" Vinyl Ester E-Glass	Test 2000 / 5 mm Epoxy Annulus / 20° C / 64 mm Vinyl Ester E-Glass	Test 2000 / Direct Embedment / 20° C / 74 mm Vinyl Ester E-Glass	Test 2001 / 5 mm Epoxy Annulus / -50° C / 64 mm Vinyl Ester E-Glass	Test 2001 / 5 mm Epoxy Annulus / 20° C / 64 mm Vinyl Ester E-Glass	Test Date	Specimen Identification
1.00E+00	303						
1.00E+03	205						
1.00E+06	110						
1.00E+09	20						
1.00E+00		301				18-Jun-99	TPI BMI 1-1999
1.19E+05		157				02-Jul-99	TPI BMI 3-1999
1.00E+00			319			11-Aug-99	TPI BMI 4-1999
4.00E+04			164			02-Sep-99	TPI BMI 6-1999
1.45E+03				313		07-Feb-01	TPI NPS 6-2001
1.54E+05				245		02-Feb-01	TPI NPS 5-2001
8.49E+05				220		08-Feb-01	TPI NPS 7-2001
3.00E+00					330	07-Mar-01	TPI NPS 1-2001
3.32E+03					294	20-Feb-01	TPI NPS 4-2001
3.72E+04					245	16-Feb-01	TPI NPS 2-2001
2.24E+03					245	28-Feb-01	TPI BMI 3-2001
1.69E+05					196	21-Feb-01	TPI NPS 8-2001
3.25E+04					196	23-Feb-01	TPI BMI 1-2001
4.60E+05					157	26-Feb-01	TPI BMI 2-2001
8.28E+05					137	02-Mar-01	TPI BMI 4-2001

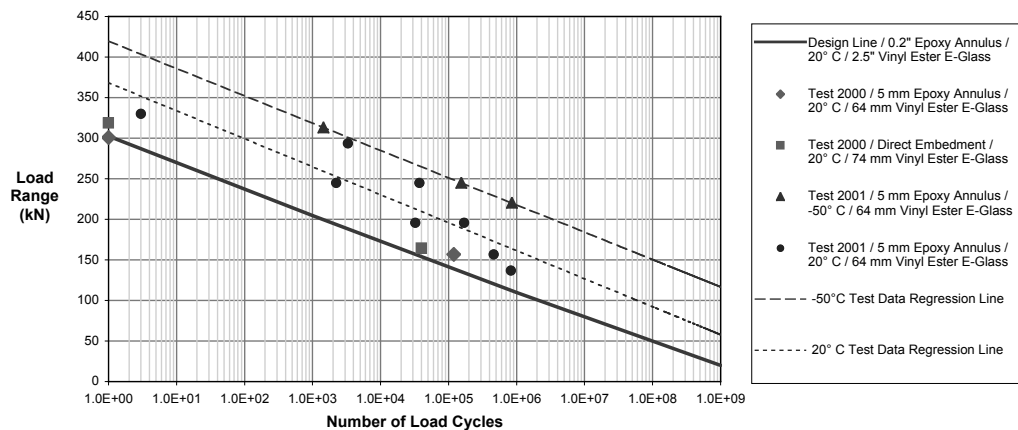

Figure 3.8 Summary of M20 Root Stud Test Results

3.4 M30 Root Stud Testing

In creating the larger M30 test specimen, the intention was to apply a scaling factor of 1.5 so that geometric similarity would allow some insight into size effects by comparing results from M20 and M30 size specimens. The only exception was to be the epoxy annulus thickness, which was to be maintained constant at 0.2” to avoid getting too near a thickness at which excess temperature from exothermic heating during cure might cause a decrease in epoxy properties. The epoxy annulus serves two key functions: 1) to allow shear between the stud and laminate to reduce peak shear stresses, and 2) to carry hoop stress around the stud.

A total of seven M30 double-ended root stud specimens were fabricated. The first six M30 root stud test specimens (#1 to #5) were manufactured using the thru-stud bonding process and specimens #6 and #7 were fabricated using direct embedment. All of the specimens were tested at the National Wind Technology Center (Figure 3.9) using the same test equipment and procedures as had been used in the earlier M20 root stud tests.

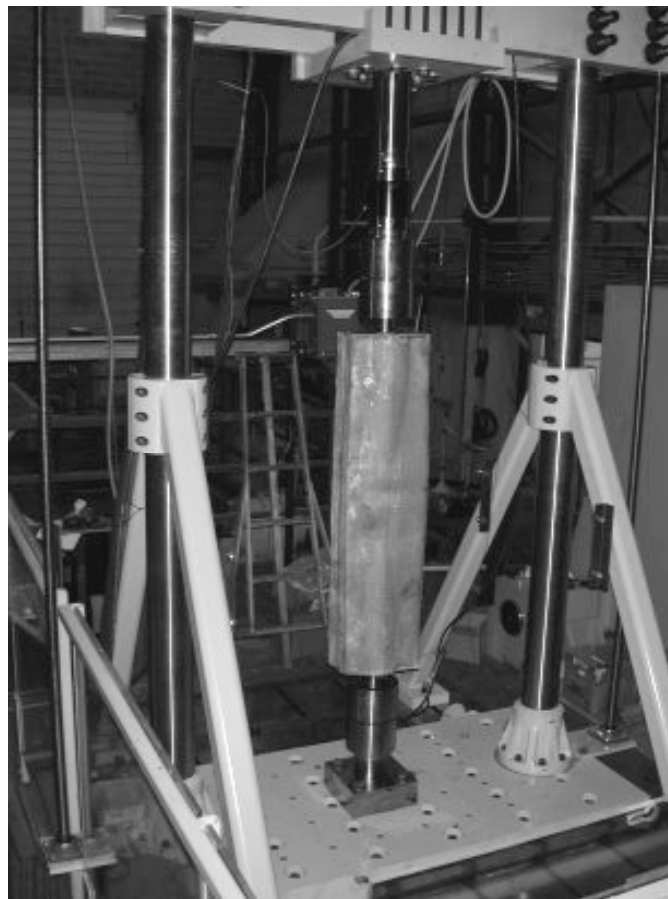

Figure 3.9 Root Stud Fatigue Test Equipment

Specimen #1 was loaded in fatigue with a range from 446/44.6 kN (100/10 kip) using a 3-Hz cycle rate. This specimen failed in 83 cycles (Figure 3.9). Several large voids were identified in the epoxy annulus and the bonding of the stud was incomplete.



Figure 3.10 Failed M30 Stud From Specimen #1

M30 root stud test specimen #3 was tested using a fatigue load of 446/44.6 kN (100/10 kip) and a 3-Hz cycle rate. This test specimen failed in 2462 cycles when the lower stud (end B) pulled out. Large voids in the epoxy annulus were identified in this test.

M30 specimens #4 and #5 applied loads were 290/2.9 kN (65/6.5 kip). Specimen #4 failed in 10,721 cycles when the top stud (end A) pulled out. A failure investigation identified large void areas in the epoxy adhesive. Specimen #5 failed after 1,930 cycles and failure investigation showed that this root stud also had a void running along its entire length.

Specimen #6 was fabricated using direct embedment and was tested using two load blocks at a testing frequency of 4-Hz. The first block was run at loads of 223/2.2 kN (50/5 kip) for 1,000,000 cycles. The second load block was run at loads of 290/2.9 kN (65/6.5 kip) for 31,400 cycles at failure when the top stud (end A) pulled out (Figure 3.10).



Figure 3.11 Failed M30 Stud From Specimen #6

Specimen #7 was tested using loads of 290/2.9 kN (65/6.5 kip) and failed at cycle 703,027 when the lower stud (end B) was pulled from the specimen. The upper stud bolt failed around 200,000 cycles and is believed that the stud bolt pretension was too low, causing the bolt failure. The failed bolt was replaced and test continued to run.

3.4.1 Review of M30 Stud Test Results

The M30 tests showed lower-than-expected strength data from the specimens and a comparison with the M20 test results is provided in Table 3.2 and Figure 3.11. Simple scaling would suggest that the bond strength for the M30 stud would be 225% of the M20. Observations after failure revealed voids in nearly all of the specimens, but that might not be the only issue involved in the strength shortfall. The test engineers noted a surface condition that would indicate a poor glass-to-epoxy bond at the fracture surface. Widespread areas of glossy and smooth epoxy gave evidence of this, with little evidence of fracture resistance, particularly in the tapered tip region. Further test work will be needed to qualify the performance of the M30 stud design.

Table 3.2 Comparison of M20 and M30 Root Stud Test Results

Load Range (kN) ----- No. of Cycles	M30 Stud / Thru-Stud Bonding	M30 Stud / Direct Embedment	M20 Stud / Manual Bonding	M20 Stud / Direct Embedment	Specimen Identification
8.30E+01	401				TPI-BMI M30-1
2.46E+03	401				TPI-BMI M30-3
1.07E+04	287				TPI-BMI M30-4
1.93E+03	287				TPI-BMI M30-5
1.00E+06		221			TPI-BMI M30-6
7.03E+05		221			TPI-BMI M30-7
3.00E+00			330		TPI NPS 1-2001
3.32E+03			294		TPI NPS 4-2001
3.72E+04			245		TPI NPS 2-2001
2.24E+03			245		TPI BMI 3-2001
1.69E+05			196		TPI NPS 8-2001
3.25E+04			196		TPI BMI 1-2001
4.60E+05			157		TPI BMI 2-2001
8.28E+05			137		TPI BMI 4-2001
1.00E+00				301	TPI BMI 4-1999
1.19E+05				157	TPI BMI 6-1999

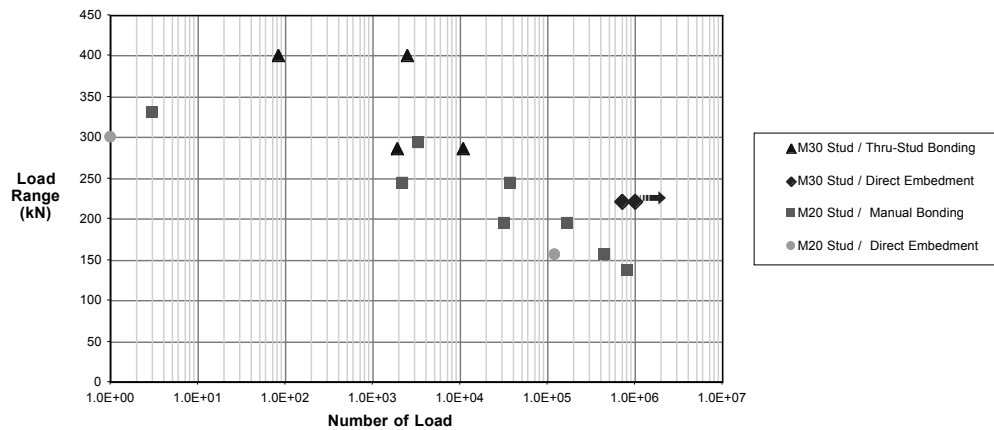

Figure 3.12 Comparison of M20 and M30 Root Stud Test Results

The issue of sample width was discussed by the test team and there was some concern that the M30 specimens had not been properly scaled in width to represent the stud performance documented by the earlier M20 tests. The scaled width was supposed to represent a single stud, but it may be that the hoop stresses generated in the test samples by the tensile loading were sufficient to spilt or delaminate the glass layers along the laminate interface at the largest hole diameter. In an actual blade, laminate splitting is prevented by fibers surrounding the root that provide hoop strength. An alternative specimen design was proposed in which the wall thickness between the stud and the specimen edge would be scaled, instead of scaling the overall specimen width. Using that design approach the M30 specimen width should be about 152 mm (6") rather than 119 mm (4.65-inches) tested in the initial M30 work.

4.0 PROJECT SUMMARY

4.1 Blade Remote Manufacturing Demonstration

- TPI Composites successfully completed a remote manufacturing demonstration in which four blades were fabricated.
- The remote demonstration used a manufacturing approach which relied upon material “kits” that were organized in the factory and shipped to the site.
- Manufacturing blades at the wind plant site presents serious logistics difficulties and does not appear to be the best approach. A better method appears to be regional manufacturing facilities, which will eliminate most of the transportation cost, without incurring the logistical problems associated with fabrication directly onsite. With this approach the remote facilities would use commonly available industrial infrastructure such as enclosed workbays, overhead cranes, and paved staging areas.
- Other remote manufacturing improvements could include development of: a) tooling designed for disassembly and shipment, b) automated equipment to measure key process variables and maintain quality assurance records, and c) more robust processes to minimize the need for highly skilled labor.

4.2 Blade Root Improvement

- Additional fatigue testing of the M20 root stud design was completed with good results. This design provides adhesive bond strength under fatigue loading that exceeds that of the fastener.
- A new thru-stud bonding concept was developed for the M30 stud design. This approach offers several manufacturing advantages; however, the test results were inconclusive. Developing the process proved difficult and many of the test articles contained voids or areas of poor adhesion.
- Further development and testing is recommended for both the thru-stud and direct embedment approaches. Additional work is also recommended to evaluate the use of cast root studs.

5.0 REFERENCES

- 1 . “Blade Manufacturing Improvements: Development of the ERS-100 Blade”, TPI Composites, SAND2001-1381, Sandia National Laboratories, May 2001.
2. Spera, D. A., Structural Properties of Laminated Douglas Fir/Epoxy Composite Material, DOE/NASA/20320-76, May 1990.
- 3 . Hunsberger, R., Musial, W., Ultimate Static Load Testing on TPI Composites USW 56-100 LS-1 and ERS-100 Rotor Blades, National Renewable Energy Laboratory, NWTC-ST-TPI-STA-01-1299-FR, 25 April 2000.
- 4 . Wind Turbine Generator Systems- Part 23: Full-scale Structural Testing of Rotor Blades, International Electrotechnical Commission, IEC TS61400-23, First Edition, 2001.

