

# Reproductive System, day 1

Grades 4-6, Lesson #11

## Time Needed

---

50-75 minutes

## Student Learning Objectives

---

To be able to ...

1. Identify the medical terms, locations, and functions of at least 7 of the structures in and near the male reproductive system.
2. Identify the medical terms, locations, and functions of at least 7 of the structures in and near the female reproductive system.

## Agenda

---

1. Discuss purpose of lesson.
2. Use transparencies or your own drawing skills to describe names, purposes, and locations of male reproductive organs.
3. Use *Reproductive System Worksheet #1* as a large group exercise to reinforce Activity #2, above.
4. Repeat Activities #2 & 3, for female reproductive organs, using *Reproductive System Worksheet #2*.
5. Give class a preview of tomorrow's lesson.

## **Materials Needed**

---

### **Classroom Materials:**

- OPTIONAL: *Reproductive System Transparency/Worksheets #1 – 2*, as 4 transparencies (if you prefer not to draw)
- OPTIONAL: Overhead projector

### **Student Materials: (for each student)**

- *Reproductive System Worksheet #1* (2 sides, back-to-back)
- *Reproductive System Worksheet #2* (2 sides, back-to-back)

## Activity

---

### 1. Explain, again, why you are doing this lesson and unit.

As you explained in Lesson 1, reiterate that you are doing this unit so that they will have correct information about things like bodies and growth; so that they will feel good about growing up; so that they'll feel more comfortable asking questions of their parents or doctors; so that they'll understand and appreciate themselves, their families and one another; and so that they will not be as likely to ever be sexually abused.

### 2. Describe names, purposes, and locations of male reproductive organs.

Use the transparencies or, better yet, draw so that you can introduce one part at a time and so that your drawing won't exactly duplicate the worksheets your students will be filling out later in the lesson.

Name and explain the functions of the parts of the male reproductive system. Here is scripting, to read in advance and paraphrase:

*Let me describe how most people's bodies are made. But know that individual differences are pretty common.*

**Side view of the male:** *This is a side view of the male reproductive system. On the outside he has two parts. Can anyone name them? That's right, 'penis' and 'scrotum.'* The job of the scrotum is to hold the "testicles" or "testes" at the proper temperature – lower than 98.6 degrees – for making sperm. The scrotum will move toward or away from the body to keep it at a lower temperature.

*Who knows the **testicles'** other job, besides producing sperm? They also make male hormones to give him a deeper voice, broader shoulders, and all the other characteristics of an adult male body.*

*Sperm are made in the testes and then move into the **epididymis** which is a long tube tightly coiled into the back of the scrotum. The sperm stay there for 2-3 months while they mature.*

*Then they travel up into his body through a tube called a **vas deferens**. He's got two, one leading from each epididymis. The sperm travel, through a vas deferens, past his **bladder** (where urine or "pee" is stored), and into the tube that will carry them out of his body, the **urethra**. The urethra is the tube that runs through his penis. In the male, the urethra has two jobs: urination (part of the urinary system), and ejaculation (part of reproductive system). On the way, the sperm gather fluids we call **semen**. These fluids come from three places: his **seminal vesicles** (two long skinny glands which contribute sugars to help nourish the sperm on their long journey), his **prostate gland** (the fluid from which is a lubricating liquid, allowing the sperm to swim freely, and his **Cowper's glands** (which mostly neutralize the acids that might still be in his urethra from the last time he urinated – "peed").*

*A man has two openings in his private parts, the urethra is one. The other opening from a man's private parts is his **anus**, where a bowel movement ("poop") comes out. Of course, even though the bladder and anus are nearby, they aren't actually PART of the reproductive system. They have nothing to do with making a baby.*

**3. Hand out *Reproductive System Worksheet #1* and fill it in as a large group exercise:**

*Let's look at the side view first and see if you all can help me name the parts. Let's start with the outside parts ...#s 4 and 7. Can anybody tell me what they're called? That's right, #4 is the penis. Everybody fill that in on your worksheet. Check your spelling against the blackboard. And so forth*

**4. Repeat activities #2 and 3, above, describing the female reproductive system on the screen or whiteboard and reinforcing it using *Reproductive System Worksheet #2*.**

**Front view of the female: OK, now let's look at the female reproductive system.**

*This opening to the outside of her body is called the **vagina**. That's where a penis would go if she had intercourse. And sperm would be released to travel up into her body in search of an egg.*

*Where do eggs and female hormones come from? Right. **Ovaries**. She has two of them and they sort of take turns ovulating, with one releasing an egg one month and, often, the other releasing one the next month. Her ovaries also make female hormones, so that her body will grow into an adult woman's.*

*When an egg leaves an ovary, it usually goes into the **fallopian tubes**. If an egg gets fertilized, that's where it will happen – in her tubes. Then it travels on down to the place it will grow for nine months.*

*What's that place called? Right. Her **uterus**. And this bottom part of the uterus, it's neck, is called the **cervix**. That's the place a doctor or nurse practitioner wipes cells from when they do a **Pap Test**. They are looking for changes in the cells of the cervix that might mean a cancer would develop. If they find that kind of changes, they can usually remove the cells that are in trouble long before they would become cancer.*

*And after a baby has grown in the uterus (remember it isn't called her stomach) for nine months, it usually comes out through the vagina.*

**Side view: Now she's facing to the side.** *A woman has three openings in her private parts. In the front, is the tube urine ("pee") comes out from. It's called the same thing we called it in the male: the **urethra**. And of course it is attached to the place where urine is stored: the **bladder**. In the middle is the opening her period comes out of, and where she has intercourse. What's it called? Right; the **vagina**. And then the third opening, besides the urethra and the vagina, is the opening a bowel movement comes out of. What did we call it in the male? Right: the **anus**.*

*Then, she has two folds of skin that protect the openings to the urethra and the vagina, called her **labia**. And in the front, where the labia meet, is the part with all the nerve endings that's usually the most sensitive to touch and that gets erect. What's it called? Right; the **clitoris**.*

*Now what about the parts we already named on the front view? Let's identify those ...*

**5. Give class a preview of tomorrow's lesson.**

Tomorrow, you will:

- respond to "Anonymous Question Box" and oral questions re: male and female reproductive systems (see lesson 1 for how to establish an anonymous question process and to the overview section of this manual for tips on responding to them)
- discuss how the parts work, as opposed to simply their names

# Reproductive System Transparency/Worksheet 1

DIRECTIONS: Fill in the name of each body part. Some will be repeated. Use correct spelling and medical, not slang, words.

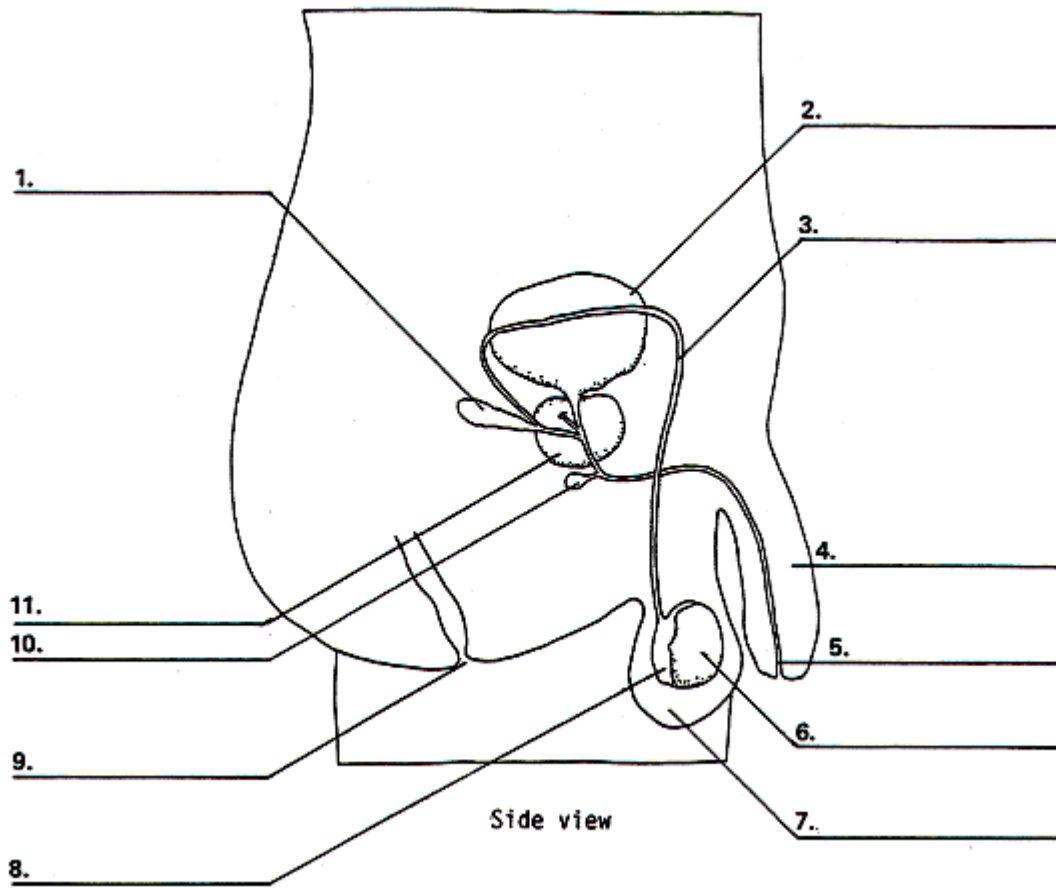

NOTE: #9 and #2 are not part of the reproductive system

Reproductive System Transparency/Worksheet 1 continued...

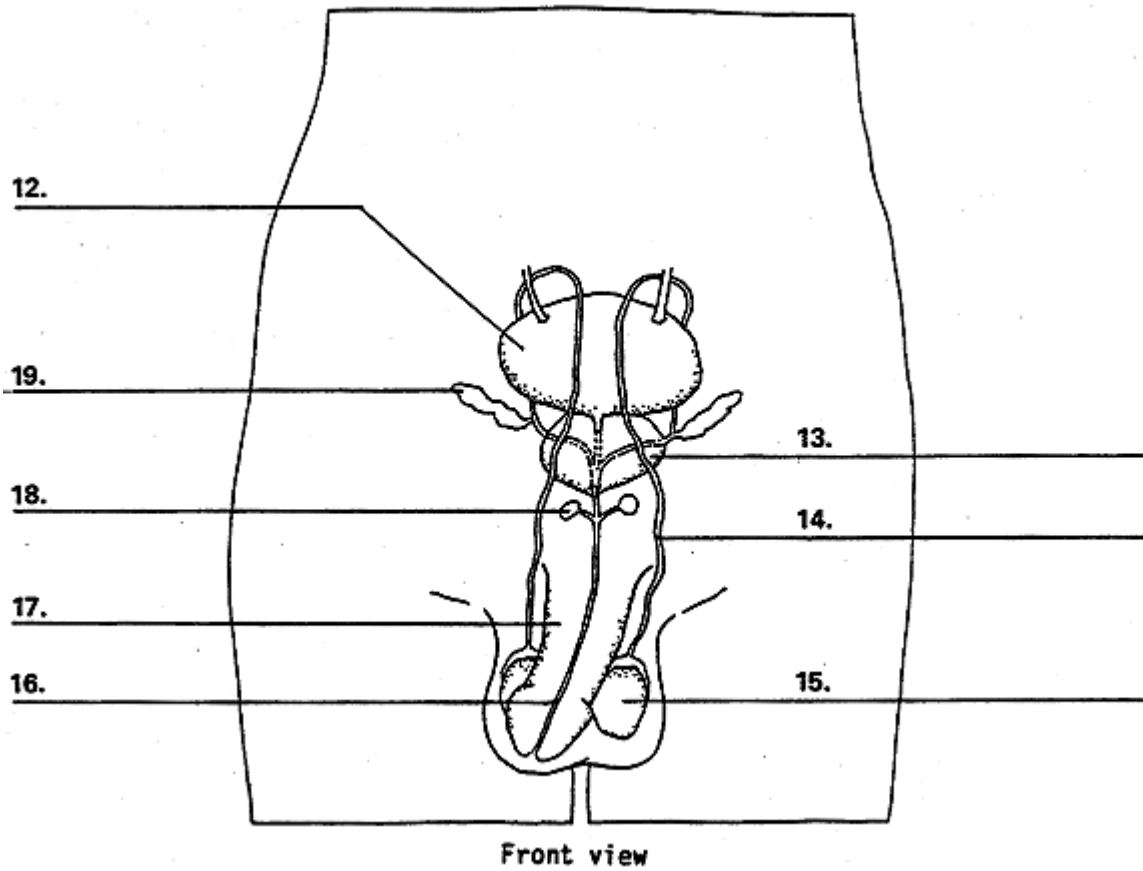

NOTE: #12 is not part of the reproductive system

## Reproductive System Transparency/Worksheet 2

DIRECTIONS: Fill in the name of each body part. Some will be repeated. Use correct spelling and medical, not slang, words.

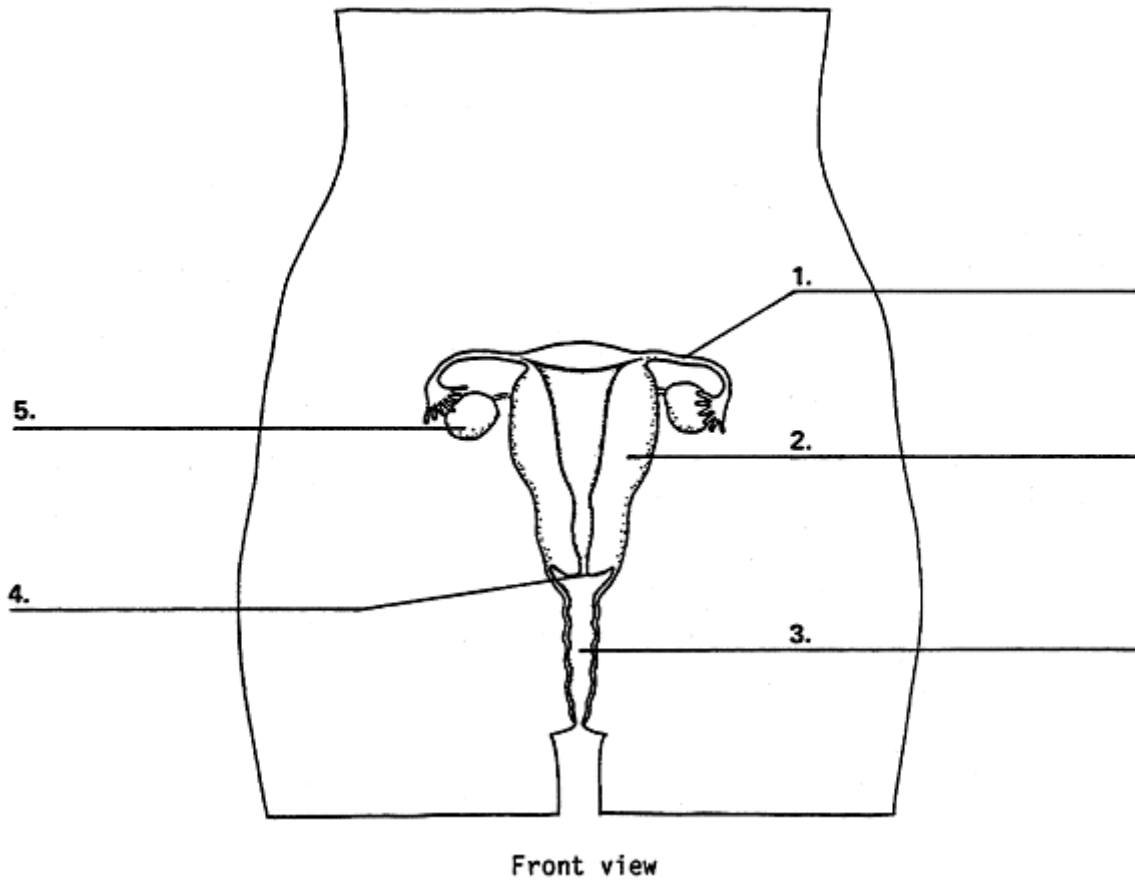



## Reproductive System Transparency/Worksheet 2 continued...

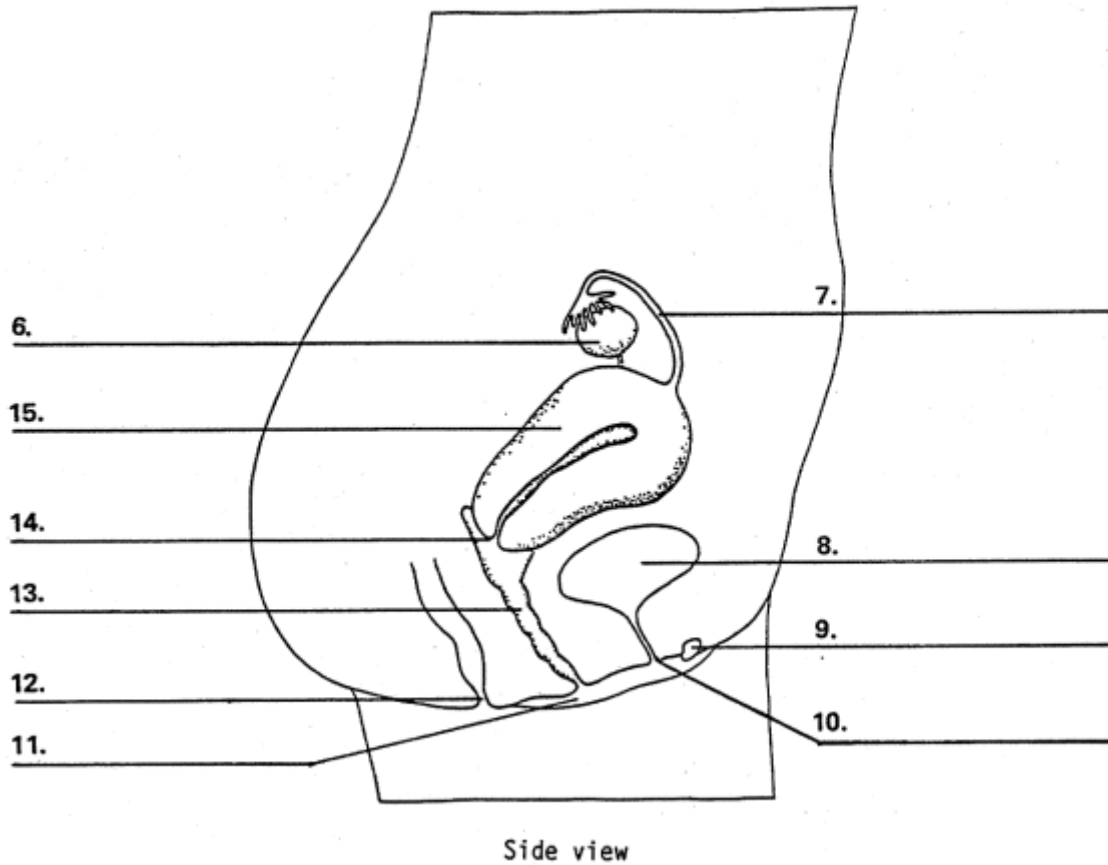

NOTE: #8, 10, and 12 are not part of the reproductive system

## Reproductive System Transparency/Worksheet 1 – answer key

DIRECTIONS: Fill in the name of each body part. Some will be repeated. Use correct spelling and medical, not slang, words.

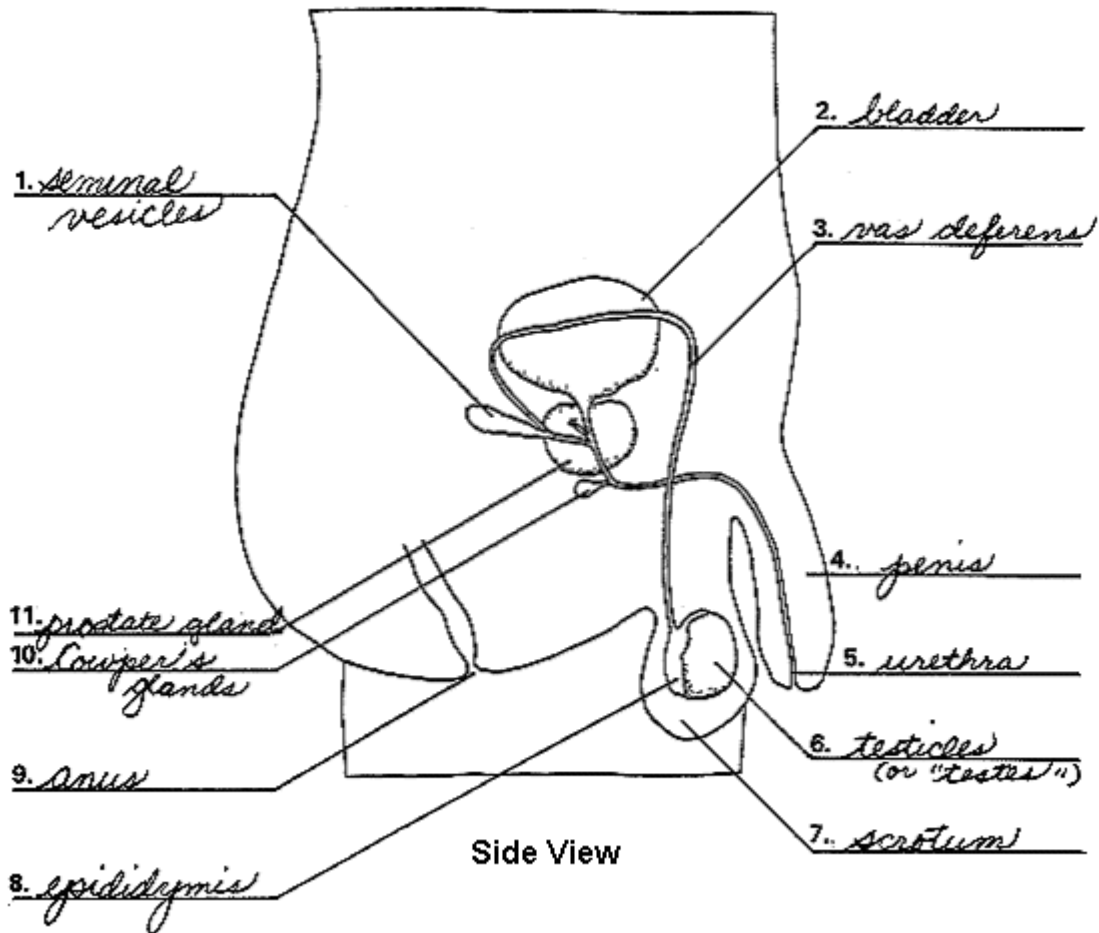

NOTE: #9 and #2 are not part of the reproductive system

# Reproductive System Transparency/Worksheet 1 continued... answer key

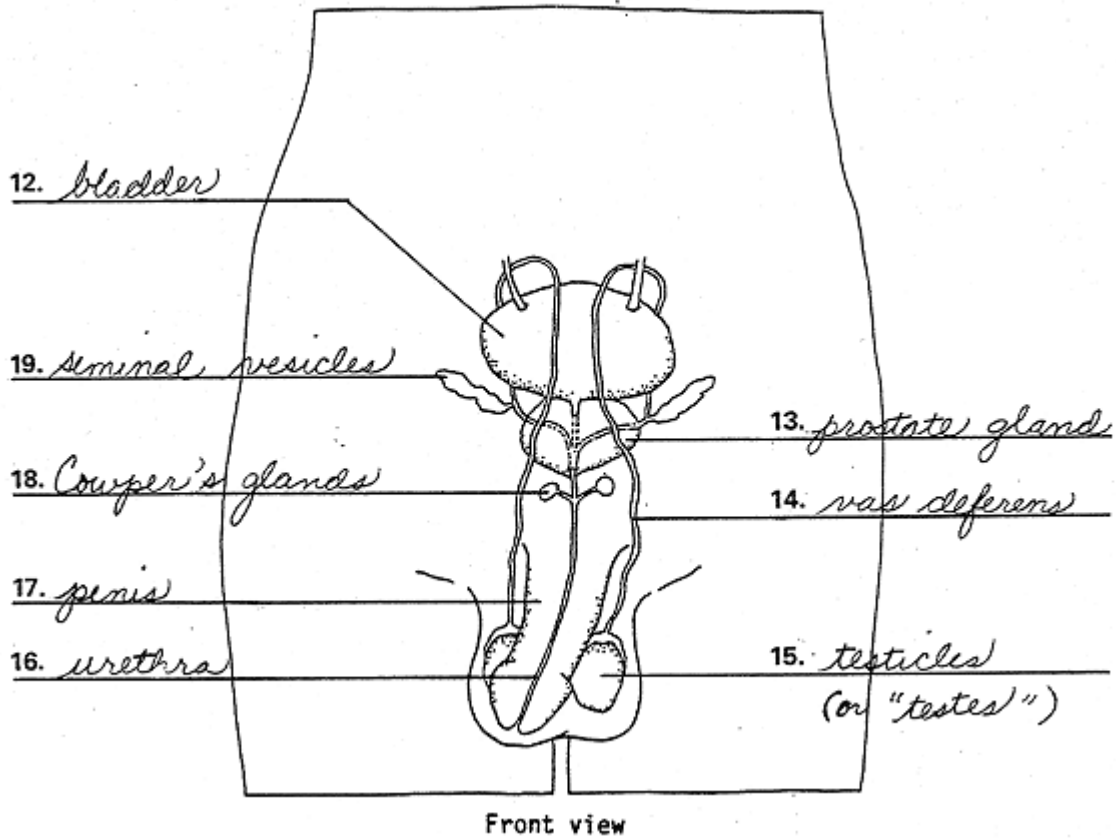

NOTE: #12 is not part of the reproductive system

## Reproductive System Transparency/Worksheet 2 – answer key

DIRECTIONS: Fill in the name of each body part. Some will be repeated. Use correct spelling and medical, not slang, words.

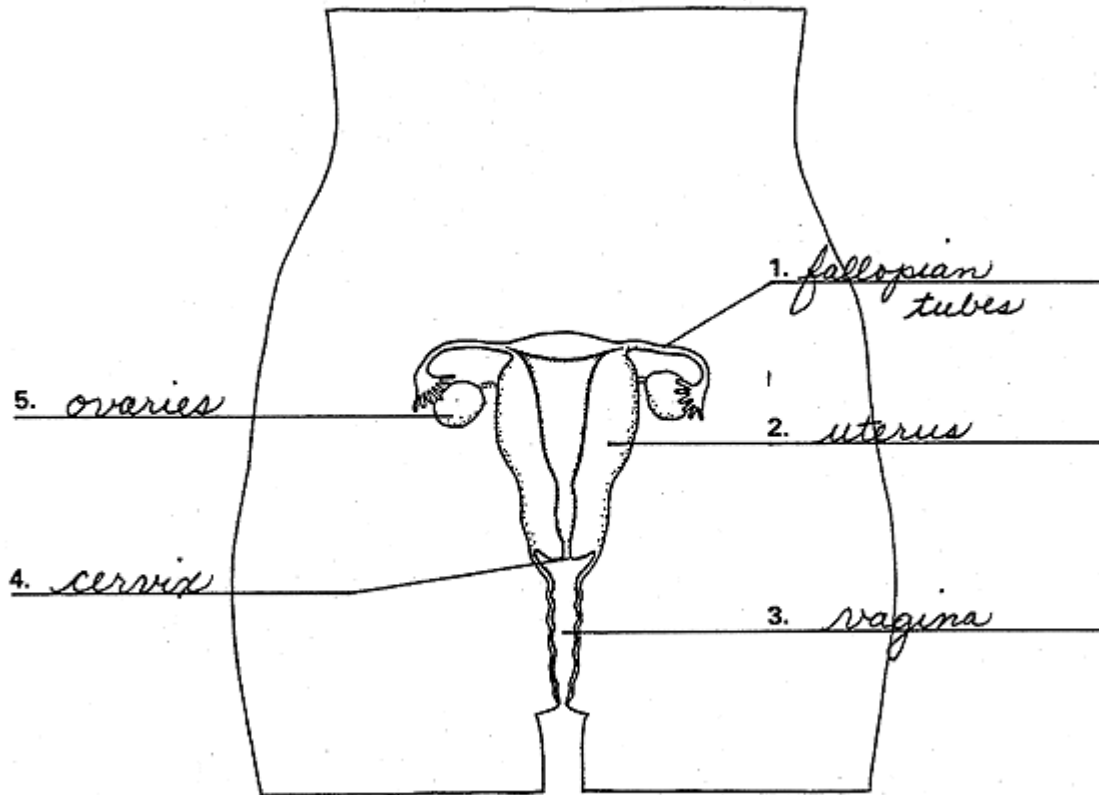

Front view

## Reproductive System Transparency/Worksheet 2 continued... answer key

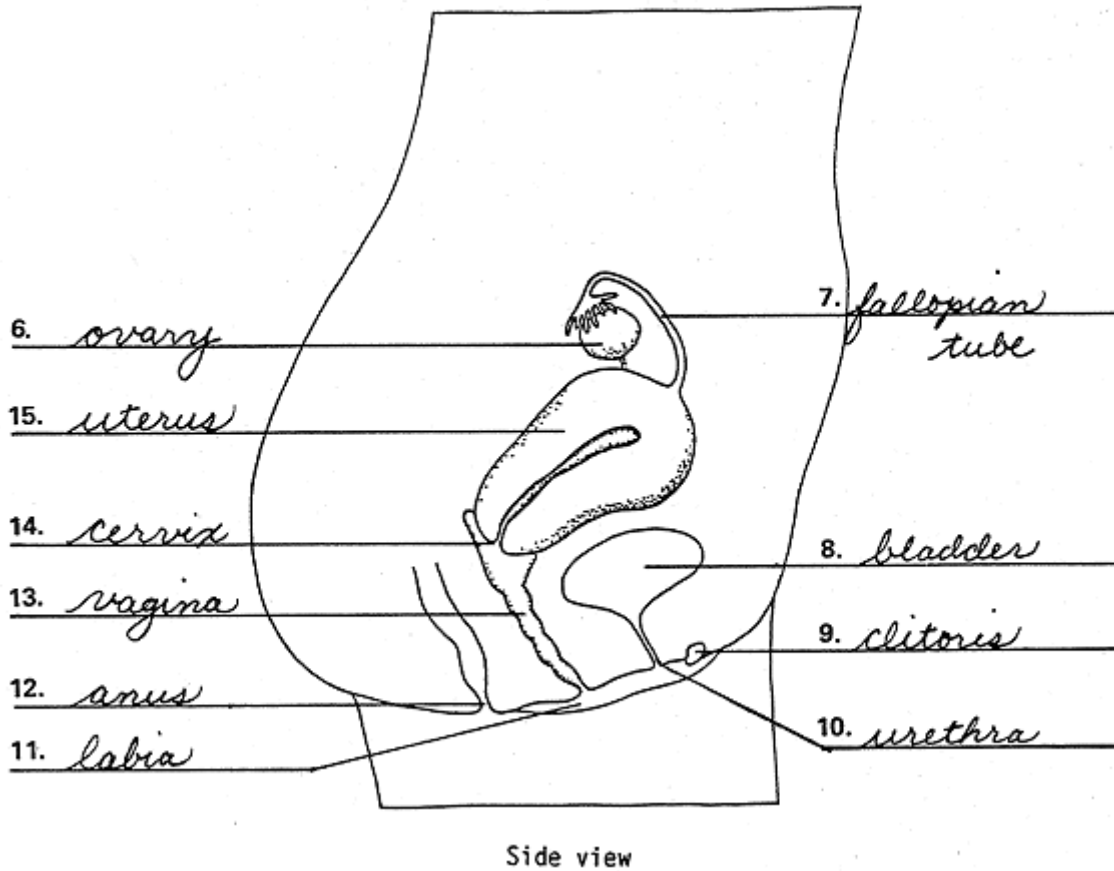

NOTE: #8, 10, and 12 are not part of the reproductive system