



U.S. Department
of Transportation

**Federal Highway
Administration**

May 11, 2000

400 Seventh St., S.W.
Washington, D.C. 20590

Refer to: HSA-CC66

Mr. Edwin M. Wood
Vice President
Barrier Systems, Inc.
1100 E. William Street, Suite 206
Carson City, NV 89701

Ed
Dear Mr. Wood:

In your March 6 letter to Mr. Dwight A. Home, you requested the Federal Highway Administration's (FHWA) acceptance for use on the National Highway System (NHS) of three different designs of your ABSORB 350 crash cushion as a National Cooperative Highway Research Program (NCHRP) Report 350 device for use at either test level 2 (TL-2) or test level 3 (TL-3). After reviewing the test reports and video coverage included with your letter, my staff recommended that some additional tests be run based on the design of the TI-3 ABSORB 350 and on its intended applications. On April 25, Mr. Owen Denman met with members of my staff and presented the results of the additional tests that you conducted.

The ABSORB 350 is a non-redirective, gating crash cushion primarily intended to shield the approach ends of temporary concrete barrier in general and Quick Change Median Barrier (QMB) segments in particular. As noted below, the ABSORB 350 may also be used to shield permanent concrete barrier at appropriate locations. The ABSORB 350 system consists of a nosepiece assembly, followed by four, eight, or nine element assemblies, and a transition/attachment assembly. These assemblies can be seen in Enclosure 1. We note that there are two types of element assemblies and that these must be alternated when installed. Both types are made from low density polyethylene and have internal structural components and connection hardware fashioned from ASTM A-36 mild steel. These elements are 800-mm tall and 610-mm wide. When empty, the element assemblies weigh 48 kg each. When filled with approximately 300 liters of water, they weigh 315 kg. The first element in an array must be kept empty to ensure proper performance. All other elements must be filled with water. The eight-element and nine-element TL-3 designs are 8.2 meters long and 9.2 meters long, respectively; the proposed four-element TL-2 design is 4.4 meters long.

Test results were contained in two reports, both prepared by Safe Technologies, Inc., in Rio Vista, California. They are entitled "NCHRP Report 350 Crash Test Results For ABSORB 350 Non-Redirective Crash Cushion (February 2000)" and a separate "ADDENDUM" to that report dated April 2000. A total of five tests were reported on an eight-element array connected to QMB segments. These were NCHRP Report 350 tests 3-40 (AET02), 3-41 (AET01), 3-43

(AET03), 3-44 (AET04), and a “modified” test 3-44 (AET11) with the actual impact point closer to the rear of the installation to demonstrate the effect of a rear corner impact. We concur with your statement that for the particular design of this device, NCHRP Report 350 test 3-42 may be waived. Summary sheets for the five tests are included as Enclosure 2. You requested a TL-3 acceptance of this design.

You also conducted two tests of a nine-element array. In the first of these tests (NCHRP Report 350 3-41/Aet06), the ABSORB 350 was attached to a free-standing temporary concrete barrier consisting of several 6-m long New Jersey shape segments. In the second test (NCHRP Report 350 3-44 “modified”/AET07), it was attached to a “fixed” concrete barrier to replicate a permanent installation. Based on the results of these tests, summarized as Enclosure 3, you requested TL-3 acceptance of a nine-element array when used to shield the ends of both temporary (minimum 6-m long segments) and permanent concrete barrier installations.

Finally, you conducted NCHRP Report 350 test 2-41 (AET05) into a four-element array at a nominal impact speed of 70 km/h and requested acceptance of this unit at TL-2 based on that one test. Enclosure 4 is a summary sheet of that test.

After reviewing the information you provided, my staff has concluded that the following designs may be considered acceptable for use on the NHS at TL-3 when such use is requested by the appropriate transportation agency:

- the eight-element design when connected to QMB units when the leading top edge of the first QMB unit is tapered as was done in the test
- the nine-element design when connected to permanent concrete barrier or to temporary concrete safety shaped barrier with individual segments having a minimum length of 6.1 m

In reviewing the single test you conducted on the four-element TL-2 design and comparing this to tests run on other crash cushions at the TL-2 impact speed of 70 km/h, we do not have adequate data to conclude that the shortened ABSORB 350 fully meets NCHRP Report 350 evaluation criteria at TL-2. Previous testing of other TL-2 crash cushions has indicated that NCBRP Report 350 test 2-40 may be critical from an occupant injury and vehicle stability standpoint and that test 2-44 may be critical in regard to vehicle stability. Test results may also differ depending on the type of barrier to which the four-element ABSORB 350 is connected, i.e., QMB, permanent concrete barrier, or non-anchored temporary concrete barrier. Should you wish to pursue acceptance of the ABSORB 350 at TL-2, please confer with Mr. Richard Powers at (202) 366.1320 to determine which test conditions will be appropriate.

Because the ABSORB 350 is a non-redirecting, gating cash cushion, care must be used in its application. As seen in your tests, vehicle penetration is likely to occur for angle hits from the

nose to near the mid-point of the array and penetration/override of the system is possible for high speed, high angle impacts near the rear of the device. Your test report states that systems like the ABSORB 350 (i.e., all gating, non-redirective crash cushions) "should be applied to hazards that are not likely to be impacted at an angle on the side at any significant velocity." We note also that proper antifreezing agents must be used as filler when the ABSORB 350 is used in areas where low temperatures can be anticipated. Other important usage considerations are noted in Appendix E (Test Article Deployment Instructions) of Safe Technologies' crash test report. All users of this device should be made aware of the factors that contribute to its proper performance.

Since the ABSORB 350 is a proprietary crash cushion, its use on Federal-aid projects, except exempt, non-NHS projects, is subject to the conditions listed in Title 23, Code of Federal Regulations, Section 635.411. A copy of this regulation is enclosed for your ready reference.

Sincerely yours,

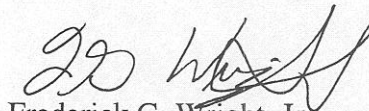

Frederick G. Wright, Jr.
Program Manager, Safety

5 Enclosures

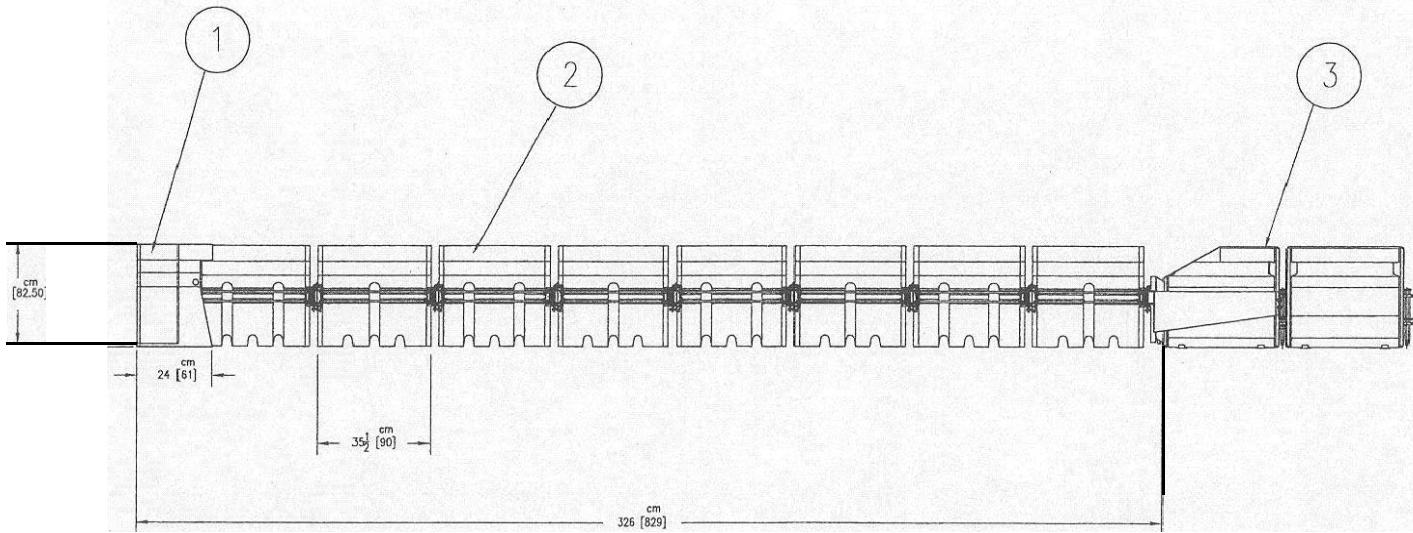
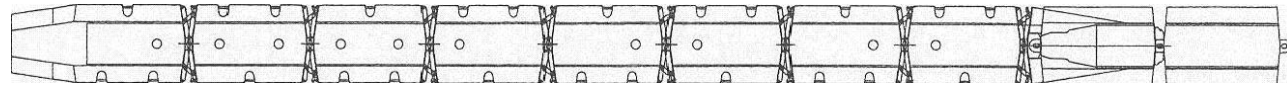

SEE B991205. BOM FOR MATERIAL LIST

NOTE:
THICKNESS OF WELD TO BE EQUAL TO THE THINNER OF 2 PIECES BEING JOINED. WELD TO BE ALL AROUND UNLESS OTHERWISE NOTED.

© 2000 Barrier Systems, Inc.
The information hereon is proprietary to Barrier Systems Inc. and shall not be disclosed, duplicated or used otherwise without the express written approval of Barrier Systems Inc.

REV.	CHANGES	DATE	BY	REQ'D	NEXT ASSY.	ITEM
A	ADD TOP VIEW	3/2/00	R.C	1	XXXXXXXX	1

SCALE: 1=40		Standard Tolerance	
DRAWN BY	DATE	INIT.	Angular ± 1/2°
APPR'D BY	2/8/00	R.R.C.	Fractional ± 1/16
TITLE: ASSEMBLY, ABSORB 350 TL3 Q.M.B			Decimal ± .010

MODEL	DRAWING NUMBER	REV
	B991205	A

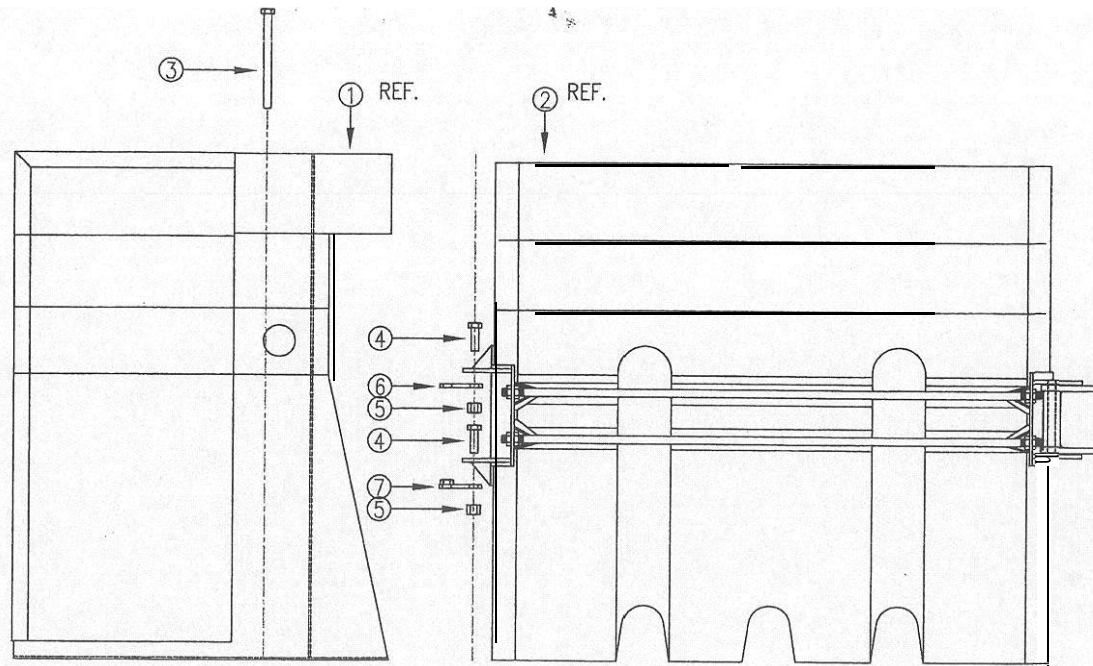

SEE B000421.BOM FOR MATERIAL LIST

NOTE:
THICKNESS OF WELD TO BE EQUAL
TO THE THINNER OF 2 PIECES
BEING JOINED. WELD TO BE ALL
AROUND UNLESS OTHERWISE NOTED.

© 2000 Barrier Systems, Inc.
The information herein is
proprietary to Barrier Systems
Inc. and shall not be disclosed,
duplicated or used otherwise
without the express written
approval of Barrier Systems Inc.

REV.	CHANGES	DATE	BY	REQ'D	NEXT ASSY.	ITEM
				1	XXXXXXX	1

SCALE: EIGHTH			Standard Tolerance	
DRAWN BY	DATE	INIT.	Angular	± 1/2°
APPR'D BY	04/27/00	JES	Fractional	± 1/16
			Decimal	± .010
TITLE: ABSORB 350 END ASSEMBLY DETAILS				

MODEL	DRAWING NUMBER	REV.
	B000421	

NOTE:
2 HOLES ON ELEMENTS 2 AND 3
AT TEST LEVEL 3

SEE DRAWING
B000422 FOR
ASSEMBLY DETAILS

3

1

2

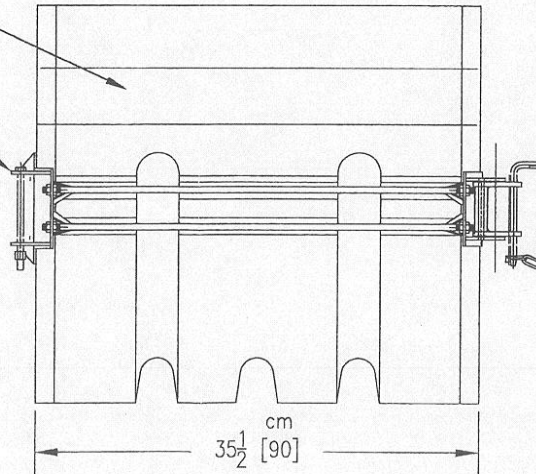
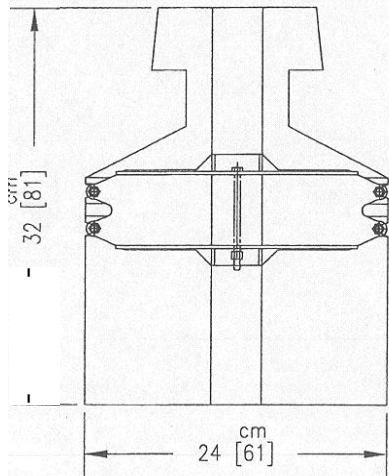
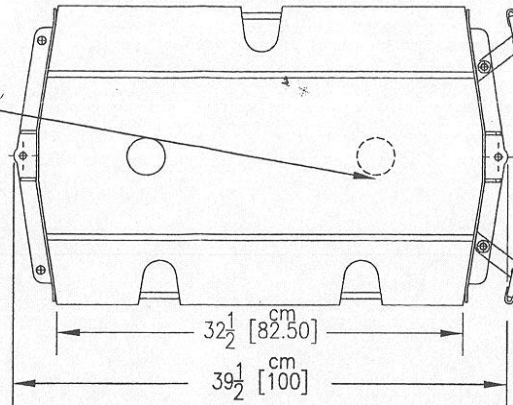

SEE B000303.BOM FOR MATERIAL LIST

NOTE:
THICKNESS OF WELD TO BE EQUAL
TO THE THINNER OF 2 PIECES
BEING JOINED. WELD TO BE ALL
AROUND UNLESS OTHERWISE NOTED

© 2000 Barrier Systems, Inc.
The information herein is
proprietary to Barrier Systems
Inc. and shall not be disclosed,
duplicated or used otherwise
without the express written
consent of Barrier Systems Inc.

REV	CHANGES	DATE	BY	REQ'D	NEXT ASSY	ITEM
5						B000310 2
9						B000304 2
4						B000211 2
8						B991205 2

SCALE: 1=10		Standard Tolerance	
DATE	INIT.	Angular	± 1/2°
3/2/00	R.R.C.	Fractional	± 1/16
APPR'D BY		Decimal	± .010
TITLE: ABSORB 350 ELEMENT			

MODEL	DRAWING NUMBER	REV.
	B000.30.3	

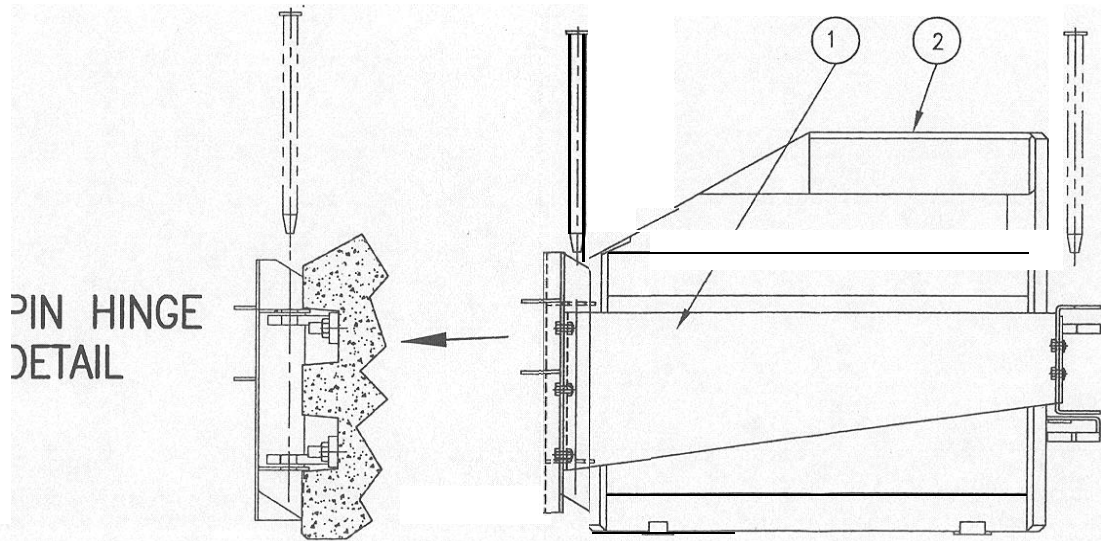
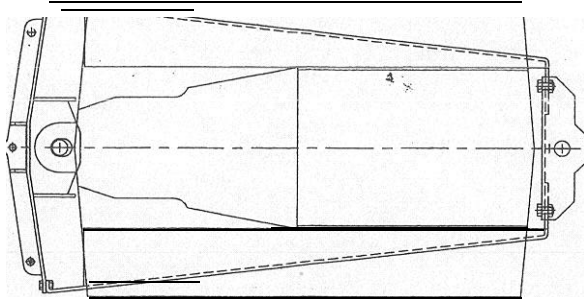

SEE XB000419.BOM FOR MATERIAL LIST

NOTE:
THICKNESS OF WELD TO BE EQUAL
TO THE THINNER OF 2 PIECES
BEING JOINED. WELD TO BE ALL
AROUND UNLESS OTHERWISE NOTED.

© 2000 Barrier Systems, Inc.
The information herein is
proprietary to Barrier Systems
Inc. and shall not be disclosed,
duplicated or used otherwise
without the express written
approval of Barrier Systems Inc.

REV.	CHANGES	DATE	BY	REQ'D	NEXT ASSY.	ITEM
				1	B991205	3

SCALE: 1=10			Standard Tolerance	
DRAWN BY	DATE	INIT.	Angular	± 1/2°
APPR'D BY	4/27/00	DGB	Fractional	± 1/16
			Decimal	± .010
TITLE: ASSEMBLY TRANSITION BARRIER ABSORB 350				

MODEL	DRAWING NUMBER	REV.
	B000419	

ENCLOSURE: 1(5 OF 6)

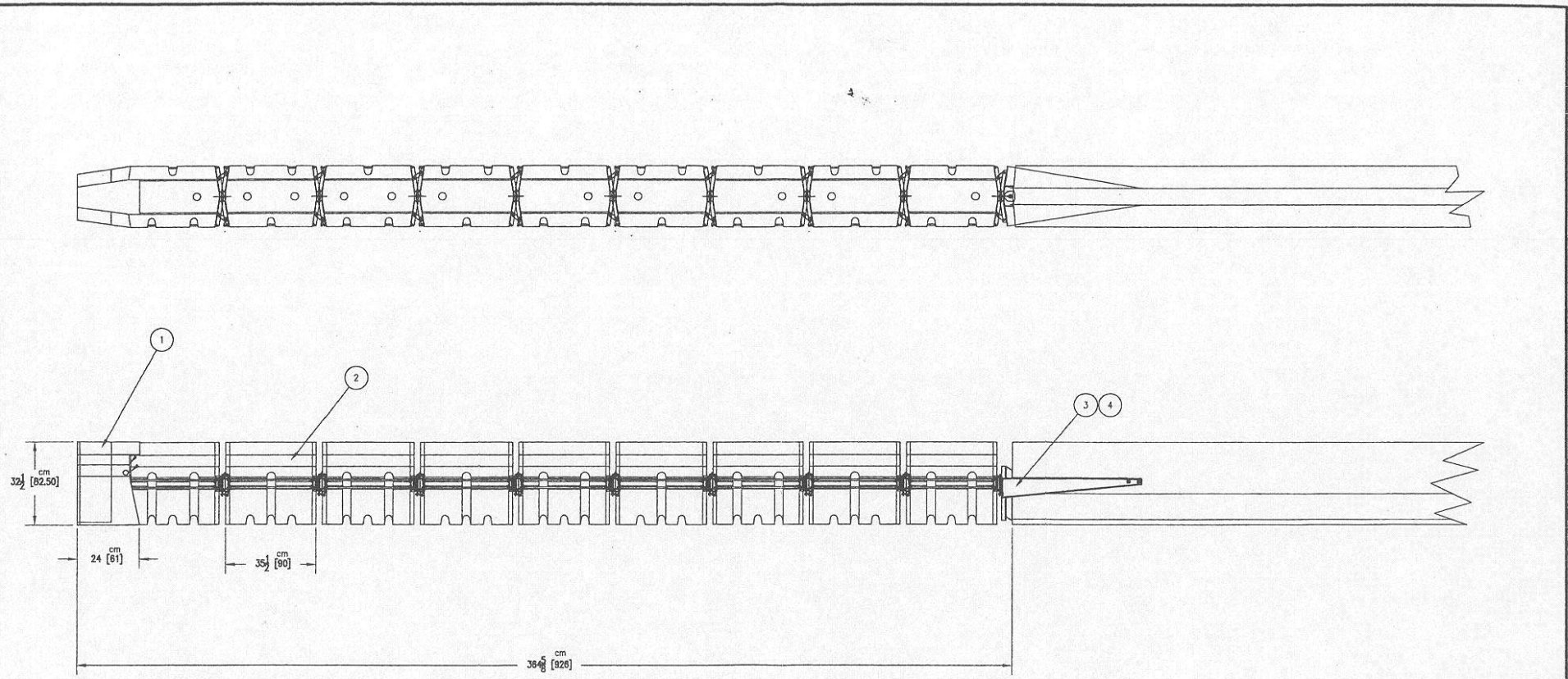

SEE B000304.BOM FOR MATERIAL LIST

NOTE:
THICKNESS OF WELD TO BE EQUAL
TO THE THINNER OF 2 PIECES
BEING JOINED. WELD TO BE ALL
AROUND UNLESS OTHERWISE NOTED.

© 2000 Barrier Systems, Inc.							
The information hereon is proprietary to Barrier Systems Inc. and shall not be disclosed, duplicated or used otherwise without the express written approval of Barrier Systems Inc.							
REV.	CHANGES	DATE	BY	REQ'D	NEXT ASSY.	ITEM	
				1		1	

SCALE: 1=40		Standard Tolerance	
DATE	INIT.	Angular	± 1/2°
3/2/00	R.R.C.	Fractional	± 1/16
APPR'D BY		Decimal	± .010
TITLE: ASSEMBLY, ABSORB 350 TL3 P.C.M.B.			

MODEL	DRAWING NUMBER	REV.
	B000304	

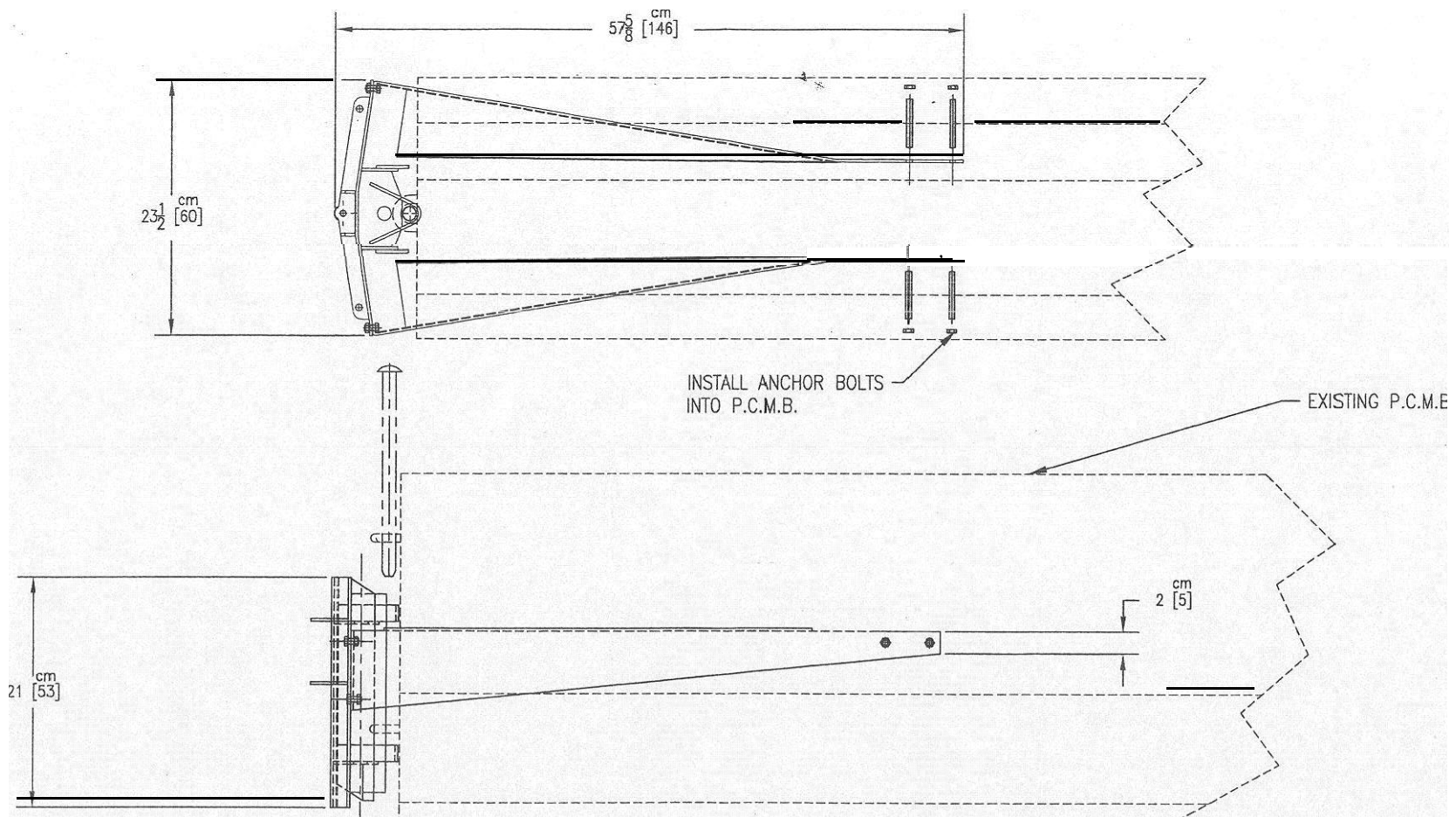

NOTE:
 THICKNESS OF WELD TO BE EQUAL
 TO THE THINNER OF 2 PIECES
 BEING JOINED. WELD TO BE ALL
 AROUND UNLESS OTHERWISE NOTED.

© 2000 Barrier Systems, Inc.

The information hereon is
 proprietary to Barrier Systems
 Inc. and shall not be disclosed,
 duplicated or used otherwise
 without the express written
 approval of Barrier Systems Inc.

REV.	CHANGES	DATE	BY	REQ'D	NEXT ASSY.	ITEM
				1	B000304	

SCALE: 1=10

DRAWN BY	DATE	INT.
APPR'D BY	4/28/00	DGB

Standard Tolerance
Angular ± 1/2°
Fractional ± 1/16
Decimal ± .010

TITLE:
 ADAPTER INSTALLATION
 ABSORB 350 P.C.M.B.

MODEL	DRAWING NUMBER	REV.
	B000420	

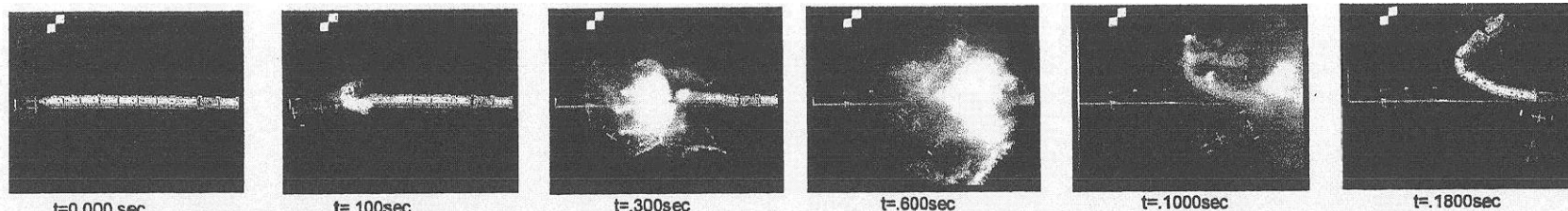

t=0.000 sec

t=.100sec

t=.300sec

t=.600sec

t=.1000sec

t=.1800sec

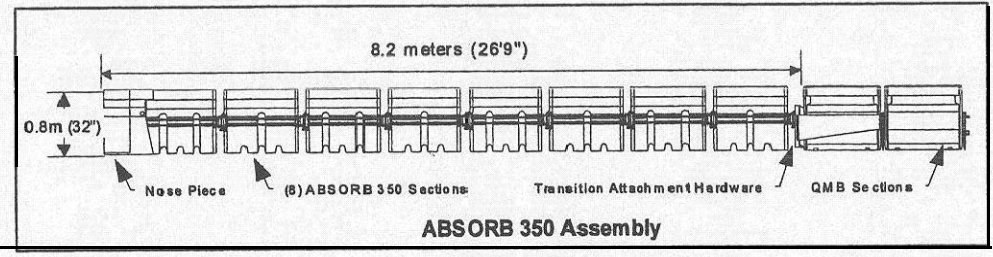
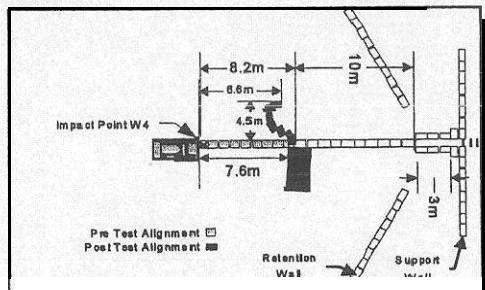

General Information

Test Agency.....	SAFE TECHNOLOGIES INC.
Test Designation	NCHRP 350 3-40
TestNo	ABSORB 350/Test #AET02
Date	2/4/00
Test Article	
Type	Barrier Systems, Inc. ABSORB 350 Non-Retardive Crash Cushion
Installation Length	8.2m overall (8 ABSORB sections w/ nose)
Size and/or dimension and material of key elements	Section length 1000mm, height 813mm, width 610mm, mass 48kg empty/315kg Full
Test Vehicle	
Type	Production Model
Designation	820C
Model	1991, Ford Festiva

Mass (kg)	
Curb	807
Testner!M.....	834
D'mnly(s)	75
Gross static.....	909
Impact Conditions	
speed (km/h)	89.3
Angle(deg)	0atW4
impact Severily (kJ)	317

Exit Conditions

Speed (km/h)	N/A
Angle (deg)	N/A
Occupant risk Values		
Impact Velocity (m/s)		
x-direction	10.2
y-direction	4.3
Ridedown Acceleration (g's)		
x - d i r e c t i o n	-11
y-direction	-3.2
THIV (m/s)	9.7
PHD (g's)	11.3
AS I.....	1.19

Vehicle Damage

Exterior		
VOS	FL-?
CDC	12FLEN2
Interior		
OCDI	AS0000000
Post-Impact Vehicular behavior (deg -gyro @ c.g)		
Maximum Roll Angle...	413 (observed <10)
Maximum Pitch Angle	49.2 (observed <10)
Maximum Yaw Angle	-198 (observed 260)

ENCLOSURE 2 (1 OF 5)

Figure 6. Summary of Results Test #AET02

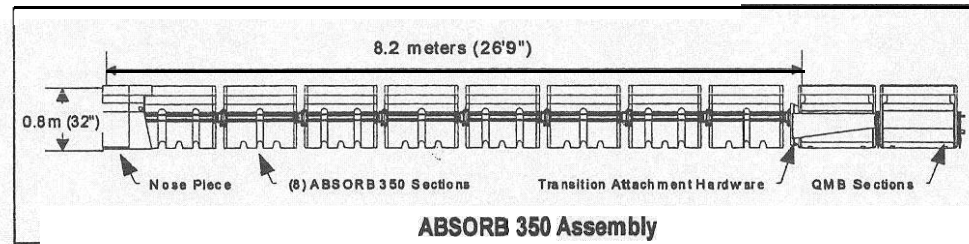
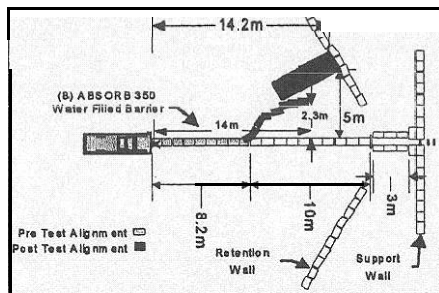
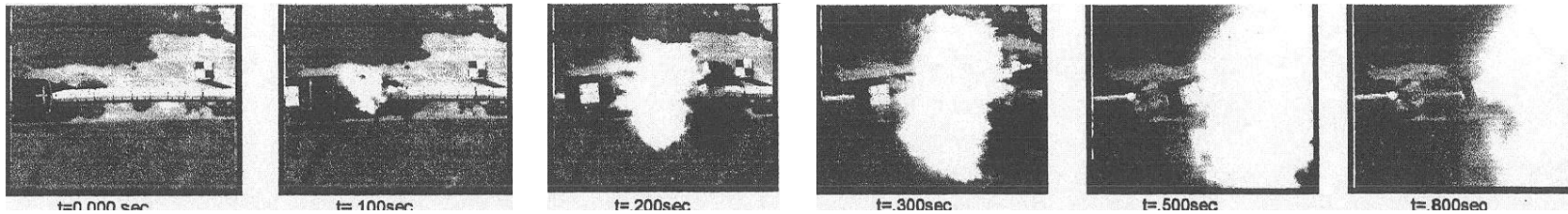

General Information

Test Agency..... SAFE TECHNOLOGIES, INC.
 Test Designation..... NCHRP3503-41
 Test No..... ABSORB 350 / Test #AET01
 Date..... 2/15/00

Test Article

Type..... Barrier Systems, Inc.
 ABSORB 350 Non-Redirective Crash Cushion

Installation Length..... 8.2m overall (8 ABSORB sections w / nose)

Size and/or dimension and material
 of key elements..... Section length 1000mm, height 813mm,
 width 610mm, mass 48kg empty / 315kg Full

Test Vehicle

Type..... Production Model
 Designation..... 2000P
 Model..... 1989, Chevrolet Silverado 2500
 3/4 Ton Pickup

Mass (kg)
 Curb..... 1901
 Test Inertial..... 1976
 Dummy(s)..... n/a
 Gross Static..... 1976

Impact Conditions

Speed (km/h)..... 99.2
 Angle (deg)..... 0
 Impact Severity (kJ)..... 750

Exit Conditions

Speed (km/h)..... 7.5
 Angle (deg)..... 27

Occupant risk Values

Impact Velocity (m/s)
 x-direction..... 9.7
 y-direction..... 0.3
 Ridedown Acceleration (g's)
 x-direction..... -11.9
 y-direction..... -4.8
 THIV (m/s)..... 9.7
 PHD (g's)..... 13.6
 ASI..... 0.99

Vehicle Damage

Exterior
 VDS..... FC-4
 CDC..... 12FDEW2
 Interior
 OCDI..... AS000000

Post-impact Vehicular behavior (deg - gyro @ c.g.)

Maximum Roll Angle..... 8.6 (observed <10)
 Maximum Pitch Angle..... -27.4 (observed < 10)
 Maximum Yaw Angle..... -31.2 (observed 30)

Figure 1. Summary of Results Test #AET01

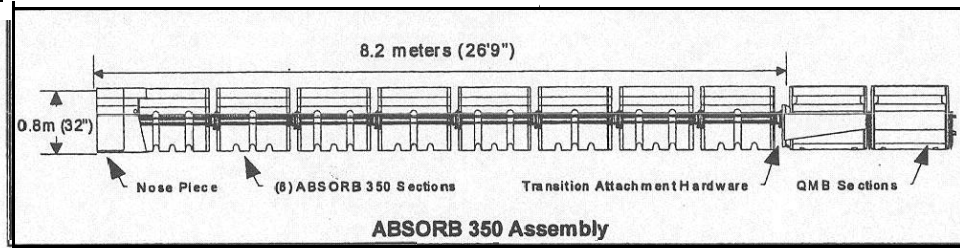
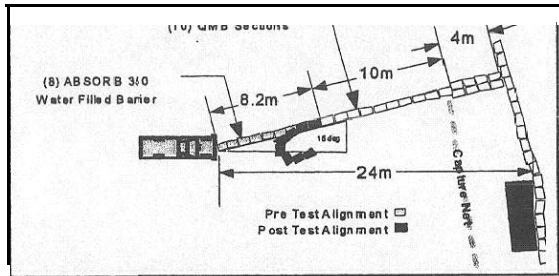
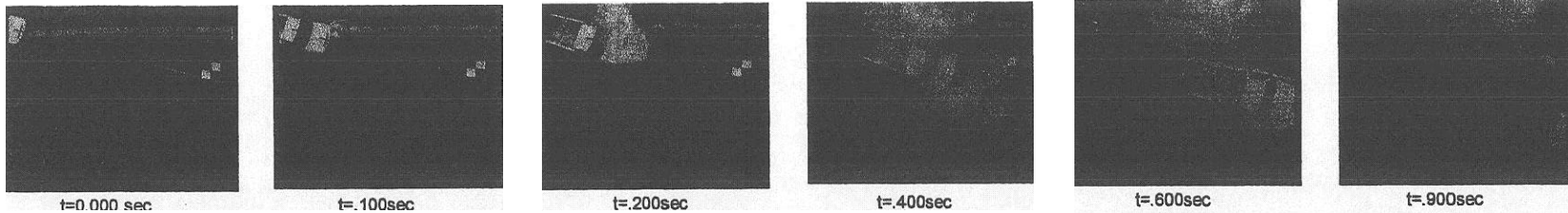

General Information

Test Agency..... SAFE TECHNOLOGIES, INC.
 Test Designation..... NCHRP 350 3-43
 Test No..... ABSORB 350 / Test #AET03
 Date..... 2/17/00

Test Article

Type..... Barrier Systems, Inc.
 ABSORB 350 Non-Redirective Crash Cushion
 8.2m overall (8 ABSORB sections w / nose)

Size and/or dimension and material

of key elements..... Section length 1000mm, height 813mm,
 width 610mm, mass 48kg empty / 315kg Full

Test Vehicle

Type..... Production Model
 Designation..... 2000P
 Model..... 1988, Chevrolet Cheyenne 2500
 3/4 Ton Pickup

Mass (kg)

Curb..... 1996
 Test Inertial..... 1984
 Dummy(s)..... n/a
 Gross Static..... 1984

Impact Conditions

Speed (km/h)..... 97.2
 Angle (deg)..... 15
 Impact Severity (kJ)..... 723

Exit Conditions

Speed (km/h)..... 74
 Angle (deg)..... 13

Occupant risk Values

Impact Velocity (m/s)
 x-direction..... 7.6
 y-direction..... -2.1
 dedown Acceleration (g's)
 x-direction..... -8.3
 y-direction..... -6.5
 HIV (m/s)..... 7.9
 HD (g's)..... 12.3
 SI..... 0.85

Vehicle Damage

exterior
 VDS..... FC-4
 CDC..... 12FDEW2
 interior

Maximum Roll Angle..... 32.3 (observed <35)
 Maximum Pitch Angle..... 11.9 (observed <15)
 Maximum Yaw Angle..... -28.7 (observed <20)

Figure 11. Summary of Results Test #AET03

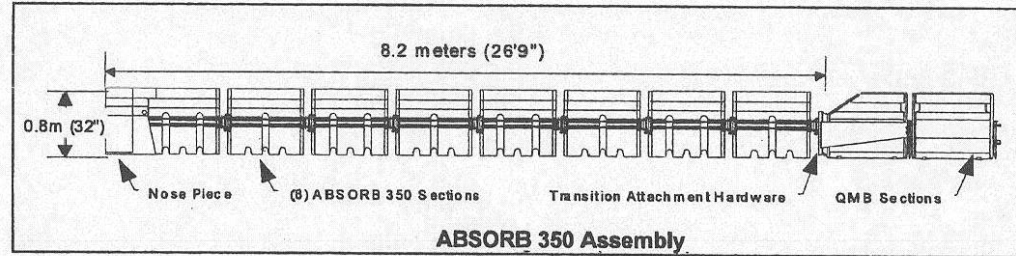
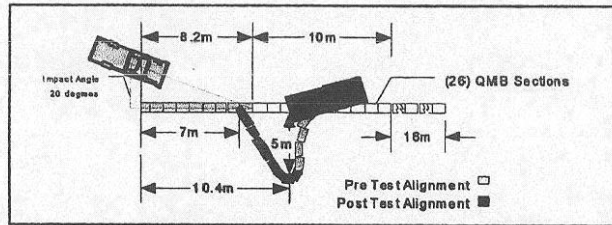
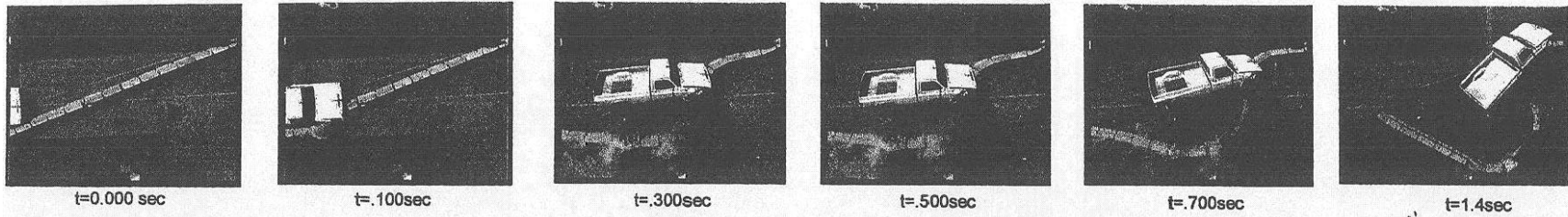

ABS RB

General Information

Test Agency..... SAFE TECHNOLOGIES, INC.
 Test Designation..... NCHRP 350 3-38
 Test No..... ABSORB 350 / Test #AET11
 Date..... 4/13/00

Test Article

Type..... Barrier Systems, Inc.
 ABSORB 350 Non-Redirective Crash Cushion

Installation Length

Installation Length..... 8.2 m overall (8 ABSORB sections w / nose)
 Size and/or dimension and material
 of key elements..... Section length 1000mm, height 813mm,
 width 610mm, mass 48kg empty / 315kg Full

Test Vehicle

Type..... Production Model
 Designation..... 2000P
 Model..... 1978, Chevrolet 3/4 Ton Pickup

Mass (kg)

Curb..... 2093
 Test Inertial..... 1975
 Dummy(s)..... n/a
 Gross Static..... 1975

Impact Conditions

Speed (km/h)..... 97.2
 Angle (deg)..... 20
 Impact Severity (kJ)..... 720

Exit Conditions

Speed (km/h)..... 0
 Angle (deg).....

Occupant risk Values

Impact Velocity (m/s)
 x-direction..... 8.9
 y-direction..... 0.4
 Ridedown Acceleration (g's)
 x-direction..... -20.7
 y-direction..... -8.8
 THIV (m/s)..... 8.8
 PHD (g's)..... 27.8
 ASI..... 0.96

Vehicle Damage

Exterior
 VDS..... FC-5
 CDC..... 12FDEW2
 Interior
 ODI..... AS0000000

Post-Impact Vehicular behavior (deg - gyro @ c.g.)

Maximum Roll Angle..... -53.9
 Maximum Pitch Angle..... -9.3
 Maximum Yaw Angle..... -43.9

RE

Figure 6. Summary of Results Test #AET11

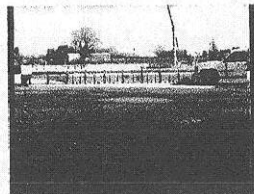

t=0.000 sec

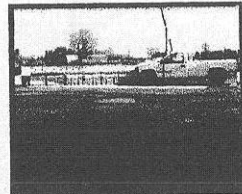

t=.100sec

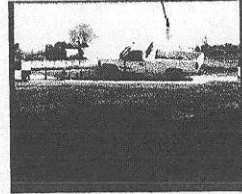

t=.200sec

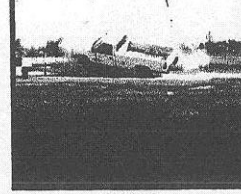

t=.300sec

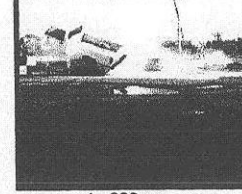

t=.600sec

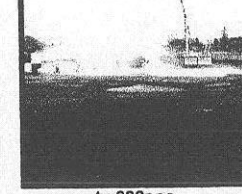

t=.900sec

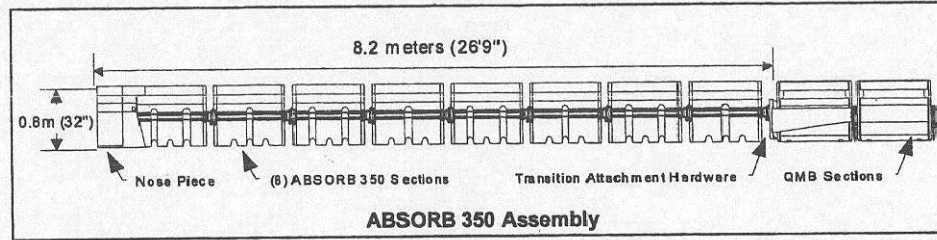
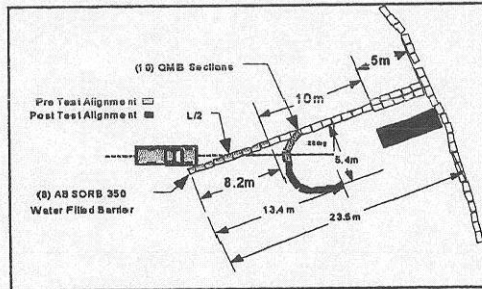

General Information

Test Agency.....	SAFE TECHNOLOGIES, INC.
Test Designation.....	NCHRP 350 3-44
Test No.....	ABSORB 350 / Test #AET04
Date.....	2/23/00
Test Article	
Type.....	Barrier Systems, Inc. ABSORB 350 Non-Redirective Crash Cushion
Installation Length.....	8.2m overall (8 ABSORB sections w / nose)
Size and/or dimension and material of key elements.....	Section length 1000mm, height 813mm, width 610mm, mass 48kg empty / 315kg Full
Test Vehicle	
Type.....	Production Model
Designation.....	2000P
Model.....	1988, Chevrolet Cheyenne 2500 3/4 Ton Pickup
Mass (kg)	
Curb.....	1923
Test Inertial.....	1930
Dummy(s).....	n/a
Gross Static.....	1930
Impact Conditions	
Speed (km/h).....	98.3
Angle (deg).....	20
Impact Severity (kJ).....	720

Exit Conditions

Speed (km/h).....	39
Angle (deg).....	15
Occupant risk Values	
Impact Velocity (m/s)	
x-direction.....	8.1
y-direction.....	0.8
Ridedown Acceleration (g's)	
x-direction.....	-14.6
y-direction.....	-13.6
THIV (m/s).....	8.1
PHD (g's).....	19
ASI.....	1.21

Vehicle Damage

Exterior	
VDS.....	FD-3
CDC.....	12FDEW3
Interior	
OCDI.....	RF0110000

Post-Impact Vehicular behavior (deg - gyro @ c.g.)

Maximum Roll Angle.....	51.6
Maximum Pitch Angle.....	-23.3
Maximum Yaw Angle.....	-25

Figure 16. Summary of Results Test #AET04

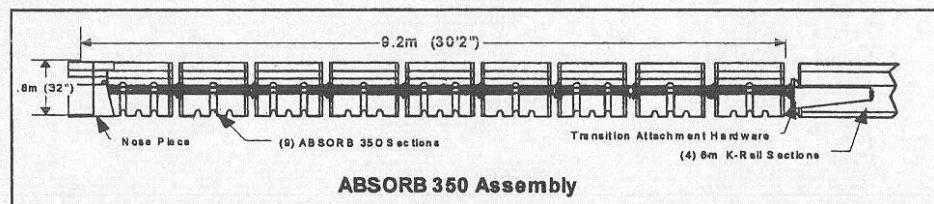
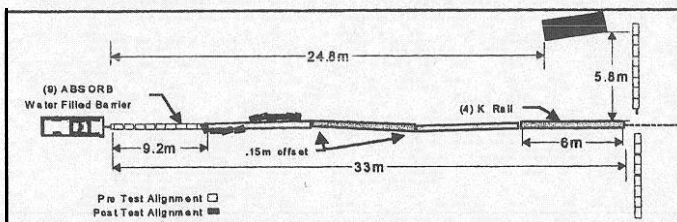
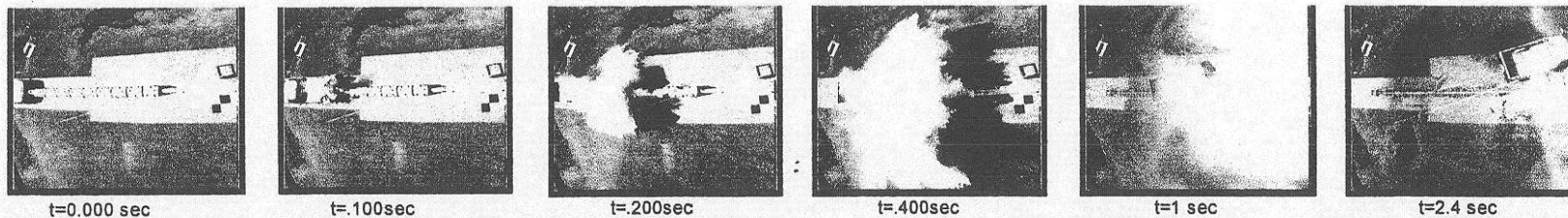

General Information

Test Agency SAFE TECHNOLOGIES, INC.
 Test Designation NCHRP 350 3-41
 Test No ABSORB 350 / Test #AET06
 Date 3/1/00

Test Article

Type Barrier Systems, Inc.
 ABSORB 350 Non-Redirective Crash Cushion
 Installation Length 9.2m overall (9 ABSORB sections w / nose)
 Size and/or dimension and material
 of key elements section length 1000mm, height 813mm,
 width 610mm, mass 48kg empty / 315kg Full

Test Vehicle

Type Production Model
 Designation 2000P
 Model 1989, GMC Sierra 3/4 Ton pickup

Mass (kg)

Curb 1932
 Test inertial 1985
 Dummy (s) n/a
 Gross static 1985

Impact Conditions

Speed (km/h) 97
 Angle (deg) 0
 Impact severity (kJ) 720

Exit Conditions

Speed (km/h) 7.9
 Angle (deg) 20

occupant risk Values

Impact Velocity (m/s)
 x-direction 10.1
 y-direction -0.3
 Ridedown Acceleration (g's)
 x-direction -14.3
 y-direction 5.4
 THIV (m/s) 10.1
 PHD (g's) 14.4
 ASI 0.95

Vehicle Damage

Exterior
 "OS" FC-3
 CDC 12FDEW1
 Interior
 OCDI AS0000000

Post-impact Vehicular behavior (deg . gyro @ c.g.)

Maximum Roll Angle 12.8 (observed <10)
 Maximum Pitch Angle -12.9 (observed <5)
 Maximum Yaw Angle -15.7 (observed 20)

Figure 26. Summary of Results Test #AET06

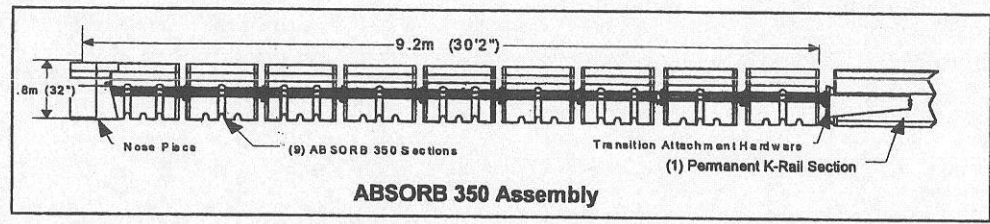
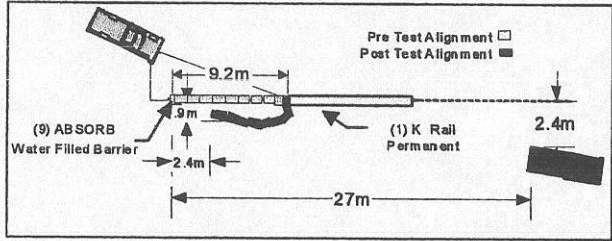
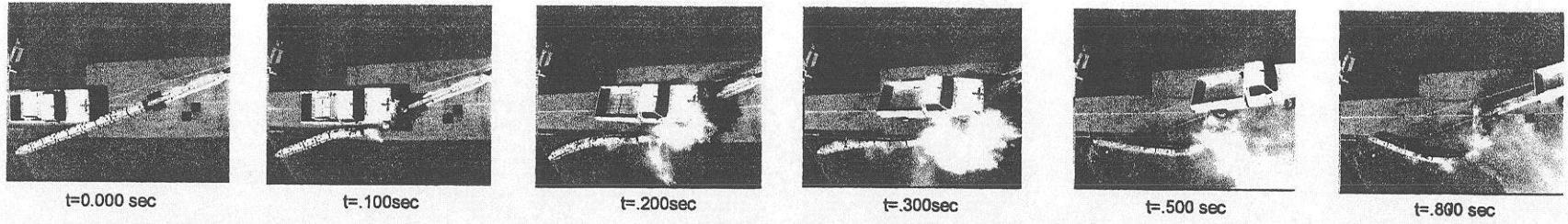

General Information

Test Agency..... **SAFE TECHNOLOGIES, INC.**
 Test Designation..... **NCHRP 350 3-38**
 Test No..... **ABSORB 350 / Test #AET07**
 Date..... **3/29/00**

Test Article

Type..... **Barrier Systems, Inc.**
ABSORB 350 Non-Redirective Crash Cushion

Installation Length..... **9.2m overall (9 ABSORB sections w / nose)**

Size and/or dimension and material
 of key elements..... **Section length 1000mm, height 813mm,
 width 610mm, mass 48kg empty / 315kg Full**

Test Vehicle

Type..... **Production Model**
 Designation..... **2000P**
 Model..... **1983, GMC 3/4 Ton Pickup**

Mass (kg)

Curb..... **1935**
 Test Inertial..... **1968**
 Dummy(s)..... **n/a**
 Gross Static..... **1968**

Impact Conditions

Speed (km/h)..... **95.5**
 Angle (deg)..... **20**
 Impact Severity (kJ)..... **694**

Exit Conditions

Speed (km/h)..... **39.4**
 Angle (deg)..... **20**

Occupant risk Values

Impact Velocity (m/s)
 x-direction..... **8**
 y-direction..... **0.6**
 Ridedown Acceleration (g's)
 x-direction..... **-27.8**
 y-direction..... **-7.3**
 THIV (m/s)..... **8**
 PHD (g's)..... **32.5**
 ASI..... **1.13**

Vehicle Damage

Exterior
 VDS..... **FC-4**
 CDC..... **12FDEW1**
 Interior
 OCDI..... **AS0000000**

Post-Impact Vehicular behavior (deg - gyro @ c.g.)

Maximum Roll Angle..... **-53.3 (observed <)**
 Maximum Pitch Angle..... **18.1 (observed <)**
 Maximum Yaw Angle..... **-15.3 (observed)**

Figure 1. Summary of Results Test #AET07

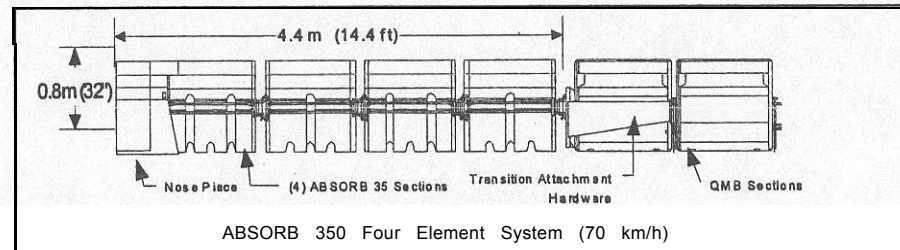
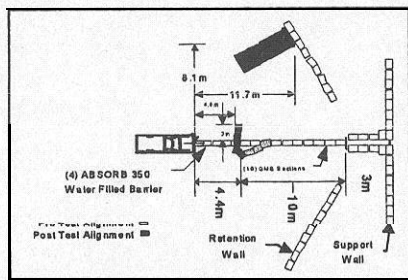
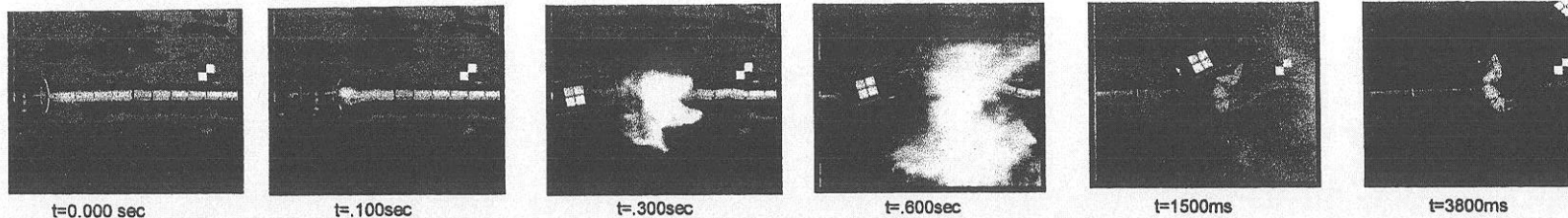

General Information

Test Agency..... SAFE TECHNOLOGIES, INC
 Test Designation..... NCHRP 350 2-41
 Test No..... ABSORB 350 / Test #AET05
 Date..... 2/15/00

Test Article

Type..... Barrier Systems, Inc.
 ABSORB 350 Non-Redirective Crash Cushion

Installation Length

Size and/or dimension and material
 of key elements..... 4.4 m overall (4 ABSORB sections w / nose)
 Section length 1000mm, height 813mm,
 width 610mm, mass 48kg empty / 315kg Full

Test Vehicle

Type..... Production Model
 Designation..... 2000P
 Model..... 1988, Chevrolet 2500 3/4 T on Pickup

Mass (kg)

Curb..... 1950
 Test Inertial..... 1958
 Dummy(s)..... n/a
 Gross Static..... 1958

Impact Conditions

Speed (km/h)..... 67.2
 Angle (deg)..... 0
 Impact Severity (kJ)..... 341

Exit Conditions

Speed (km/h)..... 9.7
 Angle (deg)..... 28

Occupant risk Values

Impact Velocity (m/s)
 x-direction 7.3
 y-direction |
 Ridedown Acceleration (g's)
 x-direction -7.7
 y-direction -3.1
 THIV (m/s)..... 7.4
 PHD (g's)..... 7.8
 ASI 0.64

Vehicle Damage

Exterior
 VDS..... FC-4
 CDC..... .12FCEN2
 Interior
 OCDI. AS0000000

Post-Impact Vehicular behavior (deg - gyro @ c.g.)

Maximum Roll Angle 8.7 (observed <5)
 Maximum Pitch Angle -0.5 (observed <10)
 Maximum Yaw Angle -50.9 (observed <30)

Figure 21. Summary of Results Test #AET05

Sec. 635.411 Material or product selection.

(a) Federal funds shall not participate, directly or indirectly, in payment for any premium or royalty' on any patented or proprietary material, specification, or process specifically set forth in the plans and specifications for a project, unless:

(1) Such patented or proprietary item is purchased or obtained through competitive bidding with equally suitable unpatented items; or

(2) The State highway agency certifies either that such patented or proprietary item is essential for synchronization with existing highway facilities, or that no equally suitable alternate exists; or

(3) Such patented or proprietary item is used for research or for a distinctive type of construction on relatively short sections of road for experimental purposes.

(b) When there is available for purchase more than one nonpatented, nonproprietary material, semifinished or finished article or product that will fulfill the requirements for an item of work of a project and these available materials or products are judged to be of satisfactory quality and equally acceptable on the basis of engineering analysis and the anticipated prices for the related item(s) of work are estimated to be approximately the same, the PS&E for the project shall either contain or include by reference the specifications for each such material or product that is considered acceptable for incorporation in the work. If the State highway agency wishes to substitute some other acceptable material or product for the material or product designated by the successful bidder or bid as the lowest alternate, and such substitution results in an increase in costs, there will not be Federal-aid participation in any increase in costs.

(c) A State highway agency may require a specific material or product when there are other acceptable materials and products, when such specific choice is approved by the Division Administrator as being in the public interest. When the Division Administrator's approval is not obtained, the item will be nonparticipating unless bidding procedures are used that establish the unit price of each acceptable alternative. In this case Federal-aid participation will be based on the lowest price so established.

(d) Appendix A sets forth the FHWA requirements regarding (1) the specification of alternative types of culvert pipes, and (2) the number and types of such alternatives which must be set forth in the specifications for various types of drainage installations.

(e) Reference in specifications and on plans to single trade name materials will not be approved on Federal-aid contracts.