



---

**U.S. Department of Commerce**

**National Oceanic and Atmospheric Administration**

**National Marine Fisheries Service**

---

**A review of the fishing gear utilized within  
the Southeast Region and their potential  
impacts on essential fish habitat**

---

**by:**

**Michael C. Barnette**

**National Marine Fisheries Service  
Southeast Regional Office  
9721 Executive Center Drive North  
St. Petersburg, FL 33702**

**February 2001**





## **A review of the fishing gear utilized in the Southeast Region and their potential impacts on essential fish habitat**

**by: Michael C. Barnette**

---

U.S. Department of Commerce  
Donald L. Evans, Secretary

National Oceanic and Atmospheric Administration  
Scott B. Gudes, Acting Under Secretary for Oceans and Atmosphere

National Marine Fisheries Service  
William T. Hogarth, Acting Assistant Administrator for Fisheries

February 2001

---

Technical Memoranda are used for documentation and timely communication of preliminary results, interim reports, or special purpose information, and have not received complete formal review, editorial control or detailed editing.

## **NOTICE**

---

The National Marine Fisheries Service (NMFS) does not approve, recommend or endorse any proprietary product or proprietary material mentioned in this publication. No reference shall be made to NMFS, nor to this publication furnished by NMFS, in any advertising or sales promotion which would indicate or imply that NMFS approves, recommends or endorses any proprietary product or proprietary material mentioned herein, or which has as its purpose an intent to cause directly or indirectly the advertised product to be used or purchased because of this NMFS publication. The views presented are those of the author and do not necessarily reflect the views of NMFS.

This report should be cited as follows:

**Barnette, M.C. 2001. A review of the fishing gear utilized within the Southeast Region and their potential impacts on essential fish habitat. NOAA Technical Memorandum NMFS-SEFSC-449, 62pp.**

Copies may be obtained by writing:  
National Technical Information Service  
5258 Port Royal Rd.  
Springfield, VA 22161  
1-800-553-6847 or 1-703-605-6000

## **ACKNOWLEDGMENT**

---

I would like to acknowledge Jeff Rester of the Gulf States Marine Fisheries Commission, for his effort in compiling his annotated bibliography of fishing impacts, as well as for his assistance and comments during the development of this paper.

# INDEX

---

Background	1
Essential Fish Habitat	2
Fishery-Related Impacts	5
Regional Fishing Gear	6
Mobile Gear	
Crab Scrape	8
Frame Trawl	8
Hydraulic Escalator Dredge	12
Otter Trawl	13
Oyster Dredge	20
Scallop Dredge (Inshore)	21
Scallop Dredge (Offshore)	21
Skimmer Trawl	22
Static Gear	
Channel Net	23
Gillnet & Trammel Net	23
Hoop Net	27
Longline	27
Poundnet	28
Trap & Pot	28
Other Gear	
Allowable Chemical	30
Barrier Net	30
Castnet	30
Clam Kicking	35
Clam Rake, Scallop Rake, Sponge Rake, & Oyster Tong	36
Dipnet & Bully Net	36
Hand Harvest	37
Harpoon	37
Haul Seine & Beach Seine	37
Hook and Line, Handline, Bandit Gear, Buoy Gear, & Rod and Reel	38
Patent Tong	38
Purse Seine & Lampara Net	39
Pushnet	39
Slurp Gun	39
Snare	40
Spear & Powerhead	40
Current Management Measures To Protect EFH	41
Summary	41
References	44
Definitions	56
Appendix: List of Authorized Gear	60

## LIST OF TABLES AND FIGURES

---

### Tables

Table 1. Estuarine and Marine EFH Components Within the Southeast Region . . . . .	3
Table 2. Summary of the Potential Physical Impacts to EFH in the Gulf of Mexico, South Atlantic, and Caribbean Developed During the December 1999 NOAA Fisheries EFH Workshop . . . . .	8

### Figures

Figure 1. Crab Scrape . . . . .	9
Figure 2. Frame Trawl . . . . .	9
Figure 3. Escalator Dredge . . . . .	9
Figure 4. Otter Trawl . . . . .	10
Figure 5. Oyster Dredge . . . . .	10
Figure 6. Scallop Dredge (Inshore) . . . . .	10
Figure 7. Scallop Dredge (Offshore) . . . . .	10
Figure 8. Skimmer Trawl . . . . .	11
Figure 9. Gillnet . . . . .	24
Figure 10. Trammel Net . . . . .	24
Figure 11. Hoop Net . . . . .	24
Figure 12. Bottom Longline . . . . .	24
Figure 13. Pelagic Longline . . . . .	25
Figure 14. Pound Net . . . . .	25
Figure 15. Fish Trap . . . . .	25
Figure 16. Crab Pot . . . . .	25
Figure 17. Collapsible Crab Trap . . . . .	26
Figure 18. Cast Net . . . . .	31
Figure 19. Bull Rake . . . . .	31
Figure 20. Hand Rake . . . . .	31
Figure 21. Oyster Tongs . . . . .	31
Figure 22. Dipnet . . . . .	32
Figure 23. Tropical Fish Net . . . . .	32
Figure 24. Lobster/Landing Net . . . . .	32
Figure 25. Beach Haul Seine . . . . .	32
Figure 26. Patent Tongs . . . . .	33
Figure 27. Purse Seine . . . . .	33
Figure 28. Components of a Purse Seine Net . . . . .	34
Figure 29. Lampara Net . . . . .	34
Figure 30. Pushnet . . . . .	34
Figure 31. Slurp Gun . . . . .	34
Figure 32. Snare . . . . .	35
Figure 33. Speargun . . . . .	35

## **BACKGROUND**

---

Habitat is increasingly recognized as critical to maintaining species diversity and supporting sustainable fisheries. The 1996 reauthorization of the Magnuson-Stevens Fishery Conservation and Management Act (Magnuson-Stevens Act) mandated that fishery management plans (FMPs) be amended to include the description and identification of essential fish habitat (EFH) for all managed species. The Magnuson-Stevens Act defined EFH as “those waters and substrate necessary to fish for spawning, breeding, feeding or growth to maturity.”

The Magnuson-Stevens Act also required that adverse impacts on EFH resulting from fishing activities be identified and minimized to the extent practicable. In order to minimize adverse impacts on EFH resulting from fishery-related activities, an evaluation of the various fishing gear types employed within the jurisdictions of all Fishery Management Councils was necessary. This evaluation developed into a profoundly difficult obstacle given the paucity of readily available information on the numerous types of gear utilized within the South Atlantic, Gulf of Mexico, and Caribbean. While there have been hundreds of studies published on gear impacts worldwide, the majority of these focus on mobile gear such as dredges and trawls. Furthermore, in addition to the approved gears within the various FMPs, there are many gears utilized within state and territorial waters that also needed to be evaluated due to the extension of defined EFH into coastal and estuarine waters. However, there are few, if any, habitat impact studies that have been conducted on many of these gear types. Due to the lack of specific information and regional fishery-related impact studies, the Gulf of Mexico Fishery Management Council's Generic Amendment for Addressing Essential Fish Habitat Requirements and the Caribbean Council's Essential Fish Habitat Generic Amendment were only partially approved by NOAA Fisheries.

To help remedy these deficiencies, an annotated bibliography (Rester 2000a; 2000b) was completed which compiled a listing of papers and reports that addressed fishery-related habitat impacts. The bibliography included scientific literature, technical reports, state and federal agency reports, college theses, conference and meeting proceedings, popular articles, memoranda, and other forms of nonscientific literature, but did not include studies that pertained to the ecosystem effects of fishing. While recognizing that fishing may have many varying impacts on EFH, the bibliography focused on the physical impacts of fishing activities on habitat.

In order to determine if the approximately 600 studies included in the bibliography were relevant to the Southeast Region, criteria were developed during a December 1999 EFH Workshop attended by NMFS scientists and managers. The criteria included whether the specified gear was utilized in the Southeast Region, whether it was utilized in the same manner (similar fisheries), and whether the habitat was similar. This review recognized that in many instances numerous epifaunal and infaunal species are an integral part of benthic habitat. Therefore, studies that document impacts (i.e., reduction in biomass or species diversity) to benthic communities have been included in this review.

Studies of gear types that were not applicable to the Southeast Region such as explosives, cyanide/poisons, and beam trawls were not included. Explosives and cyanide have been prohibited by the various Fishery Management Councils due to the documented habitat damage associated with those methods. The numerous studies conducted on beam trawls were excluded due to the fact that beam trawls are not a favored gear type within the region. While a study published by ICES (1973) concluded that otter trawls and beam trawls are similar in their action on the seabed and that there is no good reason for considering possible destructive effects of beam and otter trawls separately, it was felt that there were enough studies that specifically detailed otter trawls to exclude the numerous beam trawl studies. Studies documenting habitat damage resulting from anchoring or interactions with marine vessels (e.g., groundings, propeller scarring) were not considered in this review unless the activity was directly related to harvesting methods (e.g., clam-kicking, skimmer trawling, etc.). While anchors are utilized during various commercial and recreational fishing activities, anchors are not a type of fishing gear and, thus, were not considered. Based on these criteria, habitat impacts, recovery metrics, and management recommendations were extracted from the study and included in this review.

While DeAlteris et al. (1999) stated that fishery-related impacts to EFH need to be compared to natural causes, both in magnitude and frequency of disturbance, fishing can be adjusted or eliminated to complement particular habitats, whereas natural conditions continue unabated. Depending on the intensity and frequency of fishing, its impacts may well fall within the range of natural perturbations. However, Hall (1999) pointed out that while it is important to appreciate the range of natural variation in disturbance from currents, wind, and waves so that fishing can be put into context, the fact that the natural range is large in itself provides no basis for arguing that the additional perturbation imposed by fishing is inconsequential. Marine communities and their associated habitats have adapted to natural variation. Fishing impacts may introduce a variable that is beyond the range of natural impacts, potentially resulting in dramatic alterations in habitat or species composition. For example, Posey et al. (1996) suggested that deeper burrowing fauna are not affected by severe episodic storms, though they may still be impacted by fishing. The study site was at a depth of 13m and samples were collected to a depth of 15cm below the substrate. "Deeper burrowing" was not defined, but it implies fauna living at a depth of 7 - 15 cm (Jennings and Kaiser 1998) which is well within the depths disturbed by trawls and dredges (Krost and Rumohr 1990). Regardless, information from studies that include comparisons of fishery-related impacts to natural events have been included in the scope of this review.

## **ESSENTIAL FISH HABITAT**

---

As defined by the Magnuson-Stevens Act, EFH includes "those waters and substrate necessary to fish for spawning, breeding, feeding, or growth to maturity." Interpretation of this definition may vary, therefore, NMFS has provided further guidance to assist with the legal interpretation of EFH: *waters* - aquatic areas and their associated physical, chemical, and biological properties that are used by fish and may include aquatic areas historically used by fish where appropriate; *substrate* - sediment, hard bottom, structures underlying the waters, and associated biological communities; *necessary* - the habitat required to support a sustainable fishery and the managed species' contribution to a healthy ecosystem; and *spawning, breeding, feeding, or growth to maturity* - stages representing a species' full life cycle.

The degree of impact from fishing activities depends in large part to the susceptibility of particular habitats to damage. EFH varies in its vulnerability to disturbance, as well as its rate of recovery. For example, due to its simple composition, sediments (i.e., sand, mud) are impacted to a lesser degree than a complex coral reef under similar treatments. Coral reefs are composed of numerous structure forming species, many that grow vertically into the water column (e.g., sponges, stony corals, gorgonians) and create a greater surface area than sediments. The vertical profile and increased surface area of coral reefs allow gear to easily become snagged or entangled, thus providing more opportunities for habitat to be impacted from fishing as compared to sediments.

While NMFS and the Fishery Management Councils have jurisdiction only in Federal waters of the exclusive economic zone under the Magnuson-Stevens Act, estuarine and nearshore waters are critical to various life stages of many organisms; numerous managed species utilize estuaries and bays for reproduction or during juvenile development. Therefore, it is important to recognize these habitat areas as EFH (Table 1), as well as identifying potential threats to those habitats. A brief summary of the more recognizable habitat types follows. Further discussion on EFH, including geographical mapping of those habitats, may be found in the various Council EFH Amendments.

### **ARTIFICIAL REEFS**

The National Fishing Enhancement Act of 1984 (Title II of PL 98-623) defined artificial reefs as "...a structure which is constructed or placed in waters covered under this title for the purpose of enhancing fishery resources and commercial and recreational fishing opportunities." Prior to 1985, artificial reef development projects utilized natural or scrap materials almost exclusively because of their relatively low cost and availability. With increased funding and support, many coastal states have been able to plan and execute more effective artificial reef development activities. Many programs now are taking advantage of more advanced technologies and methodologies to design materials and structures for specific fisheries management objectives.



	<b>ESTUARINE COMPONENT</b>	<b>MARINE COMPONENT</b>
GULF OF MEXICO	estuarine emergent wetlands; mangrove wetlands; SAV; Algal flats; mud, sand, shell, and rock substrates; estuarine water column	water column; vegetated bottom; non-vegetated bottom; livebottom; coral reefs; artificial reefs; geologic features; continental shelf features
SOUTH ATLANTIC	estuarine emergent wetlands; estuarine scrub and shrub mangroves; SAV; oyster reefs and shell banks; intertidal flats; palustrine emergent and forested wetlands; aquatic beds; estuarine water column	livebottom; coral and coral reefs; artificial reefs; <i>Sargassum</i> ; water column
CARIBBEAN	salt marshes; mangrove wetlands; intertidal flats and salt ponds; soft bottom lagoons; mud flats; sandy beaches; rocky shores	water column; SAV; non-vegetated bottom; coral reefs; algal plains; geologic features; livebottom

**TABLE 1. ESTUARINE AND MARINE EFH COMPONENTS WITHIN THE SOUTHEAST REGION.**

The deployment of artificial structure on the seabed provides increased surface area for organisms to colonize and develop into a functioning reef over time. Algae and encrusting organisms cover the bare structure, similar to the ecological succession of newly exposed natural solid substrate. Finfish and invertebrate species are eventually attracted to the structure. Numerous pelagic and transient organisms also utilize the artificial reef as habitat. As these structures are designed primarily for the enhancement of fishing opportunities, fishing pressure may be focused over an artificial reef and result in subsequent impacts, such as line entanglement.

#### HARDBOTTOM AND CORAL REEFS

The majority of hardbottom in the Gulf of Mexico and South Atlantic consists of exposed limestone on which algae, coral, and sponges establish and accumulate. Hardbottom areas may be found throughout the Gulf of Mexico, especially along the west coast of Florida, as well as along the entire eastern seaboard to North Carolina. Many species important to commercial and recreational fisheries reside around banks, ledges, and small outcroppings colonized by sessile invertebrates such as hydroids, bryozoans, gorgonians, anthozoans, and algae that form complex benthic communities. Furthermore, many areas along the west coast of Florida are characterized by a thin sand veneer covering solid limestone. This layer of sand inhibits coral growth, but allows for sponge colonization. In some locales, sponges are quite abundant and provide the only substantial vertical habitat for many species.

Coral reefs have the highest biological diversity in the marine environment. Coral reefs, as opposed to encrusting, lower-profile hardbottom habitat, consist of a ridge limestone structure built by corals and algae. The calcium carbonate skeletons of living and dead corals are interlocked and cemented together by coralline algae. Over time, rubble and sand containing the shells of many other plants and animals become trapped between the skeletons adding to the reef mass. This three-dimensional structure provides a variety of refuge areas that attracts a plethora of marine species. While reefs cover only 0.2% of the ocean's area, they provide habitat to one-third of all marine fish species and tens of thousands of other species.

Hardbottom and coral reefs are perhaps the most sensitive habitat type within the Southeast Region, due to the abundance of encrusting and structure-forming species that produce complex and delicate habitats. Deep-water coral banks may be especially vulnerable to fishery-related impacts, as illustrated by the degradation of the Oculina Bank off eastern Florida. While shallow, high-profile coral reefs are generally well-mapped, patchy hardbottom, as well as deep-water pinnacles that occur throughout the Gulf of Mexico and South Atlantic are not well-mapped and frequently may be impacted by fishing activities.

#### OYSTER REEFS

Clusters of oyster shell, live oysters, and other commensal organisms form distinct oyster reef habitats. Oyster reefs tend to form wherever hard bottom occurs and sufficient current exists to transport planktonic food to the

filter-feeding oysters and to carry away sediment. Subtidal or intertidal reefs form in open bays, along the periphery of marshes, and near passes and cuts. They are particularly abundant along the side slopes of navigation channels where tidal exchange currents are dependable. The reef is three-dimensional since shells cemented together create an irregular surface that establishes a myriad of microhabitats for smaller species.

The value of oysters as filter-feeding organisms has long been recognized, however, the habitat that oyster reefs provide to resident and transient species may not be fully appreciated. The increased surface area of an oyster reef allows for greater species diversity than flat areas due to expanded habitation opportunities (Watling and Norse 1998). Reef structure formed by oysters creates vast interstitial spaces for small invertebrates and juvenile fish, analogous to a tropical coral reef. Impacts to oyster reefs, especially fishing activities that target oysters, directly reduce EFH and hamper the natural water-cleansing ability of oysters (Coen 1995). Furthermore, fishing activities adjacent to oyster reefs can have a significant impact. Fishing activities that have the ability to suspend large quantities of sediment can over-task the natural filtering ability of oysters and excess sedimentation can potentially stress or smother oysters, degrading EFH.

## SEDIMENTS

Consolidated and unconsolidated sediments within the Southeast Region include a wide variety of coarse sands, shell hash, and fine silts and muds. Benthic areas comprised of sand are easily altered by natural environmental conditions such as currents and surge that constantly reshape surface features. Larger sized sediments (e.g., gravel, cobble, boulder) are more resilient to resuspension and are relatively static. In contrast, silt, mud, and clay are extremely susceptible to resuspension, and therefore usually accumulate in areas that are either infrequently impacted by natural events or are frequently renourished with sediments (Watling and Norse 1998). Therefore, fishing activities may have a greater effect on mud bottoms than on sand.

## SUBMERGED AQUATIC VEGETATION

Submerged aquatic vegetation (SAV) is an assembly of rooted macrophytes generally found in shallow water where there is adequate light penetration to allow photosynthesis. Similar to terrestrial grasslands, SAV species establish physical assemblages of SAV beds or meadows. Also known as seagrasses, SAV provides food and habitat for waterfowl, fish, shellfish, and invertebrates; serves as nursery habitat for many marine species; produces oxygen in the water column as part of the photosynthetic process; filters and traps sediment that can cloud the water and bury bottom-dwelling organisms; protects shorelines from erosion by slowing down wave action; and removes excess nutrients, such as nitrogen and phosphorus, that could fuel unwanted growth of algae in the surrounding waters.

Two categories of SAV impact can be established: damage to the exposed plant, including leaf-shearing and burial, and disturbance to the underground stem, or rhizome. Individual leaf-shearing events do not represent a significant threat to SAV health, however, fishing activities that repeatedly shear leaves could result in SAV loss. It should be noted that impacts also range in severity depending on the species. Impacts on species that depend largely on sexual reproduction (e.g., *Halophila decipiens*) may be extreme, as flower and seed removal may hamper SAV establishment. Fishing activities that resuspend sediments attenuate ambient light, negatively impacting the photosynthetic processes of submerged plants. Furthermore, there is a potential for smothering by sediments precipitating out of the water column if the load is copious enough or the activity occurs frequently enough. For example, the growing tips of *Halophila spp.* are very close to the sediment and are extremely susceptible to burial. Disturbance to the rhizome generally presents a more serious threat to SAV survival than impacts to the exposed plant as SAV loss will occur. Fishing activities that impact the root structure of SAV undermine the ability of SAV beds to stabilize sediments and remove nutrients and should therefore be considered a serious impact to habitat.

## WATER COLUMN

The dynamic environments of the estuarine and marine water column provide rich opportunities for migrating and residential biota to thrive. The water column can be defined by a horizontal and vertical component. Horizontally, salinity gradients strongly influence the distribution of biota. Horizontal gradients of nutrients, decreasing seaward, affect primarily the distribution of phytoplankton and, secondarily, the organisms that depend on this primary productivity. Vertically, the water column may be stratified by salinity, oxygen content, and nutrients (SAFMC 1998a). The water column is especially important to larval transport. While the water column is relatively difficult to precisely define, it is no less important since it is the medium of transport for nutrients and migrating organisms between estuarine, inshore, and offshore waters (SAFMC 1998a).

## WETLANDS

Wetlands, subject to periodic flooding or prolonged saturation, are quite diverse depending on their location. Wetland types include marshes, swamps, and other areas that link land and water. Because they can be composed of freshwater (palustrine) or saltwater (estuarine), wetlands can host numerous regional plant and animal species. Wetlands in the Southeast Region include the ubiquitous salt marsh and mangroves. These areas are closely linked with the terrestrial environment and they have adapted to the extremely diverse marine, atmospheric, and terrestrial environmental conditions that prevail. Therefore, physical impacts from fishery-related activities may not be a serious concern to these habitats as compared to more sensitive marine areas.

## **FISHERY-RELATED IMPACTS**

---

All fishing has an effect on the marine environment, and therefore the associated habitat. Fishing has been identified as the most widespread human exploitative activity in the marine environment (Jennings and Kaiser 1998), as well as the major anthropogenic threat to demersal fisheries habitat on the continental shelf (Cappo et al. 1998). Fishing impacts range from the extraction of a species which skews community composition and diversity to reduction of habitat complexity through direct physical impacts of fishing gear.

The nature and magnitude of the effects of fishing activities depend heavily upon the physical and biological characteristics of a specific area in question. There are strict limitations on the degree to which probable local effects can be inferred from the studies of fishing practices conducted elsewhere (North Carolina Division of Marine Fisheries 1999). The extreme variability that occurs within marine habitats confounds the ability to easily evaluate habitat impacts on a regional basis. Obviously, observed impacts at coastal or nearshore sites should not be extrapolated to offshore fishing areas because of the major differences in water depth, sediment type, energy levels, and biological communities (Prena et al. 1999). Marine communities that have adapted to highly dynamic environmental conditions (e.g., estuaries) may not be affected as greatly as those communities that are adapted to stable environmental conditions (e.g., deep water communities). While recognizing the pitfalls that are associated with applying the results of gear impact studies from other geographical areas, due to the lack of sufficient and specific information within the Southeast Region it is necessary to review and carefully interpret all available literature in hopes of improving regional knowledge and understanding of fishery-related habitat impacts.

In addition to the environmental variability that occurs within the regions, the various types of fishing gear and how each is utilized on various habitat types affect the resulting potential impacts. For example, trawls vary in size and weight, as well as their impacts to the seabed. Additionally, the intensity of fishing activities needs to be considered. Whereas a single incident may have a negligible impact on the marine environment, the cumulative effect may be much more severe. Within intensively fished grounds, the background levels of natural disturbance may have been exceeded, leading to long-term changes in the local benthic community (Jennings and Kaiser 1998). Collie (1998) suggested that, to a large extent, it is the cumulative impact of bottom fishing, rather than the characteristics of a particular gear, that affects benthic communities. Unfortunately, a limitation

to many fishing-related impact studies is that they do not measure the long-term effects of chronic fishing disturbance. Furthermore, one of the most difficult aspects of estimating the extent of fishing impacts on habitat is the lack of high-resolution data on the distribution of fishing effort (Auster and Langton 1999).

The effects of fishing can be divided into short-term and long-term impacts. Short-term impacts (e.g., sediment resuspension) are usually directly observable and measurable while long-term impacts (e.g., effects on biodiversity) may be indirect and more difficult to quantify. Even more difficult to assess would be the cascading effects that fishery-related impacts may have on the marine environment. Additionally, various gears may indirectly impact EFH. Bycatch disposal and ghost fishing are two of the more well documented indirect impacts to EFH. While recognizing that these are serious issues that pertain to habitat, this review does not attempt to discuss these due to the secondary nature of the impacts.

The majority of existing gear impact studies focus on mobile gear such as trawls and dredges. On a regional scale, mobile gear such as trawls impact more of the benthos than any other gear. However, other fishing practices may have a more significant ecological effect in a particular area due to the nature of the habitat and fishery. Yet there are few studies that investigate other gear types, especially static gear. Rogers et al. (1998) stated that there are few accounts of the physical contact of static gear having measurable effects on benthic biota, as the area of seabed affected by each gear is almost insignificant compared to the widespread effects of mobile gear. Regardless, static gear may negatively affect EFH and, therefore, must be considered.

The exact relationship that particular impacts have on the associated community and productivity is not fully understood. While it is clear that fishing activities impact or alter EFH, the result of those impacts or the degree of habitat alteration that still allow for sustainable fishing is unknown (Dayton et al. 1995; Auster et al. 1996; Watling and Norse 1998). Hall (1994) noted that not all impacts are negative. A negative effect at one level may sometimes be viewed as a positive effect at a higher level of biological organization – particular species may be removed in small-scale disturbances yet overall community diversity at the regional scale may rise because disturbance allows more species to coexist.

## **REGIONAL FISHING GEAR**

---

The Southeast Region includes numerous diverse fisheries within the jurisdictions of the South Atlantic, Gulf of Mexico, and Caribbean Fishery Management Councils. A list of allowable gears for these fisheries is included in Appendix 1. However, there are many more fisheries that exist within the state and territorial waters along the periphery of these Councils. Some of the gear types discussed in this review are utilized solely in state or territorial waters. For example, the use of hydraulic escalator dredges, crab scrapes, and clam rakes occur strictly in state waters. While there may be associated impacts with these gear types, management responsibilities fall on the individual state authorities and are outside the auspices of the Magnuson-Stevens Act. These gear types have been included in this review due to the inclusion of state and territorial waters within the defined boundaries of EFH.

For purposes of this review, the various gear types are classified as either “mobile,” “static,” or “other” gear and are listed in alphabetical order. Included for each gear type is a brief description, as well as potential habitat impacts, habitat recovery metrics, and potential management measures as cited in the literature. Due to the absence of information on several gear types (e.g., harpoon, slurp gun, snare), the author has included a brief representation of potential habitat impacts for those not previously evaluated, in part based on discussion with other NMFS scientists and managers during a December 1999 EFH Workshop. A summary of potential habitat impacts developed during the December EFH Workshop may be found in Table 2.

**HABITAT TYPE**

<b>GEAR TYPE</b>	<b>MUD</b>	<b>SAND</b>	<b>SAV</b>	<b>RUBBLE</b>	<b>HARDBOTTOM</b>	<b>OTHER</b>	<b>REFERENCE<sup>1</sup></b>
Otter trawl	++	++	++	+	++		Berkeley et al. 1985
Roller-rigged trawl	++	++		+	+++		Van Dolah et al. 1987
Frame trawl	+	0	0		+		Berkeley et al. 1985
Midwater trawl						0 midwater	Auster et al. 1996
Skimmer trawl	+	+	+				
Scallop dredge	++	++	++	+++	+++		Auster et al. 1996
Oyster dredge	++	++	+++	++		+++ oyster reef	Barnette 1999
Hydraulic dredge	+++	+++	+++	+++		? oyster reef	Godcharles 1971
Handline; hook and line					+		Barnette 1999
Bottom longline	+	+			+		SAFMC 1991
Fish trap	?	?	++		++	+ algal plain	Quandt 1999
Crab trap	?	0	+				Eno et al. 1996
Lobster trap	?	0	+		++		Eno et al. 1996
Clam kicking	+++	+++	+++	+++			Peterson et al. 1987a
Rake	++	++	++	++		+++ oyster reef	Barnette 1999
Patent tongs	++	++	+++	++		+++ oyster reef	Barnette 1999
Bandit gear					+		Barnette 1999
Buoy gear					+		Barnette 1999
Trolling gear					+		CFMC 1999
Trot line	+	+	+				Barnette 1999
Cast net	+		+	+			De Sylva 1954
Haul seine	+	+	+			++ cumulative	Sadzinski et al. 1996
Hand/Beach seine			+			+	Barnette 1999
Push net			+				De Sylva 1954
Purse seine	+	+	?			0 midwater	Auster et al. 1996
Gill net	+	+	+	?	+		Carr 1988
Fyke net	+	+	+				Barnette 1999
Trammel net	+	+	+			0 estuarine	Barnette 1999
Pound net	0	0	0			0 estuarine	Barnette 1999
Butterfly net	0	0	0			0 estuarine	Barnette 1999
Spear		0			+		GMFMC 1993
Powerhead		0			0	0 pelagic	Barnette 1999
Hand harvest		0		+	++		Barnette 1999
Snare		0			+		Barnette 1999

Slurp gun		0		0 / +	0 / +			Barnette 1999
Bully net	0	0	0		+			Barnette 1999
Hoop net	+	+	+		+			Barnette 1999
Harpoon						0	pelagic	Barnette 1999
Hand/Dip net					+			Barnette 1999
Allowable chemical					+			Japp and Wheaton 1975
Channel net	+	+	+					
Barrier net	?	?	?	?	+			Barnette 1999
<b>PROHIBITED GEAR</b>								
Explosives	+++	+++	+++	+++	+++			Alcala and Gomez 1987
Cyanide/Bleach					+++			Barber and Pratt 1998

<sup>1</sup>For further references, consult the Annotated Bibliography on Fishing Impacts to Habitat (Rester 2000a; 2000b).

**Table 2. Summary of the Potential Physical Impacts to EFH in the Gulf of Mexico, South Atlantic, and Caribbean Developed During the December 1999 NOAA Fisheries EFH Workshop (High + + +, Medium + +, Low +, Negligible 0, Unknown ?)**

## MOBILE GEAR

### CRAB SCRAPE

A crab scrape is composed of a net bag attached to a rigid frame with short teeth (Figure 1). This gear, used exclusively in state waters, is dragged in the shallow water of bays and estuaries to catch crabs.

#### IMPACTS

There are no studies available that document potential damage to habitat. However, due to their design, their use in SAV would likely result in the potential uprooting of some plants, as well as leaf shearing (Barnette personal observations). However, crab scrapes are not typically employed in vegetated areas due to the amount of plant litter that would fill the net. Penetration of the benthos by the teeth would result in sediment resuspension.

#### RECOVERY & MANAGEMENT RECOMMENDATIONS

Due to the lack of scientific investigation on potential habitat impacts resulting from this gear, no conclusions on recovery or management recommendations are offered.

### FRAME TRAWL

Roller frame trawls (Figure 2) are primarily utilized to harvest bait shrimp in the State of Florida. They consist of a frame that holds open a net and supports slotted rollers that grip the bottom and turn freely. This motion prevents the scouring and scraping impacts primarily associated with otter trawls. Because participants in the fishery usually operate in shallow water, 9.14m (30ft) or less, frame trawls are typically limited to state waters.

#### IMPACTS

A study by Futch and Beaumariage (1965) found that while frame trawls gathered large amounts of unattached algae and deciduous *Thalassia testudinum* leaves, no SAV with roots attached were found in the trawl catch. Trawls with larger rollers (20.3cm; 8in diameter.) reduced the amount of bycatch material, with most drags



FIGURE 1. CRAB SCRAPE (West et al. 1994)

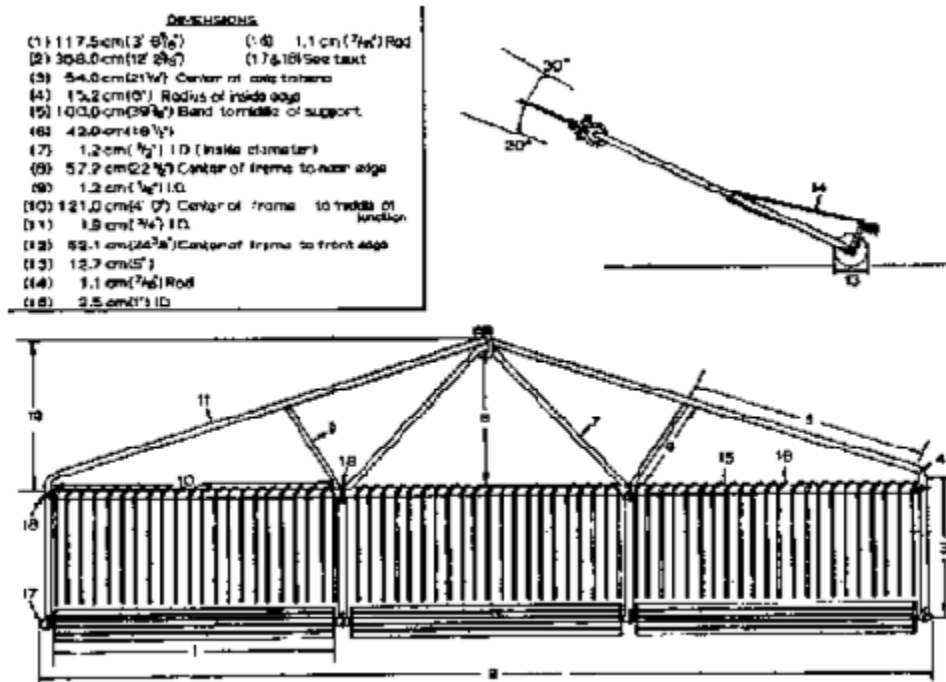

FIGURE 2. FRAME TRAWL (Tabb and Kerney 1967)

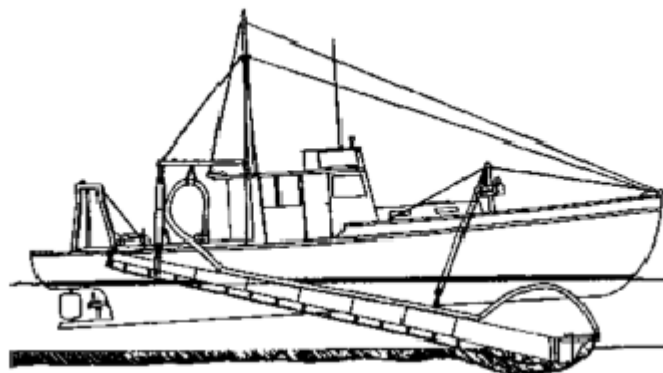

FIGURE 3. ESCALATOR DREDGE (Kyte and Chew 1975)

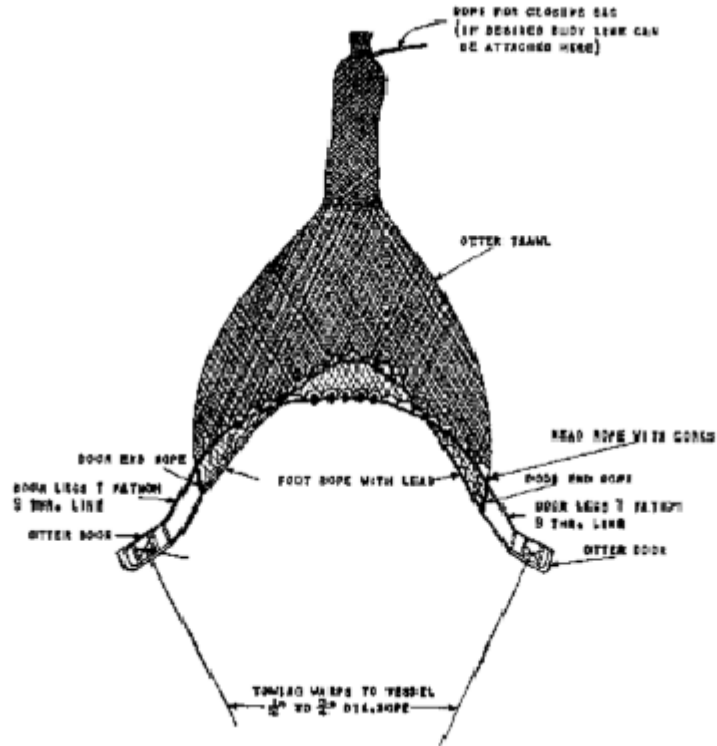

FIGURE 4. OTTER TRAWL (Richards 1955)



FIGURE 5. OYSTER DREDGE (West et al. 1994)

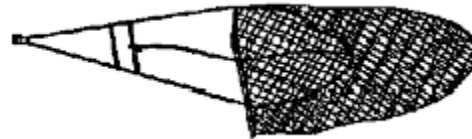

FIGURE 6. SCALLOP DREDGE (West et al. 1994)

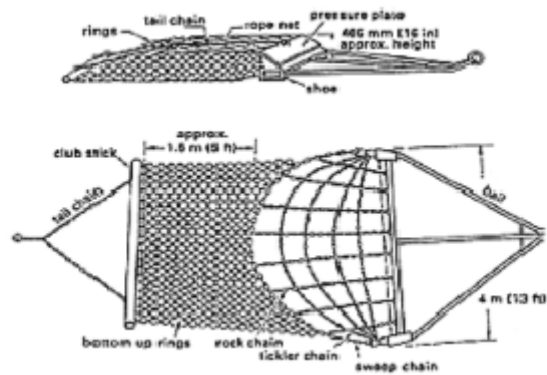
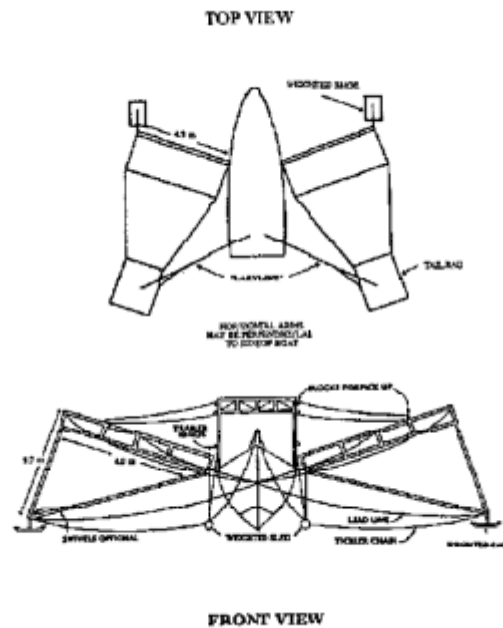

FIGURE 7. SCALLOP DREDGE (OFFSHORE)





**FIGURE 8. SKIMMER TRAWL (Coale et al. 1994)**

collecting little or no SAV or algae. When rake teeth were extended below the rollers, they had a tendency to uproot SAV. Damage to SAV beds was noted on several occasions when the boats ran aground. The study concluded that side frame trawls do negligible damage to SAV beds. This conclusion was supported by Meyer et al. (1991; 1999), who found no significant trawl impacts on shoot density, structure, or biomass with increased trawling on turtlegrass (*Thalassia testudinum*). However, these studies did not evaluate the effects of repetitive trawling. Woodburn et al. (1957) noted that the roller on the bottom of the trawl does cause the leaves ripe for shedding to break off, though this would not negatively impact the plant itself. Higman (1952) concluded that frame trawling is not sufficient to denude vegetated areas permanently nor to damage the ecology of such locations. Additionally, Tabb and Kenny (1967), while not explicitly investigating habitat impacts, believed that roller frame trawls do no significant damage to habitat.

In contrast to studies that assessed impacts to SAV, Tilmant (1979) found a high incidence of damage to stony corals in a study that investigated frame trawl impacts to hardbottom habitat in Biscayne Bay. Frame trawls turned over or crushed 80% of *Porites porites* and *Solenastrea hyades* and damaged over 50% of sponges and 38% of gorgonians in the trawl path. Macro algae, including *Halimeda* and *Sargassum*, were heavily damaged. The primary impact on *Sargassum* was that it was torn loose from the bottom resulting in an early release to the free floating state. Tilmant (1979) found it doubtful that this action was harmful to *Sargassum* unless it occurred during early column formation. It was concluded that frame trawls have a significant impact on certain benthic organisms (Tilmant 1979). Furthermore, within dense SAV communities, removal of epibenthic algae, tunicates, sponges, and other primary producers may also be significant.

#### RECOVERY

Eleven months after trawling activities stopped, evidence of trawl damage on hardbottom communities was still observed but recovery was in progress (Tilmant 1979). Approximately 15% of the gorgonians encountered were previously damaged specimens which remained alive, but were lying flat on the bottom. *Porites* showed some regeneration although most *Solenastrea* encountered were dead. Algae showed complete recovery.

## MANAGEMENT RECOMMENDATIONS

Futch and Beaumariage (1965) recommended that the diameter of the rollers be no less than 15.2cm (6in) and that the teeth of the rakes on the trawls should not extend below the roller. Furthermore, they recommend that boats employed in the frame trawl fishery that operate in shallow water should be of tunneled construction to prevent damage to SAV from propeller scarring. Tabb (1958) recommended that strainer bars should be rigid and aimed into the roller so that regardless of how far forward the net frame tips, the bars cannot dig into the bottom.

The results from Tilmant (1979) indicated that extensive damage occurs to hardbottom habitat from frame trawls. A logical recommendation that can be extrapolated from this study is the prohibition of frame trawling in areas where hardbottom habitat exists. Frame trawls, while causing negligible damage to SAV, are not compatible with hardbottom areas due to the damage it causes to complex vertical habitat (e.g., sponges, corals, gorgonians).

## **HYDRAULIC ESCALATOR DREDGE**

Hydraulic escalator dredges have been utilized since the 1940s to harvest shellfish such as clams and oysters and are designed expressly for efficient commercial harvest (Coen 1995). The dredge consists of a water pump supplying a manifold with numerous water jets mounted in front of a conveyor belt that dislodges buried organisms from the sediment (Figure 3). Hydraulic escalator dredges are currently only employed in a limited shellfish fishery in South Carolina state waters.

## IMPACTS

Hydraulic escalator dredges may penetrate the benthos approximately 45.7cm (18in), thus disturbance to the sediment may be substantial (Coen 1995). Increased turbidity, burial/smothering, release of contaminants, increased nutrients, and removal of infauna were offered as potential effects from dredging activities (Coen 1995). Turbidity was found to be elevated only in the immediate vicinity of the harvester operation and downcurrent of the study area to a distance of between 1.5 - 1.75km. Turbidity values returned to baseline levels within a few hours (Maier et al. 1998). Manning (1957) stated that hydraulic clam dredging can result in severe damage to oysters within a distance of 7.6m (25ft) downcurrent from the site of dredging. Enough sediment was displaced and redeposited to a distance of at least 15.2m (50ft), but not more than 22.9m (75ft) downcurrent, to cause possible damage to oyster spat. Beyond about 22.9m (75ft) there was no visible or measurable change in the experimental area. Sediment plumes caused by dredge activity were found by Ruffin (1995) to range from less than 1 to 64 hectares. Although sediment plumes increased turbidity and light attenuation at all depths, plumes in shallow water (<1.0m) caused greater increase in turbidity and light attenuation over background than did plumes in deeper waters. Plume decay is based largely on sediment size, with sand particles settling quickly while the silt/clay particles remain in suspension longer. Sites were monitored for storm disturbance to compare against dredge impacts. Storm events increased turbidity and light attenuation compared to calm days but not to the extremes obtained in sediment plumes. Storm events affect a large area at a low intensity while dredging intensely affects a more localized area. SAV subjected to decreased light penetration will inhibit reproduction, reduce propagule abundance, and structurally weaken SAV due to the need of plants growing higher into the water column (Ruffin 1995). Ruffin (1995) concluded that clam dredging increased light attenuation to the point of inhibiting SAV growth. As may be expected, hydraulic clam dredges are highly destructive to SAV within the immediate area of intensive dredging (Manning 1957; Godcharles 1971). Due to the capability of the water jets to penetrate the substrate to a depth of 45.7cm (18in), virtually all attached vegetation in its path is uprooted (Godcharles 1971). As the use of this gear is limited to a fishery in South Carolina where SAV does not exist, discussion of SAV impacts are included only to provide information on potential impacts should this gear type be considered in the future for other geographic areas where SAV may be found. Although there may be physical impacts associated with escalator dredge activity, the chemical effects apparently are not as dramatic. Dissolved oxygen, pH, and dissolved hydrogen sulfide were measured throughout the harvesting process at varying distances. No consistent patterns of depression or release were noted. Only in the direct plume of the harvester did they measure even a temporary reduction in dissolved oxygen and pH (Coen 1995). While it is recognized

that there is infaunal and epifaunal species mortality associated with escalator dredge activity, based on all evidence, these community impacts appear to be short-term (Godcharles 1971, Peterson et al. 1987a, Coen 1995). Coen (1995) noted that the escalator possibly provides a tilling effect of the bottom that has been observed to be beneficial to subtidal oyster and clam populations. Typically, shellfish dredging operations have typically not been considered to have deleterious results, since its effects are perceived to be negligible compared to natural environmental variation (Godwin 1973). Coen (1995) concluded that based on all direct and indirect evidence, the short-term effects of subtidal escalator harvesters are minimal, with no long-term chronic effects, even under worst case scenarios. Observed effects were often indistinguishable from ambient levels or natural variability.

#### RECOVERY

Recovery of the benthos may vary greatly depending on sediment composition. Shallower trenches with shorter residency times are typical of coarse sediments (i.e., sand), whereas trenches generated in muddy, finer sediments are typically deeper, often persisting for greater than 18 months (Coen 1995). Godcharles (1971) observed that trenches had filled in between 1 to 10 months, depending on bottom type. In regard to SAV, no trace of *Thalassia testudinum* recovery was evident after more than 1 year, though *Caulerpa prolifera* began to establish itself in dredge areas within 86 days (Godcharles 1971).

#### MANAGEMENT RECOMMENDATIONS

While no management recommendations were explicitly included in any of the literature, the evidence and results provided may support the prohibition of hydraulic escalator dredge operation within SAV habitat.

#### **OTTER TRAWL**

Perhaps the most widely recognized and criticized type of gear employed in the Southeast Region is the otter trawl (Figure 4). Utilized in both state and Federal waters of the Gulf of Mexico and South Atlantic, otter trawls pursue invertebrate species such as shrimp and calico scallops, as well as finfish species such as flounder and butterfish. As the most extensively utilized towed bottom-fishing gear (Watling and Norse 1998), trawls have been identified as the most wide-spread form of disturbance to marine systems below depths affected by storms (Watling and Norse 1998; Friedlander et al. 1999).

#### IMPACTS

The otter trawl is one of the most studied gear types, thus, there is a wealth of information on its potential impacts to habitat. Jones (1992) broadly classified the way a trawl can affect the seabed as: scraping and ploughing; sediment resuspension; and physical habitat destruction, and removal or scattering of non-target benthos. The following discussion attempts to group documented impacts into either physical-chemical (e.g., sediment resuspension, water quality) or biological impact categories. In many instances documented habitat impacts overlap these categories.

##### *Physical-Chemical Repercussions*

The degree to which bottom trawls disturb the sediment surface depends on the sediment type and the relationship between gear type, gear weight, and trawling speed (ICES 1991). Various parts of trawl gear may impact the bottom including the doors, tickler chains, footropes, rollers, trawl shoes, and the belly of the net. While the components of trawl gear are similar, trawl design may vary greatly. Potential impacts may be shared by all otter trawls, but differences in the weight of trawl doors, footrope design, and operation (tow times), will result in a broad spectrum of impact severity. Furthermore, the number and weight of tickler chains vary the degree of disturbance: Margetts and Bridger (1971) concluded that the cumulative effect of tickler chains is likely to emulsify the sediment to a depth proportional to the number of chains. Additionally, the cumulative effect of intense otter trawling is as important as gear weight and design in impacting the benthos (Ball et al. 2000). Although the effect of one passage of a fishing (trawl) net may be relatively minor, the cumulative effect and intensity of trawling may generate long-term changes in benthic communities (Collie et al. 1997).

Trawl gear disturbs the benthos as it is dragged along the bottom. Otter trawl doors, mounted ahead and on each side of the net, spread the mouth of the net laterally across the sea floor. The spreading action of the doors results from the angle at which they are mounted, which creates hydrodynamic forces to push them apart and, in concert with the trawl door's weight, also to push them toward the sea bed (Carr and Milliken 1998). The doors, due to their design and function, are responsible for a large proportion of the potential damage inflicted by a trawl. The footrope runs along the bottom of the net mouth and may be lined with lead weight and rollers. On relatively flat bottom, it is expected that the footrope would not have a major effect on the seabed and its fauna (ICES 1995). However, in areas of complex benthic habitat the footrope would likely have more impact with the benthos. The South Atlantic Calico Scallop FMP noted that during the early years of the calico scallop fishery, large quantities of benthic material was removed by trawlers. Reports were received during numerous meetings about entire "rocks" being removed. One individual provided a print-out from a depth sounder which indicated a large amount of bottom relief in a particular area prior to the calico scallop fishery. Similar bottom plots after the calico scallop fishery operated in that area indicated a relatively flat bottom (SAFMC 1998b). Additionally, while the footrope generally causes little physical substrate alteration aside from smoothing of bedforms and minor compression on relatively flat bottoms (Brylinsky et al. 1994), these minor compressions can lead to sediment "packing" after repeated trawling activity on the same general areas (Schwinghammer et al. 1996; Lindeboom and de Groot 1998). Further compression can result from the dragging of a loaded net (cod end) along the bottom. The remaining path of the trawl is influenced by the ground warps which, while not in direct contact with the seabed, can create turbulence that resuspends sediment (Prena et al. 1999).

Trawl gear, particularly the trawl doors, penetrates the upper layer of the sediments which liquefies the affected sedimentary layers and suspends sediment in the overlying water column. This sediment "cloud" generated by the interaction of the trawl gear with the benthos and the turbulence created in its wake contributes to fish capture (Main and Sangster 1979; 1981). The appearance of the sediment cloud, but not its size, is governed by the type of seabed. Brief observations on different seabed types show that soft, light-colored mud produces the most opaque and reflective type of cloud and the fine mud remains in suspension much longer than coarse sand. Studies of sediment disturbance by trawls vary greatly, though it can be concluded that benthic habitat areas composed of fine sediments (e.g., clay, mud) are affected to a greater degree than those with coarse sediments (e.g., sand). In sandy sediments, otter boards cannot penetrate deeply due to the mechanical resistance of the sediment, and the seabed in sandy areas is more rapidly restored by waves and currents (DeAlteris et al. 1999). Short-term alterations to sediment size distribution result from the various rates of redeposition of suspended sediments; as noted before, coarse grains (i.e., sand) settle out rapidly while fine grains (i.e., silt) settle out relatively slowly. In general, resuspended sediments settle out of the water column at a rate inversely proportional to sediment size (Margetts and Bridger 1971). Transport of fine grained sediments away from trawled areas due to this slow settling period may result in permanent changes to the sediment grain size of a trawled area. Again, this effect will be more pronounced in mud/silt habitats than in habitat areas consisting of heavier sand. For example, suspended sediment concentrations of 100-500mg l<sup>-1</sup> were recorded 100m astern of shrimp trawls in Corpus Christi Bay, Texas (Schubel et al. 1979), an estuary dominated by muddy sediments. The same study estimated that the total amount of sediment disturbed annually as a result of shrimp trawling was 25-209,000,000m<sup>3</sup>, which is 10-100 times greater than the amount dredged during the same period for maintenance of shipping channels in the same area.

ICES (1973) concluded that the physical effects of trawling in tidal waters can not be permanent. However, it is possible that frequently repeated trawling of one ground with a mixed sediment type bottom in strongly tidal waters might ultimately alter the nature of the bottom towards being predominantly coarse sand because the finer particles are carried away to settle elsewhere. In deeper waters, impacts may be more profound and longer lasting. Engel and Kvitek (1998) investigated two adjacent areas in 180m of water to determine the differences between a heavily trawled site and a lightly trawled site. The data indicated that intensive trawling significantly decreased habitat heterogeneity. Rocks and mounds were less common and sediments and shell fragments were more common in the highly trawled area. Rocks and mounds were more abundant in the lightly trawled area, as well as the amount of flocculent matter and detritus. They theorized that less trawling most likely results in an area with more topographical relief and allows for the accumulation of debris, whereas consistent trawling

removes rocks, smooths over mounds, and resuspends and removes debris. Likewise, Kenchington (1995) found that sand ripples were flattened and stones were displaced after a trawl passage. Churchill (1989) modeled sediment resuspension by trawling and found that this may be a primary source of suspended sediment over the outer shelf where storm-related bottom stresses are weak.

Otter trawl doors were found to have a maximum cutting depth of 50 - 300mm (Drew and Larsen 1994) and, according to Schubel et al. (1979), the footropes of shrimp trawlers in Texas disturbed approximately the upper 50mm of the sediment. Schwinghamer et al. (1996) observed that while the trawl doors may leave scours or depressions, the overall surface roughness is reduced by trawling activity. Ripples, detrital aggregations, and surface traces of bioturbation are smoothed over by the mechanical action of the trawl and the suspension and subsequent deposition of the surface sediment. In general, the passage of an otter trawl was found to have a minor physical and visual impact on the soft sedimentary seabed, represented by a flattening of the normally mounded sediment surface and some disturbance of the sessile epifauna (Lindeboom and de Groot 1998). The potential to suspend sediments varies greatly, in large part due to the type of sediment a trawl is working on. Regardless, the suspension of sediments, whether fine silt or coarse sand, impacts the chemical and physical attributes of water quality.

The resuspension of sediments may influence the uptake or release of contaminants and, depending on the frequency of disturbance, the nature of the contaminant(s). Clearly, such effects may be more significant where contaminant burdens are relatively high, e.g., near areas affected by major industrialization (ICES 1995). Repetitive trawling on the same ground may enhance nutrient release from sediments and that estimates of average trawling effort for large areas may be unsuitable for estimating these effects (ICES 1995). This has important implications on nutrient cycling in areas that are regularly trawled. PilskaIn et al. (1998) found that impacts include burial of fresh organic matter and exposure of anaerobic sediments; large nutrient delivery to the water column, possibly impacting primary production; increase in nitrate flux out of the sediments; and reduced denitrification (conversion of remineralized nitrogen into  $N_2$  gas). All of these may have desirable or undesirable ecosystem impacts. An increase in nitrate fluxes to the water column may alter primary production (phytoplankton), potentially benefitting fisheries, or stimulating deleterious phytoplankton growth that results in harmful algal blooms (PilskaIn et al. 1998).

Increased water turbidity as a result of trawling activity has the potential to compress the width of the euphotic zone, wherein light levels are sufficient to support photosynthesis (North Carolina Division of Marine Fisheries 1999). The magnitude of this effect depends on sediment size, duration and periodicity of the trawling event, gear type, season, and site-specific hydrographic and bathymetric features (Paine 1979; Kinnish 1992). Dredging studies would indicate that the effect of turbidity is greatly dependent on local conditions. Windom (1975) found that sediment resuspension caused by dredging operations significantly reduced phytoplankton growth in a naturally clear estuary (South Florida) but not in a naturally turbid estuary (Chesapeake Bay). Additionally, increased turbidity resulting from trawling activities may reduce primary production of benthic microalgae. This may have serious consequences as benthic microalgae support a variety of consumers and can be a significant portion of total primary production (Cahoon and Cooke 1992; Cahoon and Tronzo 1992; Cahoon et al. 1990; 1993). Increased turbidity also has may reduce the foraging success of visual predators (Minello et al. 1987) and contribute to the mortality of organisms by impeding the normal functioning of feeding and respiratory structures (Sherk et al. 1975).

Sediment resuspension may increase the amount of organic matter resulting from enhanced primary production and may stimulate heterotrophic microbial production. If the amount of resuspended organic material is copious, sustained proliferation of heterotrophic microflora will reduce the dissolved oxygen content within the water, and widespread hypoxia or anoxia could ensue to the detriment of benthic and pelagic fauna (West et al. 1994). Conversely, oxygen penetration into the sediment might be enhanced through trawling activity, resulting in shifts in mineralization patterns and redox-dependent chemical processes. Among other consequences, a change from anaerobic to aerobic conditions facilitates the degradation of hydrocarbons.

As Kaiser (2000) pointed out, bottom trawls are designed to stay in close contact with the seabed and an inevitable consequence of their design is the penetration and resuspension of the seabed to some extent. While it is possible to reduce the direct physical forces exerted on the seabed by modifying fishing practices, the benefits are questionable and catches would most certainly suffer. Despite attempts to improve gear design, as long as bottom dwelling species are harvested using towed gear, there will be inevitable sediment resuspension.

### *Biological Repercussions*

The physical disturbance of sediment, such as the ones previously discussed, can also result in a loss of biological organization and reduce species richness (Hall 1994). In general, the heavier the gear and the deeper its penetration of the sediment, the greater the damage to the fauna. Impacts also will vary depending on type of habitat the gear is working. Gibbs et al. (1980) determined that shrimp trawling occurring within a sandy estuary had no detectable effect on the macrobenthos. After repeated trawls the sea bottom appeared only slightly marked by the trawl's passage. However, Eleuterius (1987) noted that scarring due to shrimp trawls in Mississippi SAV was common, especially in deeper water. Trawling activities left tracks and ripped up the margins of the beds, and great masses of seagrass were often observed floating on the surface following the opening of shrimp season. Furthermore, Wenner (1983) noted that the use of an otter trawl on hardbottom habitat may inflict considerable damage. The net damages the sponge-coral habitat by shearing off sponges, soft corals, bryozoans, and other attached invertebrates. Therefore, it is not necessarily that trawl gear is doing a constant level of damage, but rather particular habitats are more vulnerable to impacts than others.

Numerous studies cite specific, direct biological impacts to habitat such as the reduction of algal and SAV biomass (Tabb 1958; Fonseca et al. 1984; Bargmann et al. 1985; Peterson et al. 1987a; Sánchez-Lizaso et al. 1990; Guillén et al. 1994; Arduzzone et al. 2000). Gelatinous zooplankton and jellyfish, which provide habitat to juvenile and other fish species, are greatly impacted as they pass through the mesh of mobile gear (Auster and Langton 1999). Fishing activity may reduce the size and number of zooplankton aggregations and disperse associated fishes. Furthermore, there is a directed trawl fishery for cannonball jellyfish in the Gulf of Mexico. While this fishery removes jellyfish which may provide habitat for juvenile fish, otter trawls utilized in this fishery do not interact with the benthos. Trawls in the Gulf of Mexico and South Atlantic have been noted to impact coral habitat, damaging and destroying various colonies (Moore and Bullis 1960; Gomez et al. 1987; Bohnsack personal observation). Loss of sponges and associated cnidarian benthos has been documented to lead to a reduction in fish catch (Sainsbury 1988; Hutchings 1990). Sponges are particularly sensitive to disturbance because they recruit aperiodically and are slow growing in deeper waters (Auster and Langton 1999). Bradstock and Gordon (1983) observed that trawling virtually destroyed large areas dominated by encrusting coralline growths (bryozoans), reducing colony size and density. Probert et al. (1997) documented the bycatch of benthic species that occurs in a deep-water trawl fishery and noted the vulnerability of pinnacle communities and deep-water coral banks such as the *Oculina* habitat area of eastern Florida. Van Dolah et al. (1983; 1987) conducted experimental trawl surveys over hardbottom habitat consisting of coral and sponge off the coast of Georgia. A single pass of an otter trawl on this habitat damaged all counted species (Van Dolah et al. 1983; 1987). However, only the density of barrel sponges was significantly decreased by trawling activities. It should be noted that these studies did not investigate the cumulative impacts of trawls. The repetitive effects of trawling over the same area can be expected to have more severe consequences to benthic habitat. While Moran and Stephenson (2000) estimated that a demersal otter trawl reduced benthos (>20cm in maximum dimensions) density by 15.5% in a single pass, Cappo et al. (1998) estimated that complete denuding of the sea bottom structure occurs after 10 - 13 trawl passes over the same area. Of equal importance are the observations of Moran and Stephenson (2000), who noted variations among trawl studies, possibly due to differences of employed ground ropes. These variations are a warning against generalizations about the impact of otter trawls on attached benthos.

As many epifaunal and infaunal organisms create structures which provide habitat for other species, summaries of these studies and their findings are included. For example, many infauna species and other bioturbators have an important role in maintaining the structure and oxygenation of muddy sediment habitats. Consequently, any

adverse effects on these organisms would presumably lead to changes in habitat complexity and community structure (Jennings and Kaiser 1998). Furthermore, the loss of biogenic epifaunal species (epibenthic habitat) increases the predation risk for juveniles of other species, thereby lowering subsequent recruitment to adult stocks (Bradstock and Gordon 1983; Walters and Juanes 1993; Jennings and Kaiser 1998). Therefore, reduction in biomass of epifaunal species may be considered a reduction or degradation of habitat in certain instances and trawling has been documented to decrease mean individual biomass of epibenthic species (Sainsbury et al. 1993; Prena et al. 1999). While it may be hard to quantify the impact this loss presents to habitat-dependent organisms, it should be noted nonetheless.

In a long-term study of Corpus Christi Bay, Texas, Flint and Younk (1983) noted that the continual minor and random disturbance, both in time and space, of channel sediments by large tanker traffic and shrimp trawling probably was sufficient to keep these communities in a state of constant disruption. This allowed the opportunists to persist more successfully than other species. The disturbed channel sites of the study, though viable, consistently had lower densities, lower numbers of species and corresponding low diversities contrasted to the lesser impacted shoal sampling sites (Flint and Younk 1983). Engel and Kvitek (1998) investigated two adjacent areas in 180m of water to determine the differences between a heavily trawled site and a lightly trawled site. They concluded that high-intensity trawling apparently reduces habitat complexity and biodiversity while simultaneously increasing opportunistic infauna and the prey of some commercial fish. The data indicated that intensive trawling significantly decreased habitat heterogeneity. All epifaunal invertebrates counted were less abundant in the highly trawled area. Bergman and Santbrink (2000) estimated direct mortality on various species of benthic megafauna from a single pass of an otter trawl (sole fishery) at between 0 - 52% for silty sediments and between 0 - 30% for sandy sediments. In general, small-sized species tend to show lower direct mortalities, when compared with larger sized species and smaller individuals of megafaunal species tend to show lower mortalities than larger-sized ones. Krost and Rumohr (1990) noted damage directly resulting from otter trawl doors. Benthic organisms were found to be reduced in number by 40 to 75% in otter board tracks, as compared to control sites. Biomass was also generally reduced. However, they found almost no differences in epibenthic species such as crustaceans. In shallow areas with densely packed sediments, inhabitants of the upper sediment layer were found to suffer most by the trawling impact.

#### *Negligible Overall Impact?*

In contrast to the above studies, there are several studies that document no significant habitat impact. Van Dolah et al. (1991) found no long-term effects of trawling on an estuarine benthic community; five months of shrimp trawling in areas previously closed to fishing were found to have no pronounced effect on the abundance, diversity, or composition of the soft bottom community when compared to nearby fished areas. They concluded that seasonal reductions in the abundance and numbers of species sampled had a much greater effect than fishing disturbance. In a power analysis of their sampling strategy, Jennings and Kaiser (1998) noted that Van Dolah et al. (1991) only considered changes in the abundance of individuals and the number of species. This assumes that the response of the infauna to trawling disturbance was unidirectional, whereas a consideration of changes in partial dominance might have been more sensitive to subtle changes in the fauna. Yet, Jennings and Kaiser (1998) stated that the results of Van Dolah et al. (1991) were plausible and that light shrimp trawls probably do not cause significant disturbance to communities in poorly sorted sediments in shallow water. Sanchez et al. (2000) determined that sporadic episodes of trawling in muddy habitats may cause relatively few changes in community composition. They found similar infaunal community changes in both fished and unfished control areas through time. Sanchez et al. (2000) also noted that the decrease in the abundance of certain species in the unfished control areas may indicate that the natural variability at the experimental site exceeds the effects of fishing disturbance. Regardless, Ball et al. (2000) commented that epifauna are generally scarce in muddy sediment habitats, and detection of fishing effects on such species has therefore been limited.

While the passage of a trawl may damage or destroy macroinfauna, Gilkinson et al. (1998) suggested that smaller infauna are resuspended or displaced by a pressure wave preceding otter trawl doors and are redeposited to the sides of the gear path. Due to a buffer effect caused by a displacement field of sediment (sand), bivalves incur

a low level of damage (5%) by the passing of a trawl door. In contrast to coarse sediment communities where the infauna are found within the top 10cm, organisms in soft mud communities can burrow up to two meters deep (Atkinson and Nash 1990). Due to their depth, it is likely that these organisms are less likely impacted by passing trawls (Jennings and Kaiser 1998), though it should be noted that the energetic costs of repeated burrow reconstruction may have long-term implications for the survivorship of individuals.

Studies documenting impacts to habitat from successive trawling are not prevalent. However, a few studies suggest that shifts in species abundance and diversity are a result of the cumulative effects of trawling. Over a longer time scale (i.e., 50 years), Ball et al. (2000) suggested that fishing disturbance may ultimately lead to an altered, but stable, community comprising a reduced number of species, and hence, diversity. Sainsbury et al. (1993; 1997) noted that composition of a multispecies fish community in Australia were at least partially habitat dependent and that historical changes in relative abundance and species composition in this region were at least in part a result of the damage inflicted on the epibenthic habitat by the demersal trawling gear.

In summary, trawling has the potential to reduce or degrade structural components and habitat complexity by removing or damaging epifauna; smoothing bedforms which reduces bottom heterogeneity; and removing structure producing organisms. Trawling may change the distribution and size of sedimentary particles; increase water column turbidity; suppress growth of primary producers; and alter nutrient cycling. The magnitude of trawling disturbance is highly variable. The ecological effect of trawling depends upon site-specific characteristics of the local ecosystem such as bottom type, water depth, community type, gear type, as well as the intensity and duration of trawling and natural disturbances. It should also be noted that there is not a direct relationship between the overall amount of trawling effort and the extent of subsequent impacts or the amount of fauna removed because trawling is aggregated and most effort occurs over seabed that has been trawled previously (Pitcher et al. 2000). Yet, several studies indicate that trawls have the potential to seriously impact sensitive habitat areas such as SAV, hardbottom, and coral reefs. In regard to hardbottom and coral reefs, it should be recognized that trawlers do not typically operate in these areas due to the potential damage their gear may incur. While trawl nets have been documented to impact coral reefs, typically resulting in lost gear (Bohnsack personal observation), these incidents are usually accidental. Partially in response to accusations of trawl activity on hardbottom habitat, a recent research effort to investigate potential impacts on the Florida Middle Ground Habitat Area of Particular Concern concluded that there was no evidence of trawl impacts or other significant fishery-related impacts to the bottom (Mallinson unpublished report). However, low-profile, patchy hardbottom or sponge habitat areas are more likely impacted from trawls due to the gear's ability to work over these habitat types without damaging the gear. Regardless, while it may be concluded that trawls have a minor overall physical impact when employed on sandy and muddy substrates, the available information does not provide sufficient detail to determine the overall or long-term effect of trawling on regional ecosystems.

#### RECOVERY

Recovery of substrate depends on sediment type, depth, and natural influences such as currents and bioturbation. Schoellhamer (1996) investigated sediment resuspension within Tampa Bay, a shallow estuary with fine non-cohesive material (muds absent), and found that sediment concentrations returned to pre-trawl conditions approximately 8 hours after disturbance. The cumulative effect of several trawlers operating were not investigated. DeAlteris et al. (1999) found that scars similar to those that occur from otter trawl boards disappear relatively quickly in a shallow sand environment, while those occurring in a deeper mud habitat took as long as two months to disappear. DeAlteris et al. (1999) also found that natural disturbances to mud substrate in 14m of water are rarely capable of disturbing the seabed. Therefore, recovery of fishery-related impacts in deeper water may be protracted due to the lack of natural events that help deposit sediments and fill trawl scars. Ball et al. (2000) determined that intensive demersal trawling over muddy seabeds leads to apparent long-term alteration of the seabed. Trawl tracks in muddy sediments may last up to 18 months, however, in areas of strong tidal or wave action, they are likely to disappear rapidly. Also, in areas where levels of bioturbation are high, and a regular turnover of sediment produces large numbers of mounds on the seabed, trawl tracks will be filled relatively quickly (Ball et al. 2000). Habitats in deeper water tend to recover at a slower rate. Berms and furrows generated by trawl doors generally disappeared within one year in sandy habitats in depths of approximately 120 -



146m (Schwinghamer et al. 1998; Prena et al. 1999). More dramatic is the estimate of 50 - 75 years to fill a typical trawl mark (~15cm scour depth) in deep water (>175m) by Friedlander et al. (1999). The greater the water movement, the faster the scars will be filled in (Jones 1992). Churchill (1989) and Krost et al. (1990) reported an increase in the frequency of tracks attributed to trawl doors in deeper water, presumably where water movement and natural impacts are less pronounced.

In general, few studies document recovery rates of habitat. Those that do investigate recovery usually only do so after a single treatment which does not reflect the reality of fishing impacts which are ongoing and cumulative. For example, Van Dolah et al. (1983; 1987) noted that hardbottom habitat in his trawl study recovered within one year. However, the experiment did not investigate the cumulative and repetitive effects of trawling at commercial intensities. As noted by an ICES (1995) study, due to the cumulative effects of trawling, focus on the scale of individual trawl impacts may be inadequate for estimating the importance of impacts on benthic communities. ICES (1994) stated that deep water coral banks (e.g., *Oculina varicosa*), due to their fragility, long-life spans, and infrequent recruitment, may be nearly exterminated by a single passage of a trawl and are unlikely to recover "within a foreseeable future." Likewise, SAV would also have a protracted recovery time in comparison to sediments. SAV recovery may vary by species and can be greater than two years if the rhizomes of the plant are removed (Homziak et al. 1982). Regardless, the majority of studies concur that shallow communities have proved to be resilient due to their adaptation to highly variable environmental conditions and thus, recovery is usually swift. Kaiser et al. (1996a) found epifaunal communities in 35m of water that were experimentally trawled were indistinguishable from control sites after six months. In areas of low current or great tidal exchange (e.g., deep ocean), where the benthos is not adapted to high sediment loads, the adverse effects of sediment resuspension by gear could persist for decades (Jones 1992). Recovery of small epibenthic organisms may be relatively rapid, but recovery of larger epibenthic organisms would be expected to be much slower. Though they did not discuss depth as a controlling factor, Sainsbury et al. (1993; 1997) indicated that there would be a considerable time lag after trawling ceases before recovery of large epibenthic organisms is substantial. In general, Boesch and Rosenberg (1981) predicted that recovery times for macrobenthos of temperate regions would be less than five years for shallow waters (including estuaries) and less than ten years for coastal areas of moderate depth.

#### MANAGEMENT RECOMMENDATIONS

The majority of management recommendations indicate that marine reserves or gear zoning may be the most effective at reducing habitat impacts. However, other specific recommendations can be extracted from several studies. Tabb (1958) recommended that otter trawls not be permitted to operate in the bait shrimp fishery due to potential impact to SAV communities. Van Dolah et al. (1987) suggested that trawls with doors attached directly to the nets would greatly reduce the bottom area damaged by trawling activities. The use of artificial reefs to protect the seabed, in particular along the perimeter of SAV habitat areas, from trawling has also been offered (Guillén et al. 1994; Ardizzone et al. 2000). The use of semi-pelagic trawls would avoid the majority of habitat impacts that demersal trawls are associated with. However, while the use of semi-pelagic nets does not significantly impact the benthos, catch efficiency may be greatly reduced. Furthermore, enforcement on the use of semi-pelagic nets remains difficult (Moran and Stephenson 2000). Carr and Milliken (1998) offered more straightforward recommendations: target certain species and modify gear appropriately; encourage the use of lighter sweeps; reduce the sea bottom available to trawlers that fish very irregular terrain; and opt for stationary gear over mobile gear.

It is suggested that where fishing effort is constrained within particular fishing grounds, and where data on fishing effort are available, studies that compare similar sites along a gradient of effort have produced the types of information on effort impact that will be required for effective habitat management (Collie et al. 1997; Auster and Langton 1999). Additionally, the use of an indicator species (e.g., quahogs) that provides a historical record of fishing disturbance events could greatly enhance the interpretation of perceived changes ascertained from samples of present-day benthic communities (Macdonald et al. 1996; Kaiser 1998). Finally, the use of tracking devices (VMS) would provide a means for identifying the most heavily fished areas and those, if any, that are presently unfished (Macdonald et al. 1996; Kaiser 1998).

Comprehensive mapping of benthic habitats may provide the necessary information to determine what areas are at risk from fishery-related impacts. Utilized in conjunction with information that details fishing effort and area, gear zoning that limits the vulnerability of sensitive habitats while minimizing economic impacts to fishery participants should be considered.

## **OYSTER DREDGE**

An oyster dredge (Figure 5) consists of a metal rectangular frame to which a bag-shaped net of metal rings is attached. The frame's lower end is called the raking bar, and is often equipped with metal teeth used to dig up the bottom. The frame is connected to a towing cable and dragged along the seabed. Oyster dredges are widely utilized in state waters along the Gulf of Mexico, as well as the South Atlantic.

### IMPACTS

Mechanical harvesting of oysters using dredges extracts both living oysters and the attached shell matrix and has been blamed for a significant proportion of the removal and degradation of oyster reef habitat (Rothschild et al. 1994; Dayton et al. 1995; Lenihan and Peterson 1998). Lenihan and Peterson (1998) observed that less than one season of oyster dredging reduced the height of restored oyster reefs by ~30%. Reduction in the height of natural oyster reefs is expected to be less than that of restored reefs because the shell matrix of natural reefs is more effectively cemented together by the progressive accumulation of settling benthic organisms, while restored reefs are initially loose piles of shell material. Regardless, it is likely that the height of natural reefs is also reduced by dredging because a large portion of extracted material from natural reefs by dredges is shell matrix. Lenihan and Peterson (1998) stated that it was probable that reduction in reef heights in a Neuse River, North Carolina estuary was due to decades of fishery-related disturbances caused by oyster dredging. At an annual removal rate of 30%, restored reefs would be completely destroyed after <4 years of harvesting. Furthermore, they determined that the height reduction of oyster reefs through fishery disturbance impacted the quality of habitat due to the seasonal bottom-water hypoxia/anoxia which caused a pattern of oyster mortality and influenced the abundance and distribution of fish and invertebrate species that utilize this temperate reef habitat (Lenihan and Peterson 1998). Their results illustrated that tall experimental reefs – those mimicking natural, ungraded reefs – were more dependable habitat for oysters and other reef organisms than short reefs – those mimicking harvest-degraded reefs – because tall reefs provided refuge above hypoxic/anoxic bottom waters. Chestnut (1955) also documented that intensive dredging over a period of years resulted in the removal of the productive layer of shell and oyster, leaving widely scattered oysters and little substrate for future crop of oysters. Glude and Landers (1953) noted that dredges mixed the sandy-mud layer and the underlying clay. Fished areas were found to be softer and have less odor of decomposition than the unfished control site. Glude and Landers (1953) also found a decrease in benthic fauna in the fished sites versus the unfished control sites.

Conversely, a study conducted by Langan (1998) which looked at the impacts oyster dredging had on benthic habitat, as well as sediment resuspension resulting from dredging activity, concluded with different results. He noted that the size frequency of oysters from the control site were biased towards older and larger specimens with poor recruitment. Oysters from the dredged site illustrated good recent recruitment, while larger specimens were not as abundant as the control site. No significant differences between the two areas were found in number, species richness, or diversity of epifaunal and infaunal invertebrates, indicating that dredge harvesting had no detectable effect on the benthic community. Sediment suspension resulting from dredging activity appeared to be localized. It should be noted that the study failed to evaluate fishing activity (number of participants, effort) on the dredged site.

### RECOVERY

No information is provided in the literature in regard to recovery metrics. However, it may be noted that recovery may be protracted as fishing intensity increases.

### MANAGEMENT RECOMMENDATIONS

Due to overfishing and disease, oysters may now be more economically valuable for the habitat they provide for other valued species than they are for the oyster fishery (Lenihan and Peterson 1998). Rothschild et al. (1994) suggested the establishment of broodstock sanctuaries that includes the designation of “no-fishing” restrictions in specific areas. Lenihan and Micheli (2000) also recommended the closure of some oyster reefs to harvest. Maintaining high densities of oysters on some intertidal reefs may help to preserve future oyster harvests and broodstock. Furthermore, protecting some reefs will also preserve the ecological functions that oyster reef provide such as improving water quality and providing essential recruitment, refuge, and foraging habitat for numerous marine species.

### **SCALLOP DREDGE (INSHORE)**

Scallop dredges are similar to crab scrapes, though scallop dredges utilized in the Southeast generally do not have teeth located on the bottom bar. Scallop dredges (Figure 6) are predominately used on SAV beds where bay scallops can be efficiently harvested, and thus, are primarily limited to state waters. Popular bay scallop fisheries exist both off Florida and North Carolina. This gear, while similar, is not the same type of dredge utilized offshore to harvest calico scallops (*Argopecten gibbus*) or Atlantic sea scallops (*Placopecten magellanicus*).

### IMPACTS

Though scallop dredges do not have teeth that would easily uproot SAV, studies have noted a reduction of algal and SAV biomass from their use (Fonseca et al. 1984; Bargmann et al. 1985). The reduction of SAV (*Zostera marina*) biomass was linearly related to the number of times a particular area was dredged, and the effects of dredging were proportionately greater on soft bottom than hard bottom (Fonseca et al. 1984). The Fonseca et al. (1984) study utilized an empty dredge that was 60% of the legal limit for a commercial dredge, and was not employed in conjunction with a boat as the commercial fishery does. Hand dredging was done to eliminate propeller scour which commonly occurs in shallow SAV beds. In commercial scalloping, the added dredge and scallop weight, as well as the propeller wash, could be expected to have a greater impact (Fonseca et al. 1984). In general, more damage from scallop dredging occurred to SAV in soft substrates (i.e., mud) than hard substrates (i.e., sand). In softer sediments, plants were uprooted and damage to underground plant tissues, including meristems, occurred. In harder sediments, damage was found to be generally greater for above ground parts; underground meristems were left intact and able to begin to repair shoots or produce new ones after impacts had ceased (Fonseca et al. 1984).

### RECOVERY

Fonseca et al. (1984) determined that in a lightly harvested SAV area, with <25% biomass removal, recovery occurred within a year. In areas where harvesting resulted in the removal of 65% of SAV biomass, recovery was delayed for two years. After four years, preharvesting biomass levels were still not obtained. These estimates were based on termination of fishery-related impacts. Continued fishing activity would likely lead to prolonged recovery and continued degradation. Homziak et al. (1982) estimated that SAV recovery can be greater than two years if the rhizomes of the plant are removed.

### MANAGEMENT RECOMMENDATIONS

Due to the importance of SAV beds as a nursery area to other species, loss of eelgrass meadows should be avoided. Fonseca et al. (1984) suggested that harvest area rotation may minimize habitat impact.

### **SCALLOP DREDGE (OFFSHORE)**

Scallop dredges (Figure 7) utilized to harvest calico or sea scallops consist of a metal frame that supports tickler chains and a metal ring bag that collects the shellfish. Though not widely utilized in the Southeast, the gear has been included in this review due to their inclusion as an approved gear in the South Atlantic. The majority of studies on scallop dredge impacts originate from areas with extensive scallop fisheries such as the northwest and northeast Atlantic.

## IMPACTS

Due to the potential for the gear to have considerable weight and the fact that it is dragged along the bottom, habitat impacts are expected to occur. Drew and Larsen (1994) estimated that a scallop dredge maximum cutting depth would be 40 - 150mm. Kaiser et al. (1996a) found that scallop dredging greatly reduced the abundance of most species, causing significant changes in the community. It was noted that a large proportion of some animals (such as echinoderms) were not captured or passed through the mesh of the gear. The scallop dredge catches contained a low proportion of non-target species which indicates that the belly rings allow the bycatch to escape. However, the study did not investigate the extent of damage/injury to organisms that were not captured. Likewise, Collie et al. (1997) found areas on Georges Bank that were impacted by scallop dredges to have lower species diversity, lower biomass of fauna, and dominated by hard-shelled bivalves, echinoderms, and scavenging decapods. Areas less impacted by dredges had higher diversity indices. However, it should be noted that portions of Georges Bank consist of cobble habitat which is encrusted with a diverse array of epibenthic species. Perhaps more applicable to the areas in the Southeast where calico scallops are harvested off North Carolina and Florida, would be a study conducted by Butcher et al. (1981), who determined that scallop dredges had little or no environmental effect when they were used on large-grained, firm sand bottom that was shaped in roughly parallel ridges. The area in this study was also noted to be a fairly uniform, low species diversity community. Turbidity caused by the turbulence of the dredge quickly dissipated due to the nature of the substrate. Additionally, Jolley (1972) found no detrimental dredging effects on sand substrates. Yet, there is a potential for dredges to impact coral adjacent to scallop beds, especially the scallop grounds which occur in close proximity to the *Oculina* Bank off eastern Florida. Should a scallop dredge impact *Oculina* coral, there would be severe results, similar to the conclusions reached by ICES (1994) for trawls. This study determined that deep water coral banks such as those composed of *Oculina varicosa*, due to their fragility, long-life spans, slow growth, and infrequent recruitment, may be nearly exterminated by a single passage of a trawl. Recovery of this habitat area, "within a foreseeable future," is unlikely (ICES 1994).

## RECOVERY

Collie et al. (1997) found that biogenic epifauna on Georges Bank showed signs of recovery after two years at a site that was dredged for scallops and then closed to fishing. The areas in the Southeast that are worked by scallop dredges largely consist of sandy substrates, therefore recovery may occur in a shorter timeframe.

## MANAGEMENT RECOMMENDATIONS

No specific or applicable management recommendations are offered in the literature. As this is not a prominent gear type, no broad management measures may be necessary. Rather, specific management measures, such as the recent expansion of the *Oculina* Bank Habitat Area of Particular Concern where fishing by bottom-tending gear is prohibited, should be offered when at-risk habitat areas are identified.

## **SKIMMER TRAWL**

Skimmer trawls are positioned along the side of a boat and pushed through the water to harvest shrimp. Two nets are typically used, one on each side of the boat. Skimmer trawls (Figure 8) are supported by a tubular metal frame that skims over the bottom on a weighted metal shoe or skid. Tickler chains are also utilized along the base of the net. Because of the construction attributes of this gear type, skimmer trawls are generally restricted to water 3.05m (10ft) or less which would limit them to state waters.

## IMPACTS

Skimmer trawls work on mud bottoms in water generally 3.05m (10ft) or less. The weighted shoe and tickler chains impact the bottom, resulting in sediment resuspension. Skimmer trawls may cause bottom damage due to improperly tuned or poorly designed gear (skids and bullets) or prop damage in shallow areas (Steele 1994). Furthermore, because skimmer trawls are used in shallow water, they may have a detrimental impact on critical nursery areas such as the marsh/water interface, SAV, or other sensitive submerged habitats. However, skimmer trawls are expected to impact the bottom less than otter trawls due to the absence of doors (Nelson 1993; Steele 1993).

Coale et al. (1994) believed that the skimmer trawl would not have any greater effects on SAV than the otter trawl. They found it doubtful that the inside weight and outer shoe of the skimmer trawl would cause greater detrimental effects to the benthos than the heavy doors of an otter trawl. Based on underwater observations, Coale et al. (1994) suggested that the weight and shoe combination may be less-damaging than otter trawls. However, habitat such as sponges and SAV are cut off by tickler chains and lead lines whereas otter trawl doors can dig in and tear up the bottom. Given the difference in the amount of area covered by each on normal tows, Kennedy, Jr. (1993) found it doubtful that there would be much difference in the amount of habitat loss between skimmer trawls and otter trawls.

#### RECOVERY

No information relative to habitat recovery from skimmer trawl impacts is provided in the literature.

#### MANAGEMENT RECOMMENDATIONS

Kennedy, Jr. (1993) recommended that the use of skimmer trawls in Florida should be restricted to those areas currently approved for otter trawls. Due to the associated impacts to SAV, a prudent recommendation would be to limit skimmer trawl use to non-vegetated substrates.

### **STATIC GEAR**

---

It has been noted by Rogers et al. (1998) that there are few accounts of the physical contact of static gear having measurable effects on benthic biota, as the area of seabed affected by each gear is almost insignificant compared to the widespread effects of mobile gear. Nevertheless, static gear can impact habitat and needs to be evaluated.

#### **CHANNEL NET**

Channel nets are fixed to pilings, docks, or shore installation and utilize current flow to capture shrimp, therefore, channel nets are limited to use within state waters.

#### IMPACTS

Though impacts of channel nets were not discussed specifically, it may be inferred from Higman (1952) that channel nets have negligible impact on habitat due to catch composition and the lack of interaction with the benthos.

#### RECOVERY & MANAGEMENT RECOMMENDATIONS

Due to the lack of scientific investigation on potential habitat impacts resulting from this gear, no conclusions on recovery or management recommendations are offered.

#### **GILLNET & TRAMMEL NET**

Gillnets (Figure 9) consist of a wall of netting set in a straight line, equipped with weights at the bottom and floats at the top, and is usually anchored at each end. As fish swim through the virtually invisible monofilament netting, they become entangled when their gills are caught in the mesh, hence the name. Gillnets may be fixed to the bottom (sink net) or set midwater or near the surface to fish for pelagic species. A trammel net (Figure 10) is made up of two or more panels suspended from a float line and attached to a single lead line. The outer panel(s) are of a larger mesh size than the inner panel. Fish swim through the outer panel and hit the inner panel which carries it through the other outer panel, creating a bag and trapping the fish. Smaller and larger fish become wedged, gilled, or tangled. Gillnets are widely used in numerous fisheries, both in state waters and in Federal waters. Trammel nets are primarily used in state waters, though they are an authorized gear in the Caribbean for both the spiny lobster and shallow water reef fish fisheries.

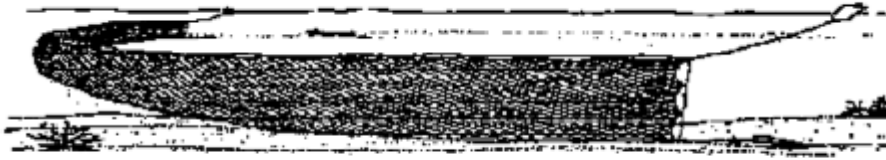

**FIGURE 9. GILLNET (West et al. 1994)**

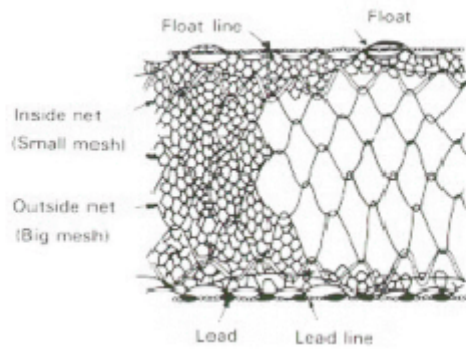

**FIGURE 10. TRAMMEL NET (Yusung Industrial Co., Ltd.)**

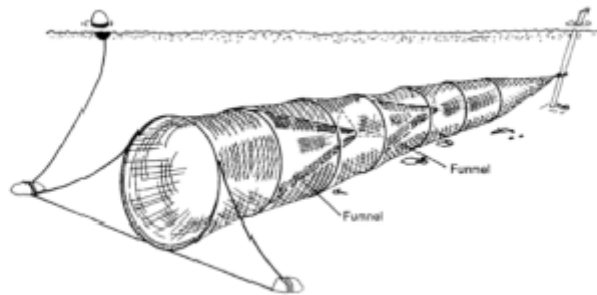

**FIGURE 11. HOOP NET (Nielsen and Johnson 1983)**

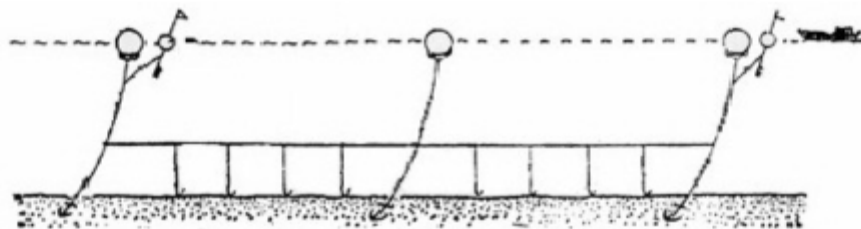

**FIGURE 12. BOTTOM LONGLINE**

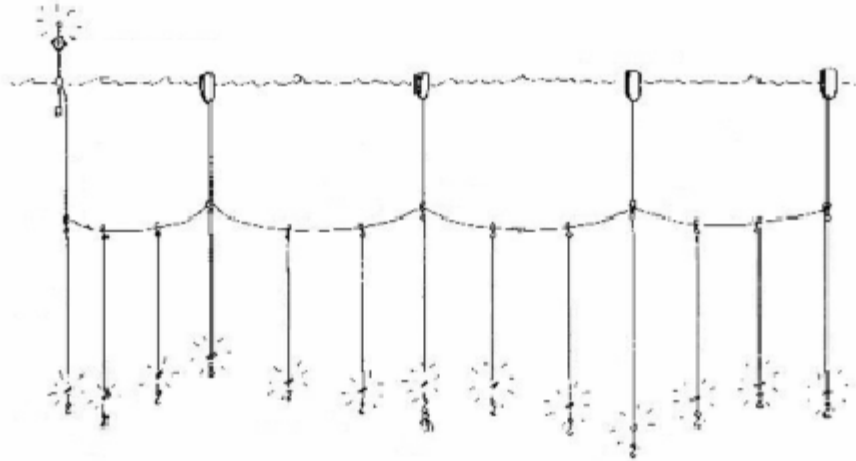

FIGURE 13. PELAGIC LONGLINE (Stephen Willoughby)



FIGURE 14. POUND NET (West et al. 1994)

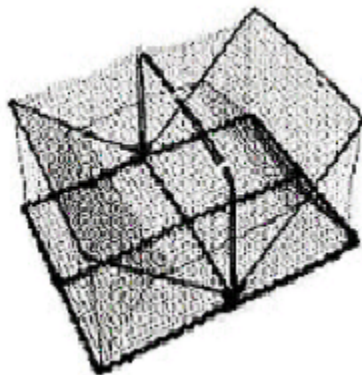

FIGURE 15. FISH TRAP

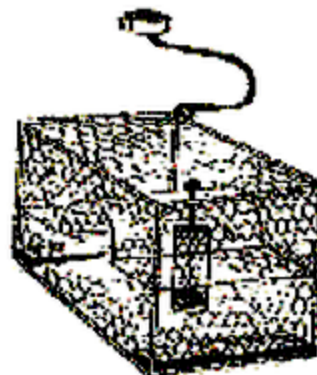

FIGURE 16. CRAB POT



**FIGURE 17. COLLAPSIBLE CRAB TRAP**

### IMPACTS

The majority of the studies that have investigated impacts of fixed gillnets have determined that they have a minimal effect on the benthos (Carr 1988; ICES 1991; ICES 1995; Kaiser et al. 1996b). An ASMFC (2000) report determined that impacts to SAV from gillnets would be minimal. Likewise, West et al. (1994) stated that there was no evidence that sink net (gillnet) activities contributed importantly to bottom habitat disturbance. However, Carr (1988) noted that ghost gillnets in the Gulf of Maine could become entangled in rough bottom. He observed one net that had its leadline and floatline twisted around each other and tightly stretched between boulders. Furthermore, Williamson (1998) noted that gillnets can snag and break benthic structures. Gomez et al. (1987) noted that gill nets set near reefs occasionally results in accidental snarring often resulting in damage to coral. Bottom set gillnets have led to habitat destruction in different regions (Jennings and Polunin 1996). Bottom gillnets set over coral may cause negative impacts as the weighted lines at the base of the net often become entangled with branching and foliaceous corals. As the nets are retrieved, the corals are broken (Öhman et al. 1993). This observation has also been noted in a study by Munro et al. (1987), which documented that reefs are frequently damaged by the hauling of set (gill) nets, and the problem has been exacerbated by the use of mechanical net haulers or power blocks.

Aside from the potential impacts cited on coral reef communities, the available studies indicate that habitat degradation from gillnets is minor. Several studies note that lost gillnets are quickly incorporated by marine species. Cooper et al. (1988) found ghost gillnets in the Gulf of Maine covered with a heavy filamentous growth, exceeding 75% coverage on some nets. Anemones, stalked ascidians and sponges were attached to and growing to the net float lines (Carr et al. 1985; Cooper et al. 1988). Erzini et al. (1997) found that lost trammel nets and gill nets in shallow water (15 - 18m) on rocky habitat (analogous to coral reefs and hardbottom habitat) were colonized by various species, primarily macrophytes, which after three months completely blocked the meshes of some parts of the nets. Some netting would contact reef habitat, becoming heavily overgrown and eventually blended into the background. After a year, most of the netting was destroyed; those remnants that remained were completely colonized by biota (Erzini et al. 1997). Erzini et al. (1997) also noted that the nets eventually became incorporated into the reefs, acting as a base for many colonizing plants and animals. The colonized nets then provided a complex habitat which was attractive to many organisms. For example, large schools of juvenile fish were often observed in the vicinity of these heavily colonized nets, which may provide a safe haven from predators. Johnson (1990) and Gerrodette et al. (1987) noted that as gillnets tend to collapse and "roll up" relatively quickly, they may form a better substrate for marine growths and thereby attract fish and other predators which may get entangled, ultimately causing the net to sink. Therefore, one may assume that gillnets may be more of a ghostfishing problem and entanglement hazard to marine life than as an impact to habitat.



#### RECOVERY & MANAGEMENT RECOMMENDATIONS

Due to the lack of scientific investigation on potential habitat impacts resulting from these gear types, no conclusions on recovery or management recommendations are offered.

#### **HOOP NET**

A hoop net (Figure 11) is a cone-shaped or flat net which may or may not have throats and flues stretched over a series of rings or hoops for support. The net is set by securing the cod or tapered end to a post or anchored to the bottom. The net is played out with the current until fully extended, and then is allowed to settle to the bottom. The net is marked with a buoy for easy retrieval and identification purposes. The duration of time that a hoop net is set depends on the same factors that influence the duration of the set of a gill net and should be determined in a similar fashion. To harvest, the hoop net is raised at the cod end and the fish are removed.

#### IMPACTS

While there are no studies that document the effect of hoop nets on habitat, due to its use primarily on flat bottoms the gear probably has less of an impact than traps.

#### RECOVERY & MANAGEMENT RECOMMENDATIONS

Due to the lack of scientific investigation on potential habitat impacts resulting from this gear, no conclusions on recovery or management recommendations are offered.

#### **LONGLINE**

Longlines use baited hooks on offshoots (gangions or leaders) of a single main line to catch fish at various levels depending on the targeted species. The line can be anchored at the bottom (Figure 12) in areas too rough for trawling or to target reef associated species, or set adrift, suspended by floats (Figure 13) to target swordfish and sharks. Longlines are widely utilized in numerous fisheries throughout the Southeast Region.

#### IMPACTS

When a vessel is retrieving a bottom longline it may be dragged across the bottom for some distance. The substrate penetration, if there is any, would not be expected to exceed the breadth of the fishhook, which is rarely more than 50mm (Drew and Larsen 1994). More importantly is the potential effect of the bottom longline itself, especially when the gear is employed in the vicinity of complex vertical habitat such as sponges, gorgonians, and corals. Observations of halibut longline gear off Alaska included in a North Pacific Fishery Management Council Environmental Impact Statement (NPFMC 1992) provide some insight into the potential interactions longline gear may have with the benthos. During the retrieval process of longline gear, the line was noted to sweep the bottom for considerable distances before lifting off the bottom. It snagged on whatever objects were in its path, including rocks and corals. Smaller rocks were upended and hard corals were broken, though soft corals appeared unaffected by the passing line. Invertebrates and other light weight objects were dislodged and passed over or under the line. Fish were observed to move the groundline numerous feet along the bottom and up into the water column during escape runs, disturbing objects in their path. This line motion has been noted for distances of 15.2m (50ft) or more on either side of the hooked fish. Based on these observations, it is logical to assume that longline gear would have a minor impact to sandy or muddy habitat areas. However, due to the vertical relief that hardbottom and coral reef habitats provide, it would be expected that longline gear may become entangled, resulting in potential impacts to habitat. Due to a lack of interaction with the benthos, pelagic longlines would have a negligible habitat impact.

#### RECOVERY

Due to the lack of sufficient scientific investigation on potential habitat impacts resulting from this gear, no conclusions on recovery are offered.

### MANAGEMENT RECOMMENDATIONS

Due to the potential entanglement impacts associated with bottom longlines, excluding their use in the vicinity of sensitive benthic habitat such as coral reefs would be an appropriate management measure.

### **POUND NET**

A pound net (Figure 14) consists of a fence constructed of netting that runs perpendicular to shore which directs fish to swim voluntarily into successive enclosures known as the heart, pound, or pocket. Pound nets are exclusively utilized in state waters.

### IMPACTS

An ASMFC (2000) report determined that impacts to SAV from pound nets are expected to be minimal, unless the net is constructed directly on SAV. West et al. (1994) also stated that pound nets do not contribute to benthic disturbance. Due to the limited amount of space a pound net may impact, it is expected that pound nets have minimal impact on habitat.

### RECOVERY & MANAGEMENT RECOMMENDATIONS

Due to the lack of sufficient scientific investigation on potential habitat impacts resulting from this gear, no conclusions on recovery or management recommendations are offered.

### **TRAP & POT**

Traps and pots (Figures 15 - 17) are rigid devices, often designed specifically for one species, used to entrap finfish or invertebrates. Generally baited and equipped with one or more funnel openings, they are left unattended for some time before retrieval. Traps and pots are weighted to rest on the bottom, marked with buoys at the surface, and are sometimes attached to numerous other traps to one long line called a trot line. Traps and pots are widely used on a variety of habitats in both state and Federal waters to harvest species such as lobster, blue crabs, golden crabs, stone crabs, black sea bass, snapper, and grouper. Wire-mesh fish traps are one of the principal fishing gears used in coral reef areas in the Caribbean (Appledorn 2000).

### IMPACTS

Due to their use to harvest species associated with coral and hardbottom habitat, traps and pots have been identified to impact and degrade habitat. Gomez et al. (1987) noted the incidental breakage of corals on which traps may fall or settle constitute the destructive effects of this gear. Within the Virgin Islands State Park, Garrison (1998) found 86% of the fish traps were set on organisms (live coral, soft coral, SAV) living on the sea floor. Damage to the live substrate has far-reaching negative effects on the marine ecosystem because the available amount of shelter and food often decreases as damage increases. Another study conducted by Garrison (1997) had similar results, as 82% of traps rested directly on live substrate, with 17% resting on stony corals. Hunt and Matthews (1999) found that lobster and stone crab traps reduce the abundance of gorgonian colonies from rope entanglement. Furthermore, seagrass smothering occurs from trap placement on SAV beds, resulting in SAV "halos." Van der Knapp (1993) noted that fish traps set on staghorn coral easily damaged the coral. It appeared that in all observed cases of injury due to traps, the staghorn coral regenerated completely, although the time for regeneration varied from branch to branch. The greatest impact noted from the setting of traps was observed when the point of the trap's frame ran into coral formations. Several different species of coral were observed to suffer damage from fish traps. Observations of at least one damaged coral specimen noted that algae growth prevented regeneration in the damaged portion of the coral. Additionally, complete deterioration of a vase sponge was observed after it had been severely damaged by a trap. Traps are not placed randomly, rather they are fished in specific areas multiple times before fishing activity moves to other grounds. Therefore, trap damage will be concentrated (cumulative effect) in particular areas rather than be uniform over all coral reef habitat.

In a recent study, Appledorn et al. (2000) commented that traps may physically damage live organisms, such as corals, gorgonians, and sponges, which provide structure and in some cases, nutrition for reef fish and invertebrates. Damage may include flattening of habitats, particularly by breaking branching corals and gorgonians; injury may lead to reduced growth rates or death, either directly or through subsequent algal overgrowth or disease infection. During initial hauling, a trap may be dragged over more substrate until it lifts off the bottom. Traps set in trotlines can cause further damage from the trotline being dragged across the bottom, potentially shearing off at their base those organisms most important in providing topographic complexity. Traps that are lost or set unbuoyed are often recovered by dragging a grappling hook across the bottom. This practice can result in dragging induced damage from all components (grappling hook, trap, trotline). The area swept by trotlines upon recovery is orders of magnitude greater than the cumulative area of the traps themselves. Appledorn et al. (2000) documented that single-buoyed fish traps off La Parguera, Puerto Rico, have an impact footprint of approximately 1m<sup>2</sup> on hardbottom or reef. Of the traps investigated in the study, 44% were set on hardbottom or reef, resulting in 23% damage to coral colonies (70cm<sup>2</sup> average), 34% damage to gorgonian colonies (56cm<sup>2</sup> average), and 30% damage to sponges, though sponges were less frequently impacted due to their patchy distribution. Trap hauling resulted in 30% of the traps inflicting additional damage to the substrate.

In a similar study focusing on fish trap impacts conducted off St. Thomas, U.S.V.I., by Quandt (1999), 40% of all traps investigated were found to be resting on reef substrate. On average, 4.98% of all hard corals and 47.17% of all gorgonians were damaged; tissue damage averaged 20.03% to each gorgonian. Secondary impacts, such as trap hauling and movement due to natural disturbances were not investigated. However, the effects of pulling a string of two or more traps would most likely be much greater than one trap alone.

Eno et al. (1996) found pots that landed on, or were hauled through beds of bryozoans caused physical damage to the brittle colonies. It was noted that several species of sea pens bent in response to the pressure wave created by a descending pot and lay flat on the seabed. When uprooted, the sea pens were able to reestablish themselves in the sediment. A species of sea fan also was found to be flexible and specimens were not severely damaged when pots were hauled over them. This suggests that in some instances the direct contact of certain gears may not be the primary cause of mortality, rather the frequency and intensity may be more important. Additionally, Sutherland et al. (1983) cited little apparent damage to reef habitats inflicted from fish traps off Florida. The study found four derelict traps sitting atop high profile reefs with four other traps observed within a live-bottom area. There was no visual evidence that traps on the high profile reef killed or injured corals or sponges. One uprooted gorgonian was observed atop a ghost trap in a live-bottom area. However, these observations were made on randomly located derelict traps. Thus, the primary impacts that may occur during deployment and recovery could not be evaluated.

#### RECOVERY

Recovery is dependent on the type of habitat the trap is deployed on and the amount of inflicted damage. A study (Mascarelli and Bunkley-Williams *in press*) evaluated that only 30% of corals recovered from damage after 120 days, while some damage was expected to be permanent. It would also be expected that impacted corals have varying recovery time depending on individual species. Van der Knapp (1993) observed full gorgonian recovery from trap impacts within a month.

#### MANAGEMENT RECOMMENDATIONS

While it appears prudent to not deploy traps on coral habitat, that recommendation may be difficult to enforce. To limit trap impacts, Stewart (1999) advised that traps should not be weighted any more than is needed for them to land upright on the sea bed. Limiting the number of traps in a trotline would limit the amount of documented habitat degradation that occurs from recovery operations.

## **OTHER GEAR**

---

### **ALLOWABLE CHEMICAL**

Collectors of live tropical reef fish commonly employ anesthetics such as quinaldine. Quinaldine (2-methylquinoline, C<sub>10</sub>H<sub>9</sub>N) is the cheapest and most available of several substituted quinolines (Goldstein 1973).

#### IMPACTS

As a result of using this compound near corals where tropical species shelter, there may be residual effects which was discussed in a study by Japp and Wheaton (1975). Short-term impacts of quinaldine include increased flocculent mucus production, retraction of polyps and failure to reexpand with a five minute observation period, and tissue discoloration in certain species. At both study sites, octocorals were found to suffer no long-term impacts. However, a minority of Scleractinians displayed minor damage, including mild discoloration and small patches of dead tissue, three months after quinaldine treatment. Two of these specimens degraded to poor condition or displayed areas of dead tissue more than six months after initial treatment. Overall, Japp and Wheaton (1975) determined that quinaldine exposure resulted in minimal damage to corals.

#### RECOVERY

As noted in Japp and Wheaton (1975), impacts appear to be temporary.

#### MANAGEMENT RECOMMENDATIONS

Due to the short-term impacts this fishing method introduces, as well as the limited nature of the fishery itself, no management recommendations are offered.

### **BARRIER NET**

Barrier nets are used in conjunction with small tropical nets or slurpguns to collect tropical aquarium species. The net is deployed to surround a coral head or outcropping and may or may not have a pocket or bag that fish are "herded" into for capture. Barrier nets may be utilized by tropical fish collectors in both state and Federal waters.

#### IMPACTS

The American MarineLife Dealers Association conducted a survey (Tullock and Resor 1996) that focused on tropical collection practices. The survey defined a sustainable fishing practice as one that a) does not cause physical damage to the reef environment; b) does not impair the captured specimen's longevity in a properly maintained aquarium environment; and c) does not damage non-target species such as coral polyps, other invertebrates, or non-aquarium fish. The survey concluded that barrier nets were a sustainable fishing practice. However, a study conducted by Öhman et al. (1993) summarized that moxy nets, a type of barrier net that is used in other regions to collect ornamental fish species, may break corals during their use. However, it is likely that damage inflicted by barrier nets would be infrequent and incidental in nature, and therefore, the gear would have a negligible effect on habitat.

#### RECOVERY & MANAGEMENT RECOMMENDATIONS

Due to the lack of scientific investigation on potential habitat impacts resulting from this gear, no conclusions on recovery or management recommendations are offered.

### **CASTNET**

Used to capture baitfish and shrimp, castnets (Figure 18) are circular nets with a weighted skirt that is thrown over a schooling target. Castnets are primarily used in shallow areas such as estuaries, though they may be used to catch baitfish offshore in Federal waters.

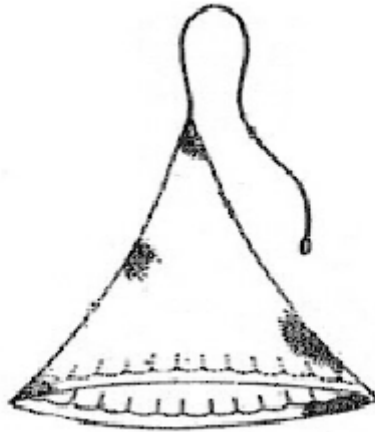

FIGURE 18. CAST NET (University of Washington, APL)

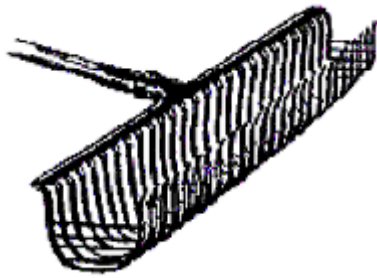
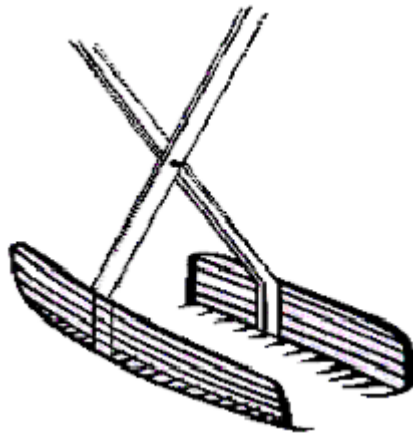

FIGURE 19. BULL RAKE FIGURE



20. HAND RAKE FIGURE



21. OYSTER TONGS

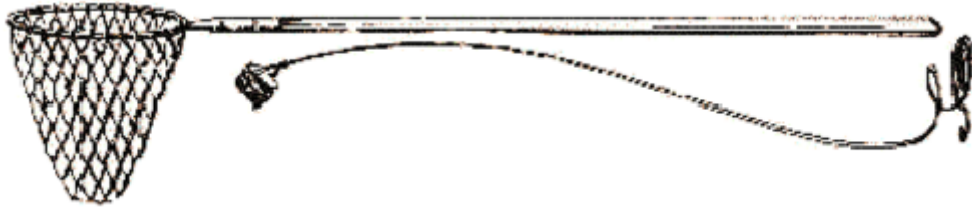

FIGURE 22. DIPNET

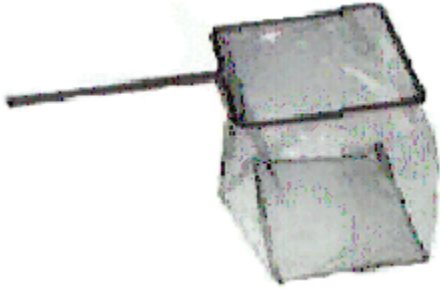

FIGURE 23. TROPICAL FISH NET

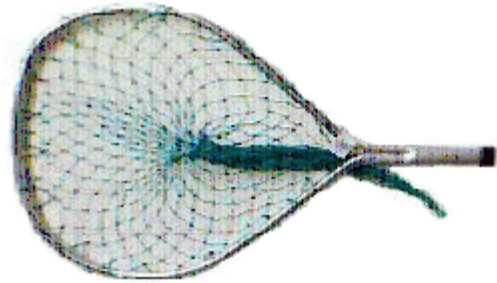

FIGURE 24. LOBSTER/LANDING NET

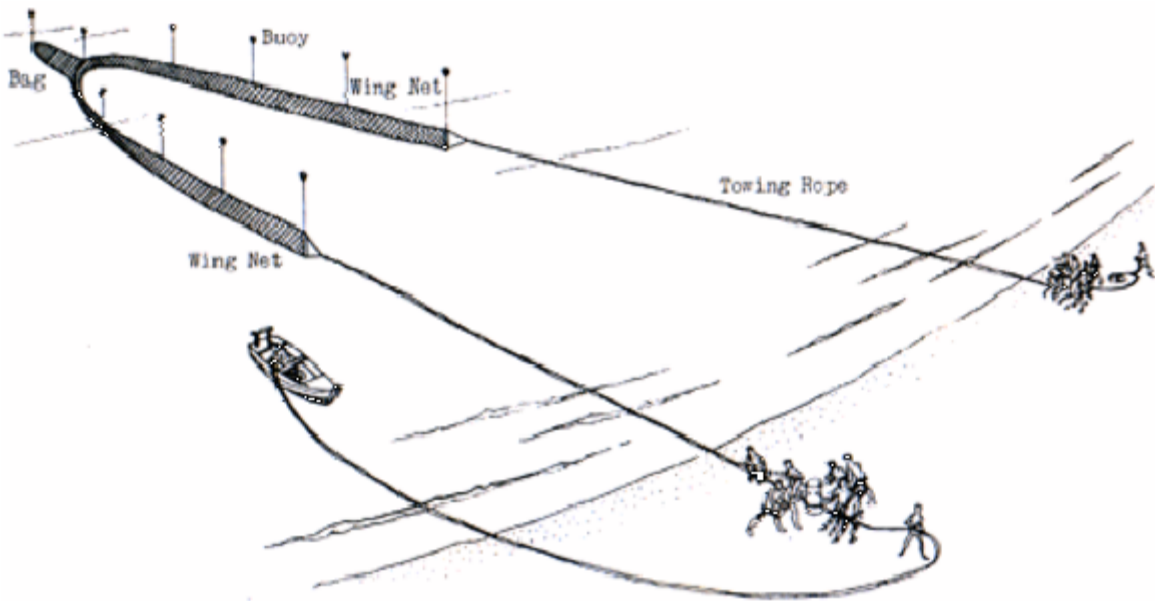

FIGURE 25. BEACH HAUL SEINE (Amita Company)

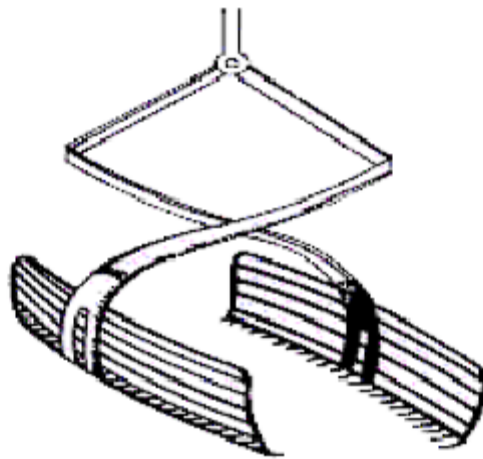

FIGURE 26. PATENT TONGS

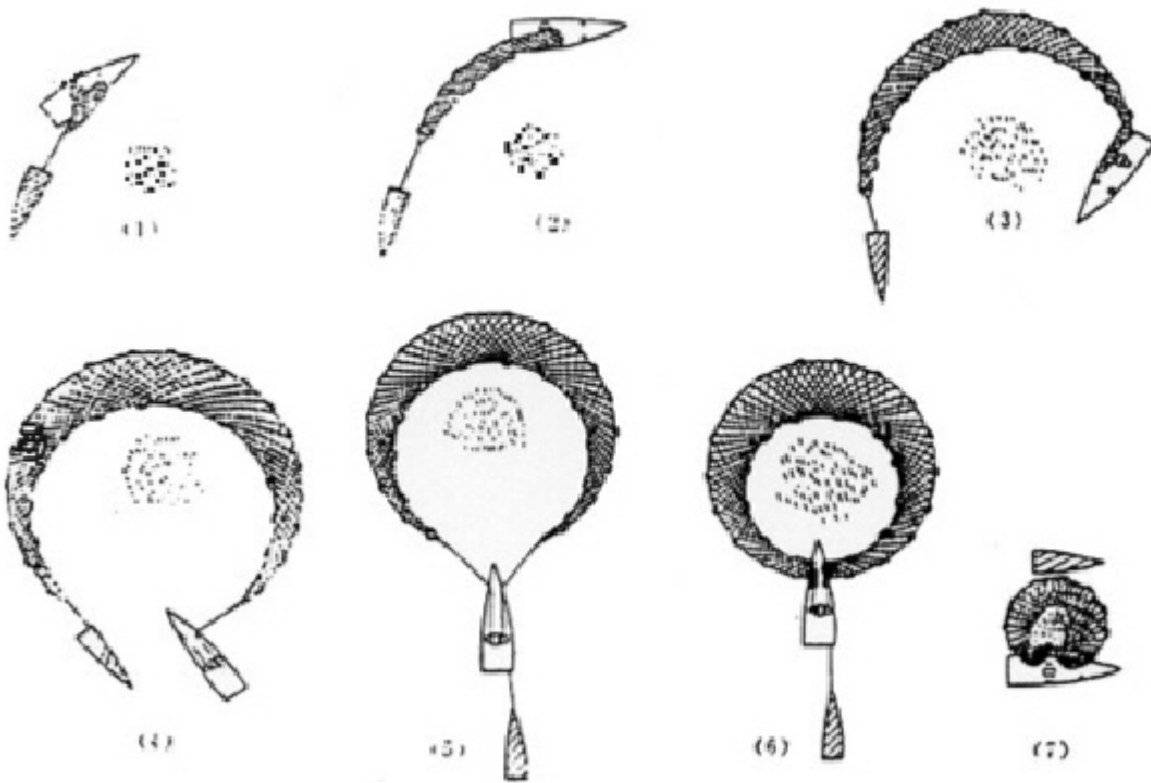

FIGURE 27. PURSE SEINE (University of Washington, APL)

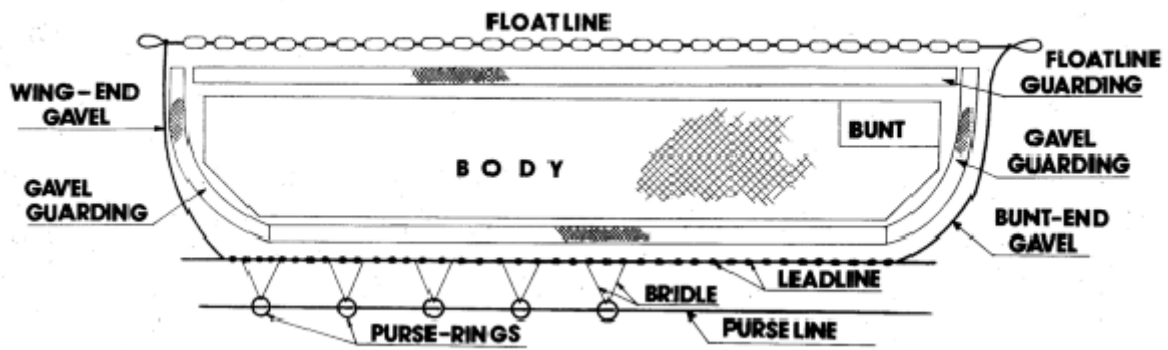

FIGURE 28. COMPONENTS OF A PURSE SEINE NET (Ben-Yami 1987)

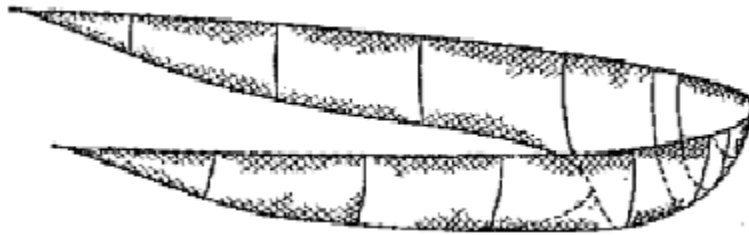

FIGURE 29. LAMPARA NET

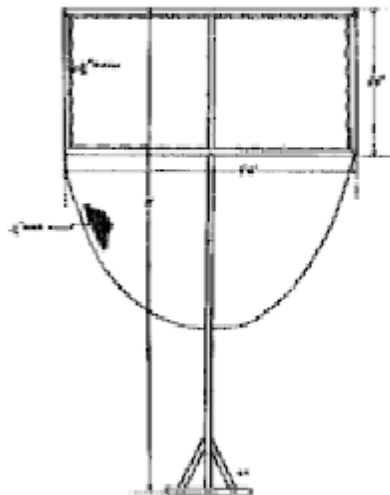

FIGURE 30. PUSHNET (De Sylva 1954)



FIGURE 31. SLURP GUN





**FIGURE 32. SNARE**



**FIGURE 33. SPEARGUN (Riffe International)**

#### IMPACTS

Castnets have the potential to dislodge organisms or become entangled if utilized over heavily encrusted substrates. Observations by the author have noted numerous castnets entangled amongst sponges and other growth around rough bottom. However, a study conducted by DeSylva (1954) determined that castnets have no detrimental effect on habitat.

#### RECOVERY & MANAGEMENT RECOMMENDATIONS

Due to the lack of documented habitat impacts, no conclusions on recovery or management recommendations are offered.

#### **CLAM KICKING**

Clam kicking is a mechanical form of clam harvest primarily practiced in the state waters of North Carolina. The practice involves the modification of boat engines in such a way as to direct the propeller wash downwards instead of backwards. The propeller wash is sufficiently powerful in shallow water to suspend bottom sediments and clams into a plume in the water column, which allows clams to be collected in a trawl net towed behind the boat (Peterson et al. 1987a).

#### IMPACTS

Several studies have noted that the practice of clam kicking reduces algal and SAV biomass (Fonseca et al. 1984; Bargmann et al. 1985; Peterson et al. 1987a). Reduction of SAV biomass was noted to increase with harvest intensity. Intense clam kicking treatments reduced SAV biomass by approximately 65% (Peterson et al. 1987a). Because of the importance of SAV to coastal fisheries and estuarine productivity, Peterson et al. (1987a) noted that intense clam kicking could have long-lasting and serious impacts on many commercially important fisheries.

However, clam harvesting had no detectable effect on the abundance of small benthic invertebrates and outside of SAV habitat, clam kicking does not appear to have any serious negative impacts on parameters of ecological value (Peterson et al. 1987a).

#### RECOVERY

SAV recovery can be greater than two years if the rhizomes of the plant are removed (Homziak et al. 1982; Peterson et al. 1987a). Peterson et al. (1987a) observed that SAV had yet to recover after four years of an intense clam kicking treatment. Although Peterson et al. (1987a) designated their heavier clam kicking treatment as "intense," they conceded that it probably falls well short of the effort that commercial clambers would apply to a productive SAV bed.

### MANAGEMENT RECOMMENDATIONS

Limit the intensity of clam fishing in SAV habitat would probably be beneficial. Peterson et al. (1987a) offered that a restriction of mechanical clam harvesters to unvegetated bottoms may be a suitable mechanism to minimize habitat damage.

### **CLAM RAKE, SCALLOP RAKE, SPONGE RAKE, & OYSTER TONG**

Rakes (Figures 19, 20) are used to harvest shellfish and sponges from shallow areas such as bays and estuaries. Oyster tongs (Figure 21), similar to two rakes fastened together and facing each other like scissors, are used by fishermen from the deck of a boat. As these gears are limited by water depth, they are exclusively utilized in state waters.

### IMPACTS

Lenihan and Micheli (2000) reported that the harvest of shellfish utilizing clam rakes and oyster tongs significantly reduce oyster populations on intertidal oyster reefs. Both types of shellfish harvesting, applied separately or together, reduced the densities of live oysters by 50-80% compared with the densities of unharvested oyster reefs. While oysters are removed, Rothschild et al. (1994) concluded that hand tongs probably have a minor effect on the actual oyster bar structure.

Peterson et al. (1987b) compared the impacts of two types of clam rakes on SAV biomass. The bull rake removed over 89% of shoots and 83% of roots and rhizomes in a completely raked area while the pea digger removed 55% of shoots and 37% of roots and rhizomes. Loss or impact on SAV by bull rake was estimated to be double the impact of the smaller pea digger rake. Peterson et al. (1987a) found raking with a pea digger rake reduced SAV biomass by approximately 25%. An earlier study conducted by Glude and Landers (1953) noted that bull rakes and clam tongs mixed the sandy-mud layer and the underlying clay. Fished areas were also softer and had less odor of decomposition than the unfished control site. A decrease in benthic fauna was noted in the fished sites versus the unfished control sites.

Sponges are an important fishery in the Florida Keys and along the west coast of Florida (NOAA 1996). Sponges are dominant organisms in deepwater passes and along hardbottom habitat communities. Sponges create vertical habitat which provides shelter and forage opportunities for other invertebrates and tropical fish species. The fishery in the Keys typically employs a four-pronged iron rake attached to the end of a 5 - 7m pole which hooks the sponges from the bottom. While no studies document the extent of habitat damage from this gear type, it may be concluded that the harvest of sponges directly reduces the amount of available habitat, and thus may present a negative localized impact.

### RECOVERY

Peterson et al. (1987a) found that SAV biomass recovered to equal and even exceeded expected values within one year.

### MANAGEMENT RECOMMENDATIONS

Lenihan and Micheli (2000) recommended the closure of some oyster reefs to shellfish harvest. Maintaining high densities of oysters on some intertidal reefs may help to preserve future oyster harvests and broodstock. Furthermore, protecting some reefs will also preserve the ecological functions that oyster reefs provide such as improving water quality and providing essential recruitment, refuge, and foraging habitat for numerous marine species. Due to the extensive habitat that sponges provide, further ecological study on the directed harvest of these organisms should be conducted.

### **DIPNET & BULLY NET**

Widely utilized to catch baitfish, crabs, or lobster, varieties of dipnets (Figure 22) consist of a long pole with a bag of netting of varying mesh size that are lowered into the water. Dipnets may also be employed to capture tropical

reef fish (Figure 23), though these utilize a short handle and very fine mesh. Additionally, landing nets or hand bully nets (Figure 24) used to capture lobster can be considered a form of dipnet. Varieties of dipnets may be used both in state and Federal waters.

#### IMPACTS

DeSilva (1954) determined that dipnets have no detrimental effect on habitat. However, the use of small dipnets (i.e., tropical fish nets and lobster hand bully nets) may result in minor isolated impacts to coral species as individuals attempt to capture specimens (Barnette personal observation).

#### RECOVERY & MANAGEMENT RECOMMENDATIONS

Due to the lack of scientific investigation on potential habitat impacts resulting from this gear, no conclusions on recovery or management recommendations are offered.

### **HAND HARVEST**

Hand harvest describes activities that capture numerous species such as lobster, scallops, stone crabs, conch, and other invertebrates by hand.

#### IMPACTS

As many small biogenic structures occur on the sediment surface, even gentle handling by divers can destroy them easily. Movement by divers were observed to cause demersal zooplankters to exhibit escape responses (Auster and Langton 1999). A study that assessed recreational SCUBA activity in the US Caribbean (Garcia-Moliner et al. 2000) concluded that approximately 2% of the total recreational divers in the USVI and 1.9% of the total recreational divers in Puerto Rico were lobstering. Potential impact of approximately 13,532 units occurred in the USVI and 14,946 units occurred in Puerto Rico. In this study, impact units consisted of two hands and two feet (4 units per diver) and impact was broadly defined as ranging from touching coral with hands to the resuspension of sediment by fins. No assessment of habitat degradation or long-term impacts was discussed. Divers pursuing lobster along coral or hardbottom communities have been observed to impact gorgonians and other encrusting organisms (Barnette unpublished observations).

#### RECOVERY & MANAGEMENT RECOMMENDATIONS

Due to the lack of scientific investigation on potential habitat impacts resulting from this gear, no conclusions on recovery or management recommendations are offered.

### **HARPOON**

Harpoons, thrown from the decks of a vessel, are utilized to target swordfish and tuna.

#### IMPACTS

As this gear is employed to harvest pelagic species, there is no contact with the benthos and, thus, no impact to habitat.

#### RECOVERY & MANAGEMENT RECOMMENDATIONS

Due to the nature of this fishery and lack of physical habitat impacts, no conclusions on recovery or management recommendations are offered.

### **HAUL SEINE & BEACH SEINE**

A haul seine (Figure 25) is an active fishing system that traps fish by encircling them with a long fence-like wall of webbing. It is made of strong netting hung from a float line on the surface and held near the bottom by a lead line. They are fished either along the shoreline (beach seine) where they are deployed in a semi-circle to trap fish between shore and net or, more typically, fish are encircled away from shore, worked into an even smaller pocket of net and lifted onto a boat for culling (Sadzinski et al. 1996). The use of this gear is limited to state waters.

### IMPACTS

Sadzinski et al. (1996) found no detectable effects from haul seining on SAV. However, possible damage from haul seining to sexual reproduction, such as flower shearing, was not examined. There are possible long-term or cumulative impacts at established haul-out sites, resulting in loss of SAV biomass (Orth personal communication). As the seine is generally used in flat benthic areas to prevent the net becoming damaged, in most cases the impact from seines would be expected to be minor and temporary.

### RECOVERY & MANAGEMENT RECOMMENDATIONS

Due to the lack of scientific investigation on potential habitat impacts resulting from this gear, no conclusions on recovery or management recommendations are offered.

## **HOOK AND LINE, HANDLINE, BANDIT GEAR, BUOY GEAR, & ROD AND REEL**

These gear types are widely utilized by commercial and recreational fishermen over a variety of estuarine, nearshore, and marine habitats. Hook and line may be employed over reef habitat or trolled in pursuit of pelagic species in both state and Federal waters.

### IMPACTS

Few studies have focused on physical habitat impacts from these gear types. Impacts may include entanglement and minor degradation of benthic species from line abrasion and the use of weights (sinkers). Schleyer and Tomalin (2000) noted that discarded or lost fishing line appeared to entangle readily on branching and digitate corals and was accompanied by progressive algal growth. This subsequent fouling eventually overgrows and kills the coral, becoming an amorphous lump once accreted by coralline algae (Schleyer and Tomalin 2000). Lines entangled amongst fragile coral may break delicate gorgonians and similar species. Due to the widespread use of weights over coral reef or hardbottom habitat and the concentration of effort over these habitat areas from recreational and commercial fishermen, the cumulative effect may lead to significant impacts resulting from the use of these gear types.

### RECOVERY & MANAGEMENT RECOMMENDATIONS

Due to the lack of scientific investigation on potential habitat impacts resulting from this gear, no conclusions on recovery or management recommendations are offered.

## **PATENT TONG**

Similar to hand tongs, hydraulic patent tongs (Figure 26) are much larger and are assisted with hydraulic lift, allowing them to purchase more benthic area in pursuit of oysters. Patent tongs are utilized in the oyster fisheries that occur in state waters.

### IMPACTS

Rothschild et al. (1994) found that hydraulic-powered patent tongs are the most destructive gear to oyster reef structure because of their capability to penetrate and disassociate the oyster reef. The capability arises from the gear weight and hydraulic power. Patent tongs operate much like an industrial crane with each bite having the ability to remove a section of the oyster bar amounting to 0.25m<sup>3</sup>.

### RECOVERY

No information is provided in the literature in regard to recovery metrics. However, it may be noted that recovery may be protracted as fishing intensity increases.

### MANAGEMENT RECOMMENDATIONS

Due to overfishing and disease, oysters may now be more economically valuable for the habitat they provide for other valued species than they are for the oyster fishery (Lenihan and Peterson 1998). Rothschild et al. (1994) suggested the establishment of broodstock sanctuaries that includes the designation of "no-fishing" restrictions in specific areas. Lenihan and Micheli (2000) also recommended the closure of some oyster reefs to harvest.

Maintaining high densities of oysters on some intertidal reefs may help to preserve future oyster harvests and broodstock. Furthermore, protecting some reefs will also preserve the ecological functions that oyster reef provide such as improving water quality and providing essential recruitment, refuge, and foraging habitat for numerous marine species.

### **PURSE SEINE & LAMPARA NET**

Purse seines (Figures 27, 28) are walls of netting used to encircle entire schools of fish at or near the surface. Spotter planes are often used to locate the schools, which are subsequently surrounded by the netting and trapped by the use of a pursing or drawstring cable threaded through the bottom of the net. When the cable has pulled the netting tight, enclosing the fish in the net, the net is retrieved to congregate the fish. The catch is then either pumped onboard or hauled onboard with a crane-operated dip net in a process called brailing. Purse seines are utilized to harvest menhaden in the Gulf and South Atlantic. Similarly, the lampara net (Figure 29) has a large central bunt, or bagging portion, and short wings. The buoyed float line is longer than the weighted lead line so that as the lines are hauled the wings of the net come together at the bottom first, trapping the fish. As the net is brought in, the school of fish is worked into the bunt and captured. In the Florida Keys a modified lampara net is used to harvest baitfish near the top of the water column. The wing is used to skim the water surface as the net is drawn in and fish are herded into the pursing section to be harvested with a dip net.

#### IMPACTS

Purse seines in the Gulf menhaden fishery frequently interact with the bottom, resulting in sediment resuspension.

#### RECOVERY

Schoellhammer (1996) estimated that sediments resuspended by purse seining activities would last only a period of hours.

#### MANAGEMENT RECOMMENDATIONS

Due to the lack of scientific investigation on potential habitat impacts resulting from this gear, no conclusions on recovery or management recommendations are offered.

### **PUSHNET**

Employed to harvest shrimp in shallow water, pushnets (Figure 30) consist of netting supported by a frame that is mounted onto a pole which is then pushed across the bottom. Pushnets are generally utilized on SAV beds where shrimp can be harvested in abundant numbers.

#### IMPACTS

DeSylva (1954) determined that pushnets have no detrimental effect on habitat.

#### RECOVERY

Due to the lack of scientific investigation on potential habitat impacts resulting from this gear, no conclusions on recovery are offered.

#### MANAGEMENT RECOMMENDATIONS

Due to the general lack of impacts and limited nature of this fishery, no management recommendations are offered.

### **SLURP GUN**

A slurp gun (Figure 31) is a self-contained, handheld device that captures tropical fish by rapidly drawing seawater containing such fish into a closed chamber. Slurp guns are typically employed on hardbottom and coral reef habitat in both state and Federal waters.

### IMPACTS

It is possible that tropical collectors may impact coral or other benthic invertebrates in pursuit of tropical species that are harvested on hardbottom or coral habitat areas. However, due to the limited force applied by a diver in an errant fin kick or hand placement, the likely effects to habitat would be minor.

### RECOVERY & MANAGEMENT RECOMMENDATIONS

Due to the lack of scientific investigation on potential habitat impacts resulting from this gear, no conclusions on recovery or management recommendations are offered.

### **SNARE**

Recreational divers pursuing spiny lobster often use a long, thin pole that has a loop of coated wire on the end called a snare (Figure 32). The loop is placed around a lobster that may be residing in a tight overhang or other inaccessible location, and then tightened by a pull toggle at the base of the pole in order to capture and extract the lobster.

### IMPACTS

While there are no studies that evaluate this gear type, it is probable that use of this gear may minimize impacts to habitat in comparison to divers that use no additional gear (hand harvest). Due to the more surgical precision with the snare, divers likely impact the surrounding habitat to a lesser extent than if capturing by hand only due to the required leverage needed by the divers to capture a lobster by hand.

### RECOVERY & MANAGEMENT RECOMMENDATIONS

Due to the lack of scientific investigation on potential habitat impacts resulting from this gear, no conclusions on recovery or management recommendations are offered.

### **SPEAR & POWERHEAD**

Divers use pneumatic or rubber band guns (Figure 33) or slings to hurl a spear shaft to harvest a wide array of fish species. Reef species such as grouper and snapper, as well as pelagic species such as dolphin and mackerel, are targeted by divers. Commercial divers sometimes employ a shotgun shell known as a powerhead at the shaft tip, which efficiently delivers a lethal charge to their quarry. This method is commonly used to harvest large species such as amberjack.

### IMPACT

Gomez et al. (1987) concluded that spearfishing on reef habitat may result in some coral breakage, but damage is probably negligible. A study that assessed recreational SCUBA activity in the US Caribbean (Garcia-Moliner et al. 2000) concluded that approximately 0.7% of the total recreational divers in the USVI and 28% of the total recreational divers in Puerto Rico are spearfishing. Potential impact would be approximately 4,736 units in the USVI and 220,264 units in Puerto Rico. In this study, impact units consisted of two hands and two feet (4 units per diver) and impact was broadly defined as ranging from touching coral with hands to the resuspension of sediment by fins. No assessment of habitat degradation or long-term impacts was discussed. It may be assumed that divers pursuing pelagic species have no effect on habitat due to the absence of any interaction with the benthos.

### RECOVERY & MANAGEMENT RECOMMENDATIONS

Due to the lack of scientific investigation on potential habitat impacts resulting from this gear, no conclusions on recovery or management recommendations are offered.

## **CURRENT MANAGEMENT MEASURES TO PROTECT EFH**

---

### **SOUTH ATLANTIC FISHERY MANAGEMENT COUNCIL**

Through the Coral, Coral Reefs, and Live/Hard Bottom Habitat FMP and its subsequent amendments, the South Atlantic Council has protected coral reefs and hardbottom habitat by prohibiting all harvest or possession of these resources, with the exception of a limited fishery for allowable octocorals (species of the subclass Octocorallia, with the exception of *Gorgonia flabellum* and *Gorgonia ventalina*). The designation of the Oculina Bank HAPC prohibited the use of bottom trawls, dredges, pots, traps, or bottom longlines in this fragile habitat area. In its Snapper Grouper FMP, the Council prohibited the use of bottom longlines in the EEZ within 50 fathoms or anywhere south of St. Lucie Inlet, Florida, as well as fish traps, entanglement gear, and bottom trawls on hardbottom habitat. Also under the Snapper Group FMP is an Experimental Oculina Research Reserve where the harvest or possession of all species within the snapper grouper complex is prohibited.

### **GULF OF MEXICO FISHERY MANAGEMENT COUNCIL**

The Gulf of Mexico Council, through its FMPs and amendments to the FMPs, have implemented various regulations that protect and benefit EFH. Seasonal or annual trawl closures, such as the Tortugas Shrimp Sanctuary which protects a considerable area off southwest Florida, have been established through their Stone Crab and Shrimp FMPs. The Reef Fish FMP and its subsequent amendments prohibited the use of poisons and explosives due to their documented impacts on habitat. Gear-specific zones were created which have provided extensive habitat benefits. Fish traps and roller ("rockhopper") trawls were prohibited within an inshore stressed area, following depth contours around the Gulf of between 18.29 - 45.72 meters (60 - 150 feet). Furthermore, longline/buoy gear prohibited areas were established along the 20-fathom contour in the eastern Gulf and the 50-fathom contour in the central-western Gulf. Additionally, two marine reserves which encompass 566.99km<sup>2</sup> (219nm<sup>2</sup>) and provide complete protection to habitat and associated marine species, were created off west central Florida to protect gag spawning aggregations. Through the Coral and Coral Reef FMP, the harvest of stony coral, seafans (*Gorgonia flabellum* and *Gorgonia ventalina*), and natural liverrock was prohibited and Habitat Areas of Particular Concern (HAPCs) were established off Florida (Florida Middle Ground) and Texas (East and West Flower Garden Bank). These HAPCs are defined by areas dominated with coral species that may easily be degraded by particular fishing activities. Therefore, the use of any fishing gear interfacing with the bottom (i.e., bottom trawls, traps, pots, and bottom longlines) was prohibited within the HAPCs. Amendments to the Coral and Coral Reef FMP also regulated the use of chemicals used by fish collectors near coral reefs.

### **CARIBBEAN FISHERY MANAGEMENT COUNCIL**

Similar to actions initiated by the Gulf of Mexico and South Atlantic Fishery Management Councils, the Caribbean Council prohibited the harvest and possession of corals and live rock through its FMP for Corals and Reef Associated Plants and Invertebrates. A recent amendment to the FMP established the Hind Bank Marine Conservation District (MCD) off St. Thomas, U.S. Virgin Islands. Within this MCD, fishing for any species is prohibited. The creation of this marine protected area provides complete protection to the local marine ecosystem under the Magnuson-Stevens Act.

## **SUMMARY**

---

Habitat is constantly degraded by a variety and combination of negative impacts such as bioturbation, pollution, storm events, coastal development, and fishery-related impacts. While pollution and development may present a far more insidious threat, fishery-related impacts represent a direct potential threat to EFH and must be evaluated under the Magnuson-Stevens Act. Reviewing the information provided in this study indicates that several fishing activities have negligible or minor impacts on EFH. As these conclusions are based on available information, it is feasible that other, undocumented impacts may occur during fishing activities. Additionally, the

absence of long-term studies and a lack of control sites hinder the ability to properly evaluate cumulative impacts. Therefore, caution should be exercised in declaring the impacts of particular fishing activities minor or negligible.

Trawling activities have come under close scrutiny due to numerous claims of widespread habitat destruction. Comparisons to forest clear-cutting have been offered in other studies (Watling and Norse 1998). However, given the available scientific information, it would appear that trawling has a minor physical impact to EFH in many areas of the Gulf of Mexico and South Atlantic. Trawls harvesting shrimp frequently operate over sandy or muddy habitat areas. The major result of these activities would be sediment resuspension which is a relatively minor and short-term impact. It should be noted that increased sedimentation may have more serious biological consequences in estuarine areas where variances in nutrient cycling may dramatically affect the localized ecosystem. Furthermore, sediment resuspension may have serious consequences in areas where heavy metals and other contaminants are found.

Special consideration should be taken when evaluating complex benthic habitat such as coral reefs. Fishing in general is a potential threat to the sustainability of coral reef habitats; due to the interspecies relationships within a coral reef community, targeting and extraction of a particular species may disturb the system and subject the reef to other stressors (Dayton et al. 1995; Jennings and Polunin 1996). Sponges and corals represent the largest and most conspicuous sessile species in hardbottom habitats in the South Atlantic (Van Dolah et al. 1987). The entire demersal stage of the life histories of many species associated with coral reefs have obligate habitat requirements or demonstrate recruitment bottlenecks. Without the specific structural components of habitat, the populations of fishes with these habitat requirements would not persist (Auster and Langton 1999). The degradation of hardbottom communities and coral reefs may reduce the amount of habitat for other species. Since competition can occur for space as well as for food (Paine 1974), fishing impacts may introduce additional stress to reef associated species, as well as to the habitat.

Oyster reefs also warrant special consideration. Impacts to oyster reefs, especially fishing activities that target oysters, directly reduce EFH and hamper the natural water-cleansing ability of oysters (Coen 1995). Furthermore, fishing activities adjacent to oyster reefs can have a significant impact. The oyster fishery in the Chesapeake Bay is perhaps the best example of the ramifications of habitat degradation. Rothschild et al. (1994) contended that fishing, both the removal of oyster and the associated degradation of oyster reef habitat, may be more important to the decline of oysters in Chesapeake Bay than either water quality or disease. The removal of any reef-building species, such as oysters, will inevitably result in large changes in the species assemblages associated with the reef structure itself (ICES 1995).

As previously mentioned, the empirical study of fishing effects is hampered by a lack of unfished control sites (Dayton et al. 1995; Jennings and Kaiser 1998). To quantify the effects of disturbance, one must use an experimental approach that compares fished (e.g., by trawls) and unfished sites (Van Dolah 1987; Collie et al. 1997). Additionally, one of the greatest challenges in assessing the effects of fishing on habitat is the lack of knowledge of potential for recovery, succession, and resilience to fishing activities (Cappo et al. 1998). Little has been written about the recovery of seafloor habitat from fishing gear effects. There are few, if any, areas within the Region that provide the opportunities to evaluate fishing impacts on "natural" habitat areas. It should be noted that "no-take" zones, gear zoning, or area rotation depending on particular gear and habitat type is the most prevalent management recommendation in the reviewed literature (Gomez et al. 1987; ICES 1991; ICES 1992; Van der Knapp 1993; McAllister and Spiller 1994; Rothschild et al. 1994; ICES 1995; Sargent et al. 1995; Auster et al. 1996; Macdonald et al. 1996; Sainsbury et al. 1997; Collie 1998; Engel and Kvitek 1998; Goñi 1998; Hall 1999; Jennings and Kaiser 1998; Lindeboom and de Groot 1998; Watling and Norse 1998; Friedlander et al. 1999; Turner et al. 1999; Bergman and Santbrink 2000; Kaiser 2000). This management recommendation may not only provide adequate and prudent habitat protection, but also the ability to better evaluate the impacts of fishing.



In many cases, fishery-related impacts may occur due to the lack of knowledge that there is a potential for an impact. The lack of detailed mapping and accurate habitat designations prevents the protection of many areas. Perhaps, one of the most beneficial exercises in an attempt to prevent fishery-related impacts would be the precise mapping of habitat. This review illustrates that several gear types are not compatible with certain habitat types (e.g., otter trawl working hardbottom and coral reefs). Once sufficient habitat maps are available, it would be possible to designate appropriate gear restrictions which, in turn, may effectively prevent further fishery-related impacts to the extent practicable.

While this review attempts to improve the knowledge base of fishery-related impacts within the Southeast Region, it is by no means complete nor entirely conclusive. As noted by Taylor (1956), "calm discussion based on scientific research should discover the answers. The pure scientist possibly could not reach a satisfactory conclusion under a lifetime of study. Then, he might not be satisfied that all knowledge of the subject had been gained. For day to day living, often it is necessary to proceed without all the facts. It may be required that certain assumptions be adopted as a guide. It should be sufficient that these assumptions are based upon clear knowledge of the basic facts. Let it be certain that these basics are facts, however - not assumptions." This observation, made 45 years earlier, accurately reflects the current situation managers are confronted with in regard to fishery-related habitat impacts.

## REFERENCES

---

- Alcala, A.C., and E.D. Gomez. 1987. Dynamiting coral reefs for fish: A resource-destructive fishing method. pp. 51-60 *in* Human Impacts on Coral Reefs: Facts and Recommendations. Antenne Museum, French Polynesia.
- Appeldorn, R.S., M. Nemeth, J. Vasslides, and M. Scharer. 2000. The effects of fish traps on benthic habitats off La Parguera, Puerto Rico. Report to the Caribbean Fishery Management Council, Hato Rey, Puerto Rico.
- Ardizzone, G.D., P. Tucci, A. Somaschini, and A. Belluscio. 2000. Is bottom trawling partly responsible for the regression of *Posidonia oceanica* meadows in the Mediterranean Sea? pp. 37-46 *in* M.J. Kaiser and S.J. de Groot (editors), The Effects of Fishing on Non-target Species and Habitats, Blackwell Science.
- ASMFC. 2000. Evaluating fishing gear impacts to submerged aquatic vegetation and determining mitigation strategies. Atlantic States Marine Fisheries Commission Habitat Management Series No. 5, Washington, D.C. 38pp.
- Atkinson, R.J.A. and R.D.M. Nash. 1990. Some preliminary observations on the burrows of *Callianassa subterranea* (Montagu) (Decapoda: Thalassinidea) from the west coast of Scotland. *J. Nat. History* 24:403-413.
- Auster, P.J., R.J. Malatesta, R.W. Langton, L. Watling, P.C. Valentine, C.L.S. Donaldson, E.W. Langton, A.N. Shepard, and I.G. Babb. 1996. The impacts of mobile fishing gear on seafloor habitats in the Gulf of Maine (Northwest Atlantic): implications for conservation of fish populations. *Reviews in Fisheries Science* 4(2):185-202.
- Auster, P.J., and R.W. Langton. 1999. The effects of fishing on fish habitat. pp. 150-187 *in* L. Beneka (editor), Fish Habitat: Essential Fish Habitat and Rehabilitation, American Fisheries Society, Symposium 22, Bethesda, Maryland.
- Ball, B., B. Munday, and I. Tuck. 2000. Effects of otter trawling on the benthos and environment in muddy sediments. pp. 69-82 *in* M.J. Kaiser and S.J. de Groot (editors), The Effects of Fishing on Non-target Species and Habitats, Blackwell Science.
- Barber, C.V., and V.R. Pratt. 1998. Poison and profits: cyanide fishing in the Indo-Pacific. *Environment* 40(8):4-9.
- Bargmann, G., M. Pedersen, and R.J. Trumble. 1985. Final environmental impact statement for the continued harvest of bottom fish in Puget Sound by commercial otter trawl gears. Washington State Department of Fisheries. 198pp.
- Barnette, M.C. 1999. Gulf of Mexico fishing gear and their potential impacts on essential fish habitat. NOAA Technical Memorandum NMFS-SEFSC-432, 24pp.
- Ben-Yami, M. 1987. Purse Seining with Small Boats, Food & Agriculture Organization of the United Nations, Rome, Italy.
- Bergman, M.J.N., and J.W. Van Santbrink. 2000. Fishing mortality of populations of megafauna in sandy sediments. pp. 49-68 *in* M.J. Kaiser and S.J. de Groot (editors), The Effects of Fishing on Non-target Species and Habitats, Blackwell Science.

- Berkeley, S.A., D.W. Pybas, and W.L. Campos. 1985. Bait shrimp fishery of Biscayne Bay. Florida Sea Grant College Program Technical Paper Number 40.
- Boesch, D.F., and R. Rosenberg. 1981. Response to stress in marine benthic communities. pp. 179-200 *in* G.W. Barret and R. Rosenberg (editors), *Stress effects on natural ecosystems*, J. Wiley and Sons, New York.
- Bohnsack, J.A. Personal communication. NOAA Fisheries Southeast Fisheries Science Center, Miami, Florida.
- Bradstock, M., and D.P. Gordon. 1983. Coral-like bryozoan growths in Tasman Bay, and their protection to conserve commercial fish stocks. *New Zealand Journal of Marine and Freshwater Research* 17:159-163.
- Brylinsky, M., J. Gibson, and D.C. Gordon, Jr. 1994. Impacts of flounder trawls on the intertidal habitat and community of the Minas Basin, Bay of Fundy. *Canadian Journal of Fisheries and Aquatic Sciences* 51:650-661.
- Butcher, T., J. Matthews, J. Glaister, and G. Hamer. 1981. Study suggests scallop dredges causing few problems in Jervis Bay. *Australian Fisheries* 40(9):9-12.
- Cahoon, L.B., R.L. Redman, and C.R. Tronzo. 1990. Benthic micralagl biomass in sediments of Onslow Bay, North Carolina. *Est. Coast. Shelf Sci.* 31:805-816.
- Cahoon, L.B., and E.J. Cooke. 1992. Benthic microalgal production in Onslow Bay, North Carolina. *Marine Ecology Progressive Series* 84:185-196.
- Cahoon, L.B. and C.R. Tronzo. 1992. Quantitative estimates of demersal zooplankton abundance in Onslow Bay, North Carolina. *Marine Ecology Progressive Series* 87:197-200.
- Cahoon, L.B., G.R. Beretich, Jr., C.J. Thomas, and A.M. McDonald. 1993. Benthic microalgal production at Stellwagen Bank, Massachusetts Bay, USA. *Marine Ecology Progressive Series* 102:179-185.
- Cappo, M., D.M. Alongi, D. Williams, and N. Duke. 1998. A review and synthesis of Australian fisheries habitat research. Volume 2: Scoping Review, Issue 4: Effects of Harvesting on Biodiversity and Ecosystems. FRDC 95/055.
- Carr, H.A. 1988. Long term assessment of a derelict gillnet found in the Gulf of Maine. pp. 984-986 *in* *Proceedings, Ocean '88. The Ocean – An International Workplace*. Halifax, Nova Scotia.
- Carr, H.A., E.A. Amaral, A.W. Hulbert, and R. Cooper. 1985. Underwater survey of simulated lost demersal and lost commercial gill nets off New England. pp. 438-447 *in* R.S. Shomura and H.O. Yoshida (editors), *Proceedings of the Workshop on the Fate and Impact of Marine Debris, 26-29 November 1984, Honolulu, Hawaii*. NOAA-TM-NMFS-SWFC-54.
- Carr, H.A., and H. Milliken. 1998. Conservation engineering: Options to minimize fishing's impacts to the sea floor. pp. 100-103 *in* E.M. Dorsey and J. Pederson (editors), *Effects of Fishing Gear on the Sea Floor of New England*, Conservation Law Foundation, Boston, Massachusetts.
- CFMC. 1999. Amendment 1 to the Fishery Management Plan for corals and reef associated plants and invertebrates of Puerto Rico and the United States Virgin Islands for establishing a marine conservation district including regulatory impact review and initial regulatory flexibility analysis and a final supplemental environmental impact statement. Caribbean Fishery Management Council, 268 Muñoz Rivera Avenue,

Suite 1108, San Juan, Puerto Rico 00918-2577.

- Chestnut, A.F., 1955. A report of the mollusk studies conducted by the UNC Institute of Fisheries Research, 1948-1954. 66pp.
- Churchill, J.H. 1989. The effect of commercial trawling on sediment resuspension and transport over the Middle Atlantic Bight continental shelf. *Continental Shelf Research* 9(9):841-864.
- Coale, J.S., Rulifson, R.A., Murray, J.D., and R. Hines. 1994. Comparisons of shrimp catch and bycatch between a skimmer trawl and an otter trawl in the North Carolina inshore shrimp fishery. *North American Journal of Fisheries Management* 14:751-768.
- Coen, L.D. 1995. A review of the potential impacts of mechanical harvesting on subtidal and intertidal shellfish resources. Unpublished report. South Carolina Department of Natural Resources, Marine Resources Research Institute.
- Collie, J. 1998. Studies in New England of fishing gear impacts on the sea floor. pp. 53-62 *in* E.M. Dorsey and J. Pederson (editors), *Effects of Fishing Gear on the Sea Floor of New England*, Conservation Law Foundation, Boston, Massachusetts.
- Collie, J.S., G.A. Escanero, and P.C. Valentine. 1997. Effects of bottom fishing on the benthic megafauna of Georges Bank. *Marine Ecology Progressive Series* 155(0):159-172.
- Cooper, R.A., H.A. Carr, and A.H. Hulbert. 1988. Manned submersible and ROV assessment of ghost gillnets on Jeffries and Stellwagen Banks, Gulf of Maine. Research Report 88-4. NOAA Undersea Research Program.
- Dayton, P.K., S.F. Thrush, M.T. Agardy, and R.J. Hoffman. 1995. Environmental effects of marine fishing. *Aquatic Conservation: Marine and Freshwater Ecosystems* 5:205-232.
- DeAlteris, J., L. Skrobe, and C. Lipsky. 1999. The significance of seabed disturbance by mobile fishing gear relative to natural processes: a case study in Narragansett Bay, Rhode Island. pp. 224-237 *in* L. Beneka (editor), *Fish Habitat: Essential Fish Habitat and Rehabilitation*, American Fisheries Society, Symposium 22, Bethesda, Maryland.
- De Sylva, D.P. 1954. The live bait shrimp fishery of the northeast coast of Florida. State of Florida Board of Conservation Technical Series Number 11.
- Drew, S.C., and R.E. Larsen. 1994. Worldwide trawl and dredge study. Unpublished report. Marine Data Systems. Plymouth, Massachusetts. 8pp.
- Eleuterius, L. 1987. Seagrass ecology along the coasts of Alabama, Louisiana, and Mississippi. pp. 11-24 *in* M.J. Durako, R.C. Phillips, and R.R. Lewis, III (editors), *Proceedings of the Symposium on Subtropical-Tropical Seagrasses in the Southeastern United States*. Fl. Mar. Res. Pub. 42. St. Petersburg, Florida. 209pp.
- Engel, J., and R. Kvitek. 1998. Effects of otter trawling on a benthic community in Monterey Bay National Marine Sanctuary. *Conservation Biology* 12(6):1204-1214.
- Eno, N.C., D.S. MacDonald, and S.C. Amos. 1996. A study of the effects of fish (crustacea/mollusc) traps on benthic habitats and species. Final report to the European Commission.

- Erzini, K., C.C. Monteiro, J. Ribero, M.N. Santos, M. Gaspar, P. Monteiro, and T.C. Borges. 1997. An experimental study of gill net and trammel net 'ghost fishing' off the Algarve (southern Portugal). *Marine Ecology Progress Series* 158:257-265.
- Flint, R.W., and J.A. Younk. 1983. Estuarine benthos: long-term community structure variations, Corpus Christi Bay, Texas. *Estuaries* 6(2):126-141.
- Fonseca, M.S., G.W. Thayer, A.J. Chester, and C. Foltz. 1984. Impact of scallop harvesting on eelgrass (*Zostera marina*) meadows: implications for management. *North American Journal of Fisheries Management* 4:286-293.
- Friedlander, A.M., G.W. Boehlert, M.E. Field, J.E. Mason, J.V. Gardner, and P. Dartnell. 1999. Sidescan-sonar mapping of benthic trawl marks on the shelf and slope off Eureka, California. *Fishery Bulletin* 97:786-801.
- Futch, C.R., and D.S. Beaumariage. 1965. A report on the bait shrimp fishery of Lee County, Florida. Florida Board of Conservation Marine Laboratory Maritime Base, Bayboro Harbor, St. Petersburg, Florida. FBCML Number 65-1.
- Garcia-Moliner, G., W.R. Keithly, Jr., and I.N. Oliveras. 2000. Recreational SCUBA diving activity in the U.S. Caribbean. Caribbean Fishery Management Council, 268 Muñoz Rivera Avenue, Suite 1108, San Juan, Puerto Rico 00918-2577. 8pp.
- Garrison, G. 1997. St. Johns, U.S. Virgin Islands fish trap study, 1992-1994. Unpublished Report. Biological Resources Division, U.S. Geological Survey, Virgin Islands National Park.
- Garrison, G. 1998. Reef fishes of St. John, U.S. Virgin Islands. pp. 325-327 in M.J. Mac, P.A. Opler, C.E. Puckett Haecker, and P.D. Doran (editors), *Status and Trends in the Nation's Biological Resources*. U.S. Department of Interior, U.S. Geological Survey. Washington, D.C.
- Gerrodette, T., B.K. Choy, and L.M. Hiruki. 1987. An experimental study of derelict gillnets in the central Pacific Ocean. SWFC, NMFS, Honolulu Laboratory, Administrative Report H-87-18.
- Gibbs, P.J., A.J. Collins, and L.C. Collett. 1980. Effect of otter prawn trawling on the macrobenthos of a sandy substratum in a New South Wales estuary. *Australian Journal of Marine and Freshwater Resources* 31:509-516.
- Gilkinson, K., M. Paulin, S. Hurley, and P. Schwinghamer. 1998. Impacts of trawl door scouring on infaunal bivalves: results of a physical trawl door model/dense sand interaction. *Journal of Experimental Marine Biology and Ecology* 224(2):291-312.
- Glude, J.B., and W.S. Landers. 1953. Biological effects on hard clams of hand raking and power dredging. USFWS Special Science Reports on Fisheries, 110:1-43.
- GMFMC. 1993. Supplemental environmental impact statement for the reef fish fishery of the Gulf of Mexico (including measures of Amendment 5). Gulf of Mexico Fishery Management Council. 3018 U.S. Highway 301 North, Suite 1000, Tampa, Florida 33619-2266.
- Godcharles, M.F. 1971. A study of the effects of a commercial hydraulic clam dredge on benthic communities in estuarine areas. State of Florida Department of Natural Resources Marine Resources Laboratory Technical Series Number 64.

- Godwin, W.F. 1973. Preliminary draft: environmental impact analysis of proposed hydraulic clam dredging activity in the New River estuary, Onslow County, North Carolina. Use of seed oysters to supplement oyster production in southern North Carolina. 19pp.
- Goldstein, R.J. 1973. Aquarist Goldstein states fear of drugged fish "all wet." *Marine Hobbyist News* 1(3):1-6.
- Gomez, E.D., A.C. Alcala, and H.T. Yap. 1987. Other fishing methods destructive to coral. pp. 65-75 *in* Human Impacts on Coral Reefs: Facts and Recommendations. Antenne Museum, French Polynesia.
- Goñi, R. 1998. Ecosystem effects of marine fisheries: an overview. *Ocean and Coastal Management* 40(1):37-64.
- Guillén, J.E., A.A. Ramos, I. Martinez, and J.L. Sánchez-Lizaso. 1994. Antitrawling reefs and the protection of *Posidonia oceanica* (L.) Delile meadows in the western Mediterranean Sea: demand and aims. *Bulletin of Marine Science* 55(2):645-650.
- Hall, S.J. 1994. Physical disturbance and marine benthic communities: life in unconsolidated sediments. *Oceanography and Marine Biology: an Annual Review* 32:179-239.
- Hall, S.J. 1999. *The Effects of Fishing on Marine Ecosystems and Communities*. Blackwell Science. Oxford, United Kingdom. 274pp.
- Higman, J.B. 1952. Preliminary investigation of the live bait shrimp fishery of Florida Bay and the Keys. Report to the Florida State Board of Conservation. Marine Laboratory, University of Miami. 8pp.
- Homziak, J.M., M.S. Fonseca, and W.J. Kenworthy. 1982. Macrobenthic community structure in a transplanted eelgrass (*Zostera marina* L.) Meadow. *Marine Ecology Progressive Series* 9:211-221.
- Hunt, J., and T. Matthews. 1999. Impact of lobster and stone crab fishery on essential fish habitat. Unpublished report. Florida Marine Research Institute, St. Petersburg, Florida.
- Hutchings, P. 1990. Review of the effects of trawling on macrobenthic epifaunal communities. *Australian Journal of Marine and Freshwater Research* 41:111-120.
- ICES. 1973. Effects of trawls and dredges on the seabed. ICES. Gear and Behavior Committee. ICES CM 1973/B:2.
- ICES. 1991. Report of the study group on ecosystem effects of fishing activities, Lowestoft, 11-15 March 1991. International Council for the Exploration of the Sea. Study Group on Ecosystem Effects of Fishing Activities. ICES CM 1991/G:7. 66pp.
- ICES. 1992. Report of the study group on ecosystem effects of fishing activities, Copenhagen, Denmark, International Council for the Exploration of the Sea. Study Group on Ecosystem Effects of Fishing Activities. ICES CM 1992/G:11. 144pp.
- ICES. 1994. Sensitivity of species to physical disturbance of the seabed – preliminary report. International Council for the Exploration of the Sea. Benthic Ecology Working Group meeting, ICES CM 1994/L:4, Annex 8.
- ICES. 1995. Report of the study group on ecosystem effects of fishing activities, Copenhagen, Denmark, 7-14 April 1992. ICES Cooperative Research Report, Number 200, 120pp.

- Japp, W.C., and J. Wheaton. 1975. Observations on Florida reef corals treated with fish-collecting chemicals. Florida Marine Research Publications, Number 10, 18pp.
- Jennings, S., and N.V.C. Polunin. 1996. Impacts of fishing on tropical reef ecosystems. *Ambio* 25:44-49.
- Jennings, S., and M.J. Kaiser. 1998. The effects of fishing on marine ecosystems. In J.H.S. Blaxter, A.J. Southward, and P.A. Tyler (editors), *Advances in Marine Biology*, 34:201-352.
- Johnson, S.W. 1990. Distribution, abundance, and source of entanglement debris and other plastics on Alaskan beaches, 1982-88. pp. 331-348 in R.S. Shomura and M.L. Godfrey (editors), *Proceedings of the Second International Conference on Marine Debris*, U.S. Department of Commerce, NOAA Technical Memorandum NMFS, NOAA-TM-NMFS-SWFSC-154.
- Jolley, J.W., Jr. 1972. Exploratory fishing for the sunray venus clam, *Macrocallista nimbosa*, in northwest Florida. Florida Department of Natural Resources Technical Series, Number 67:1-42.
- Jones, J.B. 1992. Environmental impact of trawling on the seabed: a review. *New Zealand Journal of Marine and Freshwater Research* 26(1):59-67
- Kaiser, M.J., A.S. Hill, K. Ramsay, B.E. Spencer, A.R. Brand, L.O. Veale, K. Pruden, E.I.S. Rees, B.W. Munday, B. Ball, and S.J. Hawkins. 1996a. Benthic disturbance by fishing gear in the Irish Sea: A comparison of beam trawling and scallop dredging. *Aquatic Conservation* 6(4):269-285.
- Kaiser, M.J., B. Bullimore, P. Newman, K. Lock, and S. Gilbert. 1996b. Catches in 'ghost fishing' set nets. *Marine Ecology Progress Series* 145:11-16.
- Kaiser, M.J. 1998. Significance of bottom-fishing disturbance. *Conservation Biology* 12(6):1230-1235.
- Kaiser, M.J. 2000. The implications of the effects of fishing on non-target species and habitats. pp. 383-392 in M.J. Kaiser and S.J. de Groot (editors), *The Implications of the Effects of Fishing on Non-target Species and Habitats*, Blackwell Science.
- Kenchington, T.J. 1995. A summary of the published evidence relating to habitat modification by fish draggers. pp. 109-116 in *The Canadian Maritimes Fishing: Let's Fix It, An Action Plan*, SW Nova Fixed Gear Association, Shelburne, Nova Scotia, Canada.
- Kennedy, Jr., F.S. 1993. Skimmer Trawls. Florida Department of Environmental Protection Memorandum. 2pp.
- Kinnish, M. 1992. Ecology of estuaries: Anthropogenic Effects. CRC Press, Boca Raton, Florida. pp. 357-398
- Krost, P., and H. Rumohr. 1990. Effects on the benthos of physical disturbance of the sea bed. Annex to the Ninth Report of the Benthos Ecology Working Group. ICES CM 1990/L:95, pp. 75-77.
- Kyte, M.A., and K.K. Chew. 1975. A review of the hydraulic elevator shellfish harvester and its known effects in relation to the soft-shell clam, *Mya arenaria*. Washington Sea Grant Publication Report No. WSG 75-2. University of Washington, Division of Marine Sciences. Seattle, Washington. 32pp.
- Langan, R. 1998. The effect of dredge harvesting on eastern oysters and the associated benthic community. pp. 108-110 in E.M. Dorsey and J. Pederson (editors), *Effects of Fishing Gear on the Sea Floor of New England*, Conservation Law Foundation, Boston, Massachusetts.

- Lenihan, H.S., and C.H. Peterson. 1998. How habitat degradation through fishery disturbance enhances impacts of hypoxia on oyster reefs. *Ecological Applications* 8(1):128-140.
- Lenihan, H.S. and F. Micheli. 2000. Biological effects of shellfish harvesting on oyster reefs: resolving a fishery conflict by ecological experimentation. *Fishery Bulletin* 98(1):86-95.
- Lindeboom, H.J., and S.J. De Groot. 1998. Impact II. The effects of different types of fisheries on the North Sea and Irish Sea benthic ecosystems. NIOZ Rapport 1998-1. 404pp.
- MacDonald, D.S., M. Little, N.C. Eno, and K. Hiscock. 1996. Disturbance of benthic species by fishing activities: a sensitivity index. *Aquatic Conservation: Marine and Freshwater Ecosystems* 6(4):257-268.
- Maier, P.P., P.H. Wendt, W.A. Roumillat, G.H. Steele, M.V. Levisen, and R. Van Dolah. 1998. Effects of subtidal mechanical clam harvesting on tidal creeks. South Carolina Department of Natural Resources, Marine Resources Division. 38pp.
- Main, J., and G.I. Sangster. 1979. A study of bottom trawling gear on both sand and hard ground. Scottish Fisheries Research Report Number 14. 15pp.
- Main, J., and G.I. Sangster. 1981. A study of sand clouds produced by trawl boards and their possible effects on fish capture. Scottish Fisheries Research Report Number 20. 19pp.
- Mallinson, D. Unpublished report. Florida Middle Ground HAPC cruise, August 17 - 23, 2000.
- Manning, J.H. 1957. The Maryland soft shell clam industry and its effects on tidewater resources. University of Maryland, CBL Reference Number 11. 25pp.
- Margetts, A.R., and J.P. Bridger. 1971. The effect of a beam trawl on the sea bed. ICES Council Meeting, 1971/B:8.
- Mascarelli, P.E. and L. Bunkley-Williams. An experimental field evaluation of healing in damaged, unbleached and artificially bleached star coral, *Montastraea annularis*. *Bull. Mar. Sci.* In press.
- McAllister, D.E., and G. Spiller. 1994. Trawling and dredging impacts on fish habitat and bycatch. pp. 1709-1718 in *Coastal Zone Canada 1994, Cooperation in the Coastal Zone. Conference Proceedings, Volume 4.* Coastal Zone Canada Association, Dartmouth, Nova Scotia.
- Meyer, D.L., M.S. Fonseca, P.L. Murphey, M.W. LaCroix, P.E. Whitfield, D.R. Colby, and G.W. Thayer. 1991. Impact of bait shrimp trawling on seagrass beds and fish bycatch in Tampa Bay, Florida. Unpublished Report submitted by NMFS, Southeast Fisheries Center, Beaufort Laboratory to Florida Department of Natural Resources, Marine Research Institute. DNR Contract #C4488. 28pp.
- Meyer, D.L., M.S. Fonseca, P.L. Murphey, R.H. McMichael, Jr., M.M. Byerly, M.W. LaCroix, P.E. Whitfield, and G.W. Thayer. 1999. Effects of live-bait shrimp trawling on seagrass beds and fish bycatch in Tampa Bay, Florida. *Fishery Bulletin*. 97(1):193-199.
- Minello, T., R. Zimmerman, and E. Martinez. 1987. Fish predation on juvenile brown shrimp, *Penaeus aztecus* Ives: effects of turbidity and substratum on predation rates. *National Marine Fisheries Service Fishery Bulletin* 85:59-70.
- Moore, D.R., and H.R. Bullis, Jr. 1960. A deep-water coral reef in the Gulf of Mexico. *Bulletin of Marine*



- Science of the Gulf and Caribbean 10(1):125-128.
- Moran, M.J., and P.C. Stevenson. 2000. Effects of otter trawling on macrobenthos and management of demersal scalefish fisheries on the continental shelf of north-western Australia. *ICES Journal of Marine Science* 57(3):510-516.
- Munro, J.L., Parrish, J.D. and F.H. Talbot. 1987. The biological effects of intensive fishing upon reef fish communities. *In Human Impacts on Coral Reefs: Facts and Recommendations*. Salvat, B. (ed.). Antenne Museum E.P.H.E., French Polynesia, pp. 41-49.
- Nelson, R. 1993. Skimmer Trawls. State of Florida Marine Fisheries Commission Memorandum. 2pp.
- Nielsen, L.A., and D.L. Johnson. 1983. Fisheries techniques. American Fisheries Society, Bethesda, Maryland. 468pp..
- NOAA. 1996. Florida Keys National Marine Sanctuary Final Management Plan/Final Environmental Impact Statement. National Oceanic and Atmospheric Administration. Volume II.
- North Carolina Division of Marine Fisheries. 1999. Shrimp and crab trawling in North Carolina's estuarine waters. North Carolina Department of Environment and Natural Resources, Morehead City, NC. 121pp.
- NPFMC. 1992. Final Supplemental Environmental Impact Statement and Regulatory Impact Review/Initial Regulatory Flexibility Analysis of Proposed Inshore/Offshore Allocation Alternatives (Amendment 18/23) to the Fishery Management Plans for the Groundfish Fishery of the Bering Sea and Aleutian Islands and the Gulf of Alaska. North Pacific Fishery Management Council, 605 W. 4<sup>th</sup> Avenue, Suite 306, Anchorage, AK 99501.
- Öhman, M.C., A. Rajasuriya, and O. Lindén. 1993. Human disturbance on coral reefs in Sri Lanka: a case study. *Ambio* 22:474:480.
- Orth, J.J. Personal communication. Virginia Institute of Marine Science, Gloucester, Virginia.
- Paine, R.T. 1974. Intertidal community structure. Experimental studies on the relationship between a dominant competitor and its principle predator. *Oecologia* 15:93-120.
- Paine, R. 1979. Disaster, catastrophe, and local persistence of the sea palm *Postelsia palmiformis*. *Science* 205:685-687.
- Peterson, C.H., H.C. Summerson, and S.R. Fegley. 1987a. Ecological consequences of mechanical harvesting of clams. *Fishery Bulletin* 85(2):281-298.
- Peterson, C.H., H.C. Summerson, and S.R. Fegley. 1987b. Relative efficiency of two clam rakes and their contrasting impacts on seagrass biomass. *Fishery Bulletin* 81(2):429-434.
- Pilskaln, C.H., J.H. Churchill, and L.M. Mayer. 1998. Resuspension of sediment by bottom trawling in the Gulf of Maine and potential geochemical consequences. *Conservation Biology* 12(6):1223-1229.
- Pitcher, C.R., I.R. Poiner, B.J. Hill, and C.Y. Burrige. 2000. Implications of the effects of trawling on sessile megazoobenthos on a tropical shelf in northeastern Australia. *ICES Journal of Marine Science* 57:1359-1368.

- Posey, M., W. Lindberg, T. Alphin, and F. Vose. 1996. Influence of storm disturbance on an offshore benthic community. *Bulletin of Marine Science* 59(3):523-529.
- Prena, J., P. Schwinghamer, T.W. Rowell, D.C. Gordon, Jr., K.D. Gilkinson, W.P. Vass, and D.L. McKeown. 1999. Experimental otter trawling on a sandy bottom ecosystem of the Grand Banks of Newfoundland: analysis of trawl bycatch and effect on epifauna. *Marine Ecology Progress Series* 181:107-124.
- Probert, P.K., D.G. McKnight, and S.L. Grove. 1997. Benthic invertebrate bycatch from a deep-water trawl fishery, Chatham Rise, New Zealand. *Aquatic Conservation: Marine and Freshwater Ecosystems* 7(1):27-40.
- Quandt, A. 1999. Assessment of fish trap damage on coral reefs around St. Thomas, USVI. Independent Project Report, UVI, Spring 1999. 9pp.
- Rester, J.K. 2000a. Annotated bibliography of fishing impacts on habitat. Gulf States Marine Fisheries Commission. Number 73. Ocean Springs, Mississippi. 168pp.
- Rester, J.K. 2000b. Annotated bibliography of fishing impacts on habitat - October 2000 update. Gulf States Marine Fisheries Commission. Ocean Springs, Mississippi. 19pp.
- Richards, A.R. 1955. Trawlfishing in the south-eastern Caribbean. Caribbean Commission Central Secretariat, Port-of Spain, Trinidad.
- Rogers, S.I., M.J. Kaiser, and S. Jennings. 1998. Ecosystem effects of demersal fishing: a European perspective. pp. 68-78 in E.M. Dorsey and J. Pederson (editors), *Effect of Fishing Gear on the Sea Floor of New England*. Conservation Law Foundation. Boston, Massachusetts. 160pp.
- Rothschild, B.J., J.S. Ault, P. Gouletquer, and M. Héral. 1994. Decline of the Chesapeake Bay oyster population: a century of habitat destruction and overfishing. *Marine Ecology Progress Series* 111:29-39.
- Ruffin, K.K. 1995. The effects of hydraulic clam dredging on nearshore turbidity and light attenuation in Chesapeake Bay, MD. Master's Thesis, University of Maryland. 79pp.
- SAFMC. 1991. Amendment 4 (gear restrictions and size limits), regulatory impact review, initial regulatory flexibility analysis and environmental assessment for the fishery management plan for the snapper grouper fishery of the south Atlantic region. South Atlantic Fishery Management Council. Southpark Building, Suite 306, 1 South park Circle, Charleston, South Carolina 29407.
- SAFMC. 1998a. Final Habitat Plan for the South Atlantic Region. South Atlantic Fishery Management Council. Southpark Building, Suite 306, 1 Southpark Circle, Charleston, South Carolina 29407.
- SAFMC. 1998b. Final Fishery Management Plan for the Calico Scallop Fishery in the South Atlantic Region. South Atlantic Fishery Management Council. Southpark Building, Suite 306, 1 Southpark Circle, Charleston, South Carolina 29407.
- Sadzinski, R., M. Naylor, D. Weinrich, J.H. Uphoff, Jr., H. Speir, and D. Goshorn. 1996. Effects of haul seining on submerged aquatic vegetation in upper Chesapeake Bay. Maryland Department of Natural Resources. Fisheries Technical Report Number 20. Annapolis, Maryland.
- Sainsbury, K.J. 1988. The ecological basis of multispecies fisheries and management of a demersal fishery in tropical Australia. pp. 349-382 in J.A. Gulland (ed.) *Fish Population Dynamics*, 2<sup>nd</sup> edition. John Wiley

and Sons, London.

- Sainsbury, K.J., R.A. Campbell, and A.W. Whitelaw. 1993. Effects of trawling on the marine habitat on the north west shelf of Australia and implications for sustainable fisheries management. pp. 137-145 in D.A. Hancock (editor), *Sustainable Fisheries Through Sustaining Fish Habitat*. Canberra, Australia, Australian Government Publishing Service.
- Sainsbury, K.J., R.A. Campbell, R. Lindholm, and A.W. Whitelaw. 1997. Experimental management of an Australian multispecies fishery: examining the possibility of trawl-induced habitat modification. pp. 107-112 in E.K. Pikitch, D.D. Huppert, and M.P. Sissenwine (editors), *Global Trends: Fisheries Management*. American Fisheries Society, Symposium 20, Bethesda, Maryland.
- Sánchez-Lizaso, J.L., J.E. Guillén Nieto, and A.A. Ramos Esplá. 1990. The regression of *Posidonia oceanica* meadows in El Campello (Spain). *Rapp. Comm. Int. Mer Médit.* 32(1):7.
- Sanchez, P., M. Demestre, M. Ramon, and M.J. Kaiser. 2000. The impact of otter trawling on mud communities in the northwestern Mediterranean. *ICES Journal of Marine Science* 57:1352-1358.
- Sargent, F.J., T.J. Leary, D.W. Crewz, and C.R. Kruer. 1995. Scarring of Florida's seagrasses: assessment and management options. Florida Marine Research Institute Technical Reports TR-1. Florida Marine Research Institute, St. Petersburg, Florida. 37pp. plus appendices.
- Schleyer, M.H. and B.J. Tomalin. 2000. Damage on South African coral reefs and an assessment of their sustainable diving capacity using a fisheries approach. *Bulletin of Marine Science* 67(3):1025-1042.
- Schoellhamer, D.H. 1996. Anthropogenic sediment resuspension mechanisms in a shallow microtidal estuary. *Estuarine, Coastal and Shelf Science* 43(5):533-548.
- Schubel, J.R., H.H. Carter, and W.M. Wise. 1979. Shrimping as a source of suspended sediment in Corpus Christi Bay (Texas). *Estuaries* 2(3):201-203.
- Schwinghamer, P., J.Y. Guigné, and W.C. Siu. 1996. Quantifying the impact of trawling on benthic habitat structure using high resolution acoustics and chaos theory. *Canadian Journal of Fishery and Aquatic Sciences* 5:288-296.
- Schwinghamer, P., D.C. Gordon, Jr., T.W. Rowell, J. Prena, D.L. McKeown, G. Sonnichsen, and J.Y. Guigné. 1998. Effects of experimental otter trawling on surficial sediment properties of a sandy-bottom ecosystem on the Grand Banks of Newfoundland. *Conservation Biology* 12(6):1215-1222.
- Sherk, J., J. O'Conner, and D. Neumann. 1975. Effects of suspended and deposited sediments on estuarine environments. pp. 541-558 in L. Corin (editor) *Estuarine Research. Volume II: Geology and Engineering*. Academic Press, New York.
- Steele, P. 1993. Skimmer Trawl Evaluation. Florida Department of Environmental Protection Memorandum. 3pp.
- Steele, P. 1994. Skimmer Trawls: Their Use and Development in Coastal Louisiana. Florida Department of Environmental Protection Memorandum. 6pp.
- Stewart, P.A.M. 1999. Gear modification as a management tool to limit ecosystem effects of fishing. ICES/SCOR Symposium, Ecosystem Effects of Fishing, April 1999, St. John's, Newfoundland. 20pp.

- Sutherland, D.L., G.L. Beardsley, and R.S. Jones. 1983. Results of a survey of the south Florida fish-trap fishing grounds using a manned submersible. *Northeast Gulf Science* 6(2):179-183.
- Tabb, D.C. 1958. Report on the bait shrimp fishery of Biscayne Bay, Miami, Florida. Florida State Board of Conservation, Marine Lab, University of Miami. 16pp.
- Tabb, D.C., and N. Kenny. 1967. A brief history of Florida's live bait shrimp fishery with description of fishing gear and methods. Institute of Marine Sciences, University of Miami, Miami, Florida. Contribution Number 1070 (pp. 1119-1134 *in* Proceedings of the World Scientific Conference on the Biology and Culture of Shrimp and Prawns, Mexico City, Mexico. FAO Fish Report 57(3)).
- Taylor, F.B. 1956. Is the Shrimp Trawl Net Destructive to Marine Life? Bears Bluff Laboratories, Wadmalaw Island, South Carolina. 43pp.
- Tilmant, J.T. 1979. Observations on the impact of shrimp roller frame trawls operated over hardbottom communities in Biscayne Bay, Florida. National Park Service Report Series Number P-533. 23pp.
- Tulloch, J.H. and J. Resor. 1996. The Marine Aquarium Fish Council: Certification and Market Incentives for Ecologically Sustainable Practices. Unpublished report. American MarineLife Dealers Association.
- Turner, S.J., S.F. Thrush, J.E. Hewitt, V.J. Cummings, and G. Funnell. 1999. Fishing impacts and the degradation or loss of habitat structure. *Fisheries Management and Ecology* 6:401-420.
- Van der Knapp, M. 1993. Physical damage to corals caused by trap fishing on reefs of Bonaire, Netherland Antilles. *Environmental Conservation* 20(3):265-267.
- Van Dolah, R.F., P. Hinde, and N. Nicholson. 1983. Effects of roller trawling on a hard bottom sponge and coral community. Final Report to Sanctuary Program Division, NOAA. 89pp.
- Van Dolah, R.F., P.H. Wendt, and N. Nicholson. 1987. Effects of a research trawl on a hard-bottom assemblage of sponges and corals. *Fisheries Research* 5:39-54.
- Van Dolah, R.F., P.H. Wendt, and M.V. Levinsen. 1991. A study of the effects of shrimp trawling on benthic communities in two South Carolina sounds. *Fisheries Research* 12:139-156.
- Walters, C.J., and F. Juanes. 1993. Recruitment limitation as a consequence of natural selection for use of restricted feeding habitats and predation risk taking by juvenile fishes. *Canadian Journal of Fisheries and Aquatic Sciences* 50:2058-2070.
- Watling, L., and E.A. Norse. 1998. Disturbance of the seabed by mobile fishing gear: a comparison to forest clearcutting. *Conservation Biology* 12(6):1180-1197.
- Wenner, C.A. 1983. Species associations and day-night variability of trawl-caught fishes from the inshore sponge-coral habitat, South Atlantic Bight. *Fishery Bulletin* 81(3):537-552.
- West, T.L., W.G. Ambrose, Jr., and G.A. Skilleter. 1994. A review of the effects of fish harvesting practices on the benthos and bycatch: implications and recommendations for North Carolina. Albemarle-Pamlico Estuarine Study, Raleigh, N.C., U.S. Environmental Protection Agency and N.C. Department of Health, Environment and Natural Resources. Report No. 94-06. 93pp.
- Williamson, J. 1998. Gillnet fishing. pp. 87-89 *in* E.M. Dorsey and J. Pederson (editors), Effect of Fishing Gear

- on the Sea Floor of New England. Conservation Law Foundation. Boston, Massachusetts. 160pp.
- Windom, H. 1975. Water-quality aspects of dredging and dredge-spoil disposal in estuarine environments. pp. 559-571 *in* L.Cronin (ed.), *Estuarine Research. Volume II: Geology and Engineering*. Academic Press, New York.
- Woodburn, K.D., B. Eldred, E. Clark, R.F. Hutton, and R.M. Ingle. 1957. The live bait shrimp industry of the west coast of Florida (Cedar Key to Naples). Florida State Board of Conservation Marine Laboratory Technical Series Number 21.

## DEFINITIONS

---

(<sup>1</sup>Florida Fish and Wildlife Conservation Commission - Division of Marine Fisheries, <sup>2</sup> Texas Parks and Wildlife, <sup>3</sup>Louisiana Department of Wildlife and Fisheries, <sup>4</sup>Code of Federal Regulations)

Allowable chemical: means a substance, generally used to immobilize marine life so that it can be captured alive, that, when introduced into the water, does not take Gulf and South Atlantic prohibited coral and is allowed by Florida for the harvest of tropical fish (e.g., quinaldine, quinaldine compounds, or similar substances).<sup>4</sup>

Artificial lure: any lure (including flies) with hook or hooks attached that is man-made and is used as a bait while fishing.<sup>2</sup>

Automatic reel: means a reel that remains attached to a vessel when in use from which a line and attached hook(s) are deployed. The line is payed out from and retrieved on the reel electrically or hydraulically.<sup>4</sup>

Bait: something used to lure any wildlife resource.<sup>2</sup>

Beach or haul seine: means a seine that is hauled or dragged over the bottom into shallow water or onto the beach, either by hand or with power winches.<sup>1</sup>

Bully net: means a circular frame attached at right angles to the end of a pole and supporting a conical bag of webbing. The webbing is usually held up by means of a cord which is released when the net is dropped over a lobster.<sup>4</sup>

Buoy gear: means fishing gear consisting of a float and one or more weighted lines suspended therefrom, generally long enough to reach the bottom. A hook or hooks (usually 6 to 10) are on the lines at or near the end. The float and line(s) drift freely and are retrieved periodically to remove catch and rebait hooks.<sup>4</sup>

Butterfly net: a fixed, frame-mounted net, used to fish near-surface waters, which is suspended from the side or sides of a boat, pilings, floats, rafts or shore installation.<sup>3</sup>

Cast net: means a cone-shaped net thrown by hand and designed to spread out and capture fish as the weighted circumference sinks to the bottom and comes together when pulled by a line.<sup>1</sup>

Crab dropnet: any device constructed with vegetable, synthetic, or metal fibers and without flues or throat, attached to a wire frame that forms a net basket and is used for the purpose of taking crabs. This device shall be operated solely by hand and fished in a stationary, passive manner.<sup>3</sup>

Crab trap: a cube-shaped device with entrance funnels and either a bait box or materials providing cover or shelter for peeler crabs, which is used for the sole purpose of taking crabs. This device shall be fished in a stationary, passive manner.<sup>3</sup>

Dip net: a net, usually a deep mesh bag of vegetable or synthetic materials, on a fixed frame attached to a handle and held and worked exclusively by hand and by no more than one individual. see *also Landing net*.<sup>3</sup>

Drift gillnet: means a gillnet, other than a long gillnet or a run-around gillnet, that is unattached to the ocean bottom, regardless of whether attached to a vessel.<sup>4</sup>

Entangling net: means a drift net, trammel net, stab net, or any other net which captures saltwater finfish,

shellfish, or other marine animals by causing all or parts of heads, fins, legs, or other body parts to become entangled or ensnared in the meshes or in the pockets of the net. This term does not include a cast net.<sup>1</sup>

Fish trap: (2) In the Gulf EEZ, a trap and its component parts (including the lines and buoys), regardless of the construction material, used for or capable of taking finfish, except a trap historically used in the directed fishery for crustaceans (that is, blue crab, stone crab, and spiny lobster).<sup>4</sup>

Fold-up trap: a device utilized to capture crabs which is baited and lowered to the bottom. When recovered, side panels fold up to capture crabs on the base panel.\*

Fyke net: any cone-shaped net of vegetable or synthetic fibers having throats or flues which are stretched over a series of rings or hoops to support the webbing, with vertical panels of net wings set obliquely on one or both sides of the mouth of the cone-shaped net.<sup>3</sup>

Gaff: any hand held pole with a hook attached directly to the pole.<sup>2</sup>

Gig: any hand held shaft with single or multiple points, barbed or barbless.<sup>2</sup>

Gill net: means one or more walls of netting which captures fish by ensnaring or entangling them in the meshes of the net by the gills. This term does not include a cast net.<sup>1</sup>

Handline: means a line with attached hook(s) that is tended directly by hand.<sup>4</sup>

Hook and line gear: means any handline, rod, reel, or any pole to which hook and line are attached, as well as any bob, float, weight, lure, plug, spoon, or standard bait attached thereto, with a total of ten or fewer hooks.<sup>1</sup>

Hoop net: 1. a cone-shaped net of vegetable or synthetic materials having throats or flues and which are stretched over a series of rings or hoops to support the webbing.<sup>3</sup> 2. A frame, circular or otherwise, supporting a shallow bag of webbing and suspended by a line and bridles. The net is baited and lowered to the ocean bottom, to be raised rapidly at a later time to prevent the escape of lobster.<sup>4</sup>

Landing or dip net: means a hand-held net consisting of a mesh bag suspended from a circular, oval, or rectangular rigid frame attached to a handle.<sup>1</sup>

Lead or wing net: a panel of netting of any mesh size or length, with or without weights and floats, attached to one or both sides of the mouth of a cone-shaped net having flues or throats, and set so as to deflect or guide fish toward the mouth of the net.<sup>3</sup>

Long gillnet: means a gillnet that has a float line that is more than 1,000 yd (914 m) in length.<sup>4</sup>

Longline: means a line that is deployed horizontally to which gangions and hooks are attached. A longline may be a bottom longline, i.e., designed for use on the bottom, or a pelagic longline, i.e., designed for use off the bottom. The longline hauler may be manually, electrically, or hydraulically operated.<sup>4</sup>

Menhaden seine: a purse seine used to take menhaden and herring-like species.<sup>3</sup>

Mesh area (of a net): means the total area of netting with the meshes open to comprise the maximum square footage. The square footage shall be calculated using standard mathematical formulas for geometric shapes. The square footage of seines and other rectangular nets shall be calculated using the maximum length and maximum width of the netting.<sup>1</sup>

Mesh size: the full measure of the mesh as found in use when measured as follows: Bar measure is the length of the full bar stretched from the near side of one knot to the far side of the other after being tarred, treated, or otherwise processed. Stretched measure is the full stretched distance from the near side of one knot to the far side of the opposite knot diagonally across the mesh. This measurement shall not be applicable to weaved or woven nets commonly used for menhaden fishing. In woven nets, stretched measure is the full stretched distance of the opening of the mesh; bar measure is one-half of stretched measure.<sup>3</sup>

Monofilament: a single untwisted synthetic filament.<sup>3</sup>

Mullet strike net: a gill net that is not more than 1,200 feet long and with a mesh size of not less than 3 ½ inches stretched that is not anchored or secured to the water bottom or shore and which is actively worked while being used.<sup>3</sup>

Multiple hook: means two or more fish hooks bound together to comprise a single unit or any hook with a single shank and eye and two or more pointed ends, used to impale fish.<sup>1</sup>

Pompano strike net: a gill net that is not more than 2,400 feet long and with a mesh size of not less than 5 inches stretched that is not anchored or secured to the water bottom or shore and which is actively worked while being used.<sup>3</sup>

Powerhead: means any device employing an explosive charge or a release of compressed gas, usually attached to a speargun, spear, pole, or stick (known as a "bangstick"), which detonates upon contact.<sup>1</sup>

Purse seine: any net or device commonly known as a purse seine and/or ring net that can be pursed or closed by means of a drawstring or other device that can be drawn to close the bottom of the net or the top of the net or both. Such nets are constructed of mesh of such size and design as not to be used primarily to entangle fish by the gills or other bony projection.<sup>3</sup>

Rebreather: means a closed circuit or semi-closed circuit underwater breathing apparatus that recycles and recirculates all or part of the gas mixture supplied for breathing. A rebreather is distinguished from other underwater breathing apparatuses by the inclusion of a scrubber (a component that removes carbon dioxide from the breathing gas) and a counterlung (a waterproof bag that allows the diver's exhaled breath to be captured for scrubbing and recycling back to the diver for inhalation).<sup>1</sup>

Rod and reel: means a rod and reel unit that is not attached to a vessel, or, if attached, is readily removable, from which a line and attached hook(s) are deployed. The line is payed out from and retrieved on the reel manually, electrically, or hydraulically.<sup>4</sup>

Run-around gillnet: means a gillnet, other than a long gillnet, that, when used, encloses an area of water.<sup>4</sup>

Sail Line: type of trotline with one end of the main line fixed on the shore, the other end of the main line attached to a wind-powered floating device or sail.<sup>2</sup>

Sea bass pot: means a trap has six rectangular sides and does not exceed 25 inches (63.5 cm) in height, width, or depth.<sup>4</sup>

Seine: means a small-meshed net suspended vertically in the water, with floats along the top margin and weights along the bottom margin, which encloses and concentrates fish, and does not entangle them in the meshes.<sup>1</sup> see also *Purse seine*.



Skimmer net: a net attached on two sides to a triangular frame and suspended from or attached to the sides of a boat, with one corner attached to the side of the boat and one corner resting on the waterbottom. A ski and one end of the lead line are attached to the corner of the frame that rests on the waterbottom and the other end of the lead line is attached to a weight which is suspended from the bow of the boat.<sup>3</sup>

Spear: any shaft with single or multiple points, barbed or barbless, which may be propelled by any means, but does not include arrows.<sup>2</sup>

Speargun: any hand operated device designed and used for propelling a spear, but does not include the crossbow.<sup>2</sup>\_\_\_\_\_

Stab or sink net: means a gill or trammel net, that sinks to the bottom when placed, set, or fished in water deeper than its hanging depth.<sup>1</sup>

Strike net: any gill net, trammel net or seine not anchored or secured to the water bottom or shore and which is actively worked while being used.<sup>3</sup>

Test trawl: a trawl which is not more than 16 feet along the corkline or 20 feet along the leadline or headrope.<sup>3</sup>

Trammel net: means a net constructed of two or more walls of netting hung from the same cork and lead lines, with one wall having a larger mesh than the other(s), which traps a fish in a pocket of netting when the fish pushes the smaller mesh wall through a mesh in the larger mesh wall.<sup>1</sup>

Trawl: any net, generally funnel-shaped, pulled through the water or along the bottom with otter boards to spread the mouth open while being fished. The term "trawl" also means and includes plumb staff beam trawls that do not exceed 16 feet, and that do not use otter boards but are held open laterally by a horizontal beam and vertically by two vertical beams (plumb staffs), and that are used while the vessel is under way.<sup>3</sup>

Trawl (Individual Bait-Shrimp Trawl): a bag-shaped net which is dragged along the bottom or through the water to catch aquatic life.<sup>2</sup>

Trotline: a non-metallic main fishing line with more than five hooks attached and with each end attached to a fixture.<sup>2</sup>

Umbrella net: a non-metallic mesh net that is suspended horizontally in the water by multiple lines attached to a rigid frame.<sup>2</sup>

Underwater breathing apparatus: means any apparatus, whether self-contained or connected to a distant source of air or other gas, whereby a person wholly or partially submerged in water is able to obtain or reuse air or any other gas or gasses for breathing without returning to the surface of the water.<sup>1</sup>

Wing (with reference to a seine): means a panel of netting on one or both ends of the seine, which panel has a larger mesh than the main body of the seine and is used to guide fish into the main body of the seine.<sup>1</sup>

**APPENDIX: LIST OF AUTHORIZED GEAR (64 FR 67511)**

**SOUTH ATLANTIC FISHERY MANAGEMENT COUNCIL**

Golden Crab Fishery (FMP) .....	Trap.
Crab Fishery (Non-FMP):	
A. Dredge fishery .....	A. Dredge.
B. Trawl fishery .....	B. Trawl.
C. Trap and pot fishery .....	C. Trap, pot.
Atlantic Red Drum Fishery (FMP).....	No harvest or possession in the EEZ.
Coral and Coral Reef Fishery (FMP):	
A. Octocoral commercial fishery .....	Hand harvest.
B. Live rock aquaculture fishery .....	Hand harvest.
South Atlantic Shrimp Fishery (FMP).....	Trawl.
South Atlantic Snapper-Grouper Fishery (FMP):	
A. Commercial fishery .....	A. Longline, rod and reel, bandit gear, handline, spear, powerhead.
B. Black sea bass trap and pot fishery .....	B. Pot, trap.
C. Wreckfish fishery .....	C. Rod and reel, bandit gear, handline.
D. Recreational fishery .....	D. Handline, rod and reel, bandit gear, spear, powerhead.
South Atlantic Spiny Lobster Fishery (FMP):	
A. Commercial fishery .....	A. Trap, pot, dip net, bully net, snare, hand harvest.
B. Recreational fishery .....	B. Trap, pot, dip net, bully net, snare, hand harvest.
South Atlantic Coastal Migratory Pelagics Fishery (FMP):	
A. Commercial Spanish mackerel fishery .....	A. Handline, rod and reel, bandit gear, gillnet, cast net.
B. Commercial king mackerel fishery .....	B. Handline, rod and reel, bandit gear.
C. Other commercial coastal migratory pelagics fishery .....	C. Longline, handline, rod and reel, bandit gear
D. Recreational fishery .....	D. Bandit gear, rod and reel, handline, spear.
Spiny Dogfish Fishery (FMP jointly managed by NEFMC and SAFMC):	
A. Gillnet fishery .....	A. Gillnet.
B. Trawl fishery .....	B. Trawl.
C. Hook and line fishery .....	C. Hook and line, rod and reel, spear, bandit gear.
D. Dredge fishery .....	D. Dredge.
E. Longline fishery .....	E. Longline.
F. Recreational fishery .....	F. Hook and line, rod and reel, spear.
Smooth Dogfish Fishery (Non-FMP):	
A. Gillnet fishery .....	A. Gillnet.
B. Trawl fishery .....	B. Trawl.
C. Hook and line fishery .....	C. Hook and line, rod and reel, spear, bandit gear.
D. Dredge fishery .....	D. Dredge.
E. Longline fishery .....	E. Longline.
F. Recreational fishery .....	F. Hook and line, rod and reel, spear.
Atlantic Menhaden Fishery (Non-FMP):	
A. Purse seine fishery .....	A. Purse seine.
B. Trawl fishery .....	B. Trawl.
C. Gillnet fishery .....	C. Gillnet.
D. Commercial hook-and-line .....	D. Hook and line fishery.
E. Recreational fishery .....	E. Hook and line, snagging, cast nets.
Atlantic Mackerel, Squid, and Butterfish Trawl Fishery (Non-FMP).....	Trawl.
Bait Fisheries (Non-FMP).....	Purse seine.
Weakfish Fishery (Non-FMP):	
A. Commercial fishery .....	A. Trawl, gillnet, hook and line.
B. Recreational fishery .....	B. Hook and line, spear.
Whelk Fishery (Non-FMP):	
A. Trawl fishery .....	A. Trawl.
B. Pot and trap fishery .....	B. Pot, trap.
C. Dredge fishery .....	C. Dredge.
D. Recreational fishery .....	D. Hand harvest.
Marine Life Aquarium Fishery (Non-FMP).....	Dip net, slurp gun, barrier net, drop net, allowable chemical, trap, pot, trawl.

Calico Scallop Fishery (Non-FMP):  
 A. Dredge fishery .....  
 B. Trawl fishery .....  
 C. Recreational fishery .....  
 Summer Flounder Fishery (FMP managed by MAFMC):  
 A. Commercial fishery .....  
 B. Recreational fishery .....  
 Bluefish, Croaker, and Flounder Trawl and Gillnet Fishery (Bluefish FMP managed by MAFMC).....  
 Commercial Fishery (Non-FMP).....  
 Recreational Fishery (Non-FMP).....  
 Sargassum Fishery (Non-FMP).....  
 Octopus Fishery (Non-FMP).....

A. Dredge.  
 B. Trawl.  
 C. Hand harvest.  
 A. Trawl, longline, handline, rod and reel, pot, trap, gillnet, dredge.  
 B. Rod and reel, handline, pot, trap, spear.  
 Trawl, gillnet  
 Trawl, gillnet, longline, handline, hook and line, rod and reel, bandit gear, cast net, pot, trap, lampara net, spear.  
 Rod and reel, handline, spear, hook and line, hand harvest, bandit gear, powerhead, gillnet, cast net.  
 Trawl.  
 Trap, pot.

**GULF OF MEXICO FISHERY MANAGEMENT COUNCIL**

Gulf of Mexico Red Drum Fishery (FMP).....  
 Coral Reef Fishery (FMP):  
 A. Commercial fishery .....  
 B. Recreational fishery .....  
 Gulf of Mexico Reef Fish Fishery (FMP):  
 A. Snapper-Grouper reef fish longline and hook and line fishery.  
 B. Pot and trap reef fish fishery .....  
 C. Other commercial fishery .....  
 D. Recreational fishery .....  
 Gulf of Mexico Shrimp Fishery (FMP):  
 A. Gulf of Mexico commercial fishery .....  
 B. Recreational fishery .....  
 Gulf of Mexico Coastal Migratory Pelagics Fishery (FMP):  
 A. Large pelagics longline fishery .....  
 B. King/Spanish mackerel gillnet fishery .....  
 C. Pelagic hook and line fishery .....  
 D. Pelagic species purse seine fishery .....  
 E. Recreational fishery .....  
 Gulf of Mexico Spiny Lobster Fishery (FMP):  
 A. Commercial fishery .....  
 B. Recreational fishery .....  
 Stone Crab Fishery (FMP):  
 A. Trap and pot fishery .....  
 B. Recreational fishery .....  
 Blue Crab Fishery (Non-FMP).....  
 Golden Crab Fishery (Non-FMP).....  
 Mullet Fishery (Non-FMP):  
 A. Trawl fishery .....  
 B. Gillnet fishery .....  
 C. Pair trawl fishery .....  
 D. Cast net fishery .....  
 E. Recreational fishery .....  
 Inshore Coastal Gillnet Fishery (Non-FMP).....  
 Octopus Fishery (Non-FMP).....  
 Marine Life Aquarium Fishery (Non-FMP).....  
 Coastal Herring Trawl Fishery (Non-FMP).....  
 Butterfish Trawl Fishery (Non-FMP).....  
 Gulf of Mexico Groundfish (Non-FMP):  
 A. Commercial fishery .....

No harvest or possession in the EEZ.  
 A. Hand harvest.  
 B. Hand harvest.  
 A. Longline, handline, bandit gear, rod and reel, buoy gear.  
 B. Pot, trap.  
 C. Spear, powerhead, cast net, trawl.  
 D. Spear, powerhead, bandit gear, handline, rod reel, cast net.  
 A. Trawl butterfly net, skimmer, cast net.  
 B. Trawl.  
 A. Longline.  
 B. Gillnet.  
 C. Bandit gear, handline, rod and reel.  
 D. Purse seine.  
 E. Bandit gear, handline, rod and reel, spear.  
 A. Trap, pot, dip net, bully net, hoop net, trawl, snare, hand harvest.  
 B. Dip net, bully net, pot, trap, snare, hand harvest.  
 A. Trap, pot  
 B. Trap, pot, hand harvest.  
 Trap, pot.  
 Trap.  
 A. Trawl.  
 B. Gillnet.  
 C. Pair trawl.  
 D. Cast net.  
 E. Bandit gear, handline, rod and reel, spear, cast net.  
 Gillnet.  
 Trap, pot.  
 Dip net, slurp gun, barrier net, drop net, allowable chemical, trap, pot, trawl.  
 Trawl.  
 Trawl.  
 A. Trawl, purse seine, gillnet.

B. Recreational fishery .....  
 Gulf of Mexico Menhaden Purse Seine Fishery (Non-FMP).....  
 Sardine Purse Seine Fishery (Non-FMP).....  
 Oyster Fishery (Non-FMP).....  
 Commercial Fishery (Non-FMP).....

Recreational Fishery (Non-FMP).....

B. Hook and line, rod and reel, spear.  
 Purse seine.  
 Purse seine.  
 Dredge, tongs.  
 Trawl, gillnet, hook and line, longline, handline, rod  
 and reel, bandit gear, cast net, lampara net, spear.  
 Bandit gear, handline, rod and reel, spear, bully net,  
 gillnet, dip net, longline, powerhead, seine, slurp gun,  
 trap, trawl, harpoon, cast net, hoop net, hook and  
 line, hand harvest.

**CARIBBEAN FISHERY MANAGEMENT COUNCIL**

Caribbean Spiny Lobster Fishery (FMP):

A. Trap/pot fishery .....  
 B. Dip net fishery .....  
 C. Entangling net fishery .....  
 D. Hand harvest fishery .....  
 E. Recreational fishery .....

A. Trap/pot  
 B. Dip net.  
 C. Gillnet, trammel net.  
 D. Hand harvest, snare.  
 E. Dip net, trap, pot, gillnet, trammel net.

Caribbean Shallow Water Reef Fish Fishery (FMP):

A. Longline/hook and line fishery .....  
 B. Trap/pot fishery .....  
 C. Entangling net fishery .....  
 D. Recreational fishery .....

A. Longline, hook and line.  
 B. Trap, pot.  
 C. Gillnet, trammel net.  
 D. Dip net, handline, rod and reel, slurp gun, spear.

Coral and Reef Resources Fishery (FMP):

A. Commercial fishery .....  
 B. Recreational fishery .....

A. Dip net, slurp gun.  
 B. Dip net, slurp gun, hand harvest.

Queen Conch Fishery (FMP):

A. Commercial fishery .....  
 B. Recreational fishery .....

A. Hand harvest.  
 B. Hand harvest.

Caribbean Pelagics Fishery (Non-FMP):

A. Pelagics drift gillnet fishery .....  
 B. Pelagics longline/hook and line fishery .....  
 C. Recreational fishery .....

A. Gillnet.  
 B. Longline/hook and line.  
 C. Spear, handline, longline, rod and reel.

Commercial Fishery (Non-FMP).....

Trawl, gillnet, hook and line, longline, handline, rod  
 and reel, bandit gear, cast net, spear.  
 Rod and reel, hook and line, spear, powerhead,  
 handline, hand harvest, cast net.

Recreational Fishery (Non-FMP).....