

NIST Process Control Security Testbed Architecture

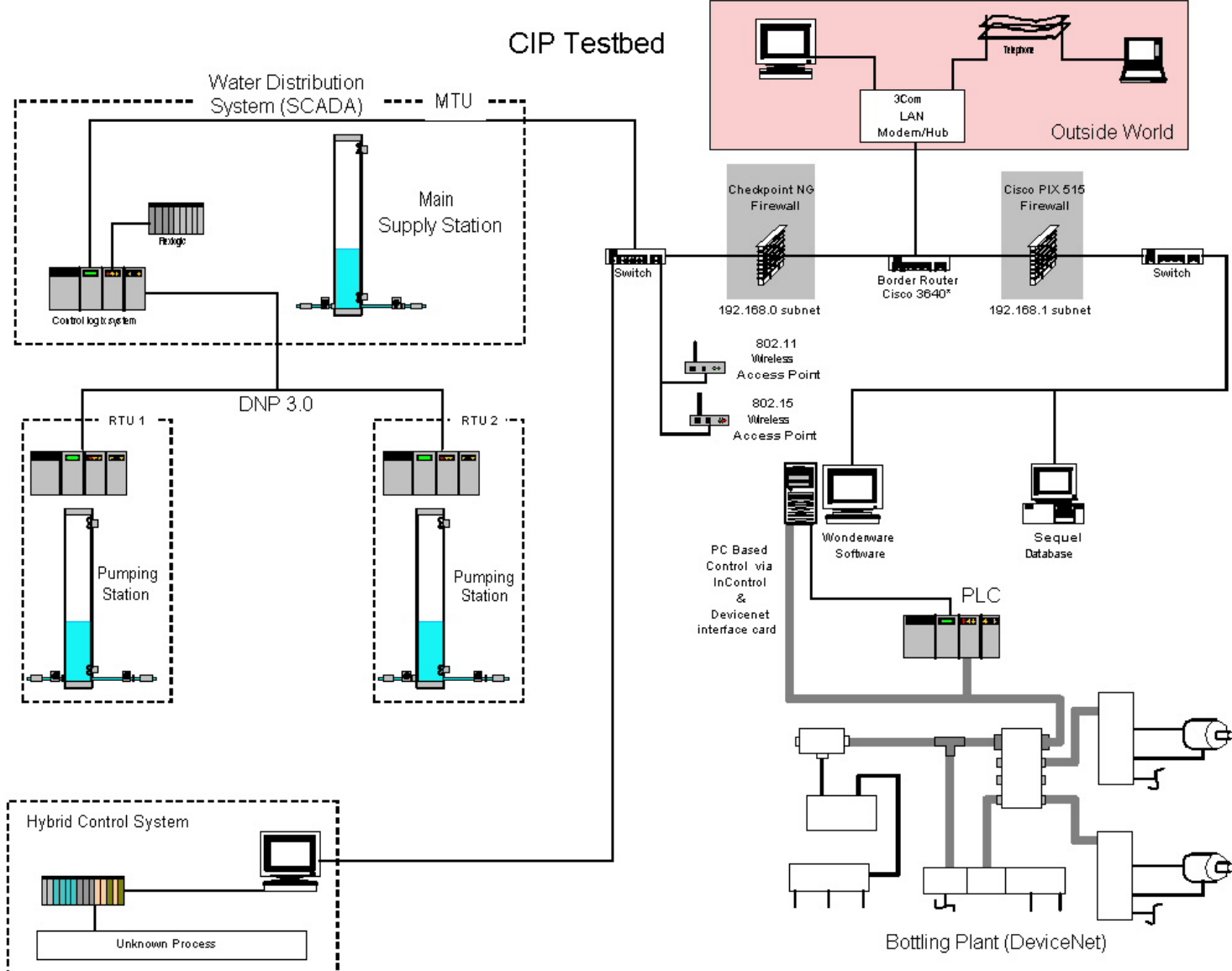

Network Hardware



- Checkpoint NG Firewall
- Cisco PIX 515E Firewall
- 3Com 802.11 wireless access point
- Compaq IPAC with wireless card
- HP Procurve 2524 Switch
- 3Com LAN 56K Modem/Hub
- 100 BaseT Hub (Needs to be replaced with a router)

Spirent Smartbits 600



- Spirent Smartbits 600
 - Network performance analysis equipment
 - LAN-3101A6 port 10/100 BaseT Ethernet module
 - Traffic generator

Water Distribution SCADA Simulation

- MTU Allen-Bradley ControlLogix/Flex IO
- RTUs Allen-Bradley SLC500
- DNP 3.0 Serial
- Ethernet
- Ultrasonic Level Transmitters
- Analog Flow Meters
- Liquid Level Switches
- Centrifugal Pumps

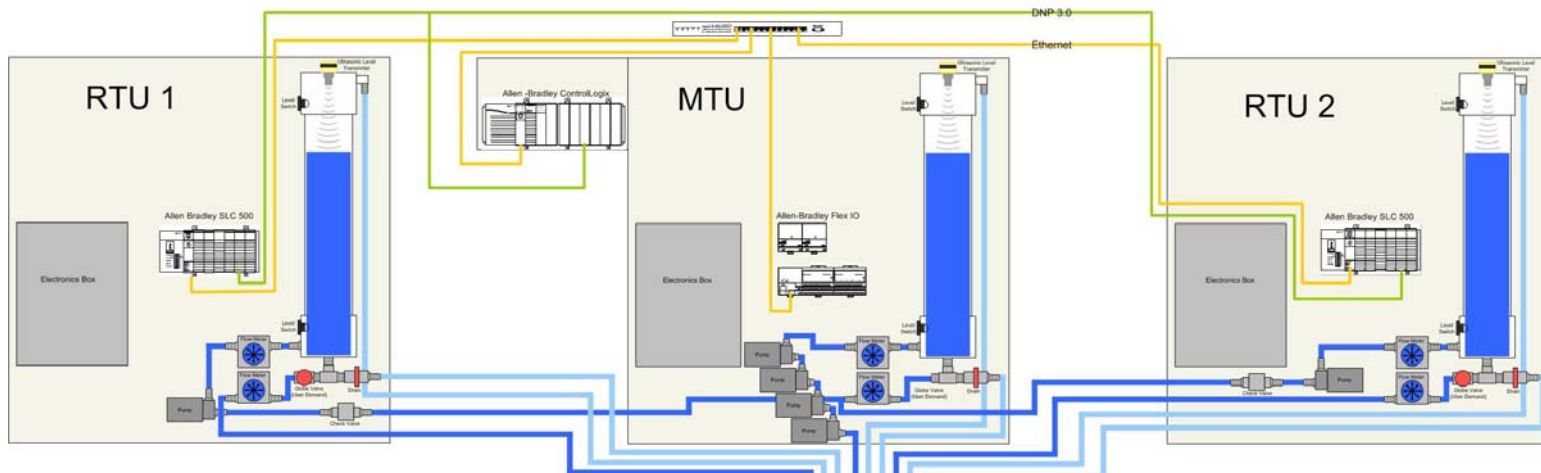

Master Terminal Unit (MTU)

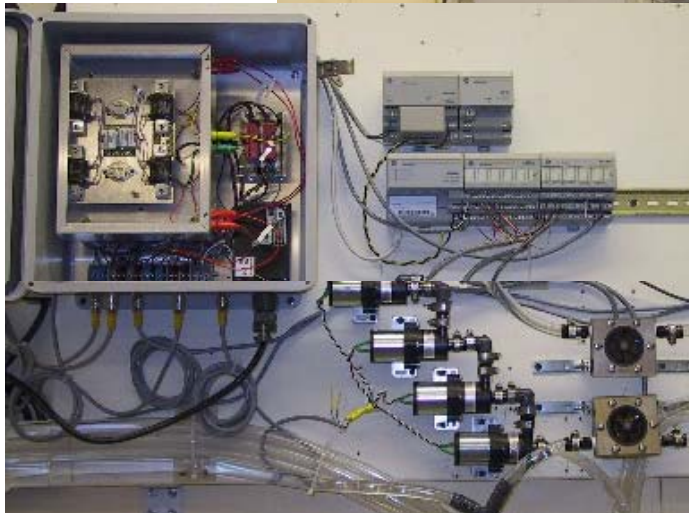

- Control Logix
 - 1756L55M12 Logix5555 Processor
 - 1756DNB DeviceNet Module
 - 1756ENBT Ethernet Bridge Module
 - Prosoft MV156 DNP3.0 RS232/422 Module
 - RS Logix5000 Software
- Flex Logix
 - 1794IE4XOE2, Analog Combo Module, 12-Bit, 4 In / 2 Out
 - 1794PS1, 85-264 Vac In / 24 Vdc Out 1 Amp Power Supply
 - 1794IB10XOB6, 10/6 24Vdc Combo
 - 1794-AENT, Ethernet Adapter w/ 24Vdc Power Supply
- Sensors & Actuators
 - LU12 Flowline Ultrasonic Level Transmitter
 - 0804BN4 Proteus Industries Flow Meter/Flow Switch
 - LLE102000 Honeywell Liquid level Sensors
 - 17651-058 Gorman-Rupp Centrifugal Pump

Remote Terminal Units (RTUs)

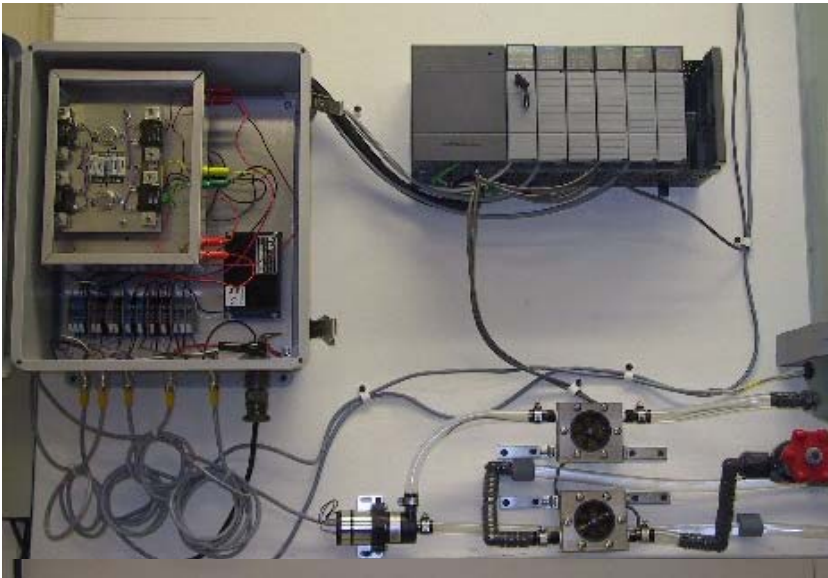

- SLC 500
 - 1747-L551 5/05 Processor
 - 1746-NO4V analog output module
 - 1746-NI4 analog input module
 - 1746-IG16 5v TTL input module
 - MVI46 Prosoft DNP3.0 RS232/422 module
 - RS Logix500 Software

Sensors & Actuators

- LU12 Flowline Ultrasonic Level Transmitter
- 0804BN4 Proteus Industries Flow Meter/Flow Switch
- LLE102000 Honeywell Liquid level Sensors
- 17651-058 Gorman-Rupp Centrifugal Pump

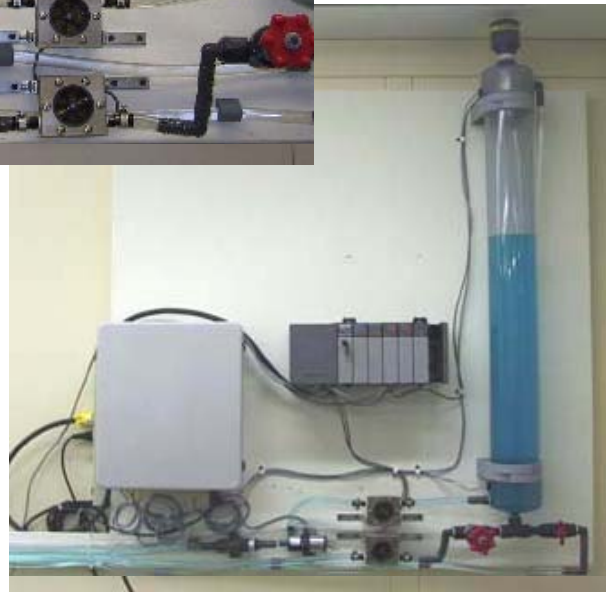

Bottling Plant Simulation



- DeviceNet I/O network
- Three controller options
 - Wonderware PC-based software PLC
 - Modicon hardware PLC
 - DeltaV Hybrid Controller
- SQL database for data logging

DeviceNet Layout

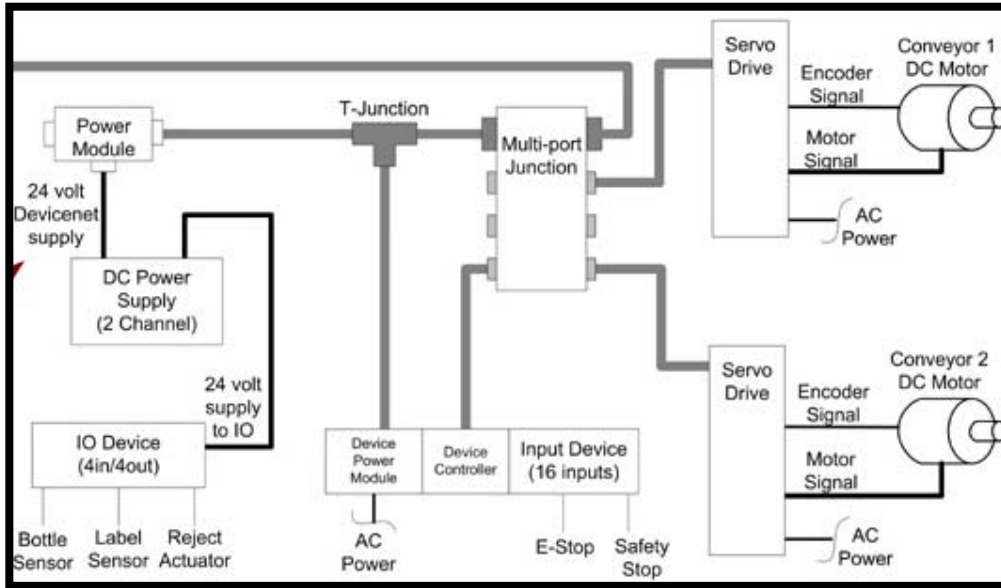

- **DeviceNet Network**

- JBBS-57-E601 BusStop passive multiport junction
- BD8D4EX4ET DC Input/Output
- GE Fanuc S2K Series Servo Drive
- API 3400 Servo Drive
- Allen-Bradley FlexIO
 - 1794-IV16 24V adapter
 - 1793-IV16 24V input
 - 1794PS13 24V power supply

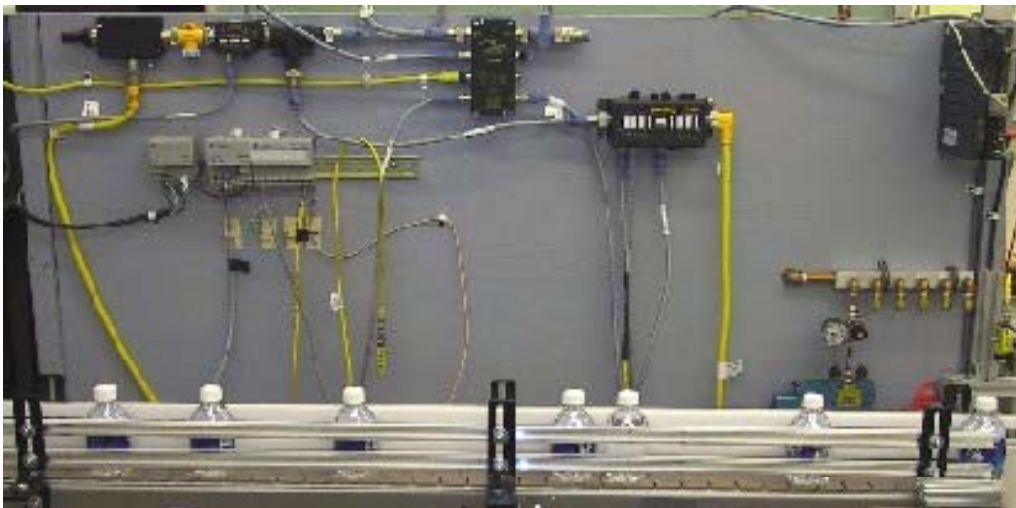

Modicon & Wonderware PLCs

Modicon Quantum PLC

- 140CPU43412A CPU
- 140NOE77111 Embedded Server Module
- AVGSACQDNET-10 DeviceNet Scanner Module
- 141MMS42501 Multi Axis Motion Module
- 140CPS11420 Power Supply
- 984 Ladder Logic Programming environment

Wonderware HMI/PLC

- InTouch HMI
- InControl PC based PLC
- SST Devicenet Board
- Industrial SQL Server

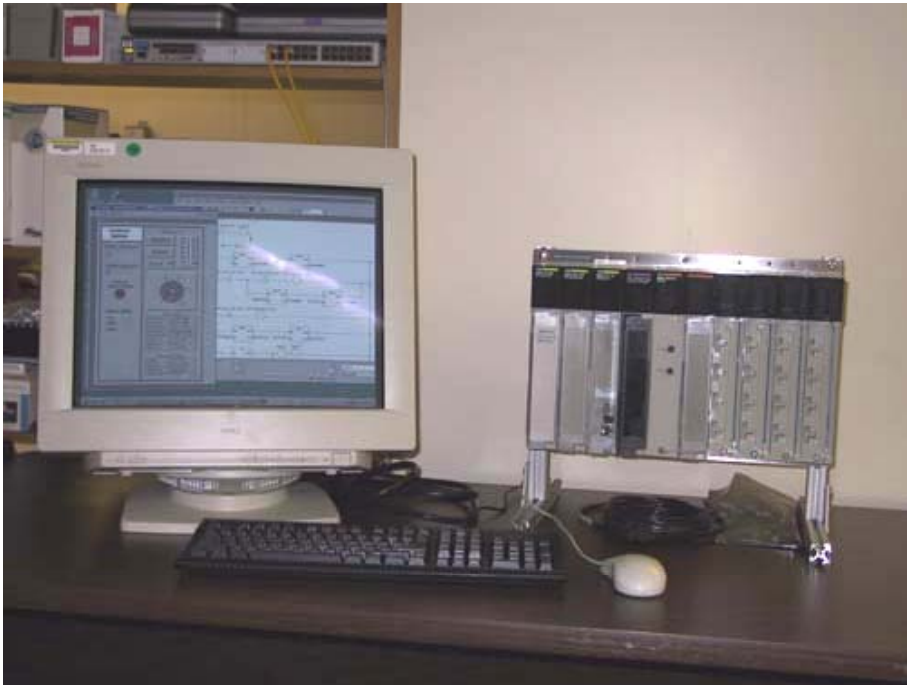

DeltaV



- Emerson DeltaV Hybrid control system
- DeviceNet I/O
- Foundation Fieldbus I/O
- Data Historian
- HMI

Web-based Video Camera

- Axis 2401 real-time web-based video server
- Sony EVI-D30 pan/tilt/zoom camera

