



NOAA Technical Memorandum NMFS-AFSC-31

The Groundfish Resources of the Aleutian Islands Region and Southern Bering Sea 1980,1983 and 1986

by

L. L. Ronholt, K. Teshima, and D. W. Kessler

U.S. DEPARTMENT OF COMMERCE
National Oceanic and Atmospheric Administration
National Marine Fisheries Service
Alaska Fisheries Science Center

February 1994

NOAA Technical Memorandum NMFS

The National Marine Fisheries Service's Alaska Fisheries Science Center uses the NOAA Technical Memorandum series to issue informal scientific and technical publications when complete formal review and editorial processing are not appropriate or feasible. Documents within this series reflect sound professional work and may be referenced in the formal scientific and technical literature.

The NMFS-AFSC Technical Memorandum series of the Alaska Fisheries Science Center continues the NMFS-F/NWC series established in 1970 by the Northwest Fisheries Center. The new NMFS-NWFSC series will be used by the Northwest Fisheries Science Center.

This document should be cited as follows:

Ronholt, L. L., K. Teshima, and W. D. Kessler. 1994. The groundfish resources of the Aleutian Islands region and southern Bering Sea 1980, 1983, and 1986. U.S. Dep. Commer., NOAA Tech. Memo. NMFS-AFSC-31, 351p.

Reference in this document to trade names does not imply endorsement by the National Marine Fisheries Service, NOAA.



NOAA Technical Memorandum NMFS-AFSC-31

The Groundfish Resources of the Aleutian Islands Region and Southern Bering Sea 1980, 1983, and 1986

by
L. L. Ronholt,¹ K. Teshima,² and D. W. Kessler¹

¹Alaska Fisheries Science Center
7600 Sand Point Way N.E., BIN C-15700
Seattle, WA 98115-0070

²Shimonoseki Branch
Seikai Regional Fisheries Research Laboratory
5-20, 2 Chome Higashiyamotocho
Simonoseki 750
Japan

U.S. DEPARTMENT OF COMMERCE

Ronald H. Brown, Secretary

National Oceanic and Atmospheric Administration

D. James Baker, Under Secretary and Administrator

National Marine Fisheries Service

Rolland A. Schmitt, Assistant Administrator for Fisheries

February 1994

This document is available to the public through:

National Technical Information Service
U.S. Department of Commerce
5285 Port Royal Road
Springfield, VA 22161

Notice to Users of this Document

This document is being made available in .PDF format for the convenience of users; however, the accuracy and correctness of the document can only be certified as was presented in the original hard copy format.

ABSTRACT

During the summer and fall of 1980, 1983, and 1986, the National Marine Fisheries Service and the Fisheries Agency of Japan conducted comprehensive trawl surveys of the groundfish resources of the Aleutian Islands. The survey area included the continental shelf and upper slope from Stalemate Bank to Unimak Pass, including Bowers Ridge and a portion of the southern Bering Sea.

The major objectives of these surveys were to define the distribution and abundance of commercial groundfish species and to assess changes in stock abundance and biological conditions over the 6-year survey period. Results of each of these yearly surveys include distribution information, biomass and population estimates, size and age composition, and length weight data for most species of commercial fish. This paper presents and compares the data from each of the three surveys.

The average total biomass estimate for the three surveys was 2.4 million metric tons. Fish made up over 96% of this biomass, and included 161 species representing 40 families. Nineteen species made up over 90% of the total available biomass. Accounting for 23% of the available biomass, walleye pollock (*Theragra chalcogramma*) with a similar biomass estimate each year was the most abundant species. Giant grenadier (*Albatrossia pectoralis*), a non-utilized species was the second most abundant species with an increasing biomass which accounted for 18% of the available resource. The other abundant species were Atka mackerel (*Pleurogrammus monopterygius*), Pacific ocean perch (*Sebastes alutus*), and Pacific cod (*Gadus macrocephalus*), accounting for 16, 8, and 7% of the resource, respectively.

CONTENTS

	<u>Page</u>
INTRODUCTION.....	1
METHODS AND MATERIALS.....	7
Vessels and Survey Periods.....	7
Gear.....	8
Trawl Mouth Height and Width Measurements.....	19
Sampling Design and Rationale.....	20
Station Sampling Procedures.....	23
Catch and Biological Data Collection Procedures.....	24
Length Frequency Measurement.....	25
Age Structure Collection.....	26
Relative Fishing Power Comparisons.....	27
Survey Precision.....	27
Environmental Data.....	28
Data Management.....	28
Species Groupings.....	28
Data Analysis Procedures.....	29
RESULTS.....	33
Sampling Effort.....	33
Survey Precision.....	39
Fishing Power Comparisons.....	40
Length Frequency Measurements.....	42
Age Structure.....	43
Length-Weight Measurements.....	44
Trawl Measurements.....	45
BIOMASS ESTIMATES.....	47
SPECIES ACCOUNTS.....	53
Walleye Pollock.....	53
Atka Mackerel.....	79
Pacific Ocean Perch.....	101
Pacific Cod.....	126
Northern Rockfish.....	144
Arrowtooth Flounder.....	159
Sablefish.....	178
Greenland Turbot.....	198
Rougheye Rockfish.....	212
Pacific Halibut.....	227
Shortraker Rockfish.....	237
Shortspine Thornyhead.....	252
Rock Sole.....	267
Skates.....	284
Flathead Sole.....	289
Rex Sole.....	296
Dover Sole.....	304
Giant Grenadier.....	309
Red Squid.....	319
CITATIONS.....	325
APPENDIX A : Indices of Abundance.....	329
APPENDIX B : Water Temperatures.....	337
APPENDIX C : Species Inventory.....	345

INTRODUCTION

Since 1979, the Alaska Fisheries Science Center (AFSC), National Marine Fisheries Service (NMFS), Seattle, Washington, and the National Research Institute of Far Seas Fisheries (NRIFSF), Fisheries Agency of Japan, Shimizu, Japan, have conducted triennial groundfish resource assessment surveys in Alaska waters. Beginning with the eastern Bering Sea in 1979, the surveys were expanded to the region around the Aleutian Islands in 1980 and further to the Gulf of Alaska in 1984. Prior to the cessation of cooperative surveys following the 1987 field season, surveys were completed for the Aleutian Islands region in 1980, 1983, and 1986, in the Gulf of Alaska in 1984 and 1987, and in the Bering Sea in 1979, 1981, 1982, and 1985.

The principal objectives of these surveys were to 1) establish a benchmark database to assess stock condition and changes over time, 2) define the distribution and relative abundance of the principle groundfish and commercially important invertebrate species, and 3) collect data to define the biological parameters of each major groundfish stock. A description of the survey methods and results obtained from the earlier research surveys have already been published in various papers or reports (Bakkala et al. 1985; Wakabayashi et al. 1985; Brown 1986; Ronholt et al. 1986; Sample et al. 1985; Wilderbuer et al. 1985).

The Aleutian archipelago consists of 47 major islands extending westward in a nearly 1,500 km arc from the Alaska Peninsula to Attu Island. The larger islands and numerous smaller islands are separated into five major groupings. These island groups going from east to west are 1) The Fox Islands, including Unimak, Akutan, Unalaska, and Umnak Islands; 2) The Islands of Four Mountains, including Chuginadak, Yunaska, and Amukta Islands; 3) The Andreanof Islands, including Seguam, Amlia, Atka, Adak, Kanaga, Tanaga, and Gareloi Islands; 4) The Rat Islands, including Amchitka, Kiska, and Buldir Islands; and 5) The Near Islands, including Shemya, Agattu, and Attu Islands (Figs. 1 and 2).

Located among the western islands are several banks and reefs; the most prominent are Petrel Bank north of Semisopochnoi Island; Buldir Reef, Tahoma Reef, and Walls Plateau which form an arc to the south of Buldir Island; and Stalemate Bank, located to the west of Attu Island. Bowers Ridge rises in a northwesterly arc approximately 400 km long north of the Rat Islands and contains the Ulm Plateau at its northwestern tip and Bowers Bank with depths shallower than 100 m.

The bathymetry of the sea floor in the area reflects the volcanic origin of the islands and is characterized by an extremely irregular bottom, narrow continental shelf, and abrupt continental slope. The Aleutian Trench defines the limit of the continental slope approximately 120 km to the south of the chain with depths ranging from 4,000 to 7,500 m. Separated by Bowers Ridge, the northern continental slope is 30 to 75 km wide and bounded by Bowers Basin in the west and the Aleutian Basin in the east.

Oceanographic studies of the Aleutian Islands are scarce and have primarily concentrated on the interchange of waters between the North Pacific Ocean, Bering Sea, and Gulf of Alaska (Favorite 1974, Favorite et al. 1976, Favorite and Ingraham 1972, Hood 1983, and Reed and Schumacher 1986). The surface waters of the major passes between the islands are characterized by strong and complex currents which are prone to rapid changes. Influenced by strong winds opposing the tidal flow, sea conditions can deteriorate rapidly and be extremely hazardous. Tidal cycles generally flood to the north and ebb to the south.

Historically, the Aleutian Islands have been an important fishing ground for foreign vessels, with total catches averaging over 73,000 t per year from 1962 to 1986 (Bakkala 1987). The modern era of foreign fisheries in the region can be traced to the early 1960s with the expansion of Japanese and Soviet fisheries to the eastern Bering Sea and Aleutian Islands region for yellowfin sole (Pleuronectes aspera) and Pacific ocean perch (Sebastes alutus) (Forrester et al. 1978). Fisheries conducted by Japan, the former U.S.S.R., the Republic of Korea, and Poland have accounted for the majority of catches in the area, with the largest fishery in the Aleutian Islands region concentrating on Pacific ocean perch, with catches of 285,000 metric tons (t) from 1964 to 1966 (Table 1). Following the decline of the Pacific ocean perch fishery after 1972, walleye pollock (Theragra chalcogramma) and Atka mackerel (Pleurogrammus monopterygius) emerged as the dominant fisheries. Incidental catches of sablefish (Anoplopoma fimbria), Pacific cod (Gadus macrocephalus), and turbot (arrowtooth flounder, Atheresthes stomias; Kamchatka flounder, A. evermanni; and Greenland turbot, Reinhardtius hippoglossoides) in the trawl fisheries have made important contributions to the catches for the area along with directed longline fisheries for sablefish and Pacific cod (Forrester et al. 1978, Forrester et al. 1983).

With the enactment of the Magnuson Fisheries Conservation and Management Act (MFCMA) in 1976, the importance of U.S. vessels in the fisheries of the area has increased (Table 2). Due primarily to U.S. joint venture efforts commencing in 1981, and intensified effort by the U.S. domestic fishery for sablefish and Greenland turbot, coupled with reductions in foreign groundfish quotas, the foreign fisheries have shifted from demersal trawling throughout the Aleutian chain to midwater trawl fisheries targeting on pelagic pollock in the international waters of the Aleutian Basin (Sasaki and Yoshimura 1987).

This report presents and compares the results of groundfish assessment surveys conducted in the Aleutian Island region in 1980, 1983, and 1986. Repeated surveys of the area have made it possible to evaluate and track trends in species distribution and abundance, size and age composition, and length-weight relationships.

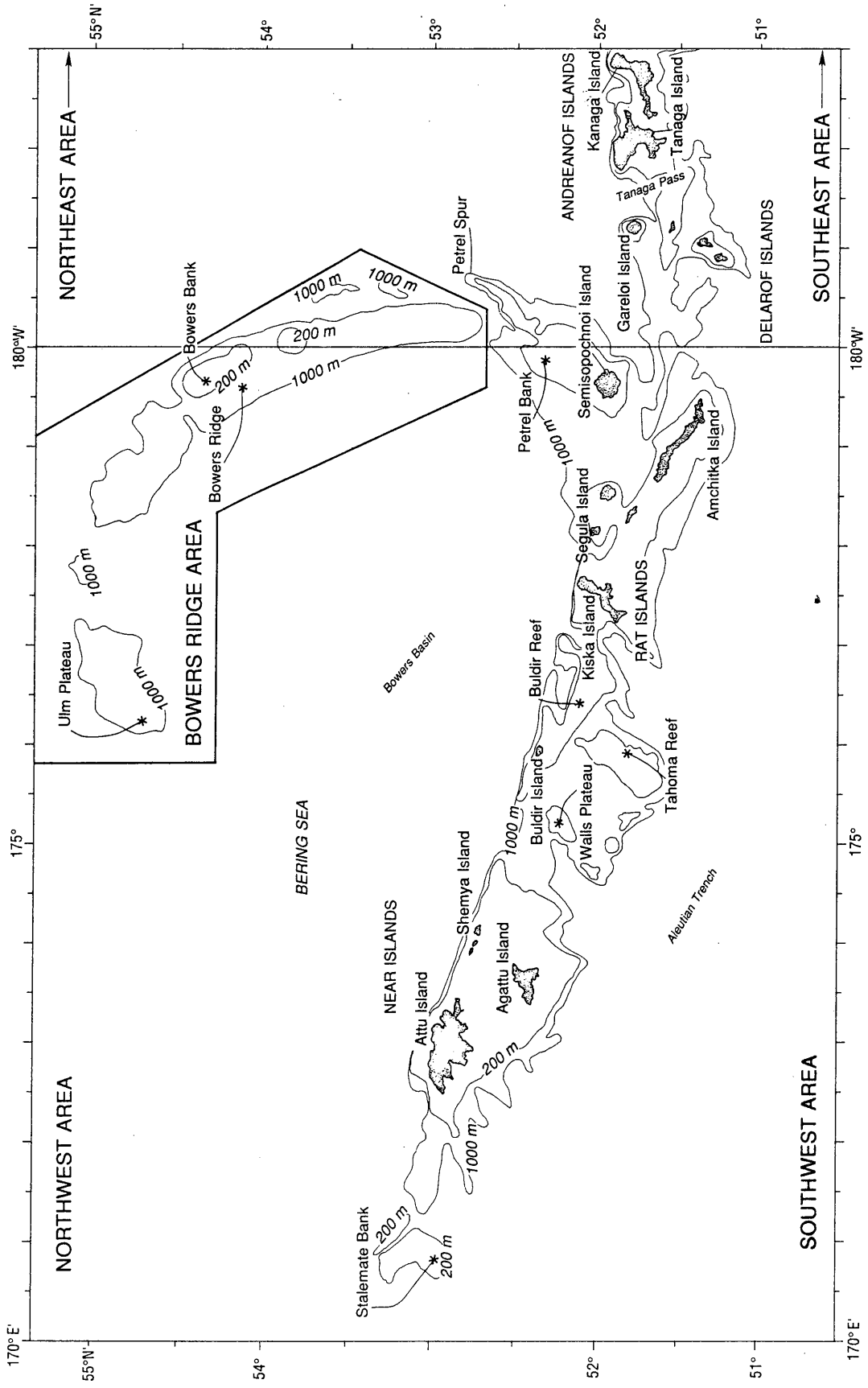

Figure 1. Western areas sampled during the U.S.-Japan 1980, 1983, and 1986 Aleutian Islands groundfish surveys.

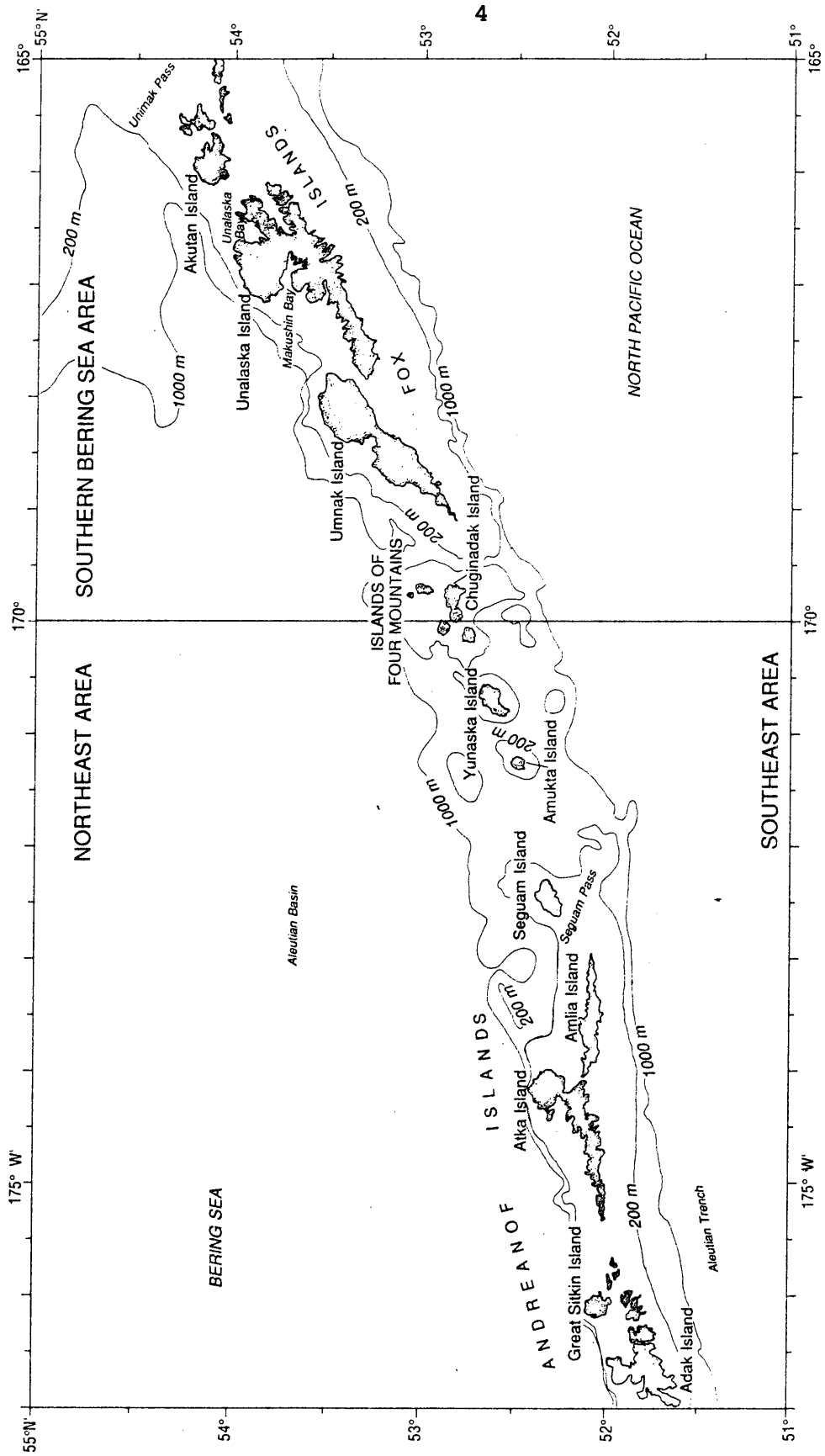

Figure 2. Eastern areas sampled during the U.S.-Japan 1980, 1983, and 1986 Aleutian Islands groundfish surveys.

Table 1. Annual groundfish catches (metric tons) in the Aleutian Islands and Southern Bering Sea areas for foreign fisheries, 1962-76^a.

Year ^b	Species					
	Walleye pollock	Pacific cod	Turbots ^c	Sablefish	Pacific ocean perch ^d	Atka Mackerel
1962	6	26	^e	-	200	-
1963	1,359	601	374	639	20,800	-
1964	560	278	475	1,534	90,300	-
1965	697	459	305	1,248	109,100	-
1966	1,277	171	59	1,338	85,900	-
1967	1,833	374	210	1,651	55,900	-
1968	2,677	294	102	1,673	44,900	-
1969	512	222	65	1,673	38,800	-
1970	179	284	559	1,247	66,900	-
1971	3,197	2,085	2,331	2,936	21,800	-
1972	1,442	438	14,197	3,531	33,200	4,515
1973	10,475	971	12,371	2,902	11,800	1,604
1974	22,661	1,350	11,983	2,477	22,400	1,377
1975	13,785	2,824	3,757	1,709	16,600	12,078
1976	4,290	4,171	3,437	1,619	14,000	20,092

^a Compiled from Forrester et al. 1978 and Forrester et al. 1983, except as noted.

^b 1970-1976 data for turbot from Bakkala et al. 1987. Cod from Thompson and Shimada 1987. 1971-1976 data includes Soviet catches for walleye pollock, Pacific cod, sablefish, and Atka mackerel.

^c Includes arrowtooth flounder, Greenland turbot, and Kamchatka flounder.

^d Data may contain rockfish species other than Pacific ocean perch, from Ito 1987.

^e Less than 1 metric ton.

Table 2. Annual groundfish catches (metric tons) in the Aleutian Islands and Southern Bering Sea areas for foreign, U.S. joint venture, and U.S. domestic fisheries, 1977-86^a.

Year	Species						
	Walleye pollock	Pacific cod	Greenland turbot	Arrowtooth flounder	Sablefish	Pacific ocean perch	Atka mackerel ^b
Foreign Vessels							
1977	7,625	3,262	2,453	2,035	1,897	8,080	20,975
1978	6,282	3,291	4,766	1,782	821	5,286	24,250
1979	9,504	5,591	6,411	6,436	782	5,487	23,264
1980	58,156	2,905	3,696	4,603	267	4,700	15,337
1981	55,516	2,914	4,398	3,624	377	3,618	14,273
1982	56,040	1,996	6,316	2,356	808	1,012	7,320
1983	56,479	2,271	4,115	3,700	575	272	1,187
1984	71,249	1,277	1,802	1,404	725	356	-
1985	51,447	839	31	11	70	-	-
1986	15,956	5	-	-	-	-	-
U.S. Joint Venture Vessels							
1977	-	-	-	-	-	-	-
1978	-	-	-	-	-	-	-
1979	-	-	-	-	-	-	-
1980	-	86	1	-	4	-	196
1981	-	1,749	2	16	156	4	1,388
1982	1,983	4,280	1	59	118	2	12,226
1983	2,547	4,700	-	53	70	8	10,407
1984	6,694	6,390	1	68	272	273	35,943
1985	7,283	5,638	2	59	63	215	37,856
1986	30,261	6,115	7	78	83	160	31,978
U.S. Domestic Vessels							
1977	-	-	-	-	-	-	-
1978	-	4	-	-	-	-	-
1979	-	2	-	-	-	-	-
1980	-	2,797	-	-	-	-	-
1981	-	5,779	-	-	-	-	-
1982	-	5,250	-	-	28	-	-
1983	-	2,984	-	-	29	-	-
1984	3,891	14,459	-	-	47	2	-
1985	583	6,213	-	17	1,956	93	-
1986	777	319	2,048	64	3,053	178	-

^a Compiled from individual species accounts in Bakkala et al. 1987.

^b Estimated values for foreign and U.S. joint-venture, catches 1980-83.

METHODS AND MATERIALS

Vessels and Survey Periods

A total of five U.S. and three Japanese vessels were used during the 1980, 1983, and 1986 Aleutian Islands surveys. Two U.S. and one Japanese trawler were chartered by the AFSC and by the NRIFSF in 1980. Both U.S. vessels, the M/V Half Moon Bay and M/V Ocean Harvester were 32.9 m west coast combination trawler-crabbers, while the Japanese vessel the Hatsue Maru No. 62 was a 50.6 m land-based stern trawler. Two NOAA ships, the R/V Miller Freeman (65.5 m) and the R/V Chapman (38.5 m), and a Japanese-chartered land-based trawler, Daito Maru No. 38 (51.8 m), participated in the 1983 survey. A U.S. combination crabber-trawler, Lets Go (25.9 m), and a Japanese land-based trawler, Ginryu Maru No. 5 (55.3 m), were chartered for the 1986 survey. The Japanese land-based trawlers were of similar type and equipped with similar fishing and navigational systems. Specifications for the U.S. and Japanese vessels are listed in Table 3.

Table 3. Characteristics of the vessels used during the U.S.-Japan 1980, 1983, and 1986 Aleutian Islands groundfish surveys.

Vessel Name	Overall length (m)	Gross Tonnage	Horse-power
<u>Half Moon Bay</u>	32.9	197	850
<u>Ocean Harvester</u>	32.9	197	1,150
<u>Hatsue Maru No. 62</u>	50.6	350	3,000
<u>Miller Freeman</u>	65.5	1,515	2,150
<u>Chapman</u>	38.5	427	1,150
<u>Daito Maru No. 38</u>	51.8	349	3,800
<u>Lets Go</u>	25.9	145	565
<u>Ginryu Maru No. 5</u>	55.3	350	3,000

The survey period extended from July through November in 1980 and 1983, and from May through September in 1986, with the most extensive coverage of the survey area being performed by the Japanese charter vessels (Table 4).

Table 4. Sampling periods of the survey vessels participating in the U.S.-Japan 1980, 1983, and 1986 Aleutian Islands groundfish surveys.

Years	Vessels	Months						
		May	June	July	Aug.	Sept.	Oct.	Nov.
1980	<u>Half Moon Bay</u>		6/30-----					8/20
	<u>Ocean Harvester</u>				7/22--			8/22
	<u>Hatsue Maru No. 62</u>				7/6-----			11/4
1983	<u>Miller Freeman</u>				7/26--			8/14
	<u>Chapman</u>					8/16--		9/5
	<u>Daito Maru No. 38</u>				7/16-----			11/4
1986	<u>Lets Go</u>				7/20-----			9/26
	<u>Ginryu Maru No. 5</u>	5/14-----						9/19

The Hatsue Maru No. 62 attempted 217 stations in two legs (7/6-11/14). The M/V Half Moon Bay attempted 129 stations (6/30-8/20) and the M/V Ocean Harvester attempted 89 stations (7/29-8/22). In the 1983 survey, 263 stations were attempted by the Daito Maru No. 38 (7/16-11/4), and 99 and 63 were attempted by the NOAA ships Miller Freeman (7/26-8/14) and Chapman (8/16-9/5), respectively. The Ginryu Maru No. 5 attempted 364 stations (5/14-9/19) and the Lets Go attempted 135 stations (7/20-9/26) during the 1986 survey.

Gear

From 1980 to 1987, all bottom trawl surveys by U.S. vessels were conducted with a standard nylon Noreastern trawl (headrope length 27 m, footrope length 32 m), a four-seam trawl with a total length of 50.2 m (Fig. 3). Because the waters surrounding the Aleutian Islands are known for their rough trawling bottom, the Noreastern trawl was fished with roller gear constructed of 45.7 cm rubber rollers in the throat and 35.6 cm rubber bobbins along the wings. Triple dandyines were 54.9 m long (Fig. 4). A 3.2 cm liner in the cod end was used to retain small fish. Steel V-type otter boards were 1.8 x 2.7 m and weighed approximately 409 kg each. This net was characterized by horizontal mouth openings ranging from approximately 14 to 18 m and a vertical opening of approximately 7 m.

The six-seam and eight-seam trawls used by the Japanese-chartered land-based trawlers were provided by the vessels and were those normally employed during commercial fishing operations. The trawls used during each survey were of various

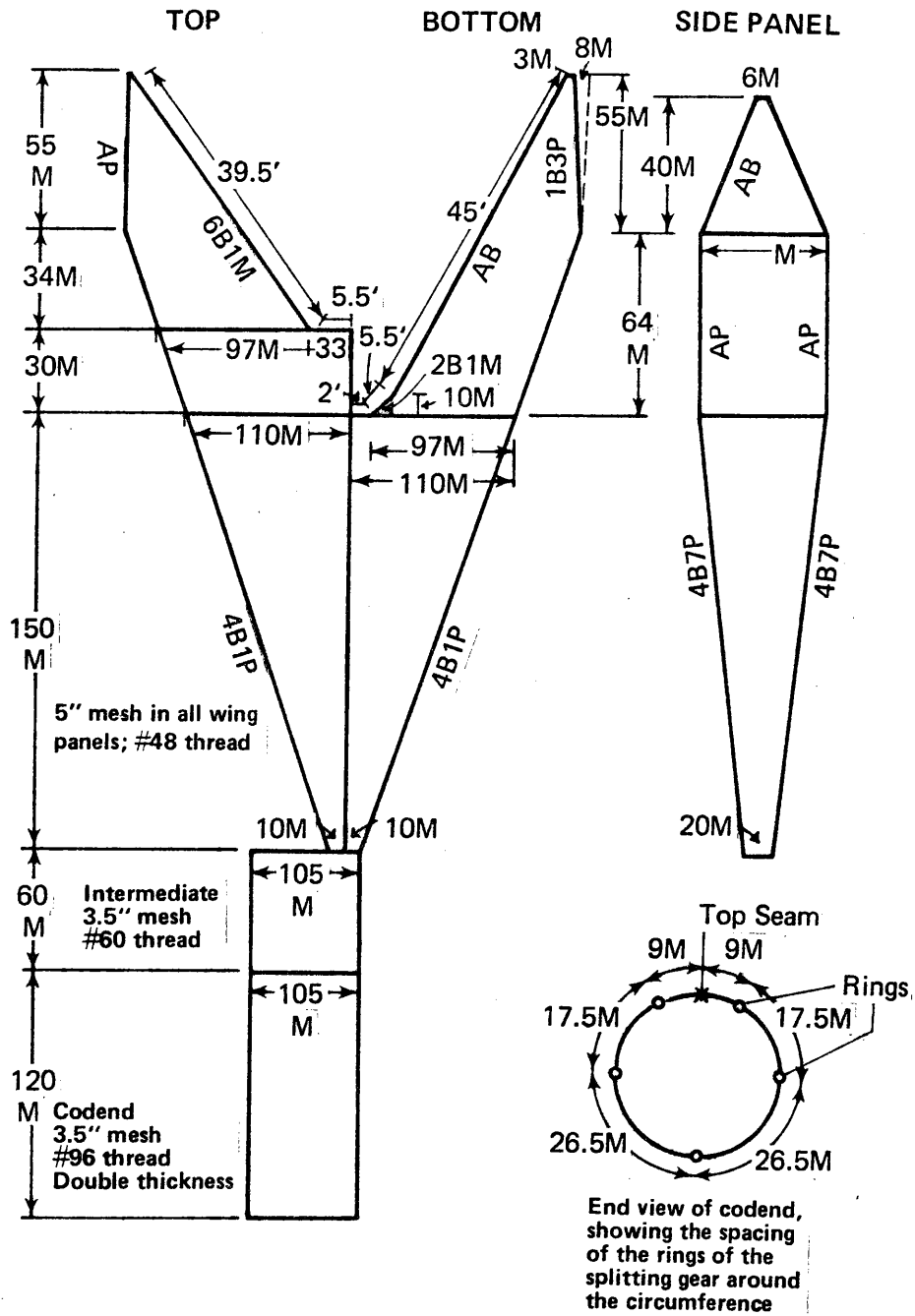

Figure 3. Schematic diagram of the 27/32 m Noreastern trawl used by the U.S. vessels during the U.S.-Japan 1980, 1983, and 1986 Aleutian Islands groundfish surveys.

ROLLER GEAR

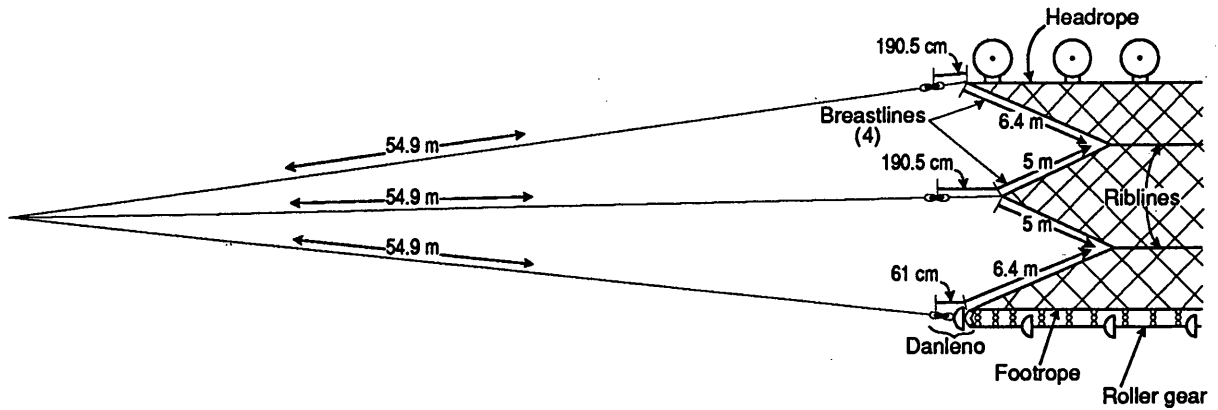
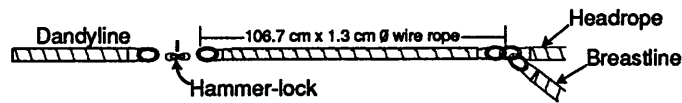
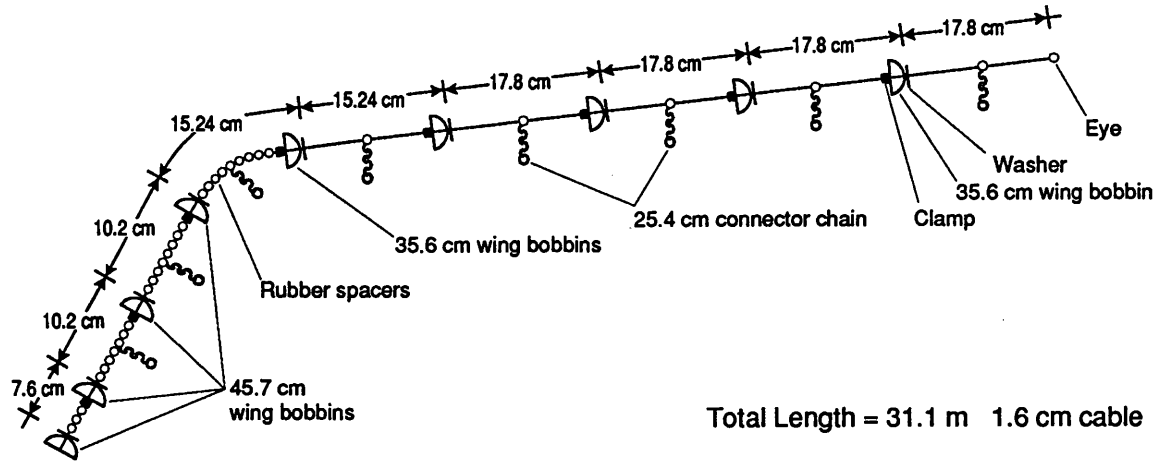

Figure 4. Schematic diagram of the roller gear and dandyline configuration used by the U.S. vessels during the U.S.-Japan 1980, 1983, and 1986 Aleutian Islands groundfish surveys.

designs. Several modifications and improvements were made on these trawls, depending on the fishing master's experience, to increase the fishing efficiency. During the 1980 survey, two different trawls were used on the Hatsue Maru No. 62. The 32/44/73 trawl (headrope length 32 m, footrope length 44 m and total length 73 m) used during leg 1 was replaced during leg 2 by the 55/65/83 trawl (Figs. 5 and 6).

Both trawls were fished with roller gear constructed of used 57 cm automobile tires in the throat and rear wings and 53 cm steel and rubber balls in the forward wings. Figure 7 shows the roller gear used during the first half of the survey. This same configuration was also used during the second half, except that the length of the center wing section was increased by 10.5 m to accommodate the larger trawl. Both trawls were fished with 82 m dandyines consisting of a single 32 m section branching to a double 50 m section, and 2.2 x 3.4 m otter boards weighing 2.4 t each in water. The 32/44/73 trawl had an estimated trawl mouth opening of approximately 5.2 m vertically and 28.8 m horizontally; the 55/65/83 trawl opened 4.5 m vertically and 21.6 m horizontally.

During the 1983 survey a 47/58/71 trawl was used by the Daito Maru No. 38 for all sampling (Fig. 8). This trawl was also fished with roller gear, although quite different from that used by the Hatsue Maru No. 62 in 1980 being constructed of 53 and 35 cm gum bobbins and 30 and 41 cm gum discs (Fig. 9). The Daito Maru No. 38 also used 80 m dandyines consisting of a 40 m single section branching to 40 m doubles, and 2.25 x 3.45 m otter boards weighing 2.4 t each in water. The mouth opening of this trawl measured approximately 5.0 m vertically and 28.3 m horizontally.

The Ginryu Maru No. 5 conducted all sampling during the 1986 survey with a 38/54/84 otter trawl fished with roller gear constructed as in 1980 i.e., 57 cm car tires in the throat and rear wings and 53 cm rubber and steel balls in the forward wings (Figs. 10 and 11). Other accessories included 100 m dandyines with a 50 m single section branching to a 50 m double section, and 2.25 x 3.5 m otter boards weighing 2.9 t each in water. The estimated average horizontal and vertical openings of the trawl mouth while fishing were 22.8 m, and 4.5 m respectively.

The general characteristics of the trawls used by the U.S. and Japanese research vessels during the triennial survey are shown in Table 5.

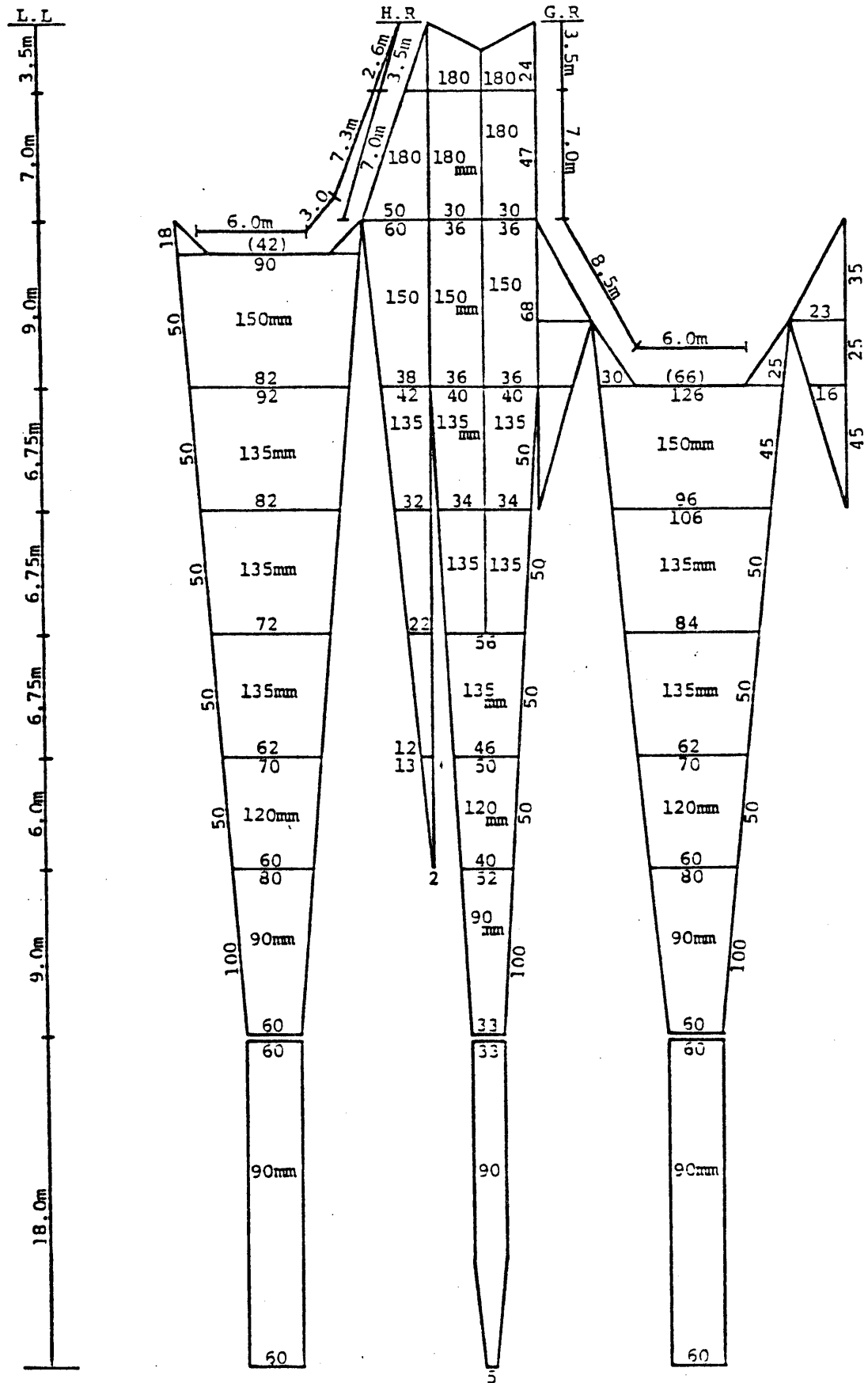
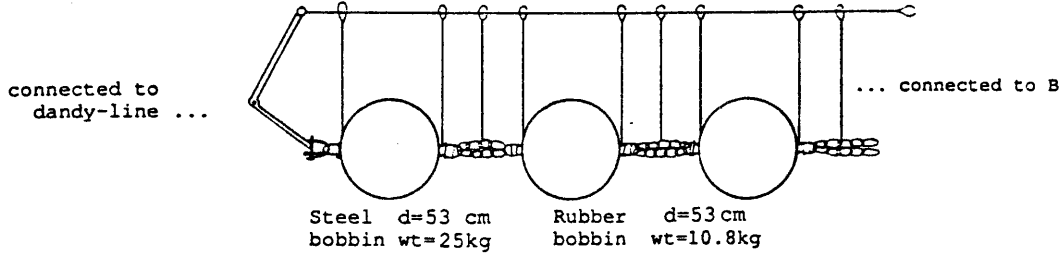
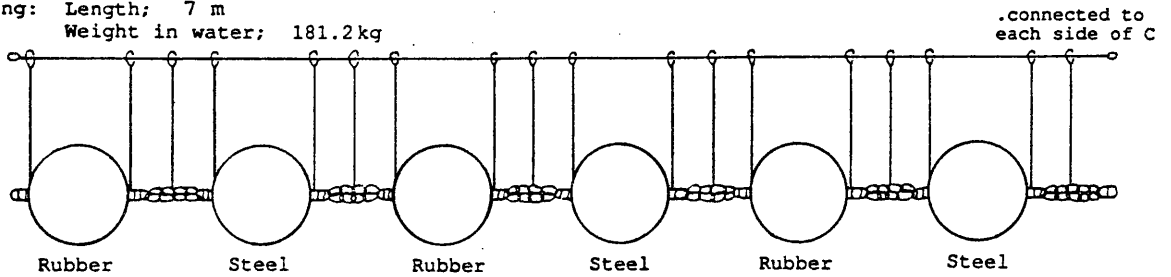

Figure 5. Schematic diagram of the 32/44 m trawl used by the Hatsue Maru No. 62 during the first half of the U.S.-Japan 1980 Aleutian Islands groundfish survey.

A Front wing: Length; 3.5 m
Weight in water; 125.4 kg



B Center wing: Length; 7 m
Weight in water; 181.2 kg



C Rear wing and Center: Length; 23 m

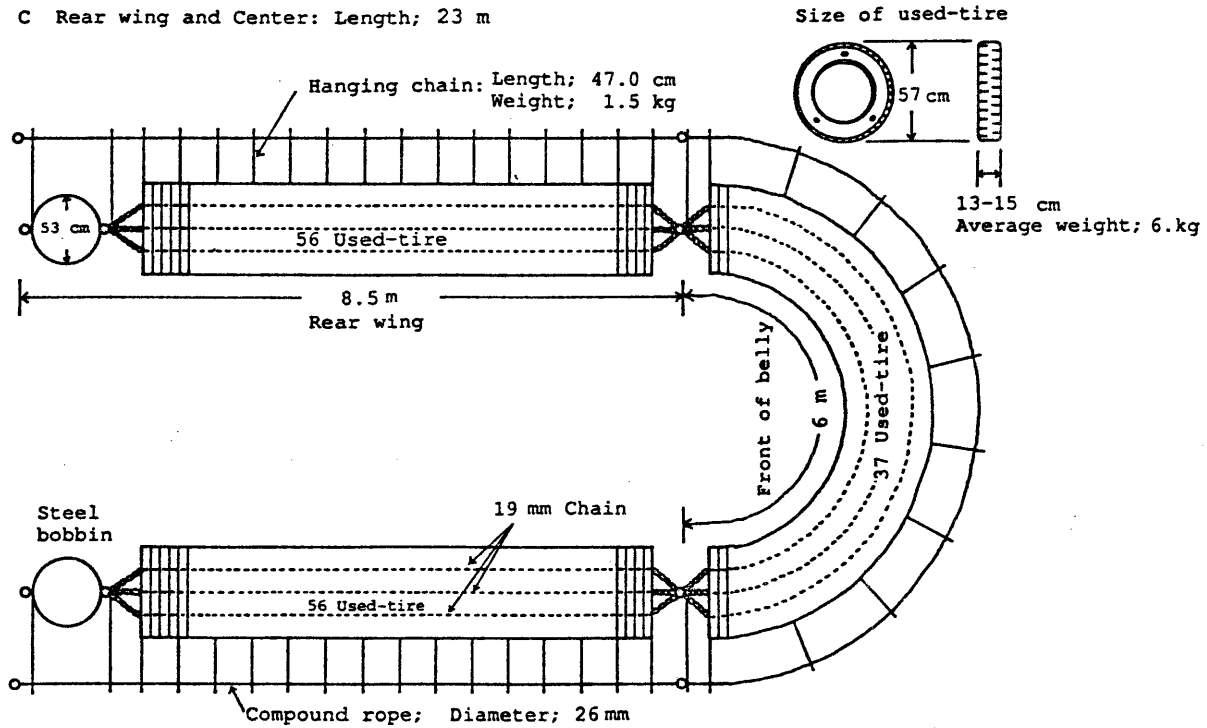

Figure 7. Schematic diagram of the footrope used by the Hatsue Maru No. 62 during the first half of the U.S.-Japan 1980 Aleutian Islands groundfish survey.

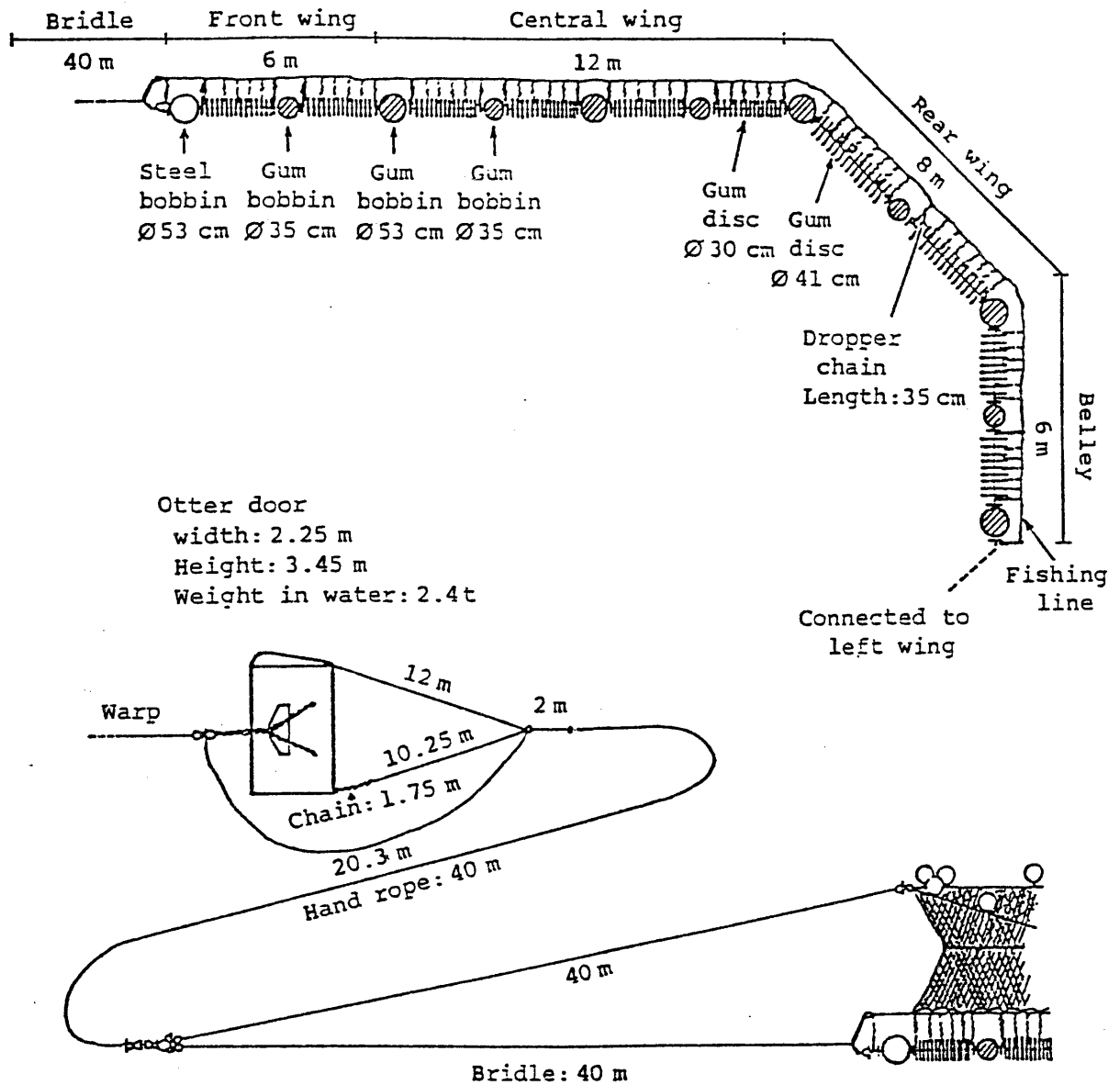

Figure 9. Schematic diagram of the roller gear and dandylines used by the Daito Maru No. 38 during the U.S.-Japan 1983 Aleutian Islands groundfish survey.

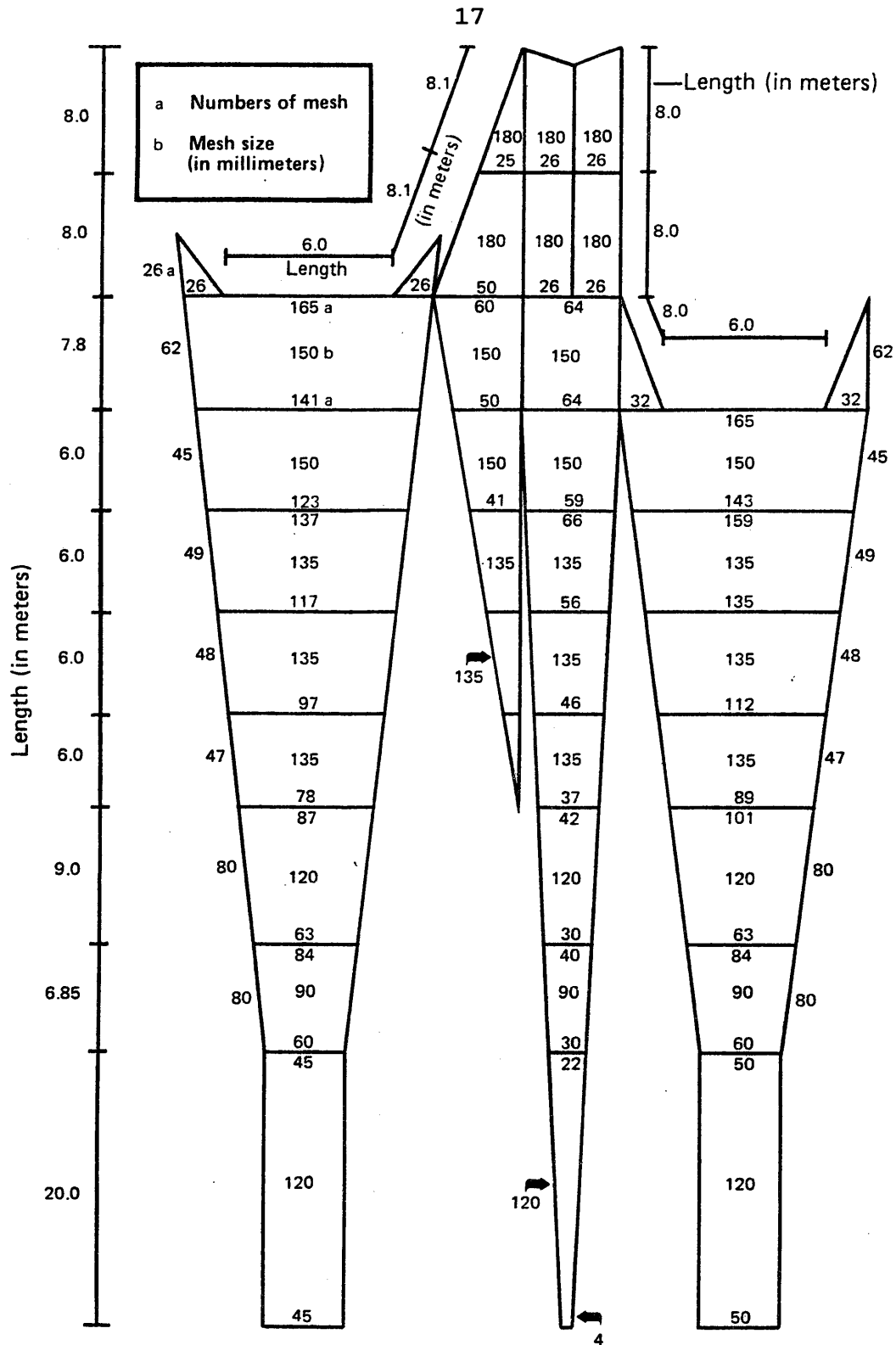

Figure 10. Schematic diagram of the 38/54 m trawl used by the Ginryu Maru No. 5 during the U.S.-Japan 1986 Aleutian Islands groundfish survey.

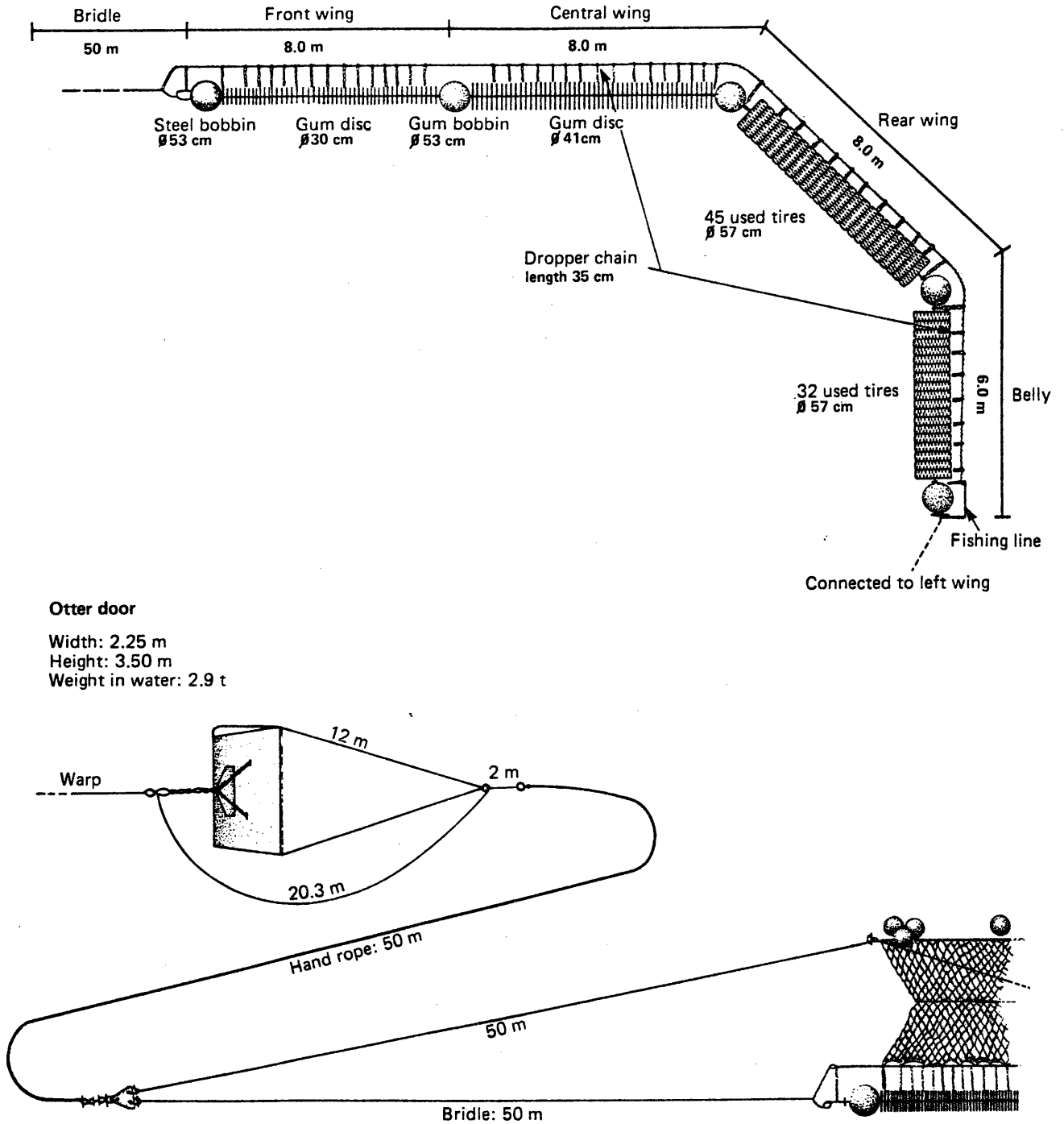

Figure 11. Schematic diagram of the roller gear and dandylines used by the Ginryu Maru No. 5 during the U.S.-Japan 1986 Aleutian Islands groundfish survey.

Table 5. Characteristics of demersal trawls used during the U.S.-Japan 1980, 1983, and 1986 Aleutian Islands groundfish surveys.

Trawl	Length		Mesh Size			Net opening	
	Head-rope (m)	Foot-rope (m)	Wing body (mm)	Inter-mediate (mm)	Cod-end (mm)	Hori-zontal (m)	Verti-cal (m)
Noreastern 1980	27.4	32.0	127	89	32	16.8	6.7
Noreastern 1983	27.4	32.0	127	89	32	18.0	5.2
Noreastern 1986	27.4	32.0	127	89	32	16.5	6.1
Japanese 1980	31.8	44.0	135-180	90,120	90 ^a	21.6	5.2
Japanese 1980	54.8	65.0	120-180	90,120	90	28.5	4.5
Japanese 1983	45.0	58.0	120-180	100,120	90	28.0	5.0
Japanese 1986	38.4	54.0	120-180	100,120	90	22.1	4.5

^a Codend was constructed of three layers of webbing.

Trawl Mouth Height and Width Measurements

The area swept technique was used to estimate the biomass of the groundfish resources. The area swept by a trawl was obtained by measuring the distance the net was towed using loran or radar readings, the net width, defined as the distance between the wing tips, and the trawl mouth height or vertical opening.

For the Japanese vessels, the trawl mouth height was measured using a net monitor transducer (Furuno FQ1) attached to the midportion of the head rope of the trawl during all three surveys. During the 1980 and 1983 surveys the wing spread (horizontal opening) was estimated using the methods developed by Koyama (1974) based on the relationship of the distance between the trawl cables measured at the trawling block and measured again approximately 1 meter aft. In 1986, direct measurements were obtained using a Furuno FQ1 transducer attached to one wing tip and entwining reflective material in the opposite wing tip as described by Wakabayashi and Teshima 1986.

Headrope height for the U.S. vessels was measured with a third wire net transducer system attached to the middle of the headrope in 1983 and by a Scanmar net mensuration system in 1986. Headrope height in 1980 and wing spread estimates for the 1980 and 1983 surveys were estimated from a small number of measurements obtained using a net monitoring system developed by the AFSC Resource Assessment and Conservation Engineering (RACE) Division, on vessels of similar size and horsepower. In 1986, direct measurements were obtained using a Scanmar net mensuration system.

Sampling Design and Rationale

The original objectives of this research program were to conduct a multispecies groundfish assessment survey and delineate commercial fish concentrations throughout the Aleutian Island region from 165° W long. to 170° E long., including Bowers Ridge. Operations were to be conducted in a dual mode; that is, the groundfish survey would proceed normally until a significantly large concentration of a commercially important species was encountered, then additional non-survey stations (reconnaissance sampling) would be conducted to delineate the geographic and bathymetric distribution and abundance of the species. When the aggregation had been adequately described, operations would return to the multispecies survey mode.

To assure a wide geographic and bathymetric distribution of the sampling effort, a stratified systematic sampling pattern was developed. The continental shelf and upper slope of the Aleutian Islands and southern Bering Sea except Bowers Ridge was divided into 30' wide longitudinal strips. Bowers Ridge was divided into 30 minute longitudinal strips where it runs east to west and 1° latitudinal strips where it runs north to south. Each strip was further divided into sampling units based on six depth intervals:

- 1) 1-100 m (1-54 fm)
- 2) 101-200 m (55-109 fm)
- 3) 201-300 m (110-164 fm)
- 4) 301-500 m (165-273 fm)
- 5) 501-700 m (274-382 fm)
- 6) 701-900 m (383-492 fm).

Because only a small number of stations were eventually completed in the two deepest depth intervals, and of the similarity of fauna, these were eventually combined into a single depth interval, 501-900 m, for the 1980 analysis and for future surveys.

One station was allocated to each sampling unit with additional sites added when sampling units were greater than 5 nautical miles (nmi) wide between depth boundaries following the criteria:

- 1) 5-10 nmi wide- 2 stations
- 2) 10-15 nmi wide- 3 stations
- 3) 15-20 nmi wide- 4 stations.

Once survey operations were underway, it became readily apparent that the time, manpower, and sampling resources were not adequate to allow completion of both the multispecies survey and the reconnaissance survey and the addition of extra stations. Therefore the priority was established to place major emphasis on completing the multispecies survey and to limit reconnaissance sampling.

For data analysis the survey area was initially divided into three major regions based upon the International North Pacific Fisheries Commission (INPFC) management areas, 1) the Aleutian Islands, 170° E - 170° W long. (part of Bering Sea INPFC area V), 2) the southern Bering Sea, 170°-165° W long. north of the Aleutian Islands (part of Bering Sea INPFC area III) and 3) the western Shumagin, 170°-165° W long. south of the Aleutian Islands (part of the Gulf of Alaska Shumagin INPFC area). Because of the extreme distance between the eastern and western survey boundaries the survey area was again divided into five major areas to better describe species distribution and abundance:

- 1) Southwest area 180-170°E long. south of the chain.
- 2) Northwest area 180-170°E long. north of the chain.
- 3) Southeast area 180-170°W long. south of the chain.
- 4) Northeast area 180-170°W long. north of the chain.
- 5) Bowers Ridge 176°E - 179°W long. north of 52°30'N lat.

Prior to the 1983 survey, an optimum sampling allocation analysis (Cochran 1977) was conducted to decide which distribution of the 1980 sampling effort would have provided the lowest variance of the biomass estimate for the following five major species: walleye pollock, Pacific cod, Atka mackerel, Pacific ocean perch, and giant grenadier (Albatrossia pectoralis). The analysis indicated that for an expected sampling effort of 300 stations, the precision of the biomass estimates could be improved from 13% to 39% by using the suggested distribution of the sampling effort; however, this distribution did not provide adequate protection against possible major shifts in the geographical distribution of these species. Therefore, the distribution of the sampling effort was adopted with the following modifications:

- 1) All areas were divided into sampling units 1° of longitude wide. Minimum sampling effort was set at one station per depth interval within each sampling unit.
- 2) The sampling effort for Bowers Ridge would remain approximately the same as during the 1980 survey.

The stations in excess of these minimum requirements were then allocated based on the results of the optimum allocation of effort sampling analysis.

Prior to the 1983 survey, it was also decided to restratify the survey area to allow a more detailed examination of the biomass distribution. With the exception of Bowers Ridge each major area was divided into subareas from 2-5° of longitude wide. The actual dimensions of each subarea were primarily based on dividing each major area into two or three subareas representing relatively equal bottom areas. These divisions resulted in 13 subareas which when overlaid by the 100-500 m and 900 m depth contours formed the survey strata.

- 1) Southwest area
 - Subarea 1 170-175°E long.
 - Subarea 2 175-178°E long.
 - Subarea 3 178°E long. - 180°
- 2) Northwest area
 - Subarea 1 172°-177°E long.
 - Subarea 2 177°E long. - 180°
- 3) Southeast area
 - Subarea 1 180°-177°W long.
 - Subarea 2 177°-174°W long.
 - Subarea 3 174°-170°W long.
- 4) Northeast area
 - Subarea 1 180°-177°W long.
 - Subarea 2 177°-174°W long.
 - Subarea 3 174°-170°W long.
- 5) Southern Bering Sea
 - Subarea 1 170°-168°W long.
 - Subarea 2 168°-165°W long.

For the 1986 survey the sampling units and stratification schemes remained unchanged from 1983. Development of the 1986 survey plan utilized data from both the 1980 and 1983 surveys. An optimum sampling allocation analysis was conducted on both data sets to again determine which distribution of the sampling effort would have resulted in the lowest variances of the biomass estimates for the dominant species for each survey. For the 1986 survey, 11 species were considered which included the same 5 species as in 1983 with the exception of giant grenadier, but also including sablefish, northern rockfish (Sebastes polyspinis), shortraker rockfish (Sebastes borealis) rougheye rockfish (Sebastes aleutianus), shortspine thornyhead (Sebastolobus alascanus), arrowtooth flounder, and Greenland turbot.

The allocation analyses based on the 1980 and 1983 data sets provided the optimum distribution of sampling effort between the six major areas. Within each major area, the sampling effort was then allocated equally between subareas with the following constraints:

- 1) The maximum sampling density for any station would be one station per 85.7 km² (25 nmi²).
- 2) The minimum sampling density for a strata would be two trawl stations.
- 3) Additional stations would be added to selected strata to equalize sampling densities so strata could be combined for analysis.
- 4) Strata that were initially allocated an odd number of sampling stations received an additional station so that the U.S. and Japanese sampling effort could be divided equally.

Station Sampling Procedures

The procedure for selecting sampling sites remained constant throughout all three surveys. No predetermined locations were sampled. The sampling units were bounded on the east and west by longitudes and the north and south by depth interval boundaries. The vessel's fishing master or captain had the option to place the station anywhere within these boundaries and usually searched near the center of the sampling unit-depth interval. Once a position had been selected, the bottom characteristics would be evaluated with an echo sounder recording changes in bottom topography and hardness. The echo sounding transect was approximately 3 miles long for the U.S. vessels during all the surveys and for the Japanese vessel in 1986 and approximately 5 miles long for the Japanese vessel during the 1980 and 1983 surveys. If the bottom appeared trawlable the vessel would reverse course and set the trawl. Fish presence or absence was never a criteria for deciding to sample or not, only the trawlability of the station. During the 1980 and 1983 surveys, the Japanese research vessel towed the trawl for 1 hour, and in 1986 for 30 minutes while the U.S. vessels attempted 30 minute tows throughout all surveys. The duration and distance of the tows were measured from the time the net reached bottom as indicated by a net sound unit until the retrieval of the trawl was started. The distance was determined by computer calculations of the differences in loran readings or measuring the difference in radar bearing when plotted on hydrographic charts (U.S. vessels) or measuring the distance on a flatbed plotter (Japanese vessels). If the selected site proved to be untrawlable or the probability of gear damage too high the vessel was allowed 30 minutes to find an alternate trawling site in close proximity to the original station. If no trawlable site was found, the station was abandoned and the vessel would transit to the next sampling site. Variations in the time trawled were caused by hang-ups or sudden discovery of changes in the bottom topography to hard-rough conditions after the tow was started. All vessels attempted to follow a uniform depth contour once a station was started, but again sudden changes in the bathymetry caused occasional large changes in depth during a tow. No special attempts were made to sample previously successful stations in subsequent surveys. All sampling was conducted during daylight hours to eliminate possible biases caused by diurnal changes in the depth distribution of any of the species. Towing speed varied by vessel and was much faster for the Japanese vessels (Table 6).

Table 6. Mean towing speeds of research vessels participating in the U.S.-Japan 1980, 1983, and 1986 Aleutian Islands groundfish surveys.

Vessel Name	Nautical miles/hour
<u>Half Moon Bay</u>	2.3
<u>Ocean Harvester</u>	2.7
<u>Miller Freeman</u>	2.9
<u>Chapman</u>	2.9
<u>Lets Go</u>	3.0
<u>Hatsue Maru No. 62</u>	3.4
<u>Daito Maru No. 38</u>	3.3
<u>Ginryu Maru No. 5</u>	4.0

Catch and Biological Data Collection Procedures

Data collection procedures were quite similar on vessels of both nations. On the Japanese vessel, all catch sorting, splitting, weighing, and measuring was accomplished in the fish processing facilities below the main deck. Catches of less than approximately 1,500 kg were completely sorted by species while larger catches were extrapolated volumetrically; that is, the volume of the total catch was measured in holding bins, then approximately 1,500 kg was removed from the bins by the factory conveyor belts and sorted by species directly into plastic baskets. Hanging scales were used to weigh the baskets. Commercially important species of fish in the sorted portion of the catch were sexed and measured to obtain length frequency data and counts. Selected baskets of each species (not measured) were weighed and counted to determine a ratio for estimating the total number of individuals in the sorted part the catch. Total catch weight and numbers were extrapolated using a ratio of the volume of the total catch to volume of the sorted portion.

On the U.S. vessel, all catch sorting, splitting, weighing, and measuring was done on the main fishing deck. Catches less than 1,150 kg were completely sorted while larger catches were extrapolated volumetrically; that is, the volume of the total catch was measured in the deck bin. Approximately 1,150 kg was then lifted out of the bin and dumped onto a sorting table using a splitting net as described by Hughes (1976). Each major species was sorted into several baskets simultaneously and set aside in a group and a second set of baskets filled and set aside. This procedure was followed until every species was entirely sorted. Then all baskets were weighed on platform scales and one basket of each species was randomly selected. Length frequency measurements were made for all commercially important species and all other selected baskets were weighed and counted. The ratio between the number of individuals and the

weight of the subsample basket was used to estimate the number of each species in the sorted portion of the catch. Total catch weight and numbers were extrapolated using a ratio of the volumes of the total catch to the sorted portion.

One hundred percent of all prohibited species were counted and returned to the water as soon as possible. Pacific halibut were counted and measured but not weighed or sexed. On the Japanese vessel they were usually removed as the catch was dumped into the holding bin. All Pacific salmon, king crab and tanner crab were weighed, sexed, and measured.

Length Frequency Measurements

Length frequency measurements were taken for all commercially important species. The total length (TL) of fish was measured, from the tip of the snout to the end of the center of the caudal fin, except for grenadiers which were measured from the tip of the snout to the anus. Red squid (Berryteuthis magister) were measured from the forward edge of the mantle to the end of the center of mantle. Crabs were measured to the nearest millimeter using stainless steel calipers. Carapace lengths (CL) were recorded for king crabs, and carapace widths (CW) for snow crabs (chionoecetes spp.).

On Japanese vessels, all commercially important species from the sorted catch were measured. Each fish was placed on a measuring board equipped with a waterproof paper length frequency strip marked in .5 cm increments. The measurement was completed by punching a hole into the paper strip at the end of the caudal fin. The total number of holes in each .5 cm increment was recorded as the length frequency for the sample. The 10 cm line of the paper strips was aligned 9.5 cm from the left end of the measuring board. This had the effect of rounding all measurements up to the nearest .5 cm interval; that is, a 49.6 cm measurement would be recorded as 50 cm, and a 50.4 would be recorded as 50.5 cm.

On U.S. vessels, length frequency measurements were taken from random basket subsamples taken when the catch was sorted. Each fish was placed on a measuring board, fitted with a plastic reusable strip marked in 1 cm increments. A pencil mark was made on the plastic strip at the end of the caudal fin. The total number of pencil marks in each centimeter increment was recorded as the length frequency. The 10 cm line of the plastic strips was aligned at 9.5 cm on the board. This had the effect of rounding all measurements to the nearest whole centimeter.

Age Structure Collection

Otoliths were taken from randomly selected samples of most commercially important fish during all 3 years. In 1980 and 1983, otoliths were only collected from hauls with fairly large catches of the desired species. This strategy resulted in more otoliths than could be processed, so the 1986 collections were allocated to each of the vessels and distributed throughout the entire survey area (Table 7).

Table 7. Age structure collection allocation scheme used during the U.S.-Japan 1986 Aleutian Islands groundfish survey.

Species	Number of Otoliths			
	U.S.		Japan	
	Aleutian Islands	Southern Bering Sea	Aleutian Islands	Southern Bering Sea
Walleye pollock	1120	280	1120	280
Pacific ocean perch	1120	210	1120	210
Sablefish	1120	210	1120	210
Atka mackerel	1120	210	1120	210
Shortraker rockfish	560	140	560	140
Rougheye rockfish	560	140	560	140
Northern rockfish	560	140	560	140
Shortspine thornyhead	560	140	560	140
Rock sole	560	140	560	140
Arrowtooth flounder	560	140	560	140
Greenland turbot	280	140	280	140

During the 1980 and 1983 surveys, only one otolith was taken from each specimen. Otoliths at each station were usually placed in vials by species sex cm-length categories. That is, for each station, all otoliths of each sex of each species of each length category were stored in one vile. However, composite otolith collections were made aboard the Hatsue Maru No. 62 and the Ocean Harvester for certain species. For these collections, all specimens of a single sex size-length interval were combined for all sampling stations within a subarea into a single otolith vial. In 1986 both otoliths were taken from each specimen and stored in a single vile.

During all three surveys, rockfish and roundfish otoliths were cleaned and stored in 50% ethyl-alcohol. Flatfish otoliths were cleaned and stored dry during the 1980 and 1983 surveys. During the 1986 survey, flatfish otoliths were stored in a solution of 50% glycerine and 50% water with the addition of

0.8 g of thymol, dissolved in a minimum of ethanol, per liter of solutions to retard growth of undesirable organisms.

Length-weight measurements were taken for most commercially important species during all three surveys. Lengths were measured to the nearest centimeter. For species weighing less than 2,600 g, individuals were weighed on magnetically dampened triple-beam platform scales to the nearest whole gram or 10 grams depending on the sea conditions and vessel stability. Larger species were weighed on hand-held hanging scales of the appropriate weight capacity. Each capacity scale had different weight calibration intervals; therefore, weights were usually recorded to the nearest 25, 50, or 100 grams. Under good weather and sea conditions, extrapolations could be made to one-half the calibrated interval. All specimens were weighed without removal of stomach contents, which for the larger species in particular added variability.

Relative Fishing Power Comparisons

Each year, during these groundfish resource assessment surveys, an attempt was made to determine the relative fishing power of one of the U.S. vessels compared to a Japanese vessel so that data from both vessels could be combined for analysis. For each comparison, catches were selected based on the original 30 minutes of longitude sampling units used to establish the sampling design of the 1980 survey. Only paired stations completed in the same sampling unit by each vessel/gear combination, or in most instances, adjoining sampling units were selected for these analysis. If an unequal number of stations were available for each vessel/gear combination, paired observations were selected based on the similarity of sampling depths.

A fishing power coefficient was calculated for each selected species as the ratio of the mean catch per unit of effort (CPUE) obtained from each vessel/gear combination.

Survey Precision

Throughout these analyses the measure of precision of the biomass estimates has been the confidence interval expressed as a percent of the biomass estimate (This measure of precision will be referred to as the confidence interval). Since the fish species being dealt with in this report are not randomly distributed, and the most abundant and important species are in fact very gregarious, the variance is proportional to the mean biomass estimates and the resulting confidence intervals are very large, reflecting a low degree of precision in the biomass estimates. The confidence intervals of the most abundant species in the survey area were examined to determine if the changes in

the sampling patterns had in reality increased the precision of the biomass estimates as intended.

Environmental Data

During all trawling operations, echo sounding traces of the bottom topography were recorded and used to determine mean trawling depths. Surface water temperatures were taken from pilothouse readouts of engine intake water or with thermometers and surface water samples obtained with buckets. Surface to bottom water temperatures profiles were taken with expendable bathythermographs (XBTs).

Data Management

Data collected during the 1980, 1983, and 1986, groundfish resource assessment surveys of the Aleutian Islands were maintained in four separate files:

- 1) Haul - station-specific data such as date, time, latitude, longitude, depth, sampling gear, temperature, and gear performance.
- 2) Position - file type containing more details on position (e.g., latitude and longitude at the start and end of net tows).
- 3) Catch - species code, weight, and number.
- 4) Length-frequency - species code, sex, length, and frequency.
- 5) Specimen - species code, sex, age-length, length-weight, reproductive condition, age structures, and stomach contents.

Data was usually recorded on preprinted forms and logged on magnetic tape or computer disk at sea; however, all data from the Hatsue Maru No. 62 and all specimen data forms were data logged at the AFSC after the cruise was completed.

After the data files were entered into the database at the AFSC they were scrutinized for errors utilizing diagnostic programs. All suspected errors were checked against original data sheets and corrected. Following correction of the data bases, copies were sent to the Groundfish group, Fishery Agency of Japan, Far Seas Fisheries Research Laboratory, Shimizu, Japan.

Species Groupings

During these surveys, scientists from both nations sometimes encountered unfamiliar species which could not be identified to species, or more familiar species which occurred together with an extremely similar species in high abundance. Therefore, for the

data analysis, certain faunal elements were combined at genus, family, or higher taxonomic levels (Table 8).

Table 8. Species groupings used for analysis of the U.S.-Japan 1980, 1983, and 1986 Aleutian Islands groundfish surveys.

Group Name	Species included	Year		
		1980	1983	1986
Skates	All Rajidae	X	X	X
<u>Coryphaenoides</u> sp.	All <u>Coryphaenoides</u>	X		
<u>Triglops</u> sp.	All <u>Triglops</u>	X		
Irish lords	All <u>Hemilepidotus</u>	X		
<u>Malacocottus</u> sp.	All <u>Malacocottus</u>	X	X	X
<u>Myoxocephalus</u> sp.	All <u>Myoxocephalus</u>	X	X	X
Arrowtooth flounder	All <u>Atheresthes</u>	X	X	X
Squids	All Squids	X		
Octopuses	All Octopuses	X	X	X

Data Analysis Procedures

Relative Fishing Power Comparisons

Since direct side-by-side trawling was not feasible, it was necessary to develop an alternative method of estimating relative fishing power differences between the U.S. and Japanese vessel/gear combinations. It was decided that the U.S. and Japanese vessels would sample alternate sampling units in the same time period so that catch rates at adjacent stations could be compared. Although this plan was attempted the actual number of paired stations which were completed in the same relative time and place was small because vessel communications were inadequate for close coordination and the vessels did not operate together for the entire survey. Catch rates at paired stations in the same or adjacent sampling units conducted within a 1 month period were compared. In 1980, only 36 paired observations were available because the U.S. vessel did not have time to fish the entire area. In 1983, vessel communications and simultaneous schedules improved and although the time available to the U.S. vessels decreased the number of comparable stations increased to 42. In 1986, they increased to 59.

Data analysis to determine relative fishing power coefficients (RFPC) by species included calculation of the ratio of the mean CPUE of the U.S. vessel-trawl combination and the Japanese vessel-trawl combination in catch per unit area,

(kg/hectare (Distance towed (km) x trawl width (km) x .01)) for each species where

$$\text{RFPC} = \frac{\text{Mean CPUE (U.S.)kg/hectares}}{\text{Mean CPUE (Japan)kg/hectares}}$$

Mean Catch Per Unit Effort and Biomass

Before any computations were conducted, several adjustments to the haul and catch files were made. The catch files for the Japanese trawl were divided by the ratio of the U.S. trawl width for a survey by the mean trawl width of the Japanese trawl of the same survey to standardize these data to one trawl width, a requirement of the computer program. In 1986, when trawl width by depth data were available for the Japanese trawl, the data were adjusted to reflect these differences. This adjustment was accomplished by selecting the shallowest depth interval trawl width as the standard and dividing the distance fished in the other depth intervals by the ratio of the trawl widths in each depth interval by the trawl width in the shallowest standard depth interval.

Biomass estimates were computed based on the most efficient trawl during each survey. Therefore, when the U.S. trawl was the most efficient at capturing a species, the Japanese catch data was multiplied by the appropriate RFPC coefficient. When the Japanese trawl was the most efficient the U.S. catches were divided by the ratio of the U.S. catches divided by the Japanese trawl catches.

For all analyses the vulnerability, or the portion of individuals in front of the trawl which were caught, was unknown and was therefore assumed to be equal to 1.0.

Mean CPUE was obtained by standardizing all catches to kilograms/square kilometer (kg/km^2), and then summing the catches and dividing by the number of stations (Wakabayashi et al. 1985). Variances of the means were also calculated.

Biomass estimates and their variances and confidence intervals were calculated using the methods developed by Alverson and Pereyra (1969). Biomass was calculated by strata, as defined in the survey design and rationale section of this paper for 1983, and the subarea or area totals were obtained by addition of the strata totals (Wakabayashi et al. 1985). The population numbers were calculated in a similar manner.

Length Frequencies and Population Size Composition

For this analysis the Japanese length frequency data were converted to the U.S. data format of 1 cm intervals by subtracting 1 mm from each length and rounding to the nearest centimeter. A relative length frequency distribution was calculated for each stratum by weighting each length frequency sample by the ratio of the station CPUE (numbers/ha) representing the sample to the sum of all the CPUEs within the stratum and

then summing the weighted frequencies for each length interval. A population size composition was constructed for each stratum by multiplying the total strata population estimate by the ratio of the relative number of frequencies in a size-sex category to the total number of relative frequencies. Subarea and area totals were obtained by addition of strata size-sex interval totals.

Age Composition

All age interpretations were accomplished by trained specialists at the Age and Growth Unit of the AFSC or by scientists at the Far Seas Fisheries Research Laboratory. These age interpretations are based upon the assumption that annuli are formed on otoliths or scales and they represent annual marks (Wakayabashi et al. 1985). For all species except Atka mackerel, the age was determined by the actual count of the annuli. For Atka mackerel, which is a late summer-fall spawner, it was determined that an annuli was not formed the first winter; therefore, 1 year was added to the age obtained by the age readers. Otoliths were used for ageing all species except Pacific cod for which scales were read.

Age data were combined by subarea or area depending upon how the data were collected to form age-length keys. Age composition was calculated by proportioning the size composition to age groups based upon the percentage of each age group in that size-sex category with the age-length key.

Growth Characteristics

Growth characteristics of the principle species were estimated by fitting the mean length-at-age data to the von Bertalanffy growth curve using a nonlinear least-squares technique (von Bertalanffy 1938).

Length-Weight

Relationships of the weight at length of the principle species were calculated using a regression analysis and curve fit of the length-weight data. A linear least square was calculated on the log-transformed data.

RESULTS

Sampling Effort

The total number of attempted stations decreased from 435 in 1980 to 425 in 1983 but increased to 499 in 1986 (Table 9, Figs. 12 and 13). Of the 435 stations attempted in 1980, 31 were unsuccessful, 64 were for special sampling, 48 were placed in the Shumagin INPFC area, (sampled only during 1980), and 45 were from an area adjacent to Adak Island which was not sampled during the 1986 survey leaving 247 1980 stations for data comparison. During 1983, 18 of the 425 attempted stations were unsuccessful, 30 were used for special sampling and 58 were conducted in the area not sampled during 1986 leaving 319 valid stations for comparison with other years. In 1986, 438 of the 499 attempted stations were used for comparison with 18 being unsuccessful and 34 being used for special sampling. The amount of total effort available for the comparison analysis increased from 57% in 1980 to 75% in 1983 and 88% in 1986. The Japanese research vessels completed 66-78% of the total sampling effort during the three survey years.

Table 9. Summary of sampling effort expended during the U.S.-Japan 1980, 1983, and 1986 Aleutian Islands groundfish surveys.

Stations	Years		
	1980	1983	1986
Attempted	435	425	499
Unsuccessful	31	18	18
Special sampling	64	30	34
West Shumagin	48	0	0
Adak military zone ^a	45	58	9
Used for comparison	247	319	438

^a 176°30'W - 178°30'W (four special sampling stations were also in the Adak military zone)

The total number of comparative sampling stations in the Aleutian Islands region increased from 211 in 1980 to 278 in 1983, and 367 in 1986 (Table 10). During all three surveys, the Japanese research vessels provided the majority of the sampling effort. In 1980, 62% of the stations were completed by the Hatsue Maru No. 62. The Daito Maru No. 38 completed 73% of the stations in 1983, and the Ginryu Maru No. 5 75% in 1986. Most of the deep water sampling, (>300 m) was completed by the Japanese research vessels, while the U.S. research vessels worked

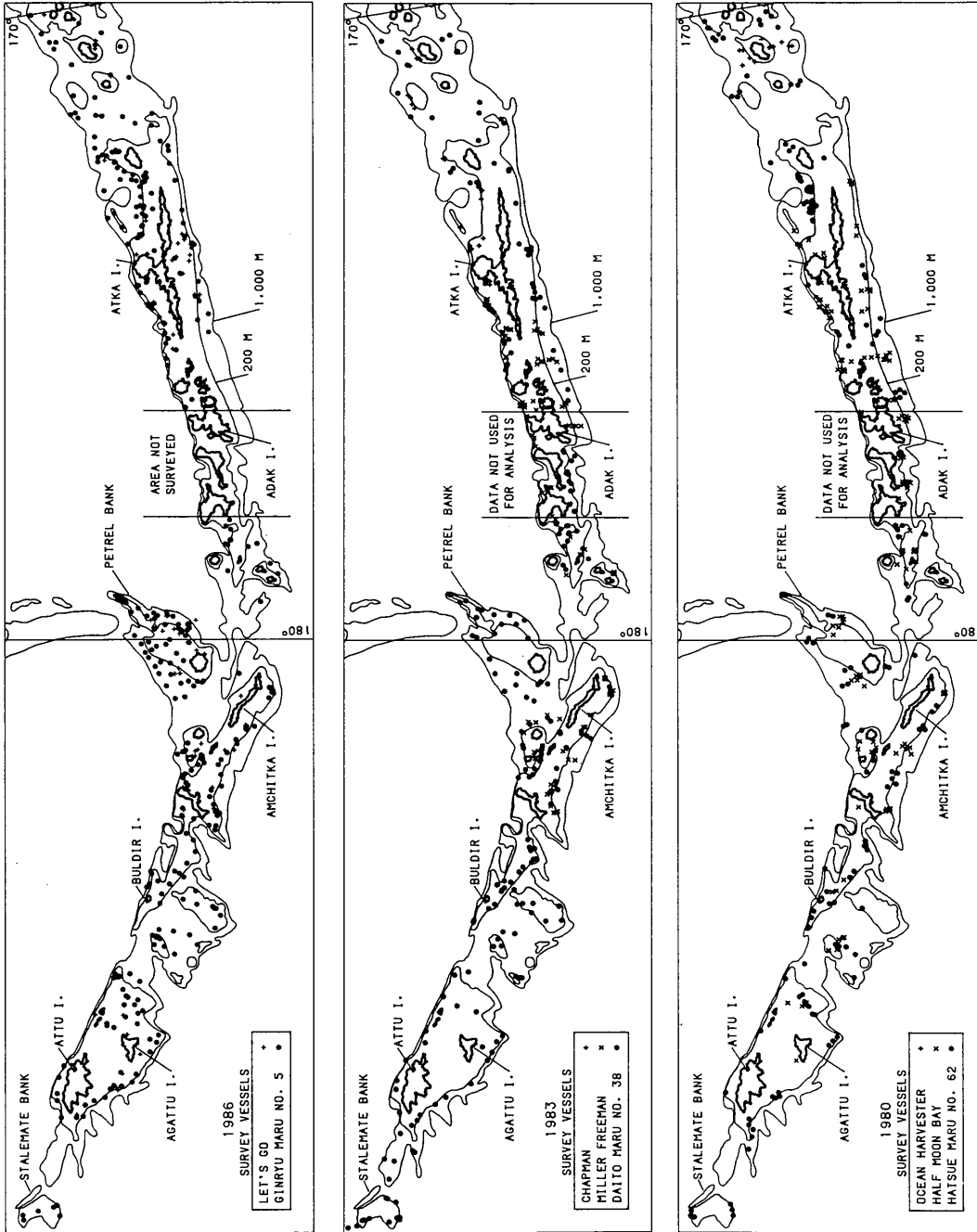

Figure 12. Survey stations used for data analysis in the Aleutian Islands areas of the U.S.-Japan 1980, 1983, and 1986 groundfish surveys.

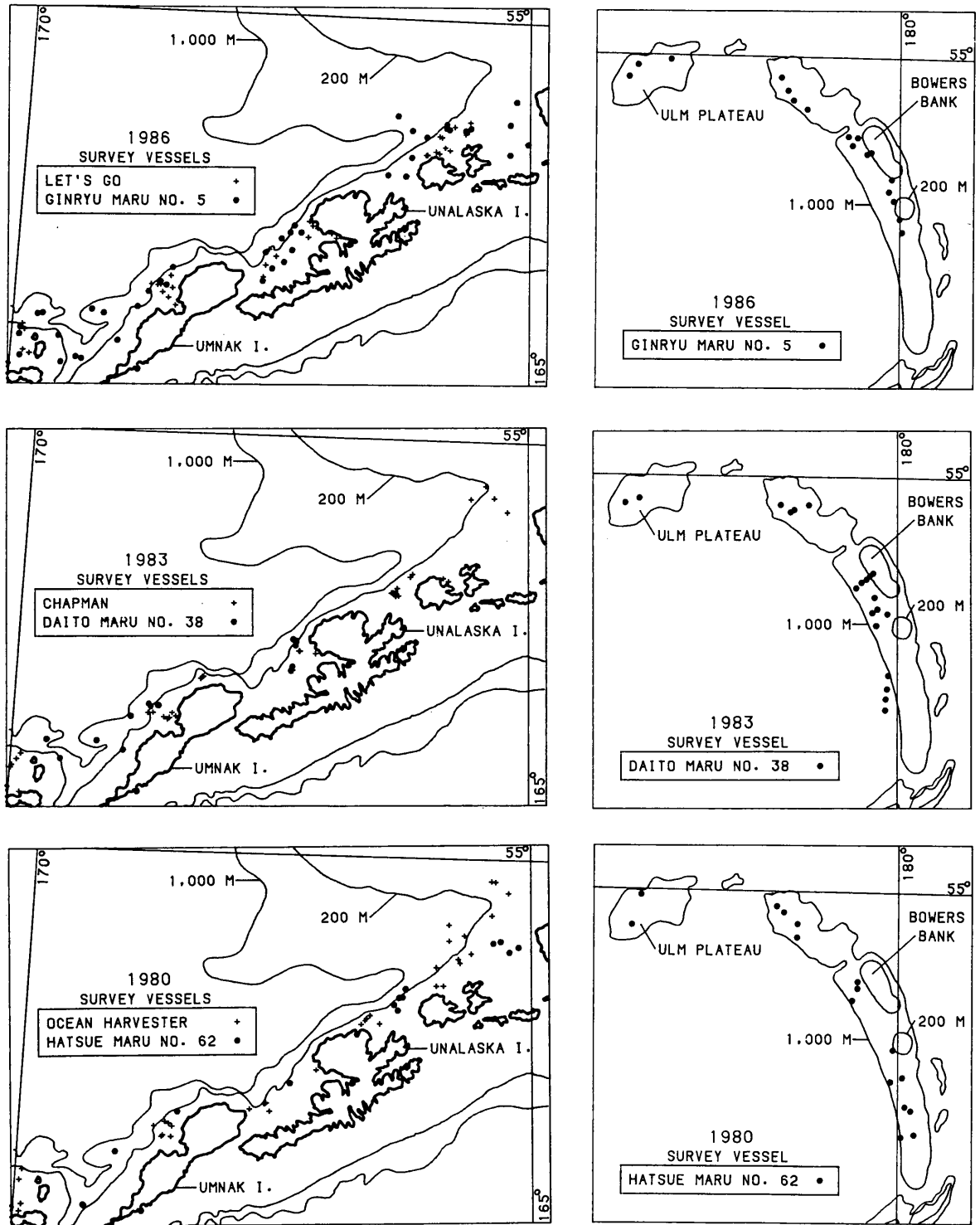

Figure 13. Survey stations used for data analysis in the Southern Bering Sea and Bowers Ridge areas of the U.S.-Japan 1980, 1983, and 1986 Aleutian Islands groundfish surveys.

primarily in shallower waters. Japanese vessels completed 100% of the stations in Bowers Ridge during all three surveys. In 1980 the U.S. vessels conducted sampling operations in all but the 500-900 m depth interval, but in 1983 and 1986 most U.S. sampling occurred at depths shallower than 300 m.

Table 10. Number of stations successfully completed in the Aleutian Islands areas during the U.S.-Japan 1980, 1983, and 1986 groundfish surveys.

Area	Depth (m)	1980			1983			1986		
		U.S.	Japan	Total	U.S.	Japan	Total	U.S.	Japan	Total
Southwest	1-100	1	0	1	0	4	4	3	5	8
	101-200	11	12	23	8	29	37	15	44	59
	201-300	5	19	24	7	18	25	3	15	18
	301-500	8	14	22	4	11	15	2	13	15
	501-900	0	6	6	3	15	18	0	7	7
	1-900	25	51	76	22	77	99	23	84	107
Southeast	1-100	0	0	0	0	1	1	4	1	5
	101-200	8	6	14	4	9	13	10	13	23
	201-300	5	3	8	5	9	14	3	10	13
	301-500	3	3	6	0	5	7	2	8	10
	501-900	0	3	3	2	5	5	0	4	4
	1-900	16	15	31	11	29	40	19	36	55
Northwest	1-100	1	0	1	1	4	5	7	6	13
	101-200	4	1	5	2	10	12	9	15	24
	201-300	2	6	8	2	9	11	3	14	17
	300-500	5	4	9	1	4	5	2	8	10
	501-900	0	8	8	3	12	15	0	8	8
	1-900	12	19	31	9	39	48	21	51	72
Northeast	1-100	2	1	3	1	1	2	5	1	6
	101-200	10	8	18	19	10	29	14	30	44
	201-300	8	9	17	10	7	17	6	21	27
	301-500	6	6	12	1	6	7	4	16	20
	501-900	1	6	7	1	15	16	0	19	19
	1-900	27	30	57	32	39	71	29	87	116
Bowers Ridge	101-200	0	0	0	0	2	2	0	1	1
	201-300	0	1	1	0	2	2	0	3	3
	301-500	0	2	2	0	5	5	0	4	4
	501-900	0	13	13	0	11	11	0	9	9
	1-900	0	16	16	0	20	20	0	17	17
Aleutian Islands	1-100	4	1	5	2	10	12	19	13	32
	101-200	33	27	60	33	60	93	48	103	151
	201-300	20	38	58	24	45	69	15	63	78
	301-500	22	29	51	8	31	39	10	49	59
	501-900	1	36	37	7	58	65	0	47	47
Total	1-900	80	131	211	74	204	278	92	275	367

In 1980 and 1983, the effort was more concentrated in the western area of the Aleutian Islands, but in 1986 the sampling effort was more evenly distributed throughout the entire Aleutians Island region (Table 11). During 1980, 24-28% of the effort from each area was distributed in the intermediate depth intervals with the shallowest depth interval accounting for only 2% of the effort. In 1983, the percentage of the sampling effort increased in the two shallowest and the deepest depth interval and in 1986 the percentage increased again in the two shallowest depth intervals.

Table 11. Distribution of sampling effort and sampling density in the Aleutian Islands areas during the U.S.-Japan 1980, 1983, and 1986 groundfish surveys.

Area	Depth (m)	Percent			Stations per 1,000 km ²		
		1980	1983	1986	1980	1983	1986
Southwest	1-100	1.3	4.0	7.3	0.2	0.9	1.8
	101-200	30.3	37.4	56.0	3.5	5.6	9.0
	201-300	31.6	25.3	16.5	10.4	10.9	7.9
	301-500	29.0	15.2	13.8	6.5	4.4	4.4
	501-900	7.9	18.2	6.4	0.9	2.6	1.0
	1-900	100.1	100.1	100.0	3.2	4.2	4.5
Southeast	1-100	3.1	2.5	10.7	0.3	0.3	1.7
	101-200	43.8	32.5	41.1	4.3	4.0	7.0
	201-300	25.0	35.0	23.2	2.5	4.4	4.1
	301-500	18.8	17.5	17.9	2.5	2.9	4.2
	501-900	9.4	12.5	7.1	1.1	1.8	1.4
	1-900	100.1	100.0	100.0	2.0	2.6	3.6
Northwest	1-100	3.2	10.4	18.1	0.4	2.1	5.5
	101-200	16.1	25.0	33.3	1.9	4.6	9.2
	201-300	25.8	22.9	23.6	7.5	10.3	15.9
	300-500	29.0	10.4	13.9	4.1	2.3	4.5
	501-900	25.8	31.3	11.1	1.4	2.6	1.4
	1-900	99.9	100.0	100.0	2.2	3.4	5.1
Northeast	1-100	5.3	2.8	5.2	1.4	0.9	2.7
	101-200	31.6	40.9	37.9	4.6	7.4	11.2
	201-300	29.8	23.9	23.3	6.9	6.9	11.1
	301-500	21.1	9.9	17.2	3.5	2.0	5.8
	501-900	12.3	22.5	16.4	1.1	2.6	3.1
	1-900	100.1	100.0	100.0	3.1	3.9	6.4
Bowers Ridge	101-200	0.0	10.0	5.9	0.0	6.4	3.2
	201-300	6.3	10.0	17.7	0.8	1.6	2.5
	301-500	12.5	25.0	23.5	1.2	3.1	2.5
	501-900	81.3	55.0	52.9	1.8	1.5	1.3
		1-900	100.1	100.0	100.0	1.6	2.0
Aleutian Islands	1-100	2.4	4.3	8.7	0.4	1.0	2.7
	101-200	28.4	33.5	41.1	3.7	4.1	9.1
Total	201-300	27.5	24.8	21.3	5.7	6.8	7.6
	301-500	24.2	14.0	16.1	3.8	2.8	4.3
	501-900	17.5	23.4	12.8	1.3	2.2	1.6
	1-900	100.0	100.0	100.0	2.6	3.4	4.5

Sampling density in the Aleutian Islands varied from 0.4 station per 1,000 km² in the 1-100 m depth interval in 1980 to 9.1 stations per 1,000 km² in the 101-200 m depth interval in 1986. Overall sampling density for all depths combined increased from 2.6 stations per 1,000 km² in 1980 to 4.5 stations per 1,000 km² in 1986. This improvement occurred in all but the deepest depth interval, but the greatest improvement occurred in the 1-100 m depth interval.

In the Southern Bering Sea the number of stations completed doubled from 1980 to 1986 with the U.S. research vessels accounting for 61% of the total sampling during both the 1980 and 1983 surveys (Table 12).

Table 12. Number of stations successfully completed in the Southern Bering Sea area during the U.S.-Japan 1980, 1983, and 1986 Aleutian Islands groundfish surveys.

Depth (m)	1980			1983			1986		
	U.S.	Japan	Total	U.S.	Japan	Total	U.S.	Japan	Total
1-100	8	3	11	11	2	13	21	10	31
101-200	7	5	12	10	4	14	10	13	23
201-300	3	2	5	4	4	8	3	5	8
301-500	3	2	5	0	3	3	0	4	4
501-900	1	2	3	0	3	3	0	5	5
Total	22	14	36	25	16	41	34	37	71

During 1986, however, they completed 48% of the sampling. As in the Aleutian Islands region, the U.S. vessels completed more shallow stations while the Japanese research vessels completed more of the deeper stations, particularly during 1983 and 1986. By percentage, the distribution of the sampling effort increased in the shallowest depth interval and decreased in all others between 1980 and 1986. The overall sampling density for the Southern Bering Sea increased from 2.8 stations per 1,000 Km² in 1980 to 5.7 stations per 1,000 km² in 1986 (Table 13).

Table 13. Distribution of sampling effort and sampling density in the Southern Bering Sea area during the U.S.-Japan 1980, 1983, and 1986 Aleutian Islands groundfish surveys.

Depth (m)	Percent			Sampling density		
	1980	1983	1986	1980	1983	1986
1-100	30.6	31.7	43.1	2.3	2.7	6.5
101-200	33.3	34.2	31.9	3.7	4.3	7.0
201-300	13.9	19.5	11.1	5.0	8.0	8.0
301-500	13.9	7.3	6.9	3.9	2.4	3.1
501-900	8.3	7.3	6.9	1.3	1.3	2.2
All Depths	100.0	100.0	100.0	2.8	3.2	5.7

Survey Precision

The change in the sampling design for the 1983 survey was based primarily on the 1980 distribution of five of the most dominant species. In 1983, the confidence intervals of the biomass estimates for four of the species improved: moderately for three species, walleye pollock (26%) giant grenadier (26%) and Pacific cod (13%); substantially for Atka mackerel (47%); and declined slightly for Pacific ocean perch (6%) (Table 14).

Table 14. Confidence intervals expressed as a percent of the mean biomass estimate for important species encountered during the U.S.-Japan 1980, 1983, and 1986 Aleutian Islands groundfish surveys.

Species	Aleutian Islands			Southern Bering Sea		
	1980	1983	1986	1980	1983	1986
Walleye pollock	67	41	42	124	128	71
Pacific cod	56	43	49	65	54	59
Atka mackerel	104	57	276	268	156	174
Pacific ocean perch	47	53	38	329	183	106
Giant grenadier	57	31	52	943	152	792
Northern rockfish	266	70	64	129	109	181
Sablefish	64	107	54	741	96	81
Arrowtooth flounder	28	28	75	214	34	169
Greenland turbot	42	45	26	22	622	342
Shortraker rockfish	41	140	39	105	308	188
Rougheye rockfish	163	66	121	8	375	713
Shortspine thornyhead	65	17	23	101	37	60

For the other seven species which occur at lower abundance, three species, northern rockfish, shortspine thornyhead, and rougheye rockfish improved while arrowtooth flounder and Greenland turbot remained relatively unchanged and sablefish and shortraker rockfish declined in precision. A closer examination of the sablefish data showed that over 63% of the total variability could be attributed to the Northeast area's, 201-300 m depth interval, which also contained 46% of the total biomass estimate for the Aleutian Islands region. For shortraker rockfish the Southwest area's 301-500 m depth interval contributed 52% to the total variance and 19% to the total biomass. If the high variation of these two area-depth intervals are discounted, the new sampling design and the increased sampling effort showed excellent overall improvement in the confidence intervals for most of the important species during the 1983 survey.

During the 1986 survey, the new sampling design did not improve the precision of the biomass estimates as much as in 1983. Of the 11 species included in the sampling allocation analysis, the confidence interval of four species, northern

rockfish, walleye pollock, shortspine thornyhead, and Pacific cod remained relatively unchanged. Four species, shortraker rockfish (101%), sablefish (53%), Greenland turbot (19%), and Pacific ocean perch (15%) improved, while three species, Atka mackerel, roughey rockfish, and arrowtooth flounder had larger confidence intervals. The large improvements in sablefish and shortraker rockfish estimates are attributable to the fact that in 1986 these species had a more even distribution than in 1983 which resulted in a lower variance associated with the biomass estimates.

For three of the four species with improved confidence intervals, the same situation was apparent as occurred in the 1983 survey; that is, one area-depth interval had extremely large catches which contributed to high variation of the biomass estimates. These are: (1) arrowtooth flounder, Northeast area, 301-500 m depth interval, 51.9% of total biomass but 98.8% of total variance; (2) Atka mackerel, Southwest area, 1-100 m depth interval, 75.9% of total biomass, 77.6% of total variance; and (3) giant grenadier, Northwest area, 501-900 m depth interval, 41.4% of total biomass, and 79.1% variance.

Confidence intervals for the Southern Bering Sea have always been very large for most species. Since the size of the survey area is quite small, the number of sampling stations has also been small, which when combined with large catches for many species, leads to extremely large estimates of variance. During the 1983 survey, the confidence intervals for four of five dominant species decreased (Pacific cod, Atka mackerel, Pacific ocean perch, and giant grenadier) and remained relatively constant for one, walleye pollock. Of the other important species the confidence intervals for Greenland turbot, shortraker rockfish, and roughey rockfish increased indicating a general decrease in precision. Results of the 1986 survey were not as clear. Six species, walleye pollock, Pacific ocean perch, sablefish, Greenland turbot, Pacific halibut, and shortraker rockfish showed improvement; one species, Pacific cod, remained relatively unchanged, and six species, Atka mackerel, giant grenadier, northern rockfish, arrowtooth flounder, and shortspine thornyhead decreased.

Fishing Power Comparisons

During the 1980 survey, 36 paired observations were available between the Half Moon Bay (27/32 m Northeastern trawl) and the Hatsue Maru No. 62 (32/44 and 55/65 m trawls). The Half Moon Bay was more effective at capturing five fish species: Pacific halibut, flathead sole, (Hippoglossoides elassodon), Atka mackerel, roughey rockfish, and Pacific ocean perch. It was also more effective at capturing red king crab (Paralithodes camtschatica). Both vessels were equally effective at capturing Greenland turbot and golden king crab (Lithodes aequispina). The Hatsue Maru No. 62 was more effective at capturing the remaining species (Table 15).

Table 15. Estimates of relative fishing power differences (CPUE of U.S. vessel divided by CPUE of Japanese vessel) for vessels participating in the U.S.-Japan 1980, 1983, and 1986 Aleutian Islands groundfish surveys.

Species	Year		
	1980	1983	1986
Skates	0.76	2.00	0.54
Arrowtooth flounder	0.94	1.36	0.30
Greenland turbot	1.03	1.38	0.41
Pacific halibut	1.36	1.46	0.63
Flathead sole	1.78	-	2.07
Dover sole	-	0.59	1.09
Rex sole	0.61	3.58	0.53
Rock sole	0.61	1.84	0.74
Sablefish	0.05	0.62	0.11
Giant grenadier	-	0.30	-
Pacific cod	0.93	0.70	0.57
Walleye pollock	0.76	0.38	0.32
Atka mackerel	4.49	-	0.24
Shortspine thornyhead	0.49	0.62	0.67
Rougheye rockfish	1.28	1.24	0.17
Pacific ocean perch	1.27	0.63	0.26
Northern rockfish	0.42	0.37	0.12
Shortraker rockfish	0.37	0.98	0.48
Tanner crab	-	-	3.10
Golden king crab	1.04	-	2.57
Red king crab	7.76	-	1.39
Red squid	-	0.12	0.11

In 1983, 42 observations were available between the NOAA ship Miller Freeman (27/32 m trawl) and the Daito Maru No. 38 (45/58 m trawl). The NOAA Ship Miller Freeman was more effective at capturing rougheye rockfish, skates (Rajidae), and all species of flatfish with the exception of Dover sole (Microstomus pacificus).

In 1986, 59 comparable stations were available between the Lets Go (27/32 m trawl) and the Ginryu Maru No. 5 (38/54 m trawl). The Lets Go was more effective in capturing Dover sole, flathead sole, and all species of crab.

The mean catch rates used to compare relative fishing power were influenced by (1) the clumped, irregular distribution of the species; (2) the ability of the fishing masters to trawl on extremely rough substrates; and (3) differences in the roller gears, trawl design, and construction materials which also allowed sampling in areas of rough substrate.

Length Frequency Measurements

Length frequency measurements were taken for all commercially important species. These measurements totaled over 126,000 in 1980, 132,000 in 1983 and 129,000 in 1986 with over 80% of the collection being taken on the Japanese research vessels (Table 16).

Table 16. Number of length frequency measurements collected during the U.S.-Japan 1980, 1983, and 1986 Aleutian Islands groundfish surveys.

Species	Years					
	1980		1983		1986	
	U.S.	Japan	U.S.	Japan	U.S.	Japan
Arrowtooth flounder	510	10,637	619	5,488	668	9,623
Greenland turbot	420	4,656	180	1,476	29	3,327
Pacific halibut	226	497	544	593	453	1,916
Flathead sole	222	1,613	468	750	887	2,713
Dover sole	27	79	0	47	0	64
Rex sole	191	1,408	69	776	0	2,099
Rock sole	1,754	8,114	3,926	8,107	4,193	12,794
Sablefish	232	4,624	347	4,170	13	4,484
Giant grenadier	0	3,626	594	5,691	0	3,226
Popeye	0	3,295	432	4,126	0	2,524
Pacific cod	4,378	3,229	3,567	7,335	3,031	11,797
Walleye pollock	9,079	17,227	8,384	20,483	6,785	18,615
Atka mackerel	2,337	2,973	338	7,205	567	4,124
Shortspine thornyhead	0	8,027	38	6,613	109	5,012
Rougheye rockfish	271	5,029	197	3,717	28	4,362
Pacific ocean perch	3,650	14,456	2,951	19,922	2,175	12,629
Northern rockfish	1,264	1,767	259	6,276	754	5,127
Shortraker rockfish	217	1,767	385	3,129	33	2,222
Red squid	0	8,308	75	2,299	0	1,948
Golden king crab	126	0	19	565	0	640
Red king crab	26	0	6	2	0	197
Alaska snow crab	78	0	41	2	0	30
Total	25,008	101,332	23,439	108,872	19,725	109,473

Age Structures

A total of 14,005 otoliths were collected in 1980, 25,468 in 1983 and 10,774 in 1986 (Table 17).

Table 17. Summary of otoliths collected during the U.S.-Japan 1980, 1983, and 1986 Aleutian Islands groundfish surveys.

Species	1980		1983		1986	
	U.S.	Japan	U.S.	Japan	U.S.	Japan
Arrowtooth flounder	0	1,154	0	520	0	328
Greenland turbot	0	113	180	137	0	653
Flathead sole	0	0	216	49	0	30
Rex sole	0	0	28	128	0	163
Rock sole	110	1,154	500	1,278	620	480
Sablefish	0	57	262	908	0	980
Pacific cod	654	56	1,580	396	0	480
Walleye pollock	2,842	3,312	2,397	6,500	840	1,496
Atka mackerel	1,208	428	143	951	120	670
Shortspine thornyhead	107	0	25	1,446	0	420
Rougheye rockfish	36	298	36	1,371	0	415
Pacific ocean perch	667	1,184	1,565	2,517	439	1,330
Northern rockfish	486	0	107	569	120	510
Shortraker rockfish	66	73	224	1,435	0	650
Total	6,176	7,829	7,263	18,205	2,139	8,605

Length-Weight Measurements

During the 1980, 1983, and 1986 surveys, 3,790, 9,731 and 13,382 individual length-weight measurements were taken (Table 18).

Table 18. Summary of length-weight observations obtained during the U.S.-Japan 1980, 1983, and 1986 Aleutian Islands groundfish surveys.

Species	Years					
	1980		1983		1986	
	U.S.	Japan	U.S.	Japan	U.S.	Japan
Arrowtooth flounder	0	70	0	56	0	328
Greenland turbot	0	113	180	0	0	633
Flathead sole	0	0	0	0	0	30
Rex sole	0	0	28	0	0	163
Rock sole	0	0	400	319	620	525
Sablefish	0	57	161	307	0	983
Pacific cod	65	157	782	390	36	946
Walleye pollock	0	130	1,316	2,431	840	1,515
Atka mackerel	826	137	17	276	226	946
Shortspine thornyhead	0	0	25	510	0	499
Rougheye rockfish	36	0	35	60	0	535
Pacific ocean perch	1,405	414	938	643	439	3,055
Northern rockfish	241	0	2	304	120	511
Shortraker rockfish	66	73	224	271	0	251
Red squid	0	0	0	56	0	161
Total	2,639	1,151	4,108	5,623	2,281	11,101

Trawl Measurements

The wing spread estimates of the Japanese trawls during the 1980 and 1983 surveys showed a wide variation, especially at water depths greater than 200 m. Wing spread measurements obtained during the 1986 survey tended to increase as the depth increased at depths less than 200 m, but remained constant at depths greater than 200 m as shown below and in figure 14.

<u>Depth Interval (m)</u>	<u>Mean Width (m)</u>
1-100	20.09
101-200	22.83
201-300	23.38
301-500	24.67
501-900	24.73

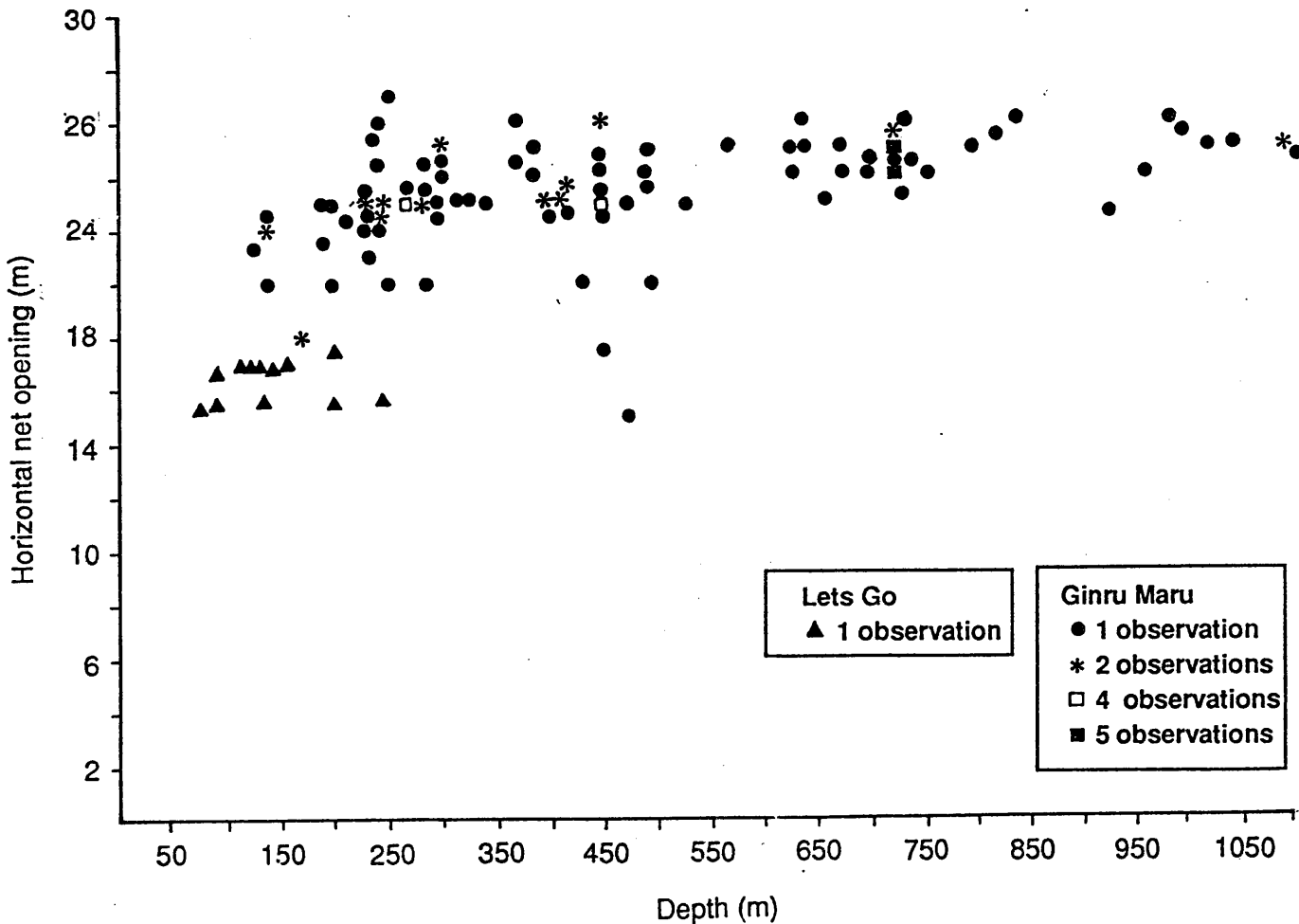

Figure 14. Wing spread measurements of trawls used during the U.S.-Japan 1986 Aleutian Islands groundfish survey.

BIOMASS ESTIMATES

Total biomass of all fish and invertebrates taken during the three surveys averaged 2.4 million t and estimates ranged from a low of 1.5 million t in 1980 to 3.3 million t in 1986 (Table 19). Estimates for biomass increased 51% between 1980 and 1983, and 41% between 1983 and 1986. Fish dominated the catches all 3 years, with invertebrates accounting for only 4% of the average biomass. The overall species composition in 1980 consisted of 124 species representing 35 families (Appendix C.). The number of pelagic species declined after 1980.

Table 19. Biomass estimates for important fish species, from the total survey area, based on the U.S.-Japan 1980, 1983, and 1986 Aleutian Islands groundfish surveys.

Species	Biomass (t)				% of Total Biomass
	1980	1983	1986	Average	
Pollock	308,745	778,666	550,517	545,976	22.92
Atka Mackerel	150,346	343,312	634,651	376,103	15.79
Pacific Ocean Perch	88,713	214,708	262,828	188,750	7.92
Pacific cod	126,445	158,767	214,923	166,712	7.00
Northern Rockfish	43,248	45,344	188,360	92,317	3.87
Arrowtooth flounder	36,860	47,795	144,946	76,534	3.21
Sablefish	142,384	78,900	136,303	119,196	5.00
Greenland turbot	44,990	65,845	88,276	66,370	2.79
Rougheye rockfish	19,797	24,816	59,454	34,689	1.46
Halibut	12,554	21,130	45,074	26,253	1.10
Shortraker rockfish	13,817	37,539	31,589	27,648	1.16
Shortspine thornyhead	20,214	15,401	24,139	19,918	0.84
Rock sole	27,948	19,213	25,720	24,294	1.02
Skates	12,295	19,437	20,736	17,489	0.73
Flathead sole	3,837	1,325	9,845	5,002	0.21
Rex sole	1,796	6,207	5,496	4,500	0.19
Dover sole	534	486	1,102	707	0.03
Giant grenadier	314,031	351,304	601,583	422,306	17.72
Other fish	78,216	59,074	110,953	82,748	3.47
All fish	1,446,770	2,289,269	3,156,495	2,297,511	96.43
All invertebrates	99,697	47,827	107,604	85,043	3.57
All species	1,546,467	2,337,096	3,264,099	2,382,554	100.00

Biomass estimates in the Aleutian Islands area were similar to the total survey area with fish making up most of the catch, and invertebrates accounting for about 4% (Table 20).

Table 20. Biomass estimates for important fish species, from the Aleutian Islands area, based on the U.S.-Japan 1980, 1983, and 1986 groundfish surveys.

Species	Biomass (t)				% of Total Biomass
	1980	1983	1986	Average	
Pollock	252,013	495,982	448,138	398,711	20.4
Atka mackerel	130,514	343,302	634,006	369,274	18.97
Pacific ocean perch	82,710	117,229	208,052	135,997	6.99
Pacific cod	52,070	113,143	172,625	112,613	5.79
Northern rockfish	42,907	43,828	124,869	70,535	3.62
Arrowtooth flounder	26,928	38,272	124,855	63,352	3.25
Sablefish	24,192	69,029	111,689	68,303	3.51
Greenland turbot	31,059	51,812	67,757	50,209	2.58
Rougheye Rockfish	18,875	21,987	55,359	32,074	1.65
Halibut	9,853	13,826	38,856	20,845	1.07
Shortraker Rockfish	12,797	24,459	23,985	20,414	1.05
Shortspine Thornyhead	19,135	13,987	23,213	18,778	0.96
Rock sole	12,159	15,188	19,376	15,574	0.80
Skates	10,122	16,262	19,492	15,292	0.79
Flathead sole	1,966	631	5,836	2,811	0.14
Rex sole	574	1,765	3,037	1,792	0.09
Dover sole	344	369	1,047	587	0.03
Giant grenadier	313,480	349,538	600,656	421,225	21.64
Other fish	47,646	44,045	64,158	51,950	2.67
All fish	1,089,344	1,774,654	2,747,006	1,870,335	96.09
All invertebrates	81,423	43,321	103,569	76,104	3.91
All species	1,170,767	1,817,975	2,850,575	1,946,439	100.00

Eight families accounted for 99% of the fish biomass. The two most abundant families were Gadidae and Macrouridae (Table 21). Squids were the dominant (74% of the total) invertebrate species group with an estimated biomass of 21,000 t.

Table 21. Biomass estimates for important fish and invertebrates by family or species group, from the Aleutian Islands area, based on the U.S.-Japan 1980, 1983, and 1986 Aleutian Islands groundfish surveys.

Family or group	Biomass (t)			
	1980	1983	1986	Average
Gadidae	304,473	609,261	621,038	511,591
Macrouridae	322,409	364,110	618,102	434,874
Hexagrammidae	130,511	343,434	634,055	369,333
Scorpaenidae	176,456	222,278	435,780	278,171
Pleuronectidae	82,943	121,902	260,838	155,228
Anoplopomatidae	24,193	69,027	111,690	68,303
Cottidae	33,624	24,570	32,211	30,135
Squids	16,461	20,786	25,982	21,076
Rajidae	10,123	16,259	19,491	15,291
Crabs	10,784	2,976	5,786	6,515
Zoarcidae	2,432	586	1,845	1,621
Octopuses	757	440	781	659
Osmeridae	a	a	1,854	615
Cyclopteridae	604	325	427	452
Agonidae	373	215	102	326
Shrimps	316	52	54	141

a Less than 1 metric ton.

Fish were distributed in all depth intervals and all subareas of the Aleutian Islands (Table 22). The lower values in the 1-100 m depth strata in 1980 and 1983 suggests inadequate sampling of the shallow depth strata during those years. The biomass estimate of over 1 million t in the Southwest area in 1986 reflects a strong year class of Atka mackerel which had an estimated biomass of over 500,000 t.

Table 22. Biomass estimates of total fish by areas and depth intervals based on the U.S.-Japan 1980, 1983, and 1986 Aleutian Islands groundfish surveys.

Area	Depth (m)	Biomass (t)		
		1980	1983	1986
Southeast	1-900	248,915	489,947	1,010,539
Southeast	1-900	162,419	391,858	383,116
Northwest	1-900	196,931	383,937	520,611
Northeast	1-900	376,475	448,045	702,356
Bowers Ridge	1-900	104,603	60,868	130,384
Aleutian Islands	1-100	16,588	244,984	743,628
	101-200	422,569	720,685	555,742
Total	201-300	159,640	242,880	446,829
	301-500	108,195	122,588	246,392
	501-900	382,351	443,517	754,415
	1-900	1,089,343	1,774,654	2,747,006
Southern Bering Sea	1-900	357,426	514,615	409,489

Total fish biomass estimates in the Southern Bering Sea ranged from 357,000 t in 1980 to approximately 515,000 t in 1983, with an average of 427,000 t (Table 23). Fish made up 98% of the catch in this area, while invertebrates contributed only 2%. Eight families accounted for 98% of the average fish biomass, with Gadidae and Scorpaenidae having the largest values (Table 24). The families Macrouridae and Hexagrammidae, which accounted for over 40% of the fish in the Aleutian Islands area, accounted for only 2% of the Southern Bering Sea fish biomass. Crabs and squids were the dominant invertebrate species groups with average estimates of 5,000 t and 900 t, respectively.

Table 23. Biomass estimates for important fish species, from the Southern Bering Sea area, based on the U.S.-Japan 1980, 1983, and 1986 Aleutian Islands groundfish surveys.

Species	Biomass (t)				% of Total Biomass
	1980	1983	1986	Average	
Pollock	56,732	282,684	102,379	147,265	33.77
Atka Mackerel	19,832	10	645	6,829	1.57
Pacific ocean perch	6,003	97,479	54,776	52,753	12.10
Pacific cod	74,375	45,624	42,298	54,099	12.40
Northern rockfish	341	1,516	63,491	21,783	4.99
Arrowtooth flounder	9,932	9,523	20,091	13,182	3.02
Sablefish	118,192	9,871	24,614	50,892	11.67
Greenland turbot	13,931	14,033	20,519	16,161	3.71
Rougheye rockfish	922	2,829	4,095	2,615	0.60
Halibut	2,701	7,304	6,218	5,408	1.24
Shortraker rockfish	1,020	13,080	7,604	7,235	1.66
Shortspine thornyhead	1,079	1,414	926	1,140	0.26
Rock sole	15,789	4,025	6,344	8,719	2.00
Skates	2,173	3,175	1,244	2,197	0.50
Flathead sole	1,871	694	4,009	2,191	0.50
Rex sole	1,222	4,442	2,459	2,708	0.62
Dover sole	190	117	55	121	0.03
Giant grenadier	551	1,766	927	1,081	0.25
Other fish	30,570	15,029	46,795	30,798	7.06
All fish	357,426	514,615	409,489	427,177	97.95
All invertebrates	18,274	4,506	4,035	8,938	2.05
All species	375,700	519,121	413,524	436,115	100.00

Table 24. Biomass estimates of important fish and invertebrates by family or species group, from the Southern Bering Sea area, based on the U.S.-Japan 1980, 1983, and 1986 Aleutian Islands groundfish surveys.

Family or group	Biomass (t)			
	1980	1983	1986	Average
Gadidae	131,107	328,310	144,677	201,365
Scorpaenidae	9,381	116,599	135,625	87,202
Anoplopomatidae	118,192	9,871	24,164	50,742
Pleuronectidae	45,925	40,267	60,186	48,793
Cottidae	27,425	4,471	9,298	13,731
Clupeidae	6	8,461	30,047	12,838
Hexagrammidae	19,844	11	658	6,838
Crabs	14,280	207	423	4,970
Rajidae	2,172	3,175	1,244	2,197
Macrouridae	570	3,020	1,025	1,538
Zoarcidae	2,146	94	941	1,060
Squids	657	522	1,463	881
Octopuses	1,451	2	58	504
Osmeridae	a	a	943	314
Cyclopteridae	42	3	16	20
Agonidae	32	3	15	17
Shrimps	27	2	18	16

a Less than 1 metric ton.

SPECIES ACCOUNTS

Walleye Pollock

Distribution and Abundance

Although walleye pollock (*Theragra chalcogramma*) are found throughout the Aleutian Islands area, their distribution was extremely clumped and uneven. Walleye pollock occurred in the highest abundance category in all areas of the Aleutian Islands, but not in the southern Bering Sea (Figs. 15-16). They were found at all depths surveyed, however the vast majority of the stock was found between 101 and 300 m with the largest portion occurring in the 101-200 m depth interval (Table 25). Compared to the 1980 and 1983 surveys more pollock were taken in the 1-100 and 201-300 m depth zones during 1986.

The total estimated biomass of walleye pollock in the Aleutian Islands increased from 252,000 t in 1980 to 496,000 t in 1983, then decreased to 448,000 t in 1986 (Fig. 17). Increases in the biomass estimates were noted in all areas in 1983, however the most significant change occurred in the Southwest area where the estimated biomass increased nearly fivefold from 37,000 to 179,000 t. Substantial increases of 49,000 t and 39,000 t also occurred in the Northwest and Southeast areas, respectively. In 1986 the largest decreases occurred in the Southwest, Northwest, and Northeast areas, but these were partially offset by increases in the Southeast and Bowers Ridge areas. Population estimates increased each year, ranging from 452.5 million in 1980 to 720.3 million in 1986.

In the Southern Bering Sea area the trend was similar but the decline was more severe than in the Aleutian Islands area. Estimated biomass increased nearly fivefold from 57,000 t in 1980 to 283,000 t in 1983, and population increased from 88.3 to 409.7 million fish during the same time period (Fig. 18). In 1986, estimated biomass decreased by 64% to 102,000 t and population decreased to 130.4 million fish.

Estimates of mean CPUE and mean lengths and weights are summarized in Table 26. In the Aleutian Islands area, pollock were largest in 1983 averaging 46.2 cm in length and 0.62 kg in weight. In the Southern Bering Sea, pollock mean lengths were greater in 1980 with a mean length of 45.8 cm, but heavier in 1986 with a mean weight of 0.8 kg (Figs. 19-20).

Size and Age Composition

During the 1980 survey, the walleye pollock stock in the Aleutian Islands area was dominated by small fish 30-35 cm in length, with small secondary modes of larger fish occurring at 45 and 51 cm (Fig. 21). These smaller fish were 3-year-old

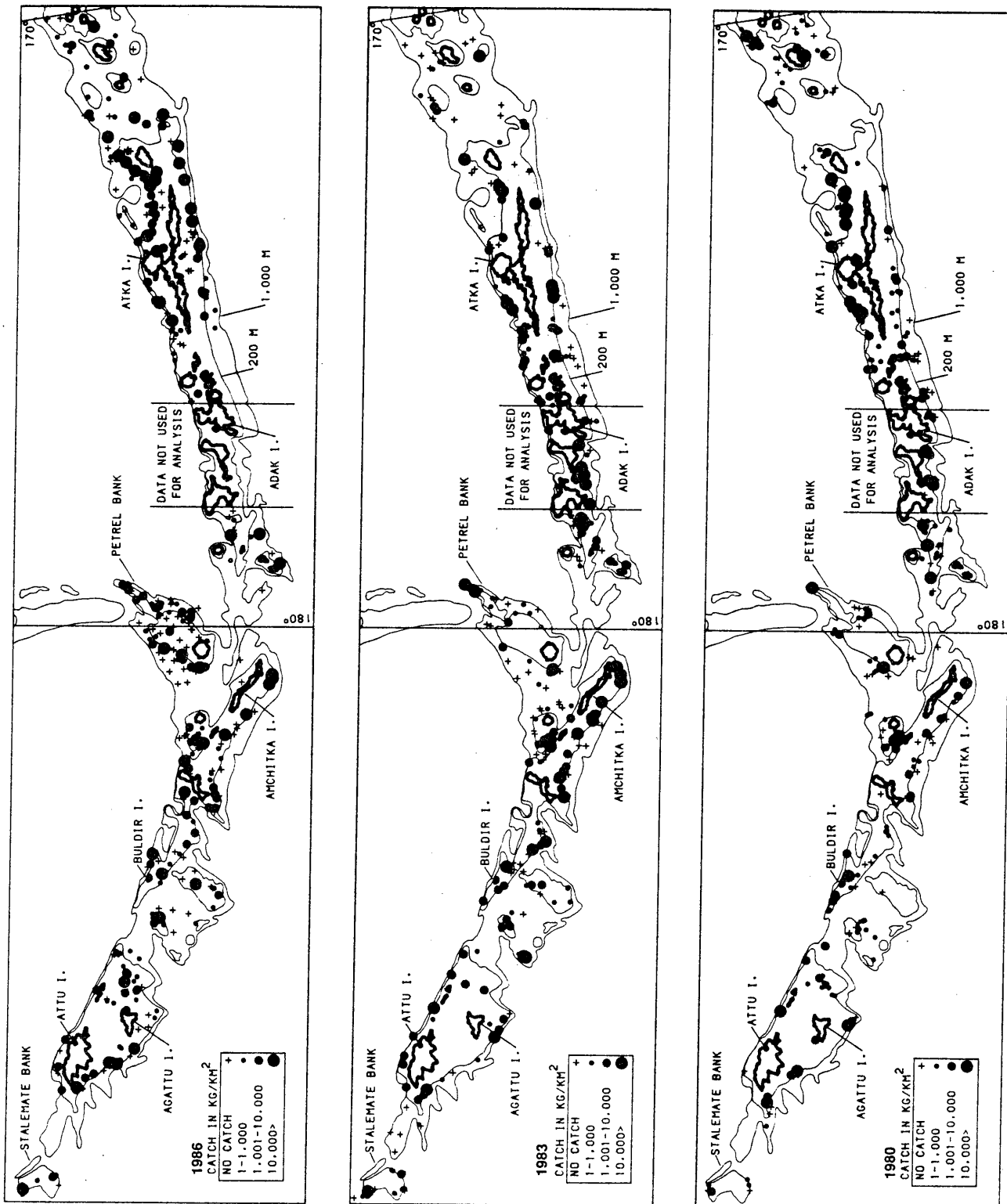

Figure 15. Distribution and relative abundance of walleye pollock in the Aleutian Islands area during the U.S.-Japan 1980, 1983, and 1986 groundfish surveys.

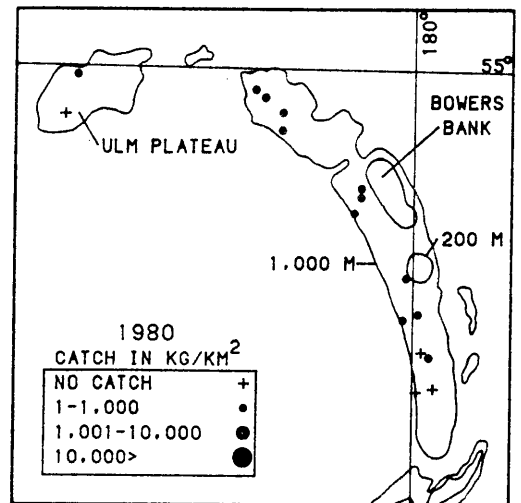
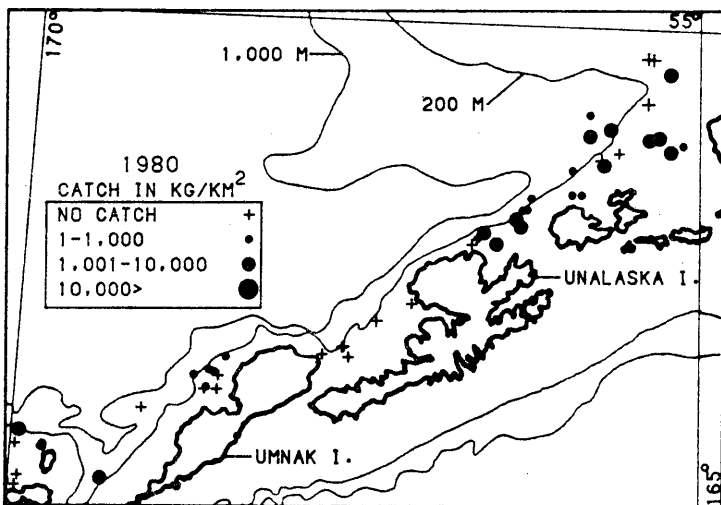
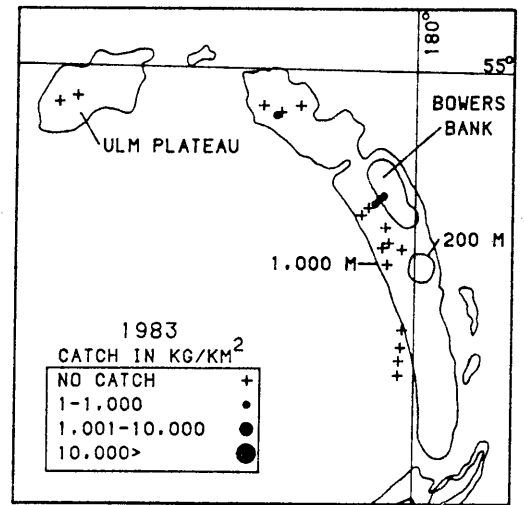
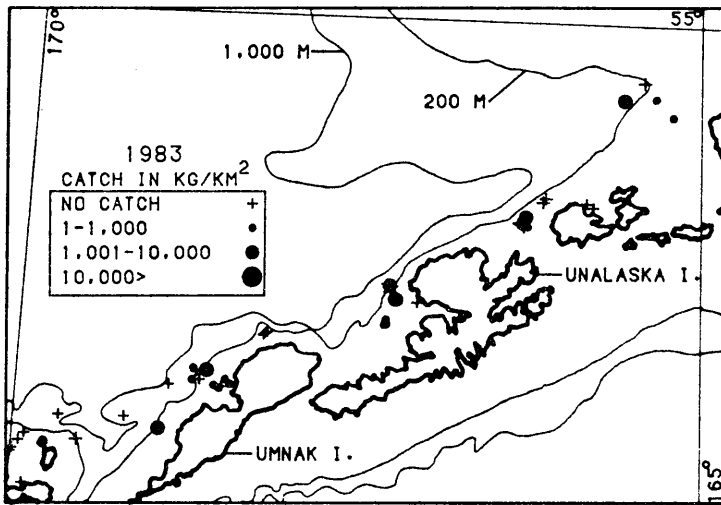
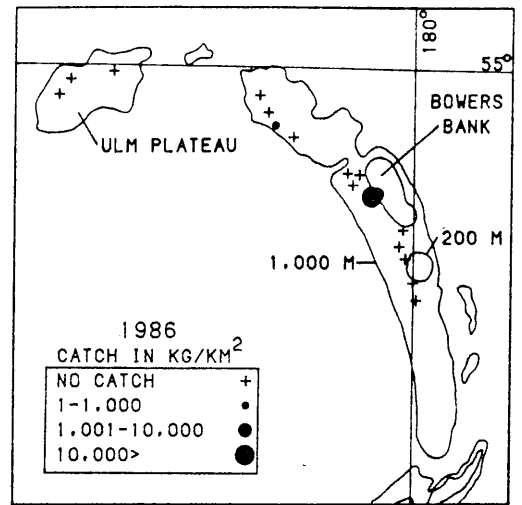
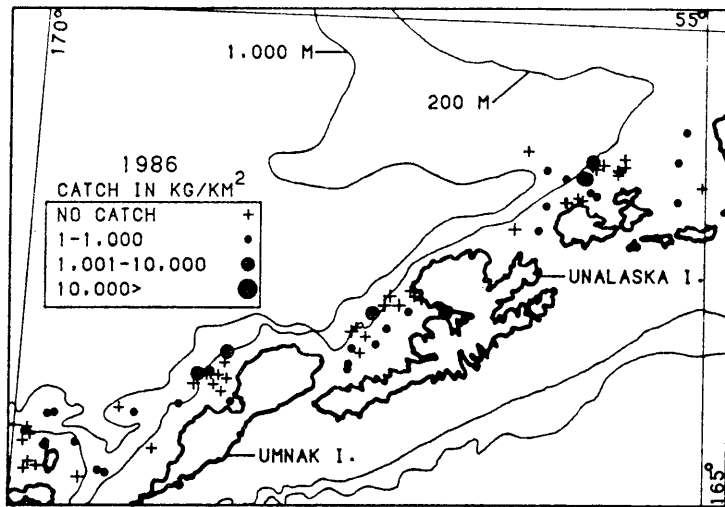

Figure 16. Distribution and relative abundance of walleye pollock in the Southern Bering Sea and Bowers Ridge areas during the U.S.-Japan 1980, 1983, and 1986 Aleutian Islands groundfish surveys.

Table 25. Estimates of biomass, biomass sampling error, and population for walleye pollock based on the U.S.-Japan 1980, 1983, and 1986 Aleutian Islands groundfish surveys.

Area	Depth (m)	Biomass (t)			Sampling Error (%)			Population (1,000s)		
		1980	1983	1986	1980	1983	1986	1980	1983	1986
Southwest	1-100	1,165	8,141	8,506				2,741.0	15,678.7	33,371.6
	101-200	26,779	139,163	72,808				57,349.0	189,408.4	114,693.8
	201-300	8,062	31,764	33,910				15,659.1	37,957.9	53,837.8
	301-500	952	265	78				1,081.1	374.1	84.5
	501-900	173	74	74				0.0	103.5	111.4
	1-900	37,131	179,407	115,376	66.5	41.3	42.3	76,830.2	243,522.6	202,099.1
Southeast	1-100	a	0	12				a	0.0	30.6
	101-200	34,245	41,996	48,892				37,972.8	54,475.9	72,651.8
	201-300	4,886	35,219	64,591				4,945.7	45,017.8	70,386.0
	301-500	861	794	5,536				1,032.7	738.9	4,513.4
	501-900	0	0	27				0.0	0.0	18.1
	1-900	39,992	78,009	119,058	247.7	136.1	53.3	43,951.2	100,232.6	147,599.9
Northwest	1-100	0	2,706	4,122				0.0	5,713.1	15,235.4
	101-200	30,095	16,286	32,784				85,411.7	35,048.6	62,907.0
	201-300	18,440	59,920	22,960				22,076.8	85,831.2	29,541.3
	301-500	15,833	0	206				13,942.3	0.0	274.1
	501-900	21	18	0				0.0	24.0	0.0
	1-900	64,389	78,930	60,072	96.6	138.3	59.4	121,430.8	126,616.9	107,957.8
Northeast	1-100	24	179	27,220				0.0	347.3	60,650.8
	101-200	46,283	138,336	56,085				139,651.3	175,065.5	115,347.1
	201-300	57,160	20,948	57,307				63,535.9	24,825.1	56,469.3
	301-500	6,943	58	4,444				7,148.0	53.0	3,601.0
	501-900	25	6	107				0.0	10.2	124.8
	1-900	110,435	159,527	145,163	117.2	86.0	77.0	210,335.2	200,301.1	236,193.0
Bowers Ridge	101-200	a	102	404				a	335.0	3,216.2
	201-300	18	2	8,057				0.0	6.0	23,243.6
	301-500	8	0	0				0.0	0.0	0.0
	510-900	40	5	8				0.0	6.3	12.4
	101-900	66	109	8,469	40.9	1,113.6	409.3	0.0	347.3	26,472.2
Aleutian Islands	1-100	1,189	11,026	39,860	0.0	982.7	223.6	2,741.0	21,739.1	109,288.4
	101-200	137,402	335,883	210,973	90.0	50.3	37.4	320,384.8	454,333.4	368,815.9
Total	201-300	88,566	147,853	186,825	132.5	73.5	46.2	106,217.5	193,638.0	233,478.0
	301-500	24,597	1,117	10,264	78.1	228.3	72.2	23,204.1	1,166.0	8,473.0
	501-900	259	103	216	639.1	162.3	382.6	0.0	144.0	266.7
	1-900	252,013	495,982	448,138	59.1	38.3	29.4	452,547.4	671,020.5	720,322.0
Southern Bering Sea	1-100	37,071	154,752	13,870				61,460.1	249,580.4	14,349.3
	101-200	12,132	105,247	68,246				18,605.0	131,729.3	95,994.6
Total	201-300	5,725	16,917	17,788				6,415.9	22,446.7	17,813.7
	301-500	1,626	5,768	2,412				1,821.9	5,925.8	2,195.3
	501-900	178	0	63				0.0	0.0	81.6
	1-900	56,732	282,684	102,379	124.1	138.0	70.8	88,302.9	409,682.2	130,434.5

a No sampling was conducted in this area-depth interval.

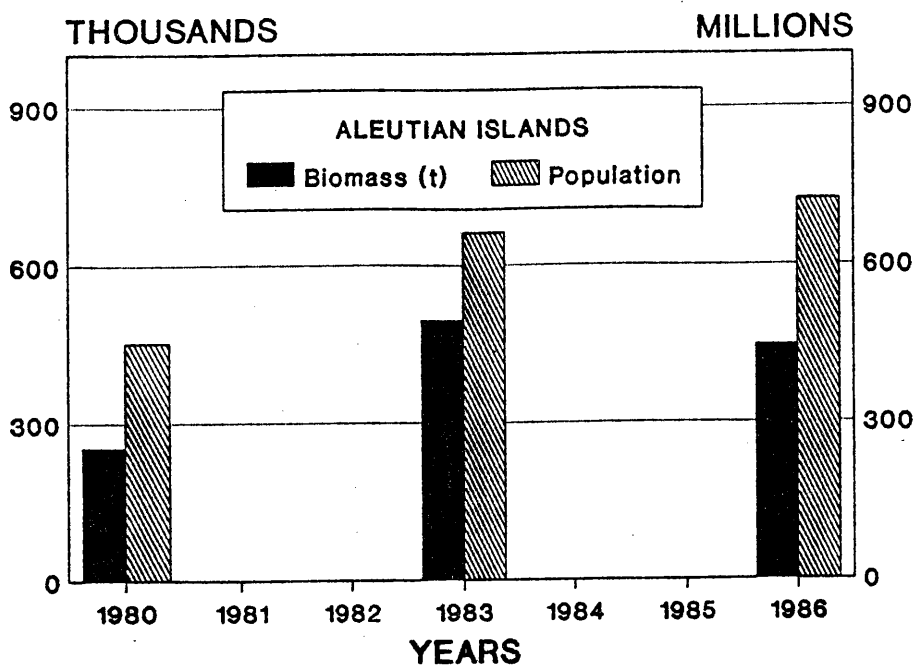

Figure 17. Estimated biomass and population of walleye pollock in the Aleutians Islands area during the U.S.-Japan 1980, 1983, and 1986 groundfish surveys.

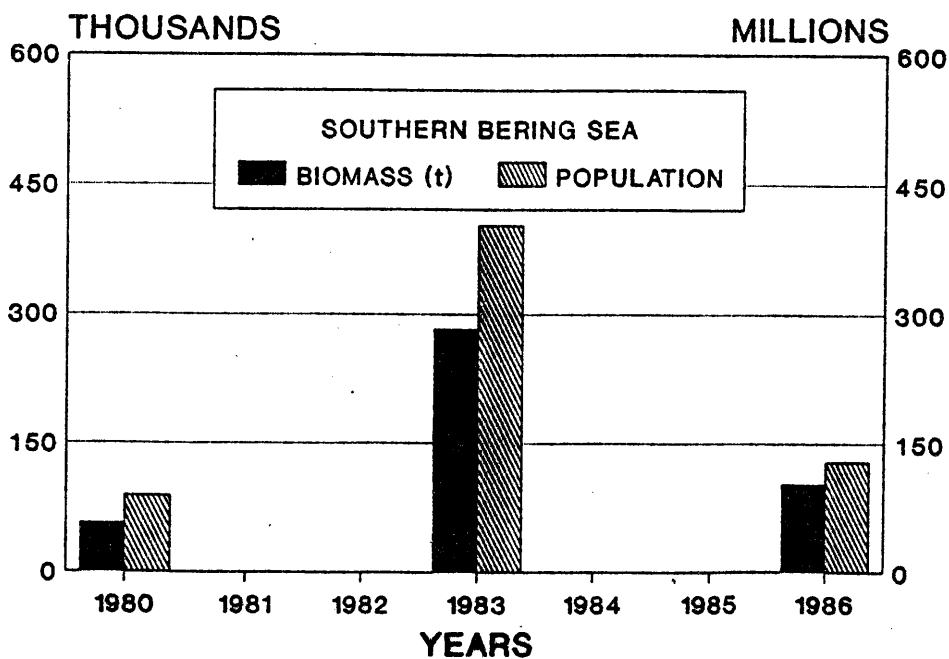

Figure 18. Estimated biomass and population of walleye pollock in the Southern Bering Sea area during the U.S.-Japan 1980, 1983, and 1986 Aleutian Islands groundfish surveys.

Table 26. Estimates of mean catch per unit effort, length and weight for walleye pollock based on the U.S.-Japan 1980, 1983, and 1986 Aleutian Islands groundfish surveys.

Area	Depth (m)	Mean CPUE (kg/km ²)			Mean Length (cm)			Mean Weight (kg)		
		1980	1983	1986	1980	1983	1986	1980	1983	1986
Southwest	1-100	508.6	2,769.6	2,260.6	30.8	37.0	0.0	0.43	0.52	0.26
	101-200	4,100.6	21,309.6	11,148.8	43.2	46.3	36.7	0.47	0.74	0.63
	201-300	3,513.3	13,842.7	14,778.2	43.1	48.4	43.1	0.52	0.83	0.62
	301-500	279.1	77.7	23.0	0.0	44.3	46.3	0.88	0.69	0.91
	501-900	24.6	10.5	10.5	0.0	0.0	0.0	0.00	0.72	0.66
	1-900	1,722.2	8,078.2	5,009.4	41.2	46.0	38.1	0.48	0.74	0.57
Southeast	1-100	a	0.0	4.4	a	0.0	0.0	a	0.00	0.37
	101-200	10,465.7	12,834.5	14,942.0	43.7	46.7	50.1	0.89	0.77	0.65
	201-300	1,546.6	11,148.9	20,447.0	49.5	48.8	51.6	0.97	0.78	0.94
	301-500	316.1	252.9	1,764.0	54.2	49.9	50.0	0.83	1.07	1.22
	501-900	0.0	0.0	9.4	0.0	0.0	0.0	0.00	0.00	1.47
	1-900	3,574.4	5,581.3	7,914.2	46.7	47.7	50.3	0.90	0.78	0.80
Northwest	1-100	0.0	1,146.6	1,746.6	31.6	37.4	0.0	0.00	0.47	0.27
	101-200	16,370.1	6,198.8	12,478.2	39.4	38.2	34.7	0.35	0.44	0.49
	201-300	17,231.9	55,992.8	21,455.6	45.9	47.5	46.1	0.83	0.61	0.73
	301-500	7,145.9	0.0	92.8	49.7	0.0	52.0	1.12	0.00	0.75
	501-900	4.8	4.1	0.0	0.0	0.0	0.0	0.00	0.71	0.00
	1-900	5,796.0	6,184.4	4,706.8	40.2	44.7	38.8	0.53	0.56	0.53
Northeast	1-100	10.9	153.8	14,196.9	38.8	47.7	0.0	0.00	0.52	0.45
	101-200	11,847.2	35,410.4	14,356.1	38.7	46.9	33.9	0.33	0.90	0.49
	201-300	23,406.3	8,577.9	23,466.3	49.9	47.6	49.1	0.91	0.87	1.03
	301-500	2,022.2	17.0	1,354.0	53.7	0.0	51.5	0.97	1.07	1.23
	501-900	4.1	1.0	17.3	0.0	0.0	0.0	0.00	0.61	0.88
	1-900	6,163.4	9,313.4	8,187.8	41.6	47.0	39.1	0.52	0.90	0.62
Bowers Ridge	101-200	a	326.8	1,295.7	a	33.5	0.0	a	0.30	0.13
	201-300	14.6	1.8	6,598.3	36.2	0.0	0.0	0.00	0.36	0.35
	301-500	5.1	0.0	0.0	0.0	0.0	0.0	0.00	0.00	0.00
	501-900	5.6	0.7	1.2	0.0	0.0	0.0	0.00	0.81	0.67
	101-900	6.6	10.7	825.9	34.9	33.5	0.0	0.00	0.31	0.32
Aleutian Islands Total	1-100	198.2	1,370.9	3,730.6	35.4	37.2	0.0	0.43	0.51	0.37
	101-200	8,837.4	20,174.7	12,672.0	41.1	45.9	36.6	0.43	0.77	0.56
	201-300	8,694.2	14,514.0	18,339.9	46.3	48.0	47.7	0.84	0.72	0.80
	301-500	1,837.8	80.9	752.1	53.8	48.5	51.5	1.05	0.95	1.21
	501-900	9.8	3.8	7.8	0.0	0.0	0.0	0.00	0.71	0.82
	1-900	3,513.9	6,497.7	5,685.4	42.1	46.2	40.0	0.56	0.75	0.62
Southern Bering Sea	1-100	7,692.7	32,112.7	2,878.2	50.6	37.7	39.9	0.60	0.63	0.96
	101-200	3,707.7	32,164.8	20,856.7	43.9	46.4	42.9	0.62	0.83	0.73
	201-300	5,715.9	16,890.8	17,760.8	50.9	45.8	46.6	0.90	0.76	1.00
	301-500	1,277.5	4,532.8	1,895.7	52.5	50.1	48.2	0.89	0.97	1.10
	501-900	78.1	0.0	27.9	0.0	0.0	0.0	0.00	0.00	0.77
	1-900	4,488.5	22,365.7	8,100.2	45.8	41.1	41.2	0.64	0.70	0.80

a No sampling was conducted in this area-depth interval.

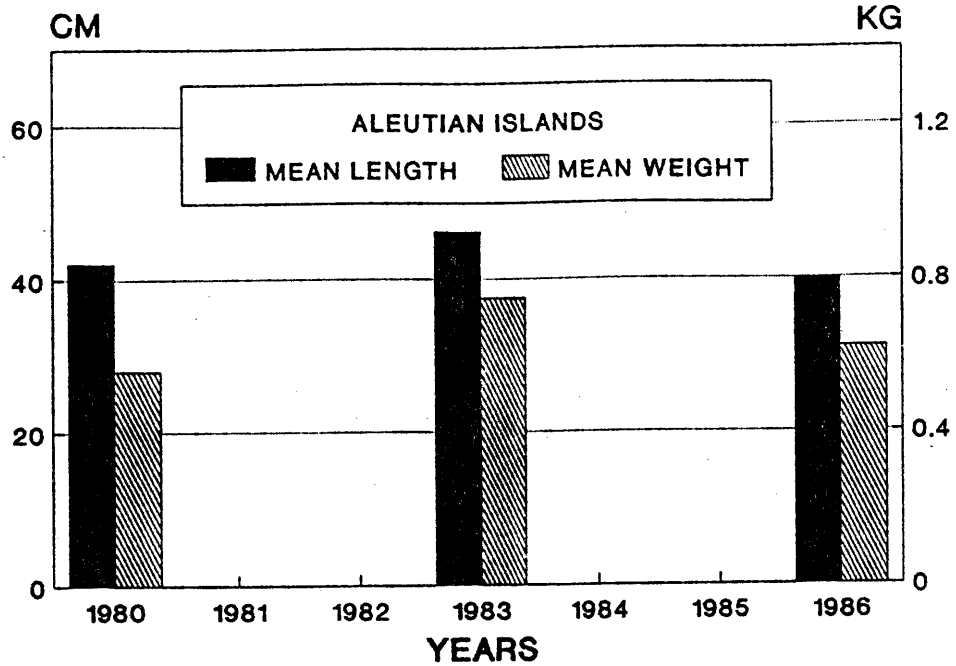

Figure 19. Mean length and weight of walleye pollock in the Aleutian Islands area during the U.S.-Japan 1980, 1983, and 1986 Aleutian Islands groundfish surveys.

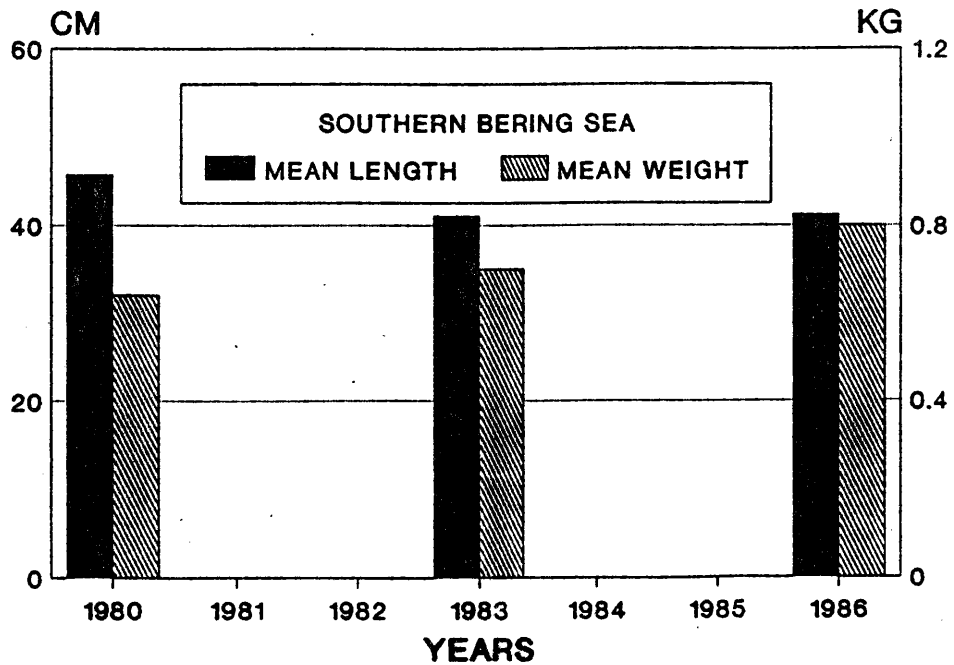

Figure 20. Mean length and weight of walleye pollock in the Southern Bering Sea area during the U.S.-Japan 1980, 1983, and 1986 Aleutian Islands groundfish surveys.

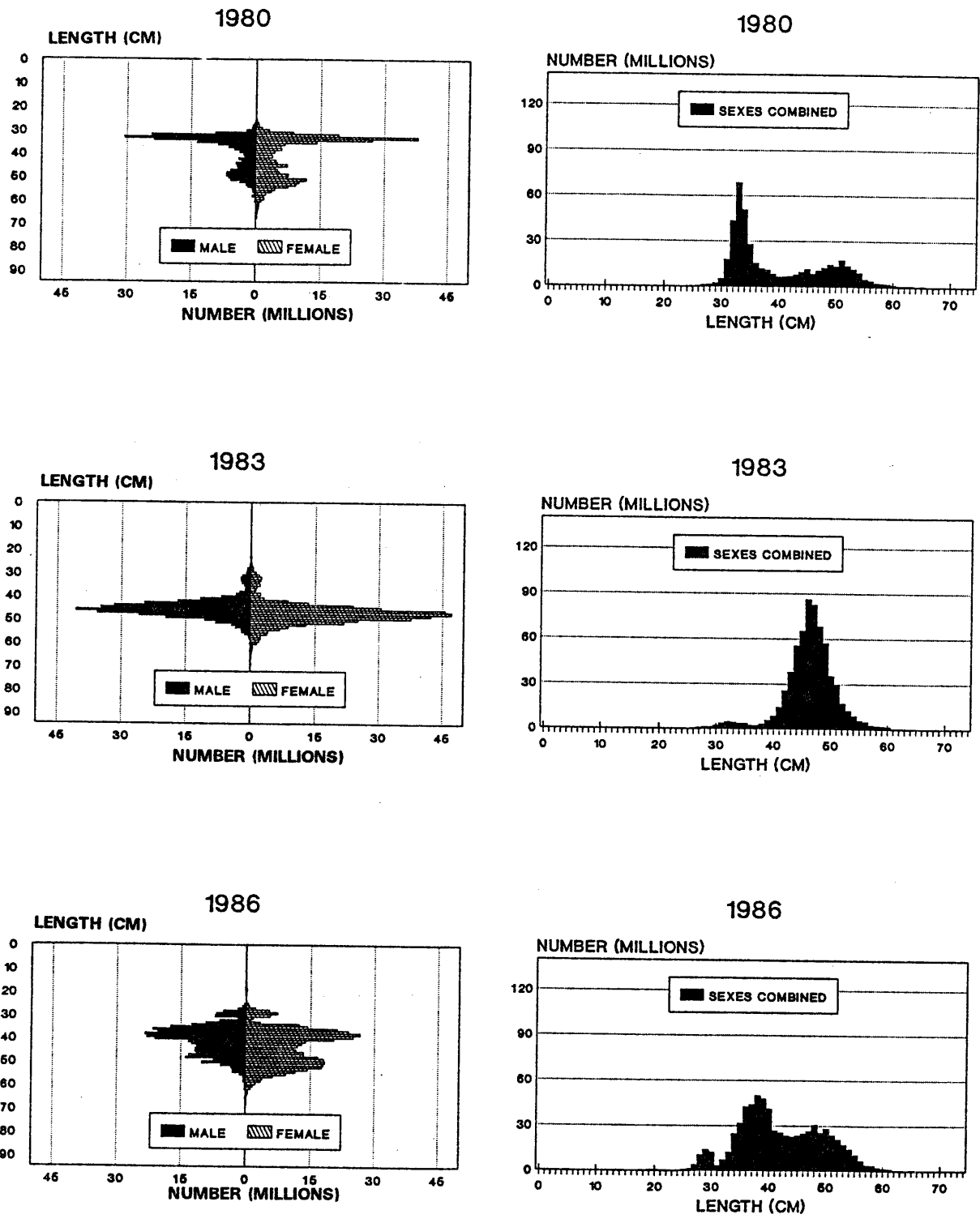

Figure 21. Size composition of walleye pollock in the Aleutian Islands area during the U.S.-Japan 1980, 1983, and 1986 groundfish surveys.

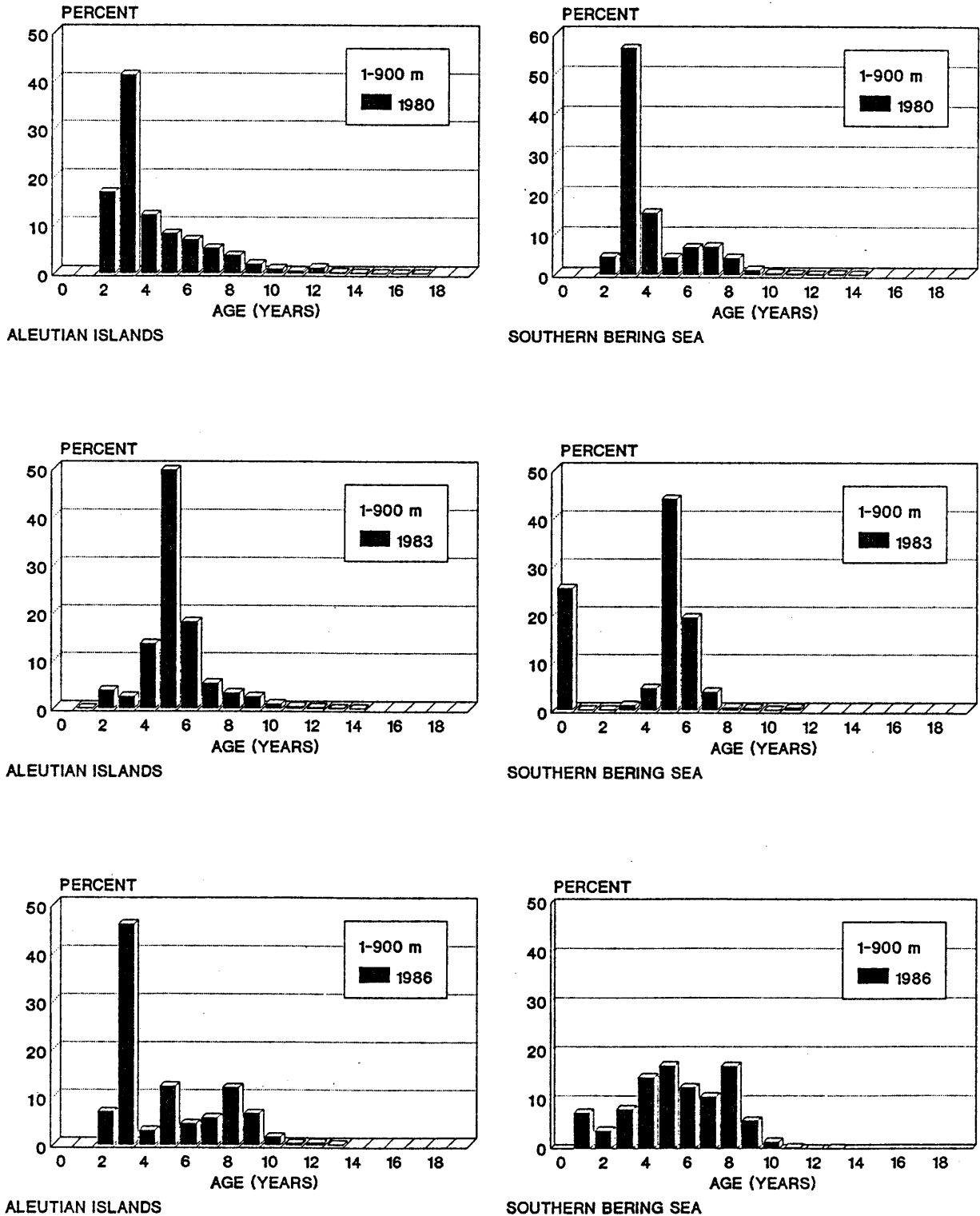

Figure 22. Age composition of walleye pollock in the Aleutian Islands and Southern Bering Sea areas during the U.S.-Japan 1980, 1983, and 1986 groundfish surveys.

pollock from the 1977 year class, which accounted for over 40% of the stock (Fig. 22). The 1978 year class, which was probably not fully available to the trawl, and the 1976 year class were the only other age groups contributing over 10% of the stock. Each successively older age group contributed fewer fish to the total stock, except for the 1968 year class of 12-year-old fish which was slightly stronger.

In 1983, there was a strong size mode of pollock between 42 and 52 cm that peaked at 46-47 cm. These 5-year-old fish contributed nearly 50% of the total stock. Six-year-old fish from the 1977 year class, which dominated in 1980, were still significant in 1983 contributing about 18%. Four-year-old fish from the weaker 1979 year class contributed about 12%. There was a weak showing of smaller 3-year-old fish 30-35 cm in length. Year classes prior to 1976 were only minor contributors.

In 1986 the size composition consisted of three size groups: a strong mode 33-42 cm in length, peaking at 38-39 cm; a mode of larger fish, 44-50 cm, peaking at 48-50 cm; and a weak incoming mode of small fish, 26-30 cm, peaking at 29 cm. The 1986 age composition was dominated by 3-year-old fish from the strong 1983 year class which contributed almost 45% of the stock. Five-year-old fish contributed nearly 12%, 8-year-old fish from the 1978 age class added 11%, and 9-year-old fish from 1977 added another 7%.

In the Southern Bering Sea a different picture was portrayed. During 1980, fish in the 35-43 cm size range were dominant making up about 55% of the stocks (Fig. 23). These were 3-year-old fish from the 1977 age class which were also dominant in the Aleutian Islands. Four-year-old fish from the 1976 age class added another 12% to the Southern Bering sea pollock stocks. No other year class contributed over 10% of the stocks in 1980.

In 1983 the Southern Bering sea stock consisted primarily of larger fish in the 41-53 cm size mode which peaked at 46-47 cm. These 5-year-old fish made up about 43% of the stocks. Six-year-old fish from the 1977 year class still contributed 18% of the stock in 1983. There was also a strong showing of extremely small 8-10 cm pollock which were 1983 young of-the-year.

During 1986, the stock consisted primarily of fish in the 43-55 cm size range and for the first time there was a showing of 19-23 cm fish. No single year class was strongly dominant in 1986, but 4-8-year-old fish from the 1978-1982 age classes made up the bulk of the stocks each year contributing from 11 to 17%. The strong year classes of 1978 and 1977 continued to contribute to the stocks as 8 and 9-year-old fish; however, the 1983 year class did not appear to be especially strong in 1986. The 1981 and 1980 year classes which did not appear in the age composition in any strength in 1983 are present as 5 and 6-year-old fish contributing about 17% and 12%, respectively. The 1983 year class which was so strong in the Aleutian Islands area during 1986 was not nearly as strong in the Southern Bering Sea.

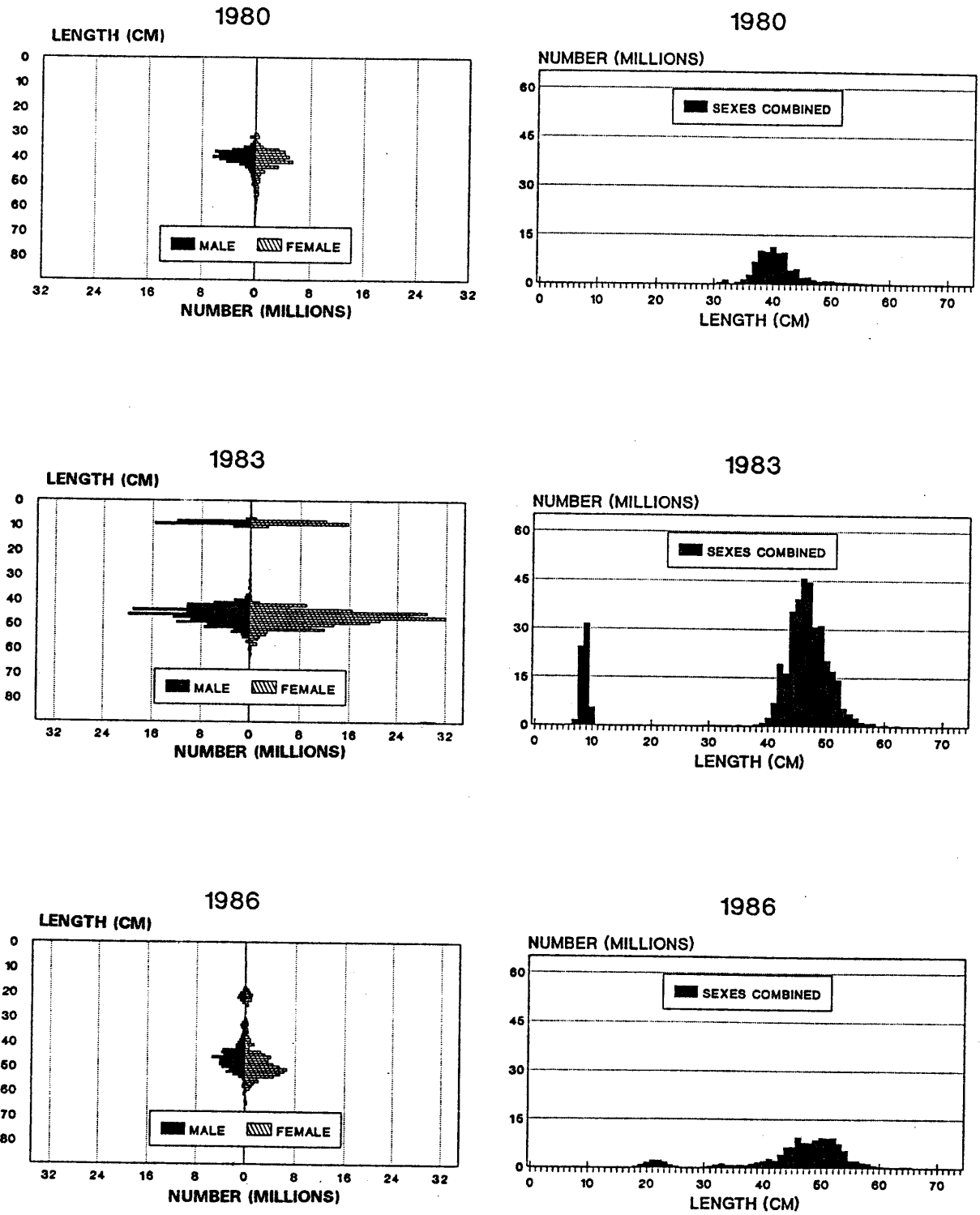

Figure 23. Size composition of walleye pollock in the Southern Bering Sea area during the U.S.-Japan 1980, 1983, and 1986 groundfish surveys.

Age composition of walleye pollock varied considerably with water depth, but in general, stocks in the shallower depths were made up of younger fish (Figs. 24-25). In 1980, in the 101-200 m depth zone 82% of the fish were age 4 or younger. Three-year-old fish were dominant contributing 50% to the stocks. Two-year-old fish from 1978 contributed 22% and 4-year-old fish another 10%. In the 201-300 m zone, 3-year-olds were still abundant but 4- 5- 6- and 7-year-olds from the 1972-76 year classes each made up more than 10% of the stocks. In the 301-500 m depth zone there were more older fish, with 5-year-old fish accounting for 20%, and 6-8-year-olds accounting for more than 10% each. Four-year-old fish still made up 10% of the stocks, but 3-year-old fish were not abundant in that depth zone. Age data for the 1-100 m depth interval in 1980 were not available.

In 1983, younger fish were predominate in the 1-100 m depth zone with 2-year-old fish making up about 38% of the stocks. Three and 4-year-olds each contributed a little more than 10% but 5-year-old fish from the 1978 age class contributed more than 23%. All three deeper depth zones had similar age compositions in 1983, with the 1978 age class of 5-year-old fish accounting for more than 45% of the fish in each zone, and 4 and 6-year-old fish each contributing more than 10%.

During the 1986 survey, 3-year-old fish were dominant in the three shallowest depth zones, accounting for about 55% of the stocks in the 1-100 m and 101-200 m zones, and more then 25% in the 201-300 m zone. In the shallowest depth, 2-year-old fish made up most of the rest of the stock. Five and 8-year-old fish from the 1981 and 1978 age classes made up most of the rest of the stocks in the 101-200 m and 201-300 m depth intervals. In the deepest depth zone, 8-year-olds from the 1978 year class and 9-year-old fish from the 1979 class made up most of the stocks.

Substantial differences were apparent in the size and age composition within the Aleutian Islands areas. In 1980, small fish in the 30-35 cm size mode dominated the size composition along the north side of the Aleutian Islands (Figs. 26-27). In the Northwest area, 3-year-old pollock were dominant making up 43% of the stock. Fish from the 1978 age class contributed 21%, and 4-year-old fish from the 1976 age class made up another 12% (Fig. 28). In the Northeast area, 2-year-old fish were dominant providing 50% of the stock and 3-year-old fish from the 1977 age class contributed 14%. On the south side of the Aleutian Islands chain, small fish in the 32-40 cm size mode were encountered in the Southwest, but not the Southeast area (Figs. 29-30). Three-year-old fish of the 1977 age class made up 45% of pollock in the Southwest area (Fig. 31). Four-year-old fish from the 1976 year class made up 22%, and 2-year-old fish from the 1978 age class contributed about 7%. In the Southeast area the majority of fish were larger, mostly in the 47-56 cm size mode. Five-year-old fish from the 1975 age class were dominant accounting for 30% of the stocks, 6-year-old fish made up 24% and 4-year-old fish contributed 17%.

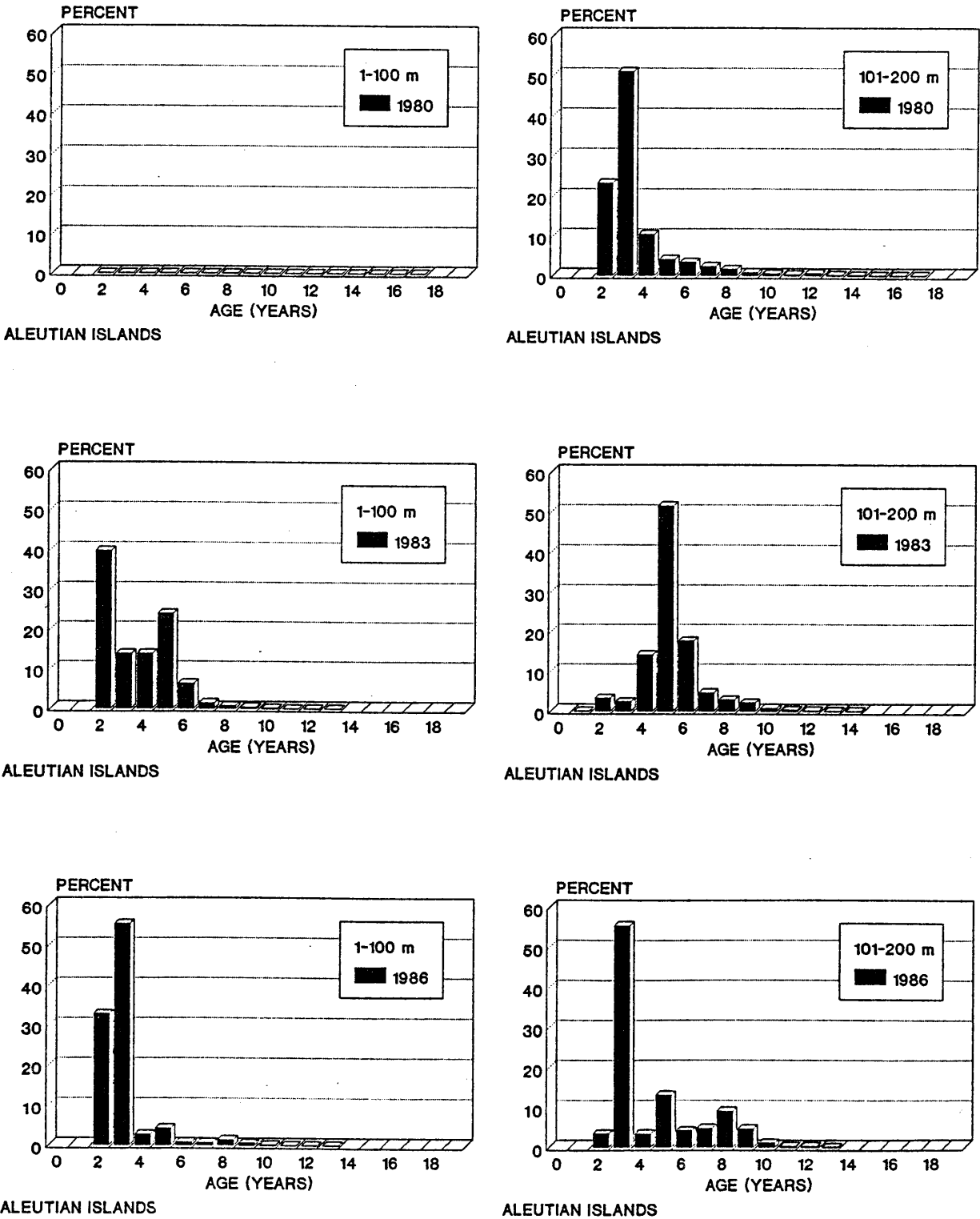

Figure 24. Age composition of walleye pollock in the 1-100 m and 101-201 m depth intervals of the Aleutian Islands area during the U.S.-Japan 1980, 1983, and 1986 groundfish surveys.

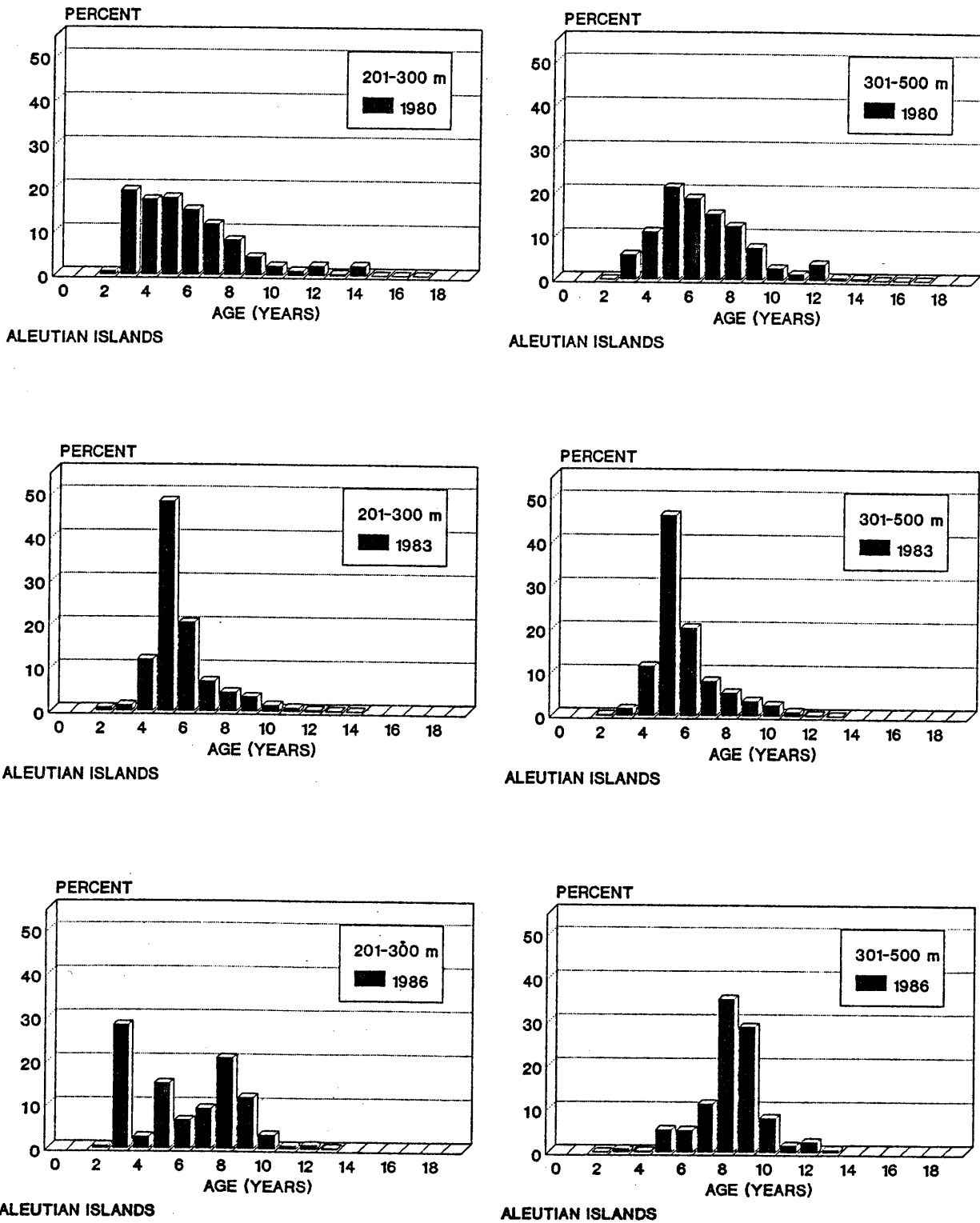

Figure 25. Age composition of walleye pollock in the 201-300 m and 301-500 m depth intervals of the Aleutian Islands area during the U.S.-Japan 1980, 1983, and 1986 groundfish surveys.

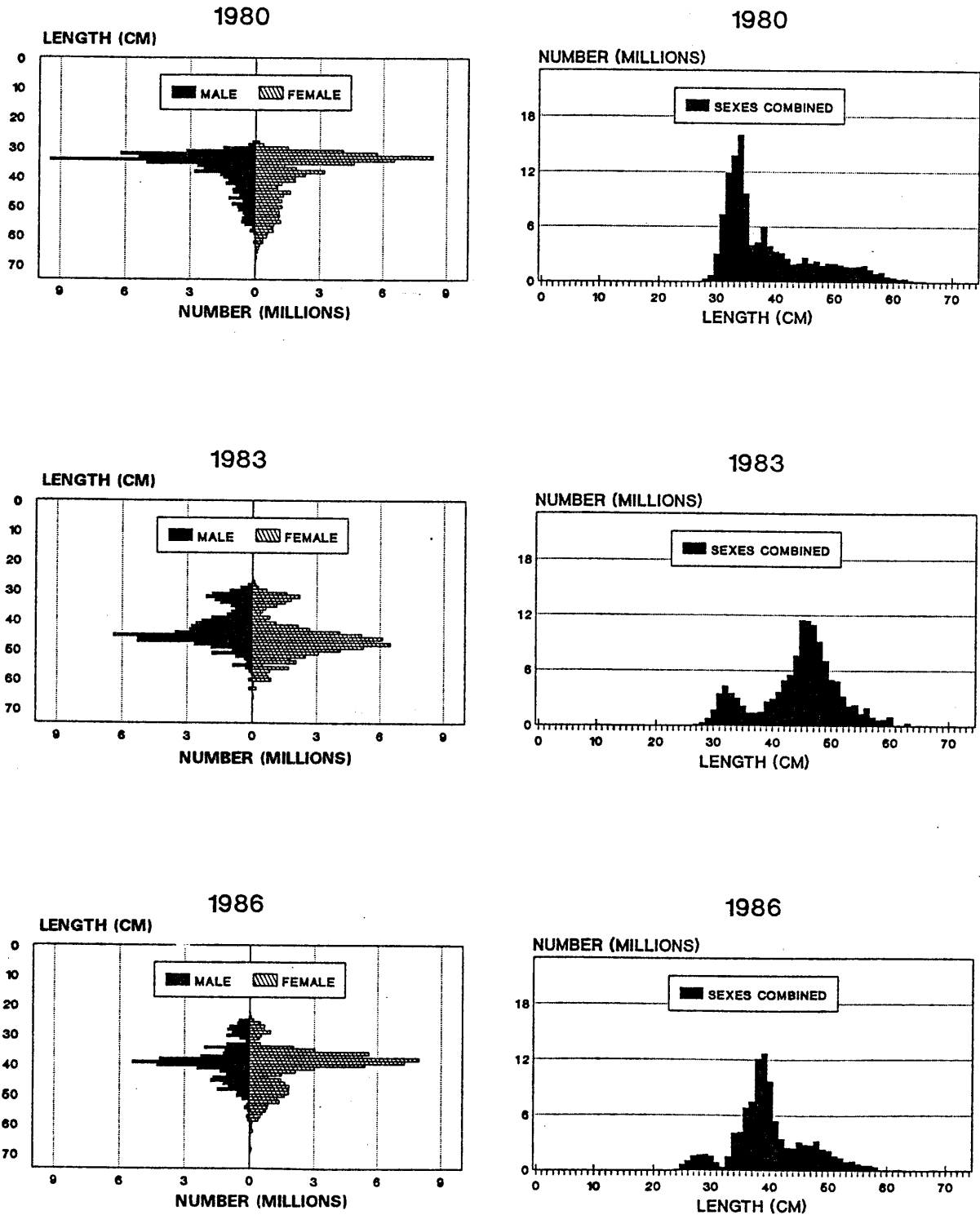

Figure 26. Size composition of walleye pollock in the Northwest area of the Aleutian Islands during the U.S.-Japan 1980, 1983, and 1986 groundfish surveys.

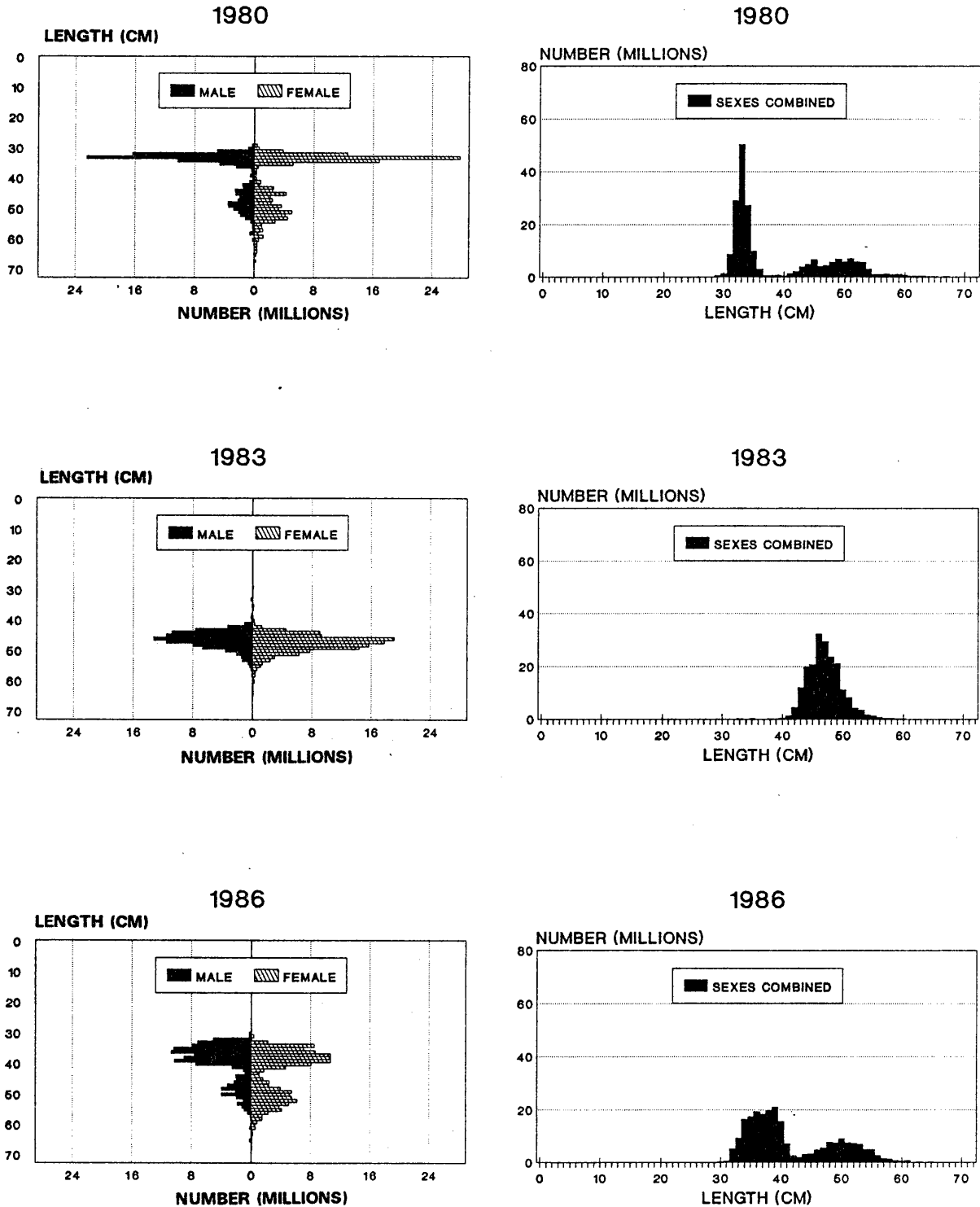

Figure 27. Size composition of walleye pollock in the Northeast area of the Aleutian Islands during the U.S.-Japan 1980, 1983, and 1986 groundfish surveys.

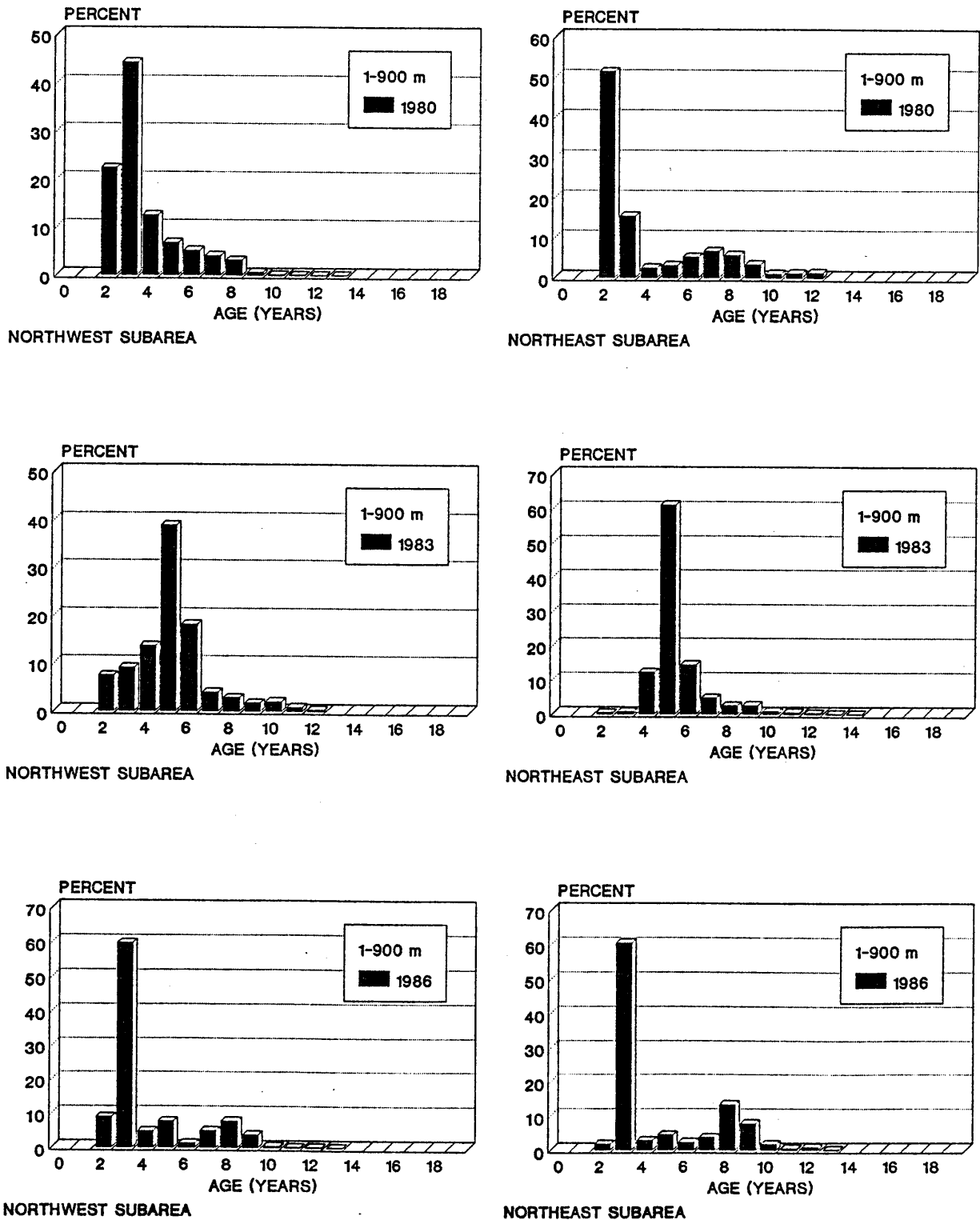

Figure 28. Age composition of walleye pollock in the Northwest and Northeast areas of the Aleutian Islands during the U.S.-Japan 1980, 1983, and 1986 groundfish surveys.

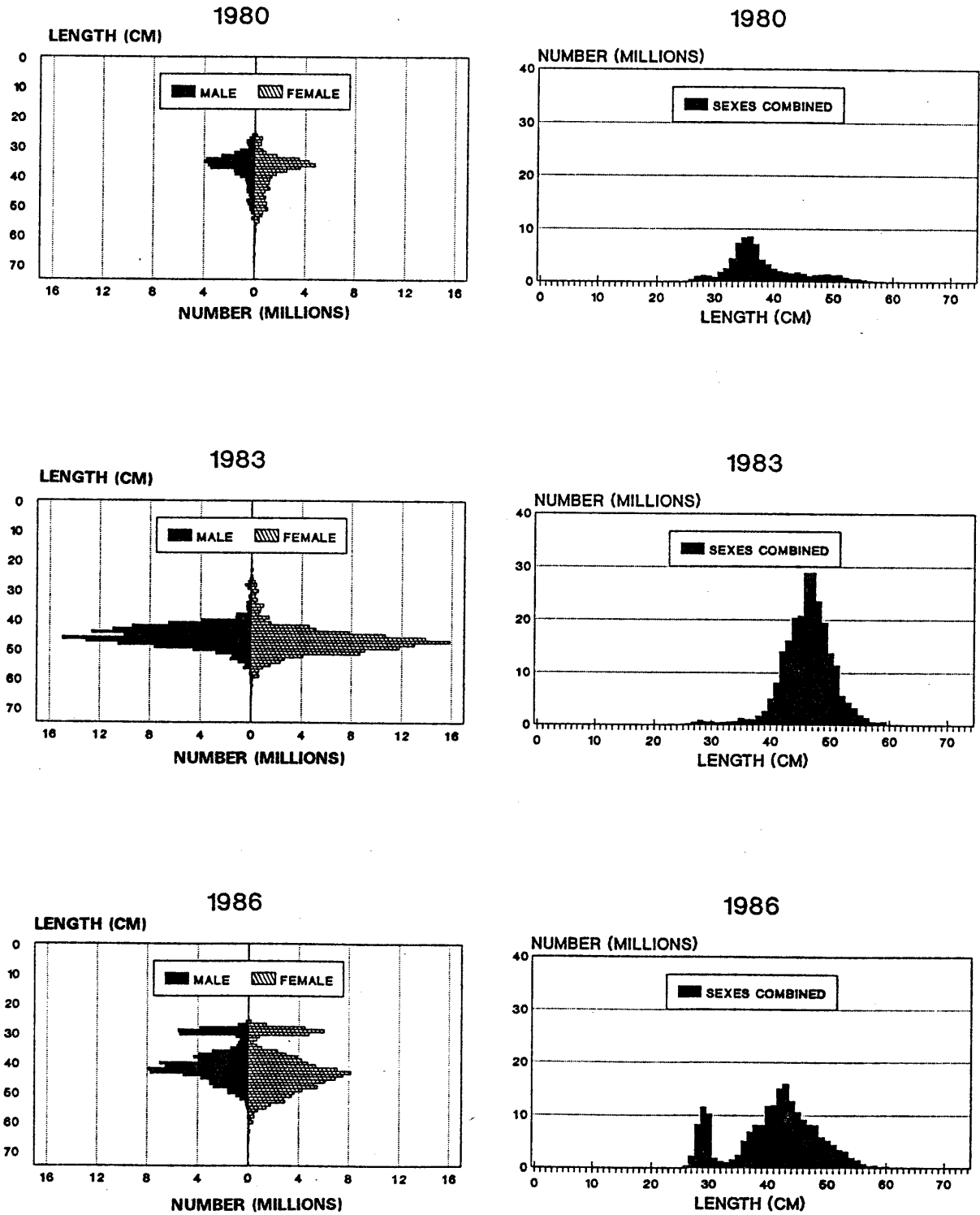

Figure 29. Size composition of walleye pollock in the Southwest area of the Aleutian Islands during the U.S.-Japan 1980, 1983, and 1986 groundfish surveys.

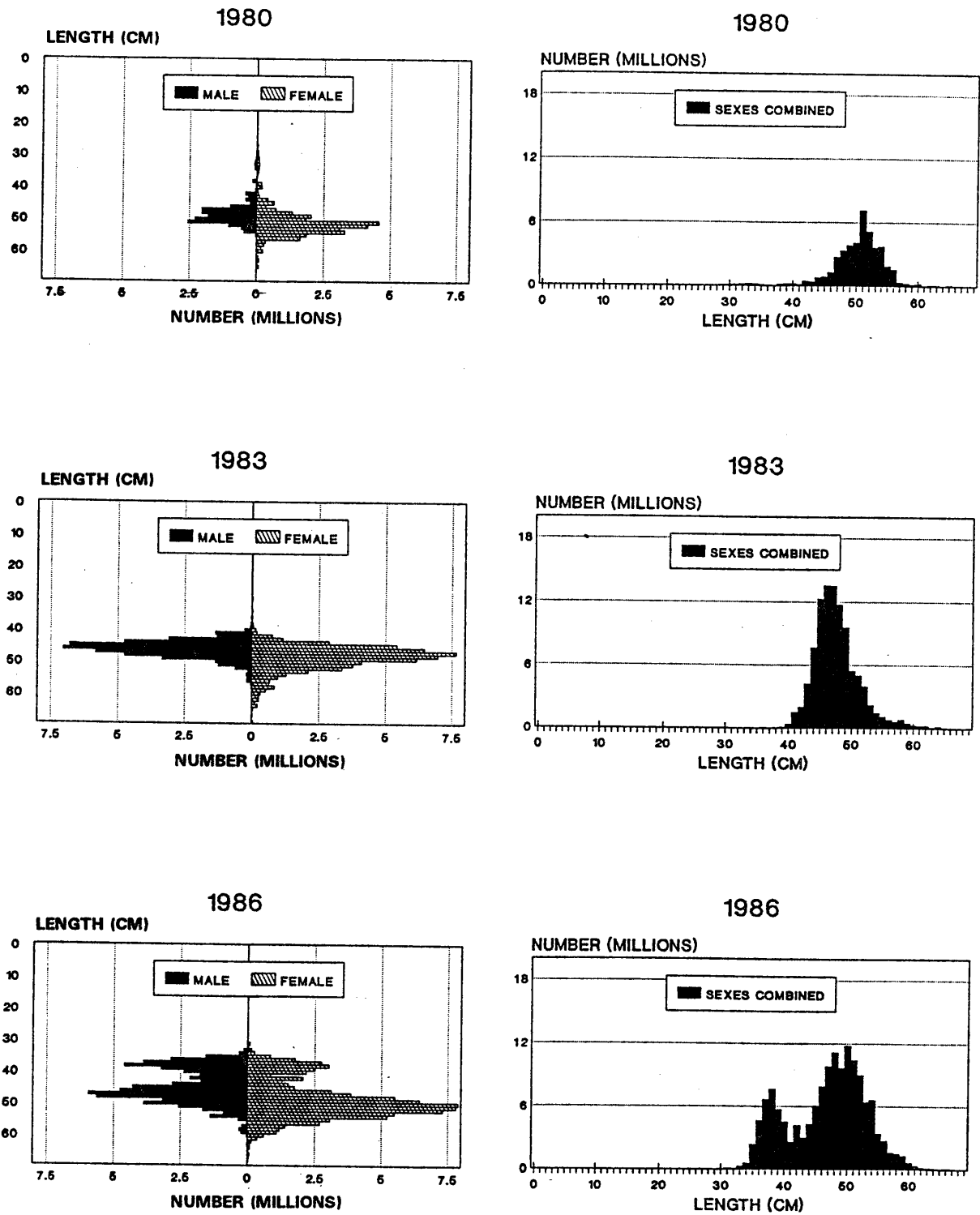

Figure 30. Size composition of walleye pollock in the Southeast area of the Aleutian Islands during the U.S.-Japan 1980, 1983, and 1986 groundfish surveys.

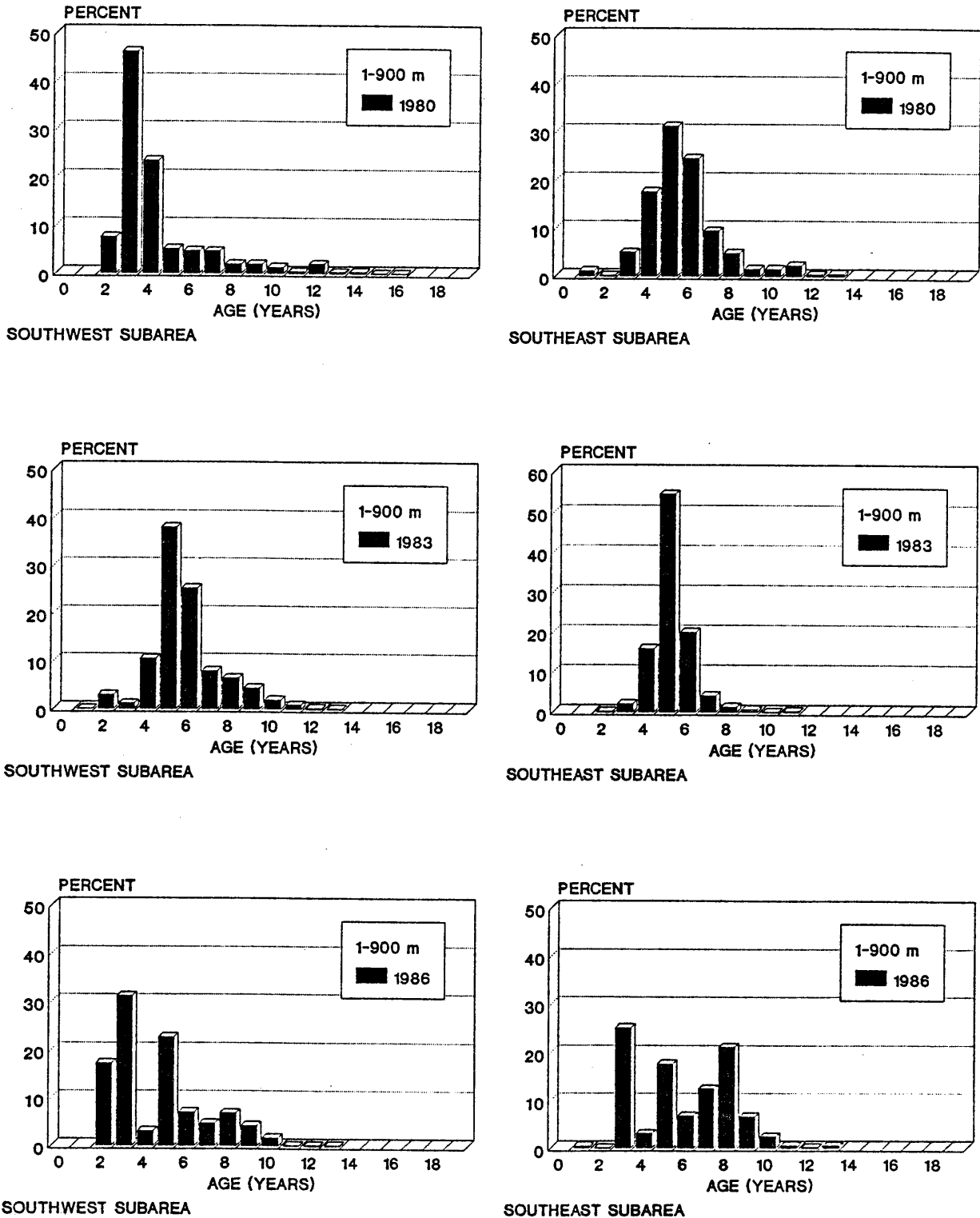

Figure 31. Age composition of walleye pollock in the Southwest and Southeast areas of the Aleutian Islands during the U.S.-Japan 1980, 1983, and 1986 groundfish surveys.

In 1983, the walleye pollock stock consisted primarily of larger fish, 42-52 cm in length, and there was a greater similarity in the size composition throughout the Aleutian Islands area. Most fish were in the 40-55 cm size mode. These were 5-year-old fish from the strong 1978 year class and they dominated the age composition in all areas. Six-year-old fish were the second most abundant age group accounting for 12-24% of the stock. Four-year-old pollock contributed an additional 10-16% of the stock. In 1983 only the Northwest area contained small pollock in the 30-35 cm size mode which consisted of 2- and 3-year-old fish from the 1980 and 1981 year classes.

In 1986, the Northwest and Northeast areas contained a dominant size mode of pollock in the 32-42 cm size range with a strong secondary mode at 44-58 cm. However stocks from the Northwest area contained an additional mode of smaller fish in the 26-30 cm size mode. The age composition of both areas were completely dominated by 3-year-old fish from the 1983 year class which contributed nearly 60% of the total stock. There was a small showing of 2-year-old fish in the Northwest area.

On the southern side of the Aleutian Islands in 1986 there was considerable difference between the size composition of the two areas. In the Southwest area the principle mode was from 35-55 cm, peaking at 43 cm, while in the Southeast area it ranged from 43-58 cm peaking at 50 cm. Both areas had secondary modes, 27-31 cm in the Southwest and 34-41 cm in the Southeast area. The 1983 year class of 3-year-old fish was less dominant then on the north side of the Aleutians, contributing 30% in the Southwest and 25% in the Southeast areas. In the Southwest area, 5-year-old fish contributed 22% to the stocks, and 2-year-old fish from 1984 an additional 17%. In the Southeast area there was a fairly large remnant of 8-year-old fish from the strong 1978 year class that made up 20% of the stocks. In addition, 5-year-old fish contributed 17%, and 7-year-old fish made up 12% of the stocks.

Mean Length-at-Age and Growth

Mean length-at-age data for walleye pollock for the three surveys do not demonstrate any definite trends within or between years (Table 27). Within the Aleutian Islands area the mean size at age appears smaller in the Southwest than other areas during all three surveys, particularly at the younger ages (Table 28).

These data show that walleye pollock in the Aleutian Islands area obtained a length of 19-21 cm by the second summer of their life. From age 1+ to 2+ they increased an average of 12 cm to around 32 cm and for the next 2 years the average annual growth increment decreased to between 5 and 6 cm so that at age 4+ years they had obtained a length of 43-46 cm. From age 5+ to 9+ the average yearly growth increment was 2.5-1.7 cm per year (Table 29). Although individuals up to 14 years in the Aleutian

Table 27. Mean length (mm) at age for walleye pollock from all areas sampled during the U.S.-Japan 1980, 1983, and 1986 groundfish surveys.

Aleutian Islands									
Age	1980			1983			1986		
	M	F	M+F	M	F	M+F	M	F	M+F
1	190	-	190	-	-	-	209	223	213
2	322	317	319	327	334	331	325	330	325
3	375	387	382	371	375	374	386	379	383
4	418	443	432	419	440	430	452	458	457
5	450	500	471	444	456	451	475	481	478
6	483	504	494	448	473	465	493	519	508
7	490	503	495	493	522	509	502	524	512
8	503	551	531	-	542	542	523	522	521
9	529	584	558	490	-	490	509	539	530
0	560	611	589	-	-	-	543	540	557
1	635	614	620	-	560	560	-	650	650
2	560	605	596	-	-	-	-	-	-
3	500	585	557	-	-	-	580	-	580
4	602	-	595	-	-	-	-	-	-

Southern Bering Sea									
Age	1980			1983			1986		
	M	F	M+F	M	F	M+F	M	F	M+F
1	-	-	-	206	-	205	-	-	-
2	336	339	338	297	301	299	294	295	294
3	390	395	392	380	380	380	384	386	385
4	422	436	429	442	453	446	413	431	418
5	476	499	490	455	472	464	444	466	450
6	477	504	495	472	494	486	466	485	474
7	482	503	496	495	526	512	480	503	492
8	519	536	531	499	532	516	489	516	504
9	521	541	536	501	533	520	504	527	518
10	507	524	513	516	553	534	518	539	532
11	493	515	504	549	544	545	530	530	530
12	491	523	515	532	566	551	519	567	540
13	490	542	529	480	578	554	530	578	568
14	510	533	525	-	650	650	-	-	-
15	500	-	500	-	-	-	-	-	-
16	-	-	-	-	-	-	-	-	-
17	-	500	500	-	-	-	-	-	-

M = males F = females

Table 28. Mean length (mm) at age for walleye pollock sampled in the Aleutian Islands areas during the U.S.-Japan 1980, 1983, and 1986 groundfish surveys.

1980												
Age	Southwest			Southeast			Northwest			Northeast		
	M	F	M+F	M	F	M+F	M	F	M+F	M	F	M+F
1	-	-	-	-	-	-	-	-	-	-	-	-
2	-	-	-	364	373	368	328	330	329	-	-	-
3	363	365	365	398	405	401	387	401	394	438	444	439
4	384	395	389	442	461	450	431	441	437	443	463	450
5	427	472	450	494	514	507	480	497	491	485	495	490
6	465	488	479	479	517	507	483	506	495	457	500	487
7	460	479	472	477	515	499	500	526	516	476	480	478
8	494	521	515	-	522	522	543	563	555	502	510	505
9	511	527	523	490	520	514	530	566	552	541	571	563
10	492	507	501	473	505	483	592	570	580	528	600	568
11	497	524	514	480	527	500	510	490	500	503	497	498
12	487	519	511	-	520	520	-	520	520	530	550	543
13	480	534	525	-	565	565	500	-	500	-	-	-
14	514	533	525	-	-	-	-	-	-	-	-	-
15	500	-	500	-	-	-	-	-	-	-	-	-
16	-	-	-	-	-	-	-	-	-	-	-	-
17	-	500	500	-	-	-	-	-	-	-	-	-

1983												
Age	Southwest			Southeast			Northwest			Northeast		
	M	F	M+F	M	F	M+F	M	F	M+F	M	F	M+F
1	205	-	205	-	-	-	-	-	-	-	-	-
2	312	322	317	320	328	324	322	326	324	279	274	277
3	380	354	368	395	411	404	352	348	349	396	393	396
4	445	441	444	433	447	439	444	454	448	448	461	454
5	453	463	458	461	472	467	452	467	461	454	475	465
6	464	471	467	478	485	482	465	477	472	483	513	505
7	468	504	494	496	507	501	483	484	483	511	543	531
8	477	508	489	487	504	497	507	521	512	528	552	542
9	479	502	493	519	540	534	496	552	522	516	547	535
10	497	513	508	526	538	531	490	570	558	524	570	547
11	513	517	516	546	573	560	609	565	598	560	556	553
12	500	530	520	564	-	564	560	600	591	525	572	553
13	480	-	480	-	564	564	-	-	-	-	585	585
14	-	-	-	-	-	-	-	-	-	-	650	650
15	-	-	-	-	-	-	-	-	-	-	-	-
16	-	-	-	-	-	-	-	-	-	-	-	-

1986												
Age	Southwest			Southeast			Northwest			Northeast		
	M	F	M+F	M	F	M+F	M	F	M+F	M	F	M+F
1	-	-	-	-	-	-	-	-	-	-	-	-
2	303	293	298	-	320	327	290	291	288	350	360	357
3	397	396	397	399	409	403	374	379	377	371	376	373
4	428	443	432	416	460	421	406	419	413	395	425	399
5	439	447	443	449	470	459	448	467	455	453	481	468
6	454	479	467	476	498	489	487	493	489	470	493	476
7	471	501	490	472	515	488	479	508	496	497	503	500
8	477	506	495	486	511	501	491	516	503	496	527	512
9	501	515	511	473	532	513	496	546	526	514	532	523
10	505	536	526	485	570	528	552	588	576	533	533	533
11	543	-	543	510	500	505	-	540	540	525	537	530
12	480	-	480	490	-	490	510	530	520	532	573	523
13	-	530	530	-	560	560	-	660	660	530	-	530

M = males F = females

Table 29. Estimates of yearly incremental growth (cm) of walleye pollock based on the U.S.-Japan 1980, 1983, and 1986 surveys.

Age	Year			Average
	1980	1983	1986	
1-2	12.9	-	11.2	12.0
2-3	5.3	4.3	5.8	5.1
3-4	4.3	5.6	7.4	5.8
4-5	3.2	2.1	2.1	2.5
5-6	0.7	1.4	3.0	1.7
6-7	2.6	4.4	0.4	2.4
7-8	3.1	-	0.9	2.0
8-9	2.7	-	2.7	2.7

Islands area and 17 years in the Southern Bering Sea are included in the samples, data after the ninth summer is lacking and too scattered to provide meaningful estimates after the ninth year. Growth curve estimates are shown in Table 30.

Table 30. Estimated von Bertalanffy growth curve parameters for walleye pollock sampled during the U.S.-Japan 1980, 1983, and 1986 groundfish surveys.

Area-Year	Sex	Range		von Bertalanffy Growth Parameters		
		Age (Years)	Length (cm)	L_{INF}	k	t_0
Aleutian Islands						
1980	M	2-15	30-62	51.71	0.390	-0.592
	F	2-17	30-67	54.16	0.437	-0.012
	M+F	2-17	30-67	54.01	0.374	-0.452
1983	M	1-13	19-70	50.85	0.469	-0.082
	F	2-14	23-71	55.28	0.382	-0.081
	M+F	1-14	19-71	53.63	0.402	-0.070
1986	M	2-13	27-64	50.96	0.394	-0.425
	F	2-13	25-66	55.08	0.324	-0.635
	M+F	2-13	25-66	53.41	0.340	-0.641
Southern Bering Sea						
1980	M	1-14	19-73	57.81	0.226	-1.585
	F	2-13	27-70	64.82	0.206	-1.323
	M+F	1-14	19-73	63.13	0.197	-1.649
1983	M	2- 9	29-53	49.80	0.365	-0.934
	F	2-11	29-58	56.71	0.243	-1.671
	M+F	2-11	29-58	54.61	0.266	-1.491
1986	M	1-13	19-60	53.38	0.422	-0.193
	F	2-13	19-65	56.10	0.335	-0.466
	M+F	1-13	19-65	54.54	0.400	-0.253

Length-Weight

Length-weight data were collected for walleye pollock during all three surveys (Fig. 32). Relationships were calculated using linear regression analysis and the results provided the following estimates of the parameters a and b for the sexes combined:

$$\begin{aligned} \text{Weight(g)} \text{ (1980)} &= .0187 \times \text{Length(cm)}^{2.853} \\ \text{Weight(g)} \text{ (1983)} &= .0179 \times \text{Length(cm)}^{2.764} \\ \text{Weight(g)} \text{ (1986)} &= .0134 \times \text{Length(cm)}^{2.845} \end{aligned}$$

Length-weight relationships for walleye pollock were extremely similar during all three surveys; however, in 1980, the fish were slightly heavier for a given length than in 1983 and 1986 and for the larger fish over 45 cm they were slightly heavier in 1983 than in 1986.

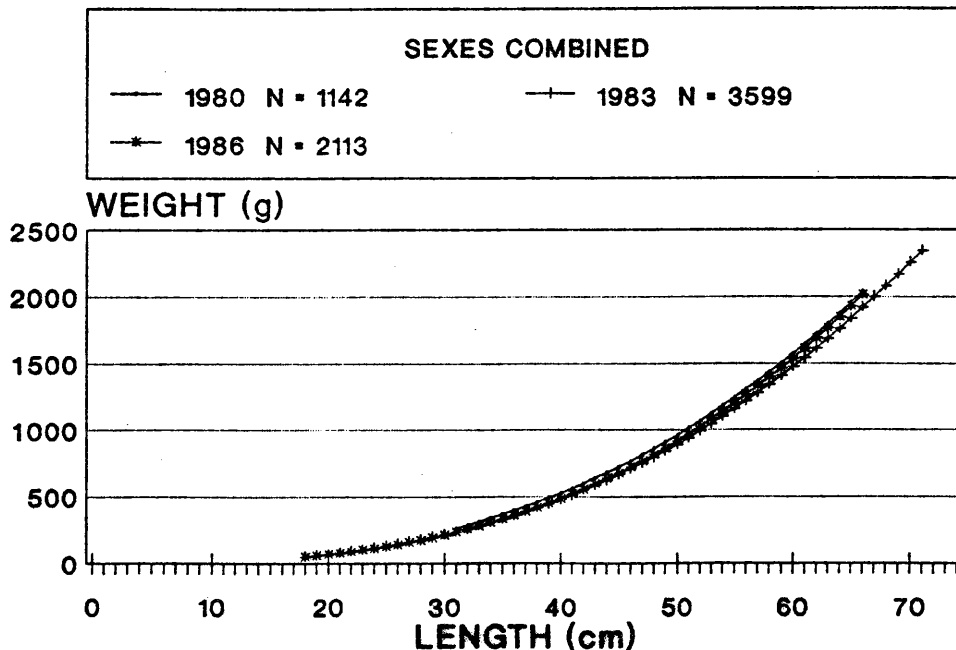

Figure 32. Length-weight relationships for walleye pollock in the Aleutian Islands area during the U.S.-Japan 1980, 1983, and 1986 groundfish surveys.

Atka Mackerel

Distribution and Abundance

Atka mackerel (Pleurogrammus monopterygius) had a discontinuous distribution in the Aleutian Islands and Southern Bering Sea areas (Figs. 33-34). This species was found clumped in extremely dense schools making precise abundance assessments difficult. Atka mackerel are primarily found in shallow water less than 200 m. Six major concentrations have been defined in the Aleutian Island area: 1) Stalemate Bank, 2) Buldir and Tahoma Reefs, 3) Kiska and Amchitka Islands, 4) Petrel Spur on the extreme northeast corner of Petrel Bank, 5) Tanaga Pass and, 6) Segum Pass.

The biomass estimate for Atka mackerel in the Aleutian Islands area more than doubled from 130,000 t in 1980 to 343,000 t in 1983 (Fig. 35, Table 31). Part of this increase was related to the lack of sampling in the 1-100 m depth interval in 1980 (Tables 10 and 11). The 144,000 t catch (1983) from the shallow water zone is disregarded the biomass in the remaining depth intervals increased by 69,000 t. This still represents a 65% increase above the 1980 Atka mackerel biomass. Biomass estimates in 1983 increased in all areas sampled except the Northeast area where it decreased by 25%.

In 1986 the biomass of Atka mackerel was 643,000 t, nearly double the 1983 estimate. However, 83% of the entire biomass, 525,000 t, occurred in the 1-100 m depth zone of the Southwest area. This enormous concentration of Atka mackerel was primarily located in the shallow waters around Kiska and Amchitka Islands.

Removing the estimate for the 1-100 m depth interval in the Southwest area leaves a 108,000 t biomass estimate for the rest of the Atka mackerel resource in the Aleutian Islands. This represents a 45% decrease from 1983 estimates and reflects a decrease of biomass estimates in most areas and depth intervals.

In the Southern Bering Sea in 1980, catches of Atka mackerel near the Island of Four Mountains contributed to a biomass estimate of nearly 20,000 t (Fig. 36). Since then, only incidental catches of Atka mackerel have been made in this area and the biomass estimates decreased to 10 t in 1983 and 600 t in 1986.

In the Aleutian Islands area the largest mean length (34.9 cm) and mean weight (0.57 kg) for Atka mackerel occurred during the 1983 survey (Table 32, Figs. 37-38).

Size and Age Composition

The following results assume that all Atka mackerel are 1 year older than the actual otolith annulus count. (See discussion on age composition in Methods and Materials section.)

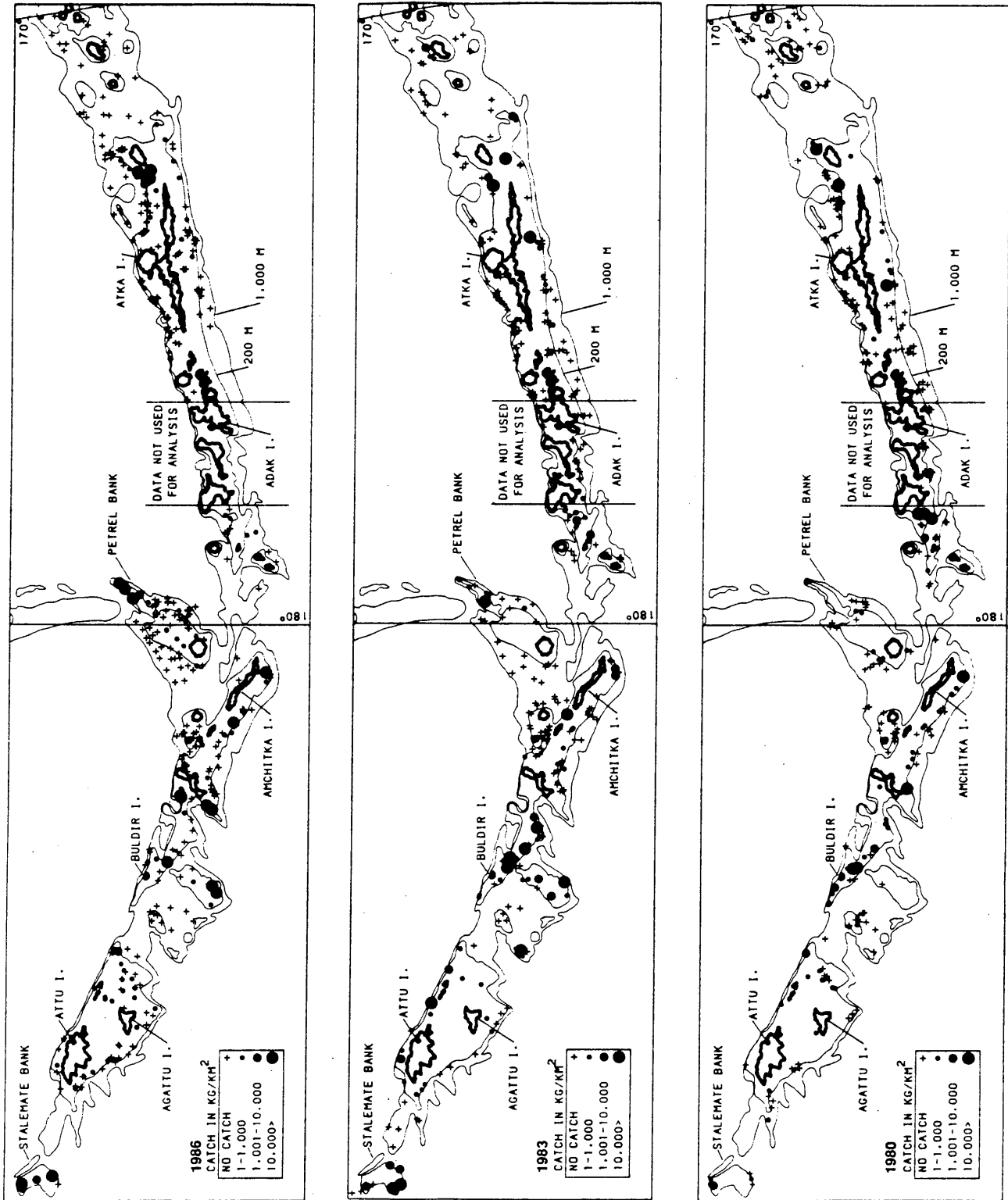

Figure 33. Distribution and relative abundance of Atka mackerel in the Aleutian Islands area during the U.S.-Japan 1980, 1983, and 1986 groundfish surveys.

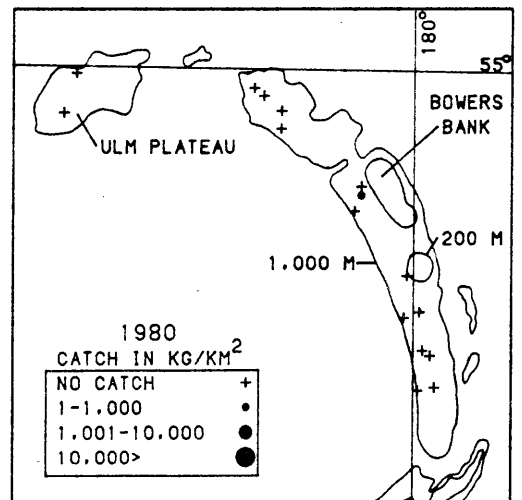
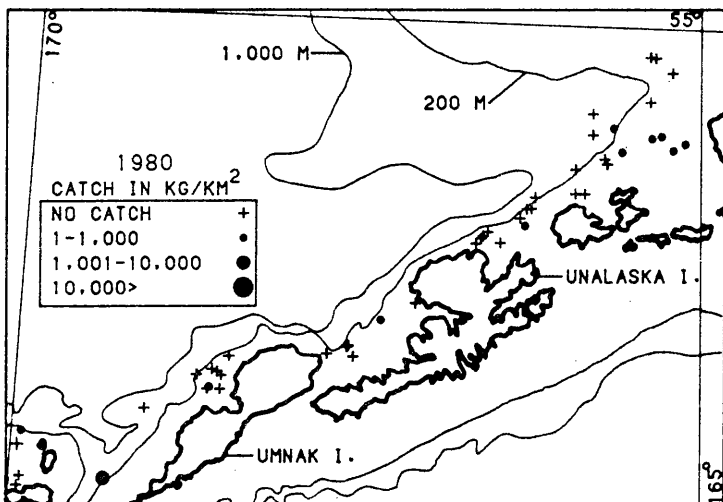
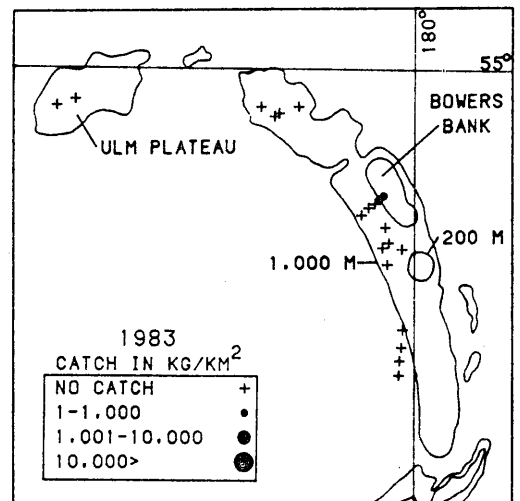
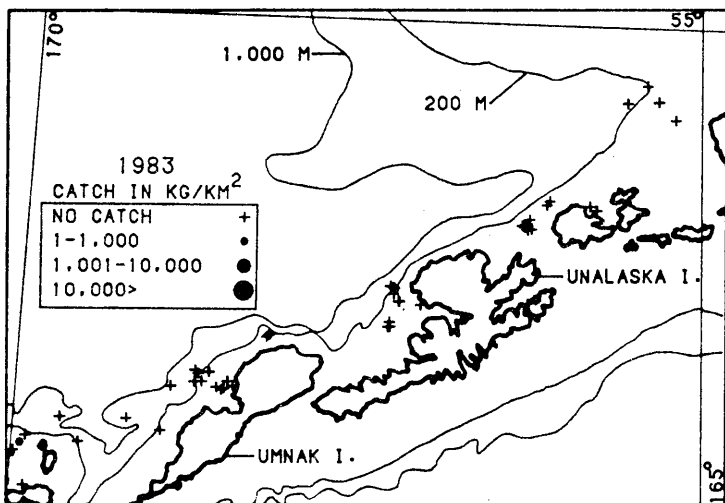
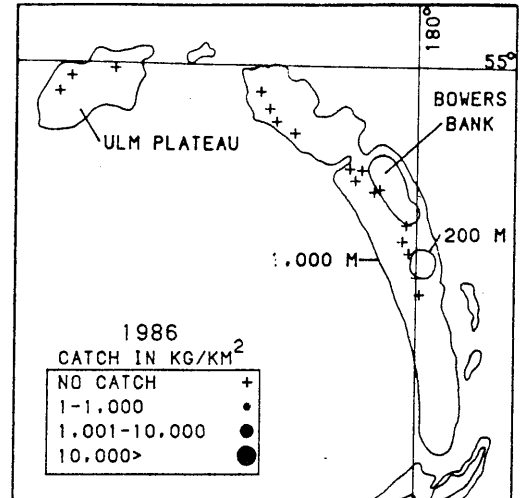
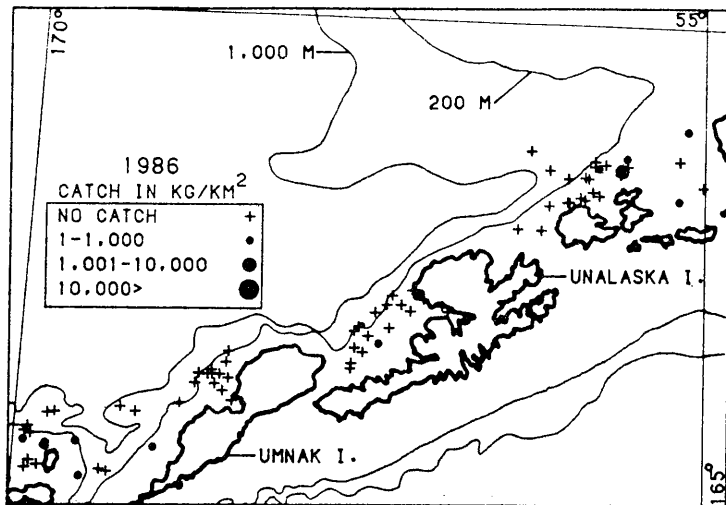

Figure 34. Distribution and relative abundance of Atka mackerel in the Southern Bering Sea and Bowers Ridge areas during the U.S.-Japan 1980, 1983, and 1986 Aleutian Islands groundfish surveys.

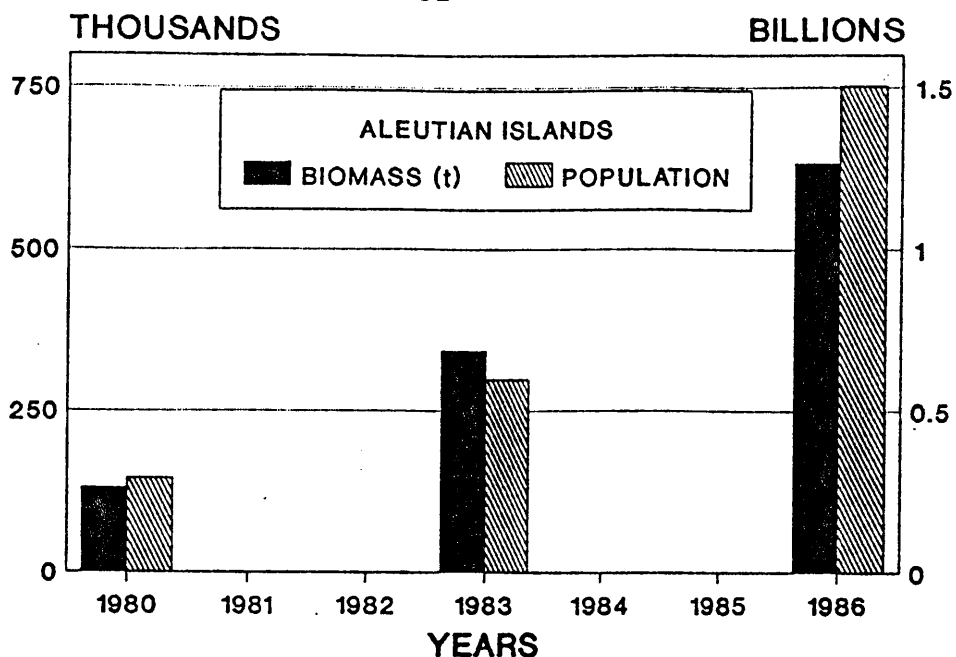

Figure 35. Estimated biomass and population of Atka mackerel in the Aleutian Islands area during the U.S.-Japan 1980, 1983, and 1986 groundfish surveys.

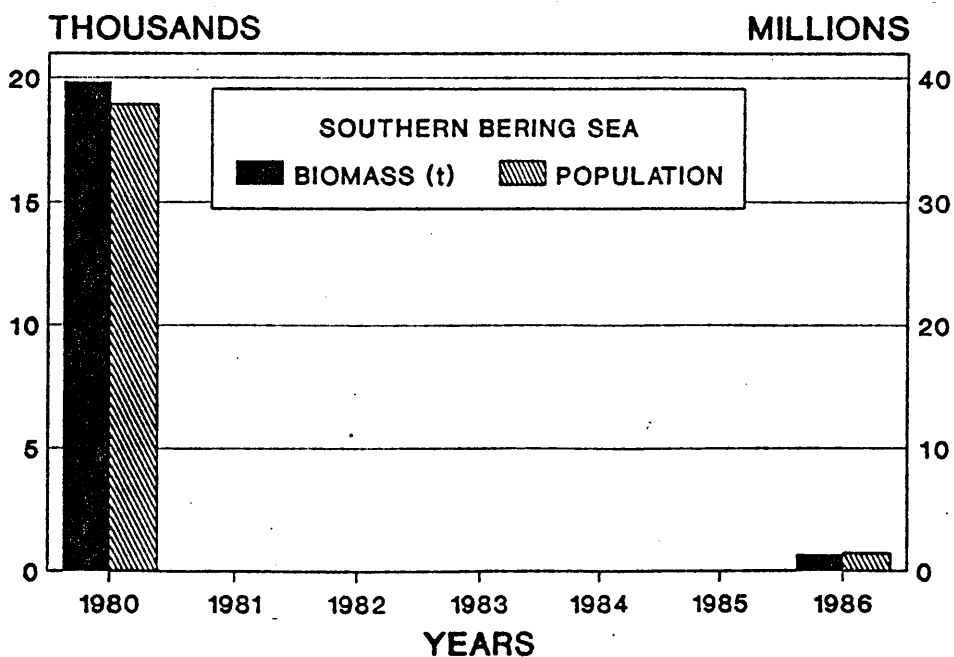

Figure 36. Estimated biomass and population of Atka mackerel in the Southern Bering Sea area during the U.S.-Japan 1980, 1983, and 1986 groundfish surveys.

Table 31. Estimates of biomass, biomass sampling error, and population for Atka mackerel based on the U.S.-Japan 1980, 1983, and 1986 Aleutian Islands groundfish surveys.

Area	Depth (m)	Biomass (t)			Sampling Error (%)			Population (1,000s)		
		1980	1983	1986	1980	1983	1986	1980	1983	1986
Southwest	1-100	96	15,322	482,546				210.8	28,279.3	1,186,003.8
	101-200	76,646	117,812	60,720				145,485.3	268,222.3	130,831.8
	201-300	631	2,087	195				1,111.2	4,961.7	624.6
	301-500	31	146	14				0.0	339.7	19.3
	501-900	11	1	0				0.0	2.5	0.0
	1-900	77,415	135,368	543,475	128.5	78.2	320.3	146,807.3	301,805.5	1,317,479.5
Southeast	1-100	a	65,814	33				a	76,537.2	258.2
	101-200	3,043	60,690	7,048				5,648.9	75,517.3	8,944.5
	201-300	76	194	6				133.9	390.8	6.8
	301-500	16	0	0				0.0	0.0	0.0
	501-900	0	0	0				0.0	0.0	0.0
	1-900	3,135	126,698	7,087	158.4	131.5	211.8	5,782.8	152,445.3	9,209.5
Northwest	1-100	0	41,075	42,785				0.0	80,052.9	115,368.3
	101-200	382	4,111	227				1,050.2	6,107.0	335.8
	201-300	1,465	27	1				2,801.2	47.9	4.3
	301-500	182	0	0				398.7	0.0	0.0
	501-900	4	0	0				0.0	0.0	0.0
	1-900	2,033	45,213	43,013	303.4	843.8	153.7	4,250.1	86,296.2	115,708.4
Northeast	1-100	94	22,121	1				0.0	38,323.6	4.1
	101-200	46,695	13,449	40,191				131,600.6	18,372.7	58,744.9
	201-300	850	451	195				1,959.1	588.5	213.6
	301-500	290	0	1				0.0	0.0	2.8
	501-900	0	0	43				0.0	0.0	51.2
	1-900	47,929	36,021	40,431	228.2	67.4	118.7	133,559.7	57,284.8	59,016.6
Bowers Ridge	101-200	a	2	0				a	4.7	0.0
	201-300	0	0	0				0.0	0.0	0.0
	301-500	2	0	0				0.0	0.0	0.0
	510-900	0	0	0				0.0	0.0	0.0
	101-900	2	2	0	0.0	0.0	0.0	0.0	4.7	0.0
Aleutian Islands total	1-100	190	144,332	525,365	0.0	274.8	331.6	210.8	223,275.7	1,301,634.4
	101-200	126,766	196,064	108,186	107.3	95.4	63.0	283,785.0	368,229.7	198,857.0
	201-300	3,022	2,759	397	221.1	112.1	132.9	6,005.4	5,988.9	849.3
	301-500	521	146	15	155.3	244.7	413.4	398.7	339.7	22.1
	501-900	15	1	43	328.2	277.6	220.1	0.0	2.5	51.2
	1-900	130,514	343,302	634,006	104.3	56.9	275.7	290,399.9	597,836.5	1,501,414.0
Southern Bering Sea	1-100	126	0	635				0.0	0.0	1,437.6
	101-200	19,694	10	9				37,757.0	14.0	21.0
	201-300	2	0	1				0.0	0.0	1.2
	301-500	10	0	0				0.0	0.0	0.0
	501-900	0	0	0				0.0	0.0	0.0
1-900	19,832	10	645	268.6	156.4	174.0	37,757.0	14.0	1,459.8	

a No sampling was conducted in this area-depth interval.

Table 32. Estimates of mean catch per unit effort, length, and weight for Atka mackerel based on the U.S.-Japan 1980, 1983, and 1986 Aleutian Islands groundfish surveys.

Area	Depth (m)	Mean CPUE (kg/km ²)			Mean Length (cm)			Mean Weight (kg)		
		1980	1983	1986	1980	1983	1986	1980	1983	1986
Southwest	1-100	41.7	5,212.6	128,247.9	31.9	34.3	0.0	0.45	0.54	0.40
	101-200	11,736.5	18,040.2	9,297.9	34.6	32.8	35.3	0.53	0.44	0.46
	201-300	275.1	909.7	85.0	29.1	33.1	36.0	0.57	0.42	0.31
	301-500	9.1	42.7	4.0	0.0	33.7	0.0	0.00	0.43	0.71
	501-900	1.5	0.1	0.0	0.0	0.0	0.0	0.00	0.31	0.00
	1-900	3,590.6	6,095.3	23,596.7	32.2	32.9	35.3	0.53	0.45	0.41
Southeast	1-100	a	41,714.0	12.5	a	38.6	0.0	a	0.86	0.17
	101-200	929.9	18,547.5	2,154.0	41.1	39.1	34.9	0.54	0.80	0.79
	201-300	24.0	61.4	1.8	0.0	34.0	0.0	0.57	0.49	0.81
	301-500	5.8	0.0	0.0	0.0	0.0	0.0	0.00	0.00	0.00
	501-900	0.0	0.0	0.0	0.0	0.0	0.0	0.00	0.00	0.00
	1-900	280.2	9,064.9	471.1	41.1	38.9	34.9	0.54	0.83	0.77
Northwest	1-100	0.0	17,406.2	18,130.8	30.6	34.3	0.0	0.00	0.51	0.38
	101-200	208.0	1,564.7	86.4	38.6	33.8	0.0	0.36	0.67	0.67
	201-300	1,368.8	25.0	1.3	0.0	34.8	32.3	0.52	0.56	0.33
	301-500	82.1	0.0	0.0	0.0	0.0	34.0	0.46	0.00	0.00
	501-900	1.0	0.0	0.0	0.0	0.0	0.0	0.00	0.00	0.00
	1-900	183.0	3,542.6	3,370.2	30.6	34.3	32.5	0.48	0.52	0.38
Northeast	1-100	42.2	18,968.8	0.7	0.0	35.1	0.0	0.00	0.58	0.33
	101-200	11,952.5	3,442.5	10,287.8	37.6	38.1	30.4	0.35	0.74	0.69
	201-300	347.9	184.5	79.8	0.0	39.4	32.7	0.43	0.77	0.91
	301-500	84.4	0.0	0.2	0.0	0.0	0.0	0.00	0.00	0.20
	501-900	0.0	0.0	7.0	0.0	0.0	0.0	0.00	0.00	0.85
	1-900	2,674.9	2,102.9	2,280.5	37.6	36.1	30.4	0.36	0.63	0.69
Bowers Ridge	101-200	a	6.5	0.0	a	0.0	0.0	a	0.44	0.00
	201-300	0.0	0.0	0.0	0.0	0.0	0.0	0.00	0.00	0.00
	301-500	1.1	0.0	0.0	0.0	0.0	0.0	0.00	0.00	0.00
	501-900	0.0	0.0	0.0	0.0	0.0	0.0	0.00	0.00	0.00
	101-900	0.2	0.2	0.0	0.0	0.0	0.0	0.00	0.44	0.00
Aleutian Islands Total	1-100	31.5	17,944.8	49,172.4	31.8	35.9	0.0	0.90	0.65	0.40
	101-200	8,153.3	11,776.5	6,498.2	35.8	34.4	33.0	0.45	0.53	0.54
	201-300	296.6	270.8	39.0	29.1	33.8	33.1	0.50	0.46	0.47
	301-500	38.9	10.6	1.1	0.0	33.7	34.0	1.31	0.43	0.65
	501-900	0.6	0.0	1.6	0.0	0.0	0.0	0.00	0.31	0.85
1-900	1,819.8	4,497.4	8,043.5	32.3	34.9	33.0	0.45	0.57	0.42	
Southern Bering Sea Total	1-100	26.1	0.0	131.7	31.9	0.0	0.0	0.00	0.00	0.44
	101-200	6,018.7	3.0	2.6	0.0	0.0	33.7	0.52	0.71	0.41
	201-300	2.0	0.0	1.1	0.0	0.0	0.0	0.00	0.00	0.97
	301-500	7.6	0.0	0.0	0.0	0.0	0.0	0.00	0.00	0.00
	501-900	0.0	0.0	0.0	0.0	0.0	0.0	0.00	0.00	0.00
1-900	1,569.0	0.8	51.0	31.9	0.0	33.7	0.52	0.71	0.44	

a No sampling was conducted in this area-depth interval.

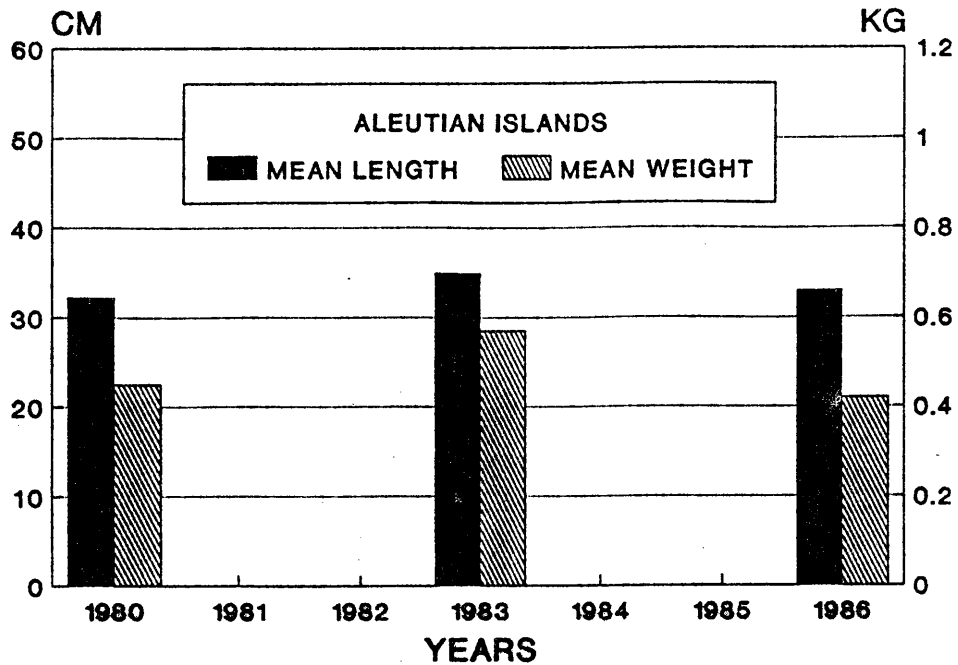

Figure 37. Mean length and weight of Atka mackerel in the Aleutian Islands area during the U.S.-Japan 1980, 1983, and 1986 groundfish surveys.

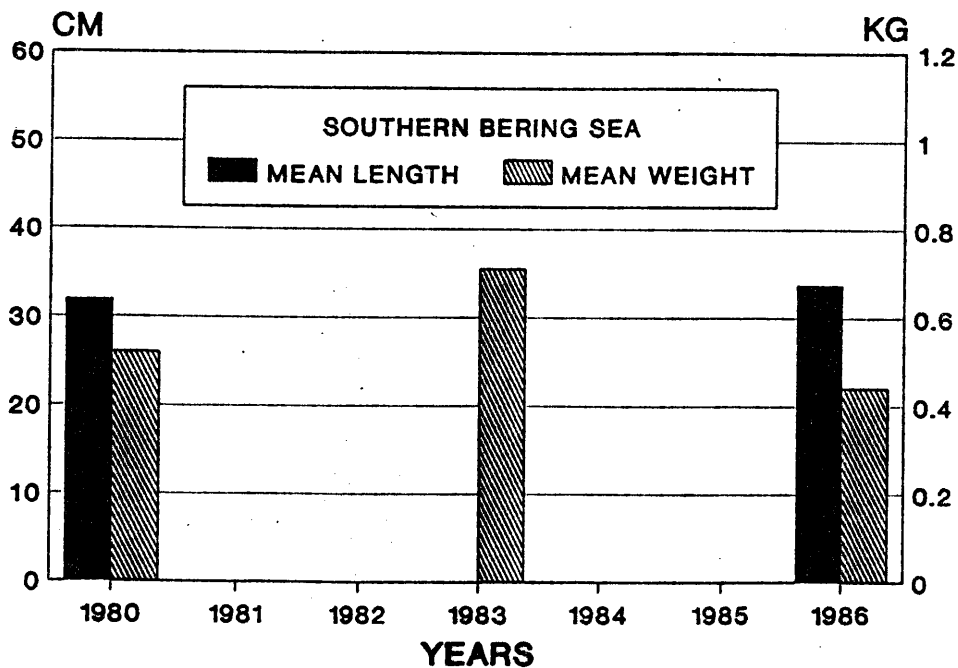

Figure 38. Mean length and weight of Atka mackerel in the Southern Bering Sea area during the U.S.-Japan 1980, 1983, and 1986 groundfish surveys.

During 1980, the Atka mackerel stock was characterized by a bimodal size composition curve consisting primarily of females of either 29-31 cm or 35-37 cm fork length (Fig. 39). Three year classes contributed nearly 90% of the total biomass. The 1977 year class contributed 39%, the 1975 year class contributed 28% and the 1976 year class contributed 19% (Fig. 40).

In 1983, the stock was again characterized by a bimodal size composition curve, however the sex ratio was nearly even. The majority of the stock consisted of individuals from 33 to 40 cm, with the primary female mode peaking at 36 cm and the primary male mode peaking at 38-39 cm. The stock was dominated by the same 1977 year class that was the major contributor in 1980, followed by the 1978 and 1979 year classes that contributed 18% and 13%, respectively.

A uni-modal size composition was present during 1986, and again the sex ratio was nearly even. The stock was dominated by a newly recruited 1983 year class. The 1982 through 1978 year classes also contributed from 18 to 5%, with decreasing contribution with increasing age. The 1977 year class which dominated the stock from 1980 and 1983 was still providing around 2% of the stock.

Examination of age data indicates several differences in age composition by depth. In 1980, 3-year-old fish dominated the stock, contributing nearly 40% in all depths for which data is available. These fish were strongly supported by 4- and 5-year old fish in all depth intervals (Fig. 41).

In 1983, the 1977 year class (age 6) was still dominating in the 1-100 m and 101-200 m depth intervals, but in the 201-300 m depth interval three year classes, 1977-1979, contributed nearly equal portions, slightly over 20% each.

In 1986, the incoming 1983 year class was the largest contributor, providing 42% and 48% of the Atka mackerel sampled in the 1-100 m and 201-300 m zones, respectively. In the 101-200 m depth interval, six year classes (1978-1983) contributed nearly equal portions to the total stock.

Size and age composition data analyzed by areas indicates numerous differences within a survey year (Figs. 42-47). In 1980, stocks in the Southwest area consisted primarily of larger fish in the 34-37 cm range. These fish were mostly 3- to 6 year-olds from the 1974 through 1977 year classes. The 1975 age group of 5-year-old fish was dominant making up 52% of the stocks in that area. In the Southeast area length data were not available in 1980, but age data indicate that the stocks were made up primarily of 3 to 5-year-olds. In the Northeast area fish were smaller, mostly in the 28-33 cm range. Size and age data for the remaining areas were not available in 1980.

In 1983 the Southwest area contained nearly equal proportions of males and females in the 29-36 cm size interval. These were dominated by 5-year-old fish with strong support of 6-year-old fish and a good showing of 4-year-olds. In the Southeast area there were more males than females, and they were in the 36-42 cm size category. Age data were not available for

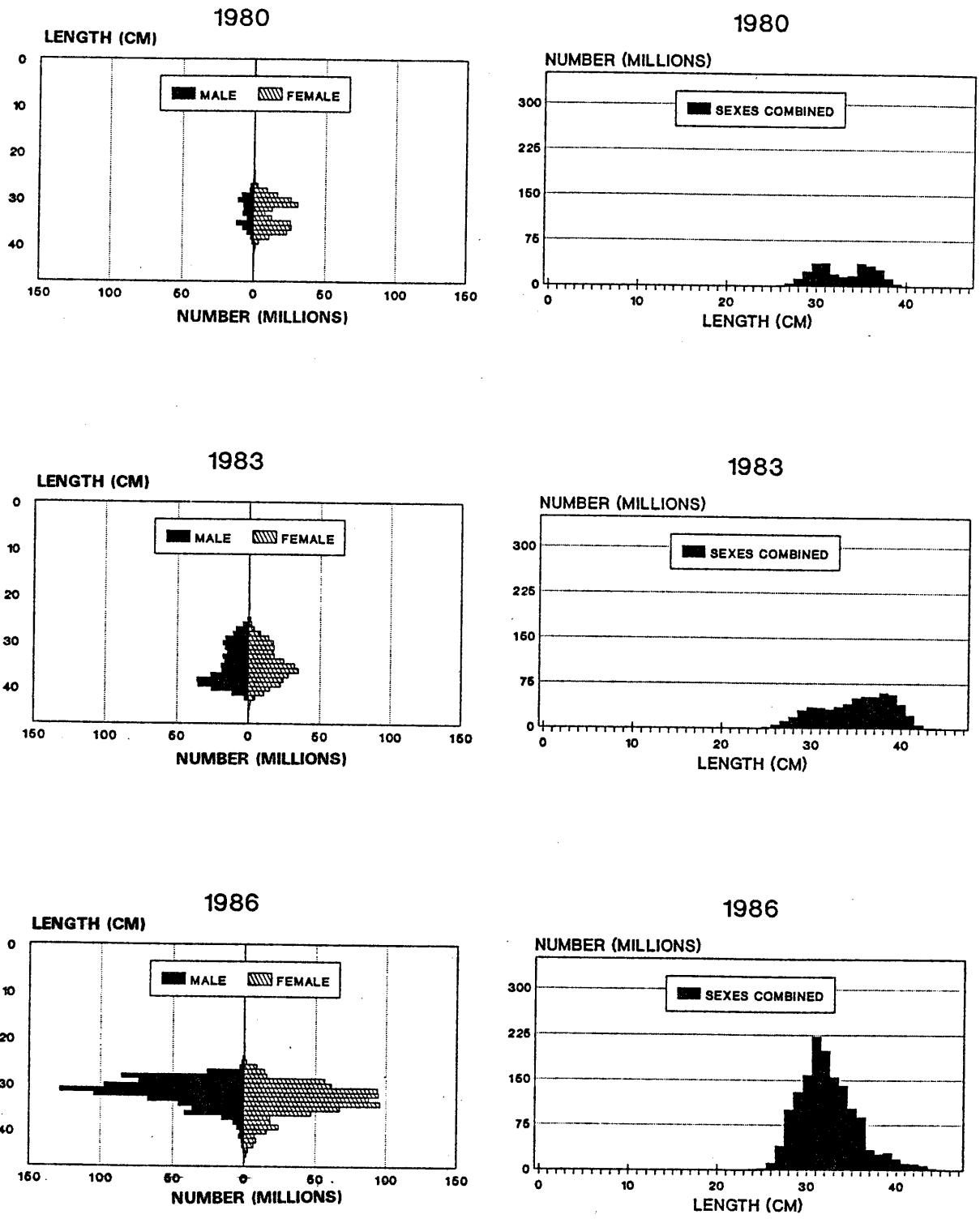
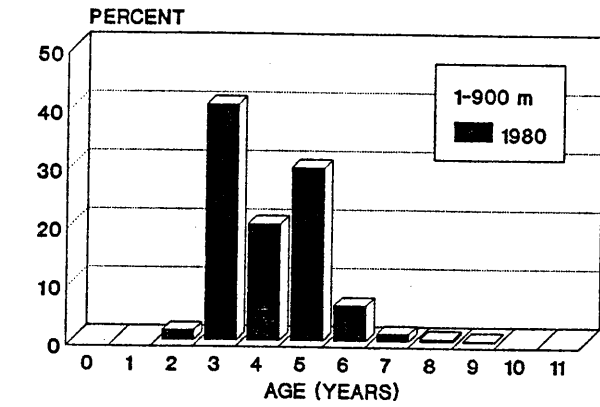
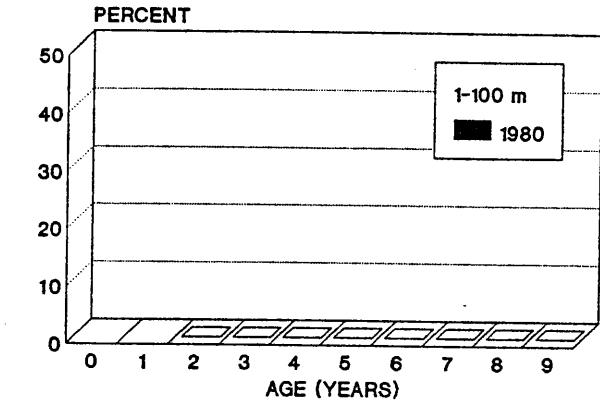

Figure 39. Size composition of Atka mackerel in the Aleutian Islands area during the U.S.-Japan 1980, 1983, and 1986 groundfish surveys.



ALEUTIAN ISLANDS



ALEUTIAN ISLANDS

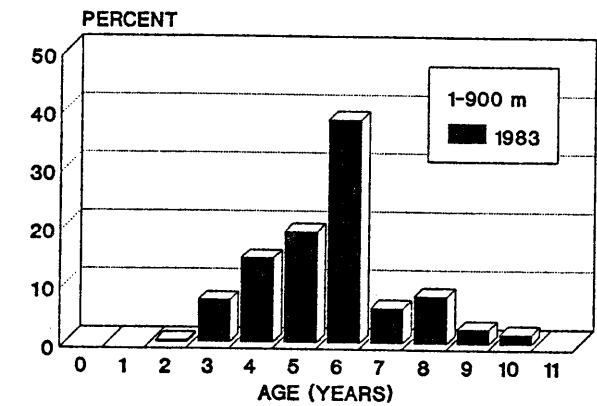

ALEUTIAN ISLANDS

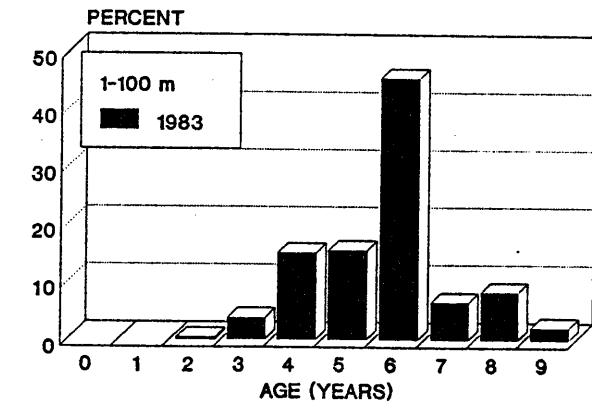

ALEUTIAN ISLANDS

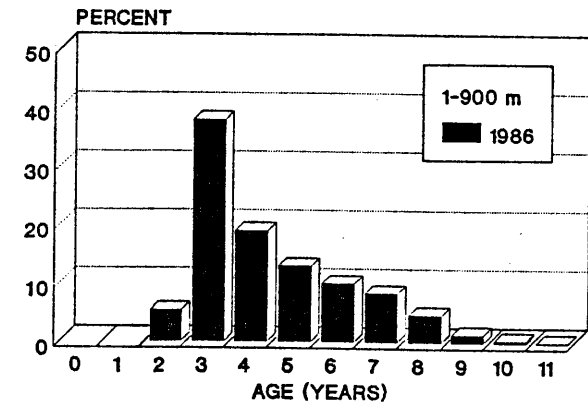

ALEUTIAN ISLANDS

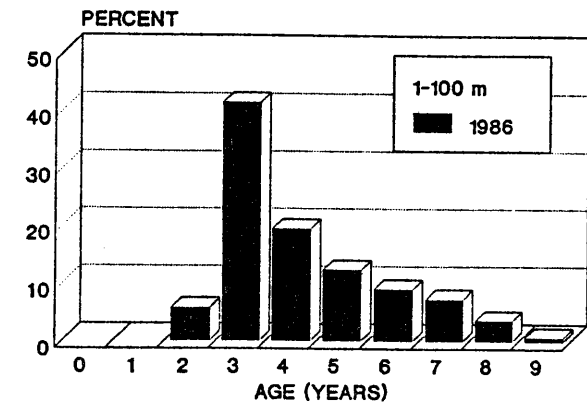

ALEUTIAN ISLANDS

Figure 40. Age composition of Atka mackerel in the 1-100 m depth interval of the Aleutian Islands area during the U.S.-Japan 1980, 1983, and 1986 groundfish surveys.

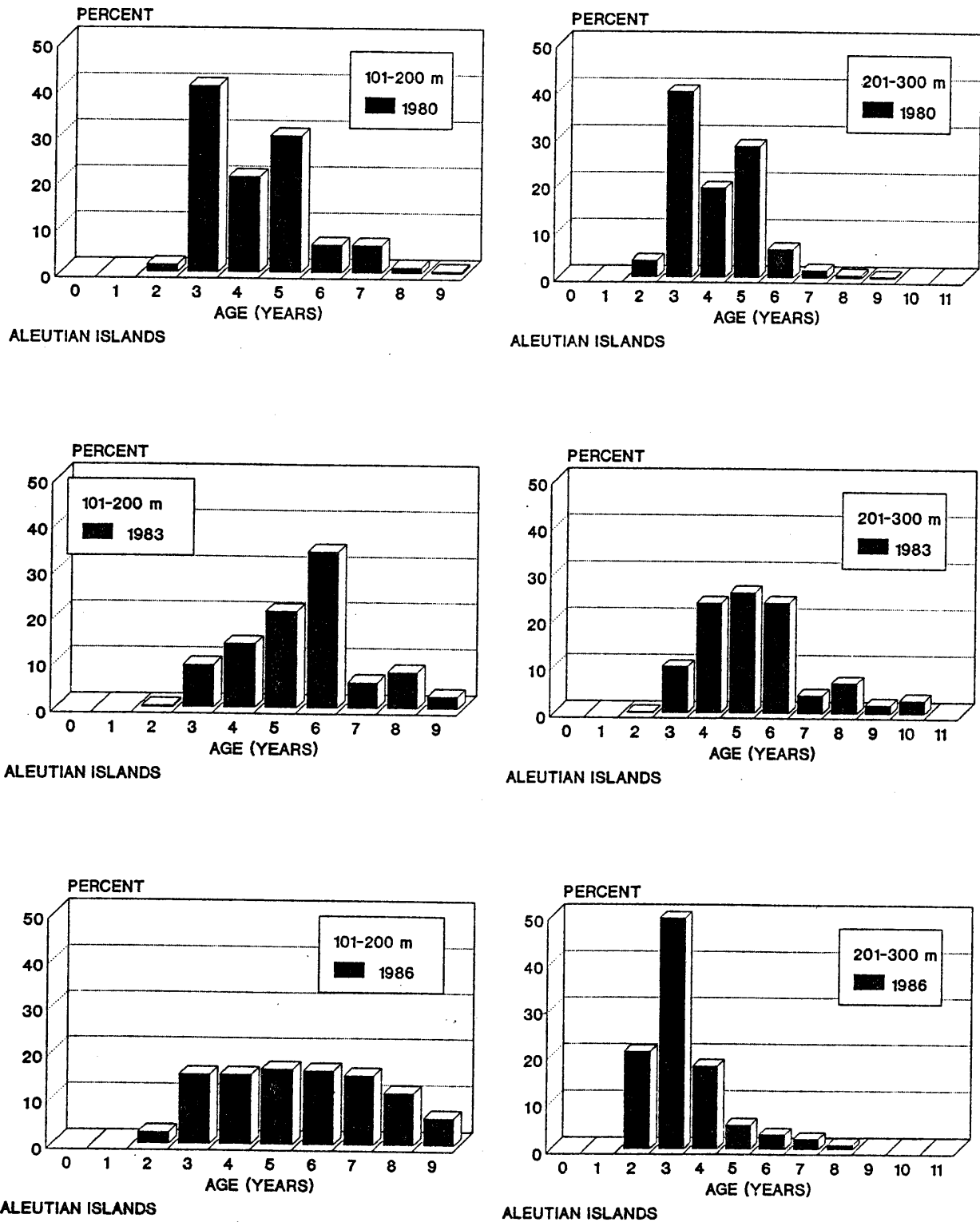

Figure 41. Age composition of Atka mackerel in the 101-200 m and 201-300 m depth intervals of the Aleutian Islands area during the U.S.-Japan 1980, 1983, and 1986 groundfish surveys.

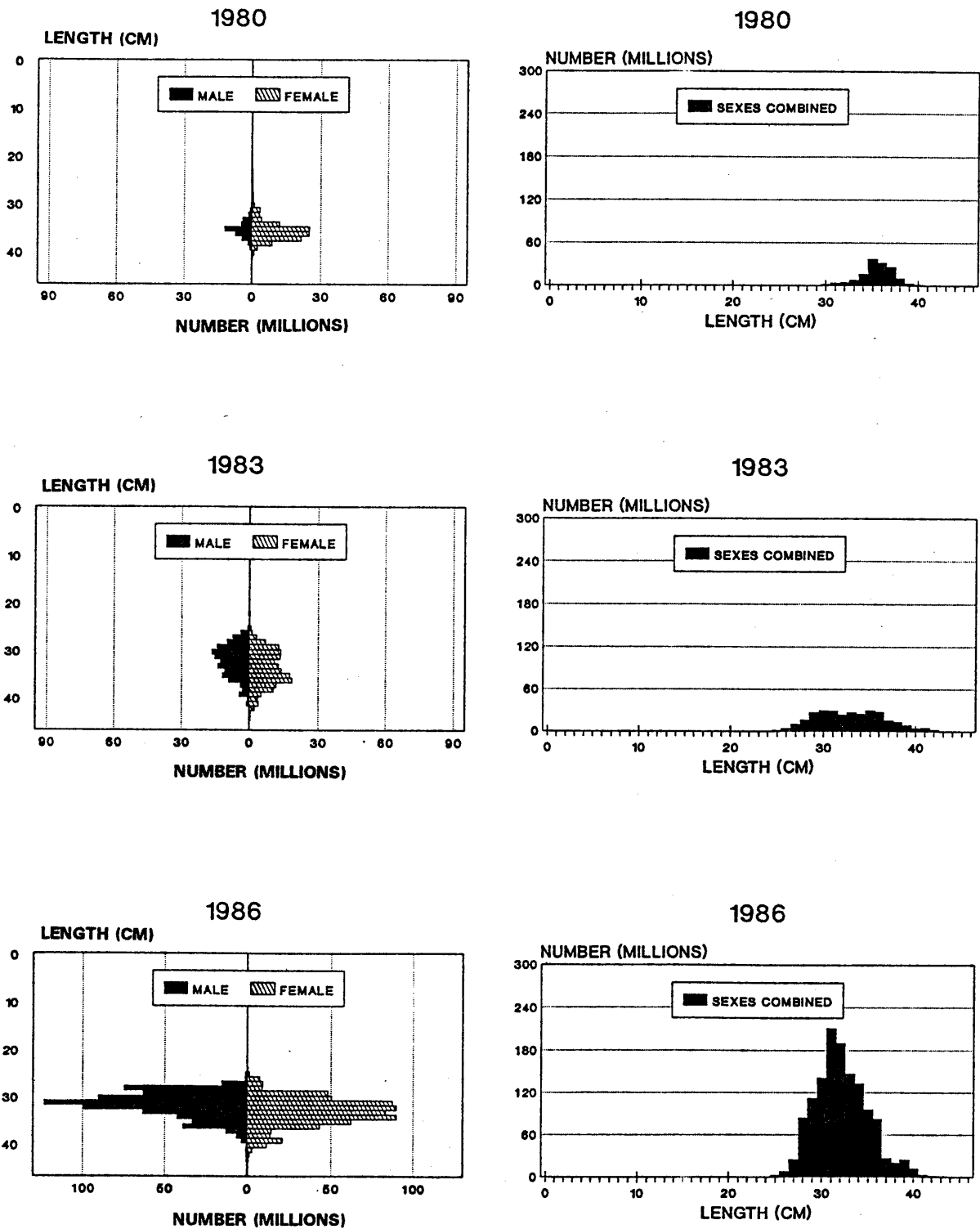

Figure 42. Size composition of Atka mackerel in the Southwest area of the Aleutian Islands during the U.S.-Japan 1980, 1983, and 1986 groundfish surveys.

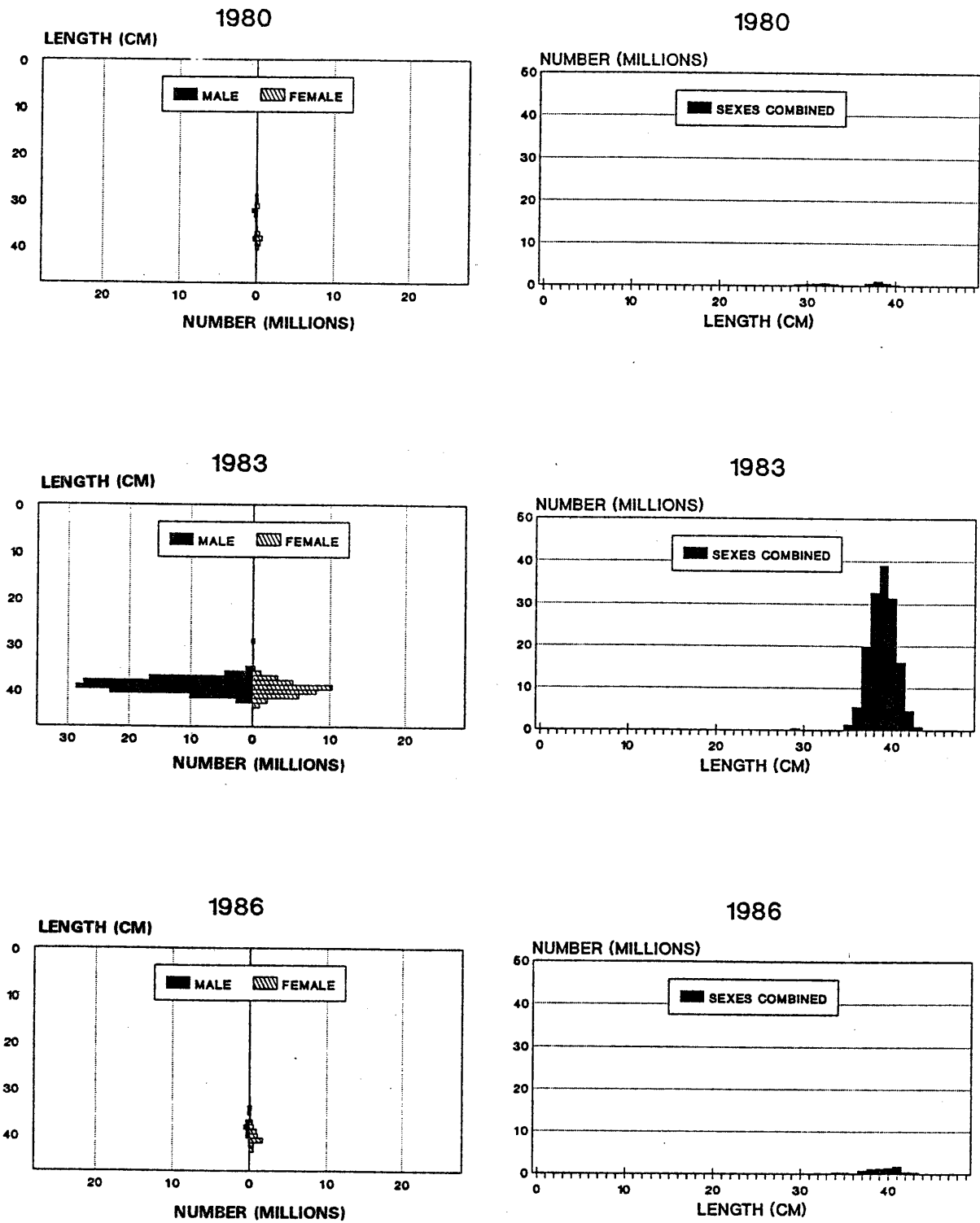

Figure 43. Size composition of Atka mackerel in the Southeast area of the Aleutian Islands during the U.S.-Japan 1980, 1983, and 1986 groundfish surveys.

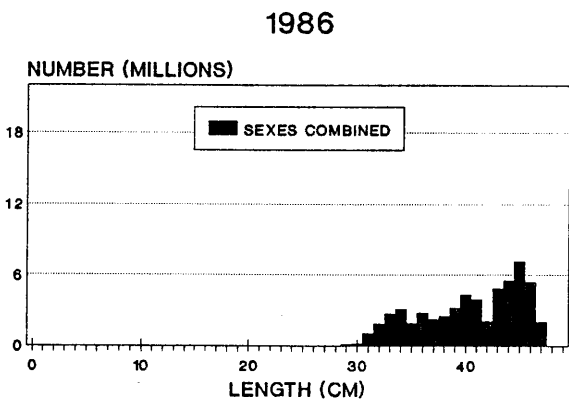
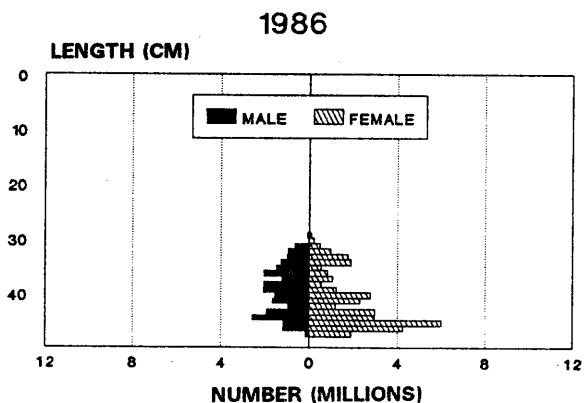
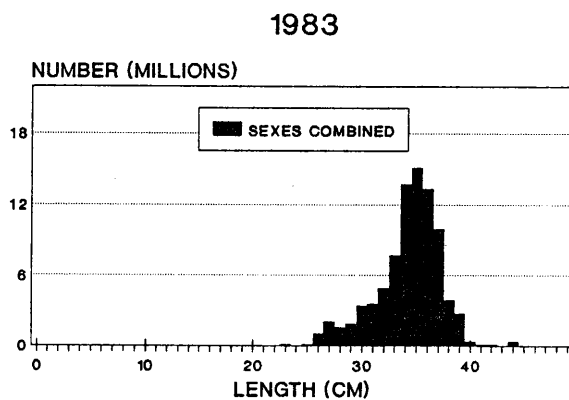
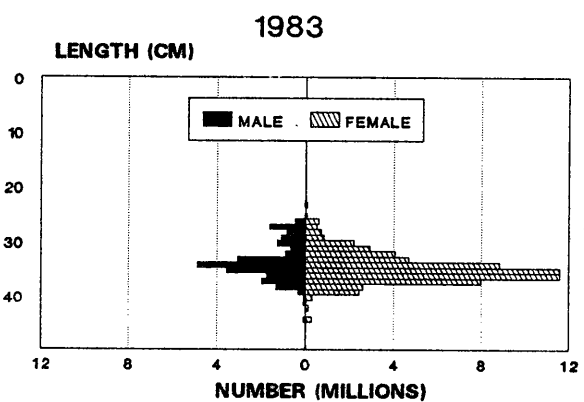
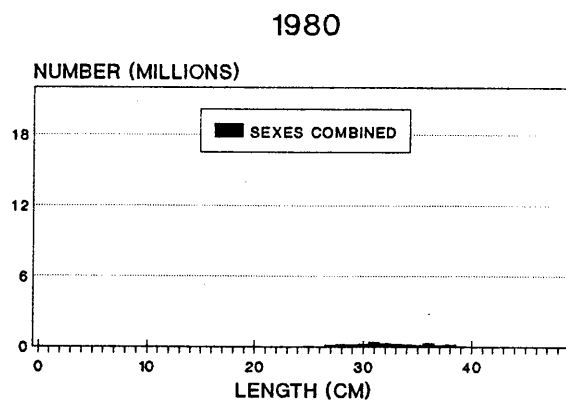
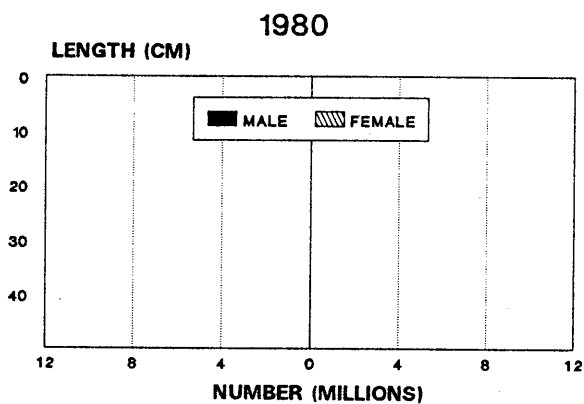

Figure 44. Size composition of Atka mackerel in the Northwest area of the Aleutian Islands during the U.S.-Japan 1980, 1983, and 1986 groundfish surveys.

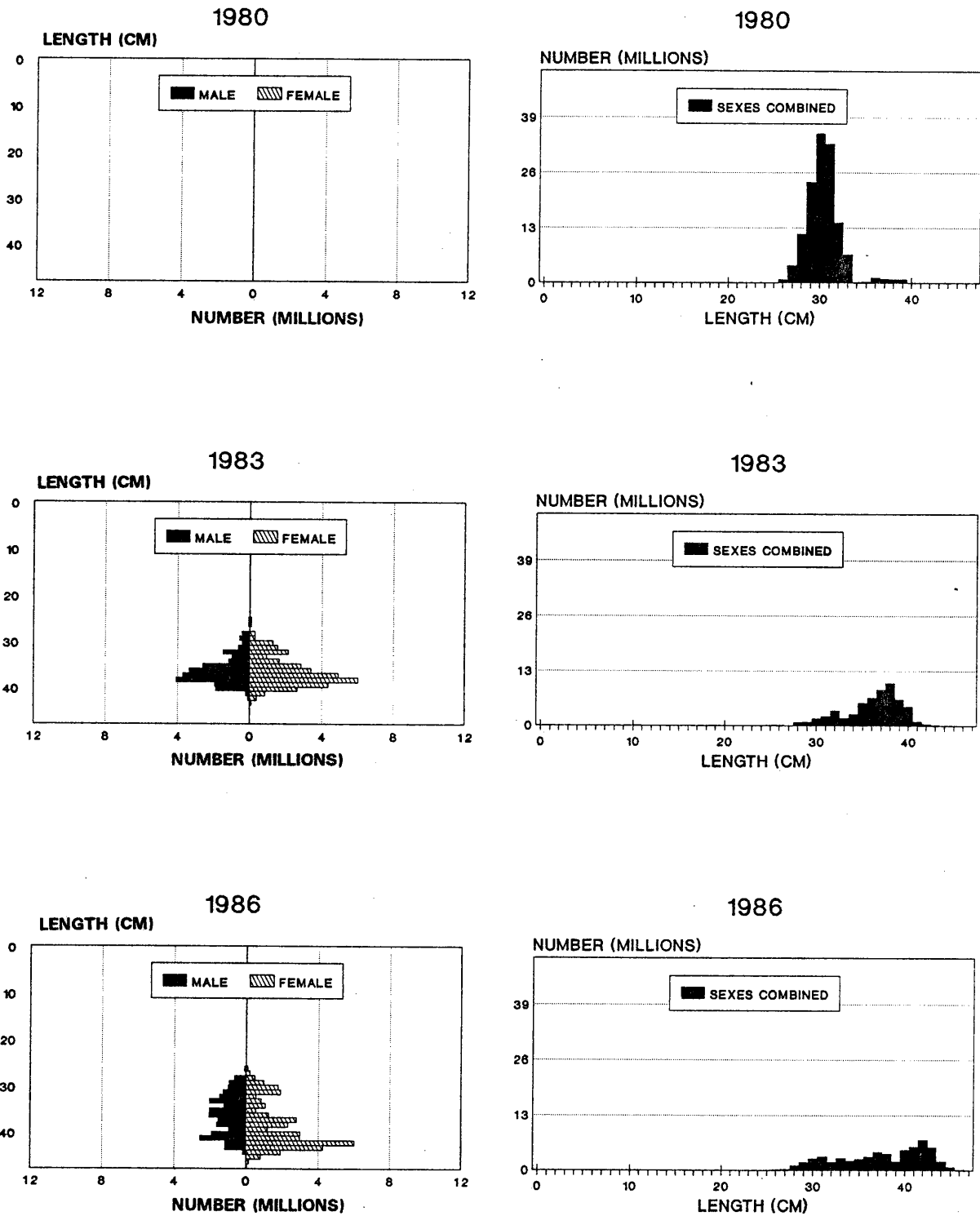

Figure 45. Size composition of Atka mackerel in the Northeast area of the Aleutian Islands during the U.S.-Japan 1980, 1983, and 1986 groundfish surveys.

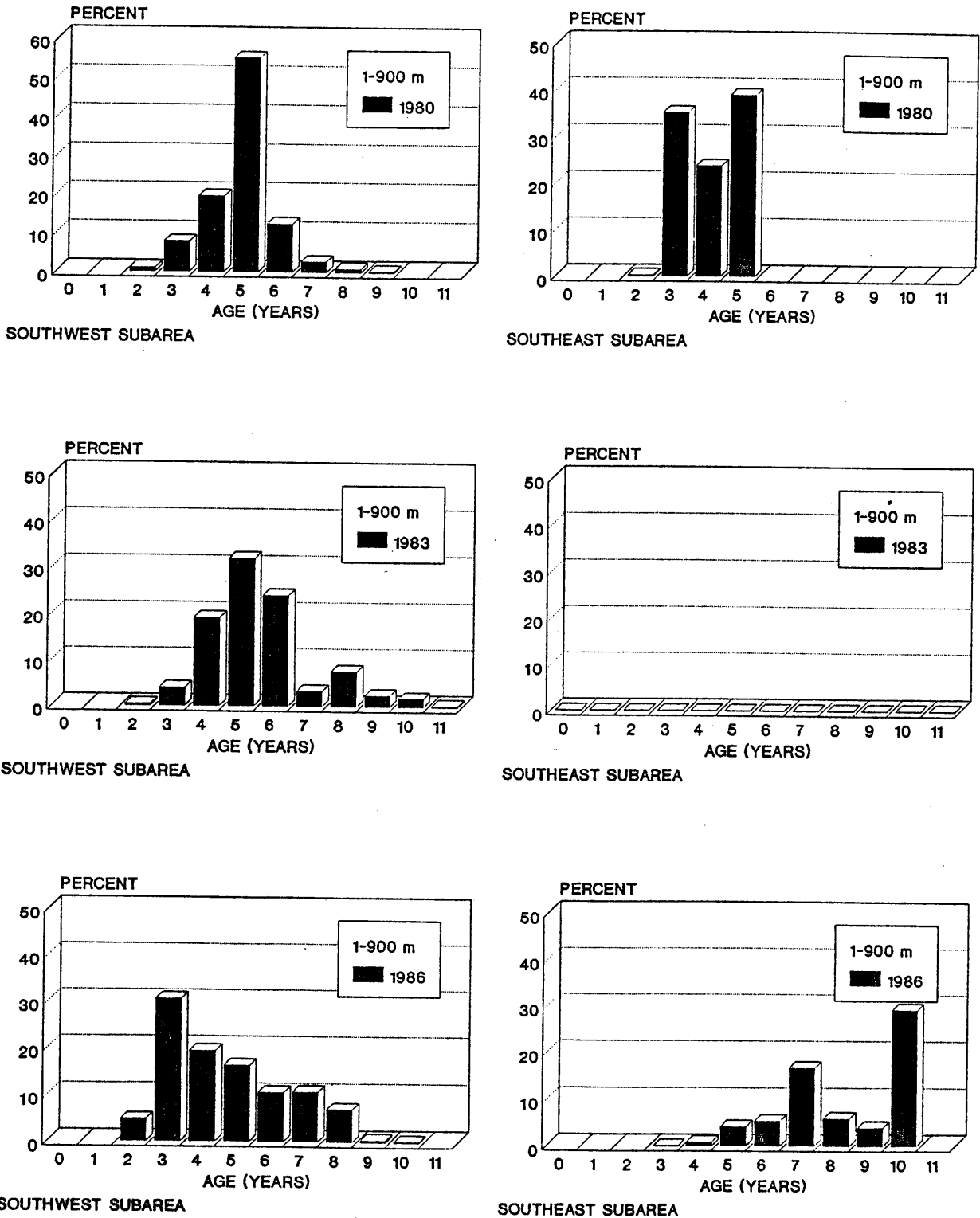
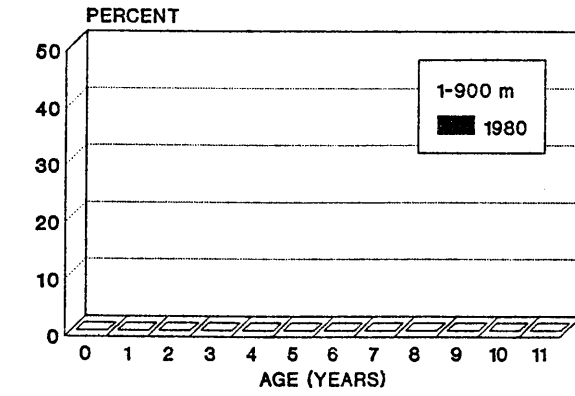
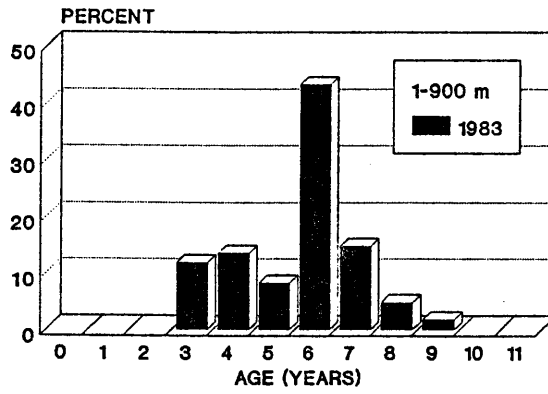

Figure 46. Age composition of Atka mackerel in the Southwest and Southeast areas of the Aleutian Islands during the U.S.-Japan 1980, 1983, and 1986 groundfish surveys.



NORTHEAST SUBAREA



NORTHEAST SUBAREA

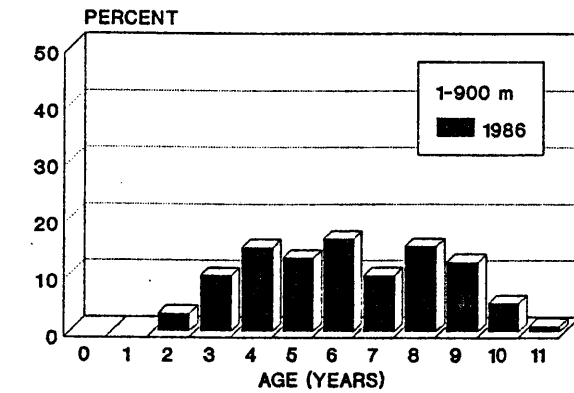

NORTHEAST SUBAREA

Figure 47. Age composition of Atka mackerel in the Northeast area of the Aleutian Islands during the U.S.-Japan 1980, 1983, and 1986 groundfish surveys.

the Southeast area in 1983. In the Northwest area there were more females than males, and they were in the 30-39 cm mode. No age data were available. In the Northeast area there were slightly more females than males and they were in the 35-40 cm size range. The 1977 year class of 6-year-old fish was dominant with major contributions of greater than 10% from 3-, 4-, and 7-year-old fish from the 1980, 1979, and 1976 year classes.

In 1986 the Atka mackerel stock in the Southwest area was composed mainly of smaller fish (28-36 cm) and there were more males than females. The age composition was dominated by 3-year-old fish with decreasing contributions from older year classes. In the three remaining areas of the Aleutian Islands the fish were larger, mostly in the 38-46 cm range. In the Southeast area most of fish were older than 5 years with 7-year-olds, and 10-year-old fish the largest contributors to the stocks. No age data are available from the Northwest area in 1986. The Northeast area was composed of several ages with 3- to 9-year-old fish contributing nearly equal portions to the stock.

Size composition in the Southern Bering Sea in 1980 was bimodal and dominated by smaller fish, mostly in the 30-35 cm range (Fig. 48). No size composition data were available for the 1983 and 1986 surveys and no age data were available from any of the three surveys.

Mean Length-at-Age and Growth

In view of the age composition and the variation in dominant year classes between concentrations of Atka mackerel, mean length-at-age data were computed based upon the data available for the six concentrations. During the 1980 survey, mean length-at-age seems quite similar for the three concentrations where age data is available. However, there may be slightly larger size at age in the Amchitka and Kiska Islands concentration (Table 33).

During 1983, a gradation of mean size-at-age is obvious with the smallest sizes occurring at the west end of the Aleutian Islands, Stalemate Bank; intermediate mean sizes in the central portion, Buldir-Tahoma Reefs and Petrel Spur; and the largest mean sizes at the eastern end, Seguam Pass (Table 34).

In 1986, a similar situation was apparent, that is, a gradation in mean size-at-age from west to east, with the largest mean size again in the eastern Aleutian Islands, Seguam Pass (Table 35).

These data show that although the western Aleutian Islands had fish of a smaller mean size-at-age during the 1983 and 1986 surveys, this has not always been the case. In 1980 the mean size-at-age was as large in the Stalemate Bank concentration as in the more central portions of the Aleutian Islands.

Age data collected during these surveys indicate that Atka mackerel on the average grow from 22 to 27 cm during their first 2 years after which the average annual growth increment decreased to 6.1 cm from age 2 to 3, 3.1 cm from age 3 to 4 and from 0.6 to 1.7 cm thereafter (Table 36).

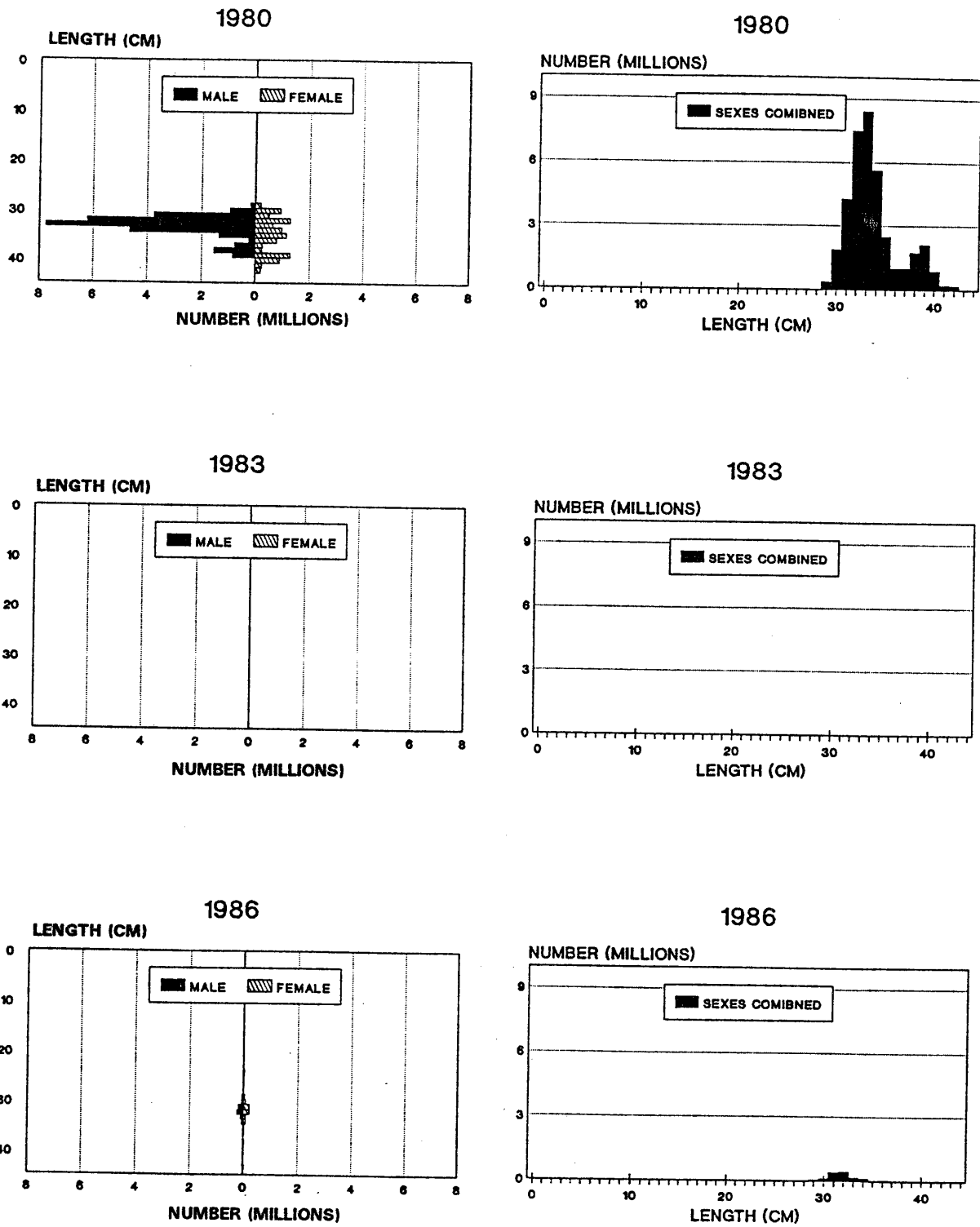

Figure 48. Size composition of Atka mackerel in the Southern Bering Sea during the U.S.-Japan 1980, 1983, and 1986 groundfish surveys.

Table 33. Mean length (cm) at age and age composition (%) for high-density Atka mackerel areas sampled during the U.S.-Japan 1980 Aleutian Islands groundfish survey.

Age	Area									
	Stalemate Bank		Buldir-Tahoma Reefs		Amchitka-Kiska Is.		Petrel Spur		Seguam Pass	
	Lgth	%	Lgth	%	Lgth	%	Lgth	%	Lgth	%
3	31.8	12.4	32.0	3.6	31.3	3.5	-	-	-	-
4	34.0	9.7	35.2	7.0	35.6	26.9	-	-	-	-
5	35.6	55.5	36.6	62.3	36.1	58.3	-	-	-	-
6	35.5	13.6	37.1	16.3	37.7	8.9	-	-	-	-
7	36.9	4.3	38.2	3.1	39.3	1.2	-	-	-	-
8	38.3	1.8	38.3	2.0	39.3	0.3	-	-	-	-
9	38.5	1.3	41.0	0.2	40.0	0.1	-	-	-	-

Table 34. Mean length (cm) at age and age composition (%) for high-density Atka mackerel areas sampled during the U.S.-Japan 1983 Aleutian Islands groundfish survey.

Age	Area									
	Stalemate Bank		Buldir-Tahoma Reefs		Amchitka-Kiska Is.		Petrel Spur		Seguam Pass	
	Lgth	%	Lgth	%	Lgth	%	Lgth	%	Lgth	%
2	26.0	0.5	-	-	-	-	30.1	0.1	-	-
3	28.5	3.9	34.0	3.4	-	-	34.5	16.3	34.8	5.3
4	30.7	11.6	33.7	27.4	-	-	35.2	18.2	38.4	13.2
5	32.1	33.8	34.2	23.8	-	-	36.8	10.4	37.9	0.1
6	35.3	24.5	35.6	34.4	-	-	36.2	25.7	38.7	63.0
7	38.2	5.3	35.1	1.0	-	-	36.5	18.2	40.4	0.1
8	35.4	8.7	37.2	6.1	-	-	37.1	6.4	39.9	7.3
9	36.1	2.2	37.9	2.7	-	-	37.9	0.1	41.5	5.4
10	35.0	2.7	40.2	0.1	-	-	-	-	-	-

Table 35. Mean length (cm) at age and age composition (%) for high-density Atka mackerel areas sampled during the U.S.-Japan 1986 Aleutian Islands groundfish survey.

Age	Area									
	Stalemate Bank		Buldir-Tahoma Reefs		Amchitka-Kiska Is.		Petrel Spur		Seguam Pass	
	Lgth	%	Lgth	%	Lgth	%	Lgth	%	Lgth	%
2	-	-	29.0	0.6	27.1	7.7	-	-	-	-
3	26.5	9.3	30.0	2.3	30.9	53.3	30.5	23.4	33.5	5.4
4	28.3	15.6	34.0	10.6	32.7	20.3	33.2	22.6	39.3	18.2
5	31.3	17.9	36.1	19.9	35.2	9.7	35.3	15.5	41.1	3.2
6	33.1	29.2	35.8	13.5	36.8	2.5	36.2	14.5	42.0	12.0
7	32.4	16.8	37.0	31.5	38.5	3.0	36.5	9.2	41.8	4.8
8	32.3	3.9	35.8	15.5	38.8	2.5	38.7	1.8	42.1	19.5
9	-	-	37.0	0.7	37.7	0.7	38.3	2.7	43.1	13.7
10	-	-	-	-	40.0	0.1	45.0	0.1	42.8	4.6
11	-	-	-	-	-	-	-	-	44.5	0.8

Table 36. Estimates of yearly incremental growth (cm) of Atka mackerel sampled during the U.S.-Japan 1980, 1983, and 1986 Aleutian Islands groundfish surveys.

Age	Year			Average
	1980	1983	1986	
2-3	8.9	-	3.3	6.1
3-4	3.4	3.0	2.8	3.1
4-5	1.1	0.4	2.2	1.2
5-6	0.3	3.0	1.7	1.7
6-7	1.6	0.3	0.4	0.7
7-8	0.3	-0.2	1.7	0.6
8-9	0.9	1.5	1.6	1.3

Length-Weight

Length-weight data were collected for Atka mackerel during all three surveys. Analysis of these data (Fig. 49) provided estimates for the constants for the sexes combined:

$$\begin{aligned} \text{Weight(g)} \text{ (1980)} &= .0171 \times \text{Length(cm)}^{2.892} \\ \text{Weight(g)} \text{ (1983)} &= .0001 \times \text{Length(cm)}^{4.288} \\ \text{Weight(g)} \text{ (1986)} &= .0077 \times \text{Length(cm)}^{3.126} \end{aligned}$$

Length-weight relationships for 1980 and 1986 were similar at smaller lengths (< 32 cm). However in 1986, fish (< 32 cm) were slightly heavier for a given length than in 1980. In 1983, Atka mackerel (< 40 cm) were somewhat lighter for a given length than during 1980 and 1986, but at lengths over 40 cm they were heavier.

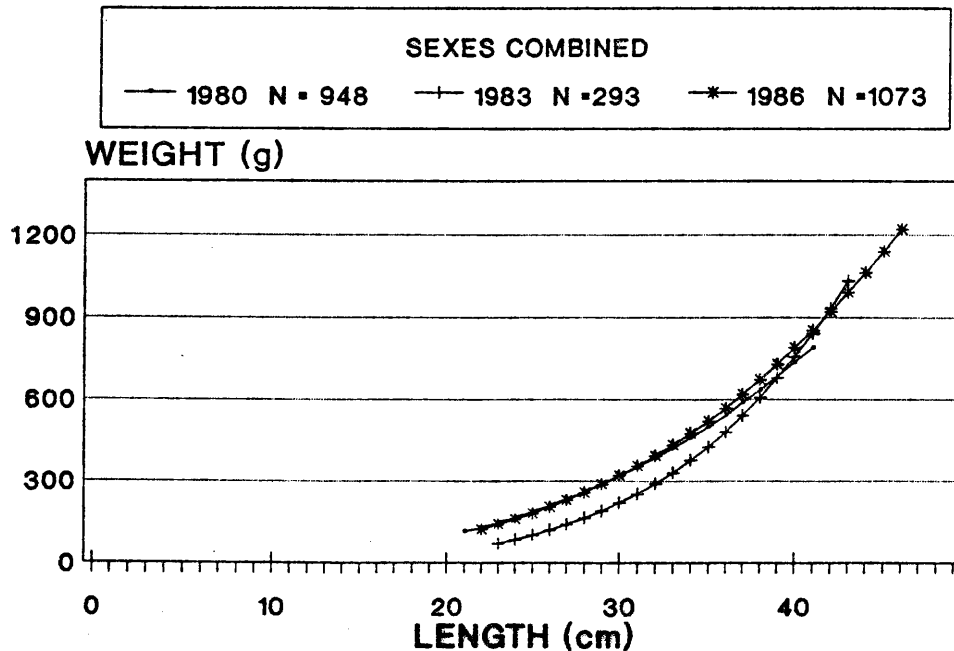

Figure 49. Length-weight relationships for Atka mackerel in the Aleutian Islands area during the U.S.-Japan 1980, 1983, and 1986 groundfish surveys.

Pacific Ocean Perch

Distribution and Abundance

Pacific ocean perch (Sebastes alutus) are found from Stalemate Bank to the Islands of Four Mountains, including Bowers Ridge, in the Aleutian Islands area and in the Southern Bering Sea area. Concentrations of high abundance were located during all three surveys on both sides of the eastern Aleutian Islands chain from Seguam Island to Great Sitkin Island, around Buldir Reef, and on Stalemate Bank in the western Aleutian Islands (Fig. 50-51). During the 1983 and 1986 surveys, additional high-density concentrations were located on Walls Plateau and off the southeast end of Amchitka Island and in 1986 around Kiska Island, Petrel Bank and on Bowers Ridge. Moderate density concentrations were encountered off of Umnak Island during all three surveys and off of Unalaska Island during the 1983 and 1986 surveys in the Southern Bering Sea area.

Between 1980 and 1983 the biomass estimate increased 141% from 83,000 t to 117,00 t (Fig. 52). Nearly all of this 44,000 t increase occurred in the Southeast area (Table 37). Biomass estimates for the Southwest and Bowers Ridge areas were only slightly higher in 1983, and there was a decrease in the biomass of the Northwest and Northeast areas.

In 1986 there was a 177% increase in the biomass estimate from 117,000 to 208,000 t. Most of this increase occurred on the north side of the Aleutian Islands chain. There was an 87,000 t increase in the Northeast area and a 24,000 t increase in the Northwest areas. A smaller increase occurred on Bowers Ridge, and moderate reductions of 14,000 t and 8,000 t occurred in the Southwest and Southeast areas. A large portion of this increase was probably attributed to the numerous large catches on Petrel Bank. There was also an increase in the number of high-density catches in the Seguam Pass region.

During the 1980 and 1983 surveys, the largest portion of the estimated biomass for Pacific ocean perch was located between 101-200 m, and lesser amounts between 201 and 300 m. In 1986 the situation was reversed with the largest portion of the biomass in the 201-300 m depth interval.

In the Southern Bering Sea, the biomass estimates were also highly variable, increasing from 6,000 t in 1980 to 95,000 t in 1983, then decreasing 57% to 55,000 t in 1986 (Fig. 53).

In both the Aleutian Islands area and the Southern Bering Sea area, the population mean maximum length (32.5 and 34.6 cm) occurred during the 1980 survey and the mean maximum weight (0.53 and 0.62 kg) during the 1986 survey (Figs. 54-55, Table 38).

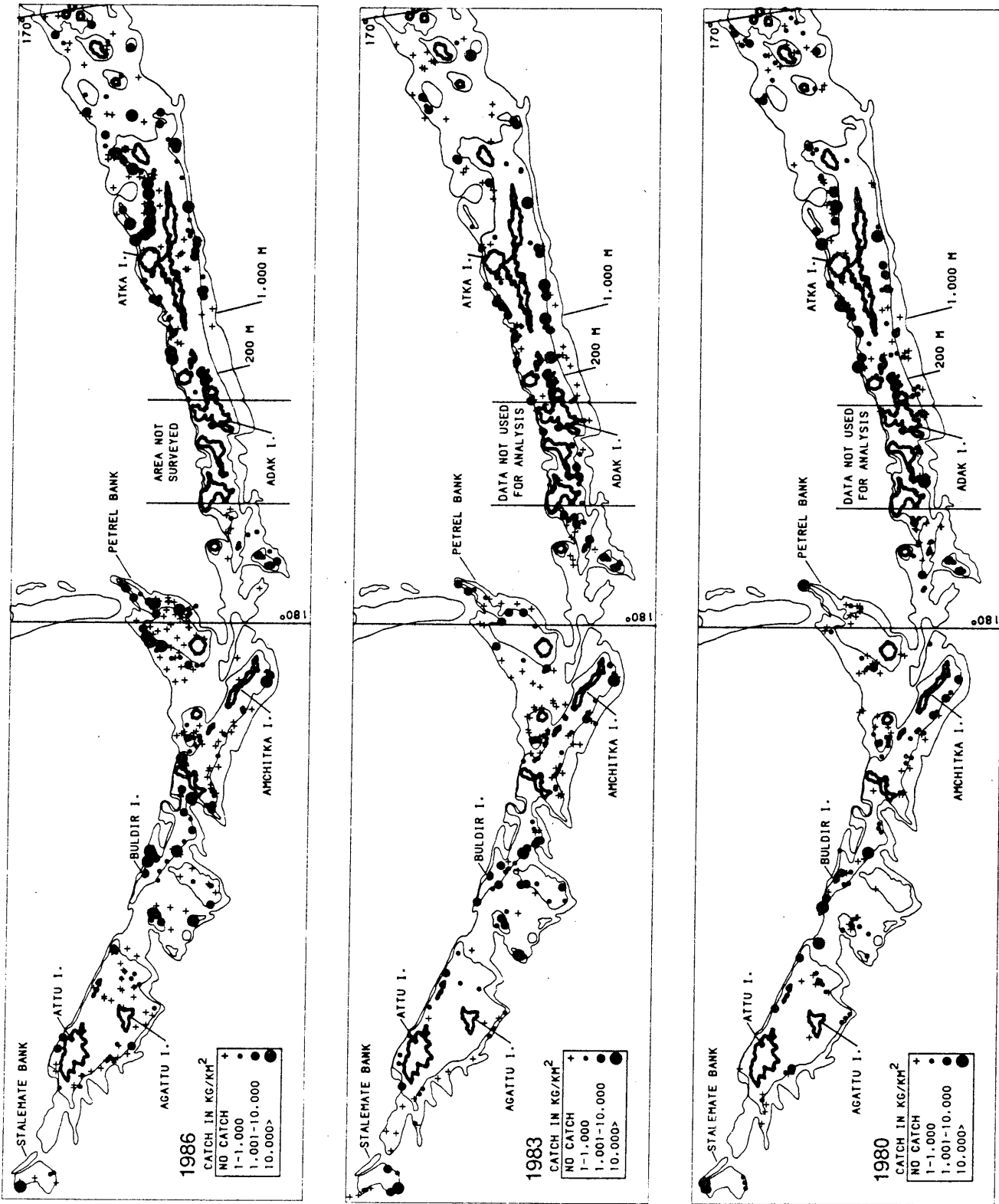

Figure 50. Distribution and relative abundance of Pacific ocean perch in the Aleutian Islands area during the U.S.-Japan 1980, 1983, and 1986 groundfish surveys.

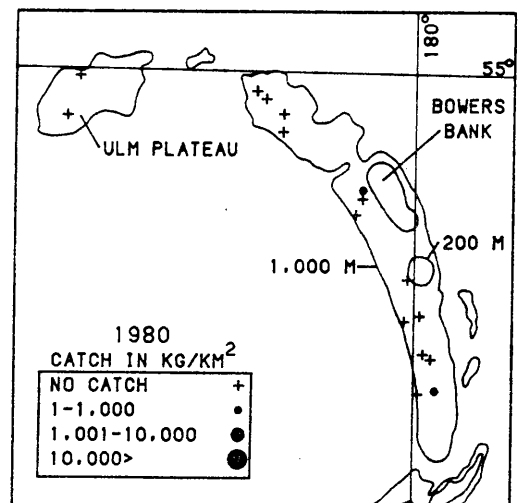
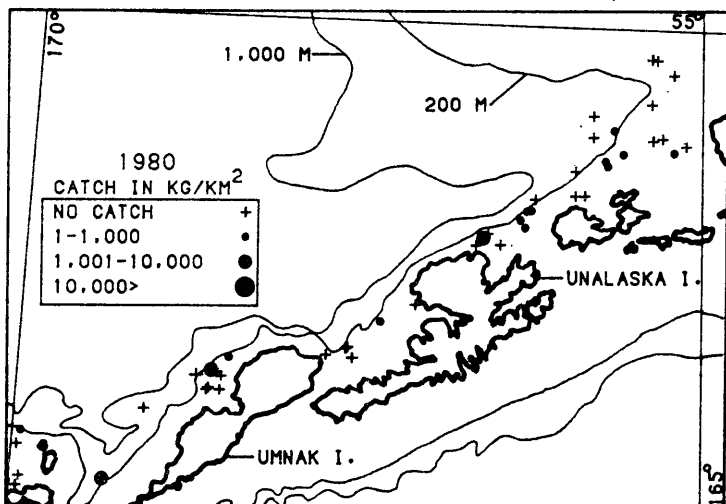
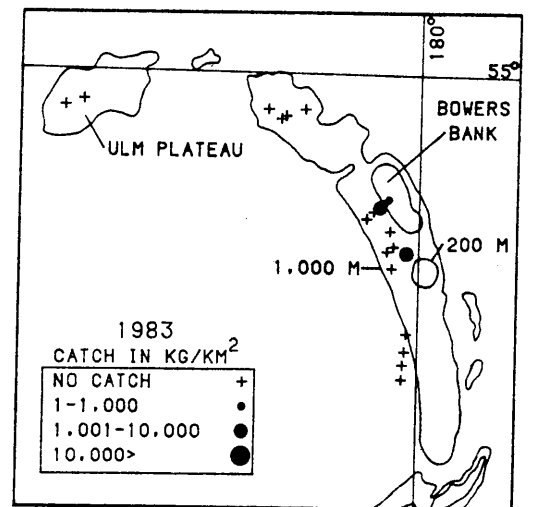
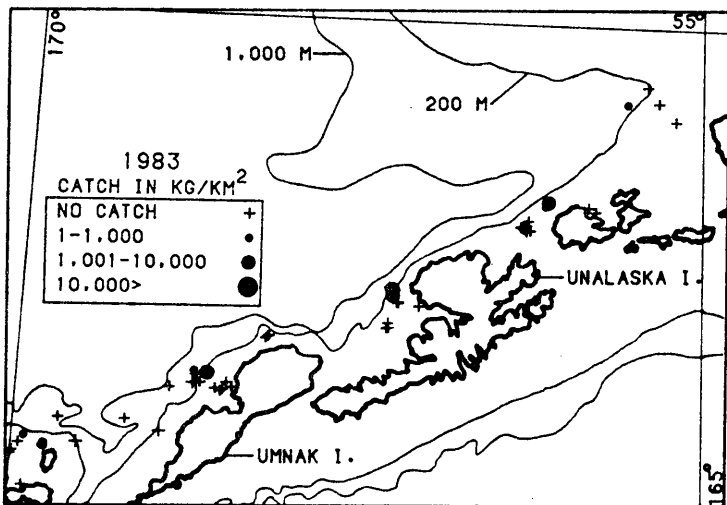
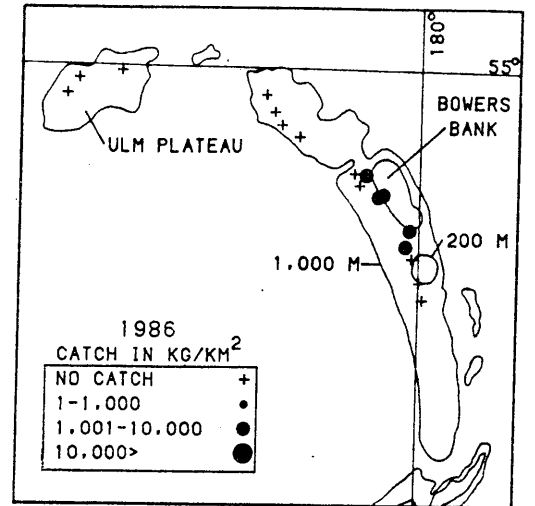
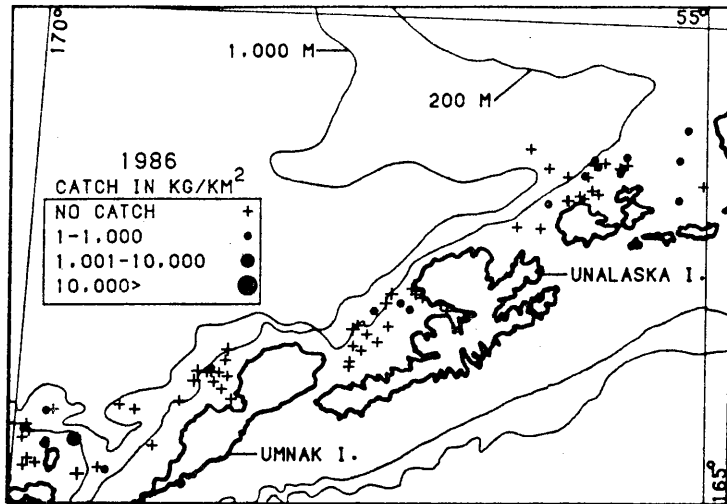

Figure 51. Distribution and relative abundance of Pacific ocean perch in the Southern Bering Sea and Bowers Ridge areas during the U.S.-Japan 1980, 1983, and 1986 Aleutian Islands groundfish surveys.

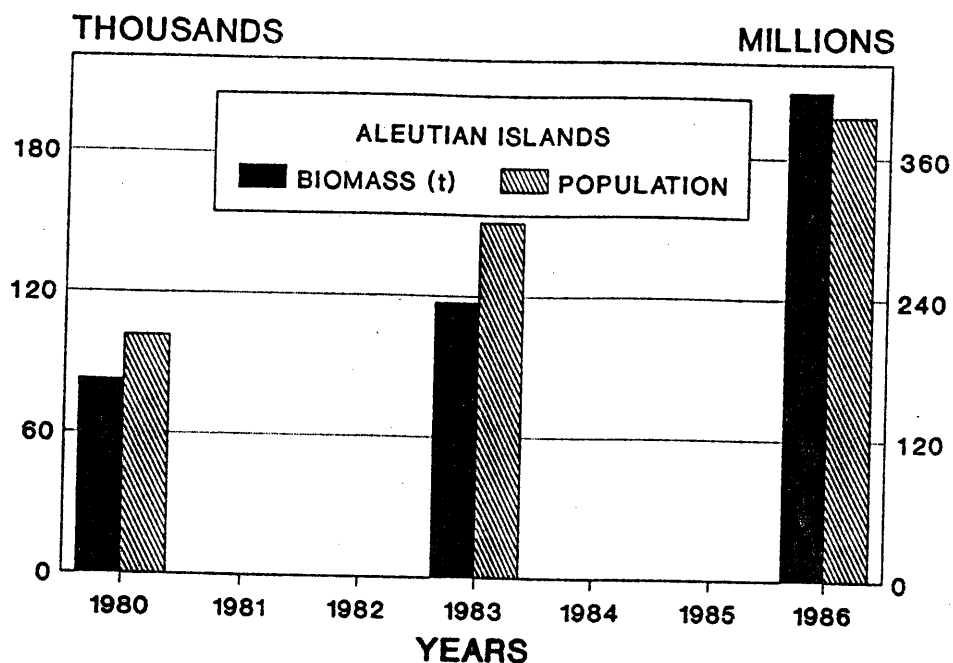

Figure 52. Estimated biomass and population of Pacific ocean perch in the Aleutian Islands area during the U.S.-Japan 1980, 1983, and 1986 groundfish surveys.

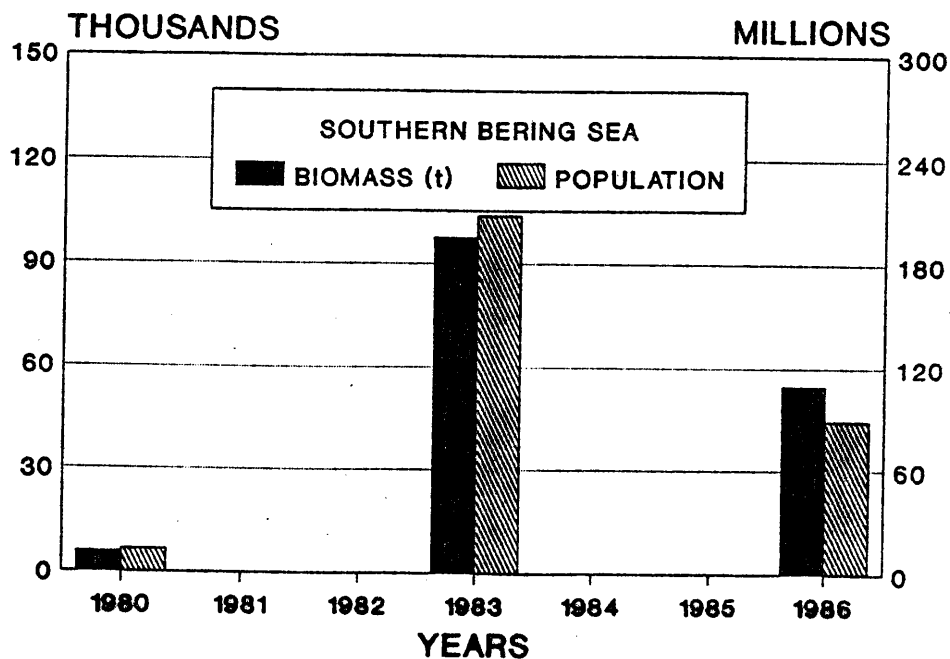

Figure 53. Estimated biomass and population of Pacific ocean perch in the Southern Bering Sea area during the U.S.-Japan 1980, 1983, and 1986 groundfish surveys.

Table 37. Estimates of biomass, biomass sampling error, and population for Pacific ocean perch based on the U.S.-Japan 1980, 1983, and 1986 Aleutian Islands groundfish surveys.

Area	Depth (m)	Biomass (t)			Sampling Error (%)			Population (1,000s)		
		1980	1983	1986	1980	1983	1986	1980	1983	1986
Southwest	1-100	0	3	130				0.0	18.9	466.6
	101-200	17,885	35,466	14,362				61,419.1	101,284.9	35,022.7
	201-300	9,645	5,176	18,132				29,239.2	11,515.9	35,889.8
	301-500	4,993	60	109				9,478.0	120.3	244.0
	501-900	18	2	0				0.0	3.6	0.0
	1-900	32,541	40,707	32,733	101.2	89.0	74.7	100,136.3	112,943.6	71,623.1
Southeast	1-100	a	320	21				a	3,197.7	399.3
	101-200	5,994	27,080	5,883				20,282.9	81,108.6	15,876.4
	201-300	1,548	24,551	30,026				3,065.6	63,199.8	57,416.6
	301-500	502	18	1,826				797.8	34.3	2,762.6
	501-900	0	0	0				0.0	0.0	0.0
	1-900	8,044	51,969	37,756	100.7	106.8	68.9	24,146.3	147,540.4	76,454.9
Northwest	1-100	0	5	0				0.0	28.4	0.0
	101-200	1	634	3,312				14.4	2,120.2	7,355.8
	201-300	1,494	2,850	24,455				3,639.2	3,649.6	36,621.1
	301-500	5,766	12	136				5,840.4	12.5	186.9
	501-900	4	0	0				0.0	0.0	0.0
	1-900	7,265	3,501	27,903	27.2	103.4	87.0	9,494.0	5,810.7	44,163.8
Northeast	1-100	159	17	3				455.5	339.2	62.6
	101-200	15,523	4,215	29,135				35,125.2	11,091.9	74,689.6
	201-300	13,944	10,348	67,804				25,803.2	14,690.8	104,294.0
	301-500	5,154	287	4,465				7,461.6	445.0	10,222.1
	501-900	30	0	0				0.0	0.0	0.0
	1-900	34,810	14,867	101,407	85.5	63.7	69.4	68,845.5	26,566.9	189,268.3
Bowers Ridge	101-200	a	126	1,546				a	189.1	3,243.2
	201-300	37	6,059	4,950				32.3	8,616.3	8,711.9
	301-500	0	0	1,757				0.0	0.0	2,082.5
	510-900	13	0	0				0.0	0.0	0.0
	101-900	50	6,185	8,253	55.8	25.0	70.4	32.3	8,865.4	14,037.6
Aleutian Islands	1-100	159	345	154	0.0	6.1	191.8	455.5	3,584.2	928.5
	101-200	39,403	67,521	54,238	93.6	88.9	70.7	116,841.6	195,794.8	136,187.8
Total	201-300	26,668	48,984	145,367	42.9	49.6	47.1	61,779.5	101,671.9	242,933.4
	301-500	16,415	377	8,293	69.6	323.6	116.2	23,577.8	612.1	15,498.1
	501-900	65	2	0	102.7	277.6	0.0	0.0	3.6	0.0
	1-900	82,710	117,229	208,052	47.3	52.6	37.5	202,654.4	301,666.6	395,547.7
Southern Bering Sea	1-100	79	0	190				500.6	0.0	1,804.3
	101-200	708	78,190	21,690				2,871.9	176,166.5	38,800.6
Total	201-300	5,047	16,638	32,520				9,950.5	26,626.5	48,309.8
	301-500	169	2,651	376				217.2	4,161.8	467.9
	501-900	0	0	0				0.0	0.0	0.0
	1-900	6,003	97,479	54,776	328.7	182.7	105.6	13,540.2	206,954.8	89,382.6

a No sampling was conducted in this area-depth interval.

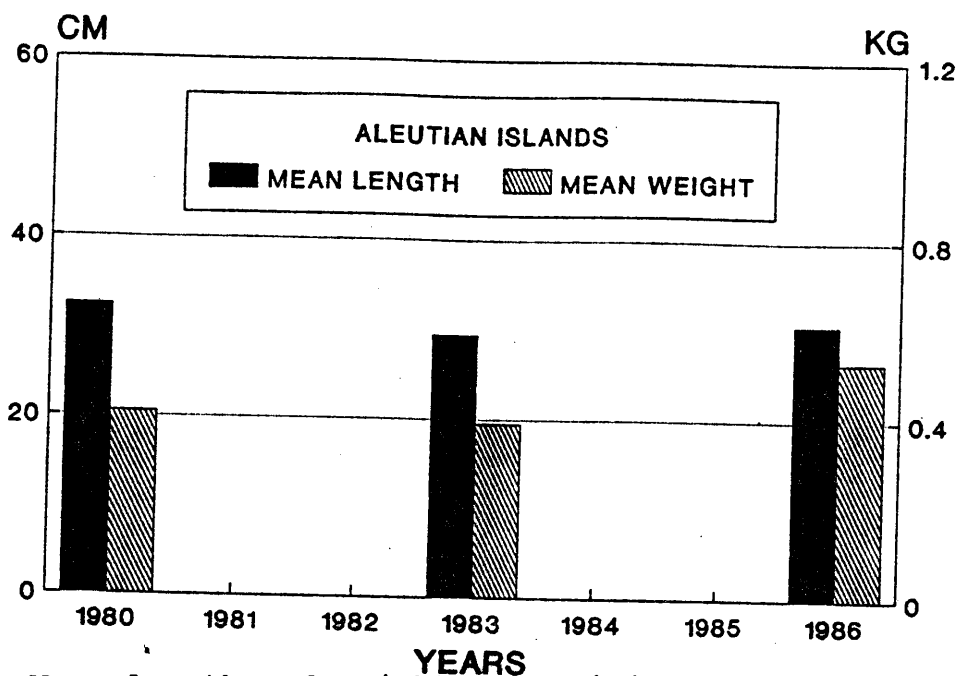

Figure 54. Mean length and weight of Pacific ocean perch in the Aleutian Islands area during the U.S.-Japan 1980, 1983, and 1986 groundfish surveys.

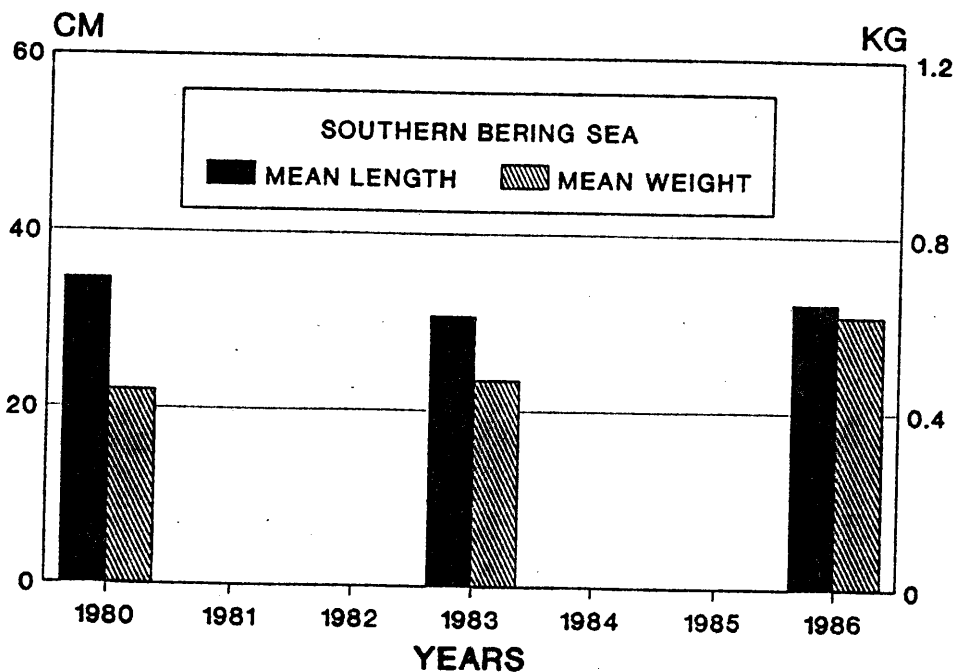

Figure 55. Mean length and weight of Pacific ocean perch in the Southern Bering Sea area during the U.S.-Japan 1980, 1983, and 1986 groundfish surveys.

Table 38. Estimates of mean catch per unit effort, length, and weight for Pacific ocean perch based on the U.S.-Japan 1980, 1983, and 1986 Aleutian Islands groundfish surveys.

Area	Depth (m)	Mean CPUE (kg/km ²)			Mean Length (cm)			Mean Weight (kg)		
		1980	1983	1986	1980	1983	1986	1980	1983	1986
Southwest	1-100	0.0	1.1	34.4	26.8	0.0	0.0	0.00	0.18	0.31
	101-200	2,738.6	5,430.8	2,199.2	30.0	28.7	29.3	0.29	0.35	0.42
	201-300	4,203.3	2,255.6	7,901.9	32.4	31.3	31.4	0.34	0.44	0.51
	301-500	1,464.6	17.5	32.1	33.5	33.2	35.1	0.53	0.54	0.47
	501-900	2.5	0.3	0.0	0.0	0.0	0.0	0.00	0.62	0.00
	1-900	1,509.3	1,832.9	1,421.2	31.2	29.0	30.5	0.33	0.36	0.46
Southeast	1-100	a	203.0	7.8	a	18.6	0.0	a	0.10	0.05
	101-200	1,831.8	8,276.0	1,798.0	26.4	28.8	27.6	0.28	0.33	0.36
	201-300	490.0	7,771.8	9,505.2	33.2	29.3	32.7	0.51	0.38	0.53
	301-500	184.5	5.6	581.9	35.3	0.0	34.8	0.63	0.51	0.66
	501-900	0.0	0.0	0.0	0.0	0.0	0.0	0.00	0.00	0.00
	1-900	719.0	3,718.2	2,509.8	31.8	28.8	28.5	0.32	0.35	0.50
Northwest	1-100	0.0	2.2	0.0	0.0	0.0	0.0	0.00	0.19	0.00
	101-200	0.7	241.5	1,260.6	31.8	27.8	0.0	0.09	0.29	0.46
	201-300	1,396.0	2,663.7	22,852.8	35.4	33.1	29.5	0.40	0.80	0.67
	301-500	2,602.4	5.4	61.6	37.6	37.2	38.7	0.99	0.95	0.74
	501-900	0.8	0.0	0.0	0.0	0.0	0.0	0.00	0.00	0.00
	1-900	653.9	274.4	2,186.4	34.8	31.1	35.4	0.75	0.60	0.63
Northeast	1-100	71.9	14.2	1.4	0.0	14.5	31.4	0.35	0.05	0.04
	101-200	3,973.4	1,078.8	7,457.7	29.5	29.1	29.0	0.44	0.38	0.39
	201-300	5,709.8	4,237.3	27,764.5	34.8	35.3	32.6	0.54	0.71	0.64
	301-500	1,501.2	83.7	1,360.4	30.3	36.7	36.6	0.69	0.65	0.43
	501-900	5.0	0.0	0.0	0.0	0.0	0.0	0.00	0.00	0.00
	1-900	1,942.7	867.9	5,719.7	32.5	32.5	31.2	0.50	0.56	0.53
Bowers Ridge	101-200	a	404.7	4,952.1	a	32.6	0.0	a	0.64	0.48
	201-300	30.2	4,962.0	4,053.7	34.8	36.7	37.7	1.14	0.69	0.57
	301-500	0.0	0.0	1,097.2	38.0	0.0	0.0	0.00	0.00	0.84
	501-900	1.8	0.0	0.0	0.0	0.0	0.0	0.00	0.00	0.00
	101-900	5.0	603.1	804.7	34.9	36.6	37.7	1.53	0.69	0.59
Aleutian Islands	1-100	26.6	43.0	14.3	26.8	18.2	31.4	0.35	0.10	0.17
	101-200	2,534.3	4,055.6	3,257.7	29.5	28.7	28.9	0.33	0.35	0.40
Total	201-300	2,617.8	4,808.5	14,270.1	34.2	31.1	31.9	0.44	0.48	0.60
	301-500	1,226.6	27.3	607.8	32.3	36.2	36.5	0.70	0.62	0.53
	501-900	2.4	0.1	0.0	0.0	0.0	0.0	0.00	0.62	0.00
	1-900	1,153.2	1,535.8	2,639.5	32.5	29.4	30.7	0.41	0.39	0.53
Southern Bering Sea	1-100	16.4	0.0	39.5	19.3	0.0	22.6	0.16	0.00	0.11
	101-200	216.3	23,895.7	6,628.7	33.2	29.9	25.4	0.25	0.44	0.56
	201-300	5,039.4	16,612.5	32,470.7	36.2	35.4	34.8	0.51	0.63	0.68
	Total	301-500	132.9	2,083.3	295.3	39.2	36.5	33.8	0.78	0.64
	501-900	0.0	0.0	0.0	0.0	0.0	0.00	0.00	0.00	
	1-900	474.9	7,712.4	4,333.9	34.6	30.7	32.4	0.44	0.47	0.62

a No sampling was conducted in this area-depth interval.

Size and Age Composition

New annuli reading criteria and interpretations and age verification have shown that Pacific ocean perch attain a much older age than previously thought. These new ageing techniques were used for all otoliths collected during the three Aleutian Islands surveys. For the 1980 survey, 78 years was the maximum age recorded. Fish as old as 98 years and 92 years were recorded in 1983 and 1986. However, the number of sampled individuals which attained these old ages was quite small. In 1980, 67% of the stock was less than 11 years old and 84% was less than 21 years old. Similar results were obtained in 1983: 81% were less than 11 years and 91% were less than 21 years. In 1986, 69% were less than 11 years and 87% were less than 21 years. Because so few individuals reach these old ages, the age composition has only been plotted for 50 years.

During 1980 the size range of Pacific ocean perch in the Aleutian Islands extended from 20 to 42 cm and the size composition was characterized by a uni-modal curve with the majority of the stock being 26-34 cm with the peak at 29-34 cm (Fig. 56). With the exception of the 1969 year class, which appears very weak, this stock was supported by the 1967-1976 year classes (Fig. 57). These nine year classes provided nearly 77% of the total population with 8-year-old fish from 1972 contributing 17% and 10-year-olds from 1970 contributing 13%.

In 1983 the size range expanded slightly, from 17 to 44 cm. The size composition curve was again uni-modal with the majority of individuals between 23 and 35 cm peaking at 28-31 cm. The proportions of smaller fish (24-27 cm) increased and larger fish (32-35 cm) decreased.

Five year classes, 1973 and 1975-1978, dominated the stock providing 75% of the total. Three year classes, 1976, 1977, and 1975 were particularly strong contributing 23, 21, and 16% of the stock, respectively. The 1972 year class which was the dominant year class during the 1980 survey contributed only 4% of the population in 1983. The 1973 year class which appeared weaker than either the 1972 or 1974 year classes in 1980 appeared stronger than those year classes in 1983.

In 1986 the size composition curve continued to be uni-modal with the largest portion of the stock in the 28-38 cm size range, and a higher percentage of larger fish in the 33-42 cm range. The seven strongest year classes (1974 and 1976-81) contributed 72% of the total population. The 1978 year class was particularly strong, contributing 26% of the stocks, more than twice the percentage of the 1977 year class which contributed 12%.

In 1986 there were major reductions in the percentage contribution of the dominant year classes of the 1983 survey. The 1976, 1977, and 1975 year classes contributed only 7.8, 11.3, and 2.8%, respectively. In particular the 1975 year class which appeared very strong in 1983 appeared weak in 1986. During all three surveys the vast majority of the Pacific ocean perch stocks were made up of 5- to 12-year-old fish.

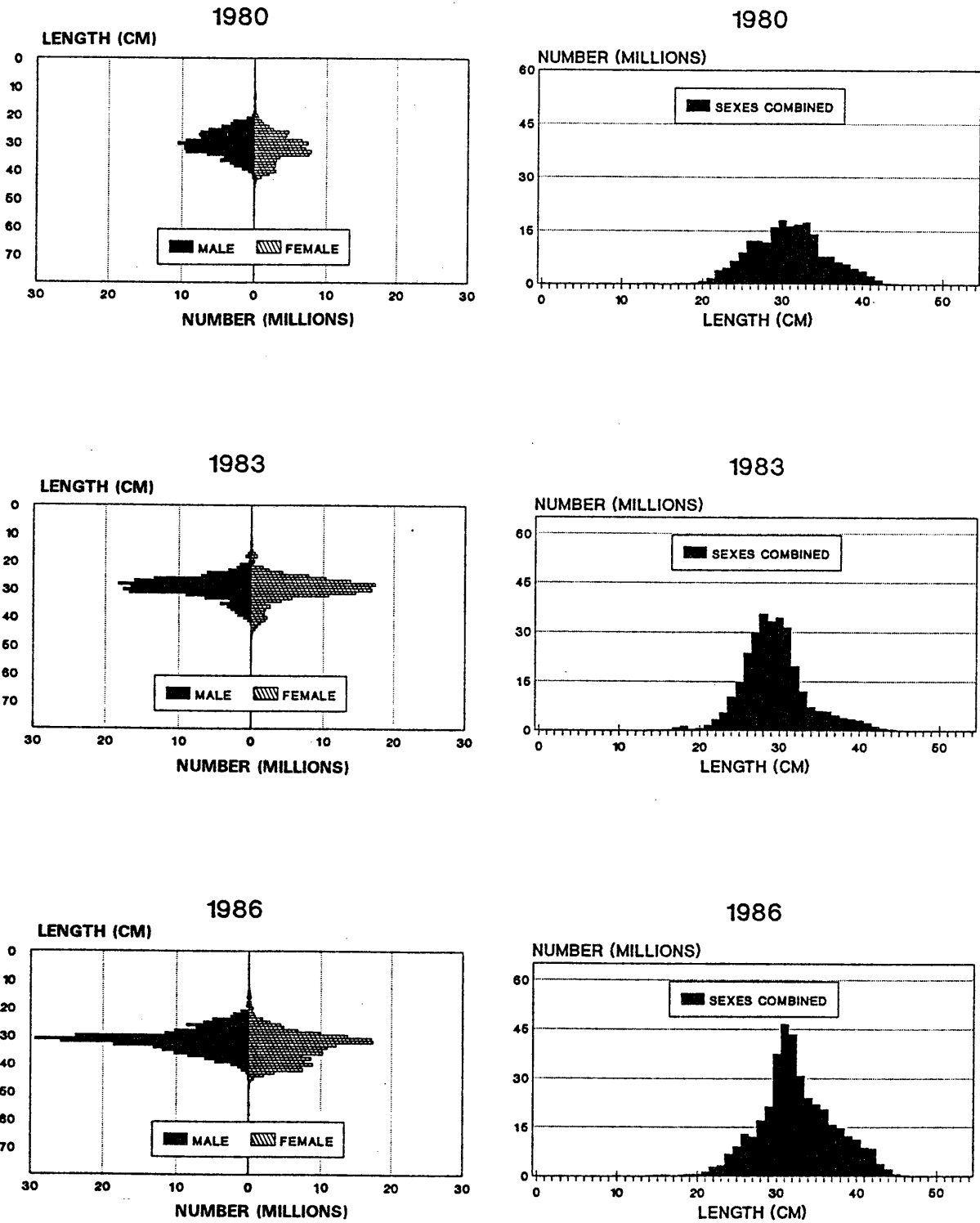

Figure 56. Size composition of Pacific ocean perch in the Aleutian Islands area during the U.S.-Japan 1980, 1983, and 1986 groundfish surveys.

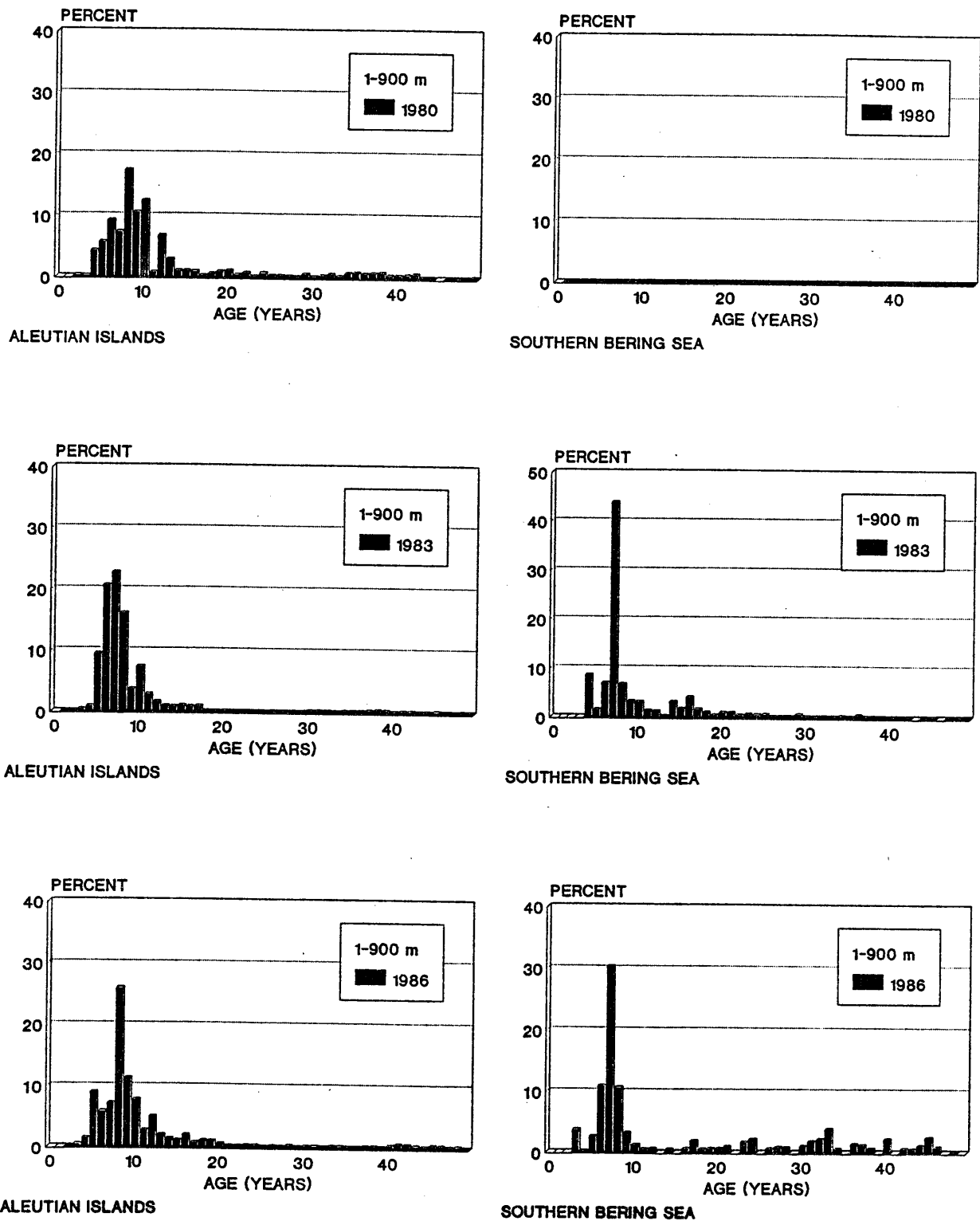

Figure 57. Age composition of Pacific ocean perch in the Aleutian Islands and Southern Bering Sea areas during the U.S.-Japan 1980, 1983, and 1986 groundfish surveys.

Analysis of the age composition data by depth intervals demonstrates considerable variability in age structure of the stock by depth (Figs. 58-59). During the 1980 survey, 13% of the stocks in the 1-100 m depth interval were 10-year-old fish from 1970, the strongest age class. The two strongest supporting year classes were 1974 and 1968, but there was a surprising contribution of older fish. In the 101-200 m depth interval the 1972 year class was strongest with the 1974, 1975, and 1971 being the primary supporting year classes. In the 201-301 m interval the 1972 year class was also the strongest, with the 1970 and 1971 year classes being next in importance. The 1970, 1968, and 1967 year classes were the largest contributors in the 301-500 m depth zone, even though each contributed less than 10% of the stocks. There was also a surprisingly strong contribution from fish 20 years and older. In all depth intervals the 1969 year class was very weak, and the 1968 year class relatively strong.

In 1983, 6-year-old fish were dominant in the shallowest water depth interval and received strongest support from the 1980 and 1976 year classes. Unlike 1980, there were no old fish found in the shallowest depth interval. In the 101-200 m and 201-300 m depth intervals the 1975-1977 year classes were dominant with the 1976 year class being strongest. In the deepest depth interval 10-year-old fish were most abundant. The 1975, 1971, and 1966 year classes were slightly stronger than the rest of the year classes which were spread quite evenly throughout the stocks. There continued to be a good showing of older fish in the deepest depth zone, however this was not quite as strong as in 1980.

During the 1986 survey, 2-year-old fish were dominant in the shallowest depth interval. The 1978 year class of 8-year-old fish was next followed by the 1981, 1977, 1976, and 1974 year classes. In the 101-200 m depth interval the 1978 year class of 8-year-old fish was the single most dominant year class contributing 30% of the stock. The 1981, 1979, 1977, and 1980 year classes made up most of the rest of the stocks in that depth interval. In the 201-301 m depth interval, 8-year-old fish made up 24% of the stocks, with support from the 1977 and 1976 year classes. In the deepest depth interval, 8-year-old fish were still dominant making up 23% of the stocks. Five-year-old fish made up another 13% of the stocks. The showing of older fish was not as strong as in other surveys.

Size and age composition were different between areas within survey years (Figs. 60-65). In 1980 the size composition was bimodal in most areas. In the Southwest area, the principle mode was at 29-34 cm and the secondary mode was at 24-29 cm. Both modes consisted of males and females of approximately the same size. Most of the fish were 8- to 10-year-olds. In the Southeast area the primary mode ranged from 25 to 30 cm and consisted of nearly equal proportions of males and females. Most of these fish were slightly younger fish of 6- to 8-years-old. The size composition curve in the Northwest area was trimodal; the principle mode ranged from 38 to 42 cm, and was mostly large

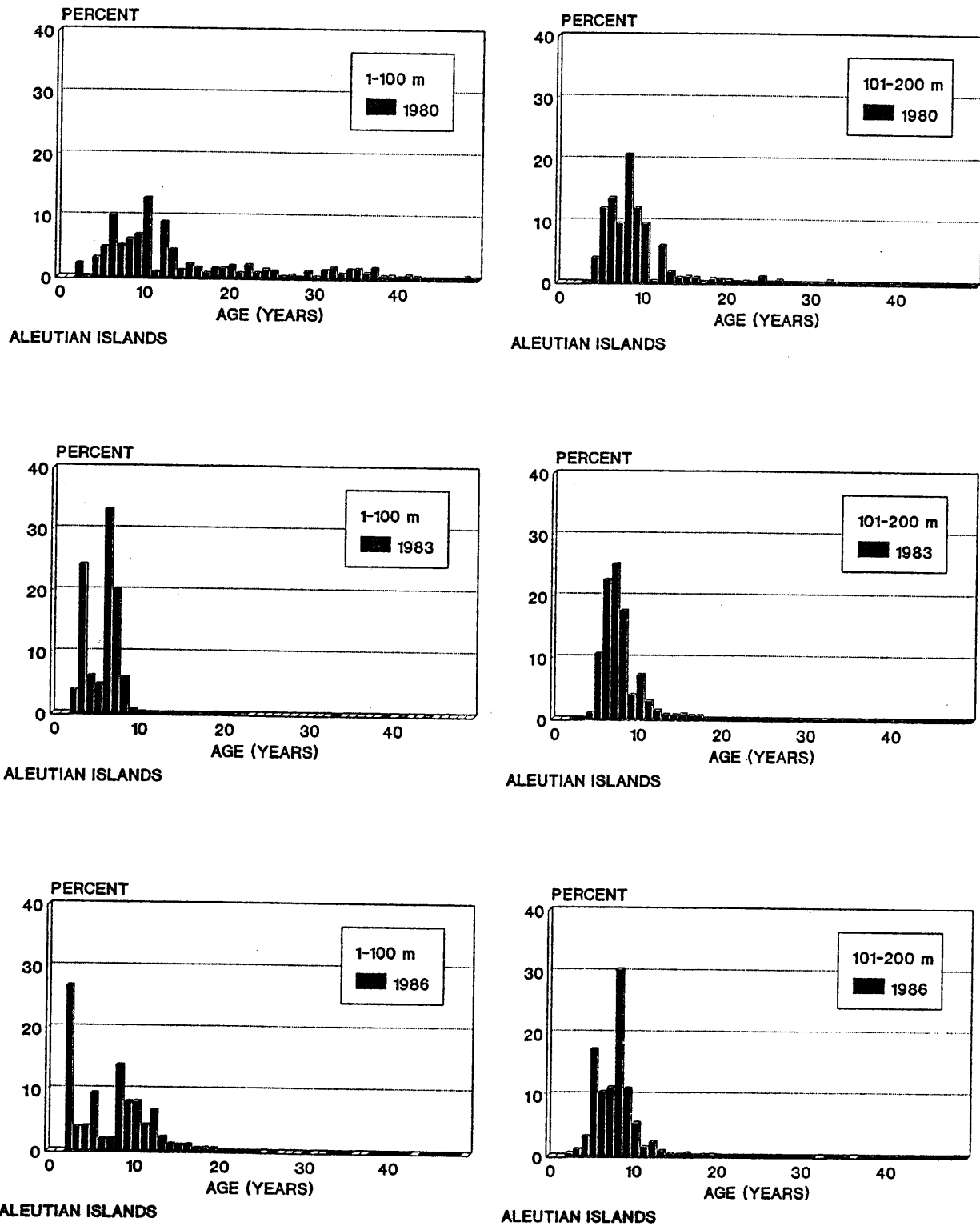

Figure 58. Age composition of Pacific ocean perch in the 1-100 m and 101-200 m depth intervals of the Aleutian Islands area during the U.S.-Japan 1980, 1983, and 1986 groundfish surveys.

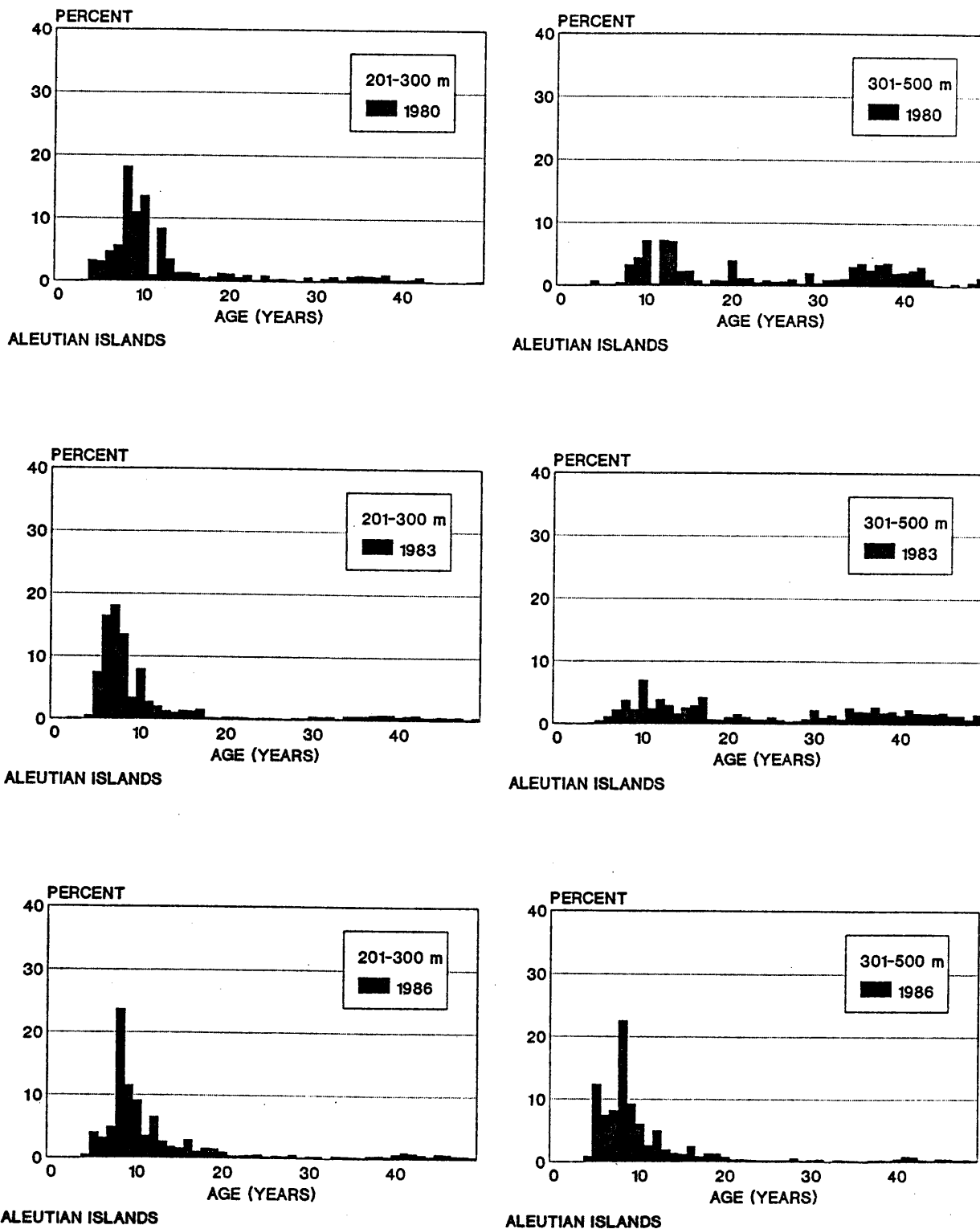

Figure 59. Age composition of Pacific ocean perch in the 201-300 m and 301-500 m depth intervals of the Aleutian Islands area during the U.S.-Japan 1980, 1983, and 1986 groundfish surveys.

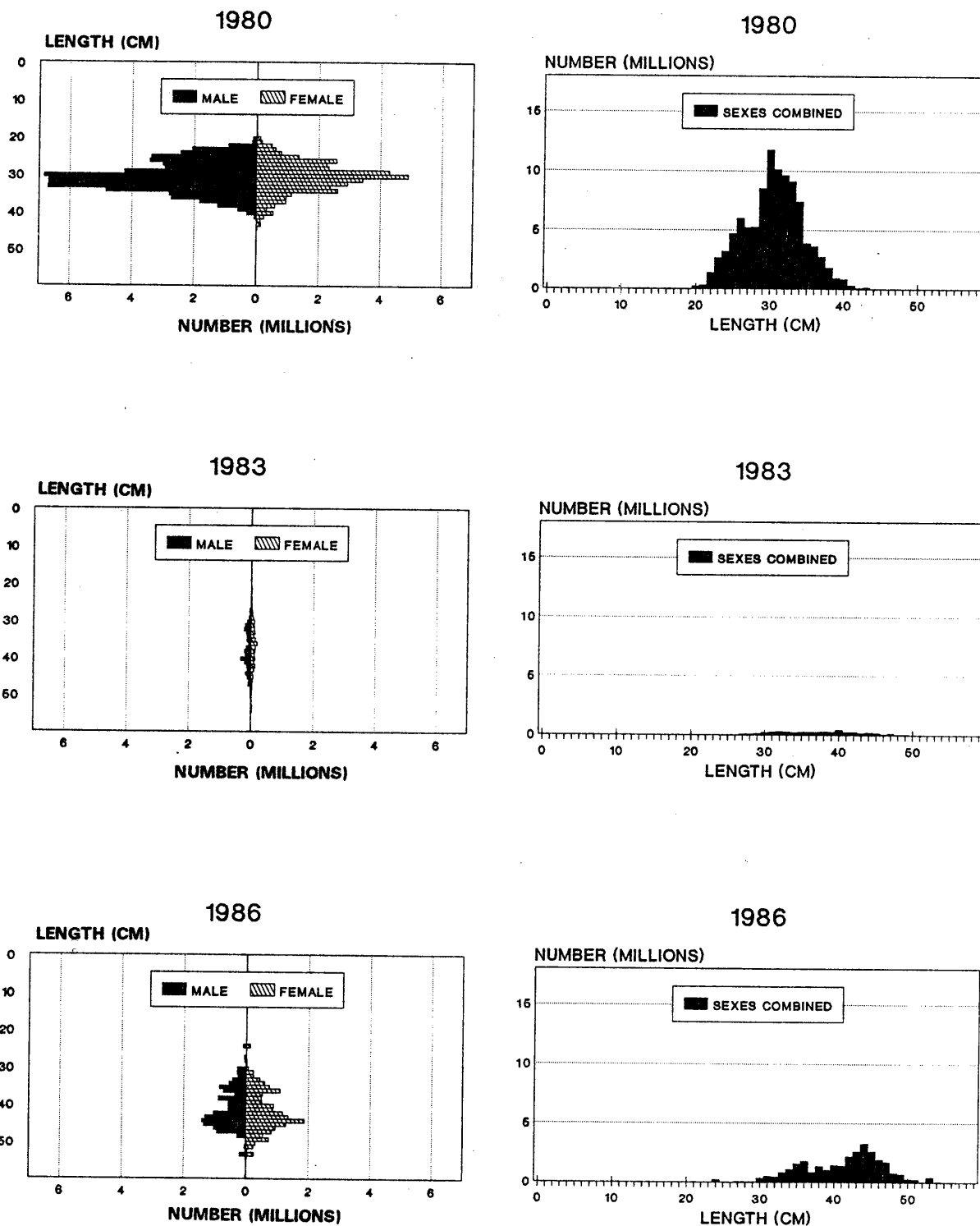

Figure 60. Size composition of Pacific ocean perch in the Southwest area of the Aleutian Islands during the U.S.-Japan 1980, 1983, and 1986 groundfish surveys.

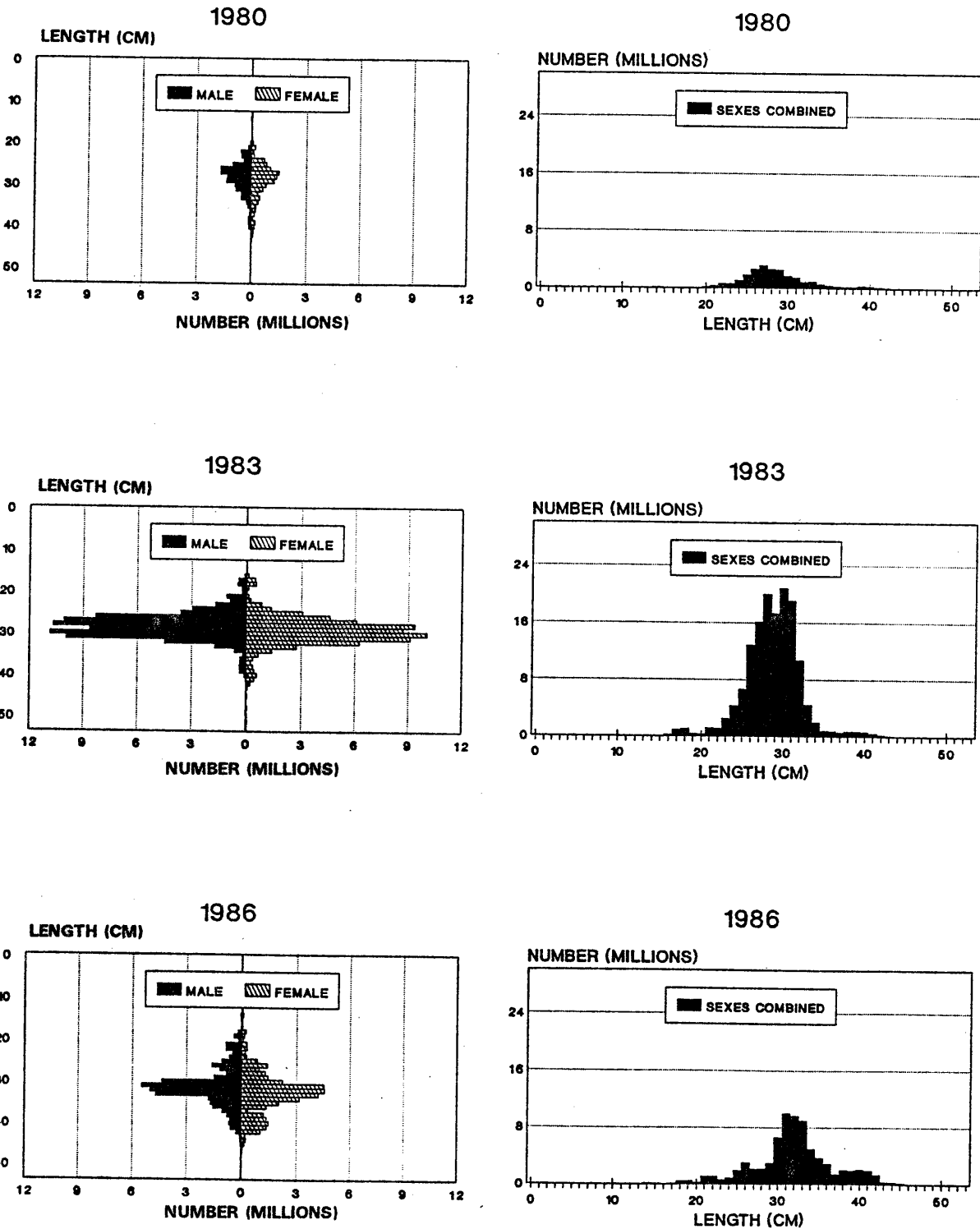

Figure 61. Size composition of Pacific ocean perch in the Southeast area of the Aleutian Islands during the U.S.-Japan 1980, 1983, and 1986 groundfish surveys.

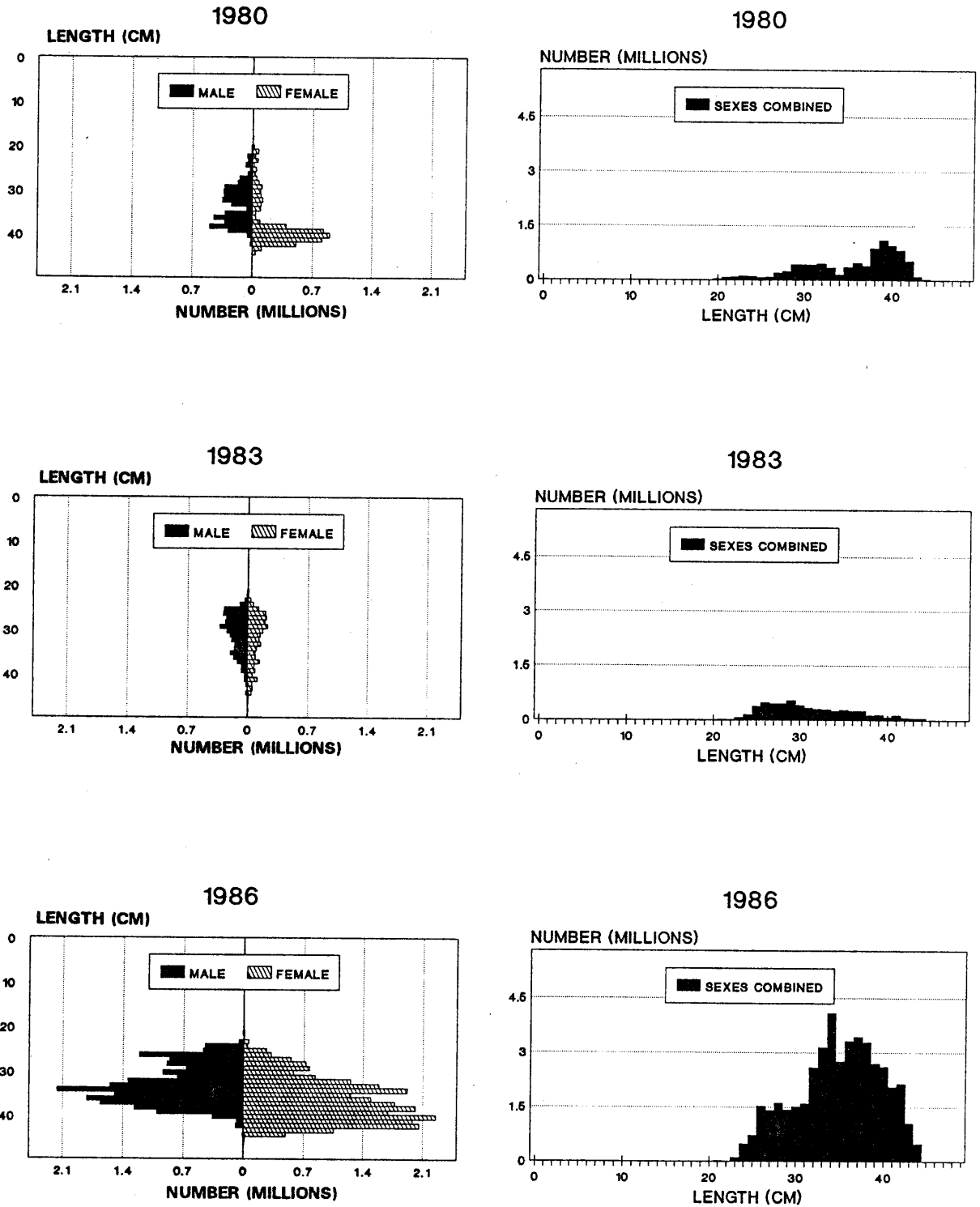

Figure 62. Size composition of Pacific ocean perch in the Northwest area of the Aleutian Islands during the U.S.-Japan 1980, 1983, and 1986 groundfish surveys.

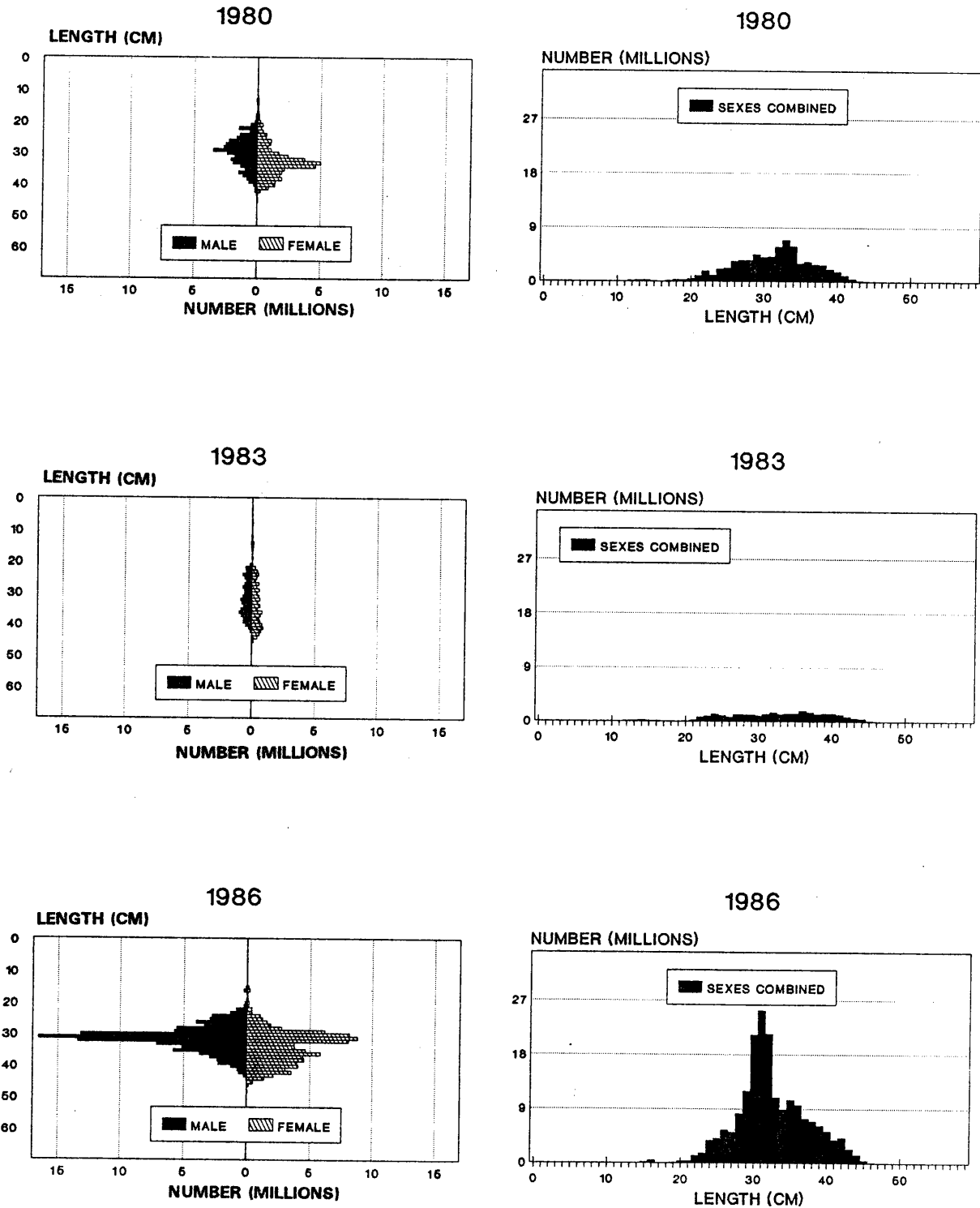

Figure 63. Size composition of Pacific ocean perch in the Northeast area of the Aleutian Islands during the U.S.-Japan 1980, 1983, and 1986 groundfish surveys.

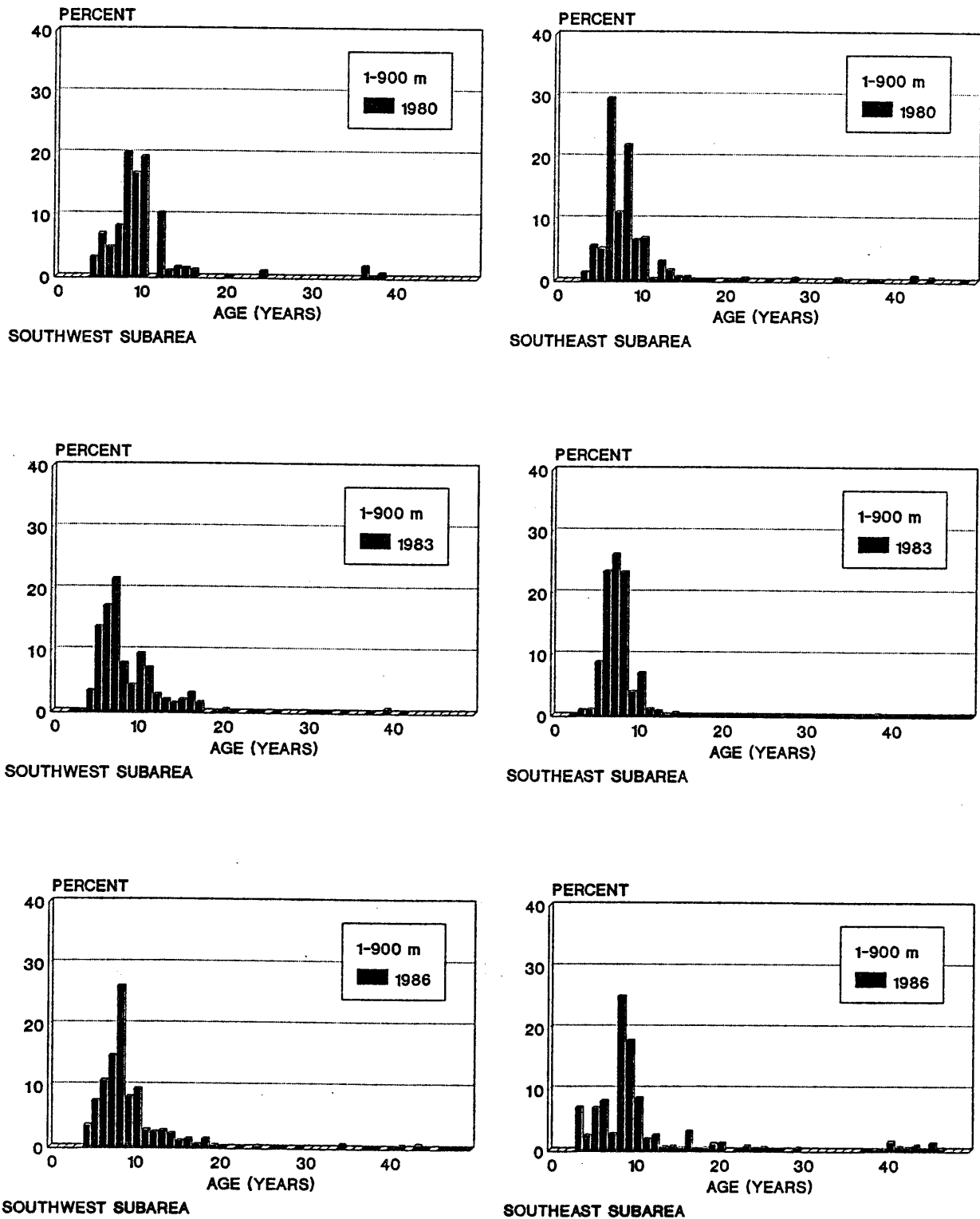

Figure 64. Age composition of Pacific ocean perch in the Southwest and Southeast areas of the Aleutian Islands during the U.S.-Japan 1980, 1983, and 1986 groundfish surveys.

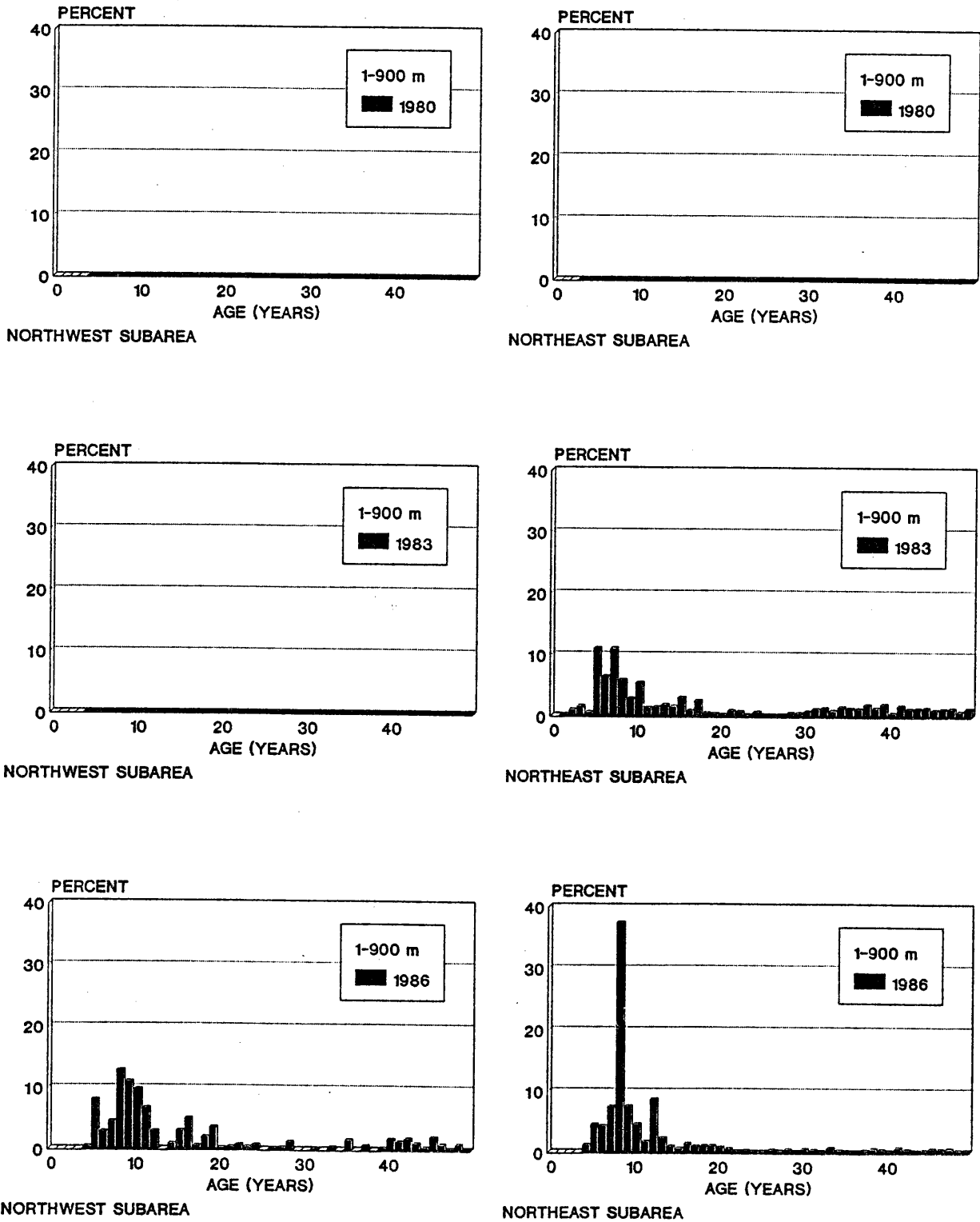

Figure 65. Age composition of Pacific ocean perch in the Northwest and Northeast areas of the Aleutian Islands during the U.S.-Japan 1980, 1983, and 1986 groundfish surveys.

females. There was a strong secondary mode at 28-33 cm, composed mostly of males, and a third weak mode at 21-24 cm consisting of both males and females. In the Southeast area the principle mode was at 29-34 cm and consisted mainly of females. The secondary mode was composed mainly of males in the 24-29 cm range. No age data are available from 1980 north of the chain.

During 1983 the size composition curves in most areas were flat without defining modes. In the Southwest area most fish were 5- to 7-years-old from the 1978-1976 year class. In the Southeast area a strong unimodal curve ranged from 23 to 34 cm. These were mostly 6- to 8-year-old fish from the 1975-1977 year classes. In the Northwest area, there were no defining size modes and no age data. There were also no defining size modes in the Northeast area, but there was a surprising showing of older year classes. However, 5- and 7-year-old fish from the 1978 and 1976 year classes were the only ages that comprised more than 10% of the stocks of that area.

In 1986 the size composition curves by areas again lacked similarity. In the Southwest area the size curve was bimodal, with the primary mode peaking at 44 cm and the secondary mode at 36 cm. Males and females were about equal. Eight-year-old fish from the 1978 year class were clearly dominant, supported by 5- to 7-year-old fish from the 1981-1979 year classes and 9- to 10-year-old fish from the 1977-1976 year classes. In the Southeast area the size curve for females was bimodal with a secondary mode, primarily females, peaking at 40 cm with very few individuals in the 36-38 cm range. Eight-year-old fish from the 1978 year class were dominant with strong support from 9-year-old fish from the 1977 year class. In the Northwest area the size composition curve was trimodal with the principal mode peaking at 34 cm. There were more large females. Eight-year-old fish from the 1978 year class were dominant, but not as much as in the other areas. There was a stronger showing of older fish. The Northeast area had a bimodal size distribution with the principle mode peaking around 31-32 cm. The secondary mode consisted primarily of females from 34 to 44 cm with the highest abundance from 35 cm to 40 cm. Eight-year-old fish from the 1978 year class were dominant making up more than 35% of the stocks in this area.

In the Southern Bering Sea in 1980 the size composition samples were small and the resulting curve extremely flat consisting mostly of fish in the 34-38 cm size range with fewer smaller fish in the 23-25 cm range (Fig. 66). No age data were available for 1980 (Fig. 57).

The 1983 size composition curve in the Southern Bering Sea was trimodal and covered a full size range from 20 to 44 cm with the principle mode in the 25-32 cm range. There were two secondary modes: one was mostly males at 34-36 cm and the other was mostly females at 39-41 cm. The age composition in 1983 was overwhelmingly dominated by 7-year-old fish which made up 44% of the stock. This age group was supported by fish from the 1979 year class, which was probably not fully recruited to the trawl,

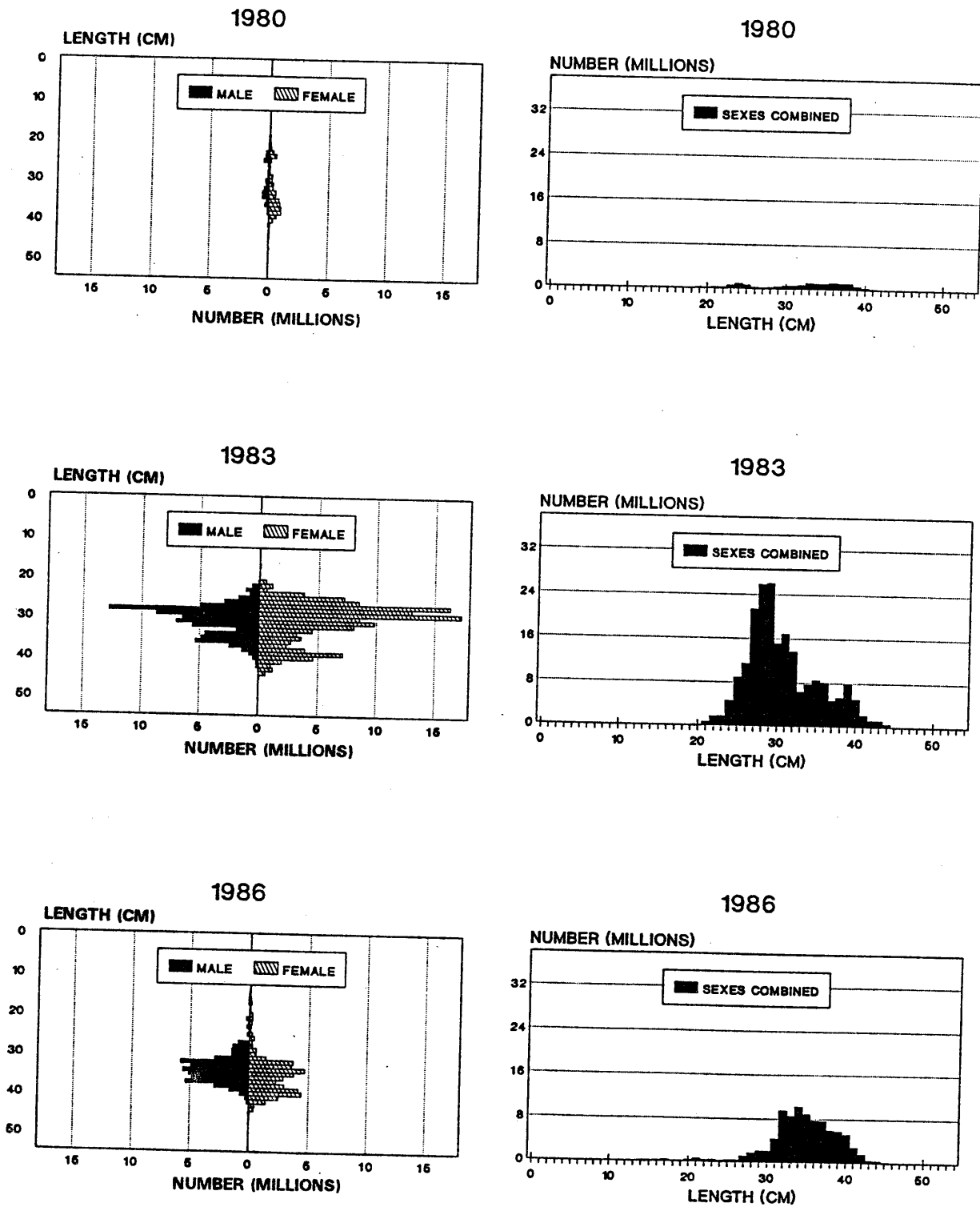

Figure 66. Size composition of Pacific ocean perch in the Southern Bering Sea area during the U.S.-Japan 1980, 1983, and 1986 Aleutian Islands groundfish surveys.

and by the 1977 and 1975 year classes which added about 7% each. Fish older than 12 years were dominated by the 1967 and 1969 classes of 14- and 16-year-olds.

In 1986, most of the stock consisted of fish from 31 to 40 cm, peaking at 34 cm. There was a mode of males in the 32-37 cm range, and two modes of females: one at 32-35 cm and the other at 37-40 cm. The age composition of this stock was dominated by the 1979 year class which added 30% to the stock. This year class was also quite strong during the 1983 survey. The population was supported by the 1980 and 1978 year classes, which contributed 11% each. In 1986, the incoming 1983 year class, not yet fully available, appears quite strong. Also, there was a higher percentage of older fish, over 20 years old, than had been seen during previous surveys.

Mean Length-at-Age and Growth

Mean lengths at age were calculated for Pacific ocean perch for all three surveys and it appears that the mean length is slightly larger to age 17 during the 1986 survey (Table 39). These data also indicate that this species obtains a length of about 8 cm by the first summer and 14-17 cm by the second summer (Table 40). The average yearly growth increment of 2 cm from age 2-3 appears to be underestimated as the average increase in mean length from age 3-4 was nearly 5 cm and for age 4-5 it was 2.5 cm. From age 5 to 8 the average increase dropped to about 2 cm per year and from age 8 to 13, growth averaged 1 cm per year. These data indicate that Pacific ocean perch have completed their growth by age 24.

Age data for Pacific ocean perch were also fitted to the von Bertalanffy growth curve which provided estimates for sexes combined of k from .152-.165, L_{INF} from 38.0-40.5, and t_0 from -0.2 to -3.6 (Table 41).

Table 39. Mean length (mm) at age for Pacific ocean perch sampled during the U.S.-Japan 1980, 1983, and 1986 Aleutian Islands groundfish surveys.

Age	1980			1983			1986			Age	1980			1983			1986		
	m	F	M+F	m	F	M+F	m	F	M+F		m	F	M+F	m	F	M+F	m	F	M+F
1	-	-	-	75	-	75	-	-	-	51	-	410	410	380	390	387	450	400	425
2	133	135	138	169	134	154	167	-	167	52	430	400	420	372	407	386	380	403	397
3	180	170	171	165	161	163	191	197	194	53	380	405	396	386	-	386	410	406	408
4	209	221	215	231	224	227	217	233	228	54	-	-	-	378	383	380	436	412	422
5	240	250	241	250	255	252	253	253	253	55	410	420	415	386	393	390	380	420	396
6	261	261	261	265	266	266	276	277	277	56	-	415	415	380	-	380	400	406	405
7	280	284	282	276	280	278	295	293	294	57	-	430	430	382	430	388	423	450	430
8	296	301	298	290	297	293	313	317	315	58	390	-	390	377	400	387	400	417	414
9	308	298	304	315	305	310	323	328	326	59	-	410	410	391	400	393	403	433	418
10	317	309	313	326	324	325	337	350	341	60	-	430	430	356	400	381	400	432	413
11	310	330	325	325	328	326	348	360	355	61	-	-	-	376	400	382	406	400	404
12	329	336	332	343	344	344	351	366	359	62	-	420	420	385	390	387	-	430	430
13	346	343	345	352	354	353	352	368	360	63	-	-	-	360	395	383	-	410	410
14	347	353	350	347	357	353	355	383	367	64	400	-	400	370	390	380	390	390	390
15	335	360	347	340	357	347	375	378	377	65	-	400	400	382	-	382	-	-	-
16	326	343	335	351	371	360	367	389	379	66	-	390	390	387	-	387	375	-	375
17	-	352	352	357	363	360	361	401	380	67	-	420	420	365	-	365	-	460	460
18	340	340	340	361	373	367	364	393	375	68	-	-	-	380	445	410	390	400	393
19	330	346	341	373	392	386	362	404	381	69	-	-	-	380	400	383	400	430	415
20	355	370	365	377	393	385	378	406	397	70	-	-	-	360	-	360	390	400	393
21	360	350	352	362	394	378	376	410	395	71	-	-	-	387	390	388	390	430	403
22	345	358	355	365	391	372	373	400	388	72	-	-	-	375	416	404	-	410	410
23	340	370	355	373	401	391	356	400	383	73	-	-	-	400	-	400	-	-	-
24	330	355	340	372	370	371	350	412	405	74	400	420	410	380	-	380	-	-	-
25	340	365	356	375	392	385	370	415	392	75	-	-	-	375	400	387	400	-	400
26	335	380	350	374	396	385	370	420	398	76	-	-	-	385	-	385	-	405	405
27	350	385	367	360	390	380	360	414	405	77	-	-	-	395	-	395	-	396	396
28	-	400	400	-	378	378	382	408	395	78	420	-	420	380	410	400	-	-	-
29	355	365	361	366	386	381	365	430	386	79	-	-	-	-	415	415	-	-	-
30	350	390	370	367	405	386	370	376	374	80	-	-	-	380	-	380	410	410	410
31	350	365	362	347	385	377	380	433	402	81	-	-	-	-	-	-	-	-	-
32	335	377	363	381	377	379	400	460	430	82	-	-	-	400	-	400	-	400	400
33	-	380	380	375	393	387	350	407	388	83	-	-	-	370	410	390	-	-	-
34	355	377	373	375	395	386	373	406	390	84	-	-	-	400	-	400	-	-	-
35	350	383	381	386	398	395	405	417	413	85	-	-	-	-	-	-	-	400	400
36	365	376	372	382	394	387	430	426	427	86	-	-	-	-	-	-	-	-	-
37	350	385	382	367	410	397	390	418	410	87	-	-	-	-	390	390	-	-	-
38	390	395	394	374	403	395	380	408	401	88	-	-	-	370	-	370	-	-	-
39	-	398	398	383	410	395	405	400	401	89	-	-	-	390	-	390	-	-	-
40	-	401	401	378	405	395	386	415	403	90	-	-	-	410	-	410	-	-	-
41	-	398	398	376	399	390	383	403	393	91	-	-	-	-	-	-	-	-	-
42	380	405	403	387	410	395	387	413	402	92	-	-	-	390	-	390	400	-	400
43	-	400	400	374	393	386	410	415	414	93	-	-	-	-	-	-	-	-	-
44	-	420	420	374	407	393	403	425	408	94	-	-	-	-	-	-	-	-	-
45	-	-	-	382	410	396	410	416	414	95	-	-	-	-	-	-	-	-	-
46	-	415	415	377	415	399	397	423	410	96	-	-	-	-	-	-	-	-	-
47	-	430	430	390	415	398	400	415	406	97	-	-	-	-	-	-	-	-	-
48	-	393	393	383	415	396	391	427	406	98	-	-	-	-	420	420	-	-	-
49	360	380	370	377	398	388	376	413	395	99	-	-	-	-	-	-	-	-	-
50	380	390	385	380	402	395	402	416	409	100	-	-	-	-	-	-	-	-	-

M = males F = females

Table 40. Estimates of yearly incremental growth (cm) of Pacific ocean perch sampled during the U.S.-Japan 1980, 1983, and 1986 Aleutian Islands groundfish surveys.

Age	Year			Average
	1980	1983	1986	
1-2	-	7.9	-	7.9
2-3	3.3	0.9	2.7	2.3
3-4	4.4	6.4	3.4	4.7
4-5	2.6	2.5	2.5	2.5
5-6	2.0	1.4	2.4	1.9
6-7	2.1	1.2	1.7	1.7
7-8	1.6	1.5	2.1	1.8
8-9	0.6	1.7	1.1	1.1
9-10	0.9	1.5	1.5	1.3
10-11	1.2	0.1	1.4	0.9
11-12	0.7	1.8	0.4	1.0
12-13	1.3	0.9	0.1	0.8
13-14	0.5	0.0	0.7	0.4

Table 41. Estimated von Bertalanffy growth curve parameters for Pacific ocean perch sampled during the U.S.-Japan 1980, 1983, and 1986 Aleutian Island groundfish surveys.

Area-Year	Sex	Range		von Bertalanffy Growth Parameters		
		Age (Years)	Length (cm)	L_{inf}	k	t_0
Aleutian Islands						
1980	m	2-78	12-49	34.87	0.219	-0.200
	F	2-74	12-43	30.15	0.138	-1.572
	M+F	2-78	12-43	37.97	0.152	-1.349
1983	m	1-92	7-45	37.99	0.165	-1.205
	F	2-98	12-48	40.23	0.141	-1.650
	M+F	1-98	7-48	39.11	0.152	-1.401
1986	m	2-92	15-45	39.11	0.175	-1.028
	F	3-85	19-47	41.56	0.163	-0.871
	M+F	2-92	15-47	40.50	0.165	-1.041
Southern Bering Sea						
1983	m	5-59	26-41	37.54	0.154	-3.619
	F	6-75	26-43	40.70	0.139	-2.718
	M+F	5-75	26-43	39.49	0.134	-3.772
1986	m	4-74	24-43	37.87	0.280	0.318
	F	5-56	28-46	41.07	0.168	-2.114
	M+F	4.74	24-46	39.45	0.221	-0.504

Length-Weight Relationships

Length-weight data provided relationships for Pacific ocean perch, sexes combined, that were very similar for all 3 years (Fig. 67). At larger sizes greater than 35 cm, Pacific ocean perch were slightly heavier in 1986 for a given length than during 1980 and slightly heavier at all comparable sizes than in 1983. Relationships for the 3 years are:

$$\begin{aligned} \text{Weight(g)} \text{ (1980)} &= .0176 \times \text{Length(cm)}^{2.981} \\ \text{Weight(g)} \text{ (1983)} &= .0091 \times \text{Length(cm)}^{3.098} \\ \text{Weight(g)} \text{ (1986)} &= .0126 \times \text{Length(cm)}^{3.033} \end{aligned}$$

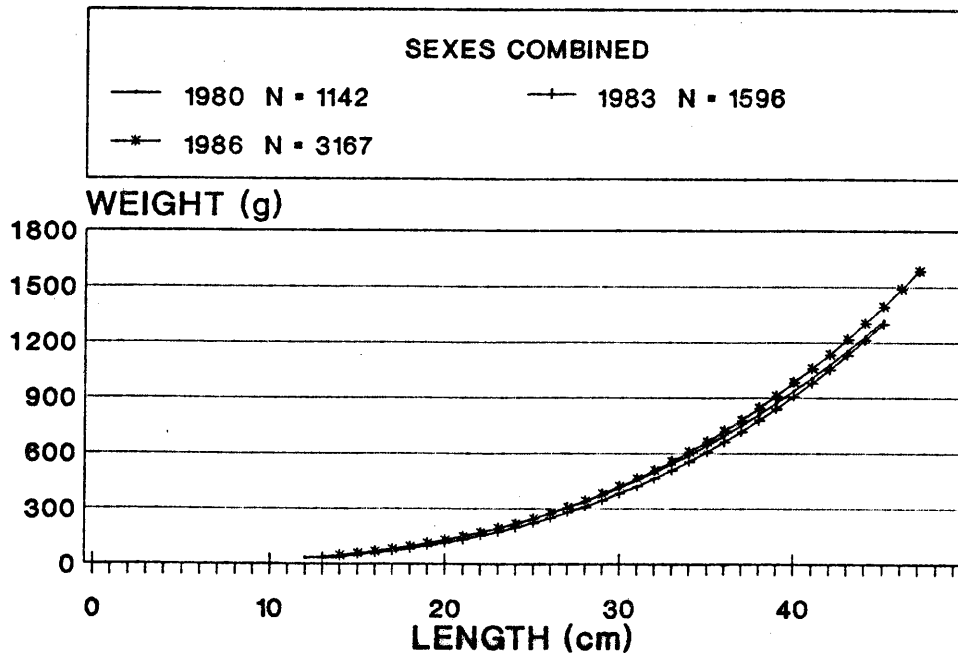

Figure 67. Length-weight relationships for Pacific ocean perch in the Aleutian Islands area during the U.S.-Japan 1980, 1983, and 1986 groundfish surveys.

Pacific Cod

Distribution and Abundance

Pacific cod (Gadus macrocephalus) were distributed throughout the Aleutian Islands and Southern Bering Sea areas primarily at depths less than 200 m (Figs. 68-69). During all three surveys, high densities of Pacific cod were found in the eastern Aleutian Islands. In 1983, high densities of Pacific cod were observed on the north side of the Aleutian chain as far west as Agattu Island, and on the south side of the Aleutian chain as far west as Buldir Island. In 1986, there was also an increase in the number of high-density stations throughout the Aleutian Islands, spreading to the west end of Attu Island on both sides of the Aleutian chain and onto Petrel Bank. No concentrations of Pacific cod were encountered on Bowers Ridge and no high-density concentrations were found in the Southern Bering Sea area.

In 1980 the biomass estimate for Pacific cod in the Aleutian Islands area was 52,000 t, and the population estimate was 21.8 million fish (Table 42, Fig. 70). However the actual biomass was probably much higher because the 1-100 m depth zone was not sampled in some areas that year. In 1983 the biomass estimate increased to 113,000 t, and the population estimates to 36.9 million fish.

In 1986 the biomass of Pacific cod increased by 152% to 173,000 t, a 60,000 t increase over the 1983 estimate. The population estimate increased to 78.9 million fish. Biomass estimates increased in all but three area-depth intervals. However, there were substantial decreases in the 101-200 m zone in the Northwest area and the 1-100 m zone in the Northeast area.

During the 1980 survey, 54% of the Pacific cod stock, 28,000 t, was located in the Northeast area. In 1983 the biomass shifted to the two northern areas which contained 69% of the stock, 78,000 t, with the Northwest area having a slightly larger portion than the Northeast. In 1986 the biomass was concentrated in the western areas which contained 65% of the stock, 113,000 t, equally divided between the Northwest and Southwest areas. During all three surveys, the largest portion of the biomass was located in the 101-200 m depth intervals.

In 1980 the Southern Bering Sea biomass was 74,000 t. By 1983, it had decreased 39% to 46,000 t and in 1986 it decreased 7% more to 42,000 t (Fig. 71). During 1980 and 1983 the largest portion of the biomass was located in the 101-200 m depth interval; however, in 1986 the 1-100 m depth interval contained slightly more than the 101-200 m depth interval.

In both the Aleutian Islands and Southern Bering Sea areas the largest mean length (61.4 cm and 56.8 cm) and mean weight (3.07 kg and 2.62 kg) occurred during the 1983 survey (Table 43, Figs. 72 and 73).

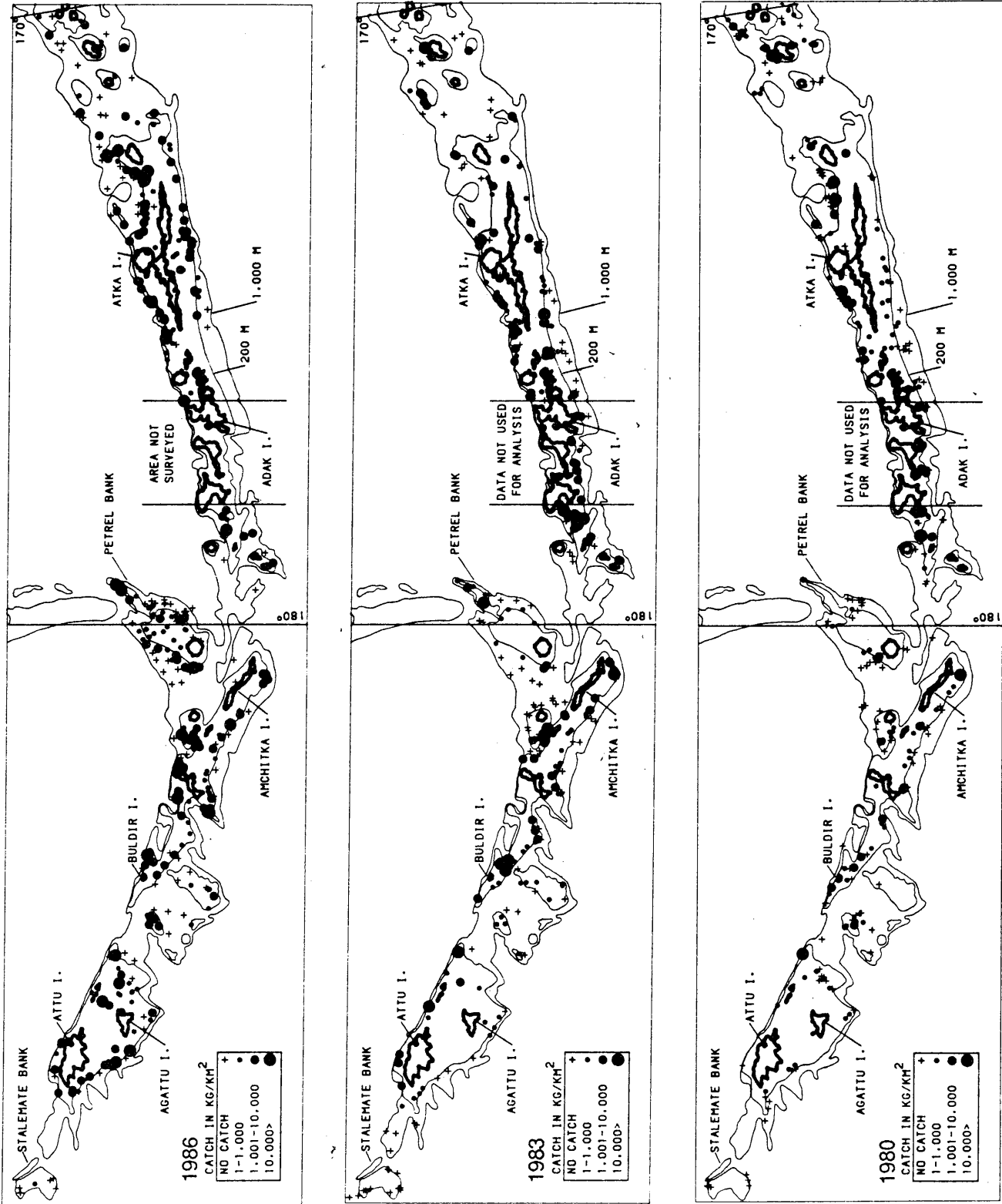

Figure 68. Distribution and relative abundance of Pacific cod in the Aleutian Islands area during the U.S.-Japan 1980, 1983, and 1986 groundfish surveys.

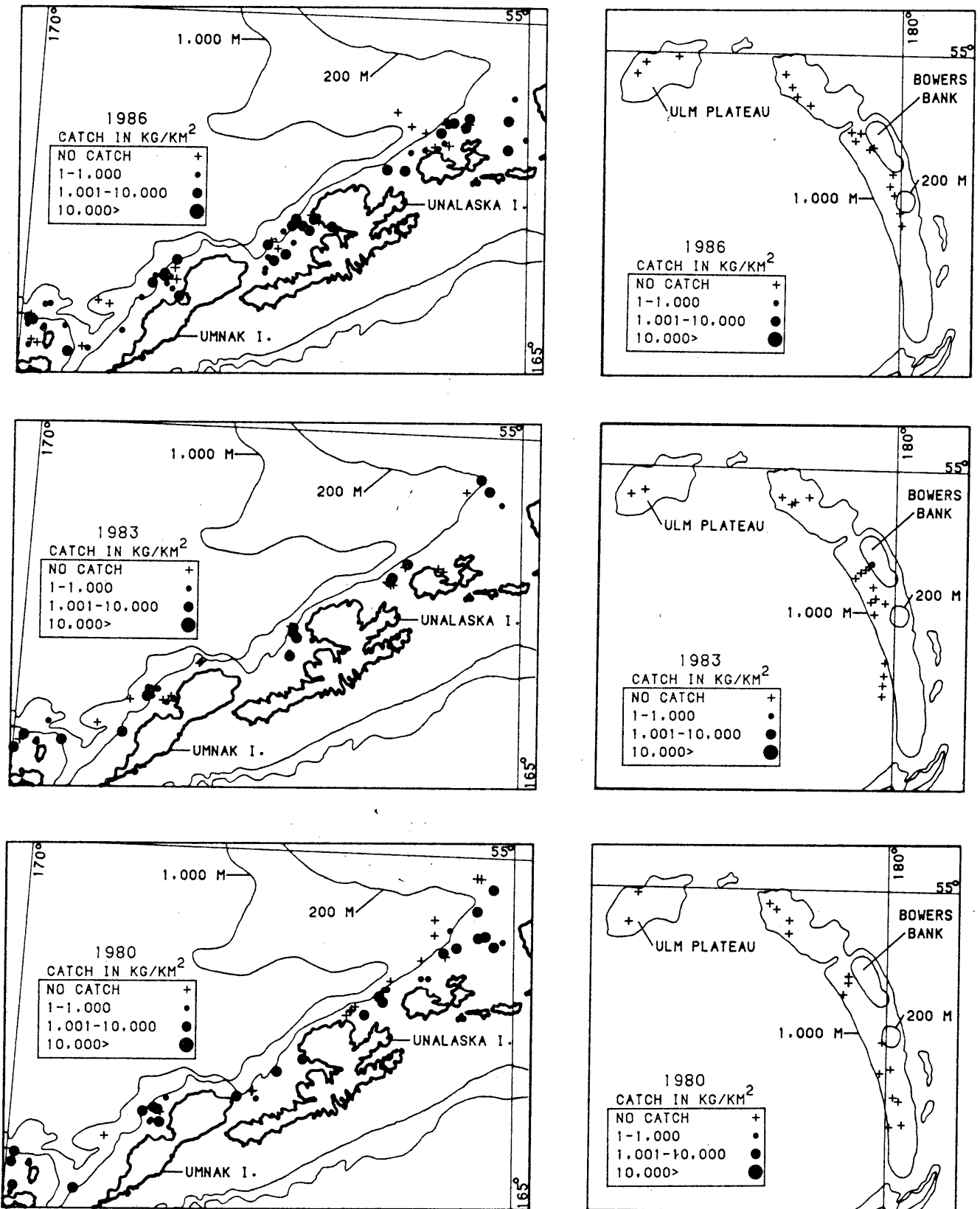

Figure 69. Distribution and relative abundance of Pacific cod in the Southern Bering Sea and Bowers Ridge areas during the U.S.-Japan 1980, 1983, and 1986 Aleutian Islands groundfish surveys.

Table 42. Estimates of biomass, biomass sampling error, and population for Pacific cod based on the U.S.-Japan 1980, 1983, and 1986 Aleutian Islands groundfish surveys.

Area	Depth (m)	Biomass (t)			Sampling Error (%)			Population (1,000s)		
		1980	1983	1986	1980	1983	1986	1980	1983	1986
Southwest	1-100	1,158	8,450	22,166				1,054.2	4,258.8	24,643.0
	101-200	10,250	8,771	29,986				2,926.0	2,976.7	8,208.7
	201-300	475	799	3,573				415.8	402.3	1,249.0
	301-500	8	30	692				1.8	13.3	289.9
	501-900	0	0	0				0.0	0.0	0.0
	1-900	11,891	18,050	56,417	59.4	132.1	76.2	4,397.8	7,651.1	34,390.6
Southeast	1-100	a	6,610	6,039				a	2,087.4	6,000.1
	101-200	5,168	6,777	13,071				3,038.8	2,334.1	4,959.7
	201-300	886	3,448	3,995				540.2	1,297.1	2,060.3
	301-500	500	35	671				158.3	16.6	267.9
	501-900	0	0	0				0.0	0.0	0.0
	1-900	6,554	16,870	23,776	73.4	52.7	217.3	3,737.3	5,735.2	13,288.0
Northwest	1-100	0	17,114	41,759				0.0	4,912.8	11,527.4
	101-200	3,754	22,891	10,085				1,433.1	6,048.4	3,965.0
	201-300	1,695	3,516	4,182				525.0	643.3	1,039.5
	301-500	60	7	340				24.1	4.2	66.8
	501-900	0	0	0				0.0	0.0	0.0
	1-900	5,509	43,528	56,366	103.8	154.8	139.8	1,982.2	11,608.4	15,598.7
Northeast	1-100	1,967	11,637	2,811				2,803.2	3,467.1	2,235.9
	101-200	17,954	18,605	28,055				5,595.5	6,942.1	9,487.4
	201-300	7,805	3,960	4,912				3,142.2	1,291.0	1,691.4
	301-500	390	497	288				174.0	190.8	163.4
	501-900	0	0	0				0.0	0.0	0.0
	1-900	28,116	34,699	36,066	110.7	26.3	44.7	11,714.9	11,871.0	13,578.1
Bowers Ridge	101-200	a	1	0				a	1.5	0.0
	201-300	0	0	0				0.0	0.0	0.0
	301-500	0	0	0				0.0	0.0	0.0
	510-900	0	0	0				0.0	0.0	0.0
	101-900	0	1	0	0.0	1,270.6	0.0	0.0	1.5	0.0
	Aleutian Islands	1-100	3,125	43,811	72,775	0.0	143.3	110.6	3,857.4	14,726.0
	101-200	37,126	57,045	81,197	78.9	34.9	29.0	12,993.4	18,302.8	26,620.8
Total	201-300	10,861	11,723	16,662	73.5	49.9	24.9	4,623.2	3,613.7	6,040.2
	301-500	958	569	1,991	153.4	361.6	98.5	358.2	224.9	799.0
	501-900	0	0	0	0.0	0.0	0.0	0.0	0.0	0.0
	1-900	52,070	113,148	172,625	56.2	43.0	48.6	21,832.2	36,867.4	78,855.4
Southern Bering Sea	1-100	30,593	11,121	20,445				14,092.6	6,886.3	10,806.0
	101-200	39,856	29,864	18,905				15,957.7	9,502.4	5,503.7
	201-300	3,606	4,236	2,832				1,142.5	1,067.0	712.5
	301-500	320	403	116				261.0	111.1	39.3
	501-900	0	0	0				0.0	0.0	0.0
Total	1-900	74,375	45,624	42,298	64.8	53.6	59.0	31,453.8	17,566.8	17,061.5

a No sampling was conducted in this area-depth interval.

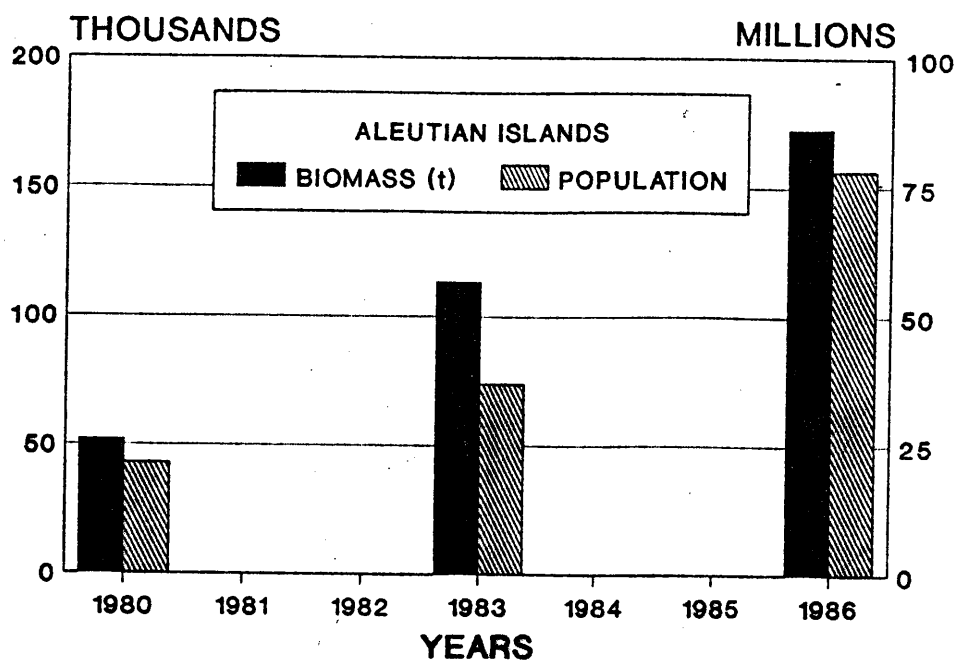

Figure 70. Estimated biomass and population of Pacific cod in the Aleutian Islands area during the U.S.-Japan 1980, 1983, and 1986 groundfish surveys.

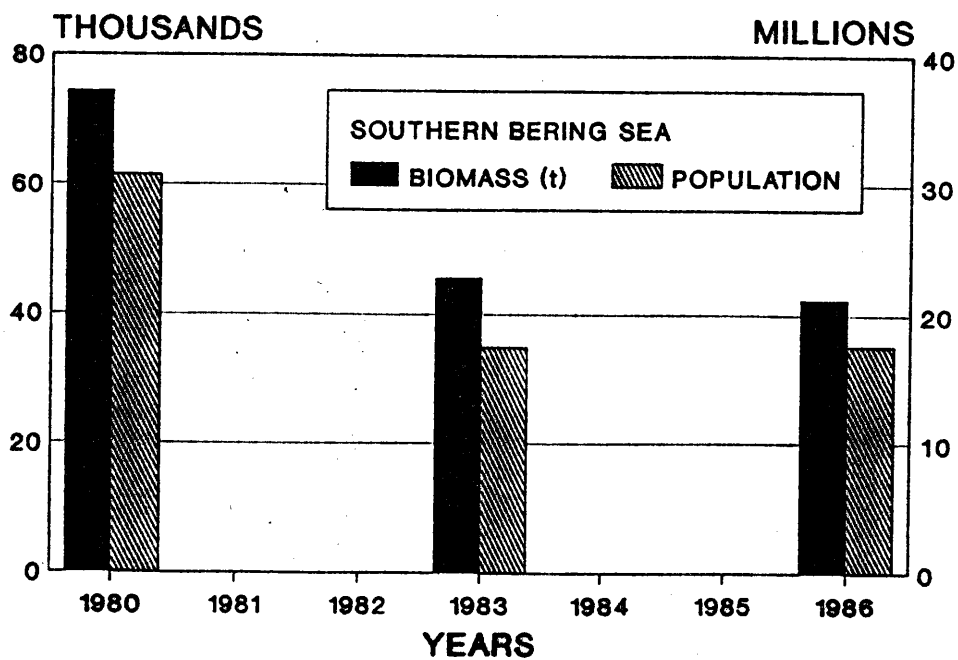

Figure 71. Estimated biomass and population of Pacific cod in the Southern Bering Sea area during the U.S.-Japan 1980, 1983, and 1986 Aleutian Islands groundfish surveys.

Table 43. Estimates of mean catch per unit effort, length, and weight for Pacific cod based on the U.S.-Japan 1980, 1983, and 1986 Aleutian Islands groundfish surveys.

Area	Depth (m)	Mean CPUE (kg/km ²)			Mean Length (cm)			Mean Weight (kg)		
		1980	1983	1986	1980	1983	1986	1980	1983	1986
Southwest	1-100	505.4	2,874.6	5,891.1	40.5	52.9	0.0	1.10	2.02	0.89
	101-200	1,569.6	1,343.0	4,591.6	65.0	63.8	60.1	3.54	2.98	3.64
	201-300	206.9	348.2	1,557.3	60.7	51.9	56.4	1.21	1.90	2.92
	301-500	2.5	8.8	203.1	58.7	0.0	0.0	4.56	2.26	2.39
	501-900	0.0	0.0	0.0	0.0	0.0	0.0	0.00	0.00	0.00
	1-900	551.5	812.7	2,449.5	47.2	57.1	59.6	2.74	2.38	1.63
Southeast	1-100	a	4,189.4	2,283.7	a	57.8	0.0	a	3.17	0.92
	101-200	1,579.5	2,071.2	3,994.8	55.5	59.0	52.3	1.85	2.95	2.63
	201-300	280.3	1,091.4	1,264.7	54.6	62.0	51.6	1.63	2.65	1.98
	301-500	183.8	11.1	213.7	56.7	0.0	64.5	3.16	2.10	2.45
	501-900	0.0	0.0	0.0	0.0	0.0	0.0	0.00	0.00	0.00
	1-900	585.8	1,207.0	1,580.5	49.6	59.2	52.8	1.87	2.96	1.72
Northwest	1-100	0.0	7,252.4	17,696.1	64.3	61.7	0.0	0.00	3.47	3.57
	101-200	2,042.2	8,712.6	3,838.6	54.1	65.7	55.1	2.32	3.88	2.64
	201-300	1,583.6	3,285.9	3,907.6	69.9	72.2	62.2	3.22	5.59	4.13
	301-500	27.2	3.0	153.3	0.0	0.0	64.0	2.51	1.60	4.78
	501-900	0.0	0.0	0.0	0.0	0.0	0.0	0.00	0.00	0.00
	1-900	495.9	3,410.5	4,416.4	62.3	64.4	56.9	2.54	3.79	3.39
Northeast	1-100	887.7	9,978.9	1,465.9	43.8	70.9	35.4	0.70	3.36	1.15
	101-200	4,595.8	4,762.3	7,181.2	57.8	59.4	59.1	3.28	2.62	3.22
	201-300	3,196.2	1,621.4	2,011.4	58.3	63.8	65.8	2.57	3.05	2.79
	301-500	113.6	144.9	87.8	51.0	63.2	57.9	2.24	2.61	1.75
	501-900	0.0	0.0	0.0	0.0	0.0	0.0	0.00	0.00	0.00
	1-900	1,569.2	2,025.7	2,034.3	55.2	62.4	55.4	2.45	2.88	2.75
Bowers Ridge	101-200	a	4.7	0.0	a	0.0	0.0	a	0.98	0.00
	201-300	0.0	0.0	0.0	0.0	0.0	0.0	0.00	0.00	0.00
	301-500	0.0	0.0	0.0	0.0	0.0	0.0	0.00	0.00	0.00
	501-900	0.0	0.0	0.0	0.0	0.0	0.0	0.00	0.00	0.00
	101-900	0.0	0.1	0.0	0.0	0.0	0.0	0.00	0.98	0.00
Aleutian Islands	1-100	520.6	5,446.9	6,811.4	47.2	59.9	35.4	0.81	2.98	1.60
	101-200	2,388.0	3,426.4	4,877.1	59.1	62.1	57.4	2.90	3.13	3.15
Total	201-300	1,066.1	1,150.8	1,635.7	59.5	63.2	62.8	2.41	3.21	2.77
	301-500	71.7	41.2	145.9	55.8	63.2	61.2	2.68	2.53	2.49
	501-900	0.0	0.0	0.0	0.0	0.0	0.0	0.00	0.00	0.00
	1-900	726.1	1,482.3	2,190.0	52.1	61.4	55.8	2.42	3.07	2.21
Southern Bering Sea	1-100	6,348.5	2,307.8	4,242.5	48.5	49.1	54.1	2.23	1.61	1.86
	101-200	12,180.4	9,126.9	5,777.6	61.0	61.3	55.4	2.57	3.19	3.25
	201-300	3,600.0	4,229.3	2,827.6	66.6	66.8	61.6	2.83	4.10	4.07
	301-500	251.5	317.0	91.1	0.0	67.4	57.6	1.23	3.61	2.89
	501-900	0.0	0.0	0.0	0.0	0.0	0.0	0.00	0.00	0.00
Total	1-900	5,884.4	3,609.8	3,346.5	53.4	56.8	55.1	2.42	2.62	2.41

a No sampling was conducted in this area-depth interval.

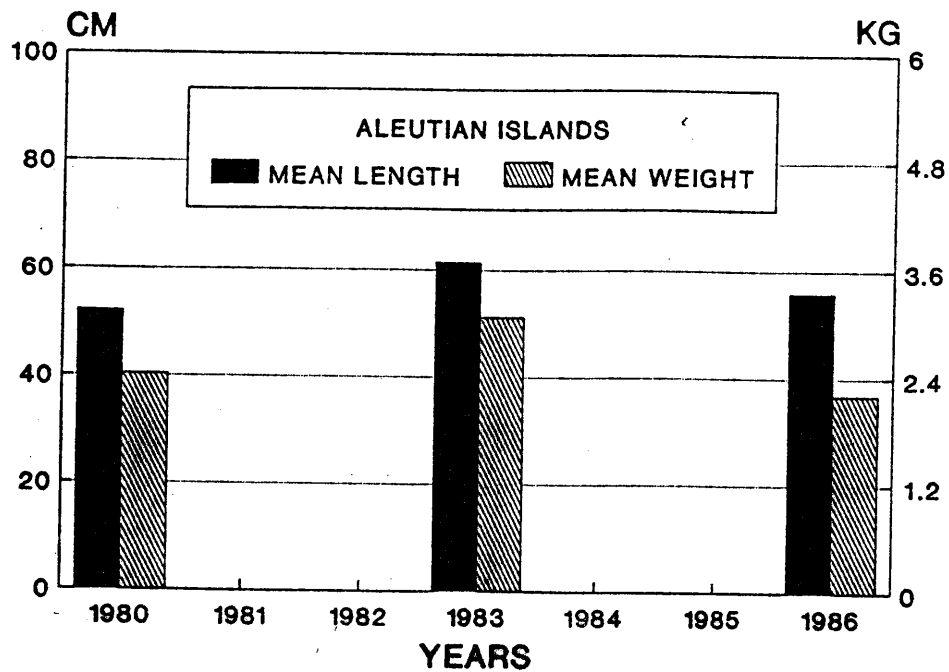

Figure 72. Mean length and weight of Pacific cod in the Aleutian Islands area during the U.S.-Japan 1980, 1983, and 1986 groundfish surveys.

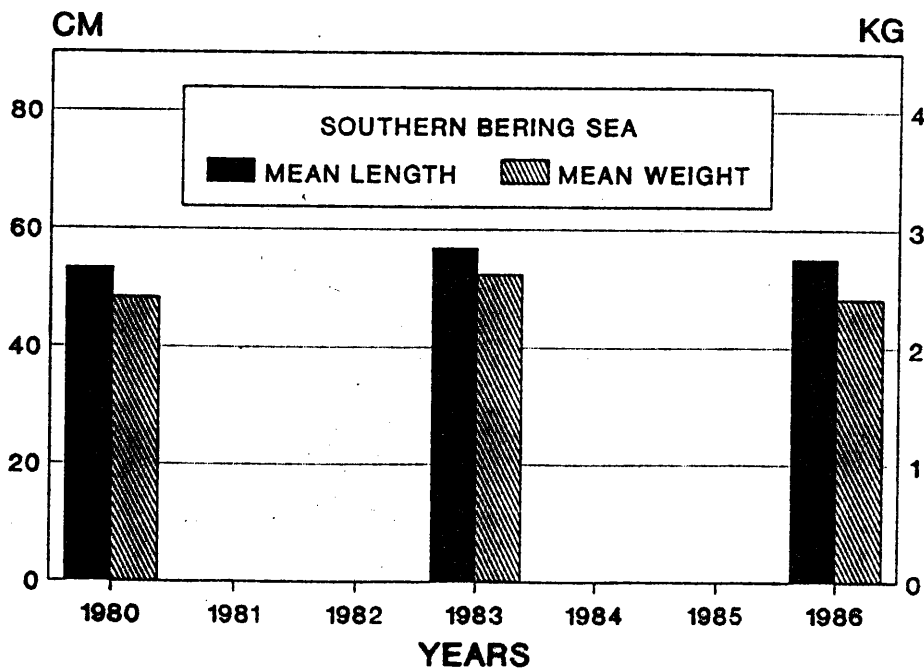

Figure 73. Mean length and weight of Pacific cod in the Southern Bering Sea area during the U.S.-Japan 1980, 1983, and 1986 Aleutian Islands groundfish surveys.

Size and Age Composition

The 1980 size composition curve for Pacific cod was extremely broad and flat, ranging from 30 to 90 cm, with less than 0.5 million fish in any size category (Fig. 74). Small modes were present, peaking at 35, 50, and 68 cm. Age data from otolith readings are available only from the 1980 survey when the stock was dominated by 2-year-old fish, which contributed 38% of the stock (Fig. 75). The 3-year-old and 1-year-old age groups contributed 20% and 14%, respectively, although the 1-year-old fish were probably not fully available for sampling.

In 1983 the size composition curve was again broad but not nearly as flat as in 1980, with several size categories containing over 1 million fish. The stock was dominated by fish greater than 48 cm with the strongest mode peaking at 53 cm and smaller modes at 60 and 70 cm.

In 1986 the size composition curve was much stronger than in 1983 with some size categories containing over 2.5 million fish. The strongest modes occurred at 35 cm and at 46 cm, with smaller modes at 69 cm and 79 cm.

During the Aleutian Islands surveys the size composition varied considerably within areas (Figs. 76-79). In 1980 the Southwest area size curve was broad and flat with no visible modes. In the Southeast area, there was one small mode that peaked at 50 cm. In the Northwest area, there were small weak modes that peaked at 42, 55, and 72 cm. The highest abundance was found in the Northeast area where at least four modes were evident; the first and strongest mode peaked at 38 cm, followed by secondary modes at 54, 67, and 86 cm.

During the 1983 survey, size compositions in the Southwest and Southeast areas were similar in that both were broad and flat without prominent modes. In the Southwest area a small mode was evident at 52 cm and in the Southeast area there was a small mode at 41 cm. There were four modes in the Northwest area peaking at 52, 60, 68, and 78 cm. This area contained a greater size range of fish; smaller fish ranged from 30 to 40 cm and large fish from 90 to 100 cm. In the Northeast area there were also four modes peaking at 52, 62, 68, and 77 cm.

During 1986 in the Southwest area there were large numbers of smaller fish ranging from 30 to 42 cm, and not as many larger fish. The Southeast area was similar with smaller fish ranging from 40 to 53 cm, and fewer larger fish. The Northwest area had more larger fish ranging from 60 to 90 cm, and less smaller fish with two modes peaking at 55 and 35 cm. In the Northeast area there were more smaller fish ranging from 32 to 55 cm, and less larger fish ranging from 60 to 100 cm.

In the Southern Bering Sea area the size composition curve in 1980 was dominated by smaller fish. The primary mode of 43-53 cm fish peaked at 49 cm with few larger fish and one small secondary mode at 80 cm (Fig. 80).

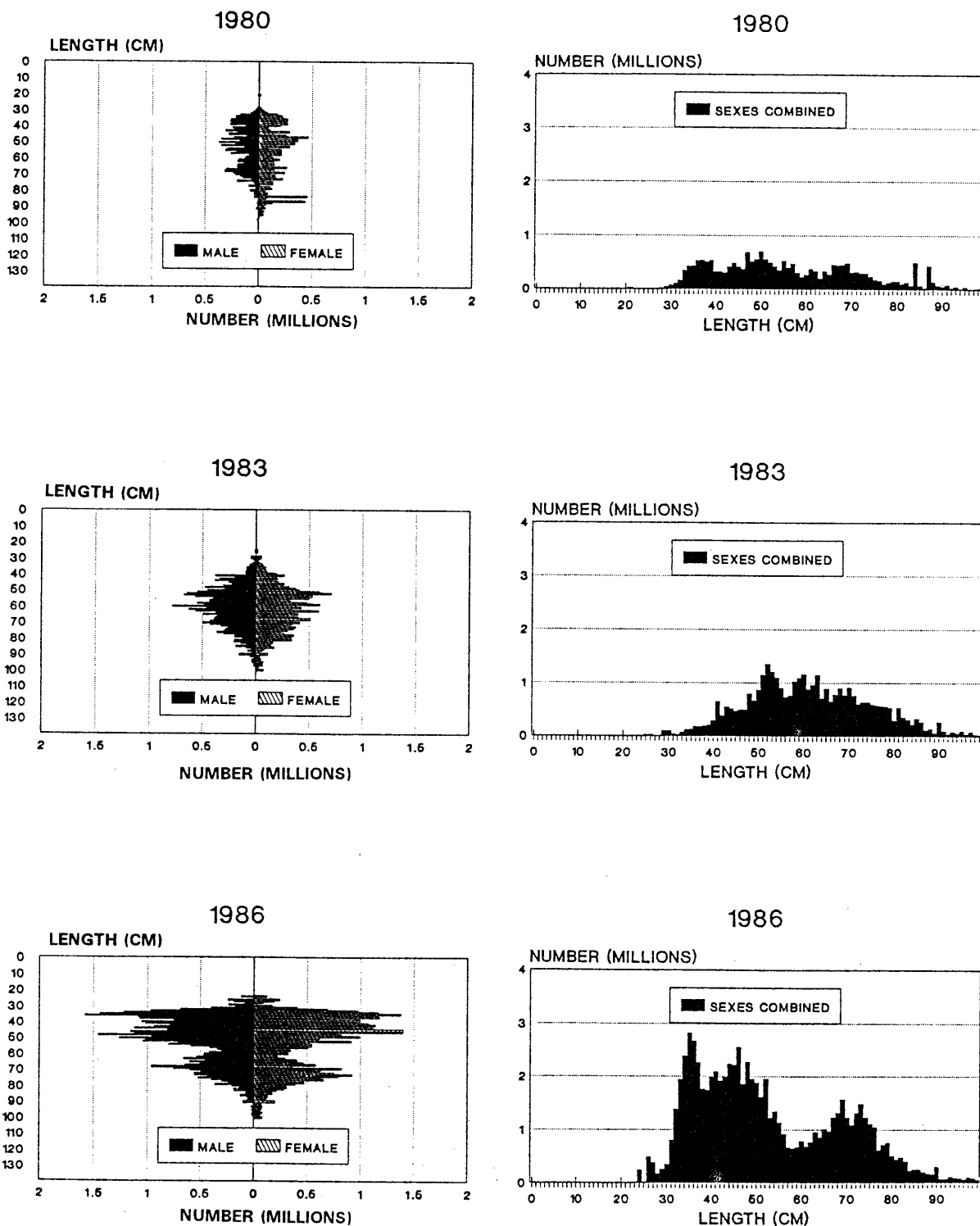

Figure 74. Size composition of Pacific cod in the Aleutian Islands area during the U.S.-Japan 1980, 1983, and 1986 groundfish surveys.

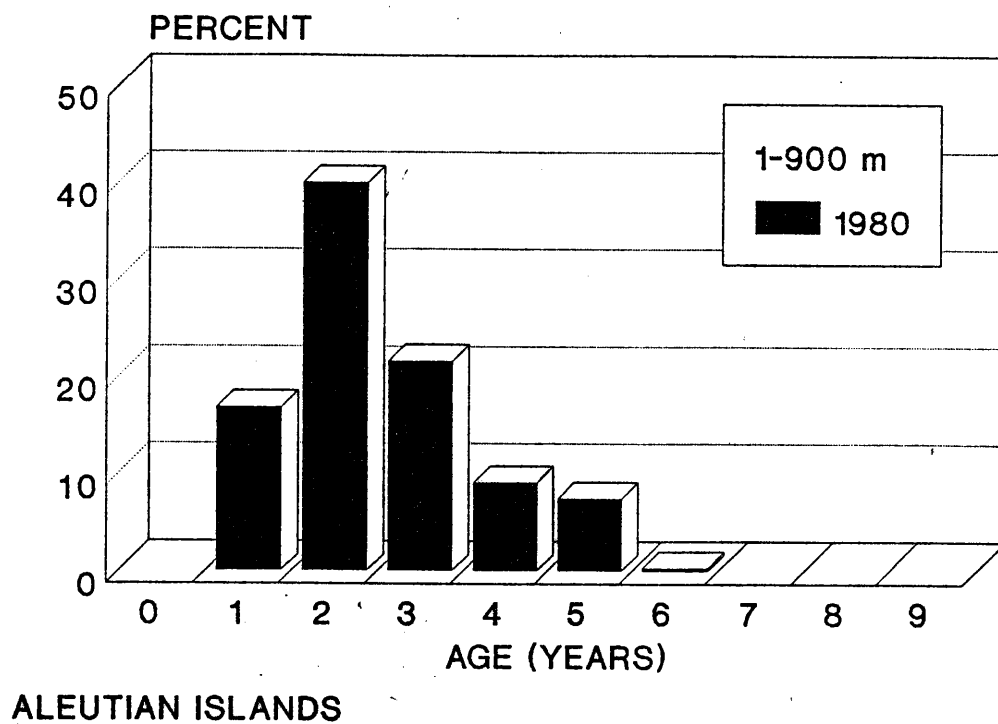

Figure 75. Age composition of Pacific cod in the Aleutian Islands area during the U.S.-Japan 1980 groundfish survey.

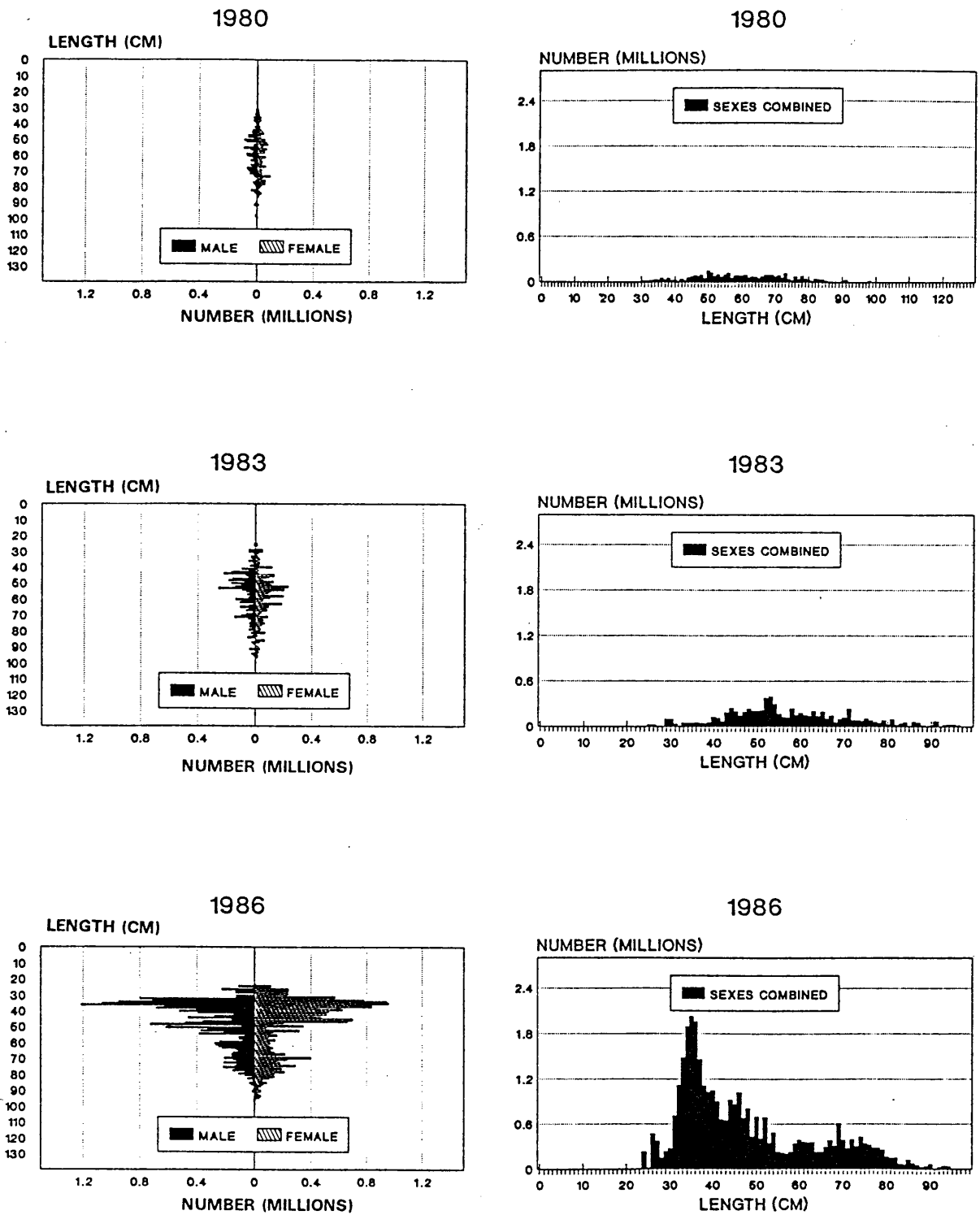

Figure 76. Size composition of Pacific cod in the Southwest area of the Aleutian Islands during the U.S.-Japan 1980, 1983, and 1986 groundfish surveys.

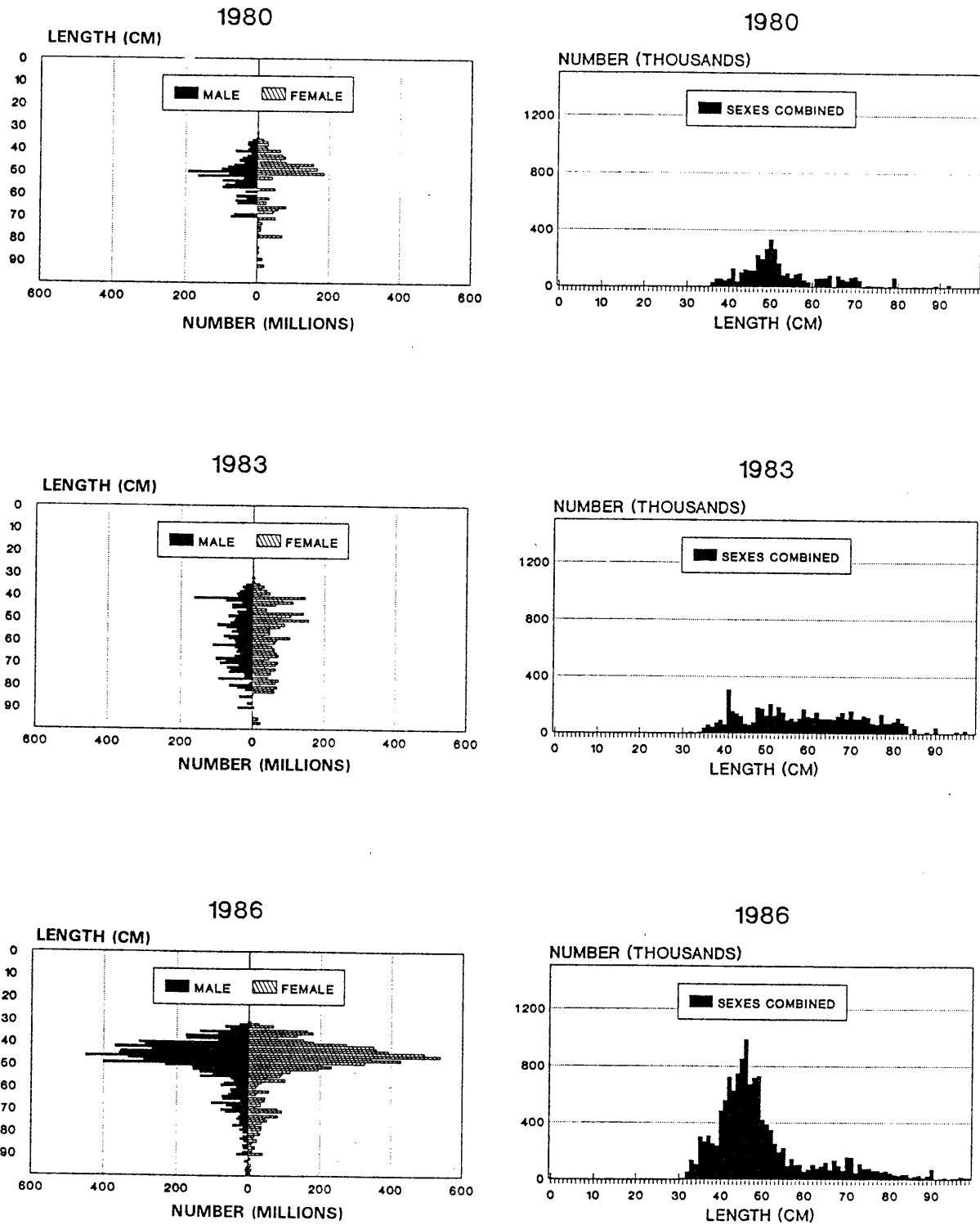

Figure 77. Size composition of Pacific cod in the Southeast area of the Aleutian Islands during the 1980, 1983, and 1986 groundfish surveys.

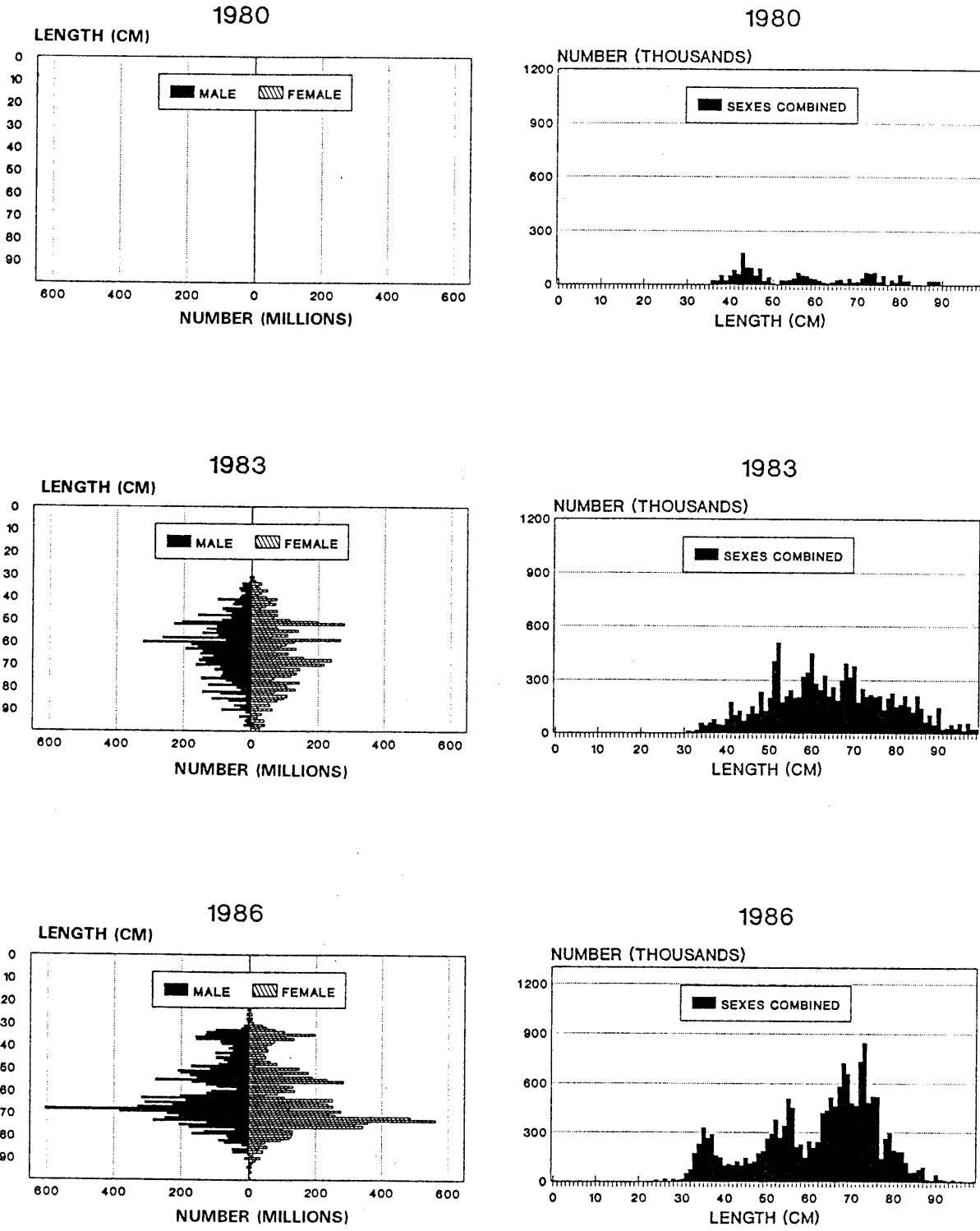

Figure 78. Size composition of Pacific cod in the Northwest area of the Aleutian Islands during the 1980, 1983, and 1986 groundfish surveys.

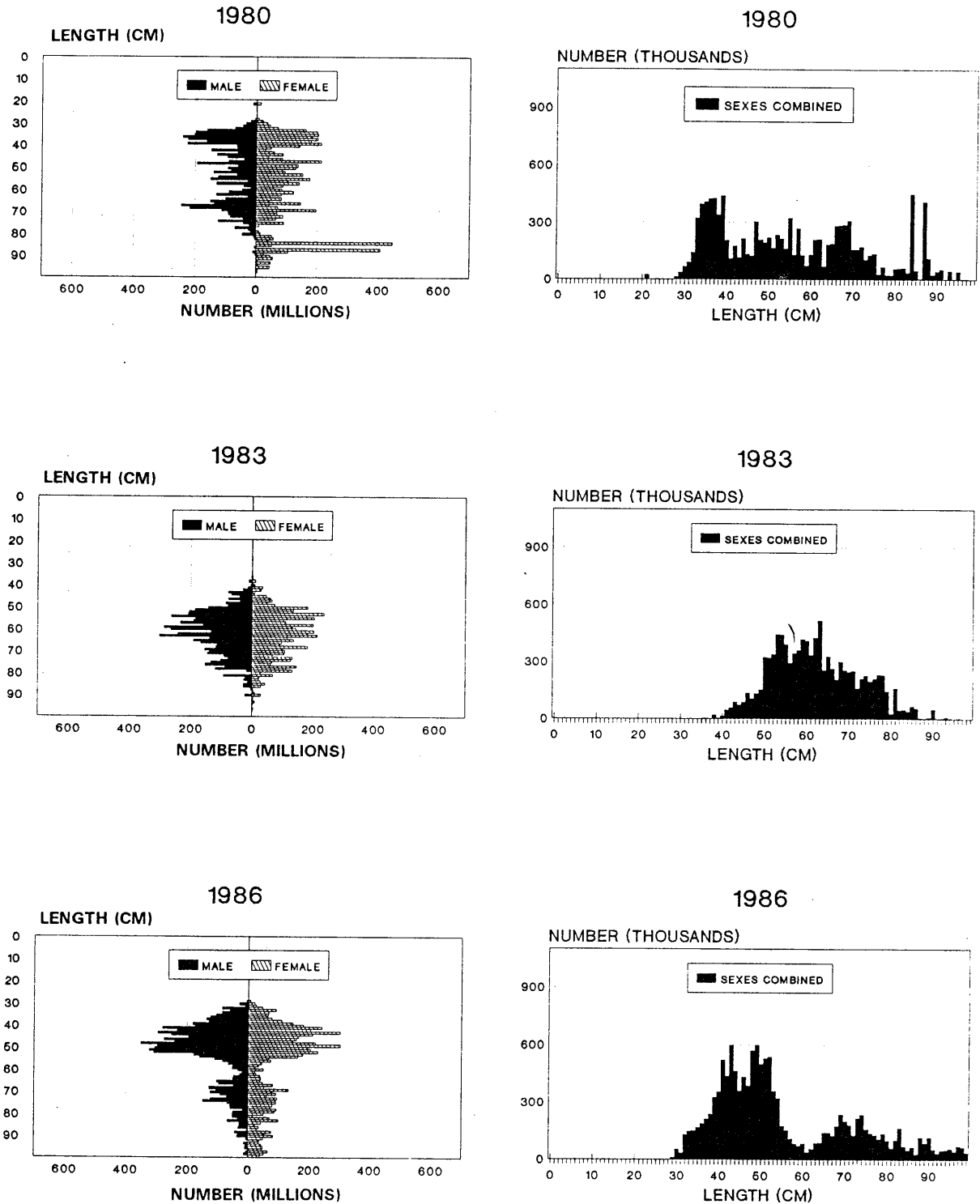

Figure 79. Size composition of Pacific cod in the Northeast area of the Aleutian Islands during the 1980, 1983, and 1986 groundfish surveys.

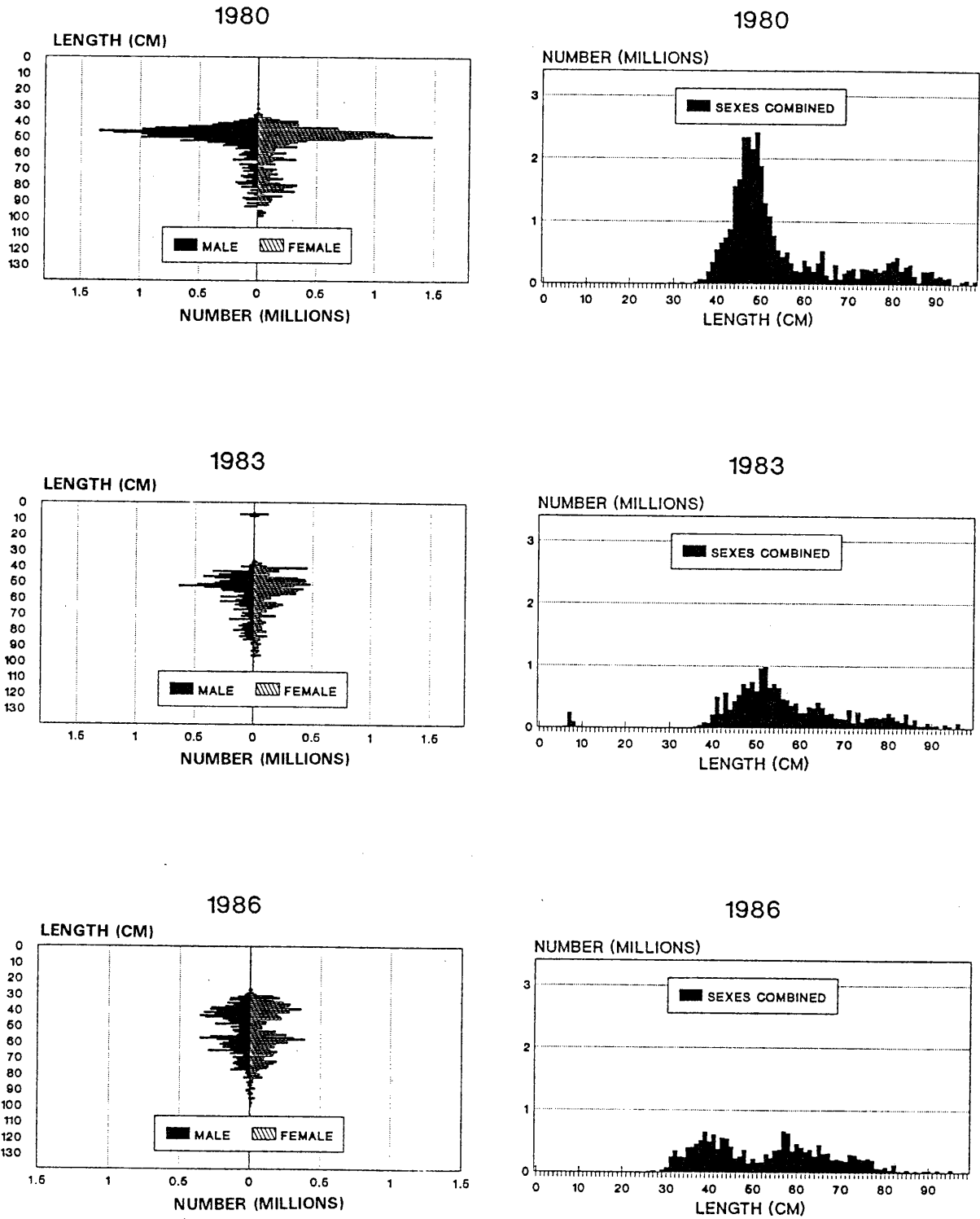

Figure 80. Size composition of Pacific cod in the Southern Bering Sea during the U.S.-Japan 1980, 1983, and 1986 Aleutian Islands groundfish surveys.

In 1983 the abundance was considerably lower, with the largest size category containing about 1 million fish. The primary size composition mode ranged from 48 to 58 cm, peaking at 52 cm. Again, there were fewer larger fish with secondary modes at 64 and 80 cm. There was also a small showing of extremely small cod, 7-8 cm, probably young-of-the-year from the 1983 year class.

During 1986 the size composition curve was composed of three weak modes, with all size categories less than about 0.7 million fish. The strongest mode ranged from 30-46 cm and peaked at 39 cm, the second mode peaked at 57 cm and a third small mode occurred at 72 cm.

Mean Length-at-Age and Growth

Mean length-at-age data, which are only available from the 1980 Aleutian Islands area, indicate a very fast rate of growth for Pacific cod (Table 44). There was only one observation for length-at-age for age 1+. By age 2+, Pacific cod had attained a mean length of 49 cm; by age 3+, they were 61 cm, and by age 4+, they were 70 cm. At age 4+, sexual dimorphism became evident and the mean length of the males and females began to diverge. At age 5+, males averaged 73 cm and females averaged 82 cm in length.

The yearly growth interval of Pacific cod tended to decrease with increasing age (Table 45). Pacific cod grew approximately 15.1 cm between age 1 and 2, 11.8 cm between age 2 and 3, and 9.1 cm between age 3 and 4. From age 4 to 5 the yearly growth increment for males decreased to 3.9 cm, but females remained at 9.9 cm.

The available age data were fitted to the von Bertalanffy growth equation and the resulting estimates of t_0 , k and L_{INF} are presented in Table 46.

Table 44. Mean length (mm) at age for Pacific cod sampled during the U.S.-Japan 1980 Aleutian Islands groundfish survey.

Age	Males	Females	Sexes combined
2	487	496	492
3	613	606	610
4	691	718	701
5	730	817	763
6	-	903	903

Table 45. Estimates of yearly incremental growth (cm) of Pacific cod based on the U.S.-Japan 1980 groundfish survey.

Age	Males	Females	Sexes combined
1-2	14.7	-	15.1
2-3	12.5	11.0	11.8
3-4	7.9	11.2	9.1
4-5	3.9	9.9	6.2
5-6	-	8.5	14.0

Table 46. Estimated von Bertalanffy growth curve parameters for Pacific cod sampled during the U.S.-Japan 1980 Aleutian Islands groundfish survey.

Area	Sex	Range		von Bertalanffy Growth Parameters		
		Age (Years)	Length (cm)	L_{INF}	k	t_0
Aleutian Islands	m	1-6	34-84	83.20	0.430	-0.065
	F	2-6	37-94	127.89	0.173	-0.786
	M+F	1-6	34-94	104.65	0.240	-0.637
Southern Bering Sea	m	2-6	40-93	99.96	0.333	0.812
	F	2-6	39-97	113.57	0.238	-0.286
	M+F	2-6	39-97	105.74	0.287	-0.080

Length-Weight Relationship

Length-weight relationships were obtained for Pacific cod for all three surveys (Fig. 81):

$$\begin{aligned} \text{Weight(g)} \text{ (1980)} &= .0128 \times \text{Length(cm)}^{2.998} \\ \text{Weight(g)} \text{ (1983)} &= .0049 \times \text{Length(cm)}^{3.215} \\ \text{Weight(g)} \text{ (1986)} &= .0057 \times \text{Length(cm)}^{3.167} \end{aligned}$$

During the 1983 survey the weight for a given length was greater than during either the 1980 or 1986 surveys and in 1980 the weight was slightly heavier than during 1986 survey.

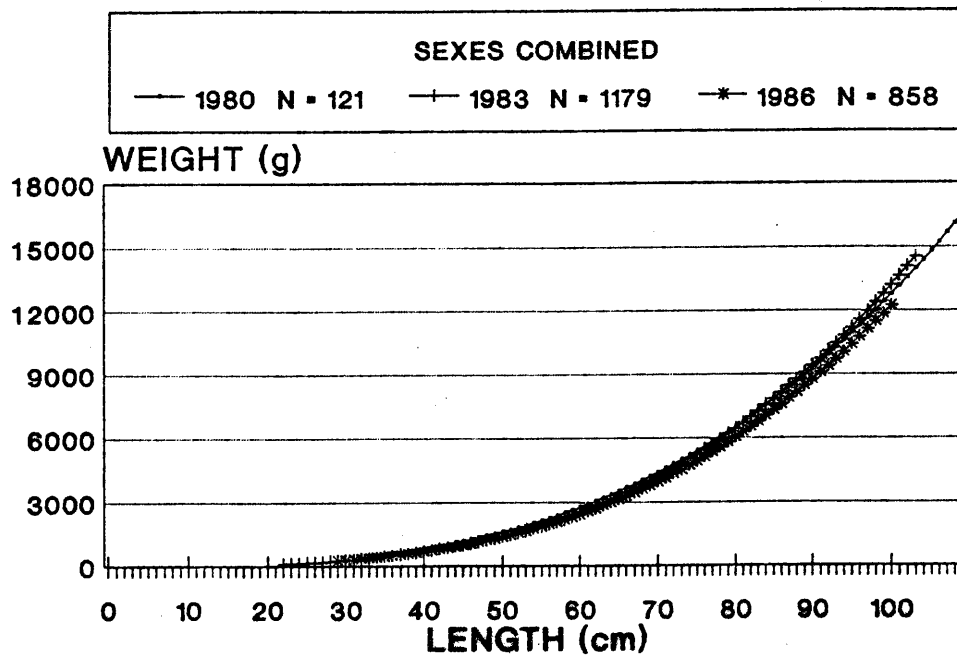

Figure 81. Length-weight relationships for Pacific cod in the Aleutian Islands area during the U.S.-Japan 1980, 1983, and 1986 groundfish surveys.

Northern Rockfish

Distribution and Abundance

Northern rockfish (Sebastes polypsinis) are distributed from Stalemate Bank to Unimak Pass primarily in waters less than 200 m deep (Figs. 82 and 83). In 1980, high densities were encountered only in the Southeast area of the Aleutian Islands, south of the Islands of Four Mountains and Amlia Island. In 1983, they were encountered only in the western areas around Buldir and Tahoma Reefs and north of Agattu Island. In 1986, high densities in the eastern areas occurred south of the Islands of Four Mountains, north of Seguam Island, and on Petrel Spur. In the western areas, high densities were located off Amchitka and Kiska Islands, on Tahoma and Buldir Reefs, and on Stalemate Bank.

In 1980, the biomass estimate totaled 43,000 t, and the population estimate was 72.1 million fish (Table 47, Fig. 84). Approximately 84% of the total biomass was located in the 101-200 m depth interval in the Southeast area.

The biomass estimate in 1983 was 44,000 t, nearly equal to the 1980 estimate, but the population estimate had increased to 118 million fish. The stock was more evenly distributed throughout the areas. Approximately 41% occurred in the Southwest area, 20% in the Southeast area, and 30% in the Northwest area.

The biomass estimate was higher in the two shallowest depth intervals of all areas except the 101-200 m depth interval of the Southeast area where there was a substantial decrease. Northern rockfish were taken on Bowers Ridge for the first time, but this may be because the 100-201 m zone was not sampled in that area in 1980.

In 1986 the biomass estimate increased nearly threefold to 125,000 t, and the population estimate rose to 347.4 million fish. Substantial increases occurred in most areas. In the Southwest area the biomass estimate increased by 443%, in the Northeast area by 532%, in the Northwest area by 206%, and in Bowers Ridge by 293%. The Southeast area which had declined 75% from 1980 to 1983 declined another 75% to only 2,300 t. The biomass estimate in the 1-100 m depth interval was 48,000 t greater than in 1983. Biomass in the 101-200 m depth zone was 31,000 t greater than in 1983, but only slightly higher than the 1980 estimate.

In the Southern Bering Sea, the biomass estimate increased 445% from 300 t in 1980 to 1,500 t in 1983, then increased 4,200% to 63,000 t in 1986. The population estimate of 0.3 million fish in 1980 increased to 19.0 million in 1983 and rose to 107.4 million fish in 1986 (Fig. 85).

Mean length and weight data for northern rockfish in the Aleutian Islands area and Southern Bering Sea area show inconsistencies and are probably inaccurate (Table 48, Figs. 86 and 87).

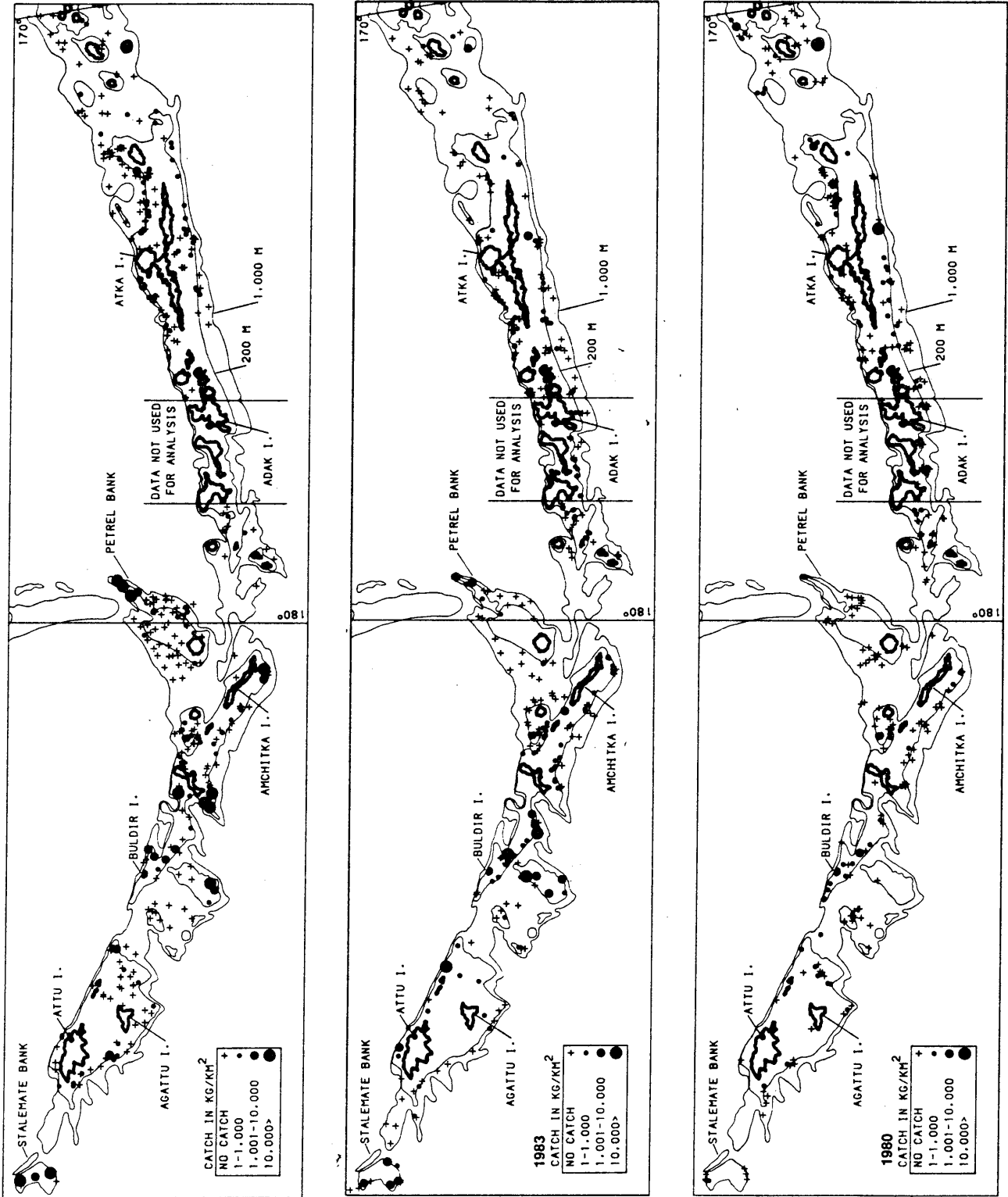

Figure 82. Distribution and relative abundance of northern rockfish in the Aleutian Islands area during the U.S.-Japan 1980, 1983, and 1986 groundfish surveys.

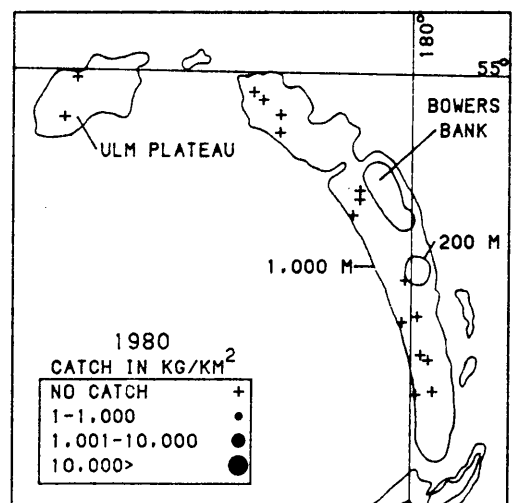
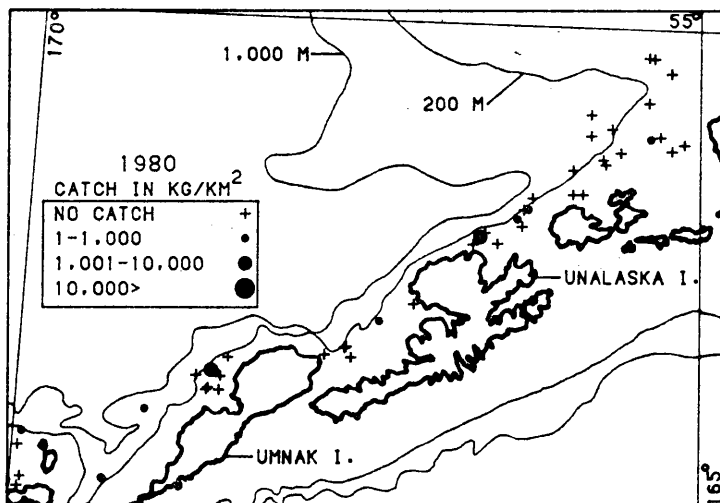
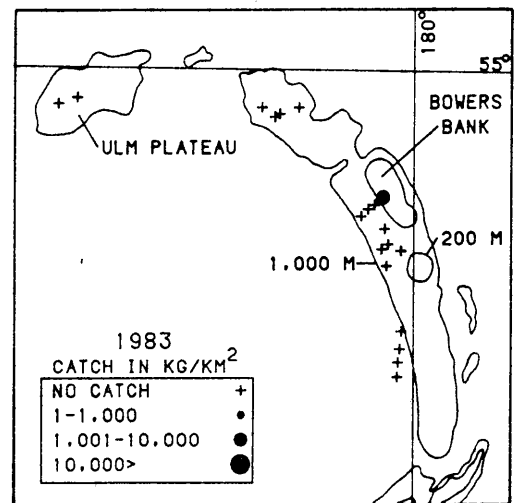
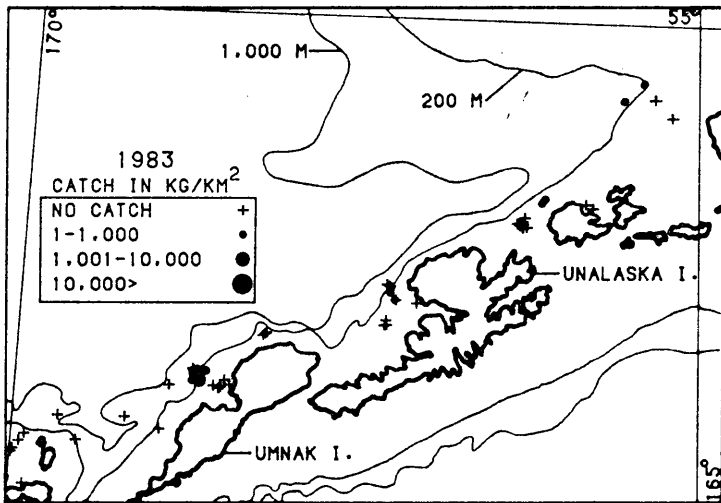
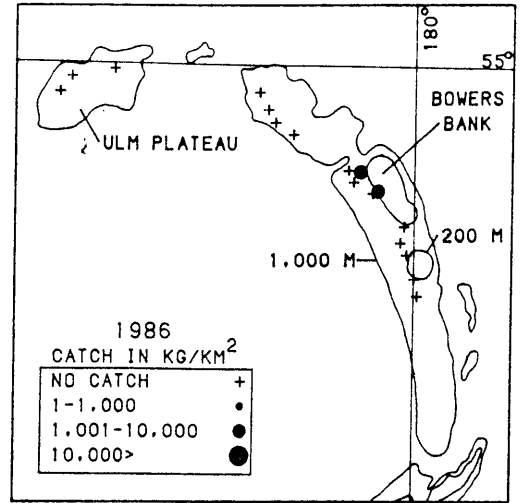
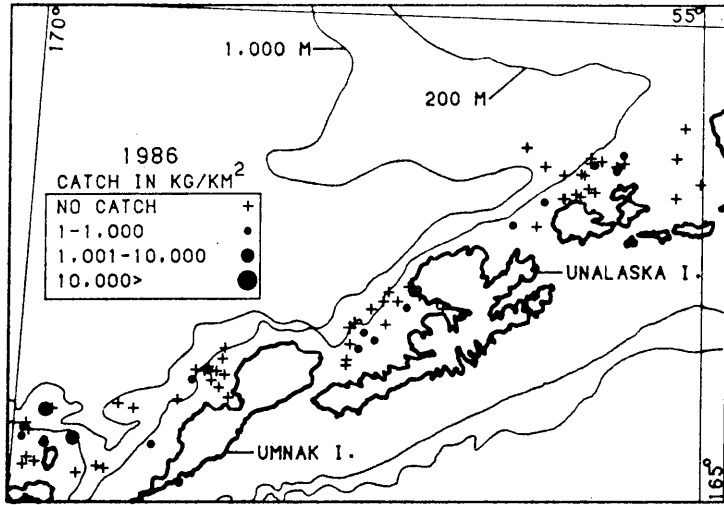

Figure 83. Distribution and relative abundance of northern rockfish in the Southern Bering Sea and Bowers Ridge areas during the U.S.-Japan 1980, 1983, and 1986 Aleutian Islands groundfish surveys.

Table 47. Estimates of biomass, biomass sampling error, and population for northern rockfish based on the U.S.-Japan 1980, 1983, and 1986 Aleutian Islands groundfish surveys.

Area	Depth (m)	Biomass (t)			Sampling Error (%)			Population (1,000s)		
		1980	1983	1986	1980	1983	1986	1980	1983	1986
Southwest	1-100	0	8,061	49,761				0.0	24,380.3	148,781.8
	101-200	4,945	9,736	30,191				10,990.0	24,380.3	76,568.4
	201-300	213	173	713				581.8	380.4	3,350.5
	301-500	6	255	1				3.7	666.4	2.8
	501-900	0	0	0				0.0	0.0	0.0
	1-900	5,164	18,225	80,666	222.0	65.9	116.4	11,575.5	50,549.8	228,703.0
	Southeast	1-100	a	7,829	9				a	28,912.4
101-200		36,196	1,248	2,093				57,368.7	2,124.5	3,975.2
201-300		15	77	201				47.1	226.5	684.6
301-500		2	44	41				7.7	70.1	93.1
501-900		0	0	0				0.0	0.0	0.0
1-900		36,213	9,198	2,344	313.3	34.0	141.9	57,423.5	31,333.5	4,818.5
Northwest		1-100	0	12,280	26,357				0.0	25,180.6
	101-200	0	748	891				0.0	2,134.9	1,721.9
	201-300	121	229	135				518.6	756.3	315.6
	301-500	2	0	1				0.0	0.0	2.9
	501-900	0	0	0				0.0	0.0	0.0
	1-900	123	13,257	27,384	399.1	281.4	146.4	518.6	28,071.8	74,158.8
	Northeast	1-100	6	457	0				51.2	1,033.0
101-200		916	1,677	11,323				1,711.7	4,420.0	33,300.9
201-300		461	9	95				838.6	31.3	213.2
301-500		24	1	2				0.0	3.2	18.9
501-900		0	0	0				0.0	0.0	0.0
1-900		1,407	2,144	11,420	116.8	145.4	97.5	2,601.5	5,487.5	33,533.0
Bowers Ridge		101-200	a	1,004	730				a	3,039.1
	201-300	0	0	2,325				0.0	0.0	4,688.5
	301-500	0	0	0				0.0	0.0	0.0
	510-900	0	0	0				0.0	0.0	0.0
	101-900	0	1,004	3,055	0.0	1,152.6	327.5	0.0	3,039.1	6,145.5
Aleutian Islands Total	1-100	6	28,627	76,127	0.0	132.3	103.9	51.2	80,248.7	228,965.8
	101-200	42,057	14,413	45,228	271.6	57.6	63.3	70,070.4	36,098.8	117,023.4
	201-300	810	488	3,469	110.9	120.1	298.0	1,986.1	1,394.5	9,251.9
	301-500	34	300	45	80.7	205.2	251.3	11.4	739.7	117.7
	501-900	0	0	0	0.0	0.0	0.0	0.0	0.0	0.0
	1-900	42,907	43,828	124,869	266.3	69.9	63.9	72,119.1	118,481.7	347,358.8
Southern Bering Sea Total	1-100	59	0	774				259.0	0.0	1,701.7
	101-200	235	1,439	62,714				62.2	18,788.0	105,704.7
	201-300	14	77	3				0.0	178.7	10.5
	301-500	6	0	0				0.0	0.0	0.0
	501-900	27	0	0				0.0	0.0	0.0
	1-900	341	1,516	63,491	128.6	109.3	180.6	321.2	18,966.7	107,416.9

a No sampling was conducted in this area-depth interval.

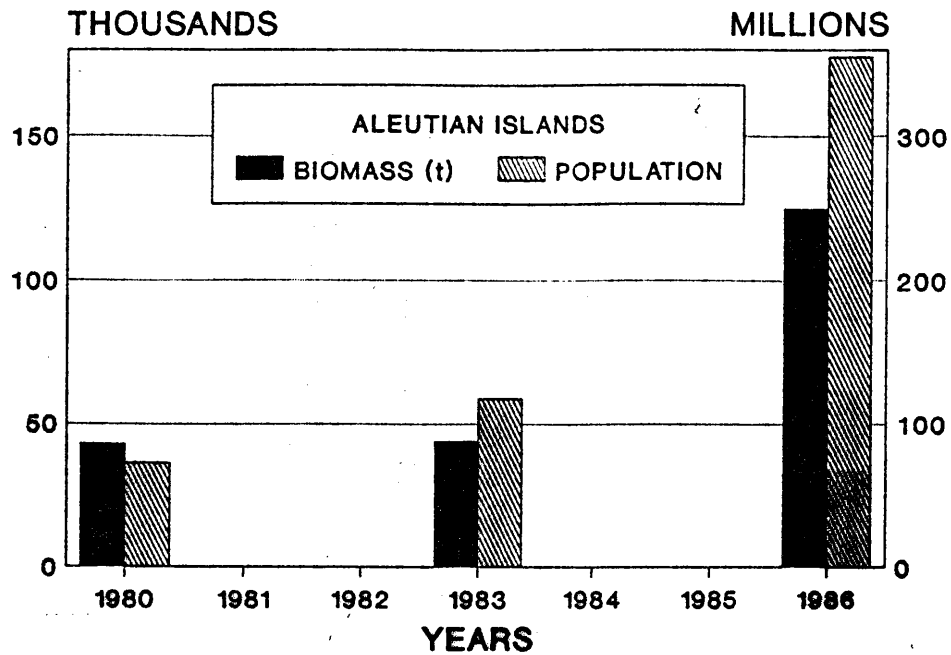

Figure 84. Estimated biomass and population of northern rockfish in the Aleutian Islands area during the U.S.-Japan 1980, 1983, and 1986 groundfish surveys.

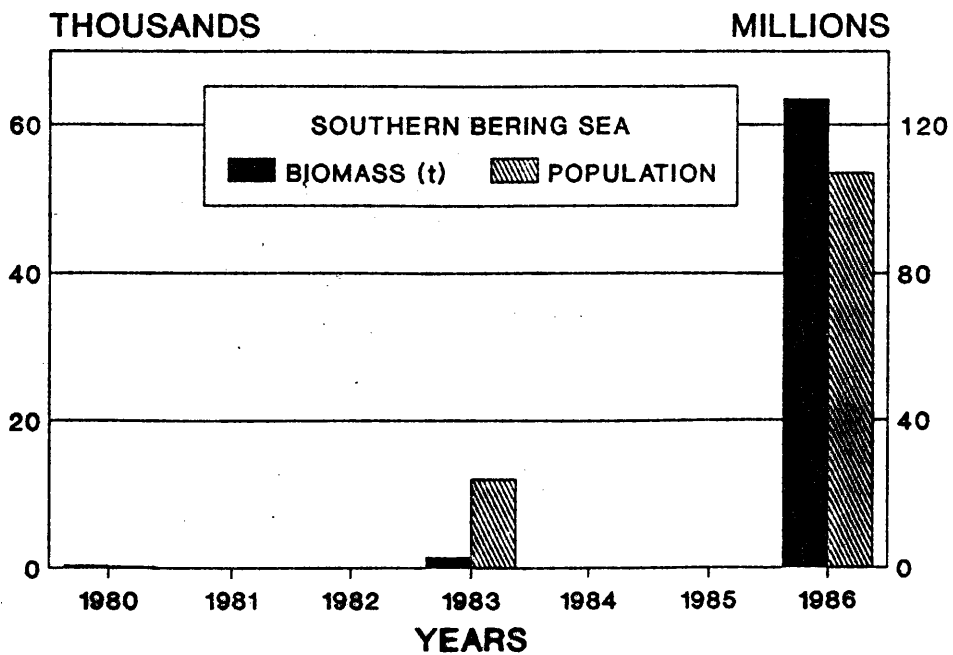

Figure 85. Estimated biomass and population of northern rockfish in the Southern Bering Sea area during the U.S.-Japan 1980, 1983, and 1986 Aleutian Islands groundfish surveys.

Table 48. Estimates of mean catch per unit effort length, and weight for northern rockfish based on the U.S.-Japan 1980, 1983, and 1986 Aleutian Islands groundfish surveys.

Area	Depth (m)	Mean CPUE (kg/km ²)			Mean Length (cm)			Mean Weight (kg)		
		1980	1983	1986	1980	1983	1986	1980	1983	1986
Southwest	1-100	0.0	2,742.5	13,225.2	29.0	27.9	0.0	0.00	0.33	0.32
	101-200	757.1	1,490.9	4,623.1	29.9	29.9	30.9	0.45	0.40	0.40
	201-300	92.9	75.2	310.7	29.9	31.9	29.0	0.37	0.45	0.21
	301-500	1.8	74.7	0.3	0.0	28.3	0.0	1.70	0.38	0.41
	501-900	0.0	0.0	0.0	0.0	0.0	0.0	0.00	0.00	0.00
	1-900	239.5	820.6	3,502.4	29.3	28.9	30.8	0.44	0.37	0.34
Southeast	1-100	a	4,962.2	3.2	a	24.7	0.0	a	0.27	0.13
	101-200	11,061.8	381.3	639.5	33.5	35.4	35.0	0.63	0.59	0.53
	201-300	4.8	24.5	63.7	0.0	36.5	29.8	0.32	0.34	0.30
	301-500	0.6	14.0	12.9	0.0	33.7	0.0	0.22	0.63	0.44
	501-900	0.0	0.0	0.0	0.0	0.0	0.0	0.00	0.00	0.00
	1-900	3,236.6	658.1	155.8	33.5	25.5	35.0	0.63	0.29	0.49
Northwest	1-100	0.0	5,204.0	11,169.3	28.5	30.0	0.0	0.00	0.49	0.37
	101-200	0.0	284.8	339.3	32.5	29.2	0.0	0.00	0.35	0.51
	201-300	113.0	214.4	125.8	30.7	27.3	24.6	0.23	0.31	0.43
	301-500	0.7	0.0	0.3	0.0	0.0	0.0	0.00	0.00	0.26
	501-900	0.0	0.0	0.0	0.0	0.0	0.0	0.00	0.00	0.00
	1-900	11.0	1,038.8	2,145.6	28.6	29.9	24.6	0.24	0.47	0.37
Northeast	1-100	2.5	391.6	0.0	0.0	30.4	0.0	0.11	0.44	0.00
	101-200	234.6	429.3	2,898.5	28.2	28.9	32.0	0.54	0.39	0.34
	201-300	188.9	3.8	38.8	0.0	28.8	36.7	0.55	0.30	0.44
	301-500	7.1	0.4	0.8	0.0	0.0	0.0	0.00	0.40	0.13
	501-900	0.0	0.0	0.0	0.0	0.0	0.0	0.00	0.00	0.00
	1-900	78.6	125.2	644.2	28.2	29.2	33.0	0.54	0.40	0.34
Bowers Ridge	101-200	a	3,217.3	2,339.7	a	26.9	0.0	a	0.33	0.50
	201-300	0.0	0.0	1,904.3	32.1	0.0	0.0	0.00	0.00	0.50
	301-500	0.0	0.0	0.0	0.0	0.0	0.0	0.00	0.00	0.00
	501-900	0.0	0.0	0.0	0.0	0.0	0.0	0.00	0.00	0.00
	101-900	0.0	97.9	297.9	32.0	26.9	0.0	0.00	0.33	0.50
Aleutian Islands Total	1-100	0.9	3,559.2	7,125.2	28.9	27.5	0.0	0.11	0.36	0.33
	101-200	2,705.0	865.7	2,716.7	29.6	29.8	34.2	0.60	0.40	0.39
	201-300	79.6	48.0	340.5	31.2	29.7	29.9	0.41	0.35	0.38
	301-500	2.5	21.7	3.3	0.0	28.8	0.0	2.97	0.41	0.38
	501-900	0.0	0.0	0.0	0.0	0.0	0.0	0.00	0.00	0.00
	1-900	598.3	574.2	1,584.2	29.2	28.2	34.1	0.59	0.37	0.35
Southern Bering Sea Total	1-100	12.2	0.0	160.7	31.6	0.0	25.3	0.23	0.00	0.45
	101-200	71.9	439.8	19,166.1	41.6	29.2	31.6	3.78	0.06	0.60
	201-300	14.2	76.9	3.5	0.0	42.5	0.0	0.00	0.47	0.33
	301-500	4.8	0.0	0.0	0.0	0.0	0.0	0.00	0.00	0.00
	501-900	11.9	0.0	0.0	0.0	0.0	0.0	0.00	0.00	0.00
	1-900	27.0	119.9	5,023.4	41.4	29.3	26.6	1.06	0.06	0.59

a No sampling was conducted in this area-depth interval.

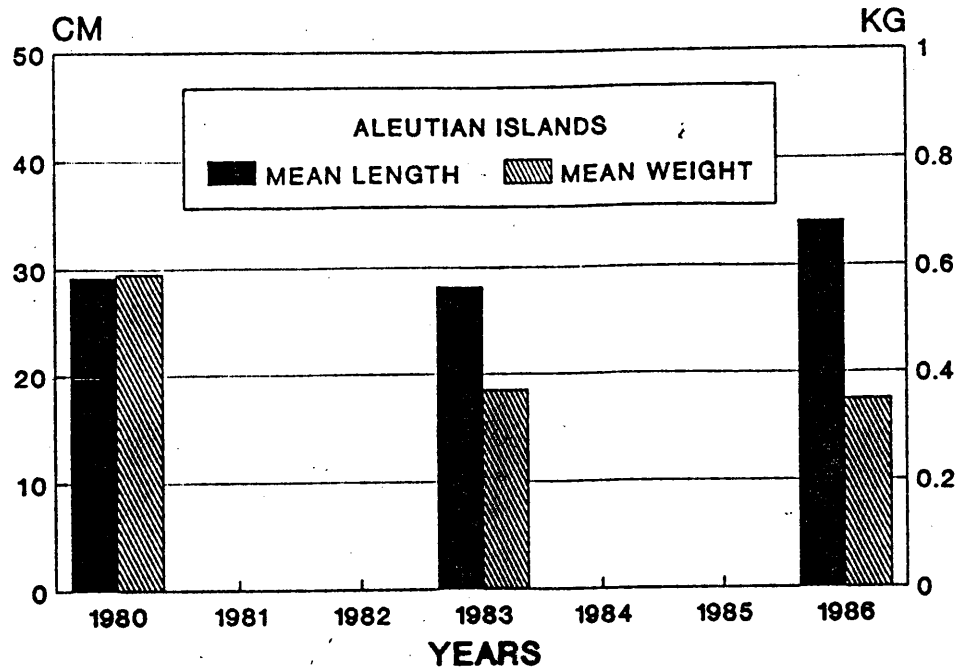

Figure 86. Mean length and weight of northern rockfish in the Aleutian Islands area during the U.S.-Japan 1980, 1983, and 1986 groundfish surveys.

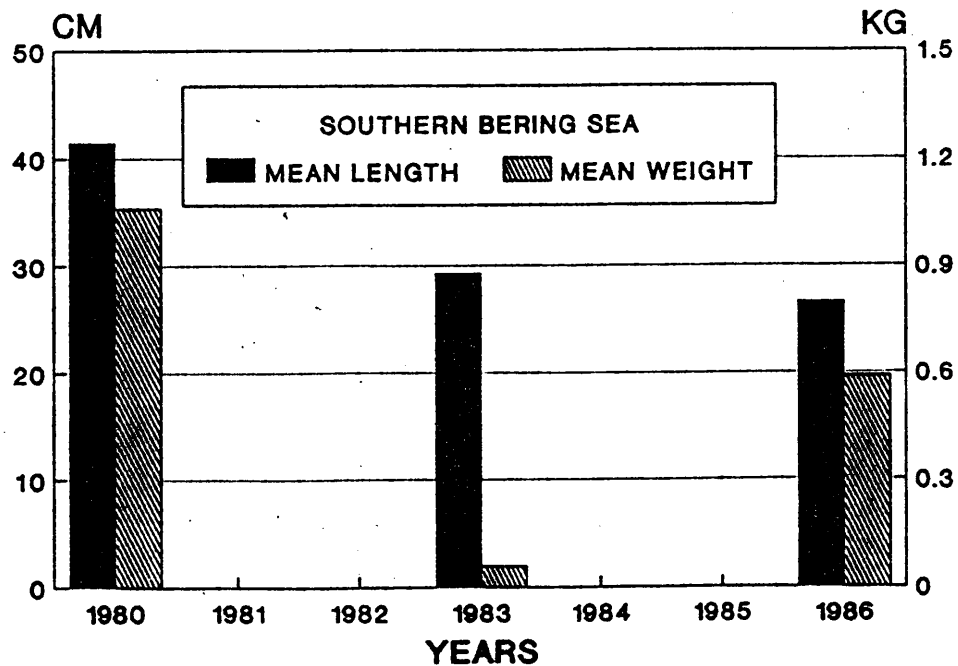

Figure 87. Mean length and weight of northern rockfish in the Southern Bering Sea area during the U.S.-Japan 1980, 1983, and 1986 Aleutian Islands groundfish surveys.

Size Composition

The size composition of northern rockfish in the Aleutian Islands during the 1980 survey was characterized by a nearly equal distribution of size categories from 30 to 39 cm, and a sex ratio slightly favoring the females (Fig. 88). During 1983 the composition was bimodal with the major mode peaking at 28-31 cm, and a smaller mode of incoming fish peaking at 23-24 cm. As in 1980 the sex ratio slightly favored the females which made up a larger percentage of the principle mode over 30 cm. In 1986, there was a strong unimodal curve from 24 to 34 cm, peaking at 29-30 cm. There were about as many males as females with the mode for females approximately 1 cm larger than for males.

Size composition curves for each of the areas are shown in Figs. 89-92. In 1980, adequate size composition data were available only from the Southeast area where northern rockfish ranged from 30 to 41 cm.

In 1983 the size composition curves in the Southwest, Northwest, and Northeast, areas were unimodal peaking at 28-31 cm. In the Southeast area, there was a strong showing of incoming younger fish ranging from 21 to 27 cm, peaking at 24 cm.

Size composition curves were similar in most areas during 1986. The Southwest, Northwest, and Northeast areas had nearly identical curves that were unimodal with the vast majority of the fish in the 25-35 cm size range, peaking at 29-30 cm. The Southeast area had a broad, flat, and weak size composition curve with specimens ranging from 29 to 39 cm and no small fish.

In the Southern Bering Sea area no size composition data were available for northern rockfish for the 1980 survey. During the 1983 survey, specimens ranged from 22 to 38 cm but were primarily in the 25-32 cm size range, and there were more females than males (Fig. 93). In 1986 the size composition curve was bimodal with two strong principle modes. The first mode was at 24-31 cm and probably represented smaller fish not fully available to the trawl. The second mode represented larger, fully recruited fish in the 33-42 cm size range.

Ageing criteria for northern rockfish are presently being developed at the AFSC using the otoliths collected during all three surveys.

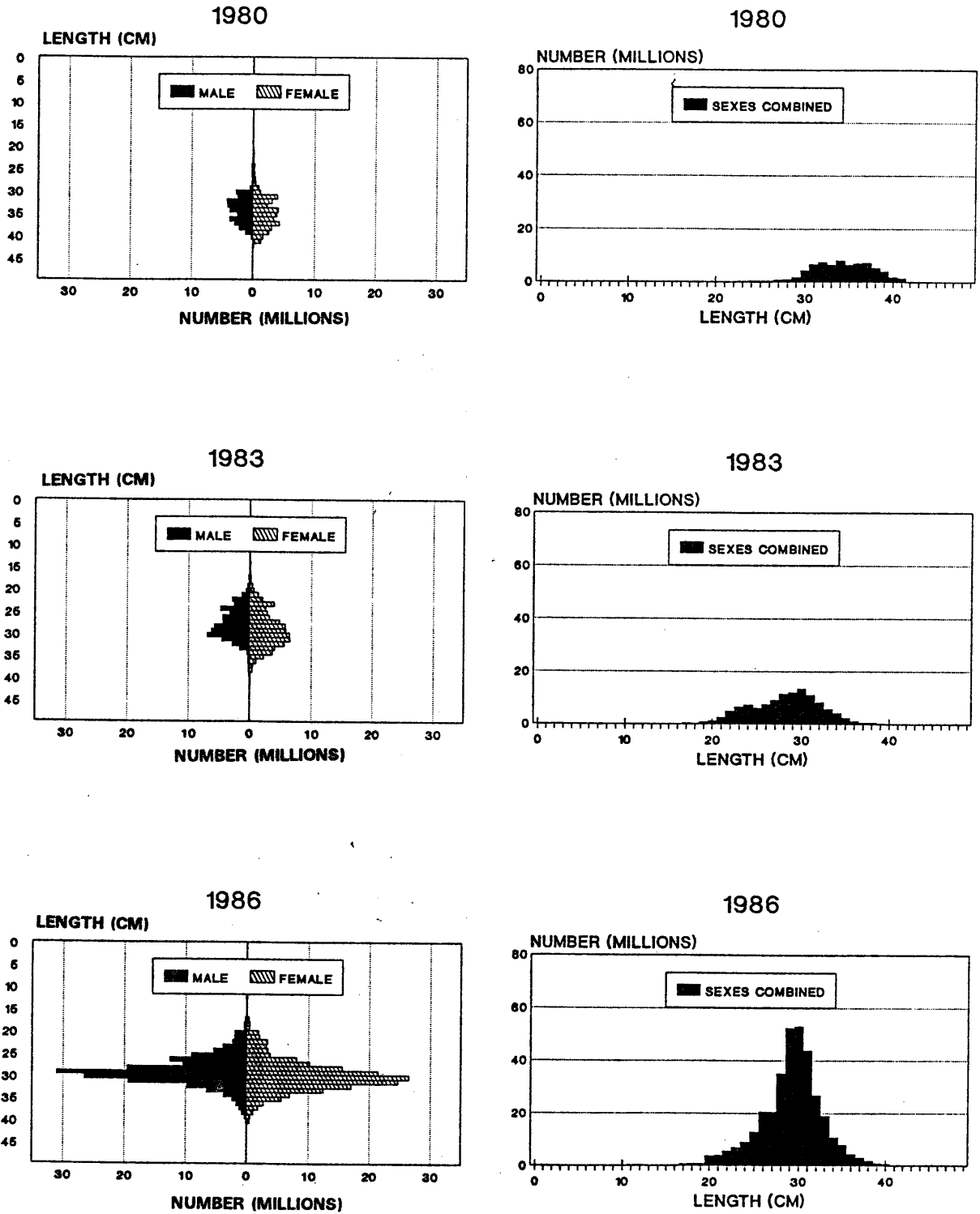

Figure 88. Size composition of northern rockfish in the Aleutian Islands area during the U.S.-Japan 1980, 1983, and 1986 groundfish surveys.

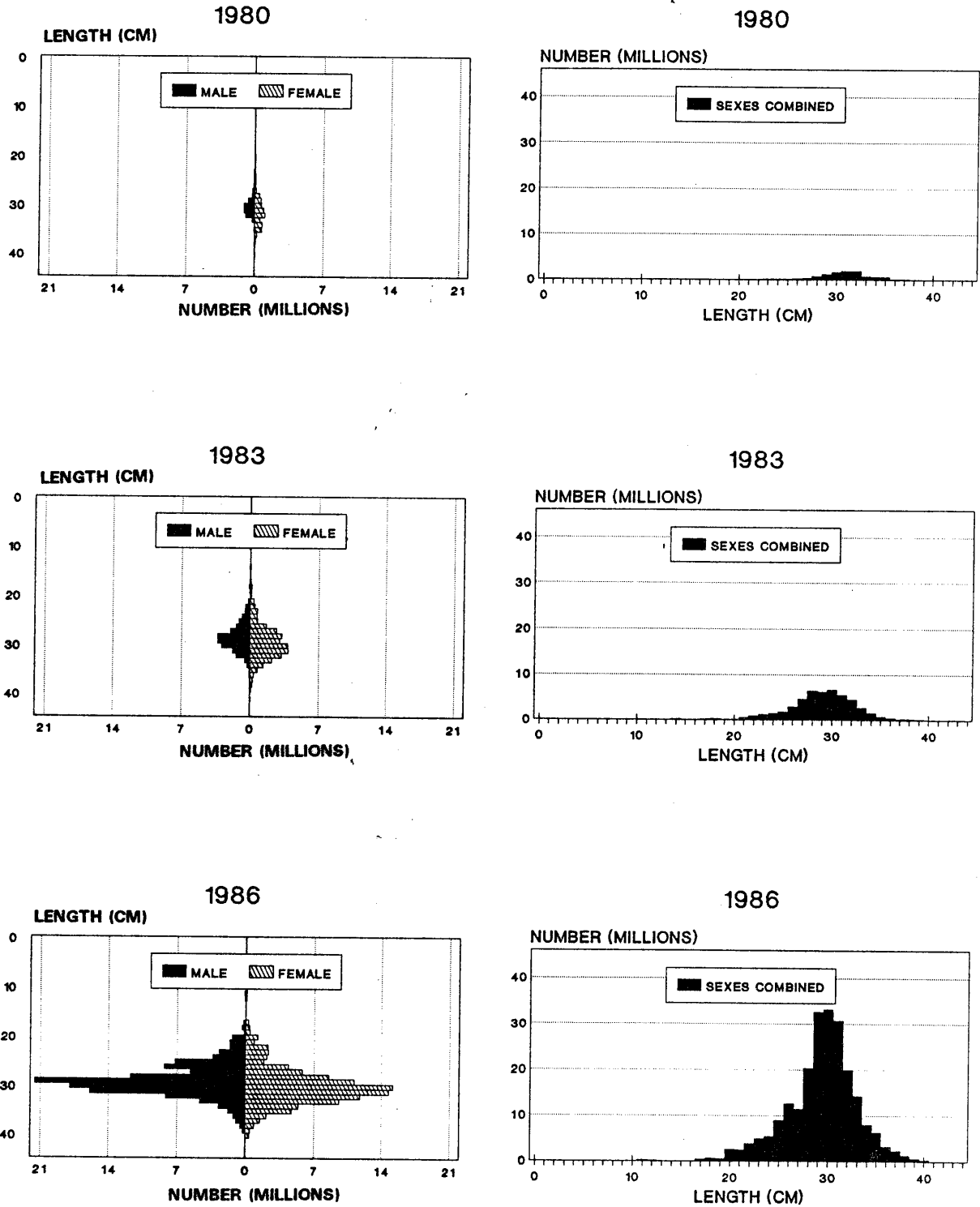

Figure 89. Size composition of northern rockfish in the Southwest area of the Aleutian Islands during the U.S.-Japan 1980, 1983, and 1986 groundfish surveys.

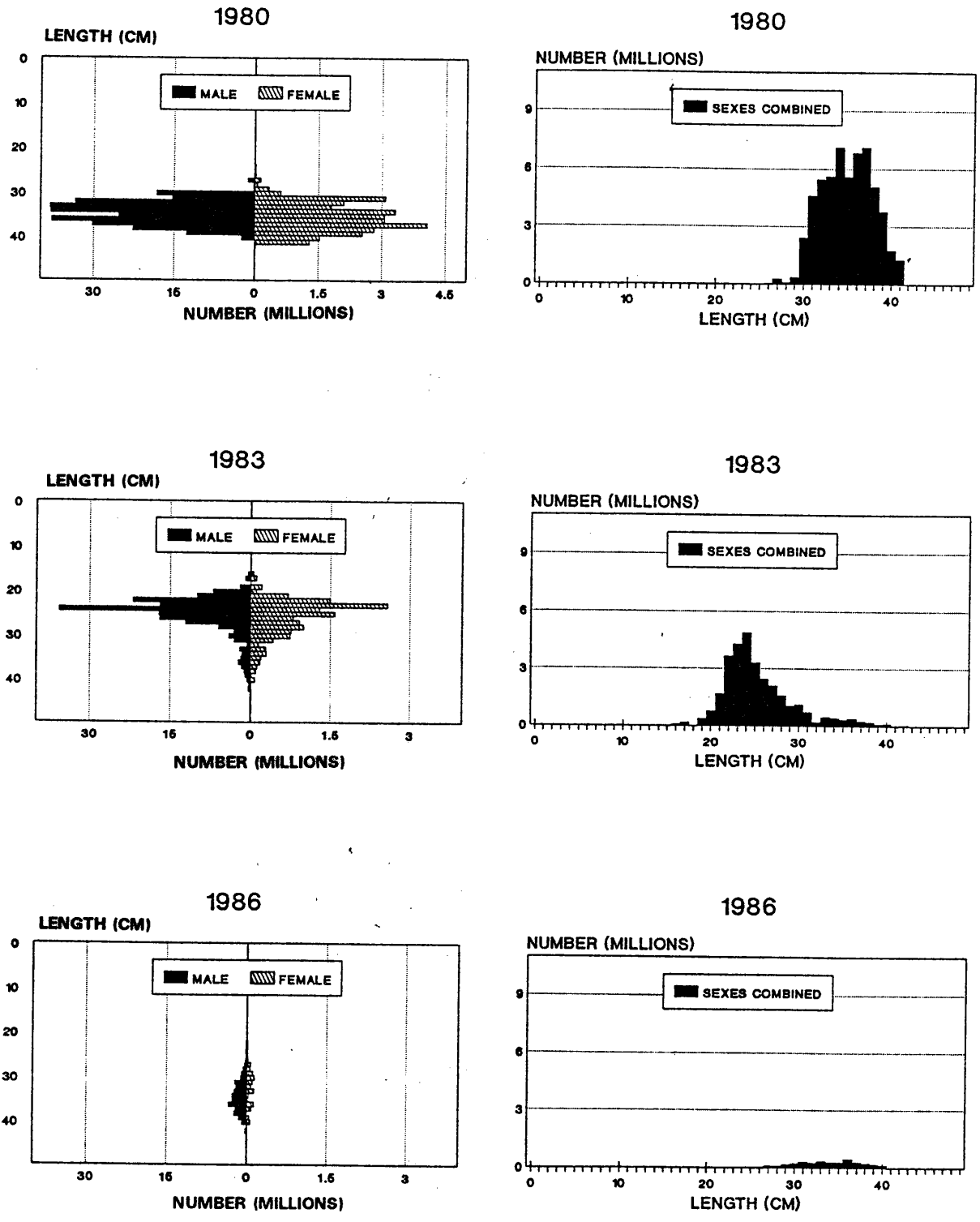

Figure 90. Size composition of northern rockfish in the Southeast area of the Aleutian Islands during the U.S.-Japan 1980, 1983, and 1986 groundfish surveys.

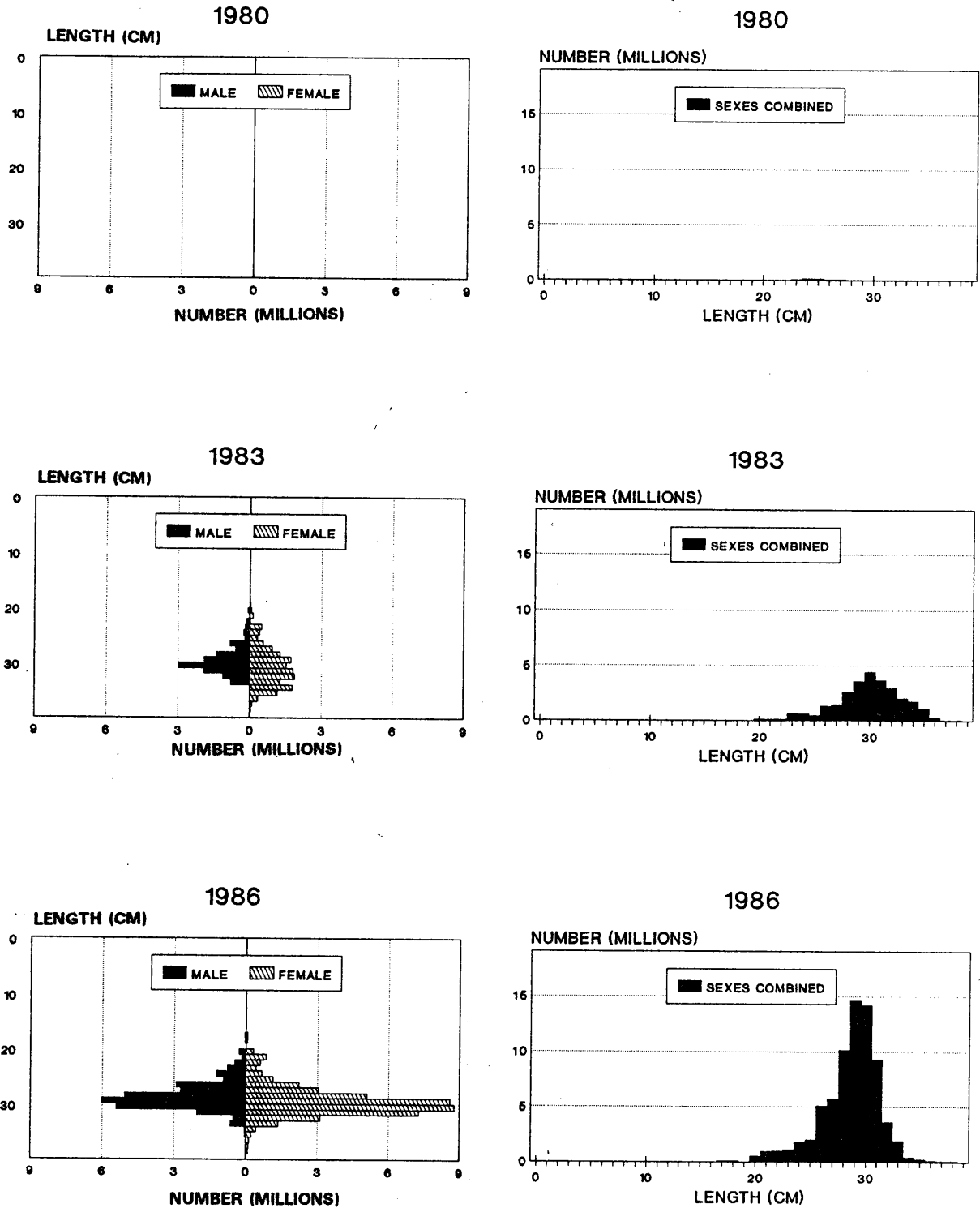

Figure 91. Size composition of northern rockfish in the Northwest area of the Aleutian Islands during the U.S.-Japan 1980, 1983, and 1986 groundfish surveys.

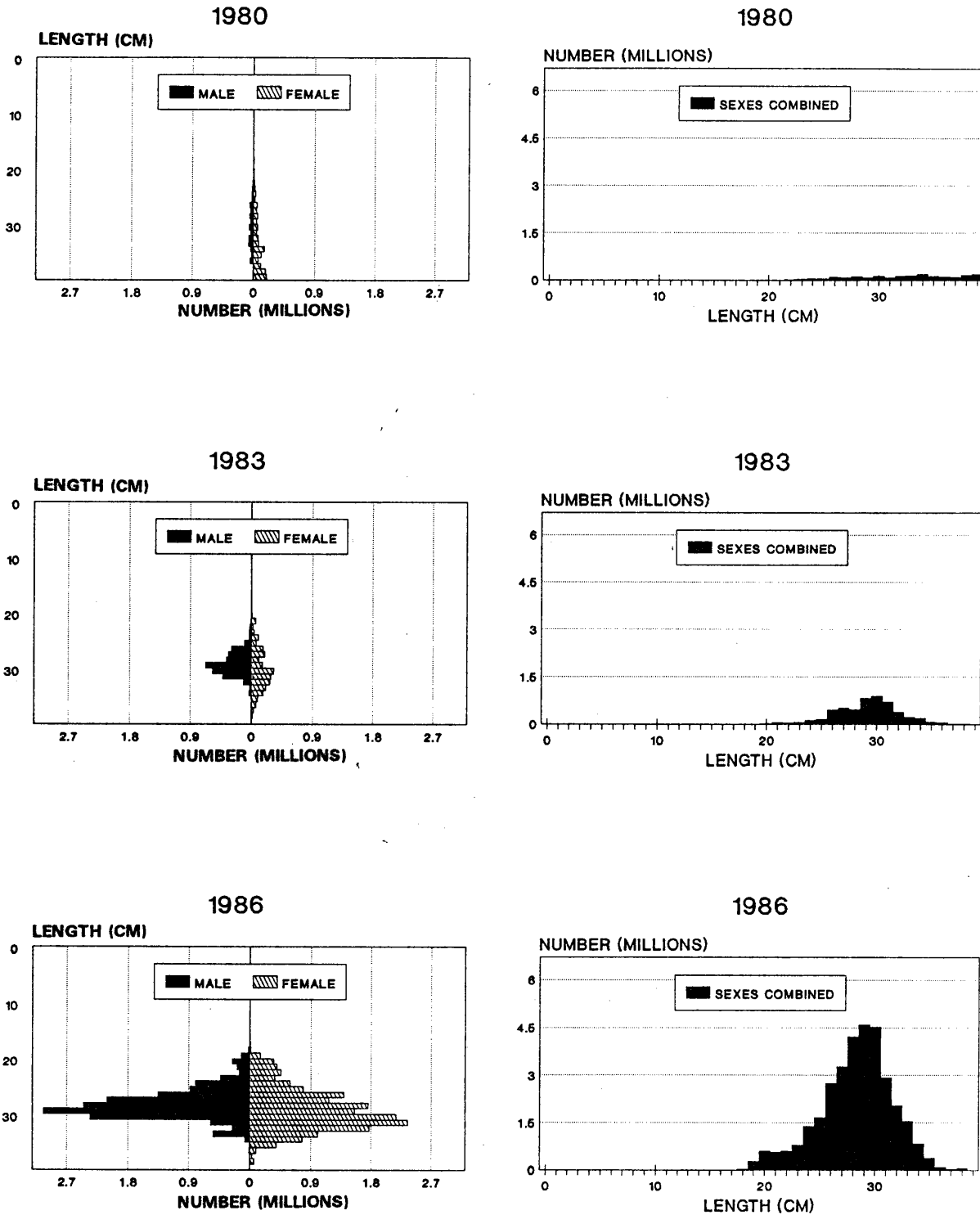

Figure 92. Size composition of northern rockfish in the Northeast area of the Aleutian Islands during the U.S.-Japan 1980, 1983, and 1986 groundfish surveys.

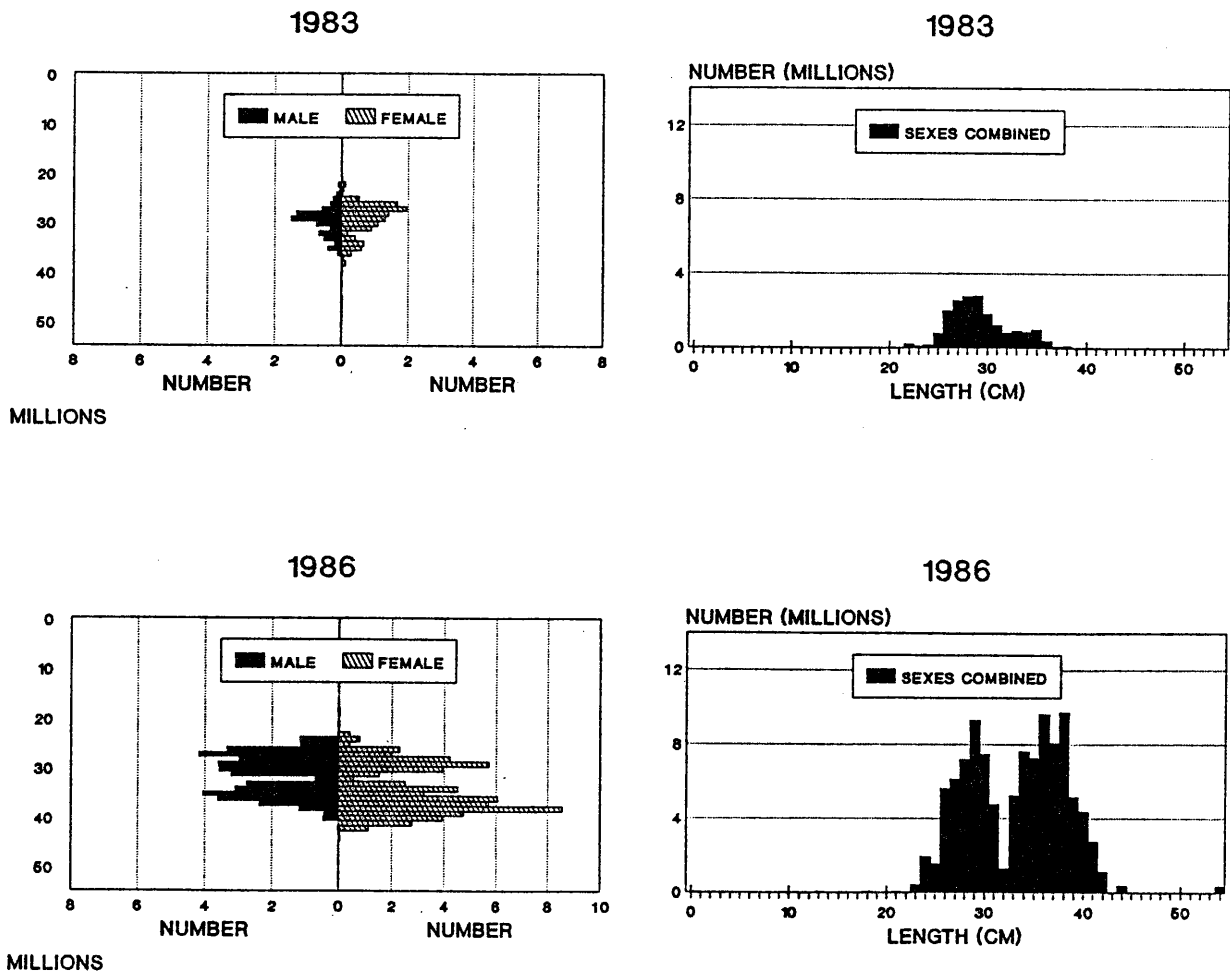

Figure 93. Size composition of northern rockfish in the Southern Bering Sea during the U.S.-Japan 1983, and 1986 Aleutian Islands groundfish surveys.

Length-Weight Relationships

Analysis of the weight at length data for northern rockfish revealed nearly identical curves and provided yearly estimates of the constants a and b (Fig. 94):

$$\begin{aligned} \text{Weight(g)} \text{ (1980)} &= .0151 \times \text{Length(cm)}^{2.996} \\ \text{Weight(g)} \text{ (1983)} &= .0314 \times \text{Length(cm)}^{2.780} \\ \text{Weight(g)} \text{ (1986)} &= .0158 \times \text{Length(cm)}^{2.982} \end{aligned}$$

During 1983, northern rockfish were slightly heavier at smaller sizes (20-26) cm than during 1980 and 1986.

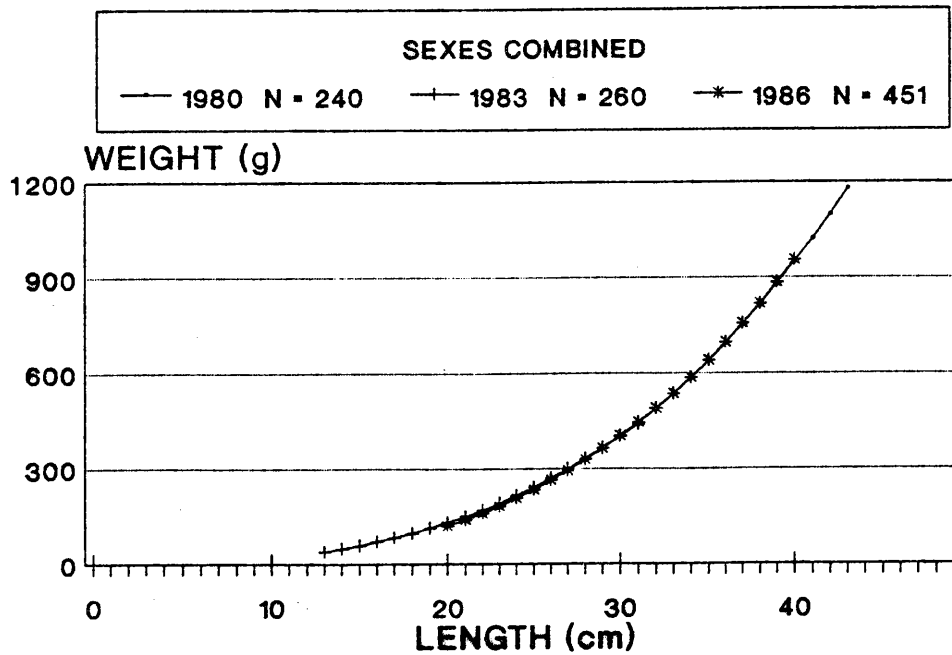

Figure 94. Length-weight relationships for northern rockfish in the Aleutian Islands area during the U.S.-Japan 1980, 1983, and 1986 groundfish surveys.

Arrowtooth Flounder

Distribution and Abundance

During 1980 and 1983, arrowtooth flounder (Atheresthes stomias) were found from low to medium densities throughout most of the Aleutian Islands region and Southern Bering Sea (Figs. 95-96). One concentration of higher density was encountered in the Seguam Pass area in 1980, but none were observed in 1983. In 1986, medium-density concentrations were more numerous throughout the Aleutian Islands area particularly on the north side of the Aleutian chain. High-density concentrations were found north of the Islands of Four Mountains, south of Seguam Island, near the Delarof Islands, on Petrel Bank, north of Amchitka Islands, and northwest of Agattu Island. During all 3 years, arrowtooth flounder were more abundant at depths greater than 300 m.

In 1980 the biomass of arrowtooth flounder was estimated at 27,000 t, and the population at 20.5 million fish. The species was distributed primarily on the north side of the Aleutian Islands chain, 38% in the Northeast, and 29% in the Northwest areas (Table 49, Fig. 97).

In 1983 the biomass estimate increased 42% to 38,000 t, and the population went to 23.0 million fish. The largest increase, over 200%, occurred in the Northeast area and there were minor increases in the Northwest and Southeast areas. Small decreases occurred in the Southwest and Bowers Ridge areas. Approximately 55% of the biomass was located in the 301-500 depth zone. Most of the stock was on the north side of the Aleutian Islands, 54% occurred in the Northeast and 24% in the Northwest areas.

In 1986, total biomass increased 326% to 125,000 t, and population increased to 98.0 million fish. Substantial increases were noted in all depth intervals and all areas of the Aleutian Islands area, with the exception of Bowers Ridge. The Northeast area contained 67% of the total biomass with the remainder being more equally divided between the other areas. The biomass estimate in the 301-500 m depth interval of the Northeast area increased over 500% to 65,824 t.

A similar situation occurred in the Southern Bering Sea area, although the increase was not quite so dramatic. From 1980 to 1983 the biomass estimate remained unchanged at 10,000 t while the population estimate declined from 14.4 to 10.6 million fish (Fig. 98). In 1986 the biomass estimate increased over 200% to 20,000 t and the population increased to 24.2 million fish.

For both the Aleutian Islands area and the Bering Sea area the maximum lengths and weights occurred during the 1983 survey (Table 50, Figs. 99 and 100). In the Aleutian Islands area the maximum length was 52.1 cm and the maximum weight was 1.68 kg. In the Southern Bering Sea the maximum length was 40.0 cm and the maximum weight 0.98 kg.

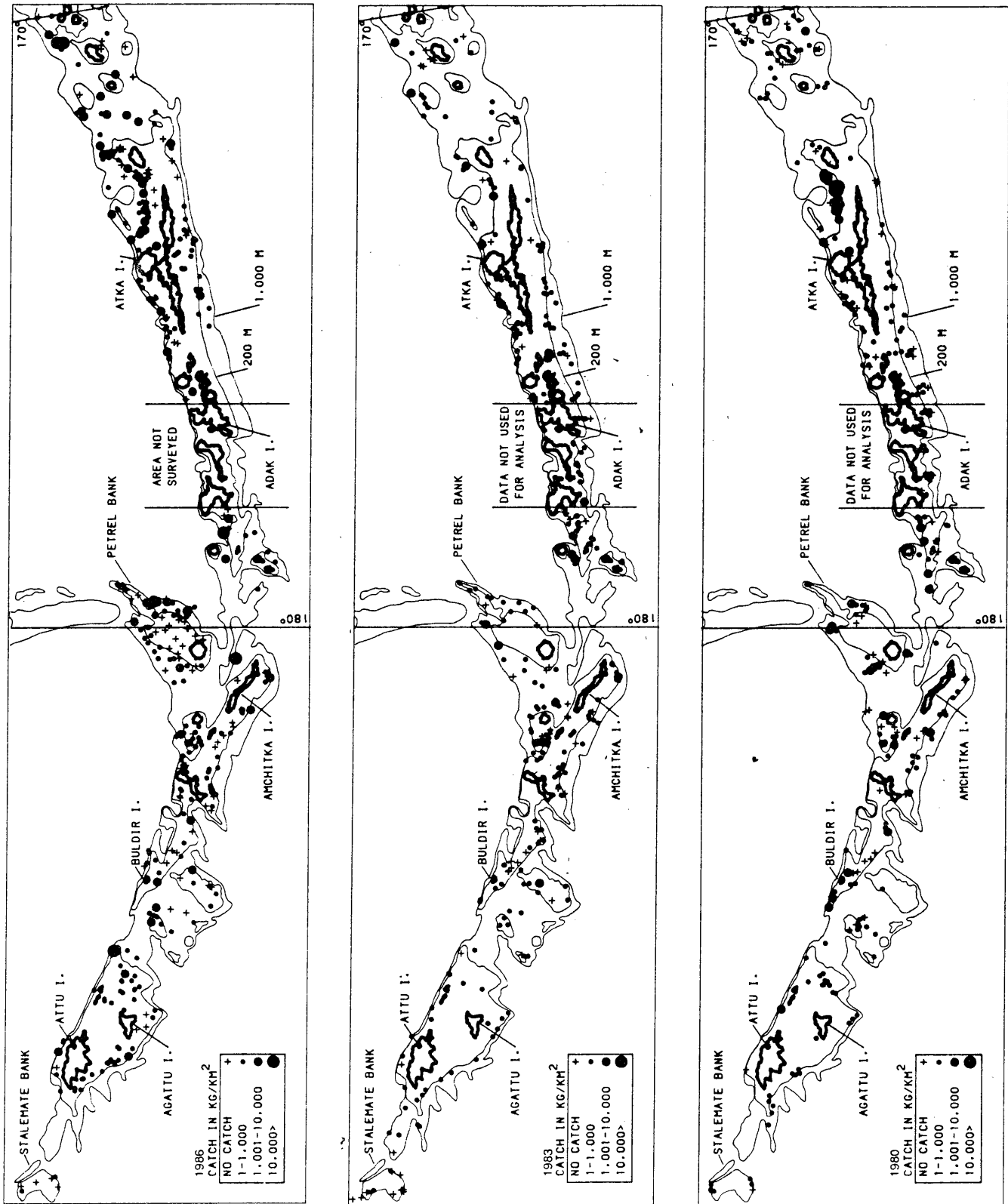

Figure 95. Distribution and relative abundance of arrowtooth flounder in the Aleutian Islands area during the U.S.-Japan 1980, 1983, and 1986 groundfish surveys.

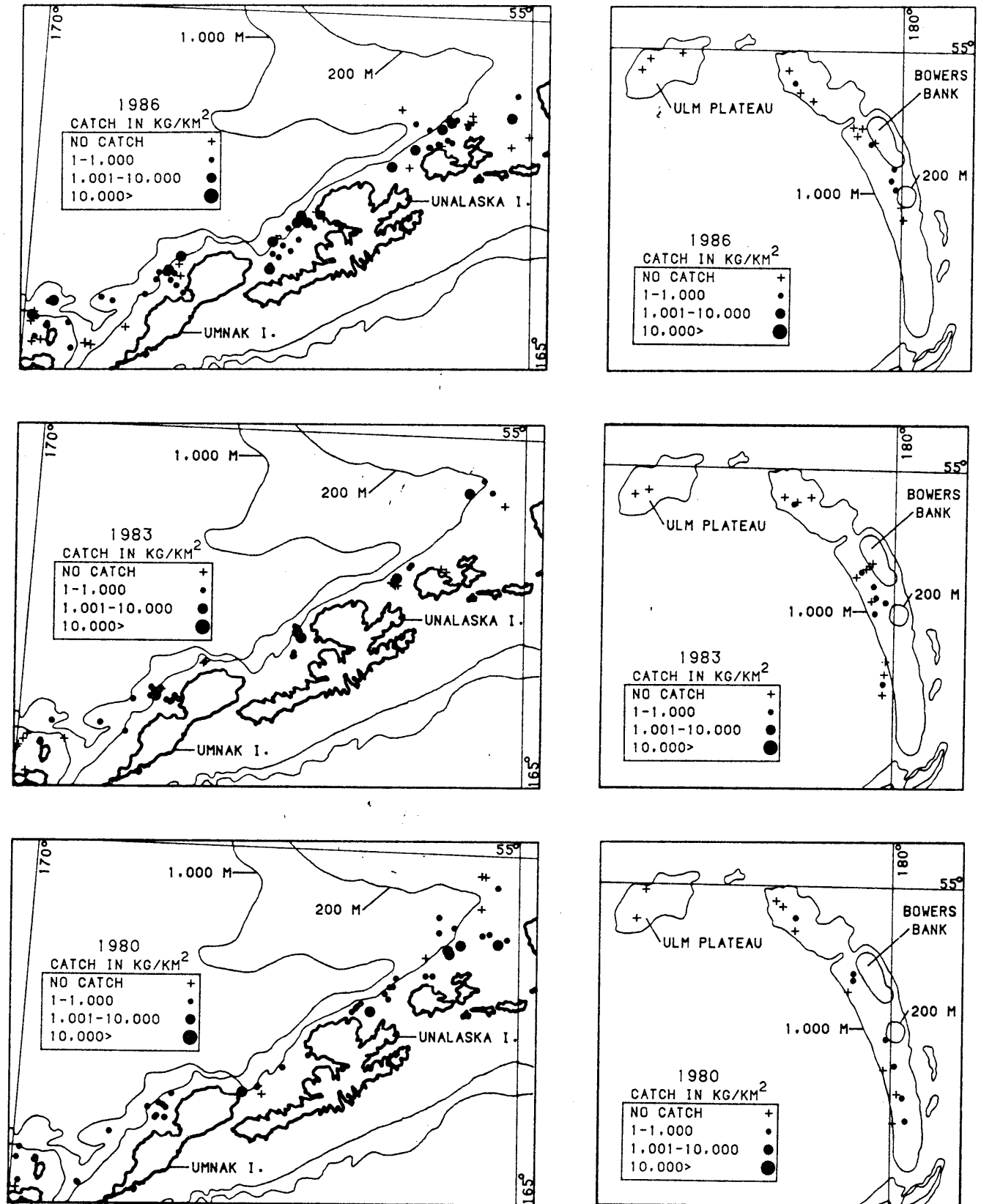

Figure 96. Distribution and relative abundance of arrowtooth flounder in the Southern Bering Sea and Bowers Ridge areas during the U.S.-Japan 1980, 1983, and 1986 Aleutian Islands groundfish surveys.

Table 49. Estimates of biomass, biomass sampling error, and population for arrowtooth flounder, based on the U.S.-Japan 1980, 1983, and 1986 Aleutian Islands groundfish surveys.

Area	Depth (m)	Biomass (t)			Sampling Error (%)			Population (1,000s)		
		1980	1983	1986	1980	1983	1986	1980	1983	1986
Southwest	1-100	56	333	132				105.4	678.6	698.5
	101-200	977	1,176	1,872				1,187.4	1,686.1	2,514.1
	201-300	730	356	2,271				674.4	265.0	2,103.1
	301-500	2,143	1,209	6,736				849.8	439.4	2,899.5
	501-900	1,711	1,107	4,602				759.3	250.9	1,273.8
	1-900	5,617	4,181	15,613	31.5	33.8	277.9	3,576.3	3,320.0	9,489.0
Southeast	1-100	a	0	92				a	0.0	470.1
	101-200	1,079	1,154	1,084				1,354.9	1,433.0	1,590.0
	201-300	884	1,442	4,351				1,023.4	1,040.9	5,067.2
	301-500	578	961	5,179				393.0	455.6	2,418.2
	501-900	170	246	653				82.1	97.8	239.2
	1-900	2,711	3,803	11,359	44.5	33.7	70.3	2,853.4	3,027.3	9,784.7
Northwest	1-100	0	1	75				0.0	4.1	166.7
	101-200	0	272	583				0.0	273.8	698.9
	201-300	441	751	1,650				304.7	480.6	1,212.1
	301-500	3,646	5,947	2,170				1,599.7	3,768.2	1,068.3
	501-900	3,645	2,278	8,703				1,389.3	820.8	2,958.5
	1-900	7,732	9,249	13,181	46.4	105.1	112.5	3,293.7	5,347.5	6,104.5
Northeast	1-100	10	133	1,710				51.2	1,171.7	8,083.2
	101-200	3,093	1,382	2,961				4,318.2	2,834.6	9,805.2
	201-300	2,430	625	2,210				3,073.6	721.1	3,171.6
	301-500	2,068	12,953	65,824				1,234.2	4,311.2	46,766.3
	501-900	2,641	5,594	11,675				1,890.3	2,241.6	4,613.4
	1-900	10,242	20,687	84,380	69.4	64.0	111.1	10,567.5	11,280.2	72,439.7
Bowers Ridge	101-200	a	0	0				a	0.0	0.0
	201-300	60	193	164				10.8	36.8	110.9
	301-500	363	85	121				83.0	17.9	66.2
	510-900	203	74	37				73.4	18.6	10.0
	101-900	626	352	322	469.6	727.4	111.6	167.2	73.3	187.1
Aleutian Islands	1-100	66	467	2,009	0.0	628.0	89.8	156.6	1,854.4	9,418.5
	101-200	5,149	3,984	6,500	93.9	29.7	28.6	6,860.5	6,227.5	14,608.2
	201-300	4,545	3,367	10,646	45.4	42.3	60.7	5,086.9	2,544.4	11,664.9
	301-500	8,798	21,155	80,030	37.1	50.5	116.5	4,159.7	8,992.3	53,218.5
	501-900	8,370	9,299	25,670	260.2	47.1	77.8	4,194.4	3,429.7	9,094.9
Total	1-900	26,928	38,272	124,855	28.3	28.2	75.0	20,458.1	23,048.3	98,005.0
Southern Bering Sea	1-100	1,439	552	904				5,032.6	2,363.5	5,688.7
	101-200	3,933	4,527	5,094				6,424.4	5,984.2	10,474.4
	201-300	1,910	540	2,489				1,449.4	452.1	2,604.5
	301-500	1,317	1,278	3,263				720.7	664.0	1,238.6
	501-900	1,333	2,626	8,341				782.8	1,188.7	4,237.6
Total	1-900	9,932	9,523	20,091	214.4	34.4	169.3	14,410.4	10,652.5	24,243.8

a No sampling was conducted in this area-depth interval.

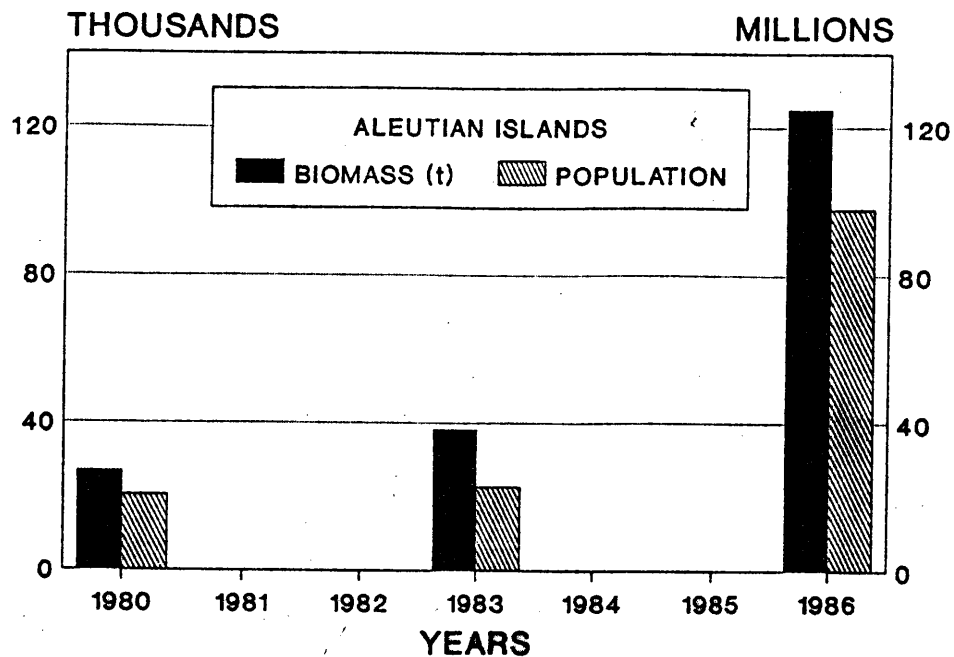

Figure 97. Estimated biomass and population of arrowtooth flounder in the Aleutian Islands area during the U.S.-Japan 1980, 1983, and 1986 groundfish surveys.

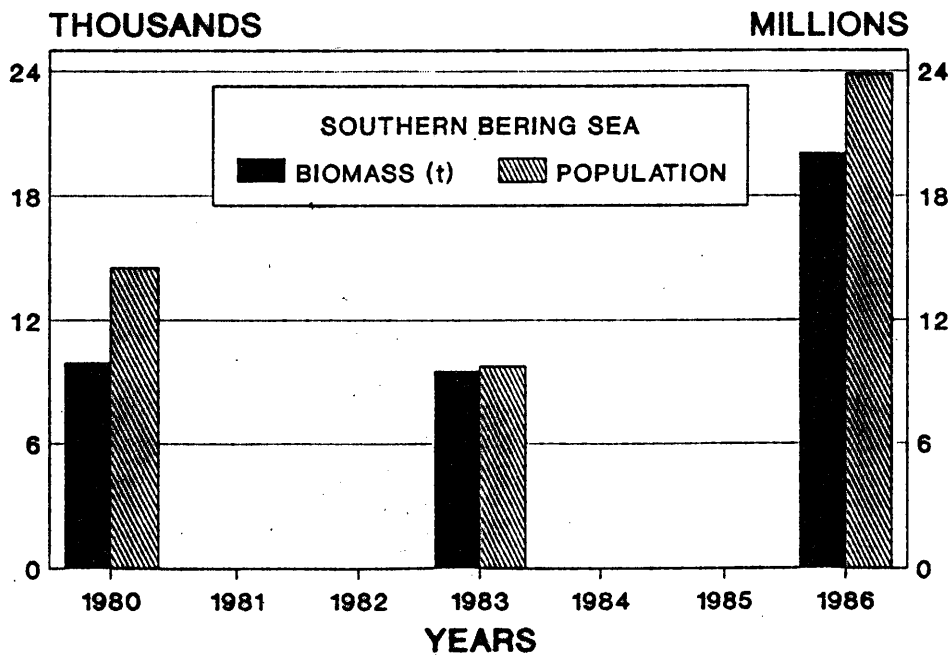

Figure 98. Estimated biomass and population of arrowtooth flounder in the Southern Bering Sea area during the U.S.-Japan 1980, 1983, and 1986 Aleutian Islands groundfish surveys.

Table 50. Estimates of mean catch per unit effort, length, and weight for arrowtooth flounder based on the U.S.-Japan 1980, 1983, and 1986 Aleutian Islands groundfish surveys.

Area	Depth (m)	Mean CPUE (kg/km ²)			Mean Length (cm)			Mean Weight (kg)		
		1980	1983	1986	1980	1983	1986	1980	1983	1986
Southwest	1-100	24.5	113.2	35.1	0.0	37.2	0.0	0.53	0.48	0.22
	101-200	149.5	180.0	286.7	38.0	40.8	39.0	0.81	0.70	0.68
	201-300	318.3	155.4	989.7	46.5	45.3	53.9	0.98	1.28	1.03
	301-500	628.5	354.5	1,975.9	56.5	60.5	57.2	2.50	2.70	2.40
	501-900	243.2	157.4	654.3	60.5	65.8	57.4	2.25	4.34	3.61
	1-900	260.5	188.3	677.9	49.1	45.0	50.4	1.53	1.24	1.62
Southeast	1-100	a	0.0	34.9	a	0.0	0.0	a	0.00	0.20
	101-200	329.7	352.8	331.4	41.7	46.9	43.7	0.80	0.80	0.68
	201-300	279.7	456.5	1,377.3	43.9	50.8	43.9	0.86	1.38	0.86
	301-500	212.3	306.1	1,650.3	57.5	55.2	47.4	1.47	2.09	2.12
	501-900	83.5	87.1	230.9	58.9	56.2	55.3	2.07	2.50	2.73
	1-900	242.2	272.1	755.1	47.4	49.9	44.6	0.95	1.25	1.16
Northwest	1-100	0.0	0.6	31.9	0.0	0.0	0.0	0.00	0.34	0.45
	101-200	0.0	103.6	221.7	45.5	42.7	0.0	0.00	0.94	0.85
	201-300	412.4	701.7	1,542.0	48.4	54.0	46.8	1.47	1.77	1.40
	301-500	1,645.3	2,684.0	979.4	54.7	51.5	56.7	2.28	1.71	1.97
	501-900	811.8	507.3	1,938.5	63.3	61.1	59.9	2.62	2.80	2.81
	1-900	696.0	724.7	1,032.8	56.8	52.8	57.2	2.35	1.85	2.11
Northeast	1-100	4.4	113.9	891.9	27.4	0.0	0.0	0.19	0.11	0.21
	101-200	791.7	353.7	757.9	31.4	41.0	43.1	0.71	0.50	0.31
	201-300	995.2	255.8	905.1	40.7	47.5	41.7	0.81	1.01	0.71
	301-500	602.2	3,772.6	20,053.5	50.1	61.7	51.4	1.68	2.91	1.41
	501-900	446.1	905.1	1,888.9	60.0	59.1	60.2	1.40	2.46	2.51
	1-900	571.6	1,207.7	4,759.4	45.5	54.6	46.8	0.97	1.83	1.17
Bowers Ridge	101-200	a	0.0	0.0	a	0.0	0.0	a	0.00	0.00
	201-300	49.3	158.0	134.3	46.2	74.0	68.5	5.59	5.24	1.44
	301-500	226.6	53.2	75.4	86.9	67.7	67.7	4.44	4.85	1.83
	501-900	28.4	10.5	5.2	0.0	69.0	60.4	2.76	4.03	3.68
	101-900	62.9	34.4	31.4	61.2	71.2	64.5	3.77	4.84	1.70
Aleutian Islands	1-100	11.0	58.1	188.1	27.4	37.2	0.0	0.42	0.25	0.21
	101-200	331.1	239.3	390.4	34.4	42.3	42.5	0.75	0.64	0.44
Total	201-300	446.3	330.5	1,045.1	44.0	50.3	44.3	0.90	1.40	0.91
	301-500	657.3	1,533.1	5,864.1	50.9	57.3	54.7	2.11	2.39	1.51
	501-900	314.6	336.3	928.2	61.2	60.0	59.5	1.99	2.69	2.77
	1-900	375.4	501.4	1,584.0	46.8	52.1	49.0	1.31	1.68	1.27
Southern Bering Sea	1-100	298.5	114.5	187.5	24.4	28.2	32.4	0.29	0.24	0.17
	101-200	1,202.1	1,383.4	1,556.7	35.8	38.4	41.1	0.61	0.88	0.49
	201-300	1,906.8	539.4	2,485.7	45.2	46.7	42.7	1.21	1.30	0.95
	301-500	1,035.3	1,004.7	2,564.0	61.0	51.9	52.8	1.83	1.96	2.69
	501-900	586.3	1,154.9	3,667.8	56.7	54.0	54.5	1.70	2.20	1.96
Total	1-900	785.8	753.5	1,589.5	39.1	40.0	39.6	0.68	0.98	0.84

a No sampling was conducted in this area-depth interval surveys.

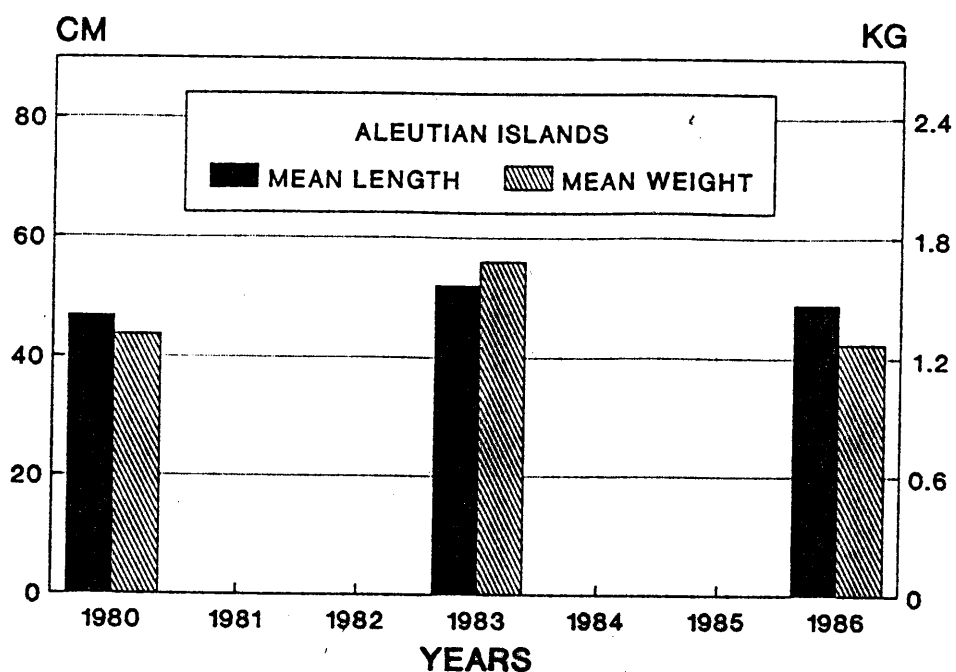

Figure 99. Mean length and weight of arrowtooth flounder in the Aleutian Islands area during the U.S.-Japan 1980, 1983, and 1986 groundfish surveys.

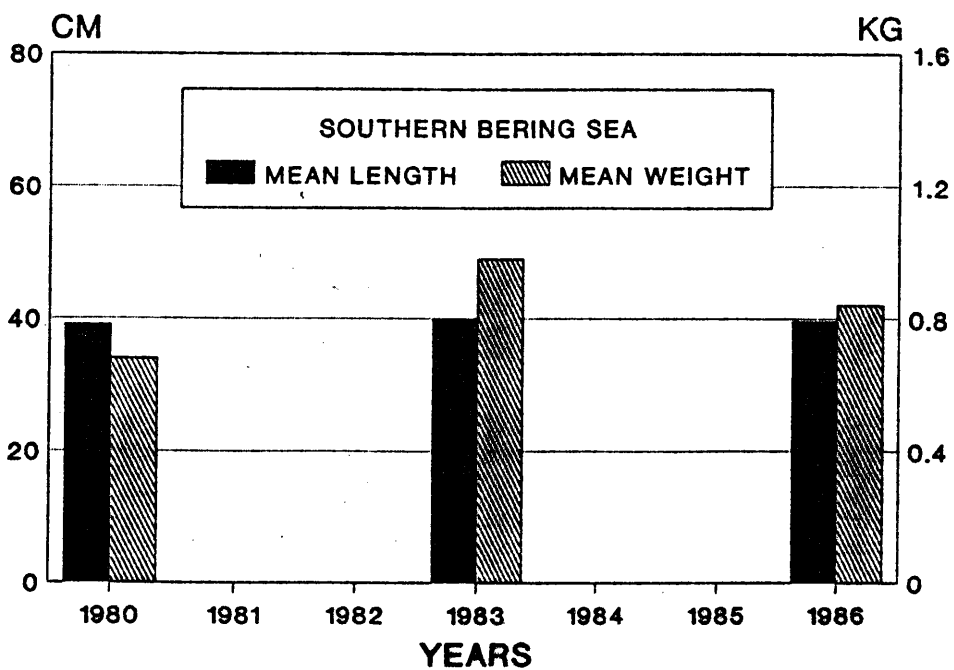

Figure 100. Mean length and weight of arrowtooth flounder in the Southern Bering Sea area during the U.S.-Japan 1980, 1983, and 1986 Aleutian Islands groundfish surveys.

Size and Age Composition

Size composition curves must be interpreted with caution because of the strong sexual dimorphism of arrowtooth flounder which starts at a young age. This sexual dimorphism may cause a strong year class to appear as two separate modes when the sexes are plotted together. Also, some size composition curve modes may consist of several year classes (see "Mean Length-at-Age and growth" sections for details).

Arrowtooth flounder in the Aleutian Islands area ranged from 15 to 90 cm with both smaller and larger fish being encountered in the 1986 survey. Nearly all fish over 65 cm were females. During 1980 and 1983 the Aleutian Islands area size composition curves were broad and flat with small modes (Fig. 101). All size categories contained less than 1 million fish, and there were more females than males. In 1980 the size modes peaked at 38, 44, and 55 cm. Most of these were 5- to 8-year-old fish, but there was a small showing of 14- to 15-year-olds from the 1966-1965 year classes (Fig. 102). Large fish older than 16 years were measured but not found in the randomly collected age samples. These older fish that were not aged represent about 18% of the stock.

In 1983 the size composition curve was again broad and flat with small modes peaking at 40, 46, 52, and 57 cm. These were primarily 5- to 8-year-old fish, but there was also a strong showing of 15-year-old fish that made up 8% of the stock. Fish older than 16 years that were measured but not aged represented about 35% of the stock in 1983.

In 1986 the size categories ranged upward to 4.5 million fish and the composition curve was at least trimodal. The stock was dominated by fish in the 40-62 cm size range, which contained at least two modes peaking at 47 cm and 54 cm. There was also a relatively strong showing of incoming fish ranging from 24 to 35 cm. Age data were not available for the 1986 survey.

Size compositions of arrowtooth flounder throughout the Aleutian Islands area varied considerably by area within survey years. In 1980 in the Southwest area, arrowtooth flounder ranged from 20 to 80 cm and the size composition contained numerous peaks of relatively the same magnitude (Fig. 103). In the Southeast, area most of the fish were in the 30-50 cm size range, and there were smaller numbers of fish over 50 cm (Fig. 104). Arrowtooth flounder in the Northwest area ranged from 30 to 76 cm and there were more large fish over 51 cm and fewer smaller fish (Fig. 105). The size composition curve in the Northeast area was similar to the Southeast area with most fish 30-50 cm in length and less fish larger than 50 cm (Fig. 106).

In 1983, in the Southwest area the size composition curve had a primary mode of smaller fish in the 30-45 cm size range. In the Southeast area the size composition curve modes were less prominent without the strong showing of smaller fish. The

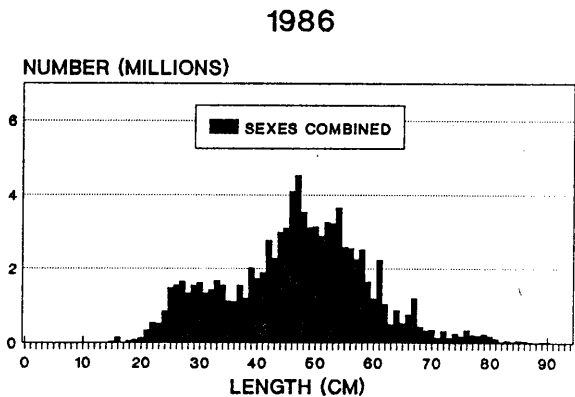
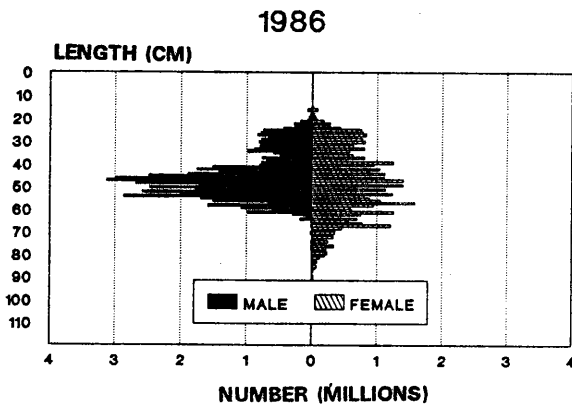
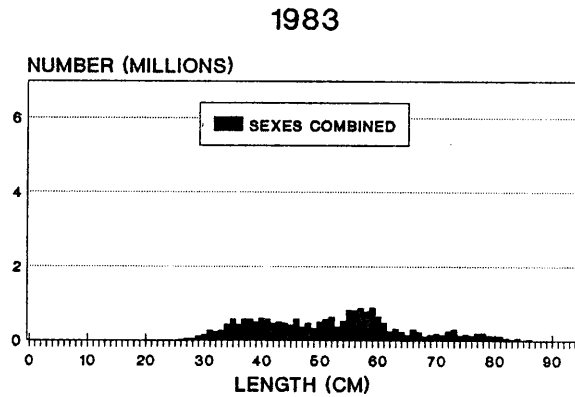
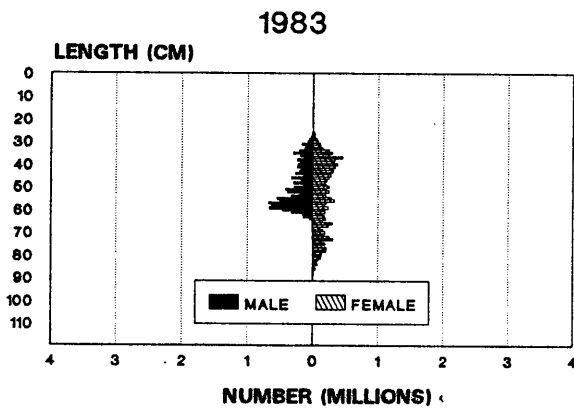
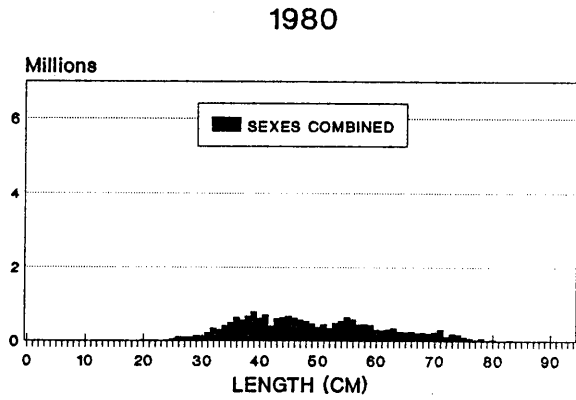
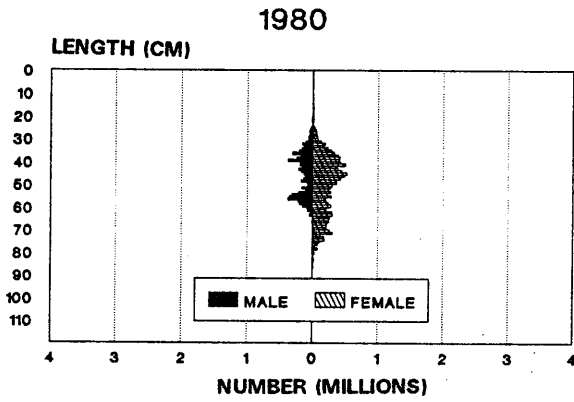
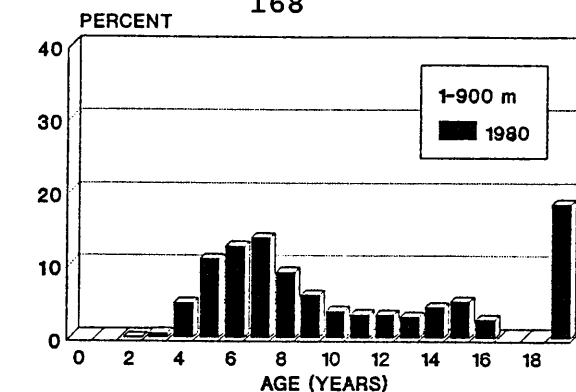
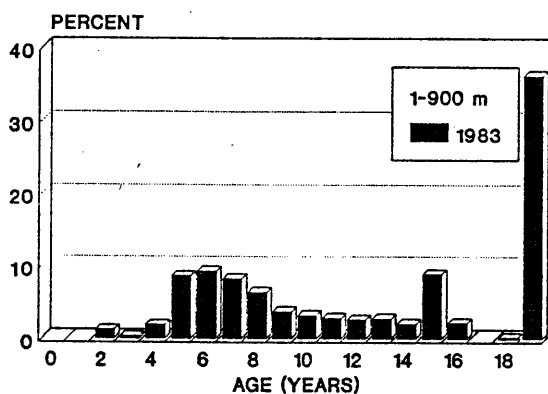

Figure 101. Size composition of arrowtooth flounder in the Aleutian Islands area during the U.S.-Japan 1980, 1983, and 1986 groundfish surveys.



ALEUTIAN ISLANDS



ALEUTIAN ISLANDS

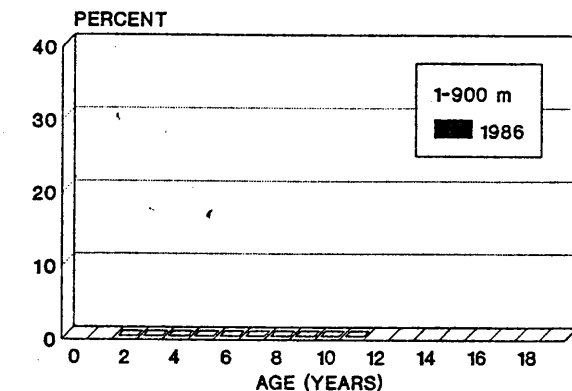

ALEUTIAN ISLANDS

Figure 102. Age composition of arrowtooth flounder in the Aleutian Islands area during the U.S.-Japan 1980, 1983, and 1986 groundfish surveys. During the U.S.-Japan 1980 and 1983 surveys many older, larger individuals occurred in the length frequency samples but were not included in the age samples. In the age composition figures, these specimens have been grouped together as 19-year-olds.

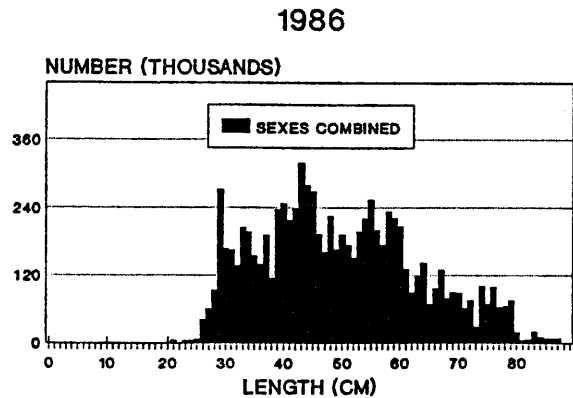
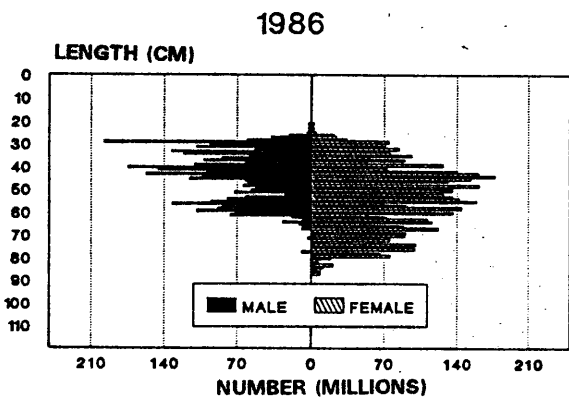
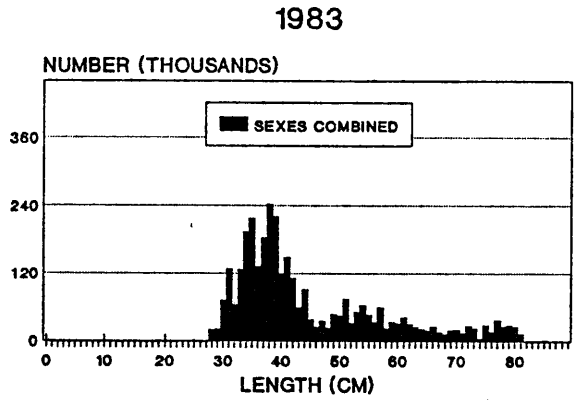
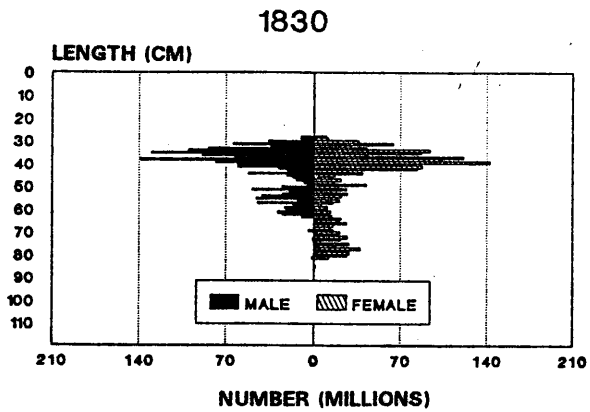
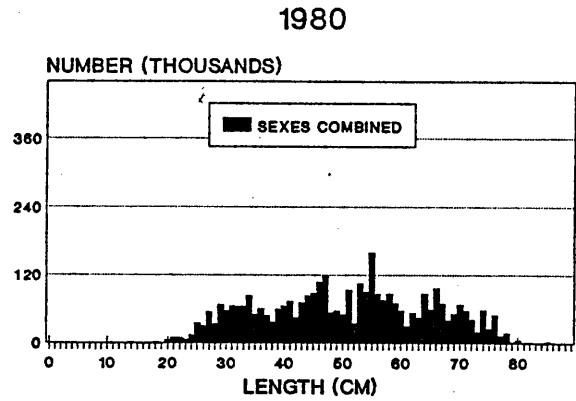
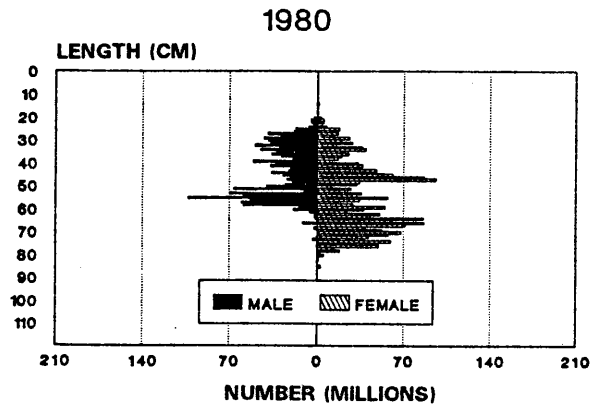

Figure 103. Size composition of arrowtooth flounder in the Southwest area of the Aleutian Islands during the U.S.-Japan 1980, 1983, and 1986 groundfish surveys.

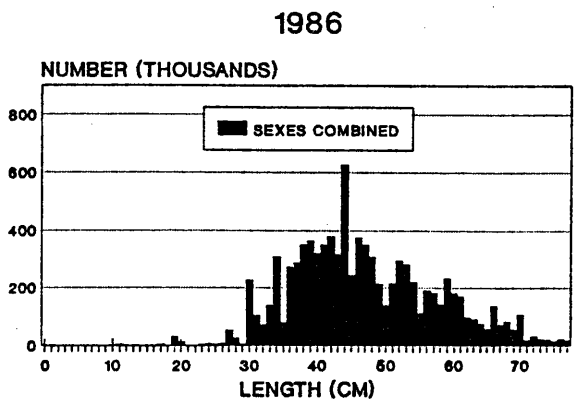
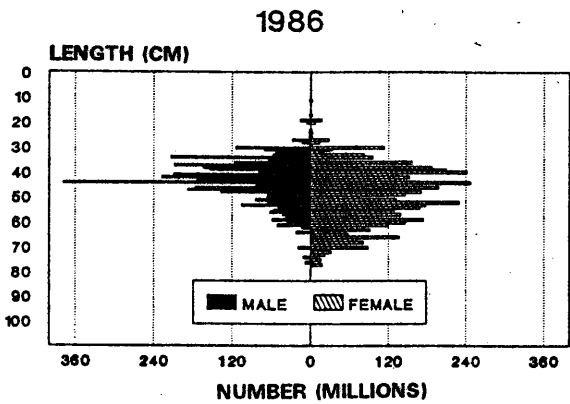
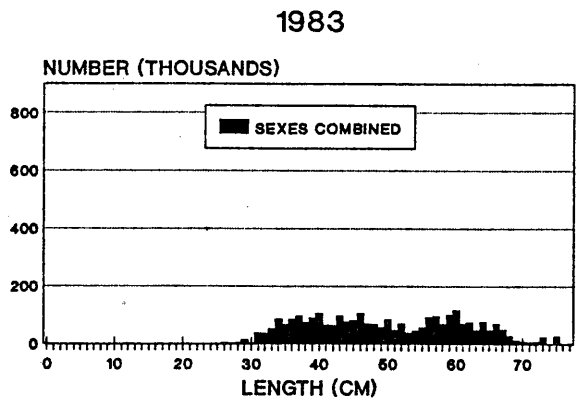
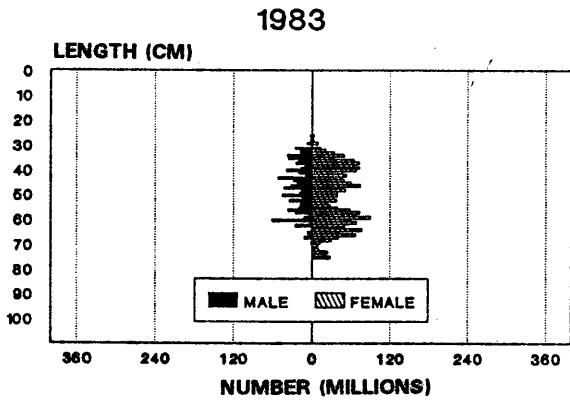
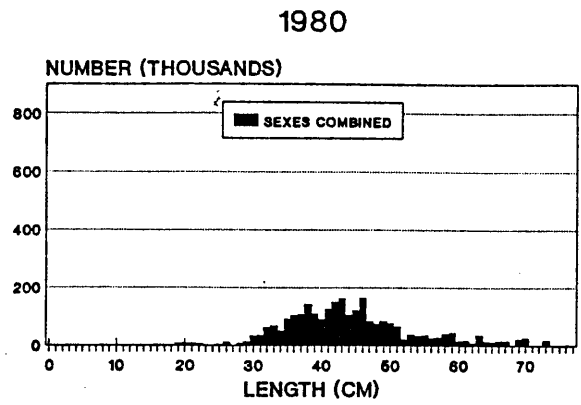
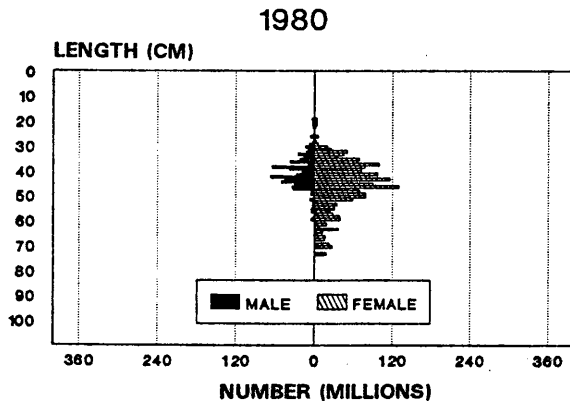

Figure 104. Size composition of arrowtooth flounder in the Southeast area of the Aleutian Islands during the U.S.-Japan 1980, 1983, and 1986 groundfish surveys.

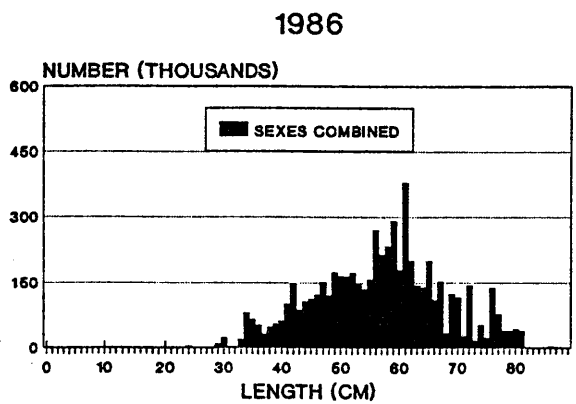
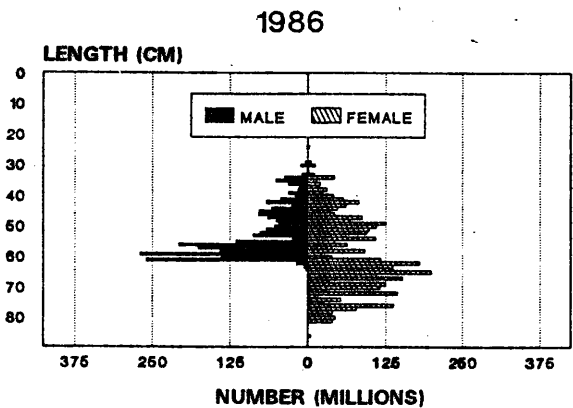
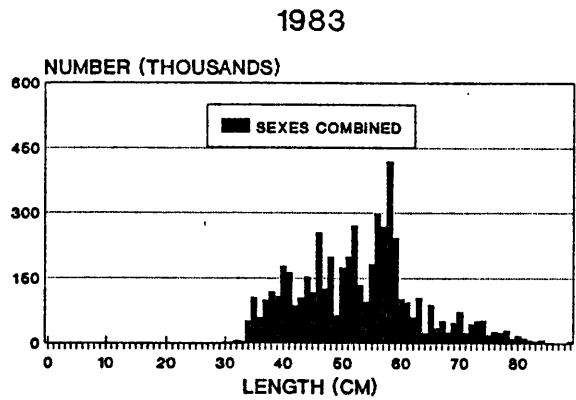
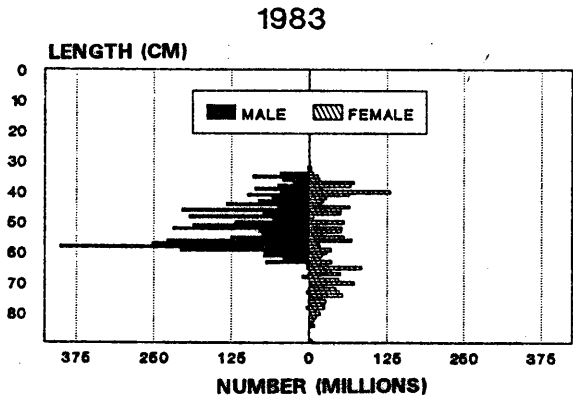
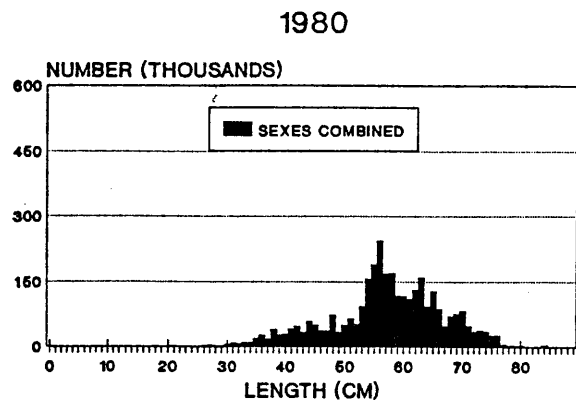
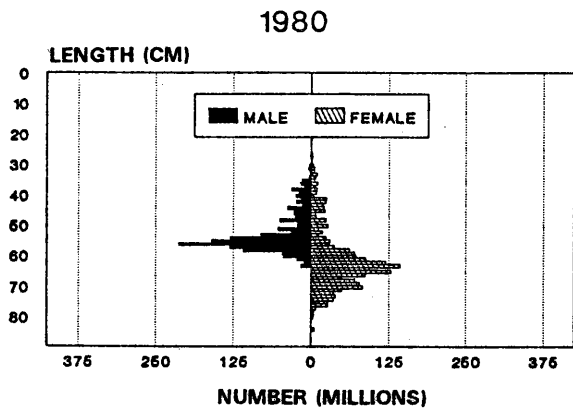

Figure 105. Size composition of arrowtooth flounder in the Northwest area of the Aleutian Islands during the U.S.-Japan 1980, 1983, and 1986 groundfish surveys.

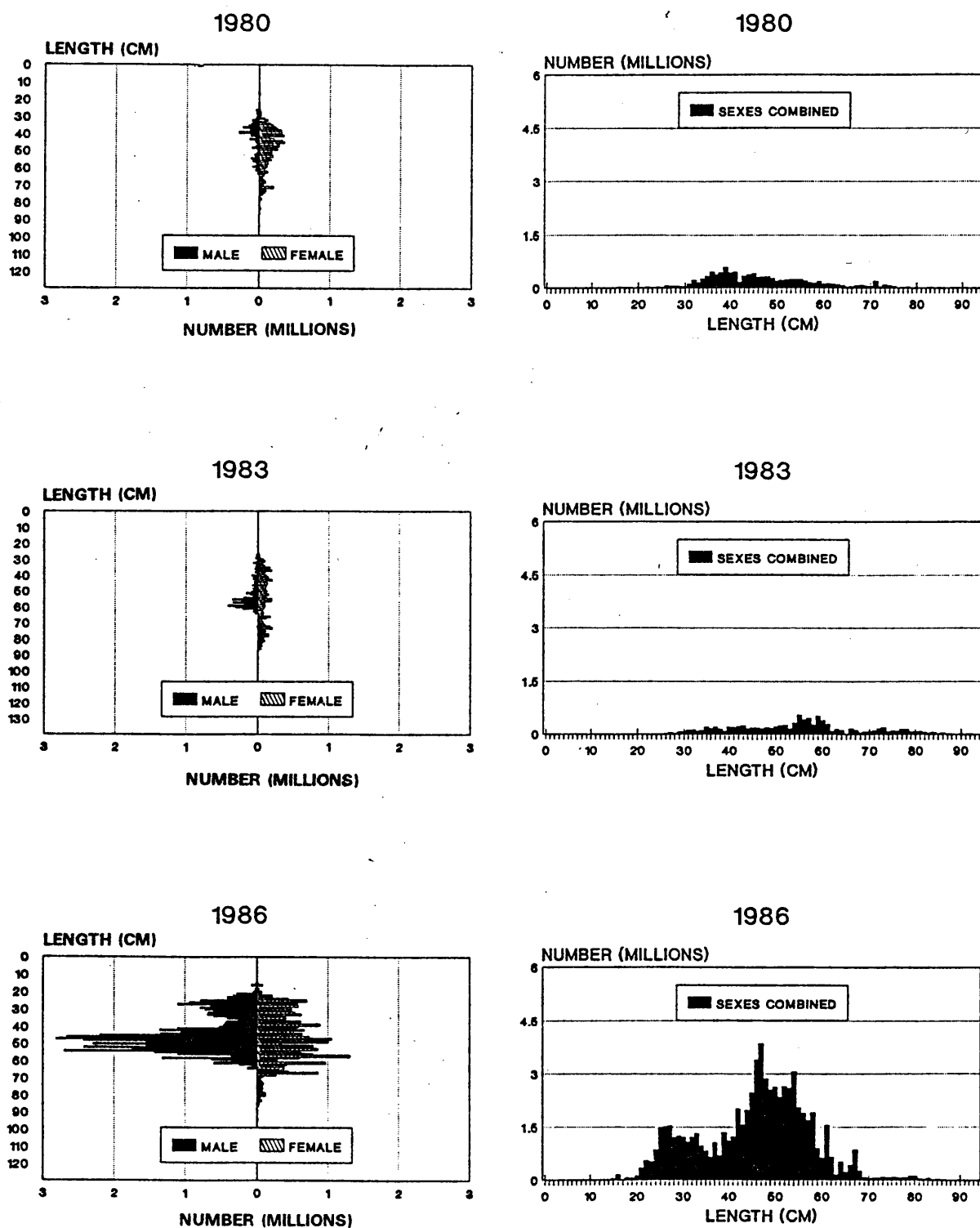

Figure 106. Size composition of arrowtooth flounder in the Northeast area of the Aleutian Islands during the U.S.-Japan 1980, 1983, and 1986 groundfish surveys.

Northwest area size composition curve had several strong modes of fish in the 40-59 cm size range. In the Northeast area, there was a showing of larger fish in the 54-61 cm size range.

Even in 1986 when the biomass was considerably larger, similarities were hard to find. In the Southwest area the primary mode ranged from 38 to 46 cm, in the Southeast from 34 to 55 cm and in Northwest from 54 to 66 cm. In the Northeast area, which had the largest biomass, the size curve was bimodal with the primary mode ranging from 38 to 62 cm and the secondary mode from 22 to 36 cm.

In the Southern Bering Sea area the 1980 size composition curve for arrowtooth flounder was trimodal with the primary mode consisting of two peaks: one at 28 cm and a second at 36 cm and a secondary mode of larger fish peaking at 48 cm (Fig. 107). In 1983, four modes are visible with the largest peaking at 35 cm, a smaller mode at 26 cm, and two extremely small modes at 47 and 58 cm. In 1986, six modes are apparent: the first was a small mode at 15 cm, the second was the largest mode peaking at 24 cm, and the rest were generally declining smaller modes peaking at 28, 37, 46, 50, and 57 cm.

Mean Length-at-Age and Growth

Mean length-at-age data for 1980 shows strong sexual dimorphism in arrowtooth flounder starting early in their life history (Table 51). Even at age 3, the first age at which both males and females were included in the samples, the average size of females was nearly 6 cm greater than males. Throughout their lives the differences in mean length-at-age continues to increase until at age 15 the females are on the average 12.8 cm longer than the males.

Yearly growth increments also varied by sex (Table 52). From age 3 to 8, female arrowtooth flounder increase in size from 4.1 to 6.0 cm per year; between age 8 and 10 the growth rate is 2-3 cm per year. Males show a similar yearly increase in size only to age 5 when the growth rate drops to 2-3 cm per year until age 10. After age 10 the yearly increase in size was generally less than 2 cm for both sexes and continued to decrease with age.

These data were fitted to the von Bertalanffy growth curve to obtain estimates of t_0 , L_{INF} and k (Table 53).

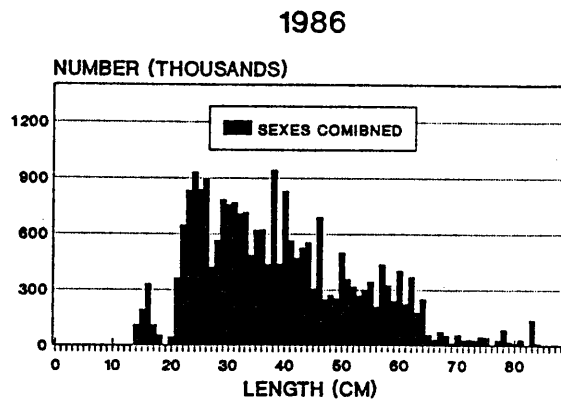
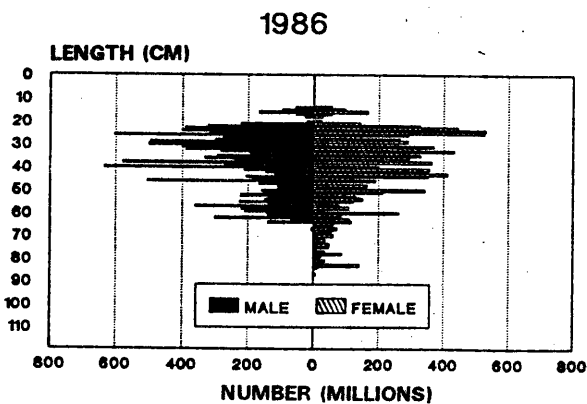
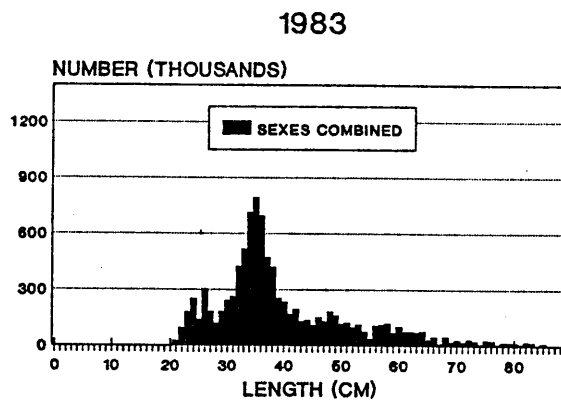
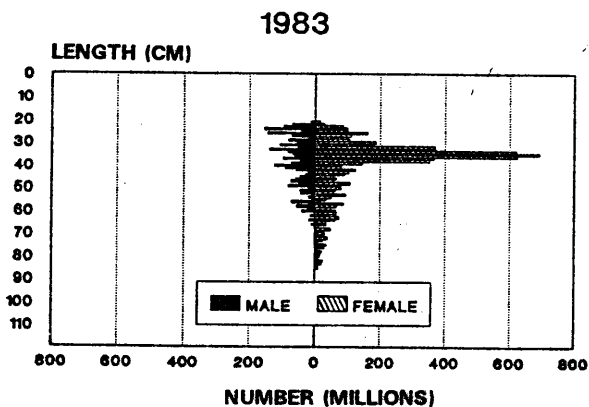
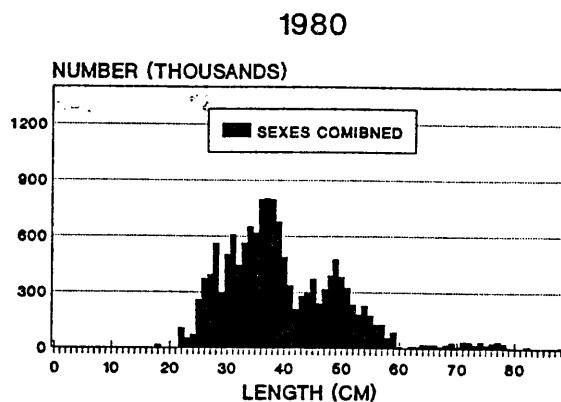
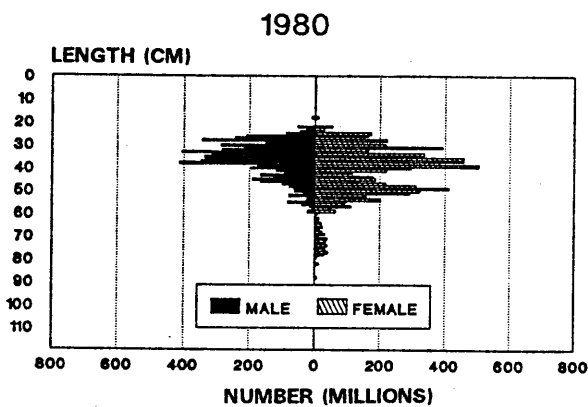

Figure 107. Size composition of arrowtooth flounder in the Southern Bering Sea during the U.S.-Japan 1980, 1983, and 1986 Aleutian Islands groundfish surveys.

Table 51. Mean length (mm) at age for arrowtooth flounder sampled during the U.S.-Japan 1980 Aleutian Islands groundfish survey.

Age	Males	Females	Sexes combined
2	-	220	220
3	197	254	226
4	253	317	281
5	293	365	316
6	321	425	365
7	354	471	411
8	382	512	442
9	410	538	459
10	433	569	506
11	447	579	520
12	459	604	545
13	475	607	533
14	486	616	529
15	494	622	534
16	492	632	518

Table 52. Estimates of yearly incremental growth (cm) of arrowtooth flounder based on the U.S.-Japan 1980 Aleutian Islands groundfish survey.

Age	Males	Females
3-4	5.6	5.3
4-5	4.0	4.8
5-6	2.8	6.0
6-7	3.3	4.6
7-8	2.8	4.1
8-9	2.8	2.6
9-10	2.3	3.1
10-11	1.4	1.0
11-12	1.2	2.5
12-13	1.6	0.3
13-14	1.1	0.9
14-15	0.8	0.6
15-16	0.8	1.0

Table 53. Estimated von Bertalanffy growth curve parameters for arrowtooth flounder sampled during the U.S.-Japan 1980 Aleutian Islands groundfish survey.

Area	Sex	Range		von Bertalanffy		
		Age (Years)	Length (cm)	Growth Parameters		
				L_{inf}	k	t_0
Aleutian Islands	m	3-16	18-54	55.65	0.145	-0.089
	F	2-16	22-66	67.51	0.188	0.611
	M+F	2-16	18-66		0.205	1.055

Length-Weight Relationship

Length-weight relationships (sexes combined) for arrowtooth flounder in the Aleutian Islands area were determined for all three surveys:

$$\begin{aligned} \text{Weight(g)} \text{ (1980)} &= 0.0007 \times \text{Length(cm)}^{3.695} \\ \text{Weight(g)} \text{ (1983)} &= 0.0234 \times \text{Length(cm)}^{2.755} \\ \text{Weight(g)} \text{ (1986)} &= 0.0020 \times \text{Length(cm)}^{3.409} \end{aligned}$$

During 1980 arrowtooth flounder over 55 cm were slightly heavier per given length than during 1986. In 1983, arrowtooth flounder in the 45-58 cm size range were lighter than during the other two survey years (Fig. 108).

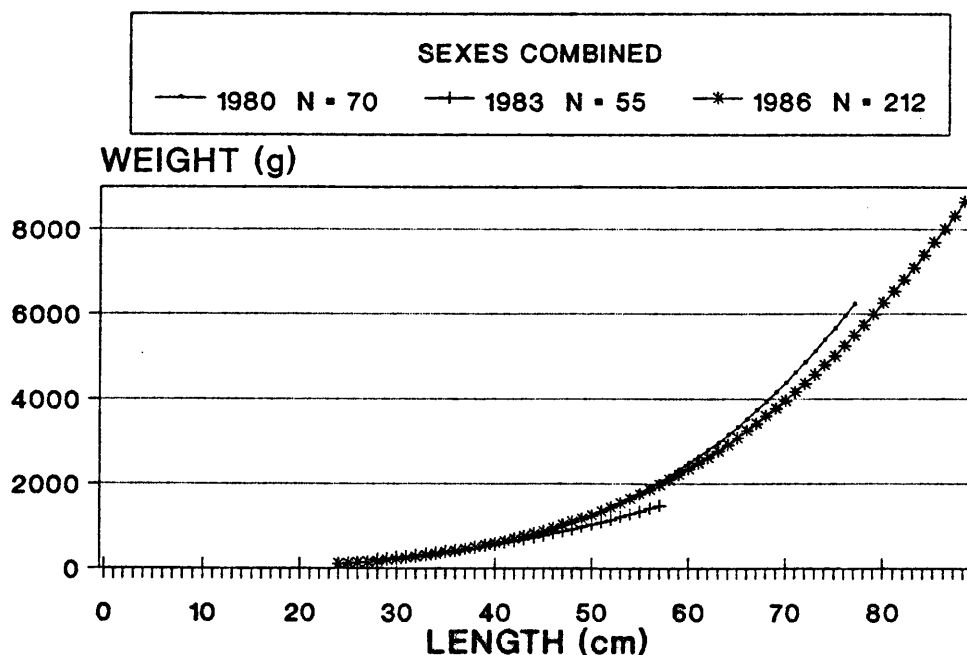

Figure 108. Length-weight relationships for arrowtooth flounder in the Aleutian Islands area during the U.S.-Japan 1980, 1983, and 1986 groundfish surveys.

Sablefish

Distribution and Abundance

Sablefish (*Anoplopoma fimbria*) were encountered from Stalemate Bank to Unimak Pass including Bowers Ridge mostly at depths greater than 200 m (Figs. 109-110). In 1980, high-density concentrations were only found west of Seguam Island. In 1983, similar concentrations were encountered, and there was an additional high-density concentration south of Seguam Island. In 1986, high-density concentrations were located north, east, and south of Seguam Island, and west of the Islands of Four Mountains. An increase in the number of medium-density concentrations occurred along both sides of the eastern Aleutian Islands during the 1983 and 1986 surveys. In 1986, they expanded north to Petrel Bank and Bowers Ridge and almost as far west as Agattu Island. There was an increase in the number of medium-density concentrations in the Southern Bering Sea particularly between the Islands of Four Mountains and Umnak Island in 1986.

The biomass estimate for sablefish in the Aleutian Islands area increased from 24,000 t in 1980 to 69,000 t in 1983, and 112,000 t in 1986 (Table 54, Fig. 111). The population estimate rose from 17.5 million fish in 1980, to 31.1 million in 1983 and 40.7 million in 1986.

In 1980, 83% of the sablefish stock was in the eastern Aleutians Islands region, with 47% of the total biomass occurring in the Northeast area. In 1983, all areas showed increases, but the most dramatic change occurred in the eastern Aleutian Islands where the Southeast area biomass increased nearly 2.5-fold and the Northeast area 3.6-fold. In 1986 the biomass estimate increased again with the most significant increases occurring along the south side of the Aleutian Islands, where the Southwest area increased 6,000 t and the Southeast area 33,000 t. Smaller increases occurred in the Northwest and Bowers Ridge areas, but the Northeast area remained unchanged.

In 1980 the biomass of the Southern Bering Sea was estimated to be 118,000 t. However this estimate may be much too high. It is unlikely that the biomass of the Southern Bering Sea is higher than the biomass of the Aleutian Islands. The lack of precision of this estimate is reflected by the extremely high sampling error of 741% (Table 14). At least part of the problem is related to RFPCs which multiplied catches of the U.S. vessel by 20 to correct for relative fishing power differences. In 1983 the biomass estimate was 10,000 t, and in 1986, it increased to 25,000 t (Fig. 112).

The mean length of sablefish was highest in 1980 and decreased each survey year, but the mean weight was lowest in 1980 and increased each survey year. (Table 55, Figs. 113-114).

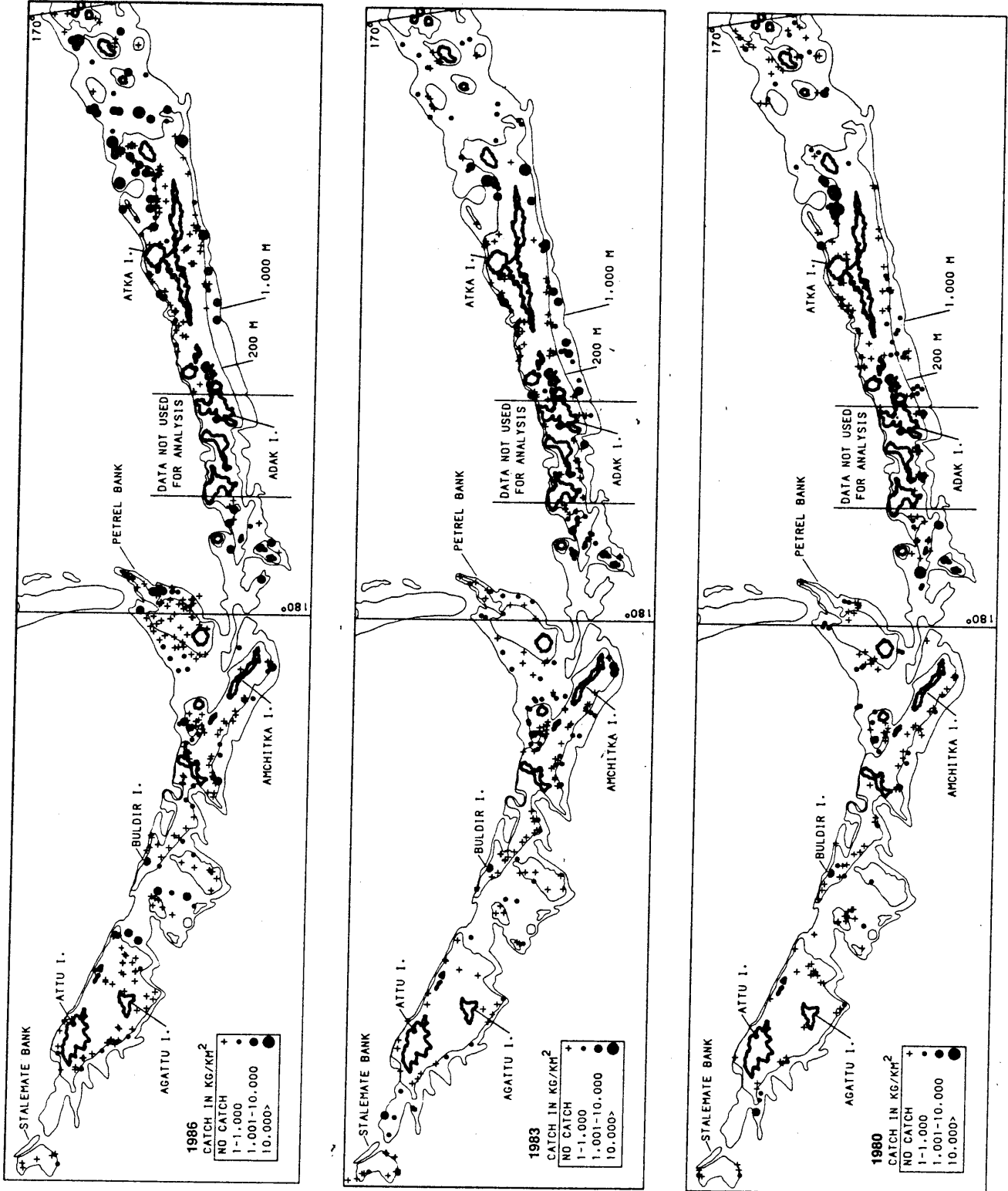

Figure 109. Distribution and relative abundance of sablefish in the Aleutian Islands area during the U.S.-Japan 1980, 1983, and 1986 groundfish surveys.

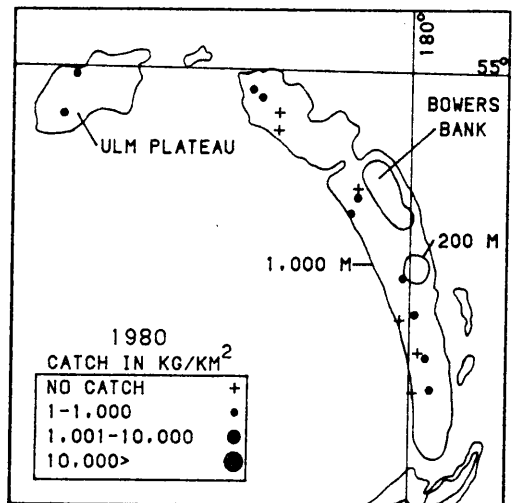
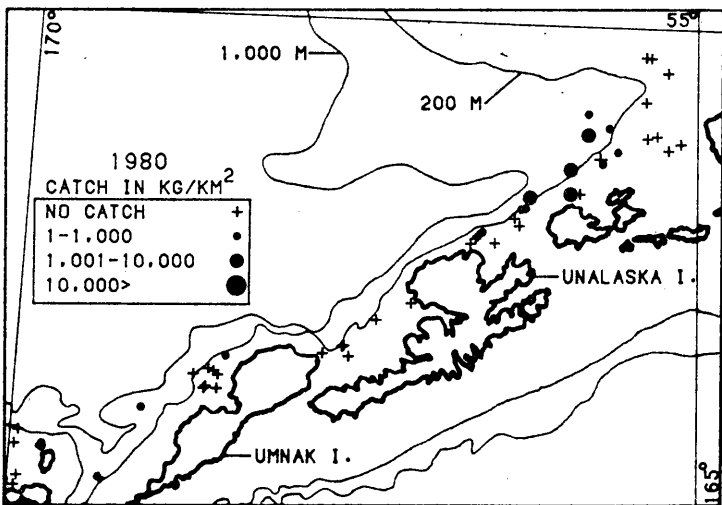
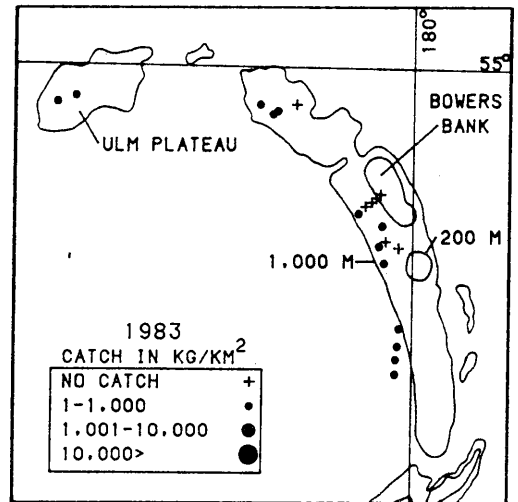
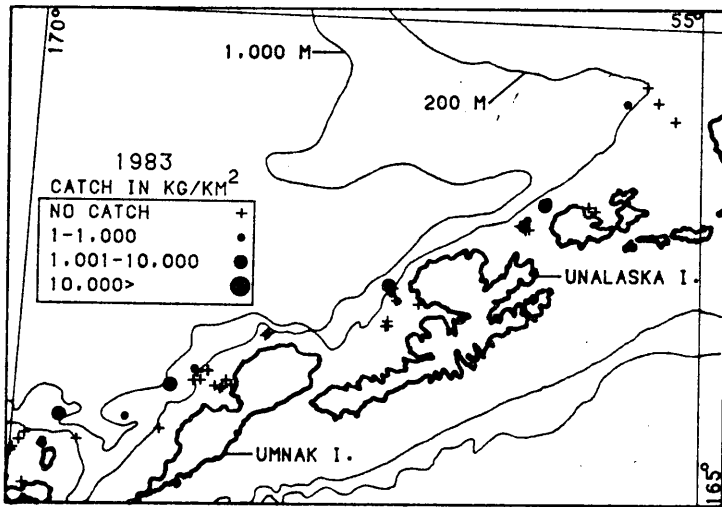
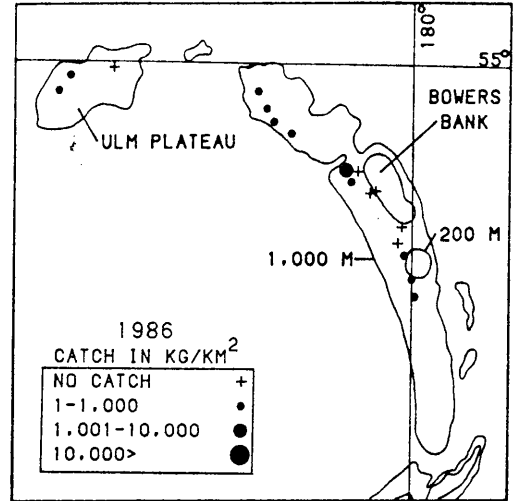
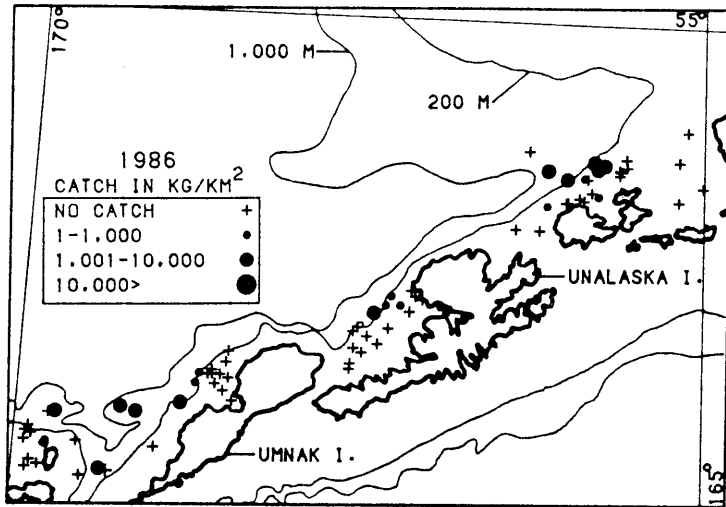

Figure 110. Distribution and relative abundance of sablefish in the Southern Bering Sea and Bowers Ridge areas during the U.S.-Japan 1980, 1983, and 1986 Aleutian Islands groundfish surveys.

Table 54. Estimates of biomass, biomass sampling error, and population for sablefish based on the U.S.-Japan 1980, 1983, and 1986 Aleutian Islands groundfish surveys.

Area	Depth (m)	Biomass (t)			Sampling Error (%)			Population (1,000s)		
		1980	1983	1986	1980	1983	1986	1980	1983	1986
Southwest	1-100	0	0	0				0.0	0.0	0.0
	101-200	0	244	0				0.0	77.7	0.0
	201-300	87	245	229				96.2	105.5	94.2
	301-500	680	884	1,630				309.8	302.8	557.8
	501-900	1,546	2,850	8,989				316.8	809.0	2,450.2
	1-900	2,313	4,223	10,848	210.1	45.3	94.9	722.8	1,295.0	3,102.2
Southeast	1-100	0	0	0				0.0	0.0	0.0
	101-200	30	10,716	101				20.3	3,227.1	25.6
	201-300	3,414	2,114	38,247				2,854.6	742.9	13,826.0
	301-500	2,737	3,693	9,955				2,182.6	1,827.3	3,714.3
	501-900	2,562	4,864	6,591				954.4	1,747.2	2,024.3
	1-900	8,743	21,387	54,894	109.4	126.9	107.1	6,011.9	7,544.5	19,590.2
Northwest	1-100	a	0	0				a	0.0	0.0
	101-200	0	0	0				0.0	0.0	0.0
	201-300	5	2	4				4.6	0.8	1.7
	301-500	76	350	338				97.3	182.4	103.9
	501-900	997	958	2,537				333.5	351.0	801.3
	1-900	1,078	1,310	2,879	75.3	92.2	47.5	435.4	534.2	906.9
Northeast	1-100	0	0	0				0.0	0.0	0.0
	101-200	5,710	1,958	7				6,231.7	1,092.3	5.1
	201-300	3,227	2,306	1,326				2,620.1	920.6	508.5
	301-500	1,132	2,643	13,594				795.5	1,205.4	5,393.0
	501-900	1,192	34,190	25,355				516.2	18,248.8	10,544.4
	1-900	11,261	41,097	40,282	120.9	178.9	53.2	10,163.5	21,467.1	16,451.0
Bowers Ridge	101-200	a	0	0				a	0.0	0.0
	201-300	0	0	0				0.0	0.0	0.0
	301-500	21	192	586				0.0	39.6	138.9
	510-900	776	820	2,200				186.4	210.2	495.6
	101-900	797	1,012	2,786	108.7	53.0	72.1	186.4	249.8	634.5
Aleutian Islands	1-100	0	0	0	0.0	0.0	0.0	0.0	0.0	0.0
	101-200	5,740	12,918	108	229.3	204.2	185.7	6,252.0	4,397.1	30.7
Total	201-300	6,733	4,667	39,806	140.0	120.4	147.0	5,575.5	1,769.8	14,430.4
	301-500	4,646	7,762	26,103	227.5	58.4	45.4	3,385.2	3,557.5	9,907.9
	501-900	7,073	43,682	45,672	67.6	168.1	43.6	2,317.3	21,366.2	16,315.8
	1-900	24,192	69,029	111,689	63.6	107.2	54.4	17,520.0	31,090.6	40,684.8
Southern Bering Sea	1-100	13,706	704	159				10,001.9	646.1	254.6
Total	101-200	4,053	1,453	8,401				2,231.1	478.0	3,278.7
	201-300	63,183	174	1,575				29,190.5	87.1	587.4
Total	301-500	10,185	2,851	5,813				6,300.7	1,160.3	1,852.1
	501-900	27,065	4,689	8,666				18,224.6	2,147.8	3,535.9
	1-900	118,192	9,871	24,614	741.4	95.6	80.8	65,948.8	4,519.3	9,508.8

a No sampling was conducted in this area-depth interval.

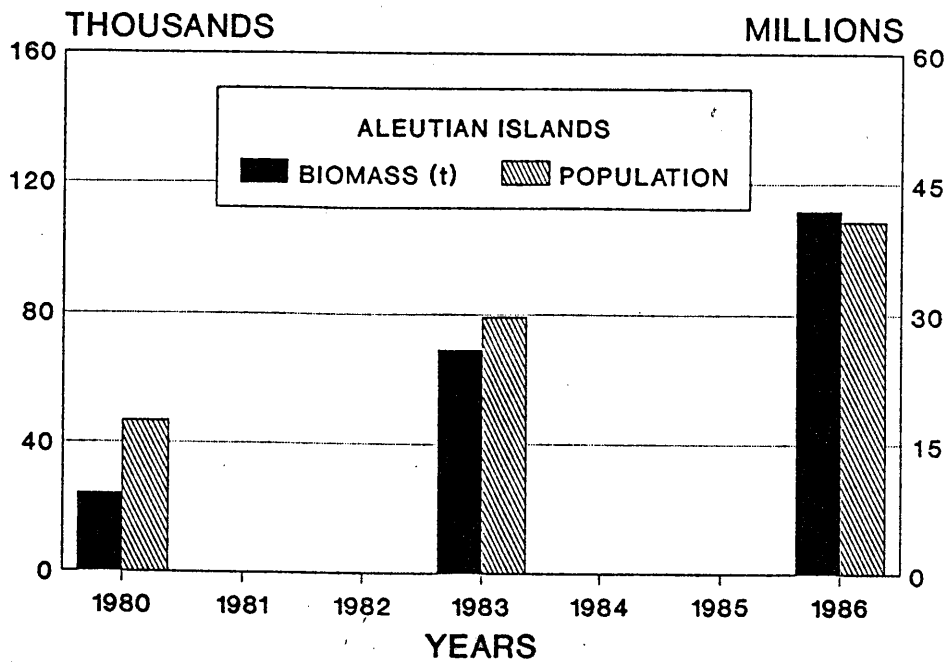

Figure 111. Estimated biomass and population of sablefish in the Aleutian Islands area during the U.S.-Japan 1980, 1983, and 1986 groundfish surveys.

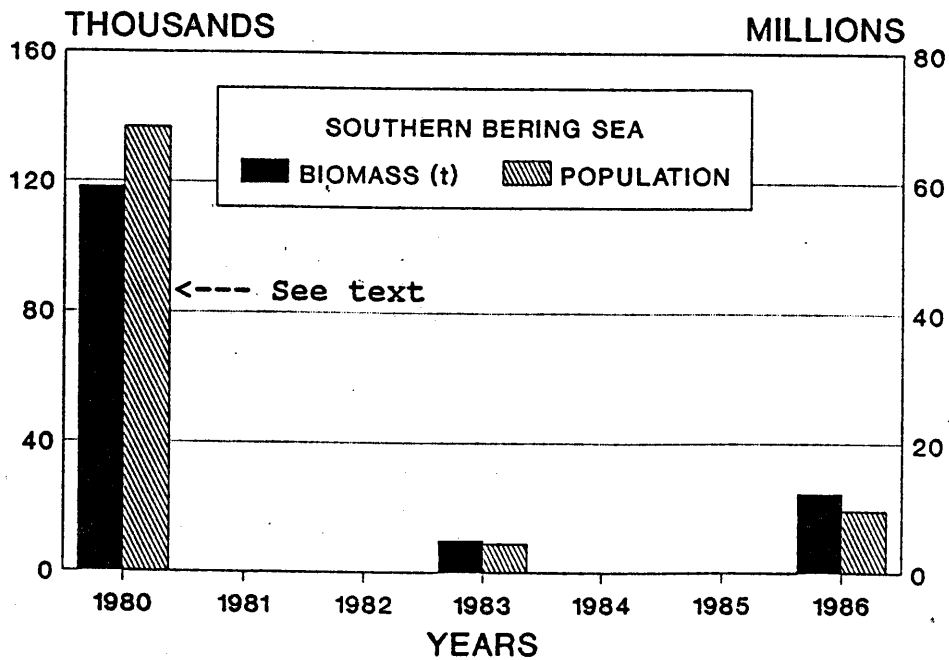

Figure 112. Estimated biomass and population of sablefish in the Southern Bering Sea area during the U.S.-Japan 1980, 1983, and 1986 Aleutian Islands groundfish surveys.

Table 55. Estimates of mean catch per unit effort, length, and weight for sablefish based on the U.S.-Japan 1980, 1983, and 1986 Aleutian Islands groundfish surveys.

Area	Depth (m)	Mean CPUE (kg/km ²)			Mean Length (cm)			Mean Weight (kg)		
		1980	1983	1986	1980	1983	1986	1980	1983	1986
Southwest	1-100	0.0	0.0	0.0	0.0	0.0	0.0	0.00	0.00	0.00
	101-200	0.0	37.3	0.0	0.0	58.9	0.0	0.00	3.12	0.00
	201-300	38.0	106.7	100.0	61.7	58.7	0.0	0.91	2.34	2.53
	301-500	199.3	259.3	478.0	63.5	64.2	50.7	2.20	3.03	2.94
	501-900	219.8	405.1	1,277.8	67.9	63.8	67.6	4.80	3.50	3.65
	1-900	107.3	190.1	471.0	66.9	63.2	59.3	3.18	3.28	3.49
Southeast	1-100	a	0.0	0.0	a	0.0	0.0	a	0.00	0.00
	101-200	9.3	3,274.8	30.8	0.0	67.8	49.3	1.50	3.31	3.93
	201-300	1,080.8	669.1	12,107.5	63.7	65.2	49.4	1.18	2.86	2.76
	301-500	1,004.9	1,176.8	3,172.0	63.0	58.3	52.1	1.26	2.01	2.76
	501-900	1,259.8	1,719.0	2,329.2	66.4	63.1	61.2	2.70	2.78	3.25
	1-900	781.5	1,530.1	3,649.0	63.8	64.2	52.2	1.45	2.83	2.81
Northwest	1-100	0.0	0.0	0.0	0.0	0.0	0.0	0.00	0.00	0.00
	101-200	0.0	0.0	0.0	0.0	0.0	0.0	0.00	0.00	0.00
	201-300	4.3	1.9	3.9	0.0	0.0	49.6	1.00	2.61	2.49
	301-500	34.3	158.0	152.4	65.9	54.0	54.8	0.78	1.89	3.24
	501-900	222.1	213.4	565.1	64.7	63.7	63.5	2.99	2.79	3.15
	1-900	97.0	102.7	225.6	64.8	60.4	61.4	2.48	2.48	3.16
Northeast	1-100	0.0	0.0	0.0	0.0	0.0	0.0	0.00	0.00	0.00
	101-200	1,461.6	501.2	1.8	0.0	55.2	44.1	0.92	2.01	1.39
	201-300	1,321.3	944.2	543.1	60.8	61.9	52.2	1.25	2.52	2.61
	301-500	329.7	769.7	4,141.6	61.4	59.0	63.1	1.42	2.16	2.52
	501-900	201.4	5,531.7	4,102.4	60.5	56.8	57.6	2.29	2.02	2.40
	1-900	628.5	2,399.2	2,272.1	60.8	57.1	48.4	1.11	2.05	2.44
Bowers Ridge	101-200	a	0.0	0.0	a	0.0	0.0	a	0.00	0.00
	201-300	0.0	0.0	0.0	0.0	0.0	0.0	0.00	0.00	0.00
	301-500	13.0	119.6	365.9	71.0	72.5	0.0	0.00	4.79	4.20
	501-900	109.0	115.2	309.0	70.5	70.0	68.3	4.17	4.03	4.46
	101-900	80.2	98.7	271.7	70.6	70.4	68.3	4.28	4.16	4.40
Aleutian Islands	1-100	0.0	0.0	0.0	0.0	0.0	0.0	0.00	0.00	0.00
	101-200	369.2	775.9	6.5	0.0	64.8	44.1	0.92	3.01	3.50
Total	201-300	660.9	458.0	3,907.7	63.6	63.1	50.7	1.21	2.65	2.75
	301-500	347.1	562.5	1,912.6	62.3	59.0	54.7	1.37	2.17	2.66
	501-900	266.0	1,579.5	1,651.5	62.9	57.9	62.2	3.06	2.18	2.79
	1-900	337.3	904.3	1,417.0	63.0	59.3	50.7	1.38	2.33	2.75
Southern Bering Sea	1-100	2,844.1	146.2	33.0	0.0	0.0	52.4	1.37	1.09	0.63
	101-200	1,238.6	444.1	2,567.5	59.7	63.0	0.0	1.82	3.00	2.52
Total	201-300	63,086.1	173.5	1,572.7	61.5	55.3	58.4	2.16	1.98	2.63
	301-500	8,003.9	2,240.2	4,567.8	63.6	61.5	54.4	1.61	2.47	3.14
	501-900	11,902.0	2,062.2	3,810.9	61.3	60.3	54.8	1.31	2.18	2.44
	1-900	9,351.2	781.0	1,947.4	61.2	60.9	56.0	1.73	2.19	2.57

a No sampling was conducted in this area-depth interval.

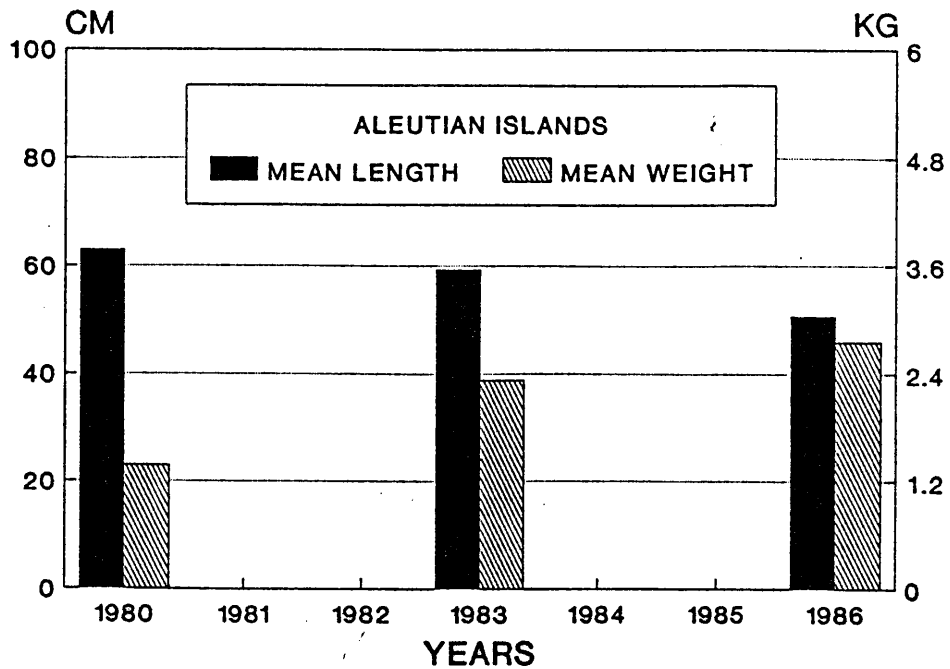

Figure 113. Mean length and weight of sablefish in the Aleutian Islands area during the U.S.-Japan 1980, 1983, and 1986 groundfish surveys.

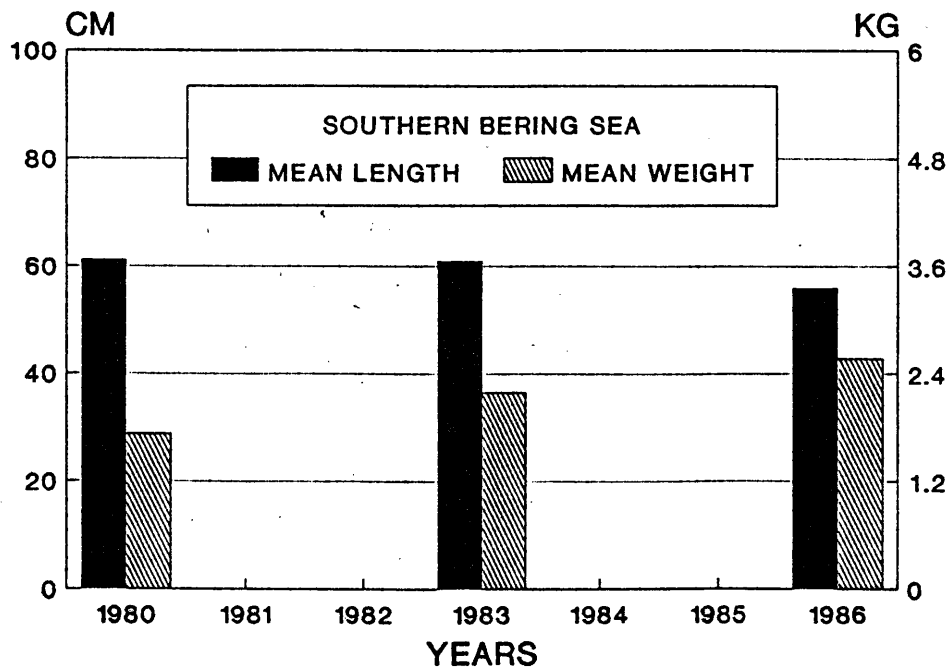

Figure 114. Mean length and weight of sablefish in the Southern Bering Sea area during the U.S.-Japan 1980, 1983, and 1986 Aleutian Islands groundfish surveys.

Size and Age Composition

In 1980, sablefish in the Aleutian Islands area ranged from 34 to 78 cm. The size curve was bimodal, with the principle mode extending from 46 to 57 cm and peaking at 49-50 cm. The secondary mode of smaller fish ranged from 36 to 42 cm and peaked at 39-40 cm (Fig. 115). No age data were available from the 1980 survey.

In 1983, there was an absence of small fish less than 47 cm. A strong mode of fish ranged from 51 to 64 cm, and peaked at 54-55 cm. There was an increase of fish in the 65-80 cm size range. The stock in 1983 consisted primarily of eight year classes, 1974-1981, with the 1978 year class of 5-year-old fish being particularly strong, contributing nearly 35% of the biomass (Fig. 116). Six- and 4-year-old fish, were also abundant, contributing nearly 20% each.

In 1986 a much stronger size composition mode was evident. A strong single mode peaked at 59-63 cm and was skewed considerably toward larger fish, particularly in the 65-75 cm range. The stock consisted of fish 2 to 4-years-old. Seven year classes, 1976-1982, dominated, accounting for over 73% of the total stock with fish in the 9 to 5-year-old age groups being the strongest.

The age composition of sablefish in the Aleutian Islands area varied with depth (Table 56). In 1983, 5- and 6-year-old fish were dominant in the 101-200 m depth interval, and 4-6-year-olds dominated in the deeper depth intervals. Three-year-old fish from the 1980 year class were more numerous in the two deeper zones. In 1986, 9- to 5-year-old fish were dominant at depths greater than 200 m.

In 1980, there was considerable similarity in the size composition of sablefish throughout all areas of the Aleutian Islands (Figs. 117-120). The major mode was near 50 cm in all four areas for which data are available. In the Southwest and Northwest areas the secondary mode was between 64 and 70 cm, in the Southeast area it peaked at 55-60 cm, and in the Northeast area it peaked at 38-34 cm.

During 1983, the Southwest area size composition curve had weak modes between 50 and 70 cm and evidence of fish larger than 80 cm. In the Southeast area, there were no distinct modes, however there was a higher proportion of larger fish 63-73 cm in length. The Northwest area curve was somewhat similar to the Southwest area in that there were several weak modes between 50 and 70 cm, but there was no evidence of fish over 80 cm. In the Northeast area, there was a strong principle mode that ranged from 53 to 62 cm, peaking at 55-56 cm. The sex ratio favored males in the Southwest area, females in the Southeast area, was fairly even in the Northwest area, and favored males in the Northeast area.

In 1986, the Southwest area size composition curve peaked in the mid-60 cm range and was the only area which contained fish over 80 cm. There were more males than females. Most fish were

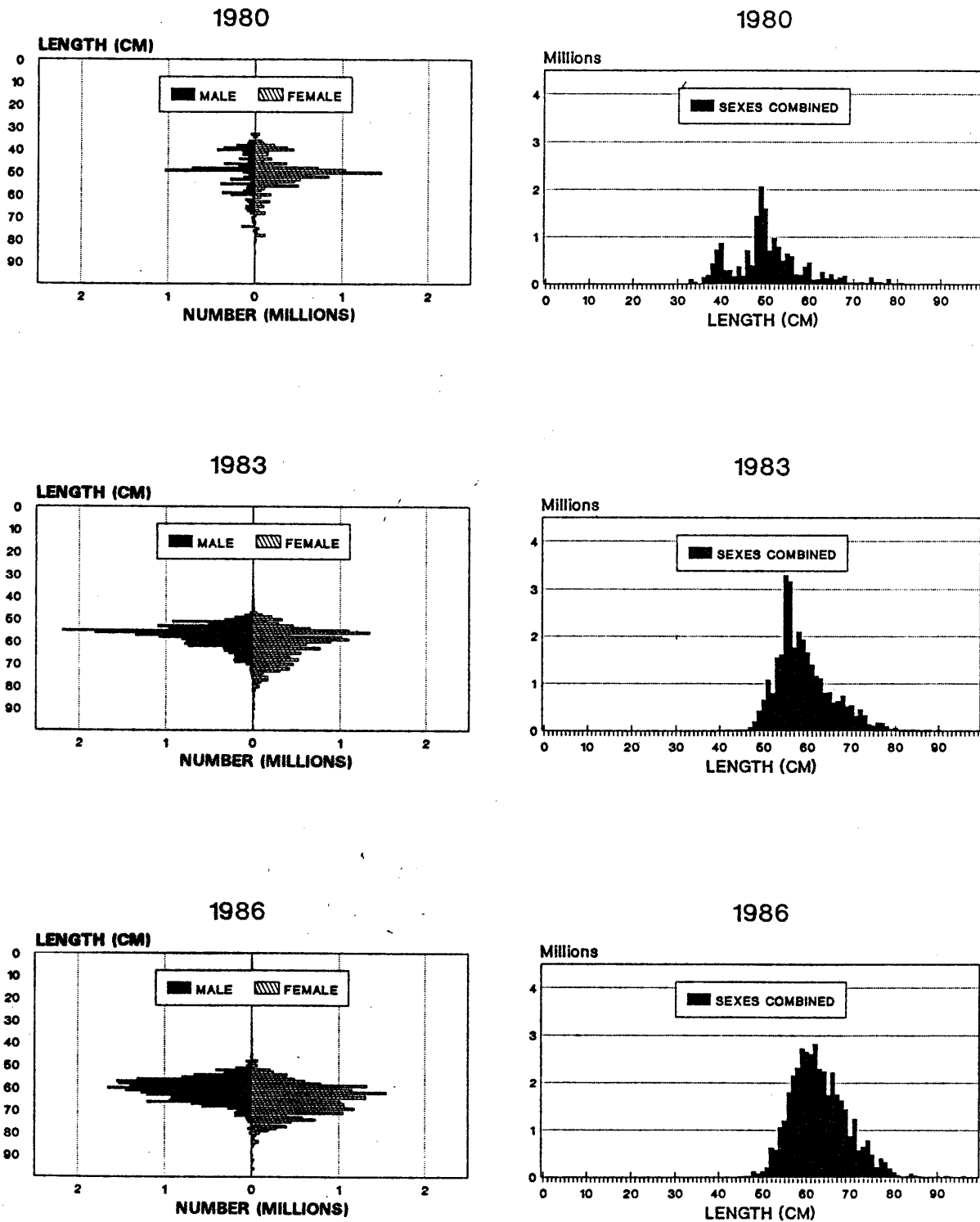
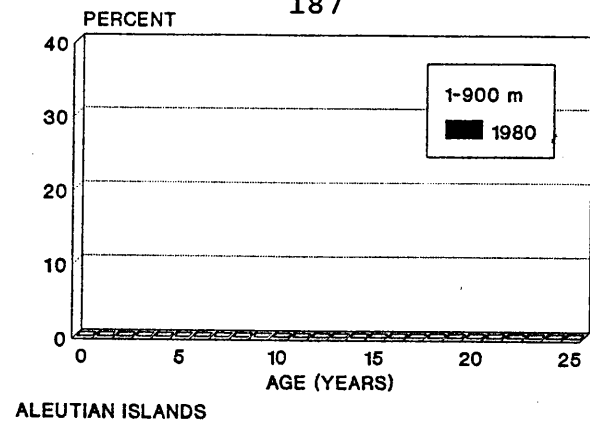
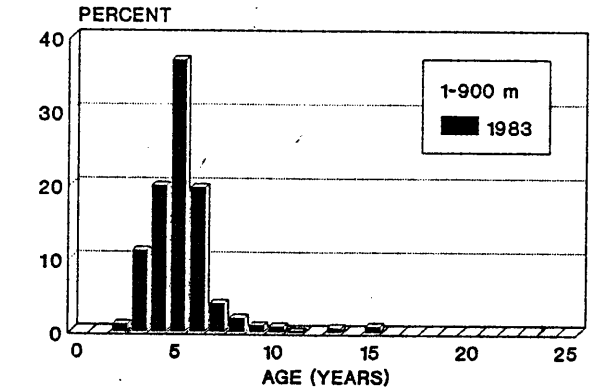

Figure 115. Size composition of sablefish in the Aleutian Islands area during the U.S.-Japan 1980, 1983, and 1986 groundfish surveys.



ALEUTIAN ISLANDS



ALEUTIAN ISLANDS

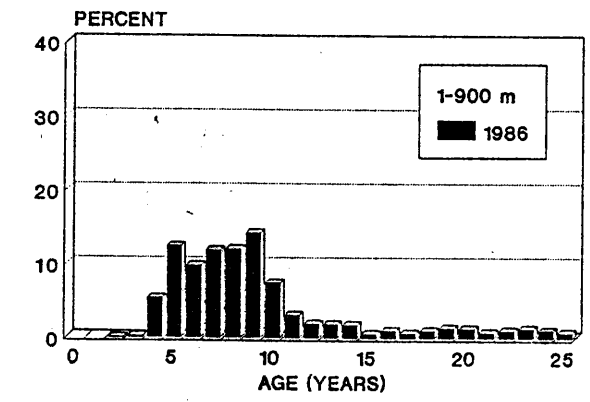

ALEUTIAN ISLANDS

Figure 116. Age composition of sablefish in the Aleutian Islands area during the U.S.-Japan 1980, 1983, and 1986 groundfish surveys.

Table 56. Age composition of sablefish by depth intervals during the U.S.-Japan 1983, and 1986 Aleutian Islands groundfish surveys.

Age	Depths (m)							
	101-200		201-300		301-500		501-900	
	1983	1986	1983	1986	1983	1986	1983	1986
2	2.21	-	0.30	0.01	1.68	0.07	0.64	0.01
3	5.13	-	3.32	0.11	10.51	0.42	13.06	0.23
4	7.36	-	12.01	4.82	19.90	5.72	23.06	5.64
5	43.37	-	37.35	12.77	37.44	12.48	35.53	12.11
6	17.90	-	24.44	9.89	17.58	10.24	19.86	9.47
7	3.29	-	6.89	13.41	4.71	10.79	3.54	11.19
8	7.48	-	2.77	10.87	1.03	12.95	0.80	12.56
9	3.42	-	2.24	15.30	0.72	13.73	0.23	13.54
10	0.15	-	1.88	8.13	1.57	7.23	0.60	7.02
11	-	-	0.28	2.86	0.16	3.08	0.05	3.27
12	-	-	-	1.78	-	2.09	-	2.02
13	2.17	-	1.89	1.74	0.49	2.09	0.15	1.87
14	-	-	-	1.96	-	1.92	-	1.56
15	2.21	-	2.05	0.58	0.62	0.50	0.27	0.57

Table 57. Age composition of sablefish by areas in the Aleutian Islands based on the U.S.-Japan 1986 Aleutian Islands groundfish survey.

Age	Subareas		
	Southwest	Northwest	Northeast
2	-	-	0.20
3	-	-	0.21
4	4.13	1.48	9.77
5	10.23	15.82	12.68
6	15.30	11.90	11.90
7	11.97	8.46	10.62
8	8.91	29.52	10.36
9	10.37	10.85	10.47
10	2.98	6.35	14.54
11	2.41	5.89	3.75
12	-	2.11	4.73
13	2.66	-	1.76
14	2.10	-	2.50
15	-	0.39	-

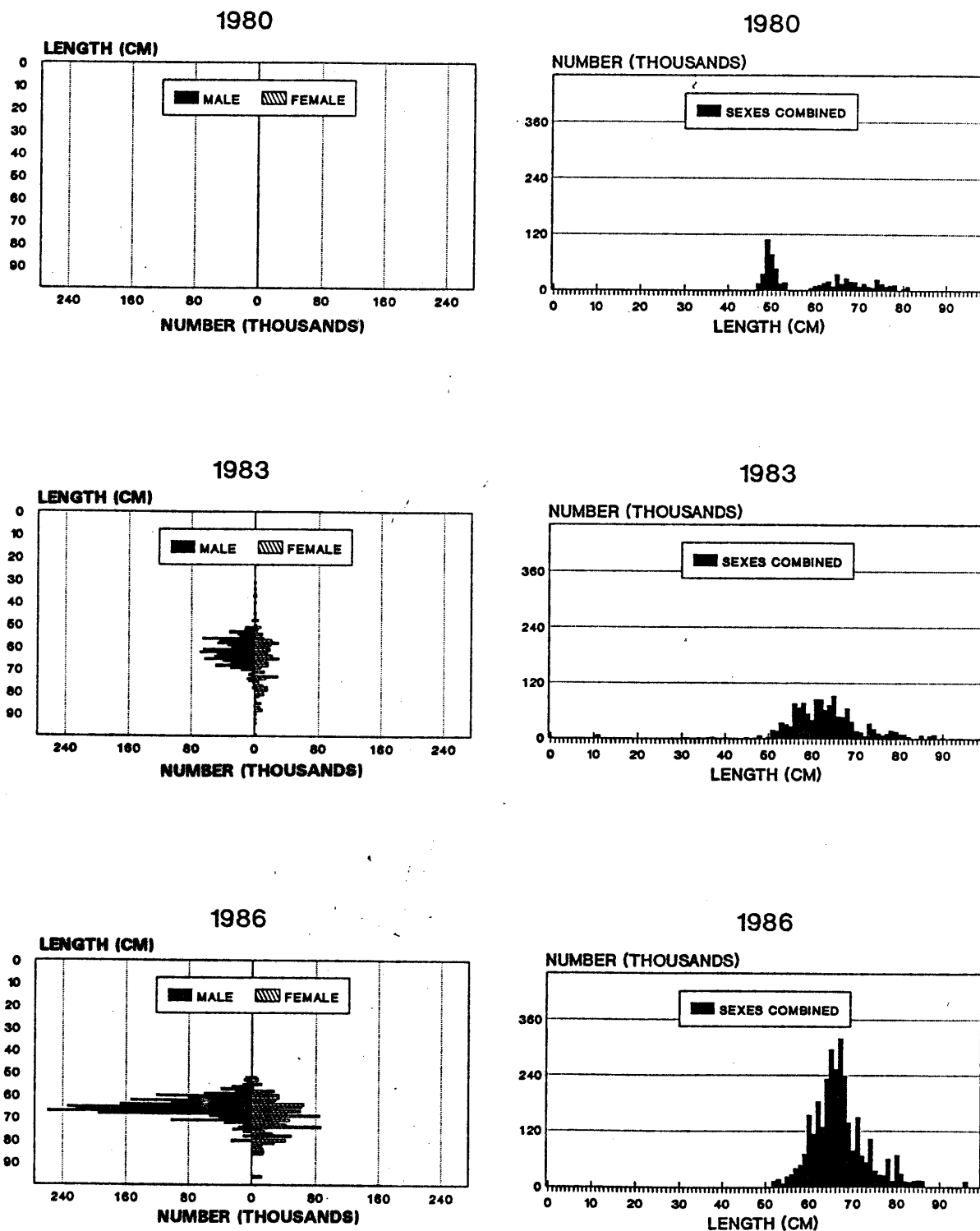

Figure 117. Size composition of sablefish in the Southwest area of the Aleutian Islands during the U.S.-Japan 1980, 1983, and 1986 groundfish surveys.

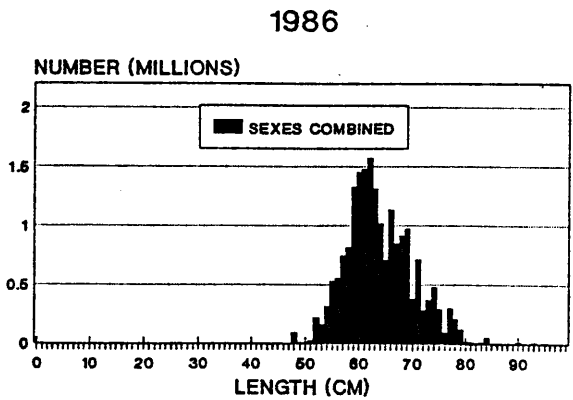
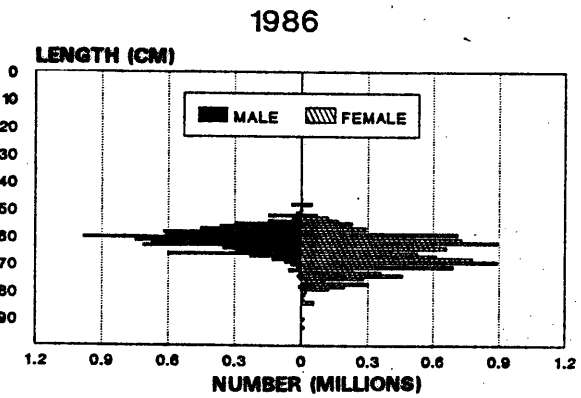
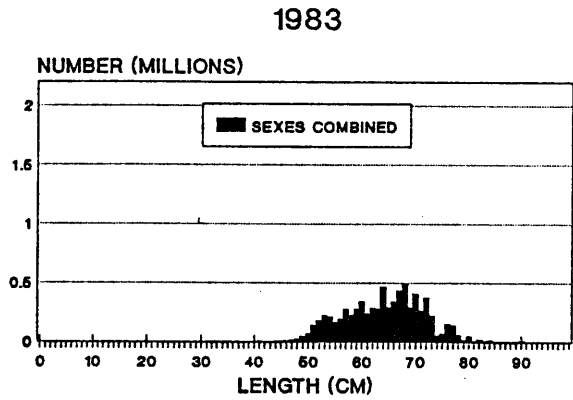
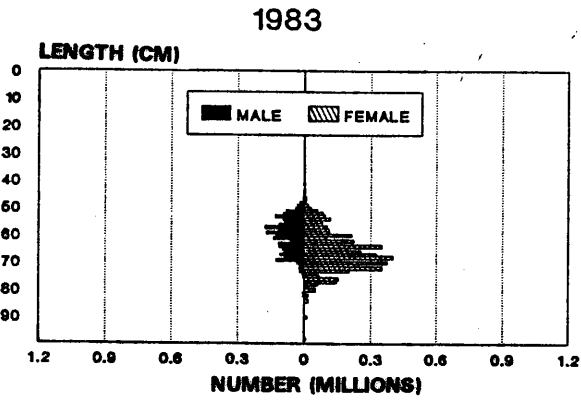
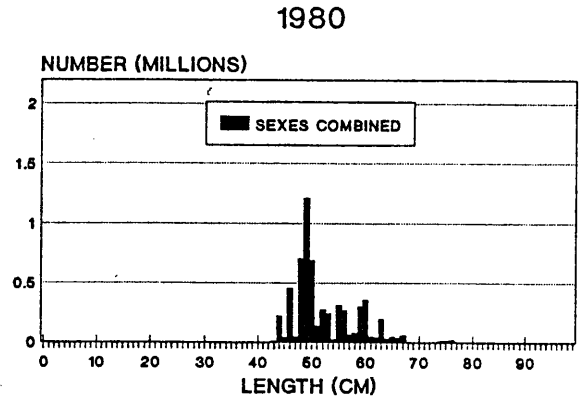
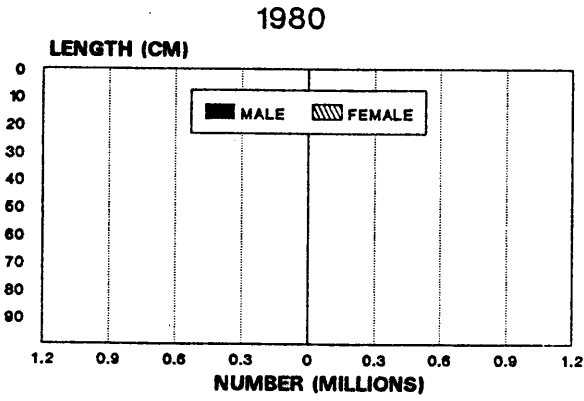

Figure 118. Size composition of sablefish in the Southeast area of the Aleutian Islands during the U.S.-Japan 1980, 1983, and 1986 groundfish surveys.

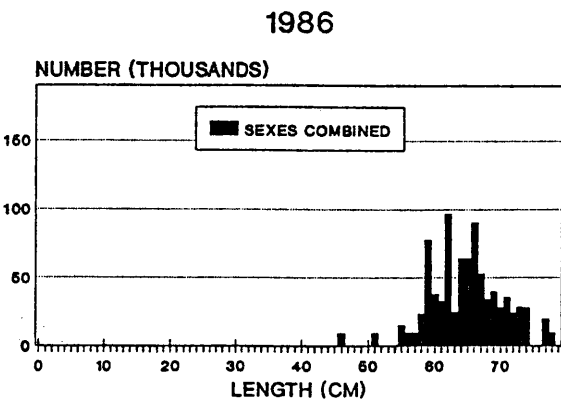
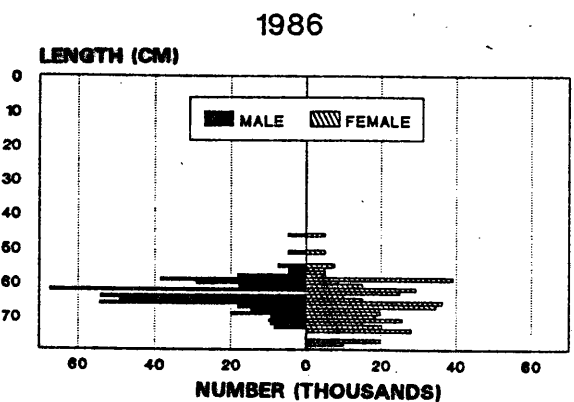
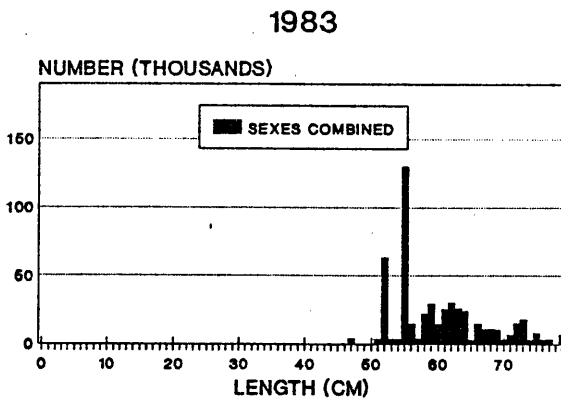
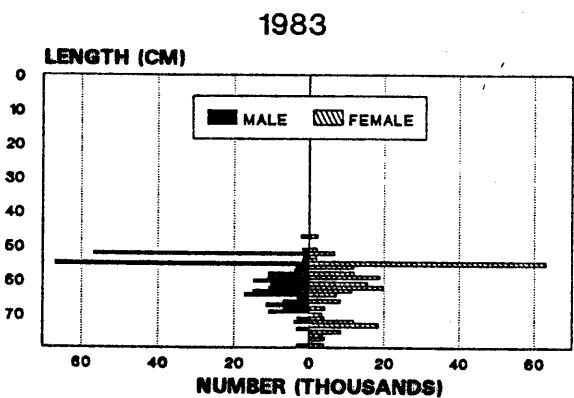
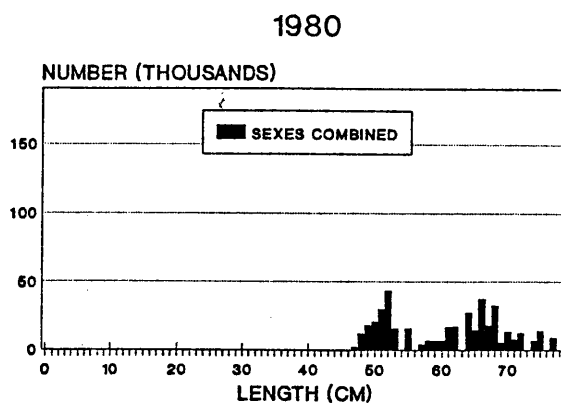
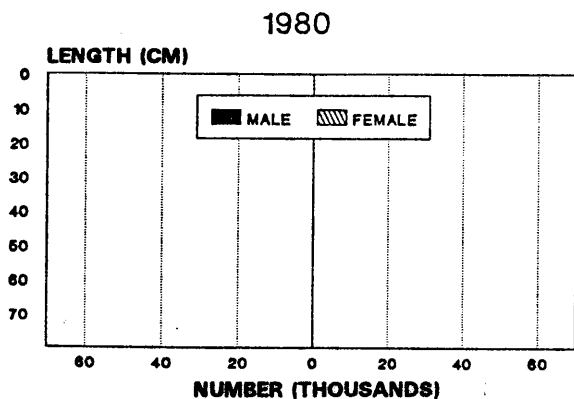

Figure 119. Size composition of sablefish in the Northwest area of the Aleutian Islands during the U.S.-Japan 1980, 1983, and 1986 groundfish surveys.

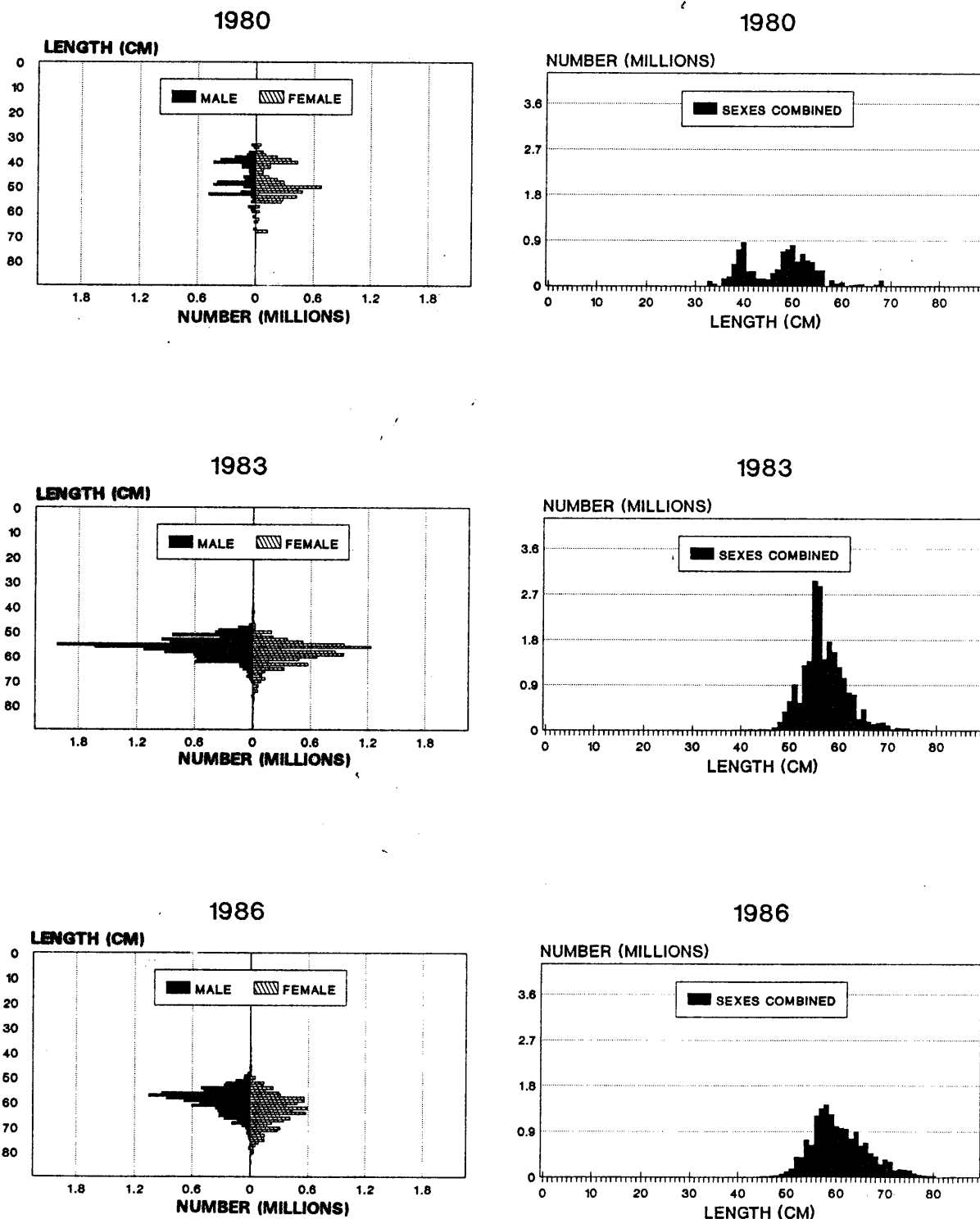

Figure 120. Size composition of sablefish in the Northeast area of the Aleutian Islands during the U.S.-Japan 1980, 1983, and 1986 groundfish surveys.

5- to 9-years-old from the 1981-1977 year classes, with 6-year-old fish from 1980 making up the largest portion of the stock (Table. 57). In the Southeast area the mode was considerably stronger peaking around 60 cm, and slightly skewed toward fish in the 60-70 cm size range. There were more females than males. No age data were available.

The size composition curve for the Northwest area peaked in the low 60 cm range. There were about as many males as females. The stock was composed primarily of 5- to 9-year-old fish, but 8-year-old fish from 1978 were dominant. The size composition curve in the Northeast area peaked in the high 50 cm range. There were about as many males as females. The 1982-1976 year classes of 4- to 10-year-old fish were the major contributors to the stock, with the 1976 year class of 10-year-old fish and the 1981 year class of 5-year-old fish providing the largest portions.

In the Southern Bering Sea area in 1980 the size composition was characterized by a unimodal curve ranging from 46 to 67 cm, peaking at 57 cm, with most of the fish between 50 and 62 cm (Fig. 121). In 1983, few measurements are available so the curve is extremely flat, ranging from 54 to 74 cm. In 1986 the stock ranged from 50 to 73 cm with a peak at 59-61 cm. During both 1980 and 1986, females out-numbered males, but in 1986 the sex ratio was nearly equal.

Mean Length-at-Age and Growth

The mean length-at-age data indicates an initial fast growth rate for sablefish, which obtained a size of 43 to 47 cm by age 2 (Table 58). Estimates of the yearly average growth increment varied considerably between 1983 and 1986. The 1983 data indicates that up until age 5 the average growth increment remained high, decreasing from 6.6 cm from age 2 to 3, to 4.0 cm from age 4 to 5. From age 5 to 7 years the average growth increment ranged from 1 to 2 cm per year (Table 59). The annual growth increment data for 1986 shows an oscillating pattern.

These data were fitted to the von Bertalanffy growth curve to provide estimate of t_0 , L_{INF} , and k (Table 60).

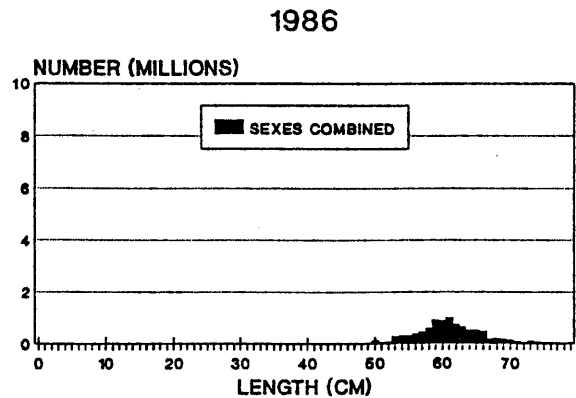
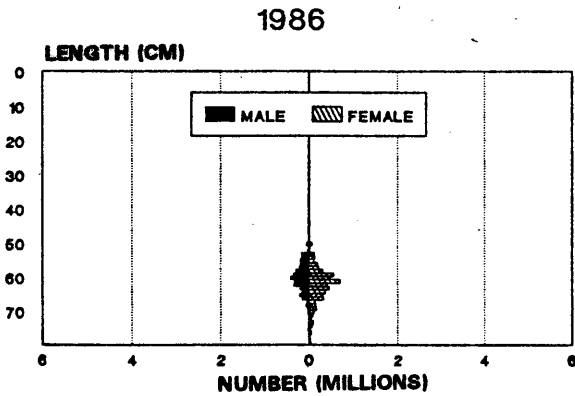
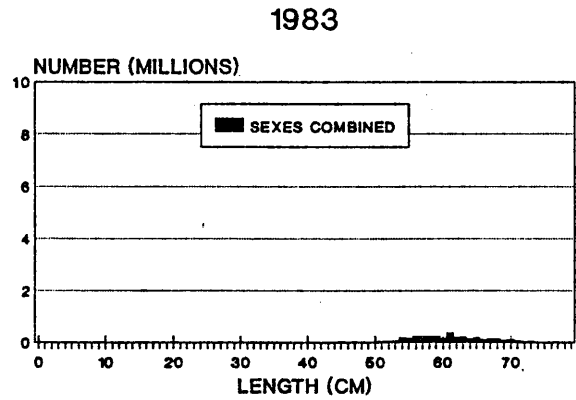
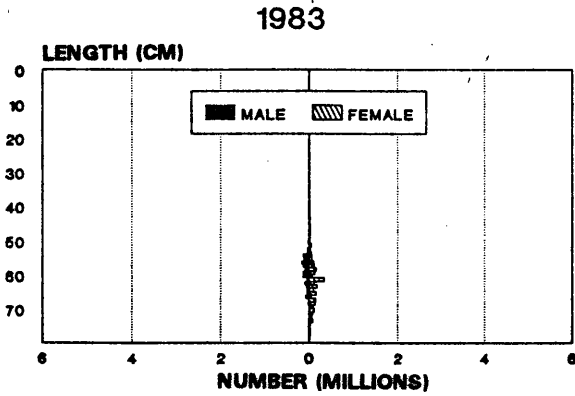
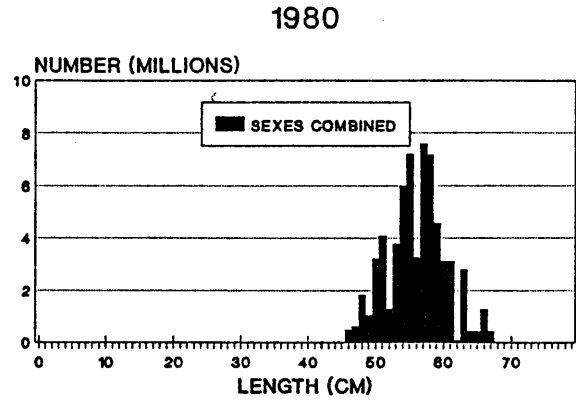
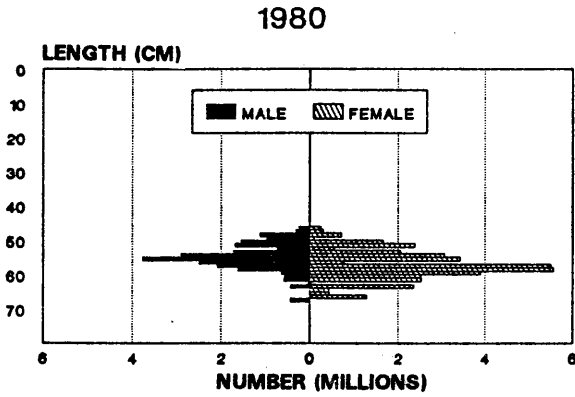

Figure 121. Size composition of sablefish in the Southern Bering Sea during the U.S.-Japan 1980, 1983, and 1986 Aleutian Islands groundfish surveys.

Table 58. Mean length (mm) at age for sablefish sampled during the U.S.-Japan 1983 and 1986 Aleutian Islands groundfish surveys.

Age	Year					
	1983			1986		
	m	F	M+F	m	F	M+F
1	-	-	-	-	-	-
2	429	443	434	470	-	470
3	494	508	500	505	-	505
4	548	553	550	555	607	582
5	583	602	590	578	604	592
6	585	624	601	587	610	599
7	612	635	619	592	646	621
8	640	720	660	611	661	635
9	-	726	735	612	664	641
10	657	-	657	628	665	644
11	-	820	820	627	672	648
12	-	-	-	619	675	643
13	-	697	700	644	710	669
14	-	-	-	644	677	659
15	660	697	680	680	710	695

Table 59. Estimates of yearly incremental growth (cm) of sablefish based on the U.S.-Japan 1980, 1983, and 1986 Aleutian Islands groundfish surveys.

Age	Year				Average
	1980	1983	1986		
2-3	-	6.6	3.5	5.1	
3-4	-	5.0	7.7	6.4	
4-5	-	4.0	1.0	2.5	
5-6	-	1.1	.7	0.9	
6-7	-	1.8	2.2	2.0	
7-8	-	4.1	1.4	2.8	

Table 60. Estimated von Bertalanffy growth curve parameters for sablefish sampled during the U.S.-Japan 1983 and 1986 Aleutian Islands groundfish surveys.

Area-Year	Sex	Range		von Bertalanffy		
		Age (Years)	Length (cm)	Growth Parameters		
				L_{inf}	k	t_0
Aleutian Islands						
1983	m	2-15	39-70	65.56	0.348	-1.090
	F	2-15	40-82	76.91	0.214	-1.911
	M+F	2-15	39-82	71.48	0.249	-1.851
1986	m	2-54	46-77	66.45	0.178	-5.735
	F	4-46	48-95	77.22	0.091	-11.765
	M+F	2-54	46-95	69.26	0.159	-7.051

Length-Weight Relationship

Length-weight data were collected during both the 1983 and 1986 surveys and the data analysis provided the yearly estimates of the constants a and b:

$$\begin{aligned} \text{Weight(g)} (1983) &= .0040 \times \text{Length(cm)}^{3.229} \\ \text{Weight(g)} (1986) &= .0016 \times \text{Length(cm)}^{3.458} \end{aligned}$$

From length categories 45-70 cm, data from both years provided nearly identical relationships; however, above 70 cm the fish were slightly heavier in 1986 for a given length than they were in 1983 (Fig. 122).

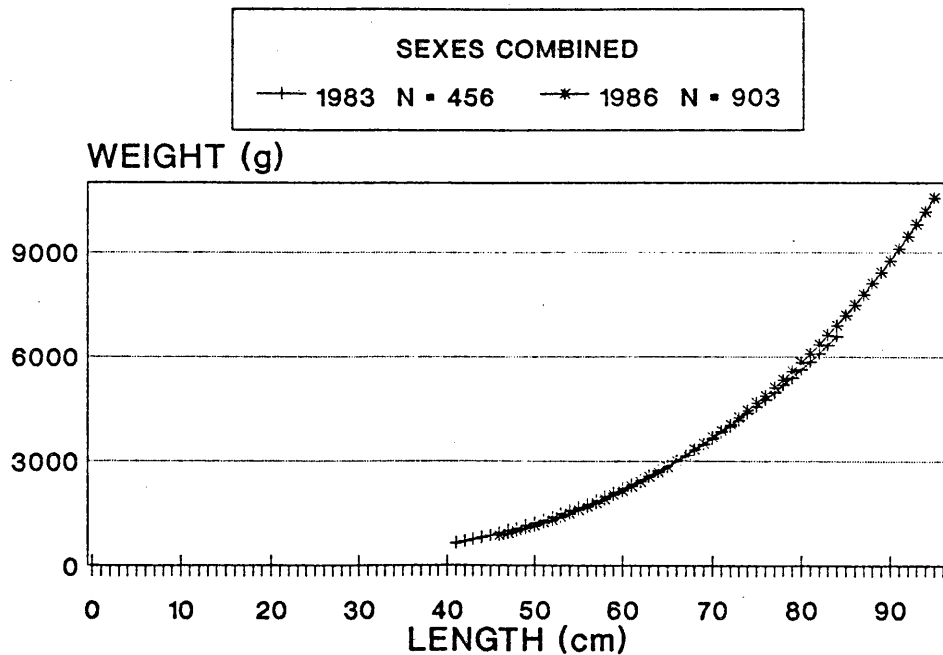

Figure 122. Length-weight relationships for sablefish in the Aleutian Islands area during the 1983 and 1986 groundfish surveys.

Greenland Turbot

Distribution and Abundance

Greenland turbot (Reinhardtius hippoglossoides) were encountered throughout the Aleutian Islands area and the Southern Bering Sea. Concentrations were located mostly on the north side of the Aleutian chain at depths greater than 300 m. High concentrations were found between Atka and Seguam Islands during both 1980 and 1986, and from Seguam Island to the Islands of Four Mountains, and on Petrel Bank in 1986 (Figs. 123-124). During the 1986 survey there was an increase in the occurrence of medium-density catches on Petrel Bank and Bowers Ridge, and along both sides of the Aleutian Islands chain west of 180° long. In the Southern Bering Sea, medium-density catches occurred west of Umnak Island and northwest of Unalaska Island.

The biomass estimate of Greenland turbot in the Aleutian Islands area increased from 31,000 t in 1980 to 52,000 t in 1983 and 68,000 t in 1986. The population estimate went from 12.6 million fish in 1980 to 13.3 million in 1983 and 18.6 million in 1986 (Table 61, Fig. 125). Each survey year, over 80% of the total biomass was located along the north side of the Aleutian chain with the largest portion located in the Northeast area. In 1983, 96% of the resource was on the north side with 76% occurring in the Northeast area. Over 98% of the Greenland turbot resource occurred at depths greater than 300 m.

In the Southern Bering Sea area the biomass estimate for Greenland turbot was 14,000 t in 1980, remained relatively unchanged at 14,000 t in 1983, and increased to 21,000 t in 1986. The population abundance decreased from 7.0 million fish in 1980 to 3.3 million in 1983, then increased to 6.6 million fish in 1986.

(Fig. 126).

Although population mean length and weights show some irregularities, they were highest in both the Aleutian Islands and Southern Bering Sea areas during the 1983 survey (Table 62, Figs. 127-128).

Size Composition

Size composition data indicate a substantial decline in the recruitment of small Greenland turbot in the Aleutian Islands during 1983 and 1986 as compared to 1980 (Fig. 129). In 1980 the size composition curve was trimodal with the largest mode made up of smaller fish consisting of equal numbers of males and females. This mode ranged from 40 to 60 cm, and peaked at 44-48 cm. The second mode was dominated by males and ranged from 60 to 71 cm, peaking at 65-68 cm. The third mode was dominated by females, and ranged from 72 to 90 cm, peaking at 79-86 cm.

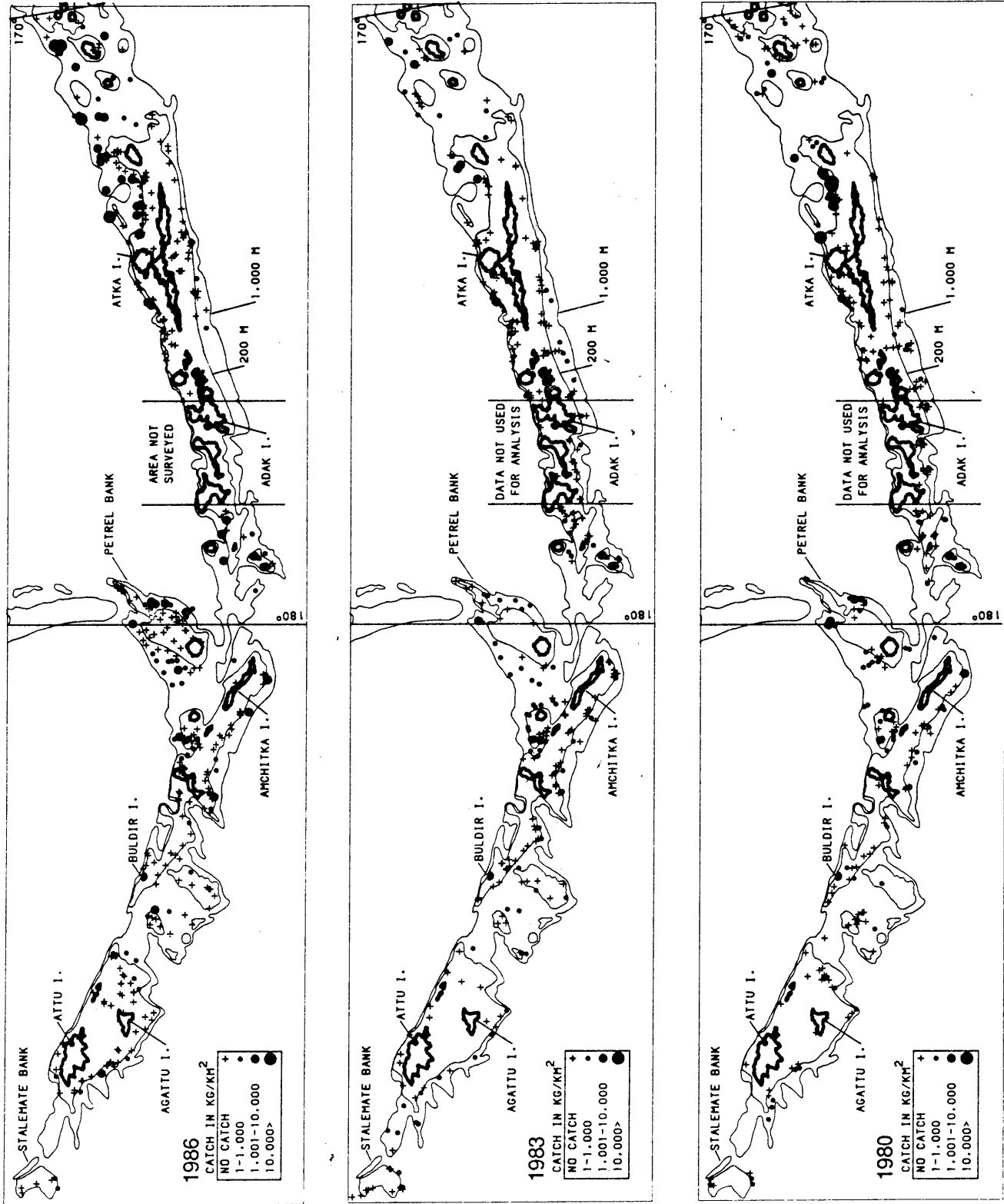

Figure 123. Distribution and relative abundance of Greenland turbot in the Aleutian Islands area during the U.S.-Japan 1980, 1983, and 1986 groundfish surveys.

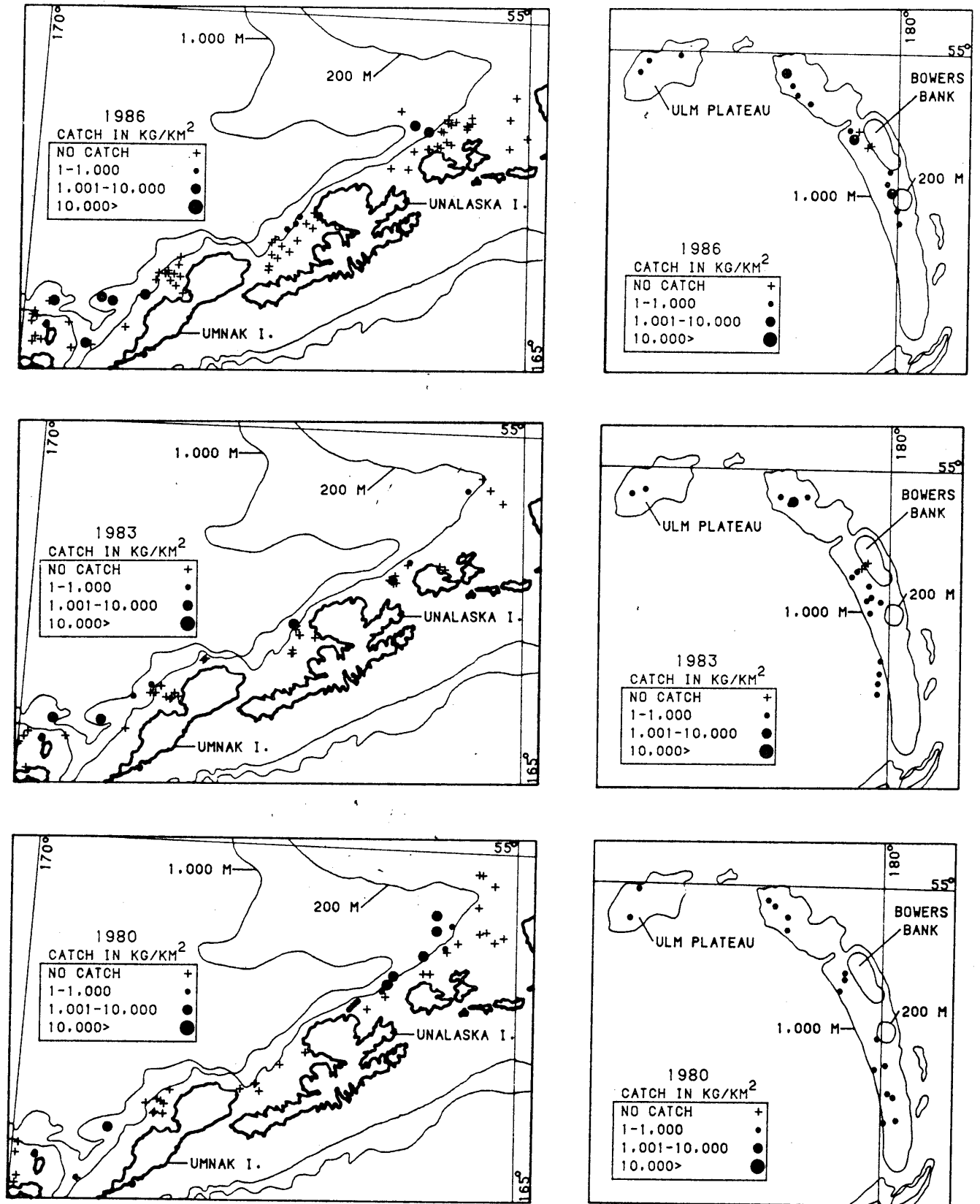

Figure 124. Distribution and relative abundance of Greenland turbot in the Southern Bering Sea and Bowers Ridge areas during the U.S.-Japan 1980, 1983, and 1986 Aleutian Islands groundfish surveys.

Table 61. Estimates of biomass, biomass sampling error, and population for Greenland turbot based on the U.S.-Japan 1980, 1983, and 1986 Aleutian Islands groundfish surveys.

Area	Depth (m)	Biomass (t)			Sampling Error (%)			Population (1,000s)		
		1980	1983	1986	1980	1983	1986	1980	1983	1986
Southwest	1-100	0	0	0				0.0	0.0	0.0
	101-200	0	7	6				0.0	5.1	1.3
	201-300	5	55	54				0.0	7.6	14.3
	301-500	605	638	2,065				299.9	122.2	637.4
	501-900	3,432	561	3,260				925.3	118.9	632.0
	1-900	4,042	1,261	5,385	87.4	33.2	73.1	1,225.2	253.8	1,285.0
Southeast	1-100	a	0	0				a	0.0	0.0
	101-200	1	0	24				0.0	0.0	3.5
	201-300	0	0	65				0.0	0.0	15.1
	301-500	468	526	1,372				81.9	105.0	353.6
	501-900	720	494	567				135.4	66.2	73.7
	1-900	1,189	1,020	2,028	171.8	57.2	70.3	217.3	171.2	445.9
Northwest	1-100	0	0	0				0.0	0.0	0.0
	101-200	0	0	0				0.0	0.0	0.0
	201-300	21	17	41				10.3	3.2	6.4
	301-500	439	2,247	1,206				184.7	919.5	245.9
	501-900	3,661	2,548	6,195				1,028.3	494.5	1,478.1
	1-900	4,121	4,812	7,442	53.5	76.7	109.9	1,225.3	1,417.2	1,730.4
Northeast	1-100	0	0	0				0.0	0.0	0.0
	101-200	52	11	0				47.7	2.1	0.0
	201-300	91	57	429				9.7	7.7	94.0
	301-500	2,433	12,679	18,418				755.1	3,483.1	6,814.0
	501-900	14,737	26,823	27,512				7,758.4	6,967.2	7,248.0
	1-900	17,313	39,570	46,359	76.5	59.8	34.4	8,570.9	10,470.1	14,156.0
Bowers Ridge	101-200	a	0	0				a	0.0	0.0
	201-300	408	7	44				355.6	9.2	6.4
	301-500	989	1,888	1,841				497.2	444.4	296.5
	510-900	2,997	3,254	4,658				549.1	515.5	677.1
	101-900	4,394	5,149	6,543	213.3	45.2	45.3	1,401.9	968.7	980.0
Aleutian Islands	1-100	0	0	0	0.0	0.0	0.0	0.0	0.0	0.0
	101-200	53	18	30	134.6	133.5	41.0	47.7	7.2	4.8
Total	201-300	525	136	633	25.4	88.0	55.6	375.6	27.7	136.2
	301-500	4,934	17,978	24,902	55.4	109.7	46.7	1,818.8	5,073.8	8,347.4
	501-900	25,547	33,680	42,192	49.0	66.0	33.3	10,396.5	5,816.2	10,108.9
	1-900	31,059	51,812	67,757	41.5	44.7	25.9	12,638.6	13,271.0	18,597.3
Southern Bering Sea	1-100	32	0	0				7.9	0.0	0.0
	101-200	61	0	0				0.0	0.0	0.0
Total	201-300	139	54	86				57.6	12.7	11.1
	301-500	2,415	1,320	9,150				1,667.3	317.0	3,336.2
	501-900	11,284	12,659	11,283				5,312.0	2,962.7	3,238.9
	1-900	13,931	14,033	20,519	22.2	622.5	342.3	7,044.8	3,292.4	6,586.2

a No sampling was conducted in this area-depth interval.

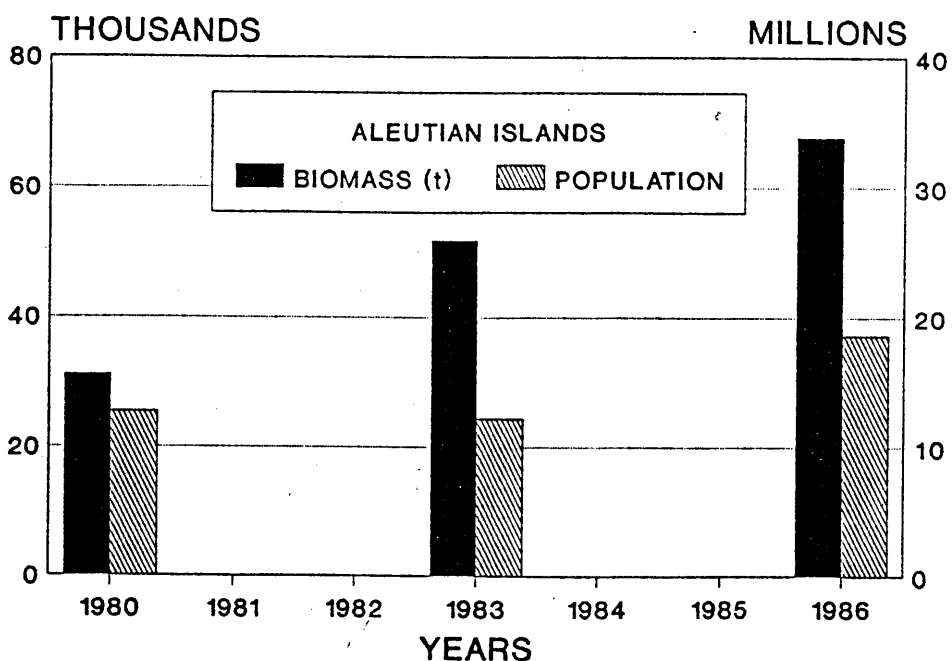

Figure 125. Estimated biomass and population of Greenland turbot in the Aleutian Islands area during the U.S.-Japan 1980, 1983, and 1986 groundfish surveys.

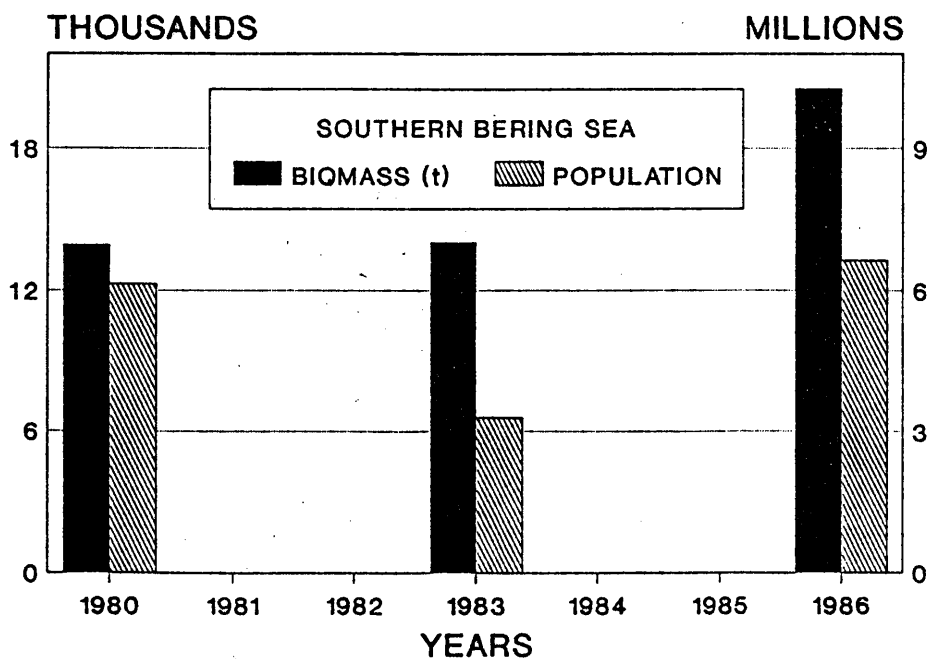

Figure 126. Estimated biomass and population of Greenland turbot in the Southern Bering Sea area during the U.S.-Japan 1980, 1983, and 1986 Aleutian Islands groundfish surveys.

Table 62. Estimates of mean catch per unit effort, length, and weight for Greenland turbot based on the U.S.-Japan 1980, 1983, and 1986 Aleutian Islands groundfish surveys.

Area	Depth (m)	Mean CPUE (kg/km ²)			Mean Length (cm)			Mean Weight (kg)		
		1980	1983	1986	1980	1983	1986	1980	1983	1986
Southwest	1-100	a	0.0	0.0	a	0.0	0.0	a	0.00	0.00
	101-200	0.0	1.0	0.9	0.0	0.0	0.0	0.00	1.33	4.42
	201-300	2.0	23.8	23.7	0.0	0.0	0.0	0.00	6.96	3.81
	301-500	177.4	187.2	605.7	68.9	71.2	54.4	2.02	5.08	3.23
	501-900	487.9	79.8	463.4	79.4	71.4	66.1	3.72	4.67	5.14
	1-900	187.5	56.8	233.8	74.0	71.3	63.3	3.30	4.87	4.18
Southeast	1-100	0.0	0.0	0.0	0.0	0.0	0.0	0.00	0.00	0.00
	101-200	0.3	0.0	7.5	0.0	0.0	0.0	0.00	0.00	6.95
	201-300	0.0	0.0	20.5	0.0	0.0	0.0	0.00	0.00	4.60
	301-500	171.8	167.6	437.1	67.3	71.0	79.2	5.72	4.79	3.61
	501-900	354.2	174.7	200.3	0.0	82.1	73.1	5.32	7.47	7.64
	1-900	106.3	73.0	134.8	67.3	75.5	75.4	5.47	5.80	4.30
Northwest	1-100	0.0	0.0	0.0	0.0	0.0	0.0	0.00	0.00	0.00
	101-200	0.0	0.0	0.0	0.0	0.0	0.0	0.00	0.00	0.00
	201-300	19.6	15.9	38.0	0.0	73.9	58.2	2.04	5.39	6.27
	301-500	197.9	1,014.2	544.4	75.0	64.4	56.4	2.35	2.62	4.75
	501-900	815.5	567.5	1,379.8	73.7	75.7	67.0	3.56	5.15	4.15
	1-900	370.9	377.0	583.1	73.9	68.6	65.3	3.36	3.55	4.25
Northeast	1-100	0.0	0.0	0.0	0.0	0.0	0.0	0.00	0.00	0.00
	101-200	13.2	2.9	0.0	0.0	0.0	0.0	1.08	5.28	0.00
	201-300	37.3	23.3	175.6	71.5	0.0	84.4	9.36	7.71	4.54
	301-500	708.6	3,693.0	5,611.0	66.0	71.5	66.8	3.22	3.52	2.70
	501-900	2,489.3	4,339.9	4,451.2	71.0	69.8	56.3	1.89	4.65	3.82
	1-900	966.2	2,310.2	2,614.8	68.6	70.4	57.2	2.01	4.22	3.29
Bowers Ridge	101-200	a	0.0	0.0	a	0.0	0.0	a	0.00	0.00
	201-300	334.3	5.8	36.3	0.0	0.0	48.4	1.15	0.77	6.95
	301-500	617.3	1,178.6	1,149.3	82.7	71.2	53.7	1.90	4.00	6.19
	501-900	420.9	457.0	654.1	84.1	84.5	72.3	5.46	6.46	6.93
	101-900	441.9	502.1	638.0	83.6	78.1	59.6	3.09	5.23	6.71
Aleutian Islands	1-100	0.0	0.0	0.0	0.0	0.0	0.0	0.00	0.00	0.00
	101-200	3.4	1.1	1.8	0.0	0.0	0.0	1.10	2.49	6.25
Total	201-300	51.5	13.3	62.1	71.5	73.9	49.2	1.40	4.92	4.67
	301-500	368.6	1,302.9	1,824.6	67.1	70.3	60.3	2.68	3.48	2.97
	501-900	960.5	1,217.9	1,525.6	72.8	71.4	59.3	2.45	4.84	4.19
	1-900	433.1	678.8	859.6	70.2	70.9	59.1	2.45	4.26	3.65
Southern Bering Sea	1-100	6.7	0.0	0.0	0.0	0.0	0.0	4.08	0.00	0.00
	101-200	18.5	0.0	0.0	0.0	0.0	0.0	0.00	0.00	0.00
Total	201-300	138.7	53.6	85.7	0.0	0.0	63.6	2.41	4.72	7.70
	301-500	1,897.9	1,037.1	7,190.4	65.4	73.3	54.1	1.46	4.21	2.75
	501-900	4,962.2	5,566.9	4,961.7	70.8	72.5	57.8	2.56	4.28	3.42
	1-900	1,102.2	1,110.2	1,623.4	68.1	72.6	56.9	2.27	4.27	3.09

a No sampling was conducted in this area-depth interval.

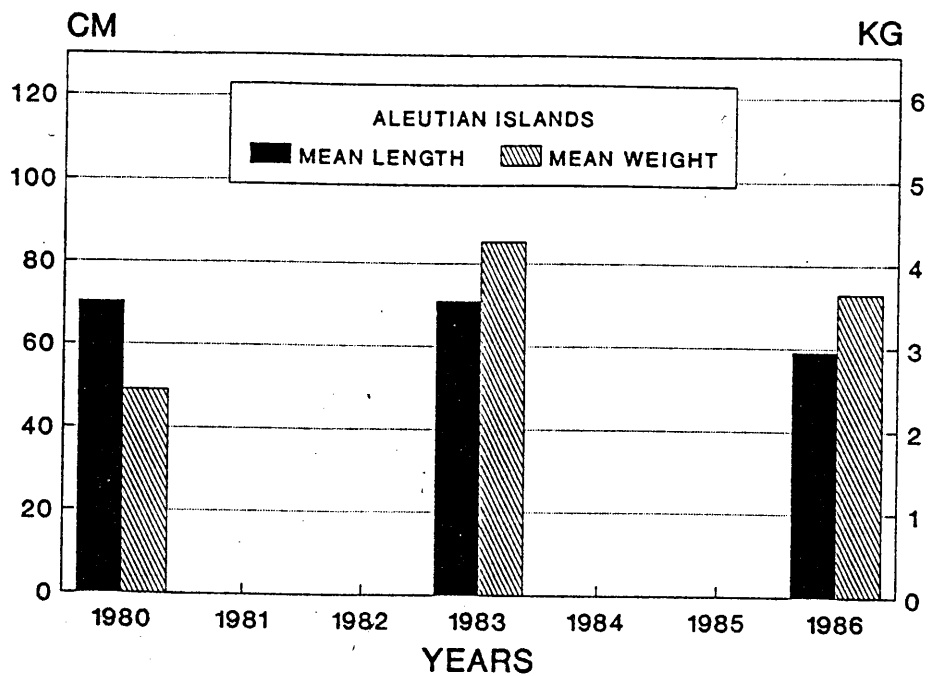

Figure 127. Mean length and weight of Greenland turbot in the Aleutian Islands area during the U.S.-Japan 1980, 1983, and 1986 groundfish surveys.

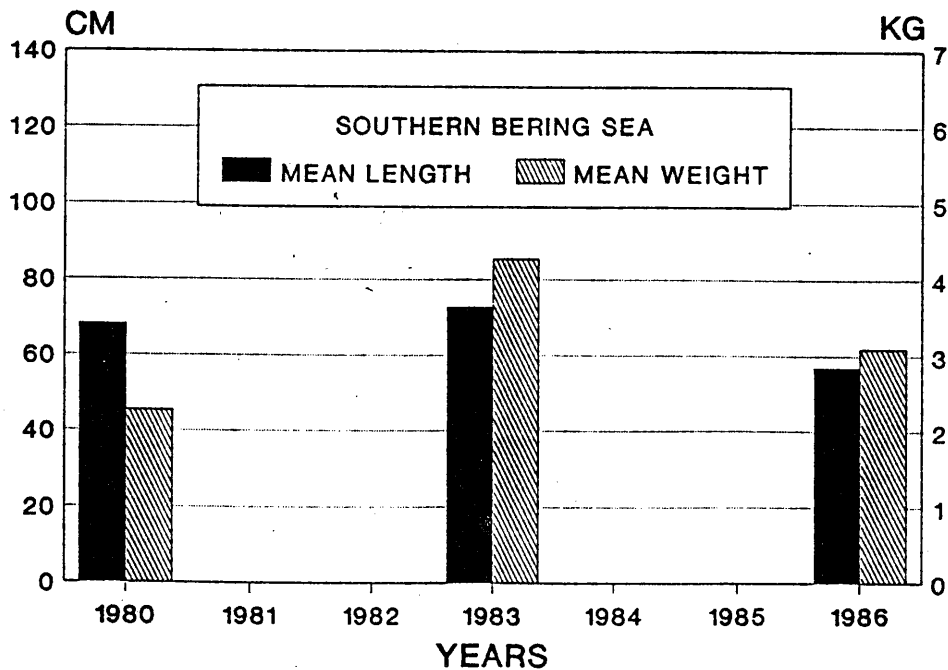

Figure 128. Mean length and weight of Greenland turbot in the Southern Bering Sea area during the U.S.-Japan 1980, 1983, and 1986 Aleutian Islands groundfish surveys.

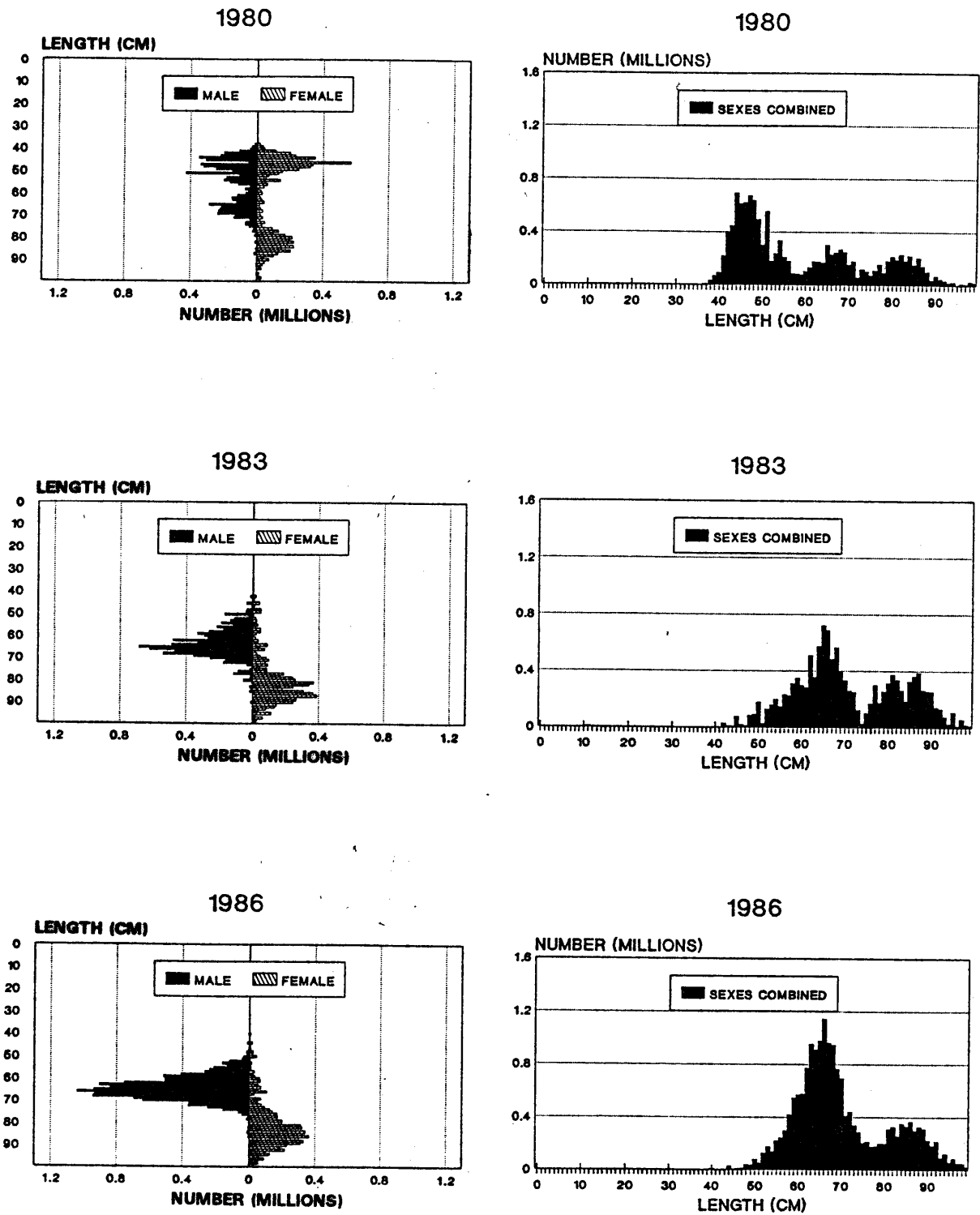

Figure 129. Size composition of Greenland turbot in the Aleutian Islands area during the U.S.-Japan 1980, 1983, and 1986 groundfish surveys.

In 1983 the size composition curve was again trimodal, but the large mode of smaller fish was not present. The principle mode was composed of larger fish dominated by males ranging from 60 to 73 cm. The secondary modes ranged from 74-84 cm to 85-94 cm and were dominated by females.

The 1986 size composition was bimodal with the strongest principle mode ranging from 60 to 76 cm, skewed toward larger fish, and dominated by males. There is a single secondary mode ranging from 77 to 100 cm dominated by females.

Size composition curves for each survey area are shown in Figs. 130-133.

No age composition data are available for Greenland turbot.

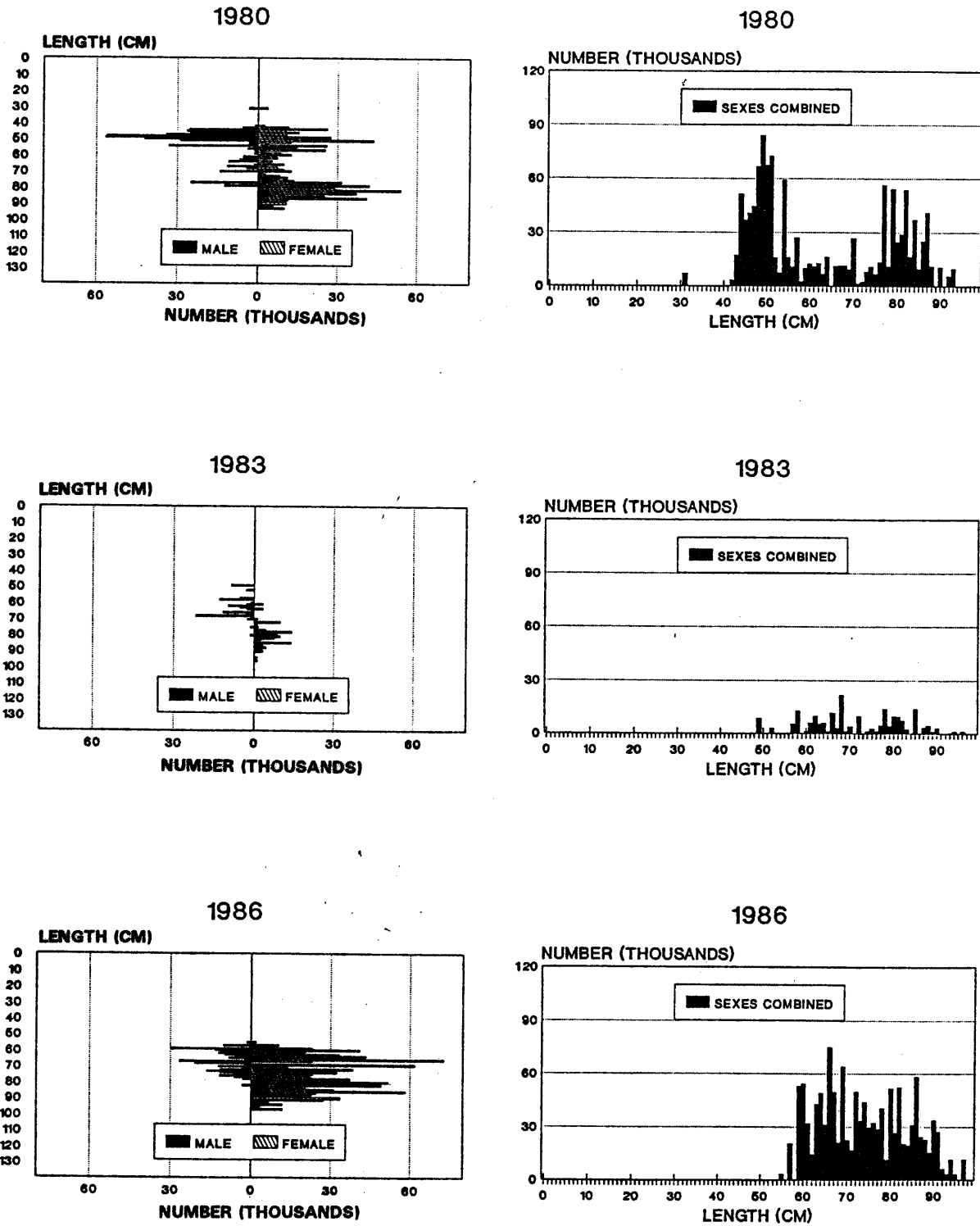

Figure 130. Size composition of Greenland turbot in the Southwest area of the Aleutian Islands during the U.S.-Japan 1980, 1983, and 1986 groundfish surveys.

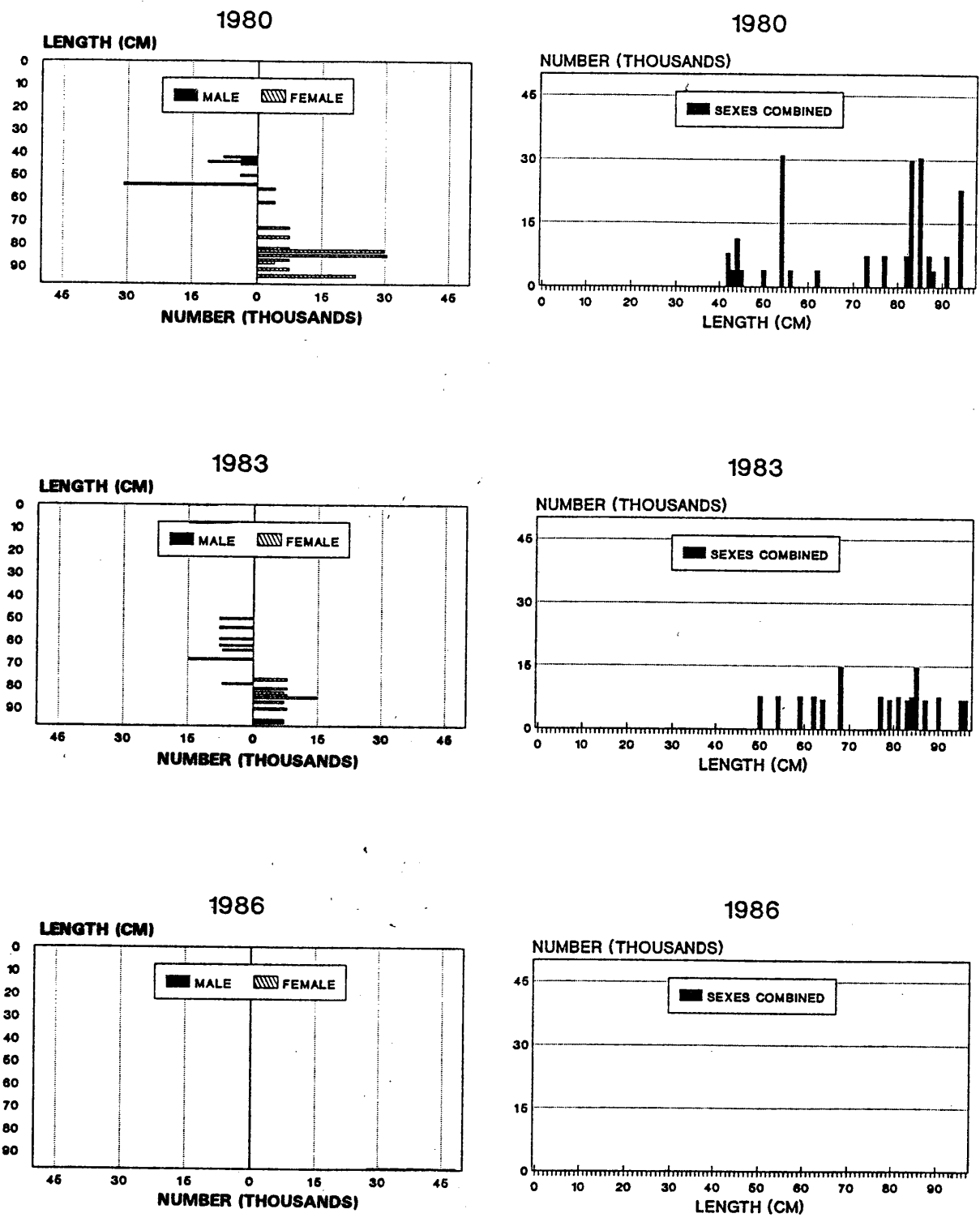

Figure 131. Size composition of Greenland turbot in the Southeast area of the Aleutian Islands during the U.S.-Japan 1980, 1983, and 1986 groundfish surveys.

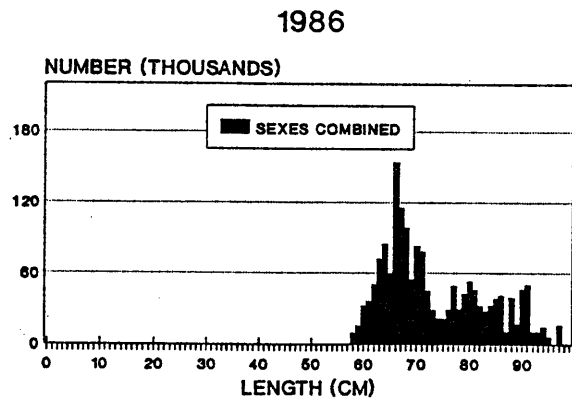
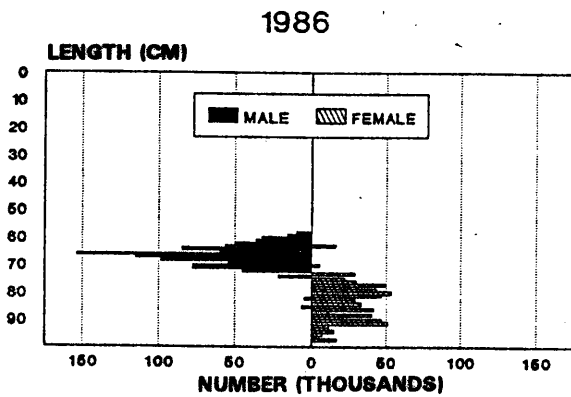
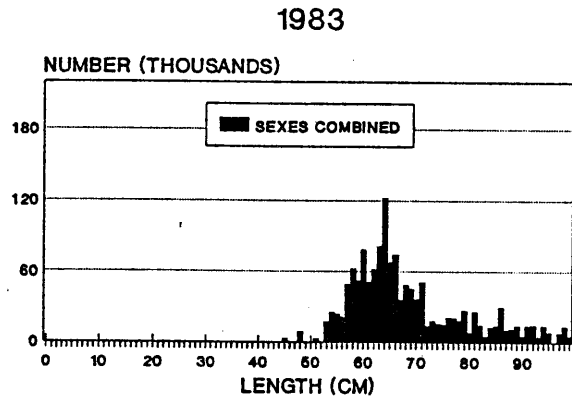
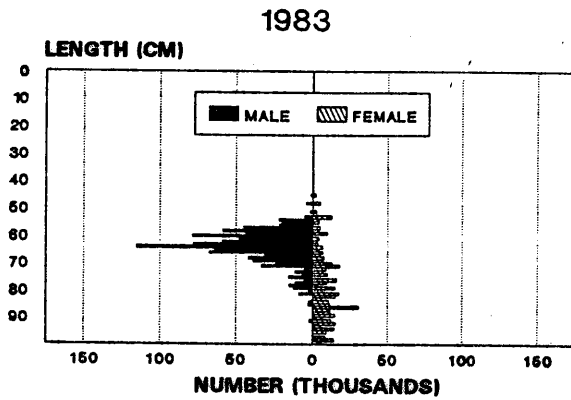
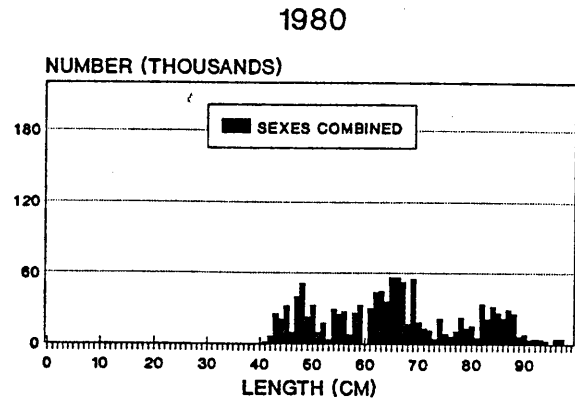
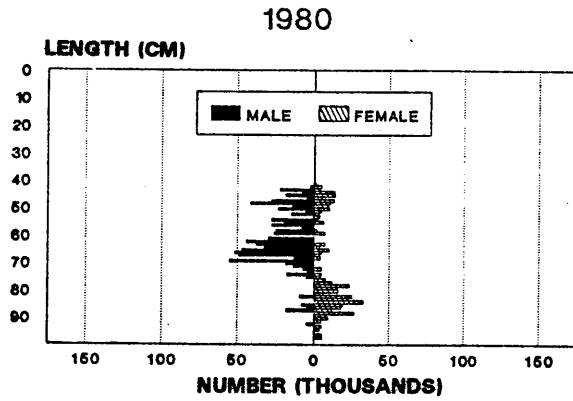

Figure 132. Size composition of Greenland turbot in the Northwest area of the Aleutian Islands during the U.S.-Japan 1980, 1983, and 1986 groundfish surveys.

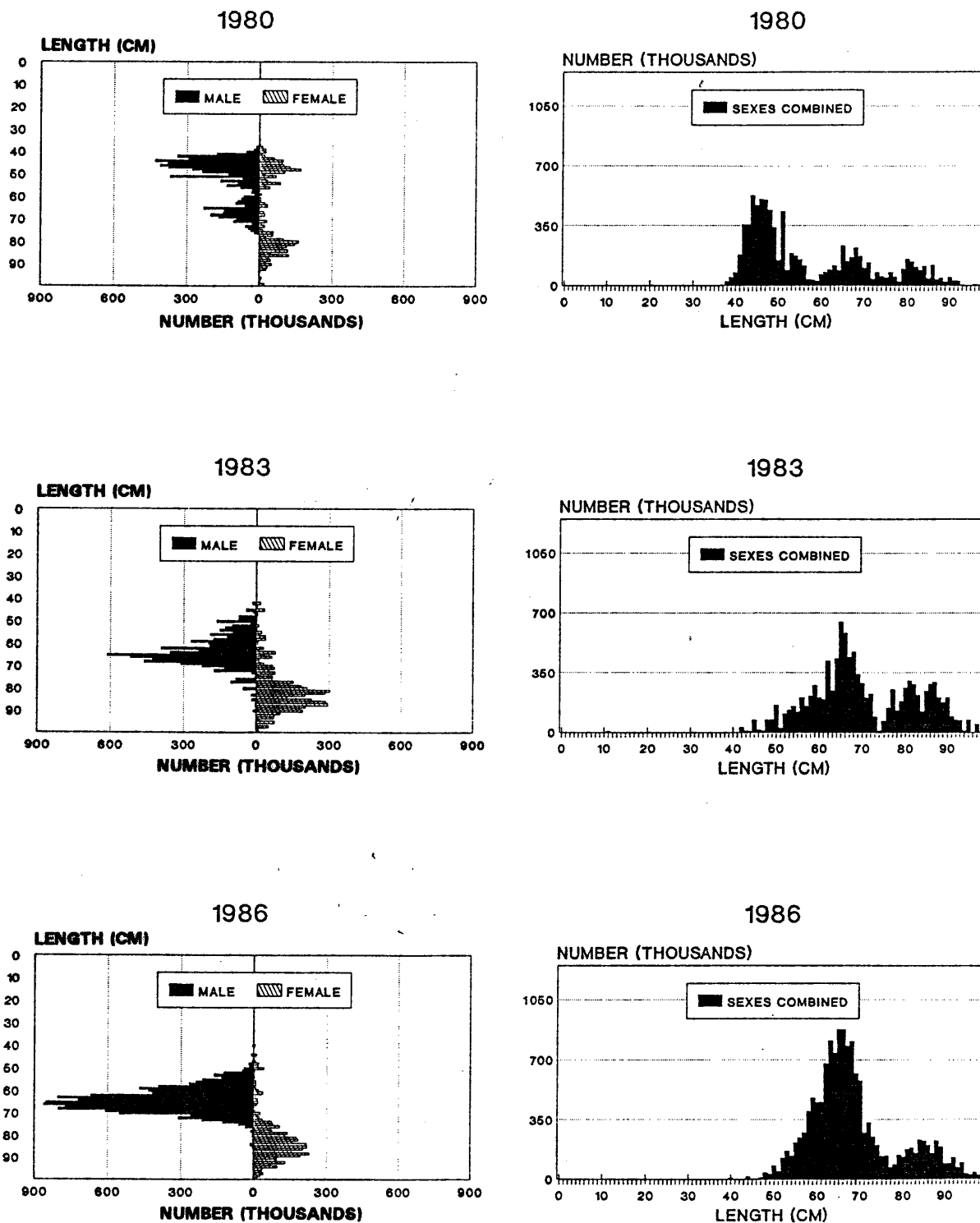

Figure 133. Size composition of Greenland turbot in the Northeast area of the Aleutian Islands during the U.S.-Japan 1980, 1983, and 1986 groundfish surveys.

Length-Weight Relationship

Greenland turbot length-weight relationships for the Aleutian Islands area are presented below:

$$\begin{aligned} \text{Weight(g)} \text{ (1980)} &= .0007 \times \text{Length(cm)}^{3.609} \\ \text{Weight(g)} \text{ (1983)} &= .0012 \times \text{Length(cm)}^{3.493} \\ \text{Weight(g)} \text{ (1986)} &= .0004 \times \text{Length(cm)}^{3.722} \end{aligned}$$

These relationships were very similar for all 3 years; however, the weight for a given length was slightly lighter during the 1980 survey (Fig. 134).

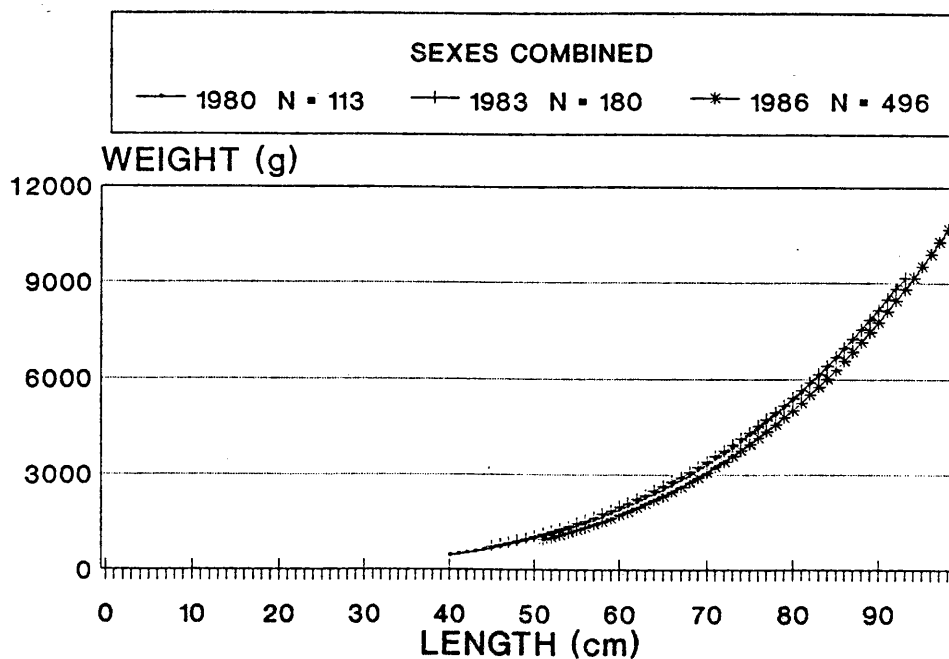

Figure 134. Length-weight relationships for Greenland turbot in the Aleutian Islands area during the U.S.-Japan 1980, 1983, and 1986 groundfish surveys.

Rougheye Rockfish

Distribution and Abundance

Rougheye rockfish (*Sebastes aleutianus*) were found throughout the Aleutian Islands area and the Southern Bering Sea in all depth intervals, but were most prevalent in the 301-500 m depth interval (Figs. 135-136). During 1980 and 1983, no high-density concentrations of rougheye rockfish were encountered, but medium-densities were found in waters of both the eastern and western Aleutian Islands. In the eastern areas medium-densities were found north of the Islands of Four Mountains, in Seguam Pass, south of Atka Island, northwest and south of Adak Island, and northwest of the Delarof Islands.

In the western areas, medium-density concentrations were found near Buldir Island and on Tahoma and Buldir Reefs. In 1986, several high-density concentrations were defined in both the eastern and western portions of the Aleutian Islands: north of Amlia Island, south of Atka Island, south of Kiska Island, on Tahoma Reef, and south of Buldir Island.

The biomass estimates for rougheye rockfish followed the same pattern as northern rockfish; the estimates were similar in 1980 and 1983, but there was a large increase in 1986. The biomass estimate went from 19,000 t in 1980 to 22,000 t in 1983, and increased 252% to 55,000 t in 1986. The population went from 23.3 million in 1980 to 20.9 million in 1983 and 47.3 million in 1986. (Table 63, Fig. 137).

In 1983 the biomass estimate increased moderately in the Southwest, Northeast, and Bowers Ridge areas and decreased 50% in the Southeast and 41% in the Northwest areas. In 1986, there were large increases in biomass in several areas. The estimate for the Southwest area increased by 733%, the Northwest area increased by 217%, and the Southeast area increased by 205%. A moderate decrease of 27% occurred in the Northeast area and the estimate for Bowers Ridge decreased by 21%.

In the Southern Bering Sea area, biomass increased from 900 t in 1980 to 2,800 t in 1983 and 4,100 t in 1986 (Fig. 138). Population went from 0.9 million in 1980 to 2.8 million in 1983 to 4.0 million in 1986.

Mean population lengths and weights for rougheye rockfish showed some irregularities (Table 64, Figs. 139-140). In the Aleutian Islands area the largest mean length occurred during the 1980 survey and the largest mean weight in the 1983 survey. In the Southern Bering Sea area the largest mean length occurred during the 1986 survey and the largest mean weight during the 1980 survey.

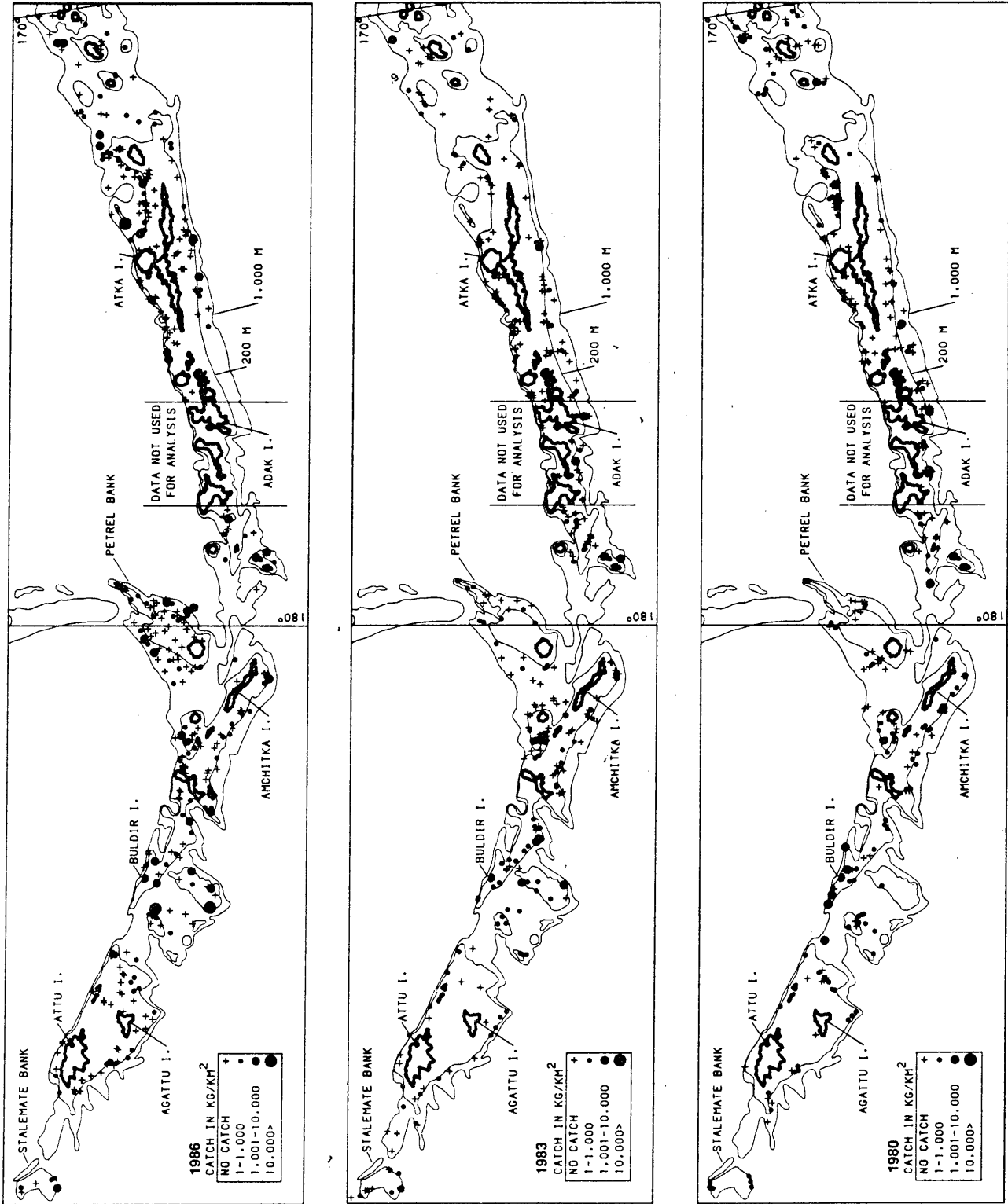

Figure 135. Distribution and relative abundance of roughgeyer rockfish in the Aleutian Islands area during the U.S.-Japan 1980, 1983, and 1986 groundfish surveys.

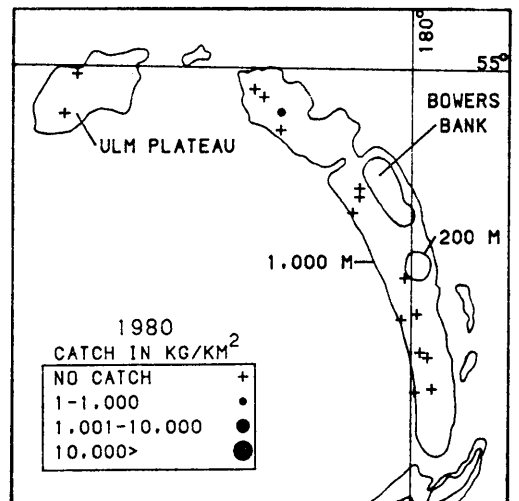
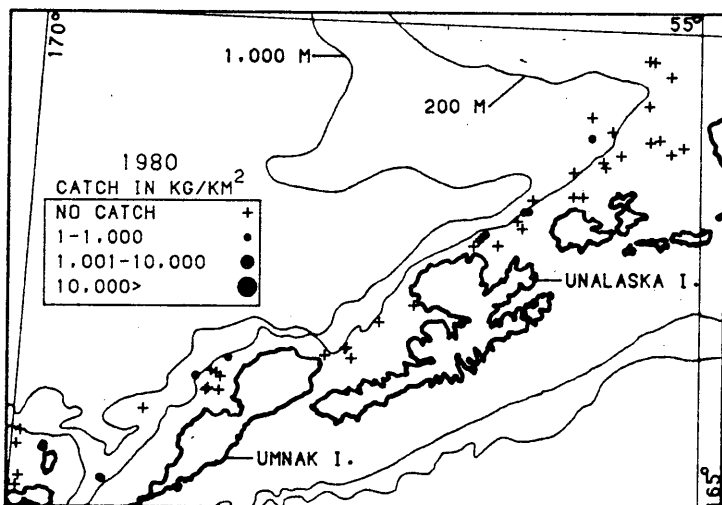
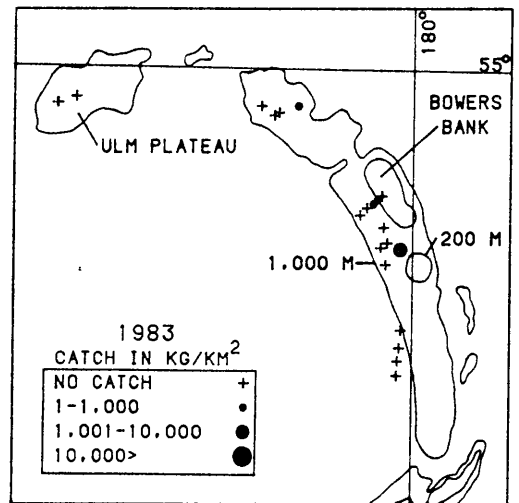
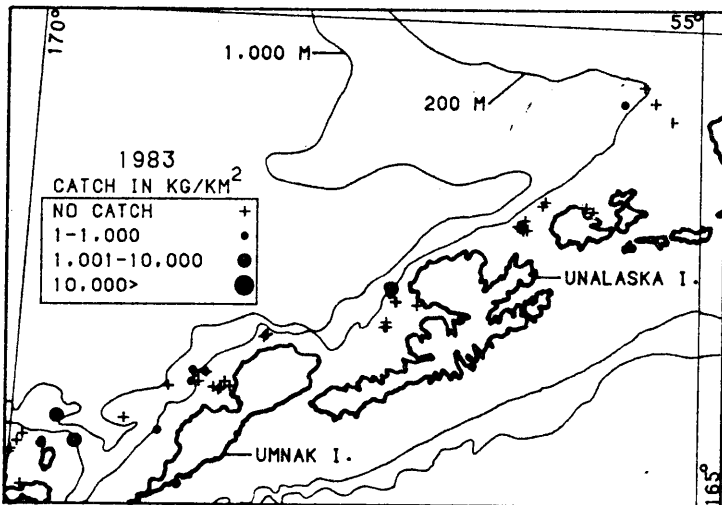
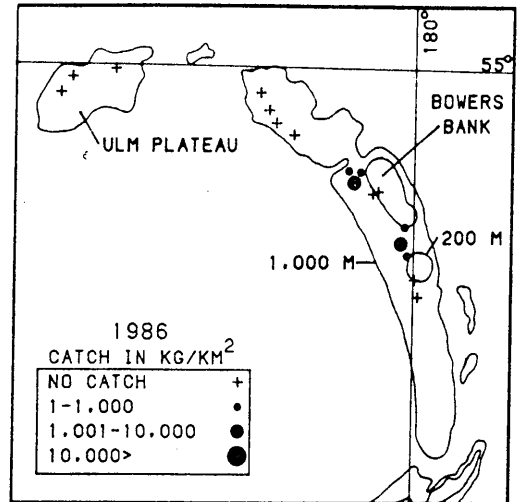
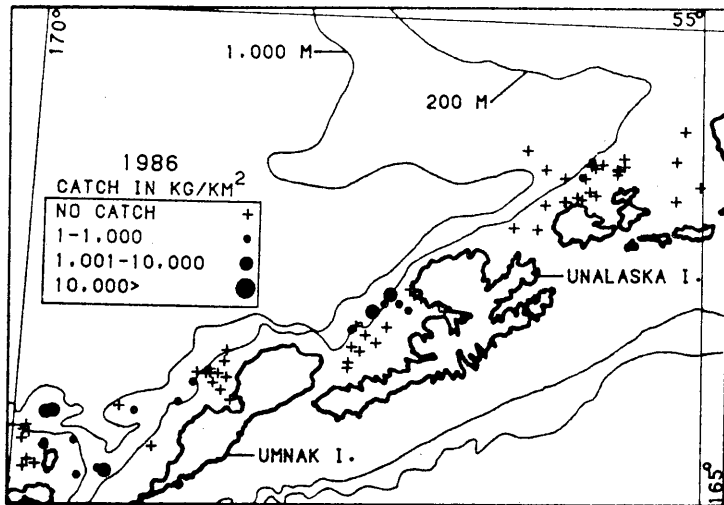

Figure 136. Distribution and relative abundance of roughey rockfish in the Southern Bering Sea and Bowers Ridge areas during the U.S.-Japan 1980, 1983, and 1986 Aleutian Islands groundfish surveys.

Table 63. Estimates of biomass, biomass sampling error, and population for rougheye rockfish based on the U.S.-Japan 1980, 1983, and 1986 Aleutian Islands groundfish surveys.

Area	Depth (m)	Biomass (t)			Sampling Error (%)			Population (1,000s)		
		1980	1983	1986	1980	1983	1986	1980	1983	1986
Southwest	1-100	0	79	95				0.0	73.8	112.6
	101-200	450	2,258	5,955				846.8	2,635.1	8,863.9
	201-300	1,038	825	283				4,641.5	1,183.6	323.1
	301-500	1,525	1,551	29,144				3,964.9	1,254.7	21,519.3
	501-900	155	139	98				124.8	100.4	69.7
	1-900	3,168	4,852	35,575	37.6	44.3	186.0	9,578.0	5,244.6	30,888.6
Southeast	1-100	a	0	0				a	0.0	0.0
	101-200	90	133	15				0.0	193.9	16.1
	201-300	256	2,541	1,243				254.6	4,144.6	1,401.1
	301-500	7,598	1,342	6,973				4717.6	1,364.0	5,525.3
	501-900	47	0	0				0.0	0.0	0.0
	1-900	7,991	4,016	8,231	368.4	140.7	67.8	4972.2	5,702.5	6,942.8
Northwest	1-100	0	11	0				0.0	13.4	0.0
	101-200	0	88	316				0.0	132.7	348.1
	201-300	361	287	320				593.6	446.8	570.6
	301-500	1,785	891	1,294				1,779.9	633.1	1,047.9
	501-900	21	0	836				0.0	0.0	612.9
	1-900	2,167	1,277	2,766	33.9	100.5	73.9	2,373.5	1,226.0	2,579.5
Northeast	1-100	0	0	0				0.0	0.0	0.0
	101-200	297	191	292				562.6	252.1	289.7
	201-300	362	363	3,047				807.9	427.4	3,058.6
	301-500	4,570	8,305	3,120				4,946.6	6,1058.0	2,118.3
	501-900	132	43	14				0.0	33.8	13.1
	1-900	5,361	8,902	6,473	100.3	192.7	83.9	6,317.1	6,871.3	5,479.7
Bowers Ridge	101-200	a	3	0				a	1.7	0.0
	201-300	0	2,895	1,113				0.0	1,831.9	756.8
	301-500	188	42	1,201				78.5	23.5	699.5
	510-900	0	0	0				0.0	0.0	0.0
	101-900	188	2,940	2,314	1,270.6	944.0	142.2	78.5	1,857.1	1,456.3
Aleutian Islands	1-100	0	90	95	0.0	1,116.4	430.3	0.0	87.2	112.6
	101-200	837	2,673	6,578	102.4	75.3	142.2	1,409.4	3,215.5	9,517.8
Total	201-300	2,017	6,911	6,006	52.1	560.9	98.3	6,297.6	8,034.3	6,110.5
	301-500	15,666	12,131	41,732	195.4	146.5	157.5	15,487.5	9,430.3	30,910.3
	501-900	355	182	948	71.0	149.8	137.9	124.8	134.2	695.7
	1-900	18,875	21,987	55,359	162.8	66.0	121.0	23,319.3	20,901.2	47,346.9
Southern Bering Sea	1-100	0	0	0				0.0	0.0	0.0
Total	101-200	25	60	256				0.0	59.5	373.8
	201-300	23	986	761				15.3	1,315.4	1,525.7
Total	301-500	874	1,768	3,000				847.7	1,419.0	2,032.9
	501-900	0	15	78				0.0	11.1	42.5
	1-900	922	2,829	4,095	8.2	375.1	712.5	863.0	2,805.0	3,974.9

a No sampling was conducted in this area-depth interval.

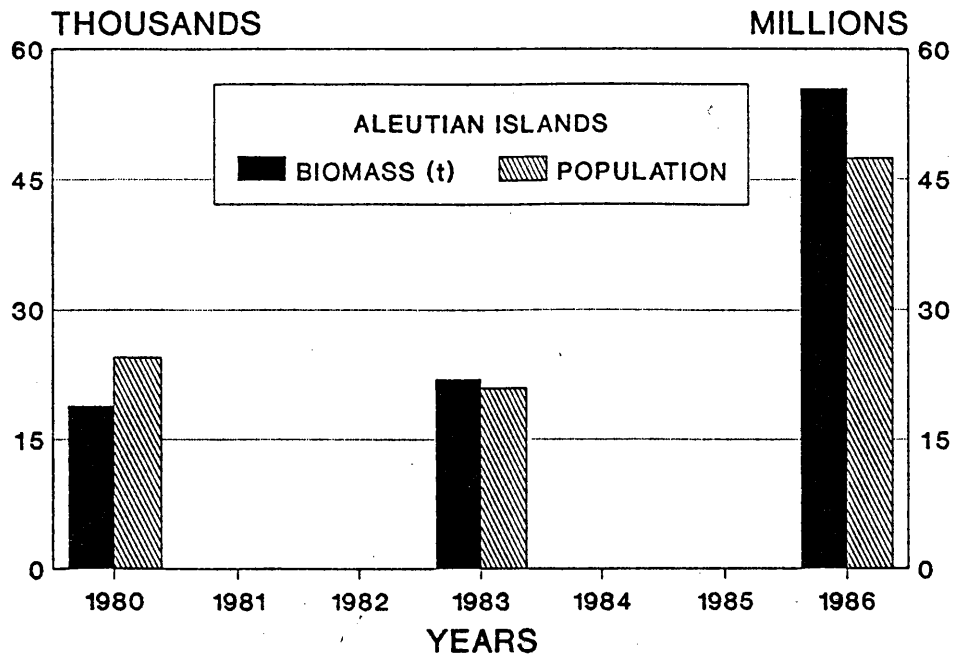

Figure 137. Estimated biomass and population of roughey rockfish in the Aleutian Islands area during the U.S.-Japan 1980, 1983, and 1986 groundfish surveys.

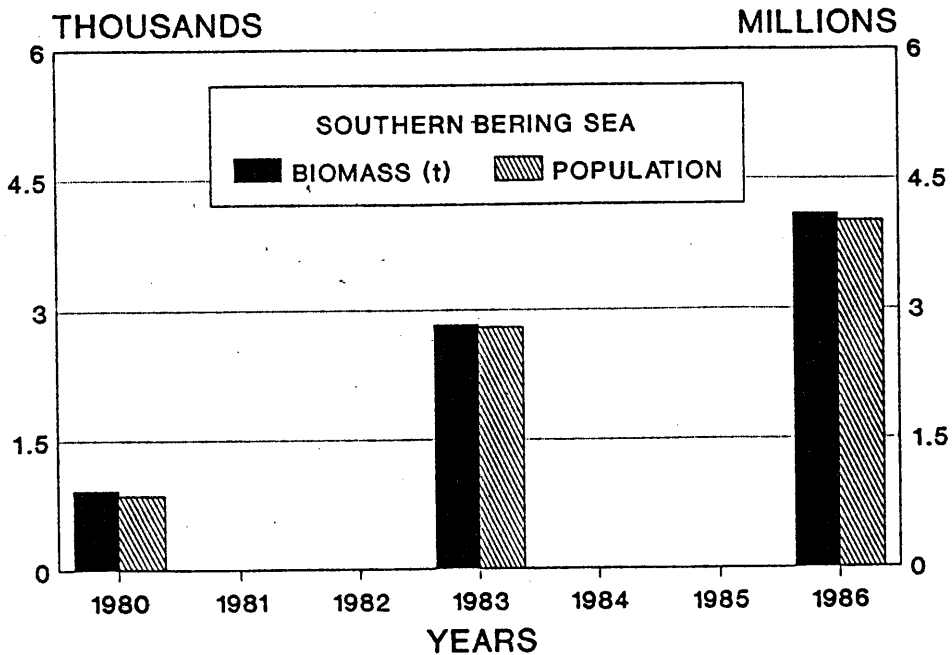

Figure 138. Estimated biomass and population of roughey rockfish in the Southern Bering Sea area during the U.S.-Japan 1980, 1983, and 1986 Aleutian Islands groundfish surveys.

Table 64. Estimates of mean catch per unit effort, length, and weight for rougheye rockfish based on the U.S.-Japan 1980, 1983, and 1986 Aleutian Islands groundfish surveys.

Area	Depth (m)	Mean CPUE (kg/km ²)			Mean Length (cm)			Mean Weight (kg)		
		1980	1983	1986	1980	1983	1986	1980	1983	1986
Southwest	1-100	0.0	26.9	25.3	0.0	37.4	0.0	0.00	1.07	0.84
	101-200	68.9	345.8	911.9	35.2	37.1	31.8	0.53	0.86	0.67
	201-300	452.4	359.4	123.5	38.2	34.1	31.5	0.23	0.69	0.87
	301-500	447.3	455.0	8,548.3	43.8	41.6	35.3	0.32	1.21	1.35
	501-900	22.1	19.7	13.9	0.0	41.4	36.0	1.25	1.37	1.40
	1-900	147.0	218.5	1,544.6	41.2	37.6	33.3	0.31	0.92	1.15
Southeast	1-100	a	0.0	0.0	a	0.0	0.0	a	0.00	0.00
	101-200	27.5	40.7	4.5	0.0	35.8	0.0	0.00	0.69	0.92
	201-300	81.1	804.3	393.4	36.9	36.8	42.3	1.01	0.61	0.90
	301-500	2,789.9	427.6	2,221.8	43.3	40.2	28.2	1.42	0.98	1.26
	501-900	22.9	0.0	0.0	0.0	0.0	0.0	0.00	0.00	0.00
	1-900	714.2	287.3	547.1	42.0	37.6	28.2	1.42	0.70	1.19
Northwest	1-100	0.0	4.8	0.0	0.0	0.0	0.0	0.00	0.85	0.00
	101-200	0.0	33.6	120.4	37.7	32.0	0.0	0.00	0.68	0.90
	201-300	337.2	268.1	299.1	31.7	33.9	28.9	0.67	0.63	0.56
	301-500	805.8	402.0	583.9	42.2	42.5	37.3	1.00	1.41	1.24
	501-900	4.7	0.0	186.2	42.5	0.0	0.0	0.00	0.00	1.36
	1-900	195.1	100.1	216.7	39.4	38.1	35.4	0.93	1.04	1.07
Northeast	1-100	0.0	0.0	0.0	0.0	0.0	0.0	0.00	0.00	0.00
	101-200	76.0	48.8	74.7	39.7	35.9	29.0	0.53	0.77	1.01
	201-300	148.2	148.5	1,247.8	38.0	38.6	29.7	0.45	0.85	1.01
	301-500	1,331.0	2,419.0	950.6	44.4	44.0	41.4	0.94	1.36	1.44
	501-900	22.3	6.9	2.3	0.0	40.9	0.0	0.00	1.27	1.11
	1-900	299.2	519.7	365.2	40.6	43.3	38.7	0.86	1.31	1.18
Bowers Ridge	101-200	a	9.8	0.0	a	0.0	0.0	a	1.77	0.00
	201-300	0.0	2,370.7	911.8	43.4	43.7	0.0	0.00	1.55	1.48
	301-500	117.7	26.5	750.0	46.9	44.8	42.4	2.40	1.80	1.73
	501-900	0.0	0.0	0.0	0.0	0.0	0.0	0.00	0.00	0.00
	101-900	19.0	286.7	225.7	45.1	43.7	42.4	2.40	1.55	1.60
Aleutian Islands Total	1-100	0.0	11.2	8.9	0.0	37.4	0.0	0.00	1.04	0.84
	101-200	53.8	160.6	395.1	35.4	36.7	30.7	0.59	0.84	0.69
	201-300	198.0	678.3	589.7	37.8	37.9	31.0	0.33	0.85	0.99
	301-500	1,170.6	879.2	3,057.8	43.7	43.0	35.0	0.93	1.29	1.35
	501-900	13.3	6.6	34.3	42.5	41.3	36.0	2.84	1.35	1.36
	1-900	263.2	288.0	702.3	41.3	40.1	33.8	0.77	1.05	1.17
Southern Bering Sea Total	1-100	0.0	0.0	0.0	0.0	0.0	0.0	0.00	0.00	0.00
	101-200	7.7	18.4	78.2	33.4	33.9	0.0	0.00	0.99	0.69
	201-300	22.5	984.7	759.5	30.0	36.0	0.0	1.47	0.75	0.49
	301-500	686.8	1,389.7	2,357.4	44.8	43.0	40.5	1.03	1.25	1.48
	501-900	0.0	6.8	34.2	0.0	0.0	0.0	0.00	1.39	1.80
	1-900	72.9	223.9	323.9	38.0	39.5	40.5	1.07	1.01	1.02

a No sampling was conducted in this area-depth interval.

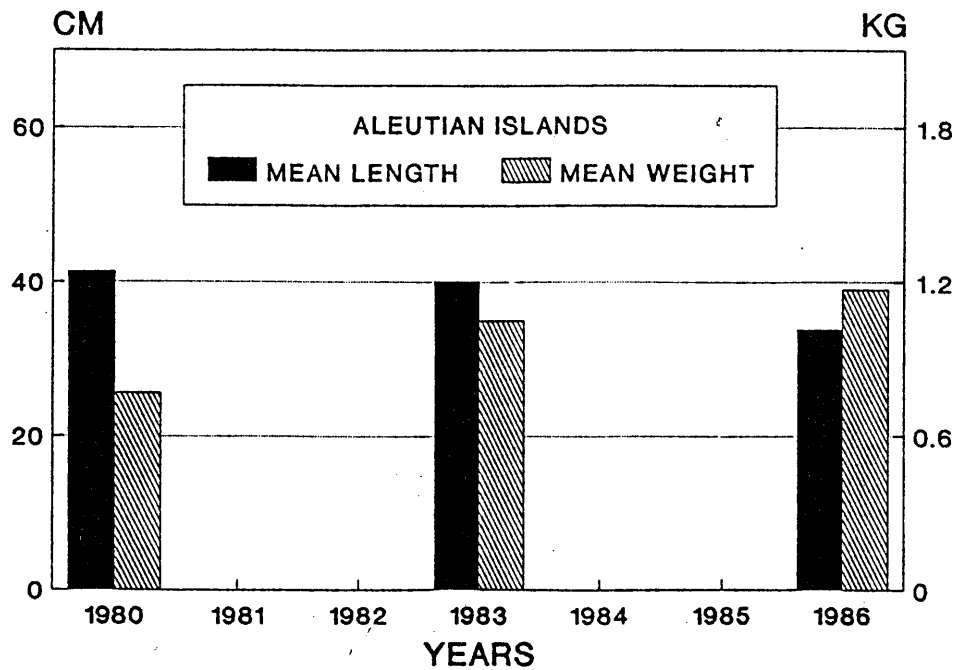

Figure 139. Mean length and weight of roughey rockfish in the Aleutian Islands area during the U.S.-Japan 1980, 1983, and 1986 groundfish surveys.

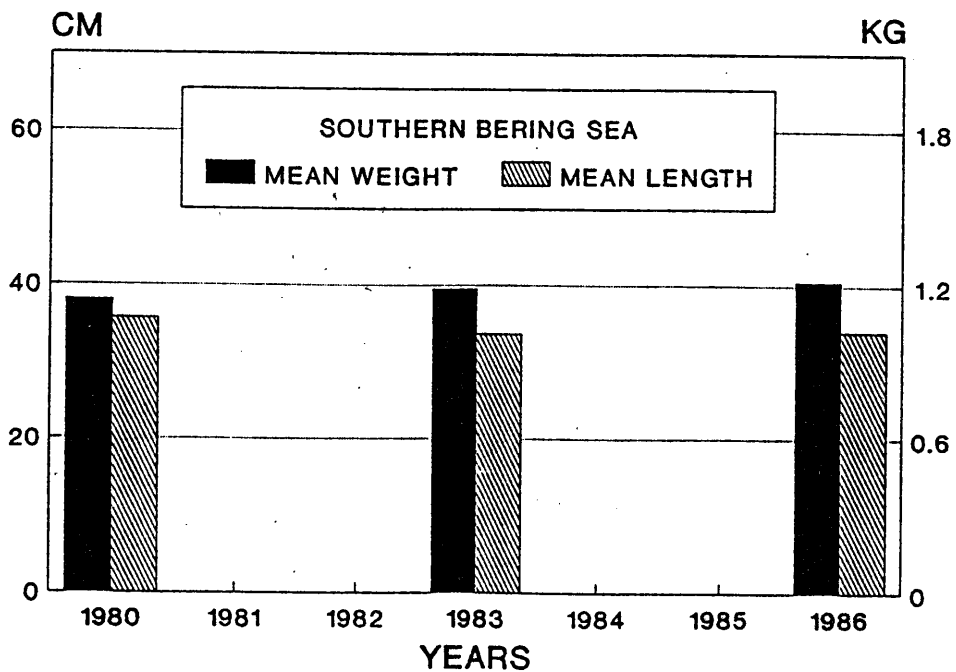

Figure 140. Mean length and weight of roughey rockfish in the Southern Bering Sea area during the U.S.-Japan 1980, 1983, and 1986 Aleutian Islands groundfish surveys.

Size Composition

Size composition data indicate that there was a decline in the proportion of smaller rougheye rockfish taken during the three survey years. In 1980 there was a bimodal size curve with the principle mode ranging from 21 to 26 cm and the secondary mode from 27 to 42 cm (Fig. 141). Both modes consisted of nearly equal proportions of males and females. In 1983 the size range shifted to larger size categories (24-49 cm) and the curve was skewed heavily toward larger fish (36-47 cm), peaking at 42-43 cm. In 1986 the size range shifted further toward larger size categories (30-53 cm), and again the curve was heavily skewed toward the larger fish, peaking at 45 cm.

Within areas, major differences in the size composition occurred most dramatically during the 1980 survey (Figs. 142-145). In the Southwest area the size range extended from 21 to 42 cm with most specimens occurring in the 27-41 cm size range, with peaks at 33-35 cm. In the Southeast area, most individuals were in the 21-31 cm size range. In the Northwest area, sizes ranged from 19 to 48 cm with the majority of the fish in the 31-48 cm size range. Four modes peaked at 22, 26, 35, and 42 cm with each successively larger mode being stronger. The size composition curve in the Northeast area is similar to the curve in the Southwest area ranging from 21 to 42 cm, with most individuals in the 27-41 cm size range.

During 1983 the Southwest area was characterized by equal numbers of fish in most size categories from 30 to 45 cm. In the Southeast area, sizes ranged from 16 to 56 cm, with most fish in the 31-50 cm size range. Fish in the Northwest area ranged from 25 to 53 cm with two modes evident, 28-34 cm and 37-44 cm. The Northeast size composition curve was heavily skewed toward fish in the 38-49 cm range.

In 1986, greater similarity was noted for the size compositions of all areas, most of which had unimodal curves skewed toward larger fish peaking around 43-45 cm. The Southwest area which dominated the 1986 size composition was bimodal and showed a strong incoming group of fish, 32-37 cm.

In the Southern Bering Sea area in 1980, the size range extended from 31 to 47 cm with a single mode from 35 to 44 cm, peaking at 40-41 cm (Fig. 146). In 1983, a much larger size range was present extending from 20 to 56 cm. The curve was bimodal with the principle mode ranging from 36 to 50 cm, peaking at 40 cm, and the secondary mode ranging from 27 to 34 cm, peaking at 31 cm. There were nearly equal numbers of males and females. In 1986 the size ranged from 17 to 58 cm. The curve was trimodal with a primary mode from 37 to 52 cm, and secondary modes from 21 to 29 cm and from 30 to 36 cm. Males were dominant in the secondary modes but males and females were nearly equal in the principle mode.

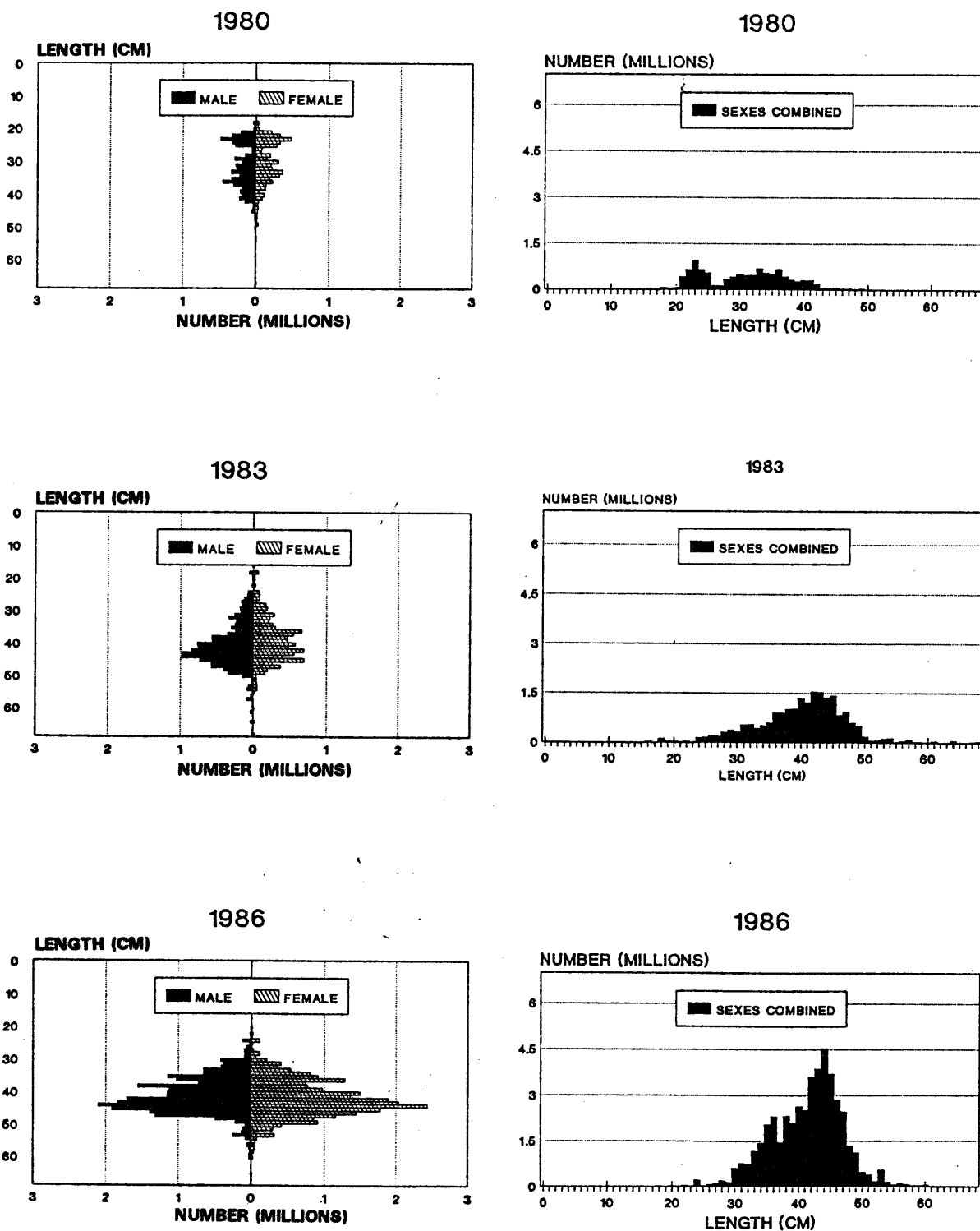

Figure 141. Size composition of roughey rockfish in the Aleutian Islands area during the U.S.-Japan 1980, 1983, and 1986 groundfish surveys.

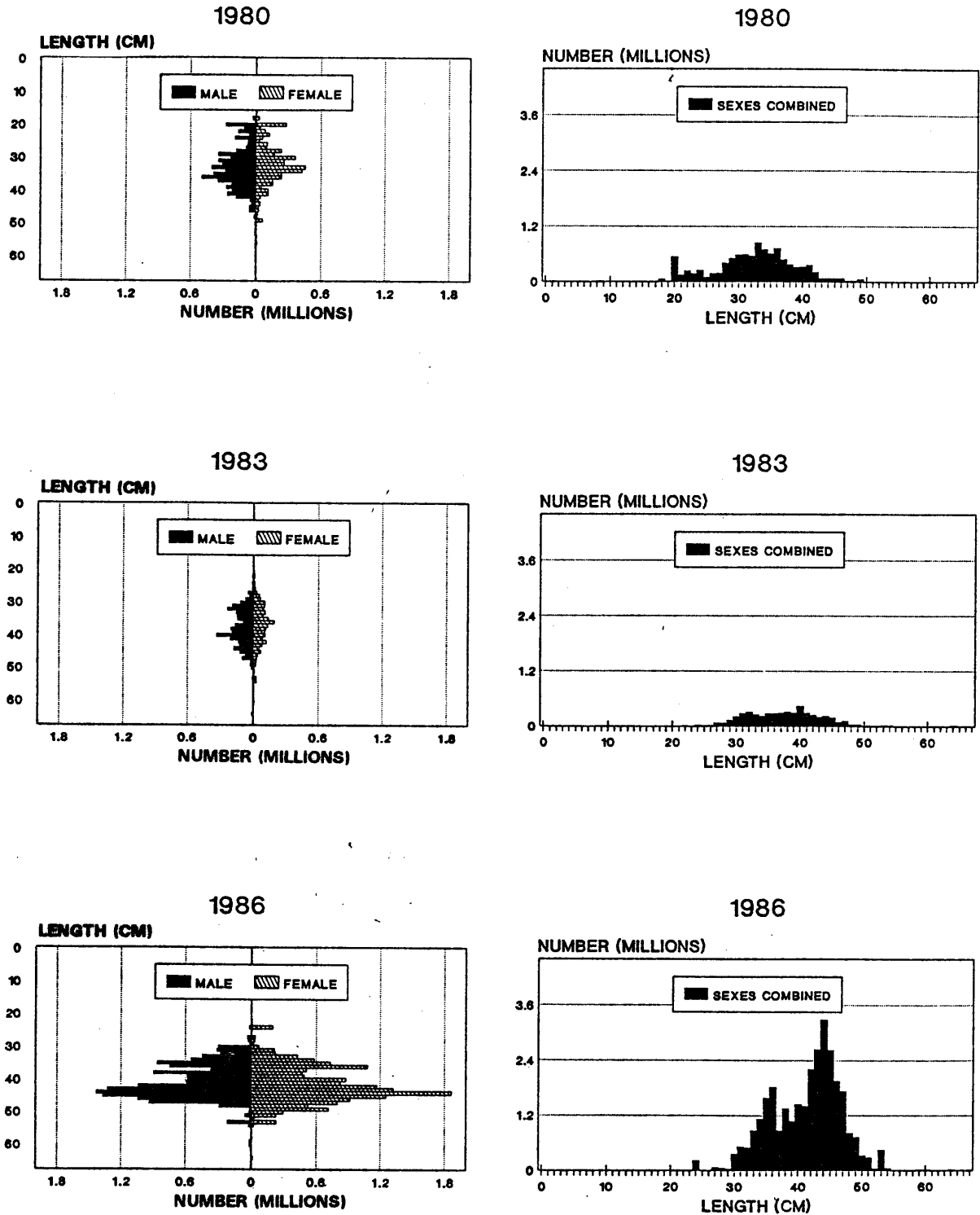

Figure 142. Size composition of roughey rockfish in the Southwest area of the Aleutian Islands during the U.S.-Japan 1980, 1983, and 1986 groundfish surveys.

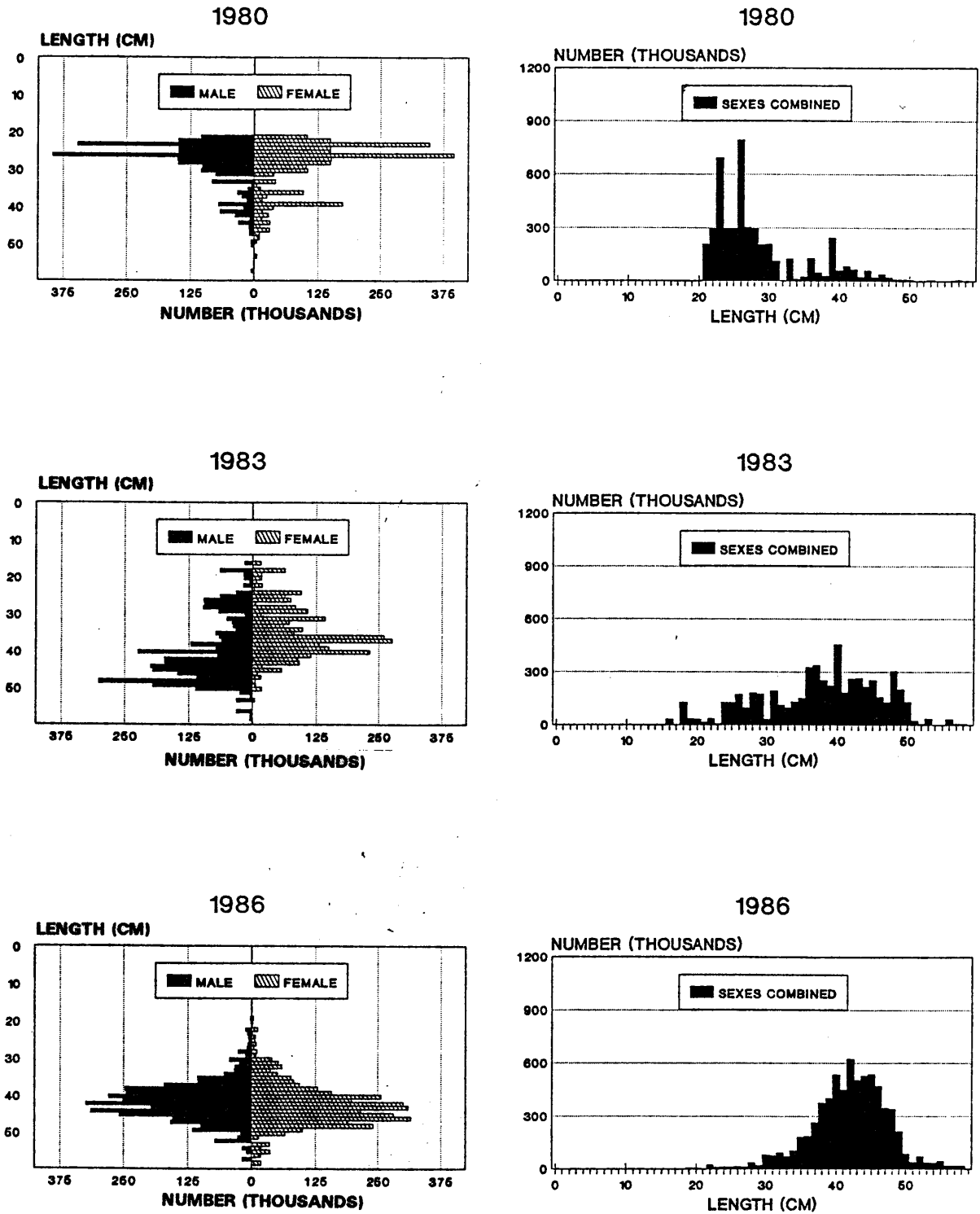

Figure 143. Size composition of roughey rockfish in the Southeast area of the Aleutian Islands during the U.S.-Japan 1980, 1983, and 1986 groundfish surveys.

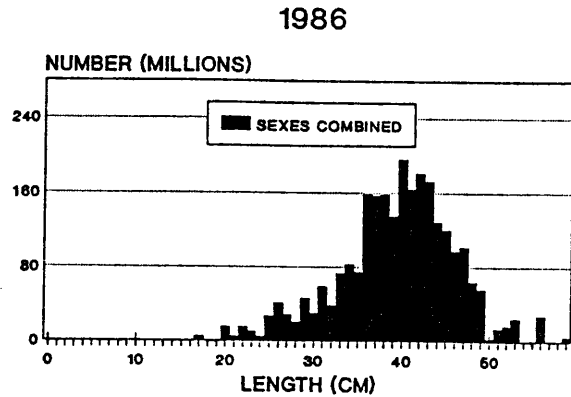
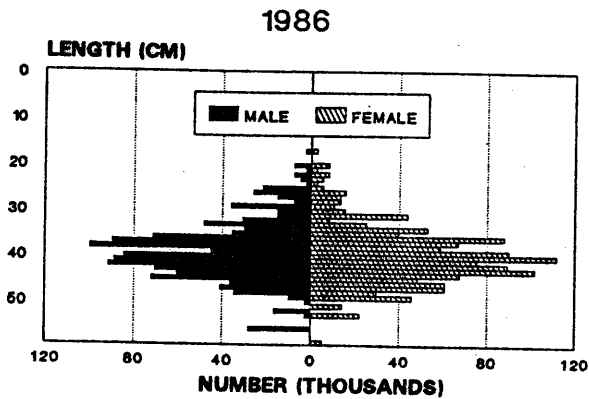
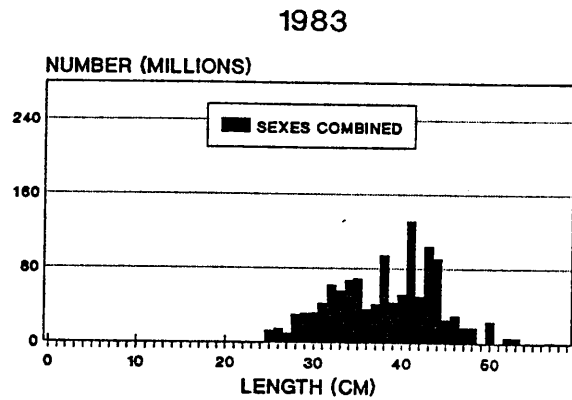
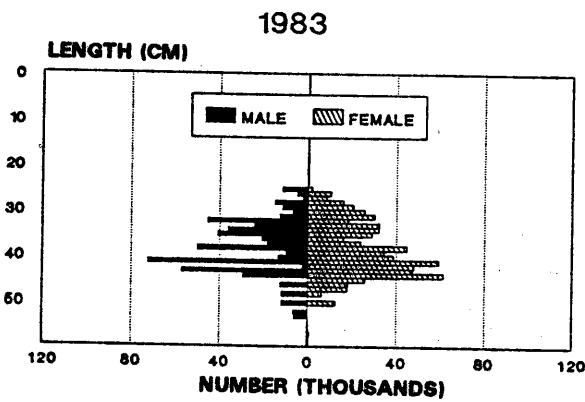
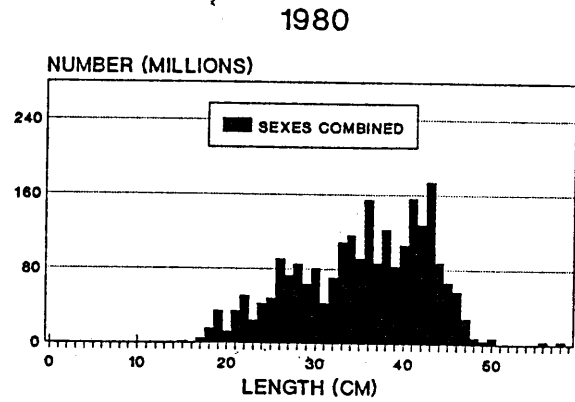
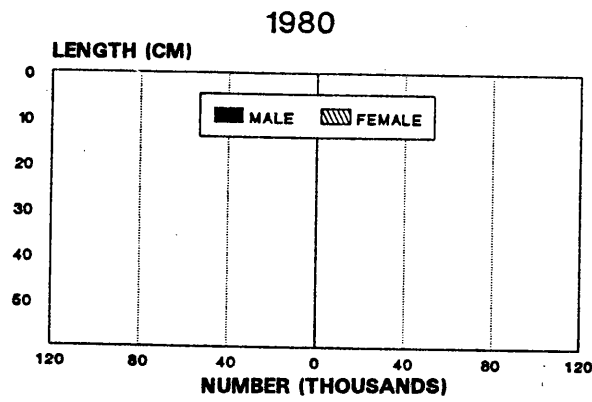

Figure 144. Size composition of rougheye rockfish in the Northwest area of the Aleutian Islands during the U.S.-Japan 1980, 1983, and 1986 groundfish surveys.

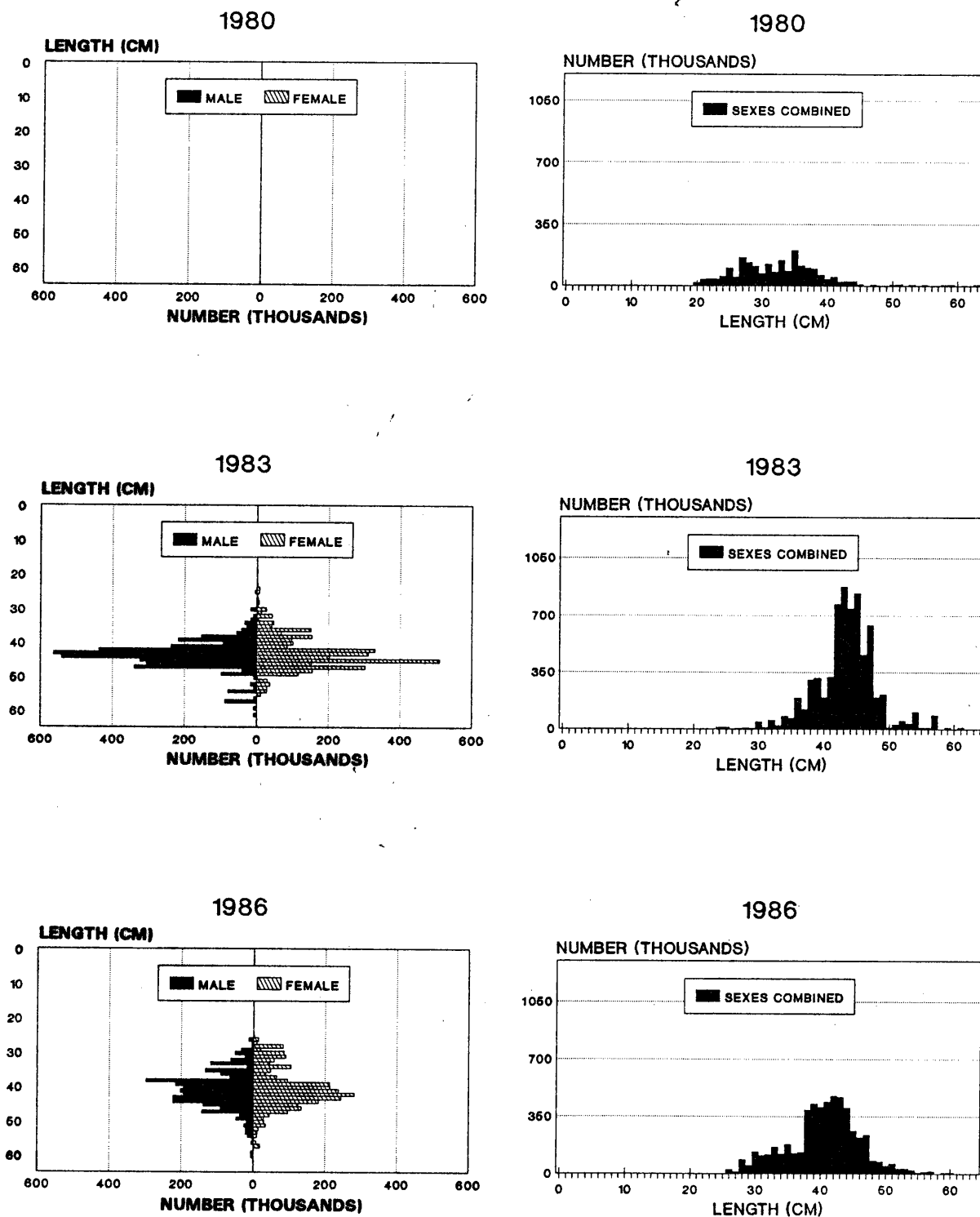

Figure 145. Size composition of roughey rockfish in the Northeast area of the Aleutian Islands during the U.S.-Japan 1980, 1983, and 1986 groundfish surveys.

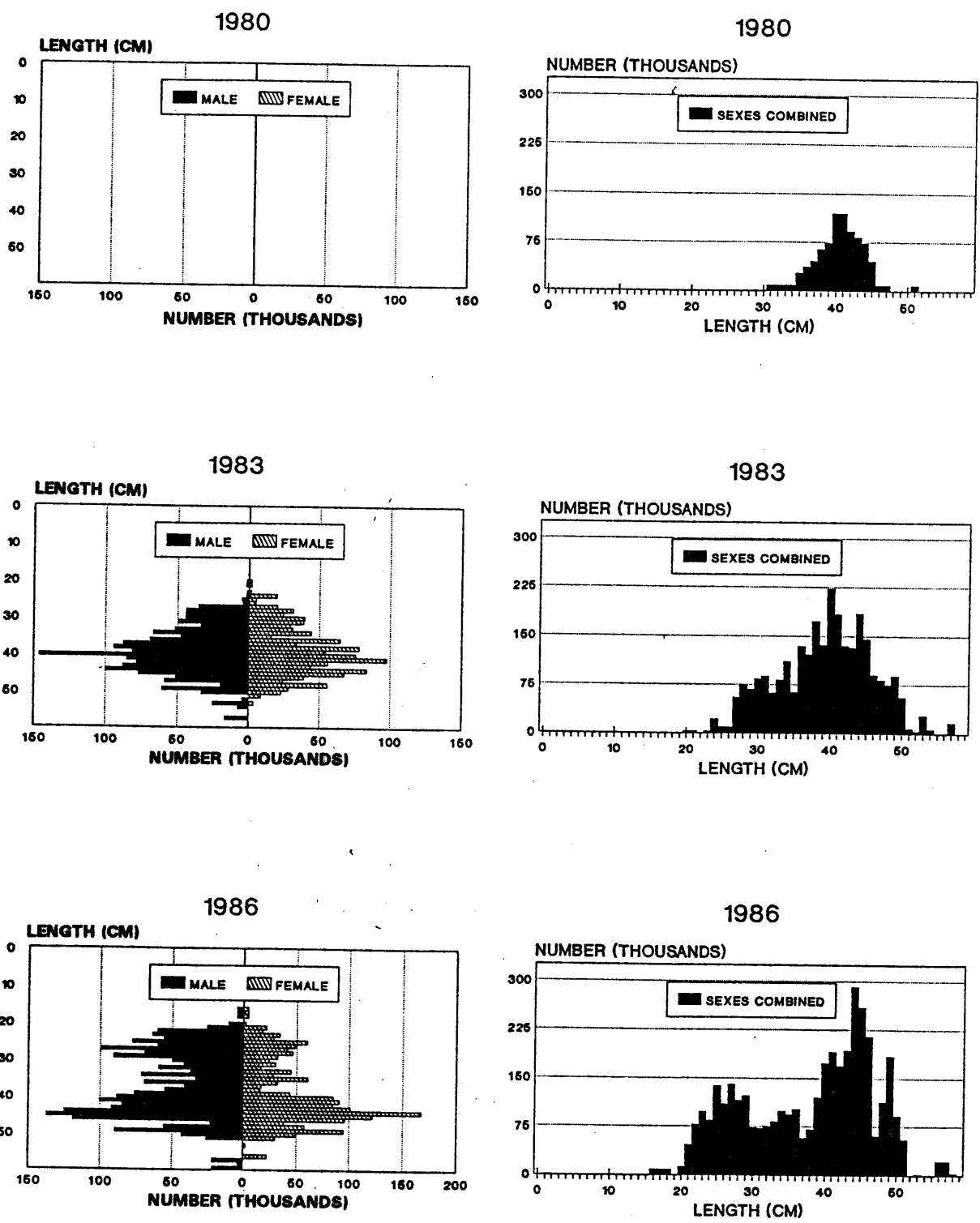

Figure 146. Size composition of roughey rockfish in the Southern Bering Sea during the U.S.-Japan 1980, 1983, and 1986 Aleutian Islands groundfish surveys.

Age determination criteria and techniques for ageing rougheye rockfish were not established at the AFSC at the time of these surveys, therefore, age data for this species are not available.

Length-Weight Relationship

Length-weight data were collected for rougheye rockfish during all three surveys; however, the sample sizes during 1980 and 1983 were quite small. These data show good agreement between the weight at length for smaller fish at sizes less than 31 cm. In 1983 the fish were slightly heavier than in 1986 and in 1980 they were slightly lighter (Fig. 147). Analysis of these data provided yearly estimates of the constants a and b:

$$\begin{aligned} \text{Weight(g)} \text{ (1980)} &= .0071 \times \text{Length(cm)}^{3.193} \\ \text{Weight(g)} \text{ (1983)} &= .0027 \times \text{Length(cm)}^{3.490} \\ \text{Weight(g)} \text{ (1986)} &= .0056 \times \text{Length(cm)}^{3.272} \end{aligned}$$

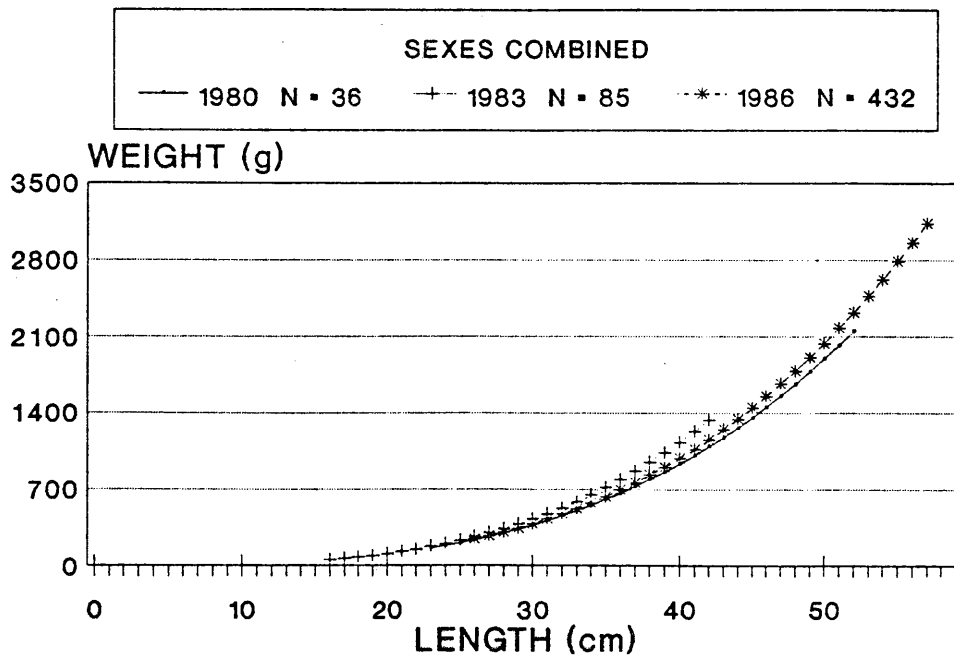

Figure 147. Length-weight relationships for rougheye rockfish in the Aleutian Islands area during the U.S.-Japan 1980, 1983, and 1986 groundfish surveys.

Pacific Halibut

Distribution and Abundance

Pacific halibut (Hippoglossus stenolepis) were found in most depth zones from Attu Island to Unimak Pass including Bowers Ridge (Figs. 148-149). High-density concentrations were not found during the 1980 and 1983 surveys. In 1980, intermediate densities were found near Buldir Island in the western Aleutians, on both sides of the eastern Aleutian Islands chain, and near the Islands of Four Mountains, Umnak Island, and Unimak Pass in the Southern Bering Sea area. In 1983 the number of intermediate density concentrations increased substantially along both sides of the eastern Aleutian Islands from the Island of Four Mountains to Adak Island. In the waters around the western Aleutian Islands, medium densities were found on both sides of the chain from Amchitka to the Buldir Islands. In the Southern Bering Sea area, medium densities were found north of the Islands of Four Mountains and north of Umnak and Unalaska Islands. In 1986, one high-density concentration was found on Bowers Ridge. Intermediate density concentrations of Pacific halibut increased slightly in the Southern Bering Sea and on both sides of the Aleutian Islands chain from Seguam Pass to Adak Islands in the eastern Aleutian Islands, and all the way to Attu Island in the western Aleutian Islands.

Throughout the three surveys there was a steady increase in the biomass estimates of Pacific halibut in the Aleutian Islands area (Table 65, Fig. 150). The Pacific halibut biomass estimate increased from 9,900 t in 1980 to 13,800 t in 1983, and then increased nearly three-fold to 39,000 t in 1986. The population increased from 1.5 million fish in 1980 to 1.6 million in 1983 and 4.8 million in 1986. The most significant increase occurred in the Bowers Ridge area which increased from no catch to 300 t in 1983 and then 16,000 t in 1986. The remaining portion of the 1983-1986 increase was fairly evenly spread among the remaining areas.

In the Southern Bering Sea area the biomass estimate of Pacific halibut increased from 2,700 t in 1980 to 7,300 t in 1983 and then decreased slightly to 6,200 t in 1986 (Fig. 151). Population abundance stayed at approximately 1.1 million fish in 1980 and 1983 and increased slightly to 1.8 million in 1986.

For both the Aleutian Islands area and Southern Bering Sea area the largest mean length and weight occurred during the 1983 survey although abnormalities occurred for other years (Table 66, Figs. 152-153).

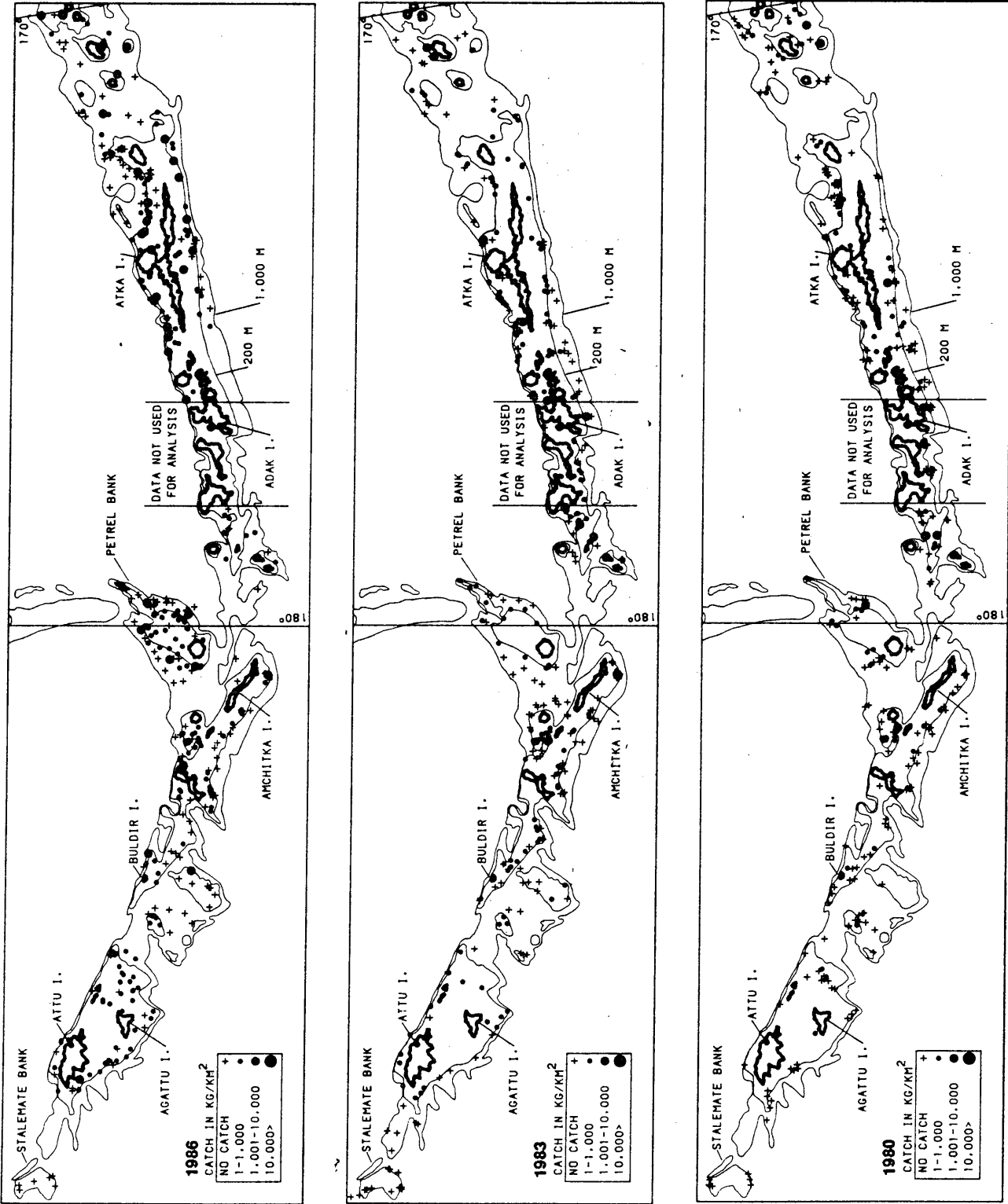

Figure 148. Distribution and relative abundance of Pacific halibut in the Aleutian Islands area during the U.S.-Japan 1980, 1983, and 1986 groundfish surveys.

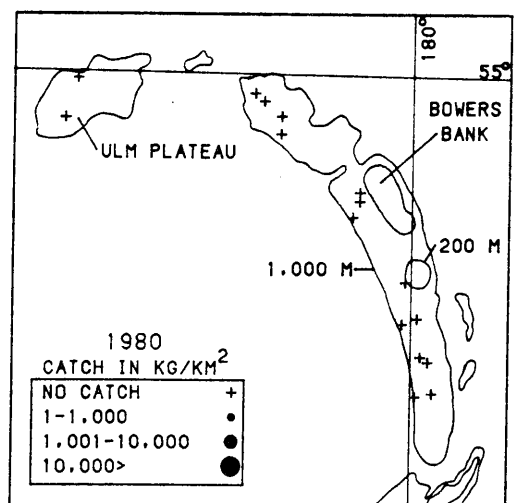
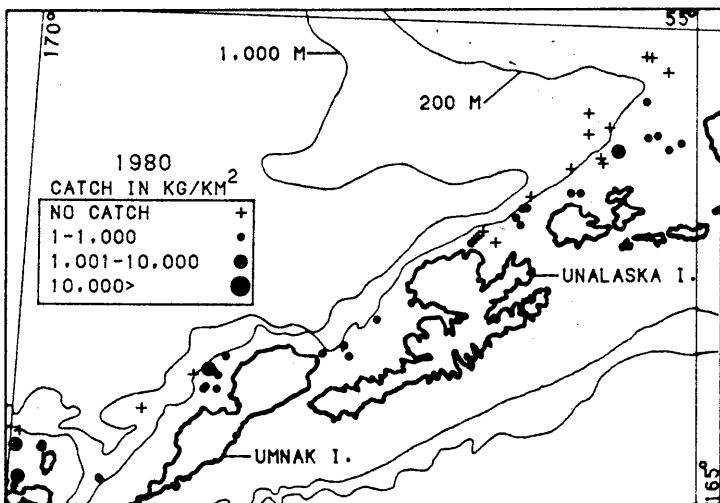
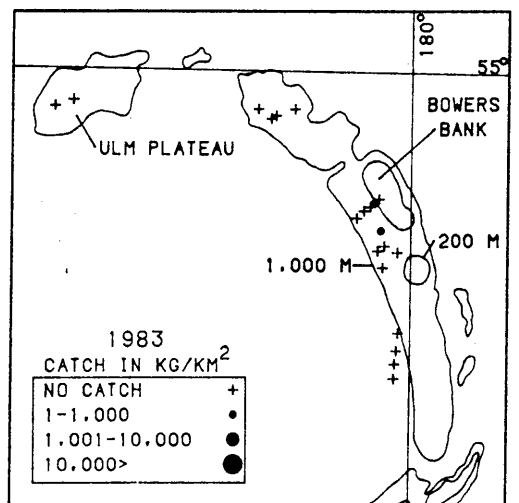
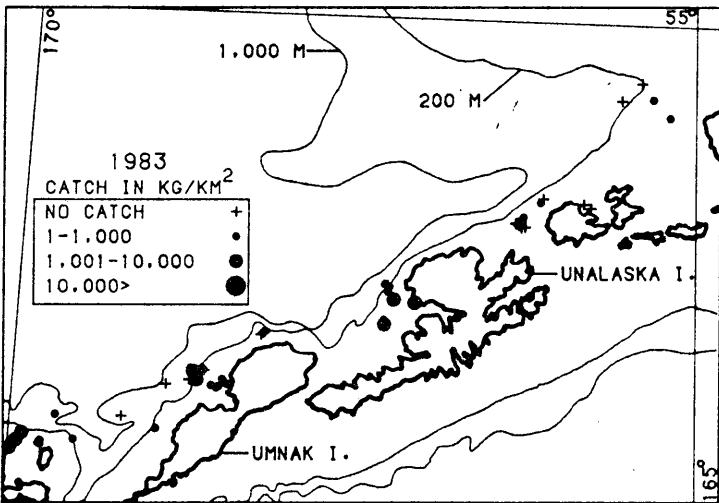
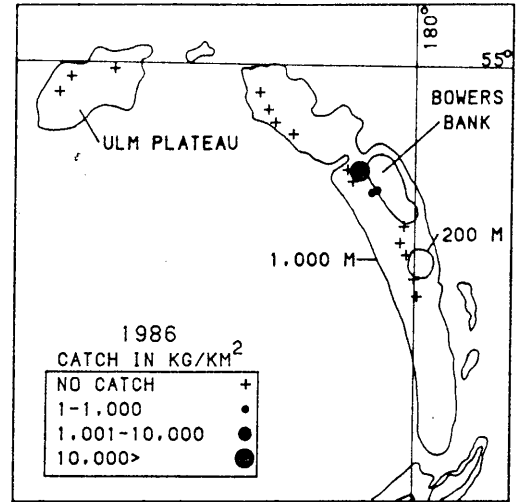
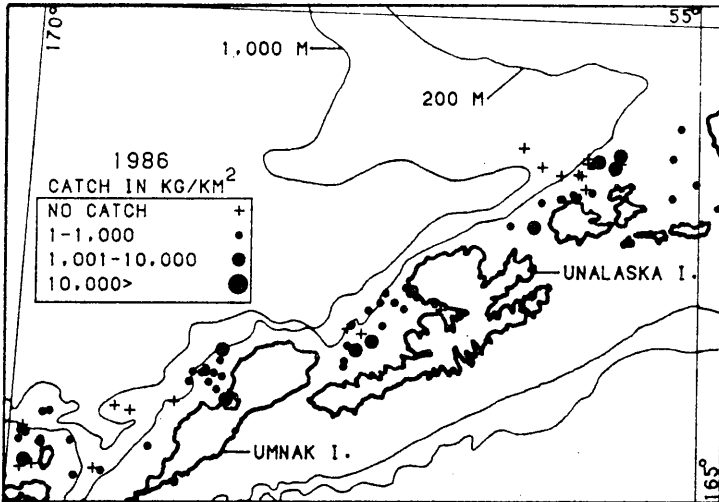

Figure 149. Distribution and relative abundance of Pacific halibut in the Southern Bering Sea and Bowers Ridge areas during the U.S.-Japan 1980, 1983, and 1986 Aleutian Islands groundfish surveys.

Table 65. Estimates of biomass, biomass sampling error, and population for Pacific halibut based on the U.S.-Japan 1980, 1983, and 1986 Aleutian Islands groundfish surveys.

Area	Depth (m)	Biomass (t)			Sampling Error (%)			Population (1,000s)		
		1980	1983	1986	1980	1983	1986	1980	1983	1986
Southwest	1-100	0	326	489				0.0	55.2	194.0
	101-200	331	475	1,913				101.7	108.3	513.0
	201-300	51	103	362				6.0	11.0	116.7
	301-500	21	234	871				1.7	23.3	112.1
	501-900	0	0	279				0.0	0.0	41.8
	1-900	403	1,138	3,914	73.9	108.7	43.3	109.4	197.8	977.6
Southeast	1-100	a	415	1,217				a	44.4	302.4
	101-200	1,760	2,193	4,075				231.0	236.9	740.0
	201-300	1,151	1,845	1,108				91.8	92.7	107.7
	301-500	1,875	663	1,487				66.1	64.0	80.5
	501-900	0	0	0				0.0	0.0	0.0
	1-900	4,786	5,116	7,887	145.3	45.2	56.3	388.9	438.0	1,230.6
Northwest	1-100	0	1,360	857				0.0	130.6	218.8
	101-200	1,377	1,185	1,431				278.8	174.5	201.6
	201-300	321	257	510				43.2	30.3	41.6
	301-500	385	115	1,526				42.3	4.2	125.9
	501-900	0	0	0				0.0	0.0	0.0
	1-900	2,083	2,917	4,324	88.3	383.4	64.8	364.3	339.6	587.9
Northeast	1-100	438	1,323	1,851				370.0	202.6	685.2
	101-200	978	1,784	2,875				194.4	344.2	453.2
	201-300	708	622	592				30.3	34.2	58.8
	301-500	457	597	839				18.8	21.0	80.7
	501-900	0	57	1,050				0.0	1.8	42.2
	1-900	2,581	4,383	7,207	53.9	31.8	80.5	613.5	603.8	1,320.1
Bowers Ridge	101-200	a	13	4				a	1.7	4.5
	201-300	0	0	15,520				0.0	0.0	663.7
	301-500	0	259	0				0.0	3.1	0.0
	510-900	0	0	0				0.0	0.0	0.0
	101-900	0	272	15,524	0.0	264.5	414.0	0.0	4.8	668.2
Aleutian Islands	1-100	438	3,424	4,414	0.0	287.0	90.4	370.0	432.8	1,400.4
	101-200	4,446	5,650	10,298	70.3	31.2	20.9	805.9	865.4	1,912.3
	201-300	2,231	2,827	18,092	104.8	75.5	355.3	171.3	168.2	988.5
	301-500	2,738	1,868	4,723	288.9	72.4	71.8	128.9	115.6	399.2
Total	501-900	0	57	1,329	0.0	236.5	125.5	0.0	1.8	84.0
	1-900	9,853	13,826	38,856	67.4	27.1	167.6	1,476.1	1,583.8	4,784.4
Southern Bering Sea	1-100	582	3,697	3,261				693.1	585.7	1,258.2
	101-200	1,905	3,235	2,711				330.7	519.5	532.9
	201-300	183	194	204				16.3	8.5	24.3
	301-500	31	50	42				11.2	5.8	18.7
	501-900	0	128	0				0.0	11.2	0.0
Total	1-900	2,701	7,304	6,218	76.6	59.2	36.8	1,051.3	1,130.6	1,834.1

a No sampling was conducted in this area-depth interval.

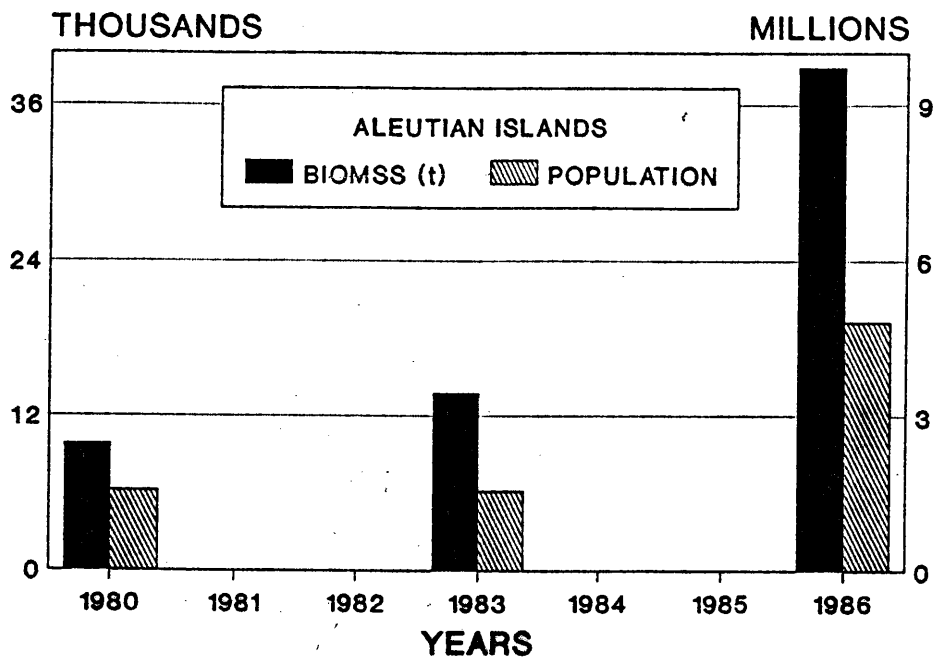

Figure 150. Estimated biomass and population of Pacific halibut in the Aleutian Islands area during the U.S.-Japan 1980, 1983, and 1986 groundfish surveys.

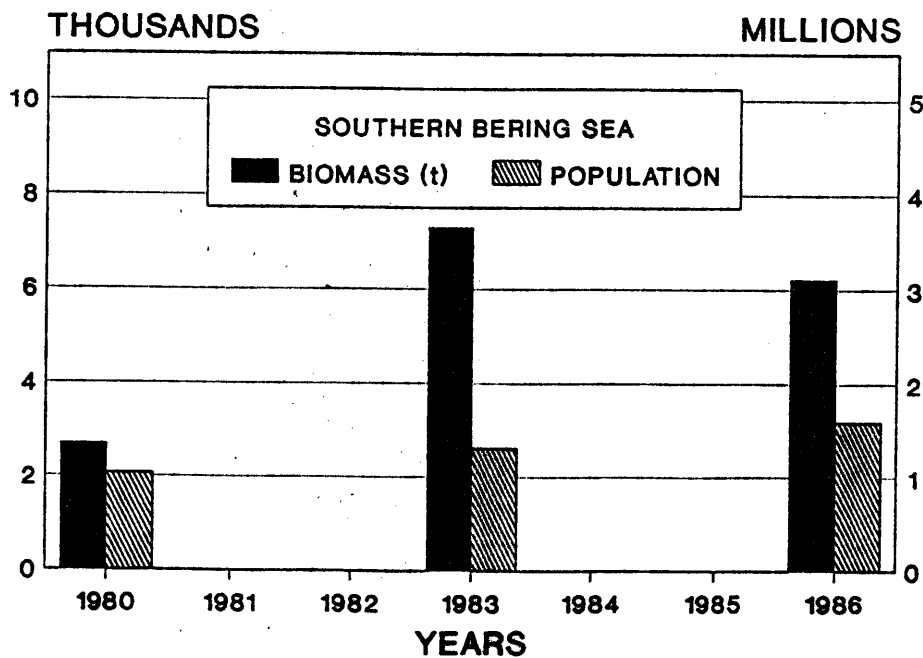

Figure 151. Estimated biomass and population of Pacific halibut in the Southern Bering Sea area during the U.S.-Japan 1980, 1983, and 1986 Aleutian Islands groundfish surveys.

Table 66. Estimates of mean catch per unit effort, length, and weight for Pacific halibut based on the U.S.-Japan 1980, 1983, and 1986 Aleutian Islands groundfish surveys.

Area	Depth (m)	Mean CPUE (kg/km ²)			Mean Length (cm)			Mean Weight (kg)		
		1980	1983	1986	1980	1983	1986	1980	1983	1986
Southwest	1-100	0.0	110.8	129.8	50.2	66.3	0.0	0.00	5.64	2.76
	101-200	50.6	72.7	293.0	56.7	55.9	63.6	3.59	4.23	3.17
	201-300	22.4	45.0	157.9	60.4	86.1	87.7	8.83	10.32	2.81
	301-500	6.2	68.6	255.6	73.0	89.1	91.0	12.70	9.46	7.72
	501-900	0.0	0.0	39.7	80.0	0.0	0.0	0.00	0.00	6.69
	1-900	18.7	51.2	170.0	58.7	64.3	65.5	4.05	5.56	3.68
Southeast	1-100	a	263.0	460.3	a	93.7	0.0	a	9.34	4.03
	101-200	538.0	670.2	1,245.3	70.4	81.5	80.2	7.61	9.34	5.81
	201-300	364.2	584.0	350.6	86.4	100.6	92.7	12.54	20.65	11.64
	301-500	688.6	211.2	473.9	103.9	91.7	112.8	28.39	10.35	16.84
	501-900	0.0	0.0	0.0	0.0	0.0	0.0	0.00	0.00	0.00
	1-900	427.8	366.0	524.3	72.0	87.9	88.7	12.30	11.82	6.64
Northwest	1-100	0.0	576.4	363.3	61.6	88.3	0.0	0.00	10.49	4.24
	101-200	749.0	451.0	544.6	79.4	73.3	67.4	3.65	7.23	7.63
	201-300	300.3	240.4	476.8	76.6	81.5	66.9	7.09	8.93	11.61
	301-500	173.9	52.0	688.7	94.7	0.0	77.4	9.15	27.12	12.05
	501-900	0.0	0.0	0.0	0.0	0.0	0.0	0.00	0.00	0.00
	1-900	187.6	228.6	338.8	76.2	80.1	68.3	4.48	8.93	7.72
Northeast	1-100	197.8	1,134.7	965.5	55.5	67.7	43.5	1.18	6.53	2.65
	101-200	250.3	456.5	736.0	77.2	66.5	71.4	5.26	5.45	6.30
	201-300	290.0	254.9	242.4	84.7	98.2	111.1	24.22	18.82	9.79
	301-500	133.0	174.0	255.5	91.9	107.7	126.5	23.64	29.00	10.39
	501-900	0.0	9.3	169.9	118.3	131.0	0.0	0.00	32.58	21.76
	1-900	144.0	255.9	406.5	68.6	69.1	58.0	4.27	7.49	5.36
Bowers Ridge	101-200	a	42.4	12.9	a	85.0	0.0	a	7.67	0.89
	201-300	0.0	0.0	12,710.7	117.6	0.0	0.0	0.00	0.00	23.39
	301-500	0.0	162.0	0.0	0.0	185.0	0.0	0.00	83.88	0.00
	501-900	0.0	0.0	0.0	0.0	0.0	0.0	0.00	0.00	0.00
	101-900	0.0	26.6	1,513.8	117.1	149.2	0.0	0.00	56.62	23.23
Aleutian Islands	1-100	73.0	425.7	413.1	57.1	76.3	43.5	1.18	7.88	3.20
	101-200	285.9	339.3	618.5	68.6	70.6	71.2	5.01	6.73	5.27
Total	201-300	219.1	277.6	1,776.1	103.3	95.8	88.8	12.96	17.54	18.24
	301-500	204.6	135.4	346.1	90.1	95.6	103.0	21.20	16.02	11.56
	501-900	0.0	2.1	48.1	100.5	131.0	0.0	0.00	32.58	14.76
	1-900	137.4	181.1	493.0	74.9	76.1	69.2	6.32	8.90	8.06
Southern Bering Sea	1-100	120.7	767.1	676.6	46.6	62.8	44.5	0.90	4.54	3.19
	101-200	582.1	988.6	828.5	64.9	70.0	70.8	5.32	6.88	5.12
	201-300	182.6	193.4	203.4	85.6	101.0	79.5	11.19	22.69	8.67
	301-500	24.5	39.6	33.2	50.7	0.0	65.6	2.79	10.40	2.25
	501-900	0.0	56.4	0.0	0.0	0.0	0.0	0.00	11.57	0.00
Total	1-900	213.7	577.9	491.9	53.3	65.5	54.4	2.62	5.58	3.90

a No sampling was conducted in this area-depth interval.

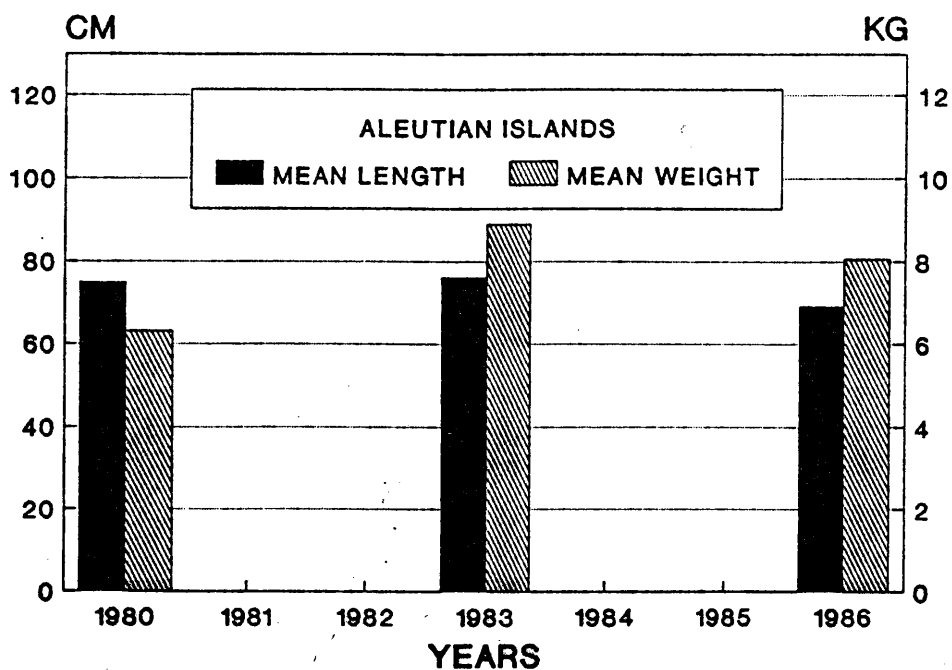

Figure 152. Mean length and weight of Pacific halibut in the Aleutian Islands area during the U.S.-Japan 1980, 1983, and 1986 groundfish surveys.

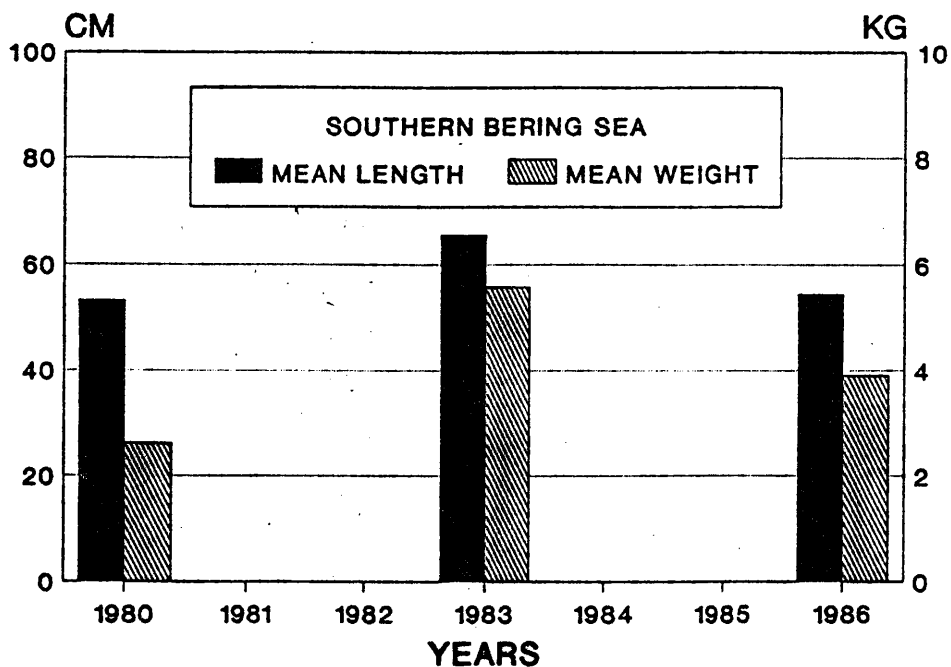

Figure 153. Mean length and weight of Pacific halibut in the Southern Bering Sea area during the U.S.-Japan 1980, 1983, and 1986 Aleutian Islands groundfish surveys.

Size Composition

Size composition curves for the Aleutian Islands area were quite similar for 1980 and 1983, however, there was a slight increase in the number of fish in the 60-99 cm size range in 1983 and fewer fish less than 50 cm (Fig. 154). In 1986 there was a strong increase in the number of fish less than 40 cm in length, and a substantial increase in the number of fish from 41 to 160 cm.

In the Southern Bering Sea area, the size composition curves lacked similarity throughout all three surveys (Fig. 155). In 1980, fish measured from 20 to 95 cm with a good showing of small fish from 30 to 44 cm, peaking near 36 cm. In 1983 there was an increase in the number of fish between 100 and 140 cm and the primary mode extended from 45 to 70 cm and peaked around 52-54 cm. By 1986, the primary mode in 1983 had shifted to 52-69 cm and peaked near 62 cm and there was a strong showing of incoming small fish 25-45 cm in length.

No age data is available for Pacific halibut during these surveys.

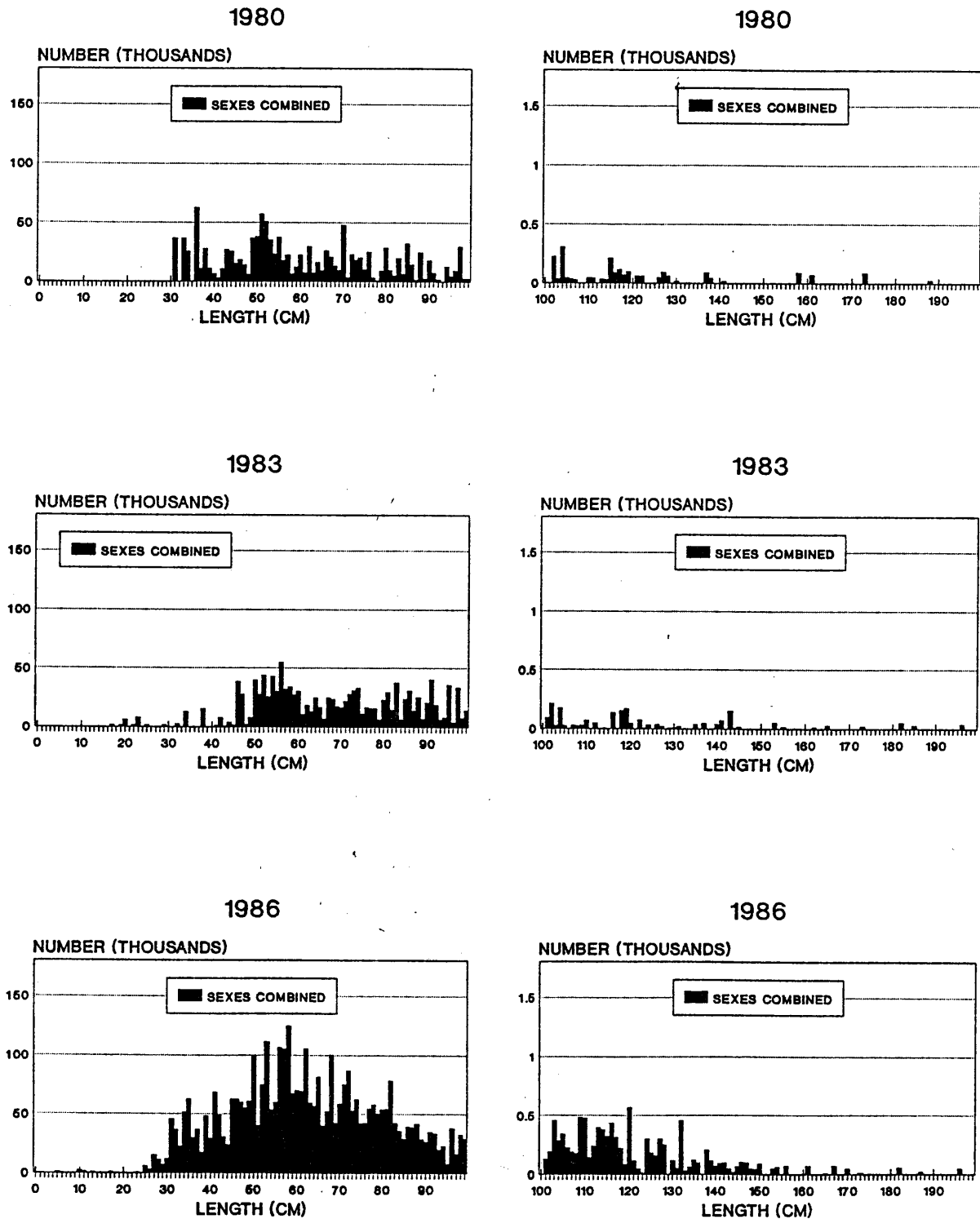

Figure 154. Size composition of Pacific halibut in the Aleutian Islands area during the U.S.-Japan 1980, 1983, and 1986 groundfish surveys.

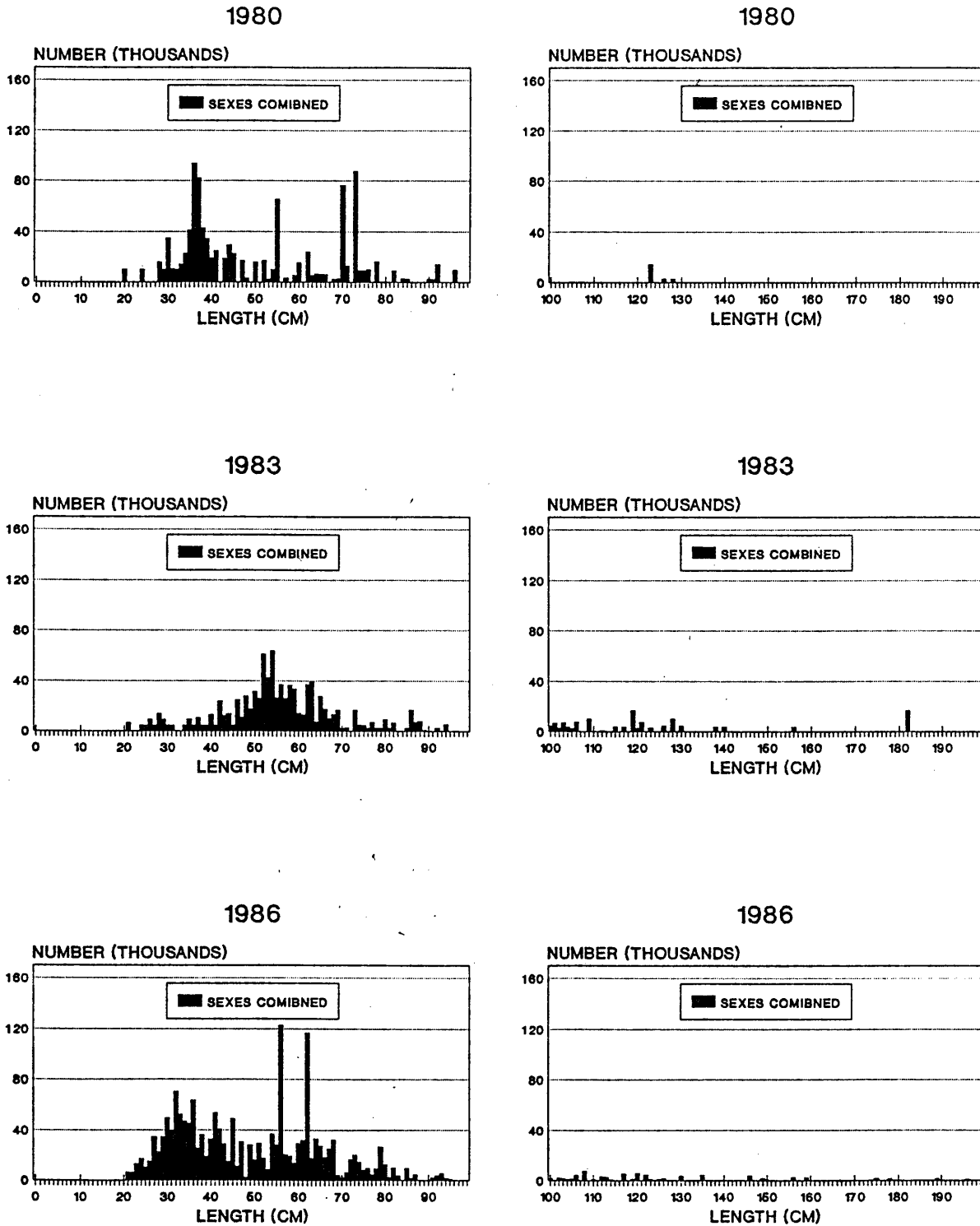

Figure 155. Size composition of Pacific halibut in the Southern Bering Sea area during the U.S.-Japan 1980, 1983, and 1986 Aleutian Islands groundfish surveys.

Shortraker Rockfish

Distribution and Abundance

Shortraker rockfish (Sebastes Borealis) were found in a discontinuous distribution throughout the Aleutian Islands area and Southern Bering Sea primarily at depths greater than 300 m (Figs. 156-157). In the eastern Aleutians they occurred on the north side of the chain from Seguam to Great Sitkin Islands and the Delarof Islands during all years. Shortraker rockfish were found on the east side of Petrel bank in 1983 but there were higher concentrations there in 1986. On the south side of the Aleutian Islands chain they were found from Seguam to Great Sitkin Islands only during 1983 and 1986. In the western Aleutian Islands areas, concentrations of higher abundance varied from year to year and did not show a definitive pattern. In the Southern Bering Sea area, they occurred in higher densities on the outer continental shelf off of Unalaska and Makushin Bays on Unalaska Island.

Biomass estimates of shortraker rockfish in the Aleutian Islands area nearly doubled, from 12,800 t in 1980 to 24,500 t in 1983, and then stayed about the same at 24,000 t in 1986 (Table 67, Fig. 158). Population estimates increased from 5.9 million fish in 1980 to 15.8 million in 1983 and 17.6 million in 1986. Increases occurred in all areas except the Northwest where the biomass decreased 41%. During 1980 and 1983 over 80% of the biomass was found in the 301-500 m depth interval, but in 1986, 50% occurred at 210-300 m and 48% at 301-500 m.

In the Southern Bering Sea area, the biomass estimates increased from 1,000 t in 1980 to 13,000 t in 1983, and then decreased to 8,000 t in 1986. Population decreased from 3.3 million fish in 1983, to 2.2 million fish in 1968 (Fig. 159). During all surveys the majority of the biomass was found in the 301-500 m depth interval.

In the Aleutian Islands area, the largest mean length and the largest mean weight occurred during the 1986 and the 1980 surveys, respectively. In the Southern Bering Sea the largest mean length and weight occurred in 1983 (Table 68, Figs. 160-161).

Size Composition

In 1980 the size composition for shortraker rockfish in the Aleutian Islands area was very non-descriptive (i.e., no size group was dominant and no distinctive modes were visible) (Fig. 162). During 1983, the size composition curve was bimodal with the largest portion of the individuals in the 28-48 cm size range and a considerably smaller mode in the 52-62 cm range. In 1986 the size composition curve was unimodal dominated by the 30-54 cm size range, and skewed slightly towards larger fish. The peak

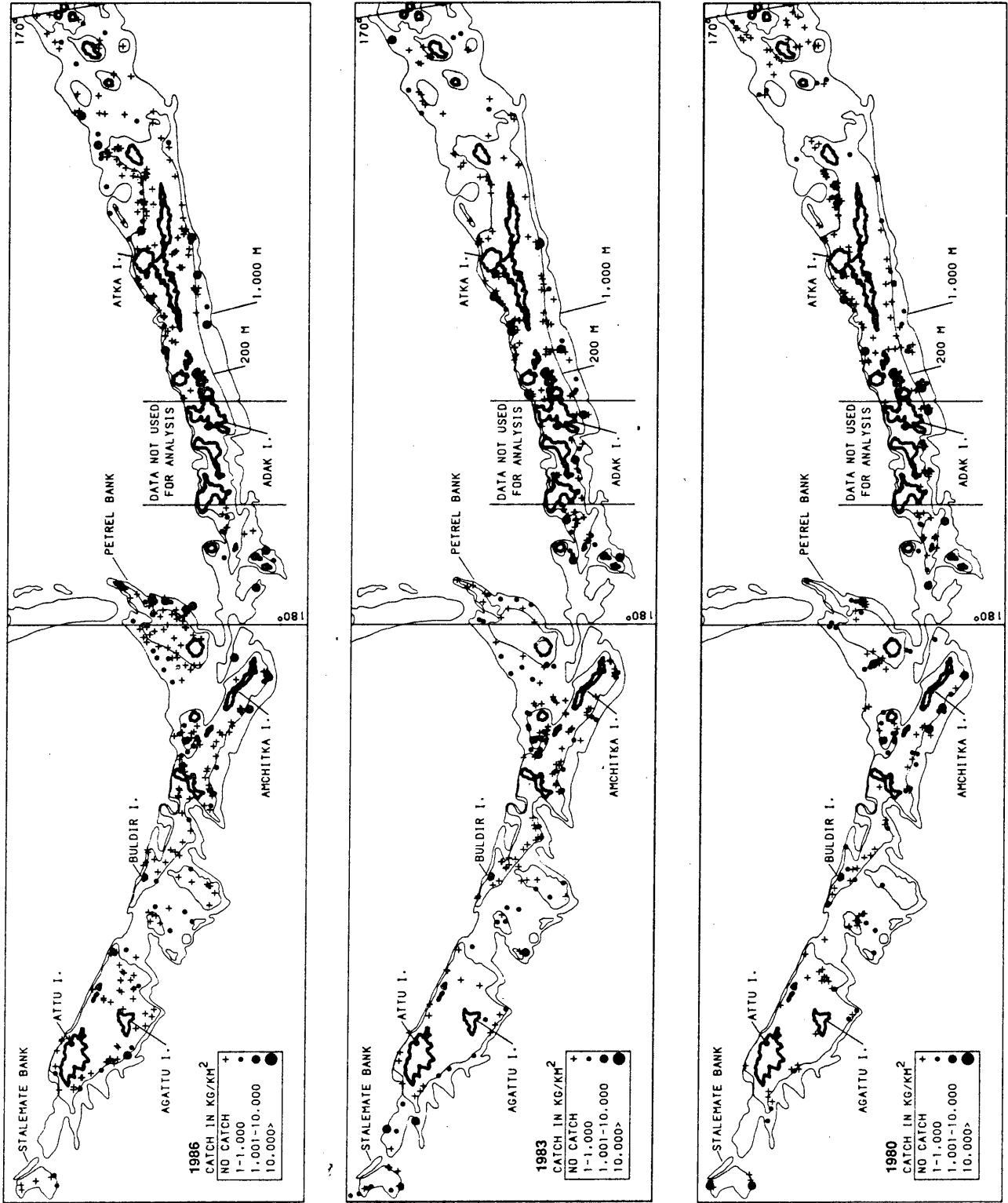

Figure 156. Distribution and relative abundance of shortraker rockfish in the Aleutian Islands area during the U.S.-Japan 1980, 1983, and 1986 groundfish surveys.

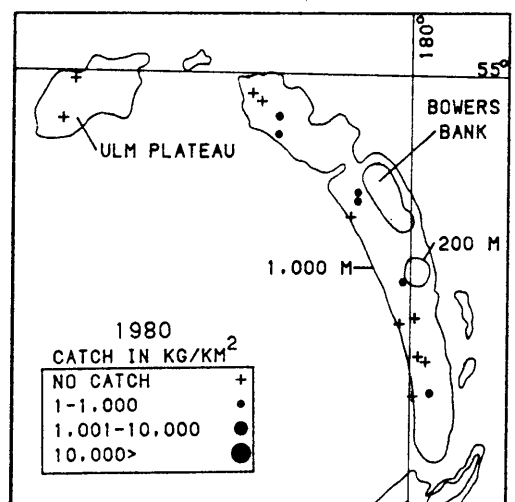
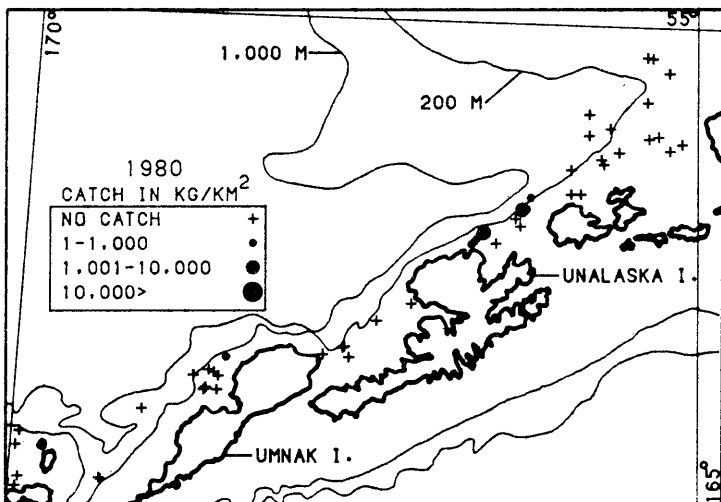
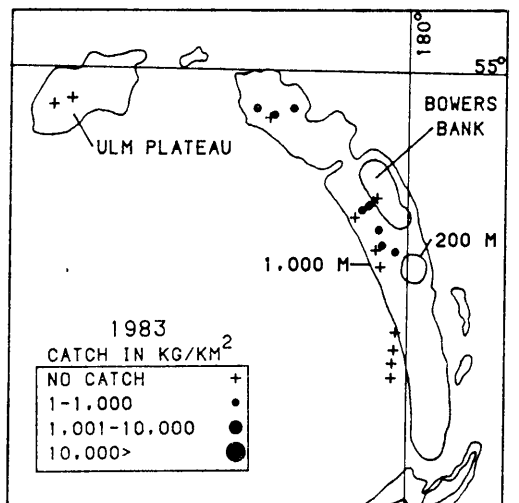
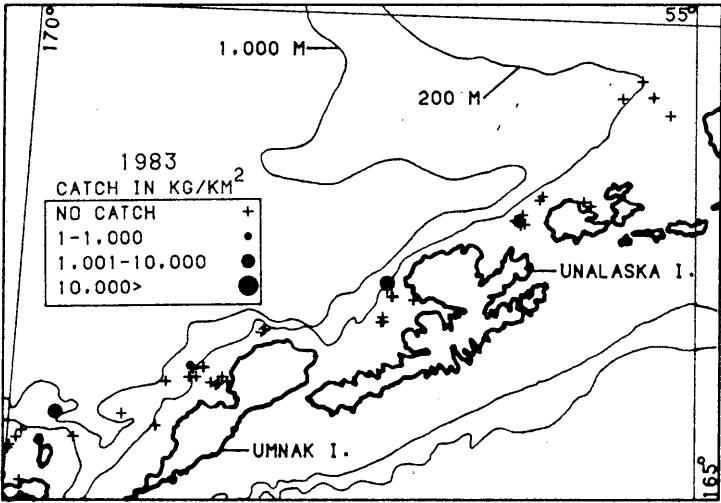
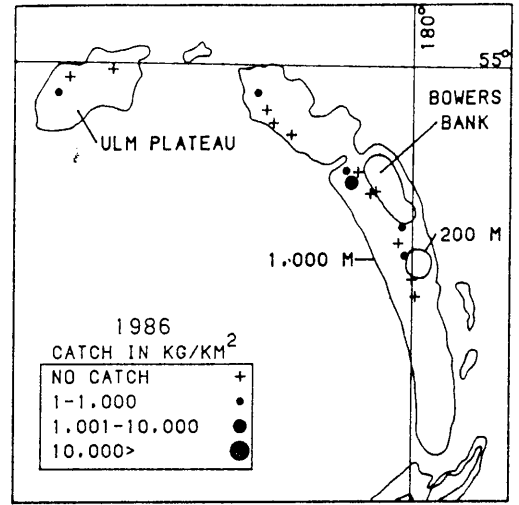
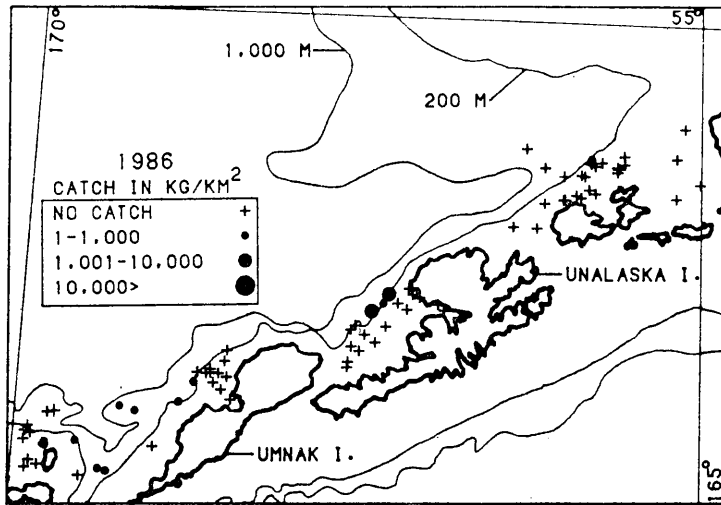

Figure 157. Distribution and relative abundance of shorttraker rockfish in the Southern Bering Sea and Bowers Ridge areas during the U.S.-Japan 1980, 1983, and 1986 Aleutian Islands groundfish surveys.

Table 67. Estimates of biomass, biomass sampling error, and population for shortraker rockfish based on the U.S.-Japan 1980, 1983, and 1986 Aleutian Islands groundfish surveys.

Area	Depth (m)	Biomass (t)			Sampling Error (%)			Population (1,000s)		
		1980	1983	1986	1980	1983	1986	1980	1983	1986
Southwest	1-100	0	76	0				0.0	77.0	0.0
	101-200	29	7	19				46.3	9.3	15.3
	201-300	111	61	44				39.2	28.8	18.1
	301-500	2,698	6,306	1,979				1,638.4	6,235.0	687.4
	501-900	664	1,211	2,655				200.1	935.2	2,703.5
	1-900	3,502	7,661	4,697	57.0	71.7	499.2	1,924.0	7,285.3	3,424.3
Southeast	1-100	a	0	0				a	0.0	0.0
	101-200	22	29	0				0.0	11.7	0.0
	201-300	273	599	275				124.8	219.3	133.2
	301-500	928	3,168	4,651				633.9	3,151.6	3,718.1
	501-900	68	661	4,963				0.0	743.8	4,514.3
	1-900	1,291	4,457	9,889	248.1	90.3	29.0	758.7	4,126.4	8,365.6
Northwest	1-100	0	0	0				0.0	0.0	0.0
	101-200	0	0	0				0.0	0.0	0.0
	201-300	140	30	9				54.1	5.7	2.0
	301-500	3,110	1,957	1,067				927.0	860.0	505.5
	501-900	616	286	2,814				287.2	153.3	1,719.3
	1-900	3,866	2,273	3,890	122.0	183.0	96.3	1,268.3	1,019.0	2,226.8
Northeast	1-100	0	0	0				0.0	0.0	0.0
	101-200	15	0	0				13.0	0.0	0.0
	201-300	68	15	33				24.9	6.4	15.1
	301-500	2,874	8,806	2,757				1,566.7	2,880.5	1,483.4
	501-900	392	472	1,037				99.3	245.2	878.6
	1-900	3,349	9,293	3,827	75.8	339.6	45.9	1,703.9	3,132.1	2,377.1
Bowers Ridge	101-200	a	0	0				a	0.0	0.0
	201-300	80	114	0				21.6	24.4	0.0
	301-500	636	649	1,527				212.5	214.5	1,185.2
	510-900	73	12	155				28.2	6.5	63.3
	101-900	789	775	1,682	480.9	170.0	158.7	262.3	245.4	1,248.5
Aleutian Islands	1-100	0	76	0	0.0	1,215.8	0.0	0.0	77.0	0.0
	101-200	66	36	19	120.8	159.8	173.4	59.3	21.0	15.3
Total	201-300	672	819	361	114.5	170.1	99.2	264.6	284.6	168.4
	301-500	10,246	20,886	11,981	50.9	163.1	30.5	4,978.5	13,341.6	7,579.6
	501-900	1,813	2,642	11,624	87.9	54.9	263.5	614.8	2,084.0	9,879.0
	1-900	12,797	24,459	23,985	41.2	139.9	39.1	5,917.2	15,808.2	17,642.3
Southern Bering Sea	1-100	95	0	0				b	0.0	0.0
	101-200	0	0	7				b	0.0	1.1
	201-300	294	694	531				b	81.3	52.6
	301-500	619	11,051	6,821				b	2,614.7	2,041.1
	501-900	12	1,335	245				b	587.3	84.8
Total	1-900	1,020	13,080	7,604	185.2	308.3	188.0	b	3,283.3	2,179.6

a No sampling was conducted in this area-depth interval.

b Fish not counted - Population not estimated.

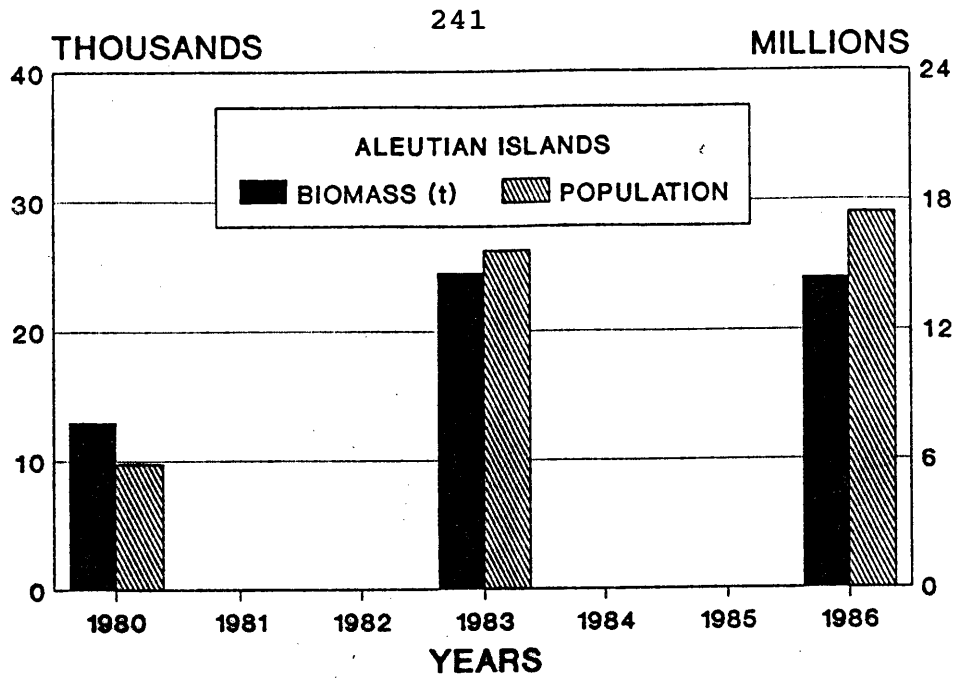

Figure 158. Estimated biomass and population of shortraker rockfish in the Aleutian Islands area during the U.S.-Japan 1980, 1983, and 1986 groundfish surveys.

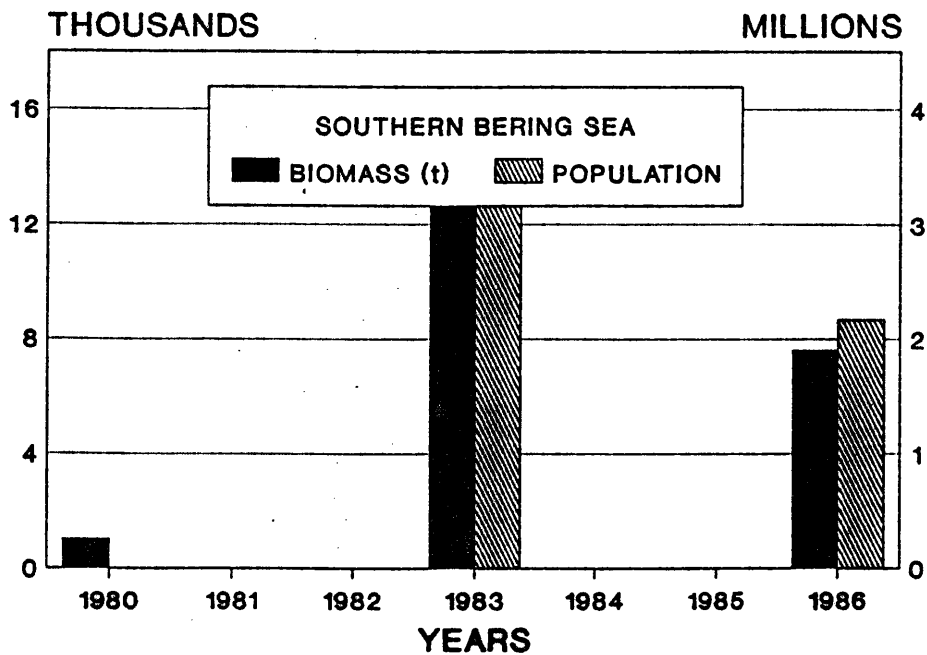

Figure 159. Estimated biomass and population of shortraker rockfish in the Southern Bering Sea area during the U.S.-Japan 1980, 1983, and 1986 Aleutian Islands groundfish surveys.

Table 68. Estimates of mean catch per unit effort, length, and weight for shortraker rockfish based on the U.S.-Japan 1980, 1983, and 1986 Aleutian Islands groundfish surveys.

Area	Depth (m)	Mean CPUE (kg/km ²)			Mean Length (cm)			Mean Weight (kg)		
		1980	1983	1986	1980	1983	1986	1980	1983	1986
Southwest	1-100	0.0	25.9	0.0	0.0	17.2	0.0	0.00	0.99	0.00
	101-200	4.5	1.1	2.9	0.0	35.9	0.0	0.63	0.76	1.08
	201-300	48.5	26.7	19.1	0.0	51.0	48.0	2.77	2.13	2.43
	301-500	791.2	1,849.7	580.6	54.0	37.0	43.5	1.65	1.03	2.83
	501-900	94.4	172.1	377.4	35.3	37.4	38.5	3.32	1.28	0.99
	1-900	162.4	345.0	204.0	39.3	36.9	43.1	1.82	1.07	1.38
Southeast	1-100	a	0.0	0.0	a	0.0	0.0	a	0.00	0.00
	101-200	6.9	8.9	0.0	0.0	0.0	0.0	0.00	2.48	0.00
	201-300	86.5	189.7	87.1	44.6	53.6	62.3	2.19	2.74	1.94
	301-500	340.6	1,009.4	1,482.1	41.2	37.8	41.9	1.44	1.01	1.24
	501-900	33.6	233.8	1,754.1	38.3	36.7	0.0	0.00	0.89	1.10
	1-900	115.5	318.9	657.4	39.7	38.4	42.1	1.68	1.08	1.18
Northwest	1-100	0.0	0.0	0.0	0.0	0.0	0.0	0.00	0.00	0.00
	101-200	0.0	0.0	0.0	0.0	0.0	0.0	0.00	0.00	0.00
	201-300	131.2	28.2	8.1	0.0	0.0	41.6	2.59	4.30	4.22
	301-500	1,403.7	883.2	481.6	47.4	50.1	54.8	3.34	2.20	2.13
	501-900	137.3	63.8	626.7	42.6	41.8	48.1	2.15	1.83	1.88
	1-900	348.1	178.1	304.8	43.8	48.8	53.1	3.04	2.16	1.94
Northeast	1-100	0.0	0.0	0.0	0.0	0.0	0.0	0.00	0.00	0.00
	101-200	3.9	0.0	0.0	0.0	0.0	0.0	1.17	0.00	0.00
	201-300	27.7	6.1	13.7	0.0	0.0	40.6	2.72	2.32	2.24
	301-500	837.2	2,565.0	839.8	45.7	58.9	38.5	1.92	3.04	1.84
	501-900	66.2	76.3	167.8	36.9	42.8	45.2	3.98	1.96	1.21
	1-900	186.9	542.5	215.9	42.6	57.7	38.9	2.05	2.96	1.61
Bowers Ridge	101-200	a	0.0	0.0	a	0.0	0.0	a	0.00	0.00
	201-300	65.1	93.7	0.0	0.0	67.7	61.0	3.69	4.37	0.00
	301-500	397.2	405.5	953.4	42.5	54.4	54.5	3.10	2.99	1.30
	501-900	10.3	1.7	21.7	0.0	0.0	51.3	2.60	1.85	2.55
	101-900	79.3	75.7	164.0	42.5	55.8	54.7	3.09	3.11	1.36
Aleutian Islands Total	1-100	0.0	9.5	0.0	0.0	17.2	0.0	0.00	0.99	0.00
	101-200	4.3	2.2	1.1	0.0	35.9	0.0	1.13	1.71	1.08
	201-300	66.0	80.5	35.4	44.6	54.7	50.3	2.53	2.86	2.04
	301-500	765.6	1,513.7	877.9	43.9	43.0	44.4	2.08	1.58	1.57
	501-900	68.2	95.5	420.3	38.1	38.1	44.6	2.96	1.26	1.21
1-900	178.5	320.5	304.3	40.7	42.4	44.5	2.18	1.56	1.38	
Southern Bering Sea Total	1-100	19.7	0.0	0.0	b	0.0	0.0	c	0.00	0.00
	101-200	0.0	0.0	2.1	b	0.0	0.0	c	0.00	6.13
	201-300	293.8	692.5	529.7	b	76.1	0.0	c	8.53	10.02
	301-500	486.2	8,684.2	5,360.6	b	60.9	54.5	c	4.26	3.37
	501-900	5.3	587.1	107.8	b	48.0	0.0	c	2.27	2.91
1-900	80.7	1,034.8	601.6	b	58.9	54.5	c	4.01	3.51	

a No sampling was conducted in this area-depth interval.

b Fish not measured.

c Fish not weighed.

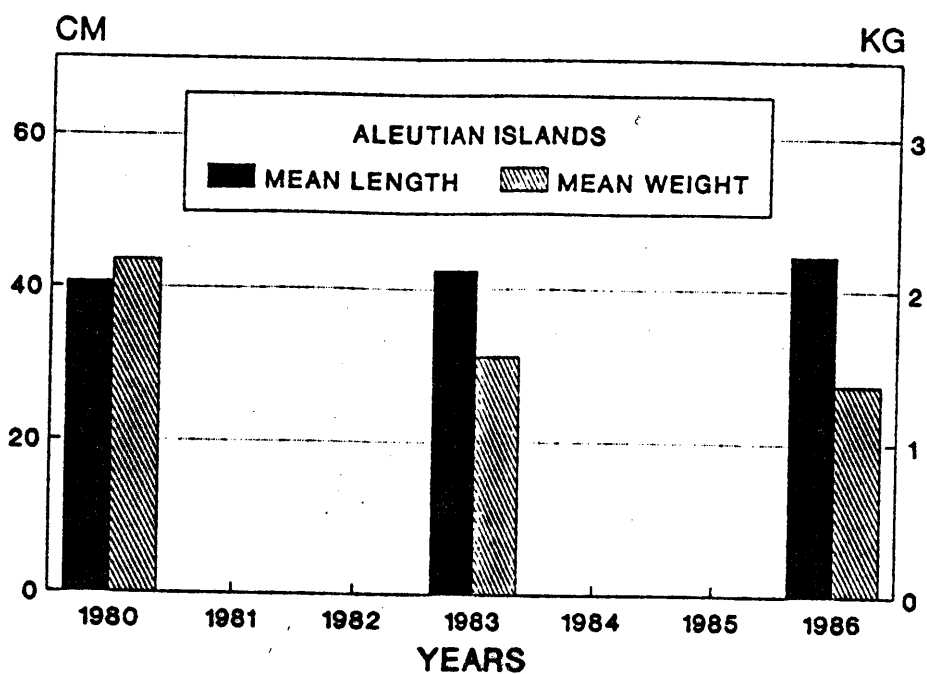

Figure 160. Mean length and weight of shortraker rockfish in the Aleutian Islands area during the U.S.-Japan 1980, 1983, and 1986 groundfish surveys.

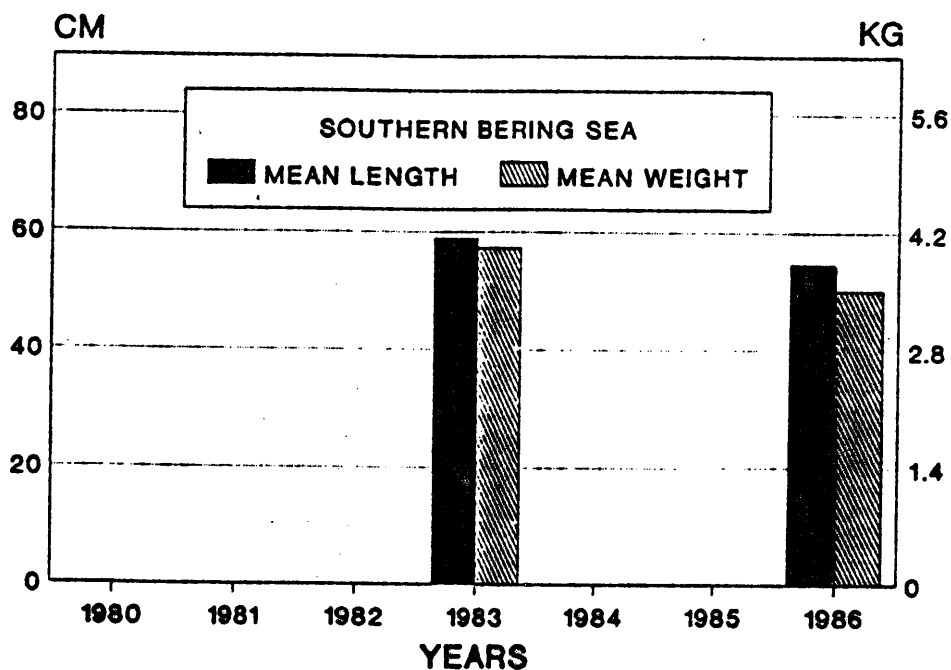

Figure 161. Mean length and weight of shortraker rockfish in the Southern Bering Sea area during the U.S.-Japan 1980, 1983, and 1986 Aleutian Islands groundfish surveys.

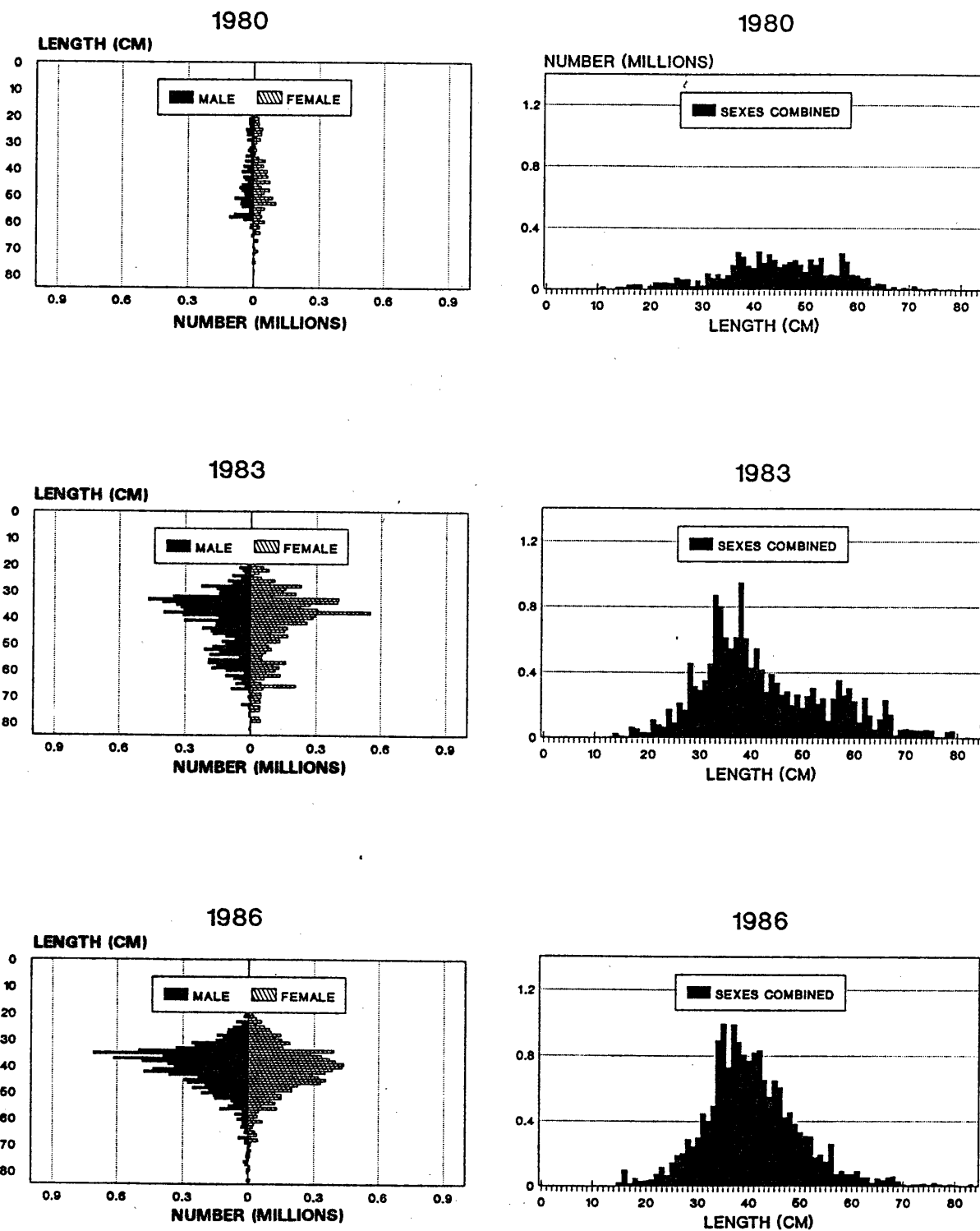

Figure 162. Size composition of shorttraker rockfish in the Aleutian Islands area during the U.S.-Japan 1980, 1983, and 1986 groundfish surveys.

mode was shifted approximately 5 cm larger than in 1983, and there was an increase in the number of fish in the 45-55 cm range, and a decrease in larger fish. During all three surveys the stock appeared to be quite evenly split between males and females.

There was considerable variation between the size composition curves in each of the areas during the three survey years (Figs. 163-166). In 1980 in the Southwest area the majority of shortraker rockfish ranged from 30 to 50 cm. There was insufficient size data in the Southeast area to provide an estimate of the size range for that year. In the Northwest area the majority of the shortrakers were in the 47-61 cm size range. The Northeast area size composition curve was similar to the Southwest with most fish ranging from 30-50 cm.

During 1983 the size composition of the southern areas of the Aleutian Islands, was similar in size range and mode with most of the fish in the 28-48 cm range. In the northern areas, the mode of the size composition curve was considerably larger, with most fish ranging from 45 to 60 cm in the Northwest and 44-68 cm in the Northeast areas.

During 1986 In the Southwest area, most individuals were from 30 to 45 cm. Size composition curves In the Southeast, Northwest and Northeast areas were similar, with most fish ranging from 30 to 60 cm, however, the Southeast and Northeast had a larger percentage of fish in the 50-60 cm range.

No size composition data were available for shortraker rockfish in the Southern Bering Sea area from the 1980 survey. During 1983 and 1986 the majority of fish were in the 40-65 cm size range, however, during 1983 there were significantly more larger specimens, in the 70-100 cm size range (Fig. 167).

In 1983 the size composition curve for the Southern Bering Sea showed no resemblance to the Northeast area of the Aleutian Islands, the closest adjacent area surveyed, where most of the stock was from 51-68 cm. in length. In 1986 the size composition of these two areas was similar but the Northeast area contained a larger number of fish in the 30-40 cm size range.

Shortraker rockfish otolith age reading and interpretation techniques were not developed at the time of these surveys, therefore no age data are available for this species.

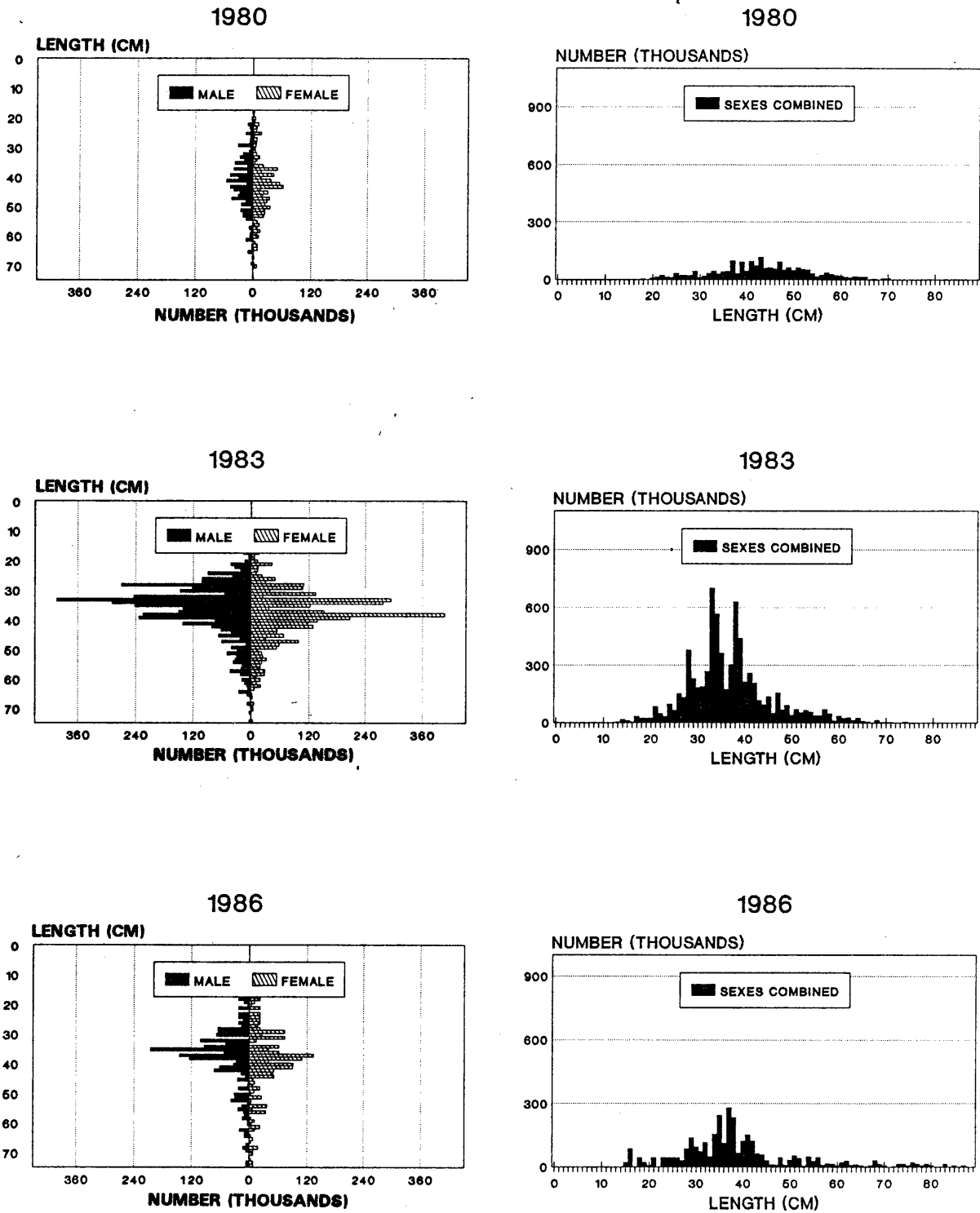

Figure 163. Size composition of shorttraker rockfish in the Southwest area of the Aleutian Islands during the U.S.-Japan 1980, 1983, and 1986 groundfish surveys.

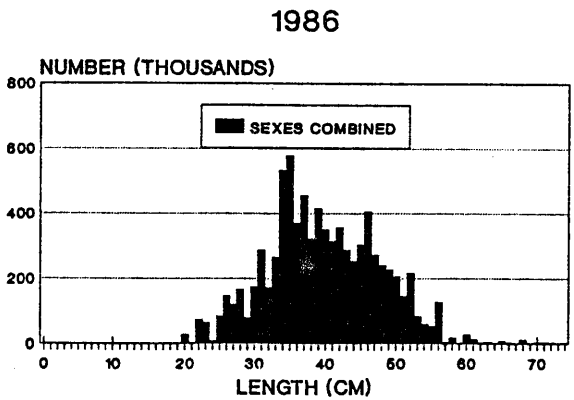
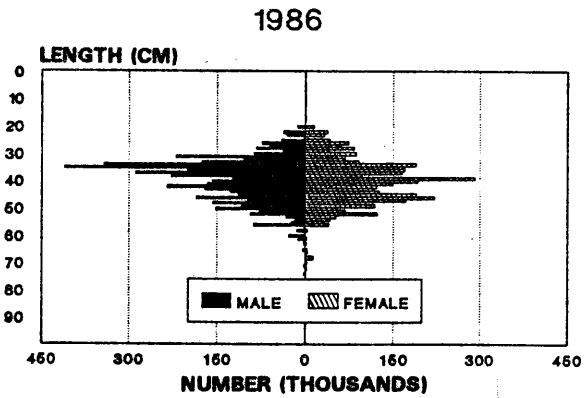
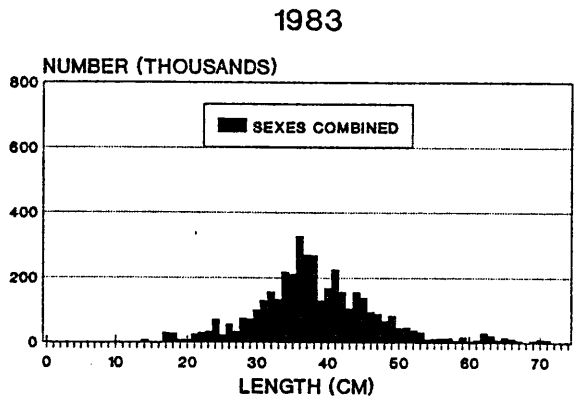
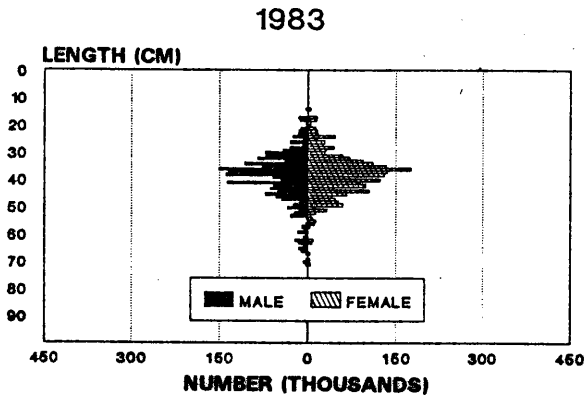
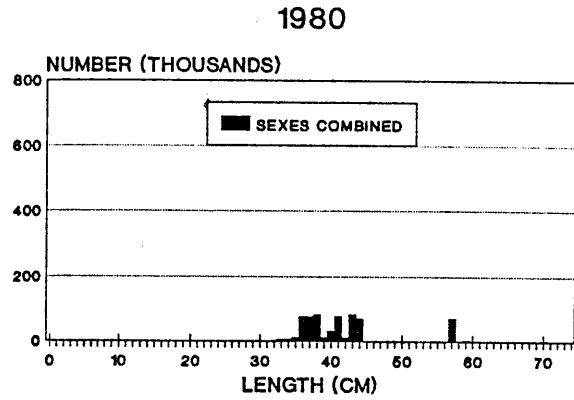
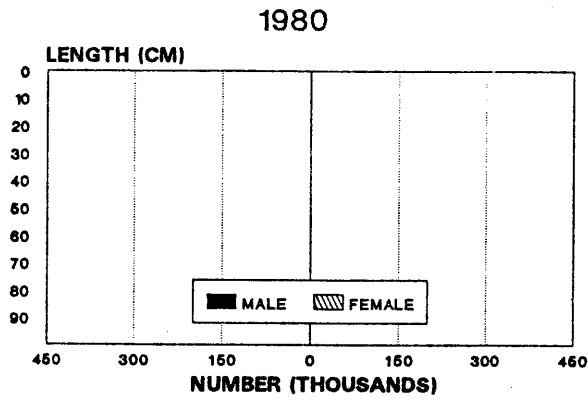

Figure 164. Size composition of shorttraker rockfish in the Southeast area of the Aleutian Islands during the U.S.-Japan 1980, 1983, and 1986 groundfish surveys.

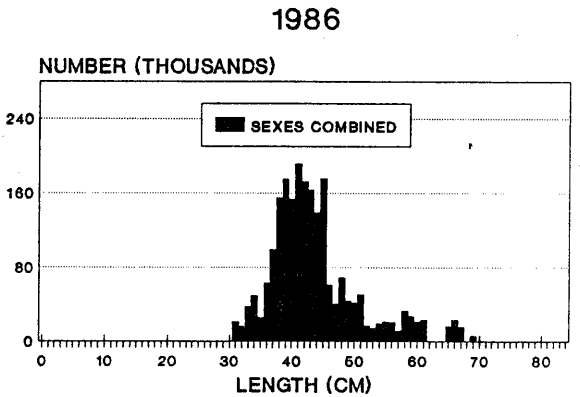
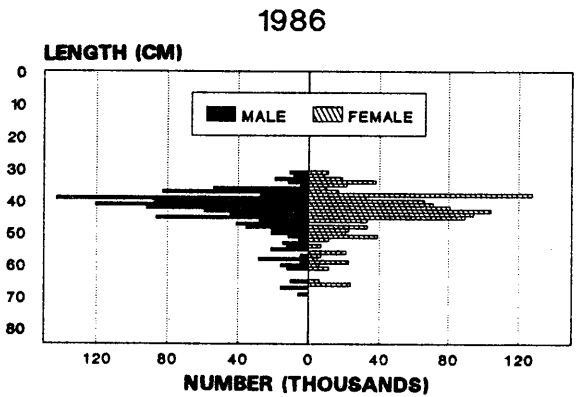
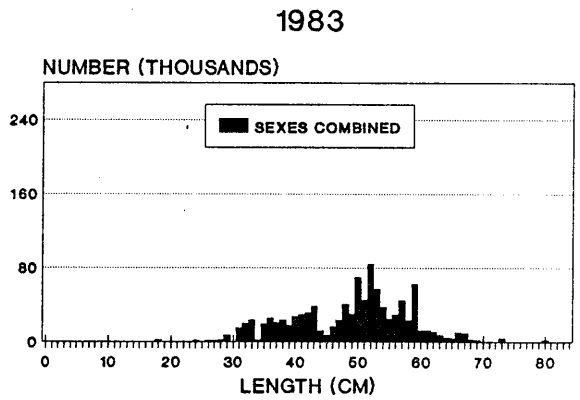
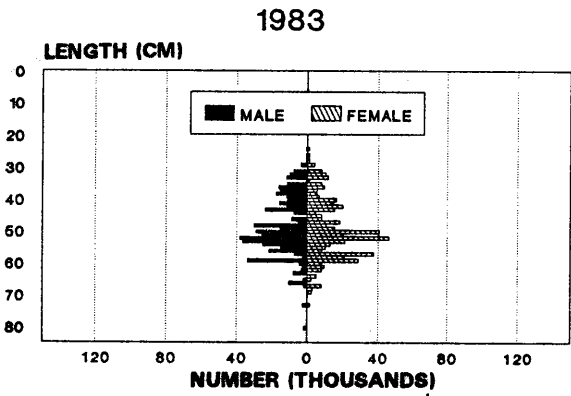
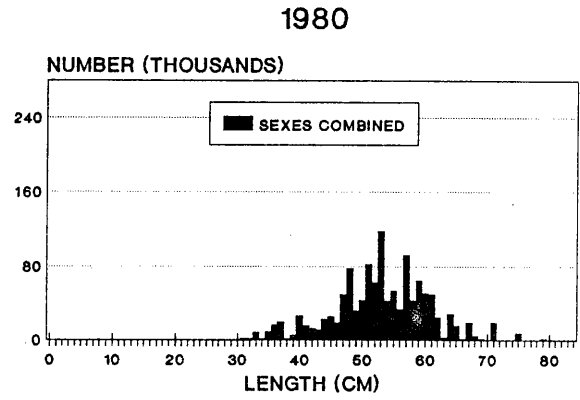
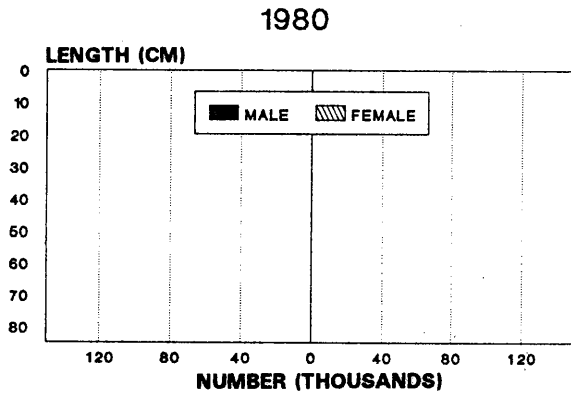

Figure 165. Size composition of shortraker rockfish in the Northwest area of the Aleutian Islands during the U.S.-Japan 1980, 1983, and 1986 groundfish surveys.

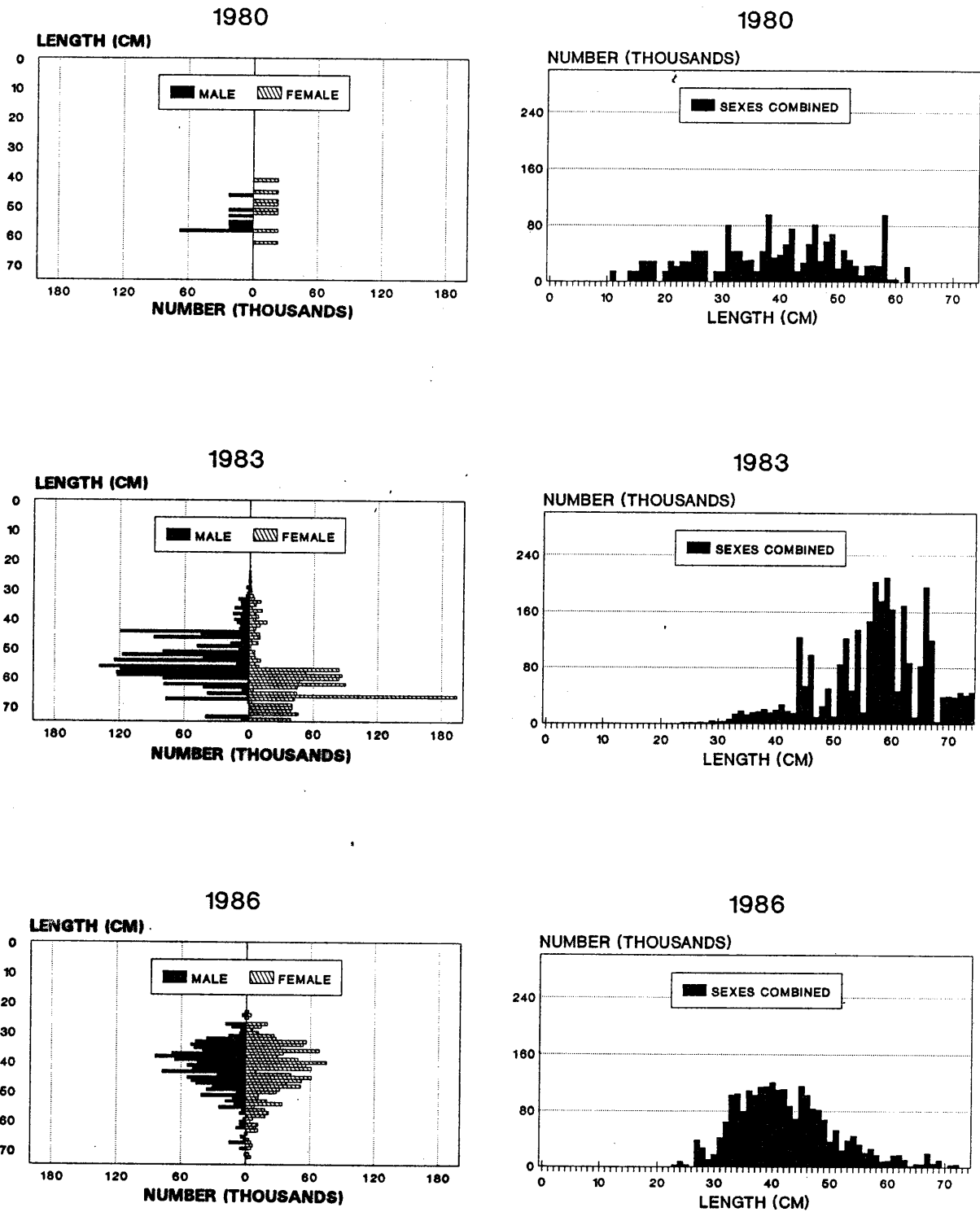

Figure 166. Size composition of shorttraker rockfish in the Northeast area of the Aleutian Islands during the U.S.-Japan 1980, 1983, and 1986 groundfish surveys.

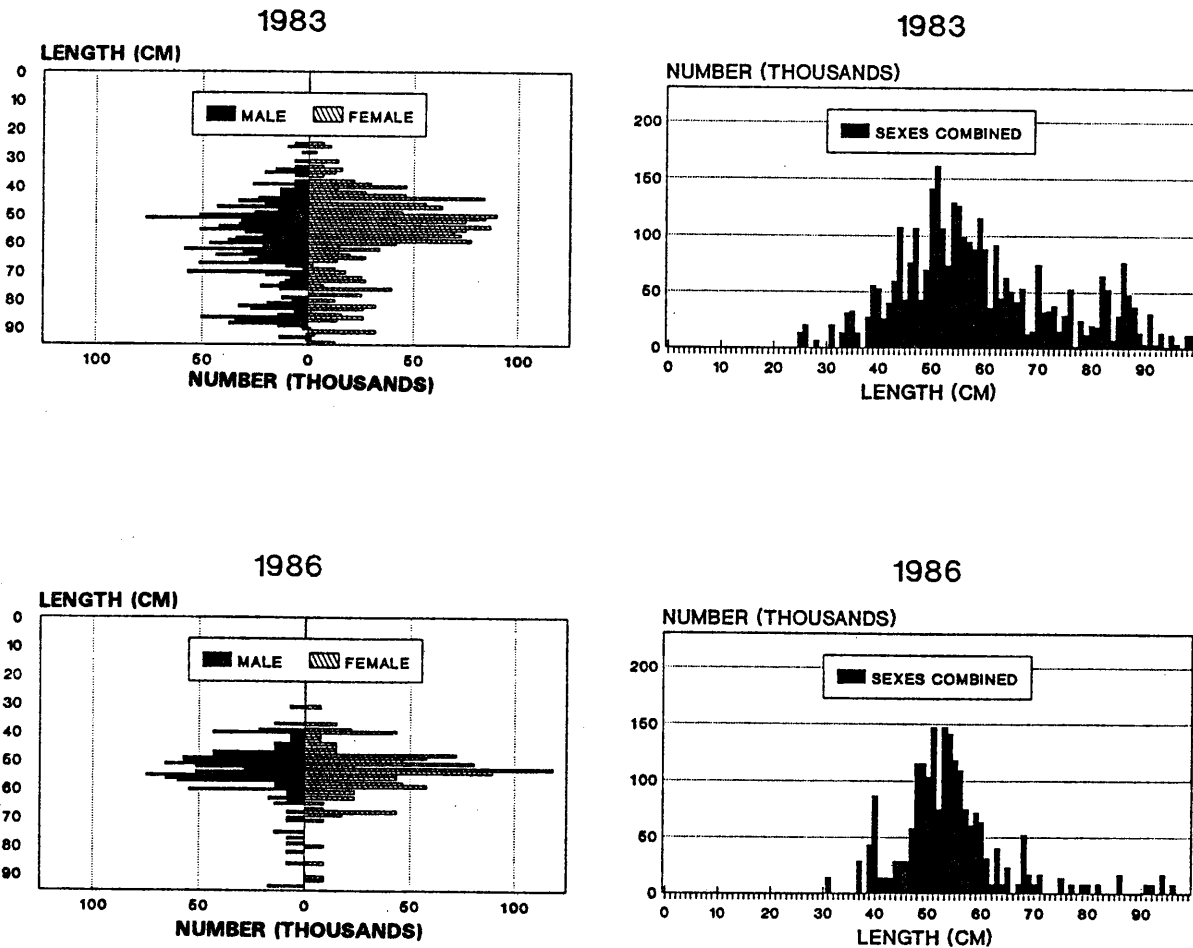

Figure 167. Size composition of shorttraker rockfish in the Southern Bering Sea area during the U.S.-Japan 1983 and 1986 Aleutian Islands groundfish surveys.

Length-Weight Relationship

Length-weight data are available for shorttraker rockfish from all three surveys. Analysis of these data indicated nearly identical agreement between the three years data (Fig. 168), and provided the following estimates of the constants:

$$\begin{aligned} \text{Weight(g)} \text{ (1980)} &= .0112 \times \text{Length(cm)}^{3.108} \\ \text{Weight(g)} \text{ (1983)} &= .0096 \times \text{Length(cm)}^{3.143} \\ \text{Weight(g)} \text{ (1986)} &= .0059 \times \text{Length(cm)}^{3.268} \end{aligned}$$

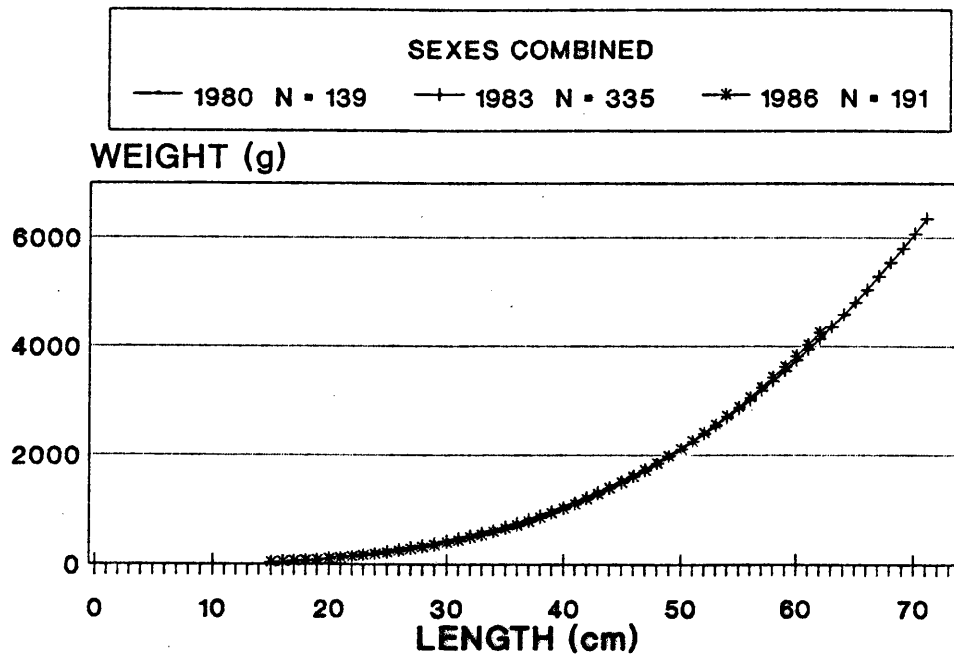

Figure 168. Length-weight relationships for shorttraker rockfish in the Aleutian Islands area during the U.S.-Japan 1980, 1983, and 1986 groundfish surveys.

Shortspine Thornyhead

Distribution and Abundance

Shortspine thornyheads (Sebastolobus alascanus) were distributed throughout the Aleutian Islands area primarily at depths greater than 500 m (Figs. 169-170). Medium densities of shortspine thornyheads were encountered in the Southwest area during the 1980 survey, and north of Atka Island, southwest of Semisopchnoi Island and on Bowers Ridge during the 1983 survey. In 1986 medium densities were also found northwest of Seguam Island, north of Atka Island, east of the Delarof Islands, on both perimeters of Petrel Bank, north of Segula Island, on Tahoma Reef, south of Buldir Island, west of Agattu Island, north of Attu Island and on Bowers Ridge.

The biomass estimate for the Aleutian Islands area decreased 26% from 19,000 t in 1980 to 14,000 t in 1983, then increased 160% to 23,000 t in 1986 (Table 69, Fig. 171). Population decreased from 41.4 million fish in 1980 to 21.9 million in 1983, then increased to 36.6 million in 1986. Most of the decrease in the 1983 biomass estimate occurred in the Southwest area. The 1986 increase was equally divided over all areas except the Southeast which remained unchanged.

In the Southern Bering Sea area the biomass of shortspine thornyheads remained relatively unchanged, going from 1,000 t in 1980 to 1,400 t in 1983, and back down to 900 t in 1986. Population went from 1.1 million fish in 1980 to 2.7 million in 1983, and 1.3 million in 1986 (Fig. 172).

In the Aleutian Islands the largest mean length and largest mean weight occurred during the 1983 survey but in the Southern Bering Sea area these parameters were both highest during the 1980 survey (Table 70, Figs. 173-174).

Size Composition

The size composition curves for shortspine thornyhead were similar throughout all surveys in the Aleutian Islands area. Size ranges were nearly identical and each size composition curve had a normal distribution, the only difference being the height of the curve which reflects abundance. The 1980 size composition curve peaked at 28 cm, slightly smaller than the 1983 curve which peaked at 31-33 cm, and the 1986 curve that peaked at 32-33 cm (Fig. 175).

Some variation was apparent between areas of the Aleutian Islands (Figs. 176-179). In 1980 the size composition curve in the Southwest area peaked at 28 cm. The size composition curve in the Northwest area was skewed towards larger fish 38-47 cm, and the Northeast size composition curve peaked at 35 cm.

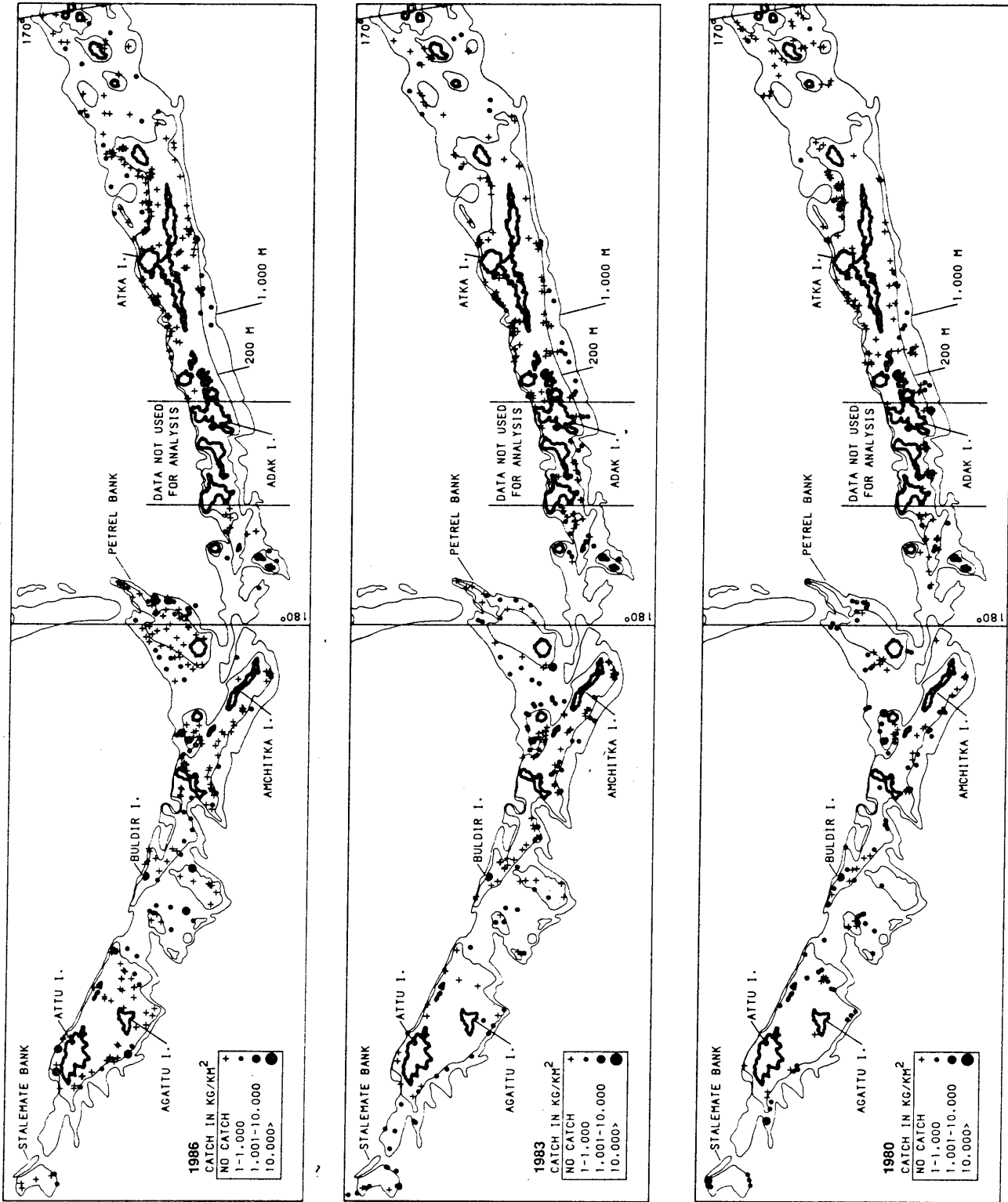

Figure 169. Distribution and relative abundance of shortspine thornyhead in the Aleutian Islands area during the U.S.-Japan 1980, 1983, and 1986 Aleutian Islands groundfish surveys.

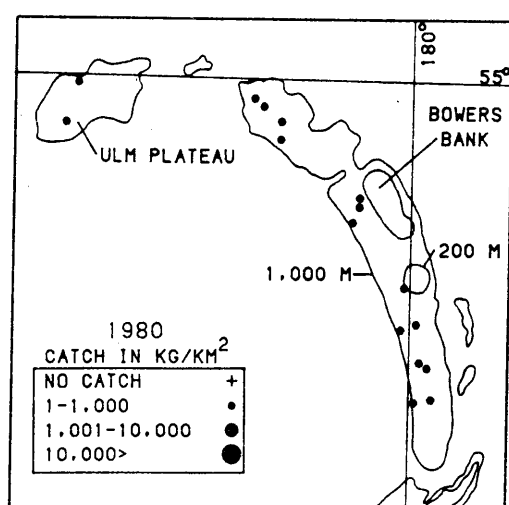
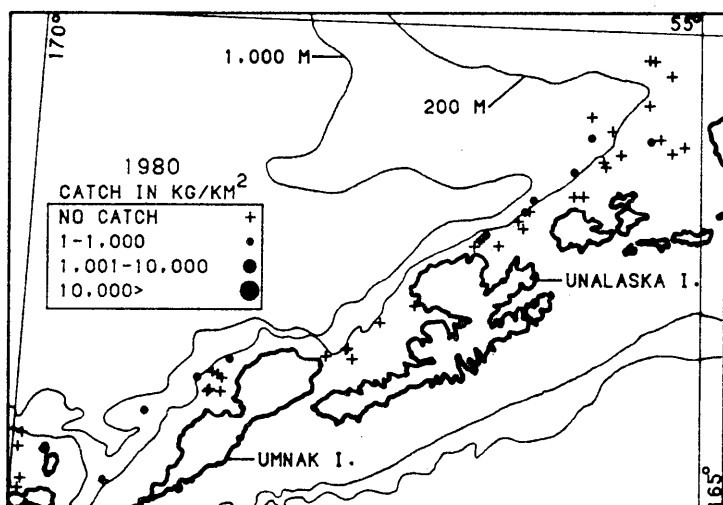
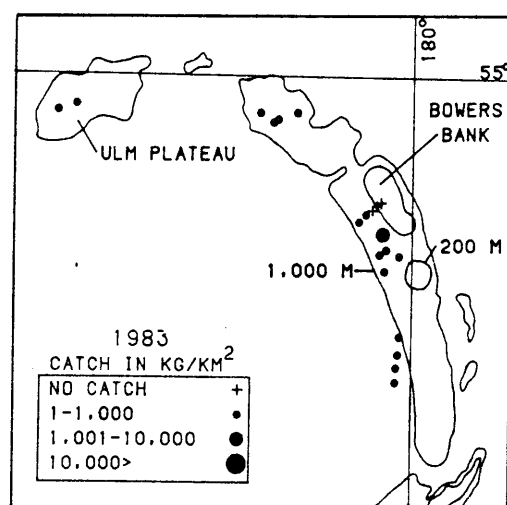
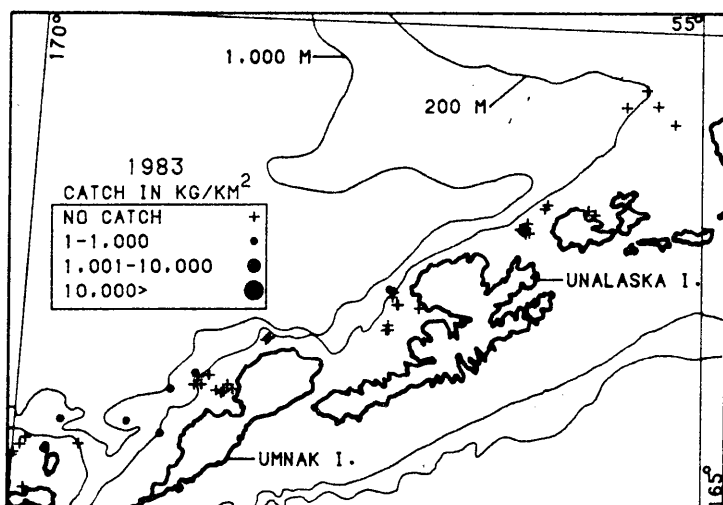
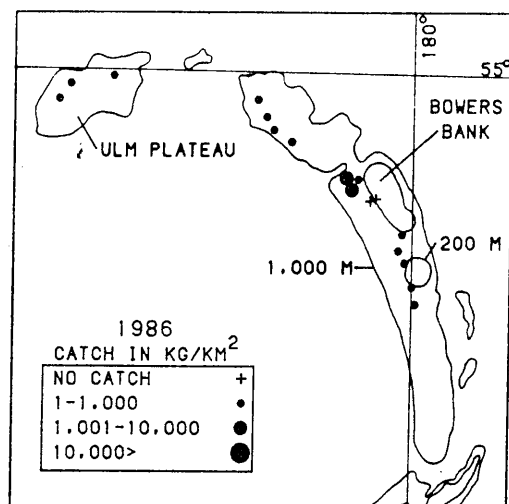
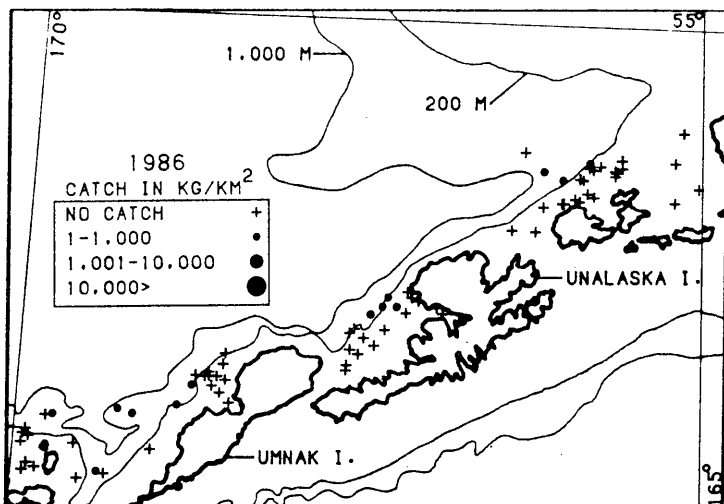

Figure 170. Distribution and relative abundance of shortspine thornyhead in the Southern Bering Sea and Bowers Ridge areas during the U.S.-Japan 1980, 1983, and 1986 Aleutian Islands groundfish surveys.

Table 69. Estimates of biomass, biomass sampling error, and population for shortspine thornyhead based on the U.S.-Japan 1980, 1983, and 1986 Aleutian Islands groundfish surveys.

Area	Depth (m)	Biomass (t)			Sampling Error (%)			Population (1,000s)		
		1980	1983	1986	1980	1983	1986	1980	1983	1986
Southwest	1-100	39	35	0				210.8	51.1	0.0
	101-200	367	18	25				651.6	46.3	20.8
	201-300	497	156	460				458.9	263.6	638.5
	301-500	1,628	969	2,487				7,724.8	1,891.4	4,767.1
	501-900	8,888	3,779	4,958				20,438.1	6,310.6	6,236.1
	1-900	11,419	4,957	7,930	102.7	34.5	82.9	29,484.2	8,563.0	11,662.5
Southeast	1-100	a	0	b				a	0.0	0.0
	101-200	11	1	0				0.0	4.7	1.9
	201-300	20	59	230				17.2	76.0	163.1
	301-500	41	739	810				56.1	1,527.7	1,730.4
	501-900	58	913	779				193.8	1,437.1	1,714.0
	1-900	130	1,712	1,819	81.5	56.9	270.0	267.1	3,045.5	3,609.4
Northwest	1-100	0	0	0				0.0	0.0	0.0
	101-200	2	0	0				20.6	0.0	0.0
	201-300	141	15	100				212.8	22.3	205.7
	301-500	100	291	2,455				112.0	506.5	3,666.8
	501-900	3,138	2,303	3,459				3,046.2	1,897.8	3,603.6
	1-900	3,381	2,609	6,014	52.1	43.4	49.7	3,397.6	2,426.6	7,476.1
Northeast	1-100	20	0	0				13.5	0.0	0.0
	101-200	4	10	2				6.8	9.0	3.3
	201-300	23	2	18				56.5	2.7	35.0
	301-500	149	688	768				277.7	1,062.2	1,125.7
	501-900	987	1,163	2,396				1,737.8	2,058.3	3,248.8
	1-900	1,183	1,863	3,184	269.5	31.2	50.7	2,092.3	3,132.2	4,412.8
Bowers Ridge	101-200	a	0	0				a	0.0	0.0
	201-300	57	204	230				129.3	331.6	342.0
	301-500	995	1,043	1,657				2,856.5	1,397.4	4,460.0
	510-900	1,970	1,599	2,379				3,179.4	3,011.2	4,598.1
	101-900	3,022	2,846	4,266	66.7	54.7	28.8	6,165.2	4,740.2	9,400.7
Aleutian Islands	1-100	59	35	0	0.0	911.2	0.0	224.3	51.1	0.0
	101-200	384	29	27	202.5	112.8	124.2	679.0	60.0	26.0
Total	201-300	738	436	1,038	58.0	650.1	66.2	874.7	696.2	1,384.9
	301-500	2,913	3,730	8,177	42.8	39.8	21.3	11,027.1	6,385.2	15,750.0
	501-900	15,041	9,757	13,971	80.7	20.4	40.0	28,595.3	14,715.0	19,400.6
	1-900	19,135	13,987	23,213	64.7	16.6	23.2	41,400.4	21,907.5	36,561.5
Southern Bering Sea	1-100	0	0	0				0.0	0.0	0.0
	101-200	5	0	1				0.0	0.0	2.7
Total	201-300	51	10	51				0.0	12.0	74.7
	301-500	53	693	485				0.0	1,637.8	733.8
	501-900	970	711	389				1,094.8	1,092.5	465.2
	1-900	1,079	1,414	926	101.3	37.1	60.4	1,094.8	2,742.3	1,276.4

a no sampling was conducted in this area-depth interval.

b Less than 0.5 ton.

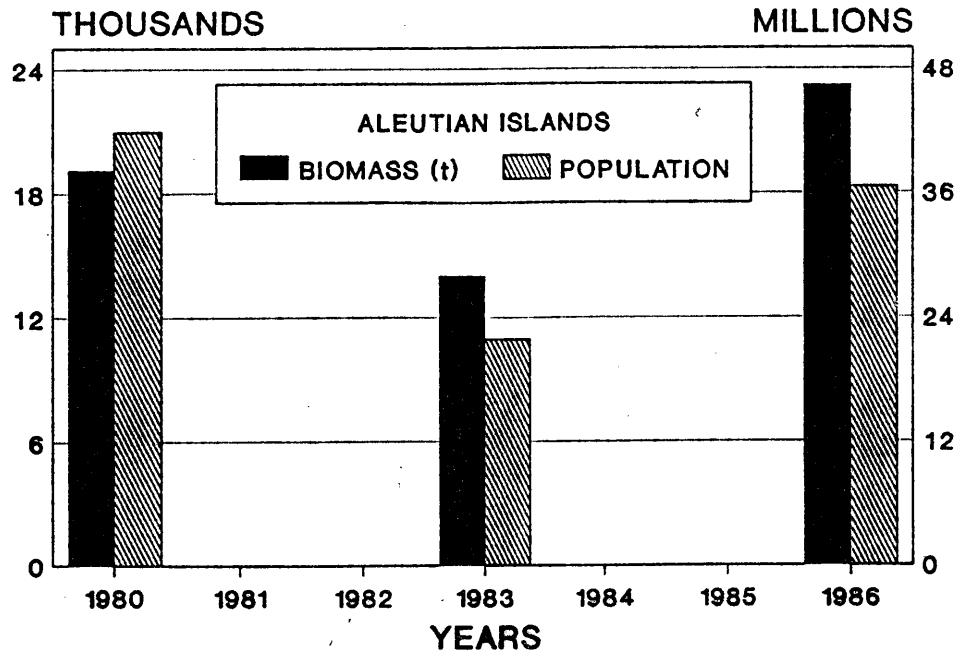

Figure 171. Estimated biomass and population of shortspine thornyhead in the Aleutian Islands area during the U.S.-Japan 1980, 1983, and 1986 groundfish surveys.

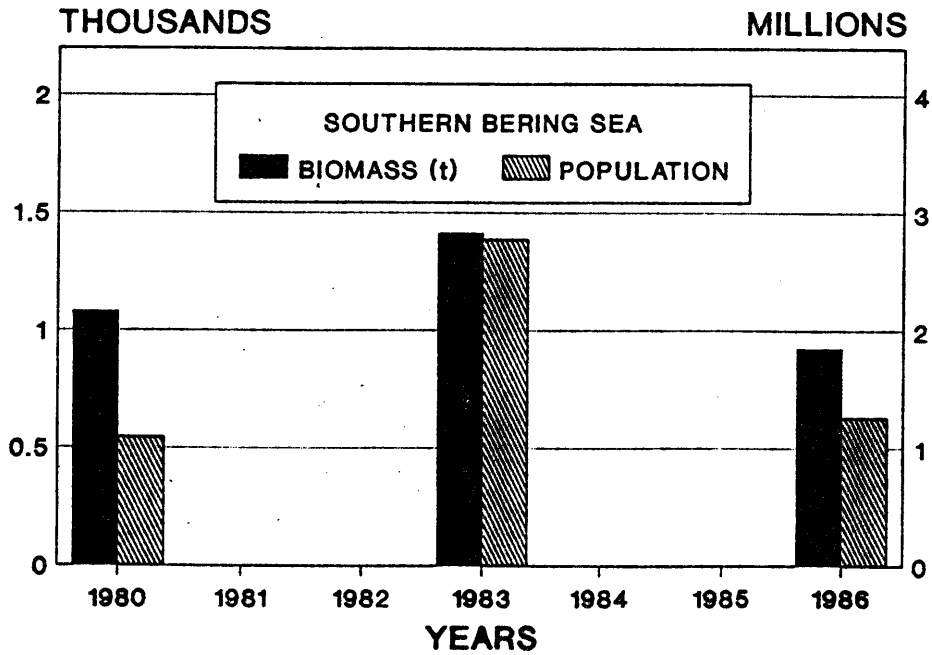

Figure 172. Estimated biomass and population of shortspine thornyhead in the Southern Bering Sea area during the U.S.-Japan 1980, 1983, and 1986 Aleutian Islands groundfish surveys.

Table 70. Estimates of mean catch per unit effort, length, and weight for shortspine thornyhead based on the U.S.-Japan 1980, 1983, and 1986 Aleutian Islands groundfish surveys.

Area	Depth (m)	Mean CPUE (kg/km ²)			Mean Length (cm)			Mean Weight (kg)		
		1980	1983	1986	1980	1983	1986	1980	1983	1986
Southwest	1-100	17.2	12.0	0.0	0.0	32.2	0.0	0.19	0.69	0.00
	101-200	56.1	2.8	3.9	0.0	0.0	33.2	0.56	0.39	1.20
	201-300	216.7	67.9	200.3	36.2	33.4	35.7	1.11	0.59	0.72
	301-500	477.4	284.3	729.4	31.7	31.8	32.3	0.19	0.51	0.53
	501-900	1,263.4	537.1	704.9	38.3	33.6	30.7	0.44	0.60	0.81
	1-900	529.6	223.2	344.3	35.5	33.2	31.3	0.38	0.58	0.69
Southeast	1-100	a	0.0	0.0	a	0.0	0.0	a	0.00	0.00
	101-200	3.4	0.3	0.1	0.0	0.0	0.0	0.00	0.18	0.15
	201-300	6.5	18.7	72.9	40.4	38.1	0.0	1.19	0.77	1.29
	301-500	15.0	235.5	258.2	31.4	37.7	35.0	0.73	0.48	0.47
	501-900	28.7	322.8	275.1	32.9	35.4	30.6	0.30	0.64	0.45
	1-900	11.7	122.5	121.0	32.5	36.1	31.6	0.49	0.56	0.50
Northwest	1-100	0.0	0.0	0.0	0.0	0.0	0.0	0.00	0.00	0.00
	101-200	1.0	0.0	0.0	0.0	0.0	0.0	0.09	0.00	0.00
	201-300	131.7	14.5	93.1	33.3	35.0	34.1	0.63	0.68	0.49
	301-500	45.1	131.3	1,107.9	35.9	32.8	37.1	1.09	0.57	0.67
	501-900	698.8	513.1	770.5	40.2	42.8	41.3	1.03	1.20	0.95
	1-900	304.3	204.5	471.2	37.9	40.7	40.7	1.00	1.07	0.80
Northeast	1-100	8.8	0.0	0.0	0.0	0.0	0.0	1.45	0.00	0.00
	101-200	0.9	2.7	0.6	0.0	42.9	0.0	0.51	1.15	0.68
	201-300	9.4	0.8	7.3	35.5	41.3	28.2	0.35	0.76	0.51
	301-500	43.5	200.3	234.1	34.0	34.7	35.5	0.54	0.65	0.71
	501-900	166.7	188.2	387.7	35.3	35.1	32.3	0.56	0.59	0.74
	1-900	66.0	108.8	179.6	35.0	35.0	32.6	0.56	0.61	0.73
Bowers Ridge	101-200	a	0.0	0.0	a	0.0	0.0	a	0.00	0.00
	201-300	46.7	166.8	188.4	35.9	34.9	29.0	0.44	0.61	0.67
	301-500	621.3	651.0	1,034.7	29.6	35.7	27.1	0.36	0.75	0.37
	501-900	276.6	224.6	334.1	33.6	34.4	33.4	0.63	0.52	0.49
	101-900	303.9	277.5	416.0	31.8	34.8	30.5	0.50	0.60	0.44
Aleutian Islands	1-100	9.8	4.4	0.0	0.0	32.2	0.0	0.26	0.69	0.00
	101-200	24.6	1.8	1.7	0.0	42.9	33.2	0.56	0.49	1.06
Total	201-300	72.5	42.8	101.9	36.1	34.7	33.7	0.83	0.63	0.74
	301-500	217.7	270.3	599.2	32.2	34.0	31.2	0.25	0.58	0.52
	501-900	565.5	352.8	505.2	36.5	35.3	32.2	0.53	0.66	0.71
	1-900	266.8	183.3	294.5	34.7	35.0	32.0	0.46	0.64	0.63
Southern Bering Sea	1-100	0.0	0.0	0.0	0.0	0.0	0.0	0.00	0.00	0.00
	101-200	1.5	0.0	0.2	0.0	0.0	0.0	0.00	0.00	0.26
	201-300	50.5	9.8	51.4	0.0	0.0	0.0	0.00	0.82	0.69
	301-500	42.0	544.6	381.1	35.1	31.8	0.0	0.00	0.42	0.67
	501-900	426.5	312.6	170.9	37.8	33.9	35.4	0.89	0.65	0.83
Total	1-900	85.4	111.9	73.2	36.1	32.6	35.4	0.99	0.51	0.73

a No sampling was conducted in this area-depth interval.

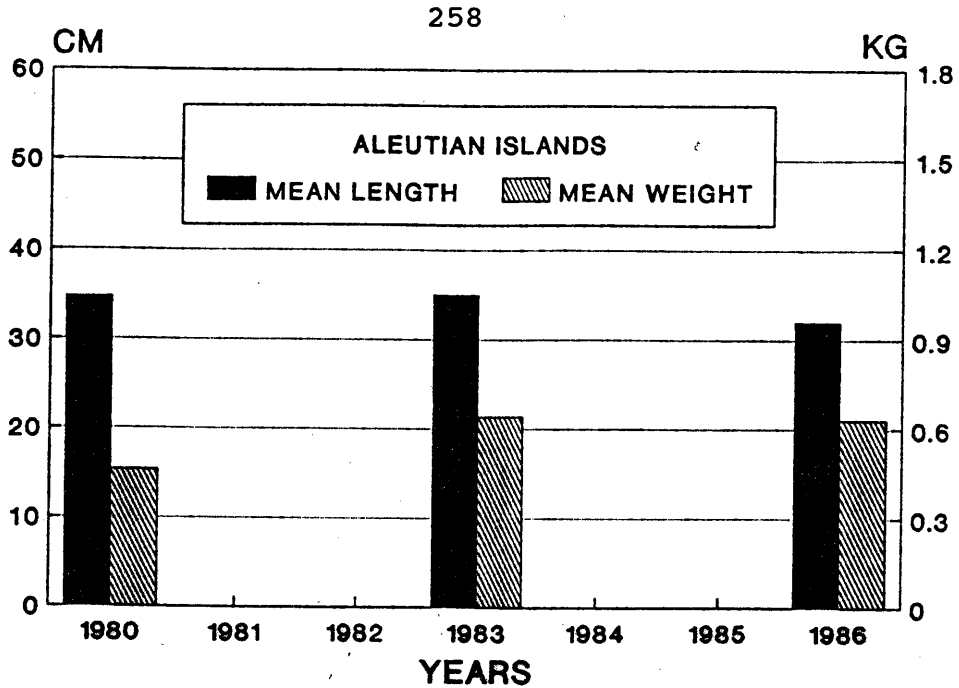

Figure 173. Mean length and weight of shortspine thornyhead in the Aleutian Islands area during the U.S.-Japan 1980, 1983, and 1986 groundfish surveys.

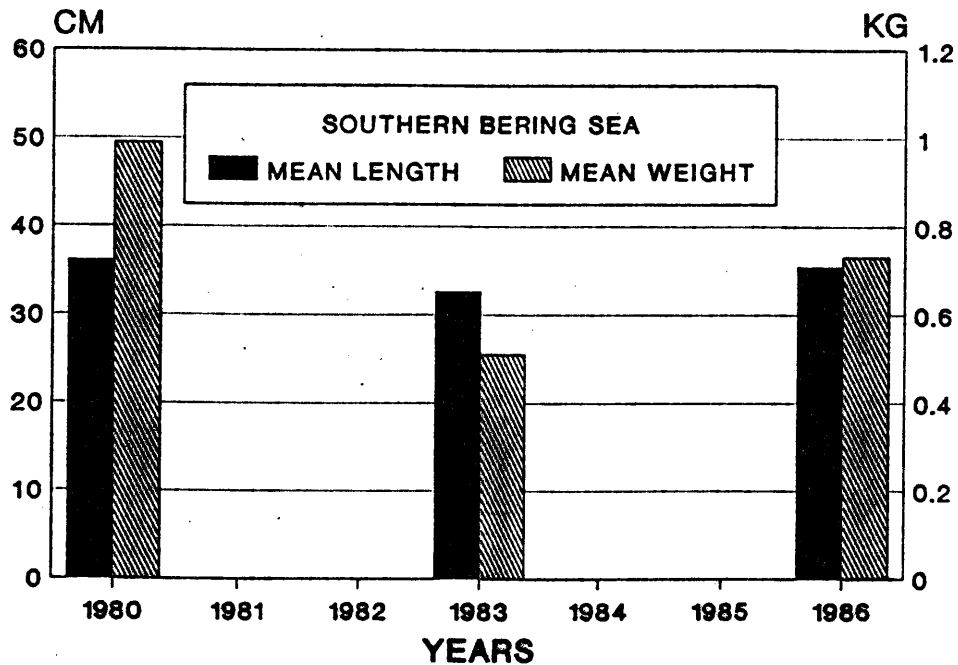

Figure 174. Mean length and weight of shortspine thornyhead in the Southern Bering Sea area during the U.S.-Japan 1980, 1983, and 1986 Aleutian Islands groundfish surveys.

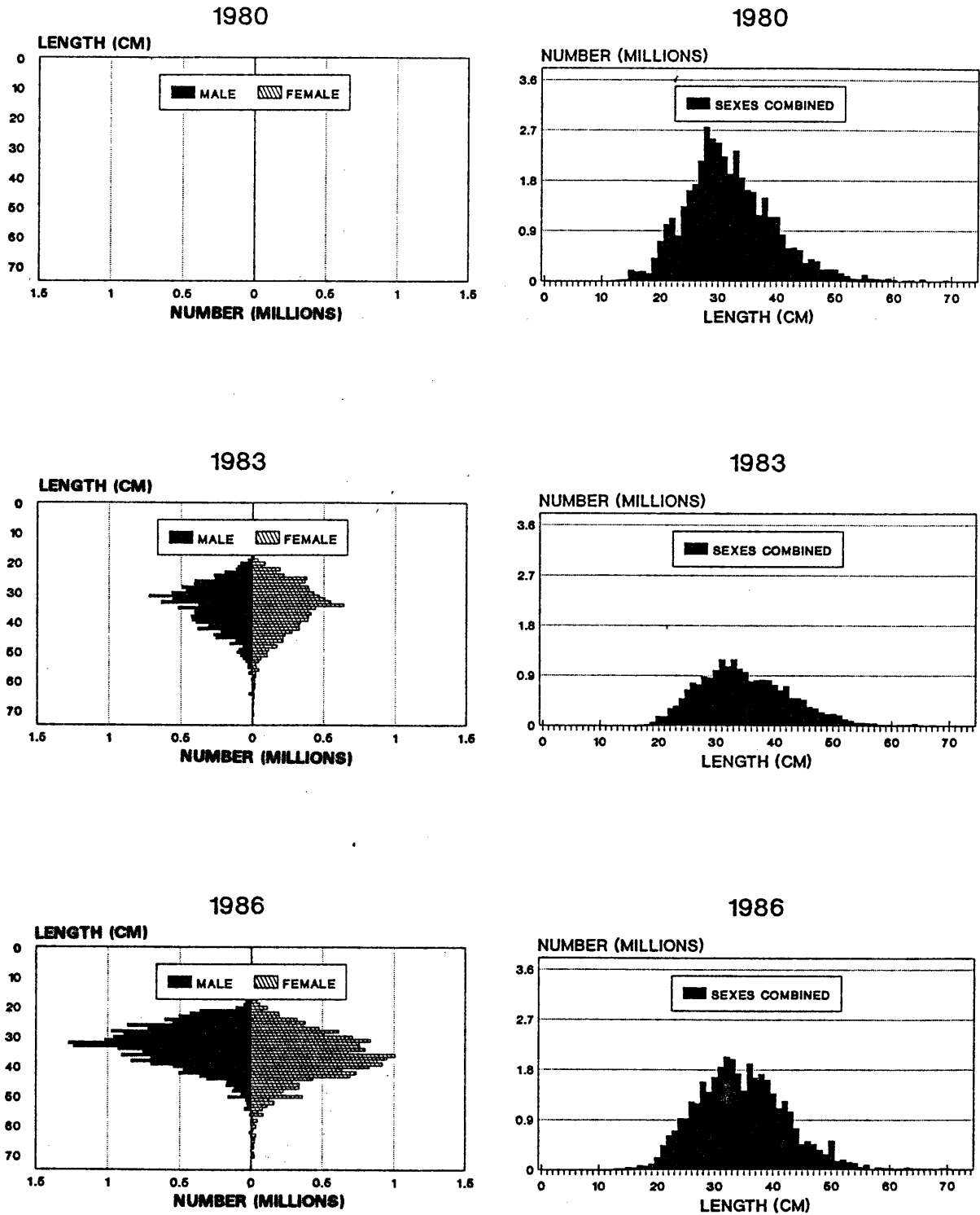

Figure 175. Size composition of shortspine thornyhead in the Aleutian Islands area during the U.S.-Japan 1980, 1983, and 1986 groundfish surveys.

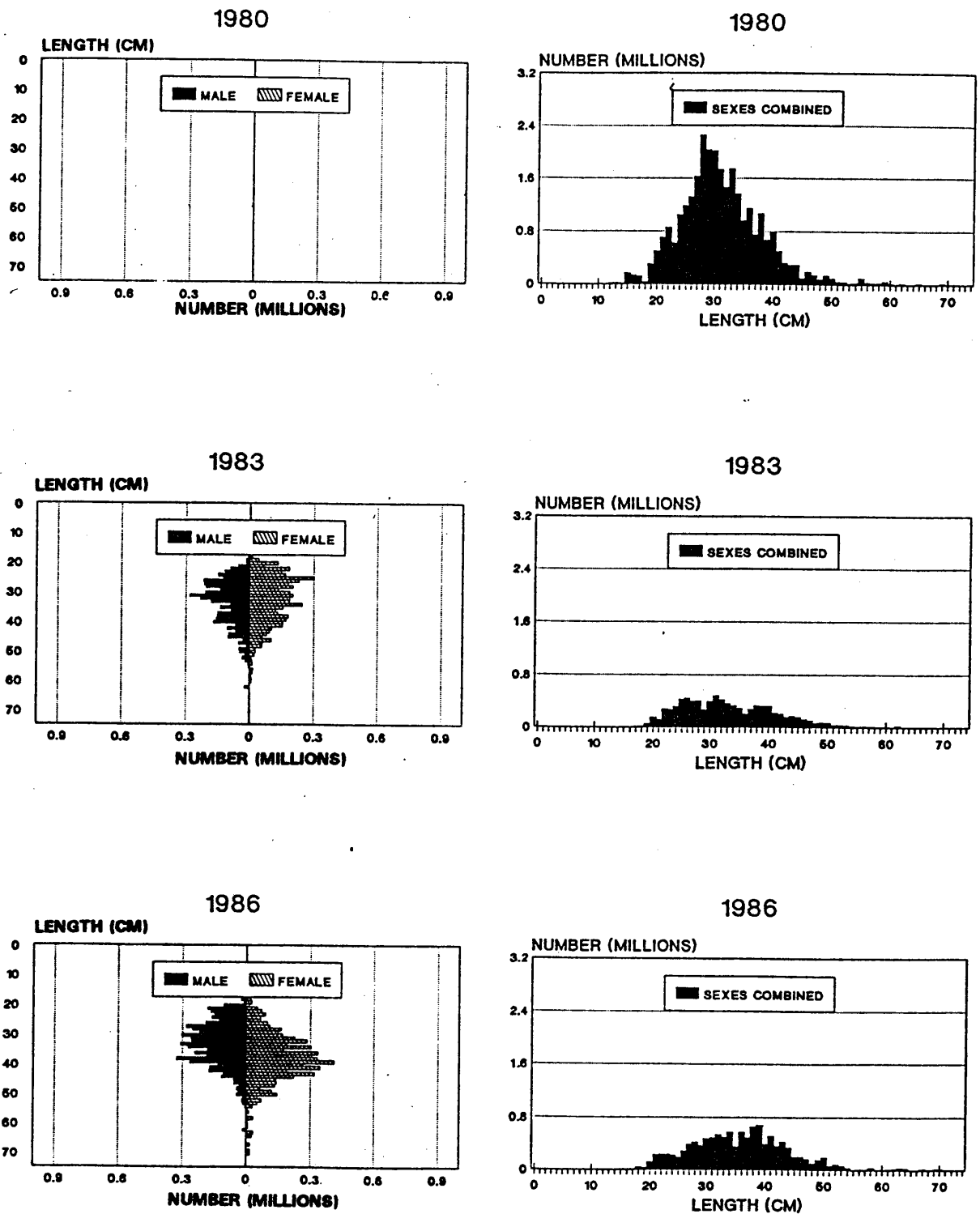

Figure 176. Size composition of shortspine thornyhead in the Southwest area of the Aleutian Islands during the U.S.-Japan 1980, 1983, and 1986 groundfish surveys.

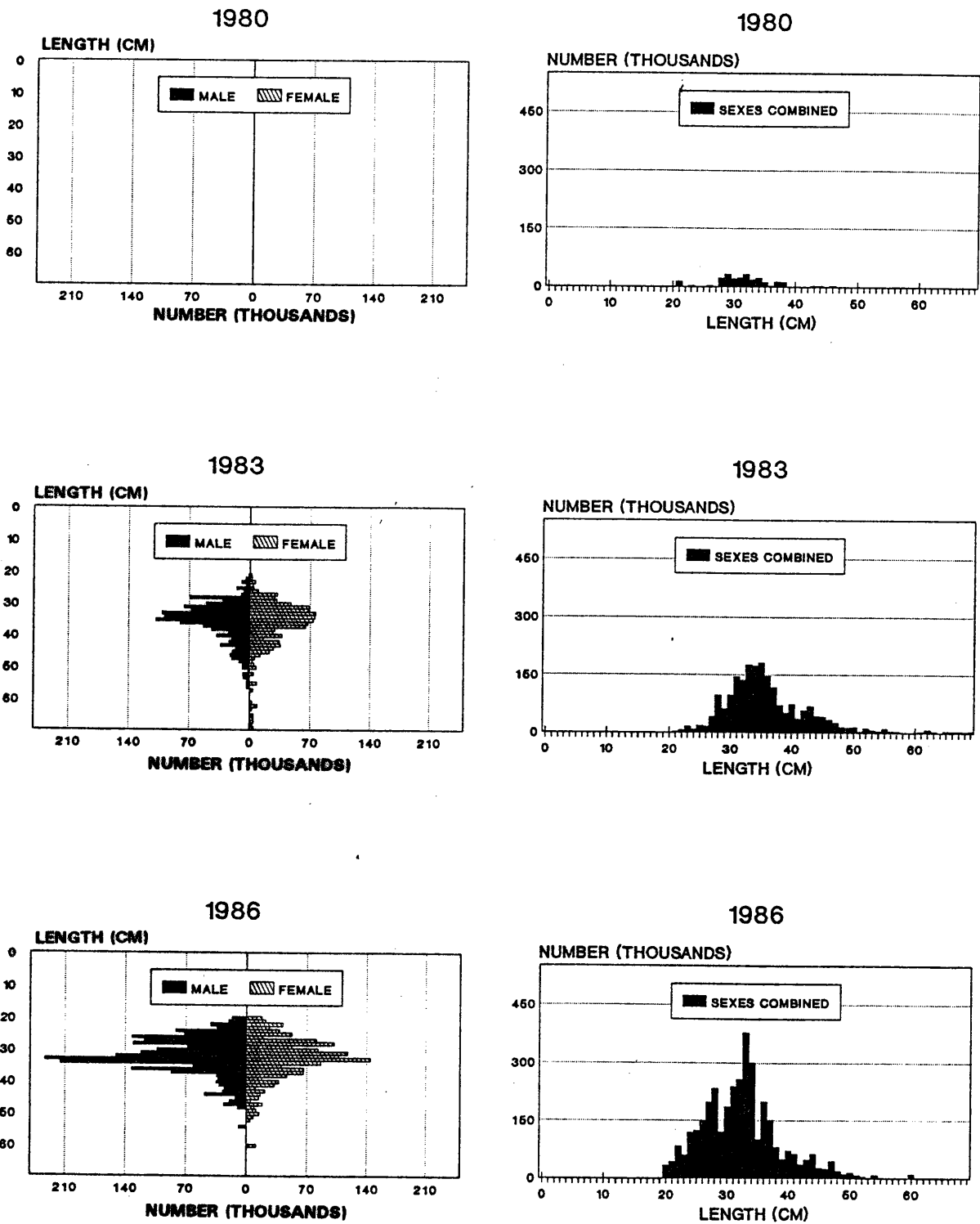

Figure 177. Size composition of shortspine thornyhead in the Southeast area of the Aleutian Islands during the U.S.-Japan 1980, 1983, and 1986 groundfish surveys.

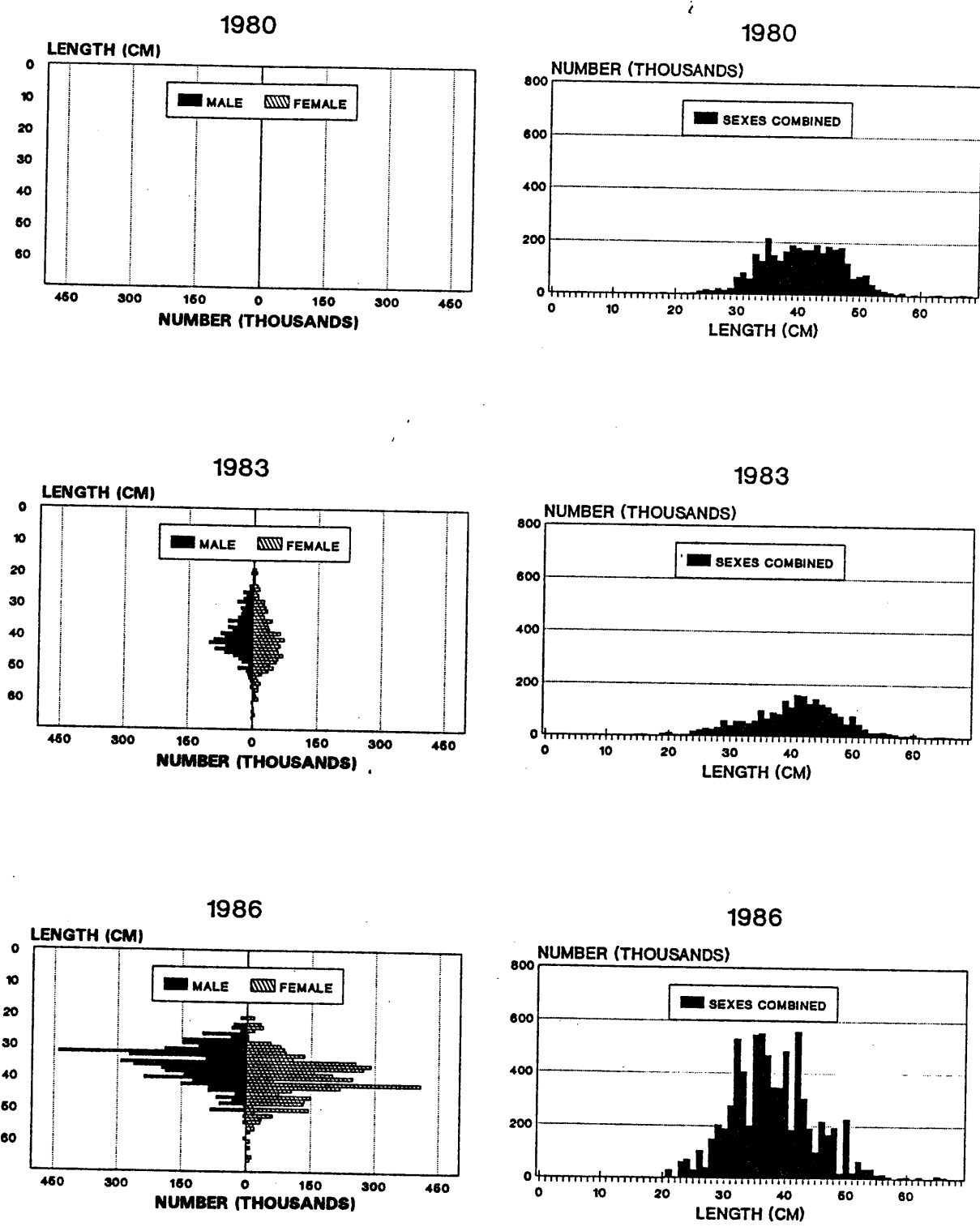

Figure 178. Size composition of shortspine thornyhead in the Northwest area of the Aleutian Islands during the U.S.-Japan 1980, 1983, and 1986 groundfish surveys.

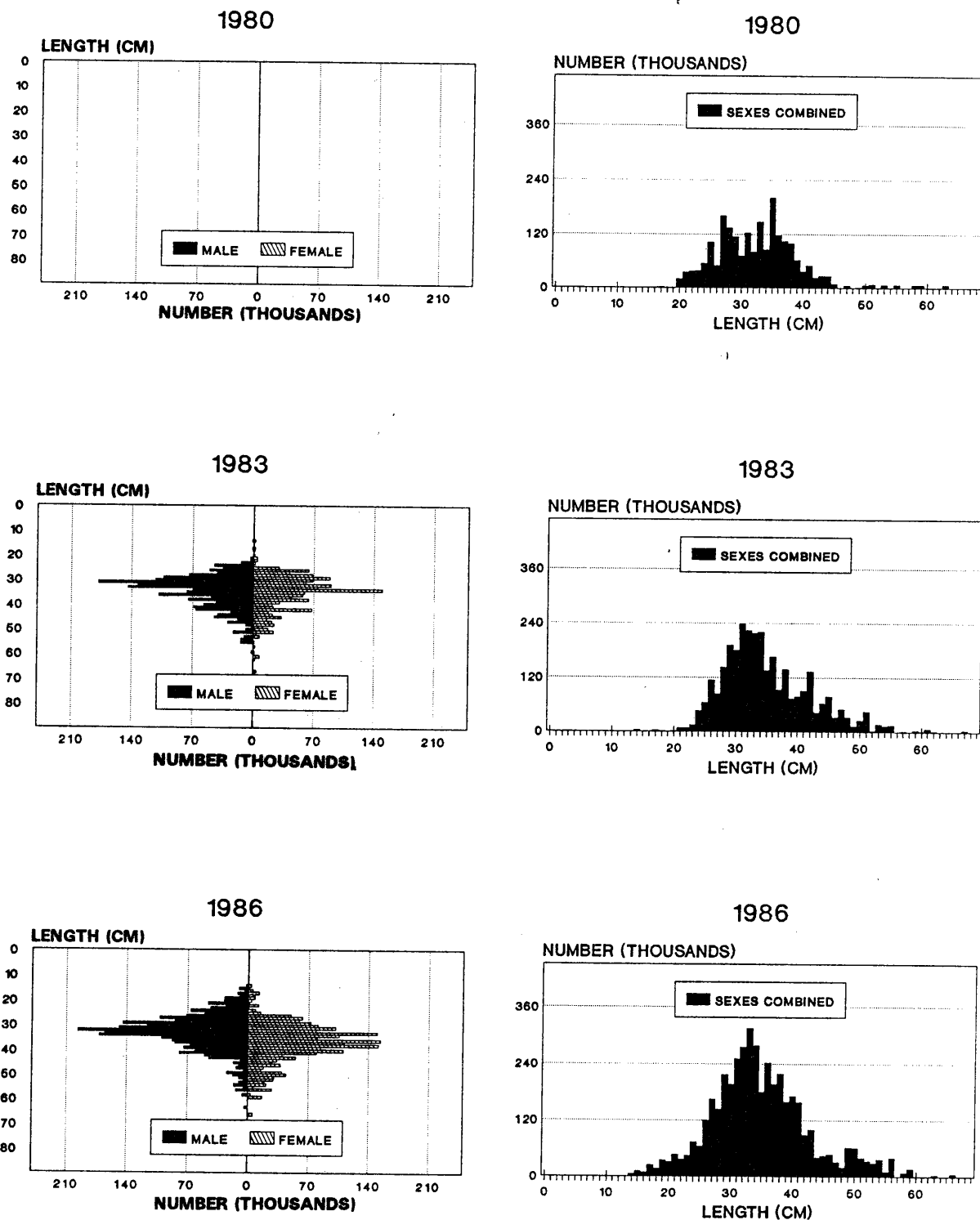

Figure 179. Size composition of shortspine thornyhead in the Northeast area of the Aleutian Islands during the U.S.-Japan 1980, 1983, and 1986 groundfish surveys.

A similar situation was noted in 1983, although the Southwest size composition curve was much flatter. The Southeast, and Northeast size composition curves peaked in the low 30 cm range. As in 1983, the size curve in the Northwest area was skewed toward larger fish peaking at 41-42 cm.

In 1986 the size curve in the Southwest area peaked in the high 30 cm range and the Southeast curve in the low 30 cms. The size composition in the Northwest area also peaked in the high 30 cms. The Northeast area size composition curve peaked in the low 30 cms similar to the Southeast curve but there were more fish greater than 50 cm in length.

In the Southern Bering Sea area the size composition curves were different each year (Fig. 180). In 1980 the size composition database was small, however, the available data indicates that most of the fish were in the 31-36 cm size range, peaking at 34 cm. During the 1983 survey most fish were in the 24-37 cm range, peaking at 31 cm. In 1986 the size composition curve was skewed towards larger fish, peaking at 38 cm, with most of the fish in the 32-41 cm range.

Techniques and criteria for ageing shortspine thornyheads have not been developed at the Alaska Fisheries Science Center, therefore no age data is available at this time. Otolith collections were made throughout these surveys so age data may become available in the future.

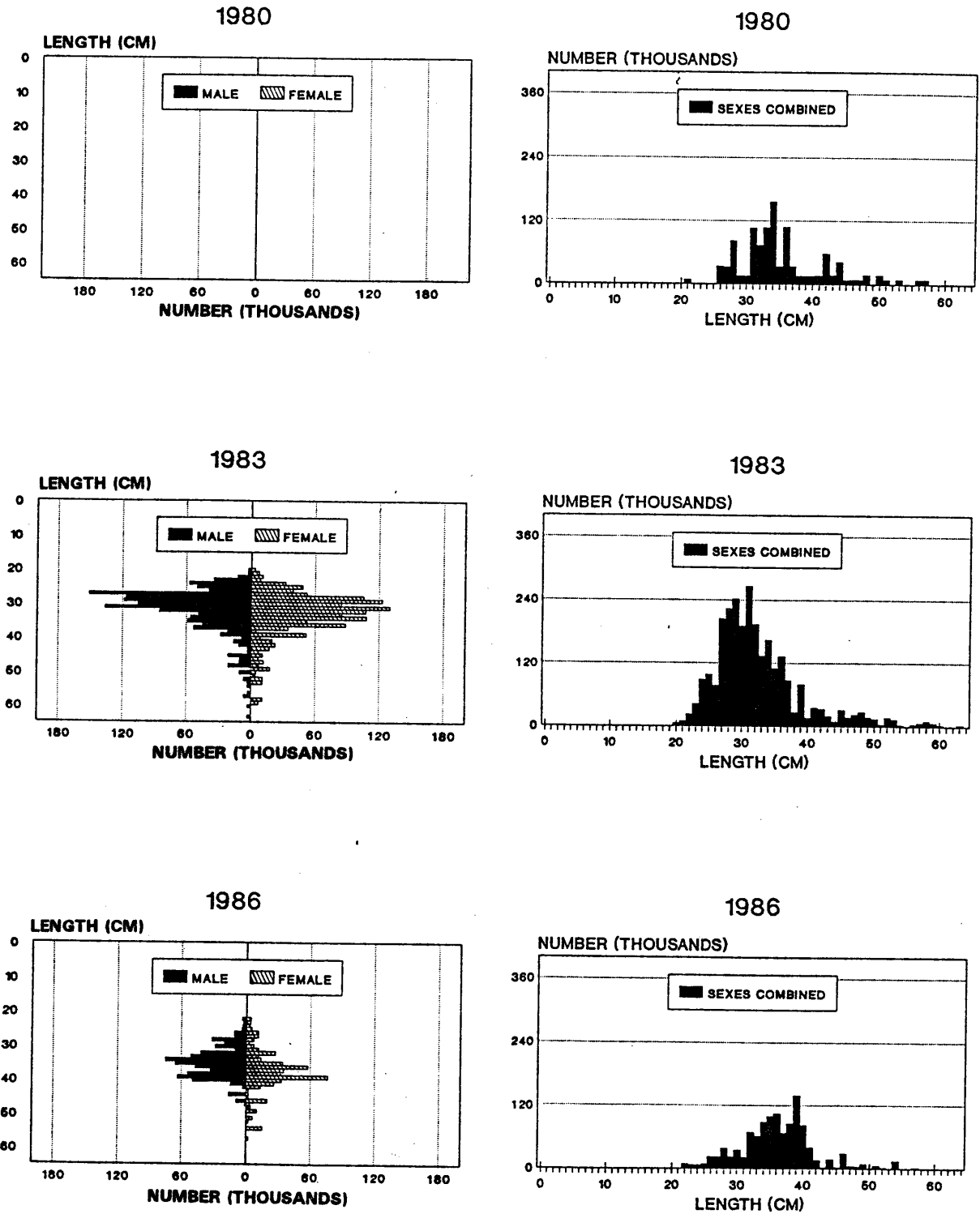

Figure 180. Size composition of shortspine thornyhead in the Southern Bering Sea area during the U.S.-Japan 1980, 1983, and 1986 Aleutian Islands groundfish surveys.

Length-Weight Relationship

Weight at length data are available from only the 1983 and 1986 surveys and are very similar for the two years, with the fish being slightly heavier for a given length in 1983 (Fig. 181). Length-weight relationships for the two years are:

$$\begin{aligned} \text{Weight(g)} \text{ (1983)} &= .0050 \times \text{Length(cm)}^{3.270} \\ \text{Weight(g)} \text{ (1986)} &= .0040 \times \text{Length(cm)}^{3.315} \end{aligned}$$

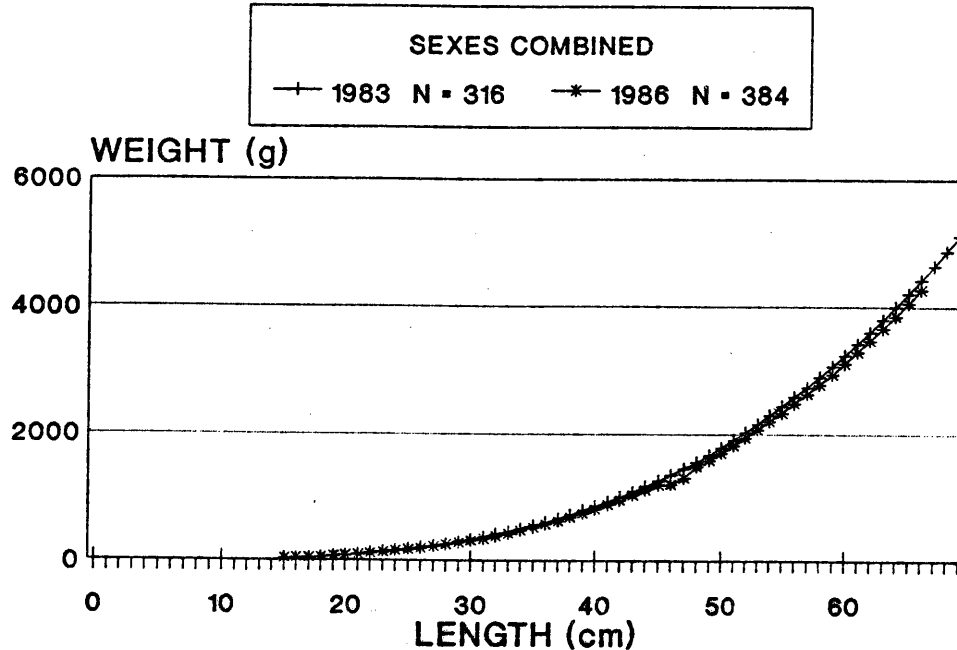

Figure 181. Length-weight relationships for shortspine thornyhead in the Aleutian Islands area during 1983 and 1986 groundfish surveys.

Rock Sole

Distribution and Abundance

Rock sole (Pleuronectes bilineata) were distributed throughout the Aleutian Islands area and the Southern Bering Sea primarily at depths less than 200 m (Figs. 182-183). Rock sole were never encountered in high densities, however, medium-density concentrations were found in the Southern Bering Sea, and on both sides of the Aleutian Islands chain as far west as Kiska Island during all three years. During the 1986 survey, medium densities of rock sole were encountered around Attu and Agattu Islands and on Petrel Bank.

The surveys for the Aleutian Islands area indicated a continuing modest increase in the rock sole stock (Table 71, Fig. 184). The biomass estimate for rock sole in the Aleutian Islands area totaled 12,000 t in 1980, increased to 15,000 t in 1983, and was 19,000 t in 1986. Population estimates went from 42.0 million fish in 1980 to 44.0 million in 1983, and 60.7 million in 1986. Most of the rock sole biomass was located in the Northeast and Southwest areas, those with the widest continental shelf. The increase in 1983 was observed in all areas except the Northeast area which decreased 38%. In 1986 the biomass estimate increased in all four areas of the Aleutian Islands.

In the Southern Bering Sea the biomass estimate of rock sole decreased substantially from 16,000 t in 1980 to 4,000 t in 1983, then increased to 6,000 t in 1986. The population estimate also decreased substantially from 52.2 million fish in 1980 to 9.6 million in 1983, then increased to 14.3 million in 1986 (Fig. 185).

Mean lengths and weights were largest during the 1983 survey in the Aleutian Islands area. In the Southern Bering Sea, mean length and weight were greatest during the 1980 and 1983 surveys, respectively (Table 72, Figs. 186-187).

Size and Age Composition

Size composition curves for rock sole in the Aleutian Islands were similar during all three surveys (Fig. 188). All curves were unimodal ranging from approximately 20 to 40 cm. In 1980 the size composition curve peaked at 26-29 cm and consisted of equal numbers of males and females. There were 13 year classes of which 6, the 1970-75 year classes, contributed over 75% to the stock (Fig. 189).

In 1983 the size composition curve peaked at 29 cm, but was skewed to the smaller fish. There was a slight increase in the larger fish, 33-40 cm in length, and an occurrence of fish in the 40-45 cm range which were not evident in the 1980 size composition. The stock was dominated by females.

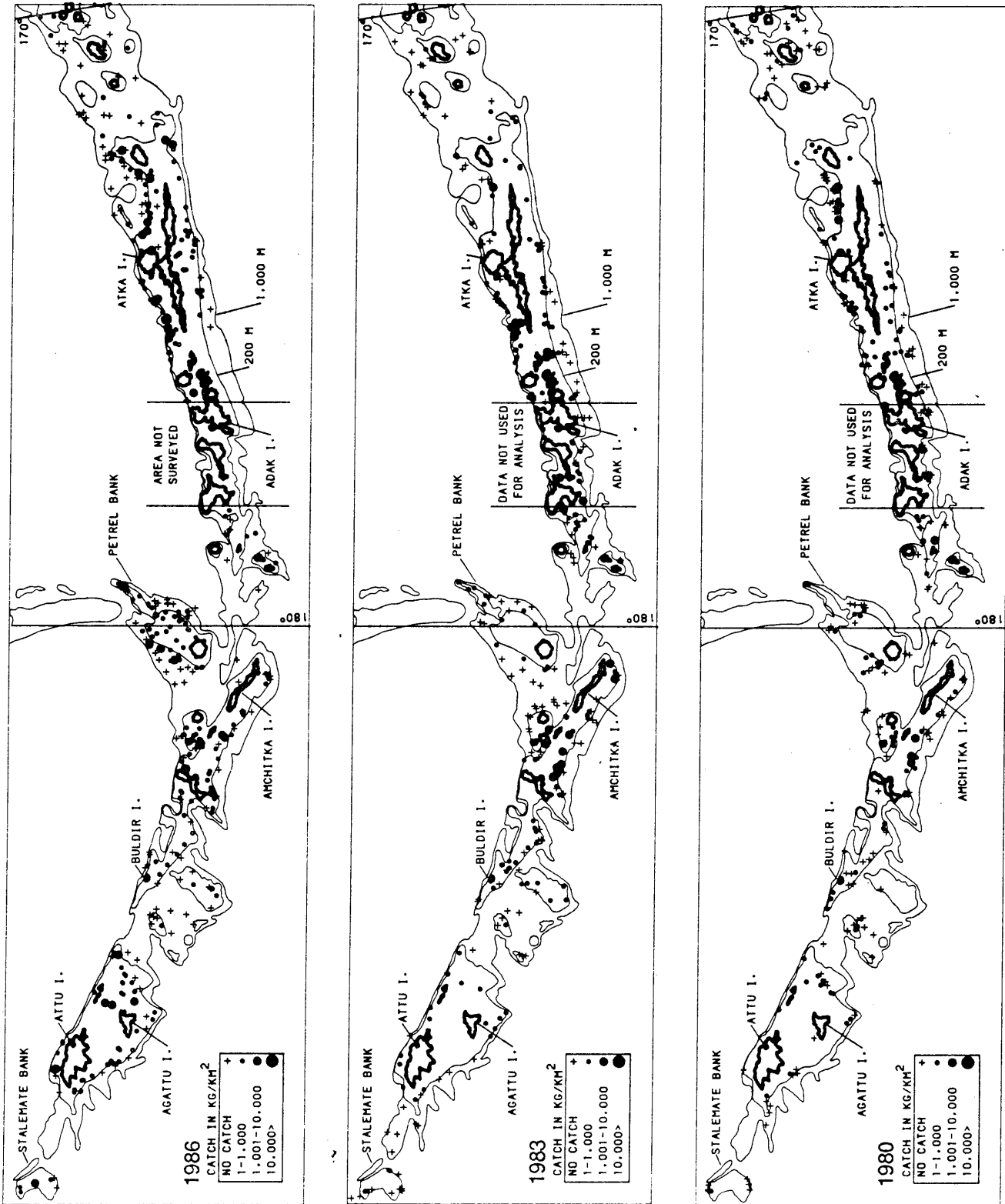

Figure 182. Distribution and relative abundance of rock sole in the Aleutian Islands area during the U.S.-Japan 1980, 1983, and 1986 Aleutian Islands groundfish surveys.

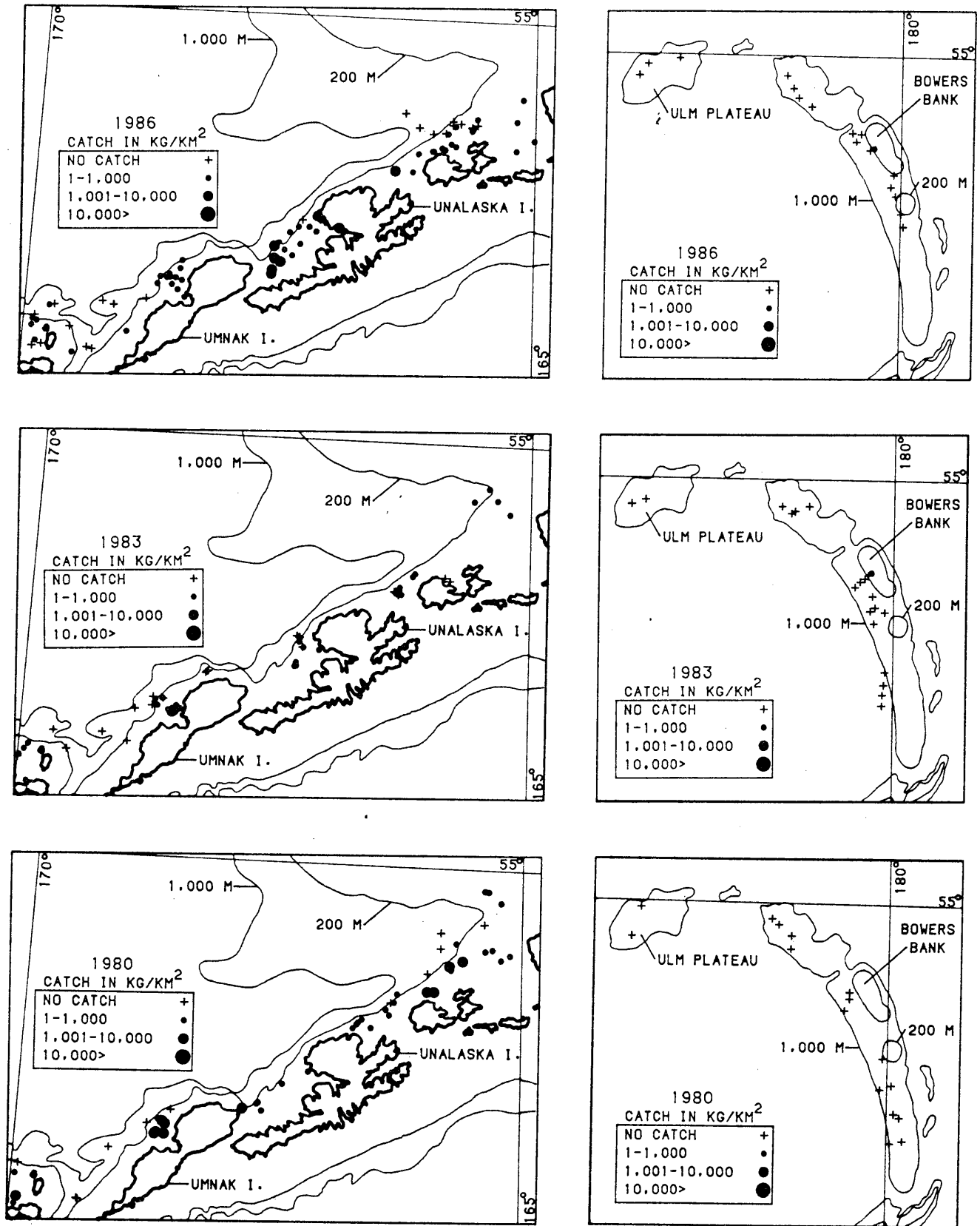

Figure 183. Distribution and relative abundance of rock sole in the Southern Bering Sea and Bowers Ridge areas during the U.S.-Japan 1980, 1983, and 1986 Aleutian Islands groundfish surveys.

Table 71. Estimates of biomass, biomass sampling error, and population for rock sole based on the U.S.-Japan 1980, 1983, and 1986 Aleutian Islands groundfish surveys.

Area	Depth (m)	Biomass (t)			Sampling Error (%)			Population (1,000s)		
		1980	1983	1986	1980	1983	1986	1980	1983	1986
Southwest	1-100	399	2,560	3,028				2,951.9	7,828.3	10,841.0
	101-200	3,630	3,158	3,351				13,893.4	9,368.9	11,519.6
	201-300	351	813	661				936.7	1,847.5	1,769.1
	301-500	10	4	11				24.1	28.8	17.6
	501-900	29	0	0				0.0	0.0	0.0
	1-900	4,419	6,535	7,051	52.1	493.3	50.2	17,806.1	19,073.5	24,147.3
Southeast	1-100	a	305	610				a	977.1	2,471.0
	101-200	1,251	1,109	1,396				3,699.0	2,487.6	4,341.6
	201-300	218	340	1,116				425.0	824.4	2,374.7
	301-500	10	67	1				0.0	143.5	2.7
	501-900	0	0	0				0.0	0.0	0.0
	1-900	1,479	1,821	3,123	41.0	43.3	42.0	4,124.0	4,432.5	9,190.0
Northwest	1-100	106	628	1,077				367.0	1,533.2	4,329.9
	101-200	647	2,068	1,155				1,726.2	4,928.5	3,821.0
	201-300	208	857	753				315.0	1,614.8	1,598.3
	301-500	21	0	369				92.8	0.0	735.7
	501-900	1	0	0				0.0	0.0	0.0
	1-900	983	3,553	3,354	108.3	42.1	57.6	2,501.0	8,076.5	10,484.9
Northeast	1-100	3,032	986	1,702				12,272.8	5,994.2	6,386.7
	101-200	1,607	1,842	3,228				4,097.2	5,452.8	8,709.5
	201-300	482	343	800				924.4	748.9	1,638.8
	301-500	136	104	112				291.9	231.7	181.5
	501-900	21	0	0				0.0	0.0	0.0
	1-900	5,278	3,275	5,842	20.9	20.3	34.3	17,586.3	12,427.6	16,916.5
Bowers Ridge	101-200	a	4	6				a	6.0	9.0
	201-300	0	0	0				0.0	0.0	0.0
	301-500	0	0	0				0.0	0.0	0.0
	510-900	0	0	0				0.0	0.0	0.0
	101-900	0	4	6	0.0	1,270.6	0.0	0.0	6.0	9.0
	Aleutian Islands	1-100	3,537	4,479	6,417	0.0	691.1	51.9	15,591.7	16,332.8
Total	101-200	7,135	8,181	9,136	35.2	23.4	15.6	23,415.8	22,243.8	28,400.7
	201-300	1,259	2,353	3,330	59.7	44.7	40.5	2,601.1	5,035.6	7,380.9
	301-500	177	175	493	194.9	195.3	130.6	408.8	404.0	937.5
	501-900	51	0	0	113.3	0.0	0.0	0.0	0.0	0.0
	1-900	12,159	15,188	19,376	21.4	222.5	19.4	42,017.4	44,016.2	60,747.7
	Southern Bering Sea	1-100	12,127	2,878	4,030				43,371.4	7,086.5
101-200		3,359	1,109	2,067				8,837.8	2,418.6	3,911.4
201-300		287	38	119				0.0	68.1	217.4
301-500		15	0	128				0.0	0.0	237.0
501-900		1	0	0				0.0	0.0	0.0
1-900		15,789	4,025	6,344	64.4	31.1	32.6	52,209.2	9,572.2	14,354.5

a No sampling was conducted in this area-depth interval.

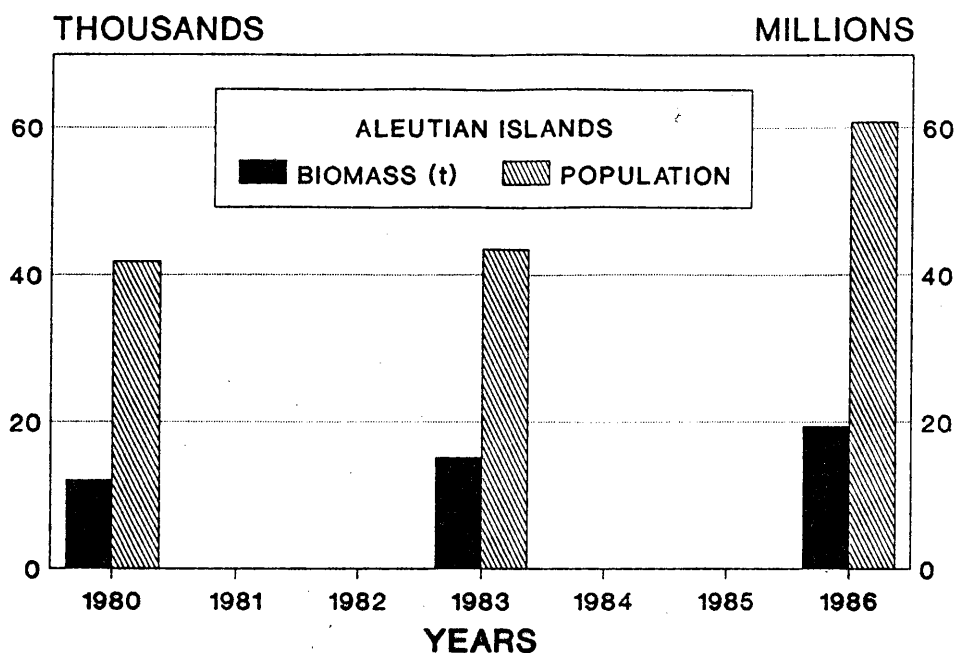

Figure 184. Estimated biomass and population of rock sole in the Aleutian Islands area during the U.S.-Japan 1980, 1983, and 1986 groundfish surveys.

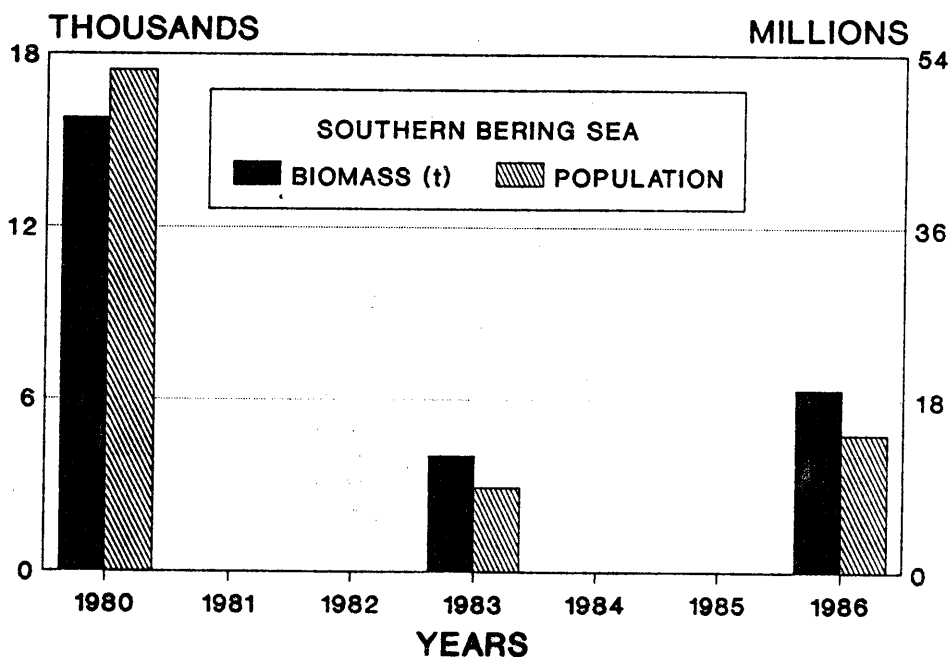

Figure 185. Estimated biomass and population of rock sole in the Southern Bering Sea area during the U.S.-Japan 1980, 1983, and 1986 Aleutian Islands groundfish surveys.

Table 72. Estimates of mean catch per unit effort, length, and weight for rock sole based on the U.S.-Japan 1980, 1983, and 1986 Aleutian Islands groundfish surveys.

Area	Depth (m)	Mean CPUE (kg/km ²)			Mean Length (cm)			Mean Weight (kg)		
		1980	1983	1986	1980	1983	1986	1980	1983	1986
Southwest	1-100	174.2	871.0	804.9	27.8	29.1	0.0	0.14	0.33	0.28
	101-200	555.8	483.6	513.1	28.6	30.3	28.2	0.27	0.33	0.29
	201-300	152.9	354.5	287.9	30.5	33.4	31.5	0.37	0.44	0.39
	301-500	2.8	1.1	3.1	0.0	0.0	30.1	0.40	0.13	0.60
	501-900	4.2	0.0	0.0	0.0	0.0	0.0	0.00	0.00	0.00
	1-900	204.9	294.3	306.1	28.4	30.1	28.4	0.25	0.34	0.29
Southeast	1-100	a	193.5	230.6	a	29.5	0.0	a	0.31	0.27
	101-200	382.4	339.0	426.7	29.3	34.2	29.4	0.34	0.46	0.33
	201-300	69.0	107.6	353.2	34.6	34.0	34.7	0.50	0.43	0.47
	301-500	3.7	21.3	0.2	0.0	0.0	0.0	0.00	0.47	0.19
	501-900	0.0	0.0	0.0	0.0	0.0	0.0	0.00	0.00	0.00
	1-900	132.2	130.3	207.6	30.5	33.0	29.9	0.36	0.42	0.35
Northwest	1-100	70.6	266.2	456.3	26.8	32.7	0.0	0.29	0.42	0.25
	101-200	352.1	787.1	439.6	30.4	32.5	30.4	0.36	0.43	0.31
	201-300	194.0	800.8	703.4	33.0	35.3	34.7	0.66	0.54	0.50
	301-500	9.3	0.0	166.6	38.2	0.0	0.0	0.22	0.00	0.42
	501-900	0.3	0.0	0.0	0.0	0.0	0.0	0.00	0.00	0.00
	1-900	88.4	278.4	262.8	29.9	33.1	31.0	0.38	0.45	0.32
Northeast	1-100	1,368.6	845.2	887.7	27.4	23.9	25.0	0.25	0.16	0.26
	101-200	411.4	471.5	826.4	30.9	33.7	29.0	0.38	0.36	0.38
	201-300	197.5	140.5	327.7	33.8	33.2	34.5	0.52	0.45	0.49
	301-500	39.7	30.3	34.2	37.8	34.2	35.6	0.47	0.46	0.62
	501-900	3.5	0.0	0.0	0.0	0.0	0.0	0.00	0.00	0.00
	1-900	294.6	191.2	329.6	29.9	28.8	27.8	0.30	0.27	0.35
Bowers Ridge	101-200	a	12.1	17.7	a	0.0	0.0	a	0.63	0.61
	201-300	0.0	0.0	0.0	0.0	0.0	0.0	0.00	0.00	0.00
	301-500	0.0	0.0	0.0	0.0	0.0	0.0	0.00	0.00	0.00
	501-900	0.0	0.0	0.0	0.0	0.0	0.0	0.00	0.00	0.00
	101-900	0.0	0.4	0.5	0.0	0.0	0.0	0.00	0.63	0.61
Aleutian Islands Total	1-100	589.3	556.9	600.6	27.5	27.5	25.0	0.23	0.28	0.27
	101-200	458.9	491.4	548.8	29.6	32.0	28.7	0.31	0.38	0.33
	201-300	123.6	231.0	326.8	33.1	34.1	33.5	0.48	0.47	0.46
	301-500	13.2	12.6	36.1	38.2	34.2	35.2	0.43	0.44	0.45
	501-900	1.9	0.0	0.0	0.0	0.0	0.0	0.00	0.00	0.00
	1-900	169.5	199.0	245.8	29.4	30.5	28.7	0.29	0.35	0.32
Southern Bering Sea Total	1-100	2,516.5	597.2	836.3	30.9	30.7	28.1	0.28	0.43	0.41
	101-200	1,026.7	339.0	631.7	34.5	31.2	31.5	0.38	0.55	0.52
	201-300	287.0	37.9	119.0	36.4	0.0	0.0	0.00	0.55	0.55
	301-500	11.8	0.0	100.3	0.0	0.0	0.0	0.00	0.00	0.54
	501-900	0.6	0.0	0.0	0.0	0.0	0.0	0.00	0.00	0.00
	1-900	1,249.3	318.5	501.9	32.0	30.8	28.7	0.30	0.46	0.44

a No sampling was conducted in this area-depth interval.

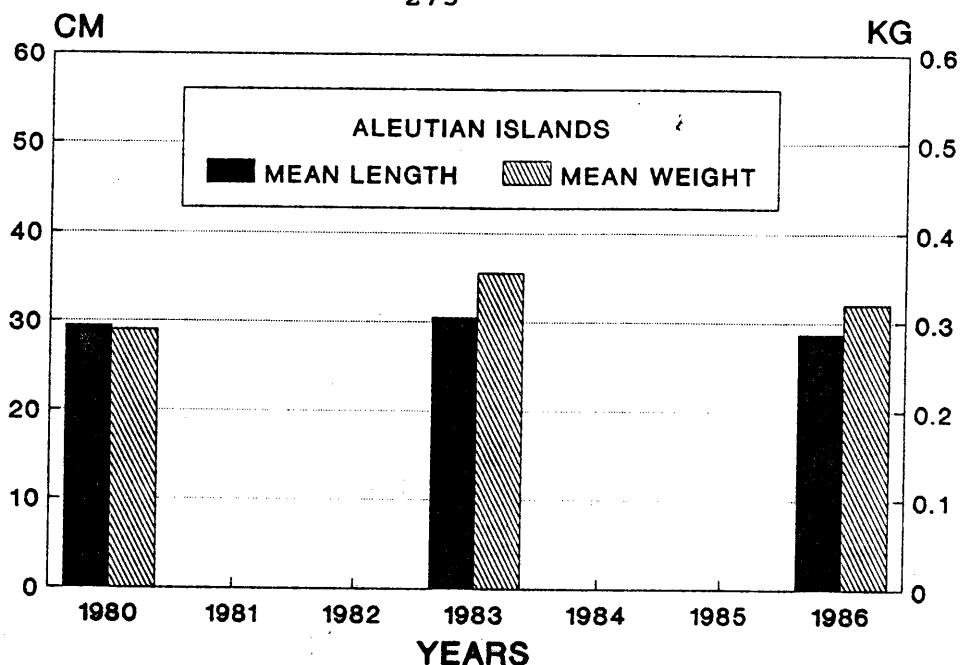

Figure 186. Mean length and weight of rock sole in the Aleutian Islands area during the U.S.-Japan 1980, 1983, and 1986 groundfish surveys.

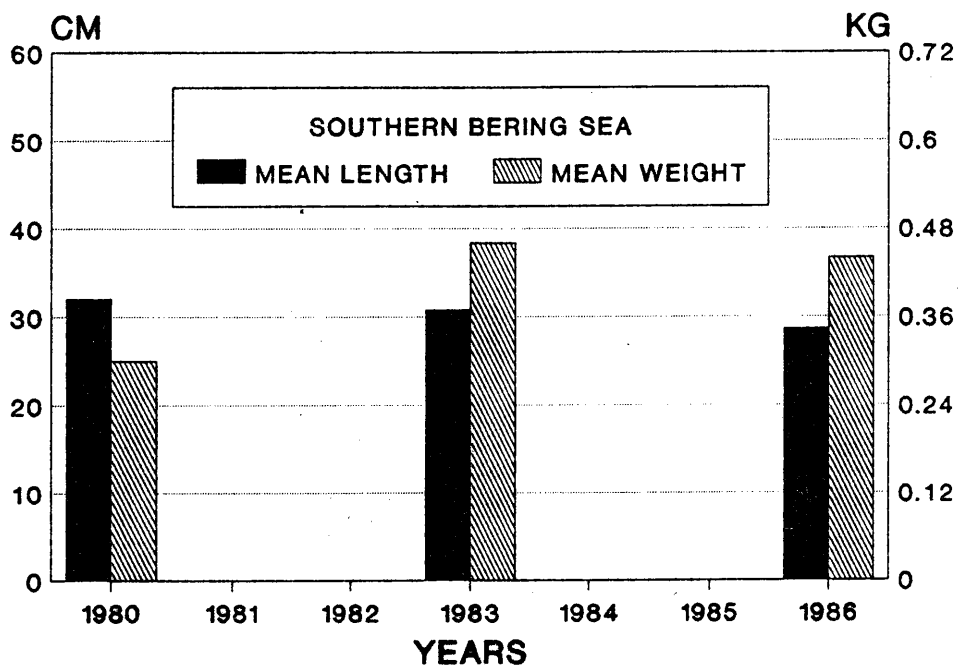

Figure 187. Mean length and weight of rock sole in the Southern Bering Sea area during the U.S.-Japan 1980, 1983, and 1986 Aleutian Islands groundfish surveys.

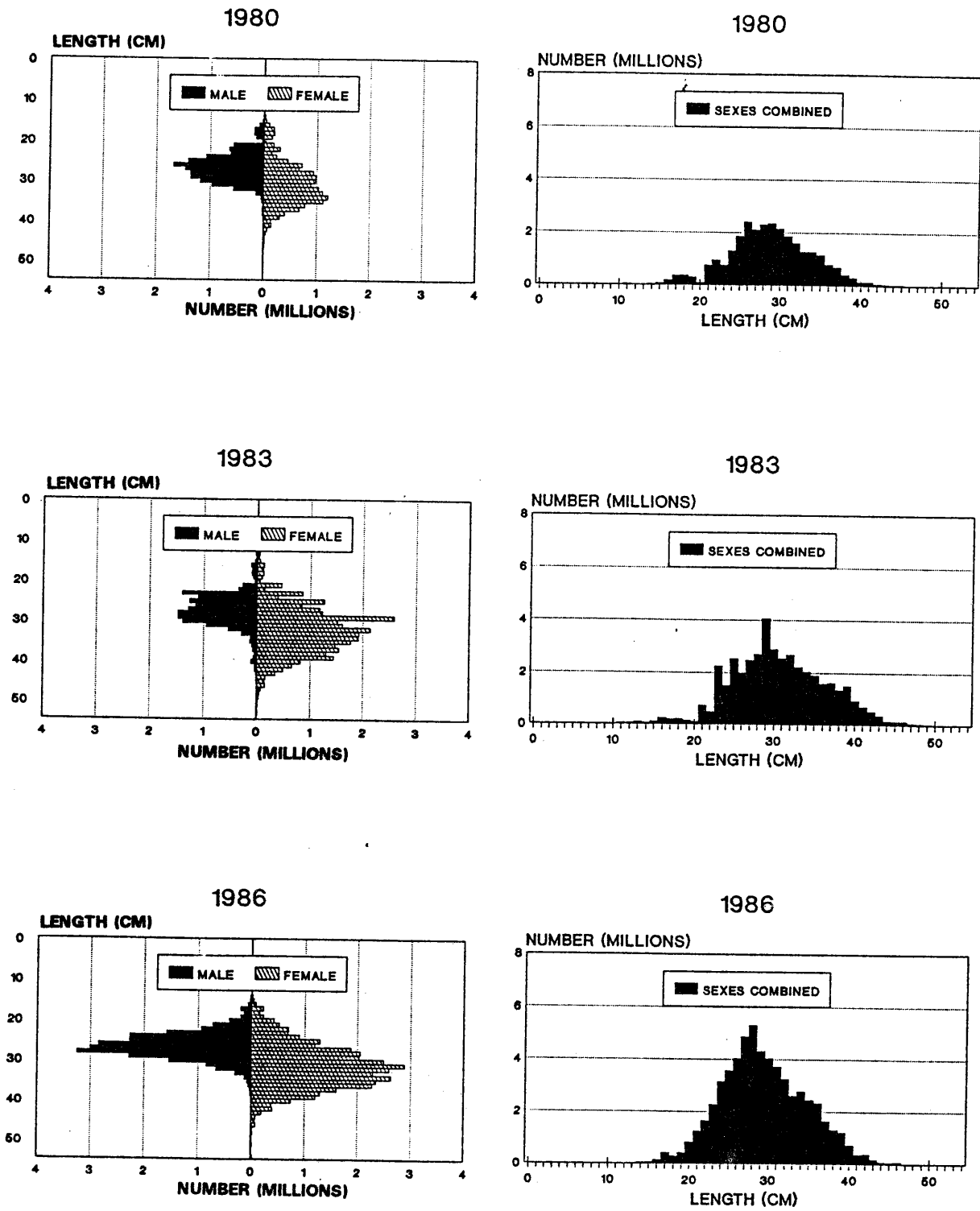

Figure 188. Size composition of rock sole in the Aleutian Islands area during the U.S.-Japan 1980, 1983, and 1986 groundfish surveys.

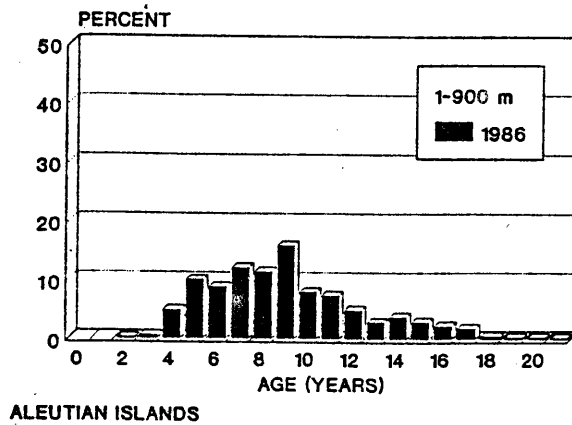
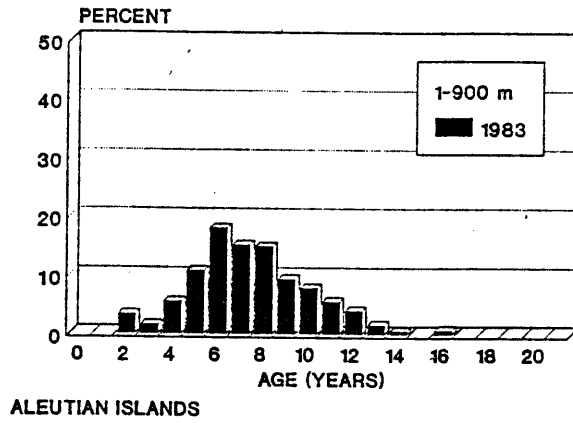
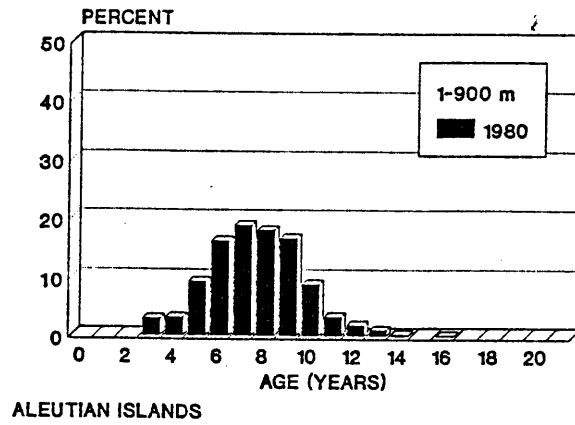

Figure 189. Age composition of rock sole in the Aleutian Islands area during the U.S.-Japan 1980, 1983, and 1986 groundfish surveys.

Fourteen year classes contributed to the rock sole stock with the 1975-78 year classes contributing approximately 54%. The 1971-74 year classes were still major contributors in 1983. The 1974 year class which made up nearly 16% of the stock in 1980 was still contributing about 8% of the stock in 1983. In 1983, the 1971 to 1973 year classes added another 16% to the stock.

In 1986, the size composition curve was again skewed toward smaller fish, peaking at 28 cm. There was a stronger showing of 19-25 cm fish and there were more intermediate (ie., 26-33 cm in length) sized fish. The sex ratio still favored the females. Eighteen year classes contributed to the age composition with the 1977-1979 and 1981 year classes contributing approximately 45% of the total stock. The 1977 year class was again dominant in 1983 contributing 15% of the stock. The 1975 and 1976 year classes which contributed about 14% of the stock in 1983 continued to contribute 7-8% in 1986. The 1971-1974 year classes which dominated during the 1980 survey, were still viable as 12-15 year-olds, contributing nearly 15% of the stock collectively.

Size composition curves for each of the areas of the Aleutian Islands are shown in Figs. 190-192. In 1980 the Southwest and Southeast size composition curves had similar ranges of 20-38 cm. The Southwest area peaked at 26-28 cm, and the Southeast area peaked at 29-30 cm. The sex ratio in the Southwest area favored males but the ratio in the Southeast area favored females. The size composition curve in the Northeast area was considerably different, ranging from 15 to 40 cm, with a mode at 17-22 cm, and a fairly equal distribution from 28 to 39 cm. The sex ratio in the Northeast area also favored females. No data was available for the Northwest area.

During the 1983 survey fish of the same size range were found in the Southeast and Southwest areas and their size composition curves peaked near 30 cm, however, the Southeast area held a higher percentage of larger fish (ie., 33-39 cm) in length. The size composition curve for the Northeast area covered the size range of 11-47 cm. The principle mode was skewed toward the smaller fish, peaking at 25 cm, and there were fish larger than 40 cm which were not present in the other areas. In all three areas the females outnumbered the males.

In 1986 there was greater similarity in the size composition curves of all three areas. All curves were unimodal with similar size ranges. The curves peaked at 27-28 cm in the Southwest area, 28-29 cm in the Southeast area, and 28 cm in the Northeast area. During the 1986 survey the sex ratio in the Southwest area was nearly equal, but in the other two areas strongly favored females.

In the Southern Bering Sea rock sole size ranges were similar for each survey. In 1980, the size composition curve was strong and unimodal, with most of the fish in the 23-32 cm size range. There were about as many males as females (Fig. 193). In 1983, the size composition curve was extremely weak and flat

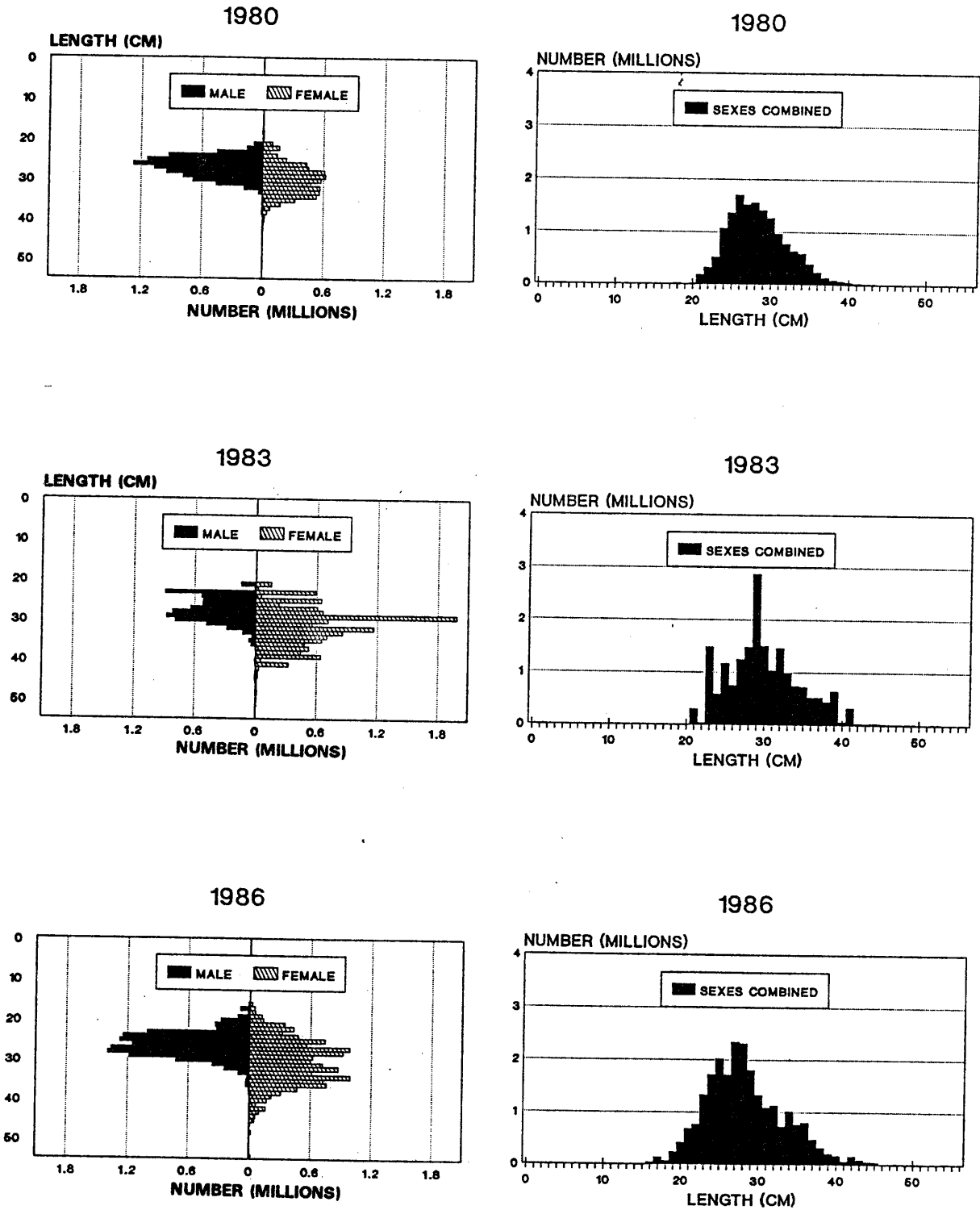

Figure 190. Size composition of rock sole in the Southwest area of the Aleutian Islands during the U.S.-Japan 1980, 1983, and 1986 groundfish surveys.

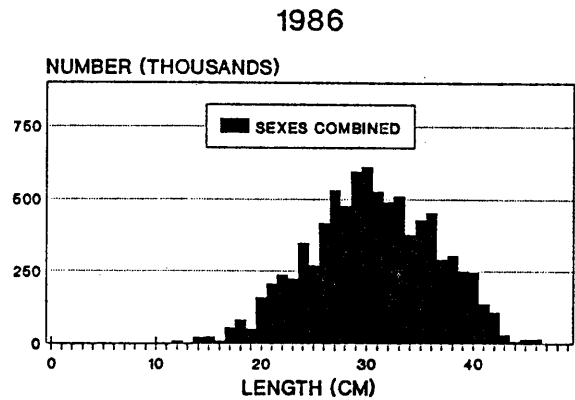
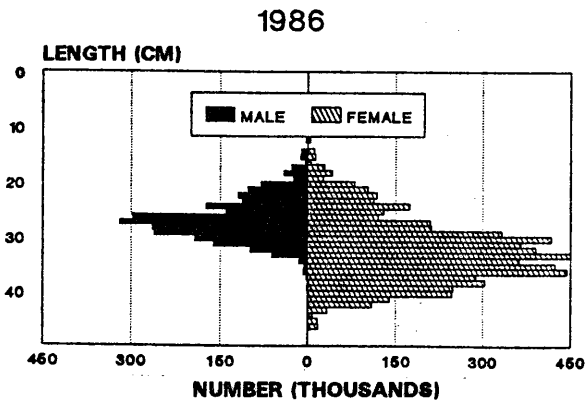
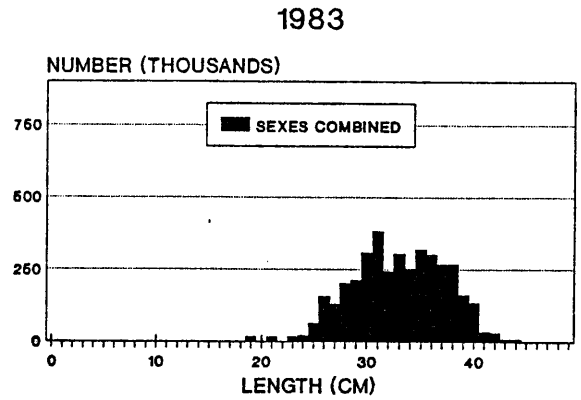
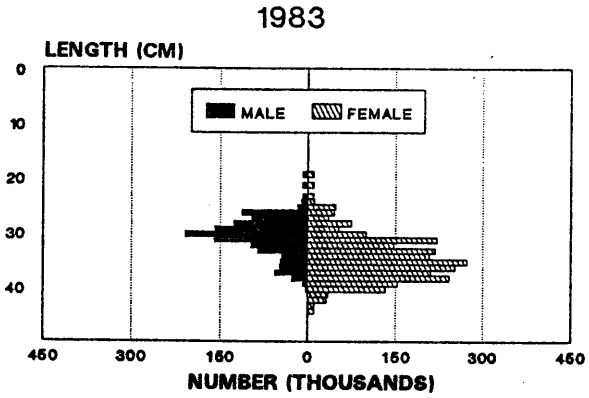
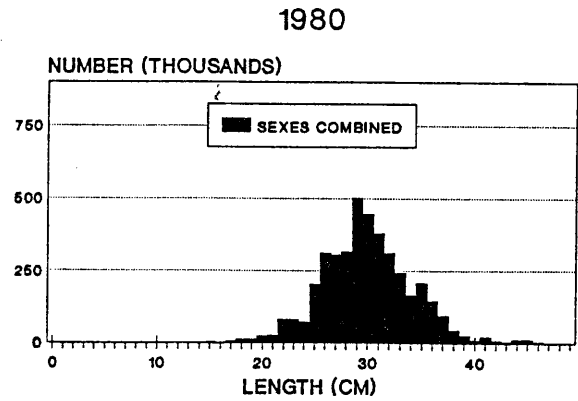
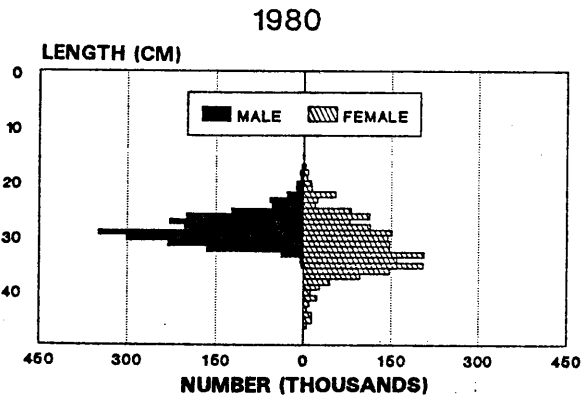

Figure 191. Size composition of rock sole in the Southeast area of the Aleutian Islands during the U.S.-Japan 1980, 1983, and 1986 groundfish surveys.

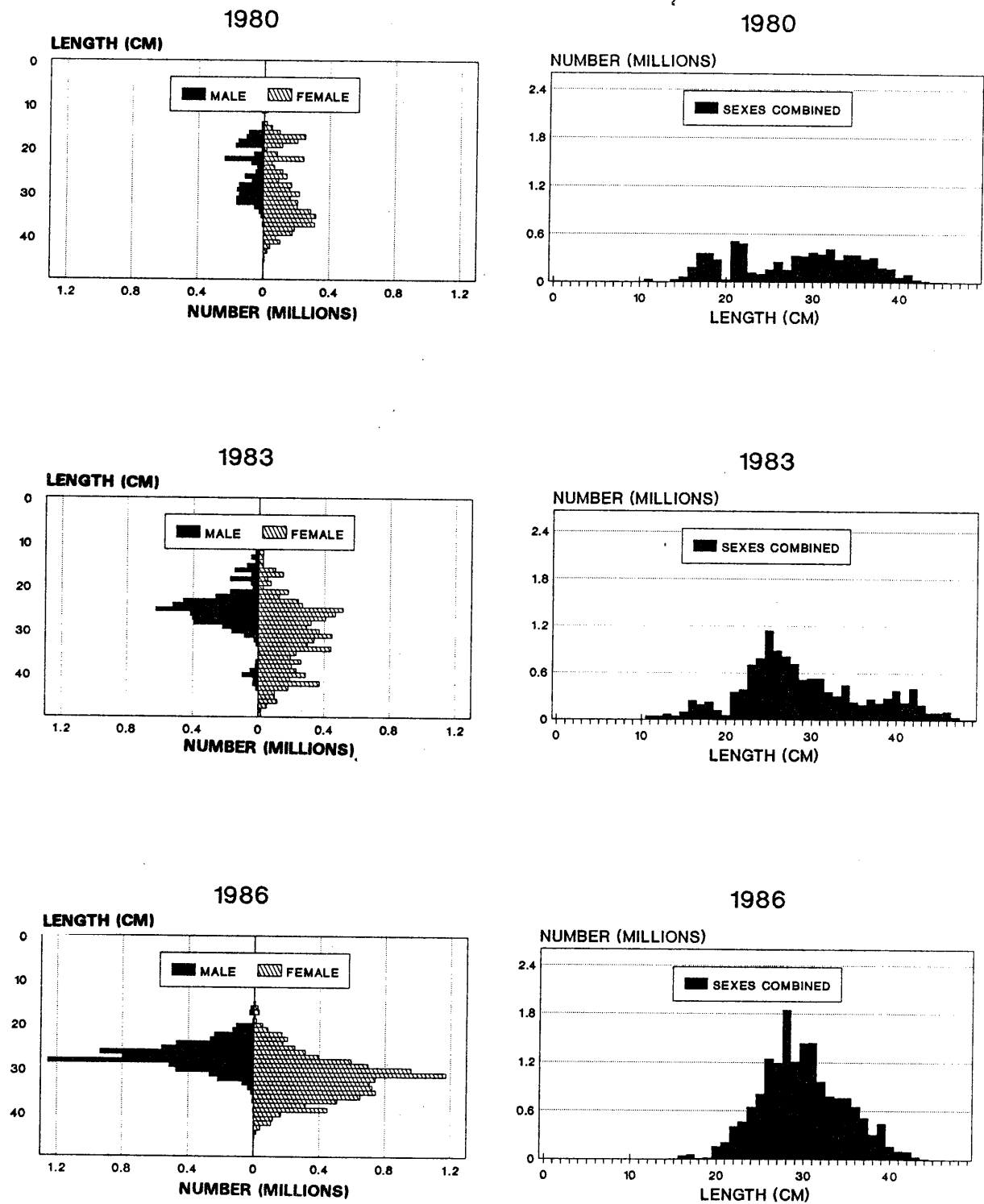

Figure 192. Size composition of rock sole in the Northeast area of the Aleutian Islands during the U.S.-Japan 1980, 1983, and 1986 groundfish surveys.

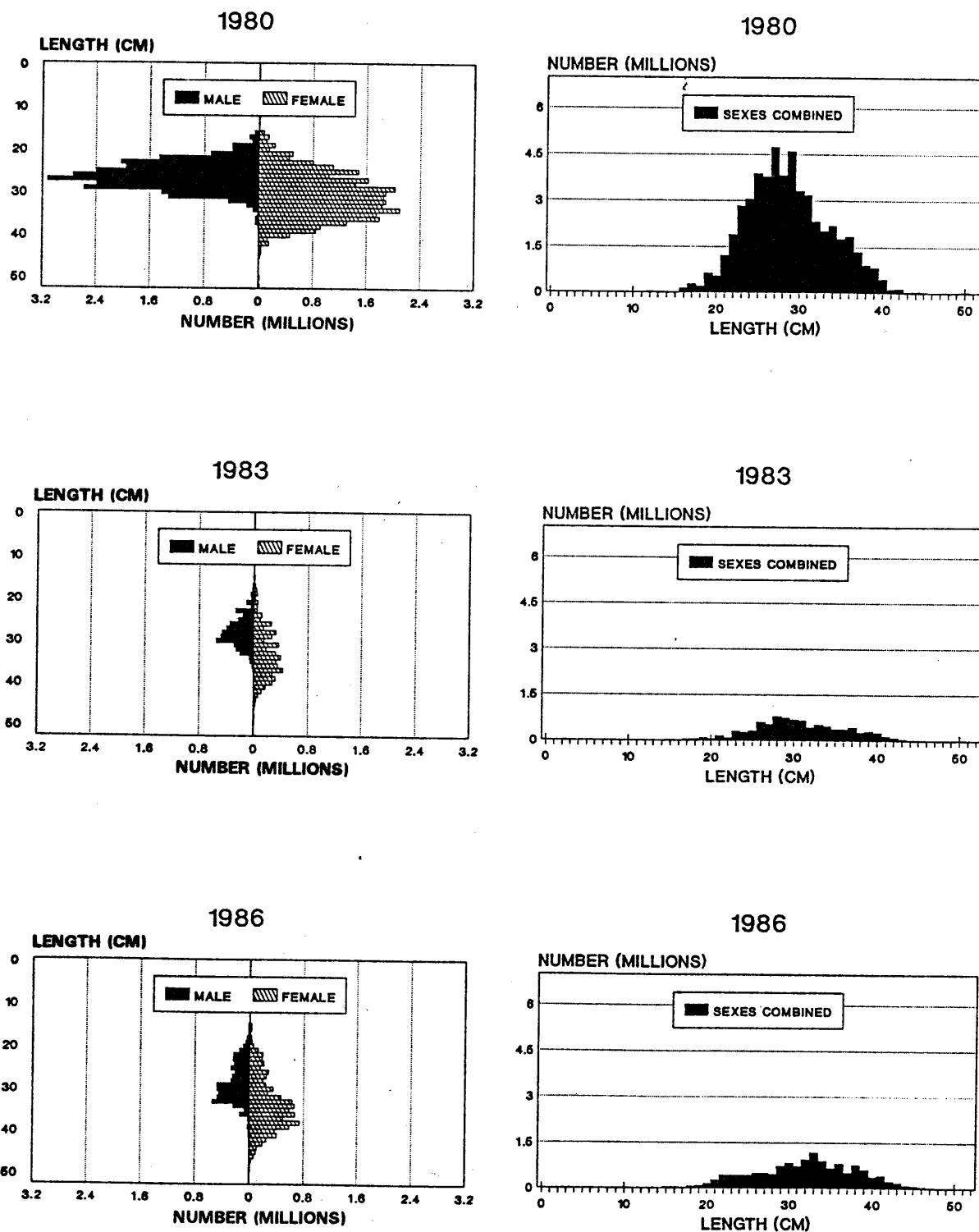

Figure 193. Size composition of rock sole in the Southern Bering Sea area during the U.S.-Japan 1980, 1983, and 1986 Aleutian Islands groundfish surveys.

with a slight mode at 27 cm, and there were more females than males. In 1986, the size composition curve continued to be weak and flat with more females, however a small mode was present peaking at 33 cm.

Mean Length-at-Age and Growth

Mean length-at-age data revealed some major differences during the three surveys (Table 73). During the 1980 survey there was a rapid rate of growth increasing from 14.7 cm at age 3 to 39.3 cm at age 13. In 1983, fish less than 9-years-old were larger at a given age than in 1980, but at ages older than 9 years they were smaller. By age 13, they had attained a mean length of only 36.1 cm. The situation in 1986 was similar in that 3-7 year-old fish were slightly larger than the same age groups in 1980 but slightly smaller than those in 1983. After age 7 the mean length-at-age increased very slowly and by age 13 was only 31.6 cm, considerably smaller than the 1980 and 1983 surveys.

Table 73. Mean length (mm) at age for rock sole sampled during the U.S.-Japan 1980, 1983, and 1986 Aleutian Islands groundfish surveys.

Age	1980			1983			1986		
	M	F	M+F	M	F	M+F	M	F	M+F
2	-	-	-	-	-	-	170	-	170
3	148	147	147	194	-	194	185	150	168
4	196	199	199	228	238	232	213	223	218
5	221	226	223	245	261	252	246	235	241
6	252	272	262	262	299	284	261	276	269
7	270	285	279	276	323	307	266	300	283
8	291	310	303	293	344	324	282	310	296
9	303	341	331	305	355	331	280	322	303
10	318	363	354	311	371	345	277	326	300
11	332	382	370	318	382	360	285	334	312
12	341	386	377	326	384	356	285	330	317
13	354	406	393	341	383	361	294	335	316
14	360	428	418	341	345	340	288	352	338
15	-	-	-	-	-	-	283	367	342
16	380	440	410	392	-	393	335	361	357

Estimates of the yearly growth increments of rock sole are shown in Table 74. These data indicate a decline in the average yearly growth rate from 4.7 cm between age 3 and 4, to 1.4 cm between age 8 and 9.

Table 74. Estimates of yearly incremental growth (cm) of rocksole based on the U.S.-Japan 1980, 1983, and 1986 Aleutian Islands groundfish surveys.

Age	Year			Average
	1980	1983	1986	
3-4	5.2	3.8	5.0	4.7
4-5	2.4	3.0	2.3	2.6
5-6	3.9	3.2	2.8	3.3
6-7	1.7	2.3	1.4	1.8
7-8	2.4	1.7	1.3	1.8
8-9	2.8	0.7	0.7	1.4

Length-at-age data were fitted to the von Bertalanffy growth equation to obtain estimates of t_0 , L_{INF} , and K (Table 75).

Table 75. Estimated von Bertalanffy growth curve Parameters for rock sole sampled during the U.S.-Japan 1980, 1983, and 1986 Aleutian Islands groundfish surveys.

Area-Year	Sex	Range		von Bertalanffy Growth Parameters		
		Age (Years)	Length (cm)	L_{inf}	k	t_0
Aleutian Islands 1980	M	3-16	12-38	39.21	0.173	0.222
	F	3-16	11-44	51.95	0.120	0.188
	M+F	3-16	11-44	50.39	0.119	0.071
1983	M	3-16	17-41	39.81	0.118	-3.068
	F	4-14	23-44	40.73	0.257	0.862
	M+F	3-16	17-44	38.47	0.230	0.119
1986	M	2-17	17-35	29.08	0.373	0.129
	F	3-21	12-43	36.48	0.243	0.286
	M+F	2-21	12-43	35.34	0.190	-1.196

Length-Weight Relationship

Length-weight data were collected during the 1983 and 1986 surveys and showed very good agreement between the 2 years (Fig. 194). In 1986 the specimens over 30 cm were slightly heavier for a given size than during 1983. These analysis provided the following estimates of the constants:

$$\begin{aligned} \text{Weight(g)} \text{ (1983)} &= .0063 \times \text{Length(cm)}^{3.156} \\ \text{Weight(g)} \text{ (1986)} &= .0057 \times \text{Length(cm)}^{3.192} \end{aligned}$$

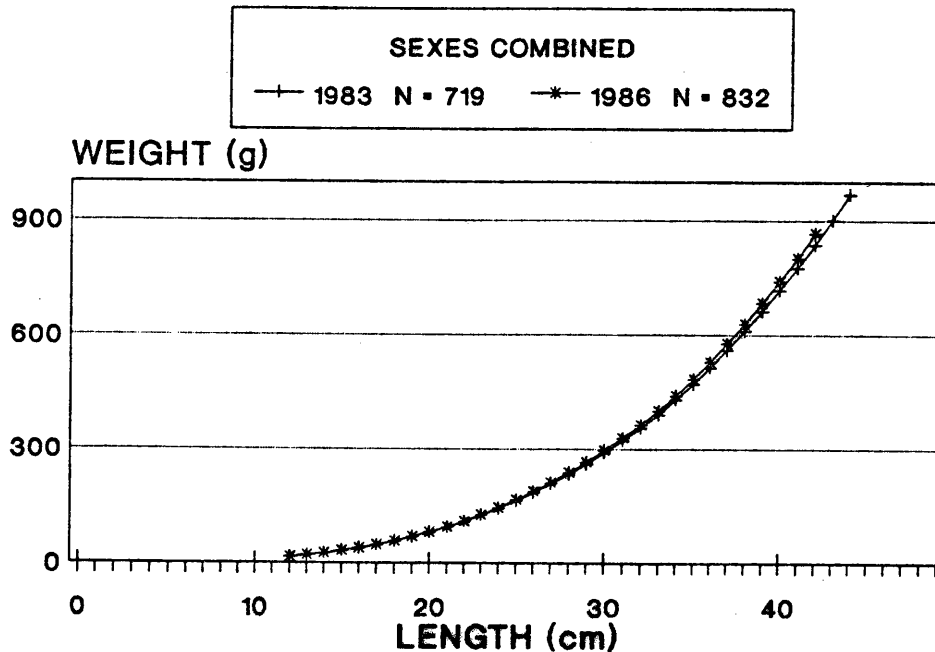

Figure 194. Length-weight relationships for rock sole in the Aleutian Islands area based on the U.S.-Japan 1983 and 1986 Aleutian Islands groundfish surveys.

Skates

Because of the difficulties faced by U.S. and Japanese scientists in identifying skates to the species level, all skates have been combined into a single species complex for discussion in this report. Seven species from two genera were identified aboard the U.S. vessels during the 1980 survey. The major species and the percentage of the biomass which they represented during the 1980 survey are: Bathyraja rosispinis 32%, B. aleutica 27%, B. kincaidii 20%, Raja binoculata 9% and R. stellulata 7%. Two other species B. abyssicola and B. trachura contributed the remaining 5%.

Distribution and Abundance

Skates were uniformly distributed throughout the Aleutian Islands area and the Southern Bering Sea primarily at depths deeper than 100 m (Figs. 195-196). Dense concentrations of skates were encountered in the western Aleutian Islands area from Attu to Amchitka Islands and in the Southern Bering Sea area north of Unalaska Island. A relatively similar distribution pattern for skates was found in the Southwest and Northwest areas during all three surveys and in the Southeast and Northeast areas during 1980 and 1983. During 1986 high densities of skates were encountered from Amukta to Seguam Passes and also near Petrel Bank.

Biomass estimates for skates in the Aleutian Islands area increased from 10,000 t in 1980 to 16,000 t in 1983, and 19,000 t in 1986. The population went from 1.6 million fish in 1980, to 5.5 million in 1983, and 7.0 million in 1986 (Table 76, Fig. 197). Skates were more abundant in the eastern Aleutian Islands and fairly uniformly distributed throughout all depth intervals greater than 100 m. However, during all three surveys the 300-500 m depth interval contained the largest percentage of the total biomass.

In the Southern Bering Sea area the biomass increased from 2,000 t in 1980 to 3,000 t in 1983 before decreasing to 1,000 t in 1986 (Table 76, Fig. 198).

Size and age composition data were not available from these surveys.

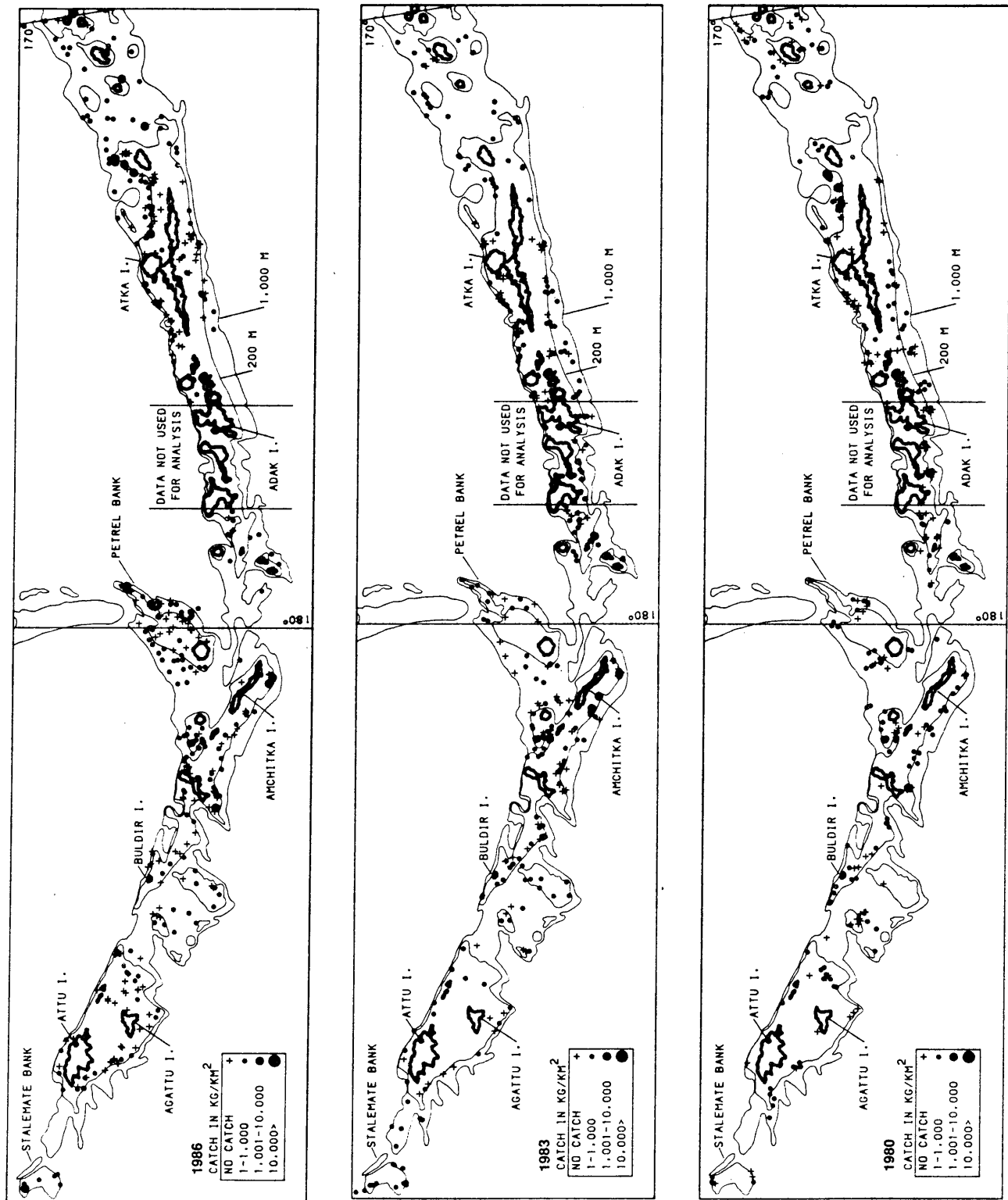

Figure 195. Distribution and relative abundance of skates in the Aleutian Islands area during the U.S.-Japan 1980, 1983, and 1986 groundfish surveys.

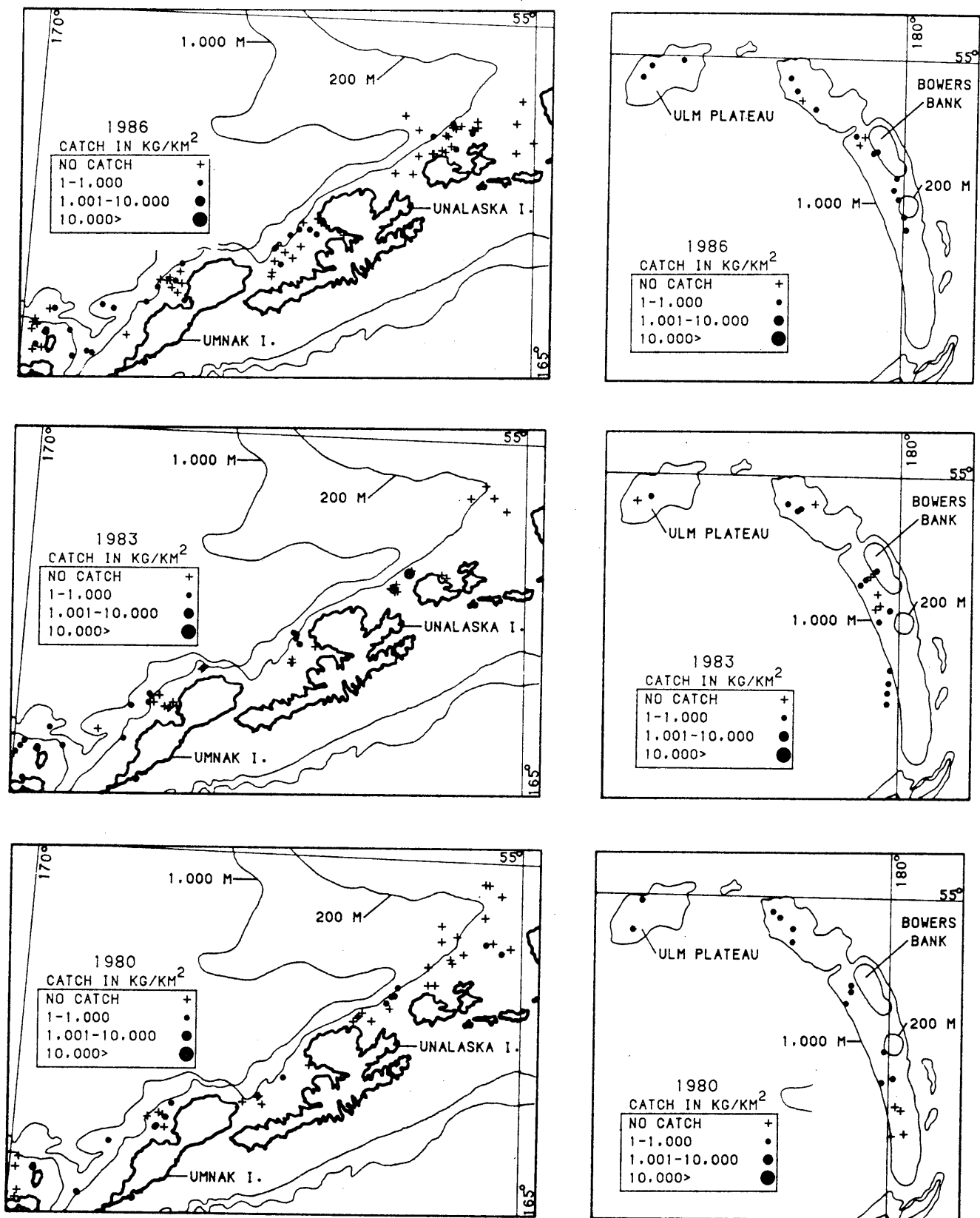

Figure 196. Distribution and relative abundance of skates in the Southern Bering Sea and Bowers Ridge areas during the U.S.-Japan 1980, 1983, and 1986 Aleutian Islands groundfish surveys.

Table 76. Estimates of biomass, biomass sampling error, and population for skates based on the U.S.-Japan 1980, 1983, and 1986 Aleutian Islands groundfish surveys.

Area	Depth (m)	Biomass (t)			Sampling Error (%)			Population (1,000s)		
		1980	1983	1986	1980	1983	1986	1980	1983	1986
Southwest	1-100	0	433	10				0.0	64.7	33.4
	101-200	1,357	193	2,357				126.0	231.3	463.9
	201-300	326	735	1,515				29.7	139.5	209.4
	301-500	234	613	323				53.6	98.8	93.0
	501-900	148	856	219				0.0	84.4	220.5
	1-900	2,065	3,830	4,424	72.0	57.3	90.5	209.3	709.8	1,020.2
Southeast	1-100	a	0	6				a	0.0	14.6
	101-200	724	469	373				286.7	132.6	86.6
	201-300	627	1,036	867				138.4	270.2	353.3
	301-500	1,194	1,278	3,996				14.4	676.0	1,280.4
	501-900	456	574	369				0.0	224.3	120.4
	1-900	3,001	3,357	5,611	88.5	71.6	79.6	439.5	1,303.1	1,855.3
Northwest	1-100	0	15	14				0.0	8.1	30.5
	101-200	55	1,219	361				0.0	237.2	94.5
	201-300	244	375	306				29.7	64.0	135.4
	301-500	568	722	924				335.3	348.9	479.9
	501-900	918	1,033	520				0.0	335.4	251.5
	1-900	1,785	3,364	2,125	46.2	45.3	28.0	365.0	994.6	991.8
Northeast	1-100	19	50	0				0.0	20.5	0.0
	101-200	106	942	1,053				3.6	203.8	219.9
	201-300	510	690	1,769				76.6	116.0	447.3
	301-500	1,123	1,848	1,772				19.9	661.3	770.0
	501-900	1,130	1,627	1,394				466.6	1,308.5	1,340.0
	1-900	2,888	5,157	5,988	79.2	36.6	35.3	566.7	2,310.0	2,777.2
Bowers Ridge	101-200	a	28	161				a	.3.0	9.0
	201-300	54	102	225				0.0	18.4	35.0
	301-500	58	53	128				0.0	22.1	33.1
	510-900	271	371	830				0.0	162.8	274.7
	101-900	383	554	1,344	106.5	339.4	79.4	0.0	266.3	351.8
Aleutian Islands Total	1-100	19	498	30	0.0	945.8	126.7	0.0	92.1	78.5
	101-200	2,242	3,851	4,305	78.1	34.8	84.5	416.3	803.8	873.9
	201-300	1,761	2,938	4,682	57.3	46.1	47.9	274.4	605.8	1,180.4
	301-500	3,177	4,514	7,143	108.7	52.0	66.4	423.2	1,805.2	2,656.4
	501-900	2,923	4,461	3,332	84.0	37.8	38.2	466.6	2,216.3	2,207.1
	1-900	10,122	16,262	19,492	33.0	20.4	30.9	1,580.5	5,522.7	6,993.6
Southern Bering Sea Total	1-100	154	0	254				24.6	0.0	46.9
	101-200	33	2,100	284				0.0	159.5	34.5
	201-300	206	99	41				0.0	17.2	6.6
	301-500	473	855	154				0.0	85.8	65.4
	501-900	1,307	121	511				0.0	55.8	326.5
1-900	2,173	3,175	1,244	27.3	797.5	96.0	24.6	318.3	479.9	

a No sampling was conducted in this area-depth interval.

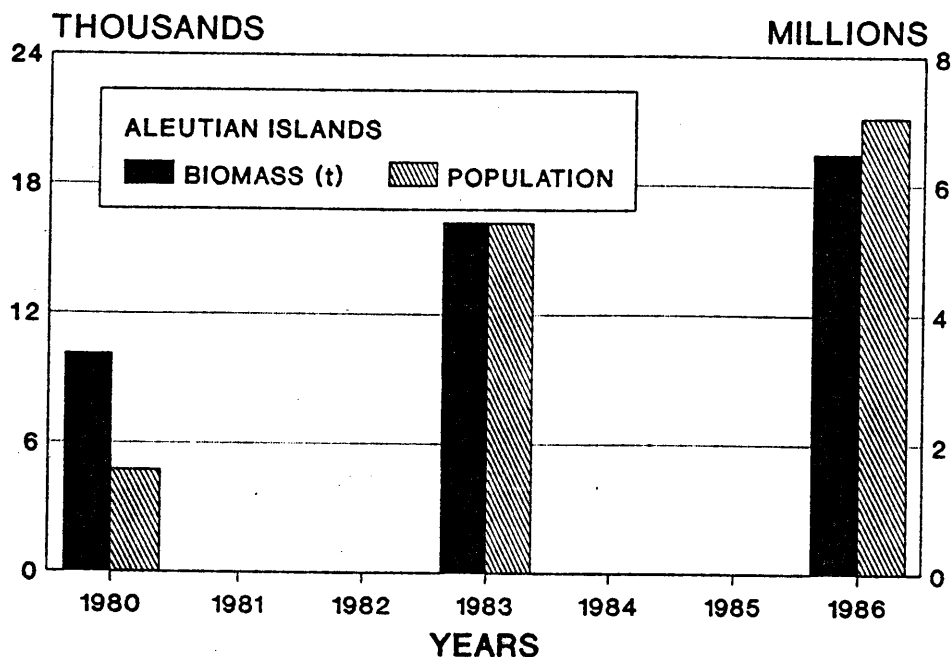

Figure 197. Estimated biomass and population of skates, in the Aleutian Islands area during the U.S.-Japan 1980, 1983, and 1986 groundfish surveys.

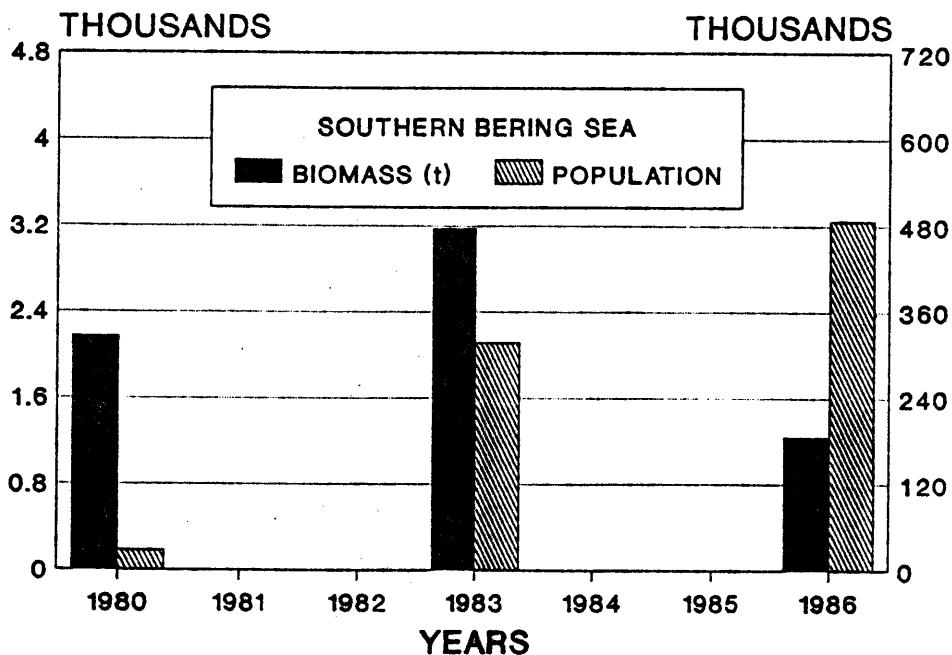

Figure 198. Estimated biomass and population of skates, in the Southern Bering Sea area during the U.S.-Japan 1980, 1983, and 1986 Aleutian Islands groundfish surveys.

Flathead Sole

Distribution and Abundance

Flathead sole (*Hippoglossoides elassodon*) were found in the Aleutian Islands area in very small quantities. This species was encountered around Agattu Island, on the south side of Kiska and Amchitka Islands, and on both sides of Atka and Amlia Islands at depths less than 200 m (Figs. 199-200).

The biomass estimate for flathead sole in the Aleutian Islands totaled 2,000 t in 1980, decreased to 600 t in 1983 and then jumped to 5,800 t in 1986 (Table 77, Fig. 201). Over 75% of the total biomass was found in the Southwest and Northeast areas.

An identical pattern was evident in the Southern Bering Sea where the biomass estimate decreased from 1,900 t, in 1980 to 700 t in 1983 before increasing to 4,000 t in 1986 (Table 77, Fig. 202).

Size Composition

Flathead sole in the Aleutian Islands ranged in length from 13 to 41 cm during the 1980 and 1983 surveys. Size composition curves were extremely flat, consisting of only a few individuals in any size category (Fig. 203). In 1980 the sex ratio favored males, in 1983, the numbers of males and females were nearly equal. In 1986, the size composition curve was unimodal and skewed toward fish in the 25-31 cm size range.

No similarity was found between size composition curves of flathead sole in the Southern Bering Sea (Fig. 204). In 1980 flathead sole ranged in size from 22 to 42 cm with most of the fish in the 26-33 cm range. In 1983 the stock consisted mainly of fish from 29 to 48 cm and the size curve had two weak modes at 33-37 and 39-46 cm. During the 1986 survey the size composition curve of flathead sole was stronger and bimodal with a primary mode of larger fish at 31-44 and a secondary mode of smaller fish 21-30 cm in length.

Because of low abundance, otolith collections were not adequate to define the age composition of the flathead sole stocks in the Aleutian Islands area and therefore no age data are available for this species.

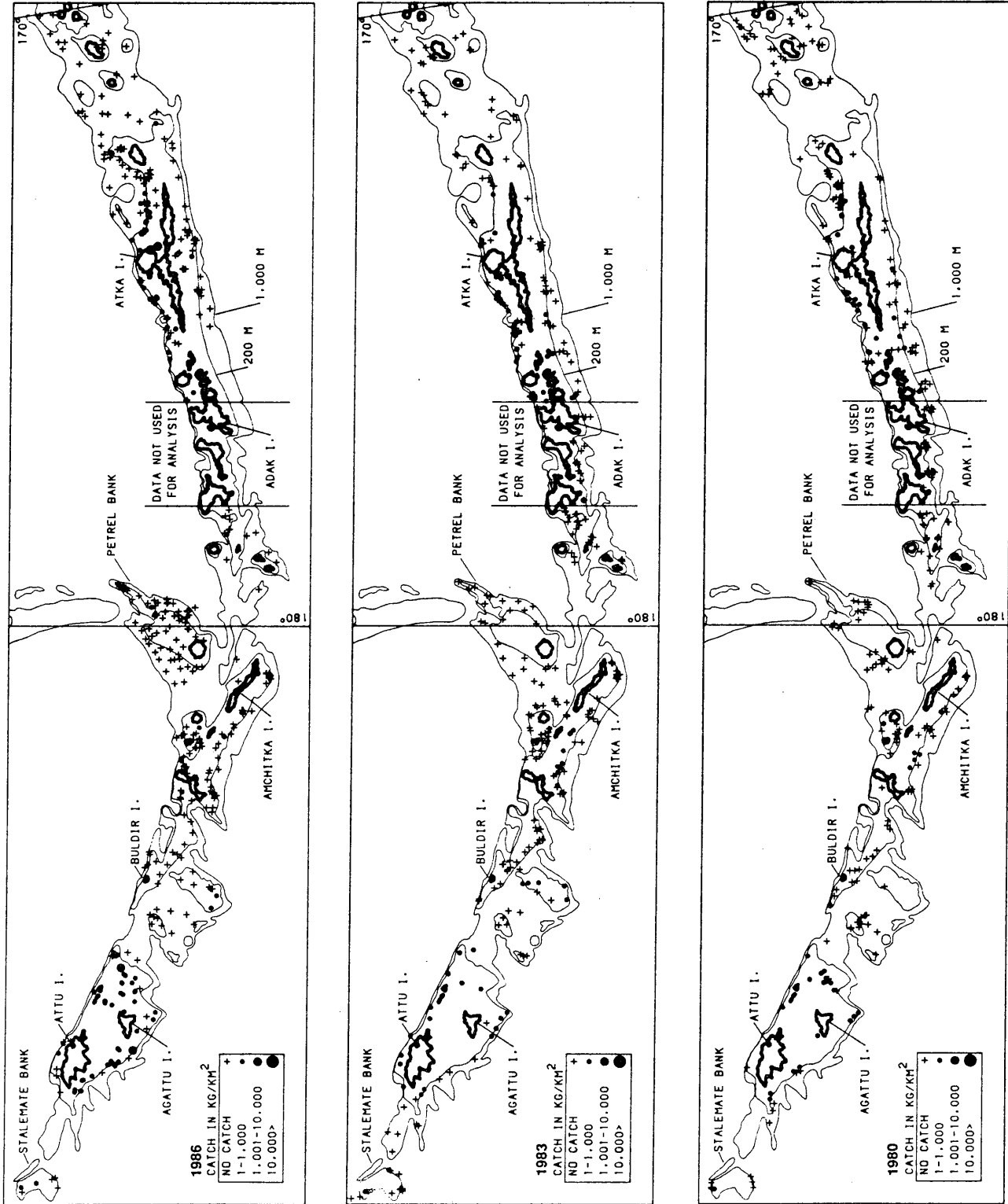

Figure 199. Distribution and relative abundance of flathead sole in the Aleutian Islands during the U.S.-Japan 1980, 1983, and 1986 groundfish surveys.

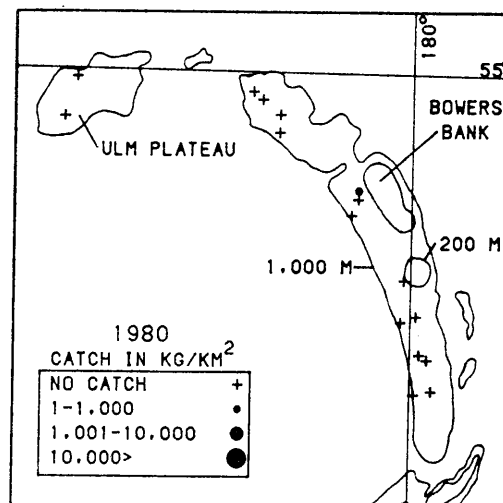
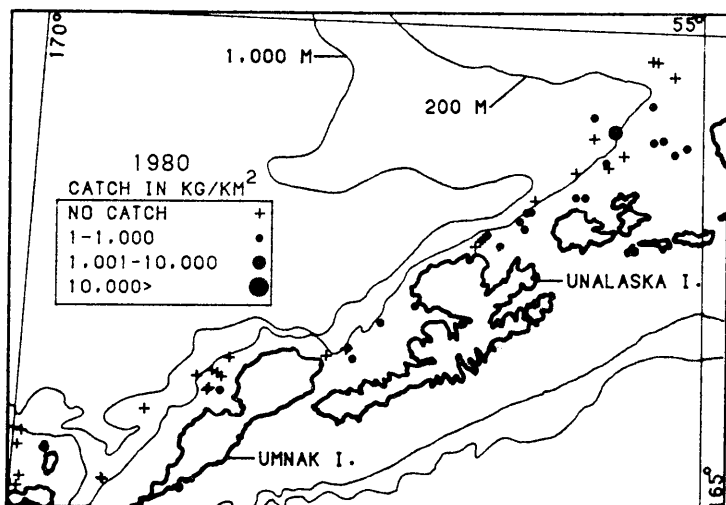
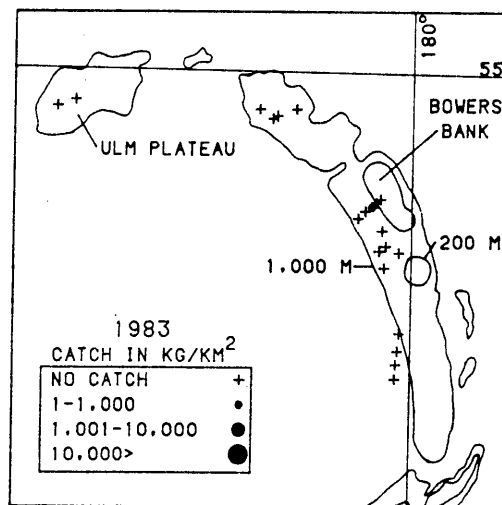
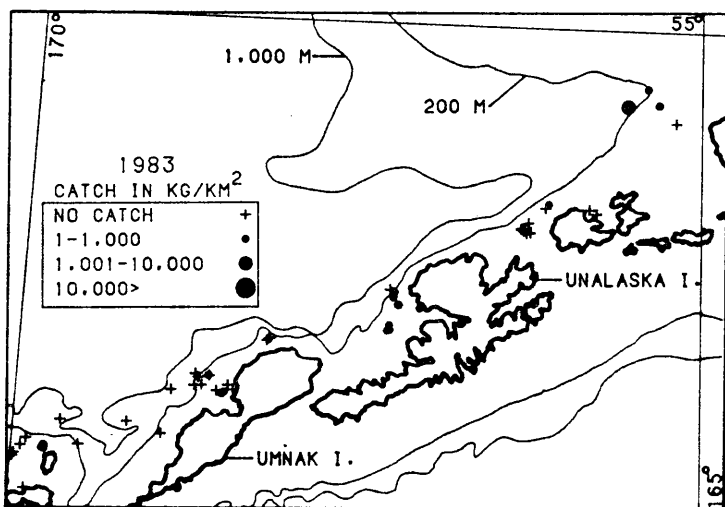
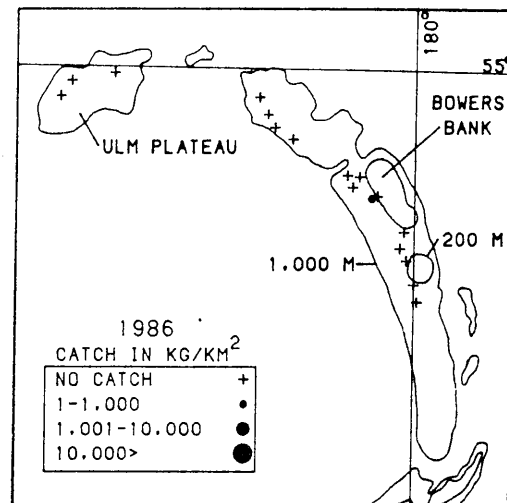
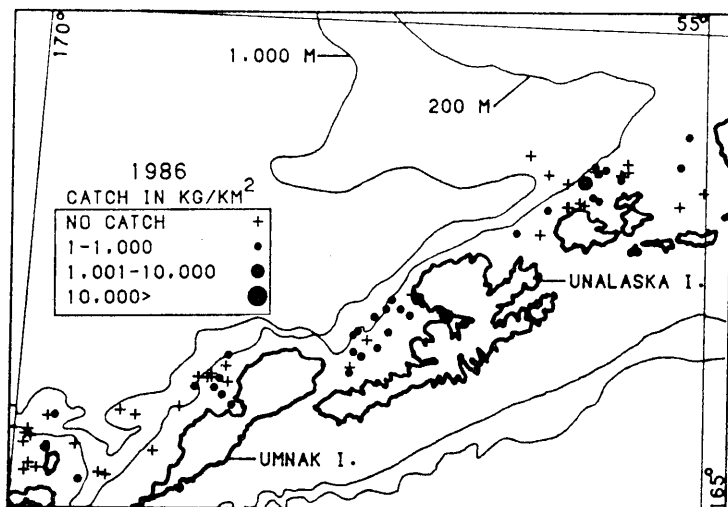

Figure 200. Distribution and relative abundance of flathead sole in the Southern Bering Sea and Bowers Ridge areas during the U.S.-Japan 1980, 1983, and 1986 Aleutian Islands groundfish surveys.

Table 77. Estimates of biomass, biomass sampling error, and population for flathead sole based on the U.S.-Japan 1980, 1983, and 1986 Aleutian Islands groundfish surveys.

Area	Depth (m)	Biomass (t)			Sampling Error (%)			Population (1,000s)		
		1980	1983	1986	1980	1983	1986	1980	1983	1986
Southwest	1-100	244	169	852				1,265.1	476.1	5,510.2
	101-200	597	171	2,211				2,662.1	529.7	10,344.1
	201-300	101	20	336				896.6	61.4	1,344.4
	301-500	21	1	10				85.2	7.4	30.3
	501-900	0	10	0				0.0	28.3	0.0
	1-900	963	371	3,409	64.0	631.6	45.2	4,909.0	1,102.9	17,229.0
Southeast	1-100	a	0	0				a	0.0	0.0
	101-200	5	5	6				0.0	13.6	6.5
	201-300	0	0	7				0.0	0.7	14.9
	301-500	0	0	0				0.0	0.0	0.0
	501-900	0	0	0				0.0	0.0	0.0
	1-900	5	5	13	145.2	250.1	152.6	0.0	14.3	21.4
Northwest	1-100	0	9	30				0.0	30.4	176.8
	101-200	0	58	58				0.0	160.3	216.9
	201-300	115	20	48				317.2	65.8	222.6
	301-500	79	0	0				0.0	0.0	0.0
	501-900	0	0	0				0.0	0.0	0.0
	1-900	194	87	136	144.9	127.1	113.6	317.2	256.5	616.3
Northeast	1-100	14	0	660				0.0	0.0	4,204.9
	101-200	378	150	1,320				1,876.7	910.3	7,180.3
	201-300	28	7	80				64.3	28.7	178.3
	301-500	90	8	47				184.4	14.8	93.2
	501-900	0	1	35				0.0	10.6	63.3
	1-900	510	166	2,142	125.5	89.6	105.6	2,125.4	964.4	11,720.0
Bowers Ridge	101-200	a	0	0				a	0.0	0.0
	201-300	294	2	136				840.5	6.0	246.4
	301-500	0	0	0				0.0	0.0	0.0
	510-900	0	0	0				0.0	0.0	0.0
	101-900	294	2	136	0.0	1,270.6	430.3	840.5	6.0	246.4
Aleutian Islands	1-100	258	178	1,542	0.0	1,204.4	82.0	1,265.1	506.5	9,891.9
	101-200	980	384	3,595	82.2	57.4	64.3	4,538.8	1,613.9	17,747.8
Total	201-300	538	49	607	53.9	103.8	91.8	2,118.6	162.6	2,006.6
	301-500	190	9	57	100.5	372.2	157.1	269.6	22.2	123.5
	501-900	0	11	35	0.0	207.8	1,099.1	0.0	38.9	63.3
	1-900	1,966	631	5,836	42.2	404.8	44.4	8,192.1	2,344.1	29,833.1
Southern Bering Sea	1-100	612	120	334				2,676.4	372.9	1,500.4
	101-200	977	232	2,003				2,910.4	700.4	4,865.6
Total	201-300	36	318	971				0.0	610.9	2,064.0
	301-500	246	24	701				298.5	46.9	1,232.9
	501-900	0	0	0				0.0	0.0	0.0
	1-900	1,871	694	4,009	68.7	132.8	57.0	5,885.3	1,731.1	9,662.9

a No sampling was conducted in this area-depth interval.

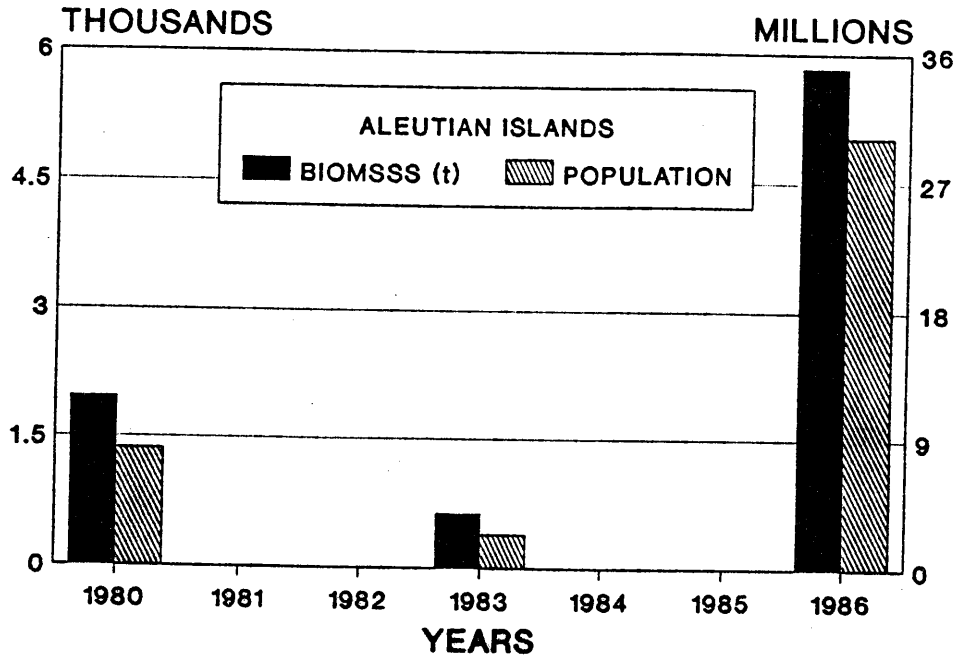

Figure 201. Estimated biomass and population of flathead sole in the Aleutian Islands area during the U.S.-Japan 1980, 1983, and 1986 groundfish surveys.

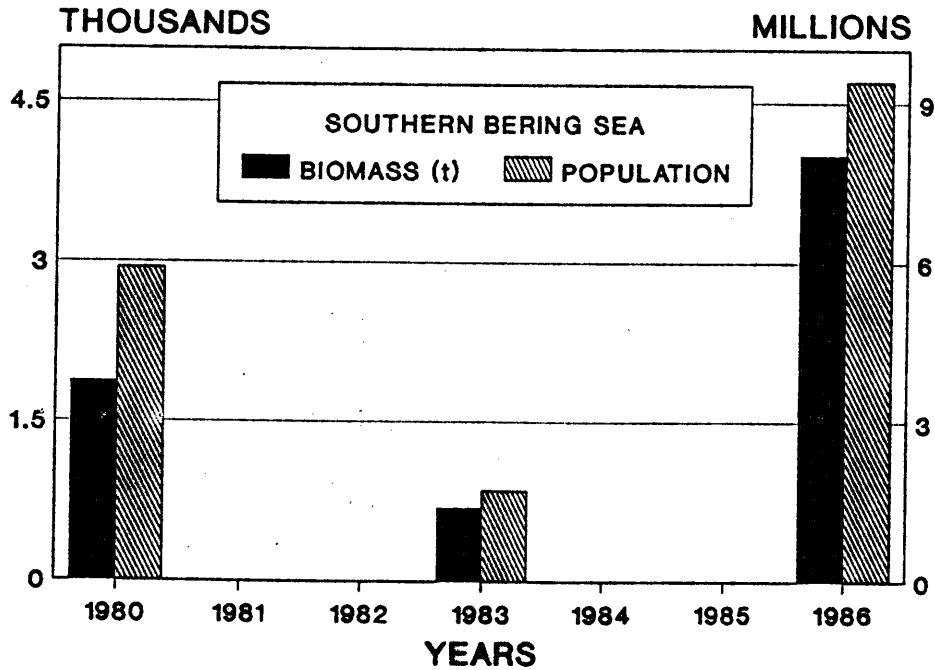

Figure 202. Estimated biomass and population of flathead sole in the Southern Bering Sea area during the U.S.-Japan 1980, 1983, and 1986 Aleutian Islands groundfish surveys.

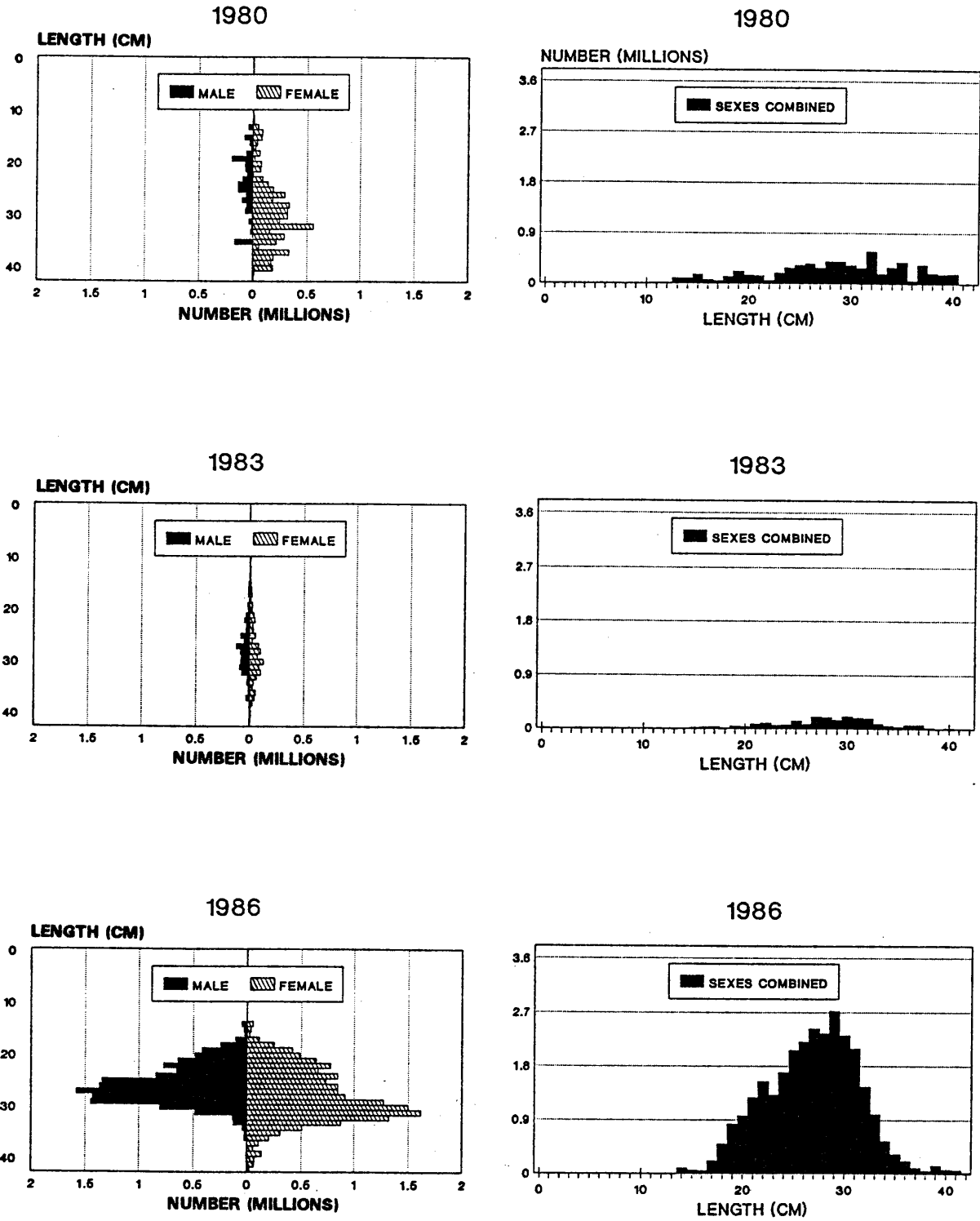

Figure 203. Size composition of flathead sole in the Aleutian Islands area during the U.S.-Japan 1980, 1983, and 1986 groundfish surveys.

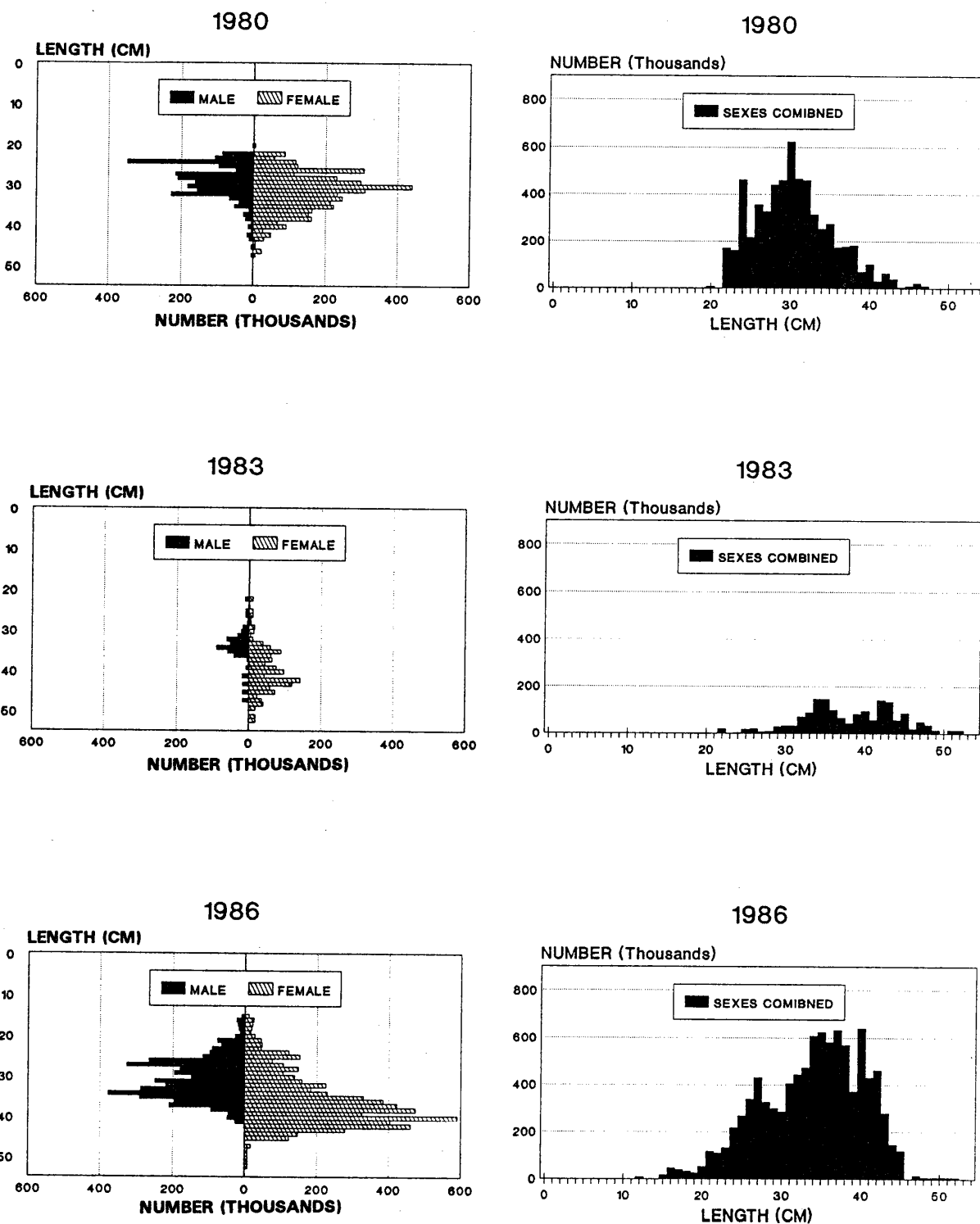

Figure 204. Size composition of flathead sole in the Southern Bering Sea area during the U.S.-Japan 1980, 1983, and 1986 Aleutian Islands groundfish surveys.

Rex Sole

Distribution and Abundance

Rex sole (Errex zachirus) occurred at very low abundances throughout the Aleutian Islands area and Southern Bering Sea at depths primarily from 201-500 m (Fig. 205-206). They were most frequently encountered in the western Aleutian Islands; around Kiska, Amchitka and Agattu Islands and in the eastern Aleutian Islands north of Atka and Amlia Islands. In the Southern Bering Sea they were found north of Unalaska Island.

The biomass estimate for rex sole in the Aleutian Islands increased from 600 t in 1980 to 1,800 t in 1983, and 3,000 t in 1986 (Table 78, Fig. 207). In the Southern Bering Sea area biomass increased from 1,200 t in 1980 to 4,400 t in 1983 and then decreased to 2,500 t in 1986 (Table 78, Fig. 208).

Size Composition

The 1980 size composition curve for rex sole in the Aleutian Islands was weak and bimodal (Fig. 209). There were more males in the 29-33 cm size range and more females in the 42-44 cm range. In 1983 there was a stronger mode of fish from 40-50 cm, consisting of more females than males. In 1986 there was a considerably stronger curve with a principle mode at 34-48 cm which again consisted of nearly equal numbers of males and females.

In the Southern Bering Sea area, the 1980 size composition curve consisted primarily of fish in the 20-35 cm size range (Fig. 210). In 1983 and 1986 these fish ranged from 36-47 cm in length.

No age data is available for rex sole because of the small number of otoliths collected.

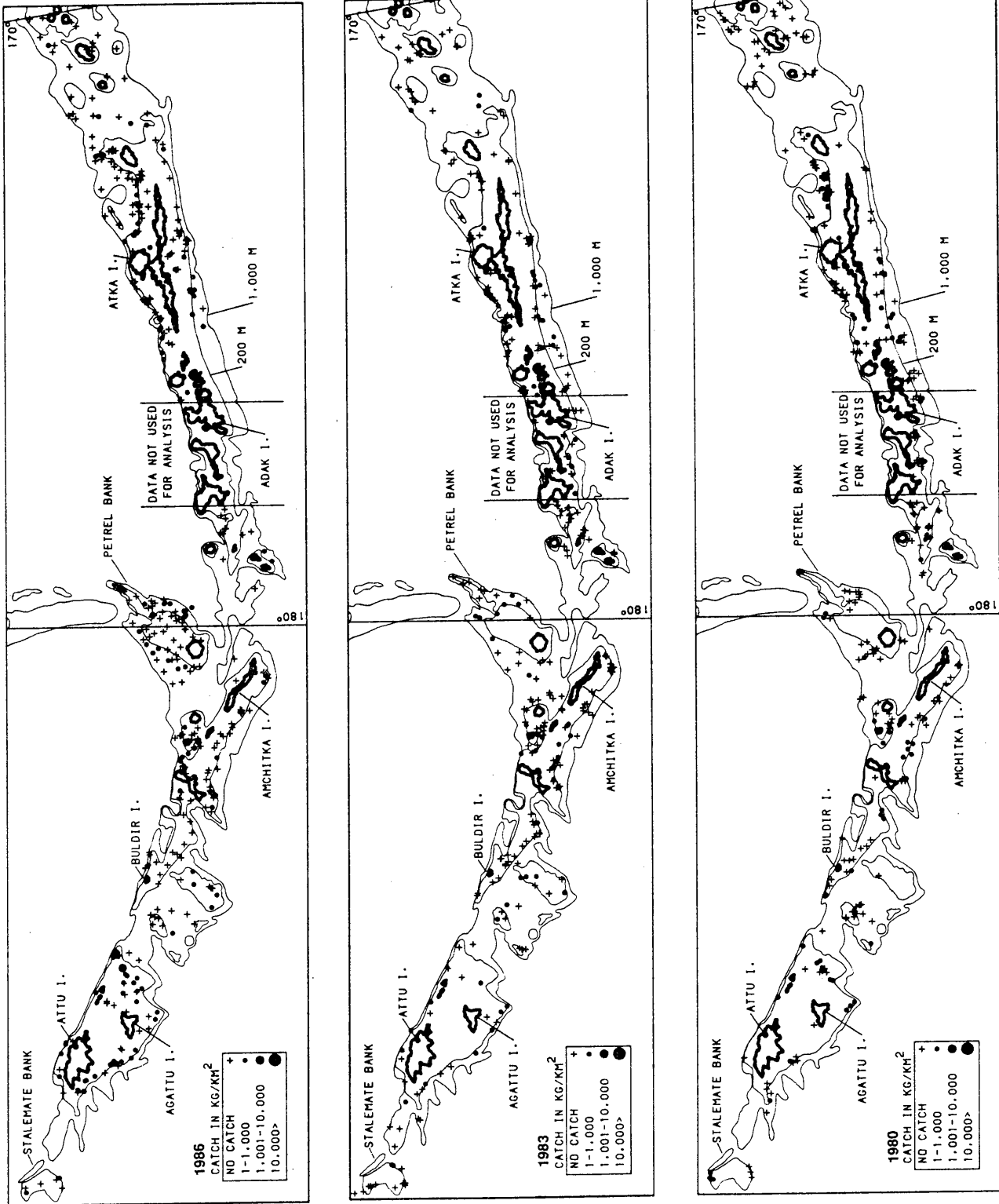

Figure 205. Distribution and relative abundance of rex sole in the Aleutian Islands area during the U.S.-Japan 1980, 1983, and 1986 Aleutian Islands groundfish surveys.

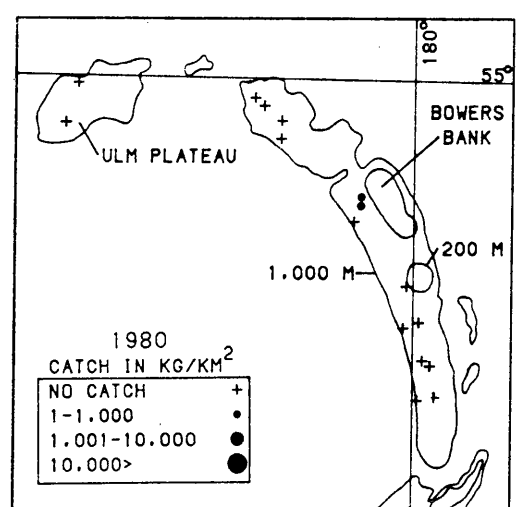
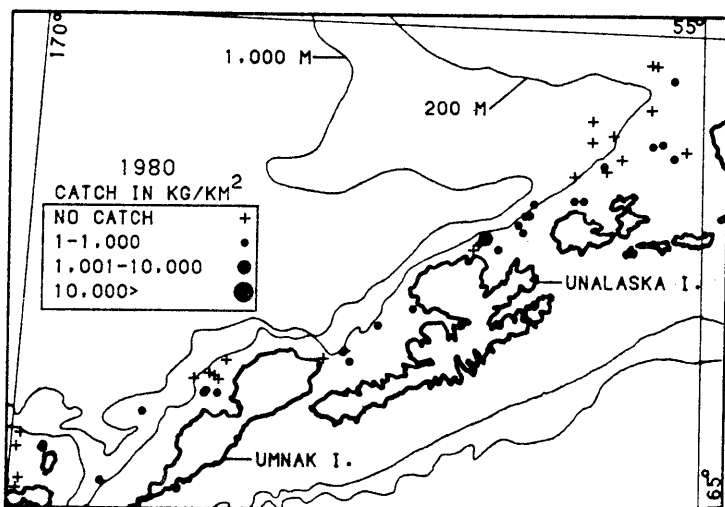
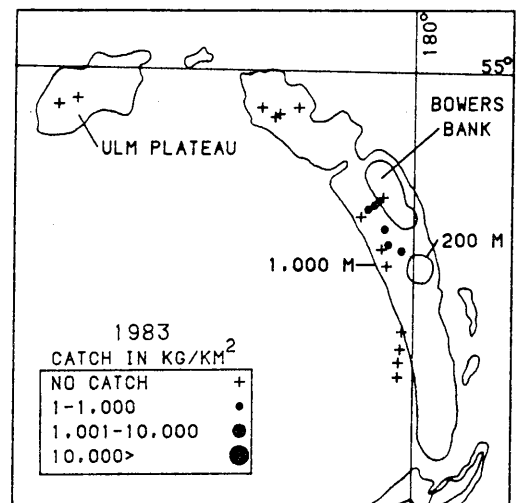
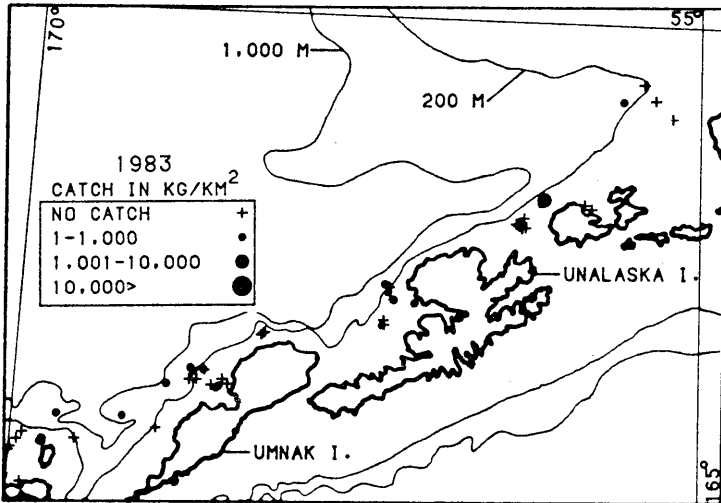
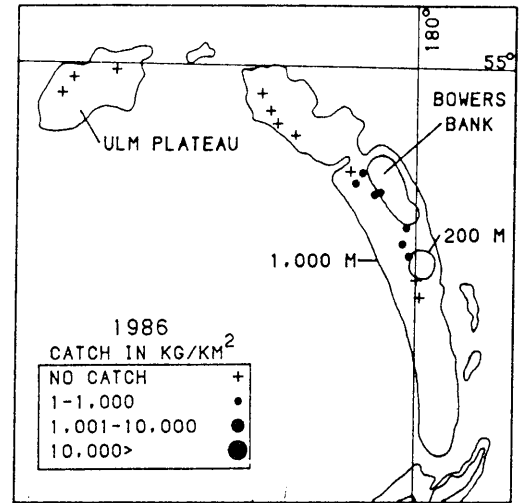
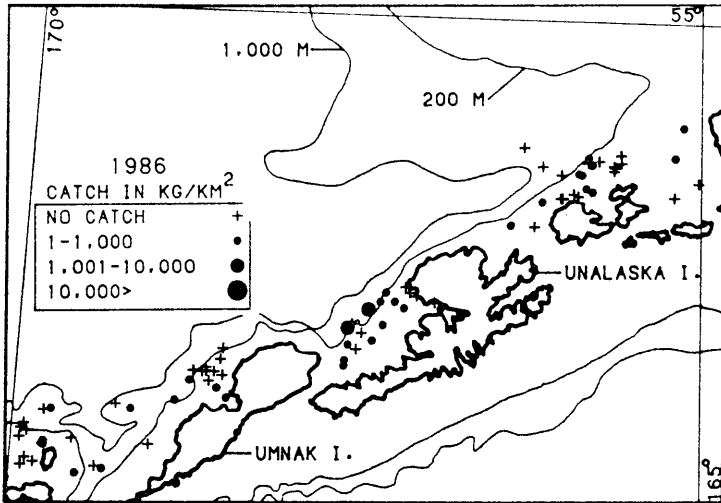

Figure 206. Distribution and relative abundance of rex sole in the Southern Bering Sea and Bowers Ridge areas during the U.S.-Japan 1980, 1983, and 1986 Aleutian Islands groundfish surveys.

Table 78. Estimates of biomass, biomass sampling error, and population for rex sole based on the U.S.-Japan 1980, 1983, and 1986 Aleutian Islands groundfish surveys.

Area	Depth (m)	Biomass (t)			Sampling Error (%)			Population (1,000s)		
		1980	1983	1986	1980	1983	1986	1980	1983	1986
Southwest	1-100	0	0	0				0.0	0.0	0.0
	101-200	77	314	518				190.0	741.1	985.6
	201-300	44	84	409				96.5	269.4	724.5
	301-500	69	42	184				190.5	87.0	401.5
	501-900	15	200	0				0.0	140.0	0.0
	1-900	205	640	1,111	55.1	99.2	57.1	477.7	1,237.5	2,111.6
Southeast	1-100	a	0	0				a	0.0	0.0
	101-200	31	5	50				41.4	11.9	97.2
	201-300	30	72	113				57.4	152.0	236.5
	301-500	47	249	77				92.6	474.2	153.8
	501-900	0	26	0				0.0	38.7	0.0
	1-900	108	352	240	102.0	38.7	585.6	191.4	676.8	487.5
Northwest	1-100	0	0	3				0.0	0.0	12.2
	101-200	0	18	11				0.0	41.9	26.5
	201-300	26	31	244				61.8	61.9	517.0
	301-500	7	305	458				47.3	432.6	860.7
	501-900	17	14	11				0.0	17.1	12.4
	1-900	50	368	727	199.2	94.0	71.1	109.1	553.5	1,428.8
Northeast	1-100	7	0	42				0.0	0.0	75.3
	101-200	23	9	22				142.3	34.5	74.5
	201-300	28	27	174				52.8	67.0	439.2
	301-500	71	134	399				147.4	320.8	1064.3
	501-900	0	178	2				0.0	128.6	4.2
	1-900	129	348	639	127.3	97.4	52.6	342.5	550.9	1,657.5
Bowers Ridge	101-200	a	5	1				a	24.1	4.5
	201-300	63	22	226				409.5	102.7	1,285.8
	301-500	19	30	93				64.7	63.2	241.5
	510-900	0	0	0				0.0	0.0	0.0
	101-900	82	57	320	293.3	94.0	245.1	474.2	190.0	1,531.8
Aleutian Islands Total	1-100	7	0	45	0.0	0.0	274.5	0.0	0.0	89.5
	101-200	131	351	602	77.9	80.5	68.4	373.7	853.5	1,183.3
	201-300	191	236	1,166	49.2	51.9	68.2	678.0	653.0	3,203.0
	301-500	213	760	1,211	79.4	43.3	29.7	542.5	1,377.8	2,721.8
	501-900	32	418	13	90.7	136.6	203.1	0.0	324.4	16.6
	1-900	574	1,765	3,037	35.9	36.4	31.4	1,594.2	3,208.7	7,217.2
Southern Bering Sea Total	1-100	206	27	51				0.0	75.7	193.4
	101-200	422	419	789				1,540.2	849.6	1,656.7
	201-300	286	182	476				675.8	312.6	954.5
	301-500	94	3,252	1,112				210.3	5,723.0	1,954.6
	501-900	214	562	31				0.0	913.9	38.5
	1-900	1,222	4,442	2,459	72.9	246.2	487.1	2,426.3	7,879.8	4,797.7

a No sampling was conducted in this area-depth interval.

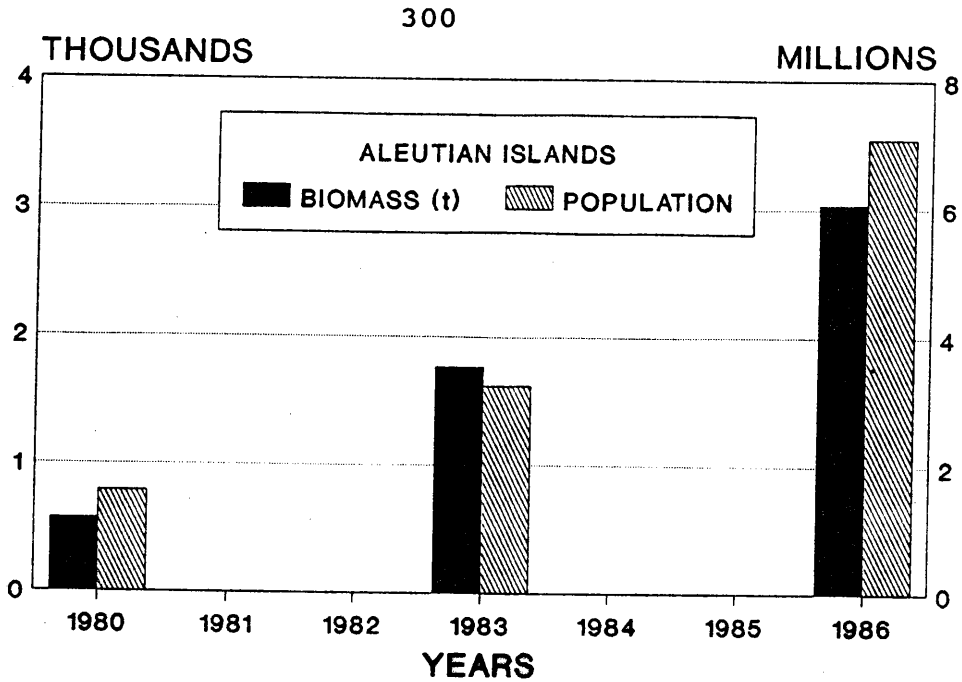

Figure 207. Estimated biomass and population of rex sole in the Aleutian Islands area during the U.S.-Japan 1980, 1983, and 1986 groundfish surveys.

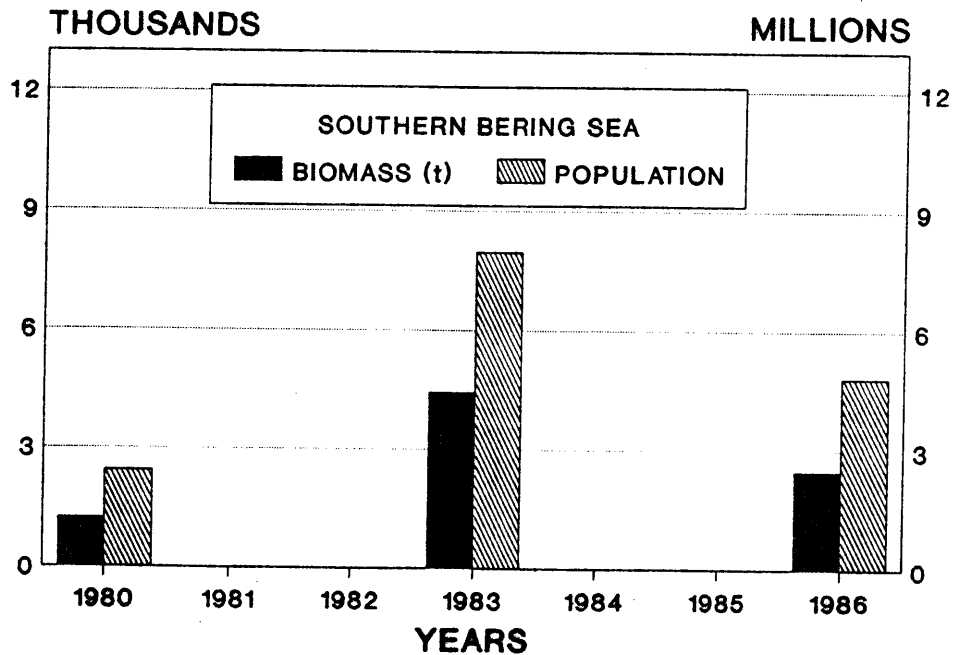

Figure 208. Estimated biomass and population of rex sole in the Southern Bering Sea area during the U.S.-Japan 1980, 1983, and 1986 Aleutian Islands groundfish surveys.

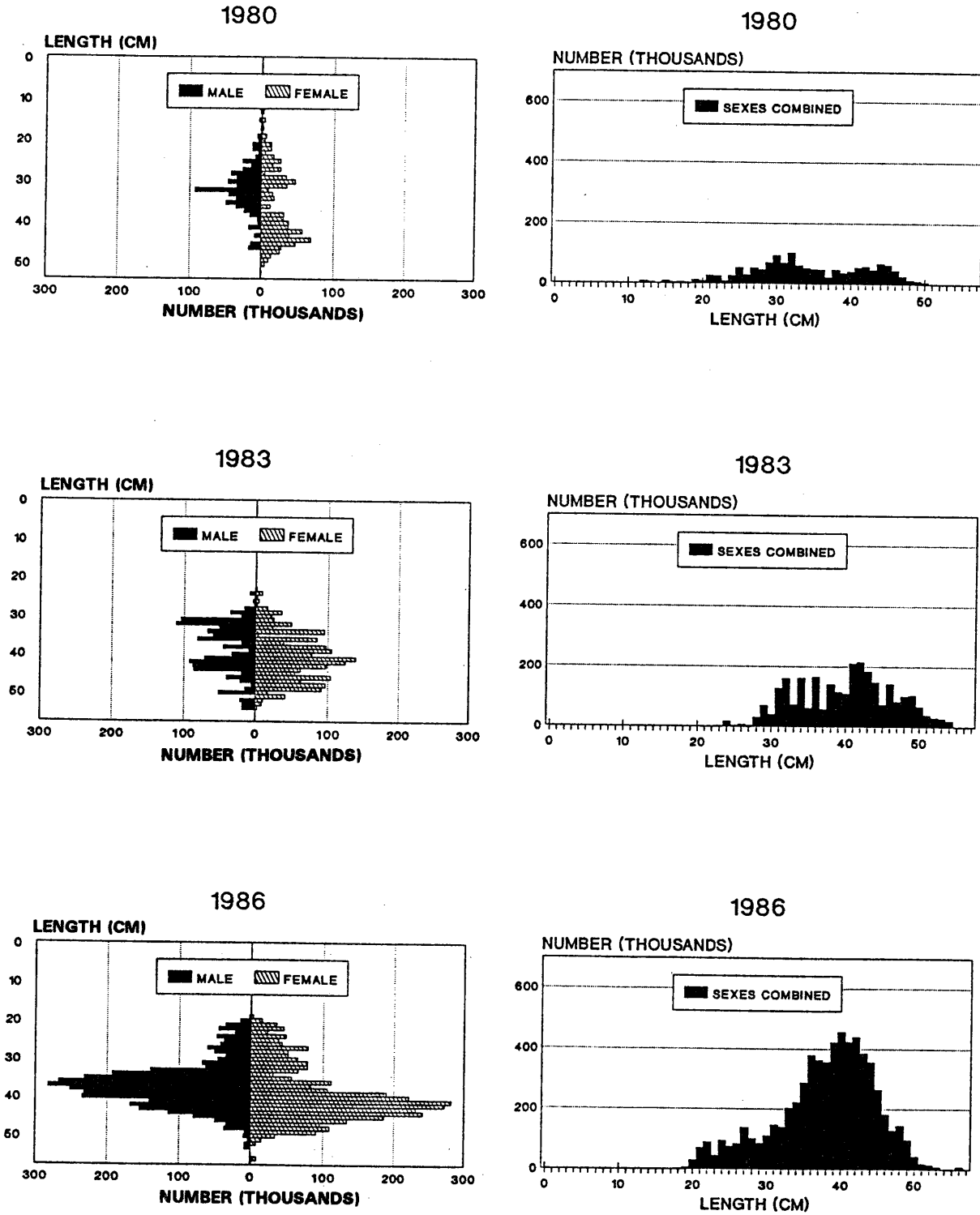

Figure 209. Size composition of rex sole in the Aleutian Islands area during the U.S.-Japan 1980, 1983, and 1986 groundfish surveys.

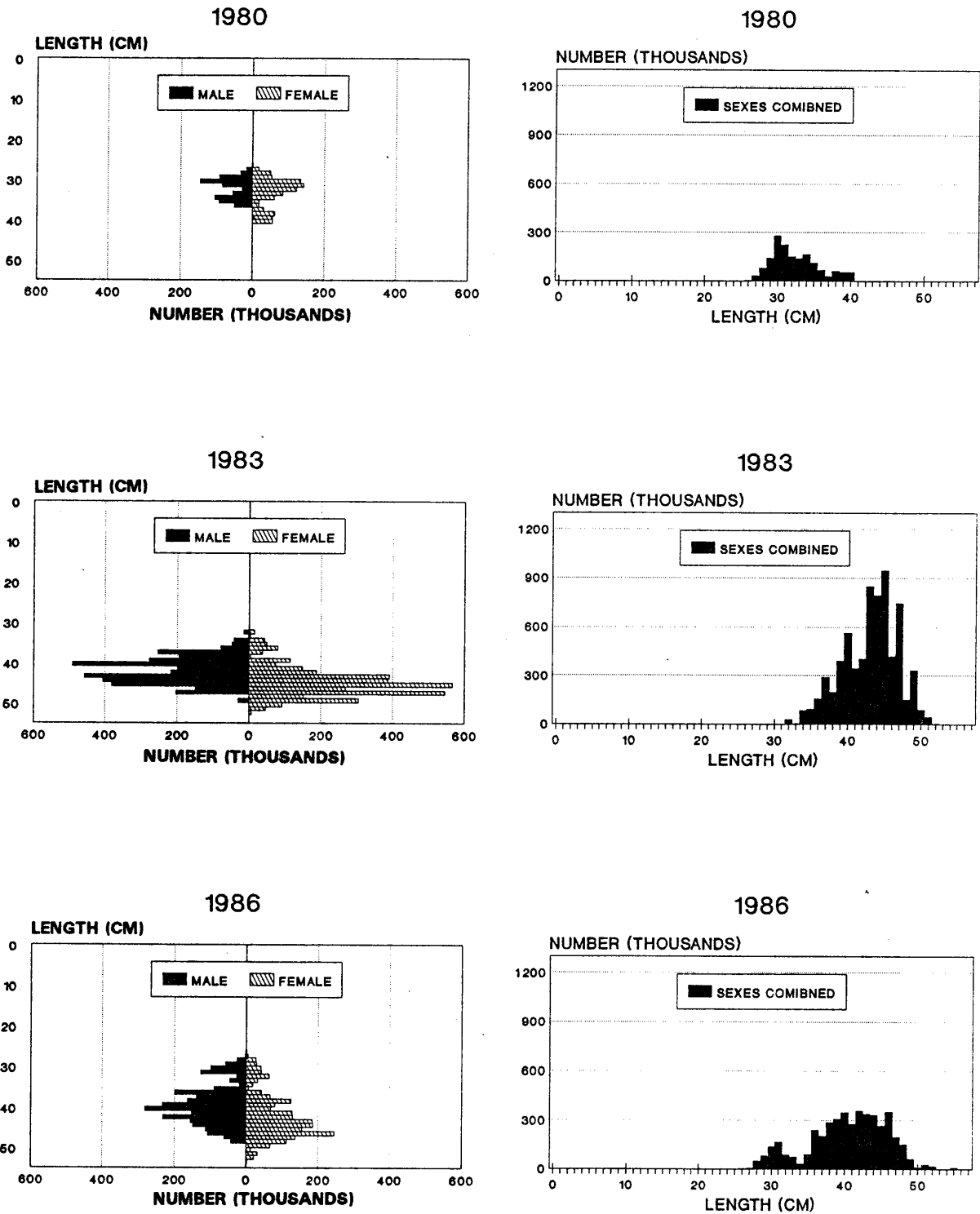

Figure 210. Size composition of rex sole in the Southern Bering Sea area during the U.S.-Japan 1980, 1983, and 1986 Aleutian Islands groundfish surveys.

Length-Weight Relationship

Length-weight data were collected only during the 1986 survey and provided the following relationship (Fig. 211):

$$\text{Weight(g) (1986)} = .0018 \times (\text{Length(cm)})^{3.387}.$$

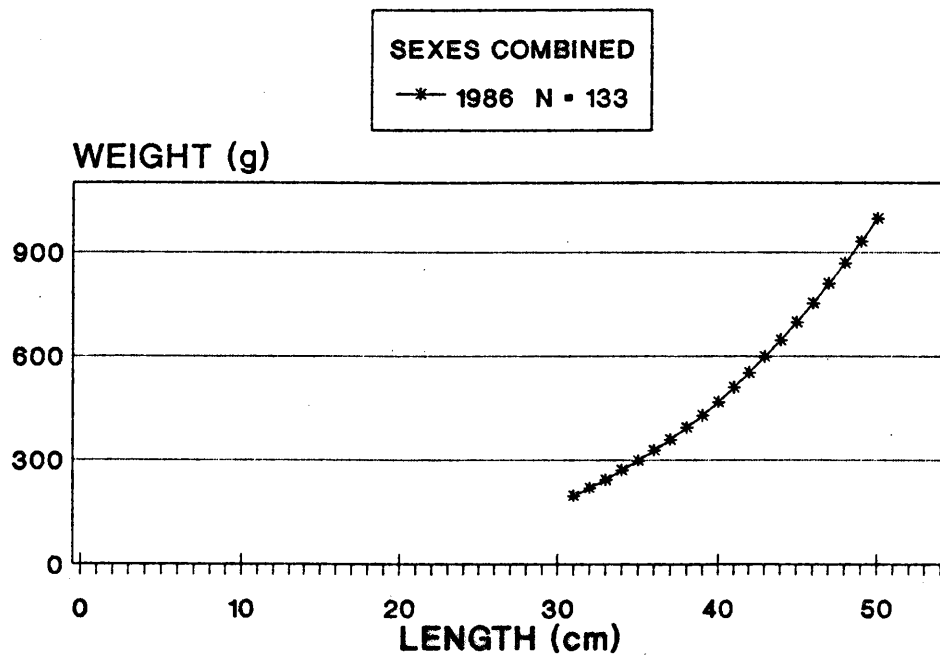

Figure 211. Length-weight relationships for rex sole in the Aleutian Islands area during the U.S.-Japan 1986 groundfish survey.

Dover Sole

Distribution and Abundance

Dover sole (Microstomus pacificus) were encountered at low abundances primarily at depths greater than 500 m throughout the Aleutian Islands area and Southern Bering Sea (Figs. 212-213).

The biomass estimate for Dover sole in the Aleutian Islands increased from 344 t in 1980 to 369 t in 1983 and 1,000 t in 1986 (Table 79, Fig. 214-215). In the Southern Bering Sea area the biomass decreased from 190 t in 1980 to 55 t in 1986.

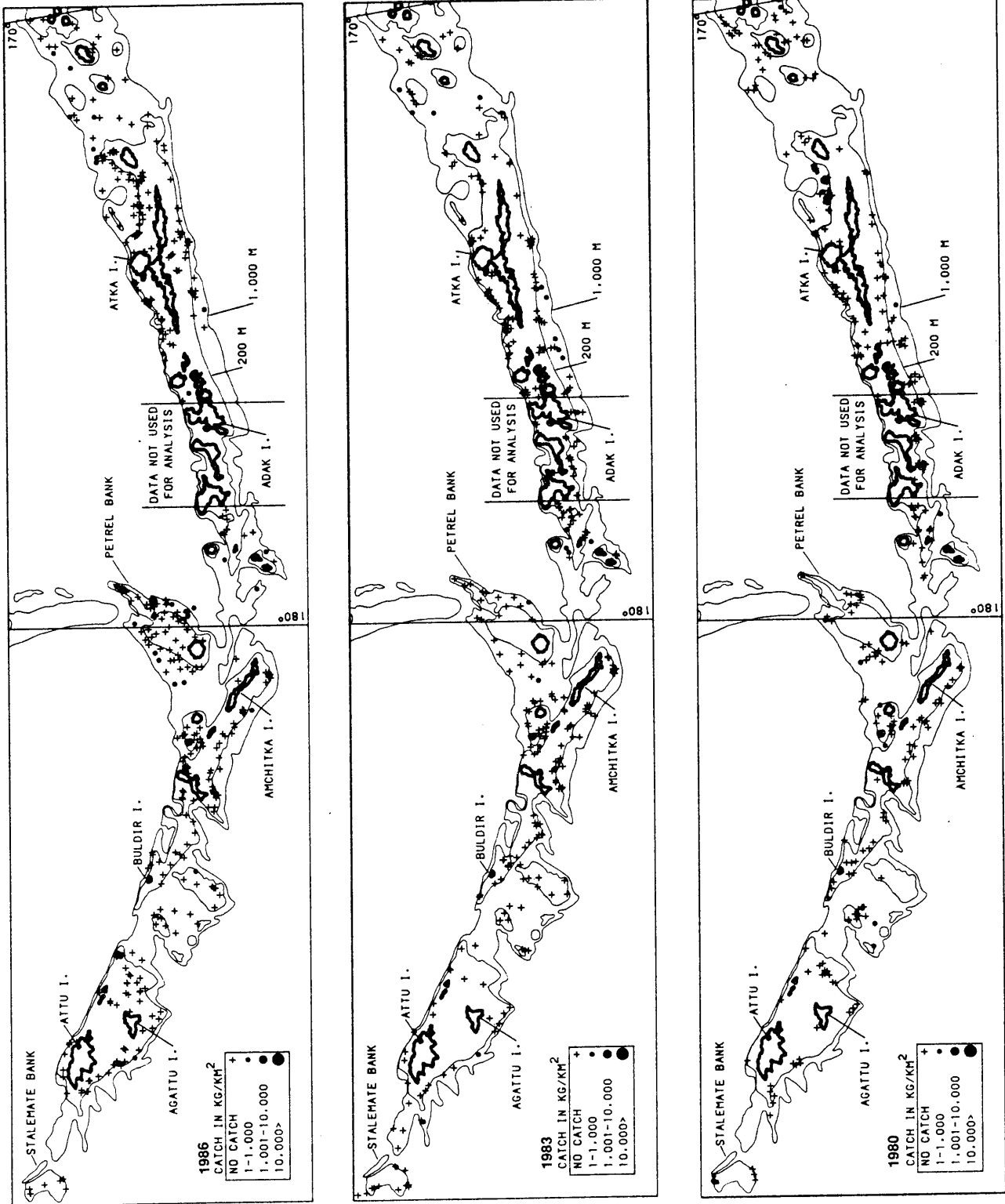

Figure 212. Distribution and relative abundance of Dover sole in the Aleutian Islands area during the U.S.-Japan 1980, 1983, and 1986 groundfish surveys.

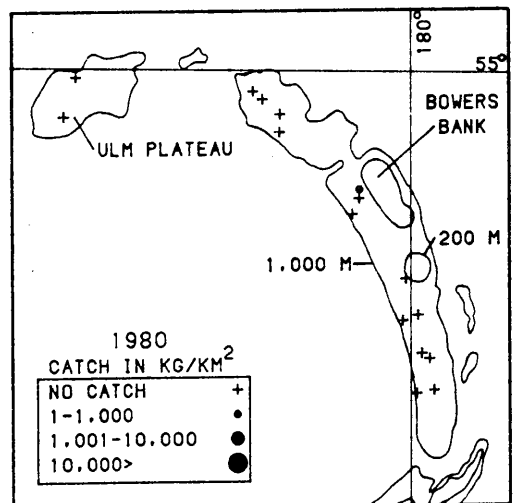
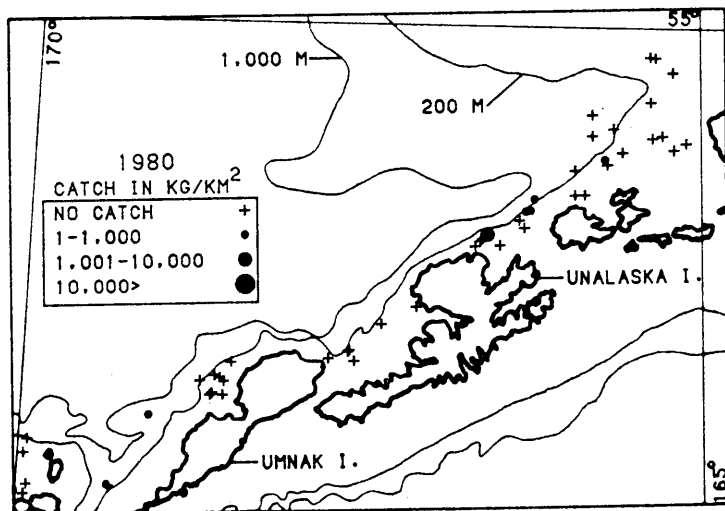
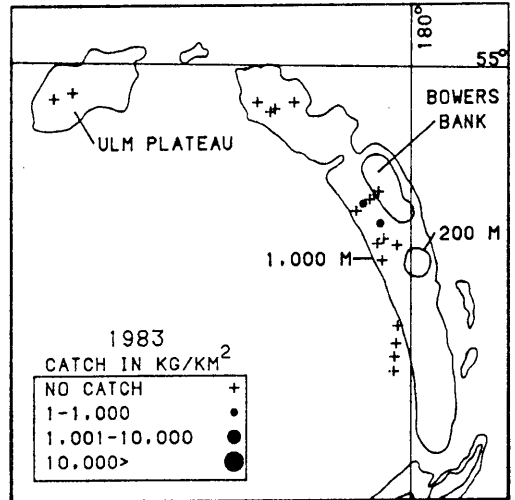
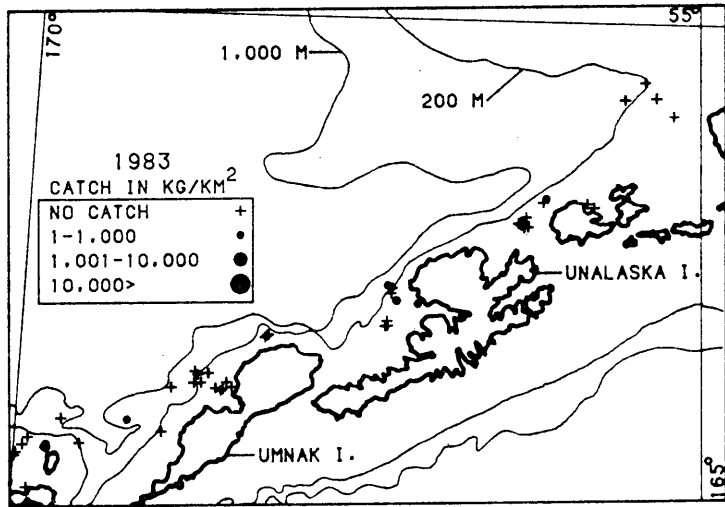
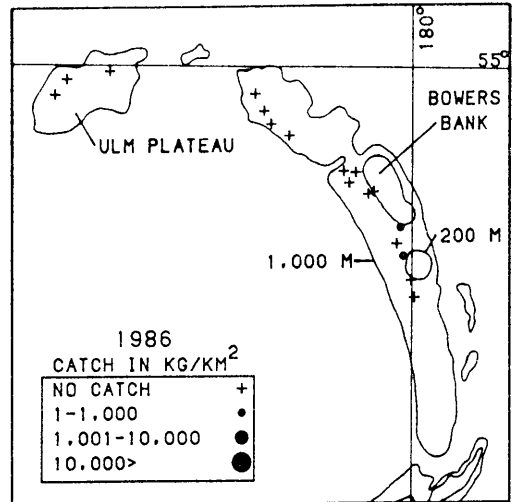
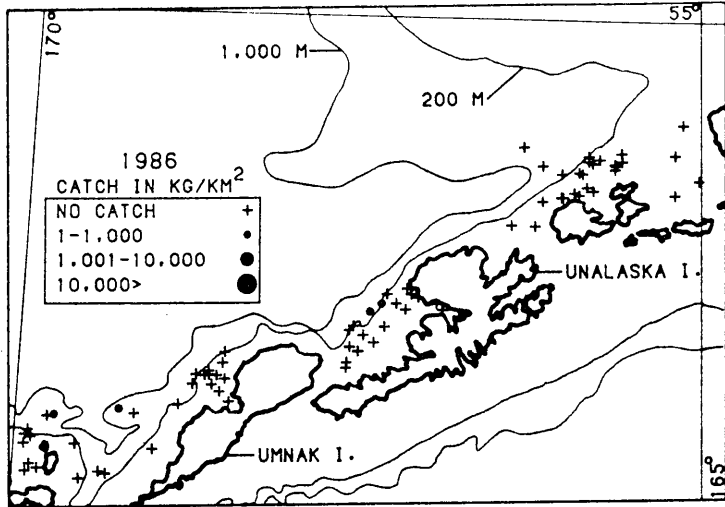

Figure 213. Distribution and relative abundance of Dover sole in the Southern Bering Sea and Bowers Ridge areas during the U.S.-Japan 1980, 1983, and 1986 Aleutian Islands groundfish surveys.

Table 79. Estimates of biomass, biomass sampling error, and population for Dover sole based on the U.S.-Japan 1980, 1983, and 1986 Aleutian Islands groundfish surveys.

Area	Depth (m)	Biomass (t)			Sampling Error (%)			Population (1,000s)		
		1980	1983	1986	1980	1983	1986	1980	1983	1986
Southwest	1-100	0	0	0				0.0	0.0	0.0
	101-200	10	0	0				0.0	0.0	0.0
	201-300	4	1	0				0.0	1.6	0.0
	301-500	1	0	6				0.0	0.0	10.7
	501-900	169	16	35				99.2	13.1	27.9
	1-900	184	17	41	1,169.7	173.7	1,086.3	99.2	14.7	38.6
Southeast	1-100	a	0	0				a	0.0	0.0
	101-200	0	0	0				0.0	0.0	0.0
	201-300	9	3	20				0.0	1.5	13.5
	301-500	0	8	10				0.0	9.8	11.6
	501-900	40	116	92				0.0	99.8	46.2
	1-900	49	127	122	52.7	232.9	37.3	0.0	111.1	71.3
Northwest	1-100	0	0	0				0.0	0.0	0.0
	101-200	0	0	0				0.0	0.0	0.0
	201-300	0	0	1				0.0	0.0	0.8
	301-500	0	0	5				0.0	0.0	6.9
	501-900	40	8	49				0.0	5.9	38.6
	1-900	40	8	55	153.8	155.7	110.9	0.0	5.9	46.3
Northeast	1-100	0	0	0				0.0	0.0	0.0
	101-200	0	0	0				0.0	0.0	0.0
	201-300	0	0	2				0.0	0.0	1.1
	301-500	9	25	32				3.8	11.9	28.1
	501-900	15	166	713				0.0	145.9	480.3
	1-900	24	191	747	178.5	90.2	163.3	3.8	157.8	509.5
Bowers Ridge	101-200	a	0	0				a	0.0	0.0
	201-300	47	0	0				0.0	0.0	0.0
	301-500	0	26	82				0.0	23.5	50.9
	510-900	0	0	0				0.0	0.0	0.0
	101-900	47	26	82	0.0	198.2	267.2	0.0	23.5	50.9
Aleutian Islands	1-100	0	0	0	0.0	0.0	0.0	0.0	0.0	0.0
	101-200	10	0	0	226.2	0.0	0.0	0.0	0.0	0.0
Total	201-300	60	4	23	44.2	219.9	207.7	0.0	3.1	15.4
	301-500	10	59	135	232.8	161.7	125.5	3.8	45.2	108.2
	501-900	264	306	889	826.6	89.9	137.7	99.2	264.7	593.0
	1-900	344	369	1,047	637.7	72.3	118.0	103.0	313.0	716.6
Southern Bering Sea	1-100	0	4	0				0.0	20.3	0.0
	101-200	0	6	0				0.0	29.3	0.0
Total	201-300	31	6	1				0.0	11.5	2.1
	301-500	83	14	42				80.8	15.6	23.0
	501-900	76	87	12				0.0	75.5	6.4
	1-900	190	117	55	228.6	203.4	899.5	80.8	152.2	31.5

a No sampling was conducted in this area-depth interval.

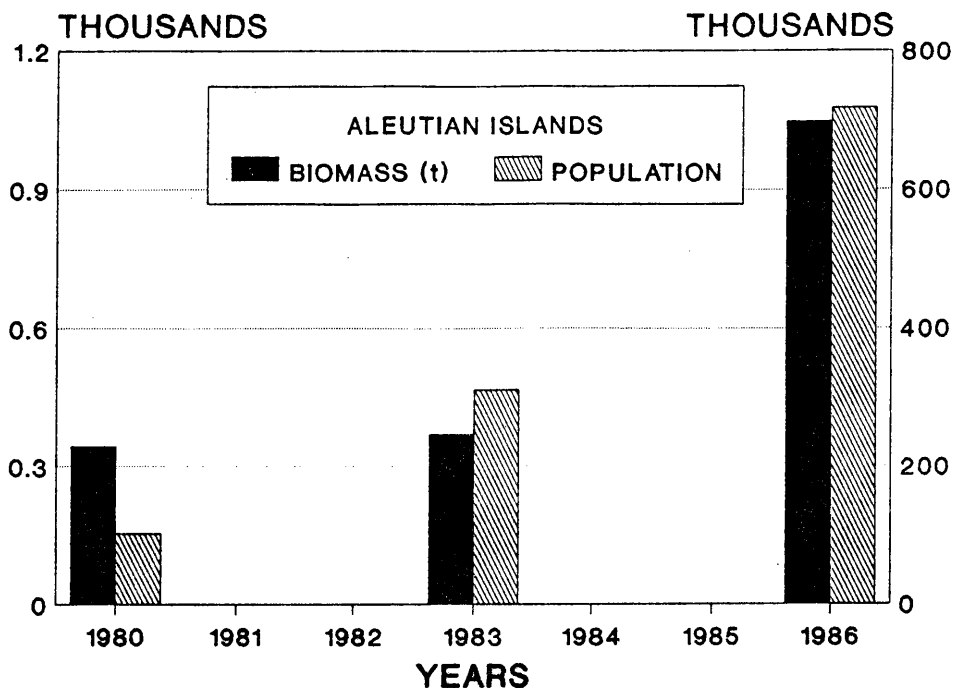

Figure 214. Estimated biomass and population of Dover sole in the Aleutian Islands area during the U.S.-Japan 1980, 1983, and 1986 groundfish surveys.

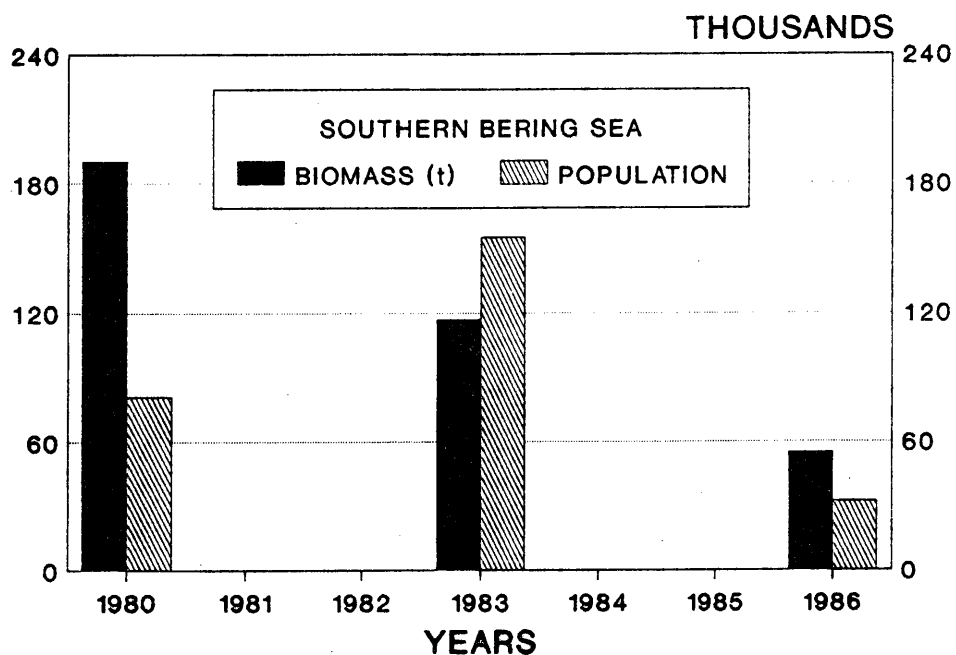

Figure 215. Estimated biomass and population of Dover sole in the Southern Bering Sea area during the U.S.-Japan 1980, 1983, and 1986 Aleutian Islands groundfish surveys.

Giant Grenadier

Although giant grenadier (*Albatrossia pectoralis*) are not being used commercially, a discussion of this species is included because of the tremendous biomass of this species which is available in the Aleutian Islands area.

Distribution and Abundance

Giant grenadier were found throughout the Aleutian Islands area including Bowers Ridge and the Southern Bering Sea areas. The highest abundance was found along the north side of the Aleutian Islands chain and in each successive survey the number of high density encounters increased (Figs. 216-217). Concentrations were found from the Islands of Four Mountains to Atka Island and around the Delarof Islands in the eastern Aleutians. In the western Aleutians high densities occurred in the deep water basin which lies between Segula Island and Petrel Bank, and on Bowers Ridge.

The biomass estimate for giant grenadier in the Aleutian Islands increased modestly from 313,000 t in 1980 to 350,000 t in 1983, then nearly doubled to 601,000 t in 1986 (Table 80, Fig. 218). The Population estimate went from 110.5 million fish in 1980, to 114.0 million in 1983, and 150.3 million in 1986. In 1983 increases occurred in the Southwest, Southeast, and Northwest areas while decreases were indicated in the Northeast and Bowers Ridge areas. In 1986, biomass increases were noted in all areas of the Aleutian Islands with the largest increases occurring in the Northwest and Northeast areas.

Biomass estimates in the Southern Bering Sea area were extremely low ranging from 600 t in 1980 to 1,800 t in 1983 (Table 80, Fig. 219).

Stock mean length and weight measurements were erratic (Table 81, Figs. 220-221). In the Aleutian Islands area the largest mean length occurred during 1980 the year of the lowest mean weight, and the largest mean weight occurred in 1986, the year of the smallest mean length.

Size Composition

As giant grenadier are very susceptible to losing the posterior portions of their caudal fin during the rigors of being sampled with otter trawls, total length measurements are of little value. The length measurement used for this species was from the anterior tip of the snout to the leading edge of the anus.

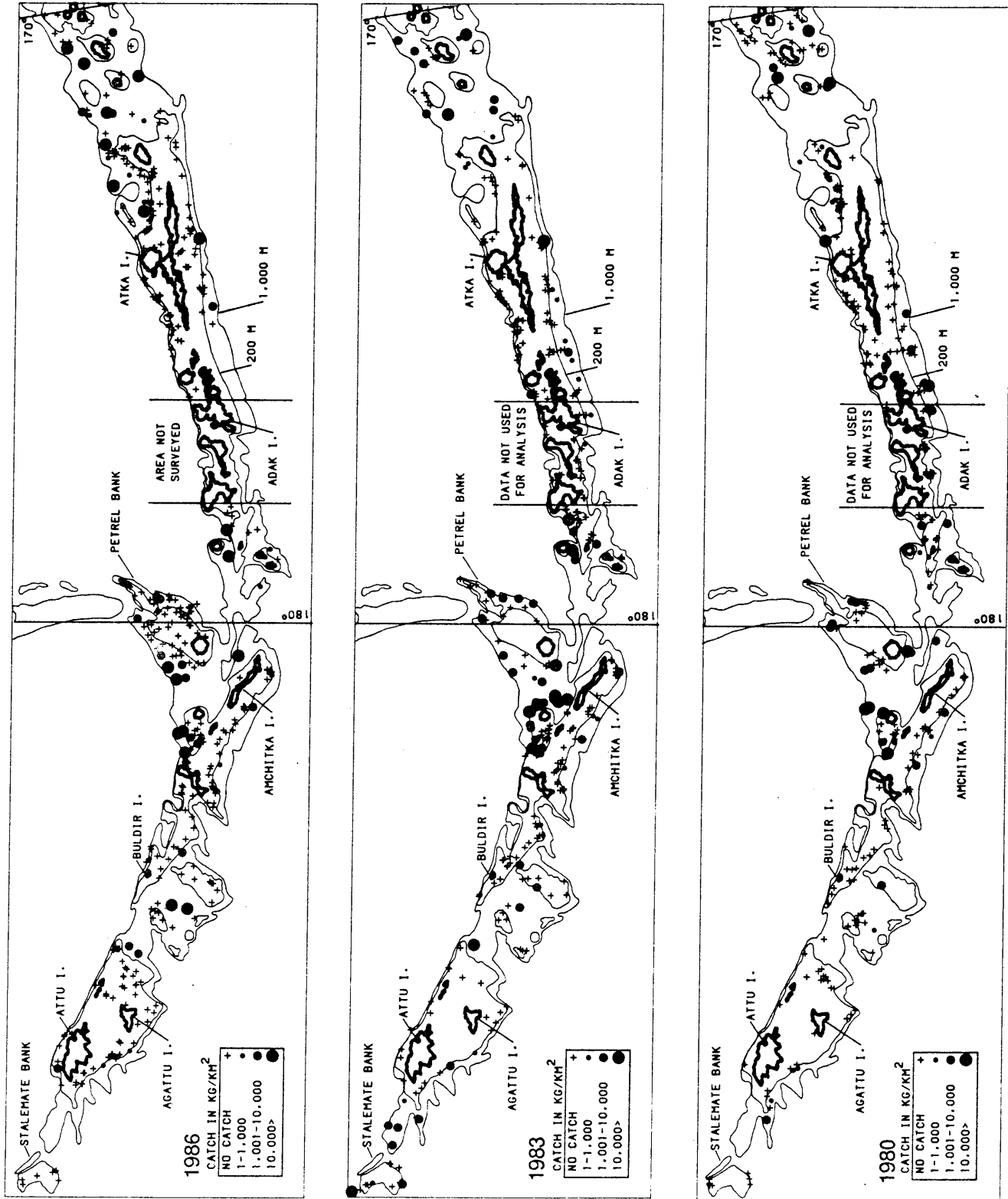

Figure 216. Distribution and relative abundance of giant grenadier in the Aleutian Islands during the U.S.-Japan 1980, 1983, and 1986 groundfish surveys.

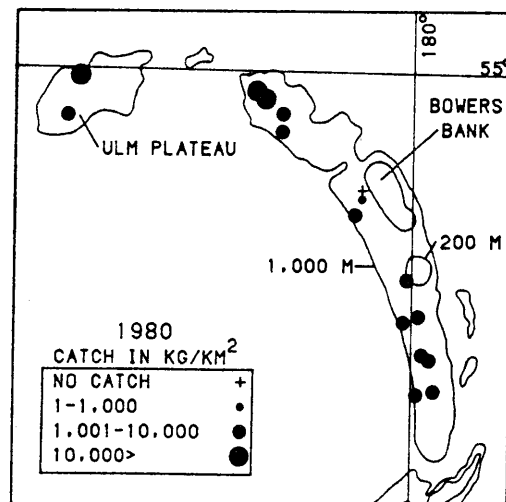
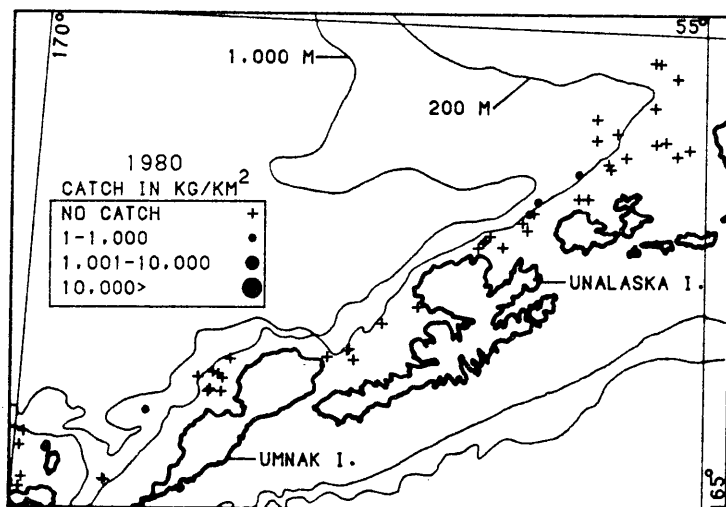
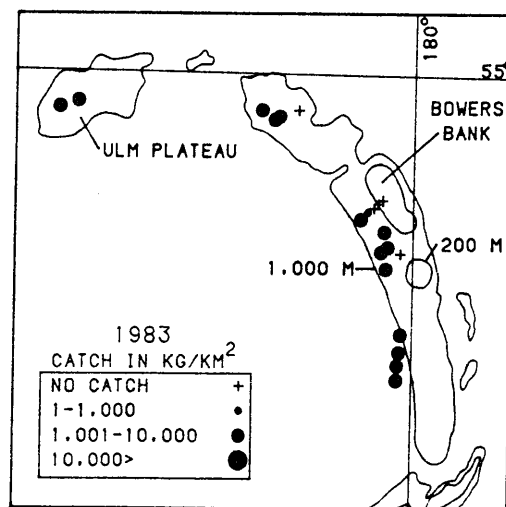
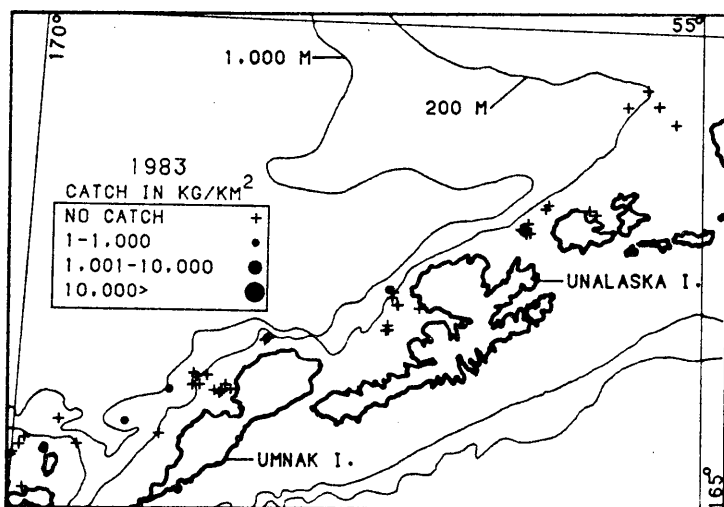
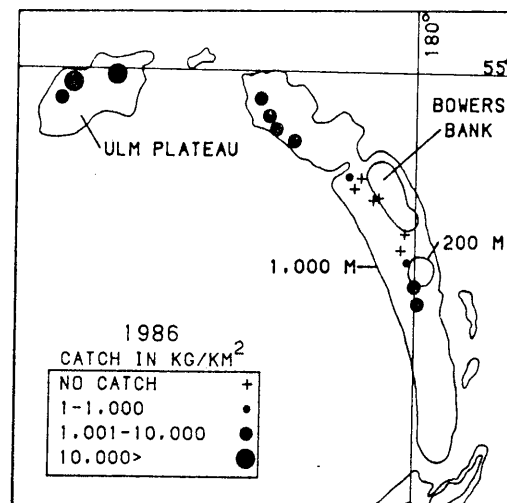
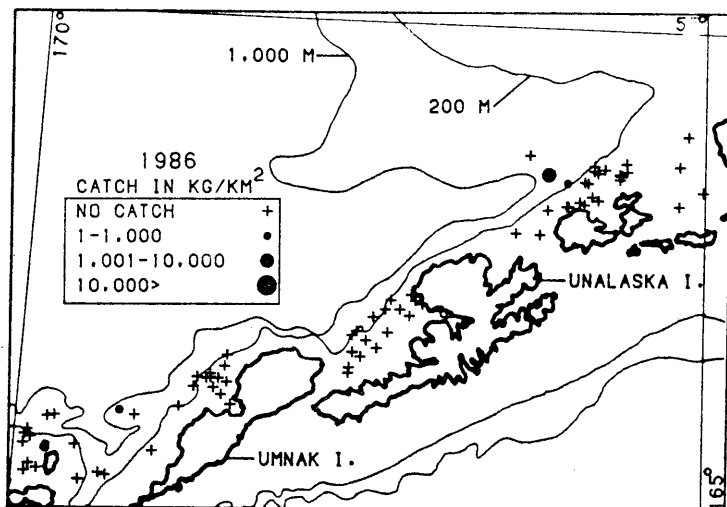

Figure 217. Distribution and relative abundance of giant grenadier in the Southern Bering Sea and Bowers Ridge areas during the U.S.-Japan 1980, 1983, and 1986 Aleutian Islands groundfish surveys.

Table 80. Estimates of biomass, biomass sampling error, and population for giant grenadier based on the U.S.-Japan 1980, 1983, and 1986 Aleutian Islands groundfish surveys.

Area	Depth (m)	Biomass (t)			Sampling Error (%)			Population (1,000s)		
		1980	1983	1986	1980	1983	1986	1980	1983	1986
Southwest	1-100	0	0	0				0.0	0.0	0.0
	101-200	0	0	0				0.0	0.0	0.0
	201-300	0	0	0				0.0	0.0	0.0
	301-500	1,170	2,116	233				251.2	506.1	40.2
	501-900	29,243	44,189	57,098				13,646.5	17,080.2	20,557.9
	1-900	30,413	46,305	57,331	713.6	78.6	110.9	13,897.7	17,586.3	20,598.1
Southeast	1-100	a	0	0				a	0.0	0.0
	101-200	0	0	0				0.0	0.0	0.0
	201-300	0	0	0				0.0	0.0	0.0
	301-500	35	4,572	3,721				0.0	1,230.1	903.1
	501-900	30,044	49,772	76,237				10,305.9	20,910.0	18,380.2
	1-900	30,079	54,344	79,958	629.6	179.3	739.3	10,305.9	22,140.1	19,283.3
Northwest	1-100	0	0	0				0.0	0.0	0.0
	101-200	0	0	0				0.0	0.0	0.0
	201-300	0	0	0				0.0	0.0	0.0
	301-500	592	2,011	3,729				162.4	367.6	737.6
	501-900	82,779	154,176	248,445				27,248.2	44,590.6	53,864.2
	1-900	83,371	156,187	252,174	54.6	43.9	90.7	27,410.6	44,958.2	54,601.8
Northeast	1-100	0	0	0				0.0	0.0	0.0
	101-200	0	0	0				0.0	0.0	0.0
	201-300	0	0	0				0.0	0.0	0.0
	301-500	390	9,328	8,732				78.3	1,633.8	1,767.9
	501-900	79,060	46,033	133,846				29,079.9	11,392.5	31,909.3
	1-900	79,450	55,361	142,578	216.7	82.5	124.2	29,158.2	12,927.0	33,677.2
Bowers Ridge	101-200	a	0	0				a	0.0	0.0
	201-300	0	0	0				0.0	0.0	0.0
	301-500	2,599	8,765	217				518.5	1,638.8	39.9
	501-900	87,568	28,576	68,398				29,213.2	12,776.3	22,080.3
	101-900	90,167	37,341	68,615	77.7	34.6	54.7	29,731.7	14,350.1	22,120.2
Aleutian Islands	1-100	0	0	0	0.0	0.0	0.0	0.0	0.0	0.0
	101-200	0	0	0	0.0	0.0	0.0	0.0	0.0	0.0
Total	201-300	0	0	0	0.0	0.0	0.0	0.0	0.0	0.0
	301-500	4,786	26,792	16,632	752.2	117.2	115.9	1,010.4	5,272.1	3,488.7
	501-900	308,694	322,746	584,024	58.1	34.3	53.0	109,493.7	108,689.6	146,791.9
	1-900	313,480	349,538	600,656	57.3	30.5	51.6	110,504.1	113,961.7	150,280.6
Southern Bering Sea	1-100	0	0	0				0.0	0.0	0.0
	101-200	0	0	0				0.0	0.0	0.0
	201-300	0	0	0				0.0	0.0	0.0
	301-500	2	0	0				0.0	0.0	0.0
	1-900	549	1,766	927	943.5	151.9	792.1	337.2	827.9	670.9
Total	501-900	549	1,766	927	943.5	151.9	792.1	337.2	827.9	670.9
	1-900	551	1,766	927	943.5	151.9	792.1	337.2	827.9	670.9

a No sampling was conducted in this area-depth interval.

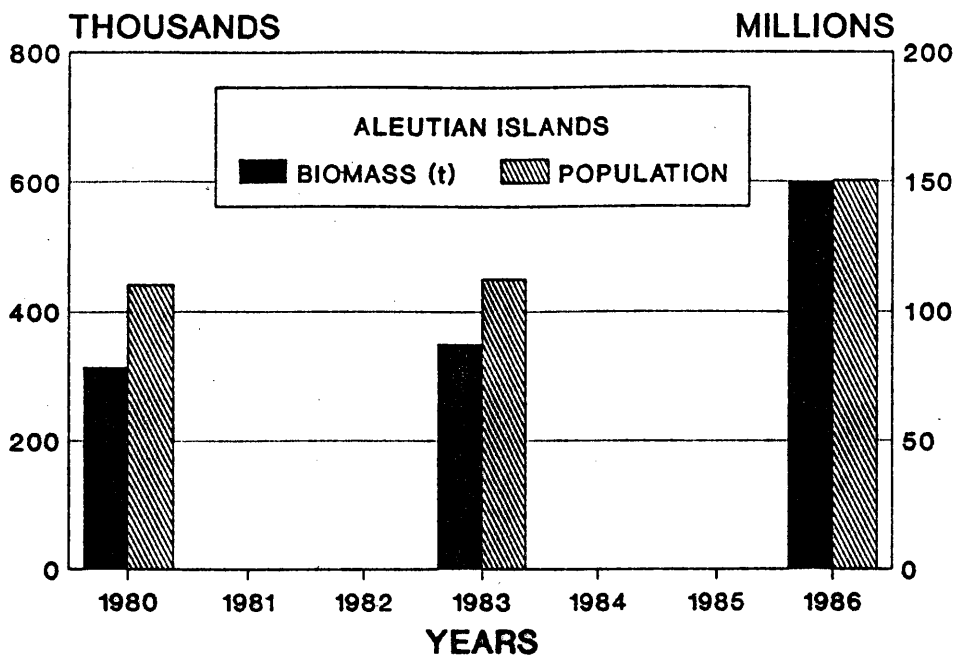

Figure 218. Estimated biomass and population of giant grenadier in the Aleutian Islands area during the U.S.-Japan 1980, 1983, and 1986 groundfish surveys.

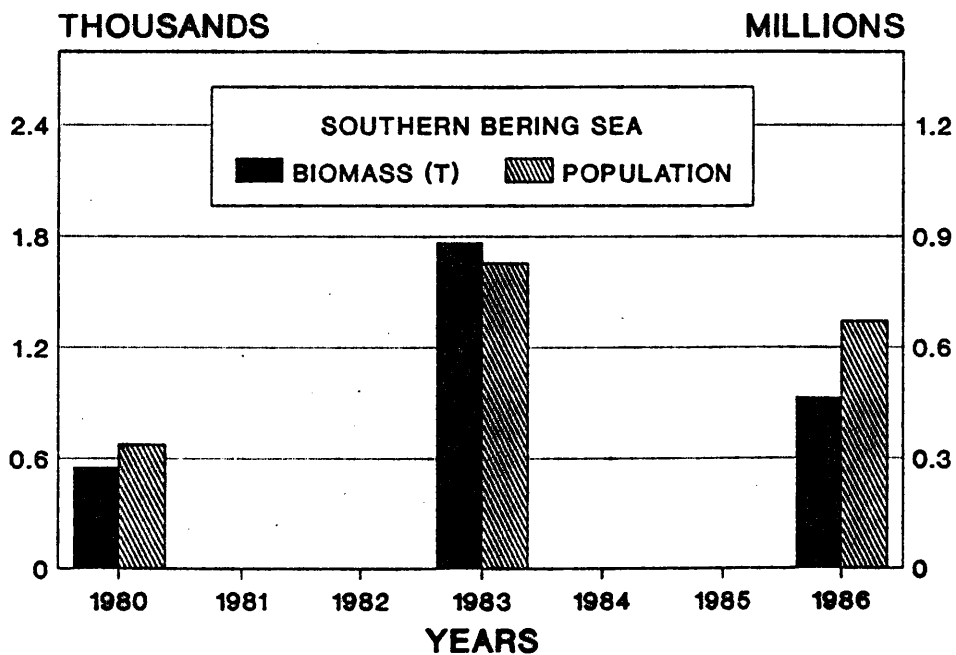

Figure 219. Estimated biomass and population of giant grenadier in the Southern Bering Sea area during the U.S.-Japan 1980, 1983, and 1986 Aleutian Islands groundfish surveys.

Table 81. Estimates of mean catch per unit effort, length, and weight for giant grenadier (*Albatrossia pectoralis*) based on the U.S.-Japan 1980, 1983, and 1986 Aleutian Islands groundfish surveys.

Area	Depth (m)	Mean CPUE (kg/km ²)			Mean Length (cm)			Mean Weight (kg)		
		1980	1983	1986	1980	1983	1986	1980	1983	1986
Southwest	1-100	0.0	0.0	0.0	0.0	0.0	0.0	0.00	0.00	0.00
	101-200	0.0	0.0	0.0	0.0	0.0	0.0	0.00	0.00	0.00
	201-300	0.0	0.0	0.0	0.0	0.0	0.0	0.00	0.00	0.00
	301-500	343.1	620.5	68.3	0.0	29.9	30.5	4.66	4.18	6.05
	501-900	4,156.9	6,281.6	8,116.6	28.6	27.0	22.9	2.14	2.58	2.82
	1-900	1,410.6	2,085.0	2,489.2	28.6	27.1	23.1	2.19	2.63	2.82
Southeast	1-100	a	0.0	0.0	a	0.0	0.0	a	0.00	0.00
	101-200	0.0	0.0	0.0	0.0	0.0	0.0	0.00	0.00	0.00
	201-300	0.0	0.0	0.0	0.0	0.0	0.0	0.00	0.00	0.00
	301-500	13.0	1,456.7	1,185.7	30.2	30.1	0.0	0.00	3.71	4.10
	501-900	14,771.2	17,589.4	26,942.0	30.2	25.8	25.5	2.88	2.39	4.09
	1-900	2,688.4	3,888.1	5,315.1	30.2	26.0	25.5	2.88	2.46	4.09
Northwest	1-100	0.0	0.0	0.0	0.0	0.0	0.0	0.00	0.00	0.00
	101-200	0.0	0.0	0.0	0.0	0.0	0.0	0.00	0.00	0.00
	201-300	0.0	0.0	0.0	0.0	0.0	0.0	0.00	0.00	0.00
	301-500	267.0	907.7	1,683.0	32.9	32.9	27.4	3.64	5.56	5.06
	501-900	18,437.3	34,339.7	55,336.0	30.9	27.5	25.3	3.06	3.46	4.51
	1-900	7,504.4	12,237.8	19,758.7	31.0	27.5	25.3	3.07	3.47	4.52
Northeast	1-100	0.0	0.0	0.0	0.0	0.0	0.0	0.00	0.00	0.00
	101-200	0.0	0.0	0.0	0.0	0.0	0.0	0.00	0.00	0.00
	201-300	0.0	0.0	0.0	0.0	0.0	0.0	0.00	0.00	0.00
	301-500	113.5	2,717.0	2,660.1	32.9	35.4	30.2	4.98	6.07	4.94
	501-900	13,354.7	7,447.9	21,655.6	30.3	29.6	25.6	2.72	4.00	4.23
	1-900	4,434.1	3,232.1	8,042.0	30.4	30.3	25.6	2.73	4.24	4.26
Bowers Ridge	101-200	a	0.0	0.0	a	0.0	0.0	a	0.00	0.00
	201-300	0.0	0.0	0.0	0.0	0.0	0.0	0.00	0.00	0.00
	301-500	1,622.6	5,472.0	135.6	0.0	32.4	33.4	5.01	5.37	5.46
	501-900	12,298.1	4,013.2	9,605.8	26.9	24.4	25.0	3.00	2.17	3.17
	101-900	9,068.2	3,641.0	6,690.6	26.9	25.3	25.1	3.03	2.52	3.17
Aleutian Islands Total	1-100	0.0	0.0	0.0	0.0	0.0	0.0	0.00	0.00	0.00
	101-200	0.0	0.0	0.0	0.0	0.0	0.0	0.00	0.00	0.00
	201-300	0.0	0.0	0.0	0.0	0.0	0.0	0.00	0.00	0.00
	301-500	357.6	1,941.6	1,218.7	32.2	32.5	31.4	4.74	5.09	4.77
	501-900	11,605.5	11,670.3	21,118.0	29.8	26.9	25.0	2.82	3.01	3.97
	1-900	4,370.9	4,579.2	7,620.3	29.9	27.2	25.1	2.84	3.11	3.99
Southern Bering Sea Total	1-100	0.0	0.0	0.0	0.0	0.0	0.0	0.00	0.00	0.00
	101-200	0.0	0.0	0.0	0.0	0.0	0.0	0.00	0.00	0.00
	201-300	0.0	0.0	0.0	0.0	0.0	0.0	0.00	0.00	0.00
	301-500	1.6	0.0	0.0	0.0	0.0	0.0	0.00	0.00	0.00
	501-900	241.5	776.6	407.6	0.0	24.1	19.8	1.63	2.13	1.38
	1-900	43.6	139.7	73.3	0.0	24.1	19.8	1.63	2.13	1.38

a No sampling was conducted in this area-depth interval.

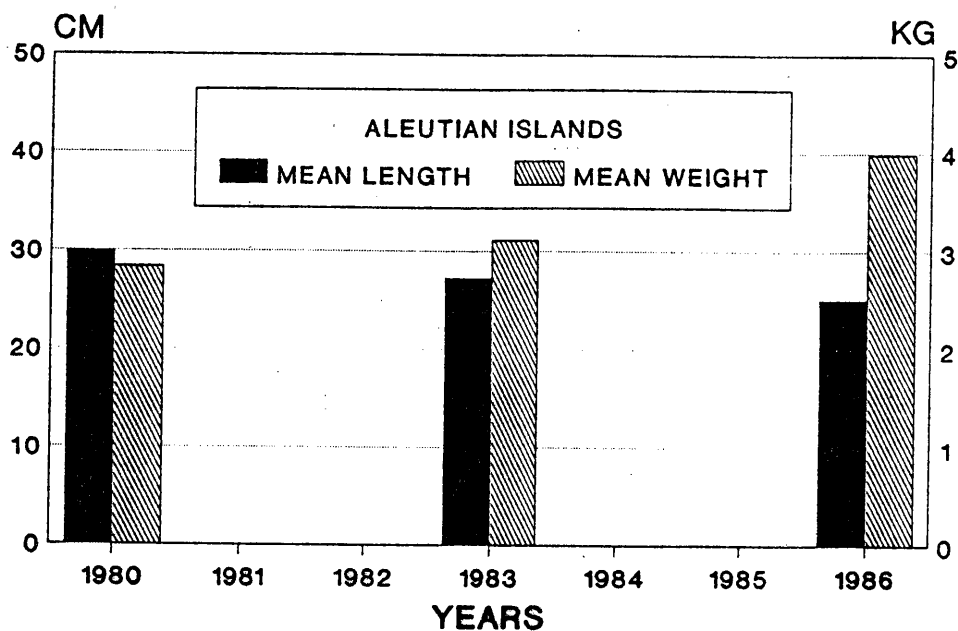

Figure 220. Mean length and weight of giant grenadier in the Aleutian Islands area during the U.S.-Japan 1980, 1983, and 1986 groundfish surveys.

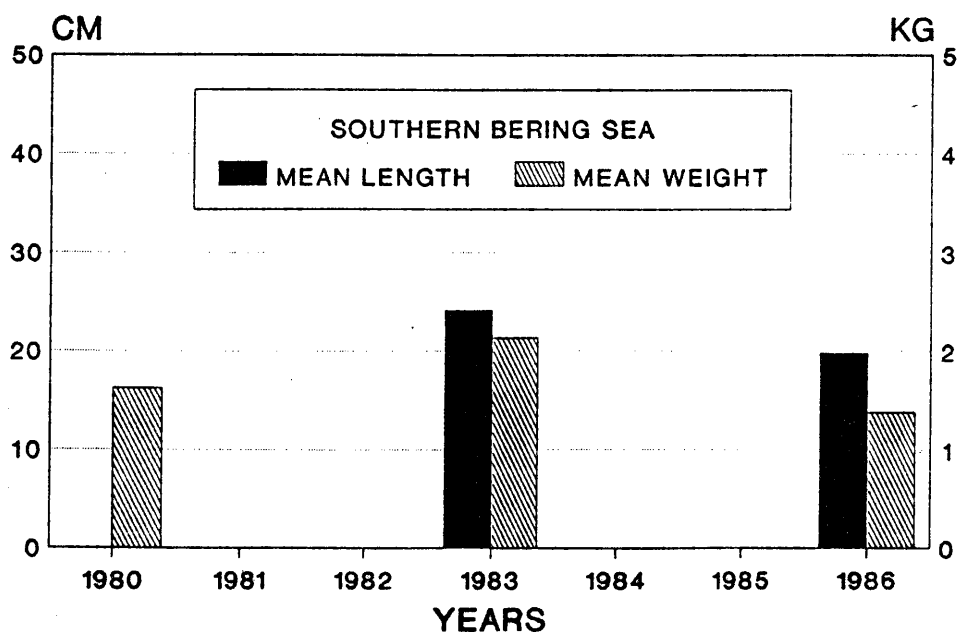

Figure 221. Mean length and weight of giant grenadier in the Southern Bering Sea area during the U.S.-Japan 1980, 1983, and 1986 Aleutian Islands groundfish surveys.

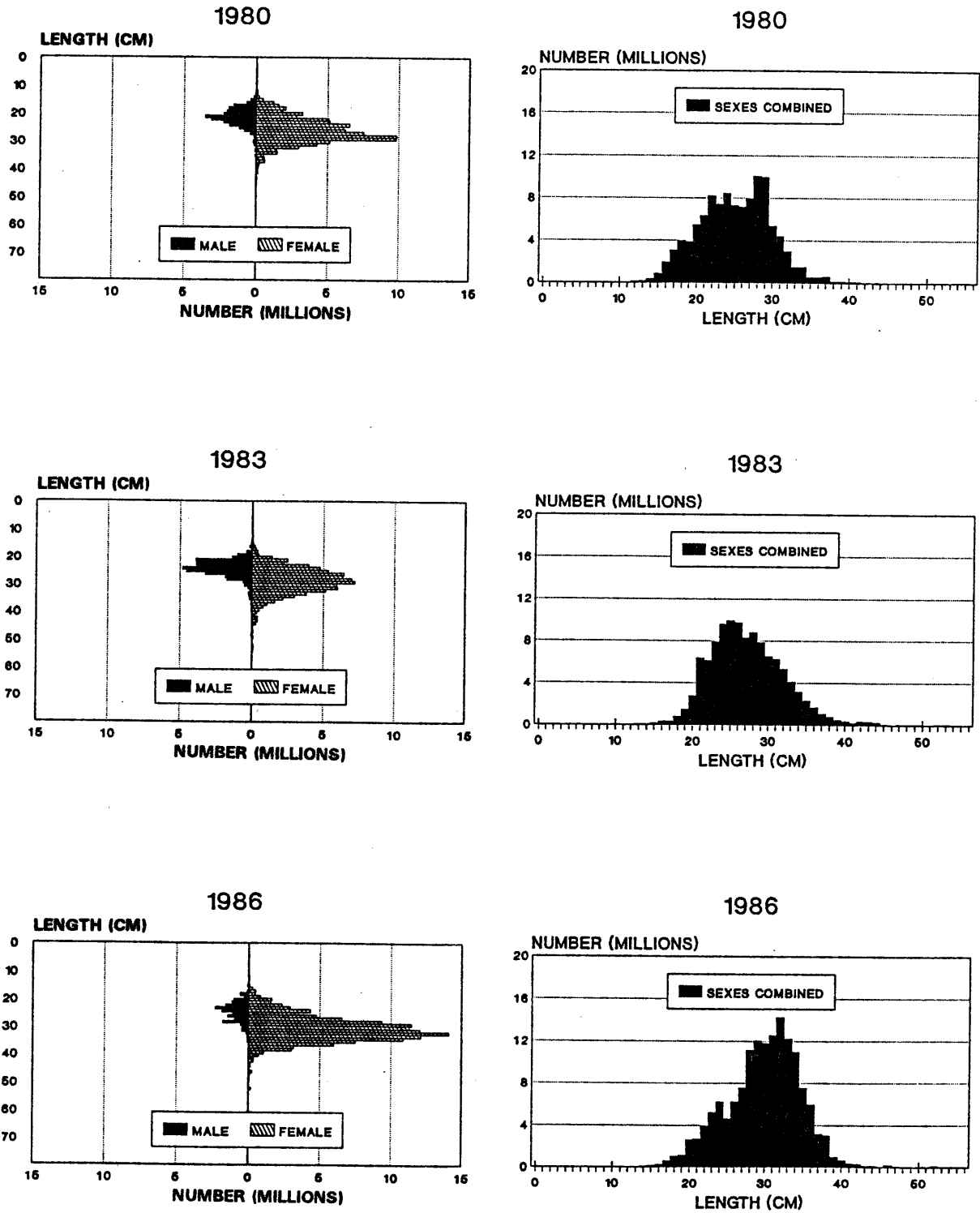

Figure 222. Size composition of giant grenadier in the Aleutian Islands area during the U.S.-Japan 1980, 1983, and 1986 groundfish surveys.

Size composition curves of Giant grenadier in the Aleutian Islands area were uni-modal with most fish ranging from 16 to 39 cm in length (Fig. 222). In 1980 the size composition curve was skewed slightly toward larger fish. There was a strong single mode of females from 20 to 31 cm, and a much weaker mode of males from 14 to 25 cm.

In 1983 the size curve was normally shaped with a strong female mode ranging from 19 to 35 cm and a considerably weaker male mode ranging from 19 to 27 cm.

In 1986 the size composition curve was skewed towards larger fish as in 1980, and was again influenced by an extremely strong mode of females ranging from 20 to 37 cm, and an extremely weak mode of males ranging from 20 to 30 cm.

Giant grenadier were characterized by strong sexual dimorphism and an extremely unequal sex ratio.

In the Southern Bering Sea, the 1980 size composition curve mode of male giant grenadiers occurred at approximately the same size range as in the Aleutian Islands area (Fig. 223). However, the female mode covered a much smaller range of 14-24 cm. In 1983 the males and females ranged from 20-26 and 20-28 cm respectively. No length data were available for 1986 from the Southern Bering Sea.

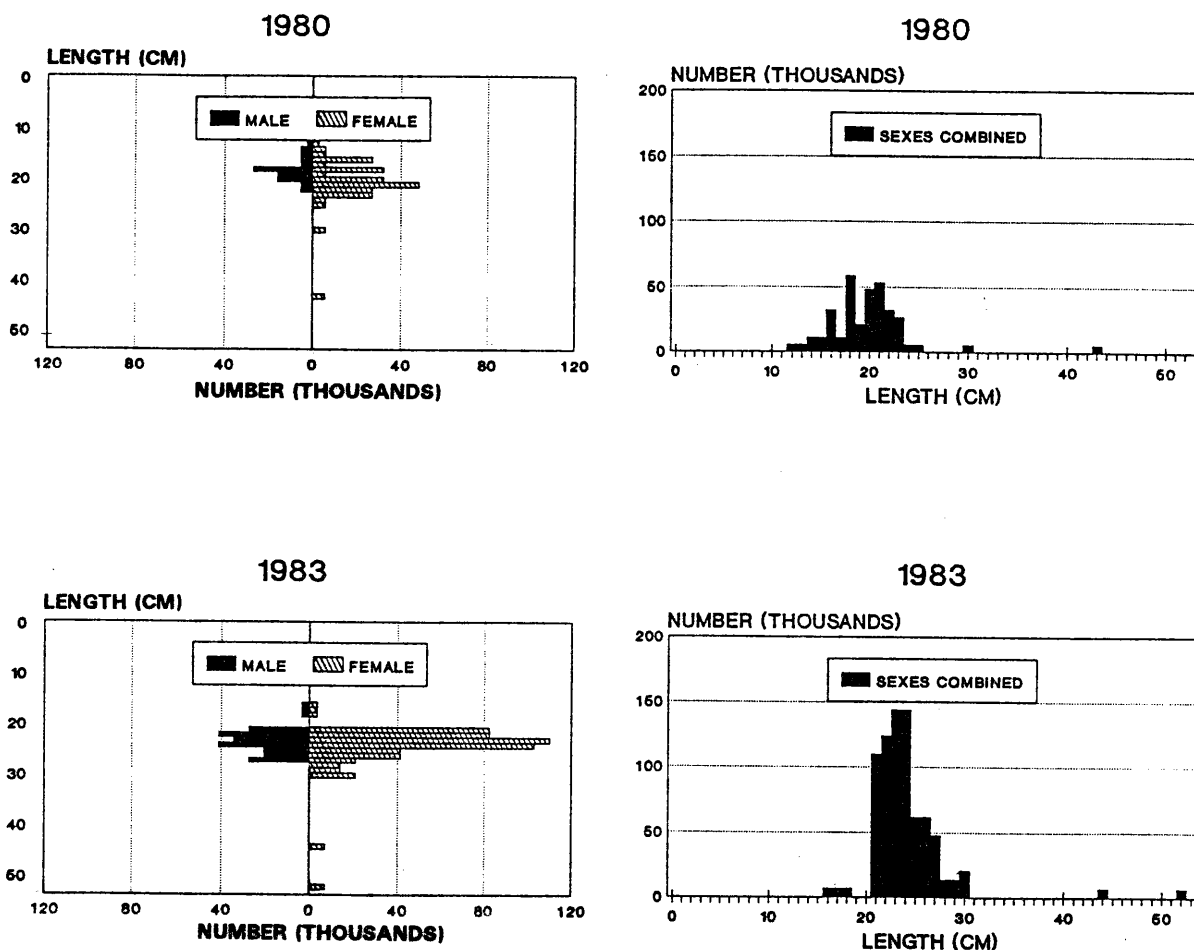

Figure 223. Size composition of giant grenadier in the Southern Bering Sea area during the U.S.-Japan 1980 and 1983 Aleutian Islands groundfish surveys.

Length-Weight Relationship

Length-weight data are only available for 1986 and provided the following relationship (Fig. 224):

$$\text{Weight(g) (1986)} = .5868 \times \text{Length(cm)}^{2.606}.$$

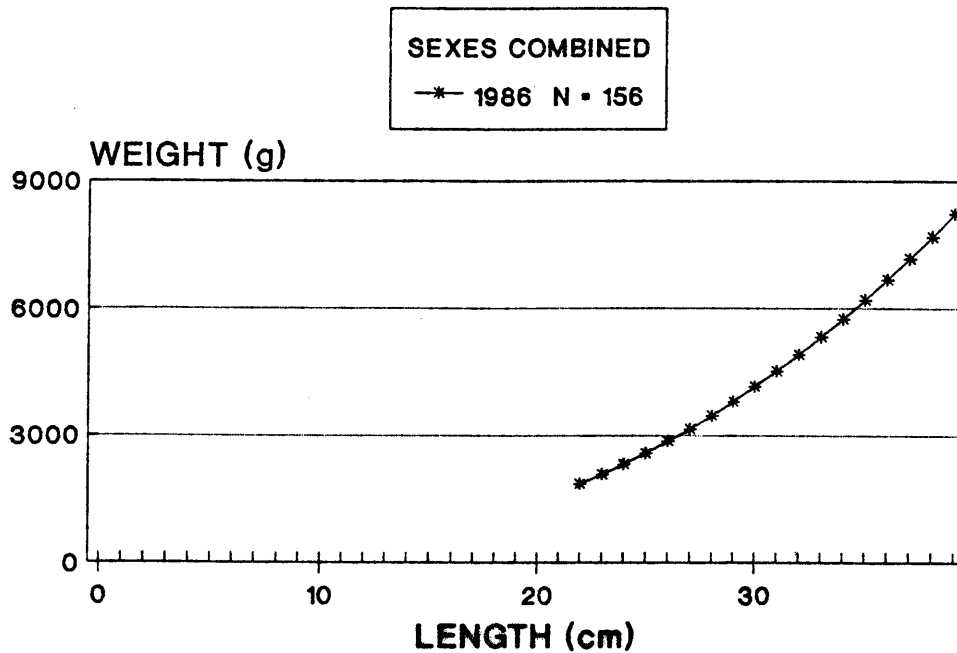

Figure 224. Length-weight relationship for giant grenadier in the Aleutian Islands area during the U.S.-Japan 1986 groundfish survey.

Red Squid

The reader is cautioned that squid resources are not adequately sampled by trawls. For this reason biomass tables are not presented in this report, and other data may not reflect true population parameters. Data on red squid (Berryteuthis magister) from the 1980 survey are not presented due to a squid identification problem that year.

Distribution and Abundance

Red squid were found throughout the Aleutian Islands area and the Southern Bering Sea primarily at depths from 201-300 m (Figs. 225-226). In 1983 and 1986, high-density concentrations were found on Stalemate Bank, and in 1986 another high-density area was found on the east side of Petrel Bank. Smaller concentrations were located south of Amchitka Island in 1983 and 1986, and north of Amlia Island, and around Petrel Bank in 1986.

Size Composition

In 1983 and 1986 the size composition curves of red squid, were very similar (Fig. 227). Mantle lengths ranged from 14-45 cm and size composition curves had normal distributions, peaking at 27 cm both years but considerably stronger in 1986 due to higher catch rates. The vast majority of the stock was in the 21-32 cm size range during both surveys with a few larger squid, 40-45 cm in length, found in 1986.

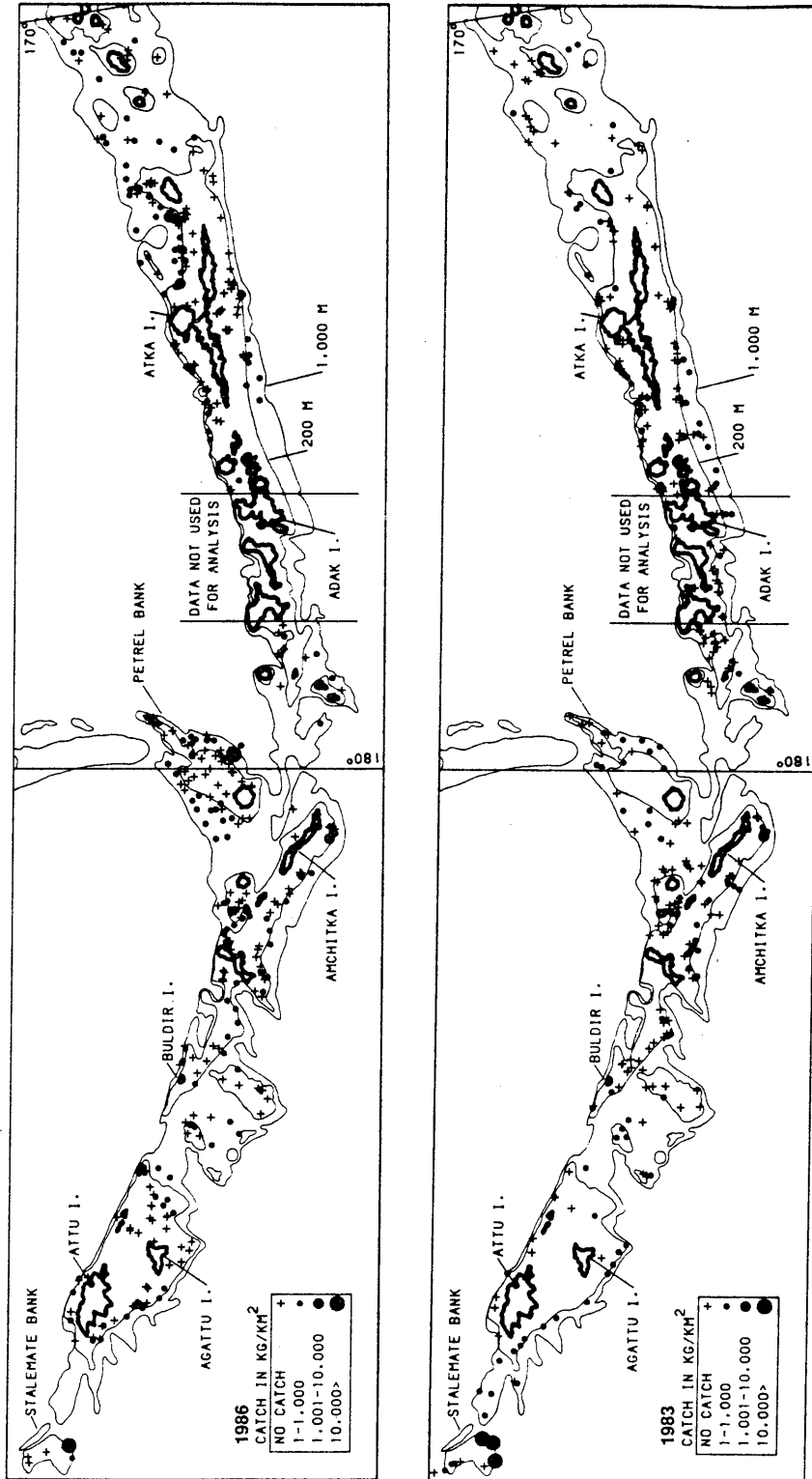

Figure 225. Distribution and relative abundance of red squid in the Aleutian Islands area during the U.S.-Japan 1983 and 1986 groundfish surveys.

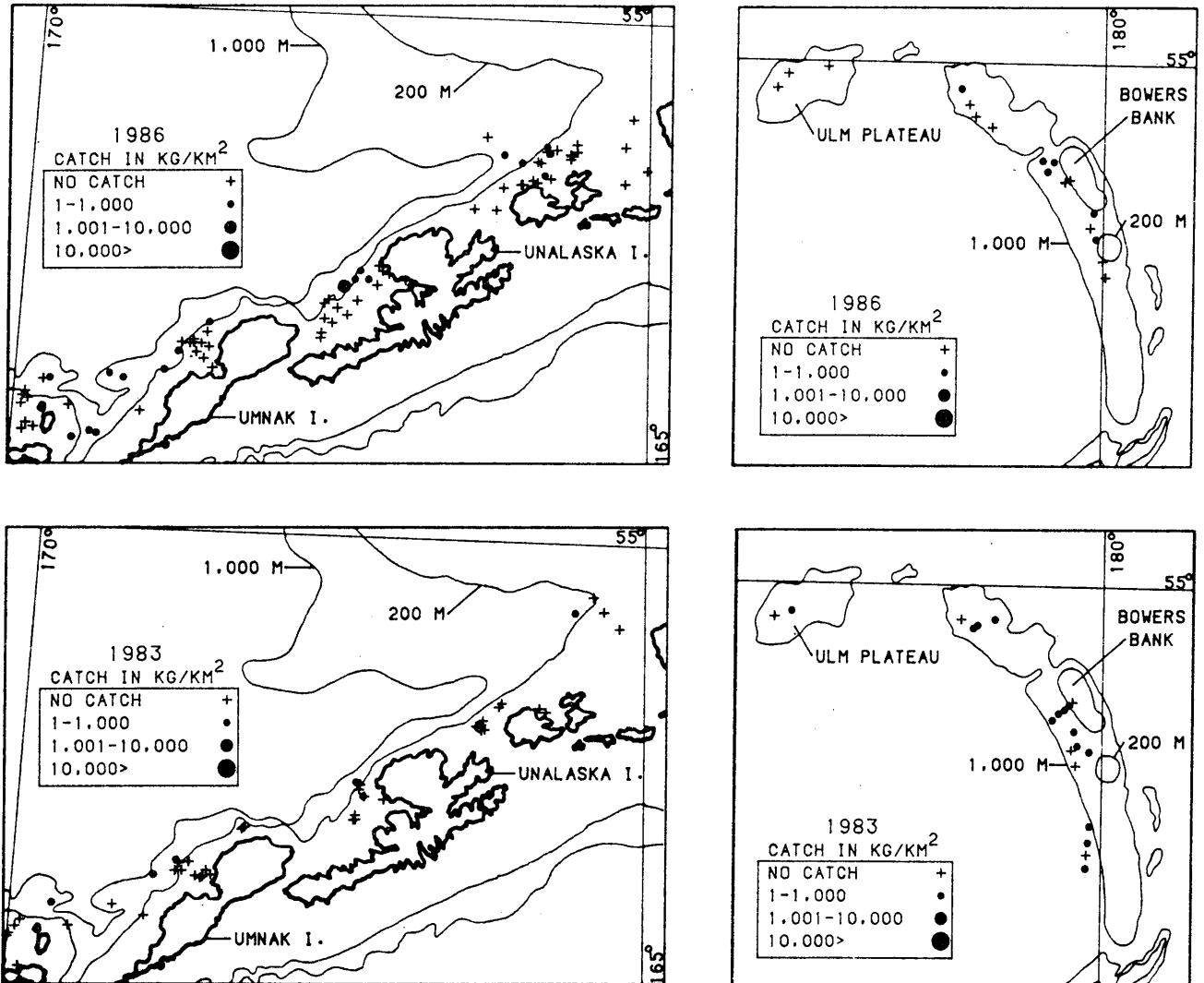

Figure 226. Distribution and relative abundance of red squid in the Southern Bering Sea and Bowers Ridge areas during the U.S.-Japan 1983 and 1986 Aleutian Islands groundfish surveys.

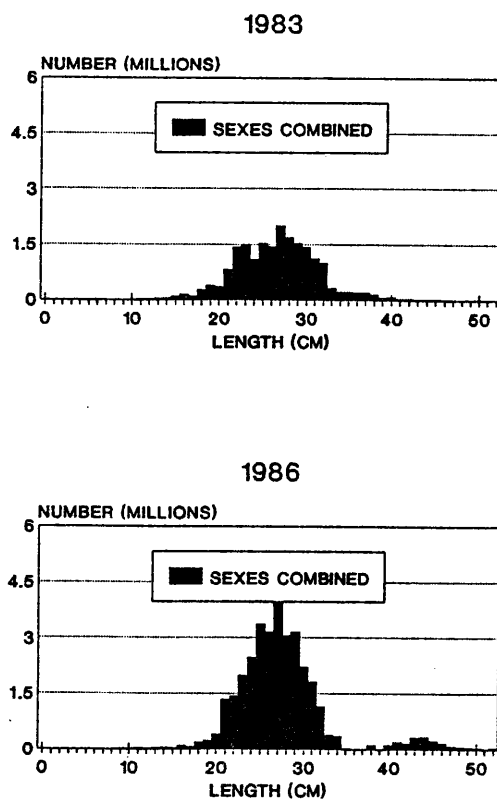

Figure 227. Size composition of red squid in the Aleutian Islands area during the U.S.-Japan 1983 and 1986 groundfish surveys.

Length-Weight Relationship

In 1986 mantle length-weight data obtained for red squid provided the following relationship (Fig. 228):

$$\text{Weight(g) (1986)} = .1470 \times (\text{Length(cm)})^{2.528}.$$

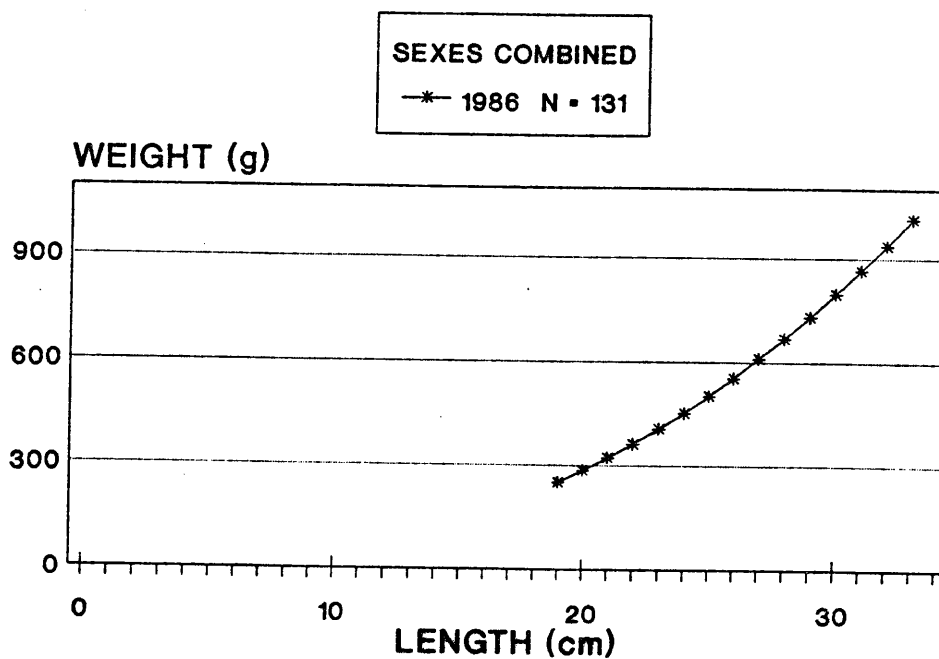

Figure 228. Length-weight relationship for red squid in the Aleutian Islands area during the U.S.-Japan 1986 groundfish survey.

CITATIONS

- Alverson, D. L., and W. T. Pereyra. 1969. Demersal fish explorations in the northeastern Pacific Ocean--An evaluation of exploratory fishing methods and analytical approaches to stock size and yield forecasts. *J. Fish. Res. Board Can.* 26:1985-2001.
- Bakkala, R. G., K. Wakabayashi, and T. M. Sample. 1985. Results of the demersal trawl surveys. *In* Bakkala, R. G., and K. Wakabayashi (editors). Results of Cooperative U.S.-Japan groundfish investigations in the Bering Sea during May-August 1979. *Int. North Pac. Fish. Comm. Bull.* 44:39-191.
- Bakkala, R. G., M. S. Alton, and D. K. Kimura. 1987. Greenland turbot and arrowtooth flounder. *In* Bakkala, R. G. and J. W. Balsiger (editors), Condition of groundfish resources of the eastern Bering Sea and Aleutian Islands Region in 1986. p. 67-81. U.S. Dep. Commer., NOAA Tech. Memo. NMFS F/NWC-117.
- Brown, E. S. 1986. Preliminary results of the 1984 U.S.-Japan cooperative bottom trawl survey of the central and western Gulf of Alaska. *In* Major R. L. (editor), Condition of groundfish resources of the Gulf of Alaska region as assessed in 1985. p. 259-296. U.S. Dep. Commer., NOAA Tech. Memo. NMFS F/NWC-106.
- Cochran, W. G. 1977. Sampling Techniques. 3rd ed. Wiley Series in Probability and Mathematical Statistics - Applied. John Wiley & Sons. N.Y., N.Y. 428 p.
- Favorite, F. 1974. On flow into Bering Sea through Aleutian Islands passes. *In* D. W. Hood and E. J. Kelly (editors), Oceanography of the Bering Sea. p. 3-37. *Inst. Mar. Sci. Occas. Publ. No. 2*, Univ. Alaska, Fairbanks, Alaska.
- Favorite, F., A. J. Dodimead, and K. Nasu. 1976. Oceanography of the subarctic Pacific region, 1960-71. *Int. North Pac. Fish. Comm. Bull.* 33:1-187.
- Favorite, F., and W. J. Ingraham. 1972. Influence of Bower Ridge on circulation in Bering Sea and influence of Amchitka Branch, Alaskan Stream on migration paths of sockeye salmon. *In* A. Y. Takenouti et al. (editors). Biological Oceanography of the northern North Pacific Ocean. p. 13-29. Idemitsu Shoten, Tokyo.
- Forrester, C. R., A. J. Beardsley, and Y. Takahashi. 1978. Groundfish, shrimp, and herring fisheries in the Bering Sea and northeast Pacific-historical catch statistics through 1970. *Int. North Pac. Fish. Comm. Bull.* 37:1-147.

- Forrester, C. R., R. G. Bakkala, K. Okada, and J. E. Smith. 1983. Groundfish, shrimp and herring fisheries in the Bering Sea and northeast Pacific-historical catch statistics, 1971-1976. *Int. north Pac. Fish. Comm. Bull.* 41:1-100.
- Hood, D. W., 1983. The Bering Sea. In B. H. Ketchum (editor), *Estuaries and enclosed seas*, p. 337-373. Elsevier. N.Y., N.Y. 500 p.
- Hughes, S.E. 1976. System for sampling large trawl catches of research vessels. *J. Fish. Res. Board Can.* 33:833-839.
- Ito, D. H. 1987. Pacific ocean perch. In R. G. Bakkala and J. W. Balsiger (editors), *Condition of groundfish resources of the eastern Bering Sea and Aleutian Islands region in 1986*, p. 117-138. U.S. Dep. Commer., NOAA Tech. Memo. NMFS F/NWC-117.
- Koyama, T. 1974. Study on the stern trawl. *Bull. Tokai Reg. Fish. Lab.* 77:181-247. (In Japanese with English abstract).
- Reed, R.K., and J.D. Schumacher, 1986. Physical oceanography of the Gulf of Alaska. In *The Gulf of Alaska: Physical Environment and Biological Resources*, D.W. Hood and S.T. Zimmerman (editors), p 57-75. NOAA and Minerals Management Service, Anchorage, AK, MMS 86-0095, NTIS PB87-103230.
- Robins, C. R. (chairman). 1991. *Common and Scientific Names of Fishes from the United States and Canada. Fifth ed.* American Fisheries Society, Spec. Publ. 20. 183 p.
- Ronholt, L. L., K. Wakayabashi, and T. K. Wilderbuer, Hirotune Yamaguchi and Keisuke Okada. 1986. Groundfish resources of the Aleutian Islands Waters Based on the U.S.-Japan trawl survey, June-November 1980. *Int. North Pac. Fish. Comm. Bull.* 48:1-251.
- Sample, T. M. 1985. Report of the 1981 cooperative U.S.-Japan bottom trawl survey of the eastern Bering Sea continental shelf and slope. U.S. Dep. Commer., NOAA Tech. Memo. NMFS F/NWC-88. 338 p.
- Sasaki, T. 1985. Studies on the sablefish resources in the North Pacific ocean. *Far Seas Fish. Res. Lab., Japan, Bull.* 22:1-108.
- Sasaki, T., and T. Yoshimura. 1987. Past progress and present condition of the Japanese pollock fishery in the Aleutian Basin. (Document no. 3189 submitted to the Annual Meeting of the INPFC, Vancouver, Canada, October, 1987.) p. 1-9. Fishery Agency of Japan.

- Thompson, G. G., and A. M. Shimada. 1987. Pacific cod. In Bakkala, R. G. (editor), Condition of groundfish resources of the eastern Bering Sea and Aleutian Islands Region in 1987. p. 33-49. U.S. Dep. Commer., NOAA Tech. Memo. NMFS F/NWC-139.
- von Bertalanffy, L. 1938. A quantitative theory of organic growth (Inquiries on growth laws. II). Hum. Biol. 10:181-213.
- Wakabayashi, K., R. G. Bakkala, and M. S. Alton. 1985. Methods of the U.S.-Japan demersal trawl surveys. In Bakkala, R. G., and K. Wakabayashi (editors). Results of Cooperative U.S.-Japan groundfish investigations in the Bering Sea during May-August 1979. Int. North Pac. Fish. Comm. Bull. 44:7-29.
- Wakabayashi, K., and K. Teshima. 1986. Wingspread measurements of trawl net using net monitor transducer. Unpubl. Manusc., 15 p. Far Seas Fisheries Research Lab., Fish. Agency of Japan.
- Wilderbuer, T. K., K. Wakabayashi, L. L. Ronholt, and H. Yamaguchi. 1985. Survey Report: Cooperative U.S.-Japan Aleutian Islands Groundfish Trawl Survey - 1980. U.S. Dep. Commer., NOAA Tech. Memo. NMFS F/NWC-93. 356 p.
- Williams, A. B. (chair). 1989. Common and Scientific Names of Aquatic Invertebrates from the United States and Canada: Decapod Crustaceans. American Fisheries Society, Spec. Publ. 17. 77 p.

APPENDIX A

INDICES OF ABUNDANCE

INDICES OF ABUNDANCE

Since 1979 the Japan Fisheries Agency and the National Marine Fisheries Service have conducted cooperative longline surveys for sablefish and other deepwater species throughout the Aleutian Islands area, Bering Sea and Gulf of Alaska (Sasaki 1985). Data from these surveys have been extremely useful in managing the sablefish resource but have not been as widely used for other species. Index of abundance data or Relative Population Weights (RPWs) from the longline surveys were calculated to compare with Mean Catch Per Unit Effort (CPUEs) from the three trawl surveys. This section compares these two indices for selected species.

Sablefish

The indices of abundance from the longline and otter trawl surveys in the Aleutian Islands area show remarkable agreement for sablefish. However, the longline index (RPW), peaked in 1985 and decreased slightly in 1986 and 1987 while the otter trawl index (CPUE), was still increasing in 1986 (Fig. A-1).

Pacific cod

The indices of abundance for Pacific cod also showed extremely good agreement increasing each year from a low in 1980 to a peak in 1986 (Fig. A-2). The longline index (RPW), indicated a decline in 1987.

Arrowtooth flounder

Although the agreement between the indices of abundance for arrowtooth flounder was not as good as that reported for sablefish and Pacific cod, similarities do exist (Fig. A-3). The longline index fluctuated from 1979 to 1986 showing a slight downward trend before increasing substantially in 1987. The otter trawl index remained relatively unchanged from 1980 to 1983 but increased substantially in 1986, suggesting a greater change than the longline index.

Greenland turbot

The general trend in indices of abundance for Greenland turbot showed good agreement, however the longline results fluctuated more because of the annual data points (Fig. A-4). The otter trawl index indicated a low abundance in 1980 with increasing abundance in 1983 and 1986, but the longline index showed a large decrease from 1979 to 1981 with increases in 1982 and 1983 followed by a slight decreases in 1984-1986 before increasing slightly in 1987.

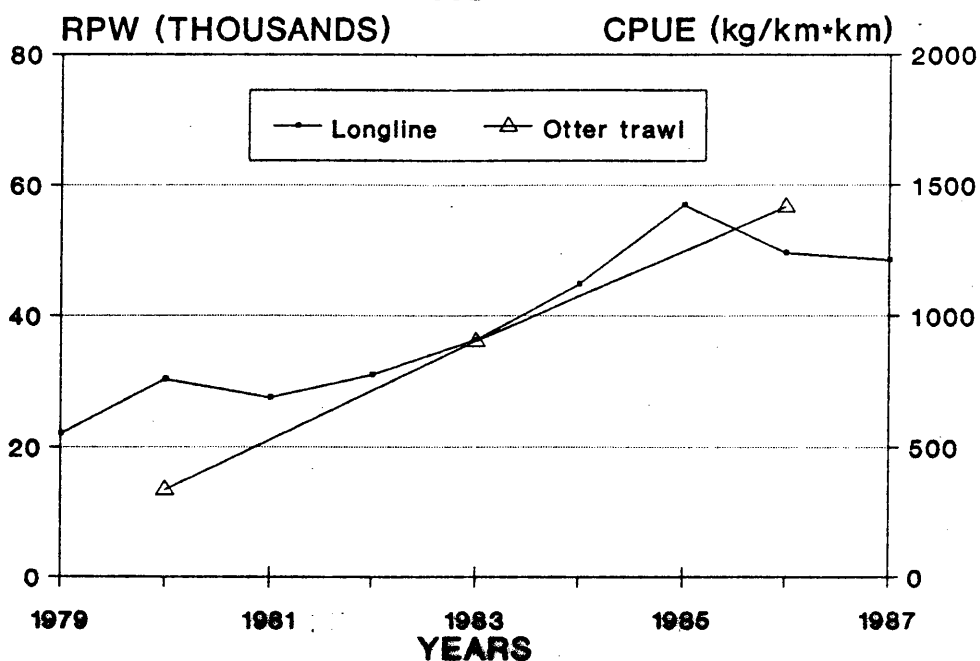

Figure A-1. Indices of abundance for sablefish during the U.S.-Japan cooperative Aleutian Islands longline surveys of 1979-87, and the U.S.-Japan 1980, 1983, and 1986 Aleutian Islands groundfish surveys.

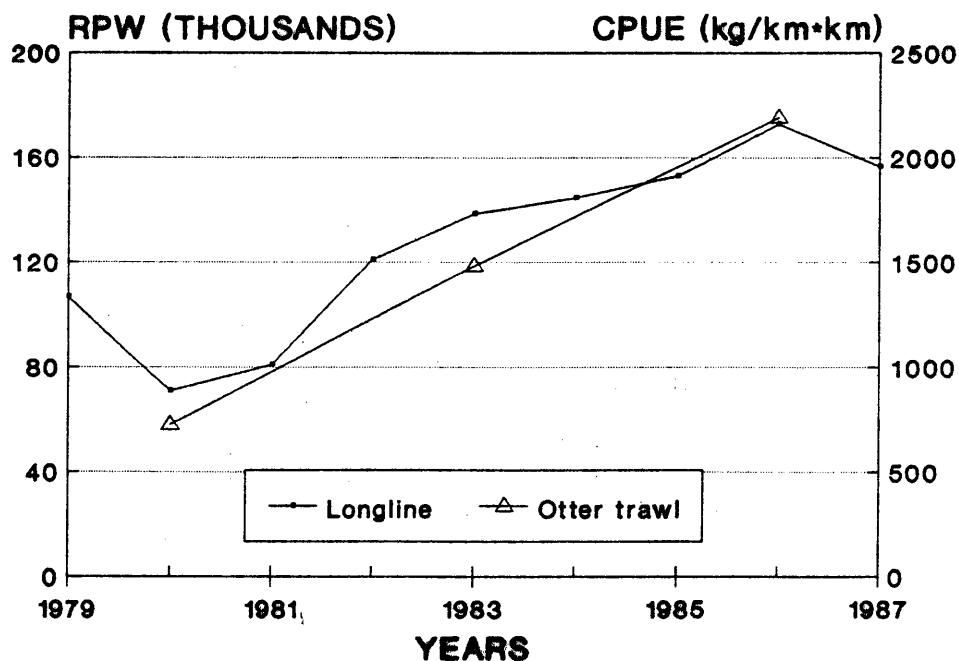

Figure A-2. Indices of abundance for Pacific cod during the U.S.-Japan cooperative Aleutian Islands longline surveys of 1979-87, and the U.S.-Japan 1980, 1983, and 1986 Aleutian Islands groundfish surveys.

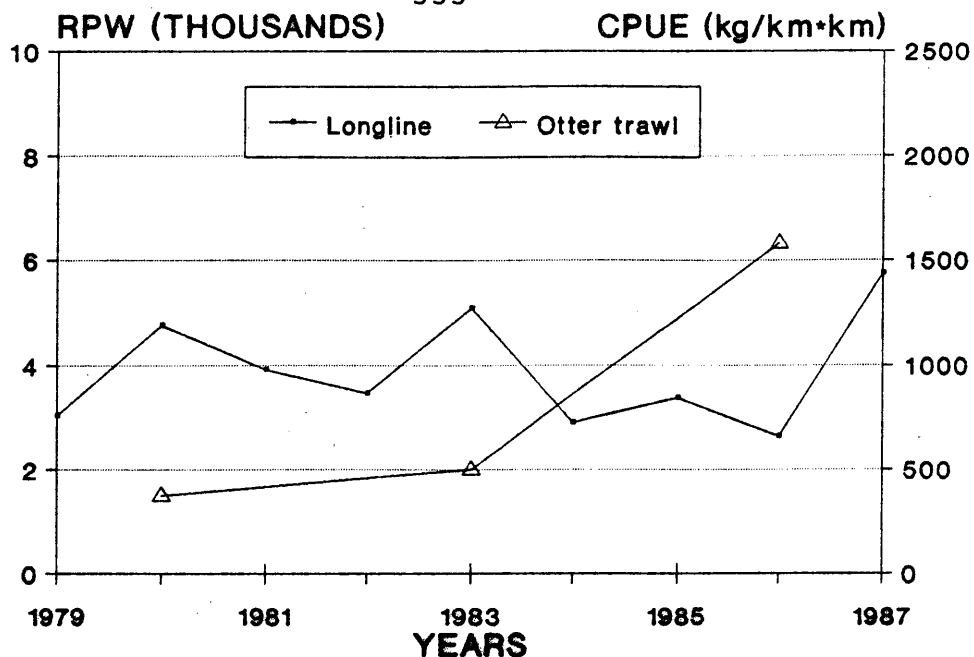

Figure A-3. Indices of abundance for arrowtooth flounder during the U.S.-Japan cooperative Aleutian Islands longline surveys of 1979-1987, and the U.S.-Japan 1980, 1983, and 1986 Aleutian Islands groundfish surveys.

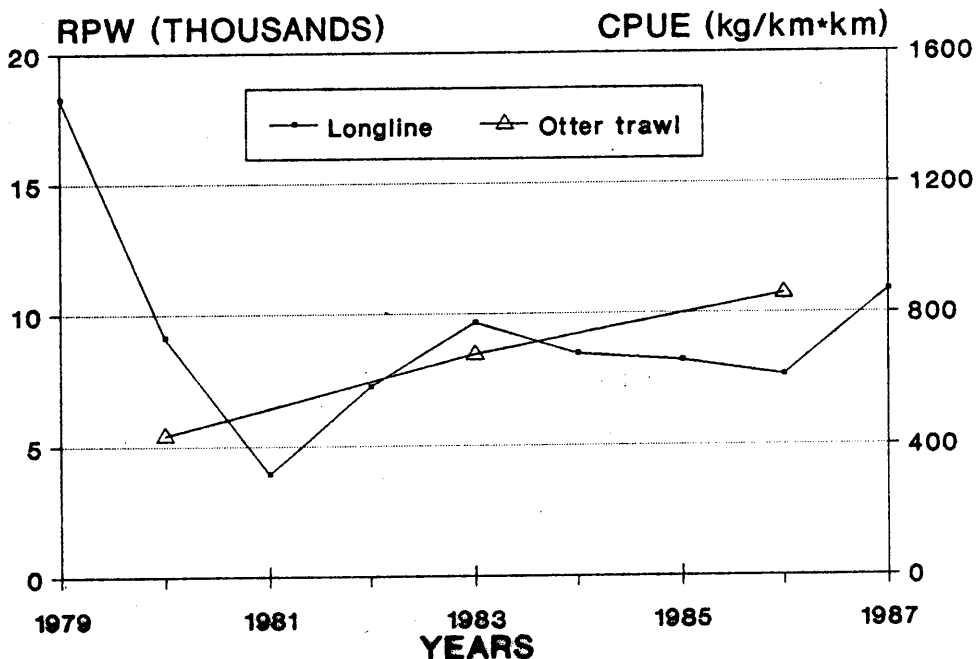

Figure A-4. Indices of abundance for Greenland turbot during the U.S.-Japan cooperative Aleutian Islands longline surveys of 1979-87, and the U.S.-Japan 1980, 1983, and 1986 Aleutian Islands groundfish surveys.

Shortspine thornyhead

The comparison between the indices for shortspine thornyhead showed contradictory trends. The longline index increased substantially from 1979 to 1980 before fluctuating around a very slight decreasing trend from 1981-1987. The otter trawl index has fluctuated around a slightly increasing trend (Fig. A-5).

Rougheye and shortraker rockfish

The indices for rougheye and shortraker rockfish, were similar to shortspine thornyhead in that there was a fluctuation around a slightly decreasing trend for the longline survey and a slightly increasing trend for the otter trawl index (Fig. A-6).

Giant grenadier

Indices of abundance for giant grenadier showed some agreement for comparable years, however, the longline index because of its yearly data points shows more fluctuations (Fig. A-7). After increasing from 1979 to 1980 and decreasing from 1981 to 1982 the index increased nearly every year until 1987. The otter trawl index indicated no change from 1980 to 1983 and then increased substantially from 1983 to 1986.

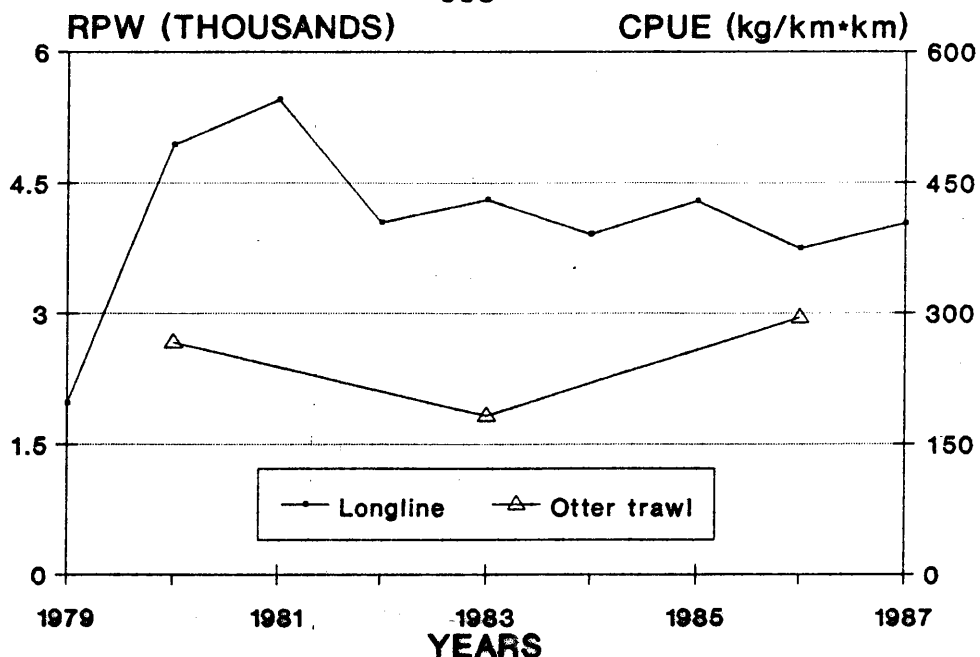

Figure A-5. Indices of abundance for shortspine thornyhead during the U.S.-Japan cooperative Aleutian Islands longline surveys of 1979-87, and the U.S.-Japan 1980, 1983, and 1986 Aleutian Islands groundfish surveys.

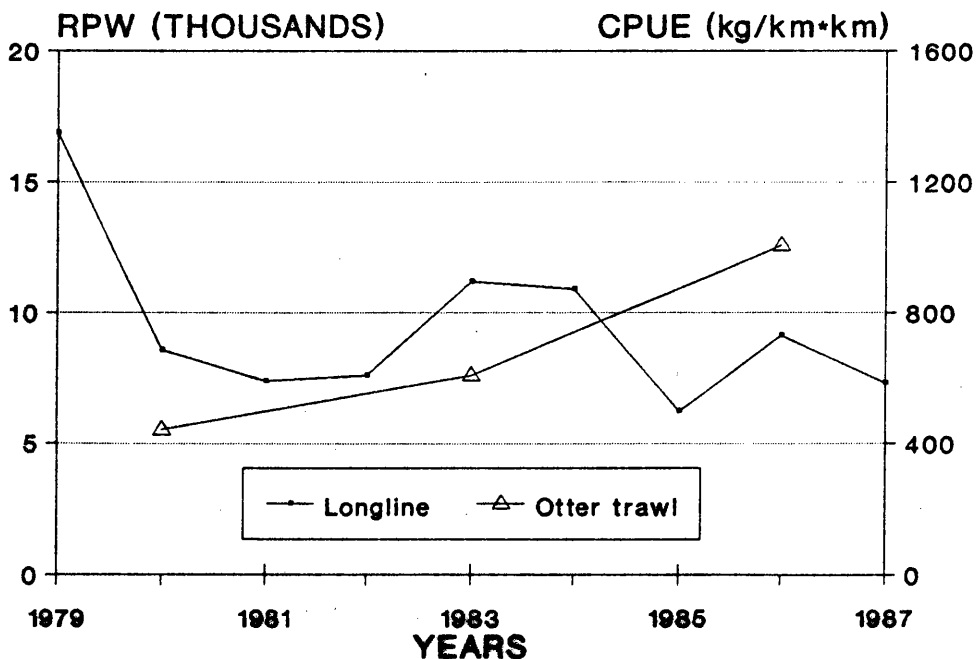

Figure A-6. Indices of abundance for rockfish, primarily rougheye and shortraker, during the U.S.-Japan cooperative Aleutian Islands longline surveys of 1979-87, and the U.S.-Japan 1980, 1983, and 1986 Aleutian Islands groundfish surveys.

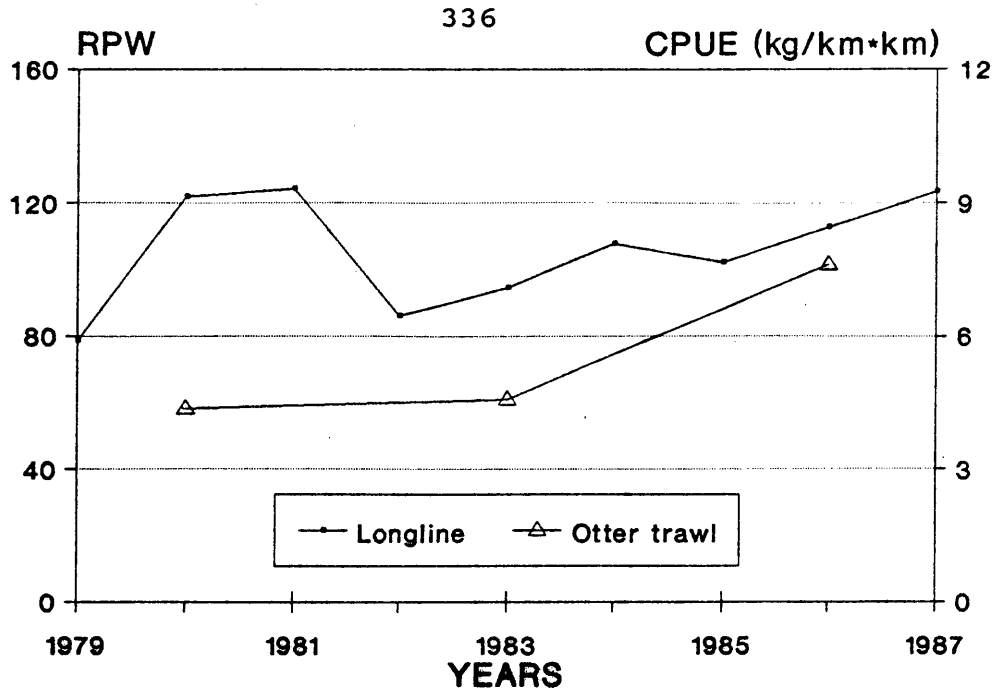

Figure A-7. Indices of abundance for giant grenadier during the U.S.-Japan cooperative Aleutian Islands longline surveys of 1979-87, and the U.S.-Japan 1980, 1983, and 1986 Aleutian Islands groundfish surveys.

337

APPENDIX B

WATER TEMPERATURES

Water temperatures

The number of water temperature measurements taken with expendable bathythermograph temperature probes (XBTs) are summarized in Table B-1. The overall annual mean surface water temperature was 6.3° C in 1980, rose to 7.4° C in 1983 then decreased to 6.9° C in 1986. Following a similar pattern mean bottom temperatures increased from 4.3° C in 1980 to 5.3° C in 1983 and then decreased slightly to 4.6° C in 1986 (Table B-2).

In general the south side of the Aleutian Islands chain had slightly warmer surface temperatures than the north side during all survey years. However in 1986 the mean surface temperature on Bowers Ridge was 10.3°C, much warmer than recorded in the other surveys. This is probably a result of survey timing. In 1986, Bowers Ridge was surveyed in August, instead of late September-October as in earlier years. While somewhat unusual in that area, it is possible for the surface water temperatures to become that warm if there is period of clear sunny calm weather.

Mean bottom temperatures at depths to 100 meters were 4.7°C in 1980, 5.7 in 1983, and 5.2 in 1986. Bottom temperatures gradually decreased with depth, to a low of 3.4° for depths between 500 and 900 meters in 1983 and 1986.

Locations of stations used in the temperature analysis are shown in Figs. B-1 to B-4.

Table B-1. Number of surface to bottom water temperature profile observations taken during the U.S.-Japan 1980, 1983, and 1986 Aleutian Islands groundfish surveys.

<u>Vessels</u>	<u>Year</u>	<u>No. of Survey Stations</u>	<u>No. of XBT^a Temperature Profiles</u>	<u>Stations Sampled (%)</u>
<u>Ocean Harvester</u>	1980	32	0	0.0
<u>Half Moon Bay</u>	1980	70	37	52.9
<u>Hatsue Maru No. 62</u>	1980	145	111	76.6
<u>Miller Freeman</u>	1983	55	48	87.3
<u>Chapman</u>	1983	44	39	88.6
<u>Daito Maru No. 38</u>	1983	220	210	95.5
<u>Lets Go</u>	1986	129	65	50.4
<u>Ginryu Maru No. 5</u>	1986	312	180	36.9

a Expendable bathythermograph.

Table B-2. Mean surface and bottom temperatures taken during the U.S.-Japan 1980, 1983, and 1986 Aleutian Islands groundfish surveys.

Surface Temperatures						
Area	1980		1983		1986	
	Mean Temp.	No. of Obs.	Mean Temp.	No. of Obs.	Mean Temp.	No. of Obs.
S. of Aleutians	7.1	93	7.4	161	6.8	159
N. of Aleutians	5.9	129	7.2	154	6.6	193
Bowers Ridge	6.2	16	7.1	20	10.3	17
Bering Sea	5.9	45	7.9	54	6.8	56
Annual Mean	6.3	283	7.4	389	6.9	425

Bottom Temperatures						
Area	1980		1983		1986	
	Mean Temp.	No. of Obs.	Mean Temp.	No. of Obs.	Mean Temp.	No. of Obs.
S. of Aleutians	4.0	87	4.5	153	4.4	76
N. of Aleutians	4.2	69	4.3	125	4.2	93
Bowers Ridge	3.4	12	3.5	20	3.5	6
Bering Sea	4.3	8	5.3	40	4.6	15

Depth Strata (m)	1980		1983		1986	
	Mean Temp.	No. of Obs.	Mean Temp.	No. of Obs.	Mean Temp.	No. of Obs.
1-100	4.7	6	5.7	24	5.2	26
101-200	4.5	46	4.9	122	4.5	72
201-300	4.1	50	4.6	81	4.2	40
301-500	3.9	39	3.9	46	3.8	29
501-900	3.6	35	3.4	65	3.4	23
Annual Mean	4.1	176	4.5	338	4.3	190

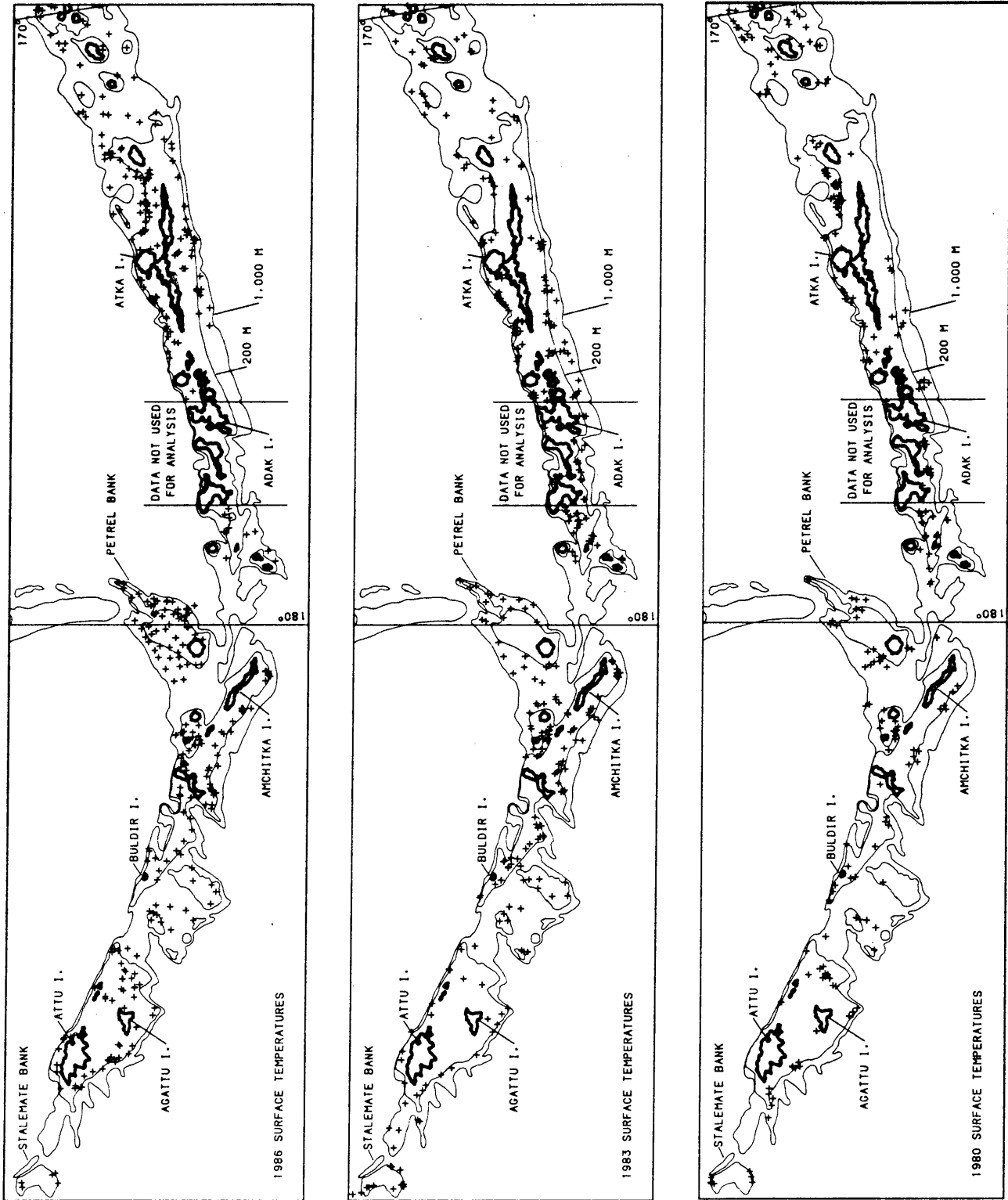

Figure B-1. Locations where surface temperatures were taken in the Aleutian Islands area during the U.S.-Japan 1980, 1983, and 1986 groundfish surveys.

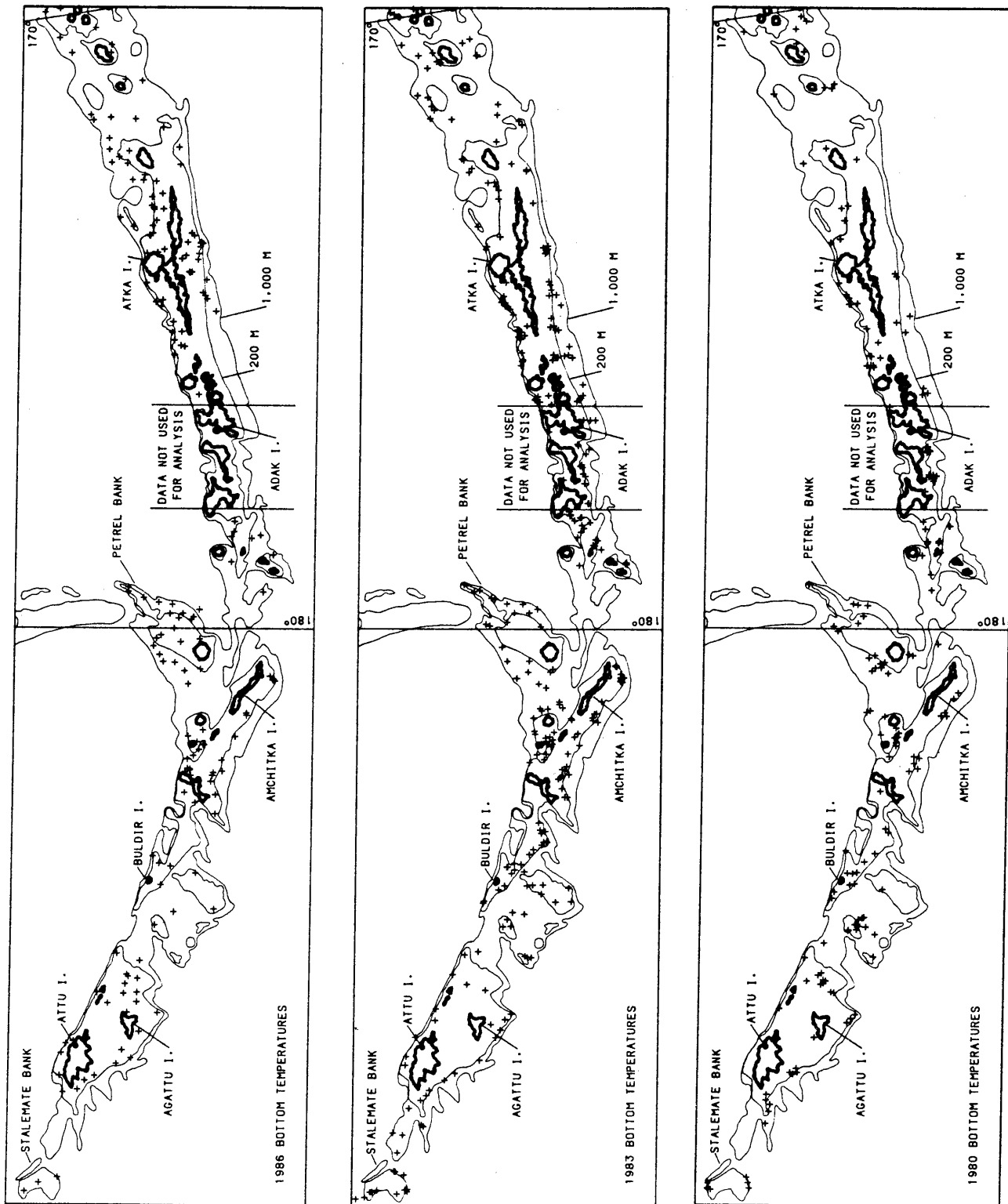

Figure B-2. Locations where bottom temperatures were taken in the Aleutian Islands area during the U.S.-Japan 1980, 1983, and 1986 groundfish surveys.

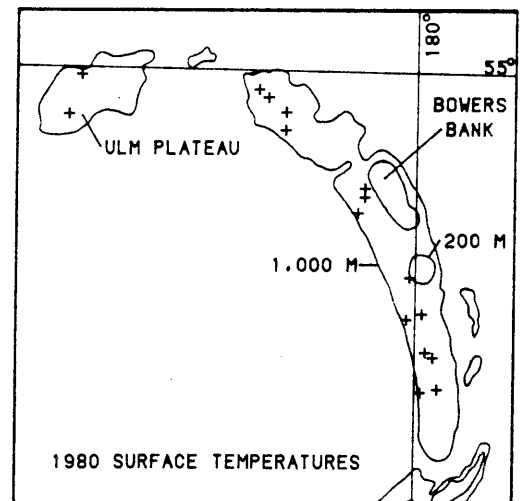
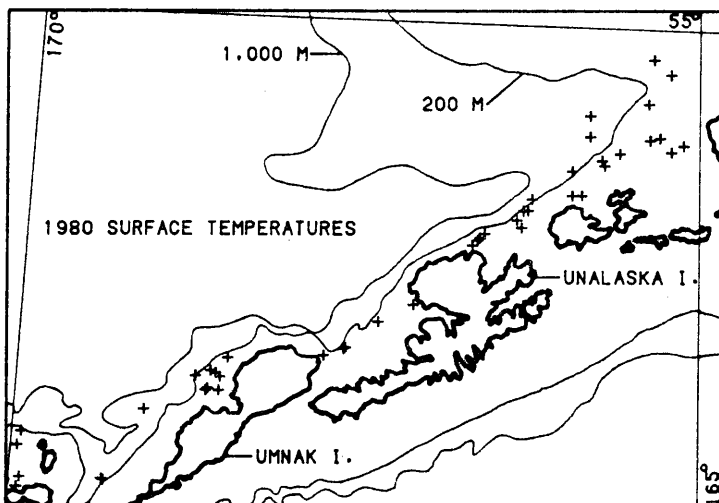
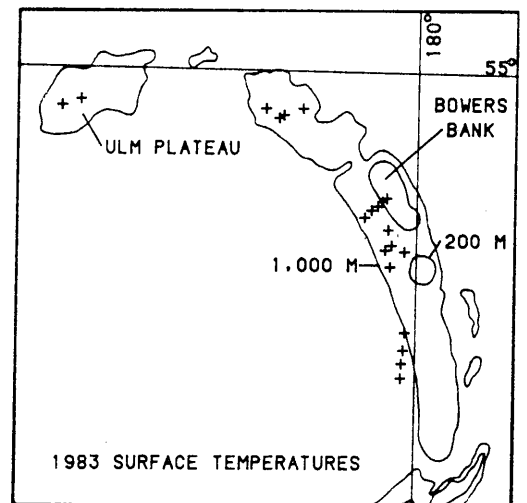
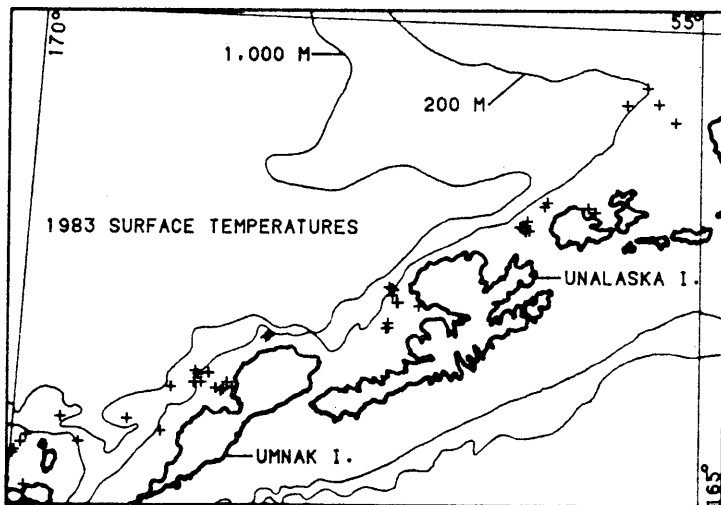
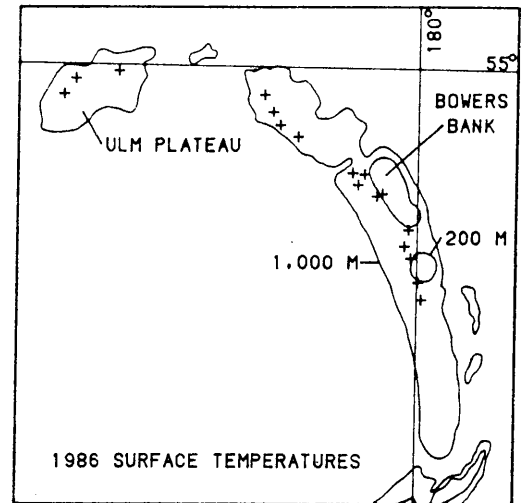
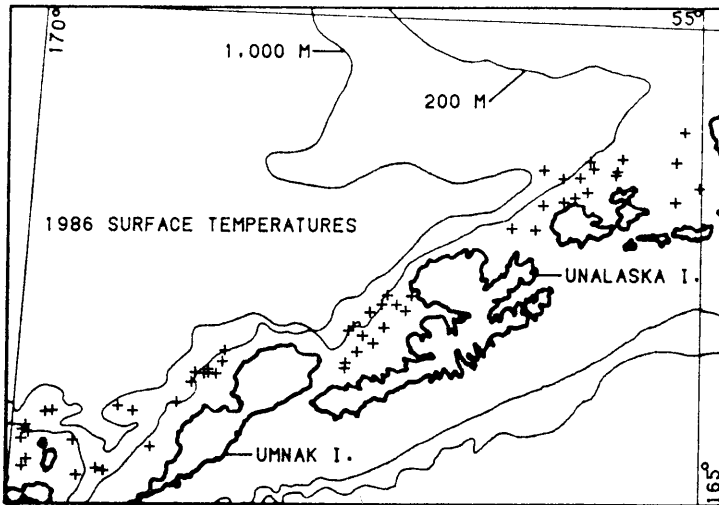

Figure B-3. Locations where surface temperatures were taken in the Southern Bering Sea and Bowers Ridge areas during the U.S.-Japan 1980, 1983, and 1986 Aleutian Islands groundfish surveys.

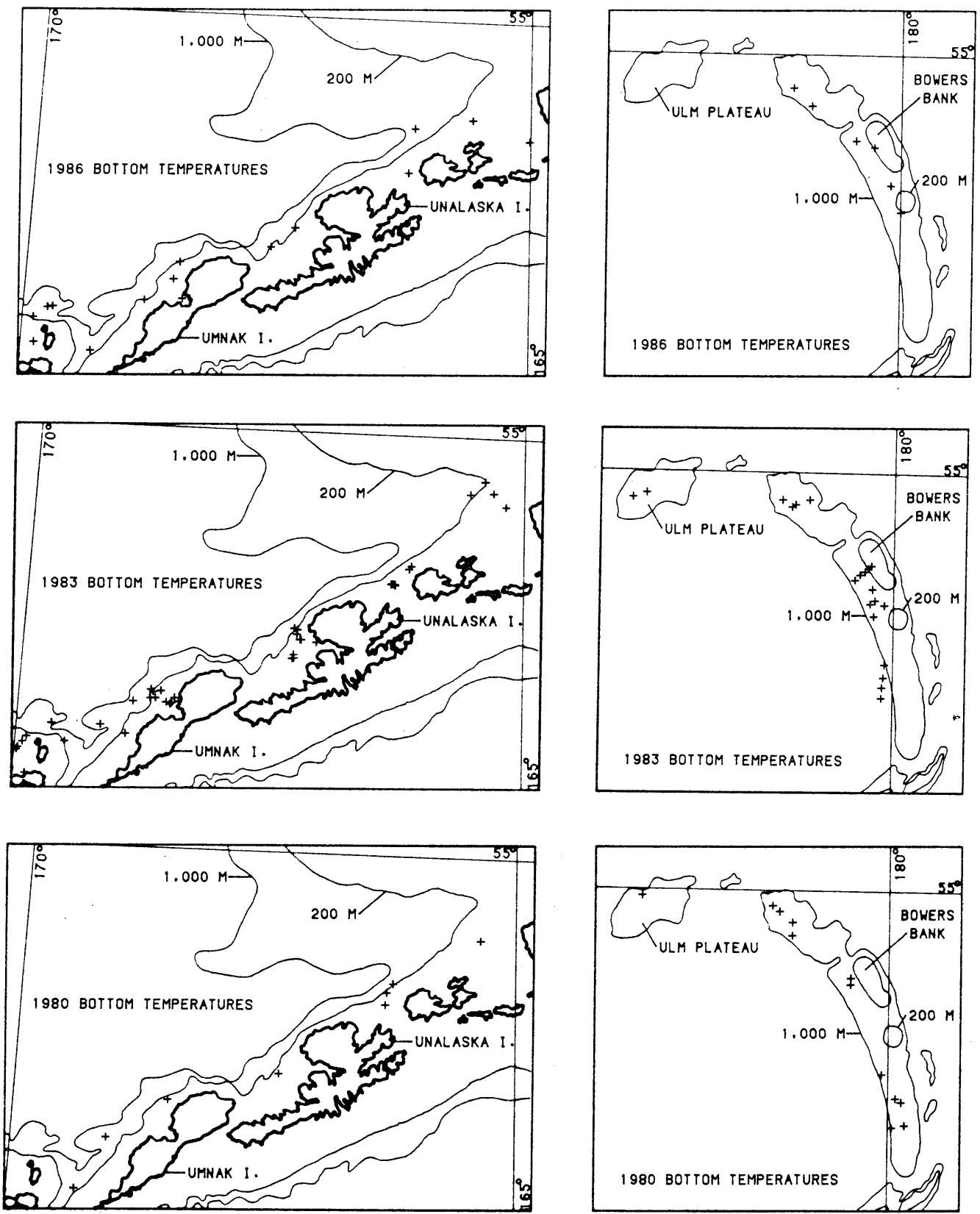

Figure B-4. Locations where bottom temperatures were taken in the Southern Bering Sea and Bowers Ridge areas during the U.S.-Japan 1980, 1983, and 1986 Aleutian Islands groundfish surveys.

APPENDIX C

SPECIES INVENTORY

Table C-1. Species recorded during the U.S.-Japan 1980, 1983, and 1986 Aleutian Islands groundfish surveys.^a

Taxon	English Common name	Japanese Standard name	Year		
			80	83	86
FISH					
Petromyzontidae	Lampreys				
<u>Lampetra tridentata</u>	Pacific lamprey	Yufutsuyatsume	X		
Lamnidae	Mackerel sharks				
<u>Lamna ditropis</u>	Salmon shark	Nezumizame	X		
Squalidae	Dogfish sharks				
<u>Somniscus pacificus</u>	Pacific sleeper shark	Ondenzame	X	X	X
<u>Squalus acanthias</u>	Spiny dogfish	Aburatsunozame	X	X	X
Rajidae	Skates				
<u>Bathyraja</u> sp.		Skate unident.	X	X	X
<u>Bathyraja abyssiicola</u>	Deepsea skate	Chihirokasube	X		
<u>Bathyraja aleutica</u>	Aleutian skate	Arasukakasube	X		
<u>Bathyraja kincaidi</u>	Sandpaper skate		X		
<u>Bathyraja lindbergi</u>	Commander skate	Komandorukasube	X		
<u>Bathyraja maculata</u>	Whiteblotched skate	Montsukikasube	X		
<u>Bathyraja minispinosa</u>	Whitebrow skate	Subesubekasube	X		
<u>Bathyraja parmifera</u>	Alaska skate	Kitatsunokasube	X		
<u>Bathyraja rosispinis</u>	Flathead skate		X		
<u>Bathyraja trachura</u>	Roughtail skate	Yasudakasube	X		
<u>Bathyraja violacea</u>	Okhotsk skate	Kitanokasube	X		
<u>Raja</u> sp.	Skate unident.			X	X
<u>Raja binoculata</u>	Big skate		X		
<u>Raja stellulata</u>	Starry skate	Kohoshikasube	X		
Clupeidae	Herrings				
<u>Clupea pallasii</u>	Pacific herring	Nishin	X	X	X
Salmonidae	Salmon and trout				
<u>Oncorhynchus gorbuscha</u>	Pink salmon	Karafutomasu	X		
<u>Oncorhynchus keta</u>	Chum salmon	Sake	X	X	X
<u>Oncorhynchus nerka</u>	Sockeye salmon	Benizake	X		
<u>Oncorhynchus tshawytscha</u>	Chinook salmon	Masunosuke	X	X	X
Osmeridae	Smelts				
<u>Mallotus villosus</u>	Capelin			X	X
<u>Thalichthys pacificus</u>	Eulachon				X
Bathylagidae	Deepsea smelts				
<u>Bathylagus</u> sp.	Deepsea smelt unident.		X		
<u>Bathylagus milleri</u>	Robust blacksmelt			X	
<u>Bathylagus pacificus</u>	Pacific blacksmelt	Yasesokoiwashi	X	X	X
<u>Leuroglossus schmidti</u>	Northern smoothtongue		X	X	X
Opisthoproctidae	Spookfishes				
<u>Macropinna microstoma</u>	Barreleye	Demeningisu	X		
Gonostomatidae	Lightfishes				
<u>Cyclothone acclinidens</u>	Benttooth bristlemouth	Senonihadaka	X		
<u>Cyclothone atraria</u>	Black bristlemouth	Onihadaka	X		
Malacosteidae	Loosejaws		X		
Chauliodontidae	Viperfishes				
<u>Chauliodus macouni</u>	Pacific viperfish	Higashihouraieso	X	X	X
Alepocephalidae	Slickheads				
<u>Bajacalifornia erimoensis</u>		Ukeguchiiwashi	X		

a - Scientific and common names of fish agree with Robins 1991.
Scientific and common names of crustaceans agree with Williams 1989.

Table C-1. (continued)

Taxon	English Common name	Japanese Standard name	Year		
			80	83	86
Searsiidae	Tube shoulders				
<u>Sagamichthys abei</u>	Shinning tube shoulder	Hanameiwashi	X		
Paralepididae	Barracudinas				
<u>Paralepis atlantica</u>	Northern duckbill barracudina		X	X	
Alepisauridae	Lancetfishes				
<u>Alepisaurus ferox</u>	Longnose lancetfish				X
Scopelarchidae	Pearleyes				
<u>Benthalbella dentata</u>	Northern pearleye	Tsumaridemeeso	X	X	
Myctophidae	Lanternfishes				
<u>Diaphus theta</u>	California headlightfish	Todohadaka	X	X	X
<u>Lampanyctus</u> sp.	Lampfish unident.				X
<u>Lampanyctus jordani</u>	Brokenline lampfish	Mamehadaka	X	X	
<u>Lampanyctus regalis</u>	Pinpoint lampfish	Mikadohadaka	X	X	
<u>Protomyctophum thompsoni</u>	Northern flashlightfish		X		X
<u>Stenobranchius leucopsarus</u>	Northern lampfish	Kohirehadaka	X	X	X
<u>Stenobranchius nannochir</u>	Garnet lampfish	Sekkihadaka	X		
Oneirodidae	Dreamers				
<u>Oneirodes thompsoni</u>					X
Moridae	Moras				
<u>Antimora microlepis</u>	Pacific flatnose	Kanadadara	X	X	X
<u>Laemonema longipes</u>		Itohikidara	X	X	X
Gadidae	Codfishes				
<u>Gadus macrocephalus</u>	Pacific cod	Madara	X	X	X
<u>Theragra chalcogramma</u>	Walleye pollock	Suketodara	X	X	X
Zoarcidae	Eelpouts				
<u>Bothrocara brunneum</u>	Twoline eelpout	Yawagenge	X	X	X
<u>Lycenchelys</u> sp.	Eelpout unident.		X		
<u>Lycodapus</u> sp.	Eelpout unident.				X
<u>Lycodapus endemoscotus</u>	Deepwater eelpout		X		
<u>Lycodes brevipes</u>	Shortfin eelpout				X X
<u>Lycodes diapteris</u>	Black eelpout		X	X	X
<u>Lycodes palearis</u>	Wattled eelpout	Hakusengaji	X	X	X
<u>Lycodes soldatovi</u>		Sokogaji	X	X	X
<u>Puzanovia rubra</u>		Akagenge	X	X	X
Macrouridae	Grenadiers				
<u>Albatrossia pectoralis</u>	Giant grenadier	Munedara	X	X	X
<u>Coryphaenoides acrolepis</u>	Pacific grenadier	Ibarahige	X	X	X
<u>Coryphaenoides cinereus</u>	Popeye	Karafutosokodara	X	X	X
<u>Coryphaenoides filifera</u>					X
Scomberesocidae	Sauries				
<u>Cololabis saira</u>	Pacific saury				X
Melamphaidae	Bigscale				
<u>Melamphaes lugubris</u>	Highsnout bigscale	Honkabutouo	X	X	
<u>Poromitra crassiceps</u>	Crested bigscale	Kabutouo	X	X	X
Trichodontidae	Sandfishes				
<u>Trichodon trichodon</u>	Pacific sandfish	Ezohatahata	X		X
Bathymasteridae	Ronquils				
<u>Bathymaster caeruleofasciatus</u>	Alaskan ronquil	Madaramedamauo	X	X	X
<u>Bathymaster signatus</u>	Searcher	Sokomedamauo	X	X	X
<u>Ronquilus jordani</u>	Northern ronquil				X X

Table C-1. (continued)

Taxon	English Common name	Japanese Standard name	Year		
			80	83	86
Stichaeidae	Pricklebacks				
<u>Bryozochthys marjorius</u>	Pearly prickleback		X	X	X
<u>Lumpenella longirostris</u>	Longsnout prickleback	Nezumiginpo	X		X
Anarhichadidae	Wolffishes				
<u>Anarhichas orientalis</u>	Bering wolffishes				X
Cryptacanthodidae	Wrymouths				
<u>Cryptacanthodes giganteus</u>	Giant wrymouth				X
Zaproridae	Prowfishes				
<u>Zaprora silenus</u>	Prowfish	Bouzuginpo	X	X	X
Ammodytidae	Sand lances				
<u>Ammodytes hexapterus</u>	Pacific sand lance	Kitaikanago	X	X	X
Icosteidae	Ragfishes				
<u>Icosteus aenigmaticus</u>	Ragfish	Irezumikonnyakuaji	X	X	X
Scorpaenidae	Scorpionfishes				
<u>Sebastes aleutianus</u>	Rougheye rockfish	Aramenuke	X	X	X
<u>Sebastes alutus</u>	Pacific ocean perch	Arasukamenuke	X	X	X
<u>Sebastes babcocki</u>	Redbanded rockfish	Akashimamenuke	X	X	
<u>Sebastes borealis</u>	Shortraker rockfish	Hireguromenuke	X	X	X
<u>Sebastes ciliatus</u>	Dusky rockfish	Nagamenuke	X	X	X
<u>Sebastes crameri</u>	Darkblotched rockfish	Yotsujimamenuke	X		
<u>Sebastes melanops</u>	Black rockfish			X	X
<u>Sebastes mystinus</u>	Blue rockfish	Aomenuke	X		X
<u>Sebastes proriger</u>	Red stripe rockfish			X	
<u>Sebastes polyspinis</u>	Northern rockfish	Kitanomenuke	X	X	X
<u>Sebastes ruberrimus</u>	Yelloweye rockfish	Arasukaakazoi	X		
<u>Sebastes variegatus</u>	Harlequin rockfish	Madaraakauo	X	X	X
<u>Sebastes zacentrus</u>	Sharpchin rockfish	Agomenuke	X		
<u>Sebastolobus alascanus</u>	Shortspine thornyhead	Arasukakichiji	X	X	X
<u>Sebastolobus altivelis</u>	Longspine thornyhead	Hirenagakichiji	X		
<u>Sebastolobus macrochir</u>	Broadbanded thornyhead	Kichiji	X	X	X
Anoplopomatidae	Sablefishes				
<u>Anoplopoma fimbria</u>	Sablefish	Gindara	X	X	X
Hexagrammidae	Greenlings				
<u>Hexagrammos decagrammus</u>	Kelp greenling	Arasuka-ainame	X	X	X
<u>Hexagrammos legocephalus</u>	Rock greenling			X	X
<u>Pleurogrammus monopterygius</u>	Atka mackerel	Kitanohokke	X	X	X
Cottidae	Sculpins				
<u>Arctediellus sp.</u>	Sculpin unident.				X
<u>Arctediellus pacificus</u>	Pacific hookear sculpin		X		
<u>Dasycottus setiger</u>	Spinyhead sculpin	Ganko	X	X	X
<u>Enophrys diceraus</u>	Antlered sculpin	Onikajika	X	X	X
<u>Enophrys lucasi</u>	Leister sculpin				X
<u>Eurymen gyrinus</u>	Smoothcheek sculpin	Yagishirikajika	X		
<u>Gymnocanthus galeatus</u>	Armorhead sculpin	Chikamekajika	X	X	X
<u>Gymnocanthus pistilliger</u>	Threaded sculpin				X
<u>Gymnocanthus tricuspis</u>	Arctic staghorn sculpin	Shiberiatsumagurokajika	X		
<u>Hemilepidotus hemilepidotus</u>	Red Irish lord	Honyokosujikajika	X		X
<u>Hemilepidotus jordani</u>	Yellow Irish lord	Nameyokosujikajika	X	X	X
<u>Hemilepidotus papilio</u>	Butterfly sculpin				X
<u>Hemilepidotus spinosus</u>	Brown Irish lord		X		
<u>Hemilepidotus zapus</u>	Longfin Irish lord		X	X	X
<u>Hemitripterus bolini</u>	Bigmouth sculpin	Kemushikajikamodoki	X	X	X
<u>Icelus cavifrons</u>	Pit-head sculpin			X	
<u>Icelus canaliculatus</u>	Porehead sculpin		X	X	X
<u>Icelus scutiger</u>		Koorimatsukajika	X	X	X
<u>Icelus spiniger</u>	Thorny sculpin	Koorikajika	X	X	X

Table C-1. (continued)

Taxon	English Common name	Japanese Standard name	Year		
			80	83	86
<u>Icelus uncinalis</u>		Himekoorikajika	X		X
<u>Jordania zonope</u>	Longfin sculpin				X
<u>Leptocottus armatus</u>	Pacific staghorn sculpin				X
<u>Malacocottus</u> sp.	Sculpin unident.			X	
<u>Malacocottus kincaidi</u>	Blackfin sculpin	Montsukikajika	X		
<u>Malacocottus zonurus</u>		Kobushikajika	X		X
<u>Myoxocephalus</u> sp.	Sculpin unident.			X	X
<u>Myoxocephalus polyacanthocephalus</u>	Great sculpin	Togekajika	X		
<u>Nautichthys oculofasciatus</u>	Sailfin sculpin				X
<u>Psychrolutes paradoxus</u>	Spineless sculpin				X
<u>Thyriscus anoplus</u>			X	X	X
<u>Triglops forficata</u>	Scissortail sculpin	Futamatakajika	X	X	X
<u>Triglops macellus</u>	Roughspine sculpin			X	
<u>Triglops pingeli</u>	Ribbed sculpin	Hokkyokukajika	X	X	X
<u>Triglops scepticus</u>	Spectacled sculpin	Niramikajika	X	X	X
Agonidae	Poachers				
<u>Aspidophoroides bartoni</u>	Aleutian alligatorfish	Tatetokubire	X	X	
<u>Bathyagonus nigripinnis</u>	Blackfin poacher	Sokotokubire	X		X
<u>Hypsagonus quadricornis</u>	Fourhorn poacher				X
<u>Podothecus acipenserinus</u>	Sturgeon poacher	Kitanotokubire	X	X	X
<u>Sarritor frenatus</u>	Sawback poacher	Yasetengutokubire	X	X	X
<u>Sarritor leptorhynchus</u>	Longnose poacher	Tengutokubire	X		
Cyclopteridae	Snailfishes				
<u>Aptocyclus ventricosus</u>	Smooth lumpsucker	Hoteiuo	X		X
<u>Careproctus bowersianus</u>			X		
<u>Careproctus candidus</u>			X		
<u>Careproctus colletti</u>		Arasukabikunin	X		
<u>Careproctus cypselurus</u>		Aibikunin	X		X
<u>Careproctus furcellus</u>		Ogurokonnyakuuo	X	X	X
<u>Careproctus gilberti</u>					X
<u>Careproctus melanurus</u>	Blacktail snailfish		X	X	
<u>Careproctus pycnosoma</u>		Konnyakuuo	X		
<u>Careproctus rastrinus</u>		Sakebikunin	X	X	X
<u>Crystallichthys cyclospilus</u>	Blotched snailfish	Zenigatasuishouo	X		X
<u>Elassodiscus</u> sp.	Snailfish unident.				X
<u>Elassodiscus caudatus</u>	Humpback snailfish		X	X	
<u>Elassodiscus tremebundus</u>		Fuuraikusauo	X	X	
<u>Eumicrotremus andriashevi</u>	Pimpled lumpsucker				X
<u>Eumicrotremus orbis</u>	Pacific spiny lumpsucker	Ibodango	X		X
<u>Lethotremus muticus</u>	Lumpsucker	Kitadangouo	X		X
<u>Liparis</u> sp.	Lumpsucker unident.		X	X	
<u>Liparis dennyi</u>	Marbled snailfish				X
<u>Nectoliparis pelagicus</u>	Tadpole snailfish			X	
<u>Paraliparis</u> sp.	Lumpsucker unident.		X	X	X
<u>Paraliparis dactylosus</u>	Red snailfish	Kokuteninkiuo	X		
<u>Rhinoliparis</u> sp.	Snailfish unident.			X	
Pleuronectidae	Righteye flounders				
<u>Atheresthes evermanni</u>	Kamchatka flounder	Aburagarei	X		
<u>Atheresthes stomias</u>	Arrowtooth flounder	Arasukaaburagarei	X	X	X
<u>Clidoderma asperrimum</u>	Roughscale flounder	Samegarei	X	X	X
<u>Embassichthys bathybius</u>	Deepsea sole	Shimofurigarei	X	X	X
<u>Errex zachirus</u>	Rex sole	Hirenaganameta	X	X	X
<u>Hippoglossoides elassodon</u>	Flathead sole	Umagarei	X	X	X
<u>Hippoglossus stenolepis</u>	Pacific halibut	Ohyo	X	X	X
<u>Microstomus pacificus</u>	Dover sole		X	X	X
<u>Platichthys stellatus</u>	Starry flounder				X
<u>Pleuronectes asper</u>	Yellowfin sole	Koganegarei	X		X
<u>Pleuronectes bilineatus</u>	Rock sole	Shumushugarei	X	X	X
<u>Pleuronectes isolepis</u>	Butter sole		X		X
<u>Pleuronectes vetulus</u>	English sole				X
<u>Reinhardtius hippoglossoides</u>	Greenland halibut	Karasugarei	X	X	X

Table C-1. (continued)

Taxon	English Common name	Japanese Standard name	Year		
			80	83	86
SQUID					
Onychoteuthidae					
<u>Moroteuthis robustus</u>	Giant squid	Nyudouika	X	X	X
Gonatidae					
<u>Berryteuthis magister</u>	Red squid	Dosuika	X	X	X
<u>Gonatopsis borealis</u>	Boreopacific gonate squid	Takoika	X		
<u>Gonatopsis makko</u>	Mako gonate squid	Makkoutakoika	X		
Cranchiidae					
<u>Taonius pavo</u>		Kujakuika	X		
OCTOPUSES					
Octopodidae					
<u>Octopus</u> sp.	Octopus unident.		X	X	X
<u>Octopus dofleini</u>	North Pacific giant octopus	Mizudako	X		
Opisthoteuthidae					
SCALLOPS					
Pectinidae					
<u>Chlamys</u> sp.	Scallops			X	X
<u>Chlamys islandica</u>	Scallop unident.				X
<u>Pecten caurinus</u>	Weathervane scallop			X	X
SHRIMP					
Pandalidae					
<u>Pandalopsis aleutica</u>	Pandalid shrimp			X	
<u>Pandalopsis ampla</u>	Aleutian bigeye			X	
<u>Pandalopsis dispar</u>	Deepwater bigeye				
<u>Pandalus borealis</u>	Sidestripe shrimp	Shimaakaebi	X		X
<u>Pandalus goniurus</u>	Northern shrimp	Hokkokuakaebi	X	X	X
<u>Pandalus hypsinotus</u>	Humpy shrimp	Benisujiebe	X		
<u>Pandalus tridens</u>	Coonstriped shrimp		X		
	Yellowleg pandalid		X		
CRAB					
Lithodidae					
<u>Lithodes aequispina</u>	Lithodid crabs				
<u>Lithodes couesi</u>	Golden king crab	Ibaraganimodoki	X	X	X
<u>Paralithodes camtschatica</u>	Scarlet king crab	Kitaibaragani	X	X	X
<u>Paralithodes platypus</u>	Red king crab	Tarabagani	X	X	X
	Blue king crab	Aburagani	X		
Majidae					
<u>Chionoecetes hybrid</u>	Spider crabs				
<u>Chionoecetes angulatus</u>	Hybrid Tanner crab				
<u>Chionoecetes bairdi</u>	Triangle Tanner crab	Togezuuwaigani	X	X	X
<u>Chionoecetes opilio</u>	Tanner crab		X	X	X
<u>Chionoecetes tanneri</u>	Snow crab	Zuwaigani	X	X	X
	Grooved Tanner crab		X		X
Cancridae					
<u>Cancer magister</u>	Cancer crabs				
	Dungeness crab				X
Atelecyclidae					
<u>Erimacrus isenbeckii</u>	Hair crabs				
	Hair crab	Kegani	X	X	X

RECENT TECHNICAL MEMORANDUMS

Copies of this and other NOAA Technical Memorandums are available from the National Technical Information Service, 5285 Port Royal Road, Springfield, VA 22167 (web site: www.ntis.gov). Paper and microfiche copies vary in price.

AFSC-

- 30 LORENZ, J. M. 1994. Distribution and habitat of adult salmon in the Situk River, Alaska: Potential impacts of flooding from Russell Fiord, 27 p. NTIS No. PB94-151859.
- 29 IGNELL, S. E., L. J. SIMON, and M. L. DAHLBERG. 1994. Estimation of salmonid bycatch in the 1989 Japanese squid driftnet fishery, 45 p. NTIS No. PB94-152105.
- 28 MORTENSEN, D. G., and H. SAVIKKO. 1993. Effects of water temperature on growth of juvenile pink salmon (Oncorhynchus gorbuscha), 12 p. NTIS No. PB94-145349.
- 27 LOW, L-L. (coordinator). 1994. Status of living marine resources off Alaska, 1993, 110 p. NTIS No. PB94-149846.
- 26 LOW, L-L. (coordinator). 1993. Status of living marine resources off the Pacific coast of the United States for 1993, 90 p. NTIS No. PB94-133733.
- 25 KINOSHITA, R. K., A. GREIG, J. D. HASTIE, and J. M. TERRY. 1993. Economic status of the groundfish fisheries off Alaska, 1992, 102 p. PB94-142759.
- 24 SINCLAIR, E. H. (editor) 1993. Fur seal investigations, 1991, 142 p. NTIS No. PB94-118171.
- 23 PARKS, N. B., F. R. SHAW, and R. L. HENRY. 1993. Results of a 1988 trawl survey of groundfish resources of the upper continental slope off Oregon, 164 p. NTIS No. PB94-118163.
- 22 YANG, M-S. 1993. Food habits of the commercially important groundfishes in the Gulf of Alaska in 1990, 150 p. NTIS No. PB94-112463.
- 21 KINOSHITA, R. K., and J. M. TERRY. 1993. Oregon, Washington, and Alaska exports of edible fishery products, 1992, 52 p. NTIS No. PB93-226652.
- 20 REEVES, J. E. 1993. Use of lower minimum size limits to reduce discards in the Bristol Bay red king crab (Paralithodes camtschaticus) fishery, 16 p. NTIS No. PB93-228187.
- 19 SYRJALA, S. E. 1993. Species-specific stratification and the estimate of groundfish biomass in the Eastern Bering Sea, 20 p. PB94-103215.
- 18 PELLA, J., M. HOFFMAN, S. HOFFMAN, M. MASUDA, S. NELSON, and L. TALLEY. 1993. Adult sockeye and pink salmon tagging experiments for separating stocks in northern British Columbia and southern Southeast Alaska, 1982-1985, 134 p. NTIS No. PB93-226660.
- 17 SEASE, J. L., J. P. LEWIS, D. C. MCALLISTER, R. L. MERRICK, and S. M. MELLO. 1993. Aerial and ship-based surveys of Steller sea lions (Eumetopias jubatus) in Southeast Alaska, the Gulf of Alaska, and Aleutian Islands during June and July 1992, 57 p. NTIS No. PB93-226025.
- 16 FISCUS, C. F. 1993. Catalogue of cephalopods at the National Marine Mammal Laboratory, 183 p. NTIS No. PB93-226678.