

# TRAINING COURSE IN GEOTECHNICAL AND FOUNDATION ENGINEERING

NHI COURSE No. 13231 - MODULE 1

PUBLICATION No. FHWA HI-97-021

NOVEMBER 1997

## SUBSURFACE INVESTIGATIONS

PARTICIPANTS MANUAL

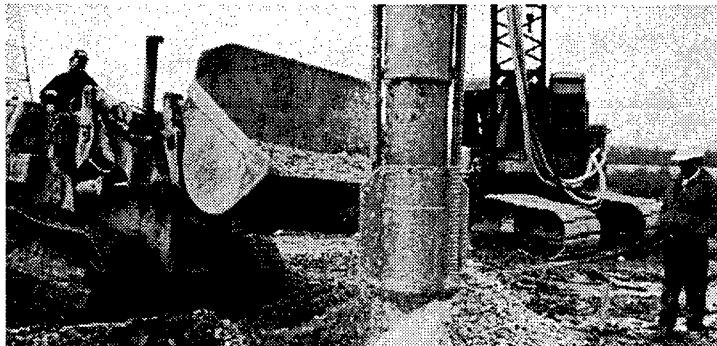
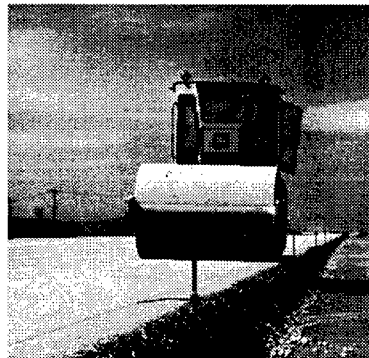
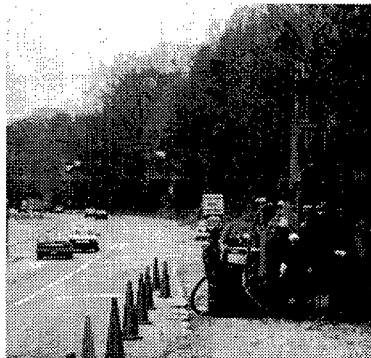
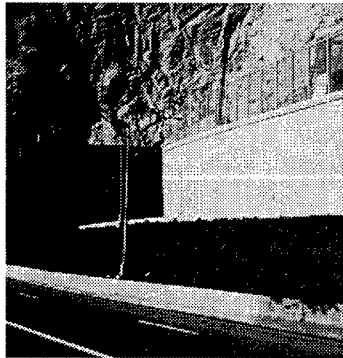
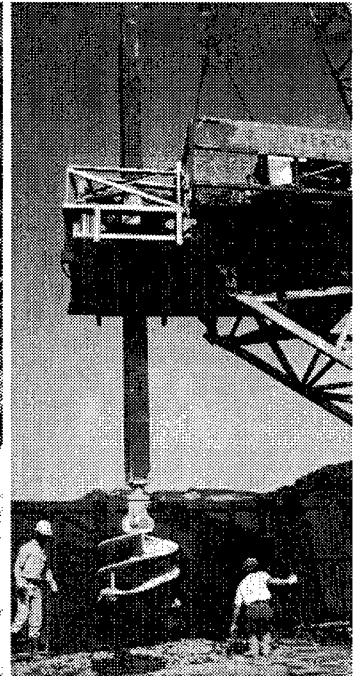
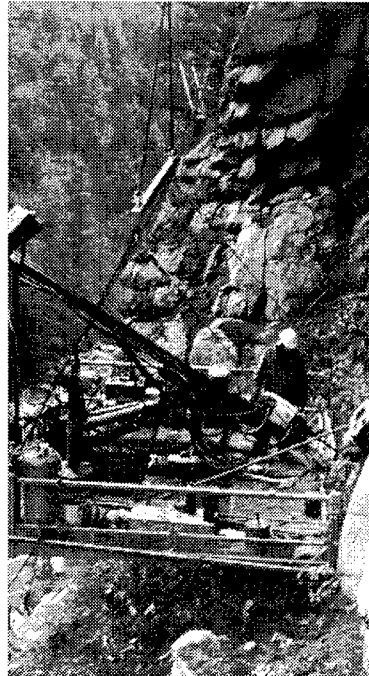
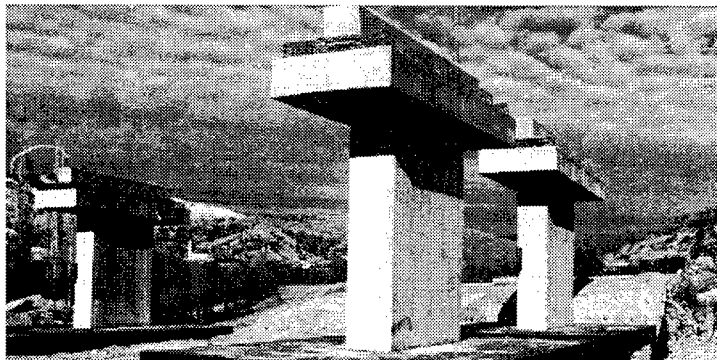

U.S. Department  
of Transportation

**Federal Highway  
Administration**



National Highway Institute

## ACKNOWLEDGMENTS

The authors would like to acknowledge the assistance of a number of professionals from Parsons Brinckerhoff Quade and Douglas, Inc.★, Woodward-Clyde Consultants▲ and Golder Associates, Inc.○ who have developed or reviewed specific sections of this manual. Many thanks to William Daly★, Kyle Ott★ and Duncan Wyllie○ for their contributions to the rock mechanics aspects of the manual; Philip Zaccheo★ and Joe Wang★ for their review of portions of the completed document; Steven Saye▲ for readily sharing Woodward-Clyde Consultants' Subsurface Exploration Committee's notes; and Jerry DiMaggio, Alan Killian, Andy Muñoz and Peter Osborn of FHWA for their thorough reviews and recommendations. Special appreciation to Ke Fan★, Togan Alper▲ for their work in preparing figures, outlines and slides for presentation; Terry Coates▲, Everlee Wright★, Wendy Castro★, Alia Abbas★ for overall word processing and compiling, and Tony Silva★ for preparation of graphics.

## NOTICE

The information in this document has been funded wholly or in part by the U.S. Department of Transportation, Federal Highway Administration (FHWA), under Contract No. DTFH 61-94-C-00104 to Parsons Brinckerhoff Quade & Douglas, Inc. The document has been subjected to peer and administrative review by FHWA, and it has been approved for publication as a FHWA document.

In this document, certain products have been identified by trade name. Also, photographs of these products have been included in the document for illustration purposes. Other products which are not identified in this document may be equally viable to those identified. The mention of any trade name or photograph of a particular product does not constitute endorsement or recommendation for use by either the authors or FHWA.

**Technical Report Documentation Page**

1. Report No. FHWA-HI-97-021		2. Government Accession No.		3. Recipient's Catalog No.	
4. Title and Subtitle  GEOTECHNICAL AND FOUNDATION ENGINEERING MODULE 1 - SUBSURFACE INVESTIGATIONS				5. Report Date November 1997	
				6. Performing Organization Code	
7. Author(s)  Principal Investigator: George Munfakh* Authors: Ara Arman <sup>▲</sup> , Naresh Samtani*, Raymond Castelli* and George Munfakh*				8. Performing Organization Report	
9. Performing Organization Name and Address  * Parsons Brinckerhoff Quade & Douglas, Inc. One Penn Plaza, New York, NY 10119  In association with: <sup>▲</sup> Woodward-Clyde Consultants 2822 O'Neal Lane, Baton Rouge, LA 70816				10. Work Unit No. (TR AIS)	
				11. Contract or Grant No. DTFH61-94-C-00104	
12. Sponsoring Agency Name and Address  Federal Highway Administration National Highway Institute 901 North Stuart Street, Suite 300 Arlington, Virginia 22203				13. Type of Report and Period	
				14. Sponsoring Agency Code	
15. Supplementary Notes  FHWA Technical Consultants - J.A. DiMaggio, A. Muñoz, A. Kilian, and P. Osborn; CO - J. Mowery III; COTR - L. Jones					
16. Abstract  The planning, executing and interpreting the results of subsurface exploration of soil and rock for the design and construction of transportation facilities are presented. The geotechnical engineer's role in subsurface investigation, exploration methodologies, equipment types and their suitability to explore for various subsurface conditions and design requirements are discussed. The use of in situ testing and geophysical surveys for subgrade characterization, proper handling, transportation and storage of soil and rock samples, as well as laboratory testing techniques to develop subsurface information is presented. Correlation of soil and rock properties, typical geotechnical reports, and subcontracting for soil and rock exploration also are discussed. Safety guidelines, health and safety procedures, and a list of equipment manufacturers are appended for further reference.					
17. Key Words  Subsurface, investigation, subgrade, exploration, drilling, coring, sampling, soil, rock, testing, in situ, laboratory, geophysical, remote sensing, groundwater, geotechnical report, transportation, highways, bridges.			18. Distribution Statement  This document is available to the public through the National Technical Information Service, Springfield, VA 22161; (703) 487-4650		
19. Security Classif. (of this report)  UNCLASSIFIED		20. Security Classif. (of this page)  UNCLASSIFIED		21. No. of Pages  305	22. Price  -



## PREFACE

This module is the first in a series of twelve modules that constitute a comprehensive training course in geotechnical and foundation engineering. Sponsored by the National Highway Institute (NHI) of the Federal Highway Administration (FHWA), the training course is given at different locations in the U.S. The intended audience is civil engineers and engineering geologists involved in the design and construction of transportation facilities.

This manual is designed to present the latest methodologies in the planning, execution and interpretation of the various subsurface investigation methods, and the development of appropriate soil and rock parameters for engineering applications.

The authors have made every effort to present the general state of the practice of subsurface exploration. It is understood that the procedures discussed in the manual are subject to local variations. It is important, therefore, for the reader to become thoroughly familiar with the local practices as well. This guide focuses on the scope and specific elements of typical geotechnical investigation programs for design and construction of highways and related transportation facilities.

Considering the broad scope and fundamental importance of this subject, this manual on subsurface investigations is organized as follows:

**Chapters 1 through 6** discuss various aspects of field investigations, including borings, sampling, in situ testing and geophysical exploration methods.

**Chapters 7 and 8** discuss laboratory testing of soil and rock materials.

**Chapters 9 and 10** present correlations of soil and rock properties.

**Chapters 11 and 12** address issues related to data management and interpretation, including evaluation of the field and laboratory test data, development of soil and rock design parameters, and the presentation of investigation findings in geotechnical reports.

**Chapter 13** contains a list of references.

**Appendix A** contains information on health and safety. **Appendix B** lists names and addresses of soil and rock drilling and testing equipment manufacturers and suppliers.

This manual by no means is complete. A number of references are presented in Chapter 13. It is highly recommended that these references be made part of the reader's library, and be reviewed in detail. An important reference is the Manual on Subsurface Investigations by AASHTO (1988).

**Finally, this manual is developed to be used as a living document. After attending the training session, it is intended that the participant will use it as a manual of practice in everyday work.** Throughout the manual, attention is given to ensure the compatibility of its content with those of the participants manuals prepared for the other training modules. **Special efforts are made to ensure that the included material is practical in nature and represents the latest developments in the field.**

## CONVERSION FACTORS

Approximate Conversions to SI Units		Approximate Conversions from SI Units	
When you know	Multiply by	When you know	Multiply by
		To find	
(a) Length			
inch	25.4	millimeter	0.039
foot	0.305	meter	3.28
yard	0.914	meter	1.09
mile	1.61	kilometer	0.621
(b) Area			
square inches	645.2	square millimeters	0.0016
square feet	0.093	square meters	10.764
acres	0.405	hectares	2.47
square miles	2.59	square kilometers	0.386
(c) Volume			
fluid ounces	29.57	milliliters	0.034
gallons	3.785	liters	0.264
cubic feet	0.028	cubic meters	35.32
cubic yards	0.765	cubic meters	1.308
(d) Mass			
ounces	28.35	grams	0.035
pounds	0.454	kilograms	2.205
short tons (2000 lb)	0.907	megagrams (tonne)	1.102
(e) Force			
pound	4.448	Newton	0.2248
(f) Pressure, Stress, Modulus of Elasticity			
pounds per square foot	47.88	Pascals	0.021
pounds per square inch	6.895	kiloPascals	0.145
(g) Density			
pounds per cubic foot	16.019	kilograms per cubic meter	0.0624
(h) Temperature			
Fahrenheit temperature(°F)	5/9(°F- 32)	Celsius temperature(°C)	9/5(°C) + 32

Notes: 1) The primary metric (SI) units used in civil engineering are meter (m), kilogram (kg), second(s), newton (N) and pascal (Pa = N/m<sup>2</sup>).  
 2) In a "soft" conversion, an English measurement is mathematically converted to its exact metric equivalent.  
 3) In a "hard" conversion, a new rounded metric number is created that is convenient to work with and remember.

**MODULE 1  
SUBSURFACE INVESTIGATIONS**

**TABLE OF CONTENTS**

	Page
LIST OF FIGURES .....	viii
LIST OF TABLES .....	xii
LIST OF NOTATIONS .....	xiv
1.0 Introduction .....	1-1
1.1 Scope of this Manual .....	1-1
1.2 Geotechnical Engineer's Role in Subsurface Exploration .....	1-1
2.0 Project Initiation .....	2-1
2.1 Project Type .....	2-1
2.1.1 New Construction .....	2-2
2.1.2 Rehabilitation Projects .....	2-2
2.1.3 Contaminated Sites .....	2-2
2.2 Existing Data Sources .....	2-4
2.3 Site Visit/plan-in-hand .....	2-5
2.4 Communication with Designers/Project Managers .....	2-6
2.5 Subsurface Exploration Planning .....	2-8
2.5.1 Types of Investigation .....	2-8
Disturbed Sampling .....	2-8
Undisturbed Sampling .....	2-8
In situ Investigation .....	2-10
Geophysical Investigation .....	2-10
Remote Sensing .....	2-10
2.5.2 Frequency and Depth of Borings .....	2-10
2.5.3 Boring Locations and Elevations .....	2-12
2.5.4 Equipment .....	2-12
2.5.5 Personnel and Personal Behavior .....	2-15
2.5.6 Plans and Specifications .....	2-15
2.6 Standards and Guidelines .....	2-15
3.0 Drilling and Sampling of Soil and Rock .....	3-1
3.1 Soil Exploration .....	3-1
3.1.1 Soil Drilling .....	3-1
Continuous Flight Augers .....	3-1
Hollow-Stem Augers .....	3-4
Bucket Auger Borings .....	3-6
Rotary Wash Borings .....	3-8
Area Specific Methods .....	3-12
Exploration Pit Excavation .....	3-12

	Logging Procedures . . . . .	3-12
	Photography . . . . .	3-13
3.1.2	Soil Samples . . . . .	3-13
	Undisturbed Samples . . . . .	3-13
	Disturbed Samples . . . . .	3-13
3.1.3	Soil Samplers . . . . .	3-13
	Split Barrel Sampler . . . . .	3-14
	Thin Wall Sampler . . . . .	3-14
	Piston Sampler . . . . .	3-19
	Pitcher Tube Sampler . . . . .	3-19
	Denison Sampler . . . . .	3-22
	Modified California Sampler . . . . .	3-22
	Continuous Soil Sampler . . . . .	3-22
	Other Soil Samplers . . . . .	3-22
	Bulk Samples . . . . .	3-24
3.1.4	Sampling Interval and Appropriate Type of Sampler . . . . .	3-24
3.1.5	Sample Recovery . . . . .	3-25
3.1.6	Sample Identification . . . . .	3-25
3.1.7	Relative Strength Tests . . . . .	3-25
3.1.8	Care and Preservation of Undisturbed Soil Samples . . . . .	3-26
3.2	Exploration of Rock . . . . .	3-29
3.2.1	Rock Drilling and Sampling . . . . .	3-29
3.2.2	Non-Core (Destructive) Drilling . . . . .	3-29
3.2.3	Types of Core Drilling . . . . .	3-30
	Coring Bits . . . . .	3-32
	Drilling Fluid . . . . .	3-34
3.2.4	Observation During Core Drilling . . . . .	3-34
	Drilling Rate/Time . . . . .	3-34
	Core Photographs . . . . .	3-34
	Rock Classification . . . . .	3-34
	Recovery . . . . .	3-35
	Rock Quality Designation (RQD) . . . . .	3-35
	Length Measurements of Core Pieces . . . . .	3-35
	Assessment of Soundness . . . . .	3-38
	Drilling Fluid Recovery . . . . .	3-38
	Core Handling and Labeling . . . . .	3-38
	Care and Preservation of Rock Samples . . . . .	3-40
3.2.5	Geologic Mapping . . . . .	3-40
3.3	Boring Closure . . . . .	3-41
3.4	Safety Guidelines for Geotechnical Borings . . . . .	3-41
3.5	Common Errors by Drillers . . . . .	3-44
4.0	Boring Log Preparation . . . . .	4-1
4.1	General . . . . .	4-1
4.2	Project Information . . . . .	4-9
4.3	Boring Locations and Elevations . . . . .	4-9
4.4	Stratigraphy Identification . . . . .	4-9
4.5	Sample Information . . . . .	4-10
4.6	Soil Description/Soil Classification . . . . .	4-10



4.6.1	Consistency and Apparent Density	4-11
4.6.2	Water Content (Moisture)	4-11
4.6.3	Color	4-11
4.6.4	Type of Soil	4-13
	Coarse-Grained Soils (Gravel and Sand)	4-13
	Feel and Smear Test	4-13
	Sedimentation Test	4-16
	Visual Characteristics	4-16
	Fine-Grained Soils	4-16
	Shaking (Dilatancy) Test	4-16
	Dry Strength Test	4-23
	Thread Test	4-23
	Smear Test	4-23
	Highly Organic Soils	4-24
	Minor Soil Type(s)	4-24
	Inclusions	4-25
	Layered Soils	4-25
	Geological Name	4-25
4.6.5	AASHTO Soil Classification System	4-26
4.7	Logging Procedures for Core Drilling	4-29
4.7.1	Description of Rock	4-29
4.7.2	Rock Type	4-29
4.7.3	Color	4-31
4.7.4	Grain Size and Shape	4-31
4.7.5	Stratification/Foliation	4-31
4.7.6	Mineral Composition	4-31
4.7.7	Weathering and Alteration	4-31
4.7.8	Strength	4-31
4.7.9	Hardness	4-31
4.7.10	Rock Discontinuity	4-33
4.7.11	Fracture Description	4-34
5.0	In Situ Testing	5-1
5.1	Standard Penetration Test	5-2
5.2	Cone Penetration Testing	5-7
5.3	Field Vane Shear Test	5-14
5.4	Pressuremeter Testing	5-18
	5.4.1 Self Boring Pressuremeter Test	5-22
5.5	Dilatometer Testing	5-23
5.6	Plate-load Tests	5-26
5.7	Geophysical Methods	5-28
	5.7.1 Electrical Resistivity/Conductivity	5-28
	5.7.2 Wave Propagation Seismic Survey	5-30
	Cross-Hole Wave Propagation Method	5-30
	Up-hole or Down-hole Wave Propagation Method	5-32
	Parallel Seismic Test	5-32
	5.7.3 Seismic Techniques	5-32
	Seismic Refraction	5-32
	Seismic Cone	5-35

	5.7.4	Ground Penetrating Radar	5-35
5.8		Remote Sensing	5-37
	5.8.1	Aerial Photographs	5-37
	5.8.2	Other Imagery	5-39
6.0		Groundwater Investigations	6-1
6.1		General	6-1
6.2		Determination of Groundwater Levels and Pressures	6-1
	6.2.1	Information on Existing Wells	6-1
	6.2.2	Open Borings	6-2
	6.2.3	Observation Wells	6-2
	6.2.4	Water Level Measurements	6-4
		Chalked Tape	6-4
		Tape with a Float	6-4
		Electric Water-Level Indicator	6-4
		Data Loggers	6-5
6.3		Determination of Field Permeability	6-5
	6.3.1	Seepage Tests	6-5
		Falling Water Level Method	6-6
		Rising Water Level Method	6-6
		Constant Water Level Method	6-6
	6.3.2	Pressure (“Packer”) Test	6-6
	6.3.3	Pumping Tests	6-9
	6.3.4	Slug Tests	6-13
7.0		Laboratory Testing for Soils	7-1
7.1		General	7-1
	7.1.1	Weight-Volume Concepts	7-1
	7.1.2	Load-Deformation Process in Soils	7-2
	7.1.3	Principle of Effective Stress	7-3
	7.1.4	Overburden Pressure	7-3
	7.1.5	Selection and Assignment of Tests	7-4
	7.1.6	Visual Identification of Soils	7-7
	7.1.7	Index Properties	7-8
		Moisture Content	7-8
		Specific Gravity	7-9
		Unit Weight	7-9
		Sieve Analysis	7-10
		Hydrometer Analysis	7-11
		Atterberg Limits	7-11
		Moisture-Density (Compaction) Relationship	7-12
		Corrosivity of Soils	7-14
		Resistivity	7-14
		Organic Content of Soils	7-15
		Classification of Soils	7-15
	7.1.8	Strength Tests	7-16
		Choice of Total or Effective Stress Analysis	7-16
		Foundations	7-16
		Excavations	7-16

	Embankments .....	7-17
	Natural Slopes .....	7-17
	Unconfined Compressive Strength of Soils .....	7-18
	Triaxial Strength .....	7-20
	Direct Shear .....	7-24
	Direct Simple Shear (DSS) Test .....	7-24
	Resilient Modulus .....	7-26
	Resonant Column .....	7-26
	Miniature (Shear) Vane .....	7-27
	California Bearing Ratio (CBR) .....	7-27
	R-Value Test .....	7-28
	7.1.9 Permeability .....	7-29
	7.1.10 Consolidation .....	7-32
	Swell Potential of Clays .....	7-34
	Collapse Potential of Soils .....	7-34
7.2	Quality Assurance for Laboratory Testing .....	7-35
	7.2.1 Storage .....	7-35
	7.2.2 Sample Handling .....	7-35
	7.2.3 Specimen Selection .....	7-36
	7.2.4 Equipment Calibration .....	7-36
	7.2.5 Pitfalls .....	7-36
8.0	Laboratory Testing for Rocks .....	8-1
	8.1 Introduction .....	8-1
	8.2 Laboratory Tests .....	8-1
	8.2.1 Strength Tests .....	8-1
	Point-Load Strength Test .....	8-1
	Uniaxial Compression Test .....	8-4
	Direct Shear Strength of Rock .....	8-5
	8.2.2 Durability .....	8-6
	Slake Durability .....	8-7
	Soundness of Riprap .....	8-8
	Durability Under Freezing and Thawing .....	8-8
	8.2.3 Strength-Deformation Characteristics .....	8-9
	Elastic Moduli .....	8-9
	Ultrasonic Testing .....	8-10
	8.3 Quality Assurance for Laboratory Testing .....	8-11
	8.3.1 Pitfalls .....	8-11
9.0	Correlation of Soil Properties .....	9-1
	9.1 Introduction .....	9-1
	9.2 Compositional Properties of Soil .....	9-1
	9.2.1 Unit Weight .....	9-1
	9.2.2 Specific Gravity .....	9-1
	9.2.3 Relative Density of Cohesionless Soils .....	9-1
	9.2.4 Consistency of Cohesive Soils .....	9-5
	9.3 Compressibility Relationships .....	9-5
	9.3.1 Elastic Parameters .....	9-5
	9.3.2 Consolidation Parameters .....	9-7

	Compression Index, $C_c$ . . . . .	9-7
	Recompression Index, $C_r$ . . . . .	9-7
	Coefficient of Vertical Consolidation, $c_v$ . . . . .	9-10
	Coefficient of Secondary Compression, $C_\alpha$ . . . . .	9-11
9.4	Permeability Relationships . . . . .	9-12
	9.4.1 Typical Values . . . . .	9-12
	9.4.2 Relationships with Gradation . . . . .	9-12
9.5	Strength Relationships . . . . .	9-15
	9.5.1 Undrained Shear Strength of Cohesive Soils . . . . .	9-15
	Undisturbed Shear Strength . . . . .	9-15
	Correlation with N-value . . . . .	9-16
	9.5.2 Drained and Effective Shear Strength of Cohesive Clays . . . . .	9-18
	9.5.3 Shear Strength of Granular Soils . . . . .	9-19
	9.5.4 Shear Strength of Compacted Soils . . . . .	9-19
10.0	Correlation of Rock Properties . . . . .	10-1
	10.1 Introduction . . . . .	10-1
	10.2 Rock Properties . . . . .	10-2
	10.2.1 Unit Weight . . . . .	10-2
	10.2.2 Compressive and Tensile Strength . . . . .	10-2
	10.2.3 Modulus of Elasticity . . . . .	10-2
	10.2.4 Shear Strength . . . . .	10-2
	10.3 Correlations . . . . .	10-11
	10.3.1 Introduction . . . . .	10-11
	10.3.2 Shale Rating System (SRS) . . . . .	10-11
	10.3.3 Rock Mass Rating System (RMR) . . . . .	10-18
	10.3.4 Unified Rock Classification System (URCS) . . . . .	10-18
	10.3.5 Slope Rock Mass Rating System (SMR) . . . . .	10-24
	10.3.6 Other Correlations . . . . .	10-24
	Correlations for Deformation Modulus . . . . .	10-24
	Correlation Between Point Load Test and Uniaxial Compressive Strength	10-24
11.0	Geotechnical Reports . . . . .	11-1
	11.1 Types of Reports . . . . .	11-1
	11.1.1 Geotechnical Investigation (Data) Reports . . . . .	11-1
	11.1.2 Geotechnical Design Reports . . . . .	11-2
	11.1.3 Geo-Environmental Reports . . . . .	11-2
	11.2 Data Presentation . . . . .	11-5
	11.2.1 Borings Logs . . . . .	11-5
	11.2.2 Subsurface Profiles . . . . .	11-5
	11.3 Limitations . . . . .	11-7
12.0	Contracting of Geotechnical Subsurface Exploration . . . . .	12-1
	12.1 Drilling and Testing Specifications . . . . .	12-1
13.0	References . . . . .	13-1
Appendix A	Typical Safety Guidelines for Drilling into Soil and Rock and Health and Safety Procedures for Entry into Borings . . . . .	A-1



## LIST OF FIGURES

<u>No.</u>	<u>Caption</u>	<u>Page</u>
2-1	Embankment Slope Failure . . . . .	2-3
2-2	Form for Field Instructions . . . . .	2-7
3-1	Drill Bits Commonly Used in North American Practice (a) Fishtail Bit, (b) Hawthorne Replaceable-Blade Drag Bit, (c) Carbide Insert Drag Bit, and (e) Diamond Plug . . . . .	3-2
3-2	Typical Continuous Flight Auger Test Set-up . . . . .	3-3
3-3	(a) Hollow-Stem Auger, (b) Cuttings From a Saturated Soil During Hollow-Stem Augering . . . . .	3-5
3-4	(a) Bucket Auger, (b) Typical Set-up of Bucket Auger and Drilling Rig . . . . .	3-7
3-5	(a) Schematic of a Drilling Rig for Rotary Wash Methods . . . . .	3-9
3-5	(b) Typical Equipment and Set-up of Rotary Wash Drilling (Note Mud Pit in the Foreground) . . . . .	3-10
3-6	(a) Split Barrel Sampler, (b) Split Barrel Sampler Opened Longitudinally with a Soil Sample . . . . .	3-15
3-7	Sample Retainers (a) Basket Shoe - the flexible fingers open to admit the sand and then close when the tube is withdrawn, (b) Spring Sample Retainer, (c) Trap Valve Retainers used to Recover Muds and Watery Samples . . . . .	3-16
3-8	(a) Schematic of Thin-Walled (Shelby) Tube, (b) Photograph of a Thin-Walled (Shelby) Tube . . . . .	3-17
3-9	Piston Sampler . . . . .	3-20
3-10	Pitcher Sampler. Schematic Drawing Showing: (a) Sampler Being Lowered into Drill Hole, (b) Sampler During Sampling of Soft Soils, (c) Sampler During Sampling of Stiff or Dense Soils . . . . .	3-21
3-11	Denison Double-Tube Core Barrel Soil Sampler . . . . .	3-23
3-12	Modified California Sampler . . . . .	3-23
3-13	Torvane Device . . . . .	3-26
3-14	Shipping Container for 76 mm Thin-Walled Tubes . . . . .	3-27
3-15	Extracted Sample Transportation and Storage . . . . .	3-28
3-16	(a) Single Tube Core Barrel, (b) Rigid Type Double Tube Core Barrel (c) Swivel Type Double Tube Core Barrel, Series "M" with Ball Bearings. . . . .	3-31
3-17	Coring Bits (a) Diamond with Conventional Waterways, (b) Diamond with Bottom-Discharge Waterways, (c) Carbide Insert-Pyramid Type, (d) Carbide Insert-Blade Type, and (e) Sawtooth . . . . .	3-33
3-18	Modified Core Recovery as an Index of Rock Quality . . . . .	3-36
3-19	Length Measurement of Core for RQD Determination . . . . .	3-37
3-20	Core Box and Labeling . . . . .	3-39
3-21	(a) Structural Mapping Coding Form for Discontinuity Survey Data . . . . .	3-42
3-21	(b) Structural Mapping Coding Form for Slope Assessment . . . . .	3-43
4-1	Typical Boring Log Form . . . . .	4-2
4-2	Typical Core Boring Log . . . . .	4-3
4-3	Typical Exploration Pit Log . . . . .	4-4
4-4	Proposed Key to Boring Log (Continued on Page 4-6) . . . . .	4-5
4-4	Proposed Key to Boring Log . . . . .	4-6
4-5	Proposed Key to Core Boring Log (Continued on Page 4-8) . . . . .	4-7

4-5	Proposed Key to Core Boring Log	4-8
4-6	Flow Chart to Determine the Group Symbol and Group Name for Coarse-grained Soils	4-15
4-7	Plasticity Chart	4-19
4-8a	Flow Chart to Determine the Group Symbol and Group Name for Fine-Grained Soils	4-21
4-8b	Flow Chart to Determine the Group Symbol and Group Name for Organic Soils	4-22
4-9	Range of Liquid Limit and Plasticity Index for Soils in Groups A-2, A-4, A-5, A-6 and A-7	4-28
5-1	(a) Schematic of SPT	5-3
5-1	(b) Typical Equipment and Set up of SPT (c) Attaching the Safety Hammer Prior to Sampling and Cathead Setup	5-4
5-2	(a) SPT Safety Hammer, (b) SPT Donut Hammer	5-5
5-3	Definition of the Number of Rope Turns and the Angles for (a) Counterclockwise Rotation and (b) Clockwise Rotation of the Cathead	5-6
5-4	Typical Electric Cone Penetrometers	5-7
5-5a	Mechanical (Dutch) Cone Modified to Measure Both Point Resistance ( $q_c$ ) and Skin Friction ( $q_s$ )	5-8
5-5b	Cone Penetration Test Results	5-9
5-6	Electric (Piezo) Friction Cone	5-10
5-7	Self-Contained CPT Truck	5-12
5-8	Interior of CPT Truck	5-12
5-9	Variation of $q_c/N$ -Ratio With Mean Grain Size	5-13
5-10	Field Shear Vanes	5-15
5-11	Schematic View of Vane Shear Device	5-16
5-12	Vane Correction Factor	5-17
5-13	Components of Menard Pressuremeter	5-19
5-14	Typical Pressuremeter and Creep Curves - Menard Type Pressuremeter	5-21
5-15	Self-Boring Pressuremeters (a) PAFSOR, (b) Camkometer	5-22
5-16	Dilatometer and Read-Out Instruments	5-24
5-17	Schematic View of Dilatometer	5-25
5-18	Typical Plate Load Test Set-Up	5-27
5-19	Electrical Resistivity Survey. (a) Wenner Method, (b) Empirical Method for Determination of Resistivity and Thickness of Each Layer	5-29
5-20	Sketch Showing Cross-Hole Technique	5-31
5-21	Parallel Seismic Test. (a) Typical Set-up, (b) Typical Results	5-33
5-22	Schematic Representation of Refraction of Seismic Energy at a Horizontal Interfaces and the Resultant Time-Distance Graph	5-34
5-23	Schematic of a Seismic Cone Penetrometer Probe	5-36
5-24	Drainage Textures. (a) Fine Textured Drainage Pattern, (b) Medium Textured Drainage Pattern, (c) Coarse Textured Drainage Pattern	5-38
5-25a	Drainage Types. (a) Dendritic Drainage Pattern, (b) Pinnate Drainage Pattern, (c) Rectangular Drainage Pattern, (d) Angulate Drainage Pattern	5-39
5-25b	Drainage Types. (e) Trellis Drainage Pattern, (f) Barbed Drainage Pattern, (g) Deranged Drainage Pattern, (h) Parallel Drainage Pattern	5-40
5-25c	Drainage Types. (i) Radial Drainage Pattern, (j) Annular Drainage Pattern, (k) Centripetal Drainage Pattern, (l) Thermokarst Drainage Pattern	5-41

5-26	Gully Shapes . . . . .	5-42
6-1	Typical Details of Observation Well Installations (a) Stand-Pipe Piezometer, (b) Driven Well Point . . . . .	6-3
6-2	Packer-Type Pressure-Test Apparatus for Determining the Permeability of Rock. (a) Schematic Diagram; (b) Detail of Packer Unit . . . . .	6-8
6-3	Layout of Piezometers for a Pumping Test . . . . .	6-10
6-4	Drawdown in an Observation Well Versus Pumping Time (Logarithmic Scale) .	6-12
6-5	Typical Slug Test Procedure . . . . .	6-13
7-1	Typical Grain Size Curve . . . . .	7-10
7-2	Typical Moisture-Density Relationship . . . . .	7-13
7-3	Unconfined Compressive Strength Test . . . . .	7-19
7-4	Mohr Diagram for Unconfined Compressive Test . . . . .	7-18
7-5	Triaxial Test Set-Up . . . . .	7-22
7-6	Mohr Diagram for Undrained Unconsolidated (UU) Triaxial Compression Test .	7-23
7-7	Mohr Diagram (a) Consolidated Drained (CD) Triaxial Test, (b) Consolidated Undrained (CU) Triaxial Test . . . . .	7-23
7-8	Direct Shear Test . . . . .	7-25
7-9	(a) Schematic of a Direct Shear Test Set-up, (b) Typical Results, (c) Determination of Shear Strength Parameters . . . . .	7-25
7-10	(a) Schematic of a Constant Head Test, (b) Schematic of a Falling Head Test . .	7-30
7-11	Flexible Wall Permeability Test . . . . .	7-31
7-12	Schematic View of One-Dimensional Consolidation Test Set-Up . . . . .	7-32
8-1	Point Load Test Apparatus . . . . .	8-3
8-2	(a) Principle of an Uniaxial Compression Test on Rock, (b) Evaluation of Uniaxial Compressive Strength for Intact Rock (subscript IR) with Random Grain Fabric . . . . .	8-4
8-3	(a) Test Set-up for Direct Shear Strength Test, (b) Generalized Shear Stress and Shear Displacement Curve . . . . .	8-5
8-4	Dimensions of Slake Durability Equipment . . . . .	8-7
8-5	Methods for Calculating Young's Modulus from Axial Stress-Axial Strain Curve . . . . .	8-9
8-6	Schematic Diagram of Typical Apparatus . . . . .	8-10
9-1	Relative Density-N-Overburden Stress Relationship for Sands . . . . .	9-3
9-2	Relationship to Correct SPT N-values for Overburden Pressure . . . . .	9-4
9-3	Consolidation Test Relationships . . . . .	9-8
9-4	Compression Ratio Versus Water Content . . . . .	9-9
9-5	Approximate Correlations Between $c_v$ and LL . . . . .	9-10
9-6	Correlation Between $C_{\alpha e}$ and Natural Water Content . . . . .	9-11
9-7	The Permeability of Sands and Gravels . . . . .	9-14
9-8	Relationship Between the Ratio of Undrained Shear Strength to Effective Overburden Pressure and Plasticity Index for Normally- Consolidated Clays . . . . .	9-16
9-9	Relationship Between the Natural Shear Strength of Undisturbed Clays and LI . . . . .	9-17
9-10	Plot of $\beta$ Against Overconsolidation Ratio, OCR . . . . .	9-17



9-11	Approximate Correlations Between Undrained Shear Strength and N-values . . . . .	9-18
9-12	Relationship Between $\phi$ and PI . . . . .	9-19
9-13	Typical Values of $\phi$ and Density for Cohesionless Soils . . . . .	9-20
9-14	Estimation of $\phi$ from N-value . . . . .	9-20
9-15	Relationship Between $\phi$ and Relative Density for Various Sands . . . . .	9-21
10-1	(a) Engineering Classification For Intact Igneous Rocks . . . . .	10-5
10-1 (Contd)	(b) Engineering Classification For Intact Sedimentary Rocks . . . . .	10-6
10-1 (Contd)	(c) Engineering Classification For Intact Limestone and Dolomite . . . . .	10-7
10-1 (Contd)	(d) Engineering Classification For Intact Metamorphic Rocks . . . . .	10-8
10-2	Relationship Between In Situ Modulus and Rock Mass Rating . . . . .	10-9
10-3	Peak and Residual Shear Strength. (a) Failure Envelope for Multiple Incline Surfaces, (b) An Example of a Discontinuity Illustrating First-and Second-order Irregularities . . . . .	10-10
10-4	Roughness Profiles and Corresponding JRC Values . . . . .	10-13
10-5	Relationship Between $J_r$ in the Q System and JRC for 200 mm and 1000 mm Samples . . . . .	10-14
10-6	(a) Shale Rating System, (b) Trends in Shear-Strength Parameters of Compacted Shale Fills as a Function of Shale Quality . . . . .	10-17
11-1	Sample Table of Contents for a Geotechnical Investigation (Data) Report . . . .	11-3
11-2	Sample Table of Contents for a Geotechnical Design Report . . . . .	11-4
11-3	Typical Subsurface Profile . . . . .	11-6

## LIST OF TABLES

<u>No.</u>	<u>Title</u>	<u>Page</u>
2-1	General Guidelines for Geotechnical Field Inspectors . . . . .	2-9
2-2	Minimum Requirements for Boring Depths . . . . .	2-11
2-3	Guidelines for Boring Layout . . . . .	2-13
2-4	List of Equipment for Field Explorations . . . . .	2-14
2-5	Frequently Used AASHTO and ASTM Standards for Field Investigations . . . . .	2-16
3-1	Dimensions of Typical Hollow-Stem Augers . . . . .	3-4
3-2	Dimensions of Drill Rods . . . . .	3-11
3-3	Dimensions of Flush-Joint Casings . . . . .	3-11
3-4	Dimensions of Coring Sizes . . . . .	3-30
4-1	Evaluation of the Apparent Density of Coarse-Grained Soils . . . . .	4-12
4-2	Evaluation of the Consistency of Fine-Grained Soils . . . . .	4-12
4-3	Adjectives to Describe Water Content of Soils . . . . .	4-12
4-4	Particle Size Definition for Gravels and Sands . . . . .	4-14
4-5	Group Symbols for Organic Soils . . . . .	4-14
4-6	Adjectives for Describing Size Distribution for Sands and Gravels . . . . .	4-14
4-7	Soil Classification Chart (Laboratory Method) . . . . .	4-17
4-7 (Contd)	Soil Classification Chart (Laboratory Method) . . . . .	4-18
4-8	Soil Plasticity Descriptions . . . . .	4-20
4-9	Examples of Description of Fine-Grained Soils . . . . .	4-20
4-10	Field Methods to Describe Plasticity . . . . .	4-23
4-11	Descriptive Terms for Layered Soils . . . . .	4-26
4-12	AASHTO Soil Classification System . . . . .	4-27
4-13	Rock Groups and Types . . . . .	4-30
4-14	Terms to Describe Grain Size of (Typically For) Sedimentary Rocks . . . . .	4-32
4-15	Terms to Describe Grain Shape (For Sedimentary Rocks) . . . . .	4-32
4-16	Terms to Describe Stratum Thickness . . . . .	4-32
4-17	Terms to Describe Rock Hardness . . . . .	4-33
4-18	Terms to Classify Discontinuities Based on Aperture Size . . . . .	4-34
5-1	Summary of Common In Situ Tests . . . . .	5-1
5-2	Methods of Borehole Preparation for Menard-Type Pressuremeter . . . . .	5-18
5-3	Typical Menard Pressuremeter Values . . . . .	5-21
6-1	Time Intervals for Reading During Pumping Test . . . . .	6-12
7-1	Common Terms in Weight-Volume Relations . . . . .	7-1
7-2	Weight-Volume Relations . . . . .	7-2
7-3	AASHTO and ASTM Standards for Frequently Used Laboratory Testing of Soils . . . . .	7-5
7-3 (Contd)	AASHTO and ASTM Standards for Frequently Used Laboratory Testing of Soils . . . . .	7-6
7-4	Some Common Errors During Laboratory Testing of Soils . . . . .	7-7
8-1	AASHTO and ASTM Standards for Laboratory Testing of Rock . . . . .	8-2

8-2	Some Common Errors During Laboratory Testing of Rocks . . . . .	8-11
9-1	Typical Soil Unit Weights . . . . .	9-2
9-2	Relative Density of Sand . . . . .	9-3
9-3	Consistency of Clay . . . . .	9-5
9-4	Elastic Constants for Various Soils . . . . .	9-6
9-5	Estimating $E_s$ from N-Value . . . . .	9-6
9-6	Estimating $E_s$ from $c_u$ . . . . .	9-6
9-7	Typical Values of $C_C$ . . . . .	9-9
9-8	Typical Values of Coefficient of Vertical Consolidation, $c_v$ . . . . .	9-10
9-9	Typical Values of $C_{\alpha e}/C_C$ . . . . .	9-11
9-10	Typical Permeability Values for Soils . . . . .	9-13
9-11	Typical Permeability Values for Highway Materials . . . . .	9-14
9-12	Estimating the Shear Strength of Clays . . . . .	9-15
9-13	Average Effective Shear Strength of Compacted Soils . . . . .	9-22
10-1	Representative Range of Dry Unit Weights . . . . .	10-3
10-2	Mechanical Properties of Rock . . . . .	10-3
10-3	Engineering Classification . . . . .	10-4
10-4	Typical Shear Strength Parameters of Intact Rock . . . . .	10-4
10-5	Residual Frictional Shear Strength . . . . .	10-12
10-6	Q System Joint Alteration Number and Residual Shear Strength . . . . .	10-15
10-7	Mohr-Coulomb Shear Strength Parameters for Typical Rock Joints and Fillings . . . . .	10-16
10-8	The Rock Mass Rating System (Geomechanics Classification of Rock Masses) .	10-19
10-8 (Contd)	The Rock Mass Rating System (Geomechanics Classification of Rock Masses) .	10-20
10-9	Guidelines for Classification of Discontinuity Conditions . . . . .	10-21
10-10	Geomechanics Classification for Rock Foundations: Shear Strength Data . . . .	10-22
10-11	Unified Rock Classification . . . . .	10-23
10-12	Slope Rock Mass Rating System (SMR) . . . . .	10-25
10-12 (Contd)	Slope Rock Mass Rating System (SMR) . . . . .	10-26

## LIST OF NOTATIONS

### CHAPTER 2

AASHTO	American Association of State Highway and Transportation Officials
ASTM	American Society for Testing and Materials
$B_f$	Width of footing
$L_f$	Length of footing

### CHAPTER 3

AASHTO	American Association of State Highway and Transportation Officials
ADSC	Association of Drilled Shaft Contractors
AQ Wireline	Designation of rock core barrel, see Table 3-4 (page 3-30)
ASTM	American Society for Testing and Materials
AV	Designation of rock core barrel, see Table 3-4 (page 3-30)
AW	Designation of flush-joint casing, see Table 3-3 (page 3-11)
AW	Designation of drill rod, see Table 3-2 (page 3-11)
AWD3	Designation of rock core barrel, see Table 3-4 (page 3-30)
AWD4	Designation of rock core barrel, see Table 3-4 (page 3-30)
AWM	Designation of rock core barrel, see Table 3-4 (page 3-30)
AX	Designation of drill rod, see Table 3-2 (page 3-11)
AX	Designation of rock core barrel, see Table 3-4 (page 3-30)
BQ Wireline	Designation of rock core barrel, see Table 3-4 (page 3-30)
BQ	Dimension of rock core size, see Table 3-4 (page 3-30)
BV	Designation of rock core barrel, see Table 3-4 (page 3-30)
BW	Designation of flush-joint casing, see Table 3-3 (page 3-11)
BW	Designation of drill rod, see Table 3-2 (page 3-11)
BWC3	Designation of rock core barrel, see Table 3-4 (page 3-30)
BWD3	Designation of rock core barrel, see Table 3-4 (page 3-30)
BWD4	Designation of rock core barrel, see Table 3-4 (page 3-30)
BX	Dimension of rock core size, see Table 3-4 (page 3-30)
BX	Designation of rock core barrel, see Table 3-4 (page 3-30)
BX	Designation of drill rod, see Table 3-2 (page 3-11)
BXB Wireline	Designation of rock core barrel, see Table 3-4 (page 3-30)
CBR	California Bearing Ratio
CP	Designation of rock core barrel, see Table 3-4 (page 3-30)
(C)AXWL	Designation of drill rod, see Table 3-2 (page 3-11)
(C)BXWL	Designation of drill rod, see Table 3-2 (page 3-11)
(C)CPWL	Designation of drill rod, see Table 3-2 (page 3-11)
(C)HCWL	Designation of drill rod, see Table 3-2 (page 3-11)
(C)NXWL	Designation of drill rod, see Table 3-2 (page 3-11)
EW	Designation of flush-joint casing, see Table 3-3 (page 3-11)
EW	Designation of drill rod, see Table 3-2 (page 3-11)
EWD3	Designation of rock core barrel, see Table 3-4 (page 3-30)
EX	Designation of drill rod, see Table 3-2 (page 3-11)
EX	Designation of rock core barrel, see Table 3-4 (page 3-30)
EXM	Designation of rock core barrel, see Table 3-4 (page 3-30)

HQ Wireline	Designation of rock core barrel, see Table 3-4 (page 3-30)
HQ	Dimension of rock core size, see Table 3-4 (page 3-30)
HW	Designation of drill rod, see Table 3-2 (page 3-11)
HW	Designation of flush-joint casing, see Table 3-3 (page 3-11)
HWD3	Designation of rock core barrel, see Table 3-4 (page 3-30)
HWD4	Designation of rock core barrel, see Table 3-4 (page 3-30)
HXB Wireline	Designation of rock core barrel, see Table 3-4 (page 3-30)
ISRM	International Society for Rock Mechanics
L	Length of rock core piece measured from center to center
LFC	Length of fully cylindrical rock core piece
LT	Length of rock core piece measured from tip to tip
(L)AQWL	Designation of drill rod, see Table 3-2 (page 3-11)
(L)BQWL	Designation of drill rod, see Table 3-2 (page 3-11)
(L)HQWL	Designation of drill rod, see Table 3-2 (page 3-11)
(L)NQWL	Designation of drill rod, see Table 3-2 (page 3-11)
(L)PQWL	Designation of drill rod, see Table 3-2 (page 3-11)
NQ	Dimension of rock core size, see Table 3-4 (page 3-30)
NQ Wireline	Designation of rock core barrel, see Table 3-4 (page 3-30)
NV	Designation of rock core barrel, see Table 3-4 (page 3-30)
NW	Designation of drill rod, see Table 3-2 (page 3-11)
NW	Designation of flush-joint casing, see Table 3-3 (page 3-11)
NWC3	Designation of rock core barrel, see Table 3-4 (page 3-30)
NWD3	Designation of rock core barrel, see Table 3-4 (page 3-30)
NWD4	Designation of rock core barrel, see Table 3-4 (page 3-30)
NX	Designation of drill rod, see Table 3-2 (page 3-11)
NX	Designation of rock core barrel, see Table 3-4 (page 3-30)
NX	Dimension of rock core size, see Table 3-4 (page 3-30)
NXB Wireline	Designation of rock core barrel, see Table 3-4 (page 3-30)
PQ Wireline	Designation of rock core barrel, see Table 3-4 (page 3-30)
PQ	Dimension of rock core size, see Table 3-4 (page 3-30)
PW	Designation of flush-joint casing, see Table 3-3 (page 3-11)
R-value	Value of resistance of the soil to lateral deformation when a vertical load acts on it
RQD	Rock Quality Designation
RW	Designation of drill rod, see Table 3-2 (page 3-11)
RW	Designation of flush-joint casing, see Table 3-3 (page 3-11)
SPT	Standard Penetration Test
SW	Designation of flush-joint casing, see Table 3-3 (page 3-11)
UW	Designation of flush-joint casing, see Table 3-3 (page 3-11)
ZW	Designation of flush-joint casing, see Table 3-3 (page 3-11)

#### CHAPTER 4

A	Code for Auger sample to be entered in the "Samples Type" column of boring log
AASHTO	American Association of State Highway and Transportation Officials
ASTM	American Society for Testing and Materials
A-1	Group symbol in the AASHTO soil classification system
A-1-a	Group symbol in the AASHTO soil classification system
A-1-b	Group symbol in the AASHTO soil classification system
A-2	Group symbol in the AASHTO soil classification system

A-2-4	Group symbol in the AASHTO soil classification system
A-2-5	Group symbol in the AASHTO soil classification system
A-2-6	Group symbol in the AASHTO soil classification system
A-2-7	Group symbol in the AASHTO soil classification system
A-3	Group symbol in the AASHTO soil classification system
A-4	Group symbol in the AASHTO soil classification system
A-5	Group symbol in the AASHTO soil classification system
A-6	Group symbol in the AASHTO soil classification system
A-7	Group symbol in the AASHTO soil classification system
A-7-5	Group symbol in the AASHTO soil classification system
A-7-6	Group symbol in the AASHTO soil classification system
B	Bedding (used to describe type of discontinuity in rock core log)
BHS	Code for Borehole shear test to be entered in the "Other Tests" column of boring log
BS	Code for Bulk sample to be entered in the "Samples Type" column of boring log
BX	Rock cored with BX core barrel, which obtains a 41 mm-diameter core
C	Code for Denison or pitcher-type core barrel sample to be entered in the "Samples Type" column of boring log
C	Close (used to describe discontinuity spacing in rock core log)
C	Code for consolidation test to be entered in the "Samples Type" column of boring log
Ca	Calcite (used to describe type of infilling in rock core log)
C <sub>c</sub>	Coefficient of curvature; = $D_{30}^2 / (D_{10} \times D_{60})$ (used for laboratory classification of soils as per Unified Soil Classifications System)
CH	Inorganic clays of high plasticity, fat clays (Group symbol in Unified Soil Classifications System)
Ch	Chlorite (used to describe type of infilling in rock core log)
CL	Inorganic clays of low to medium plasticity, gravelly clays, sandy clays, silty clays, lean clays (Group symbol in Unified Soil Classifications System)
CL	Code for California liner sample to be entered in the "Samples Type" column of boring log (Group symbol in Unified Soil Classifications System)
Cl	Clay (used to describe type of infilling in rock core log)
C <sub>u</sub>	Uniformity coefficient; = $D_{60} / D_{10}$ (used for laboratory classification of soils as per Unified Soil Classifications System)
D	Code for maximum and minimum density test to be entered in the "Samples Type" column of boring log
D <sub>10</sub>	Grain size than which 10% of the sample is smaller
D <sub>30</sub>	Grain size than which 30% of the sample is smaller
D <sub>60</sub>	Grain size than which 60% of the sample is smaller
DMT	Code for dilatometer test to be entered in the "Other Tests" column of boring log
DS	Code for direct shear test to be entered in the "Other Tests" column of boring log
EW	Extremely wide (used to describe discontinuity spacing in rock core log)
F	Friable (term to describe rock hardness)
F	Percent soil passing No. 200 sieve
F	Fault (used to describe type of discontinuity in rock core log)
Fe	Iron oxide (used to describe type of infilling in rock core log)
Fi	Filled (used to describe amount of infilling in rock core log)
Fo	Foliation (used to describe type of discontinuity in rock core log)
FV	Code for field vane shear test to be entered in the boring log
G	Code for Specific gravity test to be entered in the "Samples Type" column of boring log
GC	Clayey gravels, gravel-sand-silt mixtures (Group symbol in Unified Soil Classifications System)

	System)
GI	Group index in the AASHTO soil classification system
GM	Silty gravels, gravel-sand-silt mixtures (Group symbol in Unified Soil Classifications System)
GP	Poorly-graded gravels, gravel-sand mixtures, little or no fines (Group symbol in Unified Soil Classifications System)
GW	Well-graded gravels, gravel-sand mixtures, little or no fines (Group symbol in Unified Soil Classifications System)
Gy	Gypsum/Talc (used to describe type of infilling in rock core log)
H	Healed (used to describe type of infilling in rock core log)
H	Hard (term to describe rock hardness)
Ir	Irregular (used to describe surface shape of joint in rock core log)
I <sub>s</sub>	Point-load index
J	Joint (used to describe type of discontinuity in rock core log)
K	Code for permeability test to be entered in the "Other Tests" column of boring log
LH	Low hardness (term to describe rock hardness)
LL	Liquid Limit
M	Moderate (used to describe discontinuity spacing in rock core log)
M	Mechanical (sieve or hydrometer) analysis
MH	Moderately Hard (term to describe rock hardness)
MH	Inorganic silts, micaceous or diatomaceous fine sandy or silty soils, elastic silts (Group symbol in Unified Soil Classifications System)
ML	Inorganic silts and very fine sands, rock flour, silty or clayey fine sands or clayey silts (Group symbol in Unified Soil Classifications System)
MW	Moderately wide (used to describe discontinuity width in rock core log)
N	SPT blow count
N	Narrow (used to describe discontinuity width in rock core log)
No	None (used to describe amount or type of infilling in rock core log)
NR	No recovery of sample
NX	Rock cored with NX core barrel, which obtains a 53 mm-diameter core
OH	Organic clays of medium to high plasticity, organic salts (Group symbol in Unified Soil Classifications System)
OL	Organic silts and organic silty clays of low plasticity (Group symbol in Unified Soil Classifications System)
P	Code for thin-wall tube sample to be entered in the "Samples Type" column of boring log
Pa	Partially filled (used to describe amount of infilling in rock core log)
PI	= LL - PL ; Plasticity index
Pl	Planar (used to describe surface shape of joint in rock core log)
PMT	Code for pressuremeter test to be entered in the "Other Tests" column of boring log
Ps	Code for piston sample to be entered in the "Samples Type" column of boring log
Pt	Peat and other highly organic soils (Group symbol in Unified Soil Classifications System)
Py	Pyrite (used to describe type of infilling in rock core log)
q <sub>u</sub>	Unconfined compressive strength of clay
Qz	Quartz (used to describe type of infilling in rock core log)
R	Rough (used to describe roughness of surface in rock core log)
RQD	Rock Quality Designation
S	Soft (term to describe rock hardness)
S	Smooth (used to describe roughness of surface in rock core log)
SC	Clayey sands, sand-clay mixtures (Group symbol in Unified Soil Classifications System)

Sd	Sand (used to describe type of infilling in rock core log)
Sh	Shear (used to describe type of discontinuity in rock core log)
Slk	Slickensided (used to describe roughness of surface in rock core log)
SM	Silty sands, sand-silt mixtures (Group symbol in Unified Soil Classifications System)
SP	Poorly-graded sands, gravelly sands, little or no fines (Group symbol in Unified Soil Classifications System)
Sp	Spotty (used to describe amount of infilling in rock core log)
SR	Slightly rough (used to describe roughness of surface in rock core log)
SS	Code for standard spoon sample to be entered in the "Samples Type" column of boring log
St	Stepped (used to describe surface shape of joint in rock core log)
Su	Surface stain (used to describe amount of infilling in rock core log)
SW	Well-graded sands, gravelly sands, little or no fines (Group symbol in Unified Soil Classifications System)
T	Code for triaxial compression test to be entered in the "Other Tests" column of boring log
T	Tight (used to describe discontinuity width in rock core log)
TV	Code for torvane shear test to be entered in the "Other Tests" column of boring log
U	Code for unconfined compression test to be entered in the "Other Tests" column of boring log
USCS	Unified Soil Classification System
V	Vein (used to describe type of discontinuity in rock core log)
VC	Very close (used to describe discontinuity spacing in rock core log)
VH	Very hard (term to describe rock hardness)
VN	Very narrow (used to describe discontinuity width in rock core log)
VR	Very rough (used to describe roughness of surface in rock core log)
W	Wide (used to describe discontinuity width in rock core log)
W	Code for unit weight and natural moisture content to be entered in the "Other Tests" column of boring log
Wa	Wavy (used to describe surface shape of joint in rock core log)
X	Code for special tests performed to be entered in the "Other Tests" column of boring log

## CHAPTER 5

A	Pressure required to cause Dilatometer diaphragm to just lift-off
AASHTO	American Association of State Highway and Transportation Officials
ASTM	American Society for Testing and Materials
AW	Designation of drill rod (see Chapter 3, Table 3-2, page 3-11 for dimensions)
B	Pressure required to cause 1.1 mm deflection of the diaphragm at its center
C	Pressure required to seal the diaphragm again
CPT	Cone Penetration Test
d	Distance between electrodes
D <sub>1</sub>	Outside diameter of the samples used for SPT
DMT	Dilatometer Test
E <sub>D</sub>	Dilatometer Modulus
E <sub>M</sub>	Menard modulus
EROS	Earth Resources Observations Systems
FVT	Field Vane Shear Test
GPR	Ground Penetrating Radar
H <sub>1</sub>	Height of free fall of hammer during SPT



$I_D$	Material or deposit index
$K_D$	Lateral stress index
$K_o$	Coefficient of at-rest lateral earth pressure
$L_1$	Depth of penetration of samples during SPT
$N$	Standard Penetration Test N-value
NC	Normally Consolidated
$N_{NON-STANDARD}$	Actual blow count measured in the field using non-standard equipment or procedure
$N_{SPT}$	Standard Penetration Test N-value standardized for $W_1$ , $H_1$ , $D_1$ , and $L_1$
NW	Designation of drill rod (see Chapter 3, Table 3-2, page 3-11 for dimensions)
OC	Overconsolidated
$p_1$	Pressure B corrected for diaphragm stiffness
$p_f$	Creep pressure during Menard's pressuremeter test
PI	Plasticity Index
$p_l$	Limit pressure during Menard's pressuremeter test
PMT	Pressuremeter Test
$p_o$	Pressure A corrected for diaphragm stiffness
$p_o$	Pressure corresponding to volume $v_o$ during Menard's pressuremeter test
$q_c$	Cone tip resistance during CPT
$q_s$	Cone sleeve friction during CPT
$q_t$	Total cone resistance ( $= q_c + q_s$ ) during CPT
SLAR	Side Looking Airborne Radar
SPT	Standard Penetration Test
$t$	Time
$u_o$	In situ pore water pressure
V	Potential drop
$v_c$	Initial volume of probe during Menard's pressuremeter test
$v_f$	volume corresponding to creep pressure $p_f$ during Menard's pressuremeter test
$v_m$	$(v_o + v_f)$ during Menard's pressuremeter test
$v_o$	Difference between the volume of the hole and $v_c$
$W_1$	Weight of hammer used for SPT
X	Distance
z	Depth
$\sigma'_v$	Effective overburden pressure
$(\tau_u)_{corr}$	Corrected vane shear strength
$(\tau_u)_{field}$	Vane shear strength measured in the field
$\mu$	Correction factor to convert $(\tau_u)_{field}$ to $(\tau_u)_{corr}$ ; related to PI of soil
$\nu$	Poisson's ratio
$\rho$	Resistivity; $= 2\pi dV/I$
$\sum\rho$	The sum of the apparent resistivities

## CHAPTER 6

AASHTO	American Association of State Highway and Transportation Officials
ASTM	American Society for Testing and Materials
H	Differential head of pressure on the test section
k	Apparent permeability
L	Length of test section
P	Piezometer

PVC	Poly-vinyl chloride
Q	Constant rate of flow of water into the hole
r	Radius of the test borehole

## CHAPTER 7

A	Cross-sectional area of soil sample
AASHTO	American Association of State Highway and Transportation Officials
ASTM	American Society for Testing and Materials
CBR	California Bearing Ratio
$C_c$	Coefficient of curvature; $= D_{30}^2 / (D_{10} \times D_{60})$
CD	Consolidated Drained
CU	Consolidated Undrained
$C_u$	Uniformity coefficient; $= D_{60} / D_{10}$
$c_u$	Total cohesive strength of the soil
D	Apparent diameter of the soil particles
D	Dimensionless
d	Depth
$D_{10}$	Grain size than which 10% of the sample is smaller
$D_{30}$	Grain size than which 30% of the sample is smaller
$D_{60}$	Grain size than which 60% of the sample is smaller
$D_{85}$	Grain size than which 85% of the sample is smaller
$D_r$	Relative density of soil
DSS	Direct Simple Shear
e	Void ratio
$e_{max}$	Void ratio of soil in its loosest state
$e_{min}$	Void ratio of soil in its densest state
$G_s$	Specific gravity of soil solids
$h_1, h_2$	Heads at times $t_1$ and $t_2$ , respectively
k	Coefficient of permeability
L	Length of soil sample
LL	Liquid Limit
n	Porosity
NGI	Norwegian Geotechnical Institute
OMC	Optimum Moisture Content
P	Normal force on soil in a Direct Shear Test
PI	Plastic Index; $= LL - PL$
PL	Plastic Limit
Q	Total discharge volume
$q_u$	Unconfined compressive strength of soil
S	Degree of saturation of soil
SL	Shrinkage limit
T	Shear force on soil in a Direct Shear Test
u	Pore pressure
UU	Undrained Unconsolidated
w	Natural moisture content
$\sigma'_v$	Effective overburden pressure
$\gamma'$	Buoyant or effective unit weight

$\gamma$	Unit weight of soil
$\gamma_d$	Dry unit weight of soil in its natural state
$\gamma_{dmax}$	Dry unit weight of soil in its densest state
$\gamma_{dmin}$	Dry unit weight of soil in its loosest state
$\gamma_t$	Total unit weight of soil
$\gamma_w$	Unit weight of water ( 9.81 kN/m <sup>3</sup> )
$\delta$	Horizontal movement of soil mass in a Direct Shear Test
$\Delta H$	Vertical movement of soil mass in a Direct Shear Test
$\Delta p$	Additional loading due to foundation or embankment construction
$\Delta t$	Time for standpipe head to fall from $h_1$ to $h_2$
$\sigma'$	Effective stress
$\sigma$	Normal stress
$\sigma_1$	Total major principal stress
$\sigma_3$	Total minor principal stress
$\sigma_v$	Total overburden pressure
$\tau$	Shear stress
$\phi$	Angle of internal friction

## CHAPTER 8

A	Loaded area
AASHTO	American Association of State Highway and Transportation Officials
ASTM	American Society for Testing and Materials
D	Original diameter of rock sample
$E_{av}$	Average Young's Modulus
$E_s$	Secant Young's Modulus
$E_t$	Tangent Young's Modulus
H	Original height of rock sample
$I_{a(50)}$	Anisotropic point load strength index of rock specimen
$I_{s(50)}$	Point load strength index of rock specimen
ISRM	International Society for Rock Mechanics
N	Normal force on plane
SDI	Slake Durability Index
T	Shear force on plane
$\Delta \epsilon_a$	Change in axial strain
$\Delta \sigma$	Change in applied axial stress
$\Delta D$	Change in diameter of rock sample
$\Delta H$	Change in height of rock sample
$\epsilon_a, \epsilon_{axial}$	Axial strain in rock sample ( $\Delta H/H$ )
$\epsilon_{radial}$	Radial strain in rock sample ( $\Delta D/D$ )
$\sigma_1, \sigma_2, \sigma_3$	Major, intermediate and minor total principal stresses
$\sigma_{CIR}$	Uniaxial compressive strength of Intact Rock
$\sigma_u$	Applied axial stress

## CHAPTER 9

AASHTO	American Association of State Highway and Transportation Officials
ASTM	American Society for Testing and Materials

$p_o'$	In situ effective overburden pressure of soil
$(c_u / \sigma_v')_{nc}$	Ratio of undrained shear strength to effective overburden pressure for normally consolidated soil
$\sigma_{vo}' , \sigma_v'$	Effective overburden pressure
$c_{cu}'$	Drained or effective cohesion of soil from CU test with pore pressure measurements
$(c_u / \sigma_v')_{oc}$	Ratio of undrained shear strength to effective overburden pressure for overconsolidated soil
$c$	Shape factor
$c'$	Drained or effective cohesion of soil from drained test
$C_{\alpha}$	Coefficient of secondary consolidation
$C_{\alpha e}$	Coefficient of secondary compression in terms of strain
$C_{\alpha c}$	Coefficient of secondary compression in terms of void ratio
$C_1$	Hazen's coefficient
$C_c$	Compression index
CH	Inorganic clays of high plasticity
$c_h$	Coefficient of horizontal consolidation
CL	Inorganic clays of low to medium plasticity
$c_o$	Cohesion of as-compacted soil
CR	Compression Ratio
$C_r$	Recompression Index
$c_{sat}$	Cohesion of saturated soil
$C_u$	Uniformity coefficient; $= D_{60} / D_{10}$
$c_u$	Undrained shear strength
$c_v$	Coefficient of vertical consolidation
$d$	Primary consolidation at a specific load level
$D_{10}$	Grain size than which 10% of the sample is smaller
$D_{30}$	Grain size than which 30% of the sample is smaller
$D_5$	Grain size than which 5% of the sample is finer
$D_{60}$	Grain size than which 60% of the sample is smaller
$D_{max}$	Largest grain size in soil sample
$D_{min}$	Smallest grain size in soil sample
$D_r$	Relative density of soil
$D_s$	Effective particle diameter
$e$	Void ratio of soil
$e_f$	Final void ratio
$e_{max}$	Void ratio of soil in its loosest state
$e_{min}$	Void ratio of soil in its densest state
$e_o$	Initial void ratio of sample
$e_r$	Void ratio at beginning of rebound
$E_s$	Secant Young's Modulus
GC	Clayey gravels, poorly graded gravel-sand-clay
GM	Silty gravels, poorly graded gravel-sand-silt
GP	Poorly graded clean gravels, gravel-sand mixture
$G_s$	Specific gravity of soil solids
GW	Well graded clean gravels, gravel-sand mixture
H	Half height of consolidation sample (Length of longest drainage path)

k	Coefficient of permeability
LI	Liquidity Index
LL	Liquid Limit
MH	Inorganic clayey silts, elastic silts
ML	Inorganic silts and clayey silts
ML-CL	Mixtures of inorganic silts and clays
N	Standard Penetration Test N-value measured in blows/300 mm
$N_1$	N-value corrected for effective overburden pressure
$N_{corr}$	N-value of saturated fine or silty sands corrected for pore pressure
$N_{field}$	N-value measured in the field
OCR	Overconsolidation Ratio
OH	Organic clays and silty clays
OL	Organic silts and silty clays of low plasticity
$p_c$	Pre-consolidation pressure
PI	Plasticity Index
PL	Plastic Limit
$q_u$	Unconfined compressive strength
RR	Recompression Ratio
SC	Clayey sands, poorly graded sand-clay mixture
SM	Silty sands, poorly graded sand-silt mixture
SM-SC	Sand-silt-clay with slightly plastic fines
SP	Poorly graded clean sands, sand-gravel mixture
SW	Well graded clean sands, gravelly sands
$t_{100}$	Time required for 100% consolidation at a specific load level
$t_{50}$	Time required for 50% consolidation at a specific load level
$W_n$	Natural water content
$\phi'_{cu}$	Drained or effective friction angle of soil from CU test with pore pressure measurements
$\beta$	$(c_u / \sigma'_v)_{oc} / (c_u / \sigma'_v)_{nc}$
$\gamma$	Unit weight of the permeant
$\gamma_d, \gamma_{dry}$	Dry unit weight of soil
$\gamma_{sat}$	Saturated unit weight of soil
$\gamma_w$	Unit weight of water
$\Delta e$	Change in void ratio over $\Delta p$
$\Delta p$	Change in pressure
$\mu$	Viscosity of the permeant
$\nu$	Poisson's ratio
$\phi'$	Drained or effective friction angle of soil from drained test
$\phi_d$	Drained friction angle
$\phi_r$	Residual friction angle
$\phi_u$	Undrained angle of internal friction

## CHAPTER 10

$c, c'$	Cohesion of rock
CDS	Completely Decomposed State
E	Deformation Modulus
$E_m$	In-situ modulus of deformation
$E_t$	Tangent Young's modulus of rock specimen

f	Shear wave frequency
H	High modulus ratio
i	Angle of irregularities with average dip line
$I_{d2}$	Slake-Durability Index
$I_p$ , PI	Plasticity Index
$I_s$	Point load strength
$I_{s(50)}$	Point Load Strength
$J_a$	Joint alteration number in the Q System
JCS	Joint wall Compressive Strength
$J_r$	Joint roughness coefficient in the Q System
JRS	Joint Roughness Coefficient
$J_v$	Number of joints in unit volume of rock
L	Low modulus ratio
LPS	Latent Planes of Separation
M	Average modulus ratio
MFS	Micro Fresh State
N	Normal load
P	Plane failure
PDS	Partly Decomposed State
PLT	Point Load Test
$q_u$	Uniaxial compressive strength of rock
R	Shale rating
RMR	Rock Mass Rating
RQD	Rock Quality Designation
S	Shear force
SDI	Slake Durability Index
SMR	Slope rock Mass Rating
SPB	Preferred Breakage
SRB	Random Breakage
SRS	Shale Rating System
STS	Stained State
T	Topping failure
VFS	Visually Fresh State
$\alpha_j$	Joint dip direction
$\alpha_s$	Slope dip direction
$\beta$	Average dip angle of rock bedding
$\beta_j$	Joint dip
$\beta_s$	Slope dip
$\sigma_{a(ult)}$	Uniaxial compressive strength of rock
$\sigma_n$	Normal stress on joint
$\phi, \phi'$	Friction angle of rock
$\phi_r$	Residual friction angle

## **CHAPTER 1.0 INTRODUCTION**

### **1.1 SCOPE OF THIS MANUAL**

All transportation systems are built either on earth, in earth and/or with earth. To the transportation facility designer and builder, earth materials (soil and rock) not only form the foundation for their structures but they also constitute a large portion of the construction materials.

Unlike manufactured construction materials, the properties of soil and rock are the results of the natural processes that have formed them, and natural or man made events following their formation. The replacement of inferior foundation materials often is impractical and uneconomical. The large volume of soil and rock needed for construction of transportation facilities, as a rule, makes it prohibitive to manufacture and transport pre-engineered materials. The geotechnical engineer in designing and constructing transportation facilities is faced with the challenge of using the foundation and construction materials available on or near the project site. Therefore, the designing and building of such structures requires a thorough understanding of properties of available soils and rocks that will constitute the foundation and other components of the structures.

This manual presents the general state of the practice of subsurface exploration and focuses on the scope and specific elements of typical geotechnical investigation programs for design and construction of highways and related transportation facilities. The manual presents the latest methodologies in the planning, execution and interpretation of the various subsurface investigation methods, and the development of appropriate soil and rock parameters for engineering applications. It is understood that the procedures discussed in the manual are subject to local variations. It is important, therefore, for the reader to become thoroughly familiar with the local practices as well.

It must be pointed out that the term structure in this course and manual is used to imply engineered, constructed facilities such as embankments, pavements, bridges and others.

### **1.2 GEOTECHNICAL ENGINEER'S ROLE IN SUBSURFACE EXPLORATION**

The geotechnical engineer's<sup>1</sup> role in design and construction varies according to the distribution of responsibilities in an organization. Nevertheless, by definition, the geotechnical engineer, among others, is responsible for acquiring and interpreting soil, rock and foundation data for design and construction of various types of structures. The proper execution of this role requires a thorough understanding of the principles and practice of geotechnical engineering, subsurface investigation techniques and principles, design procedures, construction methods and planned facility utilization supplemented with a working knowledge of geology and hydrology.

The proper discharge of the geotechnical engineer's duties requires that he or she be involved from the very beginning of the planning stage of a project. A geotechnical engineer may provide, based on prior knowledge and research for example, guidance in the location of a proposed tunnel or road which may result in reduced cost, improved constructibility and other advantages. When the services of the geotechnical engineer are introduced into the project after the final project location is determined, a very

---

<sup>1</sup> The term geotechnical engineering in this manual also applies to engineering geologists who get involved in subsurface investigations for civil engineering applications.

important value engineering benefit may be missed.

Once the project location, geometry and other attributes are determined, the geotechnical engineer and the design team should jointly define the subsurface exploration needs. The geotechnical engineer should be given the responsibility and the authority to make decisions involving the details of the subsurface investigation based on his or her knowledge of the site conditions and on information gathered during the construction. It is the responsibility of the geotechnical engineer to direct the collection of existing data, to conduct field reconnaissance, to initiate the subsurface investigation, and to review its progress. When unusual or unexpected conditions are encountered during the investigation, the field geotechnical engineer should communicate these findings to the design engineer, make recommendations and implement changes as needed.

Once the samples are obtained, the geotechnical engineer must visually examine all or a representative number of the samples to have a "feel" of the material properties as a tool for determining the adequacy of the investigative program. This is an often ignored practice that may lead to misunderstandings and costly errors. Once the field investigation has progressed sufficiently to define the general stratigraphy and subsurface materials at the site, a project and site specific testing program can be initiated.

Having obtained the data from the field investigation and laboratory testing program, the focus of the geotechnical engineer's efforts turn to the reduction and evaluation of these data, the definition of subsurface stratification and groundwater conditions, the development of appropriate soil and rock design parameters, and the presentation of the investigation findings in a geotechnical report. The geotechnical engineer uses this acquired subsurface information in the analysis and design of foundations and other geotechnical elements of a highway project.



## **CHAPTER 2.0 PROJECT INITIATION**

### **2.1 PROJECT TYPE**

#### **2.1.1 New Construction**

In general there are two types of subsurface investigation that new construction may require; the first being a conceptual subsurface investigation, or route selection study, where the geotechnical engineer is asked by the designers to identify the best of several possible routes or locations for the proposed structures, or to evaluate foundation alternatives. This type of project generally does not require a detailed subsurface investigation. It is normally limited to geologic reconnaissance and some sampling, field identification of subsurface conditions to achieve generalized site characterization, and general observations such as the presence of solution cavities, organic deposits in low lying areas, and the depth of rock or competent soils, etc. Conceptual study investigations require limited laboratory testing and largely depend on the description of subsurface conditions from boring logs prepared by an experienced field engineer and/or geologist. Properly performed exploratory investigations, in cases where the designers have flexibility in locating the project to take advantage of favorable subsurface conditions, have the potential for resulting in substantial savings by avoiding problematic foundation conditions and costly construction methods.

The second and more common type of subsurface investigation is the detailed investigation to be performed for the purpose of detailed site characterization to be used for the design of the structures. Frequently, the design phase investigation is performed in two or more stages. The initial, or preliminary design, stage investigation is typically performed early in the design process prior to defining the proposed structure elements or the specific locations of foundations, embankments or earth retaining structures. Accordingly, the preliminary design investigation typically includes a limited number of borings and testing sufficient for defining the general stratigraphy, soil and rock characteristics, groundwater conditions, and other existing features of importance to foundation design. Subsequently, after the location of structure foundations and other design elements have been determined, a second, or final design, phase investigation is frequently performed to obtain site specific subsurface information at the final substructure locations for design purposes and to reduce the risk of unanticipated ground conditions during construction. Further investigation stages can be considered if there are significant design changes or if local subsurface anomalies warrant further study. When properly planned, this type of multi-phase investigation provides sufficient and timely subsurface information for each stage of design while limiting the risk and cost of unnecessary explorations.

Prior to planning and initiating the investigation, the geotechnical engineer needs to obtain from the designers the type, load and performance criteria, location, geometry and elevations of the proposed facilities. The locations and dimensions of cuts and fills, embankments, retaining structures, and substructure elements should be identified as accurately as practicable. Bridge locations, approaches, and types of bridge construction should be provided in sufficient detail to allow a determination of the location, depth, type and number of borings to be performed. In cases where the investigation is being done for buildings, such as toll plazas, tourist information centers, and recreational or rest facilities, the designers should provide the location and the footprint of the building, the location of columns, if any, and building or column loads.

### 2.1.2 Rehabilitation Projects

The detail required for the subsurface investigation of rehabilitation projects (Figure 2-1) depends on a number of variables, including:

- The condition of the facility to be rehabilitated.
- If the facility is distressed, the nature of distress (pavement failure, deep seated failures, structure settlement, slides, etc.)
- Whether the facility will be returned to its original, as-built, condition or will be upgraded, say adding another lane to a pavement or a bridge.
- If facilities will be upgraded, the proposed geometry, location, loadings and structure changes (i.e. culvert to bridge).
- The required design life of the rehabilitated facility.

The above information should be obtained to aid in planning an appropriate investigation program.

### 2.1.3 Contaminated Sites

The geotechnical engineer occasionally must perform subsurface investigations at sites with contaminated soils or groundwater. Contamination may be of a non-hazardous or hazardous nature. Sampling and handling of contaminated samples is a complicated topic which is beyond the scope of this course. However, it is necessary for all involved in geotechnical investigations to be aware of the salient points of these procedures. The US Environmental Protection Agency (EPA) document number 625/12-91/002 titled "Description and Sampling of Contaminated Soils - A Field Pocket Guide" contains guidelines and background information, and a list of useful references on the topic.

When an investigation is to be performed, acquisition records for newly obtained right-of-way (ROW) will indicate the most recent land use for the area. Furthermore, the environmental section of the agency will most probably have developed environmental impact statements (EIS) and will have identified contaminated areas and the type of contamination. The ROW and environmental sections of the agency should be routinely contacted for this information at the investigation planning stage. On rehabilitation projects where the only planned activities will be on the existing ROW the information available may vary from very complete to none. Old gravel or compacted soil roads have occasionally been constructed using waste products as dust palliatives, and where these roads were later covered with, say bituminous hot mix concrete, the subsurface exploration may encounter layers of contaminated soils. Also, there may be a risk of contaminant migration through groundwater movement from off-site sources.

Some signs of possible contamination are:

- Prior land use (e.g. landfills, gas stations, etc.).
- Stained soil or rock.
- Apparent lack of vegetation or presence of dead vegetation and trees.

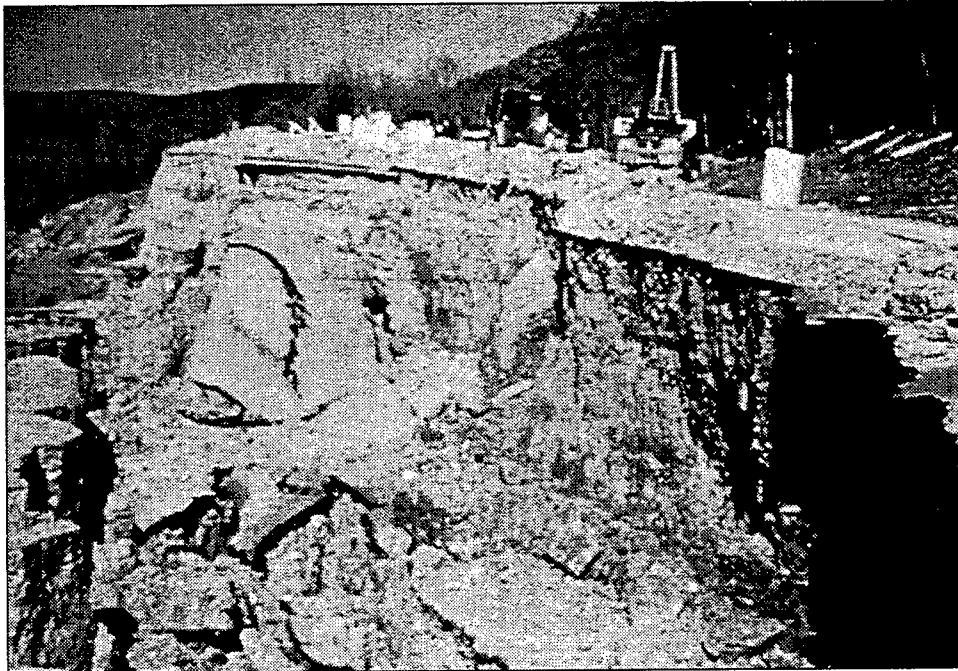

Figure 2-1: Embankment Slope Failure.

- Odors (It should be noted that highly organic soils often will have a rotten egg odor which should not be construed as evidence of contamination. However, this odor may also be indicative of highly toxic hydrogen sulfide. Drilling crews should be instructed as such).
- Presence of liquids other than groundwater or pore water.
- Signs of prior ground fires (at landfill sites). Established landfills will emit methane gas which is colorless and odorless, and in high concentrations in the presence of sparks or fire it will explode. At low concentrations under certain conditions (i.e. lightning) it will burn. Areas containing natural organic deposits also produce and emit methane gas.
- Presence of visible elemental metals (i.e., mercury).
- Low (<2.5) or High (>12.5) pH.

Easy to use field testing equipment such as air quality monitoring devices, pH measurement kits, photoionization detectors, etc. can be used to perform preliminary tests to identify the presence of some contaminants.

EPA documents provide guidelines and protocols for sampling, packaging, and transporting of contaminated soils as well as for field and laboratory testing. Additionally, many states have developed their own protocols, some of which are stricter than the ones developed by EPA. These documents need to be consulted prior to any attempt to sample or test suspect materials.

In most environmental applications, the US Department of Agriculture Soil Conservation Service (SCS) taxonomy rather than geotechnical engineering classifications are applied. A complete reference work to SCS soil taxonomy is "The Agricultural Handbook No. 18" published by the Soil Conservation Service, Washington, D.C. Copies of this handbook can be obtained through state or regional offices of SCS.

## 2.2 EXISTING DATA SOURCES

The first step in the investigation process is the review of existing data. There are a number of very helpful sources of data that can and should be used in planning subsurface investigations. Review of this information can often minimize surprises in the field, assist in determining boring locations and depths, and provide very valuable geologic and historical information which may have to be included in the geotechnical report.

Following is a partial list of useful sources of geological, historical and topographic information. Specific information available from these and other reference sources is presented in the U.S. Navy Design Manual 7.1 (1982).

- Prior subsurface investigations (historical data) at or near the project site.
- Prior construction and records of structural performance problems at the site (i.e. pile length/capacity problems, rock slides, excessive seepage, unpredicted settlement, etc.). Some of this information may only be available in anecdotal forms. The more serious ones should be investigated, documented if possible, and evaluated by the engineer.
- U.S. Geological Survey maps, reports and publications.

- State Geological Survey maps, reports and publications.
- State flood zone maps prepared by state or US Geological survey or FEMA can be obtained from local or regional offices of these agencies.
- Department of Agriculture SCS Soil Maps - A list of published soil surveys is issued annually. It should be noted that these are well researched maps but they only provide detailed information for surficial deposits. They may show frost penetration depths, drainage characteristics, etc.
- Geological Societies (Association of Engineering Geologists, Association of American State Geologists).
- Local university libraries and geology departments.
- Public Libraries and the Library of Congress.
- Earthquake data, seismicity, fault maps, etc. prepared by
  - U.S. Geological Survey
  - Earthquake Engineering Research Center (EERC), University of California, Berkeley.
  - Earthquake Engineering Research Institute (EERI), Stanford University
  - National Earthquake Engineering Research Program (NEERP), Washington, D.C.
  - National Center of Earthquake Engineering Research (NCEER), Rochester, N.Y.
  - Advanced Technology Council (ATC), Redwood City, California
- Worldwide National Earth-Science Agencies (USGS Circular 716, 1975).
- U.S. Bureau of Mines
- State and County Road Maps
- Aerial Photographs (USGS, US SCS, Earth Resource Observation System).
- Remote Sensing Images (LANDSAT, Skylab, NASA).
- Site Plans showing location of ditches, driveways, culverts, utilities, etc.
- Maps of streams, rivers and other water bodies to be crossed by bridges, culverts, etc., including bathimetric data.

The majority of the above information can be obtained from commercial sources (i.e. duplicating services) or U.S. and state government local or regional offices. Specific sources (toll free phone numbers, addresses etc.) for flood and geologic maps, aerial photographs, USDA soil surveys, can very quickly identified through the Internet.

### **2.3 SITE VISIT/PLAN-IN-HAND**

It is imperative that the geotechnical engineer, and if possible the project design engineer, conducts a reconnaissance visit to the project site to develop an appreciation of the geotechnical, topographic, and geological features of the site and become knowledgeable of access and working conditions. The plan-in-

hand site visit is a good opportunity to learn about:

- Design and construction plans
- General site conditions
- Geologic reconnaissance
- The geomorphology
- Access restrictions for equipment
- Traffic control requirements during field investigations
- Location of underground and overhead utilities
- Type and condition of existing facilities (i.e. pavements, bridges, etc.)
- Adjacent land use (schools, churches, research facilities, etc.)
- Restrictions on working hours
- Right-of-way constraints
- Environmental issues
- Escarpments, outcrops, erosion features, and surface settlement
- Flood levels
- Water traffic and access to water boring sites
- Benchmarks and other reference points to aid in the location of boreholes
- Equipment storage areas/security

#### **2.4 COMMUNICATION WITH DESIGNERS/PROJECT MANAGERS**

The geotechnical engineer should have periodic discussions with the field inspector while the investigation program is ongoing. He or she should notify the project or the design engineer of any unusual conditions or difficulties encountered, and any changes made in the investigation program or schedule. The frequency of these communications depends on the critical nature of the project, and on the nature and seriousness of the problems encountered.

Figure 2-2 illustrates a useful Field Instructions form which can be used to clearly communicate the general requirements of the investigation program to all field personnel, and to present useful contact phone numbers.

**PROJECT INFORMATION:**

Project No.: \_\_\_\_\_

Name: \_\_\_\_\_

Location: \_\_\_\_\_

Site Contact (Project Engineer): \_\_\_\_\_ Phone: \_\_\_\_\_

Utility Contact: \_\_\_\_\_ Reference No.: \_\_\_\_\_

Right of Entry Contact: \_\_\_\_\_

Other Contact (specify): \_\_\_\_\_ Home Phone: \_\_\_\_\_

Estimated Time: \_\_\_\_\_

**BORING INFORMATION**

Boring No.	Depth	Drilling Sequence	Sampling	Remarks (piezometers, water levels, etc.)

Health and Safety Provisions: Special Plan: \_\_\_\_\_

Sample type, frequency: \_\_\_\_\_

Disposal of Cuttings/Drill Fluids: \_\_\_\_\_

Boring Closure: Cuttings: \_\_\_\_\_ Grout: \_\_\_\_\_

Remarks: \_\_\_\_\_

\_\_\_\_\_

\_\_\_\_\_

\_\_\_\_\_

\_\_\_\_\_

\_\_\_\_\_

\_\_\_\_\_

\_\_\_\_\_

\_\_\_\_\_

\_\_\_\_\_

\_\_\_\_\_

Figure 2-2: Form for Field Instructions.

## 2.5 SUBSURFACE EXPLORATION PLANNING

Following the collection and evaluation of available information from the above sources, the geotechnical engineer is ready to plan the field exploration program. The field exploration methods, sampling requirements, and types and frequency of field tests to be performed will be determined based on the existing subsurface information, project design requirements, the availability of equipment, and local practice. The geotechnical engineer should develop the overall investigation plan to enable him or her to obtain the data needed to define subsurface conditions and perform engineering analyses and design. A geologist can often provide valuable input regarding the type, age and depositional environment of the geologic formations present at the site for use in planning and interpreting the site conditions.

Frequently, the investigation program must be modified after initiating the field work because of site access constraints or to address variations in subsurface conditions identified as the work proceeds. To assure that the necessary and appropriate modifications are made to the investigation program, it is particularly important that the field inspector (preferably a geotechnical engineer or geologist) be thoroughly briefed in advance regarding the nature of the project, the purpose of the investigation, the sampling and testing requirements, and the anticipated subsurface conditions. The field inspector is responsible for verifying that the work is performed in accordance with the program plan, for communicating the progress of the work to the project geotechnical engineer, and for immediately informing the geotechnical engineer of any unusual subsurface conditions or required changes to the field investigation. Table 2-1 lists the general guidelines to be followed by the geotechnical field inspectors.

### 2.5.1 Types of Investigation

Generally, there are five types of field subsurface investigation methods:

1. Disturbed sampling
2. Undisturbed sampling
3. In situ investigation
4. Geophysical investigation
5. Remote sensing

#### **Disturbed Sampling**

Disturbed samples are generally obtained to determine the soil type, gradation, classification, consistency, density, presence of contaminants, stratification, etc. The methods for obtaining disturbed samples vary from hand excavating of materials with picks and shovels to using truck mounted augers and other rotary drilling techniques. These samples are considered “disturbed” since the sampling process modifies their natural structure.

#### **Undisturbed Sampling**

Undisturbed samples are used to determine the in place strength, compressibility (settlement), natural moisture content, unit weight, permeability, discontinuities, fractures and fissures of subsurface deposits. Even though such samples are designated as “undisturbed,” in reality they are disturbed to varying degrees. The degree of disturbance depends on the type of subsurface materials, type and condition of the sampling equipment used, the skill of the drillers, and the storage and transportation methods used. **As will be discussed later, serious and costly inaccuracies may be introduced into the design if proper protocol and care is not exercised during recovery, transporting or storing of the samples.**



**TABLE 2-1**  
**GENERAL GUIDELINES FOR GEOTECHNICAL FIELD INSPECTORS**

---

---

Thoroughly comprehend purpose of field work ( i.e. to characterize the site for the intended engineering applications.)

- Be thoroughly familiar with the scope of the project, technical specifications and pay items (keep a copy of the boring location plan and specifications in the field).
  - Be familiar with site and access conditions and any restrictions.
  - Review existing subsurface and geologic information before leaving the office.
  - Constantly review the field data obtained as it relates to the purpose of the investigation.
  - Maintain daily contact with the geotechnical project engineer; brief him/her regarding work progress, conditions encountered, problems, etc.
  - Fill out forms regularly (obtain sufficient supply of forms, envelopes, stamps if needed before going to the field). Typical forms may include:
    - Daily field memos
    - Logs of borings, test pits, well installation, etc.
    - Subcontract expense report - fill out daily, co-sign with driller
  - Closely observe the driller's work at all times, paying particular attention to:
    - Current depth (measure length of rods and samplers)
    - Drilling and sampling procedures
    - Any irregularities, loss of water, drop of rods, etc.
    - Count the SPT blows and blows on casing
    - Measure depth to groundwater and note degree of sample moisture
  - Do not hesitate to question the driller or direct him to follow the specifications
  - Classify soil and rock samples; put soil samples in jars and label them; make sure rock cores are properly boxed, photographed, stored and protected.
  - Verify that undisturbed samples are properly taken, handled, sealed, labeled and transported.
  - Do not divulge information to anyone unless cleared by the geotechnical project engineer or the project manager.
  - Bring necessary tools to job (see Table 2-4).
  - Take some extra jars of soil samples back to the office for future reference.
  - Do not hesitate to stop work and call the geotechnical project engineer if you are in doubt or if problems are encountered.
  - **ALWAYS REMEMBER THAT THE FIELD DATA ARE THE BASIS OF ALL SUBSEQUENT ENGINEERING DECISIONS AND AS SUCH ARE OF PARAMOUNT IMPORTANCE.**
- 
-

## **In situ Investigation**

In situ testing and geophysical methods can be used to supplement the above types of borings. Some in situ testing devices, such as electronic cone penetrometer tests (CPT), besides being able to provide accurate data on subsurface soils by reducing disturbance associated with sampling and handling of soil samples, they can do so on a real time basis. Certain characteristics such as strength and skin friction as well as piezometric data can be obtained as the CPT progresses in the field. Since all measurements are done during the field operations and there are no laboratory samples to be tested, considerable time and cost savings may result from the use of in situ methods. In situ methods can be particularly effective when they are used in conjunction with conventional sampling to reduce the cost and the time for field work. These tests provide a host of subsurface information in addition to developing more refined correlations between conventional sampling, testing and in situ soil parameters.

## **Geophysical Investigation**

Some of the more commonly used geophysical tests are resistivity, ground penetrating radar, seismic reflection, cross hole seismic, and seismic cone penetrometer tests. Such tests are particularly effective in establishing ground stratigraphy, locating sudden changes in underground formations, determining in situ dynamic properties of soils, and locating underground cavities in karst formations, or identifying underground obstructions.

## **Remote Sensing**

Remote sensing data can effectively be used to identify terrain conditions, geologic formations, escarpments and surface reflection of faults, buried stream beds, site access conditions and general soil and rock formations. Remote sensing data from satellites (i.e LANDSAT data available from NASA), aerial photographs available from the US or state Geological services, U.S. Corps Of Engineers, commercial aerial mapping service organizations can be easily obtained, State DOTs use aerial photographs for right-of-way surveys and road and bridge alignments, and they can make them available for use by the geotechnical engineers.

The geotechnical engineer needs to be familiar with these sampling, investigation and testing techniques, as well as their limitations and capabilities before selecting their use on any project. The details of these investigation methods will be presented in subsequent chapters of this module.

### **2.5.2 Frequency and Depth of Borings**

The location and frequency of sampling depends on the type and critical nature of the structure to be built, the soil and rock formations, the known variability in stratification, and the loads to be imposed on the foundation soils. While the rehabilitation of an existing pavement may require 4 m deep borings only at locations showing signs of distress, the design and construction of a major bridge may require borings often in excess of 30 m.

Table 2-2 provides guidelines for selecting minimum boring depths, frequency and spacing for various geotechnical features. Frequently, it may be necessary or desirable to extend borings beyond the minimum depths to better define the geologic setting at a project site, to determine the depth and engineering characteristics of soft underlying soil strata, or to assure that sufficient information is obtained for cases when the structure requirements are not clearly defined at the time of drilling. **Where borings are drilled to rock, it is generally recommended that a minimum 1.5 m length of rock core be obtained to verify**

**TABLE 2-2**  
**MINIMUM REQUIREMENTS FOR BORING DEPTHS**

Areas of Investigation	Boring Depth
<p>Bridge Foundations* Highway Bridges</p> <p>1. Spread Footings</p> <p>2. Deep Foundations</p>	<p>For isolated footings of length <math>L_f</math> and width <math>\leq 2B_f</math>, where <math>L_f \leq 2B_f</math>, borings shall extend a minimum of two footing widths below the bearing level.</p> <p>For isolated footings where <math>L_f \geq 5B_f</math>, borings shall extend a minimum of four footing widths below the bearing level.</p> <p>For <math>2B_f \leq L_f \leq 5B_f</math>, minimum boring length shall be determined by linear interpolation between depths of <math>2B_f</math> and <math>5B_f</math> below the bearing level.</p> <p>In soil, borings shall extend below the anticipated pile or shaft tip elevation a minimum of 6 m, or a minimum of two times the maximum pile group dimension, whichever is deeper.</p> <p>For piles bearing on rock, a minimum of 3 m of rock core shall be obtained at each boring location to verify that the boring has not terminated on a boulder.</p> <p>For shafts supported on or extending into rock, a minimum of 3 m of rock core, or a length of rock core equal to at least three times the shaft diameter for isolated shafts or two times the maximum shaft group dimension, whichever is greater, shall be extended below the anticipated shaft tip elevation to determine the physical characteristics of rock within the zone of foundation influence.</p>
Retaining Walls	<p>Extend borings to depth below final ground line between 0.75 and 1.5 times the height of the wall. Where stratification indicates possible deep stability or settlement problem, borings should extend to hard stratum.</p> <p>For deep foundations use criteria presented above for bridge foundations.</p>
Roadways	Extend borings a minimum of 2 m below the proposed subgrade level.
Cuts	Borings should extend a minimum of 5 m below the anticipated depth of the cut at the ditch line. Borings depths should be increased in locations where base stability is a concern due to the presence of soft soils, or in locations where the base of the cut is below groundwater level to determine the depth of the underlying pervious strata.
Embankments	Extend borings a minimum depth equal to twice the embankment height unless a hard stratum is encountered above this depth. Where soft strata are encountered which may present stability or settlement concerns the borings should extend to hard material.
Culverts	Use criteria presented above for embankments.

\*From AASHTO Standard Specifications for Design of Highway Bridges

**that the boring has indeed reached bedrock and not terminated on the surface of a boulder.**

Where structures are to be founded directly on rock, the length of rock core should be not less than 3 m, and extended further if the use of socketed piles or drilled shafts are anticipated. Selection of boring depths at river and stream crossings must consider the potential scour depth of the stream bed.

The frequency and spacing of borings will depend on the anticipated variation in subsurface conditions, the type of facility to be designed, and the phase of the investigation being performed. For conceptual design or route selection studies, very wide boring spacing (up to 300 m, or more) may be acceptable particularly in areas of generally uniform or simple subsurface conditions. For preliminary design purposes a closer spacing is generally necessary, but the number of borings would be limited to that necessary for making basic design decisions. For final design, however, relatively close spacings of borings may be required as suggested in Table 2-3.

Subsurface investigation programs, regardless to how well they may be planned, must be flexible to adjust to variations in subsurface conditions encountered during drilling. The project geotechnical engineer should at all times be available to confer with the field inspector. On critical projects, the geotechnical engineer should be present during the field investigation. He/she should also establish communication with the design engineer to discuss unusual field observations and changes to be made in the investigation plans.

### **2.5.3 Boring Locations and Elevations**

It is generally recommended that a licensed surveyor be used to establish all planned drilling locations and elevations. For cases where a surveyor cannot be provided, the field inspector has the responsibility to locate the borings and to determine ground surface elevations at an accuracy appropriate to the project needs. Boring locations should be taped from known site features to an accuracy of about 1.0 m for most projects. When a topographic survey is provided, boring elevations can be established by interpolation between contours. This method of establishing boring elevations is commonly acceptable, but the field inspector must recognize that the elevation measurement is sensitive to the horizontal position of the boring. Where contour intervals change rapidly the boring elevations should be determined by optical survey.

Sometimes a bench mark (BM) is indicated on the site plans or topographic survey. If a BM is not indicated, a temporary bench mark (TBM) should be established on some permanent feature (manhole, intersection of two streets, fire hydrant, existing building, etc.). A TBM should be a feature that will remain intact during the future construction operation. Typically, the TBM is set up as an arbitrary elevation (unless the local ground elevation is uniform). Field inspectors should always indicate which TBM was used on the site plan.

An engineer's level may be used to determine elevations. The level survey should be closed to confirm the accuracy of the survey. Elevations should be reported on the logs to the nearest tenth of a meter unless other directions are received from the designers. In all instances, the elevation datum must be identified and recorded. Throughout the boring program the datum selected should remain unchanged.

### **2.5.4 Equipment**

A list of equipment commonly needed for field explorations is presented in Table 2-4.

**TABLE 2-3  
GUIDELINES FOR BORING LAYOUT\***

Geotechnical Features	Boring Layout
Bridge Foundations	<p>For piers or abutments over 30 m wide, provide a minimum of two borings.</p> <p>For piers or abutments less than 30 m wide, provide a minimum of one boring.</p> <p>Additional borings should be provided in areas of erratic subsurface conditions.</p>
Retaining Walls	<p>A minimum of one boring should be performed for each retaining wall. For retaining walls more than 30 m in length, the spacing between borings should be no greater than 60 m. Additional borings inboard and outboard of the wall line to define conditions at the toe of the wall and in the zone behind the wall to estimate lateral loads and anchorage capacities should be considered.</p>
Roadways	<p>The spacing of borings along the roadway alignment generally should not exceed 60 m. The spacing and location of the borings should be selected considering the geologic complexity and soil/rock strata continuity within the project area, with the objective of defining the vertical and horizontal boundaries of distinct soil and rock units within the project limits.</p>
Cuts	<p>A minimum of one boring should be performed for each cut slope. For cuts more than 60 m in length, the spacing between borings along the length of the cut should generally be between 60 and 120 m.</p> <p>At critical locations and high cuts, provide a minimum of three borings in the transverse direction to define the existing geological conditions for stability analyses. For an active slide, place at least one boring upslope of the sliding area.</p>
Embankments	<p>Use criteria presented above for Cuts.</p>
Culverts	<p>A minimum of one boring at each major culvert. Additional borings should be provided for long culverts or in areas of erratic subsurface conditions.</p>

\*Also see FHWA Geotechnical Checklist and Guidelines; FHWA-ED-88-053

**TABLE 2-4**  
**LIST OF EQUIPMENT FOR FIELD EXPLORATIONS**

Paperwork/Forms	Site Plan Technical specifications Field Instructions Sheet(s) Daily field memorandum forms Blank boring log forms Forms for special tests (vane shear, permeability tests, etc.) Blank sample labels or white tape Copies of required permits Field book (moisture proof) Health and Safety plan Field Manuals Subcontractor expense forms
Sampling Equipment	Samplers and blank tubes etc. Knife (to trim samples) Folding rule (measured in 1 cm increments) 25 m tape with a flat-bottomed float attached to its end so that it can also be used for water level measurements Hand level (in some instances, an engineer's level is needed) Rags Jars and core boxes Sample boxes for shipping (if needed) Buckets (empty) with lid if bulk samples required Half-round file Wire brush
Safety/Personal Equipment	Hard hat Safety boots Safety glasses (when working with hammer or chisel) Rubber boots (in some instances) Rain gear (in some instances) Work gloves
Miscellaneous Equipment	Clipboard Pencils, felt markers, grease pencils Scale and straight edge Watch Calculator Camera Compass Wash bottle or test tube Pocket Penetrometer and/or Torvane Communication Equipment (two-way radio, cellular phone)

### **2.5.5 Personnel and Personal Behavior**

The field crew is a visible link to the public. The public's perception of the reputation and credibility of the agency represented by the field crew may be determined by the appearance and behavior of the personnel and field equipment. It is the drilling supervisor's duty to maintain a positive image of field exploration activities, including the appearance of equipment and personnel and the respectful behavior of all personnel. In addition, the drilling supervisor is responsible for maintaining the safety of drilling operations and related work, and for the personal safety of all field personnel and the public. The designated Health and Safety Officer is responsible for verifying compliance of all field personnel with established health and safety procedures related to contaminated soils or groundwater. Appendix A presents typical safety guidelines for drilling into soil and rock and health and safety procedures for entry into borings.

The field inspector may occasionally be asked about site activities. The field inspector should always identify the questioner. It is generally appropriate policy not to provide any detailed project-related information, since at that stage the project is normally not finalized, there may still be on going discussions, negotiations, right-of-way acquisitions and even litigation. An innocent statement or a statement based on one's perception of the project details may result in misunderstandings or potentially serious problems. In these situations it is best to refer questions to a designated officer of the agency familiar with all aspects of the project.

### **2.5.6 Plans and Specifications**

Each subsurface investigation program must include a location plan and technical specifications to define and communicate the work to be performed.

The project location plan(s) should include as a minimum: a project location map; general surface features such as existing roadways, streams, structures, and vegetation; north arrow and selected coordinate grid points; ground surface contours at an appropriate elevation interval; and locations of proposed structures and alignment of proposed roadways, including ramps. On this plan or plans the proposed boring, piezometer, and in situ test hole locations; and a table which presents the proposed depth of each boring and in situ test hole, and the required depths for piezometer screens should be shown.

The technical specifications should clearly describe the work to be performed including the materials, equipment and procedures to be used for drilling and sampling, for performing in situ tests, and for installing piezometers. In addition, it is particularly important that the specifications clearly define the method of measurement and the payment provisions for all work items.

## **2.6 STANDARDS AND GUIDELINES**

Field exploration by borings should be guided by local practice, by applicable FHWA and state DOTs procedures, and by the AASHTO and ASTM standards listed in Table 2-5.

Current copies of these standards and manuals should be maintained in the engineer's office for ready reference. The geotechnical engineer and field inspector should be thoroughly familiar with the contents of these documents, and should consult them whenever unusual subsurface situations arise during the field investigation. The standard procedures should always be followed; improvisation of investigative techniques may result in erroneous or misleading results which may have serious consequences on the interpretation of the field data.

**TABLE 2-5  
FREQUENTLY USED AASHTO AND ASTM STANDARDS FOR FIELD INVESTIGATIONS**

Standard		Title
AASHTO	ASTM	
M 146	C 294	Descriptive Nomenclature for Constituents of Natural Mineral Aggregates
T 86	D 420	Guide for Investigating and Sampling Soil and Rock
-	D 1194	Test Method for Bearing Capacity of Soil for Static Load on Spread Footings
-	D 1195	Test Method for Repetitive Static Plate Load Tests of Soils and Flexible Pavement Components, for Use in Evaluation and Design of Airport and Highway Pavements
-	D 1196	Test Method for Nonrepetitive Static Plate Load Tests of Soils and Flexible Pavement Components, for Use in Evaluation and Design of Airport and Highway Pavements
T 203	D 1452	Practice for Soil Investigation and Sampling by Auger Borings
T 206	D 1586	Method for Penetration Test and Split-Barrel Sampling of Soils
T 207	D 1587	Practice for Thin-Walled Tube Sampling of Soils
T 225	D 2113	Practice for Diamond Core Drilling for Site Investigation
M 145	D 2487	Test Method for Classification of Soils for Engineering Purposes
-	D 2488	Practice for Description and Identification of Soils (Visual-Manual Procedure)
T 223	D 2573	Test Method for Field Vane Shear Test in Cohesive Soil
-	D 3441	Test Method for Deep, Quasi-Static, Cone and Friction-Cone Penetration Test of Soils
-	D 3550	Practice for Ring-Lined Barrel Sampling of Soils
-	D 4220	Practice for Preserving and Transporting Soil Samples
-	D 4544	Practice for Estimating Peat Deposit Thickness
-	D 4719	Test Method for Pressuremeter Testing in Soils
-	D 4750	Test Method for Determining Subsurface Liquid Levels in a Borehole or Monitoring Well (Observation Well)
-	D 5079	Practices for Preserving and Transporting Rock Core Samples
-	D 5092	Practice for Design and Installation of Ground Water Monitoring Wells in Aquifers



## CHAPTER 3.0 DRILLING AND SAMPLING OF SOIL AND ROCK

This chapter describes some of the equipment and procedures commonly used for the drilling and sampling of soil and rock. The methods addressed in this chapter are typically used to retrieve soil samples and rock cores for visual examination and laboratory testing. Chapter 5 discusses in situ testing methods which are often included in subsurface investigation programs and are performed in conjunction with conventional drilling and sampling operations.

### 3.1 SOIL EXPLORATION

#### 3.1.1 Soil Drilling

A wide variety of equipment (Appendix B - Manufacturers and Distributors of Soil Sampling Equipment) is generally available to perform borings and to obtain soil samples. The method used to advance the boring should be compatible with the soil and groundwater conditions to assure that soil samples of suitable quality are obtained. Particular care should be exercised to properly remove all slough or loose soil from the boring before sampling. Below the groundwater level, drilling fluids are often needed in soft soils or cohesionless soils to stabilize the sidewalls and bottom of the boring. Without stabilization, the bottom of the boring may heave or the sidewalls may contract, either disturbing the soil prior to sampling or preventing the sampler from reaching the bottom of the boring. In most geotechnical explorations, borings are usually advanced with 102 mm or 152 mm diameter solid-stem augers, 57 mm to 152 mm inside diameter hollow-stem augers, or rotary wash boring methods using a 60 mm to 130 mm nominal diameter drill bit. Figure 3-1 illustrates the drill bits commonly used in North American practice.

#### Continuous Flight Augers

Continuous-flight (solid-stem) auger drilling is generally limited to stiff cohesive soils where the boring walls are stable for the entire depth of the boring. Figure 3-2 illustrates how continuous flight augers are used with an auger drill. A drill bit is attached to the leading section of flight to cut the soil. The flights act as a screw conveyor, bringing cuttings to the top of the hole. As the auger drills into the earth, additional auger sections are added until the required depth is reached.

Due to their limited application, continuous flight augers are generally not suitable for use in investigations requiring soil sampling. When used, careful observation of the resistance to penetration and the vibrations or "chatter" of the drilling bit can provide valuable data for interpretation of the subsurface conditions. Clay, or "fishtail", drill bits are commonly used in stiff clay formations. Carbide-tipped "finger" bits are commonly used where hard clay formations or interbedded rock or cemented layers are encountered. Since finger bits commonly leave a much larger amount of loose soil, called slough, at the bottom of the hole, they should only be used when necessary. It is often desirable to twist the continuous-flight augers into the ground with rapid advancement and to withdraw the augers without rotation, often termed "dead-stick withdrawal", to maintain the cuttings on the auger flights with minimum mixing. This drilling method aids visual identification of changes in the soil formations. In all instances, the cuttings and the reaction of the drilling equipment should be regularly monitored to identify stratification changes between sample locations.

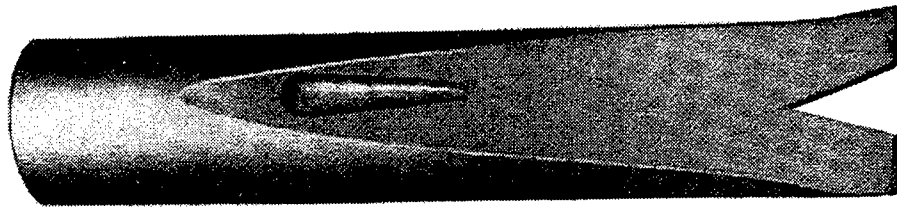

(a)

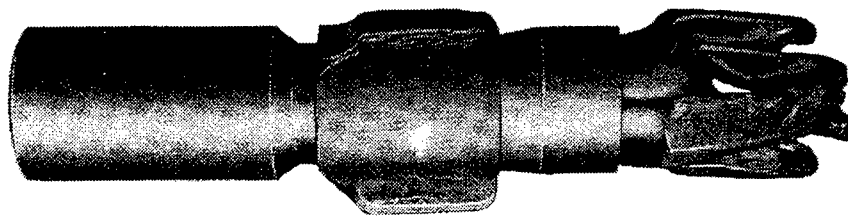

(b)

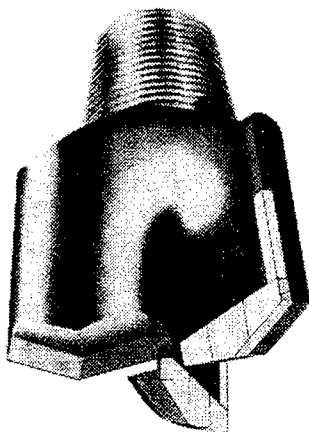

(c)

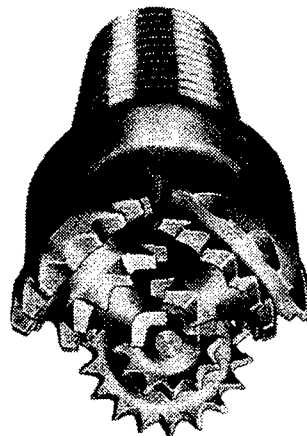

(d)



(e)

Figure 3-1: Drill Bits Commonly Used in North American Practice. (a) Fishtail Bit, (b) Hawthorne Replaceable-Blade Drag Bit, (c) Carbide Insert Drag Bit, (d) Tricone Bit, and (e) Diamond Plug. (Courtesy of Sprague & Henwood, Inc.)

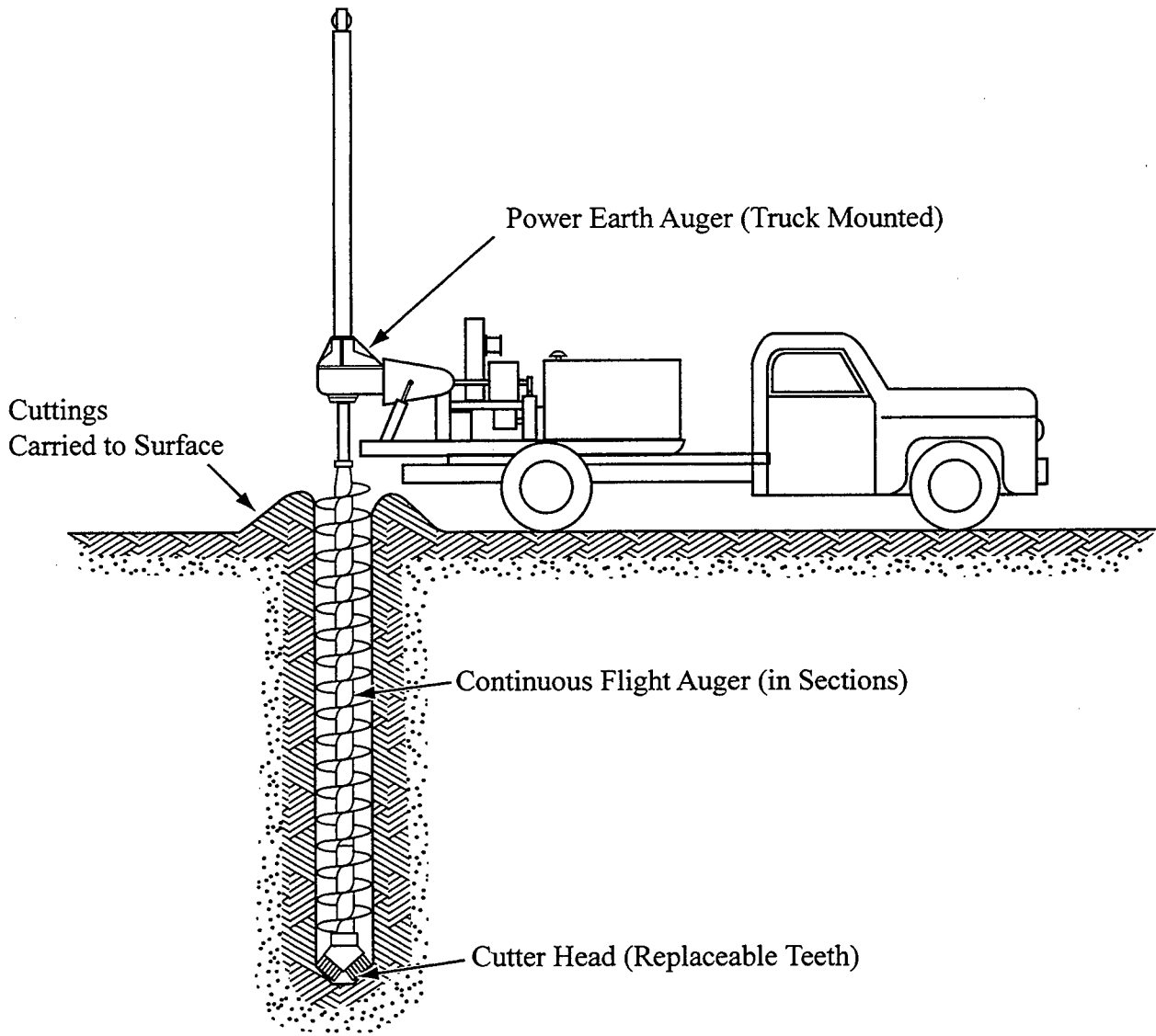

Figure 3-2: Typical Continuous Flight Auger Set-up. (Acker, 1974)

## Hollow-Stem Augers

In general appearance hollow stem augers are very similar to the continuous flight auger except, as the name suggests, it has a large hollow center. Figure 3-3a shows the various parts of a hollow stem auger. Table 3-1 presents dimensions of hollow-stem augers available on the market. When the hole is being advanced, a center stem and plug are inserted into the hollow center of the auger. The center plug with a drag bit attached and located in the face of the cutter head aids in the advancement of the hole and also prevents soil cuttings from entering the hollow-stem auger. The center stem consists of rods that connect at the bottom of the plug or bit insert and at the top to a drive adapter to ensure that the center stem and bit rotate with the augers. Most drillers prefer to advance the boring without the center plug, allowing a natural "plug" of compacted cuttings to form at the bit and thus avoiding the need to remove and replace the bit and drill rods at each sample attempt. Since the extent of this plug is difficult to control, this practice is not recommended.

Once the augers have advanced the hole to the desired sample depth, the stem and plug are removed. A sampler may then be lowered through the hollow stem to sample the soil at the bottom of the hole. If part of the augers have been seated into rock, then the standard core barrels can be used.

Hollow-stem auger methods are commonly used in cohesive soils or in granular soil formations above the groundwater level, where the boring walls may be unstable. The augers form a temporary casing to allow sampling of the "undisturbed soil" below the bit. The cuttings produced from this drilling method have limited use for visual observation purposes (see Figure 3-3b). As the boring is advanced to greater depths a considerable delay may occur before the soil cuttings appear at the ground surface. The field supervisor must be aware of these limitations in identification of soil conditions between sample locations.

Significant problems can occur where hollow-stem augers are used to sample soils below the groundwater level. The unbalanced water pressure acting against the soil at the bottom of the boring can significantly disturb the soil, particularly in granular soils or soft clays. Often the soils will heave and plug the auger, preventing the sampler from reaching the bottom of the boring. Where heave or disturbance occurs, the penetration resistance to the driven sampler can be significantly reduced. For these reasons, and others, it is considered advisable to halt the use of hollow-stem augers at the groundwater level and to convert to rotary wash boring methods.

**TABLE 3-1**  
**DIMENSIONS OF TYPICAL HOLLOW-STEM AUGERS**  
(Central Mine Equipment Company)

Inside Diameter of Hollow Stem (mm)	Outside Diameter of Flighting (mm)	Cutting Diameter of Auger Head (mm)
57	143	159
70	156	171
83	168	184
95	181	197
108	194	210
159	244	260
210	295	318

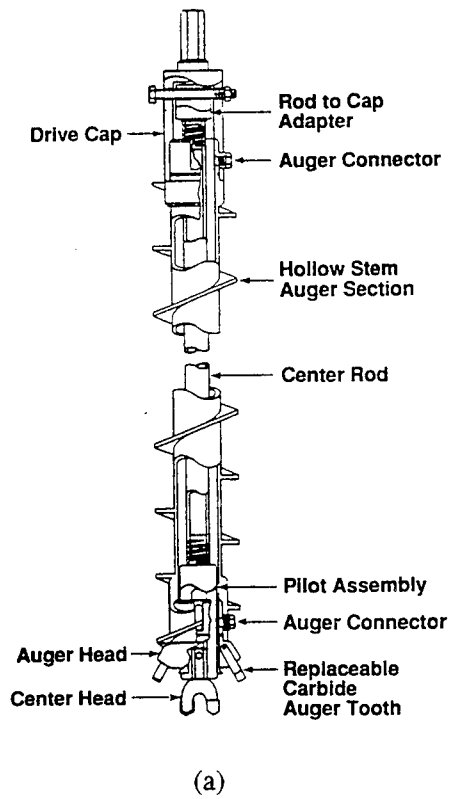

Figure 3-3: (a) Hollow-Stem Auger (ASTM 4700), (b) Cuttings from a Saturated Soil During Hollow-Stem Augering.

## Bucket Auger Borings

Bucket auger drills are used where it is desirable to remove and/or obtain large volumes of disturbed soil samples or to enter the boring to make observations and measurements, such as for projects where slope stability is an issue. In such cases, the boring is typically drilled with a 600 mm to 1200 mm diameter bucket, depending on the diameter of the required lifting equipment for personnel. Figure 3-4a shows a typical bucket auger. The bucket is typically 600 to 900 mm long and is basically an open-top metal cylinder having one or more slots cut in its base to permit the entrance of soil and rock as the bucket is rotated. At the slots the metal of the base is reinforced and teeth or sharpened cutting edge are provided to break up the material being sampled.

The boring is advanced by a rotating drilling bucket with cutting teeth mounted to the bottom. As shown in Figure 3-4b, the drilling bucket is attached to the bottom of a "kelly bar", which typically consists of two to four square steel tubes assembled one inside another so that they telescope downward, similar to a car radio antenna held upside down. At completion of each advancement, the bucket is retrieved from the boring and emptied on the ground near the drill rig.

Bucket auger borings are typically advanced by a truck-mounted drill. Small skid-mounted and A-frame drill rigs are available for special uses, such as drilling on steep hillsides or under low clearance (less than 2.5 m). Depending on the size of the rig and subsurface conditions, bucket augers are typically used to drill to depths of about 30 m or less, although large rigs with capabilities to drill to depths of 60 m or greater are available.

With the possible exception of running sand, the bucket auger is appropriate for most soil types and for soft to firm bedrock. Drilling below the water table can be completed where materials are firm and not prone to large-scale sloughing or water infiltration. For these cases the boring can be advanced by filling it with fluid (water or drilling mud), which provides a positive head and reduces the tendency for wall instability. Depending on hole conditions, down-hole logging is often precluded below water level. Down-hole inspection below zones of slow seepage can sometimes be performed, but must be preceded by careful inspection of hole conditions. Otherwise, down-hole logging below seepage zones should not be performed unless the hole is cased through the problem zone.

The bucket auger method is particularly useful for drilling in materials containing gravel and cobbles because the drilling bucket can often scoop up cobbles that may cause refusal for conventional drilling equipment. Also, because this type of rig drills in 300 to 600 mm increments and is emptied after each of these advances, it is advantageous where it is desirable to obtain large-volume samples from specific subsurface locations, such as for aggregate studies.

In hard materials (concretions or rocks larger than can enter the bucket), special-purpose buckets and attachments can be substituted for the standard "digging bucket". Examples of special attachments are:

- Coring buckets that are simply an open steel pipe with carbide cutting teeth mounted along the bottom edge of the pipe. These are used to core through hard materials.
- Rock buckets that have heavy-duty digging teeth and wider openings to collect broken materials.
- Single-shank breaking bars that are attached to the kelly bar and dropped to break up hard rock.
- Clam shells that are used to pick up cobbles and large rock fragments from the bottom of borings.

Only trained personnel should enter a bucket auger boring, and these borings should only be entered according to strict safety procedures established by the appropriate regulatory agencies. Care must be exercised to see that they are well ventilated and that there are not poisonous gases present when personnel enter for inspection or sampling. A good guideline for down-hole entry has been developed by ADSC (1995).

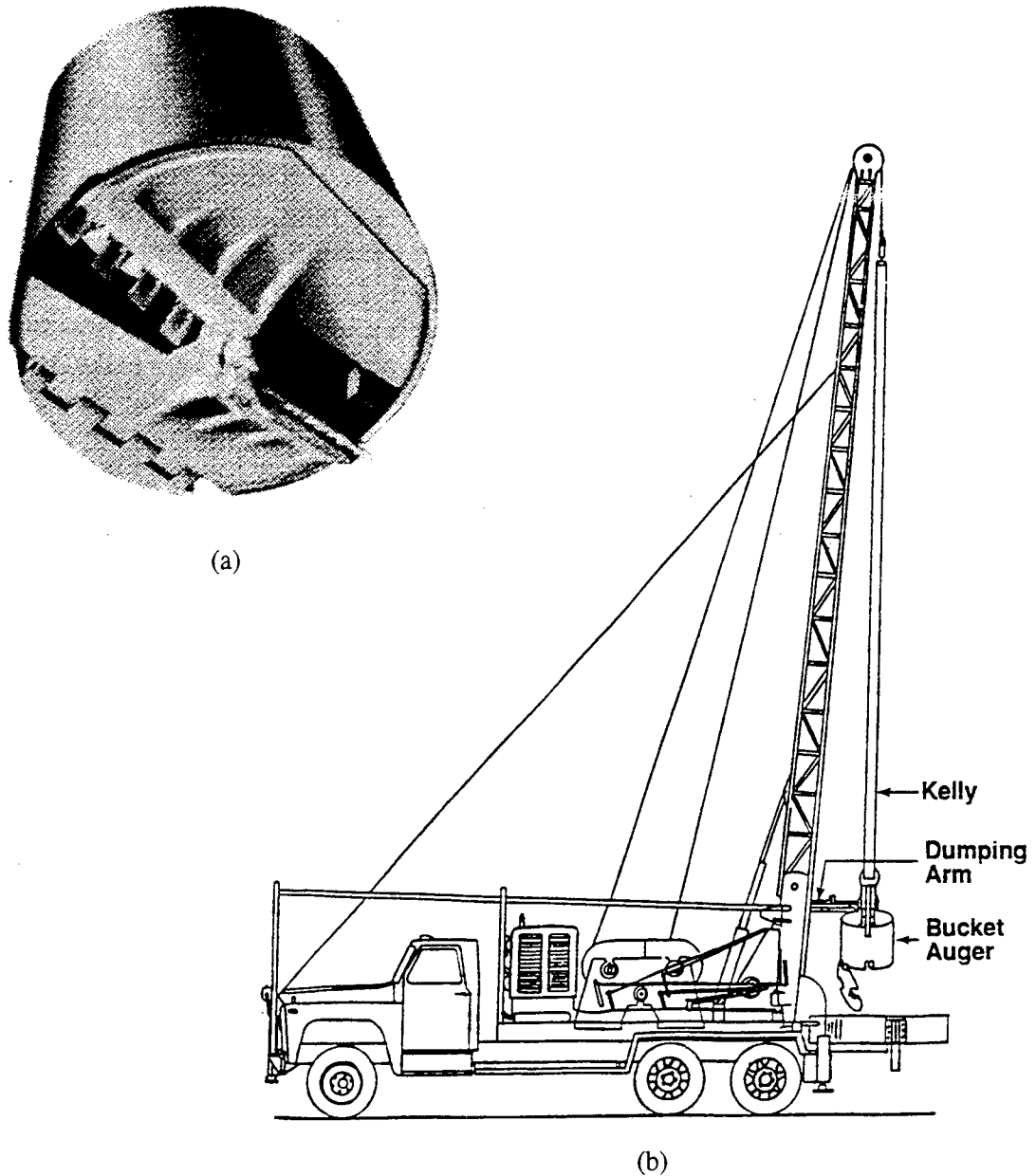

Figure 3-4: (a) Bucket Auger (Courtesy of Acker Drill Co., Inc.) (b) Typical Set-up of Bucket Auger and Drilling Rig. (ASTM 4700)

## Rotary Wash Borings

The rotary wash boring method (Figures 3-5) is generally the most appropriate method for use in soil formations below the groundwater level. In rotary wash borings, the sides of the borehole are supported either with casing or with the use of a drilling fluid. Where drill casing is used, the boring is advanced sequentially by a) driving the casing to the desired sample depth, b) cleaning out the hole to the bottom of the casing, and c) inserting the sampling device and obtaining the sample from below the bottom of the casing.

The casing is usually selected based on the outside diameter of the sampling or coring tools to be advanced through the casing, but may also be influenced by other factors such as stiffness considerations for borings in water bodies or very soft soils, or dimensions of the casing couplings. Casing for rotary wash borings is typically furnished with inside diameters ranging from 60 mm to 130 mm. Even with the use of casing, care must be taken when drilling below the groundwater table to maintain at all times a head of water within the casing above the groundwater level. Particular attention must be given to adding water to the hole as the drill rods are removed after cleaning out the hole prior to sampling. Failure to maintain an adequate head of water may result in loosening or heaving (blow-up) of the soil to be sampled beneath the casing. Tables 3-2 and 3-3 present data on available drill rods and casings, respectively.

For holes drilled using drilling fluids to stabilize the borehole walls, casing should still be used at the top of the hole to protect against sloughing of the ground due to surface activity, and to facilitate circulation of the drilling fluid. In addition to stabilizing the borehole walls, the drilling fluid (water, bentonite, foam, Revert or other synthetic drilling products) also removes the drill cuttings from the boring. In granular soils and soft cohesive soils, bentonite or polymer additives are typically used to increase the weight of the drill fluid and thereby minimize stress reduction in the soil at the bottom of the boring. For borings advanced with the use of drilling fluids, it is important to maintain the level of the drilling fluid at or above the ground surface to maintain a positive pressure for the full depth of the boring. The driller must add drilling fluid as the drilling tools are removed.

For cleaning the borehole, drag bits are commonly used in cohesive soils and loose granular deposits, whereas roller bits are typically used to penetrate dense or coarse grained granular soils, cemented zones and soft or weathered rock.

Examination of the cuttings suspended in the wash fluid provides an opportunity to identify changes in the soil conditions between sample locations. A strainer is held in the drill fluid discharge stream to catch the suspended material. In some instances the drill water return is lost or significantly reduced. The loss of drill fluid is indicative of open joints, fissures, cavities, gravel layers or highly permeable zones, and must be carefully noted on the logs.

The properties of the drilling fluid and the quantity of water pumped through the bit will determine the size of particles that can be removed from the boring with the circulating fluid. In formations containing gravel, cobbles, or larger particles, coarse material may be left in the bottom of the boring. In these instances, clearing the bottom of the boring with a larger-diameter sampler (such as a 76 mm OD split-barrel sampler) may be needed to obtain a representative sample of the formation.



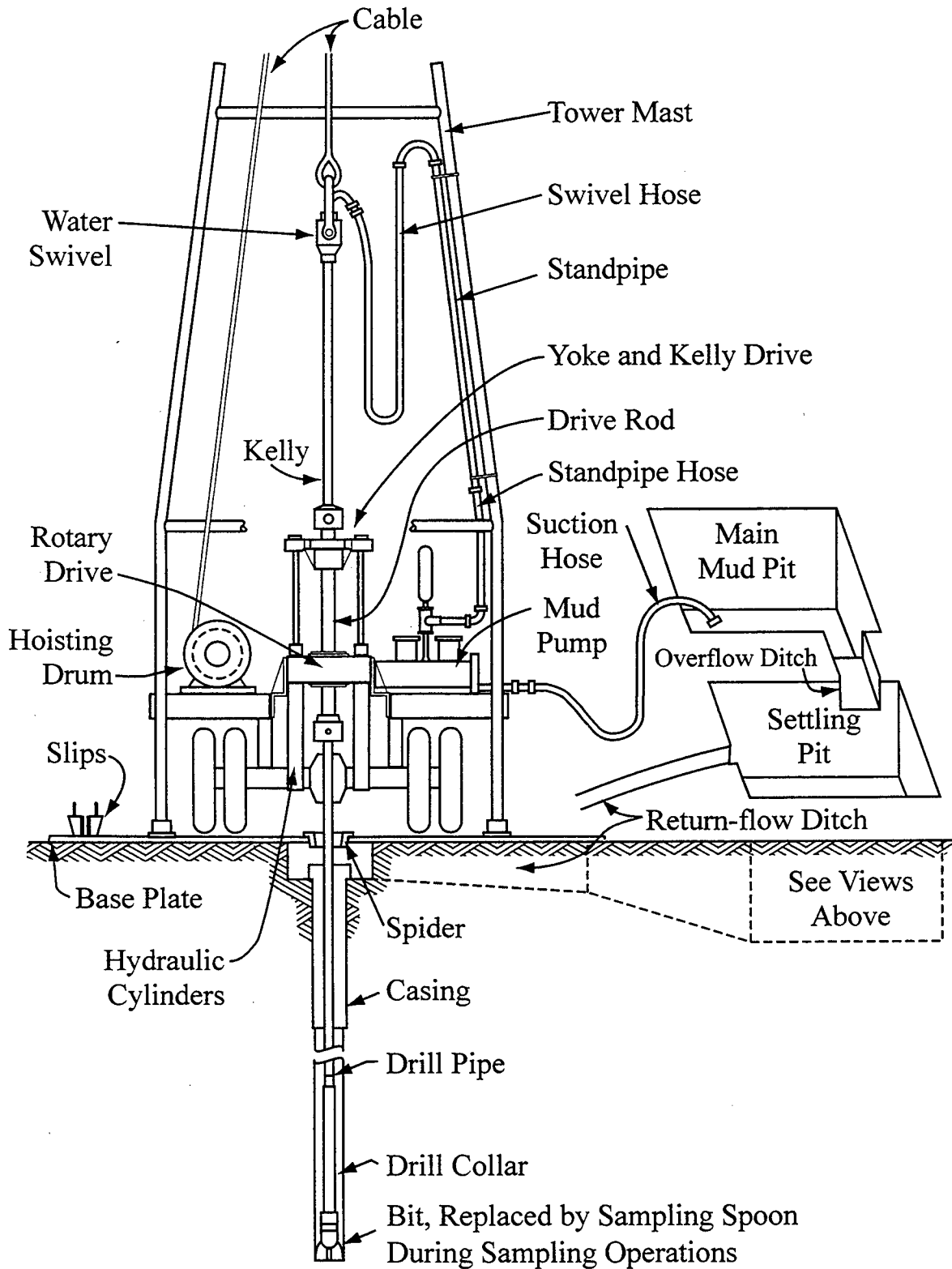

Figure 3-5: (a) Schematic of a Drilling Rig for Rotary Wash Methods. (After Hvorslev, 1948)

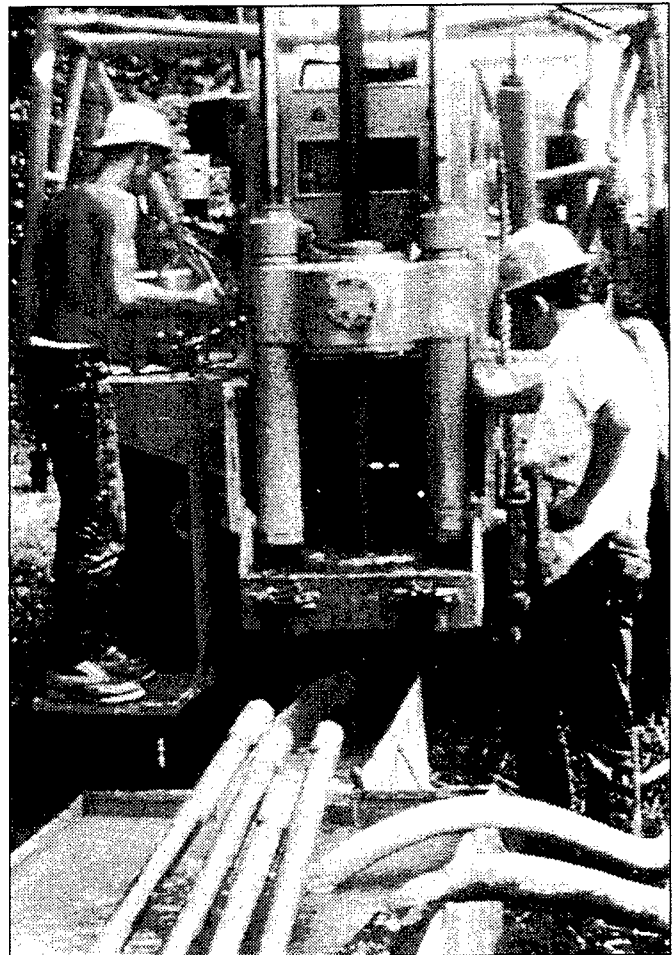
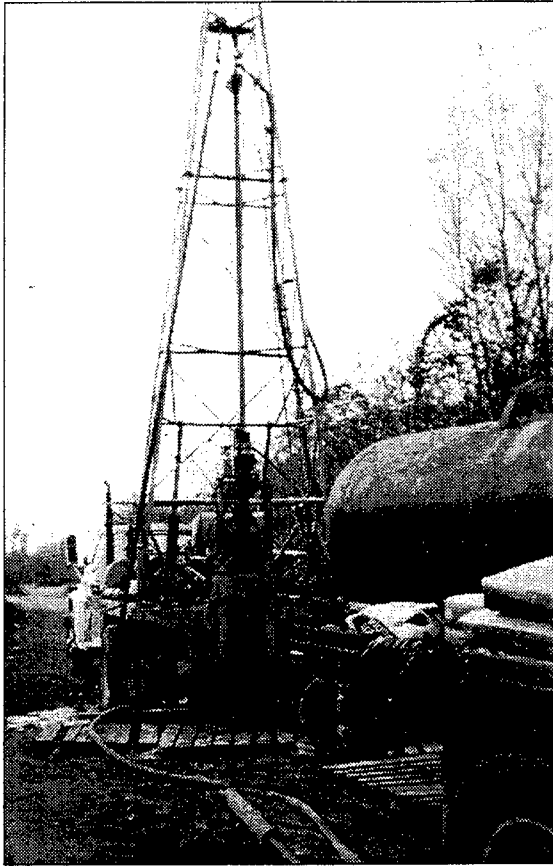

Figure 3-5 (b) Typical Equipment and Set-up of Rotary Wash Drilling. (Note Mud Pit in the Foreground in the lower Photograph).

**TABLE 3-2**  
**DIMENSIONS OF DRILL RODS**  
**(Longyear Company and Christensen Dia-Min Tools, Inc.)**

Size <sup>a</sup>	Outside Diameter of Rod (mm)	Inside Diameter of Rod (mm)	Inside Diameter of Coupling (mm) <sup>b</sup>
EX	33.3	21.4	11.1
AX	41.3	28.6	14.3
BX	48.4	35.7	15.9
NX	60.3	50.8	25.4
RW	27.8	18.3	10.3
EW	34.9	22.2	12.7
AW	44.4	31.0	15.9
BW	54.0	44.5	19.0
NW	66.7	57.2	34.9
HW	88.9	77.8	60.3
(L)AQWL	44.5	34.9	-
(C)AXWL	46.0	38.1	-
(L)BQWL	55.6	46.0	-
(C)BXWL	57.2	48.4	-
(L)NQWL	69.9	60.3	-
(C)NXWL	73.0	60.7	-
(L)HQWL	88.9	77.8	-
(C)HCWL	88.9	76.2	-
(L)PQWL	117.5 <sup>c</sup>	103.2 <sup>c</sup>	103.2
(C)CPWL	117.5	101.6	-

a X and W sizes are available from most manufacturers of drill rod. (L) indicates Longyear Company system. (C) indicates Christensen Dia-Min Tools, Inc. system.

b X and W series have a separate coupling. WL wireline series, except PQWL, are flush-joint, internally and externally, without a separate coupling.

c PQWL has a separate coupling, protruding outside the rod o.d., but internally flush. The outside diameter in table is o.d. of coupling. The outside diameter of rod is 114.3 mm.

**TABLE 3-3**  
**DIMENSIONS OF FLUSH-JOINT CASINGS**  
**(Longyear Company and Christensen Dia-Min Tools, Inc.)**

Size	Outside Diameter of Casing (mm) <sup>a</sup>	Inside Diameter of Casing (mm) <sup>a</sup>
RW	36.5	30.1
EW	46.0	38.1
AW	57.1	48.4
BW	73.0	60.3
NW	88.9	76.2
HW	114.3	101.6
PW	139.7	127.0
SW	168.3	152.4
UW	193.7	177.8
ZW	219.1	203.2

a No separate couplings. Connections are flush, internally and externally.

## **Area Specific Methods**

Drilling contractors in different parts of the country occasionally develop their own subsurface exploration methods which may radically differ from the standard methods or may be a modification of standard methods.

These methods are typically developed to meet the requirements of local site conditions. For example, a hammer drill manufactured by Becker Drilling Ltd. of Canada (Becker Hammer) is used to penetrate gravel, dense sand and boulders such as in the "SGC" material present in Arizona.

## **Exploration Pit Excavation**

Exploration pits and trenches permit detailed examination of the soil and rock conditions at a relatively low cost. Exploration pits can be an important part of geotechnical explorations where significant variations in soil conditions occur (vertically and horizontally), large soil and/or non-soil materials exist (boulders, cobbles, debris) that cannot be sampled with conventional methods, or buried features must be identified and/or measured.

Exploration pits are generally excavated with mechanical equipment (backhoe, bulldozer) rather than by hand excavation. The depth of the exploration pit is determined by the exploration requirements, but is typically about 2 to 3 m. In areas with high groundwater level, the depth of the pit may be limited by the water table. Exploration pit excavations are generally uneconomical at depths greater than about 5 m.

During excavation, the bottom of the pit should be kept relatively level so that each lift represents a uniform horizon of the deposit. At the surface, the excavated material should be placed in an orderly manner adjoining the pit with separate stacks to identify the depth of the material.

The U.S. Department of Labor's Construction Safety and Health Regulations, as well as regulations of any other governing agency must be reviewed and followed prior to excavation of the exploration pit, particularly in regard to shoring requirements.

The sides of the pit should be cleaned by chipping continuously in vertical bands, or by other appropriate methods, so as to expose a clean face of rock or soil.

Survey control at exploration pits should be done using optical survey methods to accurately determine the ground surface elevation and plan locations of the exploration pit. Measurements should be taken and recorded documenting the orientation, plan dimensions and depth of the pit, and the depths and the thickness of each stratum exposed in the pit.

See Section 3.3 for a description of procedures to backfill the exploration pit excavations.

## **Logging Procedures**

The appropriate scale to be used in logging the exploration pit will depend on the complexity of geologic structures revealed in the pit and the size of the pit. The normal scale for detailed logging is 1:20 or 1:10, with no vertical exaggeration.

In logging the exploration pit a vertical profile should be made parallel with one pit wall. The contacts between geologic units should be identified and drawn on the profile, and the units sampled (if considered

appropriate by the geotechnical engineer). Characteristics and types of soil or lithologic contacts should be noted. Variations within the geologic units must be described and indicated on the pit log wherever the variations occur. Sample locations should be shown in the exploration pit log and their locations written on a sample tag showing the station location and elevation. Groundwater should also be noted on the exploration pit log.

### Photography

After the pit is logged, the shoring will be removed and the pit may be photographed at the discretion of the geotechnical engineer. Photographs should be located with reference to project stationing and baseline elevation. A visual scale should be included in each photograph.

### **3.1.2 Soil Samples**

Soil samples obtained for engineering testing and analysis, in general, fit in one of the two following categories;

- Undisturbed
- Disturbed (but representative)

#### **Undisturbed Samples**

Undisturbed samples are typically obtained in cohesive soil strata for use in laboratory testing to determine the engineering properties of those soils. It should be noted that the term “undisturbed” soil sample refers to the relative degree of disturbance to the soil’s in situ properties. Undisturbed samples are obtained with specialized equipment designed to minimize the disturbance to the in situ structure and moisture content of the soils. Specimens obtained by undisturbed sampling methods are used to determine the strength, stratification, permeability, density, consolidation, dynamic properties and other engineering characteristics of soils.

#### **Disturbed Samples**

Disturbed samples are those obtained using equipment that destroy the macro structure of the soil but do not alter its mineralogical composition. Specimens from these samples can be used for determining the general lithology of soil deposits, for identification of soil components and general classification purposes, for determining grain size, Atterberg limits and compaction characteristics of soils, as well as correlations to other engineering characteristics (i.e. permeability, strength). Disturbed samples can be obtained with mechanical or hand augers, split barrel samplers, small excavation machines, or small hand tools.

### **3.1.3 Soil Samplers**

A wide variety of samplers are available to obtain soil samples for geotechnical engineering projects. These include standard sampling tools which are widely used as well as specialized types which may be unique to certain regions of the country to accommodate local conditions and preferences. The following discussions are general guidelines to assist geotechnical engineers and field supervisors select appropriate samplers, but in many instances local practice will control. Following is a discussion of the more commonly used types of samplers.

## **Split Barrel Sampler**

The split-barrel (or split spoon) sampler is used to obtain samples in all types of soils. The split spoon sampler is typically used in conjunction with the Standard Penetration Test (SPT), as specified in AASHTO T 206 and ASTM D 1586, in which the sampler is driven with a 63.5 kg hammer dropping from a height of 760 mm. Details of the Standard Penetration Test are discussed in Section 5.1.

In general, the split-barrel samplers are available in standard lengths of 457 mm and 610 mm with inside diameters ranging from 38.1 to 114.3 mm in 12.7 mm increments. The 38.1 mm inside diameter sampler (see Figure 3-6a) is popular because correlations have been developed between the number of blows required for penetration and several soil properties (see Chapter 9). The larger-diameter samplers are used when gravel particles are present or when more material is needed for classification tests.

The 38.1 mm inside diameter standard split barrel sampler has an outside diameter of 51 mm and a cutting shoe with an inside diameter of 34.9 mm. This corresponds to a relatively thick-walled sampler with an area ratio defined by Hvorslev (1949) of 112 percent. This high area ratio disturbs the natural characteristics of the soil being sampled, thus samples obtained as such are not considered undisturbed.

A ball check valve incorporated in the sampler head facilitates the recovery of cohesionless materials. This valve seats when the sampler is being withdrawn from the borehole, thereby preventing water pressure on the top of the sample from pushing it out. If the sample tends to slide out because of its weight, vacuum tends to develop at the top of the sample to retain it.

As shown in Figure 3-6b, when the shoe and the sleeve of this type of sampler are unscrewed from the split barrel, the two halves of the barrel may be separated and the sample may be extracted easily. The soil sample is removed from the split-barrel sampler and placed and sealed in a glass jar, sealed in a plastic bag, or a brass liner. Separate containers should be used if the sample contains different soil types. Since samples obtained with split barrels are disturbed they are not suitable for use in tests requiring the use of undisturbed specimens.

Steel or plastic sample retainers are often required to keep samples of clean granular soils in the split-barrel sampler. Figure 3-7 shows a basket shoe retainer, a spring retainer and a trap valve retainer. They are inserted inside the sampler between the shoe and the sample barrel to help retain loose or flowing materials. These retainers permit the soil to enter the sampler during driving but upon withdrawal they close and thereby retain the sample. Use of sample retainers should be noted on the boring log.

The following information should be written on a label attached to the sample container: project number, date, boring number, sample number, depth interval, and driving resistance in blows per each 150 mm interval. In addition to this information, the boring log should also note the length of sample recovered and provide a detailed description of the soils recovered in the sampler.

## **Thin Wall Sampler**

The thin-wall tube (Shelby) sampler is commonly used to obtain relatively undisturbed samples of cohesive soils for strength and consolidation testing. The sampler commonly used (Figures 3-8) has a 76 mm outside diameter, a 73 mm inside diameter and a corresponding area ratio of 9 percent. Larger diameter sampler tubes are often used where higher quality samples are required and sampling disturbance must be reduced. The test method for thin-walled tube sampling is described in AASHTO T 207 and ASTM D 1587.

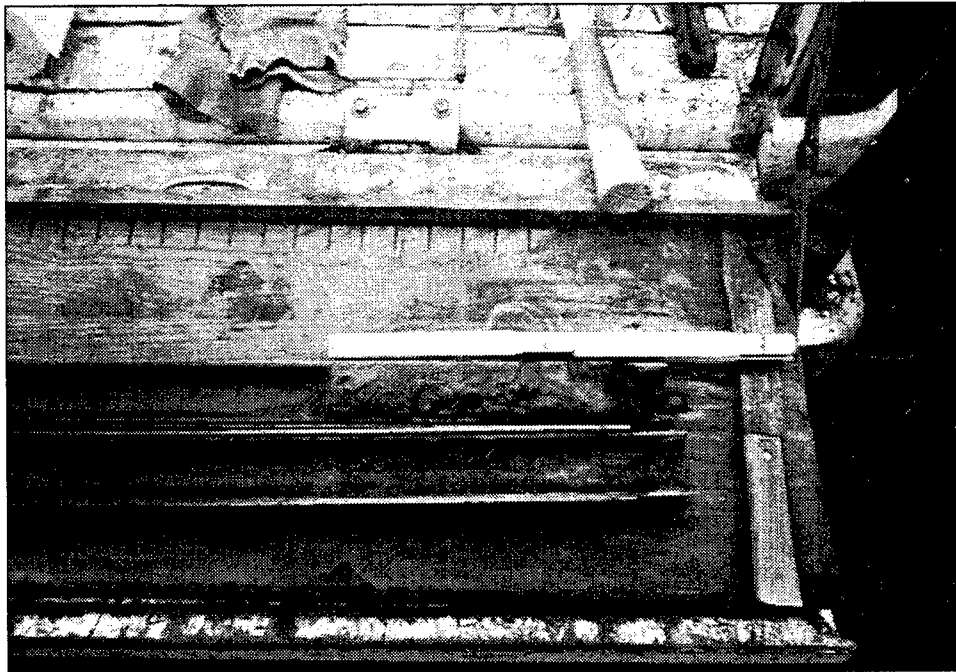
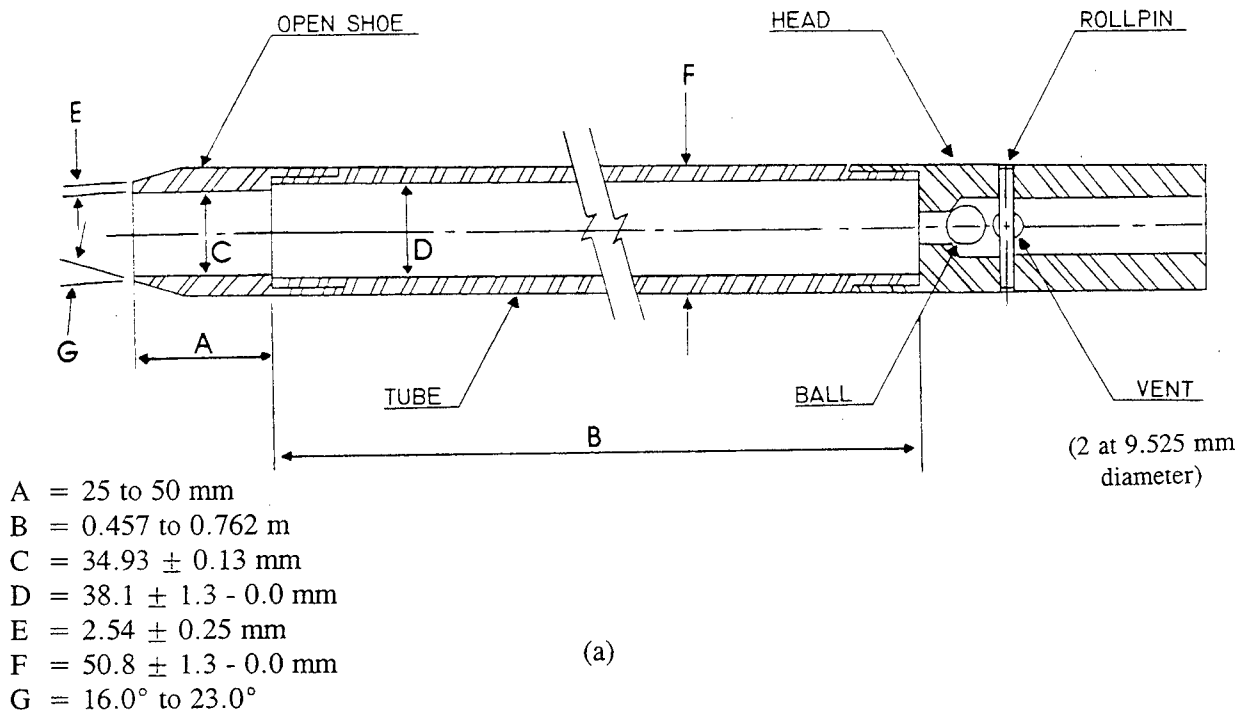

(b)

Figure 3-6: (a) Split Barrel Sampler (ASTM D 1586), (b) Split Barrel Sampler Opened Longitudinally with a Soil Sample.

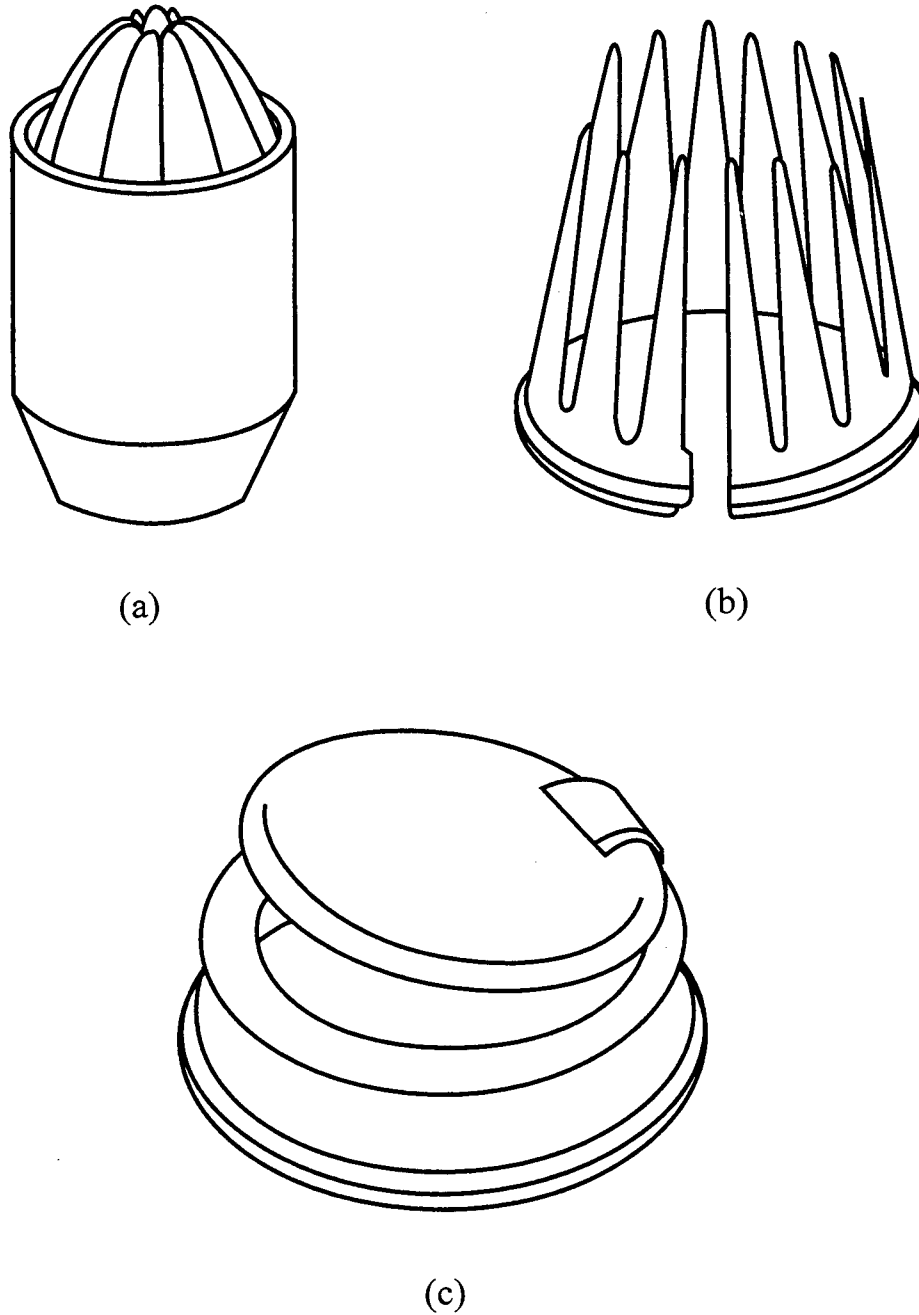
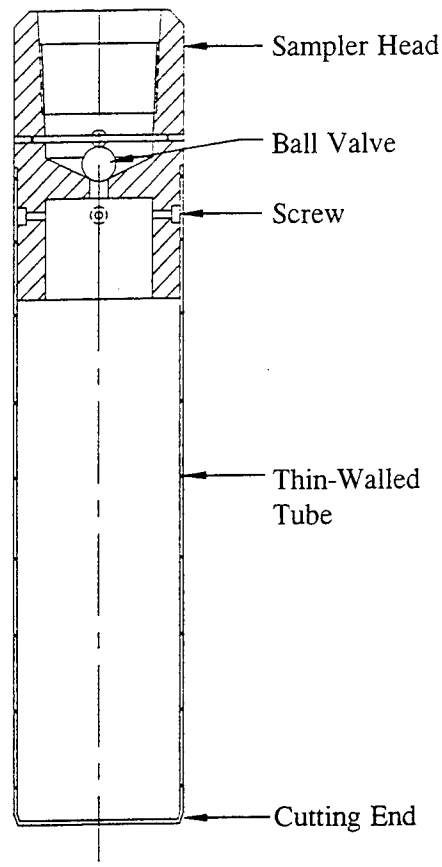
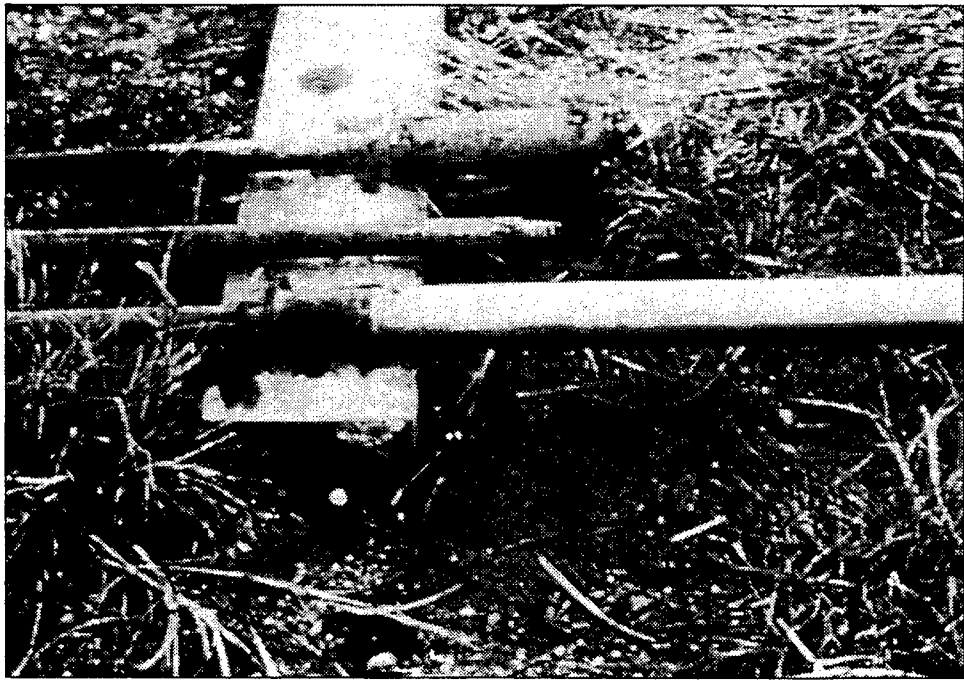

Figure 3-7: Sample Retainers (a) Basket Shoe - the flexible fingers open to admit the sand then close when the tube is withdrawn, (b) Spring Sample Retainer, (c) Trap Valve Sample Retainers used to Recover Muds and Watery Samples. (After Acker, 1974)





(a)



(b)

Figure 3-8: (a) Schematic of Thin-Walled (Shelby) Tube (After ASTM D 4700), (b) Photograph of a Thin-Walled (Shelby) Tube

The thin-walled tubes are manufactured using carbon steel, galvanized-coated carbon steel, stainless steel, and brass. The carbon steel tubes are often the lowest cost tubes but may be unsuitable if the samples are to be stored in the tubes for more than a few days or if the inside of the tubes becomes rusty, significantly increasing the friction between the tube and the soil sample. In stiff soils, galvanized carbon steel tubes are preferred since carbon steel is stronger, less expensive and galvanizing provides a degree of protection from corrosion. In offshore conditions (i.e., bridge borings), or where the samples may be stored for long time periods, stainless steel tubes are preferred. The thin-walled tube is manufactured with a special cutting edge for cutting a reduced-diameter sample (commonly 72 mm inside diameter) that helps reduce friction between the soil sample and tube. It is important that this special cutting edge be maintained in good condition. The thin-wall tubes can be pushed with a fixed head or piston head. The piston sampler is described later.

The thin-wall tube sampler should not be pushed more than the total length up to the connecting cap less 75 mm; the remaining 75 mm (minimum) of tube length is provided to accommodate the slough that accumulates to a greater or lesser extent at the bottom of the boring. Typically, sample length is approximately 600 mm. Where low density soils or soils sensitive to collapse are being sampled, a reduced push of 300 to 450 mm may be appropriate to prevent the disturbance of the sample. The thin-walled tube sampler should be slowly pushed with a single, continuous motion using the drill rig's hydraulic system. The hydraulic pressure required to advance the thin-walled tube sampler should be noted and recorded on the log. The sampler head contains a check valve that allows water to pass through the sampling head into the drill rods. This check valve must be clear of mud and sand and should be checked prior to each sampling attempt. After the push is completed, the driller should wait at least ten minutes to allow the sample to swell slightly within the tube, then rotate the drill rod string through two complete revolutions to shear off the sample, and then slowly and carefully bring the sample to the surface. In stiff soils it is often unnecessary to rotate the sampler.

After taking a thin-walled tube sample, slough or cuttings from the upper end of the tube should be removed using a cleanout tool. The length of sample recovered should be measured and the soil classified for the log. The material at the bottom end of the tube should be removed to a maximum depth of 25 mm, and the cuttings placed in a properly labeled storage jar. Both ends of the tube should then be sealed with at least a 25 mm thick layer of microcrystalline (nonshrinking) wax after placing a plastic disk to protect the ends of the sample. The remaining void above the top of the sample should be filled with moist sand. Plastic end caps should then be placed over both ends of the tube and electrician's tape should be placed over the joint between the collar of the cap and the tube and over the screw holes. The capped ends of the tubes are then dipped in molten wax. The samples must be stored upright in a protected environment to keep them from freezing and from contact with direct sunlight or high temperatures which may reduce moisture content.

In some areas of the country, the thin-walled tube samples are field extruded, rather than transported to the laboratory in the tube. This practice is generally not desirable due to the uncontrolled conditions typical of field operations, and must not be used if the driller does not have established procedures and equipment for preservation and transportation of the extruded samples.

The following information should be written on the top half of the tube and on the top end cap: project number, boring number, sample number, and depth interval. The field supervisor should also write on the tube the project name and the date the sample was taken. Near the upper end of the tube, the word "top" and an arrow pointing toward the top of the sample should be included. Putting sample information on both the tube and the end cap facilitates retrieval of tubes from laboratory storage and helps prevent mix-ups in the laboratory when several tubes may have their end caps removed at the same time.

## **Piston Sampler**

The piston sampler (Figure 3-9) is basically a thin-wall tube sampler with a piston, piston rod, and a modified sampler head. This sampler, also known as Osterberg or Hvorslev sampler, is particularly useful for sampling soft soils although it can also be used in stiff cohesive soils.

The sampler, with its piston located at the base of the sampling tube, is lowered into the borehole. When the sampler reaches the bottom of the hole, the piston rod is held fixed relative to the ground surface and the thin-wall tube is pushed into the soil slowly by hydraulic pressure or mechanical jacking. The sampler is never driven. Upon completion of sampling, the sampler is removed from the borehole and the vacuum between the piston and the top of the sample is broken by means of a vacuum-breaking device provided for this purpose in the piston. The piston head and the piston are then removed from the tube and jar samples are taken from the top and bottom of the sample for identification purposes. The tube is then labeled and sealed in the same way as a Shelby tube described in the previous section.

The quality of the samples obtained is excellent and the probability of obtaining a satisfactory sample is high. One of its major advantages is that the fixed piston tends to prevent the entrance of excess soil at the beginning of sampling, thus precluding recovery ratios greater than 100 percent. It also tends to prevent too little soil from entering near the end of sampling. Thus, the opportunity for 100 percent recovery is enhanced. The head used on this sampler also acts more positively to retain the sample than the ball valve of the thin-wall tube (Shelby) samplers.

## **Pitcher Tube Sampler**

The pitcher tube sampler is used in stiff to hard clays and soft rocks, and is well adapted to sampling deposits consisting of alternately hard and soft layers. The primary components of this sampler as shown in Figure 3-10 are an outer rotating core barrel with a bit and an inner stationary, spring-loaded, thin-wall sampling tube that leads or trails the outer barrel drilling bit, depending on the hardness of the material being penetrated.

When the drill hole has been cleaned, the sampler is lowered to the bottom of the hole (Figure 3-9a). When the sampler reaches the bottom of the hole, the inner tube meets resistance first and the outer barrel slides past the tube until the spring at the top of the tube contacts the top of the outer barrel. At the same time, the sliding valve closes so that the drilling fluid is forced to flow downward in the annular space between the tube and the outer core barrel and then upward between the sampler and the wall of the hole. If the soil to be penetrated is soft, the spring will compress slightly (Figure 3-9b) and the cutting edge of the tube will be forced into the soil as downward pressure is applied. This causes the cutting edge to lead the bit of the outer core barrel. If the material is hard, the spring compresses a greater amount and the outer barrel passes the tube so that the bit leads the cutting edge of the tube (Figure 3-9c). The amount by which the tube or barrel leads is controlled by the hardness of the material being penetrated. The tube may lead the barrel by as much as 150 mm and the barrel may lead the tube by as much as 12 mm. Sampling is accomplished by rotating the outer barrel at 100 to 200 revolutions per minute (rpm) while exerting downward pressure. In soft materials sampling is essentially the same as with a thin-wall sampler and the bit serves merely to remove the material from around the tube. In hard materials the outer barrel cuts a core, which is shaved to the inside diameter of the sample tube by the cutting edge and enters the tube as the sampler penetrates. In either case, the tube protects the sample from the erosive action of the drilling fluid at the base of the sampler. The filled sampling tube is then removed from the sampler and is marked, preserved, and transported in the same manner described above for thin-walled tubes.

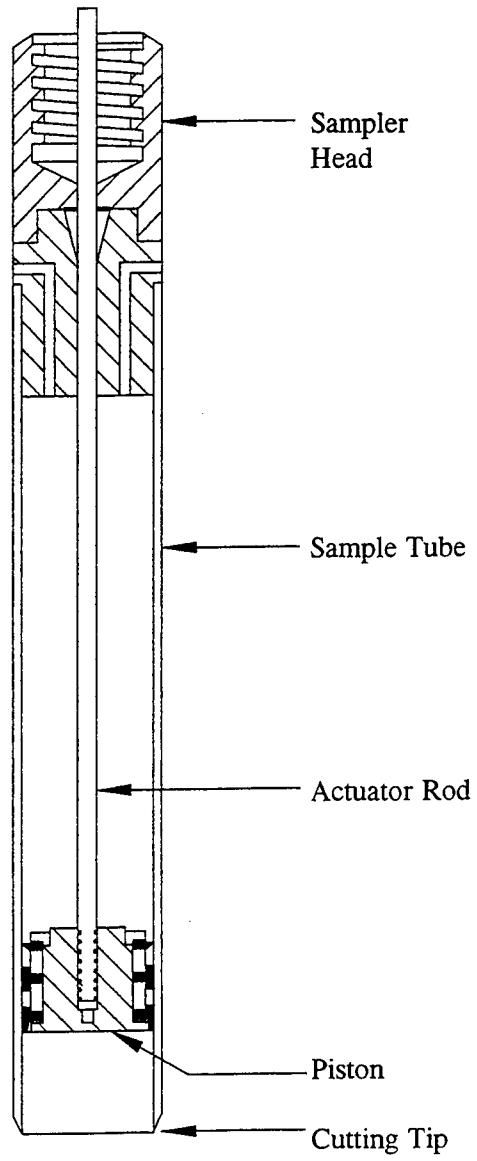

Figure 3-9: Piston Sampler. (After ASTM D 4700)

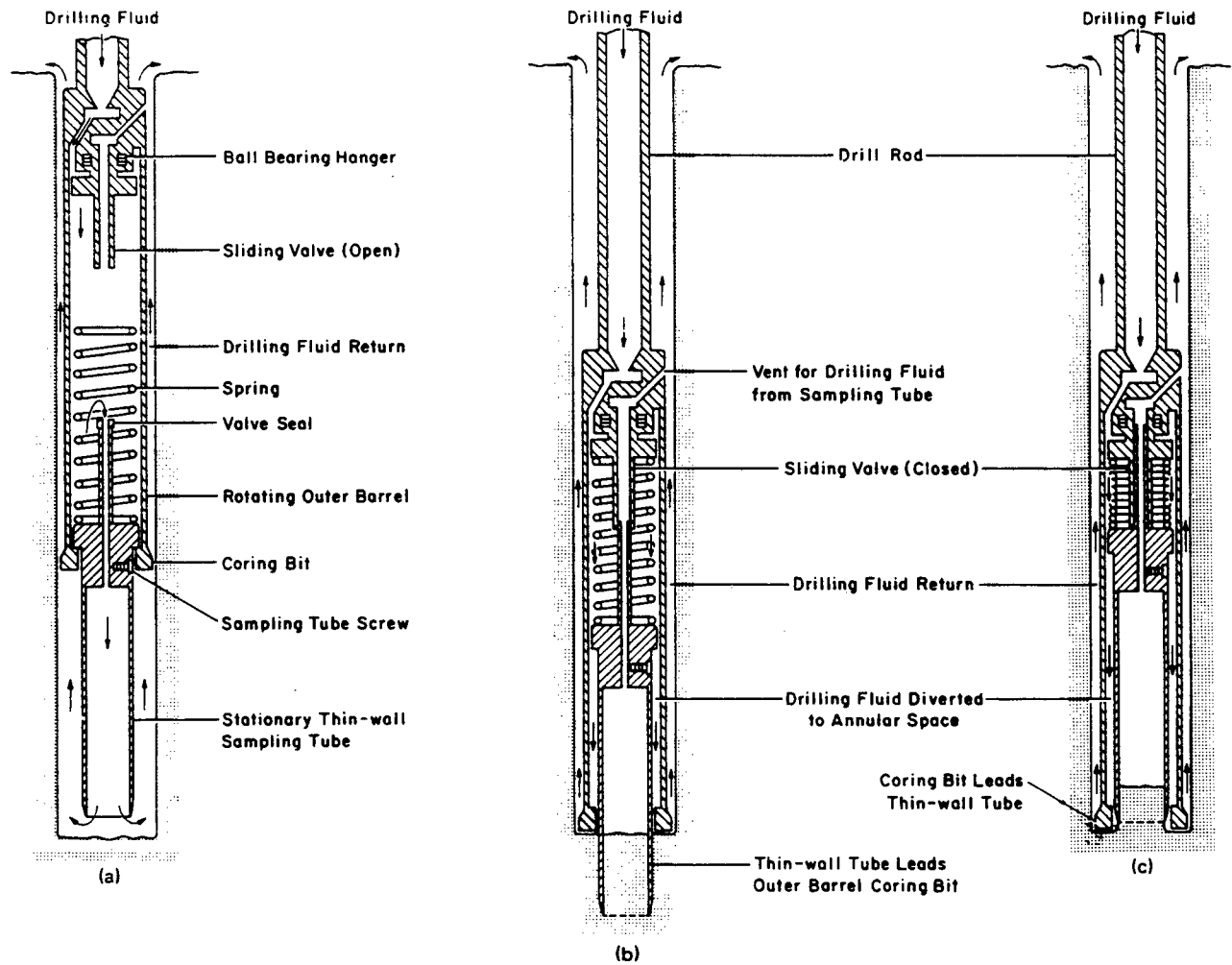

Figure 3-10: Pitcher Sampler. Schematic Drawing Showing: (a) Sampler Being Lowered into Drill Hole; (b) Sampler During Sampling of Soft Soils, (c) Sampler During Sampling of Stiff or Dense Soils. (Courtesy of Mobile Drilling, Inc.)

## **Denison Sampler**

A Denison sampler is similar to a pitcher sampler except that the projection of the sampler tube ahead of the outer rotating barrel is manually adjusted before commencement of sampling operations, rather than spring-controlled during sampler penetration. The basic components of the sampler (Figure 3-11) are an outer rotating core barrel with a bit, an inner stationary sample barrel with a cutting shoe, inner and outer barrel heads, an inner barrel liner, and an optional basket-type core retainer. The coring bit may either be a carbide insert bit or a hardened steel sawtooth bit (see Figure 3-17). The shoe of the inner barrel has a sharp cutting edge. The cutting edge may be made to lead the bit by 12 mm to 75 mm through the use of coring bits of different lengths. The longest lead is used in soft and loose soils because the shoe can easily penetrate these materials and the longer penetration is required to provide the soil core with maximum protection against erosion by the drilling fluid used in the coring. The minimum lead is used in hard or dense soils and in soils containing gravel.

The Denison sampler is used primarily in stiff to hard cohesive soils and in sands, which are not easily sampled with thin-wall samplers owing to the large jacking force required for penetration. Samples of clean sands may be recovered by using driller's mud, a vacuum valve, and a basket catch. The sampler is also suitable for sampling soft cohesive soils.

## **Modified California Sampler**

The Modified California sampler (Figure 3-12) is a lined sampler in common use in the Midwest and West, but rarely used in the East and South. The sampler is thick-walled (area ratio of 77 percent) with a sampler barrel that has an outside diameter of 64 mm and an inside diameter of 51 mm. This sampler generally has a cutting shoe similar to the split-barrel sampler, but with an inside diameter of generally 49 mm. Four 102 mm long 49 mm ID brass liners are used to contain the sample. In the West, the Modified California sampler is driven with standard penetration energy. The unadjusted blow count is recorded on the boring log. In the Midwest the sampler is generally pushed hydraulically. When pushed, the hydraulic pressure required to advance the Modified California sampler should be noted and recorded on the log. The driving resistance obtained using a Modified California sampler must be adjusted to correspond to the standard penetration test driving resistance.

## **Continuous Soil Sampler**

Several types of thick-walled, 1.5 m long samplers are presently available to obtain "continuous" samples of soil as hollow-stem augers are advanced into cohesive soil formations. These systems use bearings or fixed hexagonal rods to restrain or reduce rotation of the continuous sampler as the hollow-stem augers are advanced and the tube is pushed into undisturbed soil below the augers. The continuous samples are commonly used for visual observation, hand penetrometer tests, and classification-type laboratory tests (moisture, density). Experience shows the sampler works acceptably in most cohesive soils and in soils with thin sand layers. The continuous sampler is not considered suitable for formations of cohesionless soil below the groundwater level, soft soils, or samples that swell following sampling. Information is limited regarding the suitability of the continuous samples for strength and consolidation tests.

## **Other Soil Samplers**

A variety of special samplers are available to obtain samples of soil and soft rocks. These methods include the retractable plug, Sherbrooke, and Laval samplers. These sampling methods are used in difficult soils where the more routine methods do not recover samples.

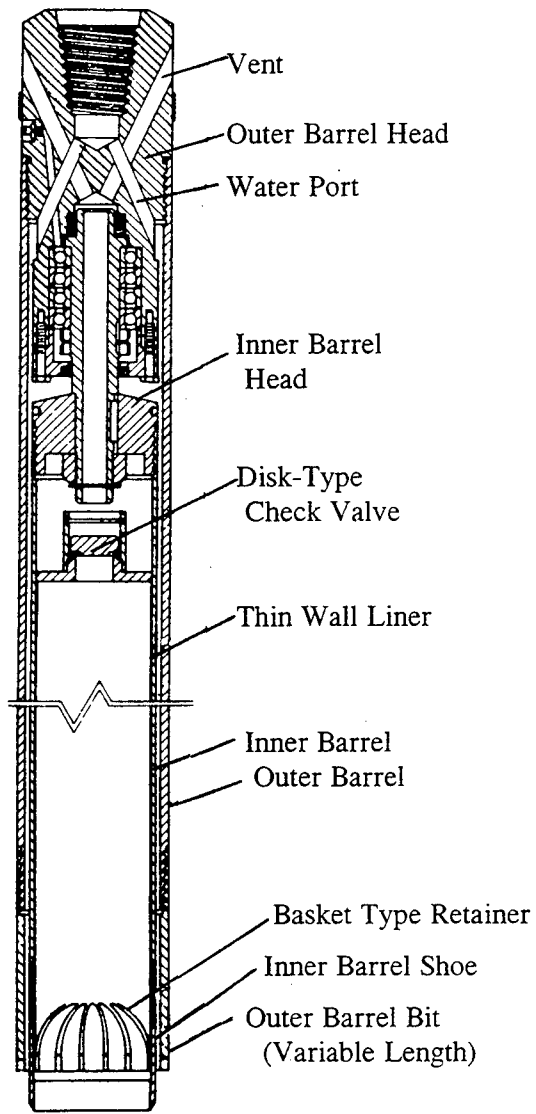

Figure 3-11: Denson Double-Tube Core Barrel Soil Sampler (Courtesy of Sprague & Henwood, Inc.)



Figure 3-12: Modified California Sampler

## **Bulk Samples**

There are a number of tests that can use or require the use of disturbed bulk samples. Bulk samples are suitable for R-value, compaction, California Bearing Ratio (CBR), and other laboratory test methods to be discussed later. Bulk samples may also be required for grain size analyses to obtain representative gradation of coarse grained material (cobbles, gravel, etc.).

Bulk soil samples may be obtained by collecting soil using hand tools without any precautions to minimize sample disturbance. The sample may be taken from the base or walls of a test pit or a trench, from drill cuttings, from a hole dug with a shovel and other hand tools, or from a stockpile. The sample should be put into a container that will retain all of the particle sizes. For large samples, plastic or metal buckets or metal barrels are used; for smaller samples, heavy plastic bags that can be sealed to maintain the water content of the samples are used.

For projects where the determination of the undisturbed properties is very critical, and where the soil layers of interest are accessible, undisturbed bulk samples can be of great value. Of all undisturbed testing methods discussed in this manual, properly obtained bulk samples produce samples with the least amount of disturbance. Such samples can be obtained from the hillsides, cuts, test pits, tunnel walls and other exposed sidewalls. Undisturbed bulk sampling is limited to cohesive soils and rocks. The procedures used for obtaining undisturbed samples vary from cutting large blocks of soil using a combination of shovels, hand tools and wire saws to using small knives and spatulas to obtain small blocks.

If the material is relatively homogeneous, then bulk samples may be taken equally well by hand or by machine. However, in stratified materials, hand excavation may be required. In the sampling of such materials it is necessary to consider the manner in which the material will be excavated for construction. If it is likely that the material will be removed layer by layer through the use of scrapers, samples of each individual material will be required and hand excavation from base or wall of the pit may be a necessity to prevent unwanted mixing of the soils. If, on the other hand, the material is to be excavated from a vertical face, then the sampling must be done in a manner that will produce a mixture having the same relative amounts of each layer as will be obtained during the borrow area excavation. This can usually be accomplished by hand-excavating a shallow trench down the walls of the test pit within the depth range of the materials to be mixed.

Once samples are obtained and transported to the laboratory in suitable containers, they are trimmed to appropriate size and shape for testing. Block samples should be wrapped with household plastic membrane and heavy duty foil and stored in block form and only trimmed shortly before testing. Each bulk sample must be identified with the following information: project number, boring or exploration pit number, sample number, sample depth and orientation.

### **3.1.4 Sampling Interval and Appropriate Type of Sampler**

In general, SPT samples are taken in both granular and cohesive soils, and thin-walled tube samples are taken in cohesive soils.

The sampling interval will vary between individual projects and between regions. A common practice is to obtain split barrel samples at 0.75 m intervals in the upper 3 m and at 1.5 m intervals below 3 m. In some instances, a greater sample interval, often 3 m, is allowed below depths of 30 m. In other cases, continuous samples may be required for some portion of the boring.



In cohesive soils, at least one undisturbed soil sample should be obtained from each different stratum encountered. If a uniform cohesive soil deposit extends for a considerable depth, additional undisturbed samples are commonly obtained at 3 to 6 m intervals. Where borings are widely spaced, it may be appropriate to obtain undisturbed samples in each boring; however, for closely spaced borings, or in deposits which are generally uniform in lateral extent, undisturbed samples are commonly obtained only in selected borings. In erratic geologic formations or thin clay layers it is sometimes necessary to drill a separate boring adjacent to a previously completed boring to obtain an undisturbed sample from a specific depth which may have been missed in the first boring.

### **3.1.5 Sample Recovery**

Occasionally, sampling is attempted, but there may be little or no material recovered. In cases where a split barrel, or an other disturbed-type sample is to be obtained, it is appropriate to make a second attempt to recover the soil sample immediately following the first failed attempt. In such instances, the sampling device is often modified to include a retainer basket, a hinged trap valve, or other measures to help retain the material within the sampler.

In cases where an undisturbed sample is desired, the field supervisor should direct the driller to drill to the bottom of the attempted sampling interval and repeat the sampling attempt. The method of sampling should be reviewed, and the sampling equipment should be checked to understand why no sample was recovered (such as a plugged ball valve). It may be appropriate to change the sampling method and/or the sampling equipment, such as waiting a longer period of time before extracting the sampler, extracting the sampler more slowly and with greater care, etc. This process should be repeated or a second boring may be advanced to obtain a sample at the same depth.

### **3.1.6 Sample Identification**

Every sample which is attempted, whether recovered or not, should be assigned a unique number composed of designators for the project number or name, boring number, sequential sample attempt number, and sample depth. Each sample should be given a unique number. Where tube samples are obtained, any disturbed tubes should be clearly marked as such.

### **3.1.7 Relative Strength Tests**

In addition to the visual observations of soil strength, a pocket (hand) penetrometer can be used to estimate the strength of soil samples. The hand penetrometer estimates the unconfined strength and is suitable for firm to very stiff clay soils. A larger foot/adaptor is needed to test softer soils. It should be emphasized that this test does not produce absolute values; rather it should be used as a guide in estimating the relative strength of soils.

Another useful field test device is a torvane (shown in Figure 3-13), which is a small diameter vane shear testing device that provides an estimate of the shear strength of cohesive soils. Variable diameter vanes are available for use in very soft to very stiff cohesive soils.

Testing with a penetrometer or torvane should always be done in natural soils as near as possible to the center of the top or bottom end of the sample. Testing on the sides of extruded samples is not acceptable. Strength values obtained from pocket penetrometer or torvane should not be used for design purposes.

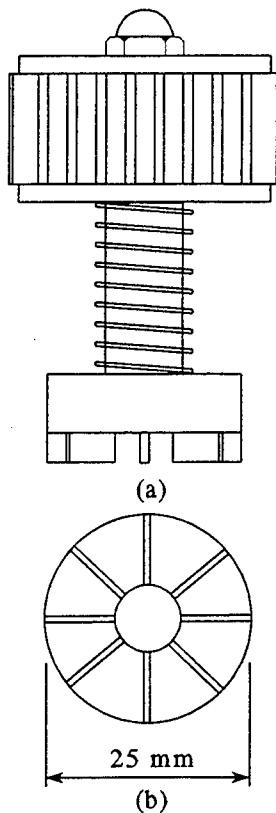

Figure 3-13: Torvane Device

### 3.1.8 Care and Preservation of Undisturbed Soil Samples

Each step in sampling, extruding, storing and testing introduces varying degrees of disturbance to the sample. Proper sampling, handling, and storage methods are essential to minimize these disturbances. The geotechnical engineer must be cognizant of disturbance introduced during the various steps in sampling through testing. The field supervisors should be sensitized about these disturbances and their consequences, and they should be trained to avoid or minimize them. A detailed discussion of sample preservation and transportation is presented in ASTM D 4220.

When tube samples are to be obtained, each of the supplied sampling tubes must be examined to assure that they are not bent, that the cutting edges are not damaged, and that the interior of the tubes are not corroded. If the walls of the tube are corroded or irregular, or if samples are stored in tubes for long periods of time, the force required to extract the samples sometimes may exceed the shear strength of the sample causing increased sample disturbance.

All samples should be protected from extreme temperatures. Samples should be kept out of direct sunlight and should be covered with wet burlap or other material in hot weather. In winter months, special precautions should be taken to prevent samples from freezing during handling, shipping and storage. As much as is practical, the thin-walled tubes should be kept vertical, with the top of the sample oriented in the up position. If available, the thin-walled tubes should be kept in a carrier with an individual slot for each tube. Padding should be placed below and between the tubes to cushion the tubes and to prevent them from striking one another. The entire carrier should be secured with rope or cable to the body of the transporting vehicle so that the entire case will not tilt or tip over while the vehicle is in motion. Figure 3-14 shows a container for shipping tube samples.

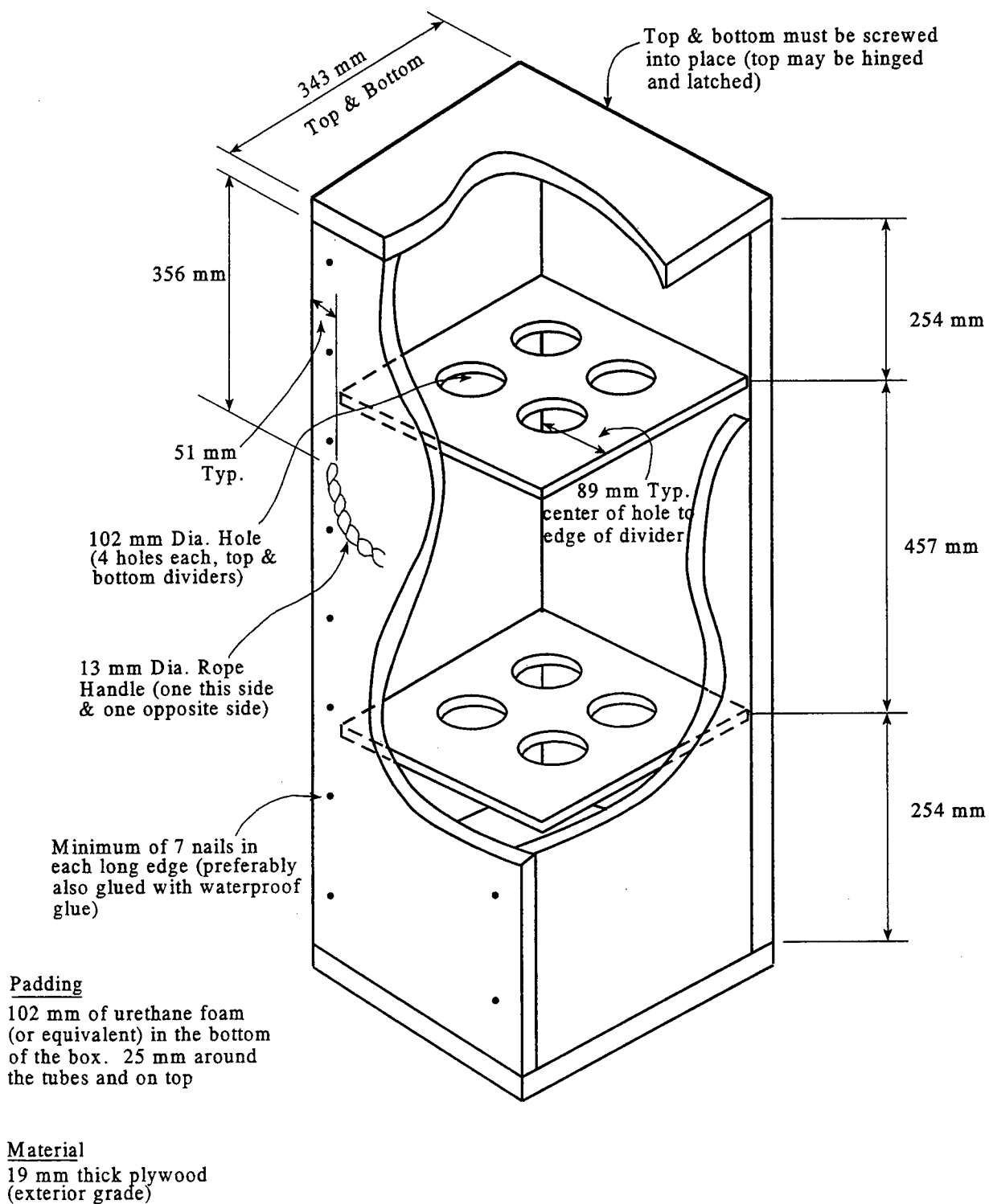

Figure 3-14: Shipping Container for 76 mm Thin-Walled Tubes (ASTM D 4220)

Samples extracted in the field or laboratory are often wrapped in clear plastic sheeting and/or in aluminum foil (Figure 3-15). Depending on the pH of the soil, the aluminum foil may react with the surface of the soil with which it comes in contact. This will result in developing a thin layer of discolored soil over the entire surface of the sample, thus making visual identification difficult and confusing. It may also result in changes in the moisture distribution across the sample. Even though plastic sheeting is also susceptible to reacting with the soil they come in contact with, past observation shows that plastic sheeting has less effect than foil. Thus it is recommended that extruded soil samples which are to be preserved be wrapped in plastic sheeting and then wrapped with foil. In general, samples should not be extracted in the field.

Some agencies still use the practice of storing extracted samples in ice cream boxes which are filled with paraffin. This practice has high probability of causing significant disturbances in sample properties. For example, after samples are placed in the containers the annular space, the top and the bottom of the containers are filled with hot paraffin. Sudden heating of the surface of the sample causes "sweating", and changes the internal moisture regime of the sample. The removal of the sample, in the laboratory, from the hardened paraffin may cause structural disturbances, specially in soft soils. In addition, paraffin becomes brittle and cracks. Therefore, the use of paraffin alone for storage, or to seal the ends of samples transported or stored in tubes, is not recommended. Sealing is best accomplished by the use of microcrystalline wax alone or a mixture of 50 percent microcrystalline wax and 50 percent paraffin, both of which are not subject to cracking.

Storage of undisturbed samples (in or out of tubes) for long periods of time under any condition is not recommended. Storage of samples for more than 30 days may substantially alter strength and consolidation properties of the samples. Laboratory data obtained from these samples should be evaluated carefully.

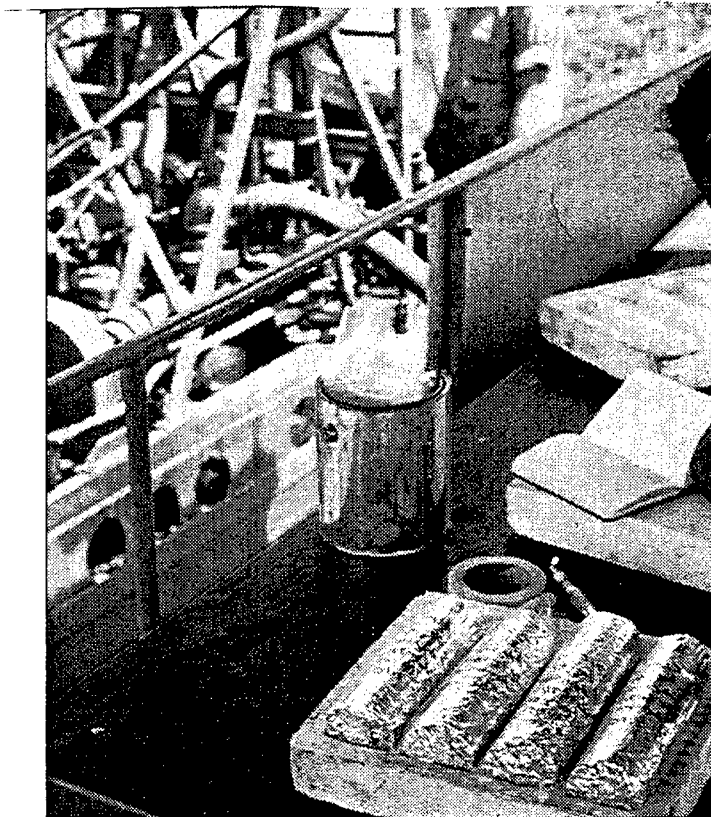

Figure 3-15: Extracted Sample Transportation and Storage.

## **3.2 EXPLORATION OF ROCK**

The methods used for exploration and investigation of rock include:

- Drilling
- Exploration pits (test pits)
- Geologic mapping
- Geophysical methods

Core drilling which is used to obtain intact samples of rock for testing purposes and for assessing rock quality and structure, is the primary investigative method. Test pits, non-core drilling and geophysical methods are often used to identify the top of rock.

Geophysical methods may also be used to obtain information on the physical properties of the rock mass for engineering purposes. Finally, geologic mapping of rock exposures or outcrops provides a means for assessing the composition and discontinuities of rock strata on a large scale which may be valuable for many engineering applications particularly rock slope design.

This chapter contains a discussion of drilling and geologic mapping; geophysical methods are discussed in section 5.7.

### **3.2.1 Rock Drilling and Sampling**

Where borings must extend into weathered and unweathered rock formations, rock drilling and sampling procedures are required. This section provides an abbreviated discussion of rock drilling and sampling methods. The use of ISRM (International Society for Rock Mechanics) Commission on Standardization of Laboratory and Field Tests (1978, 1981) guidelines are suggested for additional guidance in rock drilling and sampling and in logging rock cores.

Defining the top of rock from drilling operations can be difficult, especially where large boulders occur, below irregular residual soil profiles and in karstic terrain. In all cases, the determination of the top of rock must be done with care, recognizing that miscalculated rock excavation volume or erroneous pile length can be specified as a result of improper identification of the top of rock. As per ASTM D 2113, core drilling procedures are used when formations are encountered that are too hard to be sampled by soil sampling methods. A penetration of 25 mm or less by a 51 mm diameter split-barrel sampler following 50 blows using standard penetration energy or other criteria established by the geologist or engineer should indicate that soil sampling methods are not applicable and rock drilling or coring is required. Geophysical methods can be used to assist evaluation of the top of rock elevations.

### **3.2.2 Non-Core (Destructive) Drilling**

Non-core rock drilling is a relatively quick and inexpensive means of advancing a boring which can be considered when an intact rock sample is not required. Non-core drilling is typically used for determining the top of rock and is useful in solution cavity identification in karstic terrain. Types of non-core drilling include air-track drilling, down-the-hole percussive drilling, rotary tricone (roller bit) drilling, rotary drag bit drilling, and augering with carbide-tipped bits in very soft rocks. Drilling fluid may be water, mud, foam, or compressed air. Caution should be exercised when using these methods to define the top of soft rock since drilling proceeds rapidly, and cuts weathered and soft rock easily, frequently misrepresenting the top of rock for elevation or pile driving applications.

Because intact rock samples are not recovered in non-core drilling, it is particularly important for the field supervisor to carefully record observations during drilling. The following information pertaining to drilling characteristics should be recorded in the remarks section of the boring log:

- Penetration rate or drilling speed in minutes per 0.3 meter
- Dropping of rods
- Changes in drill operation by driller (down pressures, rotation speeds, etc.)
- Changes in drill bit condition
- Unusual drilling action (chatter, bouncing, binding, etc.)
- Loss of drilling fluid, color change, or change in drilling pressure

### 3.2.3 Types of Core Drilling

A detailed discussion of diamond core drilling is presented in AASHTO T 225 and ASTM D 2113.

Core barrels (shown in Figures 3-16a,b,c) may be single-tube, double-tube, or triple-tube. Table 3-4 presents various types of core barrels available on the market. The minimum standard is a double-tube core barrel, which offers better recovery by isolating the rock core from the drilling fluid stream. The inner tube can be rigid or fixed to the core barrel head and rotate around the core or it can be mounted on roller bearings which allow the inner tube to remain stationary while the outer tube rotates. The second or swivel type core barrel is less disturbing to the core as it enters the inner barrel and is useful in coring fractured and friable rock. In some regions only triple tube core barrels are used in rock coring. In a multi-tube system, the inner tube may be longitudinally split to allow observation and removal of the core with reduced disturbance.

**TABLE 3-4  
DIMENSIONS OF CORE SIZES  
(Christensen Dia-Min Tools, Inc.)**

Size	Diameter of Core (mm)	Diameter of Borehole (mm)
EX,EXM	21.5	37.7
EWD3	21.2	37.7
AX	30.1	48.0
AWD4, AWD3	28.9	48.0
AWM	30.1	48.0
AQ Wireline, AV	27.1	48.0
BX	42.0	59.9
BWD4, BWD3	41.0	59.9
BXB Wireline, BWC3	36.4	59.9
BQ Wireline, BV	36.4	59.9
NX	54.7	75.7
NWD4,NWD3	52.3	75.7
NXB Wireline, NWC3	47.6	75.7
NQ Wireline, NV	47.6	75.7
HWD4	61.1	92.7
HXB Wireline, HWD3	61.1	92.7
HQ Wireline	63.5	96.3
CP, PQ Wireline	85.0	122.6

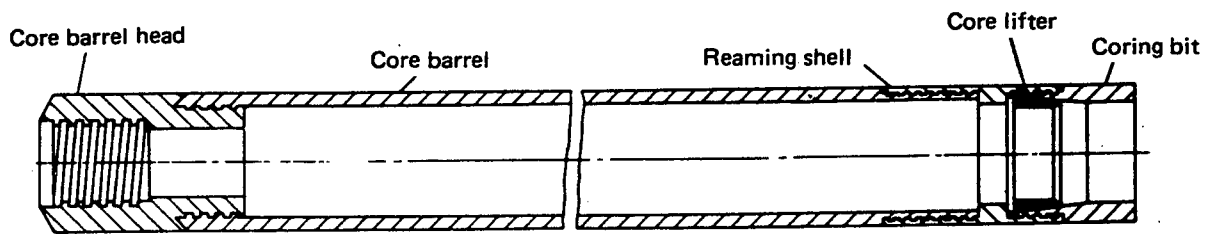

(a)

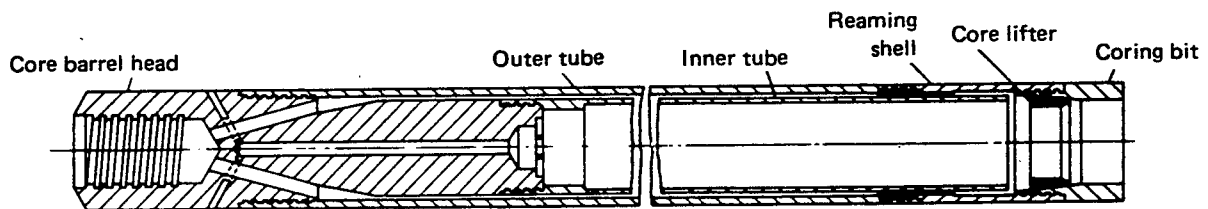

(b)

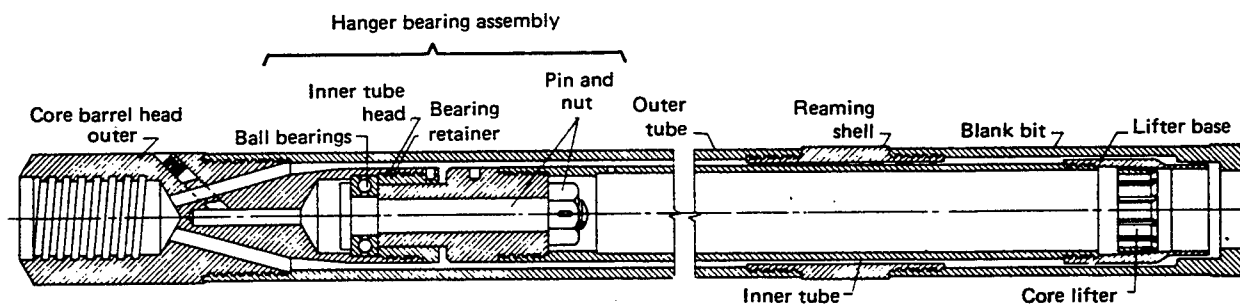

(c)

Figure 3-16: (a) Single Tube Core Barrel, (b) Rigid Type Double Tube Core Barrel (c) Swivel Type Double Tube Core Barrel, Series "M" with Ball Bearings. (Courtesy of Sprague & Henwood, Inc.)

Rock coring can be accomplished with either conventional or wireline equipment. With conventional drilling equipment, the entire string of rods and core barrel are brought to the surface after each core run to retrieve the rock core. Wireline drilling equipment allows the inner tube to be uncoupled from the outer tube and raised rapidly to the surface by means of a wire line hoist. The main advantage of wireline drilling over conventional drilling is the increased drilling production resulting from the rapid removal of the core from the hole which, in turn, decreases labor costs. It also provides improved quality of recovered core, particularly in soft rock, since this method avoids rough handling of the core barrel during retrieval of the barrel from the borehole and when the core barrel is opened. (Drillers often hammer on the core barrel to break it from the drill rods and to open the core barrel, causing the core to break.) Wireline drilling can be used on any rock coring job, but typically, it is used on projects where bore holes are greater than 25 m deep and rapid removal of the core from the hole has a greater effect on cost.

Although NX is the size most frequently used for engineering explorations, larger and smaller sizes are in use. Generally, a larger core size will produce greater recovery and less mechanical breakage. Because of their effect on core recovery, the size and type of coring equipment used should be carefully recorded in the appropriate places on the boring log.

The length of each core run should be limited to 3 m maximum. Core run lengths should be reduced to 1.5 m, or less, just below the rock surface and in highly fractured or weathered rock zones. Shorter core runs often reduce the degree of damage to the core and improve core recovery in poor quality rock.

### **Coring Bits**

The coring bit is the bottommost component of the core barrel assembly. It is the grinding action of this component that cuts the core from the rock mass. Three basic categories of bits are in use: diamond, carbide insert, and sawtooth. Figure 3-17 shows various types of coring bits. Coring bits are generally selected by the driller and are often approved by the geotechnical engineer. Bit selection should be based on general knowledge of drill bit performance for the expected formations and the proposed drilling fluid.

Diamond coring bits which may be of surface set or impregnated-diamond type are the most versatile since they can produce high-quality cores in rock materials ranging from soft to extremely hard. Compared to other types, diamond bits in general permit more rapid coring and as noted by Hvorslev (1949), exert lower torsional stresses on the core. Lower torsional stresses permit the retrieval of longer cores and cores of small diameter. The wide variation in the hardness, abrasiveness, and degree of fracturing encountered in rock has led to the design of bits to meet specific conditions known to exist or encountered at given sites. Thus, wide variations in the quality, size, and spacing of diamonds, in the composition of the metal matrix, in the face contour, and in the type and number of waterways are found in bits of this type. Similarly, the diamond content and the composition of the metal matrix of impregnated bits are varied to meet differing rock conditions.

Carbide bits use tungsten carbide in lieu of diamonds and are of several types. Two types, the standard and the pyramid carbide bits are shown in Figure 3-17 c and d. Bits of this type are used to core soft to medium-hard rock. They are less expensive than diamond bits. However, the rate of drilling is slower than with diamond bits.

Sawtooth bits consist of teeth cut into the bottom of the bit. The teeth are faced and tipped with a hard metal alloy such as tungsten carbide to provide wear resistance and thereby to increase the life of the bit. Although these bits are less expensive than diamond bits, they do not provide as high a rate of coring and do not have a salvage value. The saw tooth bit is used primarily to core overburden and very soft rock.



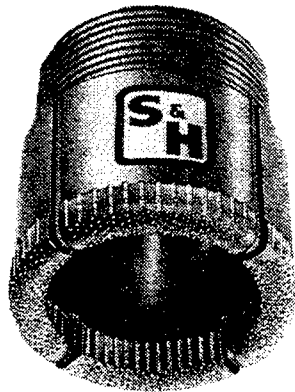

(a)

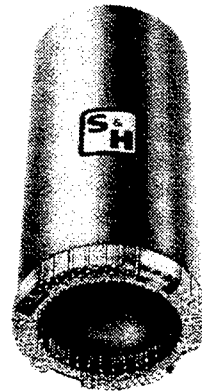

(b)



(c)

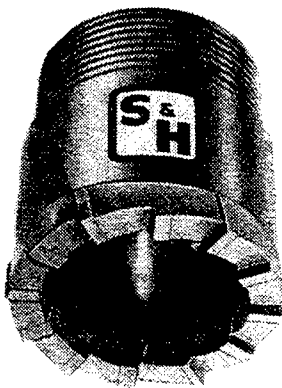

(d)

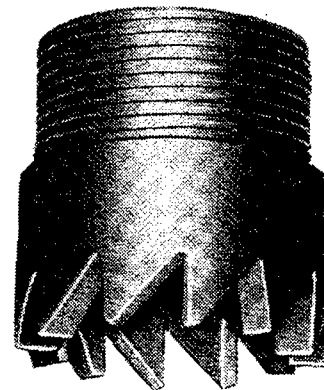

(e)

Figure 3-17: Coring Bits: (a) Diamond with Conventional Waterways, (b) Diamond with Bottom-Discharge Waterways, (c) Carbide Insert - Pyramid Type, (d) Carbide Insert - Blade Type, (e) Sawtooth. (Courtesy of Sprague & Henwood, Inc. and Acker Drill Co., Inc.)

An important feature of all bits which should be noted is the type of waterways provided in the bits for passage of drilling fluid. Bits are available with so-called "conventional" waterways, which are passages cut on the interior face of the bit (Figure 3-17a), or with bottom discharge waterways, which are internal and discharge at the bottom face of the bit behind a metal skirt separating the core from the discharge fluid (Figure 3-17b). Bottom discharge bits should be used when coring soft rock or rock having soil-filled joints to prevent erosion of the core by the drilling fluid before the core enters the core barrel.

### **Drilling Fluid**

In many instances, clear water is used as the drilling fluid in rock coring. If drilling mud is required to stabilize collapsing holes or to seal zones when there is loss of drill water, the design engineer, the geologist and the geotechnical engineer should be notified to confirm that the type of drilling mud is acceptable. Drilling mud will clog open joints and fractures, which adversely affects permeability measurements and piezometer installations. Drilling fluid should be contained in a settling basin to remove drill cuttings and to allow recirculation of the fluid. Generally, drilling fluids can be discharged onto the ground surface. However, special precautions or handling may be required if the material is contaminated with oil or other substances and may require disposal off site. Water flow over the ground surface should be avoided, as much as possible.

### **3.2.4 Observation During Core Drilling**

#### **Drilling Rate/Time**

The drilling rate should be monitored and recorded on the boring log in the units of minutes per 0.3 m. Only time spent advancing the boring should be used to determine the drilling rate.

#### **Core Photographs**

Cores in the split core barrel should be photographed immediately upon removal from the borehole. A label should be included in the photograph to identify the borehole, the depth interval and the number of the core runs. It may be desirable to get a "close-up" of interesting features in the core. Wetting the surface of the core using a spray bottle and/or sponge prior to photographing will often enhance the color contrasts of the core.

A tape measure or ruler should be placed across the top or bottom edge of the box to provide a scale in the photograph. The tape or ruler should be at least 1 meter long, and it should have relatively large, high contrast markings to be visible in the photograph.

A color bar chart is often desirable in the photograph to provide indications of the effects of variation in film age, film processing, and the ambient light source. The photographer should strive to maintain uniform light conditions from day to day, and those lighting conditions should be compatible with the type of film selected for the project.

#### **Rock Classification**

See Section 4.7 for a discussion of rock classification and other information to be recorded for rock core.

## Recovery

The core recovery is the length of rock core recovered from a core run, and the recovery ratio is the ratio of the length of core recovered to the total length of the core drilled on a given run, expressed as either a fraction or a percentage. Core length should be measured along the core centerline. When the recovery is less than the length of the core run, the non-recovered section should be assumed to be at the end of the run unless there is reason to suspect otherwise (e.g., weathered zone, drop of rods, plugging during drilling, loss of fluid, and rolled or recut pieces of core). Non-recovery should be marked as NCR (no core recovery) on the boring log, and entries should not be made for bedding, fracturing, or weathering in that interval.

Recoveries greater than 100 percent may occur if core that was not recovered during a run is subsequently recovered in a later run. These should be recorded as such; adjustments to data should not be made in the field.

## Rock Quality Designation (RQD)

The RQD is a modified core recovery percentage in which the lengths of all pieces of sound core over 100 mm long are summed and divided by the length of the core run. The correct procedure for measuring RQD is illustrated in Figure 3-18. The RQD is an index of rock quality in that problematic rock that is highly weathered, soft, fractured, sheared, and jointed typically yields lower RQD values. Thus, RQD is simply a measurement of the percentage of "good" rock recovered from an interval of a borehole. It should be noted that the original correlation for RQD (Rock Quality Designation) reported by Deere (1963) was based on measurements made on NX-size core. Experience in recent years reported by Deere and Deere (1989) indicates that cores with diameters both slightly larger and smaller than NX may be used for computing RQD. The wire line cores using NQ, HQ, and PQ are considered acceptable. The smaller BQ and BX sizes are discouraged because of more potential for core breakage and loss.

### Length Measurements of Core Pieces

The same piece of core could be measured three ways: along the centerline, from tip to tip, or along the fully circular barrel section (Figure 3-19). The recommended procedure is to measure the core length along the centerline. This method is advocated by the International Society for Rock Mechanics (ISRM), Commission on Standardization of Laboratory and Field Tests (1978, 1981). The centerline measurement is preferred because: (1) it results in a standardized RQD that is not dependent on the core diameter, and (2) it avoids unduly penalizing of the quality of rock mass for cases where the fractures parallel the borehole and are cut by a second set.

Core breaks caused by the drilling process should be fitted together and counted as one piece. Drilling breaks are usually evidenced by rough fresh surfaces. For schistose and laminated rocks, it is often difficult to discern the difference between natural breaks and drilling breaks. When in doubt about a break, it should be considered as natural in order to be conservative in the calculation of RQD for most uses. This practice would not be conservative when the RQD is used as part of a ripping or dredging estimate.

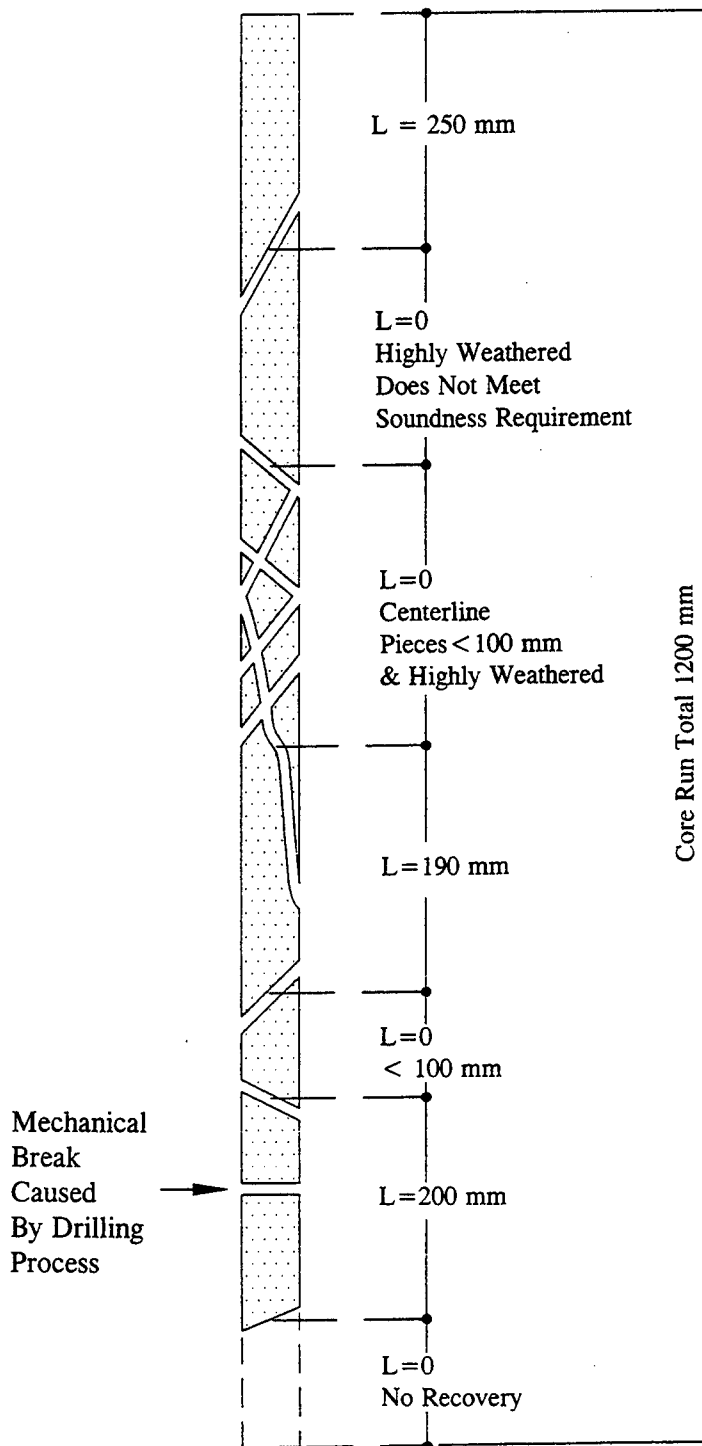

$$RQD = \frac{\sum \text{Length of Sound } > 100 \text{ mm Core Pieces}}{\text{Total Core Run Length}}$$

$$RQD = \frac{250 + 190 + 200}{1200} \times 100\%$$

RQD = 53% (Fair)

#### Rock Quality Description

RQD (Rock Quality Designation)	Description of Rock Quality
0 - 25%	Very Poor
25 - 50%	Poor
50 - 75%	Fair
75 - 90%	Good
90 - 100%	Excellent

Figure 3-18: Modified Core Recovery as an Index of Rock Quality.

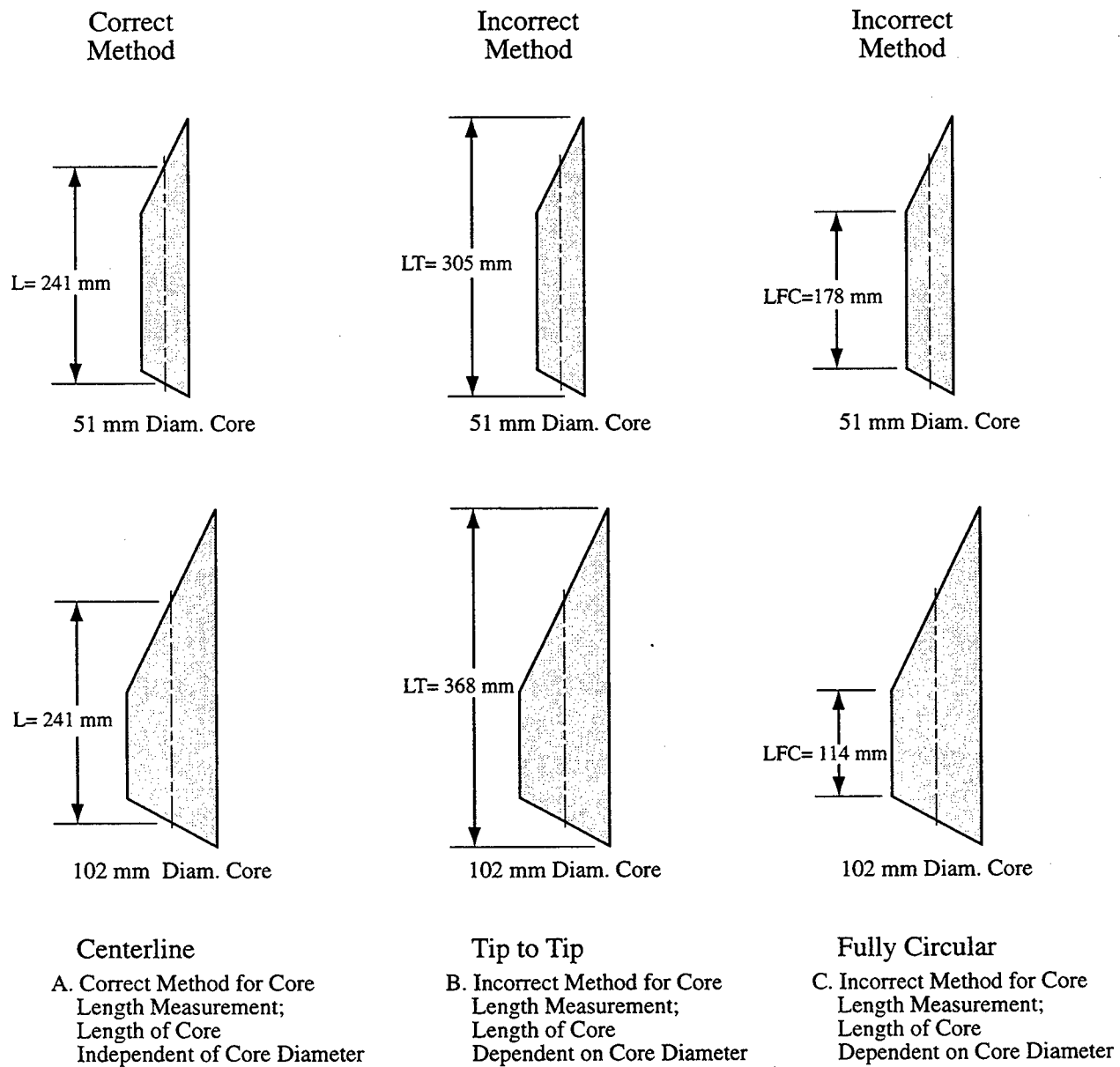

Figure 3-19: Length Measurement of Core for RQD Determination.

### Assessment of Soundness

Pieces of core which are not "hard and sound" should not be counted for the RQD even though they possess the requisite 100 mm length. The purpose of the soundness requirement is to downgrade the rock quality where the rock has been altered and weakened either by agents of surface weathering or by hydrothermal activity. Obviously, in many instances, a judgment decision must be made as to whether or not the degree of chemical alteration is sufficient to reject the core piece.

One commonly used procedure is not to count a piece of core if there is any doubt about its meeting the soundness requirement (because of discolored or bleached grains, heavy staining, pitting, or weak grain boundaries). This procedure may unduly penalize the rock quality, but it errs on the side of conservatism. A second procedure which occasionally has been used is to include the altered rock within the RQD summed percentage, but to indicate by means of an asterisk (RQD\*) that the soundness requirements have not been met. The advantage of the method is that the RQD\* will provide some indication of the rock quality with respect to the degree of fracturing, while also noting its lack of soundness.

### **Drilling Fluid Recovery**

The loss of drilling fluid during the advancement of a boring can be indicative of the presence of open joints, fracture zones or voids in the rock mass being drilled. Therefore, the volumes of fluid losses and the intervals over which they occur should be recorded. For example, "no fluid loss" means that no fluid was lost except through spillage and filling the hole. "Partial fluid loss" means that a return was achieved, but the amount of return was significantly less than the amount being pumped in. "Complete water loss" means that no fluid returned to the surface during the pumping operation. A combination of opinions from the field personnel and the driller on this matter will result in the best estimate.

### **Core Handling and Labeling**

Rock cores from geotechnical explorations should be stored in structurally sound core boxes made of wood or corrugated waxed cardboard (Figure 3-20). Wooden boxes should be provided with hinged lids, with the hinges on the upper side of the box and a latch to secure the lid in a closed position.

Cores should be handled carefully during transfer from barrel to box to preserve mating across fractures and fracture-filling materials. Breaks in core that occur during or after the core is transferred to the core box should be refitted and marked with three short parallel lines across the fracture trace to indicate a mechanical break. Breaks made to fit the core into the core box and breaks made to examine an inner core surface should be marked as such. These deliberate breaks should be avoided unless absolutely necessary.

Cores should be placed in the boxes from left to right, top to bottom. When the upper compartment of the box is filled, the next lower (or adjoining) compartment (and so on until the box is filled) should be filled, beginning in each case at the left-hand end. The depths of the top and bottom of the core and each noticeable gap in the formation should be marked by a clearly labeled wooden spacer block.

If there is less than 100 percent core recovery for a run, a cardboard tube spacer of the same length as the core loss should be placed in the core box either at the depth of core loss, if known, or at the bottom of the run. The depth of core loss, if known, or length of core loss should be marked on the spacer with a black permanent marker.

Core Box Top Outside

Subcontract No.	Box # ___ of ___
Subcontractor's Name	Date
Boring No.	
Coring Runs Contained in Box	
Depth from _____ to _____	

Core Box Top Inside

Subcontract No.	Run #	Depths	Rec (mm)	RQD (mm)	Box # ___ of ___
Boring No.	_____	_____	_____	_____	Date
Runs _____	Run #				Sketch of Location of Core within the Core Box
Depth from _____ to _____	Run #				
	Run #				
	Run #				

Subcontract No.	Run Nos.	Box _____ of _____
Boring No.	Depths	

Core Box Front and Back Face

Subcontract No.	Run Nos.
Boring No.	
Depths	Box # ___ of ___

Both Core Box End Faces

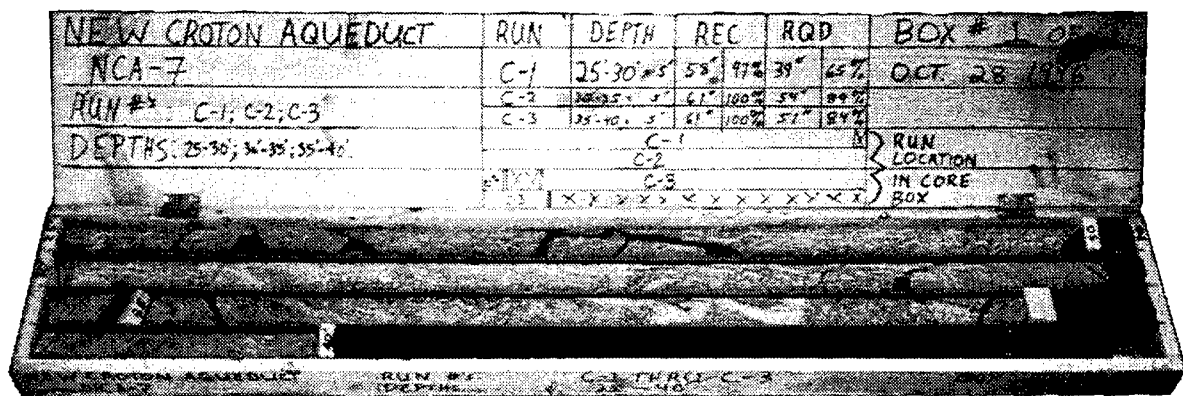

Figure 3-20: Core Box and Labeling.

The core box labels should be completed using an indelible black marking pen. An example of recommended core box markings is given in Figure 3-20. The core box lid should have identical markings both inside and out, and both exterior ends of the box should be marked as shown.

For angled borings, depths marked on core boxes and boring logs should be those measured along the axis of the boring. The angle and orientation of the boring should be noted on the core box and the boring log.

### **Care and Preservation of Rock Samples**

A detailed discussion of sample preservation and transportation is presented in ASTM D 5079. Four levels of sample protection are identified:

- Routine care
- Special care
- Soil-like care
- Critical care

Most geotechnical explorations will require routine care in placing rock core in core boxes. ASTM D 5079 suggests enclosing the core in a loose-fitting polyethylene sleeve prior to placing the core in the core box.

Special care is considered appropriate if the moisture state of the rock core (especially shale, claystone and siltstone) and the corresponding properties of the core may be affected by exposure. This same procedure can also apply if it is important to maintain fluids other than water in the sample. Critical care is needed to protect samples against shock and vibration or variations in temperature, or both. For soil-like care, samples should be treated as indicated in ASTM D 4220.

### **3.2.5 Geologic Mapping**

Geologic mapping is briefly discussed here, but is more fully described in Module 5 (Rock Slopes). Geologic mapping is the systematic collection of local, detailed geologic data, and, for engineering purposes, is used to characterize and document the condition of a rock mass or outcrop. The data derived from geologic mapping is a portion of the data required for design of a cut slope or for stabilization of an existing slope. Geologic mapping can often provide more extensive and less costly information than drilling. The guidelines presented are intended for rock and rock-like materials. Soil and soil-like materials, although occasionally mapped, are not considered in this section.

Qualified personnel trained in geology or engineering geology should perform the mapping or provide supervision and be responsible for the mapping activities and data collection. The first step in geologic mapping is to review and become familiar with the local and regional geology from published and non-published reports, maps and investigations. The mapping team should be knowledgeable of the rock units and structural and historical geologic aspects of the area. A team approach (minimum of two people, the "buddy system") is recommended for mapping as a safety precaution when mapping in isolated areas.

Procedures for mapping are outlined in an FHWA Manual (1989) on rock slope design, excavation and stabilization and in ASTM D 4879.

The first reference describes the parameters to be considered when mapping for cut slope design, which include:



- Discontinuity type
- Discontinuity orientation
- Discontinuity in filling
- Surface properties
- Discontinuity spacing
- Persistence
- Other rock mass parameters

These parameters can be easily recorded on a structural mapping coding form shown in Figure 3-21(a) and 3-21 (b). ASTM D 4879 also describes similar parameters and presents commonly used geologic symbols for mapping purposes. It also presents a suggested report outline. Presentation of discontinuity orientation data can be graphically plotted using stereographic projections. These projections are very useful in rock slope stability analyses. Chapter 3 (Graphical presentation of geological data) in the FHWA manual cited above describes the stereographic projection methods in detail.

### **3.3 BORING CLOSURE**

All borings should be properly closed at the completion of the field exploration. This is typically required for safety considerations and to prevent cross contamination of soil strata and groundwater. Boring closure is particularly important for tunnel projects since an open borehole exposed during tunneling may lead to uncontrolled inflow of water or escape of compressed air.

In many parts of the country, methods to be used for the closure of boreholes are regulated by state agencies. National Cooperative Highway Research Program Report No. 378 (1995) titled "Recommended Guidelines for Sealing Geotechnical Holes" contains extensive information on sealing and grouting. The regulations in general, require that any time groundwater or contamination is encountered the borehole be grouted using a mixture of powdered bentonite, portland cement and potable water. Some state agencies require grouting of all boreholes exceeding a certain depth. The geotechnical engineer and the field supervisor should be knowledgeable about local requirements prior to commencing the borings.

It is good practice to grout all boreholes. Holes in pavements and slabs should be filled with quick setting concrete, or with asphaltic concrete, as appropriate. Backfilling of boreholes is generally accomplished using a grout mixture. The grout mix is normally pumped through drill rods or other pipes inserted into the borehole. In boreholes filled with water or other drilling fluids the tremied grout will displace the drill fluid. Provisions should be made to collect and dispose of all displaced drill fluid and waste grout.

Exploration pits can, generally, be backfilled with the spoils generated during the excavation. The backfilled material should be compacted to avoid excessive future settlements. Tampers or rolling equipment may be used to facilitate compaction of the backfill.

### **3.4 SAFETY GUIDELINES FOR GEOTECHNICAL BORINGS**

All field personnel, including geologists, engineers, technicians, and drill crews, should be familiar with the general health and safety procedures, as well as any additional requirements of the project or governing agency.

Typical safety guidelines for drilling into soil and rock are presented in Appendix A. Minimum protective gear for all personnel should include hard hat, safety boots, eye protection, and gloves.



# SLOPE STABILITY ASSESSMENT

# ROCK MASS DESCRIPTION

### GENERAL INFORMATION

Subdivision  Km  Date  Day  Month  Year  Inspector

### Inspection Rating

- Urgent - receipt of fall/visual evidence of significant movement -
- Priority - evidence of movement or change in conditions from previous years
- Observe - identification of a specific area of potential instability
- OK - no potential instability

### Required Action

1. Inspect - inspection required within the next three months approximately - state time
2. Work of state - state stabilization work of sufficient size to be required in current year - state time
3. Slow Order - traffic at restricted speed/stopped/watchman until stabilization work carried out
4. 1-5 Years - possible stabilization - state time
5. Long-term - substantial stabilization program
6. No Action

### Assessment of Site Conditions

1. Open fractures indicative of past movement.
2. Fractures oriented such that blocks could slide or topple on to the track.
3. Evidence of recent movement.
4. Probability that rockfall/slide would be of sufficient size to reach tracks and cause derailment.
5. Serious consequence of derailment (e.g. track on narrow bench or supported by retaining wall).

### No. of supplementary sheets

Slope Length  of discontinuity data

Slope Height  Sketch  Photograph

0. No  
1. Yes

### Locality Type

1. Natural exposure
2. Construction excavation
3. Trial pit
4. Trench
5. Adit
6. Tunnel

### Remarks

(consequences, stabilization, rockfalls, slide fence)

### ROCK MATERIAL INFORMATION

Color

1. Light  
2. Dark

1. Pinkish  
2. Reddish  
3. Yellowish  
4. Brownish  
5. Olive  
6. Greenish  
7. Blueish  
8. Greyish

### Grain Size

1. Very coarse (>60 mm)
2. Coarse (2-60 mm)
3. Medium (60 μ-20 mm)
4. Fine (2-60 μ)
5. Very fine (<2 μ)

### Compressive strength

1. Very strong rock
2. Strong rock
3. Moderately strong rock
4. Moderately weak rock
5. Very weak rock
6. Very stiff soil
7. Stiff soil
8. Firm soil
9. Soft soil
10. Very soft soil

### Method of determining compressive strength

1. Measured
2. Assessed

### Rock Type

Qualifying terms to describe rock

### ROCK MASS INFORMATION

Fabric

Block size

1. Blocky  
2. Tabular  
3. Columnar

1. Very large (>8 m<sup>3</sup>)  
2. Large (0.2-8 m<sup>3</sup>)  
3. Medium (0.008-0.2 m<sup>3</sup>)  
4. Small (0.0002-0.008 m<sup>3</sup>)  
5. Very small (<0.0002 m<sup>3</sup>)

### LINE SURVEYS TO DETERMINE DISCONTINUITY SPACINGS

Plunge of line	Trend of line	Length of line (m)	No. of fractures	Spacing	Remarks
Discontinuity spacing					
1. Extremely close (<20 mm)					
2. Very close (20-60 mm)					
3. Close (60-200 mm)					
4. Moderate (200-600 mm)					
5. Wide (600-2000 mm)					
6. Very wide (2000-60000 mm)					
7. Ext. Wide (> 60000 mm)					

Figure 3-21: (b) Structural Mapping Coding Form for Slope Assessment.

It is not unusual to encounter unknown or unexpected environmental problems during a site investigation. For example, discolored soils or rock fragments from prior spills, or contaminated groundwater may be detected. The geotechnical engineer and the field supervisor should attempt to identify possible contamination sources prior to initiating fieldwork. Based on this evaluation, a decision should be made whether a site safety plan should be prepared. Environmental problems can adversely affect investigation schedules and cost, and may require the obtaining of permits from State or Federal agencies prior to drilling or sampling.

At geotechnical exploration sites where unknown or unexpected contamination is found during the fieldwork, the following steps should be taken:

1. The field supervisor should immediately stop drilling and notify the geotechnical engineer. The field supervisor should identify the evidence of contamination, the depth of contamination, and the estimated depth to the water table (if known). If liquid-phase product is encountered (at or above the water table), the boring should be abandoned immediately and sealed with hydrated bentonite chips or grout.
2. The project manager should advise the environmental officer of the governing agency and decide if special health and safety protocol should be implemented. Initial actions may require demobilization from the site.

### **3.5 COMMON ERRORS BY DRILLERS**

Drillers performance is commonly judged by the quantity of production rather than the quality of the borings and samples. Not surprisingly, similar problems develop throughout the country. All geotechnical engineers and field supervisors need to be trained to recognize these problems, and to assure that field information and samples are properly obtained. The following is a partial listing of common errors:

- Not properly cleaning slough and cuttings from the bottom of the bore hole. The driller should not be allowed to sample through slough. Preferably the driller should re-enter the boring and remove the slough before proceeding.
- In cohesionless soils, jetting should not be used to advance a split barrel sampler to the bottom of the boring.
- Poor sample recovery due to use of improper sampling equipment or procedures.
- When sampling soft or non-cohesive soils with thin wall tube samplers (i.e., Shelby tube) it may not be possible to recover an undisturbed sample because the sample will not stay in the barrel. The driller should be clearly instructed not to force recovery by overdriving the sampling barrel to grab a sample.
- Improper sample types or insufficient quantity of samples. The driller should be given clear instructions regarding the sample frequency and types of samples required. The field supervisor must keep track of the depth of the borings at all stages of the exploration to confirm proper sampling of the soil and/or rock formations.
- Improper hole stabilization. Rotary wash borings and hollow-stem auger borings below the groundwater level require a head of water to be maintained at the top of the casing/augers at all times. When the drill rods are withdrawn or as the hollow stem auger is advanced, this water level will tend to drop, and must be maintained by the addition of more drilling fluid. Without this precaution, the sides of the boring

may collapse or the bottom of the boring may heave.

- Sampler rods lowered into the boring with pipe wrenches rather than hoisting plug. The rods may be inclined and the sampler can hit the boring walls, filling the sampler with debris.
- Improper procedures for performing Standard Penetration Tests. The field supervisor and driller must assure that the proper weight and hammer drop are being used, and that friction at the cathead and along any hammer guides is minimized.



## CHAPTER 4.0 BORING LOG PREPARATION

### 4.1 GENERAL

The boring log is the basic record of almost every geotechnical exploration and provides a detailed record of the work performed and the findings of the investigation. The field log should be written or printed legibly, and should be kept as clean as is practical. All appropriate portions of the logs should be completed in the field prior to completion of the field exploration.

A wide variety of drilling forms are used by various agencies. The specific forms to be used for a given type of boring will depend on local practice. Typical boring log, core boring log and test pit log forms endorsed by the ASCE Soil Mechanics and Foundations Engineering Steering Committee are presented in Figures 4-1 through 4-3, respectively. A proposed legend for soil boring logs is presented in Figure 4-4 and a proposed legend for core boring logs is presented in Figure 4-5. This chapter presents guidelines for completion of the boring log forms, preparation of soil descriptions and classifications, and preparation of rock descriptions and classifications.

A boring log is a description of exploration procedures and subsurface conditions encountered during drilling, sampling and coring. Following is a brief list of items which should be included in the logs. These items are discussed in detail in subsequent sections:

- Topographic survey data including boring location and surface elevation, and bench mark location and datum, if available.
- An accurate record of any deviation in the planned boring locations.
- Identification of the subsoils and bedrock including density, consistency, color, moisture, structure, geologic origin.
- The depths of the various generalized soil and rock strata encountered.
- Sampler type, depth, penetration, and recovery.
- Sampling resistance in terms of hydraulic pressure or blows per depth of sampler penetration. Size and type of hammer. Height of drop.
- Soil sampling interval and recovery.
- Rock core run numbers, depths and lengths, core recovery, and Rock Quality Designation (RQD) measurements.
- Type of drilling operation used to advance and stabilize the hole.
- Comparative resistance to drilling.
- Loss of drilling fluid.
- Water level observations with remarks on possible variations due to tides, river level, etc.

<b>Project:</b> <b>Project Location:</b> <b>Project Number:</b>	<h2 style="margin: 0;">Log of Boring ____</h2> <p style="margin: 0;">Sheet 1 of ____</p>
---	--

Date(s) Drilled	Logged By	Checked By
Drilling Method	Drill Bit Size/Type	Total Depth Drilled (meters)
Drill Rig Type	Drilled By	Hammer Weight/Drop (N/m)
Apparent Groundwater Depth ____ m ATD ____ m after ____ hrs ____ m after ____ hrs		Surface Elevation (meters)
Comments	Borehole Backfill	Elevation Datum

Depth, meters	SAMPLES				MATERIAL DESCRIPTION and other remarks	Elevation, meters	Pocket Pen., kPa	Water Content, %	Liquid Limit	Plasticity Index	Other Tests
	Location	Type	Number	Sampling Resistance							
0											
1											
2											
3											
4											

Template:      Proj ID:

Printed:

Figure 4-1: Typical Boring Log Form.



<b>Project:</b> <b>Project Location:</b> <b>Project Number:</b>	<h2 style="margin: 0;">Log of Core Boring</h2> <p style="margin: 0;">Sheet 1 of</p>
---	---

Date(s) Drilled	Logged By	Checked By
Drilling Method	Drill Bit Size/Type	Total Depth Drilled (meters)
Drill Rig Type	Drilled By	Inclination from Vertical/Bearing
Apparent Groundwater Depth ___ m ATD ___ m after ___ hrs		Approx. Surface Elevation (meters)
Comments		Borehole Backfill

Depth, meters	Elevation, meters	ROCK CORE							MATERIAL DESCRIPTION	Packer Tests	Laboratory Tests	Drill Rate, meters/hour	FIELD NOTES
		Run No.	Box No.	Recovery, %	Frac. Freq.	R Q D, %	Fracture Drawing/Number	Lithology					
0													
1													

Template:      Proj ID:      Printed:

Figure 4-2: Typical Core Boring Log.

<b>Project:</b> <b>Project Location:</b> <b>Project Number:</b>	<b>Log of  Exploration Pit ____</b>
---	---

Date(s) Excavated	Logged By	Checked By
Approximate Length (meters)	Approximate Width (meters)	Approximate Depth (meters)
Excavation Equipment	Excavation Contractor	Approximate Pit Trend
Groundwater Level (meters)	Date Measured	Approx. Surface Elevation (meters)
Comments		

Depth, meters	Elevation, meters	Sample Type and Number	Pocket Pen., kPa	Graphic Log	MATERIAL DESCRIPTION and other remarks	Water Content, %	Other Tests
0							
1							
2							
3							
4							

Template: Proj ID: Printed:

Figure 4-3: Typical Exploration Pit Log.

Project:  
Project Location:  
Project Number:

## Key to Soil Symbols and Terms

Sheet 1 of 2

Depth, meters	SAMPLES				MATERIAL DESCRIPTION and other remarks	Elevation, meters	Pocket Pen., kPa	Water Content, %	Liquid Limit	Plasticity Index	Other Tests
	Location	Type	Number	Sampling Resistance							
0					<b>DESCRIPTIONS OF SAMPLER AND FIELD TEST CODES</b>						
1		S	1	15	The number of blows (15) of a 63.6 Kgr hammer falling 750 mm used to drive a 50 mm O.D. split-barrel sampler for the last 300 mm of penetration.						
2		S	2	50/150	Number of blows (50) used to drive the split-barrel a certain number of millimeters (150).						
3		P	3	1724	Thin-wall tube pushed hydraulically, using a certain pressure (1,724 kPa) to push the last 150 mm.						
4		A	4		<b>SAMPLER CODES</b> P - Thin-wall tube sample. C - Denison or Pitcher-type core-barrel sample. Ps - Piston sample. A - Auger sample. BS - Bulk sample. SS - Standard spoon sample. CL - California liner sample.						
5		NX - 65	5	40	BX - Rock cored with BX core barrel, which obtains a 41 mm-diameter core. NX - Rock cored with NX core barrel, which obtains a 53 mm-diameter core. 65 - Percentage (65) of rock core recovered. 40 - Rock Quality Designation (RQD) percentage (40).						
6		S			Sample recovered: indicated by blackened box in "Location" column.						
7		NR			Sample not recovered: indicated by vertical bar in "Location" column and "NR" (no recovery) in "Type" column.						
					<b>OTHER FIELD TEST DESIGNATIONS</b> FV - Field vane shear test. PMT - Pressuremeter test. DMT - Dilatometer test. BHS - Borehole shear test.						
						<b>ABBREVIATIONS FOR "OTHER TESTS" COLUMN</b> C - Consolidation and specific gravity tests. D - Maximum and minimum density. DS - Direct shear test. G - Specific gravity test. K - Permeability test. M - Mechanical (sieve or hydrometer) analysis. T - Triaxial compression test. TV - Torvane shear test. U - Unconfined compression test. W - Unit weight and natural moisture content. X - Special tests performed - see laboratory test results.					

Template: MS9K Proj ID: KEY

Point ID: MS9K Printed: MAY 28 97

Figure 4-4: Proposed Key to Boring Log (Continued on Page 4-6).

**Project:**  
**Project Location:**  
**Project Number:**

# Key to Soil Symbols and Terms

Sheet 2 of 2

## TERMS DESCRIBING CONSISTENCY OR CONDITION

**COARSE-GRAINED SOILS** (major portion retained on No. 200 sieve): includes (1) clean gravels and sands and (2) silty or clayey gravels and sands. Condition is rated according to relative density as determined by laboratory tests or standard penetration resistance tests.

Descriptive Term	Relative Density	SPT Blow Count
Very loose	0 to 15%	< 4
Loose	15 to 35%	4 to 10
Medium dense	35 to 65%	10 to 30
Dense	65 to 85%	30 to 50
Very dense	85 to 100%	> 50

**FINE-GRAINED SOILS** (major portion passing on No. 200 sieve): includes (1) inorganic and organic silts and clays, (2) gravelly, sandy, or silty clays, and (3) clayey silts. Consistency is rated according to shearing strength, as indicated by penetrometer readings, SPT blow count, or unconfined compression tests.

Descriptive Term	Unconfined Compressive Strength, kPa	SPT Blow Count
Very soft	< 25	< 2
Soft	25 to 50	2 to 4
Medium stiff	50 to 100	4 to 8
Stiff	100 to 200	8 to 15
Very stiff	200 to 400	15 to 30
Hard	> 400	> 30

## GENERAL NOTES

- Classifications are based on the Unified Soil Classification System and include consistency, moisture, and color. Field descriptions have been modified to reflect results of laboratory tests where deemed appropriate.
- Surface elevations are based on topographic maps and estimated locations.
- Descriptions on these boring logs apply only at the specific boring locations and at the time the borings were made. They are not warranted to be representative of subsurface conditions at other locations or times.

Major Divisions	Group Symbols	Typical Names	Laboratory Classification Criteria	Particle Size	Material			
Coarse-Grained Soils (More than half of material is larger than No. 200 sieve size)	Gravels (More than half of coarse fraction is larger than No. 4 sieve size)	GW	Well-graded gravels, gravel-sand mixtures, little or no fines	$C_u = \frac{D_{60}}{D_{10}}$ greater than 4; $C_c = \frac{(D_{30})^2}{D_{10} \times D_{60}}$ between 1 and 3  Not meeting all gradation requirements for GW	Sieve size < #200	#200 to #40 #40 to #10 #10 to #4		
		GP	Poorly-graded gravels, gravel-sand mixtures, little or no fines					
	Sands (More than half of coarse fraction is smaller than No. 4 sieve size)	Gravels with fines (Appreciable amount of fines)	GM <sup>a</sup>	Silty gravels, gravel-sand-silt mixtures	Determine percentages of sand and gravel from grain-size curve. Depending on percentage of fines (fraction smaller than No. 200 sieve) coarse-grained soils are classified as follows: Less than 5 percent . . . . . GW, GP, SW, SP More than 5 percent . . . . . GM, GC, SM, SC 5 to 12 percent . . . . . Borderline cases requiring dual symbols **	$C_u = \frac{D_{60}}{D_{10}}$ greater than 6; $C_c = \frac{(D_{30})^2}{D_{10} \times D_{60}}$ between 1 and 3  Not meeting all gradation requirements for SW	mm < 0.074	0.074 to 0.42 0.42 to 2.00 2.00 to 4.76
			GC	Clayey gravels, gravel-sand-silt mixtures				
		Clean sands (Little or no fines)	SW	Well-graded sands, gravelly sands, little or no fines				
			SP	Poorly-graded sands, gravelly sands, little or no fines				
Sands with fines (Appreciable amount of fines)	SM <sup>a</sup>	Silty sands, sand-silt mixtures	Atterberg limits below "A" line or P.I. less than 4	$C_u = \frac{D_{60}}{D_{10}}$ greater than 6; $C_c = \frac{(D_{30})^2}{D_{10} \times D_{60}}$ between 1 and 3  Not meeting all gradation requirements for SW	mm < 0.074	0.074 to 0.42 0.42 to 2.00 2.00 to 4.76		
		SC	Clayey sands, sand-clay mixtures				Atterberg limits above "A" line or P.I. greater than 7	
	SC	Clayey sands, sand-clay mixtures	Atterberg limits above "A" line or P.I. greater than 7					
Fine-Grained Soils (More than half of material is smaller than No. 200 sieve size)	Silty and Clays (Liquid limit less than 60)	ML	Inorganic silts and very fine sands, rock flour, silty or clayey fine sands or clayey silts with slight plasticity		mm < 0.074	0.074 to 0.42 0.42 to 2.00 2.00 to 4.76		
		CL	Inorganic clays of low to medium plasticity, gravelly clays, sandy clays, silty clays, lean clays					
		OL	Organic silts and organic silty clays of low plasticity					
	Silty and Clays (Liquid limit greater than 60)	MH	Inorganic silts, micaceous or diatomaceous fine sandy or silty soils, elastic silts					
		CH	Inorganic clays of high plasticity, fat clays					
		OH	Organic clays of medium to high plasticity, organic silts					
	Highly Organic Soils	Pt	Peat and other highly organic soils				Atterberg limits below "A" line or P.I. less than 4	Atterberg limits above "A" line or P.I. greater than 7

\* Division of GM and SM groups into subdivisions of d and u are for roads and airfields only. Subdivision is based on Atterberg Limits: suffix d used when L.L. is 28 or less and the P.I. is 6 or less; the suffix u used when L.L. is greater than 28.  
 \*\* Borderline classifications, used for soils possessing characteristics of two groups, are designated by combinations of group symbols. For example: GW-GC, well-graded gravel-sand mixture with clay binder.

Figure 4-4: Proposed Key to Boring Log.

Project:  
Project Location:  
Project Number:

# Key to Rock Core Log

Sheet 1 of 2

Depth, meters	Elevation, meters	ROCK CORE								MATERIAL DESCRIPTION	Packer Tests	Laboratory Tests	Drill Rate, meters/hour	FIELD NOTES
		Run No.	Box No.	Recovery, %	Frac. Freq.	R Q D, %	Fracture Drawing/Number	Lithology						
0														
1	2	3	4	5	6	7	8	9	10	11			15	16
2		1	1	100		80								Slow drilling
4					1									
					0			1	M					

12  
 a b c d e f g h  
 1: 75, J, VN, Fe, Su, Pl, S, VC  
 M: Mechanical Breakage

- 1 **Depth:** Distance (in meters) from the collar of the borehole.
- 2 **Elevation:** Elevation (in meters) from the collar of the borehole.
- 3 **Run No.:** Number of the individual coring interval, starting at the top of bedrock.
- 4 **Box No.:** Number of the core box which contains core from the corresponding run.
- 5 **Recovery:** Amount (in percent) of core recovered from the coring interval; calculated as the length of core recovered divided by the length of the run.
- 6 **Frac. Freq.:** (Fracture Frequency) The number of naturally occurring fractures in each foot of core; does not include mechanical breaks, which are considered to be induced by drilling.
- 7 **R Q D:** (Rock Quality Designation) Amount (in percent) of intact core (pieces of sound core greater than 100 mm in length) in each coring interval; calculated as the sum of the lengths of intact core divided by the length of the core run.
- 8 **Fracture Drawing:** Sketch of the naturally occurring fractures and mechanical breaks, showing the angle of the fractures relative to the cross-sectional axis of the core. "NR" indicates no recovery.
- 9 **Fracture Number:** Location of each naturally occurring fracture (numbered) and mechanical break (labeled "M"). Naturally occurring fractures are described in Column 11 (keyed by number) using descriptive terms defined on the following page (Items a - h).
- 10 **Lithology:** A graphic log presentation using symbols to represent differing rock types.
- 11 **Description:** Lithologic description in this order: rock type, color, texture, grain size, foliation, weathering, strength, and other features; descriptive terms are defined on the following page. A detailed descriptive log of overburden materials is not necessarily provided.
- 12 **Discontinuity Description:** Abbreviated description of fracture corresponding to number of naturally occurring fracture in Column 9 using terms defined on the following page (Items a - h).
- 13 **Packer Tests:** A vertical line depicts the interval over which a packer test is performed.
- 14 **Laboratory Tests:** A vertical line depicts the interval over which core has been removed for laboratory testing. Laboratory tests performed are indicated in Column 16.
- 15 **Drill Rate:** Rate (in meters per hour) of penetration of drilling. "N/O" indicates rate not observed.
- 16 **Field Notes:** Comments on drilling, including water loss, reasons for core loss, and use of drilling mud; also, laboratory tests performed on core.

Figure 4-5: Proposed Key to Core Boring Log (Continued on Page 4-8).

Project:  
Project Location:  
Project Number:

# Key to Rock Core Log

Sheet 2 of 2

Depth, meters	Elevation, meters	ROCK CORE							MATERIAL DESCRIPTION	Packer Tests	Laboratory Tests	Drill Rate, meters/hour	FIELD NOTES
		Run No.	Box No.	Recovery, %	Frac. Freq.	R Q D, %	Fracture Drawing/Number	Lithology					

## KEY TO DESCRIPTIVE TERMS USED ON CORE LOGS

### DISCONTINUITY DESCRIPTORS

- a** Dip of fracture surface measured relative to horizontal
- b** Discontinuity Type:
  - F - Fault
  - J - Joint
  - Sh - Shear
  - Fo - Foliation
  - V - Vein
  - B - Bedding
- c** Discontinuity Width (millimeters):
  - W - Wide (12.5-50)
  - MW - Moderately Wide (2.5-12.5)
  - N - Narrow (1.25-2.5)
  - VN - Very Narrow (<1.25)
  - T - Tight (0)
- d** Type of Infilling:
  - Cl - Clay
  - Ca - Calcite
  - Ch - Chlorite
  - Fe - Iron Oxide
  - Gy - Gypsum/Talc
  - H - Healed
  - No - None
  - Py - Pyrite
  - Qz - Quartz
  - Sd - Sand
- e** Amount of Infilling:
  - Su - Surface Stain
  - Sp - Spotty
  - Pa - Partially Filled
  - Fi - Filled
  - No - None
- f** Surface Shape of Joint:
  - Wa - Wavy
  - Pl - Planar
  - St - Stepped
  - Ir - Irregular
- g** Roughness of Surface:
  - Slk - Slickensided [surface has smooth, glassy finish with visual evidence of striations]
  - S - Smooth [surface appears smooth and feels so to the touch]
  - SR - Slightly Rough [asperities on the discontinuity surfaces are distinguishable and can be felt]
  - R - Rough [some ridges and side-angle steps are evident; asperities are clearly visible, and discontinuity surface feels very abrasive]
  - VR - Very Rough [near-vertical steps and ridges occur on the discontinuity surface]
- h** Discontinuity Spacing (meters):
  - EW - Extremely Wide (>20)
  - W - Wide (7-20)
  - M - Moderate (2.5-7)
  - C - Close (0.7-2.5)
  - VC - Very Close (<0.7)

### ROCK WEATHERING / ALTERATION

Description	Recognition
Residual Soil	Original minerals of rock have been entirely decomposed to secondary minerals, and original rock fabric is not apparent; material can be easily broken by hand
Completely Weathered/Altered	Original minerals of rock have been almost entirely decomposed to secondary minerals, minerals, although original fabric may be intact; material can be granulated by hand
Highly Weathered/Altered	More than half of the rock is decomposed; rock is weakened so that a minimum 50-mm-diameter sample can be broken readily by hand across rock fabric
Moderately Weathered/Altered	Rock is discolored and noticeably weakened, but less than half is decomposed; a minimum 50-mm-diameter sample cannot be broken readily by hand across rock fabric
Slightly Weathered/Altered	Rock is slightly discolored, but not noticeably lower in strength than fresh rock
Fresh	Rock shows no discoloration, loss of strength, or other effect of weathering/alteration

### ROCK STRENGTH

Description	Recognition	Approximate Uniaxial Compressive Strength (kPa)
Extremely Weak Rock	Can be indented by thumbnail	250 - 1,000
Very Weak Rock	Can be peeled by pocket knife	1,000 - 5,000
Weak Rock	Can be peeled with difficulty by pocket knife	5,000 - 25,000
Medium Strong Rock	Can be indented 5 mm with sharp end of pick	25,000 - 50,000
Strong Rock	Requires one hammer blow to fracture	50,000 - 100,000
Very Strong Rock	Requires many hammer blows to fracture	100,000 - 250,000
Extremely Strong Rock	Can only be chipped with hammer blows	> 250,000

Figure 4-5: Proposed Key to Core Boring.

- The date and time that the borings are started, completed, and of water level measurements.
- Closure of borings.

Boring logs provide the basic information for the selection of test specimens. They provide background data on the natural condition of the formation, on the ground water elevation, appearance of the samples, and the soil or rock stratigraphy at the boring location, as well as areal extent of various deposits or formations. Data from the boring logs are combined with laboratory test results to identify subgrade profiles showing the extent and depth of various materials at the subject site. Soil profiles showing the depth and the location of various types of materials and ground water elevations are plotted for inclusion in the geotechnical engineer's final report and in the plans and specifications. Detailed boring logs including the results of laboratory tests are included in the text of the report.

#### **4.2 PROJECT INFORMATION**

The top of each boring log provides a space for project specific information: name or number of the project, location of the project, drilling contractor (if drilling is contracted out), type of drilling equipment, date and time of work, drilling methods, hammer weight and fall, name of personnel logging the boring, and weather information. All information should be provided on the first sheet of each boring log.

#### **4.3 BORING LOCATIONS AND ELEVATIONS**

The boring location (coordinates and/or station and offset) and ground surface elevation (with datum) must be recorded on each boring log. Procedures discussed in Section 2.5.3 should be used for determining the location and elevation for each boring site.

#### **4.4 STRATIGRAPHY IDENTIFICATION**

The subsurface conditions observed in the soil samples and drill cuttings or perceived through the performance of the drill rig (for example, rig chatter in gravel, or sampler rebounding on a cobble during driving) should be described in the wide central column on the log labeled "Material Description", or in the remarks column, if available. The driller's comments are valuable and should be considered as the boring log is prepared. In addition to the description of individual samples, the boring log should also describe various strata. The record should include a description of each soil layer, with solid horizontal lines drawn to separate adjacent layers. It is important that a detailed description of subsurface conditions be provided on the field logs at the time of drilling. Completing descriptions in the laboratory is not an acceptable practice. Stratification lines should be drawn where two or more items in the description change, i.e., change from firm to stiff and low to high plasticity. Minor variations can be described using the term 'becoming'. A stratification line should be drawn where the geological origin of the material changes and the origin (if determined) should be designated in the material description or remarks column of the log. Dashed lines should be avoided.

The stratigraphy observations should include identification of existing fill, topsoil, and pavement sections. Careful observation and special sampling intervals may be needed to identify the presence and thickness of these strata. The presence of these materials can have a significant impact on the conclusions and recommendations of the geotechnical studies.

Individual strata should be marked midway between samples unless the boundary is encountered in a sample or special measurements are available to better define the position of the boundary.

#### **4.5 SAMPLE INFORMATION**

Information regarding the sampler types, date and time of sampling, sample type, sample depth, and recovery should be shown on each log form using notations and a graphical system or an abbreviation system as designated in Figures 4-4 and 4-5. Each sample attempt should be given a sequential number marked in the sample number column. If the sampler is driven, the driving resistance should be recorded at the specified intervals and marked in the sampling resistance column. The percent recovery should be designated as the length of the recovered sample referenced to the length of the sample attempt (example 550/610 mm).

#### **4.6 SOIL DESCRIPTION / SOIL CLASSIFICATION**

Soil description/identification is the systematic, precise, and complete naming of individual soils in both written and spoken forms (AASHTO M 145, ASTM D-2488), while soil classification is the grouping of the soil into a category; e.g., group name and symbol (AASHTO M 145, ASTM D-2487).

The soil's description should include as a minimum:

- Apparent consistency (for fine-grained soils) or density (for coarse-grained soils) adjective
- Water content condition adjective (e.g., moist)
- Color description
- Minor soil type name with "y" added if component is less than 30 percent
- Descriptive adjective for main soil type
- Particle-size distribution adjective for gravel and sand
- Plasticity adjective and soil texture (silty or clayey) for inorganic and organic silts or clays
- Main soil type name (all capital letters)
- Descriptive adjective such as "some" or "trace" for minor soil type if less than 30 percent
- Descriptive term for minor type(s) of soil
- Inclusions (e.g., concretions)
- The Unified Soil Classification System (USCS) Group Name and Symbol (in parenthesis) appropriate for the soil type in accordance with AASHTO M 145, ASTM D 3282, or ASTM D 2487. For classification of highway subgrade material, the AASHTO classification system is used.
- Geological name (e.g., Pleistocene), if known, (in parenthesis or in notes column)

The various elements of the soil description should generally be stated in the order given above. For example:



Fine-grained soils: Soft, wet, gray, high plasticity CLAY, trace f. Sand; Fat CLAY (CH); (Alluvium)

Coarse-grained soils: Dense, moist, brown, silty m-f SAND, trace f. Gravel to c. Sand; Silty SAND (SM); (Alluvium)

Some local practices omit the USCS group symbol (e.g., CL, ML, etc.) but include the group symbol at the end of the description. When changes occur within the same soil layer, such as change in apparent density, the log should indicate a description of the change, such as "same, except very dense".

#### **4.6.1 Consistency and Apparent Density**

Empirical values for the consistency of fine-grained soils and the apparent density of silts and coarse-grained soils have been developed for the blow count (*N*-value) resistance from Standard Penetration Test (AASHTO T-206, ASTM D 1586). The consistency of fine-grained soil is based on the uncorrected blow count while the apparent density of coarse-grained soil is based on the corrected blow count. Guidelines in Tables 4-1 and 4-2 are suggested to estimate the consistency or apparent density of soils.

The apparent density or consistency of the soil formation can vary from these empirical correlations for a variety of reasons. Judgment remains an important part of the visual identification process. Mechanical tools such as the pocket (hand) penetrometer, and field index tests (smear test, dried strength test, thread test, etc.) are suggested as aids in estimating the consistency of fine grained soils.

In some cases the sampler may pass from one layer into another of markedly different properties; for example, from a dense sand into a soft clay. In attempting to identify apparent density, an assessment should be made as to what part of the blow count corresponds to each layer; realizing that the sampler begins to reflect the presence of the lower layer before it reaches it.

Geotechnical evaluations of the relative density of coarse-grained soils require the blow count to be corrected to allow for changes in the overburden pressure. The criteria presented in U.S. Bureau of Reclamation Earth Manual (1960) should be used to calculate the relative density of coarse-grained soils.

#### **4.6.2 Water Content (Moisture)**

The amount of water present in the soil sample or its water content adjective should be described as dry, moist, or wet as indicated in Table 4-3.

#### **4.6.3 Color**

The color should be described when the sample is first retrieved at the soil's as-sampled water content (the color will change with water content). Primary colors should be used (brown, gray, black, green, white, yellow, red). Soils with different shades or tints of basic colors are described by using two basic colors; e.g., gray-green. Note that some agencies may require Munsell color and carry no inferences of texture designations. When the soil is marked with spots of color, the term "mottled" can be applied. Soils with a homogeneous texture but having color patterns which change and are not considered mottled can be described as "streaked".

**TABLE 4-1  
EVALUATION OF THE APPARENT DENSITY OF COARSE-GRAINED SOILS**

N-value	Apparent Density	Behavior of 13 mm Diameter Probe Rod	Relative Density, %
0 - 4	Very loose		
>4 - 10	Loose	Easily penetrated when pushed by hand	0 - 40
>10 - 30	Medium dense	Easily penetrated when driven with 2 kg. hammer	40 - 70
>30 - 50	Dense	300 mm penetration when driven with 2 kg. hammer	70 - 85
>50	Very Dense	Only a few centimeters penetration when driven with 2 kg. hammer	85 - 100

**TABLE 4-2  
EVALUATION OF THE CONSISTENCY OF FINE-GRAINED SOILS**

N-value	Consistency	Unconfined Compressive Strength, $q_u$ , kPa	Results Of Manual Manipulation
<2	Very soft	<25	Specimen (height = twice the diameter) sags under its own weight; extrudes between fingers when squeezed.
2 - 4	Soft	25 - 50	Specimen can be pinched in two between the thumb and forefinger; remolded by light finger pressure.
4 - 8	Medium stiff	50 - 100	Can be imprinted easily with fingers; remolded by strong finger pressure.
8 - 15	Stiff	100 - 200	Can be imprinted with considerable pressure from fingers or indented by thumbnail.
15 - 30	Very stiff	200 - 400	Can barely be imprinted by pressure from fingers or indented by thumbnail.
>30	Hard	>400	Cannot be imprinted by fingers or difficult to indent by thumbnail.

**TABLE 4-3  
ADJECTIVES TO DESCRIBE WATER CONTENT OF SOILS**

Description	Conditions
Dry	No sign of water and soil dry to touch
Moist	Signs of water and soil is relatively dry to touch
Wet	Signs of water and soil definitely wet to touch; granular soil exhibits some free water when densified

#### 4.6.4 Type of Soil

The constituent parts of a given soil type are defined on the basis of texture in accordance with particle-size designators separating the soil into coarse-grained, fine-grained, and highly organic designations. Soil with more than 50 percent of the particles larger than the (U.S. Standard) No. 200 sieve (0.074 mm) is designated coarse-grained. Soil (inorganic and organic) with 50 percent or more of the particles finer than the No. 200 sieve is designated fine-grained. Soil primarily consisting of less than 50 percent by volume of organic matter, dark in color, and with an organic odor is designated as organic soil. Soil with organic content more than 50 percent is designated as peat. The soil type designations follow ASTM D 2487; i.e., gravel, sand, clay, silt, organic clay, organic silt, and peat.

##### Coarse-Grained Soils (Gravel and Sand)

Coarse-grained soils consist of gravel, sand, and fine-grained soil, whether separately or in combination, and in which more than 50 percent of the soil is retained on the No. 200 sieve. The gravel and sand components are defined on the basis of particle size as indicated in Table 4-4.

The particle-size distribution is identified as well graded or poorly graded. Well graded coarse-grained soil contains a good representation of all particle sizes from largest to smallest, with  $\leq 12$  percent fines. Poorly graded coarse-grained soil is uniformly graded with most particles about the same size or lacking one or more intermediate sizes, with  $\leq 12$  percent fines.

The flow chart to determine the group symbol and group name for coarse-grained soils is given in Figure 4-6. This figure is identical to that of Figure 2 in ASTM D 2487 except for the following recommendations:

1. Capitalize primary soil type; i.e., GRAVEL.
2. Add group symbols and names to identify that the fines are organic. Some examples are presented in Table 4-5.

Gravels and sands may be described by adding particle-size distribution adjectives in front of the soil type following the criteria given in Table 4-6.

Based on correlation with laboratory tests, the following simple field identification tests can be used as an aid in identifying granular soils.

Feel and Smear Tests: A pinch of soil is handled lightly between the thumb and fingers to obtain an impression of the grittiness or of the softness of the constituent particles. Thereafter, a pinch of soil is smeared with considerable pressure between the thumb and forefinger to determine the degrees of roughness and grittiness, or the softness and smoothness of the soil. Following guidelines may be used:

- Coarse- to medium-grained sand typically exhibits a very harsh and gritty feel and smear.
- Coarse- to fine-grained sand has a less harsh feel, but exhibits a very gritty smear.
- Medium- to fine-grained sand exhibits a less gritty feel and smear which becomes softer and less gritty with an increase in the fine sand fraction.

**TABLE 4-4  
PARTICLE SIZE DEFINITION FOR GRAVELS AND SANDS**

Soil Component	Grain Size	Determination
Boulders*	300 mm +	Measurable
Cobbles*	300 mm to 75 mm	Measurable
Gravel		
Coarse	75 mm to 19 mm	Measurable
Fine	19 mm to #4 sieve (4.75 mm)	Measurable
Sand		
Coarse	#4 to #10 sieve	Measurable and visible to eye
Medium	#10 to #40 sieve	Measurable and visible to eye
Fine	#40 to #200 sieve	Measurable and barely discernible to the eye

\*Boulders and cobbles are not considered soil or part of the soil's classification or description, except under miscellaneous description; i.e., with cobbles at about 5 percent (volume).

**TABLE 4-5  
GROUP SYMBOLS FOR ORGANIC SOILS**

Group Symbol	Group Name	Remarks
SO	organic silty SAND	> 12% fines below A-line
SO	organic clayey SAND	> 12% fines below A-line
SP-SO	poorly graded SAND with organic silt	5 - 12% fines below A-line

NOTE: The present USCS does not allow the identification of whether the fines' liquid limit is less than or equal to and greater than 50.

**TABLE 4-6  
ADJECTIVES FOR DESCRIBING SIZE DISTRIBUTION FOR SANDS AND GRAVELS**

Particle-Size Adjective	Abbreviation	Size Requirement
Coarse	c.	< 30% m-f sand or < 12% f. gravel
Coarse to medium	c-m	< 12% f. sand
Medium to fine	m-f	< 12% c. sand and > 30% m. sand
Fine	f.	< 30% m. sand or < 12% c. gravel
Coarse to fine	c-f	> 12% of each size <sup>1</sup>

<sup>1</sup> 12% and 30% criteria can be modified depending on fines content. The key is the shape of the particle-size distribution curve. If the curve is relatively straight or dished down, and coarse sand is present, use c-f, also use m-f sand if a moderate amount of m. sand is present. If one has any doubts, determine the above percentages based on the amount of sand or gravel present.



- Fine-grained sand exhibits a relatively soft feel and a much less gritty smear than the coarser sand components.
- Silt components less than about 10 percent of the total weight can be identified by a slight discoloration of the fingers after smear of a moist sample. Increasing silt increases discoloration and softens the smear.

**Sedimentation Test:** A small sample of the soil is shaken in a test tube filled with water and allowed to settle. The time required for the particles to fall a distance of 100 mm is about 1/2 minute for particle sizes coarser than silt. About 50 minutes would be required for particles of .005 mm or smaller (often defined as "clay size") to settle out.

For sands and gravels containing more than 5 percent fines, the type of inorganic fines (silt or clay) can be identified by performing a shaking/dilatancy test. See fine-grained soils section.

**Visual Characteristics:** Sand and gravel particles can be readily identified visually but silt particles are generally indistinguishable to the eye. With an increasing silt component, individual sand grains become obscured, and when silt exceeds about 12 percent, it masks almost entirely the sand component from visual separation. Note that gray fine-grained sand visually appears siltier than the actual silt content.

### **Fine-Grained Soils**

Fine-grained soils are those in which 50 percent or more pass the No. 200 sieve (fines) and the fines are inorganic or organic silts and clays as defined by the plasticity chart (Figure 4-7) and decrease in liquid limit (LL) upon oven drying (Table 4-7). Inorganic silts and clays are those which do not meet the organic criteria as given in Table 4-7. The flow charts to determine the group symbol and group name for fine-grained soils are given in Figure 4-8a and b. These figures are identical to Figures 1a and 1b in ASTM D 2487 except that they are modified to show the soil type capitalized; i.e., CLAY. Dual symbols are used to indicate the organic silts and clays that are above the "A"-line. For example, CL/OL instead of OL and CH/OH instead of OH.

To describe the fine-grained soil types, plasticity adjectives, and soil types as adjectives should be used to further define the soil type's texture, plasticity, and location on the plasticity chart; see Table 4-8. Examples using Table 4-8 are given in Table 4-9.

Based on correlations and laboratory tests, the following simple field identification tests can be used to estimate the degree of plasticity of fine-grained soils.

**Shaking (Dilatancy) Test:** Water is dropped or sprayed on a part of basically fine-grained soil mixed and held in the palm of the hand until it shows a wet surface appearance when shaken or bounced lightly in the hand or a sticky nature when touched. The test involves lightly squeezing the soil pat between the thumb and forefinger and releasing it alternatively to observe its reaction and the speed of the response. Soils which are predominantly silty (nonplastic to low plasticity) will show a dull dry surface upon squeezing and a glassy wet surface immediately upon releasing of the pressure. With increasing fineness (plasticity) and the related decreasing dilatancy, this phenomenon becomes less and less pronounced.

**TABLE 4-7**  
**SOIL CLASSIFICATION CHART (LABORATORY METHOD)**

Criteria for Assigning Group Symbols and Group Names Using Laboratory Tests <sup>a</sup>			Soil Classification	
			Group Symbol	Group Name <sup>b</sup>
GRAVELS  More than 50% of coarse  Fraction retained on No. 4 Sieve	CLEAN GRAVELS  Less than 5% fines	$C_u \geq 4$ and $1 C_c \leq 3^c$	GW	Well-graded Gravel
	GRAVELS WITH FINES	$C_u \geq 4$ and $1 C_c \leq 3^c$	GP	Poorly-graded Gravel <sup>f</sup>
		Fines classify as ML or MH	GM	Silty Gravel <sup>f,g,h</sup>
	More than 12% of fines <sup>c</sup>	Fines classify as CL or CH	GC	Clayey Gravel <sup>f,g,h</sup>
SANDS  50% or more of coarse  Fraction retained on No. 4 Sieve	CLEAN SANDS  Less than 5% fines <sup>d</sup>	$C_u \geq 6$ and $1 C_c \leq 3^c$	SW	Well-graded Sand <sup>i</sup>
	SANDS WITH FINES	$C_u \geq 6$ and $1 C_c \leq 3^c$	SP	Poorly-graded Sand <sup>i</sup>
		Fines classify as ML or MH	SM	Silty Sand <sup>g,h,i</sup>
	More than 12% fines <sup>d</sup>	Fines classify as CL or CH	SC	Clayey Sand <sup>g,h,i</sup>
SILTS AND CLAYS  Liquid limit less than 50%	Inorganic	PI > 7 and plots on or above "A" line <sup>j</sup>	CL	Lean Clay <sup>k,l,m</sup>
		PI > 4 and plots on or above "A" line <sup>j</sup>	ML	Silt <sup>k,l,m</sup>
	Organic	$\frac{\text{Liquid limit - overdried}}{\text{Liquid limit - not dried}} < 0.75$	OL	Organic Clay <sup>k,l,m,n</sup> Organic Silt <sup>k,l,m,o</sup>
SILTS AND CLAYS  Liquid limit less than 50% or more	Inorganic	Pl plots on or above "A" line	CH	Fat Clay <sup>k,l,m</sup>
		Pl plots below "A" line	MH	Elastic Silt <sup>k,l,m</sup>
	Organic	$\frac{\text{Liquid limit - overdried}}{\text{Liquid limit - not dried}} < 0.75$	OH	Organic Silt <sup>k,l,m,p</sup> Organic Silt <sup>k,l,m,q</sup>
Highly organic soils	Primary organic matter, dark in color, and organic odor		Pt	Peat

**TABLE 4-7 (Continued)**  
**SOIL CLASSIFICATION CHART (LABORATORY METHOD)**

**NOTES:**

- a Based on the material passing the 75-mm sieve.
- b If field sample contained cobbles and/or boulders, add “with cobbles and/or boulders” to group name.
- c Gravels with 5 to 12% fines require dual symbols:  
 GW-GM well-graded gravel with silt  
 GW-GC well-graded gravel with clay  
 GP-GM poorly graded gravel with silt  
 GP-GC poorly graded gravel with clay
- d Sands with 5 to 12% fines require dual symbols:  
 SW-SM well-graded sand with silt  
 SW-SC well-graded sand with clay  
 SP-SM poorly graded sand with silt  
 SP-SC poorly graded sand with clay
- e  $C_u = \frac{D_{60}}{D_{10}}$        $C_c = \frac{(D_{30})^2}{(D_{10})(D_{60})}$
- f If soil contains  $\geq 15\%$  sand, add “with sand” to group name.
- g If fines classify as CL-ML, use dual symbol GC-GM, SC-SM.
- h If fines are organic, add “with organic fines” to group name.
- i If soil contains  $\geq 15\%$  gravel, add “with gravel” to group name.
- j If the liquid limit and plasticity index plot in hatched area on plasticity chart, soil is a CL-ML, silty clay.
- k If soil contains 15 to 29% plus No. 200, add “with sand” or “with gravel”, whichever is predominant.
- l If soil contains  $\geq 30\%$  plus No. 200, predominantly sand, add “sandy” to group name.
- m If soil contains  $\geq 30\%$  plus No. 200, predominantly gravel, add “gravelly” to group name.
- n  $PI \geq 4$  and plots on or above “A” line.
- o  $PI < 4$  or plots below “A” line.
- p  $PI$  plots on or above “A” line.
- q  $PI$  plots below “A” line.

**FINE-GRAINED**

50% or more passes the  
 No. 200 sieve

**COARSE-GRAINED SOILS**

more than 50% retained on  
 No. 200 sieve



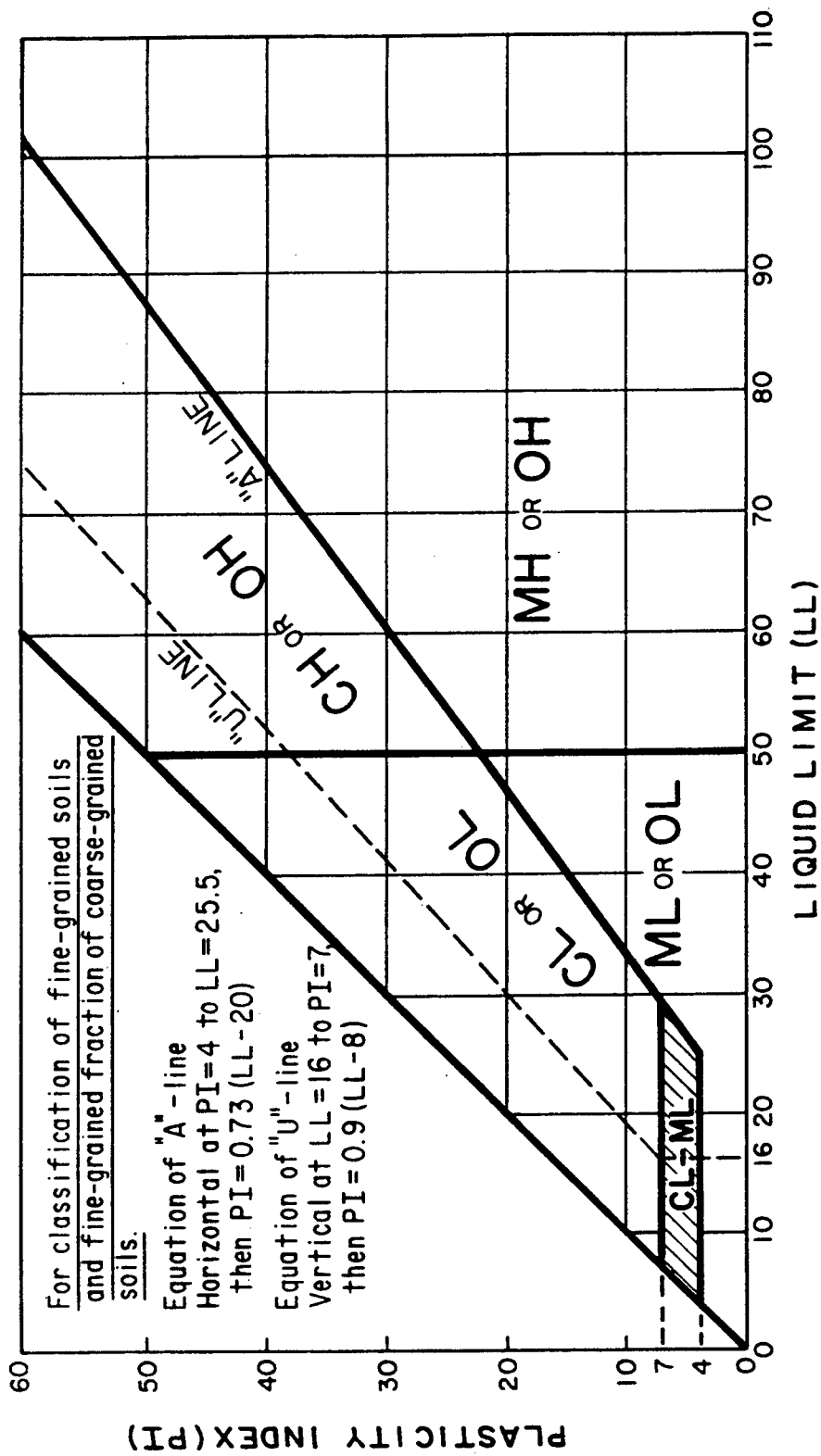

Figure 4-7: Plasticity Chart. (U.S. Bureau of Reclamation Soil Classification Hand Book, 1960)

**TABLE 4-8  
SOIL PLASTICITY DESCRIPTIONS**

Plasticity Index Range	Plasticity Adjective	Adjective for Soil Type, Texture, and Plasticity Chart Location		
		ML & MH (Silt)	CL & CH (Clay)	OL & OH (Organic Silt or Clay) <sup>1</sup>
0	nonplastic	-	-	ORGANIC SILT
1 - 10	low plasticity	-	silty	ORGANIC SILT
> 10 - 20	medium plasticity	clayey	silty to no adj.	ORGANIC clayey SILT
> 20 - 40	high plasticity	clayey	-	ORGANIC silty CLAY
> 40	very plastic	clayey	-	ORGANIC CLAY

<sup>1</sup> Soil type is the same for above or below the "A"-line; the dual group symbol (CL/OL or H/OH) identifies the soil types above the "A"-line.

**TABLE 4-9  
EXAMPLES OF DESCRIPTION OF FINE-GRAINED SOILS**

Group Symbol	PI	Group Name	Complete Description For Main Soil Type (Fine-Grained Soil)
CL	9	lean CLAY	low plasticity silty CLAY
ML	7	SILT	low plasticity SILT
ML	15	SILT	medium plastic clayey SILT
MH	21	elastic SILT	high plasticity clayey SILT
CH	25	fat CLAY	high plasticity silty CLAY or high plasticity CLAY, depending on smear test (for silty relatively dull and not shiny or just CLAY for shiny, waxy)
OL	8	ORGANIC SILT	low plasticity ORGANIC SILT
OL	19	ORGANIC SILT	medium plastic ORGANIC clayey SILT
CH	>40	fat CLAY	very plastic CLAY

**GROUP SYMBOL**

**GROUP NAME**

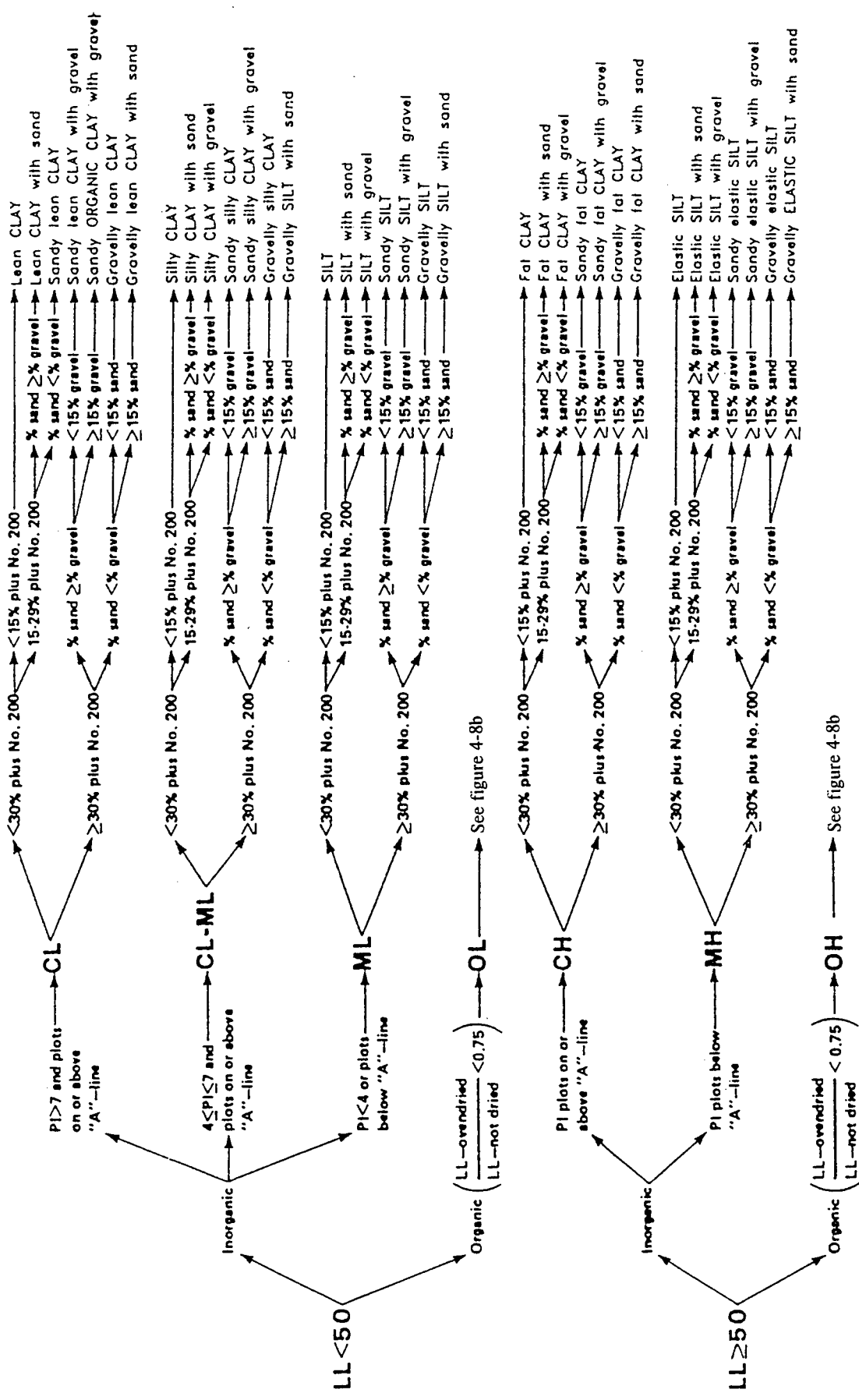

Figure 4-8a: Flow Chart to Determine the Group Symbol and Group Name for Fine-Grained Soils. (U.S. Bureau of Reclamation Soil Classification Hand Book)

GROUP NAME

GROUP SYMBOL

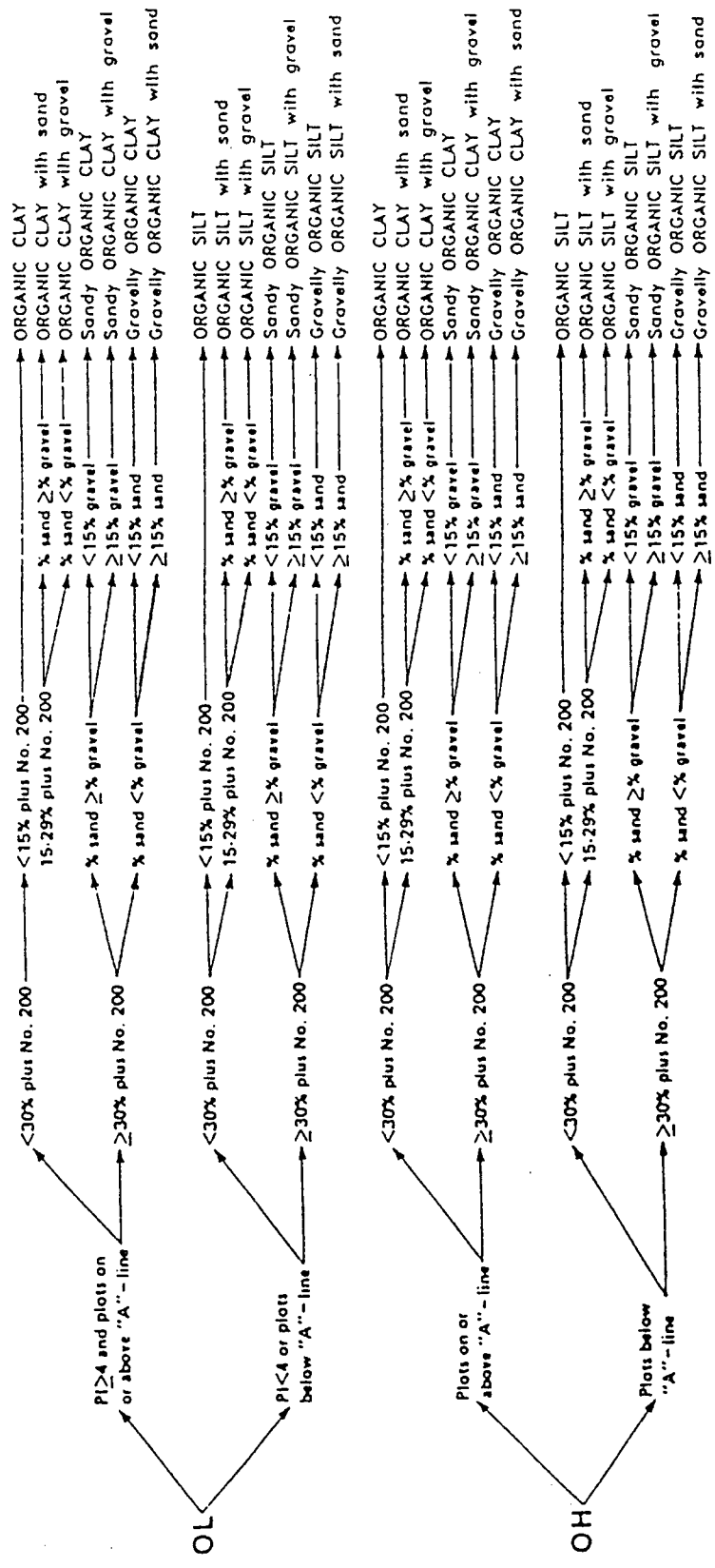

Figure 4-8b: Flow Chart to Determine the Group Symbol and Group Name for Organic Soils. (U.S. Bureau of Reclamation Soil Classification Hand Book)

**Dry Strength Test:** A portion of the sample is allowed to dry out and a fragment of the dried soil is pressed between the fingers. Fragments which cannot be crumbled or broken are characteristic of clays with high plasticity. Fragments which can be disintegrated with gentle finger pressure are characteristic of silty materials of low plasticity. Thus, materials with great dry strength are clays of high plasticity and those with little dry strength are predominantly silts.

**Thread Test:** (After Burmister, 1970) Moisture is added or worked out of a small ball (about 40 mm diameter) and the ball kneaded until its consistency approaches medium stiff to stiff (compressive strength of about 100 KPa), it breaks, or crumbles. A thread is then rolled out to the smallest diameter possible before disintegration. The smaller the thread achieved, the higher the plasticity of the soil. Fine-grained soils of high plasticity will have threads smaller than 3/4 mm in diameter. Soils with low plasticity will have threads larger than 3 mm in diameter.

**Smear Test:** A fragment of soil smeared between the thumb and forefinger or drawn across the thumbnail will, by the smoothness and sheen of the smear surface, indicate the plasticity of the soil. A soil of low plasticity will exhibit a rough textured, dull smear while a soil of high plasticity will exhibit a slick, waxy smear surface.

Table 4-10 identifies field methods to approximate the plasticity range for the dry strength, thread, and smear tests.

**TABLE 4-10  
FIELD METHODS TO DESCRIBE PLASTICITY**

Plasticity Range	Adjective	Dry Strength	Smear Test	Thread Smallest Diameter, mm
0	nonplastic	none - crumbles into powder with mere pressure	gritty or rough	ball cracks
1 - 10	low plasticity	low - crumbles into powder with some finger pressure	rough to smooth	6 to 3
> 10 - 20	medium plasticity	medium - breaks into pieces or crumbles with considerable finger pressure	smooth and dull	1-1/2
> 20 - 40	high plasticity	high - cannot be broken with finger pressure; spec. will break into pieces between thumb and a hard surface	shiny	3/4
> 40	very plastic	very high - can't be broken between thumb and a hard surface	very shiny and waxy	1/2

## Highly Organic Soils

Colloidal and amorphous organic materials finer than the No. 200 sieve are identified and classified in accordance with their drop in plasticity upon oven drying (ASTM D 2487). Further identification markers are:

1. dark gray and black and sometimes dark brown colors, although not all dark colored soils are organic;
2. most organic soils will oxidize when exposed to air and change from a dark gray/black color to a lighter brown; i.e., the exposed surface is brownish, but when the sample is pulled apart the freshly exposed surface is dark gray/black;
3. fresh organic soils usually have a characteristic odor which can be recognized, particularly when the soil is heated;
4. compared to non-organic soils, less effort is typically required to pull the material apart and a friable break is usually formed with a fine granular or silty texture and appearance;
5. their workability at the plastic limit is weaker and spongier than an equivalent non-organic soil;
6. the smear, although generally smooth, is usually duller and appears more silty; and
7. the organic content of these soils can also be determined by combustion test method (AASHTO T 267, ASTM D 2974).

Fine-grained soils, where the organic content appears to be less than 50 percent of the volume (about 22 percent by weight) should be described as soils with organic material or as organic soils such as clay with organic material or organic clays etc. If the soil appears to have an organic content higher than 50 percent by volume it should be described as peat. The engineering behavior of soils below and above the 50 percent dividing line presented here is entirely different. It is therefore critical that the organic content of soils be determined both in the field and in the laboratory (AASHTO T 267, ASTM D 2974). Simple field or visual laboratory identification of soils as organic or peat is neither advisable nor acceptable.

It is very important not to confuse topsoil with organic soils or peat. Topsoil is the thin layer of deposit found on the surface composed of partially decomposed organic materials, such as leaves, grass, small roots etc. It contains many nutrients that sustain plant and insect life. These should not be classified as organic soils or peat and should not be used in engineered structures.

## Minor Soil Type(s)

In many soils two or more soil types are present. When the percentage of the minor soil type is equal to or greater than 30 percent and less than 50 percent of the total sample, the minor soil type is indicated by adding a "y" to its name; i.e., f. gravelly, c-f. sandy, silty, clayey, silty clayey, organic silty, etc. (Note: the gradation adjectives are given for the coarse-grained soils, while the plasticity adjective is omitted for the fine-grained soils.)

When the soil type percentage is between 1 and 29 percent of the total sample, the minor soil type name is given along with an adjective:

- "trace" when the percentage is between 1 and 12 percent of the total sample; or

- "some" when the percentage is greater than 12 percent and less than 30 percent of the total sample.

### **Inclusions**

Additional inclusions or characteristics of the sample can be described by using "with" and the descriptions described above. Examples are given below:

- with petroleum odor
- with organic matter
- with foreign matter (roots, brick, etc.)
- with shell fragments
- with mica
- with parting(s), seam(s), etc. of (give soils complete description)

### **Layered Soils**

Soils of different types can be found in repeating layers of various thickness. It is important that all such formations and their thicknesses are noted. Each layer is described as if it is a nonlayered soil using the sequence for soil descriptions discussed above. The thickness and shape of layers and the geological type of layering are noted using the descriptive terms presented in Table 4-11:

Place the thickness designation before the type of layer, or at the end of each description and in parentheses, whichever is more appropriate.

Examples of descriptions for layered soils are:

- Medium stiff, moist to wet 5 to 20 mm interbedded seams and layers of: gray, medium plastic, silty CLAY (CL); and lt. gray, low plasticity SILT (ML); (Alluvium).
- Soft moist to wet varved layers of: gray-brown, high plasticity CLAY (CH) (5 to 20 mm); and nonplastic SILT, trace f. sand (ML) (10 to 15 mm); (Alluvium).

### **Geological Name**

The soil description should include the field supervisor's assessment of the origin of the soil unit and the geologic name, if known, placed in parentheses at the end of the soil description or in the field notes column of the boring log.

**TABLE 4-11**  
**DESCRIPTIVE TERMS FOR LAYERED SOILS**

Type Of Layer	Thickness	Occurrence
Parting	< 1.5 mm	
Seam	10 to 1.5 mm	
Layer	300 to 10 mm	
Stratum	> 300 mm	
Pocket		Small erratic deposit
Lens		Lenticular deposit
Varved (also layered)		Alternating seams or layers of silt and/or clay and sometimes fine sand
Occasional		One or less per 0.3 m of thickness or laboratory sample inspected
Frequent		More than one per 0.3 m of thickness or laboratory

#### 4.6.5 AASHTO Soil Classification System

The AASHTO soil classification system is shown in Table 4-12. This classification system is useful in determining the relative quality of the soil material for use in earthwork structures, particularly embankments, subgrades, subbases and bases.

According to this system, soil is classified into seven major groups, A-1 through A-7. Soils classified under groups A-1, A-2 and A-3 are granular materials where 35% or less of the particles pass through the No. 200 sieve. Soils where more than 35% pass the No. 200 sieve are classified under groups A-4, A-5, A-6 and A-7. These are mostly silt and clay-type materials. The classification procedure is shown in Table 4-12. The classification system is based on the following criteria:

- I. *Grain Size*: The grain size terminology for this classification system is as follows:
  - Gravel: fraction passing the 75 mm sieve and retained on the No. 10 (2 mm) sieve.
  - Sand: fraction passing the No. 10 (2 mm) sieve and retained on the No. 200 (0.075 mm) sieve
  - Silt and clay: fraction passing the No. 200 (0.075 mm) sieve
- ii *Plasticity*: The term *silty* is applied when the fine fractions of the soil have a plasticity index of 10 or less. The term *clayey* is applied when the fine fractions have a plasticity index of 11 or more.
- iii. If cobbles and boulders (size larger than 75 mm) are encountered they are excluded from the portion of the soil sample on which classification is made. However, the percentage of material is recorded.

To evaluate the quality of a soil as a highway subgrade material, a number called the *group index (GI)* is also incorporated along with the groups and subgroups of the soil. This is written in parenthesis after the group or subgroup designation. The group index is given by the equation



**TABLE 4-12**  
**AASHTO SOIL CLASSIFICATION SYSTEM (AASHTO M 145, 1995)**

GENERAL CLASSIFICATION	GRANULAR MATERIALS (35 percent or less of total sample passing No. 200)				SILT-CLAY MATERIALS (More than 35 percent of total sample passing No. 200)						
	A-1		A-3	A-2		A-4	A-5	A-6	A-7		
GROUP CLASSIFICATION	A-1-a	A-1-b	A-3	A-2-4	A-2-5	A-2-6	A-2-7	A-4	A-5	A-6	A-7
Sieve analysis, percent passing:											
2 mm (No. 10)	50 max.		51 min.								
0.425 mm (No. 40)	30 max.		10 max.								
0.075 mm (No. 200)	15 max.			35 max.	35 max.	35 max.	35 max.	36 min.	36 min.	36 min.	36 min.
Characteristics of fraction passing 0.425 mm (No. 40)											
Liquid limit	6 max.		NP	40 max. 10 max.	41 min. 10 max.	40 max. 11 min.	41 min. 11 min.	40 max. 10 max.	41 min. 10 max.	40 max. 11 min.	41 min. 11 min.*
Plasticity index											
Usual significant constituent materials	Stone fragments, gravel and sand		Fine sand	Silty or clayey gravel and sand			Silty soils		Clayey soils		
Group Index**	0	0	0	0	0	4 max.		8 max.	12 max.	16 max.	20 max.

Classification procedure: With required test data available, proceed from left to right on chart; correct group will be found by process of elimination. The first group from left into which the test data will fit is the correct classification.

\*Plasticity Index of A-7-5 subgroup is equal to or less than LL minus 30. Plasticity Index of A-7-6 subgroup is greater than LL minus 30 (see Fig 4-9).

\*\*See group index formula (Eq. 4-1) Group index should be shown in parentheses after group symbol as: A-2-6(3), A-4(5), A-6(12), A-7-5(17), etc.

$$GI=(F-35)[0.2+0.005(LL-40)] + 0.01(F-15) (PI-10) \quad (4-1)$$

where F is the percent passing No. 200 sieve, LL is the liquid limit and PI is the plasticity index. The first term of Eq. 4-1 is the partial group index determined from the liquid limit. The second term is the partial group index determined from the plasticity index. Following are some rules for determining group index:

- If Eq. 4-1 yields a negative value for GI, it is taken as zero.
- The group index calculated from Eq. 4-1 is rounded off to the nearest whole number, e.g., GI=3.4 is rounded off to 3; GI=3.5 is rounded off to 4.
- There is no upper limit for the group index.
- The group index of soils belonging to groups A-1-a, A-1-b, A-2-4, A-2-5, and A-3 will always be zero.
- When calculating the group index for soils belonging to groups A-2-6 and A-2-7, the partial group index for PI should be used, or

$$GI=0.01(F-15) (PI-10) \quad (4-2)$$

In general, the quality of performance of a soil as a subgrade material is inversely proportional to the group index.

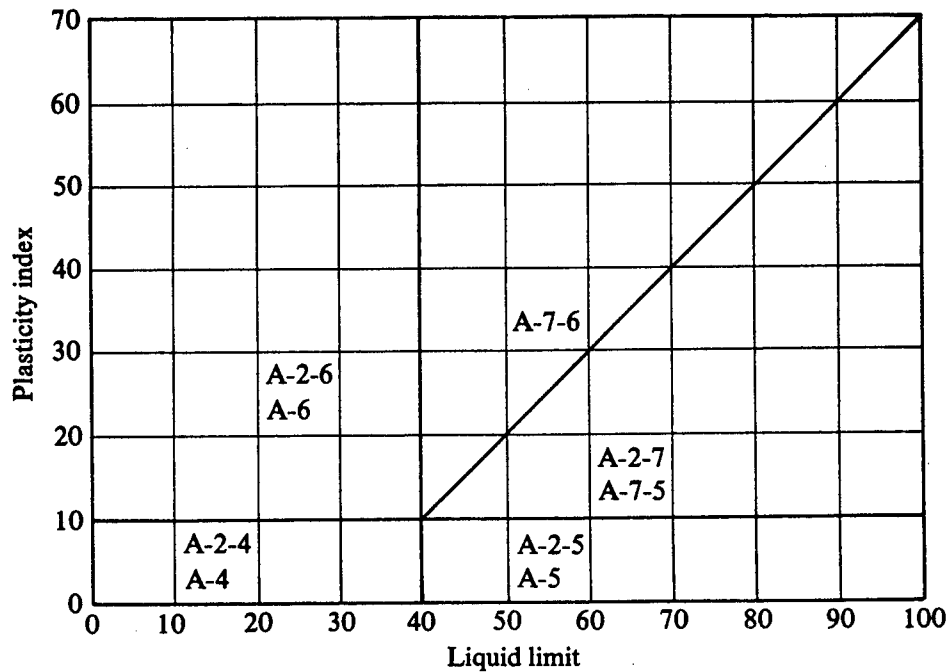

Figure 4-9: Range of Liquid Limit and Plasticity Index for Soils in Groups A-2, A-4, A-5, A-6 and A-7 (AASHTO M 145, 1995)

## **4.7 LOGGING PROCEDURES FOR CORE DRILLING**

As with soil boring logs, rock or core boring logs should be as comprehensive as possible under field conditions, yet be terse and precise. The level of detail should be keyed to the purpose of the exploration as well as to the intended user of the prepared logs. Although the same basic information should be presented on all rock boring logs, the appropriate level of detail should be determined by the geotechnical engineer and/or the geologist based on project needs. Borings for a bridge foundation may require more detail concerning degree of weathering than rock structure features. For a proposed tunnel excavation, the opposite might be true. Extremely detailed descriptions of rock mineralogy may mask features significant to an engineer, but may be critical for a geologist.

### **4.7.1 Description of Rock**

Rock descriptions should use technically correct geological terms, although local terms in common use may be acceptable if they help describe distinctive characteristics. Rock cores should be logged when wet for consistency of color description and greater visibility of rock features. The guidelines presented in the "International Society for Rock Mechanics Commission on Standardization of Laboratory and Field Tests" (1978, 1981), should be reviewed for additional information regarding logging procedures for core drilling.

The rock's lithologic description should include as a minimum the following items:

- Rock type
- Color
- Grain size and shape
- Texture (stratification/foiliation)
- Mineral composition
- Weathering and alteration
- Strength
- Other relevant notes

The various elements of the rock's description should be stated in the order listed above. For example:

"Limestone, light gray, very fine-grained, thin-bedded, unweathered, strong"

The rock description should include identification of discontinuities and fractures. The description should include a drawing of the naturally occurring fractures and mechanical breaks.

### **4.7.2 Rock Type**

Rocks are classified according to origin into three major divisions: igneous, sedimentary, and metamorphic, see Table 4-13. These three groups are subdivided into types according to mineral and chemical composition, texture, and internal structure. For some projects a library of hand samples and photographs representing lithologic rock types present in the project area should be maintained.

**TABLE 4-13**  
**ROCK GROUPS AND TYPES**

Igneous		
Intrusive (Coarse Grained)	Extrusive (Fine Grained)	Pyroclastic
Granite Syenite Diorite Diabase Gabbro Peridotite Pegmatite	Rhyolite Trachyte Andesite Basalt	Obsidian Pumice Tuff
Sedimentary		
Clastic (Sediment)	Chemically Formed	Organic Remains
Shale Mudstone Claystone Siltstone Sandstone Conglomerate Limestone, oolitic	Limestone Dolomite Gypsum Halite	Chalk Coquina Lignite Coal
Metamorphic		
Foliated	Nonfoliated	
Slate Phyllite Schist Gneiss	Quartzite Amphibolite Marble Hornfels	

### **4.7.3 Color**

Colors should be consistent with a Munsell Color Chart and recorded for both wet and dry conditions as appropriate.

### **4.7.4 Grain Size and Shape**

The grain size description should be classified using the terms presented in Table 4-14. Table 4-15 is used to further classify the shape of the grains.

### **4.7.5 Stratification/Foliation**

Significant nonfracture structural features should be described. The thickness should be described using the terms in Table 4-16. The orientation of the bedding/foliation should be measured from the horizontal with a protractor.

### **4.7.6 Mineral Composition**

The mineral composition should be identified by a geologist based on experience and the use of appropriate references. The most abundant mineral should be listed first, followed by minerals in decreasing order of abundance. For some common rock types, mineral composition need not be specified (e.g. dolomite, limestone).

### **4.7.7 Weathering and Alteration**

Weathering as defined here is due to physical disintegration of the minerals in the rock by atmospheric processes while alteration is defined here as due to geothermal processes. Terms and abbreviations used to describe weathering or alteration are presented in Figure 4-5.

### **4.7.8 Strength**

The point load test, described in Section 8.2.1, is recommended for the measurement of sample strength. The point-load index,  $I_p$ , from the point load test, should be converted to uniaxial compressive strength in the field. Various categories and terminology recommended for describing rock strength based on the point load test are presented in Figure 4-5. Figure 4-5 also presents guidelines for common qualitative assessment of strength while mapping or during primary logging of core at the rig site by using a geological hammer and pocket knife. The field estimates should be confirmed where appropriate by comparison with selected laboratory tests.

### **4.7.9 Hardness**

Hardness is commonly assessed by the scratch test. Descriptions and abbreviations used to describe rock hardness are presented in Table 4-17.

**TABLE 4-14**  
**TERMS TO DESCRIBE GRAIN SIZE OF (TYPICALLY FOR) SEDIMENTARY ROCKS**

Description	Diameter (mm)	Characteristic
Very coarse grained	> 4.76	Individual grains can be easily distinguished by eye Individual grains can be distinguished by eye Individual grains can be distinguished by eye with difficulty Individual grains cannot be distinguished by unaided eye
Coarse grained	2.00 -4.76	
Medium grained	0.42 -2.00	
Fine grained	0.074-0.420	
Very fine grained	< 0.074	

**TABLE 4-15**  
**TERMS TO DESCRIBE GRAIN SHAPE (FOR SEDIMENTARY ROCKS)**

Description	Characteristic
Angular	Showing very little evidence of wear. Grain edges and corners are sharp. Secondary corners are numerous and sharp.
Subangular	Showing definite effects of wear. Grain edges and corners are slightly rounded off. Secondary corners are slightly less numerous and slightly less sharp than in angular grains.
Subrounded	Showing considerable wear. Grain edges and corners are rounded to smooth curves. Secondary corners are reduced greatly in number and highly rounded.
Rounded	Showing extreme wear. Grain edges and corners are smoothed off to broad curves. Secondary corners are few in number and rounded.
Well-rounded	Completely worn. Grain edges or corners are not present. No secondary edges or corners are present.

**TABLE 4-16**  
**TERMS TO DESCRIBE STRATUM THICKNESS**

Descriptive Term	Stratum Thickness
Very Thickly bedded	> 1 m
Thickly bedded	0.5 to 1.0 m
Thinly bedded	50 mm to 500 mm
Very Thinly bedded	10 mm to 50 mm
Laminated	2.5 mm to 10 mm
Thinly Laminated	< 2.5 mm

**TABLE 4-17**  
**TERMS TO DESCRIBE ROCK HARDNESS**

Description (Abbr)	Characteristic
Soft (S)	Reserved for plastic material alone.
Friable (F)	Easily crumbled by hand, pulverized or reduced to powder and is too soft to be cut with a pocket knife.
Low Hardness (LH)	Can be gouged deeply or carved with a pocket knife.
Moderately Hard (MH)	Can be readily scratched by a knife blade; scratch leaves a heavy trace of dust and scratch is readily visible after the powder has been blown away.
Hard (H)	Can be scratched with difficulty; scratch produces little powder and is often faintly visible; traces of the knife steel may be visible.
Very Hard (VH)	Cannot be scratched with pocket knife. Leave knife steel marks on surface.

#### 4.7.10 Rock Discontinuity

Discontinuity is the general term for any mechanical discontinuity in a rock mass having zero or low tensile strength. It is the collective term for most types of joints, weak bedding planes, weak schistosity planes, weakness zones, and faults. The symbols recommended for the type of rock mass discontinuities are listed in Figure 4-5.

The spacing of discontinuities is the perpendicular distance between adjacent discontinuities. The spacing should be measured in centimeters or millimeters, perpendicular to the planes in the set. Figure 4-5 presents guidelines to describe discontinuity spacing.

The discontinuities should be described as closed, open, or filled. Aperture is used to describe the perpendicular distance separating the adjacent rock walls of an open discontinuity in which the intervening space is air or water filled. Width is used to describe the distance separating the adjacent rock walls of filled discontinuities. The terms presented in Table 4-18 should be used to describe apertures.

Terms such as "wide", "narrow" and "tight" are used to describe the width of discontinuities such as thickness of veins, fault gouge filling, or joints openings. Guidelines for use of such terms are presented in Figure 4-5.

For the faults or shears that are not thick enough to be represented on the boring log, the measured thickness is recorded numerically in millimeters.

In addition to the above characterization, discontinuities are further characterized by the surface shape of the joint and the roughness of its surface. Refer to Figure 4-5 for guidelines to characterize these features.

Filling is the term for material separating the adjacent rock walls of discontinuities. Filling is characterized by its type, amount, width (i.e., perpendicular distance between adjacent rock walls) and strength. Figure 4-5 presents guidelines for characterizing the amount and width of filling. The strength of any filling material along discontinuity surfaces can be assessed by the guidelines for soil presented in the last three columns of Table 4-2. If non-cohesive fillings are identified, then identify the filling qualitatively, e.g., fine sand.

**TABLE 4-18**  
**TERMS TO CLASSIFY DISCONTINUITIES BASED ON APERTURE SIZE**

Aperture	Description	
<0.1 mm 0.1 - 0.25 mm 0.25 - 0.5 mm	Very tight Tight Partly open	"Closed Features"
0.5 - 2.5 mm 2.5 - 10 mm > 10 mm	Open Moderately open Wide	"Gapped Features"
1-10 cm 10-100 cm > 1 m	Very wide Extremely wide Cavernous	"Open Features"

#### 4.7.11 Fracture Description

The location of each naturally occurring fracture and mechanical break is shown in the fracture column of the rock core log. The naturally occurring fractures are numbered and described using the terminology described above for discontinuities.

The naturally occurring fractures and mechanical breaks are sketched in the drawing column. Dip angles of fractures should be measured using a protractor and marked on the log. For nonvertical borings, the angle should be measured and marked as if the boring was vertical. If the rock is broken into many pieces less than 25 mm long, the log may be crosshatched in that interval, or the fracture may be shown schematically.

The number of naturally occurring fractures observed in each 0.5 m of core should be recorded in the fracture frequency column. Mechanical breaks, thought to have occurred due to drilling, are not counted. The following criteria can be used to identify natural breaks:

1. A rough brittle surface with fresh cleavage planes in individual rock minerals indicates an artificial fracture.
2. A generally smooth or somewhat weathered surface with soft coating or infilling materials, such as talc, gypsum, chlorite, mica, or calcite obviously indicates a natural discontinuity.
3. In rocks showing foliation, cleavage or bedding it may be difficult to distinguish between natural discontinuities and artificial fractures when these are parallel with the incipient weakness planes. If drilling has been carried out carefully then the questionable breaks should be counted as natural features, to be on the conservative side.
4. Depending upon the drilling equipment, part of the length of core being drilled may occasionally rotate with the inner barrels in such a way that grinding of the surfaces of discontinuities and fractures occurs. In weak rock types it may be very difficult to decide if the resulting rounded surfaces represent natural or artificial features. When in doubt, the conservative assumption should be made; i.e., assume that they are natural.



The results of core logging (frequency and RQD) can be strongly time dependent and moisture content dependent in the case of certain varieties of shales and mudstones having relatively weakly developed diagenetic bonds. A not infrequent problem is "discing", in which an initially intact core separates into discs on incipient planes, the process becoming noticeable perhaps within minutes of core recovery. The phenomena are experienced in several different forms:

1. Stress relief cracking (and swelling) by the initially rapid release of strain energy in cores recovered from areas of high stress, especially in the case of shaley rocks.
2. Dehydration cracking experienced in the weaker mudstones and shales which may reduce RQD from 100 percent to 0 percent in a matter of minutes, the initial integrity possibly being due to negative pore pressure.
3. Slaking cracking experienced by some of the weaker mudstones and shales when subjected to wetting and drying.

All these phenomena may make core logging of fracture frequency and RQD unreliable. Whenever such conditions are anticipated, core should be logged by an engineering geologist as it is recovered and at subsequent intervals until the phenomenon is predictable. An added advantage is that the engineering geologist can perform mechanical index tests, such as the point load or Schmidt hammer test (see Chapter 8), while the core is still in a saturated state.



## CHAPTER 5.0 IN SITU TESTING

In situ tests are used to provide field measurements of soil and rock properties. In situ test methods commonly used in the continental U.S. are summarized in Table 5-1 and are discussed in detail in subsequent sections. The reader is referred to Wroth (1984) for a detailed summary and general applications of in situ test methods.

**TABLE 5-1  
SUMMARY OF COMMON IN SITU TESTS  
(After Canadian Geotechnical Manual, 1992)**

Type of Test	Suitable for	Not suitable for	Properties that can be determined	Remarks
Standard Penetration Test (SPT)	Sand	Soft to firm clays	Qualitative evaluation of compactness. Qualitative comparison of subsoil stratification.	See Section 5.1
Cone Penetration Test (CPT)	Sand, silt, and clay	Gravel	Continuous evaluation of density and strength of sands. Continuous evaluation of undrained shear strength in clays.	See Section 5.2 Test is best suited for the design of footings and piles in sand; tests in clay are more reliable when used in conjunction with vane tests
Field Vane Shear Test (FVT)	Clay	Sand and Gravel	Undrained shear strength	See Section 5.3 Test should be used with care, particularly in fissured, varved and highly plastic clays.
Pressuremeter Test (PMT)	Soft rock, dense sand, gravel, and till	Soft sensitive clays, loose silts and sands	Compressibility	See Section 5.4
Dilatometer Test (DMT)	Sand and Clay	Gravel	Empirical correlation for soil type, $K_0$ , overconsolidation ratio, undrained shear strength, and modulus	See Section 5.5
Plate Load Test	Sand, clay and rock		Deformation modulus, modulus of subgrade reaction, bearing capacity.	See Section 5.6 Strictly applicable only if the deposit is uniform; size effects must be considered in other cases.

## 5.1 STANDARD PENETRATION TEST

The standard penetration test (SPT) is performed during a test boring to obtain an approximate measure of the soil resistance to dynamic penetration and a disturbed sample of the soil. Although the test can be performed in a wide variety of soils, the most consistent results are found in sandy soils where large gravel particles are absent. Almost all US soil drilling rigs are equipped to perform the SPT. In fact, the SPT is the most common in situ geotechnical test. The detailed procedure for the SPT is described in AASHTO T-206 or ASTM D 1586. The overall equipment and setup for the SPT are shown in Figure 5-1a,b,c.

To perform the test, the drilling crew, after advancing the test boring to the desired depth, first remove the string of drill rods slowly and clean out the hole to the desired depth of testing. During this procedure, the head of water in the hole is maintained at or above the ground water level to avoid any inflow of water into the hole that can disturb the soil and cause erroneously low (conservative) test results. After the drilling tools are removed, a standard 51 mm O.D. split spoon sampler, as shown in Figure 3-6, is attached to the drill rods and lowered carefully to the bottom of the hole. With the sampler resting at the bottom of the hole, a 63.5 kg weight is allowed to fall freely 760 mm onto a collar that is attached to the top of the drill rod string until 450 mm of penetration has been achieved. The blows required to drive each 150 mm increment are counted. The SPT N-value, which is defined as the sum of the blows required to drive the sample for the second and third increments, is commonly used with established correlations to estimate a number of soil parameters, particularly the shear strength and density of cohesionless soils. If the sampler cannot be driven 450 mm, the number of blows per each 150 mm increment and per each partial increment is recorded on the boring log. For partial increments, the depth of penetration is recorded in addition to the number of blows.

The two most common hammers in North American practice are the safety and donut hammers. The safety hammer illustrated in Figure 5-2a is a long weight which slides over the drill rods and impacts against an internal anvil. The donut hammer illustrated in Figure 5-2b is a short, wide weight centered on a guide pipe which strikes an external anvil above the drill rods. In some instances, non-standard hammers or different-size samplers are needed. These variations must be clearly identified on the boring logs so that the appropriate adjustments to the penetration resistance can be made using the method described by LaCroix and Horn (1973):

$$N_{\text{SPT}} \approx \left( \frac{W_1 H_1}{6.2 D_1^2 L_1} \right) N_{\text{NON-STANDARD}} \quad (5-1)$$

where,  $W_1$  = the weight of the hammer in kilograms

$H_1$  = the height of free fall of the hammer in centimeters

$D_1$  = the outside diameter of the sampler in centimeters

$L_1$  = the depth of penetration in centimeters

The actual blow count (without adjustment), hammer, sampler size, and drill rod size should be recorded on the field log, and an asterisk or other notation should be added to identify that the recorded value does not represent a standard N-value.

Drill rods should be A or AW at depths less than 15 m and N or NW at depths exceeding 50 m. The use of a down hole hammer should not be allowed unless the geotechnical engineer and designer agree to its use. In no case should a down hole hammer be operated below the level of fluid inside the boring or casing.

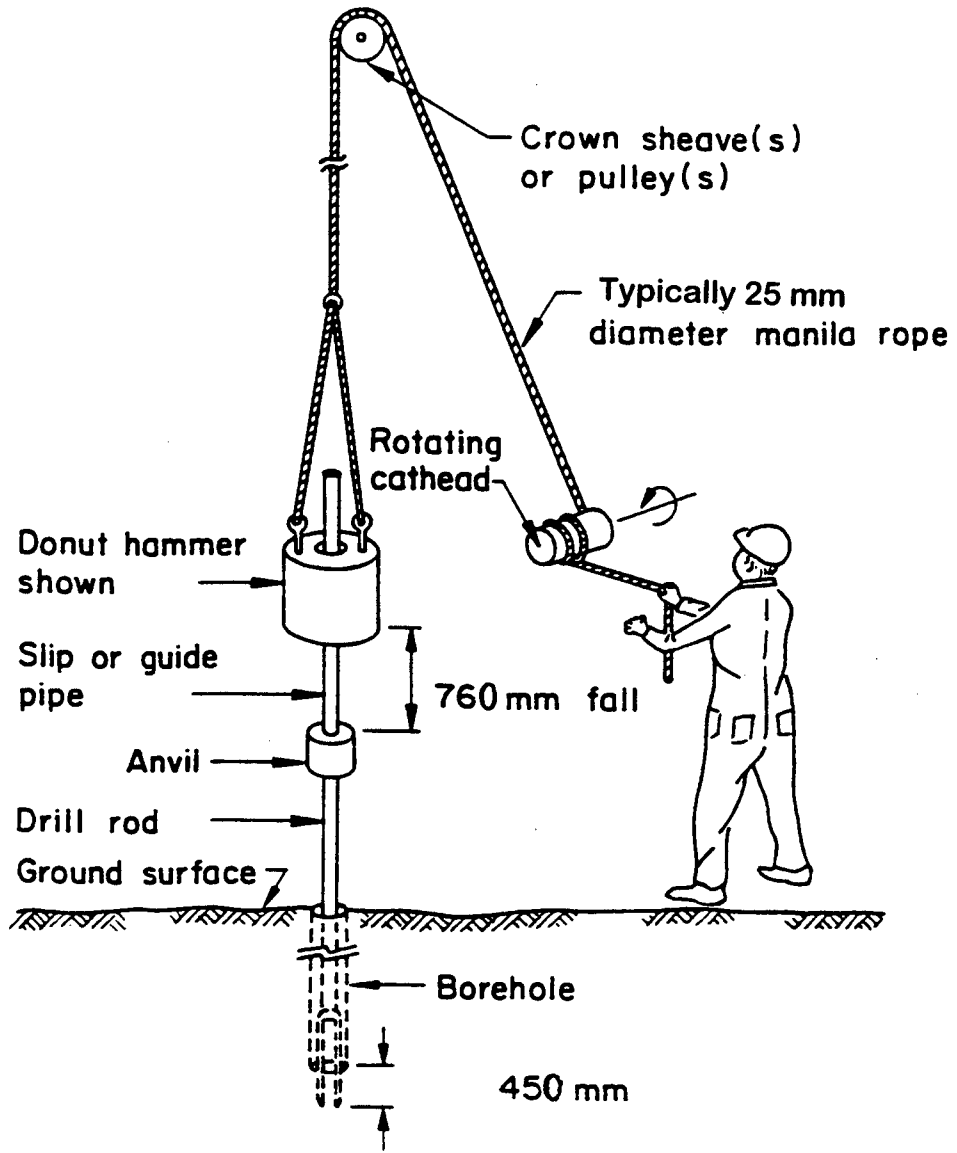
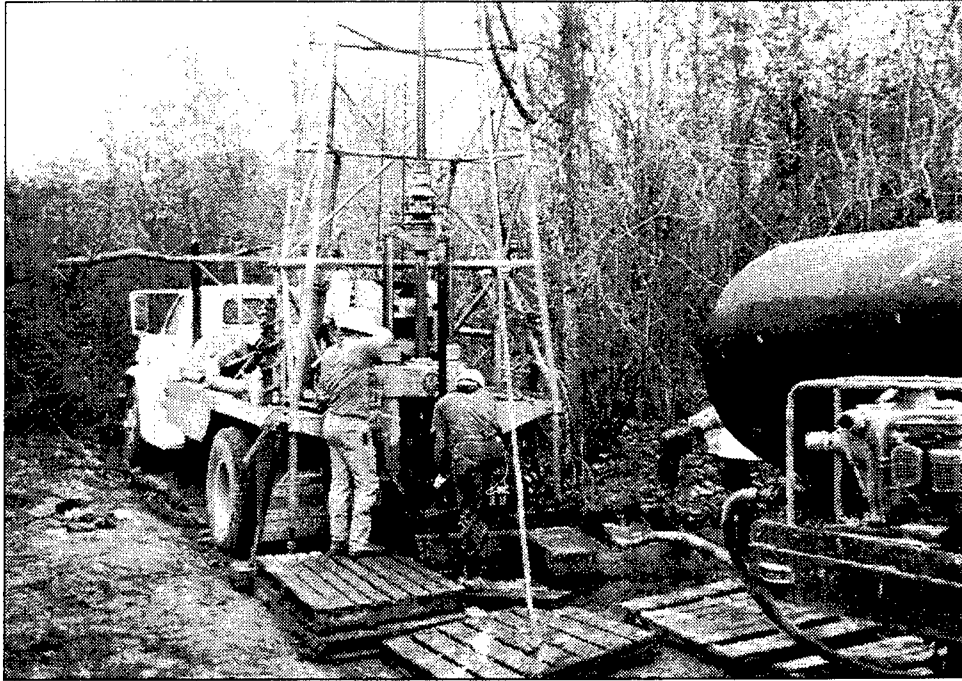

Figure 5-1: (a) Schematic of SPT (Kovacs, *et. al.*, 1983)



(b)



(c)

Figure 5-1: (b) Typical Equipment and Set-up of SPT, (c) Attaching the Safety Hammer Prior to Sampling and Cathode Set-up

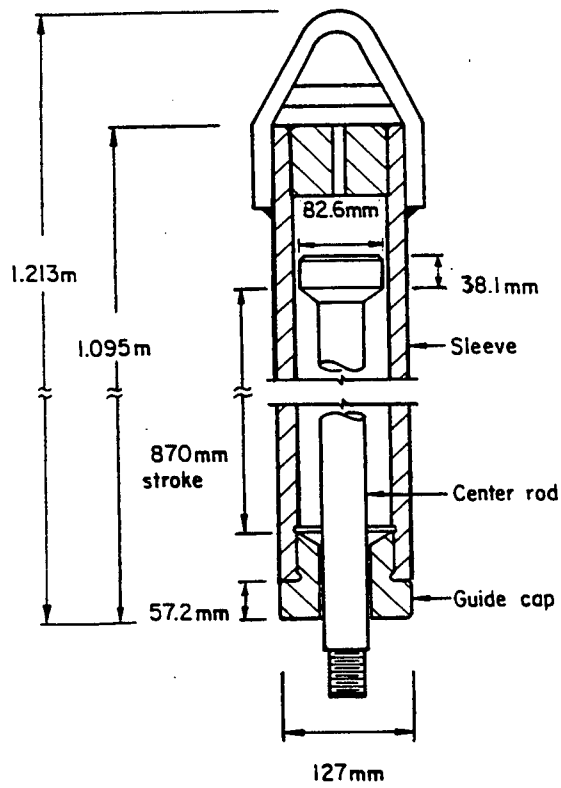

(a)

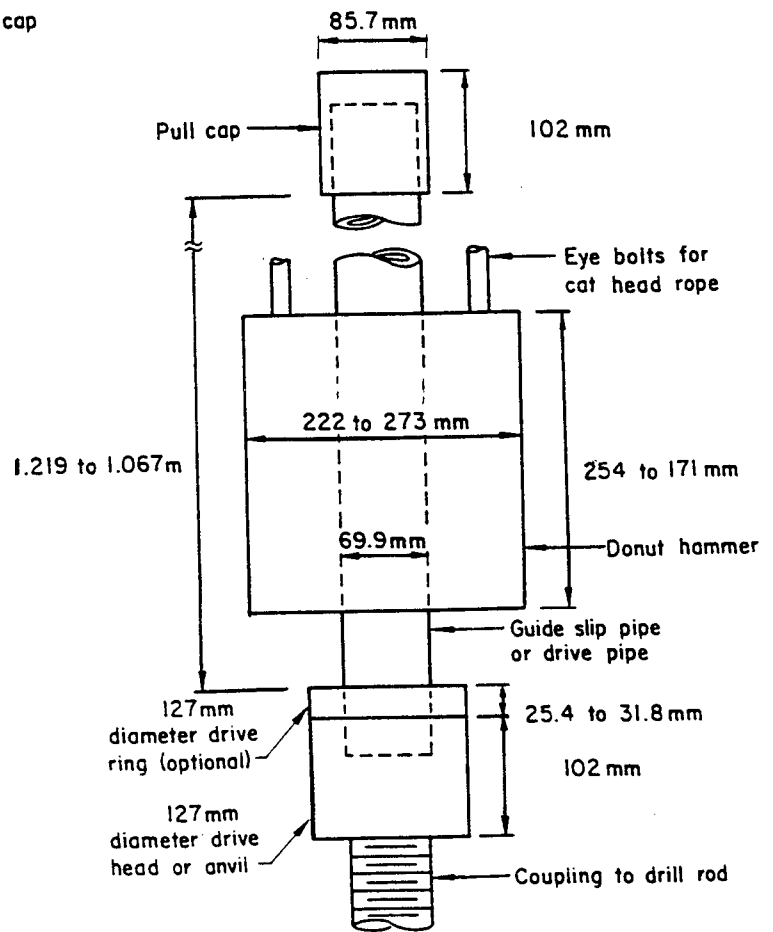

(b)

Figure 5-2: (a) SPT Safety Hammer. (b) SPT Donut Hammer. (Kovacs, *et. al.*, 1983)

The hammer drop rate should be about 30 to 40 blows per minute. The raising and dropping of the hammer should be accomplished by using a trip, automatic, or semiautomatic hammer drop system or if a drop system is not available, by using a cathead to pull a rope attached to the hammer. Not more than  $2\frac{1}{4}$  rope turns on the cathead should be used. A counterclockwise rotation of the cathead, taking the rope off the top of the cathead, is the preferred method for lifting the hammer. Figure 5-3 presents the definitions of the number of rope turns for counterclockwise and clockwise rotation of the cathead.

A variety of factors can cause a significant variation in the driving resistance of the split-barrel sampler:

- Additional wraps of rope ( $1\frac{3}{4}$  wraps with counterclockwise rotation are standard)
- Improper height of drop
- Rope condition
- Weather condition (wet rope - dry rope)
- Presence of rust, oil, or grease on the cathead
- Friction between the hammer and hammer guide
- Insufficient slack in rope when releasing the hammer
- Type of hammer (Automatic, safety, drop)

AASHTO T 206 and ASTM D 1586 state that the SPT test can be halted when the number of blows exceeds 100 total, the number of blows exceeds 50 in any 150 mm increment, or if the sampler has not advanced as a result of the last 10 consecutive blows. Sampling can then be continued following the guidelines outlined in AASHTO T 225 (Diamond Core Drilling for Site Investigation).

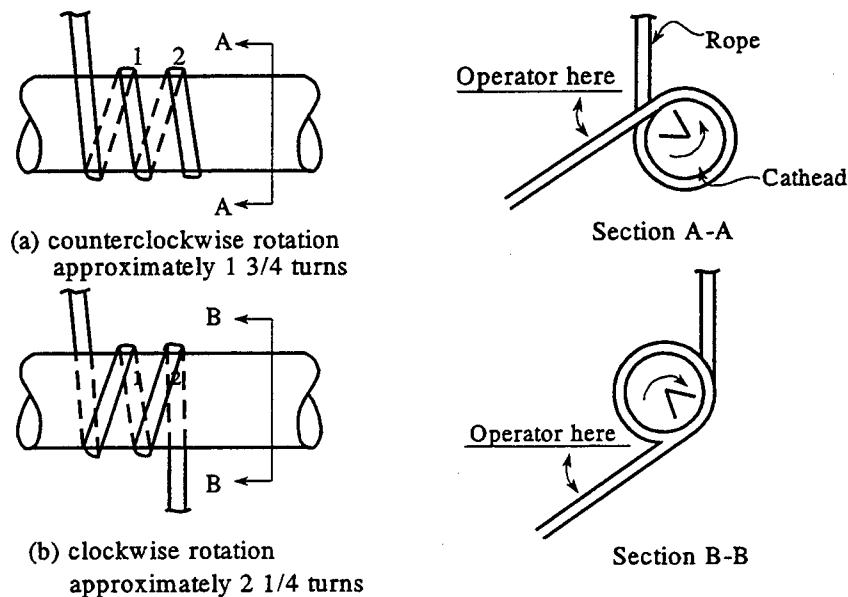

Figure 5-3: Definition of the Number of Rope Turns and the Angles for (a) Counterclockwise Rotation and (b) Clockwise Rotation of the Cathead. (AASHTO T-206, ASTM D 1586)



## 5.2 CONE PENETRATION TESTING

The Cone Penetration Test (CPT) is a simple test that is becoming very widely used in soft clays and in fine to medium coarse sands. The test is not applicable in gravels and very stiff/hard clays. CPT soundings are typically performed in conjunction with borings and sampling, and often represent an economical means of reducing the number of borings, and/or increasing the frequency of exploratory holes. Cone penetration test soundings should be conducted in accordance with ASTM D 3441.

There are at least five configurations of CPT equipment currently being used (Figure 5-4) (Bowles, 1988):

1. Mechanical: This is the earliest type and is often referred to as the "Dutch Cone" since it originated in the Netherlands. A typical later configuration with a friction sleeve is shown in Figure 5-5a.
2. Electric friction: This represents one of the first modifications using strain gauges to measure  $q_c$  and  $q_s$ , see Figure 5-6.
3. Electric piezocone: In this modification of the electric friction cone, the pore water pressure at the cone tip can be measured.
4. Electric piezo/friction: This reflects a further modification to measure point resistance, sleeve friction and pore pressure.
5. Seismic cone: This is a recent modification to include a vibration pickup to obtain data to compute shear wave velocity from a surface shock so that the dynamic shear modulus can be computed.

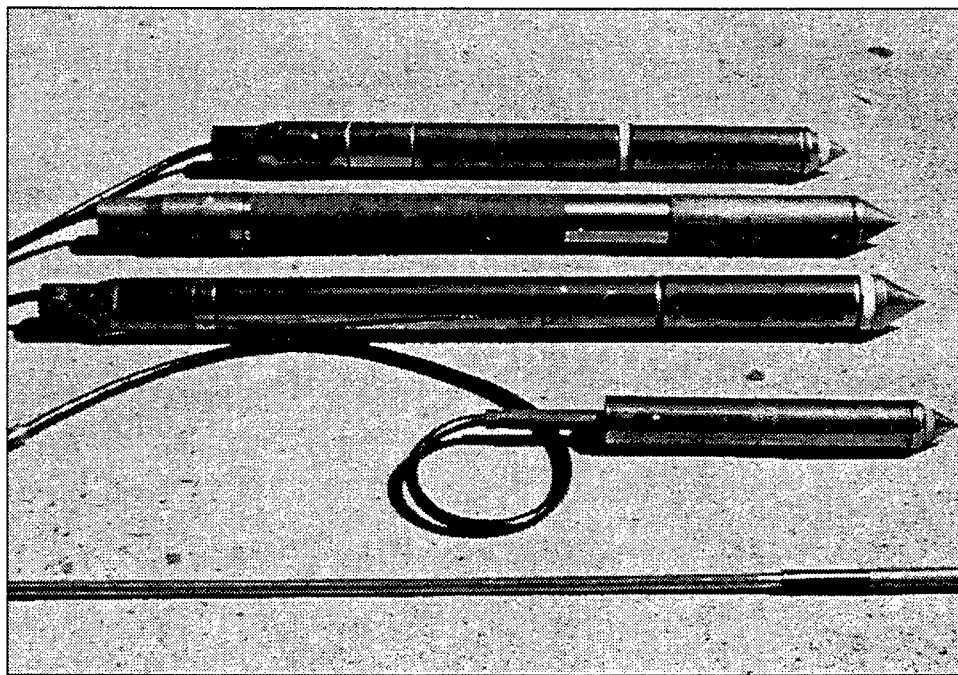

Figure 5-4: Typical Electric Cone Penetrometers.

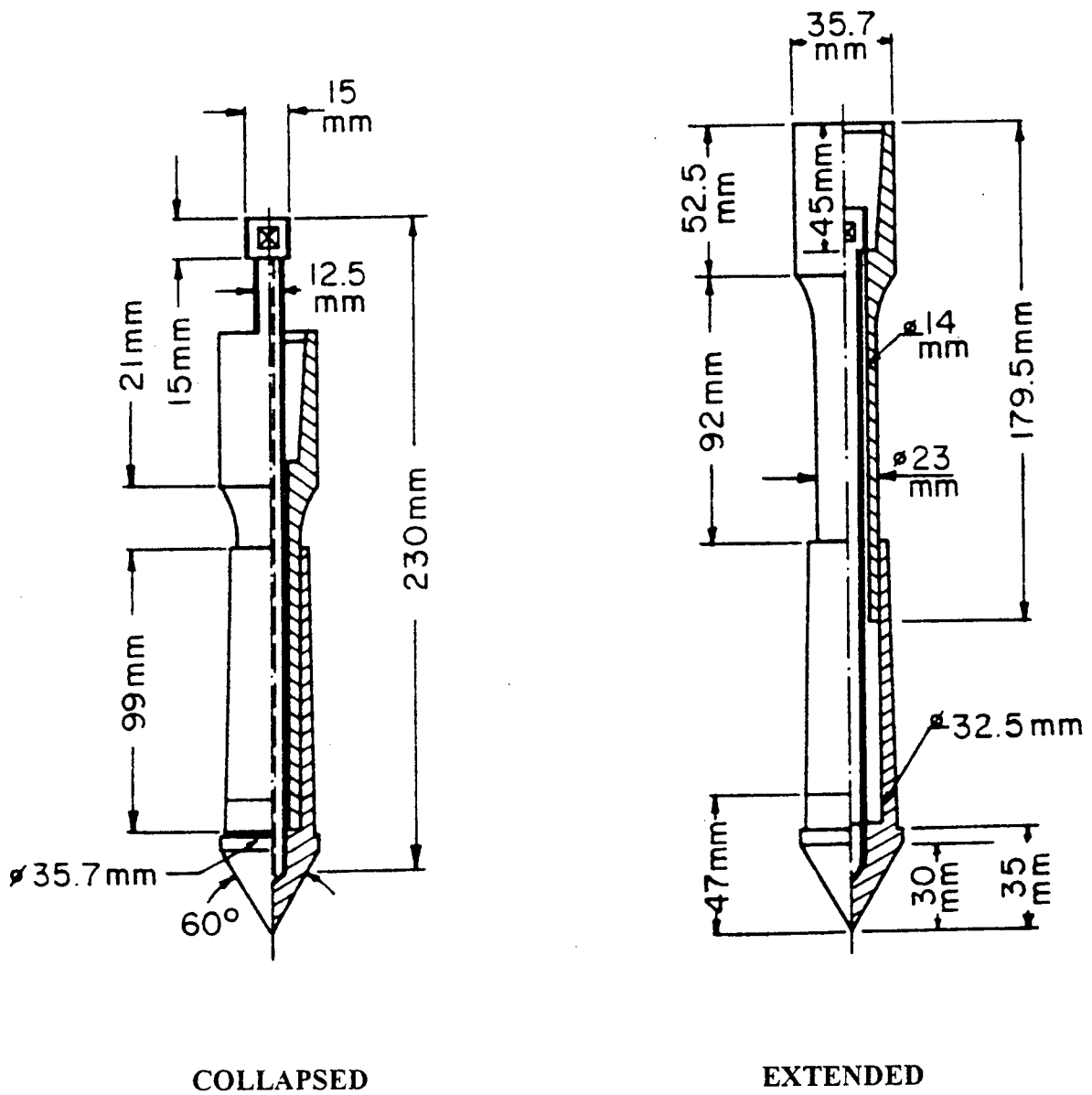

Figure 5-5a: Mechanical (Dutch) Cone Modified to Measure Both Point Resistance ( $q_c$ ) and Skin Friction ( $q_s$ ). (After ASTM D 3441)

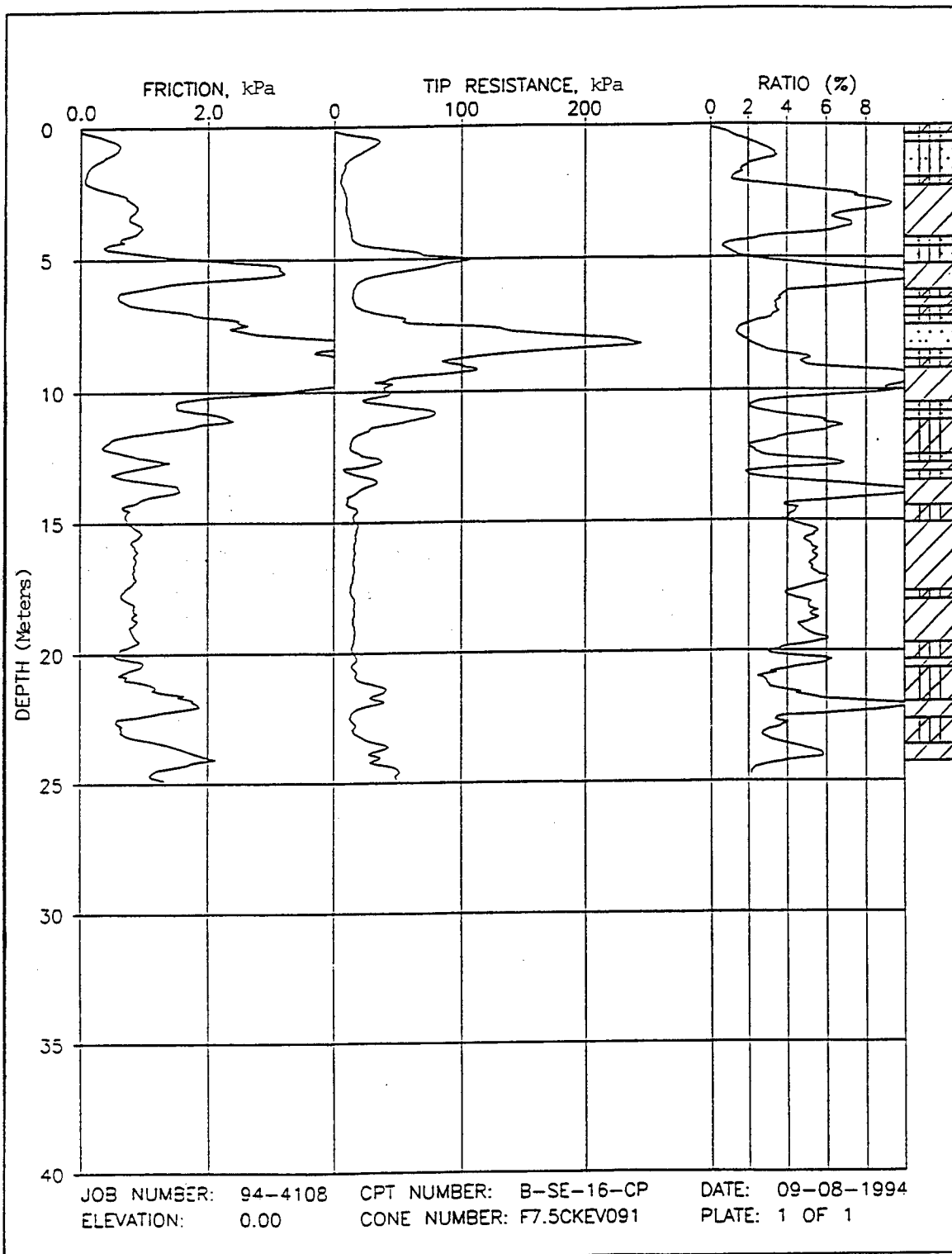
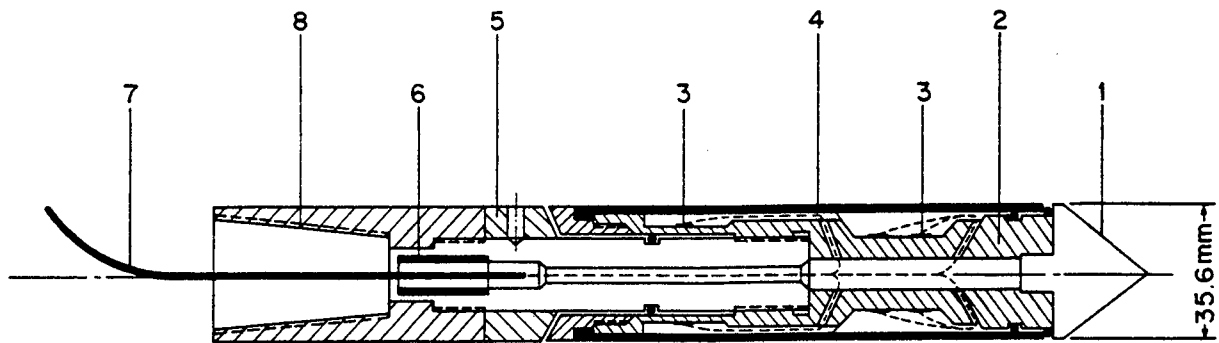

Figure 5-5b: Cone Penetration Test Results.



- 1 Conical Point (10 cm<sup>2</sup>)
- 2 Load Cell
- 3 Strain Gages
- 4 Friction Sleeve (150 cm<sup>2</sup>)
- 5 Adjustment Ring
- 6 Waterproof Bushing
- 7 Cable
- 8 Connection with Rods

Figure 5-6: Electric (Piezo) Friction Cone. (After ASTM D 3441)

Typical equipment consists of a conical tip and cylindrical friction sleeve mounted at the end of a series of hollow sounding rods mounted in a truck (Figure 5-7). The usual conical tip has a 60-degree apex angle and a projected cross-sectional area of about 10 cm<sup>2</sup>. Both the conical tip and cylindrical friction sleeve have diameters of 43.7 mm. A set of hydraulic rams is used to push this assembly in the soil at a rate of 10 to 20 mm/s (Figure 5-8). In commonly used electric cone soundings, continuous electric signals from strain gages mounted in the cone are transmitted by a cable in the sounding rods to analog and digital recorders.

The test information is recorded at 30 mm intervals and consists of depth, cone tip resistance ( $q_c$ ), sleeve friction ( $q_s$ ), and friction ratio (sleeve friction divided by tip resistance or  $q_s/q_c$ ). The test may be periodically halted to attach 1 m rods to extend the depth. A typical data set is shown on Figure 5-5b as obtained from an electric cone using strip recorders and continuous logging. With a mechanical cone (Figure 5-5a) in position 1 the cone and friction jacket are in an collapsed or seated state. In position 2 the cone is pushed down by the inner surrounding rods to a depth "a" until a collar engages the cone; in this position the tip resistance,  $q_c$ , is measured. In position 3 the friction sleeve is advanced to measure  $q_s$ . In position 4, both the sleeve and tip are advanced and the total resistance,  $q_t = q_c + q_s$  is obtained. This procedure gives a check on  $q_s$  which can be computed as  $q_s = q_t - q_c$  to compare with that from position 3. The distances, "a" and "b" are normally 35 mm.

The electric cone penetrometer offers obvious advantages over the mechanical penetrometer, such as more rapid procedure, continuous recording, higher accuracy and repeatability, potential for automatic data logging, reduction and plotting. Although electric cone penetrometers carry a higher initial cost, the most significant advantage is repeatability and accuracy.

The excess pore pressure measured during penetration is a useful indicator of the soil type and provides an excellent means for detecting stratigraphic detail and appears to be a good indicator of stress history (Konrad and Law, 1987b). In addition, when the steady penetration is stopped momentarily, the dissipation of the excess pore pressure with time can be used as an indicator of the coefficient of consolidation. Finally, the equilibrium pore-pressure value, i.e., the pore pressure when all excess pore pressure has dissipated, is a measure of the phreatic elevation in the ground (Canadian Geotechnical Manual, 1992).

An inclinometer type system may be contained within an electric cone to monitor deviation from plumb since subsurface obstructions may cause the cone to deviate from vertical alignment. If the cone slope increases (i.e., excessive deviation from plumb) the quality of data deteriorates and the test may need to be abandoned.

Cone resistance and pore pressures are governed by a large number of variables, such as soil type, density, stress level, soil fabric, and mineralogy. Many theories exist to promote a better understanding of the process of a penetrating cone, but correlations with soil characteristics remain largely empirical.

Empirical correlations have also been proposed for relating the results of the CPT to the SPT as well as to soil parameters such as shear strength, density index, compressibility, and modulus (Riaund and Mirand, 1992; Robertson and Campanella, 1983 a,b).



Figure 5-7: Self-Contained CPT Truck (Photo courtesy of M. Tumay of Louisiana Transportation Research Center)

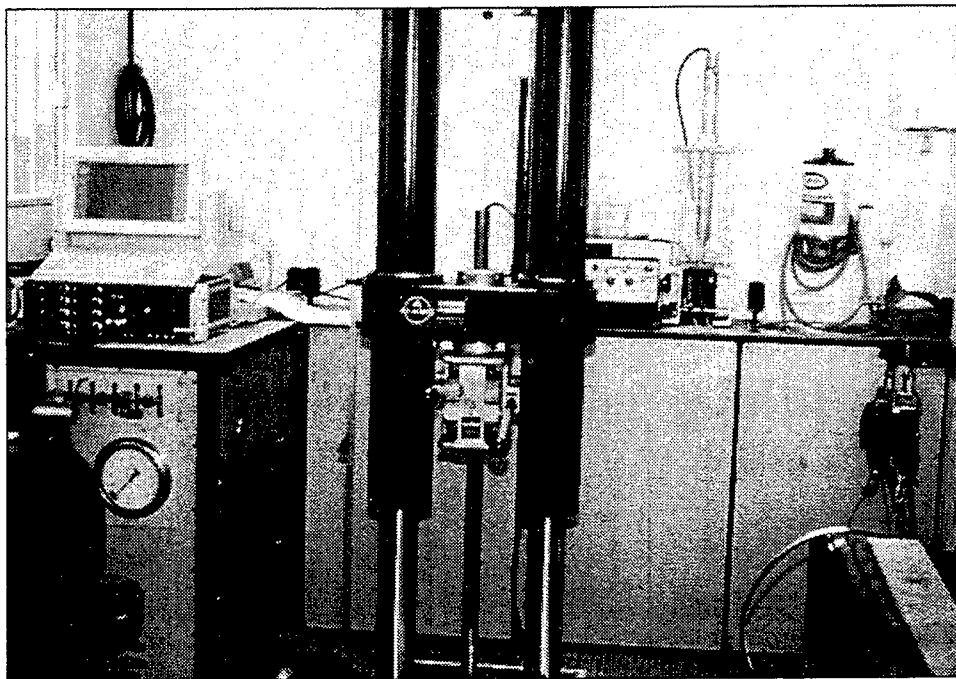

Figure 5-8: Interior of CPT Truck (Photo courtesy of M. Tumay of Louisiana Transportation Research Center)

The use of the CPT to estimate equivalent SPT values is becoming a common application for foundation design. The major advantages of the CPT over the SPT are its continuous profile and the higher accuracy and repeatability it provides; subsequently if a good CPT-SPT correlation exists, very comprehensive equivalent SPT values can be obtained. The relationship between the CPT, represented by the tip resistance,  $q_c$ , and the SPT, represented by the blowcount  $N$ , has been determined in a number of studies over the past three decades (Meigh and Nixon, 1961; Thornburn, 1970; Schmertmann, 1970; Burbridge, 1982; Robertson *et. al.*, 1983; Burland and Burbridge, 1985). The relationship between CPT and SPT is expressed in terms of the ratio  $q_c/N$  ( $\text{kN/m}^2$  per blow over 0.3 m); various relations from available literature of  $q_c/N$  data versus mean particle size of soils tested are summarized by the Canadian Geotechnical Manual (1992) and are shown in Figure 5-9.

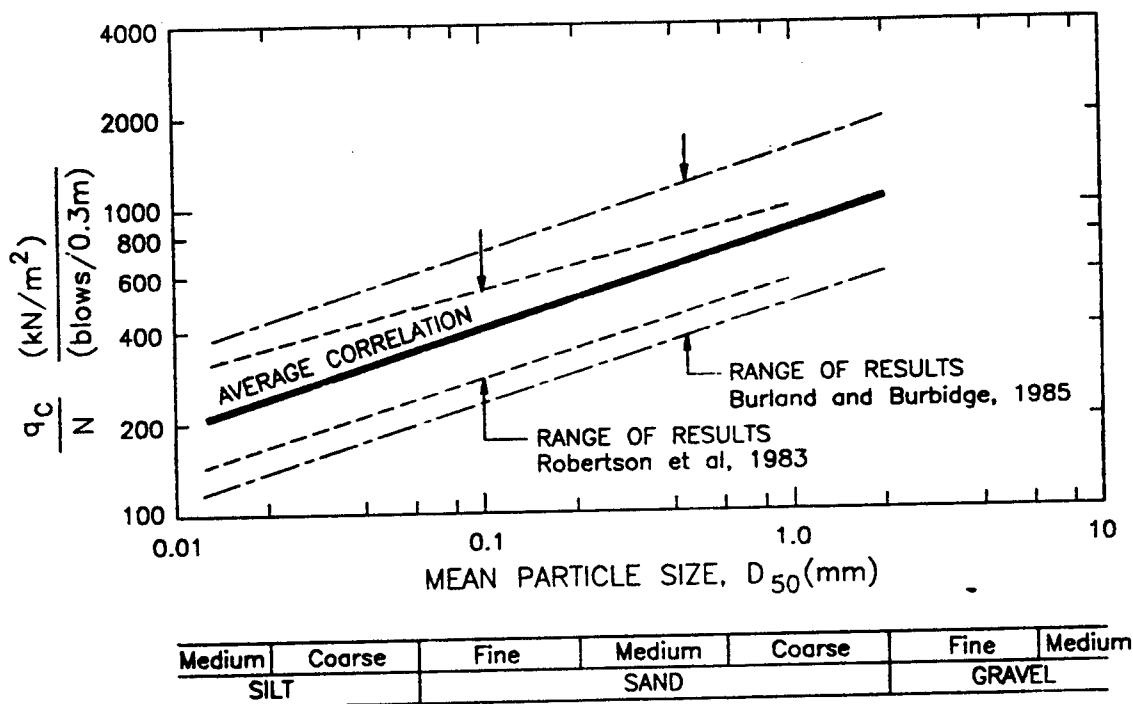

Figure 5-9: Variation of  $q_c/N$ -Ratio With Mean Grain Size. (Robertson *et. al.*, 1983; Burland and Burbridge, 1985). The dashed lines show the upper and lower limits of observations.

### 5.3 FIELD VANE SHEAR TEST

The Vane Shear Test (AASHTO T 223, ASTM 2573), sometimes referred to as the Swedish Vane Test, provides a means of obtaining an indication of the strength of cohesive soils.

The test procedure requires pushing a four-bladed vane into undisturbed soil layers and rotating it until a cylindrical volume of the soil, theoretically, having height and diameter dimensions the same as the vane fails in shear (Figure 5-10). The torque required to cause the failure is read and translated into force applied to the total surface area of the failed cylinder. This value is used as the strength of the soil. Correlations with unconfined compressive or triaxial strength of soils exist for areas where this test method has been used extensively. Such correlations are very useful tools for the interpretation of test results.

Equipment details vary somewhat; however, the vane device shown in Figure 5-11 is fairly typical with a torque applied through the reduction gears shown so the rate is at about 1 to 6 degrees per minute with the provision to measure the angle of rotation. It is necessary to measure (or calibrate) for the friction (both soil and bearings) in the torque rods so this can be deducted from the total peak torque to obtain the shear strength torque. Also it is common to crank the vane to failure, then continue cranking for 10 to 12 revolutions to remold the soil at the vane, rest a period and then make a remolded vane shear test to obtain the remolded torque. This testing procedure has been used successfully.

The vane test and the interpretation of the test results are subject to some limitations or errors, which need to be taken into account. The insertion of the vane blade produces a displacement and remolding of the soil. Experience shows that thicker blades tend to produce reduced strengths. For acceptable results, the blade thickness should not exceed 5 percent of the vane diameter (Canadian Geotechnical Manual, 1992). In sands and varved clays the results are not reliable.

In reality the torque applied to cause the failure is not consumed by the resistance provided on the assumed cylindrical surface only but it is partially used by the shear distortion of an ill defined zone crudely parallel to the surfaces of the cylindrical area. Furthermore if the test is performed by pushing the vane through the soil into an undisturbed layer the frictional resistance offered by the interface of drilling rods to which the vane is attached may be substantial. The strength values produced by this method do not coincide with strength values produced by conventional tests performed in the laboratory with undisturbed samples. Correlations, however, can be developed to convert the vane shear results to undrained triaxial test results (Arman, *et. al.*, 1975).

The failure mode around a vane is complex. The test interpretation is based on the simplified assumption of a cylindrical failure surface corresponding to the periphery of the vane blade (Aas, 1965). The undrained shear strength can be calculated from the measured torque, provided that the shear strengths on the horizontal and vertical planes are assumed equal. In reality, however, the vane shear test measures a weighted average of the shear strength on vertical and horizontal planes. It is possible to determine the horizontal and vertical shear strength for either plane by performing the test in similar soil conditions using vanes of different shapes or height/diameter ratios. It has been found that, in general, the ratio of horizontal/vertical shear strength is less than unity; when this is applicable, a field vane value of  $\tau_u$  is a conservative estimate of the shear strength along the vertical plane.

The measured vane shear strength requires correction. Bjerrum (1972) proposed a correction factor  $\mu$ , which related the corrected vane strength,  $(\tau_u)_{corr}$ , to the field vane shear strength,  $(\tau_u)_{field}$ , as follows:

$$(\tau_u)_{corr} = \mu (\tau_u)_{field} \quad (5-2)$$





Figure 5-10: Field Shear Vanes.

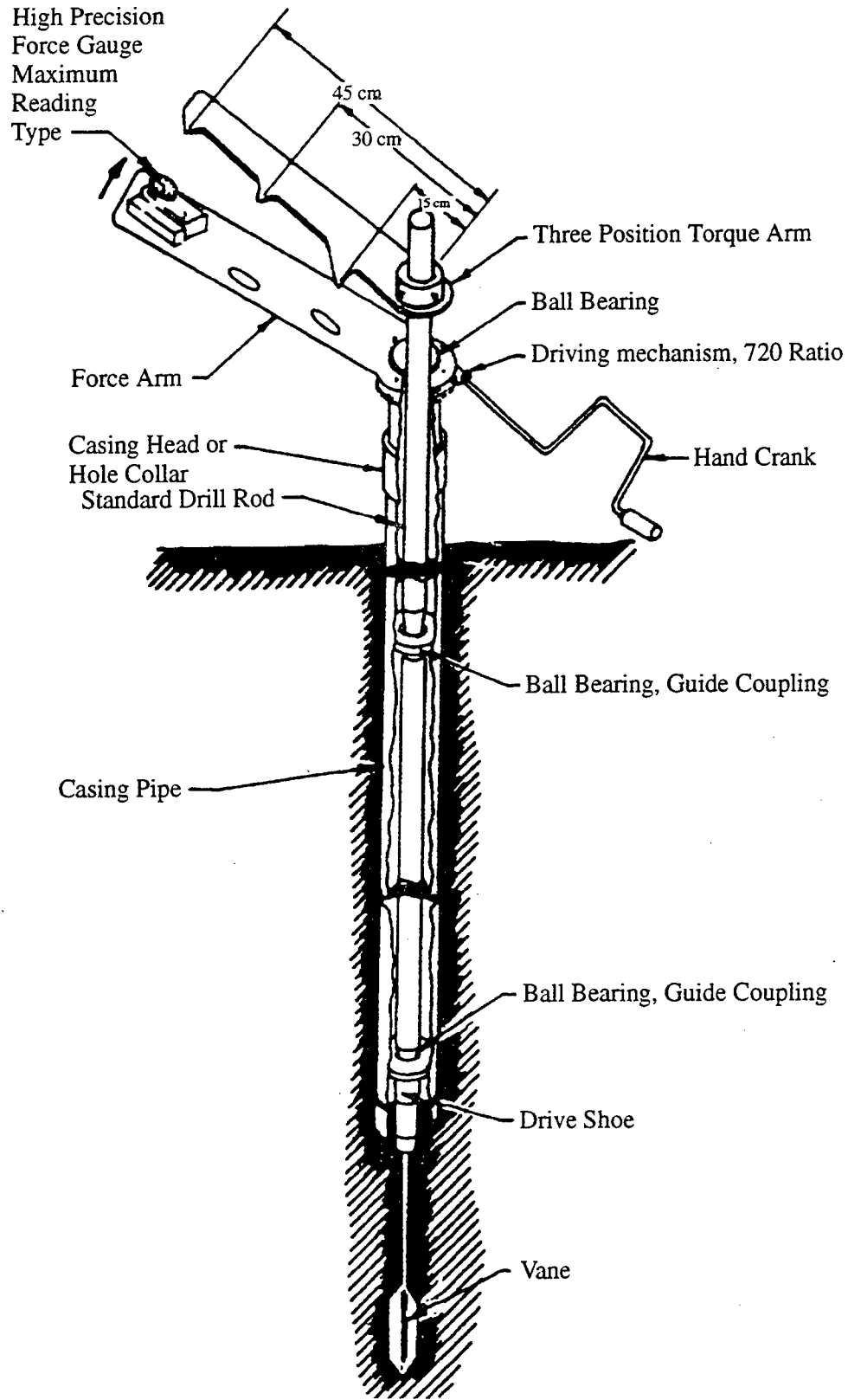
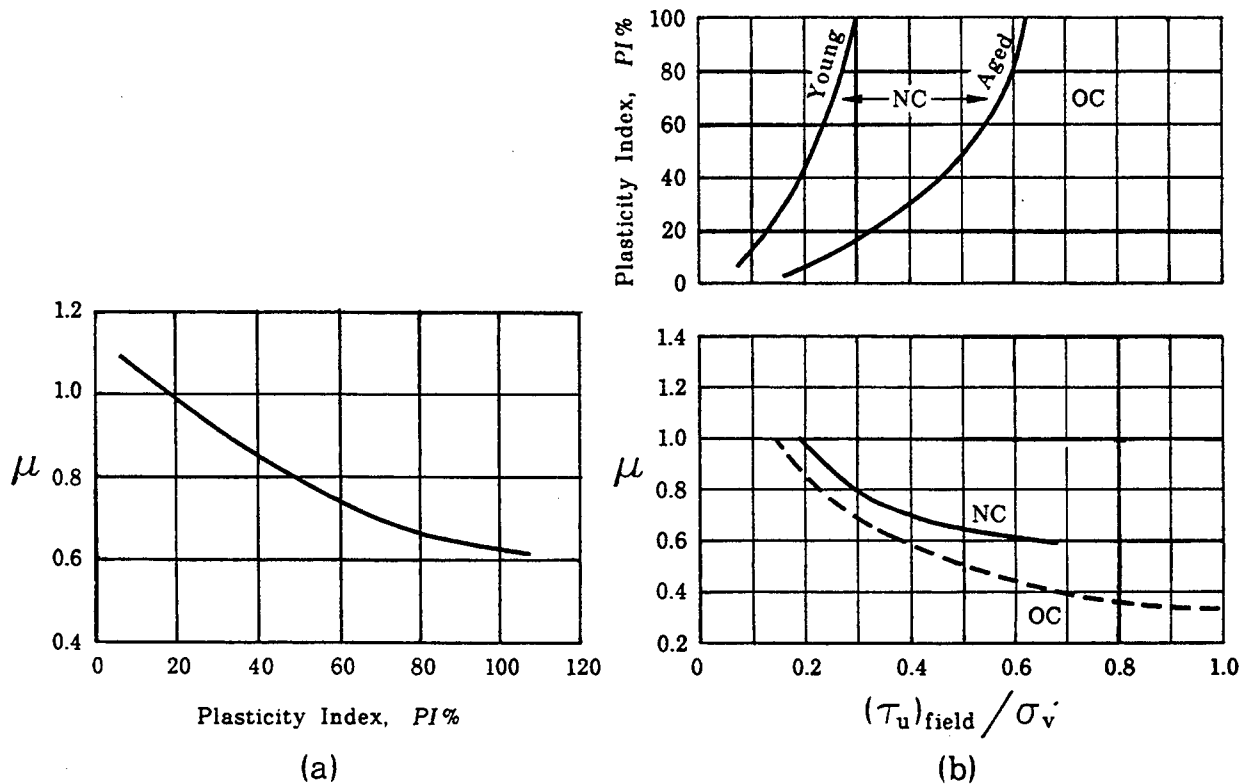

Figure 5-11: Schematic View of Vane Shear Device. (After NAVFAC 7.01, 1982)

where  $\mu$  varies with plasticity index (PI) as shown in Figure 5-12a. Aas *et. al.* (1986) made a substantial reevaluation of the Bjerrum chart to include OCR and aging, and presented a revised chart shown in Figure 5-12b where  $\mu$  is given as a function of the ratio  $(\tau_u)_{field}/\sigma'_v$ , and  $\sigma'_v$  is the effective overburden pressure. Both charts are included since Bjerrum's chart is well known; however, Aas *et. al.*'s chart is more rational. Figure 5-12b is used by entering the top chart with PI and  $(\tau_u)_{field}/\sigma'_v$  to establish whether the clay is within the normally consolidated (NC) range between the limits "young" and "aged", or overconsolidated (OC). The bottom chart of Figure 5-12b is then used to obtain  $\mu$ , for the  $(\tau_u)_{field}/\sigma'_v$  and corresponding NC or OC curve. Aas *et. al.* (1986) recommend a maximum design value of  $\mu$  of 1.0 for  $(\tau_u)_{field}/\sigma'_v$  less than 0.20 since  $\mu$  is rather sensitive for low values of  $(\tau_u)_{field}/\sigma'_v$ . Refer to Aas *et. al.* (1986) for further details. The vane shear test can also be used to estimate the OCR (Mayne and Mitchell, 1988).

Similar to the SPT, the vane shear test is made every 0.75 to 1 m of depth and the vane shear strength is usually plotted against depth to provide a strength profile. It is good practice to carry out, in parallel with vane shear tests, other in situ tests such as the CPT, which yield continuous profiles, and to correlate these results with vane shear test values. ASTM STP 1014 (1988) contains papers on recent developments in testing and interpretation of vane shear tests.



Figures 5-12: Vane Correction Factor. (a) Bjerrum, 1972, and (b) Aas, *et. al.*, 1986

## 5.4 PRESSUREMETER TESTING

Pressuremeters are used to measure the in situ deformation (compressibility) and strength properties of a wide variety of soil types, weathered rock and low to moderate strength intact rock. The borehole pressuremeter test (PMT), which was developed around 1956 (Menard, 1956), is conducted in a carefully prepared borehole which is about 10 percent oversized. The pressuremeter probe consisting of three parts (top, cell, and bottom) as shown in Figure 5-13 is then inserted and expanded to and then into the soil. The top and bottom guard cells are expanded first to reduce end-condition effects on the middle (the cell) part which is used to obtain the volume versus cell pressure relationship used in data reduction. ASTM D 4719 presents the procedures for a Menard-type pressuremeter test. Additional guidelines to be followed during testing are presented by the manufacturer of the instrument, Roctest (1978). Briaud (1989) discusses the pressuremeter test in detail in "The Pressuremeter Test in Highway Applications" publication No. FHWA-IP-89-008.

It is extremely important to minimize disturbance of the borehole wall during the drilling process. Appropriate drilling procedures are described by Baguelin, *et. al.* (1978). Normal drilling and sampling techniques, which are generally intended to minimize disturbance of the collected samples, may not be suitable for pressuremeter testing. Drilling methods should be selected to prevent collapse of the borehole walls, minimize erosion of the soil, and prevent softening of the soil (Finn *et. al.*, 1984). When tests are conducted in a soil type where limited local experience in pressuremeter testing is available, several methods of drilling should be evaluated to determine the optimum method. General guidance in the initial selection of drilling methods for various soil types is presented in Table 5-2.

**TABLE 5-2**  
**METHODS OF BOREHOLE PREPARATION FOR MENARD-TYPE PRESSUREMETER**  
**(Canadian Geotechnical Manual, 1992)**

Soil Type	Drilling Methods
Firm to Stiff Clay	Pushed tube with internal chamfer
Stiff to Hard Clay	Pushed or driven tube with internal chamfer Core drilling with mud or possibly foam flush Continuous flight auger
Silt	Pushed or driven tube with internal chamfer Core drilling with mud or possibly foam flush (very stiff to hard silts)
Sand	Pushed or driven tube with internal chamfer (with mud below the water table) Core drilling with mud flush (dense to very dense sands)
Gravel	Very difficult to avoid disturbance. A driven slotted casing is sometimes used, however disturbance is significant due to lateral displacement of the soil
Glacial Till	<ul style="list-style-type: none"> <li>• Core drilling with mud (very dense finer grained tills with high silt and/or clay content)</li> <li>• Driven thick-walled tube with internal chamfer (medium dense to dense finer grained tills as above)</li> <li>• Driven slotted casing (applicable only to medium dense tills - very high soil disturbance)</li> </ul>
Weak/Weathered Rock	Core drilling with mud or possibly foam flush
Sound Rock	Core drilling with water, mud or foam flush

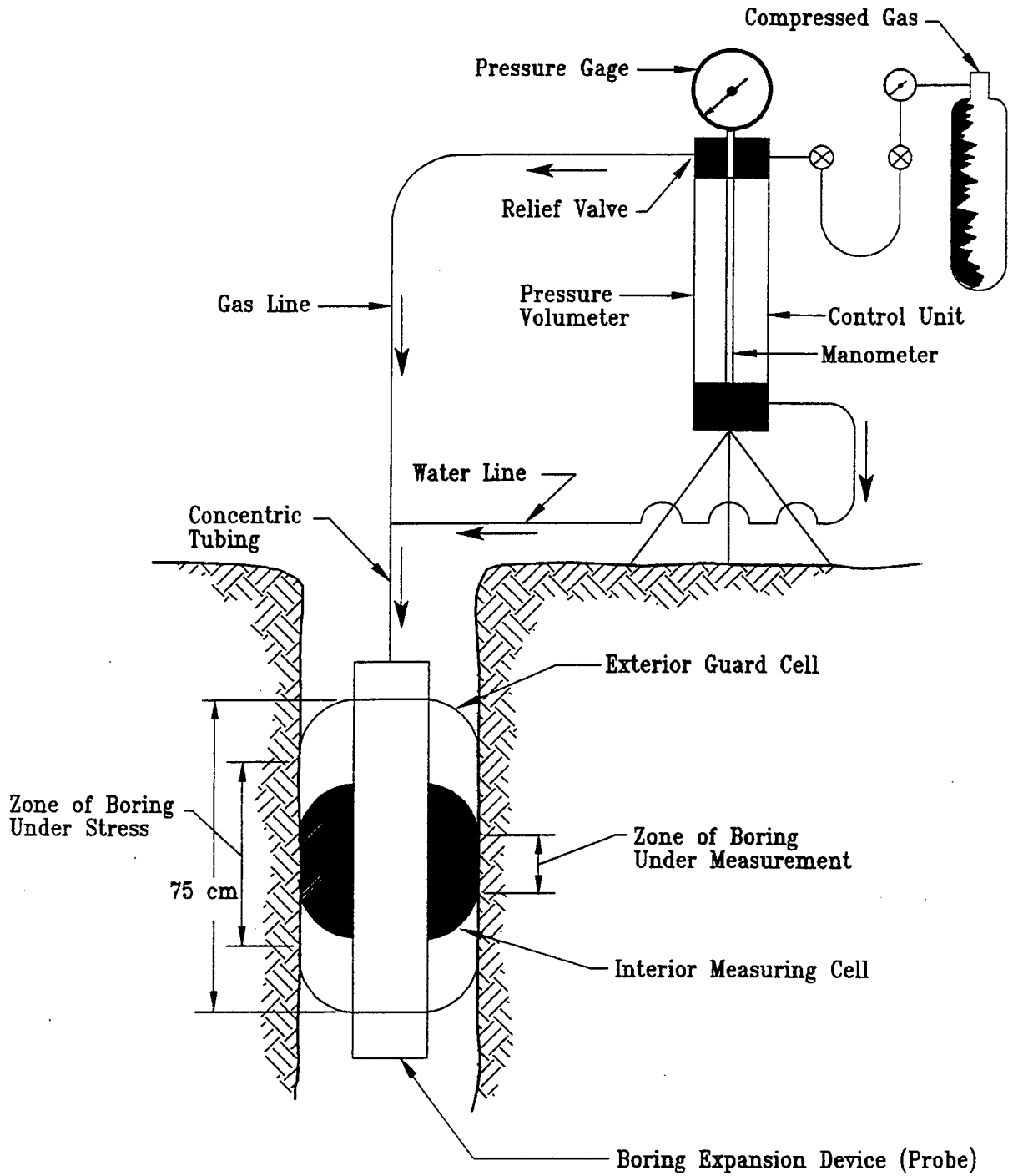

Figure 5-13: Components of Menard Pressuremeter. (After NAVFAC 7.01, 1982)

Typically, Menard-type pressuremeter tests are carried out as stress controlled tests by applying a series of increasing pressure increments. The maximum pressure expected during the test should be divided into a minimum of ten equal pressure increments. Each pressure increment is maintained for a one minute period with volume or radial strain measurements recorded at intervals of 15, 30, and 60 seconds. All pressure increments should be maintained for the same time period. Tests are generally considered to be complete when the volume of the liquid injected during the test is equal to the initial volume of the borehole. In hard soils and rocks it may not be possible to inject this volume and the test is terminated at the maximum pressure for the system. If the sides of the borehole are excessively enlarged either by improper sizing of the drilling equipment or erosion of the borehole wall, the maximum inflation volume of the probe may be reached prior to injection of the required volume.

Strain controlled tests are possible for instruments that measure displacements of the borehole walls directly with either calipers or transducers. Computer controlled load application greatly simplifies the test procedure; however, the availability of equipment is limited. Strain rate selection is important for clays, particularly in the plastic stress range (Anderson, 1979; Windle and Wroth, 1977).

The results of a standard Menard-type pressuremeter test corrected for volume and membrane resistance are shown in Figure 5-14 as the Pressuremeter Curve. Since the system reads total hydrostatic pressure it must be corrected for the hydrostatic pressure in the measuring circuit above the water table. In the first stage of the test, the volume increases rapidly with small changes in pressure as the probe is inflated against the soil. The volume at the point where the curve becomes approximately linear is termed  $v_o$  which is equal to the difference between the volume of the hole and the initial volume of the probe. The corresponding pressure at this point is called  $p_o$ . However, this pressure does not represent the true in situ pressure in the ground because of stress relief during the formation of the hole. At higher pressures the volume increases slowly with pressure. The creep volume change in this pressure range is small and approximately constant, which indicates pseudo-elastic behavior of the soil. The slope of the volume-pressure curve in this range is related to the shear modulus of the soil. The pressure corresponding to the end of the constant creep volume measurements is called the creep pressure,  $p_f$ . At higher pressure, the volume and the creep volume increase rapidly indicating the development of soil failure around the probe. The pressure-volume curve tends to approach an asymptotic limit corresponding to the limit pressure  $p_l$ .

The various soil deformation moduli are derived by using the pressure-volume relationship shown in Figure 5-14 in conjunction with the elasticity theory. The theoretical basis for the pressuremeter test which was developed first by Lamé (1852) is the radial expansion of a cavity in an infinite elastic medium. Details of the cavity expansion theory are presented in Baguelin *et al.* (1978) and Mair and Wood (1987). Based on these elasticity principles and Figure 5-14, the Menard Modulus ( $E_M$ ) is given by:

$$E_M = 2(1+\nu)(v_c + v_m)(p/v) \quad \text{with } v_m = 0.5(v_o + v_f) \quad \text{and } p/v = (p_f - p_o)/(v_f - v_o) \quad (5-3)$$

where  $\nu$  is the Poisson's ratio,  $v_c$  is the initial volume of the probe and  $p_o$ ,  $p_f$ ,  $v_o$  and  $v_f$  are as defined in Figure 5-14. The Poisson's ratio depends on the type of soil or rock and drainage conditions, i.e., fine grained or coarse grained soil and undrained or drained loading. General guidance on the selection of an appropriate Poisson's ratio is presented in Mair and Wood (1987).

The Menard limit pressure is defined as that pressure at which the volume is equal to twice the initial volume of the hole, i.e.,  $2(v_o + v_c)$ . Various methods are available to determine the limit pressure as described by Baguelin *et al.* (1978). The ratio of the pressuremeter modulus to the limit pressures tends to be a constant characteristic of any given soil type. Typical values are shown in Table 5-3.

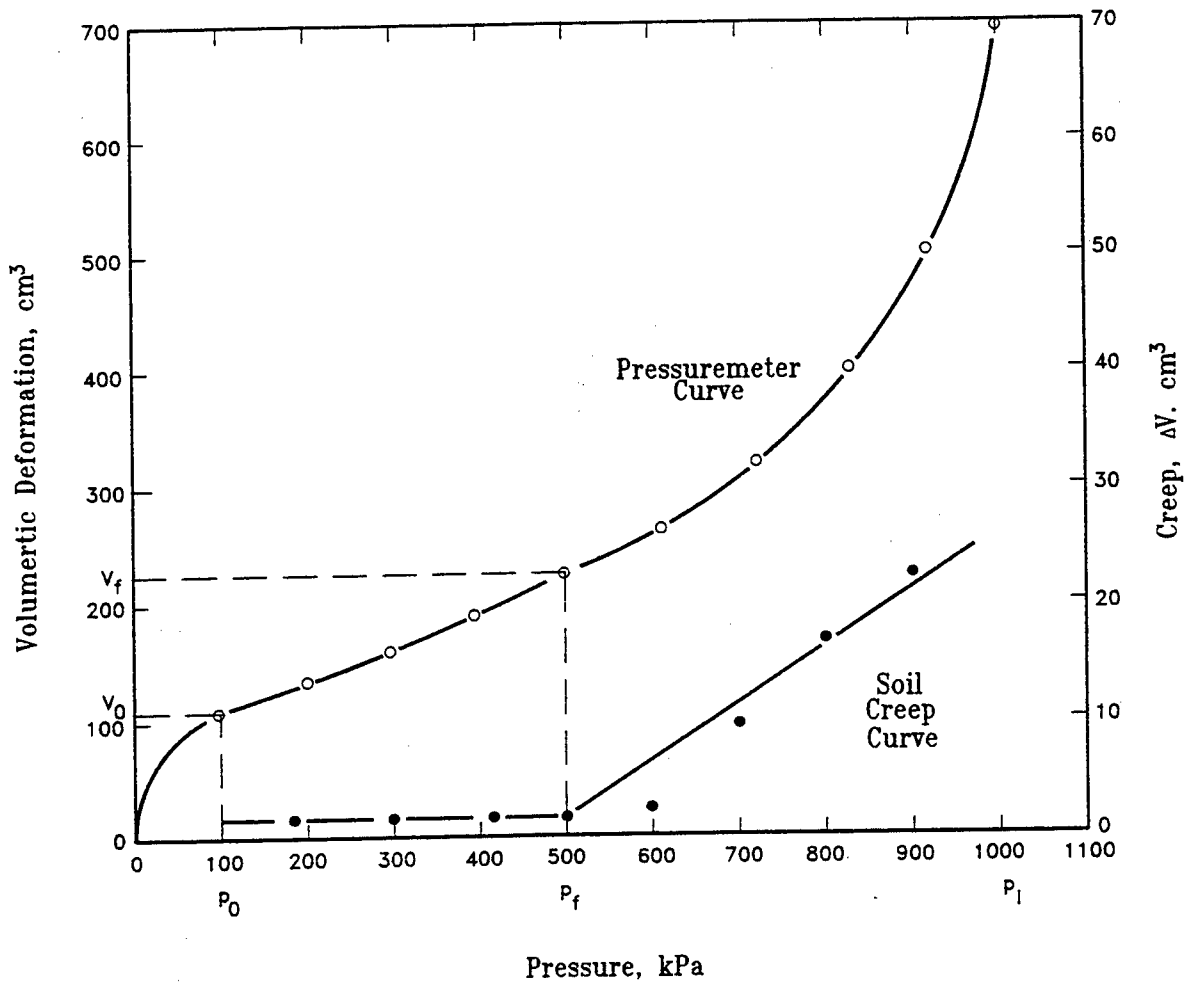

Figure 5-14: Typical Pressuremeter and Creep Curves - Menard Type Pressuremeter. (Canadian Geotechnical Manual, 1992)

**TABLE 5-3**  
**TYPICAL MENARD PRESSUREMETER VALUES**  
 (Canadian Geotechnical Manual, 1992)

Type of Soil	Limit Pressure (kPa)	$E_M/p_1$
Soft clay	50 - 300	10
Firm clay	300 - 800	10
Stiff clay	600 - 2500	15
Loose silty sand	100 - 500	5
Silt	200 - 1500	8
Sand and gravel	1200 - 5000	7
Till	1000 - 5000	8
Old fill	400 - 100	12
Recent fill	50 - 300	12

### 5.4.1 Self Boring Pressuremeter Test

The self boring pressuremeter is similar to a Menard-type pressuremeter as it consists essentially of a thick-wall tube with a flexible membrane attached to the outside. The instrument is pushed into the ground and the soil, displaced by a sharp cutting shoe, is removed up the center of the instrument by the action of a rotating cutter or jetting device just inside the shoe of the instrument. The cuttings are flushed to the surface by drilling mud, which is pumped down to the cutting head. Figure 5-15 shows two basic types of self-boring pressuremeter.

Once the instrument is at the desired depth, and following the dissipation of excess pore-water pressure, the membrane surrounding the instrument is expanded against the soil. The expansion at the center of the instrument is measured by displacement transducers. Pore pressure cells can be incorporated into the membrane to monitor changes in pore-water pressures.

The self-boring pressuremeter can be installed into relatively soft soils and the test results can be interpreted using analytical methods. A summary of the methods of interpretation is presented by Mair and Wood (1987) and by Briaud (1989).

The Menard-type pressuremeter test and the self-boring pressuremeter test should be considered as two distinct and separate tests. The Menard-type pressuremeter test is usually interpreted using empirical correlations related to specific design rules. Pressuremeter test results can be used to determine  $K_0$  and the estimated value of undrained shear strength of in situ fine grained soils.

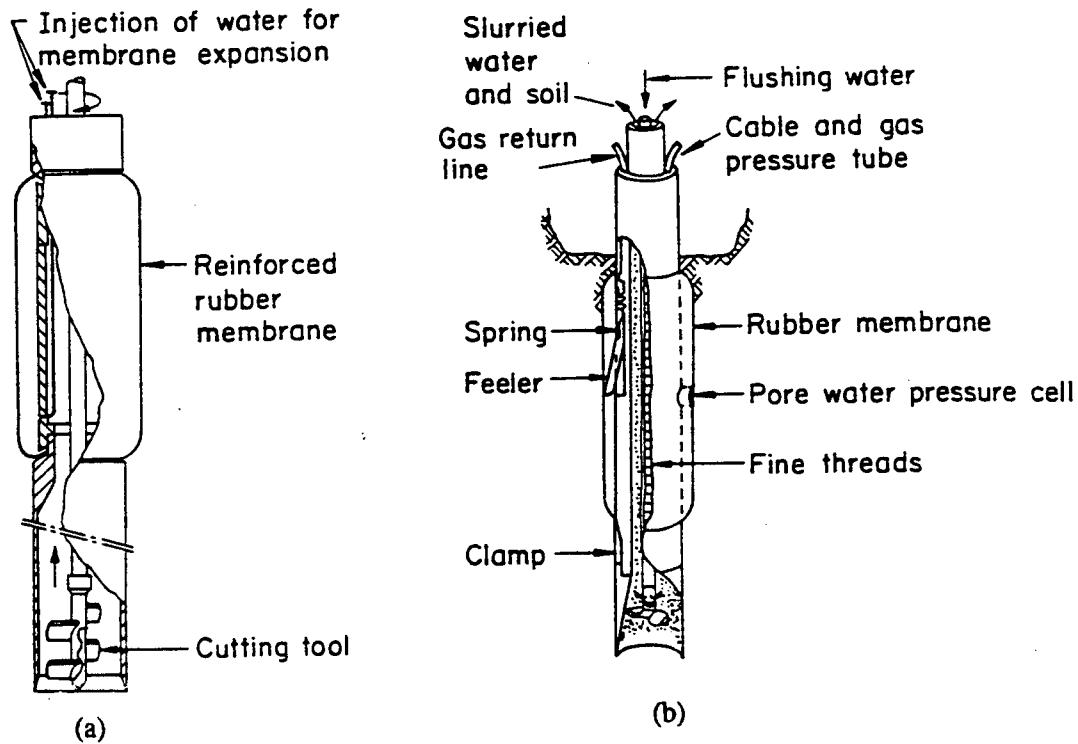

Figure 5-15: Self-Boring Pressuremeters, (a) PAFSOR, (b) Camkometer. (Jamiolkowski *et al.*, 1985)



## 5.5 DILATOMETER TESTING

The flat dilatometer was developed by Marchetti in the later 1970's in Italy (Riaund and Miran, 1992). The dilatometer consists of a stainless steel probe as illustrated in Figures 5-16 and 5-17. It has a sharp cutting edge. A 60-mm diameter stainless steel membrane is centered on and flush with one side of the blade.

The dilatometer is attached to a string of drill rods and pressed, or at times driven, into the ground. A single, combination gas and electrical line extends through the drill rods and down to the blade from a surface control and pressure readout box. The dilatometer is pressed into the ground in 15 to 30 cm increments. The force or blows required to cause penetration provide information similar to that of CPT and SPT. At each increment of penetration, three pressures are measured: the pressure "A" required to cause the diaphragm to just lift off; the pressure "B" to cause 1.1 mm deflection of the diaphragm at its center, and upon the release of pressure, the pressure "C", which is needed to seat the diaphragm again. The observed pressures are corrected for the stiffness of the diaphragm. The corrected pressure A is designated  $p_0$  and the pressure B is  $p_1$ . Marchetti (1980) proposed the following three index parameters:

$$\begin{aligned} I_D &= \frac{p_1 - p_0}{p_0 - u_0} && \text{Material or Deposit Index} \\ K_D &= \frac{p_0 - u_0}{\sigma'_v} && \text{Lateral Stress Index} \\ E_D &= 38.2(p_1 - p_0) && \text{Dilatometer Modulus} \end{aligned} \tag{5-4}$$

where  $u_0$  is the in situ pore pressure, and  $\sigma'_v$  is the in situ effective overburden pressure.

The dilatometer test has been tentatively correlated with other penetration tests. Specifically, the test may provide reasonable estimates of the horizontal stress and overconsolidation ratio, which are traditionally difficult properties to measure. The proposed empirical correlations, although requiring a substantial database for verification, relate the test results to basic geotechnical engineering parameters. The test data can be quickly reduced in the field, which allows evaluation of anomalous results. In addition, these test results and inferred soil properties can be plotted in a nearly continuous profile to illustrate the variations with depth.

Since the dilatometer test is a recent test, it has had limited field exposure. Therefore, the general validity of the soil property correlations is uncertain. As with any penetration test, the dilatometer test has limited use in very dense or cemented soils and in soils containing appreciable gravel or coarser fragments. In the case of gravelly deposits, the blade may deviate from vertical penetration, causing difficulty in interpreting the horizontal stress parameters, and, in some cases, the blade may be bent or the inflatable membrane may be torn.

In addition to soils, rock dilatometer tests can be conducted to measure the in situ deformation modulus of the rock mass within 'N'-size or 76 mm-diameter boreholes at the site. The test procedures follow the manufacturer's recommendations (Roctest, 1987).

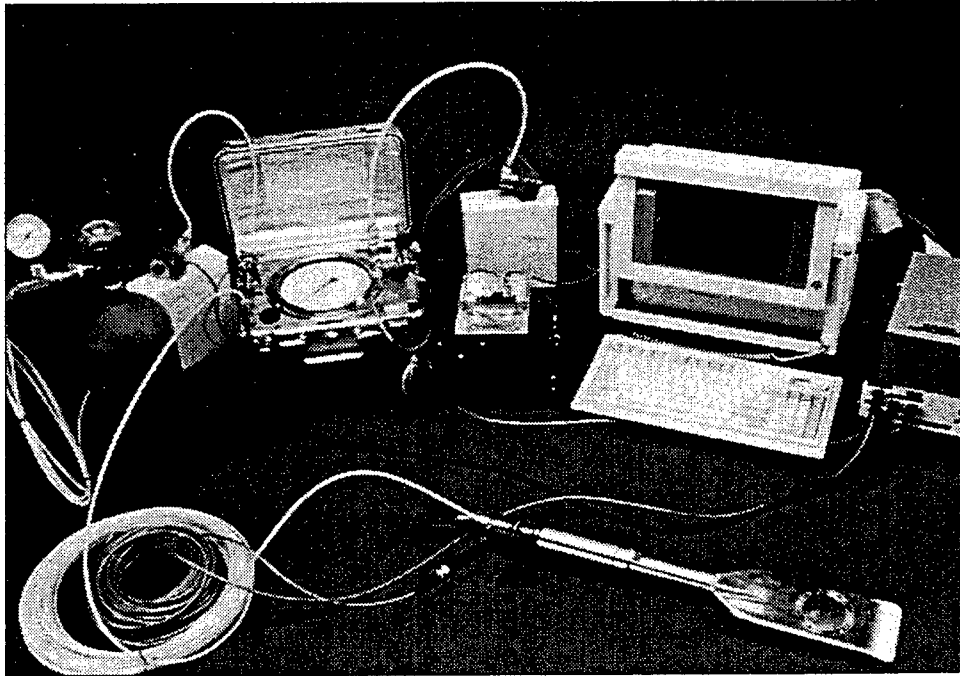

Figure 5-16: Dilatometer and Read-Out Instruments.

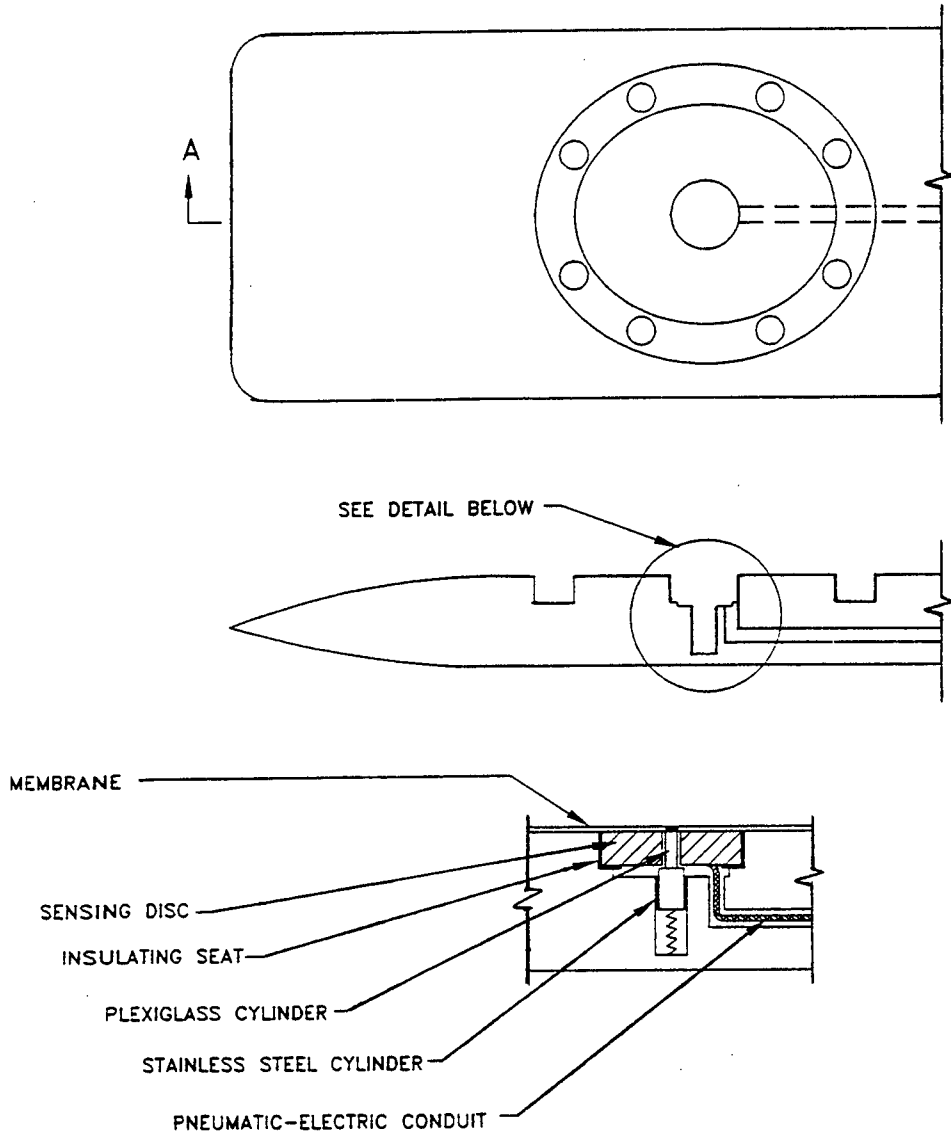

Figure 5-17: Schematic View of Dilatometer.

## 5.6 PLATE-LOAD TESTS

The plate-load test has been a traditional in situ method for estimating the bearing capacity of foundations on soil, and for obtaining the soil modulus for the purpose of estimating the settlement of foundations on soil or rock. Plate-load tests involve measuring the applied load and penetration of a plate being pushed into a soil or rock mass. The test is most commonly carried out in shallow pits or trenches but is also undertaken at depth in the bottom of a borehole or pit. In soils, the test is carried out to determine the shear strength and deformation characteristics of the material beneath the loaded plate. The ultimate load is not often attainable in rock where the test is primarily used to determine the deformation characteristics.

Figure 5-18 shows a typical plate-load test set-up. The method of performing this test is presented in ASTM D 1194. The usual practice is to load the test area with small steel plates of diameters from 0.3 to 1.0 m, or with square sides of 0.3 x 0.3 or 0.6 x 0.6 m. The test is usually carried out either as a series of maintained loads of increasing magnitude or at a constant rate of penetration. In the former, the ground is allowed to consolidate under each load before a further increment is applied; this will yield the drained deformation characteristics and also strength characteristics if the test is continued to failure. In the latter, the rate of penetration is generally such that little or no drainage occurs, and the test gives the corresponding undrained deformation and strength characteristics.

In extrapolating the results of the plate-load tests to full size footings, the following should be considered:

1. The results of a single plate-load test apply only to the ground that is significantly stressed by the plate and this is typically at a depth of about 1.5 times the diameter or width of the plate. The depth of ground stressed by a prototype structural foundation will, in general, be much greater than that stressed by the model test. Thus, the results of the loading tests carried out at a single elevation do not normally give a direct representation of the prototype foundation.
2. The soil at greater depths has more overburden pressure acting to confine it, therefore, it is effectively "stiffer" than the near surface soils that are stressed during the plate-load test. This significantly affects the load-settlement response which is used to define the ultimate bearing capacity.
3. Significant ground disturbance may occur while excavating to gain access to the test position. This may result in an irreversible change in the properties which the test is intended to study. For example, in stiff fissured overconsolidated clay, some swelling and expansion of the clay due to opening of fissures and other discontinuities will inevitably occur during the setting-up process, and can considerably reduce the values of the deformation moduli.

To partially account for the above shortcomings, it will generally be necessary to carry out a series of plate-load tests at different depths. These tests should be carried out such that each test subjects the ground to the same effective stress level it would experience at a particular working load. NAVFAC DM 7.1 (1982) presents procedures for interpretation of the plate-load tests. These are discussed in detail in Module 7 (Shallow Foundations).

Plate-load tests represent a part of the soil investigation procedures performed for foundation design, and should be undertaken in conjunction with other methods. The tests should be performed under the direction of specialists thoroughly familiar with foundation investigations and design.

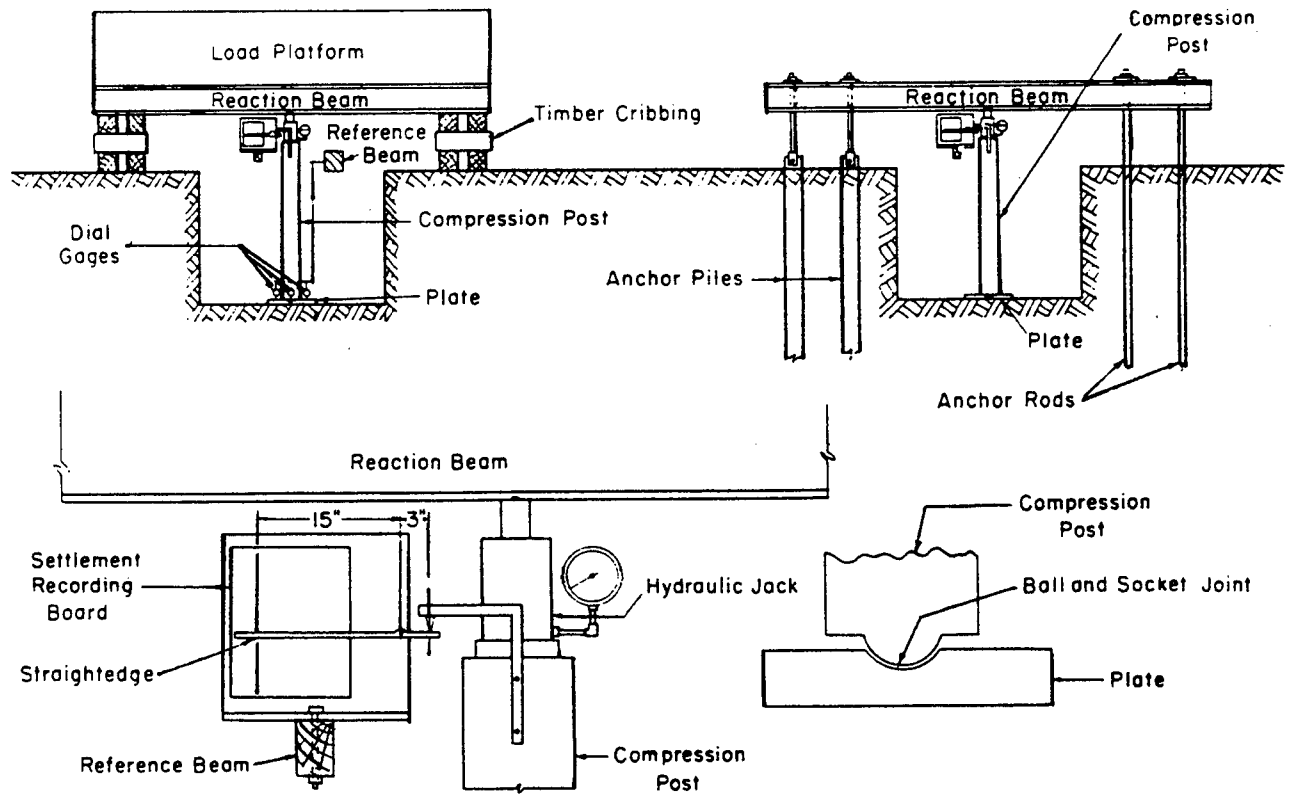

Figure 5-18: Typical Plate Load Test Set-Up. (After ASTM D 1194)

## 5.7 GEOPHYSICAL METHODS

Geophysical methods of exploration provide a rapid and economical means of supplementing information obtained by direct exploratory methods such as borings, test pits and test trenches from which samples of soil and rock are retrieved for visual classification and laboratory testing and direct measurements of the depth to groundwater can be made. The geophysical methods are basically indirect methods of exploration in which changes in certain physical characteristics such as magnetism, density, electrical resistivity, elasticity or a combination of these are used as an aid in developing subsurface information.

Geophysical methods are particularly useful in subsurface exploration for the design of projects, such as highways, that have large longitudinal extent compared to lateral extent and in explorations for the rehabilitation of existing highway structures that have been subject to general deterioration or scour, for which foundation information is unavailable, or whose foundations are not accessible for inspection. These methods of exploration can be used for establishing the stratification of subsurface materials, the profile of the top of bedrock, the depth to groundwater, the limits of deposits of potential granular borrow materials and of organic deposits, the presence of voids and abandoned underground excavations, the location of buried pipes, the depths of foundations of existing structures and the integrity of inaccessible existing foundations.

It should be noted that data from geophysical exploration must always be correlated with the information from direct methods of exploration which permit visual classification of materials, direct measurement of the depth to groundwater, and laboratory testing to obtain the geotechnical parameters necessary for design.

Various types of geophysical exploration techniques are now available. The following sections cover some of the commonly used techniques: electrical resistivity/conductivity survey, wave propagation seismic (cross-hole/up-hole/down-hole) survey, seismic cone or refraction survey and ground penetrating radar. It should be noted that the interpretation of test results require a great deal of expertise and experience; thus, these test results should be used only by experienced engineers and geologists.

### 5.7.1 Electrical Resistivity/Conductivity

Each type of soil or rock formation offers its own distinguishing level of resistance when subjected to an electrical current. The resistance offered by soil and rock deposits is highly dependent on the electrolytic properties of the formation, and thus on the moisture and dissolved salt content of soils and rock. It is also affected by the density and void ratio of soils, by temperature variations in the soil or rock, by the porosity of rocks, and by changes in the strata. The resistivity method is particularly useful in locating gravel deposits within a fine grained soil.

There are a variety of methods used to measure the resistivity of soils and rocks. They are basically applied to determine the depth and areal extent of various deposits and formations, to identify the location of the groundwater table, to verify the stratification, and to locate the interface of soil and rock or soil and gravel deposits. The "Field Measurement of Soil Resistivity Using The Wenner Four Electrode Method" (ASTM G 57) is the most commonly used test in the U.S.

The Wenner method utilizes four electrodes placed partially in the soil, in line and equidistant from each other (Figure 5-19a). A low magnitude current,  $I$ , which in general is a very low frequency alternating current is passed through the outer electrodes. The potential drop,  $V$ , is read from the inner electrodes. The current and the potential drop are then used to determine the resistivity,  $\rho(=2\pi dV/I)$ , of the soil or rock in which  $d$  is the distance between the electrodes.

In most cases, the soil profile may consist of various layers with different resistivities. In that case, an overall or apparent resistivity is obtained. To obtain an actual resistivity of various layers and their thicknesses, an empirical method is usually used. A number of traverses are established at a given location and the electrodes are moved along these traverses to determine changes in resistivity and therefore changes in deposits and formations. This involves conducting a number of tests at various electrode spacings (that is,  $d$  is changed). The sum of the apparent resistivities,  $\Sigma\rho$ , is plotted against the spacing,  $d$ . The plot thus obtained will have relatively straight segments. The slope of these straight segments will give the resistivity of individual layers. The thicknesses of various layers can be estimated as shown in Figure 5-19b.

Resistivity methods are most useful when they are supplemented by more established and conventional methods such as borings/corings. These tests (see Section 7.1.7) are also influenced by the presence of underground obstructions and natural deposits in the vicinity of the test site. These include pipelines (particularly with cathodic protection); buried tanks; cables; nearby metal fences; and mineral deposits (such as iron).

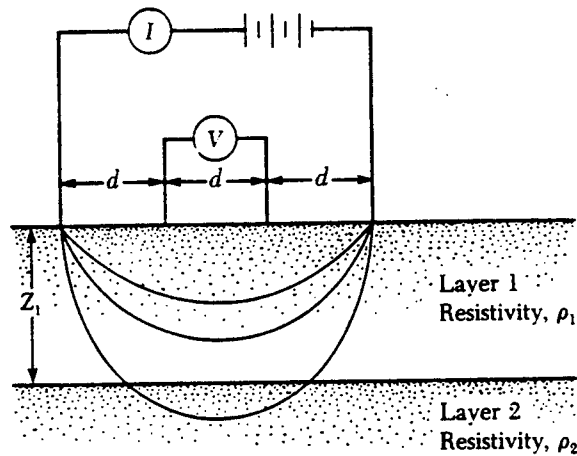

(a)

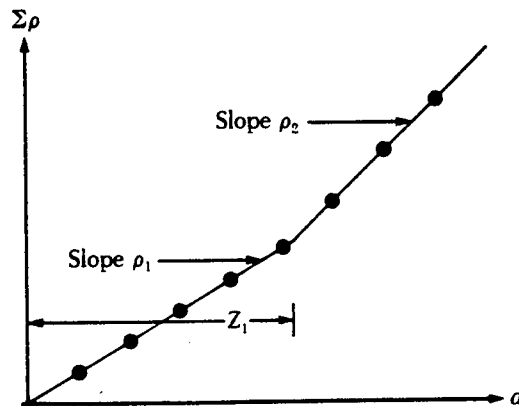

(b)

Figure 5-19: Electrical Resistivity Survey: (a) Wenner Method, (b) Empirical Method for Determination of Resistivity and Thickness of Each Layer.

### 5.7.2 Wave Propagation Seismic Survey

These methods were developed to permit the measurement of the shear modulus, damping and Poisson's ratio of soils for use in dynamic analysis. Brief descriptions of the most widely used tests are given below:

#### Cross-Hole Wave Propagation Method

In the cross-hole method (Stokoe and Woods, 1972), the velocity of wave propagation from one borehole to a second borehole is measured. There are four sources of major concern in conducting cross-hole shear tests: the boreholes, the seismic source, the seismic receiver, and the recording and timing equipment. At least two boreholes are required, a source borehole within which a seismic impulse is generated and a receiver borehole in which is located a geophone with horizontal and vertical velocity transducers that are used to record compression and shear waves respectively. Although a minimum of two boreholes must always be used, for extensive investigations and for increased accuracy, whenever possible, three or more boreholes are preferred (see Figure 5-20). If more than two boreholes are installed in a straight line, wave velocities can be calculated from the intervals of time required for passage between any two boreholes. Thus, the necessity for precisely recording the triggering time is eliminated (Stokoe and Hoar, 1978). In addition, the boreholes must be as close to vertical as possible to properly measure travel distance. In general, any borehole 10 m or more deep should be surveyed using an inclinometer or another logging device to determine verticality (Woods, 1978) and/or accurately determine the travel distance at the depth of each crosshole measurement.

Although both impulsive and steady-state seismic sources are in use, the impulsive sources predominate. The major criterion for a seismic source is that it must be capable of generating predominantly one kind of wave, and must be capable of repeating desired characteristics at a predetermined energy level.

Velocity transducers which have natural frequencies of 4 to 15 Hz are adequate for detecting (receiving) the shear and compression waves as they arrive from the source. The receivers must be properly oriented and should be securely coupled to the sides of the boring. The impulse energy needed to produce shear and compression waves is sometimes generated by driving a split spoon sampler into the soil. The 63.5 kg hammer used for Standard Penetration Tests is dropped approximately 150 mm onto the drill rods attached to the sampler. The blow excites a trigger transducer attached to the drill rods that, in turn, transmits a signal to commence recording to an oscilloscope to which it also is attached.

This recording equipment should be able to resolve arrival times of up to 0.2 milliseconds (ms) or 5 percent of the travel time. Storage oscilloscopes are often used for this purpose. The hammer blow which activates the trigger transducer simultaneously sends a compression wave down the drill rod and split spoon sampler and into the soil. Shear and compression waves are generated in the soil and the arrival times of these waves at the velocity transducers in the geophone in the receiver borehole are recorded. The time delay between the triggering of the wave and the arrival of the wave at the receiver borehole (2-borehole system) or the time delay between the arrival of a wave at the two receiver holes in a 3-borehole system, as determined from the oscilloscope record is the wave travel time. The wave velocity is determined by dividing the distance between the holes as measured in the inclinometer survey by the travel time. The test is normally conducted every 1 to 2 meters.



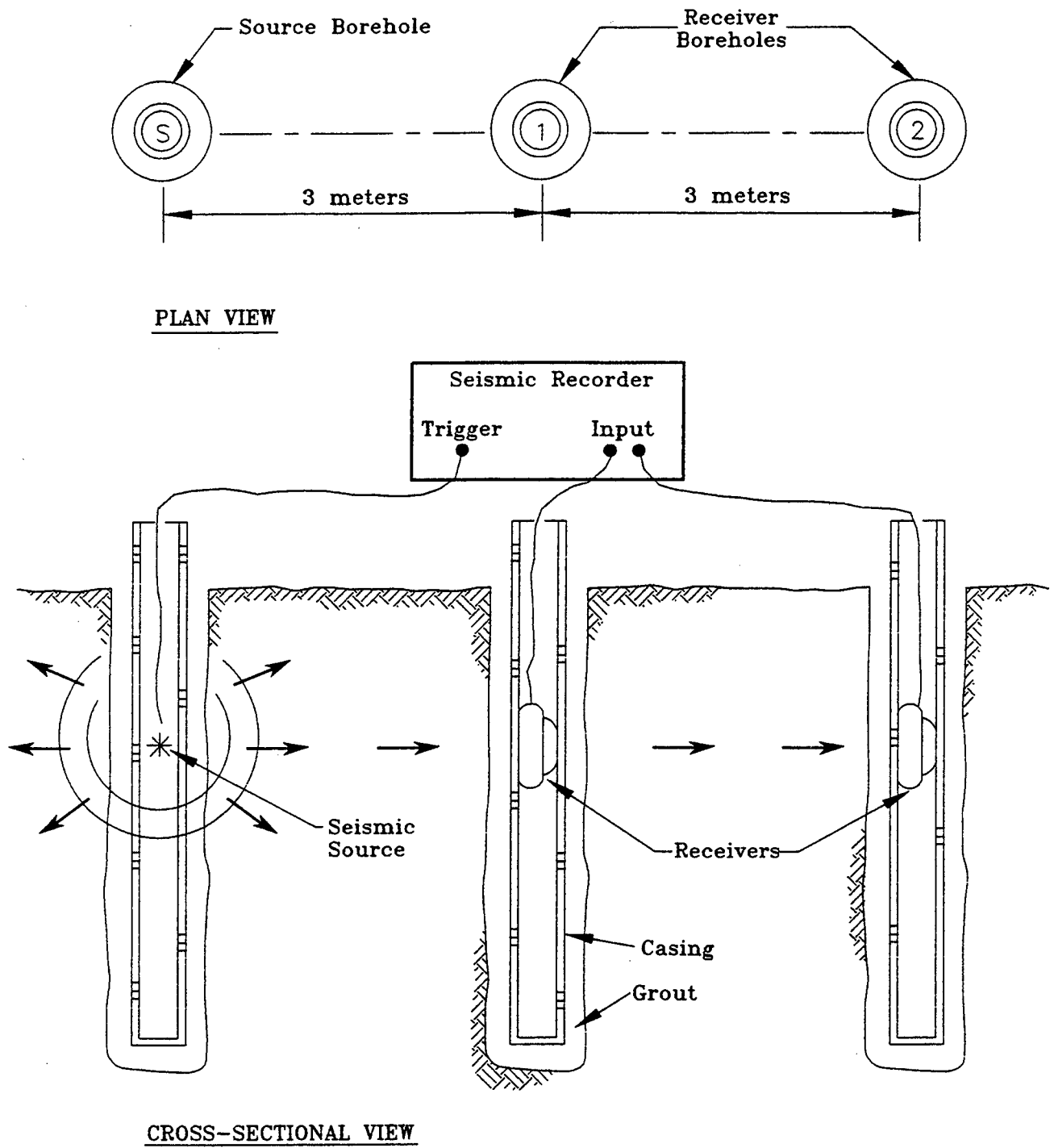

Figure 5-20: Sketch Showing Cross-Hole Technique. (After ASTM D 4428)

## **Up-hole or Down-hole Wave Propagation Method**

Up-hole or down-hole tests can be performed within one borehole. In the up-hole method, the sensor is placed at the surface and shear waves are generated at various depths within the borehole. In the down-hole method, the excitation is applied at the surface and one or more sensors are placed at different depths within the hole. Both the up-hole and the down-hole methods give average values of wave velocities for the soil between the excitation and the sensor if one sensor is used, or between the sensors, if more than one is used in the borehole (Richart, 1977).

## **Parallel Seismic Test**

The parallel seismic test is a version of the down-hole test which was developed for checking the integrity and length of piles, drilled shafts and slurry trench walls in situations where the top of the foundation is no longer accessible. This test is frequently used to settle disputes concerning the founding level of piles and drilled shafts.

The test is based on the principle that the length or depth of a deep foundation is directly related to the time taken for a stress wave to travel down that foundation. By measuring the travel time of a pulse to various levels, the depth of continuous deep foundations can be calculated.

Figure 5-21a shows a typical layout for the parallel seismic test. A small diameter hole is drilled adjacent to and deeper than the pile or structure under test. A closed end tube is then installed, filled with water, and a piezo-electric receiver lowered to the bottom. The probe is raised in steps of 450 mm, and the side of the pile is struck with a hammer. If necessary the hammer blow can be on the structure itself as long as this is near the foundation head. The stress wave travels down the shaft and through a minimum thickness of soil, where it is detected by the receiver probe.

Transit time is measured and a profile of signals is built up as shown in Figure 5-21b. When a change in the rate of time increases with depth, it indicates either the foundation tip or a discontinuity in the foundation element.

### **5.7.3 Seismic Techniques**

#### **Seismic Refraction**

Seismic refraction techniques are used to measure material velocities, from which are computed depths to changes in strata. Material types are judged from correlations with velocities. These techniques have been used to investigate subsurface conditions from the ground surface to depths of approximately 300 m.

A typical setup of field equipment for the investigation of a two-layer system is shown in Figure 5-22. Point A on this diagram is the source of the seismic impulse. Points  $D_1$  through  $D_{12}$  represent the locations of the detectors or geophones, whose spacing is dependent on the amount of the detail required and the depth to the strata being investigated. In general, the spacing must be such that the length from  $D_1$  to  $D_{12}$  is three to four times the depth being investigated. The geophones are connected by cable to recording devices, which may be truck-mounted or may be portable units placed at ground surface. A high-speed camera is used to record the time at which the seismic impulse is generated and the time of arrival of the wave front at each geophone. A continuous profile along a line may be obtained by moving the geophones along the line, generating a new impulse from the same source point each time the geophones are moved, and recording, for each shot, the time of initiation of the wave and the "first arrival times."

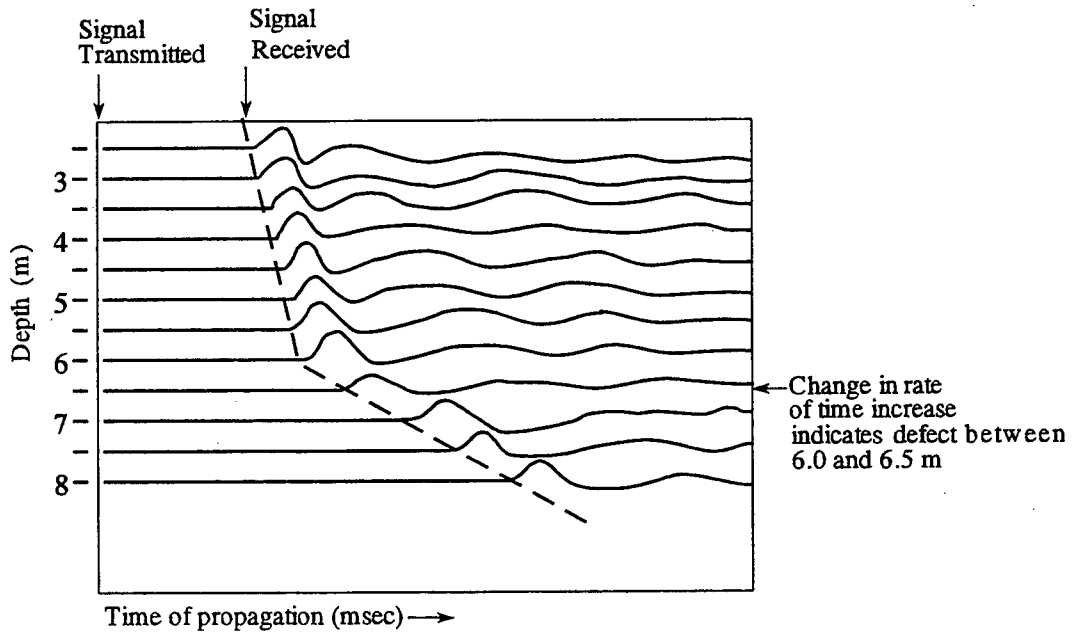
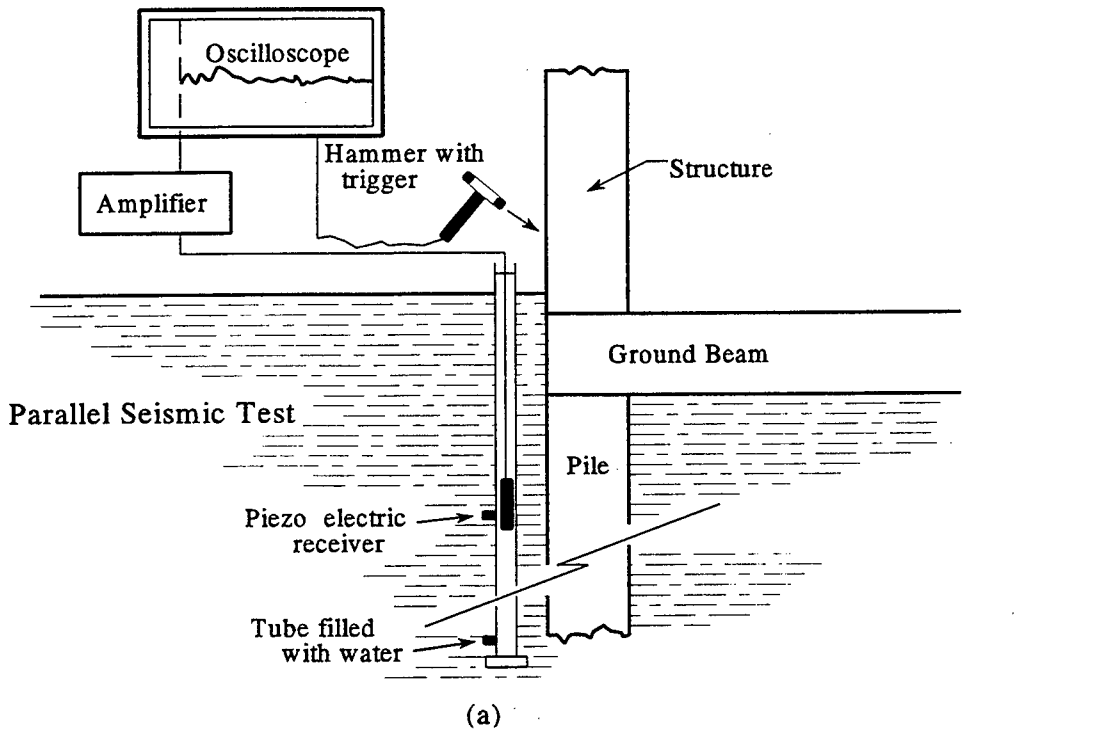

Figure 5-21: Parallel Seismic Test, (a) Typical Set-up, (b) Typical Results.

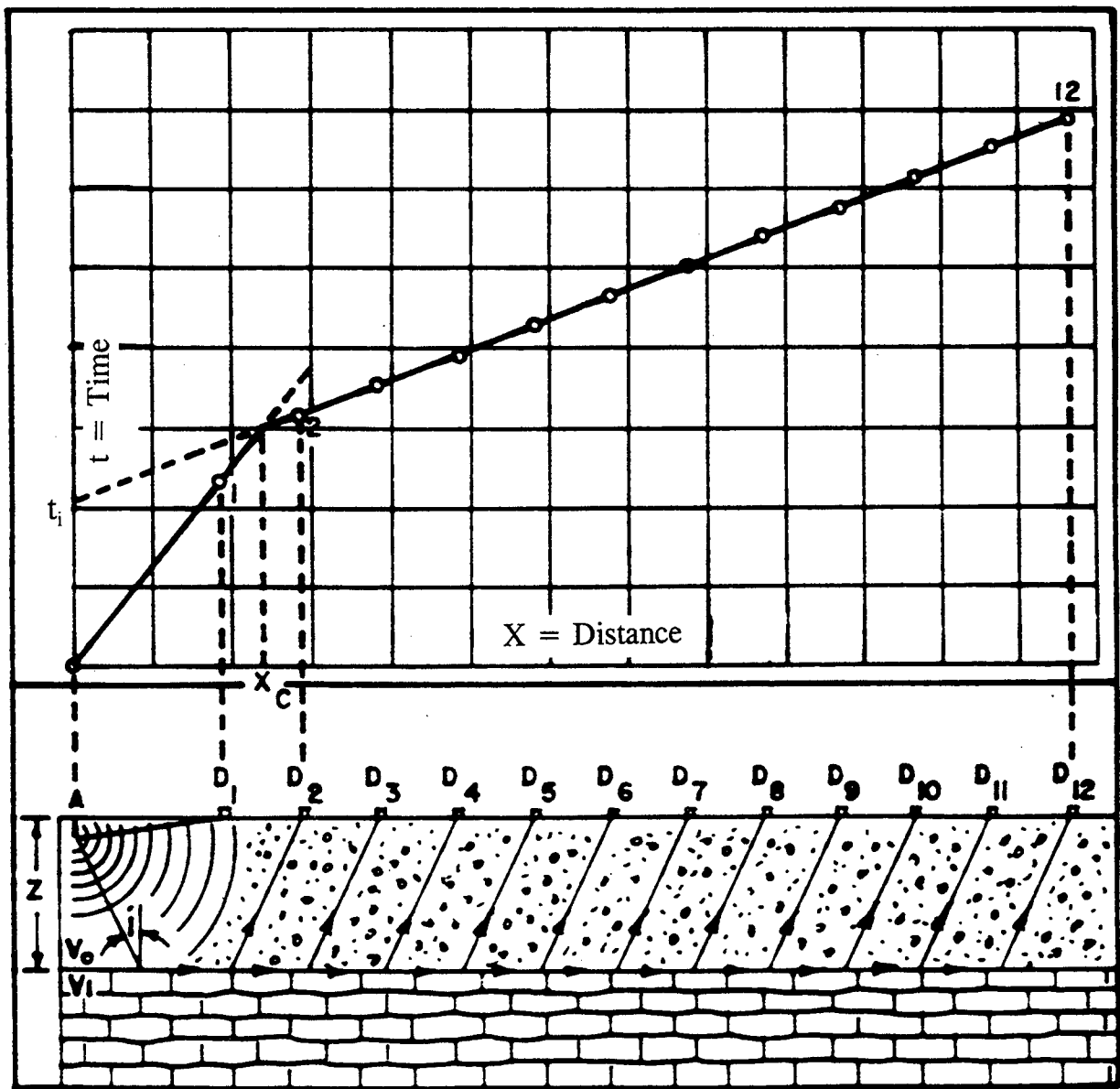

Figure 5-22: Schematic Representation of Refraction of Seismic Energy at a Horizontal Interface and the Resultant Time-Distance Graph. (Lowe and Zaccheo, 1991)

The data from the film records are plotted in the form of time-distance graphs such as that shown in the upper part of Figure 5-22. The slopes of this plot represent the velocity of the seismic wave as it passes through the various subsurface materials present. These velocities are used in standard formulas to determine the depth to the interface between the layers of material of differing seismic wave velocity. They are also used to obtain a general idea of the nature of the materials present.

### **Seismic Cone**

The principles used in determining dynamic modulus of soils with this method are similar to those of the crosshole testing: The seismic cone is a cone penetrometer with geophones incorporated into the cone (see Figure 5-23). The cone is pushed down into the soil layer of interest, a wooden block is placed on the ground a certain distance away. The block is struck with a hammer. The arrival of the shear wave is detected by the geophones in the cone and transmitted to a recording device above ground. The test is repeated in 0.9 m intervals. The difference between travel time of shear waves show the travel time through that 0.9 m layer of soil. The results are interpreted in a manner similar to that used with the crosshole test results as discussed above.

### **5.7.4 Ground Penetrating Radar (GPR)**

Ground penetrating radar (GPR) is a relatively new application which has been used for many purposes, among which are the continuous profiling of the surface of bedrock and the groundwater table; the detection of voids in soil and rock; the detection of voids within and below pavements; the location of utilities and buried objects; the detection of holes in clay liners; the detection of karst and mincavities; and the location of reinforcing bars in pavements. As with the seismic and resistivity methods described above, it is necessary to have borings for correlation and calibration when the technique is used to delineate subsurface conditions.

This method of exploration consists of the radiation of repetitive electromagnetic impulses into the ground from the surface and the recording of the travel time of the pulses reflected from the ground surface and from discontinuities in the subsurface profile. The travel times of the reflected pulses are used to determine the depth to the discontinuities and to delineate these discontinuities. Reflection of the radar signals is caused by differences in the conductivity of the materials through which the signal passes and the relative dielectric constants of the materials penetrated. The presence of clay layers in the subsurface may mask features below those layers.

The equipment used for GPR surveys includes a radar impulse generator; low- and high-frequency antennas that are used both to transmit the applied radar signal and to receive the reflected signal; a graphic recorder; a magnetic tape recorder, which is optional; and a converter for d.c. operation. Antennas with high frequencies, (300 to 900 MHz), produce a greater resolution of detail over a shallower depth, whereas antennas with low frequencies (80 to 120 MHz) provide greater penetration but with less resolution.

During operation, all of the equipment for the radar survey except the antenna are usually mounted in a van or similar vehicle. The sled-mounted antenna is towed over the ground surface behind the vehicle at speeds that range from 0.8 to 1.5 km/hr. Distances along the alignment can be measured by a bicycle-wheel type of measuring device mounted to the vehicle bumper. For cases where the terrain is not suitable for a vehicle, the antenna can be towed by hand. The remaining equipment, which is connected to the antenna by a cable several hundred meters in length, is moved from one intermediate point to another. The intermediate points are located so that when the antenna is towed for the full length of the cable in both directions from each point, complete coverage of the line is obtained. As the antenna is towed, reflected

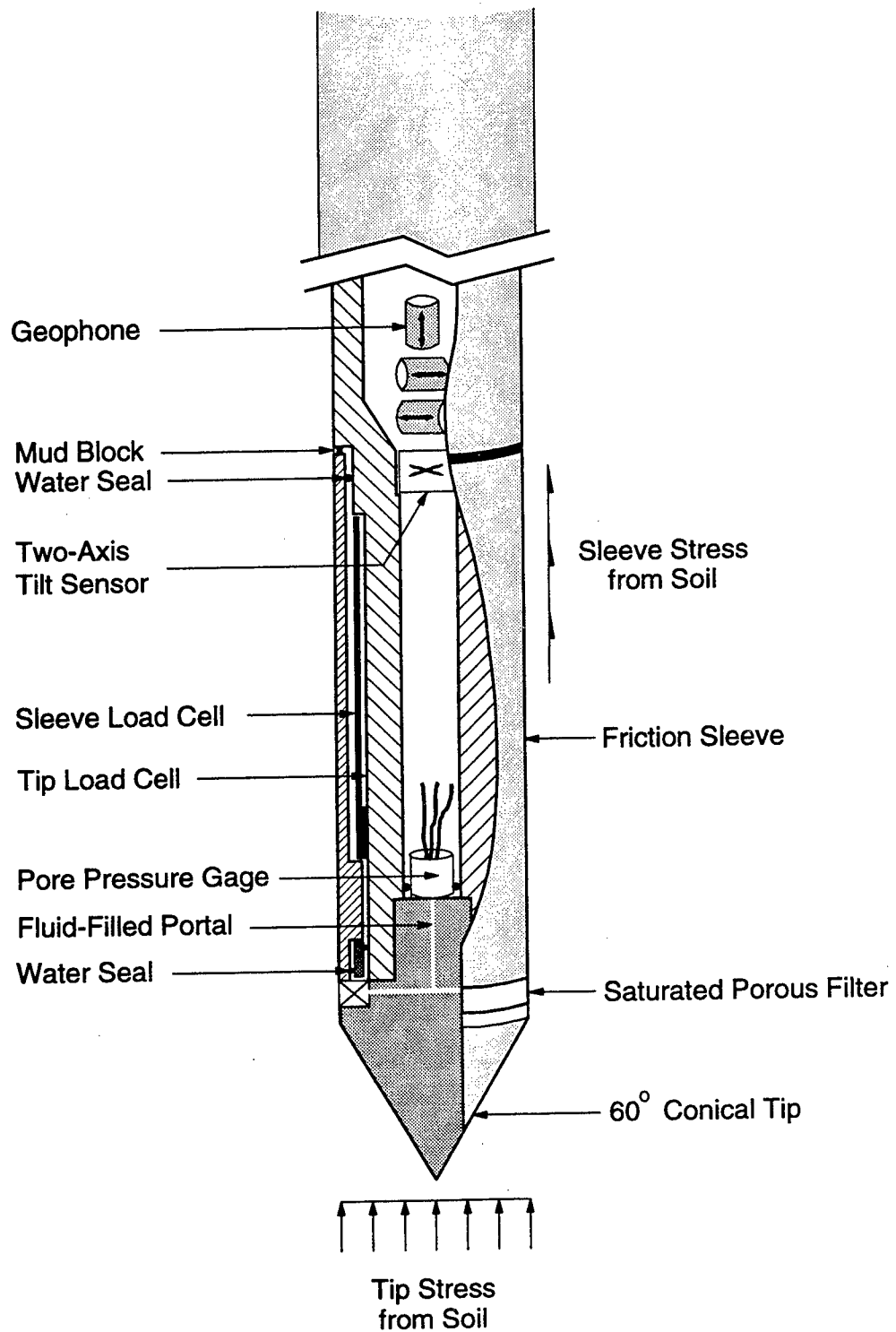

Figure 5-23: Schematic of a Seismic Cone Penetrometer Probe (Courtesy of ARA, Inc.)

signals are printed graphically on the strip-chart recorder, thereby permitting preliminary field evaluation. The use of a magnetic tape recorder permits later playback and processing of data.

## **5.8 REMOTE SENSING**

Remote sensing technologies, once restricted for use by the military and intelligence agencies, have been made available to the general public for non military or non-intelligence activities. They include aerial photography and various types of images produced by satellites.

### **5.8.1 Aerial Photographs**

Aerial photographs are widely used for projects covering large strips or areas (highways, airports, ports etc.). Aerial photographs at resolutions 1:6,000 to 1:80,000 are available for the entire country. They can be obtained from the U. S. Geological Survey (USGS); Reston, Virginia or state geological survey offices, the Soil Conservation Service, district offices of the U.S. Corps of Engineers, NASA, state and county tax assessors offices, commercial aerial photo services and others. They are normally available in 22.5 cm frames with 30% to 60% overlap for stereoscopic viewing. When viewed under a stereoscope three dimensional topographic features can be discerned by a trained person. Such features as buried stream beds, surface expressions of faults, major outcrops, sudden changes of geology, drainage patterns, and escarpments can be identified from aerial photographs. The aerial photographs are very useful tools not only for locating new facilities, and right-of-ways but also for planning of subsurface explorations.

The Earth Resources Observation Systems (EROS) center at Sioux Falls, S.D. 57198 can provide satellite photographs taken from a circular orbit 918 km above the earth. These images are useful in determining more global aspects of the area such as general topography, major fault lines, water bodies and sedimentation patterns, beach erosion, cultural features etc. This information may be useful in subsurface exploration planning and performance of large projects in undeveloped areas. They are of little use on most routine work. High resolution images taken from the Skylab satellite from 435 km above the earth are also available from the above source. Photographs cover approximately 160 km x 160 km area and are useful in determining geological features.

The interpretation of aerial photographs for geotechnical engineering purposes is based on four landform pattern elements, often called "keys". These patterns are:

- topography
- drainage
- tone variation
- gully shape

Aerial photographic interpretation is the systematic study of visual elements relating to the origin, geomorphic history, and composition of distinct landforms that appear in aerial photographs. Through the analysis of pattern elements visually apparent on an aerial photograph, the geomorphic composition or parent material of a site is interpreted or inferred.

Similar landforms under similar conditions have the same combinations of the same pattern elements. For example, beach ridges in Florida have the same appearance as beach ridges in Indiana; glacial landforms in New York have the same appearance as glacial features in Wisconsin; landforms developed on shale in North Dakota are similar to those formed in California.

The topography of a landform is described by indicating its degree of dissection and continuity. Typical topographic descriptions would include: flat table rocks, massive hills, karst topography, parallel ridges, conical hills, pitted plains.

Drainage is studied according to its pattern type and its texture or density. It is probably the most important single identifier of landforms. Drainage patterns are classified by their texture and form. Texture is divided into three categories: fine, medium and coarse, based on the drainage patterns appearance in 1:20,000 (200 meters per centimeter) aerial photographs.

Fine-textured drainage patterns have an average spacing between tributaries and first order stream of less than 6 mm. Medium-textured drainage has spacings in the range of 6 mm to 50 mm. Coarse textured drainage has spacings in excess of 50mm. Fine drainage patterns indicate high levels of surface runoff and impervious bedrock or soils of low permeability. Coarse drainage patterns indicate relatively little runoff and permeable bedrock or soils. Representative appearances of fine, medium, and coarse drainage are shown in Figure 5-23.

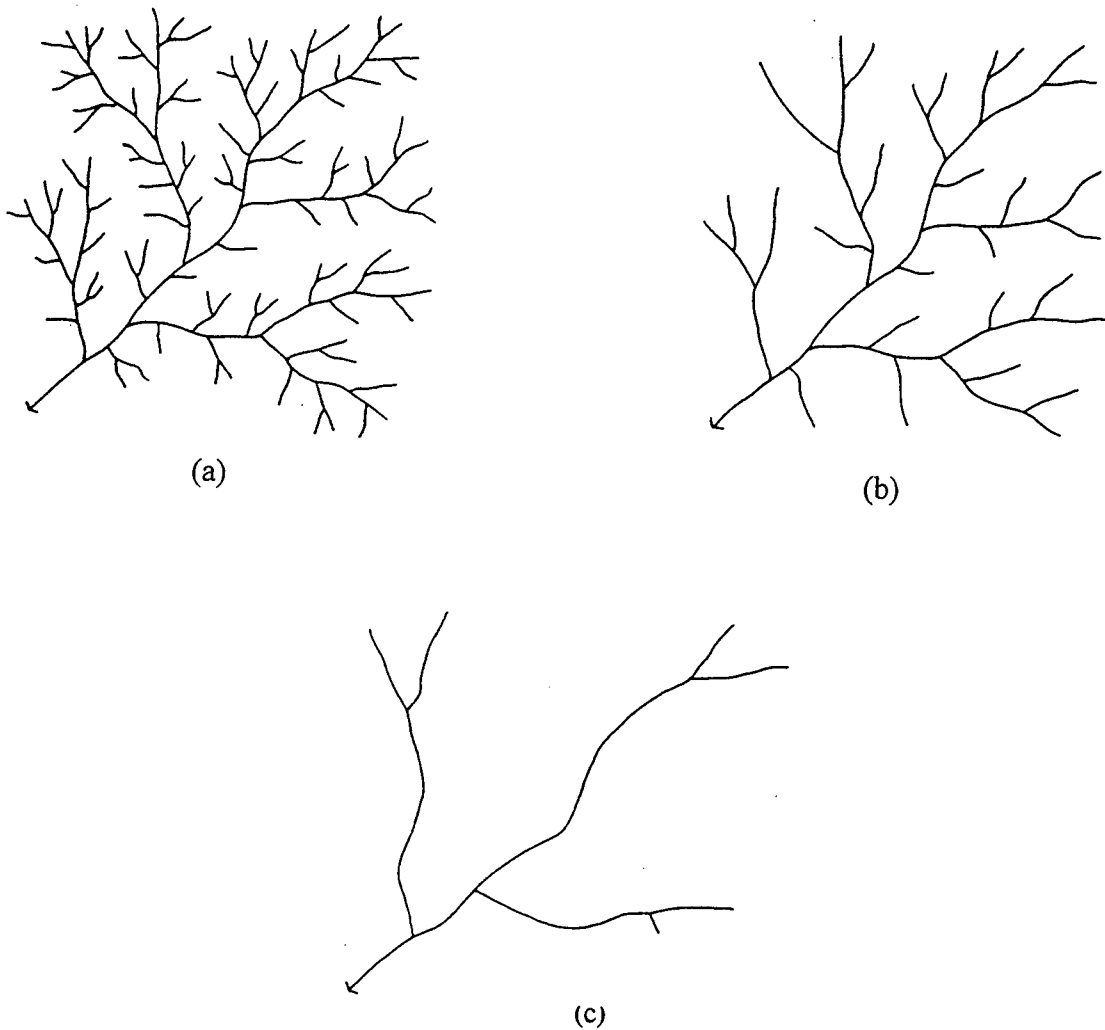

Figure 5-24: Drainage Textures. (a) Fine Textured Drainage Pattern, (b) Medium Textured Drainage Pattern, (c) Coarse Textured Drainage Pattern. (Way, 1973)



Associated with drainage texture is drainage type. Twelve basic drainage types exist, as shown in Figure 5-24. The combination of drainage texture and drainage type is a primary indicator of soil or rock type.

The third photographic interpretation key is tonal variation. Tonal variations are relative. In general light tones indicate well-drained coarse soils and dark tones indicate poorly drained fine-grained soils. The range of tonal variations and possible soil types indicated are:

- White - exposed sand and gravel
- Light gray - basically coarse - grained soils with some fines
- Dark gray - fine-grained soils with poor drainage
- Dark gray/black - poor drainage, high water table, organic soils

Characteristic gully shapes and soil types associated with these shapes are shown in Figure 5-25.

### 5.8.2 Other Imagery

Other forms of remote sensing imagery include thermal imagery, magnetic imagery and Side Looking Airborne Radar (SLAR) imagery. In their interpretation, the same techniques are used as for interpretation of aerial photography.

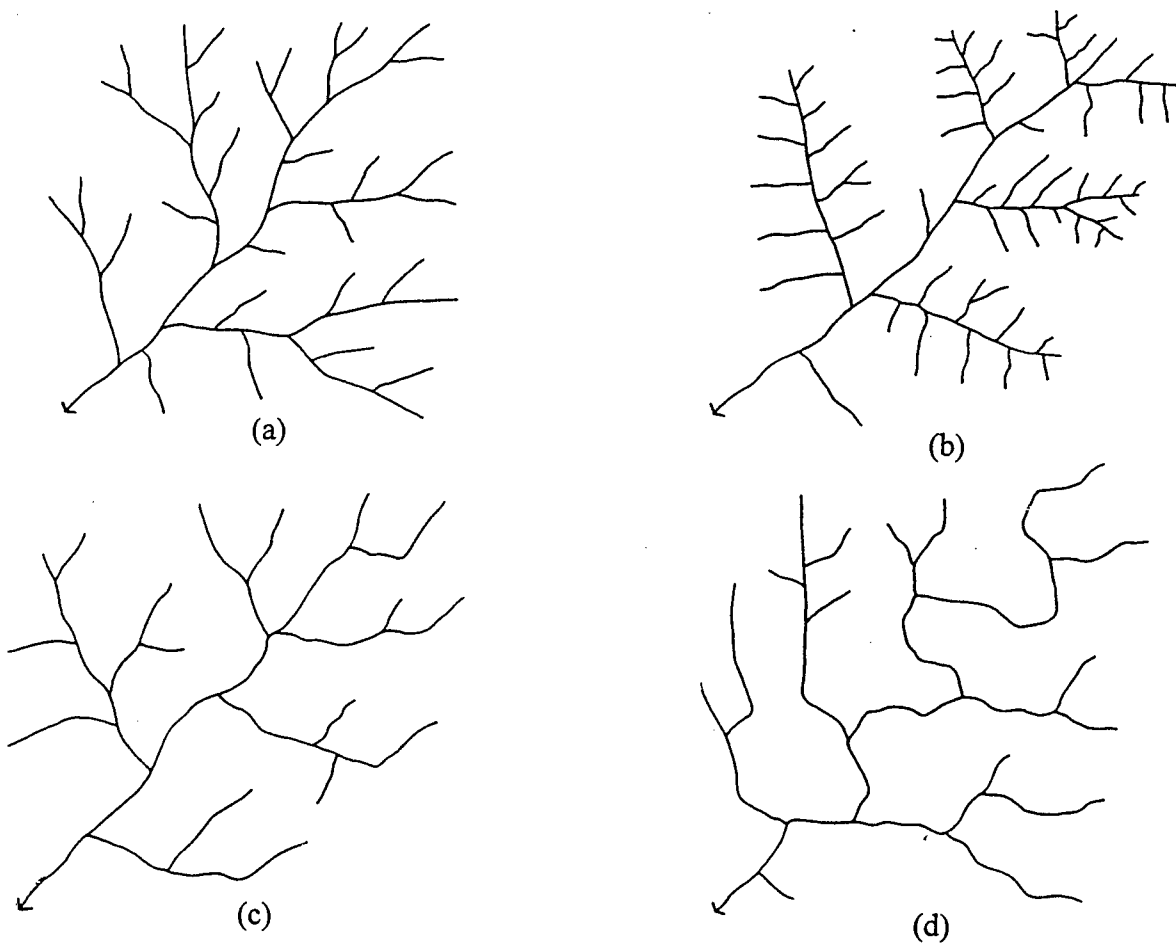
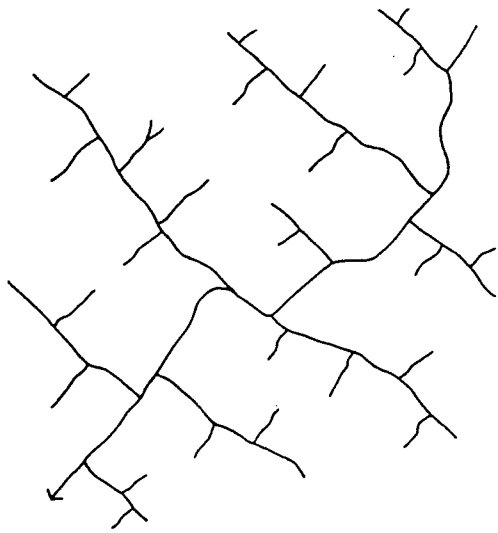
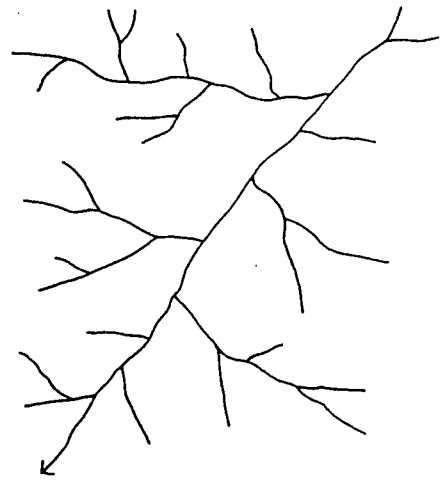

Figure 5-25a: Drainage Types. (a) Dendritic Drainage Pattern, (b) Pinnate Drainage Pattern, (c) Rectangular Drainage Pattern, (d) Angulate Drainage Pattern. (Way, 1973)



(e)



(f)

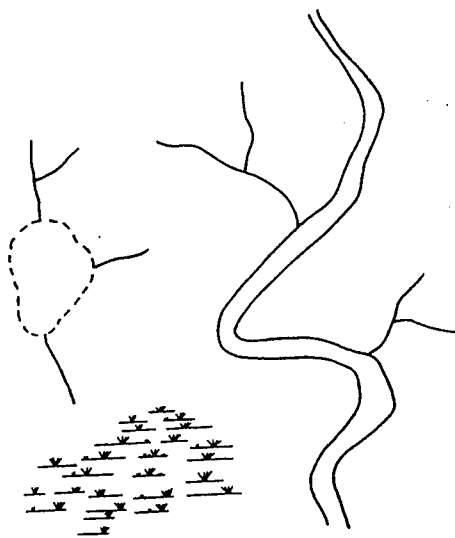

(g)

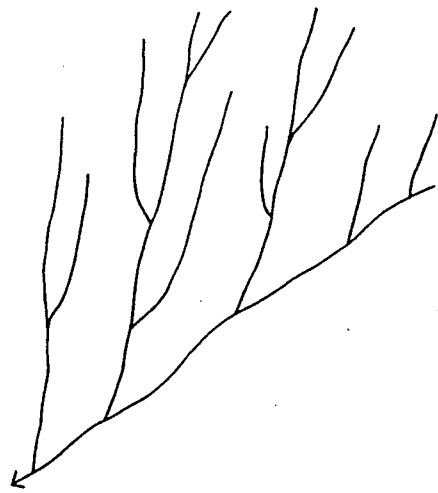

(h)

Figure 5-25b: Drainage Types. (e) Trellis Drainage Pattern, (f) Barbed Drainage Patten, (g) Deranged Drainage Pattern, (h) Parallel Drainage Pattern. (Way, 1973)

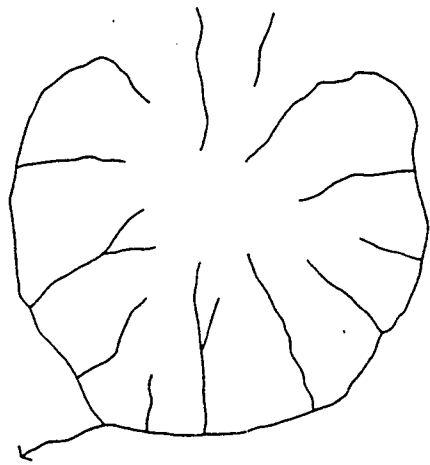

(i)

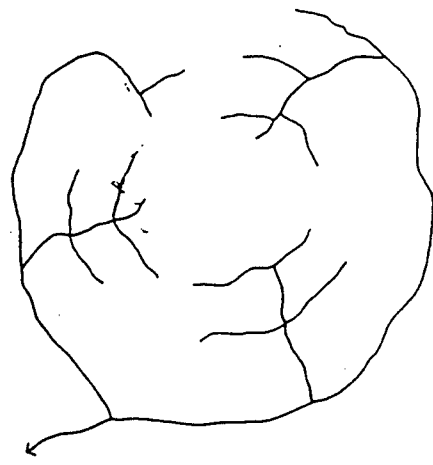

(j)

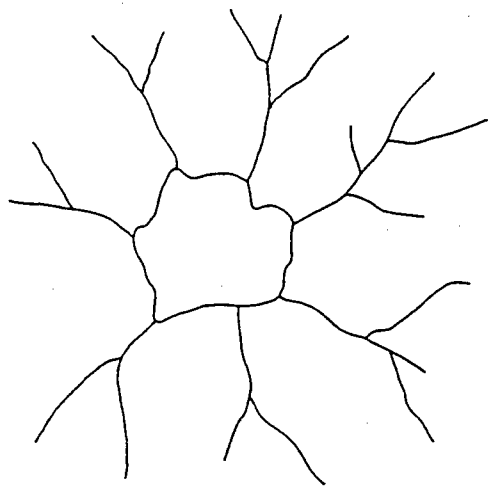

(k)

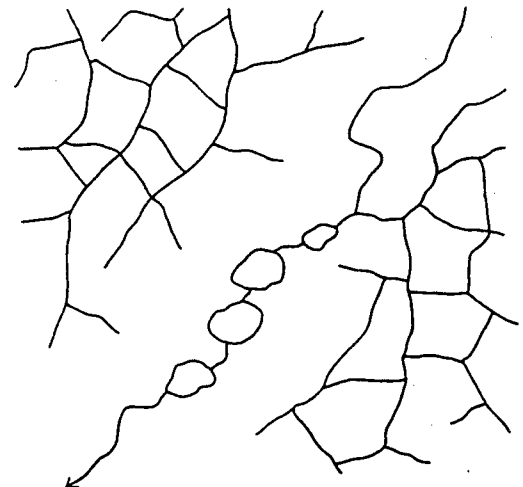

(l)

Figure 5-25c: Drainage Types. (i) Radial Drainage Pattern, (j) Annular Drainage Pattern, (k) Centripetal Drainage Pattern, (l) Thermokarst Drainage Pattern. (Way, 1973)





MATERIALS	CROSS SECTIONS	PROFILES
Cohesive clays and silty clays (Usually found in lake beds, marine terraces and clay-shale areas)		<p data-bbox="1117 243 1273 275">Land surface</p>  <p data-bbox="1117 422 1273 453">Gully profile</p> <p data-bbox="1062 558 1328 590">Low uniform gradient</p>
Moderately cohesive weakly cemented sand-clays. Coastal plains and many bedrock areas	<p data-bbox="586 621 855 653">Weathered soil profile</p>  <p data-bbox="659 936 781 968">Loose soil</p>	 <p data-bbox="1073 894 1317 926">Compound gradient</p>
Moderately cohesive silt (Primarily loess and alluvial silt deposits. Also fine volcanic ash falls)		<p data-bbox="1073 989 1317 1020">Compound gradient</p>  <p data-bbox="997 1293 1390 1325">Fins and pinnacles near head end</p>
Noncohesive granular materials (Often found in terraces and outwash plains)		<p data-bbox="976 1356 1414 1388">Very steep coarse material, few fines</p>  <p data-bbox="1065 1703 1325 1734">Well-graded mixtures</p>

Figure 5-26: Gully Shapes. (Way, 1973)

## **CHAPTER 6.0 GROUNDWATER INVESTIGATIONS**

### **6.1 GENERAL**

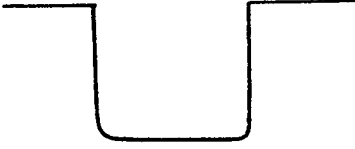
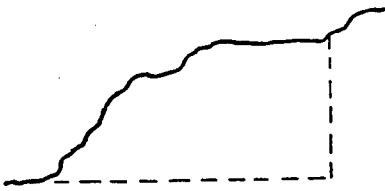
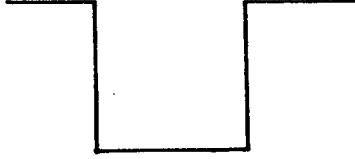
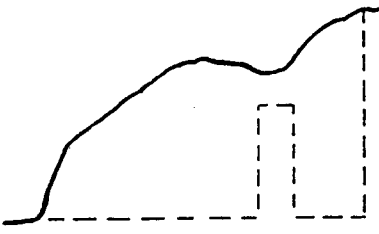
Groundwater conditions and the potential for groundwater seepage are fundamental factors in virtually all geotechnical analyses and design studies. Accordingly, the evaluation of groundwater conditions is a basic element of almost all geotechnical investigation programs. Groundwater investigations are of two types as follows:

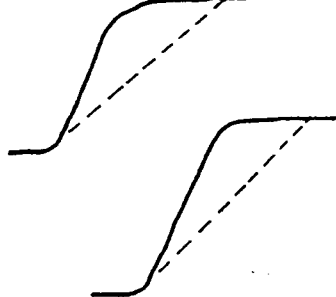
- Determination of groundwater levels and pressures and
- Determination of the permeability of the subsurface materials.

Determination of groundwater levels and pressures includes measurements of the elevation of the groundwater surface or table and its variation with the season of the year; the location of perched water tables; the location of aquifers (geological units which yield economically significant amounts of water to a well); and the presence of artesian pressures. Water levels and pressures may be measured in existing wells, in boreholes and in specially installed observation wells. Piezometers are used where the measurement of the ground water pressures are specifically required (i.e. to determine excess hydrostatic pressures, or the progress of primary consolidation).

Determination of the permeability of soil or rock strata is needed in connection with seepage studies for leakage of dams, yield of wells, construction groundwater lowering, etc. Permeability is determined by means of various types of seepage, pressure, pumping and slug tests.

### **6.2 DETERMINATION OF GROUNDWATER LEVELS AND PRESSURES**

Observations of the groundwater level and pressure are an important part of all geotechnical explorations, and the identification of groundwater conditions should receive the same level of care given to soil descriptions and samples. Measurements of water entry during drilling and measurements of the groundwater level at least once following drilling should be considered a minimum effort to obtain groundwater level data, unless alternate methods, such as installation of observation wells, are defined by the geotechnical engineer. Detailed information regarding groundwater level observations can be obtained from ASTM D 4750, "Standard Test Method For Determining Subsurface Liquid Levels in a Borehole or Monitoring Well" and ASTM D 5092 "Design and Installation of Ground Water Monitoring Wells in Aquifers".

#### **6.2.1 Information on Existing Wells**

Many states require the drillers of water wells to file logs of the wells. These are good sources of information of the materials encountered and water levels recorded during well installation. The well owners, both public and private, may have records of the water levels after installation which may provide extensive information on fluctuations of the water level. This information may be available at state agencies regulating the drilling and installation of water wells (e.g., the Department of Transportation, the Department of Natural Resources, etc.).

### 6.2.2 Open Borings

The water level in open borings should be measured after any prolonged interruption in drilling, at the completion of each boring, and at least 12 hours (preferably 24 hours) after completion of drilling. Additional water level measurements should be obtained at the completion of the field exploration and at other times designated by the engineer. The date and time of each observation should be recorded.

Drilling mud obscures observations of the groundwater level owing to filter cake action and the higher specific gravity of the drilling mud compared to that of the water. If drilling fluids are used to advance the borings, the drill crew should be instructed to bail the hole prior to making groundwater observations.

### 6.2.3 Observation Wells

The observation well, also referred to as piezometer, is the fundamental means for measuring water head in an aquifer and for evaluating the performance of dewatering systems. In theory, a "piezometer" measures the pressure in a confined aquifer or at a specific horizon of the geologic profile, while an "observation well" measures the level in a water table aquifer (Powers, 1992). In practice, however, the two terms are at times used interchangeably to describe any device for determining water head.

The term "observation well" is applied to any well or drilled hole used for the purpose of long-term studies of groundwater levels and pressures. Existing wells and bore holes in which casing is left in place are often used to observe groundwater levels. These, however, are not considered to be as satisfactory as wells constructed specifically for the purpose. The latter may consist of a standpipe installed in a previously drilled exploratory hole or a hole drilled solely for use as an observation well.

Details of typical observation well installations are shown in Figure 6-1. The simplest type of observation well is formed by a small-diameter polyvinyl chloride (PVC) pipe set in an open hole. The bottom of the pipe is slotted and capped, and the annular space around the slotted pipe is backfilled with clean sand. The area above the sand is sealed with bentonite, and the remaining annulus is filled with grout, concrete, or soil cuttings. A surface seal, which is sloped away from the pipe, is commonly formed with concrete in order to prevent the entrance of surface water. The top of the pipe should also be capped to prevent the entrance of foreign material; a small vent hole should be placed in the top cap. In some localities, regulatory agencies may stipulate the manner for installation and closure of observation wells.

Driven well points are another common type for use in granular soil formations (Figure 6-1b). The well is formed by a stainless steel or brass well point threaded to a galvanized steel pipe. An open boring or rotary wash boring is advanced to a point several centimeters above the measurement depth and the well point is driven to the desired depth. A seal is commonly required in the boring above the well point with a surface seal at the ground surface.

Note that observation wells may require development (see ASTM D 5092) to minimize the effects of installation, drilling fluids, etc. Minimum pipe diameters should allow introduction of a bailer or other pumping apparatus to remove fine-grained materials in the well to improve the response time.

Local or state jurisdictions may impose specific requirements on "permanent" observation wells, including closure and special reporting of the location and construction that must be considered in the planning and installation. Licensed drillers and special fees also may be required.

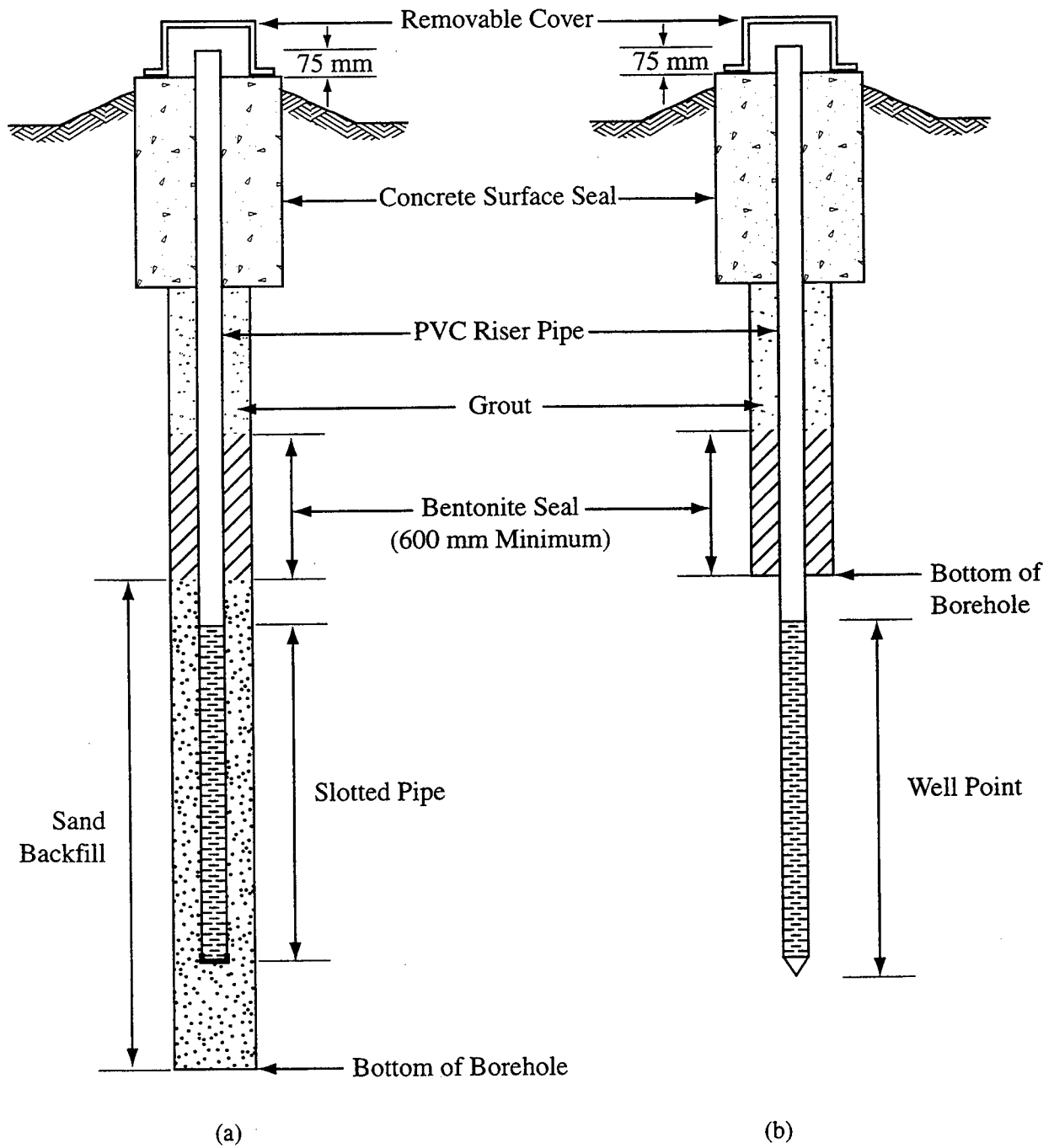

Figure 6-1: Typical Details of Observation Well Installations. (a) Stand-Pipe Piezometer, (b) Driven Well Point.

Piezometers are available in a number of designs. Commonly used piezometers are of the pneumatic and the vibrating wire type. Interested readers are directed to Course Module No. 11 (Instrumentation) or Dunnicliff (1988) for a detailed discussion of the various types of piezometers.

#### **6.2.4 Water Level Measurements**

A number of devices have been developed for sensing or measuring the water level in observation wells. Following is a brief presentation of the three common methods that are used to measure the depth to groundwater. In general, common practice is to measure the depth to the water surface using the top of the casing as a reference, with the reference point at a common orientation (often north) marked or notched on the well casing.

##### **Chalked Tape**

In this method a short section at the lower end of a metal tape is chalked. The tape with a weight attached to its end is then lowered until the chalked section has passed slightly below the water surface. The depth to the water is determined by subtracting the depth of penetration of the line into water, as measured by the water line in the chalked section, from the total depth from the top of casing. This is probably the most accurate method, and the accuracy is useful in pump tests where very small drawdowns are significant. The method is cumbersome, however, when taking a series of rapid readings, since the tape must be fully removed each time. An enameled tape is not suitable unless it is roughened with sandpaper so it will accept chalk. The weight on the end of the tape should be small in volume so it does not displace enough water to create an error.

##### **Tape with a Float**

In this method, a tape with a flat-bottomed float attached to its end is lowered until the float hits the water surface and the tape goes slack. The tape is then lifted until the float is felt to touch the water surface and it is just taut; the depth is then measured. With practice this method can give rough measurements, but its accuracy is poor. A refinement is to mount a heavy whistle, open at the bottom, on a tape. When it sinks in the water, the whistle will give an audible beep as the air within it is displaced.

##### **Electric Water-Level Indicator**

This battery operated indicator consists of a weighted electric probe attached to the lower end of a length of electrical cable that is marked at intervals to indicate the depth. When the probe reaches the water a circuit is completed and this is registered by a meter mounted on the cable reel. Various manufacturers produce the instrument, utilizing as the signaling device a neon lamp, a horn, or an ammeter. The electric indicator has the advantage that it may be used in extremely small holes.

The instrument should be ruggedly built, since some degree of rough handling can be expected. The distance markings must be securely fastened to the cable. Some models are available in which the cable itself is manufactured as a measuring tape. The sensing probe should be shielded to prevent shorting out against metal risers. When the water is highly conductive, erratic readings can develop in the moist air above the actual water level. Sometimes careful attention to the intensity of the neon lamp or the pitch of the horn will enable the reader to distinguish the true level. A sensitivity adjustment on the instrument can be useful. If oil or iron sludge has accumulated in the observation well, the electric probe will give unreliable readings.



## **Data Loggers**

When timed and frequent water level measurements are required as in the case of a pump test or a slug test (see Section 6.3.3 or 6.3.4), data loggers prove very useful. Data loggers are in the form of an electric transducer near the bottom of the well which senses changes in water level as changes in pressure. A data acquisition system is used to acquire and store data.

A data logger can eliminate the need for onsite technicians on night shifts during an extended field permeability test. A further significant saving is in the technician's time back in the office. The preferred models of the data logger not only record the water level readings but permit the data to be downloaded into a personal computer and, with appropriate software, to be quickly reduced and plotted.

These devices are also extremely useful for cases where measurement of artesian pressures is required or where data for tidal corrections during field permeability tests is necessary.

## **6.3 DETERMINATION OF FIELD PERMEABILITY**

### **6.3.1 Seepage Tests**

Seepage tests in boreholes constitute one means of determining the permeability of overburden in situ. They are particularly valuable in the case of materials such as sands or gravels because undisturbed samples of these materials for laboratory permeability testing are difficult or impossible to obtain. Three types of tests are in common use; namely the falling, the rising and the constant water level methods.

In general, either the rising or the falling level methods should be used if the permeability is low enough to permit accurate determination of the water level. In the falling level test, the flow is from the hole to the surrounding soil and there is danger of clogging of the soil pores by sediment in the test water used. This danger does not exist in the rising level test, where water flows from the surrounding soil to the hole, but there is the danger of the soil at the bottom of the hole becoming loosened or quick if too great a gradient is imposed at the bottom of the hole. If the rising level is used, the test should be followed by sounding of the base of the hole with drill rods to determine whether heaving of the bottom has occurred. The rising level test is the preferred test. In those cases where the permeability is so high as to preclude accurate measurement of the rising or falling water level, the constant level test is used.

Holes in which seepage tests are to be performed should be drilled using only clear water as the drilling fluid. This precludes the formation of a mud cake on the walls of the hole or clogging of the pores of the soil by drilling mud. The tests are performed intermittently as the borehole is advanced. When the hole reaches the level at which a test is desired, the hole is cleaned and flushed using clear water pumped through a drill tool with shielded or upward-deflected jets. Flushing is continued until a clean surface of undisturbed material exists at the bottom of the hole. The permeability is then determined by one of the procedures given below. Specifications sometimes require a limited advancement of the borehole without casing upon completion of the first test at a given level, followed by cleaning, flushing, and repeat testing. The difficulty of obtaining satisfactory in situ permeability measurements makes this requirement a desirable feature since it permits verification of the test results.

Data which must be recorded for each test regardless of the type of test performed include:

1. the depth from the ground surface to the groundwater surface both before and after the test,

2. the inside diameter of the casing,
3. the height of the casing above the ground surface,
4. the length of casing at the test section,
5. the diameter of the borehole below the casing,
6. the depth to the bottom of the boring from the top of the casing,
7. the depth to the standing water level from the top of the casing, and
8. a description of the material tested.

### **Falling Water Level Method**

In this test, the casing is filled with water, which is then allowed to seep into the soil. The rate of drop of the water surface in the casing is observed by measuring the depth of the water surface below the top of the casing at 1, 2 and 5 minutes after the start of the test and at 5-minute intervals thereafter. These observations are made until the rate of drop becomes negligible or until sufficient readings have been obtained to satisfactorily determine the permeability. Other required observations are listed above.

### **Rising Water Level Method**

This method, most commonly referred to as the “time lag method” (US Army Corps of Engineers, 1951), consists of bailing the water out of the casing and observing the rate of rise of the water level in the casing at intervals until the rise in the water level becomes negligible. The rate is observed by measuring the elapsed time and the depth of the water surface below the top of the casing. The intervals at which the readings are required will vary somewhat with the permeability of the soil. The readings should be frequent enough to establish the equalization diagram. In no case should the total elapsed time for the readings be less than 5 minutes. As noted above, a rising level test should always be followed by a sounding of the bottom of the hole to determine whether the test created a quick condition.

### **Constant Water Level Method**

In this method water is added to the casing at a rate sufficient to maintain a constant water level at or near the top of the casing for a period of not less than 10 minutes. The water may be added by pouring from calibrated containers or by pumping through a water meter. In addition to the data listed in the above general discussion, the data recorded should consist of the amount of water added to the casing at 5 minutes after the start of the test, and at 5-minute intervals thereafter until the amount of added water becomes constant.

### **6.3.2 Pressure (“Packer”) Test**

A test in which water is forced under pressure into rock through the walls of a borehole provides a means of determining the apparent permeability of the rock, and yields information regarding its soundness. The information thus obtained is used primarily in seepage studies. It is also frequently used as a qualitative measure of the grouting required for reducing the permeability of rock or strengthening it. Pressure tests should be performed only in holes that have been drilled with clear water.

The apparatus used for pressure tests in rock is illustrated schematically in Figure 6-2a. It comprises a water pump, a manually-adjusted automatic pressure relief valve, pressure gages, a water meter, and a packer assembly. The packer assembly, shown in Figure 6-2b, consists of a system of piping to which two expandable cylindrical rubber sleeves, called packers, are attached. The packers, which provide a means of sealing off a limited section of borehole for testing, should have a length at least five times the diameter of the hole. They may be of the pneumatically, hydraulically, or mechanically expandable type. Pneumatic or hydraulic packers are preferred since they adapt to an oversized hole whereas mechanical packers may not. However, when pneumatic/hydraulic packers are used, the test apparatus must also include an air or water supply connected, through a pressure gage, to the packers by means of a high-pressure hose as shown in Figure 6-2a. The piping of the packer assembly is designed to permit testing of either the portion of the hole between the packers or the portion below the lower packer. Flow to the section below the lower packer is through the interior pipe; flow to the section between the packers is provided by perforations in the outer pipe, which have an outlet area two or more times the cross-sectional area of the pipe. The packers are normally set 0.6, 1.5 or 3 m apart and it is common to provide flexibility in testing by having assemblies with different packer spacing available, thereby permitting the testing of different lengths of the hole. The wider spacings are used for rock that is more uniform; the short spacing is used to test individual joints that may be the cause of high water loss in otherwise tight strata.

The test procedure used depends upon the condition of rock. In rock that is not subject to cave-in, the following method is in general use. After the borehole has been completed it is filled with clear water, surged, and washed out. The test apparatus is then inserted into the hole until the top packer is at the top of the rock. Both packers are then expanded and water under pressure is introduced into the hole, first between the packers and then below the lower packer. Observations of the elapsed time and the volume of water pumped at different pressures are recorded as detailed in the paragraph below. Upon completion of the test, the apparatus is lowered a distance equal to the space between the packers and the test is repeated. This procedure is continued until the entire length of the hole has been tested or until there is no measurable loss of water in the hole below the lower packer. If the rock in which the hole is being drilled is subject to cave-in, the pressure test is conducted after each advance of the hole for a length equal to the maximum permissible unsupported length of the hole or the distance between the packers, whichever is less. In this case, the test is limited, of course, to the zone between the packers.

The magnitudes of these test pressures are commonly 100, 200 and 300 kPa above the natural piezometric level. However, in no case should the excess pressure above the natural piezometric level be greater than 23 kPa per meter of soil and rock overburden above the upper packer. This limitation is imposed to insure against possible heaving and damage to the foundation. In general, each of the above pressures should be maintained for 10 minutes or until a uniform rate of flow is attained, whichever is longer. If a uniform rate of flow is not reached in a reasonable time, the engineer must use his/her discretion in terminating the test. The quantity of flow for each pressure should be recorded at 1, 2 and 5 minutes and for each 5-minute interval thereafter. Upon completion of the tests at 100, 200 and 300 kPa the pressure should be reduced to 200 and 100 kPa, respectively, and the rate of flow and elapsed time should once more be recorded in a similar manner.

Observation of the water take with increasing and decreasing pressure permits evaluation of the nature of the openings in the rock. For example, a linear variation of flow with pressure indicates an opening that neither increases nor decreases in size. If the curve of flow versus pressure is concave upward it indicates that the openings are enlarging; if convex, the openings are becoming plugged. Detailed discussion for interpretation of pressure tests is presented by Cambefort (1964).

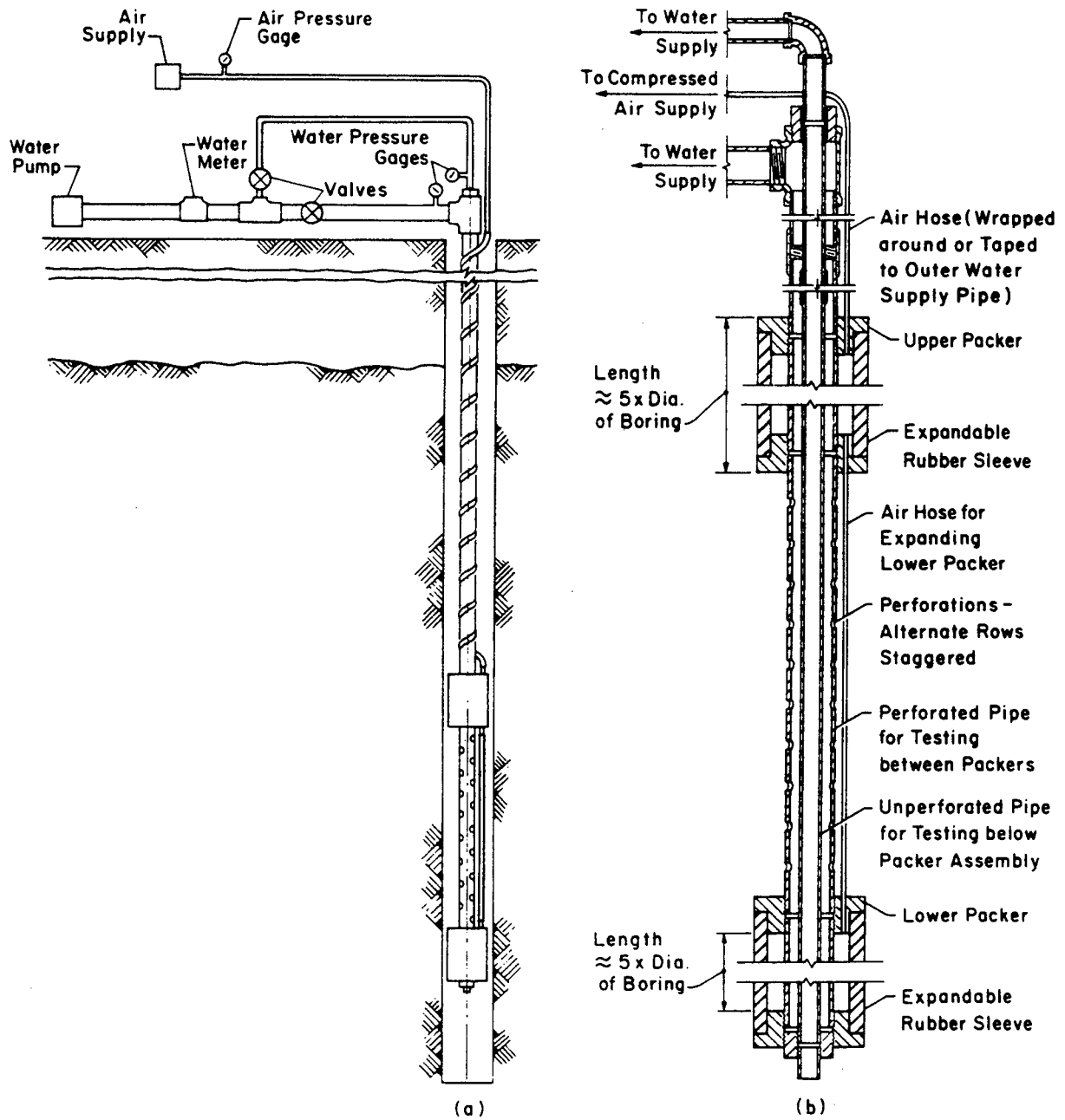

Figures 6-2: Packer-Type Pressure-Test Apparatus for Determining the Permeability of Rock. (a) Schematic Diagram; (b) Detail of Packer Unit. (Lowe and Zaccheo, 1991)

Additional data required for each test are as follows:

1. the depth of the hole at the time of each test,
2. the depth to the bottom of the top packer,
3. the depth to the top of the bottom packer,
4. the depth to the water level in the borehole at frequent intervals (this is important since a rise in water level in the borehole may indicate leakage around the top packer. Leakage around the bottom packer would be indicated by water rising in the inner pipe.),
5. the elevation of the piezometric level,
6. the length of the test section,
7. the radius of the hole,
8. the length of the packer,
9. the height of the pressure gage above the ground surface,
10. the height of the water swivel above the ground surface, and
11. a description of the material tested.

The formulas used to compute the permeability from pressure tests data are (from Earth Manual US Bureau of Reclamation, 1960):

$$k = \frac{Q}{2\pi LH} \ln \frac{L}{r} \text{ for } L \geq 10r$$
$$k = \frac{Q}{2\pi LH} \sinh^{-1} \frac{L}{2r} \text{ for } 10r > L \geq r$$

(6-1)

where,  $k$  is the apparent permeability,  $Q$  is the constant rate of flow into the hole,  $L$  is the length of the test section,  $H$  is the differential head on the test section and  $r$  is the radius of the borehole.

The formulas provide only approximate values of  $k$  since they are based on several simplifying assumptions and do not take into account the flow of water from the test section back to the borehole. However, they give values of the correct magnitude and are suitable for practical purposes.

### 6.3.3 Pumping Tests

Continuous pumping tests are used to determine the water yield of individual wells and the permeability of subsurface materials in situ. The data provided by such tests are used to determine the potential for leakage through the foundations of water-retaining structures and the requirements for construction dewatering systems for excavations.

The test consists of pumping water from a well or borehole and observing the effect on the water table by measuring the water levels in the hole being pumped and in an array of observation wells. The observation wells should be of the piezometer type. The depth of the test well will depend on the depth and thickness of the strata to be tested. The number, location, and depth of the observation wells or piezometers will depend on the estimated shape of the groundwater surface after drawdown. Figure 6-3 shows a typical layout of piezometers for a pumping test. As shown in Figure 6-3, the wells should be located on the radial lines passing through the test well. Along each of the radial lines there should be a minimum of four wells, the innermost of which should be within 7.5 m of the test well; The outermost should be located near the limits of the effect of drawdown, and the middle wells should be located to give the best definition of the drawdown curve based on its estimated shape.

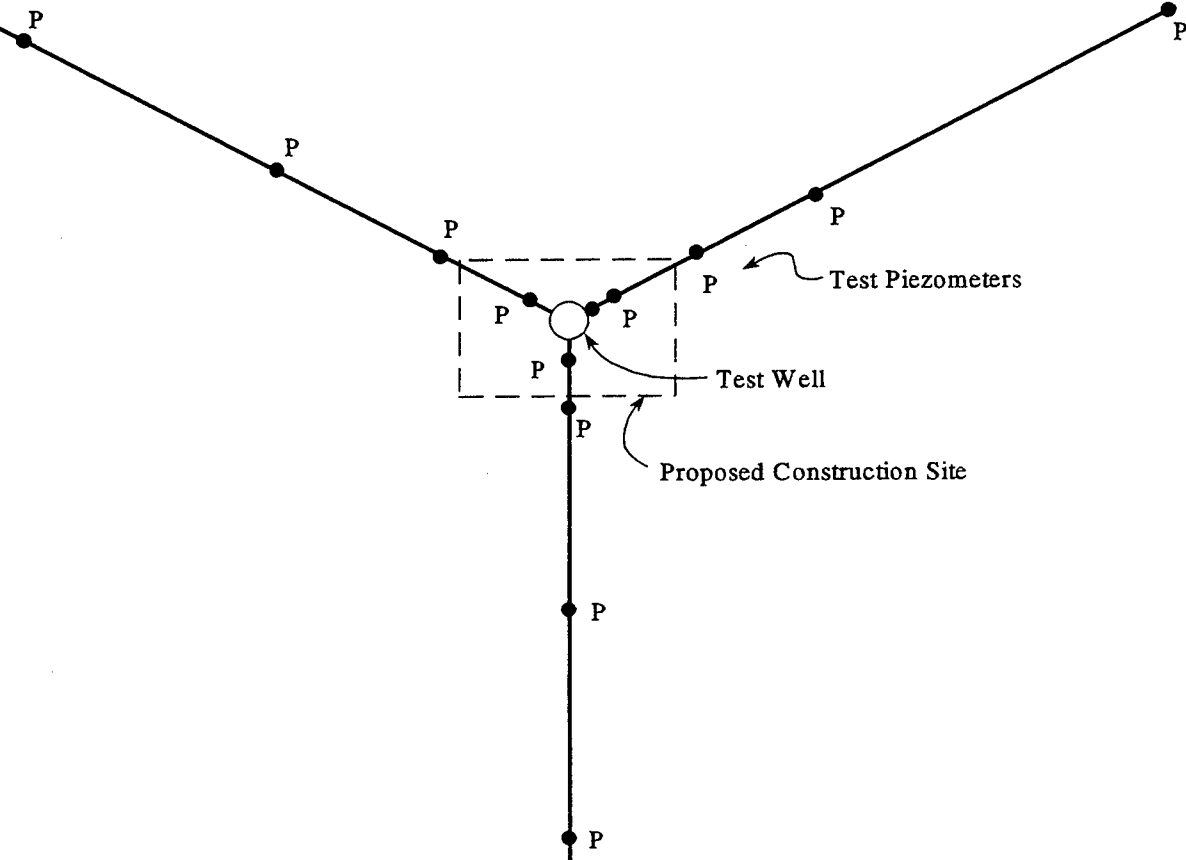

Figure 6-3: Layout of Piezometers for a Pumping Test.

The pump used for these tests should have a capacity of 1.5 to 2 times the maximum anticipated flow and should have a discharge line sufficiently long to obviate the possibility of the discharge water recharging the strata being tested. Auxiliary equipment required include an air line to measure the water level in the test well, a flow meter, and measuring devices to determine the depth to water in the observation well. The air line, complete with pressure gage, hand pump, and check valve, should be securely fastened to the pumping level but in no case closer than 0.6 m beyond the end of the suction line. The flow meter should be of the visual type, such as an orifice. The depth-measuring device for the observation well may be any of the types described in Section 6.2.

The test procedure is as follows: Upon completion of the well or borehole, the hole is cleaned and flushed, the depth of the well is accurately measured, the pump is installed, and the well is developed. The well is then tested at 1/3, 2/3 and full capacity. Full capacity is defined as the maximum discharge attainable with the water levels in the test and observation wells stabilized. Each of the discharge rates is maintained for 4 hours after further drawdown in the test and observation well has ceased, or for a maximum of 48 hours, whichever occurs first. The discharge must be maintained constant during each of the three stages of the test and interruptions of pumping are not permitted. If pumping should accidentally be interrupted, the water level should be permitted to return to its full non-pumping level before pumping is resumed. Upon completion of the drawdown test, the pump is shut off and the rate of recovery is observed.

The basic test well data which must be recorded are:

1. the location, top elevation and depth of the well,
2. the size and length of all blank casing in the well,
3. the diameter, length, and location of all screen casing used; also the type and size of the screen opening and the material of which the screen is made,
4. the type of filter pack used, if any,
5. the water elevation in the well prior to testing, and
6. the location of the bottom of the air line.

Basic data required for each observation well are:

1. the location, top elevation, and depth of the well,
2. the size and elevation of the bottom of the casing (after installation of the well),
3. the location of all blank casing sections,
4. the manufacturer, type, and size of the pipes etc.
5. the depth and elevation of the well and
6. the water level in the well prior to testing.

Pump data required are the manufacturer's model designation, pump type, maximum capacity, and capacity at 1800 rpm. The drawdown test data required for each discharge rate consist of the discharge and drawdown of the test well and the drawdown of each observation well at the time intervals shown in Table 6-1.

The required recovery curve data consist of readings of the depth to water at the test location and observation wells at the same time intervals given in Table 6-1. Readings are continued until the water level returns to the prepumping level or until adequate data have been obtained. A typical time-drawdown curve is shown in Figure 6-4. Generally, the time-drawdown curve becomes straight after the first few minutes of pumping. If true equilibrium conditions are established, the drawdown curve will become horizontal.

**TABLE 6-1**  
**TIME INTERVALS FOR READING DURING PUMPING TEST**

Elapsed Time	Time Interval for Readings
0-10 min	0.5 min
10-60 min	2.0 min
1-6 hour	15.0 min
6-9 hour	30.0 min
9-24 hour	1.0 hour
24-48 hour	3.0 hour
> 48 hour	6.0 hour

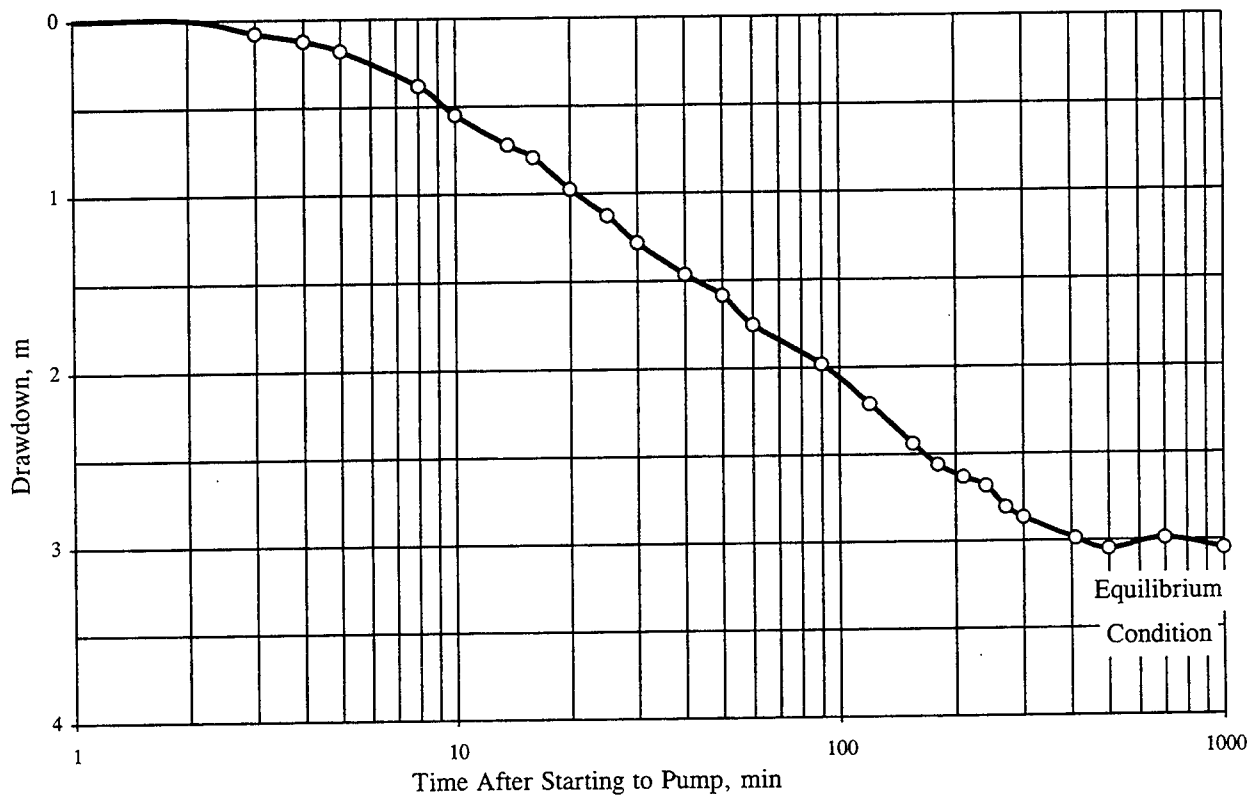

Figure 6-4: Drawdown in an Observation Well Versus Pumping Time (Logarithmic Scale)



### 6.3.4 Slug Tests

Using slug tests to determine permeability has become common in environmental investigations. Figure 6-5 presents a typical slug test procedure. It is conducted in a borehole in which a screened (slotted) pipe is installed. A plastic slug is submerged below the water table until equilibrium has been established; then the slug is removed suddenly, causing an “instantaneous” lowering of the water level within the observation well. Finally, as the well gradually fills up with water, the refill rate is recorded. This is often referred to as the “slug out” procedure.

The permeability,  $k$ , is then determined from the refill rate. In general, the more rapid the refill rate, the higher the  $k$  value of the screened sediments.

It is also possible to run a “slug in” test. This is similar to the slug out test, except the plastic slug is suddenly dropped into the water, causing an “instantaneous” water level rise. The decay of this water level back to static is then used to compute the permeability. A slug in and slug out test can be performed on the same well.

Alternatively, instead of using a plastic slug, it is possible to lower the water level in the well using compressed air (or raising it using a vacuum) and then suddenly restore atmospheric pressure by opening a quick-release valve.

With either method, a pressure transducer and data logger are used to record time and water levels. In instances where water-level recovery is slow enough, hand-measured water levels (see Section 6.2) are adequate. Once, the data have been collected, drawdown is graphed versus time, and various equations and/or curve-matching techniques are used to compute permeability.

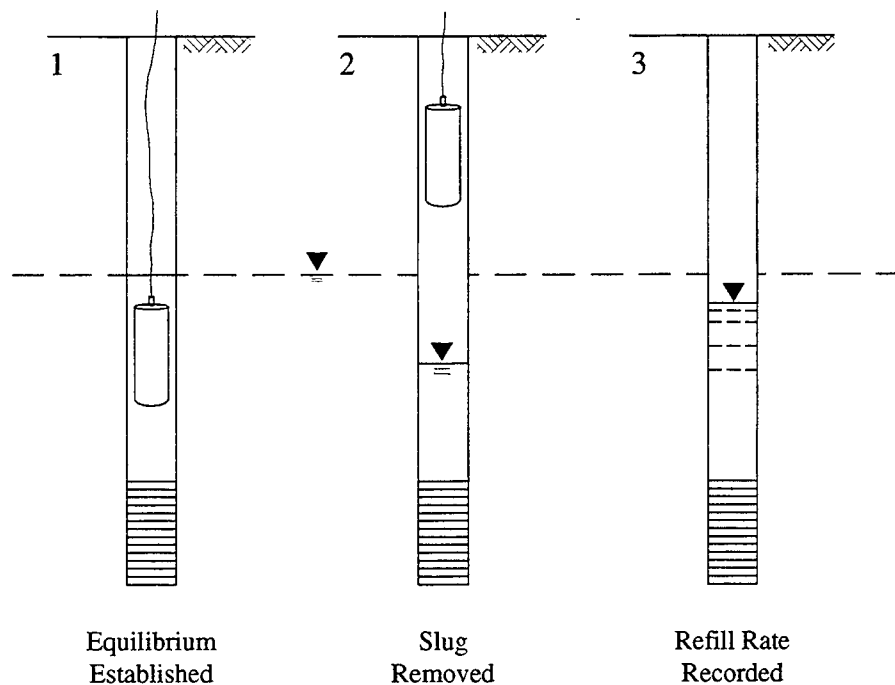

Figure 6-5: Typical Slug Test Procedure.

Much of the popularity of these tests results from the ease and low cost of conducting them. Unfortunately, however, slug tests are not very reliable. They can give wrong answers, lead to misinterpretation of aquifer characteristics, and ultimately, improper design of dewatering or remediation systems. Several shortcomings of the slug tests may be summarized as follows (Driscoll, 1986):

1. Variable accuracy: Slug tests may be accurate or may underestimate permeability by one or two orders or magnitude. The test data will provide no clue as to the accuracy of the computed value unless a pumping test is done in conjunction with slug tests.
2. Small zone of investigation: Because slug tests are of short duration, the data they provide reflect aquifer properties of just those sediments very near the well intake. Thus, a single slug test does not effectively integrate aquifer properties over a broad area.
3. Slug tests cannot predict the storage capacity of an aquifer.
4. It is difficult to analyze data from wells screened across the water table.
5. Rapid slug removal often causes pressure transients that can obscure some of the early test data.
6. If the true static water level is not determined with great precision, large errors can result in the computed permeability values.

Therefore, it is crucial that a qualified hydrogeologist assesses the results of the slug tests and ensures that they are properly applied and that data from them are not misused. Although the absolute magnitude of the permeability value obtained from slug tests may not be accurate, a comparison of values obtained from tests in holes judiciously located throughout a site being investigated can be used to establish the relative permeability of various portions of the site.

## CHAPTER 7.0 LABORATORY TESTING FOR SOILS

### 7.1 GENERAL

Laboratory testing of soils is a fundamental element of geotechnical engineering. The complexity of testing required for a particular project may range from a simple moisture content determination to specialized strength testing. However, testing can be expensive and time consuming. The geotechnical engineer, therefore, should recognize the project's issues ahead of time so as to optimize the testing program, particularly strength and consolidation testing.

Before describing the various soil test methods, the soil's behavior under load will be examined and common soil mechanics terms introduced. The following discussion only includes basic concepts of soil behavior. However, the engineer must grasp these concepts in order to select the appropriate tests to model the in-situ conditions. The terms and symbols shown will be used in all the remaining modules of the course. Basic soil mechanics textbooks should be consulted for further explanation of these and other terms.

#### 7.1.1 Weight-Volume Concepts

A sample of soil is usually composed of soil grains, water and air. The soil grains are irregularly shaped solids which are in contact with other adjacent soil grains. The weight and volume of a soil sample depends on the specific gravity of the soil grains (solids), the size of the space between soil grains (voids and pores) and the amount of void space filled with water. Common terms associated with weight-volume relationships are shown in Table 7-1. Of particular note is the void ratio,  $e$ , which is a general indicator of the relative strength and compressibility of a soil sample, i.e., low void ratios generally indicate strong soils of low compressibility, while high void ratios may indicate weak, compressible soils.

A summary of weight-volume (unit weight) relations is presented in Table 7-2.

**TABLE 7-1  
COMMON TERMS IN WEIGHT-VOLUME RELATIONS (After Cheney and Chassie, 1993)**

Property	Symbol	Units <sup>1</sup>	How obtained (AASHTO/ASTM)	Direct Applications
Moisture Content	$w$	D	By measurement (T 265/ D 4959)	Classification and in weight-volume relations
Specific Gravity	$G_s$	D	By measurement (T 100/D 854)	Volume computations
Unit weight	$\gamma$	FL <sup>-3</sup>	By measurement or from weight-volume relations	Classification and for pressure computations
Porosity	$n$	D	From weight-volume relations	Defines relative volume of solids to total volume of soil
Void Ratio	$e$	D	From weight-volume relations	Defines relative volume of voids to volume of solids

<sup>1</sup> F=Force or weight; L = Length; D = Dimensionless. Although by definition moisture content is a dimensionless fraction (ratio of weight of water to weight of solids), it is commonly reported in percent by multiplying the fraction by 100.

**TABLE 7-2**  
**WEIGHT-VOLUME RELATIONS (After Das, 1990)**

Unit-Weight Relationship	Dry Unit Weight (No Water)	Saturated Unit Weight (No Air)
$\gamma = \frac{(1+w)G_s\gamma_w}{1+e}$	$\gamma_d = \frac{\gamma}{1+w}$	$\gamma_{sat} = \frac{(G_s + e)\gamma_w}{1+e}$
$\gamma = \frac{(G_s + Se)\gamma_w}{1+e}$	$\gamma_d = \frac{G_s\gamma_w}{1+e}$	$\gamma_{sat} = [(1-n)G_s + n]\gamma_w$
$\gamma = \frac{(1+w)G_s\gamma_w}{1 + \frac{wG_s}{S}}$	$\gamma_d = G_s\gamma_w(1-n)$	$\gamma_{sat} = \left(\frac{1+w}{1+wG_s}\right)G_s\gamma_w$
$\gamma = G_s\gamma_w(1-n)(1+w)$	$\gamma_d = \frac{G_s\gamma_w}{1 + \frac{wG_s}{S}}$	$\gamma_{sat} = \left(\frac{e}{w}\right)\left(\frac{1+w}{1+e}\right)\gamma_w$
	$\gamma_d = \frac{eS\gamma_w}{(1+e)w}$	$\gamma_{sat} = \gamma_d + n\gamma_w$
	$\gamma_d = \gamma_{sat} - n\gamma_w$	$\gamma_{sat} = \gamma_d + \left(\frac{e}{1+e}\right)\gamma_w$
	$\gamma_d = \gamma_{sat} - \left(\frac{e}{1+e}\right)\gamma_w$	

In above relations,  $\gamma_w$  refers to the unit weight of water (=9.81 kN/m<sup>3</sup>).

### 7.1.2 Load-Deformation Process in Soils

When a load is applied to a soil sample, the deformation which occurs will depend on the grain to grain contact (intergranular) forces and the amount of water in the voids. If no pore water exists, the sample deformation will be due to sliding between soil grains and deformation of the individual soil grains. The rearrangement of soil grains due to sliding accounts for most of the deformation. Adequate deformation is required to increase the grain contact areas to take the applied load. As the amount of pore water in the void increases, the pressure it exerts on soil grains will increase and reduce the intergranular contact forces. In fact, tiny clay particles may be forced completely apart by water in the pore space.

Deformation of a saturated soil is more complicated than that of dry soil as water molecules, which fill the voids, must be squeezed out of the sample before readjustment of soil grains can occur. The more permeable a soil is, the faster the deformation under load will occur. However, when the load on a saturated soil is quickly increased, the increase is carried entirely by the pore water until drainage begins. Then more and more load is gradually transferred to the soil grains until the excess pore pressure has

dissipated and the soil grains readjust to a denser configuration. This process is called consolidation and results in a higher unit weight and a decreased void ratio.

### 7.1.3 Principle of Effective Stress

The consolidation process demonstrates the very important principle of effective stress, which will be used in all the remaining modules of this course. Under an applied load, the total stress in a saturated soil sample is composed of the intergranular stress and pore pressure (neutral stress). As the pore water has no shear strength and is incompressible, only the intergranular stress is effective in resisting shear or limiting compression of the soil sample. Therefore, the intergranular contact stress is called the effective stress.

Simply stated, the principle of effective stress states that *the total stress ( $\sigma$ ) on any plane within a soil mass is equal to the sum of the effective stress ( $\sigma'$ ) and the pore pressure ( $u$ ).*

When pore water drains from soil during consolidation, the area of contact between soil grains increases, which increases the level of effective stress and therefore the soil's shear strength. In practice, staged construction of embankments is used to permit increase of effective stress in the foundation soil before subsequent fill load is added. In such operations the effective stress increase is frequently monitored with piezometers to ensure the next stage of embankment can be safely placed.

In general, soil deposits below the water table will be considered saturated and the ambient pore pressure at any depth may be computed by multiplying the unit weight of water ( $\gamma_w$ ) by the height of water above that depth. The total stress at that depth may be found by multiplying the total unit weight ( $\gamma$ ) of the soil by the depth. The effective stress is obtained as  $\sigma' = \sigma - u$ .

The preceding presentation about effective stresses is strictly valid only for completely saturated soils. For partially saturated soil, the effective stress will be influenced by the soil structure and degree of saturation (Bishop, *et. al.*, 1960). Also, in some cases the continuous void spaces that exist in the soil can behave as bundles of capillary tubes of variable cross-section. Due to the capillary action, water may rise above the static groundwater table and change the pore water pressure.

### 7.1.4 Overburden Pressure

The laboratory testing required to deal with soil-related issues involves simulating in situ conditions. Soils existing at a depth below the ground surface are affected by the weight of the soil above that depth. The influence of this weight, known generally as the *overburden pressure*, causes a state of stress to exist which is unique at that depth, for that soil. When a soil sample is removed from the ground, that state of stress is relieved as all confinement of the sample has been removed. In testing, it is important to reestablish the in situ stress conditions and to study changes in soil properties when additional stresses representing the expected design loading are applied. As previously mentioned, the effective stress (grain to grain contact) is the controlling factor in shear and consolidation. Therefore, the designer should try to duplicate the effective stress condition during most testing.

The test stresses are estimated from either the total or effective overburden pressure. The engineer's first task is determining the total and effective overburden pressure variation with depth. This relatively simple task involves determining the average total unit weight (density) for each soil layer in the soil profile, and determining the depth of the water table. Unit weight may be accurately determined from density tests on undisturbed samples or estimated from standard penetration test values and visual examination of the soil.

The water table is routinely recorded on the boring logs. The total overburden pressure ( $\sigma_v$ ) is found by multiplying the total unit weight of each soil layer by the layer thickness and continuously summing the results with depth. The effective overburden pressure ( $\sigma'_v$ ) at any depth is determined by accumulating the weight of all layers above that depth as follows:

1. Soils *above* the water table: multiply the total unit weight by the thickness of each respective soil layer above the desired depth, i.e.,  $\sigma'_v = \sigma_v$ .
2. Soils *below* the water table: subtract pore pressure from  $\sigma_v$  or reduce the total unit weight,  $\gamma_t$ , by the unit weight of water  $\gamma_w = 9.81 \text{ kN/m}^3$ ; i.e., use effective unit weights,  $\gamma'$ , and multiply by the thickness of each respective soil layer between the water table and the desired depth,  $d$ . In other words:

$$\sigma'_v = \sigma_v - (\gamma_w)(d) \quad \text{or} \quad \sigma'_v = \gamma'(d) \quad (7-1)$$

A plot of effective overburden pressure versus depth is called a  $\sigma'_v$  diagram and is used in all aspects of foundation testing and analysis.

### 7.1.5 Selection and Assignment of Tests

Certain considerations regarding laboratory testing, such as when, how much, and what type, can only be decided by an experienced geotechnical engineer. The following minimal criteria should be considered while determining the scope of the laboratory testing program:

- Project type (bridge, embankment, rehabilitation, buildings, etc.)
- Size of the project
- Loads to be imposed on the foundation soils
- Types of loads (i.e., static, dynamic, etc.)
- Critical tolerances for the project (i.e., settlement limitations)
- Vertical and horizontal variations in the soil profile as determined from boring logs and visual identification of soil types in the laboratory
- Known or suspected peculiarities of soils at the project location (i.e., swelling soils, collapsible soils, organics, etc.)
- Presence of visually observed intrusions, slickensides, fissures, concretions, etc.

The selection of tests should be considered preliminary until the geotechnical engineer is satisfied that the test results are sufficient to develop reliable soil profiles and provide the soil parameters needed for design.

Below are brief discussions of frequently used soil properties and tests. These discussions assume that the reader will have access to the latest volumes of AASHTO and ASTM standards containing details of test procedures and will study them in connection with this presentation. Table 7-3 presents a summary list of AASHTO and ASTM tests frequently used for laboratory testing of soils.

**TABLE 7-3  
AASHTO AND ASTM STANDARDS FOR FREQUENTLY USED  
LABORATORY TESTING OF SOILS**

Test Category	Name of Test	Test Designation	
		AASHTO	ASTM
Visual Identification	Practice for Description and Identification of Soils (Visual-Manual Procedure)	-	D 2488
	Practice for Description of Frozen Soils (Visual-Manual Procedure)	-	D 4083
Index Properties	Test Method for Determination of Water (Moisture) Content of Soil by Direct Heating Method	T 265	D 4959
	Test Method for Specific Gravity of Soils	T 100	D 854
	Method for Particle-Size Analysis of Soils	T 88	D 422
	Test Method for Amount of Material in Soils Finer than the No. 200 (75- $\mu$ m) Sieve		D 1140
	Test Method for Liquid Limit, Plastic Limit, and Plasticity Index of Soils	T 89 T 90	D 4318
	Test Method for Laboratory Compaction Characteristics of Soil Using Standard Effort (600 kN.m/m <sup>3</sup> )	T 99	D 698
	Test Method for Laboratory Compaction Characteristics of Soil Using Modified Effort (2,700 kN.m/m <sup>3</sup> )	T 180	D 1557
Corrosivity	Test Method for pH of Peat Materials	-	D 2976
	Test Method for pH of Soils	-	D 4972
	Test Method for pH of Soil for Use in Corrosion Testing	T 289	G 51
	Test Method for Sulfate Content	T 290	D 4230
	Test Method For Resistivity	T 288	D 1125 G 57
	Test Method for Chloride Content	T 291	D 512
	Test Methods for Moisture, Ash, and Organic Matter of Peat and Other Organic Soils	T 194	D 2974
	Test Method for Classification of Soils for Engineering Purposes	M 145	D 2487 D 3282

**TABLE 7-3 (Continued)**  
**AASHTO AND ASTM STANDARDS FOR FREQUENTLY USED**  
**LABORATORY TESTING OF SOILS**

Test Category	Name of Test	Test Designation	
		AASHTO	ASTM
Strength Properties	Test Method for Unconfined Compressive Strength of Cohesive Soil	T 208	D 2166
	Test Method for Unconsolidated, Undrained Compressive Strength of Cohesive Soils in Triaxial Compression	T 296	D 2850
	Test Method for Consolidated-Undrained Triaxial Compression Test on Cohesive Soils	T 297	D 4767
	Method for Direct Shear Test of Soils Under Consolidated Drained Conditions	T 236	D 3080
	Test Methods for Modulus and Damping of Soils by the Resonant-Column Method	-	D 4015
	Test Method for Laboratory Miniature Vane Shear Test for Saturated Fine-Grained Clayey Soil	-	D 4648
	Test Method for Bearing Ratio of Soils in Place	-	D 4429
	Test Method for CBR (California Bearing Ratio) of Laboratory-Compacted Soils	-	D 1883
	Test method For Resilient Modulus of Soils	T 294	-
Test Method for Resistance R-Value and Expansion Pressure of Compacted Soils	T 190	D 2844	
Permeability	Test Method for Permeability of Granular Soils (Constant Head)	T 215	D 2434
	Test Method for Measurement of Hydraulic Conductivity of Saturated Porous Materials Using a Flexible Wall Permeameter	-	D 5084
Compression Properties	Test Method for One-Dimensional Consolidation Properties of Soils	T 216	D 2435
	Test Methods for One-Dimensional Swell or Settlement Potential of Cohesive Soils	T 258	D 4546
	Test Method for Measurement of Collapse Potential of Soils	-	D 5333



## 7.1.6 Visual Identification of Soils

Guidelines for visual identification of soils can be used in field as well as laboratory investigations.

<b>Visual Identification of Soils</b>	
AASHTO ASTM	- D 2488, D 4083
Purpose	<ol style="list-style-type: none"> <li>1. Verify the field description of soil color and soil type.</li> <li>2. Select representative specimens for various tests.</li> <li>3. Select specimens for special tests (i.e., slickensided soils for triaxial testing) to determine the effects of the soil macro structure on the overall properties of the deposit.</li> <li>4. Locate and identify changes, intrusions (i.e., silt seams) and disturbances within a sample.</li> <li>5. Verify or revise the soil description to be included in the boring logs or in soil profile presentations.</li> </ol>
Procedure	The visual examination should be done expeditiously. Choose an ideal crew size of three: One to take samples out of their containers, unwrap them for examination and rewrap upon completion, one to perform the visual examination as per above ASTM standards, and a third person to take notes.
Commentary	<p>Prior to assigning laboratory tests, all soil samples submitted to a laboratory should be subjected to visual examination and identification. It is advisable for the geotechnical engineer to be present during the opening of samples for visual inspection. He should remain in contact with the laboratory, as he can offer valuable assistance in assessing soil properties.</p> <p><b>Disturbed Samples</b> As discussed earlier, disturbed samples are normally bulk samples of various sizes. Visual examinations of these samples are limited to the color, contents (i.e., gravel, concretions, sand, etc.) and consistency, as determined by handling a small, representative piece of the sample. The color of the soil should be determined by examining the samples in a jar or sealed can, where the moisture content is preserved near or at its natural condition. If more than one sample is obtained from the same deposit, the uniformity of the sample or lack of it is determined at this stage. This determination is used to decide on the proper mixing and quartering of disturbed samples to obtain representative specimens.</p> <p><b>Undisturbed Samples</b> Undisturbed samples should be opened for examination one sample at a time. Prior to opening, the sample number, depth and other identifying marks placed on the sample tube or wrapping should be checked against field logs. Samples should be laid on their side on a clean table top. If samples are soft, they should be supported in a sample cradle of appropriate size; they should not be examined on a flat table top.</p> <p>Samples should be examined in a humid room where possible, or in rooms where the temperature is neither excessively warm nor cold.</p> <p>Once the samples are unwrapped, the technician, engineer or geologist examining the sample identifies its color, soil type, variations and discontinuities identifiable from surface features such as silt and sand seams, trace of organics, fissures, shells, etc.</p> <p>The apparent relative strength, as determined by the use of a hand-held penetrometer, is often noted during this process. Samples should be handled very gently to avoid disturbing the material. The examination should be done quickly before changes in the natural moisture content occur.</p>

### 7.1.7 Index Properties

Index properties are used to characterize soils and determine their basic properties such as moisture content, specific gravity, particle size distribution, consistency and moisture-density relationships.

Moisture Content	
AASHTO ASTM	T 265 D 4959
Purpose	To determine the amount of water present in a quantity of soil in terms of its dry weight and to provide general correlations with strength, settlement, workability and other properties.
Procedure	Oven-dry the soil at a temperature of $110 \pm 5^\circ\text{C}$ to a constant weight (evaporate free water); this is usually achieved in 12 to 18 hours.
Commentary	<p>Determination of the moisture content of soils is the most commonly used laboratory procedure. The moisture content of soils, when combined with data obtained from other tests, produces significant information about the characteristics of the soil. For example, when the in situ moisture content of a sample retrieved from below the phreatic surface approaches its liquid limit, it is an indication that the soil in its natural state is susceptible to larger consolidation settlement.</p> <p>Serious errors may be introduced if the soil contains other components, such as petroleum products or easily ignitable solids. When the soils contain fibrous organic matter, absorbed water may be present in the organic fibers as well as in the soil voids. The test procedure does not differentiate between pore water and absorbed water in organic fibers. Thus the moisture content measured will be the total moisture lost rather than free moisture lost (from void spaces). As discussed later, this may introduce serious errors in the determination of Atterberg limits.</p>

<b>Specific Gravity</b>	
AASHTO ASTM	T 100 D 854
Purpose	To determine the specific gravity of the soil grains.
Procedure	The specific gravity is determined as the ratio of the weight of a given volume of soil solids at a given temperature to the weight of an equal volume of distilled water at that temperature, both weights being taken in air.
Commentary	<p>Some qualifying words like <i>true</i>, <i>absolute</i>, <i>apparent</i>, <i>bulk or mass</i>, etc. are sometimes added to "specific gravity". These qualifying words modify the sense of specific gravity as to whether it refers to soil grains or to soil mass. The soil grains have permeable and impermeable voids inside them. If all the internal voids of soil grains are excluded for determining the true volume of grains, the specific gravity obtained is called <i>absolute</i> or <i>true</i> specific gravity.</p> <p>Unless otherwise specified, the specific gravity, <math>G_s</math>, of a soil without any qualifications is taken to be the <i>true</i> or <i>absolute</i> and is considered to be the average value for the soil grains. If numerical values are given in a discussion where it may not be clear to what the specific gravity is referred, the magnitude of the values may indicate the correct usage since the specific gravity of the soil grains will always be larger than the bulk specific gravity based on inclusion of the soil voids in the computations.</p> <p>Complete de-airing of the soil-water mix during the test is imperative while determining the <i>true</i> or <i>absolute</i> value of specific gravity.</p> <p>A value of specific gravity is necessary to compute the void ratio of a soil, it is used in the hydrometer analysis, and it is useful to predict the unit weight of a soil (see Table 7-2). Occasionally, the specific gravity may be useful in soil mineral classifications; e.g., iron minerals have a larger value of specific gravity than silicas.</p>

<b>Unit Weight</b>
Unit weight for undisturbed soil samples in the laboratory is simply determined by weighing a portion of a soil sample and dividing by its volume. Where undisturbed samples are not available, the unit weight is estimated indirectly from weight-volume relations (see Table 7-2).

Sieve Analysis	
AASHTO ASTM	T 88 D 422, D 1140
Purpose	To determine the percentage of various grain sizes. The grain size distribution is used to determine the textural classification of soils (i.e., sand, silty clay, etc.) which in turn is useful in evaluating the engineering characteristics of soils such as permeability and susceptibility to frost action.
Procedure	<p>"Wash" a prepared representative sample through a series of sieves (screens). The amount retained on each sieve is collected dried and weighed to determine the percentage of material passing that sieve size.</p> <p>Figure 7-1 shows a typical grain size curve. From the curve, grain sizes such as <math>D_{85}</math>, <math>D_{60}</math>, <math>D_{10}</math>, etc. are obtained. The D refers to the grain size, or apparent diameter, of the soil particles and the subscript (85, 60, 10) denotes the percent which is smaller. The various particle sizes (<math>D_{10}</math>, <math>D_{30}</math>, etc.) are then used to determine the coefficients of uniformity (<math>C_u</math>) and concavity (<math>C_c</math>) to help classify the soil (see Section 4.6). For fine-grained soils (&lt; No. 200 sieve), a hydrometer test is generally conducted to help identify the entire range of sizes (see next section).</p> <div style="text-align: center;"> <p>Figure 7-1: Typical Grain Size Curve.</p> </div>
Commentary	<p>Obtaining a representative specimen for testing and sample preparation are critical aspects of this test. When samples are dried for testing or "washing," it may be necessary to break up the soil clods. This operation should be performed with care to avoid crushing of especially sand and soft carbonate particles. If the soil contains a substantial amount of fibrous organic materials the organics may have a tendency to plug the openings of the sieves during washing. The material settling over the sieve during washing should be continuously stirred to avoid plugging.</p> <p>Openings of fine (&lt; No. 200) mesh or fabric are easily distorted as a result of normal handling and use. They should be replaced often. A simple way to determine whether sieves should be replaced is the periodic examination of the stretch of the sieve fabric on its frame. The fabric should remain taut; if it sags, it has been distorted and should be replaced. A common cause of serious errors is the use of "dirty" sieves. Some soil particles, because of their shape, size or adhesion characteristics, have a tendency to be lodged in the sieve openings. If sieves are not cleaned free of lodged particles, they will produce erroneous results.</p>

<b>Hydrometer Analysis</b>	
AASHTO ASTM	T 88 D 1140
Purpose	To determine distribution (percentage) of particle sizes smaller than No. 200 sieve and identify the silt, clay and colloids percentages in the soil.
Procedure	Soil passing the No. 200 sieve is mixed with a dispersant and distilled water and placed in a special graduated cylinder in a state of liquid suspension. The specific gravity of the mixture is periodically measured to determine the rate of settlement of soil particles. The relative size and percentage of fine particles are determined based on Stoke's law for settlement of idealized spherical particles.
Commentary	<p>The principal value of the hydrometer analysis is in obtaining the clay fraction (percent finer than 0.002 mm). This is because the soil behavior for a cohesive soil depends principally on the type and percent of clay minerals, the geologic history of the deposit, and its water content rather than on the distribution of particle sizes.</p> <p>Replicable results can be obtained when soils are largely composed of common mineral ingredients. Results can be distorted and erroneous when the composition of the soil is not taken into account to make corrections for the specific gravity of the specimen. Particle size of highly organic soils cannot be determined by the use of this method.</p>

<b>Atterberg Limits</b>	
AASHTO ASTM	T 89, T 90 D 4318
Purpose	To describe the consistency and plasticity of fine-grained soils with varying degrees of moisture.
Procedure	<p>For the portion of the soil passing the No. 40 sieve, the moisture content is varied to identify three stages of soil behavior in terms of consistency. These stages are known as the liquid limit (LL), plastic limit (PL) and shrinkage limit of soils.</p> <p>The liquid limit is arbitrarily defined as the water content at which 25 blows of the liquid limit machine closes a standard groove cut in the soil pat for a distance of 12.7 cm.</p> <p>The plastic limit is also arbitrarily defined as the water content at which a thread of soil, when rolled down to a diameter of 3 mm, will crumble.</p> <p>The shrinkage limit (SL) is defined as that water content below which no further soil volume change occurs with further drying.</p>
Commentary	<p>The Atterberg limits test attempts to show the relationship of moisture content to the consistency and behavior of soils in terms of three quantities namely, the liquid limit (LL), plastic limit (PL) and the plastic (or plasticity) index (<math>PI = LL - PL</math>) of soils. By and large, these are arbitrary and empirical values. They were originally developed for agronomic purposes. Their widespread use by engineers has resulted in the development of a large number of very useful empirical relationships for characterizing soils.</p> <p>Considering the abstract and manual nature of the test procedure, Atterberg limits should only be performed by experienced technicians. Lack of experience, and lack of care will introduce serious errors in the test results.</p>

<b>Moisture-Density (Compaction) Relationship</b>	
AASHTO ASTM	T 99 (Standard Proctor), T 180 (Modified Proctor) D 698 (Standard Proctor), D 1557 (Modified Proctor)
Purpose	To determine the maximum dry density attainable for a given soil and the (optimum) moisture content corresponding to this density.
Procedure	Compaction tests are performed using disturbed, prepared soils with or without additives. Normally, soil passing the No. 4 sieve is mixed with water to form samples at various moisture contents ranging from the dry state to wet state. These samples are compacted in layers in a mold by a hammer in accordance with a specified nominal compaction energy. Dry density is determined based on the moisture content and the unit weight of compacted soil. A curve of dry density and moisture content is plotted as shown in Figure 7-2 and the maximum ordinate on this curve is identified; this is referred to as the maximum dry density and the moisture content at which this dry density occurs is termed as the optimum moisture content (OMC).
Commentary	<p>In the construction of highway embankments, earth dams, structure foundations and many other facilities, loose soils must be compacted to increase their densities. Compaction increases the strength characteristics of soils, thereby increasing the bearing capacity of foundations constructed over them. Compaction also decreases the amount of undesirable settlement of structures and increases the stability of slopes and embankments.</p> <p>The density of soils is measured as the unit dry weight, <math>\gamma_d</math>, (weight of dry soil divided by the bulk volume of the soil). It is a measure of the amount of solid materials present in a unit volume. The higher the amount of solid materials, the stronger and more stable the soil will be.</p> <p>To provide a "relative" measure of compaction, the concept of relative compaction is used. Relative compaction is the ratio (expressed as a percentage) of the density of compacted or natural in situ soils to the maximum density obtainable in a compaction test. Often it is necessary to specify the achieving of a certain level of relative compaction (e.g. 95%) in the construction or preparation of foundations, embankments, pavement sub-bases and bases, and for deep-seated deposits such as loose sands. The design and selection of a placement method to improve the strength, dynamic resistance and consolidation characteristics of deposits depend heavily on relative compaction measurements.</p> <p>When additives such as Portland cement, lime, or fly ash are used to determine the maximum density of mixed compacted soils in the laboratory, care should be taken to duplicate the expected delay period between mixing and compaction in the field. It should be kept in mind that these chemical additives start reacting as soon as they are added to the wet soil. They cause substantial changes in soil properties, including densities achievable by compaction. If in the field the period between mixing and compaction is expected to be three hours, for example, then in the laboratory the compaction of the soil should also be delayed three hours after mixing the stabilizing additives.</p> <p>Where a variety of soils are to be used for construction, a moisture-density relationship for each major type of soil present at the site should be established.</p> <p>Relative density rather than density is often a more useful parameter in assessing the engineering characteristics of soils. It is important to determine, for example, the relative density of sands to assess their liquefaction potential. Relative density, <math>D_r</math>, is defined as:</p> $D_r = \frac{e_{\max} - e}{e_{\max} - e_{\min}} \times 100\% = \frac{\gamma_{d \max}}{\gamma_d} \times \frac{\gamma_d - \gamma_{d \min}}{\gamma_{d \max} - \gamma_{d \min}} \times 100\% \quad (7-2)$

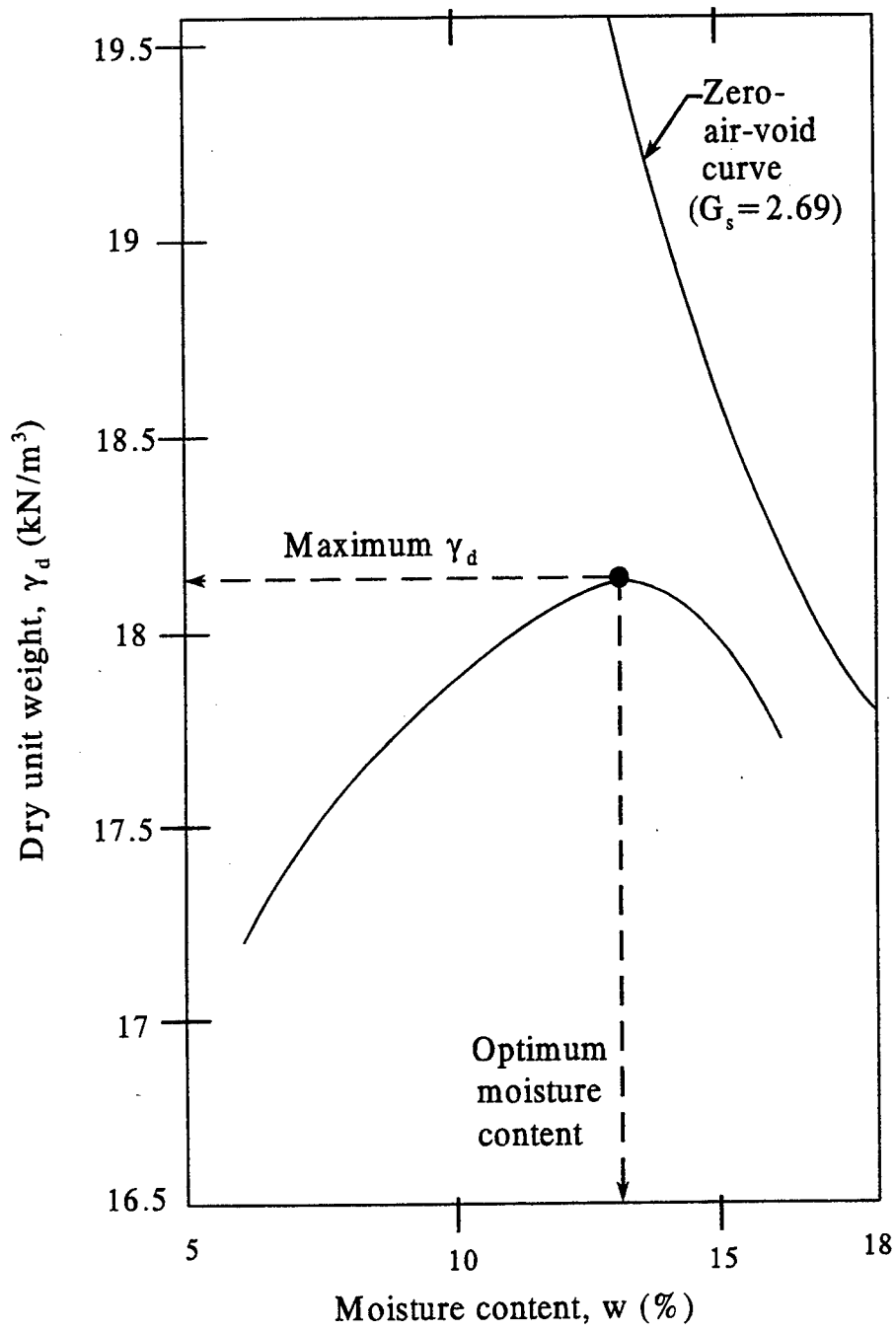

Figure 7-2: Typical Moisture-Density Relationship.

<b>Corrosivity of Soils</b>	
AASHTO ASTM	T 288, T 289, T 290, T 291 G 51, D 512, D 1125, D 2976. D 4230 , D 4972
Purpose	To determine the aggressiveness and corrosivity of soils, pH, sulfate and chloride content of soils.
Procedure	Usually the pH of a soil material is determined electrometrically by a pH meter which is a potentiometer equipped with a glass-calomel electrode system calibrated with buffers of known pH. Measurements are commonly performed on a suspension of soil, water and/or alkaline (usually calcium chloride) solutions.
Commentary	Because of their environment or composition soils may have varying degrees of acidity or alkalinity, as measured by the pH test. Measurements of pH are particularly important for determining corrosion potential where metal piles, culverts, anchors, metal strips, or pipes are to be used.

<b>Resistivity</b>	
AASHTO ASTM	T 288 G 57
Purpose	To determine the corrosion potential of soils
Procedure	The laboratory test for measuring the resistivity of soils is performed using dried prepared soil passing the No. 8 screen. The soil is placed in a box approximately 10.2 cm x 15.2 cm x 4.5 cm with electrical terminals attached to the sides of the box such that they remain in contact with the soil. The terminals in turn are connected to an ohmmeter. A reading of the current passing through the dry soil is taken as the baseline reference resistance. The soil material is then removed and 50 ml to 100 ml of distilled water is added and thoroughly mixed, and placed back in the box. Another reading is taken. The conductivity (conductivity is the reverse of resistivity) of the soil as read by the ohmmeter increases as water is added. The procedure is repeated until the conductivity begins dropping. The highest conductivity, or the lowest resistivity, is used to compute the resistivity of the soil. The method is very sensitive to the distribution of water in the soils placed in the box. The resistivity may also vary significantly with the presence of soluble salts in soils.
Commentary	Where construction materials susceptible to corrosion are to be used in subgrades it is necessary to determine the corrosion potential of soils. This test is routinely performed for structures where metallic reinforcements, soil anchors, nails, culverts, pipes, or piles are included.



<b>Organic Content of Soils</b>	
AASHTO ASTM	T 194 D 2974
Purpose	To help classify the soil and identify its engineering characteristics.
Procedure	Oven-dried (at $110 \pm 5^\circ\text{C}$ ) samples <u>after</u> determination of moisture content are further gradually heated to $440^\circ\text{C}$ which is maintained until the specimen is completely ashed (no change in mass occurs after a further period of heating). The organic content is then calculated from the weight of the ash generated.
Commentary	<p>Organic materials affect the behavior of soils in varying degrees. The behavior of soils with low organic contents (&lt;20% by weight) generally are controlled by the mineral components of the soil. When the organic content of soils approaches 20%, the behavior changes to that of organic, or peaty soils. The consolidation characteristics, permeability, strength and stabilization of these soils are largely governed by the properties of organic materials. Thus it is important to determine the organic content of soils. It is not sufficient to simply label a soil as "organic" without showing the organic content.</p> <p>Organic soils are those formed throughout the ages at low-lying sediment-starved areas by the accumulation of dead vegetation and sediment. Top soils are very recently formed mixtures of soil and vegetation that form part of the food chain. Top soils are not suitable for use in construction and therefore its organic content is not determined.</p>

<b>Classification of Soils</b>	
AASHTO ASTM	M 145 D 2487, D 3282
Purpose	To provide in a very concise manner information on the type and fundamental characteristics of soils, their utility as construction or foundation materials, their constituents, etc.
Procedure	See Section 4.6
Commentary	See Section 4.6

### 7.1.8 Strength Tests

Design of shallow or deep foundations, stability analysis of earthen structures and cuts and fills require a thorough understanding of the strength properties of soils. The selection of soil strength information needed and types of tests to be performed vary depending on the type of construction, the foundation design, the intensity, type and duration of loads to be imposed, and soil types existing at the site.

The strength, expressed as shear strength, can be determined by field and/or laboratory tests. Some of the field tests used have been discussed in earlier sections of this module. Commonly used laboratory tests are unconfined compression, triaxial, direct shear, and CBR tests. Resonant column tests are used where dynamic or earthquake loads are expected.

Both undisturbed and remolded or compacted samples are used for strength tests. Where soils are to be disturbed and remolded, compacted or stabilized specimens are tested for strength determination at specified moisture contents and densities. These may be chosen on the basis of design requirements or the in situ density and moisture content of soils. Where obtaining undisturbed samples is not practical (i.e., non-cohesive soils) specimens remolded to close proximity of their natural moisture content and density are prepared for testing. If the in situ density is not known, a series of tests is conducted on soils in their loosest, densest and intermediate states.

#### Choice of Total or Effective Stress Analysis

Before the designer selects strength tests he/she must choose whether the total or effective stress analysis is appropriate. Following is a brief discussion on the choice of type of analysis and tests for some common cases (Bishop and Henkel, 1962; Carter and Bentley, 1990).

#### Foundations

Foundations impose both shear stresses and compressive stresses (confining pressures) on the underlying soil. The shear stress must be carried by the soil skeleton but the compressive stresses are initially carried largely by the resulting increase in pore water pressures as explained in Sections 7.1.2 and 7.1.3. This leaves the effective stresses little changed, which implies that the foundation loading is not accompanied by any increase in shear strength. As excess pore pressures dissipate, the soil consolidates and effective stresses increase, leading to an increase in shear strength. Thus, for foundations, it is the short term condition - the immediate response of the soil - that is most critical. This is the justification for the use of quick undrained shear strength tests and total stress analysis for foundation design.

#### Excavations

With excavations, compressive stresses are reduced by removal of soil but shear stresses are imposed on the sides of the excavation owing to removal of lateral support. Initially, the reduction in compressive stresses is manifested within the soil mainly as a reduction in pore water pressures, with little change in effective stresses so that, as with foundations, soil shear strength remains little affected by the changed loading. Eventually, water flows into the soil that forms the excavation sides, restoring the pore-water pressures. This reduces the effective stresses, causes swelling and reduces shear strength. Thus, for excavations, long-term conditions may be more critical particularly for excavations in overconsolidated clay. Since long-term pore pressures depend on drainage conditions and cannot be simulated by soil tests, an effective stress analysis must be used so that pore water pressures can be considered separately from stresses in the soil skeleton.

## Embankments

During embankment construction, additional layers of material impose a pressure on the lower part of the embankment. As with structural foundations, this tends to create increased pore water pressures and, by the same argument, short-term conditions are an important consideration. This implies that total stress analysis and quick undrained shear strength tests are appropriate, and up to the 1960s it was not uncommon for embankments to be designed in this way. However, additional stresses can be created by the compaction process itself but, offsetting this, the material is unlikely to be saturated so that a significant proportion of the added pressures may be carried immediately by the soil skeleton. These complications make it impossible to simulate the total response of the soil in a test specimen, and, to overcome this, effective stress analysis is now used. Also, it is usually more economical to design embankments for long-term stability and to monitor pore water pressures during construction, slowing down the rate of construction where necessary, to keep them within safe limits.

A special case of embankment stability, often quoted in text books, is that of the rapid drawdown of water level behind an embankment dam. In this case, the soil in the embankment has had time to consolidate under its own weight (implying long-term conditions) but support from the adjacent water is withdrawn rapidly (implying short-term conditions). This can be simulated by the consolidated undrained (CU) triaxial test, in which the specimens are allowed to drain and consolidated under the applied cell pressure. Once consolidation is complete, specimens are sheared rapidly under conditions of no drainage. In this way, the response of the soil to both long-term consolidation and short-term shearing is simulated in the test, allowing a total stress analysis to be used. The simulation of long-term conditions in a test is assumed to be possible in this case because the water in the reservoir ensures that the soil on the up-stream face of the dam will always be saturated. However, the rapid drawdown condition can be better, more thoroughly analyzed in terms of effective stresses, using the effective stress strength parameters which must be measured anyway for normal long-term stability analysis of the dam slopes. The use of the CU test without pore pressure measurement is still necessary for the initial design of embankments which may be subject to rapid drawdown conditions.

## Natural Slopes

Natural slopes represent the ultimate long term equilibrium state of a profile formed by geologic processes. The pore pressures are controlled by the prevailing groundwater conditions which correspond to steady seepage subject to minor seasonal variations in the groundwater level. In principle, the analysis is the same as that for the long term equilibrium of a cut or an excavation. Thus for natural slopes, an effective stress analysis is appropriate.

<b>Unconfined Compressive Strength of Soils</b>	
AASHTO ASTM	T 208 D 2166
Purpose	To determine the undrained cohesive strength ( $c_u$ ) of cohesive soils.
Procedure	<p>As the test designation implies, the soil specimens are tested without any confinement or lateral support (<math>\sigma_3=0</math>) (Figure 7-3). Axial load is rapidly applied to the sample to cause failure. At failure the total minor principal stress is zero (<math>\sigma_3=0</math>) and the total major principal stress is <math>\sigma_1</math> (see Figure 7-4). In common terminology, the value of <math>\sigma_1</math> is written as <math>q_u</math> and is referred to as the unconfined compression strength. Since the undrained strength is independent of the confining pressure, <math>c_u = \sigma_1/2</math> or <math>q_u/2</math>.</p> <div style="text-align: center;"> <p style="text-align: center;">Normal Stress, <math>\sigma</math> (Total Stress) <math>\sigma = q_u =</math> Compressive Strength</p> </div> <p>Figure 7-4: Mohr Diagram for Unconfined Compressive Test</p>
Commentary	<p>The determination of unconfined compressive strength of undisturbed, remolded or compacted soils is limited to cohesive or naturally or artificially cemented soils. Since the angle of internal friction, <math>\phi</math>, is inherently zero, application of this test to non-cohesive soils may result in underestimation of the shear strength.</p> <p>The shear strength measured as per this procedure is a reasonable approximation of the undrained in situ strength. If used by experienced personnel, it provides reliable results. The stress-strain relationship curves and failure modes observed during testing provide an understanding of the soil properties in addition to strength. For example, an ill-defined failure or yielding of the sample under continuing loading signifies a relatively soft, fat clay, while a sudden failure indicates the brittle structure of a desiccated clay or cemented material. The stress-strain curves developed from these tests should be used with caution when determining soil modulus for input to numerical analyses, such as finite element analysis, which are very sensitive to minor variations of the modulus.</p> <p>Soils with inclined fissures, sand and silt lenses and slickensides have a tendency to fail prematurely along these weaker planes in unconfined compression tests. It is essential therefore that such failure modes be reported to the geotechnical engineer, who in turn may want to request further, more sophisticated testing such as triaxial tests to obtain more realistic determination of the in situ strength.</p> <p>The test is inexpensive and requires a relatively short period of time to complete. However, due to the absence of lateral pressures and lack of control over pore pressures it has inaccuracies.</p>

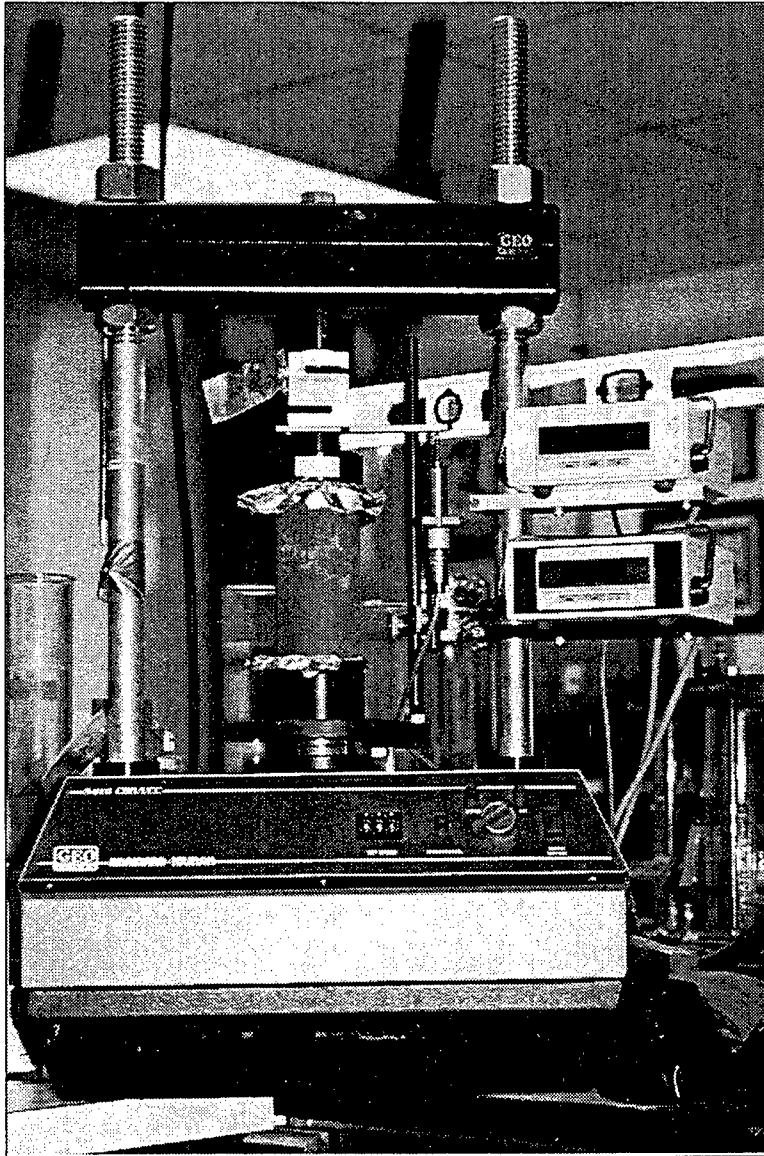

Figure 7-3: Unconfined Compressive Strength Test.

<b>Triaxial Strength</b>	
AASHTO ASTM	T 296, T 297 D 2850, D 4767
Purpose	To determine strength characteristics of soils including detailed information on the effects of confinement and lateral stresses, pore pressure, drainage and consolidation. Triaxial tests may also be used to determine the angle of internal friction of mixed soils (i.e., sandy clay) or to compensate for the effects of various intrusions and fissures and Young's Modulus and damping coefficient of soils for foundations subjected to dynamic loads.
Procedure	<p>A triaxial test set-up is shown in Figure 7-5. Test samples are typically 50 to 75 mm in diameter and have a height to length ratio between 2 and 3. The sample is encased by a thin rubber membrane and placed inside a plastic cylindrical chamber that is usually filled with water or glycerine. The sample is subjected to a confining pressure (<math>\sigma_3</math>) by compression of the fluid in the chamber. (Note that air is sometimes used as a compression medium.) To cause shear failure in the sample, axial stress is applied through a vertical loading ram (commonly called <i>deviator stress</i> = <math>\sigma_1 - \sigma_3</math>). Axial stress may be applied at a constant rate (strain controlled) by means of a hydraulic press or through dead weight increments or hydraulic pressure (stress controlled) until the sample fails.</p> <p>The axial load applied by the loading ram corresponding to a given axial deformation is measured by a proving ring or load cell attached to the ram. Connections to measure drainage into or out of the sample, or to measure pressure in the pore water (as per test conditions) are also provided.</p>
Commentary	<p>In general, there are five types of triaxial tests:</p> <ul style="list-style-type: none"> <li>• Undrained Unconsolidated (UU test)</li> <li>• Consolidated Undrained (CU test)</li> <li>• Consolidated Drained (CD test)</li> <li>• Consolidated Undrained with pore pressure measurement (<math>\overline{\text{CU}}</math> test)</li> <li>• Cyclic loading</li> </ul> <p>In a UU test, the samples are not allowed to drain or consolidate prior to or during the testing. The results of undrained tests depend on the degree of saturation (S) of the specimens. Where S=100%, the test results will show the angle of internal friction <math>\phi=0</math> and a cohesion value of <math>c_u</math> (theoretically equal to that obtained in the unconfined compression test) (Figure 7-6). This test does not produce reliable results for saturated granular (S=100%) soils.</p> <p>The UU test is fast and mainly applicable in cases where subgrade soils will be loaded quickly without allowing time for foundation materials to consolidate. Such a case may occur during the time period soon after construction of an embankment over a soft clay layer.</p> <p>In CU tests without pore pressure measurements, the specimen is allowed to drain and consolidate under the confining pressure of the cell. Once the primary consolidation is completed (as determined from pore pressure observations), the drainage is blocked and the deviator stress is applied. Undrained cohesion and <math>\phi</math> angles can be determined for most soils from CU test results. The CU test is applicable where a rapid drawdown condition is expected or when an embankment or other load is expected to be quickly imposed upon an existing, consolidated subgrade. The pore pressure and lateral loading conditions expected to develop in the field can be reasonably duplicated in the laboratory. The test procedure is time consuming and relatively expensive.</p>

<b>Triaxial Strength</b>	
AASHTO ASTM	T 296, T 297 D 2850, D 4767
Commentary (Continued)	<p><math>\overline{CU}</math> tests are performed in the same manner as CU tests except that pore pressure measurements are obtained during loading. This allows determination of the undrained shear strength parameters, <math>c</math> and <math>\phi</math>, described above. In addition, the pore pressure data can be used to determine the drained, or effective, shear strength parameters, <math>c'</math> and <math>\phi'</math> (Figure 7-7).</p> <p>CD tests are performed by first consolidating the specimen. Failure loads are then applied slowly while the specimen is allowed to drain and dissipate the excess hydrostatic pressures. CD tests are used to determine the drained shear strength parameters <math>c'</math> and <math>\phi'</math>, which are generally applicable for evaluating long term loading conditions.</p> <p>For CU, <math>\overline{CU}</math>, and CD tests, usually three or more confining pressures are used to develop a strength envelope by the use of Mohr diagrams as shown in Figure 7-7.</p> <p>Cyclic loading tests may be performed using the triaxial equipment similar to those used for consolidated-undrained triaxial tests by applying a uniform sinusoidal load. The resulting axial strains and stresses are measured to compute modulus of damping.</p> <p><u>Selection of confining pressures:</u> The triaxial tests are usually conducted at confining pressures which approximately simulate the state of effective stresses at the depth at which the sample was obtained. Usually three confining pressures are chosen. For analysis of cut slopes and other cases where the vertical stress is not increased, the selected confining pressures can be equal to the existing effective overburden pressure <math>\sigma'_v</math>, <math>0.8\sigma'_v</math>, and <math>1.2\sigma'_v</math>. For cases such as foundation or embankment construction, where vertical stresses are increased, the selected confining pressure can be equal to the existing effective overburden pressure (<math>\sigma'_v</math>), the maximum anticipated future vertical pressure (<math>\sigma'_v + \Delta p</math>), and an intermediate pressure.</p>

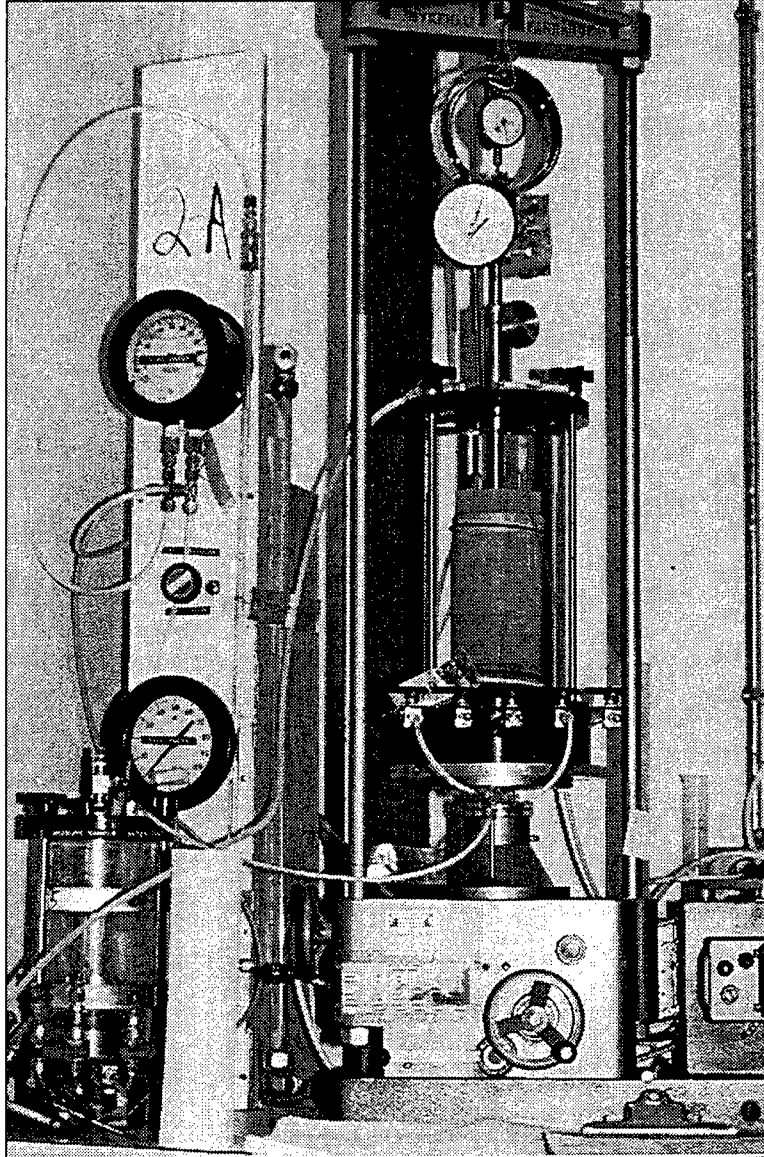

Figure 7-5: Triaxial Test Set-Up.



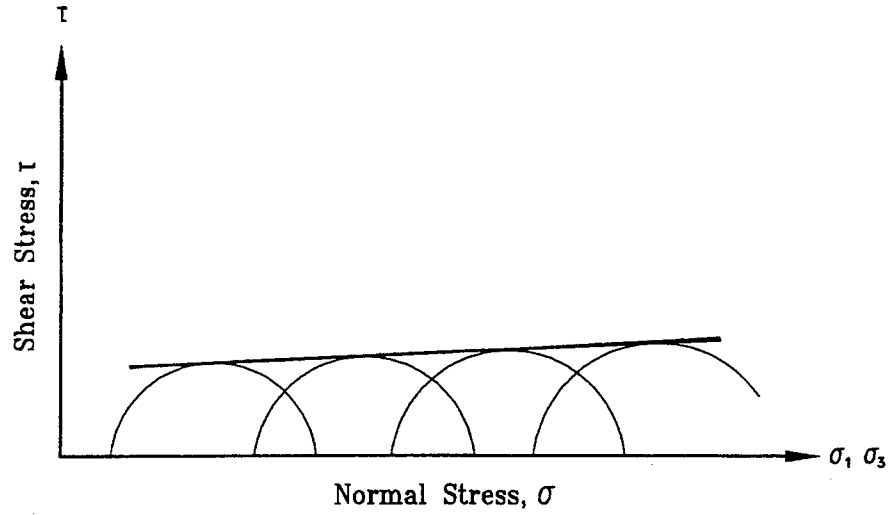

Figure 7-6: Mohr Diagram for Undrained Unconsolidated (UU) Triaxial Compression Test.

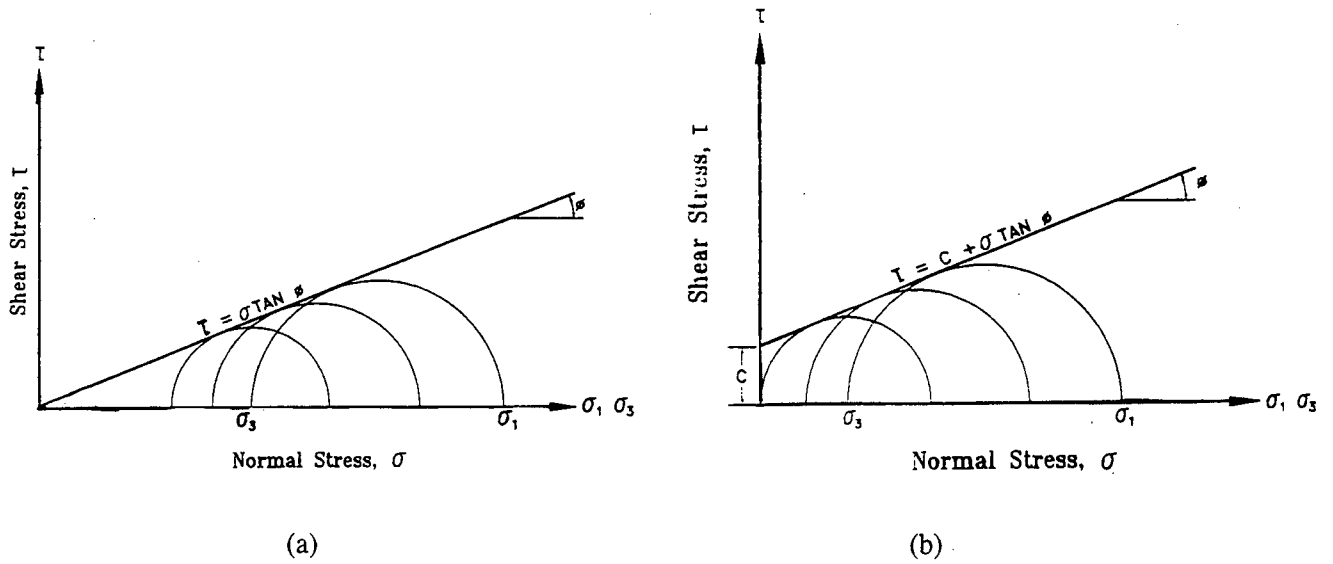

Figure 7-7: Mohr Diagram (a) Consolidated Drained (CD) Triaxial Test, (b) Consolidated Undrained (CU) Triaxial Test.

<b>Direct Shear</b>	
AASHTO ASTM	T 236 D 3080
Purpose	To determine the shear strength of soils along a defined planar surface
Procedure	The direct shear test is performed by placing a specimen into a cylindrical or square-shaped direct shear box which is split in the horizontal plane (Figure 7-8). A vertical (normal) load is applied over the specimen. While either the upper or lower part of the box is held stationary, a horizontal load is exerted on the other part of the box in an effort to shear the specimen on a predefined horizontal plane (Figure 7-9). The test is repeated at least three times using three different normal loads. The results are plotted in the form of normal loads versus strength or stress at failure as shown in Figure 7-9c. The cohesion and angle of internal friction values can be determined from this plot. Unconsolidated undrained, consolidated undrained and consolidated drained tests can be run in the direct shear device.
Commentary	<p>The direct shear test is the oldest and simplest form of shear test arrangement. However, it has several inherent shortcomings due to which the reliability of the results may be questionable. The shortcomings are as follows:</p> <ul style="list-style-type: none"> <li>• The failure plane is predefined and horizontal; this plane may not be the weakest.</li> <li>• The area of the failure plane decreases as the test progresses, which may introduce errors in computing unit stresses.</li> <li>• As compared to the triaxial test, there is little control on the drainage of the soil.</li> <li>• The stress conditions across the soil sample are very complex. The distribution of normal stresses and shearing stresses over the sliding surface is not uniform; typically the edges experience more stress than the center. Due to this, there is progressive failure of the specimen, i.e., the entire strength of the soil is not mobilized simultaneously.</li> </ul> <p>In spite of the above shortcomings, the direct shear test is commonly used as it is simple and easy to perform. It does provide reasonably reliable values for cohesion and angle of internal friction. It is most suitable for determining the angle of internal friction of non-cohesive soils. Research has shown that for soils with angles of internal friction of 35 degrees or more, the direct shear test may produce results as much as 4 degrees higher than that obtained by triaxial tests. Below 35 degrees there appears to be good correlation with values obtained from triaxial tests.</p> <p>The direct shear test is particularly applicable to those foundation design problems where it is necessary to determine the angle of friction between the soil and the material of which the foundation is constructed, e.g., the friction between the base of a concrete footing and underneath soil. In such cases, the lower box is filled with soil and the upper box contains the foundation material.</p> <p><b>Direct Simple Shear (DSS) Test</b></p> <p>The DSS test was developed in an attempt to refine the direct shear test and overcome its inherent uncertainties. Earlier DSS test devices used a cylindrical specimen confined in rubber membrane reinforced with a series of evenly spaced rigid rings. Later versions developed by the Norwegian Geotechnical Institute (NGI) used square specimens with hinged end plates that could tilt to maintain fixed specimen length during shearing. The NGI version is used by a number of European geotechnical agencies. Some of the studies performed show that this device provides a means of studying plane strain (i.e., embankment loads). Other studies show that similar to the conventional direct shear test, the DSS test also has its inherent shortcomings, such as non-uniform stress distribution during shearing.</p>

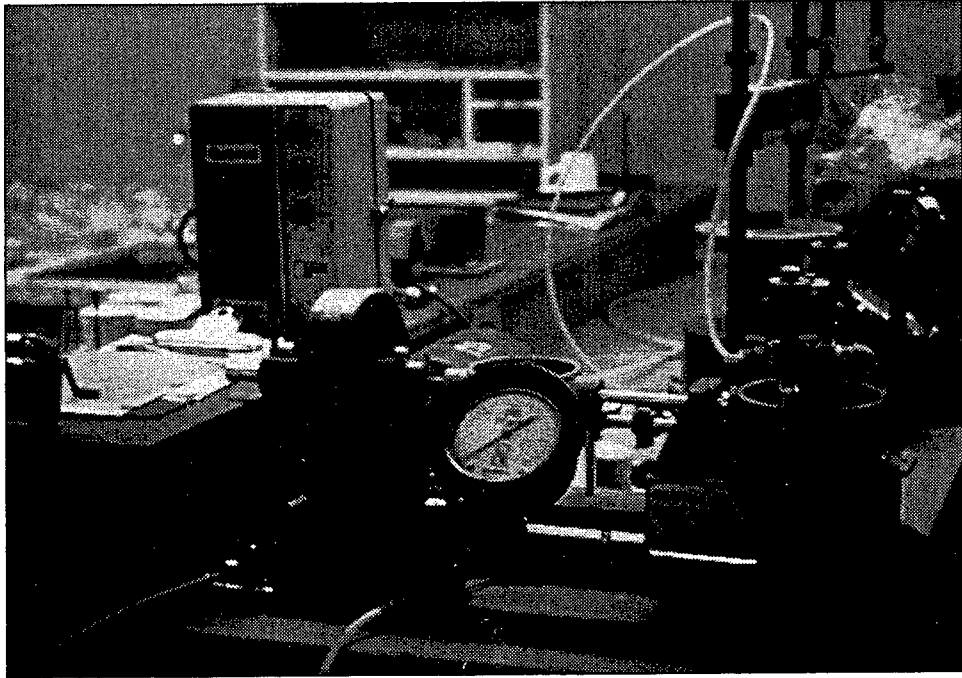

Figure 7-8: Direct Shear Test.

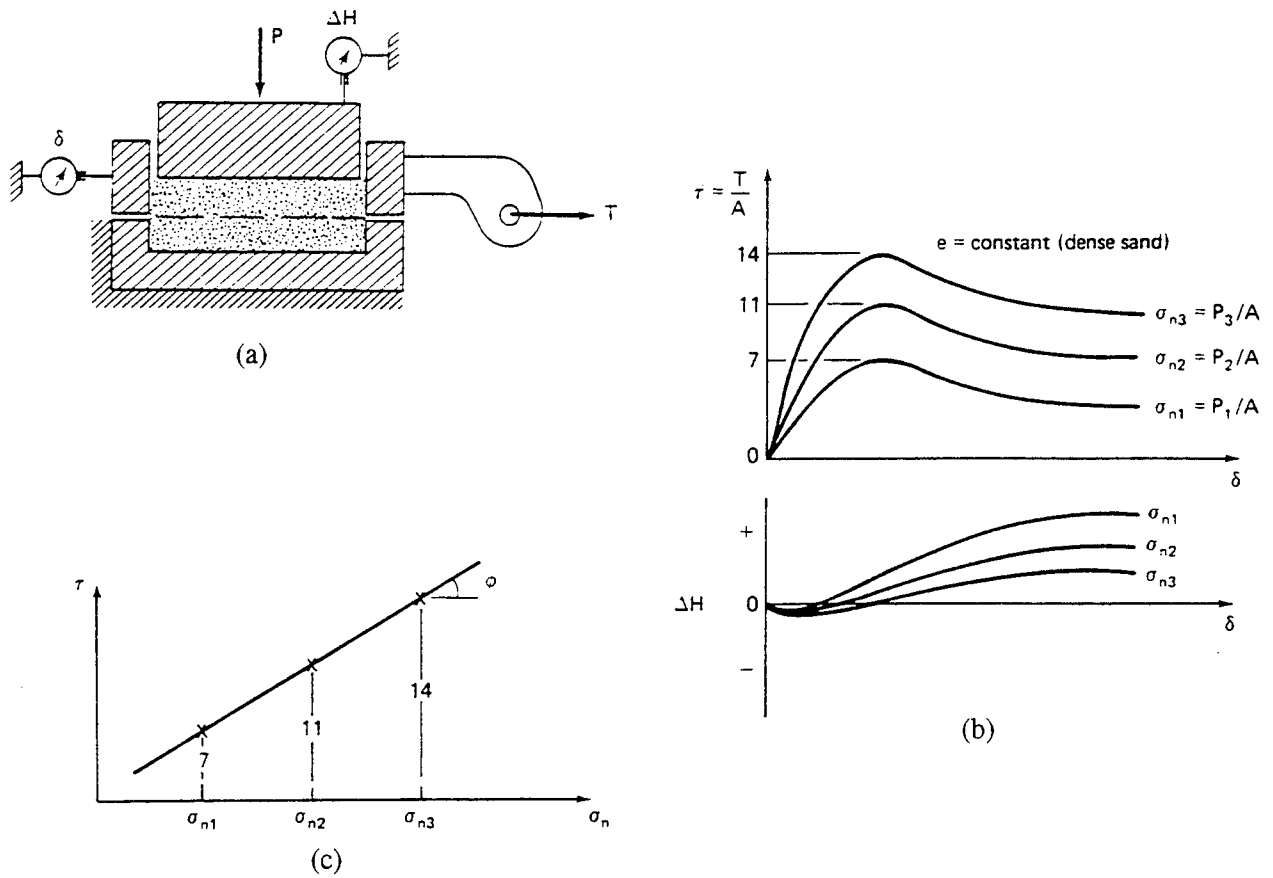

Figure 7-9: (a) Schematic of a Direct Shear Test Set-up, (b) Typical Results, (c) Determination of Shear Strength Parameters.

<b>Resilient Modulus</b>	
AASHTO ASTM	T 294 -
Purpose	To determine the constitutive relationships between stress and loading of pavement component materials.
Procedure	A compacted or undisturbed cylindrical specimen is placed in an oversized triaxial chamber. An axial deviator stress of constant magnitude and duration and frequency is applied at the same time that a lateral stress is maintained in the triaxial chamber. The recoverable or resilient axial strain of the specimen is measured for varying increments of axial stresses.
Commentary	The test is time-consuming and requires special test and laboratory setup. One specimen can be used for a variety of axial loads. Both undisturbed and disturbed specimens representing the pavement materials can be used. Sample preparation of remolded specimens requires a thorough appreciation of the existing or expected field conditions. Values obtained can be used to determine the linear or non-linear elastic response of pavements.

<b>Resonant Column</b>	
AASHTO ASTM	- D 4015
Purpose	To determine the shear modulus, shear damping and Young's moduli of soils for cases where dynamic forces are involved.
Procedure	Specially prepared cylindrical specimens are placed in an oversized triaxial chamber. Very low amplitude, longitudinal or torsional vibrations are applied to one end of the specimen. The resonant frequency, the system damping and the strain amplitudes are measured at various stages of the test by the use of motion transducers.
Commentary	The test is time-consuming and requires special test and laboratory setup. Ambient vibrations, if not known, substantially alter the test results. When performed by experienced specialists, the test is reliable. Similar results can be obtained from a series of field seismic tests.

<b>Miniature (Shear) Vane</b>	
AASHTO ASTM	- D 4648
Purpose	To determine the undrained shear strength of saturated clays where $\phi=0$
Procedure	The test is performed by inserting a four-bladed vane into the soil and rotating it by applying a torque to shear a cylindrical surface. The shear strength is computed from the torque required to shear the soil. The miniature vane is similar to the field vane shear device, except that it is smaller (blade diameter 12.7 mm, blade height 25.4 mm).
Commentary	<p>The test assumes that the stresses applied are limited to the cylindrical surface represented by the diameter and the height of the vane. This is hardly the case in reality. Depending on the cohesion and stiffness, the soils in an area radiating outward from the surface of the idealized cylindrical zone are also disturbed by the shearing action of the vane. A portion of the torque therefore is used to mobilize this zone. Thus the assumption that the only sheared zone is the one defined by the outline of the vane blades introduces varying degrees of error.</p> <p>The analysis of the test also assumes that strength of the soil being tested is isotropic, which is not true for all deposits. The test is, however, a useful tool for measuring anisotropy and residual strength of saturated cohesive soils.</p> <p>The laboratory vane shear test should not be used as strength test. It is an index test and it will only provide relative values and not true strength.</p>

<b>California Bearing Ratio (CBR)</b>	
AASHTO ASTM	T 193 D 4429 (for field); D 1883 (for laboratory)
Purpose	To determine the bearing capacity of a soil under controlled moisture and density conditions.
Procedure	<p>The test results are expressed in terms of a bearing ratio which is commonly known as the California Bearing Ratio (CBR). The CBR number (or, simply CBR) is obtained as the ratio of the unit load required to cause a certain depth of penetration of a piston into a compacted specimen of soil at some water content and density, to the <i>standard unit load</i> required to obtain the same depth of penetration on a standard sample of crushed stone (usually limestone).</p> <p>The CBR test is run on three identically compacted samples. Each series of the CBR test is run for a given relative density and moisture content. The geotechnical engineer must specify the conditions (dry, at optimum moisture, after soaking, 95% relative density, etc.) under which each test should be performed.</p>
Commentary	CBR is a practical bearing capacity test. Various well-established, tried and proven pavement design methods are based on the CBR value derived from field or laboratory tests. The test results are used for highway, airport, parking lot and other pavement designs using empirical local or agency-specific methods (i.e., FHWA, FAA, AASHTO, etc.).

<b>R-Value Test</b>	
AASHTO ASTM	T 190 D 2844
Purpose	To determine the ability of a soil to resist lateral deformation when a vertical load acts upon it. The resistance is indicated by the R-value.
Procedure	<p>Measuring the R-value of a soil is done with a stabilometer. A stabilometer is similar to a triaxial device consisting of a metal cylinder in which there is a rubber membrane; the annular space between the two is filled with oil that transmits lateral pressure to the specimen.</p> <p>Compacted, unstabilized or stabilized soils and aggregates, can be used in these tests. Samples are compacted using a special kneading compaction device. When the specimen is vertically loaded, a lateral pressure is transmitted to the soil, which can be measured on a pressure gage. From the displacement measured for a specified lateral pressure, the R-value is determined.</p>
Commentary	<p>The R-Value test was developed by the California Division of Highways for use in the empirical design method developed by them. Later it was widely adopted for use in pavement design. The kneading compactor used to prepare the test samples is considered to more closely model the compaction mode of field equipment by its kneading action. Specimens fabricated by this method develop internal structures more representative of actual field compacted materials where soil particles are kneaded together rather than densified by impact force.</p> <p>The R-Value is used either directly or translated into more common factors (i.e., CBR) through correlation charts to be used with other more common design methods (i.e., AASHTO). This test method indirectly measures the strength of pavement materials by measuring the resistance to deformation under lateral and normal stresses.</p> <p>The test also allows the measurement of swell pressure of expansive soils. The strength data is used in the design of pavements to determine the thickness of various components of pavement structures. The swell pressure or expansion pressure data is used in determining the suitability of expansive soils for use under pavements and the intensity of stress needed, in the form of overburden, to control the expansion of these soils.</p>

### 7.1.9 Permeability

<b>Permeability of Soils</b>	
AASHTO ASTM	T 215 D 2434, D 5084
Purpose	To determine the potential of flow through soils.
Procedure	<p>The ease with which a fluid passes through a porous medium is expressed in terms of coefficient of permeability, <math>k</math>. There are two standard types of test procedures to directly determine <math>k</math>. These are the constant-head and the falling-head procedures (see Figure 7-10).</p> <p>In both procedures, undisturbed, remolded or compacted samples can be used. The permeability of coarse materials is determined by the constant head permeability test. The permeability of clays is normally determined by the use of a falling head permeameter. The difference between the two tests is that in one case the hydraulic gradient affecting the permeability of the specimen is kept constant, while in the other it is allowed to decrease as the water permeates the specimen. Estimates of permeability are obtained from time required for a measured volume of water to pass through the soil as shown in Figure 7-10.</p>
Commentary	<p>Permeability or the ease with which liquids move through porous media is one of the major parameters used in selecting the suitability of soils and their treatment for various types of construction.</p> <p>In some cases it may be desirable to place a high-permeability material immediately under a pavement surface to facilitate the removal of water seeping into the base or sub-base courses. In other cases, such as retention pond dikes, it may be detrimental to use high-permeability materials. Permeability also significantly influences the choice of backfill materials.</p> <p>Both test procedures determine permeability of soils under specified conditions. The geotechnical engineer must establish which test conditions are representative of the problem under consideration. As with all other laboratory tests, the geotechnical engineer has to be aware of the limitations of this test. The process is sensitive to the presence of air or gases in the voids and in the permeant or water. Prior to the test, distilled, de-aired water should be run through the specimen to remove as much of the air and gas as practical. It is a good practice to use de-aired or distilled water at temperatures slightly higher than the temperature of the specimen. As the water permeates through the voids and cools, it will have a tendency to dissolve the air and some of the gases, thus removing them during this process. The result will be a more representative, albeit idealized, permeability value.</p> <p>The type of permeameter, (i.e., flexible wall versus rigid) may also affect the final results. For testing of fine-grained, low-permeability soils, the use of flexible-wall permeameters is recommended which are essentially very similar to the triaxial test apparatus (see Figure 7-11). When rigid wall units are used, the permeant may find a route at the sample-permeameter interface, thus it may drain through that interface rather than travel through the specimen. This will produce erroneous results.</p> <p>It should also be emphasized that permeability is sensitive to viscosity. In computing permeability, the correction factors for viscosity and temperatures should be applied. During testing, the temperature of the permeant and the laboratory should be kept constant.</p> <p>Laboratory permeability tests produce reliable results under ideal conditions. Permeability of fine-grained soils can also be computed from one-dimensional consolidation test results.</p>

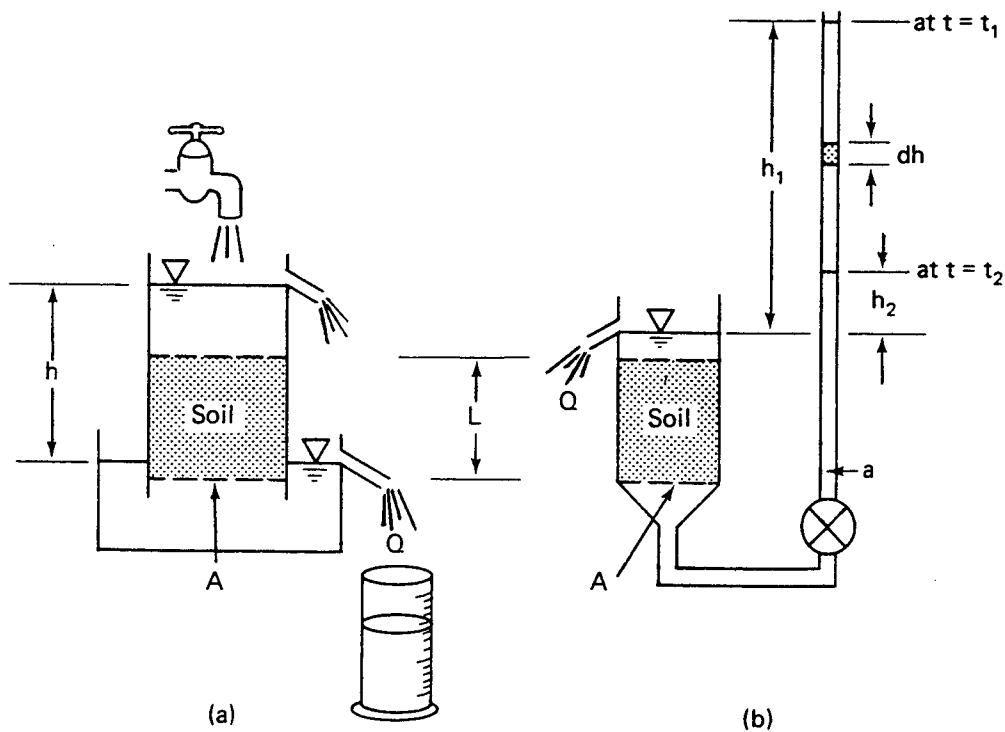

Computation of Coefficient of Permeability,  $k$

For Constant Head Test (Figure a):

$$k = \frac{QL}{h A t} \tag{7-3}$$

where  $Q$  = total discharge volume,  $m^3$ , in time,  $t$  (seconds), and  
 $A$  = cross-sectional area of soil sample,  $m^2$

For Falling Head Test (Figure b)

$$k = 2.3 \frac{aL}{A \Delta t} \log_{10} \frac{h_1}{h_2} \tag{7-4}$$

where  $a$  = area of standpipe,  
 $A, L$  = soil sample area and length,  
 $\Delta t$  = time for standpipe head to decrease from  $h_1$  to  $h_2$ .

Figure 7-10: (a) Schematic of a Constant Head Test, (b) Schematic of a Falling Head Test.



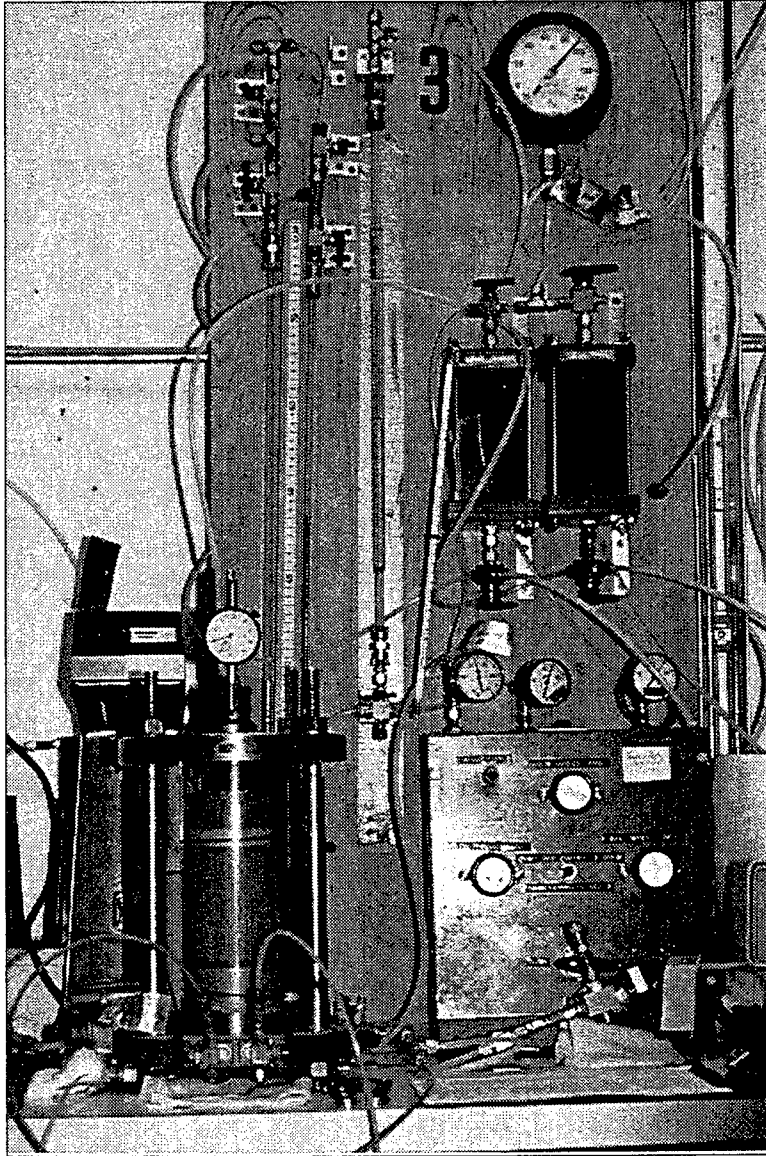

Figure 7-11: Flexible Wall Permeability Test.

### 7.1.10 Consolidation

Consolidation	
AASHTO ASTM	T 216 D 2435
Purpose	Determination of stress-strain-time properties of saturated soils under sustained loads
Procedure	<p>The test is generally performed using a small-diameter, thin specimen cut and trimmed out of an undisturbed sample. Selection of representative samples for testing is critical. Prepared samples are placed in a loading device and subjected to incremental loads, which are doubled every 24 hours. Experience has shown that for mineral soils in the laboratory, 24 hours is sufficient for the completion of the primary consolidation under a given increment.</p> <p>Generally, it is desirable to perform an unload-reload cycle during the test, with the unloading initiated at a loading increment along the virgin portion of the consolidation curve. The unload-reload cycle provides a more reliable estimate of the recompression characteristics of the soil.</p> <p>Figure 7-12 shows a schematic view of one dimensional consolidation test set-up. Typical results and parameters are shown and discussed in Section 9.3.2.</p>
<p>Figure 7-12: Schematic View of One-Dimensional Consolidation Test Set-Up.</p>	

## Consolidation

AASHTO ASTM	T 216 D 2435
Commentary	<p>When saturated soil masses are subjected to incremental loads, they undergo various degrees of dimensional change. Initially, the incremental load is resisted and carried by the liquid phase of the soil, which develops excess hydrostatic pressure (equivalent to the load) in the soil voids. Depending on the permeability and the availability of drainage layer(s) in contact with the soil, the liquids in the voids begin draining and continue to do so until the excess hydrostatic pressure is dissipated. As the hydrostatic pressure decreases, a proportional amount of the incremental load is transferred to the solid portion of the soil. When the excess hydrostatic pressure reaches zero, all of the new load is carried by the soil's solids.</p> <p>This gradual transfer of stresses causes the soil particles to reorient themselves. Soils thus go through plastic deformation called primary consolidation. In granular, high-permeability soils, this transfer takes place very quickly (since water can drain fast); therefore, consolidation of these soils takes place and is completed during early stages of loading. In cohesive, low-permeability soils, primary consolidation may take a long time, which may affect the long-term performance of the structures supported by these soils.</p> <p>The one-dimensional consolidation test is most commonly used for the determination of consolidation properties of soils. This test method assumes that dimensional change due to consolidation will take place in the vertical direction. This assumption is generally acceptable for stiff or medium, confined cohesive soils, but it is not true for soft soils or for soils that are not confined (i.e., bridge approaches). The data and the analysis produced from this test have proved to be reasonably reliable.</p> <p>In many clays the primary consolidation is typically followed by secondary compression which is caused by the reorientation of the viscous, physiochemically held water on soil particles under continued loading. In thick clay deposits, the magnitude of secondary compression may be substantial. For soils known for their tendency to have significant secondary compression particularly under heavy incremental loads, it may be necessary to predict the long-term effects of secondary compression. In that case, each incremental of the test load is left in place until such time that the time-settlement curve plotted for that load becomes asymptotic to a horizontal line.</p> <p>Heavy organic clays also require longer loading periods. The time-settlement curves produced by heavy organic soils may not clearly show the end of the primary consolidation. In those cases, it may be necessary to monitor the pore pressures of the soil to determine the end of the primary stage. It should be noted that the magnitude of secondary, long term, compression of highly (20% or more) organic soils may be as large or larger than the primary consolidation. Secondary compression in these soils takes place as a result of the continuing compression of organic fibers. The substantial dissipation of the excess hydrostatic pressures during the test does not signal the end of significant compression; expulsion of absorbed water with associated compression from the body of the fiber itself may continue for a long period of time.</p>

<b>Swell Potential of Clays</b>	
AASHTO ASTM Test	T 256 D 4546
Purpose	To estimate the swell potential of (expansive) soils
Procedure	The swell potential is determined by observing the swell of a laterally confined specimen when it is surcharged and flooded. Alternatively, after the specimen is inundated the height of the specimen is kept constant by adding loads. The vertical stress necessary to maintain zero volume change is the swelling pressure.
Commentary	<p>Swelling is a characteristic reaction of some clays to saturation. The potential for swell depends on the mineralogical composition. While montmorillonite (smectite) exhibits a high degree of swell potential, illite has none to moderate swell characteristics, and kaolinite exhibits almost none. The percentage of volumetric swell of a soil depends on the amount of clay, its relative density, the compaction moisture and density, permeability, location of the water table, presence of vegetation and trees, overburden pressure, etc. Swelling of foundation, embankment or pavement soils result in serious and costly damage to structures above them.</p> <p>It is therefore important to estimate the swell potential of these soils. The one dimensional swell potential test is used to estimate the percent swell and swelling pressures developed by the swelling soils.</p> <p>This test can be performed on undisturbed, remolded or compacted specimens. It provides a reliable measure of one dimensional swell pressures and percentages. However, if the soil structure is not confined (i.e. bridge abutment) such that swelling may occur laterally as well as vertically, triaxial test chambers can be used to determine three dimensional swell characteristics.</p>

<b>Collapse Potential of Soils</b>	
AASHTO ASTM	- D 5333
Purpose	To estimate the collapse potential of soils
Procedure	The collapse potential of suspected soils is determined by placing an undisturbed, compacted or remolded specimen in the consolidometer ring and in a loading device at their natural moisture content. A load is applied and the soil is saturated to measure the magnitude of the vertical displacement.
Commentary	<p>Loess or loess type soils is predominantly composed of silts, and contain 3% to 5% clay. Loess deposits are wind blown formations. Loess type deposits have similar composition and they are formed as a result of the removal of organics by decomposition or the leaching of certain minerals (calcium carbonate). In both cases disturbed samples obtained from these deposits will be classified as silt. When dry or at low moisture content the in situ material gives the appearance of a stable silt deposit. At high moisture contents these soils collapse and undergo sudden changes in volume. Loess, unlike other non-cohesive soils, will stand on almost a vertical slope until saturated. It has a low relative density, a low unit weight and a high void ratio. Structures founded on such soils, upon saturation, may be seriously damaged from the collapse of the foundation soils.</p> <p>The collapse during wetting occurs due to the destruction of clay binding which provide the original strength of these soils. It is conceivable that remolding and compacting may also destroy the original structure.</p>

## 7.2 QUALITY ASSURANCE FOR LABORATORY TESTING

The ability to maintain the quality of samples is largely dependent on the quality assurance program followed by the field and laboratory staff. Significant changes in the material properties may take place as a result of improper storage, transportation and handling of samples resulting in misleading test, and therefore design, results.

### 7.2.1 Storage

Undisturbed soil samples should be transported and stored such that their structure and their moisture content are maintained as close to their natural conditions as practicable (AASHTO T 207, ASTM D 4220 and 5079).

Specimens stored in special containers should not be placed, even temporarily, in direct sunlight. Undisturbed soil samples should be stored in an upright position with the top side of the sample up.

Long term storage of soil samples should be in temperature controlled environments. The temperature control requirements may vary from subfreezing to ambient and above, depending on the environment of the parent formation. The relative humidity for soil storage normally should be maintained at 90 percent or higher.

Long term storage of soil samples in sampling tubes is not recommended. During long term storage the sample tubes may experience corrosion. This accompanied by the adhesion of the soil to the tube may develop such resistance to extrusion that some soils may experience internal failures during the extrusion. Often these failures can not be seen by the naked eye; only x-ray radiography (ASTM D 4452) will reveal the presence of such conditions. If these samples are tested as undisturbed specimens the results may be misleading.

Long term storage of samples, even under the best conditions, may cause changes in the characteristics of the of samples. Research has shown that soil samples stored more than fifteen or more days undergo substantial changes in strength characteristics. Soil samples stored for long periods of time provide poor quality specimens, and often unreliable results. Stress relaxation, temperature changes and prolonged exposure to the environment in these cases may have serious impacts on the sample characteristics.

### 7.2.2 Sample Handling

Careless handling of undisturbed soil samples may cause major disturbances with serious design and construction consequences.

Samples should always be handled by experienced personnel in a manner that, during preparation, the sample maintains its structural integrity and its moisture condition. Saws and knives used to trim soils should be clean and sharp. Preparation time should be kept to a minimum, especially where the maintenance of the moisture content is critical. Specimens, during their preparation, should not be exposed to direct sun or to precipitation. If samples, in or out of containers, are dropped it is reasonable to expect that they will be disturbed. They should not be used for critical tests (i.e. elastic moduli, triaxial) requiring undisturbed specimens.

### **7.2.3 Specimen Selection**

The selection of representative specimens for testing is one of the most important aspects of sampling and testing procedures. Selected specimens must be representative of the formation or deposit being investigated. Seldom one finds a uniform homogeneous deposit or formation.

The senior laboratory technician, the geologist and/or the geotechnical engineer need to study the drilling logs, understand the geology of the site, and visually examine the samples before selecting the test specimens. Samples should be selected on the basis of their color, physical appearance, and structural features. Specimens should be selected to represent all types of materials present at the site, not just the worst or the best. Samples with discontinuities and intrusions may cause premature failures in the laboratory. They, however, would not cause such failures in situ. Such failures should be noted but not selected as representative of the deposit of the formation.

There is no single set of rules that can be applied to all specimen selection. In selecting the proper specimens, the geotechnical engineer, the geologist and the senior laboratory technician must apply their knowledge of the area, and their experience with the type of structures for which the testing is being performed.

### **7.2.4 Equipment Calibration**

All laboratory equipment should be periodically checked to verify that they meet the tolerances as established by the AASHTO and ASTM test procedures. Sieves, ovens, compaction molds, triaxial and permeability cells should be periodically examined to assure that they meet the opening size, temperature and volumetric tolerances. Compression or tension testing equipment, including proving rings and transducers should be checked quarterly and calibrated at least once a year using U.S. Bureau of Standards certified equipment. Scales, particularly electronic or reflecting mirror types, should be checked at least once every day to assure that they are leveled and in proper adjustment. Electronic equipment and software should also be checked periodically (i.e. quarterly) to assure that all is well.

### **7.2.5 Pitfalls**

Sampling and testing of soils are the most important and fundamental steps in the design and construction of all types of structures. Omissions or errors introduced in these steps, if gone undetected, will be carried through the process of design and construction resulting often in costly or possibly unsafe facilities. Table 7-4 lists some of the more common errors that result from careless handling of samples or laboratory procedures. Table 7-4 should in no way be construed as being a complete list of possible errors and omissions in handling or testing of soil specimens; there are many more. These are just some of the more common ones.

**TABLE 7-4**  
**SOME COMMON ERRORS DURING LABORATORY TESTING OF SOILS**

- 
1. Improperly protected samples; resulting in moisture loss and structural disturbance.
  2. Rough handling of samples during extrusion of samples; samples being extruded not properly supported upon their exit from the tube.
  3. Long term storage of soil samples in Shelby tubes.
  4. Improper numbering or identification of samples.
  5. Storage of samples in unfit environments.
  6. Visually examining and identifying of soil samples without removal of smear from the sample surface.
  7. Relying solely on pocket penetrometer or miniature vane reading for strength.
  8. Careless selection of "representative" specimens for testing.
  9. Not having a sufficient number of samples to select from.
  10. Selection of specimens without consulting the field logs.
  11. Selection of specimens without recognizing disturbances caused by sampling, the presence of cuttings, drilling mud or other foreign matter.
  12. Depending solely on the visual identification of soils for classification.
  13. Classifying soils as peat or organic without performing organic content tests. Visual classifications of organic soils may be very misleading.
  14. Drying soils in overheated or underheated ovens.
  15. Using old worn-out equipment; old screens for example, particularly fine (<No. 40) mesh ones need to be inspected and replaced often, worn compaction mold or compaction hammers (an error in the volume of a compaction mold is amplified 30x when translated to unit volume) should be checked and replaced if needed.
  16. Careless performance of Atterberg Limits; unadjusted drop height of the Liquid Limit machine, or too thickly or too thinly rolled Plastic Limit specimens.
  17. The use of tap water for tests where distilled water is specified.
  18. Improper curing of stabilization test specimens.
  19. Assuming that all samples are saturated as received.
  20. Saturation by improperly applying high back pressures.
  21. Use of poorly fitting o-rings, membranes etc. in triaxial or permeability tests.
  22. Uneven trimming of ends and sides of undisturbed samples.
  23. Missing slickensides and natural fissures. Not reporting slickensides and natural fissures.
  24. Mistaking failures due to slickensides as shear failures.
  25. Using unconfined compression test results (stress-strain curves) to determine elastic moduli.
  26. Terminating incremental loading of consolidation tests before the completion of the primary stage.
  27. Using improper loading rate for strength tests.
  28. Developing guesstimated e-log p curves from accelerated, incomplete consolidation tests.
  29. "Reconstructing" soil specimens, disturbed by sampling or handling, for undisturbed testing.
  30. Mislabeling of laboratory test specimens.
  31. Taking shortcuts: using non-standard equipment or non-standard test procedures.
  32. Failure to periodically calibrate testing equipment.
  33. Failure to test a sufficient number of samples to obtain representative results in variable material.
-





## CHAPTER 8.0 LABORATORY TESTING FOR ROCKS

### 8.1 INTRODUCTION

Rock testing is performed to determine the strength and elastic properties of intact specimens and degradation/disintegration potential of rock specimens. The parameters derived from the tests are used for the design of rock cuts and shallow and deep foundations, and for assessment of shore protection materials. Deformation and strength properties of intact specimens are also used to assess the larger-scale in situ rock mass properties. Other aspects of in situ rock mass properties that should be considered in evaluating rock mass strength and deformation include discontinuities (spacing, orientation, shear strength), hydrostatic conditions and rock stress history.

### 8.2 LABORATORY TESTS

Table 8-1 presents a summary list of laboratory rock tests recommended by ASTM, AASHTO and ISRM. There are no equivalent AASHTO standards for the routine rock tests cited. The following sections briefly discuss the routine tests used for a typical highway project involving construction in rock. They are denoted with an asterisk (\*) in Table 8-1.

#### 8.2.1 Strength Tests

The laboratory determination of the strength of rocks is done by the use of one of the following tests: point load strength, unconfined compression, and direct shear.

<b>Point-Load Strength Test</b>	
ISRM	
Purpose	To determine strength classification of rock materials through an index test.
Procedure	<p>Rock specimens in the form of core (diametral and axial), cut blocks or irregular lumps are broken by application of concentrated load through a pair of spherically truncated, conical platens. The distance between specimen-platen contact points is recorded. The load is steadily increased, and the failure load is recorded.</p> <p>There is little to no sample preparation. However, specimens should conform to the size and shape requirements as specified by ISRM. In general, for the diametral test, core specimens with a length/diameter ratio of 1.0 are suitable while for the axial test core specimens with length/diameter ratio of 0.3-1.0 are suitable. Samples for the block and the irregular lump test should have a length of <math>50 \pm 35</math> mm and a depth/width ratio between 0.3 and 1.0 (preferably close to 1.0). The test specimens are typically tested at their natural water content.</p> <p>Size corrections are applied to obtain the point load strength index, <math>I_{s(50)}</math>, of a rock specimen. A strength anisotropy index, <math>I_{a(50)}</math>, is determined when <math>I_{s(50)}</math> values are measured perpendicular and parallel to planes of weakness.</p> <p style="text-align: right;"><i>Continued on Page 8-3</i></p>

**TABLE 8-1  
AASHTO AND ASTM STANDARDS FOR LABORATORY TESTING OF ROCK**

Test Category	Name of Test	Test Designation	
		AASHTO	ASTM
Point Load Strength	Suggested method for determining point load strength	-	-
		ISRM*	
Compressive Strength	Compressive strength of intact core specimen (in unconfined compression)	-	D 2938*
	Creep-cylindrical hard rock core specimens, in uniaxial compression	-	D 4341
	Creep-cylindrical soft rock core specimens, in uniaxial compression	-	D 4405
	Creep-cylindrical hard rock core specimens, in triaxial compression	-	D 4406
	Triaxial compressive strength of undrained rock core specimens without pore pressure	T 226	D 2664
Tensile Strength	Direct tensile strength of intact rock core specimens	-	D 2936
	Splitting tensile strength of intact rock core specimens	-	D 3967
Direct Shear	Laboratory direct shear strength tests - rock specimens, under constant normal stress	-	D 5607*
Permeability	Permeability of rocks by flowing air	-	D 4525
Durability	Slake durability of shales and similar weak rocks	-	D 4644*
	Rock slab testing - riprap soundness, by use of sodium/magnesium sulfate	-	D 5240*
	Rock-durability, for erosion control under freezing/thawing conditions	-	D 5312*
Strength - Deformation	Elastic moduli of intact rock core specimens in uniaxial compression	-	D 3148*
	Laboratory determination of pulse velocities and ultrasonic elastic constants in rock	-	D 2845*

ISRM = International Society for Rock Mechanics

\* = Typical or routine rock testing procedures briefly described in this manual

### Point-Load Strength Test

ISRM

Commentary

The test can be performed in the field with portable equipment or in the laboratory (Figure 8-1). The point load strength index is often used to predict uniaxial compressive strength. On average, uniaxial compressive strength is 20 to 25 times point load strength. However, the ratio can vary between 15 and 50, especially for anisotropic rocks.

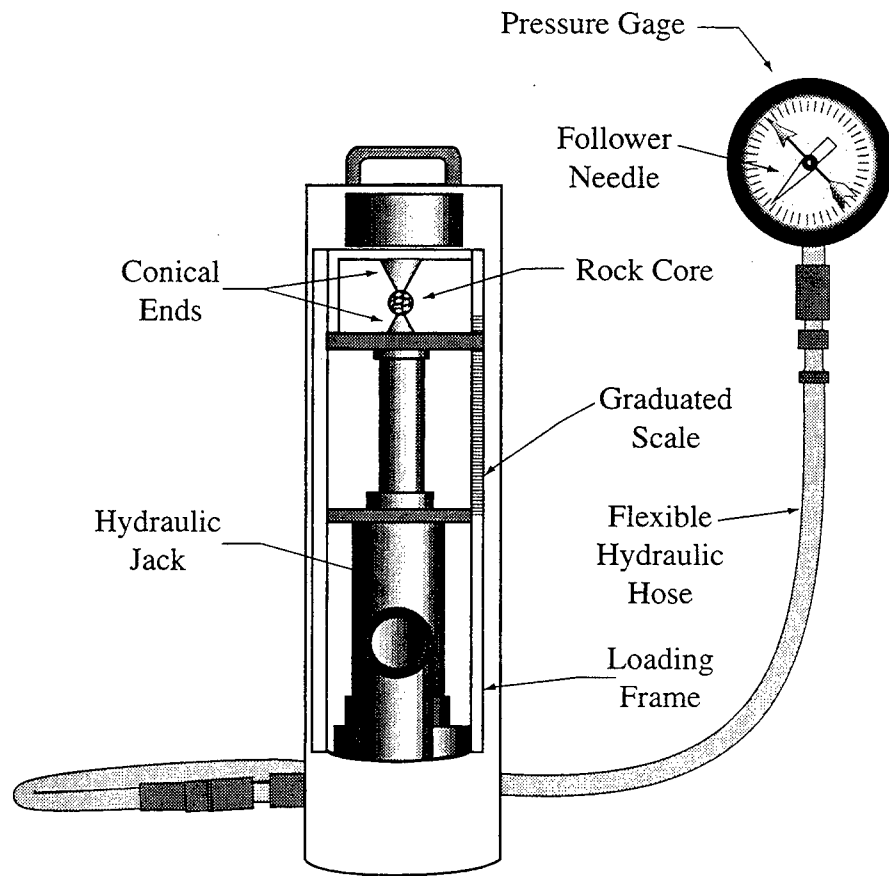

Figure 8-1: Point Load Test Apparatus. (Adopted from RocTest)

<b>Uniaxial Compression Test</b>	
AASHTO ASTM	- D 2938
Purpose	To determine the uniaxial compressive strength of rock.
Procedure	<p>In this test, cylindrical rock specimens are tested in compression without confinement. In general, the test procedure is similar to the unconfined compression test for soils. The test specimen should be a rock cylinder of length-to-width ratio in the range of 2 to 2.5 with flat, smooth, and parallel ends cut perpendicular to the cylinder axis.</p> <div style="text-align: center;"> </div> <div style="text-align: center;"> </div>
Commentary	<p>The uniaxial compression test is the simplest and fastest test for the determination of the rock strength. The results of this test generally produce conservative values of intact rock strength. The results are influenced by the moisture content of the specimens. The geotechnical engineer and the geologist in charge need to make a decision as to the moisture content (i.e., natural, saturated, etc.) under which the rock should be tested. The rate of loading and the condition of the two ends of the rock will also affect the final results. The ends have to be nearly parallel to each other and clean of powder or small debris. The rate of loading should be closely controlled as per the ASTM test procedure. Inclined fissures, soft rock intrusions and other anomalies will often cause premature failures on those planes. They should be noted so that where appropriate other tests such as triaxial tests can be required.</p>

## Direct Shear Strength of Rock

AASHTO  
ASTM

-  
D 5607

Purpose

To determine the shear strength characteristics of rock along a plane of weakness.

Procedure

The laboratory test equipment is shown in Figure 8-3. The specimen is placed in the lower half of the shear box and encapsulated in either synthetic resin or mortar. The specimen must be positioned so that the line of action of the shear force lies in the plane of the discontinuity to be investigated, and the normal force acts perpendicular to this surface.

Once the encapsulating material has hardened, the specimen is mounted in the upper half of the shear box in the same manner. A strip approximately 5 mm wide above and below the shear surface must be kept free of encapsulating material. The test is then carried out by applying a shear force  $T$  under a constant normal load,  $N$ .

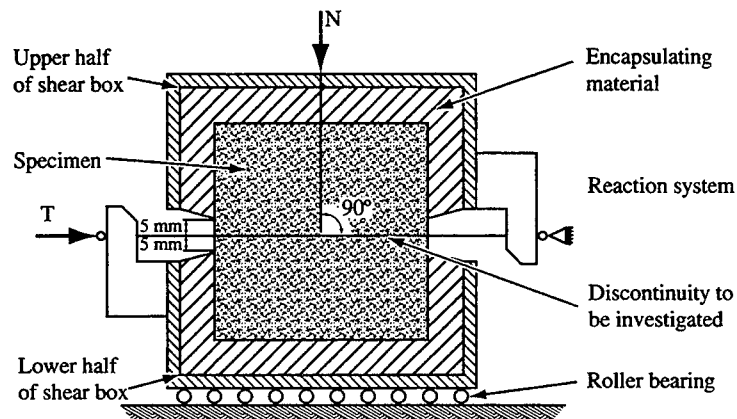

(a)

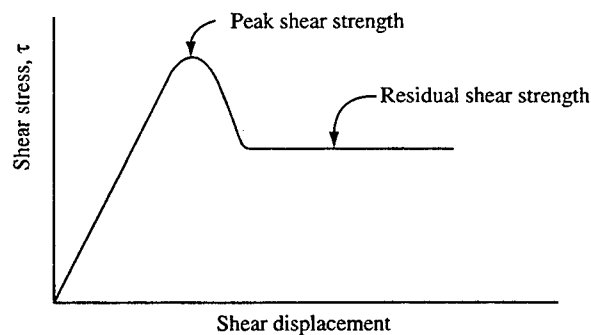

(b)

Figure 8-3: (a) Test Set-up for Direct Shear Strength Test, (Wittke, 1990) (b) Generalized Shear Stress and Shear Displacement Curve. (ASTM D 5607, 1995)

<p>Commentary</p>	<p>Determination of shear strength of rock specimens is an important aspect in the design of structures such as rock slopes, foundations and other purposes. Pervasive discontinuities (joints, bedding planes, shear zones, fault zones, schistosity) in a rock mass, and genesis, crystallography, texture, fabric, and other factors can cause the rock mass to behave as an anisotropic and heterogeneous discontinuum. Therefore, the precise prediction of rock mass behavior is difficult.</p> <p>For nonplanar joints or discontinuities, shear strength is derived from a combination base material friction and overriding of asperities (dilatancy), shearing or breaking of the asperities, rotations at or wedging of the asperities (Patton, 1966). Sliding on and shearing of the asperities can occur simultaneously. When the normal force is not sufficient to restrain dilation, the shear mechanism consists of the overriding of the asperities. When the normal load is large enough to completely restrain dilation, the shear mechanism consists of the shearing off of the asperities.</p> <p>Using this test method to determine the shear strength of intact rock may generate overturning moments that induce premature tensile breaking. Thus, the specimen would fail in tension first rather than in shear.</p> <p>Rock shear strength is influenced by the overburden or normal pressure; therefore, the larger the overburden pressure, the larger the shear strength.</p> <p>In some cases, it may be desirable to conduct tests in situ rather than in the laboratory to determine a representative shear strength of the rock mass, particularly when design is controlled by discontinuities filled with very weak material.</p>
-------------------	---

### 8.2.2 Durability

The measurement of the durability of rock becomes an issue when it is to be subjected to the elements (e.g., flowing water, wetting and drying, wave action, freeze and thaw, etc.) in its proposed use. Tests to measure durability depend on the type of rock, on its use and on the elements to which the rock will be subjected. The basis for durability tests are empirical and the results produced are an indication of the rock's resistance to natural processes; the rock's behavior in actual use may vary greatly from the test results. These tests, however, provide reasonably reliable tools for quality control. The suitability of various types of rock for different uses should, in addition to these test results, depend on their performance in previous applications. An example of the use of rock durability tests is for evaluation of shale in rock fill embankments.

<b>Slake Durability</b>	
AASHTO ASTM	- D 4644 (for shales and similar weak rocks)
Purpose	To determine the durability of shale or other weak or soft rocks subjected to cycles of wetting and drying.
Procedure	<p>In this test dried fragments of rock of known weight are placed in a drum fabricated with 2.0 mm square mesh wire cloth. Figure 8-4 shows a schematic of the test apparatus. The drum is rotated in a horizontal position along its longitudinal axis while partially submerged in distilled water to promote wetting of the sample. The specimens and the drum are dried at the end of the rotation cycle (10 minutes at 20 rpm) and weighed. After two cycles of rotating and drying the weight loss and the shape and size of the remaining rock fragments are recorded and the Slake Durability Index (SDI) is calculated. Both the SDI and the description of the shape and size of the remaining particles are used to determine the durability of soft rocks.</p>
	<p>Figure 8-4: Dimensions of Slake Durability Equipment. (ASTM D 4644, 1995)</p>
Commentary	The test is typically performed on shales and other weak rocks that may be subject to degradation in the service environment. When some shales are newly exposed to atmospheric conditions, they may degrade rapidly and affect the stability of a rock cut, the subgrade on which a foundation is to be placed or the base and side walls of drilled shafts prior to placement of concrete.

<b>Soundness of Riprap</b>	
AASHTO ASTM	- D 5240
Purpose	To determine the soundness of rock subjected to erosion.
Procedure	The procedure is known as the Rock Slab Soundness Test. Two representative, sawed, rock slab specimens are immersed in a solution of sodium or magnesium sulfate and dried and weighed for five cycles. The percent weight loss as a result of these tests is expressed as percent soundness.
Commentary	One of the most effective means to control erosion is by covering exposed soil with riprap, or geosynthetics and riprap. Rock used in this mode is subject to degradation from weathering affects. This test is commonly used to estimate this mode of degradation. A similar test for aggregates is available through ASTM C 88.

<b>Durability Under Freezing and Thawing</b>	
AASHTO ASTM	- D 5312
Purpose	To determine the resistance of rock used for erosion control to freezing and thawing.
Procedure	Slabs of representative rock specimens are subjected to freezing and thawing cycles in the laboratory. The loss of dry weight at the end of five freezing, thawing and drying cycles is expressed as percent loss due to freeze/thaw.
Commentary	This test is useful in assessing the durability of rock due to weathering effects. It can also be used to assess the durability of armor stones placed for shore protection or riprap placed for shoreline protection or dam embankment protection.

As discussed above, none of these tests provide results which can be used independent of each other or independent of other tests and experience. Often the behavior of rip-rap rock in actual use will vary widely from the laboratory behavior.



8.2.3 Strength - Deformation Characteristics

Elastic Moduli	
AASHTO ASTM	- D 3148
Purpose	To determine the strength-deformation characteristics of rock and permit comparison with other rocks, or determine the suitability of rock to applied loads.
Procedure	<p>This test is performed by placing an intact rock specimen in a loading device and recording the deformation of the specimen under axial stress. The Young's modulus, either average, secant or tangent moduli, can be determined by plotting axial strain versus stress curves (Figure 8-5).</p> <div style="display: flex; justify-content: space-around;"> <div style="text-align: center;"> <p>(a) Tangent Modulus Measured at a Fixed Percentage of Ultimate Strength</p> </div> <div style="text-align: center;"> <p>(b) Average Modulus of Linear Portion of Axial Stress-Strain Curve</p> </div> </div> <div style="text-align: center; margin-top: 20px;"> <p>(c) Secant Modulus Measured up to a Fixed Percentage of Ultimate Strength</p> </div> <p>Figure 8-5: Methods for Calculating Young's Modulus from Axial Stress-Axial Strain Curve. (ASTM D 3148, 1995)</p>
Commentary	The results of these tests cannot always be replicated because of variations in the structure of the rock specimen. They provide reasonably reliable data for engineering applications but must be adjusted to take into account rock mass characteristics such as jointing and variable weathering. When evaluation of settlement of a foundation is considered necessary, the modulus must be determined.

Ultrasonic Testing	
AASHTO ASTM	- D 2845
Purpose	To determine the pulse velocities of compression and shear waves in rock and the ultrasonic elastic constants of isotropic rock.
Procedure	<p>Ultrasound waves are transmitted through a carefully prepared rock specimen. The ultrasonic elastic constants are calculated from the measured travel time and distance of compression and shear waves in a rock specimen. Figure 8-6 shows a schematic diagram of typical apparatus used for ultrasonic testing.</p> <div style="text-align: center;"> </div> <p>Note: Components shown by dashed lines are optional, depending on method of travel-time measurement and voltage sensitivity of oscilloscope.</p> <p>Figure 8-6: Schematic Diagram of Typical Apparatus (ASTM D 2845)</p>
Commentary	<p>The primary advantages of ultrasonic testing are that it yields compression and shear wave velocities, and ultrasonic values for the elastic constants of intact homogeneous isotropic rock specimens. Elastic constants for rocks having pronounced anisotropy should not be calculated by this procedure.</p> <p>The values of elastic constants often do not agree with those determined by static laboratory methods or the in situ methods. Measured wave velocities likewise often do not agree with seismic velocities, but offer good approximations. The ultrasonic evaluation of rock properties of intact rock specimens is useful for preliminary prediction of static properties by means of relationships between the intact rock properties and static properties. The test method is useful for evaluating the effects of uniaxial stress and water saturation on pulse velocity. When compared with wave velocities obtained from field geophysical tests, the results provide an index of the degree of fissuring within the rock mass. Although this test is not commonly performed for standard projects, it is relatively inexpensive to perform and may be useful for larger, more complex projects such as tunnels.</p>

### 8.3 QUALITY ASSURANCE FOR LABORATORY TESTING

In general, the quality assurance guidelines presented for soils in Chapter 7 also apply for rock tests. Herein, only some pitfalls applicable to rock testing are presented.

#### 8.3.1 Pitfalls

As indicated in Chapter 7, omissions or errors introduced during laboratory testing, if undetected, will be carried through the process of design and construction resulting often in costly or possibly unsafe facilities. Table 8-2 lists some of the more common errors that result from careless handling of rock specimens or laboratory procedures during rock testing. Table 8-2 should in no way be construed as being a complete list of possible errors and omissions in handling or testing of rock specimens; there are many more. These are just some of the more common ones.

**TABLE 8-2**  
**SOME COMMON ERRORS DURING LABORATORY TESTING OF ROCKS**

- 
- 
1. Improper protection of samples resulting in moisture loss and structural disturbance.
  2. Improper numbering or identification of samples.
  3. Storage of samples in unfit environments.
  4. Careless selection of "representative" specimens for testing.
  5. Selection of specimens without consulting the field logs.
  6. Selection of specimens without recognizing disturbances caused by coring procedures.
  7. Using old worn-out equipment.
  8. Use of poorly fitting o-rings, membranes etc. in triaxial or permeability tests.
  9. Uneven trimming of ends and sides of intact cores.
  10. Not recognizing or reporting joints and discontinuities.
  11. Mistaking failures due to joint displacement as shear failures.
  12. Using improper loading rate for strength tests.
  13. Fracturing of rock specimens during sawing.
  14. Mislabeling of laboratory test specimens.
  15. Taking shortcuts; using non-standard equipment.
  16. Failure to periodically calibrate testing equipment.
  17. Failure to test a sufficient number of samples to obtain representative results in variable material.
- 
-



## CHAPTER 9.0 CORRELATION OF SOIL PROPERTIES

### 9.1 INTRODUCTION

Engineers and geologists are often expected to give predictions of soil behavior even when little or no relevant laboratory test results are available. In many cases only soil identification and index properties are available. The aim of this chapter is to present correlations which can be valuable for preliminary design. These correlations can be useful for identifying unusual soil behavior and verifying test results.

This chapter presents typical values of engineering properties for various types or classes of soil, together with commonly used correlations between soil characteristics and engineering properties. The scope of this chapter is limited to correlations with soil classification tests, index properties and Standard Penetration N-values. In addition, some explanations are given of the engineering relevance of the various properties; and the justification of correlations between properties is discussed.

The field of soil property correlations is diverse and complex. A thorough coverage of this topic is beyond the scope of this manual. Interested readers are encouraged to refer to works by Kulhawy and Mayne (1990) and Carter and Bentley (1991) which present a comprehensive compilation of correlations.

**It must be emphasized that predictions based on correlations can never be substituted for proper testing. In general, all correlations must be considered approximate since various factors such as sensitivity, stress history, and aging can significantly influence soil properties.**

### 9.2 COMPOSITIONAL PROPERTIES OF SOIL

A knowledge of the general compositional characteristics of any soil is useful for a variety of purposes, ranging from estimation of simple weight-volume relationships to prediction of specific mechanical properties. The relationships in this section aid in these estimates and predictions.

#### 9.2.1 Unit Weight

The relationships between various types of unit weight were introduced in Chapter 7, see Table 7-2. Table 9-1 presents typical unit weights along with ranges of void ratio for a variety of soils.

#### 9.2.2 Specific Gravity

The specific gravity does not vary widely for most soils. A value of 2.67 is commonly used for cohesionless soils and a value of 2.70 for inorganic clay; values for organic soils are lower.

#### 9.2.3 Relative Density of Cohesionless Soils

In situ relative density for sands is commonly estimated from the N-value. Figure 9-1 presents a relationship between the N-value, the relative density and the overburden pressure expressed in terms of normalized overburden stress, where  $p_a$  is the atmospheric pressure (Holtz and Gibbs, 1979). Table 9-2 presents a fairly reliable correlation of N-value with relative density. Similar relationships have also been derived based on the cone penetration test and the dilatometer test (Riaund and Miran, 1992; Kulhawy and Mayne, 1990).

**TABLE 9-1**  
**TYPICAL SOIL UNIT WEIGHTS (From Kulhawy and Mayne, 1990)**

Soil Type	Approximate Particle Size, mm			Uniformity Coefficient $D_{60}/D_{10}$	Void Ratio		Normalized Unit Weight				
	$D_{max}$	$D_{min}$	$D_{60}$		$e_{max}$	$e_{min}$	Dry, $\gamma_{dry}/\gamma_w$		Saturated, $\gamma_{sat}/\gamma_w$		
							Min	Max	Min	Max	
Uniform granular soil	-	-	-	0.92	0.35	-	-	-	-	-	-
Equal spheres (theoretical)											
Standard Ottawa sand	0.84	0.59	0.67	1.0	0.50	1.47	1.76	1.49	2.10		
Clean, uniform sand	-	-	-	1.2 to 2.0	0.40	1.33	1.89	1.35	2.18		
Uniform, inorganic silt	0.05	0.005	0.012	1.2 to 2.0	0.40	1.28	1.89	1.30	2.18		
Well-graded granular soil											
Silty sand	2.0	0.005	0.02	5 to 10	0.30	1.39	2.04	1.41	2.28		
Clean, fine to coarse sand	2.0	0.05	0.09	4 to 6	0.20	1.36	2.21	1.38	2.37		
Micaceous sand	-	-	-	-	0.40	1.22	1.92	1.23	2.21		
Silty sand and gravel	100	0.005	0.02	15 to 300	0.14	1.43	2.34	1.44	2.48		
Silty or sandy clay	2.0	0.001	0.003	10 to 30	0.25	0.96	2.16	1.60	2.36		
Gap-graded silty clay with gravel or larger	250	0.001	-	-	0.20	1.35	2.24	1.84	2.42		
Well-graded gravel, sand, silt, and clay	250	0.001	0.002	25 to 1000	0.13	1.60	2.37	2.00	2.50		
Clay (30 to 50% < 2 $\mu$ size)	0.05	0.5 $\mu$	0.001	-	0.50	0.80	1.79	1.51	2.13		
Colloidal clay (over 50% < 2 $\mu$ size)	0.01	10 $\text{\AA}$	-	-	0.60	0.21	1.70	1.14	2.05		
Organic silt	-	-	-	-	3.00	0.64	1.76	1.39	2.10		
Organic clay (30 to 50% < 2 $\mu$ size)	-	-	-	-	4.40	0.48	1.60	1.30	2.00		

Note:  $\gamma_w = 9.80 \text{ kN/m}^3$

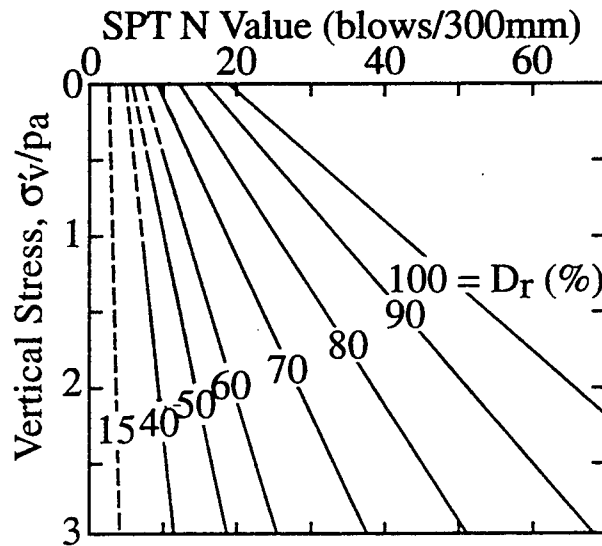

Figure 9-1: Relative Density-N-Overburden Stress Relationship for Sands. (After Holtz and Gibbs, 1979)

**TABLE 9-2**  
**RELATIVE DENSITY OF SANDS**  
 (Peck, *et. al.*, 1974)

N Value (blows/300 mm)	Relative Density
0 to 4	Very Loose
4 to 10	Loose
10 to 30	Medium
30 to 50	Dense
> 50	Very Dense

The N-values should be corrected for the overburden and pore pressure effects. Figure 9-2 presents a relationship for obtaining corrected N-values,  $N_1$ . Unless otherwise mentioned, the correlations presented herein are based on uncorrected N-values.

For saturated fine or silty sands, the N-value should also be corrected for pore pressure effects as follows (Terzaghi and Peck, 1948):

$$N_{\text{corrected}} = 15 + 0.5(N_{\text{field}} - 15) \tag{9-1}$$

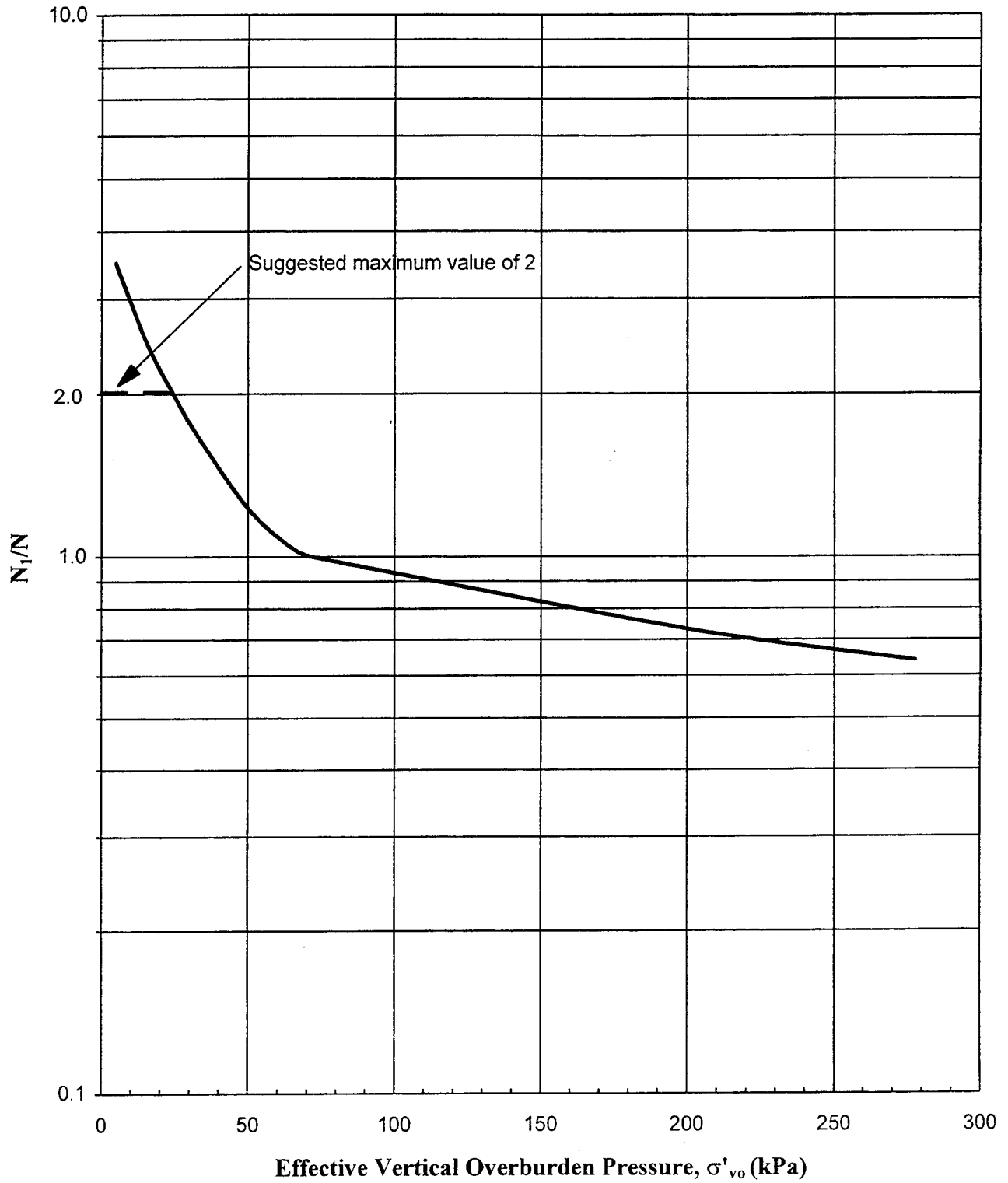

Figure 9-2: Relationship to Correct SPT N-values for Overburden Pressure (Peck and Bazaraa, 1969)



### 9.2.4 Consistency of Cohesive Soils

As with the relative density correlations, the consistency of soil has been correlated with in situ tests. Table 9-3 presents commonly used correlations with the N-value. In general, these correlations must be considered as crude approximations.

**TABLE 9-3**  
**CONSISTENCY OF CLAY**  
(Peck, *et. al.*, 1974)

N Value (blows/300mm)	Consistency
0 to 2	Very Soft
2 to 4	Soft
4 to 8	Medium
8 to 15	Stiff
15 to 30	Very Stiff
> 30	Hard

## 9.3 COMPRESSIBILITY RELATIONSHIPS

The compression of soils in response to loading can be broadly divided into two types: elastic settlement and time-dependent settlement. Elastic settlements are instantaneous, recoverable, and are commonly calculated from linear elastic theory. Time-dependent settlements occur in both granular and cohesive soils, although the response time for granular soils is usually short. In addition to being time-dependent, the soil's response to loading is non-linear, and deformations are only partially recoverable. Two types of time-dependent settlement are recognized. Primary consolidation results from the squeezing out of water from the soil voids under the influence of excess pore water pressures generated by the applied loading. Secondary compression occurs essentially after all the excess pore pressures have been dissipated (i.e., after primary consolidation is substantially complete). The mechanisms involved, however, are not fully understood. The compressibility of granular soils is more difficult to predict with any accuracy, largely because of the difficulty of obtaining and testing undisturbed soil samples. For granular soils, compression or settlements are usually estimated by indirect methods.

### 9.3.1 Elastic Parameters

The stress-strain (elastic) modulus can be obtained from the slope (tangent or secant) of stress-strain curves from triaxial tests. Table 9-4 presents typical ranges of the secant elastic modulus,  $E_s$ , and Poisson's ratio,  $\nu$  for various types of soil. Both  $E_s$  and  $\nu$  are heavily dependent on the method of laboratory test (confined, unconfined, undrained, drained), the degree of confinement, overconsolidation ratio, water content, strain rate, and sample disturbance. Thus, considerable judgment is required to obtain reasonably reliable values for design use. Tables 9-5 and 9-6 present correlations of  $E_s$  with N-values and undrained shear strength,  $c_u$ .

**TABLE 9-4**  
**ELASTIC CONSTANTS FOR VARIOUS SOILS (After AASHTO, 1995)**

Soil	Elastic Modulus, $E_s$ (MPa)	Poisson's Ratio, $\nu$ (dimensionless)
Clay		
Soft Sensitive	2 - 15	0.4 - 0.5
Medium stiff to stiff	15 - 50	(undrained)
Very stiff	50 - 100	
Loess	15 - 60	0.1 - 0.3
Silt	2 - 20	0.3 - 0.35
Fine sand		
Loose	8 - 12	0.25
Medium dense	12 - 20	
Dense	20 - 30	
Sand		
Loose	10 - 30	0.2 - 0.35
Medium dense	30 - 50	
Dense	50 - 80	0.3 - 0.4
Gravel		
Loose	30 - 80	0.2 - 0.35
Medium dense	80 - 100	
Dense	100 - 200	0.3 - 0.4

**TABLE 9-5**  
**ESTIMATING  $E_s$  FROM N-VALUE (After AASHTO, 1995)**

Soil	$E_s$ , MPa
Silts, sandy silts, slightly cohesive mixtures	$0.4 N_1$
Clean fine to medium sands and slightly silty sands	$0.7 N_1$
Coarse sands and sands with little gravel	$N_1$
Sandy gravel and gravels	$1.17 N_1$

$N_1$  = N-value corrected for depth (see Figure 9-2). For saturated fine sands and silts, the N-value should also be corrected for pore pressure effects using Eq. 9-1.

**TABLE 9-6**  
**ESTIMATING  $E_s$  FROM  $c_u$  (After AASHTO, 1995)**

Soil	$E_s$ , MPa
Soft sensitive clay	$400c_u - 1,000c_u$
Medium stiff to stiff clay	$1,500c_u - 2,400c_u$
Very stiff clay	$3,000c_u - 4,000c_u$

### 9.3.2 Consolidation Parameters

The time-dependent compressibility of fine grained soils is usually measured by means of consolidation tests. Results may be expressed in a number of ways. Figure 9-3 presents the commonly used presentation and the various parameters used to describe the consolidation test results.

Following are the four primary variables used to estimate consolidation settlements (see Figure 9-3):

- Compression Index,  $C_c$  or Compression Ratio, CR
- Recompression Index,  $C_r$  or Recompression Ratio, RR
- Coefficient of (vertical) Consolidation,  $c_v$
- Coefficient of Secondary Consolidation,  $C_\alpha$

#### Compression Index, $C_c$

Over 70 different correlations have been published for correlating  $C_c$  to index properties of clays. Although there is considerable scatter, the Terzaghi and Peck (1967) relationship between  $C_c$  and liquid limit, LL, for normally consolidated natural clay is still popular and is given as follows:

$$C_c \approx 0.009(LL-10) \quad (9-2)$$

This relationship has a reliability range of  $\pm 30\%$  and is valid for inorganic clays of sensitivity up to 4 and liquid limit up to 100.

Another useful relationship relates  $C_c$  to PI as follows (Wroth and Wood, 1978):

$$C_c \approx 0.5G_s(PI/100) \quad (9-3)$$

in which  $G_s$  is the specific gravity of solids. Using a typical  $G_s = 2.7$  for clays gives  $C_c \approx PI/74$ .

For other relations of  $C_c$  with index properties, the reader is referred to Kulhawy and Mayne (1990). Typical values of  $C_c$  for some soils are presented in Table 9-7.

An alternative to  $C_c$  is the compression ratio, CR, defined as  $C_c/(1+e_0)$  in which  $e_0$  = initial void ratio. Normalizing  $C_c$  in this manner tends to reduce the data scatter. Figure 9-4 shows the typical range in CR in terms of natural water content as reported by Lambe and Whitman (1979).

#### Recompression Index, $C_r$

Typical values of  $C_r$  range from 0.015 to 0.35 (Roscoe, *et. al.*, 1958) and are often assumed to be 10 to 20 percent of  $C_c$  (Ladd, 1973).

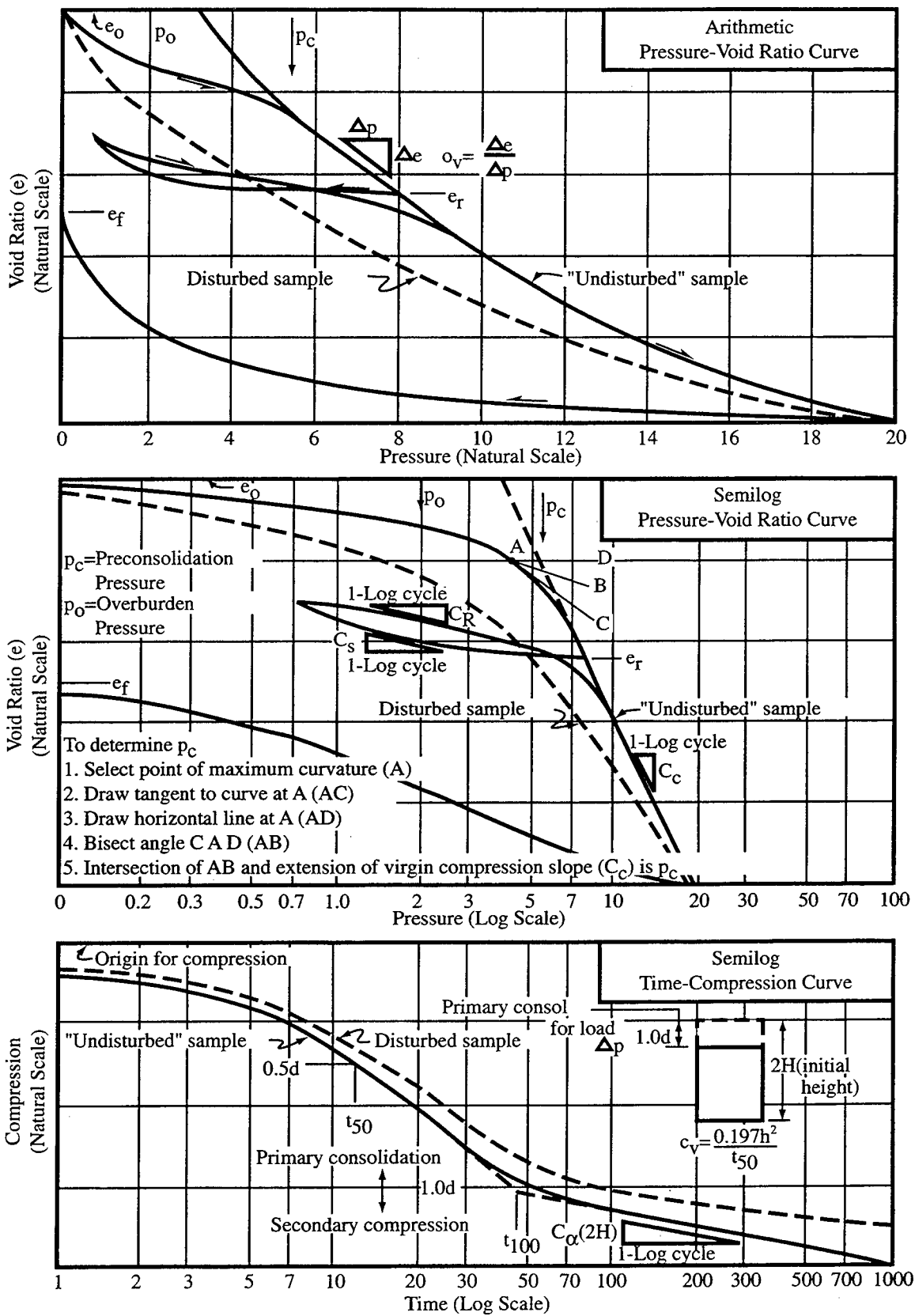

Figure 9-3: Consolidation Test Relationships. (NAVFAC, DM-7.1, 1982)

**TABLE 9-7**  
**TYPICAL VALUE OF  $C_c$  (After Holtz and Kovacs, 1981)**

Soil	$C_c$
Normally consolidated medium sensitive clays	0.20 to 0.50
Chicago silty clay (CL)	0.15 to 0.30
Boston Blue Clay (CL)	0.30 to 0.50
Vicksburg Buckshot clay (CH)	0.50 to 0.60
Swedish medium sensitive clays (CL-CH)	1 to 3
Canadian Leda clays (CL-CH)	1 to 4
Mexico City clay (MH)	7 to 10
Organic clays (OH)	4 and up
Peats (Pt)	10 to 15
Organic silts and clayey silts (ML-MH)	1.5 to 4.0
San Francisco Bay Mud (CL)	0.4 to 1.2
San Francisco Old Bay clays (CH)	0.7 to 0.9
Bangkok clay (CH)	0.4

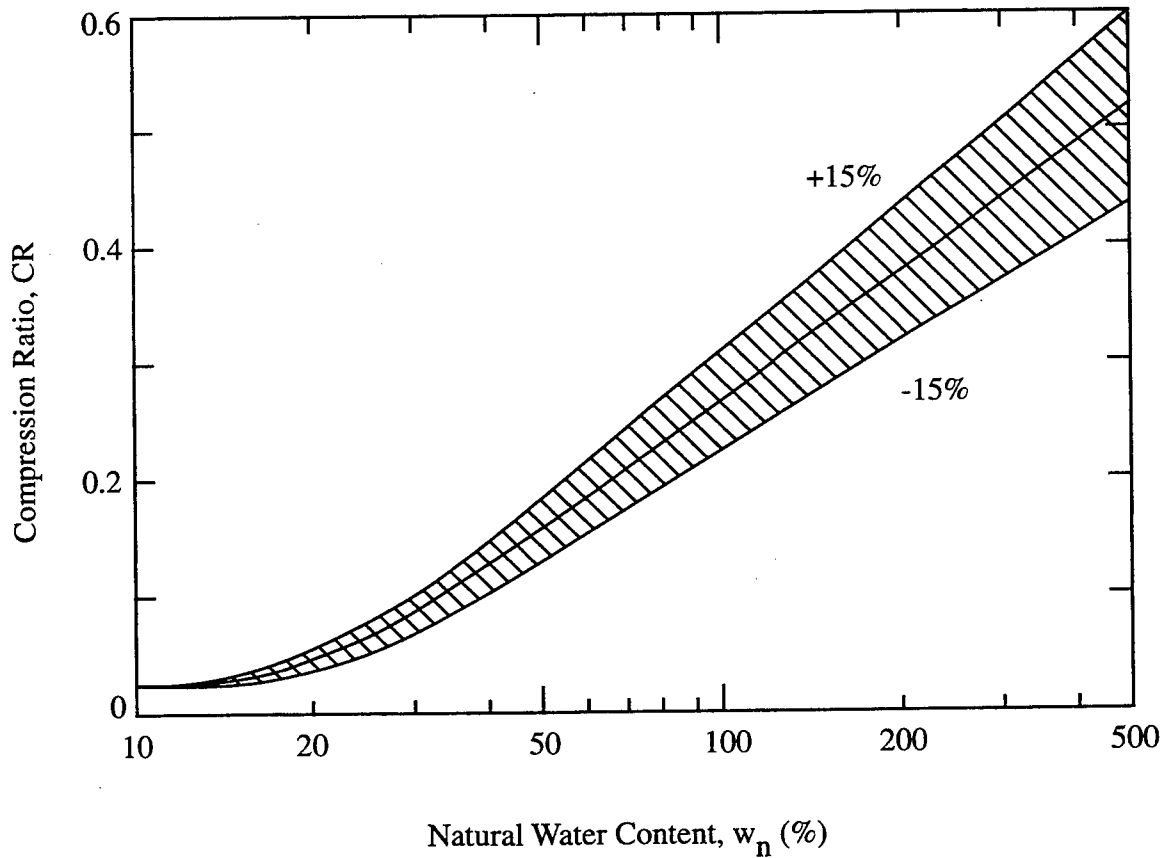

Figure 9-4: Compression Ratio Versus Water Content. (Lambe and Whitman, 1969)

**Coefficient of Vertical Consolidation,  $c_v$**

Because of the wide range of permeabilities that exist in soils (see Section 9.4), the coefficient of consolidation can itself vary widely, from less than 1 m<sup>2</sup>/yr for clays of low permeability to 1000 m<sup>2</sup>/yr or more for very sandy clays, fissured clays and weathered rocks. Some typical values for clays are given in Table 9-8 and an approximate correlation with liquid limit is shown in Figure 9-5. Often, for clays containing fissures or fine bands of sands, the coefficient of horizontal consolidation,  $c_h$ , may be much higher than  $c_v$  and may govern.

**TABLE 9-8**  
**TYPICAL VALUES OF COEFFICIENT OF VERTICAL CONSOLIDATION,  $c_v$**   
 (Compiled by Carter and Bentley, 1991)

Soil	$c_v$	
	(cm <sup>2</sup> /s x 10 <sup>-4</sup> )	(m <sup>2</sup> /yr)
Boston Blue Clay (CL)	40±20	12±6
Organic silt (OH)	2-10	0.6-3
Glacial lake clays (CL)	6.5-8.7	2.0-2.7
Chicago silty clay (CL)	8.5	2.7
Swedish medium sensitive clays (CL-CH)		
1. laboratory	0.4-0.7	0.1-0.2
2. field	0.7-3.0	0.2-1.0
San Francisco Bay Mud (CL)	2-4	0.6-1.2
Mexico City clay (MH)	0.9-1.5	0.3-0.5

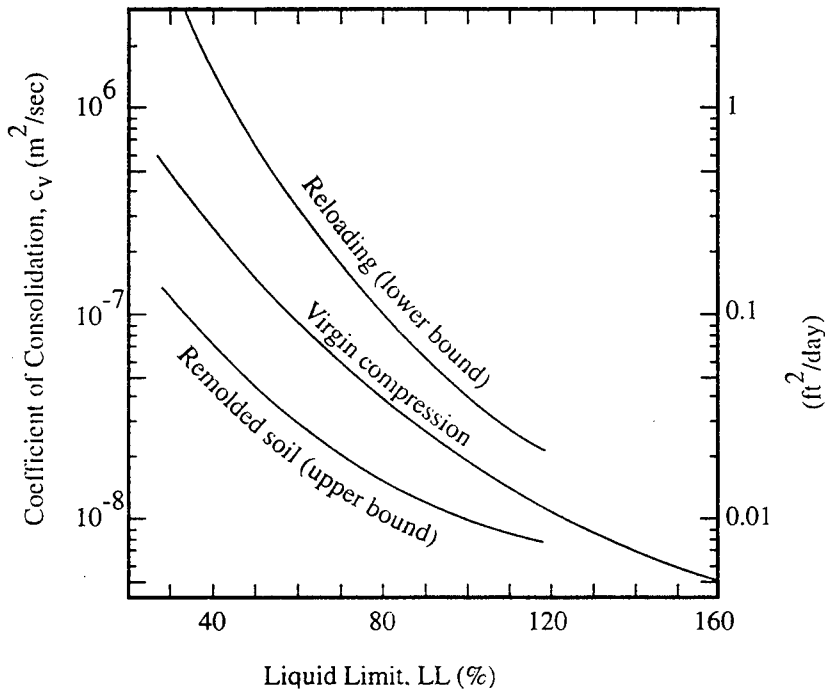

Figure 9-5: Approximate Correlations Between  $c_v$  and LL. (NAVFAC, DM-7.1, 1982)

### Coefficient of Secondary Compression, $C_{\alpha}$

This coefficient may be expressed either in units of strain ( $C_{\alpha\epsilon}$ ) or void ratio ( $C_{\alpha e}$ ) per log cycle of time as follows (see Figure 9-3):

$$C_{\alpha\epsilon} = d\epsilon/d(\log t); \quad C_{\alpha e} = de/d(\log t); \quad C_{\alpha\epsilon} = C_{\alpha e}/(1 + e_0) \quad (9-4)$$

$C_{\alpha e}$  is usually assumed to be related to  $C_c$  with values of  $C_{\alpha e}/C_c$  typically in the range 0.025-0.006 for inorganic soils and 0.035-0.085 for organic soils. Some typical values are given in Table 9-9. Figure 9-6 presents a correlation between  $C_{\alpha e}$  and natural water content.

**TABLE 9-9**  
**TYPICAL VALUES OF  $C_{\alpha e}/C_c$  (Carter and Bentley, 1991)**

Soil	$C_{\alpha e}/C_c$
Organic silts	0.035 - 0.06
Amorphous and fibrous peat	0.035 - 0.085
Canadian muskeg	0.09 - 0.10
Leda clay (Canada)	0.03 - 0.06
Post-glacial Swedish clay	0.05 - 0.07
Soft blue clay (Victoria, B.C.)	0.026
Organic clays and silts	0.04 - 0.06
Sensitive clay, Portland, ME	0.025 - 0.055
San Francisco Bay Mud	0.04 - 0.06
New Liskeard (Canada) varved clay	0.03 - 0.06
Mexico City clay	0.03 - 0.035
Hudson River silt	0.03 - 0.06
New Haven organic clay silt	0.04 - 0.075

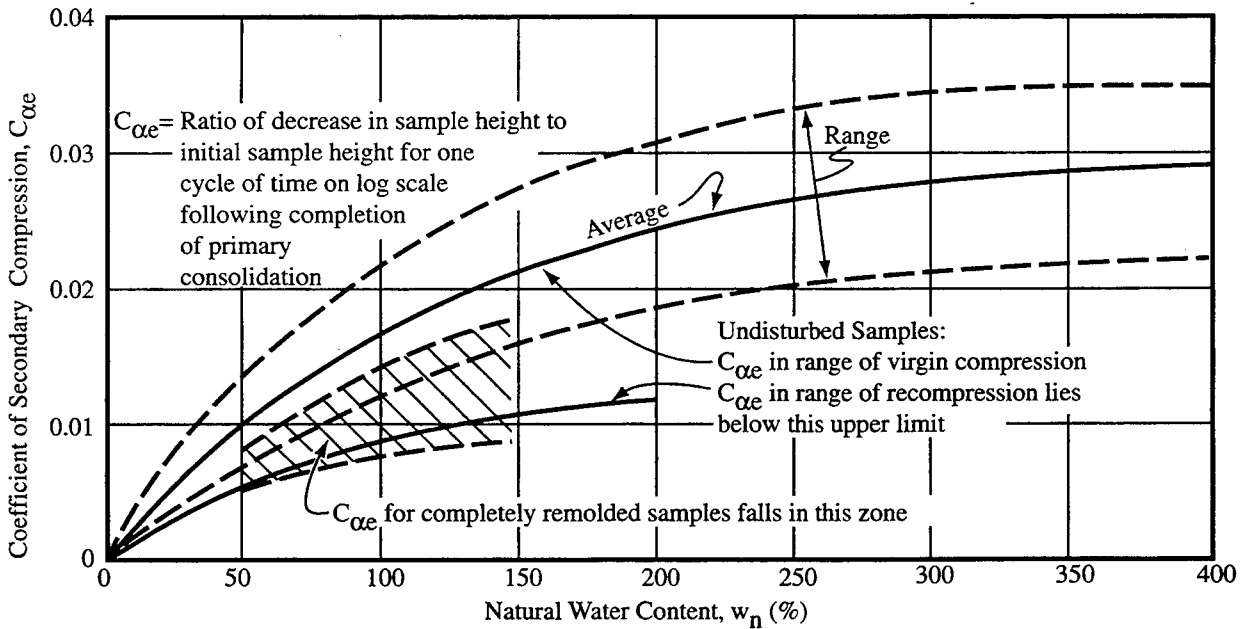

Figure 9-6: Correlation Between  $C_{\alpha e}$  and Natural Water Content. (NAVFAC, DM-7.1, 1982)

## 9.4 PERMEABILITY RELATIONSHIPS

The permeability of a soil is strongly influenced by its macroscopic structure, e.g., clays containing fissures or fine bands of sand will have permeabilities which are many times higher than that of the clay material itself. Also, since the flow tends to follow the line of least resistance, stratified soils often have horizontal permeabilities which are many times the vertical permeability. Because of the small size of laboratory specimens and the way they are obtained and prepared, large scale (soil mass) features are absent and test results do not give a true indication of field values in soils with a pronounced macro-structure. Moreover, laboratory tests usually constrain water to flow vertically through the specimen whereas the horizontal permeability may be much greater, and hence of overriding importance, so far as site conditions are concerned. Field tests overcome these shortcomings, but, since the pattern of water flow from a well can only be guessed, interpretation of the test results is difficult and uncertain. Thus, one set of problems is exchanged for another.

### 9.4.1 Typical Values

The permeability of a soil is commonly quantified in terms of the coefficient of permeability,  $k$ , as discussed in Chapter 7. The typical range of values encountered is presented in Table 9-10 which is based on information originally presented by Casagrande and Fadum (1940). Superimposed on Table 9-10 are typical values for compacted soil (using Modified Proctor test), classified by the Unified System (Carter and Bentley, 1991). Typical permeability values for highway construction materials are given in Table 9-11.

### 9.4.2 Relationships with Gradation

A theoretical equation developed by Taylor (1948) relating  $k$  to the soil gradation, void ratio and permeant properties, is as follows:

$$k = D_s^2 \frac{\gamma}{\mu} \frac{e^3}{(1+e)} c \quad (9-5)$$

where  $k$  is the coefficient of permeability,  $D_s$  is an effective particle diameter,  $\gamma$  is the unit weight of the permeant,  $\mu$  is the viscosity of the permeant,  $e$  is the soil void ratio and  $c$  is a shape factor.

In soils, the permeant is usually water and the effective particle diameter  $D_s$  is usually taken as  $D_{10}$ . This leads to the Hazen formula:

$$k = C_1 D_{10}^2 \quad \text{where} \quad C_1 = \frac{\gamma}{\mu} \frac{e^3}{(1+e)} c \quad (9-6)$$

Based on experimental work with clean sands, Hazen (1911) proposed a value between 0.01 and 0.015 for  $C_1$ , where  $k$  is in m/s and  $D_{10}$  is in mm. However, this ignores the large effect that even small changes in  $e$  will have on the value of  $k$ , as can be seen from Equation (9-5).

Figure 9-7 presents plots of  $k$  against  $D_{10}$ , based on experimental results, in which the value of  $e$  has been taken into account. These correlations were developed for sands and gravels. The greater range of particle size which is present in most clays and the effects of the clay mineralogy make such correlations more restrictive for clays.



**TABLE 9-10  
TYPICAL PERMEABILITY VALUES FOR SOILS (After Carter and Bentley, 1991)**

	10 <sup>-11</sup>	10 <sup>-10</sup>	10 <sup>-9</sup>	10 <sup>-8</sup>	10 <sup>-7</sup>	10 <sup>-6</sup>	10 <sup>-5</sup>	10 <sup>-4</sup>	10 <sup>-3</sup>	10 <sup>-2</sup>	10 <sup>-1</sup>	1			
Coefficient of permeability (log scale)															
	m/s														
	cm/s														
Permeability:	Practically impermeable			Very low			Low			Medium			High		
Drainage conditions:	Practically impermeable						Poor			Good					
Typical soil groups:	GC → GM →			SM			SW →			GW →					
	CH SC SM-SC			MH			SP →			GP →					
	MC-CL														
Soil types:	Homogeneous clays below the zone of weathering			Silts, fine sands, silty sands, glacial till, stratified clays			Fissured and weathered clays and clays modified by the effects of vegetation			Clean sands, sand and gravel mixtures			Clean gravels		

Note: The arrow adjacent to group classes indicates that permeability values can be greater than the typical value shown.

**TABLE 9-11**  
**TYPICAL PERMEABILITY VALUES FOR HIGHWAY MATERIALS (Krebs & Walker, 1971)**

Material	Permeability (m/s)
Uniformly graded coarse aggregate	0.4 - $4 \times 10^{-3}$
Well-graded aggregate without fines	$4 \times 10^{-3}$ - $4 \times 10^{-5}$
Concrete sand, low dust content	$7 \times 10^{-4}$ - $7 \times 10^{-6}$
Concrete sand, high dust content	$7 \times 10^{-6}$ - $7 \times 10^{-8}$
Silty and clayey sands	$10^{-7}$ - $10^{-9}$
Compacted silt	$7 \times 10^{-8}$ - $7 \times 10^{-10}$
Compacted clay	less than $10^{-9}$
Bituminous concrete (new pavements)*	$4 \times 10^{-5}$ - $4 \times 10^{-8}$
Portland cement concrete	less than $10^{-10}$

\* Values as low as  $10^{-10}$  have been reported for sealed, traffic compacted highway pavement.

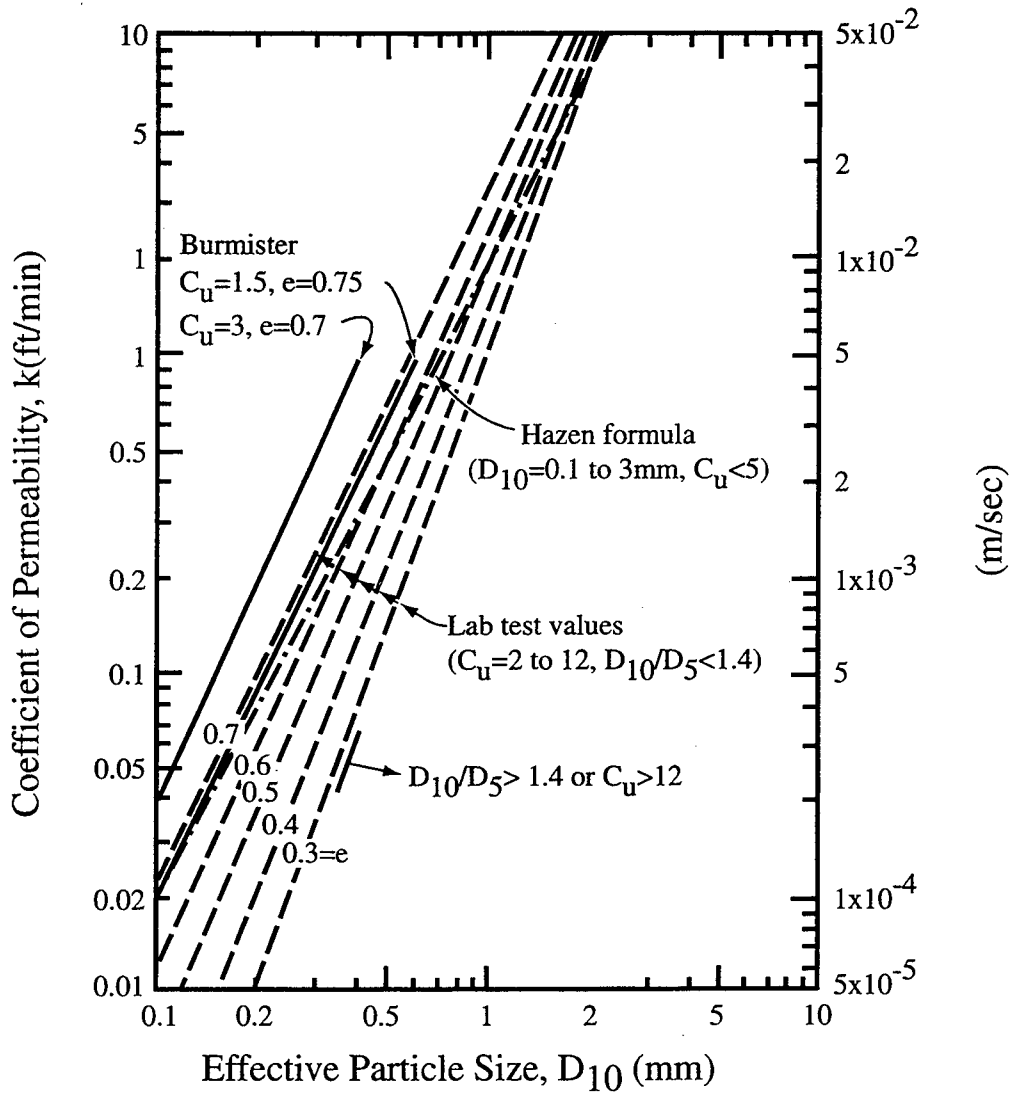

Figure 9-7: The Permeability of Sands and Gravels. (NAVFAC, DM-7.1, 1982)

## 9.5 STRENGTH RELATIONSHIPS

It is usually assumed that the shear strength of soils is governed by the Mohr-Coulomb failure criterion as explained in Chapter 7. This criterion is expressed in terms of cohesion,  $c$ , and angle of internal friction,  $\phi$ . Before the designer selects strength parameters, he/she must choose whether the undrained ( $c_u, \phi_u$ ) or drained ( $c', \phi'$ ) stress analysis is appropriate. Guidelines for choosing the appropriate analysis have been presented in Chapter 7.

### 9.5.1 Undrained Shear Strength of Cohesive Soils

For most saturated clays, tested under quick undrained conditions, the angle of shearing resistance,  $\phi_u$ , is zero. This means that the shear strength of the clay is a fixed value and is equal to the apparent cohesion,  $c_u$ , at a specific moisture content.

A rough idea of the undrained shear strength may be crudely estimated by molding a piece of clay between the fingers and applying the observations indicated in Table 9-12. **The values in Table 9-12, however, should not be used for design.** Standard penetration test N-values also provide an approximate estimate of undrained shear strength, as presented in Table 9-3.

**TABLE 9-12**  
**ESTIMATING THE SHEAR STRENGTH OF CLAYS (After Peck, *et. al.*, 1974)**

Unconfined Compressive Strength, $q_u (=2c_u)$ , (kPa)	Descriptive term (Consistency)	Characteristics
< 25	Very Soft	Exudes between fingers when squeezed
25 - 50	Soft	Molded by light finger pressure
50 - 100	Medium	Molded by strong finger pressure
100 - 200	Stiff	Readily indented by thumb
200 - 400	Very Stiff	Readily indented by thumbnail
> 400	Hard	Indented with difficulty by thumbnail

Note: This table can be used in conjunction with Table 9-3 to correlate  $c_u$  and N-value.

### Undisturbed Shear Strength

It is found that for most normally consolidated clays, the undrained shear strength is proportional to the effective overburden pressure. For such soils, Skempton (1957) proposed a relationship shown in Figure 9-8 between the shear strength/overburden pressure ratio ( $c_u/\sigma'_v$ ) and plasticity index (PI). This figure also includes results obtained by a number of other researchers. As can be seen, their findings vary and **such relations should be used with caution.** However, such correlations particularly by Skempton (1957) are useful for preliminary estimates and for checking laboratory data on normally consolidated clays.

As discussed in Chapter 7, the liquid limit (LL) and plastic limit (PL) are moisture contents which, for a particular sample of clay, correspond to specific values of undrained shear strength. It therefore follows that, the shear strength depends on the value of the natural moisture content,  $w_n$ , in relation to the LL and PL values. This can be conveniently expressed by using the concept of liquidity index, LI, defined by:

$$LI = \frac{w_n - PL}{LL - PL} = \frac{w_n - PL}{PI} \quad (9-7)$$

A useful relationship for predicting the undrained shear strength of undisturbed clays based on liquidity index is presented in Figure 9-9.

The shear strength of undisturbed clays depends on the consolidation history of the clay as well as its fabric characteristics. In general, the undrained strength ratio,  $c_u/\sigma'_v$ , increases with increasing overconsolidation as measured by the overconsolidation ratio, OCR. Figure 9-10 presents a non-dimensional relationship to estimate the  $c_u/\sigma'_v$  for overconsolidated clays. **Like other relations, this relationship must also be used with caution particularly as it was derived from limited data (5 clays).** In practical terms, it is more straightforward to measure the undrained shear strength of overconsolidated clays than to predict it from other indices.

### Correlation with N-value

Attempts have been made to correlate the unconfined compressive strength or the undrained shear strength of clays with Standard Penetration Test N-values, with varying degrees of success. Some suggested relationships are given in Figure 9-11. **These relationships are crude approximations.** Therefore, they should only be used for preliminary estimates and verifying laboratory test data.

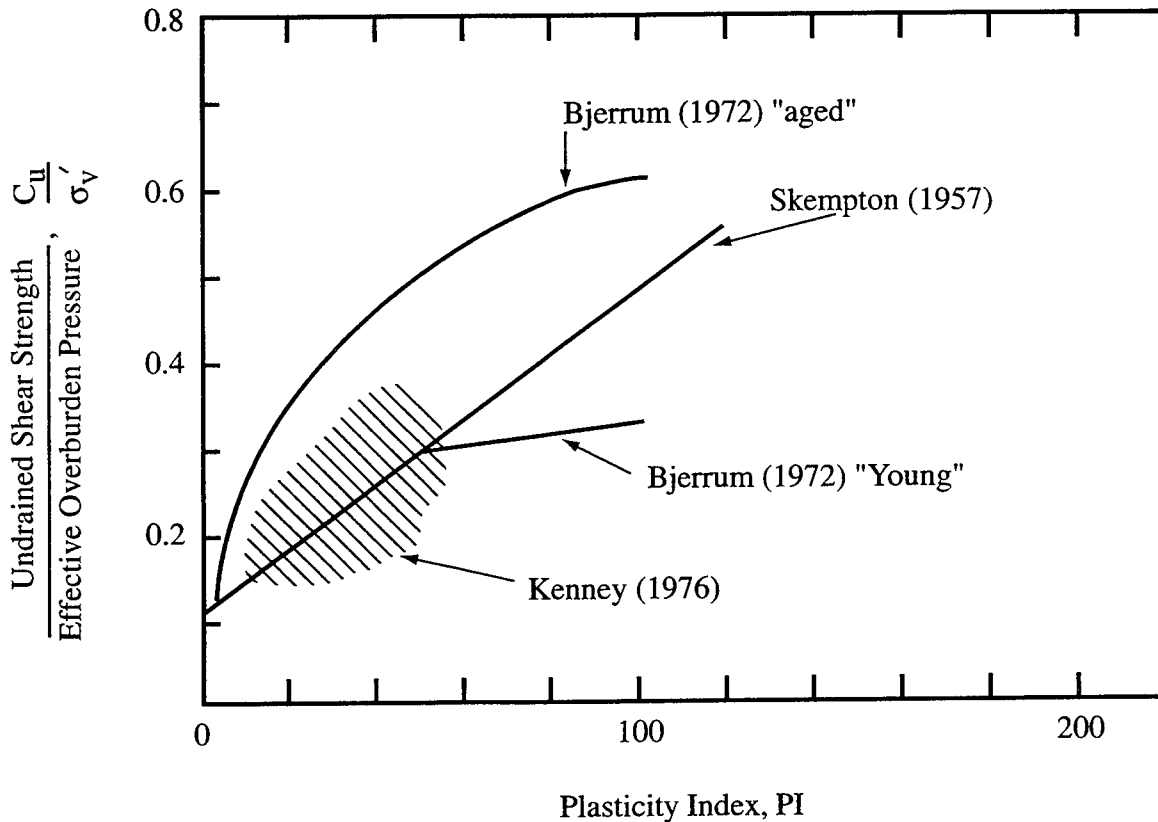

Figure 9-8: Relationship Between the Ratio of Undrained Shear Strength to Effective Overburden Pressure and Plasticity Index for Normally-Consolidated Clays. (Holtz and Kovacs, 1981)

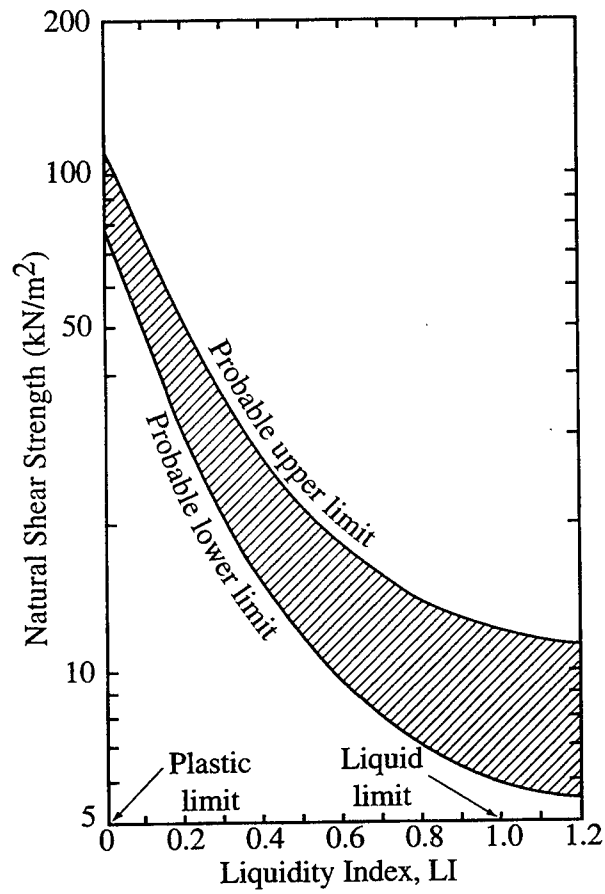

Figure 9-9: Relationship Between the Natural Shear Strength of Undisturbed Clays and LI. (Carter and Bentley, 1991)

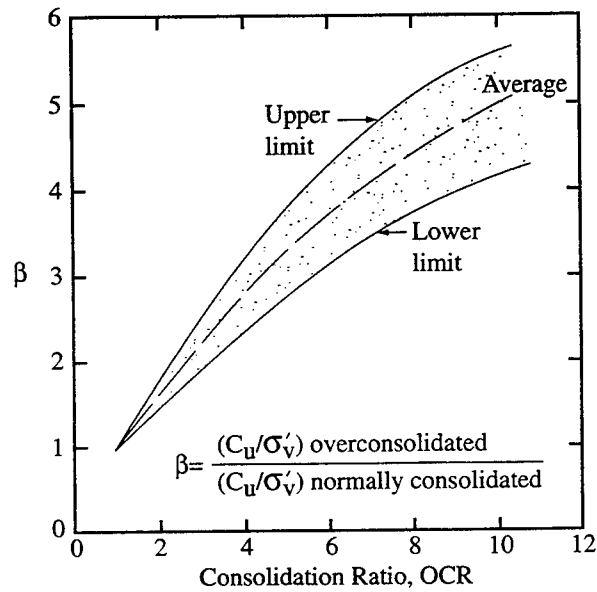

Figure 9-10: Plot of  $\beta$  Against Overconsolidation Ratio, OCR. (Das, 1987)

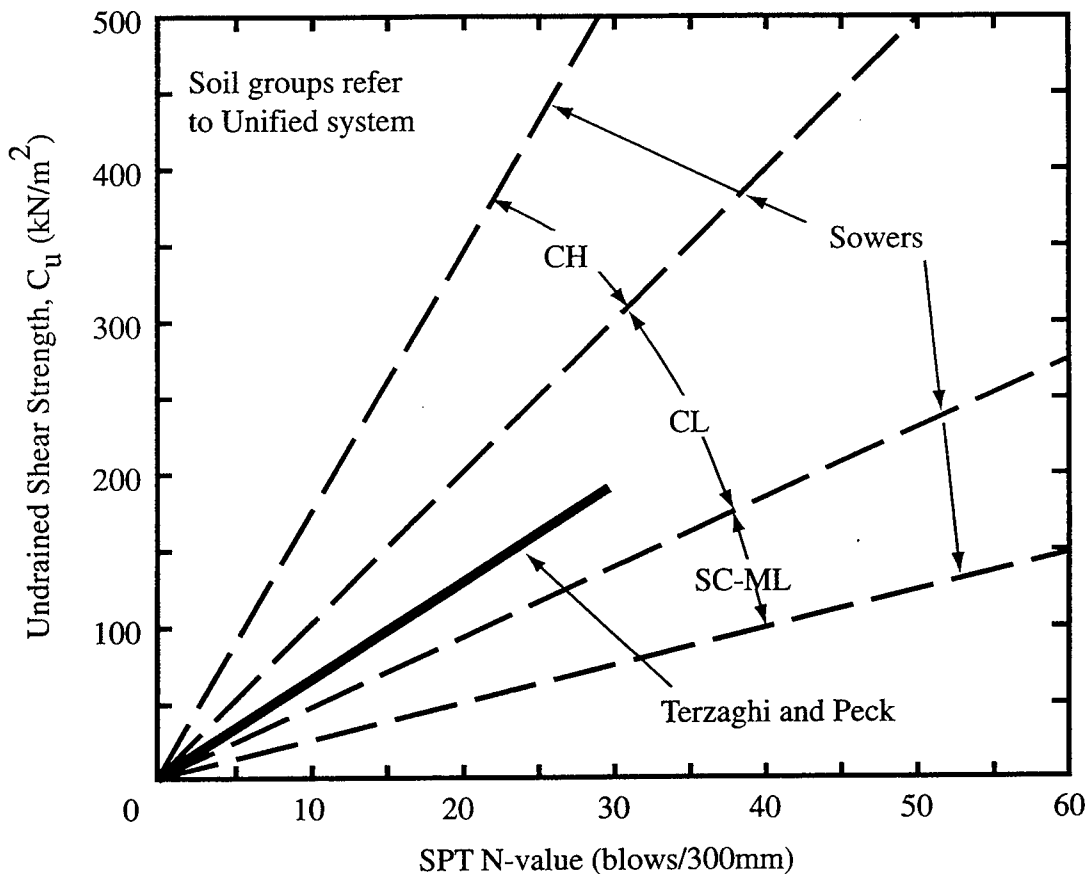

Figure 9-11: Approximate Correlations Between Undrained Shear Strength and N-values. (After Sowers, 1979)

### 9.5.2 Drained and Effective Shear Strength of Cohesive Soils

As discussed in Chapter 7, it is often important to carry out stability calculations in terms of effective stresses. The soil strength parameters used in these calculations are obtained from either drained direct shear box or drained triaxial tests (giving  $c'$  and  $\phi'$ ) or from CU triaxial tests with pore pressure measurement (giving  $\phi'_{cu}$  and  $c'_{cu}$ ). Practically, there is minor difference between the two sets of values for saturated clays resulting from the soil being tested under different boundary conditions and stress paths.

A relationship between drained shear strength and plasticity index, PI, for normally consolidated and remolded clays is shown in Figure 9-12. Also shown in this figure is a relationship between the residual shear strength, angle of internal friction, and PI. The existence of these relationships arises because both PI and shear strength reflect the clay mineral composition of the soil; as the clay mineral content increases, the PI increases and the strength decreases. Due to wide scatter in lab test results, there are no generally accepted correlations between peak shear strength of overconsolidated clays and PI.

As described previously, the strength of clays, in effective stress terms, is basically frictional such that  $c' = 0$ . This certainly is the case with saturated clays but partially saturated clays, where meniscus effects draw the particles together to produce inter-particle stresses, may appear to have a small cohesion value, though this itself is a frictional phenomenon.

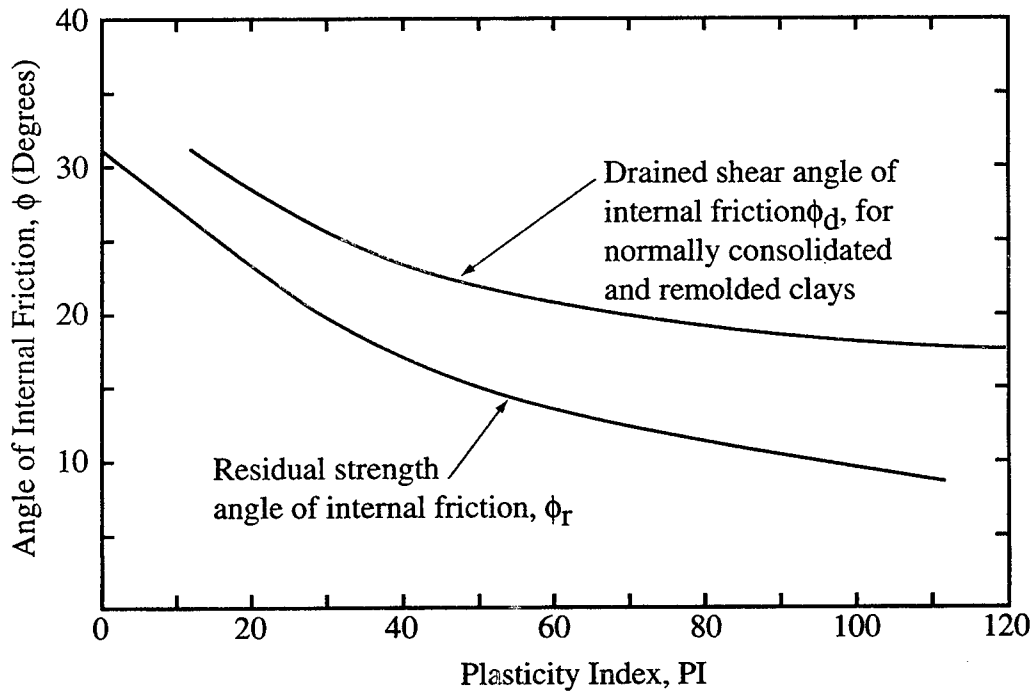

Figure 9-12: Relationships Between  $\phi$  and PI. (After Gibson, 1953)

### 9.5.3 Shear Strength of Granular Soils

Because of their high permeability, pore water pressures do not build up when granular soils are subjected to shearing forces. The complication of total and effective stresses is therefore avoided and the phenomenon of apparent cohesion, or undrained shear strength, does not occur. Consequently, the shear strength of granular soils is defined exclusively in terms of frictional resistance between the grains, as measured by the angle of shearing resistance,  $\phi$ .

Typical values of  $\phi$  for sands and gravels are given in Figure 9-13. A relationship between dry density or relative density and  $\phi$  is shown in Figure 9-13. The material types indicated in the figure relate to the Unified Classification System. Peck et. al. (1974) give a correlation with N-values, shown in Figure 9-14. The correlation between N-values and relative density is also shown, enabling a comparison to be made with Figure 9-13. For fine sands under water table, the N-values should be corrected using Eq. 9-1 for pore pressure effects in addition to the correction for overburden pressure as per Figure 9-2.

Examination of Figures 9-13 and 9-14 shows reasonable agreement between the two correlations. However, considerable variation can exist within each soil type, as indicated by Figure 9-15, which shows plots of  $\phi$  against relative density for a number of sands.

### 9.5.4 Shear Strength of Compacted Soils

Typical values for the shear strength of compacted soils are given in Table 9-13. Values refer to soils compacted to maximum dry density obtained in the standard compaction test. Consolidated undrained (CU) triaxial tests were used to determine the shear strengths.

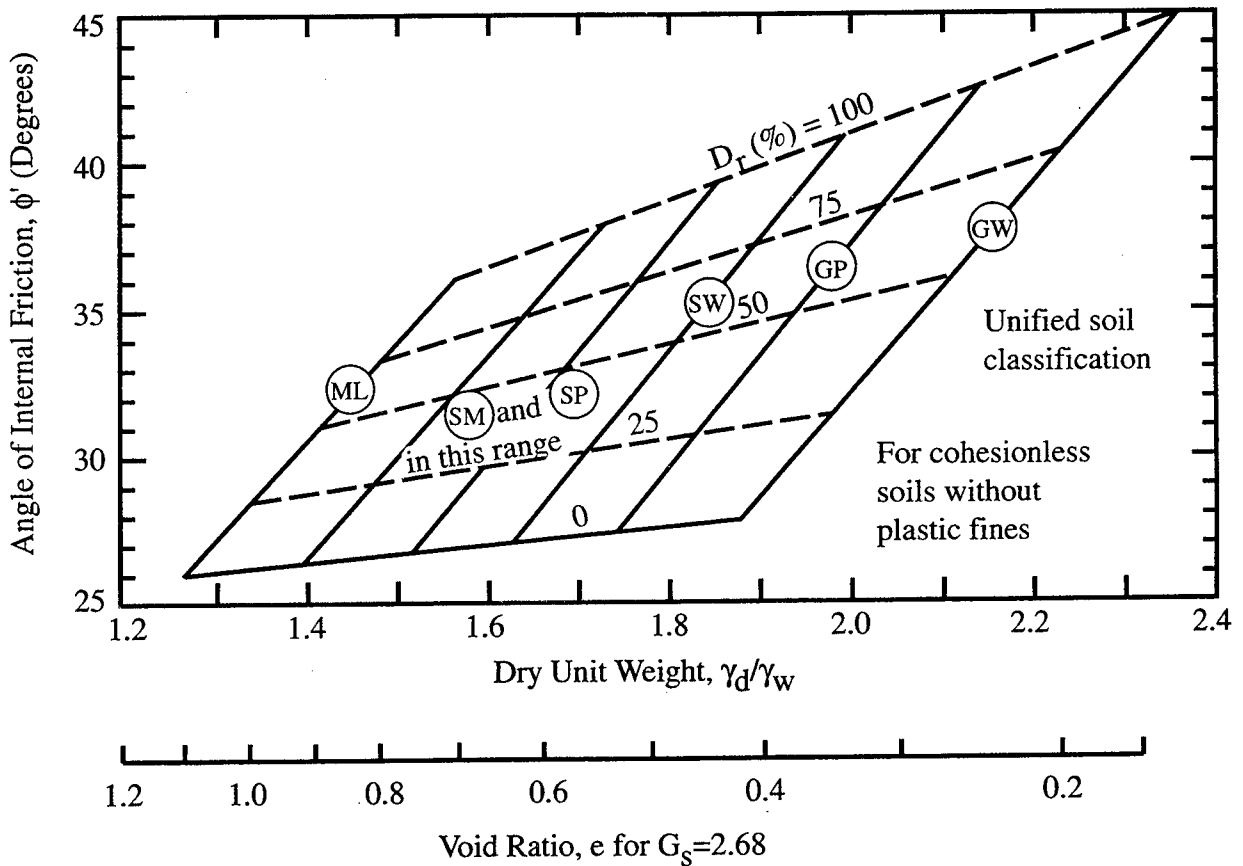

Figure 9-13: Typical Values of  $\phi$  and Density for Cohesionless Soils. (NAVFAC, DM-7.1, 1982; Kulhawy and Mayne, 1990)

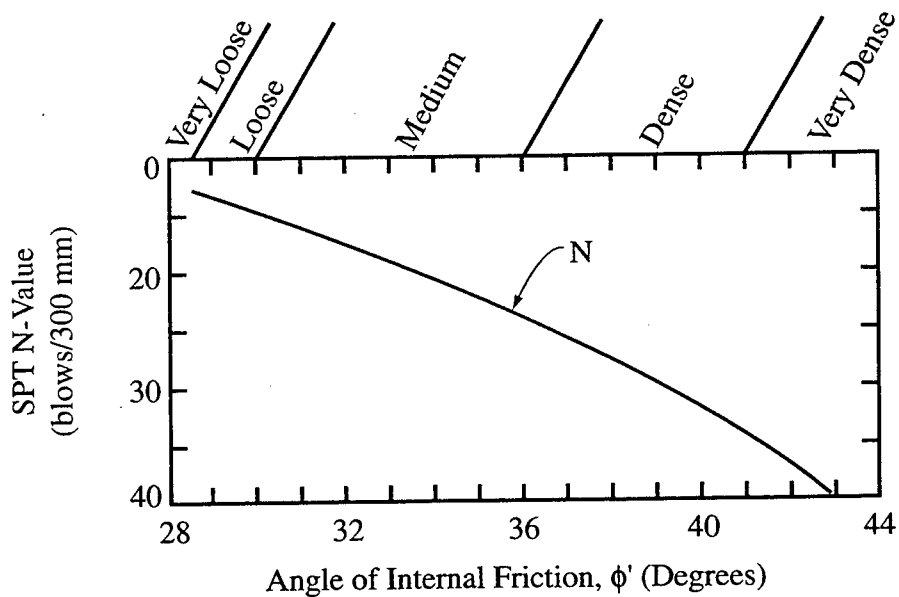

Figure 9-14: Estimation of  $\phi$  from N-value. (After Peck, *et. al.*, 1974)



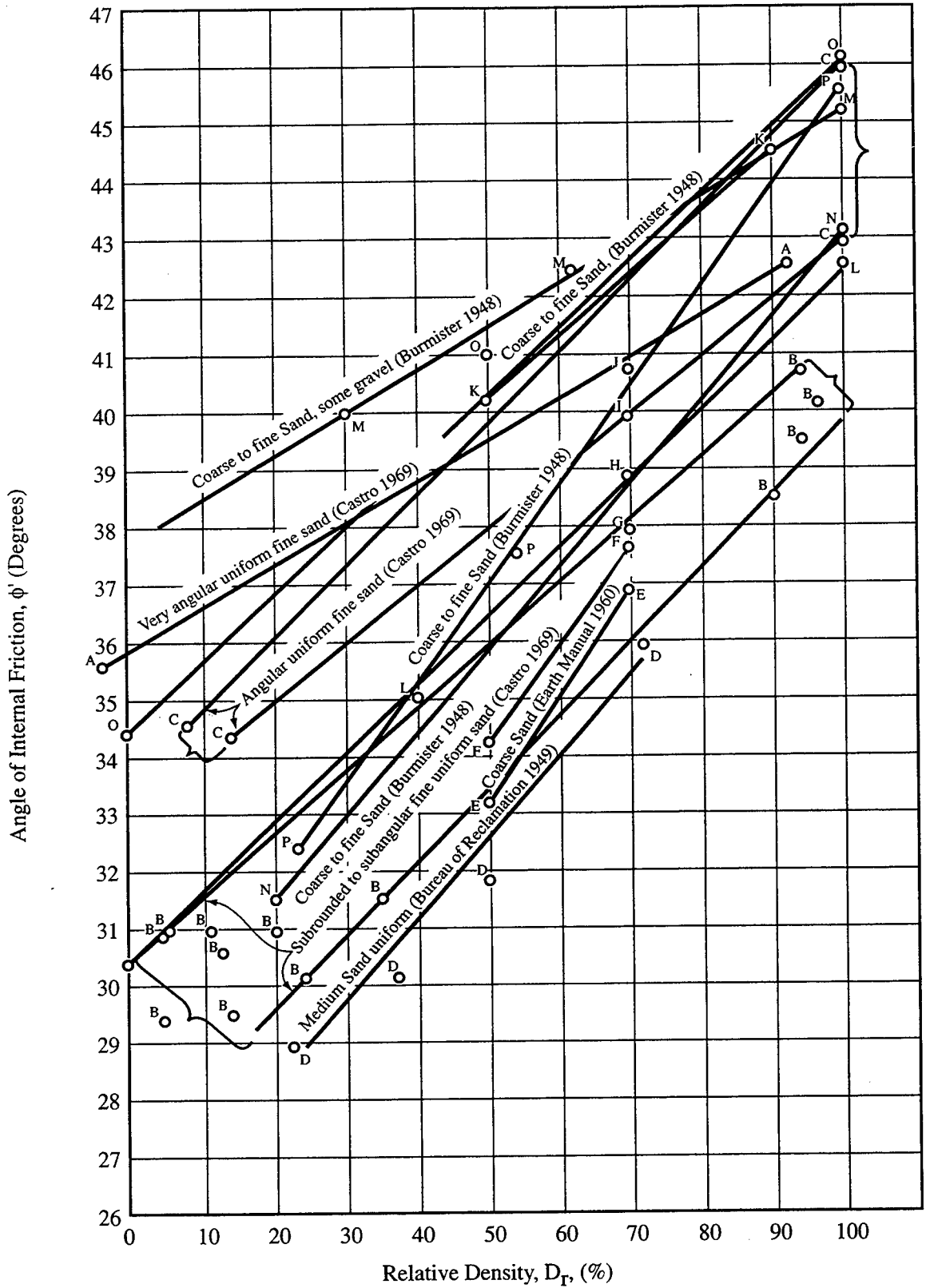

Figure 9-15: Relationship Between  $\phi$  and Relative Density for Various Sands. (Hilf, 1975)

**TABLE 9-13**  
**AVERAGE EFFECTIVE SHEAR STRENGTH OF COMPACTED SOILS**  
 (After Bureau of Reclamation, 1973)

Unified Classification	Soil Type	Standard Proctor Compaction (AASHTO T 99)		As Compacted Cohesion, $c_o$ (kPa)	Saturated Cohesion, $c_{sat}$ (kPa)	Friction Angle, $\phi$ (deg)
		Maximum Dry Density ( $kN/m^3$ )	Optimum Moisture Content (%)			
GW	well graded clean gravels, gravel-sand mixture	> 18.7	< 13.3	*	*	> 38
GP	poorly graded clean gravels, gravel sand mixture	> 17.3	< 12.4	*	*	> 37
GM	silty gravels, poorly graded gravel-sand-silt	> 17.9	< 14.5	*	*	> 34
GC	clayey gravels, poorly graded gravel-sand-clay	> 18.1	< 14.7	*	*	> 31
SW	well graded clean sands, gravelly sands	$18.7 \pm 0.8$	$13.3 \pm 2.5$	$39 \pm 4$	*	$38 \pm 1$
SP	poorly graded clean sands, sand-gravel mixture	$17.3 \pm 0.3$	$12.4 \pm 1.0$	$23 \pm 6$	*	$37 \pm 1$
SM	silty sands, poorly graded sand-silt mixture	$17.9 \pm 0.2$	$14.5 \pm 0.4$	$51 \pm 6$	$20 \pm 7$	$34 \pm 1$
SM-SC	sand-silt-clay with slightly plastic fines	$18.7 \pm 0.2$	$12.8 \pm 0.5$	$50 \pm 21$	$14 \pm 6$	$33 \pm 4$
SC	clayey sands, poorly graded sand-clay mixture	$18.1 \pm 0.2$	$14.7 \pm 0.4$	$75 \pm 15$	$11 \pm 6$	$31 \pm 4$
ML	inorganic silts and clayey silts	$16.2 \pm 0.2$	$19.2 \pm 0.7$	$67 \pm 10$	$9 \pm *$	$32 \pm 2$
ML-CL	mixtures of inorganic silts and clays	$17.1 \pm 0.3$	$16.8 \pm 0.7$	$63 \pm 17$	$22 \pm *$	$32 \pm 3$
CL	inorganic clays of low to medium plasticity	$17.0 \pm 0.2$	$17.3 \pm 0.3$	$87 \pm 10$	$13 \pm 2$	$28 \pm 2$
OL	organic silts and silty clays of low plasticity	*	*	*	*	*
MH	inorganic clayey silts, elastic silts	$12.9 \pm 0.6$	$36.3 \pm 3.2$	$72 \pm 30$	$20 \pm 9$	$25 \pm 3$
CH	inorganic clays of high plasticity	$14.8 \pm 0.3$	$25.5 \pm 1.2$	$103 \pm 34$	$11 \pm 6$	$19 \pm 5$
OH	organic clays and silty clays	*	*	*	*	*

The entry  $\pm$  indicates 90 percent confidence limits of the average value, \* denotes insufficient data, > is greater than, < is less than

## CHAPTER 10.0 CORRELATION OF ROCK PROPERTIES

### 10.1 INTRODUCTION

With the exception of some low-strength rocks, the engineering behavior of rock masses within and upon which transportation structures are constructed is determined by the discontinuity systems which divide the rock mass into discrete, prismatic blocks. With the exception of the durability testing discussed in Chapter 8.0, results of laboratory testing are of limited direct applicability to design of rock structures.

Of the three rock types (igneous, metamorphic and sedimentary), sedimentary rocks comprise 75% of the rocks exposed at the ground surface. Among the sedimentary rocks, the rocks of the shale family (shale, siltstone, mudstone and claystone) predominate, representing over 50% of the exposed sedimentary rocks (Foster, 1975). The distribution of rock types within the United States is discussed in National Cooperative Highway Research Program Report 132 (Witczak, 1972).

Deterioration of shale family rocks and weakly cemented, friable sandstones is the cause of many of the maintenance problems in the national highway system, with respect to cuts, embankments and foundations. For example, deterioration of cut slopes in shales will result in flatter slopes. Shale used in embankments when compacted will break down and result in a material less pervious than anticipated for a rock fill. In general, maintenance problems for slopes can be avoided by making them flatter or by spraying them with protective coating. When excavation for a structural foundation is made, the foundation level must be protected against slaking; this can be accomplished by spraying a protective coating on the rock, or by leaving a small lift of shale cover until concrete is ready to be placed. Effective use of the results of durability testing described in Chapter 8.0 can reduce future maintenance problems in new route construction and in reconstruction of existing routes.

For harder, stronger, more durable rocks, the results of laboratory testing should be considered as index properties providing general guidance as to the strength and deformability of the rock mass.

Design of rock structures is still frequently done on the basis of an empirical evaluation of rock mass properties guided by experience, consideration of rock mass structure and use of the index properties and correlations based on the index properties and other parameters, such as joint spacing and roughness and Rock Quality Designation (RQD).

As in the case of the evaluation of soil properties, a number of correlations have been developed for evaluation of rock properties. However, compared to many of the soil correlations which have a broad data base, rock property correlations reported in the technical literature often have a limited data base and should be used with caution. An attempt should be made to develop correlations applicable to the specific rock formations in a particular state. The development of such correlations is well worth the expenditure of time and effort.

This chapter presents ranges of rock properties reported in the literature, some basic rock property correlations and brief discussions of their relevance to the design of rock structures. **The reader is strongly encouraged to refer to the original references to understand the basis of the correlations and the classification systems presented in this chapter and for additional information.**

## **10.2 ROCK PROPERTIES**

This section presents ranges of rock properties reported in the technical literature.

### **10.2.1 Unit Weight**

Because the specific gravity of the basic rock-forming minerals exhibits a narrow range, the unit weight is an indicator of the degree of induration of the rock unit and is thus an indirect indicator of rock strength. Strength of the intact rock material tends to increase proportionally to the increase in unit weight. Representative dry unit weights for different rock types are contained in Table 10-1.

### **10.2.2 Compressive and Tensile Strength**

A wide range of compressive and tensile strengths can exist for a particular geologic rock type, depending upon porosity, cementation, grain size angularity and degree of interlocking of mineral grains, and orientation of load application with respect to microstructure (e.g., foliation in metamorphic rocks). The wide variation in compressive and tensile strengths is indicated in Table 10-2 (Obert and Duvall, 1967).

### **10.2.3 Modulus of Elasticity**

As additionally indicated in Table 10-2, intact rock can exhibit a wide range of modulus of elasticity. In many sedimentary and foliated metamorphic rocks, the modulus of elasticity is generally greater parallel to the bedding or foliation planes than perpendicular to them, due to closure of parallel weakness planes.

Table 10-3 and Figure 10-1 show an intact rock classification system based on uniaxial compressive strength and modulus ratio (the ratio of modulus of elasticity to uniaxial compressive strength). The broad range of strength and modulus values shown in the figure is informative. The above system considers intact rock specimens only. It does not consider the natural fractures (discontinuities) in the rock mass. To estimate the rock mass modulus, which accounts for rock strength and fracturing, the relationships shown in Figure 10-2 which were developed from the RMR (Rock Mass Rating) values discussed in Section 10.3.3 should be used.

### **10.2.4 Shear Strength**

As noted in Chapter 8.0, rock shear strength is measured by the triaxial compression test and by the direct shear test. The triaxial test generally is used to determine the shear strength of the intact rock. The direct shear test is used to determine the shear strength of a discontinuity, such as a joint.

As for the other strength properties, there is a relatively wide range in the shear strength values measured in the laboratory by the triaxial test, particularly in the cohesion intercept. Representative ranges for three rock types are contained in Table 10-4.

The shear strengths of the intact rock and of the discontinuity surface have peak and residual values of the frictional component of shear strength (Figure 10-3). Relatively small movements can reduce shear strength from peak to residual values. The peak values can be conceived as the composite of the residual shear strength and a geometrical component,  $i$ , related to asperities (roughness) on the joint plane. Movement reduces or eliminates the asperities, resulting in reduced shear strength. Only first order irregularities, the major undulations on the joint surface, should be considered in evaluating the geometric component of shear strength. Second order irregularities, i.e., the small bumps and ripples on the joint surface, which have much higher values of  $i$ , should not be considered. This concept is illustrated in Figure 10-3.

**TABLE 10-1  
REPRESENTATIVE RANGE OF DRY UNIT WEIGHTS**

Rock Type	Unit Weight Range (KN/M <sup>3</sup> )
Shale	22-25
Sandstone	17-27
Limestone	19-28
Schist	25-29
Gneiss	25-29
Granite	24-29
Basalt	20-30

1. Dry unit weights are for moderately weathered to unweathered rock.
2. Wide range in unit weights for shale, sandstone, and limestone represents effect of variations in porosity, cementation, grain size, etc.
3. Specimens with unit weights falling outside the ranges contained herein may be encountered.

**TABLE 10-2  
MECHANICAL PROPERTIES OF ROCK  
(Obert and Duvall, 1967)**

Rock Type and Number of Test Groups	Compressive Strength of Test Group (MPa)			Tensile Strength of Test Group (MPa)		Modulus of Rupture (MPa)			Static Modulus of Elasticity of Test Group (GPa)		Dynamic Modulus of Elasticity of Test Group (GPa)	
	Max.	Min.	> 50% of Data within	Max.	Min.	Max.	Min.	> 50% of Data within	Max.	Min.	Max.	Min.
Amphibolite(13)	502	204				50	25				100	45
Basalt (9)	348	79				45	15				85	40
Dabase (10)	348	155	265/335			55	30	34/36			95	70
Diorite (11)	324	150	165/235			50	15				40	24
Dolomite (10)	348	60				25	15				80	20
Gneiss (15)	244	150	165/235			20	10	12/18			100	25
Granite (17)	285	154	165/235	54	28	25	10	12/18	74	17	80	10
Greenstone (11)	305	110				45	10		60	46	100	20
Limestone (16)	185	35	135/200			35	2.5		80	28	95	10
Marble (8)	230	45	200/235			20	10					
Marlstone (15)	190	70	65/135			30	2.5		32	4	45	10
Quartzite (11)	610	140				45	10					
Sandstone (18)	230	32		19	7	25	4	4/7	49	9	55	5
Shale (18)	225	73	65/135			30	2		51	11	65	10
Siltstone (8)	307	35				35	8				60	7

**TABLE 10-3**  
**ENGINEERING CLASSIFICATION OF INTACT ROCK**  
 (Deere and Miller, 1966; Stagg and Zienkiewicz, 1968)

I. On basis of strength ( $\sigma_{a(ult)}$ )

Class	Description	Uniaxial compressive strength (MPa)
A	Very high strength	Over 220
B	High strength	110-220
C	Medium strength	55-110
D	Low strength	28-55
E	Very low strength	Less than 55

II. On basis of modulus ratio ( $E_t/\sigma_{a(ult)}$ )

Class	Description	Modulus ratio <sup>b</sup>
H	High modulus ratio	Over 500
M	Average (medium) ratio	200-500
L	Low modulus ratio	Less than 200

<sup>a</sup> Rocks are classified by both strength and modulus ratio such as AM, BL, BH, CM, etc.

<sup>b</sup> Modulus ratio =  $E_t/\sigma_{a(ult)}$  where  $E_t$  is tangent modulus at 50% ultimate strength and  $\sigma_{a(ult)}$  is the uniaxial compressive strength.

**TABLE 10-4**  
**TYPICAL SHEAR STRENGTH PARAMETERS OF INTACT ROCK**  
 (Stagg and Zienkiewicz, 1968)

Rock type	$\sigma_{a(ult)}$ MPa		c, cohesion MPa	$\phi$ (deg)
Granite	Range	65-270	9-40	51-58
	Average	165	24	55
Limestone	Range	20-200	3-35	37-58
	Average	100-135	16-22	50
Sandstone	Range	20-200	4-40	48-50
	Average	55-135	10-25	48

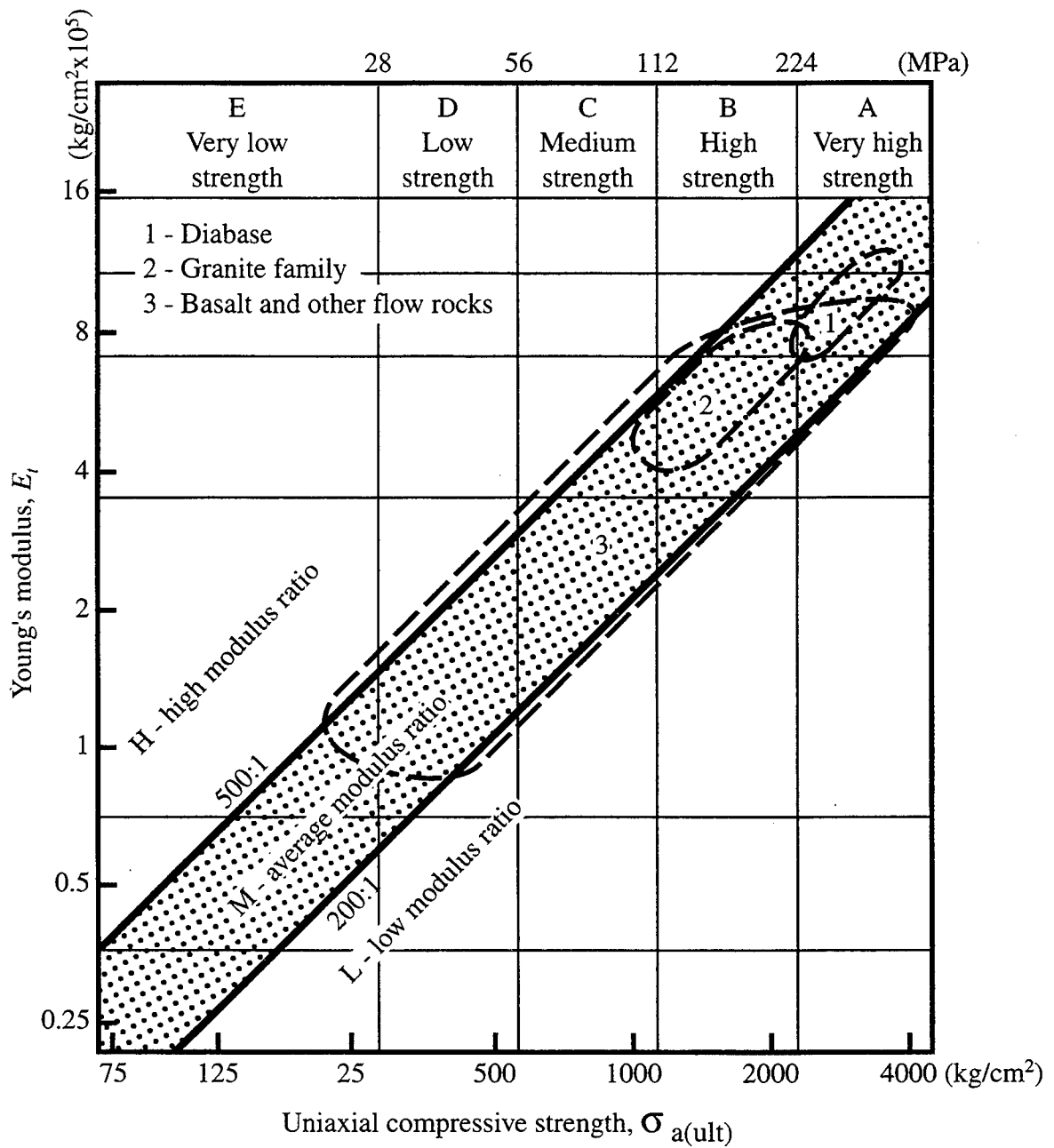

$E_t$  = tangent modulus at 50% ultimate strength.  
Classify rock as AM, BH, BL, etc.

Figure 10-1: (a) Engineering Classification For Intact Igneous Rocks. (Deere and Miller, 1966; Stagg and Zienkiewicz, 1968)

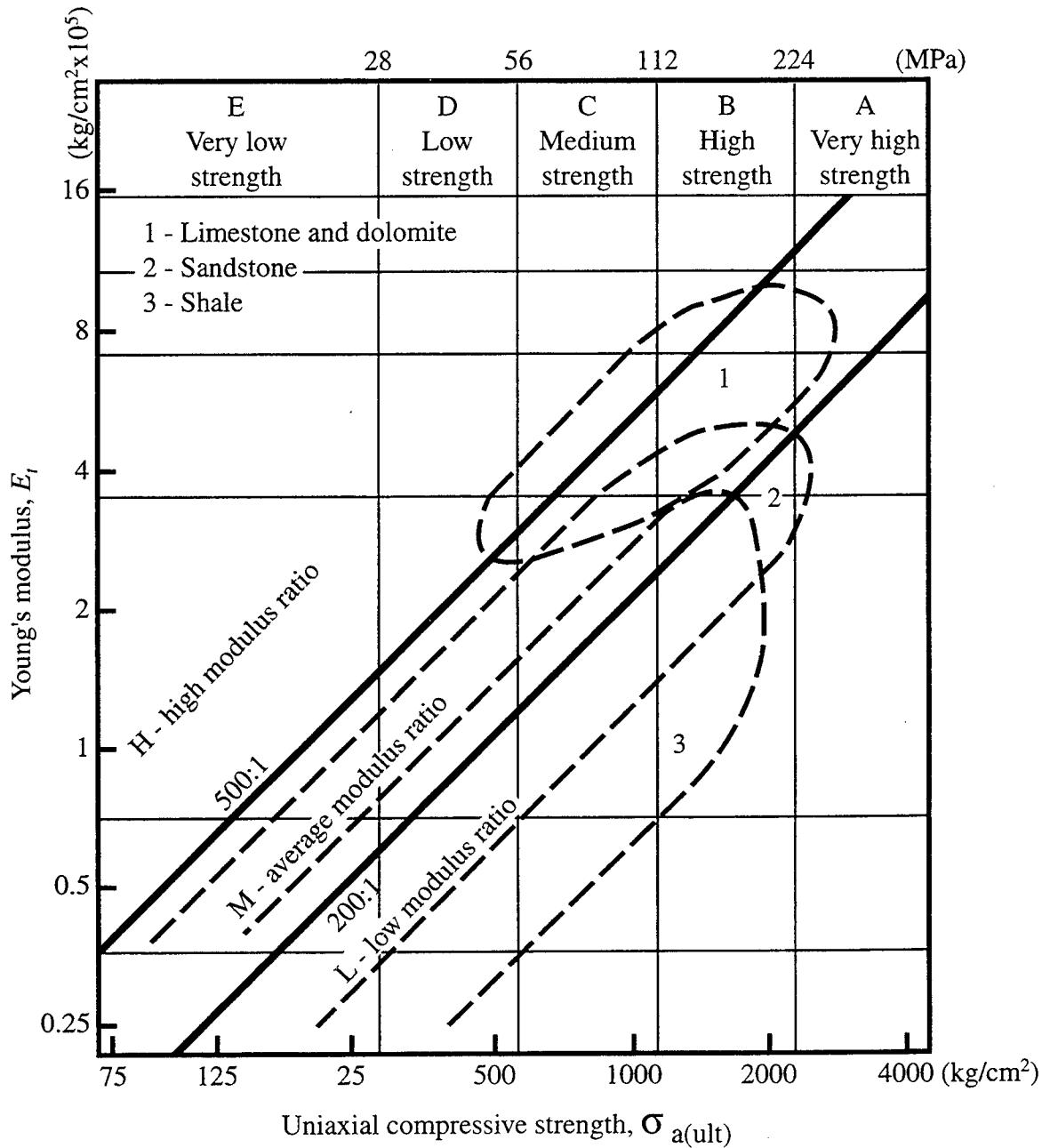

$E_t$  = tangent modulus at 50% ultimate strength.  
 Classify rock as AM, BH, BL, etc.

Figure 10-1 (Contd): (b) Engineering Classification For Intact Sedimentary Rocks. (Deere and Miller, 1966; Stagg and Zienkiewicz, 1968)



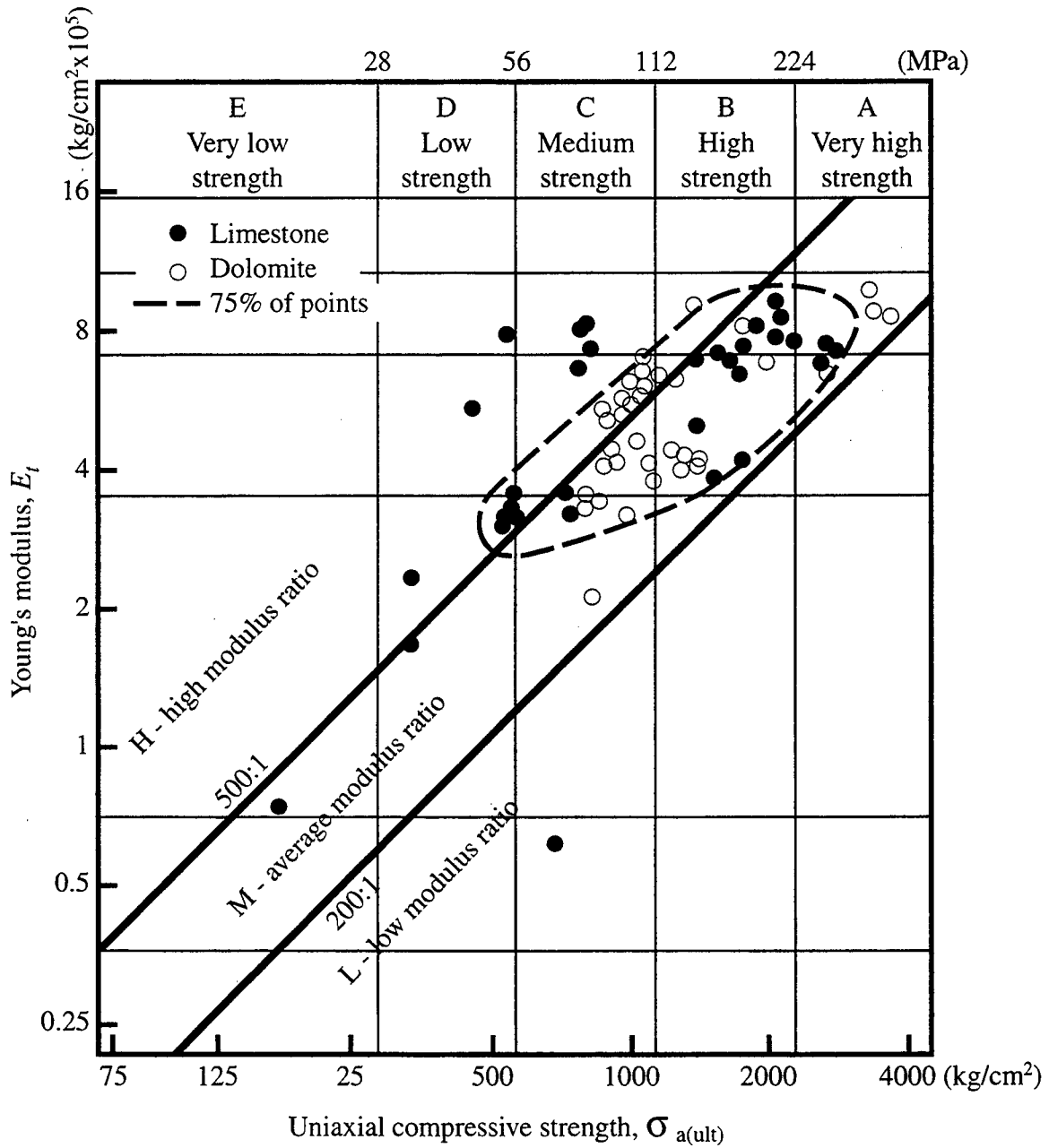

$E_t$  = tangent modulus at 50% ultimate strength  
 classify rock as AM, BH, BL, etc.

Figure 10-1 (Contd): (c) Engineering Classification For Intact Limestone and Dolomite. (Deere and Miller, 1966; Stagg and Zienkiewicz, 1968)

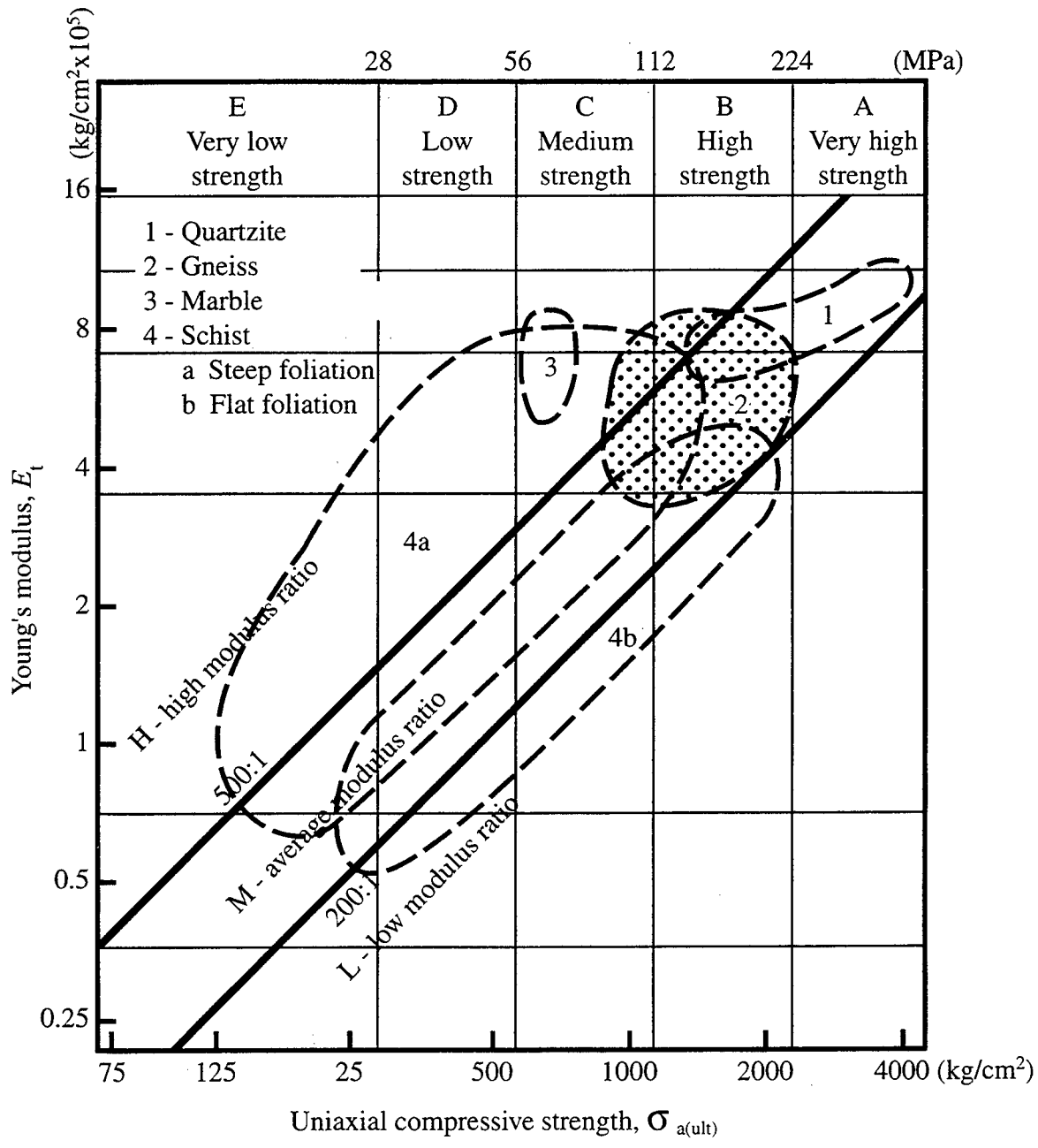

$E_t$  = tangent modulus at 50% ultimate strength  
 classify rock as AM, BH, BL, etc.

Figure 10-1 (Contd): (d) Engineering Classification For Intact Metamorphic Rocks (Deere and Miller, 1966; Stagg and Zienkiewicz, 1968)

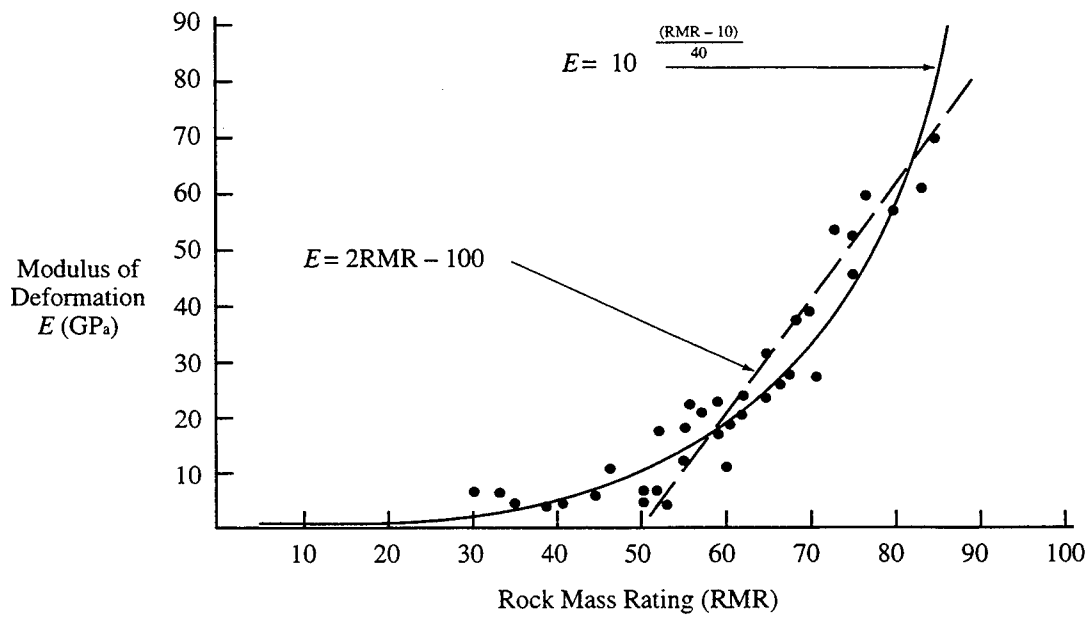
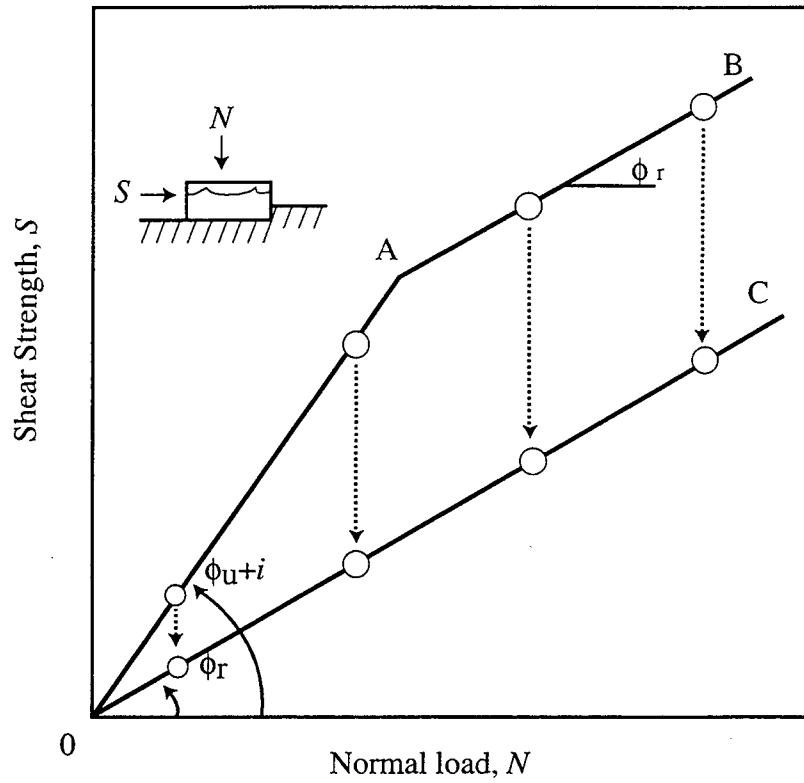
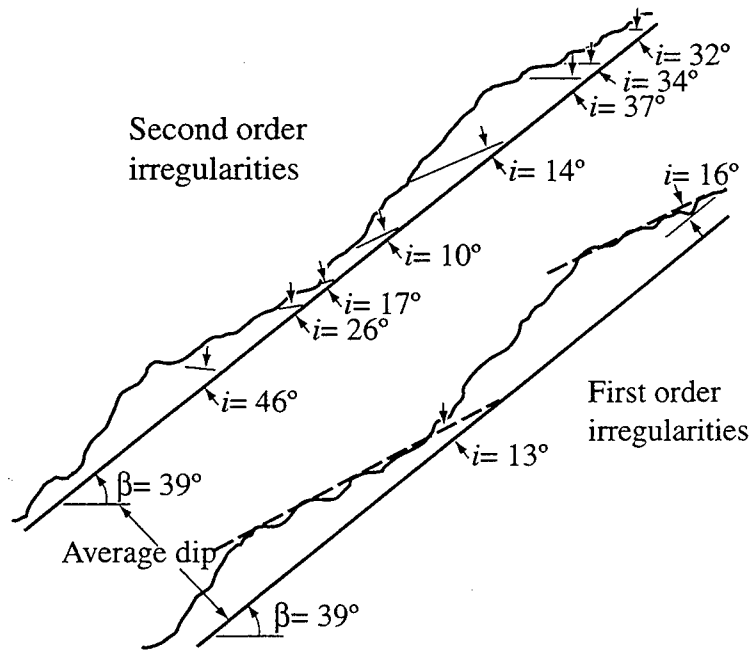

Figure 10-2: Relationship Between In Situ Modulus and Rock Mass Rating. (Wyllie, 1992)



(a)



(b)

Figure 10-3: Peak and Residual Shear Strength. (a) Failure Envelope for Multiple Inclined Surfaces, (b) An Example of a Discontinuity Illustrating First- and Second-order Irregularities. (Deere, et. al. 1966; Stagg and Zienkiewicz, 1968)

Approximate values of residual frictional shear strength for various rock types are contained in Table 10-5. The recommended range for the geometrical component,  $I$ , based on first order asperities, is  $10^\circ$  to  $15^\circ$ .

As an alternative, the frictional component,  $I$ , can be replaced by the following expression:

$$i = \text{JRC} \log_{10} \frac{\text{JCS}}{\sigma_n} \quad (10-1)$$

where, JRC = Joint Roughness Coefficient  
JCS = Joint Wall Compressive Strength  
 $\sigma_n$  = Normal Stress on Joint

JRC can be evaluated using Figure 10-4 and Figure 10-5. Figure 10-5 correlates JRC with the joint roughness coefficient  $J_r$  of the Q-System of rock mass classification. The joint alteration number,  $J_a$ , can be used to estimate the residual shear strength, as shown in Table 10-6. Figure 10-4 and Figure 10-5 and Table 10-6 can be used in the field during mapping of outcrops. An additional tabulation of joint shear strength, including joints with soil fillings, is contained in Table 10-7. For more detailed description of the Q-system and its use the reader is referred to Barton (1988).

## 10.3 CORRELATIONS

### 10.3.1 Introduction

Because it is often difficult to obtain from laboratory testing the design parameters necessary for design of rock structures, a number of empirical correlations have been developed from which these parameters can be estimated from intact rock and rock mass characteristics which can be directly observed in the field and from simple laboratory tests. Many of these correlations have been developed by extension from rock mass classification systems which have been developed over the past 20 years.

### 10.3.2 Shale Rating System (SRS)

From 35 to 40 percent of the rocks exposed at the ground surface belong to the shale family of sedimentary rocks. Many of the difficulties encountered in the construction and maintenance of transportation routes are related to the presence of these rocks.

The Shale Rating System (Franklin, 1981) can be used to evaluate these rocks on the basis of Plasticity Index (PI), Slake Durability Index (SDI) and Point Load Strength Index (PLSI). The first two are simple laboratory tests and the PLSI can be performed in the field on core and irregularly-shaped rock specimens. The Shale Rating is determined from these parameters, as shown in Figure 10-6(a).

Based on field performance, correlations have been developed (Franklin, 1981) between the Shale Rating and (1) lift thicknesses and compacted densities; (2) trends in embankment slope angle as a function of embankment height; and (3) trends in shear strength parameters of compacted fills. The last correlation is presented in Figure 10-6 (b). The reader is referred to the original paper by Franklin.

**TABLE 10-5**  
**RESIDUAL FRICTIONAL SHEAR STRENGTH**  
**(Barton, 1973; Hoek and Bray, 1977)**

Rock Type	$\phi_r$ -degrees
Amphibolite	32
Basalt	31-38
Conglomerate	35
Chalk	30
Dolomite	27-31
Gneiss (schistose)	23-29
Granite (fine grain)	29-35
Limestone	33-40
Porphyry	31
Sandstone	25-35
Shale	27
Siltstone	27-31
Slate	25-30

Lower value is generally given by tests on wet rock surfaces.

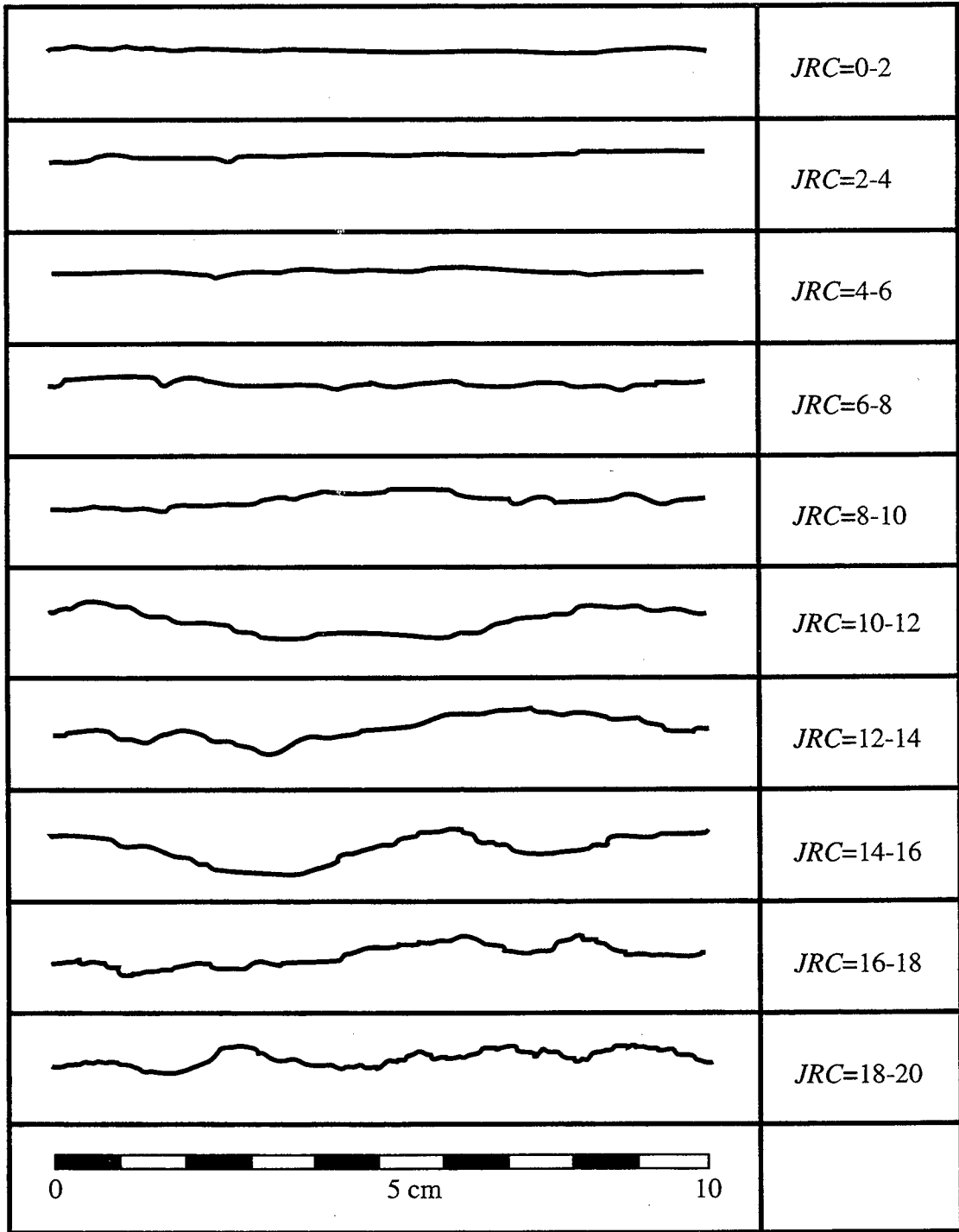

Figure 10-4: Roughness Profiles and Corresponding JRC Values. (Barton 1973; Hoek, *et. al.*, 1995)









Description	Profile	$J_r$	JRC 200 mm	JRC 1 m
Rough		4	20	11
Smooth		3	14	9
Slickensided				
	Stepped	2	11	8
Rough		3	14	9
Smooth		2	11	8
Slickensided				
	Undulating	1.5	7	6
Rough		1.5	2.5	2.3
Smooth		1.0	1.5	0.9
Slickensided				
	Planar	0.5	0.5	0.4

Figure 10-5: Relationship Between  $J_r$  in the Q System and JRC for 200 mm and 1000 mm Samples. (Barton, 1973; Hoek, *et. al.*, 1995)

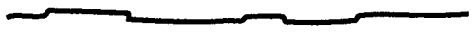

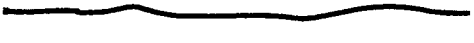
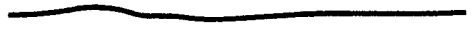
**TABLE 10-6**  
**Q SYSTEM JOINT ALTERATION NUMBER AND RESIDUAL SHEAR STRENGTH**  
**(Barton, 1988)**

	$J_a$	Approx $\phi_r$
(a) Rock wall contact		
A. Tightly healed, hard, non-softening, impermeable filling i.e., quartz or epidote	0.75	(-)
B. Unaltered joint walls, surface staining only	1.0	(25 - 35°)
C. Slightly altered joint walls. Non-softening mineral coatings, sandy particles, clay-free disintegrated rock etc.	2.0	(25 - 30°)
D. Silty- or sandy-clay coatings, small clay-fraction (non-softening)	3.0	(20 - 25°)
E. Softening or low friction clay mineral coatings, i.e., kaolinite, mica. Also chlorite, talc, gypsum, graphite, etc., and small quantities of swelling clays.	4.0	(8 - 16°)
(b) Rock wall contact before 10 cms shear		
F. Sandy particles, clay-free disintegrated rock etc.	4.0	(25 - 30°)
G. Strongly over-consolidated, non-softening, clay mineral fillings (continuous, but <5 mm thickness)	6.0	(16 - 24°)
H. Medium or low over-consolidation, softening, clay mineral fillings. (Continuous, but <5 mm thickness)	8.0	(12 - 16°)
J. Swelling-clay fillings, i.e., montmorillonite (continuous, <5 mm thickness) Value of $J_a$ depends on percent of swelling clay-size particles, and access to water, etc.	8 - 12	(6 - 12°)
(c) No rock wall contact when sheared		
K, L, Zones or bands of disintegrated or crushed rock and clay (see M. G, H, J for description of clay condition)	6, 8, or 8 - 12	(6 - 24°)
N. Zones of bands of silty- or sandy-clay, small clay fraction (non-softening)	5.0	(-)
O, P, Thick, continuous zones or bands of clay (see G, H, J for description of clay condition)	10, 13, or 13 - 20	(6 - 24°)

**TABLE 10-7**  
**MOHR-COULOMB SHEAR STRENGTH PARAMETERS**  
**FOR TYPICAL ROCK JOINTS AND FILLINGS\***  
**(Franklin and Dusseault, 1989)**

		Typical ultimate strengths $\phi$ , deg ( $c = 0$ )	
Thick joint fillings			
	Smectite clays	5 - 10	
	Kaolinite	12 - 15	
	Illite	16 - 22	
	Chlorite	20 - 30	
	Portland cement grout	16 - 22	
	Quartz and feldspar sand	28 - 40	
Rock joints <sup>†</sup>			
	Crystalline limestones	42 - 49	
	Porous limestones	32 - 48	
	Chalk	30 - 41	
	Sandstones	24 - 35	
	Quartzite	23 - 44	
	Shales	22 - 37	
	Coarse igneous rocks	31 - 48	
	Fine igneous rocks	33 - 52	
	Schists	32 - 40	
		Typical peak strengths <sup>‡</sup>	
		c, MPa	$\phi$ , deg
	Sandstone	0.12 - 0.66	32 - 37
	Siltstone	0.10 - 0.79	20 - 33
	Pyroclastic rock	0.14 - 0.36	36 - 39
	Seatearth (mudstone)	0.06 - 0.18	15 - 24
	Mudstone	0.00 - 0.46	22 - 39

\* Because of the considerable variations in test methods and in the rocks themselves, and due to the curvature of peak strength envelopes, the data give only a very rough guide to rock properties. The peak strength results are for carboniferous (Coal Measures) rock strata.

<sup>†</sup> Summary by Lama and Vutukuri (1978).

<sup>‡</sup> After Hassani and Scoble (1985).

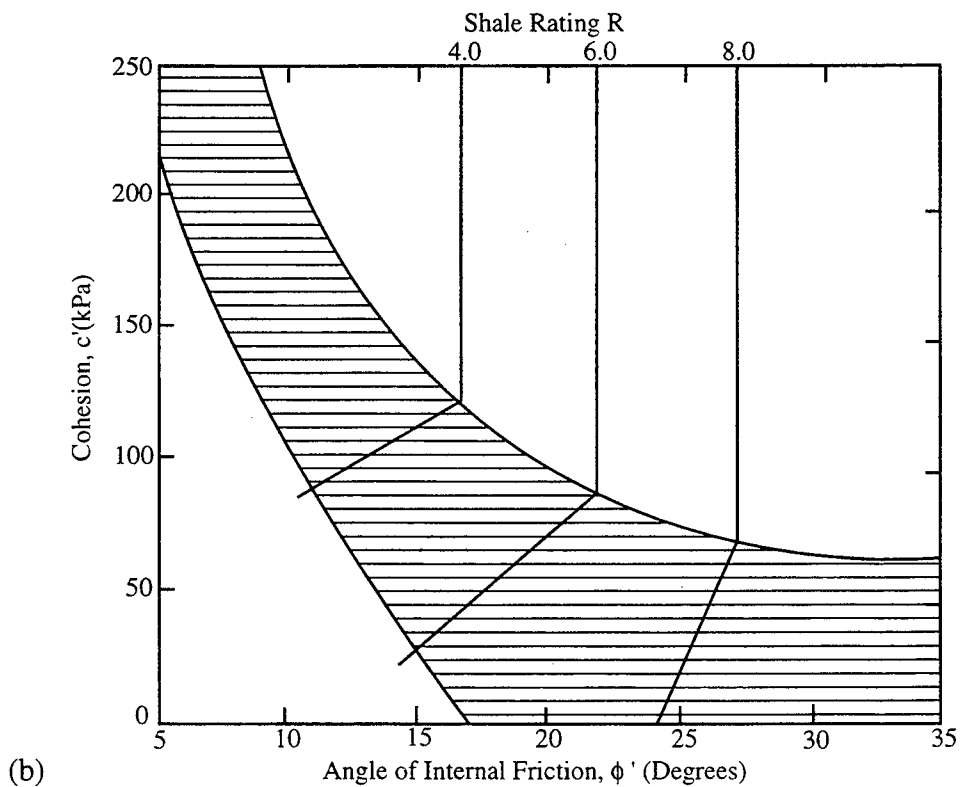
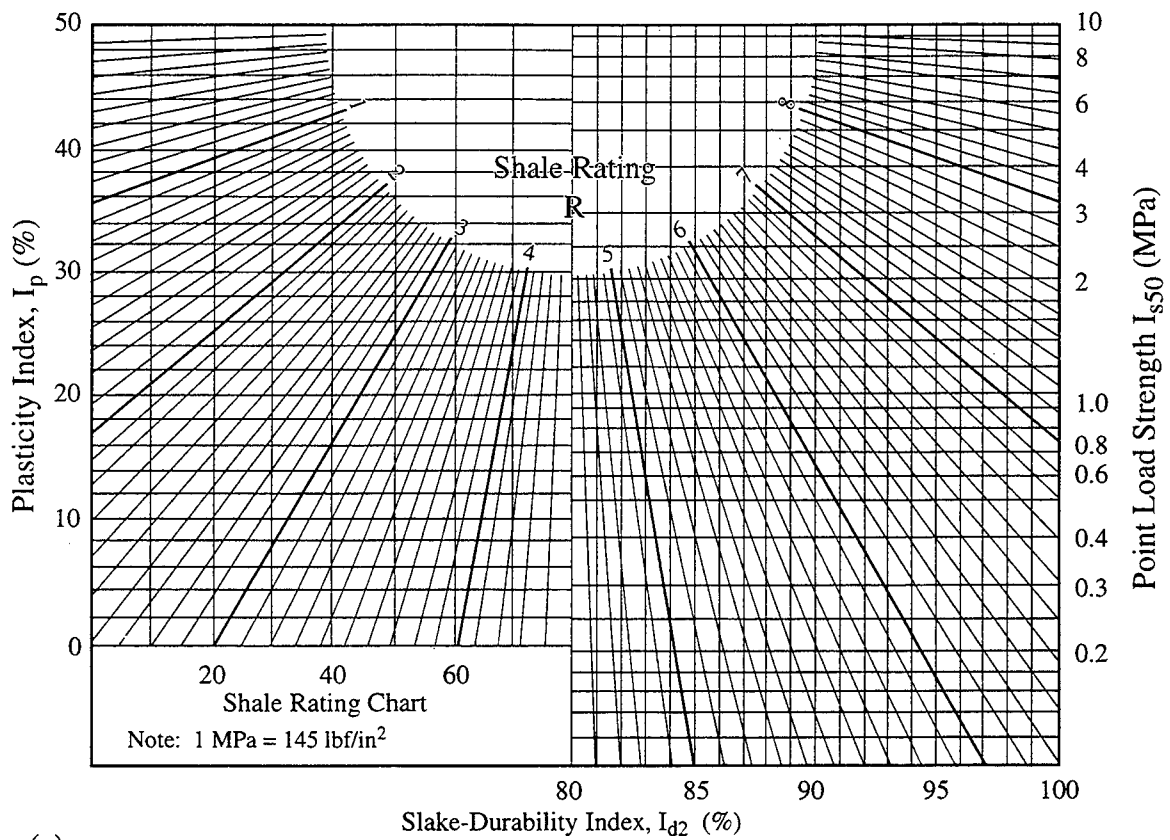

Figure 10-6: (a) Shale Rating System, (b) Trends in Shear-Strength Parameters of Compacted Shale Fills as a Function of Shale Quality. (Franklin, 1981)

### 10.3.3 Rock Mass Rating System (RMR)

The Rock Mass Rating (RMR) rock classification system uses six parameters to evaluate a rock mass. Originally intended for tunneling applications, it has been extended for the design of cut slopes and foundations. The six parameters used to determine the RMR value are:

- Uniaxial compressive strength or point load strength index
- RQD
- Spacing of discontinuities
- Condition of discontinuities
- Groundwater conditions
- Orientation of discontinuities

If test data or field information concerning the above parameters are not available, the RMR can still be determined based on the correlations described below.

In the absence of compressive or point load strength data, rock strength can be estimated using the Unified Rock Classification System (URCS) described in Section 10.3.4. In the absence of rock core, RQD can be estimated from the relationship:

$$\text{RQD} = 115 - 3.3 J_v \quad (10-2)$$

where  $J_v$  is the estimated number of joints in one cubic meter of rock.

The basic RMR system is contained in Table 10-8. Guidance for evaluation of the discontinuity conditions is contained in Table 10-9.

The RMR was developed by Bienawski (1989), who derived several correlations between RMR and other parameters. These correlations are:

$$\text{For RMR} > 50 \quad \text{Deformation Modulus, } E(\text{GPa}) = 2 \text{ RMR} - 100 \quad (10-3)$$

$$\text{For RMR} < 50 \quad \text{Deformation Modulus, } E(\text{GPa}) = 10^{(\text{RMR} - 10)/40} \quad (10-4)$$

$$\text{Friction Angle, } \phi = 0.5 \text{ RMR} + 5 \quad (10-5)$$

The deformation modulus is the elastic modulus for a rock mass. It can be determined by large scale field tests. However, since most projects cannot justify the cost for such testing, Eq. 10-3 can be used which is based on field data from larger projects.

In both these correlations, the RMR is used without the adjustment for discontinuity orientation.

Another series of correlations based on RMR is shown in Table 10-10. Again, the RMR is used without the adjustment for orientation.

### 10.3.4 Unified Rock Classification System (URCS)

The URCS is summarized in Table 10-11. Among other things, it provides an evaluation of the intact rock strength required for the RMR system and its derivatives on the basis of the rock's response to a hammer blow. As such, it is valuable during preliminary investigations. The reader is referred to Williamson (1984) for a detailed description of the URCS.

**TABLE 10-8**  
**THE ROCK MASS RATING SYSTEM**  
**(GEOMECHANICS CLASSIFICATION OF ROCK MASSES)**  
**(Bieniawski, 1989)**

Parameter		Ranges of Values						
1	Strength of intact rock material	10	4 - 10	2 - 4	1 - 2	For this low range, uniaxial compressive test is preferred		
	Point-load strength index (MPa)	250	100 - 250	50 - 100	25 - 50	5-25	1-5	< 1
2	Uniaxial compressive strength (MPa)	15	12	7	4	2	1	0
	Rating	90 - 100	75 - 90	50 - 75	25 - 50	< 25		
3	Drill core quality RQD (%)	20	17	13	8	3		
	Rating	> 2 m	0.6 - 2 m	200 - 600 mm	60 - 200 mm	< 60 mm		
4	Spacings of discontinuities	20	15	10	8	5		
	Condition of discontinuities (See Table 10-9)	Very rough surfaces Not continuous No separation Unweathered wall rock	Slightly rough surfaces Separation < 1 mm Slightly weathered walls	Slightly rough surfaces Separation < 1 mm Highly weathered wall	Slickensided surfaces or Gouge < 5 mm thick or Separation 1 - 5 mm Continuous	Soft gouge > 5 mm thick or Separation > 5 mm Continuous		
5	Rating	30	25	20	10	0		
	Inflow per 10 m tunnel length (L/min)	None	< 10	10 - 25	25 - 125	> 125		
Groundwater	Ratio	0	< 0.1	0.1 - 0.2	0.2 - 0.5	> 0.5		
	Joint water pressure Major principal stress	or	or	or	or	or		
General conditions	General conditions	Completely dry	Damp	Wet	Dripping	Flowing		
	Rating	15	10	7	4	0		

**TABLE 10-8 (Continued)**  
**THE ROCK MASS RATING SYSTEM**  
**(GEOMECHANICS CLASSIFICATION OF ROCK MASSES)**  
**(Bieniawski, 1989)**

B. Rating Adjustment for Discontinuity Orientations						
Strike and Dip Orientations of Discontinuities		Very Favorable	Favorable	Fair	Unfavorable	Very Unfavorable
Tunnels and mines		0	-2	-5	-10	-12
Foundations		0	-2	-7	-15	-25
Slopes		0	-5	-25	-50	-60

C. Rock Mass Classes Determined from Total Ratings						
Rating	100 ← 81	80 ← 61	60 ← 41	40 ← 21	← 20	
Class no.	I	II	III	IV	V	
Description	Very good rock	Good rock	Fair rock	Poor rock	Very poor rock	

D. Meaning of Rock Mass Classes						
Class no.	I	II	III	IV	V	
Average stand-up time	20 yr for 15 m span	1 yr for 10 m span	1 wk for 5 m span	10 h for 2.5 m span	30 min for 1 m span	
Cohesion of the rock mass (kPa)	> 400	300-400	200-300	100-200	< 100	
Friction angle of the rock mass (degrees)	> 45	35-45	25-35	15-25	< 15	

**TABLE 10-9**  
**GUIDELINES FOR CLASSIFICATION OF DISCONTINUITY CONDITIONS**  
**(Bieniawski, 1989)**

Parameter	Ratings				
Discontinuity length (persistence continuity)	< 1 m 6	1-3 m 4	3-10 m 2	10-20 m 1	> 20 m 0
Separation (aperture)	None 6	< 0.1 mm 5	0.1-1.0 mm 4	1-5 mm 1	> 5 mm 0
Roughness	Very rough 6	Rough 5	Slightly rough 3	Smooth 1	Slickensided 0
Infilling (gouge)		Hard filling		Soft filling	
	None 6	< 5 mm 4	> 5 mm 2	< 5 mm 2	> 5 mm 0
Weathering	Unweathered 6	Slightly weathered 5	Moderately weathered 3	Highly weathered 1	Decomposed 0

Some conditions are mutually exclusive. For examples, if infilling is present, it is irrelevant what the roughness may be, since its effect will be overshadowed by the influence of the gouge.

**TABLE 10-10**  
**GEOMECHANICS CLASSIFICATION FOR ROCK FOUNDATIONS:**  
**SHEAR STRENGTH DATA**  
(Serafim and Pereira, 1983; Bieniawski, 1989)

Rock Mass Properties					
RMR	100-81	80-61	60-41	40-21	<20
Rock Class	I	II	III	IV	V
Cohesion, kPa	>400	300-400	200-300	100-200	<100
Friction, deg	>45	35-45	25-35	15-25	<15
Modulus, GPa	>56	18-56	5.6-18	1.8-5.6	<1.8
Shear Strength of Rock Material					
Cohesion, MPa	>25	15-25	8.5-15	4.5-8.5	<4.5
Friction, deg	>65	55-65	48-55	41-48	<41
Frictional Shear Strength of Discontinuities, degrees					
Rating for Condition of Discontinuities	30	25	20	10	0
Completely dry	45	35	25	15	10
Damp	43	33	23	13	<10
Wet	41	31	21	11	<10
Dripping	39	29	19	10	<10
Flowing	37	27	17	<10	<10



**TABLE 10-11**  
**UNIFIED ROCK CLASSIFICATION (After Williamson, 1984)**

Design Notation: Weathering, Strength, Discontinuity, Weight (e.g., BCDB)

Degree of Weathering

Representative		Altered	Weathered			
			> Gravel Size		< Sand Size	
Micro Fresh State (MFS) A	Visually Fresh State (VFS) B	Stained State (STS) C	Partly Decomposed State (PDS) D		Completely Decomposed State (CDS) E	
Unit weight Relative Absorption		Compare to fresh state	Non-plastic	Plastic	Non-plastic	Plastic

Estimated Strength

Reaction to Impact of 4.5 N (1 lb) Ballpeen Hammer				Remolding <sup>(1)</sup>
“Rebounds” (Elastic) (RQ) A	“Pits” (Tensional) (PQ) B	“Dents” (Compression) (DQ) C	“Craters” (Shears) (CQ) D	Moldable (Friable) (MQ) E
> 103 MPa <sup>(2)</sup>	55-103 MPa <sup>(2)</sup>	21-55 MPa <sup>(2)</sup>	7-21 MPa <sup>(2)</sup>	< 7 MPa <sup>(2)</sup>

<sup>(1)</sup> Strength estimated by soil mechanics techniques

<sup>(2)</sup> Approximate unconfined compressive strength

Discontinuities

Very Low Permeability			May Transmit Water	
Solid (Random Breakage) (SRB) A	Solid (Preferred Breakage) (SPB) B	Solid (Latent Planes of Separation) (LPS) C	Nonintersecting Open Planes (2-D) D	Intersecting Open Planes (3-D) E
			Attitude	Interlock

Unit Weight

> 2.55 g/cc A	2.40-2.55 g/cc B	2.25-2.40 g/cc C	2.10-2.25 g/cc D	< 2.10 g/cc E
------------------	---------------------	---------------------	---------------------	------------------

### 10.3.5 Slope Rock Mass Rating System (SMR)

The SMR, an extension of the RMR, is a system used in the preliminary assessment of natural rock slopes and rock cuts. It is contained in Table 10-12. For a more detailed description of this system, the reader is referred to Bienawski (1989)

### 10.3.6 Other Correlations

Other useful correlations have been developed in addition to those discussed above. Among these are the following:

#### Deformation Modulus

The following correlation between the deformation modulus, E, and the shear wave frequency in cycles per second, f, was obtained from Goodman (1980).

$$E \text{ (GPa)} = 0.054f - 9.2 \quad (10-6)$$

#### Correlation Between Point Load Strength Index and Uniaxial Compressive Strength

The Point Load Strength Index and the Uniaxial Compressive Strength are used as input to several of the classification systems described in this chapter. The following correlation has been developed between these two values:

$$q_u = 24 I_s \quad (10-7)$$

where,  $q_u$  = uniaxial compressive strength  
 $I_s$  = point load strength index

However, as noted in Goodman (1980), this correlation can be inaccurate for weak rocks such as the shale family, poorly cemented sandstones, and porous limestones. Development of correlations for site specific rock units is strongly recommended.

**TABLE 10-12**  
**SLOPE ROCK MASS RATING SYSTEM (SMR)**  
 (Bieniawski, 1989)

Parameter		Ranges of Values				
1	Strength of intact rock material	> 10	4 - 10	2 - 4	1 - 2	For this low range, uniaxial compressive test is preferred
	Point-load strength index (Mpa)	> 250	100 - 250	50 - 100	25 - 50	
2	Rating	15	12	7	4	2 1 0
	Drill core quality RQD (%)	90 - 100	75 - 90	50 - 75	25 - 50	< 25
3	Rating	20	17	13	8	3
	Spacings of discontinuities	> 2 m	0.6 - 2 m	200 - 600 mm	60 - 200 mm	< 60 mm
4	Rating	20	15	10	8	5
	Condition of discontinuities (See Table 10-9)	Very rough surfaces Not continuous No separation Unweathered wall rock	Slightly rough surfaces Separation < 1 mm Slightly weathered walls	Slightly rough surfaces Separation < 1 mm Highly weathered wall	Slickensided surfaces or Gouge < 5 mm thick or Separation 1 - 5 mm Continuous	Soft gouge > 5 mm thick or Separation > 5 mm Continuous
5	Rating	30	25	20	10	0
	Groundwater in joint	Completely dry	Damp	Wet	Dripping	Flowing
5	Rating	15	10	7	4	0

**TABLE 10-12 (Continued)**  
**SLOPE ROCK MASS RATING SYSTEM (SMR)**  
**(Bieniawski, 1989)**

Joint Adjustment Ratings for Joints						
Case	Very Favorable	Favorable	Fair	Unfavorable	Very Unfavorable	
P	> 30°	30-20°	20-10°	10-5°	< 5°	
T	0.15	0.40	0.70	0.85	1.00	
P/T						
P	< 20°	20-30°	30-35°	35-45°	> 45°	
P	0.15	0.40	0.70	0.85	1.00	
T	1	1	1	1	1	
P	> 10°	10-0°	0°	0°-(-10°)	< -10°	
T	< 110°	110-120°	> 120°			
P/T	0	-6	-25	-50	-60	

$\alpha_j$  = joint dip direction.  
 $\beta_j$  = joint dip.  
 $\alpha_s$  = slope dip direction.  
 $\beta_s$  = slope dip.

P = plane failure.  
 T = toppling failure.

Adjustment Rating for Methods of Excavation of Slopes				
Method	Natural Slope	Presplitting	Smooth Blasting	Deficient Blasting
F4	+15	+10	+8	-8

$SMR = RMR - (F_1 \times F_2 \times F_3) + F_4$

Tentative Description of SMR Classes				
Class No.	IV	III	II	I
SMR	21-40	41-60	61-80	81-100
Description	Poor	Fair	Good	Very Good
Stability	Unstable	Partially stable	Stable	Fully stable
Failures	Planar or large wedges	Some joints or many wedges	Some blocks	None
Support	Extensive corrective	Systematic	Occasional	None

## **CHAPTER 11.0 GEOTECHNICAL REPORTS**

### **11.1 TYPES OF REPORTS**

Upon completion of the field investigation and laboratory testing program the geotechnical engineer will collect and evaluate the data, and perform engineering analyses for the design of foundations, cuts, embankments, and other required facilities. Additionally, the geotechnical engineer will typically be responsible for producing a report or reports to present the subsurface information obtained from the site investigations and to provide technical recommendations. The evaluation and interpretation of the investigation data were discussed in Chapters 7 and 8 of this module, and the geotechnical analyses and design procedures to be implemented for the various types of highway facilities will be the subject of the remaining modules of this short course. This chapter provides guidelines and recommendations for developing a geotechnical report.

The geotechnical engineer will generally prepare one of three types of reports: A geotechnical investigation (or data) report; a geotechnical design report, or a geo-environmental report. The choice depends on the requirements of the highway agency (Owner) and the agreement between the geotechnical engineer and the facility designer.

#### **11.1.1 Geotechnical Investigation (Data) Reports**

Geotechnical investigation reports generally have three major components:

1. **Background Information:** The initial sections of the report summarize the geotechnical engineer's understanding of the facility for which the report is being prepared and the purposes of the geotechnical investigation. They also present a general description of site conditions, geology and geologic features, drainage, ground cover and accessibility, and any peculiarities of the site that may affect the design.
2. **Work Scope:** The second part of the investigation report documents the scope of the investigation program and the specific procedures used to perform this work. These sections will identify the types of investigation methods used; the number, location and depths of borings, exploration pits and in situ tests; the types and frequency of samples obtained; the dates when the field investigation was performed; the subcontractors used to perform the work; the types and number of laboratory tests performed; the testing standards used; etc.
3. **Data Presentation:** This portion of the report, generally contained in appendices, presents the data obtained from the field investigation and laboratory testing program, and typically includes final typed logs of all borings, exploration pits and piezometer or well installations, water level readings, data plots from each in situ test hole, summary tables and individual data sheets for all laboratory tests performed, rock core photographs, geologic mapping data sheets and summary plots, subsurface profiles developed from the field and laboratory test data, etc. Often, the investigation report will also include copies of existing information such as boring logs or laboratory test data from previous investigations at the project site.

The intent of a geotechnical investigation report should be to document the investigation performed and present the data obtained. This type of report should avoid making interpretations of the subsurface

conditions and should not include design recommendations. The geotechnical investigation report is sometimes used when the field investigations are subcontracted to a geotechnical consultant, but the data interpretation and design tasks are to be performed by the owner's or the prime consultant's in-house geotechnical staff.

A sample table of contents for a geotechnical investigation report is presented in Figure 11-1.

### **11.1.2 Geotechnical Design Reports**

A geotechnical design report typically provides an assessment of existing subsurface conditions at a project site, summarizes the procedures and findings of any geotechnical analyses performed, and provides appropriate recommendations for design and construction of foundations, earth retaining structures, embankments, cuts and other required facilities. Unless a separate investigation (data) report has previously been developed, the geotechnical design report will also include documentation of any subsurface investigations performed and a presentation of the investigation data as described in Section 11.1.1. A sample table of contents for a geotechnical design report is presented in Figure 11-2.

Since the scope, site conditions, and design requirements of each project are unique, the specific contents of a geotechnical design report must be tailored for each project. In general, however, the geotechnical design report must address all the geotechnical issues that may be anticipated on a project. The report must identify each soil and rock unit of engineering significance, and must provide recommended design parameters for each of these units. Groundwater conditions are particularly important for both design and construction and, accordingly, they need to be carefully assessed and described. For every project, the subsurface conditions encountered in the site investigation need to be compared with the geologic setting to better understand the nature of the deposits and to predict the degree of variability between borings.

Each geotechnical design issue must be addressed in accordance with the methodology described in subsequent modules of this training course, and the results of these studies need to be concisely and clearly discussed in the report. Of particular importance is an assessment of the impact of existing subsurface conditions on construction operations (e.g., the effect of boulders on pile driving, a high groundwater table on excavation, or rock hardness on rippability, etc.). The above issues are but a few of the items that need to be addressed in a geotechnical design report.

### **11.1.3 Geo-Environmental Reports**

When the geotechnical investigation indicates the presence of contaminants at the project site the geotechnical engineer may be requested to prepare a geo-environmental report outlining the investigation findings and making recommendations for the remediation of the site.

The preparation of such a report usually requires the geotechnical engineer to work with a team of experts, since many aspects of the contamination or the remediation may be beyond his/her expertise. A typical team preparing a geo-environmental report may be composed of, besides the geotechnical engineer, geologists, hydrogeologists, toxicologists, air quality and regulatory experts.

The report should contain all of the components of the geotechnical investigation report, as discussed above. Additionally, it will have a clear and concise discussion of the nature and extent of contamination, the risk factors involved, if applicable, a contaminant transport model and, if known, the source of the contamination (i.e., landfill, industrial waste water line, broken sanitary sewer, underground storage tanks, etc.).

1.0	INTRODUCTION
2.0	SCOPE OF WORK
3.0	SITE DESCRIPTION
4.0	FIELD INVESTIGATION
5.0	BRIEF DISCUSSION OF LABORATORY TESTS PERFORMED
6.0	SITE CONDITIONS, GEOLOGIC SETTING
7.0	DISCUSSION OF FINDINGS, CONCLUSIONS, AND RECOMMENDATIONS
7.1	GENERAL
7.1.1	Subgrade Soil/Rock Types
7.1.2	Soil/Rock Properties
7.2	GROUND WATER CONDITIONS/ OBSERVATIONS
7.3	OTHER (I.E. DYNAMIC, HYDRAULIC CONDUCTIVITY, ETC.) PROPERTIES
7.4	CHEMICAL ANALYSIS
8.0	FOUNDATION
8.1	ANALYSES-OPTIONS
9.0	FIELD PERMEABILITY TESTS
10.0	REFERENCES

LIST OF APPENDICES

Appendix A	Boring Location Plan and Subsurface Profiles
Appendix B	Boring Logs and Core Logs With Core Photographs
Appendix C	Field Permeability Test Data
Appendix D	Pump Test Data
Appendix E	Laboratory Test Results
Appendix F	Existing Information

LIST OF FIGURES

LIST OF TABLES

Figure 11-1: Sample Table of Contents for a Geotechnical Investigation (Data) Report.

1.0	INTRODUCTION
1.1	Project Description
1.2	Scope of Work
2.0	GEOLOGY
2.1	Regional Geology
2.2	Site Geology
3.0	EXISTING GEOTECHNICAL INFORMATION
3.1	Discussion
4.0	SUBSURFACE EXPLORATION PROGRAM
4.1	Borings
4.2	Laboratory Testing
5.0	SUBSURFACE CONDITIONS
5.1	Topography
5.2	Stratigraphy
5.3	Soil Properties
5.4	Groundwater Conditions
6.0	RECOMMENDATIONS FOR BRIDGE FOUNDATIONS
6.1	Design Alternatives
6.2	Group Effects
6.3	Foundation Settlement
6.4	Downdrag
6.5	Lateral Loading
6.6	Construction Considerations
6.7	Pile Testing
7.0	RECOMMENDATIONS FOR EARTH RETAINING STRUCTURES
8.0	ROADWAY RECOMMENDATIONS
8.1	Embankments
8.2	Cuts
8.3	Pavement
9.0	SEISMIC CONSIDERATIONS
9.1	Seismicity
9.2	Seismic Hazard Criteria
9.3	Liquefaction Potential
10.0	CONSTRUCTION RECOMMENDATIONS

LIST OF REFERENCES

LIST OF FIGURES

APPENDICES

Appendix A	Boring Logs
Appendix B	Laboratory Test Data
Appendix C	Existing Subsurface Information

Figure 11-2: Sample Table of Contents for a Geotechnical Design Report.



The team may also be required to present solutions (i.e. removal of the contaminated material, pump and treating of the groundwater, installation of slurry cut-off walls, or the abandonment of that portion of the right-of-way, etc.) to remediate the site.

The geo-environmental report should also address the regulatory issues pertinent to the specific contaminants found and the proposed site remediation methods.

## **11.2 DATA PRESENTATION**

### **11.2.1 Boring Logs**

Boring logs and exploration pit logs should be prepared in accordance with the procedures and format discussed in Chapter 3. Because of the large number of data points developed, boring and exploration pits logs are normally prepared using software capable of storing, manipulating and presenting geotechnical data. Two software packages commonly used are the gEOTECHNICAL INTEgrator, or gINT (1994), and LOGDRAFT (1995).

gINT can be used to store subsurface exploration data, to compute laboratory data and to produce boring logs, laboratory reports, graphs, tables, histograms and text. It also has the capability for importing or exporting ASCII, .WKS, .DAT and HPGL files. It allows exporting of files to word processing, or to CADD software.

LOGDRAFT is a menu-based boring log drafting program. Its computer aided drafting tools let users create custom boring log formats which can include graphic logs, monitoring well details, data graphing and more. Test results can also be graphically shown on the logs. Custom designed legends explaining graphic symbols and containing additional notes can be added to boring logs for greater clarity. LOGDRAFT includes a library of soil, sampler, and monitoring well symbols as well as other symbols used on boring logs. Geological profiles can be generated by the program and may be annotated with text and drawings. In addition, LOGDRAFT supports output of AutoCAD DXF files.

These and other similar software also allow the orderly storage of project data for future reference.

### **11.2.2 Subsurface Profiles**

Geotechnical reports are normally accompanied by the presentation of subsurface profiles developed from the field and laboratory test data. Longitudinal profiles are typically developed along the roadway or bridge alignment, and a limited number of transverse profiles may be included for key locations such as at major bridge foundations, cut slopes or high embankments. Such profiles provide an effective means of summarizing pertinent subsurface information and illustrating the relationship of the various investigation sites. The subsurface profiles, coupled with judgment and an understanding of the geologic setting, aid the geotechnical engineer in his/her interpretation of subsurface conditions between the investigation sites.

In developing a two-dimensional subsurface profile, the profile line (typically the roadway centerline) needs to be defined on the base plan, and the relevant borings project to this line. Judgment needs to be exercised in the selection of the borings since projection of the borings, even for short distances, may result in misleading representation of the subsurface conditions in some situations.

The profile should be presented at a scale appropriate to the depth of the borings, frequency of the borings, and length of the section. Generally, a vertical scale of 1:10 or 1:20 should be used. Distortion of the

horizontal/vertical scales should be avoided, if possible, to show the true relationship of subsurface features.

The subsurface profile can be presented with reasonable accuracy and confidence at the locations of the borings. Generally, however, owners and designers would like the geotechnical engineer to present a continuous subsurface profile that shows an interpretation of the location, extent and nature of subsurface formations or deposits between borings. At a site where rock or soil profiles vary significantly between boring locations, the value of such presentations become questionable. The geotechnical engineer must be very cautious in presenting such data. Such presentations should include clear and simple caveats explaining that the profiles as presented cannot be fully relied upon. Should there be need to provide highly reliable continuous subsurface profiles, the geotechnical engineer should increase the frequency of borings and/or utilize geophysical methods to determine the continuity, or the lack of it, of subsurface conditions.

A typical subsurface profile is shown in Figure 11-3.

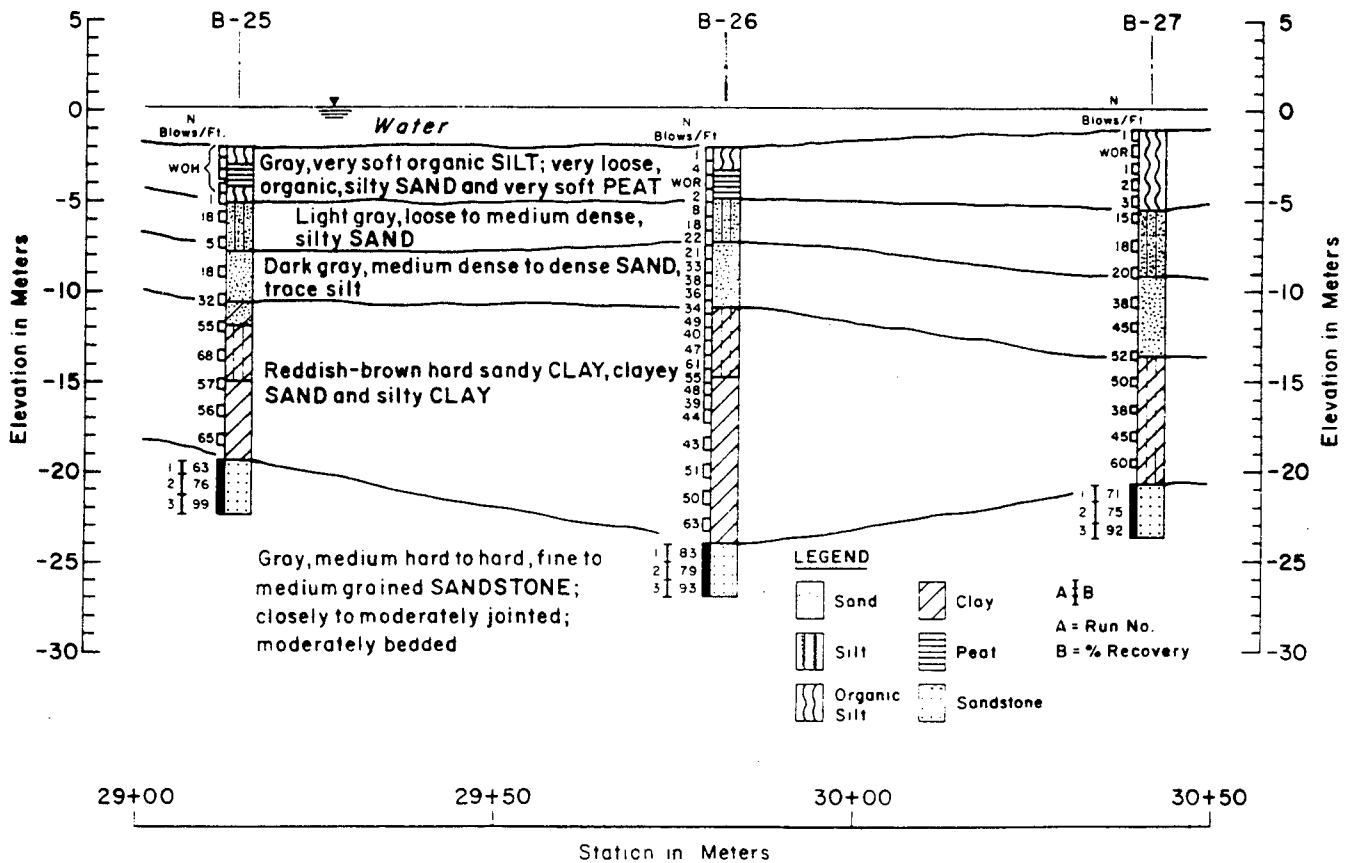

Figure 11-3: Typical Subsurface Profile. (Lowe and Zaccheo, 1991)

### 11.3 LIMITATIONS

Soil and rock exploration and testing have inherent uncertainties. Thus the user of the data who may be unfamiliar with the variability of natural and manmade deposits should be informed in the report of the limitations inherent in the extrapolation of the limited subsurface information obtained from the site investigation. A typical statement, found in geotechnical reports prepared by consultants, that can be included in a geotechnical report is shown below.

“Professional judgments and recommendations are presented in this report. They are based partly on evaluation of the technical information gathered, partly on historical reports and partly on our general experience with subsurface conditions in the area. We do not guarantee the performance of the project in any respect other than that our engineering work and the judgment rendered meet the standards and care of our profession. It should be noted that the borings may not represent potentially unfavorable subsurface conditions between borings. If during construction soil conditions are encountered that vary from those discussed in this report or historical reports or if design loads and/or configurations change, we should be notified immediately in order that we may evaluate effects, if any, on foundation performance. The recommendations presented in this report are applicable only to this specific site. These data should not be used for other purposes.”

The reader is referred to a document entitled “Important Information About Your Geotechnical Engineering Report”, which is published by ASFE, The Association of Engineering Firms Practicing In The Geosciences [Phone No. (301) 565-2733]. This document presents suggestions for writing a geotechnical report and observations to help reduce the geotechnical-related delays, cost overruns and other costly headaches that can occur during a construction project.

AASHTO recommends the use of site-specific disclaimer clauses for DOT projects, particularly for construction bids and plans. Specific disclaimer clauses are preferred to the use of general disclaimer clauses which may not be enforceable. Examples of site-specific disclaimers is shown below.

“The boring logs for BAF-1 through BAF-4 are representative of the conditions at the location where each boring was made but conditions may vary between borings.”

“Although boulders in large quantities were not encountered on this site in the borings that are numbered BAF-1 through BAF-4, previous projects in this area have found large quantities of boulders. Therefore, the contractor should be expected to encounter substantial boulder quantities in excavations. The contractor should include any perceived extra costs for boulder removal in this area in his bid price for Item xxx.”



## **CHAPTER 12.0 CONTRACTING OF GEOTECHNICAL SUBSURFACE EXPLORATION**

It is common practice with many agencies to outsource or contract drilling, or complete drilling and testing programs to external sources.

Whether the subsurface exploration work is performed by the agency or by others it is ultimately the geotechnical engineer's responsibility to assure the appropriateness of exploration and testing procedures. Thus it is essential to scrutinize the qualifications, quality control and quality assurance procedures, the equipment and personnel, the professional reputation and the safety record of the contractor, or the consultant.

### **12.1 DRILLING AND TESTING SPECIFICATIONS**

Testing and drilling specifications should be prepared by the geotechnical engineer and the geologist. They should, as a minimum, contain clear concise statements and descriptions of the following items:

For drilling/coring:

- Type of the project (embankment, bridge, etc.)
- Location of the project
- Site access information
- Site access problems- if known
- Drilling site survey and borehole location information
- Contaminants- if applicable
- Special health and safety requirements
- Site map
- Preliminary plans, if available
- Types of samples to be obtained
- Standards to be followed (ASTM, local, others)
- Type of equipment to be used
- Environmental constraints
- Minimum drilling/coring crew size
- Qualifications of the field supervisor (i.e. field geologist, engineer, etc.)

- Identification of who will supervise the boring/coring operations
- Procedures to be followed to transport samples
- Destination of the samples
- Frequency of shipping of samples
- Name, phone number and address of the geotechnical engineer or geologist in charge
- Nature and number of field tests to be performed

If the contract is for drilling/coring and testing the following items should be included in the information provided to the contractor:

- The type of tests to be performed
- Testing standards to be followed (ASTM, AASHTO, Local)
- Laboratory QA/QC procedures or requirements
- Minimum number of each type of test to be performed
- Reporting formats
- Contents of the geotechnical report

Each request for proposal for subsurface exploration should also contain a realistic, flexible schedule to be reviewed and accepted by the contractor.

The drilling contractor should be required to provide a formal document outlining its health and safety program. Additionally, the contractor should provide the number of accidents resulting in man days lost during the previous year, as well as its insurance rating.

The contractual terms, including payments for services, liability, indemnity, failure to complete the job, etc. are normally covered by each agency's procurement or contracting office.

The agency should always reserve the right to review the progress of the work and to provide on site supervision of drilling, field testing, or laboratory testing.

Prior to accepting a contractor for a given project the geotechnical engineer and/or the geologist should perform an on site and paper review of the contractor's capabilities.

A practice which may be considered as an integral part of the traditional advertising and selection process of contractors, is the review of the facilities, equipment and experience of the top two or three selected contractors prior to awarding a blanket or specific contract.

## CHAPTER 13.0 REFERENCES

- Aas, G. (1965). "A study of the effect of vane shape and rate of strain on the measured values of in situ shear strength of clays." *Proc., 6th ICSMFE*, Montreal, Canada, 141-145.
- Aas, G., Lacasse, S., Lunne, I., and Hoeg, K. (1986). "Use of in situ tests for foundation design in clay." *Proc., In Situ '86*, ASCE, 1-30.
- Acker, W. L., III (1974). *Basic Procedures for Soil Sampling and Core Drilling*, Acker Drill Co. Inc., P.O. Box 830, Scranton, Pa. 18501.
- ADSC: The International Association of Foundation Drilling. (1995). "Recommended procedures for the entry of drilled shaft foundations excavations."
- American Association of State Highway and Transportation Officials (AASHTO). (1995). *Standard specifications for transportation materials and methods of sampling and testing: part II: tests*, Sixteenth Edition, Washington, D.C.
- American Association of State Highway and Transportation Officials (AASHTO). (1988). *Manual on Subsurface Investigations*, Developed by the Subcommittee on Materials, Washington, D.C.
- American Society for Testing and Materials. (1995). "ASTM book of standards." 4.08-09, Philadelphia, Pa.
- Anderson, W. F. (1979). Discussion on "Design parameters for stiff clays." *Proc., 7th European Conf. on Soil Mech. and Found. Engrg.*, Brighton, England, 149-152.
- Arman, A., Poplin, J. and Ahmad, N. (1975). "Study of the Vane Shear." *Proc. Conf. On In Situ Measurement of Soil Properties*, ASCE, Vol. 1, North Carolina State University, Raleigh, N.C.
- Baguelin, F., Jezequel, J. F., and Shields, D. H. (1978). *The pressuremeter and foundation engineering*, Trans Tech Publication, Switzerland.
- Barrett, J., et. al. (1980). "Procedures recommended for overburden and hydraulic studies of surface mines." GTR-INT-71. U.S. Forest Service, Intermountain Forest and Equipment Station, Ogden, UT, 106.
- Barton, N. (1988). "Rock mass classification and tunnel reinforcement using the Q-system." *Rock Classification Systems for Engineering Purposes*, ASTM, STP 984, 59-84.
- Barton, N. (1973). "Review of a new shear strength criterion for rock joints." *Engineering Geology*, Elsevier, Vol. 7, 287-332.
- Bazaraa, A.R.S. (1967). *Use of the standard penetration test for estimating settlements of shallow foundations on sand*, Ph.D. thesis, University of Illinois, Urbana, Il.
- Bieniawski, Z. T. (1989). *Engineering rock mass classifications*, John Wiley and Sons, Inc., New York.

- Bieniawski, Z. T. (1972). "Propagation of brittle fracture in rock." *Proc., 10th U.S. Symp. on Rock Mech.*, Johannesburg, South Africa.
- Bishop, A. W., Alpan, I., Blight, G. E., and Donald, I. B. (1960). "Factors controlling the strength of partially saturated cohesive soils." *Proc., Research Conference on Shear Strength of Cohesive Soils*, ASCE, 503-532.
- Bishop, A. W., and Bjerrum, L. (1960). "The relevance of the triaxial test to the solution of stability problems." *Proc., Research Conference on Shear Strength of Cohesive Soils*, ASCE, 437-501.
- Bishop, A. W., and Henkel, D. J. (1962). *The measurement of soil properties in the triaxial test*, The English Language Book Society, London, U.K.
- Bjerrum, L. (1972). "Embankments on soft ground." *Proc., Specialty Conf. on Performance of Earth and Earth-Supported Structures*, ASCE, Lafayette, 1-54.
- Bowles, J. E. (1988). *Foundation analysis and design*, A.T. Brown and J. M. Morriss, eds., McGraw-Hill Company, New York.
- Briaud, J. L. (1989). "The pressuremeter test for highway applications." *Federal Highway Administration (FHWA) No. #: FHWA-IP-89-008*, Washington, D.C., 148.
- Bruce, D. A., Xanthakos, P. P., and Abramson, L. W. (1994). Jet grouting, *Ground Control and Improvement*, Chapter 8, 580-683.
- Burbridge, M. C. (1982). "A case study review of settlements on granular soils." M.Sc. thesis, Imperial College of Science and Technology, London University, U.K.
- Burland, J. B., and Burbridge, M. C. (1985). "Settlement of foundations on sand and gravel." *Proc., Inst. Civil Engrg.*, 78 (Part 1), 1325-1381.
- Burmister, D. M. (1970). "Suggested methods for identification of soils." *Special Procedures for Testing Soil and Rock for Engineering Purposes*, ASTM, Special Tech. Publication 479, 311-23.
- Cambefort, H. (1964). "Injection des sols: tome 1." *Principes et Methodes*, Paris, France (in French).
- Campanella, R. G., and Robertson, P. K. (1981). "Applied cone research." *Symp. on Cone Penetration Testing and Experience*, ASCE, St. Louis, Missouri, 343-362.
- Canadian geotechnical manual.* (1992) . Canadian Geotechnical Society, Canada.
- Carter, M., and Bentley, S. P. (1991). *Correlations of soil properties*, Pentech Press Limited, London, U.K.
- Casagrande, A., and Fadum, R. E. (1940). "Notes on soil testing for engineering purposes." *Publication 268*, Graduate School of Engineering, Harvard University, Cambridge, Ma.
- Cheney, R. S., and Chassie, R. G. (1993). "Soils and foundations workshop manual." *Federal Highway Administration (FHWA) Circular No. #: FHWA: HI-88-009*, Washington D.C., 399.



- Das, B. M. (1990). *Principles of geotechnical engineering*, Ray Kingman and Jane Parker, eds., PWS-Kent Publishing Company, Boston, Ma, 665.
- Das, B. M. (1987). *Advanced soil mechanics*, McGraw-Hill Company, New York.
- Deere, D. U. (1963). "Technical description of rock cores for engineering purposes." *Felmechanik und Ingenieur Geologis*, 1 (1), 16-22.
- Deere, D. U., and Deere, D. W. (1989). "Rock quality designation (RQD) after 20 years." *Contract DACW39-86-M-4273*, Department of the Army, U.S. Army Corps of Engineers, Washington, D.C.
- Deere, D. U., and Miller, R. P. (1966). *Engineering classification and index properties of intact rock*, Tech. Report. No. AFWL-TR-65-116, Air Force Weapons Lab., Kirtland Air Force Base, New Mexico.
- Driscoll, F. G. (1986). *Groundwater and wells, 2nd Edition*, Johnson Filtration Systems, Inc., St. Paul, MN, 1089 p.
- Dunnicliff, J. (1988). *Geotechnical instrumentation for monitoring field performance*, John Wiley and Sons, Inc., New York.
- Earth Sciences Information Center*, USGS: Internet address: <http://mapping.usgs.gov/esic/index.html>.
- Federal Highway Administration (FHWA)*. (1989). "Rock slopes: design, excavation, stabilization." *Circular No. #: FHWA: TS-89-045*, Washington, D.C.
- Finn, P. S., Nisbet, R. M., and Hawkins, P. G. (1984). "Guidance on pressuremeter, flat dilatometer and cone penetration tests in sand." *Géotechnique*, 34 (1), 81-97.
- Ford, P.J., Turina, P.J., and Seely, D.E. (1984). *Characterization of hazardous waste sites - a methods manual: vol. II, available sampling methods*, 2nd Edition, EPA 600/4-84-076 (NTIS PB85-521596). Environmental Monitoring Systems Laboratory, Las Vegas, NV.
- Foster, R. S. (1975). *Physical geology*, Merrill, Columbus, OH.
- Franklin, J. A. (1981). "A shale rating system and tentative applications to shale performance." *Shales and Swelling Soils*, Transportation Research Record 790, Transportation Research Board, Washington D.C.
- Franklin, J. A., and Dusseault, M. B. (1989). *Rock engineering*, McGraw-Hill Company, New York.
- Geosystem Logdraft III. (1992-1993). "Software for boring log drafting." *Von Guten Engineering Software, Inc.*, Fort Collins, Colorado.
- gINT, gEotechnical INTegrator Software 3.2. (1991). "gINT, gEotechnical INTegrator Software 3.2, Documentation." *Geotechnical Computer Applications, Inc.*, Santa Rosa, California.
- Gibson, R. E. (1953). "Experimental determination of the true cohesion and true angle of internal friction

- in clays." *Proc., 3rd Int. Conf. on Soil Mech. and Found. Engrg.*, Zurich, Switzerland, 126-130.
- Goodman, R. E. (1980). *Introduction to rock mechanics*, John Wiley and Sons, Inc., New York.
- Hassani, F.P., and Scoble, M.J. (1985). "Fictional mechanism and properties of rock discontinuities." *Proc. Int. Symp. Fundamentals of Rock Joints*, Björkliden, Sweden, 185-196
- Hazen, A. (1911). Discussion of "Dams on sand foundations." *Transactions*, ASCE, 73, 199-203.
- Hilf, J. W. (1975). "Compacted fill." *Foundation Engineering Handbook*, H. F. Winterkorn and H. Y. Fang, eds., Van Nostrand Reinhold, New York.
- Hoek, E., and Bray, J. W. (1977). *Rock slope engineering*, Institution of Mining and Metallurgy, London, U.K.
- Hoek, E., Kaiser, P.K., and Bawden, W.F. (1995). *Support of underground excavations in hard rock*, A.A. Balkema, Rotterdam, Netherlands
- Holtz, R. D., and Kovacs, W. D. (1981). *An introduction to geotechnical engineering*, Prentice-Hall, Inc., Englewood Cliffs, NJ.
- Holtz, W. G., and Gibbs, H. J. (1979). Discussion of "SPT and relative density in coarse sand." *J. Geotech. Engrg.*, ASCE, 105 (3), 439-441.
- Hough, B. K. (1969). *Basic soils engineering*, Ronald Press, New York.
- Hunt, R. E. (1984). *Geotechnical Engineering Investigation Manual*, McGraw-Hill Inc., 983.
- Hvorslev, M. J. (1948). *Subsurface exploration and sampling of soils for civil engineering purposes*, U.S. Army Corps of Engineers, Waterways Experiment Station, Vicksburg, Miss.
- International Society for Rock Mechanics Commission on Standardization of Laboratory and Field Tests. (1979). "Suggested Methods for Determining Water Content, Porosity, Density, Absorption and Related Properties and Swelling and Slake-Durability Index Properties." *International J. Rock Mech. Min. Sci. And Geo Mech. Abstr.*, Vol. 16, Great Britian, 141-156.
- Jamiolkowski, M., Ladd, C. C., Germaine, J. T., and Lancellotta, R. (1985). "New Developments in Field and Laboratory Testing of Soils." *Proceedings, 11th International Conference on Soil Mechanics and Foundation Engineering*, Vol. 1, San Franscisco, Ca, 57-153.
- Konrad, J. M., and Law, K. T. (1987b). "Undrained shear strength from piezocone tests." *Canadian Geotechnical Journal*, 24 (3), 392-405.
- Kovacs, W. D., Salomone, L. A., and Yokel, F. Y. (1983). "Energy Measurements in the Standard Penetration Test." *Building Science Series 135*, National Bureau of Standards, Washington, 73.
- Krebs, R. D., and Walker, E. D. (1971). "Highway materials." *Publication 272*, Department of Civil Engrg., Massachusetts Institute of Technology, McGraw-Hill Company, New York, 107.

- Kulhawy, F. H., and Mayne, P. W. (1990). "Manual on estimating soil properties for foundations design." *Report EL-6800*, Electric Power Research Institute, Palo Alto, Ca.
- Lacroix, Y., and Horn, H. M. (1973). "Direct determination of relative density and its use on earthwork construction projects." ASTM, STP 523, 251-280.
- Ladd, C. C. (1973). "Estimating settlements of structures supported on cohesive soils." *Seminar on Settlement of Structures - Part I*, ASCE, New York, NY.
- Ladd, C. C., and Foott, R. (1974). "A new design procedure for stability of soft clay." *J. Geotech. Engrg.*, ASCE, 100 (3), 763-786.
- Ladd, C. C., and Foott, R. (1973). "Estimating settlements of structures supported on cohesive soils." *Seminar on Settlement of Structures - Part I*, ASCE, New York, NY.
- Lama, R.D., and Vutukuri, V.S. (1978). "Handbook on mechanical properties of rock." *Series on Rock and Soil Mechanics*, vol. 4, Trans. Tech. Pub., Rockport, Mass.
- Lambe, T. W., and Whitman, R. V. (1979). *Soil mechanics: SI version*, John Wiley and Sons, Inc., New York.
- Lame, G. (1852). *Lecons sur la theorie mathematique d'elasticite des corps solides*, Bachelier, Paris, France (in French).
- Lowe III, J., and Zaccheo, P. F. (1991). "Subsurface explorations and sampling." *Foundation Engineering Handbook*, H. Y. Fang, ed., Van Nostrand Reinhold, New York, 1-71.
- Lutenegger, A. J., DeGroot, D. J., Mirza, C., and Bozozuk, M. (1995). "Recommended guidelines for sealing geotechnical exploratory holes." *Federal Highway Administration, FHWA Report #: 378*, Washington, D.C.
- Mair, R. J., and Wood, D. M. (1987). "Pressuremeter testing methods and interpretation." *Ground Engineering Report: In-situ testing*, Construction Industry Research and Information Association (CIRIA), Butterworths, London, U.K.
- Marchetti, S. (1980). "In situ tests by flat dilatometer." *J. Geotech. Engrg.*, ASCE, 106 (3), 299-321.
- Mayne, P. W., and Mitchell, J. K. (1988). "Profiling of overconsolidation ratio in clays by field vane." *Canadian Geotechnical Journal*, 25 (1), 150-158.
- Meigh, A. C., and Nixon, I. K. (1961). "Comparison of in situ tests for granular soils." *Proc., 5th Int. Conf. on Soil Mech. and Found. Engrg.*, Paris, France, 499-507.
- Menard, L. (1956). "An apparatus for measuring the strength of soils in place." M.Sc. thesis, University of Illinois, Urbana, Illinois.
- Mesri, G. (1973). "Coefficient of secondary compression." *J. Soil Mech. and Found. Engrg.*, ASCE, 99 (1), 123-137.

- Mesri, G., and Godlewski, P. M. (1977). "Time and stress-compressibility interrelationship." *J. Geotech. Engrg.*, ASCE, 103 (5), 417-430.
- NAVFAC, DM-7.1. (1982). "Soil mechanics." *Naval Facilities Engineering Command*, Department of the Navy, Alexandria, Va.
- NAVFAC, P-418. (1983). "Dewatering and groundwater control." *Naval Facilities Engineering Command*, Department of the Navy; *Publication No. TM 5-818-5*, Department of the Army; *AFM 88-5: Chapter 6*, Department of the Air Force.
- Obert, L., and Duvall, W. I. (1967). *Rock mechanics and the design of structures in rock*, John Wiley and Sons, Inc., New York.
- Patton, F. D. (1966). "Multiple modes of shear failure in rock." *Proc., 1st Int. Congress on Rock Mechanics*, Lisbon, Portugal, 509-13.
- Peck, R.B., and Bazaraa, A.R.S. (1969). "Discussion of 'Settlement of Spread Footings on Sand', by D'Appolonia, D'Appolonia, and Brissette." *Journal of Soil Mechanics and Foundation Division*, ASCE.
- Peck, R. B., Hansen, W. E., and Thornburn, T. H. (1974). *Foundation engineering*, John Wiley and Sons, Inc., New York.
- Powers, J. P. (1992). *Construction dewatering*, John Wiley and Sons, Inc., New York.
- Rehm, B.W., Stolzenburg, T. R., and Nichols, D. G. (1985). "Field measurement methods for hydrogeologic investigations: a critical review of the literature." EPRI EA-4301, Electric Power Research Institute, Palo Alto, Ca.
- Riaund, J. L., and Miran, J. (1992). "The cone penetrometer test." *Federal Highway Administration, FHWA Report #: SA-91-043*, Washington, D.C.
- Richart, F. E. Jr. (1977). "Dynamic stress-strain relations for soils - state of the art report." *Proc., Ninth Int. Conf. on Soil Mech. and Found. Engrg.*, Tokyo, Japan, 605-612.
- Robertson, P. K., Campanella, R. G., and Wightman, A. (1983). "SPT-CPT correlations." *J. Geotech. Engrg.*, ASCE, 109 (11), 1449-1459.
- Robertson, P. K., and Campanella, R. G. (1983a). "Interpretation of cone penetration tests - part I: sand." *Canadian Geotechnical Journal*, 20 (4), 718-733.
- Robertson, P. K., and Campanella, R. G. (1983b). "Interpretation of cone penetration tests - part II: clay." *Canadian Geotechnical Journal*, 20 (4), 734-743.
- ROCTEST. (1987). *Probex-1 dilatometer instruction manual*, ROCTEST, Inc., Plattsburgh, New York.
- ROCTEST. (1978). *Pressuremeter model g-am, the pressuremeter test principles, testing equipment and test procedure*, ROCTEST, Inc., Plattsburgh, New York.

- Roscoe, K. H., Schofield, A. N., and Wroth, C. P. (1958). "On yielding of soils." *Géotechnique*, London, U.K., 8 (2), 2-52.
- Schmertman, J. H. (1970). "Static cone to compute static settlement over sand." *J. Soil. Mech. and Found. Engrg.*, ASCE, 96 (3), 1011-1043.
- Serafim, J. L. and Pereira, J. P. (1983). "Considerations of the geomechanics classification of Bieniawski." *Proc. Intl. Symp. Engrg. Geol. and Underground Construction*, Lisbon, 1133-44.
- Skempton, A. W. (1957). Discussion on "The planning and design of new hong kong airport." *Proc., Inst. Civil Engrg.*, 7 (3), 305-307.
- Skempton, A. W., and Northey, R. D. (1952). "The sensitivity of clays." *Géotechnique*, London, U.K., 3 (2), 30-53.
- Soil Conservation Service (SCS). (1983). *National soils handbook*, Information Division, Washington, D.C.
- Sowers, G.F. (1979). *Introductory soil mechanics and foundations*, Macmillan, New York.
- Stagg, K. G., and Zienkiewicz, O.C. (1968). *Rock mechanics in engineering practice*, John Wiley and Sons, Inc., New York.
- Stokoe, K. H., and Hoar, R. J. (1978). "Variables affecting in-situ seismic measurement." *Proc., Specialty Conf. on Earthquake Engrg. and Soil Dynamics*, ASCE, Pasadena, Ca, 919-938.
- Stokoe, K. H., and Woods, R. D. (1972). "In situ shear wave velocity by cross-hole method." *J. Soil Mech. Found. Div.*, ASCE, 98 (5), 443-460.
- Taylor, D. W. (1948). *Fundamentals of soil mechanics*, John Wiley and Sons, Inc., New York.
- Terzaghi, K., and Peck, R. B. (1967). *Soil mechanics in engineering practice*, John Wiley and Sons, Inc., New York.
- Thornburn, S. (1970). "Discussion." *Proc., Conf. on Behavior of Piles*, Inst. Civil Engrg., London, U.K., 53-54.
- U.S. Army Corps of Engineers. (1951). "Time lag and soil permeability in groundwater observations." *Waterways Experiment Station*, Bulletin No. 36, Vicksburg, Miss.
- U.S. Department of the Interior, Bureau of Reclamation. (1986). "Soil classification handbook unified soil classification system." *Training Manual No. 6*; January, Geotechnical Branch, Washington, D.C.
- U.S. Department of the Interior, Bureau of Reclamation. (1973). *Design of small dams*, United States Government Printing Office, Washington, D.C.
- U.S. Department of the Interior, Bureau of Reclamation. (1960). *Earth manual*, United States Government Printing Office, Washington, D.C.

- U.S. Environmental Protection Agency (EPA). (1991). *Description and sampling of contaminated soils*, (EPA/625/12-9/002; November), Washington, D.C.
- Way, D.S. (1973). *Terrain analysis*, Dowden, Hutchinson & Ross, Inc., Stroudsburg, Pa.
- Williamson, D. A. (1984). "Unified rock classification system." *Bulletin of the Association of Engineering Geologists*, XXI (3), Eugene, OR, 345-354.
- Windle, D., and Wroth, C. P. (1977). "In situ measurement of the properties of stiff clays." *Proc., 9th Int. Conf. on Soil Mech. and Found. Engrg.*, Tokyo, Japan, 347-352.
- Witczak, M. W. (1972) . "Relationships between physiographic units and highway design factors." *National Cooperative Highway Research Program: Report 132*, Washington D.C.
- Witke, W. (1990). *Rock mechanics: theory and applications with case histories*, Springer-Verlag, New York.
- Woods, R. D. (1978). "Measurement of soil properties - state of the art report." *Proc., Specialty Conf. on Earthquake Engrg. and Soil Dynamics*, ASCE, Pasadena, Ca, 91-178.
- Wroth, C. P. (1984). "The interpretation of in situ soil tests." *Géotechnique*, London, U.K., 34 (4), 449-489.
- Wroth, C. P., and Wood, D. M. (1978). "The correlation of index properties with some basic engineering properties of soils." *Canadian Geotechnical Journal*, 15 (2), 137-145.
- Wyllie, D. C. (1992). *Foundations on rock*. First Edition, Chapman and Hall, London, 333.

**APPENDIX A**  
**TYPICAL SAFETY GUIDELINES FOR DRILLING INTO SOIL AND ROCK**  
**AND HEALTH AND SAFETY PROCEDURES FOR ENTRY INTO BORINGS**

**A.1 TYPICAL SAFETY GUIDELINES FOR DRILLING INTO SOIL AND ROCK**

**A.1.1 Purpose**

The purpose of this operating procedure is to provide guidelines for safe conduct of drilling operations with truck-mounted and other engine-powered drill rigs. The procedure addresses off-road movement of drill rigs, overhead and buried utilities, use of augers, rotary and core drilling, and other drilling operations and activities.

**A.1.2 Application**

The guidelines apply to projects in which truck-mounted or other engine-powered drill rigs are used. Normally for drill rigs operated by contractors, drill rig safety is the responsibility of the contractor.

**A.1.3 Responsibility and Authority**

Drill rig safety and maintenance is the responsibility of the drill rig operator.

**A.1.4 Safety Guidelines**

**Movement of Drill Rigs**

Before moving a rig, the operator must do the following:

1. To the extent practical, inspect the planned route of travel for depressions, gullies, ruts, and other obstacles.
2. Check the brakes of the truck/carrier, especially if the terrain along the route of travel is rough or sloped.
3. Discharge all passengers before moving on rough or steep terrain.
4. Engage the front axle (on 4 x 4, 6 x 6, etc., vehicles) before traversing rough or steep terrain.

Driving drill rigs along the sides of hills or embankments should be avoided; however, if sidehill travel becomes necessary, the operator must conservatively evaluate the ability of the rig to remain upright while on the hill or embankment and take appropriate steps to ensure its stability.

Logs, ditches, road curbs, and other long and horizontal obstacles should be normally approached and driven over squarely, not at an angle.

When close lateral or overhead clearance is encountered, the driver of the rig should be guided by another person on the ground.

Loads on the drill rig and truck must be properly stored while the truck is moving, and the mast must be in the fully lowered position.

After the rig has been positioned to begin drilling, all brakes and/or locks must be set before drilling begins. If the rig is positioned on a steep grade and leveling of the ground is impossible or impractical, the wheel of the transport vehicle should be blocked and other means of preventing the rig from moving or tipping over should be employed.

#### **A.1.5 Buried and Overhead Utilities**

The location of overhead and buried utility lines must be determined before drilling begins, and their locations should be noted on boring plans or assignment sheets.

When overhead power lines are close, the drill rig mast should not be raised unless the distance between the rig and the nearest power line is at least 6 m, or other distance as required by local ordinances, whichever is greater. The drill rig operator or assistant should walk completely around the rig to make sure that proper distance exists.

When the drill rig is positioned near an overhead line, the rig operator should be aware that hoist lines and power lines can be moved towards each other by wind. Presence of power lines requires special safety provisions as they present serious danger

#### **A.1.6 Clearing the Work Area**

Before a drill rig is positioned to drill, the area should be cleared of removable obstacles and the rig should be leveled if sloped. The cleared/leveled area should be large enough to accommodate the rig and supplies.

#### **A.1.7 Safe Use of Hand Tools**

OSHA regulations regarding hand tools should be observed in addition to the guidelines provided below:

1. Each tool should be used only to perform tasks for which it was originally designed.
2. Damaged tools should be repaired before use or they should be discarded.
3. Safety goggles or glasses should be worn when using a hammer or chisel. Nearby coworkers and bystanders should be required to wear safety goggles or glasses also, or to move away.
4. Tools should be kept cleaned and stored in an orderly manner when not in use.

#### **A.1.8 Safe Use of Wire Line Hoists, Wire Rope, and Hoisting Hardware**

Safety rules described in 29 CFR 1926.552 and guidelines contained in the Wire RPE User's Manual, published by the American Iron and Steel Institute, will be used whenever wire line hoists, wire rope, or hoisting hardware are used.



### **A.1.9 Protective Gear**

#### **Minimum Protective Gear**

Items listed below should be worn by all members of the drilling team while engaged in drilling activities:

- Hard hat
- Safety shoes (shoes or boots with steel toes and shanks)
- Gloves

#### **Other Gear**

Items listed below should be worn when conditions warrant their use. Some of the conditions are listed after each item.

- **Safety goggles or glasses** should be worn when: (1) driving pins in and out of drive chains, (2) replacing keys in tongs, (3) handling hazardous chemicals, (4) renewing or tightening gauge glasses, (5) breaking concrete, brick, or cast iron, (6) cleaning material with chemical solutions, (7) hammering or sledging on chisels, cold cuts, or bars, (8) cutting wire lines, (9) grinding on abrasive wheels, (10) handling materials in powered or semipowered form, (11) scraping metal surfaces, (12) sledging rock bits or core heads to tighten or loosen them, (13) hammering fittings and connections, and (14) driving and holding the rivets.
- **Safety belts and lifelines** should be worn by all persons working on top of an elevated derrick beam. The lifeline should be secured at a position that will allow a person to fall no more than 8 feet.
- **Life vests** must be used for work over water.

### **A.1.10 Traffic Safety**

Drilling in streets, parking lots, or other areas of vehicular traffic requires definition of the work zones with cones, warning tape, etc., and compliance with local police requirements.

### **A.1.11 Fire Safety**

1. Fire extinguishers should be kept on or near drill rigs for extinguishing small fires.
2. If methane is suspected in the area, a combustible gas instrument (CGI) shall be used to monitor the air near the borehole. All work should stop at 25 percent of the lower explosive limit.
3. Work shall stop during lightning storms.

## **A.2 HEALTH AND SAFETY PROCEDURES FOR ENTRY INTO BORINGS**

### **A.2.1 Purpose**

Down-hole geologic logging entails lowering a person into an uncased boring generally to gather information on the stratigraphy of the soil. Descent in some cases may exceed 30 m. The boring is a confined space, hence, hazards typical of confined spaces may be present. The major ones are oxygen deficiency, flammable concentrations of gases or vapors, toxic concentrations of gas or vapors, and wall collapse. Because visual inspection of the walls of the boring is essential to the logging process, the borings cannot be cased. These guidelines are prepared for down-hole logging operations, sound and uniform health and safety procedures that are in compliance with federal and state regulations.

These guidelines of the procedure are in full compliance with OSHA regulations contained in 29 CFR 1926.552, 29 CFR 1926.800 and incorporate more stringent regulations promulgated by Cal-OSHA and described in Section 1542, Subchapter 4, and Article 108, Subchapter 7, Division 4, Title 8 of the California Administrative Code (CAC). In all cases the local and state regulations regarding confined space entry and shaft entry must be reviewed and provisions more stringent than those contained in this operating procedure should be observed.

### **A.2.2 Applicability**

This procedure applies to down-hole logging operations associated with geotechnical projects where toxic chemical releases are not known to have occurred. **The procedure may be used for downhole logging operations where toxic chemical releases have occurred, but only as an attachment to a site-specific health and safety plan that assesses the exposure risks associated with the logging operation and prescribes appropriate chemical-specific procedures for worker protection against the excessive exposure.**

### **A.2.3 Responsibility and Authority**

The field supervisor and/or the geotechnical engineer have overall responsibility for safe conduct of the downhole logging operation and may not delegate that responsibility to another person.

### **A.2.4 Health and Safety Requirements**

#### **Permit Acquisition**

Some states, such as California, require permits for construction of shafts to be entered by personnel and exceeding a certain depth (1.5 m in California). State and local government permit requirements shall be reviewed and complied with before any shaft is constructed.

#### **Pre-entry Inspection**

A qualified geotechnical specialist (engineer/geologist) shall be present a sufficient amount of time during the drilling process to thoroughly inspect and record the material and stability characteristics of the shaft and decide whether the walls of the shaft are stable enough so that it may be entered safely. Entry shall not be permitted if, in the specialist's opinion, the walls could collapse.

A qualified geotechnical specialist is an individual who has the following minimum qualifications:

1. Extensive hands-on experience in drilling and downhole geologic logging of uncased large-diameter borings so that the person is considered an expert by peers.
2. Experience in performing down-hole inspection or logging in the local area where work is being performed and/or experience in performing down-hole inspection/logging in other areas with similar geologic characteristics.
3. Prior training by other experienced geotechnical professionals.
4. Familiarity with the safe operation of the drilling and logging equipment being used, and the special difficulties, hazards, and mitigation techniques used in down-hole geologic logging.

### **Surface Casing and Proximity of Material to the Shaft Opening**

The upper portion of the shaft shall be equipped with a surface ring-collar to provide casing support of the material within the upper 1.2 m or more of the shaft. The ring collar shall extend to 300 mm above the ground surface or as high as necessary to prevent drill cuttings and other loose material or objects from falling into or blocking access to the shaft. Drill cuttings, detached auger buckets, and other loose equipment must be placed far enough away from the shaft opening or secured in a fashion that would prevent them from falling into the shaft.

### **Gas Test**

Prior to entry into a shaft, tests shall be performed to determine if the atmosphere in the shaft is not oxygen deficient and does not contain explosive or toxic levels of gases or vapors. Testing shall continue throughout the logging process to assure that dangerous atmospheric conditions do not develop. Monitoring instruments shall include a combustible gas meter and an oxygen meter. Where toxic gases or vapors may be present, a monitoring instrument equipped with a photoionization detector should be used for detection and quantification.

### **Ladders and Cable Descents**

A ladder may be used to descend a shaft provided that the shaft is no deeper than 6 m. A mechanical hoisting device shall be used with shafts more than 6 m deep.

### **Hoists**

Hoists may be powered or hand operated and must be worm geared or powered both ways. They must be designed so that when power is stopped, the load cannot move. Controls for powered hoists must be the deadman type with non-locking switch or control. A device for shutting off the power shall be installed ahead of the operating control. Hoist machines shall not have cast metal parts. Each hoist must be tested with twice the maximum load before being put into operation and annually thereafter. California regulations require a minimum safety factor of 6 for hoists. Test results shall be kept on file at the geotechnical engineer's office and other offices as required by the agency engaged in the geologic logging procedure. The hoist cable must have a diameter of at least 8 mm. Drill rigs may not be used to raise or lower personnel in shafts unless they meet the requirements in this section.

## **Cage**

An enclosed covered metal cage shall be used to raise and lower persons in the shaft. The cage shall have a minimum safety factor of 4 and shall be load tested prior to use. The exterior of the cage shall be free of projections and sharp corners. Only closed shackles shall be used in cage rigging. The cage shall be certified by a registered mechanical engineer as having met all the design specifications. The certificate and load test results shall be kept on file.

## **Emergency Standby**

In addition to the hoist or drill rig operator, an emergency standby person shall be positioned at the surface near the shaft whenever there is a geotechnical specialist in the shaft.

## **Communication**

A two-way electrically-operated communication system shall be in operation between the standby person and the geotechnical specialist whenever the standby person and the geotechnical specialist is in a shaft that is over 6 m in depth or when the ambient noise level makes unamplified voice communication difficult. A cellular telephone at the drill rig is strongly recommended.

## **Safety Equipment**

The geotechnical specialist must use the following safety equipment while in the shaft:

1. An approved safety harness designed to suspend a person upright. The harness must be attached to the hoist cable through a hole in the head guard. Attaching the harness to the head guard or cage is strictly prohibited.
2. Hardhat.
3. A steel cone-shaped or flat head guard or deflector with a minimum diameter of 450 mm must be attached to the hoist cable above the harness.

## **Electrical Devices**

Electrical devices, such as lamps, combustible gas and toxic vapor detectors, and electric tools, must be approved for use in hazardous locations.

## **Surface Hazards**

The storage and use of flammable or other dangerous chemicals at the surface must be controlled to prevent them from entering the shaft.

## **Water Hazard**

The presence of water in the shaft must be determined before the shaft is entered. If the shaft contains more than 1.2 m of water, the level of water must be reduced to less than 1.2 m before entry is permitted. If a shaft is entered when water is present, the depth of the water must be measured periodically and the water level kept below 1.2 m if work is to continue.

### **Air Supply**

NIOSH-approved supplied-air respirators (SCBA or airline) shall be available in the cage for use in the shaft when oxygen deficient atmosphere or toxic gases or vapors are encountered. If an airline system is used, the air pump or compressed air supply must be attended to by a person at the surface.

### **Illumination**

Light intensity in the portion of the shaft being logged must be at least 3 m center-to-center. Lighting devices must be explosion-proof.

### **Work/Rest Periods**

Time spent continuously in a shaft must not exceed two hours.



**APPENDIX B  
MANUFACTURERS AND DISTRIBUTORS OF EQUIPMENT  
FOR SAMPLING AND TESTING**

Manufacturers and Distributors of Soil Sampling Equipment. (Compiled from Barrett *et al.*, 1980; Ford *et al.*, 1984, Rehm *et al.*, 1985; SCS, 1983)

Supplier	Equipment
Acker Drill Company P.O. Box 830 Scranton, PA 18501	Power-driven samplers
Art's Manufacturing and Supply (AMS) 105 Harrison American Falls, ID 83211 1-800-635-7330	Manual Samplers In situ soil recovery Auger and probe Planer auger
Boyle Brothers P.O. Box 25068 1624 Pioneer Road Salt Lake City, UT 84125	Power-driven samplers
Carl's Machine Shop and Supply Co. 1202 Main St. Woodward, OK 73081	Power-driven samplers
Mining Products Division Christensen Diamond Products Company 1937 S. 300 West Salt Lake City, UT 74115	Power-driven samplers
Pitcher Drilling Company 75 Allemany Street Daly City, CA 94014	Power-driven samplers
Reed Tool Company 105 Allen Street P.O. Box 3641 San Angelo, TX 76901	Power-driven samplers
Reese Sale Company P.O. Box 645 2301 Gibson St. Bakersfield, CA 93302	Power-driven samplers
Sauze Technical Products Corp. 345 Cornelia St Plattsburgh, NY 12901 518-561-6440	Eijkelcamp stoney soil auger

Supplier	Equipment
Service Truck Body Shop 1259 Murray Alexandria, LA 71301	Manual samplers
Soilmoisture Equipment Corp. P.O. Box 30025 Santa Barbara, CA 93105 805-964-3525	Manual samplers
Soiltest, Inc. P.O. Box 931 2205 Lee Street Evanston, IL 60202 312-869-5500	Power-driven samplers Penetrometer Sieves
Wildco 301 Cass Street Saginaw, MI 48602 517-799-8100	Manual samplers
Clements Associates, Inc. RR 1 Box 186 Newton, IA 50208 515-792-8285	Manual samplers
Forestry Suppliers P.O. Box 8397 Jackson, MS 39284-8397	Manual samplers Clinometer
Gidding Machine Company 401 Pine Street P.O. Box 406 Fort Collins, CO 80521	Power-driven samplers
Hansen Machine Works 1628 North C Street Sacramento, CA 95814	Veihmeyer probe
Joy Manufacturing Company Montgomery Industrial Center Montgomeryville, PA 19936	Power-driven samplers
Longyear Company 925 Delaware Street, SE Minneapolis, MN 55414	Power-driven samplers
Mobile Drilling Company 3807 Madison Ave. Indianapolis, IN 46227	Power-driven samplers
Oakfield Apparatus Company P.O. Box 65 Oakfield, WI 53065	Manual samplers



Supplier	Equipment
Odgers Drilling, Inc. Ice Lake road Iron River, MI 49935	Power-driven samplers
Penndrill Manufacturing Div. Pennsylvania Drilling Co. P.O. Box 8562 Pittsburgh, PA 15220	Power-driven samplers
Roctest 94 Industrial Blvd. Pittsburg, NY 12901-2016 Tel: (800) 477-2506; (518) 561-3300	Soil and Rock Instrumentation Soil and Rock in situ test equipment (Dilatometers, Pressuremeters, Vane Borers, Penetrometers, Packers, Piezometers, etc.) Laboratory Equipment for Rock Testing
Geokon 48 Spenscer Street Lebanon, NH 03766 Tel: (603) 448-1562	Geotechnical Instrumentation
ELE/Soiltest ELE International SoilTest Product Div. Direct - Lake Bluff, IL Tel: (800) 323-1242	Soil, Concrete and Asphalt Testing Equipment
Brainard-Kilman 2175 West Park Ct. P.O. Box 1959 Stone Mountain, GA 30086 Tel: (800) 241-9468	Material (Soil Geosynthetics, Concrete, Asphalt, Laboratory) Testing Equipment and Geotechnical Instrumentation
Geotest Instrument Corp. 1840 Oak Ave. Evanston, IL 60201-3193 Tel: (800) 523-5883 Ext 800	Soil Testing Equipment for Laboratory and Construction
Forestry Suppliers Inc. P.O. Box 8397 Jackson, MS 39284-8397 Tel: (800) 647-5368	Sampling Equipment Safety Equipment

The above information is compiled from manufacturers trade literature and "Description and Sampling of Contaminated Soils" EPA/625/12-41/002 U.S. EPA, Cincinnati, OH. This list is not complete and other manufacturers may make equipment similar to those presented above.

