



U.S. DEPARTMENT OF ENERGY

OFFICE OF FOSSIL ENERGY

NATIONAL ENERGY TECHNOLOGY LABORATORY

HYDROGEN *from* COAL PROGRAM

RESEARCH, DEVELOPMENT, AND DEMONSTRATION PLAN

FOR THE PERIOD 2007 THROUGH 2016

EXTERNAL DRAFT

SEPTEMBER 2007



Table of Contents

	Page
Executive Summary	iv
1. Introduction	1
2. Overall DOE Hydrogen Program and Vision	4
3. Hydrogen from Coal Program – Mission and Goals	5
4. Technical Discussion	7
4.1 Current Technology	7
4.2 Comparison of Current and Future Technology	9
5. Technical Plan	14
5.1 Central Production Pathway	19
5.1.1 Goal and Milestones – Central Production Pathway	19
5.1.2 Activities – Central Production Pathway	20
5.1.3 Technologies – Central Production Pathway	20
5.1.3.1 Advanced WGS reaction systems	21
5.1.3.2 Advanced membrane separation systems	23
5.1.3.3 Reverse selective hydrogen separation systems	27
5.1.3.4 Polishing filters (ultra-clean hydrogen purification systems)	28
5.1.3.5 Advanced adsorption/solvent systems	28
5.1.3.6 Advanced concepts	29
5.1.3.7 Hydrogen Storage at Central Facilities	30
5.1.4 Technical Targets – Central Production Pathway	30
5.1.4.1 WGS Reaction Technical Targets	32
5.1.4.2 Hydrogen Separation Technical Targets	32
5.1.4.3 Advanced Polishing Filter Technical Targets	34
5.1.5 Technical Barriers – Central Production Pathway	35
5.1.5.1 Barriers	35
5.1.5.2 WGS Reaction Barriers	35
5.1.5.3 Hydrogen Separation Barriers	36
5.1.6 Technical Task Descriptions – Central Production Pathway	37
5.2 Alternate Hydrogen Production Pathway	39
5.2.1 Goal and Milestones – Alternate Hydrogen Production Pathway	39
5.2.2 Activities – Alternate Hydrogen Production Pathway	39
5.2.3 Technologies – Alternate Hydrogen Production Pathway	41

5.2.3.1	Liquid Fuels Production/Delivery/Conversion.....	41
5.2.3.2	SNG Production.....	42
5.2.3.3	Fuels Reforming in Distributed Production Facilities	42
5.2.4	Technical Targets – Alternate Hydrogen Production Pathway	42
5.2.4.1	Hydrogen-Rich Liquids Production and Conversion via Reforming Technical Targets.....	42
5.2.4.2	SNG Production and Conversion via Reforming Technical Targets	43
5.2.5	Technical Barriers – Alternate Hydrogen Production Pathway	44
5.2.5.1	General Barriers	44
5.2.5.2	Liquid Fuels and SNG Production, Delivery, and Conversion via Reforming Barriers.....	44
5.2.6	Technical Task Descriptions – Alternate Hydrogen Production Pathway.....	45
5.3	Polygeneration.....	46
5.3.1	Goals and Milestones – Polygeneration	46
5.3.2	Activities – Polygeneration.....	46
5.3.3	Technologies – Polygeneration.....	47
5.3.3.1	High-Value Carbon Products	47
5.3.3.2	Cokes and Pitches.....	47
5.3.3.3	Chemicals.....	48
5.4	Storage.....	48
5.4.1	Goal and Milestones – Storage.....	48
5.4.2	Activities – Storage	48
5.4.3	Technologies – Storage.....	49
5.4.4	Technical Targets – Storage	49
5.4.5	Technical Barriers – Storage.....	51
5.4.6	Technical Task Descriptions – Storage.....	51
5.5	Utilization.....	52
5.5.1	Goal and Milestones – Utilization.....	53
5.5.2	Activities – Utilization.....	53
5.5.3	Technologies – Utilization.....	53
5.5.3.1	Advanced Engine Types.....	53
5.5.4	Technical Guidelines – Utilization	54
5.5.5	Technical Barriers – Utilization	55
5.5.6	Technical Task Descriptions – Utilization.....	55

6. Implementation Plan	56
6.1 Coordination with Other DOE/Federal Programs (Associated Programs):	
Jointly Funded Projects	56
6.1.1 Other Coordination Activities	56
6.1.1.1 Hydrogen Fuel Initiative.....	57
6.1.1.2 Hydrogen and Fuel Cell Interagency Task Force	57
6.1.1.3 International Partnership for the Hydrogen Economy (IPHE)	58
6.2 Performance Assessment and Peer Reviews	58
6.3 Accomplishments and Progress.....	59
6.3.1 Technical Progress.....	59
6.3.1.1 Central Hydrogen Production Pathway	59
6.3.1.2 Alternate Hydrogen Production Pathways.....	61
6.3.1.3 Systems Engineering.....	61
6.3.2 Program Accomplishments.....	61
6.4 Communications, Outreach, and Technology Transfer	61
6.5 Next Steps	62
7. Appendix	63
7.1 Acronyms	63
7.2 Program Contacts	67

Executive Summary

In his 2003 State of the Union address, President Bush announced a \$1.2 billion Hydrogen Fuel Initiative (HFI)¹ to reverse America's growing dependence on foreign oil and reduce greenhouse gas emissions. The President urged the development of commercially viable hydrogen fuels and technologies for cars, trucks, homes, and businesses. The Hydrogen Fuel Initiative includes research activities conducted by the U.S. Department of Energy (DOE) and the U.S. Department of Transportation (DOT).

Additionally, DOE requested that the National Academy of Sciences (NAS) review the proposed coordinated Hydrogen Program. The NAS report,² released in February 2004, concluded that: "A transition to hydrogen as a major fuel in the next 50 years could fundamentally transform the U.S. energy system, creating opportunities to increase energy security through the use of a variety of domestic energy resources for hydrogen production while reducing environmental impacts, including atmospheric carbon dioxide (CO₂) emissions and criteria pollutants."

Secretary of Energy Samuel Bodman remarked on DOE's hydrogen research activities at the National Hydrogen Association Annual Conference in March 2005, where he stated: "The progress that DOE and the automotive and energy industries have made so far has us on the path to an industry commercialization decision in 2015. If our research program is successful, it is not unreasonable to think we could see the beginning of mass market penetration by 2020."

The DOE Hydrogen Posture Plan³ of December 2006 describes the planned activities, milestones, and targets for successfully integrating and implementing technology research, development and demonstration (RD&D) needed to cost-effectively produce, store, and distribute hydrogen for use in fuel cell vehicles and electricity generation.

The Posture Plan was developed by the Offices of Energy Efficiency and Renewable Energy (EERE), Fossil Energy (FE), Science (SC), Nuclear Energy (NE), and DOT. EERE is the lead office for the President's Hydrogen Fuel Initiative within DOE. As stated in the Posture Plan, "Technologies will continue to be evaluated and developed to produce low-cost hydrogen from domestic and secure sources of coal with the capture and sequestration of carbon dioxide."

FutureGen

DOE's FutureGen Initiative will serve as a research platform to establish the technical feasibility, economic viability, and broad acceptance of co-producing electricity and hydrogen from coal with zero emissions, including CO₂.

FutureGen is a government/industry cost-shared project to build a 275-megawatt Integrated Gasification Combined-Cycle (IGCC) test facility for evaluating cutting-edge technologies. The goals of FutureGen are to: 1) sequester at least 90% of CO₂ initially, and eventually up to 100%; 2) prove the effectiveness, safety, and permanence of CO₂ sequestration by validating the technology at large-scale, real-world conditions; 3) establish technology standards and protocols for CO₂ measuring, monitoring, and verification; and 4) validate the engineering, economic, and environmental viability of advanced coal-based, zero emission technologies for commercial readiness in 2020.

¹ President's Hydrogen Fuel Initiative, http://www1.eere.energy.gov/hydrogenandfuelcells/presidents_initiative.html

² National Academy of Sciences, *The Hydrogen Economy: Opportunities, Costs, Barriers, and R&D Needs*, February 2004, http://www.nap.edu/catalog.php?record_id=10922.

³ Department of Energy, *Hydrogen Posture Plan, December 2006*, http://www.hydrogen.energy.gov/pdfs/hydrogen_posture_plan_dec06.pdf

The use of coal — America’s largest domestic fossil energy resource — offers the potential for producing abundant, economically attractive hydrogen to provide both increased energy security and reduction of CO₂ emissions. The Hydrogen from Coal RD&D Plan encompasses FE’s technical activities to meet the goals of the Hydrogen Posture Plan. Coal-based hydrogen production offers a means to transition to a hydrogen-based economy while carbon-free technologies can be further advanced and proved to be commercially attractive.

The Hydrogen from Coal RD&D Plan

The FE Hydrogen from Coal Program was initiated in fiscal year 2004 (FY 2004) to support the President’s Hydrogen Fuel Initiative, DOE’s goals in the Hydrogen Posture Plan, and the FutureGen project.⁴ The mission of the Hydrogen from Coal Program is to develop advanced technologies through joint public and private RD&D. These technologies will facilitate the transition to the hydrogen economy and the use of our nation’s abundant coal resources to produce, store, deliver, and utilize affordable hydrogen in an environmentally responsive manner. Where applicable, the Hydrogen from Coal Program will coordinate its activities with related clean coal programs (e.g., gasification and sequestration) and other organizations in DOE such as EERE.

Goals: The goals of the Hydrogen from Coal Program are:

- Production
 - Central Production Pathway
 - By the end of 2016, prove the feasibility of a 60 percent efficient, near-zero emissions, coal-fueled hydrogen and power co-production facility that reduces the cost of hydrogen by 25 percent compared to current coal-based technology.⁵
 - Alternate Hydrogen Production Pathway
 - By the end of 2014, make available an alternative hydrogen production pathway, including a product reforming system, for decentralized production of hydrogen from high hydrogen content hydrocarbon liquids and/or substitute natural gas (SNG) that can be delivered through the existing fuel distribution infrastructure.
 - Polygeneration
 - By 2015, make available processes to enhance coal facility profitability by producing a variety of high-value, coal-derived chemicals and/or carbon materials that can be incorporated into the central or alternate pathway hydrogen production systems.
- Storage – Complete small-scale research to identify promising hydrogen storage technologies for transportation applications.
- Utilization – Complete the development of hydrogen and hydrogen-natural gas mixture engine modifications and operations by the end of 2009.

⁴ Office of Fossil Energy, FutureGen factsheet, <http://www.fossil.energy.gov/programs/powersystems/futuregen/>

⁵ Overall efficiency depends on product mix (i.e., electricity and hydrogen). The 60 percent efficient facility is based on the product mix in Case 3 in Section 4.2 of the RD&D Plan.

Technology Elements

The Hydrogen from Coal Program will improve upon current technology and make available new, innovative technologies that can produce and deliver affordable hydrogen from coal with significantly reduced or near-zero emissions. The technologies that comprise the program, and those that enable the achievement of the program's goals, include activities that are part of the Hydrogen Fuel Initiative and those associated technologies that are being developed in other coal and carbon sequestration-related programs. The specific activities in this RD&D Program are shown in the large blue-shaded box in Figure ES-1. There are two key hydrogen production pathways for the program — the central production pathway (pure gaseous hydrogen) and the alternate hydrogen production pathway (via hydrogen-rich liquid fuel and substitute natural gas (SNG)). In conjunction with these two pathways, polygeneration — the production of high-value carbon-based materials or chemicals — will utilize the facilities, products, or intermediate products of a hydrogen, liquid fuels, or SNG plant that also co-produces electricity. The high-value, carbon-based materials or chemicals produced through polygeneration will increase the economic viability of these facilities, making them more attractive and ultimately enhancing profitability.

A description of each production pathway follows:

- 1) Central production pathway – Hydrogen is produced at a large, central facility by converting coal into hydrogen. These plants may or may not co-produce electricity and/or other high-value products, and will be designed to allow capture and ultimately sequestration of CO₂.
- 2) Alternate production pathway – Hydrogen-rich, zero-sulfur liquids and SNG are produced from coal at a central location. Hydrogen-rich liquids and SNG potentially can be transported through the existing petroleum or natural gas pipeline delivery networks to distributed locations (refueling stations), where they then can be reformed into hydrogen near the end-user.

Figure ES-1. Office of Fossil Energy Hydrogen Program Components

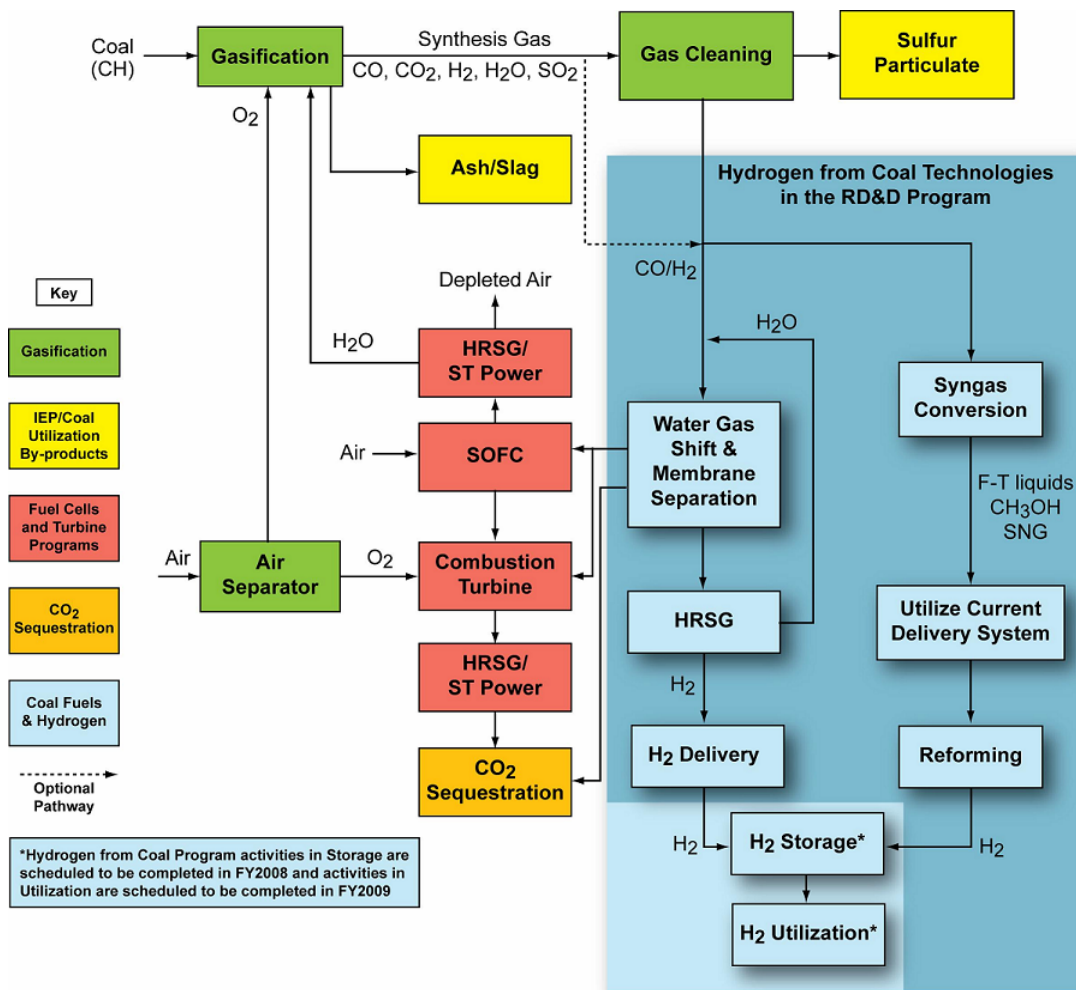

Overview of Technology in the RD&D Plan

The areas of research and technical elements that the program will pursue include:

- Central Production
 - Perform research on new strategies for water-gas shift (WGS), membrane separations, adsorption/solvent separation systems, polishing filters (for high hydrogen purity) and advanced concepts such as chemical looping and process intensification. Process intensification is the concept of developing novel technologies that combine multiple processes into one step, use new control methods, or integrate alternative energy technologies with hydrogen from coal technologies. Central Production will also include analysis and evaluation of the coal to hydrogen pathway (production, delivery, and distribution) to the end user.
 - Develop processes to produce high-value, carbon-based materials (i.e., polygeneration) from coal-fed facilities associated with the central and alternate hydrogen production pathways.
- Alternate Hydrogen Production Pathway
 - Develop hydrogen-rich, liquid fuels and SNG production and reforming technologies.

- Storage
 - Investigate the hydrogen storage capabilities of unique storage systems such as metal frameworks.
- Utilization
 - Modify and optimize conventional and advanced internal combustion engines to operate on hydrogen or hydrogen-natural gas mixtures and demonstrate the performance of these engines.

Research efforts also will be coordinated with other programs such as EERE's Hydrogen, Fuel Cells, and Infrastructure Technologies Program, to leverage technical skills and funding, minimize duplication of efforts, optimize resource (funds/manpower) utilization, and achieve maximum synergism while ensuring that the nation's energy security and environmental goals are addressed.

Accomplishments and Progress

The Hydrogen from Coal Program has successfully transitioned from its initial start-up in FY 2004 to full operations. The Program has been actively soliciting proposals from industry, universities, and other organizations to help the program achieve its goals in support of the HFI and FutureGen project. Currently, the program has 38 projects that conduct research to develop:

- Advanced technologies targeted toward higher efficiency and reduced hydrogen production costs from central station plants such as the FutureGen project configuration;
- Alternate pathways that produce hydrogen from high hydrogen content liquids and SNG;
- Polygeneration of high value chemicals and carbon products;
- High hydrogen capacity storage materials; and
- Processes for utilizing hydrogen and/or hydrogen-natural gas mixtures in internal combustion engines as a near-term strategy to deploy hydrogen.

Research progress is periodically reviewed to update the RD&D Plan with respect to goals, technical targets, milestones and program schedules. This FY 2007 RD&D Plan update reflects the most recent status of the Hydrogen from Coal Program.

Technical

Significant progress already has been made toward meeting the technical targets that are provided in Section 5 for hydrogen separation. Eltron Research, Inc.'s hydrogen separation membrane has shown at laboratory scale the potential for meeting the Program's long-range 2015 targets. Importantly, this project was selected by R&D Magazine as one of the 100 most technologically significant products in 2005. A major research emphasis is also being placed on developing technologies that combine two or more processes in one unit in order to reduce costs and plant footprint. As an example, Media and Process Technology's WGS membrane reactor combines hydrogen production and separation in one unit. A field test at a commercial hydrotreating facility was conducted which successfully demonstrated hydrogen selectivity and chemical stability in a gas stream containing hydrogen, hydrocarbons, hydrogen sulfide, and ammonia. Scale-up and manufacturing potential of the ceramic membrane has also been demonstrated.

Additionally, the Southwest Research Institute (SwRI) has made significant gains in advanced hydrogen membrane manufacture. They successfully fabricated an initial series of metal alloy membranes that are some of the thinnest (3 microns), largest area (110 square inches), and highest performance separation

membranes reported. Their membrane exceeded the DOE Hydrogen Program and 2010 DOE Fossil Energy targets - showing a pure H₂ flux of 242 scfh/ft². Initial estimates for the total final production cost of these membranes are \$45.50/ft².

Program

Hydrogen production from coal is closely linked with the system's up-front gasification technologies and downstream CO₂ capture and sequestration. Therefore, these three DOE programs have been coordinated within the Office of Clean Coal to enhance integration of the separate programs. Additionally, the Hydrogen from Coal Program continues to coordinate with other DOE offices by participating in the development of various planning documents and in the DOE Hydrogen Program Annual Merit Review of the sponsored projects.

Benefits

- **Achieve energy security and a sustainable hydrogen economy by economically producing hydrogen from coal.**
 - The United States is becoming increasingly dependent on imported oil for transportation fuels. Increased demand from developing countries for the finite world oil reserves is expected to raise crude oil prices and cause world oil production to peak, possibly over the next 20–30 years. Some analysts' projections suggest that this peaking may already be occurring or may occur within the next decade. U.S. coal reserves nearly equal the total proven world conventional oil reserves – a 250-year supply of U.S. coal at today's domestic production rates. Hydrogen represents a clean alternative fuel that can help to reduce the nation's requirements for imported oil.
- **Reduce environmental concerns associated with energy use in automotive and stationary power applications through the clean production of hydrogen from coal in tandem with carbon management.**
 - Gasification technologies have shown the potential to produce clean synthesis gas from coal with virtually zero pollutant emissions. Carbon sequestration technologies that are being developed will provide the capability to cost-effectively use concentrated CO₂ streams in enhanced oil recovery, geological storage, and accelerated biomass growth processes for fuel production. Fuel cells are poised to provide efficient, emission-free power from hydrogen in both automotive and stationary power applications. The potential emissions benefits for hydrogen from coal with sequestration, and use in fuel cell vehicles compared to hybrid electric vehicles and internal combustion vehicles, are shown in Figure ES-2.
- **Ensure the availability of a major primary energy resource that can be used for the production of hydrogen in volumes sufficient to provide the fuel that will be needed for the future fuel cell-powered vehicle market.**

Figure ES-2. Resource Extraction through Vehicle End Use – System Emissions Hydrogen from Coal and Use in Fuel Cell Vehicles Compared to Gasoline Use in Hybrid Electric and Internal Combustion Engine Vehicles (100 million vehicles)

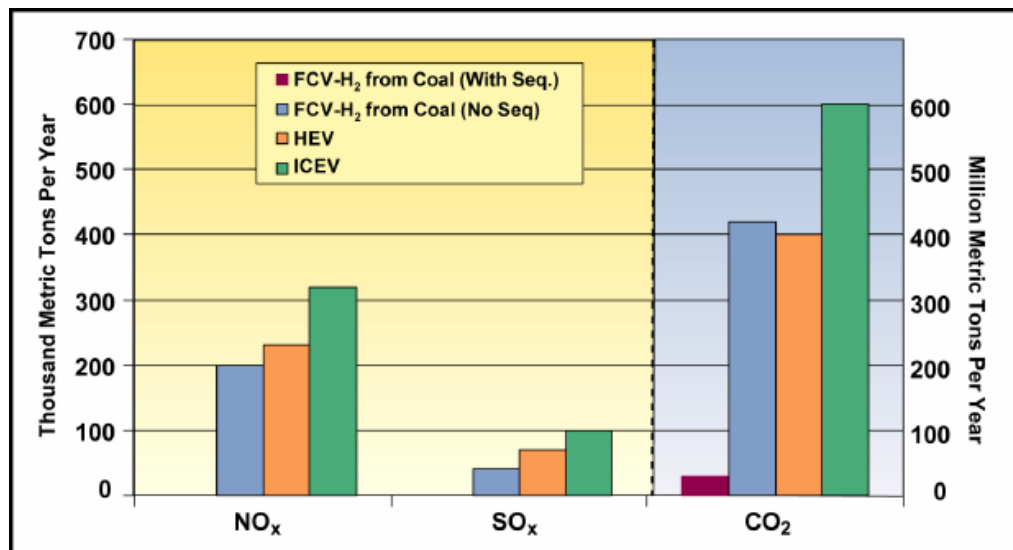

Technical Activity Gantt Chart Summary

The specific sub-element activities and their associated timelines are shown in the Gantt chart in Figure ES-3, which summarizes: a) the activities and technologies associated with hydrogen production from large central plants, b) the activities and technologies associated with the alternate pathway for distributed hydrogen production from hydrogen-rich liquids and SNG, and c) small scale research activities being conducted in storage and utilization technologies for hydrogen from coal.

This Multi-Year Research, Development, and Demonstration Plan (MYP) addresses the strategies, goals and progress of the program, and defines the research areas where the program uses its expertise to support the President's Hydrogen Fuel Initiative and the DOE FutureGen project.

This RD&D Plan is organized by section, as follows:

- Section 1. Introduction
- Section 2. Overall DOE Hydrogen Program and Vision
- Section 3. Hydrogen from Coal Program Mission and Goals
- Section 4. Technical Discussion
- Section 5. Technical Plan
- Section 6. Implementation Plan

Detailed activities and technical targets are provided in the Technical Plan in Section 5. Implementation of the above activities will be coordinated closely with the related activities supported by the Office of Fossil Energy and the Office of EERE, and other organizations both inside and outside the government.

Figure ES-3. Hydrogen from Coal Research, Development, and Demonstration Program

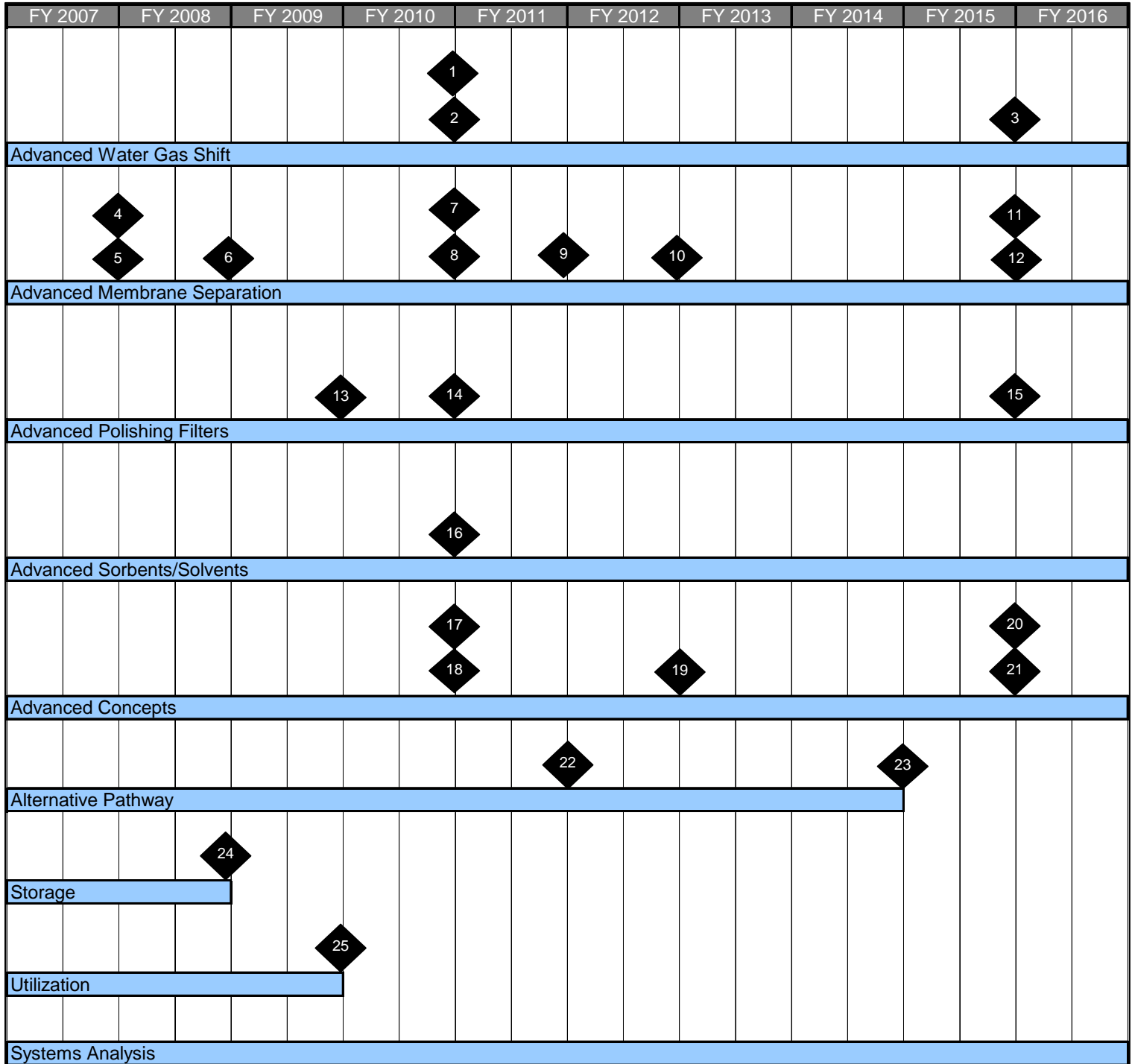

Key to Figure ES-3:**Advanced water-gas shift**

1. End of 2010: Go/no-go decision on further development of advanced water-gas shift reaction technologies
2. End of 2010: Systems analysis verifies achievement of 2010 technical targets.
3. End of 2015: Systems analysis verifies achievement of 2015 technical targets.

Advanced membrane separations

4. End of 2007: Downselect most promising membrane separation technologies.
5. Beginning of 2008: Initiate pre-engineering scale development of 1st generation membrane separation technology.
6. Beginning of 2009: Initiate engineering-scale design and construction of 1st generation membrane separation technology.
7. End of 2010: Systems analysis verifies achievement of 2010 technical targets.
8. Beginning of 2011: Initiate pre-engineering of 2nd generation module.
9. Beginning of 2012: Integrate and test 1st generation membrane separation technology into FutureGen plant.
10. Beginning of 2013: Initiate engineering-scale design and construction of 2nd generation advanced hydrogen production and separation technologies.
11. End of 2015: Systems analysis verifies achievement of 2015 technical targets.
12. Beginning of 2016: Integrate 2nd generation advanced hydrogen production and separation technologies into advanced co-production facilities.

Advanced polishing filters

13. End of 2009: Downselect most promising polishing filter technologies for further development.
14. End of 2010: Verify achievement of targets for gas turbines and SOFCs.
15. End of 2015: Verify achievement of targets for PEM fuel cells.

Advanced sorbents/solvents

16. End of 2010: Downselect most promising advanced sorbents/solvents for further development.

Advanced concepts/process intensification

17. End of 2010: Identify and downselect most promising advanced concepts for further development.
18. End of 2010: Initiate pre-engineering scale development of 1st generation advanced concepts.
19. Beginning of 2013: Initiate engineering-scale design and construction of advanced concepts.
20. End of 2015: Verify achievement of 2015 technical targets for advanced separations.
21. Beginning of 2016: Integrate engineering-scale advanced concepts into co-production facility.

Alternative Pathway

22. End of 2011: Determine the most feasible alternate hydrogen from coal pathway(s) and reforming system(s) for producing hydrogen-rich liquid fuels and SNG that are able to meet the hydrogen cost target.
23. End of 2014: Optimize, integrate and make available an alternate hydrogen production pathway and reforming system to produce decentralized hydrogen from coal.

Storage

24. End of 2008: Successfully complete laboratory/bench-scale research on promising novel hydrogen storage systems.

Utilization

25. End of 2009: Successfully complete research to modify and optimize advanced engine types fueled by hydrogen and/or hydrogen-natural gas mixtures.

1. Introduction

The Administration's National Energy Policy (NEP) was released in May 2001. The NEP made more than 100 recommendations to achieve the goals of:

- Modernizing energy conservation;
- Modernizing our energy infrastructure;
- Increasing our energy supplies;
- Accelerating protection of the environment; and
- Increasing our nation's energy security.

In response to recommendations in the NEP with regard to hydrogen and fuel cell technologies, DOE organized meetings in November 2001 and April 2002, which resulted in the *National Vision of America's Transition to a Hydrogen Economy – to 2030 and Beyond*⁶ and the *National Hydrogen Energy Roadmap*.⁷ These documents summarize the potential for hydrogen in America's future and the challenges that must be overcome to realize the vision of a hydrogen economy.

Hydrogen from Coal Program Mission

The mission of the Hydrogen from Coal Program is to develop advanced and novel technologies that will ensure the use of our nation's abundant coal resources to produce, store, deliver, and utilize affordable hydrogen in a safe and environmentally clean manner. Accomplishment of this mission will help facilitate the transition to the hydrogen economy.

Figure 1. Fossil Fuel Reserves

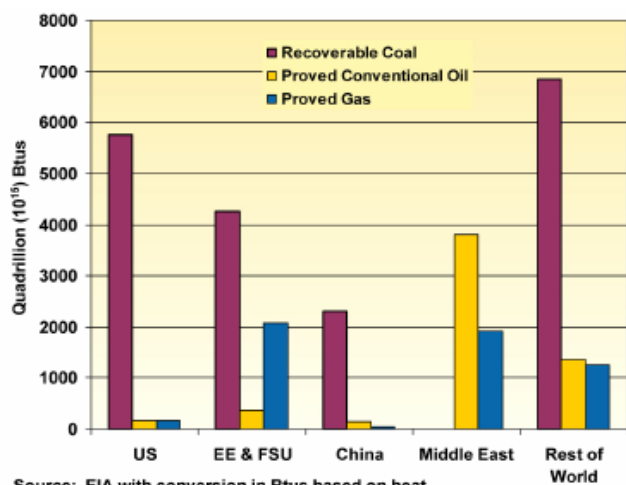

Source: EIA with conversion in Btus based on heat

U.S. coal reserves nearly equal total proved world conventional oil reserves

In his State of the Union address in January 2003, the President announced the Hydrogen Fuel Initiative, proposing a five-year, \$1.2 billion research initiative to develop pathways for the production, delivery, storage, and utilization of hydrogen. EERE, with support from the Offices of FE, SC, and NE, prepared the Hydrogen Posture Plan to outline DOE activities, milestones, and deliverables to facilitate the United States' transition to a hydrogen economy. The Hydrogen Posture Plan was updated in December 2006. In February 2003, DOE announced the FutureGen project, which will be a prototype plant that will integrate hydrogen and power production from coal, and utilize carbon sequestration, serving as a testing facility for future technologies.

More recently, in February 2006, the President announced the Advanced Energy Initiative, which promotes clean energy technology research at DOE to change the way we fuel our vehicles and the way we power our homes and businesses. Hydrogen and clean coal technologies are two important areas of this initiative.

⁶ Office of EERE, *A National Vision of America's Transition to a Hydrogen Economy – To 2030 and Beyond*, http://www.hydrogen.energy.gov/pdfs/vision_doc.pdf.

⁷ Office of EERE, *National Hydrogen Energy Roadmap*, http://www.hydrogen.energy.gov/pdfs/national_h2_roadmap.pdf.

In support of these various initiatives and projects, FE established the Hydrogen from Coal Program to develop advanced, novel, and innovative hydrogen production technologies based on coal, our nation’s most abundant domestic fossil fuel resource (see Figure 1). This RD&D Plan includes the program’s strategies and goals through 2016. The Plan also defines the research areas where the program will focus its expertise to develop the technologies needed to support the President’s Advanced Energy Initiative, Hydrogen Fuel Initiative, the Hydrogen Posture Plan, and the FutureGen project.

As a preeminent primary source of energy, coal is an abundant domestic resource, with the United States boasting hundreds of years of supply at current demand levels. The production of hydrogen from coal for use in fuel cell vehicles in the transportation sector will reduce U.S. reliance on foreign imports of petroleum. It is estimated that, when used in 100 million fuel cell vehicles, hydrogen produced from coal could reduce petroleum demand by 3 million barrels per day from today’s 20 million barrels per day of demand.

A benefits analysis evaluated the system encompassing resource extraction and transportation, followed by conversion (e.g., a refinery to make gasoline from petroleum, or a plant to produce hydrogen from coal), and finally end use of hydrogen in vehicles. The analysis estimated that hydrogen produced from coal can offer environmental benefits compared to gasoline powered vehicles, as shown in Figures 2 and 3.

Figure 2 shows that, with carbon sequestration in the production of hydrogen from coal, net system emissions of CO₂ will be nearly eliminated compared to the internal combustion engine vehicle and hybrid electric vehicle systems. Without sequestration, emissions of CO₂ will be lower than internal combustion engine systems. Figure 3 shows the emissions reduction of criteria pollutants.

The Hydrogen from Coal RD&D Plan provides a roadmap that the program will pursue to develop the technologies necessary for coal to meet the goals of the President’s Advanced Energy Initiative, Hydrogen Fuel Initiative, and the FutureGen project. It discusses current and future technologies for the production of hydrogen from coal, and identifies associated programs that will contribute to the development of facilities for the co-production of hydrogen and power with near-zero emissions. The Plan will serve as a resource document for the program and will be updated as goals, milestones, and targets are achieved, and as assumptions on markets and technologies change.

Figure 2. CO₂ Emissions from FCV, HEV, and ICEV Transportation Systems (100 million vehicles)

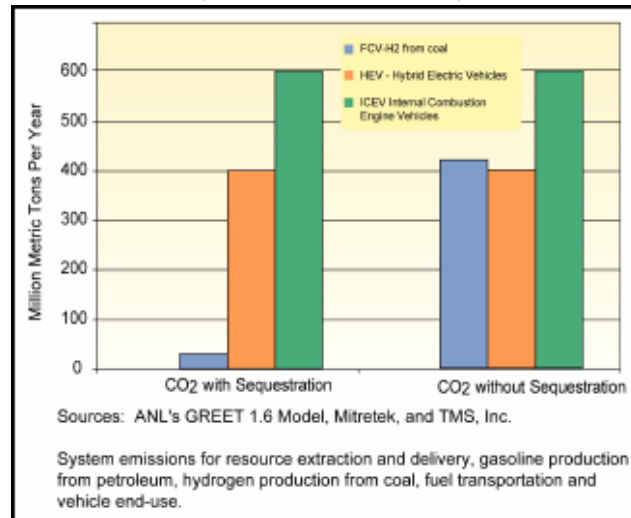
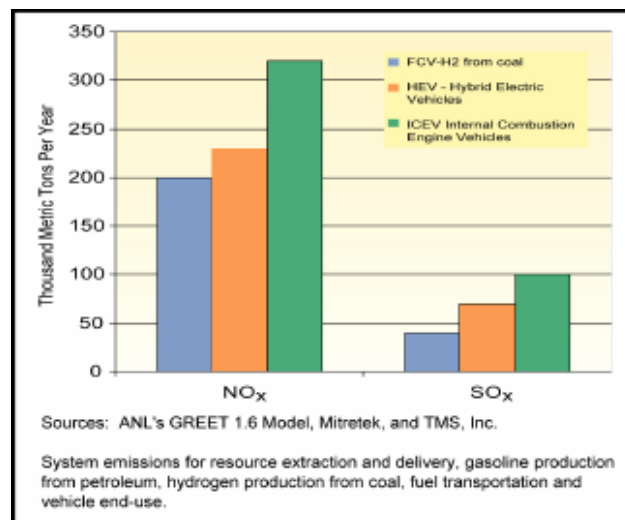

Figure 3. Criteria Emissions from FCV, HEV, and ICEV Transportation Systems (100 million vehicles)



FutureGen – The World’s First Zero-Emission, Coal-Based Electricity and Hydrogen Power Plant

On February 27, 2003, the President announced that the United States would sponsor the world’s first coal-based, integrated zero-emission electricity and hydrogen power plant. Former Secretary of Energy Spencer Abraham unveiled FutureGen as a prototype fossil fuel power plant of the future — a \$1.5 billion government/industry partnership that would simultaneously test and verify the large-scale sequestration of CO₂ from a process that produces significant quantities of electricity and hydrogen by use of coal gasification processes. As a Presidential Initiative, the FutureGen Project aims to draw upon the best scientific research to address the issue of global climate change.

FutureGen is highly relevant to the DOE mission and is designed to achieve the goals of several overarching Presidential initiatives and priorities. The project will establish the technical and economic feasibility of zero-emission power plants by producing electricity and hydrogen from coal, while capturing and sequestering CO₂ emissions. FutureGen’s ability to produce hydrogen using current technology and to evaluate advanced hydrogen production technology will support the President’s Hydrogen Fuel Initiative.

The FutureGen plant will be a nominal 275-MW (net equivalent output) prototype that produces electricity and hydrogen, and sequesters one to two million metric tons of carbon dioxide per year. FutureGen will support efforts to assure that U.S. fossil energy resources can meet increasing demands for affordable energy without compromising the quality of life for future generations of Americans. The FutureGen project will employ coal gasification technology integrated with combined-cycle electricity generation and hydrogen production, while capturing and sequestering the carbon dioxide. When operational, this zero-emission prototype will be the cleanest fossil fuel-fired power plant in the world. The project will be designed and constructed as a living laboratory, with the flexibility to conduct full-scale and scaleable slipstream tests of advanced technologies as they emerge from FE’s core research program. The RD&D activities under the Hydrogen from Coal Program will provide advanced modules for evaluation in the FutureGen facility. Hydrogen will enable the use of pollution-free, commercially viable fuel cells to power cars, trucks, homes, and businesses. Within this context, FutureGen can be regarded as a means for establishing coal as a clean, reliable, and secure source of hydrogen. Hydrogen is being viewed as the fuel of the future for the transportation sector and stationary fuel cell power generation.

The FutureGen project will require 10 years to complete. The project is a public/private partnership involving the DOE and a broad, open alliance of industrial coal producers and electric utilities, as well as state governments and international participants, with results shared among all participants and industry as a whole. The DOE signed a cooperative agreement with the FutureGen Industrial Alliance, which was formally organized as a Delaware non-profit corporation on July 27, 2005. Currently, the Alliance has 12 companies (American Electric Power; Southern Company; CONSOL Energy, Inc.; Rio Tinto Energy America; Peabody Energy; PPL Corporation; E.ON US; BHP Billiton; Foundation Coal Corp.; China Huaneng Group; Xstrata Coal Pty Limited; and Anglo American). International organizations are invited to participate in the project, with the governments of India and South Korea having signed agreements with the United States to join the project. International participation will maximize the global applicability and acceptance of the FutureGen concept and technology, thereby building an international consensus on the role of coal and sequestration in addressing global climate change and energy security. Discussions with other countries are ongoing.

In July 2006, the FutureGen Industrial Alliance announced its short list of candidate sites for the FutureGen plant after an extensive evaluation. The Alliance concluded that four sites are best suited to host the plant. They include: Mattoon, Illinois, Tuscola, Illinois, Heart of Brazos near Jewett, Texas, and Odessa, Texas. These sites will move forward to the next step, which includes a comprehensive National Environmental Policy Act (NEPA) evaluation by DOE.

2. Overall DOE Hydrogen Program and Vision

DOE, in coordination with DOT, is responsible for implementing the President's Hydrogen Fuel Initiative. The Hydrogen Posture Plan outlines the activities, milestones, and deliverables that DOE and DOT plan to pursue to facilitate our nation's transition to a hydrogen economy. Because hydrogen can be produced from a wide variety of resources — fossil fuels, renewables, and nuclear — several offices within DOE will play a key role in the Initiative. The Offices of EERE, FE, SC, and NE, and DOT are each using their unique technological expertise and experience with their respective resources to successfully develop technologies to produce, deliver, store, and utilize hydrogen from a diverse group of feedstocks for a broad range of technologies and markets. EERE will coordinate DOE's overall Hydrogen Program. The Department of Transportation will contribute its expertise in development of safety codes, standards, and regulations; safety education, outreach, and training; and RD&D on medium- and heavy-duty vehicles.

The vision statement for the overall DOE Hydrogen Program, encompassing efforts in all DOE program offices, was developed during the National Hydrogen Vision Meeting in November 2001. The vision states: "Hydrogen is America's clean energy choice. Hydrogen is flexible, affordable, safe, domestically produced, used in all sectors of the economy, and in all regions of the country."

3. Hydrogen from Coal Program – Mission and Goals

The mission of the Hydrogen from Coal Program is to develop advanced and novel technologies, through joint public and private RD&D, which will facilitate the use of our nation's abundant coal resources. The RD&D will provide the pathways to produce affordable hydrogen from coal in an environmentally clean manner, and facilitate the transition to the hydrogen economy as outlined in the Hydrogen Posture Plan.

The goals for the elements of the Hydrogen from Coal Program are provided below with a brief discussion.

In the Central Production Pathway, hydrogen is produced at a large-scale central facility where coal is converted into hydrogen or into hydrogen and electric power as co-products. This approach fully supports the FutureGen project by requiring capture of the CO₂ generated during the production of the hydrogen, which then could be sequestered. The hydrogen produced at these central plants then must be delivered and distributed to the end users.

■ Production

– Central Production Pathway

- By the end of 2016, prove the feasibility of a 60 percent efficient,⁸ near-zero emissions, coal-fueled hydrogen and power co-production facility that reduces the cost of hydrogen by 25 percent compared to current coal-based technology.

An alternative to producing hydrogen gas at a central location and having to deliver this hydrogen to the end users is to produce hydrogen-rich, zero-sulfur liquid fuels or SNG from coal in a large-scale central facility that also could co-produce electric power. The liquid product or SNG (*i.e.*, a hydrogen carrier) would be transported through the existing petroleum fuels or natural gas distribution network to sub-central or distributed locations close to the end users (refueling stations). At distributed plants, liquid fuels or SNG would be reformed into hydrogen at the refueling station. This pathway is envisioned as an interim pathway for hydrogen production and use until a widespread hydrogen delivery infrastructure is available. Development of such a hydrogen infrastructure could take at least several decades.

– Alternate Hydrogen Production Pathway

- By the end of 2014, make available an alternative hydrogen production pathway, including a product reforming system, for decentralized production of hydrogen from high hydrogen content hydrocarbon liquids and/or SNG that can be delivered through existing fuel distribution infrastructure.

Polygeneration will investigate the production of high-value, carbon-based chemicals and materials in plants that produce hydrogen, liquid fuels, or SNG to improve economic performance.

- By 2015, make available processes to enhance coal facility profitability by producing a variety of high-value, coal-derived chemicals and/or carbon materials that can be incorporated into the central or alternate pathway hydrogen production systems.

■ Storage – Complete small-scale research to identify promising hydrogen storage technologies for transportation applications.

⁸ Overall efficiency depends on product mix (*i.e.*, electricity and hydrogen). The 60 percent efficient facility is based on the product mix in Case 3 in Section 4.2 of the RD&D Plan.

- Utilization – Successfully complete the development of hydrogen and hydrogen-natural gas mixture engine modifications and operations by the end of 2009.

4. Technical Discussion

4.1 Current Technology

Today, hydrogen is produced from coal by gasification followed by processing the resulting synthesis gas, and is used primarily to produce hydrogen for the production of ammonia for fertilizer. Coal-derived synthesis gas also is being converted to methanol for use as an intermediate product in the chemical industry. Methanol also can be used as a hydrogen carrier for subsequent reforming applications or use in fuel cells, such as those being considered for small portable devices including laptop computers. Advanced liquid-phase methanol production from coal technology has been successfully demonstrated at the Eastman Chemical Complex in Kingsport, Tennessee, a DOE Clean Coal Technology Demonstration Program project.

In its simplest form, the process used to produce hydrogen from coal is shown schematically in Figure 4. The coal first is gasified with oxygen and steam to produce a synthesis gas consisting mainly of carbon monoxide (CO) and hydrogen (H₂), with some CO₂, sulfur, particulates, and trace elements. Oxygen (O₂) is added in less than stoichiometric quantities so that complete combustion does not occur. This process is highly exothermic, with temperatures controlled by the addition of steam. Increasing the temperature in the gasifier initiates devolatilization and breaking of weaker chemical bonds to yield tars, oils, phenols, and hydrocarbon gases. These products generally further react to form H₂, CO, and CO₂. The fixed carbon that remains after devolatilization is gasified through reactions with O₂, steam, and CO₂ to form additional amounts of H₂ and CO. These gasification reactions are shown in Figure 5.

Figure 4. Current Hydrogen from Coal Production

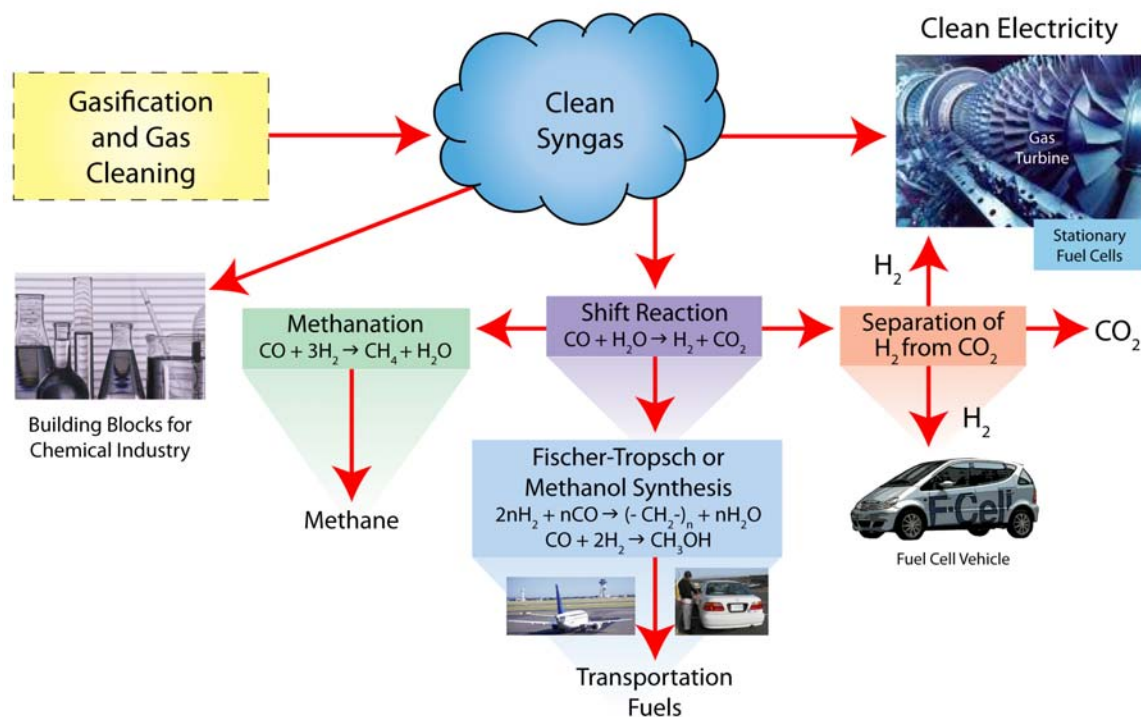
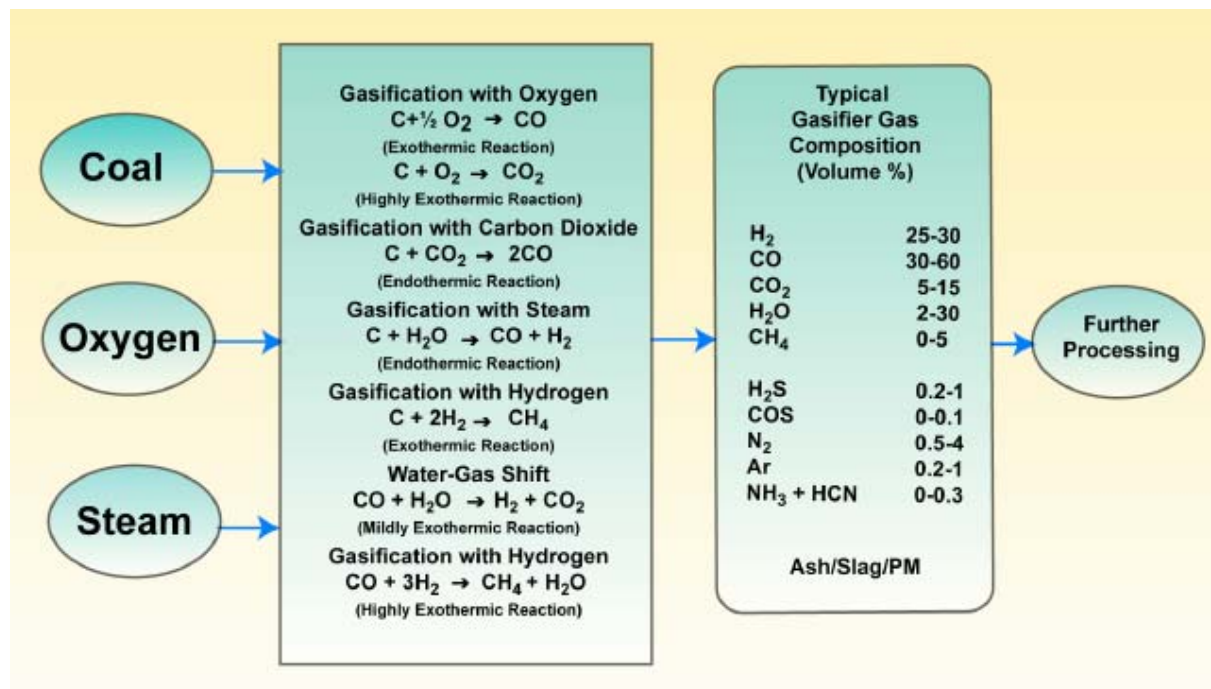

Figure 5. Major Gasification Reactions



The minor and trace components of coal also are transformed in the gasification reactor. Under the sub-stoichiometric reducing conditions of gasification, most of the fuel's sulfur converts to hydrogen sulfide (H₂S), but some (3–10 percent) also converts to carbonyl sulfide (COS). Nitrogen bound with the fuel generally converts to gaseous nitrogen (N₂), with some ammonia (NH₃) and a small amount of hydrogen cyanide (HCN) also being formed. Most of the chlorine content of the fuel is converted to hydrogen chloride (HCl) gas and some particulate-phase chlorides.

Minerals in the feedstock (ash) separate and leave the bottom of the gasifier as an inert slag (or bottom ash), a potentially marketable solid product.⁹ The fraction of the ash entrained with the syngas, which is dependent upon the type of gasifier employed, requires removal downstream in particulate control equipment, such as filters and water scrubbers. This particulate typically is recycled to the gasifier to ensure high carbon conversion. Some gasifiers also yield devolatilization or pyrolysis products (*e.g.*, coal tars, oils, phenols), some of which can be sold. The remaining products can and must be controlled to eliminate any potential environmental impacts.

Trace elements associated with both organic and inorganic components of the coal, such as mercury and arsenic, are released during gasification and settle in different ash fractions (*e.g.*, fly ash, bottom ash, slag) and gaseous emissions. The particular chemical species and physical forms of condensed-phase and vapor-phase trace elements are functions of gasifier design and operating conditions.

The temperature of the synthesis gas as it leaves the gasifier is generally in the range of 1,000 °F to 1,900 °F, depending upon the type of gasifier selected. With current technology, the gas has to be cooled to ambient temperatures to remove contaminants, although with some designs, steam is generated as the synthesis gas is cooled. Depending on the system design, a scrubbing process is used to remove HCN, NH₃, HCl, H₂S, and particulates, and operates at low temperatures with synthesis gas leaving the process

⁹ When applicable, char must be separated from slag or bottom ash before it can be marketed.

at about 72 °F. The H₂S and COS, once hydrolyzed, are removed by dissolution in, or reaction with, an organic solvent and converted to valuable by-products, such as elemental sulfur or sulfuric acid with 99.8 percent sulfur recovery. The residual gas from this separation can be combusted to satisfy process-heating requirements.

This raw clean synthesis gas must be re-heated to 600–700 °F for the first of two WGS reactors that produce additional hydrogen through the catalytically assisted equilibrium reaction of CO with H₂O to form CO₂ and H₂. The exothermic reaction in the WGS reactor increases the temperature to about 800 °F, which must be cooled to the required inlet temperature for the second WGS reactor in the range of 250–650 °F, depending on design. The WGS reaction increases the H₂/CO ratio in the final mixture. Overall, about 70 percent of the feed fuel's heating value is associated with the CO and H₂ components of the gas, but can be higher depending upon the gasifier type. Hydrogen must be separated from the shifted gas containing CO₂, CO, and other contaminants, and lastly undergo a polishing step that removes any remaining sulfur, CO, and other trace contaminants in order to meet the requirements for various end-uses (*e.g.*, fuel cell vehicles).

Instead of maximizing conversion of synthesis gas to hydrogen production, an alternate pathway prior to the introduction of a hydrogen infrastructure could be to convert the synthesis gas into hydrogen-rich liquids (*e.g.*, Fischer-Tropsch [F-T] liquids) for use as liquid transportation fuels or reformable fuels to produce hydrogen for fuel cell applications. A similar approach would be to catalytically convert the synthesis gas to SNG for reforming into hydrogen at small-scale distributed plants near the end-user.

4.2 Comparison of Current and Future Technology

At the present time, no coal-based facilities employing modern gasification systems have been constructed that produce both hydrogen and electric power; however, similar facilities based on heavy oil partial oxidation are in operation. Conceptual plants fed with coal have been simulated using computer models to estimate the technical performance and economics of a co-production plant producing hydrogen and power, based on current technology. Computer simulations also have been developed for conceptual plants that produce hydrogen and some excess power, based on advanced technologies that are presently unavailable for commercial deployment. The status of these advanced technologies varies. Some are close to commercialization while others are farther back in the R&D pipeline. Table 1 summarizes the information developed from three of these computer simulations, all of which include carbon sequestration technologies. A more detailed evaluation of additional co-production cases can be found in the Mitretek report, *Hydrogen from Coal*.¹⁰

¹⁰ *Hydrogen from Coal*, Mitretek Technical Paper MTR 2003-31, July 2002.

Table 1. Summary of Hydrogen from Coal Cases

	Units	CASE 1	CASE 2	CASE 3 ¹¹
Technology Readiness Goal	-	Current	2015	2015
Carbon Sequestration	%	Yes (87%)	Yes (100%)	Yes (100%)
Hydrogen	MMscfd	119	158	153
Coal (As Received)	tons/day	3,000	3,000	6,000
Efficiency	%HHV	59	75.5	59
Excess Power	MW	26.9	25	417
Power Value	mils/kWh	53.6	53.6	53.6
Capital	\$million	417	425	950
RSP of Hydrogen	\$/MMBtu (\$/kg)	8.18 (1.10)	5.89 (0.80)	3.98 (0.54)

Notes:

- 1) Coal cost is \$29/ton (and is assumed to de-escalate at 1.5 percent below general inflation), and the assumed plant capacity factor is 85 percent.
- 2) For carbon sequestration, the co-produced power is assumed to have a value of \$53.6/MWh, based on an additional cost of power production from Natural Gas Combined-Cycle (NGCC) plants with sequestration of 18 mills/kWh and natural gas priced at \$3.15/MM Btu (reference EPRI report 1000316).
- 3) For sequestration, it is assumed that \$10 per ton of carbon is added for sequestration after the concentrated CO₂ stream has been isolated, and the CO₂ stream is compressed to 200 bars (2,900 psi).
- 4) Financial assumptions used for these simulations: 25-year plant life; 67%/33% debt/equity financing; 15% return on equity; 8% interest for a 16-year term; 3% inflation with coal de-escalation of 1.5% per annum below general inflation; 16-year double declining balance depreciation; 40% combined federal and state tax rate; 3-year construction with 50% output in start-up year; carbon sequestration cost of \$10/ton.

Case 1, shown schematically in Figure 6, is a process to produce hydrogen using conventional technology coupled with carbon capture and sequestration. The process assumes that a General Electric (GE) quench gasification system (formerly ChevronTexaco gasification) with conventional acid removal and a pressure swing adsorption (PSA) system for hydrogen recovery are used. All of the CO₂ is removed prior to the PSA unit, compressed to 200 bars (2,900 psi), and sequestered for an additional cost of \$10 per ton of carbon (\$3 per ton of CO₂). In this configuration, 87 percent of the carbon in the feed is ready for sequestering. The capital cost of the plant is estimated at \$417 million with a required selling price (RSP) of the hydrogen at \$8.18/MMBtu (\$1.10/kilogram (kg) of hydrogen). The amount of hydrogen produced is 119 million standard cubic feet per day (MMscfd), and there are 27 MW of excess power.

¹¹ Case 3 is a co-production case with twice the coal feedstock as Cases 1 and 2, with equal quantities of coal feed used to produce hydrogen and electricity. Efficiency for this case is reduced compared to Case 2 because of the lower efficiency associated with the large quantity of electric power production in Case 3.

Figure 6. Schematic of Current Technology to Produce Hydrogen from Coal with Carbon Sequestration (Case 1)

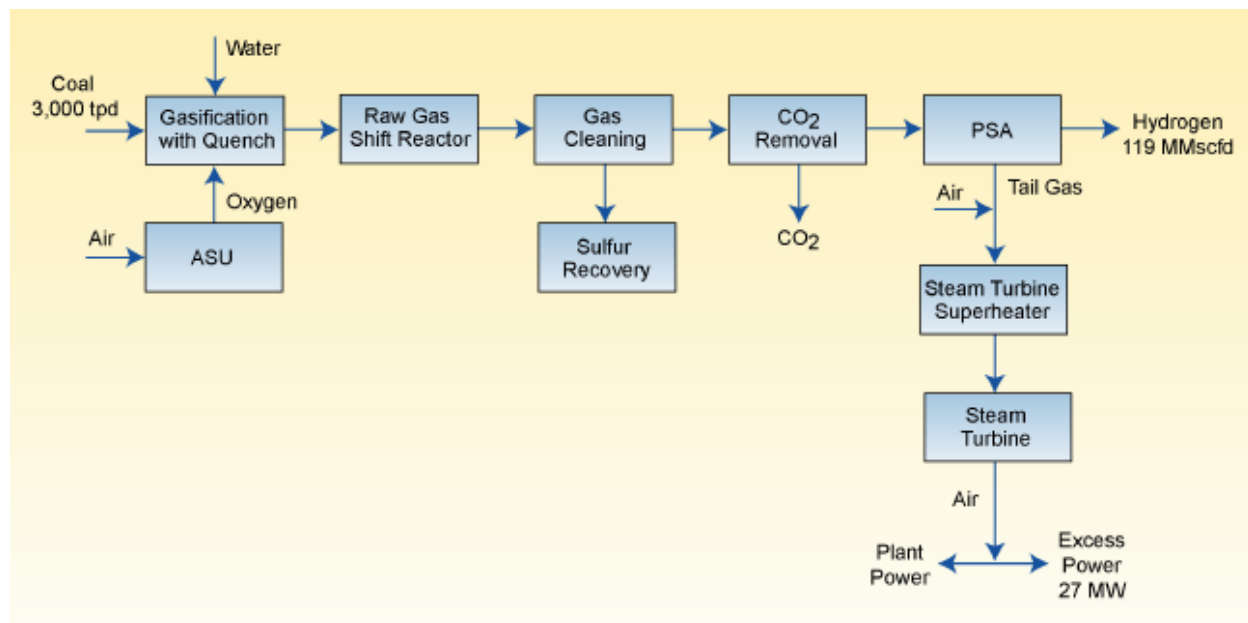

Case 2 represents a process for hydrogen production from coal that uses advanced gasification technology, and advanced membrane technology for hydrogen separation with CO₂ removal, and is carbon sequestration-ready. A schematic of the process is shown in Figure 7. In this configuration, advanced E-gas gasification with hot gas cleanup is used in combination with a ceramic membrane system operating at nearly 600 °C (1,100 °F), which is capable of shifting and separating hydrogen from clean synthesis gas. It is assumed that 90 mole percent of the hydrogen in the synthesis gas is recovered in this membrane system, assumed to be similar to the diffusion membrane system under development by the Inorganic Membrane Technology Laboratory at Oak Ridge National Laboratory (ORNL).

The hydrogen produced in Case 2 is separated at high pressure, with the hydrogen product produced at low pressure. The hydrogen must be compressed to various pressures depending on its use or storage. The remaining tail gas, containing mostly CO₂ with some CO and H₂, is combusted with O₂ in a gas turbine to provide power for the plant. O₂ is used so that a concentrated stream of CO₂ is readily produced for sequestration. Heat is recovered from both the gas turbine exit gas and from the hot hydrogen in heat recovery steam generators (HRSGs), where the steam produced is sent to a steam turbine to provide additional power. This efficiency improvement is due to improved gasifier design combined with hot-gas cleanup that eliminates the need to cool and then reheat the synthesis gas, combined with efficient hydrogen membrane separation incorporating the WGS reaction. The capital cost for the facility is \$425 million, with the required selling price of hydrogen estimated at \$5.89/MMBtu (\$0.79/kg). The amount of hydrogen produced is 158 MMscfd with 25 MW of excess power.

Figure 7. Schematic of Advanced Technology to Produce Hydrogen from Coal with Carbon Sequestration (Case 2)

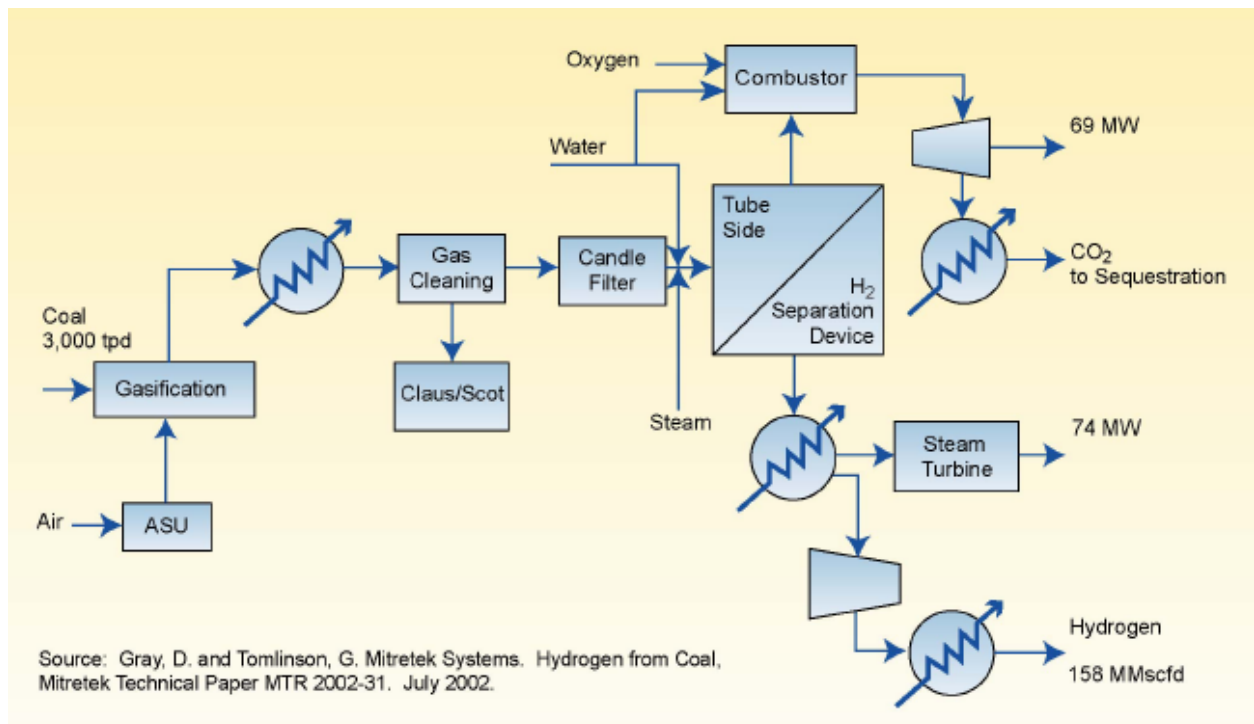

Case 3, shown in Figure 8, is an example of an advanced co-production concept plant that is expected to be similar to the FutureGen prototype fossil fuel power plant. This case produces 153 MMscfd of hydrogen and 417 MW of excess power, and will employ advanced gasification, combustion and turbine systems, membrane separation, and carbon capture and sequestration in a co-production plant producing hydrogen and electric power using technologies similar to Case 2. In Case 3, a separate gasification train is utilized specifically to produce clean electric power. These highly efficient hydrogen and electricity co-production plants could provide significant additional reductions in the cost of hydrogen, reducing the cost to \$4/MMBtu (\$0.54/kg) assuming power is sold at \$53.6/MWh.

The use of solid oxide fuel cells (SOFC) to generate electricity from hydrogen can also be introduced in these plants. In this configuration, hydrogen production costs can be reduced to about \$3/MMBtu (\$0.40/kg), depending on the price of electric power.

In summary, successful DOE-sponsored R&D efforts in the Hydrogen from Coal Program and associated programs are necessary to achieve the goal of a 25 percent reduction in hydrogen cost as shown in Case 2, and the additional cost reductions depicted in Case 3.

Noblis, Inc. (formerly Mitretek Systems) is currently updating the hydrogen from coal case studies that will compare updated current technology with the most advanced technologies for membrane separation (e.g., the Eltron Research, Inc. cermet membrane). These new cases are projected to be provided and validated by March 2008, and will be incorporated in the next version of the MYP.

Figure 8. Schematic of Advanced Co-Production Concept with Carbon Sequestration (Case 3)

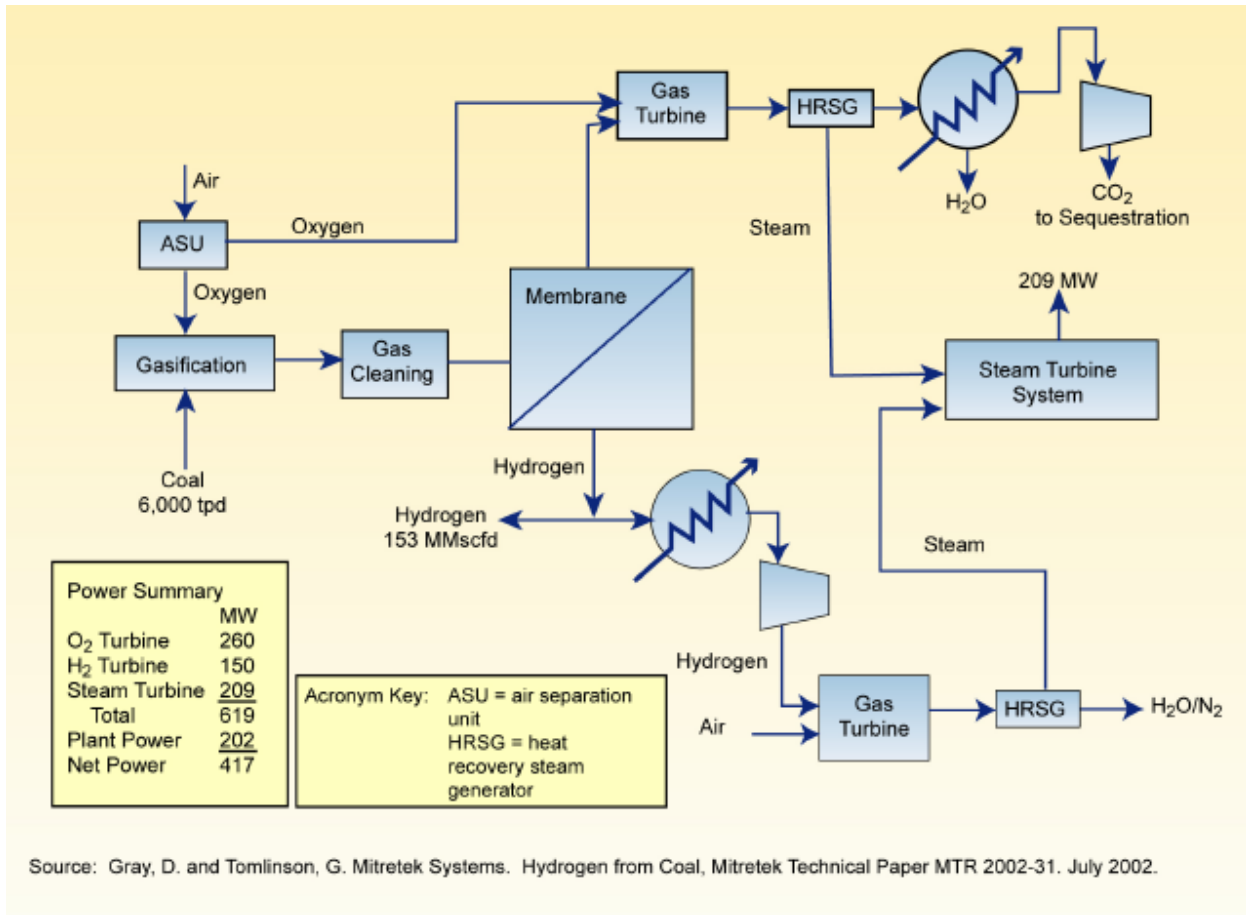

5. Technical Plan

The Hydrogen from Coal Multi-Year RD&D Plan supports the President's Advanced Energy Initiative, Hydrogen Fuel Initiative, and the FutureGen project through joint public and private RD&D of advanced and novel hydrogen-related technologies for the future hydrogen energy system. The number preceding each element below references the section under which that element of the technical plan is discussed.

- 5.1 Production – Central Production Pathway
- 5.2 Production – Alternate Hydrogen Production Pathway
- 5.3 Production – Polygeneration
- 5.4 Storage
- 5.5 Utilization

As successes are achieved, this RD&D program will improve existing technology and make available new, innovative technology that can produce and deliver affordable hydrogen from coal with significantly reduced or near-zero emissions. These technologies will be discussed in detail in this section, and are further broken down into specific technological areas. Each technology will include goals and milestones as well as technical targets, where appropriate. These goals and milestones are being validated and/or updated based on the changing market and technical needs and the progress being achieved with individual projects.

The technologies that comprise the plan include activities in the Hydrogen Fuel Initiative and those associated technologies that are being developed in other coal and sequestration-related programs. The specific activities in this RD&D Program are shown in the large shaded box in Figure 9. There are two hydrogen production pathways included in this Plan, the central production pathway (gaseous hydrogen) and the alternate hydrogen production pathway (hydrogen-rich liquid fuel and SNG). Polygeneration, an option that can be deployed with both the central and alternate hydrogen production pathways, could utilize the co-production facilities, products, or intermediate products to produce high-value carbon-based materials. The program builds on expected RD&D successes in associated programs within FE. Figure 10 shows the interrelationship between the Hydrogen from Coal research areas and the associated programs and initiatives. The Gantt chart presented in Figure 11 shows the schedule proposed for each of the technologies being developed by the program.

Figure 9. Office of Fossil Energy Hydrogen Program Components

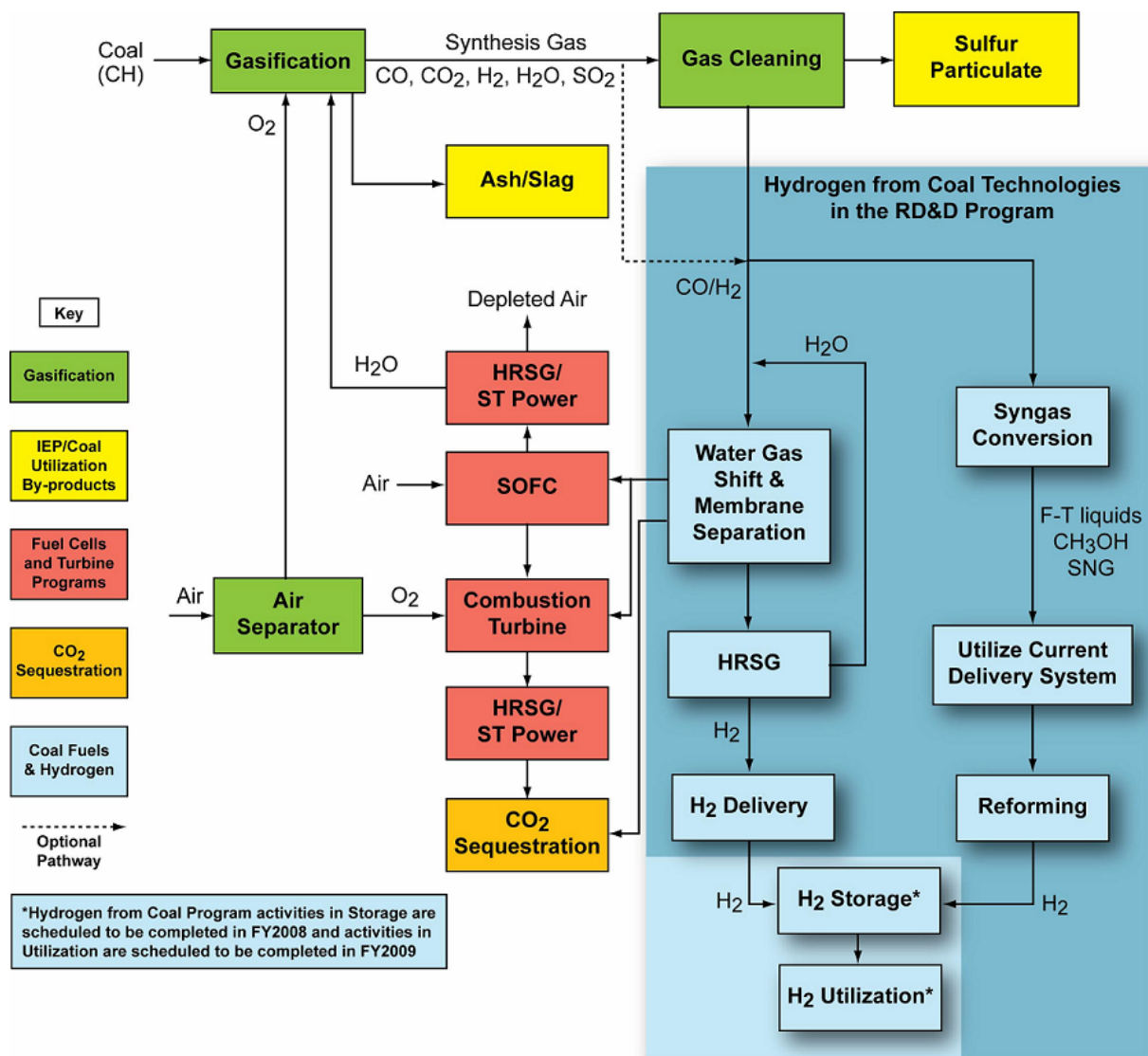

Figure 10. The Hydrogen from Coal Program and Support of Other Programs and Initiatives

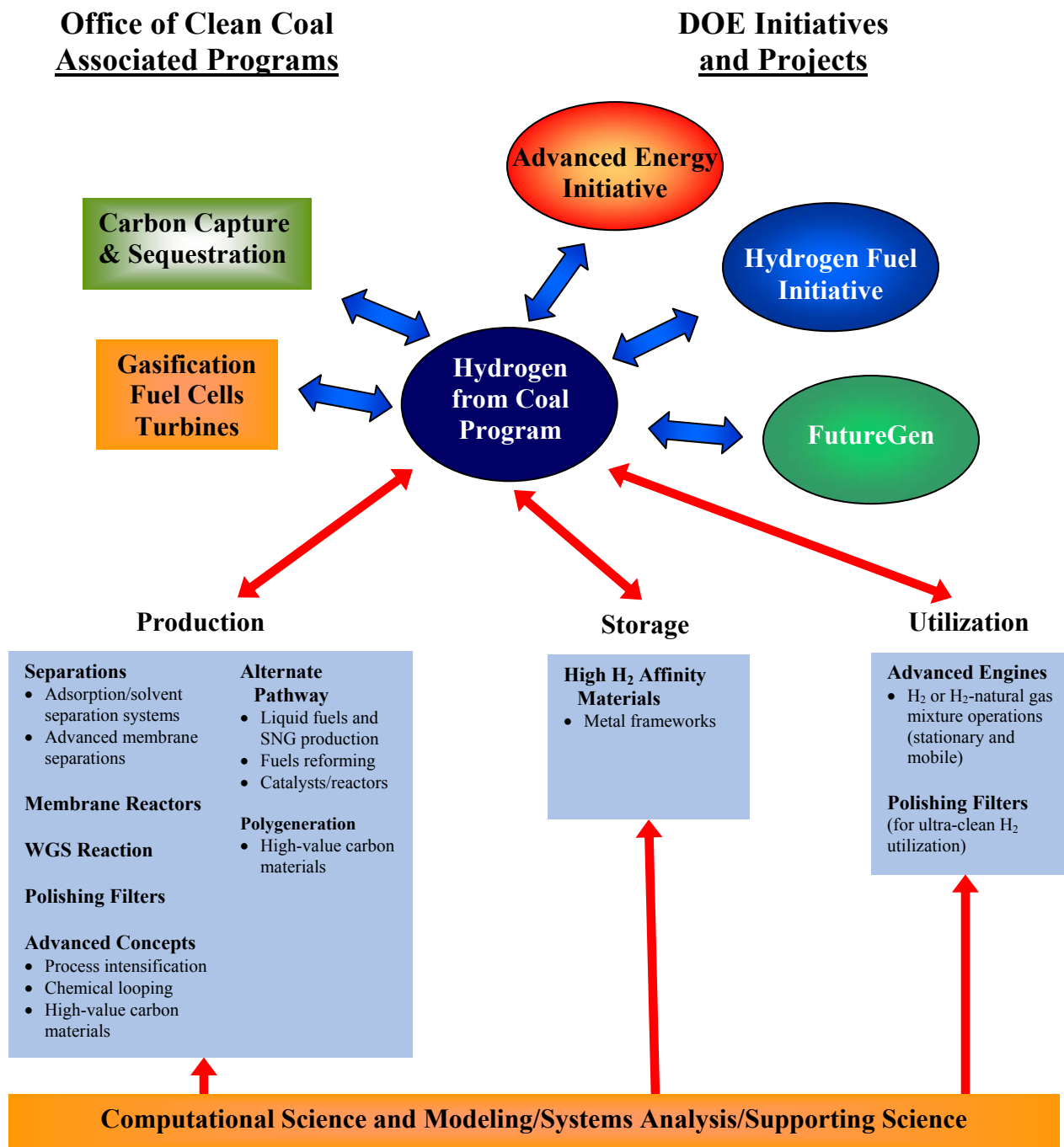
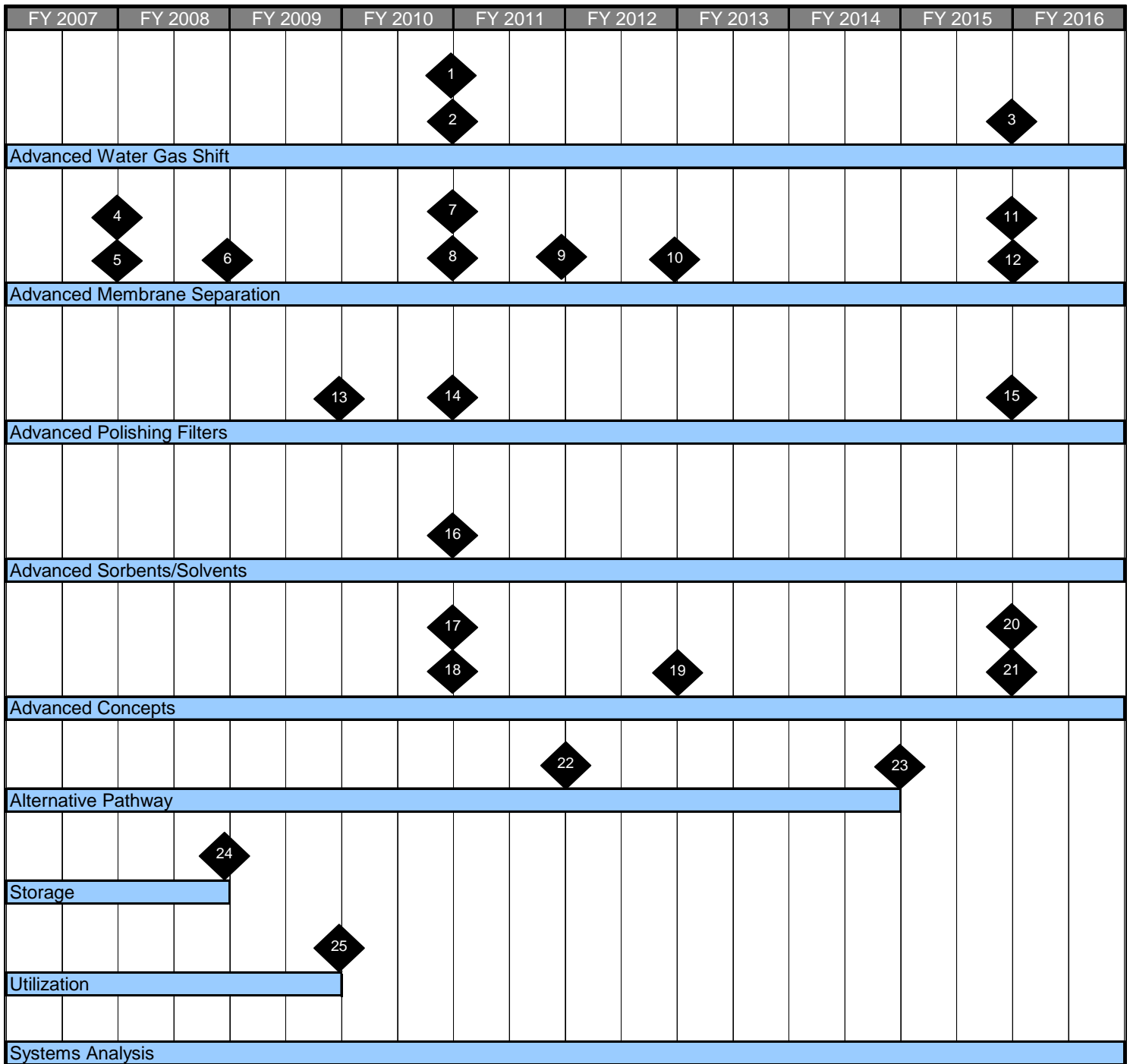

Figure 11. Hydrogen from Coal Research, Development, and Demonstration Program



Key to Figure 11:**Advanced water-gas shift**

1. End of 2010: Go/no-go decision on further development of advanced water-gas shift reaction technologies
2. End of 2010: Systems analysis verifies achievement of 2010 technical targets.
3. End of 2015: Systems analysis verifies achievement of 2015 technical targets.

Advanced membrane separations

4. End of 2007: Downselect most promising membrane separation technologies.
5. Beginning of 2008: Initiate pre-engineering scale development of 1st generation membrane separation technology.
6. Beginning of 2009: Initiate engineering-scale design and construction of 1st generation membrane separation technology.
7. End of 2010: Systems analysis verifies achievement of 2010 technical targets.
8. Beginning of 2011: Initiate pre-engineering of 2nd generation module.
9. Beginning of 2012: Integrate and test 1st generation membrane separation technology into FutureGen plant.
10. Beginning of 2013: Initiate engineering-scale design and construction of 2nd generation advanced hydrogen production and separation technologies.
11. End of 2015: Systems analysis verifies achievement of 2015 technical targets.
12. Beginning of 2016: Integrate 2nd generation advanced hydrogen production and separation technologies into advanced co-production facilities.

Advanced polishing filters

13. End of 2009: Downselect most promising polishing filter technologies for further development.
14. End of 2010: Verify achievement of targets for gas turbines and SOFCs.
15. End of 2015: Verify achievement of targets for PEM fuel cells.

Advanced sorbents/solvents

16. End of 2010: Downselect most promising advanced sorbents/solvents for further development.

Advanced concepts/process intensification

17. End of 2010: Identify and downselect most promising advanced concepts for further development.
18. End of 2010: Initiate pre-engineering scale development of 1st generation advanced concepts.
19. Beginning of 2013: Initiate engineering-scale design and construction of advanced concepts.
20. End of 2015: Verify achievement of 2015 technical targets for advanced separations.
21. Beginning of 2016: Integrate engineering-scale advanced concepts into co-production facility.

Alternative Pathway

22. End of 2011: Determine the most feasible alternate hydrogen from coal pathway(s) and reforming system(s) for producing hydrogen-rich liquid fuels and SNG that are able to meet the hydrogen cost target.
23. End of 2014: Optimize, integrate and make available an alternate hydrogen production pathway and reforming system to produce decentralized hydrogen from coal.

Storage

24. End of 2008: Successfully complete laboratory/bench-scale research on promising novel hydrogen storage systems.

Utilization

25. End of 2009: Successfully complete research to modify and optimize advanced engine types fueled by hydrogen and/or hydrogen-natural gas mixtures.

5.1 Central Production Pathway

A hydrogen from coal process, in a carbon-constrained world, requires development of technologies that can reduce the cost of producing high-purity hydrogen from coal while generating sequestration-ready CO₂ streams. The initial step to produce hydrogen from coal involves coal gasification to produce synthesis gas. This gas, requiring subsequent cleaning, is mainly a mixture of hydrogen and carbon monoxide, with some CO₂, sulfur, particulate matter, and trace impurities. The resulting clean synthesis gas is shifted to produce more hydrogen in the WGS reactors. Hydrogen, CO₂, and trace components are separated for final use, or captured for sequestration in the case of CO₂.

FE's Office of Clean Coal (OCC) and the National Energy Technology Laboratory (NETL) Strategic Center for Coal, the program implementer, have R&D activities on coal gasification and carbon sequestration technologies to improve the efficiency of power production and to reduce the environmental impact of coal use. These gasification, sequestration, gas turbine, and fuel cell development efforts are not part of the direct Hydrogen from Coal Program, but instead are technologies under development in other OCC and NETL programs. Therefore, R&D efforts in these research areas represent associated rather than direct elements of the Hydrogen from Coal Program.

The focus of the Hydrogen from Coal Program RD&D efforts is on those technologies that shift and separate hydrogen from coal-derived synthesis gas, including process intensification efforts that reduce processing steps, combine functions, and significantly improve efficiency and costs. Today's unit operations are effective but also are expensive and energy-intensive. For example, in conventional systems, the initial cleaning step requires the synthesis gas to be cooled from more than 1,800 °F as it leaves the gasifier, to ambient temperature for gas cleanup. Following cleaning, the synthesis gas must then be re-heated to 650–700 °F for the first of two WGS reactors for production of additional hydrogen. Lastly, hydrogen must be separated and purified from the mixed gas stream.

Technology that can combine one or more of these steps without the inefficiency of cooling and reheating will make the process more efficient and cost effective. Novel technologies could be developed that combine the processes into one step (*i.e.*, process intensification technology), and also remove impurities such as sulfur and CO₂ into one stream that can be jointly sequestered.

5.1.1 Goal and Milestones – Central Production Pathway

Goal: By the end of 2016, prove the feasibility of a 60 percent efficient, near-zero emissions, coal-fueled hydrogen and power co-production facility that reduces the cost of hydrogen by 25 percent compared to current coal-based technology.¹²

Milestones:

- By the end of 2007, downselect the most promising membrane separation technologies
- By the end of 2010, make a go/no-go decision on further development of advanced WGS reaction technologies
- By the end of 2013, complete development of pre-engineering modules for producing high-purity hydrogen
- By the end of 2015, complete design and construction of engineering scale modules for hydrogen production from a coal gasification combined-cycle co-production plant

¹² Overall efficiency depends on product mix (*i.e.*, electricity and hydrogen). The 60 percent efficient facility is based on the product mix in Case 3 in Section 4.2 of the RD&D Plan.

- By the end of 2016, demonstrate hydrogen modules integrated into a near-zero emission plant producing hydrogen and electric power with sequestration at a 25 percent lower cost (to produce hydrogen)

5.1.2 Activities – Central Production Pathway

Table 2 lists some of the RD&D activities of the Hydrogen from Coal Program that are under investigation.

Table 2. Relevant Current R&D Program Activities

Category	Technology
<i>Pure Metallic Membranes</i>	<ul style="list-style-type: none"> • Palladium and palladium alloy membrane reactors • Manufacturing techniques for palladium and palladium alloy membranes
<i>Cermet Membranes</i>	<ul style="list-style-type: none"> • Ceramic-metal composite membranes • Fabrication and manufacturing of cermet membranes
<i>Microporous Membranes</i>	<ul style="list-style-type: none"> • Carbon molecular sieves • Inorganic membranes • Metal-composite membranes • Fabrication methods
<i>Reverse Selective Hydrogen Separation Membranes</i>	<ul style="list-style-type: none"> • Nanocomposite membranes for reverse selective separation
<i>Process Intensification</i>	<ul style="list-style-type: none"> • Combined WGS and CO₂ selective membranes • Combined WGS and hydrogen separation membrane that is contaminant tolerant • High temperature shift catalyst integrated with a palladium alloy membrane
<i>Non-Membrane Based Technologies</i>	<ul style="list-style-type: none"> • Combined WGS and CO₂ sorbent reactor • Iron-calcium cycle process to produce hydrogen and sequestration-ready CO₂ • CO₂ sorbent process to produce hydrogen and simultaneously capture CO₂ • CO₂ hydrate process for gas separations • Advanced solvent systems

Both FE and NETL have acquired extensive research experience in all aspects of producing hydrogen from coal through their participation in the Advanced Power Systems, Ultra-Clean Fuels, and Advanced Research programs. Exploratory research previously sponsored by FE and NETL has pioneered studies on palladium-copper alloy membranes; tested novel membranes with regard to flux, durability, and impurity resistance; evaluated WGS kinetics and advanced reactor systems; and explored new concepts and fundamental studies on novel separation systems.

5.1.3 Technologies – Central Production Pathway

The Central Production Pathway technologies within the Hydrogen from Coal Program are provided in the list below and discussed in further detail in the denoted section of the MYP.

5.1.3.1 Advanced WGS reaction systems

5.1.3.2 Advanced membrane separation systems (for hydrogen separation)

- Microporous membranes
- Metallic, metal alloys, and hydrogen permeable cermets

5.1.3.3 Advanced CO₂ separation systems

5.1.3.4 Polishing filters (ultra-clean hydrogen purification systems)

5.1.3.5 Advanced adsorption/solvent systems

5.1.3.6 Advanced concepts

- Intensified processes for gas cleanup, WGS, and hydrogen separation systems
- Chemical looping

5.1.3.7 Hydrogen Storage at Central Facilities

5.1.3.1 Advanced WGS reaction systems

Partial oxidation of coal and other carbon-based solid/liquid feedstocks produces a synthesis gas with a composition ranging from 30–45 percent H₂, 35–55 percent CO, and 5–20 percent CO₂ (dry basis). If the H₂-to-CO ratio of the syngas from the gasifier is not appropriate for the synthesis of fuels or chemicals, the ratio can be adjusted using the WGS reaction. The WGS reaction converts CO and H₂O to CO₂ and H₂:

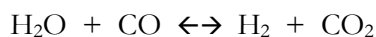

This reaction also is used to increase the concentration of hydrogen in the syngas, and when coupled with an appropriate separation technology, it can produce high yields of high-purity hydrogen.

The WGS reaction is reversible, with the forward WGS reaction being mildly exothermic. Conversion to H₂ and CO₂ is thermodynamically limited and favored at lower temperatures. Higher temperatures improve the rate of reaction, but decrease the yield of hydrogen. In order to achieve high yields at high rates of reaction, the reaction is typically carried out in multiple adiabatic reactor stages, with lower reactor inlet temperatures in the latter stages. The yield also may be improved by using excess steam or by removing hydrogen to shift the WGS equilibrium to the right. Steam also is used to minimize undesirable side reactions that compete with the WGS reaction.

One or two staged reactors are typically employed in commercial WGS technology to produce hydrogen by steam reforming of natural gas. Commercial catalysts have been developed to achieve optimum performance in the different stages and are summarized in Table 3. Only fixed-bed reactors are currently used in commercial applications with these catalysts. Multiple reactors with inter-cooling are used to optimize the WGS reaction temperature profile. Steam reforming plants typically employ either a two-stage system using high (Fe/Cr) and low (Cu/Zn) temperature shift catalysts in series, or a single stage with high- or medium-temperature shift catalyst followed by a PSA hydrogen separation system. Partial oxidation plants used to gasify oils, coke, and coal employ multiple reactor stages using either the high-temperature or sour gas (Co/Mo) shift catalyst in all beds. No gas cleanup is required upstream of the WGS reactors with the sour gas shift catalyst. For low-temperature shift, catalyst life is limited due to loss of activity. For high-temperature shift, catalyst life is limited due to increases in pressure drop and loss of activity. Technology options for residual CO cleanup/H₂ purification include methanation (old), PSA (current), and polymer membranes (new). Possible impurities in the product hydrogen are CO, CO₂, CH₄, and higher hydrocarbons, as well as methanol.

Table 3. Performance of Commercial WGS Catalysts

Performance Criteria	Units	Low/Medium Temperature Shift	High Temperature Shift	Sour Gas Shift
Catalyst Form	-	pellets	pellets	pellets
Active Metals	-	Cu/Zn & Cu/Zn/Al	Fe/Cr	Co/Mo
Reactor Type	-	multiple fixed beds (last bed)	multiple fixed beds	multiple fixed beds
Temperature ^a	°C	200–270/300	300–500	250–550
Pressure	psia	~450	450–750	~1100
CO in Feed	-	low	moderate to high	high
Residual CO	%	0.1–0.3	3.2–8	0.8–1.6
Approach to Equilibrium	°C	8–10	8–10	8–10
Min Steam/CO Ratio	molar	2.6	2.8	2.8
Sulfur Tolerance	ppmv	<0.1	<100	>100 ^b
COS Conversion	-	no	no	Yes
Chloride Tolerance	-	low	moderate	moderate
Stability/Durability	years	3–5	5–7	2–7

^a Lower temperature limit is set by water dew point at pressure.

^b Sulfur is required in the feed gas to maintain catalyst activity.

In summary, the advantages of low-/medium-temperature shift processes are:

- WGS equilibrium favors hydrogen production at low temperatures, maximizing hydrogen yield.
- Undesirable side reactions like F-T synthesis are minimized.
- Processes integrate well with conventional gas cleanup technologies that produce hydrogen at near-ambient temperatures and pipeline pressures (400 psi); minimal or no reheat required.
- Temperature range overlaps ranges for advanced gas cleanup processes for sulfur, mercury, etc.
- Processes can be coupled with newer preferential oxidation (PrOx) technologies to produce very low CO in the hydrogen product.
- Steam requirements are low.

The disadvantages are:

- WGS kinetics are more favorable at higher temperatures.
- Low-temperature shift catalysts are easily poisoned.
- Temperature range is below the range of metal and ceramic membranes that could be used for separation.
- Copper (Cu) in catalyst promotes methanol side reaction (methanol emissions from hydrogen plants are regulated by the U.S. Environmental Protection Agency (EPA)).
- Any condensation of water in the reactor will irreversibly damage the catalyst.

The advantages of high-temperature shift processes are:

- WGS kinetics improve with higher temperatures.

- Processes can operate at very high pressures (~1,000 psi).
- Catalysts exhibit greater tolerance for potential poisons.
- Temperature range is consistent with metal and ceramic membranes.

The disadvantages are:

- WGS equilibrium is less favorable at higher temperatures.
- Undesirable side reactions (F-T synthesis) are favored at higher temperatures.
- Steam requirement increases with temperature, both to improve equilibrium and minimize side reactions.
- Hexavalent chromium (from the catalyst) presents a wastewater treatment and catalyst disposal issue.

WGS catalysts and reactors could be improved by further R&D to increase hydrogen yield at higher operating temperatures, improve catalyst tolerance of syngas impurities, minimize undesirable side reactions, expand pressure and temperature operating ranges, and simplify/combine processing steps to reduce costs.

5.1.3.2 Advanced membrane separation systems

Modern gasification and WGS technology produce synthesis gas, a mixture of H₂, CO, CO₂, and other chemical compounds. There are several gas separation technologies that could separate constituents of the synthesis gas (syngas), mainly H₂ and CO₂, and that could supply O₂ from air for gasification reactions. The Hydrogen from Coal Program seeks to develop technologies to improve the separation of H₂ and/or conversely, CO₂ from synthesis gas streams that will reduce capital and operating costs and improve thermal efficiency and environmental performance. Membranes to separate O₂ from air are being developed in the OCC Gasification Technologies Program.

Current hydrogen recovery methods typically employ PSA, cryogenics, or polymer membrane systems. Each of these technologies has limitations: PSA typically recovers less of the feed-stream hydrogen and is limited to modest temperatures; cryogenics is generally used only in large-scale facilities with liquid hydrocarbon recovery because of its high capital cost; and current polymer membrane systems are susceptible to chemical damage from H₂S and aromatics, as well as having limited temperature tolerance.

There are significant opportunities to make advancements in these separations with the development of various types of advanced membranes that can separate hydrogen from CO₂, advanced solvent systems, and other advanced systems such as reverse selective hydrogen separation membranes (which separate CO₂ and other mixed gases leaving a concentrated hydrogen stream) and low-temperature hydrate processes that can separate CO₂ from hydrogen. Much of the work will develop technology modules that are efficiently integrated into the plant systems, and optimized with the temperature and pressure requirements of the plant and the specifications of the product for delivery.

Advancements in hydrogen membrane separation technologies have the potential to reduce costs, improve efficiency, and simplify hydrogen production systems. Desirable characteristics of separation membranes are high hydrogen flux at low pressure drops; tolerance to contaminants, especially sulfur and CO; low cost; and operation at system temperatures of 250–500 °C. Many current hydrogen membrane technologies are at the research phase, but because of their characteristics, they have the potential to provide hydrogen purity above 99.99 percent.

Membranes can be classified as organic, inorganic, or hybrid (a mixture of organic and inorganic materials). Within each of these classes, membranes can be characterized based on their properties. The

Hydrogen from Coal Program currently is focused on microporous and metallic membranes, which include pure metal and hydrogen-permeable ceramic-metal membranes (*i.e.*, cermets). The program previously included dense ceramic membranes (and also non-hydrogen permeable cermets) as part of its research activities. Dense ceramic membranes separate hydrogen from mixed gas streams by transferring hydrogen ions (*i.e.*, protons) and electrons through the membrane matrix. These membranes have interesting characteristics such as high-temperature operation, mechanical stability, and very high hydrogen selectivity. However, hydrogen flux rates are low at gasifier effluent and gas clean-up technology operating conditions, which would significantly increase the cost of the separation module. Therefore, the program is de-emphasizing RD&D activities on dense ceramic membranes.

A brief characterization of the current membrane technologies being developed by the Hydrogen from Coal Program is provided below. Other membranes are not precluded, provided they show potential to meet the technical targets and help the Hydrogen from Coal Program meet its goals and milestones.

- **Microporous Membranes** – These membranes are microporous filters that separate molecules through a molecular diffusion transport mechanism determined by the pore diameter and particle size. Flux increases linearly with increasing pressure, and there is usually a strong dependence of flux increase with higher temperatures. Materials such as ceramics, graphite, or metal oxides can be used in making these membranes. These materials provide significant thermal and chemical stability in harsh operating environments. The pores in the membrane may vary between 0.5 nanometers (nm) and 5 nm.

An experimental analysis performed on one microporous membrane showed that, at the reported selectivity, only modest hydrogen recoveries (20–30%) were obtained. At higher hydrogen recoveries, hydrogen purity suffered, and CO₂ capture fell below 90%. This is not sufficient to meet DOE goals of 90% carbon capture and the market-based need to be able to recover 95–98% of the hydrogen. Over the approximate 12-month period that culminated in May 2007, the membrane was tested and evaluated at NETL over 400 hours at temperatures up to 400 °C. During testing, various gas constituents, including pure hydrogen, hydrogen/carbon dioxide, and hydrogen/carbon dioxide/helium were used. The microporous membrane would have had to improve by about an order of magnitude for it to show potential in terms of DOE's IGCC, hydrogen production and carbon capture targets, but this did not occur. Furthermore, there appears to be no development path likely to achieve this for this particular membrane. Based on these results, the Program has selected not to continue further investment in this microporous membrane project's development.

- **Metallic Membranes** – These membranes include pure metal or metal alloys, and hydrogen permeable cermets. The flux for these membranes is proportional to the differences of the square roots of the partial pressures across the membrane. Because of the transfer mechanism involved, 100 percent pure hydrogen can be recovered. A description of the two metallic membrane sub-types is provided below.
 - **Pure metal and metal alloy membranes.** Pure metal and metal alloy membranes transport gaseous hydrogen via an atomic mechanism whereby the metal or metal alloy, usually made with palladium (Pd), dissociates the molecular hydrogen into atoms that pass through the Pd metal film, and the atoms recombine into hydrogen molecules on the other side of the membrane. These metallic membranes typically comprise metal composites, thin Pd, or a Pd-alloy metal layer supported on an inexpensive, mechanically strong support. The hydrogen diffuses to the metal surface where dissociative chemisorption occurs, followed by absorption into the bulk metal and diffusion through the metal lattice and recombination into molecular hydrogen at the opposite surface, and finally diffusion away from the metal membrane. These micro-thin metallic films are poisoned by gaseous impurities like sulfur compounds and carbon monoxide, and at high temperatures they undergo phase changes that significantly reduce the

hydrogen flux. Alloying with other metals like copper and silver reduces this phase change propensity.

- **Hydrogen permeable cermet.** In the second type of metallic membrane, a dense mixed conducting ceramic matrix phase is combined with a hydrogen-permeable metallic second phase. This metallic phase, which is composed of a hydrogen permeable metal or metal alloy, functions in the same way as the metallic membranes described previously. In this mixed membrane, the mechanism of hydrogen transfer is a combination of proton and electron conductivity in addition to atomic hydrogen transfer. However, atomic hydrogen transfer is orders of magnitude greater than the contribution of proton and electron conductivity, and thus the overriding mechanism in estimating the flux. Therefore, the flux for this membrane is more closely related to that of metallic membranes (*i.e.*, represented by the difference in the square roots of the partial pressures). The membranes can operate at temperatures in the range of 400–600 °C, and can produce 100 percent pure hydrogen because of the transfer mechanism involved. These ceramic/metal composites offer the potential to overcome many of the limitations of metal membranes. This includes inhibition of phase change and increased tolerance to impurities in the synthesis gas.

Table 4 shows the wide range of performance characteristics for microporous and hydrogen permeable cermet membranes under development by FE and NETL. As discussed under the technical targets in section 5.1.4.2, some of these performance metrics are approaching the desired flux rates of about 300 ft³/hr/ft² at 100 psi delta P hydrogen partial pressure and the desired operating temperature range of 250–550 °C. However, other characteristics, such as the ability to withstand harsh chemical environments and desired durability, have not yet been demonstrated.

Table 4. Examples of Current Status of Membrane Development Activities Sponsored by FE and NETL

Membrane Type	Units	Microporous	Hydrogen permeable cermet
Flux ^a	ft ³ /hour/ft ²	20–100 ^b	~220
Temperature	°C	300–600	300–400
Sulfur tolerance	ppmv	N/D	~20
Cost,	\$/ft ²	150–200	<200
Potential timing ^c	years	10+ years	10+ years
ΔP Estimated ^d	psi	100	100
ΔP Function	-	linear	square root

^a For 100 psi ΔP (hydrogen partial pressure basis)

^b Flux rate not confirmed by NETL during small-scale validation.

^c Potential timing for development

^d ΔP Estimated – all flux rates have been corrected to an estimated 100 psi ΔP (hydrogen partial pressure basis) across the membrane at 50 psia on the permeate or sweep side

N/D = not determined

The Relationship between Membrane Flux and Partial Pressure of Hydrogen

With some exceptions, most hydrogen separation membrane research is in the laboratory research phase. Therefore, most of the current information on membranes, particularly the flux, is based on observed data under specifically controlled experiments that may not reflect real-world operating conditions in a hydrogen from coal production facility. However, based on scientific and engineering theory and observation data in the laboratory, estimates of the hydrogen flux at desired operating pressures can be determined.

As previously mentioned, membrane flux is dependent upon the partial pressure of hydrogen, and the relationship between the two differs depending upon the type of membrane. Specifically, microporous membranes exhibit a flux that is directly proportional to the hydrogen partial pressure differential across the membrane. In metal or hydrogen-permeable cermet membranes, the flux is proportional to the difference in the square roots of the partial pressures or the natural log of the partial pressure gradient according to Sieverts' Law. In dense ceramic and non-hydrogen permeable cermets, flux is proportional to the natural log of the pressure gradient across the membrane, based on the Nernst potential.

Flux rates need to be converted from observed experimental results to desired operating pressure conditions to evaluate their status relative to technical targets. Table 5 shows these mathematical relationships for the different membrane types.

Table 5. Relationships for Flux as a Function of Hydrogen Partial Pressure Differentials for Different Membrane Types

Membrane Type	ΔP function	Equation
Microporous	linear	$\text{Flux}_{\text{est M}} = \text{Flux}_{\text{obs M}} * (\Delta P_{\text{est}} / \Delta P_{\text{obs}})$
Pure metallic (includes pure metal and metal alloys)	square root	$\text{Flux}_{\text{est P}} = \text{Flux}_{\text{obs P}} * \frac{P * [(P_{\text{f est}}^{0.5} - P_{\text{s est}}^{0.5}) / (P_{\text{f obs}}^{0.5} - P_{\text{s obs}}^{0.5})]}$
Hydrogen-permeable cermet	square root	$\text{Flux}_{\text{est P}} = \text{Flux}_{\text{obs P}} * \frac{P * [(P_{\text{f est}}^{0.5} - P_{\text{s est}}^{0.5}) / (P_{\text{f obs}}^{0.5} - P_{\text{s obs}}^{0.5})]}$
Dense ceramic	natural logarithm	$\text{Flux}_{\text{est D}} = \text{Flux}_{\text{obs D}} * \frac{D * [\ln(P_{\text{f est}}/P_{\text{s est}}) / \ln(P_{\text{f obs}}/P_{\text{s obs}})]}$
Dense ceramic with non-hydrogen permeable second phase (electron conducting)	natural logarithm	$\text{Flux}_{\text{est D}} = \text{Flux}_{\text{obs D}} * \frac{D * [\ln(P_{\text{f est}}/P_{\text{s est}}) / \ln(P_{\text{f obs}}/P_{\text{s obs}})]}$

$\text{Flux}_{\text{est M}}$ is the estimated flux for microporous membranes

$\text{Flux}_{\text{obs M}}$ is the observed, or tested, flux for microporous membranes

ΔP_{est} is the ΔP of hydrogen partial pressure to be estimated

ΔP_{obs} is the observed, or tested, hydrogen partial pressure

$\text{Flux}_{\text{est P}}$ is the estimated flux for hydrogen permeable metallic, metal alloy, or cermet membranes

$\text{Flux}_{\text{obs P}}$ is the observed, or tested, flux for hydrogen permeable metallic, metal alloy, or cermet membranes

$P_{\text{f est}}$ is the estimated feed side hydrogen partial pressure

$P_{\text{s est}}$ is the estimated sweep (permeate) side hydrogen partial pressure

$P_{\text{f obs}}$ is the observed, or tested, feed side hydrogen partial pressure

$P_{\text{s obs}}$ is the observed, or tested, sweep (permeate) side hydrogen partial pressure

$\text{Flux}_{\text{est D}}$ is the estimated flux for dense ceramic or non-hydrogen permeable cermet membranes

$\text{Flux}_{\text{obs D}}$ is the observed, or tested, flux for dense ceramic or non-hydrogen permeable cermet membranes

Figure 12 shows the effect of changes in partial pressure on the flux of hydrogen membranes. This graph is based on a reference assumed flux of $60 \text{ ft}^3 \text{ hour}^{-1} \text{ ft}^{-2}$ with a hydrogen partial pressure ΔP of 20 psi and an assumed sweep (permeate) side hydrogen partial pressure of 1 psi for all membrane types. For commercial applications, the sweep, or permeate, side hydrogen partial pressure is assumed to be 50 psi.

One of the key conclusions observed from Figure 12 is that it is important to set desired technical targets near the expected operating conditions. In the case of hydrogen from coal technologies, hydrogen separation membranes are expected to operate with at least 50 psi hydrogen partial pressure on the permeate side and a hydrogen partial pressure ΔP of 100–300 psi is expected. For example, when converting assumed observed test data from a ΔP of 20 psi and a permeate side partial pressure of 1 psi to operating conditions of 100 psi ΔP and 50 psi permeate side, a decline in flux for dense ceramic membranes is seen, a slight increase for Pd-type, but a linear improvement related to ΔP for microporous membranes.

Figure 12. Effect of Changes in ΔP and Sweep Side Pressure on Flux of Hydrogen Membranes

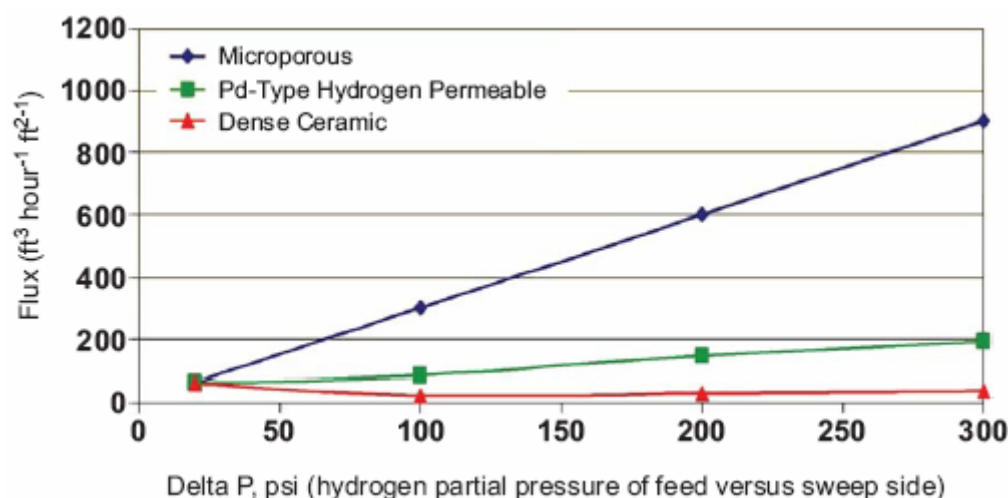

In addition to hydrogen partial pressure, other operating conditions such as temperature and quality of the feed stream can also influence hydrogen flux. Membrane attributes such as durability, cost, tolerance to contaminants, hydrogen recovery, and purity are also important factors in development of robust membranes that can be integrated into coal-based hydrogen production facilities.

The Hydrogen from Coal Program is in the process of establishing consistent guidelines for testing membrane technologies to facilitate evaluation and progress of research efforts. The Program is also developing standard reporting criteria so that technologies can be more readily evaluated and assessed.

5.1.3.3 Reverse selective hydrogen separation systems

Removal of CO_2 from the process stream provides another method to separate H_2 . CO_2 can be separated from syngas through commercially available CO_2 absorption systems as is being done at the Great Plains Project in North Dakota. These are continuous scrubbing systems that typically are available as three basic types: chemical, physical, and hybrid. All the processes operate in essentially the same manner by scrubbing the mixed gas in absorption towers to collect the CO_2 , and then regenerating the solvent and releasing the CO_2 . After separation, the CO_2 stream is dried, compressed, and

transported to a utilization site (*e.g.*, enhanced oil recovery) or to a sequestration site (*e.g.*, abandoned oil well).

The objective of advanced CO₂ separation technologies is the efficient, low-cost removal of CO₂ and other trace impurities from hydrogen-CO₂ mixtures. If hydrogen is the product gas, separation of trace impurities with the CO₂ may be a preferred option. These technologies include membranes, CO₂ hydrates, and improved adsorbent/solvent systems. Nanostructured, polymeric membranes that are embedded with nanoparticles to modify the gas transport properties of the base polymer, show potential to achieve the desired selective CO₂ separation. These polymeric membranes are referred to as reverse selective membranes that can also be incorporated with amine groups to facilitate H₂S and CO₂ removal.¹³

CO₂ sorbents and hydrates are examples of other options which could be explored that selectively remove CO₂ from mixed gas streams. Sorbents work by adsorbing CO₂ gas molecules onto the surface of a solid. Commercial processes are available, but they are expensive and energy-intensive, operate at cold gas temperatures, and have low CO₂ sorption capacity. New CO₂ sorbents have the potential to remove CO₂ at warm gas temperatures (250–350 °C), which is ideal for gasification systems. Also, these new sorbents could remove CO₂ at WGS temperature conditions without additional cooling. However, no sorbents that are regenerable and operate at warm gas temperatures are commercially available.

CO₂ hydrates remove CO₂ by forming a crystalline lattice around the gas molecule, subsequently trapping the molecule. The solid hydrate is formed by reducing the temperature of the synthesis gas stream to 34 °F at pressures ranging from 500–600 psi. Water nucleates and surrounds the CO₂ molecule, trapping it within the crystalline lattice of the hydrate. The solid hydrate, contained within a slurry, is removed and heat is added to release the CO₂ molecule. The process shows promise but must be further researched and demonstrated to continuously control production of hydrates, and to gain an understanding of system integration issues.

5.1.3.4 Polishing filters (ultra-clean hydrogen purification systems)

Hydrogen produced from coal can be used for various applications, including transportation (in future proton exchange membrane (PEM) fuel cells or internal combustion engines), gas turbine and SOFC power generation, and crude oil refining. The hydrogen purity requirement is dependent on the applications in which it is used. PEM fuel cells, which may be used in future fuel cell vehicles, require the most stringent standards with CO levels below 10 ppm and sulfur levels below 10 parts per billion (ppb). A polishing filter device, possibly adjacent to the end use, may be required to meet the particular hydrogen quality level based on the application requirement. R&D efforts are focused on identifying materials and processes that can be used as polishing filters to reduce multiple contaminants to the application target levels specified in Section 5.1.4.3.

5.1.3.5 Advanced adsorption/solvent systems

Advanced adsorption (*i.e.*, advanced PSA) and other solvent systems have the potential to improve current hydrogen separation technologies. These technologies can help lower the cost of current hydrogen separation from large centralized coal plants until membrane technologies become commercially available. These technologies may include novel catalysts, adsorbers, or solvents that make current technologies more efficient, improve environmental performance, increase operating capacity, and reduce operating and maintenance costs. In future versions of this MYP, advanced adsorption/

¹³ Winston Ho, “Development of Novel Water-Gas Shift Membrane Reactor,” Paper presented at the Hydrogen, Fuel Cells, and Infrastructure Technology Program Review Meeting, May 19–22, 2003.

solvent systems may have a greater emphasis since they build on current technology. It is being considered that a working group be formed to review the potential for improvement in conventional systems for hydrogen separation and to evaluate the ease of incorporation into plant projects such as FutureGen.

5.1.3.6 Advanced concepts

The Hydrogen from Coal Program is investigating advanced concepts through process intensification. Process intensification is the concept of developing novel technologies that, compared to current technology, bring about dramatic improvements that lead to more compact, energy efficient, and lower cost technologies. As related to hydrogen production from coal, these concepts could be a “one-box” process that combines synthesis gas cleanup, the WGS reaction, and hydrogen separation. Others include new process control methods or novel concepts that integrate alternative energy sources into the hydrogen from coal production facility. These advanced concepts will require long-term research efforts before they are ready for larger-scale development, but could significantly improve the production of hydrogen from coal. One concept being developed involves integrating the WGS reaction with hydrogen membrane separation.

Advanced WGS reactors are being developed to use sulfur-tolerant catalysts that produce more hydrogen from synthesis gas at lower cost. Membrane reactors have been identified as a potentially beneficial technology for use in new WGS applications. By combining the reaction with selective removal of one of the reaction products, a single reactor can operate simultaneously at high temperature and high conversion, and possibly without the requirement of excess steam. Conceptually, such a reactor could use a membrane that is highly permeance-selective for either H₂ or CO₂.

The conditions for WGS in a membrane reactor would be very different from those encountered in a conventional shift reactor. In particular, at higher conversion rates, the partial pressure of steam would be low and the gas phase would be predominantly either CO₂ or H₂, depending on which species was not removed through the membrane. The catalysts used in conventional WGS reactors have not been extensively studied at these conditions, and it is not known whether they will be suitable for use in membrane reactors.

In either case, membrane reactors are being considered for this application with the expectation that, among other advantages, using a membrane reactor would not require cooling the gasifier product as much as is required in a conventional shift reactor. WGS is a reversible, exothermic reaction, and consequently the conversion is limited at high temperatures by thermodynamic equilibrium. The use of a highly permeance-selective membrane reactor would avoid this problem, driving the reaction to high conversion rates at elevated temperatures by selectively removing either H₂ or CO₂. While this conceptually removes the limitation on conversion at high temperature, it is unknown what effect it will have upon the rate of reaction or mass transfer limitations. Conducting the WGS reaction over commercial, high-temperature iron oxide catalysts is known to be inhibited by the CO₂ reaction product. While the kinetics are not inhibited by the H₂ reaction product, it is not known whether the active (Fe₃O₄) state of the catalyst can be maintained in the situation where CO₂ is removed and where an excess of steam is neither needed nor desired. In a membrane reactor, one or the other of these compositional regimes will be encountered.

Chemical looping is another advanced concept for producing and separating streams of hydrogen and CO₂ from mixed gases and trace constituents. Chemical looping for hydrogen production from coal involves three key steps: hydrogasification, carbonation, and calcination. Hydrogasification converts carbon and hydrogen contained in the coal into methane. Water/steam is used to control the reaction and adjust for different coal types. The methane/water mixture then enters the carbonation vessel where

it is reacted with additional water to form CO₂ and hydrogen. Calcium oxide (CaO) or another oxide is added to the vessel and reacts with the CO₂ to form calcium carbonate (CaCO₃). Hydrogen is removed and can be further purified if necessary. The CaCO₃ then is sent to a calcination reactor where heat is added to break down the CaCO₃ into CaO (which can be recycled back to the carbonation vessel) and CO₂ (which can be stored or sequestered).

5.1.3.7 Hydrogen Storage at Central Facilities

Hydrogen produced from coal at centrally located facilities may require bulk storage capable of meeting daily or seasonal variations in demand at the facility itself (for central power applications) or in the market.

The most common current method of storing gaseous hydrogen is in pressurized steel tanks. Storage pressures are typically greater than 2,000 psi, but could be higher. Hydrogen could also be stored as a cryogenic liquid, which provides higher volumetric density storage compared to compressed gas storage. However, well-insulated vessels are required to minimize hydrogen evaporation/boil-off. A significant amount of energy is also consumed during the liquefaction process.

Hydrogen storage in geologic formations is also an option for bulk hydrogen storage to meet variations in demand. Praxair has recently developed a hydrogen storage cavern that is integrated with its Gulf Coast hydrogen pipeline system to increase availability of hydrogen supply for refinery customers.¹⁴ Additionally, geologic formations have been widely used for natural gas storage and are expected to play a major role in storage of carbon dioxide captured from coal facilities.

The addition of hydrogen storage facilities at a central plant will impact the costs of hydrogen production and delivery. Minimizing the amount of hydrogen storage required, the costs, and the footprint while continuing to meet facility and market demand are key objectives. The Hydrogen from Coal Program will conduct technical analyses to identify storage requirements, and perform R&D on novel bulk storage technologies and designs. Some technologies developed for on-board storage applications, which do not meet the stringent targets for size, weight and volume, may be useful for large, bulk off-board storage where these targets are not as stringent. Some of these technologies may exhibit features that are attractive to bulk storage, such as reduced compression requirements, simpler and safer operation and maintenance, or lower cost.

5.1.4 Technical Targets – Central Production Pathway

The technical targets in this RD&D Plan, unless otherwise indicated, represent the status of the specific technologies after completion of R&D, but prior to demonstration of the technologies. These technologies will be validated in modules at the FutureGen facility or other facilities that can accommodate similarly scaled engineering modules, as detailed in the Gantt charts in Figure 11. As a point of reference, the status of the technologies is provided in the technical target tables.

It is important to understand the composition of the synthesis gas exiting the gasifier when developing the targets for contaminant levels for both WGS and hydrogen separation technologies. Table 6 shows the contaminant levels in raw and cleaned synthesis gas from Illinois #6 bituminous coal. Additionally, the FE Gasification Technologies Program goals for synthesis gas cleanup are also shown. It should be noted that raw synthesis gas composition will vary by coal type; therefore, lower sulfur coals could have

¹⁴ Praxair, Inc., *Increase Hydrogen Supply Availability with Cavern Storage*, [http://www.praxair.com/praxair.nsf/0/3A0AB529A089B473852571F0006398A3/\\$file/027847_PRAX_RefinSpec_4_1ow_res.pdf](http://www.praxair.com/praxair.nsf/0/3A0AB529A089B473852571F0006398A3/$file/027847_PRAX_RefinSpec_4_1ow_res.pdf).

raw synthesis gas sulfur levels that are much lower than that shown in Table 6, perhaps as low as 700–1,200 ppmv based on some studies.¹⁵

Table 6. Contaminant Levels in Raw and Cleaned Synthesis Gas using Conventional Cleaning Technologies and FE Gasification Program Goals for Synthesis Gas Cleanup

Contaminant	Units	Raw Synthesis Gas Composition ^a	Cleaned Synthesis Gas Composition ^a	FE Gasification Program Goals ^b
H ₂ S	ppmv	9,524	102	0.04
NH ₃	ppmv	675	0.4	1,000
HCl	ppmv	425	~0	< 1
Hg	ppbv	3	0.3	< 1

^a *Novel Gas Cleaning/Conditioning for Integrated Gasification Combined Cycle: Volume I – Conceptual Commercial Evaluation*, Siemens Power Generation, Inc. and Gas Technology Institute, under DOE Contract DE-AC26-99FT40674, December 2005.

^b Tennant, J., “Gasification: Ultra Clean & Competitive,” DOE/NSF EPSCoR Conference 2005, Morgantown, WV, June 2005.

As Table 6 shows, most major contaminants can be reduced to very low levels through conventional synthesis gas cleaning technologies, and achieve the goals of the Gasification Technologies Program. If that program’s cleanup goals were achieved, then conventional WGS rather than a sour gas shift to produce additional hydrogen would be preferred. An alternative for advanced systems would be to assume that sulfur can be controlled to about 100 ppmv by use of warm gas cleanup, but without substantial removal of other contaminants such as ammonia, HCl, or mercury below that seen in the gasifier effluent. These contaminants, along with CO₂, would be simultaneously removed by the separation device and thereby significantly reduce the cost to produce fuel cell-grade hydrogen for transportation applications. The 2015 targets for WGS and membrane separation assume tolerances for the identified contaminants consistent with this methodology. However, under the current cleaned synthesis gas composition, sulfur levels in the form of H₂S are considerably higher than the Gasification Technologies Program goal and would require a sour gas shift that might affect advanced hydrogen membrane separators as well as PEM or other fuel cell technologies (as shown in the Advanced Polishing Filter Technical Targets – Table 9).

To reiterate, it is also expected that efficiency requirements for advanced concepts (*i.e.*, process intensification) will require “warm gas cleanup,” which will have higher levels of sulfur than conventional cleaning. In addition, these advanced concepts may require that the effluent from the gasifier be processed without major cleaning. Therefore, the advanced concepts may require WGS and membrane separation with sulfur, ammonia, and chloride tolerances that are found in the raw gasifier effluent. This suggests that the WGS and membrane tolerances to contaminants in the synthesis gas require a better quantitative definition and may be different depending on the specific research approach being pursued.

¹⁵ *Impact of CO₂ Capture on Transport Gasifier IGCC Power Plant*, Bonsu, A., et. al., Southern Company Services – Power Systems Development Facility; Booras, G., Electric Power Research Institute (EPRI), Breault, R., National Energy Technology Laboratory (NETL); Salazar, N., Kellogg, Brown and Root, Inc., International Technical Conference on Coal Utilization and Fuel Systems, Clearwater, FL, May 21-25, 2006.

5.1.4.1 WGS Reaction Technical Targets

Table 7 summarizes the performance criteria and targets for the WGS reaction. Commercially available technologies had already achieved the 2005 technical targets that were detailed in the 2004 Hydrogen from Coal RD&D Plan. Therefore, the 2005 technical targets were removed for this plan, and RD&D efforts are focused on achieving the 2010 and 2015 targets. The basis for the 2015 technical targets assumes a single, compact WGS reactor operable over a wide range of temperatures and pressures with minimal undesirable side reactions and tolerance of common impurities found in coal-derived syngas. A catalyst lifetime of greater than 10 years is desirable, and depending on the form of the catalyst within the reactor, it may need to equal the expected operational life of the reactor. The cost goal is a 30 percent reduction over today's fixed-bed systems and a wider range of operating temperatures.

Table 7. WGS Reaction Technical Targets

Performance Criteria	Units	Current Status	2010	2015
Reactor Type	-	Multiple fixed beds	Advanced configurations - tbd	
Catalyst Form	-	Pellets	Advanced configurations - tbd	
Active Metal	-	Cu/Zn or Fe/Cr or Co/Mo	Advanced configurations - tbd	
Feed Temperature	°C	200–300	>250	>400
Feed Pressure	psia	450–1150	>450	>750
Approach to Equilibrium	°C	8–10	<6	<4
Min. Steam/CO Ratio	Molar	2.6	<2.6	<2
Sulfur Tolerance, ppmv	-	Varies	>20	>100
COS Conversion	-	Varies	Partial	Total
Chloride Tolerance, ppmv	-	Varies	> 3	>100
Stability/Durability	Years	3–7	>7	>10
Catalyst Cost	\$/lb	~5	<5	<5

5.1.4.2 Hydrogen Separation Technical Targets

The key performance criteria for successful incorporation of membrane separation reactors into hydrogen from coal configurations are shown in Table 8. Although high flux rates and low cost are the key parameters, there also are other critical criteria that must be satisfied. Ideally, the temperature of operation should be in a range compatible with warm synthesis gas cleaning technologies.

Experimental results from several projects in the Program have met the 2007 targets and have shown progress towards the 2010 targets.

Table 8. Hydrogen Separation Technical Targets*

Performance Criteria	Units	Current Status ^(a) (H ₂ -permeable cermet)	2007 Target	2010 Target	2015 Target
Flux ^(b)	ft ³ /hour/ft ²	~220	100	200	300
Temperature	°C	300–400	400–700	300–600	250–500
S Tolerance	ppmv	Yes (~20 ppmv)	----	20	>100
Cost	\$/ft ²	<200	150	100	<100
WGS Activity	-	N/A	Yes	Yes	Yes
ΔP Operating Capability ^(c)	psi	1,000 (tested)	100	Up to 400	Up to 800 to 1,000
Carbon Monoxide Tolerance	-	Yes	Yes	Yes	Yes
Hydrogen Purity ^(d)	%	>99.999%	95%	99.5%	99.99%
Stability/Durability	years	0.9 (tested)	1	3	5

^a Current status is shown for only one separation membrane – hydrogen-permeable cermet. Additional current status information is provided on microporous membranes in Table 4 of this report.

^b For 100 psi ΔP (hydrogen partial pressure basis)

^c ΔP = total pressure differential across the membrane reactor

^d Polishing filters may be needed downstream of the separation system in order to remove final traces of CO, sulfur, and other impurities to meet PEM fuel cell requirements. These targets exclude the effect of polishing filters.

* Technical targets are for membrane types described previously – research that is currently supported by FE and NETL. Research on other membranes is not precluded if the potential flux, cost, and tolerance to impurities are promising. Research is also encouraged on advanced solvent and adsorption technologies to separate hydrogen. Reverse selective hydrogen separation systems that separate CO₂ also are promising. The technical targets for hydrogen membranes relate to hydrogen from coal technology in which delta P will be around 100 psi and the membrane will require resistance to contaminants (CO and H₂S). Technical targets for hydrogen membranes that are included in the EERE HFCIT RD&D Plan are for systems that operate at lower delta P and have less contaminants.

Because the WGS reaction is exothermic and a large amount of shift is expected to occur within the membrane reactor, the membrane reactor also should operate in a temperature range compatible for the WGS to occur. An acceptable range would be 400–500 °C. It has been demonstrated that WGS activity is an essential function of the membrane reactor for coal-to-hydrogen applications. In addition, for metallic membranes where catalytic activity for hydrogen dissociation is important, tolerance to sulfur compounds such as H₂S and COS is desirable. Failure to achieve sulfur tolerance would require an additional sulfur polishing step in the coal-to-hydrogen plant configuration.

The membrane also must be structurally capable of withstanding the expected pressure drop across the system. Current coal gasification systems operate around 40 atmospheres of pressure; therefore if the hydrogen product from the membrane is at 5–10 atmospheres, the differential pressure across the membrane would be about 450–525 psi. Future coal gasification systems for hydrogen may operate at 80 atmospheres, so that the system pressure differential across the membrane could be as high as 800–1,000 psi. The membrane must also resist or be tolerant to atomic rearrangements, surface roughening, and formation of impurity over-layers that could adversely affect structural integrity in a WGS environment. In addition, it is critical that any membrane system be completely tolerant to carbon monoxide. It is also important to achieve higher hydrogen flux while simultaneously minimizing the pressure drop across the

membrane in order to reduce the hydrogen product compression requirement. These target criteria are independent of membrane type.

5.1.4.3 Advanced Polishing Filter Technical Targets

The targets for advanced polishing filters are shown in Table 9. Because end-use applications for hydrogen have different tolerance levels for various contaminants, separate targets are shown for SOFCs, PEM fuel cells, and hydrogen gas turbines.

Table 9. Advanced Polishing Filter Technical Targets

Contaminant	SOFC	PEM Fuel Cells ^a	Gas Turbine
Total non-particulates	Not available	100 ppm	Not available
Total sulfur (H ₂ S, COS, etc.)	60 ppbv	4 ppbv S ^b	750 ppmv fuel gas 20 ppmv for Selective Catalytic Reduction (SCR).
Total halides (Cl, F, Br)	100 ppbv	50 ppb ^c	5 ppmv fuel gas
Total fuel-nitrogen (NH ₃ , HCN)	Not Available	0.1 ppmv NH ₃	Fuel-bound nitrogen 200-400 ppmv
Total alkali metals (Na, K, Li vapor and solid phases)	Not Available	Not Available	100 ppbv fuel gas
Volatile Metals (V, Ni, Fe, Pb, Ca, Ba, Mn, P)	5 ppbv As 0.2 ppmv Se 30 ppbv Cd	Not Available	20 ppbw Pb ^d 10 ppbw V ^d 40 ppbw Ca ^d 40 ppbw Mg ^d
Water	Not Available	5 ppm ^e	Not Available
Total hydrocarbons (C ₁ basis)	Not Available	2 ppm ^f	Not Available
Oxygen	Not Available	5 ppm	Not Available
Carbon dioxide	Not Available	1 ppm ^g	Not Available
Carbon monoxide	Not Available	0.2 ppm	Not Available
Formaldehyde	Not Available	0.01 ppm	Not Available
Formic acid	Not Available	0.2 ppm	Not Available
Particulates	Not Available	1 µg/L H ₂ < 10 µm diameter	0.1-0.5 ppmw fuel gas

^a EERE *Hydrogen, Fuel Cells, and Infrastructure Technologies Multi-year RD&D Plan*, Appendix C: Hydrogen Quality, April 2007. Based on Society of Automotive Engineers specification in *SAE-2719 – Information report on the Development of a Hydrogen Quality Guideline for Fuel Cell Vehicles*.

^b Includes, for example, hydrogen sulfide (H₂S), carbonyl sulfide (COS), carbon disulfide (CS₂) and mercaptans.

^c Includes, for example, hydrogen bromide (HBr), hydrogen chloride (HCl), chlorine (Cl₂) and organic halides (RX).

^d Specification for Fuel Gases for Combustion in Heavy-Duty Gas Turbines, GEI 41040G, GE Power Systems, Gas Turbines, January 2002.

<http://www.netl.doe.gov/technologies/coalpower/turbines/refshelf/GE%20Turbine%20Fuel%20Specs.pdf>

^e As a result of water threshold level, the following constituents should not be found; however, should be tested if there is a question on water content:

Sodium (Na⁺) @ < 0.05 μmole/mole H₂ or < 0.05 μg/liter

Potassium (K⁺) @ < 0.05 μmole/mole H₂ or < 0.08 μg/liter

Potassium hydroxide (KOH) @ < 0.05 μ mole/mole H₂ or < 0.12 μg/liter

^f Includes, for example, ethylene, propylene, acetylene, benzene, phenol (paraffins, olefins, aromatic compounds, alcohols, aldehydes). Total hydrocarbons may exceed 2 μmole/mole due only to CH₄ if the total does not exceed 100 μmole/mole.

^g The SAE document does not conform with ISO on CO₂. SAE has agreed to harmonize that with ISO in the first revision cycle.

5.1.5 Technical Barriers – Central Production Pathway

The following technical and economic barriers must be overcome to meet the goals and objectives of the Hydrogen from Coal Central Production Pathway.

5.1.5.1 Barriers

A. High Cost. The cost of current technologies to produce hydrogen from coal must be reduced. This includes improved efficiency of the process, and reduced capital and operating costs.

B. Lack of Demonstration of Novel Technologies. Many novel separation processes (*e.g.*, advanced membranes) have not been demonstrated at a scale sufficient to determine their potential for lower cost and efficient integration into advanced hydrogen from coal production systems.

C. Complex Process Designs. Complex process systems that have a greater number of process units require a larger plant footprint and are nearly always more difficult to improve in terms of efficiency. “Process intensification,” in which multiple process function technologies are integrated into one process step — such as combined gas cleanup, WGS reaction, and hydrogen separation — offer potential advantages in scalability of the design, as well as better efficiency and lower costs. Various candidate process intensification processes and/or units require significant RD&D to establish their techno-economic viability.

5.1.5.2 WGS Reaction Barriers

D. Impurity Intolerance/Catalyst Durability. The WGS reaction occurs after coal has been gasified to produce synthesis gas. Impurities in the synthesis gas may act as poisons, deactivating the catalyst and damaging the structural integrity of the catalyst bed. Improved catalysts and reactor systems are needed to maintain catalyst activity throughout the reactor, and in some cases, eliminate the post-gasification synthesis gas cleanup step upstream of the WGS reactor.

E. Operating Limits. The synthesis gas produced from gasification exits the gasifier at a high temperature. The WGS reaction then is carried out in two separate stages: a high-temperature shift and a low-temperature shift. The development of advanced WGS catalysts and reactor systems that are more robust and can operate over a wide range of temperatures can eliminate the need for two separate stages, potentially reducing capital costs.

F. Undesired Side Reactions. Reactions that produce species other than hydrogen and CO₂ must be minimized in the WGS reactor.

5.1.5.3 Hydrogen Separation Barriers

There are several technology options available that can be used to separate hydrogen from synthesis gas. The following broad set of barriers must be overcome to reduce the cost and increase the efficiency of these separation technologies.

G. Hydrogen Embrittlement of Metals. Below 300 °C, hydrogen can embrittle and induce a phase change in certain types of separation membranes. Embrittlement reduces the durability and effectiveness of the membrane for selectively separating hydrogen. Hydrogen also embrittles the structural steels of the membrane housing and gas handling systems.

H. Thermal Cycling. Thermal cycling can cause failure in some membranes, reducing its durability and operating life.

I. Poisoning of Catalytic Surfaces. Metallic membranes must dissociate molecular hydrogen into hydrogen atoms before it can diffuse through the separation layer. The presence of trace contaminants, particularly sulfur, can poison the surface sites that are catalytically active for this purpose, diminishing the effectiveness of the membrane.

J. Loss of Membrane Structural Integrity and Performance. Depending on conditions, membranes may be subject to atomic rearrangements, surface roughening, pitting, and formation of impurity over-layers that may adversely affect structural integrity and performance. This becomes more important for the supported thin film membranes envisioned to enhance flux and minimize cost. For example, oxidizing gas mixtures (oxygen, steam, and carbon oxides) have been observed to cause metallic membranes to rearrange their atomic structure at temperatures greater than 450 °C. This results in the formation of defects that reduce membrane selectivity for hydrogen. Some ceramic membranes exhibit poor thermo-chemical stability in CO₂ environments, resulting in the conversion of membrane materials into carbonates. In solvent systems, impurities can cause less effective absorption and may lead to excessive loss of solvent, which will increase cost and decrease separation efficiency.

K. Lack of Seal Technology and Materials. High-temperature, high-pressure seals are difficult to make using ceramic substrates.

L. Defects During Fabrication. Fabrication of microporous membranes requires a reduction in membrane pore size, which is accomplished by deposition techniques. It is ideal to prepare a high-flux, continuous zeolite membrane with one synthesis layer that is free of defects. No synthesis and evaluation methods exist for tunable pore-size membranes used in separating H₂ from light gases at high temperature and in chemically challenging environments. The chemical deposition of thin palladium or palladium-alloy membranes onto support structures is an important technical challenge in the fabrication of defect-free membranes. Large-scale manufacturing methods for defect-free thin films and membranes and modules in mass production must be developed and demonstrated.

M. Low Selectivity. Hydrogen selectivity of some zeolite-supported membranes decreases with increasing temperature, particularly above 150°C. However, temperatures typically need to be greater than 300°C to produce the hydrogen flux rates needed for commercial applications.

N. Technologies Do Not Operate at Optimal Process Temperatures. Processes that can be designed to operate at or near system conditions, without the need for cooling and/or re-heating, will be more efficient. Ideally, the temperature of operation should be in a range similar to outlet conditions

from the second WGS reactor at 300–500 °C to eliminate the need for this re-heating. However, the lower operating temperature potentially will lower the flux rate to unacceptable rates, which poses a technical challenge.

O. Conductivity Rates. Proton and electron conductivities across ITM membranes have to be improved, as does mixed conductivity.

P. Excessive Heat. Some novel separation processes, such as CO₂ removal through the formation of hydrates, are highly exothermic, requiring the integration of heat transfer systems in these processes.

Q. Impurities in Hydrogen from Coal. PEM fuel cells require a highly pure hydrogen product. Technologies are needed that can reduce the CO in hydrogen product streams to less than 10 ppm, and sulfur-containing compounds to less than 10 ppb.

5.1.6 Technical Task Descriptions – Central Production Pathway

Table 10 summarizes the tasks for the central production pathway technologies.

Table 10. Task Descriptions for Central Production Pathway Technologies

Task Number	Task Description	Barriers Addressed by Task
1	<p><i>Advanced Shift Technologies</i></p> <ul style="list-style-type: none"> • Develop advanced shift catalysts that are more active and are impurity-tolerant. • Conduct the WGS reaction using a high-temperature membrane without added catalyst. • Develop integrated single-step shift-membrane separation technology. 	A, C, D, E, F
2	<p><i>Advanced Hydrogen Separation</i></p> <ul style="list-style-type: none"> • Review and analyze separation technology to determine the current status, needs for advanced technology, preferred separation options, and scale-up to prepare modules. • Link membrane development work to material surface characterization studies in order to understand effects of impurities and operating conditions on short- and long-term membrane performance. • Conduct RD&D to explore technology for preferred advanced separation systems such as PSA, membranes, solvents, reverse selective systems, and other technology alternatives. • Identify low-cost materials for hydrogen separation. • Use molecular sieves to stabilize membranes. • Develop appropriate membrane seal and fabrication technologies and methods for module preparation and scale-up. 	A, C, and Barriers G through Q
3	<p><i>Polishing Filters Development</i></p> <ul style="list-style-type: none"> • Develop polishing filter technologies that enable hydrogen product streams to meet fuel quality requirements for PEM fuel cells efficiently and at low cost. 	A, Q
4	<p><i>Reverse Selective Hydrogen Separations</i></p> <ul style="list-style-type: none"> • Identify low-cost materials for CO₂ separations. • Develop reverse selective hydrogen membranes for cost-effective separation of CO₂ and other gases from mixed gas streams. • Develop advanced adsorption, hydrates, or other novel technologies for the cost-effective capture of CO₂ from mixed gas streams. 	M through Q
5	<p><i>Advanced Concepts</i></p> <ul style="list-style-type: none"> • Investigate advanced and novel process concepts that integrate several processes — gas cleanup, WGS reaction, and hydrogen separation — into one step. • Investigate novel, “out-of-the-box” technologies that can produce hydrogen from coal directly or indirectly. 	A, C
6	<p><i>Demonstrations</i></p> <ul style="list-style-type: none"> • Demonstrate and test advanced technologies to confirm laboratory, bench-scale, and pre-engineering module results. 	A, B

5.2 Alternate Hydrogen Production Pathway

In addition to central station hydrogen production, coal can be converted to high hydrogen-content, liquid hydrocarbon carriers and SNG through alternate production technology pathways. These products have the benefit of being delivered through the Nation's existing fuel distribution infrastructure and reformed to provide the hydrogen near the point of use, thus providing a potential acceleration of hydrogen market penetration until hydrogen pipeline systems are installed. The evaluation and identification of these alternate pathways will be an important part of this RD&D Plan. Computational studies and analyses are expected to play a key role in identifying promising reaction chemistries and chemical processing routes. The cost, efficiency, and benefits associated with these alternate hydrogen production pathways has to be evaluated on a system basis for comparison to other possible hydrogen system pathways. These activities will be coordinated with the appropriate EERE Hydrogen Program activities.

5.2.1 Goal and Milestones – Alternate Hydrogen Production Pathway

Goal: By 2014, make available an alternative hydrogen production pathway, including a product reforming system, for decentralized production of hydrogen from high hydrogen content hydrocarbon liquids and/or SNG that can be delivered through the existing fuel distribution infrastructure.

Milestones:

- By the end of 2011, determine the most feasible alternate hydrogen from coal pathway(s) and reforming system(s) for producing hydrogen-rich liquid fuels and SNG that are able to meet the hydrogen cost target.
- By the end of 2014, optimize, integrate, and make available an alternate hydrogen production pathway and reforming system to produce decentralized hydrogen.

5.2.2 Activities – Alternate Hydrogen Production Pathway

Table 11 lists the alternate hydrogen production pathway technologies that are currently funded by the Hydrogen from Coal Program.

Table 11. Relevant R&D Program Activities

Category	Technology
<i>Liquid Fuels Production</i>	<ul style="list-style-type: none"> • Testing of iron-based catalysts to produce high hydrogen content, coal-derived liquid fuels • Evaluate cobalt catalyst-based technology to produce high hydrogen content liquid fuels from coal-derived synthesis gas • Evaluate the potential of coal-derived ethanol as a carrier for producing decentralized hydrogen • Analyze thermal stability, chemical make-up, low-temperature properties, combustion and emissions, elastomer swell behavior, and storage stability
<i>SNG Production</i>	<ul style="list-style-type: none"> • Develop advanced SNG production technologies
<i>Fuels Reforming</i>	<ul style="list-style-type: none"> • Conduct reforming studies of coal-derived liquids to hydrogen • Evaluate performance of reformer on high hydrogen content, coal-derived liquid fuels

FE has a long history as a leader in researching, developing, and demonstrating the production of liquid fuels from coal-derived synthesis gas. FE's RD&D program has included the Liquid Phase Methanol (LPMEOH) demonstration project, a DOE Clean Coal Technology Demonstration Program project. Air Products and Chemicals, Inc. (APCI) was the lead on the \$213-million project, which demonstrated commercial-scale production of methanol and dimethyl ether (DME) from coal-derived synthesis gas. The project produced nearly 104 million gallons of methanol, subsequently used by Eastman Chemical as the basis for producing a variety of chemical products.

Over a 20-year period from 1981 through 2001, DOE funded the Alternative Fuels Development unit (AFDU) located at LaPorte, Texas that was operated and maintained by APCI. The AFDU utilized simulated coal-derived synthesis gas to produce zero-sulfur F-T liquid fuels, DME, and alcohols and successfully demonstrated liquid phase WGS. Based on the technical advancements made at the AFDU and DOE-sponsored systems engineering studies, the current cost to produce liquid fuels from coal is projected to be about \$61 per barrel of coal-derived liquid fuel on a crude oil equivalent basis for a 50,000 bpd plant that co-produces 124 MWe net power.¹⁶ Systems analysis studies of advanced conceptual plants that co-produce F-T fuels and electric power have projected that liquid fuels can be produced at less cost, for about \$35–40 per barrel of coal-derived liquid fuel. Although significant improvements in the cost of liquid fuels have been made in the past, additional improvements can enable this hydrogen production pathway to become an economic alternative.

As part of the President's Clean Coal Power Initiative (CCPI), Waste Management and Processors, Inc. and its partners were selected to perform a six-year project to convert coal waste into electric power and clean, synthesis gas-derived liquid fuels. It is anticipated that the project will convert more than 4,700 tons per day of anthracite coal waste into electric power and more than 5,000 barrels per day of liquid fuels. This fuel could eventually serve as significant early source of hydrogen for an emerging hydrogen economy.

In the 1970s, concerns over a potential shortage of natural gas fostered considerable interest in the production of SNG from coal. A number of large-scale demonstration projects were planned. Of these projects, only one was ever built, in Beulah, North Dakota. The increased availability of North American natural gas in the 1980s and 1990s ended interest in large-scale production of SNG from coal. However, Dakota Gasification Company's Beulah plant still produces about 170 MMscfd of SNG from lignite. In addition, it has expanded operations to co-produce ammonia, ammonium sulfate, cresylic acid, nitrogen, phenol, and krypton and xenon gases. In 2000, the plant began exporting CO₂ for use in enhanced oil recovery (EOR). Currently, about 95 MMscfd of CO₂ produced at the plant are transported via a 205-mile long pipeline to EnCana Corporation's Weyburn oil field in southern Saskatchewan, Canada. The CO₂ is used for tertiary oil recovery, resulting in 5,000 barrels per day of incremental oil production or an additional 130–140 million barrels of oil over the life of the project. The initial investment for this project was \$1.3 billion (Canadian) by EnCana for field facilities, and \$100 million (\$U.S.) by Dakota Gasification for the pipeline and supporting facilities. Annual net revenue generated by the sale of the CO₂ from the plant is between \$15 million and \$18 million. The Weyburn field is also the subject of a long-term monitoring program to assess the final deposition of the CO₂ being injected in this project.

Increased demand for natural gas since the 1990s has resulted both in higher prices and more imports of natural gas, a trend that is anticipated to continue. The Energy Information Administration (EIA) *Annual Energy Outlook 2007* (AEO2007) reference case projects the wellhead natural gas price to be relatively stable (\$5.46/MMBtu in 2015 and \$6.52/MMBtu by 2030) compared to current prices. However this

¹⁶ National Energy Technology Laboratory, Baseline Technical and Economic Assessment of a Commercial-Scale Fischer-Tropsch Liquids Facility, DOE/NETL-2007/1260, April 9, 2007.

represents approximately a three-fold increase over historical wellhead prices for natural gas, which have averaged around \$2/MMBtu. Spot prices for natural gas have ranged from \$6.30/MMBtu to \$8.50/MMBtu over the 12 month period ending August 2, 2007, and the EIA short-term energy outlook projects Henry Hub prices to average about \$8/MMBtu for the remainder of 2007 and 2008. Additionally, U.S. production is not expected to match the pace of consumption; therefore much of the predicted future demand is anticipated to be supplied by imports of liquefied natural gas (LNG). Although natural gas prices may continue to show volatility, if the average price remains above \$6.00 per MMBtu, the economics of SNG production may again be attractive, particularly if produced from lower cost feedstocks such as coal.

A DOE/NETL study¹⁷ examined a conceptual, site-specific location in Texas that co-produces at least three products: electric power, hydrogen or SNG, and CO₂. The electric power would be sold to the grid, the hydrogen would be sent by pipeline to the Gulf Coast petroleum refineries, the SNG would be sold as a natural gas supplement, and the CO₂ would be pipelined to the West Texas oil fields for enhanced oil recovery (EOR). The use of EOR provides an economically attractive option for sequestering CO₂, and thus reduces greenhouse gas emissions from the lignite conversion. There may be an opportunity for petroleum refiners to use low-cost Texas lignite in place of natural gas to provide the hydrogen necessary for their refining operations. Also, lignite could be used to produce SNG as a natural gas supplement, and electric power could also be generated from the lignite and dispatched to the Texas grid.

This study showed that siting a mine-mouth, lignite-fed gasification plant in Texas, to produce hydrogen, SNG, electric power, and CO₂, could be economically feasible in an era of high natural gas prices. For the case where the three products are electricity, SNG, and CO₂, the costs for SNG range from \$5.00/MMBtu to \$6.90/MMBtu (higher heating value (HHV) basis). This depends on the gasification system, the value of co-produced power, and the value of the CO₂. For this study, it was assumed that these plants would be baseload and that the value of the electricity is \$35.6/MWh and \$12/ton for the CO₂. If natural gas prices remain above \$6.00/MMBtu, then the configuration using an advanced dry feed gasification system would be economically viable for production of SNG.¹⁸ It is planned to examine this option for other low-rank coals such as Wyoming sub-bituminous and North Dakota lignite coals that are priced lower than Texas lignite.

5.2.3 Technologies – Alternate Hydrogen Production Pathway

The following R&D elements are contained in the Alternate Hydrogen Production Pathway and are listed by the section in which they are discussed:

- 5.2.3.1 Liquid fuels production/delivery/conversion
- 5.2.3.2 SNG production
- 5.2.3.3 Fuels reforming in distributed production facilities

5.2.3.1 Liquid Fuels Production/Delivery/Conversion

Hydrogen-rich liquid fuels that are produced from synthesis gas, including coal-derived synthesis gas, have the potential to use the existing petroleum product delivery and storage infrastructure with little to no modification. These liquid fuels can be delivered to retail fueling stations where the liquids can be

¹⁷ *Polygeneration of SNG, Hydrogen, Power, and Carbon Dioxide from Texas Lignite*, Mitretek Systems and Marano, J., December 2004.

¹⁸ A 20 percent inflation factor has been applied to the report's calculations done in mid-2004 that showed an estimated required selling price of \$5.00/MMBtu for the case that uses an advanced dry feed gasification system.

reformed on-site, or to sub-central hydrogen production locations to produce pure hydrogen. In the latter case, final delivery of the hydrogen to the retail outlets can be made using hydrogen tube trailers. In the longer term, with advancements in carbon sequestration technologies, there is the possibility of capturing and storing carbon from the much larger sub-central liquid fuels reforming facilities so that environmental concerns are alleviated.

5.2.3.2 SNG Production

Conversion of coal to SNG could supplement existing natural gas supplies that have experienced price volatility in the last several years. SNG uses the same infrastructure as natural gas and could be an attractive alternative as a hydrogen carrier for fuel cell-based transportation systems. In a future hydrogen energy system, SNG could be distributed using the existing natural gas infrastructure to distributed or sub-central reforming stations to produce hydrogen.

5.2.3.3 Fuels Reforming in Distributed Production Facilities

Separation of hydrogen from synthesis gas-derived liquid fuels and SNG through reforming in distributed hydrogen production sites (re-fueling stations) has many benefits, including the ability to use the existing liquid fuels or natural gas infrastructure to deliver these fuels to the distributed production sites. Distributed production of hydrogen through steam methane reforming is a promising technology to produce hydrogen from natural gas and hydrogen-rich liquids during the near-term transition to a hydrogen economy — an option that does not require significant modification or investment in capital-intensive infrastructure associated with centralized facilities. There is also potential to use advanced technology for the reforming of liquid fuels (hydrocarbons and alcohols) to produce hydrogen, which would take advantage of process intensification with a corresponding reduction in product cost.

5.2.4 Technical Targets – Alternate Hydrogen Production Pathway

The technical targets in this RD&D Plan, unless otherwise indicated, represent the status of the technology after completion of R&D, but prior to demonstration of the technology in modules at engineering scale.

5.2.4.1 Hydrogen-Rich Liquids Production and Conversion via Reforming Technical Targets

In Table 12, it is assumed that the zero-sulfur hydrogen-rich liquid fuels produced from coal-derived synthesis gas at a central plant are transported via the existing petroleum pipeline system to a decentralized refueling station where the liquids are reformed into hydrogen. The size of the liquid fuels plant is 50,000 barrels per day of coal-derived, hydrogen-rich liquid fuels; the capacity of each re-fueling station would be 1,500 kg of hydrogen per day (or 1,500 gallons of gasoline equivalent (gge)).

To establish the potential cost of the pathway for producing hydrogen from substitute natural gas and coal-derived liquids reformed at a refueling station, the reforming costs for distributed production of hydrogen from natural gas and hydrogen-rich liquids were derived from the National Academies comprehensive review of the hydrogen economy¹⁹ for consistency. The cost of production of hydrogen-rich liquid fuel feedstock from coal is also updated using the recently published NETL report²⁰ for current cost, and the 2014 future cost for coal-derived liquids are based on goals identified in a recent

¹⁹ National Research Council and the National Academy of Engineering, “The Hydrogen Economy – Opportunities, Costs, Benefits and R&D Needs”, 2004.

²⁰ Current Fischer-Tropsch Liquids Cost from “Baseline Technical and Economic Assessment of a Commercial Fischer-Tropsch Liquid Facility.” NETL Report 2007/1260, April 9, 2007.

report to Congress.²¹ The current cost of liquid fuels from coal is estimated to be \$2.90/gge if the liquid feed cost is \$73 per barrel (\$61 per barrel crude oil equivalent) of coal-derived liquid product produced by the F-T process, and the reforming efficiency is assumed to be 60%. Cost of delivery of the liquid fuel is insignificant. The estimated cost of reforming at the fueling site is \$2.35 per gge of hydrogen, for a total distributed hydrogen production cost of \$5.25/gge of hydrogen. Deployment of advanced technology for the production of coal-derived F-T fuels is expected to lower the cost to \$42 per barrel (\$35 per barrel on a crude oil equivalent basis). The cost of hydrogen feedstock would be \$1.42/gge of hydrogen assuming a future reforming efficiency of 70%. If advanced technology is utilized for both liquid feedstock production and reforming, the total cost of hydrogen would be \$2.69/gge, which is a 49 percent reduction from the estimated current cost. This estimated cost for advanced technology is well within the DOE cost target of \$2.00/gge to \$3.00/gge of hydrogen.

Table 12: Technical Targets for Production of Coal-derived High Hydrogen-Content Liquids, Transported and Reformed at the Refueling Station

Characteristics	Units	2004 Status	2015
High Hydrogen-Content Liquids Cost	\$/gge	2.90 ¹	1.42 ²
Electricity Cost	\$/gge	0.17	0.13
Variable Non-fuel O&M	\$/gge	0.13	.07
Fixed Operating Cost	\$/gge	0.25	0.13
Capital Charges	\$/gge	1.80	0.94
Total Cost	\$/gge	5.25	2.69

Note: National Research Council and the National Academy of Engineering, “The Hydrogen Economy – Opportunities, Costs, Benefits and R&D Needs”, 2004. The estimate is based on Table E-35, page 179 and Table E-36, page 180 for reforming natural gas with the assumption that reforming of F-T liquids would cost 10 percent more for all categories except for the cost of the F-T liquids which was determined as identified in footnotes 1 and 2.

1. Current Fischer-Tropsch Liquids Cost from “Baseline Technical and Economic Assessment of a Commercial Fischer-Tropsch Liquid Facility”, NETL Report 2007/1260, April 9, 2007. ((F-T liquids at \$61 per barrel (COE) + \$12 = \$73 per barrel X 1/0.60 X 1/ 42 gal per barrel = \$2.90/gge))
2. DOE future cost for F-T Liquids, “Development Plan for Coal-to-Liquid Fuels”, Office of Fossil Energy/ National Energy Technology Laboratory Report September 2006. ((F-T liquids at \$35 per barrel (COE) x 1.2 = \$ 42 per barrel X 1/0.70 X 1/42 gal per barrel = \$1.42))

5.2.4.2 SNG Production and Conversion via Reforming Technical Targets

Table 13 provides the technical targets for SNG production from coal, which are based on conversion of Texas lignite and are from the Mitretek (presently Noblis) report, *Polygeneration of SNG, Hydrogen, Power, and Carbon Dioxide from Texas Lignite*, December 2004. Production costs may vary if other coal feedstocks are used or if SNG production occurs at other locations. The current production cost for SNG from Texas lignite is estimated to be \$7.67/MMBtu (LHV). SNG will utilize the existing natural gas pipeline infrastructure and can subsequently be reformed into hydrogen at distributed, refueling station locations. SNG will therefore be subject to distribution charges similar to natural gas. The 2010 target for SNG production is \$5.55/MMBtu. The current and future SNG production costs were used to establish the feedstock costs for the distributed reforming station. The feedstock requirement was established by using reforming efficiencies defined in the National Academy study. The technical targets for distributed

²¹ “Development Plan for Coal-to-Liquid Fuels,” Office of Fossil Energy/National Energy Technology Laboratory Report September 2006.

natural gas reforming for current and future technologies are also taken from the National Academy study.²²

Table 13: Technical Targets for Production of Coal-derived Substitute Natural Gas (SNG), Transported and Reformed at the Refueling Station

Characteristics	Units	2004 Status	2015
Natural Gas Cost	\$/gge	1.65 ¹	1.03
Electricity Cost	\$/gge	0.15	0.12
Variable Non-fuel O&M	\$/gge	0.12	.06
Fixed operating Cost	\$/gge	0.23	0.12
Capital Charges	\$/gge	1.64	0.85
Total	\$/gge	3.79	2.18

Note: National Research Council and the National Academy of Engineering, “The Hydrogen Economy – Opportunities, Costs, Benefits and R&D Needs”, 2004, Table E-35, page 179 and Table E-36, page 180.

1. SNG production cost is based on the Mitretek Technical Report, *Polygeneration of SNG, Hydrogen, Power, and Carbon Dioxide from Texas Lignite*, December 2004. Present cost of SNG - \$7.67 per million btu’s x 1 MM btu’s / 7.75 gge of hydrogen = \$0.99 per gge. 2010 cost \$5.55 per million btu’s x 1 MM btu’s / 7.75 gge of hydrogen = \$0.72 per gge. The 2004 reforming efficiency is projected by NAE to be 0.60 therefore feedstock cost would be \$0.99 X 1/0.60 = \$1.65 /gge. The 2015 reforming efficiency is projected as 0.70 therefore the feedstock cost would be \$0.72 X 1/0.70 = \$1.03 /gge.

5.2.5 Technical Barriers – Alternate Hydrogen Production Pathway

5.2.5.1 General Barriers

A. Lack of Demonstration of Novel Technologies. Integrated operation of the coal-to-syngas into the hydrogen-rich liquids process has to be demonstrated at a commercial-scale unit in the United States. Use of hydrogen-rich liquids derived from synthesis gas needs to be demonstrated in reforming/fuel cell systems to confirm their suitability as hydrogen carriers, and to identify and confirm the optimal liquid to be used through computational chemistry analysis.

5.2.5.2 Liquid Fuels and SNG Production, Delivery, and Conversion via Reforming Barriers

B. Low Efficiency. To be an effective hydrogen carrier, synthesis gas-derived liquids and SNG must be produced, delivered, and converted into hydrogen in an efficient manner that overrides the number of energy-using steps required to provide the hydrogen. The current system is inefficient, and improvements must be made through improved catalysts, reactors, and production of optimal liquids.

C. Catalyst and Reactor Systems Not Optimized. These systems require improvements in reactor design and advanced catalysts to improve the liquid fuel production process, including the use of coal-derived, CO-rich synthesis gas.

D. Processes for SNG Production Not Optimized. SNG production processes need to be optimized to improve process efficiency and operations.

²² National Research Council and the National Academy of Engineering, “The Hydrogen Economy – Opportunities, Costs, Benefits and R&D Needs”, 2004.

E. The Optimal Hydrogen-Rich, Synthesis Gas-Derived Liquid Fuel for Reforming Has Not Been Identified. Work must be done to identify the most optimal hydrogen-rich, synthesis gas-derived liquid fuel that can be used for hydrogen generation at distributed hydrogen production sites.

F. High Capital Costs. Current, small-scale, distributed reformer technologies are too expensive to supply hydrogen at a cost comparable to that of gasoline. Multiple-unit operations and insufficient heat integration contribute to large, costly production and purification subsystems. Improved reforming and shift catalysts are needed to reduce side reactions and improve performance, bearing in mind the availability of the catalyst materials. Shift, separation, and purification costs need to be reduced by developing new technology such as single-step shift with integrated membrane technology.

G. High Operating Costs. Operating and maintenance costs are too high for distributed hydrogen generation plants that use hydrogen-rich, synthesis gas-derived liquids as feedstocks. Improved processes that require less operator control and maintenance are needed.

H. Lack of CO₂ Capture. Small-scale, distributed generation and sub-central reforming of fossil fuel-derived liquid fuels will emit greenhouse gases. Cost-effective capture of CO₂ from distributed generation facilities is more difficult than at central locations. Research is needed to discover potential options to sequester CO₂ from distributed generation systems.

5.2.6 Technical Task Descriptions – Alternate Hydrogen Production Pathway

Table 14 shows the technical tasks for the alternative hydrogen production pathway — hydrogen-rich, synthesis gas-derived liquid fuel production, reforming technology, computational analysis, and demonstrations.

Table 14. Tasks for Alternate Hydrogen Production Technologies

Task Number	Task Description	Barriers Addressed by Task
1	<p><i>Computational Chemistry and Dynamic Analysis</i></p> <ul style="list-style-type: none"> Develop computational and analytical tools to simulate hydrogen-rich, synthesis gas-derived liquid fuels and SNG production to determine the optimum processes. Develop the computational and analytical tools to simulate the separation of hydrogen from hydrogen-rich, synthesis gas-derived liquid fuels and SNG in sub-central or distributed production facilities. 	C, E
2	<p><i>Hydrogen-rich, Synthesis Gas-Derived Liquid Fuels Production</i></p> <ul style="list-style-type: none"> Develop novel reactor and catalyst systems to produce the most optimal, hydrogen-rich, synthesis gas-derived liquid fuels for reforming applications. 	B, C
3	<p><i>SNG Production</i></p> <ul style="list-style-type: none"> Develop and optimize advanced SNG production technologies. 	D
4	<p><i>Reforming Technology</i></p> <ul style="list-style-type: none"> Optimize distributed reformers for hydrogen-rich, synthesis gas-derived liquid fuels and SNG. 	E, F, G, H
5	<p><i>Demonstrations</i></p> <ul style="list-style-type: none"> Demonstrate reforming of the most optimal, hydrogen-rich, synthesis gas-derived liquid fuels and SNG in distributed reforming applications. 	A

5.3 Polygeneration

To further improve the potential for economically competitive production of hydrogen from coal for the Central and Alternate Production Pathways, the Hydrogen from Coal Program implemented an overarching research activity on polygeneration. The concept of polygeneration involves the production of high-value coal-derived chemicals and/or carbon materials utilizing the facilities, products, or intermediate products from central and alternate production pathway facilities integrated with electricity production. The technologies to make these high-value products would share the utilities and other infrastructure with these major facilities and provide a synergistic cost benefit for producing both hydrogen and higher value materials. In addition to enhancing facility profitability and reducing our dependence on petroleum, this strategy also has the benefit of potentially limiting the movement of our domestic chemical and carbon products manufacturing facilities to offshore locations. From a broad research perspective, the DOE's goal is to further the development of chemical and carbon materials technologies beyond early laboratory scale efforts in order to better validate the technical and economic merits of the proposed processes.

5.3.1 Goals and Milestones – Polygeneration

Goal: By 2015, make available processes to enhance coal facility profitability by producing a variety of high-value, coal-derived chemicals and/or carbon materials that can be incorporated into the central or alternate pathway hydrogen production systems.

5.3.2 Activities – Polygeneration

Table 15 lists the polygeneration technologies currently under development by the Hydrogen from Coal Program.

Table 15. Relevant Polygeneration R&D Program Activities

Category	Technology
<i>High-value carbon products</i>	<ul style="list-style-type: none"> • Removal of SO_x and NO_x over coal/petroleum derived activated carbon • Utilization of bituminous coal for water treatment • Production of carbon foams from pitch • Production of activated carbon for CO₂ removal from coal-derived pitch/polymer • Development of a sulfur-based approach to making premium carbon products from coal
<i>Cokes and Pitches</i>	<ul style="list-style-type: none"> • Production of cokes and pitches as feedstocks for making carbon products • Production of needle coke • Catalytic extraction of coal to make highly oriented cokes
<i>Chemicals</i>	<ul style="list-style-type: none"> • Production of new products from the F-T process: chemicals to enhance lubricity and energy content of F-T jet/diesel fuels • Production of chemicals from biomass at a coal/biomass hydrogen facility • Production of CO and CO₂ – free hydrogen and carbon nanotubes

The Polygeneration R&D portion of the Hydrogen from Coal Program resides mainly with two consortia – the Consortium for Premium Carbon Products from Coal (CPCPC) and the Consortium for Fossil Fuel Science (CFFS). These organizations have been performing fundamental and laboratory-scale R&D for many years in a university-based structure that also includes government/industry advisory boards. During the course of their existence they have supported many students who have moved on to important positions in industry, government and academia and published a large number of papers in major scientific journals. Several of the senior researchers have received awards through their sponsored research, including the prestigious Storch Award, bestowed annually by the American Chemical Society to a researcher who has made significant contributions in the field of fuel chemistry.

After the President's announcement of the Hydrogen Fuel Initiative in 2003, the consortia were advised to focus their research more toward investigating technologies that will facilitate the introduction of the hydrogen economy. Rather than the previous emphasis on research to produce fuels strictly as replacements for petroleum-based fuels in conventional and advanced engines, the researchers were directed to focus more on strategies that produce reformable hydrogen-rich fuels for fuel cell-powered vehicles and stationary power supply units in alignment with the Program's Alternative Pathway. With the subsequent inclusion of Polygeneration in the Program, it provided the consortia with the opportunity to incorporate research on many novel approaches to enhance the economics of hydrogen from coal plants. This new direction includes the necessity of developing research paths that limit greenhouse gases and other emissions from their advanced, coal-based technologies. A review of the current projects in Table 15 shows that major strides have been made to align the consortia's research with the goals of the Hydrogen from Coal Program.

5.3.3 Technologies – Polygeneration

The following R&D elements are contained in the Polygeneration portion of the Program and are listed by the section in which they are discussed:

5.3.3.1 High-value carbon products

5.3.3.2 Cokes and Pitches

5.3.3.3 Chemicals

5.3.3.1 High-Value Carbon Products

There are a multitude of high value carbon materials that can be produced from coal, either from a reconstituted solid or liquid extract, for example activated carbon for water treatment. The applied research resides within the CPCPC and is industry-driven, with over 40 member companies. Members companies include: anthracite and bituminous coal producers, manufacturers of specialty carbon and graphite products, activated carbon producers, municipally-owned water treatment facilities, anthracite filter media producers, carbon fiber and composite producers, aluminum producers, carbon black and coal tar pitch producers, battery manufacturers, and coal-fired electric utilities. Industrial partners identify, select, and partially fund projects that they deem as having potential for producing competitively priced premium carbon products from coal or coal-derived feedstocks to enhance the profitability of hydrogen from coal production facilities.

5.3.3.2 Cokes and Pitches

The Coal Extraction Program at West Virginia University is exploring the use of coal extract to make binder pitch and impregnating pitch for manufacturing graphite electrodes for electric-arc steelmaking furnaces, and binder pitch for manufacturing anodes for aluminum reduction cells. In addition, the coal

extract is being used as a raw material to make specialty cokes for carbon product manufacture. These cokes will contain much less nickel and vanadium than the petroleum cokes that they would replace, which should reduce their catalytic loss in processing.

5.3.3.3 Chemicals

The CFFS, a five-university research consortium, is conducting a basic research program focused on developing innovative and economical technologies for producing hydrogen and hydrogen-rich liquid fuels and chemicals. Currently, about 16 professors and 30 graduate and postdoctoral students participate in the program. Recent research on chemicals production emphasizes novel techniques to enhance the energy (hydrogen content) of liquid fuels; production of chemicals from biomass at a facility that blends biomass with coal to reduce the carbon footprint; and methods to produce hydrogen with no carbon emissions by incorporating the carbon in carbon nanotubes as the byproduct of hydrogen production. These nanotubes can be sold as a value-added product for various uses or simply stored as a permanent carbon sequestration option.

5.4 Storage

The hydrogen storage program element within the Hydrogen from Coal RD&D Plan focuses on developing novel storage systems, such as metal frameworks (MFs), to store hydrogen on board a vehicle.

5.4.1 Goal and Milestones – Storage

Goal: Complete small-scale research to identify promising hydrogen storage technologies for transportation applications.

Milestones:

- By the end of 2008, successfully complete laboratory/bench-scale research on promising novel, hydrogen storage systems.
- Examine and report on the feasibility of scaling up novel hydrogen storage systems.

5.4.2 Activities – Storage

Projects dealing with hydrogen storage or the development of materials with hydrogen storage applications that are funded by DOE and NETL are listed in Table 16 below.

Table 16. Relevant R&D Program Activities

Category	Technology
<i>Carbon Nanotubes</i>	<ul style="list-style-type: none"> • Carbon nanostructures from coal-derived liquid feedstocks.
<i>Metal-Frameworks</i>	<ul style="list-style-type: none"> • Design, synthesis, and study of a new class of lightweight, thermally stable, microporous metal organic materials. • Synthesis and structural characterization of MFs and application of high throughput sorption measurements.

Hydrogen storage on carbon nanotubes was investigated to determine their capacity in reference to DOE target values. The results obtained through September 2004 did not find that commercially

available samples of single-walled carbon nanotubes were able to store sufficient hydrogen to meet the targets. Although a means to improve the storage capacity by partial oxidation with CO₂ was found, the performance of the activated material was still insufficient to warrant further investigation. In 2005, a decision was reached to not implement any new research on carbon nanotubes for hydrogen storage.

Initial exploratory work on metal frameworks shows that these materials have promise as potential storage materials for hydrogen. Thus, research emphasis for hydrogen storage has shifted to these materials.

5.4.3 Technologies – Storage

The on-going FE-sponsored research on metal frameworks shows that their preparation is simple, inexpensive, and of high yield. Initial experiments on these materials are favorable, but more research is required to make a go/no-go decision for further development. There are other hydrogen storage technologies, such as compressed and liquefied gas storage and chemical and metal hydrides. The Hydrogen, Fuel Cells, and Infrastructure Technologies Program within EERE is investigating many of these technologies. The Hydrogen from Coal Program will coordinate activities with EERE, and determine the need to investigate other potential storage materials.

5.4.4 Technical Targets – Storage

The technical targets in Table 17 are from the EERE Hydrogen, Fuel Cells & Infrastructure Technologies Program Multi-Year RD&D Plan, Table 3.3.2 Technical Targets: DOE's Hydrogen On-Board Storage System Technical Targets (p. 3.3-9 and 3.3-10). These technical targets represent the status of the technology after completion of R&D, but prior to technology validation.

Table 17. Preliminary Hydrogen Storage Technical Targets

	Units	2007 Target ^a	2010 Target	2015 Target
Useable, specific-energy from H ₂ (net useful energy/max system mass) ^b (“Gravimetric Capacity”)	kWh/kg (kg H ₂ /kg)	1.5 (0.045)	2 (0.06)	3 (0.09)
Useable energy density from H ₂ (net useful energy/max system volume) (“Volumetric Capacity”)	Kwh/L (kg H ₂ /L)	1.2 (0.036)	1.5 (0.045)	2.7 (0.081)
Storage system cost ^c	\$/kWh net (\$/kg H ₂)	6 (200)	4 (133)	2 (67)
Fuel cost at the pump ^d	\$/gge	--	2-3	2-3
Operating ambient temperature ^e	°C	-20/50 (sun)	-30/50 (sun)	-40/60 (sun)
Cycle life (1/4 tank to full) ^f	Cycles	500	1000	1500
Cycle life variation ^g	% of mean (min) @ % confidence	N/A	90/90	99/90
Min. and max. delivery temp. of H ₂ from tank	°C	-30/85	-40/85	-40/85
Minimum full-flow rate	(g/s)/kW	0.02	0.02	0.02
Minimum delivery pressure of H ₂ from tank; FC=fuel cell, ICE = internal combustion engine	Atm (abs)	8 FC 10 ICE	4 FC 35 ICE	3 FC 35 ICE
Maximum delivery pressure of H ₂ from tank ^h	Atm (abs)	100	100	100
Transient response 10%-90% and 90%-10% ⁱ	s	1.75	0.75	0.75
Start time to full-flow at 20°C ^j	s	15	5	5
Start time to full-flow at -20°C ^j	s	30	15	15
System fill time	min	10	3	2.5
Loss of useable H ₂ ^k	(g/h)/kg H ₂ stored	1	0.1	0.05
Fuel Purity (H ₂ from storage system) ^l	%	99.99 (dry basis)		
Permeation and leakage ^m	Sec/h	Meets or exceeds applicable standards		
Toxicity	-	Meets or exceeds applicable standards		
Safety	-	Meets or exceeds applicable standards		

Notes for Table 17

Useful constants: 0.2778kWh/MJ, ~33.3kWh/gal gasoline equivalent.

^a Some near-term targets have been achieved with compressed and liquid tanks. Emphasis is on materials-based technologies.

^b Generally the “full” mass (including hydrogen) is used, for systems that gain weight, the highest mass during discharge is used.

^c 2003 US\$; total cost includes any component replacement if needed more than 15 years or 150,000 mile life.

^d 2005 US\$; includes off-board costs such as liquefaction, compression, regeneration, etc; based on H₂ production cost of \$2 to \$3/gasoline gallon equivalent untaxed, independent of production pathway. For pathway-dependent interim targets, refer to the production section.

^e Stated ambient temperature plus full solar load. No allowable performance degradation from -20 to 40 °C. Allowable degradation outside these limits is TBD.

^f Equivalent to 100,000; 200,000; and 300,000 miles respectively (current gasoline tank spec).

^g All targets must be achieved at end of life.

^h For delivery to the tank, in the near term, the forecourt should be capable of delivering 10,000 psi compressed hydrogen, liquid hydrogen, or chilled hydrogen (77 K) at 5,000 psi. In the long term, it is anticipated that delivery

pressures will be reduced to between 50 and 150 atm for solid state storage systems, based on today's knowledge of sodium alanates.

ⁱ At operating temperature.

^j Flow must initiate within 25 percent of target time.

^k Total hydrogen lost from the storage system, including leaked or vented hydrogen; relates to loss of range.

^l The storage system will not provide any purification, but will receive incoming hydrogen at the purity levels required for the fuel cell. Some storage technologies may produce contaminants for which effects are unknown; these will be addressed as more information becomes available.

^m Total hydrogen lost into the environment as H₂; relates to hydrogen accumulation in enclosed spaces. Storage system must comply with CSA/NGV2 standards for vehicular tanks. This includes any coating or enclosure that incorporates the envelope of the storage system.

5.4.5 Technical Barriers – Storage

A. High Cost. The cost of storage systems is too high, particularly compared to conventional storage systems for petroleum fuels. Low-cost materials and components for hydrogen storage systems are needed, as well as low-cost, high-volume manufacturing methods.

B. Excessive Weight and Volume. The weight and volume of hydrogen storage systems is presently much too low. Materials and components are needed that are compact, lightweight, and would permit greater storage capacity of hydrogen per unit weight of storage media.

C. Low Efficiency. Energy efficiency is a challenge for all hydrogen storage approaches. For reversible solid-state materials, the energy required to move hydrogen in and out is an issue. In addition, the energy associated with compression and liquefaction must be considered for compressed and liquid hydrogen technologies.

D. Lack of Durability. Durability of hydrogen storage systems is inadequate. Materials and components are needed that allow hydrogen storage systems with a long lifetime.

E. Lack of Codes and Standards. A systematic approach to applicable codes and standards for hydrogen storage systems and interface technologies, which will facilitate implementation and/or commercialization and ensure safety and public acceptance, has not been established. Standardized hardware and operating procedures, and applicable codes and standards are required.

F. Lack of Life Cycle and Efficiency Analyses. There are no analyses of the full life cycle cost and efficiency for hydrogen storage systems.

5.4.6 Technical Task Descriptions – Storage

Table 18 lists the tasks for development of novel, on-board hydrogen storage technologies.

Table 18. Tasks for Hydrogen Storage Technologies

Task Number	Task Description	Barriers Addressed by Task
1	<i>Hydrogen Storage Materials R&D</i> <ul style="list-style-type: none"> • Develop promising storage materials to meet targets. • Verify the most promising storage materials to meet targets. 	A through F
2	<i>Advanced Concepts R&D</i> <ul style="list-style-type: none"> • Develop and characterize advanced storage concepts that meet 2015 targets. 	A through F

5.5 Utilization

Hydrogen and hydrogen-natural gas blends may be used directly as a fuel for advanced stationary and transportation engines. This approach to supplemental fueling with hydrogen represents a beneficial nearer-term, low-emission strategy that could result in an acceleration of hydrogen demand. Further, this approach provides a bridge to future fuel cell use in transportation applications, and is in concert with the goals of the DOE FreedomCar Program. Blending hydrogen with natural gas and its use in advanced engine types, such as homogenously charged compression ignition (HCCI) engines, could enable a new, low-emission demand for hydrogen. Conceptually, as the hydrogen infrastructure expands, these same engine systems, with further retrofits and refinements now being developed, could utilize 100 percent hydrogen. With 100 percent hydrogen utilization, lean burning may provide ultra-low NO_x emissions requiring no after-treatment NO_x technology. Further, with no fuel-based carbon and reduced oil consumption via a future suitable combination of engine design and oil formulation, oxidation after-treatment may not be required. Complete elimination of after-treatment would provide economic and performance benefits.

Natural gas has become the fuel of choice for many transit vehicle operators, providing emission benefits in certain applications. However, when compared to conventional diesel fuel emissions of primary pollutants and greenhouse gases, natural gas may not provide the levels of advantage that were initially anticipated; in some fleets that have been studied, the emissions actually can be greater. One study of natural gas-fueled heavy-duty vehicles indicated that methane emissions led to higher CO₂-equivalent emissions than the diesel-fueled vehicles. There is room for improvement, potentially through displacement of some of the natural gas with hydrogen.

Combustion of mixtures of hydrogen with natural gas allows for leaner operation at lower combustion temperatures leading to lower NO_x emissions than use of natural gas alone, while providing enhancements to the combustion process that permit recovery of the power and energy consumption penalties associated with natural gas. Further, the displacement of fuel carbon via hydrogen addition reduces CO, CO₂, and unburned hydrocarbon emissions. Two broad areas of research need to be addressed: 1) optimizing the ratio of hydrogen-to-methane in the fuel mixture based on emissions and engine performance, and coordinated with research being performed on delivery and storage of hydrogen/methane mixtures; and 2) computational and laboratory research on the use of hydrogen/methane mixtures in advanced engines that offer step-out advantages in emissions and performance.

In summary, this activity may enable hydrogen from coal to be delivered along with natural gas and used in internal combustion engines, thus assisting the nation in its transition from liquid fuels to hydrogen with incipient emission reduction benefits.

5.5.1 Goal and Milestones – Utilization

Goal: Complete the development of hydrogen and hydrogen-natural gas mixture engine modifications and operations by 2009.

Milestones:

- By the end of 2009, successfully complete research to modify and optimize advanced engine types fueled by hydrogen and/or hydrogen-natural gas mixtures.
- Examine and report on the feasibility of modified and optimized advanced engine types fueled by hydrogen and/or hydrogen-natural gas mixtures.

5.5.2 Activities – Utilization

Previous activities have demonstrated a novel, laser-based ignition system for hydrogen spark ignition engines. This technology offers the potential for further extension of the lean misfire limit and reduced NO_x emissions. Table 19 lists the current utilization projects that are part of the Hydrogen from Coal Program.

Table 19. Relevant Current RD&D Activities of the Program

Category	Technology
<i>Fuel and engine development and optimization</i>	<ul style="list-style-type: none"> • Optimize hydrogen-natural gas mixture composition and utilization through laboratory studies of spark ignition engine operation • Evaluate hydrogen-natural gas blends as a fuel for conventional natural gas engines • Evaluate the suitability of hydrogen supplementation for operating a natural gas engine at ultra-lean conditions • Confirm the feasibility of using hydrogen-natural gas blends to improve performance, efficiency, and emissions of a HCCI engine

5.5.3 Technologies – Utilization

5.5.3.1 Advanced Engine Types

Fuel cells are the optimal choice for utilization of hydrogen in transportation and stationary applications. However, fuel cell technology for the transportation sector has to overcome significant technical and economic barriers in order to establish a market. The modification and optimization of current engines, as well as advanced engine types (*e.g.*, HCCI engines), may provide a nearer-term market for hydrogen until fuel cells are advanced to the point of commercial viability.

Hydrogen used in advanced engines can achieve very low emissions. The NO_x emissions are reduced due to the lean-burn, low-temperature nature of the combustion process. Carbon-based emissions (CO₂, CO, unburned hydrocarbons) are present in low concentrations but may be further reduced via reduction of engine oil consumption. Research is needed to develop and optimize advanced engines for hydrogen use to minimize emissions of NO_x and lube oil consumption, while maximizing the distance traveled by vehicles between refueling trips.

5.5.4 Technical Guidelines – Utilization

The technical guidelines in Table 20 represent the status of the technology after completion of R&D, and include demonstration of the technology in heavy-duty advanced engines. The timing of the RD&D is provided in the Gantt charts in Figure 11.

Table 20. Hydrogen Utilization Technical Guidelines for Heavy Duty Engines

Performance Criteria	Units	2007 Target
Total Hydrocarbons	g/bhp-hr	20
Non-Methane Hydrocarbons	g/bhp-hr	0.05*
NO _x	g/bhp-hr	0.5*
CO	g/bhp-hr	5.0
CO ₂	g/bhp-hr	330 (not regulated)
PM	g/bhp-hr	0.01*
Efficiency	-	40% thermal efficiency (unregulated)

* Based on 2007–2010 EPA on-highway heavy-duty engine emission standards.

As an example of regulations being proposed for clean light duty vehicles, Table 21 shows the California Low-emission Vehicle Regulation including LEV (Low Emission Vehicles), ULEV (Ultra-Low Vehicle Emissions), SULEV (Super-Ultra-Low-Emission vehicles). These regulations can be used as guidelines for ICE light duty hydrogen-compressed natural gas (HCNG) and hydrogen engines.

Table 21. LEV II Exhaust Mass Emissions Standards for New 2005 and Subsequent Model LEVs, ULEVs and SULEVs for Passenger Cars, Light Duty Trucks

Vehicle Type	Durability	Vehicle Emission Category	NMOG (g/mi)	Carbon Monoxide (g/mi)	Oxides of Nitrogen (g/mi)	Formaldehyde (mg/mi)	Particulates (mg/mi)
All PCs / LDT 8,500 lbs or less	50,000	LEV	0.075	3.4	0.05	15	n/a
		LEV Option 1	0.075	3.4	0.07	15	n/a
		ULEV	0.04	1.7	0.05	8	n/a
	120,000	LEV	0.09	4.2	0.07	18	0.01
		LEV Option 1	0.09	4.2	0.1	18	0.01
		ULEV	0.055	2.1	0.07	11	0.01
SULEV	0.01	1	0.02	4	0.01		

Source: California Low-Emissions Vehicle Regulations, Amended February 2007, Page 37

CNG and HCNG, when used in light duty vehicles, could provide air emissions that are consistent with the requirement of the California standards. Table 22 shows an example of emission results for a Ford F150, which can be used as a guideline.

Table 22. Ford 150 Emission Results (LDV)

Fuel	Units	NMHC	CO	NOx
HCNG	g/mile	0.018	0.251	0.084
Gasoline	g/mile	0.115	1.551	0.167
CNG	g/mile	0.023	0.567	0.110

Source: Kirk Collier, Collier Technologies, presentation at 2004 DOE Hydrogen, Fuel Cells & Infrastructure Technologies Program Review, entitled “Hydrogen and Natural Gas Blends; Converting Light and Heavy Duty Vehicles” May, 2004, PowerPoint slide entitled “Emissions Results LDV, Ford F150”

5.5.5 Technical Barriers – Utilization

A. High Cost. The cost of modifying engines to operate on hydrogen or hydrogen-natural gas mixtures must be evaluated. If performance and cost are competitive with current technologies, engines that operate on hydrogen or hydrogen-natural gas mixtures may be a plausible interim option until fuel cell technology is fully developed.

B. Lack of Optimized Design and Operation. The low heating value of a hydrogen and/or hydrogen-natural gas mixture will require adjustments in the operation and design of engines. Consumption of engine lubricating oil must be addressed to achieve minimum carbon-based emissions for 2015 without oxidation catalyst.

5.5.6 Technical Task Descriptions – Utilization

Table 23 describes the tasks for development of hydrogen utilization technologies.

Table 23. Tasks for Hydrogen Utilization Technologies

Task Number	Task Description	Barriers Addressed by Task
1	<ul style="list-style-type: none"> • <i>Advanced engines research:</i> Modify and optimize advanced engine systems to operate on hydrogen or hydrogen-natural gas mixtures • Demonstrate optimized engines in vehicles or stationary power systems at small scale • 1,000-hour tests to determine impact on engine life and durability • Evaluate and compare the emissions and economics of advanced engines operating on hydrogen or hydrogen-natural gas mixtures to conventional technologies 	A, B

6. Implementation Plan

The Hydrogen from Coal Program was initiated in FY 2004 as part of the President's Hydrogen Fuel Initiative, and supports the FutureGen project. The Program is in an operational mode, having initiated RD&D activities by requesting research proposals and selecting project performers. Continued execution and development of the Hydrogen from Coal Program requires proper management controls to ensure that the program is progressing toward its goals and objectives.

6.1 Coordination with Other DOE/Federal Programs (Associated Programs): Jointly Funded Projects

The successful development of low-cost, affordable hydrogen production from fossil fuels coupled with sequestration of CO₂ is dependent on technologies being developed in a number of ongoing associated RD&D programs within FE and NETL. These technologies are needed for:

- CO₂ capture and sequestration;
- Advanced coal gasification, including feed handling systems;
- Efficient gasifier design and materials engineering;
- Advanced synthesis gas cleanup technologies;
- Advanced membrane separation technology to produce a lower-cost source of oxygen from air;
- Fuel cell modules that can produce electric power at coal-fired integrated gasification combined-cycle power plants; and
- Hydrogen fuel gas turbines.

In response to comments by the National Academy of Sciences, the Hydrogen from Coal Program was organizationally grouped together with the Carbon Sequestration Program to enhance coordination and collaboration with respect to carbon sequestration and hydrogen production from coal. Figure 13 shows the various programs and projects with which the Hydrogen from Coal Program will coordinate in addition to the Sequestration Program. Coordination of efforts and sharing of information and experience will help ensure the successful transition to a hydrogen energy system.

6.1.1 Other Coordination Activities

The Hydrogen from Coal Program interacts with several different programs and federal organizations outside of the Office of Fossil Energy. These include the Hydrogen Fuel Initiative, the Hydrogen Interagency Task Force, and the International Partnership for a Hydrogen Economy (IPHE).

Figure 13. Coordination of the Hydrogen from Coal Program with Associated Programs, the FutureGen Project, and EERE's Hydrogen Program

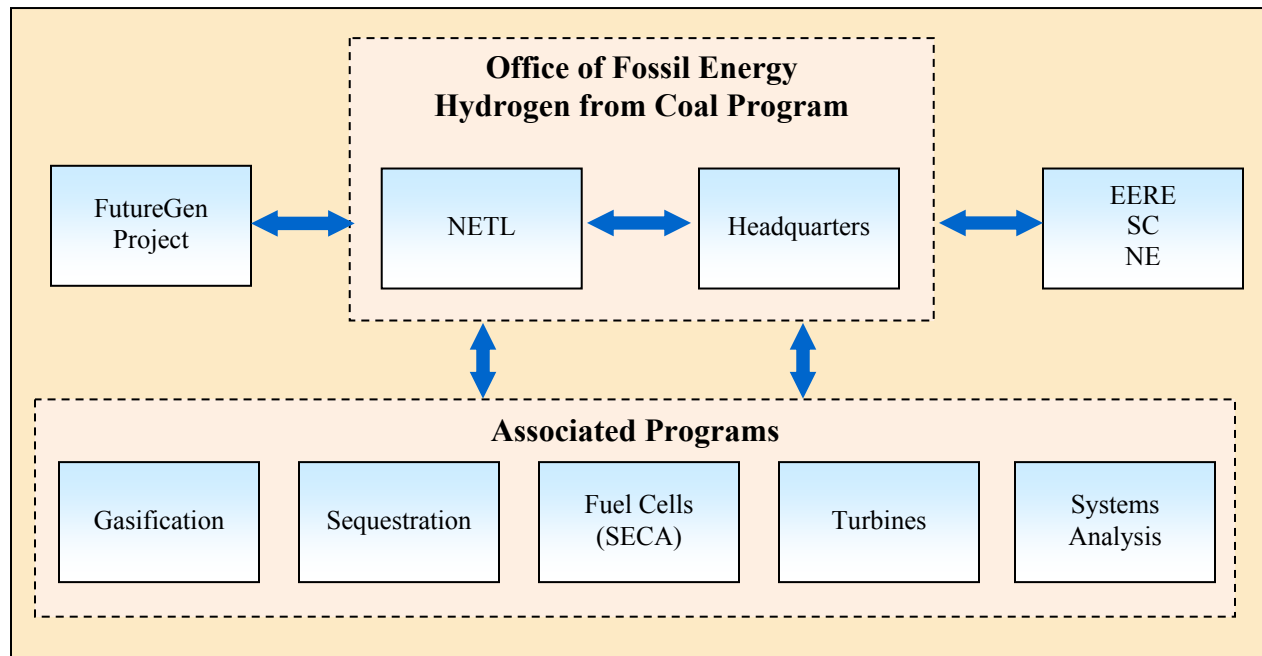

6.1.1.1 Hydrogen Fuel Initiative

Through the Hydrogen Fuel Initiative and Advanced Energy Initiative, the Hydrogen from Coal Program has strengthened its coordination with the overall DOE Hydrogen Program by participating in joint planning meetings and the development of key strategic planning documents such as the DOE Hydrogen Posture Plan. The R&D activities sponsored by the Hydrogen from Coal Program are annually evaluated at the DOE merit review meeting. Additionally, the program contributes to DOE's Hydrogen Program Annual Progress Report and other planning and management activities. It is expected that FE's participation and coordination with other hydrogen program offices will continue, to ensure that the program pathways are being pursued in an aggressive and efficient manner with minimal overlap. Coordination of efforts and sharing of information and experience will help ensure the successful transition to hydrogen energy systems.

6.1.1.2 Hydrogen and Fuel Cell Interagency Task Force

The Hydrogen and Fuel Cell Interagency Task Force was established in April 2003 to fulfill a statutory requirement and to serve as a mechanism to facilitate collaboration among federal agencies engaged in hydrogen and fuel cell R&D activities. In November 2006, the Hydrogen and Fuel Cell Technical Advisory Committee (HTAC), an advisory committee to the Secretary of Energy, recommended that agency members on the Interagency Task Force be represented at the Assistant Secretary level to ensure a continued high-level of commitment and decision-making on hydrogen activities. The Assistant Secretary for Fossil Energy represents the Hydrogen from Coal Program on the Interagency Task Force. The Task Force, chaired by the Assistant Secretary of EERE, held its initial meeting in August 2007. The Task Force also includes representatives from the following organizations:

- DOE Offices of EERE; Fossil Energy; Nuclear Energy, Science, and Technology; and Science;

- The National Institute of Standards and Technology (NIST);
- Department of Defense (DoD);
- Department of Transportation (DOT);
- Department of Education;
- Department of Agriculture (USDA);
- Executive Office of the President, Office of Science and Technology Policy (OSTP);
- General Services Administration (GSA);
- United States Postal Service (USPS);
- Environmental Protection Agency (EPA);
- National Aeronautics and Space Administration (NASA); and
- The National Science Foundation (NSF).

The Interagency Task Force operates a web site (www.hydrogen.gov) to provide the public with information being obtained from the President's Hydrogen Fuel Initiative.

6.1.1.3 International Partnership for the Hydrogen Economy (IPHE)

The IPHE was established in 2003 and consists of 16 countries and the European Union (EU). The Hydrogen from Coal Program contributes to the IPHE by attending meetings and offering its expertise on hydrogen from coal production technologies. The partners of the IPHE include nearly 3.5 billion people; account for over \$35 trillion in Gross Domestic Product (GDP) (approximately 85 percent of the world's GDP), and over 75 percent of electricity used worldwide; and produce greater than two-thirds of CO₂ emissions, while consuming two-thirds of the world's energy. The IPHE focuses its efforts on:

- Developing common codes and standards for hydrogen fuel utilization;
- Establishing cooperative efforts to advance the research, development, and deployment of hydrogen production, storage, transport, and end-use technologies;
- Strengthening exchanges of pre-competitive information necessary to build the kind of common hydrogen infrastructures necessary to allow this transformation to take place; and
- Formalizing joint cooperation on hydrogen R&D to enable sharing of information necessary to develop hydrogen-fueling infrastructure.

6.2 Performance Assessment and Peer Reviews

Performance assessment provides essential feedback on the effectiveness of the Program's mission, goals, and strategies. It is built into every aspect of program management and provides managers with a consistent stream of information on which to base decisions about program directions and priorities. The overall Hydrogen Fuel Initiative has annual merit review meetings of funded projects to report progress and provide program managers the opportunity to evaluate progress toward program goals and milestones. The RD&D Plan will be annually reviewed and updated to reflect changes in technical and economic assumptions and accomplishments of its research activities. These annual reviews of the RD&D Plan will provide program managers the opportunity to update the goals and objectives of the Program by utilizing the most current data generated by the Program. On a periodic basis, project managers conduct reviews to evaluate progress toward goals. The project managers will provide their

input into the MYP by review and comment on individual projects, and their assessment of the progress being made to achieve the program goals, milestones, and targets. Formal meetings will be held with the NETL Technology Manager and HQ Program Manager on an annual basis and fact sheets will be provided on individual projects on a periodic basis.

6.3 Accomplishments and Progress

The Hydrogen from Coal Program has successfully transitioned from its initial start-up in FY 2004 to full operations. The Program has been actively soliciting proposals from industry, universities, and other organizations to help achieve its goals in support of the HFI and FutureGen Project. Currently, the program has 38 projects that are conducting research in a wide number of areas (Table 24). Additionally, the program issued two requests for proposals in early FY 2006 — one for research projects on novel polishing filters and process intensification, and a second one for alternate production and utilization technologies. In FY 2006, the program initiated research activities in co-production of hydrogen/substitute natural gas and electricity to improve plant economics.

Table 24. Hydrogen from Coal Research Projects

Research Area*	Number of Projects
Membrane research	6
Module scale-up	1
Membrane reactors & process intensification	9
CO ₂ removal	1
Novel sorbent	1
Polishing filters	1
Polygeneration	2
Liquid H ₂ carriers	7
SNG production and reforming	2
Storage	2
Utilization	6
TOTAL	38

*Complementary projects are supported by the Gasification and Sequestration Programs.

6.3.1 Technical Progress

The Hydrogen from Coal Program has only been in existence since 2004, with most of its projects initiated in FY 2005 and thereafter. However, several of the activities undertaken by the program have produced advancements and progress in technology development as outlined in the next several paragraphs.

6.3.1.1 Central Hydrogen Production Pathway

While the program is in the early stages of implementation, technical progress has been made toward achieving several of its goals, milestones, and technical targets. For example, in the area of hydrogen separation, early laboratory-scale research by Eltron Research, Inc. has demonstrated significant progress

toward the long-range targets for 2015 (Table 25). Eltron has demonstrated operation of a 1.3 lb per day hydrogen separation facility to obtain pre-engineering scale data. Successful scale-up of the Eltron membrane design will help increase plant thermal efficiencies and reduce the capital and operating costs of coal-based FutureGen concepts. This project was selected by *R&D Magazine* as one of the 100 most technologically significant products in 2005.

The Southwest Research Institute has demonstrated a self-supporting Pd-Cu alloy membrane that meets the 2010 DOE Program performance flux targets with reduced thickness (5 micron) membranes.

Table 25. Progress toward Separation Targets

Performance Criteria	Units	Current Status ^(a)	2007 Target	2010 Target	2015 Target
Flux ^(b)	ft ³ /hour/ft ²	~220	100	200	300
Temperature	°C	300–400	400–700	300–600	250–500
S Tolerance	ppmv	~20	----	20	>100
Cost	\$/ft ²	<200	150	100	<100
WGS Activity	-	N/A	Yes	Yes	Yes
ΔP Operating Capability ^(c)	psi	1,000 (tested)	100	Up to 400	Up to 800 to 1,000
Carbon Monoxide Tolerance	-	Yes	Yes	Yes	Yes
Hydrogen Purity ^(d)	%	>99.999	95	99.5	99.99
Stability/Durability (years)	years	0.9 (tested)	1	3	5

^a Current status is based on best available Hydrogen-permeable membrane technology to date (2006) that meets the targets under laboratory conditions. Laboratory results will need to be verified at larger scales prior to commercial deployment.

^b For 100 psi ΔP (hydrogen partial pressure basis)

^c ΔP = total pressure differential across the membrane reactor

^d Polishing filters may be needed downstream of the separation system in order to remove final traces of CO, sulfur, and other impurities to meet PEM fuel cell requirements. These targets exclude the effect of polishing filters.

* *Technical targets are for membrane types described previously; research that is currently supported by FE and NETL Research on other membranes is not precluded if the potential flux, cost, and tolerance to impurities are promising. Research also is encouraged on advanced solvent and adsorption technologies to separate hydrogen. Reverse selective systems that separate CO₂ also are promising. The technical targets for hydrogen membranes relate to hydrogen from coal technology in which ΔP will be around 100 psi, and the membrane will require resistance to contaminants (CO and H₂S). Technical targets for hydrogen membranes that are included in the EERE HFCIT RD&D Plan are for systems that operate at lower ΔP and have less contaminants.*

The hydrogen separation membrane types that are being investigated include, as per their classification:

- Hydrogen-permeable cermet and metal and metal alloy (Argonne National Laboratory (ANL), Eltron Research, Inc., Southwest Research Institute (SWRI), NETL, REB Research and Consulting, Worcester Polytechnic Institute).
- Microporous (Media and Process Technology, Inc.).

In the Central Production area of process intensification, a WGS membrane reactor is being developed by several organizations including Media and Process Technologies. Media and Process Technology, Inc.'s goal is to meet performance requirements in terms of hydrogen/CO selectivity (50 to less than

100), hydrothermal stability (50 psia steam), and chemical stability (resistance to sulfur and hydrocarbons poison). A field test at a commercial hydrotreating facility was conducted that successfully demonstrated selectivity and chemical stability in a gas stream containing hydrogen, hydrocarbons, hydrogen sulfide and ammonia.

Other multi-process configurations are being investigated, including:

- Contaminant-resistant WGS membrane reactors to separate pure hydrogen from mixed coal-derived gases (Aspen Products Group, Inc.; Gas Technology Institute (GTI); Lehigh University; NETL; Ohio State University; University of Wyoming (Western Research Institute); United Technologies Corp.).
- Development of a single module for performing gas cleanup and hydrogen separation (GE Global Research).

6.3.1.2 Alternate Hydrogen Production Pathways

- Two projects were selected in FY 2005 to optimize the production of F-T liquids as high-hydrogen content materials for subsequent reforming, to produce hydrogen at sub-central or distributed locations near the point of use. Each project will produce research quantities of F-T liquids, which will then be evaluated for their reforming capability (Integrated concepts and Research Corporation, Headwaters, Inc., Louisiana State University, Iowa State University, Abengoa Inc., University of Kentucky).

6.3.1.3 Systems Engineering

- Systems engineering analytical activities support the Hydrogen from Coal program by providing: a) current cost estimates for the hydrogen pathways and associated plant/component configurations; and b) R&D guidance regarding the materials, equipment, and system configurations that are likely to offer optimum efficiency and cost. Previous systems engineering results were used by the National Academy of Engineering, which showed that hydrogen from coal (including carbon storage) offered the lowest cost among the many hydrogen production options (Leonardo Technologies, Inc., Noblis, Inc, Research and Development Solutions, and Technology & Management Services, Inc.).

6.3.2 Program Accomplishments

In addition to the technical achievements of program-funded research, the program also has increased its coordination with other DOE programs since its inception. Because hydrogen production from coal is closely linked with the system's up-front gasification technologies and downstream CO₂ capture and sequestration, these three DOE programs have been coordinated within the Office of Clean Coal to enhance integration of the separate programs. Additionally, the Hydrogen from Coal Program continues to coordinate with other DOE offices on the President's Hydrogen Fuel Initiative, participating in the development of various planning documents and recently participating in the DOE Hydrogen Program Annual Merit Review and Peer Evaluation.

6.4 Communications, Outreach, and Technology Transfer

Information dissemination, communications, and outreach activities are an important and integral part of the Hydrogen from Coal Program. Hydrogen from Coal Program officials communicate the Program's mission, strategies, accomplishments, and technology capabilities to a variety of stakeholder audiences

including Congress, the public, educational institutions, industry, and other government and non-government organizations. Program staffs perform the following communications, outreach, and technology transfer in addition to their other programmatic duties:

- present technical status and program overviews at public forums;
- manage the FE and NETL public Web site, and document and references lists;
- manage official correspondence; and
- coordinate reviews of FE/NETL-related statements by other DOE offices and federal agencies.

The Program also participates in various conferences and workshops to exchange information with industry, government, and academia throughout the world. For example, the Program actively participates in the International Technical Conference on Coal Utilization and Fuel Systems (*i.e.*, the Clearwater Coal Conference), National Hydrogen Association conferences, and the International Pittsburgh Coal Conference.

6.5 Next Steps

The Hydrogen from Coal Program has transitioned from its FY 2004 initial start-up mode to an operational/implementation mode. The Program will continue to issue solicitations as appropriate, and will continue with current RD&D activities that support implementation of the FutureGen Project and the Advanced Energy, Hydrogen Fuel, and Clean Coal Power Initiatives. In the future, as hydrogen from coal technologies mature, additional input from technical and merit reviews by academia, industry, and other stakeholders will enable updates to the technical targets and sub-program elements in this RD&D Plan. The RD&D Plan will be updated periodically based on RD&D progress and subsequent go/no-go decisions and funding appropriations. Systems analysis and evaluation will continue to guide the direction of research, and an update of economical and technical cases is expected to be available before the next revision to the Hydrogen from Coal RD&D Plan. The Program will continue collaborating with associated programs in the Office of Clean Coal to ensure efficient utilization of resources and successful development and integration of hydrogen from coal technologies into clean coal processes and the FutureGen project. The Program also will continue to work closely with EERE, SC, and NE on implementation of the Hydrogen Fuel Initiative to meet its goals and objectives.

7. Appendix

7.1 Acronyms

Government Agency/Office Acronyms

ANL	Argonne National Laboratory
DoD	Department of Defense
DOE	Department of Energy
DOT	Department of Transportation
EERE	Office of Energy Efficiency and Renewable Energy
EIA	Energy Information Administration
EPA	Environmental Protection Agency
FE	Office of Fossil Energy
GSA	General Services Administration
HFCIT	Hydrogen, Fuel Cells, & Infrastructure Technologies Program
NASA	National Aeronautics and Space Administration
NE	Office of Nuclear Energy
NETL	National Energy Technology Laboratory
NIST	National Institute of Standards and Technology
NSF	National Science Foundation
OCC	Office of Clean Coal
ORNL	Oak Ridge National Laboratory
OSTP	Executive Office of the President – Office of Science and Technology Policy
SC	Office of Science
USDA	United States Department of Agriculture
USPS	United States Postal Service

General Acronyms

ΔP	Delta P (change in pressure)
$^{\circ}C$	degrees Celsius
$^{\circ}F$	degrees Fahrenheit
AEO2006	Annual Energy Outlook 2006
AFDU	Alternative Fuels Development Unit
APCI	Air Products and Chemicals, Inc.
AR	As received
CCPI	Clean Coal Power Initiative
CFFS	Consortium for Fossil Fuel Science
cm ²	Square centimeter
EPRI	Electric Power Research Institute
EU	European Union
FCV	Fuel Cell Vehicle

ft ²	Square feet
ft ³	Cubic feet
F-T	Fischer-Tropsch
FY	Fiscal year
g/bhp-hr	grams per brake-horsepower-hour
GDP	Gross domestic product
gge	gallons of gasoline equivalent
GTI	Gas Technology Institute
HCCI	Homogeneously charged compression ignition
HEV	Hybrid electric vehicle
HFI	Hydrogen Fuel Initiative
HHV	Higher Heating Value
HRSG	Heat recovery steam generator
ICEV	Internal Combustion Engine Vehicle
IGCC	Integrated Gasification Combined Cycle
IPHE	International Partnership for the Hydrogen Economy
K	Degrees Kelvin
kg	Kilogram
kWh	Kilowatt-hour
LHV	Lower heating value
LNG	Liquefied natural gas
LPMEOH	Liquid Phase Methanol (plant)
MF	Metal framework
min	Minute
ml	Milliliter
MMBtu	Million Btu
MMscfd	Million standard cubic feet per day
MW	Megawatts
MWh	Megawatt-hour
MYP	Multi-Year Plan
NAS	National Academies of Science
N/A	Not available
N/D	Not demonstrated
NEP	National Energy Policy
NEPA	National Environmental Policy Act
NGCC	Natural Gas Combined Cycle (power plant)
nm	Nanometer
PEM	Proton Exchange Membrane
PM	Particulate matter
ppb	Parts per billion
ppbv	Parts per billion on a volume basis
ppm	Parts per million

ppmv	Parts per million on a volume basis
PrOx	Preferential Oxidation
PSA	Pressure Swing Adsorption
psi	Pounds per square inch
psia	Pounds per square inch absolute
psig	Pounds per square inch gauge
R&D	Research and Development
RD&D	Research, Development, and Demonstration
RSP	Required Selling Price
RTI	Research Triangle Institute
SCOHS	Selective Catalytic Oxidation of Hydrogen Sulfide
SCR	Selective catalytic reduction
SNG	Substitute natural gas
SOFC	Solid Oxide Fuel Cell
SWRI	Southwest Research Institute
UNDEERC	University of North Dakota Energy and Environmental Research Center
U.S.	United States
WGS	Water-Gas Shift

Chemical Symbols/Names

Ag	Silver
Al	Aluminum
Ba	Barium
Br	Bromine
Ca	Calcium
Cl	Chlorine
CO	Carbon Monoxide
Co	Cobalt
CO ₂	Carbon Dioxide
COS	Carbonyl Sulfide
Cr	Chromium
Cu	Copper
DME	Dimethyl ether
F	Fluorine
Fe	Iron
Fe ₃ O ₄	Synthetic Iron Oxide (Magnetite or Iron Oxide Black)
H ₂	Hydrogen
Hg	Mercury
H ₂ O	Water
H ₂ S	Hydrogen Sulfide
HCl	Hydrogen Chloride (Hydrochloric Acid)
HCN	Hydrogen Cyanide

K	Potassium
Li	Lithium
Mg	Magnesium
Mn	Manganese
Mo	Molybdenum
N ₂	Nitrogen
Na	Sodium
NH ₃	Ammonia
Ni	Nickel
NO _x	Nitrogen Oxides
O ₂	Oxygen
P	Phosphorus
Pb	Lead
Pd	Palladium
SO ₂	Sulfur dioxide
SrCeO ₃	Strontium cerium oxide
V	Vanadium
Zn	Zinc

7.2 Program Contacts

C. Lowell Miller, Ph.D

Director, Office of Sequestration, Hydrogen,
and Clean Coal Fuels

U.S. Department of Energy
1000 Independence Avenue, SW
Washington, DC 20585-1290
Phone: 301-903-9451
Email: lowell.miller@hq.doe.gov

Daniel C. Cicero, Ph.D

Technology Manager, Hydrogen & Syngas

Office of Coal & Power R&D
U.S. Department of Energy
National Energy Technology Laboratory
3610 Collins Ferry Road
Morgantown, WV 26507-0880
Phone: 304-285-4826
Email: daniel.cicero@netl.doe.gov

Mark Ackiewicz

Program Manager, Hydrogen & Clean Coal Fuels

U.S. Department of Energy
1000 Independence Avenue, SW
Washington, DC 20585-1290
Phone: 301-903-3913
Email: mark.ackiewicz@hq.doe.gov