

The Van Geet Off-Grid Home: An Integrated Approach to Energy Savings



C. Dennis Barley, Paul Torcellini, and Otto Van Geet
National Renewable Energy Laboratory

The Van Geet Off-Grid Home: An Integrated Approach to Energy Savings

C.D. Barley, P. Torcellini, and O. Van Geet

Prepared under Task No. BET4.8001



NREL

National Renewable Energy Laboratory
1617 Cole Boulevard, Golden, Colorado 80401-3393
303-275-3000 • www.nrel.gov

Operated for the U.S. Department of Energy
Office of Energy Efficiency and Renewable Energy
by Midwest Research Institute • Battelle

Contract No. DE-AC36-99-GO10337

NOTICE

This report was prepared as an account of work sponsored by an agency of the United States government. Neither the United States government nor any agency thereof, nor any of their employees, makes any warranty, express or implied, or assumes any legal liability or responsibility for the accuracy, completeness, or usefulness of any information, apparatus, product, or process disclosed, or represents that its use would not infringe privately owned rights. Reference herein to any specific commercial product, process, or service by trade name, trademark, manufacturer, or otherwise does not necessarily constitute or imply its endorsement, recommendation, or favoring by the United States government or any agency thereof. The views and opinions of authors expressed herein do not necessarily state or reflect those of the United States government or any agency thereof.

Available electronically at <http://www.osti.gov/bridge>

Available for a processing fee to U.S. Department of Energy and its contractors, in paper, from:

U.S. Department of Energy
Office of Scientific and Technical Information
P.O. Box 62
Oak Ridge, TN 37831-0062
phone: 865.576.8401
fax: 865.576.5728
email: <mailto:reports@adonis.osti.gov>

Available for sale to the public, in paper, from:

U.S. Department of Commerce
National Technical Information Service
5285 Port Royal Road
Springfield, VA 22161
phone: 800.553.6847
fax: 703.605.6900
email: orders@ntis.fedworld.gov
online ordering: <http://www.ntis.gov/ordering.htm>





The Van Geet home in the Rocky Mountains west of Denver, Colorado. This view from the southwest shows the south-facing glazing for passive solar heating and the solar hot-water collectors in the foreground. The 1,000-watt photovoltaic array east of the house is not shown in this view (NREL/PIX 08226).

Table of Contents

Executive Summary	ix
1. Introduction	1
1.1 Background	1
1.2 Design and Analysis Team	2
1.3 Design Philosophy and Goals	2
1.4 Report Organization	3
2. The Design Process	5
2.1 Location and Site Characteristics	5
2.2 Climate	5
2.3 Preliminary Design	7
2.4 Basic Design Parameters	8
2.5 Pre-Construction Modeling	11
3. The House As Built	16
3.1 Architectural Features	16
3.2 Construction Details	20
3.3 Infiltration and Ventilation	21
4. The Space Heating and Cooling System	23
4.1 Overview	23
4.2 Description of Thermal Energy Features	24
4.3 Performance Evaluation	28
5. The Domestic Hot-Water System	32
6. The Electrical Energy System	35
6.1 Description	35
6.2 Loads and System Components	37
6.3 Energy Performance Modeling	46
6.4 Results	47
7. Conclusions and Recommendations	50
7.1 Evaluation of the Design	50
7.2 Lessons Learned	51
7.3 General Recommendations	52
8. References	54

Definitions

AC	alternating current
ACH	air changes per hour
ASHRAE	American Society of Heating, Refrigerating, and Air-conditioning Engineers
BA	Building America
BESTEST	Building Energy Simulation Test
BLC	building loss coefficient
BTC	building time constant
CMU	concrete masonry unit
DAS	data acquisition system
DC	direct current
DHW	domestic hot water
DOE	U.S. Department of Energy
EIFS	Exterior Insulated Finishing System
ELA	equivalent leakage area
GFX	gravity film exchange
HC	high capacity
HVAC	heating, ventilating, and air-conditioning
IEA	International Energy Agency
LPG	liquefied propane gas
MEC	Model Energy Code
MPPT	maximum power point tracker
NIMBY	"Not in my backyard"
NREL	National Renewable Energy Laboratory
PV	photovoltaic
R-value	thermal resistance of insulation

Definitions (continued)

SHGC	solar heat gain coefficient
SLR	solar load ratio
SERI	Solar Energy Research Institute
SERI-RES	SERI's Residential Energy Simulator
SOC	state of charge
STEM	Short-Term Energy Monitoring
TMY	Typical Meteorological Year
WTG	wind turbine generator

Executive Summary

The Van Geet home near Denver, Colorado, exemplifies the effectiveness of coupling energy conservation measures with renewable energy utilization in a modern residence. The remote location, with no utility connections available, and the owner's interest in renewable energy motivated the ambitious design. This design attracted the interest of the Building America (BA) program and was studied as a research home. As a result, the BA program provided energy engineering throughout the design, construction, and performance evaluation phases. The American Society of Heating, Refrigerating, and Air-conditioning Engineers (ASHRAE) also recognized the success of this project by awarding it an ASHRAE Technology Award in 2001.

This project's significance is the successful integration of numerous energy-conservation and renewable-energy features into a beautiful, comfortable, and very energy-efficient off-grid home. The integrated design of the 3,176-ft² house includes a tight, well-insulated thermal envelope, passive solar heating (direct gain and Trombe wall), a wood-burning stove, natural ventilation cooling, active solar water heating, high-efficiency electrical appliances, and a photovoltaic (PV) hybrid electrical power system. Some lifestyle adjustments by the energy-conscious occupants also contribute to the energy savings. This report analyzes the effects of occupant behavior separately from the effects of the building design. Liquefied propane gas (LPG) is used for cooking, clothes drying, backup space heating, backup water heating, and backup electrical generation.

In addition to describing the house and its performance, this report also illustrates a recommended design process. This approach of climate-sensitive, whole-house, passive-solar design has evolved over the past 20 years, along with the development of computer simulation tools to aid in the design process. Proceeding in stages from the initial concept through the final design and performance evaluation, this process includes (1) setting a goal for energy efficiency at the outset, (2) applying rules of thumb, (3) checking and adjusting basic design parameters (solar load ratio [SLR] and building time constant [BTC]), and (4) using computer simulation to fine-tune the design.

The heating and cooling design includes the following features:

- 13% of floor area in south-facing glass (direct gain) and Trombe wall (SLR = 1.29; see Section 2.4)
- Glazing Solar Heat Gain Coefficients (SHGC) tuned to the various façades (SHGC of 0.65 on the south and 0.40 on other façades).
- Thermal mass in concrete block walls with R-20 exterior insulation (BTC = 2.5 days; see Section 2.4)
- R-40 ceiling insulation
- Natural ventilation and cooling
- No overhangs needed.

The performance evaluation is based on both monitoring and modeling to achieve the most accurate and meaningful analysis possible. Monitoring is important because it provides real data on actual building performance. Modeling is useful for the following purposes:

- Calculating the *total* auxiliary (non-solar) heating energy required, including LPG (which was measured) and firewood (which can only be estimated)
- Evaluating occupant behavior effects separately from building performance
- Evaluating performance for a typical weather year, rather than an arbitrary year
- Comparing the actual building to a standard code reference case.

Thus, in this study, the measured data were used to calibrate the model, and then the model was used to analyze performance. By comparing this design to a standard reference case at the time of construction (1995 Model Energy Code [MEC 1995]), assuming the same conventional occupant behavior in both homes, we credit the *house* with 77% energy savings. Then by repeating the modeling of the Van Geet home based on the more energy-conscious behavior of this family (mainly thermostat setpoints), we credit the *occupants* with an additional 12% energy savings, for a total heating and cooling energy savings of 89%. The heating energy usage (there is no cooling energy usage) in the house as occupied amounts to the following:

- 13.4 MMBtu/year
- 1.39 kBtu/°F·day
- 4.22 kBtu/year per ft² of conditioned floor area
- 0.44 Btu/°F·day·ft².

The solar domestic hot water (DHW) system provides most of the needed annual DHW. The backup LPG water heater is turned off and bypassed almost all the time. Only during occasional extended periods of cloudy weather in December and January is the backup used. Performance data on this mode of operation were not collected. However, based on the owner's account, it is evident that the DHW is heated nearly 100% by solar energy.

The stand-alone hybrid electrical power system includes these features:

- Nominal 1000-watt amorphous silicon PV array, with a maximum power-point tracking controller
- Nominal 400-watt wind turbine generator (negligible energy contribution)
- Nominal 42.7-kWh battery bank (effective capacity 7.8 kWh = 58 load-hours)
- 4-kW inverter
- 7.5-kW gasoline generator, converted for LPG (derated to 2.3 kW; see Section 6.2).

The total electrical load, including a well pump, high-efficiency lighting and refrigerator, and other appliances amounts to 3,240 Wh/day (1,183 kWh/year). The generator starts about two times per month, runs 1% of the time, and produces 197 kWh of electricity annually (which is 17% of the total load). Thus, the hybrid system has a net effect of meeting 83% of the electrical load from renewables (mainly PV).

The overall energy savings for the home are 89% heating and cooling, 83% electrical, and nearly 100% domestic water heating. This home more than meets the general criterion of 70% HVAC and lighting savings for Building America research homes.

1. Introduction

The Van Geet home near Denver, Colorado, exemplifies the effectiveness of coupling energy conservation measures with renewable energy utilization in a modern residence. The remote location, with no utility connections available, and the owner's interest in renewable energy motivated the ambitious design. This design attracted the interest of the Building America (BA) program (Building America 2004) and was studied as a research home.¹ As a result, the BA program provided energy engineering throughout the design, construction, and performance evaluation phases. The house was engineered as a system using hourly simulations. The American Society of Heating, Refrigerating, and Air-conditioning Engineers (ASHRAE) also recognized the success of this project by awarding it a first place ASHRAE Technology Award in 2001 for Alternative and Renewable Energy Use (ASHRAE 2001).

This project's significance is the successful integration of numerous energy-conservation and renewable-energy features into a beautiful, comfortable, and very energy-efficient off-grid home. The integrated design includes a tight, well-insulated thermal envelope, passive solar heating, natural cooling, active solar water heating, high-efficiency electrical appliances, and a photovoltaic (PV) hybrid electrical power system. Some lifestyle adjustments by the energy-conscious occupants also contribute to the energy savings. This report analyzes the effects of occupant behavior separately from the effects of the building design.

The purposes of this report are to

- Describe this example of a highly effective design
- Demonstrate the process of designing such a home
- Analyze the performance of this home
- Provide guidance for future energy-efficient housing projects.

1.1 Background

Buildings consume more than one-third of the nation's total energy and approximately two-thirds of the nation's electricity (Energy Information Administration 2002). Typical uses for energy in homes include space heating and cooling, water heating, lighting, cooking, refrigeration, laundry, and other electrical appliances. When electricity is used, the energy usually comes from distant, large-scale power plants. Although people do not generally recognize the houses they live in as polluters, houses are indeed significant polluters, with much of the pollution being produced remotely.

Building America is an industry-driven program sponsored by the U.S. Department of Energy (DOE). The program advocates a systems-engineering approach to accelerate the development and adoption of advanced building energy technologies in production housing. Building America partners with crosscutting residential building industry teams to produce advanced homes on a community scale. Residential building systems are evaluated by conducting successive design, test, redesign, and retest iterations until cost and performance trade-offs yield innovations that can be implemented in production-scale housing. The initial goal of this

¹ In its earlier stages, this project was supported by DOE's Exemplary Buildings Program.

program was 30% to 50% heating and cooling energy savings, compared to local standard practice.² The program also seeks to assess the comfort and efficiency of various facets of the building design, toward improvements in future projects. The National Renewable Energy Laboratory (NREL) serves as the field manager of the Building America program; this role includes research, technical support, and monitoring the activities of the various industry teams.

The research homes portion of the Building America program is dedicated to promoting energy efficiency through the design, construction, and evaluation (through monitoring and modeling) of buildings that exhibit a more ambitious degree of energy savings. In general, research buildings should demonstrate that passive solar design and demand-side management strategies reduce heating, ventilating and air-conditioning (HVAC) and lighting energy requirements by 70% when compared to local standard practice. This goal is aggressive, and only very low-energy buildings qualify for further study and evaluation. The Van Geet home qualified and was undertaken as a Building America research homes project. It exceeds the 70% savings criterion, as is shown in this report.

1.2 Design and Analysis Team

Otto Van Geet is the owner, designer, and builder of the home under study. Additional NREL staff members, Paul Torcellini and Nancy Carlisle, assisted with architectural and engineering aspects of the design. Michael Smith, also of NREL, performed computer simulations as part of the design and evaluation processes. NREL subcontractors Greg Barker and Ed Hancock assisted with the data acquisition system (DAS). Greg Barker also assisted with the analysis. NREL staff member Dennis Barley completed the final analysis and reporting. Sheila Hayter, of NREL, and Paul Kriescher, of Lightly Treading, Inc., provided valuable peer reviews of this report. Student interns Michael Ketcham, David Bonfoey, Michael Frank, Micah Sherman, and Kathleen Obrecht also contributed. The DOE Office of Energy Efficiency and Renewable Energy provided funding to study this house.

1.3 Design Philosophy and Goals

The key to success in a venture of this type is setting a goal for a low-energy building before the design begins. This focus becomes one element of the purpose of the building. Waiting until an architect has designed a home and then trying to include energy efficiency features is not nearly as effective as establishing energy efficiency as a goal at the outset. Why is this important? Every time someone builds a house, they are creating an energy demand for the lifetime of that house. Another way of looking at the situation is that the owner is buying into energy futures for the lifetime of the house. Considering energy efficiency starting with the onset of the building design process provides homeowners with the ability to minimize their risk of energy price increases, by buying into conservation and solar technologies, without sacrificing amenities or comfort. Additional benefits of low-energy buildings are less pollution and reduction of power infrastructure (power plants and power lines are typically NIMBY³ items). Energy-efficient homes create less pollution and reduce power infrastructure.

² More recently, the goal for production housing has been increased to 40% to 70% of whole-house energy use.

³ NIMBY stands for “Not in my backyard!”

The best results are obtained with a whole-building design approach—that is, designing the house as a single package where the components work together. Also, the most effective approach depends on the local climate. What works well in one climate might not be recommended in a different climate. This approach of climate-sensitive, whole-house, passive-solar design has evolved over the past 20 years, along with the development of computer simulation tools to aid in the design process.

In housing markets where production builders use a few floor plans and replicate them many times, the use of simulations to optimize performance is very appropriate. Designers create a computer model of a house early in the design process. Using this model, the design team meets the space requirements of the house and then uses the simulation tools to determine orientation, window sizes and locations, overhang lengths, levels of insulation, and the amount of thermal mass. After the envelope design is complete, a mechanical system is designed to work with the building. In some cases, the air-conditioning or heating systems can be eliminated. In many cases, the total cost of the home turns out to be the same as or less than that of a conventional design. For examples of such projects, see "Current Projects" at the Building America Home Page (2004).

1.4 Report Organization

Based on the principles discussed in Section 1.3, this project proceeded through design, construction, monitoring, performance analysis, and evaluation phases. These phases are described in the following chapters of this report.

Chapter 2: The Design Process

- Location and site characteristics
- Description of the climate
- Goals and initial design
- Basic design parameters
- Fine-tuning: Parametric modeling study

Chapter 3: The House As Built

- Photos
- Floor plans
- Construction details
- Infiltration and ventilation

Chapter 4: The Space Heating and Cooling System

- Description
- Monitoring
- Modeling and performance evaluation

Chapter 5: The Domestic Hot Water System

- Description
- Performance

Chapter 6: The Electrical Energy System

Description

Performance

Chapter 7: Conclusions and Recommendations

2. The Design Process

The design process applied and demonstrated here includes four basic stages:

1. Setting the design goals, including energy efficiency (Section 2.3)
2. Sketching a preliminary design based on rules-of-thumb for energy-efficient building design (Section 2.3)
3. Adjusting two basic parameters that are crucial to passive solar performance: the solar load ratio and the building time constant (Section 2.4)
4. Fine-tuning the design, based on a parametric analysis of design features using a computer simulation model (Section 2.5).

First, the site and the local climate are assessed in Sections 2.1 and 2.2.

2.1 Location and Site Characteristics

The Van Geet residence is located in the Rocky Mountains, north of Idaho Springs, Colorado, about 25 miles west of the Denver area, at a latitude of 40° north and an elevation of 9,300 ft above sea level. This rural location provides clear, scenic views of the continental divide and the surrounding Colorado peaks. Small aspen and evergreen trees surround the home, but do not shade its solar energy features. The nearest electrical power line is 1.5 miles away. The cost of extending the power grid to reach the home site has been estimated as over \$100,000, so this option was ruled out. Liquefied propane gas (LPG) delivery is available at the site; prices ranged from \$0.65/gal to \$0.92/gal during 1998 to 2000. Water is available from a 300-ft-deep well on the site.

2.2 Climate

The climate is generally cold and sunny. There are 9,623 heating °F-days and zero cooling degree-days, based on temperature data measured at the site and adjusted for departures from normal (see next paragraph). The annual average global solar radiation was measured as 4.37 kWh/m²·day. This is 5% less than the Typical Meteorological Year (TMY; Marion and Wilcox 1994) value of 4.6 kWh/m²·day at nearby Boulder, likely as a result of the more frequent afternoon thunderstorms at the site in July and August. In the Denver-Boulder area, the mean annual percent of possible sunshine is 69%. The annual average precipitation is about 26 in. at nearby Winter Park. There are sporadic high winds at the site, especially during the colder months. However, a consistent wind resource, necessary for the effective use of wind energy, is not present.

For pre-construction modeling purposes (Section 2.5), TMY weather data for Boulder (elevation 5,361 ft) were adjusted for the site elevation of 9,300 ft by assuming a -10°F temperature differential. For the post-construction performance evaluation modeling reported in Chapter 4, a presumably more-accurate treatment of a "local TMY" was possible. Ambient temperature and global solar radiation were recorded by the data acquisition system (DAS) at the home hourly (or more often) throughout the year 2000. In order to represent a "typical" year, these temperature data were adjusted monthly by the departures from normal at Evergreen, the nearest weather station from which these data are available (NCDC 2000). Evergreen is about 23 miles from the

home site and about 2,300 feet lower in elevation. Because no such solar radiation departure-from-normal data were available from any nearby site, the year 2000 insolation data measured at the site were used without adjustment in the modeling. Figures 2.1 and 2.2 show seasonal profiles of this weather data set.

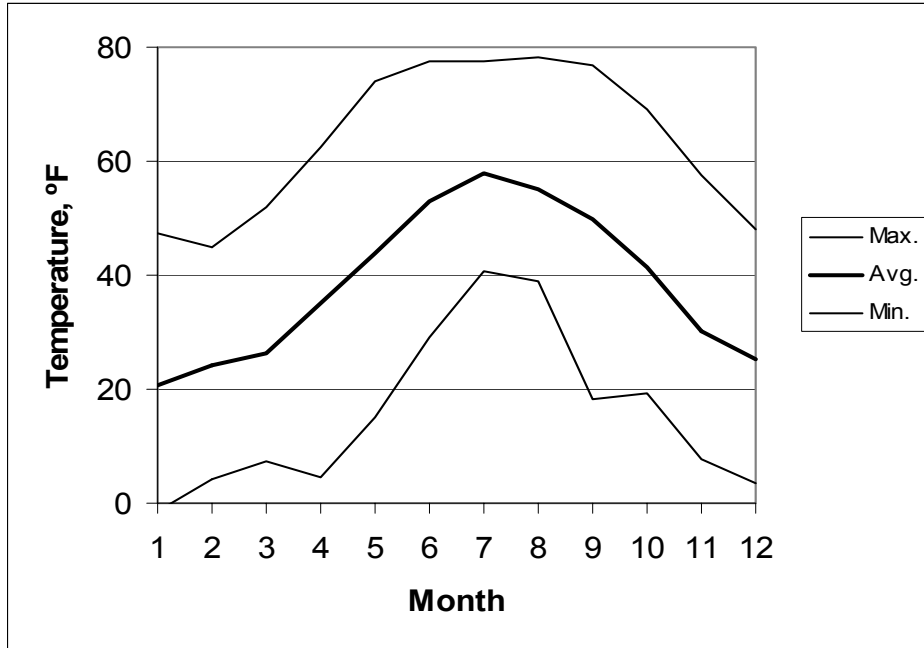

Figure 2.1. Monthly temperatures at the home site

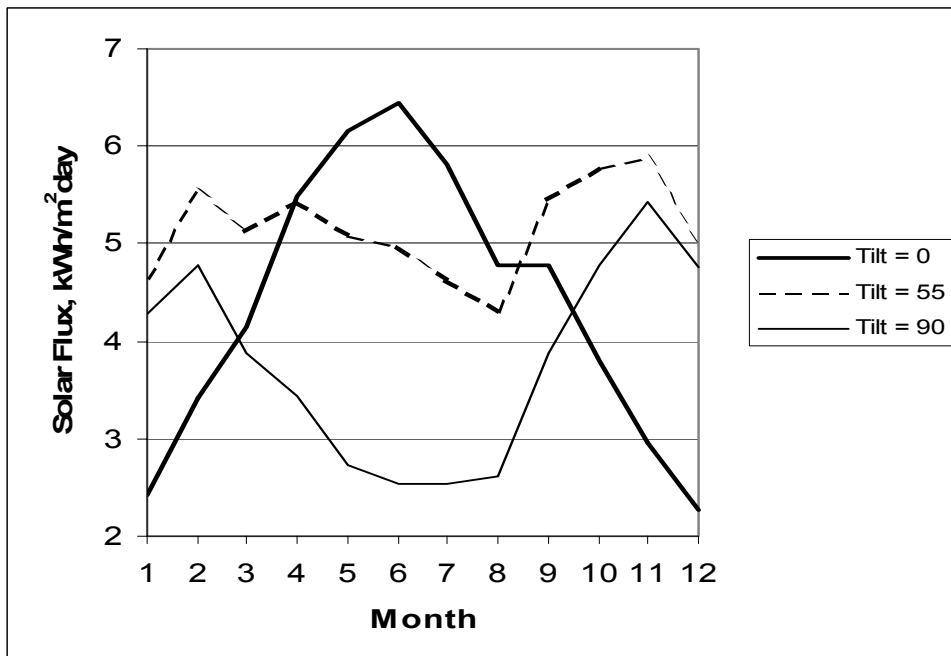

Figure 2.2. Monthly average solar radiation at the home site

The profile for Tilt = 90° in Figure 2.2 pertains to the south-facing glazing of the passive solar heating system. This radiation is well timed to provide heat in the winter without overheating in the summer. The profile for Tilt = 55° (latitude +15°), which is more uniform throughout the year, pertains to both the solar hot-water collector and the photovoltaic array. Annual averages are as follows:

- Horizontal: 4.37 kWh/m²·day
- Vertical: 3.80 kWh/m²·day
- Tilted 55°: 5.15 kWh/m²·day.

2.3 Preliminary Design

The design process began in June 1995. Initial, fundamental considerations included these features:

- Desired floor plan
- Comfort
- A remote site with no utility connections
- Economy: Minimize energy costs (thermal and electrical)
- Environmental impact
- Low operation and maintenance requirements desired
- Garage to be kept above freezing.

Because of the off-grid situation, a very energy-efficient design—in which conservation measures were coupled with solar technologies such as passive solar space heating, solar water heating, and a PV system—was indicated as the likely least-cost solution. The initial envelope design proceeded based on rules-of-thumb for low-energy building design, such as the following:

- Simple, compact envelope design (low surface-to-volume ratio)
- Long east-west axis
- Most of the glazing area on the southern side
- Significant thermal mass within the thermal envelope
- Ample exterior insulation
- Low-emissivity glazings.

The basic plan of the two-story building includes a great room with a cathedral ceiling, kitchen, dining room, family room, four bedrooms, three baths, a third floor loft, and a two-car garage. (Photos and architectural drawings are shown in Chapter 3.) The energy design minimizes space-conditioning loads by using a good thermal envelope and passive solar design, including thermal storage. Windows dominate the southern façade for solar gains and daylighting. Behind some of the south-facing windows are opaque, masonry, thermal storage walls, known as Trombe walls⁴. These serve to store solar heat and delay its delivery into the home for

⁴ For further information on Trombe walls, see http://www.nrel.gov/buildings/highperformance/trombe_walls.html.

approximately 6 hours, making it available past the time when the sun has set.

The Trombe wall sections are positioned near the corners of the walls, so they do not diminish the scenic views and open feeling of the home. They are also inconspicuous from the outside, as they resemble adjacent windows. High-mass exterior walls and some high-mass interior walls serve to store solar gains in the winter and stabilize indoor temperatures in the summer. The exterior walls are constructed of dry-stack concrete blocks with 5-in. expanded polystyrene insulation attached to the outside surface. It is important that the insulation be installed on the *outside* surface of the concrete walls, in order for the thermal mass to be effective in moderating indoor temperatures. A concrete slab floor with perimeter insulation was also planned as a heat storage component.

After laying out the envelope, the internal heat loads were minimized by specifying energy-efficient lighting and appliances. This, along with the cool climate, allows for the use of natural ventilation as the primary cooling system. Solar collectors heat water for domestic use. Electricity is supplied by a PV/wind/battery hybrid system. LPG is used for cooking, clothes drying, backup space heating, backup water heating, and backup electrical generation.

2.4 Basic Design Parameters

Two basic design parameters are crucial to the performance of any passive solar building:

- The solar-load ratio (SLR)
- The building time constant (BTC).

Many other design details also affect performance, and those are best studied using computer simulation analysis as discussed in Section 2.5. However, if the SLR and BTC are not in the proper ranges, good performance is not possible. Thus, it is important to check these parameters during this early design stage. Table 2.1 shows the building envelope analysis necessary for these calculations.⁵

The SLR compares the annual solar radiation incident on the south fenestration to the annual heating load. In this case, the annual average radiation incident on the southern façade is 3.80 kWh/m²-day (Section 2.2), and the total south aperture area (including windows and Trombe wall sections, excluding the garage) is 424 ft². Thus, the average incident solar amounts to 186 MMBtu/year. The building loss coefficient (BLC) is estimated as 624 Btu/°F·hr (Table 2.1). With 9,623 °F·days per year (Section 2.2), the annual average heating load is 144 MMBtu/yr. Comparing these two numbers, the SLR is $186/144 = 1.29$. That is, the incident solar is about 29% more than the annual heating load. Of course, some of the incident solar radiation is reflected or absorbed by the glass or vented when it is not needed. Computer simulations are needed to analyze these details. However, if the SLR were much less than one, the solar gains could not possibly meet the bulk of the heating load, regardless of other passive design details. If the SLR were, for example, 1.5 or more, significant overheating would likely occur unless shades or other devices were used to control solar gains.

⁵ This analysis is in addition to the room-by-room heat-load analysis that is routinely used for sizing radiant floor and baseboard equipment. Details of this procedure are described in Manual J (ACCA 2002). Local building inspectors vary in how strictly they enforce such standards in passive solar homes.

Table 2.1. Calculation of Building Loss Coefficient, Heat Capacity (HC), and Time Constant

Component	Area ft ²	R-Factor ft ² ·°F·hr/Btu	UA Btu/°F·hr	HC/Area Btu/°F·ft ²	HC Btu/°F
North windows	73.2	3.28	22.3	0.00	0
North walls	875.6	20.00	43.8	12.59	11024
East windows	17.3	3.28	5.3	0.00	0
East door, outside	20.0	4.00	5.0	0.00	0
East door, buffered ^a	20.0	5.00	2.0	0.00	0
East walls, outside	289.8	20.00	14.5	12.59	3649
East frame, buffered ^a	54.0	11.00	2.5	0.00	0
East block, buffered ^a	130.0	11.00	5.9	12.59	1637
South windows	327.5	3.28	99.9	0.00	0
South Trombe	96.0	3.28	29.3	19.95	1915
South walls	549.3	20.00	27.5	12.59	6916
West windows	75.4	3.28	23.0	0.00	0
West doors	34.0	5.00	6.8	0.00	0
West walls	652.8	20.00	32.6	12.59	8219
Framed wall sections	428.0	20.00	21.4	0.00	0
Roof, main area	1169.0	37.00	31.6	0.00	0
Roof, over BRs	622.0	37.00	16.8	0.00	0
Floor under BRs*	622.0	25.00	12.4	0.00	0
Slab	(P ^b = 129.3)	(F ^c = 0.666)	86.1	N/A	N/A
Infiltration	(V ^d = 31,600)	(0.34 ACH)	135.4	N/A	N/A
Interior block walls	222.0	N/A	0.0	19.95	4429
TOTALS:			624.1		37788
Time Constant, hr:	60.6				
Solar/Load:	1.29				

^a UA (conductance-area product) is reduced by half because garage is a tempered space

^b Perimeter of slab (ft)

^c Heat-loss coefficient from ASHRAE 1997, Chapter 27, equation 6

^d Volume of air (ft³)

The BTC compares the amount of thermal storage, or heat capacity, to the load. In this home, the thermal mass⁶ is estimated as about 38 kBtu/°F (Table 2.1). All of this heat capacity is enclosed within the thermal envelope (the insulation), which enables it to be effective in stabilizing indoor temperatures. Mass that is outside the insulation does not have the same effect. When this heat capacity is divided by the BLC of 624 Btu/°F·hr, the quotient, or the BTC, is about 61 hours or 2.5 days. The effect of the thermal mass also depends on where it is located in the house, the thermal conductivity of the material, the interior surface area, blockage by home furnishings, etc. Again, computer simulations are needed to analyze these effects in detail. However, the BTC does provide a simple indication of the amount of thermal storage. Because this house has a time constant of several days, it is capable of storing heat from one day to the next, an important aspect of why this house works well. A much smaller time constant, such as 0.5 days, would indicate that the building is not capable of storing much energy from one day to the next, regardless of other design details. Figure 2.3 illustrates the effect of time constant.

This analysis illustrates how energy conservation, timely solar gains, and thermal mass work together to determine how well the house will perform. It is recommended that these two simple design indicators—the SLR and the BTC—be reviewed early in the design process to increase the likelihood of a successful design.

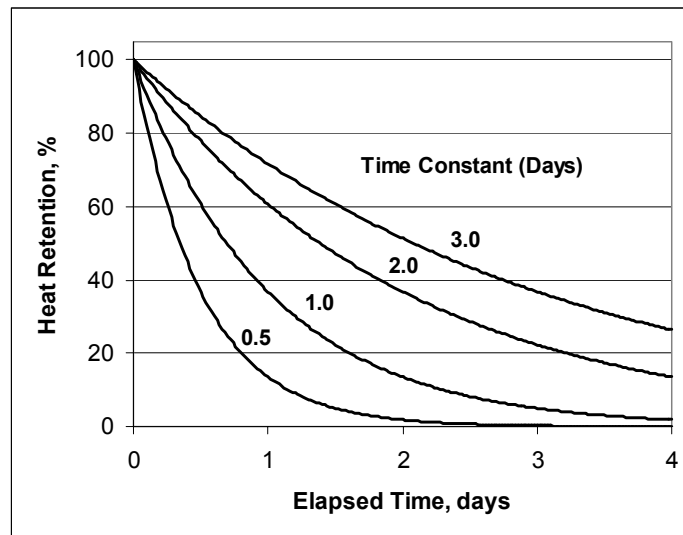

Figure 2.3. Illustration of the effect of building time constant

⁶ This thermal mass does not include the concrete slab, for reasons discussed in the Section 4.2/Slab Floor. It consists of the exterior and some interior walls, which are described in Section 3.2.

2.5 Pre-Construction Modeling

For the next step in the design process, a computer simulation model was used to fine-tune the design. SERI-RES is a time-series, thermal network computer simulation model that is intended for analyzing energy performance of residences that incorporate passive solar design features. This model was written under the guidance of the Solar Energy Research Institute (SERI, now NREL). The name SERI-RES stands for SERI's Residential Energy Simulator. The program can analyze complex thermal systems, including Trombe walls, energy-efficient windows, and other technologies for heating and cooling a home. The mathematical solution technique incorporated into the computer code uses forward finite differences with time steps of 1 hour or less. SERI-RES has been well tested through experimentation and practical use and is one of the benchmark programs for the International Energy Agency (IEA undated reference) testing procedure, BESTEST (Judkoff and Neymark 1995).

SUNREL (Deru et al. 2002a) is a newer, upgraded version of SERI-RES that has also been tested satisfactorily using the BESTEST procedure. This model became available and was used during the later stages of the Van Geet project (Chapter 4). Upgraded features in SUNREL include

- more flexible input structure
- a more sophisticated model for advanced window systems
- algorithms to handle shading by overhangs and side fins of finite length
- a comprehensive routine for infiltration and natural ventilation, driven by temperature and wind effects.

In the spring of 1996, the preliminary design described in Section 2.3 was fine-tuned through a parametric analysis of its features, using the SERI-RES computer simulation model described above. TMY weather data for nearby Boulder, Colorado, were adjusted for the site elevation of 9,300 ft for this purpose, as described in Section 2.2. Thus, the house was optimized for the climate in which it is located.

Because this house does not have a mechanical cooling system, indoor temperatures during the late summer and early fall months may occasionally get too high. This is because the sun is lower in the sky than in mid-summer, increasing the solar gains through the south-facing windows, while it is still rather warm outside. Venting by opening windows is usually adequate to relieve such overheating. Because SERI-RES does not include a suitable natural ventilation model, the venting was modeled as a whole-house fan with a capacity of 1000 CFM and a setpoint of 65°F. Thus, in lieu of indicating of the degree of overheating, the model indicates the quantity of heat that needs to be removed to keep the house comfortable. This provides a rough indication of possible overheating problems.

The sensitivity of energy performance to various building design features is shown in Figure 2.4 and Table 2.2. The purpose of this parametric study is to identify the features that have the greatest impacts on energy performance. The solid, lower portion of each bar in the graph indicates auxiliary heating energy that is required annually. The textured, upper portion of each bar indicates excess energy that must be vented to prevent overheating, as described in the previous paragraph. The first bar, labeled “Suggested,” represents the suggested design resulting from this parametric study. Other bars in the graph represent hypothetical variations on that design. Each of these hypothetical cases is based on an extreme value of a parameter that may

not be physically realistic; this serves to indicate an upper limit on the effect of varying that parameter.

These results are interpreted as follows:

- **Suggested.** This result represents the suggested building design, based on the results of this parametric study. See Chapter 3 for a description of the house as actually built, which is somewhat different.
- **SHGC = 0.00, 0.43, and 0.86.** The solar heat gain coefficient (SHGC) is defined as the fraction of the solar energy incident on a window that enters the building. This gain includes sunlight that is transmitted through the glass, as well as the portion of the energy absorbed by the glass that enters the building by convection and radiation from the inside surface. Here, the SHGC was set to three successive values. SHGC = 0 represents windows that do not let any solar energy through the glass. SHGC = 0.86 represents a single pane of clear glass (a practical upper limit on solar transmission). SHGC = 0.43 is halfway between the two bounding values. Energy performance is very sensitive to this parameter, in terms of both heating and cooling. See additional comments after the next paragraph.
- **WinR99.** The window R-Value is set to R-99, or $U \approx 0$, virtually eliminating heat loss through the windows. This high value reduces the auxiliary heating load to zero, while greatly increasing the venting, emphasizing the importance of this parameter.

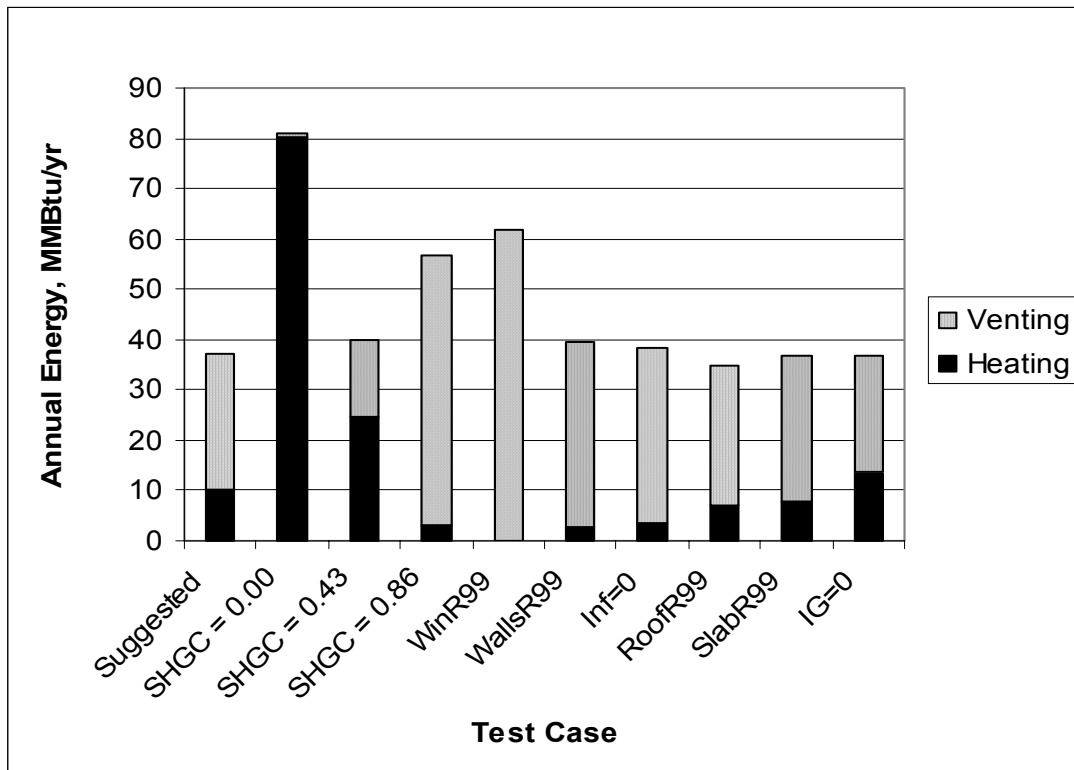

Figure 2.4. Parametric study of house design features, based on SERI-RES simulations

Table 2.2. Parametric study of house design features, based on SERI-RES simulations (see Figure 2.4)

Case	Annual Heating Energy (MMBtu/yr)	Annual Cooling (Venting) (MMBtu/yr)
Suggested	10.32	26.81
SHGC = 0.00	80.20	0.64
SHGC = 0.43	24.82	14.96
SHGC = 0.86	3.12	53.64
Windows R99	0.00	61.95
Walls R99	2.68	36.68
Infiltration = 0	3.67	34.82
Roof R99	7.09	27.91
Slab R99	8.00	28.79
Internal Gains = 0	13.62	23.01

Based on the results for SHGC and WinR99 (above), a great deal of emphasis was placed on the windows. The south-facing window area and the amount of thermal mass were both increased (to the levels cited in Section 2.4). South-facing glazing was selected to maximize the solar gain, while minimizing heat loss—a low-e coating on surface 3⁷ and a high SHGC (0.65).⁸ The south-facing glazing was sized such that no backup heat would be required on a sunny day and one following cloudy day. Windows on the north, east, and west façades were located and sized to provide adequate natural ventilation, daylighting, and desired view without causing unnecessary heat loss in the winter or overheating in the summer. The simulations showed that these windows should have a low-e coating and a lower SHGC (0.40). Table 3.1 shows further details of window specifications throughout the house.

- **WallsR99.** The wall insulation R-Value is set to R99, virtually eliminating heat loss through the walls. The auxiliary heating load is rather sensitive to the wall insulation R-value. A value of R-20 was selected, based on diminishing returns as more insulation is added.
- **Inf=0.** The natural infiltration rate of outside air into the house is set to zero, representing a building that is airtight. A rate of 0.25 air changes per hour (ACH) was assumed in the “Suggested” case, although it is hard to predict this rate very accurately prior to construction. The parametric study shows that making the building tighter would be effective in reducing

⁷ Surface 3 is the outside surface of the inside pane of glass of a double-pane window. The low-e coating is applied to this surface for windows installed in primarily heating climates.

⁸ This SHGC was selected as the highest available value for a commercially available window having a low U-value.

the auxiliary energy consumption. However, a ventilation rate of 0.35 ACH is recommended to maintain good indoor air quality (ASHRAE 1999). Thus, efforts were made to construct a very tight house while providing for controllable ventilation through the use of operable windows. A blower-door test on the completed building is described in Section 3.3.

- **RoofR99.** The roof insulation R-Value is set to R-99, virtually eliminating heat loss through the roof. This slightly decreases auxiliary heating. However, the design for the roof already includes 12-in., R-36 batt insulation. It would be difficult to increase the amount of insulation.
- **SlabR99.** R-99 insulation is added underneath the 4-in. concrete slab floor, in addition to the 2-in. slab-edge insulation that is already included in the design. This only slightly reduces the auxiliary heating. Thus, slab insulation was not installed.

In this pre-construction simulation study, we looked at the effect of slab insulation on the heating load. However, we did not analyze the possible discomfort of an uninsulated slab, which did in fact become a problem (Section 4.2/Passive Solar Heating/Slab Floor). Heat loss to the ground is the subject of very complex analysis, because of factors such as three-dimensional geometry, energy transport by water vapor movement, varying amounts of water in the soil, different types of soil, and the depth of the water table. None of the public-domain computer simulation models, including SERI-RES and SUNREL, handles this phenomenon adequately. See Deru and Kirkpatrick (2002b and 2002c) for a treatment of this topic.

- **IG=0.** Internal heat gains from occupants and appliances were set to zero. This variation slightly increases the auxiliary heating and decreases the overheating. High-efficiency lighting and refrigeration were already included in the design, for the sake of electrical energy efficiency. No further measures are indicated by this result.

The resulting passive solar design includes 328 ft² of direct-gain window area (10% of the floor area) and 96 ft² of Trombe wall area (3% of the floor area) in the conditioned space. In the garage, the direct-gain area is 24 ft² (4% of the floor area) and the Trombe wall area is 48 ft² (8% of the floor area). Architectural drawings were prepared (Chapter 3), and construction began.

SERI-RES was used again to predict the energy savings resulting from the final house design and to compare the "Suggested" design resulting from the parametric study to a reference case. For this comparison, a base-case building having the same floor area and usage characteristics and which complies with the Model Energy Code (MEC 1995) was simulated. The reference case is a solar neutral building, meaning the window area is 18% of the conditioned floor area and is distributed equally on all four walls.

Some characteristics of the two buildings are given in Table 2.3. The R-values in this table are net values for the construction element. The value for floor represents the insulated perimeter of the slab on grade, with no insulation under the slab. Table 2.4 and Figure 2.5 show the results of these simulations. The overall building energy savings for heating is estimated as 93%. The need to vent excess heat is increased, although the model is not able to evaluate the effectiveness of natural ventilation in avoiding overheating.

Table 2.3. Comparison of Building Features

Case	<u>R value (ft²·°F·hr/Btu)</u>				<u>SHGC</u>
	Walls	Roof	Floor	Windows	Windows
Base Case	7.99	35.7	7.1	1.85	0.77
Suggested Design	17.93	39.5	15.45	4.17	0.69

Table 2.4. Phase-2 Energy Performance Predictions

Case	Heating (MMBtu/yr)	Venting (MMBtu/yr)
Base Case	156.72	11.97
Suggested Design	10.32	26.81

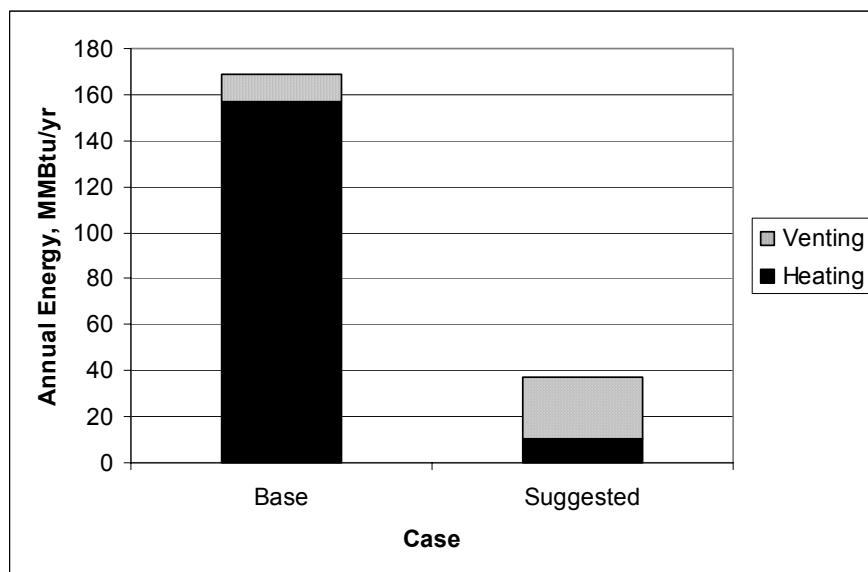

Figure 2.5. Annual energy comparison

3. The House As Built

Construction of the home began in the spring of 1996. Numerous volunteers and subcontractors performed the work under the supervision of Otto Van Geet. The Van Geet family—two adults, two children, a cat and two dogs—occupied the house in October 1998. Details of the house design are described in this chapter.

3.1 Architectural Features

A view of the home from the southwest corner is shown in the frontispiece of this report. Figure 3.1 shows a view from the southeast, in which the attached garage and the bedrooms above it are visible. Trombe wall sections can be discerned in the garage's central section of south-facing windows and the lower half of the two adjacent window sections. Views looking out through windows from the interior of the house in Figure 3.2, from the great room, and Figure 3.3, from the loft, give a sense of the open feeling of the house and the scenery outside. In Figure 3.2, the wall section immediately to the right of the lower row of windows and beneath the arched window above is one of the Trombe wall sections (compare view in the frontispiece).



Figure 3.1. Southeastern view of the Van Geet home (NREL/PIX 08224)



Figure 3.2. View looking out from the great room on the main floor (NREL/PIX 08321)



Figure 3.3. View looking out from the loft

Figures 3.4, 3.5, and 3.6 show architectural drawings of the four-bedroom, three-bath home as it was built. The conditioned space floor area is 3,176 ft², including the third-floor loft. The garage is an additional 589 ft², for a total area of 3,765 ft². The first floor features a family room, two bedrooms, bath, laundry room, mechanical room, and the two-car garage. The second floor consists of a great room with cathedral ceiling, kitchen, dining room, master bedroom suite, fourth bedroom, and bath. This floor is the main living space of the family. It is mostly daylit and heated by direct gain solar power. The wood-burning stove is located between the great room and the kitchen. Figure 3.6 shows the third floor is a loft.



Figure 3.4. The first floor plan of the Van Geet home, as built



Figure 3.5. The second floor plan of the Van Geet home, as built

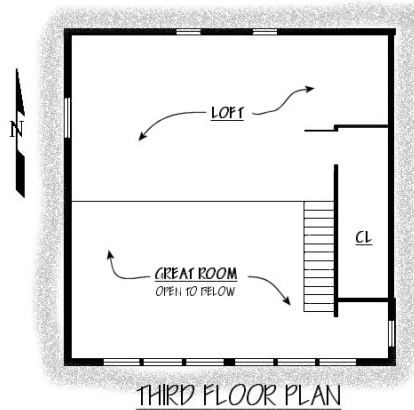

Figure 3.6. The loft of the Van Geet home, as built

3.2 Construction Details

Exterior Walls

The exterior walls of the house consist of dry-stack 8-in. concrete masonry units (CMU). Every third cell is reinforced with steel and filled with concrete. In the Trombe wall sections, all the cells are filled with concrete. The Trombe wall sections also feature a selective surface facing the glass (Section 4.2). The exterior of the block is finished with 5 in. of expanded polystyrene and covered with a synthetic stucco finish, known as an Exterior Insulated Finishing System (EIFS). The inside of the house is finished with plaster. The thermal resistance of this assembly is estimated as R-20, based primarily on the continuous layer of polystyrene insulation with no thermal bridges.

Below Grade

The outside of the 3-ft-deep stem wall is insulated with 2 in. of extruded polystyrene, for a thermal resistance of R-10. This insulation method has the effect of insulating the edges of the 4-in.-thick slab-on-grade floor. There is no insulation under the slab. (See discussion of this feature in Section 2.5/SlabR99 and Section 4.2/Passive Solar Heating/Slab Floor.)

Roof

Above the great room and loft, the roof has a 6/12 pitch and is insulated with R-38 fiberglass batts in 14-in. engineered wooden I-beam rafters spaced 24 in. apart. The thermal resistance of this assembly is estimated as R-37. In the roof above the bedrooms, with a 4/12 pitch, fiberglass insulation was blown into the prefabricated trusses, for an estimated net thermal resistance of R-40. Both roof sections use standing-seam metal roofing.

Windows

Windows feature Cardinal[®] double-pane, low-emissivity glazings in wooden frames with exterior aluminum cladding. On the southern façade, model LoE-178 is used; the low-emissivity coating is on the outside surface of the inside glazing (surface 3). Placing the low-e coating on surface 3 provides a high SHGC. Table 3.1 lists additional window specifications. The reasons for selecting glazings with these various properties are discussed in Section 2.5/WinR99.

3.3 Infiltration and Ventilation

The design strategy includes the following approaches to provide adequate indoor air quality without imposing an undue heating load by overventilating.

Construct a Tight Building

Blower-door testing was conducted in January 1999. The measurements indicate 2,008 cfm of air leakage under a building pressurization of 50 Pascals (CFM50) and an equivalent leakage area (ELA) of 112 in.² This ELA corresponds to an annual average natural infiltration rate of about 0.34 ACH, based on ANSI/ASHRAE Standard 136 (ASHRAE, 1993).⁹

Minimize Indoor Air Contaminants

LPG water heaters are used for the hydronic backup space-heating system and for backup domestic water heating. Both are sealed-combustion units. The sealed combustion helps to prevent the contamination of indoor air by combustion products. (It also prevents room air from being used as combustion gas, increasing the overall efficiency.) In the cooking area, a hood exhausts fumes to the outdoors. The clothes dryer also vents to the outside. A central vacuum system with a single collection bag in the mechanical room provides filtering and minimizes reintroduction of dust into the home.

Provide Natural Ventilation

The house is ventilated and cooled through natural ventilation when windows are opened. Windows are placed so as to provide cross-ventilation and to mix and circulate the air in the house (see discussion in Section 4.2/Natural Cooling).

⁹ This calculation is based on a floor area of 3,676 ft², corresponding to a complete third floor, and a weather factor 1.17, based on comparison to cities with similar ambient temperatures and wind exposures.

Table 3.1. Glazing Specifications

Zone	Façade	Type	<u>U</u> (BTU/ft²/Hr/°F)	SHGC	<u>Glass Area</u> (ft²)
Main	North	Low-e	0.30	0.40	32.9
Main	West	Low-e	0.31	0.40	65.2
Main	West	Low-e	0.30	0.40	5.1
Main	East	Low-e	0.30	0.40	2.7
Main	South	Low-e	0.31	0.65	193.5
Downstairs	North	Low-e	0.30	0.40	23.7
Downstairs	West	Low-e	0.30	0.40	5.1
Downstairs	South	Low-e	0.31	0.65	92.1
Upstairs bedroom	South	Low-e	0.31	0.65	41.9
Upstairs bedroom	East	Low-e	0.30	0.40	14.6
Upstairs bedroom	North	Low-e	0.30	0.40	16.6
Garage	South	Double	0.50	0.77	24.0
Garage	North	Low-e	0.31	0.65	11.1
Trombe Walls					
Garage	South	Double	0.50	0.77	48.0
Downstairs	South	Double	0.50	0.77	48.0
Main	South	Double	0.50	0.77	48.0

4. The Space Heating and Cooling System

4.1 Overview

Figure 4.1 illustrates the basic components of the home's thermal energy system.

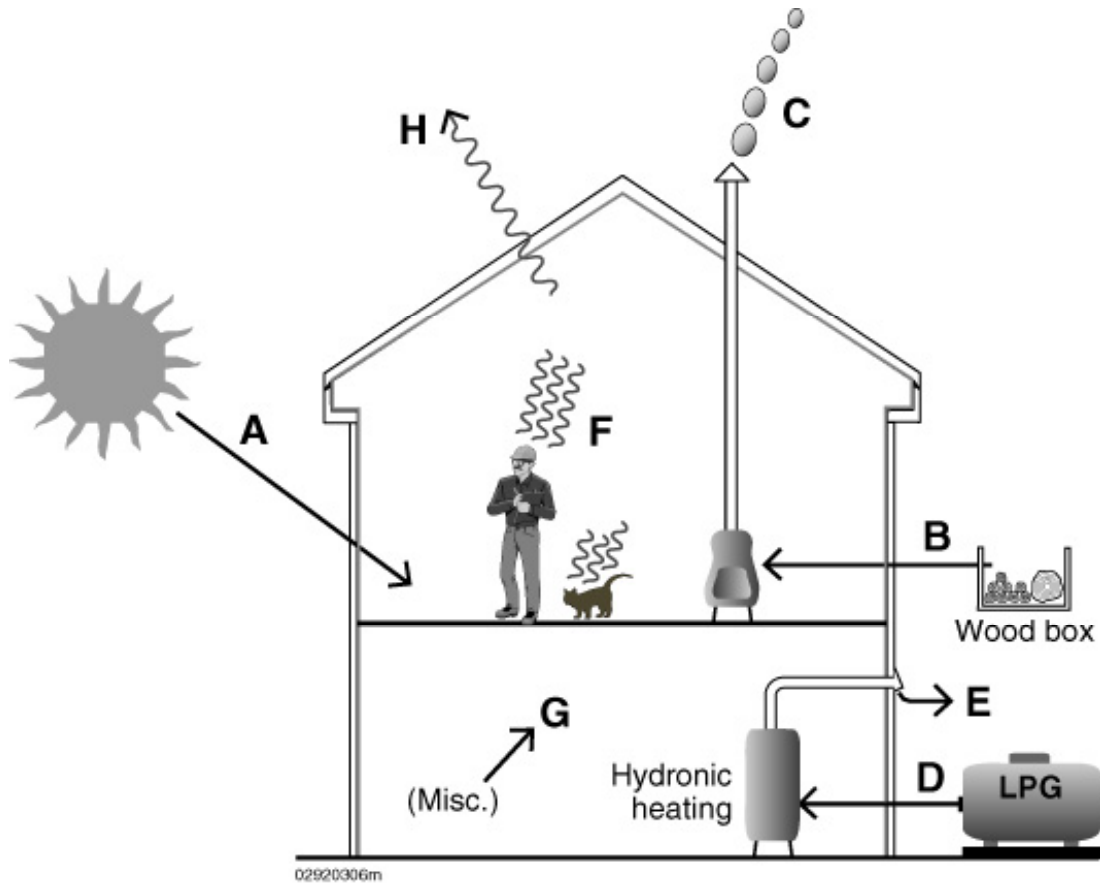

Figure 4.1. Pictorial diagram of thermal energy flows in and out of the house

The energy fluxes shown in this diagram are as follows:

- A Sunlight enters the house through various glazings, the most significant of which are on the southern façade. This passive solar design provides most of the heat for the home.
- B Wood gathered at the home site is burned in a wood stove for auxiliary heat when the occupants are so inclined.
- C Some of the wood heat escapes through the smokestack.
- D As a backup heating system, LPG is used to heat water that is circulated through baseboard heaters and radiant floors, when called for by any of six thermostats.
- E Some of the LPG heat escapes through the flue.
- F People and pets generate heat within the house.
- G Other sources of heat within the house include lights, electrical appliances, the LPG cook stove, and the LPG clothes dryer.
- H Heat is lost from the house by conduction through the envelope, infiltration, and intentional ventilation to exhaust odors or cool the home.

Some of these quantities are difficult to measure. For example, the amount of wood used has been estimated by the owner as 1/2 face cord (24 ft³) per year. However, the moisture content and the associated energy content per cubic foot of wood are unknown, as are the efficiencies of the wood stove and its long smokestack.

A primary concern from both environmental and economic perspectives is the amount of LPG that is used. However, the portion of the auxiliary heat that comes from wood versus LPG is at the discretion of the occupants and may be considered arbitrary. The LPG usage also depends on miscellaneous internal heat sources (item G, above), some of which are unknown.

Another factor in the performance evaluation is the Van Geets' lifestyle. As energy conservation enthusiasts, this family is happy to use energy-efficient appliances and to wear sweaters around the house with lowered thermostat settings. This affects the performance of the house, which would be somewhat different with a more conventional family living in it.

For these reasons, a combination of monitoring and modeling is used for the best possible performance evaluation in Section 4.3. First, the thermal features of the building are described in more detail.

4.2 Description of Thermal Energy Features

The thermal design of the house, resulting from the process described in Chapter 2, includes these items:

- A simple, compact envelope design with a low surface-to-volume ratio
- Thermal mass and insulation in the exterior walls

- U-factors and SHGC's in the windows
- Direct gain passive solar (10% of floor area)
- Trombe wall (3% of floor area)
- Natural cooling
- Wood stove
- Hydronic (hot water) backup heating system (LPG)
- LPG range and clothes dryer.

These features are described in more detail below.

Thermal Envelope Design

Section 2.3 describes the initial design of the thermal envelope. Section 2.5 presents the parametric computer simulation analysis that was used to fine-tune the design. Section 3.1 shows as-built floor plans and some photographs of the home. Section 3.2 provides insulation and window specifications.

Passive Solar Heating

The passive solar heating design for this house was based on rules of thumb, as described in Section 2.3; basic design parameters are described in Section 2.4; and the computer simulation analysis is described in Section 2.5. The final as-built design includes the following features.

Direct Gain

The term "direct gain" refers to the method of passive solar heating in which sunlight enters the living space directly, through windows. Much of this energy heats the home immediately; therefore, it is important that the solar gains occur at the same time heat is needed. For this purpose, south-facing windows are most in synch with seasonal heating needs. The solar gains also heat the thermal mass, which is important for providing heat later when the sun is not shining. The amount of energy that goes into the thermal mass depends on where the mass is located in the house.

In the Van Geet house, the total window area (excluding the Trombe wall) on the south side of the house (excluding the garage) is 328 ft², which is 10% of the floor area (including the third floor loft). The non-south window area in the house totals 166 ft², or 5% of the floor area. Table 3.1 shows more detailed window specifications.

Trombe Wall

The Trombe Wall sections in the house described in Sections 2.3 and 3.2 amount to 96 ft² (3% of the floor area). This feature helps to balance the direct solar gain by providing delayed heating. A black selective coating on the masonry surface absorbs the sun's heat. The insulated clear glazing and the air space between the glazing and the masonry surface minimize heat loss. The selective surface is Solar-L-Foil, a product of MTI Solar, Inc. It consists of a copper foil with a shiny nickel outer-surface overcoat and a thin layer of black chrome oxide. The coating has a solar absorbance greater than 0.95 and a long-infrared emittance less than 0.11. The foil was

attached to the masonry with the adhesive coating on the foil as well as a commercial spray-on adhesive, using a hard rubber roller. The 8-in.-thick concrete block wall, with filled cores, stores heat for release into the building later in the day (approximately 6 hours later). The warm inside wall surface provides radiant comfort to the occupants of the home. Even though the Trombe walls receive some heat during the summer, it is easily dissipated because of the natural ventilation of the house and mild summer temperatures.

Masonry Walls

A very significant amount of thermal mass, or heat capacity, is provided by the concrete block exterior walls described in Section 3.2. The total area of these walls is about 2,815 ft² (including 222 ft² of interior masonry walls), and the heat capacity is about 38,000 Btu/°F, as calculated in Table 2.1.

Slab Floor

A 4-in.-thick concrete slab constitutes the floor on the lower level of the house. It was intended that this thermal mass would store heat from sunlight entering through the south glazing and impinging on the slab. However, as discussed in Section 2.5/SlabR99 and Section 3.2/Below Grade, no insulation was installed underneath the slab. In fact, the house occupants have covered a portion of the slab with a carpet to mitigate the discomfort of the cold floor. Evidently, heat losses from the slab to the ground are rendering the slab useless as a heat storage component. Fortunately, this house performs very well in spite of this feature, because of the ample thermal mass in the exterior concrete block walls with exterior insulation. *As a lesson learned for future projects, slab floors intended as heat storage components should be insulated underneath the entire slab.* Full insulation is also recommended under heated slabs.

Overhangs

It was determined that overhangs are not needed in this particular case (see the following discussion under the heading of “Natural Cooling”). Overhangs provide a mechanism to block high summer sun. They are critical for passive solar designs in climates that have cooling loads.

Natural Cooling

A mechanical cooling system is not needed in the Van Geet home because of these factors:

Cool Climate

As described in Section 2.2 and shown in Figure 2.1, there are 0 cooling degree-days, the monthly average temperature never exceeds 60°F, and the maximum temperature recorded during a 1-year period was less than 80°F.

Ample Thermal Mass

See "Masonry Walls" in the previous section and Section 2.4. The house cools off overnight, and the thermal mass helps to keep the house cool during the warm or hot days.

Reduced Internal Gains

High-efficiency lighting and refrigeration, as described in Chapter 6, help to reduce the amount of heat generated within the house.

Thus, natural ventilation (in the form of operable windows) was designed into the open floor plan as the primary cooling system. The windows were sized and located for cross-flows and stack effect¹⁰ to provide ample natural ventilation. As shown in Table 3.1, windows with a low SHGC were used on the east and west walls to minimize solar gains in the summer. The insulating and temperature-retaining properties of the high-mass walls further control the temperature in the home.

In passive solar design common practice, overhangs are often used to shade the south glazings from the summer sun to avoid overheating. In this case, overhangs are not necessary, because of the combination of the cool weather, ample interior thermal mass, low internal gains, and steep summer sun angles (latitude = 40°, the noontime elevation of the sun in June is about 73°). This conclusion was indicated by the simulations and later confirmed by both the collected data and the experience of the occupants. In this situation, the minimal advantage of overhangs in the summer is outweighed by the unwanted shading that would diminish solar gains in the spring and fall seasons. In a climate with warmer summers, overhangs should be used. Because of this natural cooling design, the cooling load in the home is zero. If this had been a typical house, mechanical air conditioning would have been needed to maintain comfort. This is a significant energy savings.

Wood Stove

A manually stoked wood-burning stove located between the great room and the kitchen also provides heat to the dining room and the third-floor loft (see floor plans in Chapter 3). At the discretion of the occupants, this wood stove may be used as an alternative to the LPG-fired hydronic baseboard and radiant floor heating system (described in next section). This catalytic stove is the Encore model from the Vermont Castings, Majestic Products line. It is rated at 44 kBtu/hr¹¹ and features a thermostat. Combustion air is ducted into the unit from outside the house to avoid the waste of heated indoor air.

Hydronic Backup Heating System

As a backup for the passive solar and wood-stove heating systems, heat can be supplied to the house by a hydronic heating system. LPG heats the water in a standard 40-gallon water heater. When any of six thermostats in the home call for heat, hot water is circulated through radiant floor heaters and convection baseboard heaters. The hot-water circulation pumps are powered by direct current from the PV/hybrid power system described in Chapter 6. The hot-water heater is rated at 40 kBtu/hr, derated by 4% per 1000 ft above 2000 ft to a rate of 28 kBtu/hr at the site altitude. Based on the building loss coefficient of 624 Btu/°F·hr (Table 2.1), this unit can heat the house to 45°F above ambient in steady-state conditions.

¹⁰ "Stack effect" refers to air movement that is driven by the difference between indoor and outdoor temperatures. Warmer air flows out of upper windows, while cooler air enters the house through lower windows.

¹¹ The heating rate is probably reduced as a result of the altitude above sea level, although we do not have any information to quantify this effect.

Radiant floor heating has the advantage of providing a comfortable environment with lower thermostat settings. In a passive solar home, where the need for backup heat is highly variable, it is especially important that the backup heating system can respond quickly to changing loads, as when the sun sets or cloudy weather occurs. Heated concrete slabs are not recommended in this application because of the time needed to heat and cool the concrete. In the Van Geet home, radiant heat is installed on the bottom side of the wooden second floor, which has a faster response time than concrete. However, it still takes about 4 to 6 hours for the wooden radiant floor system to respond to changing loads. A recommended alternative to radiant floor systems in passive solar homes is the use of panel radiators, which respond more quickly and provide some radiant heating effect. In addition, radiant floor systems consume more circulation pump energy than either baseboard or radiant panel hydronic systems, because of the long circulation path through the tubing. This is a disadvantage, especially in off-grid homes.

Cook Stove

LPG fuels the kitchen cook stove. This appliance uses a glow bar oven ignition system that draws 500 W when operating. This is a substantial load on the electrical power system, and an alternative type is recommended for off-grid applications. The spark ignition system used on the stovetop uses an insignificant amount of electricity. The exhaust hood is controlled manually, with a manual damper to reduce air leakage.

Clothes Dryer

The clothes dryer, located in the laundry room on the first floor, is fueled by LPG and vented to the outside. This appliance features a moisture-sensing control.

4.3 Performance Evaluation

Section 4.1 described the combination of monitoring and modeling used to achieve the most accurate and meaningful analysis of energy performance possible. Monitoring is important because it provides real data on actual building performance. On the other hand, modeling is useful for the following reasons:

- Calculating the *total* auxiliary (non-solar) heating energy required, including LPG (which was measured) and firewood (which can only be estimated)
- Evaluating occupant behavior effects separately from building performance
- Evaluating performance for a typical weather year, rather than an arbitrary year
- Comparing the actual building to a standard code reference case.

In this study, measured data were used to calibrate the model, and then the model was used to analyze performance.

Monitoring

A standard procedure for measuring the performance of new homes in the Building America program is Short-Term Energy Monitoring (STEM) testing. STEM is a method developed at NREL to determine key thermal parameters of a building *in situ*, based on a 3-day test sequence (Judkoff et al. 2000). However, this approach was deemed impractical for the Van Geet home.

The STEM test procedure involves the use of electrical heaters to measure the conductance of the building shell independently of the performance of the HVAC system. Because the Van Geet home is off-grid, a sufficient supply of electricity for the test was not available for this purpose. Instead, an automated data acquisition system (DAS) was used to monitor the actual performance of the occupied building over a longer time span.

Two Campbell Scientific, Inc., model CR10X dataloggers were installed to measure performance for an extended time period with the house occupied. The "shed" datalogger was located in the electrical equipment shed under the PV array (Figure 6.4). This unit was mainly dedicated to recording the performance of the electrical system discussed in Chapter 6. The "house" datalogger was located in the mechanical room on the first floor (Figure 3.4) and recorded mostly thermal performance measurements. The two dataloggers were installed on December 24 (house) and 28 (shed), 1999, and operated until September 2, 2001. A number of operational problems caused downtime and periods of lost data. The most complete yearlong sequence of data was collected between April 12, 2000, and April 11, 2001, with only 8 days missing from the house dataset and 7 days missing from the shed data. These gaps were filled with data from preceding and subsequent days for analysis purposes.

Figure 4.2 shows measured building performance for a period of one week in January 2000. For this week, the outdoor temperature was near the long-term monthly average of 20.7°F. Backup heat was used to keep the second floor north bedroom above 65°F each night. During a period of

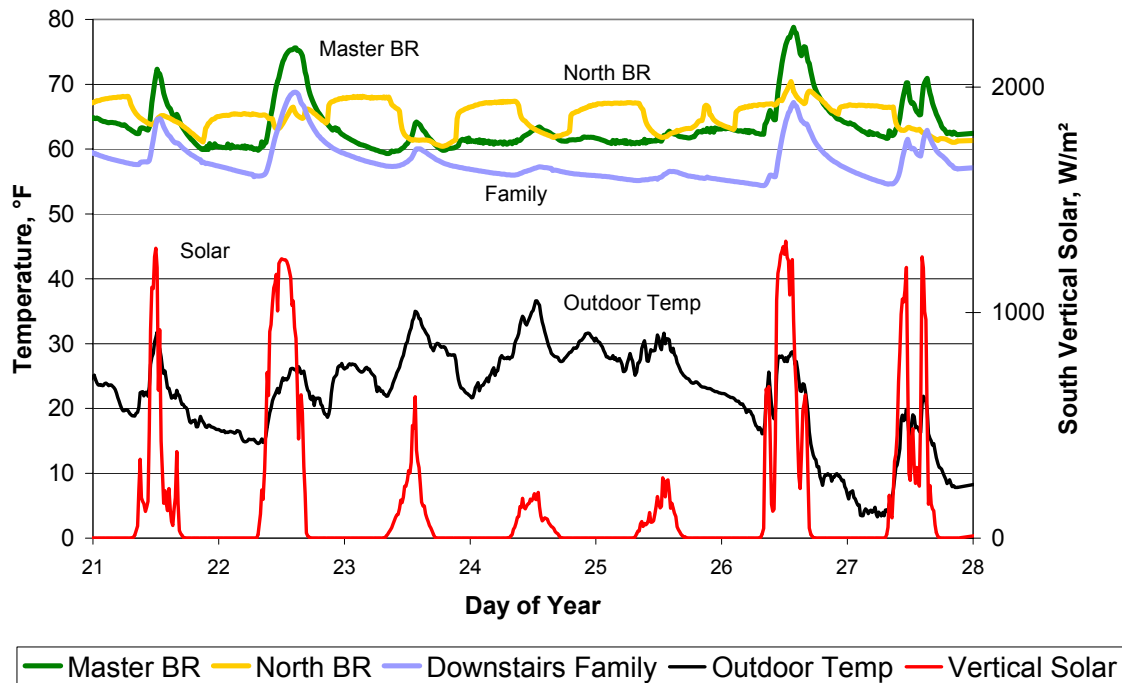

Figure 4.2. Sample of measured performance data for the fourth week of January 2000

3 rather cloudy days, backup heat kept the master bedroom (on the south side) above 60°F, while the less-used family room on the lower level was allowed to cool off to 55°F. These and additional data were used to calibrate the SUNREL model for the modeling analysis presented below.

Modeling

As energy conservation enthusiasts, the Van Geets are happy to use energy efficient appliances and to wear sweaters around the house with lowered the thermostat settings. This affects the performance of the house, which would be somewhat different with a more conventional family living in it. Two separate comparisons are made using the SUNREL model described in Section 2.5 to distinguish the performance of the house from the behavior of the occupants:

1. The Van Geet home is compared to a standard reference case at the time of construction (1995 Model Energy Code [MEC 1995]), assuming the same conventional occupant behavior (thermostat setpoints and internal heat generation) in both homes. This comparison credits the *house* with 77% energy savings for heating and cooling.
2. The actual behavior of the occupants was used in the model to evaluate their energy-conscious lifestyle. The difference between this and the previous case indicates the contribution lifestyle makes to the energy savings. This comparison credits the *occupants* with an additional 12% energy savings, for a total heating and cooling reduction of 89% when compared to the MEC reference case.

Figure 4.3 illustrates these quantities.

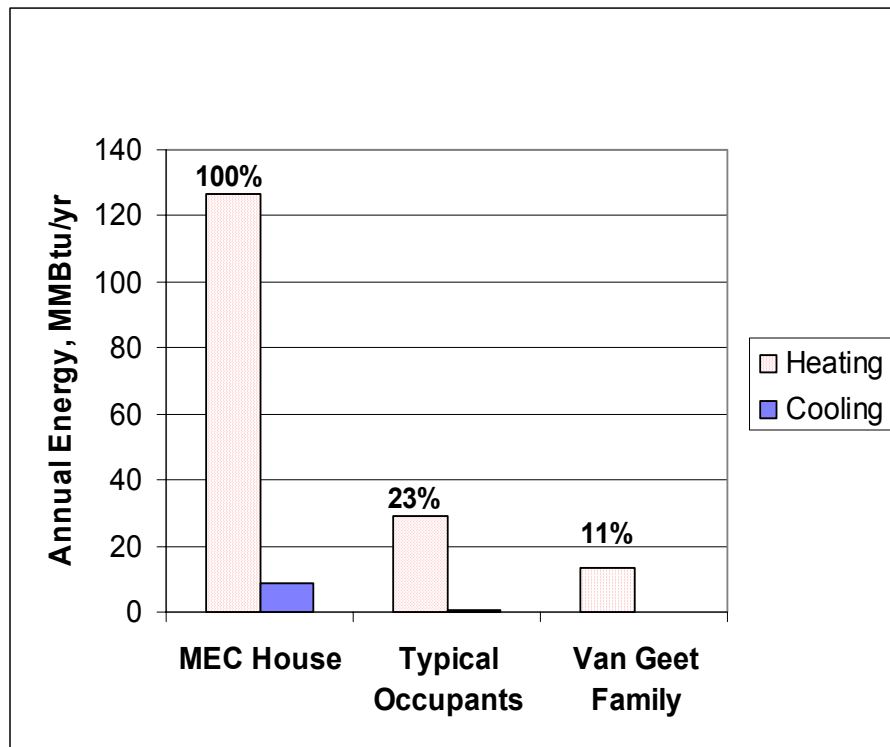

Figure 4.3. Heating and cooling energy savings attributed to house with "typical occupants" and with the Van Geet family's more energy-conservative lifestyle

The heating energy usage (there is no cooling energy usage) in the house, as occupied, amounts to

- 13.4 MMBtu/year
- 1.39 kBtu/°F·day
- 4.22 kBtu/year per ft² of conditioned floor area
- 0.44 Btu/°F·day·ft².

5. The Domestic Hot-Water System

Description

Domestic hot water (DHW) is heated by an active solar system with LPG backup. Four Solaron model CL6083 collectors¹², each 4 ft by 8 ft, constitute a collection area of about 120 ft² (11.1 m² for the calculation below). These collectors were salvaged from another home and are not a currently available product. The collectors are mounted on a freestanding structure just southwest of the house (see frontispiece) for easy maintenance access and solar orientation independent of the building geometry. The array is tilted at an angle of 55° from horizontal (latitude +15°) for optimum exposure in winter, toward a goal of meeting all or most of the hot-water load throughout the year. Pumps powered by a dedicated PV system (visible above the collector array in the frontispiece) circulate a solution of propylene glycol through the collector, underground piping,¹³ and heat exchangers in two 80-gallon water tanks for heat storage. These tanks are Ford Product Corporation model TC 80 20LD, with built-in heat exchangers. The glycol solution circulates in counterflow to the DHW through the two tanks. A standard 40-gallon LPG water heater, with sealed combustion, is plumbed in series with the two solar storage tanks to provide supplemental heat as needed. The unit is rated at 40 kBtu/hr, derated by 4% per 1000 ft above 2000 ft to a rate of 28 kBtu/hr at the site altitude.

Controls

A 25-W dedicated PV system powers the DC pumps directly, creating a self-regulating system with no additional controls. If the solar DHW system were larger (more panels) or mounted at a smaller slope angle, summer overheating would most likely be a problem. As it is, the system reaches a maximum temperature (with the heat losses equal to the solar gains) of about 180°F when there is no draw. The high temperature and pressure relief valve in the system has never been triggered.

Sizing

In order to put the sizing of this solar hot-water system into perspective, we compare the incident solar radiation to the household hot-water load, on an annual basis. The hot-water usage was measured as 14,211 gal/year (38.9 gal/day). This usage is only 58% of the Building America Benchmark (Hendron et al. 2004) typical value of 67.3 gal/day, reflecting the Van Geets' energy-conscious lifestyle and the use of a water-conserving type of dishwasher and shower heads. The temperature of the water entering the home from the 300-ft well is about¹⁴ 50°F. While standing in the 120-gallon steel pressure tank (State Industries model SPMD-119), the well water is warmed by indoor air to about 62°F. Passing through the wastewater heat exchanger (see section entitled “Wastewater Heat Exchanger” below), the water is additionally heated an average of

¹² This collector model does not feature a selective surface. In this application, with the large collector sizing and with the critical performance occurring in winter, a selective surface is deemed unnecessary.

¹³ The piping is ¾-in. copper with 1-in. foam insulation.

¹⁴ The DAS measured the total flow volume and the average pipe temperature during each time step. Because the flow rate was not constant during each time step, these data do not enable a rigorous calculation of the volume-average water temperature.

3.5°F. Thus, the inlet water temperature to the solar water heating system is about 66°F. Based on a typical hot water setpoint temperature of 120°F, the annual hot water load amounts to the following:

$$14,211 \text{ gal/year} \times (120-66)^{\circ}\text{F} \times 8.337 \text{ lb/gal} \times 1 \text{ Btu/lb}\cdot^{\circ}\text{F} \\ = 6.40 \text{ MMBtu/year (17,500 Btu/day)}.$$

Recalling from Section 2.2 that the annual average solar radiation incident on the tilted surface is 5.15 kWh/m²·day, the SLR and system efficiency for the DHW system are calculated as follows:

$$\text{SLR} = (5.15 \text{ kWh/m}^2\cdot\text{day} \times 11.1 \text{ m}^2) / (17,500 \text{ Btu/day}) \times (3,413 \text{ Btu/kWh}) = 11.1$$

$$\text{System efficiency} = 1/11.1 = 9\%.$$

In a more conventional, grid-connected home, with electrical backup water heating, an active solar water heating system would typically be sized at about SLR = 2, operate at about 35% efficiency, and meet about 2/3 of the load. Relative to that reference case, this system is upsized by a factor of 5 to 6 in order to meet nearly 100% of the load (see next paragraph). The diminishing returns that apply to system sizing versus performance are evident in this comparison.

Performance

During the year of data collection, the backup water heater tank losses exceeded the heat added by the fuel, and the water leaving the tank was on average cooler than the water entering. This suggested that the system might perform adequately without the backup water heater and its LPG consumption. With this in mind, the owner has changed the operating strategy by turning off the water heater and bypassing it with valves in the water circulation loop, most of the time in order to avoid tank losses. Now, the solar water heating is so effective that only on rare occasions, during extended cloudy periods in December or January, is the backup water heater used. Performance data on this mode of operation were not collected. However, based on the owner's account, it is evident that the DHW is heated nearly 100% by solar energy, as might be expected with a system of this size in a sunny climate. It should be noted that the Van Geet family is somewhat flexible about when hot water is used, and this helps in avoiding the use of the backup water heater. After the evaluation period, the vertical-axis washing machine was replaced with a horizontal-axis model, which uses significantly less water. This further reduces the hot water load.

Wastewater Heat Exchanger

The domestic hot water system is further enhanced by the use of a gravity film exchange (GFX) heat exchanger (Vaughn model GFX-S3-60) that recovers heat from drain water to preheat the cold-water supply to the water heater. This device can transfer some of the heat in wastewater, as it passes out the drainpipe, into the incoming cold water, when the usage and drainage occur concurrently (as with a shower). However, when the usage and drainage occur at different times (as with a washing machine, dishwasher, or bath), this opportunity is not present. Also, some heat may be transferred from the room air to the incoming cold water as it passes through or rests in the heat exchanger. In the Van Geet home, the average temperature rise of water passing through the heat exchanger is 3.5°F. This is in addition to the 12°F rise undergone by the water

as it stands in the pressure tank (see discussion on previous page in section entitled “Sizing”). Compared to the overall rise of the hot water temperature from 50°F (from the well) to 120°F (to the taps), $3.5/(120-50) \times 100\% = 5\%$ of the energy is added by this device. This amounts to an estimated 415 kBtu/yr.

Interconnection with Hydronic Heating System

The solar DHW system may be linked to the backup hydronic space-heating system by operating valves that were installed for this purpose. The intent of this arrangement was to further reduce LPG usage by using solar-heated water to assist the passive solar heating system. This mode of operation was tested and then discontinued. In the case of a home that is largely heated by passive solar, such as this one, the backup heating is generally needed only during extended cloudy periods. Of course, the solar hot water system is similarly affected by those same weather conditions. Thus, a large capacity (thousands of gallons) of hot-water storage would be needed to carry the building through those times. When the Van Geets' DHW system was dispatched for space heating, the 160-gallon hot-water storage capacity was exhausted quickly. It is more cost-effective to burn a little wood or LPG on these rather rare occasions than to invest in a much larger hot-water storage tank. Also, not using the solar hot water system for space heating enabled the owner to turn off the LPG hot-water heater, which had large standby losses (see Performance, above.)

6. The Electrical Energy System

6.1 Description

Because the Van Geet home is remote from the utility power grid, a stand-alone hybrid power system was installed to meet the electrical loads. Figure 6.1 shows a one-line diagram of this system. Its main components include these elements:

- PV array
- Maximum Power Point Tracker (MPPT) charge controller for the PV array
- Wind turbine generator (WTG), installed later
- Battery bank
- Inverter
- Engine generator (Genset), fueled with LPG or gasoline
- Direct current (DC) loads
- Alternating current (AC) well pump
- Other AC loads.

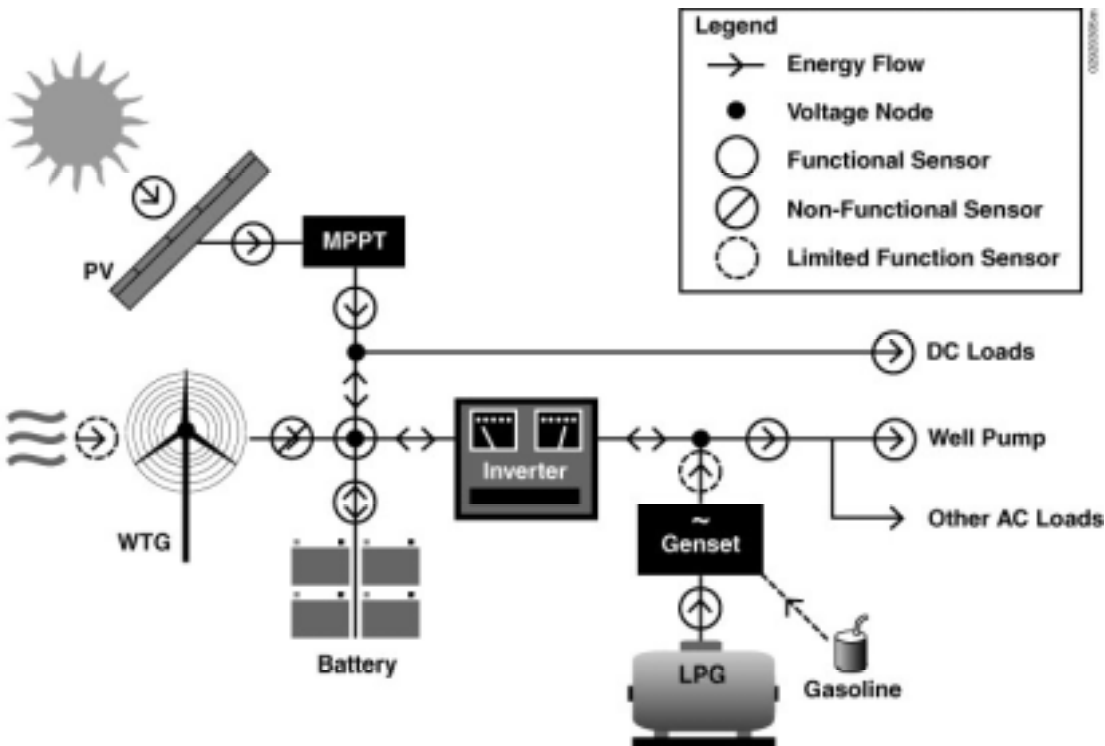

Figure 6.1. Schematic diagram of the electrical system

These components are described in more detail in the following sections of this report. The PV array and the WTG contribute to meeting the DC loads directly and to charging the batteries. The inverter converts DC power to AC power to meet the AC loads. When the loads cannot be fully met by the PV array, the WTG, and the batteries working together, then the genset is run. While the genset meets the AC loads, the inverter works in reverse to convert excess AC power to DC, which may meet the DC loads and charge the batteries. The genset is controlled manually by the owner of the home, based on observation of a TriMetric model 2020 battery system monitor, which counts amp-hours in and out of the battery bank. When a low state-of-charge (SOC) is indicated, the genset is run until a high SOC is indicated. This "cycle-charging" strategy has the effect of exercising the batteries between a minimum SOC, a higher genset-shutoff SOC, and a fully charged state (100% SOC) that may be attained by the PV array and the WTG.

A data acquisition system (DAS) consisting of a Campbell CR10X data logger (see also Section 4.3/Monitoring) and numerous voltage, current, power, and solar radiation transducers (or sensors) was installed and operated between December 28, 1999, and September 2, 2001. Figure 6.1 shows the locations of the sensors. Unfortunately, a number of problems with the DAS detracted from the completeness of the acquired data set. These problems, along with measures that were taken to deal with them, are:

- The wind speed was measured near the PV array (Section 6.2/Photovoltaics). However, this location is remote from the WTG and is sheltered by the house and the PV array. Therefore, wind speeds incident on the WTG were not measured.
- The WTG power sensor failed early in the test period, so no usable data were obtained. However, by observing a visual power meter, the owner determined that even in windy weather, the wind power levels are very small compared to the loads. In the analysis, the contribution of wind power was neglected. See further discussion in the next section regarding the performance of the WTG.
- The inverter DC power was not measured. We planned to determine this quantity by calculating the difference between other power flows on the DC bus. The failure of the WTG power sensor lends an uncertainty to this calculation. However, during periods of very low wind speed, as determined by the PV array anemometer, this uncertainty was minimized, and the performance of the inverter could be studied.
- The first genset installed was fueled by LPG. During its period of operation, the genset power sensor failed. When this genset wore out, it was replaced by a larger, gasoline-powered genset. During this period, the gasoline usage was not measured. Then the second genset was modified for LPG. It is only during this third period that concurrent genset fuel and power measurements were recorded. Thus, we only have about 4 months of data on the fuel efficiency of the current generator.

The following general procedure was followed to evaluate the performance of the system with all of these omissions from a complete data set:

- The performance of each individual component was characterized as well as possible, using the existing data.
- Based on these component characterizations, a time-series computer simulation model was used to analyze the system performance.

- LPG usage data were used to check and calibrate the model, for the period when such data were recorded.
- The model was then used to predict the annual energy performance of the system.

These steps are described more fully below.

6.2 Loads and System Components

Loads

In following the integrated systems-engineering approach, energy conservation measures were considered in conjunction with the design of the energy supply system. Because off-grid power generation tends to be significantly more expensive than grid power, it is appropriate and cost-effective to invest in high-efficiency lighting and appliances that are not common in grid-connected homes. DC appliances may be selected to reduce power conversion losses in the inverter (a DC-powered refrigerator is used in this house). Also, parasitic or phantom loads are managed using manual switches on the microwave oven, kitchen stove (clock and electronic ignition), computer, and entertainment electronics. These measures allow for a smaller power system, saving money on the supply side.

In designing the lighting system, a first step is to make use of natural daylighting to reduce the need for electric lights. In the Van Geet home, at least one window was included in each room, and where possible, multiple windows in different directions. Interior finishes are light in color to help keep areas as bright as possible and minimize the need for electric lighting. The next step is to select highly energy-efficient electrical lighting fixtures. The Van Geet home uses compact fluorescent lamps and T-8 fluorescent lamps. These fixtures not only reduce the electrical lighting demand by 70%, but also reduce internal heat gains, lowering the home's cooling load.

The Van Geets purchased an energy-efficient refrigerator that runs on DC power. The nominal 16-ft³ Sun Frost Model RF16 is rated at 24 volts x 21 amp-hours = 504 Wh/day (184 kWh/yr¹⁵). This refrigerator consumes only 28% the Building America Benchmark (Hendron et al. 2004) value of 669 kWh/yr, which is considered typical for new homes in 2004,¹⁶ along with a corresponding reduction in internal heat generation. The ENERGY STAR® criterion for a refrigerator of this type and size is 396 kWh/yr (ENERGY STAR undated reference). The Sun Frost is rated at less than half of the ENERGY STAR criterion for energy consumption. This is a significant energy-conservation feature. This load fluctuates as the refrigerator-freezer unit switches on and off to maintain a constant temperature.

The AC Loads in the home include the following:

- Well pump
- Central vacuum system
- Dishwasher

¹⁵ This value is based on the rated energy use at 70°F. The temperature was less than 70°F throughout the Van Geet home more than half the time. Lower room temperature corresponds to lower energy consumption.

¹⁶ Typical refrigerators used significantly more energy in 1996, when this home was built.

- Clothes washer
- Clothes dryer (LPG)
- Kitchen stove (LPG, with electric clock and ignition)
- Microwave oven
- Electronic equipment
- Other plug-in loads.

It is evident that the Van Geets have a typical array of electrical appliances in their home.

The well pump is Goulds model 7GS07422, 4-in. submersible, two-wire, 240-volt, $\frac{3}{4}$ -HP, which draws 950 watts at rated loading and 1,325 watts at maximum loading. A Trace T-240 step-up transformer is used to convert the inverter voltage of 120 V to the pump voltage of 240 V. As a lesson learned, it would have been better to use a three-wire pump, which features a smaller inrush (starting) current and, therefore, requires a smaller inverter.

Figures 6.2 and 6.3 show the AC and DC load profiles for a typical week and the total load for an entire year, respectively. The total load only occasionally exceeds 1,000 W, and its maximum value is 1,480 W. Operation of the 950-watt well pump shows up as brief peaks in the AC load profile. Most loads occur in the morning and early afternoon. The early afternoon loads typically include the large appliances, such as the dishwasher, clothes washer, and clothes dryer. The DC load averages 30 W (720 Wh/day; 263 kWh/year). This load includes the DC refrigerator (estimated as 21 W), as well as the circulation pumps in the backup hydronic heating system. The total load averages 135 W (3,240 Wh/day; 1,183 kWh/year).

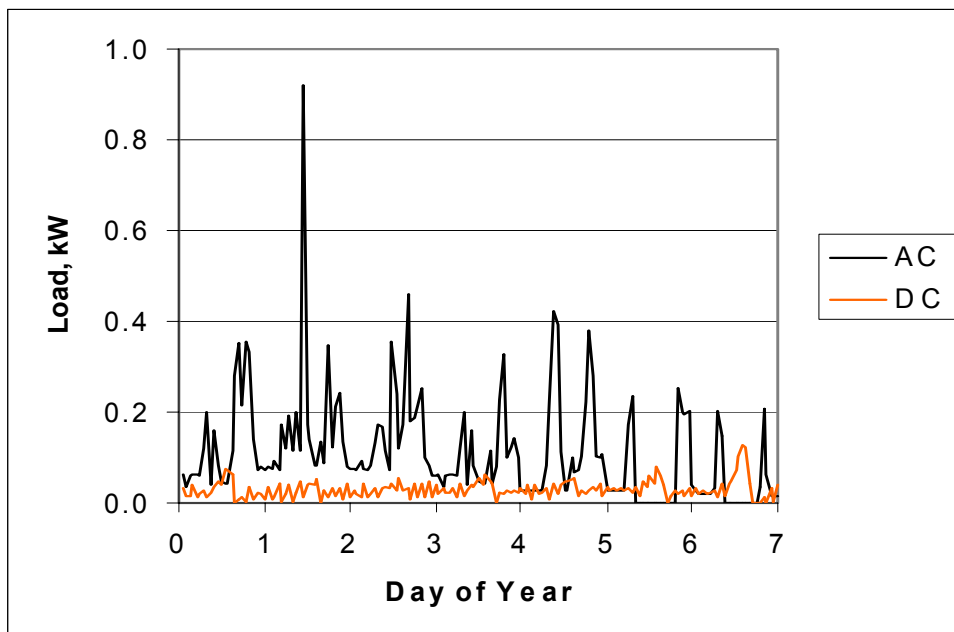

Figure 6.2. Typical week of hourly average AC and DC load profile

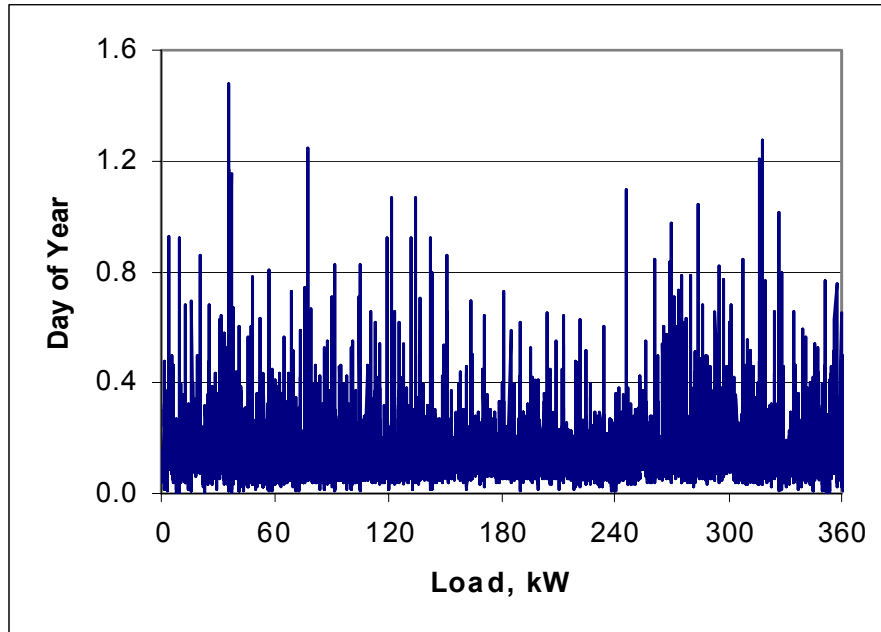

Figure 6.3. Total load for a 1-year period

Photovoltaics

A 300-ft², nominal 1,000-watt PV array provides most of the electric power for the house. Figure 6.4 shows the array is mounted on a freestanding structure, which also houses the inverter, batteries, and genset, about 50 ft east of the house. The PV modules are amorphous silicon on glass, manufactured by Advanced Photovoltaics Systems (APS), model EN25, 25 watts each, 48 panels total, originally 1200 watts, but degraded to less than 1000 watts. Because the system is not grid-tied, and in order to compensate for the shorter days in winter, the PV array is tilted at an angle of 55° from horizontal, which is 15° steeper than the latitude angle of 40°. As shown in Figure 2.2, this tilt angle provides a reasonably flat profile of the solar resource throughout the year. This profile also reflects the effect of the frequent afternoon thunderstorms in July and August. The annual average solar radiation is 4.37 kWh/m²·day on a horizontal surface and 5.15 kWh/m²·day on the PV array plane.

The performance of the array is enhanced by the use of a Solar Converters, Inc., model PT12/24-60 MPPT control. This device enables the PV array to function at a variable voltage, which may differ from the battery voltage, in order to maximize the power output as the incident solar flux varies.

Figure 6.5 shows the measured performance of the PV array, in conjunction with the associated MPPT charge controller. Most of the data points are clustered near a line, representing power proportional to the solar flux, with a slope of 750 electrical watts per kW/m² of solar flux. This



Figure 6.4. PV array (shown as roof of shed) and weather station (located on right of photo)

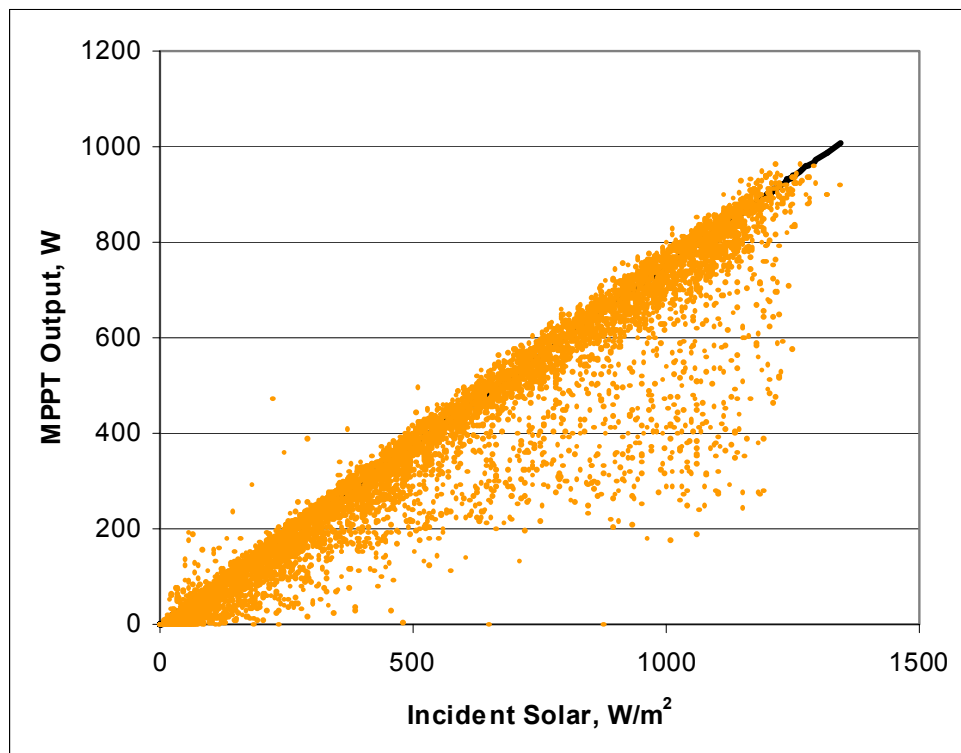

Figure 6.5. Performance of the PV array and MPPT control

corresponds to 75% of the nominal power rating of the PV array. Scatter within this cluster represents the sensitivity of performance to ambient temperature, dirt on the array surface, or other effects. Additional points that are scattered beneath the main cluster on the graph represent the limited usability of power in the hybrid system at that time (i.e., when the loads are small and the batteries are in a highly charged state, the PV array may be regulated to a power level lower than its potential). Snow cover on the array could show up in either cluster, depending on how severely it blocks the sunlight. The total power generated by the array in 1 year was measured as 1,315 kWh, whereas the potential power generation is estimated as 1,400 kWh/yr, based on the linear fit in Figure 6.5. Based on these numbers, 94% of the energy available from the PV array was utilized in the system. Thus, very little PV energy was lost as a result of the limitation of electrical storage capacity.

Wind Turbine

A Southwest Windpower AIR-403 WTG was installed in June 2000, on a freestanding, 27-ft tower about 50 ft west of the house. As shown in Figure 6.6, the WTG is sited among some loosely spaced pine trees of about the same height. This limits its exposure to the wind. Also, as mentioned previously in Section 2.2, the wind at this site is very inconsistent. The result is that little energy is produced by the WTG in this application.



Figure 6.6. WTG on 27-foot tower

Engine Generator

Section 6.1 discusses the history of genset replacement and modification. The unit currently in use is a Kohler model 7.5C62, 240-volt, 7.5-kW gasoline genset that was converted for LPG fuel use. When generating 120 volts on one phase only, using LPG, at the site altitude of 9,300 feet, its actual power output is about 2.3 kW.¹⁷

LPG usage was recorded with a gas meter connected to the DAS. At the site altitude of 9,300 ft, the air density ratio (ADR) is estimated as 0.707 (ASHRAE 1997, Chap. 6, Eqn. 3), corresponding to a pressure of 0.707 atmospheres (atm) or 10.39 pounds/in.² (psi). In the gas meter, we estimate the pressure to be 0.5 psi higher: 10.89 psi (0.741 atm). At this pressure, 1 gallon of LPG occupies 43.3 ft³ as a gas (Avallone and Baumeister 1996, Table 4.2.7). The energy content of the fuel is estimated as 2,500 Btu/ft³ at 1 atm (ASHRAE 1997, Chap. 17) x 0.741 = 1,853 Btu/ft³ in this application.

The relationship between energy generation and fuel usage with the current genset is shown in Figure 6.7. This graph does not reflect part-load operation of the genset; rather, it reflects full-load operation for various portions of the 1-hour DAS recording interval. When generating 2.3 kW of electricity, the fuel usage is about 60 ft³/hr (1.39 gal/hr). This corresponds to 1.65 kWh/gal, 48,300 Btu/kWh, and an overall genset efficiency of 7.1%.

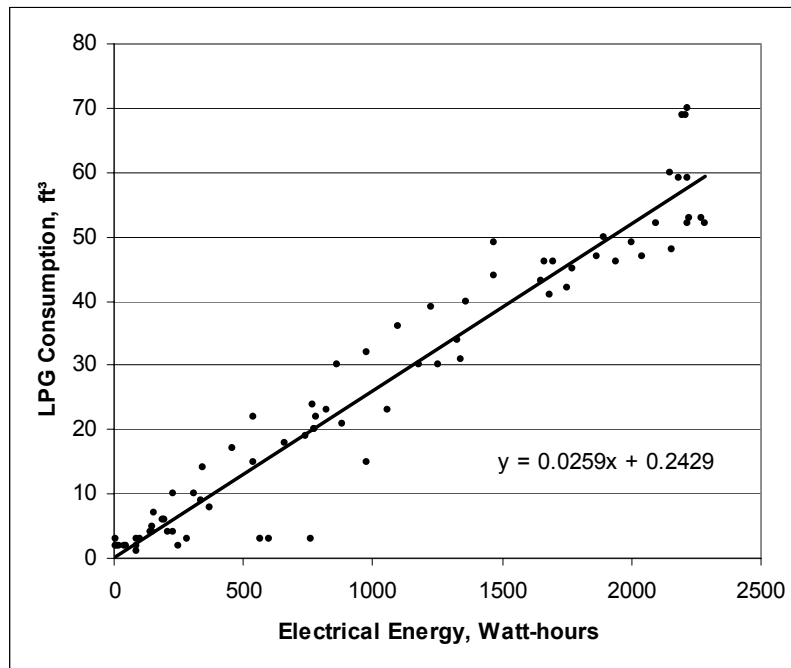

Figure 6.7. LPG genset fuel curve

¹⁷ The altitude derating alone is 4%/1000 ft, or $(1 - 9.3 \times .04) \cdot 7.5 \text{ kW} = 4.7 \text{ kW}$.

Batteries

The battery bank consists of two parallel strings, each with 12 Exide EC21 cells in series. Each cell is rated at 2 volts and 890 amp-hours, so the nominal system voltage and storage capacity are 24 volts and 42.7 kWh, respectively. The batteries had been used elsewhere before their installation in this system, so it is likely that their capacity has diminished somewhat with use.

Figure 6.8 shows a running tally of the electrical charge in and out of the battery bank for a period of more than 600 days. There is an upward trend to this graph much of the time, indicating more charge entering the batteries than leaving. This may be interpreted as overcharging, in which energy is dissipated as heat or boiling of the electrolyte. A level trend near the middle of the graph indicates that overcharging did not occur during a period of about 100 days. This portion of the graph is enlarged in Figure 6.9. The peak-to-peak amplitude in Figure 6.9 indicates the dynamic range of battery charge in the system. This reflects both the capacity of the battery bank and the dispatch strategy (i.e., the SOC level at which the genset was started to avoid further discharge and begin recharging the batteries). This SOC was not measured, and it may have varied significantly as a result of the manual control of the genset. Based on Figure 6.9, the dynamic capacity of the battery bank in this application is observed to be about 325 amp-hours at 24 volts (7.8 kWh). This is only 18% of the nominal capacity of the battery bank, and it corresponds to 58 hours of the average total load. During this same 100-day interval, the round-trip energy efficiency of the battery (i.e., power out/power in) was 85.7%.

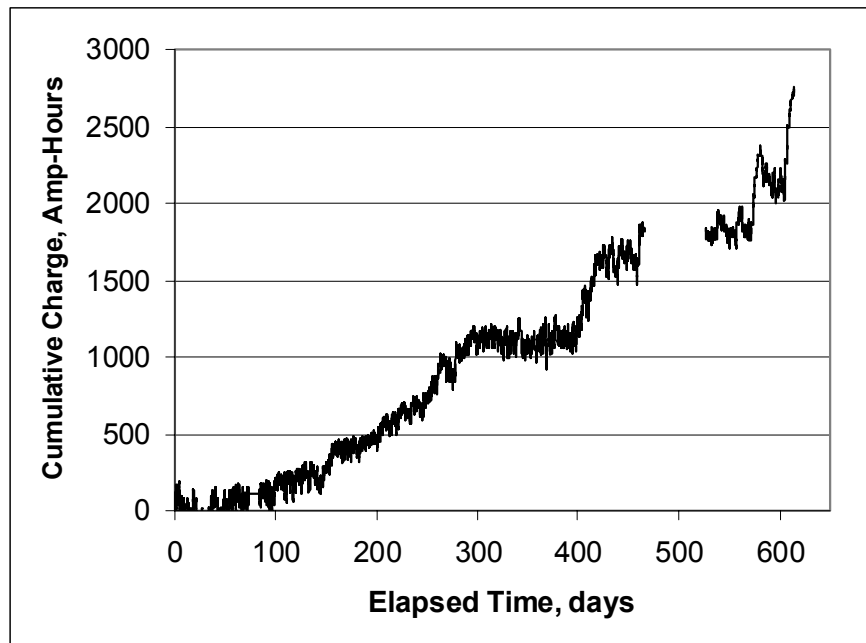

Figure 6.8. Battery charge-discharge history, showing overcharging

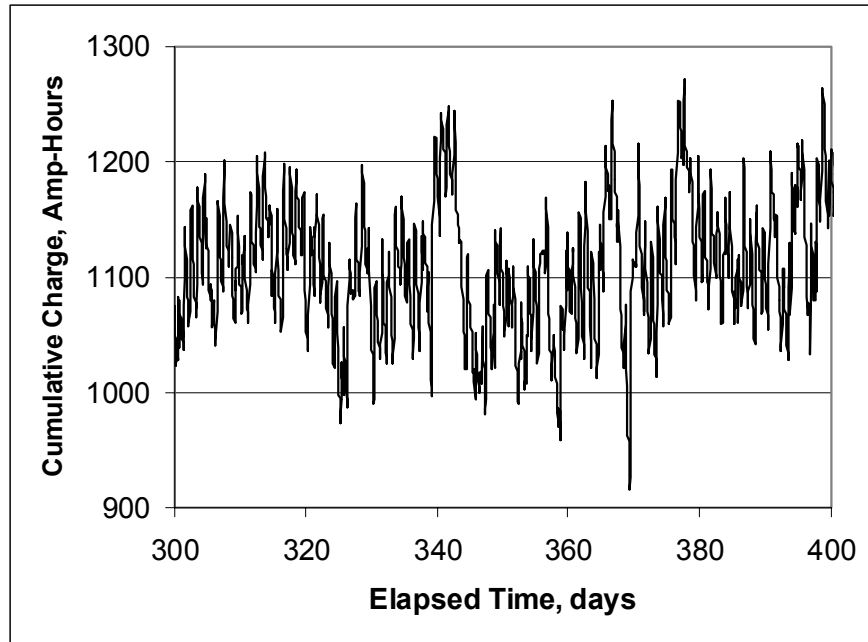

Figure 6.9. Period of battery history showing no overcharging

Inverter

As a rule-of-thumb, the inrush current for starting motors is typically 6 times the operating current. This requirement must be kept in mind when sizing an inverter. The Van Geets' well pump, when starting, might draw $6 \times 950 = 5,700$ watts under rated loading or $6 \times 1,325 = 7,950$ watts under maximum loading. This is in addition to any other electrical loads on line at the same time. The Trace Technologies model SW4024 inverter, rated at 4 kW continuous and 8 kW peak (up to 1 minute), installed in this system has proven to be adequate.

The actual performance of the inverter in this system is difficult to verify, because of DAS problems discussed previously in this report (Section 6.1). However, for certain periods of operation, when the wind speed was minimal and AC power sensors were working, reasonably consistent data were collected. Figure 6.10 depicts power conversion in both directions (DC to AC and AC to DC). The upper-right quadrant in this figure corresponds to conversion from DC to AC; this mode of conversion is studied more closely in Figure 6.11, where efficiency is plotted. The large amount of scatter in Figure 6.11 may be a result of measurement problems related to the failure of the WTG power sensor. Nonetheless, the general trend of the graph conforms to the efficiency curve provided by the manufacturer. The lower-left quadrant in Figure 6.10 corresponds to conversion from AC to DC, as when the battery is charged with excess genset energy. Based on the slope of a line informally fit to these points, the efficiency of the inverter in this mode (acting as a rectifier) is about 88%.

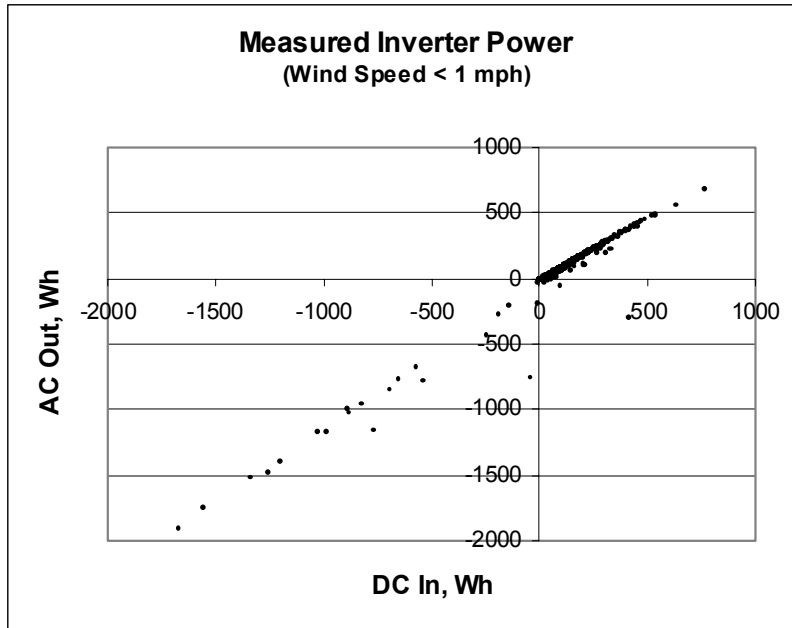

Figure 6.10. Inverter AC versus DC power for a selected time period

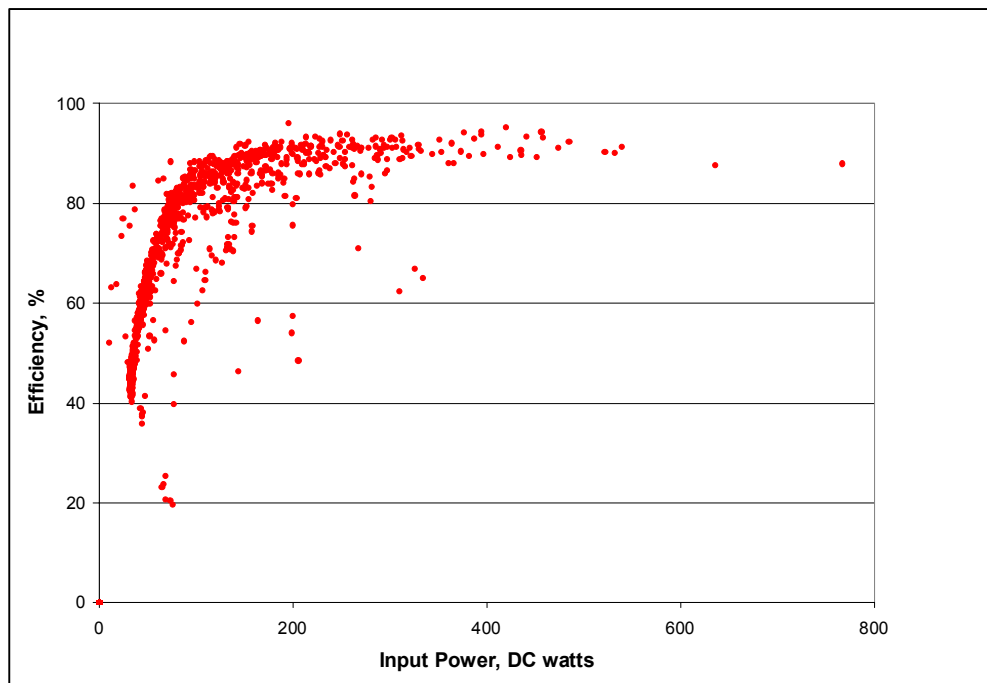

Figure 6.11. Measured inverter efficiency

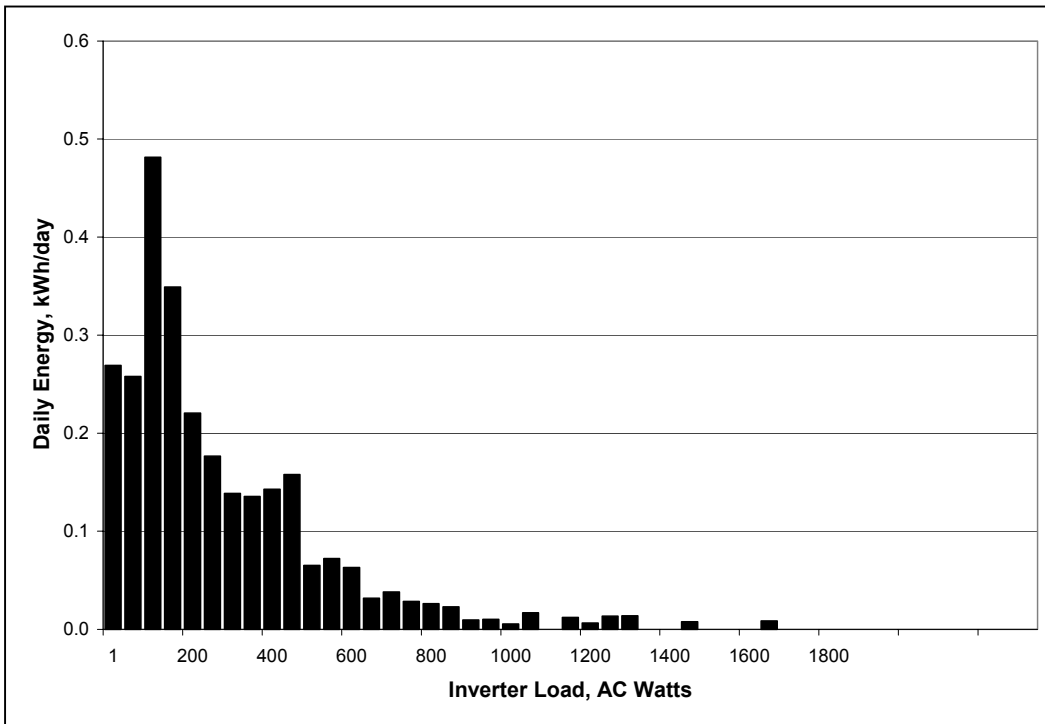

Figure 6.12. Inverter loading histogram

It is evident in Figure 6.11 that the inverter efficiency is poor at low power levels. This poor efficiency is because the inverter consumes some standby power, even with no load, when it is active. (When the load is actually zero, the inverter can be turned off either manually or automatically to avoid this loss.) The amount of the electrical load occurring at low power levels, where the inverter is inefficient, is an important aspect of the performance of this type of system. In Figure 6.12, the AC load on the inverter is analyzed to show the power levels (in watts) where most of the load (in kWh) occurs. This figure illustrates the large portion of the load that occurs at low power levels, where the efficiency of the inverter is poorest. Although inverter efficiency is often cited at rated power, it is evident here that the effective efficiency of an inverter is likely to be significantly lower than rated efficiency. In this case, the effective efficiency of the inverter is estimated as 85% (see next section).

6.3 Energy Performance Modeling

As previously discussed above, a time-series computer model (Barley 1998) was used to analyze the annual energy performance of this electrical system based on the incomplete data that were collected. It is a quasi-steady-state model, in which it is assumed that all quantities, including the genset on/off control function, are constant over each 1-hour time step. The model is run for 8760 hours to simulate 1 year of system operation. The battery is modeled as a finite charge capacity with constant round-trip energy efficiency. The inverter is modeled with separate, constant efficiencies for DC-AC and AC-DC conversion. The model can accommodate either AC or DC loads, but not both. In this analysis, the total load was modeled as an AC load. This should have a rather small impact on the results, for two reasons:

- The DC load is small compared to the AC load
- Moving the DC loads to the AC bus would at times be an advantage, and at times a disadvantage, in terms of system performance.

Inputs to the model include the following:

- The measured total hourly electrical load for 1 year
- Hourly global solar radiation measured at the site for 1 year
- PV capacity of 750 W per kW/m² of incident solar flux, per Figure 6.5
- The genset fuel curve fit in Figure 6.7
- Batteries with 15.6 kWh of charge capacity, dispatched between 50% and 100% SOC, so as to match the dynamic charge capacity of 7.8 kWh inferred from Figure 6.9. The energy efficiency was set at 85.7%, as determined in Section 6.2.
- The inverter is the component with the most uncertainty. Figures 6.11 and 6.12 suggest that the average efficiency for DC-AC conversion might be in the range 80% to 90%. This parameter was adjusted to 85% to calibrate the model, as discussed below. The rectification efficiency, for AC-DC conversion, was set at 88%, as described above.
- The dispatch strategy was modeled by starting the genset when the SOC falls to 50% and running it at full power (2.3 kW) until the SOC reaches 80%. This strategy approximates the manual control that was implemented by the owner.
- No wind power was modeled, because wind speed data are not available and the contribution of wind power to the system was observed to be small.

The model was calibrated against the measured LPG usage of 2,696 ft³ (62.3 gal of liquid) during the period December 9, 2000, through April 3, 2001, when the new genset was running on LPG and the DAS was operating. This calibration was achieved by adjusting the inverter efficiency parameter in the model to 85%, which is well within the expected range. Thus, the model seems to provide a good approximation of the actual system performance.

6.4 Results

The model predicts that in 1 year, the genset starts 28 times, runs 84 hours, produces 197 kWh of electricity (which is 17% of the total load), and consumes 117 gal of LPG. This prediction agrees well with the owner's experience of operating the system. Figures 6.13 and 6.14 show a 5-day sequence of hourly performance and monthly energy totals, respectively. In Figure 6.14, the solar totals represent energy *available* from the PV array, per the linear curve fit in Figure 6.5; these values include energy that was not actually generated, because of regulation of the PV array to avoid over-charging the battery. Also, some of this energy offsets losses in the battery and inverter. It appears in the figure that the load varies with the available PV power, perhaps reflecting the occupants' lifestyle of using more electricity when solar power is available.

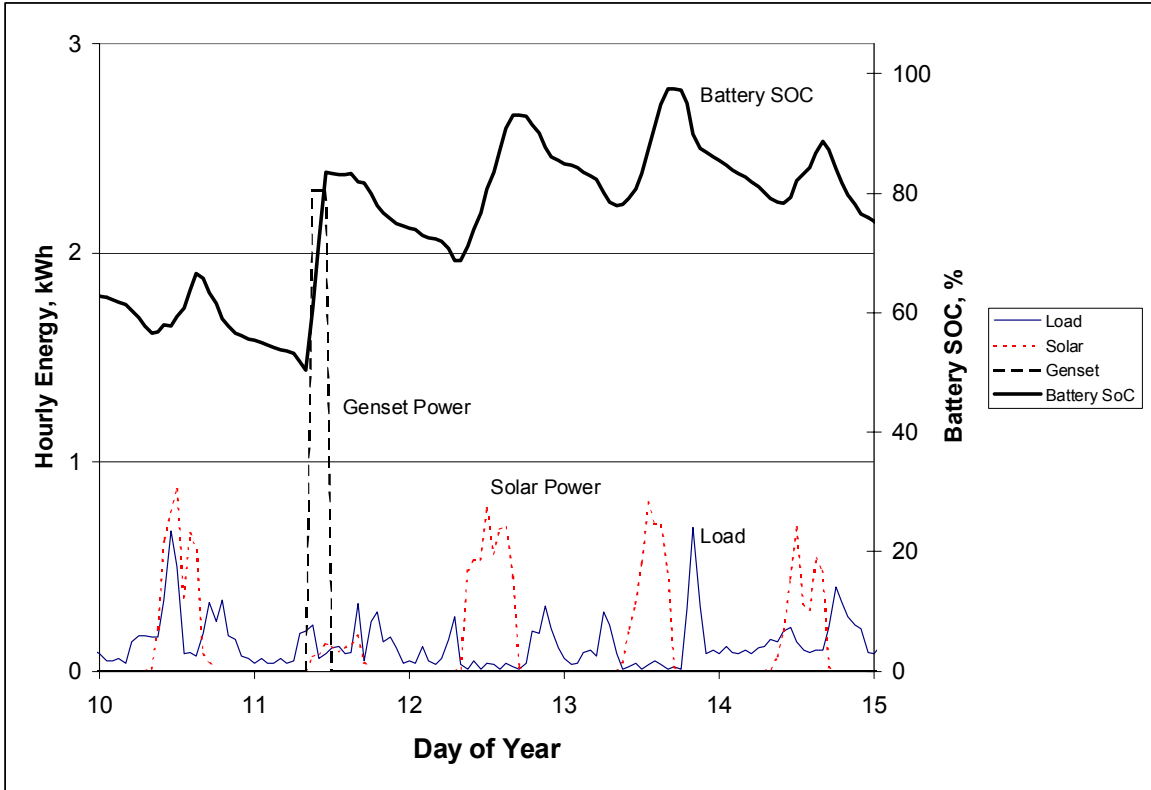

Figure 6.13. Modeled hourly performance of the electrical system

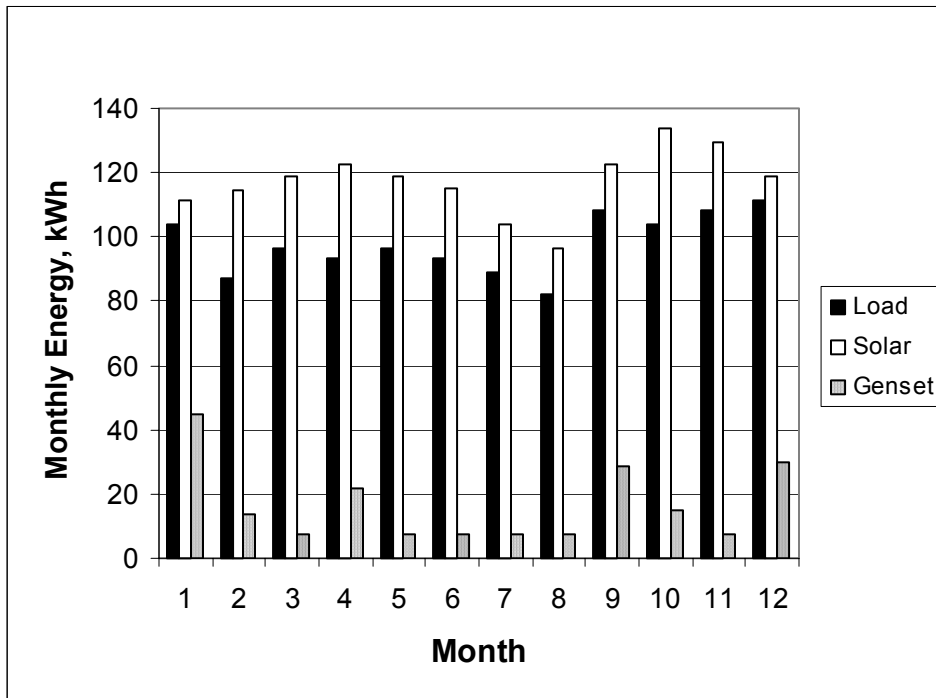

Figure 6.14. Modeled energy performance of the electrical system

At the average delivered price of \$0.78/gal, the LPG usage amounts to \$0.46/kWh generated and \$0.077/kWh of total load. This cost is only the LPG cost per unit of energy produced and is not the cost of energy in the system. The cost of energy would also include the capital cost of equipment (which is difficult to ascertain in this case) and other costs.

Speculation about the performance of this home in a grid-connected application is as follows. The batteries and genset would be eliminated from the system. The PV array would generate 1,400 kWh/yr. If all of this generated electricity were converted to AC with the assumed average inverter efficiency of 85%, 1,190 kWh/yr would be available to meet the loads. The total annual load was measured as 1,183 kWh/yr. Thus, this system would approximately break even on energy exchanges with the grid. In this perspective, the energy generated by the genset in the stand-alone system is seen to compensate for losses in the system, including PV power that could not be utilized because of limited storage capacity.

Subsequent to this analysis, the Van Geets have installed a new, energy-efficient, horizontal-axis washing machine. This new washing machine is expected to further improve the performance of the electrical system.

7. Conclusions and Recommendations

7.1 Evaluation of the Design

The Van Geets enjoy this home and have had very few problems with it. Much of the construction was done by the Van Geets themselves. They have shown that these technologies are not difficult to install or live with. This home serves as a good example for architects and builders, in that it incorporates many renewable energy features without sacrificing modern conveniences. The house also demonstrates that direct gain and Trombe walls can be added to a home without sacrificing aesthetics. Even though some of the technologies used to achieve these results are not considered mainstream, many of the features of the house can be replicated in housing stock today to achieve significant energy savings.

The energy performance of this home is very good. Savings are estimated as

- 89% heating and cooling, based on the 1995 MEC reference case
- nearly 100% domestic water heating, based on the owner/occupant's account
- 70% lighting, based on the efficiency of fluorescent lights relative to incandescent lights
- 83% electrical, based on the 17% portion of the load met by the back-up generator.

The performance of this home exceeds the general criterion of 70% savings in HVAC and lighting energy for Building America research homes. The heating energy usage (there is no cooling energy usage) in the house as occupied amounts to

- 13.4 MMBtu/year
- 1.39 kBtu/°F·day
- 4.22 kBtu/year per ft² of conditioned floor area
- 0.44 Btu/°F·day·ft².

Actual LPG deliveries to the home averaged 256 gal/yr over a 3-year period. This LPG was used for backup space heating, backup domestic water heating, backup electrical generation, cooking, and clothes drying. Some changes to the system, both during and after this 3-year period, would be expected to change to LPG usage:

- The backup domestic water heater is now turned off most of the time, which significantly decreases the LPG usage.
- Laundry is now often dried on a clothes line, reducing the use and thus the LPG consumption of the clothes dryer.
- The inverter is now operated in the "search mode," which reduces standby losses when there is no electrical load and, thus, genset LPG consumption.
- The vertical-axis washing machine was replaced with a horizontal-axis model, which reduces water usage, water pumping energy, and water-heating energy.
- The genset was replaced with a larger and, perhaps, less efficient one, which might increase the LPG usage somewhat.

During the most recent LPG delivery year as of this writing (September 2002 through September 2003), the LPG usage was only 108 gallons. In addition, about 1/2 face cord (24 ft³) per year of firewood is burned to heat the home. The moisture content and, thus, the energy content of wood are unknown. Nonetheless, either 108 gal or 256 gal of LPG and 1/2 face cord of wood is a very modest amount of fuel usage for a beautiful, bright, 3,176-ft² off-grid home in a climate with 9,623 heating °F-days.

7.2 Lessons Learned

Insulate Slab Floors

Although difficult to model, experience in this case has shown that an uninsulated slab floor is likely to be uncomfortably cold. Especially if the slab is intended as a heat-storage device or radiant-heating component, insulation underneath the entire slab is a must (Sections 2.5 and 4.2).

Solar DHW Backup

In a solar domestic hot-water system with very high performance (approaching 100% solar energy), the use of an instantaneous water heater is recommended for backup. This type of backup system would provide occasional auxiliary heat as needed, without the stand-by losses of a tank-type water heater. Instantaneous water heaters that are compatible with solar water heating systems feature a lower minimum heating rate, to augment the solar pre-heated water (Chapter 5).

Don't Use a Solar DHW System to Backup a Passive Solar Heating System

Because cloudiness affects both systems at the same time, an uneconomical amount of heat storage is needed to make it work (Chapter 5).

Make the DAS Robust

Data acquisition components, such as sensors, do fail in the field. Especially at remote sites where it is difficult to check the data frequently, some redundancy should be built into the design to compensate for possible component failures (Sections 4.3 and 6.1).

Measure the Wind Resource

If planning to implement wind energy, it is important to measure the wind speed at the site, preferably for a period of 1 year. Personal impressions of the wind resource tend to be biased by occasional high winds, whereas the benefit of a wind turbine depends on the consistency of the wind speed over the course of a year. Also, wind-speed data from nearby sites are not very useful, because the wind resource varies considerably with the local terrain (Chapter 6).

Use the PV System During Construction

At a remote (off-grid) site such as this, it is very useful to have the PV system functioning early in the construction process, so that electrical power tools can be used.

Use a Horizontal-Axis Washing Machine

This type of washing machine uses significantly less water, reducing energy consumption for water pumping and heating.

Avoid Glow-Bar Oven Ignition Systems

This feature consumes about 500 watts of electricity when in use, which is expensive on an off-grid system. A spark ignition system is recommended. A pilot light is another alternative (Section 4.2/Cook Stove).

Use a Three-Wire Well Pump

This type of well pump imposes a smaller surge current on the electrical system during startup, lowering the required inverter size (Section 6.2/Loads and Inverter).

7.3 General Recommendations

Engineer the Home as a System

Passive solar heating that is not done properly can perform poorly. The design process that is demonstrated here worked well. The recommended steps are as follows:

- Planning for energy efficiency from the start
- Initial design based on rules of thumb
- Good solar load ratio and building time constant
- Parametric modeling to fine-tune the design.

Use Energy Conservation Plus Renewables

In any situation, a practical and economical design involves energy conservation measures in conjunction with energy supply systems. In an off-grid situation, the cost of energy is typically much higher than in a grid-connected situation. Thus, energy conservation features are even more important in off-grid designs.

After making good use of daylighting, energy-efficient lighting is recommended. Compact fluorescent fixtures should be used. Use halogen lamps where fluorescent fixtures cannot be utilized. An energy reduction for lighting of 70% can be achieved by using fluorescent fixtures. Other high-efficiency appliances, such as refrigerators, should be used (see Chapter 6/Loads for further details).

Low-flow toilets, faucets, and showerheads should be installed where appropriate. This includes toilets that are 1.6 gallons or less, horizontal-axis washing machines, and other resource-saving appliances and fixtures (see Wilson and Morrill [1999] for further information of this type).

Thermal Mass

Insufficient thermal mass is a common cause of poor performance in passive solar homes. A BTC of about 2 days or more is recommended when large energy savings are desired (Section 2.4).

Controls

Because solar gains do not always occur when the heat is needed, some controls are needed to maintain comfort. To prevent overheating, interior shading devices, such as Venetian blinds or draperies, are recommended. Natural ventilation cooling should also be provided (Section 4.2). In addition, a reliable, automatic back-up heating system is recommended.

Overhangs

Overhangs are not needed in this case because of the cold climate (0 cooling degree days), high thermal mass, low internal gains as a result of energy-efficient electrical appliances, and high summer sun angles. However, in most situations, overhangs should be used. They should always be evaluated in pre-construction modeling.

Do Not Use a Radiant Slab as Backup for a Passive Solar System

The backup system in a passive solar building needs to respond quickly to changes in the weather, including cloudiness and sunset. Concrete slabs do not heat and cool quickly enough to maintain consistent comfort as conditions vary (see Section 4.2/Hydronic Backup Heating System for further discussion).

Landscaping

Water efficient landscaping (e.g., landscaping using natural water supplies) should be considered. Typically, native vegetation should be used because the water requirement of these plants is consistent with local weather. Deciduous plantings should be used on the east and west sides to shade these windows in the summer, while evergreens will shield the north side from cold winds in the winter. No trees should be located so as to shade the south exposure. Be aware that even deciduous trees can significantly block the needed sunlight in winter. The collection and storage of rainwater for watering purposes is also recommended.

Analysis

Combine performance monitoring with modeling to provide the most meaningful evaluation of system performance (Sections 4.1 and 4.3).

8. References

- ACCA (2003). *Manual J - Residential Load Calculations*. Arlington, VA: Air Conditioning Contractors of America.
- ASHRAE (1993). ANSI/ASHRAE Standard 136-1993, *A Method of Determining Air Change Rates in Detached Dwellings*. Atlanta, GA: American Society of Heating, Refrigerating, and Air-conditioning Engineers, Inc.
- ASHRAE (1997). *Handbook of Fundamentals*. Atlanta, GA: American Society of Heating, Refrigerating, and Air-Conditioning Engineers, Inc.
- ASHRAE (1999). *ASHRAE 62-1999*, Ventilation for Acceptable Indoor Air Quality. Atlanta, GA: American Society of Heating, Refrigerating, and Air-conditioning Engineers, Inc.
- ASHRAE (2001). "ASHRAE Recognizes Outstanding HVAC&R Industry Achievements," news release 1/27/01. Atlanta, GA: American Society of Heating, Refrigerating, and Air-Conditioning Engineers, Inc.
- Avallone, E.A.; Baumeister, T., III, Editors. (1996) *Marks' Standard Handbook for Mechanical Engineers*, 10th Ed. New York: McGraw-Hill.
- Barley, C.D. (1998). *Hybrid Power Design Handbook (with Software)*, edition 2.1. Golden, CO: National Renewable Energy Laboratory, C. Dennis Barley, <http://www.indra.com/~dbarley>.
- Building America Home Page (2004). <http://www.buildingamerica.gov>. Last accessed 7/5/04.
- Deru, M.; Judkoff, R.; Torcellini, P. (2002a). *SUNREL Technical Reference Manual*, NREL/BK-550-30193. Golden, CO: National Renewable Energy Laboratory.
- Deru, M.P.; Kirkpatrick, A.T. (2002b). "Ground-Coupled Heat and Moisture Transfer from Buildings Part 1 - Analysis and Modeling," *Transactions of the ASME, Journal of Solar Energy Engineering*, Vol 124, No. 1, pp 10-16.
- Deru, M.P.; Kirkpatrick, A.T. (2002c). "Ground-Coupled Heat and Moisture Transfer from Buildings Part 2 - Application," *Transactions of the ASME, Journal of Solar Energy Engineering*, Vol 124, No. 1, pp 17-21.
- Energy Information Administration (2002). *Annual Energy Review*. Washington, D.C.: U.S. Dept. of Energy. <http://www.eia.doe.gov/>. Energy Star. Washington, DC: U.S. Environmental Protection Agency. <http://www.energystar.gov>. Last accessed January 21, 2004.
- Hendron, R.; Anderson, R.; Judkoff, R.; Christensen, C.; Eastment, M.; Norton, P.; Reeves, P.; Hancock, E. (2004). *Building America Performance Analysis Procedures*, Rev. 1. NREL/TP-550-35567. Golden, CO: National Renewable Energy Laboratory.
- IEA. Paris: International Energy Agency. <http://www.iea.org/>. Last accessed January 21, 2004.
- Judkoff, R.; Balcomb, J.D.; Hancock, C.E.; Barker, G.; Subbarao, K. (2000). Side-By-Side Thermal Tests of Modular Offices: A Validation Study of the STEM Method. NREL/TP-550-23940. Golden, CO: National Renewable Energy Laboratory, 39 pp.

- Judkoff, R.D.; Neymark, J.S. (Feb. 1995). *International Energy Agency Building Energy Simulation Test (BESTEST) and Diagnostic Method*. NREL/TP-472-6231. Golden, CO: National Renewable Energy Laboratory. (Note, the BESTEST method has been adopted by ASHRAE and is the basis of ANSI/ASHRAE Standard 140-2001.)
- Marion, W.; Wilcox, S. (1994). *Solar Radiation Data Manual for Flat-Plate and Concentrating Collectors*. NREL/TP-463-5607. Golden, CO: National Renewable Energy Laboratory (available from NTIS, DE93018229).
- MEC (1995). *Model Energy Code*. Prepared and maintained by the Council of American Building Officials (CABO) with participation by Building Officials and Code Administrators International, Inc. (BOCA), International Conference of Building Officials (ICBO). Falls Church, VA: Council of American Building Officials.
- NCDC (2000). *Annual Climatological Summary* for Evergreen, Colorado. Asheville, NC: National Climatic Data Center, National Oceanic & Atmospheric Administration, U.S. Dept. of Commerce.
- Wilson, A.; Morrill, J. (1999). *Consumer Guide to Home Energy Savings*, 7th Ed. Washington, D.C.: American Council for an Energy Efficient Economy.
<http://www.aceee.org/consumerguide/>. Last accessed January 21, 2004.

REPORT DOCUMENTATION PAGE

Form Approved
OMB No. 0704-0188

The public reporting burden for this collection of information is estimated to average 1 hour per response, including the time for reviewing instructions, searching existing data sources, gathering and maintaining the data needed, and completing and reviewing the collection of information. Send comments regarding this burden estimate or any other aspect of this collection of information, including suggestions for reducing the burden, to Department of Defense, Executive Services and Communications Directorate (0704-0188). Respondents should be aware that notwithstanding any other provision of law, no person shall be subject to any penalty for failing to comply with a collection of information if it does not display a currently valid OMB control number.

PLEASE DO NOT RETURN YOUR FORM TO THE ABOVE ORGANIZATION.

1. REPORT DATE (DD-MM-YYYY) August 2004		2. REPORT TYPE Technical Report		3. DATES COVERED (From - To)		
4. TITLE AND SUBTITLE The Van Geet Off-Grid Home: An Integrated Approach to Energy Savings			5a. CONTRACT NUMBER DE-AC36-99-GO10337			
			5b. GRANT NUMBER			
			5c. PROGRAM ELEMENT NUMBER			
6. AUTHOR(S) C.D. Barley, P. Torcellini, and O. Van Geet			5d. PROJECT NUMBER NREL/TP-550-32765			
			5e. TASK NUMBER BET4.8001			
			5f. WORK UNIT NUMBER			
7. PERFORMING ORGANIZATION NAME(S) AND ADDRESS(ES) National Renewable Energy Laboratory 1617 Cole Blvd. Golden, CO 80401-3393				8. PERFORMING ORGANIZATION REPORT NUMBER NREL/TP-550-32765		
9. SPONSORING/MONITORING AGENCY NAME(S) AND ADDRESS(ES)				10. SPONSOR/MONITOR'S ACRONYM(S) NREL		
				11. SPONSORING/MONITORING AGENCY REPORT NUMBER		
12. DISTRIBUTION AVAILABILITY STATEMENT National Technical Information Service U.S. Department of Commerce 5285 Port Royal Road Springfield, VA 22161						
13. SUPPLEMENTARY NOTES						
14. ABSTRACT (Maximum 200 Words) The Van Geet home near Denver, Colorado, exemplifies the effectiveness of coupling energy conservation measures with renewable energy utilization in a modern residence. The remote location, with no utility connections available, and the owner's interest in renewable energy motivated the ambitious design. This design attracted the interest of the Building America (BA) program and was studied as a research home. As a result, the BA program provided energy engineering throughout the design, construction, and performance evaluation phases. The American Society of Heating, Refrigerating, and Air-conditioning Engineers (ASHRAE) also recognized the success of this project by awarding it an ASHRAE Technology Award in 2001.						
15. SUBJECT TERMS Van Geet House; energy efficient house; off-grid house; Building America; U.S. Department of Energy						
16. SECURITY CLASSIFICATION OF:			17. LIMITATION OF ABSTRACT UL	18. NUMBER OF PAGES	19a. NAME OF RESPONSIBLE PERSON	
a. REPORT Unclassified	b. ABSTRACT Unclassified	c. THIS PAGE Unclassified			19b. TELEPHONE NUMBER (Include area code)	

Standard Form 298 (Rev. 8/98)
Prescribed by ANSI Std. Z39.18

A Strong Energy Portfolio for a Strong America

Energy efficiency and clean, renewable energy will mean a stronger economy, a cleaner environment, and greater energy independence for America. Working with a wide array of state, community, industry, and university partners, the U.S. Department of Energy's Office of Energy Efficiency and Renewable Energy invests in a diverse portfolio of energy technologies.

Research and Development of Buildings

Our nation's buildings consume more energy than any other sector of the U.S. economy, including transportation and industry. Fortunately, the opportunities to reduce building energy use—and the associated environmental impacts—are significant.

DOE's Building Technologies Program works to improve the energy efficiency of our nation's buildings through innovative new technologies and better building practices. The program focuses on two key areas:

• Emerging Technologies

Research and development of the next generation of energy-efficient components, materials, and equipment

• Technology Integration

Integration of new technologies with innovative building methods to optimize building performance and savings

For more information contact:

EERE Information Center
1-877-EERE-INF (1-877-337-3463)
www.eere.energy.gov



U.S. Department of Energy
**Energy Efficiency
and Renewable Energy**

An electronic copy of this factsheet is available on the Building America Web site at www.buildingamerica.gov

Visit our Web sites at:

www.buildingamerica.gov

www.pathnet.org

www.energystar.gov



Building America Program

George S. James • New Construction • 202-586-9472 • fax: 202-586-8134 • e-mail: George.James@ee.doe.gov
Terry Logee • Existing Homes • 202-586-1689 • fax: 202-586-4617 • e-mail: terry.logee@ee.doe.gov
Lew Pratsch • Integrated Onsite Power • 202-586-1512 • fax: 202-586-8185 • e-mail: Lew.Pratsch@hq.doe.gov
Building America Program • Office of Building Technologies, EE-2J • U.S. Department of Energy • 1000 Independence Avenue, S.W. • Washington, D.C. 20585-0121 • www.buildingamerica.gov

Building Industry Research Alliance (BIRA)

Robert Hammon • ConSol • 7407 Tam O'Shanter Drive #200 • Stockton, CA 95210-3370 • 209-473-5000 • fax: 209-474-0817 • e-mail: Rob@consol.ws • www.bira.ws

Building Science Consortium (BSC)

Betsy Pettit • Building Science Consortium (BSC) • 70 Main Street • Westford, MA 01886 • 978-589-5100 • fax: 978-589-5103 • e-mail: Betsy@buildingscience.com • www.buildingscience.com

Consortium for Advanced Residential Buildings (CARB)

Steven Winter • Steven Winter Associates, Inc. • 50 Washington Street • Norwalk, CT 06854 • 203-857-0200 • fax: 203-852-0741 • e-mail: swinter@swinter.com • www.carb-swa.com

Davis Energy Group

David Springer • Davis Energy Group • 123 C Street • Davis, CA 95616 • 530-753-1100 • fax: 530-753-4125 • e-mail: springer@davisenergy.com • deg@davisenergy.com • www.davisenergy.com/index.html

IBACOS Consortium

Brad Oberg • IBACOS Consortium • 2214 Liberty Avenue • Pittsburgh, PA 15222 • 412-765-3664 • fax: 412-765-3738 • e-mail: boberg@ibacos.com • www.ibacos.com

Industrialized Housing Partnership (IHP)

Subrato Chandra • Florida Solar Energy Center • 1679 Clearlake Road • Cocoa, FL 32922 • 321-638-1412 • fax: 321-638-1439 • e-mail: subrato@fsec.ucf.edu • www.baihp.org

National Association of Home Builders (NAHB) Research Center

Tom Kenney • National Association of Home Builders (NAHB) Research Center • 400 Prince George's Boulevard • Upper Marlboro, MD 20774 • 301-430-6246 • fax: 301-430-6180 • toll-free: 800-638-8556 • www.nahbrc.org/

National Renewable Energy Laboratory

Ren Anderson • 1617 Cole Boulevard, MS-2722 • Golden, CO 80401 • 303-384-7433 • fax: 303-384-7540 • e-mail: ren_anderson@nrel.gov • www.nrel.gov

Tim Merrigan • 1617 Cole Boulevard, MS-2722 • Golden, CO 80401 • 303-384-7349 • fax: 303-384-7540 • e-mail: tim_merrigan@nrel.gov • www.nrel.gov

Oak Ridge National Laboratory

Pat M. Love • P.O. Box 2008 • One Bethel Valley Road • Oak Ridge, TN 37831 • 865-574-4346 • fax: 865-574-9331 • e-mail: lovepm@ornl.gov • www.ornl.gov

Produced for the U.S. Department of Energy (DOE) by the National Renewable Energy Laboratory, a DOE national laboratory.

August 2004 • NREL/TP-550-32765

Printed with a renewable-source ink on paper containing at least 50% wastepaper, including 20% postconsumer waste.

Bringing you a prosperous future where energy is clean, abundant, reliable, and affordable