

# **Builder System Performance Package Targeting 30%–40% Savings in Space Conditioning Energy Use**

**Period of Performance: December 2002 to December 2003**



**Consortium for Advanced Residential Buildings**  
*Norwalk, Connecticut*

*Prepared under Subcontract No. KAAX-3-33441-01*



# **Builder System Performance Package Targeting 30%–40% Savings in Space Conditioning Energy Use**

**Period of Performance:  
December 2002 to December 2003**

Consortium for Advanced Residential Buildings  
*Norwalk, Connecticut*

NREL Technical Monitor: Mark Eastment

Prepared under Subcontract No. KAAX-3-33441-01



## **NREL**

**National Renewable Energy Laboratory**  
1617 Cole Boulevard, Golden, Colorado 80401-3393  
303-275-3000 • [www.nrel.gov](http://www.nrel.gov)

Operated for the U.S. Department of Energy  
Office of Energy Efficiency and Renewable Energy  
by Midwest Research Institute • Battelle

Contract No. DE-AC36-99-GO10337

## NOTICE

This report was prepared as an account of work sponsored by an agency of the United States government. Neither the United States government nor any agency thereof, nor any of their employees, makes any warranty, express or implied, or assumes any legal liability or responsibility for the accuracy, completeness, or usefulness of any information, apparatus, product, or process disclosed, or represents that its use would not infringe privately owned rights. Reference herein to any specific commercial product, process, or service by trade name, trademark, manufacturer, or otherwise does not necessarily constitute or imply its endorsement, recommendation, or favoring by the United States government or any agency thereof. The views and opinions of authors expressed herein do not necessarily state or reflect those of the United States government or any agency thereof.

Available electronically at <http://www.osti.gov/bridge>

Available for a processing fee to U.S. Department of Energy and its contractors, in paper, from:

U.S. Department of Energy  
Office of Scientific and Technical Information  
P.O. Box 62  
Oak Ridge, TN 37831-0062  
phone: 865.576.8401  
fax: 865.576.5728  
email: <mailto:reports@adonis.osti.gov>

Available for sale to the public, in paper, from:

U.S. Department of Commerce  
National Technical Information Service  
5285 Port Royal Road  
Springfield, VA 22161  
phone: 800.553.6847  
fax: 703.605.6900  
email: [orders@ntis.fedworld.gov](mailto:orders@ntis.fedworld.gov)  
online ordering: <http://www.ntis.gov/ordering.htm>



# Table of Contents

<b>Part I. Best Practices for Achieving 30% Space Conditioning Energy Savings in Single-Family Detached Homes Cold-Climate Homes</b> .....	<b>1</b>
Background and Introduction .....	1
Primary Recommendations .....	1
Secondary Recommendations.....	2
Primary Recommendations for the Envelope .....	2
Primary Recommendations for the Equipment .....	24
Secondary Recommendations.....	28
Case Study #1: Don Simon Homes.....	31
Introduction.....	31
Background .....	32
Standard Practice Home.....	33
Prototype Home.....	33
CARB Recommendations.....	34
Prototype Testing.....	42
ENERGY STAR Compliance .....	45
Case Study #2: Wausau Homes .....	46
Introduction.....	46
Background .....	46
Standard Practice Home.....	46
Prototype Home.....	49
CARB Recommendations.....	50
Furnace-Sizing Methods.....	56
Prototype Home Testing .....	56
Mechanical Drawings .....	58

## Table of Contents (continued)

<b>Part II: Best Practices for Achieving 30% - 40% Space Conditioning Energy Savings in Single-Family Detached Homes in Hot-Humid Climates .....</b>	<b>61</b>
Background and Introduction .....	61
Primary Recommendations .....	62
Secondary Recommendations.....	63
Primary Recommendations for the Envelope .....	63
Primary Recommendations for the Equipment .....	70
Secondary Recommendations.....	77
First Prototype Case Study: Four Generations of CARB / Mercedes Homes Concrete-Wall Prototypes.....	79
Background .....	79
Alternate Wall Systems.....	81
Revised Base Case .....	82
Final Building Specifications .....	83
Building Design and Engineering.....	85
Construction Process and Analysis .....	87
Code Compliance .....	90
Sales and Marketing .....	90
Second Prototype Case Study: Michele II .....	91
Product and System Research .....	91
Construction Process Analysis .....	94
Code Compliance .....	95
Cost and Performance.....	95
Sales and Marketing .....	96
Testing of the Second Prototype .....	96
Third Prototype Case Study .....	97
Pre-Production Houses Concepts and Development.....	97
Construction Process Analysis .....	101
Cost and Performance.....	104
Community-Scale Implementation .....	104

## Table of Contents (continued)

Fourth Prototype Case Study .....	108
Summary .....	108
Design Objectives .....	109
Summary of Innovation System Design Strategies .....	109
Definition of Reference House .....	111
Comparison of Final Performance and Cost Tradeoffs with Current Builder Practice .....	112
Cost Comparison .....	115
Recommendations for Future Improvements in Design Details, Construction Practices, and Quality-Control Practices .....	116
<b>Part III: Best Practices for Achieving 30% - 40% Space Conditioning Energy Savings in Single-Family Detached Hot-Dry Climate Homes .....</b>	<b>117</b>
Background and Introduction .....	117
Primary Recommendations .....	117
Secondary Recommendations .....	119
Primary Recommendations for the Envelope .....	119
Primary Recommendations for the Equipment .....	129
Secondary Recommendations .....	134
Case Study #1: Beazer, Southern California .....	136
Introduction .....	136
Systems Engineering and Building Specifications .....	136
Additional Changes of Interest to the Builder .....	136
Blower-Door Testing .....	140
On-Going and Future Work with Beazer Southern California .....	141
Case Study #2: Beazer Homes, Sacramento, California .....	142
Background .....	142
Standard Specifications .....	142
Base Case .....	143

## Table of Contents (continued)

Prototype Alternatives.....	143
Prototype Final Specifications .....	146
Modeled Prototype Performance .....	146
Test Objectives.....	147
Case Study #3: Second (PV) Prototype .....	148
Background .....	148
Initial Standard Specifications .....	148
First Prototype Specifications.....	148
Delayed Implementation.....	149
Initial Specifications Changes .....	149
The SMUD “Power Roof” Program.....	150
Beazer “Power House” .....	150
Photovoltaic Power Generation.....	151
Current Implementation.....	153

## List of Terms Used

ABS	acrylonitrile butadiene styrene plastic (an easily machined, tough, low-cost rigid thermoplastic material with high impact strength)
AC	air conditioning
ACCA	Air-Conditioning Contractors of America
ACH	air changes per hour
AFUE	annual fuel utilization efficiency
B-vent	double-walled combustion gas ventilation piping for gas- or oil-burning appliances
CARB	Consortium for Advanced Residential Buildings
C.E.C.	California Energy Commission
CFC	chloro-fluoro carbon
CFM	cubic feet per minute
CMU	concrete masonry unit
CO	carbon monoxide
DSH	Don Simon Homes
DX cooling coil	direct expansion cooling coil
EF	energy factor
EIFS	Exterior Insulation Finish System
ELA	effective leakage area
EPS	expanded polystyrene
FSEC	Florida Solar Energy Center
HERS	Home Energy Rating Score
HSPF	heating seasonal performance factor
HUD	Housing and Urban Development
HVAC	heating, ventilating, and air-conditioning
ICF	insulated concrete form
IRC	International Residential Code
low-e	low-emissivity
MEC	Model Energy Code
MMBtu	million Btu
NFRC	National Fenestration Rating Council



OC	on center
OSB	oriented strand board
OVE	optimal value engineered
pa	pascals
PV	photovoltaic
PVC	poly-vinyl chloride
R&D	research and development
REM/Design	software for determining residential energy usage
SEER	Seasonal Energy Efficiency Ratio
SHGC	solar heat gain coefficient
SHR	sensible heating ratio
SMUD	Sacramento Municipal Utility District
SWA	Steven Winters Associates, Inc.
TJI	manufacturer of truss joists
VT	visible transmittance
UL	Underwriter's Lab
WECC	Wisconsin Energy Conservation Commission
WESH	Wisconsin ENERGY STAR Homes
WISCheck	software based on Wisconsin's version of the MEC
XPS	extruded polystyrene

## I. Best Practices for Achieving 30% Space Conditioning Energy Savings in Single-Family Detached Cold-Climate Homes



**Figure I-1. A CARB cold-climate house**

### **Background and Introduction**

The Consortium for Advanced Residential Building (CARB), one of the Building America teams, has worked with several cold-climate builders on home designs (Figure I-1) that achieve at least a 30% savings relative to the Model Energy Code (MEC). This report describes the recommended best practices to achieve these savings without compromising health or safety.

A list of Primary Recommendations and one of Secondary Recommendations is included, followed by a discussion of each item on the list. Case studies drawn from CARB's Building America experiences are presented as examples.

### ***Primary Recommendations***

#### **Envelope**

- Insulated low-E windows
- Exterior wall framing: 2 x 6 studs at 24 in. on-center
- Lumber-saving framing details (open three-stud corners, ladder bracing at interior partitions, right-sized headers)

- Unfaced cavity insulation with air sealing and vapor retarder, achieving blower door tightness criterion of 1/4 cubic feet per minute (CFM) @ 50 Pascals per square foot of building envelope area
- Full Oriented Strand Board (OSB) sheathing; or semi-permeable insulating sheathing with OSB corner bracing
- Well designed and executed building envelope water-management system
- Exterior insulation at band joists
- Interior foundation insulation or insulation within the foundation wall

## Equipment

- Manual J / Manual D HVAC sizing
- Condensing furnace (91% AFUE+)
- Power-vented water heater
- Ducts mastic sealed (leakage to outside less than 5% of fan-flow)
- No ducts in outside walls, floor cantilevers, or attics
- No panned returns
- Central air-return with transfer grills at secondary spaces (balanced air-flows)
- Source point humidity control ventilation with low-sone bath fans on automated control
- No unvented gas appliances (except a gas range with a range hood exhausting to the outside)
- Exhaust-only fresh-air ventilation

## ***Secondary Recommendations***

- In-line framing
- Energy-efficient lighting
- ENERGY STAR™ appliances
- Compact duct distribution system

## ***Primary Recommendations for the Envelope***

### Insulated Low-E Windows

#### **Discussion**

- Low-E coated double-glazed windows are universally applicable to cold-climate homes. A low-E coating reduces heat loss in cold weather and heat gain in hot weather (i.e., it has a high total-unit R-value).

This glass has the following characteristics, which can be found on the label attached to all glass (Figure I-2). Look for the National Fenestration Rating Council (NFRC ratings, which are slightly different from conventional ratings).

#### Desirable Low-E Glazing Characteristics for Cold Climates

- Total unit R-value should be more than 3.0.
- If possible, buy glass with the low-E coating on the #3 surface (this is the third of four surfaces on the two sheets of glass, counting in from the outside) to reduce heat loss to the outside. It is very likely that low-E glass with a high visible transmittance (VT) or high solar heat gain coefficient (SHGC); for enhanced passive solar gain, will have the coating on the #3 surface because it will be intended for use in cold climates, where passive gain is important.

#### Benefits Demonstrated in CARB/Building America Projects

- The cost-effectiveness of low-E glazing has been demonstrated in every CARB cold-climate project.
- The low-E coating provides the equivalent of another layer of glazing at a much lower cost.
- Low-E glazing feels warmer, making it possible to dispense with registers located directly below windows, and thus reducing the cost of air distribution.
- The risk of condensation is reduced because of the high R-value.

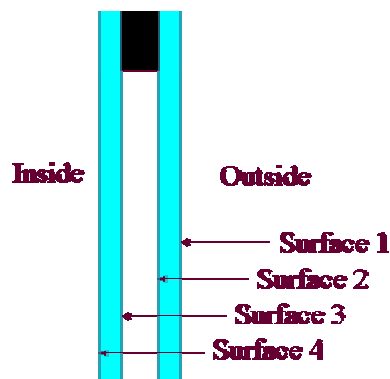

**Figure I-2. Low-E glazing for cold climates**

## Exterior Wall Framing: 2x6 Studs at 24 in. On-Center

### Discussion

The 2 x 6 studs at 24 in. on-center use less lumber than 2 x 4 studs at 16 in. on-center (assuming in both cases that measures are taken to reduce unnecessary studs – see next item). Less lumber means less thermal loss through the studs.

There is no need for concern about the longer span of the top plate. If a joist or rafter rests dead-center between the studs, at least one of the plates will span and support the load when using double top plates. See the “Secondary Recommendations” section for a discussion of in-line framing and single top plates. The primary concern with the use of 24 in. on-center studs is the capability of the exterior and interior finishes to span the extra distance between studs.

In practice, the lower strength of ½-in. board does not pose a problem for most home-buyers. Interior partitions using studs at 24 in. on-center and covered with ½-in. gypsum board are in wide use. But for custom or luxury levels of construction, it is recommended that 5/8-in. gypsum board be used with 24 in. on-center studs.

Some exterior finishes cannot span 24 in. With vinyl siding, it may be necessary to buy a heavier gauge material; check with the manufacturer’s specifications for the maximum allowable span. Stucco applied over 1 in. of Expanded Polystyrene (EPS) foam also cannot span 24 in. Wall sheathing panels of all kinds are span-rated, so check the rating before choosing sheathing or exterior finish panels.

### Application in CARB/Building America Case Studies

- CARB has used studs at 24 in. on-center in several projects.
- In most cases, in-line framing was used (see Secondary Recommendations).
- Where vinyl siding was used, CARB switched to all-OSB sheathing.
- Because the walls were fully sheathed, no changes were necessary in the thickness of vinyl siding.
- No problems arose with regard to interior finish.

## Lumber-Saving Framing Details

### Discussion

Many lumber saving details are possible that not only reduce cost, but save energy, along with saving timber.

### Open Three-Stud Corners

As shown in Figure I-3, the three studs normally used at an outside corner can be rearranged to create an open cavity that can be insulated later (in the conventional box arrangement, the cavity must be insulated by the framers; typically this is not done). The stud that provides nailing for wallboard can be replaced by a 1 x 6, or by drywall clips.

### Ladder Bracing at Interior Partitions

As shown in Figure I-4, the conventional method of framing at a T-intersection creates an uninsulated cavity. It also uses more material than necessary. Replacing the two studs normally used with three to five pieces of blocking saves lumber, provides a use for cut-off lumber pieces, and allows insulation to continue through the T-intersection. The blocking can be replaced by a 1 x 6 (as shown), or by drywall clips.

For production convenience, builders commonly use the same (maximum) header size for all openings. This is wasteful of expensive large-dimension framing and increases heat loss because headers conduct more heat than does an insulated cavity. Simply using two (or three) header sizes for different width openings resolves this problem with a minimum of extra measuring.

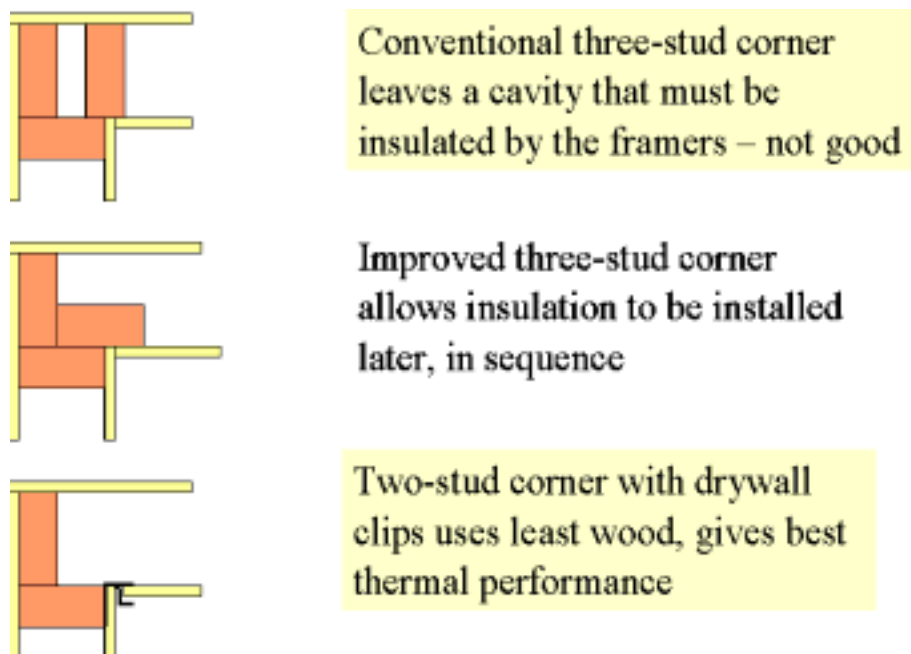

**Figure 1-3. Three-stud corners**

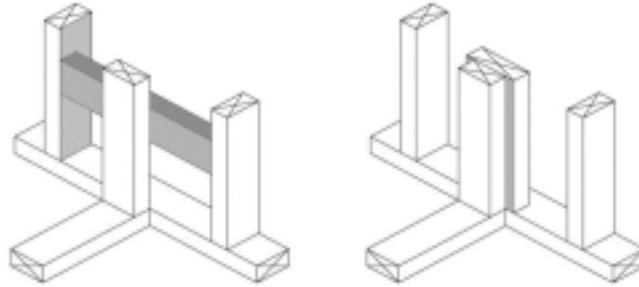

**Figure I-4. Ladder bracing at T-intersections**

#### Benefits Demonstrated in CARB/Building America Case Studies

- As part of its “value engineering” work for several builders, CARB has demonstrated the cost and energy savings of lumber-saving framing details.
- On a typical 2,000-ft<sup>2</sup> two-story home (see the Don Simon Case Study), these measures can save 750 board feet of lumber.

#### Air Sealing

##### **Discussion**

Moisture can penetrate through solid materials by “osmosis,” a problem discussed later in the section about “Vapor Retarder.” In all but the coldest climates most moisture problems stem not from osmosis, but from humid inside air leaking into the wall cavities and condensing on the cold sheathing or from cold outside air reaching inside surfaces, causing condensation and mold.

There are three solutions to this problem:

- Reduce the inside humidity
- Make the cavity warmer by using insulating sheathing (this only works for inside air leaking out)
- Prevent inside or outside air from circulating within the cavity.

#### Reducing Interior Relative Humidity

Very high inside relative humidity is not healthy for people or the building and should be prevented. The goal is not to dry the home out, but to keep inside relative humidity at healthy levels (35% to 50%). The occasions where inside humidity might exceed 50%, along with recommended cures, are as follows:

- A small home with many occupants (provide adequate ventilation – see later discussion)
- An unventilated shower (provide adequate ventilation)
- A dryer exhaust terminates within the living space (terminate outside)
- Use of a humidifier (never install one except where necessary to protect flooring in dry climates)
- Use of an unvented gas heater (strongly discourage their use – see below).

Heat-recovery ventilators are not recommended. They are expensive, require maintenance, and often are irritating to occupants because they tend to run all the time, delivering substantial flows of air that is colder than room air.

### Using Insulating Sheathing

While insulating sheathing can help reduce condensation in walls, it is not the solution of choice for reasons discussed in detail below.

### Air Sealing

Air sealing is the primary defense against condensation within cavities or on cold inside surfaces.

Because vapor retarders seldom if ever seal around penetrations or at edges, vapor retarders should not be thought of as an air-sealing measure. Leakage occurs at edges, corners, joints, and penetrations. If these areas are sealed, the gypsum board by itself seals the broad expanses of wall and ceiling, without the help of the vapor retarder.

### Air-Sealing Techniques

Care must be taken to seal off all the passages by which interior air can migrate within the walls and into the attic or into cathedral ceiling cavities. The following areas should be sealed:

- Between electrical boxes and gypsum board (typically using low-expansion foam)
- Openings in the back of electrical boxes or installing boxes in an air-sealing shell made for the purpose
- Holes for electrical or plumbing in the top and bottom plates of exterior walls and in the top plates of interior partitions where wiring runs into the attic or a cathedral ceiling (figures I-5 and I-6)
- All penetrations into the attic or a cathedral ceiling, including the following:
  - o Bathroom fan housings
  - o Recessed light fixtures
  - o Skylights and light tubes
  - o Air diffusers
  - o Smoke alarm outlet boxes.

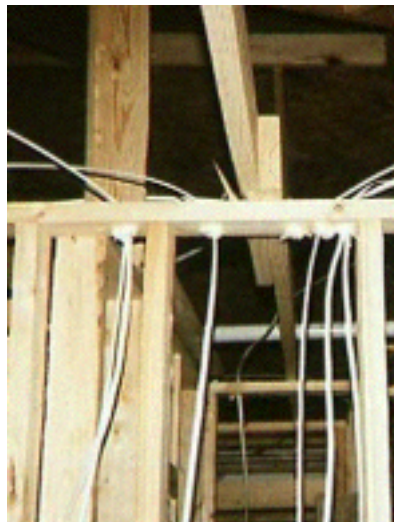



**Figure I-5. Sealing techniques**

It is also important to seal cracks and holes in the outside of walls.

*Why? Air leaks to the outside can suck inside air into the walls. They contribute to heat loss in this way, as well as causing condensation.*



**Figure I-6. Sealing techniques around wiring**

There are many sealing products available, each suited for a particular job:

- Foam guns (Figure I-7)
  - o This foam is the all-purpose sealing tool for nearly any gap
  - o Low-expansion foam is available in cans that attach to inexpensive application guns
  - o These guns feature a screw-plunger that closes off the nozzle and keeps the gun clean between uses
  - o There is also a can of cleaner that can be attached to the gun
  - o For large gaps, high-expansion foam is available.
- Sill sealer
  - o The gap under the mud sill can be foamed with low-expansion foam
  - o Protecto Wrap, called the “Triple Guard.” (Figure I-8), is an alternative recommended product
- Other gaps in the wall
  - o Another product by Protecto-Wrap, “Energy Plate Liner” seals the gap between the subfloor and wall plate (Figure I-9)
  - o The easiest and best way to seal the horizontal gaps above and below top and bottom wall plates is to extend OSB or plywood sheathing down or up to cover the gaps.
- Sealing around windows
  - o If windows with flanges are used and they are properly flashed, air leakage between the window frame and the wall framing is unimportant
  - o However, filling these gaps with fiberglass or low-expansion foam will keep inside air from circulating and reduce condensation
  - o If ordinary wood windows are used without frames, it is very important to foam the gap between the window and the framing with low-expansion foam



**Figure I-7. Foam gun**



**Figure I-8. Sill sealer**

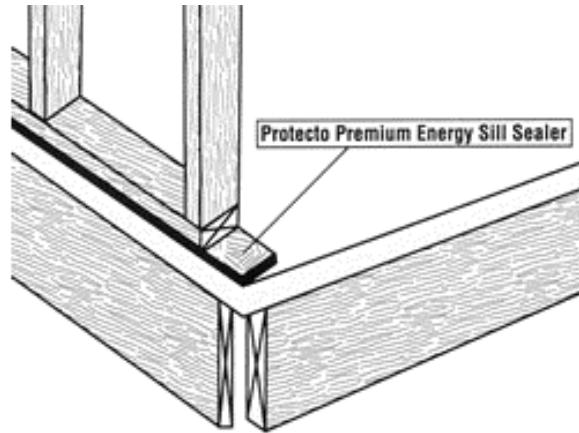

**Figure I-9. Energy plate liner**

### Air-Sealing Criterion

CARB recommends that building envelope tightness measures, including air sealing, result in no more than 1/4 CFM per square foot of envelope area leakage when measured at 50 Pascals in a blower door test.

### Application in CARB/Building America Case Studies

Gap sealing has proved to be a crucial aspect of high-performance home construction and is used on most CARB homes. CARB homes consistently achieve the targeted air leakage rates.

### *Un-faced Cavity Insulation and Vapor Retarder*

#### **Discussion**

There are many types of insulation available, but none are as cost-effective as fiberglass batts. Fiberglass comes with and without facings. A kraft-paper facing adds cost, but if properly installed it provides a good vapor retarder for all but the coldest climates. CARB has found that it is rare for insulating sub-contractors to install faced batts properly. An acceptable job of insulating is more likely if unfaced batts with a separate vapor retarder are specified. Also, the vapor retarder can be “tuned” to the climate if it is separate from the insulation.

### Unfaced Batt Installation

Unfaced batts should be installed as follows:

- Cut batts the proper width to fit narrow stud spaces
- Fit batts around wiring and piping. Split batts front to back so they fit on both sides of wiring.

- Fit batts to completely fill all the cavities, with a minimum of gaps and voids, to prevent any air that leaks into the cavity from circulating.

The R-value of a given thickness of fiberglass insulation increases as more fiberglass is added (density increases). For a modest increase in material cost, the R-value of 3-1/2 in. of insulation can increase from R-11 to R-13 or R-15. These denser insulations are readily available.

### Vapor Retarder

Once the walls and ceilings are sealed to inhibit air movement, a vapor retarder can be chosen to suit a specific climate. The vapor retarder should be just enough of a barrier to control osmosis in the coldest weather, and no more. As the number of continuous cold days without a warming period decreases, the effectiveness of the vapor retarder should also decrease.

*Why: A vapor retarder inhibits the desirable ability of the wall to dry toward the inside in the event that it gets wet for any reason.*

Specific recommendations include the following:

- In regions with more than 8,000 degree-days a continuous 6-mil polyethylene membrane or foil-backed gypsum wallboard are preferred solutions. Foil-backed gypsum board should not be used with tile or any other wall covering that creates a vapor retarder, such as vinyl wall fabric, because the gypsum board will then be trapped between two vapor retarders, enhancing the possibility of moisture damage.
- For less severe cold climates, 6-mil poly is acceptable, but vapor retarder paint is the recommended solution. Vapor retarder paint is a “good enough” vapor retarder with the advantage that it allows any moisture in the walls to dry to the interior.
- Kraft or foil facings on fiberglass batts are not recommended unless they are carefully installed:
  - Facings should be “face stapled, not “inset stapled,” to avoid the puckers between the studs and insulation that occur with inset stapling (see figure I-10).
  - Face staples must be set flush with the studs to allow proper installation of drywall.

### Application in CARB/Building America Case Studies:

CARB homes in cold climates typically have 6-mil poly vapor retarders over unfaced fiberglass batts. While the poly is not ideal in less than severely cold climates, it has performed satisfactorily.

### *Full OSB Sheathing or 1-in. Extruded Polystyrene (XPS) Insulating Sheathing*

#### **Discussion**

Insulating sheathing has the following advantages and disadvantages relative to OSB or plywood sheathing:

### Advantages

- It helps reduce condensation, especially in mild weather.
- It provides useful additional wall insulation, including insulation over the studs, plates and headers, which are otherwise a partial thermal short-circuit over 20% of the exterior wall.
- It provides outside insulation over band joists and headers.

### Disadvantages

- Insulated sheathing adds cost.
- Insulated sheathing only applies to walls, and not the attic, which has an area comparable to the walls. Therefore, careful gap sealing is crucial regardless of the type of sheathing. An investment in gap sealing is much more important than investing in extra insulation.
- The IRC does not allow 1x4 let-in bracing or metal bracing to be part of the wind-bracing system. At 7/16-in. OSB or plywood wind bracing, only ½ in. of insulation can be applied, providing only R-2 or R-2.5 insulating value over the approximately 30% of the wall that typically has wind bracing.
- Insulation does not support exterior finishes as well as wood panels and cannot be used under (for example) wood shingles. If the advantages of 24 in. stud spacing are to be realized, OSB sheathing will be required under many finishes.
- Insulating sheathing is least helpful in preventing condensation in the coldest weather because the R-value of the sheathing is not high enough to increase the interior sheathing surface temperature above the dew point during very cold conditions and condensation results.
- Even with insulated sheathing, air sealing is crucial. Once the cavity is well-sealed, the insulating sheathing loses its importance in controlling condensation.

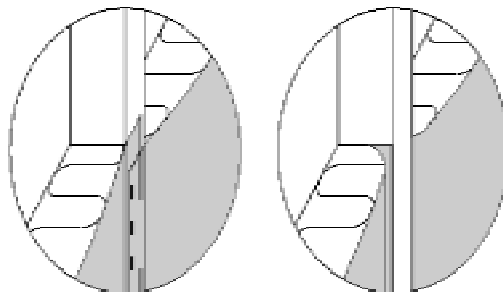

**Figure I-10. The difference between face stapled (left) and inset stapled (right) Kraft or foil-faced fiberglass batts**

These pros and cons balance each other. CARB recommends either full OSB or plywood sheathing, or 1-in. extruded polystyrene (XPS) foam sheathing or, ½-in. XPS foam over OSB or plywood wind bracing panels.

In cold climates, NEVER use the type of insulated sheathing that has vapor-retarding skins (typically some form of polyethylene sheet). This practice traps any moisture that gets into the walls.

CARB also does not recommend the use of highly vapor-permeable sheathing material (gypsum-based products).

*Why? The combination of a water-absorbing exterior cladding, such as brick; a strong interior vapor retarder, such as 6-mil poly; and a vapor-permeable sheathing, such as gypsum sheathing together can create serious condensation and rot if the home is air conditioned.*

#### Application in CARB/Building America Case Studies

For both William Ryan Homes and Don Simon Homes, CARB substituted full OSB sheathing for both permeable sheathing and for highly impermeable foam sheathing. The energy cost was small, the added condensation risk was not important. Other CARB cold-climate builders have routinely used OSB sheathing without problems.

#### Well-Designed and Executed Building Envelope Water Management System

##### **Discussion**

Preventing water intrusion through the envelope is very important and typically neglected. The areas of greatest concern (beginning at the top of the house) are listed below, with numbers referring to Figure I-11.

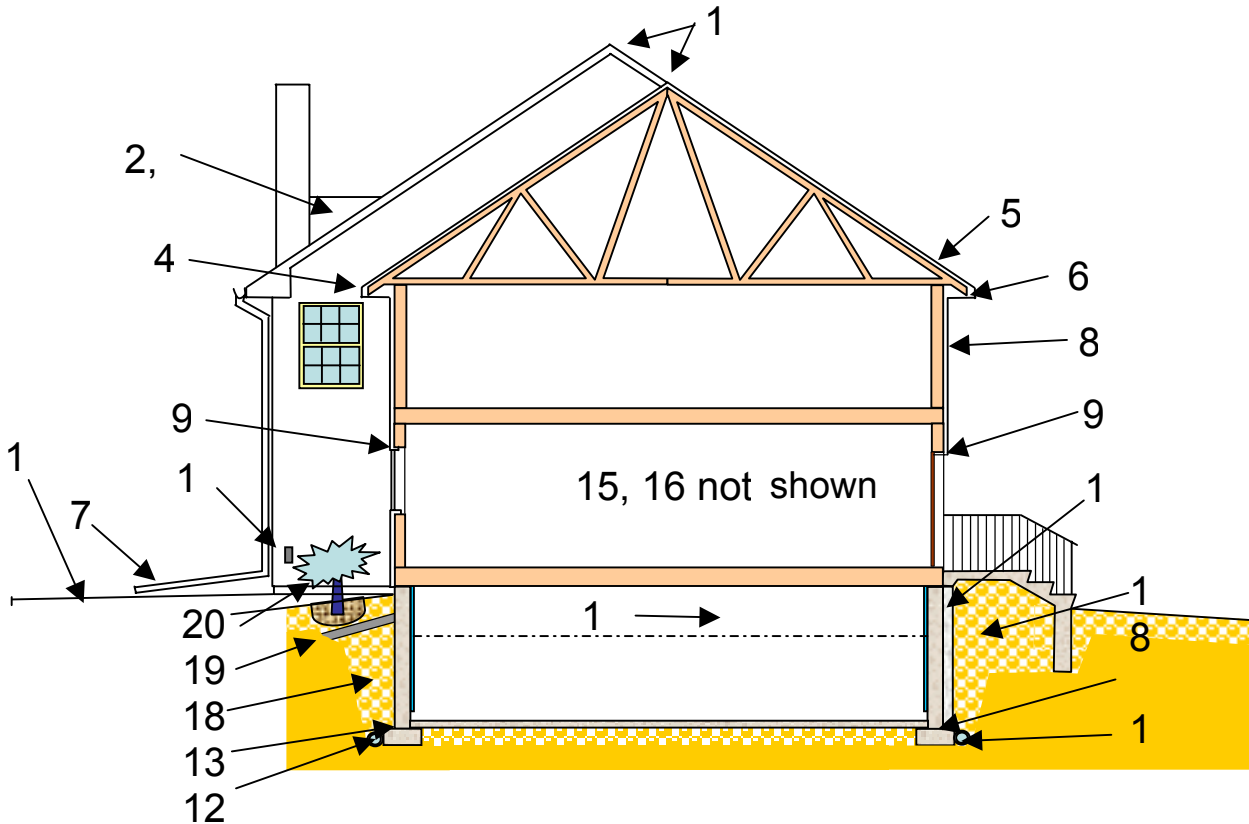

**Figure I-11. Preventing water intrusion**

***Explanation of Figure I-11: Preventing Water Intrusion***

**Roof**

**1. Prevent Rain and Snow Leakage into Ridge Vents**

The usefulness of roof cavity venting is controversial, but the practice is currently required by code. Minimizing rain and snow entry through the ridge vents is more important than ensuring a lavish flow of air. Choose a product on the basis primarily of how well it blocks water entry and secondarily on how well it ventilates.

**2. Provide Adequate “Crickets” Behind Chimneys and Other Projections through the Roof**

There must be a way of sending water around the objects like chimneys and skylights that block the flow of water down the roof. Behind tall objects like chimneys, install the largest and steepest “cricket” (small gabled roof) that will fit. This will also help prevent the buildup of snow.

### **3. Place Chimneys, Dormers, etc., away from Valleys and Adequately Separated from Each Other**

Water collects and runs down valleys. Running valleys together (for example, between closely spaced dormers) or placing a chimney or other obstruction in a valley almost guarantees water leakage. During winter, snow will collect in these tight spaces and cause ice dams.

### **4. Use “Kick-Out” Flashing At The Joint Between An Eave And A Sidewall**

Where a roof runs into a sidewall, “step flashing” is required at the joint. If the roof stops before the wall does, the water that collects against the step flashing will run in behind the siding unless it is directed back out onto the roof by “kick-out” flashing.

### **5. Use An Impervious Layer At Valleys And Eaves**

At eaves and valleys, an impervious layer of peel-and-stick modified bituminous flashing material should be installed under the roofing.

*Why? When it is about 20 degrees outside, snow on the roof is likely to melt, run down to the eaves, and freeze there, creating an ice dam. Further melting will run back up the roof behind the dam and leak through the shingles. The impervious layer keeps most of this water from entering the building.*

In snowy climates, a 3-ft band is recommended in both places. In very snowy climates, the entire roof might be better covered with metal roofing to encourage snow to slide off.

### **6. Size Gutters Properly and Provide More Than the Minimum Number of Downspouts**

In snowy climates, the lip of gutters should be just below the plane of the roof shingles to minimize damage during snow slide-off. Larger gutters with frequent downspouts are more able to handle downpours.

### **7. Discharge Downspouts At Least 10 Ft Away From The Sidewall**

Simply spilling a downspout onto a splash block will not keep this concentrated flow of water from flowing against the foundations.

- Extend downspouts at least 10 ft away from the house
- If a solid extension piece is used, it can be placed within a projecting planting bed to avoid interfering with mowing
- Collapsible extensions are available that can be mowed over.

## **Sidewalls**

### **8. Use “Rain-Screen” Sidewall Construction**

All siding materials leak. If the siding is designed as the only surface that sheds water, the smallest imperfection will let water in. Once in, the water cannot get out, and it will cause rot in the framing. Exterior Insulation Finish System (EIFS) is a prime example of this kind of construction. The only siding that actually sheds water is triple-layer wood shingles, where water that leaks in is kicked back out by the shingle beneath.



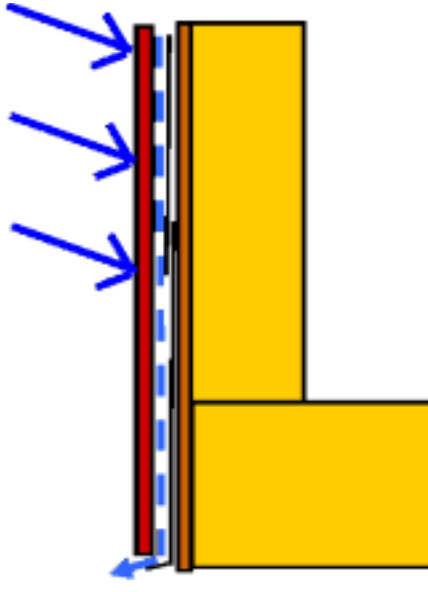

**Figure I-12. Rain-screen sidewall construction**

The proper way to build an exterior wall (Figure I-12) is as follows:

- Treat the cladding as a screen that stops the wind and most of the rain, but lets some water in
- Behind the cladding, protected from the wind, is the water-repellant membrane
- Because there is no wind pressure behind the cladding, water that penetrates will simply fall down the wall by gravity
- Because water will be running down the membrane, all flashing around windows, doors and other penetrations must be shingled top over bottom (see next item)
- Because water will be running down the membrane, wood or wood composite siding should not be placed hard against the membrane; use wood spacers or special sheet material made for the purpose.

The water-repellant membrane should be made as follows:

- Exposed OSB sheathing, exposed foam sheathing, or housewrap with vertical joints taped with red sheathing tape and horizontal joints protected with “Z” flashing (upper leg behind the upper sheet, lower leg over the lower sheet) made of metal or peel-and-stick flashing membrane
- Do not rely on surface-applied peel-and-stick flashing strips over the outside of horizontal joints; use the Z-flashing method in all cases.

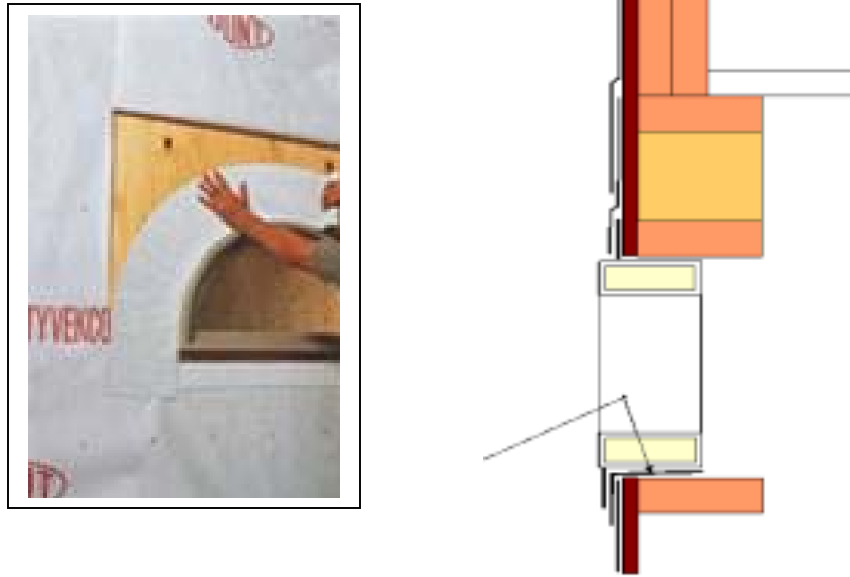

**Figure I-13. Peel-and-stick flashing membranes used around windows and doors**

### **9. Properly Flash Around Windows And Doors**

The manufacturers of peel-and-stick flashing membranes, such as DuPont's FlexWrap, publish detailed instructions on the use of these products around windows and doors (Figure I-13). The typical requirements are as follows:

- If using housewrap, cut a flap over the top flange of the window and tape it up out of the way
- Apply tape over the side flanges
- Apply tape over the top flange and over the top of the side tapes
- Fold the flap down over the top flange and secure with tape
- Do not tape the bottom flange, which should lap over the housewrap; leave open for water to get out.

### **10. Use Flashing instead of Caulking around Wall Penetrations such As Bracket Lights, Hose Bibbs, and Exterior Receptacles**

- At penetrations for outlet boxes, use prefabricated blocks (with vinyl siding) or create a mounting block that is shingle-flashed to the water-repellant membrane behind the cladding
- Seal between the cladding and penetrations where convenient, but don't rely on this sealant to stop the water.

## Foundations

### **11. Cover Crawl Space Floors with an Impervious and Durable Material**

Building scientists have shown that an essential means of preventing wet crawl spaces is to cover the floor with concrete or a plastic membrane. Fiberglass reinforced polyethylene is the membrane material of choice.

### **12. Provide Adequate Drainage of Ground Water through Footing Drains**

- Measures taken to prevent surface water from reaching the foundations in most cases will solve water problems
- In some cases, high groundwater will keep the footings wet
- Water from wet footings can rise by capillary action into the foundations
- A good protection is to install drainage at the bottom of the footings
- These drains should be perforated PVC, not corrugated ABS
- They must drain to the surface by gravity
- If that is not possible, they must run to a dry well or to a sump pump that discharges the water well away from the foundations.

### **13. Provide a Membrane between Footings and Foundation Walls**

In cases where ground water persists near or at the level of the footings, it is highly advisable to add a layer of plastic membrane on top of the footings. This membrane keeps water from rising into the foundations by capillary action (“rising damp”). Occasional penetrations for dowels are not a problem.

## Porches and Terraces

### **14. Support Terraces, Porches and Decks at the Sidewall to Maintain a Slope away from the Sidewalls**

All structures that abut the home need to be supported on solid supports:

*Why? Even well-compacted backfill will slowly settle over time. If the terrace or porch is supported only on fill, it is likely sooner or later to slope the wrong way. Once this happens, the problem escalates, because more water flows toward the home, increasing settlement.*

Also, supporting a porch on fill places fill against the band joist framing, which is very bad practice.

### **15. Drain Subgrade under Terraces to Prevent Backflow toward Foundations**

- Terraces are often set over a recessed, gravel-filled bed
- This bed acts like a swimming pool, holding water that flows through the cracks between the stones

- If this “pool” is not drained away, water can collect and drain back against the foundations.

## Grading and Planting

### 16. Use Loose Stones or Other Means to Prevent Splashback from Eaves without Gutters

Water falling off un-guttered eaves, especially for two or more stories, will splash back onto the siding, causing unsightly stains, damaging the siding and removing the finish. A layer of loose stones set in a bed will help to break up the water and minimize splashing.

### 17. Grade away from the Sidewalls around all Sides of the Home (Figure I-14)

- Typical requirements are to grade away 6 in. in the first 10 ft
- This is sometimes impractical; for narrow spaces, grade more steeply
- At uphill conditions, create a swale (crosswise drainage ditch) between the slope and the foundations, making sure the swale drains to one or both sides.

### 18. Compact Backfill Against The Foundation To Prevent Settlement

- Builders often backfill quickly to provide access to the floor deck
- This backfill will settle, so that surface water flows back toward the foundations, creating serious water problems
- Instead, compact the backfill as it goes in to 90% compaction, in 6-in. layers
- Make sure the foundation is properly braced before backfilling.

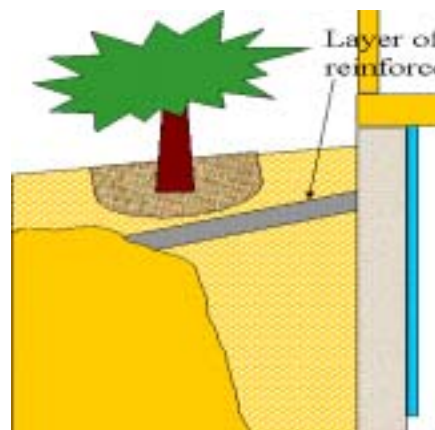

Figure I-14. Grading and planting

## **19. Provide a “Ground Roof” Spanning from the Foundations over Porous Backfill to Non-Porous Subsoil**

A “Ground Roof” is an idea invented by building scientist William Rose. It provides very effective protection for foundations against water intrusion from surface run-off. In combination with positive surface drainage away from the foundation, the ground-roof provides additional protection from water intrusion when the surface becomes saturated or otherwise loses its ability to effectively drain surface water.

## **20. If there is no Ground Roof, do not plant near the Home**

So-called “foundation planting” is destructive to the home in many ways

- It encourages mildew by inhibiting air flow
- It restricts proper maintenance of the home’s outside skin
- Most important, watering the foundation planting automatically waters the backfill and, therefore, the foundations
- The ground roof prevents water from flowing down, so planting can occur above it
- In all other cases, keep shrubs and trees at least 5 ft from the foundations.

### Application in CARB/Building America Case Studies

Working with its builder team-members, CARB encourages the use of most or all of the above measures. Some measures, such as the prohibition against foundation planting, are widely ignored, because the builder does not install the planting or try to educate the homeowner. Increasingly, these measures are becoming more of an issue with builders, because of concerns about litigation for mold.

The above measures are all good practice, and taken together will go a very long way toward preventing moisture-related problems throughout the building envelope.

## **Exterior Insulation at Band Joists**

### **Discussion**

No one has developed a simple, cost-effective method for insulating the band joist area, which typically accounts for 10% of the exterior wall. The most common solution, fiberglass insulation stuffed inside the band joists, is not the preferred solution. Inside basement air, which may be humid, can circulate behind the fiberglass (which is typically not installed carefully), condense on the band joist, and cause mold, or sometimes rot (this is less likely to occur at the second floor band).

XPS insulating sheathing warms up the band joist and inhibits condensation. However, approximately 30% of the band joist that is located at wind bracing will only be insulated with ½-in. foam insulation yielding R-2.5, which is not adequate. Thus, inside fiberglass will still be required, and condensation can occur behind the fiberglass.

One alternative that is often recommended, but seldom practiced, is to set the band joist in by 1-1/2 in. (assuming 2 x 6 wall construction) and to fill this gap with foam insulation

placed before sheathing. This system requires training framers in an unfamiliar practice and requires the framers to place the insulation. If they don't have the insulation at hand, it will be omitted, and no one will see the error.

Any system for insulating more carefully inside the band joist requires that the insulation be tightly fit between joists for that portion of the band where the framing is perpendicular to the outside wall, typically more than half its length. Many schemes have been proposed to accomplish this, but none have proved practical.

Balancing these issues, CARB recommends this solution:

- Include as part of the gap sealing the installation of urethane foam sealant at the perimeter of the fiberglass batt inserts placed inside the band joists. This has the advantage of simply extending gap sealing work that is needed elsewhere on the job.

#### Application in CARB/Building America Case Studies

CARB's builders have not seen this as an important issue (current practices does not lead to call-backs). They have therefore typically added fiberglass batt insulation inside the band joists. Given a rise in concern about mold, CARB expects that its builders may agree to the recommended added gap sealing.

### Interior Foundation Insulation or Insulation Within the Foundation Wall

#### **Discussion**

Insulating basements is increasing for two reasons:

- More people are finishing their basements
- It is not possible to achieve a 30% reduction in space conditioning without insulating the basement, including the portion above grade.

Unfortunately, improperly installed basement insulation can cause major mold problems.

*Why? Basements are at the bottom of the house. Any water overflowing within the living space or entering the roof or walls will tend to end up in the basement. Basement walls are vulnerable to surface and underground water entry. Finally, basement walls are often cold enough to cause the humidity in the basement air to condense. Insulation may cover up water problems, or keep walls cold during humid weather, both leading to mold growth.*

There are four ways to insulate a basement wall:

- Insulate the outside surface: CARB does not recommend this approach for two reasons:
  - o It is very difficult to prevent the insulation from becoming a hidden route for termite access to the framing
  - o No method has been invented to finish the insulation above grade (which is the most important insulation on the wall) with a material that will stand up to weed-whackers, mowers, and other mechanical damage and that looks acceptable.

- Insulate on both sides: Insulated Concrete Form (ICF) foundations are growing in popularity. But because they have exterior foam insulation, they have the same problems as exterior insulated walls.
- Insulate the inside surface: This is one of the two ways recommended by CARB, providing the insulation is installed as recommended or another example of insulation on the inside surface of the basement wall is the proprietary precast foundation, “Superior Wall.”
- Insulate within a concrete wall: This configuration (for example as the in the “T-Mass” system by Dow) is also recommended.



**Figure I-15. Precast foundation system**



**Figure I-16. The T-Mass system**

### **Insulating on the Inside Surface**

Tests performed by CARB and others show that condensation forms between batt insulation and the basement wall if any air is allowed to circulate in the gap. CARB has had success with foam insulation adhesive-applied to the inside of the wall, effectively eliminating air circulation and, therefore, eliminating mold potential. This approach is incorporated into the proprietary Superior Wall precast foundation system (Figure I-15), which has a layer of XPS foam cast into the inside face

### **Insulating within a Concrete Wall**

The T-Mass system suspends a layer (typically 2 in. thick) of Dow XPS foam (“Styrofoam”) between the wall forms, creating a 10-in.-thick wall with two 4-in.-thick wythes of concrete sandwiching the foam (Figure I-16). In this system, the inner wythe will stay close to the temperature of the basement, avoiding condensation under nearly all conditions.

### **Application in CARB/Building America Case Studies**

CARB has used Superior Wall foundations on several of its homes. Preliminary results from extensive tests performed for Cambridge Homes in Chicago show that adhesive-applied foam yields excellent results.



## ***Primary Recommendations for the Equipment***

### ***Manual J / Manual D: Heating and Air-Conditioning System Sizing***

#### **Discussion**

Increasingly in northern climates, builders are installing forced-air heating, which (unlike hydronic systems) can be fitted with air conditioning (AC). Such systems are typically designed by rules of thumb. This results in wastefully oversized systems and improperly sized distribution has long published a simple, but effective, method of determining loads (“Manual J”), sizing equipment (“Manual S”), and sizing ductwork (“Manual D”). These design tools are available in extremely user-friendly computerized form.

#### **Applications in CARB/Building America Case Studies**

All CARB projects have been designed using Manual J / Manual D computerized calculation, except those special cases where a more sophisticated program has been used. CARB often finds that systems are dramatically oversized, as one safety factor is piled on another. It is important that the designer have sufficient information to account properly for all envelope efficiency measures, which often result in a downsizing of equipment and ductwork sizes.

### **Condensing Furnace**

#### **Discussion**

A wide variety of reliable furnaces are available with seasonal efficiencies of 90% or more. Highly efficient furnaces create an exhaust of such a low-temperature that there is insufficient stack effect to exhaust the gases; and acid condenses out of the gases during discharge. These furnaces therefore require plastic or stainless steel flues with power-driven exhaust. These flues, along with air intakes feeding sealed combustion chambers, typically discharge through the side wall, and have limits on length of run and number of elbows. Avoiding the difficulty of threading a B-vent through the plans is replaced by a limitation on where the furnace can be placed, in order to stay within the maximum allowable horizontal length of run of the vent. The units are somewhat more costly than conventional furnaces.

#### **Benefits Demonstrated in CARB/Building America Projects**

CARB always recommends furnaces with a seasonal efficiency of 90% or greater in its cold climate homes. Compared with atmospheric furnaces, which typically have 80% seasonal efficiency, these furnaces save about 12% of the heating energy.

### **Power-Vented Water Heater**

#### **Discussion**

Along with a sealed combustion furnace, a power-vented water heater is a must in a well-sealed home as a safety measure to prevent backdrafting. Backdrafting can occur if all the exhaust systems are running together: ventilation fans, dryer, kitchen range hood, and bath fans. It is more cost-effective to install power-vented heating appliances than a

complicated balanced-flow ventilation system (which might not be operating when needed).

#### Applications in CARB/Building America Case Studies

CARB recommends power-vented water heaters in all its homes.

#### Ducts Mastic Sealed (Leakage Less Than 5% Of Fan-Flow)

##### **Discussion**

Properly sealed ducts make sure air gets to the spaces intended, rather than leaking into a plenum space. It also minimizes the chances of creating pressure differentials from space to space that would induce airflow through the envelope. The process of sealing each joint reduces the chances of unconnected ductwork, a surprisingly common mistake.

Tape is not recommended as an alternative to mastic. Various tapes are tested to UL 181 standards, which supposedly makes them reliable for use on metal or plastic ductwork. However, it has been found that some duct tape (which is not suitable for taping ducts) passes UL 181. Mastic provides the most reliable duct sealing method.

All ductwork, including the air handler compartment (which typically has many leaky joints) should be mastic sealed. A common goal for duct leakage, measured using a “duct blaster” test, is 5 to 6% leakage to the outside.

#### Benefits Demonstrated in CARB/Building America Projects

Mastic duct sealing recommended for use in all CARB homes. Energy savings can be relatively modest, or substantial, depending upon how well-constructed the ductwork system is to begin with. Well-sealed ducts perform better (they send the air where it is designed to go), and they minimize the infiltration of air from garages and attics.

Another advantage is that having to go seal all the ducts makes it much more likely that all duct joints will be connected; unconnected ducts are surprisingly common. To be sure the sealing has worked, it is advisable to perform a duct-blaster test.

#### No Ducts In Outside Walls, Floor Cantilevers, or Attics

##### **Discussion**

Ducts belong within the conditioned envelope.

*Why? Ducts in unconditioned spaces, or in outside wall cavities, place the hottest (or coldest) element in the house closest to outside air temperatures.*

#### Applications in CARB/Building America Case Studies

An important technical goal in all CARB designs has been to centralize the ductwork and to the greatest extent possible keep all the ductwork within the conditioned envelope. This maximizes the efficiency of the entire HVAC system.

## No Panned Returns.

### Discussion

“Panning” is commonly used to create a return air plenum between two floor joists. In some cases, this practice is justified. But all too often, the panning extends to the outside wall. In this case, the reduced pressure in the return system actively draws outside air into the ductwork through cracks under and above the mudsill. Also, panned returns are hard to seal, which tends to draw air into the system in unwanted places, unbalancing the system and reducing overall system efficiency.

### Applications in CARB/Building America

Return air ductwork in CARB homes are not panned, reducing the potential for duct leakage (see next item).

## Central Air-Return with Transfer Grilles at Secondary Spaces (Balanced Air-Flows)

### Discussion

There is nothing wrong with adding a ducted return from each room, as long as the returns are not panned and as long as they remain within the conditioned envelope of the home. However, ducted returns are an unnecessary expense in most housing and are a definite liability if they run in the attic.

A more reliable and cost-effective approach is to provide a central return and make sure that there are transfer grilles or transfer ducts, of adequate size, that allow air to return from individual closed rooms to the central space. A common requirement is that the difference in static pressure between any two rooms remain below 2.5 Pascals. This is a low, but achievable, number.

The worst possible conditions occur when there is neither a ducted return nor a transfer grille (Figure I-17).

*Why? If one space is pressurized, some other space will be de-pressurized. In both cases, air is forced through cracks into or out of walls and attics, increasing energy losses. Moist inside air is also drawn into the walls and ceiling, creating the potential for condensation.*

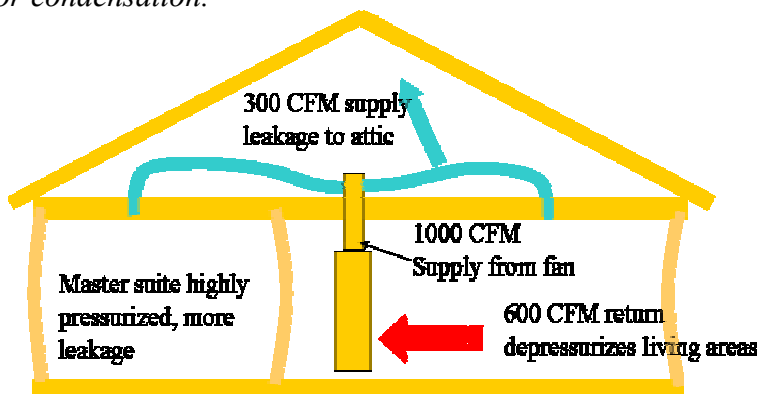

Figure I-17. Unequal pressurization in a home

### Applications in CARB/Building America Projects

CARB has used several different, cost-effective methods of transferring return air without compromising acoustic or visual privacy. The most workable is a high grille on one side of an interior wall cavity and a low grille on the other. Sometimes rooms do not have any common wall with the main space (for example, a door at the end of a corridor). In these cases, grilles can often be put into and out of a closet, or grilles can be located opposite each other over the door.

### Source Point Humidity Control Ventilation with Low-Sone Bath Fans on Automated Control

#### **Discussion**

A workable and cost-effective ventilation system is important, especially as small homes are built with tight envelopes. Elaborate systems, while workable, are typically not cost-effective and require continuing maintenance (that might be discontinued). The best solution is to ventilate where the greatest humidity loads (in bathrooms) or toxic gases (at gas ranges) are located. The bathroom vents, if properly designed, can be arranged to run for extended periods, to help ventilate the entire home.

### Applications in CARB/Building America Projects

CARB's "standard" cold-climate bath exhaust system consists of a high-efficiency (quiet, low-sone) bathroom fan properly ducted to the outside, coupled with a controller. The controller can be a simple one with an on-off switch and an adjustable (by removing the cover) extended-run control. In a typical case, the fan will continue running for 20 minutes every time it is turned on. It is essential to have a quiet and efficient fan so that the extended running time is not annoying or wasteful of energy.

### No Unvented Gas Appliances (Except Gas Range with Range Hood Exhausting to the Outside)

#### **Discussion**

Unvented gas appliances, such as fireplaces or heaters, may or may not be a health hazard (this is controversial). What is not controversial is that they are potentially highly destructive to the framing of the building. These devices create vast quantities of water if they are run for extended periods, because the main products of complete combustion are water vapor and carbon dioxide. This water vapor raises the interior relative humidity to unreasonably high levels. Not only does this create mold within the home (typically behind clothes in closets), but any inside air that enters the wall cavities or attic carries with it large amounts of moisture, which then condenses and causes rot.

### Application in CARB/Building America Case Studies

CARB recommends against the use of these devices and insists that all gas ranges be equipped with a range hood that ventilates to the outside. These are basic safety and indoor air quality measures that should always be observed.

## **Secondary Recommendations**

### **In-Line Framing**

#### **Discussion**

To obtain full benefit from 24-in. on-center wall studs (Figure I-18) it pays to adjust the plan to a 2-ft module, then align the floor joists and rafters on the 2-ft grid, so that all horizontal framing lands over a stud. This in principle eliminates the need for a double top plate, for additional savings.

Floor framing members may need to be increased in weight to handle the increased load without adding to the bounce of the floor. Also, the floor deck needs to be increased in thickness to prevent it from flexing between joists under point loads.

#### Application in CARB/Building America Case Studies

With Don Simon Homes, Beazer Homes in Houston, NVR/Ryan Homes, and William Ryan Homes, CARB has been successful in simplifying the plans and aligning the framing. However, in none of these cases did we use a single top plate: the advantages of overlapping and interlocking at corners and intersections outweighed the savings in lumber.

### **Energy-Efficient Lighting**

#### **Discussion**

One of the most important ways in which energy is wasted is the use of incandescent lamps. Until recently, however, most fluorescent lamps had disadvantages that limited their use to some bathroom and kitchen lights (with high-end homes dispensing with them altogether). These disadvantages are rapidly being eliminated by successive generations of compact fluorescent lamps. While some still exhibit a time delay before they are fully bright, their color can be quite authentic, especially when reflected from a recessed can, or diffused through the shade of a lamp. Lights that are seldom used can remain incandescent with little loss in energy. Also, fluorescent lamps typically do not work as well outdoors as incandescent lamps.



**Fig. I-18. In-line framing**

### Application in CARB/Building America Case Studies

Because of the past history of ineffective fluorescent lighting, CARB's builders have steered clear of fluorescent lighting, responding to market resistance to their use. As market acceptance grows, CARB will continue to suggest the increased use of fluorescent lamps in built-in fixtures.

### ENERGY STAR Appliances

#### **Discussion**

Two of the most important appliances from a water-use and energy efficiency point of view are the washer and dryer, which are seldom supplied by the builder. However, the builder should include a gas line to make it possible for the homeowner to install a gas dryer. In most cases, gas energy is less costly than electricity. The two main appliances supplied by the builder where efficiency is important are the refrigerator and the dishwasher. There are now hundreds of models of refrigerators that are ENERGY STAR rated, and their use should be routine. There are also many energy-efficient dishwashers available.

### Application in CARB/Building America Projects

CARB has had mixed success in encouraging builders to install ENERGY STAR appliances. Typically, as with McStain in Boulder, Colorado, ENERGY STAR appliances are requested by buyers in certain markets where energy performance is a major issue. In other cases, aesthetics or quiet operation govern, and the ENERGY STAR rating is not considered an important issue. This is gradually changing as ENERGY STAR becomes better known.

### Compact Duct-Distribution System

#### **Discussion**

If low-E glazing is used and the home's envelope is relatively tight, it is possible to discharge conditioned air from inside walls in most cases without compromising comfort. By providing a central duct shaft with short branches to inside walls (Figure I-19), ductwork runs can be dramatically reduced.

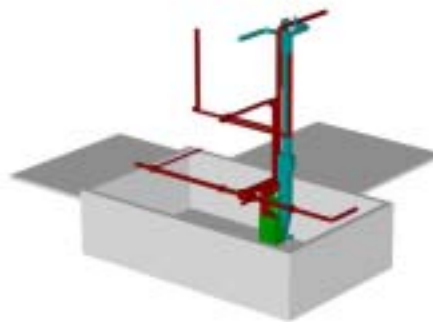

**Figure I-19. Ductwork with short branches to inside walls**

### Application in CARB/Building America Case Studies

Compact duct distribution systems have played a central role in many CARB projects. This often requires minor adjustments to the plan, which seldom interfere with the design or plan efficiency.

### Exhaust-Only or Exhaust/Supply Fresh-Air Ventilation

#### **Discussion**

For more continuous ventilation than the extended run of spot ventilation fans, all bathroom exhausts can be collected together and routed through an “in-line” high-efficiency fan located in the attic (Figure I-20). This fan can be controlled by an adjustable controller such as Tamarack Industries’ “Airetrak” controller or the Grasslin pin timer. As this system de-pressurizes the home, it tends to prevent inside air from entering the wall and attic cavities, helping to control condensation. It is important that there be no atmospheric combustion appliances using the house air for combustion. Both the furnace and water heater need to be power vented. In very tight homes, it is also advisable to install a 6-in. or 8-in. diameter air intake from the outside to the return air plenum of the furnace, to provide a certain source of outside air. This duct should be equipped with a manual damper to control the flow, which occurs whenever the furnace fan is operating

### Applications in CARB/Building America Case Studies

CARB used this system in its project with NVR/Ryan homes in Rochester, New York.

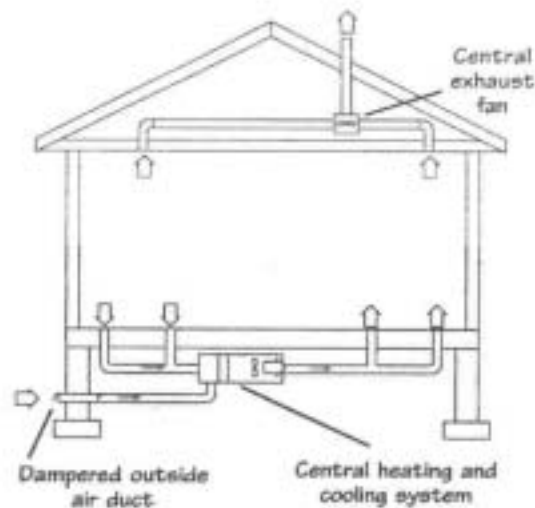

**Figure I-20. “In-line” high-efficiency fan located in the attic**

---

## **Case Study #1: Don Simon Homes**

### ***Introduction***

In the past year, Steven Winter Associates, Inc., (SWA) has partnered with two new production builders in Wisconsin. Both Wausau Homes and Don Simon Homes are affiliated with the Wisconsin ENERGY STAR Homes Program. Wisconsin ENERGY STAR Homes (WESH) is sponsored by Wisconsin's Focus on Energy Program, a public-private partnership offering energy information and services to energy utility customers throughout Wisconsin. The goals of this program are to encourage energy efficiency and the use of renewable energy, enhance the environment, and ensure the future supply of energy for Wisconsin. This partnership has been made possible, in part, through a Building America grant from the U.S. Department of Energy to the State of Wisconsin.

This case study summarizes CARB's involvement in the design, construction, and testing of a prototype home for Don Simon Homes (DSH) in Madison, Wisconsin (Figure I-21). The intent of this program was to bring the Building America "Lessons Learned" to the Wisconsin state initiative.



**Figure I-21. Newly completed Don Simon Prototype Home**



## ***Background***

Founded in 1956, DSH is the largest builder of single-family homes in Dane County, Wisconsin. Family-owned and operated, the company has 50 full-time employees. In addition, DSH builds and certifies 100% of their homes as Green Built Homes. Green Built Home™ is a green building initiative that reviews and certifies compliance with sustainable building and energy standards. It is a voluntary program under the Wisconsin Environmental Initiative and is sponsored by participating homebuilder associations, leading utility companies, organizations promoting green building and energy efficiency, and the State of Wisconsin.

With an integrated systematic approach to home building, Don Simon Homes purchases the land, develops the site, and sells the lot and home as a single package. This neighborhood development strategy creates added value for communities and customers with economies of scale in land development and construction. The company's two primary target markets are first-time homebuyers and affordable move-ups. Ranking among the top 10 builders in Dane County for luxury homes, more than 70% of DSH are customized and built to the homeowners' specifications.

CARB became involved with DSH through the WESH. As one of the two building groups selected to participate in the WESH program, DSH agreed to use one of their most popular homes as a test case for improvements to their standard practice. The Huntington III model (Figure I-22) was selected for the prototype.



**Figure I-22. Don Simon Homes  
Huntington III Model**

### **Standard Practice Home**

The first step was a review of DSH standard building specifications. The base specifications are summarized below.

<b>Wall Construction:</b>	Exterior Walls 2 x 6 Studs at 16 in. On-Center with R-19 Cavity Insulation and 5/8-in. Celotex Structural Insulated Sheathing on the Exterior (R-5) Interior Walls 2 x 4 Studs at 24 in. On-Center
<b>Roof Construction:</b>	Wood Trusses with R-40 Insulation
<b>Foundation Walls:</b>	R-5 Insulation Required by Wisconsin Code
<b>Windows:</b>	Double Pane, Vinyl (Visions 2000, Single Slider Series)
<b>Mechanical Equipment:</b>	Janitrol 92% Annual Fuel Utilization Efficiency (AFUE) Furnace with Air Conditioning Honeywell T8112C, D Electronic Programmable Thermostat A.O. Smith 40 Gallon FPSH40 Power-Vented Water Heater, EF = 0.62 (A Power-Vented Water Heater is a WESH Program Requirement) Conventional, manually switched bath fans

A site visit to a standard Huntington III provided insight into the standard HVAC installation practices (Figure I-23). As shown in figures I-24 through I-26, it typically includes:

- High and low return grilles in each bedroom
- Panned returns
- Supply and return ducts in outside walls
- Floor supplies under windows.

### **Prototype Home**

The Huntington III is a 1,456-ft<sup>2</sup>, two-story home with an attached garage. It includes three bedrooms, two and a half baths, a kitchen, dining room, and living room. This home is set on a full foundation.

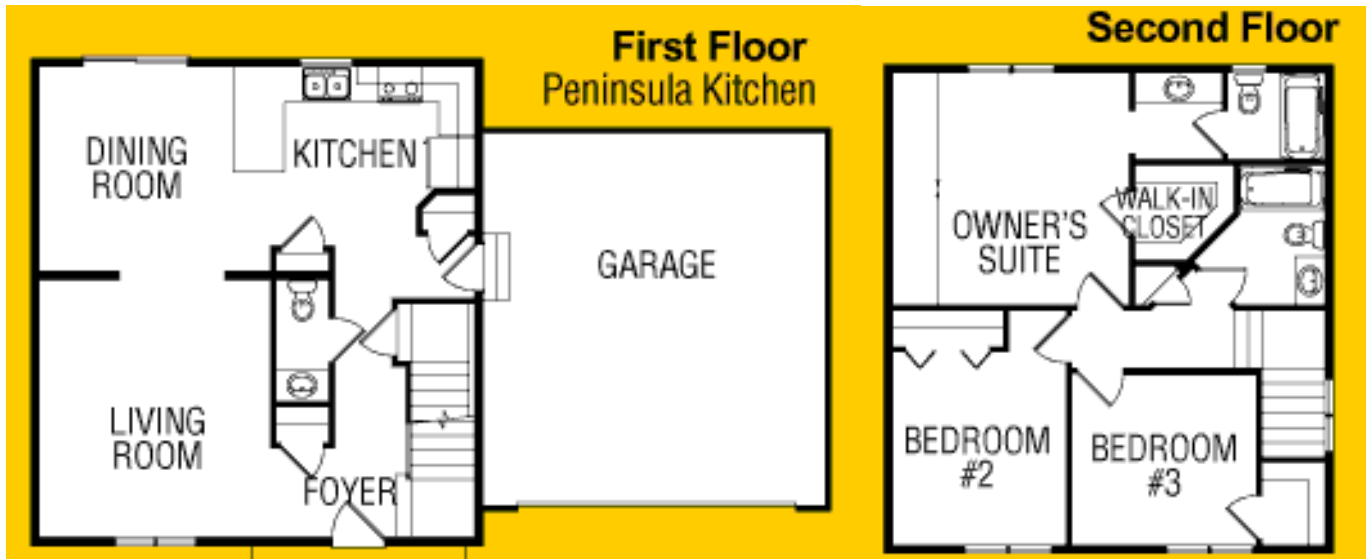

Figure I-23. Floor plan for Don Simon home

***CARB Recommendations***

After the review of DSH’s standard building specifications, CARB recommended a list of improvements for a “whole building systems” approach to design. During a design meeting held June 25, 2002, each of these recommendations was presented to DSH and evaluated by their staff:

- Architectural Redesign
- Optimal Value Engineered Framing
- Exterior Foundation Insulation up to Sill
- Low-E, Argon Windows
- Mechanical Ventilation
- Redesigned HVAC System.



**Figure I-24. High and low returns in exterior walls**



**Figure I-25. Supply ducts in exterior walls**

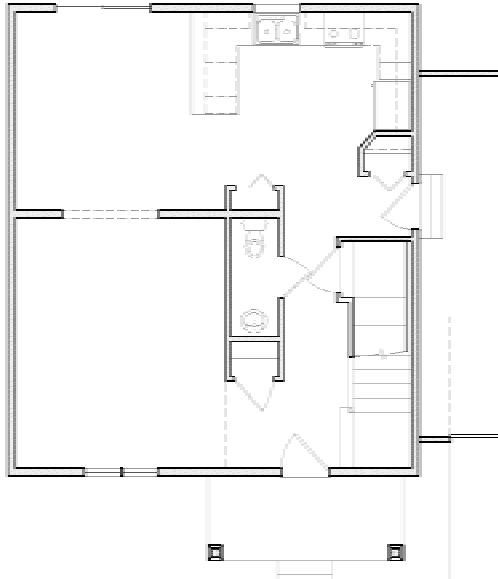

**Figure I-26. Panned returns**

### *Architectural Redesign*

An architectural review of the Huntington III was performed to rationalize the floor plan and maximize the use of the space. As part of the value engineering, adjustments were made in wall and window locations. Access from the garage was provided with a single step up into the stair landing of the house. By shifting the entrance location, additional space was gained for kitchen storage. Space previously designated as a pantry was utilized for mechanical chases. Minimal changes were made to the second floor plan. The second floor linen closet was reduced to accommodate the second floor return duct (Figure I-27).

**Original First Floor Plan**



**Redesigned First Floor**

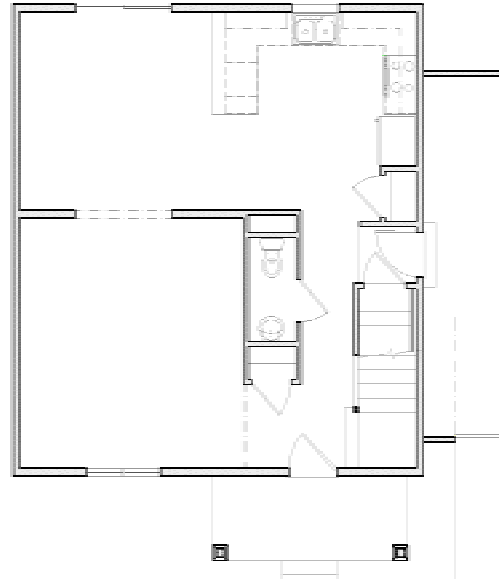

**Second Floor Plan**

**Figure I-27. Floor plans showing maximized use of space**

## Optimal Value Engineered Framing

Standard construction for the exterior walls includes the following: 2 x 6 studs at 16 in. on-center, R-19 Cavity Insulation, 5/8-in. Celotex Structural Insulated Sheathing on the exterior, an interior vapor barrier, and taped joints. Although the Celotex provides additional insulating value, it has a polyethylene coating on both sides. When combined with the interior vapor barrier and sealed joints, it effectively creates a double vapor barrier. With no way for moisture to escape, this could lead to mold and mildew problems.

For the prototype, CARB recommended optimal value engineered (OVE) framing (Figure I-28). This includes inline 2 x 6 studs at 24 in. on-center, Oriented Strand Board (OSB) sheathing on the exterior, and two stud corners with drywall clips (or three-stud corners, Figure I-29). The OSB replaced the insulated sheathing and bracing, eliminated the double vapor barrier, and reduced the concern for moisture problems in the wall cavity.

These advanced framing techniques have been in use for more than 20 years and have a proven track record of cost savings. CARB provided a complete set of framing drawings for the prototype, met with the framer in advance to discuss the procedures, and was present during the framing process.

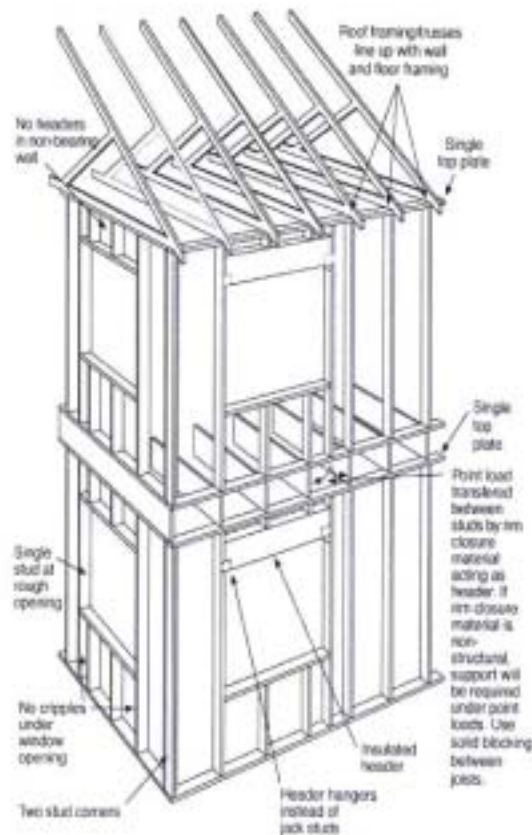

**Figure I-28. Optimal value-engineering framing techniques**

**Improved three-stud corner allows insulation to be installed later**



**Conventional three-stud corner leaves un-insulated hole**

**Two-stud corner with drywall clips**

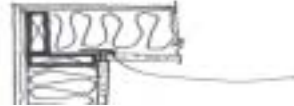

**Figure I-29. Corner framing options**

### *Exterior Foundation Insulation up to Sill*

Wisconsin code requires a minimum insulation level of R-5 for the foundation. Typically, DSH installs Warm N' Dri, a 1-in. insulation and drainage board, to grade level. This leaves the above-grade portion of the foundation uninsulated. To provide greater energy savings, CARB suggested the insulation be brought up to the sill level despite aesthetic concerns and the possibility for mechanical damage to the exposed insulation. The builder opted to include this suggestion in the design of this prototype. Figure I-30 shows the foundation of the prototype home with full insulation.



**Figure I-30. Prototype foundation insulation detail**

### *Low-E Windows*

To improve performance and meet the ENERGY STAR requirements, Low-E windows were recommended. As discussed in the standard specifications, double-pane, vinyl-frame windows are typically installed. However, DSH offers a window upgrade option. For the prototype home, DSH installed Visions 2000, vinyl-frame, double-pane, Low-E, argon-filled windows. The NFRC rated performance values for these windows are  $U = 0.33$  and  $SHGC = 0.30$ .

### *Mechanical Ventilation*

As part of the WESH program, a mechanical ventilation system must be provided for the home that is capable of delivering a continuous airflow equal to 20 cubic feet per minute (CFM) for the master bedroom and 10 CFM for each additional bedroom. There are no specific control or sound requirements. A standard bath fan with an airflow of 40 CFM, as measured by a balometer, satisfies the WESH program requirements for a three-bedroom home. CARB recommended that DSH go a step further to assure that the fan be relatively quiet, provide higher airflow and operates for greater periods of time.

DSH installed a Broan Solitaire Ultra Silent Series fan in the master bathroom and a similar model in both the powder room and second floor bath. Model S80U has a rated flow of 80 CFM, with a sound rating of 1.0 Sone. Each of the second floor bath fans is controlled by an EFI fan/light control with off delay. This control integrates the operation of the bathroom exhaust fan and the light. After the light is turned off, the fan will continue to operate for a preset time interval ranging from 1 to 60 minutes. This assures that the bathroom fan operates frequently enough to adequately remove moisture (Figure I-31)



**Figure I-31. Prototype home bath fan and control**



### Redesigned HVAC System

A key part of the prototype was the design of the HVAC system. To improve the design and ensure consistent HVAC system distribution performance, CARB developed an HVAC layout and provided it to DSH and the mechanical contractor. As previously discussed, the framing layout impacts the location of mechanical chases. Therefore, a coordination meeting with the framer and on-site assistance during the framing of the prototype were necessary to verify proper installation. An additional site visit was made during the installation of the mechanical system.

Heating and cooling loads were calculated using Wrightsoft software, which is based on the ACCA Manual J methods. Energy code compliance was verified using WISCheck software, which is based on Wisconsin's version of the Model Energy Code. Modeling with Rem/Rate, Residential Energy Analysis Software (version 10.3), was done by WESH to determine ENERGY STAR compliance.

Manual J heating and cooling loads were used to determine the required equipment size for the prototype. Equipment for a typical Huntington III includes a Janitrol GMNT series, 92.6% AFUE high-efficiency gas furnace, with a rated input of 60,000 BTUH and a 2-ton, SEER 10 condensing unit. The furnace and the air-conditioning system were downsized for the prototype. A smaller Janitrol GMNT series furnace, with a rated input of 40,000 BTUH and a 1.5-ton condensing unit were installed. Table I-1 summarizes the design loads and required CFMs for each room. Using these airflows, a duct layout was developed for the prototype. Figures I-53 and I-54 provide the mechanical plans.

**Table I-1. Design Loads and Required CFMs**

Room Name	Design Loads (Btu/h)		Flow (CFM)		
	Heating	Cooling (facing East)	Heating	Cooling	Design CFM
Dining Room	3663	1846	143	143	145
Kitchen	2170	1963	85	152	95
Living Room	3850	1549	150	120	135
Owner's Suite	2648	1443	103	112	105
Master Bath	1179	432	46	33	45
Bath #2	427	112	17	9	15
Bedroom #2	2689	1089	105	84	105
Bedroom #3	2622	1257	102	97	105
Basement	0	0	0	0	0
<b>TOTAL:</b>	<b>19,248</b>	<b>9,691</b>	<b>751</b>	<b>750</b>	

Total Flow:	750 CFM
AC Capacity (0.7 SHR):	1.5 tons
ACCA Furnace capacity (25% oversize):	25,000 Btu/h

As previously discussed, return grilles are normally installed for each bedroom. The CARB layout replaced those returns with high/low or over the door transfer grilles in each of the secondary bedrooms. A high central return was installed in the second floor hallway to pick up the return the air from the bedrooms. To provide more privacy and reduce noise transmission, a separate return was provided for the master suite. Where the two returns meet, a portion of the existing linen closet was used as a chase for the duct down to the first floor.

On the first floor, a low central return was built in the space previously used as a pantry. The new design eliminated the need for panned return branches. On the supply side, changes included fewer elbows and appropriately sized supply ducts. Most importantly, no supply ducts were run in the exterior walls. Supply ducts for the second floor were run vertically in the interior first floor wall cavities and horizontally out to floor registers. The supply for the kitchen was run vertically in the central chase and horizontally between floor joists to serve a ceiling diffuser (figures I-32 through I-36).



**Figure I-32. Supply duct in wall cavity up to second floor**



**Figure I-33. Kitchen supply duct in central chase**



**Figure I-34. High/low transfer grille**



**Figure I-35. Second-floor high central return and over-door transfer grille**



**Figure I-36. First-floor low central return**

### ***Prototype Testing***

The final step was the side-by-side testing of the prototype house against a standard Huntington III. CARB tested both the houses on January 27-28, 2003, with assistance from Dave Kinyon of WESH and Hans Hoffman of Hoffman Energy Consultants, Inc. The tests included:

- Envelope Leakage (Blower Door test)
- Duct Leakage (Duct Blaster)
- Airflow measurements at the registers (LoFlo Balometer)
- Transfer Grille Performance
- Bath fan airflow measurements.

Blower-door tests were performed to compare the leakage of the two homes. As summarized in Table I-2, the envelopes of both homes are tight. Even with the changes in framing (2 x 6 at 24 in. on-center [OC] versus 2 x 6 at 16 in. OC) and sheathing (OSB versus structural insulated sheathing), the leakage of the two homes is equivalent.

**Table I-2. Blower Door Test Results**

<b>Blower Door Test Results</b>	<b>CFM<sub>50</sub></b>	<b>ACH<sub>n</sub></b>	<b>ELA @ 4 Pa</b>
Prototype	784	0.13	28.5
Control	755	0.13	27.5

Figure I-37 shows a comparison of the duct leakage for the two homes tested using a Duct Blaster. Both the total duct leakage and the duct leakage to the outside are shown. The leakage is further broken down into supply and return leakage for each of these categories.

Using an Alnor LoFlow Balometer, the supply and return airflows were measured at each register. A comparison of the supply and return airflows for each floor is shown in the Figure I-38. The floor-to-floor and supply-to-return airflows are better balanced in the prototype.

The supply airflows for both the Prototype and Control houses are summarized in Table I-3. Again, the airflows are better balanced in the prototype, particularly for the bedrooms.

**Don Simon Homes Duct Blaster Test Results**

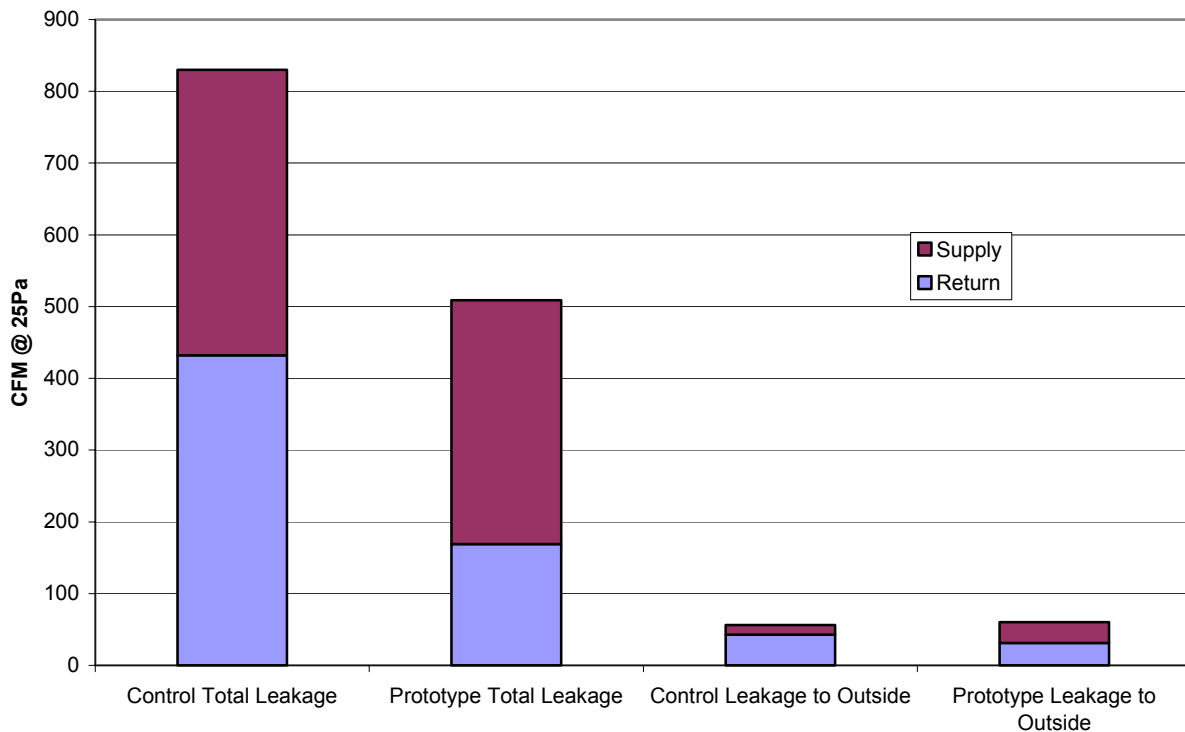

**Figure I-37. Comparison of duct leakage in the two homes**

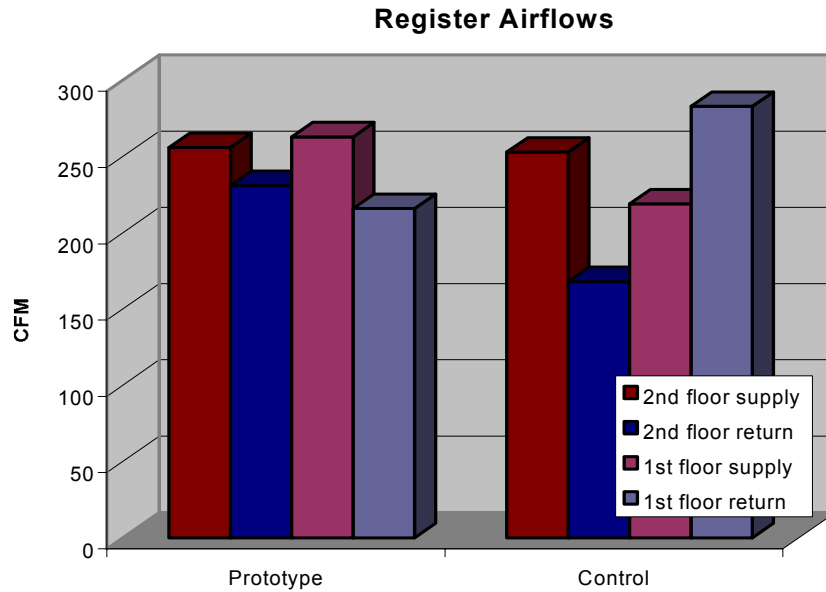

**Figure I-38. A comparison of supply and return airflows**

Return air paths for this home were provided by both transfer grilles and door undercuts. The transfer grilles for Bedroom #2 were installed in a stud bay, with one register high on the inside of the room and the other low in the hallway. For Bedroom #3, the transfer grille was installed over the door. Both the supply and transfer grille airflows were measured with the balometer. Pressure measurements were taken with the transfer grilles open and closed. A 3/4-in. door undercut can deliver approximately 40 cfm of air with less than a 3-pa pressure drop. As shown in Table I-3, the combination of door undercuts and transfer grilles provides adequate air and pressure balancing.

**Table I-3. Transfer Grille Performance**

Transfer Grille Performance	Supply (cfm)	Transfer (cfm)	$\Delta P$ Open (Pa)	$\Delta P$ Closed (Pa)
Bedroom #2 (hi/lo)	69	30	1.1	2.8
Bedroom #3 (over door)	76	35	0.9	2.9

As previously discussed, a Broan Solitaire Ultra Silent Series fans with an EFI fan/light control was installed in the master bathroom. Measurements taken with the balometer indicated the fan was drawing 50 cfm, although it is rated for 80 cfm. The published fan ratings are based on a static pressure of 0.1 inch. The pressure drop for 4-in. flex duct is 0.6 inches per 100 feet of length. Therefore, a duct run of 20 ft will have a pressure drop of 0.12 in., without turns or a termination cap. This could account for the reduced airflow.

### ***ENERGY STAR Compliance***

As part of the Wisconsin ENERGY STAR Homes Program (WESH), three site visits are made to each home. During the initial inspection, the framing is checked before the insulation is installed. Next, the insulation is inspected before the walls are covered with sheet rock. Finally, a number of tests are performed on the completed house, including a blower door test to determine envelope leakage. These test results are then incorporated into the REM model to determine the final Home Energy Rating Score (HERS) of each home.

Using REM models provided by Hans Hoffman, the test results for infiltration and duct leakage were added to determine the final HERS score for both homes. With a minimum score of 86.0 required to meet ENERGY STAR, the prototype home achieved a HERS score of 89.2. The standard Huntington III received a HERS score of 88.0. Don Simon Homes' cooperation with both WESH and CARB has had a positive impact on the performance of these homes.

---

## **Case Study #2: Wausau Homes**

### ***Introduction***

This case study summarizes CARB's involvement in the design, construction, and testing of a modular prototype home for Wausau Homes in Wausau, Wisconsin (Figure I-39). The intent of this program was to bring the Building America "Lessons Learned" to the Wisconsin state initiative.

### ***Background***

Since 1960, Wausau Homes has been producing technologically advanced housing and housing components. The Wausau Homes Group includes eight manufacturing facilities, supporting over 700 builders. Wausau is one of the leading producers of system-built homes in Wisconsin and throughout central and southeastern United States. Wausau has developed a system of finished components that are easily transported to and constructed at the jobsite. In addition, Wausau manufactures a modular home product. With a total production of approximately 4,000 homes per year, the modular homes account for about 20% or 800 homes annually.

In an agreement with Wisconsin Energy Star Homes (WESH), Wausau Homes committed to building modular and panelized homes with increased energy efficiency standards. CARB embarked on a pilot program, in cooperation with WESH and the Wisconsin Energy Conservation Commission (WECC). The intent of this program is to bring the Building America "Lessons Learned" to the Wisconsin state initiative. Wausau was one of two building groups selected to participate and agreed to use one of their most popular modular homes as a test case for improvements to their standard practice.

CARB visited the manufacturing plant, located in Wausau, Wisconsin, to evaluate the production of building components and advise on manufacturing steps to ensure that the final products are Wisconsin ENERGY STAR compliant. WESH certification is awarded after multiple on-site visits during construction and a final performance test. CARB and WESH worked with Wausau Homes to incorporate changes in the design phase, practices used on the factory floor, and the selection of components for the system-built homes. The result is a prototype home (Figure I-40), which incorporates the CARB recommendations discussed in this report.

### ***Standard Practice Home***

The first step was a review of Wausau's standard building specifications, an on-site evaluation of the manufacturing practices at the plant, and an observation of the set and finishing of a home in the field. The base specifications are summarized below.



**Figure I-39. Newly completed Wausau  
Prototype Home**



**Figure I-40. Wausau/CARB  
prototype home**



<b>Wall Construction:</b>	Exterior walls 2 x 6 studs at 16 in. on-center with R-19 cavity insulation  <i>Interior walls 2 x 4 studs at 16 in. on-center</i>
<b>Roof Construction:</b>	<i>Wood trusses with R-40 insulation</i>
<b>Foundation Walls:</b>	<i>R-5 insulation required by Wisconsin code</i>
<b>Windows:</b>	<i>Clear, Double-pane, vinyl frame</i>
<b>Mechanical Equipment:</b>	90% AFUE furnace  Air-conditioning optional Conventional, manually switched bath fans No HVAC duct design provided

A site visit to a Wausau home similar to the Monfort II provided insight into the standard HVAC installation practices. Although the standard practice varies with each contractor, it typically includes the following:

- Floor supplies with baseboard-style registers, provided by the plant
- Unbalanced airflows
- No duct layout provided to the contractor, leading to inconsistent results
- Return grilles from each bedroom, installed at the plant
- Panned returns in the basement, installed in the field.

Before designing the prototype HVAC system, Wausau took field measurements in an existing modular home. The tests indicated that the supply and return airflows varied considerably in each room. In addition, the standard floor registers installed at the plant are all the same size (18 in. long), regardless of airflow. The standard register (Figure I-41) is oversized for this application. For the average room design airflow, this register only has throw and spread distances of 4.5 ft.



**Figure I-41. Standard register**

### **Prototype Home**

As part of their commitment to the program, Wausau agreed to use one of their most popular modular homes as a test case for improvements to their standard practice. The Monfort II (Figure I-42) is a 1,335-ft<sup>2</sup> ranch-style home. It includes three bedrooms, two baths, a kitchen/dining room, and a laundry room. This home is set on a full foundation. It is shipped in two pieces, which are aligned and joined at the site.

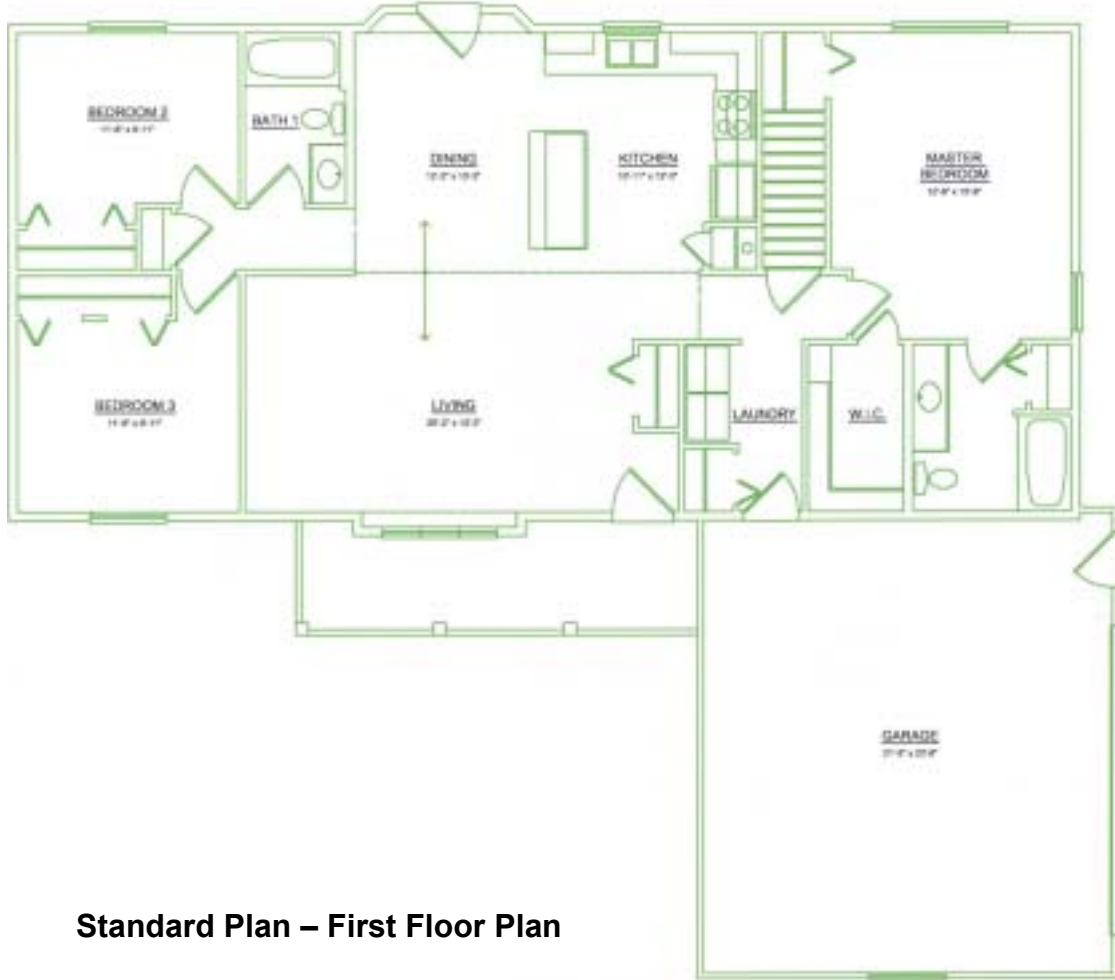

**Standard Plan – First Floor Plan**

**Figure I-42. Wausaw prototype home, the Monfort II**

## ***CARB Recommendations***

After the review of Wausau's standard building specifications and manufacturing practices, CARB recommended a list of improvements for a "whole building systems" approach to design. During a design meeting held June 26, 2002, each of these recommendations was presented to Wausau and evaluated by their staff.

- Architectural Redesign
- Advanced Air-Sealing Techniques
- Improved Flashing Details
- Low-E Windows
- Mechanical Ventilation
- Redesigned HVAC System.

### ***Architectural Redesign***

An architectural review of the Monfort II was performed to rationalize the floor plan and maximize the use of the space. To improve traffic patterns throughout the home, changes in the direction of some door swings were recommended. Other suggestions included increased closet storage in the master bedroom and a workstation off of the kitchen. Although these recommendations were well received by the Wausau design team, a customer had already purchased the home selected for the prototype. Therefore, the architectural changes could not be incorporated in this prototype.

### ***Advanced Air-Sealing Techniques***

CARB team members visited the manufacturing plant to evaluate the construction techniques, which included insulation and air sealing. They were also on-site to observe the delivery and set up of a modular unit similar to the Monfort II. Close attention was paid to the joining of the two halves at the marriage wall.

Typically, Wausau attaches batt insulation at the plant to both halves of the unit along the marriage wall, as shown in figures I-43 and I-44. Once at the site, the two units are joined and this insulation is intended to fill the space between the modules. The modular design requires a  $\frac{3}{4}$ -in. gap between the two units for proper alignment.

Theoretically, air movement between the two modules is prevented by the batt insulation attached to each half. However, it was observed during the set process that much of the insulation was torn off during alignment. Once the first unit is placed on the foundation, the second one must slide past it to get into place. If the insulation is torn off during this step, the air barrier is ineffective.



**Figure I-43. Batt insulation for sealing marriage wall**



**Figure I-44. Gasket seal at marriage wall**

As a result of these observations, CARB recommended that either a Sof-Seal gasket material or expandable spray foam be used to seal around the marriage wall. Because spray foam does not fully expand during cold weather, Wausau agreed to use it only during summer installations, as shown in Figure I-45. For winter installations, the gasket material will be installed.

#### *Improved Flashing Details*

Window installation and flashing are completed at the manufacturing plant. The homes are covered with Tyvek Home Wrap, which is cut to accommodate the windows. Previously, a bituminous, self-sealing tape was used to seal between the bottom of the window and the Tyvek (Figure I-46). However, CARB saw opportunities for improving this detail.



**Figure I-45. Expandable spray foam at marriage wall**



**Figure I-46. Self-sealing tape at base of window**



**Figure I-47. Manufacturer's recommended window flashing detail**

CARB suggested that Wausau incorporate the manufacturer's recommended window flashing practices. First, the Tyvek is folded over the framed window opening on the bottom and both vertical sides, to prevent any moisture from entering. The window is then inserted, and the vertical sides are sealed with a tape designed specifically for this application. After the window is in place, the Tyvek above the window is folded down to the frame and sealed on either side with the Tyvek tape (Figure I-47).

### *Low-E Windows*

To meet the ENERGY STAR requirements, Low-E windows were recommended. As discussed in the standard specifications, double-pane, vinyl-frame windows are typically installed. However, Wausau offers a window upgrade option. For the prototype home, Wausau installed Vetter ProV, HiPro 4, vinyl-frame, double-pane, Low-E windows. The NFRC-rated performance values for these windows are  $U = 0.35$  and  $SHGC = 0.34$ .

### *Mechanical Ventilation*

As part of the WESH program, a mechanical ventilation system must be provided for the home that is capable of delivering a continuous airflow equal to 20 cubic feet per minute (CFM) for the master bedroom and 10 CFM for each additional bedroom. There are no specific control or sound requirements. A standard bath fan with an airflow of 40 CFM, as measured by a balometer, satisfies the WESH program requirements for a three-bedroom home. CARB recommended that Wausau go a step further to assure that the fan be relatively quiet, provide higher airflow and operates for greater periods of time.

Wausau installed a Broan Solitaire Ultra Silent Series fan in each of the two bathrooms (Figure I-48). Model S80U has a rated flow of 80 CFM, with a sound rating of 1.0 Sone. Each of these fans is controlled by an EFI fan/light control with off delay. This control integrates the operation of the bathroom exhaust fan and the light. After the light is turned off, the fan will continue to operate for a preset time interval ranging from 1 to 60 minutes. This assures that the bathroom fan operates frequently enough to adequately remove moisture.



**Figure I-48. Prototype home bath fan and control**

### *Redesigned HVAC System*

A key part of the prototype was the design of the HVAC system. As the manufacturer, Wausau has limited control over the design and installation of the mechanical system. With the exception of floor penetrations and register selection, the mechanical work is done on site by a separate contractor. To improve the design and ensure consistent HVAC system distribution performance, CARB developed an HVAC layout and provided it to the homebuilder and the mechanical contractor.

Heating and cooling loads were calculated using Wrightsoft software, which is based on the ACCA Manual J methods. Energy code compliance was verified using WISCheck software, which is based on Wisconsin's version of the Model Energy Code. Modeling with Rem/Rate, Residential Energy Analysis Software (version 10.3) was done by WESH to determine ENERGY STAR compliance.

The required equipment size for the Monfort II was selected based on the Manual J heating and cooling loads. Table I-4 summarizes the design loads and required CFMs for each room.

Using these airflows, a duct layout was developed for the prototype (Figure I-49). See figures I-54 and I-54 for the mechanical plans. Although the supply layout did not change significantly from the standard installation, the new design had a major impact on the return layout.

As previously discussed, return grilles are normally installed at the plant for each bedroom. The CARB layout replaced those returns with transfer grilles and a door undercut for each of the secondary bedrooms. A low central return was built into a closet at the plant, as shown in Figure I-50. A separate return was provided for the master suite to meet the greater airflow requirements, provide privacy, and reduce noise transmission. The new design eliminated the need for panned return branches. On the supply side, changes included a decreased number of takeoffs, fewer elbows, and register selection.

**Table I-4. Design Loads and Required CFMs**

Room Name	Design Loads (Btu/h)		Flow (CFM)		
	Heating	Cooling (East)	Heating	Cooling (East)	Design CFM
Master Bedroom	4053	1695	75	106	110
Master Bath	728	205	15	13	15
Living Room	7767	2694	137	168	150
Kitchen	1470	2007	27	127	50
Dining Room	2683	848	48	53	50
Bath	412	126	8	8	10
Bedroom #2	2502	1023	46	64	50
Bedroom #3	2502	1023	46	64	50
Basement (uncond.)	0	0	198	0	115
TOTAL:	22,117	9,621			

Total Flow:	600 CFM
AC Capacity (0.7 SHR):	1.5 tons
ACCA Furnace capacity (25% oversize):	28,000 Btu/h

Appropriately sized floor registers were provided by the plant, as shown in Figure I-51. For the average room design airflow, a 2-<sup>1</sup>/<sub>4</sub>-in. x 12-in. register has a throw of 6 ft with a spread of 8 ft.

After the mechanical system was installed, testing was done by CARB and WESH to determine the performance of the system. The layout in Figure I-52 shows the supply and return airflows found during testing. The central return, shown in the hall off the kitchen, was returning 400 CFM back to the unit. This return serves the kitchen, dining room, living room, bath 1, bedroom 2, and bedroom 3. The sum of those supply airflows is 402 CFM. The return in the master suite, which serves the master bedroom and bath 2, had a measured airflow of 161 CFM. The sum of those supply airflows is 155 CFM. The supply and return airflows for this home were well balanced.

Similar tests were performed to determine the airflows of the transfer grilles and the bathroom exhaust fans. The combined area of the transfer grilles and the door undercuts provided adequate return airflows from the secondary bedrooms. Although each bathroom exhaust fan is rated for 80 CFM, the master bath fan was only exhausting 36 CFM and the common bath was tested at 45 CFM. The published fan ratings are based on a static pressure of 0.1 in. The type of duct material used, length of the duct run, and the number of turns all impact the pressure drop and the resulting fan performance. Additional follow-up work is underway to improve the bath fan performance.



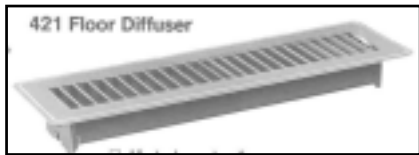

**Figure I-49. Floor Diffuser used in Prototype**



**Figure I-50. Central Return in Hall**



**Figure I-51. Prototype Return**

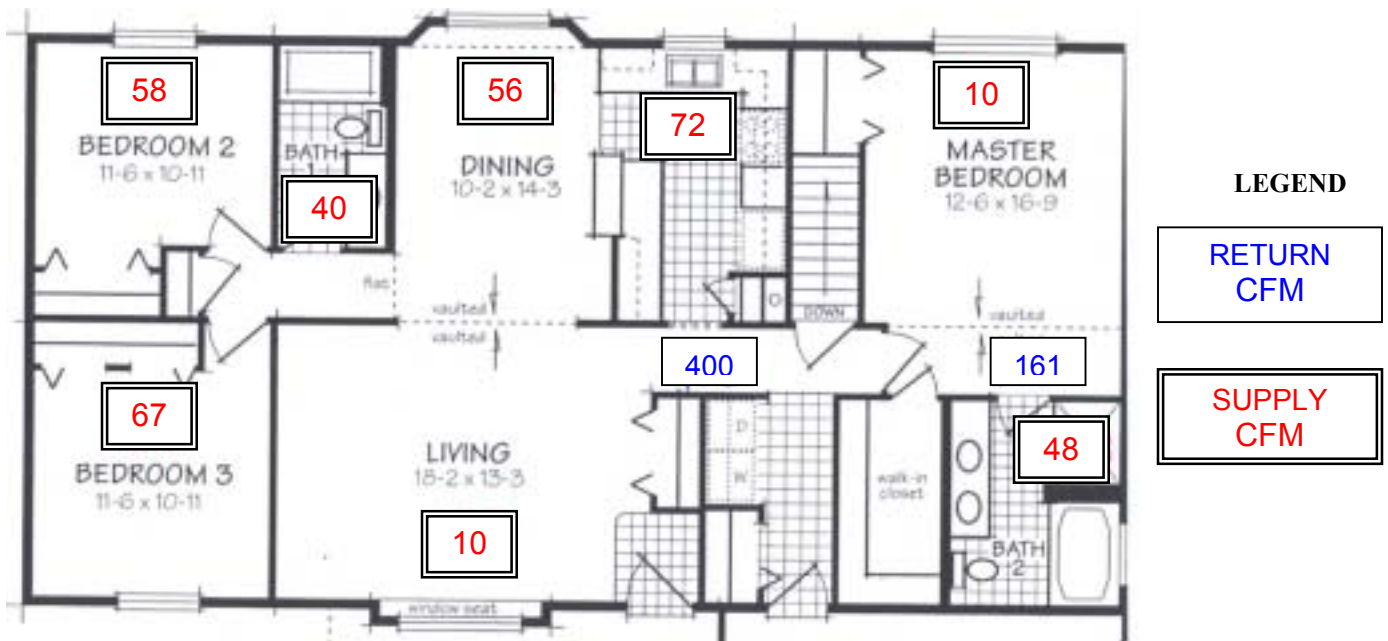

**Figure I-52. Layout of supply and return airflows**



## ***Furnace-Sizing Methods***

Initially, there was some confusion regarding the appropriate furnace size. The CARB Manual J calculations were based on a winter design temperature of  $-11^{\circ}\text{F}$  and  $0.35 \text{ ACH}_n$ . Wausau provided the contractor with a WIS Check calculation based on  $-20^{\circ}\text{F}$ ,  $0.5 \text{ ACH}_n$ , and 15% oversize. WESH also provided the contractor with a WIS Check calculation based on  $-20^{\circ}\text{F}$ ,  $0.19 \text{ ACH}_n$ , and 15% oversize.

The air change rate of  $0.5 \text{ ACH}_n$  used by Wausau is the maximum allowable input, but not necessarily the recommended value. Similarly, 15% is the maximum oversize allowed by the WIS Check program. Wausau was being conservative by using both of these maximum allowed input values. Also, the Wisconsin Administrative Code specifies the winter design temperature to be used depending upon which of four climate zones the home is located in. The required winter design temperature was  $-20^{\circ}\text{F}$ , 9 degrees lower than the ASHRAE design temperature. Using this extreme design temperature adds approximately 10% oversizing to the furnace, making the additional 15% oversizing unnecessary.

The standard MEC Check program, upon which WIS Check is based, does not include equipment sizing. Further, WIS Check is a design tool, but was not intended for equipment sizing. Now that the inputs into WIS Check have been revised, the disparity between sizing calculations can be avoided in the future. Unfortunately, this confusion was not resolved before furnace selection. The unit installed was larger than the one originally specified. However, the contractor agreed to set it on the lowest fan speed. With minor modifications, the problem was resolved, and the system was balanced.

## ***Prototype Home Testing***

The final step was the testing of the prototype house after construction was completed. The testing was performed by WESH, with assistance by CARB. Those present for the demonstration included: participants from Wausau Homes, the mechanical contractor, and representatives from Carrier Corporation.

In addition to the airflow measurements shown in the Redesigned HVAC System section of this report, Blower Door tests were performed on the Prototype Home. The home is tight, as indicated by Blower Door measurements of:  $\text{CFM}_{50} = 1073$ ,  $\text{ACH}_n = 0.15$ , and an ELA of  $48.08 \text{ in.}^2$  at 4 Pascals.

Significant leakage was found around the attic scuttle (165 CFM) and around both bath fan housings (33/41 CFM). These test results were put into Rem/Rate to obtain a final Home Energy Rating Score (HERS). With a minimum score of 86.0 required to meet Energy Star, this home achieved a HERS score of 87.8.

Based on the test results and feedback from those involved, future work with Wausau would include the following refinements:

- Increased transfer grille sizes to reduce dependence on door undercuts
- Extending supply plenum to locate registers under windows

- Downsized duct to kitchen supply in the kickspace
- Properly sized take-offs and register boots

Return air paths for this home were provided by transfer grilles and door undercuts. Because door undercut performance varies with the type of flooring, larger transfer grilles sized for the total return airflow were recommended. This would ensure adequate return airflows, regardless of the door undercut.

In the standard supply duct layout, the bedroom supply registers are located beneath the windows. The supply run was shortened for this house. In the future, the registers will remain under the windows. The kitchen supply duct was sized for cooling and provided excessive airflow. Dampers were used to balance the system during the testing. A smaller duct would be specified for future installations.

For the prototype home, 4-in.-diameter supply ducts were specified for each bathroom. The contractor only had 6-in.-diameter take-offs readily available. Also, the supply boots provided by the plant were 6 in. diameter. To conform to the design layout, the 6-in. take-off was transitioned down to a 4-in. duct and then transitioned back up to fit the 6-in. supply boot. Obviously, this does not simplify the duct layout. In the future, efforts will be made to determine the availability of 4-in. boots and take-offs and comply with standard-size fittings.

**Mechanical Drawings**

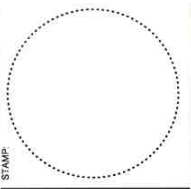
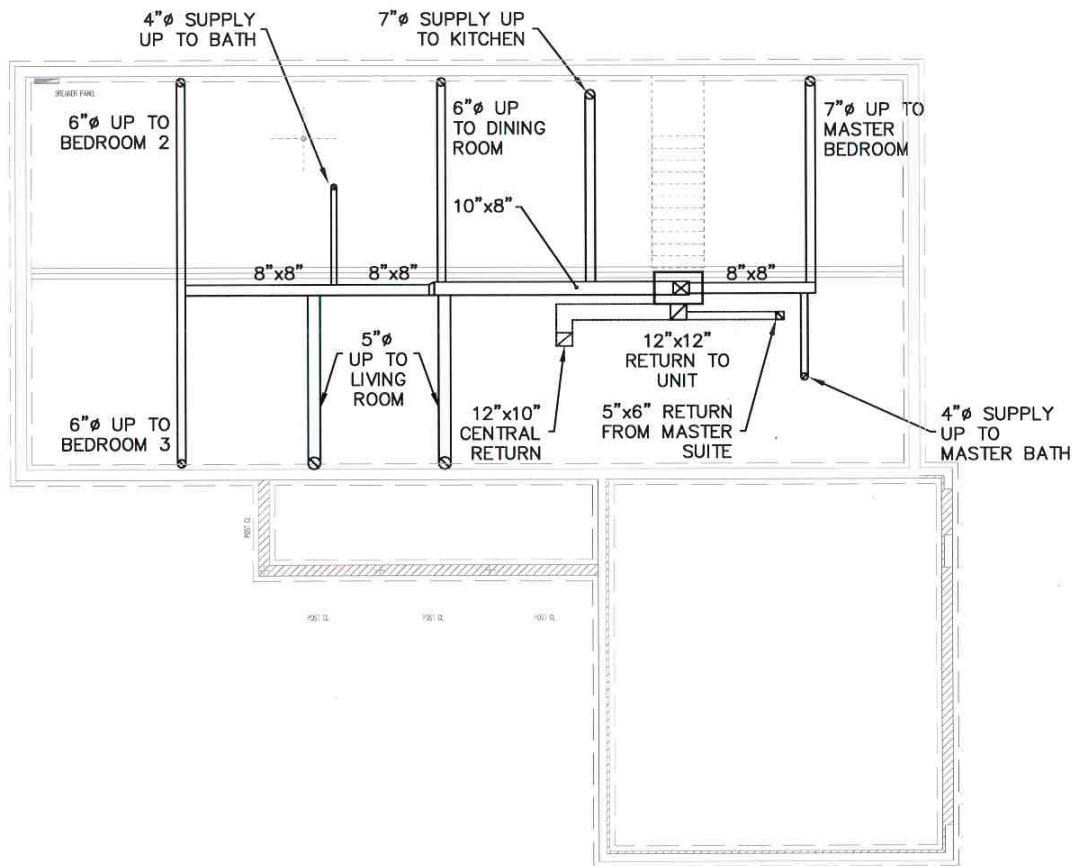

STAMP

**Steven Winter Associates, Inc.**  
 50 Washington Street  
 Norwalk, CT 06854  
 Telephone: (203) 857-0200  
 Telefax: (203) 852-0741  
 www: swinter.com

**WAUSAU HOMES**  
 MONFORT II

CONSULTANT:

SCALE: 1/8" = 1'-0"  
 PROJECT NO: WECC: 01  
 DRAWN BY: AM  
 CHECKED BY: DG  
 DATE: 9-11-02

**BASEMENT  
 MECHANICAL  
 LAYOUT**

SHEET OF

**M-100**

**Figure I-53. Mechanical drawing**

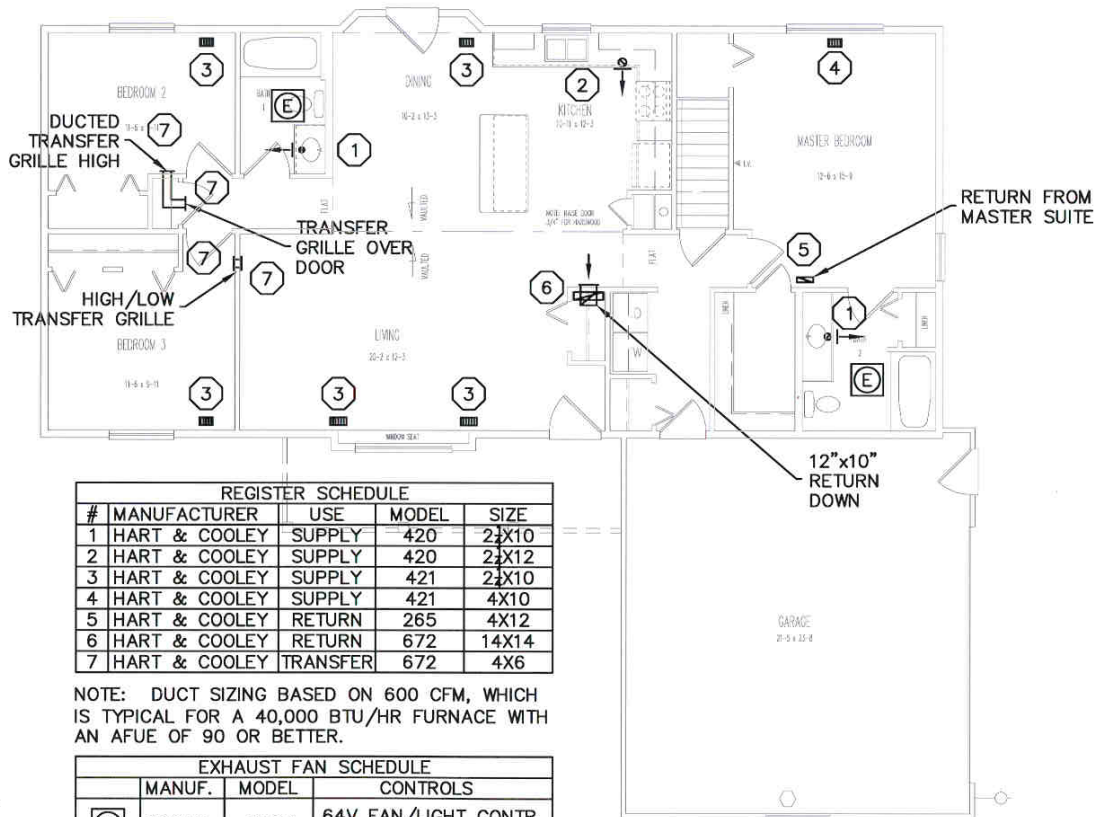

REGISTER SCHEDULE				
#	MANUFACTURER	USE	MODEL	SIZE
1	HART & COOLEY	SUPPLY	420	24X10
2	HART & COOLEY	SUPPLY	420	24X12
3	HART & COOLEY	SUPPLY	421	24X10
4	HART & COOLEY	SUPPLY	421	4X10
5	HART & COOLEY	RETURN	265	4X12
6	HART & COOLEY	RETURN	672	14X14
7	HART & COOLEY	TRANSFER	672	4X6

NOTE: DUCT SIZING BASED ON 600 CFM, WHICH IS TYPICAL FOR A 40,000 BTU/HR FURNACE WITH AN AFUE OF 90 OR BETTER.

EXHAUST FAN SCHEDULE		
MANUF.	MODEL	CONTROLS
(E) BROAN	S50U	64V FAN/LIGHT CONTR. WITH OFF DELAY

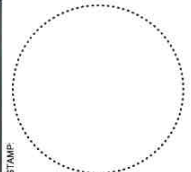

STAMP

**Steven Winter Associates, Inc.**  
 50 Washington Street  
 Torrington, CT 06867-0900  
 Telephone: (203) 852-0700  
 Telefax: (203) 852-0744  
 www: swinter.com



WAUSAU HOMES  
 MONFORT II

SCALE: 1/8" = 1'-0"  
 PROJECT NO: WECC: 01  
 DRAWN BY: AM  
 CHECKED BY: DG  
 DATE: 9-11-02

FIRST FLOOR  
 MECHANICAL  
 LAYOUT

SHEET OF

**M-101**

Figure I-54. Mechanical drawing



## Part II: Best Practices for Achieving 30% - 40% Space Conditioning Energy Savings in Single-Family Detached Home in a Hot-Humid Climate



**Figure II-1. A CARB home built in a hot-humid climate**

### Background and Introduction

The Consortium for Advanced Residential Building (CARB), one of the Building America teams, has worked with several hot-humid climate builders on home designs (Figure II-1) that achieve at least a 30% savings relative to the Model Energy Code (MEC). This section of the report describes the recommended best practices to achieve these savings without compromising health or safety.

A list of Primary Recommendations and one of Secondary Recommendations is included, followed by a discussion of each item on the list. Case studies drawn from CARB's Building America experiences are presented as examples. CARB has experience with both one- and two-story frame homes in hot-humid climates. However, to supplement the "best practices" recommendations of other Building America teams, concrete wall technology is presented here in lieu of wood framing as the best practice for one-story homes.

Concrete (or concrete masonry) wall slab-on-grade construction has the significant advantage of being termite resistant when coupled with metal interior studs. In addition, concrete provides the superior hurricane-wind resistance required in many hot-humid locations. CARB has extensive experience with concrete-wall homes in Florida, where concrete masonry homes are common. Poured in place concrete walls have proven to be more cost-effective than conventional concrete masonry units for builders constructing enough homes to justify the cost of prefabricated aluminum forms. For other builders, poured-in-place concrete in conventional forms, or concrete masonry units can be substituted without changing the best practice recommendations.

## **Primary Recommendations**

### Envelope

- Double-glazed low emissivity (low-E) windows (Figure II-2) with shading coefficient of 0.4 or less
- 6-in. poured-in-place concrete with  $\frac{3}{4}$ -in. foil-faced poly-isocyanurate foam, 1 x 2 strapping and gypsum board; or
- 8-in. concrete block with 1-1/2-in. EPS, 1 x 2 strapping and gypsum board
- Exterior stucco finish
- Steel interior studs at 24 in. on-center
- Fire barrier air sealing at attic
- Conventional wood-truss roof with OSB sheathing
- Reflective roofing material

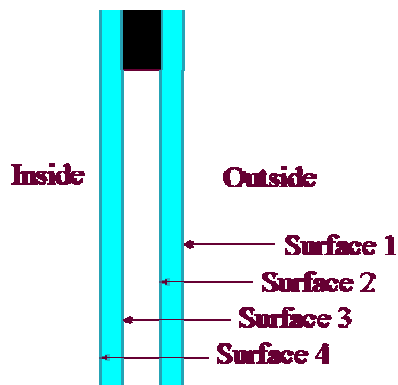

**Figure II-2. Double-glazed, low-E window**

## Equipment

- Manual J / Manual D HVAC sizing
- Seasonal Energy Efficiency Ratio (SEER)-12 air conditioner/ Heating Season Performance Factor (HSPF) 7.5 heat pump (minimum)
- Conventional atmospherically vented or power-vented gas-fired water heater located in garage
- Ducts mastic sealed (leakage less than 5% of fan-flow)
- Ducts and air handler within conditioned envelope
- Compact duct distribution system
- Central air return with transfer grills or jump ducts at secondary spaces (balanced air-flows)
- Provide filtered supply-only ventilation as needed
- No unvented gas appliances (except a gas range with a range hood exhausting to the outside)

### ***Secondary Recommendations***

- Energy-efficient lighting.
- ENERGY STAR appliances.

### ***Primary Recommendations for the Envelope***

Double-Glazed Low-E Windows with Shading Coefficient of 0.4 or Less

#### **Discussion**

Spectrally selective, low-E coated, double-glazing is applicable to all hot-humid climate homes. A selective low-E coating greatly reduces the amount of incoming solar energy (it has a low Solar Heat Gain Coefficient [SHGC]).

The U-factor of the glazing is strongly influenced by the frames: uninsulated aluminum frames increase the conductivity of the overall window substantially (typically doubling the U-factor relative to the center of the glass). This may or may not increase the annual heat loss, depending upon the climate (windows with a higher U-factor may cool the house at night through radiation). However, thermal break aluminum or vinyl windows reduce the *peak* cooling load, which can help to reduce the size of the AC equipment.

Look for the NFRC ratings, which are slightly different from conventional ratings. The desirable glass has the following characteristics, which can be found on the label attached to all glass:



### Desirable Low-E Glazing Characteristics for Hot-Humid Climates:

- Total unit U-value should be 0.35 or less if thermally broken aluminum or vinyl sash and frames are used. A typical U-value for aluminum sash is 0.6 or more.
- The SHGC should be 0.40 or lower.
- The low-E coating should be on the #2 surface, to reduce heat gain from the outside. This is typical for most low-E glazing.
- Because occupants enjoy seeing out through untinted glass, it is desirable to use (more expensive) “spectrally selective” glazing, which couples high visible transmittance (VT) with a low SHGC. A high VT will also decrease the use of electricity for lighting, reducing the cooling load and overall energy use. Glass is available having a VT over 0.65 coupled with an SHGC of 0.42, but it is not commonly used in residential windows. Cheaper low-E glazings have VT’s as low as 0.35. Low values will result in a noticeable violet color to the glass.

### Benefits Demonstrated in CARB/Building America Case Studies

- The cost-effectiveness of low-E glazing has been demonstrated in every CARB hot-humid climate project.
- The low-E coating provides the equivalent of another layer of glazing at a much lower cost.
- Low-E glazing makes it possible to dispense with registers located close to the windows, thus reducing the cost of air distribution.

### Six-inch Poured-in-Place Concrete

#### **Discussion**

The hot-humid climate zone includes most of the areas in the country where hurricane-force winds are common. When designing for high-wind areas, stronger exterior walls are usually necessary. Also, as shown in Case Study #3, homes built of poured in place concrete or concrete masonry are commonly used for wind and vermin resistance, especially in Florida. Homes built with masonry walls and metal interior framing avoid all wood framing below the level of the top plate, reducing the risk of termite damage.

For larger builders, the investment in a set of prefabricated aluminum forms is likely to pay for itself at a reasonable return on investment by reducing the time of construction and the cost of the exterior finish. The smooth exterior surface created by the aluminum forms eliminates at least one base coat on the exterior stucco. Although CARB’s experiment with a precast wall system was not cost-effective, precast systems (if the joints are properly treated) can also be used.

Polyisocyanurate foam board (polyiso foam) provides high thermal efficiency at a reasonable cost. The optimal thickness of the foam was determined through simulations to be  $\frac{3}{4}$  in. in mid-Florida, resulting in a composite R-value of R-8.5, taking account of the reflectivity of the foil face, this higher R-value is achieved by creating an air space between the foil-faced polyiso foam and the gypsum board interior by inserting  $\frac{3}{4}$ -in.

strapping between the foam and the gypsum board. The foam is tacked in place with adhesive, then secured by nailing the strapping through the foam. According to the IRC, wiring can run horizontally in the 3/4-in. void space providing that it is protected by 1/16-in. metal plates everywhere that it penetrates a piece of strapping.

Benefits Demonstrated in CARB/Building America Case Studies:

- Concrete walls poured in prefabricated aluminum forms resulted in noticeable savings for a production builder compared with concrete masonry units, and produced a strong, smooth, accurate, easily finished wall system.
- CARB has successfully demonstrated the use of 3/4-in. foil-faced polyiso foam with 3/4-in. wood strapping in Central Florida. This system proved to be substantially more energy-efficient than the conventional method used with concrete block, which employs radiant barrier paper without added insulation.

## Eight-inch Concrete Block

### **Discussion**

While concrete block is the common method of producing masonry homes because of its low cost, it has many disadvantages relative to concrete, especially that poured within aluminum forms. With its many voids, the block easily transmits water. Walls must be designed to dry toward the inside. Poly and foil-faced polyiso foam is not acceptable because it is a strong vapor retarder, so EPS is the recommended alternative (XPS can also be used if desired). Foil must not be used, to allow drying to the interior. Thicker EPS is required for two reasons: it has a lower R-value than polyiso; and the R-value of the reflective foil is lost.

Applications in CARB/Building America Case Studies:

CARB has not experimented with concrete block, but has observed the potential for water problems and has calculated a low R-value with the conventional insulation and interior finish application (steel studs, foil-faced paper, and gypsum board).

## Exterior Stucco Finish

### **Discussion**

Applying the stucco directly to the relatively smooth surface of the concrete wall is simplified versus application on concrete block. A primer is applied to the walls to improve adherence, and a one or two coat finish can be sprayed or troweled on the primed surface.

Benefits Demonstrated in CARB/Building America Case Studies:

Labor savings for the simplified stucco can be significant, helping to offset the higher cost or more efficient equipment and the better windows. In some of the prototypes with aluminum forms, the builder was able to apply only one coat of stucco over a primer.

## Non-Combustible Air Gap Sealing at Attic

### **Discussion**

Every opening into the attic for plumbing vents, bath fan exhausts, and electrical wiring needs to be gap sealed to prevent air movement between the attic and the living space. Most building codes consider this gap-sealing to be fire-stopping when it occurs around chimneys, ducts and pipes, and therefore require it to be non-combustible (mastic or foam products are available for this purpose). Although the code does not specifically require non-combustible fire-stopping at electrical wiring, inspectors may require that all gap sealing be done with non-combustible material.

### Applications in CARB/Building America Case Studies:

Gap sealing is an essential part of a successful energy-efficient project. CARB has helped convince builders that the extra attention to this detail is worthwhile, partly by showing the significant gaps typical of a conventional project. Once the builder is convinced, the added effort becomes routine.

## Conventional Wood-Truss Roof with OSB Sheathing.

### **Discussion**

Stick-framed roofs are common in areas with low labor cost, for small homes (less than approximately 1,200 ft<sup>2</sup> of roof). However, stick framing (especially for hipped roofs) requires somewhat complex engineering that is carefully followed in the field, a requirement that is seldom met. Gang-nail trusses are engineered using sophisticated computer programs, and because they are fabricated in a plant, they have reliable characteristics, leaving little to chance. In high-wind areas, it is crucial to properly secure the trusses with hurricane clips or straps.

### Applications in CARB/Building America Case Studies

All CARB projects are built with pre-engineered gangnail trusses. In one case, CARB demonstrated notable cost savings if the builder switched to trusses, but the builder chose to retain stick-framing.

## Reflective Roofing Material.

### **Discussion**

Studies by the Florida Solar Energy Center (FSEC) have shown that roofs that reflect sunlight stay cooler and maintain a cooler temperature in the attic. If ducts are located in the attic, reflective roofs are especially effective in reducing both energy consumption and peak cooling loads. Reflective roofs also reduce the “heat island” effect where highly absorptive roofs raise the ambient temperature in the local microclimate. White asphalt shingles have only a moderate cooling effect, but the shingles themselves do not get as hot and are likely to last longer than dark-colored shingles. To achieve real cooling effects, the roofing material needs to be either tile or metal, either of which can be painted with reflective paints. To achieve dark color, “selective” paint is available that

reflects much of the infrared component of the sunlight while absorbing enough light to create a dark color.

In areas where asphalt shingles are the norm, it is difficult to convince builders to switch to metal or tile solely on the basis of cooling effects alone. However, both types of roof are much more resistant to hail damage than are asphalt composition shingles, and both provide some protection from burning brands for homes exposed to wildfire damage. Algae does not form on either tile or metal roofs to the extent that it does on asphalt shingles. Finally, tile and metal roofing properly applied are more wind-resistant than asphalt shingles.

A full discussion of this subject is found in the *Journal of Light Construction*, June 2003, Pages 75 through 81 (order through [www.jlconline.com](http://www.jlconline.com)). Also, a rating organization is up and running: the website for the Cool Roofs Rating Council, listing many rated products, is [www.coolroofs.org](http://www.coolroofs.org).

#### Applications in CARB/Building America Case Studies

CARB has demonstrated reflective roofing in southern California, where tile roofs are normal. In Florida and Texas, low first cost and buyer resistance to white shingles have led builders to choose dark asphalt shingles despite the many advantages of metal or tile. However, higher-end homes are often roofed with tile or metal, and this feature is likely to trickle down to lower-cost homes in the future, as has happened in many hot-dry climate locations.

### Building Envelope Water Management System

#### Discussion

The stucco covered concrete walls of the recommended best practices home eliminate many of the water management problems found in wood-frame construction. Figure II-3 shows the cast-in projection against which the window flange is nailed and sealed. The

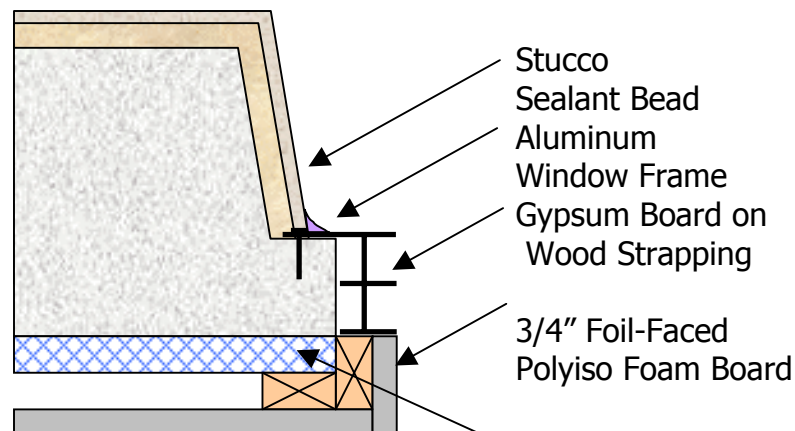

**Figure II-3. Detail of window surround with cast-in “buck” to receive the window flange. Cast-in projection against which the window flange is nailed and sealed.**

stucco finish then meets and bonds with the aluminum window frame. This detail is formed on all sides of the window; a marble or wood sill can replace the gypsum board at the sill detail.

### **Recommended Measures**

#### **Roof (Figure II-4)**

1. Provide Adequate “Crickets” Behind Chimneys and Other Projections through the Roof  
There must be a way of sending water around the objects like chimneys and skylights that block the flow of water down the roof. Behind tall objects like chimneys, install the largest and steepest “cricket” (small gabled roof) that will fit. This will also prevent the buildup of plant debris.
2. Place Chimneys, Dormers, etc., away from Valleys and Adequately Separated from Each Other  
Water collects and runs down valleys. Running valleys together (for example, between closely spaced dormers) or placing a chimney or other obstruction in a valley almost guarantees water leakage. Plant debris collects in these places, holding water and accelerating the deterioration of the roofing.

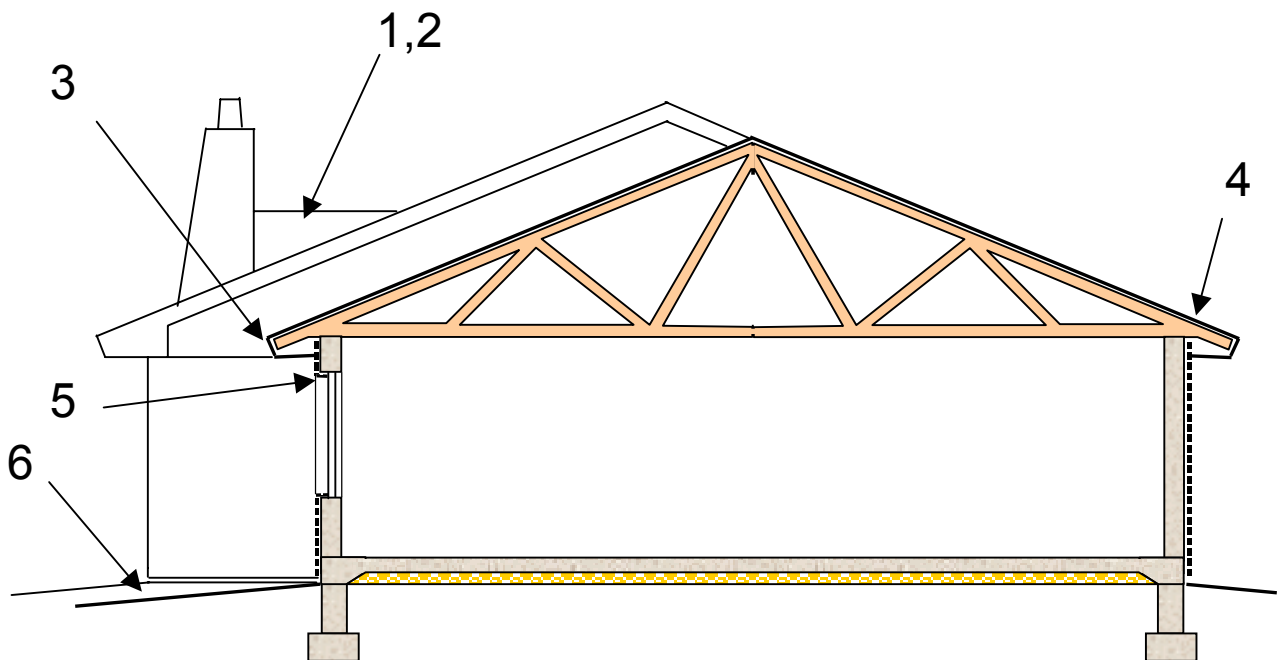

**Figure II-4. Preventing water intrusion**

3. Use “Kick-Out” Flashing at the Joint between an Eave and a Sidewall  
Where a roof runs into a sidewall, “step flashing” is required at the joint. If the roof stops before the wall does, the water that collects against the step flashing will run in behind the siding unless it is directed back out onto the roof by “kick-out” flashing.
4. Use an Impervious Layer at Valleys  
At eaves and valleys, an impervious layer of peel-and-stick modified bituminous flashing material should be installed under the roofing.  
*Why? During heavy rains, water concentrated in valleys, and can build up high enough to back up under the slates or shingles. An impervious layer drains any overflowing water to the eaves before it soaks into the roof sheathing.*
5. Properly Flash around Windows and Doors  
The bond between the stucco and aluminum frame cannot be relied upon to ensure water-tightness. A fillet of sealant, although far from an ideal form of sealant joint, is adequate to deflect any water that reaches the deeply inset windows. This sealant bead needs periodic replacement, which is straightforward. This detail would not work with vinyl windows, which expand and contract enough to break the bond between the sealant and the window frame. Also, aluminum windows are welded at the corners and typically do not leak, unlike vinyl and wood window frames, almost all of which leak at the corners.
6. Carefully Plan Grading around the Home to Ensure that Heavy Rainfall Will Find Its Way to Drains without Flooding the House
  - Typical requirements are to grade away 6 in. in the first 10 ft
  - Provide simple retaining walls where necessary
  - In dead-flat land, mound up under slab with compacted gravel to ensure drainage away from building

#### Applications in CARB/Building America Case Studies

The above measures are all good practice, and taken together will help prevent moisture-related problems throughout the building envelope. Because CARB hot-humid-climate builders seldom have problems related to water management in walls, most of the recommendations relate to roofs, which are exposed to the torrential downpours characteristic of most hot-humid climate.

## ***Primary Recommendations for the Equipment***

### Manual J / Manual D HVAC Sizing

#### **Discussion**

Air Conditioning Contractors of America has long published a simple, but effective, method of determining loads (“Manual J”) and sizing ductwork (“Manual D”). These design tools are available in user-friendly computerized form for about \$400 each. Also available is a linked program for drawing duct layouts.

Oversizing AC systems in hot-humid climates is likely to cause mold problems. Dehumidifying is an essential part of the cooling process. Unless humidity is removed from the air in the room, reducing its temperature will create condensation on any cool surface and create cold, clammy conditions. In addition, to compensate for the clamminess, the temperature is likely to be set much lower than would be the case if the space were drier, thus wasting energy.

It takes several minutes after the AC cycles on before any condensate actually leaves the living space through the condensate drain, which is an essential step in the dehumidifying process. When the AC unit is too large for the load, it will “short cycle” and shut off before any water leaves the living space. For maximum dehumidification and overall comfort, the unit should be sized as small as possible, while reducing the indoor temperature to tolerable (not ideal) levels during the hottest weather when it is running continuously. Manual J calculations will ensure that the unit is sized for this condition.

In addition to “right-sizing” the unit for optimum comfort, low-E glazing and better insulation allow further down-sizing of the AC unit(s), for a saving in initial cost. In larger homes, downsizing may allow one unit to replace two, for additional savings. This cost saving in part compensates for the extra cost of the low-E glazing that is necessary to allow the downsizing, in a classic case of “whole-house” interaction between building components.

#### Applications in CARB/Building America Case Studies

All CARB projects have been designed using Manual J / Manual D computerized calculation, except those special cases where a more sophisticated program has been used. CARB often finds that systems designed by HVAC contractors are dramatically oversized, as one safety factor is piled on another. It is important that the HVAC designer have sufficient information to account properly for all envelope efficiency measures, which often result in a downsizing of equipment and ductwork sizes.

### SEER-12 Air Conditioner and HSPF-7.5 Heat Pump

#### **Discussion**

Until recently, SEER-10 air conditioning equipment has been standard across the country. Gradually, SEER-11 or SEER-12 equipment is becoming more widely used. Simulations show that SEER-12 equipment is nearly always cost-effective, and it is

nearly always required in order to meet ENERGY STAR™ standards. SEER-14 equipment is often cost-effective in those cases where the buyer directly compares operating costs with the cost of borrowing with the aim of reducing his total monthly outlay. As it is rare for owners to do this, SEER-14 equipment is typically judged “not cost effective,” despite its potential to lower monthly ownership cost.

Heat pumps are preferable to electric resistance heating in all but the mildest of climates. A unit with a heating season performance factor (HSPF) of 7.5 or more will reduce the electric consumption during heating by more than 50% relative to electric resistance heating.

#### Applications in CARB/Building America Case Studies

For most builders upgrading to SEER-12 is a major step, and for the present, it is a practical goal. In the case of Mercedes Homes, after the initial prototype that incorporated a SEER-14 unit, further prototypes and final production homes used a SEER-11 AC/HSPF-7 heat pump unit.

### Conventional Gas-Fired Water Heater Located in Garage

#### **Discussion**

Because of the dominance of hot weather, water heaters are best kept out of the living space, and in a place where their skin losses will not increase the cooling load. This also obviates the need for power-vented equipment, and makes gas-fired equipment attractive. There is no justification for electric resistance water heating except where rates are very low, or where natural gas is not available and propane is not desired or is prohibited. The heater can either be located free-standing in the garage, within a closet off the garage, or within a closet in the outside wall. The closet should be finished and insulated from the house. In all cases, ventilation grilles are required to provide combustion air for the unit.

#### Applications in CARB/Building America Case Studies

Water heaters in CARB hot-humid prototypes have been located freestanding in the garage or in a closet off the garage. Water heaters in attics are not desirable because of the difficulty of access and the consequences of leakage.

### Ducts Mastic Sealed (Leakage less than 5% of Fan-Flow)

#### **Discussion**

Sealing ductwork is very important in the single-story, slab-on-grade homes with ductwork running exposed within the attic. CARB’s recommended best practices involve moving the ductwork and air handler to within the conditioned envelope, eliminating losses to the attic. Even in this configuration, mastic sealing the ducts is a highly desirable measure. Properly sealed ducts make sure air gets to the spaces intended, rather than leaking into a plenum space. It also minimizes the chances of creating pressure differentials from space to space that would induce airflow through the envelope. The process of sealing each joint reduces the chances of unconnected ductwork, a surprisingly common mistake.



Tape is not recommended as an alternative to mastic. Various tapes are tested to UL 181 standards, which supposedly makes them reliable for use on metal or plastic ductwork. However, it has been found that some duct tape (which is not suitable for taping ducts) passes UL 181. Mastic provides the most reliable duct sealing method.

All ductwork, including the air handler compartment (which typically has many leaky joints) should be mastic sealed. A common goal for duct leakage, measured using a “duct blaster” test, is 5 to 6% leakage to the outside.

#### Applications in CARB/Building America Case Studies

Mastic duct sealing recommended for use in all CARB homes. Energy savings can be relatively modest, or substantial, depending upon how well constructed the ductwork system is to begin with. To be sure the sealing has worked, it is advisable to perform a duct blaster test.

### Ducts and Air Handler within Conditioned Envelope

#### **Discussion**

The main force of CARB’s efforts to protect ductwork from hot attics in hot-dry climates has been to bury ductwork within attic insulation. CARB is experimenting with buried ductwork in hot-humid climates. Although the technique shows promise, it remains controversial, and we have pursued other approaches. Working with Mercedes Homes in Melbourne, Florida, CARB developed a way of creating a plenum within the attic truss space to receive ductwork (see Case Studies). In its latest version, the bottom chord of the trusses are canted upward to form a vaulted space, which is then covered by the framers with sheathing board or a roll-out membrane. Small truss sections are then applied over the membrane or board to form the continuation of the bottom chord, in order to provide a level ceiling (Figure II-5).

CARB also has used dropped ceiling to house ductwork, again requiring framers to install a layer of sheathing board between the plenum and the attic. As part of a system of ceiling crops, CARB ran a main duct through a suspended box that functioned as part of a space divider and as a plant shelf. Dropped ceilings are typically unpopular with builders, which is the stimulus behind the development of the plenum truss (Figure II-6).

### Applications in CARB/Building America Case Studies

The builder with whom this design was developed, Mercedes Homes, has not incorporated the idea into his production housing because of some added cost. However, the concept is ripe for further development and offers a straightforward way to incorporate almost all ductwork within the conditioned envelope. Testing has confirmed that the environment within the plenum is nearly identical to that in the house

### Compact Duct Distribution System

#### **Discussion**

If low-E glazing is used and the home's envelope is relatively tight, it is possible to discharge conditioned air from inside walls or from ceiling diffusers up to 12 ft from the window wall in most cases without compromising comfort. Such "inside throw" layouts cut ductwork runs, saving money and reducing the amount of ductwork that needs to run outside the plenum truss.

### Applications in CARB/Building America Case Studies

Compact duct distribution systems have played a central role in many CARB projects. It is a crucial part of efforts to bring ductwork inside the conditioned envelope by using the "plenum truss" approach.



**Figure II-5. Plenum truss after lining (left) and after ductwork and lower chord are installed (right)**



**Figure II-6. Boxed-in main duct between kitchen and living room**

## Central Air Return with Transfer Grilles at Secondary Spaces (Balanced Air-Flows)

### Discussion

There is nothing wrong with adding a ducted return from each room, as long as the returns are not panned and as long as they remain within the conditioned envelope of the home. However, ducted returns are an unnecessary expense in most housing and are a definite liability if they run in the attic.

A more reliable and cost-effective approach is to provide a central return and make sure that there are transfer grilles or transfer ducts, of adequate size, that allow air to return from individual closed rooms to the central space. A common requirement is that the differences in static pressure between any two rooms remain below 2.5 Pascals. This is a low but achievable number; however, 3 pascals is the common target number.

The worst possible conditions occur when there is neither a ducted return nor a transfer grille (Figure II-7).

*Why? If one space is pressurized, some other space will be de-pressurized. In both cases, air is forced through cracks into or out of walls and attics, increasing energy losses. Many examples of “soot” accumulation can be traced to pressure imbalances.*

The plenum truss provides an ideal way of transferring air from one space to another, merely by installing grilles into the plenum, which then functions as a return air plenum.

### Applications in CARB/Building America Case Studies:

Besides using the plenum truss, CARB has used several different, cost-effective methods of transferring return air without compromising acoustic or visual privacy. A common solution is a high grille on one side of an interior wall cavity, and a low grille on the other. Sometimes rooms do not have any common wall with the main space (for example, a door at the end of a corridor). In these cases, grilles can often be put into and out of a closet; or grilles can be located opposite each other over the door.

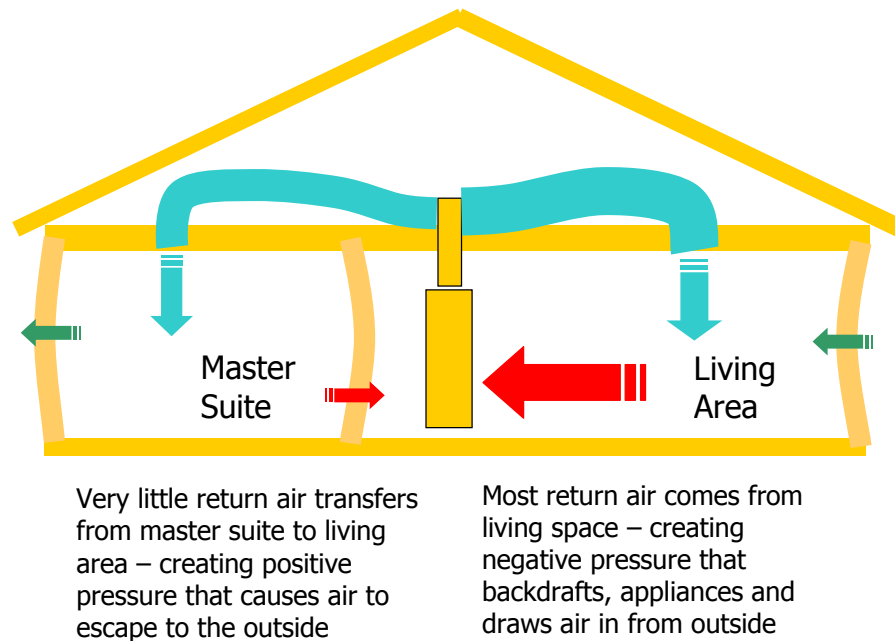

**Figure II-7. The result of unequal pressures in a house because of lack of a ducted return or a transfer grille**

## Provide Supply-Only Ventilation

### Discussion

Some level of ventilation is desirable in all homes, especially those with a tightly sealed envelope. Because the walls are of concrete and all openings through the ceiling into the attic are sealed, the CARB best practice home is likely to be very tight. One factor reducing the need for ventilation is that the only combustion heating appliance, the water heater, is located in the garage and gets makeup air directly from outdoors.

The range exhaust, bath fans, and dryer all discharge house air to the outdoors, creating a deficit that needs to be made up. CARB has found in poorly sealed wood-framed homes that despite the presence of an open 6-in. duct into the return air plenum, replacement air preferentially enters through crack and leaks, with virtually no air coming through the duct. Some of these leaks will be from the garage, potentially allowing car exhaust fumes to enter the home. The only proof against such leakage is to pressurize the home enough to prevent air from entering house from the garage, overcoming any wind pressure that is likely to occur. This would require a substantial amount of continuous ventilation, which would not only be very costly to operate, but would compromise comfort.

Hence, the first step in controlling ventilation air is to carefully seal the wall and carefully weatherstrip any openings between the garage and the home. Once this is done, ventilation becomes a matter of providing adequate comfort for a reasonable operating cost. CARB continues to examine systems involving sophisticated controls, but

recommends a simple, practical, and cost-effective solution: install a 6-in. sheet metal duct running as directly as possible from the outdoors to the return air plenum of the air handler. Whenever the air handler runs, approximately 50 CFM of outdoor air will be drawn into the house by the fan. If added ventilation is needed, the air handler can be run manually on its “fan” setting. A manual damper should be installed on this intake duct, to allow the homeowner to eliminate the ventilation if desired. Incoming air is automatically filtered in the air handler if the outside air duct runs to the return air plenum (Figure II-8).

Another option is a separate fan unit that draws in outside air, filters it, and distributes it to (typically) bedrooms. The unit operates independently of the central fan, but can be linked with the bath fans, range fan and dryer exhaust to guarantee filtered makeup air when these appliances are running.

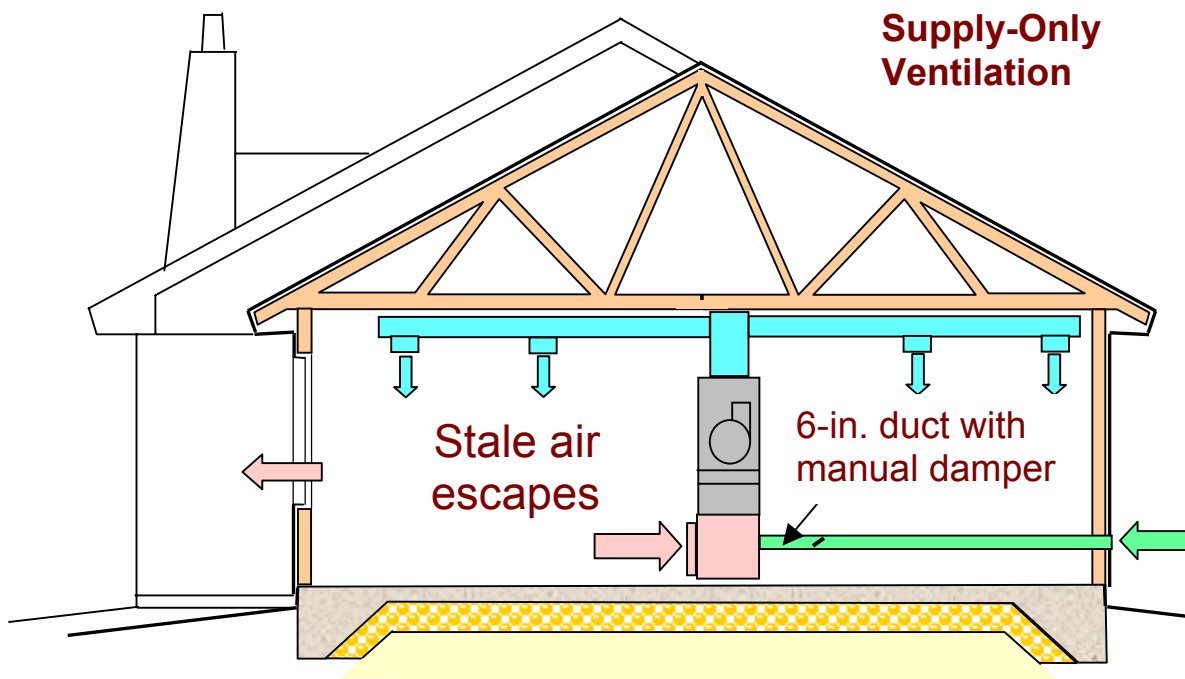

**Figure II-8. Supply-only ventilation**

## No Unvented Gas Appliances (Except Gas Range with Range Hood Exhausting to the Outside)

### **Discussion**

Unvented gas appliances, such as fireplaces or heaters, may or may not be a health hazard, depending upon whether the flame is properly adjusted. What is not controversial is that they are potentially highly destructive to the framing and finishes of the building. These devices create large quantities of water if they are run for extended periods, because the main products of complete combustion are water vapor and carbon dioxide. This water vapor can raise the interior relative humidity to unreasonably high levels. Combined with the supply-only ventilation required for hot-humid climates, highly humid indoor air can be driven into the construction, with the potential for rot.

### Applications in CARB/Building America Case Studies

CARB recommends against the use of these devices, and insists that all gas ranges be equipped with a range hood that ventilates to the outside. These are basic safety and indoor air quality measures that should always be observed.

### **Secondary Recommendations**

#### Energy-Efficient Lighting

### **Discussion**

One of the most important ways in which energy is wasted (especially in hot climates, where the lighting load creates an additional cooling load) is the use of incandescent lamps. Until recently, however, most fluorescent lamps had disadvantages that limited their use to some bathroom and kitchen lights (with high-end homes dispensing with them altogether). These disadvantages are rapidly being eliminated by successive generations of compact fluorescent lamps. While some still exhibit a time delay before they are fully bright, their color can be quite authentic, especially when reflected from a recessed can, or diffused through the shade of a lamp. Lights that are seldom used can remain incandescent with little loss in energy. Also, fluorescent lamps typically do not work as well outdoors as incandescent lamps.

### Applications in CARB/Building America Case Studies

Because of the past history of ineffective fluorescent lighting, CARB's builders have steered clear of fluorescent lighting, responding to market resistance to their use. As market acceptance grows, CARB will continue to suggest the increased use of fluorescent lamps in built-in fixtures.

#### ENERGY STAR Appliances

### **Discussion**

Two of the most important appliances from a water-use and energy efficiency point of view are the washer and dryer, which are seldom supplied by the builder. However, the builder should include a gas line to make it possible for the homeowner to install a gas

dryer. In most cases, gas energy is less costly than electricity. The two main appliances supplied by the builder where efficiency is important are the refrigerator and the dishwasher. There are now hundreds of models of refrigerators that are ENERGY STAR rated, and their use should be routine. There are also many energy-efficient dishwashers available.

#### Applications in CARB/Building America Case Studies

CARB has had mixed success in encouraging builders to install ENERGY STAR appliances. Typically, as with McStain in Boulder, Colorado, ENERGY STAR appliances are requested by buyers in certain markets where energy performance is a major issue. In other cases, aesthetics or quiet operation governs, and the ENERGY STAR rating is not considered an important issue. This is gradually changing as ENERGY STAR becomes better known.

---

## **First Prototype Case Study: Four Generations of CARB / Mercedes Homes Concrete-Wall Prototypes**

Date: Early 2000



**Figure II-9. A Mercedes concrete-wall prototype home**

### ***Background***

The original impetus for this project was to take the information gained in the first CARB hot-humid climate test house (with Beazer Homes in Houston, Texas) and implement those findings in a second hot-humid climate zone project. The chosen location in central Florida, along with a climate similar to Houston, brings with it additional obstacles and opportunities for innovations.

Mercedes Homes joined CARB and agreed to develop a series of prototypes (Figure II-9). Headquartered in Melbourne, Florida, Mercedes is active in six Florida markets as well as Dallas-Fort Worth, Texas, and Charlotte, North Carolina. When the project started in 1997, Mercedes ranked 55<sup>th</sup> among the top 100 volume builders and has rapidly climbed in volume in the last three years (Table II-1).

Most sales are to entry-level or first-time move-up buyers. In central Florida, where Mercedes was founded in 1984, single-family home construction is dominated by site-built concrete-block exteriors. Popular with buyers because of their resistance to hurricane force winds and subterranean termites, concrete-block homes are labor intensive to construct and not particularly energy efficient. On-going shortages of skilled masons and a desire to increase factory prefabrication and energy efficiency led Mercedes Homes on a search for a viable substitute to block work for its homes. Before CARB's involvement, Mercedes had actively pursued R & D projects on its own, focused solely on the replacement wall system and had constructed three panelized concrete prototypes, all of which proved too costly for its current market niche. The company was also very interested in improving energy efficiency, the primary goal for CARB.



Using an existing model as the base case (Table II-2), CARB performed “REM/Design” computer modeling and based on estimated costs, determined that the prototype should have R-10 wall insulation and insulating low-e glazing.

**Table II-1. Mercedes Ranking in Volume Builders**

Item	1997	2001	2002	2003
<b>Ranking</b>	55	59	47	24
<b>Homes Built</b>	1450	1927 (1200+ in central and northern FL)	2493	3066
<b>Revenue</b>	175 million	275 million	396 million	575 million

**Table II-2. Initial Base Case**

Item	Specification
<b>Home model</b>	2,078 ft <sup>2</sup> Morgan Cove four bedroom, elevation 'D'
<b>Foundations</b>	Uninsulated concrete slab on grade
<b>Exterior walls</b>	8-in. reinforced concrete masonry with pre-formed concrete headers and perimeter bond beam
<b>Roof structure</b>	Prefabricated wood trusses at 24 in. on-center
<b>Wall cladding</b>	Two-coat stucco, no primer
<b>Wall interior finish and insulation</b>	¾-in. wood strapping with foil rated at R-4.2, covered with gypsum wallboard
<b>Attic insulation</b>	R-19 blown-in fiberglass
<b>Natural gas</b>	Not available
<b>Heat pump</b>	SEER-11, HSPF 7
<b>Air handler location</b>	Garage
<b>Ductwork</b>	R-6 insulated flex ducts running in attic
<b>Window frames</b>	Painted aluminum, non-thermally-broken
<b>Glazing</b>	Single glazed, grey tint
<b>Water heater</b>	Electric resistance

## **Alternate Wall Systems**

### **Background**

Before the search and evaluation of potential alternate wall systems, a performance-based specification was developed to limit and focus the selection process. The ultimately selected exterior wall system would need to be:

- Marketable to consumers used to masonry construction
- Able to withstand sustained hurricane-force winds
- Resistant to termites and other wood-destroying insects
- Energy efficient
- Cost effective
- Able to be factory panelized or pre-fabricated.

This specification and preliminary research into available alternate systems led to the initial selection of four distinct assemblies for further evaluation.

### **Insulated Concrete Forms**

The ICF wall system studied for the Mercedes prototype is manufactured by Lite-Forms International of Sioux City, Iowa. The forms consist of an inner and an outer layer of 2-in.-thick Owens Corning extruded polystyrene separated by plastic spacers 12 in. on-center. This panel-type ICF system allows the outer surface to be stripped for reuse after the cast-in-place concrete is set. The exterior raw concrete surface would then receive a sprayed stucco finish virtually identical in appearance to the standard block product. On the interior, the XPS is routed out for the electric romex wiring, and the interior gypsum board finish is screwed to the plastic form flanges originally used to hold the foam forms in place.

### **Autoclaved Aerated Concrete**

The second system given closer scrutiny was Ytong's Value Panel AAC system. The 8-ft x 2-ft x 8-in.-thick solid panels were to be pre-engineered based on shop drawings and installed in vertical planks along the perimeter of the slab. The AAC panels require no additional insulation in this climate and receive the two-coat exterior stucco finish similar to concrete block. Electric wiring can run in channels routed into the block or between ¾-in. furring strips (the prevailing practice in central Florida). Interior gypsum board is nailed directly to the panels or to the furring strips.

### **Panelized Light-Gauge Steel Framing with Flexible Stucco**

The 18- or 20-gauge steel studs would be placed 24 in. on-center, aligning directly under the roof trusses for direct axial bearing. Then a 6-in.-deep stud is required to resist the design wind load of 40 PSF and a maximum axial truss load of 1700#. The steel walls

would be pre-panelized in a plant setting, with 5/8-in. cement-board exterior sheathing manufactured by PLYCEM screw attached before delivery to the site. The field-applied exterior finish would be an elastomeric synthetic stucco product manufactured by GRAILCOAT, LLC. This product is flexible, waterproof, able to bridge joints in the panels, and can give the finished look of traditional stucco. The GRAILCOAT is a single-coat sprayed application.

The steel-wall panels would be insulated with 6-1/4-in. fiberglass insulation with an R-value of 21. The calculated whole wall R-value, taking into account the thermal conductivity of the steel, was R-10, meeting the upgrade target. Two-dimensional thermal flow modeling using “ALGOR” confirmed that an interior thermal break between the steel flange and the gypsum board finish would not be required in this climate.

### Ficon Panels

Further research uncovered FICON panels, pre-assembled by Ficon, Inc., of Picayune, Mississippi, a company with 15 years experience in panelized commercial buildings. FICON panels are welded, not screwed. In place of cement board panels screwed to the exterior flanges, protruding flange anchors attached to the outer flange of the studs are set directly into 1-1/4-in. deep, wet concrete poured onto a smooth form. The result is steel framing integrally tied to a smooth 5000-psi concrete plate with no additional mechanical fastening. FICON panels can be fabricated up to 20 ft in length and provide all the shear resistance required in the high-wind zone around Melbourne.

Of the several systems investigated, Ficon panels seemed the most promising and were chosen for the prototype.

### **Revised Base Case**

Mercedes Homes decided to shift prototype development to a simpler starter home that they felt would be more representative of their market strategy. The revised base case would be the recently developed Nicole Isle Deluxe, Elevation “D.” This plan contains 1504 ft<sup>2</sup> of living space comprised of three bedrooms, two baths, an eat-in kitchen, and a vaulted-ceiling great room. There is also a two bay garage and a rear covered porch. The building specifications are identical to the original base case.

Additional Right-J computer modeling was performed for various insulation and glazing alternates. The results are shown in Table II-3.

**Table II-3. Base-Case Home Results**

<b>Option</b>	<b>Specifications</b>	<b>Peak load</b>	<b>Required HVAC</b>
Base Case	Single-glazed grey-tint windows, R-5 walls, R-19 ceiling, AHU in garage, ducts in the attic, SEER 10 equipment	32,571 Btuh	3.0 tons
Alternate 1	Insulated Low-E windows, R-10 walls, R-19 ceiling, AHU in conditioned space, <i>ducts in conditioned space</i> , SEER 12 equipment	21,733 Btuh	2.0 tons
Alternate 2	Insulated Low-E windows, R-10 walls, <i>R-30 ceiling</i> , AHU in conditioned space, <i>ducts in the attic</i> , SEER 12 equipment	22,667 Btuh	2.0 tons
Alternate 3	Insulated Low-E windows, R-10 walls, R-19 ceiling, AHU in conditioned space; <i>50% of ducts in conditioned space</i> , SEER 12 equipment	23,867 Btuh	2.0 tons

***Final Building Specifications***

Based on the performance trade-offs determined by the above analysis and the cost and performance trade-offs of the alternate wall systems researched, the final prototype specifications were based on Alternate 3 and are listed in Table II-4. It should be noted that the compact, highly efficient floor plan, the limited glazing area, the strict rectilinear building footprint, (resulting in a high floor area to building envelope area ratio) and the mild climate tended to diminish the effects of improving the envelope performance. Therefore, strategies that may be cost effective given more complex (or less efficient) building forms are not cost effective in this home.

**Table II-4. Final Prototype Specifications Based on Alternate 3**

<b>Home model</b>	<b>Nicole Isle Deluxe, Elevation “D”, 1504 ft<sup>2</sup></b>
Foundation	Slab on grade, uninsulated
Wall construction	FICON panels with 1-1/4-in. 5000 psi concrete-plate facing Specified: 18-gauge steel studs at 24 in. on-center Actually installed: 16-gauge steel studs at 16 in. on-center
Exterior finish	Grailcoat elastomeric synthetic stucco
Roof construction	Prefabricated roof trusses at 24 in. on-center
Interior partitions	25-gauge steel studs at 24 in. on-center
Windows	Soft-coat, low-E, double-insulated glass in non-thermal-break aluminum frames (SHGC = 0.55)
Wall insulation	6-1/4-in. full-width, unfaced fiberglass blankets. Effective whole-wall R-value equals R-10.5
Ceiling insulation	Unfaced, friction fit, R-19 fiberglass blankets
Ducts and AHU	Air-handler enclosed in an insulated, air-sealed closet at the corner of the garage within the conditioned space; approximately 50% of the duct surface area within the conditioned space, the remainder exposed to the attic; single central return is ducted directly off of the air-handler return plenum
HVAC	Modeled: SEER 12 heatpump, 2-ton capacity Actually installed: SEER 13, non-CFC (Puron)
ENERGY STAR	Maximum allowable 43.8 MMBtu/year Upgraded design uses 35.2 MMBtu/yr; easily qualifies for ENERGY STAR (actual HERS score = 90) Base Case uses 46.1 MMBtu/year, does not qualify for ENERGY STAR
Percentage Saving	31.5% annual savings in cooling energy 38.5% annual savings in heating energy

## ***Building Design and Engineering***

This was the first time the FICON panel wall system was used in a residential application, so careful coordination was required. Based on the stock building plans, shop drawings were produced by the panel fabricator for review by the CARB design team and by Mercedes (Figure II-10). The plans were approved with only minor modification, and panel fabrication proceeded. The slab foundation edge detail required minor modification to properly receive the FICON panels, with a recessed edge detail designed and coordinated between FICON and Mercedes (Figure II-11). Top plate and roof truss connections were similarly designed and engineered.

Concurrently, CARB designers and HVAC engineers worked to cost-effectively integrate the duct system into the house plan. It was during this task, where the 8-ft ceiling at the master bedroom offered obstacles to full integration via soffits or drops. It was decided to place a portion of the duct system on the bottom chords of the trusses and to insulate over the ducts. This configuration is controversial because of concerns about condensation on the ducts in a hot-humid attic during the cooling season. To assess the outcome, CARB monitored temperature and relative humidity at the duct surfaces under the insulation. If successful, the buried duct approach would offer a simple, easy-to-engineer alternative to true inside-the-envelope HVAC, without the necessity of architectural integration and the associated costs. When installed with tight connections and minimal leakage, a buried duct system would offer near-equivalent performance to true inside-the-envelope duct installations, while reducing cost and simplifying engineering. Results showed small, but measurable, amounts of condensation except where ducts were deeply buried (at a dropped ceiling). Because results did not show the entire absence of condensation needed to convince builders, simply burying the ductwork without other measures to eliminate condensation was deemed not advisable.

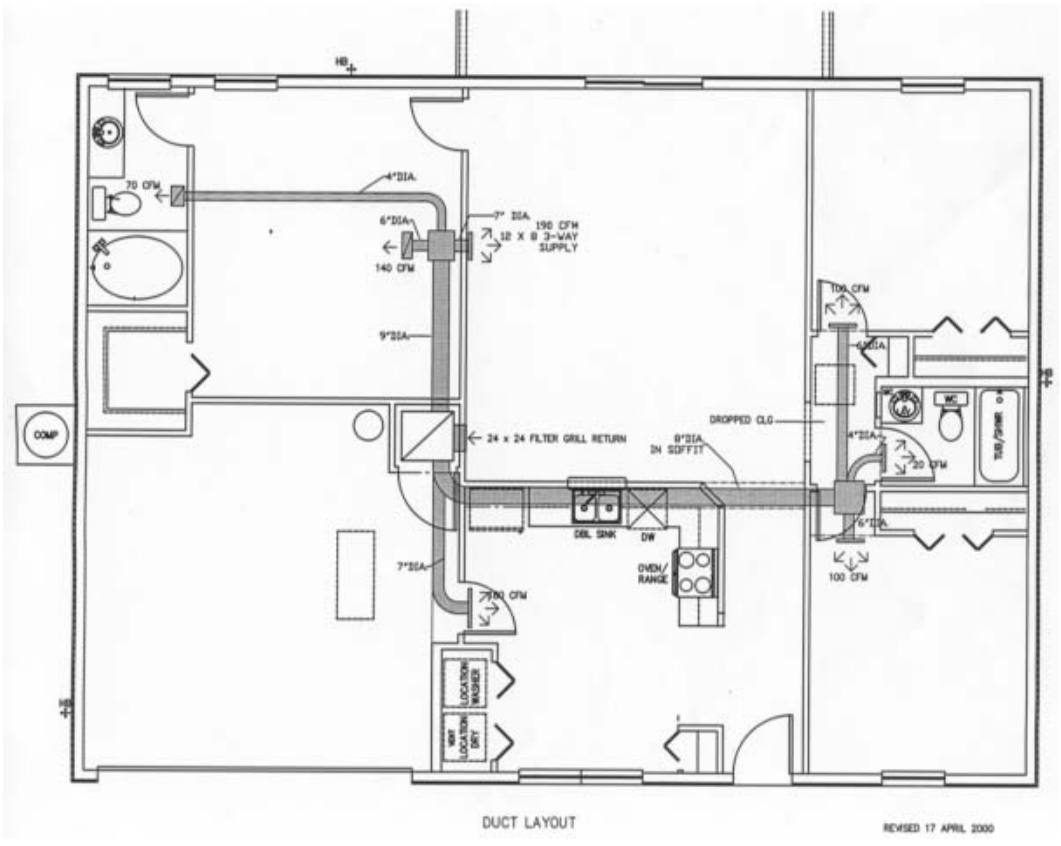

**Figure II-10. Duct system layout**



**Figure II-11. Ficon panels joining at a corner. Sill is at left, head at right.**

The remainder of the building design and engineering did not deviate substantially from standard practice and, as such, no additional significant design/engineering efforts were required. This simplified process was an intentional decision meant to reduce the builder's learning curve and enable the builder to more quickly adopt the innovations across the entire product line.

### ***Construction Process and Analysis***

As the slab-on-grade foundation differed little from standard practice, preparation and installation went smoothly. Normal production builder delays had stalled the start of the foundation, so the FICON panels had already been fabricated several weeks before the foundation installation. The timing thus allowed the panels to be shipped from the plant in Mississippi on a just-in-time manner, arriving just as the slab finishing was proceeding. After the required 5-day cure, Mercedes proceeded with the wall panel installation using a crane set procedure. All wall panels were set and secured in under 5 hours. Because of variation in the slab-edge recess, it became necessary to grind down one concrete panel edge to achieve a flush exterior condition. Additionally, one panel corner broke, requiring a patch, and leveling shims were needed at several locations. For a first time use and installation by the builder, the process was seen as relatively smooth and glitch free. Unlike the CMU walls it replaced, the FICON panels do possess much less tolerance for deviation, making an accurate slab installation essential.

Once the walls were assembled, double top plates were bolted to the top steel wall channel. The double plate was necessitated by the 16-in. on-center framing, which did not allow the direct truss bearing as called for in the original specifications. The walls also varied from specification in that the steel framing is 16 gauge, not 18 gauge, as called for. FICON admits to being overly conservative in the panel engineering for this first



residential project and concedes that a 24-in. on-center, 18-gauge steel wall panel is more than adequate and would have cut costs significantly. This over-engineering increased the anticipated production and shipping costs of the panels to a point where they would not be economically viable for this particular building type. Before the first prototype was completed, it had become clear that the Ficon system would not work in production, and CARB and Mercedes were already working on the second prototype, using poured-in-place concrete (see next section).

After the top plates were set, trusses were lifted into place using the same crane used for the panels. The total time required for the wall and roof truss installation was 2 days. This is a full 4 days less than required by the traditional concrete block method. Another advantage over block construction is the elimination of mid-course building inspections, which delay the progress. The FICON system enables the building inspector to make his first post-foundation site visit after the building shell is fully assembled.

The roof trusses for this home, and nearly all of Mercedes products, are clear span, with no interior load bearing. In this manner, the interior partitions proceed after the shell is complete. The non-load bearing partitions are 25-gauge steel studs at 24-in. on-center. Mercedes has employed several techniques of integrating the steel into typical residential partition construction, including using wood sills and plates, and using steel sills with wood blocking for trim attachment. For this project the latter was employed, with door openings being framed with standard 2 x 4s, a very efficient and trade-friendly technique. In lieu of screws for steel-to-steel attachment a hand held “crimper” was used to securely bond the steel members together without the use of fasteners.

Although the high performance low-E windows installed in this home are a major contributor to the overall level of energy efficiency, their installation did not vary at all from standard practice and, therefore, presented no real obstacles in terms of installation.

The installation of the HVAC system was a substantial departure from current Mercedes standard practice and, as such, did present some difficulties. None of the encountered difficulties were, however, technical in nature but were a result of resistance on the part of the HVAC contractor. Even though full engineering drawings and installation instructions were provided, the HVAC subcontractor installed a substantially conventional system. The ducts installed in the attic were not placed on the bottom truss chords, but were suspended from the web members. The contractor argued that the ducts must be suspended by code. Code documentation was subsequently provided showing that ducts must be *supported* not *suspended*, and that ceiling joists qualify as supports. Mercedes then forced the HVAC contractor to remove and correct the duct installation in accordance with the specifications. Additionally, at a site visit during the rough framing stage, it was observed that the ducts at the bedroom wing could be further consolidated into a existing ceiling drop. This was accomplished and recorded into the design drawings and specifications (Figure II-12).

Because this particular HVAC contractor was not trained in high-pressure refrigerant (Puron) systems, a separate Mercedes subcontractor from the Orlando region was brought in to complete the installation. Apparently the connection between the return plenum (first contractor) and the air-handler (second contractor) was not adequately sealed, resulting in an unexpected return side leak that showed up during field testing.



**Figure II-12. Photo of boxed-in ductwork main crossing main living area, running from air handler to bedrooms**

A minor deviation from the specifications was also observed relative to the attic insulation. The insulation contractor failed to bury the ducts in the prescribed R-19 insulation at the area over the master bedroom. The Mercedes job superintendent brought the insulation installer back to complete the work as specified.

### **Code Compliance**

The FICON panel-wall system, in its first-ever residential application, was a major departure from anything Mercedes had tried before or from anything the local building department had ever seen before. As such, full engineering documentation on the wall system's structural performance was submitted to the building department with the building permit application. The supporting engineering data and the FICON panels' obvious structural attributes combined to elicit a fast approval for the permit application.

Although not specifically reviewed during the permit process, the issue of the duct supports was broached and resolved during the construction process. The HVAC installer claimed that the Florida code specifically required that all ducts installed in the attic be suspended from the truss web members. A conversation with the Brevard County Building Department clarified this view and cited the applicable code statute. Paragraph 410.1.ABCD.3.3.6.4 states that ducts must be *supported* at intervals not greater than 5 ft, and that the supports must be at least 1-1/2-in. wide. It further states that ceiling joist (truss bottom chords) may be considered supports.

There is apparently no specific code reference to the issue of burying ducts under the insulation, so this innovation posed no code compliance concerns.

### **Sales and Marketing**

Mercedes from the beginning was concerned that the selected wall system not have attributes that could be seen as a downgrade in a market where buyers expected masonry construction. The choice of the steel/concrete wall panels effectively answered that concern.

What Mercedes learned from this project is that the CARB systems-engineering approach gives them an additional valuable marketing advantage, that of substantially higher energy efficiency at no additional cost. In this instance, the cost of the better windows is offset by the down-sized HVAC system, while the thermally protected ducts and air-handler cost the same as the standard set-up. Mercedes felt that its market would respond to the energy efficiency pitch and planned to implement it state wide. Marketability was viewed as higher than the standard base-case construction methodology, partly as a result of the higher energy efficiency, but also through the buyer-perceived improvements in strength and storm resistance. The cycle time for building construction was also reduced compared to the base case, mostly attributable to the panelized wall system.

The first prototype was completed in May 2000, with short-term field testing performed in a 2-week span immediately following completion. Concurrently, as this first prototype design and specifications were being developed, CARB and Mercedes Homes worked on the plans for the second prototype, initially intended to utilize Insulated Concrete Forms (ICFs).

---

## Second Prototype Case Study

Date: mid 2000



**Figure II-13. The best-selling SF Michele II house built by Mercedes**

### ***Product and System Research***

For this second prototype home, Mercedes chose a larger design, the best-selling 2000-ft<sup>2</sup> Michele II to test the new specifications (Figure II-13; Table II-5).

Although the FICON wall system from the previous home was viewed as an excellent performer in terms of speed of erection, strength, energy performance, and marketability, the installed cost of the system proved too high. Insulated concrete forms (ICFs) were given a second hard look to determine if they could provide performance similar to the FICON house at a more cost-effective price point. Once real-cost information was obtained, Mercedes decided it too was not cost-effective for its market segment. Poured-in-place concrete, a material in which Mercedes had some experience, was selected as the replacement.

Unlike insulated concrete forms, poured-in-place concrete walls require the installation of insulation after the concrete forms are stripped. After reviewing the options, including computer modeling with Rem/Design, foil-faced, ¾-in. polyisocyanurate was selected. The rigid insulation boards are to be adhered directly to the interior surface of the concrete before installation of the interior partitions, eliminating cutting and fitting, and providing a continuous thermal barrier.

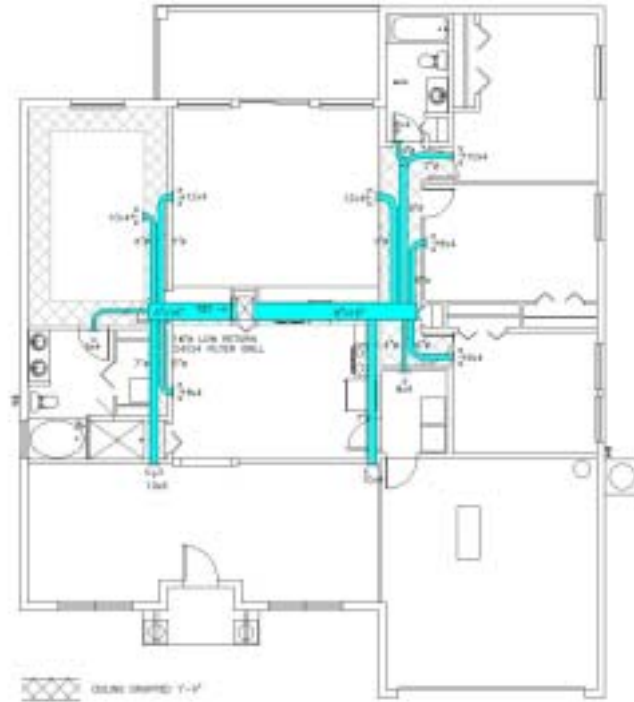

**Figure II-14. Plan of second prototype home showing central air handler with boxed-in ductwork across the main living space**

The decision to go with the fully inside-the-envelope HVAC system and the architectural integration necessary for that methodology forced the project planners to modify the plan for the interior air-handler installation and for the dropped-duct chases (Figure II-14). The earlier decision to utilize 9-ft-tall exterior walls and flat ceilings throughout allowed the HVAC integration to be accomplished easily. The 12-in.-deep duct drops were arranged in a manner sympathetic to the plan, as well as functional to the air-distribution requirements. Placing a soffit between the kitchen and greatroom provided a break in the ceiling plane between the two spaces and provided a chase for the main supply trunk. A coffered ceiling detail was used at the master bedroom for the master bedroom and greatroom supply ducts. Similarly, the bedroom hall was dropped with the three bedrooms and the hall bath supplied through high wall registers directly off that hallway. The biggest change to the existing plan was the placement of the air-handler in a utility closet in the kitchen. The closet placement, between the kitchen and greatroom, also serves architecturally as a space divider in the otherwise open plan. The engineering aspect of the altered HVAC configuration required no special analysis, and resulted in a compact, substantially downsized system.

The use of 6-in. poured concrete in lieu of the standard CMU required modest re-engineering, but is a system familiar to Mercedes and, therefore, presented no obstacles (Figure II-15). Other changes in the second prototype were simple specification changes and required no additional engineering. As successful as this second prototype was, reaching ENERGY STAR performance levels with a 20-day reduction in construction time and a cost savings of several hundred dollars over standard practice, the significant

**Table II-5. Final Second Prototype Specifications**

<b>Item</b>	<b>Specification</b>
<b>Home model</b>	2000-ft <sup>2</sup> Michele II
<b>Foundation</b>	Slab-on-grade, un-insulated
<b>Wall construction</b>	6-in. poured in place concrete, 9-ft-high, conventional forms
<b>Wall finish</b>	Two-coat sprayed-on stucco
<b>Roof construction</b>	Prefabricated roof trusses at 24 in. on-center
<b>Interior partitions</b>	25-gauge steel studs at 24 in. on-center
<b>Windows</b>	Double-glazed, soft-coat low-E in non-thermal break aluminum frames, SHGC = 0.55
<b>Wall insulation</b>	¾-in. foil faced polyisocyanurate, R-5.4
<b>Ceiling insulation</b>	R-19 loose fill fiberglass
<b>HVAC</b>	Tempstar heatpump, 11 SEER, 2.5-ton
<b>Ducts</b>	Fully inside conditioned space in 1-ft. drops below 9-ft ceiling plane. Duct chases are air-sealed from the attic with 1/8-in. laminated fiber sheathing
<b>Air handler</b>	Interior mechanical closet
<b>ENERGY STAR</b>	Maximum allowable: 54.9 MMBtu/year; Actual 48.1 MMBtu/year; Base case 64.4 MMBtu/year
<b>Energy saving</b>	47% HVAC energy savings Cooling energy reduction 40% Heating energy reduction 72% HERS Score = 87.5

amount of architectural plan/HVAC coordination required did not provide Mercedes with the flexibility they need to expand the concept across its full product line. This limitation led to the development of the six pre-production homes, the Third Prototypes.

The combination of load-reducing specifications allowed the use of a 2.5-ton heat-pump in the prototype versus the 4-ton unit required in the base-case home.

### ***Construction Process Analysis***

The slab construction did not alter from builder standard and proceeded on schedule and without incident. The forms for the poured 6" concrete walls followed immediately after slab completion and were installed in several hours. The concrete pour followed the next day, with the forms stripped after a 24-hour cure period. The cycle time for the exterior walls was three days—two days less than the standard block method. After form stripping, some additional prep work was required to the concrete surface prior to the stucco application. This problem was addressed through the use of better forms in the next set of buildings.

After the intervening weekend, the clear-span, flat-bottom chord trusses were installed. As these trusses are simpler than most Mercedes currently uses (no scissors, vaults, or other architectural features), the installation and tie-down saved additional time. Once the home was weathered-in, (roofing on, windows installed), the next step was the installation of the polyisocyanurate insulation to the interior of the concrete walls.



**Figure II-15. Eight-foot-long panels of insulation being applied over 9-ft-high poured walls, held in place by strapping. In production, there was little or no extra cost for 9-ft-long insulation. (The roof in the picture belongs to the adjacent house.)**

Because the ¾-in. rigid insulation was installed before the interior partitions, only minimal cutting and fitting was required. The insulation boards were adhered continuously along the interior surface of the building perimeter forming a complete, non-broken surface with no thermal breaks. The insulation boards used measured 4 in. x 8 ft, so a yet-faster installation is anticipated when Mercedes switches all its production to this manner. The resulting higher purchasing power will cause 4-ft x 9-ft boards to drop in cost to the per-square-foot equivalent of the stock 4 x 8 boards.

The next step in the process is the installation of sole plates for the interior partitions. Before the light-gauge steel partitions were installed, the plates were used to identify where the ceiling drops would later be installed. Once identified, a laminated fiber sheathing air-barrier was applied to the truss bottom chords at the drop locations. The light-gauge steel studs were then installed at 24 in. on-center. The extra step of installing the air barrier before the partitioning assures that a continuous air barrier would exist between the attic and the duct chases. This method proved to be fast, simple, inexpensive, and production-friendly. Initially, the framing sub was skeptical about the framed-down drops, saying they would increase cost. After it was pointed out that the use of flat ceilings throughout the house would save considerable time and material versus the vaulted ceilings now used, the framer reversed his opinion and said the new procedure would not cause a cost increase.

Following the partitioning was the HVAC installation. The compactness of the system and ease at which it was accessed by the installer ensured a fast, accurate installation. Instead of running the ducts in the attic, as is the norm, the HVAC sub-contractor could do the entire installation from a ladder on the main level. Initially skeptical, the subcontractor is now convinced of the logic in this approach. A substantial savings was, however, obtained on the materials side of the subcontract, where a 4-ton system was downsized to 2.5 tons, and the amount of ductwork was reduced by a similar ratio. In total, the new HVAC system cost approximately \$600 *less* than a standard installation.

### **Code Compliance**

The one major departure from standard practice that had relevance to code compliance was the use of the poured-concrete exterior walls in lieu of the block walls. One of the significant deficiencies of using CMU for the wall systems is the onerous inspection process. After the block is laid up, but before the cores are grouted, the bottom block at each slab-to-vertical-steel rod connection must be visible to the inspector. This means breaking a hole in one block every 4 feet along the perimeter to allow inspection. After inspection, the holes are blocked and the cores grouted solid. Another inspection is then required at the completion of the bond beam at the top of the wall. With the poured system, the forms and steel are inspected before pour, with the next inspection after the trusses are installed, a much more streamlined process.

### **Cost and Performance**

Two primary objectives of this prototype were proven out following this post-construction analysis. One objective was to reduce the total cycle time required to



complete a house. This second prototype reduced the complete cycle to 80 days from 100; nearly a 3-week savings. Second, and perhaps most important, was to reach ENERGY-STAR levels of performance, without an increase in first cost. The final analysis demonstrated that the cumulative savings achieved from the down-sized HVAC, compact duct distribution, the concrete walls, and the simplified trusses, more than offset the increase costs for the better windows and the additional air barrier at the duct drops. Mercedes Homes reports a net savings of several hundred dollars for the prototype over the base-case, not counting the savings achieved through the cycle time reduction. Factoring in the real dollar savings achieved through cycle time reduction, Mercedes estimates the actual cost of construction for the prototype was up to \$1,000 less than that of the base-case control house. Thermal performance was also excellent (Table II-5).

### ***Sales and Marketing***

Mercedes' initial aim from a marketing standpoint was to be able to actively market a home with ENERGY STAR level of performance, and storm and decay resistance, at a comparable cost to its existing products. By establishing a cost basis for the advanced-systems-engineering construction and by verifying projected performance level, this prototype project proved to Mercedes that its marketing goal was reachable. Based on the observable success demonstrated with this and the previous prototype, Mercedes committed to re-tooling its central Florida product line to incorporate the new strategies. This commitment is given form in working with CARB on the development of six new models introduced in central Florida in the fall of 2000 and statewide in spring 2001.

### ***Testing of the Second Prototype***

Testing included blower door and duct blaster testing, There was no side-by-side control house; a typical Mercedes Home of similar size and with standard construction specifications was used for comparison.

The objectives of the testing in this instance was to confirm the relative tightness of the envelope as this home utilized a completely new wall system, and to confirm the tightness of the duct system. Weather conditions prevented a short-term cooling energy use evaluation.

Envelope and duct leakage testing was performed. The home was very tight with an envelope leakage of 1249 cfm at 50 Pascals or 0.133 natural air changes per hour using the Sherman-Grimsrud methodology. The duct leakage was found to be 107 cfm to the outside, or 9 percent of the rated air handler flow. This leakage is high given that the ducts are intended to be within the conditioned space. The first-time installation of the laminated fiber sheathing air barrier at the drop locations was not ideal.

None then less the resulting tightness of the concrete wall system was validated which helped convince the builder that the prototype concrete wall system is an excellent choice based on performance for this climate zone.

---

## Third Prototype Case Study

Date: 2001



**Figure II-16. A Mercedes home**

### ***Pre-Production Houses Concepts and Development***

Based on the prototype successes outlined above, CARB and the Mercedes Homes product development team set out to develop specifications for a new series of homes which Mercedes could then offer statewide by all its divisions (Figure II-16). The goal of this product development was the same as the previous prototypes: ENERGY STAR performance in a production friendly, durable, marketable package, with no increase in first cost. The homes offered and their prices, including land, were Keri Isle at \$108,900; Bradley Isle at \$111,900; Lindsey Isle at \$142,900; and Nicole Isle Deluxe at \$86,900. Two of the home models were deemed too complicated and were discontinued.

Convinced by the cost, performance, and marketability success of the poured concrete walls, Mercedes made a substantial capital investment in a modular aluminum concrete-form system and brought a concrete-form crew in-house on a full-time basis. These highly sophisticated forms feature modular window forms that create cast-in bucks for their standard window sizes and are 9 feet in height (Mercedes's new standard) (figures II-17 and II-18). When stripped, the forms leave an exceptionally clean surface requiring only minimal prep work before the sprayed-on one-coat stucco application. The finished walls take an average of 2 days to complete (versus 6 days for the block walls) and cost several hundred dollars less, primarily as a result of the savings in using one-coat stucco versus the two-coat stucco application required over block work.

For the pre-production houses, it was decided to replace the insulated-glass soft-coat low-E windows used in the two prototypes with a new product recently introduced to the

market by two major glass manufacturers: pyrolytic hard-coat low-E with the ability to be installed monolithically (single-glazed). Although the R-value of the glass is lower than the traditional insulated soft-coat windows, the relatively mild climate in central Florida and the conservative amount of glazing in the Mercedes houses (10% to 13% of floor area) made this approach viable with a further reduction in cost with only a minor drop in performance. The SHGC of the glazing is only slightly higher than that of the double-glazed low-E7 product used on the first two prototypes.

The most significant change from the second prototype was the manner in which the pre-production houses accommodate the inside-the-envelope HVAC. Rather than coordinating ceiling drops with the architectural plan, an entirely new approach was proposed. This approach, dubbed the “Plenum Truss” system, takes advantage of the 9-ft walls and flat ceilings of the new Mercedes models and uses a series of specially designed trusses (Figure II-19) to provide an air-sealed chase above the flat ceiling, but below the attic insulation.



**Figure II-17. Prefabricated aluminum forms in place and braced**



**Figure II-18. Wall forms stripped, with window form in place**

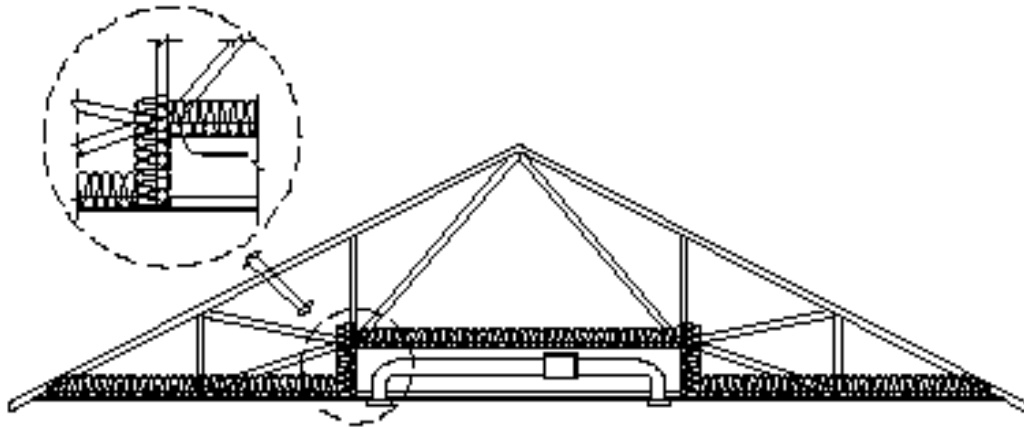

**Figure II-19. Specially designed trusses**

The area defined by the plenum truss chase was superimposed on the floor plans of the six new houses under development and refined to provide HVAC distribution coverage to all interior spaces, using as small an area as possible. All six floor plans are shown at the end of this section (figures II-24, II-25, and II-26).

Once the plenum area was resolved, trusses were laid out for each of the six plans and the individual trusses were engineered (figures II-20 and II-21). The materials and methods utilized to provide the air barrier between the attic and the chase were given careful study and consideration. Cost, strength, durability, ease of installation, heat and moisture resistance and transfer, production friendliness, and simplicity attributes were weighed and judged to determine the selected method. Although CARB designers and engineers preferred a reinforced infiltration barrier product in 8-ft-wide rolls, Mercedes opted for a laminated fiber sheathing product for the first four homes. The last two homes received the roll product. This topic is discussed further in the section “Construction Process Analysis.”

The final specifications of the pre-production houses are summarized in Table II-7.

**Table II-7. Final Specifications of the Pre-production Houses**

<b>Foundation</b>	<b>Slab-on-grade, un-insulated.</b>
Wall construction	Six-in. poured-in-place reinforced concrete, 9 ft high, using modular aluminum forms. One-coat spray-on stucco finish
Wall finish	One-coat sprayed-on stucco
Roof construction	Plenum space roof trusses at 24 in. on-center
Interior partitions	25-gauge steel studs, 24 in. on-center
Windows	Single-glazed, pyrolytic, low-E glass in aluminum frames
Wall insulation	¾-in. polyisocyanurate, R-5.4
Ceiling installation	R-19 blown-in fiberglass
HVAC	Tempstar heat pump, SEER 11 (Capacity varies by plan)
Ducts	100% inside-conditioned-space, located in plenum truss space
Air handler	Interior Mechanical Closet



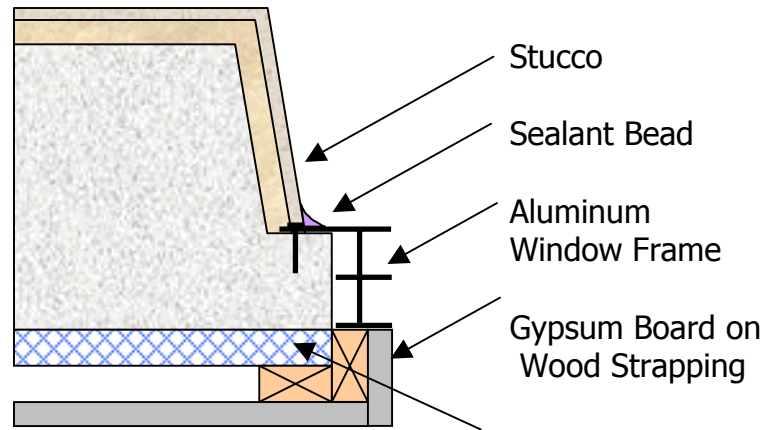
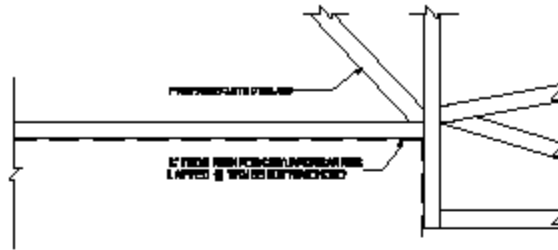

**Figure II-22. Detail of window jamb**

proceed. It was subsequently discovered that the glass in several of the windows was installed backwards, requiring correction.

The actual window installation was simplified over past procedures. The concrete window forms create cast-in-place bucks and a sloped sill. The aluminum window flanges are fastened directly to the concrete without wood bucks or blocking, another labor and material saving (Figure II-22).

The area of greatest difficulty was encountered in installing the air-barrier between the attic and the plenum duct space. Although originally specified to be a reinforced rolled product, Mercedes chose instead to use a laminated fiber sheathing produced by “Thermoply.” This resulted in many more joints and seams than envisioned, and additional cutting, fitting, and patching. Also encountered was a lack of understanding by the mechanical subs who thought nothing of cutting holes in the barrier. Additional installation instructions were produced for the supervisors and installers, this time using the rolled fabric material (Figure II-23). This process was found to be more acceptable, but still not fully grasped by the installers, and therefore not as fast, accurate, or complete as intended. Mercedes estimates the additional cost for the plenum trusses and barrier installation to be several hundred dollars. Given the inefficiencies observed in the first six applications, CARB estimates that a somewhat more refined process with a trained crew could get the additional cost down to \$200, at or below the upper limit of cost effectiveness. The installation of the HVAC systems proceeded relatively smoothly. The ease of working on the floor below the plenum was obvious as compared to the typical attic installation. After an initial learning curve, estimates for duct installation time savings were 33%, another potential cost savings. The remaining mechanicals, partitioning, and finishing followed existing standard practice, and were not substantially affected by the new processes.



**STEP 1**

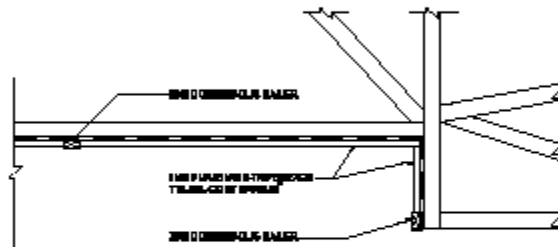

**STEP 2**

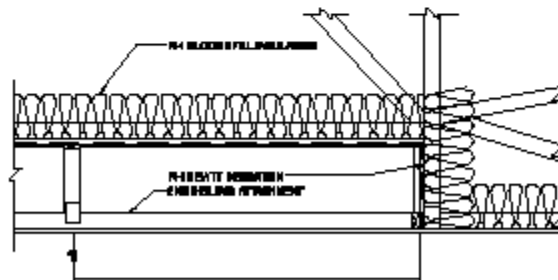

**STEP 3**

**PLENUM LINING DETAIL**

Figure II-23. Plenum lining detail



## ***Cost and Performance***

The primary objective of this project was to improve the energy performance of a standard Mercedes production home while reducing the construction cycle time, without incurring an increase in initial cost. Initial computer modeling of the six designs using the final pre-production house specifications show that the homes will all exceed ENERGY STAR levels of performance with HERS Ratings of 86 or higher. ENERGY STAR performance testing provided by Florida Power & Light's Built Smart Program confirmed the modeled analysis with all homes receiving ENERGY STAR certification. In terms of actual construction time, the six pre-production houses mirrored the experience of the second prototype, achieving a reduction in total construction time of 10 to 20 days, a substantial improvement. It should be noted that the potential cost savings for that time reduction, such as a decrease in finance and interest costs, are not considered in reviewing the hard cost impacts of the new methods, and when considered, further improve the cost equation. Mercedes has requested that CARB not quote specific costs, but has agreed to allow us to present a more broad cost equation analysis. The cost savings for the poured concrete walls over the standard block walls is about \$100. Going to a one-coat stucco application versus the two-coat required for the block walls is a far more substantial savings, amounting to hundreds of dollars.

The cost increase for the single-glazed low-E windows over the standard windows averages about \$300 per house. The savings provided by downsizing the HVAC system (allowed by the reduced cooling and heating load) an average of 1 ton is \$400. Current cost estimates for the added cost of the plenum truss system is about \$700. In total, the current cost savings for the pre-production houses is approximately \$200 over standard practice, clearly meeting the original objectives of this project.

## ***Community-Scale Implementation***

Anxious to apply the newly developed technology across its Central Florida market area, Mercedes designated three new subdivisions to receive the new houses. A total of 175 new CARB houses were completed in 2001. However, as the homes tested by Florida Power & Light achieve ENERGY STAR status with no credit given for the inside-the-envelope ducts (a deficiency in its program which is based on the Florida Energy Code) and the fact that the plenum truss requires additional refinement for community-scale implementation, Mercedes launched those three subdivisions without the plenum truss. Mercedes also found that the single-glazed windows with an exposed low-E surface was too hard to keep clean and switched back to double-glazed low-E windows, again in non-thermally broken aluminum frames.

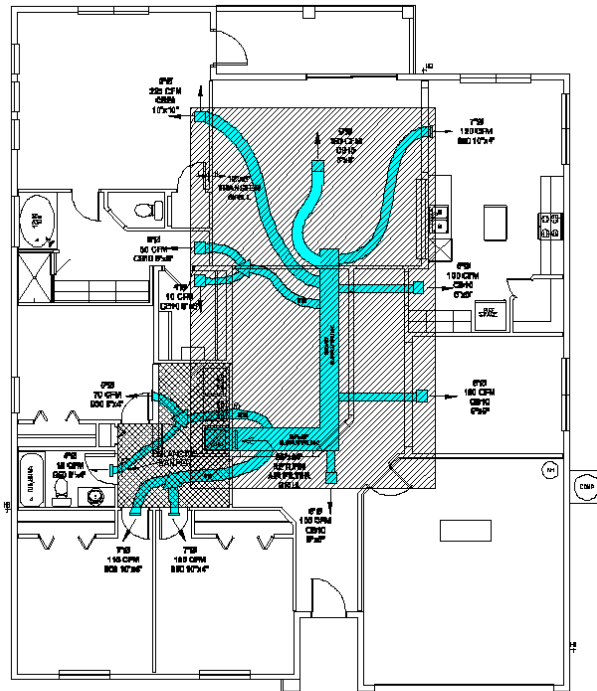

NOTE:  
INTERNATIONAL COMFORT PRODUCTS-ARJL-FCR0310A  
TEMPERATURE CONTROLLING UNIT - TCR0300A  
BUSHWACKER RISE SYSTEM (PART NUMBERS LISTED) OR EQUIV.

LORA ISLE 2414

Figure II-24. Plenum Truss Duct System layout (Lora Isle Model)

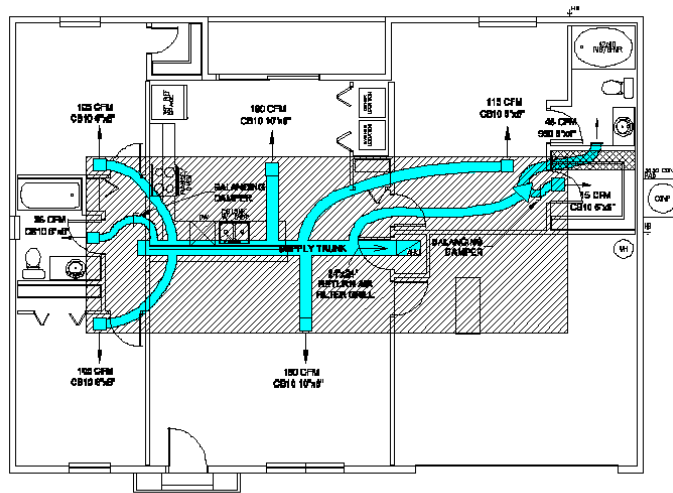

NOTE:  
INTERNATIONAL COMFORT PRODUCTS-ARJL-FCR0310A  
TEMPERATURE CONTROLLING UNIT - TCR0300A  
BUSHWACKER RISE SYSTEM (PART NUMBERS LISTED) OR EQUIV.

KERI ISLE "00" 1365\_01

Figure II-25. Plenum Truss Duct System layout (Keri Isle Model)

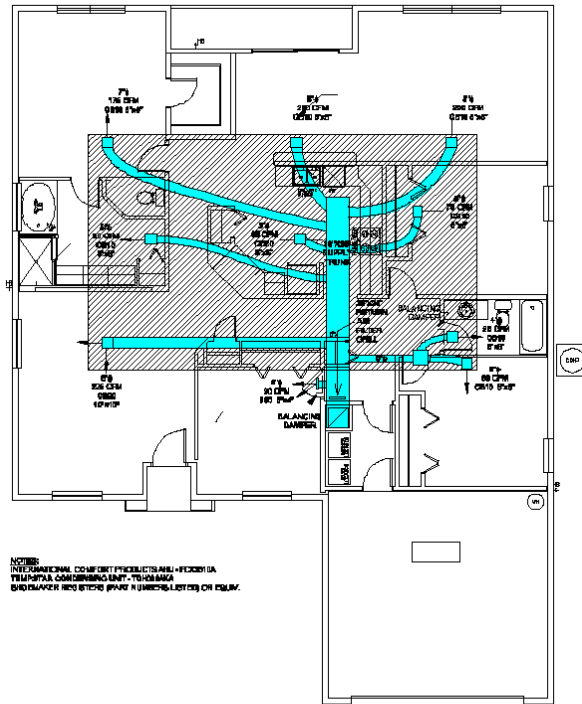

LINDSEY ISLE 2203  
220300CR\_01

SK-M-5  
5 SEP 00

Figure II-26. Plenum Truss Duct System layout (Lindsey Isle Model)

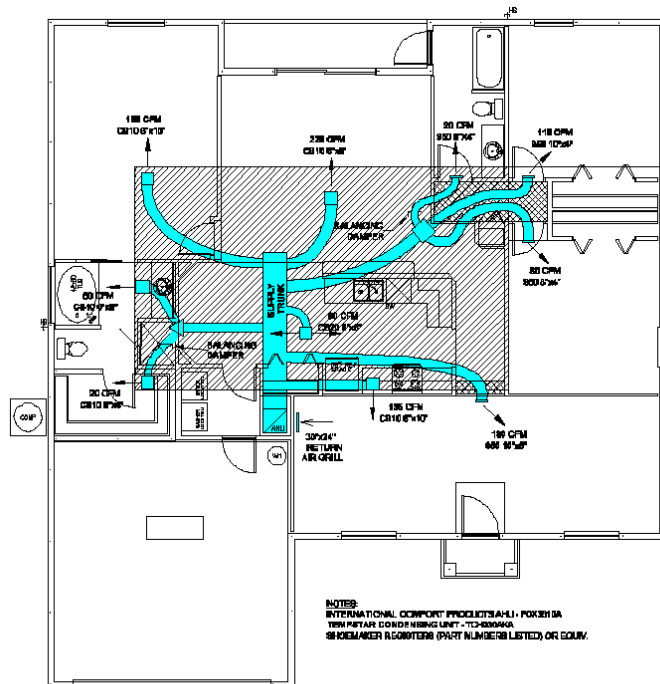

CATHY ISLE "00" 1877\_03

Figure II-27. Plenum Truss Duct System layout (Cathy Isle Model)

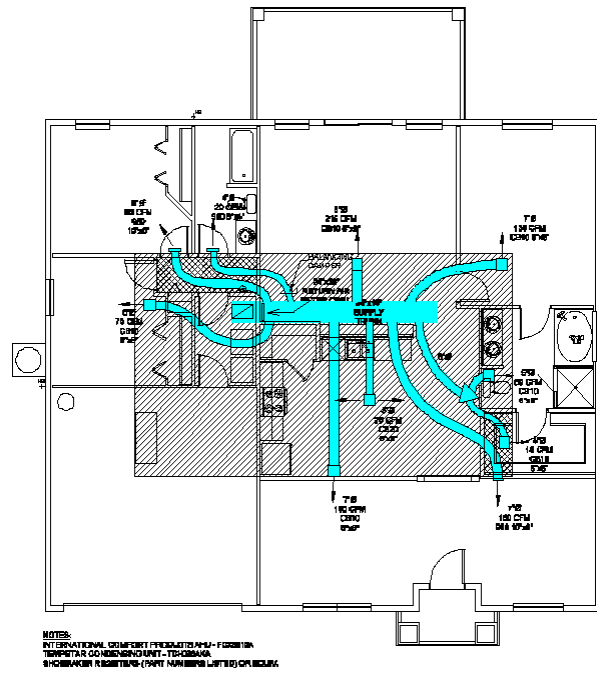

MICHELE ISLE "00" 1813\_00

Figure II-27. Plenum Truss Duct System layout (Michele Isle Model)

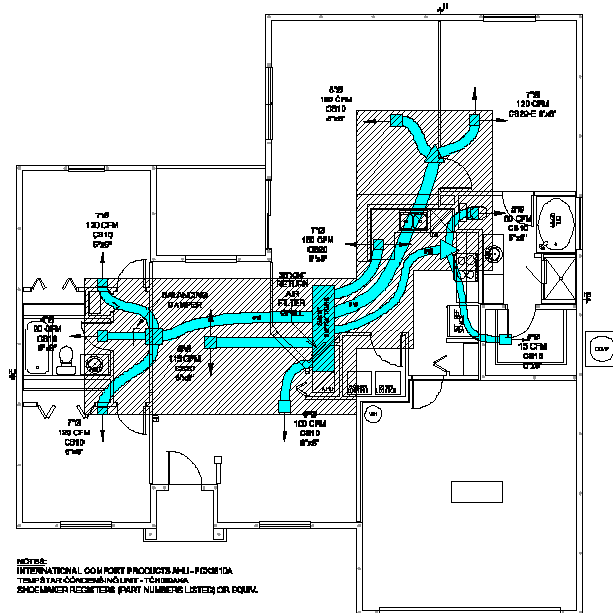

BRADLEY 1628

Figure II-28. Plenum Truss Duct System layout (Bradely Model)

---

## Fourth Prototype Case Study

Date: 2002



**Figure II-29. Mercedes Homes fourth prototype under construction**



**Figure II-30. Mercedes home fourth prototype finished**

### ***Summary***

Three design objectives were defined to explore, test, and evaluate higher performance building systems for Mercedes Homes, located in Melbourne, Florida (figures II-29 and II-30): refine the “plenum truss,” the first version of which was demonstrated earlier; continue and refine the production use of poured concrete walls; and explore the effects of the use of double-glazed low-E windows. Besides these three innovative system design strategies, an inside-the-envelope air handler and two ways of accomplishing return-air transfer were also demonstrated and evaluated. The reference house is defined (in this case builder standard practice), and a comparison made of final performance/cost tradeoffs with current builder practice, including leakage comparison, overall energy performance comparison, cost comparison, and AC equipment-sizing comparison. Finally, recommendations are made for future improvements in design details, construction practices, and quality-control practices, including air sealing, exploring alternate plenum liners, downsizing AC equipment, and exploring the effects of the production use of double glazed low-e windows.

## ***Design Objectives***

### **Refine Plenum Truss**

The initial design of the plenum truss had a rectangular cross-section, which increased the board footage of material in the trusses relative to a conventional truss. Also, it required the installation of vertical insulation around all four sides of the truss. This, combined with the absence of credit (given by the ENERGY STAR rating program in use in Florida) for the savings resulting from the use of the truss, caused Mercedes to proceed with production without the use of the plenum truss. A new design was developed using less wood and eliminating vertical walls at the side. This design was incorporated into a prototype and tested.

### **Continue and Refine Production Use of Poured-Concrete Walls**

The poured-concrete wall assembly developed in the pre-production prototypes was so successful that Mercedes purchased a second set of aluminum forms. An objective of this prototype design was to examine how the system was working in the field in production.

### **Explore Effects of Production Use of Double-lazed Low-e Windows**

Because of the difficulty in keeping the single-glazed low-E glazing clean, and as evidence of the company's commitment to energy conservation, Mercedes decided to switch to double-glazed low-E windows (in un-insulated aluminum frames) for their production. An objective of the prototype design was to test the effects of this change and assess whether it justified a down-sizing of the AC capacity.

## ***Summary of Innovative System-Design Strategies***

### **Concrete Wall Assembly with Two-Coat Stucco**

Because of the smoothness of the concrete when cast in the aluminum forms, Mercedes was able to eliminate a base primer coat under the finish stucco, saving hundreds of dollars on the stucco subcontract. As described above, after some difficulties at the beginning, the mix and aggregate were adjusted to create a smooth casting operation without disturbing the rebar cages.

Inside, a  $\frac{3}{4}$ -in. layer of polyisocyanurate R-Max insulation with an R-5.4 rating is adhesive-applied to the wall. Over this is 1X strapping at 24 in. on-center and around openings, supporting  $\frac{1}{2}$ -in. gypsum wallboard. As is standard, inspector-approved practice in Florida homes with masonry exterior walls, electrical wiring runs just behind the gypsum board in the  $\frac{3}{4}$ -in. space formed by the strapping, into shallow-work boxes.

### **Low-E Double Glazing**

Windows are supplied by Kinco and have a soft-coat Cardinal low-E coating. Frames are uninsulated aluminum, which when calculated according to the standard NFRC algorithm

degrades the U-factor of a typical window by 100%, from about 0.35 to about 0.7. This change has little effect on energy use because of the small contribution conductive heat gain and loss make to energy consumption in this mild climate. It does, however, increase the peak load relative to thermally insulating frames. Vinyl frames were priced-out as an alternative due to their better thermal qualities. These were considered and rejected because of concerns about their reliability in hurricanes. The selected windows have a SHGC (center of glass) of 0.35. To account for the aluminum frame CARB calculated an actual SHGC of 0.40

### Inside-the-Envelope Air Handler

As in earlier prototypes, the air handler was brought into the utility room from the garage, reducing duct system air leakage, reducing conductive heat loss, and avoiding any possibility of drawing contaminated air from the garage into the system.

### Plenum Truss Housing Most of the AC Ductwork; Attic Ductwork Buried Under Insulation

This, the second version of the plenum truss, has a triangular cross-section. Not only does this eliminate the need for vertical insulation on the long sides of the plenum, but it reduces the amount of wood in the truss nearly to that of a standard truss (Figure II-31).

As in the previous design, the framers attach a membrane to form the “roof” of the plenum, effectively sealing it from the attic (see discussion of performance and recommended improvements below). CARB’s arguments in favor of a rolled membrane were again passed over in favor of foil-faced cardboard sheets of “Energy Brace.” This done, 2 x 4 runners were attached to provide nailing for the small inserted frames that support the ceiling, which were added next, completing the plenum.

Ductwork was then installed between the ceiling frames and the plenum roof and ends, except for one section at Bedroom #4 and the adjacent hall, where ducts had to run outside the plenum. Based on previous monitoring that showed little or no condensation at ductwork under the insulation, these ducts were covered over with R-30 blown-in attic insulation.

Through-the-wall return air-transfer grilles were installed at each bedroom. In addition, grilles were installed between the master bedroom and the plenum and between the plenum and the central space that was served by the central air return, for a performance comparison with through-the-wall grilles.



**Figure II-31. The revised plenum truss at successive stages of construction**

***Definition of Reference House***

**Plan Type**

The plan, which Mercedes calls the “Michelle Isle Deluxe,” has 2,078 ft<sup>2</sup> of living space on one floor (slab on grade, with no insulation at the slab edge), 4 bedrooms, with an attached two-car garage. The elevations feature a hipped roof with 12-in. overhangs all around, a hipped-roofed covered porch at the rear, and a gabled entry portico in front. As is typical with Mercedes’ plans, it is “binuclear,” with bedrooms on both sides of a band of central living spaces. This plan type works exceptionally well with the plenum truss concept because of its compactness.



## Wall System

Until the CARB prototypes led them to switch to poured concrete, Mercedes followed the prevailing approach in this area of Florida in using 8-in. hollow CMU walls with precast concrete headers and a cast-in-place bond beam. Because of the irregularity of the outside surface, a two-coat minimum stucco application was necessary to create a smooth exterior. Inside, 1X furring strips are attached to the block walls and covered with a foil-faced paper radiant barrier, which is rated at R-4.

## Glazing

Single-glazed gray-tinted glass windows in uninsulated aluminum frames were used, as is common in Florida.

## Air Handler Location

In the first CARB prototype, the air handler (which in standard practice is located in an inside corner of the garage) was simply walled off from the garage and made accessible from the inside, effectively bringing it into the conditioned space. In the present design, the air handler is moved closer to the center of the plan, next to the washer and dryer in the utility room.

## Ductwork

Ductwork followed standard practice in being located in the attic, using R-6 insulation.

## Insulation Levels

Outside walls had a claimed insulation level of R-4, although the actual level was likely lower. The attic was insulated with R-19 blown-in fiberglass.

## ***Comparison of Final Performance and Cost Tradeoffs with Current Builder Practice***

### Leakage Rate

Overall, the house had an ELA of 141-in.<sup>2</sup> Plenum leakage, most of which could easily be closed, amounted to and ELA of 24-in.<sup>2</sup> Duct leakage to the outside was very low (less than 3%), showing the effectiveness of the “inside-the-envelope” design of the prototype (Figure II-30).

The graph shows that the air within the plenum truss is very close in temperature and humidity to that in the space below, proving that the ducts in the plenum are effectively within the conditioned space.

## Overall Energy Performance Comparison

There are several different homes that need to be compared, listed in order of increasing performance:

- Regional standard practice simulated with REM-Rate
- Builder standard practice simulated with REM-Rate
- Prototype simulated with REM-Rate
- Modified prototype (with SEER-12 AC equipment) simulated with REM-Rate

Table II-8 summarizes the performance of the prototype compared with regional practice and with builder practice, showing an overall heating and cooling source energy decrease of 41% and 37%.

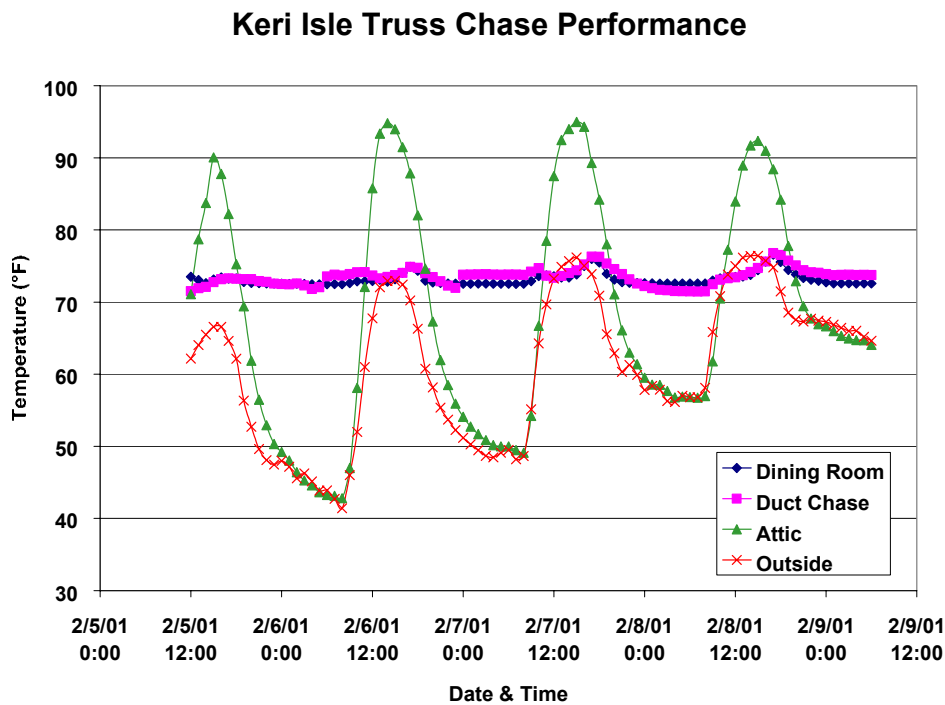

Figure II-30. Keri Isle truss chase temperatures

**Table II-8. Comparison of Energy Performance Keri Isle as-built**

	Regional Standard Practice		Builder Standard Practice		Prototype As-Built		% Source Energy Savings	
	therm (kWh)	Source Energy (MMBtu*)	therm (kWh)	Source Energy (MMBtu*)	therm (kWh)	Source Energy (MMBtu*)	Over Regional Practice	Over Builder Practice
<b>Whole House</b>								
Natural Gas	442	45	442	45	347	35	21%	21%
Electricity	12757	155	12211	149	10380	126	19%	15%
Total		200		194		162	19%	17%
<b>Space Conditioning</b>								
Heating	203	21	203	21	108	11	47%	47%
Cooling	6015	73	5469	67	3638	44	40%	33%
Total		94		87		55	41%	37%

**Table II-9. Comparison of Energy Performance Keri Isle SEER 12 AC**

	Regional Standard Practice		Builder Standard Practice		SEER 12 Prototype		% Source Energy Savings	
	therm (kWh)	Source Energy (MMBtu*)	therm (kWh)	Source Energy (MMBtu*)	therm (kWh)	Source Energy (MMBtu*)	Over Regional Practice	Over Builder Practice
<b>Whole House</b>								
Natural Gas	442	45	442	45	347	35	21%	21%
Electricity	12757	155	12211	149	10050	122	21%	18%
Total		200		194		158	21%	19%
<b>Space Conditioning</b>								
Heating	203	21	203	21	108	11	47%	47%
Cooling	6015	73	5469	67	3308	40	45%	40%
Total		94		87		51	45%	41%

\* The data Source Energy in Btus is as defined in NREL's "Building Analysis House Performance Procedures, Sept. 2001."

Table II-9 summarizes the performance of a hypothetical modified prototype in which the SEER-11 AC equipment being used was raised to SEER-12. In this case, the prototype decreased the overall heating and cooling source energy by 45% and 41% compared respectively with the regional and builder standard practice.

NREL measured and simulated the performance of the Keri Isle and Lora Isle products, using DOE-2, showing a 28% and 35% reduction compared with standard builder practice. These data correlate well with the prototype performance simulated by REM-Rate. The lower energy reductions in those two houses relative to this prototype was primarily the result of using single-sheet low-E glazing, as opposed to double-sheet low-E glazing in the present prototype.

### **Cost Comparison**

While Mercedes does not wish to publish exact figures, the following approximations will give a good sense of the overall costs.

#### **Concrete wall**

Saving of about \$100 compared with CMU (taking account of reduction in construction time of about 3 days).

#### **Stucco**

Eliminating one coat saves \$400 for this plan.

#### **Low-e windows**

Additional cost for this plan over the standard single glazed tinted windows is \$713.

#### **Redesigned plenum truss**

Adds about \$700 for dropped ceiling framing and liner – trusses cost the same. Potential cost in production = \$350.

#### **Downsizing AC by one ton**

Saves \$450 for a full ton at current prices.

#### **Overall cost increase**

About \$213

Cost savings to the homeowner are shown in Table II-10, which compares the prototype to current builder practice.

#### **AC Equipment Sizing**

The reduction in duct leakage, increased wall and attic insulation, and especially the use of double low-E glazing greatly lowered the peak AC demand, while improving comfort.

As a result, the AC equipment could be downsized from 3 tons to 2 tons (over 1,000 SF/ton). However, the buyer requested gas heating; the smallest unit available delivered 1,200 CFM, which required a 3-ton AC unit, so that the potential cost savings from downsizing was not realized in the prototype. The oversizing is probably not great enough to cause mold problems, although it will undoubtedly reduce comfort by increasing the average interior relative humidity.

**Recommendations for Future Improvements in Design Details, Construction Practices and Quality Control Practices**

**Air Sealing**

While the house had a low infiltration rate and the ductwork had a very low leakage rate, almost all the leakage in the ductwork and about a third of the overall house leakage rate could be eliminated by simple sealing measures at various penetrations through the plenum ceiling. We measured an equivalent leakage area of around 25 in<sup>2</sup>, consisting of gaps around security wiring, gas piping, and the combustion air intake pipe. These could easily be closed.

**Explore Alternate Plenum Liners**

Although the builder feels a solid board is preferable as the ceiling liner of the plenum, we feel that a rolled-out membrane of some kind, held in place by 1 x 2 strapping, would save both time and material cost.

**Downsize AC Equipment**

As noted above, the builder should choose the right sized AC equipment, not only to save money, but to avoid potential comfort and mold problems. We feel that proper customer education could overcome the perceived loss of quality from a smaller AC unit.

**Table II-10. A Comparison of the Prototype to Current Builder Practice**

Item	Annual Cost (Dollars)			Annual Consumption (Therms, kWh)		
	Current Practice	Prototype	% Saved	Current Practice	Prototype	% Saved
Natural Gas	221	174	21	442	347	21
Electricity	1098	934	15	12211	10380	15
Heating	101	54	47	203	108	47
Cooling	491	327	33	5469	3638	33
Other	787	787	0			
Heat + Cool	592	381	36			
Total Cost	1318	1108	16			

## Part III: Best Practices for Achieving 30% - 40% Space Conditioning Energy Savings in Single-Family Detached Homes in a Hot-Dry Climate



**Figure III-1. A CARB house built in a hot-dry climate**

### **Background and Introduction**

The Consortium for Advanced Residential Building (CARB), one of the Building America teams, has worked with several hot-dry climate builders on home designs that achieve at least a 30% savings relative to the Model Energy Code (MEC) (Figure III-1). This report describes the recommended best practices to achieve these savings without compromising health or safety.

A list of Primary Recommendations and one of Secondary Recommendations is included, followed by a discussion of each item on the list. Case studies drawn from CARB's Building America experiences are presented as examples. Because most homes in this region are one-story slab-on-grade construction, as are all the ones dealt with by CARB, the recommendations are tailored to this form of construction.

### ***Primary Recommendations***

#### ***Envelope***

- Double-glazed, low-E windows with Solar Heat Gain Coefficient (SHGC) of 0.4 or less
- Exterior wall framing and sheathing
  - 2 x 4 studs at 16 in. on-center with traditional stucco on 1-in. EPS, with ½-in. EPS over ½-in. OSB at shear wall panels, or
  - 2 x 6 studs at 24 in. on-center with full ½-in. OSB sheathing and any cladding

- Lumber-saving framing details (open corner details, ladder bracing at T-intersections, right-sized headers, no headers at non-bearing partitions, studs at 24 in. on center at interior partitions)
- Unfaced cavity insulation, and air sealing, achieving blower door tightness criterion of 1/4 CFM at 50 Pascals per square foot of building envelope area
- Building envelope water management system
- Reflective roofing material

### *Equipment*

- Manual-J / Manual-D HVAC sizing
- SEER-12 air conditioner with 0.85 SHR
- AFUE 80 gas furnace
- Conventional atmospherically vented gas-fired water heater located in garage
- Ducts mastic sealed (leakage to outside less than 5% of fan-flow)
- Ducts buried under attic insulation
- Compact duct distribution system
- Central return air register with transfer grilles at secondary spaces (maximum pressure difference between spaces with doors closed = 2.5 Pa)
- Provide filtered supply-only ventilation
- No unvented gas appliances (except a gas range with a range hood exhausting to the outside).

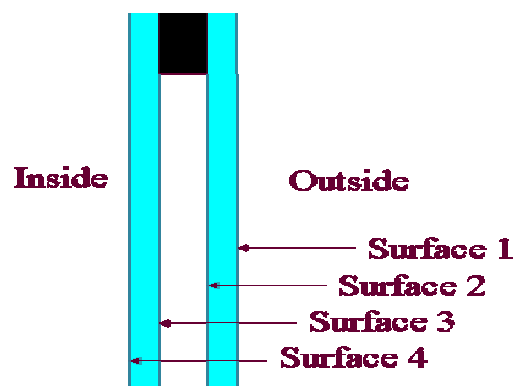

**Figure III-2. Low-e double-glazed windows**

## **Secondary Recommendations**

- Energy-efficient lighting
- ENERGY STAR appliances
- Plenum truss

## **Primary Recommendations for the Envelope**

### *Low-E Windows*

#### **Discussion**

Selective low-E coated double-glazing is applicable to all hot-dry climate homes. A selective low-E coating on surface 2 greatly reduces the amount of incoming solar energy (it has a low Solar Heat Gain Coefficient [SHGC]) (Figure III-2).

The U-factor of the glazing is strongly influenced by the frames: uninsulated aluminum frames increase the conductivity of the overall window substantially (typically doubling the U-factor relative to the center of the glass). This may or may not increase the annual heat loss, depending upon the climate (windows with a higher U-factor may cool the house at night through radiation). However, thermal break aluminum or vinyl windows reduce the peak cooling load, which can help to reduce the size of the AC equipment.

Look for the NFRC ratings, which are slightly different from conventional ratings. The desirable glass has the following characteristics, which can be found on the label attached to all glass:

#### Desirable Low-E Glazing Characteristics for Hot-Dry Climates

- Total unit U-value should be 0.35 or less, only for thermally broken or vinyl sash and frames.
- The SHGC should be 0.40 or lower.
- The low-E coating should be on the #2 surface, to reduce heat gain from the outside. This is typical for most low-E glazing.
- Because occupants enjoy seeing out through untinted glass, it is desirable to use (more expensive) “spectrally selective” glazing, which couples high visible transmittance (VT) with a low SHGC. A high VT will also decrease the use of electricity for lighting, reducing the cooling load and overall energy use. Glass is available having a VT more than 0.65 coupled with an SHGC of 0.42, but it is not commonly used in residential windows. Cheaper low-E glazings have VTs as low as 0.35. Low values will result in a noticeable violet color to the glass. Benefits Demonstrated in CARB/Building America Case Studies
- The cost-effectiveness of low-E glazing has been demonstrated in every CARB hot-dry climate project.



- The low-E coating provides the equivalent of another layer of glazing at a much lower cost.
- Low-E glazing makes it possible to dispense with registers located close to the windows, thus reducing the cost of air distribution.

### *Exterior Wall Framing and Sheathing:*

- 2 x 4 studs with 1-in. EPS and Conventional Stucco with ½-in. OSB and ½-in. EPS at Shear Panels, or
- 2 x 6 studs at 24 in. on-center with Full OSB Sheathing

### **Discussion**

Because of the almost universal use of two- or three-coat conventional stucco in the hot-dry areas of the west, 2 x 4 studs at 16 in. on-center with 1-in. EPS foam is the most common form of sidewall construction. The closer stud spacing is required because the EPS is too flexible to span 24 in. without cracking the two-coat stucco. Three-coat stucco is seldom used outside southern California, where the 16-in. stud spacing is typically used for seismic resistance. If using three-coat stucco outside seismic zones, consider 2 x 4 studs at 24 in. on-center, with EPS sheathing.

Over the EPS is a layer of #30 felt (which is about as heavy as the 15-pound felt use decades ago – note that it is *number-30* felt, not *30-pound* felt) and wire stucco lath applied with washers. In wetter climates, two layers of felt are desirable. The outer layer tends to stick to the stucco, so that any water that gets past the outermost water barrier (stucco or sealant) cannot drain between the stucco and the paper—hence the need for a second layer of paper. This problem does not typically arise in hot-dry climates, where precipitation typically occurs as short periods of intense rain, between which the wall can dry to the inside. Therefore, the second layer of paper is seldom used. In any area where sustained rainfall can occur (for example, the Los Angeles basin where several successive days of heavy rain can occur), two layers of felt are strongly recommended.

For all other claddings, a wall of 2 x 6 studs at 24 in. on-center with full OSB sheathing provides about the same R-value and uses less lumber than 2 x 4 studs at 16 in. on-center when EPS sheathing is employed, assuming in both cases that measures are taken to reduce unnecessary studs—see next item. The entire outside wall is sheathed with OSB, which greatly increases the shear resistance of the home relative to one sheathed only where necessary for wind and seismic resistance. Cladding that is nailed to the studs and is not rated for nailing at 24 in. on-center (as conventional vinyl siding) needs to be nailed to the sheathing at least once between studs.

In hot-dry climates, the use of exterior wall panels in lieu of sheathing and added cladding is quite feasible for affordable housing—its primary disadvantage is their appearance. Such panels provide the required shear resistance for wind or seismic loading. Fiber-cement panels are ideal for this purpose. Wall panels of all kinds are span-rated, and their shear resistance depends on the nailing pattern. Check these rating before choosing sheathing or exterior finish panels.

A single top plate can be used with 24-in. on-center 2 x 6 studs providing:

- The wall meets seismic and wind loads
- Each joint in the plate is bridged by a 0.036-in. galvanized plate 3-in. x 6-in., with six 8x nails on each side (per IRC R602.3.2 Exception)
- The trusses are centered on the studs within a tolerance of  $\pm 1$  in. (per IRC R602.3.2 Exception).

If a double plate is used, trusses can be located anywhere (per IRC R602.3.3 Exception 1).

One concern with the use of 24-in. on-center studs is the capability of the interior finishes to span the extra distance between studs.

*Why? To achieve the strength that 1/2-in. gypsum board has spanning studs at 16 in. on-center, you would need 5/8-in. gypsum board to span 24 in.*

In practice, the lower strength of 1/2-in. board does not pose a problem for most homebuyers. Interior partitions using studs at 24 in. on-center and covered with 1/2-in. gypsum board are in wide use. For custom or luxury levels of construction, it is recommended that 5/8-in. gypsum board be used with 24-in. on-center studs.

#### Applications in CARB/Building America Case Studies

- CARB has not used studs at 24 in. on-center in hot-dry climates, because all the projects have had stucco finish.
- Because of the mismatch between 16-in. studs and 24-in. trusses, in-line framing was not used.

#### *Lumber-Saving Framing Details*

##### **Discussion**

Many lumber-saving details are possible that not only reduce cost, but save energy, along with saving timber.

##### Open Corner Details

As shown in Figure III-3, the three studs normally used at an outside corner can be rearranged to create an open cavity that can be insulated later (in the conventional box arrangement, the cavity must be insulated by the framers; typically this is not done). The stud that provides nailing for wallboard can be replaced by a 1 x 6 or by drywall clips.

##### Ladder Bracing at T-Intersections

As shown in Figure III-4, the conventional method of framing at a T-intersection creates an uninsulated cavity. It also uses more material than necessary. Replacing the two studs normally used with three to four pieces of blocking saves lumber provides a use for cut-off lumber pieces and allows insulation to continue through the T-intersection. The blocking can be replaced by a 1 x 6 (as shown), and drywall clips can be added between the blocking for additional attachment points.

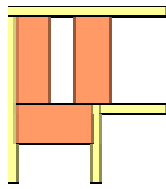

Conventional three-stud corner leaves a cavity that must be insulated by the framers – not good

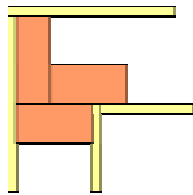

**Improved three-stud corner allows insulation to be installed later, in sequence**

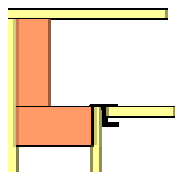

Two-stud corner with drywall clips uses least wood, gives best thermal performance

Figure III-3. Open corner details

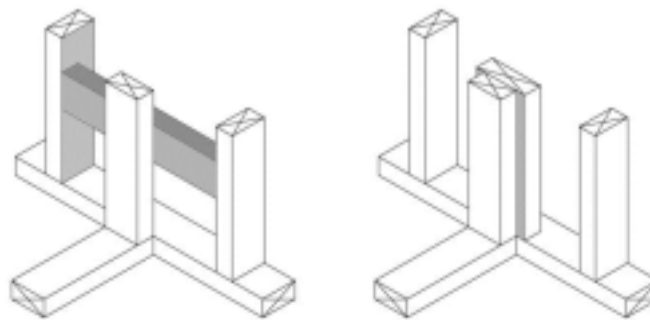

Figure III-4. T-Intersection details that allow insulation to run by

### Right-Sized Headers

For production convenience, builders commonly use the same (maximum) header size for all openings. This is wasteful of expensive large-dimension framing and increases heat loss because headers conduct more heat than does an insulated cavity. Simply using two (or three) header sizes for different width openings resolves this problem with a minimum of extra measuring.

### No Headers at Non-Bearing Partitions

It is a waste of material to use headers at non-bearing partitions. This practice results from concern that framers will not take the time to check whether or not the partition is bearing. Better supervision, better plans, and insistence on plan-checking allow such headers to be dispensed with.

### Studs at 24 in. On-Center at Interior Partitions

As discussed above, ½-in. gypsum board over studs at 24 in. on-center does not seem to concern buyers, at least for production housing (even high-end products).

### Applications in CARB/Building America Case Studies

As part of its “value engineering” work for several builders, CARB has demonstrated the cost and energy savings of lumber-saving framing details.

In one case (Del Webb), earlier value-engineering consulting by SWA established the practice, so that the measures were already in place when CARB began work with them.

### *Air Sealing*

#### **Discussion**

The widespread use of stucco over EPS sheathing in the western United States results in remarkably tight homes without extensive gap sealing. One energy consultant calculated an *average* ACH<sub>n</sub> (natural air changes per hour) of 0.28 among new builder homes in the Phoenix area. Also, the absence of serious moisture and mold problems reduces the incentive for air sealing. However, other factors are at work that indicates the need for better gap sealing in the wall between the house and the garage. Dryer, range, and bath exhaust fans can depressurize the house, causing air to migrate in through gaps in this wall. This problem is of concern for indoor air quality, and most “green builder” programs give points for separating the garage from the house, providing a separate fan-powered exhaust from the vicinity of the air handler, or installing a CO detector in the living space. CO detectors are sometimes problematic because of reliability problems, but weather stripping the door to the garage and carefully gap sealing the common wall is strongly recommended. Of much greater concern is sealing the return air ductwork and the air handler, if it is located within the garage, and this issue is discussed in the following section.

## Air-Sealing Techniques

There are many sealing products available, each suited for a particular job:

- Foam guns (Figure III-5)
  - This foam is the all-purpose sealing tool for nearly any gap
  - Low-expansion foam is available in cans that attach to inexpensive application guns
  - These guns feature a screw-plunger that closes off the nozzle and keeps the gun clean between uses
  - There is also a can of cleaner that can be attached to the gun
  - For large gaps, high-expansion foam is available
- Sill sealer
  - The gap under the mud sill can be foamed with low-expansion foam
  - An alternative recommended product is by Protecto Wrap called the “Triple Guard” (Figure III-5).



**Figure III-5. Foam gun (left) and sill sealer (right)**

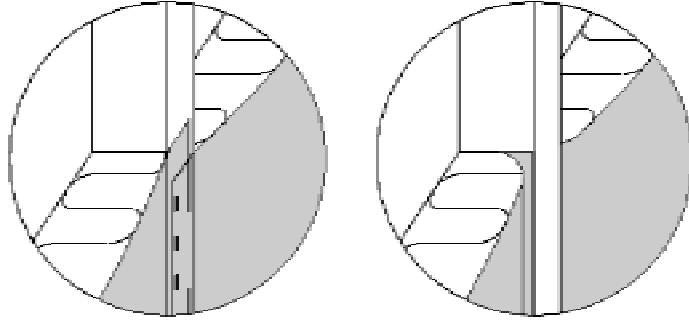

**Figure III-6. Vapor retarder installation**

#### Vapor Retarder

Kraft or foil facings on fiberglass batts are not recommended unless they are carefully installed (Figure III-6):

- Facings should be “face stapled, not “inset stapled,” to avoid the puckers between the studs and insulation that occur with inset stapling
- Face staples must be set flush with the studs to allow proper installation of drywall.

#### Applications Demonstrated in CARB/Building America Case Studies

CARB homes in hot-dry climates have not used vapor retarders, as they were built under the UBC, which does not require them. For future homes built under the IRC, the above recommendations will be made.

#### *Building Envelope Water-Management System*

##### **Discussion**

Hot-dry climates by definition do not have persistent wet weather. As a result, detailing practices that would be disastrous in the northeast or northwest are used without problems. Cement stucco bonds to the window frame without the need for sealant. The screed at the base of the wall contains weep holes to drain any water that gets behind the stucco (although these probably don't work with a single layer of building paper, as discussed earlier). Typical homes with hardboard siding and trim have simple flashings, typically over windows and doors, with sealant added where needed for extra protection.

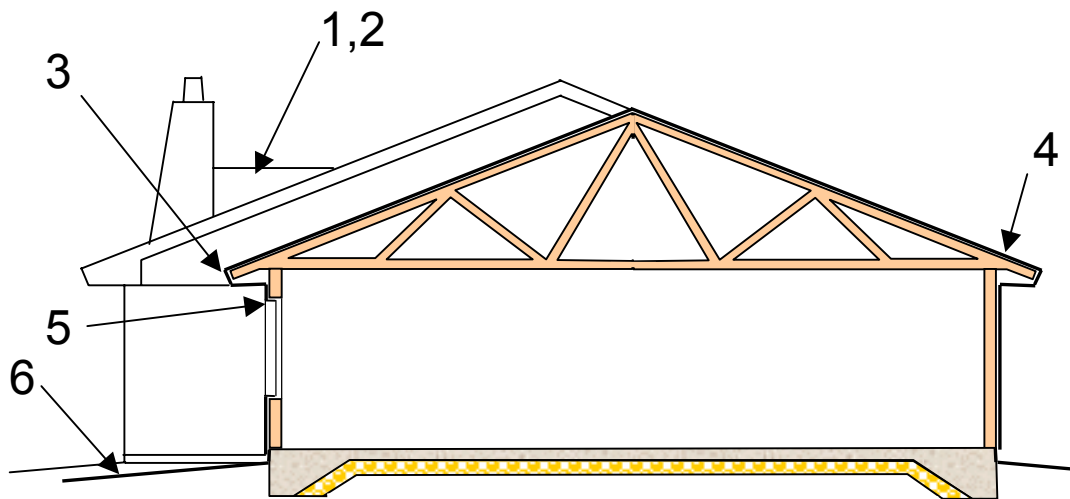

**Figure III-7. Water-management recommendations**

Recommended Water-management Measures (Figure III-7)

*Roof*

1. Provide Adequate “Crickets” Behind Chimneys and Other Projections through the Roof

There must be a way of sending water around the objects like chimneys and skylights that block the flow of water down the roof. Behind tall objects like chimneys, install the largest and steepest “cricket” (small gabled roof) that will fit. This will also help prevent the buildup of snow.

2. Place Chimneys, Dormers, etc., away from Valleys and Adequately Separated from Each Other

Water collects and runs down valleys. Running valleys together (for example, between closely spaced dormers) or placing a chimney or other obstruction in a valley almost guarantees water leakage. During winter, snow will collect in these tight spaces and cause ice dams.

3. Use “Kick-Out” Flashing at the Joint between an Eave and a Sidewall

Where a roof runs into a sidewall, “step flashing” is required at the joint. If the roof stops before the wall does, the water that collects against the step flashing will run in behind the siding unless it is directed back out onto the roof by “kick-out” flashing.

#### 4. Use an Impervious Layer at Valleys

At eaves and valleys, an impervious layer of peel-and-stick modified bituminous flashing material should be installed under the roofing.

- *Why? During heavy rains, water concentrated in valley and can build up high enough to back up under the slates or shingles. An impervious layer drains any overflowing water to the eaves before it soaks into the roof sheathing.*

#### 5. Properly Flash Around Windows And Doors

A useful measure to prevent rotting sills (especially in areas where several days of rain can occur in sequence) is to lap the #30 felt over the window flanges in such a way as to maintain the drainage plane (Figure III-8). Felt can also be laid on the sill and up the jambs in such a way as to minimize the entry of water. For extra-safe flashing, use a peel-and-stick flashing membrane, which can be shaped as needed to flash at window sills. Do not tape over the bottom window flange, but leave an opening for water to get out.

#### 6. Carefully plan grading around the home to ensure that heavy rainfall will find its way to drains without flooding the house

- Typical requirements are to grade away 6 in. in the first 10 ft
- Provide simple retaining walls where necessary.

Many communities require a detailed contour plan showing drainage; make one even if it is not required.

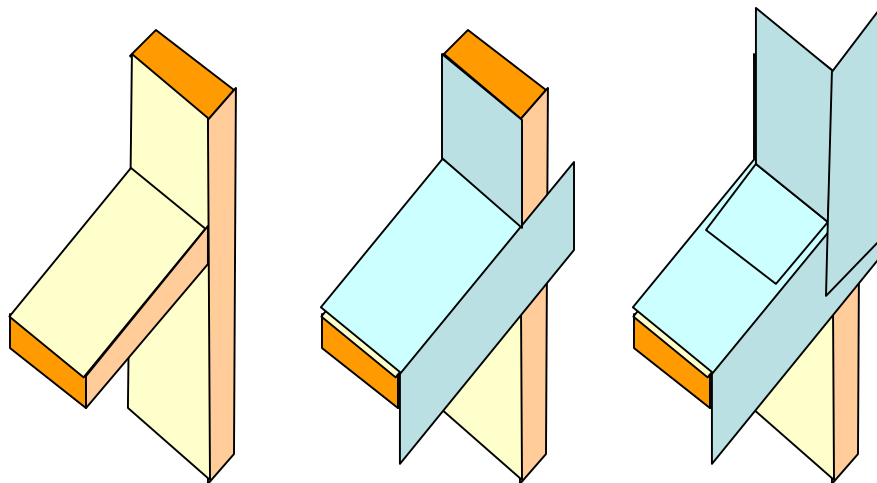

**Figure III-8. Sequence of applying #30 felt at a window sill**



## Applications in CARB/Building America Case Studies

The above measures are all good practice and, taken together, will help prevent moisture-related problems throughout the building envelope. Because CARB builders in hot-dry climates seldom have problems related to water management in walls, most of the recommendations relate to roofs, which are exposed to the torrential downpours characteristic of most hot-dry climate.

### *Reflective Roofing Material*

#### **Discussion**

Ductwork running in a hot attic is one of the largest cooling loads in a hot-dry climate home. SWA has measured a substantial temperature rise between the air handler and the registers, when flex ducts insulated to R-4.2 level ran in a hot attic. CARB's primary thrust in resolving this problem has been two-fold: (1) developing the "plenum truss," which provides space for ductwork within the conditioned envelope without requiring dropped ceilings, and (2) burying ductwork under attic insulation. The latter technique is recommended below.

Even if some of the ductwork is protected from attic heat (as recommended below), it is not practical to cover all the ductwork, so reducing the temperature in the attic is highly desirable. Careful testing by the Florida Solar Energy Center (FSEC) shows that either radiant barrier sheathing or a reflective roof can substantially reduce attic temperatures. Of the two techniques, CARB believes that reflective roofs are the more desirable. A radiant barrier on the underside of the roof sheathing noticeably increases the temperature of roof shingles. If these are not white or near-white (unpopular colors), they will tend to be "cooked" by the radiant barrier, with unknown effects on their life.

The "classic" way to create a reflective roof is by using glazed light-colored tiles or glossy light-colored painted steel panels. New products have recently appeared that provide improved reflectivity from dark-colored roofs, through the use of spectrally selective paints (that perform similarly to spectrally selective glazing). In all cases, reflective roofs help reduce the "heat island" effect in densely populated areas.

A full discussion of this subject is found in the *Journal of Light Construction*, June 2003, pages 75 through 81 (order through [www.jlconline.com](http://www.jlconline.com)). Also, a rating organization is up and running; the Web site for the Cool Roofs Rating Council, listing many rated products, is [www.coolroofs.org](http://www.coolroofs.org).

## Applications in CARB/Building America Case Studies

CARB has not had the opportunity to use reflective roofing, as suitable products are just coming on the market. CARB has also not used radiant barrier sheathing in hot-dry climates, for the reasons stated above.

## ***Primary Recommendations for the Equipment***

### ***Manual J / Manual D HVAC Sizing***

#### **Discussion**

Air Conditioning Contractors of America has long published a simple, but effective, method of determining loads (“Manual J”) and sizing ductwork (“Manual D”). These design tools are available in user-friendly computerized form for about \$400 each. Also available is a linked program for drawing duct layouts.

While oversizing AC systems in hot-dry climates is not likely to cause mold problems (as oversizing does in hot-humid climates), larger units are more expensive. Even when properly sized, it is often possible to reduce the size by making energy-saving improvements to the home. In a classic case of “whole-house” interaction, the savings in downsizing air conditioning units can be used to help defer the cost of the added duct insulation and better glazing, which complete the circle by making the down-sizing possible in the first place.

#### Applications in CARB/Building America Case Studies

All CARB projects have been designed using Manual J / Manual D computerized calculation, except those special cases where a more sophisticated program has been used. CARB often finds that systems designed by HVAC contractors are dramatically oversized, as one safety factor is piled on another. It is important that the HVAC designer have sufficient information to account properly for all envelope efficiency measures, which often result in a downsizing of equipment and ductwork sizes.

### ***SEER-12 Air Conditioner with 0.85 SHR***

#### **Discussion**

Until recently, SEER-10 air-conditioning equipment has been standard across the country. Gradually, SEER-12 equipment is becoming more widely used. Simulations show that SEER-12 equipment is nearly always cost-effective, and it is nearly always required in order to meet ENERGY STAR standards. SEER-14 equipment, while cost-effective for special projects where longer paybacks are acceptable, is typically too costly for production or affordable housing. However, at today’s reduced interest rates SEER-14 equipment is very likely to be cost-effective as the monthly additional carrying cost is reduced relative to the savings provided. Unfortunately, buyers typically do not make the connection between energy savings and the cost of a mortgage; and they especially do not understand that break-even occurs with longer paybacks when interest rates are low.

#### Applications in CARB/Building America Case Studies

On special projects (for example, Beazer’s solar-powered homes in Sacramento), CARB has been able to include SEER-14 equipment. For most builders, however, upgrading to SEER-12 is a major step and, for the present, it is a practical goal. In the case of Del Webb (at the time very skeptical that energy savings sell), it was not possible to convince them to upgrade from SEER-10 to SEER-12.

## *AFUE 80 Gas Furnace*

### **Discussion**

For hot-dry climates, winters are typically cold enough to warrant the use of gas as a fuel (rather than electric resistance heating); they are not cold enough to warrant the expense and maintenance problems of higher efficiency equipment.

### Applications in CARB/Building America Case Studies

Except for experiments with individual prototypes (that were not followed up in production by the builder), CARB hot-dry climate projects have used AFUE 80 furnaces.

## *Conventional Gas-Fired Water Heater Located in Garage*

### **Discussion**

Because of the dominance of hot weather, water heaters are best kept out of the living space, where their skin losses will not increase the cooling load. This also obviates the need for power-vented equipment and makes gas-fired equipment attractive. There is no justification for electric-resistance water heating except where rates are very low. The heater can either be located free-standing in the garage, within a closet off the garage, or within a closet in the outside wall. The closet should be finished and insulated from the house. In all cases, ventilation grilles are required to provide combustion air for the unit.

### Applications in CARB/Building America Case Studies

Water heaters in CARB hot-dry climates have been located freestanding in the garage or in a closet off the garage.

## *Ducts Mastic Sealed (Leakage Less Than 5% of Fan Flow)*

### **Discussion**

Sealing ductwork is very important in the single-story, slab-on-grade homes characteristic of hot-dry climates, where ductwork typically runs in the attic (or in the case of CARB prototypes, under attic insulation or inside the conditioned envelope). Properly sealed ducts make sure air gets to the spaces intended, rather than leaking into a plenum space. It also minimizes the chances of creating pressure differentials from space to space that would induce airflow through the envelope. The process of sealing each joint reduces the chances of unconnected ductwork, a surprisingly common mistake.

Tape is not recommended as an alternative to mastic. Various tapes are tested to UL 181 standards, which supposedly makes them reliable for use on metal or plastic ductwork. However, it has been found that some duct tape (which is not suitable for taping ducts) passes UL 181. Mastic provides the most reliable duct sealing method.

All ductwork, including the air handler compartment (which typically has many leaky joints) should be mastic sealed. A common goal for duct leakage, measured using a “duct blaster” test, is 5 to 6% leakage to the outside.

### Benefits Demonstrated in CARB/Building America Case Studies

Mastic duct sealing recommended for use in all CARB homes. Energy savings can be relatively modest or substantial, depending upon how well-constructed the ductwork system is to begin with. Well-sealed ducts perform better (they send the air where it is designed to go), and they minimize the infiltration of air from garages and attics. Another advantage is that having to go seal all the ducts makes it much more likely that all duct joints will be connected; unconnected ducts are surprisingly common. To be sure the sealing has worked, it is advisable to perform a duct-blast test (Figure III-9).

#### *Ducts Buried under Attic Insulation*

##### **Discussion**

CARB has been experimenting with burying ductwork under attic insulation since 1996 and has recently helped persuade the California Title 24 program to accept the practice. Cost analyses have indicated that the added cost would be from zero to \$100 for a typical home. By mounding blown-in attic insulation, small ductwork can be covered to an R-30 level. Various techniques are possible for covering larger ducts and plenums, but these add cost and in low-pitched roofs are impractical to achieve. CARB's recommendation is to bury as much of the ductwork as possible without special effort (such as wrapping with fiberglass batts). Some cost is saved by the HVAC subcontractor in not having to suspend the ductwork within often-tight quarters. Different diffuser boots might be desirable, allowing the ducts to enter from the side instead of the top, thus keeping them closer to the ceiling.

### Benefits Demonstrated in CARB/Building America Case Studies

A noticeable reduction in duct skin loss is possible with no change in construction cost.

#### *Compact Duct Distribution System*

##### **Discussion**

If low-E glazing is used and the home's envelope is relatively tight, it is possible to discharge conditioned air from inside walls or from ceiling diffusers up to 12 ft from the window wall in most cases without compromising comfort. Such "inside throw" layouts cut ductwork runs, saving money and reducing the amount of ductwork that needs to be protected from attic heat.

### Applications in CARB/Building America Case Studies

Compact duct distribution systems have played a central role in many CARB projects. It is a crucial part of efforts to bring ductwork inside the conditioned envelope by using the "plenum truss" approach described below.

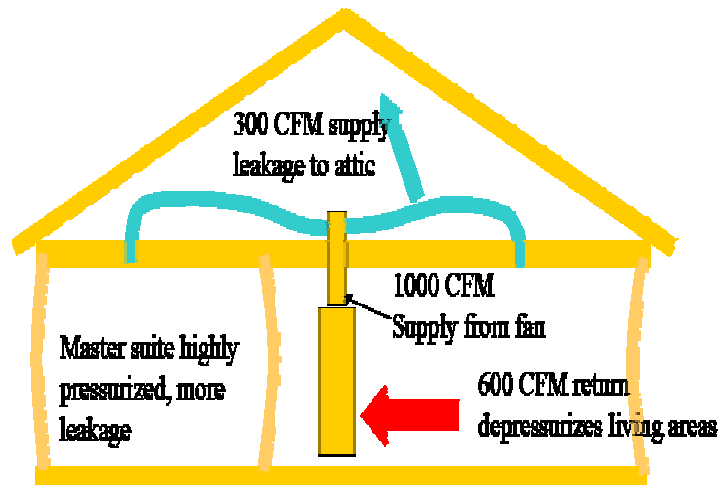

Figure III-9. Duct distribution and pressure zones

### *Central Air Return with Transfer Grills at Secondary Spaces (Balanced Air-Flows)*

#### **Discussion**

There is nothing wrong with adding a ducted return from each room, as long as the returns are not panned and as long as they remain within the conditioned envelope of the home. However, ducted returns are an unnecessary expense in most housing and are a definite liability if they run in the attic.

A more reliable and cost-effective approach is to provide a central return and make sure that there are transfer grilles or transfer ducts, of adequate size, that allow air to return from individual closed rooms to the central space. A common requirement is that the differences in static pressure between any two rooms remain below 2.5 Pascals. This is a low, but achievable, number.

The worst possible conditions occur when there is neither a ducted return nor a transfer grille.

*Why? If one space is pressurized, some other space will be de-pressurized. In both cases, air is forced through cracks into or out of walls and attics, increasing energy losses. Many examples of “soot” accumulation can be traced to pressure imbalances.*

#### Applications in CARB/Building America Case Studies

CARB has used several different, cost-effective methods of transferring return air without compromising acoustic or visual privacy. The most workable is a high grille on one side of an interior wall cavity and a low grille on the other. Sometimes rooms do not have any common wall with the main space (for example, a door at the end of a corridor). In these

cases, grilles can often be put into and out of a closet, or grilles can be located opposite each other over the door.

### *Provide Supply-Only Ventilation where Needed*

Homes in hot-dry climates are typically not ventilated, despite often being very well sealed. The newly adopted residential ventilation standard ASHRAE 62.2 does not require mechanical ventilation in hot-dry climates and in most of California (in areas with less than 4500 heating degree-days). However, care is needed to make sure there is adequate “makeup” air to replace the air exhausted from the home by various appliances. One factor reducing the need for ventilation in hot-dry climates is that combustion appliances are seldom located within the living space, but rather are in the attic or garage.

No criterion is agreed upon to decide when a home should include supply-only ventilation. A reasonable rule of thumb that CARB recommends (until a better-established number is available through building science) is that supply-only ventilation in a hot-dry climate should be included for homes with a natural infiltration rate of about 50 CFM or less. This is equivalent to an ACH<sub>n</sub> of 0.28 air changes per hour for a 1,200-ft<sup>2</sup> home with 9-ft ceilings.

When needed, the supply-only (positive-pressure) ventilation device can be as simple as a 6-in. flex or sheet metal air intake duct from outside to return air plenum, with a manual damper. Because of the prevalence of dust and pollen in dry climates, CARB recommends positive ventilation, including the ability to filter the incoming air, as well as timer controlled exhaust ventilation at source points.

### *No Unvented Gas Appliances in Conditioned Space (except Gas Range with Range Hood Exhausting to the Outside)*

#### **Discussion**

Unvented gas appliances, such as fireplaces or heaters, may or may not be a health hazard, depending upon whether the flame is properly adjusted. What is not controversial is that they are potentially highly destructive to the framing of the building. These devices create large quantities of water if they are run for extended periods, because the main products of complete combustion are water vapor and carbon dioxide. This water vapor can raise the interior relative humidity to unreasonably high levels. Hot-dry home construction is predicated on prevailing dry conditions, and the introduction of substantial amounts of humidity, especially during winter, could be detrimental to the home’s structure. This is especially a problem in the typically tightly constructed stucco homes found in the West.

#### Applications in CARB/Building America Case Studies

CARB recommends against the use of these devices and insists that all gas ranges be equipped with a range hood that ventilates to the outside. These are basic safety and indoor air quality measures that should always be observed.

## **Secondary Recommendations**

### ***Energy-Efficient Lighting***

#### **Discussion**

One of the most important ways in which energy is wasted is the use of incandescent lamps. Until recently, however, most fluorescent lamps had disadvantages that limited their use to some bathroom and kitchen lights (with high-end homes dispensing with them altogether). These disadvantages are rapidly being eliminated by successive generations of compact fluorescent lamps. While some still exhibit a time delay before they are fully bright, their color can be quite authentic, especially when reflected from a recessed can, or diffused through the shade of a lamp. Lights that are seldom used can remain incandescent with little loss in energy. Also, fluorescent lamps typically do not work as well outdoors as incandescents.

#### Applications in CARB/Building America Case Studies

Because of the past history of ineffective fluorescent lighting, CARB's builders have steered clear of fluorescent lighting, responding to market resistance to their use. As market acceptance grows, CARB will continue to suggest the increased use of fluorescent lamps in built-in fixtures.

### ***ENERGY STAR Appliances***

#### **Discussion**

Two of the most important appliances from a water-use and energy efficiency point of view are the washer and dryer, which are seldom supplied by the builder. However, the builder should include a gas line to make it possible for the homeowner to install a gas dryer. In most cases, gas energy is less costly than electricity. The two main appliances supplied by the builder where efficiency is important are the refrigerator and the dishwasher. There are now hundreds of models of refrigerators that are ENERGY STAR rated, and their use should be routine. There are also many energy-efficient dishwashers available.

#### Applications in CARB/Building America Case Studies

CARB has had mixed success in encouraging builders to install ENERGY STAR appliances. Typically, as with McStain in Boulder, Colorado, ENERGY STAR appliances are requested by buyers in certain markets where energy performance is a major issue. In other cases, aesthetics or quiet operation governs, and the ENERGY STAR rating is not considered an important issue. This is gradually changing as ENERGY STAR becomes better known.

### ***Plenum Truss***

#### **Discussion**

The main force of CARB's efforts to protect ductwork from hot attics in hot-dry climates has been to bury the ductwork. In Florida's hot-humid climate, CARB has developed

another strategy that was originally conceived in its work with Del Webb, developing a plenum within the truss space to receive ductwork. In its latest version, the bottom chord of the trusses is canted upward to form a vaulted space, which is then covered by the framers with sheathing board or a roll-out membrane. Small truss sections are then applied over the membrane or board to form the continuation of the bottom chord in order to provide a level ceiling (Figure III-10).

#### Applications in CARB/Building America Case Studies

The builder with whom this design was developed, Mercedes Homes, has not incorporated the idea into his production housing because of some added cost. However, the concept is ripe for further development and offers a straightforward way to incorporate almost all ductwork within the conditioned envelope. Testing has confirmed that the environment within the plenum is in fact very close to that in the house.



**Figure III-10. CARB's plenum truss**



---

## Case Study #1: Beazer, Southern California

### ***Introduction***

Steven Winter Associates (SWA), which manages CARB, performed the initial work with Beazer Southern California in 1998 under the auspices of the U.S. Department of Housing and Urban Development's (HUD) PATH program. That project – designing, building, and publicizing a high efficiency production home model in Simi Valley, California—established SWA's credibility in the eyes of the Beazer senior management and became the basis for ongoing product improvement efforts under CARB. These efforts have culminated in the adoption of a wide range of high-performance CARB-inspired specifications across the division's entire production of more than 700 homes annually.

### ***Systems Engineering and Building Specifications***

The initial specifications were those being employed by Beazer at the start of CARB involvement in the spring 1998. Changes to the basic specifications occurred in two steps: initial prototype construction and production implementation. A synopsis of the original building specifications follows:

<b>Foundation:</b>	Slab-on-grade, uninsulated
<b>Wall Construction:</b>	2 x 4 frame, 16 in. on-center exterior and interior
<b>Exterior Finish:</b>	Three-coat stucco over #30 building felt over 6-in. on-center horizontal wire
<b>Roof Construction:</b>	Engineered trusses at 24 in. on-center
<b>Windows:</b>	Dual-pane tinted glass in aluminum frames
<b>Wall Insulation:</b>	Kraft-faced R-13 fiberglass
<b>Ceiling Insulation:</b>	Unfaced R-19 blankets
<b>HVAC:</b>	Horizontal AFUE 0.80 gas furnace with SEER 10 A/C condenser (Most plans have two systems)
<b>AHU Location:</b>	Air-handling unit in attic
<b>Ducts:</b>	R-4.2 insulated flex ducts, in attic and vertical chases to first floor

Using these specifications, a base-case plan was selected. The Roseman is a two-story home containing 2,734 ft<sup>2</sup> of living space with four bedrooms (figures III-11 and III-12). The home was selected as one of the best sellers in the Simi Valley market and also as it was representative of most plans in the Beazer plan inventory, thus allowing easier concept implementation across the entire product line.

CARB performed DOE 2.1 fuel and energy use analysis, as well as equipment-sizing analysis. The tabulated results of that analysis showed that the home needed 3.5 tons of AC on the second floor and 4 tons on the first; the total annual energy bill would be \$1,614, of which \$1,270 was electricity and \$344 was gas.



IC

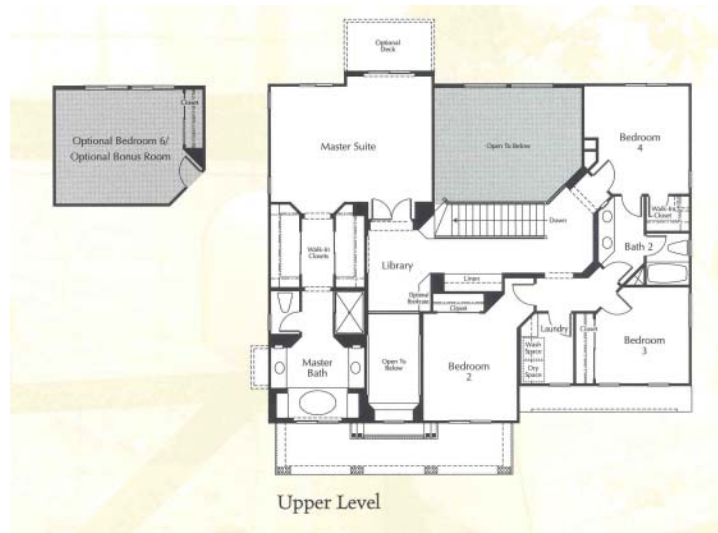

Figure III-11. The Roseman is a two-story home



**Figure III-12. The Roseman**

Based on the 35% decrease in annual heating and cooling costs this represents a 0.3-year payback on initial investment.

This prototype included many other features that are not relevant for this case study. However, they led to a delay before Beazer began working with CARB to develop more “production friendly” changes to their product line. Beginning in the early spring 2001, Beazer contacted CARB to begin work on three new home plans for its upcoming development in Stevenson Ranch, California. With state Title 24 changes eminent, Beazer wanted its new product to meet and exceed those requirements, ahead of the implementation date to “set us apart in the market place.”

Using the mid-sized of the three plans for Stevenson Ranch, (3,446 ft<sup>2</sup> two-story), CARB performed a systems-engineering analysis using REM/Design software and Beazer supply-cost information. A package of recommended specifications was arrived at and accepted by Beazer. The primary performance related specifications follow. Again, changes from the base case specification are shown in italics:

<b>Foundation:</b>	Uninsulated, slab-on-grade
<b>Wall construction:</b>	2 x 4 frame @ 16 in. on-center <i>with foam air sealing package</i>
<b>Exterior finish:</b>	Three-coat stucco over #30 building felt, <i>over OSB shear panels, and horizontal wire 6 in. on-center</i>
<b>Roof construction:</b>	Pre-engineered trusses at 24 in. on-center <i>(w/ radiant barrier at specific California Climate Zones)</i>
<b>Windows:</b>	Insulated <i>soft-coat low-E in vinyl frames (SHGC = 0.33)</i>
<b>Wall insulation:</b>	Unfaced R-13 fiberglass batts
<b>Ceiling insulation:</b>	R-38 loose fill fiberglass
<b>HVAC:</b>	<i>Attic mounted horizontal gas furnaces with SEER 12 A/C condensers (two systems)</i>
<b>Ducts:</b>	<i>Mastic sealed R-4.2 flex ducts (less than 6% leakage)</i>

Based on these specifications and plan 3446 in Climate Zone 12, cooling energy savings is 50% and heating energy savings is 15% compared to base case specifications. In addition, required cooling capacity is reduced by 3 tons to 4.5 tons total.

These specifications, which were initially implemented in the Stevenson Ranch subdivision, have been adopted across all Beazer Southern California's communities (with minor variation based upon C.E.C. Climate Zones) beginning on January 1, 2002. In addition to the performance-related specifications, Beazer has adopted a CARB-recommended ventilation strategy for all its new homes. The exhaust-only package consists of Panasonic 90 cfm bath fans on automatic timer controls in all full baths.

### ***Cost Considerations for Upgraded Specifications***

Using cost figures obtained through the Beazer purchasing department the cost impacts are as follows:

* Low-E windows	+ \$690
* R-38 attic insulation:	+ \$150
* Radiant barrier	+ \$400
* Down-sized HVAC (\$500/ton)	- \$1500
* SEER 12 (\$150/ton)	+ \$675
* Duct sealing	+ <u>\$200</u>
<b>Total cost impact</b>	<b>+ \$615</b>

### ***Additional Changes of Interest to the Builder***

Beazer and their HVAC contractor expressed great interest in converting from two separate AC systems to a single-zoned HVAC system. CARB partner Honeywell supplied WestPac, the HVAC contractor, and had previously agreed to be involved in the new system development.

In addition, CARB visited two in-progress subdivisions in Palmdale, Country Club Ridge, and The Greens for the purpose of visually observing current practice with the newly implemented specifications. Among the energy-related observations were the following (Figure III-14):

- Steel shear panels were used, creating a major thermal “short-circuit.” CARB recommended the use of Simpson Strong-Tie’s “Strong-Wall” shear wall panel throughout.
- The vinyl windows were of poor quality.
- The bottom truss chords were 2 x 4 (not 2 x 6 as thought by the builder), making buried duct installation more feasible.
- Much of the PEX water piping was located in exterior walls, and piping and supply manifolds were exposed to the attic, posing a significant potential freeze problem. (Plumbing on future projects was kept in inside walls.)

- Framing box-downs (at arches for example, Figure III-15) were not air-sealed to separate them from the unconditioned attic. Also, holes through the top plates for pipe, wire and duct penetrations were not sealed.

Open-web trusses were suggested to provide superior access for ducts, but the builder felt they were too expensive when compared with TJI's.

**Blower-Door Testing**

In order to verify building envelope performance, CARB conducted a site visit and performed blower-door testing at one Beazer model home in the Palmdale region, after improved air-sealing protocol had been established. The blower door testing results from a 3,209-ft<sup>2</sup> Country Club Vista model corresponds with an estimated natural infiltration rate of 0.15 ACH<sub>nat.</sub>, confirming the effectiveness of the air-sealing measures. In addition, duct-blaster results obtained from the WestPac, the HVAC subcontractor, verified that the system was performing as specified with total leakage less than 5% of fan flow.

**Table III-1. Blower-Door Testing Results**

<b>“C” Regression Coefficient</b>	<b>“n” Regression Coefficient</b>	<b>CFM at 50 Pa</b>	<b>ACH at 50 Pa</b>
173.6	0.60	1791	3.68



**Figure III-13. Domestic hot-water piping (PEX tubing) located in attic and exterior walls**

### ***On-Going and Future Work with Beazer Southern California***

With the above specifications implemented division wide, CARB is working with Beazer on the next generation of system-engineering building improvements. Primary to this work is the study and implementation of an insulation-buried HVAC duct strategy along with the use of single-zoned HVAC systems in lieu of the now-standard dual non-zoned installations. Our early studies show an average ½-ton HVAC system capacity reduction is allowable as a result of peak load reduction using the buried duct strategy. The zoned single-system strategy appears to represent a significant cost savings to the builder. Assuming constant capacity, the single-zoned configuration could save up to \$1,500 per home without a decrease in overall comfort or performance.



**Figure III-14. Framing box-downs are not air-sealed**

---

## **Case Study #2: Beazer Homes, Sacramento, California**

### ***Background***

The focus of this project is to explore cost-effective, energy-efficient strategies in the context of single-family residential construction in central California and to implement the successful strategies on a community scale. Based on recent experience with a similar Building America/CARB project in Houston, Texas, and a project in planning at the mid-Atlantic seaboard, Beazer Homes U.S.A. has agreed to participate in this project and in the research of construction materials and methods capable of dramatically increasing energy efficient without an increase in first cost.

Beazer Homes U.S.A. produces approximately 7,000 homes a year nationally and is the largest volume builder in the Sacramento region. All Beazer homes in this market are single-family detached and are marketed to first-time, move-up, and empty-nest buyers. Home sizes range from 1,400 ft<sup>2</sup> up to over 3000 ft<sup>2</sup>. Ninety percent of these production homes are single-story.

### ***Standard Specifications***

All homes produced by Beazer Homes Northern California utilize the same basic specifications. Based on a standard selected plan, buyers are offered myriad options for customization, including front elevations, interior arrangements, and pre-fab fireplaces.

All homes are built on slab-on-grade foundations. The foundations are not post-tensioned, but are heavily reinforced to counter the seismic design loads. Other than potential seismic activity, the soils are relatively stable and not subject to thermal or moisture-content swelling. Numerous and substantial steel tie-downs are formed in the slab both at the perimeter and at interior shear wall locations. In practical terms, each foundation is custom engineered.

Exterior wall framing is stick built 2 x 4 at 16 in. on-center. The seismic shear panels (at both exterior and interior locations) are specifically engineered and detailed. The manufacturer, size, location, number, and attachment of each mechanical tie-down are specified. The remainders of the exterior walls are essential in-fill, although they do resist imposed axial load from the roof trusses. All wall-framing material is Douglas-Fir, including solid 4-by header stock. Exterior corners and partition-to-exterior wall tee intersections utilize three studs. The homes generally employ either 9- or 10-ft ceiling heights. Interior wall framing is also primarily 2 x 4 at 16 in. on-center. Headers are typically installed at all openings, even non-load bearing locations.

Roof framing is composed of pre-fabricated roof trusses placed 24 in. on-center. Nearly all trusses have flat bottom chords (flat ceilings) with additional spatial volume generated by the 9- or 10-ft-high walls. Roof truss tie-downs are also specifically engineered for each application and are detailed, like the shear walls on the structural plans.

Exterior walls are finished with cement stucco. Before stucco application, horizontal wires are run over the exterior framing at 12 in. on-center, and #30 building paper is placed over the wire. One-inch EPS foam insulation is then placed over the building paper, to which chicken wire mesh is then attached. The stucco is a traditional two-coat cement-based application and develops a thickness of ½ in. Beazer has expressed concern about the durability of the EPS foam under the stucco and has asked that in the course of this project alternates be explored.

The exterior wall is completed by the installation of 3-½-in. unfaced fiberglass batt insulation and ½-in. interior gypsum board. R-30 unfaced friction fit fiberglass batts are installed at the ceiling level, and ½-in. gypsum board is attached to the bottom truss chords.

The windows used by this division consist of high-performance soft-coat low-E glass (shading coefficient = 0.46) installed in aluminum non-thermal break single-hung frames. Glazing areas are typically generous, 18 to 24% of floor area. (Beazer has expressed resistance to lowering glazing area, so that option was not pursued.)

Standard HVAC systems consist of an attic-mounted gas-fired horizontal furnace with a DX cooling coil connected to an exterior SEER 10 condensing unit. The furnaces are natural draft rated at 80.0 AFUE. All ductwork is R-4.2 flex and is attic run. Except for the largest of homes, a single, ducted, ceiling mounted return is utilized. Duct surface area exposed to the attic is generally in the range of 17% of floor area.

### **Base Case**

For the purposes of this study, it was decided to use an investigation technique that would allow for objectively measured results against a known standard. A base case/control strategy is therefore employed. This method will provide for direct side-by-side energy-use testing and cost comparison.

The model chosen for the base-case is the one-story 1,872-ft<sup>2</sup> Memories Plan #1. It represents a mid-sized home in the Beazer inventory that would allow successful innovations to be easily implemented into other standard plans, both larger and smaller. Plan #1 contains three bedrooms and two baths. Other spaces include a kitchen/greatroom, laundry and formal living room/dining room space. In its standard configuration, this home also has a two-bay garage with an additional tandem garage space.

The location selected to build the prototype is the Memories subdivision approximately 5 miles west of downtown Sacramento. The site is directly contiguous with the Reflections subdivision, which features slightly smaller homes. Memories is marketed as a move-up community.

### **Prototype Alternatives**

Using REM/Design EEBA Residential Energy Analysis Software v8.43 and Wrightsoft Right-Suite Residential v4.1.27, alternate HVAC and envelope specifications were explored in order to determine the operating cost savings (i.e., energy savings) of the explored options. The process explores the benefits of applying single variables to the



Base Case, for example **Alt. 1** (installing ducts within conditioned space), **Alt. 2** (upgrading to SEER 12 air conditioner), and **Alt. 3** (upgrading to vinyl-framed windows). These variables are then combined to compound these benefits. In modeling combinations of variables, consideration is given to those most likely to be cost-effective. Subsequent computer runs indicate energy savings and load reductions and point to cost tradeoffs of various combinations. From these results, the combination with the highest cost/benefit can be identified.

**Alt. 4** combines two variables (upgrading to vinyl windows, removing rigid insulation) to reveal an energy-saving measure that may result in significant construction cost savings and is key to the cost/energy balance to be reached. **Alt. 5** retains full R-17 insulation combined with all three variables to indicate greatest energy savings, albeit with cost increase. **Alt. 6** shows that the cost-savings of keeping the aluminum windows represents an energy penalty compared with **Alt. 7**, which trades the rigid insulation for a modest upgrade to vinyl windows.

The dry Sacramento climate carries a relatively small latent cooling load, allowing use of equipment with a sensible heat ratio (SHR) of 0.85, instead of the conventional 0.70 SHR used in most climates. Together with the other energy-saving measures, this allows a 2-ton air conditioner to comfortably cool the house, bringing the cost of an efficient SEER 12 unit within reach.

**Base Case:** R-17 wall insulation, aluminum windows, 10 SEER A/C, ducts in unconditioned space

Peak sensible A/C load is **22,802 Btuh**, required A/C is **3.0 tons\*\***

**Alternate 1:** R-17 wall insulation, aluminum windows, 10 SEER A/C, ducts in conditioned space

Peak sensible A/C load is **19,949 Btuh**, required A/C is **2.5 tons\*\***

\*Energy Savings Heating: 11% Cooling: 6%  
Heat/Cool: 8%

**Alternate 2:** R-17 wall insulation, aluminum windows, 12 SEER A/C, ducts in unconditioned space

Peak sensible A/C load is **22,802 Btuh**, required AC is **3.0 tons\*\***

\*Energy Savings Heating: 0% Cooling: 17%  
Heat/Cool: 10%

**Alternate 3:** R-17 wall insulation, vinyl windows, 10 SEER A/C, ducts in unconditioned space

Peak sensible A/C load is **22,802 Btuh**, required A/C is **3.0 tons\*\***

\*Energy Savings Heating: 16% Cooling: 0%  
Heat/Cool: 6%

**Alternate 4:** R-13 wall insulation, vinyl windows, 10 SEER AC, ducts in unconditioned space

Peak sensible A/C load is **23,688 Btuh**, required AC is **3.0 tons\*\***

\*Energy Savings Heating: 11% Cooling: -1%  
Heat/Cool: 3%

**Alternate 5:** R-17 wall insulation, vinyl windows, 12 SEER AC, ducts in conditioned space

Peak sensible A/C load is **19,949 Btuh**, required AC is **2.5 tons\*\***

\*Energy Savings Heating: 29% Cooling: 30%  
Heat/Cool: 30%

ENERGY STAR Compliant

**Alternate 6:** R-17 wall insulation, aluminum windows, 12 SEER AC, ducts in conditioned space

Peak sensible A/C load is **19,949 Btuh**, required AC is **2.5 tons\*\***

\*Energy Savings Heating: 15% Cooling: 29%  
Heat/Cool: 24%

**ENERGY STAR Compliant**

**Alternate 7:** R-13 wall insulation, vinyl windows, 12 SEER AC, ducts in conditioned space

Peak sensible A/C load is **20,706 Btuh**, required AC is **2.0 tons\*\*\***

\*Energy Savings Heating: 24% Cooling: 29%  
Heat/Cool: 27%

**ENERGY STAR Compliant**

**Notes:**

\* Energy savings compared to base case.

\*\* at 0.70 Sensible Heat Ratio (SHR)

\*\*\* at 0.85 Sensible Heat Ratio (SHR)

A review of the above computer simulations results revealed that, all else being equal, the house performed better without foam sheathing and with vinyl windows, than with the foam sheathing and non-thermal break aluminum windows. The simulations suggest that the removal of the foam sheathing produces a very minimal performance penalty and that the aluminum windows produce a significant heating season penalty. This result was found to be somewhat surprising; therefore, additional analysis was performed using DOE2.1E energy-analysis software to isolate the impact of the above variables. The result of that simulation confirmed the earlier REM/Design analysis in that the heating load was indeed negatively impacted by the aluminum windows, and the foam sheathing did little to impact the heating and cooling loads.

### ***Prototype Final Specifications***

The results of the above computer simulations were reviewed and analyzed from a first-cost standpoint. It is the goal of this final analysis to determine the most effective manner of substantially improving the performance of the prototype house, as measured against the base case, without an increase in first cost. The result of this approach is the prototype final specifications and is as follows:

<b>Foundation:</b>	Slab-on-grade, uninsulated
<b>Wall construction:</b>	2 x 4 wood frame, 16 in. on-center site built. Traditional cement stucco facing installed over wire mesh on lapped building paper. O.S.B. sheathing at engineered shear wall locations.
<b>Roof construction:</b>	Prefabricated roof trusses at 24 in. on-center
<b>Interior partitions:</b>	2 x 4 wood framing at 16 in. on-center. O.S.B. sheathed at engineered shear wall locations.
<b>Windows:</b>	Insulating glass, high-performance, Low-E single hung in vinyl frame. Solar Heat Gain Coefficient = 0.39
<b>Wall insulation:</b>	Unfaced 3-1/2-in. fiberglass batts R-13
<b>Ceiling insulation:</b>	Unfaced, friction fit R-30 blankets.
<b>HVAC:</b>	SEER 12 air-conditioning condensing unit, 2-ton capacity. Upflow natural draft 80.0 AFUE natural-gas furnace.
<b>Ducts and AHU:</b>	The air-handler (furnace) located in the garage (central to the plan). All supply ducts located in air-sealed drops below the bottom truss chords within the conditioned space. Compact distribution w/ interior throws.

### ***Modeled Prototype Performance***

The combination of specifications, as described above in **Alternate 7**, (4e in Appendix A), qualifies the prototype as an ENERGY-STAR-rated home with a modified end use load (MMBtu/year) of 52.3, as compared to the maximum allowable usage of 55.8 MMBtu/year.

The same house with the base-case (standard) specifications would fail to qualify for ENERGY STAR with a calculated MMBtu/year of 59.6, again compared to the maximum allowable usage of 55.8 MMBtu/year.

REM/Design calculates a 29.7% annual savings in cooling energy and a 24.3% savings in heating energy for the prototype over the same house with standard specifications.

### ***Test Objectives***

The objective of this short-term test is to evaluate and compare the energy performance of the new Beazer Homes Northern California prototype house and a base-case house, both located in a residential development near Sacramento, California. The specific features to be evaluated in the prototype house include ducts within conditioned space (interior chase below truss bottom chords), impact of vinyl versus aluminum windows, exterior wall thermal performance, and downsized SEER-12 heat pump.

---

### Case Study 3: Second (PV) Prototype



**Figure III-16. A Beazer Northern California home**

#### ***Background***

CARB's work with Beazer Homes Northern California under the Building America Program began in September 1999 at the request of Ian McCarthy, President and CEO of Beazer Homes U.S.A., Inc. The Northern California division, operating out of Roseville, a suburb of Sacramento, is Beazer's largest and most profitable division, accounting for 1,200 housing starts a year. All Beazer Northern California homes are single-family detached and are marketed to first-time, move-up, and empty-nester buyers. Home sizes range from 1,200 ft<sup>2</sup> to over 3000 ft<sup>2</sup>. Ninety percent of these homes (Figure III-16) are single story.

Our initial meeting with representatives of the Northern California division resulted in an understanding that CARB would assist them in implementing cost-effective energy-efficient strategies on a community-wide scale through the use of the design / build / test / redesign / build / test / implement paradigm.

#### ***Initial Standard Specifications***

At the inception of this initiative, all Beazer Homes Northern California products utilized the same basic specifications. These specifications are detailed in Case Study 2

#### ***First Prototype Specifications***

Using RemDesign software several alternate specification combinations were explored to arrive at the best specification package in terms of cost and performance for the 1,872-ft<sup>2</sup> home selected as the base-case. That package consisted of upgrading to SEER 12, improving the windows to a high-performance, soft-coat, low-E in vinyl frames and placing the ducts in conditioned space. In addition, because of the dry climate conditions, a higher sensible heat ratio (SHR) of 0.85 was specified for the HVAC system. This

combination of features allows the HVAC system to be downsized to 2 tons from the original 3 tons and, therefore, offset the cost of the higher efficiency equipment. The first prototype specifications are identical to Case Study 2 with the following exceptions:

### *Windows*

#### **Insulated soft-coat low-E (SHGC = 0.34), vinyl frames**

In terms of performance, these changes produce an annual 30% reduction in cooling energy, 29% reduction in heating energy, and a 30% reduction in total HVAC energy use.

### ***Delayed Implementation***

Architecturally, the integration of the ducts into the plan was worked out with a great deal of sensitivity and was thought by CARB to actually enhance the architecture of the floor plan by creating lower ceiling transitions between the front public spaces and the rear family areas, as well as in the bedroom hallway. Subsequent positive review of the plan by the homes architects, Bloodgood-Sharp-Buster, reinforced this analysis. Additionally, the HVAC subcontractor, Buetler Air-Conditioning, reviewed the proposed arrangement from an installation/performance standpoint and agreed with CARB's assessment that substantial benefits existed over standard practice. None-the-less, Beazer's marketing concerns remained, as well as their assertion that placing a home different from the standard offerings into a master-planned community was problematic. They essentially halted the project.

Even though this development was seen as a major obstacle from the CARB perspective, critical information was gained on how the Beazer Northern California division operates, which in turn allowed us to refocus our efforts to on what they viewed as a more "production-friendly" strategy.

### ***Initial Specification Changes***

To allow cross-the-board implementation of proposed strategies, CARB reviewed "plug-and-play" specification options that would provide Beazer the performance improvements they were seeking without changing production methodologies. This investigation resulted in CARB recommending three specification changes to the homes: soft-coat low-E windows in vinyl frames, SEER 12 condensing units, and ducts mastic sealed to 6% leakage or less. These recommendations were presented to Beazer in October 2000, roughly 1 year from the initiation of the project, along with Rem-Design computer simulations showing a 25% overall reduction in heating and cooling energy use over standard practice. These changes would also cause the homes to perform well in excess of HERS 86. By mid-November, Beazer had confirmed that they would begin to phase in the new specification package in new developments starting in January 2001. As this process unfolded, events occurred causing huge spikes in energy costs and rolling black-outs across California. These events in turn prompted Beazer to embark on a much more ambitious initiative of very high performing homes culminating in their "Power House" program.

### ***The SMUD “Power Roof” Program***

Sacramento Municipal Utility District (SMUD) has long been a progressive electrical utility in promoting energy efficiency and providing builders with incentives to improve their homes in particular with respect to reducing cooling energy use and peak demand loads. A current program, “SMUD Advantage Home,” has enjoyed great builder participation largely through its easy-to-meet requirements and the \$500 subsidy offered to builders who participate. To achieve more aggressive results, SMUD has introduced a separate program to promote distributed generation through residential photovoltaic installations called “Solar Advantage Roof.” The program offers builders two options: EPV Modules and Atlantis SunSlates.

For option #1, the EPV Modules, SMUD proposes to sell installed 2-kW systems complete with modules, inverter, associated wiring, and electrical components for \$2.40/watt. The EPV Modules are the less-efficient amorphous non-crystalline type of PV system, which generates approximately 4.7 watts/ft<sup>2</sup>. The 2-ft x 4-ft modules are arrayed in panels of four modules each and are installed on raised channels above the roof surface. A 2-kW system requires 48 modules covering 408 ft<sup>2</sup>.

For option #2, SMUD proposes to sell a complete SunSlates PV system including the Atlantis SunSlates, inverter, and associated wiring, without installation for \$2.60/watt. The SunSlates utilize crystalline technology and generate approximately 10 watts/ft<sup>2</sup>. Additionally, the SunSlate product is itself a roofing product, being laminated directly to fiber-cement shingles, and is functionally and aesthetically compatible with the concrete roof tiles standard to the region.

### ***Beazer “Power House”***

After reviewing the two options provided by SMUD, Beazer decided to opt for the second, more-expensive system, because of its simplicity and aesthetic appeal and to first offer it to homebuyers at its “Roseview” subdivision. Working with CARB and SMUD, Beazer decided to standardize the SunSlates PV system at 3.3 kW. This had the potential advantage of being able to handle all or nearly all of the annual electrical load required by the home, creating a “zero net electrical house,” something Beazer was eager use as a marketing tool. To assure these claims could be met, further improvements were made to the Power House home specifications, including a SEER 14 condensing unit, R-38 attic insulation, and air ducts placed on the lower truss chords and insulated over. The final specifications are outlined below:

<b>Foundation:</b>	Uninsulated slab-on-grade
<b>Wall construction:</b>	2 x 4 wood frame 16 in. on-center. Traditional stucco over wire, 1-in. EPS foam, wire mesh, #30 building paper and horizontal support wire
<b>Roof construction:</b>	pre-fab wood trusses 24 in. on-center
<b>Windows:</b>	Insulated soft-coat low-E in vinyl frames (SHGC = 0.33, U = 0.36)
<b>Walls:</b>	Unfaced fiberglass batt and 1-in. EPS foam (R = 17)

- Ceiling insulation:** Blown fiberglass, R-38
- HVAC:** SEER 14 condensing unit, AFUE 80 horizontal gas furnace, attic mounted
- Ducts:** R-4.2 flex ducts, insulation buried at truss bottom chords.

Without consideration of the PV system, the houses built to these specifications far exceed ENERGY STAR requirements with a modified end-use load of (MMBtu/year) of 33.5 compared to 35.9 to reach HERS 86.

### ***Photovoltaic Power Generation***

For the Sacramento region, with a southern exposure on a 6/12 roof pitch, a 3.3-kW Sunslate system will generate 5900 kWh annually, based on manufacturer- and SMUD-provided data. Preliminary analysis indicated that this generation capacity would be adequate to offset yearly electric usage for many of Beazer's more modest sized offerings, including the five models being offered at Roseview (Figure III-17). Table III-2 and Figure III-18 illustrate the simulated energy consumption of the Beazer 1330 model versus monthly power generation of the 3.3-kW SunSlates PV system.

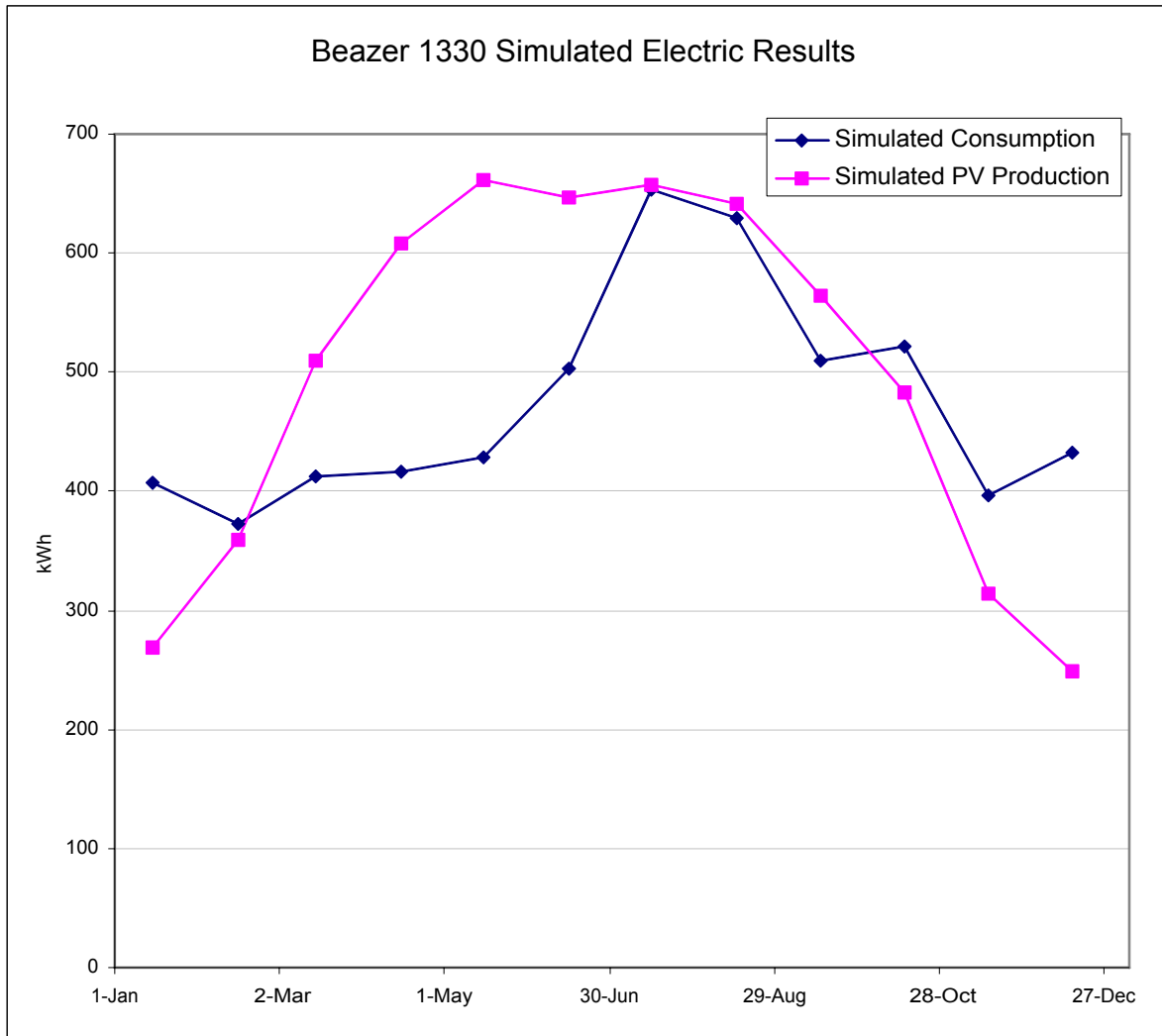

**Figure III-17. Illustration of five Beazer 1330 models being offered at Roseview with 3.3-kW Sunslate PV systems**



**Table III-2. Simulated energy consumption of the Beazer 1330 Model versus monthly power generation of the 3.3-kW SunSlates PV system**

<b>Month</b>	<b>Simulated kWh Consumption w/ SEER 14</b>	<b>PV kWh Production for Southern Orientation</b>
January	407	269
February	373	359
March	412	510
April	416	608
May	429	661
June	503	647
July	653	658
August	629	641
September	510	564
October	522	483
November	397	314
December	432	249
<b>Total</b>	<b>5683</b>	<b>5963</b>



**Figure III-18. Graph of simulated energy consumption of the Beazer 1330 Model versus monthly power generation of the 3.3-kW SunSlates PV system**

From the above analysis, we see that the yearly PV output of 5,963 kWh exceeds the yearly electrical consumption of the 1330 plan home by 280 kWh, resulting in a “zero-net-electrical” house. Similar analysis of the other plans offered at Roseview find that the two smallest plans, the 1043 and the 1165, require 4440 kWh and 5449 kWh, respectively, both lower than the annual PV output. The largest plan, the 1474, requires 6394 kWh annually, exceeding the PV generation of the 3.3-kW system by 401 kWh.

### ***Current Implementation***

Including the very substantial cost subsidies provided by SMUD for the photovoltaic systems, Beazer is offering the option to its buyers for \$11,200, essentially a direct pass-along cost. The initial community for this option, Roseview, is a starter home neighborhood, thus most of the prospective buyers are young and tight on cash for down payments. The result is that as attractive as the heavily subsidized option is, most buyers cannot afford it, or at least think they can't. As of November 1, 2001, four homes have received the PowerHouse option, three models and a spec house. It should be noted that the spec house sold very quickly after being placed on the market, indicating a potential avenue to increased sales that is making the PV system standard on some of the offerings. Beazer has not yet embraced this approach, but the division president is very enthusiastic about getting substantial numbers of PV houses built and this may be a viable method of accomplishing that.

The second Beazer community offering the PowerHouse option is Piazza Del Sol, a neighborhood of somewhat larger and more expensive homes just west of Sacramento. The homes will feature the same specs as in Roseview and the same 3.3-kW system. Slabs have been started and reservations are being accepted, but no information of the number of PV options is available. A third community, Highland Green, directly adjacent to Roseview is to start shortly with six plans in a size range between the first two PV communities. It is hoped that marketing and sales information from these three different subdivisions can be used to focus and refine the PowerHouse program to maximize sales.

# REPORT DOCUMENTATION PAGE

*Form Approved*  
OMB No. 0704-0188

The public reporting burden for this collection of information is estimated to average 1 hour per response, including the time for reviewing instructions, searching existing data sources, gathering and maintaining the data needed, and completing and reviewing the collection of information. Send comments regarding this burden estimate or any other aspect of this collection of information, including suggestions for reducing the burden, to Department of Defense, Executive Services and Communications Directorate (0704-0188). Respondents should be aware that notwithstanding any other provision of law, no person shall be subject to any penalty for failing to comply with a collection of information if it does not display a currently valid OMB control number.

**PLEASE DO NOT RETURN YOUR FORM TO THE ABOVE ORGANIZATION.**

<b>1. REPORT DATE (DD-MM-YYYY)</b> July 2004		<b>2. REPORT TYPE</b> Subcontract Report		<b>3. DATES COVERED (From - To)</b> December 2002–December 2003	
<b>4. TITLE AND SUBTITLE</b> Builder System Performance Package Targeting 30% - 40% Savings in Space Conditioning Energy Use			<b>5a. CONTRACT NUMBER</b> DE-AC36-99-GO10337		
			<b>5b. GRANT NUMBER</b>		
			<b>5c. PROGRAM ELEMENT NUMBER</b>		
<b>6. AUTHOR(S)</b> Consortium for Advanced Residential Buildings			<b>5d. PROJECT NUMBER</b> NREL/SR-550-34560		
			<b>5e. TASK NUMBER</b> BET4.8004		
			<b>5f. WORK UNIT NUMBER</b>		
<b>7. PERFORMING ORGANIZATION NAME(S) AND ADDRESS(ES)</b> CARB Steven Winter Associates 50 Washington Street Norwalk, CT 06854				<b>8. PERFORMING ORGANIZATION REPORT NUMBER</b> KAAX-3-33441-01	
<b>9. SPONSORING/MONITORING AGENCY NAME(S) AND ADDRESS(ES)</b> National Renewable Energy Laboratory 1617 Cole Blvd. Golden, CO 80401-3393				<b>10. SPONSOR/MONITOR'S ACRONYM(S)</b> NREL	
				<b>11. SPONSORING/MONITORING AGENCY REPORT NUMBER</b> NREL/SR-550-34560	
<b>12. DISTRIBUTION AVAILABILITY STATEMENT</b> National Technical Information Service U.S. Department of Commerce 5285 Port Royal Road Springfield, VA 22161					
<b>13. SUPPLEMENTARY NOTES</b> NREL Technical Monitor: M. Eastment					
<b>14. ABSTRACT (Maximum 200 Words)</b> The Consortium for Advanced Residential Building (CARB), one of the Building America teams, describes recommended best practices to achieve 30% - 40% energy savings without compromising health or safety in houses built in cold climates, hot-humid climates, and hot-dry climates.					
<b>15. SUBJECT TERMS</b> Building America; energy-efficient houses; CARB, Consortium for Advanced Residential Buildings; U.S. Department of Energy; DOE					
<b>16. SECURITY CLASSIFICATION OF:</b>			<b>17. LIMITATION OF ABSTRACT</b> UL	<b>18. NUMBER OF PAGES</b>	<b>19a. NAME OF RESPONSIBLE PERSON</b>
<b>a. REPORT</b> Unclassified	<b>b. ABSTRACT</b> Unclassified	<b>c. THIS PAGE</b> Unclassified			<b>19b. TELEPHONE NUMBER (Include area code)</b>

## A Strong Energy Portfolio for a Strong America

Energy efficiency and clean, renewable energy will mean a stronger economy, a cleaner environment, and greater energy independence for America. Working with a wide array of state, community, industry, and university partners, the U.S. Department of Energy's Office of Energy Efficiency and Renewable Energy invests in a diverse portfolio of energy technologies.

## Research and Development of Buildings

Our nation's buildings consume more energy than any other sector of the U.S. economy, including transportation and industry. Fortunately, the opportunities to reduce building energy use—and the associated environmental impacts—are significant.

DOE's Building Technologies Program works to improve the energy efficiency of our nation's buildings through innovative new technologies and better building practices. The program focuses on two key areas:

### • Emerging Technologies

Research and development of the next generation of energy-efficient components, materials, and equipment

### • Technology Integration

Integration of new technologies with innovative building methods to optimize building performance and savings

For more information contact:  
EERE Information Center  
1-877-EERE-INF (1-877-337-3463)  
[www.eere.energy.gov](http://www.eere.energy.gov)



U.S. Department of Energy  
**Energy Efficiency  
and Renewable Energy**

An electronic copy of this factsheet is available on the Building America Web site at [www.buildingamerica.gov](http://www.buildingamerica.gov)

## Visit our Web sites at:

[www.buildingamerica.gov](http://www.buildingamerica.gov)

[www.pathnet.org](http://www.pathnet.org)

[www.energystar.gov](http://www.energystar.gov)



### Building America Program

George S. James • New Construction • 202-586-9472 • fax: 202-586-8134 • e-mail: [George.James@ee.doe.gov](mailto:George.James@ee.doe.gov)

Terry Logee • Existing Homes • 202-586-1689 • fax: 202-586-4617 • e-mail: [terry.logee@ee.doe.gov](mailto:terry.logee@ee.doe.gov)

Lew Pratsch • Integrated Onsite Power • 202-586-1512 • fax: 202-586-8185 • e-mail: [Lew.Pratsch@hq.doe.gov](mailto:Lew.Pratsch@hq.doe.gov)

Building America Program • Office of Building Technologies, EE-2J • U.S. Department of Energy • 1000 Independence Avenue, S.W. • Washington, D.C. 20585-0121 • [www.buildingamerica.gov](http://www.buildingamerica.gov)

### Building Industry Research Alliance (BIRA)

Robert Hammon • ConSol • 7407 Tam O'Shanter Drive #200 • Stockton, CA 95210-3370 • 209-473-5000 • fax: 209-474-0817 • e-mail: [Rob@consol.ws](mailto:Rob@consol.ws) • [www.bira.ws](http://www.bira.ws)

### Building Science Consortium (BSC)

Betsy Pettit • Building Science Consortium (BSC) • 70 Main Street • Westford, MA 01886 • 978-589-5100 • fax: 978-589-5103 • e-mail: [Betsy@buildingsscience.com](mailto:Betsy@buildingsscience.com) • [www.buildingscience.com](http://www.buildingscience.com)

### Consortium for Advanced Residential Buildings (CARB)

Steven Winter • Steven Winter Associates, Inc. • 50 Washington Street • Norwalk, CT 06854 • 203-857-0200 • fax: 203-852-0741 • e-mail: [swinter@swinter.com](mailto:swinter@swinter.com) • [www.carb-swa.com](http://www.carb-swa.com)

### Davis Energy Group

David Springer • Davis Energy Group • 123 C Street • Davis, CA 95616 • 530-753-1100 • fax: 530-753-4125 • e-mail: [springer@davisenergy.com](mailto:springer@davisenergy.com) • [deg@davisenergy.com](mailto:deg@davisenergy.com) • [www.davisenergy.com/index.html](http://www.davisenergy.com/index.html)

### IBACOS Consortium

Brad Oberg • IBACOS Consortium • 2214 Liberty Avenue • Pittsburgh, PA 15222 • 412-765-3664 • fax: 412-765-3738 • e-mail: [boberg@ibacos.com](mailto:boberg@ibacos.com) • [www.ibacos.com](http://www.ibacos.com)

### Industrialized Housing Partnership (IHP)

Subrato Chandra • Florida Solar Energy Center • 1679 Clearlake Road • Cocoa, FL 32922 • 321-638-1412 • fax: 321-638-1439 • e-mail: [subrato@fsec.ucf.edu](mailto:subrato@fsec.ucf.edu) • [www.baihp.org](http://www.baihp.org)

### National Association of Home Builders (NAHB) Research Center

Tom Kenney • National Association of Home Builders (NAHB) Research Center • 400 Prince George's Boulevard • Upper Marlboro, MD 20774 • 301-430-6246 • fax: 301-430-6180 • toll-free: 800-638-8556 • [www.nahbrc.org/](http://www.nahbrc.org/)

### National Renewable Energy Laboratory

Ren Anderson • 1617 Cole Boulevard, MS-2722 • Golden, CO 80401 • 303-384-7433 • fax: 303-384-7540 • e-mail: [ren\\_anderson@nrel.gov](mailto:ren_anderson@nrel.gov) • [www.nrel.gov](http://www.nrel.gov)

Tim Merrigan • 1617 Cole Boulevard, MS-2722 • Golden, CO 80401 • 303-384-7349 • fax: 303-384-7540 • e-mail: [tim\\_merrigan@nrel.gov](mailto:tim_merrigan@nrel.gov) • [www.nrel.gov](http://www.nrel.gov)

### Oak Ridge National Laboratory

Pat M. Love • P.O. Box 2008 • One Bethel Valley Road • Oak Ridge, TN 37831 • 865-574-4346 • fax: 865-574-9331 • e-mail: [lovepm@ornl.gov](mailto:lovepm@ornl.gov) • [www.ornl.gov](http://www.ornl.gov)

Produced for the U.S. Department of Energy (DOE) by the National Renewable Energy Laboratory, a DOE national laboratory. July 2004 • NREL/SR-550-34560

Printed with a renewable-source ink on paper containing at least 50% wastepaper, including 20% postconsumer waste.