

Introduction to Building Systems Performance: Houses that Work II. Revised February 2005

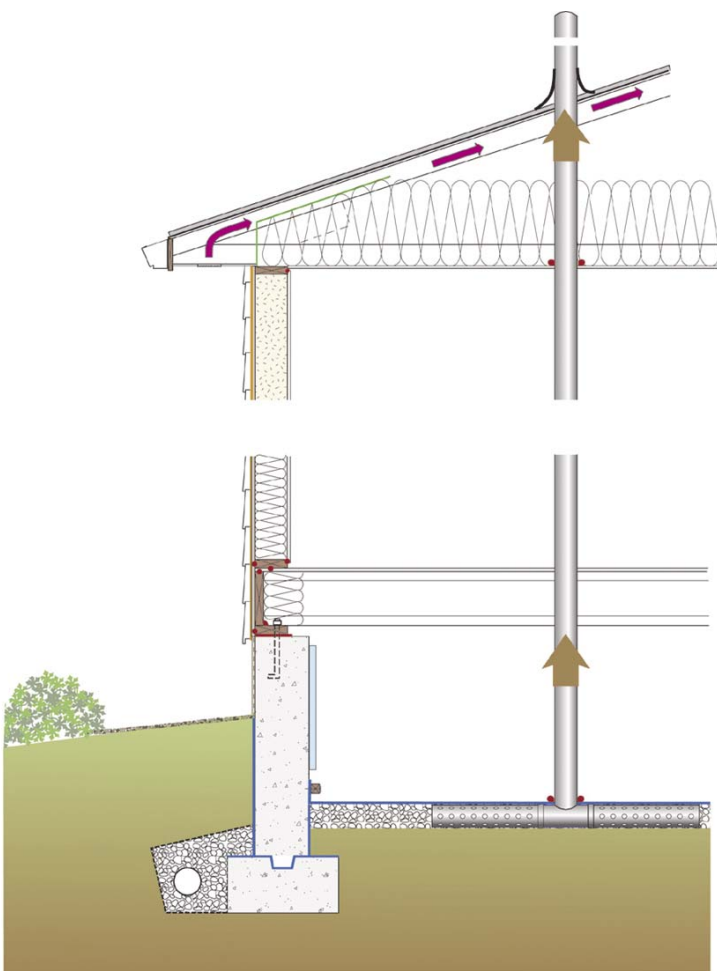

Building Science Consortium

Westford, Massachusetts

Prepared under Subcontract No. KAAX-3-32443-01



Introduction to Building Systems Performance: Houses That Work II. Revised February 2005

January 2003–December 2003

*Building Science Consortium
Westford, Massachusetts*

NREL Technical Monitor: Bob Hendron

Prepared under Subcontract No. KAAX-3-32443-01



NREL

National Renewable Energy Laboratory
1617 Cole Boulevard, Golden, Colorado 80401-3393
303-275-3000 • www.nrel.gov

Operated for the U.S. Department of Energy
Office of Energy Efficiency and Renewable Energy
by Midwest Research Institute • Battelle

Contract No. DE-AC36-99-GO10337

NOTICE

This report was prepared as an account of work sponsored by an agency of the United States government. Neither the United States government nor any agency thereof, nor any of their employees, makes any warranty, express or implied, or assumes any legal liability or responsibility for the accuracy, completeness, or usefulness of any information, apparatus, product, or process disclosed, or represents that its use would not infringe privately owned rights. Reference herein to any specific commercial product, process, or service by trade name, trademark, manufacturer, or otherwise does not necessarily constitute or imply its endorsement, recommendation, or favoring by the United States government or any agency thereof. The views and opinions of authors expressed herein do not necessarily state or reflect those of the United States government or any agency thereof.

Available electronically at <http://www.osti.gov/bridge>

Available for a processing fee to U.S. Department of Energy and its contractors, in paper, from:

U.S. Department of Energy
Office of Scientific and Technical Information
P.O. Box 62
Oak Ridge, TN 37831-0062
phone: 865.576.8401
fax: 865.576.5728
email: <mailto:reports@adonis.osti.gov>

Available for sale to the public, in paper, from:

U.S. Department of Commerce
National Technical Information Service
5285 Port Royal Road
Springfield, VA 22161
phone: 800.553.6847
fax: 703.605.6900
email: orders@ntis.fedworld.gov
online ordering: <http://www.ntis.gov/ordering.htm>



Table of Contents

Executive Summary	vii
Preface.....	viii
Definitions	xi
Introduction: House Design Recommendations by Climate	Introduction - 1
Our New Hygro-Thermal Regions	Introduction - 2
Section 1. Houses That Work for Hot-Humid Climates	1-1
Introduction	1-1
Building America Best Practices for Hot-Humid Climates	1-1
Process: Building Design, Systems Engineering, and Commissioning	1-2
Site: Drainage, Pest Control, and Landscaping	1-3
Foundation: Moisture Control and Energy Performance	1-3
Envelope: Moisture Control and Energy Performance	1-4
Mechanicals / Electrical / Plumbing	1-4
Building Profile #1: The Houston	1-6
Building Science Details	1-7
Climate-Specific Details	1-9
Field Experience Notes	1-12
Material Compatibility and Substitutions	1-14
Building Profile #2: The Maitland	1-16
Building Science Details	1-17
Climate-Specific Details	1-20
Field Experience Notes	1-22
Material Compatibility and Substitutions	1-24
Building Profile #3: Orlando SIPs House	1-25
Building Science Details	1-26
Climate-Specific Details	1-28
Field Experience Notes	1-30
Material Compatibility and Substitutions	1-30
Building Profile #4: The Montgomery	1-32
Building Science Details	1-33
Climate-Specific Details	1-36
Field Experience Notes	1-38
Material Compatibility and Substitutions	1-40
Table 1: Building Materials Property Table.....	1-41

Table of Contents (continued)

Section II: Houses That Work for Cold Climates	2-1
Introduction	2-1
Building America Best Practices for Cold Climates.....	2-2
Process: Building Design, Systems Engineering, and Commissioning.....	2-2
Site: Drainage, Pest Control, and Landscaping	2-3
Foundation: Moisture Control and Energy Performance	2-3
Envelope: Moisture Control and Energy Performance	2-4
Mechanicals / Electrical / Plumbing.....	2-4
Building Profile #5: The Chicago	2-6
Building Science Details.....	2-7
Climate-Specific Details	2-10
Field Experience Notes	2-12
Material Compatibility and Substitutions	2-13
Building Profile #6: The Denver	2-15
Building Science Details.....	2-16
Climate-Specific Details	2-19
Field Experience Notes	2-21
Material Compatibility and Substitutions	2-23
Building Profile #7: The Minneapolis	2-25
Building Science Details.....	2-26
Climate-Specific Details	2-28
Field Experience Notes	2-29
Material Compatibility and Substitutions	2-32
Section III: Houses That Work for Mixed-Humid Climates	3-1
Introduction	3-1
Building America Best Practices for Mixed-Humid Climates	3-2
Process: Building Design, Systems Engineering, and Commissioning.....	3-2
Site: Drainage, Pest Control, and Landscaping	3-3
Foundation: Moisture Control and Energy Performance	3-3
Envelope: Moisture Control and Energy Performance	3-4
Mechanicals / Electrical / Plumbing.....	3-4
Building Profile #8: The Charlotte	3-6
Building Science Details.....	3-7
Climate-Specific Details	3-10
Field Experience Notes	3-13
Material Compatibility and Substitutions	3-14

Table of Contents (continued)

Building Profile #9: The Atlanta	3-16
Building Science Details	3-17
Climate-Specific Details	3-20
Field Experience Notes	3-22
Material Compatibility and Substitutions	3-24
Building Profile #10: The Louisville	3-26
Building Science Details	3-27
Climate-Specific Details	3-30
Field Experience Notes	3-33
Material Compatibility and Substitutions	3-35
Section IV: Houses That Work for Hot-Dry / Mixed- Dry Climates	4-1
Introduction	4-1
Building America Best Practices for Hot-Dry/Mixed-Dry Climates	4-2
Process: Building Design, Systems Engineering, and Commissioning	4-2
Site: Drainage, Pest Control, and Landscaping	4-3
Foundation: Moisture Control and Energy Performance	4-3
Envelope: Moisture Control and Energy Performance	4-4
Mechanicals / Electrical / Plumbing	4-4
Building Profile #11: The Albuquerque	4-6
Building Science Details	4-7
Climate-Specific Details	4-9
Field Experience Notes	4-11
Material Compatibility and Substitutions	4-14
Building Profile #12: The Sacramento	4-16
Building Science Details	4-17
Climate-Specific Details	4-20
Field Experience Notes	4-22
Material Compatibility and Substitutions	4-24
Building Profile #13: The Tucson	4-26
Building Science Details	4-27
Climate-Specific Details	4-29
Field Experience Notes	4-31
Material Compatibility and Substitutions	4-33
Appendix A: Unvented Roof Summary Article	A-1
Appendix B: Sand Layers Should Not Be Placed Between Polyethylene Vapor Barriers and Concrete Floor Slabs	B-1
Appendix C. Summary of Building Profiles	C-1

Executive Summary

The U.S. Department of Energy's (DOE) Building America Program is reengineering new and existing American homes for energy efficiency, energy security, and affordability. Building America works with the residential building industry to develop and implement innovative building energy systems—innovations that save builders and homeowners millions of dollars in construction and energy costs. This industry-led, cost-shared partnership program has the following goals:

- Reduce whole-house energy use by 40-70% and reduce construction time and waste
- Improve indoor air quality and comfort
- Integrate clean onsite power systems
- Encourage a systems engineering approach for design and construction of new homes
- Accelerate the development and adoption of high performance residential energy systems.

In 2001, the Building America Building Science Consortium (BSC) developed the Web-based Houses That Work (HTW) as a climate-specific technical resource for designing and building homes that use 30% less energy or space conditioning and hot water than the 1995 Model Energy Code (MEC). That resource reflected the experience gained from 5 years of Building America teamwork, including insights gained during the construction of more than 8,000 production homes from across the country. Houses That Work was, and is, a freely accessible learning resource and reference for builders, building product manufacturers, building researchers, and the general public.

Houses That Work II (HTWII) is more comprehensive and more detailed than the original HTW and represents the latest BSC experience and results under the Building America program. Specifically, HTWII includes the following:

- Updated North American hygro-thermal regions map that is aligned with the Department of Energy climate zones and map proposed for the International Energy Conservation Code (IECC)
- Climate-specific Best Practices with performance criteria for high-performance home design and construction
- Three Building Profiles per climate
- A Building Materials Property Table populated with technical and performance specifications from product manufacturers and building research members of the BSC.

This report has five sections—an overall HTWII introduction and four sections explaining the four most important hygro-thermal regions: Hot-Humid, Mixed-Humid, Cold, and Hot-Dry/Mixed-Dry. The introduction contains the hygro-thermal map, and each climate section contains Best Practices and three Building Profiles. HTWII in its entirety is also available on the BSC web site (www.buildingscience.com/housesthatwork). HTWII is also replete with electronic building science references. Simply click on the URL from the BSC web site to access the resource.

Preface

This report is a combination of principles, technical information, and graphic design/construction details driven by two systems: the physical and the legal.

The Physical System

The laws of physics (generally) and building science (specifically) are, pardon the expression, “cast in concrete”; that is, they define or *express* an order of things. These laws can be ignored but, ultimately, cannot be broken or changed. Think of the example of gravity—it’s not just a good idea, it’s the law. You can “ignore” it, but almost always at your peril.

For *Houses That Work*, this means understanding and managing the way that four things move on or through homes:

- Water
- Vapor
- Air
- Heat.

The *Houses That Work* Best Practices and Building Profiles focus on these four phenomena. Builders who follow the guidance provided can create high-performance homes that are safe, healthy, durable, comfortable, and economical to operate.

The Legal System

These laws were developed to *give* an order to things—they are “man-made,” sometimes arbitrary, and always changeable. These laws can be broken but, ultimately, cannot be ignored. Think of the example of speeding—you can break the speeding limit no trouble at all, but you do so at some legal risk. Sooner or later the speed limit will require your attention. Because houses are among our most durable and valuable goods, we are pretty interested in how we build them to manage long-term risk or legal liability. *Houses That Work* is about the design and construction of high-performance homes for managing just such risk and liability.

How these Two Systems Tie Together in Houses That Work

Understanding and honoring the physical system can determine how much time and money you or your company will have to spend understanding and dealing with the second. This may involve some increase in initial costs, but is also likely to reduce at least the potential for long-term liability costs. Basically, it’s the “pay now or pay later” order of things. It’s not a given that your first costs will increase when applying the best building science, but it is a given that considering your long-term costs along with your initial costs is a great way to manage the hazards associated with the legal system. And as a bonus, understanding and honoring the physical system almost always results in valuable and durable products—such as your home—becoming even more valuable and durable.

As with most situations in life, *Houses That Work* holds true to three well-known proverbs:

- The devil is in the details
- Everything is connected to everything else
- It depends.

Accordingly, *Houses That Work* is subject to the following:

- Contains a lot of technical information and details for what we believe are functional and practical building profiles
- Is based on systems engineering and goes to great lengths to express how changing one element of an assembly or system can affect other elements of the same assembly or system
- Gives climate-specific guidance, with precipitation, temperature, and humidity being factors upon which the nature and make-up of buildings are most dependent.

Having said this, there is no way that the information provided in *Houses That Work* can be considered as anything but guidance, nor should the details here be lifted directly into project drawings or specifications. The information is not intended to replace professional engineering, professional design, professional judgment, or common sense. And just as design, material selections, and construction details may change from one climate zone to the next, local environmental factors in your specific location or even on one particular lot can lead to changes not covered in any particular *Houses That Work* building profile.

To bolster your own professional judgment and building common sense, we offer the following ten building science principles to keep in the front and back of your head as you use *Houses That Work* to guide you in building high-performance homes. It should not be a surprise that all of these principles are at least indirectly related to moisture. Even in hot-dry climates, moisture events related to occupant activities, leaks, and singular climate events can bedevil the performance and durability of today's homes.

1. Our efforts to save energy and reduce the flow of heat through building assemblies have reduced drying potentials and, therefore, increased the importance of controlling moisture flow through building assemblies.
2. Ideally, building assemblies should be designed to dry to both the interior and exterior. In heating climates, the primary drying potential is to the exterior (but not necessarily exclusively so); in cooling climates, the primary drying potential is to the interior (but not necessarily exclusively so); and in climates with both heating and cooling, some drying potential in both directions is typically a good idea (but not necessarily exclusively so).
3. Building materials last longer when their faces are exposed to similar or equal temperature and humidity. This is why the ventilation of claddings, particularly those that store moisture (reservoir claddings), can be important.
4. Drainage planes, air barriers, and thermal barriers must be continuous to be truly effective. Being able to trace each of these on a full elevation drawing without lifting your finger (or pencil or pointer) from the elevation is a good test of continuity.
5. In moisture control, the priority is liquid water first, particularly when it comes in the forms of rain and groundwater. In these forms it is referred to as "bulk" water. Following are air-transported vapor and then diffusive vapor, all other things being equal. It's always a question of quantities and rates, of wetting and drying, and the tolerance of materials (individually and in combination) for each and all of the above.

6. Three things destroy materials in general and wood in particular: water, heat, and ultra-violet radiation. Of these three, water is the most important by an order of magnitude.
7. When the rate of wetting exceeds the rate of drying, accumulation occurs.
8. When the quantity of accumulated moisture exceeds the storage capacity of the material or assembly, problems occur.
9. The storage capacity of a material or assembly depends on time, temperature, and the material itself.
10. The drying potential of an assembly decreases with the level of insulation and increases with the rate of air flow (except in the case of air flow in severe cold climates during cold periods where interior moisture levels are high).

Definitions

ADA	Airtight Drywall Approach
AP	Air permeability (ASTM E2178-01)
ASTM	American Society for Testing and Materials
BA	Building America
BSC	Building Science Consortium
cfm	cubic feet per minute
CGSB	Canadian General Standards Board
DOE	U.S. Department of Energy
EPS	Expanded Polystyrene
ERV	Energy-Recovery Ventilation
FS	Flame Spread (ASTM E84)
HDD	Heat Degree Days
HPR	Hydrostatic Pressure Resistance (AATCC127)
HRV	Heat-Recovery Ventilation
HSPF	Heating Seasonal Performance Factor
HTW	Houses That Work
HTWII	Houses That Work II
HVAC	Heating, Ventilation, and Air-Conditioning
ICC	International Code Council
IECC	International Energy Conservation Code
MEC	Model Energy Code
MERV	Minimum Efficiency Reporting Value
OSB	Oriented Strand Board
perm	Building Science Consortium definition: a perm is a unit of measurement that reflects how readily water vapor passes through a material of a certain thickness. A material with a perm rating less than 1 is considered impermeable, greater than 1 but less than 10 perms is considered vapor semi-permeable, and greater than 10 perms is considered vapor permeable

Definitions (continued)

RH	Relative Humidity
SD	Smoke Development (ASTM E84)
SHGC	Solar Heat Gain Coefficient
SNAPSHOT	Short Non-Destructive Approach to Provide Significant House Operation Thresholds
TIP	Termite Infestation Problem
WA	Water Adsorption (ASTM C209)
w/c	water to concrete ratio
XPS	Extruded Polystyrene

Introduction: House Design Recommendations by Climate

Buildings should be suited to their environments. We have accepted that design and construction must be responsive to varying seismic risks, wind loads, and snow loads. We also consider soil conditions, frost depth, orientation, and solar radiation. Yet we typically ignore the variances in temperature, rainfall, exterior and interior humidity, and their interaction.

Building envelopes and mechanical systems should be designed for a specific hygro-thermal region (Map 1), rain exposure (Map 2), and interior climate. While there are similarities among hygro-thermal regions, there may also be important differences as a result of annual rainfall. It is cold and dry in Wyoming; it is cold and somewhat wet in Wisconsin. Therefore, significantly different design and construction practices would be called for in these two states. The Building Science Consortium (BSC) design recommendations are based on the hygro-thermal regions with reference to the annual rainfall. Local climate must be addressed if it differs significantly from the climate described for a particular design.



Our recommendations are based on our experience with what works and what does not work, from forensic investigations of building failures, and from the results of test houses and thousands of houses constructed by builder partners of the Building America (BA) program. These design recommendations are the starting point for a thoughtful approach to designing a specific house in a specific location and climate, often for a specific purpose. We include the reasoning behind our selection of different envelope assemblies for different climates. We also discuss the greatest risks for moisture-related problems in each specific design.

A house is a system of inter-related systems and materials. Consequently, a change in one component might have dramatic, even catastrophic, effects on the performance of that assembly or the house as a whole. In each of the Building Profiles, we discuss the critical elements in the envelope that should be altered only with detailed understanding of the effects that follow the change. To learn more about how a slight change in a wall assembly can have disastrous consequences for a house and the builder, go to the article on Brick Veneer, Rain, and Sun at www.buildingscience.com/resources/walls/brick_veneer_rain_sun.pdf.

Cost is usually a factor in designing and building houses, especially affordable houses. Every project has a budget. Nevertheless, durability and its value to the owner should not be jeopardized just to save a few dollars on construction costs. We point out ways in which the recommended houses can be made even more robust at some additional cost. The designer, builder, and future owner will have to decide how much more to spend for a house that performs better and longer.

Houses That Work (HTW) consists of three sets of guidance: Best Practices, Building Profile, and the Building Materials Properties Table. These are briefly described here.

Best Practices

Based largely on BSC Building America Performance Targets (available at the BSC web site www.buildingscience.com/buildingamerica/targets.htm), the Best Practices lay out the general principles and performance objectives for designing and constructing high performance homes in a given climate.

Building Profiles

The Building Profiles presented in this report are representative constructions consisting of the following:

- A cross-sectional drawing
- Building science details
- Climate-specific details
- Field experience notes, and
- Material compatibility and substitutions.

The Building Materials Property Table

This table lists nearly 50 of the most common building materials with performance specifications, such as vapor permeability, that support the selection or the substitution of building materials based on building science and overall performance of the envelope system.

The first two sets of guidance, Best Practices and Building Profiles, contain many links to other BSC technical resources that BSC staff and production builder partners use for more detailed follow-up instruction or explanation.

Used in concert, the *Houses That Work* elements provide a comprehensive and detailed technical resource on climate-specific residential construction.

Our New Hygro-Thermal Regions

Climate-specific design and construction of high-performance homes is a cornerstone of all BSC work. With BSC input, Building America recently modified the criteria and North American climate map defining the eight hygro-thermal regions (Map 1). The changes are not drastic, but they are important because they make our criteria and map more consistent with the boundaries of the Climate Zones proposed by the Department of Energy (DOE) for the International Energy Conservation Code (IECC), and approved in September 2003 by the International Code Council (ICC): www.energycodes.gov/implement/pdfs/color_map_climate_zones_Mar03.pdf. Whenever the building science community and the code community get on (literally) the same page, this is good news for builders of any homes, but particularly those that build climate-tuned, high-performance homes.

Here is how the two maps align:

- | | |
|--------------------------|---|
| • New Hot-Humid region | DOE Proposed Climate Zones 1, 2A, 3A below the warm-humid line, and 2B below the warm-humid line (“A” represents the “moist” portion of the DOE temperature zones, and “B” represents the “dry” portion). |
| • New Hot-Dry region | DOE Proposed Climate Zones 3B, plus 2B above the warm-humid line. |
| • New Mixed-Humid region | DOE Proposed Climate Zones 4A, plus 3A above the warm-humid line. |

- New Marine region DOE Proposed Climate Zones 3C and 4C
- New Mixed-Dry region DOE Proposed Climate Zone 4B
- New Cold region DOE Proposed Climate Zones 5 and 6
- New Severe Cold region DOE Proposed Climate Zone 7
- New Subarctic/Arctic Region DOE Proposed Climate Zone 8.



Map 1-1. The New Building America Hygro-Thermal Regions

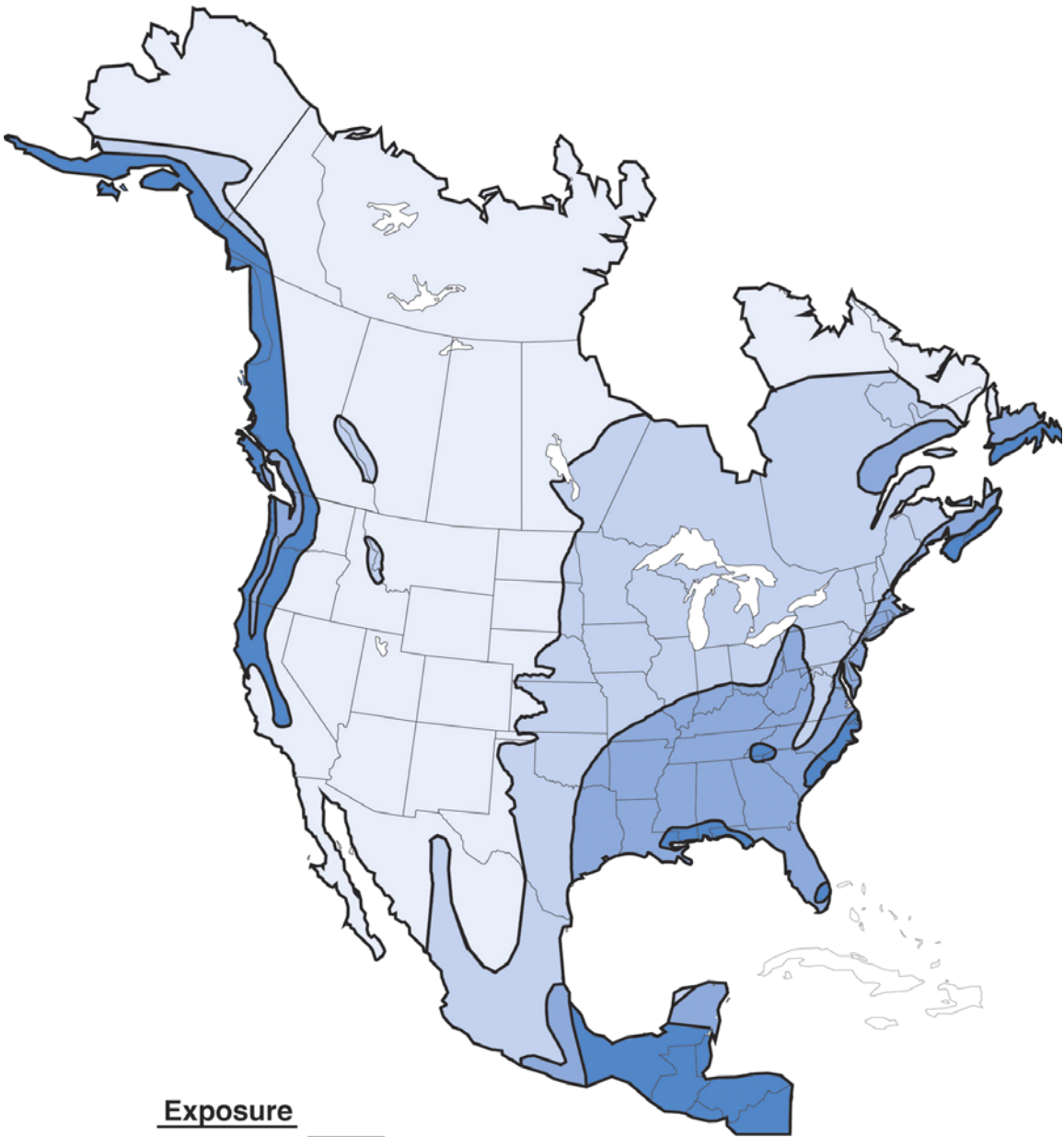

Exposure

Extreme		Over 60" Pressure Equalized Rain Screen/Pressure Moderated Screen
High		40" - 60" Rain Screen/Vented Cladding/Vented Drainage Space
Moderate		20" - 40" Drainage Plane/Drainage Space
Low		Under 20" Face Seal

Map 1-2. Annual Precipitation

DOE assigns specific locations to climate zones based the county in which the site is located. These county assignments may be found on the Building America web site (www.eere.energy.gov/buildings/building_america). However, the following approximate definitions of each climate region have been developed based on heating degree-days, average temperatures and precipitation:

New: Subarctic/Arctic²

A subarctic and arctic climate is defined as a region with approximately 12,600 heating degree days (65°F basis)³ or more.

New: Very Cold

A very cold climate is defined as a region with approximately 9,000 heating degree days (65°F basis)⁴ or more and fewer than approximately 12,600 heating degree days (65°F basis).

*(Previously this was called **Severe Cold**, which was a defined as a region with approximately 8,000 heating degree days or more.)*

New: Cold

A cold climate is defined as a region with approximately 5,400 heating degree days (65°F basis)⁵ or more and fewer than approximately 9,000 heating degree days (65°F basis)⁶.

*(Previously this was called **Cold**, which was a climate is defined as a region with approximately 4,500 heating degree days or more and fewer than approximately 8,000 heating degree days.)*

New: Mixed-Humid

A mixed-humid climate is defined as a region that receives more than 20 in. (50 cm) of annual precipitation (Map 2), has approximately 5,400 heating degree days (65°F basis)⁷ or fewer, and where the average monthly outdoor temperature drops below 45°F (7°C) during the winter months.

*(Previously this was called **Mixed-Humid**, which was a climate defined as a region that receives more than 20 in. of annual precipitation, has approximately 4,500 heating degree days or less and where the average monthly outdoor temperature drops below 45°F during the winter months.)*

New: Hot-Humid

A hot-humid climate is defined as a region that receives more than 20 in. (50 cm) of annual precipitation and where one or both of the following occur:

- A 67°F (19.5°C) or higher wet bulb temperature for 3,000 or more hours during the warmest 6 consecutive months of the year; or

² BSC has not yet developed climate-specific building science guidance for the new Subarctic/Arctic region.

³ Celsius: 7,000 heating degree days (18°C basis)

⁴ Celsius: 5,000 heating degree days (18°C basis)

⁵ Celsius: 3,000 heating degree days (18°C basis)

⁶ Celsius: 5,000 heating degree days (18°C basis)

⁷ Celsius: 3,000 heating degree days (18°C basis)

- A 73°F (23°C) or higher wet bulb temperature for 1,500 or more hours during the warmest 6 consecutive months of the year.⁸

*(Previously this was called **Hot-Humid**, which was a climate defined as a region that receives more than 20 in. of annual precipitation and where the monthly average outdoor temperature remains above 45°F throughout the year.)*

New: Hot-Dry and Mixed-Dry

A hot-dry climate is defined as a region that receives less than 20 in. (50 cm) of annual precipitation and where the monthly average outdoor temperature remains above 45°F (7°C) throughout the year.

A mixed-dry climate is defined as a region that receives less than 20 in. (50 cm) of annual precipitation, has approximately 5,400 heating degree days (50° F basis) or less, and where the average monthly outdoor temperature drops below 45°F (7°C) during the winter months.

On the new DOE climate map, this includes zones 2B, 3B, and 4B.

*(Previously this was called: **Hot-Dry/Mixed-Dry**, which is a climate defined as a region that receives less than 20 in. of annual precipitation and where the monthly average outdoor temperature remains above 45°F throughout the year.)*

A mixed-dry climate is defined as a region that receives less than 20 in. of annual precipitation.

New: Marine⁹

A marine climate meets all of the following criteria:

- A mean temperature of coldest month between 27°F (−3°C) and 65°F (18°C)
- A warmest month mean of less than 72°F (22°C)
- At least 4 months with mean temperatures more than 50°F (10°C)
- A dry season in summer. The month with the heaviest precipitation in the cold season has at least three times as much precipitation as the month with the least precipitation in the rest of the year. The cold season is October through March in the Northern Hemisphere and April through September in the Southern Hemisphere.

Note: Don't forget that it is always the conditions that you actually experience in your area that determine the appropriate building design and construction details. The Building America Climate Zones provide simplified groupings of geographic locations that may actually vary greatly in terms of weather, and therefore should be viewed as guidelines.

⁸ These last two criteria are identical to those used in the ASHRAE definition of warm-humid climates and are very closely aligned with a region where the monthly average outdoor temperature remains above 45°F (7°C) throughout the year.

⁹ BSC has not yet developed climate-specific building science guidance for the new Marine region. In the interim, guidance provided in the HTWII Mixed-Humid climate generally applies.

I. Houses That Work for Hot-Humid Climates

Introduction

For the purpose of defining best practices in this report, a hot-humid climate is considered a region that receives more than 20 in. of annual precipitation and where one or both of the following conditions occur:¹

- A 67°F (19.5°C) or higher wet bulb temperature for 3,000 or more hours during the warmest 6 consecutive months of the year, or
- A 73°F (23°C) or higher wet bulb temperature for 1,500 or more hours during the warmest 6 consecutive months of the year.

The intense solar radiation in this climate imposes a large thermal load on the house that can increase cooling costs and affect comfort. The approach presented in HTWII minimizes the impact of solar radiation on the building, its mechanical system, and its occupants.

Moisture is a significant problem in this climate, more so in those areas that receive more than 40 in. of annual precipitation. The ambient air has significant levels of moisture most of the year. Because air conditioning is installed in most new homes, cold surfaces are present on which condensation can occur. Controlling the infiltration of this moisture-laden air into the building envelope and keeping moisture away from cold surfaces are major goals of design and construction.

Housing types vary greatly throughout all of the different climate zones, but nowhere is the contrast so great as in the Hot-Humid climate of the southern United States.

In many parts of Florida, block wall assemblies predominate, whereas wood frame is most commonly used in Texas. For this reason, we have chosen three different Building Profiles that we think best represent the Hot-Humid climate:

- **The “Houston”** —two-story, slab-on-grade, first floor brick veneer, second floor fiber cement lap siding, conditioned attic with asphalt shingle roof (Figure 1-1)
- **The “Maitland”** —two-story, slab-on-grade, both floors stucco, conditioned attic, tile roof (Figure 1-8)
- **The “Orlando SIPs House”** —two-story, slab-on-grade, both floors stucco, conditioned attic, tile roof (Figure 1-14)
- **The “Montgomery”** —one-story, conditioned crawlspace, vinyl/aluminum lap siding, unconditioned attic, standing-seam metal roof (Figure 1-19).

A substantial amount of repetition is present in these Building Profiles, but is necessary in order to provide comprehensive, stand-alone, examples of performance packages that achieve 40% energy savings while maintaining or improving quality and durability. Photographs and a case study for a production builder project in a Hot-Humid climate are available on the Building America portion of the Building Science Corporation Web site. The case study explores the builder's experience with the Building America program and discusses the reasons for the specific design and construction details that are used by Pulte Homes in Houston, Texas. Additional information on construction methods and alternative designs are included in the *EEBA Builder's Guide Hot-Humid Climates* and in the *EEBA Water Management Guide* (www.eeba.org/bookstore).

¹ This definition is identical to the ASHRAE definition of warm-humid climates and is very closely aligned with a region where the monthly average outdoor temperature remains above 45°F (7°C) throughout the year.

Building America Best Practices for Hot-Humid Climate

The primary consideration for high-performance Building America homes in hot-humid climates is maintaining moisture control both inside the home and within building assemblies, particularly as energy conservation shifts the relationship between sensible and latent loads. Reducing solar gain, using energy conserving appliances and compact fluorescent lighting, reduces the size of the sensible load relative to the latent load. This affects the ability of the air conditioner to remove moisture or dehumidify the air.

The following Best Practices are based on our Building America Performance Targets (www.buildingscience.com/buildingamerica/targets.htm) and are reflected in the four Hot-Humid building profiles: the “Houston,” the “Maitland,” the “Orlando SIPs House,” and the “Montgomery.” All climate-specific Best Practices are identified with a bolded and bracketed [HH].

Process: Building Design, Systems Engineering, and Commissioning

Design for Energy Performance

Energy performance for space conditioning and hot water 40% better than the 1995 MEC base case house (i.e., equal to 10% better than ENERGY STAR® performance requirements)

Systems Engineering

Design structure using advanced framing methods (see www.buildingscience.com/housethatwork/advancedframing/default.htm or www.buildingscience.com/resources/presentations/advanced_framing.pdf)

Design structure to accommodate the most efficient duct distribution system that places all ducts and air handling equipment within conditioned space (see www.buildingscience.com/resources/misc/wood_efficiency.pdf; specifically Figure 1-4)

Design and detail structure for durability, in terms of wall and roof assembly drying potential, continuous drainage plane, and continuous thermal barrier that clearly defines the conditioned space (see the Building Profiles section of this report) [HH]

Commissioning: Performance Testing

Air leakage (determined by blower door depressurization testing) should be less than 2.5 in.²/100 ft² surface area leakage ratio (CGSB [Canadian General Standards Board], calculated at a 10-Pa pressure differential); or 1.25 in.²/100 ft² leakage ratio (ASTM [American Society for Testing and Materials], calculated at a 4-Pa pressure differential); or 0.25 cubic feet per minute/square feet (cfm/ft²) of building envelope surface area at a 50-Pa air pressure differential. If the house is divided into multiple conditioned zones, such as a conditioned attic or conditioned crawl space, the blower door requirement must be met with the access to the space open, connecting the zones.

Ductwork leakage to the exterior for ducts distributing conditioned air should be limited to 5% of the total air-handling system rated air flow at high speed (nominal 400 cfm per ton) determined by pressurization testing at 25 Pa. Two acceptable compliance mechanisms are (1) test duct leakage to outside at finish stage or (2) test total duct leakage at duct rough-in stage.

Forced-air systems that distribute air for heating and cooling should be designed to supply airflow to all conditioned spaces and zones (bedrooms, hallways, basements), as well as to provide a return path from all conditioned spaces or zones. Interzonal air pressure differences, when doors are closed, should be limited to 3 Pa. This is typically achieved by installing properly sized transfer grilles or jump ducts (see www.buildingscience.com/resources/mechanical/transfer_grille_detail.pdf and www.buildingscience.com/resources/mechanical/transfer_grille_sizing_charts.pdf).

Mechanical ventilation system airflow should be tested during commissioning of the building.

Testing of the house should be completed as part of the commissioning process. The SNAPSHOT (Short Non-Destructive Approach to Provide Significant House Operation Thresholds) form is available for download as a convenient way to record the testing information (see www.buildingscience.com/buildingamerica/snapshot_form.pdf). Instructions for completing the form are also available (see www.buildingscience.com/buildingamerica/snapshot_instructions.pdf). Unique or custom house plans should each be tested. In a production setting, each model type (i.e., floor plan) should be tested until two consecutive houses of this model type meet testing requirements. At this point, testing on this model type can be reduced to a sampling rate of one in seven (i.e., one test, with six "referenced" houses). Small additions to a floor plan (e.g., bay window, conversion of den to bedroom) should be considered the same model type; major changes (e.g., bonus room over the garage, conversion of garage into casita or hobby room, etc) should be considered a separate model type.

Site: Drainage, Pest Control, and Landscaping

Drainage

Grading and landscaping shall be planned for movement of building run-off away from the home and its foundation, with roof drainage directed at least 3 ft beyond the building and a surface grade of at least 5% maintained for at least 10 ft around and away from the entire structure.

Pest Control

Based on local code and Termite Infestation Probability (TIP) maps, use environmentally appropriate termite treatments, bait systems, and treated building materials that are near or have ground contact (see www.uky.edu/Agriculture/Entomology/entfacts/). [HH]

Landscaping

Plantings should be held back as much as 3 ft and no less than 18 in. from the finished structure, with any supporting irrigation directed away from the finished structure. Decorative ground cover—mulch or pea stone, for example—should be thinned to no more than 2 in. for the first 18 in. from the finished structure (see Building Profiles). [HH]

Foundation: Moisture Control and Energy Performance

Moisture Control

The building foundation shall be designed and constructed to prevent the entry of moisture and other soil gases (see Building Profiles). [HH]

Slabs require a 6-mil polyethylene sheeting directly beneath the concrete or an equivalent approach (such as rigid insulation) that accomplishes vapor control and capillary control for the slab. The vapor barrier must continuously wrap the slab as well as the grade beam.

Sub-slab drainage where necessary shall consist of a granular capillary break directly beneath the slab vapor barrier.

Use radon resistant construction practices as described on the EPA radon control web site (www.epa.gov/iaq/radon/construc.html).

Energy Performance

Slabs in this climate are generally not insulated, even at the perimeter, because of the low overall heating load (less significant delta-T overall) and code restrictions on below-grade use of rigid foam insulation. Local codes and economics permitting, consider the use of borate-treated rigid insulation on the slab perimeter (see the Building Profiles and photo detail at www.buildingscience.com/buildingamerica/casestudies/fairburn.htm). [HH]

Envelope: Moisture Control and Energy Performance

Moisture Control

Water management. Roof and wall assemblies must contain elements that provide drainage in a continuous manner over the entire surface area of the building enclosure, including lapped flashing systems at all penetrations. See the Building Profiles or the *EEBA Water Management Guide* for specific details for various wall assemblies. [HH]

Vapor management. Roof and wall assemblies must contain elements that, individually and in combination, permit drying of interstitial spaces (see Building Profiles). [HH]

Energy Performance

Air leakage. Exterior airflow retarder is foam sheathing; interior air-flow retarder is gypsum board sealed to the slab and frame walls (Airtight Drywall Approach [ADA]). For details of the ADA for interior airflow retarders, see the Building Profiles. [HH]

Windows. We recommend one of two approaches:

- U-factor 0.35 or lower and SHGC (solar heat gain coefficient) 0.35 or less, regardless of climate
- Climate and/or orientation-specific glazing properties if the builder can employ passive solar orientation and design and if occupants can be expected to operate window shading in concert with time of day and weather conditions. [HH]

Mechanicals/Electrical/Plumbing

Systems Engineering

Heating, Ventilation, and Air-Conditioning (HVAC) system design, both equipment and duct, should be done as an integral part of the architectural design process.

HVAC system sizing should follow ACCA Manual J, and duct sizing should follow ACCA Manual D (see www.buildingscience.com/resources/mechanical/509a3cooling_system_sizing_pro.pdf).

Mechanical ventilation should be an integral part of the HVAC system design (see the Building Profiles or www.buildingscience.com/resources/mechanical/advanced_space_conditioning.pdf).

A whole house dehumidification system integral to the air handling system is recommended for this climate (see the Building Profiles and www.buildingscience.com/resources/mechanical/conditioning_air.pdf). [HH]

Energy Performance

Air conditioner or heat pump shall be installed according to best practices; see www.buildingscience.com/resources/mechanical/air_conditioning_equipment_efficiency.pdf.

Major appliances meet high-energy efficiency standards using current appliance ratings. Only those appliances in the top one-third of the DOE Energy Guide rating scale should be selected. For further details, see www.eren.doe.gov/consumerinfo/energy_savers/appliances.html.

Occupant Health and Safety

Base rate ventilation. Controlled mechanical ventilation per ASHRAE Standard 62.2.

Spot ventilation. Intermittent spot ventilation of 100 cfm should be provided for each kitchen; all kitchen range hoods must be vented to the outside (no recirculating hoods). Intermittent spot ventilation of 50 cfm, or continuous ventilation of 20 cfm when the building is occupied, should be provided for each washroom/bathroom.

All combustion appliances in the conditioned space must be sealed combustion or power vented. Specifically, any furnace inside conditioned space should be a sealed-combustion 90%+ unit. Any water heater inside conditioned space should be power vented or power-direct vented. Designs that incorporate passive combustion air supply openings or outdoor supply air ducts not directly connected to the appliance should be avoided.

Provide filtration systems for forced air systems that provide a minimum atmospheric dust spot efficiency of 30% or MERV (Minimum Efficiency Reporting Value) of 6 or higher.

Indoor humidity should be maintained in the range of 25% to 60% by controlled mechanical ventilation, mechanical cooling, or dehumidification (see www.buildingscience.com/resources/moisture/relative_humidity_0402.pdf).

Carbon monoxide detectors (hard-wired units) shall be installed (at one per every approximate 1000 ft²) in any house containing combustion appliances or an attached garage.

Information relating to the safe, healthy, comfortable operation and maintenance of the building and systems that provide control over space conditioning, hot water or lighting energy use shall be provided to occupants.

Envelope/Mechanicals Management

Plumbing. No plumbing in exterior walls. Air seal around plumbing penetrations in pressure boundary (air barrier) such as rim (band) joist or ceiling.

Electrical. Seal around wires penetrating air barrier or pressure boundary.

Building Profile #1. The Houston

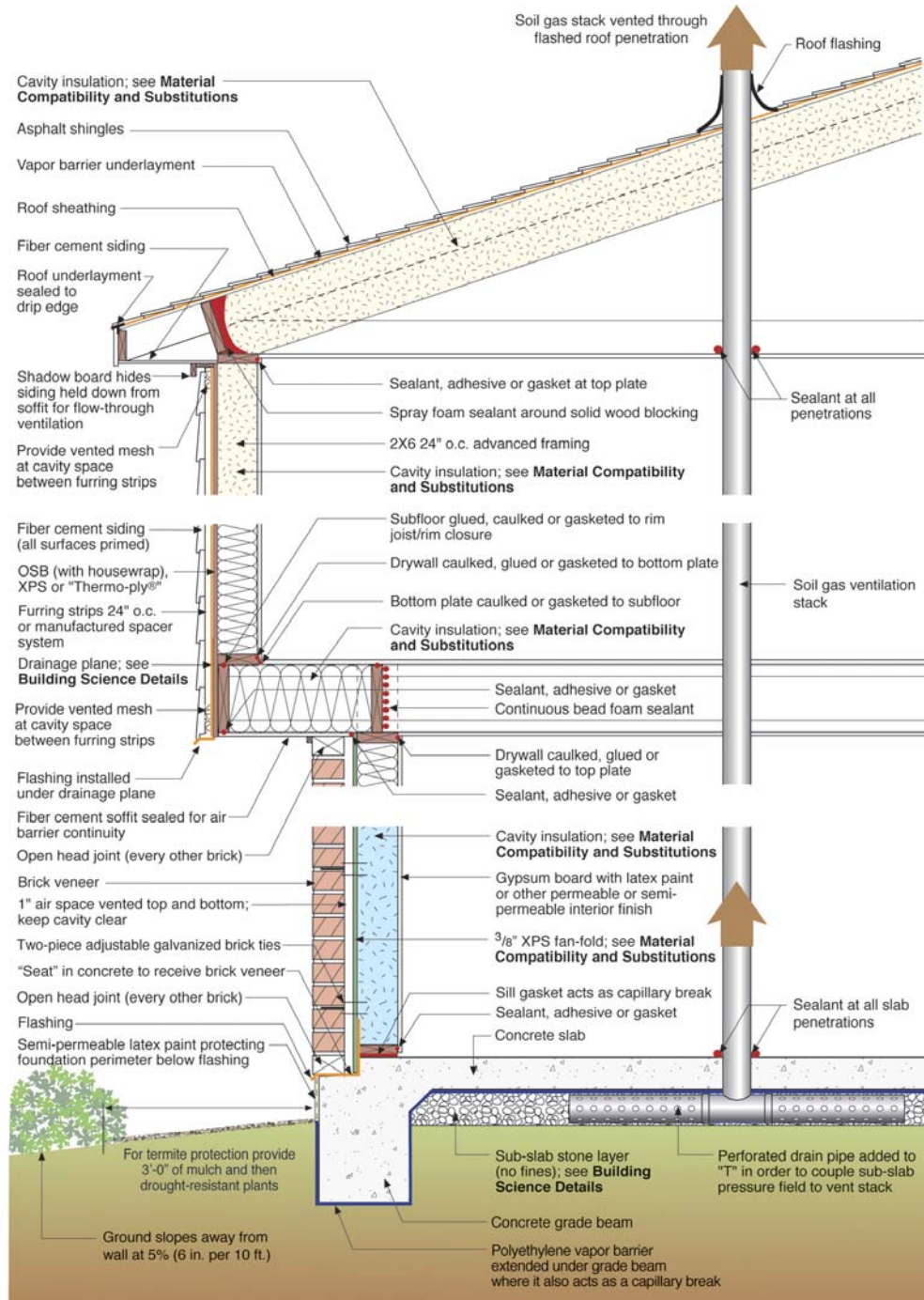

Foundation: Slab
 Above Grade Wall: Wood frame
 Attic: Conditioned
 Roof: Asphalt shingles
 Cladding (1st floor): Brick veneer
 Cladding (2nd floor): Fiber cement siding

Figure 1-1. Cross section of the Houston

Building Science Details

Air Sealing Details at Transitions

Air sealing can be particularly difficult, but no less important, at assembly transitions, such as top-of-wall/roof assembly junctions, band joists, and between attached garages and living spaces. These three are discussed below because they have proven to be a consistent challenge for builders.

Top-of-Wall/Roof Assembly Junction

The continuity of an exterior air barrier can be maintained at this junction if the air barrier material (foam insulation or stucco cladding, for example) is used continuously for the wall, soffit, and fascia. The continuity of an interior air barrier can be maintained through a combination of cut foam blocks and sealant/caulk, or spray foam. Note that neither cellulose nor fiberglass (batt or blown) can be used for the air barrier.

Band Joists

Continuity of an exterior air barrier can be maintained at the band joist with sealed or taped housewrap or rigid foam insulation. Continuity of an interior air barrier can be maintained through a combination of cut foam blocks and sealant/caulk, or spray foam. Note that neither cellulose nor fiberglass (batt or blown) can be used for the air barrier. The air barrier detail on second-story band joists is important because it is inaccessible (covered by structural/finish floor and ceiling finish) after construction. The air barrier/thermal envelope detail is important on ground floor band joists because of the thermal bridge that can occur at the top of crawlspace foundation walls (as the result of the air barrier and thermal envelope moving from the outside to the inside of the building envelope and termite inspection zones located at the top of crawlspace foundation walls). Note that while fiberglass batts fulfill the requirement for protection from ignition in the open band joists, fiberglass batt material by itself cannot maintain the air barrier.

Attached Garages

The building envelope surfaces shared between conditioned space and an unconditioned garage must have a continuous air barrier. See Figure 1-2 for details in terms of using sealants and rigid insulation to create a continuous air barrier between the attached garage and living space. Refer to www.buildingscience.com/housethatwork/airsealing/default.htm for air sealing details.

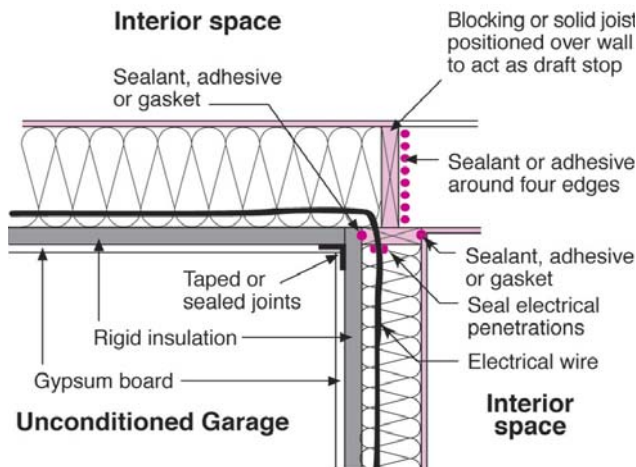

Figure 1-2. Creating a continuous air barrier

Drying Mechanisms

In any climate, vapor control is based on the relationships among the following: the permeability of wall components, the type of cladding (reservoir or non-reservoir), the presence/lack/nature of an air space, and the magnitude/duration of the vapor drive (based on the relationship between the exterior and interior moisture content and temperature differences). The type of sheathing and housewrap used in any wall assembly must be based on an understanding of these inter-relationships. See “Insulations, Sheathings, and Vapor Diffusion Retarders” for more information (www.buildingscience.com/resources).

Because the wall and roof assemblies in this building profile have a vapor retarder or vapor barrier on the exterior, high vapor permeability of the interior sheathing and finish (gypsum wallboard and latex paint) are necessary to facilitate the drying of the wall assembly to the interior.

Drainage Plane, Air Barrier, and Vapor Control

In this wall assembly, the 3/8-in. extruded polystyrene (XPS) fan-fold rigid insulation is acting as the drainage plane (as well as providing a contribution to the thermal barrier). While the XPS does function as a secondary air barrier, the primary air barrier is the interior gypsum board installed using the Airtight Drywall Approach. Note that on the second floor cantilever, there is both an interior and an exterior air barrier. Sealing the joints between sections of the fiber cement soffit is difficult, so blocking is installed and sealed between the floor joists directly above the top plate of the first floor wall. The 1-in. air space vented top and bottom by the open head joints provides a mechanism for controlling solar-driven moisture from the brick veneer (a reservoir cladding), as does the 3/8-in. XPS fan-fold rigid insulation by acting as a vapor barrier and draining condensed moisture. For more information on the phenomenon of solar-driven moisture and reservoir claddings, go to

www.buildingscience.com/resources/walls/solar_driven_moisture_brick.htm. See Field Experience Notes for more information on this sheathing and Material Compatibility and Substitutions if you are not using this sheathing material.

Window Flashing

Window flashing details are wall assembly or cladding specific (Figure 1-3 and *EEBA Water Management Guide* www.eeba.org/bookstore).

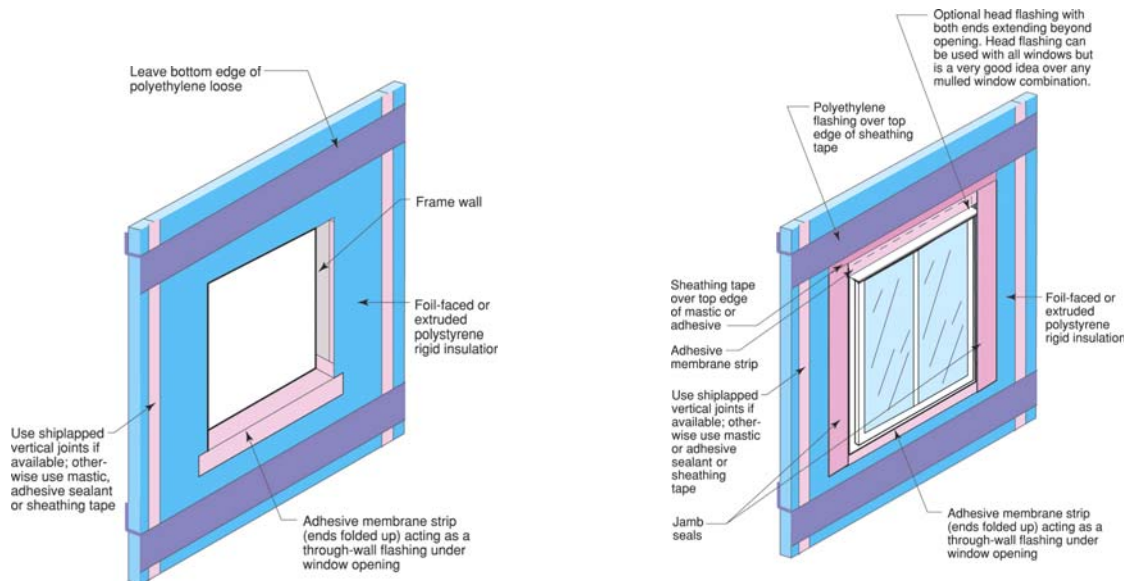

Figure 1-3. Window flashings

Advanced Framing

An important element of high performance wood-frame construction is an advanced framing package, in this case including cross-bracing or some alternative for shear resistance. For more detailed information on advanced framing techniques, see www.buildingscience.com/housethatwork/advancedframing/default.htm.

Framing on Slabs

Installing a capillary break between the sill plate and a concrete slab on all walls—exterior, interior, partition—is good practice. A closed cell foam sill sealer or gasket works well. Alternatively, a strip of sheet polyethylene can be used. This isolates the framing from any source of moisture that may be either in or on the concrete slab (and using sill sealer on all walls maintains wall height exactly the same).

Soil Gas Ventilation

The sub-slab to roof vent system handles conditions that are difficult, if not impossible, to assess before completion of the structure — confined concentrations of air-borne radon, soil treatments (termiticides, pesticides) methane, etc. The cost of this "ounce" of prevention is well balanced against the cost of the "pound" of cure. Note that this system is a passive system that can easily be converted to an active ventilation system by installing an in-line fan in the stack in the attic.

Thermal Barrier

In this climate, moisture control does not require specific levels of insulation. Inside/outside temperature differences do not require cavity-warming exterior rigid insulation to control wintertime condensing surface temperatures. Having said this, insulating sheathing in general is a good idea. We recommend full cavity fill in the walls, but the 2-x-6 framing is more about advanced framing than the depth of cavity insulation that can be achieved. The R-22 cellulose or R-30 batts in the conditioned attic have proven to be adequate to provide interior conditions for enhanced HVAC equipment durability and duct performance when these systems are located in the attic. Cellulose netting or fiberglass batt supports create an insulation “belly” and accommodate cavity fill depth that exceeds the depth of the truss top chord.

Sub-slab Stone Bed

The 4-in.-deep ¾-in. stone bed functions as a granular capillary break, a drainage pad, and a sub-slab air pressure field extender for the soil gas ventilation system. The sub-slab stone bed is a practical method for venting soil gas should it be necessary.

Climate-Specific Details

Termite Management

In hot-humid climates, termites are best managed with a three-pronged approach that deals with the three things termites need — cover from sunlight, moisture, and food (wood or paper):

Reduced cover. Keep plantings 3 ft away from the building perimeter, thin the ground cover (wood mulch or pea stone) to no more than 2 in. depth for the first 18 in. around the building and maintain any termite inspection zone on the exterior of the foundation.

Moisture control. Maintain slope away from building as shown, carry roof load of water at least 3 ft away from building and make sure that irrigation is directed away from the building.

Chemical treatment. Use an environmentally appropriate soil treatment (such as Termidor®) and a building materials treatment (such as Bora-Care®) for termite-prone near-grade wood materials.

Inter-relationship of first three points. Because a builder and a homeowner’s ability to employ or stick to each of the three strategies above will vary, make sure that an inability to fully employ one strategy is compensated for by complete rigor with the others. For example, if for some reason, chemical treatment of soil or building materials is not an option, then complete rigor in moisture control and ground cover is required.

Asphalt Shingles and a Roofing Vapor Barrier

Solar-driven moisture through standard roofing papers under asphalt shingles requires that a vapor impermeable roofing underlayment be installed between the asphalt shingles and the structural roof deck. See the Building Materials Property Table (www.buildingscience.com/housethatwork/buildingmaterials.htm) for suitable materials. For an in-depth discussion of the phenomenon of solar-driven moisture in hot-humid climates in roof assemblies, go to www.buildingscience.com/resources/roofs/unvented_roof.pdf.

Conditioned Attics

This assembly (Figure 1-4) may require discussion with the local building code official. For further information, read the article entitled “Unvented Roof Summary” (Appendix A).

Mechanical Systems

The following are key elements of a system for this climate:

Sealed Combustion Gas Furnace. This provides energy efficiency and health/safety with the unit inside conditioned space.

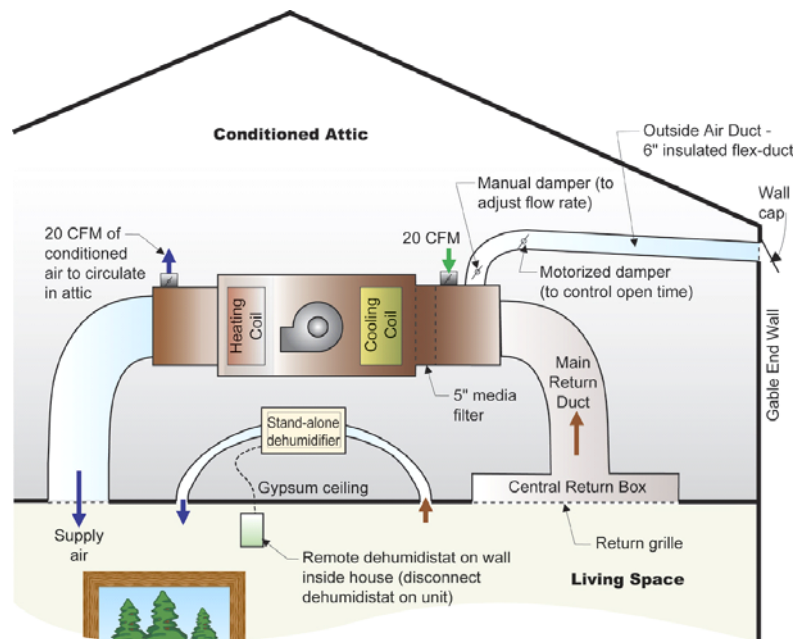

Figure 1-4. A conditioned attic

Minimum 12 SEER A/C Unit. This ensures energy efficient management of sensible load.

Central-fan Integrated Supply Ventilation. This system is simple, effective, and economical. It provides fresh, filtered, outside air in a controlled amount using the existing HVAC delivery system for even distribution and mixing. Set-up intermittent central-fan integrated supply, designed to ASHRAE 62.2P rate, with fan cycling control set to operate the central air handler 10 min every hour to provide ventilation air distribution and whole-house averaging of air quality and comfort conditions (\$125 to \$150). Include a normally closed motorized damper in the outside air duct with the AirCycler™ FRV control (+\$50 to \$60). See Appendix B for more detailed information.

Supplemental Dehumidification. All homes in this climate call for supplemental dehumidification because the reduced sensible load of high-performance homes reduces the dehumidification the A/C unit provides, extends shoulder seasons, and raises the impact of occupant-generated moisture. The ducted stand-alone dehumidifier in the attic controlled by a humidistat located in the living space has proven to be the most effective and economical system for the production home building setting. Our recommended system (+\$300 to \$350) includes GE dehumidifier model AHG40FCG1 located in an insulated enclosure in the attic and ducted to the living space, Honeywell humidistat model H8808C located in the living space, and Honeywell switching relay (with transformer) model RA89A 1074. For a detailed discussion of supplemental dehumidification see

www.buildingscience.com/resources/mechanical/conditioning_air.pdf.

Ducts in Conditioned Space. The preferred method for keeping HVAC ducts and mechanical equipment inside conditioned space is to either move them down from the attic, or move the conditioned boundary up (to the underside of the roof sheathing) so that the attic is conditioned as shown in Figure 1-5. In no case should HVAC ducts be placed within exterior wall assemblies — this is not what is meant by ducts in conditioned space. A vented attic assembly may be used in this climate as long as the ceiling plane is air tight and no ductwork or air-handling equipment is located in the attic.

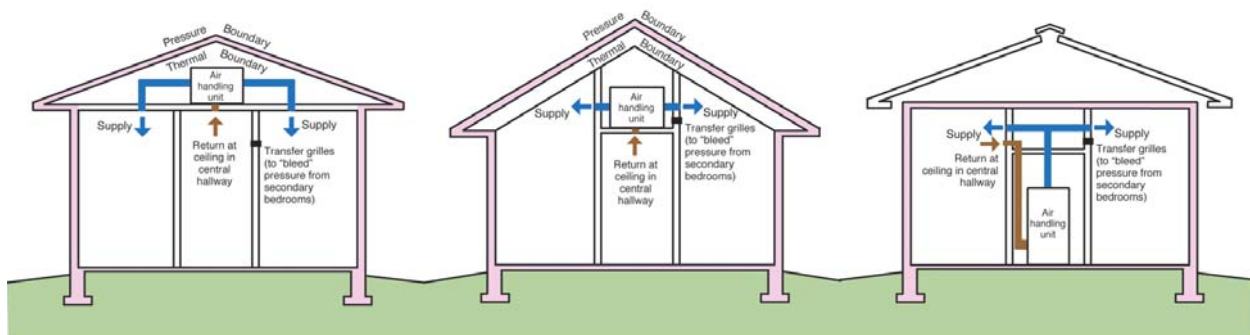

Note: Colored shading depicts the building's thermal barrier and pressure boundary. The thermal barrier and pressure boundary enclose the conditioned space.

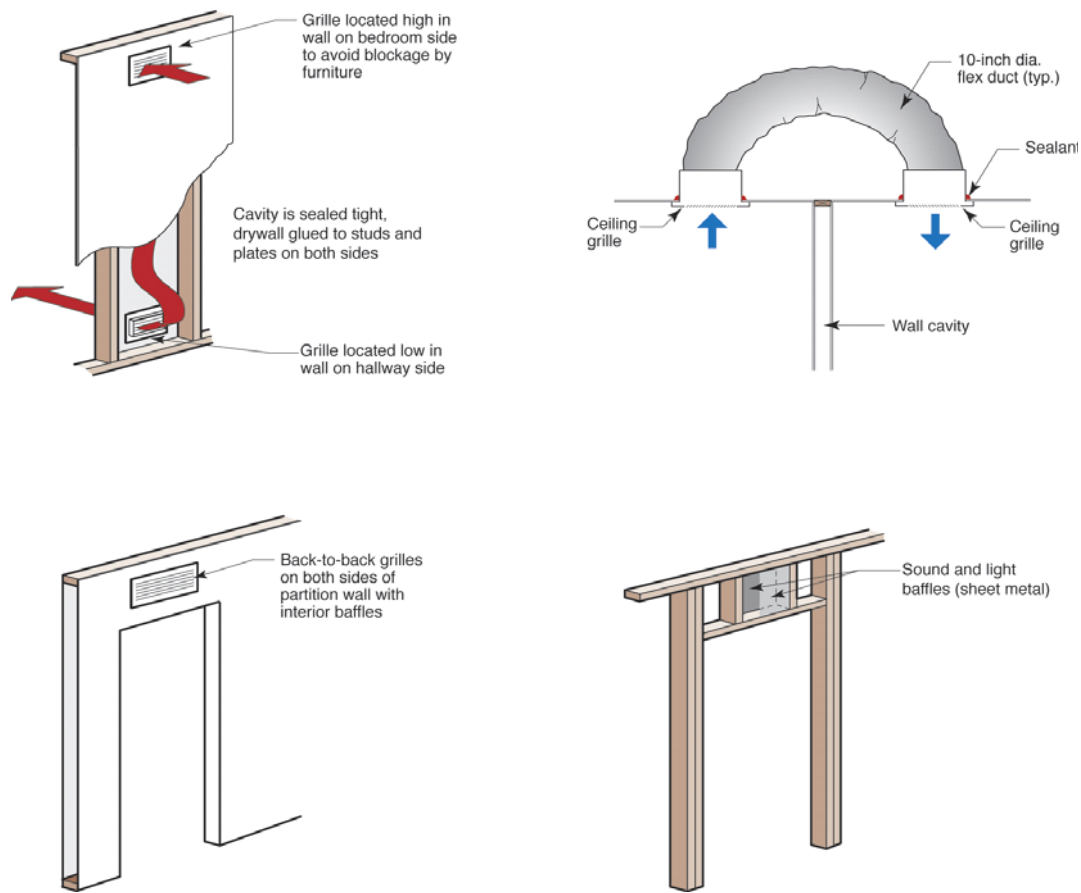

Figure 1-6. Transfer grilles and jump ducts

Transfer Grilles and Jump Ducts. Single air returns require transfer grilles to provide return pathways that prevent pressurization of bedrooms. Appropriate sizing for ducts, including these pressure relief methods, can be seen in Figure 1-6, with additional information at the BSC web site (www.buildingscience.com/resources/mechanical/509a3_cooling_system_sizing_pro.pdf).

Water Heater. Any type of gas water heater (in terms of venting) is adequate if the water heater is located in the garage. If the water heater is located inside conditioned space, then it must be a gas-power vented or power-direct vented unit, or an electric water heater.

Field Experience Notes

3/8-in. XPS Fan-Fold Rigid Insulation

In order for this material to function as a drainage plane, all joints must be overlapped or sealed. This thin material is easily penetrated—all holes must be sealed.

Air Sealing

Unvented assemblies—walls or roofs—are robust when the air sealing is robust. The hardest spots are not the fields but the margins/edges of assemblies. Spray foam applied at the margins (truss/rafter end blocking) may seem more expensive than cutting in air stops and caulking between each truss or rafter, but the labor savings and air sealing quality of spray foam make it a good choice.

Brick Shelf in Slab Perimeter

The brick veneer "seat" is readily accomplished by securing dimensional lumber of the desired size to the inside top edge of the concrete form.

Brick Veneer and the Air Space

Harking back to "old-timer" practices—place a thin sand layer at the bottom of the 1-in. air space (to act as a bond break for mortar droppings) and leave bricks out intermittently in the first course. After the veneer is completed, the sand and mortar droppings can be easily removed and the missing bottom course brick mortared in. Head joints in the top and bottom course must be left clear for top and bottom venting of this space. Masons must also be aware of protecting the integrity of the XPS foam sheathing as they work, given its function as the wall's drainage plane. Educate this trade with some building science basics about the impact of their work on building envelope performance.

Advanced Framing

For a technical resource that may help with resistance to advanced framing methods from local code officials, see the *Building Safety Journal* article written by Nathan Yost of BSC at www.buildingscience.com/resources/articles/1619_Yost&Edminster_for_au.pdf.

Energy Trusses

There are a number of different truss configurations that yield greater depth at the heel, but they vary quite a bit in cost. The truss shown in Figure 1-7 (sometimes called a "slider" truss) has proven to be among the most cost-competitive. And of course, the pitch of the roof affects just how much insulation you can get at this location, regardless of the type of truss.



Figure 1-7. A "slider" truss

HVAC Commissioning

The most efficient equipment means little if the system is not set up and started up properly. Follow high performance start-up procedures such as the following:

www.buildingscience.com/resources/mechanical/air_conditioning_equipment_efficiency.pdf.

Fiber-cement Siding

Getting set up and taking the time to back-prime this material and to prime all cuts may seem like quite an added burden, but it enhances the long-term performance of this reservoir cladding. A quick-drying primer in a “slop bucket,” lightweight cloth gloves, and disposable foam brush for “dabbing” make it manageable.

Material Compatibility and Substitutions

Exterior Sheathing/Building "Paper"

Because the brick veneer is a reservoir cladding, relief from solar-driven moisture must come from the free-and-clear 1-in. continuous air space or the vapor impermeable layer just interior to the cladding, or both (as is the case in this building profile). The vapor impermeable XPS rigid insulation sheathing can be replaced with housewrap and oriented-strand board (OSB), if a free-and-clear 1-in. continuous air space between the brick veneer and the rest of the wall assembly is provided and maintained.

Cavity Insulation Materials

Acceptable cavity insulation includes any that have relatively high vapor permeability—cellulose, fiberglass, or foam (as long as air sealing is accomplished by a separate component or system when cellulose or fiberglass is used). Because this wall assembly is designed to dry exclusively to the interior, do not use any layers in the assembly interior to the exterior sheathing that have low vapor permeability. Note that when foam insulation is left exposed in an assembly, a "thermal barrier" or "protection against ignition" may be required. Code implementation/interpretation has proven to be particularly troublesome for "gray" areas, such as spaces that are conditioned but not occupied (conditioned attics and crawlspaces).

Soffit Material

Fiber cement material was selected for the soffit because of its robustness with regard to moisture. Excellent control of moisture, air, and heat flow is critical at this overhang of interior floor space.

Flooring

Many finished flooring materials—either because of their impermeability (sheet vinyl, for example) or sensitivity to moisture (wood strip flooring, for example)—should only be installed over a slab with a low w/c ratio ($\cong 0.45$ or less) or a slab allowed to dry (<0.3 g/24hr/ft²) before installation of flooring. In general, sheet vinyl flooring should be avoided.

Sub-slab Sand Layers

A sand layer (to prevent differential drying and cracking) should never be placed between a vapor barrier and a concrete slab. Place the concrete directly on top of the vapor barrier. This problem is better handled with a low w/c ratio ($\cong 0.45$ or less) and water curing of the concrete with wetted burlap or ponding for up to 72 hr.

Vapor Barrier Roofing "Paper"

Note that it is the combination of reservoir roof cladding and conditioned attic that dictates the low permeability roofing underlayment. The roofing underlayment should have a permeability of less than 1 perm.²

Interior Latex Paint

The substitution of low permeability interior finishes (vinyl wall paper, oil-based paints) for latex paint is strongly discouraged because drying to the interior is critical in hot-humid climates.

Gypsum Wallboard

Areas of potentially high moisture, such as bathrooms, laundry rooms, and kitchens are excellent candidates for non-paper faced wallboard systems (e.g., James Hardie's Hardibacker[®], GP's DensArmor[®], USG's Fiberock[®]). In addition, paper-faced gypsum board should never be used as interior sheathing or backer for tub or shower surrounds where ceramic tile or marble (any material with joints or grout lines) is used as the finish.

² Building Science Consortium definition: a perm is a unit of measurement that reflects how readily water vapor passes through a material of a certain thickness. A material with a perm rating less than 1 is considered impermeable, greater than 1 but less than 10 perms is considered vapor semi-permeable, and greater than 10 perms is considered vapor permeable.

Building Profile #2. The Maitland

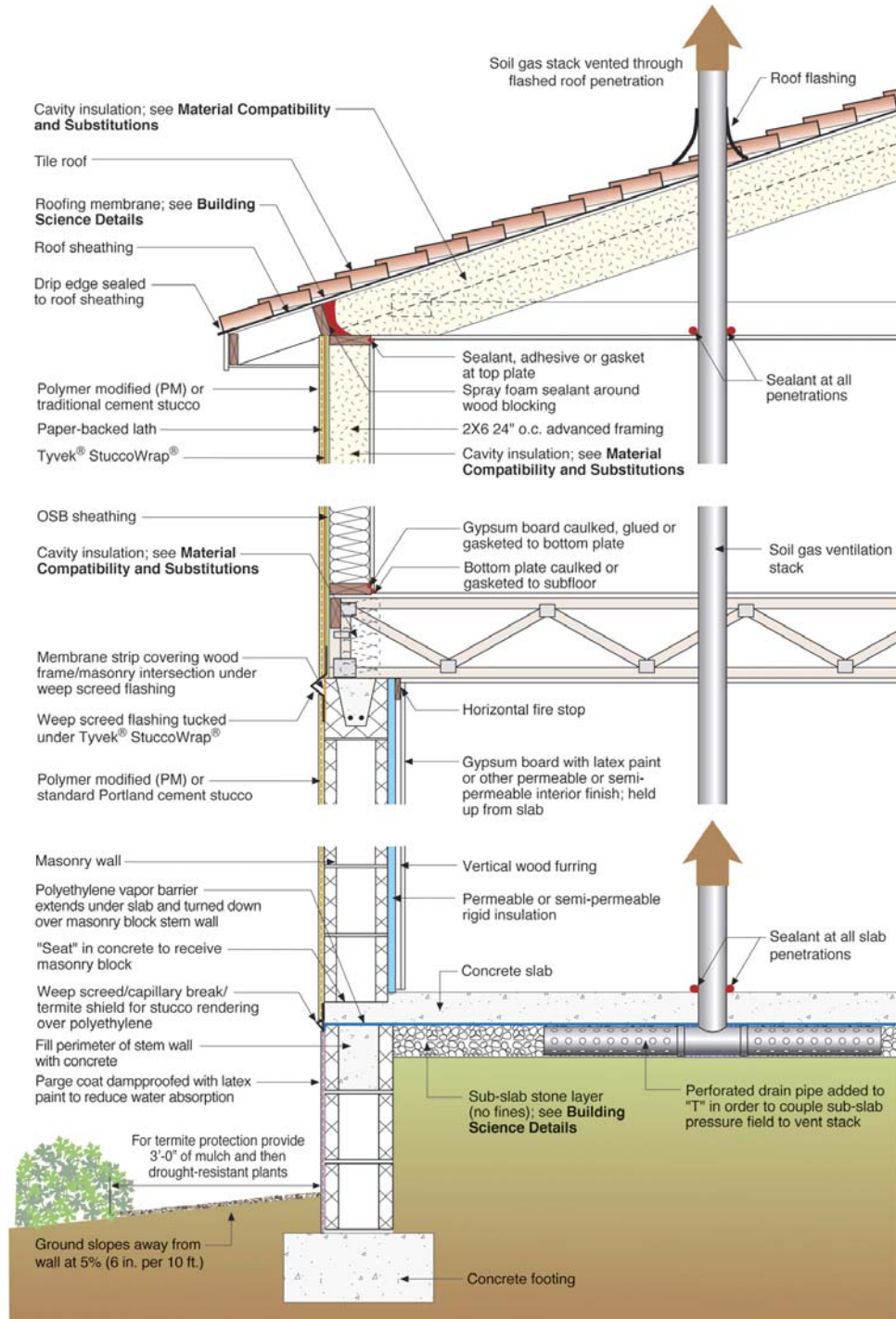

Foundation: Stem wall & slab Cladding (1st floor): Stucco Cladding (2nd floor): Stucco
 Attic: Conditioned Above Grade Wall (1st floor): Masonry Above Grade Wall (2nd floor): Wood frame
 Roof: Tile

Figure 1-8. Cross section of the Maitland

Building Science Details

Air Sealing Details at Transitions

Air sealing can be particularly difficult, but no less important, at assembly transitions such as top-of-wall/roof assembly junctions, band joists, and between attached garages and living spaces. These three are discussed below because they have proven to be a consistent challenge for builders.

Top-of-wall/Roof Assembly Junction. The continuity of an exterior air barrier can be maintained at this junction if the air barrier material (foam insulation or stucco cladding, for example) is used continuously for the wall, soffit, and fascia. The continuity of an interior air barrier can be maintained through a combination of cut foam blocks and sealant/caulk, or spray foam. Note that neither cellulose nor fiberglass (batt or blown) can be used for the air barrier.

Band joists. Continuity of an exterior air barrier can be maintained at the band joist with sealed or taped housewrap or rigid foam insulation. Continuity of an interior air barrier can be maintained through a combination of cut foam blocks and sealant/caulk, or spray foam. Note that neither cellulose nor fiberglass (batt or blown) can be used for the air barrier. The air barrier detail on second-story band joists is important because it is inaccessible (covered by structural/finish floor and ceiling finish) after construction. The air barrier/thermal envelope detail is important on ground-floor band joists because of the thermal bridge that can occur at the top of crawlspace foundation walls (as the result of the air barrier and thermal envelope moving from the outside to the inside of the building envelope and termite inspection zones located at the top of crawlspace foundation walls). Note that while fiberglass batts fulfill the requirement for protection from ignition in the open band joists, fiberglass batt material by itself cannot maintain the air barrier.

Attached garages. The building envelope surfaces shared between conditioned space and an unconditioned garage must have a continuous air barrier. See Figure 1-9 for details in terms of using sealants and rigid insulation to create a continuous air barrier between the attached garage and living space. Refer to www.buildingscience.com/housethatwork/airsealing/default.htm for air-sealing details.

Drying Mechanisms

In any climate, vapor control is based on the relationships among the following: the permeability of wall components, the type of cladding (reservoir or non-reservoir), the presence/lack/nature of an air space, and the magnitude/duration of the vapor drive (based on the relationship between the exterior and interior

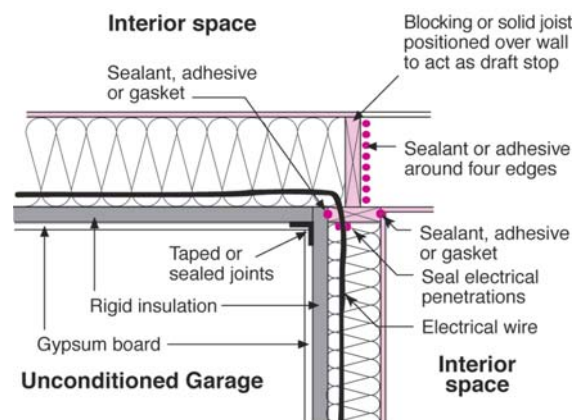

Figure 1-9. Using sealants and rigid insulation to create a continuous air barrier

moisture content and temperature differences). The type of sheathing and housewrap used in any wall assembly must be based on an understanding of these inter-relationships. See “Insulations, Sheathings, and Vapor Diffusion Retarders” for more information (www.buildingscience.resources).

In both the first and second story wall assemblies, drying can occur to the exterior and the interior as long as permeable latex paints are used. The use of semi-permeable rigid insulation on the interior of the first story masonry wall assembly allows drying to the interior at a controlled rate. Either expanded polystyrene (EPS) or extruded polystyrene (XPS) can be used in this location. We recommend that less than 1 in. of XPS be used. A thicker layer retards inward drying too much because of its lower vapor permeability.

Drainage "Step" in Slab Perimeter.

The block "seat" is readily accomplished by securing dimensional lumber of the desired size to the inside top edge of the concrete form.

Drainage Plane, Air Barrier, and Vapor Control

The drainage plane on the first story exterior wall is the face of the stucco. The drainage plane on the second story exterior wall is the StuccoWrap®. Flashing details at penetrations on each story must reflect this difference. The building paper behind the weep screen flashing at the transition from first to second story is an important “back-up” protection against liquid water penetration into the wall assembly. The first-floor air barrier is the concrete block (with continuity at the top of the wall provided by the cap block). On the second floor, the air barrier is both the exterior stucco rendering and the interior gypsum board installed using the Airtight Drywall Approach. Control of moisture drive inward from the outside is accomplished by the relative impermeability of the OSB on the second story. On the first story, the storage capacity and insensitivity of the concrete block mitigates the impact of moisture penetration in the wall assembly, and the entire assembly permits drying in both directions.

Window Flashing

Window flashing details are wall assembly or cladding specific. See Figure 1-10 and refer to the *EEBA Water Management Guide* (www.eeba.org/bookstore).

Advanced Framing

An important element of high performance wood-frame construction is an advanced framing package. For more detailed information on advanced framing techniques, see www.buildingscience.com/housethatwork/advancedframing/default.htm.

Framing on Sab

Installing a capillary break between the sill plate and a concrete slab on all walls—exterior, interior, partition—is good practice. A closed cell foam sill sealer or gasket works well. Alternatively, a strip of sheet polyethylene can be used. This isolates the framing from any source of moisture that may be either in or on the concrete slab (and using sill sealer on all walls maintains wall height exactly the same).

Soil Gas Ventilation

The sub-slab to roof vent system handles conditions that are difficult if not impossible to assess before completion of the structure—confined concentrations of air-borne radon, soil treatments (termiticides, pesticides), methane, etc. The cost of this "ounce" of prevention is well balanced against the cost of the "pound" of cure. Note that this system is a passive system that can easily be converted to an active ventilation system by installing an in-line fan into the stack in the attic.

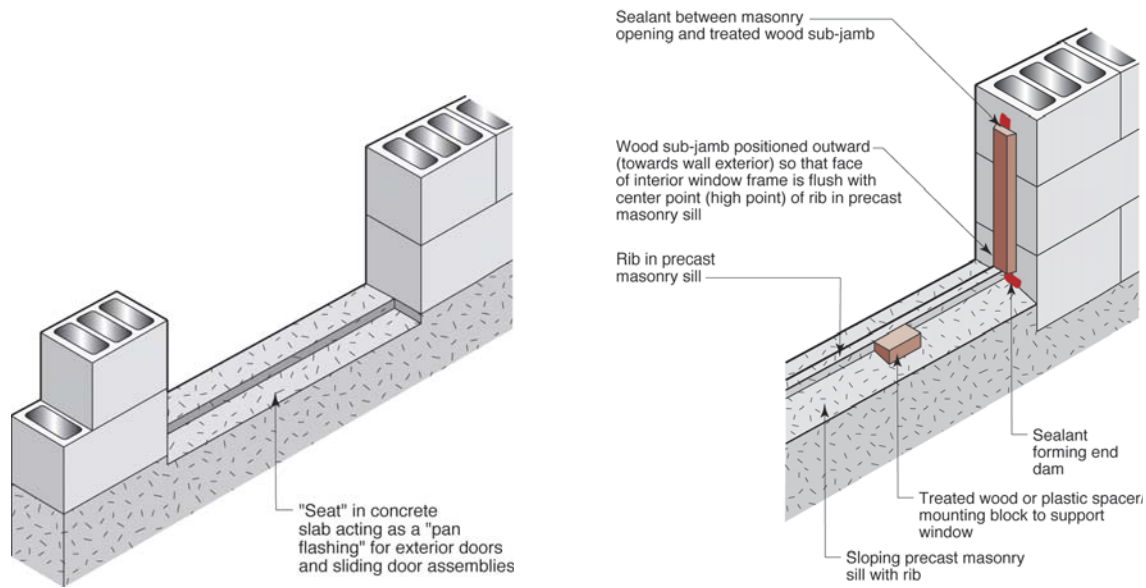

Exterior door pan flashing “seat”

Window sill drainage detail

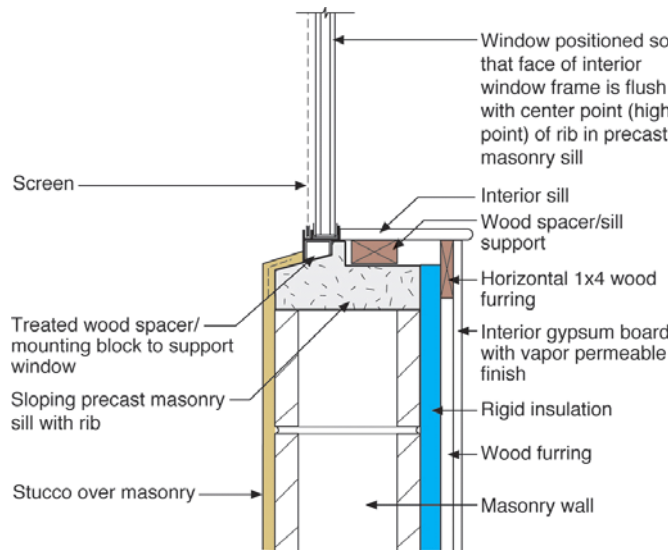

Window sill drainage section

Figure 1-10. Window Flashings

Thermal Barrier

In this climate, moisture control does not require specific levels of insulation. Inside/outside temperature differences do not require cavity-warming exterior rigid insulation to control wintertime condensing surface temperatures. Having said this, insulating sheathing in general is a good idea. We recommend full cavity fill in the walls, but the 2-x-6 framing is more about advanced framing than the depth of cavity insulation that can be achieved. The R-22 cellulose or R-30 batts in the conditioned attic have proven to be adequate to provide interior conditions for enhanced HVAC equipment durability and duct

performance when these systems are located in the attic. Cellulose netting or fiberglass batt supports create an insulation “belly” and accommodate cavity fill depth that exceeds the depth of the truss top chord.

Sub-Slab Stone Bed

The 4-in.-deep $\frac{3}{4}$ -in. stone bed functions as a granular capillary break, a drainage pad, and a sub-slab air pressure field extender for the soil gas ventilation system. The sub-slab stone bed is a practical method for venting soil gas should it be necessary.

Climate-Specific Details

Termite Management

In hot-humid climates, termites are best managed with a three-pronged approach that deals with the three things termites need — cover from sunlight, moisture, and food (wood or paper):

Reduced cover. Keep plantings 3 ft away from the building perimeter, thin the ground cover (wood mulch or pea stone) to no more than 2 in. depth for the first 18 in. around the building, and maintain the termite inspection zone on the exterior of the foundation above grade.

Control moisture. Maintain slope away from building as shown, carry roof load of water at least 3 ft away from building, and make sure that irrigation is directed away from the building.

Chemical treatment. Use an environmentally appropriate soil treatment (such as Termidor[®]) and a building materials treatment (such as Bora-Care[®]) for termite-prone near-grade wood materials.

Inter-relationship of first three points. Because a builder and a homeowner’s ability to employ or stick to each of the three strategies above will vary, make sure that an inability to fully employ one strategy is compensated for by complete rigor by the others. For example, if for some reason, chemical treatment of soil or building materials is not an option, then complete rigor in controlling moisture and ground cover must be maintained.

Conditioned Attics

This assembly may require discussion with local building code official. See Appendix A for assistance.

Mechanical Systems

The following are key elements of a system for this climate:

Sealed combustion gas furnace. This provides energy efficiency and health/safety with the unit inside conditioned space.

Minimum 12 SEER A/C unit. Provides energy efficient management of sensible load.

Central-fan-integrated supply ventilation. This system is simple, effective, and economical. It provides fresh, filtered, outside air in a controlled amount using the existing HVAC delivery system for even distribution and mixing. Set-up intermittent central-fan-integrated supply, designed to ASHRAE 62.2P rate, with fan cycling control set to operate the central air handler 20 minutes every hour to provide ventilation air distribution and whole-house averaging of air quality and comfort conditions (\$125 to \$150). Include a normally closed motorized damper in the outside air duct with the AirCycler[™] FRV control (+\$50 to \$60). See Appendix B for more detailed information.

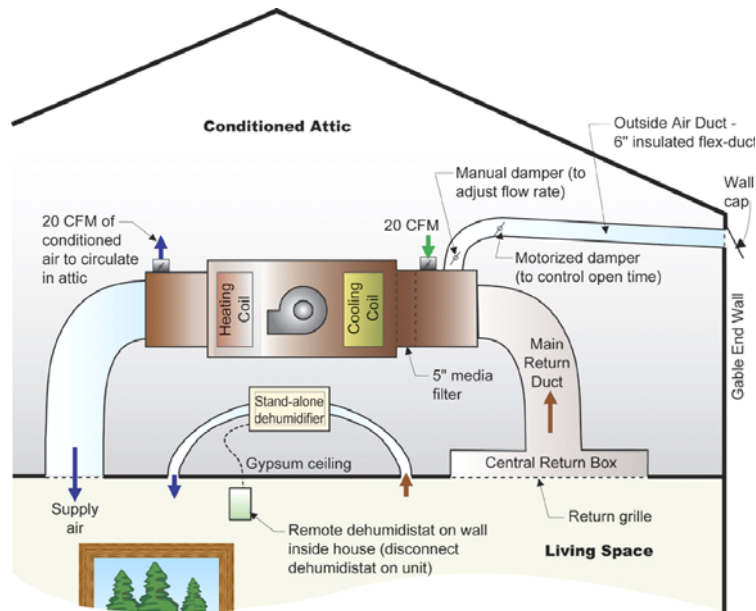

Figure 1-11. Dehumidification

Supplemental dehumidification. All homes in this climate call for supplemental dehumidification because the reduced sensible load of high performance homes reduces the dehumidification the AC unit provides, extends shoulder seasons, and raises the impact of occupant-generated moisture. The ducted stand-alone dehumidifier in the attic controlled by a humidistat located in the living space has proven to be the most effective and economical system for the production home building setting. Our recommended system (+\$300 to \$350) includes GE dehumidifier model AHG40FCG1 located in an insulated enclosure in the attic and ducted to the living space, Honeywell humidistat model H8808C located in the living space, and Honeywell switching relay (with transformer) model RA89A 1074 (Figure 1-11). For a detailed discussion of supplemental dehumidification, see www.buildingscience.com/resources/mechanical/conditioning_air.pdf.

Ducts in conditioned space. The preferred method for keeping HVAC ducts and mechanical equipment inside conditioned space is to either move them down from the attic, or move the conditioned boundary up (to the underside of the roof sheathing) so that the attic is conditioned, as shown in Figure 1-12. In this building profile, a conditioned attic can be used for HVAC ducts and equipment. In no case should HVAC ducts be placed within exterior wall assemblies—this is not what is meant by ducts in conditioned space. A vented attic assembly may be used in this climate as long as the ceiling plane is airtight and no ductwork or air handling equipment is located in the attic.

Transfer grilles and jump ducts. Single air returns require transfer grilles to provide return pathways that prevent pressurization of bedrooms (Figure 1-12). Appropriate sizing for ducts, including these pressure relief methods, can be found at www.buildingscience.com/resources/mechanical/509a3_cooling_system_sizing_pro.pdf.

Water heater. Any type of gas water heater (in terms of venting) is adequate if the water heater is located in the garage. If the water heater is located inside conditioned space, then it must be a gas power vented or power-direct vented unit, or an electric water heater.

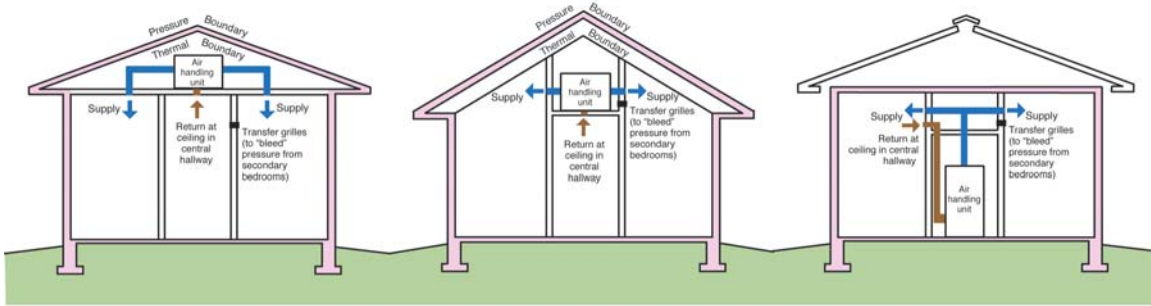

Note: Colored shading depicts the building's thermal barrier and pressure boundary. The thermal barrier and pressure boundary enclose the conditioned space.

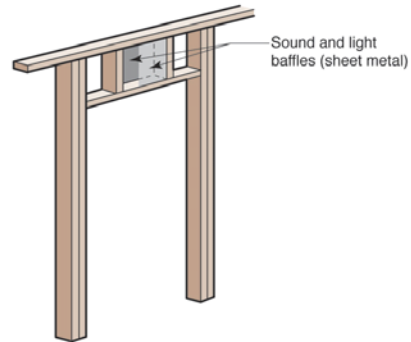
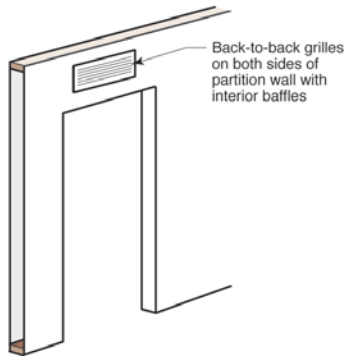
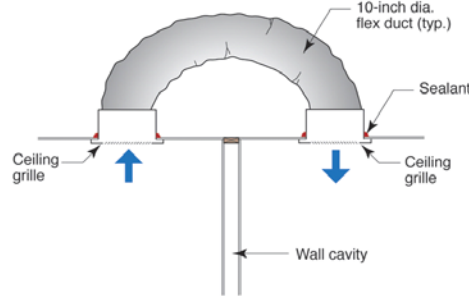
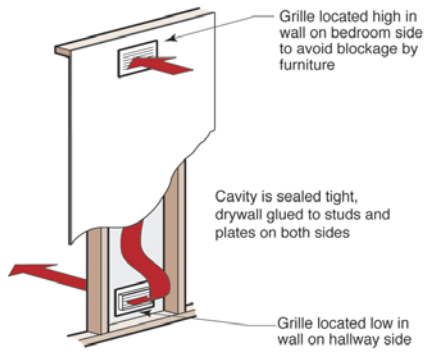

Figure 1-12. Placement of ducts and transfer grilles

Field Experience Notes

Air Sealing

Unvented assemblies—walls or roofs—are robust when the air sealing is robust. The hardest spots are not the "fields" but the "margins" of assemblies. Spray foam may seem like an expensive element of the assembly, but the labor savings and air sealing quality in comparison to the alternatives make it a good choice.

Roofing

Roofing tiles in general, and light-colored ones in particular, have proven a wise choice to reduce cooling loads in this climate. For more information, see www.buildingscience.com/resources/roofs/performance_of_unvented_attics.pdf or the ENERGY STAR® Reflective Roof Product List at www.energystar.gov/ia/products/prod_lists/roof_prods_prod_list.xls.

Elastomeric Paints and Stucco

We have found that acrylic latex paints generally outperform elastomeric paints on stucco. While elastomeric paints have excellent crack-spanning capability, they can be much less vapor-permeable than acrylic latex paints. Elastomeric paints have been known to blister when moisture gets into the assembly. In hot-humid climates, the higher vapor permeability of latex paints is overall more important than the higher crack-spanning capability of elastomeric paints unless a high permeability (greater than 20 perms) elastomeric paint coating is used.

Advanced Framing

For a technical resource that may help with resistance to advanced framing methods from local code officials, see the *Building Safety Journal* article written by Nathan Yost of BSC at www.buildingscience.com/resources/articles/16-19_Yost&Edminster_for_au.pdf.

Energy Trusses

A number of different truss configurations yield greater depth at the heel, but they vary quite a bit in cost. The truss (Figure 1-13, sometimes called a “slider” truss) has proven to be among the most cost-competitive. And of course, the pitch of the roof affects just how much insulation you can get at this location, regardless of the type of truss.

HVAC Commissioning

The most efficient equipment means little if the system is not set up and started up properly. Follow high performance start-up procedures such as the following: www.buildingscience.com/resources/mechanical/air_conditioning_equipment_efficiency.pdf.



Figure 1-13. Energy trusses, also known as a “slider truss”

Material Compatibility and Substitutions

Exterior Sheathing/Building "Paper"

We do not recommend any substitutions behind stucco and a wood-framed wall. The paper-backed lath is an excellent bond break for the stucco and the unique corrugated profile of the StuccoWrap® is an excellent drainage plane material. In addition, structural sheathing is required for its resistance to wind loads in this hurricane-prone region. Note that a cladding/sheathing combination capable of passing the hurricane impact test is a critical component of any wall assembly within many areas of this climate region.

Cavity Insulation Materials

Acceptable cavity insulation includes any that have relatively high vapor permeability—cellulose, fiberglass, or foam (as long as air sealing is accomplished by a separate component or system when cellulose or fiberglass is used). Because this wall assembly is designed to dry exclusively to the interior, do not use any layers in the assembly interior to the exterior sheathing that have low vapor permeability. Note that when foam insulation is left exposed in an assembly, a "thermal barrier" or "protection against ignition" may be required. Code implementation/interpretation has proven to be particularly troublesome for "gray" areas, such as spaces that are conditioned but not occupied (conditioned attics and crawlspaces).

Eave Blocking and Spray Foam

Because stucco is used as the exterior cladding, it can be used continuously on the soffit and fascia (replacing the spray foam and blocking) to move the air barrier from the top of the wall to the roof overhang (see Hot-Dry/Mixed-Dry Climate Building Profiles).

Flooring

Many finished flooring materials—either because of their impermeability (sheet vinyl, for example) or sensitivity to moisture (wood strip flooring, for example)—should only be installed over a slab with a low w/c ratio ($\cong 0.45$ or less) or a slab allowed to dry (<0.3 g/24hr/ft²) before installation of flooring. In general, sheet vinyl flooring should be avoided.

Sub-Slab Sand Layers

A sand layer under the slab (to prevent differential drying and cracking) should never be placed between a vapor barrier and a concrete slab. Cast the concrete directly on top of the vapor barrier. This problem is better handled with a low w/c ratio (≈ 0.45 or less) and wetted burlap covering during initial curing (see Appendix B).

Latex Paint

The substitution of low permeability finishes (vinyl wall paper, oil-based paints) for latex paint is strongly discouraged because of reduced drying potential. (Note that there are latex paints with very low vapor permeabilities, but they are generally clearly labeled as such.)

Gypsum Wallboard

Areas of potentially high moisture, such as bathrooms, laundry rooms, and kitchens are excellent candidates for non-paper faced wallboard systems (e.g., James Hardie's Hardibacker®, GP's DensArmor®, USG's Fiberock®). In addition, paper-faced gypsum board should never be used as interior sheathing or backer for tub or shower surrounds where ceramic tile or marble (any material with joints or grout lines) is used as the finish.

Building Profile #3. The Orlando SIPs House

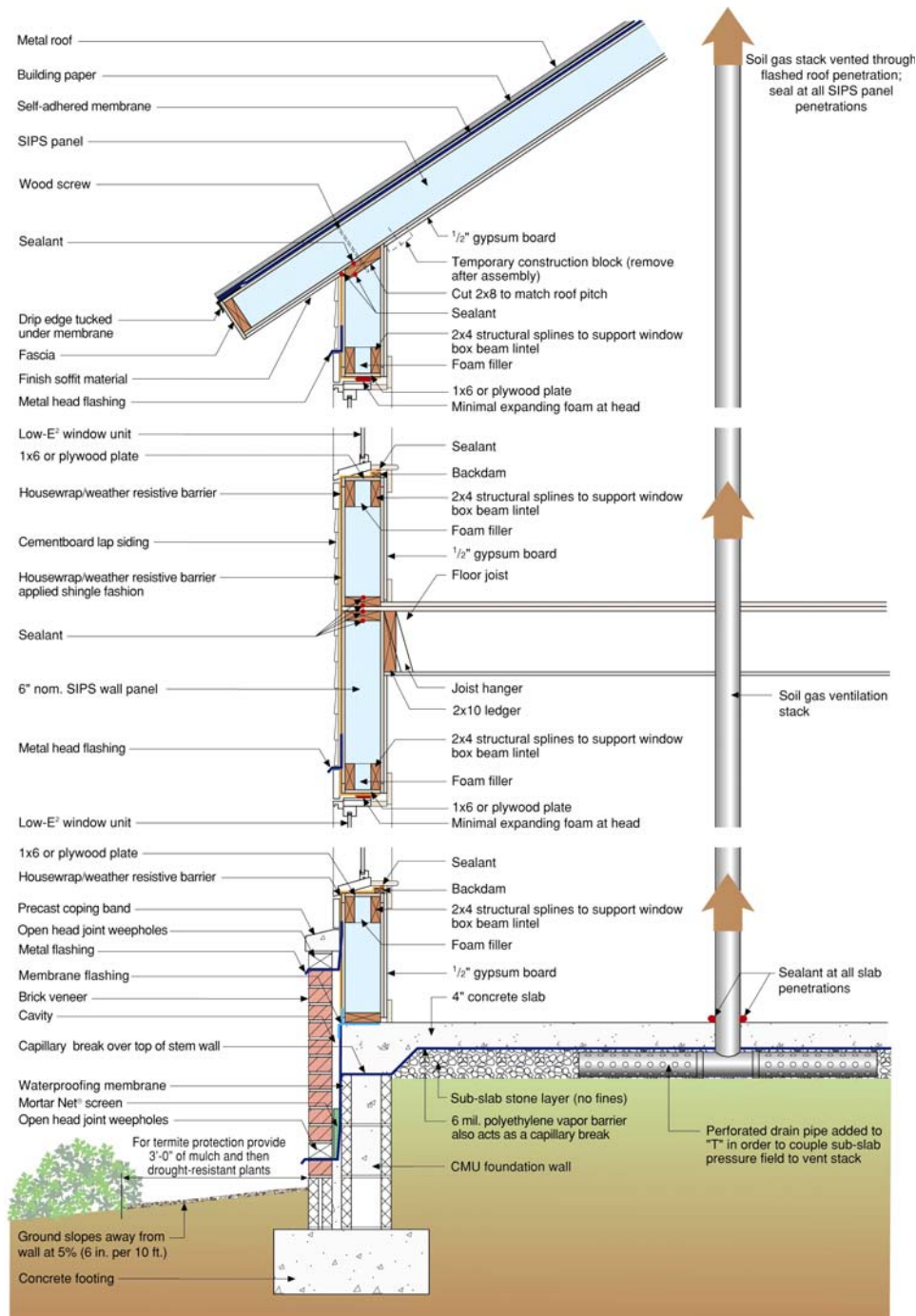

Foundation: Block stem wall and slab
 Attic: Cathedral ceilings / conditioned attic
 Wall Cladding: Cement board siding / brick veneer

Roof Cladding: Metal
 Above-Grade Wall: SIPs panel

Figure 1-14. Cross section of the Orlando SIPs House

Building Science Details

Air Sealing Details at Transitions

Air sealing is important at assembly transitions such as top-of-wall/roof assembly junctions, SIPS panel joints, and between attached garages and living spaces.

Top-of-Wall / Roof Assembly Junction

Air-barrier continuity can be provided at this junction if sealant is used on the top and bottom of the top plate. See Figure 1-15 for an alternative roof framing option using SIPS panels.

SIPS Panel Joints

Air-barrier continuity can be provided at SIPS panel joints with a continuous bead of sealant between foam sections and a continuous bead of sealant between the plywood or OSB skin panels on the interior (Figure 1-16). See Figure 1-17 for an alternative above-grade wall spline detail. Also note on the cross section the wall/floor air-sealing detail between the first and second floors.

Attached Garage

The building enclosure surfaces shared between conditioned space and an unconditioned garage must have a continuous air barrier.

Drying Mechanisms

In any climate, vapor control is based on the relationships among the following: the permeability of wall components, the type of cladding (reservoir or non-reservoir), the presence/lack/nature of an air space, and the magnitude/duration of the vapor drive (based on the relationship between the exterior and interior moisture content and temperature differences). The type of sheathing and housewrap used in any wall assembly must be based on an understanding of these inter-relationships.

In both the first- and second-story wall assemblies, drying can occur to the exterior and the interior as long as permeable latex paints are used.

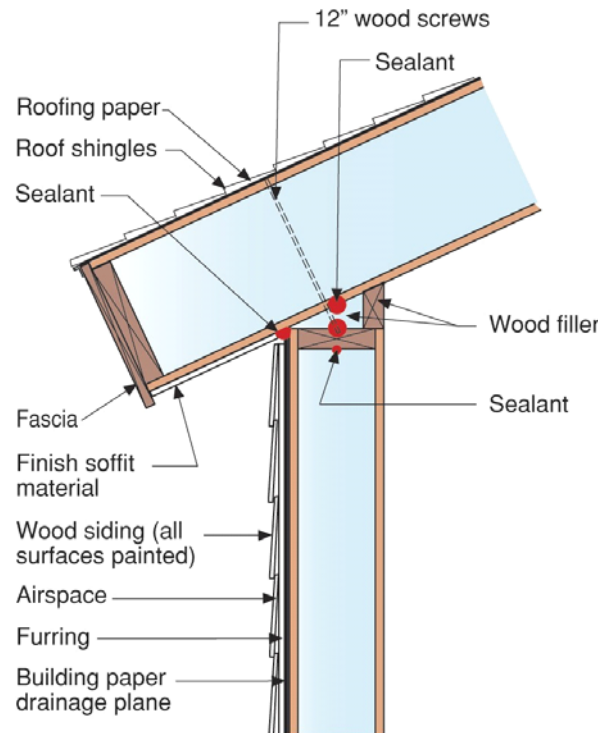

Figure 1-15. Alternative SIPS roof framing

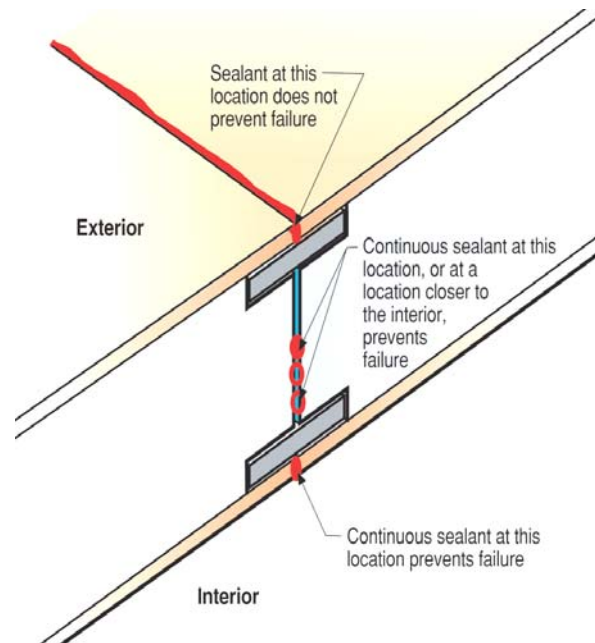

Figure 1-16. Sealant locations between panels

Drainage Plane, Air Barrier, and Vapor Control

The primary drainage plane behind both the cement board and the brick veneer is the housewrap/weather resistant barrier (WRB) over the SIPS panel and the waterproofing membrane over the slab and stem wall. Flashing details at penetrations must reflect this difference.

The housewrap/weather resistant barrier (WRB) is an important “back-up” protection against liquid water penetration into the SIPS panels. On first and second floor, the air barrier is the SIPS panel. Control of moisture drive from the outside in is accomplished by the relative impermeability of the SIPS panel.

The roofing paper underneath the standing seam metal roof has two functions. It serves as a slip surface for the roofing for expansion and contraction of the metal, and it serves as a secondary drainage plane for moisture that might condense on the underside of the metal roofing as the result of night-sky radiation and subsequent condensation.

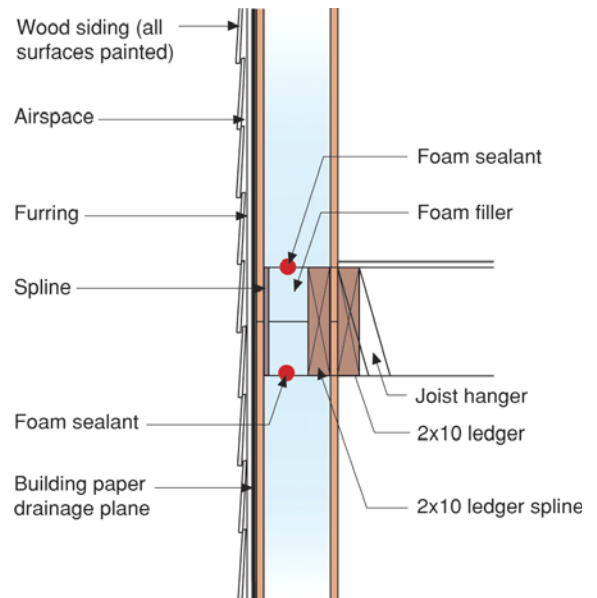

Figure 1-17: Above-grade wall spline

Window Flashing

Window flashing details are wall assembly or cladding specific. See Figure 1-18 for a detail of a load-bearing window jamb assembly.

Framing on Slabs

Installing a capillary break between the sill plate and a concrete slab on all walls—exterior, interior, partition—is good practice. A closed-cell foam sill sealer or gasket works well. Alternatively, a strip of sheet polyethylene can be used. This isolates the framing from any source of moisture that may be either in or on the concrete slab (and using sill sealer on all walls maintains wall height exactly the same).

Soil Gas Ventilation

The sub-slab to roof vent system handles conditions that are difficult if not impossible to assess prior to completion of the structure—confined concentrations of air-borne radon, soil treatments (termiticides, pesticides) methane, etc. The cost of this “ounce” of prevention is well balanced against the cost of the “pound” of cure. Note that this system is a

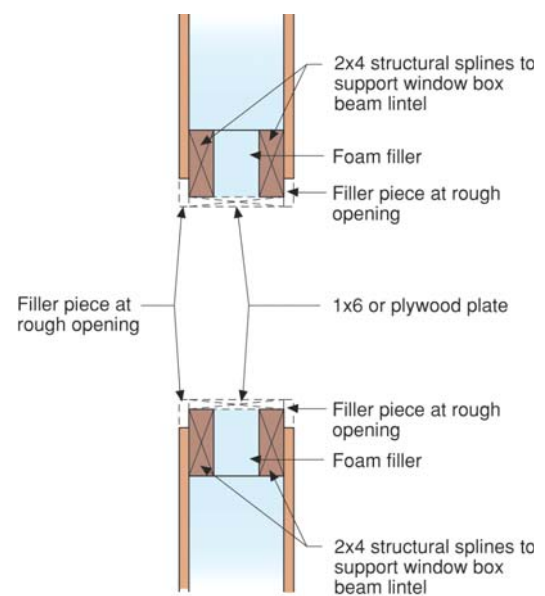

Figure 1-18. Load-bearing window jamb assembly

passive system that can easily be converted to an active ventilation system by installing an in-line fan into the stack in the attic.

Thermal Barrier

The foam sandwiched between the plywood skins of the SIPS panels on the walls and roof is the thermal barrier. It should be noted that in this climate, moisture control does not require specific levels of insulation; but, it does require joints between panels be sealed to control air-transported moisture.

Inside/outside temperature differences do not require cavity-warming exterior rigid insulation to control wintertime condensing surface temperatures.

Sub-slab Stone Bed

The 4-in.-deep $\frac{3}{4}$ -in. stone bed functions as a granular capillary break, a drainage pad, and a sub-slab air-pressure field extender for the soil gas ventilation system. The sub-slab stone bed is a practical method for venting soil gas should it be necessary.

Climate-Specific Details

Termite Management

In hot-humid climates, termites are best managed with a three-pronged approach that deals with the three things termites need—cover from sunlight, moisture, and food (wood or paper).

Reduced cover. Keep plantings 3 ft away from the building perimeter, thin the ground cover (wood mulch or pea stone) to no more than 2-in. depth for the first 18 in. around the building, and maintain the termite inspection zone on the exterior of the foundation above grade.

Control moisture. Maintain slope away from building as shown, carry roof load of water at least 3 ft away from the building, and make sure that irrigation is directed away from the building.

Chemical treatment. Use an environmentally appropriate soil treatment (such as Termidor[®]) and a building-materials treatment (such as Bora-Care[®]) for termite-prone near-grade wood materials.

Interrelationship of first three points. Because a builder and a homeowner's ability to employ or stick to each of the three strategies above will vary, make sure that an inability to fully employ one strategy is compensated for by complete rigor by the others. For example, if for some reason chemical treatment of soil or building materials is not an option, then maintain complete rigor in controlling moisture and ground cover.

Conditioned Attics

As an alternative to cathedral ceilings, a conditioned attic may be constructed to house HVAC equipment or be used as additional useful living space. This assembly may require discussion with local building code official. See Appendix C for assistance.

Mechanical Systems

The key elements of a system for this climate are as follows:

Sealed-combustion gas furnace. This is necessary for energy efficiency and health/safety with the unit inside conditioned space.

Minimum 12 SEER AC unit. This enables energy-efficient management of sensible load.

Central-fan-integrated supply ventilation. This system is simple, effective, and economical. It provides fresh, filtered, outside air in a controlled amount using the existing HVAC delivery system for even distribution and mixing. Set up the intermittent central-fan-integrated supply, designed to ASHRAE 62.2P rate, with fan-cycling control set to operate the central air handler as much as 33% of the time, but not less than 25% of the time. This should occur at least every 3 hours to provide ventilation air distribution and whole-house averaging of air quality and comfort conditions (\$125 to \$150). Include a normally closed motorized damper in the outside air duct with the AirCycler™ FRV control (+\$50 to \$60). See http://www.buildingscience.com/resources/mechanical/air_distribution.pdf for more detailed information.

Supplemental dehumidification. All homes in this climate call for supplemental dehumidification; the reduced sensible load of high-performance homes reduces the dehumidification that the AC unit provides, extends shoulder seasons, and raises the impact of occupant-generated moisture.

There are a number of different ways to accomplish supplemental dehumidification with varying costs and performance advantages (For a detailed discussion of supplemental dehumidification, see http://www.buildingscience.com/resources/mechanical/conditioning_air.pdf). One low-cost yet effective approach and one more costly but higher performance/systems-engineered approach are described as follows:

Ducted stand-alone dehumidifier: This system is a "site-constructed" and consists of an off-the-shelf standard dehumidifier ducted in the attic and controlled by a dehumidistat located in the living space. This arrangement of individual components has proven to be an effective and economical system for the production home-building setting. The installed cost ranges from approximately \$350 to \$550. The system consists of any ENERGY STAR dehumidifier that uses a blower wheel instead of a paddle fan to move air past the coil (dehumidifier located in attic in an insulated enclosure and ducted to living space), a Honeywell dehumidistat model H8808C located in living space, and a Honeywell switching relay (with transformer) model RA89A 1074.

Note: The following manufacturers make ENERGY STAR-qualified blower wheel stand-alone dehumidifiers:

LG Electronics

(<http://www.lge.com/catalog/prodlist?categoryId=CTG100515&modelCategoryId=CTG1000521&parentId=CTG1000440>) all models

Haier America (http://www.haieramerica.com/categories.php?cat_id=2) all models

Heat Controller (<http://www.heatcontroller.com/>) all BHD models use a turbo-impeller with turned blades.

You can check the EPA ENERGY STAR Web site for dehumifiers from these manufacturers (http://www.energystar.gov/index.cfm?c=dehumid.pr_dehumidifiers).

Aprilaire 1700. This is a truly engineered, coherently manufactured, supplemental dehumidification system with built-in air filtration, ducted design, and a controls package that integrates central-blower cycling for distribution, dehumidification, and intermittent introduction of outside air ventilation. The system is also designed for flexibility; it can be connected to the conditioned space directly or to the central air-distribution system in a number of configurations. It's also compact and lightweight enough to be set on or hung from most framing. The product cost for this system is currently about \$1,100. For more information, see <http://www.aprilaire.com/category.asp?id=F63D255EB0054BBF811DBB024BF068FA>.

For more information on other high performance supplemental dehumidification systems, see <http://www.thermastor.com/DesktopDefault.aspx>.

Ducts in conditioned space. The preferred method for keeping HVAC ducts and mechanical equipment inside conditioned space is moving them down from the attic. In this building profile, a conditioned attic can be used for HVAC ducts and equipment. In no case should HVAC ducts be placed within exterior wall assemblies—this is not part of what is meant by ducts in conditioned space. A vented attic assembly may be used in this climate as long as the ceiling plane is airtight and no ductwork or air-handling equipment is located in the attic.

Transfer grilles. Single air returns require transfer grilles to provide return pathways that prevent pressurization of bedrooms. Appropriate sizing for ducts, including these pressure relief methods, can be found in the [Cooling System Sizing Pro](http://www.buildingscience.com/resources/mechanical/509a3_cooling_system_sizing_pro.pdf) (http://www.buildingscience.com/resources/mechanical/509a3_cooling_system_sizing_pro.pdf).

Water heater. Any type of gas water heater (in terms of venting) works if the water heater is located in the garage. If the water heater is located inside conditioned space, then it must be a gas power vented or power-direct vented unit or an electric water heater.

Field Experience Notes

Air Sealing and Caulking of Panel Joints

An increase in moisture content can occur as a result of air leakage through SIP panel joints. Air-transported moisture will migrate to the cold side of the panel causing the cold side of the panel to expand relative to the warm side. See Figure 1-16 for recommended air-sealing locations between panels.

Roofing

Light-colored standing-seam metal roofs yield the best cooling load reduction of any roof claddings. We recommend a metal roof that meets the EPA/DOE ENERGY STAR qualifications (<http://128.121.47.106/index.cfm>).

HVAC Commissioning

The most efficient equipment means little if the system is not set up and started up properly. Follow high-performance start-up procedures.

Material Compatibility and Substitutions

Exterior Sheathing / Building "Paper"

A variety of building papers or housewraps installed shingle fashion can act as the drainage plane in this assembly. While drying to the exterior is not the primary mechanism in this climate, the combinations of building papers and exterior sheathings in this assembly (and their relative permeabilities) promote intermittent drying in this direction.

Flooring

Many finished flooring materials — either because of their impermeability (sheet vinyl, for example) or sensitivity to moisture (wood strip flooring, for example) — should only be installed over a slab with a low w/c ratio (≈ 0.45 or less) or a slab allowed to dry (<0.3 grams/24hrs/ft²) prior to installation of flooring. In general, sheet vinyl flooring should be avoided.

Sub-slab Sand Layers

A sand layer under the slab (to prevent differential drying and cracking) should never be placed between a vapor barrier and a concrete slab. Cast the concrete directly on top of the vapor barrier. This problem is

better handled with a low w/c ratio (≈ 0.45 or less) and wetted burlap covering during initial curing (see Appendix C).

Latex Paint

The substitution of low permeability finishes (vinyl wall paper, oil-based paints) for latex paint is strongly discouraged because of reduced drying potential. (Note that there are latex paints with very low vapor permeabilities, but they are generally clearly labeled as such.)

Gypsum Wallboard

Areas of potentially high moisture, such as bathrooms, laundry rooms, and kitchens are excellent candidates for non-paper faced wallboard systems (e.g., James Hardie's Hardibacker®, GP's DensArmor®, USG's Fiberock®). In addition, paper-faced gypsum board should never be used as interior sheathing or backer for tub or shower surrounds where ceramic tile or marble (any material with joints or grout lines) is used as the finish.

Building Profile #4. The Montgomery

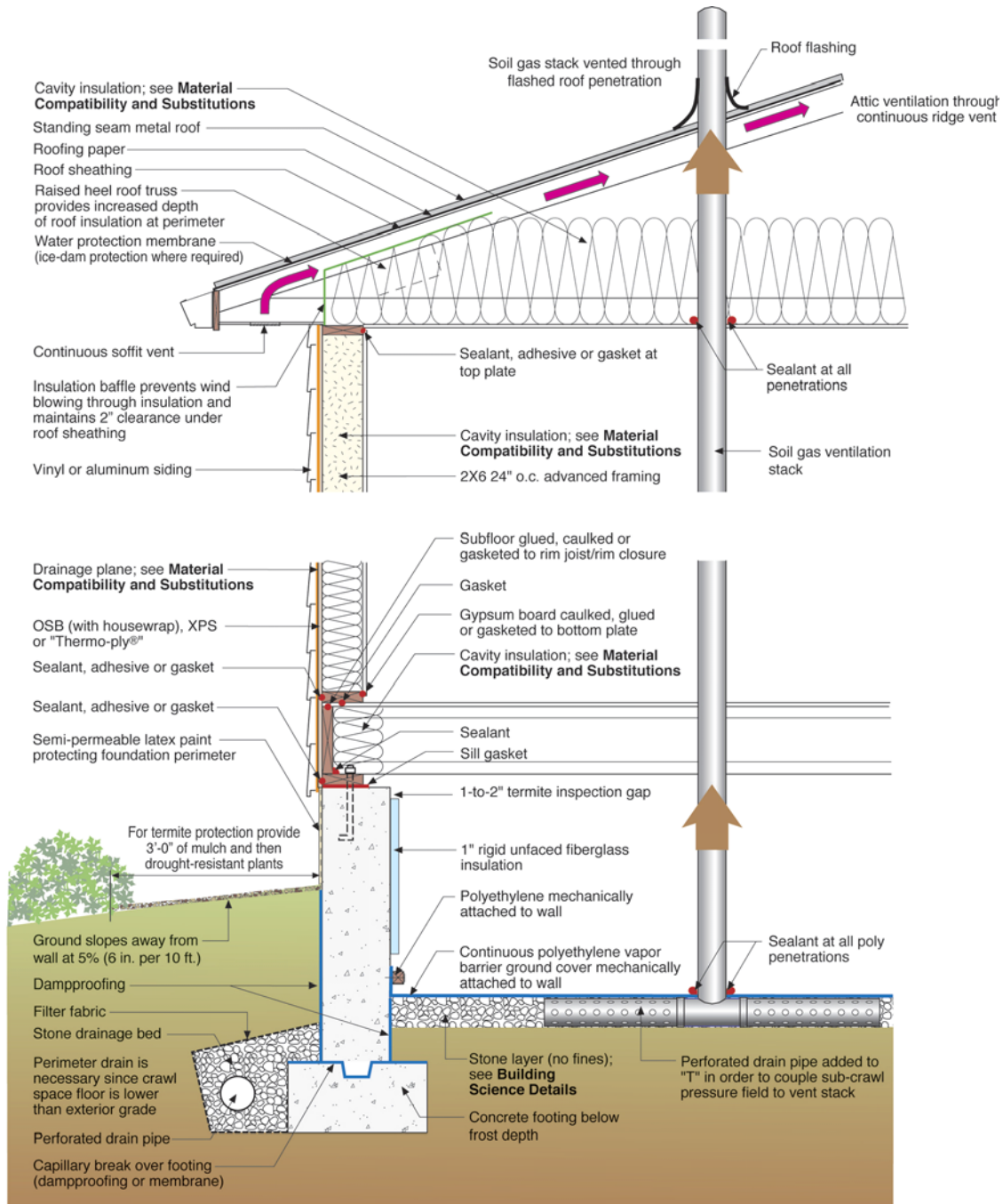

Foundation: Conditioned crawl Attic: Unconditioned Cladding: Vinyl or aluminum siding
 Above Grade Wall: Wood frame Roof: Standing seam metal roof

Figure 1-19. Cross Section of the Montgomery

Building Science Details

Conditioned Crawlspace

Conditioning of the crawlspace means that this space must be constructed much like a living space—it must be supplied by the HVAC system and have a transfer grille to return air back to the HVAC system located in the living space. The supply air should be directed horizontally across the crawlspace with good enough “throw” to provide some mixing, not directed down at the floor. Sizing of the supply air flow should be based on about 5% of the conditioned crawlspace floor area (for example: $0.05 \text{ cfm/ft}^2 * 1,600 \text{ft}^2 = 80 \text{ cfm}$ for a 1,600 ft² conditioned crawlspace). A single 6-in.-diameter supply duct typically suffices. Transfer air should go back to the central area of the living space above the crawlspace. Two grilles (10 in. by 4 in.) on opposite sides of the crawlspace are usually sufficient. The transfer area should be calculated in the same manner as for closed bedrooms connecting to hallways, using the 3-Pa pressure difference limit. Some form of mechanical moisture control for the crawlspace is necessary. We recommend one of the following approaches:

1. Controlled ventilation strategy using the intermittent central fan-integrated supply—it provides both mixing and moisture removal for the crawlspace as well as the house
2. A stand-alone dehumidifier installed in the crawlspace
3. A continuously operating crawlspace exhaust fan with make-up air extracted from the house.

In the Montgomery, the rigid insulation is applied to the interior face of the exterior foundation walls. Moisture control is important to proper performance, in particular the vapor barrier ground cover on the floor of the crawlspace. The vapor barrier must be continuous and sealed to the perimeter wall and any supporting piers.

Air Sealing Details at Transitions

Air sealing can be particularly difficult, but no less important, at assembly transitions such as band joists, and between attached garages and living spaces. These are discussed below because they have proven to be a consistent challenge for builders.

Band joists. Continuity of an exterior air barrier can be maintained at the band joist with sealed or taped housewrap or rigid foam insulation. Continuity of an interior air barrier can be maintained through a combination of cut foam blocks and sealant/caulk, rigid draftstopping material (wood blocking) and sealant/caulk, or spray foam. Note that neither cellulose nor fiberglass (batt or blown) can be used for the air barrier. The air barrier detail on second-story band joists is important because it is inaccessible (covered by structural/finish floor and ceiling finish) after construction. The air barrier/thermal envelope detail is important on ground floor band joists because of the thermal bridge that can occur at the top of crawlspace foundation walls (as the result of the air barrier and thermal envelope moving from the outside to the inside of the building envelope and termite inspection zones located at the top of crawlspace foundation walls). Note that while fiberglass batts fulfill the requirement for protection from ignition in the open band joists, fiberglass batt material by itself cannot maintain the air barrier.

Attached Garages. The building envelope surfaces shared between conditioned space and an unconditioned garage must have a continuous air barrier. See Figure 1-20 for details in terms of using sealants and rigid insulation to create a continuous air barrier between the attached garage and living space. Refer to www.buildingscience.com/housethatwork/airsealing/default.htm for air-sealing details.

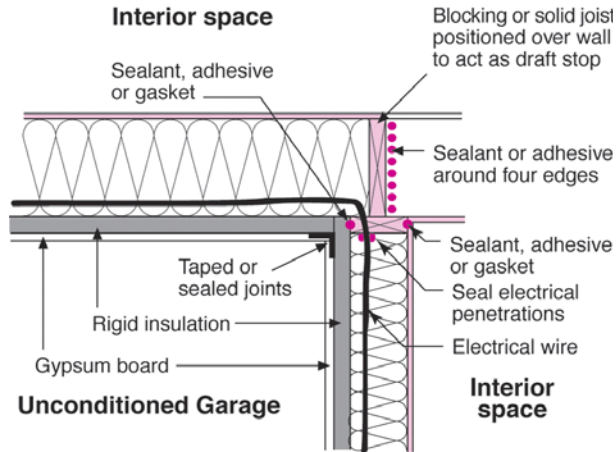

Figure 1-20. Creating a continuous air barrier

Drying Mechanisms

In any climate, vapor control is based on the relationships among the following: the permeability of wall components, the type of cladding (reservoir or non-reservoir), the presence/lack/nature of an air space, and the magnitude/duration of the vapor drive (based on the relationship between the exterior and interior moisture content and temperature differences). The type of sheathing and housewrap used in any wall assembly must be based on an understanding of these inter-relationships. See “Insulations, Sheathings, and Vapor Diffusion Retarders” for more information (www.buildingscience.com/resources).

This wall assembly permits drying to both the interior and the exterior (depending on the selection of exterior sheathing—see Material Compatibility and Substitutions). The roof assembly is designed to dry only to the interior (without continuous back-venting of the impermeable metal roof, little if any drying can take place to the exterior).

Drainage Plane, Air Barrier, and Vapor Control

This wall assembly is a screen system—the vinyl siding promotes air movement through all laps; the drainage plane is the lapped building paper or housewrap installed over the exterior sheathing. Alternatively, the exterior surface of the Thermo-ply[®] sheathing applied “shingle fashion” acts as the drainage plane. The roofing paper underneath the standing seam metal roof has two functions. It serves as a slip surface for the roofing for expansion and contraction of the metal, and it serves as a secondary drainage plane for moisture that might condense on the underside of the metal roofing as the result of night-sky radiation and subsequent condensation. Note that the OSB roof deck has the capacity to act as a hygric buffer and store moisture.

Thermal Barrier

In this climate, moisture control does not require specific levels of insulation. Inside/outside temperature differences do not require any cavity-warming exterior rigid insulation to control wintertime condensing surface temperatures. Having said this, insulating sheathing in general is a good idea. We recommend full cavity fill in the walls, but the 2-x-6 framing is more about advanced framing than the depth of cavity insulation that can be achieved.

Window Flashing

Window flashing details are wall assembly or cladding specific (Figure 1-21 and refer to the *EEBA Water Management Guide* available at www.eeba.org/bookstore).

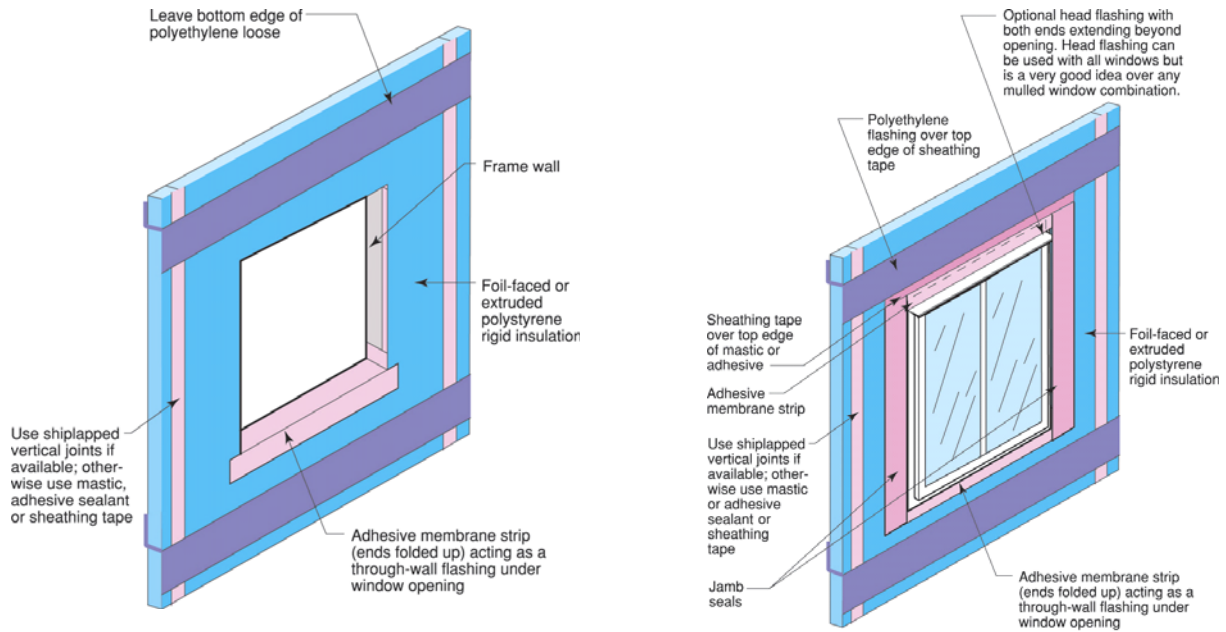

Figure 1-21. Window flashing

Advanced Framing

An important element of high performance wood-frame construction is an advanced framing package, in this case including cross bracing for shear resistance. For more detailed information on advanced framing techniques, see www.buildingscience.com/housethatwork/advancedframing/default.htm.

Framing on Slabs

Installing a capillary break between the sill plate and a concrete slab on all walls—exterior, interior, partition—is good practice. A closed cell foam sill sealer or gasket works well. Alternatively, a strip of sheet polyethylene can be used. This isolates the framing from any source of moisture that may be either in or on the concrete slab (and using sill sealer on all walls maintains wall height exactly the same).

Soil Gas Ventilation

The crawlspace to roof vent system handles conditions that are difficult if not impossible to assess before completion of the structure—resultant confined concentrations of air-borne radon, soil treatments (termiticides, pesticides) methane, etc. The cost of this "ounce" of prevention is well balanced against the cost of the "pound" of cure. A conditioned crawlspace only heightens the importance of soil gas ventilation. Note that this system is a passive system, but it can easily be converted to an active ventilation system by installing an in-line fan into the stack in the attic.

Sub-Slab Stone Bed

The 4-in.-deep $\frac{3}{4}$ -in. stone bed functions as a granular capillary break, a drainage pad, and a sub-slab air pressure field extender for the soil gas ventilation system. The sub-slab stone bed is a practical method for venting soil gas should it be necessary.

Crawlspace Access

The preferred location for crawlspace access is through the subfloor; any access through the perimeter wall must be air-sealed and insulated.

Climate-Specific Details

Termite Management

In hot-humid climates, termites are best managed with a three-pronged approach that deals with the three things termites need—cover from sunlight, moisture, and food (wood or paper):

Reduced cover. Keep plantings 3 ft away from the building perimeter, thin the ground cover (wood mulch or pea stone) to no more than 2 in. depth for the first 18 in. around the building, and maintain the termite inspection zone on the exterior of the foundation above grade.

Control moisture. Maintain slope away from building as shown, carry roof load of water at least 3 ft away from building, and make sure that irrigation is directed away from the building.

Chemical treatment. Use an environmentally appropriate soil treatment (such as Termidor[®]) and a building materials treatment (such as Bora-Care[®]) for termite-prone near-grade wood materials.

Inter-relationship of first three points. Because a builder and a homeowner's ability to employ or stick to each of the three strategies above will vary, make sure that an inability to fully employ one strategy is compensated for by complete rigor by the others. For example, if for some reason chemical treatment of soil or building materials is not an option, then complete rigor in controlling moisture and ground cover must be maintained.

Mechanical Systems

The following are key elements of a system for this climate:

Sealed-combustion gas furnace. This provides energy efficiency and health/safety with the unit inside conditioned space.

Minimum 12 SEER A/C unit. This air-conditioning unit provides energy efficient management of sensible load.

Central-fan-integrated supply ventilation. This system is simple, effective, and economical. It provides fresh, filtered, outside air in a controlled amount using the existing HVAC delivery system for even distribution and mixing. Set-up intermittent central-fan-integrated supply, designed to ASHRAE 62.2P rate, with fan cycling control set to operate the central air handler 20 minutes every hour to provide ventilation air distribution and whole-house averaging of air quality and comfort conditions (\$125 to \$150). Include a normally closed motorized damper in the outside air duct with the AirCycler[™] FRV control (+\$50 to \$60). See www.buildingscience.com/resources/mechanical/air_distribution.pdf for more detailed information.

Supplemental dehumidification. All homes in this climate call for supplemental dehumidification because the reduced sensible load of high performance homes reduces the dehumidification the A/C unit provides, extends shoulder seasons, and raises the impact of occupant-generated moisture. The ducted stand-alone dehumidifier in the attic controlled by a humidistat located in the living space has proven to be the most effective and economical system for the production home building setting. Our recommended system (+\$300 to \$350) includes GE dehumidifier model AHG40FCG1 located in an insulated enclosure in the attic and ducted to living space, Honeywell humidistat model H8808C located in the living space, and Honeywell switching relay (with transformer) model RA89A 1074. For a detailed discussion of supplemental dehumidification see www.buildingscience.com/resources/mechanical/conditioning_air.pdf.

Ducts in Conditioned Space

The preferred method for keeping HVAC ducts and mechanical equipment inside conditioned space is to keep them in the living space. Moving the conditioned boundary down so that the crawlspace is conditioned works as well, as shown in Figure 1-22. The crawlspace must be conditioned (with the air barrier and thermal barrier following the foundation) so that the crawlspace does not become a potentially large moisture trap. In no case should HVAC ducts be placed within exterior wall assemblies—this is not what is meant by ducts in conditioned space.

Alternatively, if ducts must be located in the attic, the conditioned boundary must be moved up to the underside of the roof sheathing so that the attic is conditioned.

Transfer Grilles and Jump Ducts

Single central air returns require transfer grilles to provide return pathways that prevent pressurization of bedrooms. Appropriate sizing and placement of these pressure relief methods, can be seen in Figure 1-23 with additional details at

www.buildingscience.com/resources/mechanical/509a3_cooling_system_sizing_pro.pdf.

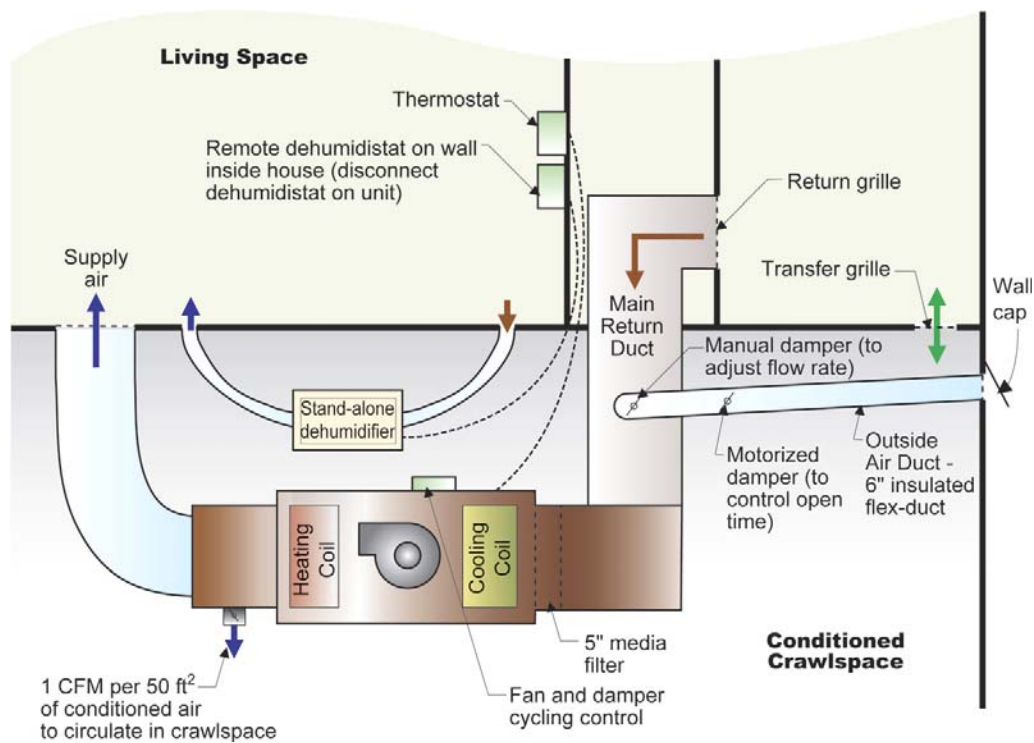

Figure 1-22. Mechanical system and ventilation in conditioned crawlspace

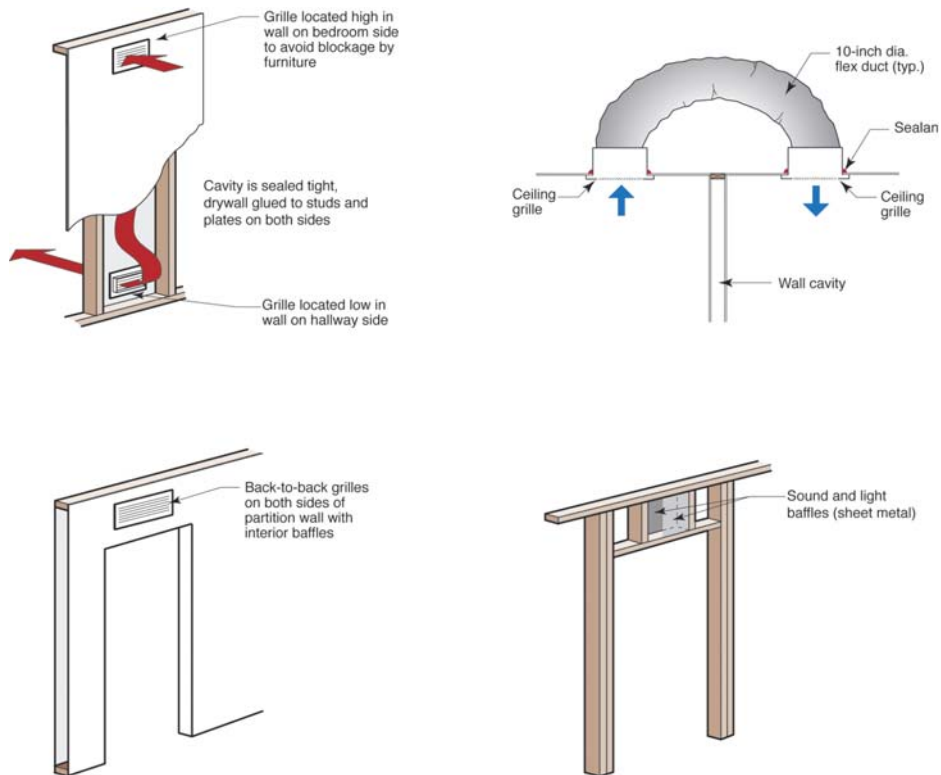

Figure 1-23. Transfer grilles and jump ducts

Water Heater

Any type of gas water heater (in terms of venting) is adequate if the water heater is located in the garage. If the water heater is located inside conditioned space, then it must be a gas power vented or power-direct vented unit, or an electric water heater.

Field Experience Notes

Air Sealing

Unvented assemblies—walls or roofs—are robust when the air sealing is robust. The hardest spots are not the "fields" but the "margins" of assemblies. Spray foam applied at the margins (truss/rafter end blocking) may seem like an expensive element of the assembly, but the labor savings and air sealing quality in comparison to the alternatives make it a good choice.

Roofing

Light-colored standing seam metal roofs yield the best cooling load reduction of any roof claddings, which is important in this climate. We recommend a metal roof that meets the EPA/DOE ENERGY STAR qualifications: [208.254.22.7/index.cfm?c=roof_prods.pr_crit_roof_products](https://www.energy.gov/eere/buildings/208.254.22.7/index.cfm?c=roof_prods.pr_crit_roof_products).

Flashing Details

Because the vinyl siding is a screened wall cladding system, flashing details should be accomplished in the plane of the drainage plane (building paper or house wrap), not the cladding. Do not caulk siding and

do not rely on "J"-channels as part of the drainage plane. (In other words, never consider vinyl siding, aluminum siding, or any siding for that matter, as the weather barrier).

Termite Inspection Gap

Our experience has shown that building inspectors will accept a 1- to 2-in. (rather than a 6-in.) termite inspection gap. This reduces the extent of uninsulated concrete and, therefore, reduces the associated heat loss.

Advanced Framing

For a technical resource that may help with resistance to advanced framing methods from local code officials, see the *Building Safety Journal* article written by Nathan Yost of BSC at www.buildingscience.com/resources/articles/1619_Yost&Edminster_for_au.pdf.

Energy Trusses

There are a number of different truss configurations that yield greater depth at the heel, but they vary quite a bit in cost. The truss shown in Figure 1-24 (sometimes called a “slider” truss) has proven to be among the most cost-competitive. And of course, the pitch of the roof affects just how much insulation you can get at this location, regardless of the type of truss.

Conditioned Crawlspaces

This assembly may require some local building code official "building science persuasion." See the *Building Safety Journal* article written by Nathan Yost of BSC: www.buildingscience.com/resources/articles/24-27_Yost_for_author.pdf.

HVAC Commissioning

The most efficient equipment means little if the system is not set up and started up properly. Follow high performance start-up procedures such as the following: www.buildingscience.com/resources/mechanical/air_conditioning_equipment_efficiency.pdf.



Figure 1-24. Energy truss, also known as a “slider truss”

Material Compatibility and Substitutions

Exterior Sheathing/Building "Paper"

A variety of building papers or housewraps installed shingle fashion can act as the drainage plane in this assembly. While drying to the exterior is not the primary mechanism in this climate, the combinations of building papers and exterior sheathings in this assembly (and their relative permeabilities) promote intermittent drying in this direction. Note that OSB is more vapor permeable than XPS insulation, which is more vapor permeable than Thermo-Ply[®] (see Table 1, Building Material Properties).

Cavity Insulation Materials

Acceptable cavity insulation includes any that has relatively high vapor permeability—cellulose, fiberglass, or foam (as long as air sealing is accomplished by a separate component or system when cellulose or fiberglass is used). This permits drying to both the interior and exterior in this wall assembly. Note that when foam insulation is left exposed in an assembly, a "thermal barrier" or "protection against ignition" may be required. Code implementation/interpretation has proven to be particularly troublesome for "gray" areas, such as spaces that are conditioned but not occupied (conditioned attics and crawlspaces).

Cast Concrete Foundation Walls

If block is used instead of cast concrete for foundation walls, the bond beam becomes essential to maintain air barrier continuity at the top of the block wall.

Crawlspace Floor

Ideally, the crawlspace floor would be a 4-in. gravel (free-draining, no fines) bed, polyethylene sheeting layer, and "rat" (2-in. low-strength cast concrete) slab, making this space more amenable to light storage and housing of HVAC equipment. The cost of this approach may outweigh the benefits for builders and buyers. If a concrete slab is cast, it should be placed directly on top of the vapor barrier.

Wall Sheathing

Moisture drive in a hot-humid climate is predominantly from the outside in. Select the wall sheathing and building paper combination to maintain functions of drainage plane and shear resistance and relatively low vapor permeability. Consult the Building Materials Property Table (Table 1).

Latex Paint

The substitution of low permeability finishes (vinyl wall paper, oil-based paints) for latex paint is strongly discouraged because of reduced drying potential.

Gypsum Wallboard

Areas of potentially high moisture, such as bathrooms, laundry rooms, kitchens, are excellent candidates for non-paper faced wallboard systems (e.g., James Hardie's Hardibacker[®], GP's DensArmor[®], USG's Fiberock[®]). In addition, paper-faced gypsum board should never be used as interior sheathing or backer for tub or shower surrounds where ceramic tile or marble (any material with joints or grout lines) is used as the finish.

Table 1. Building Materials Property Table

HPR = Hydrostatic Pressure Resistance (AATCC127)

AP = Air permeability (ASTM E2178-01)

FS = Flame Spread (ASTM E84)

SD = Smoke Development (ASTM E84)

WA = Water Adsorption (ASTM C209)

MATERIAL	VAPOR PERMEABILITY (Perm-in) ^a					R-VALUE	OTHER RELEVANT PROPERTY	COMMENTS	WEB LINK FOR MORE INFO
	TYPICAL RELEVANT DIMENSION	REPRESENTATIVE WET CUP	REPRESENTATIVE DRY CUP	WATER ABSORPTION ^c					
Exterior Sheathings									
Plywood (CDX)	3/8-in.	3.5	0.75	na	0.5	FS = 76-200 SD = 130	At saturation, factor of 10 increase in permeability —14 - 20.5 perms ^b	www.apawood.org/level_c.cfm?content=pub_tch_libmain	
OSB	3/8-in.	2	0.75	na	0.5	FS = 148 SD = 137	At saturation, marginal increase in permeability — 2.8 - 3.4 perms	www.osbguide.com/osbliterature.html	
Fiberboard - asphalt impregnated	7/16-in.	15	14.5	2.3 - 7%	1.2	FS > 75 AP = 0.82	among the most vapor permeable of exterior sheathings	www.temple.com/Fiberboard/fiberbracket/fbrpg8.html www.cascades.com/cas/en/1_0/1_0_1/1_0_1_3/1_0_1_3_3_19b.jsp	
Thin profile structural sheathing	0.078 to 0.137-in.	0.5 - 0.6	0.5 - 0.6	na	0.2 - 3.4		R-value dependent on air space; this sheathing is essentially an exterior vapor barrier	www.simplex-products.com/pages/thermoply/TechSheetTP109M.pdf	
Foil-faced PIR insulation	1-in.	0.03	0.01	0%	7	FS = 5 SD = 165	combined thermal, vapor transmission & combustion properties must be used appropriately	www.pima.org/techinfo.html	
XPS rigid insulation	1-in.	1	1	0.10%	5	FS = 5 SD = 165 AP = 0?	Compare/contrast moisture properties to EPS CAREFULLY	www.dow.com/webapps/lit/litorder.asp?filepath=styrofoam/pdfs/noreg/179-04429.pdf&pdf=true	

Table 1. Building Materials Property Table (continued)

VAPOR PERMEABILITY (Perm-in) ^a								
MATERIAL	TYPICAL RELEVANT DIMENSION	REPRESENTATIVE WET CUP	REPRESENTATIVE DRY CUP	WATER ABSORPTION ^c	R-VALUE	OTHER RELEVANT PROPERTY	COMMENTS	WEB LINK FOR MORE INFO
Exterior Sheathings (continued)								
XPS (skinned)	3/8-in.	0?	0?		1.5		polypro skin enables the fan-fold, but can be removed and greatly affects vapor permeability	
EPS rigid insulation (Type 1)	1-in.		5	6%	3.7	FS = 115 SD = 430 AP = 12.2	Compare/contrast moisture properties to EPS, CAREFULLY	www.legerlite.ca/En/Tech_data.html
Glass mat faced gypsum board (DensGlass [®])	½-in.		23	5%	0.56	FS = 0 SD = 0	among the most vapor permeable of exterior sheathings	www.gp.com/gypsum/sheathing/codes.html
Wall Claddings								
Brick	3-1/2-in.	1.7 - 13.7			0.1		Properties as variable as the material, but water storage capacity is always very high	
Traditional stucco	7/8-in.	5.8	3.8		0.1		Properties as variable as the material, but almost always has relatively high vapor permeability	
Polymer-modified stucco							Vapor permeability is dependent on paint, with latex pain generally in the 2-3 perm range and with elastomeric paint highly variable	
Cedar/redwood lap siding (unfinished)	3/8-in.				0.5	FS = 69 SD = 98		www.cedar-siding.com/about_us/brochuresandpublications/images/93-501.jpg
Pine/spruce/fir lap siding (unfinished)	3/8-in.	0.4 - 5.4			0.5			
Fibercement lap siding (primed all surfaces)								
Vinyl lap siding	n/a							

Table 1. Building Materials Property Table (continued)

VAPOR PERMEABILITY (Perm-in) ^a								COMMENTS	WEB LINK FOR MORE INFO
MATERIAL	TYPICAL RELEVANT DIMENSION	REPRESENTATIVE WET CUP	REPRESENTATIVE DRY CUP	WATER ABSORPTION ^c	R-VALUE	OTHER RELEVANT PROPERTY			
Interior Wallboards									
Standard paper-faced	½-in.		40			FS = 15 SD = 0	Both faces and core highly water vapor permeable; paper faces highly susceptible to mold and mildew growth		
DensArmor Plus™	½-in.	23	12	5%		FS = 10 SD = 0	Paper facings are replaced with fiberglass mat facings for increased resistance to moisture, mold, and mildew	www.gp.com/gypsum/densarmorplus	
Fiberock®	½-in.								
Hardie Tilebacker	½-in.								
DensShield®	½-in.						A tilebacker board with the top face acrylic coating acting as water and moisture barrier	www.gp.com/gypsum/tilebacker/index.html	
Durock®	½-in.								
Cavity Fill Insulations									
Fiberglass/Rockwool (unfaced batt)	3-1/2-in.	168	120		11	FS = 10 SD = 10	The thermal performance of all batt insulation depends on independent air sealing components and details	www.owenscorning.com/around/insulation/products/pfqi.asp	
Cellulose	3-1/2-in.		75	<15%	13	FS < 25 SD < 50	Although the air tightness of cellulose insulation is significantly better than some other common cavity fill insulation, its thermal performance still depends on independent air sealing components and details	www.us-gf.com/contractors-n-specs.asp	
Modified spray urethane	3-1/2-in.		16	0%	12.6 to 14	FS < 250 SD < 400 AP = 0.008		www.icynene.com/professionals/insulationfact.htm	

Table 1. Building Materials Property Table (continued)

VAPOR PERMEABILITY (Perm-in) ^a								
MATERIAL	TYPICAL RELEVANT DIMENSION	REPRES- TATIVE WET CUP	REPRES- TATIVE DRY CUP	WATER ABSORP- TION ^c	R- VALUE	OTHER RELEVANT PROPERTY	COMMENTS	WEB LINK FOR MORE INFO
Flooring								
Hardwood	¾-in.							
Softwood	¾-in.							
Glazed tile	3/8-in.							
Synthetic carpet								
Organic fiber carpet								
Linoleum								
Vinyl tile							essentially vapor impermeable — not recommended with concrete floors, particularly with high w/c ratios	
Vinyl sheet	1/32 to 1/16 in.						essentially vapor impermeable — not recommended with concrete floors, particularly with high w/c ratios	
VAPOR PERMEANCE AIR PERM. (Perms) (L/s*m2 @ 75 Pa)								
Building Papers								
15# asphalt roofing paper		6 (dry cup) - 31 (wet cup)		0.4			vapor permeable at any moisture content	
30# asphalt roofing paper				0.19				
Tyvek [®]		58 (wet cup)		0.0045*		HPR = 210 cm	(@ wind pressure 30 mph, NOT 75 Pa)	www.tyvek.com/na/homewrap/english/products/sys_home.htm
Typar [®]	0.013"	14 (dry cup)		0.0023		HPR = 165 cm		
FortiFiber [®] Jumbo Tex [®]								

Table 1. Building Materials Property Table (continued)

MATERIAL	TYPICAL RELEVANT DIMENSION	VAPOR PERMEANCE AIR PERM.		OTHER RELEVANT PROPERTY	COMMENTS	WEB LINK FOR MORE INFO
		(Perms)	(L/s*m2 @ 75 Pa)			
Building Papers						
Polyethylene	0.006" (6 mils)	0.03	0?		a vapor barrier appropriate only for severe cold climates	
MemBrain™	2-mil	1 (dry cup) - 10+ (wet cup)			well-suited as a vapor pressure boundary for cold and mixed climates	www.certainteed.com/pro/insulation/index.html?url=/pro/insulation/html/resid/index.html
Coatings						
Vapor retarder primer	0.25 mm	0.5				
Latex paint (primer+sealer)		3.5 - 6.1				
Exterior acrylic paint		5.5				
Semi-gloss vinyl acrylic enamel		6.6				
Exterior oil-based paint (3 coats)		0.3 - 1.0				
Oil paint (1 coat+primer)		1.6 - 3				
Elastomeric paint					lots of variability in water vapor permeability	www.magnawall.com/handbook.pdf

^a The water vapor permeability of a material is roughly inversely proportional to its thickness—doubling the thickness halves the permeability. It’s more complicated for films and coatings, however, and this rule should not be applied to these materials.

^b Building Science Consortium definition: a perm is a unit of measurement that reflects how readily water vapor passes through a material of a certain thickness. A material with a perm rating less than 1 is considered impermeable, greater than 1 but less than 10 perms is considered vapor semi-permeable, and greater than 10 perms is considered vapor permeable.

^c Although manufacturers often report this property per ASTM C209 and as a per cent by weight, this only gives information about the material's POROSITY (overall quantity of water absorbed over an indefinite—long, often 24 hours—time period) and what is much more useful is the material's water absorption coefficient, a measure of WICKING (initial rate of capillary transport). There is unfortunately NO relationship between the two, no ASTM standard for the water absorption coefficient, and few manufacturers in North America have measured or reported water absorption coefficients. When researching a building product, strongly encourage manufacturers to PROVIDE the water absorption coefficient.

II. Houses That Work for Cold Climates

Introduction

For the purpose of this report, a cold climate is considered a region with approximately 5,400 heating degree days or more, but fewer than 9,000 heating degree days. In North America, most cold climates vary in annual precipitation from less than 20 in. to more than 60 in. Condensation of warm interior air on cold surfaces within the building assembly is a concern in design and construction. In addition, in many areas ground water presents a concern because most houses are built with basements or crawl spaces. Rain, snow, and ice damming represent threats to the integrity of the building envelope. Until recently, the focus in terms of moisture control in cold climates was moisture drive from the interior during the heating season. The widespread introduction of centralized cooling in cold climates, however, can produce cold interior surfaces on which warm moist air infiltrating from the exterior can condense during the summer. If interior vapor barriers are installed in conjunction with air conditioning, serious moisture problems can occur. Interior vapor barriers should be avoided in this climate region. Note that there is a difference between an interior vapor barrier and interior vapor retarder (see “Insulations, Sheathings and Vapor Diffusion Retarders” at www.buildingscience.com/resources). Controlling moisture and air flow in the building envelope in this climate is critical to designing and building a durable, comfortable home.

We have chosen three Building Profiles that represent different regional building practices in cold climates:

- **The “Chicago”**—two-story, stick-framed, basement, first- and second-floor vinyl siding, vented attic, asphalt shingle roof (Figure 2-1)
- **The “Denver”**—two-story, stick-framed, basement with sub-crawl, stucco, vented cathedral ceiling, asphalt shingle roof (Figure 2-6)
- **The “Minneapolis”**—one-and-a-half-story, stick-framed, slab-on-grade, stucco, vented cathedral ceiling, asphalt shingle roof (Figure 2-12).

A substantial amount of repetition is present in these Building Profiles, but is necessary in order to provide comprehensive, stand-alone, examples of performance packages that achieve 40% energy savings while maintaining or improving quality and durability.

For information about a production builder from this climate, see www.buildingscience.com/buildingamerica/casestudies/prairie_crossing.htm. This case study explores the builder's experience with the BA program and discusses the reasons for the specific design and construction details that were used at Prairie Crossing. For an additional case study of a green townhouse infill project in Cleveland, Ohio, see www.buildingscience.com/buildingamerica/casestudies/ecovillage.htm. To see the detailed drawings on Advanced Framing and Air Sealing Techniques, go to www.buildingscience.com/housesthatwork. Additional information on construction methods and alternative designs is available in the *EEBA Builder's Guide for Cold Climates*.

Building America Best Practices for Cold Climates

High-performance Building America homes in cold climates must cope with substantial moisture drive from the building interior and into the building envelope during the heating season, as well as ground water and moisture issues given that full basements and crawlspace basements dominate within this climate zone. Many, if not most, high-performance production homes within this climate zone are being equipped with central forced-air conditioning systems, introducing yet another moisture stress that requires control in the design and outfitting of the envelope and HVAC system.

The following Best Practices have been compiled primarily from two BSC resources: the Building America Performance Targets (www.buildingscience.com/buildingamerica/targets.htm) and the Cold Climate Building Profiles, the “Denver,” the “Chicago,” and the “Minneapolis.” All climate-specific Best Practices are identified with a bolded and bracketed [C].

Process: Building Design, Systems Engineering, and Commissioning

Design for Energy Performance

Energy performance for space conditioning and hot water is 40% better than the 1995 Model Energy Code base case house (i.e., 10% better than ENERGY STAR[®] performance requirements).

Systems Engineering

Design structure using advanced framing methods (see www.buildingscience.com/housethatwork/advancedframing/default.htm or www.buildingscience.com/resources/presentations/advanced_framing.pdf).

Design structure to accommodate the most efficient duct distribution system that places all ducts and air handling equipment within conditioned space (see www.buildingscience.com/resources/misc/wood_efficiency.pdf, specifically Figure 3 and page 5).

Design and detail structure for durability, in terms of wall and roof assembly drying potential, continuous drainage plane, and continuous thermal barrier that clearly defines the conditioned space (See Building Profiles). [C]

Commissioning – Performance Testing

Air leakage (determined by blower door depressurization testing) should be less than 2.5 in.²/100 ft² surface area leakage ratio (CGSB [Canadian General Standards Board], calculated at a 10-Pa pressure differential); or 1.25-in.²/100 ft² leakage ratio (ASTM, calculated at a 4-Pa pressure differential); or 0.25 cfm/ft² of building envelope surface area at a 50-Pa air pressure differential. If the house is divided into multiple conditioned zones, such as a conditioned attic or conditioned crawl space, the blower door requirement must be met with access to the space open, connecting the zones.

Ductwork leakage to the exterior for ducts distributing conditioned air should be limited to 5% of the total air handling system rated air flow at high speed (nominal 400 cfm per ton) determined by pressurization testing at 25 Pa. Two acceptable compliance mechanisms are (1) test duct leakage to outside at finish stage or (2) test total duct leakage at duct rough-in stage.

Forced-air systems that distribute air for heating and cooling should be designed to supply airflow to all conditioned spaces and zones (bedrooms, hallways, basements), as well as to provide a return path from all conditioned spaces or zones. Interzonal air pressure differences, when doors are closed, should be limited to 3 Pa. This is typically achieved by installing properly sized transfer grilles or jump ducts (see www.buildingscience.com/resources/mechanical/transfer_grille_detail.pdf and www.buildingscience.com/resources/mechanical/transfer_grille_sizing_charts.pdf).

Mechanical ventilation system airflow should be tested during building commissioning.

Testing of the house should be completed as part of the commissioning process. The SNAPSHOT form is available for download as a convenient way to record the testing information (see www.buildingscience.com/buildingamerica/snapshot_form.pdf). Instructions for completing the form are also available (see www.buildingscience.com/buildingamerica/snapshot_instructions.pdf). Unique or custom house plans should each be tested. In production settings, each model type (i.e., floor plan) should be tested until two consecutive houses of this model type meet testing requirements. Then, testing on this model type can be reduced to a sampling rate of one in seven (i.e., one test, with six "referenced" houses). Small additions to a floor plan (e.g., bay window, conversion of den to bedroom) should be considered the same model type; major changes (e.g., bonus room over the garage, conversion of garage into a hobby room, etc) should be considered a separate model type.

Site: Drainage, Pest Control, and Landscaping

Drainage

Grading and landscaping shall be planned for movement of building run-off away from the home and its foundation, with roof drainage directed at least 3 ft beyond the building, and a surface grade of at least 5% maintained for at least 10 ft around and away from the entire structure.

Pest Control

Based on local code and Termite Infestation Probability (TIP) maps, use environmentally appropriate termite treatments, bait systems, and treated building materials that are near or have ground contact (See www.uky.edu/Agriculture/Entomology/entfacts/). [C]

Landscaping

Plantings should be held back as much as 3 ft and no less than 18 in. from the finished structure, with any supporting irrigation directed away from the finished structure. Decorative ground cover—mulch or pea stone, for example—should be thinned to no more than 2 in. for the first 18 in. from the finished structure (See Building Profiles). [C]

Foundation: Moisture Control and Energy Performance

Moisture Control

The building foundation shall be designed and constructed to prevent the entry of moisture and other soil gases. (See Building Profiles). [C]

Semi-permeable rigid insulation should be used as both a thermal layer and vapor control beneath the slab—a 6-mil poly vapor barrier is required if rigid insulation is not used here. Use either rigid insulation or poly, not both. [C]

Sub-slab drainage shall consist of a granular capillary break directly beneath the slab vapor barrier.

Perimeter drainage should be used per the Building Profiles – Cold Climates. [C]

Use radon resistant construction practices as described on the EPA radon control web site (www.epa.gov/iaq/radon/construc.html).

Energy Performance

A basement insulation system (type of insulation, location, thermal/air sealing/vapor permeability properties/fire rating) that controls the flow of heat and moisture is required for this climate. A number of different approaches will work; a number will not (see Building Profiles and www.buildingscience.com/resources/foundations/basement_insulation_systems.pdf). [C]

Envelope: Moisture Control and Energy Performance

Moisture Control

Water management. Roof and wall assemblies must contain elements that provide drainage in a continuous manner over the entire surface area of the building enclosure, including lapped flashing systems at all penetrations. See the Building Profiles or the *EEBA Water Management Guide* for specific details for various wall assemblies. [C]

Vapor management. Roof and wall assemblies must contain elements that, individually and in combination, permit drying of interstitial spaces. In this climate, control of the first condensing surface by boosting the thermal resistance of exterior sheathing is an important element of high performance construction. See Building Profiles. [C]

Energy Performance

Air leakage. Exterior airflow retarder (foam sheathing) or interior air-flow retarder (gypsum board) is sealed to the slab and frame walls (Airtight Drywall Approach [ADA]). For details of the ADA for interior airflow retarders, see the Building Profiles. [C]

Windows. One of two approaches is recommended:

- U-factor 0.35 or lower and SHGC (solar heat gain coefficient) 0.35 or less, regardless of climate
- Climate and/or orientation-specific glazing properties if the builder can employ passive solar orientation and design, and occupants can be expected to operate window shading in concert with time of day and weather conditions. [C]

Mechanicals / Electrical / Plumbing

Systems Engineering

HVAC system design, both equipment and duct, should be done as an integral part of the architectural design process.

HVAC system sizing should follow ACCA Manual J and duct sizing should follow ACCA Manual D (see www.buildingscience.com/resources/mechanical/509a3_cooling_system_sizing_pro.pdf)

Mechanical ventilation should be an integral part of the HVAC system design (see Figure 13 in www.buildingscience.com/housesthatwork/cold/default.htm and www.buildingscience.com/resources/mechanical/advanced_space_conditioning.pdf.) [C]

Energy Performance

Air conditioner or heat pump shall be installed according to best practices (see www.buildingscience.com/resources/mechanical/air_conditioning_equipment_efficiency.pdf).

Major appliances meet high-energy efficiency standards using current appliance ratings. Only those appliances in the top one-third of the DOE Energy Guide rating scale should be selected. For further details, see www.eren.doe.gov/consumerinfo/energy_savers/appliances.html and “Using Wood Efficiently” at www.buildingscience.com/resources/misc/wood_efficiency.pdf.

Occupant Health and Safety

Base-rate ventilation. Controlled mechanical ventilation per ASHRAE Standard 62.2.

Spot ventilation. Intermittent spot ventilation of 100 cfm should be provided for each kitchen; all kitchen range hoods must be vented to the outside (no recirculating hoods). Intermittent spot ventilation of 50 cfm or continuous ventilation of 20 cfm when the building is occupied should be provided for each washroom/bathroom.

All combustion appliances in the conditioned space must be sealed combustion or power vented. Specifically, any furnace inside conditioned space should be a sealed-combustion 90%+ unit. Any water heater inside conditioned space should be power vented or power-direct vented. Designs that incorporate passive combustion air supply openings or outdoor supply air ducts not directly connected to the appliance should be avoided.

Provide filtration systems for forced-air systems that provide a minimum atmospheric dust spot efficiency of 30% or MERV (Minimum Efficiency Reporting Value) of 6 or higher.

Indoor humidity should be maintained in the range of 25 to 60% by controlled mechanical ventilation, mechanical cooling, or dehumidification. (See www.buildingscience.com/resources/moisture/relative_humidity_0402.pdf.)

Carbon monoxide detectors (hard-wired units) shall be installed (at one per every approximate 1,000 ft²) in any house containing combustion appliances and/or an attached garage.

Information relating to the safe, healthy, comfortable operation and maintenance of the building and systems that provide control over space conditioning, hot water, or lighting energy use shall be provided to occupants.

Envelope/Mechanicals Management

Plumbing. No plumbing in exterior walls. Air seal around plumbing penetrations in pressure boundary (air barrier) such as rim (band) joist or ceiling.

Electrical. Seal around wires penetrating air barrier or pressure boundary.

Building Profile #5. The Chicago

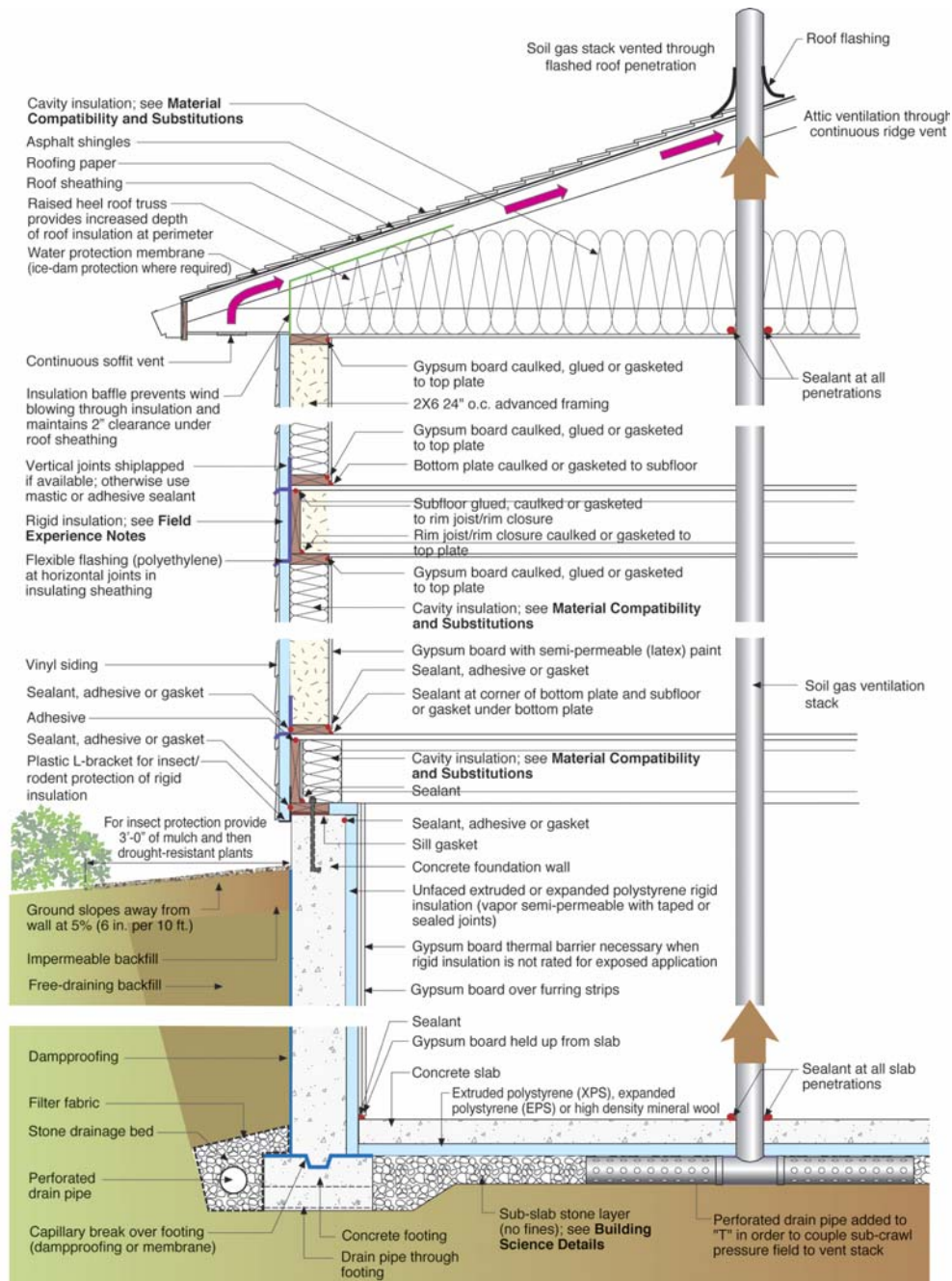

Foundation: Basement

Above Grade Walls: Wood frame

Attic: Unconditioned

Roof: Asphalt shingles

Cladding: Vinyl siding

Figure 2-1. Cross section of the Chicago

Building Science Details

Ducts in Conditioned Space

The Chicago (Figure 2-1) is designed to accommodate HVAC equipment and ducts in the basement and living space, not in an unconditioned attic. HVAC ducts should not be run in exterior walls.

Air Sealing Details at Transitions

Air sealing can be particularly difficult, but no less important, at assembly transitions such as band joists and between attached garages and living spaces. These are discussed below because they have proven to be a consistent challenge for builders.

Band joists. Continuity of an exterior air barrier can be maintained at the band joist with sealed or taped housewrap or rigid foam insulation. Continuity of an interior air barrier can be maintained through a combination of cut foam blocks and sealant/caulk, rigid draftstopping material (wood blocking) and sealant/caulk, or spray foam. Note that neither cellulose nor fiberglass (batt or blown) can be used for the air barrier. The air barrier detail on second-story band joists is important because it is inaccessible (covered by structural/finish floor and ceiling finish) after construction. Note that while fiberglass batts fulfill the requirement for protection from ignition in the open band joists, fiberglass batt material by itself cannot maintain the air barrier.

Attached garages. The building envelope surfaces shared between conditioned space and an unconditioned garage must have a continuous air barrier. See Figure 2-2 for details in terms of using sealants and rigid insulation to create a continuous air barrier between the attached garage and living space. See also www.buildingscience.com/housethatwork/airsealing/default.htm.

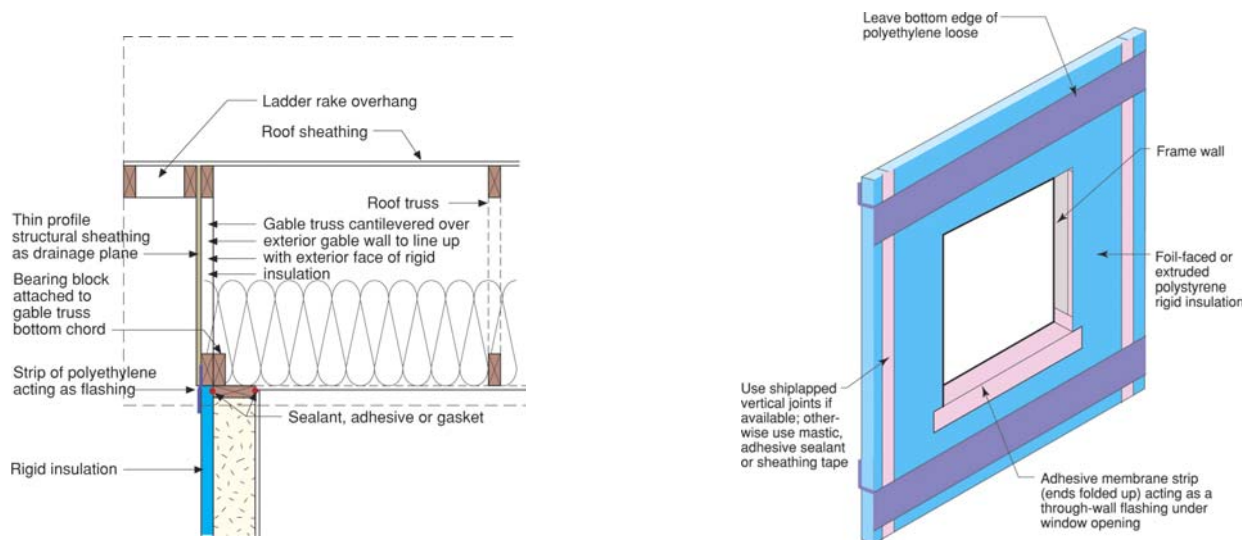

Figure 2-2. Air sealing and an attached garage.

Drying Mechanisms

In any climate, vapor control is based on the relationships among the following: the permeability of wall components, the type of cladding (reservoir or non-reservoir), the presence/lack/nature of an air space, and the magnitude/duration of the vapor drive (based on the relationship between the exterior and interior moisture content and temperature differences). The type of sheathing and housewrap used in any wall assembly must be based on an understanding of these inter-relationships. See “Insulations, Sheathings, and Vapor Diffusion Retarders” for more information (www.buildingscience.com/resources/walls/insulation_sheathing.pdf).

In cold climates, the moisture load in the winter months is primarily from the interior, so roof and wall assemblies are generally designed to dry primarily to the exterior. Wintertime condensation control can be facilitated by elevating the temperature of the first condensing surface (the outside of the exterior sheathing) via the use of insulating sheathing. When XPS (with relatively low permeability) is used, then only slow drying is available to the exterior. Accordingly, most drying occurs to the interior during the summer months. Therefore, interior vapor barriers should not be installed. Note that there is a difference between an interior vapor barrier and an interior vapor retarder. Particular care must be taken to prevent the entry of bulk water (i.e., leaks) and to control interior relative humidity in the coldest months (see Material Compatibility and Substitutions).

Drainage Plane, Air Barrier, Vapor Control

This wall assembly is a screen system—the vinyl siding promotes air movement through all laps; the drainage plane is the lapped building paper or housewrap installed over the exterior sheathing. Note how flashing maintains the continuity of the drainage plane at transitions. Continuity of the drainage plane on gable end walls framed over stud walls with exterior insulating sheathing can be accomplished as shown in Figure 2-2.

This building profile has a continuous air barrier on the interior (Airtight Drywall Approach on ceiling and walls (see www.buildingscience.com/housethatwork/airsealing/default.htm) and on the exterior walls (the sealed rigid insulation).

In cold climates, walls are generally designed to dry to the exterior, with the exterior of the wall being five times more vapor permeable than the interior, or they are designed with insulating sheathing in order to control the temperature of the condensing surfaces. The thickness of the insulating sheathing is determined by calculation based on the severity of the climate (see “Insulations, Sheathings and Vapor Diffusion Retarders” at www.buildingscience.com/resources/walls/insulation_sheathing.pdf). Walls constructed with insulating sheathing are designed to dry to the interior during the summer months. Latex paint or some other vapor retarder (i.e., the kraft facing on fiberglass batts or CertainTeed’s MemBrain™ Smart Vapor Retarder) acts to slow moisture entry into the framed assembly from the interior during the winter. Ideally, the more vapor permeable EPS rigid insulation works well as the thickness of insulation goes beyond 1 in. (see Field Experience Notes for more discussion).

Rough Opening Flashing

Flashing must be installed at the plane of the XPS rigid insulation for drainage plane continuity (Figure 2-2). For more details see the *EEBA Water Management Guide* at www.eeba.org/bookstore.

Advanced Framing

This advanced framing wall assembly replaces structural sheathing with cross bracing or some alternative for shear resistance. Thermal performance and reduced drywall cracking are additional benefits of a comprehensive approach. See www.buildingscience.com/housethatwork/advancedframing/default.htm for details.

Framing on Slabs

Installing a capillary break between the sill plate and a concrete slab on all walls—exterior, interior, partition—is good practice. A closed cell foam sill sealer or gasket works well. Alternatively, a strip of sheet polyethylene can be used. This isolates the framing from any source of moisture that may be either in or on the concrete slab (and using sill sealer on all walls maintains the same wall height).

Soil Gas Ventilation

The sub-slab to roof vent system handles conditions that are difficult if not impossible to assess before completion of the structure—resultant confined concentrations of air-borne radon, soil treatments (termiticides, pesticides) methane, etc. The cost of this “ounce” of prevention is well balanced against the cost of the “pound” of cure.

Sub-Slab Stone Bed

The 4-in.-deep, ¾-in. stone bed functions as a granular capillary break, a drainage pad, and a sub-slab air pressure field extender for the soil gas ventilation system. Without it, a soil gas ventilation system is not practical, and the only capillary break between the slab and ground is the polyethylene vapor barrier or the rigid insulation under the slab.

Thermal Barrier

Cavity-warming exterior rigid insulation is important in this climate, where the average monthly temperature for the coldest month of the year goes below 45°F. The heat loss through the basement walls is significant enough to warrant 1-1/2 to 2 in. of rigid insulation. Note that the insulation must either comply with local codes for protection against ignition or be covered with material such as gypsum wallboard. See the BSC article on basement insulation systems at www.buildingscience.com/resources/foundations/basement_insulation_systems.pdf.

Vented Attic

Soffit and ridge vents provide more effective attic ventilation than gable-end vents. Gable exhaust fans do not provide effective attic ventilation. They are generally temperature-controlled when relative humidity is often the condition that requires higher ventilation rates. They can also depressurize the house causing loss of conditioned air. Generally, the area of the gable and soffit vents combined with the leakage of the attic ceiling is such that the fan pulls air not just from the exterior vent, but also from the conditioned space below.

Climate-Specific Details

Below-Grade Insulation

Ground temperatures make foundation wall and slab insulation an important part of the thermal barrier.

Above-Grade Insulation

Homes in this climate benefit from exterior insulation that warms whatever structural material is to its interior, protecting it from the moisture degradation that can occur as the result of condensation.

Ice Dam Protection

The combination of adequate insulation just above the exterior wall and air sealing at the wall-roof assemblies transition is essential to prevent ice dams. But ice dams can occur even in properly detailed roof assemblies from differential solar snow melt. A water protection membrane at the eave is recommended on all roof assemblies in this climate, along with continuous soffit ventilation where a vented attic design is used.

Mechanical Systems

Heating and Cooling. A sealed combustion hot air furnace and SEER 12 air conditioning unit is recommended. A single central return requires transfer grilles to provide return path and avoid pressurizing bedrooms (Figure 2-3).

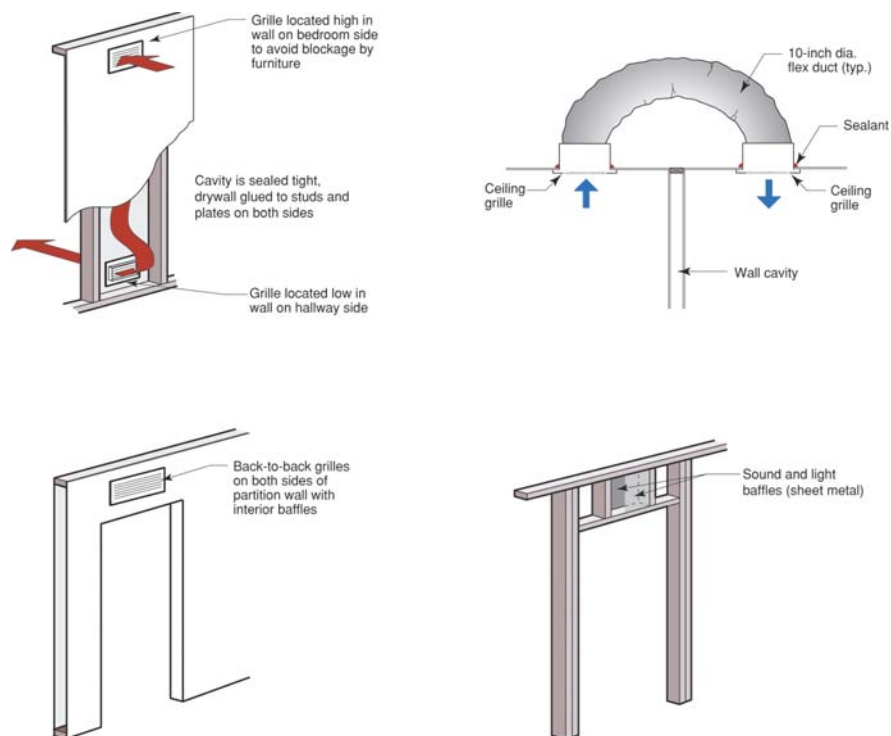
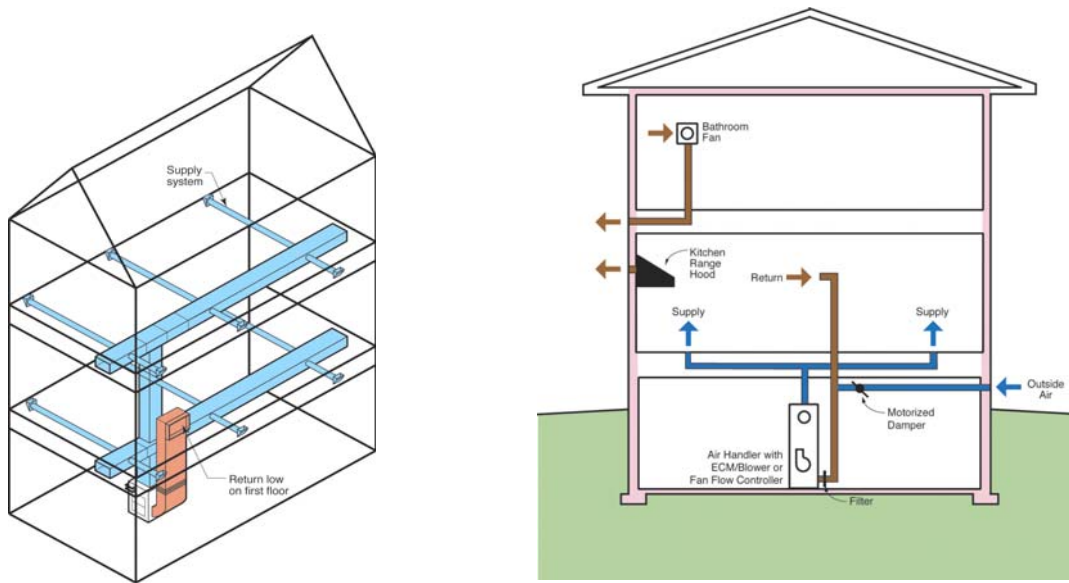

Figure 2-3. Transfer grille and jump duct approaches

Ventilation. For homes with central forced-air distribution systems, we recommend an intermittent central-fan-integrated supply, designed to provide the ASHRAE 62.2P recommended rate, with fan cycling control set to operate the central air handler 20 minutes every hour to provide ventilation air distribution and whole-house averaging of air quality and comfort conditions (\$125 to \$150). Outside air fraction should be designed to keep mixed air temperature at furnace heat exchanger above 50°F, usually not more than a 10%. Include a normally closed motorized damper in the outside air duct (+\$50 to \$60) (Figure 2-4)



Basement Configuration

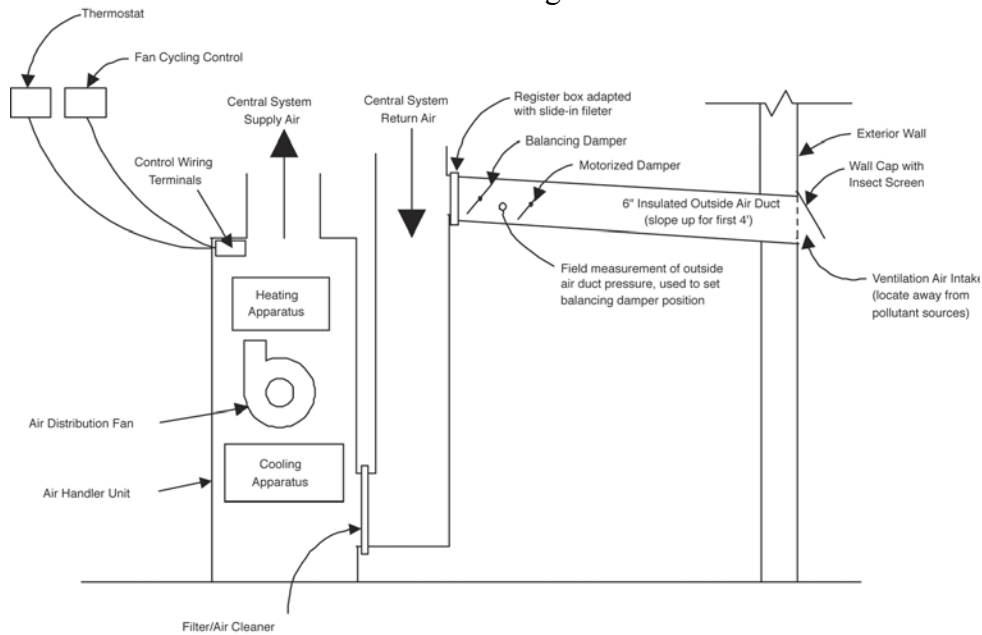

Figure 2-4. Recommended ventilation system in the “Chicago”

In “Severe Cold” climates and where flows result in lower than 50°F mixed air temperatures, ventilation can be accomplished using a continuous exhaust system (see next section “For homes without central forced air distribution”), a heat-recovery ventilator (HRV), or an energy-recovery ventilator (ERV). HRV or ERV systems should not be hard-connected to the HVAC system.

For homes without central forced-air distribution system, we recommend a continuous multi-point exhaust, designed to provide the ASHRAE 62.2P recommended flow rate, pulling from each bedroom (unless the bedroom has a bathroom, in which case it will pull from the bathroom), and pulling from at least one location in the principal living area. A fan-cycling control for the central air handler provides mixing only. Any combustion appliances must be power-direct vented sealed combustion.

Water heater. Any type of gas water heater (in terms of venting) is adequate if the water heater is located in the garage. If the water heater is located inside conditioned space, then it must be a gas power vented or power-direct vented unit, or an electric water heater.

Insect Management

In cold climates, insect pressure (termites and carpenter ants) is less pronounced than in warmer climates, but important nonetheless. A three-pronged approach deals with the three things insects need—cover, moisture, and food (wood or paper):

Reduced cover. Keep plantings 3 ft away from the building perimeter, thin the ground cover (wood mulch or pea stone) to no more than 2 in. depth for the first 18 in. around the building, and maintain any termite inspection zone on the foundation.

Control moisture. Maintain slope away from building as shown, carry roof load of water at least 3 ft away from building, and make sure that irrigation is directed away from the building.

Chemical treatment. Use an environmentally appropriate building materials treatment (such as Bora-Care[®]) for insect-prone, near-grade wood materials.

Inter-relationship of first three points. Because a builder and a homeowner’s ability to employ or stick to each of the three strategies above will vary, make sure that an inability to fully employ one strategy is compensated for by complete rigor with the others. For example, if for some reason, chemical treatment of soil or building materials is not an option, then complete rigor in moisture control and ground cover is required.

Field Experience Notes

Selection of Rigid Insulation

Most builders select rigid insulation based on costs and handling properties. Although the vapor permeability of both EPS and rigid fiberglass insulation can make them particularly well suited to cold climate envelope assemblies, their lack of availability and user-friendliness generally make XPS insulation the builder choice. For these reasons, we recommend 1-in. or thicker XPS in most wall assemblies. But remember, the type of sheathing to use is always a question that should be asked in the context of the given cladding and the level of control that can be expected over interior relative humidity via mechanical ventilation. See “*Insulations, Sheathings, and Vapor Diffusion Retarders*” for more information (www.buildingscience.com/resources).

Joint Treatment in Rigid Insulation

Shiplapped rigid foam insulation has proven to be available in only very limited areas. Mastic works as a water sealant, but its long-term performance is not known (although it appears promising). Flexible flashing with polyethylene film is straightforward and creates a natural weatherlap and, therefore, is the preferred approach.

Flashing Details

Because the vinyl siding is a screened wall cladding system, flashing details should be accomplished in the plane of the drainage plane (building paper or house wrap, rigid foam or sheathing), not the cladding. Do not caulk siding and do not rely on the "J"-channel as part of the drainage plane. (In other words, never consider vinyl siding, aluminum siding, or any siding for that matter, as the weather barrier).

Advanced Framing

For a technical resource that may help with resistance to advanced framing methods from local code officials, see the *Building Safety Journal* article written by Nathan Yost of BSC at www.buildingscience.com/resources/articles/16-19_Yost&Edminster_for_au.pdf.

Stepped Foundation Insulation Detail

Maintaining thermal barrier continuity in stepped foundations has proven difficult or easy to neglect. Figure 2-5 shows how the rigid foam needs to be cut and placed.

Energy Trusses

A number of different truss configurations yield greater depth at the heel, but they vary quite a bit in cost. The truss shown in Figure 2-5 (sometimes called a "slider" truss) has proven to be among the most cost-competitive. And of course, the pitch of the roof affects just how much insulation you can get at this location, regardless of the type of truss.

Material Compatibility and Substitutions

Rim Joist Material

With claddings such as vinyl siding that track the dimensional changes in structural materials to which they are attached, a rim joist material such as engineered lumber is recommended because it is more dimensionally stable (less shrinkage) than solid sawn material.

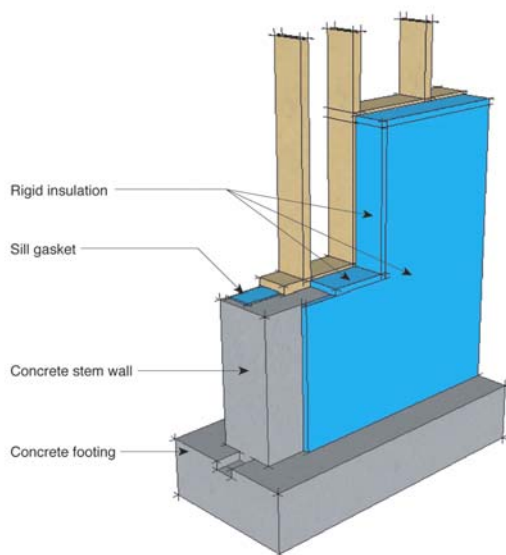

Figure 2-5. Stepped foundation detail on the left and trusses on the right

Rim Joist Blocking

An alternative to this detail is to spray foam insulation on the rim joist to maintain air barrier continuity at this transition.

Drainage Plane on Rigid Insulation

An alternative to flashing, shiplapping, or sealing the XPS insulation for continuity of the drainage plane, is to apply a housewrap to the outside of the insulation. The housewrap then becomes the continuous drainage plane. It is also possible to install the housewrap under the XPS insulation (this is a more common commercial wall system approach).

Interior Latex Paint

The substitution of low permeability interior finishes (vinyl wall paper, oil-based paints) for latex paint will result in severely limiting or eliminating any drying potential that the wall assembly has to the interior. These interior treatments are not recommended.

Cavity Insulation Materials

Acceptable cavity insulation includes any that has relatively high vapor permeability—cellulose, fiberglass, or foam (as long as air sealing is accomplished by a separate component or system when cellulose or fiberglass is used). The decision may also be based on properties other than building science.

Gypsum Wallboard

Areas of potentially high moisture, such as bathrooms, basements, kitchens, are excellent candidates for non-paper faced wallboard systems (e.g., James Hardie's Hardibacker[®], GP's DensArmor[®], USG's Fiberock[®]). In addition, paper-faced gypsum board should never be used as interior sheathing or backer for tub or shower surrounds where ceramic tile or marble (any material with joints or grout lines) is used as the finish.

Cast Concrete Foundation Walls

If block is used instead of cast concrete for foundation walls, the bond beam becomes essential to maintain air barrier continuity at the top of the block wall.

L-channel Detail on Cladding at Base of Exterior Wall

Any stop can be used at the bottom, exposed edge of the rigid insulation to prevent insect and rodent intrusion, as long as it does not interfere with the foam's function as the drainage plane.

Building Profile #6. The Denver

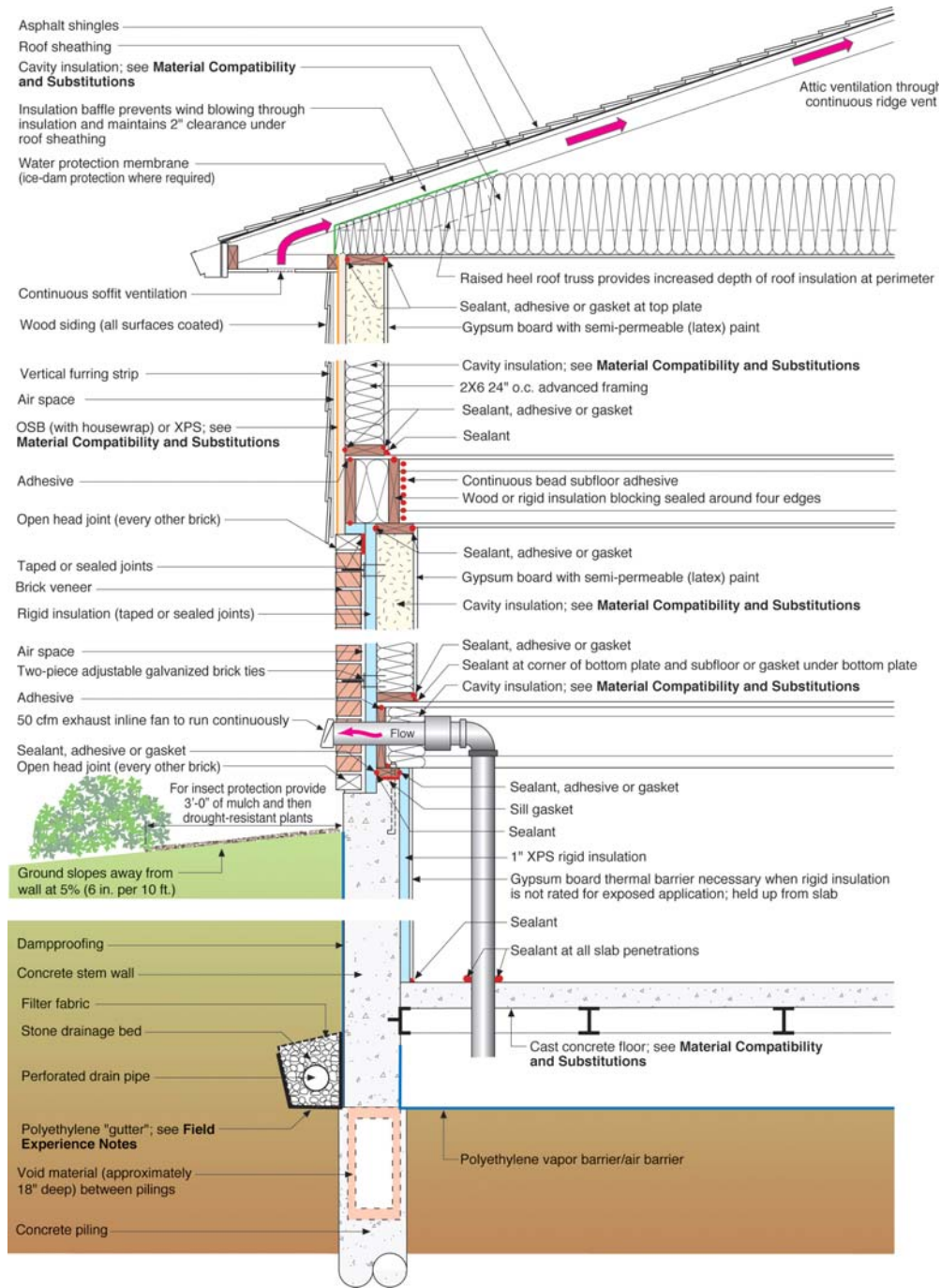

Foundation: Basement w/sub-crawl
Above Grade Walls: Wood frame

Attic: Unconditioned
Roof: Asphalt shingles

Cladding (1st floor): Brick veneer
Cladding (2nd floor): Wood siding

Figure 2-6. Cross section of the Denver

Building Science Details

Ducts in Conditioned Space

The Denver (Figure 2-6) is designed to accommodate HVAC equipment and ducts in the basement and living space, not in the unconditioned attic. HVAC ducts should not be run in exterior walls.

Air Sealing Details at Transitions

Air sealing can be particularly difficult, but no less important, at assembly transitions such as band joists, and between attached garages and living spaces. These are discussed below because they have proven to be a consistent challenge for builders.

Band joists. Continuity of an exterior air barrier can be maintained at the band joist with sealed or taped housewrap or rigid foam insulation. Continuity of an interior air barrier can be maintained through a combination of cut foam blocks and sealant/caulk, rigid draftstopping material (wood blocking) and sealant/caulk, or spray foam. Note that neither nor fiberglass (batt or blown) can be used for the air barrier. The air barrier detail on second-story band joists is important because it is inaccessible (covered by structural/finish floor and ceiling finish) after construction. Note that while fiberglass batts fulfill the requirement for protection from ignition in the open band joists, fiberglass batt material by itself cannot maintain the air barrier.

Attached garages. The building envelope surfaces shared between conditioned space and an unconditioned garage must have a continuous air barrier. See Figure 2-7 for details in terms of using sealants and rigid insulation to create a continuous air barrier between the attached garage and living space. See also www.buildingscience.com/housethatwork/airsealing/default.htm.

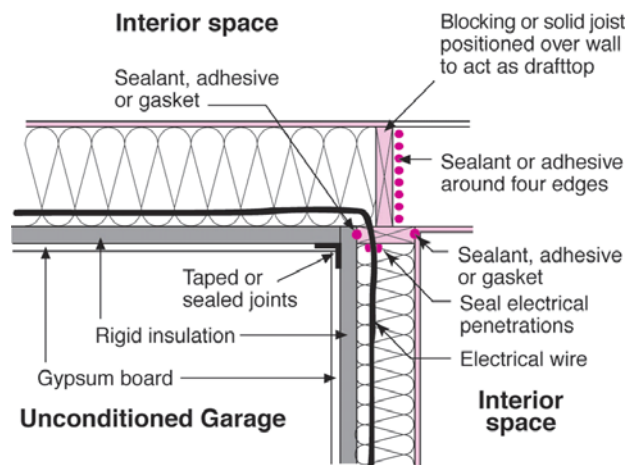

Figure 2-7. Creating a continuous air barrier

Drying Mechanisms

In any climate, vapor control is based on the relationships among the following: the permeability of wall components, the type of cladding (reservoir or non-reservoir), the presence/lack/nature of an air space, and the magnitude/duration of the vapor drive (based on the relationship between the exterior and interior moisture content and temperature differences). The type of sheathing and housewrap used in any wall assembly must be based on an understanding of these inter-relationships. See “Insulations, Sheathings, and Vapor Diffusion Retarders” for more information

www.buildingscience.com/resources/walls/insulation_sheathing.pdf.

In cold climates, the moisture load in the winter months is primarily from the interior, so roof and wall assemblies are designed to dry primarily to the exterior. Wintertime condensation control can be facilitated by elevating the temperature of the first condensing surface (the outside of the exterior sheathing) via the use of insulating sheathing. When XPS (with relatively low permeability) is used, then only slow drying is available to the exterior. Accordingly, the majority of drying occurs to the interior during the summer months. Therefore, interior vapor barriers should not be installed. Note that there is a difference between an interior vapor barrier and an interior vapor retarder. Particular care must be taken to prevent the entry of bulk water (i.e., leaks) and control interior relative humidity in the coldest months. See Material Compatibility and Substitutions.

Drainage Plane, Air Barrier, Vapor Control

On the second story, the drainage plane is the housewrap—it must be weatherlapped at any horizontal joints. On the first story, the rigid insulation becomes the drainage plane—all vertical joints must be shiplapped, flashed, or sealed; all horizontal joints must be sealed or taped. Note how flashing maintains the continuity of the drainage plane at transitions.

This building profile has a continuous air barrier on both the interior (Airtight Drywall Approach on ceiling and walls—see www.buildingscience.com/housethatwork/airsealing/default.htm) and the exterior walls (the housewrap on the second story and sealed rigid insulation on the first story).

In cold climates, walls are generally designed to dry to the exterior, with the exterior of the wall being five times more vapor permeable than the interior, or they are designed with insulating sheathing in order to control the temperature of the condensing surfaces. The thickness of the insulating sheathing is determined by calculation based on the severity of the climate (see “Insulations, Sheathings and Vapor Diffusion Retarders” at www.buildingscience.com/resources). Walls constructed with insulating sheathing are designed to dry to the interior during the summer months. Latex paint or some other vapor retarder (i.e., the kraft facing on fiberglass batts or CertainTeed’s MemBrain™ Smart Vapor Retarder) acts to slow moisture entry in to the framed assembly from the interior during the winter. Ideally, the more vapor permeable EPS rigid insulation works well as the thickness of insulation goes beyond 1 in. (see Field Experience Notes for more discussion).

Rough Opening Flashing

See Figure 2-8 for details on the brick veneer flashing (for drainage plane continuity). For more details, see the *EEBA Water Management Guide* at www.eeba.org/bookstore.

Advanced Framing

On the first story, structural sheathing is replaced with cross bracing or some alternative for shear resistance in the wall assembly. Thermal performance and reduced drywall cracking are additional benefits of a comprehensive approach. See

www.buildingscience.com/housethatwork/advancedframing/default.htm for details.

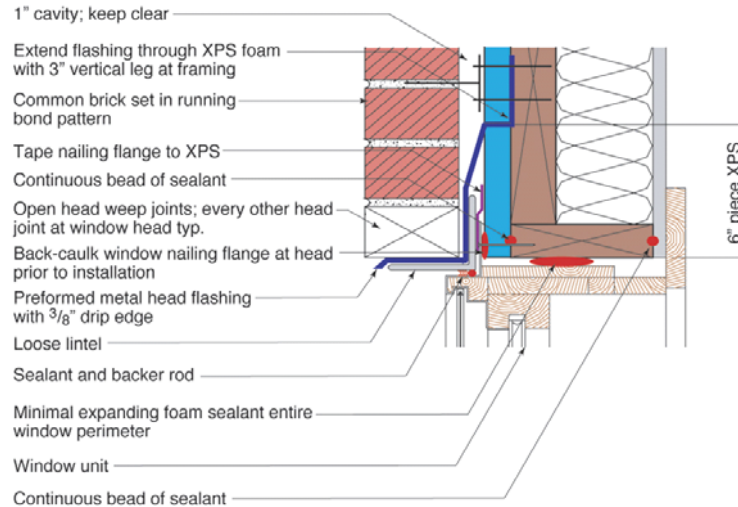

Figure 2-8. Brick veneer flashing

Framing on Slabs

Installing a capillary break between the sill plate and a concrete slab on all walls—exterior, interior, partition—is good practice. A closed cell foam sill sealer or gasket works well. Alternatively, a strip of sheet polyethylene can be used. This isolates the framing from any source of moisture that may be either in or on the concrete slab (and using sill sealer on all walls maintains wall height exactly the same). In this profile, only garage walls would be affected.

Soil Gas Ventilation

Soil gas ventilation is accomplished by the continuous exhaust ventilation system in the structural sub-crawlspace. Radon, soil moisture, and any volatilized organic substances that may be in the soil from previous land use (such as agriculture) are all handled with this exhaust system. The continuous polyethylene sheeting should still be installed on the floor of the sub-crawl to reduce the soil gas load that the continuous exhaust ventilation system handles. Alternatively, a passive system exiting through the roof can be used.

Thermal Barrier

Cavity-warming exterior rigid insulation is important in this climate where the average monthly temperature for the coldest month of the year goes below 45°F. The heat loss through the basement walls is significant enough to warrant 1-1/2 to 2 in. of rigid insulation. Note that the insulation must either comply with local codes for protection against ignition or be covered with material such as gypsum wallboard.

Vented Attic

Soffit and ridge vents provide more effective attic ventilation than gable-end vents. Gable exhaust fans do not provide effective attic ventilation. They are generally temperature-controlled, when relative humidity is often the condition that requires higher ventilation rates. They can also depressurize the house causing loss of conditioned air. Generally, the area of the gable and soffit vents combined with the leakage of the attic ceiling is such that the fan pulls air not just from the exterior vent, but also from the conditioned space below.

Climate-Specific Details

Below-Grade Insulation

Ground temperatures make foundation wall and slab insulation an important part of the thermal barrier.

Above-Grade Insulation

Homes in this climate benefit from exterior insulation that warms whatever structural material is to its interior, protecting it from the moisture degradation that can occur as the result of condensation.

Ice Dam Protection

The combination of sufficient roof pitch, adequate insulation just above the exterior wall, and air sealing at the wall-roof assemblies transition is essential to prevent ice dams. But ice dams can occur even in properly detailed roof assemblies from differential solar snow melt. A water protection membrane at the eave is recommended on all roof assemblies in this climate.

Mechanical Systems

Heating and Cooling. A sealed combustion hot air furnace and SEER 12 air conditioning unit is recommended. A single central return requires transfer grilles to provide return path and avoid pressurizing bedrooms (Figure 2-9).

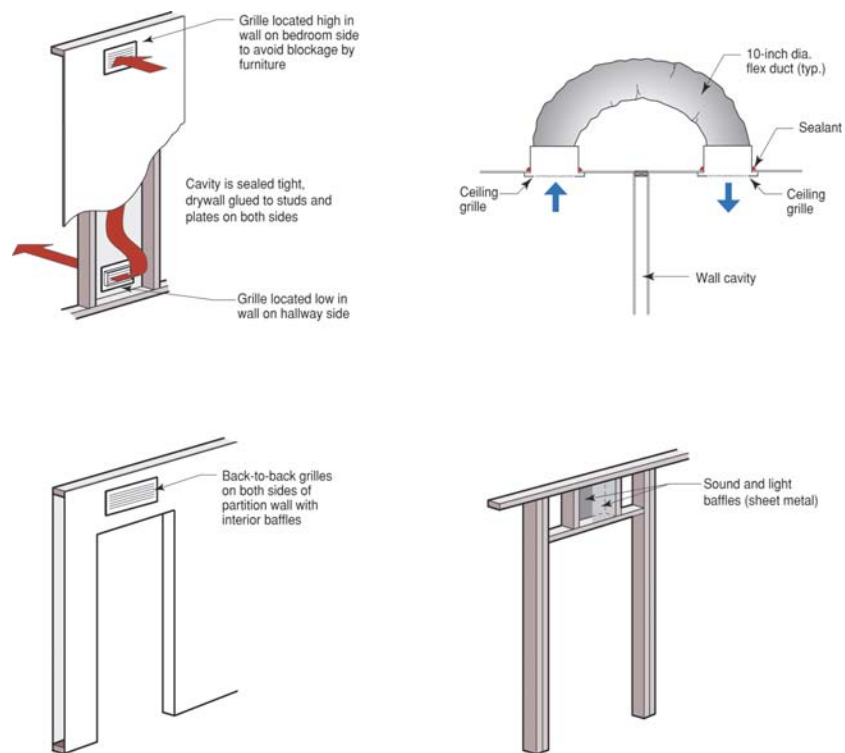
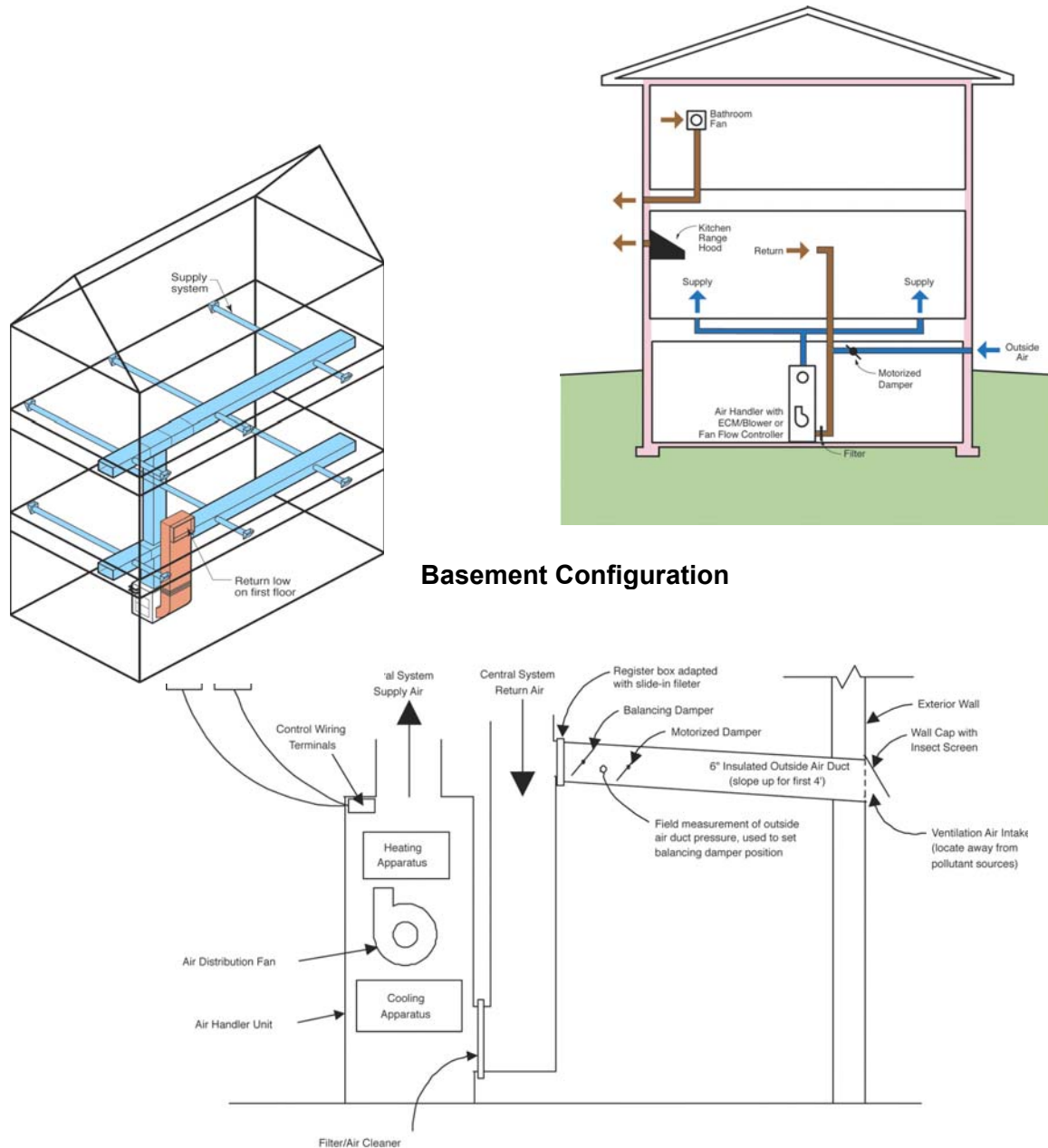

Figure 2-9. Return grilles

Ventilation. For homes with central forced air distribution system, we recommend an intermittent central-fan-integrated supply, designed to provide the ASHRAE 62.2P recommended rate, with fan cycling control set to operate the central air handler 20 minutes every hour to provide ventilation air distribution and whole-house averaging of air quality and comfort conditions (\$125 to \$150). Outside air fraction should be designed to keep mixed air temperature at the furnace heat exchanger above 50°F, usually not more than a 10%. Include a normally closed motorized damper in the outside air duct (+\$50 to \$60) (Figure 2-10).



Basement Configuration

Figure 2-10. Recommended ventilation system

For homes without central forced air distribution system. Continuous multi-point exhaust, designed to provide the ASHRAE 62.2P recommended flow rate, pulling from each bedroom (unless the bedroom has a bathroom, in which case it will pull from the bathroom), and pulling from at least one location in the principal living area. Any combustion appliances must be power-direct vented sealed combustion.

Water heater. Any type of gas water heater (in terms of venting) is adequate if the water heater is located in the garage. If the water heater is located inside conditioned space, then it must be a gas power vented or power-direct vented unit, or an electric water heater.

Structural Sub-crawlspace

This detail is actually soil- rather than climate-specific. For areas with expansive soils, the simplest solution is to build post-tensioned slab-on-grade foundations that “float” over and in expansive soils. If homes must have basements, the structural sub-crawlspace resists the lateral forces of expanding soils, while deep piles carry the house structural load to bear on deep stable material. This sub-structural crawlspace must have a continuous vapor barrier ground cover and must be vented to prevent moisture problems. A continuous 50 to 100 cfm exhaust fan accomplishes this ventilation without any significant or real effect on the pressure balance within the basement, the rest of the home, or with any combustion sources that may be in the home (50 cfm for homes 2,000 ft² or less, and 100 cfm for homes more than 2,000 ft²).

Insect Management

In cold climates, insect pressure (termites and carpenter ants) is less pronounced than in warmer climates, but important nonetheless. A three-pronged approach deals with the three things insects need—cover, moisture, and food (wood or paper):

Reduced cover: Keep plantings 3 ft away from the building perimeter, thin the ground cover (wood mulch or pea stone) to no more than 2 in. depth for the first 18 in. around the building, and maintain any termite inspection zone on the foundation.

Control moisture: Maintain slope away from building as shown, carry roof load of water at least 3 ft away from building, and make sure that irrigation is directed away from the building.

Chemical treatment: Use an environmentally appropriate building materials treatment (such as Bora-Care[®]) for insect-prone, near-grade wood materials.

Inter-relationship of first three points: Because a builder and a homeowner’s ability to employ or stick to each of the three strategies above will vary, make sure that an inability to fully employ one strategy is compensated for by complete rigor with others. For example, if for some reason chemical treatment of soil or building materials is not an option, then complete rigor in moisture control and ground cover is required.

Field Experience Notes

Selection of Rigid Insulation

Most builders select rigid insulation based on costs and handling properties. Although the vapor permeability of both EPS and rigid fiberglass insulation can make them particularly well suited to cold climate envelope assemblies, their lack of availability and user-friendliness generally make XPS insulation the builder choice. For these reasons, we recommend 1-in. or thicker XPS in most wall assemblies. But remember, the type of sheathing to use is always a question that should be asked in the context of the given cladding and the level of control that can be expected over interior relative humidity via mechanical ventilation. See “Insulations, Sheathings, and Vapor Diffusion Retarders” for more information (www.buildingscience.com/resources).

Joint Treatment in Rigid Insulation

Shiplapped rigid foam insulation has proven to be available in only very limited areas. Mastic works as a water sealant but its long-term performance is not known (although it appears promising). The flexible flashing with polyethylene film is straightforward and creates a natural weatherlap and therefore is the preferred approach.

Reservoir Claddings

Solar-driven moisture can be a significant problem with cladding such as wood clapboards and brick if wind, rain, and sun work together to saturate the siding and then drive this moisture into the wall assembly. The primary defense against this is the continuous back-venting of the air space interior to the cladding. The low permeability of the material just to the interior of the air space is a secondary defense. A 3/8-in. space works well for the wood clapboard (large enough for free flow of water and air and not large enough to create problems at windows, doors, or cornerboards). For more information on this topic, see www.buildingscience.com/resources/walls/solar_driven_moisture_brick.htm. A 1-in. air space and open head joints (top and bottom of wall) are required for the brick veneer. Harking back to "old-timer" practices—one could place a thin sand layer at the bottom of the 1-in. air space (to act as a bond break for mortar droppings) and leave bricks out intermittently in the first course. After the veneer is completed, the sand and mortar droppings can be easily removed and the missing bottom course brick mortared in.

Brick Ties

The two-piece adjustable ties are strongly recommended, given the 1-in. air space and foam insulation. See the Masonry Institute Technical Notes at www.brickinfo.org/pdfs/44b.pdf.

Brick Shelf in Foundation Wall

The brick veneer "seat" is readily accomplished by securing dimensional lumber of the desired size to the inside top edge of the concrete form.

Perimeter Drainage in Expansive Soils

The plastic trough in which the perforated drain pipe is placed in this assembly prevents water collected in the pipe from passing into the soil around the foundation pilings. This is an important foundation detail in expansive soils.

Advanced Framing

For a technical resource that may help with resistance to advanced framing methods from local code officials, see the *Building Safety Journal* article written by Nathan Yost of BSC at www.buildingscience.com/resources/articles/16-19_Yost&Edminster_for_au.pdf.

Stepped Foundation Insulation Detail

Maintaining thermal barrier continuity in stepped foundations has proven difficult, or easy, to neglect. Figure 2-11 shows how the rigid foam needs to be cut and placed.

Energy Trusses

There are a number of different truss configurations that yield greater depth at the heel, but they vary quite a bit in cost. The truss shown in Figure 2-11 (sometimes called a "slider" truss) has proven to be among the most cost-competitive. And of course, the pitch of the roof affects just how much insulation you can get at this location, regardless of the type of truss.

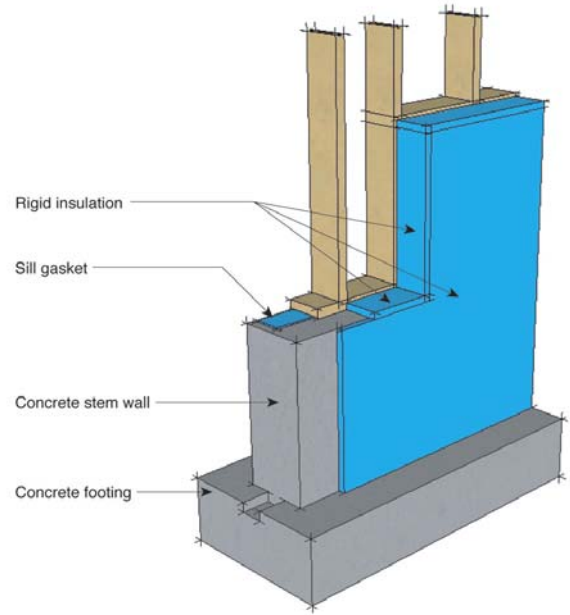

Figure 2-11. Trusses and stepped foundations

Material Compatibility and Substitutions

Exterior Sheathing

On the second story of this building, cavity-warming rigid insulation (usually strongly recommended for cold climates) is lacking. It is, therefore, doubly important that the exterior elements of this wall be vapor permeable or vapor semi-permeable. A material such as fiberglass-faced gypsum board (DensGlass Gold[®], for example) is more permeable than plywood, which is more permeable than OSB (oriented strand board), although all are acceptable. A material such as a faced high-density paperboard (Energy Brace[®] or Thermo-ply[®], for example) is vapor impermeable and is not recommended in this climate. See Table 1: Building Materials Property Table for more information.

Rim Joist Blocking

An alternative to this detail is to spray foam insulation on the rim joist to maintain air barrier continuity at this transition.

Drainage Plane on Rigid Insulation

An alternative to flashing, shiplapping, or sealing the XPS insulation for continuity of the drainage plane is to apply a housewrap to the outside of the insulation. The housewrap then becomes the continuous drainage plane. It is also possible to install the housewrap under the XPS insulation (this is a more common commercial wall system approach).

Interior Latex Paint

The substitution of low permeability interior finishes (vinyl wall paper, oil-based paints) for latex paint will result in severely limiting or eliminating any drying potential that the wall assembly has to the interior. These interior treatments are not recommended.

Cavity Insulation Materials

Acceptable cavity insulation includes any that has relatively high vapor permeability—cellulose, fiberglass, or foam (as long as air sealing is accomplished by a separate component or system when cellulose or fiberglass is used). The decision may also be based on properties other than building science.

Floor System Between Basement and Sub-Crawl

We selected the cast concrete system as the most robust and moisture resistant of the options—wood, steel, and concrete.

Gypsum Wallboard

Areas of potentially high moisture (such as bathrooms, basements, and kitchens) are excellent candidates for non-paper faced wallboard systems (e.g., James Hardie's Hardibacker[®], GP's DensArmor[®], USG's Fiberock[®]). In addition, paper-faced gypsum board should never be used as interior sheathing or backer for tub or shower surrounds where ceramic tile or marble (any material with joints or grout lines) is used as the finish.

Building Profile #7. The Minneapolis

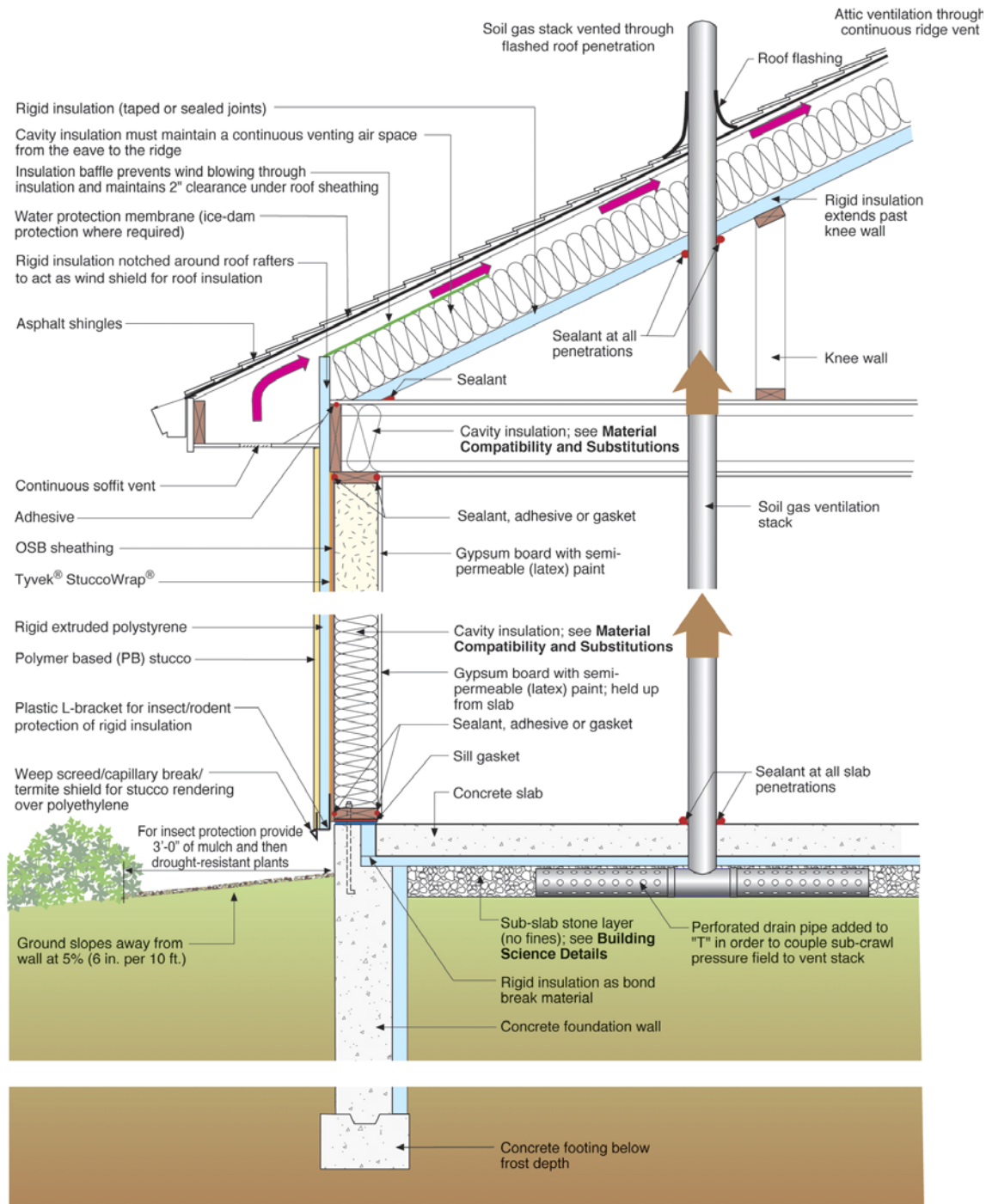

Foundation: Slab-on-grade

Attic: Vented cathedral ceiling

Cladding: Stucco

Above Grade Walls: Wood frame

Roof: Asphalt shingles

Figure 2-12. Cross section of the Minneapolis

Building Science Details

Cathedralized Roof

This roof assembly has continuous back-venting from eave to ridge of the structural roof deck, providing higher drying potential of the assembly to the exterior. This, in combination with the low vapor permeability of the rigid insulation on the interior of the assembly that keeps interior moisture out of the roof assembly, makes for a robust, cold-climate, cathedralized system.

Ducts in Conditioned Space

This building profile accommodates HVAC equipment and ducts in the living space. HVAC ducts should not be run in exterior walls or in the slab where an increased potential for condensation exists.

Air Sealing Details at Transitions

Air sealing can be particularly difficult, but no less important, at assembly transitions such as band joists, and between attached garages and living spaces. These are discussed below because they have proven to be a consistent challenge for builders.

Band joists. Continuity of an exterior air barrier can be maintained at the band joist with sealed or taped housewrap or rigid foam insulation. Continuity of an interior air barrier can be maintained through a combination of cut foam blocks and sealant/caulk, rigid draftstopping material (wood blocking) and sealant/caulk, or spray foam. Note that neither nor fiberglass (batt or blown) can be used for the air barrier. The air barrier detail on second-story band joists is important because it is inaccessible (covered by structural/finish floor and ceiling finish) after construction. Note that while fiberglass batts fulfill the requirement for protection from ignition in the open band joists, fiberglass batt material by itself cannot maintain the air barrier.

Attached garages. The building envelope surfaces shared between conditioned space and an unconditioned garage must have a continuous air barrier. See Figure 2-13 for details in terms of using sealants and rigid insulation to create a continuous air barrier between the attached garage and living space (see also www.buildingscience.com/housesthatwork/airsealing/default.htm).

Drying Mechanisms

In any climate, vapor control is based on the relationships among the following: the permeability of wall components, the type of cladding (reservoir or non-reservoir), the presence/lack/nature of an air space,

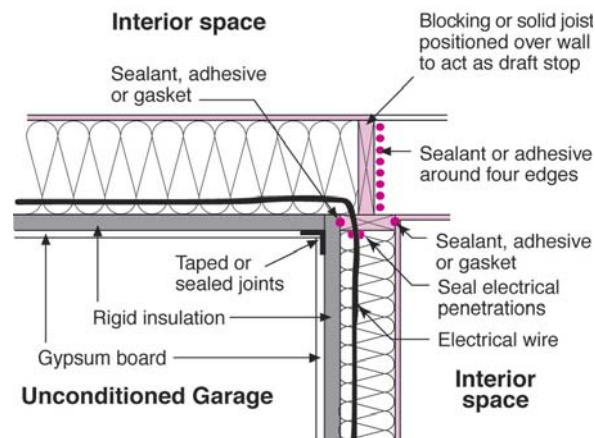

Figure 2-13. Creating a continuous air barrier

and the magnitude/duration of the vapor drive (based on the relationship between the exterior and interior moisture content and temperature differences). The type of sheathing and housewrap used in any wall assembly must be based on an understanding of these inter-relationships. See “Insulations, Sheathings, and Vapor Diffusion Retarders” for more information (www.buildingscience.com/resources/walls/insulation_sheathings.pdf).

In cold climates, the moisture load in the winter months is primarily from the interior, so roof and wall assemblies are generally designed to dry primarily to the exterior. Wintertime condensation control can be facilitated by elevating the temperature of the first condensing surface (the outside of the exterior sheathing) via the use of insulating sheathing. When XPS (with relatively low permeability) is used, then only slow drying is available to the exterior. Accordingly, the majority of drying occurs to the interior during the summer months. Therefore, interior vapor barriers should not be installed. Note that there is a difference between an interior vapor barrier and an interior vapor retarder. Particular care must be taken to prevent the entry of bulk water (i.e., leaks) and to control interior relative humidity in the coldest months (see Material Compatibility and Substitutions).

Drainage Plane, Air Barrier, Vapor Control

The drainage plane on this stucco-clad wall assembly is the building paper (in this case, StuccoWrap[®]).

This building profile has a continuous air barrier on both the interior (Airtight Drywall Approach on ceiling and walls—see www.buildingscience.com/housethatwork/airsealing/default.htm) and the exterior walls (sealed rigid insulation). Note that framing of the second story knee wall after the rigid insulation is installed makes for a continuous air barrier at the roof line.

In cold climates, walls are generally designed to dry to the exterior, with the exterior of the wall being five times more vapor permeable than the interior, or they are designed with insulating sheathing in order to control the temperature of the condensing surfaces. The thickness of the insulating sheathing is determined by calculation based on the severity of the climate (see “*Insulations, Sheathings and Vapor Diffusion Retarders*” at www.buildingscience.com/resources). Walls constructed with insulating sheathing are designed to dry to the interior during the summer months. Latex paint or some other vapor retarder (i.e., the kraft facing on fiberglass batts or CertainTeed’s MemBrain™ Smart Vapor Retarder) acts to slow moisture entry in to the framed assembly from the interior during the winter. Ideally, the more vapor permeable EPS rigid insulation works well as the thickness of insulation goes beyond 1 in. (see Field Experience Notes for more discussion).

Rough Opening Flashing

Because the drainage plane is the StuccoWrap, flashing details must occur at this point in the wall assembly. See *the EEBA Water Management Guide* at www.eeba.org/bookstore for flashing details.

Advanced Framing

Although roof trusses that accommodate second floor half-stories are available, solid sawn framing may be more practical and cost-effective and must be used with the thermal barrier details shown in this assembly. The 24-in., on-center spacing, single-top plate, and in-line framing are strongly recommended in this climate because of the clear benefits in terms of thermal performance and reduced drywall cracking. See www.buildingscience.com/housethatwork/advancedframing/default.htm for details.

Framing on Slabs

Installing a capillary break between the sill plate and a concrete slab on all walls—exterior, interior, partition—is good practice. A closed cell foam sill sealer or gasket works well. Alternatively, a strip of sheet polyethylene can be used. This isolates the framing from any source of moisture that may be either in or on the concrete slab (and using sill sealer on all walls maintains wall height exactly the same).

Soil Gas Ventilation

The sub-slab to roof vent system handles conditions that are difficult, if not impossible, to assess before completion of the structure—resultant confined concentrations of air-borne radon, soil treatments (termiticides, pesticides) methane, etc. The cost of this “ounce” of prevention is well balanced against the cost of the “pound” of cure.

Thermal Barrier

Cavity-warming exterior rigid insulation is important in this climate where the average monthly temperature for the coldest month of the year goes below 45°F. The heat loss through the basement walls is significant enough to warrant 1-1/2 to 2 in. of rigid insulation. Note that the insulation must either comply with local codes for protection against ignition or be covered with material such as gypsum wallboard.

Climate-Specific Details

Below-Grade Insulation

The combination of stem wall and slab insulation is an important element in reducing heat loss and preventing condensation. Note the thermal break provided by the rigid insulation separating the slab from the concrete stem wall.

Above-Grade Insulation

Homes in this climate benefit from exterior insulation that warms whatever structural material is to its interior, protecting it from the moisture degradation that can occur as the result of condensation.

Ice Dam Protection

The combination of sufficient roof pitch, adequate insulation just above the exterior wall, and air sealing at the wall-roof assemblies transition is essential to prevent ice dams. But ice dams can occur even in properly detailed roof assemblies from differential solar snow melt. A water protection membrane at the eave is recommended on all roof assemblies in this climate.

Stucco Cladding

This polymer-modified stucco wall assembly is water-managed as a drain-screen system. For more information on water management strategies for different building assemblies in different climates and levels of precipitation, see the appropriate *EEBA Builder's Guide* (www.eeba.org/bookstore).

HVAC Configuration

For homes with central forced air distribution system, an intermittent central-fan-integrated supply ventilation system is recommended. The system should be designed to provide the ASHRAE 62.2P recommended flow rate, with fan cycling control set to operate the central air handler 20 minutes every hour to provide distribution of ventilation air and whole-house averaging of air quality and comfort conditions (\$125 to \$150). The outside air fraction should be designed to keep mixed air temperature at the furnace heat exchanger above 50°F, usually not more than 10%. Include a normally closed motorized damper in the outside air duct (+\$50 to \$60) (Figure 2-14).

For homes without a central forced-air distribution system, we recommend a continuous multi-point exhaust, designed to provide the ASHRAE 62.2P recommended flow rate. This would pull from each bedroom (unless the bedroom has a bathroom, in which case it will pull from the bathroom) and from at least one location in the principal living area. Any combustion appliances must be power-direct vented sealed combustion.

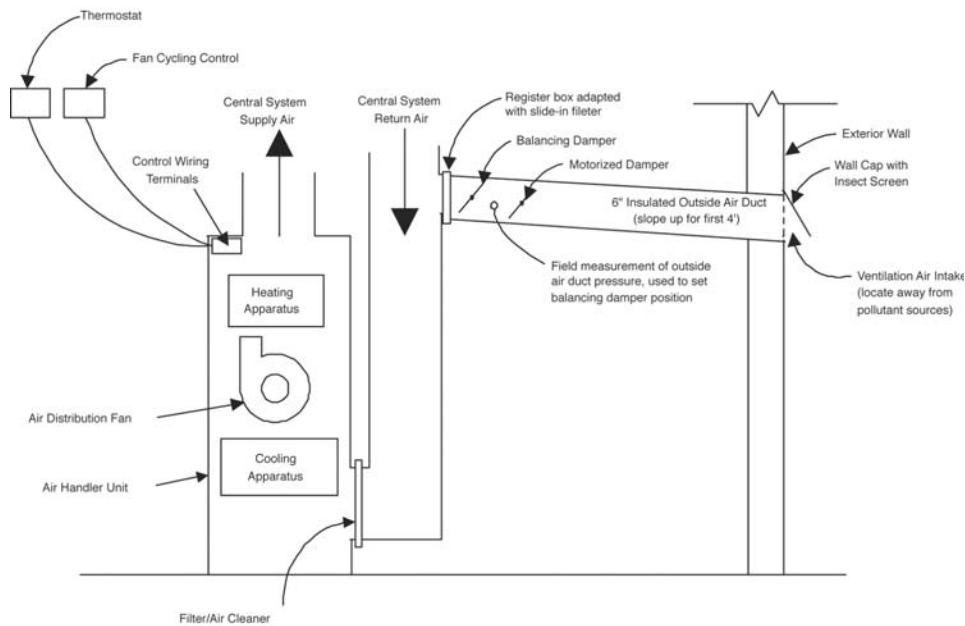

Figure 2-14. HVAC configuration

Insect Management

In cold climates, insect pressure (termites and carpenter ants) is less pronounced than in warmer climates, but is important nonetheless. A three-pronged approach deals with the three things insects need—cover, moisture, and food (wood or paper):

Reduced cover. Keep plantings 3 ft away from the building perimeter, thin the ground cover (wood mulch or pea stone) to no more than 2 in. depth for the first 18 in. around the building, and maintain any termite inspection zone on the foundation.

Control moisture. Maintain slope away from building as shown, carry roof load of water at least 3 ft away from building, and make sure that irrigation is directed away from the building.

Chemical treatment. Use an environmentally appropriate building materials treatment (such as Bora-Care[®]) for insect-prone, near-grade wood materials.

Inter-relationship of first three points. Because a builder and a homeowner's ability to employ or stick to each of the three strategies above will vary, make sure that an inability to fully employ one strategy is compensated for by complete rigor with others. For example, if for some reason, chemical treatment of soil or building materials is not an option, then complete rigor in moisture control and ground cover is required.

Field Experience Notes

Selection of Rigid Insulation

Most builders select rigid insulation based on costs and handling properties. Although the vapor permeability of both EPS and rigid fiberglass insulation can make them particularly well suited to cold climate envelope assemblies, their lack of both availability and user-friendliness generally make XPS

insulation the builder choice. For these reasons, we recommend 1-in. or thicker XPS in most wall assemblies. But remember, the type of sheathing to use is always a question that should be asked in the context of the following:

- The given cladding; and
- The level of control that can be expected over interior relative humidity via mechanical ventilation. (See “Insulations, Sheathings, and Vapor Diffusion Retarders” for more information www.buildingscience.com/resources).

Joint Treatment in Rigid Insulation

Shiplapped rigid foam insulation has proven to be available in only very limited areas. Mastic works as a water sealant but its long-term performance is not known (although it appears promising). The flexible flashing with polyethylene film is straightforward and creates a natural weatherlap and, therefore, is the preferred approach.

Stucco Flashing Detail

Where a roof intersects an exterior wall (for example, on a garage attached to a gable end), the flashing detail for the stucco should look like Figure 2-15 and employ a kick-out flashing.

Advanced Framing

For a technical resource that may help with resistance to advanced framing methods from local code officials, see the *Building Safety Journal* article written by Nathan Yost of BSC at www.buildingscience.com/resources/articles/1619_Yost&Edminster_for_au.pdf.

Energy Trusses

There are a number of different truss configurations that yield greater depth at the heel, but they vary quite a bit in cost. The truss shown in Figure 2-16 (sometimes called a “slider” truss) has proven to be among the most cost-competitive. And of course, the pitch of the roof affects just how much insulation you can get at this location, regardless of the type of truss.

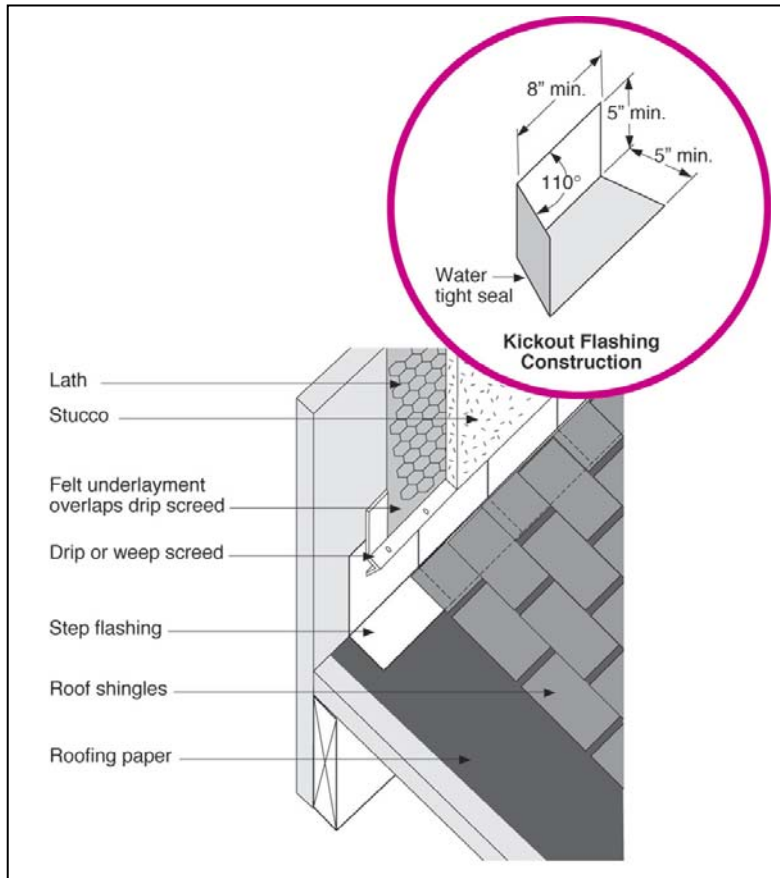

Figure 2-15. Stucco flashing



Figure 2-16. A "slider" truss

Material Compatibility and Substitutions

Slab Foundation

A monolithic slab with rigid insulation extending out below grade horizontally (shallow frost-protected foundation) can be used in this climate for slab-on-grade foundations. For more details, see Figure 2-17 and the American Society of Civil Engineers standard, "*Design and Construction of Frost-Protected Shallow Foundations*" (www.pubs.asce.org/BOOKdisplay.cgi?9991154).

Flooring

Many finished flooring materials—either because of their impermeability (sheet vinyl, for example) or sensitivity to moisture (wood strip flooring, for example)—should only be installed over a slab with a low w/c ratio (≈ 0.45 or less) or a slab allowed to dry (<0.3 grams/24hrs/ft²) before installation of flooring. In general, sheet vinyl flooring should be avoided.

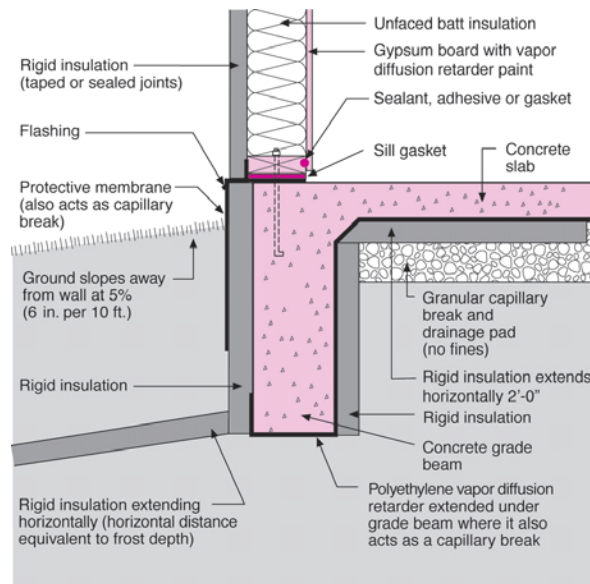

Figure 2-17. Slab foundation details

Interior Latex Paint

The substitution of low permeability interior finishes (vinyl wall paper, oil-based paints) for latex paint will result in severely limiting or eliminating any drying potential that the wall assembly has to the interior. These interior treatments should be avoided.

Cavity Insulation Materials

Acceptable cavity insulation includes any that has relatively high vapor permeability—cellulose, fiberglass, or foam (as long as air sealing is accomplished by a separate component or system when cellulose or fiberglass is used). The decision may also be based on properties other than building science.

Stucco

Given the annual rainfall for the Minneapolis region, traditional stucco should not be substituted for polymer-modified stucco. A material such as DensGlass Gold[®] can be used as sheathing and function as the drainage plane with mastic used to seal all joints.

Slab Insulation

A polyethylene vapor barrier is not necessary with this design because of the moisture control properties of the rigid insulation. If a polyethylene vapor barrier is installed with the rigid insulation, it must be installed on top of the rigid insulation in direct contact with the concrete. A sand layer should not be placed between the polyethylene or rigid insulation and the concrete slab. The polyethylene should never be installed under the rigid insulation. See also “*Why Sand Layers Should Not Be Placed Under Slabs*” at www.buildingscience.com/resources/foundations/sand_layers_under_slab.htm.

Gypsum Wallboard

Areas of potentially high moisture (such as bathrooms, basements, and kitchens) are excellent candidates for non-paper faced wallboard systems (e.g., James Hardie’s Hardibacker[®], GP’s DensArmor[®], USG’s Fiberock[®]). In addition, paper-faced gypsum board should never be used as interior sheathing or backer for tub or shower surrounds where ceramic tile or marble (any material with joints or grout lines) is used as the finish.

III. Houses That Work for Mixed-Humid Climates

Introduction

For the purpose of defining best practices in this report, a mixed-humid climate is considered a region that receives more than 20 in. of annual precipitation, has approximately 4,500 heating degree days or fewer, and where the monthly average outdoor temperature drops below 45°F during the winter months. This winter temperature limit establishes a “southern” boundary for this climate region and provides the rationale for differentiating regions where unvented roofs can be constructed without controlling the temperature of the roof deck, using insulation to address wintertime condensation.

This is a particularly challenging climate—we have significant heating, significant cooling, high moisture levels most of the year, and many areas of moderate to high rainfall. Controlling the infiltration of moisture-laden air into the building envelope and keeping moisture away from cold surfaces are major goals of design and construction. Ideally, wall and roof assemblies are designed to promote drying to both the interior and exterior in this climate.

For the Mixed-Humid climate we have chosen three Building Profiles that we think best represent the climate and regional building practices:

- **The “Charlotte”** —two-story, stick-framed, conditioned crawlspace, first floor brick veneer, second-floor wood lap siding, vented attic, asphalt shingle roof (Figure 3-1)
- **The “Atlanta”** —two-story, stick-framed, slab-on-grade, both stories vinyl sided, vented attic, asphalt-shingle roof (Figure 3-7)
- **The “Louisville”** —one-story, stick-framed, full basement, vinyl siding, cathedral ceiling (no attic), asphalt-shingle roof (Figure 3-14).

A substantial amount of repetition is present in these Building Profiles, but is necessary in order to provide comprehensive, stand-alone, examples of performance packages that achieve 40% energy savings while maintaining or improving quality and durability.

For information about a production builder in a Mixed-Humid climate see www.buildingscience.com/buildingamerica/casestudies/default.htm. This case study explores the builder's experience with the Building America program and discusses the reasons for the specific design and construction details that are used at Health-E Community Enterprises. To see detailed drawings on Advanced Framing and Air Sealing Techniques go to www.buildingscience.com/housesthatwork/advancedframing/default.htm. Additional information on construction methods and alternative designs is included in the *EEBA Builder's Guide for Mixed-Humid Climates* (www.eeba.org/bookstore).

Building America Best Practices for Mixed-Humid Climates

High-performance Building America homes in mixed-humid climates are faced with a significant heating season (typically up to 4,500 heating degree days and monthly average outdoor temperatures dropping below 45°F during winter months), as well as a cooling season with significant latent load. Reducing solar gain, using energy conserving appliances and compact fluorescent lighting reduces the sensible load. This affects the ability of the air conditioner to remove moisture or dehumidify the air because the latent load is a larger fraction of total cooling load. Therefore, correct sizing of air conditioning systems is especially important in the control of interior humidity in mixed-humid climates. Oversizing air conditioning systems in this climate typically leads to moisture problems.

The following Best Practices are based on our Building America Performance Targets (www.buildingscience.com/buildingamerica/targets.htm) and are reflected in the three Mixed-Humid Building Profiles, the “Charlotte,” the “Atlanta,” and the “Louisville.” All climate-specific Best Practices are identified with a bolded and bracketed [HH].

Process: Building Design, Systems Engineering, and Commissioning

Design for Energy Performance

Energy performance for space conditioning and hot water is 40% better than the 1995 Model Energy Code base case house (i.e., equal to 10% better than ENERGY STAR[®] performance requirements).

Systems Engineering

Design structure using advanced framing methods (see www.buildingscience.com/housethatwork/advancedframing/default.htm or www.buildingscience.com/resources/presentations/advanced_framing.pdf).

Design structure to accommodate the most efficient duct distribution system that places all ducts and air handling equipment within conditioned space (see www.buildingscience.com/resources/misc/wood_efficiency.pdf; specifically Figure 3 and page 5).

Design and detail structure for durability, in terms of wall and roof assembly drying potential, continuous drainage plane, and continuous thermal barrier that clearly defines the conditioned space (see Building Profiles). [MH]

Commissioning: Performance Testing

Air leakage (determined by blower door depressurization testing) should be less than 2.5 in.²/100 ft² surface area leakage ratio (CGSB, calculated at a 10-Pa pressure differential); or 1.25 in.²/100 ft² leakage ratio (ASTM, calculated at a 4-Pa pressure differential); or 0.25 cfm/ft² of building envelope surface area at a 50-Pa air pressure differential. If the house is divided into multiple conditioned zones, such as a conditioned attic or conditioned crawl space, the blower door requirement must be met with the access to the space open, connecting the zones.

Ductwork leakage to the exterior for ducts distributing conditioned air should be limited to 5% of the total air-handling system rated air flow at high speed (nominal 400 cfm per ton) determined by pressurization testing at 25 Pa. Two acceptable compliance mechanisms are (1) test duct leakage to outside at finish stage or (2) test total duct leakage at duct rough-in stage.

Forced air systems that distribute air for heating and cooling should be designed to supply airflow to all conditioned spaces and zones (bedrooms, hallways, basements) as well as to provide a return path from all conditioned spaces or zones. Interzonal air pressure differences, when doors are closed, should be

limited to 3 Pa. This is typically achieved by installing properly sized transfer grilles or jump ducts (see www.buildingscience.com/resources/mechanical/transfer_grille_detail.pdf and www.buildingscience.com/resources/mechanical/transfer_grille_sizing_charts.pdf).

Mechanical ventilation system airflow should be tested during commissioning of the building.

Testing of the house should be completed as part of the commissioning process. The SNAPSHOT form is available for download as a convenient way to record the testing information (see www.buildingscience.com/buildingamerica/snapshot_form.pdf). Instructions for completing the form are also available (see www.buildingscience.com/buildingamerica/snapshot_instructions.pdf). Unique or custom house plans should each be tested. In a production setting, each model type (i.e., floor plan) should be tested until two consecutive houses of this model type meet testing requirements. At that point, testing on the same model type can be reduced to a sampling rate of one in seven (i.e., one test, with six "referenced" houses). Small additions to a floor plan (e.g., bay window, conversion of den to bedroom) should be considered the same model type; major changes (e.g., bonus room over the garage, conversion of garage into a hobby room, etc.) should be considered a separate model type.

Site: Drainage, Pest Control, and Landscaping

Drainage

Grading and landscaping shall be planned for movement of building run-off away from the home and its foundation, with roof drainage directed at least 3 ft beyond the building, and a surface grade of at least 5% maintained for at least 10 ft around and away from the entire structure.

Pest Control

Based on local code and Termite Infestation Probability (TIP) maps, use environmentally appropriate termite treatments, bait systems, and treated building materials that are near or have ground contact (see www.uky.edu/Agriculture/Entomology/entfacts/) [MH]

Landscaping

Plantings should be held back as much as 3 ft and no less than 18 in. from the finished structure, with any supporting irrigation directed away from the finished structure. Decorative ground cover—mulch or pea stone, for example—should be thinned to no more than 2 in. for the first 18 in. from the finished structure (see Building Profiles). [MH]

Foundation: Moisture Control and Energy Performance

Moisture Control

The building foundation shall be designed and constructed to prevent the entry of moisture and other soil gases (see Building Profiles). [MH]

Slabs require a 6-mil polyethylene vapor barrier directly beneath the concrete or an equivalent approach (such as rigid insulation) that accomplishes vapor control for the slab. The vapor retarder must continuously wrap the slab as well as the grade beam.

Sub-slab drainage shall consist of a granular capillary break directly beneath the slab vapor retarder.

Use radon resistant construction practices as described on the EPA radon control web site (www.epa.gov/iaq/radon/construc.html).

Energy Performance

Slabs in this climate shall be insulated at the perimeter (energy modeling reveals significant heat loss at this portion of the building envelope during the heating season). Consider the use of borate-treated rigid insulation on the slab perimeter (see Building Profiles and photo detail at www.buildingscience.com/buildingamerica/casestudies/fairburn.htm). [MH]

Envelope: Moisture Control and Energy Performance

Moisture Control

Water management. Roof and wall assemblies must contain elements that provide drainage in a continuous manner over the entire surface area of the building enclosure, including lapped flashing systems at all penetrations. See the Building Profiles and the *EEBA Water Management Guide* for specific details for various wall assemblies. [MH]

Vapor management. Roof and wall assemblies must contain elements that, individually and in combination, permit drying of interstitial spaces. See the Building Profiles. [MH]

Energy Performance

Air leakage. The exterior air flow retarder (foam sheathing) or interior air flow retarder (gypsum board) is sealed to the slab and frame walls (Airtight Drywall Approach [ADA]). For details of the ADA for interior air flow retarders, see www.buildingscience.com/housethatwork/airsealing/default.htm.

Windows. We recommend one of two approaches:

- U-factor 0.35 or lower and SHGC (solar heat gain coefficient) 0.35 or less, regardless of climate
- Climate or orientation-specific glazing properties if the builder can employ passive solar orientation and design concepts, and occupants can be expected to operate window shading in concert with time of day and weather conditions. [MH]

Mechanicals / Electrical / Plumbing

Systems Engineering

HVAC system design, both equipment and duct, should be done as an integral part of the architectural design process. HVAC system sizing should follow ACCA Manual J and duct sizing should follow Manual D (see www.buildingscience.com/resources/mechanical/509a3_cooling_system_sizing_pro.pdf).

Mechanical ventilation should be an integral part of the HVAC system design (see the Building Profiles and www.buildingscience.com/resources/mechanical/advanced_space_conditioning.pdf). [MH]

Energy Performance

Air conditioner or heat pump shall be installed according to best practices (see www.buildingscience.com/resources/mechanical/air_conditioning_equipment_efficiency.pdf).

Major appliances should meet high-energy efficiency standards using current appliance ratings. Only those appliances in the top one-third of the DOE Energy Guide rating scale should be selected. (For details, see www.eren.doe.gov/consumerinfo/energy_savers/appliances.html.)

Occupant Health and Safety

Base rate ventilation. The mechanical ventilation is controlled per ASHRAE Standard 62.2.

Spot ventilation. Intermittent spot ventilation of 100 cfm should be provided for each kitchen; all kitchen range hoods must be vented to the outside (no recirculating hoods). Intermittent spot ventilation of 50 cfm, or continuous ventilation of 20 cfm when the building is occupied should be provided for each washroom/bathroom.

All combustion appliances in the conditioned space must be sealed combustion or power vented. Specifically, any furnace inside conditioned space should be a sealed-combustion 90%+ unit. Any water heater inside conditioned space should be power vented or power-direct vented. Designs that incorporate passive combustion air supply openings or outdoor supply air ducts not directly connected to the appliance should be avoided.

Provide filtration systems for forced air systems that provide a minimum atmospheric dust spot efficiency of 30% or MERV of 6 or higher.

Indoor humidity should be maintained in the range of 25 to 60% by controlled mechanical ventilation, mechanical cooling, or dehumidification (see www.buildingscience.com/resources/moisture/relative_humidity_0402.pdf).

Carbon monoxide detectors (hard-wired units) shall be installed (at one per every approximate 1000 ft²) in any house containing combustion appliances and/or an attached garage.

Information relating to the safe, healthy, comfortable operation and maintenance of the building and systems that provide control over space conditioning, hot water or lighting energy use shall be provided to occupants.

Envelope/Mechanicals Management

Plumbing. No plumbing in exterior walls. Air seal around plumbing penetrations in the pressure boundary (air barrier), such as rim (band) joist or ceiling.

Electrical. Seal around wires penetrating the air barrier or pressure boundary.

Building Profile #8. The Charlotte

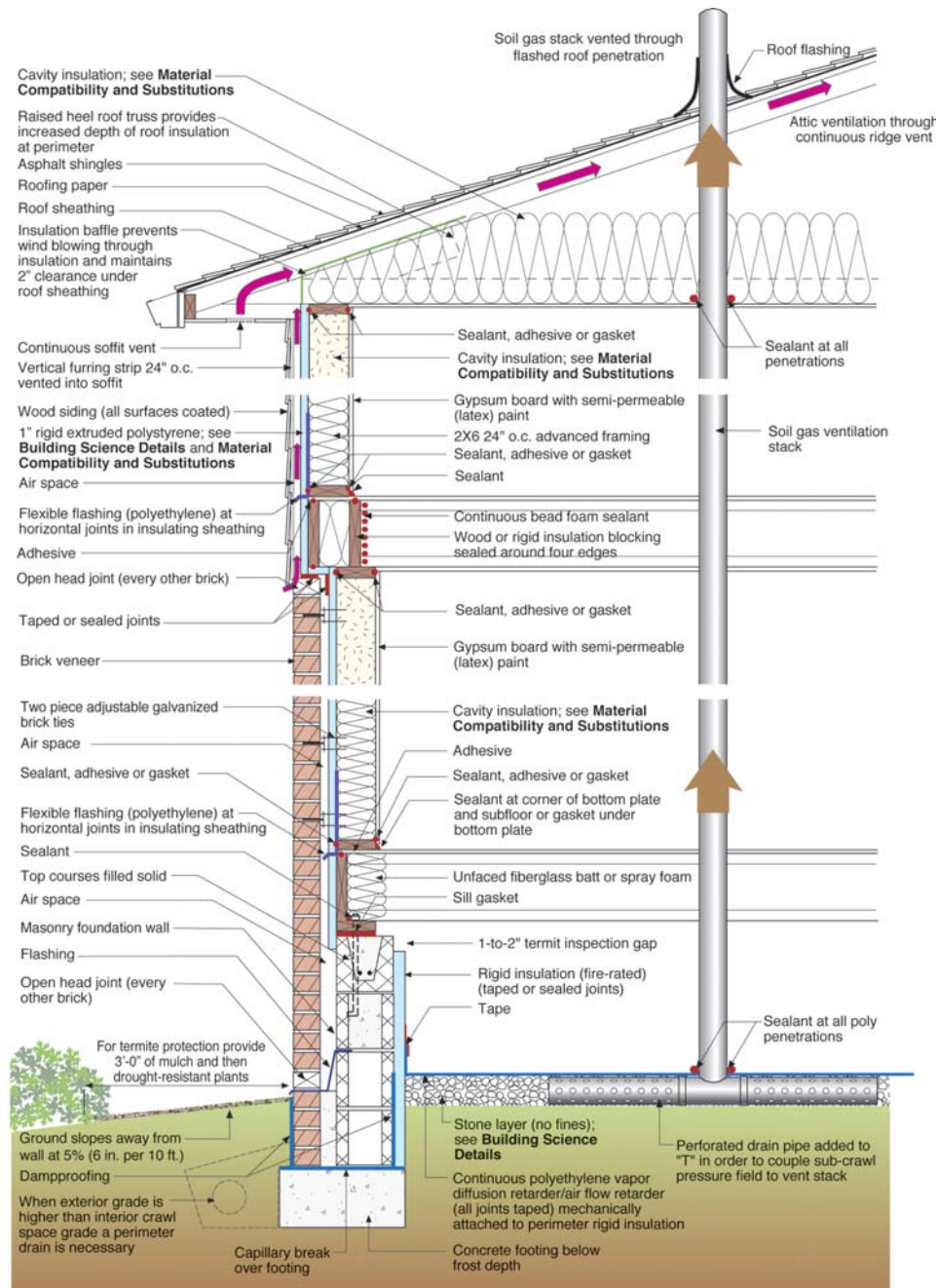

Foundation: Conditioned crawl space
Above Grade Walls: Wood frame

Attic: Unconditioned
Roof: Asphalt shingles

Cladding (1st): Brick veneer
Cladding (2nd): Wood siding

Figure 3-1. Cross section of the Charlotte

Building Science Details

Ducts in Conditioned Space

This building profile (Figure 3-1) is designed to accommodate HVAC equipment and ducts in either the living space or in the conditioned crawlspace. HVAC ducts should not be run in exterior walls.

Conditioned Crawlspace

Conditioning of the crawlspace means that this space must be constructed much like a living space—it must be supplied by the HVAC system and have a transfer grille to the living space to return air back to the HVAC system. The supply air should be directed horizontally across the crawlspace with good enough “throw” to provide some mixing, not directed down at the floor. Sizing of the supply air should be about 5% of the conditioned crawlspace floor area (For example: $0.05 \text{ cfm/ft}^2 * 1600 \text{ ft}^2 = 80 \text{ cfm}$ for a 1,600 ft² conditioned crawlspace). A single 6-in. diameter supply duct typically suffices. Transfer air should go back to the central area of the living space above the crawlspace. Two grilles (10 in. by 4 in.) on opposite sides of the crawlspace are usually sufficient. The transfer area should be calculated in the same manner as for closed bedrooms connecting to hallways, using the 3-Pa pressure difference limit. Some form of mechanical moisture control for the crawlspace is necessary. We recommend one of the following approaches:

1. A controlled ventilation strategy using the intermittent central fan-integrated supply—it provides both mixing and moisture removal for the crawlspace as well as the house.
2. A stand-alone dehumidifier installed in the crawlspace.
3. A continuously operating crawlspace exhaust fan with make-up air extracted from the house.

In the Charlotte, the rigid insulation is applied to the interior face of the exterior foundation walls. Moisture control is important to proper performance, in particular the vapor barrier ground cover on the floor of the crawlspace. The vapor barrier must be continuous and sealed to the perimeter wall and any supporting piers.

Air Sealing Details at Transitions

Air sealing can be particularly difficult, but no less important, at assembly transitions such as band joists and between attached garages and living spaces. These are discussed below because they have proven to be a consistent challenge for builders.

Band joists. Continuity of an exterior air barrier can be maintained at the band joist with sealed or taped housewrap or rigid foam insulation. Continuity of an interior air barrier can be maintained through a combination of cut foam blocks and sealant/caulk, rigid draft-stopping material (wood blocking) and sealant/caulk, or spray foam. Note that neither cellulose nor fiberglass (batt or blown) can be used for the air barrier. The air barrier detail on second-story band joists is important because it is inaccessible (covered by structural/finish floor and ceiling finish) after construction. The air barrier/thermal barrier detail is important on ground floor band joists because of the thermal bridge that can occur at the top of basement and crawlspace foundation walls (as the result of the air barrier and thermal barrier moving from the outside to the inside of the building envelope and termite inspection zones located at the top of basement and crawlspace foundation walls). Note that while fiberglass batts fulfill the requirement for protection from ignition in the open band joists, fiberglass batt material by itself cannot maintain the air barrier.

Attached garages. The building envelope surfaces shared between conditioned space and an unconditioned garage must have a continuous air barrier. See Figure 3-1 for details in terms of using

sealants and rigid insulation to create a continuous air barrier between the attached garage and living space. For more details see Figure 3-2 and www.buildingscience.com/housethatwork/airsealing/default.htm).

Drying Mechanisms

In any climate, vapor control is based on the relationships among the following: the permeability of wall components, the type of cladding (reservoir or non-reservoir), the presence/lack/nature of an air space, and the magnitude/duration of the vapor drive (based on the relationship between the exterior and interior moisture content and temperature differences). The type of sheathing and housewrap used in any wall assembly must be based on an understanding of these inter-relationships. See “Insulations, Sheathings, and Vapor Diffusion Retarders” for more information (www.buildingscience.com/resources/walls/insulation_sheatings.pdf).

In Mixed-Humid climates, roof and wall assemblies are best designed to dry to both the exterior and interior. This is not always possible when rigid exterior insulating sheathings are used because of their low vapor permeability. With insulating sheathings only inward drying is possible. Accordingly, the majority of drying occurs to the interior during the summer months. Therefore, interior vapor barriers should not be installed. Note that there is a difference between an *interior vapor barrier* and an *interior vapor retarder*. Particular care must be taken to prevent the entry of bulk water (i.e., leaks) and to control interior relative humidity in the coldest months. See Material Compatibility and Substitutions. The moisture potential represented by the reservoir wall claddings is controlled by a fully vented air space. The conditioned crawlspace will dry primarily to the exterior, given the vapor permeability of the concrete block and brick veneer.

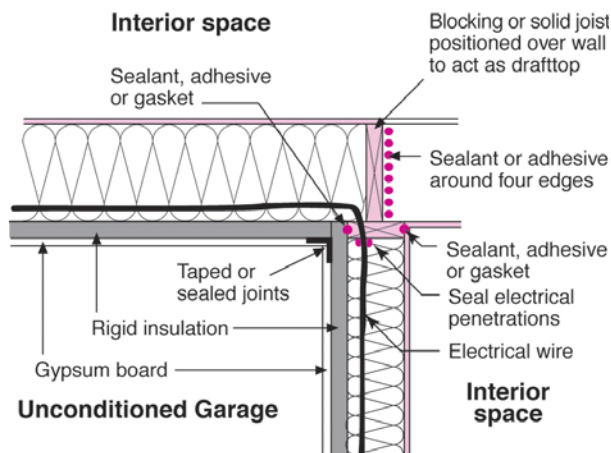

Figure 3-2. Air sealing

Drainage Plane, Air Barrier, Vapor Control

The drainage plane runs along the exterior surface of the foam sheathing. All vertical joints must be shiplapped, flashed, or sealed; all horizontal joints must be sealed or taped.

This building profile has a continuous air barrier on the interior (Airtight Drywall Approach on ceiling and walls, see www.buildingscience.com/housesthatwork/airsealing/default.htm) and on the exterior walls (the sealed rigid insulation).

In Mixed climates, wall and roof assemblies can be designed to dry primarily to the exterior (during the heating season), to the interior (during the cooling season), or in both directions. This last approach, the bi-directional drying potential, is generally preferred. For more detailed discussion of the three approaches, see the discussion of wall and roof design in the *EEBA Builder's Guides* (www.eeba.org/bookstore). Because the permeability of the latex-painted gypsum board is greater than that of the XPS rigid insulation, the wall assembly for the “Charlotte” will dry primarily to the interior.

Rough Opening Flashing

Flashing must be installed at the plane of the XPS rigid insulation for drainage plane continuity. See Figure 3-3 and the *EEBA Water Management Guide* for sequential flashing details (www.eeba.org/bookstore).

Advanced Framing

Cross bracing (or other alternative for shear resistance) replaces structural sheathing in this wall assembly. Thermal performance and reduced drywall cracking are additional benefits of a comprehensive approach to advanced framing (see www.buildingscience.com/housesthatwork/advancedframing/default.htm for details).

Soil Gas Ventilation

The sub-crawl ground cover to roof vent system handles conditions that are difficult if not impossible to assess before completion of the structure—resultant confined concentrations of air-borne radon, soil treatments (termiticides, pesticides) methane, etc. The cost of this “ounce” of prevention is well balanced against the cost of the “pound” of cure.

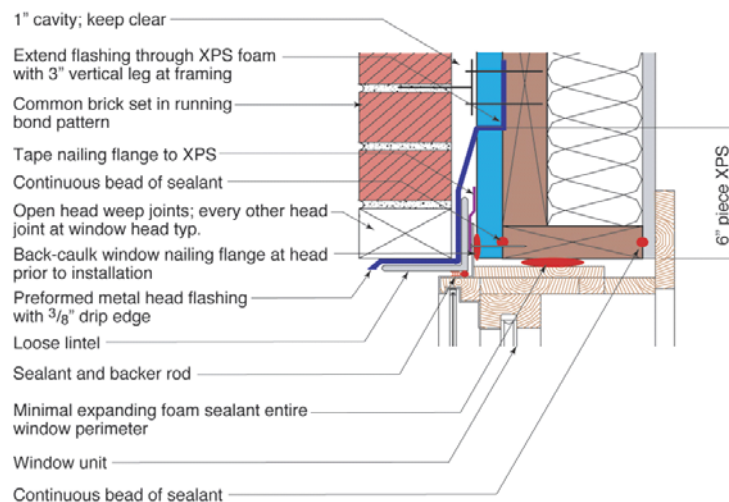

Figure 3-3. Rough opening flashing

Sub-crawl Ground Cover Stone Bed

The 4-in.-deep, 3/4-in. stone bed functions as a granular capillary break, a drainage pad, and an air pressure field extender for the soil gas ventilation system. Without it, a soil gas ventilation system is not practical.

Thermal Barrier

Cavity-warming exterior rigid insulation is important in this climate where the average monthly temperature for the coldest month of the year goes below 45°F. The rule of thumb that BSC uses is 1/4-in. of rigid insulation per 1,000 heating degree days (HDD). One inch of rigid insulation generally works well for this climate. The heat loss through the crawlspace walls is significant enough to warrant insulation. Note that the insulation must comply with local codes for protection against ignition.

Crawlspace Access

The preferred location for crawlspace access is through the subfloor; any access through the perimeter wall must be air sealed and insulated.

Climate-Specific Details

Vented Attic

Soffit and ridge vents provide more effective attic ventilation than gable-end vents. Gable exhaust fans do not provide effective attic ventilation. They are generally temperature-controlled, when relative humidity is often the condition that requires higher ventilation rates. They can also depressurize the house causing loss of conditioned air. Generally, the area of the gable and soffit vents, combined with the leakage of the attic ceiling, is such that the fan pulls air not just from the exterior vent but also from the conditioned space below.

Mechanical systems

Heating and Cooling. We recommend a sealed combustion 90+ condensing gas furnace or an air-source heat pump, ENERGY STAR[®]-rated or better (HSPF \geq 8.0, [Heating Seasonal Performance Factor] see www.energystar.gov/index.cfm?c=airsrc_heat_pr_as_heat_pumps, follow appropriate sizing procedures). For more detailed information, see www.buildingscience.com/resources/mechanical/509a3_cooling_system_sizing_pro.pdf.

Transfer Grilles. The single central return requires transfer grilles to provide an adequate return air path and avoid pressurizing bedrooms, as shown in Figure 3-4.

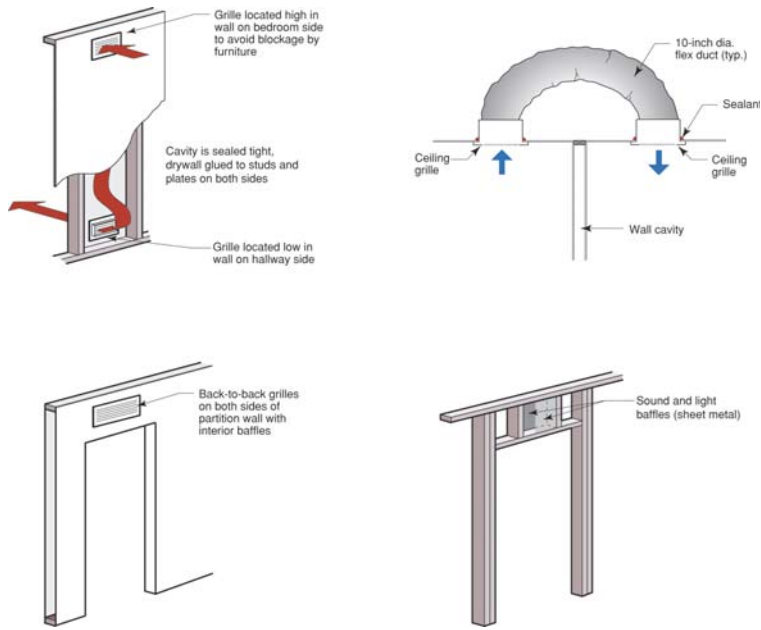

Figure 3-4. Transfer grille and jump duct approaches

Mechanical Ventilation. We recommend an intermittent central-fan-integrated supply, designed to provide the ASHRAE 62.2 recommended flow rate, with the fan-cycling control set to operate the central air handler 20 minutes every hour to provide ventilation air distribution and whole-house averaging of air quality and comfort conditions (\$125 to \$150). Include a normally closed motorized damper in the outside air duct with the AirCycler™ FRV control (+\$50 to \$60) (Figure 3-5).

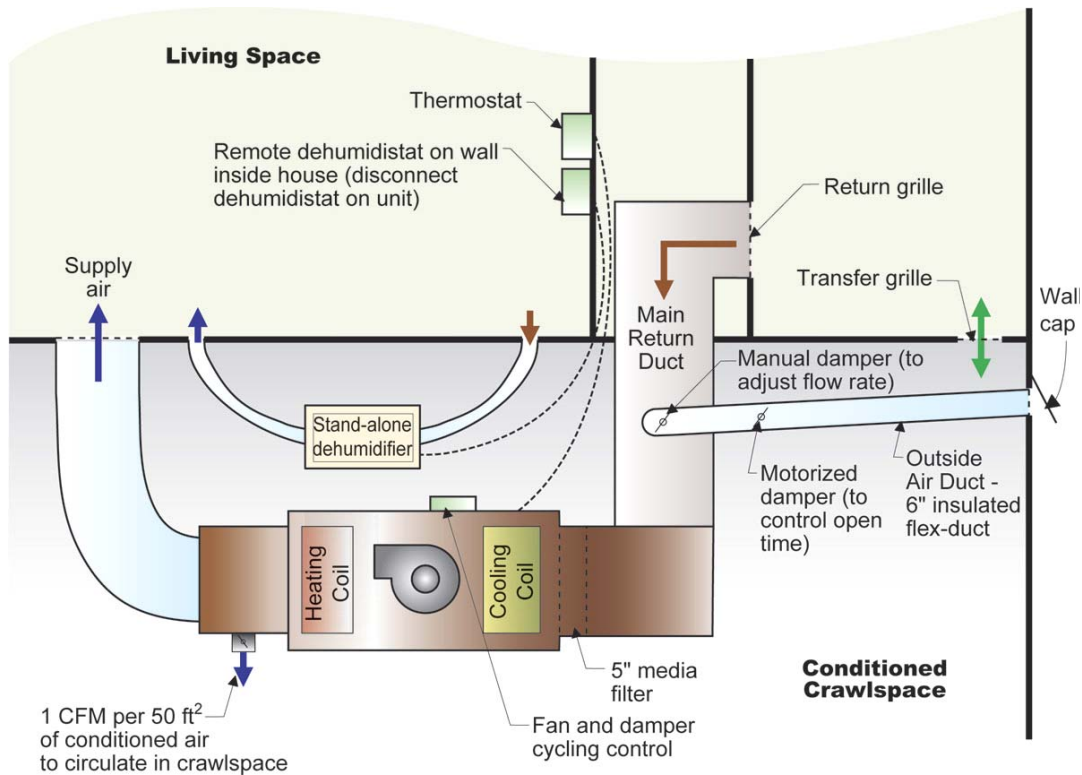

Figure 3-5. Mechanical system and ventilation in conditioned crawlspace

Termite Management

Termites are best managed with a three-pronged approach that deals with the three things termites need—cover from sunlight, moisture, and food (wood or paper):

Reduced cover. Keep plantings 3 ft away from the building perimeter, thin the ground cover (wood mulch or pea stone) to no more than 2 in. depth for the first 18 in. around the building, and maintain any termite inspection zone on the foundation.

Control moisture. Maintain slope away from building as shown, carry roof load of water at least 3 ft away from building, and make sure that irrigation is directed away from the building.

Chemical treatment. Use an environmentally appropriate soil treatment (such as Termidor®) and a building materials treatment (such as Bora-Care®) for termite-prone near-grade wood materials.

Inter-relationship of first three points. Because a builder and a homeowner's ability to employ or stick to each of the three strategies above will vary, make sure that an inability to fully employ one strategy is compensated for by complete rigor with the others. For example, if chemical treatment of soil or building materials is not an option, then complete rigor in moisture control and ground cover is required.

Field Experience Notes

Termite Control

Local codes and interpretations by building inspectors can make details involving rigid insulation difficult. We have found that the top-of-foundation wall inspection zone shown in this Building Profile meets with building official acceptance and results in a limited break in the thermal barrier.

Air Sealing

Most codes can be interpreted to require only protection of foam from “ignition” in crawlspaces (“where entry is made only for service of utilities”). The same applies to foam at the rim joist (this is an interstitial space protected from ignition by gypsum wall board on one side and floor sheathing on the other). Protection from ignition can be accomplished with 1-½ -in.-thick (38 mm) mineral fiber insulation, ¼-in.-thick (6.4 mm) wood structural panels, 3/8-in. (9.5 mm) particleboard, ¼-in. (6.4 mm) hardboard, 3/8-in. (9.5 mm) gypsum board, or corrosion-resistant steel having a base metal thickness of 0.016 in. (0.406 mm)

Brick Veneer and the Air Space

Harking back to “old-timer” practices, place sand at the bottom of the 1-in. air space to act as a bond break for mortar droppings and leave bricks out intermittently in the first course. After the veneer is completed, the sand and mortar droppings can be easily removed and the missing course brick mortared in. Head joints in the top and bottom course must be left clear for top and bottom venting of this space.

Masons must also be aware of protecting the integrity of the XPS foam sheathing as they work, given its function as the wall’s drainage plane. Educate this trade with some building science basics about the impact of their work on building envelope performance.

Brick Ties

The two-piece adjustable ties are strongly recommended, given the 1-in. air space and foam insulation. See the Masonry Institute Technical Notes at www.brickinfo.org/pdfs/44b.pdf.

HVAC Commissioning

The most efficient equipment means little if the system is not set up and started up properly. Follow high-performance start-up procedures, such as those described on the BSC web site, www.buildingscience.com/resources/mechanical/air_conditioning_equipment_efficiency.pdf. Although this resource is primarily for refrigerant cooling systems, most of it applies to heat pumps.

Conditioned Crawlspaces

This assembly may require some local building code official “building science persuasion.” See the *Building Safety Journal* article written by Nathan Yost of BSC (www.buildingscience.com/resources/articles/24-27_Yost_for_author.pdf).

Energy Trusses

There are a number of different truss configurations that yield greater depth at the heel, but they vary quite a bit in cost. The truss shown in Figure 3-6 (sometimes called a “slider” truss) has proven to be among the most cost-competitive. And of course, the pitch of the roof affects just how much insulation you can get at this location, regardless of the type of truss.

Advanced Framing

For a technical resource that may help with resistance to advanced framing methods from local code officials, see the *Building Safety Journal* article written by Nathan Yost of BSC at www.buildingscience.com/resources/articles/16-19_Yost&Edminster_for_au.pdf.

Material Compatibility and Substitutions

Exterior Sheathing

The use of other common exterior sheathing materials—OSB, plywood or thin-profile structural sheathing (e.g., Thermo-ply[®])—in this assembly must be done with recognition of the impact on heat and moisture transfer.

Both OSB and plywood are more vapor permeable than rigid foam insulation, a good thing when the cavity-warming ability of the rigid insulation is lost. But keep in mind that behind the brick veneer (a reservoir cladding), the greater vapor permeability of the OSB or plywood heightens the importance of the continuous 1-in. air space.

On the other hand, Thermo-ply[®] is less vapor permeable than rigid foam insulation and will pretty much eliminate drying potential to the exterior, a potential problem during the heating season, particularly the further north you build in this mixed climate. Builders in the northern half of this climate region who use Thermo-ply[®] as an exterior sheathing should ensure that controlled ventilation and occupant use of point exhaust fans keep the interior relative humidity below 30% during the peak of their heating season.



Figure 3-6. Slider truss

Rim Joist Blocking

An alternative to this detail is to spray foam insulation on the rim joist to maintain air barrier continuity at this transition.

Drainage Plane on Rigid Insulation

An alternative to flashing, shiplapping, or sealing the XPS insulation for continuity of the drainage plane is to apply a housewrap to the outside of the insulation. The housewrap then becomes the continuous drainage plane.

Interior Latex Paint

The substitution of low permeability interior finishes (vinyl wall paper, oil-based paints) for latex paint is strongly discouraged as drying to the interior is important in mixed-humid climates.

Cavity Insulation Materials

Acceptable cavity insulation includes any that has relatively high vapor permeability—cellulose, fiberglass, or foam (as long as air sealing is accomplished by a separate component or system when cellulose or fiberglass is used). The decision may also be based on properties other than building science.

Crawlspace Floor

Ideally, the crawlspace floor would be a 4-in. gravel (free-draining, no fines) bed, polyethylene layer and "rat" (2-in. low strength cast concrete) slab, making this space more amenable to light storage and housing of HVAC equipment. The cost of this approach may outweigh the benefits for builders and buyers. If a concrete slab is cast, it should be placed directly on top of the vapor barrier.

Gypsum Wallboard

Areas of potentially high moisture, such as bathrooms, basements, and kitchens, are excellent candidates for non-paper faced wallboard systems (e.g., James Hardie's Hardibacker[®], GP's DensArmor[®], USG's Fiberock[®]). In addition, paper-faced gypsum board should never be used as interior sheathing or backer for tub or shower surrounds where ceramic tile or marble (any material with joints or grout lines) is used as the finish.

Building Profile #9. The Atlanta

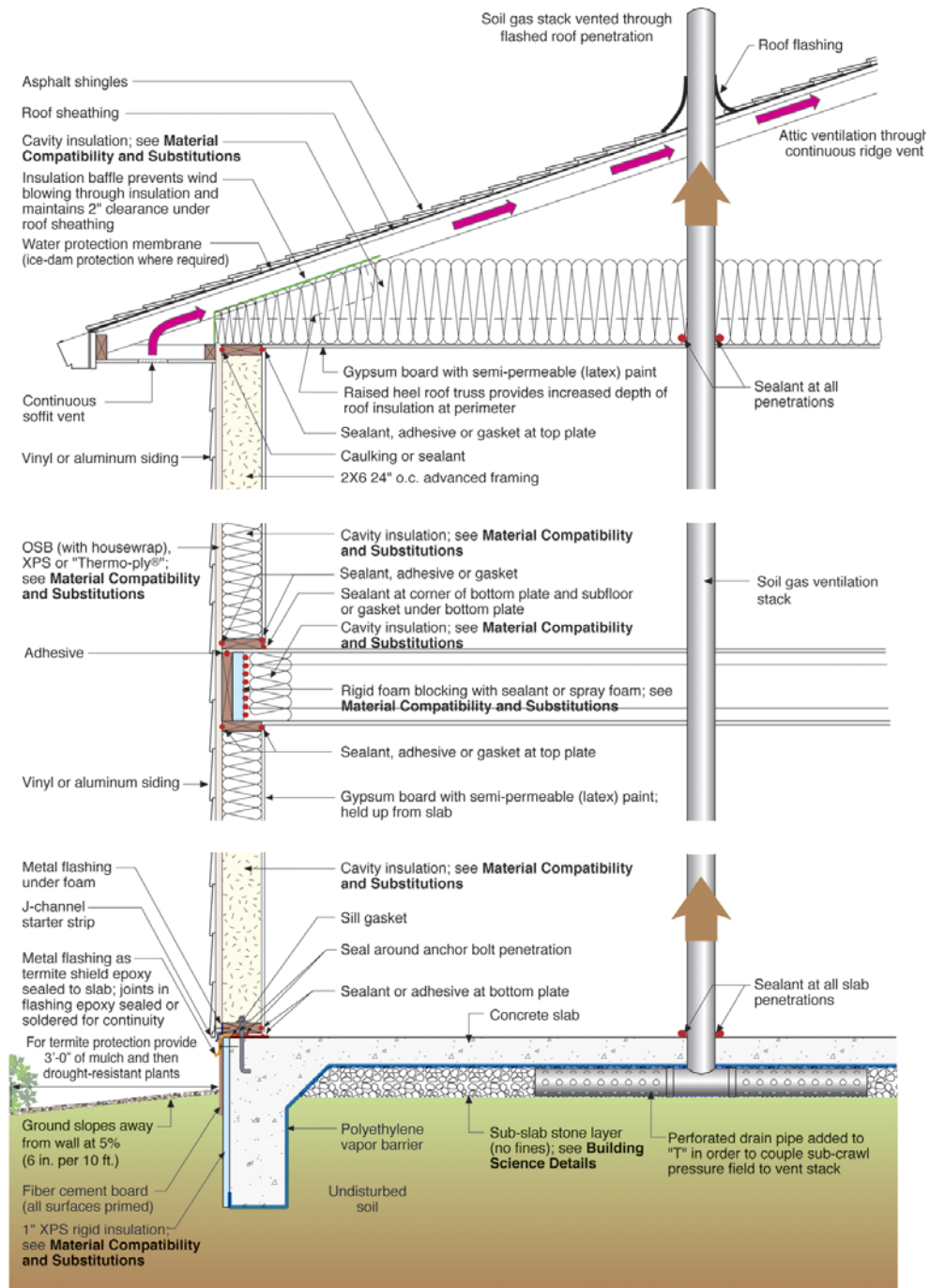

Foundation: Slab-on-grade
Above Grade Walls: Wood frame

Attic: Vented
Roof: Asphalt shingles

Cladding (1st): Vinyl siding
Cladding (2nd): Vinyl siding

Figure 3-7. Cross section of the Atlanta

Building Science Details

Ducts in Conditioned Space

This building profile (Figure 3-7) is designed to accommodate HVAC equipment and ducts in the living space, with the equipment typically in an interior closet. HVAC ducts should not be run in exterior walls or the slab, locations that increase the potential for condensation and consequential air quality problems.

Air Sealing Details at Transitions

Air sealing can be particularly difficult, but no less important, at assembly transitions such as band joists and between attached garages and living spaces. These are discussed below because they have proven to be a consistent challenge for builders.

Band Joists. Continuity of an exterior air barrier can be maintained at the band joist with sealed or taped housewrap or rigid foam insulation. Continuity of an interior air barrier can be maintained through a combination of cut foam blocks and sealant/caulk, rigid draft-stopping (wood blocking) and sealant/caulk, or spray foam. Note that neither cellulose nor fiberglass (batt or blown) can be used for the air barrier. The air barrier detail on second-story band joists is important because it is inaccessible (covered by structural/finish floor and ceiling finish) after construction. The air barrier/thermal barrier detail is important on ground floor band joists because of the thermal bridge that can occur at the top of basement and crawlspace foundation walls (as the result of the air barrier and thermal barrier moving from the outside to the inside of the building envelope and termite inspection zones located at the top of basement and crawlspace foundation walls). Note that while fiberglass batts fulfill the requirement for protection from ignition in the open band joists, fiberglass batt material by itself cannot maintain the air barrier.

Attached Garages. The building envelope surfaces shared between conditioned space and an unconditioned garage must have a continuous air barrier. See Figure 3-8 for details in terms of using sealants and rigid insulation to create a continuous air barrier between the attached garage and living space. For more details see www.buildingscience.com/housethatwork/airsealing/default.htm.

Drying Mechanisms

In any climate, vapor control is based on the relationships among the following: the permeability of wall components, the type of cladding (reservoir or non-reservoir), the presence/lack/nature of an air space, and the magnitude/duration of the vapor drive (based on the relationship between the exterior and interior moisture content and temperature differences). The type of sheathing and housewrap used in any wall assembly must be based on an understanding of these inter-relationships. See “Insulations, Sheathings, and Vapor Diffusion Retarders” for more information (www.buildingscience.com/resources/walls/insulation_sheathings.pdf).

In the Mixed-Humid climate, roof and wall assemblies are best designed to dry to both the exterior and interior. This is not always possible when rigid exterior insulating sheathings are used because of their low vapor permeability. Accordingly, most drying occurs to the interior during the summer months. Therefore, interior vapor barriers should not be installed. Note that there is a difference between an interior vapor barrier and an interior vapor retarder. Because the interior finish is more vapor permeable than the exterior sheathing, the wall assembly for the “Atlanta” has greater drying potential to the interior (more cooling season drying potential) than to the exterior (less heating season drying potential; see Material Compatibility and Substitutions).

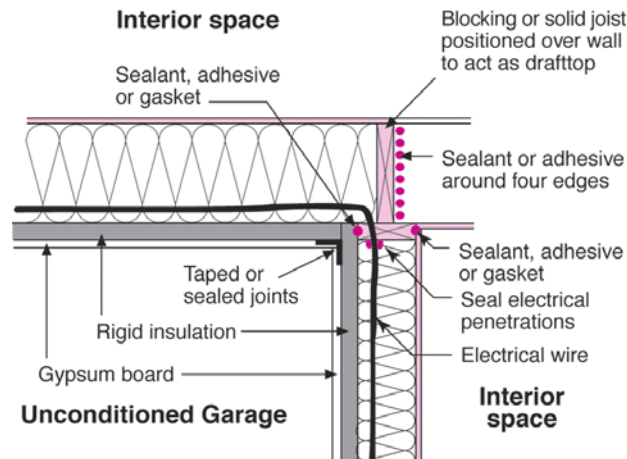

Figure 3-8. Creating a continuous air barrier

Drainage Plane, Air Barrier, Vapor Control

The drainage plane runs along the exterior surface of the foam sheathing. All vertical joints must be shiplapped, flashed, or sealed; all horizontal joints must be sealed or taped.

This building profile has a continuous air barrier both on the interior walls (Airtight Drywall Approach on ceiling and walls, see www.buildingscience.com/housethatwork/airsealing/default.htm) and on the exterior walls (the sealed rigid insulation).

In mixed climates, wall and roof assemblies can be designed to dry primarily to the exterior (during the heating season), to the interior (during the cooling season), or in both directions. The last approach, with bi-directional drying potential, is generally preferred. For more detailed discussion of the three approaches, see the discussion of wall and roof design in the *EEBA Builder's Guides* (www.eeba.org/bookstore).

Rough Opening Flashing

Flashing must be installed at the plane of the XPS rigid insulation for drainage plane continuity. See Figure 3-9 and the *EEBA Water Management Guide* for sequential flashing details (www.eeba.org/bookstore).

Advanced Framing

Cross bracing (or other alternative for shear resistance) replaces structural sheathing in this wall assembly. Thermal performance and reduced drywall cracking are additional benefits of a comprehensive approach to advanced framing. See www.buildingscience.com/housethatwork/advancedframing/default.htm for details.

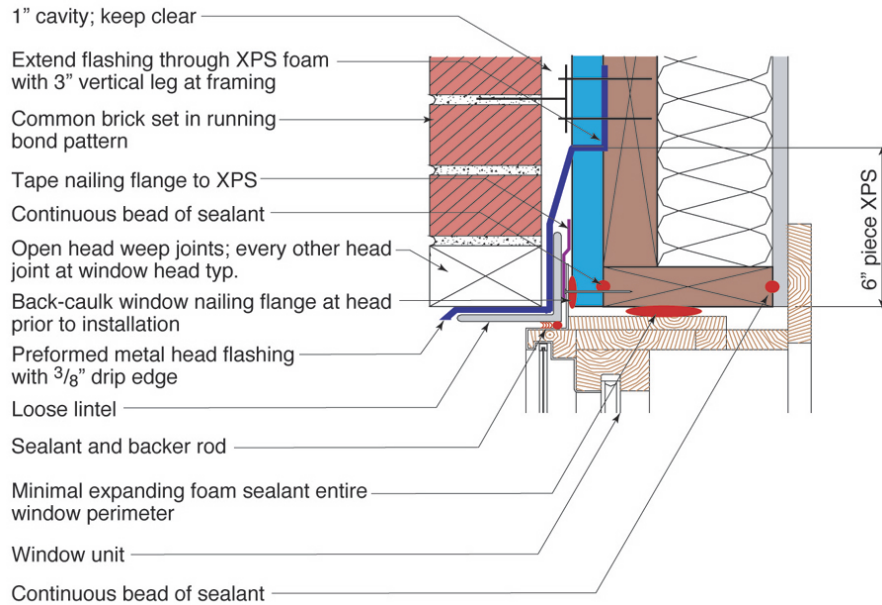

Figure 3-9. Rough opening flashing

Framing on Slabs

Installing a capillary break between the sill plate and a concrete slab on all walls—exterior, interior, partition—is good practice. A closed cell foam sill sealer or gasket works well. Alternatively, a strip of sheet polyethylene can be used. This isolates the framing from any source of moisture that may be either in or on the concrete slab (and using sill sealer on all walls maintains wall height exactly the same).

Soil Gas Ventilation

The sub-slab to roof vent system handles conditions that are difficult, if not impossible, to assess before completion of the structure—resultant confined concentrations of air-borne radon, soil treatments (termiticides, pesticides) methane, etc. The cost of this “ounce” of prevention is well balanced against the cost of the “pound” of cure.

Sub-Slab Stone Bed

The 4-in.-deep, 3/4-in. stone bed functions as a granular capillary break, a drainage pad, and a sub-slab air pressure field extender for the soil gas ventilation system. Without it, a soil gas ventilation system is not practical, and the only capillary break between the slab and ground is the polyethylene vapor barrier.

Thermal Barrier

Cavity-warming exterior rigid insulation is important in this climate where the average monthly temperature for the coldest month of the year goes below 45°F. The rule of thumb that BSC uses is 1/4-in. of rigid insulation per 1,000 heating degree days (HDD). One inch of rigid insulation generally works well for this climate. In this climate, the heat loss through the slab perimeter is significant enough to warrant insulation. Note that the insulation system must comply with local codes for protection against insects, particularly termites.

Climate-Specific Details

Vented Attic

Soffit and ridge vents provide more effective attic ventilation than gable-end vents. Gable exhaust fans do not provide effective attic ventilation. They are generally temperature-controlled, when relative humidity is often the condition that requires higher ventilation rates. This can also depressurize the house causing loss of conditioned air. Generally, the area of the gable and soffit vents, combined with the leakage of the attic ceiling, is such that the fan pulls air not just from the exterior vent, but also from the conditioned space below.

Mechanical Systems

Heating and Cooling. We recommend a sealed combustion 90+ condensing gas furnace or an air-source heat pump, ENERGY STAR-rated or better (HSPF ≥ 8.0) (see www.energystar.gov/index.cfm?c=airsrc_heat_pr_as_heat_pumps, follow appropriate sizing procedures). For more detailed information, see www.buildingscience.com/resources/mechanical/509a3_cooling_system_sizing_pro.pdf.

Transfer Grilles. The single central return requires transfer grilles to provide an adequate return path and avoid pressurizing bedrooms, as shown in Figure 3-10.

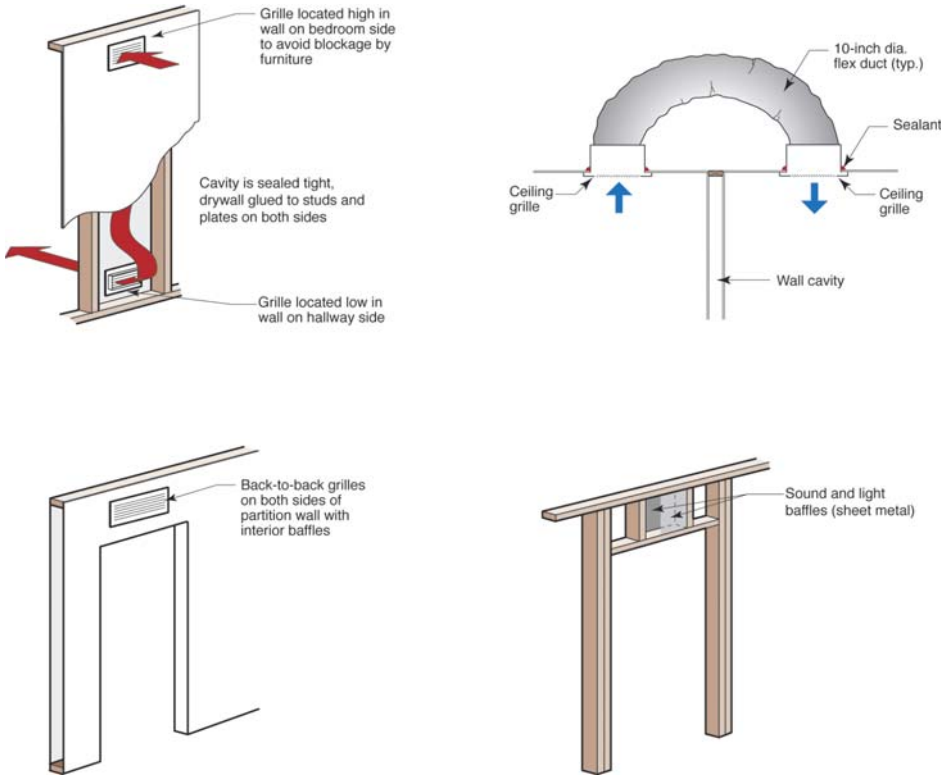
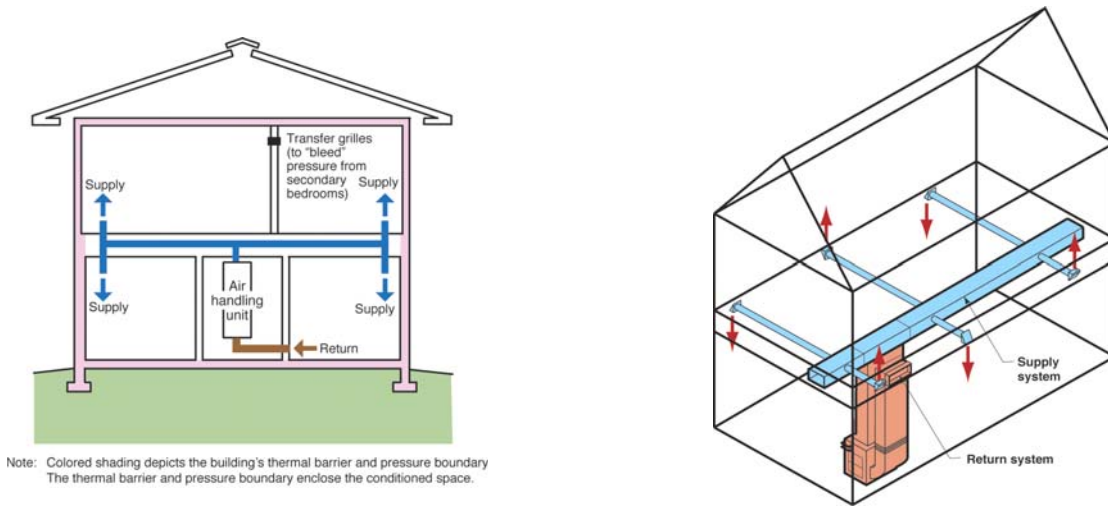

Figure 3-10. Transfer grille and jump ducts approaches

Mechanical Ventilation. We recommend an intermittent central-fan-integrated supply, designed to provide the ASHRAE 62.2P recommended flow rate, with fan cycling control set to operate the central air handler 20 minutes every hour to provide ventilation air distribution and whole-house averaging of air quality and comfort conditions (\$125 to \$150). Include a normally closed motorized damper in the outside air duct with the AirCycler™ FRV control (+\$50 to \$60) (Figure 3-11).



Interior Closet Configuration

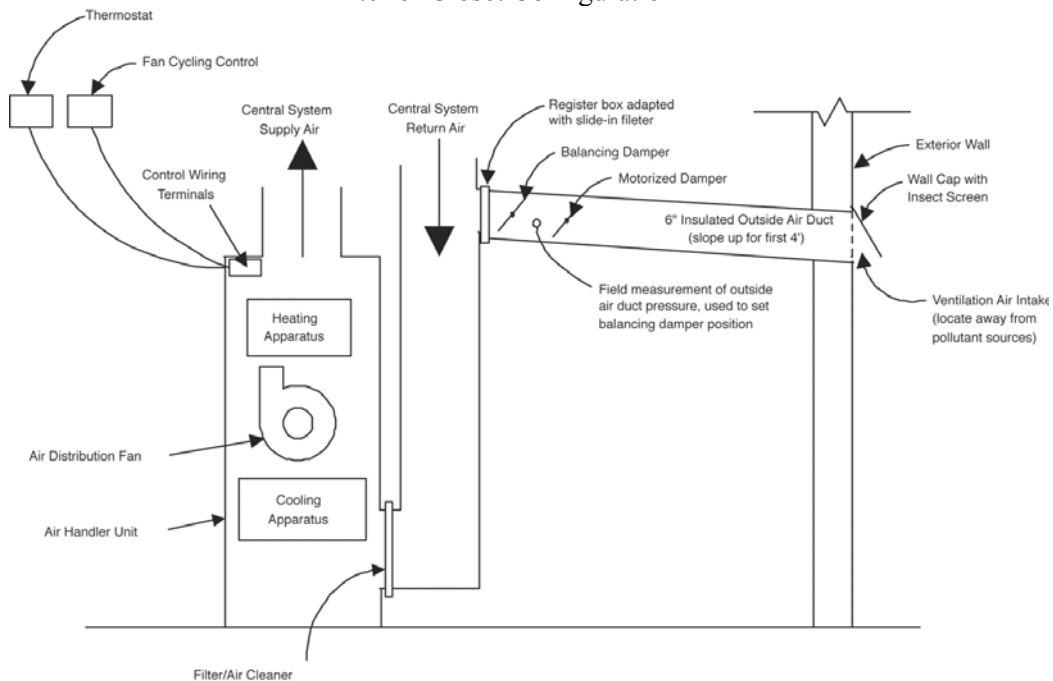

Figure 3-11. Mechanical ventilation for the “Atlanta”

Termite Management

Termites are best managed with a three-pronged approach that deals with the three things termites need—cover from sunlight, moisture, and food (wood or paper):

Reduced cover. Keep plantings 3 ft away from the building perimeter, thin the ground cover (wood mulch or pea stone) to no more than 2 in. depth for the first 18 in. around the building, and maintain any termite inspection zone on the foundation.

Control moisture. Maintain slope away from building as shown, carry roof load of water at least 3 ft away from building, and make sure that irrigation is directed away from the building.

Chemical treatment. Use an environmentally appropriate soil treatment (such as Termidor[®]) and a building materials treatment (such as Bora-Care[®]) for termite-prone near-grade wood materials (see also Field Experience Notes below).

Inter-relationship of first three points. Because a builder and a homeowner's ability to employ or stick to each of the three strategies above will vary, make sure that an inability to fully employ one strategy is compensated for by complete rigor with the others. For example, if chemical treatment of soil or building materials is not an option, then complete rigor in moisture control and ground cover is required.

Field Experience Notes

Gable End Exterior Sheathing Detail

Continuity of the drainage plane on gable end walls must be maintained. We recommend the detail shown in Figure 3-12.

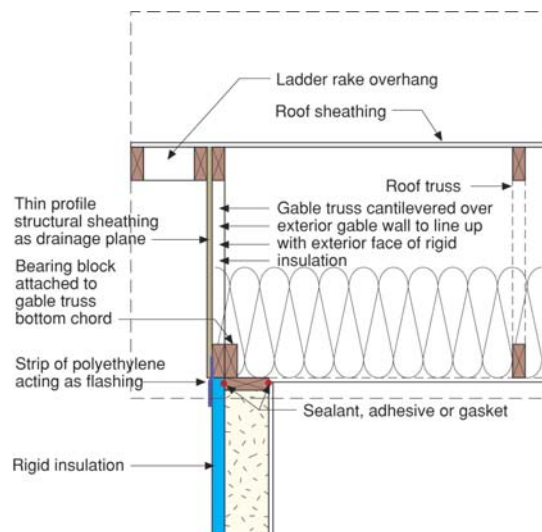

Figure 3-12. Gable end exterior sheathing detail

Flashing Details

Because the vinyl siding is a screened wall-cladding system, flashing details should be accomplished in the plane of drainage (building paper or house wrap), not the cladding. Do not caulk siding and do not rely on the "J"-channel as part of the drainage plane. In other words, never consider vinyl siding, aluminum siding (or any siding, for that matter) as the weather barrier.

Termite Control

Local codes and interpretations by building inspectors can make details involving rigid insulation difficult. We have found that building officials generally accept the flashing/fibercement board shown in the Building Profile and in Figure 3-13.

Termite Flashing Continuity

In order for the metal flashing to be effective, all joints must be epoxy-sealed (or welded) and the horizontal edge must be epoxy-sealed to the concrete.

Air Sealing

The hardest spots are not the fields but the margins/edges of assemblies. Air sealing at transitions such as rim joists and eaves requires either exacting blocking and caulk/sealant or spray foam insulation. Many Building America production builders have found the labor savings of spray foam insulating/air sealing to be well worth the added material cost.

HVAC Commissioning

The most efficient equipment means little if the system is not set up and started up properly. Follow high performance start-up procedures such as those described on the BSC web site (www.buildingscience.com/resources/mechanical/air_conditioning_equipment_efficiency.pdf) Although this resource is primarily for refrigerant cooling systems, most of it applies to heat pumps.

Energy Trusses

There are a number of different truss configurations that yield greater depth at the heel, but they vary quite a bit in cost. The truss shown in Figure 3-13 (sometimes called a "slider" truss) has proven to be among the most cost-competitive. And of course, the pitch of the roof affects just how much insulation you can get at this location, regardless of the type of truss.



Figure 3-13. Flashing (left) and slider trusses (right)

Advanced Framing

For a technical resource that may help with resistance to advanced framing methods from local code officials, see the *Building Safety Journal* article written by Nathan Yost of BSC at www.buildingscience.com/resources/articles/16-19_Yost&Edminster_for_au.pdf.

Material Compatibility and Substitutions

Exterior Sheathing

The use of other common exterior sheathing materials—OSB, plywood or thin-profile structural sheathing (e.g., Thermo-ply[®])—in this assembly must be done with recognition of the impact on heat and moisture transfer.

Both OSB and plywood are more vapor permeable than rigid foam insulation, a good thing when the cavity-warming ability of the rigid insulation is lost. But keep in mind that behind the brick veneer (a reservoir cladding), the greater vapor permeability of the OSB or plywood heightens the importance of the continuous 1-in. air space.

On the other hand, Thermo-ply[®] is less vapor permeable than rigid foam insulation and will pretty much eliminate drying potential to the exterior, a potential problem during the heating season, particularly the further north you build in this Mixed climate. Builders in the northern half of this climate region who use Thermo-ply[®] as an exterior sheathing should ensure that controlled ventilation and occupant use of point exhaust fans keep the interior relative humidity below 30% during the peak of their heating season.

Rim Joist Blocking

An alternative to this detail is to spray foam insulation on the rim joist to maintain air barrier continuity at this transition.

Drainage Plane on Rigid Insulation

An alternative to flashing, shiplapping, or sealing the XPS insulation for continuity of the drainage plane is to apply a housewrap to the outside of the insulation. The housewrap then becomes the continuous drainage plane.

Interior Latex Paint

The substitution of low permeability interior finishes (vinyl wall paper, oil-based paints) for latex paint is strongly discouraged because drying to the interior is important in mixed-humid climates.

Cavity Insulation Materials

Acceptable cavity insulation includes any that has relatively high vapor permeability—cellulose, fiberglass, or foam (as long as air sealing is accomplished by a separate component or system when cellulose or fiberglass is used). The decision may also be based on properties other than building science.

Flooring

Many finished flooring materials—either because of their impermeability (sheet vinyl, for example) or sensitivity to moisture (wood strip flooring, for example)—should only be installed over a slab with low w/c ratio (≈ 0.45 or less) or a slab allowed to dry (<0.3 grams/24hrs/ft²) before installation of flooring. In general sheet vinyl flooring should be avoided.

Gypsum Wallboard

Areas of potentially high moisture, such as bathrooms, basements, kitchens, are excellent candidates for non-paper faced wallboard systems (e.g., James Hardie's Hardibacker[®], GP's DensArmor[®], USG's Fiberock[®]). In addition, paper-faced gypsum board should never be used as interior sheathing or backer for tub or shower surrounds where ceramic tile or marble (any material with joints or grout lines) is used as the finish.

L-channel Detail on Cladding at Base of Exterior Wall

Any stop can be used at the bottom, exposed edge of the rigid insulation to prevent insect and rodent intrusion, as long as it does not interfere with the foam's function as the drainage plane.

XPS versus EPS Exterior Foundation Foam Insulation

There are three rigid insulations appropriate for exterior use on foundations where the insulation will extend below grade and be in contact with soil conditions:

XPS. This material's density, impact resistance, and resistance to liquid penetration make it the preferred material.

EPS. In areas where resistance to insects (especially termites and carpenter ants) is a desired or required characteristic of the insulation, EPS may be indicated because it is the only foam insulation that comes with a borate-treatment. However, water penetration and subsequent leaching of the borate treatment require a capillary break between the soil and the insulation. This is best accomplished with a gravel layer and Enkadrain[®] mat just exterior to the EPS insulation.

Rigid Fiberglass. This is a great material for exterior insulation because of its drainability and resistance to insect degradation. However, availability of this material has been and remains the main constraint on its use.

Building Profile #10. The Louisville

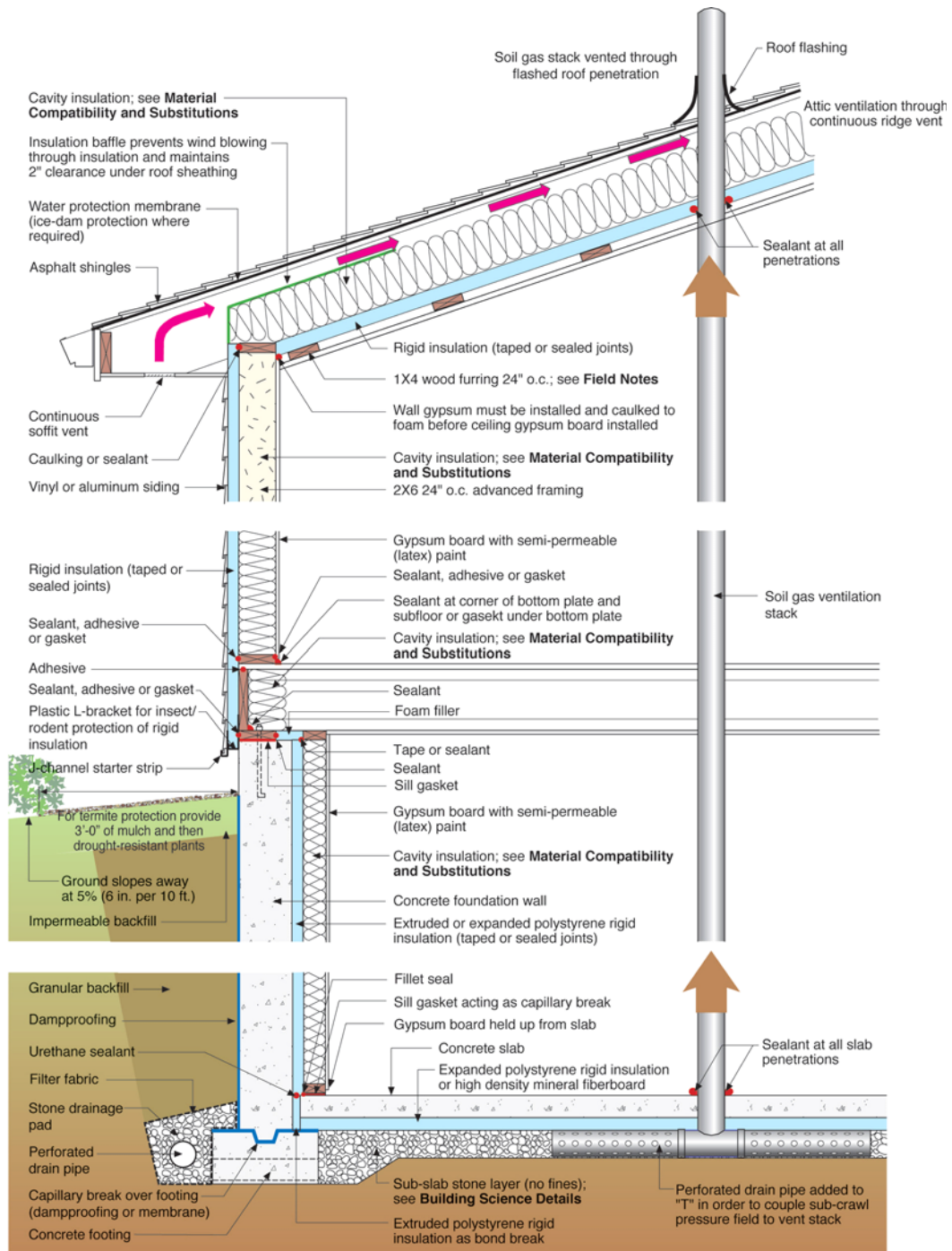

Foundation: Basement
 Above Grade Walls: Wood frame

Attic: Vented cathedral ceiling
 Roof: Asphalt shingles

Cladding: Vinyl siding

Figure 3-14. Cross section of the Louisville

Building Science Details

Ducts in Conditioned Space

This Building Profile (Figure 3-14) is designed to accommodate HVAC equipment and ducts in either the living space or in the basement. HVAC ducts should not be run in exterior walls.

Cathedral Roof Assembly

The continuous eave-to-ridge venting just to the inside of the structural roof deck serves to thermally decouple everything to the exterior of this air space from everything to its interior (sometimes called a “cold” roof). It is the continuity of the air space, the thermal barrier, and the air barrier that makes this roof assembly work.

Air Sealing Details at Transitions

Air sealing can be particularly difficult, but no less important, at assembly transitions such as band joists and between attached garages and living spaces. These are discussed below because they have proven to be a consistent challenge for builders.

Band joist. Continuity of an exterior air barrier can be maintained at the band joist with sealed or taped housewrap or rigid foam insulation. Continuity of an interior air barrier can be maintained through a combination of cut foam blocks and sealant/caulk, rigid draft-stopping (wood blocking) sealant/caulk, or spray foam. Note that neither cellulose nor fiberglass (batt or blown) can be used for the air barrier. The air barrier detail on second-story band joists is important because it is inaccessible (covered by structural/finish floor and ceiling finish) after construction. The air barrier/thermal barrier detail is important on ground floor band joists because of the thermal bridge that can occur at the top of basement and crawlspace foundation walls (as the result of the air barrier and thermal barrier moving from the outside to the inside of the building envelope and termite inspection zones located at the top of basement and crawlspace foundation walls). Note that while fiberglass batts fulfill the requirement for protection from ignition in the open band joists, fiberglass batt material by itself cannot maintain the air barrier.

Attached garages. The building envelope surfaces shared between conditioned space and an unconditioned garage must have a continuous air barrier. See Figure 3-15 for details in terms of using sealants and rigid insulation to create a continuous air barrier between the attached garage and living space. For more details see www.buildingscience.com/housethatwork/airsealing/default.htm.

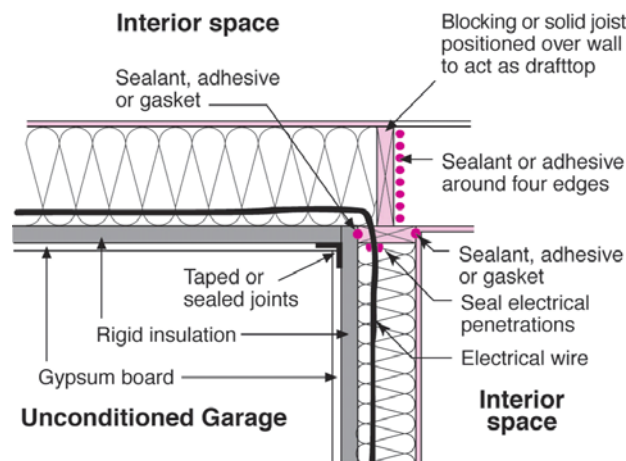

Figure 3-15. Creating a continuous air barrier

Drying Mechanisms

In any climate, vapor control is based on the relationships among the following: the permeability of wall components, the type of cladding (reservoir or non-reservoir), the presence/lack/nature of an air space, and the magnitude/duration of the vapor drive (based on the relationship between the exterior and interior moisture content and temperature differences). The type of sheathing and housewrap used in any wall assembly must be based on an understanding of these inter-relationships. See “*Insulations, Sheathings, and Vapor Diffusion Retarders*” for more information (www.buildingscience.com/resources/walls_insulation_sheatings.pdf).

In mixed-humid climates, roof and wall assemblies are best designed to dry to both the exterior and interior. This is not always possible when rigid exterior insulating sheathings are used because of their low vapor permeability. Accordingly, most drying occurs to the interior during the summer months. Therefore, interior vapor barriers should not be installed. Note that there is a difference between an interior vapor barrier and an interior vapor retarder (see Material Compatibility and Substitutions).

Drainage Plane, Air Barrier, Vapor Control

The drainage plane runs along the exterior surface of the foam sheathing. All vertical joints must be shiplapped, flashed, or sealed; all horizontal joints must be sealed or taped.

This building profile has a continuous air barrier on both the interior walls (Airtight Drywall Approach on ceiling and walls, see www.buildingscience.com/housesthatwork/airsealing/default.htm) and the exterior walls (the sealed rigid insulation).

In mixed climates, wall and roof assemblies can be designed to dry primarily to the exterior (during the heating season), to the interior (during the cooling season) or in both directions. This last approach, with bi-directional drying potential, is generally preferred. For more detailed discussion of the three approaches, see the discussion of wall and roof design in the *EEBA Builder's Guides* (www.eeba.org/bookstore). Because the permeability of the latex-painted gypsum board is greater than that of the XPS rigid insulation, the wall assembly in the “Louisville” is designed to dry more to the interior.

Rough Opening Flashing

Flashing is always installed in the plane of drainage for continuity. This means that when a different material or “layer” makes up the drainage plane, window flashing details must move accordingly. See Figure 3-16 and the *EEBA Water Management Guide* for sequential flashing details (www.eeba.org/bookstore).

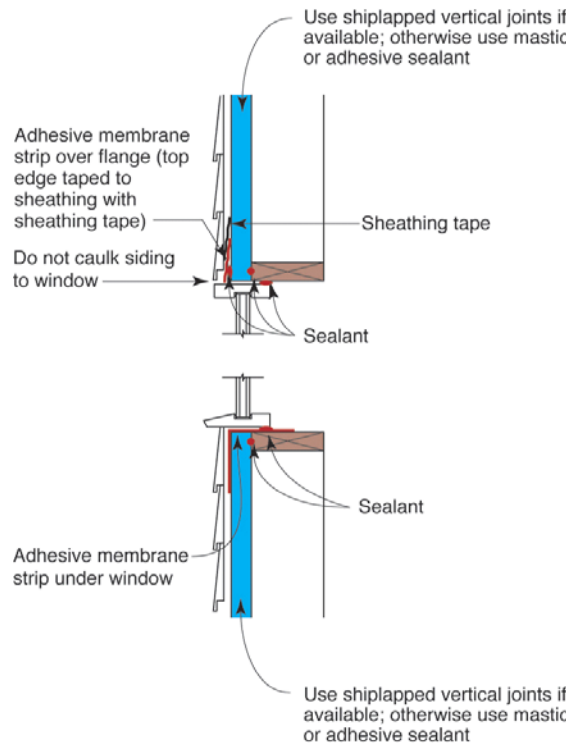

Figure 3-16. Rough opening flashing

Advanced Framing

The use of non-structural sheathing in this wall assembly means that cross bracing or some alternative for shear resistance is required. The reduced use of lumber, improved thermal performance and reduced drywall cracking are benefits of a comprehensive approach to advanced framing. See www.buildingscience.com/housethatwork/advancedframing/default.htm for details.

Framing on Slabs

Installing a capillary break between the sill plate and a concrete slab on all walls—exterior, interior, partition—is good practice. A closed cell foam sill sealer or gasket works well. Alternatively, a strip of sheet polyethylene can be used. This isolates the framing from any source of moisture that may be either in or on the concrete slab. Using sill sealer on all walls maintains the same wall height.

Soil Gas Ventilation

The sub-slab to roof vent system handles conditions that are difficult if not impossible to assess before completion of the structure—resultant confined concentrations of air-borne radon, soil treatments (termiticides, pesticides) methane, etc. The cost of this “ounce” of prevention is well balanced against the cost of the “pound” of cure.

Sub-slab Stone Bed

The 4-in.-deep, 3/4-in. stone bed functions as a granular capillary break, a drainage pad, and a sub-slab air pressure field extender for the soil gas ventilation system. Without it, a soil gas ventilation system is not practical and the only capillary break between the slab and ground is the polyethylene vapor barrier.

Thermal Barrier

Cavity-warming exterior rigid insulation is important in this climate where the average monthly temperature for the coldest month of the year goes below 45°F. The rule of thumb that BSC uses is ¼ in. of rigid insulation per 1,000 heating degree days (HDD). One inch of rigid insulation generally works well for this climate. The heat loss through the basement walls is significant enough to warrant insulation. Note that the insulation must comply with local codes for protection against ignition.

Basement and Slab Insulation

Although the basement walls and basement slab as shown clearly go beyond what is required by any code for this climate, this assembly assumes that the basement either is or will become a living space. It is not, however, the energy performance that is driving this design, but rather occupant comfort, dust mite control, and reduced potential for moisture problems that justifies the added cost of the assembly's insulation. See the BSC technical resource “Basement Insulation Systems” for other basement wall assemblies that work well

(www.buildingscience.com/resources/foundations/basement_insulation_systems.pdf).

Foundation Sealant Details

Note that the inside bead of sealant or caulk is an air sealing detail. The sealant between the two sheets of rigid insulation is actually a seal against insect and soil gas infiltration—this calls for a chemical bonding that can be accomplished with two-part urethane.

Climate-Specific Details

Mechanical Systems

Heating and Cooling. We recommend a sealed combustion gas furnace, for both energy efficiency and health/safety reasons, with the unit located inside conditioned space. (The “Louisville”— which encounters just under 5,000 heating degree days—is just about at the margin of heat pump winter-time efficiency, hence the recommendation for a gas heating and separate electric cooling system). We also recommend a minimum 12 SEER A/C unit, for energy efficient management of sensible load. Follow appropriate sizing procedures, using the guidelines on the BSC web site for more detailed information (www.buildingscience.com/resources/mechanical/509a3_cooling_system_sizing_pro.pdf).

Transfer Grilles. The single central return requires transfer grilles or jump ducts to provide an adequate return air path and avoid pressurizing bedrooms, as shown in Figure 3-17.

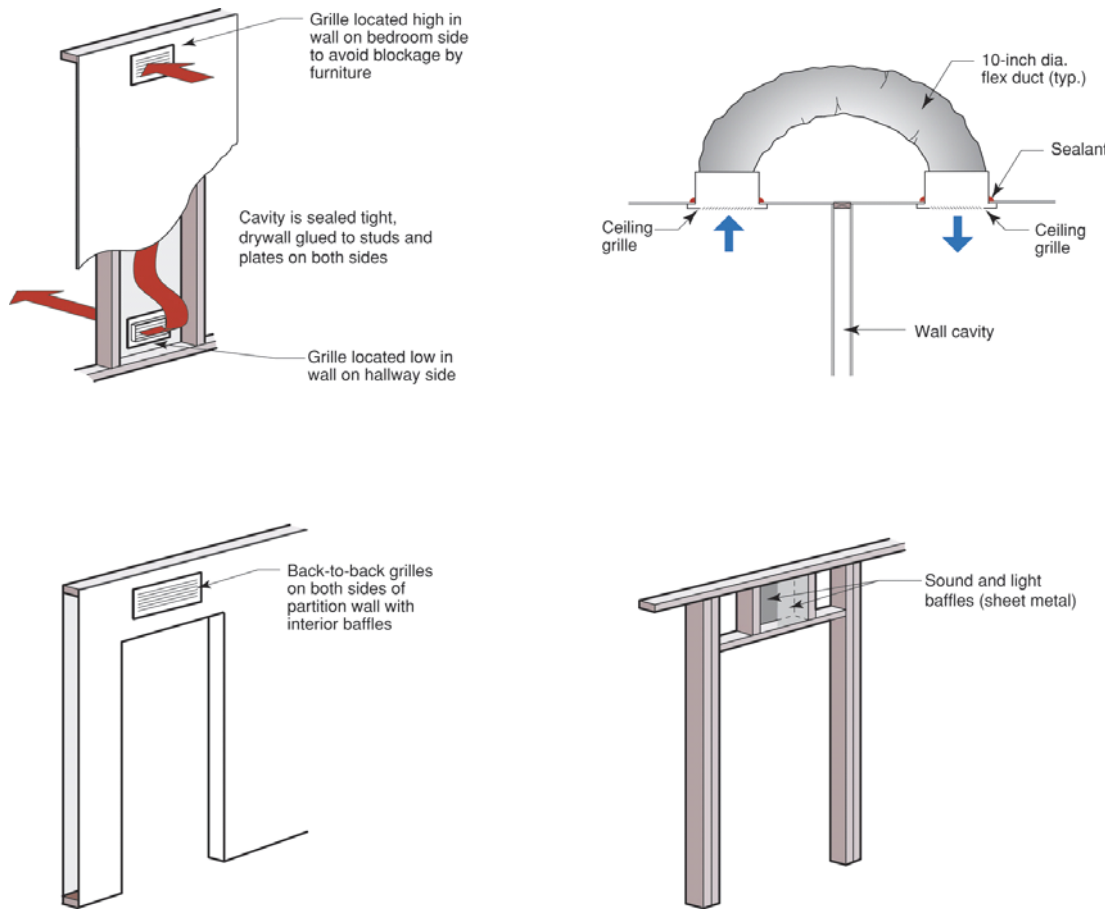
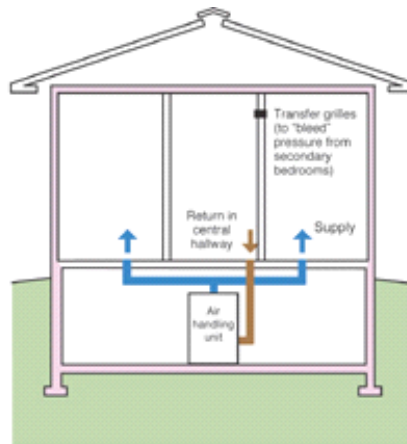
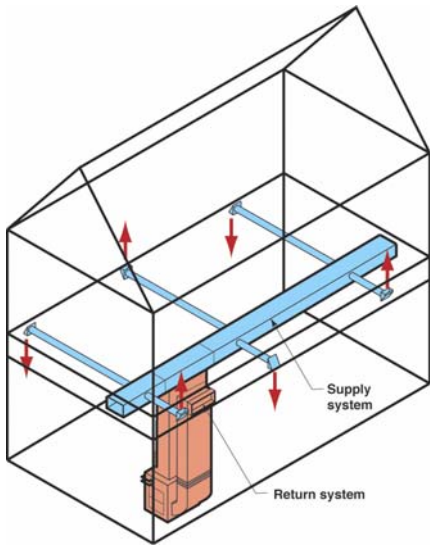

Figure 3-17. Transfer grille and jump duct approaches

Mechanical Ventilation. We recommend an intermittent central-fan-integrated supply system, designed to provide the ASHRAE 62.2P recommended flow rate, with fan cycling control set to operate the central air handler 20 minutes every hour to provide ventilation air distribution and whole-house averaging of air quality and comfort conditions (\$125 to \$150). Include a normally closed motorized damper in the outside air duct with the AirCycler™ FRV control (+\$50 to \$60) (Figure 3-18).



Note: Colored shading depicts the building's thermal barrier and pressure boundary. The thermal barrier and pressure boundary enclose the conditioned space.

Basement Configuration

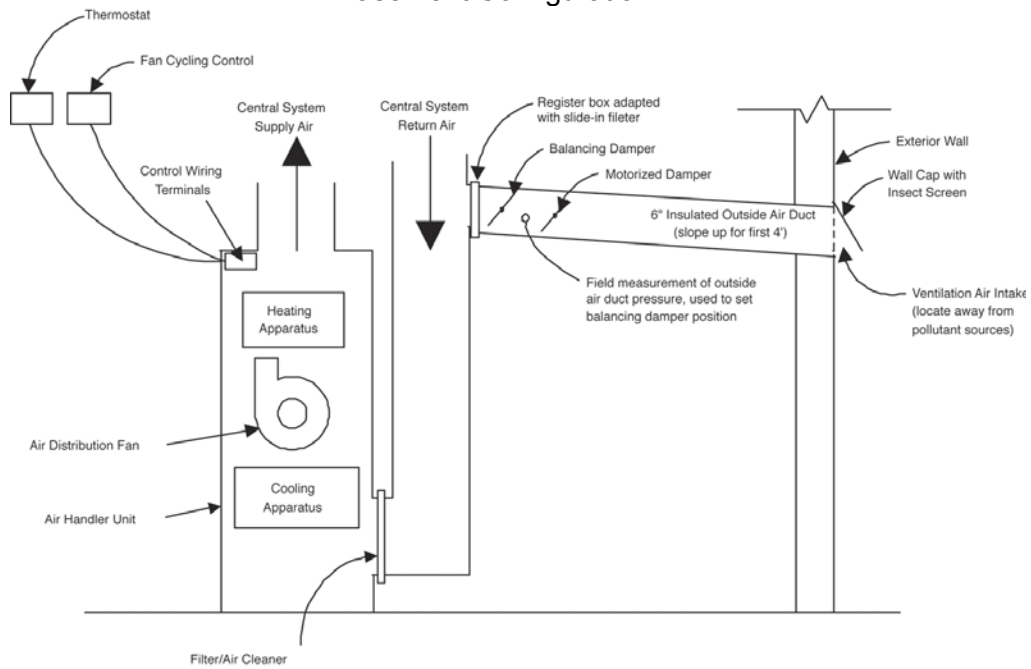

Figure 3-18. Mechanical ventilation in the “Louisville”

Termite Management

Termites are best managed with a three-pronged approach that deals with the three things termites need—cover from sunlight, moisture, and food (wood or paper):

Reduced cover. Keep plantings 3 ft away from the building perimeter, thin the ground cover (wood mulch or pea stone) to no more than 2 in. depth for the first 18 in. around the building. Maintain any termite inspection zone on the foundation.

Control moisture. Maintain slope away from building as shown, carry roof load of water at least 3 ft away from building. Make sure that irrigation is directed away from the building.

Chemical treatment. Use an environmentally appropriate soil treatment (such as Termidor[®]) and a building materials treatment (such as Bora-Care[®]) for termite-prone near-grade wood materials.

Inter-relationship of first three points. Because a builder and a homeowner's ability to employ or stick to each of the three strategies above will vary, make sure that an inability to fully employ one strategy is compensated for by complete rigor with the others. For example, if chemical treatment of soil or building materials is not an option, then complete rigor in moisture control and ground cover is required.

Field Experience Notes

Termite Control

Local codes and interpretations by building inspectors can make details involving rigid insulation difficult. Even though foam used on the interior of a basement wall is exempt from typical code restrictions on the use of rigid foam insulation, an inspection zone at the top of the insulated and studded-out wall could be incorporated without unduly comprising the thermal barrier at this location.

Air Sealing

The air sealing details in the basement and at the first floor rim joist do not include any foam insulation or other materials that require protection from ignition. Note that if foam insulation were used at these locations, it could not be left exposed, according to the language used in many building codes.

Flashing Details

Because the vinyl siding is a screened wall cladding system, flashing details should be accomplished in the plane of drainage (building paper or house wrap), not the cladding. Do not caulk siding and do not rely on "J"-channel as part of the drainage plane. In other words, never consider vinyl siding, aluminum siding (or any siding, for that matter) as the weather barrier.

HVAC Commissioning

The most efficient equipment means little if the system is not set up and started up properly. Follow high-performance start-up procedures such as those described on the BSC web site (www.buildingscience.com/resources/mechanical/air_conditioning_equipment_efficiency.pdf). Although this resource is primarily for refrigerant cooling systems, most of it applies to heat pumps as well.

Energy Trusses

A number of different truss configurations yield greater depth at the heel, but they vary quite a bit in cost. The truss shown in Figure 3-19 (sometimes called a "slider" truss) has proven to be among the most cost-competitive. And, of course, the pitch of the roof affects just how much insulation you can get at this location, regardless of the type of truss.



Figure 3-19. Slider truss

Advanced Framing

For a technical resource that may help with resistance to advanced framing methods from local code officials, see the *Building Safety Journal* article written by Nathan Yost of BSC at www.buildingscience.com/resources/articles/16-19_Yost&Edminster_for_au.pdf.

Stepped Foundation Insulation Detail

Maintaining thermal barrier continuity in stepped foundations has proven easy to neglect. The detail in Figure 3-20 shows how the rigid foam needs to be cut and placed.

Cathedral Ceiling Interior Finish

To maintain air barrier continuity at the top of the exterior walls, a break with tradition is required. The wall gypsum board must go up before the ceiling board. Furring strips (1 x 4) secured through the foam insulation to the roof framing make hanging the ceiling a lot less painful. Using 2 x 4 rather than 1 x 4 furring provides the required space for shallow electrical boxes in the ceiling (i.e., the continuous thermal barrier and air barrier of the ceiling rigid insulation is maintained).

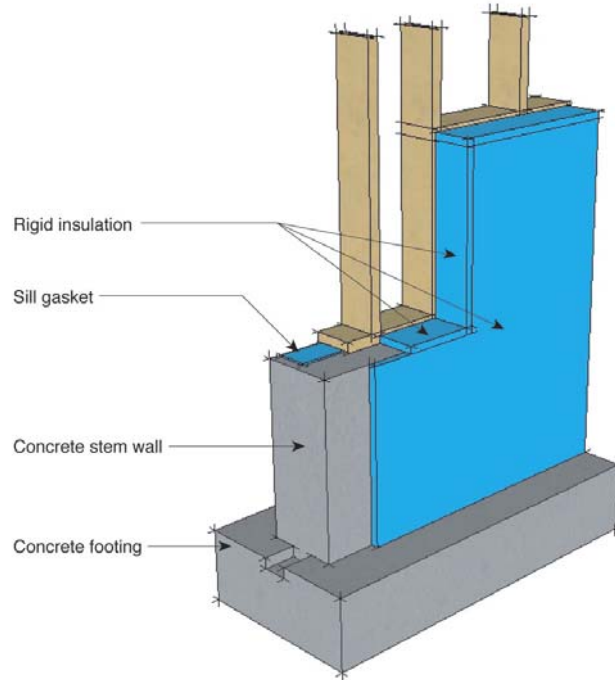

Figure 3-20. Stepped foundation insulation detail

Material Compatibility and Substitutions

Exterior Sheathing

The use of other common exterior sheathing materials—OSB, plywood, or thin-profile structural sheathing (e.g., Thermo-ply[®])—in this assembly must be done with recognition of the impact on heat and moisture transfer.

Both OSB and plywood are more vapor permeable than rigid foam insulation, a good thing when the cavity-warming ability of the rigid insulation is lost. But keep in mind that behind any reservoir cladding, the greater vapor permeability of the OSB or plywood would make a continuous 1-in. air space essential.

On the other hand, Thermo-ply[®] is less vapor permeable than rigid foam insulation and will pretty much eliminate drying potential to the exterior. This presents a potential problem during the heating season, particularly the further north you build in this mixed climate. Builders in the northern half of this climate region who use Thermo-ply[®] as an exterior sheathing should ensure that controlled ventilation and occupant use of point exhaust fans keep the interior relative humidity below 30% during the peak of their heating season.

Rim Joist Blocking

An alternative to this detail is to spray foam insulation on the rim joist to maintain air barrier continuity at this transition.

Drainage Plane on Rigid Insulation

An alternative to flashing, shiplapping, or sealing the XPS insulation for continuity of the drainage plane is to apply a housewrap to the outside of the insulation. The housewrap then becomes the continuous drainage plane.

Interior Latex Paint

The substitution of low permeability interior finishes (vinyl wall paper, oil-based paints) for latex paint is strongly discouraged because drying to the interior is important in mixed-humid climates.

Cavity Insulation Materials

Acceptable cavity insulation includes any that has relatively high vapor permeability—cellulose, fiberglass, or foam (as long as air sealing is accomplished by a separate component or system when cellulose or fiberglass is used). The decision may also be based on properties other than building science.

L-channel Detail on Cladding at Base of Exterior Wall

Any stop can be used at the bottom, exposed edge of the rigid insulation to prevent insect and rodent intrusion, as long as it does not interfere with the foam's function as the drainage plane.

Cast Concrete Foundation Walls

If block is used instead of cast concrete for foundation walls, the bond beam becomes essential to maintain air barrier continuity at the top of the block wall.

Gypsum Wallboard

Areas of potentially high moisture, such as bathrooms, basements, and kitchens, are excellent candidates for non-paper faced wallboard systems (e.g., James Hardie's Hardibacker[®], GP's DensArmor[®], USG's Fiberock[®]). In addition, paper-faced gypsum board should never be used as interior sheathing or backer for tub or shower surrounds where ceramic tile or marble (any material with joints or grout lines) is used as the finish.

Flooring

Many finished flooring materials—either because of their impermeability (sheet vinyl, for example) or sensitivity to moisture (wood strip flooring, for example)—should only be installed over a slab with low w/c ratio (≈ 0.45 or less) or a slab allowed to dry (<0.3 grams/24hrs/ft²) before installation of flooring. In general, sheet vinyl flooring should be avoided.

IV. Houses That Work for Hot-Dry/Mixed-Dry Climates

Introduction

Hot-Dry and Mixed-Dry climates share an important climatic feature: precipitation is less than 20 in. annually. There is an important climatic difference, however, between the two: Hot-Dry climates do not have a monthly average temperature that drops below 45°F, while Mixed-Dry climates do. The significance of this threshold will become evident in the following sections.

Moisture is, in general, not as much of a problem in these climates as the others. Even if the house gets wet, the dry (and often hot) conditions will usually quickly dry it out. Nevertheless, problems can occur when even a brief period of heavy rain deposits several inches of water onto a poorly designed or constructed building. Improper irrigation can also replace precipitation as a moisture source, and leaks can be expected to happen. If water collects in an area that cannot quickly dry, deterioration of the building can occur.

Intense solar radiation is a problem in these climates, specifically in terms of managing the cooling load on the building and preventing ultra-violet degradation of many building materials, such as wood, paint, and plastics. An associated phenomenon (the lack of precipitation) means managing the fire risk of the structure is especially important, particularly in terms of exterior claddings and landscaping.

The coldest-month-of-the-year average temperature threshold of 45°F is determinant in both roof and wall assemblies. It is critical for building design because the dew point temperature of air at 70°F and 35% relative humidity (RH) is approximately 40°F. Consequently, interior air at 70°F and 35% RH (which is a realistic condition in a tightly constructed house) will condense on a surface that is 40°F or cooler. The amount of water that will condense on the interior surface of the exterior sheathing (the first condensing surface) is a function of the dew point temperature of the interior air, the amount of air leakage into the wall, and the vapor permeability of the materials in the wall. Small amounts of condensation will not be a problem if the wall allows drying to the exterior. Adding a 5°F “buffer” or safety factor to the interior design temperature/humidity dew point (40°F dew point, 70°F, 35% RH) yields the 45°F monthly threshold temperature.

Using a thin 1-in. layer of insulating sheathing (R-4) will warm the temperature of the first condensing surface, decreasing the chance that significant condensation will ever occur in the wall assembly. For this reason, we recommend an insulating sheathing in Mixed-Dry climates.

We have chosen three Building Profiles that we think represent building science and regional building practices in Hot-Dry and Mixed-Dry climates:

- The “Albuquerque”** —one-story, stick-framed, slab-on-grade, stucco exterior, vented attic, asphalt shingle roof (with information provided for a optional conditioned crawlspace). This Building Profile is suitable for a Mixed-Dry climate (Figure 4-1).
- The “Sacramento”** —two-story, stick-framed, post-tensioned slab-on-grade, first story with fiber-cement siding/second story with stucco, vented attic, tile roof (with information provided for a one-story with unvented, conditioned attic). This Building Profile is suitable for a Hot-Dry climate (Figure 4-8).
- The “Tucson”** —one-story, stick-framed, slab-on-grade, stucco exterior, flat ceiling (no attic), membrane roof. This Building Profile is also suitable for a Hot-Dry climate, with information provided for moving this building to a mixed-dry climate (Figure 4-15).

A substantial amount of repetition is present in these Building Profiles, but is necessary in order to provide comprehensive, stand-alone, examples of performance packages that achieve 40% energy savings while maintaining or improving quality and durability.

For information about a production builder from each of these two climate regions, see www.buildingscience.com/buildingamerica/casestudies/default.htm. These case studies explore builder experience with the BA program and discuss the reasons for the specific design and construction details that Artistic Homes and Pulte Homes employ. To see detailed drawings on Advanced Framing and Air Sealing Techniques, go to www.buildingscience.com/housethatwork/advancedframing/default.htm. Additional information on construction methods and alternative designs is included in the *Builder's Guide for Hot-Dry and Mixed-Dry Climates* (www.eeba.org/bookstore).

Building America Best Practices for Hot-Dry/Mixed-Dry Climates

High performance Building America homes in hot-dry/mixed-dry climates are faced with a significant heating season (up to 5400 heating degree days, and for mixed-dry climates, monthly average outdoor temperatures dropping below 45°F during winter months), as well as a significant cooling season.

The following Best Practices are based on our Building America Performance Targets (www.buildingscience.com/buildingamerica/targets.htm) and are reflected in the three Building Profiles: the “Albuquerque,” the “Tucson,” and the “Sacramento.” All climate-specific best practices are identified with a bolded and bracketed [HD-MD].

Process: Building Design, Systems Engineering, and Commissioning

Design for Energy Performance

Energy performance for space conditioning and hot water is 40% better than the 1995 Model Energy Code base case house (i.e., equal to 10% better than ENERGY STAR performance requirements).

Systems Engineering

Design the structure using advanced framing methods (see www.buildingscience.com/housethatwork/advancedframing/default.htm or www.buildingscience.com/resources/presentations/advanced_framing.pdf).

Design the structure to accommodate the most efficient duct distribution system that places all ducts and air-handling equipment within conditioned space (see www.buildingscience.com/resources/misc/wood_efficiency.pdf; specifically Figure 3 and page 5).

Design and detail the structure for durability, in terms of wall and roof assembly drying potential, continuous drainage plane, and continuous thermal boundary that clearly defines the conditioned space (see Building Profiles). [HD-MD]

Commissioning: Performance Testing

Air leakage (determined by blower door depressurization testing) should be less than 2.5 in.²/100 ft² surface area leakage ratio (CGSB, calculated at a 10-Pa pressure differential); or 1.25 in.²/100 ft² leakage ratio (ASTM, calculated at a 4-a pressure differential); or 0.25 cfm/ ft² of building envelope surface area at a 50-Pa air pressure differential. If the house is divided into multiple conditioned zones, such as a conditioned attic or conditioned crawl space, the blower door requirement must be met with the access to the space open, connecting the zones.

Ductwork leakage to the exterior for ducts distributing conditioned air should be limited to 5% of the total air-handling system rated air flow at high speed (nominal 400 cfm per ton) determined by pressurization

testing at 25 Pa. Two acceptable compliance mechanisms are (1) test duct leakage to outside at finish stage, or (2) test total duct leakage at duct rough-in stage.

Forced-air systems that distribute air for heating and cooling should be designed to supply airflow to all conditioned spaces and zones (bedrooms, hallways, basements), as well as to provide a return path from all conditioned spaces or zones. Interzonal air pressure differences, when doors are closed, should be limited to 3 Pa. This is typically achieved by installing properly sized transfer grilles or jump ducts (see www.buildingscience.com/resources/mechanical/transfer_grille_detail.pdf and www.buildingscience.com/resources/mechanical/transfer_grille_sizing_charts.pdf).

Mechanical ventilation system airflow should be tested during commissioning of the building.

Testing of the house should be completed as part of the commissioning process. The SNAPSHOT form is available for download as a convenient way to record the testing information (see www.buildingscience.com/buildingamerica/snapshot_form.pdf). Instructions for completing the form are also available (see www.buildingscience.com/buildingamerica/snapshot_instructions.pdf). Unique or custom house plans should each be tested. In a production setting, each model type (i.e., floor plan) should be tested until two consecutive houses of this model type meet testing requirements. At that point, testing on the same model type can be reduced to a sampling rate of one in seven (i.e., one test, with six "referenced" houses). Small additions to a floor plan (e.g., bay window, conversion of den to bedroom) should be considered the same model type; major changes (e.g., bonus room over the garage, conversion of garage into a hobby room, etc.) should be considered a separate model type.

Site: Drainage, Pest Control, and Landscaping

Drainage

Grading and landscaping shall be planned for movement of building run-off away from the home and its foundation, with roof drainage directed at least 3 ft beyond the building, and a surface grade of at least 5% maintained for at least 10 ft around and away from the entire structure.

Pest Control

Based on local code and Termite Infestation Probability (TIP) maps, use environmentally appropriate termite treatments, bait systems, and treated building materials that are near or have ground contact (see www.uky.edu/Agriculture/Entomology/entfacts/) [HD-MD]

Landscaping

Plantings should be held back as much as 3 ft and no less than 18 in. from the finished structure, with any supporting irrigation directed away from the finished structure. Decorative ground cover—mulch or pea stone, for example—should be thinned to no more than 2 in. for the first 18 in. from the finished structure (see Building Profiles). [HD-MD]

Foundation: Moisture Control and Energy Performance

Moisture Control

The building foundation shall be designed and constructed to prevent the entry of moisture and other soil gases (see Building Profiles). [HD-MD]

Slabs require a 6-mil polyethylene vapor barrier directly beneath the concrete or an equivalent approach (such as rigid insulation) that accomplishes vapor and capillary control for the slab. The vapor barrier must continuously wrap the slab as well as the grade beam.

Sub-slab drainage should consist of a granular capillary break directly beneath the slab vapor retarder.

Use radon resistant construction practices as described on the EPA radon control web site (www.epa.gov/iaq/radon/construc.html).

Energy Performance

Slabs in mixed-dry climates should be insulated at the perimeter (energy modeling reveals significant heat loss at this portion of the building envelope during the heating season). Consider the use of borate-treated rigid insulation on the slab perimeter. In hot-dry climates, slabs do not require insulation (see Building Profiles and photo details at www.buildingscience.com/buildingamerica/casestudies/fairburn.htm). [HD-MD]

Envelope: Moisture Control and Energy Performance

Moisture Control

Water management. Roof and wall assemblies must contain elements that provide drainage in a continuous manner over the entire surface area of the building enclosure, including lapped flashing systems at all penetrations. See the Building Profiles and the *EEBA Water Management Guide* for specific details for various wall assemblies. [HD-MD]

Vapor management. Roof and wall assemblies must contain elements that, individually and in combination, permit drying of interstitial spaces. See the Building Profiles. [HD-MD]

Energy Performance

Air leakage. The exterior air flow retarder (e.g., foam sheathing) or interior air flow retarder (e.g., gypsum board) is sealed to the slab and frame walls (Airtight Drywall Approach). For details of the ADA for the interior air flow retarder, see www.buildingscience.com/housesthatwork/airsealing/default.htm.

Windows. We recommend windows with U-factor 0.35 or lower and SHGC (solar heat gain coefficient) 0.35 or lower. [HD-MD]

Mechanicals / Electrical / Plumbing

Systems Engineering

HVAC system design, both equipment and duct, should be done as an integral part of the architectural design process.

HVAC system sizing should follow ACCA Manual J, and duct sizing should follow Manual D (see www.buildingscience.com/resources/mechanical/509a3_cooling_system_sizing_pro.pdf).

Mechanical ventilation should be an integral part of the HVAC system design (see the Building Profiles and www.buildingscience.com/resources/mechanical/advanced_space_conditioning.pdf). [HD-MD]

Energy Performance

Air conditioner or heat pump should be installed according to best practices (see www.buildingscience.com/resources/mechanical/air_conditioning_equipment_efficiency.pdf).

Major appliances should meet high-energy efficiency standards using current appliance ratings. Only those appliances in the top one-third of the DOE Energy Guide rating scale should be selected (for details, see www.eren.doe.gov/consumerinfo/energy_savers/appliances.html).

Occupant Health and Safety

Base rate ventilation: Controlled mechanical ventilation per ASHRAE Standard 62.2.

Spot ventilation: intermittent spot ventilation of 100 cfm should be provided for each kitchen; all kitchen range hoods must be vented to the outside (no recirculating hoods). Intermittent spot ventilation of 50 cfm, or continuous ventilation of 20 cfm when the building is occupied, should be provided for each washroom/bathroom.

All combustion appliances in the conditioned space must be sealed combustion or power vented. Specifically, any furnace inside conditioned space should be a sealed-combustion 90%+ unit. Any water heater inside conditioned space should be power vented or power-direct vented. Designs that incorporate passive-combustion air-supply openings or outdoor supply air ducts not directly connected to the appliance should be avoided.

Provide filtration systems for forced-air systems that provide a minimum atmospheric dust-spot efficiency of 30% or MERV of 6 or higher.

Indoor humidity should be maintained in the range of 25% to 60% by controlled mechanical ventilation, mechanical cooling, or dehumidification (see www.buildingscience.com/resources/moisture/relative_humidity_0402.pdf).

Carbon-monoxide detectors (hard-wired units) shall be installed (at one per every approximate 1000 ft²) in any house containing combustion appliances and/or an attached garage.

Information relating to the safe, healthy, comfortable operation and maintenance of the building and systems that provide control over space conditioning, hot water, or lighting energy use shall be provided to occupants.

Envelope/Mechanicals Management

Plumbing. No plumbing in the exterior walls. Air seal around plumbing penetrations in the pressure boundary (air barrier) such as rim (band) joist or ceiling.

Electrical. Seal around wires penetrating the air barrier or pressure boundary.

Building Profile #11. The Albuquerque

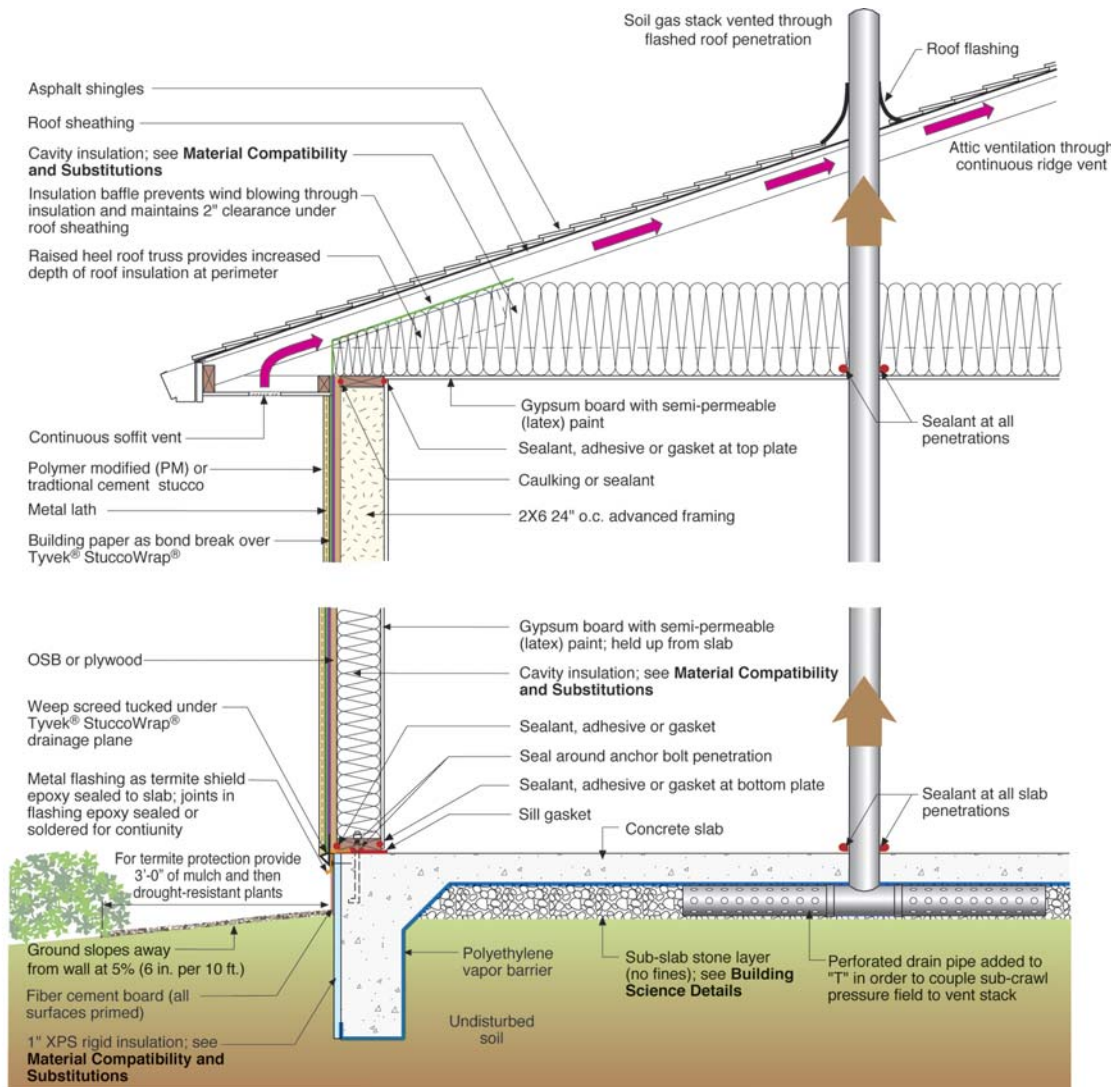

Foundation: Slab-on-grade
Above Grade Wall: Wood frame

Attic: Unconditioned
Roof: Asphalt shingles

Cladding: Stucco

Figure 4-1. Cross section of the Albuquerque

Building Science Details

Ducts in Conditioned Space

This building profile is designed to accommodate HVAC equipment and ducts in the living space, specifically in dropped soffits where design and layout permit. HVAC ducts should not be run in exterior walls or the slab.

Air Sealing Details at Transitions

Air sealing can be particularly difficult, but no less important, at assembly transitions such between attached garages and living spaces.

Attached Garages. The building envelope surfaces shared between conditioned space and an unconditioned garage must have a continuous air barrier. See Figure 4-2 and www.buildingscience.com/housethatwork/airsealing/default.htm for details in terms of using sealants and rigid insulation to create a continuous air barrier between the attached garage and living space.

Drying Mechanisms

In any climate, vapor control is based on the relationships among the following: the permeability of wall components, the type of cladding (reservoir or non-reservoir), the presence/lack/nature of an air space, and the magnitude/duration of the vapor drive (based on the relationship between the exterior and interior moisture content and temperature differences). The type of sheathing and housewrap used in any wall assembly must be based on an understanding of these inter-relationships. See “Insulations, Sheathings, and Vapor Diffusion Retarders” for more information

(www.buildingscience.com/resoruces/walls/insulation_sheathings.pdf). This wall assembly permits drying to both the interior and the exterior (depending on the selection of exterior sheathing). For further information, see the Building Materials Property Table (Table 1).

Drainage Plane, Air Barrier, and Vapor Control

The drainage plane in this wall assembly is the Dupont StuccoWrap[®] weatherlapped onto the OSB structural sheathing (the building paper just exterior to the drainage plane is the bond break for the stucco cladding). An annual precipitation of 8 in. (30-year average for Albuquerque) means that a face-sealed stucco cladding can work, but this system is designed with a drainage plane as a “belt and suspenders” approach for long-term durability.

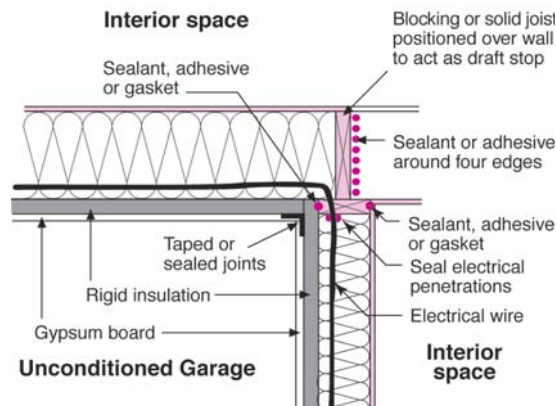

Figure 4-2. Continuous air barrier

The air barrier is the interior gypsum board installed using the Airtight Drywall approach (see Air Sealing Details).

The wall and roof assemblies in this building are “flow-through” assemblies, with moderate to high relative vapor permeability in all components of the wall and roof. This bi-directional drying is the preferred approach in mixed-dry climates.

Rough Opening Flashing

Window and door flashing details are wall assembly or cladding specific and depend on whether the windows are installed before or after the drainage plane. Refer to the *EEBA Water Management Guide* for more information (www.eeba.org/bookstore).

Advanced Framing

This wall assembly employs all of the advanced framing methods except alternative shear resistance (structural sheathing is used). For advanced framing details, see www.buildingscience.com/housethatwork/advancedframing/default.htm.

Framing on Slabs

Installing a capillary break between the sill plate and a concrete slab on all walls—exterior, interior, partition—is good practice. A closed-cell foam sill sealer or gasket works well. Alternatively, a strip of sheet polyethylene can be used. This isolates the framing from any source of moisture that may be either in or on the concrete slab (and using sill sealer on all walls maintains the same wall height).

Soil Gas Ventilation

The sub-slab to roof vent system handles conditions that are difficult, if not impossible, to assess before completion of the structure—residual confined concentrations of air-borne radon, soil treatments (termiticides, pesticides), methane, etc. The cost of this “ounce” of prevention is well balanced against the cost of the “pound” of cure.

Sub-Slab Stone Bed

The 4-in.-deep, 3/4-in. stone bed functions as a granular capillary break, a drainage pad, and a sub-slab air pressure field extender for the soil gas ventilation system. Without it, a soil gas ventilation system is not a practical solution, and the only capillary break between the slab and ground is the polyethylene vapor barrier.

Thermal barrier

In general, we recommend cavity-warming exterior rigid insulation in climates where the average monthly temperature for the coldest month of the year goes below 45°F. But in this assembly, the excellent drying potential of the “flow-through” wall assembly is achieved in part by the absence of any rigid insulation with relatively low vapor permeability. Because mixed-dry climates have significant, but not extreme, periods of winter temperatures below 45°F, either approach to thermal performance/vapor control works well.

In Albuquerque, the heat loss through the slab perimeter is significant enough to warrant slab-edge insulation. See Termite Control under Field Experience Notes for the details.

Vented Attic

Soffit and ridge vents provide more effective attic ventilation than gable-end vents. Gable exhaust fans do not provide effective attic ventilation. They are generally temperature-controlled, when relative humidity is often the condition that requires higher ventilation rates. They can also depressurize the house causing

loss of conditioned air. Generally, the area of the gable and soffit vents, combined with the leakage of the attic ceiling, is such that the fan pulls air not just from the exterior vent, but also from the conditioned space below.

Climate-Specific Details

Mechanical Systems

Heating. Our recommendation to high-performance production homebuilders in mixed-dry climates is to use combination space/domestic water heating systems (i.e., “combo” units), but this recommendation comes heavily qualified. For details, see Figure 4-3 and the BSC technical resource “Combo Space/Water Heating Systems: ‘Duo Diligence’,”

(www.buildingscience.com/resources/mechanical/combo_systems.pdf).

Cooling. Evaporative cooling is prevalent in Mixed-Dry Climates. We recommend refrigerant cooling in high-performance homes in this climate region for three reasons:

1. Refrigerant cooling permits year-round controlled ventilation; evaporative cooling does not.
2. Evaporative cooling can be prone to moisture and indoor air quality problems without frequent and diligent system maintenance. Refrigerant cooling is not.
3. While there can be a slight energy penalty with refrigerant cooling in comparison to evaporative cooling, this penalty must be balanced against the year-round comfort provided by refrigerant cooling (evaporative cooling has difficulty supplying comfort in high humidity situations) and the substantial water savings associated with refrigerant cooling (a growing issue in mixed-dry climates).

Follow appropriate sizing procedures. For more detailed information, see

www.buildingscience.com/resources/mechanical/509a3_cooling_system_sizing_pro.pdf.

Transfer Grilles. The single central return requires transfer grilles to provide an adequate return path and avoid pressurizing bedrooms, as shown in Figure 4-4. Appropriate sizing for ducts, including these pressure relief methods, can be found at

www.buildingscience.com/resources/mechanical/509a3_cooling_system_sizing_pro.pdf.

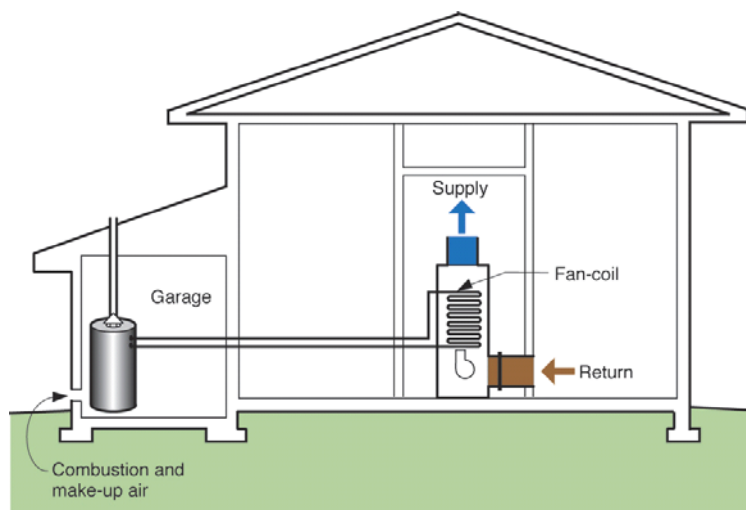

Figure 4-3. Combo heating system

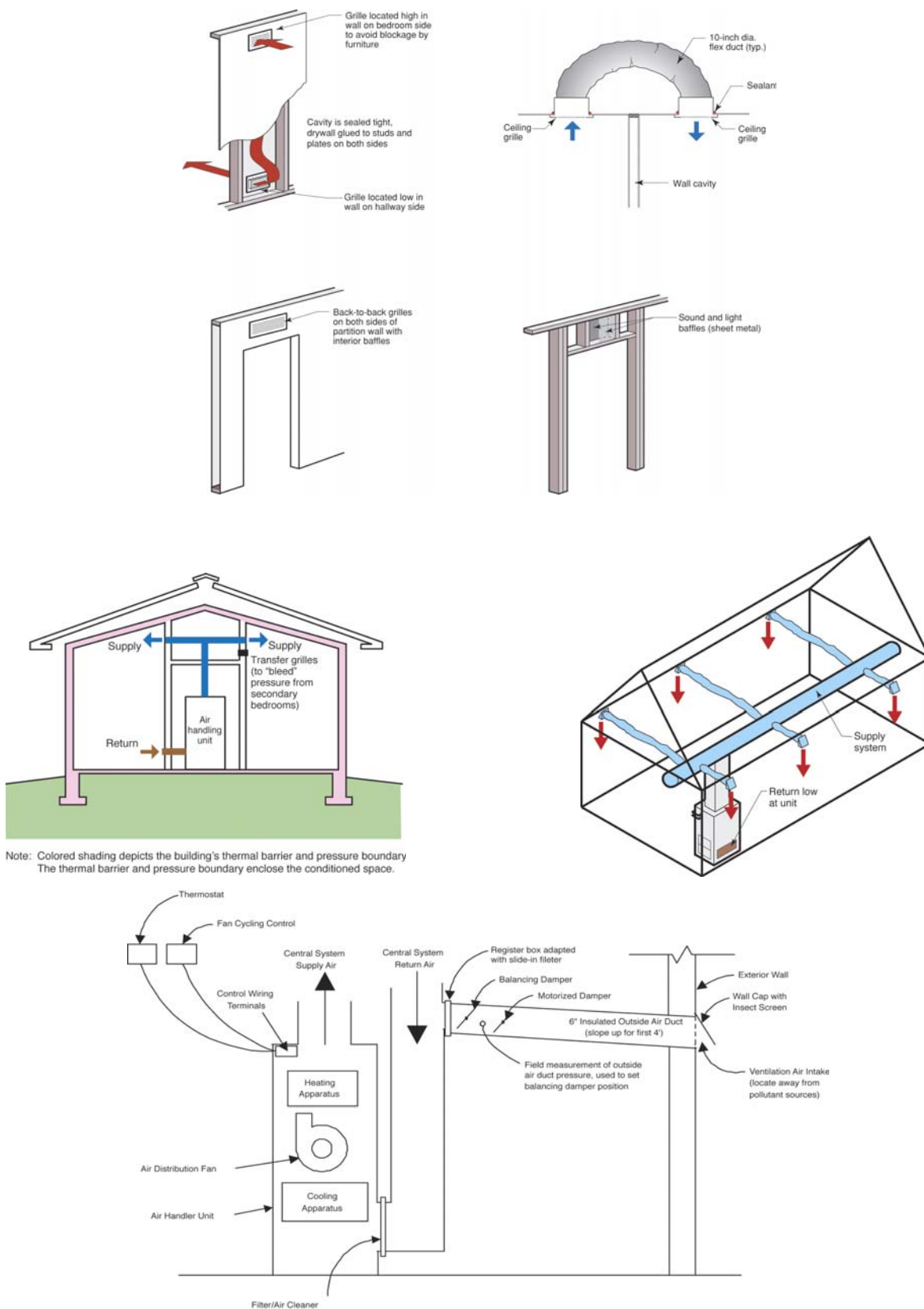

Figure 4-4. Ducting, transfer grilles, and interior closet configuration

Controlled Mechanical Ventilation. We recommend an intermittent central-fan integrated supply, designed to provide the ASHRAE 62.2P recommended flow rate, with fan-cycling controls set to operate the central air handlers 20 minutes every hour to provide ventilation air distribution and whole-house averaging of air quality and comfort conditions (installed cost: \$125 to \$150). Include a normally closed motorized damper in the outside duct with the AirCycler™ FRV control (installed cost: \$50 to \$60). This ventilation system is illustrated in Figure 4-4.

Termite Management

Termites are best managed with a three-pronged approach that deals with the three things termites need—cover from sunlight, moisture, and food (wood or paper):

Reduced cover. Keep plantings 3 ft away from the building perimeter, thin the ground cover (wood mulch or pea stone) to no more than 2-in. depth for the first 18 in. around the building, and maintain any termite inspection zone on the exterior of the foundation above grade.

Control moisture. Maintain slope away from building as shown, carry roof load of water at least 3 ft away from building, and make sure that irrigation is directed away from the building.

Chemical treatment. Use an environmentally appropriate soil treatment (such as Termidor®) and a building materials treatment (such as Bora-Care®) for termite-prone near-grade wood materials.

Inter-relationship of first three points. Because a builder and a homeowner's ability to employ or stick to each of the three strategies above will vary, make sure that an inability to fully employ one strategy is compensated for by complete rigor with the others. For example, if chemical treatment of soil or building materials is not an option, then complete rigor in moisture control and ground cover is required.

Landscaping for wildfire control

Keeping woody materials of any type, living or otherwise, away from the building is good practice in dry climates where wildfires present a significant risk.

Field Experience Notes

Termite Control

Local codes and interpretations by building inspectors can make details involving slab insulation difficult. We have found that building officials accept the flashing/FiberCement board shown in the Building Profile and in Figure 4-5.



Figure 4-5. Flashing with FiberCement board

Termite Flashing Continuity

In order for the metal flashing to be effective, all joints must be epoxy-sealed (or welded) and the horizontal edge must be epoxy-sealed to the concrete.

HVAC Commissioning

The most efficient equipment means little if the system is not set up and started up properly. Follow high-performance start-up procedures such as those described on the BSC web site (www.buildingscience.com/resources/mechanical/air_conditioning_equipment_efficiency.pdf).

In dry climates, it is generally a good idea to set up the air distribution fan to run a little longer at the end of each cycle to bump up the sensible efficiency.

Location of HVAC Outdoor Unit

It's tempting to put the condenser right on the roof where evaporative cooling units are typically located, particularly when lot lines are very tight. We do not recommend a rooftop location of the condenser for several reasons: it makes even routine maintenance more difficult, it puts the unit at what is most likely the hottest spot on the entire property, and it introduces more roof penetrations.

Energy Trusses

There are a number of different truss configurations that yield greater depth at the heel, but they vary quite a bit in cost. The truss shown in Figure 4-6 (sometimes called a “slider” truss) has proven to be among the most cost-competitive. And of course, the pitch of the roof affects just how much insulation you can get at this location, regardless of the type of truss.

Advanced Framing

For a technical resource that may help with resistance to advanced framing methods from local code officials, see the *Building Safety Journal* article written by Nathan Yost of BSC at www.buildingscience.com/resources/articles/16-19_Yost&Edminster_for_au.pdf.



Figure 4-6. Slider truss

Slab

In dry climates, it is quite common for builders to use a sand layer in between the polyethylene sheet (“poly”) and the cast concrete to prevent differential drying and cracking problems. This moisture-holding layer should never be placed between the poly and concrete. Differential drying and subsequent cracking should be handled with a low-water-content concrete and wetted burlap covering. For more information, see www.buildingscience.com/resources/foundations/sand_layer_under_slab.htm.

Keeping Ducts in Conditioned Space

Many builders in Mixed-Dry climates build in areas where the prevailing architecture can make locating all ducts and HVAC equipment in conditioned space more than a bit challenging, particularly when moving from smaller, more affordable homes to more architecturally complex upgrade homes. Moving from slab-on-grade to a conditioned crawlspace is one way to maintain the local architectural style while improving performance. The detail in Figure 4-7 shows how one Mixed-Dry climate Building America production builder used a conditioned crawlspace to move ducts into conditioned space cost-efficiently, in terms of builder construction costs, homeowner operating costs, and maintained energy and comfort. The following section describes some points to remember when making the change from slab-on-grade to a conditioned crawlspace.

Conditioned crawlspace. Conditioning of the crawlspace means that this space must be constructed much like a living space; it must be supplied by the HVAC system and have a transfer grille to return air back to the HVAC system through the living space. The supply air should be directed horizontally across the crawlspace with good enough “throw” to provide some mixing, not directed down at the floor. Sizing of the supply air should be about 5% of the conditioned crawlspace floor area (for example: $0.05 \text{ cfm/ft}^2 \times 1600 \text{ ft}^2 = 80 \text{ cfm}$ for a 1600 ft^2 conditioned crawlspace). A single 6-in.-diameter supply duct typically suffices. Transfer air should go back to the central area of the living space above the crawlspace. Two grilles (10 in. by 4 in.) on opposite sides of the crawlspace are usually sufficient. The transfer area should be calculated in the same manner as for closed bedrooms connecting to hallways, using the 3-Pa pressure difference limit. Some form of mechanical moisture control for the crawlspace is necessary. We recommend one of the following approaches:

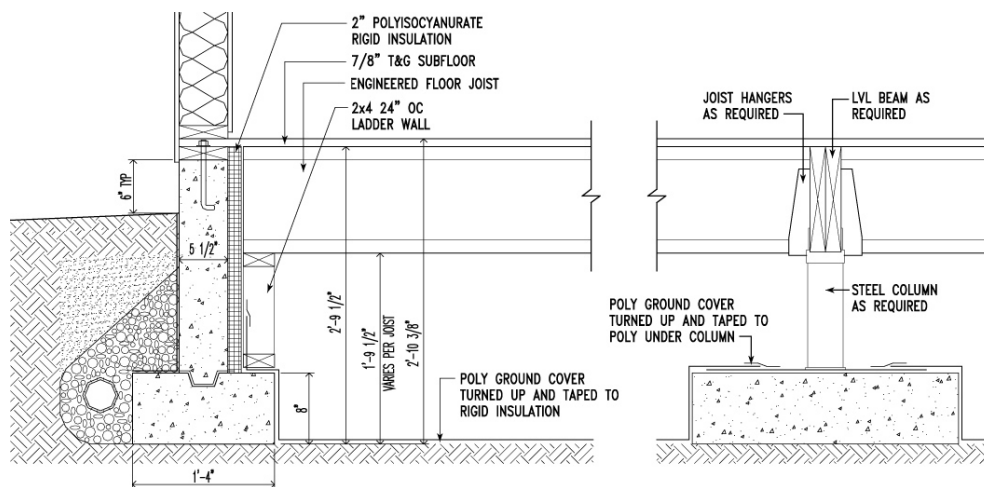

1. A controlled ventilation strategy using the intermittent central fan-integrated supply, which provides both mixing and moisture removal for the crawlspace as well as the house
2. A stand-alone dehumidifier installed in the crawlspace
3. A continuously operating crawlspace exhaust fan with make-up air extracted from the house.

In the “Albuquerque,” the rigid insulation is applied to the interior face of the exterior foundation walls. Moisture control is important to proper performance, in particular the vapor barrier ground cover on the floor of the crawlspace. The vapor barrier must be continuous and sealed to the perimeter wall and any supporting piers. This crawlspace assembly may require discussion with the local building code official. See the *Building Safety Journal* article written by Nathan Yost of BSC: www.buildingscience.com/resources/articles/24-27_Yost_for_author.pdf.

Crawlspace Access

The preferred location for crawlspace access is through the subfloor; any access through the perimeter wall must be air sealed and insulated.

Air Sealing

Most codes can be interpreted to require only protection of foam from “ignition” in crawlspaces (“where entry is made only for service of utilities”). The same applies to foam at the rim joist (this is an interstitial space protected from ignition by gypsum wall board on one side and floor sheathing on the other). Protection from ignition can be accomplished with 1½ -in.-thick (38 mm) mineral fiber insulation, 1/4-in.-thick (6.4 mm) wood structural panels, 3/8-in. (9.5 mm) particleboard, ¼-in. (6.4 mm) hardboard, 3/8-in. (9.5 mm) gypsum board, or corrosion-resistant steel having a base metal thickness of 0.016 in. (0.406 mm).

Layout and Floor Framing

The introduction of floor framing means that floor plans and dimensions that worked well for a slab may no longer be efficient in terms of wood use. Be prepared to investigate the relationship between design and efficient wood use. For more information, see “*Using Wood Efficiently: From Optimizing Design to Minimizing the Dumpster*” (www.buildingscience.com/resources/misc/wood_efficiency.pdf).

Material Compatibility and Substitutions

Interior Latex Paint

The substitution of low permeability interior finishes (vinyl wall paper, oil-based paints) for latex paint is strongly discouraged because drying to the interior is important in mixed climates.

Building Papers with Stucco

There must always be two separate components here: the bond break material and the drainage plane. Although StuccoWrap® is advertised as both a drainage plane material and the layer receiving the stucco, these two components should never be combined or reversed.

Exterior Sheathing Materials

In this assembly, the use of a reservoir cladding suggests that a moisture-sensitive material such as fiberboard should not be used. On the other hand, the lack of cavity-warming exterior insulation means that an impermeable sheathing such as thin-profile structural sheathing (e.g., Thermo-ply®, Energy Brace) should not be used. Plywood is an acceptable substitution for OSB in this wall assembly. For more information, see the Building Materials Property Table (Table 1) or “*Insulations, Sheathings, and Vapor Diffusion Retarders*” (www.buildingscience.com/resources/walls/insulation_sheathings.pdf).

Cavity Insulation Materials

Acceptable cavity insulation includes any that have relatively high vapor permeability—cellulose, fiberglass, or foam (as long as air sealing is accomplished by a separate component or system when cellulose or fiberglass is used). The decision may also be based on properties other than building science.

Flooring

Because curing concrete releases significant moisture for several months after being cast, we recommend that a low w/c concrete ratio (<0.45) be used to protect the integrity of finished flooring. We also recommend that vinyl flooring not be installed over a concrete slab.

Gypsum Wallboard

Areas of potentially high moisture, such as bathrooms, basements, and kitchens, are excellent candidates for non-paper-faced wallboard systems (e.g., James Hardie's Hardibacker[®], GP's DensArmor[®], USG's Fiberock[®]). In addition, paper-faced gypsum board should never be used as interior sheathing or backer for tub or shower surrounds where ceramic tile or marble (any material with joints or grout lines) is used as the finish.

XPS Versus EPS Exterior Foundation Foam Insulation

There are three rigid insulations appropriate for exterior use on foundations where the insulation will extend below grade and be in contact with soil conditions:

XPS. This material's density, impact resistance, and resistance to liquid penetration make it the preferred material.

EPS. In areas where resistance to insects (especially termites and carpenter ants) is a desired or required characteristic of the insulation, EPS may be indicated because it is the only foam insulation that comes with a borate-treatment. However, water penetration and subsequent leaching of the borate treatment require a capillary break between the soil and the insulation. This is best accomplished with a gravel layer or an Enkadrain[®] mat just exterior to the EPS insulation.

Rigid Fiberglass. This is a great material for exterior insulation because of its drainability and resistance to insect degradation. However, availability of this material has been and remains the main constraint on its use.

Building Profile #12. The Sacramento

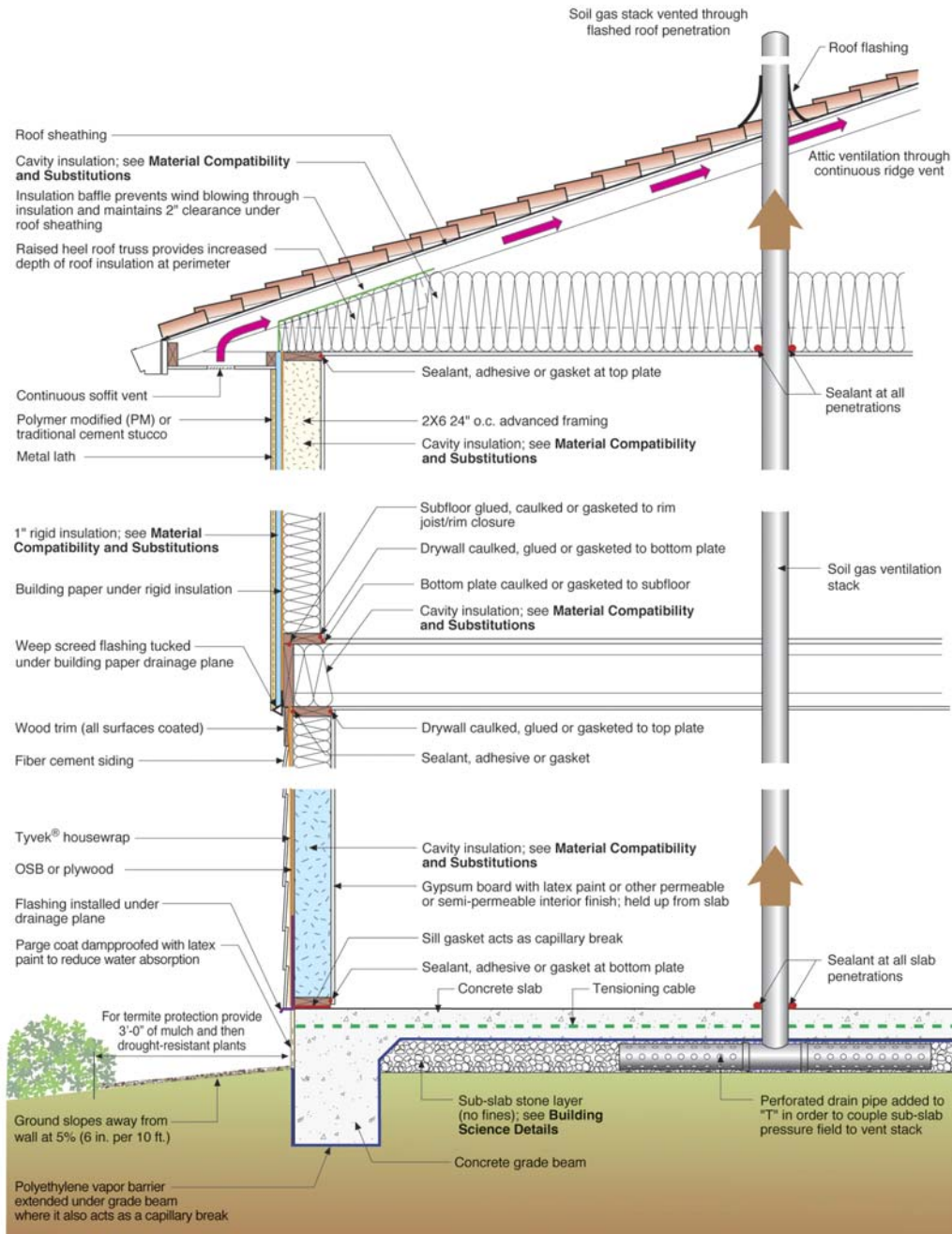

Foundation: Post-tensioned slab-on-grade Attic: Unconditioned Cladding (1st floor): Fiber cement siding
 Above Grade Walls: Wood frame Roof: Tile Cladding (2nd floor): Stucco

Figure 4-8. Cross section of the Sacramento

Building Science Details

Ducts in Conditioned Space

This building profile is designed to accommodate HVAC equipment and ducts in the living space, specifically with the air handler in an interior closet and the ducts in the second floor framing, resulting in a blow-up/blow-down duct system. HVAC ducts should not be run in exterior walls or the slab.

Air-Sealing Details at Transitions

Air sealing can be particularly difficult, but no less important, at assembly transitions such as band joists and between attached garages and living spaces. These are discussed below because they have proven to be consistent challenges for high-performance production builders.

Band joists. Continuity of an exterior air barrier can be maintained at the band joist with sealed or taped housewrap or rigid foam insulation. Continuity of an interior air barrier can be maintained through a combination of cut foam blocks and sealant/caulk, rigid draft-stopping (wood blocking) and sealant/caulk, or spray foam. Note that neither cellulose nor fiberglass (batt or blown) can be used for the air barrier. The air barrier detail on second-story band joists is important because it is inaccessible (covered by structural/finish floor and ceiling finish) after construction. The air barrier/thermal barrier detail is important on ground floor band joists because of the thermal bridge that can occur at the top of crawlspace foundation walls (as the result of the air barrier and thermal barrier moving from the outside to the inside of the building envelope and termite inspection zones located at the top of basement and crawlspace foundation walls). Note that while fiberglass batts fulfill the requirement for protection from ignition in the open band joists, fiberglass batt material by itself cannot maintain the air barrier.

Attached garages. The building envelope surfaces shared between conditioned space and an unconditioned garage must have a continuous air barrier. See Figure 4-9 and www.buildingscience.com/housethatwork/airsealing/default.htm for details in terms of using sealants and rigid insulation to create a continuous air barrier between the attached garage and living space.

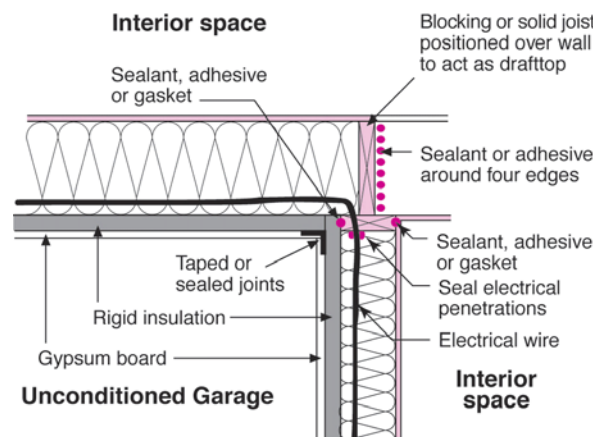

Figure 4-9. Creating a continuous air barrier

Drying Mechanisms

In any climate, vapor control is based on the relationships among the following: the permeability of wall components, the type of cladding (reservoir or non-reservoir), the presence/lack/nature of an air space, and the magnitude/duration of the vapor drive (based on the relationship between the exterior and interior moisture content and temperature differences). The type of sheathing and housewrap used in any wall assembly must be based on an understanding of these inter-relationships. See “Insulations, Sheathings, and Vapor Diffusion Retarders” for more information

(www.buildingscience.com/resources/walls/insulation_sheathings.pdf). The wall assembly in the “Sacramento” permits drying to the interior and limited drying to the exterior (vapor semi-permeable XPS insulation on the second story, OSB on the first story).

Drainage Plane, Air barrier, and Vapor Control

The drainage plane in this wall assembly is the layer of building paper on both stories.

The air barrier is the interior gypsum board installed using the Airtight Drywall approach (see Air Sealing Details). The wall and roof assemblies in this building are “flow-through” assemblies, with some degree of vapor permeability in all components of the wall and roof. This bi-directional drying is the preferred approach in Mixed-Dry climates. The most common exterior rigid insulation used in this assembly is expanded polystyrene (EPS), a semi-vapor permeable sheathing.

Rough Opening Flashing

Window and door flashing details are wall assembly or cladding specific and depend on whether the windows are installed before or after the drainage plane. Refer to the *EEBA Water Management Guide* for (www.eeba.org/bookstore) more information

Advanced framing

This wall assembly employs all of the advanced framing methods, including structural bracing rather than structural sheathing on the first floor. For advanced framing details, see www.buildingscience.com/resources/misc/wood_efficiency.pdf. For information on the inset shear panel developed as part of a comprehensive approach to advanced framing in seismic regions, see Figure 4-10 and www.buildingscience.com/resources/walls/default.htm.

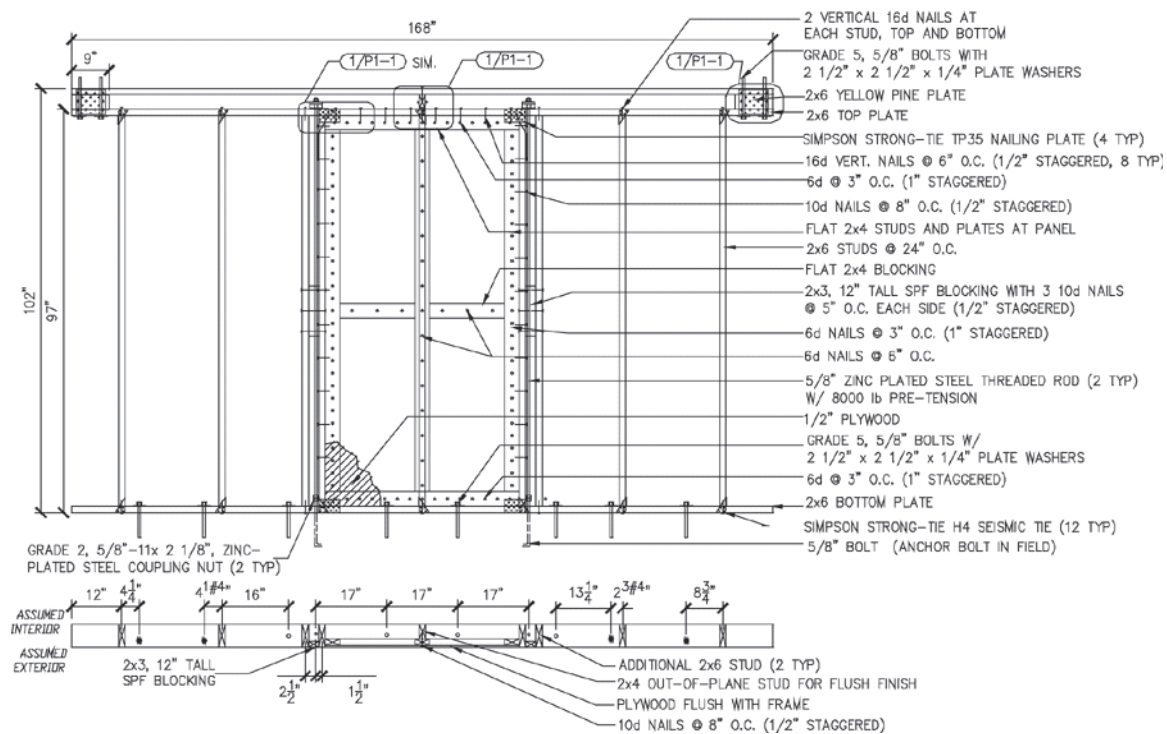

Fig. 66. Advanced framing detail

Framing on Slabs

Installing a capillary break between the sill plate and a concrete slab on all walls—exterior, interior, partition—is good practice. A closed-cell foam sill sealer or gasket works well. Alternatively, a strip of sheet polyethylene can be used. This isolates the framing from any source of moisture that may be either in or on the concrete slab (and using sill sealer on all walls maintains the same wall height).

Soil Gas Ventilation

The sub-slab to roof vent system handles conditions that are difficult, if not impossible, to assess before completion of the structure—residual confined concentrations of air-borne radon, soil treatments (termiticides, pesticides), methane, etc. The cost of this “ounce” of prevention is well balanced against the cost of the “pound” of cure.

Sub-Slab Stone Bed

The 4-in.-deep, 3/4-in. stone bed functions as a granular capillary break, a drainage pad, and a sub-slab air pressure field extender for the soil gas ventilation system. Without it, a soil gas ventilation system is not practical, and the only capillary break between the slab and ground is the polyethylene vapor barrier.

Thermal Barrier

In Sacramento, the heat loss through the slab perimeter is significant enough to warrant slab-edge insulation.

Vented Attic

Soffit and ridge vents provide more effective attic ventilation than gable-end vents. Gable exhaust fans do not provide effective attic ventilation. They are generally temperature-controlled, when relative humidity is often the condition that requires higher ventilation rates. They can also depressurize the house causing loss of conditioned air. Generally, the area of the gable and soffit vents, combined with the leakage of the attic ceiling, is such that the fan pulls air not just from the exterior vent, but also from the conditioned space below.

Climate-Specific Details

Mechanical Systems

Heating. We recommend a sealed combustion hot-air furnace. Sealed combustion allows the unit to be located within the conditioned space with no compromise in indoor air quality or combustion safety.

Cooling. Although evaporative cooling is prevalent in Mixed-Dry Climates, we recommend refrigerant cooling in high-performance homes in this climate region for three reasons:

1. Refrigerant cooling permits year-round controlled ventilation; evaporative cooling does not.
2. Evaporative cooling can be prone to moisture and indoor air quality problems without frequent and diligent system maintenance. Refrigerant cooling is not.
3. While there can be a slight energy penalty with refrigerant cooling in comparison to evaporative, this penalty must be balanced against the year-round comfort provided by refrigerant cooling (evaporative cooling has difficulty supplying comfort in high humidity situations) and the substantial water savings associated with refrigerant cooling (a growing issue in mixed-dry climates).

Follow appropriate sizing procedures. For more detailed information, see www.buildingscience.com/resources/mechanical/509a3_cooling_system_sizing_pro.pdf.

Transfer Grilles. The single central return requires transfer grilles to provide an adequate return path and avoid pressurizing bedrooms, as shown in Figure 4-11. For appropriate sizing of ducts, including these pressure relief methods, go to www.buildingscience.com/resources/mechanical/509a3_cooling_system_sizing_pro.pdf.

Controlled Mechanical Ventilation. We recommend an intermittent central-fan-integrated supply, designed to provide the ASHRAE 62.2P recommended flow rate, with fan cycling controls set to operate the central air handlers 20 minutes every hour to provide ventilation air distribution and whole-house averaging of air quality and comfort conditions (installed cost: \$125 to \$150). Include a normally closed motorized damper in the outside duct with the AirCycler™ FRV control (installed cost: \$50 to \$60) (See Figure 4-12).

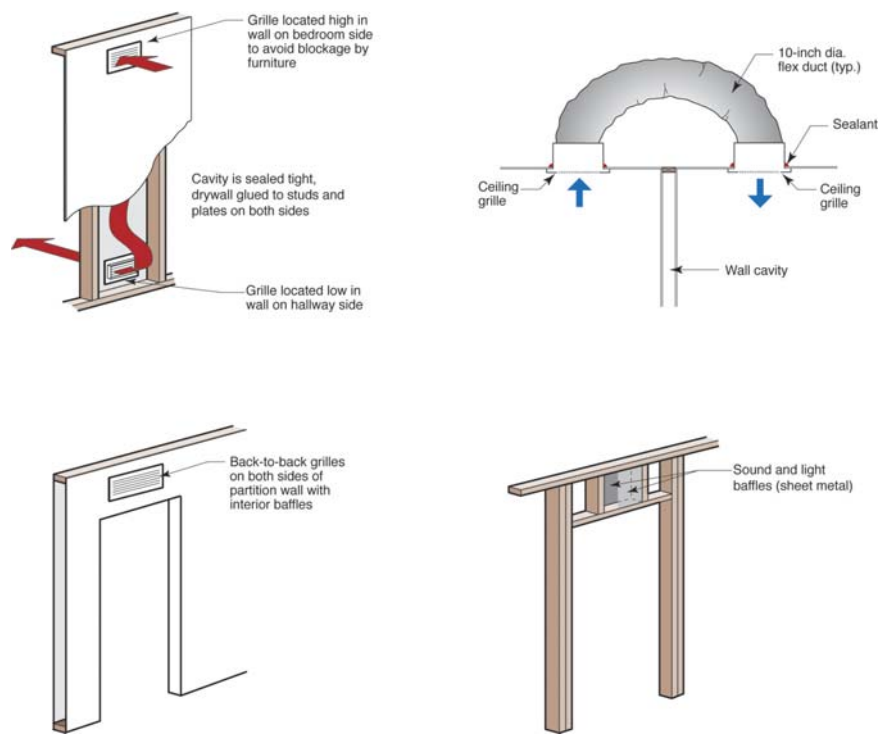

Figure 4-11. Transfer grilles and jump ducts

Termite Management

Termites are best managed with a three-pronged approach that deals with the three things termites need—cover from sunlight, moisture, and food (wood or paper):

Reduced cover. Keep plantings 3 ft away from the building perimeter, thin the ground cover (wood mulch or pea stone) to no more than 2 in. depth for the first 18 in. around the building, and maintain any termite inspection zone on the exterior of the foundation above grade.

Control moisture. Maintain slope away from building as shown, carry roof load of water at least 3 ft away from building, and make sure that irrigation is directed away from the building.

Chemical treatment. Use an environmentally appropriate soil treatment (such as Termidor[®]) and a building materials treatment (such as Bora-Care[®]) for termite-prone near-grade wood materials.

Inter-relationship of first three points. Because a builder and a homeowner's ability to employ or stick to each of the three strategies above will vary, make sure that an inability to fully employ one strategy is compensated for by complete rigor with the others. For example, if chemical treatment of soil or building materials is not an option, then complete rigor in moisture control and ground cover is required.

Landscaping for Wildfire Control

Keeping woody materials of any type, living or otherwise, away from the building is good practice in dry climates where wildfires present a significant risk.

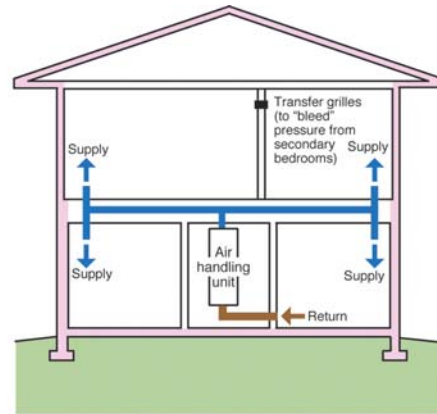
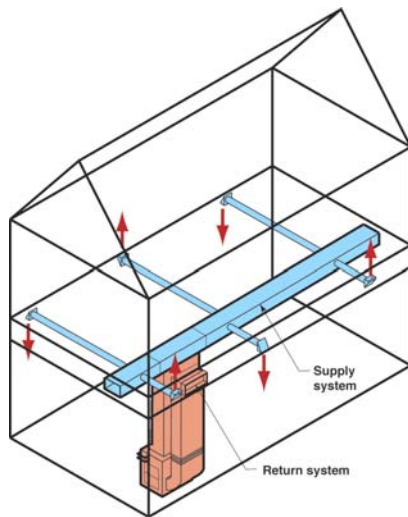

Note: Colored shading depicts the building's thermal barrier and pressure boundary. The thermal barrier and pressure boundary enclose the conditioned space.

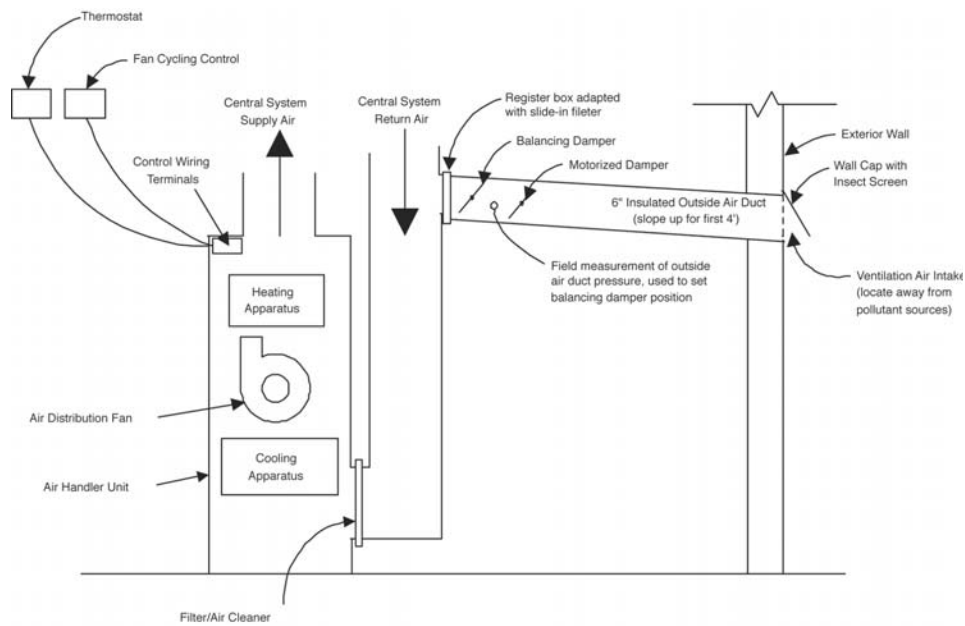

Figure 4-12. HVAC configuration in the “Sacramento”

Field Experience Notes

HVAC Commissioning

The most efficient equipment means little if the system is not set up and started up properly. Follow high-performance start-up procedures such as those described on the BSC web site (www.buildingscience.com/resources/mechanical/air_conditioning_equipment_efficiency.pdf). In dry climates, it is generally a good idea to set up the air distribution fan to run a little longer at the end of each cycle to bump up the sensible efficiency.

Energy Trusses

There are a number of different truss configurations that yield greater depth at the heel, but they vary quite a bit in cost. The truss shown in Figure 4-13 (sometimes called a “slider” truss) has proven to be among the most cost-competitive. And of course, the pitch of the roof affects just how much insulation you can get at this location, regardless of the type of truss.

Advanced Framing

For a technical resource that may help with resistance to advanced framing methods from local code officials, see the *Building Safety Journal* article written by Nathan Yost of BSC at www.buildingscience.com/resources/articles/16-19_Yost&Edminster_for_au.pdf.

Slab

In dry climates, it is quite common for builders to use a sand layer in between the polyethylene sheet (“poly”) and the cast concrete to prevent differential drying and cracking problems. This moisture-holding layer should never be placed between the poly and concrete. Differential drying and subsequent cracking should be handled with a low-water-content concrete and wetted burlap covering. For more information, see www.buildingscience.com/resources/foundations/sand_layer_under_slab.htm.



Figure 4-13. Slider truss

Single-Story Homes and Unvented/Conditioned Attic

Keeping all ducts and HVAC equipment in conditioned space with slab-on-grade, single story homes can be accomplished by moving the thermal barrier and air barrier up to the roof line, making the attic an unvented, conditioned space (Figure 4-14). Below are the associated building science points to consider when making the change to an unvented roof/conditioned attic:

Air Sealing Details. Unvented assemblies (walls or roofs) are robust when the air sealing is robust. The hardest spots are not the fields but the margins/edges of assemblies. Spray foam applied at the margins (truss/rafter end blocking) may seem more expensive than cutting in air stops and caulking between each truss or rafter, but the labor savings and air sealing quality of spray foam make it a better choice.

Cavity Insulation. Cellulose netting or fiberglass batt supports create the insulation “belly” and accommodate cavity fill depth that exceeds the depth of the truss top chord.

Local Acceptance. This assembly may require discussion with the local building code official. See our Unvented Roof Summary Article for assistance at www.buildingscience.com/resources/roofs/unvented_roof_summary_article.pdf.

HVAC Configuration. See Figure 4-12 for the basic HVAC setup in this structure.

Moving this Assembly to Mixed-Dry Climates. If an unvented roof/conditioned attic assembly is employed where the coldest monthly average temperature drops below 45°F, we recommend that a rigid insulation be added exterior to the structural roof deck to warm the assembly to the interior of the rigid insulation, thereby reducing the potential for condensation problems in the structural roof deck. See Figure 4-14 and “Insulations, Sheathings, and Vapor Diffusion Retarders” (www.buildingscience.com/resources) for more information:

Tile roof. Tile roofs perform particularly well in this climate and are generally recommended when an unvented attic is used. See www.energystar.gov/ia/products/prod_lists/roof_prods_prod_list.xls for more information.

Material Compatibility and Substitutions

Interior Latex Paint

The substitution of low-permeability interior finishes (vinyl wall paper, oil-based paints) for latex paint is strongly discouraged because drying to the interior is important in mixed climates.

Exterior Sheathing Materials

In the second story of this assembly, the use of a reservoir cladding suggests that a moisture sensitive material such as fiberboard should not be used. On the other hand, the lack of cavity-warming exterior insulation means that an impermeable sheathing such as thin-profile structural sheathing (e.g., Thermo-Ply[®], Energy Brace) should not be used. Plywood is an acceptable substitution for OSB in this wall assembly. For more information, see the Building Materials Property Table (Table 1) or the BSC paper “*Insulations, Sheathings, and Vapor Diffusion Retarders*”

(www.buildingscience.com/resources/walls/insulation_sheathings.pdf)

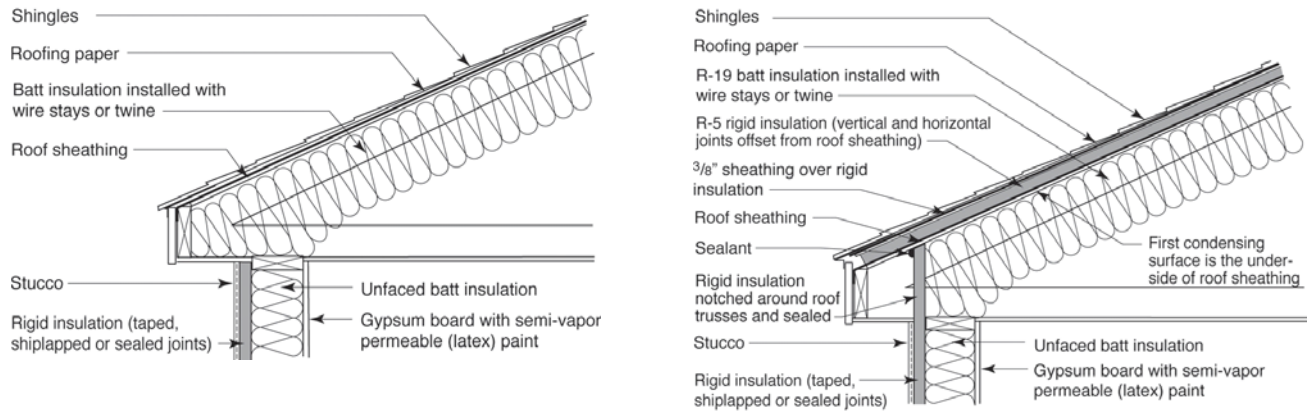

Figure 4-14. Unvented, conditioned attic design

Cavity Insulation Materials

Acceptable cavity insulation includes any that have relatively high vapor permeability—cellulose, fiberglass, or foam (as long as air sealing is accomplished by a separate component or system when cellulose or fiberglass is used). The decision may also be based on properties other than building science.

Flooring

Because curing concrete releases significant moisture for several months after being cast, we recommend that a low w/c concrete ratio (<0.45) be used to protect the integrity of finished flooring. We also recommend that vinyl flooring not be installed over a concrete slab.

Gypsum Wallboard

Areas of potentially high moisture, such as bathrooms, basements, and kitchens, are excellent candidates for non-paper faced wallboard systems (e.g., James Hardie’s Hardibacker[®], GP’s DensArmor[®], USG’s Fiberock[®]). In addition, paper-faced gypsum board should never be used as interior sheathing or backer for tub or shower surrounds where ceramic tile or marble (any material with joints or grout lines) is used as the finish.

HVAC

A hot water-to-air coil in an air-handling unit can be used to replace the gas furnace heat exchanger. The coil can be connected to a standard gas water heater with a draft hood located in the garage, outside the conditioned space. Alternatively, the gas water heater can be sealed combustion (or power-vented) and located within the conditioned space. However, before you make this change, be sure to read the following technical resource: “*Combo Space/Water Heating Systems – “Duo Diligence”*” (www.buildingscience.com/resources/mechanical/combo_systems.pdf).

Building Profile #13. The Tucson

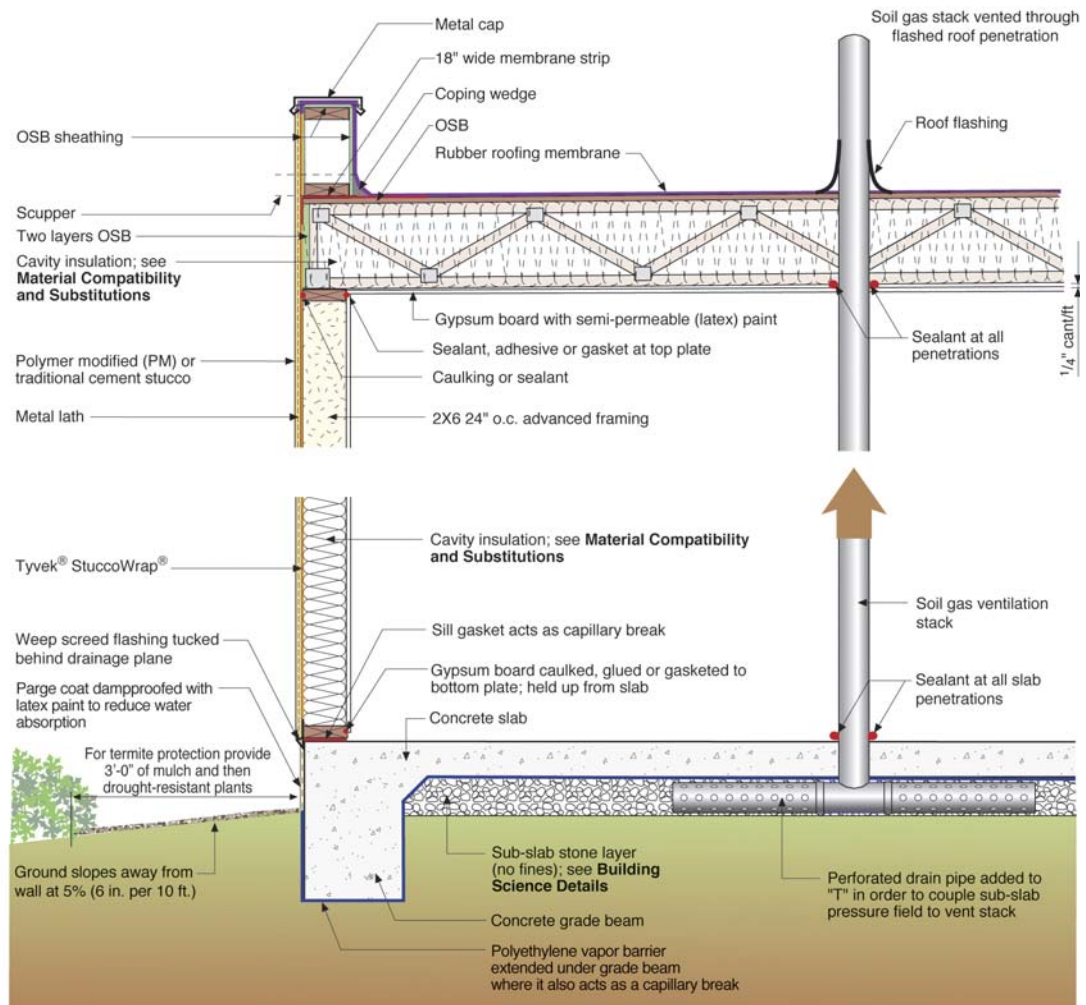

Foundation: Slab-on-grade
Above Grade Wall: Wood frame

Attic: None
Roof: Membrane

Cladding: Stucco

Figure 4-15. Cross section of the Tucson

Building Science Details

Ducts in Conditioned Space

This building profile is designed to accommodate HVAC equipment and ducts in the living space, specifically in dropped soffits and in a utility space in the building core. HVAC ducts should not be run in exterior walls or the slab.

Air Sealing Details at Transitions

Air sealing can be particularly difficult, but no less important, at assembly transitions such as top-of-wall/roof assembly junctions and between attached garages and living spaces. These are discussed below because they have proven to be a consistent challenge for high performance production builders.

Top-of-wall/roof assembly junction. The continuity of an exterior air barrier can be maintained at this junction if the air barrier material (foam insulation or stucco cladding, for example) is used continuously for the wall, soffit, and fascia. The continuity of an interior air barrier can be maintained through a combination of cut foam blocks and sealant/caulk, or spray foam. Note that neither cellulose nor fiberglass (batt or blown) can be used for the air barrier.

Attached garages. The building envelope surfaces shared between conditioned space and an unconditioned garage must have a continuous air barrier. See Figure 4-16 and www.buildingscience.com/housethatwork/airsealing/default.htm for details in terms of using sealants and rigid insulation to create a continuous air barrier between the attached garage and living space.

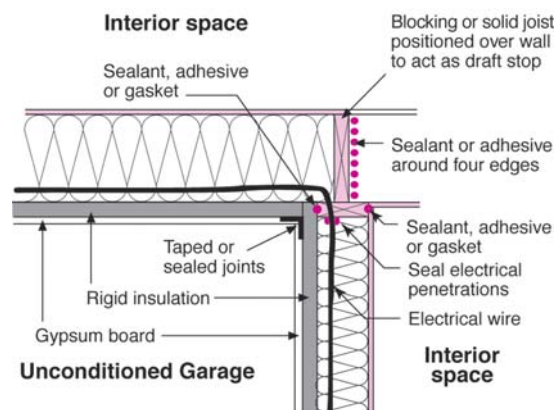

Figure 4-16. Creating a continuous air barrier

Drying Mechanisms

In any climate, vapor control is based on the relationships among the following: the permeability of wall components, the type of cladding (reservoir or non-reservoir), the presence/lack/nature of an air space, and the magnitude/duration of the vapor drive (based on the relationship between the exterior and interior moisture content and temperature differences). The type of sheathing and housewrap used in any wall assembly must be based on an understanding of these inter-relationships. See “*Insulations, Sheathings, and Vapor Diffusion Retarders*” for more information (www.buildingscience.com/resources/walls/insulation_sheathing.pdf). This wall assembly permits drying to both the interior and the exterior (depending on the selection of exterior sheathing). For further details, see the Building Material Properties Table (Table 1).

Drainage Plane, Air Barrier, and Vapor Control

The drainage plane in this wall assembly is the Dupont StuccoWrap® weatherlapped onto the OSB structural sheathing (the paper-backed lath serves as the bond break for the stucco cladding). An annual precipitation of 8 in. (30-year average for Tucson) means that a face-sealed stucco cladding can work, but this system is designed with a drainage plane as a “belt and suspenders” approach for long-term durability.

The air barrier is the interior gypsum board installed using the Airtight Drywall Approach (see Air Sealing Details).

The wall assembly in this building is a “flow-through” assembly, with moderate to high relative vapor permeability in all components. This bi-directional drying is the preferred approach in mixed-dry climates. The membrane roof in this building means that drying to the interior is essential, and vapor permeable components and interior finishes should be used.

Rough Opening flashing

Window and door flashing details are wall assembly or cladding specific and depend on whether the windows are installed before or after the drainage plane. Refer to the *EEBA Water Management Guide* for more information (www.eeba.org/bookstore).

Advanced Framing

This wall assembly employs all of the advanced framing methods except alternative shear resistance (structural sheathing is used). For advanced framing details, see www.buildingscience.com/housethatwork/details.htm.

Framing on Slabs

Installing a capillary break between the sill plate and a concrete slab on all walls—exterior, interior, partition—is good practice. A closed cell foam sill sealer or gasket works well. Alternatively, a strip of sheet polyethylene can be used. This isolates the framing from any source of moisture that may be either in or on the concrete slab (and using sill sealer on all walls maintains wall height exactly the same).

Soil Gas Ventilation

The sub-slab to roof vent system handles conditions that are difficult if not impossible to assess before completion of the structure, such as residual confined concentrations of air-borne radon, soil treatments (termiticides, pesticides) methane, etc. The cost of this “ounce” of prevention is well balanced against the cost of the “pound” of cure.

Sub-Slab Stone Bed

The 4-in.-deep, 3/4-in. stone bed functions as a granular capillary break, a drainage pad, and a sub-slab air pressure field extender for the soil gas ventilation system. Without it, a soil gas ventilation system is not

practically possible, and the only capillary break between the slab and ground is the polyethylene vapor barrier.

Thermal Barrier

In all but the slab foundation, the thermal barrier is accomplished by cavity insulation. Slab insulation is not necessary in this climate, because the heat loss and gain is not sufficient to warrant insulation, from either an energy or building-science perspective.

Roofing

Light-colored membrane roofing performs better than conventional dark colored membrane roofing in this climate. See www.energystar.gov/ia/products/prod_lists/roof_prods_prod_list.xls for more information.

Climate-Specific Details

Mechanical Systems

Heating. We recommend a sealed-combustion hot-air furnace. Sealed combustion allows the unit to be located within the conditioned space with no compromise in indoor air quality or combustion safety. See Figure 4-17 for the space conditioning system layout.

Cooling. Although evaporative cooling is prevalent in Hot-Dry Climates, we recommend refrigerant cooling in high-performance homes in this climate region for three reasons:

1. Refrigerant cooling permits year-round controlled ventilation. Evaporative cooling does not.
2. Evaporative cooling can be prone to moisture and indoor air quality problems without frequent and diligent system maintenance. Refrigerant cooling is not.
3. While there can be a slight energy penalty with refrigerant cooling in comparison to evaporative cooling, this penalty must be balanced against the year-round comfort provided by refrigerant cooling (evaporative cooling has difficulty supplying comfort in high humidity situations) and the substantial water savings associated with refrigerant cooling (a growing issue in Hot-Dry climates).

Follow appropriate sizing procedures. For more details, see www.buildingscience.com/resources/mechanical/509a3_cooling_system_sizing_pro.pdf.

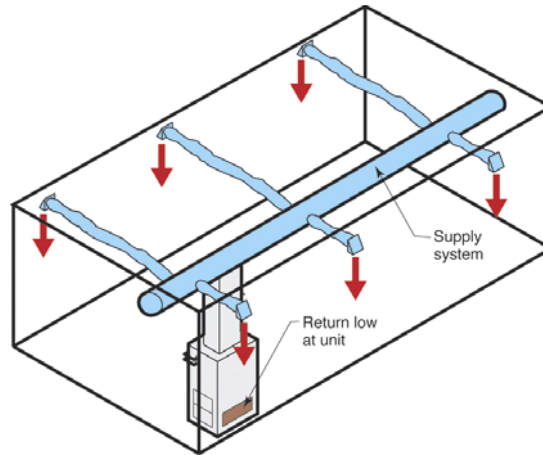

Figure 4-17. Heating and cooling system layout

Ducting. The single central return requires transfer grilles to provide an adequate return air path and avoid pressurizing bedrooms, as shown in Figure 4-18. Appropriate sizing for ducts, including these pressure relief methods, can be found at www.buildingscience.com/resources/mechanical/509a3_cooling_system_sizing_pro.pdf.

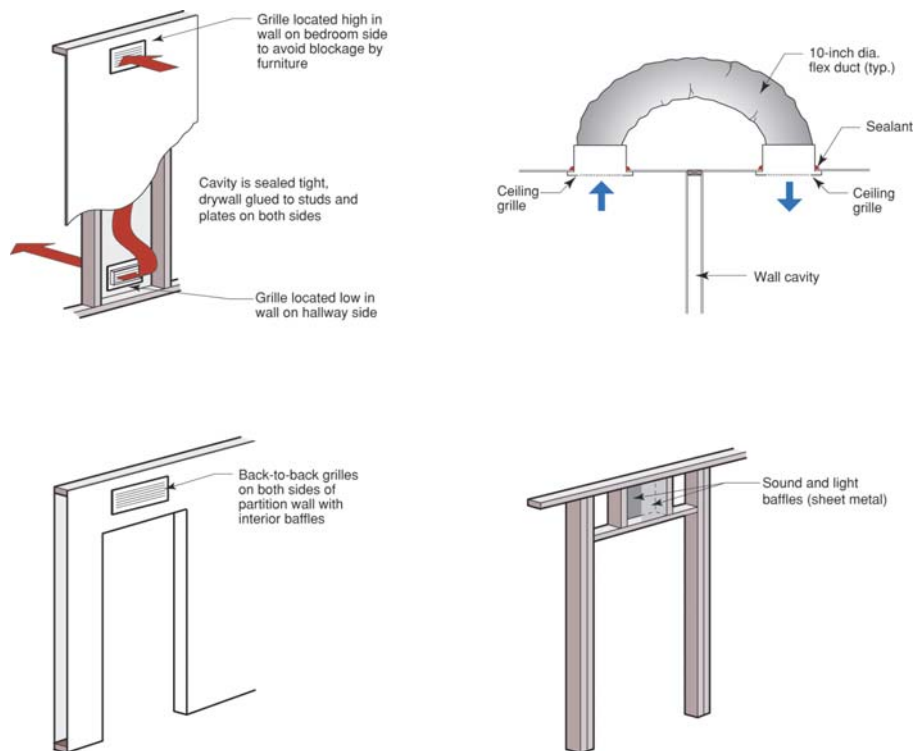

Figure 4-18. Transfer grilles and jump ducts

Controlled mechanical ventilation. We recommend an intermittent central-fan-integrated supply, designed to provide the ASHRAE 62.2P recommended flow rate, with fan cycling controls set to operate the central air 20 minutes every hour to provide ventilation air distribution and whole-house averaging of air quality and comfort conditions (installed cost: \$125 to \$150). Include a normally closed motorized damper in the outside duct with the AirCycler™ FRV control (installed cost: \$50 to \$60). For more information on controlled mechanical ventilation, see www.buildingscience.com/resources/mechanical/default.htm.

Termite Management

Termites are best managed with a three-pronged approach that deals with the three things termites need—cover from sunlight, moisture, and food (wood or paper):

Reduced cover. Keep plantings 3 ft away from the building perimeter, thin the ground cover (wood mulch or pea stone) to no more than 2 in. depth for the first 18 in. around the building, and maintain any termite inspection zone on the exterior of the foundation above grade.

Control moisture. Maintain slope away from building as shown, carry roof load of water at least 3 ft away from building, and make sure that irrigation is directed away from the building.

Chemical treatment. Use an environmentally appropriate soil treatment (such as Termidor®) and a building materials treatment (such as Bora-Care®) for termite-prone near-grade wood materials.

Inter-relationship of first three points. Because a builder and a homeowner's ability to employ or stick to each of the three strategies above will vary, make sure that an inability to fully employ one strategy is compensated for by complete rigor with the others. For example, if chemical treatment of soil or building materials is not an option, then complete rigor in moisture control and ground cover is required.

Landscaping for Wildfire Control

Keeping woody materials of any type, living or otherwise, away from the building is good practice in dry climates where wildfires present a significant risk.

Field Experience Notes

HVAC Commissioning

The most efficient equipment means little if the system is not set up and started up properly. Follow high-performance start-up procedures such as those described on the BSC web site (www.buildingscience.com/resources/mechanical/air_conditioning_equipment_efficiency.pdf). In dry climates, it is generally a good idea to set up the air distribution fan to run a little longer at the end of each cycle to bump up the sensible efficiency.

Location of HVAC Outdoor Unit

It's tempting to put the condenser right on the roof where the evaporative cooling unit was, particularly when lot lines are very tight. We do not recommend a rooftop location for the condenser for several reasons: It makes even routine maintenance more difficult, it puts the unit at what is most likely the hottest spot on the entire property, and it introduces more roof penetrations.

Advanced Framing

For a technical resource that may help with resistance to advanced framing methods from local code officials, see the *Building Safety Journal* article written by Nathan Yost of BSC at www.buildingscience.com/resources/articles/16-19_Yost&Edminster_for_au.pdf.

Slabs

In dry climates, it is quite common for builders to use a sand layer in between the polyethylene sheet ("poly") and the cast concrete to prevent differential drying and cracking problems. This moisture-holding layer should never be placed between the poly and concrete. Differential drying and subsequent cracking should be handled with a low-water-content concrete and wetted burlap covering. For more information, see www.buildingscience.com/resources/foundations/sand_layer_under_slab.htm.

Moving this Assembly to Mixed-Dry Climates

This "flat-roof" assembly is routinely moved to colder climates without any change in the design/construction of the assembly. We recommend that in any climate where the average monthly temperature for the coldest month drops below 45°F, one of the following four methods be employed to significantly reduce the potential for condensation problems in the structural roof deck (Figure 4-19):

1. Add rigid insulation above the roof deck, raising the temperature of the roof deck to control condensation. Rigid polyisocyanurate insulation is recommended for its temperature stability. The amount of rigid insulation required is calculated based on the climate location. See "*Insulations, Sheathings and Vapor Diffusion Retarders*" (www.buildingscience.com/resources/walls/insulation_sheathing.pdf).
2. Spray rigid foam insulation on the underside of the roof deck and cover with fibrous cavity insulation. The thickness of the spray foam insulation is calculated as in #1 above.
3. Locate all of the insulation above the roof deck.
4. Spray the entire cavity with foam insulation.

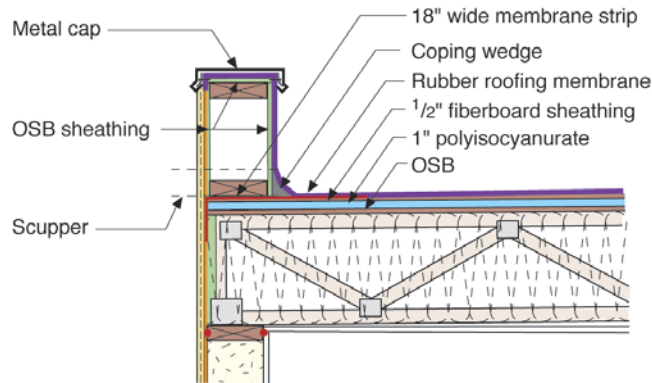

Figure 4-19. Flat-roof assembly

Material Compatibility and Substitutions

Interior Latex Paint

The substitution of low permeability interior finishes (vinyl wall paper, oil-based paints) for latex paint is strongly discouraged because drying to the interior is important in mixed climates.

Building Papers with Stucco

There must always be two separate components here: the bond break material and the drainage plane. Although StuccoWrap[®] is advertised as both a drainage plane material and the layer receiving the stucco, these two components should never be combined or reversed.

Exterior Sheathing Materials

In this assembly, the use of a reservoir cladding requires that a moisture-sensitive material such as fiberboard should not be used. Plywood is an acceptable substitution for OSB in this wall assembly. For more information, see the Building Materials Property Table (Table 1) or “*Insulations, Sheathings, and Vapor Diffusion Retarders*” (www.buildingscience.com/resources/walls/insulation_sheating.pdf).

Cavity Insulation Materials

Acceptable cavity insulation includes any that have relatively high vapor permeability—cellulose, fiberglass, or foam (as long as air sealing is accomplished by a separate component or system when cellulose or fiberglass is used). The decision may also be based on properties other than building science.

Flooring

Because curing concrete releases significant moisture for several months after being cast, we recommend that a low w/c concrete ratio (<0.45) be used to protect the integrity of finished flooring. We also recommend that vinyl flooring not be installed over a concrete slab.

Gypsum Wallboard

Areas of potentially high moisture, such as bathrooms, basements, and kitchens, are excellent candidates for non-paper-faced wallboard systems (e.g., James Hardie’s Hardibacker[®], GP’s DensArmor[®], USG’s Fiberock[®]). In addition, paper-faced gypsum board should never be used as interior sheathing or backer for tub or shower surrounds where ceramic tile or marble (any material with joints or grout lines) is used as the finish.

Appendix A: Unvented Roof Summary Article

“Unvented Attic Discussion,” Revised January 2003, Joseph Lstiburek.

Unvented Roof (Conditioned Attics): Theory and Practice

Building codes typically require attic ventilation; the origin of this requirement comes from cold climate demands to avoid ice damming and vent internally generated moisture. In hot (cooling-dominated) climates, the purpose of attic ventilation is to remove solar gain from the roof, thereby reducing the contribution of roof cooling load. In typical houses, the contribution of the roof-cooling load to the total load is on the order of 10%.

However, our modeling and research has shown that the requirement for venting attics in hot-dry and hot-humid climates is of questionable validity. Our studies on houses in various locations (including Las Vegas, Tucson, and the southeastern United States) have shown that by moving the ceiling air barrier and thermal barrier to the roof plane, better building airtightness can be achieved, and that the elimination of heat gain to the attic ductwork (as a result of conduction and leakage) more than offsets the additional heat gain caused by not venting the attic.

Placement of the air handler and ductwork system in this conditioned attic space negates the effect of duct leakage, which is commonly 10%-20% of the rated air handler flow in typical construction. For houses with tile roofs, operating temperature for this “conditioned attic” or “attic utility area” has been measured at typically within 5° to 7°F of indoor temperatures, without any direct space conditioning (i.e., conditioned by duct leakage and conduction); this provides less harsh operating conditions for the ductwork and air handler than typical unconditioned attics.

An excellent (and entertaining) discussion of the basics is found in the article: “Unvented Attic Discussion” (Lstiburek 1999).

Detailed studies are also on the same web page; the paper that addresses both computer models and test houses is “*Measurement of Attic Temperatures and Cooling Energy Use In Vented and Sealed Attics in Las Vegas, Nevada.*” The paper “Questions posed regarding unvented roofs” provides a summary of typical questions on the performance and applicability of unvented roof systems.

Unvented Roof Assembly Details (Air and Thermal Barriers)

Moving the thermal and air barrier from the flat ceiling plane to the roof deck requires special detailing; because the attic is now conditioned space, it must be air sealed and insulated. Typical areas requiring draftstopping are the intersection between the “conditioned attic” and the “unconditioned attic” typically found over the garage or the porch. Details addressing these air barrier questions show the requirement for thermal barrier (i.e., insulation) and air barrier continuity around all of the conditioned space.

In addition to this prescriptive detailing, the houses should be subjected to a blower-door test protocol, with the attic hatch open, which tests the airtightness of the entire building shell, including the unvented roof. This test truly determines whether the air barrier details, taken in aggregate, are effective. We recommend the airtightness goal used in the Building America program. The airtightness goal is based on the surface area of the building, and is tighter than the majority of typical residential construction.

Of course, controlled mechanical ventilation is a recommended addition to all houses.

Unvented Roof Assembly Material Performance

One of the first questions brought up when unvented roof systems are proposed is whether it will be detrimental to the life of the building materials in the assembly. In addition to measuring the energy

performance of test houses in various locations, Building Science Corporation also measured temperatures of attic air, roof sheathing (plywood/OSB), and roof tiles or shingles.

The resulting data showed that when a vented tile roof in Las Vegas was compared with an unvented cathedralized roof, the maximum roof sheathing temperature difference was 17°F (see “Questions posed regarding unvented roofs”). The maximum measured roof sheathing temperature of 154°F for the unvented attic was well within acceptable temperature limits (less than 180°F) (see “Unvented-cathedralized attics: Where we’ve been and where we’re going”).

Furthermore, Las Vegas would be among the “worst case” locations for elevated temperatures of building materials (108°F ASHRAE 0.4% design temperature); few locations (e.g., Phoenix) have design conditions worse than that location.

The air handler and HVAC system (ductwork) are operating at much less stressful temperatures (within 3° to 5°F of indoor setpoint, instead of typical attic temperatures), and no ultraviolet light enters via roof vents. These factors will tend to increase lifespan of this mechanical equipment and ductwork systems in unvented roofs.

Climate Data

As mentioned in “Questions posed regarding unvented roofs,” unvented attics with cathedralized insulation can be recommended in the continental United States wherever the monthly average outdoor dry bulb temperature does not fall below 45°F; this coincides with the definition of a hot-dry or hot-humid climate.

This temperature limitation is a function of potential condensation problems within the roof assembly. The logic behind this decision is detailed in the web page “Unvented Roof Systems.” As mentioned in that article, unvented assemblies can be built in mixed or cold climates, but further detailing is necessary.

At www.weather.com (The Weather Channel Web Site), monthly average temperature information is available, in order to determine climate location (cold, mixed, or hot zone). Data for Tucson, Arizona, are shown below; it shows a lowest monthly temperature averaging above 45°F:

Tucson, AZ	Apr	May	Jun	Jul	Aug	Sep	Oct	Nov	Dec	Jan	Feb	Mar	Apr
Mean outdoor temp (°F)	66	74	84	87	85	81	71	59	52	52	55	59	66

Tucson, Arizona, Average Monthly Temperatures

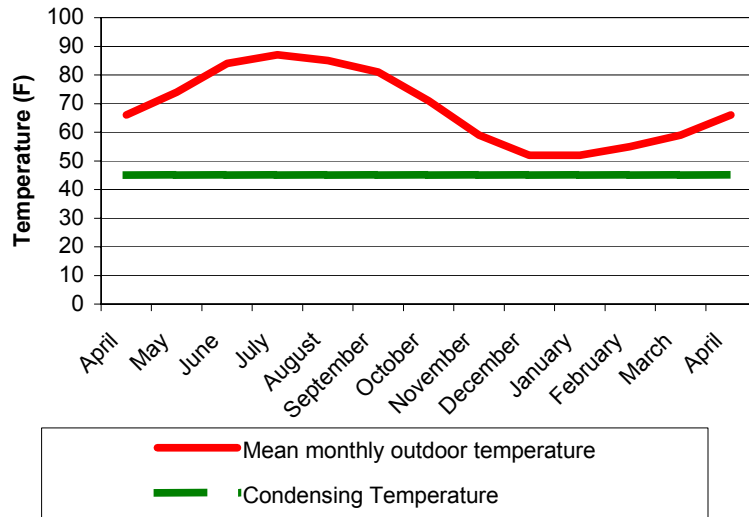

In addition, this data includes average precipitation records, which will allow the differentiation between humid and dry climate zones (i.e., over 20 in./year or under). Tucson's historical data shows an average precipitation per year of ~13 in. (hot dry zone).

References for this Article

Kohta Ueno, Building Science Corporation, 2003

This article was written to tie together and summarize the various papers on unvented conditioned cathedralized attics found on our website. We realize that there is a wealth of information, and much of it too detailed to understand or digest in a single sitting. Furthermore, building officials might not have the time available to carefully examine the many documents on the page; this is meant to summarize the main arguments, and provide pointers to where detailed information and measured data can be found.

The articles dealing with unvented roofs are as follows (in chronological order):

From www.buildingscience.com/resources/resources.htm#Roofs

“Measurement of Attic Temperatures and Cooling Energy Use In Vented and Sealed Attics in Las Vegas, Nevada.” Armin F. Rudd, Joseph W. Lstiburek, and Neil A. Moyer. Presented at the ‘96 Excellence in Building Conference, 14-17 November, and published in EEBA Excellence, The Journal of the Energy Efficient Building Association, Spring 1997. Energy Efficient Building Association, Minneapolis, MN

“Vented and Sealed Attics In Hot Climates.” A. F. Rudd and Joseph W. Lstiburek. Presented at the ASHRAE Symposium on Attics and Cathedral Ceilings, Toronto, June 1997. ASHRAE Transactions TO-98-20-3. American Society of Heating Refrigeration and Air-Conditioning Engineers, Atlanta, GA.

BSC Figures 1 and 2 (Unvented Roof Insulation and Framing Details, Air Barrier at Unvented Roof)

“Questions posed regarding unvented roofs.” A. F. Rudd. 2000.

“Unvented-cathedralized attics: Where we’ve been and where we’re going.” A. F. Rudd, Joseph W. Lstiburek, and Kohta Ueno. 2000.

“Unvented Roof Systems.” Joseph W. Lstiburek. 2001.

“Unvented Roofs, Hot-Humid Climates, and Asphalt Shingles.” January 2003, Joseph Lstiburek.

Appendix B: Sand Layers Should Not Be Placed Between Polyethylene Vapor Barriers and Concrete Floor Slabs

by Joseph Lstiburek, Ph.D., P. Eng.

Excess slab moisture intrusion problems resulting in flooring failures, mold growth, and other microbial contamination problems are typically caused by sand layers located between polyethylene vapor barriers and concrete floor slabs.

The sand layers become reservoirs for water in the liquid state (bulk water) that enters the sand layers by gravity flow from the top, sides and bottom of the sand layers (Figure 1). The liquid water is both held in the sand layers and redistributed within the sand layers by capillarity (Figure 2). Additionally, because of these capillary forces, the liquid water is incapable of draining out of the sand layers. The only mechanism of drying of the sand layers is upwards through the concrete slabs by vapor diffusion and capillary draw (Figure 3).

There is no barrier or protection for the upward moisture flow through the concrete slabs from the wetted sand layers. The intended protection for upward moisture flow from below grade are the polyethylene vapor barriers, but this intended moisture protection has been rendered ineffective by the gravity flow wetting mechanism that has saturated the sand layers that are located above the polyethylene vapor barriers.

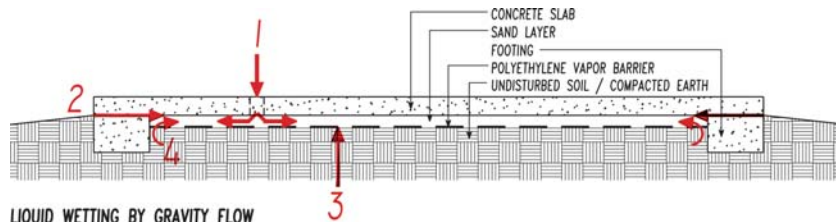

LIQUID WETTING BY GRAVITY FLOW
 1. THROUGH TOP OF SLAB BY RAIN, CURING PROCESSES, CUTTING, FINISHING, CLEANING, WATER TESTING, etc.
 2. THROUGH SLAB/FOOTING INTERFACE BY IRRIGATION WATER, SURFACE WATER AND GROUND WATER
 3. THROUGH JOINTS, PENETRATIONS AND PUNCTURES IN POLYETHYLENE VAPOR BARRIER BY GROUND WATER
 4. AROUND THE EDGE OF POLYETHYLENE VAPOR BARRIER AT FOOTING EDGE

FIG. 1 WETTING MECHANISMS

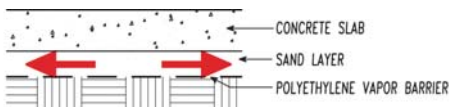

- WATER MIGRATES Laterally - PULLED BY CAPILLARY ACTION
- WATER IS UNABLE TO DRAIN DOWNWARDS THROUGH ANY GAPS, PENETRATIONS, OR PUNCHES IN THE POLYETHYLENE VAPOR BARRIER DUE TO "BLOTTER PAPER" EFFECT (CAPILLARY FORCES) OF THE SAND LAYER

FIG. 2 WATER DISTRIBUTION IN SAND LAYER

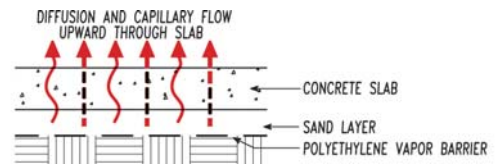

- SAND LAYER BECOMES WATER RESEVOIR TO SUPPLY WATER FOR UPWARD FLOW THROUGH CONCRETE SLAB BY VAPOR DIFFUSION AND CAPILLARY TRANSMISSION
- DRYING DOWNWARD BY VAPOR DIFFUSION OR CAPILLARY IS NOT POSSIBLE DUE TO POLYETHYLENE VAPOR BARRIER

FIG. 3 UPWARD DRYING THROUGH SLAB

The moisture flow upwards through the concrete slabs by vapor diffusion and capillary transmission passes through the top surface of the concrete slabs, as well as through floor surface treatments and leads to mold and other microbial contamination problems.

The rate of wetting of the sand layers by the gravity-flow wetting mechanism is several orders of magnitude larger than the rate of drying of the sand layers by the vapor diffusion and capillary transmission drying mechanism. The sand layers become water reservoirs that continually supply water for the upward flow through the concrete slabs by vapor diffusion and capillary transmission.

Picture the sand layers as "blotter paper" that, once wetted, do not let water drain out of them. The only method of drying available to the "blotter paper" is evaporation. In the case of the sand layers the only method of "evaporation" is upward through the concrete slabs because of the presence of the polyethylene vapor barrier under the sand layers.

Concrete slabs should be placed in direct contact with polyethylene vapor barriers. A sand layer should not be installed between concrete slabs and polyethylene vapor barriers.

Where concrete slabs are in direct contact with polyethylene vapor barriers a reservoir is not created if rainfall occurs during the construction process and penetrates the slab or if wet curing is used. Additionally, wet concrete cutting operations, cracks in slabs, gaps and penetrations in the polyethylene vapor barrier coupled with cleaning, water testing, ground water migration or irrigation do not affect slab moisture transmission if a reservoir is absent or cannot be created between the polyethylene and the concrete slab.

When concrete slabs are cast directly over polyethylene vapor barriers, the concrete water-to-cement (w/c) ratio must be correctly specified in order to control bleed water and plastic shrinkage cracking. Bleed water will not be present if the w/c ratio is below 0.5, and plastic shrinkage cracking becomes negligible when the w/c ratio is below the range of 0.48 to 0.45. Differential drying and slab curl are controlled with either a curing compound or a temporary covering of plastic sheeting.

Concrete slabs with a w/c ratio of 0.45 or less should be placed directly on a polyethylene vapor barrier coupled with a curing compound or a temporary plastic sheeting slab covering in order to avoid problems.

The following four reasons are generally cited for using a sand layer over polyethylene vapor barriers:

1. The sand layer controls bleed water with high w/c ratio concrete slabs
2. The sand layer reduces curl with high w/c ratio concrete slabs when top-side curing is not controlled
3. The sand layer reduces plastic shrinkage cracking with high w/c ratio concrete slabs
4. The sand layer protects the polyethylene vapor barrier from punctures.

The first three reasons are based on sound technical arguments. However, each of the first three are based on the condition that the sand layer be prevented from getting wet during the construction process and beyond and are typically associated with floor slabs that are placed "after the building is enclosed and the roof is watertight." Additionally, the first three are based on the condition that wet curing such as ponding or continuous sprinkling will not occur or that joint sawing using wet methods or power washing will not occur. The first three are also conditional on slab and foundation designs that will not be sensitive to ground water wetting from local water tables and local irrigation.

In the case of exposed slab construction, the first three reasons are rendered moot because the conditions for their use are not met, nor can they be met. Accordingly, a sand layer should not be specified.

The fourth reason, "puncture protection," is based on incorrect physics. A sand layer is not necessary to protect polyethylene vapor barriers. Vapor diffusion is a direct function of surface area. Rips, holes, tears, and punctures in sheet polyethylene vapor barriers constitute a very small surface area of vapor

transmission compared to the total floor slab area. If 95% of the surface area of the slab is protected by a vapor barrier, then that vapor barrier is 95% effective. This holds true only if air flow or air leakage is not occurring through the vapor barrier. Where concrete is in direct contact with the polyethylene vapor barrier this is the case. Air flow is not occurring. The concrete slab is an "air-barrier" and the polyethylene is the "vapor barrier" and an effective vapor barrier even if the polyethylene has numerous punctures.

In the case of exposed slab construction there is no justification for the use of a sand layer between the polyethylene vapor barrier and the concrete slabs.

The specification of a sand layer over a polyethylene vapor barrier is typically directly responsible for flooring failures, cold, and microbial contamination problems.

Appendix C. Summary of Building Profiles

Climate/ Building Profile	# Stories	Wall Type	Foundation	Wall Cladding	Roof	Roof Cladding
Cold						
Chicago	2	Stick-framed	Full basement/ cast concrete	Vinyl siding	Vented unconditioned attic	Asphalt shingle
Denver	2	Stick-framed	Full basement w/ sub-crawl	Brick veneer/wood siding	Vented unconditioned attic	Asphalt shingle
Minneapolis	1.5	Stick-framed	Slab-on-grade	Stucco	Vented cathedral	Asphalt shingle
Mixed-Humid						
Atlanta	2	Stick-framed	Slab-on-grade	Vinyl siding	Vented unconditioned attic	Asphalt shingle
Charlotte	2	Stick-framed	Conditioned crawl/ block wall	Brick veneer	Vented unconditioned attic	Asphalt shingle
Louisville	1	Stick-framed	Full basement/ cast concrete	Vinyl siding	Vented cathedral	Asphalt shingle
Hot-Dry/Mixed-Dry						
Albuquerque	1	Stick-framed	Slab-on-grade	Stucco	Vented unconditioned attic	Asphalt shingle
Sacramento	2	Stick-framed	Post-tensioned slab-on-grade	Fibercement siding	Vented unconditioned attic	Tile
Tucson	1	Stick-framed	Slab-on-grade	Stucco	None	Low-slope membrane
Hot-Humid						
Houston	2	Stick-framed	Slab-on-grade	Brick/ Fibercement	Conditioned attic	Asphalt shingle
Orlando	2	Block/ stick frame	Block stem wall & slab	Stucco	Conditioned attic	Tile
Montgomery	1	Stick-framed	Conditioned crawl/ cast concrete wall	Vinyl or aluminum lap siding	Vented unconditioned attic	Standing seam metal

REPORT DOCUMENTATION PAGE

Form Approved
OMB No. 0704-0188

The public reporting burden for this collection of information is estimated to average 1 hour per response, including the time for reviewing instructions, searching existing data sources, gathering and maintaining the data needed, and completing and reviewing the collection of information. Send comments regarding this burden estimate or any other aspect of this collection of information, including suggestions for reducing the burden, to Department of Defense, Executive Services and Communications Directorate (0704-0188). Respondents should be aware that notwithstanding any other provision of law, no person shall be subject to any penalty for failing to comply with a collection of information if it does not display a currently valid OMB control number.

PLEASE DO NOT RETURN YOUR FORM TO THE ABOVE ORGANIZATION.

1. REPORT DATE (DD-MM-YYYY) March 2005		2. REPORT TYPE Subcontractor Report		3. DATES COVERED (From - To) January 2003 – December 2003	
4. TITLE AND SUBTITLE Introduction to Buildings Systems Performance: Houses That Work II. Revised February 2005			5a. CONTRACT NUMBER DE-AC36-99-GO10337		
			5b. GRANT NUMBER		
			5c. PROGRAM ELEMENT NUMBER		
6. AUTHOR(S) Building Science Consortium			5d. PROJECT NUMBER NREL/SR-550-37664		
			5e. TASK NUMBER BET5.8004		
			5f. WORK UNIT NUMBER		
7. PERFORMING ORGANIZATION NAME(S) AND ADDRESS(ES) Building Science Consortium 70 Main St. Westford, MA 01886				8. PERFORMING ORGANIZATION REPORT NUMBER KAAX-3-32443-01	
9. SPONSORING/MONITORING AGENCY NAME(S) AND ADDRESS(ES) National Renewable Energy Laboratory 1617 Cole Blvd. Golden, CO 80401-3393				10. SPONSOR/MONITOR'S ACRONYM(S) NREL	
				11. SPONSORING/MONITORING AGENCY REPORT NUMBER NREL/SR-550-37664	
12. DISTRIBUTION AVAILABILITY STATEMENT National Technical Information Service U.S. Department of Commerce 5285 Port Royal Road Springfield, VA 22161					
13. SUPPLEMENTARY NOTES NREL Technical Monitor: Bob Hendron					
14. ABSTRACT (Maximum 200 Words) Buildings should be suited to their environments. Design and construction must be responsive to varying seismic risks, wind loads, and snow loads, as well as soil conditions, frost depth, orientation, and solar radiation. In addition, building envelopes and mechanical systems should be designed for a specific hygro-thermal regions, rain exposure, and interior climate. The Building Science Consortium (BSC) design recommendations are based on the hygro-thermal regions with reference to the annual rainfall. Local climate must be addressed if it differs significantly from the climate described for a particular design.					
15. SUBJECT TERMS Building America; energy-efficient houses; Building Science Consortium; BSC; U.S. Department of Energy; DOE					
16. SECURITY CLASSIFICATION OF:			17. LIMITATION OF ABSTRACT UL	18. NUMBER OF PAGES	19a. NAME OF RESPONSIBLE PERSON
a. REPORT Unclassified	b. ABSTRACT Unclassified	c. THIS PAGE Unclassified			19b. TELEPHONE NUMBER (Include area code)

A Strong Energy Portfolio for a Strong America

Energy efficiency and clean, renewable energy will mean a stronger economy, a cleaner environment, and greater energy independence for America. Working with a wide array of state, community, industry, and university partners, the U.S. Department of Energy's Office of Energy Efficiency and Renewable Energy invests in a diverse portfolio of energy technologies.

Research and Development of Buildings

Our nation's buildings consume more energy than any other sector of the U.S. economy, including transportation and industry. Fortunately, the opportunities to reduce building energy use—and the associated environmental impacts—are significant.

DOE's Building Technologies Program works to improve the energy efficiency of our nation's buildings through innovative new technologies and better building practices. The program focuses on two key areas:

• Emerging Technologies

Research and development of the next generation of energy-efficient components, materials, and equipment

• Technology Integration

Integration of new technologies with innovative building methods to optimize building performance and savings

For more information contact:

EERE Information Center
1-877-EERE-INF (1-877-337-3463)
www.eere.energy.gov



U.S. Department of Energy
**Energy Efficiency
and Renewable Energy**

An electronic copy of this factsheet is available on the Building America Web site at www.buildingamerica.gov

Visit our Web sites at:

www.buildingamerica.gov

www.energystar.gov



Building America Program

George S. James • New Construction • 202-586-9472 • fax: 202-586-8134 • e-mail: George.James@ee.doe.gov
Terry Logee • Existing Homes • 202-586-1689 • fax: 202-586-4617 • e-mail: terry.logee@ee.doe.gov
Lew Pratsch • Integrated Onsite Power • 202-586-1512 • fax: 202-586-8185 • e-mail: Lew.Pratsch@hq.doe.gov
Building America Program • Office of Building Technologies, EE-2J • U.S. Department of Energy • 1000 Independence Avenue, S.W. • Washington, D.C. 20585-0121 • www.buildingamerica.gov

Building Industry Research Alliance (BIRA)

Robert Hammon • ConSol • 7407 Tam O'Shanter Drive #200 • Stockton, CA 95210-3370 • 209-473-5000 • fax: 209-474-0817 • e-mail: Rob@consol.ws • www.bira.ws

Building Science Consortium (BSC)

Betsy Pettit • Building Science Consortium (BSC) • 70 Main Street • Westford, MA 01886 • 978-589-5100 • fax: 978-589-5103 • e-mail: Betsy@buildingsscience.com • www.buildingscience.com

Consortium for Advanced Residential Buildings (CARB)

Steven Winter • Steven Winter Associates, Inc. • 50 Washington Street • Norwalk, CT 06854 • 203-857-0200 • fax: 203-852-0741 • e-mail: swinter@swinter.com • www.carb-swa.com

Davis Energy Group

David Springer • Davis Energy Group • 123 C Street • Davis, CA 95616 • 530-753-1100 • fax: 530-753-4125 • e-mail: springer@davisenergy.com • deg@davisenergy.com • www.davisenergy.com/index.html

IBACOS Consortium

Brad Oberg • IBACOS Consortium • 2214 Liberty Avenue • Pittsburgh, PA 15222 • 412-765-3664 • fax: 412-765-3738 • e-mail: boberg@ibacos.com • www.ibacos.com

Industrialized Housing Partnership (IHP)

Subrato Chandra • Florida Solar Energy Center • 1679 Clearlake Road • Cocoa, FL 32922 • 321-638-1412 • fax: 321-638-1439 • e-mail: subrato@fsec.ucf.edu • www.baihp.org

National Association of Home Builders (NAHB) Research Center

Tom Kenney • National Association of Home Builders (NAHB) Research Center • 400 Prince George's Boulevard • Upper Marlboro, MD 20774 • 301-430-6246 • fax: 301-430-6180 • toll-free: 800-638-8556 • www.nahbrc.org/

National Renewable Energy Laboratory

Ren Anderson • 1617 Cole Boulevard, MS-2722 • Golden, CO 80401 • 303-384-7433 • fax: 303-384-7540 • e-mail: ren_anderson@nrel.gov • www.nrel.gov

Tim Merrigan • 1617 Cole Boulevard, MS-2722 • Golden, CO 80401 • 303-384-7349 • fax: 303-384-7540 • e-mail: tim_merrigan@nrel.gov • www.nrel.gov

Oak Ridge National Laboratory

Pat M. Love • P.O. Box 2008 • One Bethel Valley Road • Oak Ridge, TN 37831 • 865-574-4346 • fax: 865-574-9331 • e-mail: lovepm@ornl.gov • www.ornl.gov

Produced for the U.S. Department of Energy (DOE) by the National Renewable Energy Laboratory, a DOE national laboratory.

March 2005 • NREL/SR-550-37664

Printed with a renewable-source ink on paper containing at least 50% wastepaper, including 20% postconsumer waste.

Bringing you a prosperous future where energy is clean, abundant, reliable, and affordable