

Guidelines for Oil and Gas Operations In Polar Bear Habitats

OCS Study
MMS 93-0008



U.S. Department of the Interior
Minerals Management Service
Alaska OCS Region



Guidelines for

Oil and Gas Operations In Polar Bear Habitats

Edited by:

Joe C. Truett
LGL Ecological Research Associates, Inc.
1410 Cavitt Street
Bryan, TX 77801

August 1993

This study was funded by the Minerals Management Service, U.S. Department of the Interior, Washington, D.C., under Contract Number 14-35-0001-30572. This report has been reviewed by the Minerals Management Service and approved for publication. Approval does not signify that the contents necessarily reflect the views and policies of the service, nor does mention of trade names or commercial products constitute endorsement or recommendation for use.



ACKNOWLEDGEMENTS

Many people provided assistance in development of this handbook. Without the help of the following individuals the task would have been much more difficult and the product less effective.

Steve Treacy and Cleve Cowles ably represented the U.S. Minerals Management Service (MMS) during the performance of the contract that produced this handbook. Other MMS personnel contributed in the planning stages; they include Jim Regg, Nancy Swanton, Frank Wendling, and Glenn Yankus.

Canadian biologists provided invaluable assistance. In particular, we acknowledge the outstanding efforts of Peter Clarkson and Andy Derocher, who contributed many ideas and much printed material. Ian Stirling helped direct us to these biologists and to sources of printed information. Mitch Taylor and John Lee provided information on polar bear biology and reactions to humans. Mary Tapsell kindly loaned photographs.

Several individuals with the U.S. Fish and Wildlife Service provided major assistance. Steve Amstrup reviewed the draft manuscript and graciously allowed the use of some of his photographs. Lori Quackenbush, Gerald Garner, Scott Schliebe, and Jon Nickles contributed helpful manuscript reviews and provided materials. John Bridges and Scott Schliebe helped in planning and manuscript review.

Craig George of the North Slope Borough's Department of Wildlife Management contributed useful ideas, information, and suggestions.

Individuals with industry assisted during the planning stages, provided advice on the technology of detection and deterrence, and contributed other materials. Bob Griffith (ARCO Alaska), Michelle Gilders (BP Exploration), John Monarch (Chevron U.S.A.), and Bill Sands (Western Geophysical) contributed ideas and written materials during the early stages of the project. Bill Sands provided useful photographs. Joe Polya and Wade Srock (Conoco) provided information about Conoco's use of a trip-wire detection system. Jeff Marley (Margo Enterprises, Calgary, Alberta) and Lloyd Morris (Alaska Telecom) provided helpful advice about various detection and deterrent methods.

Several LGL personnel contributed significantly to the effort. Warren Ballard edited and otherwise assisted with final handbook preparation. Vijay Chippa assisted in developing the format for the polar bear data base, an effort related to this handbook preparation. Eileen Brooks, Audrey Bishop, and Peggy Kircher processed the manuscript in its various forms, patiently enduring computer and other malfunctions; Peggy prepared part of the computer graphics. John Richardson helped in various ways and at various stages to expedite manuscript preparation.

Photos were scanned and archived by Mark Simpson who also converted some of the graphics to digital form as well as creating others. Mark also did the final manuscript layout and acted as printers' liason. Jean Erwin did her usual tenacious job of proofing final output and drafts and helped with final printing arrangements.

Table of Contents

ACKNOWLEDGEMENTS	i
LIST OF FIGURES	iii
LIST OF TABLES	iv
CHAPTER 1. INTRODUCTION	1
Joe C. Truett, LGL Ecological Research Associates, Inc.	
CHAPTER 2. POLAR BEAR BIOLOGY	3
Ray Schweinsburg, Arizona Game & Fish Department	
CHAPTER 3. ATTRACTION TO HUMAN ACTIVITY	17
Dick Shideler, Alaska Department of Fish & Game	
CHAPTER 4. DETECTION SYSTEMS	25
John Hechtel, Alaska Department of Fish & Game	
CHAPTER 5. DETERRENT METHODS	35
Dick Shideler, Alaska Department of Fish & Game	
CHAPTER 6. PERSONNEL RESPONSIBILITIES AND TRAINING	51
Ray Schweinsburg, Arizona Game & Fish Department	
CHAPTER 7. LAWS AND REGULATIONS CONCERNING POLAR BEARS	61
Richard Tremaine, LGL Alaska Research Associates, Inc.	
CHAPTER 8. SITE DESIGN AND OPERATION	67
Denis Thomson and William Koski, LGL Limited	
CHAPTER 9. RESPONSIBILITIES AND PROTOCOL FOR BEAR ENCOUNTERS ..	81
Richard Tremaine, LGL Alaska Research Associates, Inc.	
CHAPTER 10. PREPARATION OF SITE-SPECIFIC BEAR INTERACTION PLAN	85
Richard Tremaine, LGL Alaska Research Associates, Inc.	

Appendices

APPENDIX 4-1. Schematic of trip-wire system	89
APPENDIX 4-2. Manufacturers of detection systems	90
APPENDIX 5-1. Sources for bear deterrents	91
APPENDIX 5-2. Design of electric fence systems	92
APPENDIX 10-1. Polar bear observation form	103

List of Figures

Figure 2-1	Relative sizes of young and adult polar bears	3
Figure 2-2	Polar bear tracks in snow	4
Figure 2-3	Approximate winter and summer distributions of polar bears in offshore areas of Alaska	6
Figure 2-4	Sea ice zones in late winter, Beaufort Sea, Alaska	7
Figure 2-5	Polar bear dens	9
Figure 2-6	Polar bear food web	10
Figure 2-7	Ringed seals and bearded seals around hole in ice	11
Figure 2-8	Female with cubs	14
Figure 2-9	Bear in warning posture	15
Figure 3-1	Tracks of a bear that investigated a tugboat frozen into ice at West Dock, Prudhoe Bay	19
Figure 3-2	Female and her older cub feed at an inadequately protected food cache	20
Figure 3-3	This female and young cub were attracted to the tent camp by food odors	21
Figure 3-4	Artificial lead "downcurrent" of the SSDC at ARCO's "Cabot" prospect	22
Figure 4-1	Typical layout of trip-wire system at an exploratory drilling island	26
Figure 4-2	Exterior alarm (strobe and horn mounted on tower) and floodlights facing outward toward trip wire were part of CONOCO's detection system at "Badami II" drillsite	28
Figure 5-1	Diagram of wire skirting system for elevated camps	40
Figure 5-2	Diagram of exit "cage"	41
Figure 5-3	Fencing may not deter a motivated bear	43
Figure 5-4	A selection of bear repellents	44
Figure 6-1	Seismic exploration	52
Figure 6-2	Training materials	54
Figure 6-3	Kulluk drilling station	55
Figure 6-4	Seal Island drilling station	57
Figure 6-5	Seismic train	59
Figure 8-1	Idealized permanent camp design	69
Figure 8-2	Idealized design for semi-permanent camp	70
Figure 8-3	Improper camp layout	70
Figure 8-4	ARCO "Fiord" ice island exploratory drill site	71
Figure 8-5	Back of hotel at Deadhorse	71
Figure 8-6	ARCO "Kalubik" ice island exploratory drill site	72
Figure 8-7	Kuparuk industrial center, Kuparuk oilfield	73
Figure 8-8	Seismic operations, being mobile, cannot always be equipped with skirting around buildings	75
Figure 8-9	Chevron "Karluk" ice island drill site was the first Alaska project where a polar bear interaction plan was applied	76
Figure 8-10	Idealized temporary camp	78
Figure 9-1	Polar Bear sighting protocol	83
<hr/>		
Appendix Figure 5-2.1	Selection of electrical fence materials	99
Appendix Figure 5-2.2	Typical barrier and electrical fence designs	100

List of Tables

Table 2-1 Seasonal ice regimes 8
Table 4-1 Summary of detections systems 33
Table 5-1 Legal status of deterrence methods 36
Table 5-2 Effectiveness and feasibility of deterrence methods 39



(M. Taylor)

CHAPTER 1. INTRODUCTION

JOE C. TRUETT
P.O. Box 211
Glenwood, New Mexico 88039

Whenver humans and polar bears meet, the potential exists for conflict. Because industrial development and other human activities in polar bear habitat have increased in recent years, encounters between humans and bears have become more common. Activities associated with the exploration for and development of offshore oil and gas deposits pose particular risks because they occur in polar bear habitat and sometimes attract bears.

Industrial development in polar bear country carries a responsibility to protect human life and property and to prevent unnecessary injury, disturbance, or death to bears. Protecting human life and property are constant concerns of industry operators in the Arctic. The bears themselves are important not only to the Native cultures, in which they have played an important role for centuries, but also to society at large.

The purpose of this handbook is to help minimize human-polar bear encounters at industrial sites and to prevent undesirable results from encounters that cannot be avoided. The handbook provides relevant information about polar bear biology, discusses why bears are attracted to sites and how they can be detected, gives the methods for and legal restrictions on deterring bears, and tells how personnel should be trained and operations designed to best avoid undesirable encounters. Laws and regulations pertaining to bear encounters are explained and a set of operational procedures (protocol) to follow when bears are encountered is provided.

OFFSHORE INDUSTRIAL OPERATIONS

In Alaska, polar bears occur mainly in the Chukchi and Beaufort seas. In these areas, the major industrial operations in polar bear habitat are conducted by the oil and gas industry. The United States government has conducted seven oil and gas lease sales in Outer Continental Shelf (OCS) waters of the Chukchi and Beaufort seas, and the State of Alaska has conducted sales in waters nearer shore and on land. These sales opened the door to petroleum exploration and development.

Industrial activities associated with the search for oil and its extraction and processing can occur in some form throughout the year. Many of the operations take place in winter, when sea ice cover is complete and polar bears are most abundant nearshore. Some activities also occur during the brief summer period when open water dominates nearshore areas and polar bears range largely north of the lease areas on the permanent ice pack.

Activities typically involve discrete units of people and machines; the units may be mobile or stationary. Seismic operations comprise an important part of oil exploration; they involve the use of electronic recording devices to pick up a sound reflected from geologic strata, and are typically carried out from vehicle trains traveling across the frozen sea. Other mobile units include supply trains and aircraft support. Stationary operations are usually associated with well drilling or petroleum extraction and processing.

Petroleum-related activities include temporary as well as relatively permanent types of operations. The initial stages of exploration usually involve seismic operations that occupy sites for a few days or less. Exploratory drilling requires stationary platforms that may exist for several months or more. Production facilities to extract or process oil or gas may persist for the life of an oilfield. Temporary field operations of several kinds may be required to support a permanent facility.

POTENTIAL PROBLEMS

Human-bear encounters during the past 20 years at offshore industry sites in Alaska have resulted in few serious consequences to people or bears. One bear has been reported killed in the last several years and no human deaths have occurred. However, in the Canadian Arctic, where industry has operated more extensively in polar bear habitat, bear-human encounters that resulted in the injury to or death of bears or

humans have been more common (See CHAPTER 8, page 67).

Bears intruding on industrial sites have commonly damaged equipment and interrupted work schedules. Bears can be destructive in their attempts to reach food, to test non-food items for edibility, or to investigate the novel objects or situations at work sites. Work crews responding to polar bear visits lose valuable work time.

If OCS development accelerates in Alaska, the frequency of encounters between bears and humans can be expected to increase. Industry personnel can reduce these encounters and their adverse consequences to a minimum, but only if they understand bears and learn appropriate responses to their presence.

SCOPE AND LIMITATIONS OF HANDBOOK

This handbook is designed to help operators in oil and gas lease areas of the Alaskan Beaufort and Chukchi seas and other areas to deal with polar bear encounters. In Canada, extensive efforts have been made to establish guidelines for human activities in bear country. Preparation of this handbook drew heavily on the Canadian experience.

This handbook presents a summation of current knowledge and judgement concerning polar bear-human encounters. Nine topics that are important for OCS operators to understand are discussed:

- Polar bear biology.
- Bear attraction and ways to minimize it.
- Systems for detecting bears.
- Methods for deterring bears.
- Training of personnel to watch for and avoid bears.
- Legal regulations governing human-bear interactions.
- Site design and operation to minimize bear problems.
- A step-wise procedure (protocol) for bear encounters.
- Instructions for preparing a bear interaction plan.

The protocol for bear encounters and the instructions for preparing a bear interaction plan deviate little from what is already standard practice for OCS arctic operations in Alaska.

The handbook is the product of an interdisciplinary meeting and an extensive analysis of printed information, all tempered by the experience and opinions of polar bear experts. Bear biologists, industry personnel with experience in polar bear habitat, and relevant agency representatives have all been involved in its development. Sources of information that expand upon the material provided in this handbook appear as a bibliographical list at the end of each chapter.

The handbook has several important limitations. It does not discuss how operators should protect bears in case of an oil spill or other emergency. Although it provides information on deterring bears, legal rulings in the United States place important constraints on the use of deterrents, as discussed later. Most important, it will not in itself prevent problems when humans encounter bears; the degree of training, vigilance, and common sense of each person working in bear habitat remain extremely important ingredients.

Some of the information will be outdated as time passes. Future research and experience, particularly that related to bear detection and deterrence, will probably increase the ability of OCS operators to avoid bear problems. Current legal restrictions in Alaska could eventually change to provide different options from that which now exist with respect to the use of and research on deterrents. Whatever happens in the future, we believe that operators studying this handbook will greatly improve their chances of avoiding serious problems with polar bears.

CHAPTER 2. POLAR BEAR BIOLOGY

RAY E. SCHWEINSBURG
 Arizona Game and Fish Department
 2222 West Greenway Road
 Phoenix, Arizona 85023

No other animal so perfectly symbolizes the north as does the polar bear. The great white bear endlessly prowls the Arctic ice fields searching for prey. It is almost wholly dependent on the sea ice as a hunting platform and is rarely found far from it. It is the only bear classified as a marine mammal.

PHYSICAL CHARACTERISTICS

An appreciation of the physical characteristics of polar bears leads one to respect their capabilities. It also prepares people to better detect their presence and to assess the risks when bears are encountered.

Adult bears are large. Males weigh between 550 and 1300 pounds (250 to 600 kilograms) during the spring and up to 1500 pounds (700 kilograms) during summer. When on all fours, large males may stand up to 5 feet (1.5 meters) at the shoulder, and may approach 10 feet (3 meters) tall when on their hind legs. Adult females are smaller than males, weighing between 250 and 650 pounds (115 to 300 kilograms), depending on season and reproductive status (DeMaster and Stirling 1981, Bromley 1985).

Young bears grow for several years before nearing adult size. In March of their first spring, cubs weigh around 20-30 pounds (10-15 kilograms), by the second spring they weigh 100-175 pounds (45-80 kilograms), and in their third spring they weigh 155-310 pounds (70-140 kilograms). Females reach adult size in 4 or 5 years; males continue to grow for 8 or 10 years (DeMaster and Stirling 1981) (Fig. 2-1).

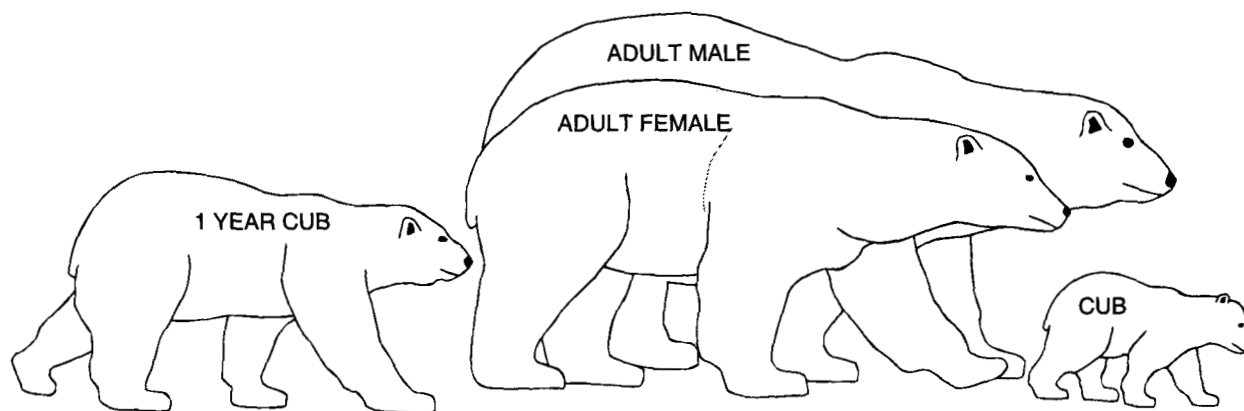

Figure 2-1. Relative sizes of young and adult polar bears.

Pelt

Polar bears are not snow white. They appear ivory white to creamy yellow in color, depending upon the pelt growth stage. Each year in spring and summer they molt their old coat and grow a new one.

The outside guard hairs of the pelt resemble thin, monofilament fishing line. The guard hairs are tough and easily cleaned of blood and blubber.

Beneath the guard hairs, there is a wooly undercoat, which, along with a fat layer, helps insulate the bear. Polar bears will enter water at air temperatures lower than 40 degrees below zero Fahrenheit (-40 degrees Celsius).

Sign

Polar bear sign is seen more often than the bears themselves and can alert workers to potential risks. Bear scats or droppings look like frozen puddles of black tar. Bear tracks resemble human tracks, except that they are wider abeam and sometimes show toe and claw marks (Fig. 2-2). Signs of bear predation on seals include caved-in lairs, blood near lairs or seal breathing holes in the ice, and skinned-out seal carcasses.

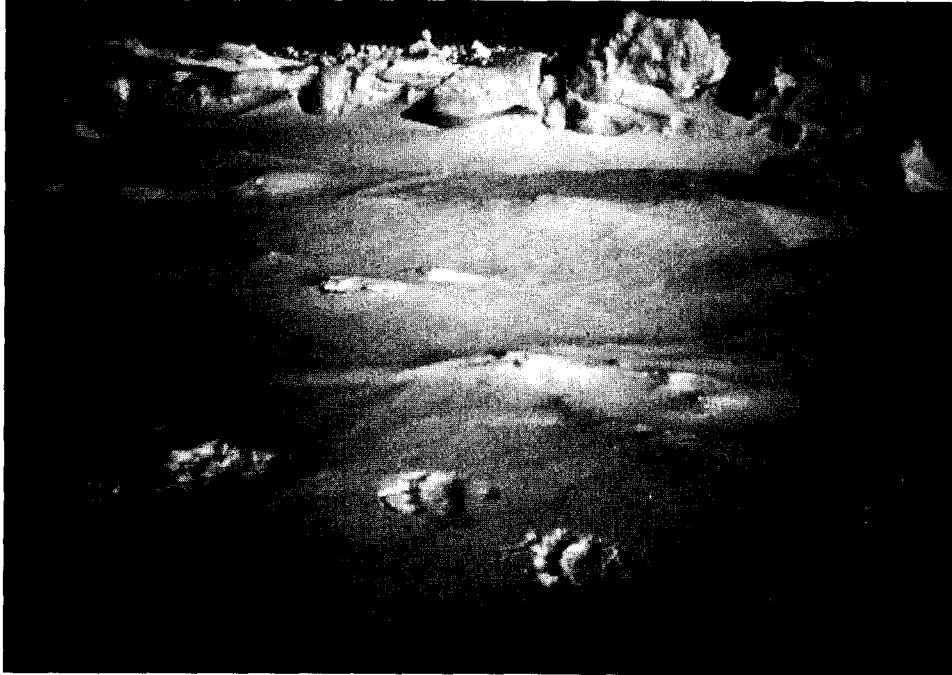

Figure 2-2. Polar bear tracks in snow (R. Schweinsburg).

Athletic Ability and Strength

On land, polar bears are faster and more agile than humans. They can run at speeds of over 25 miles per hour (30 to 40 kilometers per hour) and can walk over 100 miles (160 kilometers) in 24 hours (Bromley 1985). They can jump surprisingly high, scale steep slopes, and rapidly negotiate rubble fields where a man can scarcely walk.

But polar bears, especially fat adults, tire easily and may overheat if pursued at high speeds for too long a time period. Several have been killed by overheating when chased with helicopters or snow machines.

Bears are excellent swimmers. They have been encountered in open water 60 miles (100 kilometers) from the nearest land or ice. They can swim at speeds of 6 miles per hour (10 kilometers per hour) and can remain submerged for over 2 minutes (Bromley 1985).

Bears are very strong. They can easily pull a several-hundred-pound seal through a hole in the ice and on many occasions have ripped apart highly durable equipment.

Senses and Intelligence

As with their athletic prowess, bears come equipped with senses generally superior to those of humans. They possess an extremely acute sense of smell, they can see at least as well as a human, and there is some evidence that they can hear frequencies lower than can humans (Bromley 1985).

One oil patch worker described the polar bear as the rhesus monkey of the Arctic because of its intelligence. They can learn many things in only one trial, and are quickly able to figure out latches and gates and to locate the best vantage points from which to ambush prey.

DISTRIBUTION AND ABUNDANCE

Polar bears are mammals of the sea ice. They range as far north as 88 degrees (Amstrup and DeMaster 1988), which is beyond the northernmost extent of land. In Alaska, they occur as far south as St. Matthew Island and the Pribilof Islands in the Bering Sea and are commonly found up to 180 miles (300 kilometers) offshore in the Chukchi and Beaufort seas (Amstrup and DeMaster 1988). Rarely are they found far inland (Fig. 2-3).

Marking studies indicate that two more or less distinct polar bear populations occupy Alaska offshore areas (Amstrup and DeMaster 1988). One population inhabits the Alaskan-Canadian Beaufort Sea, extending as far east as Banks Island in Canada and west to the vicinity of Point Lay, Alaska. The second population, shared with Siberia, inhabits the Chukchi and Bering seas southwest and west of Point Lay.

Biologists estimate there are 2000 polar bears in the Beaufort Sea (Amstrup and DeMaster 1988). No estimates exist for the Chukchi Sea. Although they are more abundant in certain ice types and localities than in others, they can turn up unexpectedly anywhere in their range at any time.

Habitat Features Affecting Distribution

The marine and coastal regions inhabited by polar bears vary from place to place in their quality as polar bear habitat. The powerful forces of temperature, wind, and ocean currents shape the ice surfaces into characteristic textures and patterns that change seasonally and with distance from shore (Fig. 2-4). Coastal land forms differ depending on location. Below are described some of the most easily-recognized features of the sea ice and coast that influence bear distribution.

- **Leads** are open-water areas surrounded by sea ice. Some occur unpredictably from place to place but many recur in the same general places year after year.
- **Polynyas** are areas where leads persist predictably in winter or spring, as in the nearshore zone of the Chukchi Sea from Barrow to Point Lay.
- **Landfast ice**, or **fast ice**, occurs near shore and is anchored to the bottom in two depth zones—in shallow areas where depths are less than the ice thickness, and in deeper areas where pressure ridges become grounded (Fig. 2-4). Most OCS development occurs in this zone. Landfast ice is mostly flat, stable, and extends in late winter and spring out to 60-foot (20-meter) water depths; it becomes increasingly rough and irregular in deeper water where currents exert pressure in winter and where ice floes are commonly incorporated. It is particularly rough in the grounded-ice zone. It melts during the first half of summer, leaving generally open water in late summer and early fall. It begins to refreeze in late September or in October, thickening through winter and spring (Table 2-1).
- The **grounded-ice zone**, or **shear zone**, occurs in winter where the seaward edge of the landfast ice meets the moving ice beyond. It usually appears as a rubble field or as windrows of pushed-up ice. This zone typically contains a lead at its outer edge that can open and close dramatically with changes in direction of ice drift.
- **Pack ice** is the free-floating ice that makes up most of the Polar Ice Cap. It consists of loosely- or closely-packed pans that vary in diameter from a few feet to several miles. In composition, it includes first-year ice that melts each summer plus multi-year (permanent) ice. Typically, it appears rough-surfaced and is unstable, constantly drifting and moving.
- The **transition zone** contains the winter ice between the shear zone and the edge of the permanent pack ice. The ice in this zone continually shifts, cracking apart to form leads that refreeze into lanes of young ice.
- **Barrier islands** are long, narrow gravel or tundra-covered berms found just offshore of and parallel to some portions of the coast. They are usually associated with shallow lagoons on their landward sides.

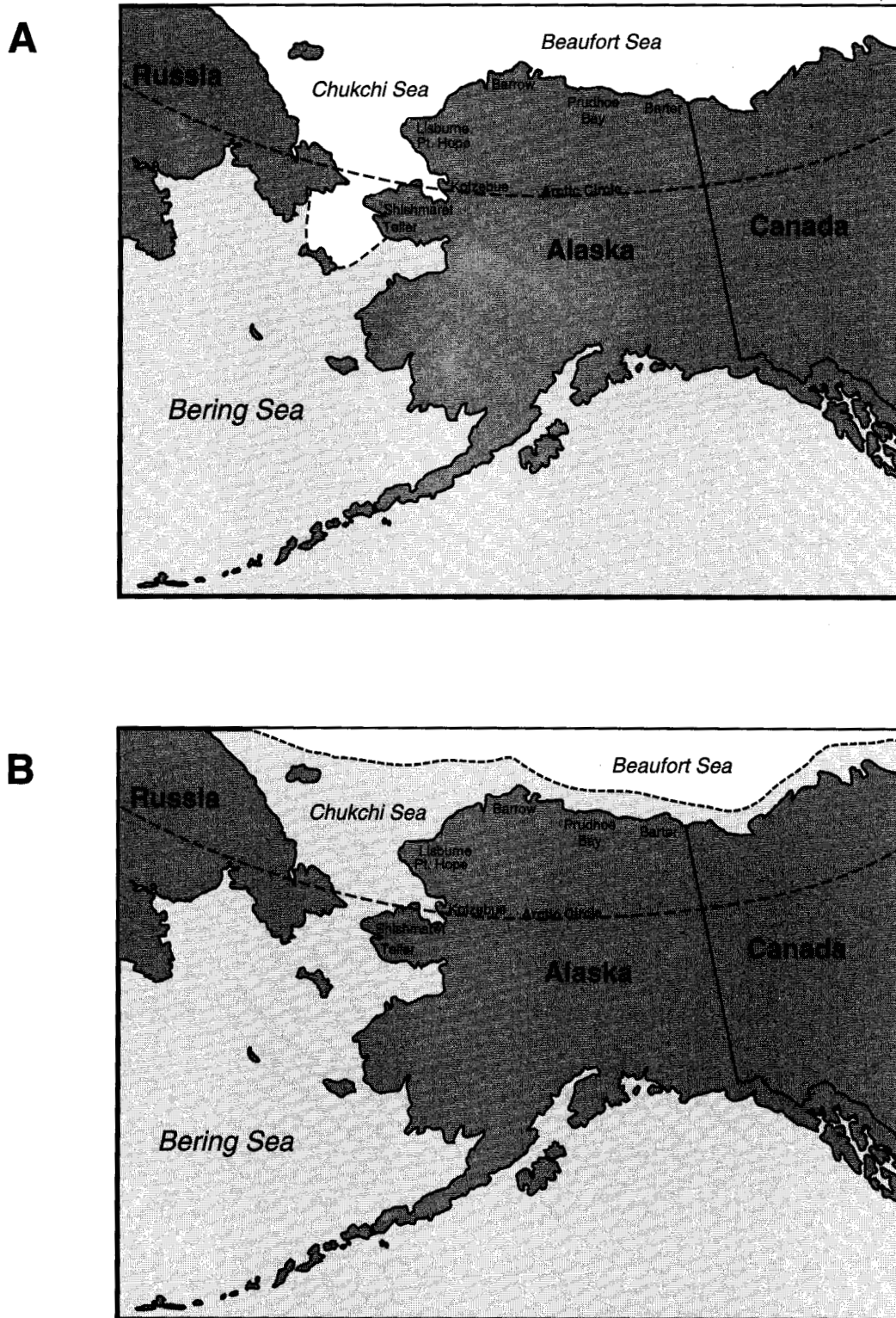

Figure 2-3. Approximate winter (a) and summer (b) distributions (white area) of polar bears in offshore areas of Alaska (from Amstrup et al. 1986).

- Much of the **mainland** along Alaska's northern coast is flat to rolling with little sharp relief. The Beaufort Sea coastline exhibits greater relief in the east than in the west; the Chukchi Sea coast exhibits considerably more relief than the Beaufort, especially near Cape Lisburne where the western end of the Brooks Range meets the sea to form steep cliffs.

South of the permanent ice pack, the features of the sea ice vary dramatically from season to season (Table 2-1). Near land, ice begins to form in sheltered bays and inlets usually during late September. As temperatures continue to drop, the land fast ice builds outward from the land and the annual pack ice begins to reform in the transition zone. Most of the area between shore and the pack ice has ice cover by some time in October; this ice is thickest and most stable from mid-winter until spring.

During May and June, the heat from the sun creates surface sheets of water atop the fast ice. Large cracks soon appear in the ice, which breaks up into huge slabs and unconsolidated floes. Ice breakup at the mouths of rivers is considerably accelerated by spring flooding of streams, which occurs during a short period in May or early June.

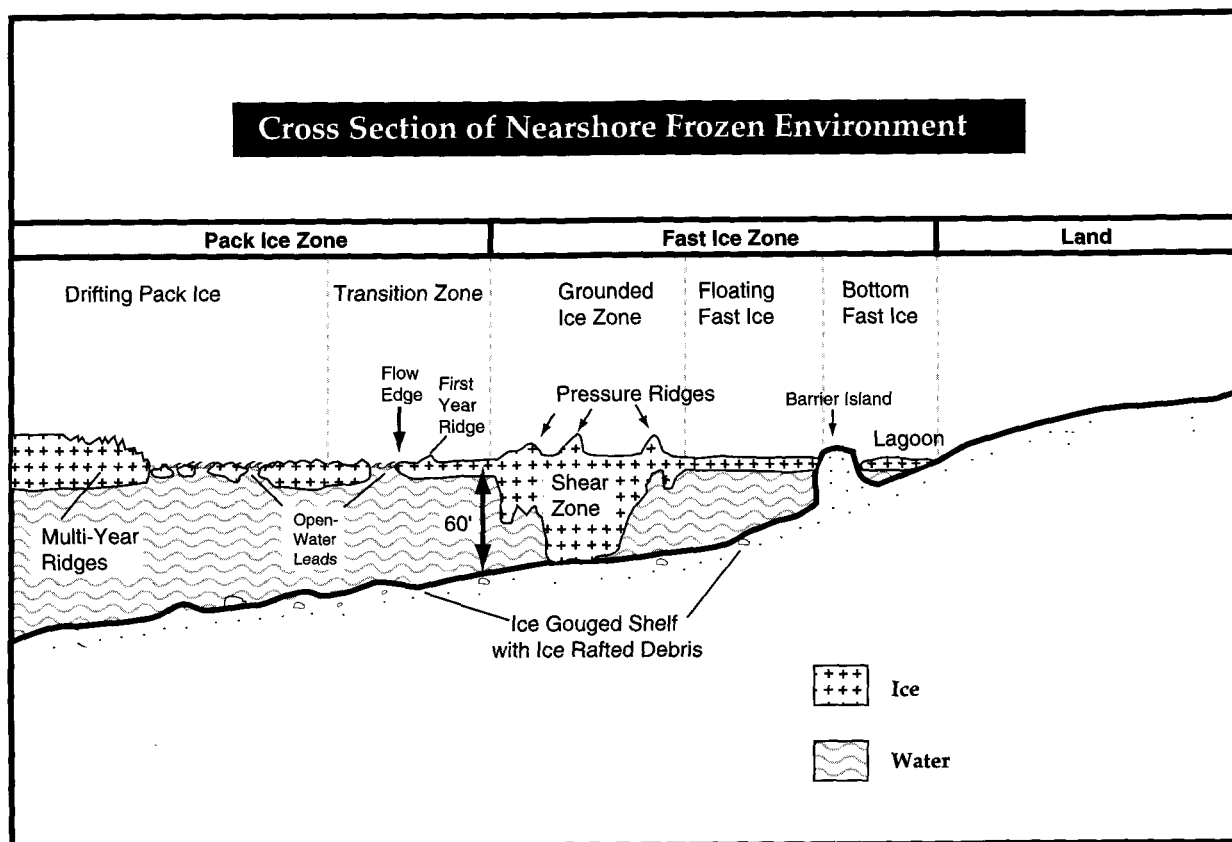

Figure 2-4. Sea ice zones in late winter, Beaufort Sea, Alaska.

August and September are the months of maximum open water. During this time the ice again retreats northward to the edge of the permanent pack. By late summer, the Chukchi Sea may become essentially ice-free except in its northern parts. In the Beaufort Sea, although there are times in late summer when the ocean near land is completely open, northerly winds can at any time push large amounts of unconsolidated ice south to block shipping lanes and shorelines.

Table 2-1. Average seasonal regimes in the Beaufort Sea and Chukchi Sea fast ice (adapted from LaBelle et al. 1983).

Ice Phase	Central Beaufort Sea Coast	Central Chukchi Sea Coast
New Ice Forms	3 October	10 October
First Continuous Fast Ice	Mid October	Early November
Extension/ Modification of Fast Ice	Nov.-Jan./Feb	Nov./Dec-Jan./Feb
Stable Ice Sheet Inside 15-m Isobath	Jan./Feb.-Apr./May	Feb.-Apr./May ¹
River Flooding Fast Ice	25 May	1 May
First Melt Pools	10 June	10 May
First Openings and Movement	30 June	10 June
Nearshore Area Largely Free of Fast Ice	1 August	5 July

¹Locally, the ice may not achieve any prolonged stability.

Seasonal Distribution

The distribution of polar bears is strongly influenced by the local and annual patterns of ice formation, distribution, and thaw (Stirling 1990). The reforming of the landfast ice sheet in late fall and early winter triggers the return toward land of polar bears from the permanent pack ice far offshore. By late fall in Alaska, bears may be found anywhere seaward of the Beaufort and Chukchi coasts. In winter, they range as far south in the Chukchi Sea as Bering Strait and, in some years, to St. Lawrence Island in the Bering Sea (Amstrup and DeMaster 1988).

Bears prefer broken ice because seal hunting is better there than in open water or in unbroken ice. Bears have difficulty catching seals in open water, and it is hard for them to catch seals in the fast ice except where the ice sheet is broken. Also, some biologists believe that a greater proportion of young and inexperienced seals live farther offshore in broken ice than in the fast ice.

In the Beaufort Sea, bears have to move north in summer only about 95 miles (150 kilometers) to reach the permanent pack (Garner et al. 1990). East-west movements in the Beaufort Sea have exceeded 400 miles in a single year and some bears have been tracked over 50,000 square miles, an area the size of the state of Washington (Amstrup 1986).

In the Chukchi and Bering seas, the distance between the maximum ice cover (winter) and minimum ice cover (summer) is much greater than in the Beaufort—about 930 miles (1,500 kilometers). In these areas, bear movements are extensive; for example, minimum distances moved by six radio-tagged bears during a 12- to 20-month period ranged from 2880-3970 miles (4650-6400 kilometers). The areas occupied by the individual bears averaged 96,500 square miles (250,000 square kilometers) (Garner et al. 1990).

In Alaska, few bears come ashore during the open-water period. But there are exceptions; in the Beaufort Sea bears sometimes drift to the coast on stray pack ice and thus may turn up unexpectedly anywhere along the coast in summer.

Researchers who have marked and radio-tracked bears have found that individual bears display seasonal fidelity to particular areas within their home ranges. However, they are not always tied to these locations (Stirling 1990) and will move if they have to. For instance, in Alaska during years of heavy ice cover when the locations of leads change, bears move away from areas they normally occupy (Amstrup 1986), presumably because seals are harder to hunt where there are few leads (Amstrup 1986, Amstrup and DeMaster 1988, Stirling 1990).

Adult female bears in the western Canadian Arctic often occupy habitats nearer land than do males, for two reasons. First, only pregnant females dig and occupy winter dens, many of which are on land. Also, in general, female polar bears with cubs avoid other bears, which are more common away from shore. Large

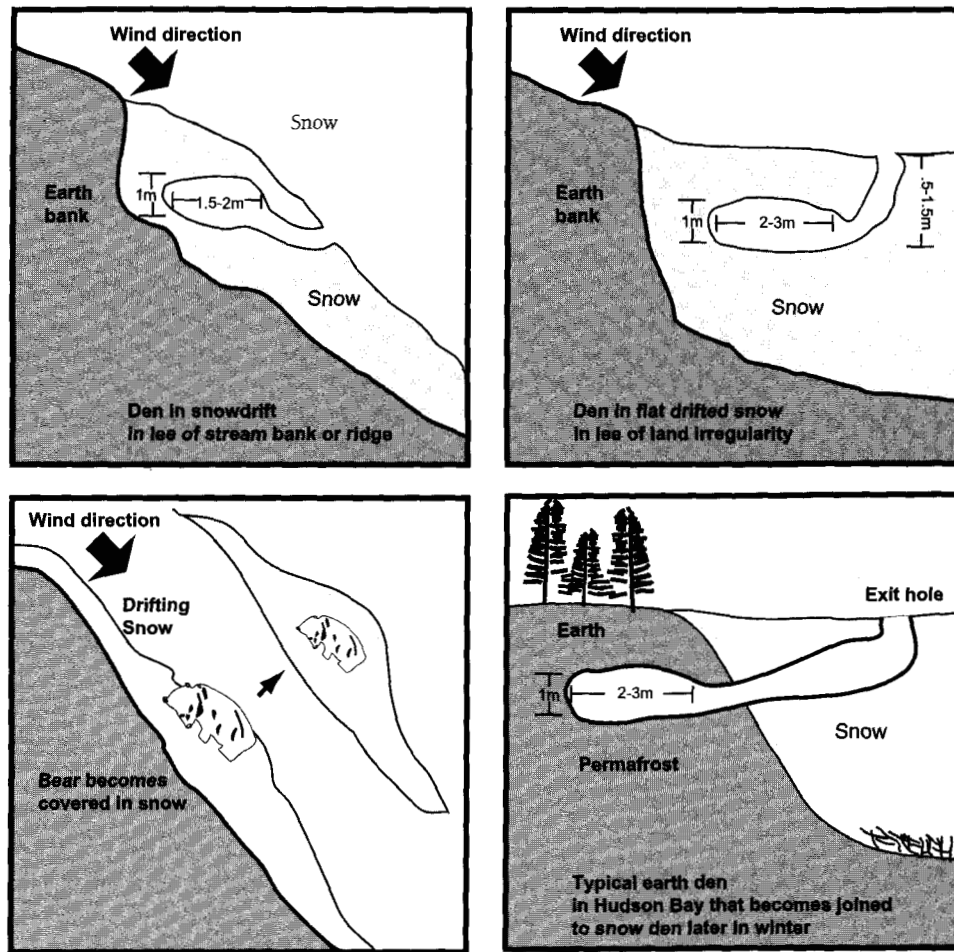

Figure 2-5. Polar Bear dens (modified from Stirling 1988).

males in particular tend to be found further offshore (Stirling 1990), except during the breeding period when they come nearer shore to search for females.

Patterns of female distribution near land may differ somewhat in Alaska (Amstrup and DeMaster 1988), where a larger proportion of denning may occur offshore (Amstrup and DeMaster 1988). Analysis of recent radio-tracking studies indicates that, of 90 dens found in Alaska, 53% were on drifting pack ice, 42% were on land, and 4% were on landfast ice (S. C. Amstrup, U.S. Fish and Wildlife Service, Anchorage, pers. comm.). Fewer bears seem to den in the Chukchi-Bering seas (only 8-10 cases have been documented for Alaska) than in the Beaufort Sea, but most of the Chukchi-Bering dens found have been on land (Garner et al. 1990).

In many places, polar bears den in concentrations, probably because good sites for dens are localized. Pregnant females choose denning areas that have enough topographic relief and the proper slope aspect (south-facing) to catch and hold snow banks under a variety of autumn conditions (Fig. 2-5). In the Beaufort Sea, these conditions appear to be most common on the mainland near the coastline. The region between the Colville River delta in Alaska and Herschel Island in Canada seems particularly attractive to denning bears. Flaxman Island near Alaska's Canning River delta also appears to be a traditional denning area as does Pingkok Island west of Prudhoe Bay. Most dens found on land in Alaska have been less than 6 miles (10 kilometers) from the coastline although some occurred up to 36 miles (60 kilometers) inland.

FOOD HABITS AND FEEDING

In Arctic waters where polar bears feed, most of the nutrients that support animal life are locked under the ice (Fig. 2-6). In this harsh and nutrient-sparse environment, polar bears sustain life by preying on a few species that bring those nutrients back to the surface.

Diet

The polar bear is the largest non-aquatic carnivore in the world and makes most of its living hunting and killing seals. Ringed seals are the main prey in Alaska; these and bearded seals (Fig. 2-7) dominate the diet (Amstrup and DeMaster 1988) though bears also occasionally prey heavily on walrus and small whales. Walrus are more important to bears in the Chukchi Sea than in the Beaufort Sea because walrus are relatively scarce in the Beaufort Sea. Less important food items include birds, seaweed, eggs, berries, lemmings, shrubs, lichens, and grass (Bromley 1985), and in some localities caribou and muskoxen.

Polar bears scavenge many things. They seek out animal carcasses (especially whales), garbage, and food caches. Besides eating the things people consider food, they chew on and may eat a variety of manufactured items: rubber, plastic, garbage, rope, canvas, motor oil, machine grease, snowmachine seats, chemicals, and batteries (Bromley 1985). Some of these items are poisonous (Amstrup et al. 1989).

Polar bears also occasionally eat other polar bears and humans. Large males may kill and eat cubs, and recorded instances exist of adult bears being killed and eaten by other adults. There are also several documented cases of polar bears killing and eating humans.

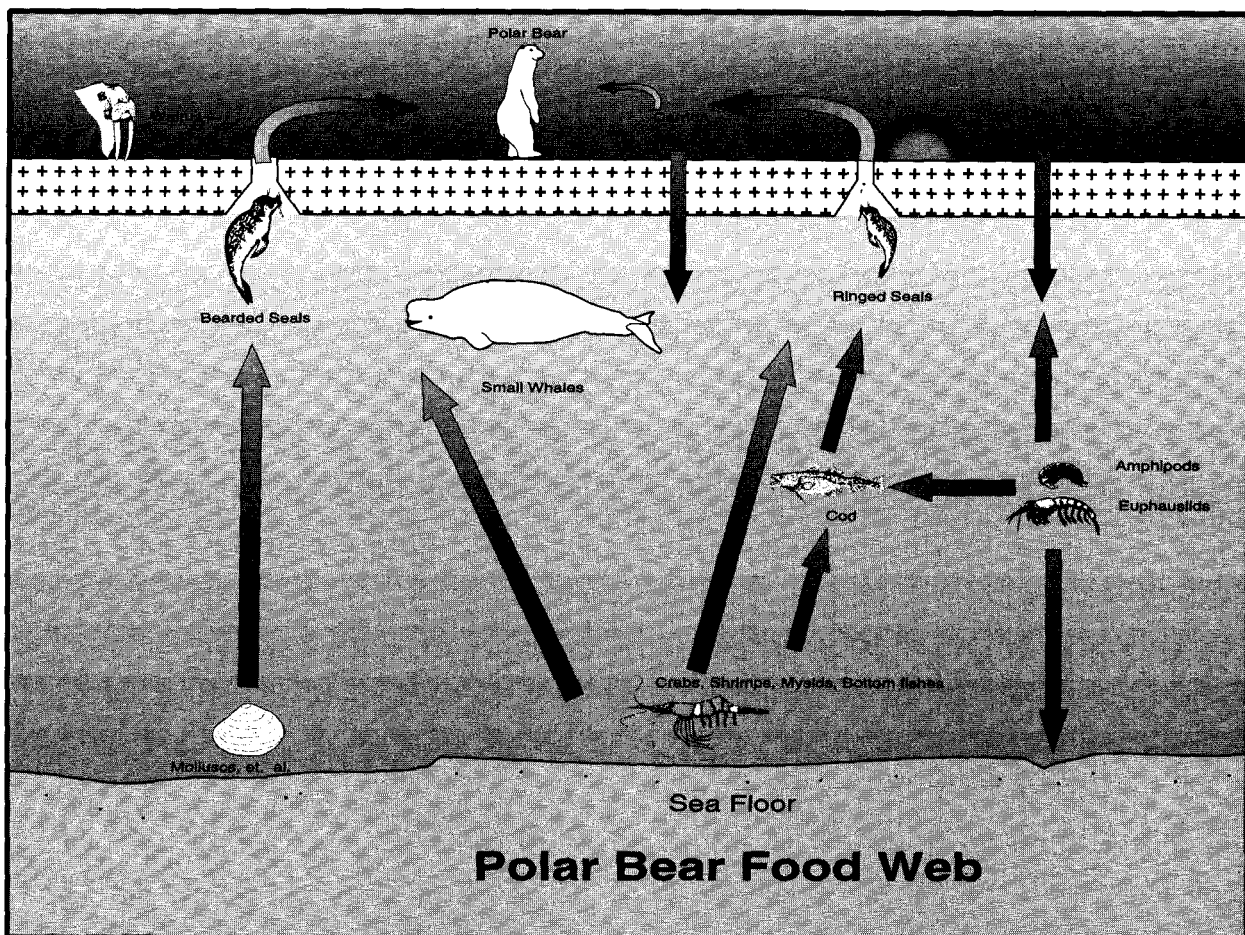

Figure 2-6. Polar Bear food web.



Figure 2-7. Ringed seals (small) and bearded seals (large) around hole in ice (R. Schweinsburg).

Hunting Behavior

Polar bears use four main techniques for hunting seals. Some of these methods may be used on potential human prey.

- **Still-hunting:** Bears ambush seals by waiting patiently beside breathing holes or leads (Stirling 1990). When the seal appears, the bear grabs it with its jaws.
- **Digging out:** When a seal lair on the sea ice is covered by snow, a bear may use its sense of smell to determine if the lair is occupied and to locate the escape hole to the water below. If the seal is in its lair, the bear may run and pounce on top of the lair, which often collapses, pinning the seal or obstructing its escape hole, giving the bear time to catch the seal. The bear may also dig through deep snow into a lair. If the seal is not there, the bear may wait in ambush for it to return.
- **Stalking:** During the spring and summer, when seals are basking on top of the ice, polar bears stalk them. The bear creeps forward until it is close enough to charge and catch the seal. Another form of stalking takes place when a bear swims in a lead using its long neck like a periscope to search for a basking seal. It then very carefully swims close, rushes out of the water, and kills the seal.
- **Swimming:** Some bears have learned how to catch seals in open water. When the seal submerges, the bear swims toward it, lying quietly in the water each time the seal resurfaces. Eventually the bear gets close enough to grab the seal (Furnell and Ooloyok 1980).

Feeding Behavior

A polar bear has to catch approximately one seal a week to maintain itself (Amstrup 1986, Amstrup and DeMaster 1988). After making a kill, the bear immediately begins feeding because the kill could be stolen if a larger bear comes along.

Bears can eat up to 10% of their body weight in 30 minutes. The stomach of a large bear may hold up to 200 pounds (90 kilograms) of food (Best 1977).

It is important for polar bears to keep their fur clean to get the maximum benefit from its insulative qualities. Thus, after feeding, they may wash if water is near a kill, or rub in the snow. They also groom themselves by licking blubber and blood from their pelt (Stirling 1990).

If ringed seals are abundant and easily caught, bears may eat only the skin and blubber. Remains of kills are quickly scavenged by other bears, Arctic foxes, and birds. Scavenging kills of adult bears probably helps many young bears survive until they become skillful hunters themselves.

POPULATION BIOLOGY

Life Cycle

Polar bears breed during April and May and males travel long distances during this time searching for females. When a male finds a female, he stays with her a few days, breeds and then goes off in search of another.

During early November and December, the pregnant females search out deep snow drifts in which to dig their dens (Stirling 1990). They stay in the dens all winter, but they can be aroused from their dens by disturbance. Although all sexes and ages of bears may den for short periods to wait out storms or times of food scarcity, only pregnant females den all winter.

Cubs are born during December and January (Stirling 1990). Normally, a female has two cubs, but often one and sometimes three are born (Larsen 1978). They are blind and helpless at birth, weighing less than two pounds (1 kilogram) and needing the care of the mother to survive. She holds them to her teats to nurse them and keep them warm. Temperatures in the den are usually much higher than outside, and the cubs could not survive without the shelter of the den and their mother's care (Amstrup and DeMaster 1988). The mother does not eat while denning; both she and her cubs live on her fat reserves.

Cubs grow rapidly and weigh about 25 pounds (11 kilograms) when they emerge from the maternity den during late March or April (Amstrup and DeMaster 1988). After several short conditioning forays, the female abandons the den and takes the cubs to the sea ice to hunt for seals.

For the next two years, the cubs depend largely upon the mother for survival and training. One-year-old cubs usually cannot catch seals; they stay close to their mother. Two-year-olds are more independent, but most are still not adept hunters, particularly in the difficult skills of hunting through the ice. They are forced to leave their mother usually during their third spring when she again becomes sexually receptive and no longer avoids large males. The cubs have to leave or they may be killed by the males.

Fortunately, it is not long until young, inexperienced seals are basking on top of the ice. The 3-year-old cubs can catch them and scavenge from other kills. The subadults that survive their difficult early years grow rapidly. These young, inexperienced bears are the most likely to get into trouble with humans.

Summer is the time of plenty for polar bears. It is then that sufficient fat reserves are built up to last through the winter. By autumn, many bears have doubled their previous winter weights.

Reproduction and Mortality

Males breed earlier than females but take longer to mature. Males are capable of breeding by their third year, but few probably mate before 6 years of age. They do not attain their full weight and strength until 8 or 10 years. They may live until their mid-20s and one old male bear caught by biologists was 34. Females in Alaska begin breeding by their fifth or sixth year and breed for the last time when they are around 18. Few live longer than their mid-20s, although the maximum recorded age for a female was 32. Females typically live longer than males (Amstrup 1986, Amstrup and DeMaster 1988, Anonymous 1990).

Polar bears have one of the lowest reproductive capacities of any mammal. A female usually has one cub the first time she gives birth, and after that she averages 1.6 cubs per litter (Lentfer and Hensel 1980). Each female produces at a maximum about five litters, and the average female may produce only one or two litters during her life. Thus, few cubs are produced to replace bears that die. For that reason, bear populations recover slowly from declines.

As with most mammals, the young have the highest death rate. Causes of cub mortality include dying in the den, starving, unable to keep up with their mothers, and being killed by other bears.

Once they reach adulthood, polar bears have few natural enemies. Wolves can kill smaller bears and occasionally a bear is killed or injured by a walrus. Bears also die of disease and are known to have parasites, such as *Trichinella*. Some bears starve when seals are scarce.

Most adult bears are killed by human hunters. In Alaska, hunting is regulated by the Marine Mammal Protection Act, which allows hunting only for subsistence purposes (See CHAPTER 7).

Some bears also are killed in human/bear conflicts associated with development. In Canada, about 15% of all bears killed in encounters with humans were killed in industrial settings (Stenhouse et al. 1988). Most of those deaths were probably preventable.

RESPONSES TO HUMANS

Polar bears continually search for food. They invariably investigate not only things that smell or act like food, but also novel sights or odors not resembling food to a human. They also tend to follow tracks such as those left by other bears, humans, or snowmachines. There is evidence that some kinds of oil drilling platforms attract seals, which in turn attract bears (Stirling 1988). These behaviors, dealt with in greater detail in Chapter 3, all tend to lead polar bears to camps and industrial installations.

General Response Patterns

Once bears find a camp or industrial site, they often will enter to explore and search for food. They are intelligent and able to figure out ways through obstacles or how best to utilize spaces or objects for hiding or ambush cover.

If a bear receives a food reward, it is almost certain to return. The more times it is rewarded, the harder it will be for people to make it leave and the more dangerous it becomes. It is not desirable to have bears hanging around camps. Humans do not act or smell like seals, but they are about the same size and may be attractive to bears.

All sex and age classes of polar bears and all times of year are represented in human/bear conflicts. Most conflicts have involved subadult males, which tend to be more pugnacious and less cautious than others. Encounters can occur at any time; in Canada most have occurred during the ice-free period of late summer and early fall (Stenhouse et al. 1988).

Body Language

Polar bears are unique as individuals and it is impossible to predict with certainty what one will do in every instance. It is advisable to always treat them as if they were dangerous. Knowing what different bear postures signify may help people encountering bears to avoid disasters. The main thing to remember is that polar bears are hunters and make their living as predators. In general terms, they will react to humans by either:

- avoiding them,
- displaying curiosity,
- treating them as another bear, or
- attempting to prey upon them.

Many bears will move away upon encountering humans. They may initially approach in a halting or circuitous manner with head held high to sniff the wind and may stand on their hind legs; this behavior sequence almost always is a sign of curiosity (Fig. 2-8). When they drop to all fours, they frequently leave in a fast walk, pace, or lope, looking back over their shoulders.

Conversely, some bears are not fearful and will continue to approach and display curiosity. The closer they come to humans, the more explosive the situation becomes because the bear can more easily be surprised or feel threatened at close quarters, and this may precipitate an attack. At such times, bears may act aggressively toward humans as they would another bear.

Polar bears are generally solitary except for the strong bond between mother and cubs, and during the breeding season. However, many may temporarily assemble at whale carcasses or other abundant food. When bears meet, they interact with one another according to a dominance hierarchy reinforced by behavioral signs. It is important to know these signs and what they mean because bears use the same signs in close encounters with humans.

Females with cubs generally avoid other bears, but if encountered by another bear, the female may bluff, if not too close, or fight. A female will act the same when she encounters a human at close range. She may bluff as follows: lower her head (Fig. 2-9), make hissing and chomping sounds, and turn and display her side. If she is very close, she may charge. No one has been killed in these kinds of attacks and the female usually breaks off the encounter herself when she feels she has removed the threat to her cubs.

Generally speaking, other sizes and sexes of bears that feel threatened also bluff. They turn sideways and walk stiff-legged or slowly, lower their heads, lay their ears back, and chomp their jaws or hiss. These are all warning signals. If ignored, the bear may next charge. These kinds of displays can emanate from any bear that is inadvertently encountered at close range or that has been allowed to approach too closely.



Figure 2-8. Female with cubs (note arrow) (S. Amstrup).

A polar bear intent on preying on a human acts differently. It may be seen in the initial stalking stages of creeping closer, peering over pressure ridges, or even walking or trotting boldly forward. But, usually it is first seen, if seen at all, rushing full speed forward from some ambush point. Its ears will be perked intently forward, focussed on the prey. There is no bluffing and no warning. A bear with predatory intent does not simply maul victims, it bites them, usually on the head and neck as it would a seal. The chances are high that a human being in this kind of an encounter will be killed.

Because of their speed, agility, strength, intelligence, and predatory nature, polar bears should be respected as potentially very dangerous. Avoidance of close encounters is the best safeguard in polar bear country. When in the polar bear's world, humans should take extreme care to stay out of their way.

WHAT TO DO IF ATTACKED

If you inadvertently get too close to a female polar bear with cubs and are attacked, some biologists advise that it is probably best to play dead (Fleck and Herrero 1988). Fall down and lock your fingers behind your head with elbows protecting your face. Draw your knees up into the fetal position. The female will usually leave once she is satisfied that the threat to her cubs is removed. Don't move for a considerable time after the bears have left.

Other biologists think it may be appropriate to retreat from a female with cubs in denning areas, if retreat is possible (G. Garner, U.S. Fish and Wildlife Service, Anchorage, pers. comm.). Moving away from a female with young cubs may reduce the chance that she will perceive the person as a threat.

When pursued or attacked by a single bear clearly unattended by cubs, it is probably best to try to escape or to act aggressively. Sometimes dropping a parka or other item will divert the bear's attention. An unarmed human doesn't stand much of a chance against an adult bear, but fighting, bluffing, or distracting the bear may add time for someone nearby to mount a rescue effort.



Figure 2-9. Bear in warning posture (S. Amstrup).

In January, 1975, a construction worker was killed by a polar bear while working alone on the deck of a barge on an artificial island in the Beaufort Sea. The bear had come onto the barge unnoticed, probably by means of piled snow that had been shovelled from the deck. It apparently had killed the man instantly and dragged his body to the sea ice. When the worker failed to show up, others searched for him. They found the bear, with the man's partially-consumed body, some distance from the barge. The bear was killed and found to be in poor condition. No polar bear had ever been seen close to the barge before the accident (Fleck and Herrero 1988).

**Again, the best defense is to be alert in polar bear country.
Avoid encounters in the first place.**

LITERATURE CITED

- Amstrup, S.C. 1986. Polar bear. Pages 791-804 in Audubon Wild. Rep.
- _____, I. Stirling, and J.W. Lentfer. 1986. Past and present status of polar bears in Alaska. Wildl. Soc. Bull. 14:241-254.
- _____, and D. DeMaster. 1988. Polar bear - *Ursus maritimus*. Pages 39-56 in J.W. Lentfer, ed. Selected marine mammals of Alaska: species accounts with research and management recommendations. Marine Mammal Comm., Washington, D.C.
- _____, G. Gardner, K.C. Myers, and F.W. Oehme. 1989. Ethylene glycol (antifreeze) poisoning in a free-ranging polar bear. Vet. and Human Tox. 31:317-319.
- Anonymous. 1990. Northwest Territories polar bear management plan. Dept. Renewable Resources, NWT Govt., Yellowknife. 120pp.
- Best, R.C. 1977. Ecological aspects of polar bear nutrition. Pages 203-211 in R.L. Phillips and C. Jonkel, eds. Proc. 1975 Predator Symp., Univ. of Montana, Missoula.
- Bromley, M. 1985. Safety in bear country: a reference manual. Dept. Renewable Resources, NWT Govt., Yellowknife, 105pp.
- DeMaster, D., and I. Stirling. 1981. Mammalian species—*Ursus maritimus*. The American Society of Mammalogists. No. 145.
- Fleck, S., and S. Herrero. 1988. Polar bear-human conflicts. Cont. Rep. No. 3, Dept. Renewable Resources, NWT Govt., Yellowknife. 155 pp.
- Furnell, D., and D. Ooloyok. 1980. Polar bear predation on ringed seals in ice-free water. Can. Field-Nat. 94:88-89.
- Garner, G.W., S.T. Knick, and D.C. Douglas. 1990. Seasonal movements of adult female polar bears in the Bering and Chukchi seas. Int. Conf. Bear Res. and Manage. 8:219-226.
- La Belle, J.C., J.L. Wise, R.P. Voelker, R.H. Schulze, and G.M. Wehl. 1983. Alaska marine atlas. Alaska Environmental Information and Data Center, Univ. Alaska, Anchorage.
- Larsen, T. 1978. The world of the polar bear. Hamlyn Publ. Group Ltd., London. 96pp.
- Lentfer, J.W., and R.J. Hensel. 1980. Alaskan polar bear denning. Conf. Bear Res. and Manage. 4:101-108.
- Stenhouse, G.B., J.L. Lee, and K.G. Poole. 1988. Some characteristics of polar bears killed during conflicts with humans in the Northwest Territories. Arctic 41:275-278.
- Stirling, I. 1988. Attraction of polar bears (*Ursus maritimus*) to offshore drilling sites in the eastern Beaufort Sea. Polar Record 24(148):1-8.
- _____. 1990. Polar bears and oil: ecologic perspectives. Pages 223-233 in Sea mammals and oil: confronting the risks. Academic Press, Inc.

CHAPTER 3. ATTRACTION TO HUMAN ACTIVITY

DICK SHIDELER

Alaska Department of Fish and Game
1300 College Road
Fairbanks, Alaska 99701

*I*an Stirling (pers. comm.) of the Canadian Wildlife Service recounted the following story. Canadian researchers, flying polar bear surveys in the Beaufort Sea, encountered a set of polar bear tracks wandering back and forth across the ice. At one point the tracks abruptly changed direction and headed straight for 30 miles (48 kilometers) until they approached an exploratory drill rig. The orientation of the tracks indicated that the bear had been attracted to the rig.

Operators conducting exploratory drilling from the Single Steel Drilling Caisson (SSDC) at ARCO's "Fireweed" prospect in the western Beaufort Sea observed bears commonly approach the drill ship by following the "lead" in the ice created downcurrent from the ship. Several bears swam and hunted seals in this lead. On at least two occasions, bears played with and flattened markers placed to record ice movements around the ship (Bear Monitor's Report, "Fireweed" Prospect).

Andy Derocher (pers. comm.) of the University of Alberta related an observation of a polar bear that had been attracted to an Arctic research facility. The bear jumped over 8 feet (2.5 meters) onto the roof of the kitchen and almost successfully dug its way into the kitchen by tearing away the stove flue.

On several flights during fall, 1992, the MMS bowhead whale survey team observed numerous polar bears feeding on a bowhead whale carcass just east of Kaktovik. The peak number of bears observed, 30, was on October 4 (S. Treacy, MMS, 1993).

WHY ARE BEARS ATTRACTED TO HUMAN ACTIVITY AND OBJECTS?

The above examples illustrate several characteristics of polar bear attraction to human activities and man-made objects:

- Food offers a strong motivation.
- Curiosity sometimes appears to be as strong a motivation as food.
- Curiosity often results in bears obtaining food.
- Bears can detect attractants from far away and will move long distances to them.
- The reason(s) for the attraction may not be readily apparent to humans.

In the Arctic marine environment, the polar bear is the top predator and fears only other bears, or occasionally humans, walruses, or killer whales. Therefore, polar bears have learned that anything that smells, looks, or sounds slightly out of place is more likely to be food than a threat.

Polar bears are intelligent and curious, and have a tendency to manipulate objects. These qualities often manifest themselves in a fearlessness toward humans and a willingness to inspect human activities and man-made objects.

Bears of either sex and all ages can be attracted to human activities. However, in Alaska most oil and gas exploration and production occur onshore or in coastal waters, where females with cubs, pregnant females moving to nearshore or onshore denning areas, or subadults of either sex are most likely to be encountered. Adult males tend to frequent the transition zone farther seaward where adult seals are more abundant, and subadults and females with cubs tend to avoid these adult males (Taylor 1982, Amstrup and

DeMaster 1988, Stirling 1988b). During the breeding season, adult males may move shoreward looking for breeding females.

Some bears are motivated more than others to seek out industry camps. Subadults are more likely to be food-stressed and, therefore, are attracted to human activity more commonly than are well-fed bears; they also are less likely to leave if a potential food source is present (Fleck and Herrero 1988, Stirling 1988a). The individual's experience is also a factor—the bear could previously have obtained food at the same location, or the bear may have been rewarded by finding food at another site and may have learned to associate food with human activity.

PROBLEMS WITH ATTRACTION

The attraction of polar bears to industrial work sites presents hazards to the bears (Stirling 1988a, Derocher and Stirling 1991). For example, a bear approached the polar bear monitor at ARCO's "Stinson" exploration site in the Alaska Beaufort Sea and was killed by the monitor, who felt his life was threatened. Similar incidents have been reported from Canadian exploration sites (Fleck and Herrero 1988, Stirling 1988a). Bears also have died when they ingested toxic substances used around industrial sites (Amstrup et al. 1989).

Bears at industrial sites also may injure or kill workers and damage or destroy equipment. Bears have killed several people at Canadian oil industry sites (Fleck and Herrero 1988). In Alaska, bears have damaged or destroyed property including ice monitoring and lighting equipment, snowmachines, and helicopters.

The presence of bears may lead to work stoppages and restrictions on outdoor work. At one Canadian drillsite the entire crew was held up for several hours, at a cost of over \$100,000 (Stirling 1988a). Similarly, work delays have occurred at several Alaskan drillsites. According to a CONOCO drilling supervisor, outdoor work at the "Northwest Milne" prospect was halted for most of a shift because a bear was around the site (D. Mountjoy, Conoco Northwest Milne Project, pers. comm.). Likewise, polar bears around the West Dock Seawater Treatment Plant and the Endicott Main Production Island in Arctic Alaska have restricted outdoor activities.

Finally, sites that attract bears could be in technical violation of the law. A stringent interpretation of the U.S. Marine Mammal Protection Act could include artificial attraction of bears to industry sites under the definition of "take," which is illegal (See CHAPTER 7).

MAKING POTENTIAL ATTRACTANTS LESS ATTRACTIVE

Anecdotal literature from the 19th century to the present provides a number of examples of bears being attracted to human activities, but documentation concerning the nature of the attractants is poor. For discussion, it is useful to think of three types of attractants—those that stimulate a bear's curiosity simply because they are novel, those perceived by a bear as food, and those that provide a bear sanctuary from the elements.

Novel Stimuli

Novel stimuli other than food seem to attract bears, though the bears may be attracted because they have learned to associate novelty with food. The bear attracted 30 miles to the drilling operation (see previous page) could have been responding to novel sounds, smells, or food odors. Bears approached the SSDC at ARCO's "Fireweed" operation crosswind and upwind, indicating that they were reacting to sights or sounds of the operation rather than to its odor. Bears also approached the ice breaker Robert LeMeur as it assisted on the Shell-Western Exploration and Production, Inc. (SWEPI) "Crackerjack" prospect in the northern Chukchi Sea (Brueggeman et al. 1992) and one bear investigated a tug frozen in the ice at West Dock (Fig. 3-1). Bears have frequently approached scientific and survey parties that had no food or garbage on them; the bears were apparently attracted by the noise or movement (Feazel 1991).

Bears often follow trails and other linear features, frequently without food as a cue. They have followed snowmachine trails and gravel and ice roads, sometimes for miles (Larsen 1989). A polar bear that visited

CONOCO's "Northwest Milne" exploratory drillsite used the project's ice road to travel to the nearest onshore production drillpad (D. Mountjoy, CONOCO Northwest Milne Project, pers. comm.).



Figure 3-1. Tracks of a bear that investigated a tug boat frozen into ice at West Dock, Prudhoe Bay (D. Shideler).

Food and Food Odors

Food and food odors are powerful attractants, and success in obtaining food is a potent reward to a bear visiting a worksite (See CHAPTER 2 and Figs. 3-2 and 3-3). There are a number of ways bears can be attracted by or obtain food around industrial sites. Workers may feed bears directly or feed them indirectly by leaving food or garbage where it is accessible. Inadvertent habitat modification may locally increase the abundance of natural foods (for example, leads downstream from structures may attract seals). Bears may even eat some industrial materials that humans do not consider food.

Kitchen odors coming from exhaust stacks are powerful attractants, as Andy Derocher's observation at the start of this chapter indicates. Under the right wind conditions such odors are detectable by bears at considerable distances. Unfortunately, there are no feasible methods to reduce this odor. But if an approaching bear receives no food reward for its effort there is little incentive for it to remain in the area, and it will either wander off on its own, or at the very least, be deterred more easily (See CHAPTER 5).

Deliberate feeding of food to bears can be a most serious type of attractant. Bears will not only make an immediate association between humans and food, but the proximity of the bear and human puts both in potential danger. Deliberate feeding is illegal under the Marine Mammal Protection Act and has been almost completely eliminated around petroleum industry activities in Alaska, partly by terminating employees who feed animals. Indirect feeding, such as leaving food for foxes or other scavengers, still occurs. Such action can result in a bear learning to associate food with human presence as readily as if the feeding were deliberate.

Accessible garbage often creates conflicts between humans and polar bears. Virtually all activities associated with the oil and gas industry, from seismic exploration to the operation of major processing facilities, generate garbage that is a potential attractant. The extent to which garbage can become an attractant depends on the nature of its storage and disposal.

Temporary storage bins ("dumpsters") and vehicles containing lunch remains are two common attractants near industrial sites. Polar bears have climbed into garbage bins at North Slope oil fields. Although

polar bears entering vehicles to obtain food has not been documented, there is no reason to believe that they would not exploit this situation if given the opportunity. Grizzly and black bears learned to pull windows off pickups and climb into vehicles to obtain lunches and lunch remains during construction of the Trans-Alaskan Pipeline System (TAPS). Grizzlies at Prudhoe Bay have also climbed into vehicles to obtain garbage.

Permanent dumps are also sources of garbage that polar bears will exploit, as the well-publicized situation in Churchill, Manitoba, has demonstrated (Lunn and Stirling 1985). In Alaska, polar bears have exploited dumps at the Distant Early Warning (DEW) stations at Oliktok (just north of the Kuparuk Oilfield) at Cape Lisburne, and at village dumps at Barrow and Kaktovik.

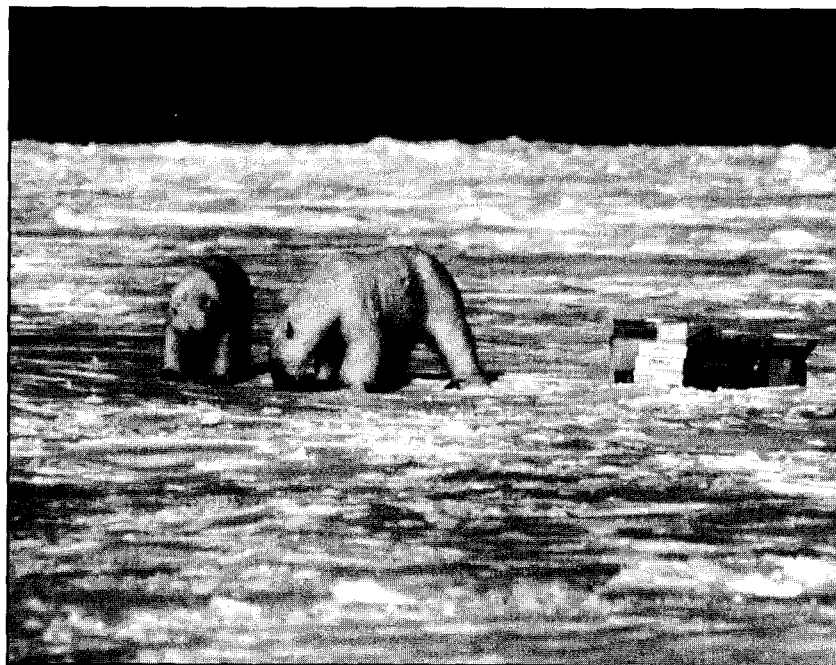

Figure 3-2. This female and her older cub feed at an inadequately protected food cache (D. Thomson).

Adequate methods now exist for temporary storage and disposal of garbage. In many exploratory drilling projects, garbage is kept in bags inside the camp, and incinerated daily at the site's sanitary disposal unit (SDU) along with camp sewage sludge (See CHAPTER 8). This is probably ideal for storing and disposing garbage because there are few steps between the source and its disposal, and it does not provide an attractant to bears. In all situations, the need to have a clean camp should be emphasized in polar bear orientation programs and regulations, and the policy should be vigorously enforced.

Unfortunately, not all SDU's have the capacity to handle wet garbage and sewage sludge. Therefore, an alternate but less desirable method is to backhaul garbage daily to an approved central disposal site—either an incinerator or landfill. Temporary storage in this case can be either inside the camp, or less ideally, in a bear-proof dumpster; dumpsters designed to keep out grizzlies should exclude polar bears (See CHAPTER 5). Likewise, bearproof garbage cans can be used at temporary work sites and can be emptied daily (See CHAPTER 8).

Sewage lagoons have attracted grizzlies during construction of TAPS and elsewhere. A polar bear that mauled an oil industry worker in Canada was initially attracted to the site by a broken sewage line (Fleck and Herrero 1988). These observations suggest that, if major offshore processing facilities were constructed with on-site sewage treatment, the odor would attract polar bears. If sewage is to be stored or processed offshore, the lagoons and related facilities should be made bear-proof (See CHAPTER 5). For most current exploratory drilling projects in Alaska, sewage is incinerated in the SDU, or is back-hauled to a central facility such as the North Slope Borough in Deadhorse, Alaska.

Carcasses of various kinds also attract bears. Polar and grizzly bears have been observed feeding on whale and walrus carcasses along the Beaufort and Chukchi seacoasts. In fall, 1989, whalers from the village

of Nuiqsut butchered a bowhead whale at the West Dock facility in Prudhoe Bay. Polar bears, occasionally numbering 12 at one time (there were unconfirmed reports of 19), fed on the carcass. During fall, 1992, numerous bears congregated around the remains of bowhead whales left by subsistence whalers along the beach at Barrow. Bears were also attracted to meat stored at houses in Barrow, and a few spent several days at the village dump (Albert 1992). Industrial development near coastal features such as barrier islands that may trap floating carcasses could have a higher rate of bear visitation because bears initially attracted by the odor of carcasses would then investigate the development. There are few feasible solutions to these problems other than towing or slinging the carcasses elsewhere.

Industrial materials such as plastic and vinyl, parts of cables, snowmachine seats, and insulation are attractive to polar bears as food (Lunn and Stirling 1985, Stirling 1988a, Derocher and Stirling 1991). Bears have even chewed batteries, with fatal consequences in at least one case (Lunn and Stirling 1985). Bears have eaten petroleum products such as hydraulic and lubricating oils (Lunn and Stirling 1985, Stirling 1988a), and have on a number of occasions sniffed and licked the patches of snow where snowmachine exhaust dripped.

Polar bears have investigated the drilling muds and cuttings disposal areas around exploratory drilling projects in the Beaufort Sea, and grizzly bears have licked and eaten drilling mud additives in Prudhoe Bay. A deadly industrial substance to which bears are attracted is ethylene glycol antifreeze. A polar bear died north of Prudhoe Bay after ingesting a mixture of ethylene glycol and rhodamine B dye used to mark ice runways (Amstrup et al. 1989).

It would be virtually impossible to eliminate the availability of such items as plastic-coated cables. However, particular attention can be paid to storing industrial fluids and additives such as lubricants and antifreeze in containers or buildings that bears cannot access (See also Chapter 8).

Habitat alteration created by offshore activities can attract bears. A source of attractant unique to bottom-founded platforms [e.g., SSDC's, CIDS's, or the Mobile Arctic Caisson ("Molikpaq")] in the transition zone is the downcurrent lead created by ice being deflected by the structure (Fig. 3-4). These artificial leads attract seals, which in turn attract bears. The SSDC used for drilling at ARCO's "Fireweed" and "Cabot" sites created leads where polar bears were observed hunting seals. Icebreakers opening leads in consolidated ice have created similar conditions. An icebreaker off the northern coast of Russia created a lead that immediately attracted polar bears, walruses, and seals (Belikov and Gorbunov 1991). There is no feasible solution to this form of attraction.

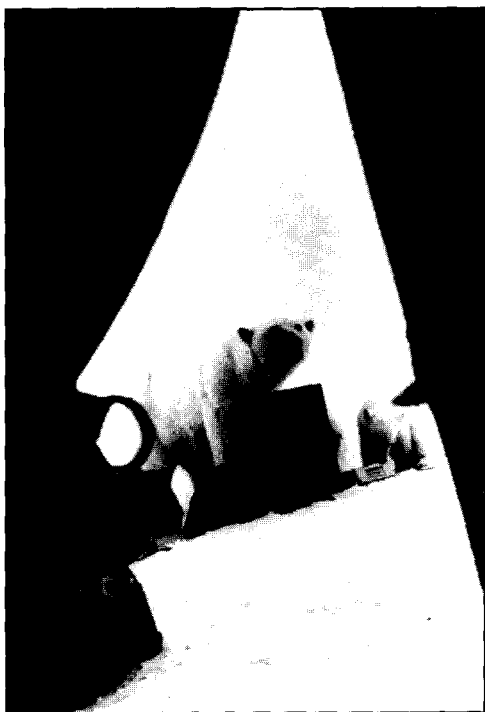

Figure 3-3. This female and young cub were attracted to the tent camp by food odors. This situation is doubly dangerous—the bear could attack camp residents, and the bear can learn to associate people with food (D. Thomson).

Structures as Sanctuaries

Some structures associated with oil and gas exploration and production are attractants apparently because they provide a refuge during the open-water season. In the Canadian Beaufort Sea, a bear swam to an artificial gravel island, and remained there a few days until authorities could tranquilize and remove it. Meanwhile, the drilling crew remained on standby (Stirling 1988a). Bears have also attempted to climb onto idling or drifting icebreakers. There are no preventive measures available for these potential problems, but increased vigilance is important.



Figure 3-4. Artificial lead "downcurrent" of the SSDC at ARCO's "Cabot" prospect. Seals were present in the lead when photo was taken (D. Shideler).

CONCLUSIONS

Polar bears can be attracted to oil and gas facilities and activities for various reasons. Some reasons, such as the presence of human food and garbage, are obvious. However, other reasons are less obvious because they are related to the bear's curious nature as well as its predilection to be attracted to substances that humans normally don't consider to be food. Precautions with food storage and preparation and with garbage disposal will reduce, but not eliminate, the attractiveness of a site. All oil and gas operators in polar bear habitat should assume that a bear will approach, and should prepare for an encounter. This preparation should start with site design (See CHAPTER 8) to ensure that facility layout will enhance bear detection and deterrence and reduce worker exposure to bears that may be attracted to the site.

LITERATURE CITED

- Albert, T. 1992. Memorandum to Ben Nageak, November 9, 1992. North Slope Borough Dept. Wildlife Manage. Barrow, AK.
- Amstrup, S.C., and D.P. DeMaster. 1988. Polar bear. Pages 41-56 in J.W. Lentfer, ed. Selected marine mammals of Alaska: species accounts with research and management recommendations. U.S. Marine Mammal Commission. 275pp.
- _____, G. Gardner, K.C. Meyers, and F.W. Oehme. 1989. Ethylene glycol (antifreeze) poisoning in a free-ranging polar bear. *Vet. and Human Toxicol.* 31(4): 317-319.
- Belikov, S.E., and Y. Gorbunov. 1991. Distribution and migrations of the polar bear in the Soviet Arctic in relation to ice conditions. Pages 70-74 in S.C. Amstrup and O. Wiig, eds. Polar bears: proceedings of the tenth working meeting of the IUCN/SSC polar bear specialist group. Occas. Pap. IUCN/SSC No. 7. IUCN, Gland, Switzerland. 107pp.
- Brueggeman, J.J., R.A. Grotefendt, M.A. Smultea, G.A. Green, R.A. Rowlett, C.C. Swanson, D.P. Volsen, C.E. Bowlby, C.I. Malme, R. Mlawski, and J.J. Burns. 1992. 1991 marine mammal monitoring program: Crackerjack and Diamond prospects, Chukchi Sea. Final Rep. by Ebasco, Inc., to Shell Western Exploration & Production, Inc., and Chevron USA. 184pp.
- Derocher, A.E., and I. Stirling. 1991. Oil contamination of polar bears. *Polar Record.* 27: 56-57.
- Feazel, C.R. 1991. White bear. Ballentyne, New York. 223pp.
- Fleck, S., and S. Herrero. 1988. Polar bear-human conflicts. NWT Govt. Contract Rept. No. 3. Yellowknife, NWT. 155pp.
- Larsen, T. 1989. The world of the polar bear. Chartwell Books, Secaucus, New Jersey. 96pp.
- Lunn, N.J., and I. Stirling. 1985. The significance of supplemental food to polar bears during the ice-free period of Hudson Bay. *Can. J. Zool.* 63: 2291-97.
- Stirling, I. 1988a. Attraction of polar bears (*Ursus maritimus*) to offshore drilling sites in the eastern Beaufort Sea. *Polar Record.* 24: 1-8.
- _____. 1988b. Polar bear. Univ. Michigan Press, Ann Arbor. 220pp.
- Taylor, M.K. 1982. The distribution and abundance of polar bears (*Ursus maritimus*) in the Beaufort and Chukchi Seas: Chapters I and II. Ph.D. diss., Univ. Minnesota, St. Paul. 353pp.
- Treacy, S.D. 1993. Aerial surveys of endangered whales in the Beaufort Sea, fall 1992. OCS Study MMS 93-0023, USDOl, MMS, Alaska OCS Region. Anchorage, AK. 135pp.

CHAPTER 4. DETECTION SYSTEMS

JOHN HECHTEL
Alaska Department of Fish and Game
1300 College Road
Fairbanks, Alaska 99701

During winter 1991-92, CONOCO installed a trip wire bear detection system around its Northwest Milne exploratory drilling project just offshore of Milne Point in the Beaufort Sea. On March 23, a polar bear was spotted approaching the island. Observers saw it trip the wire, which triggered visual and auditory alarms at the rig and kitchen. All personnel stayed inside while the bear was in the vicinity. A bear monitor watched the bear during the day until it wandered off.

In the early morning hours of March 25, in dense fog (visibility less than 100 yards), the alarm once again sounded. All personnel were kept indoors until daylight, when inspection of the tripwire revealed a bear had triggered the alarm. It had walked within 100 feet of the island, and had crawled into an empty dumpster along the access road.

Offshore oil development activities in northern Alaska occur in polar bear habitat. Because bears are attracted to such sites, it is important that bears be detected as soon as possible so that neither workers nor bears are surprised by each other's presence. Darkness, cold, wind, fog, and other conditions can make it difficult to know when bears are nearby. Further, the infrequency of bear visits, the routine of work schedules, and worker fatigue often lead to complacency on the part of personnel. Systems capable of detecting bears and warning people of their presence serve two primary functions: (1) to protect human safety by preventing bear maulings and (2) to preclude the need for harassing or killing a bear that is threatening people. Therefore, it is important to review the principles, considerations, and options regarding detection systems for polar bears at offshore oil facilities.

GENERAL CONSIDERATIONS

Ideally, a detection system for polar bears should have the following characteristics:

- Not be prohibitively expensive.
- Be easy to set up or install.
- Require little maintenance.
- Operate from a simple, efficient power source.
- Reset itself automatically.
- Have a large enough detection zone to provide adequate advance warning.
- Allow problem-free human access.
- Not generate false alarms.
- Detect all bears approaching under all conditions.

In reality there is no such system. The variety of activities associated with offshore oil exploration—from seismic work to production facilities—tends to preclude one solution. The trade-offs in expense, installation time, and maintenance of each system must be considered relative to the needs of a particular site or activity.

There exists a wide variety of systems with the potential for detecting polar bears. These range from human observers, dogs, and trip wires to high-tech systems such as radar, infrared, and microwave. Many are modifications of security systems developed for other purposes. Some have already been tested and shown to be effective on bears, and some have been used in analogous contexts. But most conventional detection systems, though theoretically promising, need field testing and possible modification before they can be deployed on a routine basis because of the special problems and extreme environmental conditions

involved.

It is important to consider detection systems in the planning stages of projects. This is more efficient than trying to retrofit a detection system to existing operations (See CHAPTER 8). No system will adequately compensate for improperly designed camps that have blind spots, unskirted buildings, poor lighting, and other inadequacies.

A detection system is best integrated into an overall site design effort. Some elements of a facility may simultaneously provide detection as well as other functions. For example, floodlights, in addition to being generally useful to camp workers, may aid in detecting bears and may even cause a bear to avoid the lighted camp area during dark periods (See CHAPTER 5).

Several important considerations need to be addressed regardless of the system under consideration. The entire perimeter of the facility must be protected; that is, the detection system should encompass all working, sleeping, kitchen, dining, and waste storage areas. The detection zone must be located far enough from the edge of the site so adequate warning of a bear approach is given. Camp design should allow easy visual inspection of all areas by eliminating obstacles and hiding spots to the extent possible. Drifting of snow, which can provide bears access or hiding places or cause the detection system to malfunction, must be mitigated by periodic snow removal. A gate system must provide convenient human access without allowing undetected entry by bears.

A system must not only detect a bear but also must communicate alarm and escape instructions to vulnerable workers. An effective alarm or signal, and a procedure for safe retreat in case of an alarm, are integral parts of any detection system (See also CHAPTER 8). Integrating the detection signal into the camp alarm is the preferred approach. This may initially require a modest amount of time and expense to accomplish, but will prove worthwhile. Because of the dark and cold conditions faced by workers, communicating the alarm is difficult. A strobe/siren combination distinct from other alarms (e.g. fire, H₂S) and placed in a number of locations around the facility (Fig. 4-1) is warranted.

In most situations bears will be detected only at close range. Thus, workers will usually want to retreat quickly when the alarm is given, even when the cause for the alarm may not immediately be evident. Determining what actually triggered the device may not occur until some time afterward, so false alarms must be minimized.

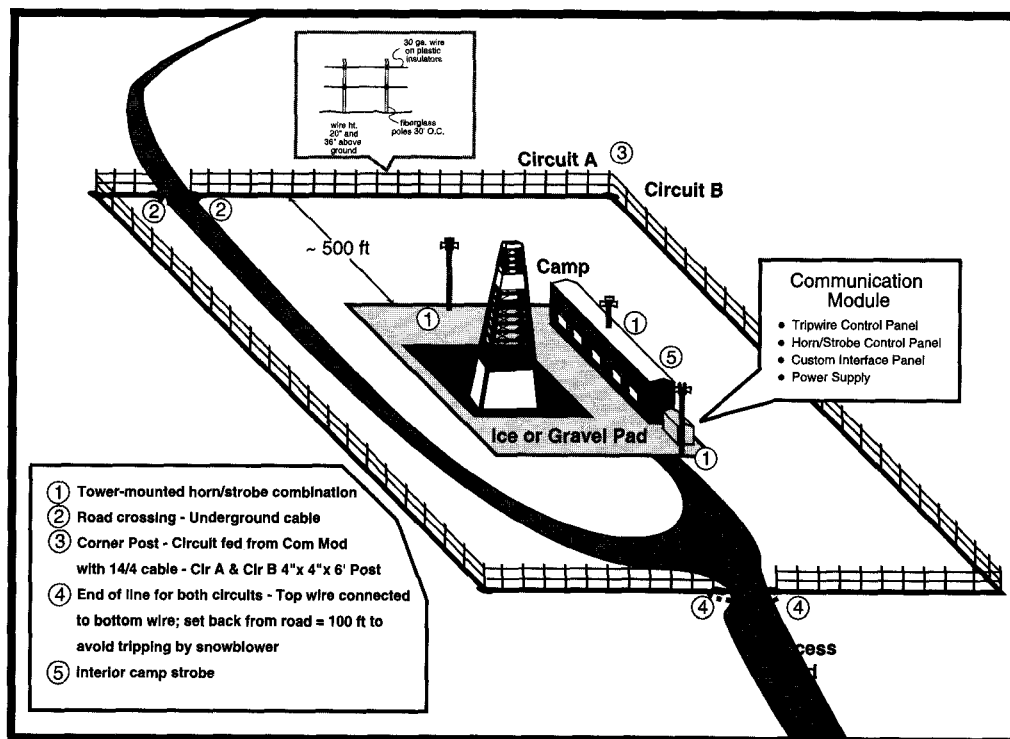

Figure 4-1. Typical layout of trip-wire system at an exploratory drilling island (modified from CONOCO, Inc.)

Some security systems that expect many trips employ a secondary step involving identification of the intruder, using another detection method activated only after the main system is triggered. For example, a radar system may detect movement near a rig. An infrared imager could then be used to determine whether the target was human, bear, or fox. Another system uses a combination of microwave and video mounted together as a unit. A trip of the microwave beam automatically activates the video (can be low light, night vision or infrared) which is transmitted to the guard. This tends to be a more expensive approach but may be useful at certain sites.

A discussion of the specific attributes of various detection systems follows. The amount of available information varies with the type of system. There are four general categories of practical approaches to bear detection: bear guards, physical barriers, electronic barriers, and remote sensing devices.

BEAR GUARDS

Bear guards are sentinels employed to alert workers when bears approach. Guards can be humans or dogs, or the two can be used in combination.

Human Bear Monitors

Description: Workers may be hired to stand watch either as a full time job, or as part of their other duties (See CHAPTER 6). Bear monitors are recommended for all operations regardless of the other systems used. A bear monitor's duties may involve periodic scanning of the area or reconnaissance trips on snowmachines or helicopters in the rig vicinity. Other situations may involve a crew member assigned to keep a lookout for bears during work assignments away from a permanent camp. Keeping track of bears while they remain near a facility is also another useful function.

Advantages: Properly trained monitors can respond to unique circumstances beyond the capabilities of other systems. Local hunters with experience and knowledge of sea ice and bear behavior can often contribute to a safer operation.

Limitations: Extreme weather conditions, darkness, cold, and fatigue all limit even the best monitor's ability to detect bears. The quality of individual monitors will be highly variable.

Effectiveness: Under certain circumstances using bear monitors can be an effective method independently of other systems. Success is largely a function of the individual workers involved. Interest, motivation, training, and a schedule that prevents fatigue are probably the most important factors. It is important to have individuals designated as bear monitors rather than just telling everyone to keep an eye out for bears (See CHAPTER 6).

Cost/Availability: The cost and availability of effective bear monitors vary greatly from place to place.

Tested/Used?: See CHAPTER 6.

Bear Dogs

Description: Dogs can be used to alert people to the presence of bears. Dogs must be staked out and cared for by an experienced handler. They should be fed once a day and care must be taken so dog food does not become a bear attractant. Dogs can be used in conjunction with bear monitors.

Advantages: Barking dogs may deter an approach by a bear.

Limitations: As with humans, weather, darkness, and cold can cause problems. Dogs aren't constantly vigilant and may be caught unaware; individual dogs will vary in response. Prior to their use, dogs should be trained around bears, which is extremely difficult. Dogs may even attract bears and be killed. Barking is the usual alarm and it could be missed. Dogs must be properly cared for and fed but not treated as pets, which takes experience and time.

Effectiveness: The effectiveness of dogs is highly variable. Trained dogs can be used to detect nearby bears, but cannot be relied on to always detect a bear.

Cost/Availability: Well-trained bear dogs are practically unavailable, and even if obtainable are very expensive.

Tested/Used?: Dogs have been used traditionally in the arctic to hunt bears. Dogs have proven useful

for detecting polar bears in Spitsbergen (Nyholm 1976). Some work in Canada has also demonstrated the potential use of dogs (Carpenter 1989); it is possible that the former Soviet Union will be a potential source of dogs and information about their use. Many breeds of bear dogs are still being trained and used there.

PHYSICAL BARRIERS

Physical barrier systems use wires that encircle a site. An important consideration is the total length necessary to adequately enclose the site. This can be as much as 2600-3200 feet (850-1050 meters) if the wire is placed 100-250 feet (33-82 meters) away from the edge of the facility. Other important aspects of physical barriers are the support poles on which the wire is hung and potential problems with wind, ice buildup, snow drifting, and snow removal. Barriers should be accompanied by a built-in alarm system (See Appendix 4-1). A summary of the advantages and applications of the various systems is provided in Table 4-1. Addresses of manufacturers of the various systems are contained in Appendix 4-2.

Trip-Wire System

Description: One to three strands (usually two) of thin (30 gauge) wire strung on support poles can encircle facilities from small camps to exploratory rigs (Fig. 4-1). Support poles must be anchored in the snow—it may be necessary to drill holes in the ice and freeze them into place. Also, the support poles should not be so flexible that they bend over or break instead of the wire breaking. The lower strand is at a minimum height of 20 inches (0.5 meters) which prevents foxes from tripping it, and a second wire can be strung at 36 inches (0.9 meters). An approaching bear triggers the alarm (Fig. 4-2) by walking through and breaking the wire. The fence should be located at least 30-100 feet (10-33 meters) from the edges of the facility. It should be far enough to provide time for workers to respond to an intruding bear, but if it is too far from the edge of the facility, snow removal and maintenance can be a problem. The system works best if the perimeter is separated into two to four segments so that the general area that has been penetrated can be readily identified. It can be powered by batteries or by the camp generator.

Advantages: Trip wire systems are inexpensive, portable, and relatively easy to install and maintain.



Figure 4-2. Exterior alarm (strobe and horn mounted on tower) and floodlights facing outward toward trip wire were part of CONOCO's detection system at "Badami II" drillsite (D. Shideler).

They can be used in a wide range of situations.

Limitations: There is the possibility that a bear could get through the wire barrier without breaking it (Woolridge and Gilbert 1979), or that the wire could break as a result of ice-loading and wind (Woolridge 1978). Existing systems must be manually reset—breaks in the wire require splicing or possible replacement. The system may require considerable maintenance if many breaks occur. Preliminary tests of an auto-reset trip wire showed promise but the project was terminated without definitive results.

Effectiveness: The trip wire system is one of the most effective systems tested to date. In tests, trip wires detected 100% of all bears and have been refined to the point where they function well with few false alarms (Stenhouse 1982, 1983). When properly set up and maintained, such systems are very reliable, and minor modifications could make existing systems even more reliable.

Cost/Availability: Costs range from as low as \$175 for a trip wire kit for small camps to as much as \$14,000 for a complete modified system that is integrated into the alarm system at the drill rig. Materials purchased and skills developed during the initial application can be re-used to lower the costs at subsequent operations.

Tested/Used?: This is one of the better tested and most often used systems (Graf et al. 1993; Gary and Sutherland 1989; Stenhouse 1982, 1983; Stenhouse and Cattet 1984; Woolridge 1978, 1980, 1983, and Gilbert 1979). Trip wires have been used around North Slope Borough whale research camps (C. George, North Slope Borough Dept. Wildl. Manage., pers. comm.). A modified trip-wire system was used during winter 1991-92 at the CONOCO Milne rig in Alaska with good results (Appendix 4-1).

Proximity Detector

Description: An electrical current or radar field is directed along a set of wires that form a perimeter fence. At close range, an approaching human or animal creates a change in the field, triggering an alarm.

Advantages: The system is lightweight, portable, easy to set up and take down, and effective.

A commercially available system called REPELS has three sensitivity settings that should make it relatively selective. The wires simply guide radar rather than carrying current so they can be easily tied in case of breaks.

Limitations: Anchoring the fence poles during installation may be difficult. REPELS is expensive per unit length of perimeter and may be prohibitive for protecting large areas.

Effectiveness: It is unknown how reliable the system is under arctic conditions.

Cost/Availability: A REPELS kit for a 100-yard (100-meter) perimeter costs about \$10,000.

Tested/Used?: An earlier 22 gauge, 7-strand nylon insulated-wire system built by Woolridge was ineffective (Gary and Sutherland 1989; Woolridge 1978, and Gilbert 1978). The new REPELS system, though untested in the field, appears to address the problems encountered by Woolridge. Tests are needed to examine the effects of extreme cold on the equipment and the power source and to evaluate the system's ability to detect polar bears but not give false alarms for foxes.

ELECTRONIC BARRIERS: BISTATIC SYSTEMS

Instead of using a wire fence enclosing a facility, electronic barriers employ paired units—transmitters or emitters with receivers, usually placed at the corners of the protected perimeter. These create an electronic fence that is sensitive to intruders.

Microwave/Bistatic Surveillance Radar

Description: A transmitter beams a microwave signal along a section of perimeter to a receiver. Any movement within the beam triggers the alarm. It is possible to set threshold levels to reject some targets. A portable model with limited terrain-following potential will soon become commercially available.

Advantages: Microwave motion detectors may be suitable for larger, semi-permanent facilities.

The system automatically resets. Portable models requiring no alignment might have applications for emergencies.

Limitations: Cold below -40° Fahrenheit and irregular terrain cause problems. Most units require careful

alignment. Winds over 70 miles per hour (113 kilometers per hour) can cause vibrations that result in false alarms, but using a center-mounted instead of the side-mounted model can help. An enclosure can be used to prevent exposure to low temperatures and bears, or a small heating element (like an oil pan heater) can be attached to the units (M. Henry, Alyeska Pipeline, Anchorage, pers. comm.). The relatively short effective range between the transmitting and receiving units may limit the use of these systems at larger facilities or necessitate the use of two overlapping pairs to protect one long side of the perimeter.

Effectiveness: This system is very effective.

Cost/Availability: Center-mounted long-range models such as RACON (series 14000) cost about \$3,600 per transmitter-receiver (T/R) pair. A portable system, such as RACON PRLS that should be available in 1993, will cost about \$40,000 for a set of four.

Tested/Used?: A version of the RACON microwave unit underwent preliminary tests at Churchill, Manitoba (Stenhouse 1982 and 1983). Arctic and red foxes triggered the system during the tests (Stenhouse 1982), but apparently it may be possible to set threshold levels that could ignore foxes. Tests to establish this are needed before its widespread deployment. Some combination microwave/video units are being produced where a trip of the microwave beam automatically activates a surveillance camera pointed at the section where the trip occurred. The forthcoming portable PRLS system should also be field tested when it becomes available to determine its practicality and usefulness.

Laser

Description: The laser system consists of a high-energy laser light source transmitting to an optical receiver. This forms a photoelectric trip beam that, when interrupted, triggers an alarm.

Advantages: The narrow beam of a laser can be positioned high enough so that foxes won't trip it.

Limitations: Anything that breaks the beam triggers the alarm. Woolridge apparently found it effective at 0.6 miles (1 km) during heavy snow (Gray and Sutherland 1989), but other indications are that dense fog could be a problem (Korschgen and Green 1983). The effects of extreme cold are unknown.

Effectiveness: Unknown.

Cost/Availability: Unknown.

Tested/Used?: Lasers have not been tested with bears. One study used the system to monitor bird movements (Korschgen and Green 1983). More tests on the limitations caused by weather and the effectiveness in detecting bears in the field are needed.

REMOTE SENSING DEVICES: MONOSTATIC SYSTEMS

These systems consist of single units that scan areas surrounding a facility. They may sense changes in background levels of heat (passive infrared) or create a microwave/radar field and detect changes in the field caused by movements of intruders. They operate on line of sight, and while useful for detecting distant approaches on level terrain or movement through a narrow area, they can present logistical problems when monitoring facility perimeters.

Monostatic Surveillance Radar/Microwave Transceiver

Description: These systems consist of a single unit that uses microwave/radar in either the X band (around 9.4-10.5 GHz) or the K band (around 24.1 GHz) and Doppler shifts to detect the presence of an intruder moving within the detection zone.

Motorola's Monostatic Surveillance Radar (MSR) consists of an antenna/receiver/transmitter in the X band, a signal processor, and a control display unit. It is portable and weighs only 35-75 pounds (16-34 kilograms) without batteries. This radar system is a point sensor that transmits and receives an X-band radar signal and uses Doppler shift to detect motion from 1-5 miles (2-8 kilometers) away in its line of sight.

Southwest Microwave has a microwave transceiver that also uses a field disturbance system to detect intruders. Their unit has a potential range cut-off feature to allow detection zones ranging from 50-200 feet in the X band or 100-400 feet in the K band. The range cut-off prevents distant activity beyond the area of

interest from triggering the alarm. Four or more transceivers can be employed to protect a perimeter.

Advantages: The MSR units are lightweight and portable. They can determine range, azimuth, velocity, and indicate whether the target is moving toward or away from the user. Resetting is unnecessary, and the system theoretically should require little maintenance. Some distance, size, and speed parameters can potentially be set to limit false alarms. Transceivers have advantages over bistatic systems since alignment is unnecessary.

Limitations: The MSR units are expensive and may not allow complete coverage of the area around the site. Both systems require some kind of heating during extreme cold. False alarms (from foxes, for example) will create problems.

Effectiveness: Both systems should be very effective.

Cost/Availability: The MSR units cost about \$100,000, but costs are expected to drop significantly. Transceivers cost about \$1,854 apiece.

Tested/Used?: The system needs testing under arctic conditions; its reliability under field conditions is unknown. It could be used in combination with another system that could identify distant targets detected by the radar or intruders tripping the microwave transceiver.

Infrared Devices

Description: There are two types of infrared detection devices—thermal imagers and sensors. Both detect heat sources.

A thermal imaging device is in effect a camera that uses heat instead of light to produce the image. A video display can be monitored or an alarm can be rigged to trigger at the appearance of a heat source in the field of view. The device operates in the 8-12 micron band and is capable of detecting temperature differences of 0.3° Fahrenheit (0.16° Centigrade). The imager can be mounted atop a tower and rotated on a Gimbal mount.

The second type of infrared device (in the 8-14 micron range) is merely a passive sensor that triggers an alarm when a moving target changes the background radiation in the telescope's field of view. Sensors can detect temperature differences of 1.8° Fahrenheit (1° Centigrade) with a 500 foot (164 meter) nominal detection range for humans.

Advantages: The imager can scan at considerable distances and should be able to identify and follow animals even through darkness and fog. Sensors are also very effective at detecting targets.

Limitations: The imaging technology is still very expensive, and requires a fair amount of maintenance. More practical solid-state infrared imagers should become available in the near future. Foxes as well as bears will trigger the alarm, and infrared systems would have to include a means of identifying the target.

Effectiveness: Theoretically, infrared systems should be good at detecting bears.

Cost/Availability: Imagers can cost \$130,000 new and are readily available. Passive infrared sensors cost about \$5,000 for a set of four.

Tested/Used?: Preliminary tests of older infrared technology demonstrated that the 8-14 micron band could readily detect bears and other animals in high winds (31 miles per hour or 50 kilometers per hour) and low temperatures (1° Fahrenheit or -17° Centigrade) (Fitch and Hoos 1986). Newer imaging systems need testing, but it is probably best to wait for solid-state technology. Lack of selectivity will limit the usefulness of passive infrared sensors.

Surveillance Systems

Description: Standard security systems such as surveillance cameras (low light, infrared, and night vision) could be used alone or in combination with lighting or infrared illuminators to help bear monitors detect bears.

Advantages: These systems could be used along with other systems to determine what actually triggered the alarm. (See Microwave/Bistatic Surveillance Radar.)

Limitations: Their operation is limited to some extent by severe environmental conditions and they require an operator.

Effectiveness: They can be effective under the right conditions.

Cost/Availability: Variable.

Tested/Used?: The SSDC does use cameras to view ice conditions not visible from the deck and to check for bears before on-ice activities. They haven't been widely used or tested specifically for detecting polar bears.

MATCHING DETECTION SYSTEMS TO FACILITIES

Because of the variety of activities associated with offshore oil development, flexibility of approach is important. Both similarities and differences exist between problems encountered during seismic exploration and those encountered around production facilities. Responses to emergencies such as oil spills present particular problems in bear detection.

Large, permanent production facilities can afford more elaborate systems. Units such as microwave motion sensors may initially be more expensive and difficult to install, but they have long-term advantages related to efficiency and maintenance. Problems with these systems may arise from false alarms (such as those caused by foxes).

Bottom-founded drilling units such as CIDS's and SSDC's are protected from bears by their steep-sided structure and do not normally need perimeter protection (See CHAPTER 8). Bear detection systems are necessary in these cases only when snow or ice ramps provide potential access by bears to the deck areas, or when workers engage in operations off the rig such as loading supplies or conducting oil spill drills.

Drilling operations on gravel and ice islands are temporary operations with large potentials for bear problems. Perimeter protection is important and the trip-wire system probably is the best readily-available option at present.

Crews responding to emergency situations such as oil spills could use portable systems that can be set up quickly and easily. Trip wires and some of the new untested technology such as the RACON PRLS may be useful during such emergencies. Human monitors also are usually needed under such circumstances.

People doing seismic work, resupply, or any work outside protected areas at larger facilities are best protected by having designated bear monitors. These monitors would be responsible for routine checks for bears (See CHAPTER 6) though they may have other duties as well.

SUMMARY

Detecting polar bears in the vicinities of offshore industrial sites in the Alaskan arctic is important for human safety as well as for the welfare of bears. No one system will address the variety of problems encountered at all types of facilities (see Table 4-1).

Human monitors designated to watch for bears (often in combination with another type of system) are useful at most kinds of operations as are well-lighted work areas. Mobile work crews away from lighted facilities also are best served by bear monitors.

At gravel and ice-island drilling rigs, trip-wire systems have proved useful and effective. Larger, longer-term operations might make good use of some of the more expensive technology. New developments in microwave, radar, and infrared security devices are now becoming available commercially. Anticipated cost reductions for doppler radar units and the expected availability of solid-state infrared technology in the next year or so may provide other options.

The importance of effective, reliable detection systems and the availability of promising but untested security systems indicates that more field testing is needed. Because of the specific needs and extreme climate, detection systems must be tested under actual conditions so research scientists and facilities operators can determine which are best for the various applications relating to offshore oil exploration and production.

Table 4-1. Summary of characteristics and potential applications of various detection systems.

DETECTION SYSTEM	SUMMARY	APPLICATIONS
TRIP WIRE	<ul style="list-style-type: none"> Effective Selective Relatively inexpensive Relatively high maintenance Well-tested; ready to use 	<ul style="list-style-type: none"> Small camps Gravel and ice islands
PROXIMITY DETECTOR	<ul style="list-style-type: none"> Effective Probably selective Relatively expensive Relatively high maintenance Needs testing 	<ul style="list-style-type: none"> Similar to trip wire
MICROWAVE	<ul style="list-style-type: none"> Effective Possibly not selective Expensive Relatively difficult to install, easy to maintain Needs more testing 	<ul style="list-style-type: none"> Suitable for more permanent facilities if questions regarding selectivity resolved
INFRARED	<ul style="list-style-type: none"> Effective Not selective; need to identify targets Inexpensive Moderate maintenance Needs Testing 	<ul style="list-style-type: none"> Not recommended
RADAR	<ul style="list-style-type: none"> Effective for line of sight movement Not selective; need to identify targets Expensive Installation and complete perimeter coverage difficult Needs testing 	<ul style="list-style-type: none"> Might be useful in conjunction with systems that identify targets.
CONVENTIONAL SECURITY SYSTEM	<ul style="list-style-type: none"> Various surveillance cameras and other systems may have potential in certain applications but require testing 	<ul style="list-style-type: none"> Might be useful in conjunction with other systems such as infrared and radar

LITERATURE CITED

- Carpenter, W. D. 1989. The Canadian Eskimo dog: the original defence against the polar bear. (Abstract only). Page 71 in NWT Dept. of Renewable Resources. Bear-people conflicts: Proc. of a Sym. on Manage. Strategies (1989). NWT Dept. of Renewable Resources, Yellowknife.
- Fitch, R., and L. M. Hoos. 1986. A study to evaluate infra-red thermography techniques for detecting polar bears (*Ursus maritimus*) at Cape Churchill, Manitoba, November, 1984. Pages 2-23 in Infra-red detection and acoustic deterrent study, Cape Churchill, Manitoba, 1984. NWT Dept. of Renewable Resources, Yellowknife. File Rep. No. 55. 49pp.
- Graf, L. H., P.L. Clarkson, and J. Nagy. 1993. Safety in bear country, a reference manual, Second edition, Dept. of Renewable Resources, Government of the Northwest Territories, Yellowknife, NWT. 146 pp.
- Gray, P. A., and M. Sutherland. 1989. A review of bear detection systems. Bear-people conflicts: Proc. of a Symp. on Manage. Strategies (1989). NWT Dept. of Renewable Resources, Yellowknife.
- Korschgen, C. E., and W. L. Green. 1983. A laser system to remotely sense bird movements. J. Wildl. Manage. 47(4).
- Nyholm, E. 1976. On polar bears in Spitzbergen. Pages 12-29 in Norwegian Polar Yearbook, 1975-76, Norsk Polarklubb, Oslo. (In Norwegian.)
- Stenhouse, G. B. 1982. Bear detection and deterrent study, Cape Churchill, Manitoba, 1981. NWT Dept. of Renewable Resources, Yellowknife. File Rep. No. 23. 64pp.
- _____. 1983. Bear detection and deterrent study, Cape Churchill, Manitoba, 1981. NWT Dept. of Renewable Resources, Yellowknife. File Rep. No. 31. 58pp.
- _____, and M. Cattet. 1984. Bear detection and deterrent study, Cape Churchill, Manitoba, 1981. NWT Dept. of Renewable Resources, Yellowknife. File Rep. No. 44. 62pp.
- Woolridge, D. R. 1978. Deterrent and detection systems. Rep. to NWT Govt., Yellowknife. 40pp.
- _____. 1980. A field study of electronic polar bear detection and deterrent devices: Churchill, 1980. Rep. to NWT Govt., Yellowknife. 45pp.
- _____. 1983. Polar bear electronic deterrent and detection systems. Int. Conf. Bear Res. and Manage. 5:264-269.
- _____, and B. K. Gilbert. 1979. Polar bear detection and deterrent systems. Rep. to NWT Govt., Yellowknife. 37pp.

CHAPTER 5. DETERRENT METHODS

DICK SHIDELER
Alaska Department of Fish and Game
1300 College Road
Fairbanks, Alaska 99701

During the autumn, 1992, whaling season at Barrow, about 30 polar bears were attracted to beached whale carcasses near the village. Fearing for the safety of villagers and the bears, Federal, State, and Borough biologists used noisemakers and plastic bullets to scare the bears away. However, many bears learned to ignore these devices (C. George, North Slope Borough Dept. Wildl. Manage, pers. comm.) and by October it became necessary to "drive" bears away using helicopters and snowmachines. Although the helicopters initially moved the bears, some quit avoiding it and responded only to snowmachines. By this combination of techniques, the bears were safely escorted away from the village (J. Burgner, North Slope Borough Dept. Wildl. Manage., pers. comm., G. Carroll, Alaska Dept. Fish and Game, pers. comm.).

While studying polar bears at Spitzbergen Island in northwest Norway, Erik Nyholm used Karelian bear dogs to warn him of polar bear visits and to scare the bears away. On numerous occasions the dogs were used to drive off persistent bears which would have been shot otherwise (Nyholm 1976).

Waterfowl biologists near Churchill, Manitoba, installed an electric fence around their camp to protect them from polar bears which frequented the area during summer and fall. Prior to fence installation, at least seven bears had entered the compound. After fence installation, no bears entered the compound (Davies and Rockwell 1986).

Under current provisions of the U.S. Marine Mammal Protection Act, it is illegal for unauthorized persons to deliberately harass polar bears. To "harass" includes some methods used to deter bears. Therefore, only authorized persons from Federal, State, or local wildlife agencies can legally use some methods on polar bears in the United States.

This chapter is intended to guide individuals that may be authorized to deter polar bears and to provide the theory and methods of deterrence to achieve improved site design and operations. We describe deterrent methods that can be used without specific authorization, and those that can be used only by authorized personnel (Table 5-1).

WHAT IS A DETERRENT AND HOW DOES IT WORK?

Simply stated, a deterrent is a means of preventing bears from reaching a goal that people don't want them to reach. A repellent is a specific type of deterrent that is portable and activated by an individual to protect himself or his equipment. For example, the Karelian bear dogs and the projectiles used in firearms described at the beginning of this chapter are repellents, but the electric fence is a deterrent.

Polar bears are "goal-oriented". Deterrents attempt to short-circuit goal-oriented behavior in at least one of three ways: (1) by creating barriers to prevent bears from reaching their goals; (2) by scaring bears so that goal-oriented behavior is interrupted and they leave; or (3) by causing physical pain so the bears leave. To be effective, the deterrent should be painful, as well as startling, because bears quickly habituate (learn to not respond) to nonpainful stimuli.

Table 5-1. Summary of authorization status for various methods of deterring polar bears in Alaska. This table is a summary of our interpretations of actions which could result in a "take" of a polar bear and may cause problems for the operator.

Deterrent Type ⁽¹⁾	No Authorization Required (Passive)	Authorized Use Only (Active)
Bear Monitors ⁽²⁾		X
Biological Sounds	X	
Physical Barriers, Containers	X	
Electric Fences	X	
Artificial Light	X	
Noisemakers		X
Dogs ⁽²⁾		X
Vehicles, Helicopters		X
Chemical Spray		X
Chemical Coatings	X	
Projectiles		X

(1) Operators should check with U.S. Fish and Wildlife Service, Marine Mammals Management, Anchorage, Alaska, for current status and to determine what constitutes a "take".

(2) Assumes these will be used for active deterrence, as opposed to detection only.

GENERAL GUIDELINES FOR DETERRENT USE

Persons responsible for deterring bears can carry out their jobs more easily and safely by following a few basic guidelines:

- **Reduce or eliminate attractants.** Bears will be much easier to deter if potential attractants are reduced or nonexistent.
- **Ensure that bears can escape easily.** If you attempt to drive a bear away, make sure the bear has clear and alternate escape routes. Remember that bears do not always move in the direction you desire, so make sure acceptable alternatives are available.
- **Have a backup or escape route for deterrence personnel.** Have a person trained in firearms use present (if firearms are allowed), and have a clear escape route for all personnel involved in deterrence.
- **Ensure that other personnel are in a safe place.** Make sure that personnel cannot inadvertently encounter a bear that is being deterred, and that they are not in the path of deterrents that may cause injury (e.g., projectiles, vehicles).
- **Deter in a biologically relevant direction.** Bears will be more easily deterred toward the sea ice, or the direction from which they came.

EVALUATION OF DETERRENTS AND REPELLENTS

Deterrents have been tested since people first encountered bears. For the oil and gas industry, deterrents which will likely be most effective should:

- Be applicable to all sex and age classes of bears.
- Be effective under a broad range of Arctic conditions (e.g., temperature, wind, ice loading).
- Obtain the desired response without injuring bears or people.
- Allow the bear to perform the desired behavior (e.g., to escape or avoid a situation).
- Be easy to use with minimal personnel training.
- Be consistently used in a variety of places and settings.

Unfortunately, no deterrents meet all these criteria, so it is necessary to select the most effective deterrents for anticipated use. In general, it is unwise to rely on only one deterrent. The selected deterrent will be most effective when it is integrated with an effective alarm system, and proper site design and operations (See CHAPTERS 4 and 8). Personal repellents should be used only when a backup equipped with a firearm is present, unless an emergency situation occurs.

The following types of **deterrents** are evaluated:

- Bear monitors
- Biological sounds
- Physical barriers and containers
- Electric fences
- Artificial light
- Noisemakers
- Dogs
- Vehicles and helicopters
- Chemical sprays and coatings
- Firearms-propelled projectiles

We describe each deterrent or repellent, discuss its proven or potential effectiveness and assess its advantages and the precautions necessary for its use on polar bears. For this evaluation we relied heavily

on the Canadian Safety in Bear Country manual (Graf et al. 1993), research by the Northwest Territories Department of Renewable Resources, and deterrent experience elsewhere in Canada and Alaska. We also include methods used on grizzly bears that appear promising for use on polar bears—these are specifically identified to set them apart from proven techniques on polar bears. Applicability of methods to various activities and types of installations that may be involved in oil and gas exploration and production are summarized in Table 5-2.

Bear Monitors

Description: Bear monitors often are Inuit (Canada) or Inupiat (Alaska) Eskimos that are hired as full-time monitors because of their extensive experience with bears. They often have other responsibilities as well but their job is to watch for bears and take deterrent action if needed. For example, in Alaska there may be one monitor per 12-hour shift who makes visual sweeps of an area hourly, thus fulfilling a detection rather than deterrent role. Monitors often prepare reports of bear sightings and some may be lookouts during on-ice activities such as spill drills or loading of supplies from rolligon trains (See CHAPTER 6).

Effectiveness: Effectiveness of monitors varies with the individual's sense of responsibility, training, and experience. Highly motivated individuals with experience around sea ice and polar bears are probably most effective because they can select the best response to fit the particular conditions.

Advantages: Monitors are mobile, and if trained in deterrent techniques, can select the most appropriate one for a particular situation. They can ensure that potential deterrent actions are planned for various kinds of operations, and usually they can function under a variety of environmental conditions.

Precautions: Effectiveness can be reduced by human psychological factors (e.g., boredom, fatigue, lack of motivation) and environmental conditions (e.g., cold, wind, poor visibility). Use of monitors requires an effective communications system. Supervisory personnel must recognize the importance of the monitor's role and consider his advice when appropriate. The monitor usually must be close to the bear to take deterrent action, risking injury if the bear is not deterred. An unskilled or untrained monitor can give the crew a false sense of security.

Biological Sounds

Description: Biological sounds are those that are relevant to the bears, such as those used by bears for communication. Electronically synthesized aggressive polar bear "roars" between 100 and 600 Hertz (Hz) frequencies, with proper changes in amplitude over time broadcast directionally at over 120 decibels from strategically placed loudspeakers provide the most promise (Wooldridge 1978, Wooldridge and Belton 1980).

Effectiveness: Bait station tests at Churchill, Manitoba, resulted in 70% of the polar bears avoiding baits. Since these tests were conducted on hungry and often habituated bears, a better response might be expected with "naive" bears. Only one bear, a female with cubs, reacted aggressively and she subsequently avoided the sounds also. Sounds were effective out to several hundred meters from the sound source (Wooldridge 1978).

One field application was tried at a Beaufort Sea drill rig. Only one bear was tested and it withdrew at a distance of 875 yards (800 meters) and continued to withdraw (Wooldridge and Belton 1980).

Advantages: This system is easy to install at fixed sites (e.g., at corners of a drillpad) or on mobile vehicles (e.g., on a security patrol vehicle). It does not require close contact with bears. It can be operated with a minimum of training, does not require major site modification, and can be integrated with a detection/ alarm system. It is useful under a broad range of environmental conditions and will not harm the bear. The major advantage of this system over noisemakers is that bears have negative experiences with similar natural sounds from other bears. Bears did not habituate to the sounds.

Precautions: Although this method has promise (it was 70% effective during tests at Churchill), it has not been adequately evaluated under field conditions. If not played loudly (over 120 dB measured 3 feet or 1 meter from speaker), these sounds can attract curious bears. Also, noises from drill rigs or processing facilities may mask the sounds. The sound should be broadcast directionally so the target bear can easily escape. Best location for the sound source is at the outer edge of a facility to deter an approaching bear rather than in the interior of a site where a bear may not be able to locate and avoid the source.

Table 5-2. Effectiveness and feasibility of various deterrents for selected oil and gas activities.
(1=poor, 2=moderate, 3=good, 4=promising but insufficient data, N=not applicable or unnecessary.)

	Temporary camps (seismic or rolligon trains)		Winter exploration (ice, gravel, or natural island)		Summer exploration (gravel or natural island)		Production (gravel islands)		Caisson (on-ice supply or drills) ^(a)	
	Effect.	Feas.	Effect.	Feas.	Effect.	Feas.	Effect.	Feas.	Effect.	Feas.
Bear Monitors	3	3	3	3	3	3	3	3	3	3
Biological Sounds	4	2	4	3	4	3	4	2	4	3
Barriers										
Skirting	N	N	2	3	2	3	2	3	N	N
Fences	N	N	2	3	2	3	2	3	N	N
Entry cages	3	1	3	3	3	3	3	3	2	2
Containers	3	3	3	3	3	3	3	3	N	N
Electric Fences	4	4 ^(b)	4	4 ^(b)	3	3	3	4	3	4 ^(b)
Lights	4	3	3	3	N	N	3	3	3	3
Shots, Firecrackers	1	3 ^(c)	1	3 ^(c)	1	3 ^(c)	1	3 ^(c)	1	3 ^(c)
Crackershells, etc.	2	3 ^(c)	2	3 ^(c)	2	3 ^(c)	2	3 ^(c)	2	3 ^(c)
Horns	2	3	2	3	2	3	2	3	2	3
Dogs	3	1	3	3	3	3	3	3	3	2
Vehicles	3	3	3	3	3	3	3	3	3	3
Helicopters	3	1 ^(d)	3	2 ^(d)	3	2 ^(d)	3	2 ^(d)	3	1 ^(d)
Chemicals	2	3	2	3	2	3	2	3		
Projectiles										
Plastic bullets	2	3	2	3	2	3	2	3	2	3
Rubber batons	3	2 ^(e)	3	2 ^(e)	3	2 ^(e)	3	3	3	2 ^(e)

(a) CIDS, SSDC, etc. with small area on ice adjacent to vessel; assumes vessel decks are inaccessible to bears.
(b) Assumes portable, high-visibility fence that is effective on polar bears.
(c) Rated "N" if no firearms allowed.
(d) Feasibility reduced based on likelihood helicopter stationed on-site.
(e) Feasibility reduced because deterrent must be used by authorized security officers, which are not usually available at mobile or temporary sites.

Physical Barriers and Containers

Description: Physical barriers include fences, skirting under buildings, and special-use barriers such as gates on walkways or stairs and exit cages around doorways. They can be used easily at semipermanent or permanent facilities but may not be practical for mobile activities such as seismic exploration or geological reconnaissance.

Fences can be used around an entire site, or just around high-use areas such as the camp. Standard 8 feet (2.6 meters) chain link fences and fences of high-tensile strength "hogwire" ("pagewire" in Canada) are suitable for deterring a bear that is not strongly motivated to enter. Barrier fences should be at least 8 feet (2.6 meters) high (10 feet [3.3 meters] is preferable), and should be attached to steel or treated wood posts that are braced at the corners. The gate should swing outward and close against a post (or a stop strongly attached to a post) so that a bear leaning against the gate will feel no give (Graf et al. 1993). Additional design standards for barrier fences are included in Graf et al. (1993).

Skirting can be used to prevent bears from hiding under raised buildings, from where they could ambush or inadvertently encounter personnel leaving buildings. The open space under the building should be closed completely, or at least under and adjacent to the entrances. Plywood is commonly used. However, closed plywood reduces air flow under the building, which increases heat transfer and can melt underlying ice or permafrost. Chain link or hogwire are good choices for skirting because they allow air circulation and visibility yet keep bears out. New or used hogwire or chain link fencing can be attached at the top to steel girders supporting the building, and at the bottom to clips driven or frozen into the pad (Fig. 5-1).

Exit cages enclose doorways or stair landings to prevent bears from reaching persons exiting buildings and allow personnel time to re-enter the building (A. Derocher, Univ. of Alberta, pers. comm.). Most buildings used in exploratory drilling and production have raised stairways and/or walkways under which a bear could hide (See CHAPTER 8); these are high-risk areas for bear encounters. Although windows for viewing outside are sometimes included in arctic entrances, these tend to frost or fog up and personnel forget to use them. The exit cage should include a locking door that opens outward (so that a bear leaning against it feels no give). It can be built on skids or with fork pockets so that it can be slid away for snow removal. The cage can be built from rebar, chainlink, or similar material in a mesh pattern that allows good visibility yet is stout enough to prevent a bear from pushing or reaching through. The cage dimensions should be large enough, or the mesh small enough, so that a bear cannot reach a person inside (Fig. 5-2).

Bearproof *storage containers* are needed for storing food, garbage, and industrial chemicals when

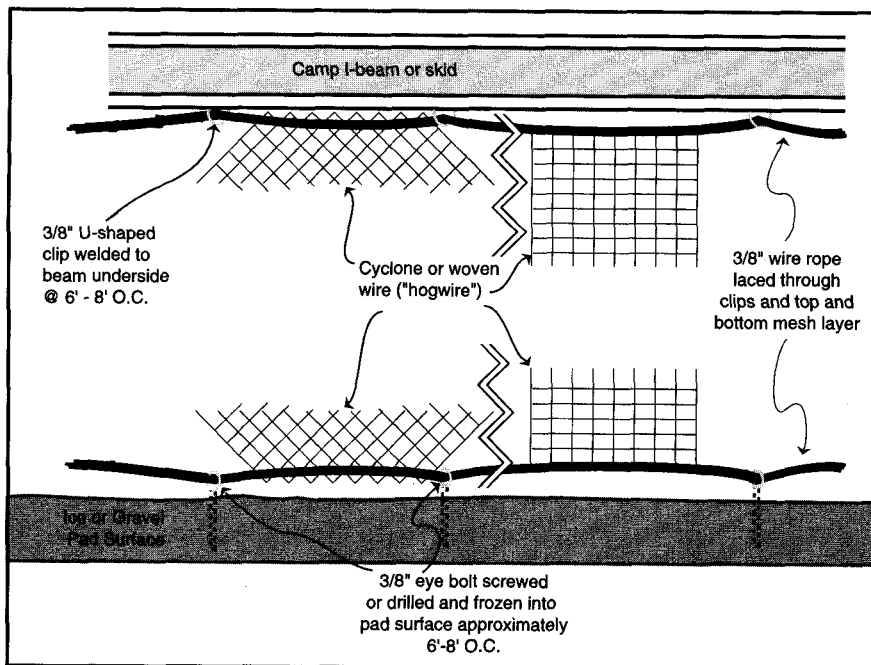

Figure 5-1. Diagram of wire skirting system for elevated camps.

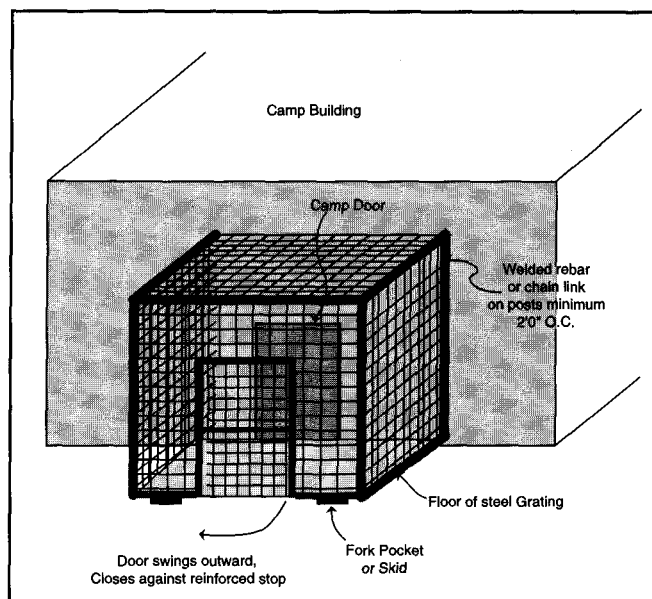

Figure 5-2. Diagram of exit "cage".

buildings are unavailable for storage. According to the Interagency Grizzly Bear Committee, bears access containers by: (1) scratching or clawing until they penetrate the sides; (2) batting or bouncing on the container until it gives way; or (3) gripping an exposed lock, break or seam with teeth or claws and forcing the material apart. They recommended that, for a container to be bearproof, it should be capable of withstanding at least 200 foot-pounds of force and have no external locks or hinges (IGBC 1989).

Containers such as 55-gallon steel drums with locking tops, large military surplus steel ammoboxes with modified bolt-down closures, and specially-constructed steel boxes have been successfully tested for storing food by the U.S. Interagency Grizzly Bear Committee (1989). Small portable containers of ABS plastic have been used successfully by backpackers in grizzly and black bear country. Steel is necessary in polar bear habitat because plastic containers may shatter at extremely low temperatures. Steel containers would be suitable for small seismic testing or geologic survey parties. Larger containers, such as steel shipping containers ("conexes"), have also been used to store food and industrial chemicals.

Bearproof containers are also necessary for the temporary storage and/or transport of garbage. At least two companies market bearproof garbage bins that are used in many U.S. and Canada parks (See Appendix 5-1). The North Slope Borough Service Area 10 (the utility responsible for garbage pickup and disposal around the existing North Slope oilfields and nearby exploration sites) is evaluating bearproof bin designs.

Industrial chemicals should also be stored in bearproof containers. Although bears have been known to puncture 55-gallon steel drums, these are often effective. The standard plywood "mud boxes" used to store and transport dry drilling-mud additives are not bearproof, but drilling-mud does not appear to be a strong attractant. Additives such as salts, which often are stored in bags, should be stacked out of reach of bears or stored inside a building.

Effectiveness: Barrier fences have deflected bears that are not highly motivated to enter. A standard chain link fence deterred a travelling polar bear as it approached the Central Power Station at Prudhoe Bay (C. Clemens, Purcell Services Ltd., pers. comm.). A grizzly at Prudhoe Bay paralleled a 15-foot (5-meter) high plastic mesh snow fence for over 550 yards (500 meters) before returning to its original direction of travel. Observations such as these suggest that barrier fences provide a visual as well as a physical barrier which may prevent access by bears if no strong attractant is present.

Skirting around buildings is effective if there are no strong attractants such as food or sewage under buildings.

Exit cages are promising, but have not been tested.

Steel storage containers (like those used for grizzly bears) should be effective, although they have not been tested with polar bears. Conexes have successfully deterred polar bears trying to obtain stored whale

meat and blubber near Prudhoe Bay.

Garbage bins apparently have not been tested on polar bears. Nevertheless, as with food containers, standard steel garbage containers ("dumpsters") modified with special bearproof lids have effectively deterred grizzly bears (S. Cain, Teton National Park, pers. comm.) and should work on polar bears.

Advantages: Physical *barriers* and *containers* require little if any maintenance. They are easily incorporated into site design and operations, are useful under a variety of environmental conditions, and have little potential for injury to bears or humans. Food and garbage containers reduce the availability of these attractants.

Precautions: *Fences* can be circumvented. Bears have torn through, tunneled under, or pushed down chain link fences around strong attractants such as dumps, so barrier fences alone should not be relied upon to deter a motivated bear. Fences can cause excessive snow drifting, which in itself could provide an entry point into an area. Gates are weak points in any fence because they cannot be fixed in place and because workers may not keep them shut. Although fences may be effective deterrents, when they fail problems can arise because bears may become trapped and, thus, more dangerous and more difficult to deter.

Skirting will not deter a highly motivated bear. Plywood skirting can cause excessive snow drifting and, on ice pads, can result in unacceptable levels of heat transfer from the building to the ice. Therefore, some companies have objected to use of plywood. Chain link or other heavy-duty mesh should provide an acceptable alternative.

Exit cages may give a false sense of security. Employees must look before leaving buildings or stairways and must remember to close the door.

Electric Fences

Description: *Electric fences* suitable for deterring polar bears should produce an electric shock to a conductive surface such as the nose or tongue. The shock should be sufficient to cause an involuntary and locally severe skeletal muscle contraction without interfering with heart function or burning the skin. This requires not only that the "hot" (current-carrying) wire contact a conductive surface, but that the animal has good electrical continuity with the ground or ground wire. Design considerations for electric fences are provided in Appendix 5-2.

Bears usually contact the fence by attempting to go through or under it, or by licking or sniffing it. "Baiting" the fence (such as attaching sardine cans to the "hot wires," or smearing grease on wire "tape") increases the effectiveness of an electric fence because it ensures good electrical contact and frequently causes the bear to roll backwards rather than becoming entangled in the fence. However, "baiting" has several disadvantages: (1) if a site has no other food attractants, the bait could possibly attract a bear that may otherwise not have approached; (2) baiting may appear to be a double standard to personnel at the site, who are required to pick up all trash or food items; and (3) baiting may violate the definition of "take" under the Marine Mammal Protection Act.

Electric fencing should consist of several strands of wire or wire "tape" at sufficient intervals to ensure that the bear will not crawl under, through, or over the fence (Fig. 5-3). The wires are attached to vertical poles that are nonconductive, or if conductive, fitted with insulators. The wires can alternate hot and ground, be all hot, or be a high-visibility tape or composite of both hot and ground wires. Some designs utilize all hot wires on the vertical portion of the fence, with a "mat" of conductive material lying horizontally on the ground below it. Other methods for enhancing the conductivity of the ground include periodically wetting it, or spreading conductive material such as calcium chloride on the surface. Electric fences are often used with a barrier fence as a backup physical deterrent or as a visual barrier. However, some stand-alone, portable applications appear promising.

The fence charger delivers the charge to the wires. There are a number of suitable chargers available (See Appendix 5-2), powered by either AC or DC current. Some models are also equipped with solar panels, a useful addition in summer.

Effectiveness: Any electric fence is only as effective as the strength of the shock delivered to the animal. All bear species present a special problem because their thick fur reduces the chance of skin contact with the fence. Polar bears present an even greater problem than other species because their fur is thicker and denser, and their feet are more furred than other species. A further complication is that snow, an effective electrical insulator, prevents good electrical contact between the bear and the ground. The fence described at the

beginning of this chapter was effective because wet tundra vegetation provided a good ground. That system would be less effective if used on an ice island or dry gravel island. On dry gravel, a ground mat may be used to ensure good ground continuity, but if snow drifts over the mat it could become useless.

One promising solution to the above problems is use of a high-visibility polypropylene "tape", from 0.6 inches (1.5 centimeters) to 1.5 inches (3.4 centimeters) wide, which contains woven hot and ground wires separated by polyethylene cloth (See Appendix 5-2). Tape reduces the chance of the bear contacting only one of the wires, and has the additional benefit of providing a visual stimulus. Baiting the tape with small quantities of fish oil, grease, or other odoriferous material assures that the bear will lick or sniff the fence, thus getting a good electrical contact. This tape can be used in a portable, stand-alone system.

Under the proper conditions an electric fence could be used as a stand-alone deterrent, but its effectiveness can be enhanced by combining it with a barrier fence. The visual stimulus of a barrier fence in combination with the shock from an electric fence should be a good deterrent. The barrier fence may need to be only a visual rather than physical barrier if the electrical fence operates correctly, but such a system is untested.

Advantages: Electric fences are useable under a variety of environmental conditions without requiring human presence. Electric shocks from the fences provide a strong deterrent effect and bears do not habituate to the fence. Relatively permanent installations are available. With proper installation, the fences are harmless to humans.

Precautions: **No electric fence design has been determined to be effective with polar bears on snow or ice.** The design must fit the situation and most designs require routine maintenance to ensure good electrical conductivity. Bears shocked on the torso while going through a fence may destroy the fence. The gate is a weak point and operators may have to settle for a standard barrier gate or use the same hand-operated electrical gate used with portable installations. With experience, some bears may learn to crawl through wires without contacting them (Stenhouse 1982).



Figure 5-3. Fencing may not deter a motivated bear (R. Schweinsburg).

Artificial Light

Description: Artificial light is the illumination provided by the electrical lighting system at industry sites. Bears in the tests at Churchill, Manitoba, and other areas avoided artificial lights (P. Clarkson, NWT Dept. Renewable Resources, pers. comm.).

Effectiveness: Effectiveness of lighting as a deterrent has not been conclusively demonstrated, but much inferential evidence suggests it can be effective for all bears that are not hungry or highly motivated.

Advantages: Lighting is usually a standard practice at most operations and sites. It can serve as both a deterrent and detection system. Immediate human presence is not required. It is harmless to bears and humans, and is easily installed and operated with little additional training.

Precautions: Lighting may not work on all bears and may not be effective during some environmental conditions, such as in fog or whiteouts. **It should not be relied on as the sole deterrent.**

Noisemakers

Description: Noisemakers include explosive devices, such as firecrackers, warning shots, crackershells, and screamers, and sonic devices such as boat horns or sirens.

Warning shots can be fired using conventional ammunition in a shotgun or rifle by aiming away from bears, people, and facilities.

Firecrackers are usually loud explosives such as "cherry bombs," "M-80s," "thunderflashes," and "seal bombs". Roman candles have a strong visual display which may be effective. The effective range of firecrackers is limited by the distance they can be thrown. Slingshots have been used to extend the range.

Crackershells (also called "teleshot" or "twinshot") have an appearance like standard shotgun shells (Fig. 5-4). They are fired from a 12-gauge shotgun with an improved cylinder or open choke barrel. There is an initial report at the muzzle followed by a louder explosion at a range of 82-110 yards (75-100 meters) or more, depending on load. They are fairly accurate although individual loads may vary, sometimes hooking or diving at the outer ranges.

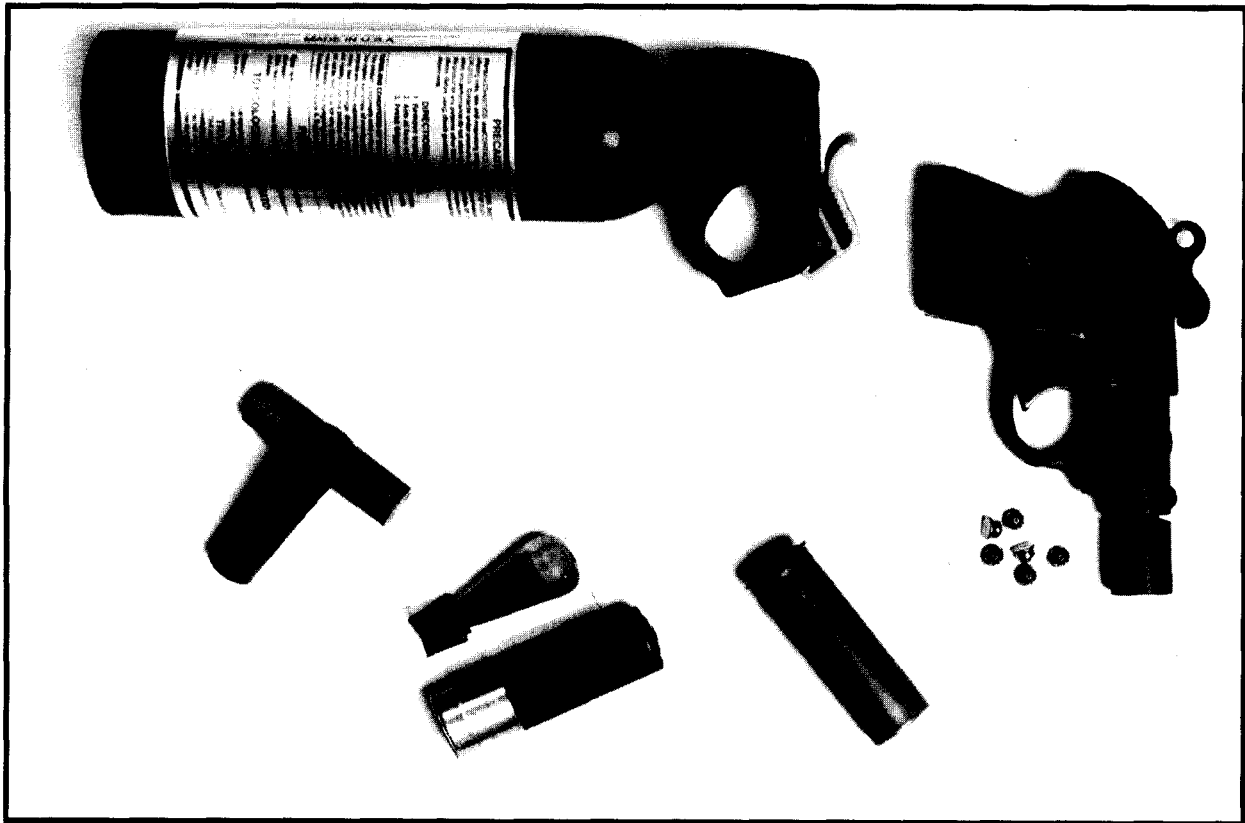

Figure 5-4. A selection of bear repellents. Clockwise from the right: launcher for 15mm scare cartridge, and .22 cal (6mm) blanks used as igniter; 12 ga. "crackershell"; 12 ga. plastic bullet; 15mm "banger" and "screamer" cartridges; capsicum spray.

Screamers are used with a special .22 caliber (15 millimeter) blank pistol (Fig. 5-4). The blank propels and ignites the device, which makes a screaming noise and emits a bright light from the muzzle to the ground. The range is about 110 yards (100 meters) and accuracy is low. The visual display is prominent at night and provides a source of light for observing the bear.

Bangers (Fig. 5-4) have noise characteristics similar to crackershells, but they are fired from the same pistol as a screamer. They are less accurate than crackershells.

Horns include vehicle horns or loud, hand-held "boat horns" using blasts of Freon as propellants. Boat horns allow control over direction and length of blast but not tone. Canisters come in varying sizes.

Sirens may come as small portable models, but are most likely to be mounted on a patrol vehicle or included in a drilling rig's alarm system. Some types emit a relatively steady tone; others "warble".

Effectiveness: The effectiveness of noisemakers, regardless of type, varies considerably among individual bears. Some bears do not respond and they can habituate rapidly if noisemakers are used repeatedly without some other type of physical deterrent such as plastic bullets. Warning shots are probably least effective. Bears at Churchill, Manitoba, have habituated rapidly to cracker shells and to a lesser degree to screamers (L. Brouzes, Manitoba Dept. Renewable Resources, pers. comm.). As noted at the beginning of this chapter, polar bears at Barrow, Alaska, initially responded more to screamers, but eventually could be moved only by firing a crackershell that exploded behind them (G. Carroll, Alaska Dept. Fish and Game, pers. comm.).

As with other noisemakers, the effectiveness of vehicle horns varies. At Churchill, Manitoba, Freon horns repelled approaching bears 81% of the time, but they ran only 5-44 yards (5-40 meters) before slowing down (Miller 1987).

Advantages: Noisemakers are generally harmless to bears although larger firecrackers or crackershells could conceivably injure bears hit in the face or eyes. Stubborn bears have been deliberately hit with crackershells with no apparent harm. Noisemakers are portable, and those launched by firearms provide greater distance between bear and shooter. Crackershells are used in the same weapons used for nonlethal (deterrent) plastic bullets and lethal lead slugs. Horns and sirens are easily used by minimally trained personnel. Warning shots allow immediate use of lethal force if some cartridges remain unfired. All devices are currently available to the public from commercial sources (See Appendix 5-1).

Precautions: Some bears may not react to some or all noisemakers, and those that do react may not leave. Bears will eventually habituate to noisemakers; therefore, other repellents or deterrents should be available.

Warning shots can be safety hazards for bears, people, and equipment.

Firecrackers that are loud or intense enough to repel bears could also injure humans. Their short range allows little chance for further action if the bear is not repelled. Firecrackers are a potential fire hazard around volatile chemicals and gases.

Crackershells present a safety hazard for the shooter due to occasional misfiring either in the shotgun barrel or just out of the muzzle. The shot wad on some earlier models would occasionally jam in the barrel, creating a safety hazard if another crackershell or a lead slug was fired without the barrel being cleared. Cylinder-bore or improved-cylinder barrel firearms must be used. Crackershells will jam in autoloaders. Shooter should practice to gain proficiency, especially in estimating range—a shot past the bear could frighten it toward the shooter. A bear could be injured if hit in the eye. Although crackershells weigh considerably less than lethal slugs or plastic bullets, the similar size of all three makes it easy to mistake one for the other when loading cartridges in tense situations.

Screamers and bangers require a separate firearm (pistol) with special inserts. Cartridges fall out easily, and the pistol is small and hard to handle with gloves or cold hands. They are inaccurate and are potentially harmful if the shooter accidentally hits someone or a bear. They are a fire hazard if used around volatile chemicals and gases.

Horns used at close range provide little chance for further action if a bear is not repelled. A few bears at Churchill, Manitoba, responded to Freon boat horns with aggressive displays before withdrawing (Miller 1987).

Sirens are not as directional as other noisemakers.

Dogs

Description: Dogs are trained to bark at a bear's approach, and to chase it away by biting. Dogs have not been used for either detection or deterrence in Alaska. Eskimo dogs have been used in Canada, and Karelian bear dogs have been used in Russia and Scandinavia (see second example at start of this chapter). Dogs are generally secured unless a handler is with them.

Effectiveness: Well-trained dogs are very effective in driving bears away.

Advantages: Well-trained dogs serve the dual purpose of detection and deterrence, although they must be chained for the former and released for the latter. Dogs can operate in a variety of environmental conditions, although they are less active in severe storms (when bears also are usually less active). Well-trained dogs are not safety hazards, but untrained dogs may run from a bear and lead it back to the handler or the site.

Precautions: **It is necessary to use trained and experienced dogs** to detect and deter bears. Not all dogs will bark at a bear's approach. Dogs must be cared for and they can be killed by a bear. If more than one dog is used, they can injure each other by fighting. The presence of dog food and dog waste can attract bears, and fatigue and boredom can reduce a dog's performance. There is little control over the direction a dog chases a bear; this is important where buildings are not skirted or are set up with dead ends (most drill rigs have some dead ends).

Vehicles and Helicopters

Description: Vehicles that have been used to deter bears include snowmachines, pickup trucks and cars, heavy duty diesel trucks, loaders, forklifts, dozers, and helicopters.

Effectiveness: Polar bears may or may not respond to idling vehicles, but usually respond if drivers move vehicles toward them or change the pitch or loudness of the engine by "revving" it. Bears at Barrow, Kaktovik, and Prudhoe Bay, Alaska, have been chased away with normal highway vehicles, snowmachines, and helicopters. Loaders and forklifts have been used to haze bears off exploratory drilling islands, and from drill pads around Prudhoe Bay. Snowmachines are very effective as evidenced by the example at the beginning of this chapter.

Helicopters have been effective in hazing bears from oil and gas drilling islands, but as the example at the start of this chapter indicates, are not always effective, especially when used by pilots inexperienced in moving bears.

Advantages: Vehicles, and often helicopters, are present at most sites. Vehicles and helicopters are mobile and can "escort" a bear in the desired direction. Operators are less exposed to the bear than when other deterrents are used.

Precautions: Chasing bears too far or too fast can cause injury or death due to overheating and stress. Polar bears, especially adult males, are not efficient runners, and their thick fur and blubber cause them to overheat easily. **Therefore, bears should not be chased for more than 5 minutes before allowing them to rest and cool off.** During the polar bear "roundup" at Barrow, wildlife officials took 4-5 hours to move bears 5-6 miles (8-10 kilometers) (J. Burgner, North Slope Borough Dept. Wildl. Manage., pers. comm.).

If the operator becomes distracted or the vehicle fails mechanically, bears, operators, other personnel, equipment, and/or buildings could be endangered. There are limitations to the mobility of vehicles and helicopters. For example, Prudhoe grizzlies learned that highway vehicles and equipment could not leave gravel pads, and would wait until the vehicle left. Helicopters cannot easily maneuver among buildings. Most vehicles cannot operate effectively during whiteout or other severe weather conditions.

Some polar bears may not respond, or may respond inappropriately, to vehicles and helicopters. Adult male bears, especially, may not respond to vehicles at all, and other bears may have become habituated to vehicles or, worse yet, food-conditioned so that they are attracted to vehicles. Some bears have attacked heavy equipment. During the construction of the Kuparuk oilfield, a polar bear attacked a loader that was trying to move it off a drill site (G. Craig, ARCO Cabot Prospect, pers. comm.). In Canada, a bear attacked a forklift that was protecting a mauling victim (Fleck and Herrero 1988).

Inexperienced pilots hazing bears tend to follow the bear too closely. The bear might either "freeze" in place, or learn that the helicopter won't harm it. It is more effective to remain from a hundred meters or even a mile away, depending on the bear's reaction (R. Schweinsburg, Arizona Game and Fish Dept., pers. comm.).

Chemical Sprays and Coatings

Description: *Sprays* consist of aerosol cans of an active ingredient, a propellant, and a dye that indicates the spray pattern (Fig. 5-4). Generally, the active ingredient is 7%-10% oleoresin capsicum, the chemical ingredient in cayenne pepper, thus the common name "pepper spray." The device consists of an extruded aluminum can and trigger with a safety assembly to prevent accidental discharge. It is marketed as Counter Assault™, BearGuard™ or Back Country Escort™ in the US, and Standoff™ in Canada. Claims of effective spray distance vary among products, but generally do not exceed 26 feet (8 meters). Experience suggests that the spray is effective out to 15-21 feet (5-6 meters), depending on wind conditions. The Counter Assault distributor in Alaska recommends using the product at temperatures above 10° F (-12° C). Informal tests at -10° F (-23° C) produced a liquid stream about 1 inch (3-4 centimeters) in diameter and 9-12 feet (3-4 meters) long.

The bear must be sprayed in the face and eyes. The spray produces a short-term effect of bronchoconstriction and a strong eye and nose irritant. There are no long-term effects on bears or people; most bears sprayed showed effects for 10-15 minutes, thus within this time personnel must get to a safe place or prepare for further deterrent action if necessary.

Coatings include various chemicals, such as ammonia, Pine Sol™, and capsicum, that have been used to coat materials to discourage bears from eating them (Hunt 1985, Miller 1987). They are included here only as last-resort measures to reduce bear damage to certain types of materials such as hoses and electrical cables.

Effectiveness: *Sprays* have been used in five cases with polar bears, all in the Churchill, Manitoba, vicinity. The spray stopped approaches (not necessarily charges) by aggressive bears (Clarkson and Quaife 1991). Sprays have been effective in repelling grizzly and black bears, and are credited with stopping attacks by grizzlies (Hunt 1985), but some grizzlies failed to react at all (R. Smith, Alaska Dept. Fish and Game, pers. comm.).

Coatings used in tests at Churchill involved baits covered with ammonia, Pine Sol™, or capsicum products. Polar bears were repelled in less than 3% of tests with Pine Sol™ (Miller 1987). Polar bears spent less time at ammonia-covered baits than at coating-free baits, but some black and grizzly bears appeared to be attracted by ammonia (Hunt 1985).

Advantages: Sprays are a potential nonlethal alternative where firearms are not allowed. The spray devices are light, portable, and require minimal training for use. They are widely available at sporting goods and other stores. Although accidental discharge could disable the operator over the short-term, there are no long-term harmful effects on bears or humans.

Coatings are nonlethal to humans and other wildlife, although high concentrations could injure people or animals.

Precautions: Use of sprays require several precautions:

- Capsicum spray should be kept in airtight containers when carried in vehicle cabs or aircraft, because if discharged it could disable the operator. Some airlines will not allow capsicum to be carried in the cabin.
- People prone to asthma may experience breathing difficulty if lightly exposed to capsicum spray.
- Each spray can should be tested to insure that it is working properly. There have been several cases with earlier production lots of "Counter Assault" where a can leaked, or the trigger assembly failed to operate properly and the entire can emptied in one blast or did not spray.
- Cans should be replaced after 1-2 years. Some cans have leaked after a year or so from purchase date apparently because the seal between the can and trigger assembly failed.
- During temperatures less than 10° Fahrenheit or -8° Centigrade the can should be kept in a warm spot, such as under a parka.
- The configuration of the trigger assembly on the most common design in the U.S. has resulted in some operators spraying themselves—practice removing the safety and firing a short burst.

- If a human is accidentally sprayed, immediately flush all exposed parts in cold water. Sometimes a hot shower, even several hours post-contact, will reactivate some of the symptoms.
- Spray is very susceptible to wind; therefore, it must be used in a downwind direction.

Coatings have not been rigorously tested. Some do not repel some bears. Strong solutions of ammonia or other chemicals may injure bears.

Projectiles

Description: Three types of projectiles have been successfully used on polar bears and other bear species: (1) 12-gauge "plastic bullet;" (2) "bear thumper;" and (3) 38-millimeter baton guns developed for human riot control. Bird shot fired from a shotgun has also been used, but is not recommended because of potential injury to bears or bystanders. The "thumper" is no longer manufactured and will not be discussed further.

Plastic bullets are also called ferret slugs, bear deterrent rounds, or soft slugs. They are 12-gauge, 112-grain urethane plastic slugs, shaped like a bomb with fins folded inside the shell casing (Fig. 5-4). They are fired directly at the bear from a conventional single-shot, double-barrelled, or (preferably) pump shotgun. They are accurate within a 1-foot diameter circle at 44 yards (40 meters), although affected by wind. More recent models (e.g., Bear Deterrent Round™ and Strike Two™) have greater accuracy and deliver greater energy than older models.

The firearm of choice for plastic bullets is a 12-gauge pump shotgun with: (1) cylinder or improved cylinder bore, (2) rifle sights, (3) slit cut in the magazine cover to assist in extracting a shell should it become jammed, and (4) firing and loading mechanism de-greased for winter use (Clarkson 1989). A pump shotgun is recommended because lead slugs can remain in the magazine in case a bear attacks, while a plastic bullet or crackershell can be loaded into the chamber by hand. However, unlike a single- or double-barrelled shotgun, a pump cannot be broken open at the breech to check for an obstruction in the barrel. **Autoloaders should not be used with plastic bullets or crackershells because they jam!** The firearm can also be fitted with a laser or other light-enhancing sight for low-light conditions.

Rubber batons are fired from a single-shot, specialized gun. The Arwen 37™ baton gun fires a hard rubber cylinder, 37 millimeters in diameter (Graf et al. 1993). The baton usually tumbles end-over-end, and its effective range is 32-55 yards (30-50 meters). It is available only to law-enforcement agencies or security organizations.

A recent, more promising model (SageCO "Puncher"™) modifies the Arwen 37™ to use a rifled baton to improve accuracy and increase delivered energy. The new baton is softer rubber, thus reducing risk of injury without sacrificing energy. It is currently being evaluated at several U.S. and Canadian parks (R. LeBlanc, Banff National Park [Canada], pers. comm.).

Effectiveness: *Plastic bullets* in improved models have not been tested as thoroughly as in original models, but they appear to be relatively effective based on several field situations involving grizzly and black bears. Some polar bears feeding on whale carcasses at Barrow in fall 1992 gradually habituated to being hit by plastic bullets (G. Carroll, Alaska Dept. Fish and Game, pers. comm.). Other bears reacted strongly by running off (J. Bridges, U.S. Fish and Wildl. Serv., pers. comm.). Plastic bullets have turned a charging polar bear (S. Amstrup, U.S. Fish and Wildl. Serv., pers. comm.).

Rubber batons in tests at Churchill, Manitoba (Stenhouse 1982), and in use by NWT Conservation Officers, were very effective when polar and grizzly bears were hit. They caused immediate withdrawal of all but starving bears. A baton was used to stop a charging bear by hitting it in the chest (Graf et al. 1993). The relatively large size of the projectile gives it greater momentum than the plastic bullet, resulting in a "thump" rather than a "sting."

Advantages: Plastic bullets and rubber batons deliver an immediate negative reinforcer.

Plastic bullets are portable, are used in conventional firearms that accept crackershells or lead slugs, are available to the public, require only minor training (beyond general firearms training), and are relatively accurate compared to other types of deterrents and to original model baton guns. The slug can be smeared with a marker to enable the shooter to locate the hit. The shooter can be farther out of range than with some

other deterrents (e.g., boat horns). No bears have ever shown aggressive responses, short-term or long-term, to being hit by plastic bullets.

Rubber batons are portable, and provide negative reinforcement that is more effective than that induced by plastic bullets due to the size of the projectile. Their range is similar to that of plastic bullets, and no aggressive responses have been reported.

Precautions: *Plastic bullets* require several precautions in their use:

- **They are lethal to bears and humans at short ranges.** Bears hit in soft tissue areas at less than 44 yards (40 meters) and humans hit at less than 110 yards (100 meters) can be severely injured or killed. The operator should aim only for the large muscle mass of the rear quarters, and remember to correct for windage. Our recommendation to anyone permitted to use such a device is to shoot for the rear 1/3 of the rump or thigh area; this avoids penetrating the peritoneal cavity or causing eye injury.
- Accuracy of plastic bullets, although generally acceptable, may be erratic, especially when there are strong cross winds. Under good conditions, a qualified shooter should be able to hit within approximately a 1-foot (0.3-meter) diameter circle at 130 feet (40 meters).
- Because of the relatively light weight of plastic bullets, some highly motivated bears do not respond.
- Bullets will occasionally jam in autoloaders.

Rubber batons likewise require precautions:

- **They are lethal to bears and humans at short range.** Misplaced shots have killed polar bears. Because the projectile is heavier than a plastic bullet, more care must be used with this firearm, especially if a bear is emaciated. Original model batons are much less accurate than plastic bullets—the new model is reportedly more accurate than the original model.
- Rubber baton use is restricted to enforcement or security organizations.
- Considerable training is required to become proficient with a baton gun; a minimum of 25 shots is recommended (Stenhouse 1982). Because of reportedly improved accuracy, new models may require less training for proficiency.
- The initial cost of the baton firearm and projectile is high relative to that of a shotgun and plastic bullet. Baton loads are very expensive (approximately \$15/load). New models are reported to be re-loadable; therefore, their cost to operate may decrease significantly.
- Use of batons requires a separate firearm for self-defense if deterrence fails.

CONCLUSIONS

The function of a deterrent is to prevent a bear from getting into a situation that is dangerous to bears or people, or that may result in damage to equipment. The effectiveness of a deterrent or repellent varies with its intended application. The selection of deterrent methods should be integrated with site design and operations, and tailored to the particular activity in question. It is preferable to use stationary deterrents such as electric fences or biological sounds to deter a bear before it enters a facility, but these should not be relied upon solely. Skirting or other physical barriers should also be included. For most applications, the deterrent system starts with a properly trained bear monitor who can (1) ensure that the deterrent is maintained in peak working condition, (2) select and use the optimal repellent method, (3) assist in detection, and (4) notify the proper supervisors when the bear is no longer a potential threat. The most important function of a trained bear monitor may be to respond appropriately when a particular deterrent or repellent fails, and an alternative must be used. No deterrent is 100% reliable or effective; therefore, the presence of deterrents should not be a substitute for employee vigilance and early detection.

LITERATURE CITED

- Clarkson, P.L. 1989. The twelve gauge shotgun: a bear deterrent weapon. Pages 55-59 in M. Bromley, ed. Bear-people conflicts: proceedings of a symposium on management strategies. NWT Dept. Renew. Resources, Yellowknife. 246pp.
- _____, and L.R. Quaife. 1991. Safety in bear country detection and deterrent testing. Unpubl. research proposal by Safety in Bear Country program, NWT Dept. Renew. Resources, Inuvik, and ESSO Resources Canada, Calgary, Alberta. 23pp.
- Davies, J.C., and R.F. Rockwell. 1986. An electric fence to deter polar bears. Wildl. Soc. Bull. 14: 406-409.
- Fleck, S., and S. Herrero. 1988. Polar bear-human conflicts. Rep. to Parks Canada, Prairie Region, and NWT Dept. Renew. Resources, Yellowknife. 155pp.
- Graf, L. H., P.L. Clarkson, and J. Nagy. 1993. Safety in bear country, a reference manual, Second edition, Dept. of Renewable Resources, Government of the Northwest Territories, Yellowknife, NWT. 146 pp.
- Hunt, C.L. 1985. Descriptions of five promising deterrent and repellent products for use on bears. Unpubl. rep. to U.S. Fish and Wildl. Serv., Office of Grizzly Bear Recovery Coordinator, Missoula, Montana. 55pp.
- IGBC (Interagency Grizzly Bear Committee). 1989. Bear-resistant containers: minimum design and structural standards inspection and testing methodology. U.S. Forest Serv., Intermountain Region. Ogden Utah. 35pp.
- LeBlanc, R. 1992. The aversive conditioning of a roadside-habituated grizzly bear within Banff Park. Unpubl. progr. rep., Banff Warden Service, Banff National Park. Lake Louise, Alberta. 7pp.
- Miller, G.D. 1987. Field tests of potential polar bear repellents. Int. Conf. Bear Res. and Manage. 7: 383-390.
- Nyholm, E. 1976. On polar bears in Spitzbergen. Pages 12-29 in Norwegian Polar Yearbook, 1975-76. Norsk Polarklubb, Oslo. (In Norwegian)
- Stenhouse, G. 1982. Bear deterrent and detection study, Cape Churchill, Manitoba, 1981. File Rept. no. 23. NWT Dept. Renew. Resources, Yellowknife. 65pp.
- Wooldridge, D.R. 1978. Deterrent and detection systems: Churchill, Manitoba. Unpubl. rept. to NWT Govt. by Wooldridge Biological Consulting, Burnaby, British Columbia. 40pp.
- _____, and P. Belton. 1980. Natural and synthesized aggressive sounds as polar bear repellents. Int. Conf. Bear Res. and Manage. 4: 85-91.

CHAPTER 6. PERSONNEL RESPONSIBILITIES AND TRAINING

RAY E. SCHWEINSBURG
Arizona Game and Fish Department
2222 West Greenway Road
Phoenix, Arizona 85023

The goal of this document is to prevent all bear-human conflict. That will happen only when workers are well informed and trained to avoid or contend with dangerous situations. The purpose of this chapter is to detail the steps necessary to prepare and train personnel for safely working in polar bear country.

A typical offshore industrial operation will have three classes of personnel with respect to responsibilities regarding bears: bear monitors, monitor supervisors, and other personnel. Monitors are responsible for detecting bears near operations and ensuring the safety of other crew members. Monitor supervisors oversee and direct all aspects of on-site safety and observation with reference to polar bears. Other personnel must learn proper procedures for working in bear country and for responding to bears and bear alerts.

BEAR MONITORS

Polar bear monitors are specially trained personnel that serve in detection, early warning, and safety with respect to polar bears around industrial facilities. Monitors are sometimes called "bear watches". Their job is to ensure that bear-human encounters are avoided to the extent possible.

Responsibilities

The duties of the monitors are to:

- Survey work areas from a vantage point or from a vehicle to detect polar bears or signs of their presence.
- Alert personnel preparing to work in exposed situations if polar bears or their sign have been recently seen.
- Warn all personnel when a bear is seen, reported, or suspected to be in the area, and ensure that people move to a safe place according to a prearranged escape plan.
- Protect crews as they escape to safe sites, if escape proves necessary. Legal deterrence of polar bears in Alaska is constrained to some extent by law (See CHAPTER 7), with which bear monitors should be familiar.
- Report and record encounters, observations of conflicts, and behavior of polar bears seen in a Daily Polar Bear Log. Fill out and submit Polar Bear Observation Forms to the State of Alaska as required by Bear Interaction Plan (Chapter 10).
- Recommend alterations in the configuration and operation of facilities if such actions seem necessary to alleviate potential bear problems.

Surveys entail two main efforts: walking or driving the perimeter of the work site to look for bear sign, and scanning areas in and around the facility at specified times. Schedules for each of these efforts can be regular or irregular depending on (1) whether there is a need to gather information about bears, (2) the type of camp or installation involved, and (3) crew work schedules and times when personnel are most at risk.

Selection and Training

Polar bear monitors should be selected for their sense of responsibility, observational ability, patience, interest in safety, and knowledge of wildlife. Hiring an additional crew member to fill this role may not be necessary, in which case the monitor should be selected from among personnel whose other duties (Fig. 6-1) naturally fit with procedures to avoid bear-human encounters, such as:

- Loader operators
- Ice surveillance personnel
- Safety officers



Figure 6-1. Seismic exploration (Western Geophysical).

Polar bear monitors must receive special training. They need to undergo a thorough indoctrination in environmental affairs and receive a safety orientation. Training should be done in conjunction with experienced people from U.S. Fish and Wildlife Service (USFWS) and Alaska Department of Fish and Game (ADF&G). The monitors have several training needs:

- View the video "Polar Bears: Safety and Survival" and learn about new materials as they become available.
- Review the recording sheets and maintain constant awareness of the need to consistently and accurately record information.
- Complete a course in firearms familiarization, safety, and storage if company policy allows firearms on the site.
- Understand the availability of various kinds of bear detection systems and their limitations (See CHAPTER 4).
- Receive special and rigorous training in the use of deterrents (See CHAPTER 5) if government and company policies allow the use of deterrents.
- Receive thorough training in the use of on-site communications systems.
- Receive training and drill-practice in the proper procedures to follow during a polar bear alert or conflict.
- Become familiar with site design, especially with (1) potential problem areas such as improper garbage disposal or ambush sites, and (2) escape routes available for bears (See CHAPTER 8).
- Receive training in the use of binoculars and other optical aids such as spotting or night-vision scopes.

MONITOR SUPERVISORS

Monitor supervisors oversee and direct all aspects of on-site safety and observation in reference to polar bears. It may be possible for one person to serve as both bear monitor and monitor supervisor.

Responsibilities

The monitor supervisor has the responsibility to:

- Supervise bear monitors to ensure consistency of observations and reporting.
- Prearrange escape routes and safe sites for personnel in the event a bear appears.
- See that crews are informed and trained about escape procedures.
- Standardize and simplify all warning and escape communications and procedures.
- Cancel work during a bear alert when personnel are in imminent danger of coming in contact with a polar bear.
- Recommend additional training for, or replacement of, bear monitors.
- Brief crews before any work begins in areas not well protected by the monitoring system in use.
- Set up a Daily Polar Bear Log and supervise the recording of polar bear observations in the log.
- Communicate with government agency personnel and other shore-based individuals (See CHAPTERS 9 and 10).

Selection and Training

Monitor supervisors should be selected for their supervisory skills, their ability to communicate with workers and others, and their understanding of the need for consistency and accuracy in reporting. Choices for the position are people such as rig supervisor, alerts engineer, or safety officer, whose duties already include supervision, communication, or recording.

Training of monitor supervisors is generally similar (although not identical) to that of monitors in that they should:

- View the video "Polar Bears: Safety and Survival" and study any new materials as they are produced.
- Understand thoroughly the on-site communications systems, safety systems, and polar bear early-warning alert systems.
- Become familiar with channels of communication to government wildlife agencies and procedures for reporting polar bear problems, incidents, observations, or "takes" (See CHAPTERS 9 and 10).
- Understand proper procedures for maintaining a Daily Polar Bear Log and recording observations related to bears.
- Learn how to set up crew briefing and debriefing sessions.
- Supervise polar bear alert drills.

OTHER PERSONNEL

Responsibilities

All other personnel at a rig also have responsibilities with regard to avoiding polar bear conflicts. They must:

- Comply with safety rules.
- Maintain constant alertness when working in situations where bears may be present.
- Become informed about the special problems and safety procedures necessary to work in bear country.

Training

All rig personnel should undergo training so that the need to absolutely avoid bear-human conflicts is understood and ways of doing so are practiced. During the course of this training, all personnel should:

- View the video "Polar Bears: Safety and Survival" and take the same program of environmental affairs and safety orientation as the monitors.
- Receive instruction in polar bear alert communication systems, safe sites, and escape procedures.
- Practice on-site bear alert drills.
- Come to understand the extreme importance of the proper disposal of garbage, the storage of food, and the hazards of feeding wildlife (See CHAPTERS 3 and 8). Cooks and people handling food and garbage need special training in this regard.

PERSONNEL TRAINERS AND TRAINING MATERIALS

Selected individuals with appropriate knowledge and skills will be needed as personnel trainers. A workshop for training these trainers should be held each year. Yearly training sessions are desirable to bring in new trainers, to keep experienced trainers current with new material, and to hear experiences and recommendations from the field for improving the training program. The responsibility for holding yearly training sessions and for developing a training system should be held jointly by industry and government.

There will be an ongoing need to develop fresh training materials (Fig. 6-2) and to distribute new information resulting from experience or research. Meeting this need probably will be the joint responsibility of industry and government. The kinds of new materials and information that will be most useful for training include the following:

- Updated or new polar bear safety videos.
- Posters and regional magazines or newspapers that depict safety and behavioral information about bears.
- Revised handbooks.
- Streamlined training programs.
- Instruction in the use of new equipment.
- Customized safety plans for the various types of industrial sites: bear-inaccessible, bear-accessible, and mobile.

Figure 6-2. Training Materials

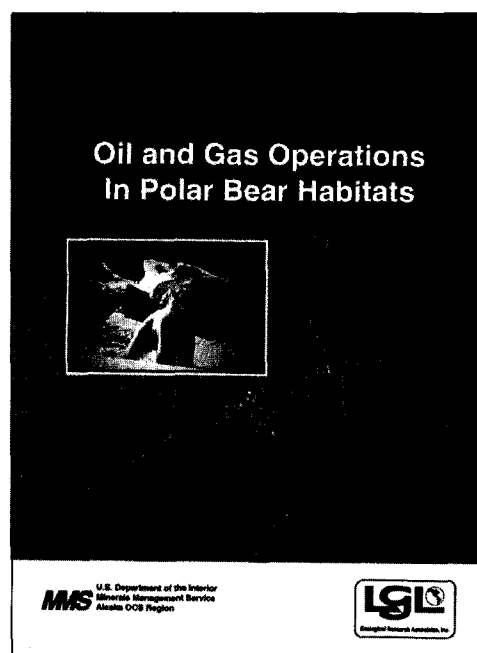

SITE-SPECIFIC RESPONSIBILITIES

Because each site is unique, the number of bear monitors and monitor supervisors and the level of effort needed at each site to ensure adequate observation and protection will vary. Site design, operations schedules, kinds of work being done on-site, environmental conditions, prevalence of bears, and common sense will help operators determine what is required. Adequate coverage will be the responsibility of the site operations supervisor.

The intensity and nature of the effort required of personnel will differ among three general types of industrial operations (See also CHAPTER 8):

- Those on stationary structures that are inaccessible to polar bears because of their height and wall steepness.
- Those that are stationary and situated low enough to allow access by polar bears, and
- Those that are mobile.

Sites Inaccessible to Bears

Structures that are inaccessible to polar bears (Fig. 6-3) require substantially less personnel effort to avoid bear problems than do accessible sites. Polar bear monitors will be needed at two times on inaccessible structures:

- When regular observations of polar bears are needed to gather information.
- When on-ice activities such as oil spill drills and equipment loading are required as part of the work scheduled at the site.

Regular observations may be required at some rigs to determine polar bear presence in relation to season, ice type, or some other factor. This requirement may result from the research needs of government agencies or industry and typically would come with a data-collection purpose and protocol. If government sees the need to collect data, notification should be included as a part of the permitting process (See CHAPTER 10) to provide industry with adequate time to prepare. It is normally the government's responsibility in these cases to analyze and report results of the data collected.

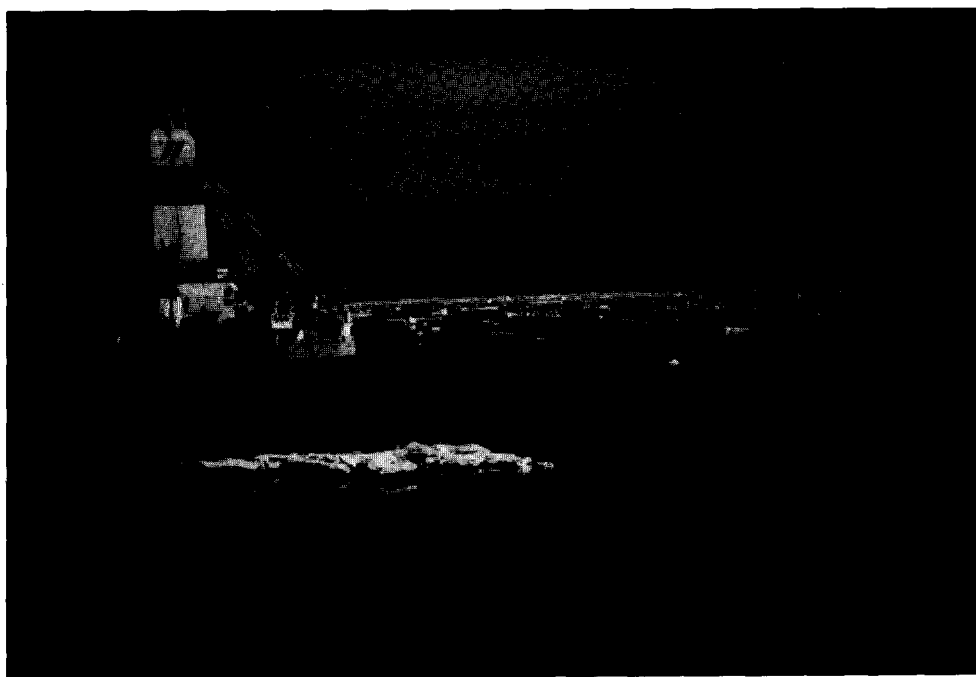

Figure 6-3. Kulluk drilling station (L.Quackenbush).

Even if observations to collect data are not needed, crews at times will have to leave the protection of inaccessible structures to monitor ice, to load or unload supplies or equipment, or to respond to oil spills or other emergencies. During these times they will be accessible to polar bears, and safety precautions not otherwise necessary must be instituted.

All on-ice activities, except for emergencies, should take place at predetermined times. Polar bear monitors should be informed of work schedules ahead of time by rig supervisors or monitor supervisors, and immediately prior to on-ice activities they should scan the work area for polar bears or tracks of bears. Depending on light conditions and equipment, a helicopter or ground-based vehicle should be used to reconnoiter the area within one mile (1.6 kilometers) of the site, following specific procedures (See also Chapter 8):

- Bear monitors should continuously scan the outer reaches of the work area while the crew descends and while they are on the ice, or alternatively, sweep the area periodically in a vehicle.
- If it is dark, the work area must be lighted. Illumination should extend out to several hundred yards beyond work areas unless some other remote detection system is deployed. No potential ambush areas should remain dark.
- Polar bear monitors should descend to the ice and sweep the work area in a vehicle to look for bears or bear sign before the work crew descends.
- If bears are sighted or their presence suspected, the polar bear monitor must inform the crew or rig supervisor and then make a decision to delay or proceed with the work.
- If a polar bear detection system other than visual observation is deployed (See CHAPTER 4), it is the polar bear monitor's responsibility to set it up and to ensure that it is working.

If a bear or bears should be discovered after the crew is on the ice, the polar bear monitor should respond in an ordered sequence of action:

- The first responsibility is to alert every crew member. The alert system should contain redundancy among such methods as sirens, alarm flares, radio communication, hand signals, light or flash signals, and driving to the workers and alerting them.
- The second responsibility is to help the crew move to pre-assigned safe areas and ultimately to return safely to the rig. This is best done with a vehicle.
- The third responsibility is to watch the bear (or bears) and report when it (or they) have left, if the departure can be determined.
- The fourth responsibility is to debrief the crew after the incident is over and acquire feedback from personnel for improving the system.

The polar bear monitors may also be responsible for deterring bears, if company policy and government regulations allow (See CHAPTERS 5 and 7). Deterrence is normally necessary only in extremely unusual events such as an emergency that requires evacuation of a rig while polar bears are nearby or an oil spill that requires around-the-clock work on the ice. To meet these responsibilities adequately, bear monitors must have undergone adequate deterrence training. The responsibilities are as follows:

- Polar bear monitors should attempt to deter any bears approaching or threatening a work crew unable to reach safety.
- Polar bear monitors may have to kill a polar bear when no other method can avoid a human injury or death.

Sites Accessible to Polar Bears

Many industrial facilities, such as low-lying ice or gravel islands (Fig. 6-4), barges, or semi-permanent camps, are accessible to polar bears. These are usually located in ice types not favored by bears, but bears still could appear at any time. Further, bears that travel in such areas may be those that are starving and

therefore may be more dangerous than well-fed ones. In such areas, the monitor supervisor must combat complacency, which can be predicted to occur in the crew because vigilance is more difficult to maintain where bears are rarely seen than where they are common.

Polar bear monitors are more important at accessible sites than at inaccessible ones. Not only must they monitor and report polar bear sightings, they must be vigilant for longer periods and will more frequently need to activate alert and escape procedures.

Bear monitors must employ several levels of defense at accessible structures. The first line of defense is design modifications to eliminate polar bear ambush or hiding spots and to provide enclosures to protect work areas (See CHAPTER 8). The second line of defense is the maintenance of polar bear detection systems (See CHAPTER 4). Redundancy should be built into detection strategies to ensure as much as possible that an intruding bear will be detected. Polar bear monitors should deploy and regularly check mechanical or electronic detection systems from a vehicle.

Two other considerations are important to monitors at accessible sites. Protection of work crews deployed from the sites is carried out the same as outlined above for on-ice workers at inaccessible sites. Proper garbage disposal is especially important (See CHAPTER 3); monitors must be trained to spot garbage problems and to make recommendations to avoid improper disposal.



Figure 6-4. Seal Island drilling station (L. Quackenbush).

Mobile Units

Mobile units are exemplified by seismic and supply trains (Fig. 6-5) that are continuously moving from place to place. In these units, work crews are often accessible to polar bears. Bear monitors assume major responsibilities in mobile operations because many other types of detection systems are impractical (See CHAPTER 4). In general, bear monitors in mobile units can employ the procedures outlined above for accessible sites and on-ice operations at inaccessible sites, perhaps with modifications keyed to moving operations.

Mobile units have the additional potential for causing female bears to abandon maternity dens (See CHAPTER 8). To minimize disturbance to denning bears, operations supervisors or monitor supervisors in mobile units have the following responsibilities:

-
- Check with government agencies prior to operations to see if the planned activity will occur in known or suspected denning habitat.
 - Schedule activities for seasons when polar bears are not in the dens, if operations must take place in denning areas.
 - Avoid, to the extent possible, known denning areas and areas with suitable topography for dens.

Little is known about the level of disturbance that causes abandonment of polar bear dens, or about the fate of mother and cubs when a den is abandoned. Thus, it is important to document in detail each known abandonment, to better understand how to eliminate the problem in the future.

In the event that operations are approved in known denning habitat, or in habitat that seems likely to hold bear dens, polar bear monitors should:

- Contact the U.S. Fish and Wildlife Service or the Alaska Department of Fish and Game prior to operations to get advice on which sites and terrain types to avoid (See CHAPTER 9).
- Watch for any evidence during operations that any dens in the vicinity have been disturbed.
- Immediately report any known disturbance of a denning bear. Relay in writing as much information about the incident as possible, including events that took place prior to and during the disturbance.

DETERRING OR KILLING BEARS

All personnel should know that harassing, disturbing, or killing polar bears is prohibited by the Marine Mammal Protection Act (See CHAPTER 7). Most deterrence actions (See CHAPTER 5) are illegal in the United States except if performed by authorized persons. In the event that such actions become unavoidable, polar bear monitors should follow up by taking these steps:

- Record in detail the sequence and nature of events leading up to and surrounding the incident as well as the names of the people involved.
- Notify the appropriate government agency (See CHAPTER 9) and, if a bear is killed, properly skin, preserve, and dispose of the hide and skull to the proper authority.

Supervisors of operations should institute the following policies regarding deterrence:

- Make all personnel aware of the legal prohibitions on disturbing or killing bears.
- Emphasize early detection and avoidance rather than deterrence.
- Do not allow Native personnel, including any that are bear monitors, to pursue subsistence hunting activities while employed at an industry site.
- Adopt either a firearms prohibition or strict firearms regulation policy for each site.

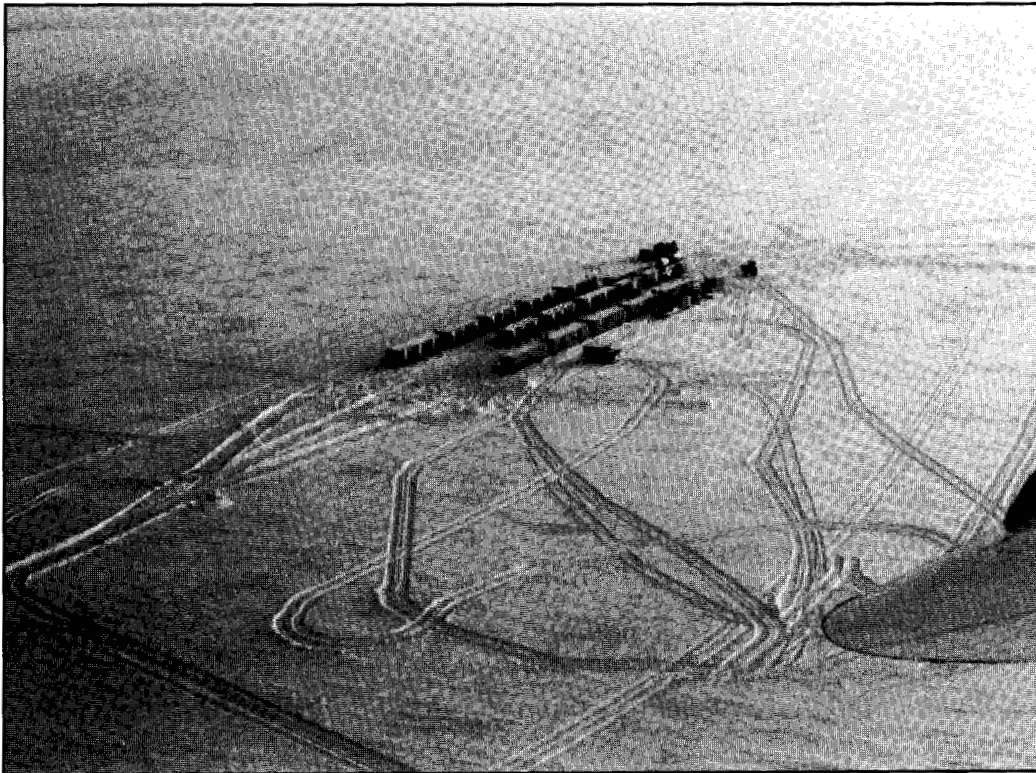

Figure 6-5. Seismic train (W. Sands).

CHAPTER 7. LAWS AND REGULATIONS CONCERNING POLAR BEARS

RICHARD L. TREMAINE
LGL Alaska Research Associates
4175 Tudor Centre Drive
Anchorage, Alaska 99508

Three governmental bodies—the Federal Government, the State of Alaska, and the North Slope Borough—regulate petroleum development activities in polar bear habitat in Alaska. The three use their regulatory authority to minimize impacts to polar bears in different ways. The Federal government has management jurisdiction primarily over polar bear populations but no habitat management authority designed specifically to protect polar bears. The state and borough have just the opposite—habitat management authority, but no authority over bear populations. The concerns of these agencies about polar bears overlap, but much of their regulatory authority does not. Their separate sets of permitting and operating regulations for petroleum-related activities do overlap somewhat.

Polar bears may be attracted to petroleum-related activities at any time (See CHAPTER 3), leading to encounters between bears and people. In addition, polar bears are susceptible to human-related disturbance during denning and under some other circumstances (See CHAPTER 2). Regulations and guidelines concerning interactions with polar bears are intended to reduce the potential impacts of encounters to both people and bears.

FEDERAL GOVERNMENT

In 1972 Congress passed the Marine Mammal Protection Act (Act), which granted special protection to all marine mammals in the United States, including polar bears. The intent of the Act and subsequent regulations was to ensure that marine mammal populations stay at (or return to) healthy levels. The Act covers marine areas out to 200 nautical miles from U.S. coasts as well as anywhere marine mammals occur on land.

In Alaska, the protection of polar bears, walrus, and sea otters under the Act is the responsibility of the U.S. Fish and Wildlife Service (USFWS). All other marine mammal species occurring off Alaska are the responsibility of the National Marine Fisheries Service. The Act has been amended several times during the past two decades, as have USFWS regulations pertaining to it.

The Act prohibits the “taking” of marine mammals. “Take” is defined to mean “harass, hunt, capture, or kill, or attempt to harass, hunt, capture or kill any marine mammal”. Taking is illegal whether it occurs intentionally or unintentionally. By interpretation, taking is said to occur whenever human activity causes a polar bear to change its behavior. Killing a polar bear in defense of human life, disturbing a polar bear by trying to take a picture of it, and scaring a polar bear away from buildings are all violations under the law and the law does not differentiate between them. Exceptions to this include Federal, state, or local government officials who are authorized to take a marine mammal in the course of their official duties.

Taking a polar bear by other individuals is legal under some circumstances. Native Alaskans living on the coast are allowed to hunt polar bears for subsistence and handicraft purposes provided it is not done in a wasteful manner. The incidental, but not intentional, taking of small numbers of marine mammals is allowed during commercial fishing, for scientific purposes, and for U.S. citizens who engage in a specified activity (other than commercial fishing) within a specified geographic region provided they have received a special dispensation from the Federal government.

It is the latter category that includes petroleum exploration activities. The U.S. Fish and Wildlife Service implemented “incidental take” regulations concerning polar bears and walrus for oil exploration activities in the Chukchi Sea in 1991, but only for the open water season. Regulations are being developed by the USFWS for the incidental take of polar bears and Pacific walrus during petroleum related activities in the Beaufort Sea area for all seasons. Once regulations are in place, U.S. citizens (oil companies) can request a Letter of Authorization (LOA) to take small numbers of marine mammals.

If regulations are not in place for an area or time of year required by a certain activity, the U.S. Fish and Wildlife Service can be petitioned to promulgate the regulations so that a LOA can be granted. For example, any oil and gas exploration done during the ice-covered season in the Chukchi Sea is not covered by incidental

take regulations. The exploration company may petition the USFWS to promulgate these regulations to allow the take of small numbers of polar bears. However, the company is not required to do so. If the company feels that they are not likely to encounter any bears, they may not want to participate in the regulation process. Without a LOA, the company accepts the risk that a polar bear may approach the facility, and almost any contact can be interpreted as a take under the Act. In this case, the company would be in violation of the Act and subject to a fine.

In addition to offering protection to polar bears by the Act, the U.S. in 1976 signed the International Agreement on the Conservation of Polar Bears, with all five coastal countries in the circumpolar arctic region (Canada, Denmark [Greenland], Norway, the former Soviet Union, and the United States). All the countries agreed to "protect the ecosystems of which polar bears are a part, with special attention to habitat components such as denning and feeding sites and migration patterns...". The Agreement also included restrictions on who can take polar bears, the means of taking, and commercial trade of polar bear parts.



Bears "taken" for research (S. Amstrup).

STATE OF ALASKA

The primary authority the state has to protect polar bears comes through the Alaska Coastal Management Program (ACMP). This program allows state agencies to review all activities located in the state's coastal zone or affecting it. It emphasizes the protection of coastal habitats and species that utilize them.

The lead state agency for reviewing proposed coastal activities for consistency with the ACMP is the Division of Governmental Coordination (ADGC), which other departments, including Alaska Department of Fish and Game (ADF&G), advise. Typical activities in polar bear habitat on which ADF&G comments include lease sales, exploratory drilling or seismic projects, and waste disposal permits.

For activities on state lands or water, ADGC coordinates review of permits for a project to include specific stipulations that render these consistent with the ACMP. These stipulations are attached to each agency's permits; the ADGC has no permitting authority of its own. The state is also required to comply with the North Slope Borough's coastal management plan when it reviews projects. For Federal lands and waters, the state issues a general concurrence which includes specific stipulations that it certifies will bring the Federal project into compliance with the state and borough CMP.

There are no regulations specific to polar bears that ADF&G or any other state department can use to protect these animals and their habitat. However, state law mandates that opportunities for subsistence usage of coastal areas and resources be recognized and assured. Additionally, the ACMP and North Slope Borough's coastal management plan mandate that polar bear denning must be protected. ADF&G combines

the mandates of state law and ACMP to set requirements on OCS activities that protect dens, educate workers, and plan for polar bear interactions that are designed to minimize conflicts between polar bears and people.

The Department of Environmental Conservation (DEC) has issued regulations that restrict solid waste disposal so as to minimize harm to wildlife. Although these regulations do not focus on polar bears, they apply to all activities occurring on state lands and waters. Most of the DEC regulations are independent of the ACMP although they provide for additional stipulations on activities which may affect the coastal zone.



Polar bear den (R. Schweinsburg).

NORTH SLOPE BOROUGH

The North Slope Borough covers an area from south of Point Hope north and east to Canada. As with the state, it has a Coastal Management Plan but this one emphasizes protection of subsistence resources rather than coastal habitats. The borough's CMP is addressed in the state consistency review process for a project or action. This is important in relation to polar bears since they are included as a subsistence resource under the borough CMP but are not a state managed species and therefore not covered by state subsistence regulations. The borough also has land use regulations that are similar to zoning ordinances. The borough has no direct authority over activities on Federal lands or waters and must rely on its input into the state consistency review process for these activities.

In 1987, the North Slope Borough Fish and Game Management Committee and the Inuvialuit Game Council from Canada signed an agreement on polar bear management in the southern Beaufort Sea region. This agreement governs Native take of polar bears from the shared Beaufort Sea population, which inhabits both U.S. and Canadian waters and on-shore areas. Among other measures, the agreement protects bears in dens and family groups with cubs, sets a hunting season, provides a framework for setting annual quotas for each country, and establishes a reporting system to collect information from harvested polar bears. The agreement has no regulatory backing but is voluntarily adhered to by the Natives of both countries.

PERMITTING

The Federal agency that issues permits for petroleum-related activities in Federal waters is the Minerals Management Service (MMS). During permitting, MMS reviews recommendations made by other Federal and state agencies and, where authorized to do so, may include these as stipulations.

Authorization from the USFWS is required for each petroleum-related activity before any "take" of a polar bear related to that activity is legal. Several steps are necessary for acquiring such permission. The operator must petition the USFWS for the promulgations of regulations pursuant to Section 101(a)(5) of the Act that would allow incidental "taking" of polar bears. These activities can be authorized for no longer than five years and must occur in a specified area. The request must include information on the activity as a whole as well as information concerning several specific items listed in the regulations.

Once USFWS receives and evaluates the request for incidental take, and determines that the request meets criteria established in the Act, regulations are developed for that specific activity in a specified geographical area. A LOA can then be sought by the operator. This LOA must specify the published regulations to be followed, the allowable length of time for the activity, and any additional terms and conditions that the USFWS determines are necessary. If the terms or conditions of the LOA are not complied with, the LOA may be revoked and polar bear "take" would not be authorized. Incidental "takes" do not allow for Native subsistence hunting while the hunter is employed and at a petroleum-related work site. Likewise, unless the Act is changed or LOAs that specifically authorize deterrent activities are issued, the use of deterrents to drive polar bears away may be considered "takes" (See CHAPTER 5).

The state and borough permitting process for activities that impact polar bears on state land is streamlined. The state issues a permit for an activity to occur. Included in that permit are stipulations having three parts based on both state and borough regulations. The stipulations require consultation between the operator and the agencies to determine and avoid polar bear den locations. It requires the operator to prepare a polar bear interaction plan and conduct a training program for field personnel. The state provides a list of topics that should be included in the plan, which must be approved by the state before it is carried out (See CHAPTER 9). Requirements for the plan include procedures for interactions with polar bears; reporting and documenting polar bear encounters; siting field camps to minimize polar bear problems; and locating, reporting, and avoiding denning locations. The state has the authority to approve or disapprove the Polar Bear Interaction Plans.

The USFWS becomes involved in the state review process by assisting in the identification of den locations. It also reviews the proposed training program and interaction plan, but has no authority to approve or disapprove them.

Having a polar bear interaction plan may help to avoid conflicts with bears but it does not alleviate the liability of the operator if a "take" occurs. The "taking" of polar bears is still a violation of the Act unless a LOA is in effect.



Female bear with young cubs (J.Lee)

REPORTING

Until the USFWS has formal regulations for incidental take of bears in the Beaufort Sea area, there are no Federal reporting requirements for polar bear encounters. However, USFWS personnel are routinely consulted for advice on the plans required by the state, and all information provided to the state is shared with the USFWS on a routine basis. Also, Federal agency personnel are on call to respond to polar bear incidents should the need arise.

Several reporting requirements exist for polar bear encounters during industry operations. When polar bears pose an immediate problem, or an emergency situation occurs concerning polar bears, operators should contact designated persons within either ADF&G or USFWS (See CHAPTER 9). At the end of every field season, reports of all polar bear sightings and encounters must be submitted to ADF&G. These reports follow a specified format (See CHAPTER 10) and include information on the environmental conditions, bear behavior, human activity, and occurrence of events which transpired during each sighting or encounter.

These reports are shared with the USFWS and are cataloged in a research and management database. Over time, these observations will assist in determining means of reducing polar bear incidents and increasing human and bear safety when encounters occur.

CHAPTER 8. SITE DESIGN AND OPERATION

DENIS THOMSON
LGL Limited
22 Fisher Street, P.O. Box 280
King City, Ontario, Canada L0G 1K0

WILLIAM KOSKI
LGL Limited
22 Fisher Street, P.O. Box 280
King City, Ontario, Canada L0G 1K0

In 1973, a seismic operation took place in the vicinity of Kendall Island in the Beaufort Sea. A cat operator had just finished lunch and was leaving the cookshack. As he was walking down the steps preceded by the cook, a polar bear hiding beneath the structure leaped out and killed him with a single blow to the back of his head. The bear was not seen by either man before it struck; it attacked without provocation or warning (R. Schweinsburg, pers. comm.).

In Canada between 1965 and 1985, 251 polar bears and 6 people were killed and 14 people were non-fatally injured in polar bear-human encounters (Fleck and Herrero 1988, Stenhouse et al. 1988, Herrero and Fleck 1990). In the Northwest Territories, 46% of injurious interactions occurred at mining or hydrocarbon exploration camps, and most of the aggressive interactions between polar bears and humans occurred when attractants were present (Fleck and Herrero 1988). Thirty-three bears were killed at industrial sites (Stenhouse et al. 1988).

Fewer conflicts apparently have occurred in the Alaska portion of the Beaufort Sea. For example, only one polar bear has been reported killed by oil industry personnel in recent years. This incident involved non-compliance with a company polar bear plan and probably could have been avoided (LGL 1990). But, because industrial activity continues in offshore areas of Alaska, there is an ongoing need to design and operate facilities such that injuries and deaths of bears and people can be avoided. This chapter provides advice on how to design and operate industrial sites to minimize problems with bears.

GENERAL CONSIDERATIONS

Risk from and to polar bears can be reduced tremendously by proper design and operation of industry sites. Adherence to a few basic precautions goes a long way toward eliminating problems.

Operating Principles

Laying out and operating an industry camp to minimize bear problems requires advance planning. Once a camp is in place, it becomes more difficult to retrofit for bear detection and avoidance. Major components of a bear response program typically include the following:

- Locate sites of operation apart from areas preferred by bears for travelling, hunting, or denning.
- Design sites to be inaccessible to bears and to facilitate detection and deterrence of bears.
- Establish general operating rules for handling food and garbage and for other activities that might attract bears or lead to encounters with them.
- Install bear detection devices to provide early warning of bears approaching, and design the placement of facilities to enhance visibility (See CHAPTER 4).

-
- Use bear-proof fences and other deterrents where appropriate to keep bears away; this includes skirting or fencing potential bear hiding or ambush sites (See CHAPTER 5).
 - Develop a personnel training program and schedule and set up strict personnel responsibilities and schedules to detect bears, warn other personnel, and (if warranted) deter bears (See CHAPTERS 6 and 10).
 - Prepare a contingency plan should detection or deterrence fail.

Rules for Personnel

Some strict rules need to be taught to personnel upon their arrival at the site. These are best presented both in training programs and as posted notices in camp. They should include the following:

- Always look before leaving any building.
- Keep the camp clean of litter and other items that may attract bears.
- Do not sleep in the open.
- Do not go for unannounced walks away from camp.
- Scan for bear tracks before leaving camp for any purpose.
- Do not leave food or garbage in unattended vehicles.

Additional rules apply when personnel are working away from camp. Under these circumstances, observe the following precautions:

- Check with the bear monitor or supervisor before leaving to ensure that bears have not been sighted in the intended work area.
- Leave a map of your route and destination with a supervisor.
- Bring a firearm and a bear deterrence device if allowable by camp policy.
- Bring a two-way radio.
- Use a vehicle, especially if alone.
- If the vehicle stalls, call for help; do not walk back.
- Do not litter.

Biologists analyzing accounts of bears injuring or killing people have concluded that the past experiences of a bear with people's food and garbage have a major influence on its future response to humans (Herrero and Fleck 1990). Precautions about food and garbage handling need to be observed by personnel as follows:

- Place food and garbage only in designated areas.
- Do not eat or keep food in sleeping or working areas, outside, or in vehicles and aircraft.
- Do not carry food on your person.
- Do not feed bears or any other wildlife (food left for foxes and birds will attract bears).

Under all circumstances, employees should immediately report all bear sightings or sign of bears to the monitor supervisor. Also, employees need to be told that it is illegal under the Marine Mammal Protection Act to approach or pursue a bear in such a way that it affects their movements or behavior (See CHAPTER 7). This includes approaches for the purposes of viewing or photographing the bear (Lentfer 1990).

GENERAL FEATURES OF SITE DESIGN

Operators must attend to five aspects of the work situation and work site design to best insure protection against bear problems. These are: (1) worksite location, (2) facilities layout and design, (3) fencing and other barriers against bears, (4) food storage and garbage disposal, and (5) bear detection systems.

Location

Polar bears tend to concentrate along open-water leads and other areas where hunting is best (See CHAPTER 2). During the open-water period, most polar bears occupy the drifting sea ice beyond most areas currently subject to industrial activity; thus, most encounters with bears will occur after freeze-up.

Whenever possible, work sites in winter should be located away from the following kinds of places (Bromley 1985):

- Broken-ice areas beyond the outer edge of the landfast ice.
- Leads and other open-water areas in the ice.
- Heavily-pressured nearshore ice.
- Known bear travel or problem areas.
- Known bear denning areas.
- Locations where terrain obstructs visibility.

In Alaska, types of locations to avoid if possible include the outer edge of the landfast ice, the offshore shear zone, traditional whale-butchering sites where bears may congregate during whaling, and, in winter, denning areas onshore such as those known to occur in the Arctic National Wildlife Refuge (Amstrup and Garner 1989).

Bears occasionally occur on land during the open-water period. These bears wander along the coast looking for food. Bears have been seen on barrier islands and artificial islands in summer.

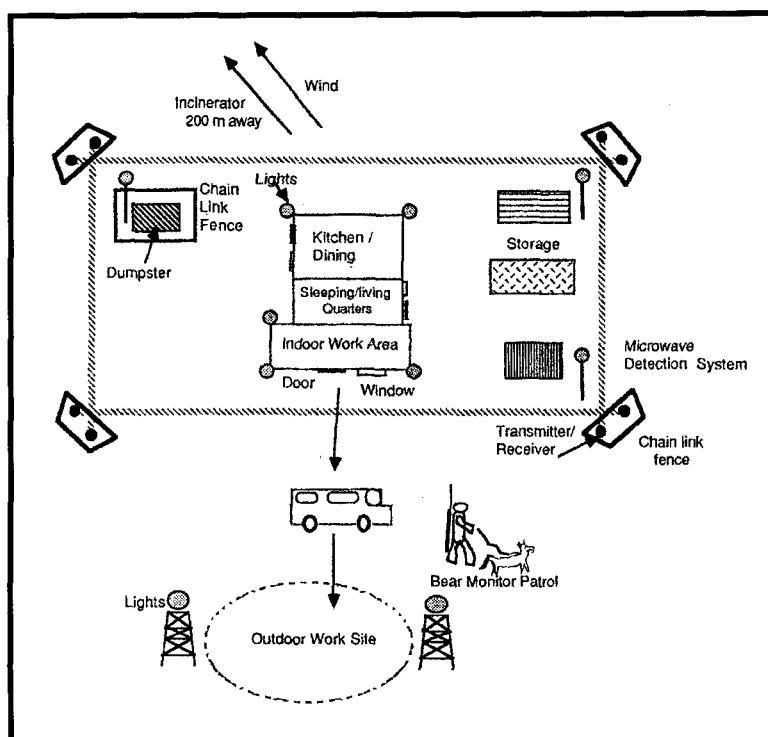

Figure 8-1. Idealized permanent camp design.

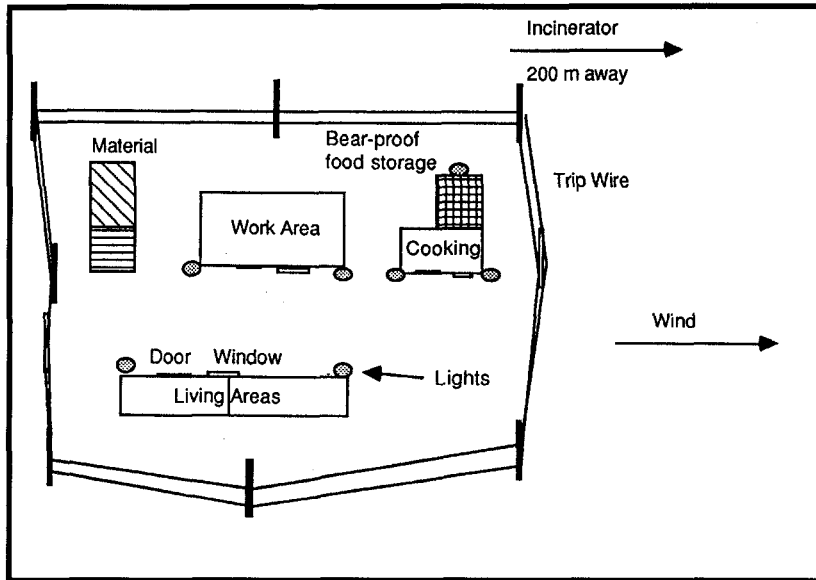

Figure 8-2. Idealized design for semi-permanent camp.

Facilities Layout and Design

Polar bears are curious and will investigate unusual features or situations within their domain (Fleck and Herrero 1988). Even if operators have followed all the precautions about food and garbage handling, a bear may investigate a camp because of its novelty (See CHAPTER 3). Operators must assume, therefore, that bears will visit work camps.

Camps should be designed so that bears can be detected, and if they enter, that they cannot find hiding places (Figs. 8-1, 8-2, and 8-3). Some guidelines are:

- Block off crawl spaces under buildings and cubbyholes under stairs (Figs 8-4, 8-5), and install bear-proof fencing or other mesh barriers around stairwells not visible from indoors (See CHAPTER 5). Polar bears have hidden in unfenced spaces and ambushed workers; thus, leaving hiding places near doors is particularly unwise.
- Design the camp with a few large buildings or tents rather than several small ones; this reduces the chances that a bear in camp will be hidden from view (Bromley 1985).
- Leave no dead ends or cul-de-sacs where a bear could be cornered or feel that it is cornered and where a person could be trapped by a bear (Fig. 8-5).
- Space buildings and tents apart and put them in a line or in a semi-circle so that it is easy to get unobstructed views (Fig. 8-6) (Bromley 1985).

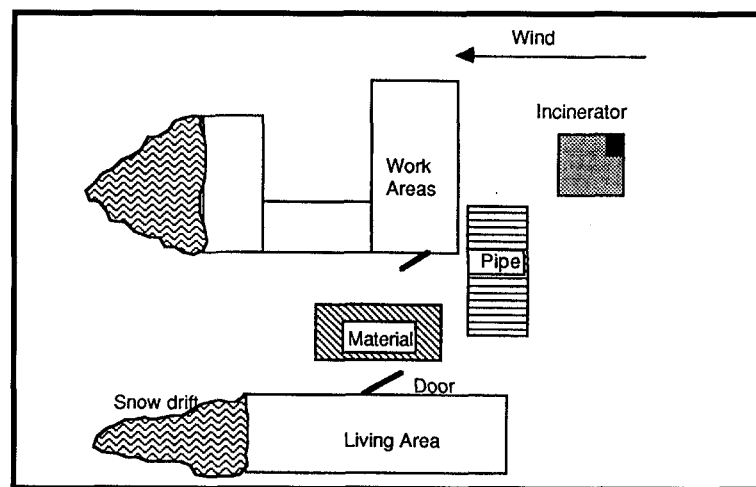

Figure 8-3. Improper camp layout.

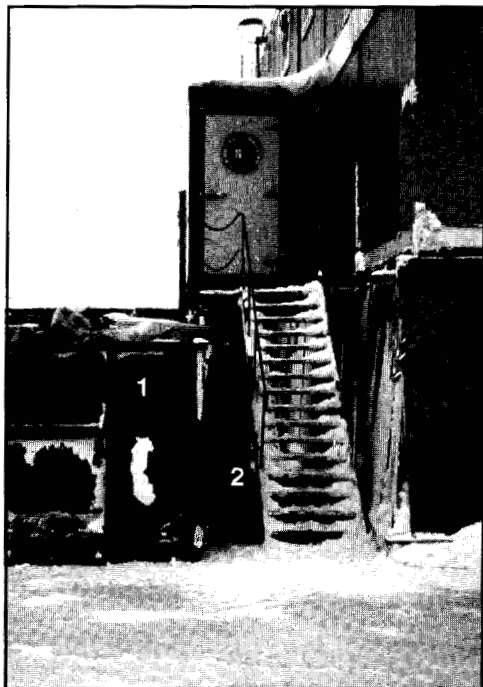
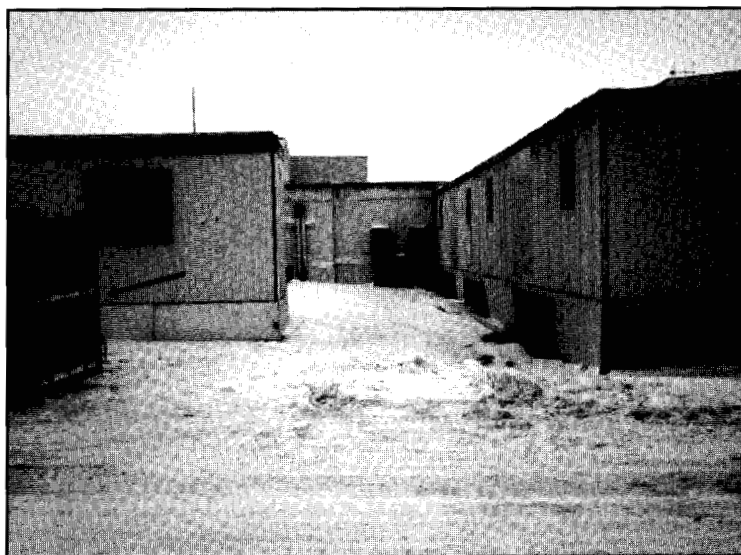

Figure 8-4. ARCO "Fiord" ice island exploratory drill site. Note plywood skirting around camp. Problem areas are the dumpster (1) which is right under the entrance and the lack of skirting (2) under the stairwell. A bear attracted by the dumpster could ambush people from under the stairs (D. Shideler).

- Locate cooking and food storage areas and latrines at least 50 yards (46 meters) from sleeping and working areas in unfenced camps. In all camps, locate areas containing food apart from and visible to people in sleeping and working areas (Bromley 1985).
- Place garbage incineration areas at least 200 yards (180 meters) from unfenced camps, but visible from camp (Bromley 1985).
- Locate sleeping quarters upwind from food storage, cooking, and garbage disposal areas (Bromley 1985).
- Cover walkways and work areas in permanent camps so that required outdoor activity is minimized, especially during dark periods.
- Orient door openings and windows so that persons exiting buildings have an unobstructed view of the immediate area outside.
- Protect workers at windowless door exits by constructing a chain-link or re-bar observation cage enclosing the door and staircase area on the outside (See CHAPTER 5).

Figure 8-5. Back of hotel at Deadhorse, AK. There is a dead end with a dumpster (arrow) around a blind corner from the kitchen door (around corner to left). Lighting was poor and there was no skirting around buildings (D. Shideler).



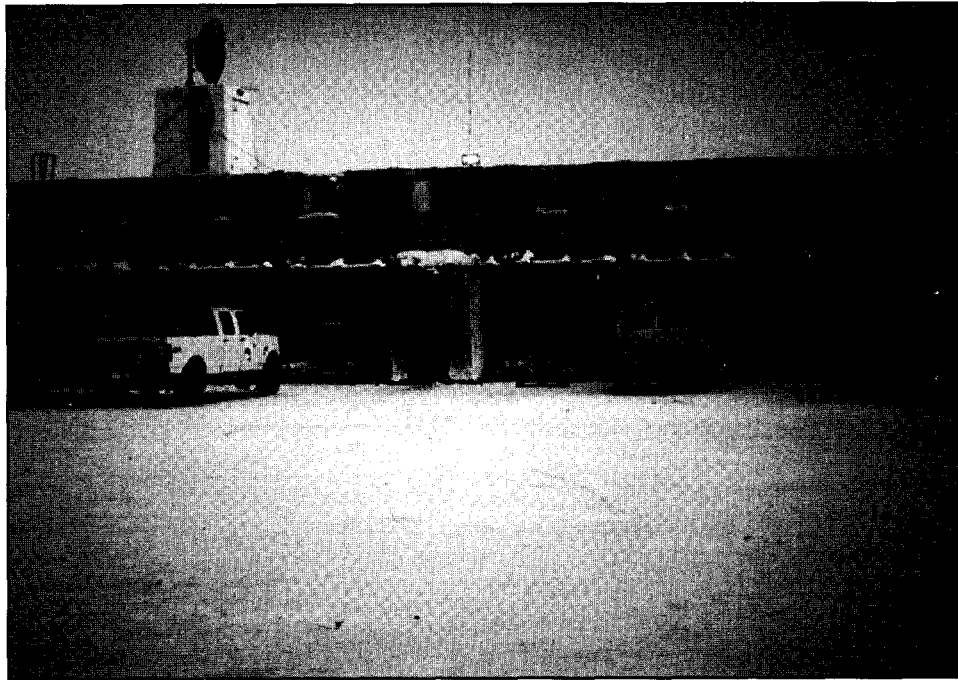

Figure 8-6. ARCO "Kalubik" ice island exploratory drill site. Camp is on the ice so no skirting was required. Note the good line of sight from the main entrance (D. Shideler).

- Provide an enclosure around stairways and a bear-proof gate at the bottom.
- Place mirrors at blind corners and maintain them frost-free.
- Where snow conditions permit, have exterior doors open outward and close against a solid stop so that a bear pushing against it will not feel it "give".
- Maintain unobstructed walkways and clear lines of sight between common destinations within the camp (Fig. 8-6).
- Store materials and supplies so that they provide no hiding places for bears, especially near doors, walkways, and work areas (Bromley 1985).
- Keep snow cleared from around buildings and fences.
- Align buildings to minimize drifting of snow.
- Provide good lighting around doors, outdoor work areas, food storage areas, garbage disposal areas, and any other areas that people commonly use.

Fencing and Other Barriers

Fencing and other barriers are often useful for enclosing entire camps or sites within camps (See CHAPTER 5). It is important to construct fences or other barriers that are effective, because improper fencing may allow bears access to workers who are not vigilant.

Fences or other barriers must be patrolled on a regular basis to ensure that the integrity of the system is maintained. In particular, snow or ice buildup at the base of a barrier could provide a ramp for bears to cross the barrier.

Garbage Disposal and Food Storage

About 40% of the polar bear attacks that cause injury are related to the attractiveness of food or garbage (Herrero and Fleck 1990). Bears find much of their natural food with their noses, thus, nature has provided them an extraordinarily keen sense of smell. To survive, they must be able to sniff out invisible seal breathing holes in the ice and seals concealed in snow dens on the ice. They can smell food, garbage, and other human-

generated waste from many miles away. When a bear comes to associate human presence with easy food, and this may take very little experience, it will seek out similar situations thereafter (Follmann and Hechtel 1990).

Deterrents are often less effective if food acts as an attractant (Fleck and Herrero 1988). On the other hand, if a bear is attracted to a camp by food odors and is not rewarded by food, it will not associate the camp with a meal and is less likely to return.

General rules for dealing with garbage (Fig. 8-7) and human waste at sites of operation include the following (Follmann and Hechtel 1990):

- Incinerate all garbage and human waste if at all possible. Conduct burning in the morning or after the evening meal. If garbage is incinerated at night, the smell could attract bears to camp when everyone is asleep.
- Daily burn all garbage completely to ash in a forced-air incinerator (Follmann and Hechtel 1990).
- In large, permanent camps, keep fresh garbage inside the kitchen or outside in sealed steel containers in an area surrounded by a bear-proof fence (Follmann and Hechtel 1990).
- At temporary work sites, store garbage in bear-proof, odorless containers and have it transported daily to a permanent camp where it eventually can be incinerated (Follmann and Hechtel 1990).
- Always locate dumpsters and temporary garbage holding areas away from doors or other places where bears could easily hide and ambush people.



Figure 8-7. Kuparuk industrial center, Kuparuk oilfield. Hotel is on pilings with no skirting. The dumpster located near the kitchen door could attract bears and the dumpster and access to areas under the building provide bears with hiding places (D. Shideler).

- Wash all unburnable trash, such as food cans, before storing in a garbage bin.
- Treat dishwater with lye and disinfectant and dispose of it well away from camp (Bromley 1985).
- Use chemical toilets in preference to latrines. If a latrine must be used, cover latrine waste with lime on a regular basis. Burn tampons and sanitary napkins (Bromley 1985).
- Use vehicles and garbage chutes to move garbage. Avoid walking outside carrying garbage.

Rules for storing, cooking, and eating food need to be as stringent as those for handling garbage and human waste. Important precautions follow:

- Store food in bear-proof enclosures or buildings, or in buildings that are surrounded by bear-proof fencing (Follmann and Hechtel 1990).
- Lock freezers, refrigerators, and other food storage areas because a bear can easily open a door.
- Do not feed bears or other wildlife. Intentional feeding of bears should be made grounds for dismissal because, after bears become used to obtaining handouts, they are particularly dangerous to people.
- Keep food out of sleeping and working quarters, vehicles, and aircraft. Emergency food for use in vehicles and aircraft should be stored in odorless and airtight containers (Bromley 1985).
- Produce as few food wastes as possible. Use leftovers as quickly as possible and do not leave them lying around the kitchen (Bromley 1985).
- Take special precautions with fat and grease because polar bears are strongly attracted to them. Store them in air-tight containers and burn excess amounts in a hot fire or reuse them right away. Do not pour waste cooking fat outside. Select non-greasy foods as much as possible, especially in temporary or mobile camps where fencing and other deterrents cannot be used (Bromley 1985). Keep the kitchen cabinets, walls, and air vents clean of grease. Use an air cleaner over the stove to trap grease before it gets away, and keep the air cleaner clean.
- Treat oil, lubricants, other fluids, snow mobile seats, rubber boats, tents, rubber, and wire insulation as you would food. In the past, bears have been attracted to, chewed on, or tried to eat these items.
- Do not carry food around camp; this is especially important when a person is alone and it is dark.

The methods used in each camp for handling food and garbage need to be described in the personnel training programs (See CHAPTER 6). Cooks and other personnel handling food need to be especially familiar with the rules about food and garbage handling. All personnel need to be told about the necessity of keeping the camp clean, and about restrictions on eating and storing food in sleeping quarters, vehicles, and work areas, and outside of buildings.

Detection Systems

The purpose of a detection system is to give early warning of the presence of a bear and then to communicate the warning. Detection systems can include lights, bear monitors, dogs, trip wires, and other devices (See CHAPTER 4). The layout of the detection system is crucial to its success. Important considerations are:

- Include a bear detection system in the initial planning stages of camp design.
- Design the system so that human activity will interfere minimally with its functioning.
- Set up the system so that the operator can determine at least the general area where penetration has occurred.
- Adjust the design to accommodate site-specific circumstances.
- Incorporate floodlights into all detection systems because bears tend to be active at night and tend to avoid well-lighted areas.
- Protect fragile system components such as electronic transmitters or receivers with bear-proof housing.
- Tie the detection system to an alarm audible to workers inside and outside and distinguishable from other alarms.

SPECIFIC OPERATION TYPES

Several types of oil-related activity occur in polar bear habitat. Seismic operations, well-drilling, and production operations dominate in terms of camp size and the required complexity of polar bear response programs. In addition, occupation of temporary camps, use of winter roads to and from sites, and aircraft operations need to plan for polar bear encounters. Details of site design and operation differ among the types of activity.

Seismic Operations

The polar bear walked up to my D9 Caterpillar tractor, swatted it a few times, and then walked away (Tractor driver, Barrow Strait, NWT, pers. comm.).

Geological and geophysical surveys are conducted prior to drilling to find areas that could contain oil or gas deposits (Fig. 8-8). In arctic offshore areas, these operations are usually carried out in winter on the sea ice. The ice must be at least 4 feet (1.2 meters) thick to support the heavy equipment that is used. In the Beaufort Sea, the ice is usually this thick from about 1 February to 31 May.



Figure 8-8. Seismic operations, being mobile, cannot always be equipped with skirting around buildings (W. Sands).

A typical seismic operation that uses a vibrator includes three separate working groups:

- A survey crew with one or two vehicles that moves ahead of the operation and marks places where the sounds are to be made.
- The main operation which consists of four or five vibrator vehicles, four or five vehicles carrying recording instruments, a recording vehicle, and a tender.
- A movable camp with kitchen, incinerator, and sleeping vehicles.

If vibrators and other vehicles carrying data recorders have wheels, bulldozers may also move ahead of the vibrators and prepare ice roads. If the vehicles have tracks, as they usually do, the bulldozers are needed only when snow cover is heavy.

Four to five miles (6.4 to 8.0 kilometers) can be covered in the typical 16- to 18-hour day of a seismic operation. During working hours, the seismic convoy operates continuously and produces considerable airborne and underwater noise in addition to the physical movements of men and machines. In rare instances bears approach seismic convoys, probably out of curiosity, but most interactions with polar bears are likely to occur during pre-seismic survey operations or at camp sites (discussed later). Considerations for mobile operations are:

- **Do not approach or pursue a bear**, even if only to view or photograph it.
- Use polar bear monitors to detect bears when working away from the main operation.
- Coordinate with supervisor, bear monitor, or polar bear response coordinator any work to be conducted outside vehicles.
- Illuminate all work areas, as well as the entire convoy area, with lights.
- Avoid moving convoys through known denning areas during the period when dens are in use (late November to mid-April), and avoid approaching within 1 mile of occupied dens. Contact government personnel beforehand (See CHAPTER 9) to determine if your surveys might approach occupied dens.
- Handle food and garbage as in a temporary camp. Incineration is the preferred and safest method of garbage disposal. If this is not possible, store garbage in bear-proof, odorless containers and transport it out daily. Store food in a bear-proof vehicle and do not store or eat food in other than designated food preparation or dining vehicles.
- Set up camps to enhance visibility of areas that are accessible to bears.

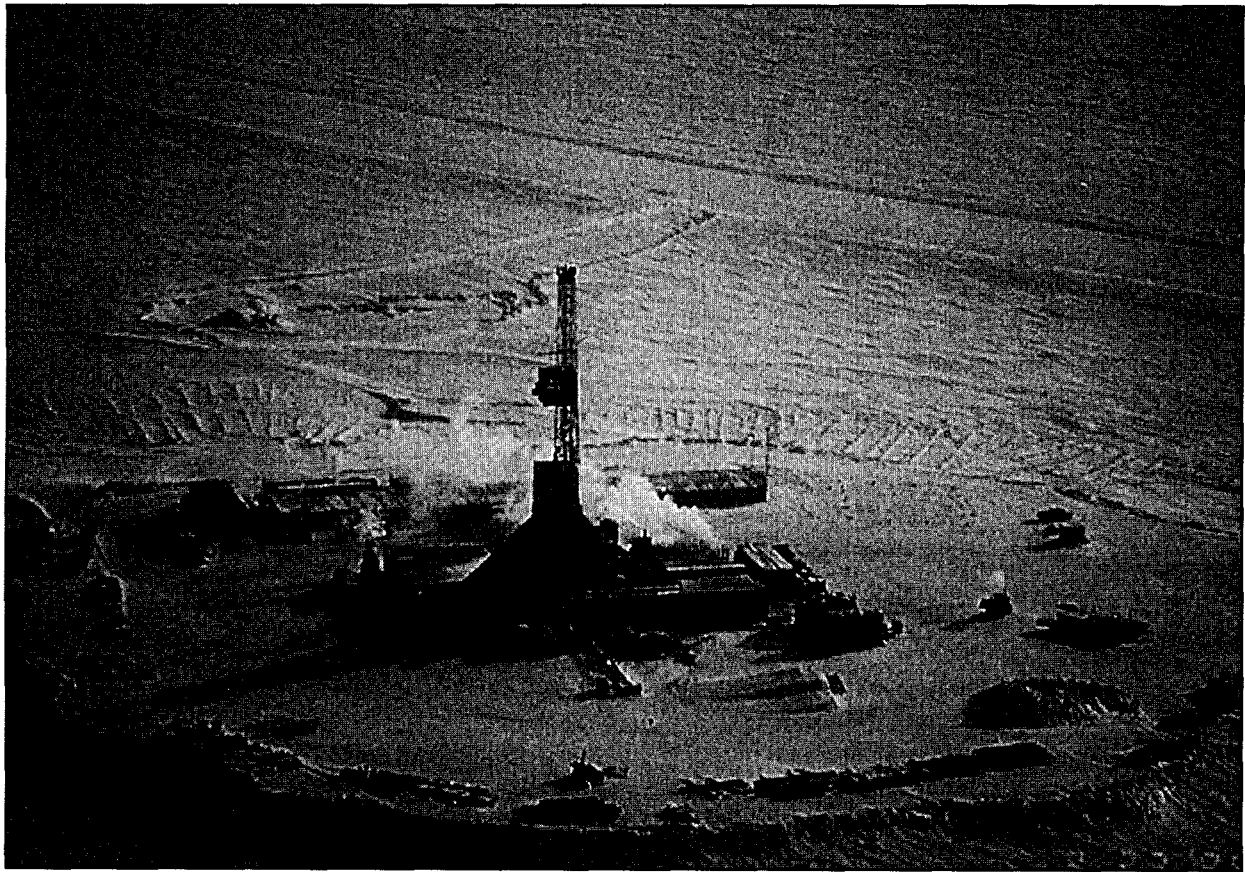

Figure 8-9. Chevron "Karluk" ice island drill site was the first Alaska project where a polar bear interaction plan was applied. Note the open areas around the rig and storage areas around the perimeter. The camp was directly on the ice and no skirting was required. Garbage was incinerated on-site (March 1989) (D. Shideler).

Drilling and Production Facilities

Several types of structures are used to support offshore drilling operations in the Arctic. The most commonly used ones are as follows:

- Artificial islands are used in water less than 50 feet (15.2 meters) deep. Some are made of gravel hauled from land across nearshore ice in winter. Once a gravel island is built, a drilling rig may be barged to it during the summer or hauled to it on an ice road in the winter. Some artificial islands are made of ice (Fig. 8-9); they are constructed in winter by spraying sea water in the air to form ice crystals that fall on the ice and make it thicker. The thickened ice sinks and becomes grounded on the sea floor. Most artificial islands are constructed in the approximate period from December to May, during which time an ice access road with daily traffic may link them to land.
- Natural barrier-islands are also used as drilling platforms. Unlike other platforms, they may contain denning habitat.
- Several types of bottom-founded mobile drilling units are used in shallow to medium-depth waters. The concrete island drilling system (CIDS) is a mobile, water-ballasted, composite concrete/steel unit capable of year-round operations in the Arctic. Caisson-retained islands (CRI) are similar in construction and design to gravel islands but the island is bounded by concrete or steel caissons which rest on the ocean floor; thus, the sides of the island are much steeper. The single steel drilling caisson (SSDC) is a very large modified crude carrier that can be sunk on subsea gravel berms or a steel support structure (the MAT). Provisions for these bottom-founded units are generally transported by supply vessel during the open-water period, and by rolligon train over the ice in the winter.
- Drill ships are used in deep water and primarily during the open-water period, but can operate in light and moderate ice conditions with icebreaker support. A barge and tug typically provide oil spill response capabilities and refuelling support.

Offshore drilling operations are most likely to encounter polar bears when the ice first moves to the site in the fall. At this time bears are moving southward with the pack ice (Amstrup and DeMaster 1988). During winter, the open-water areas around some types of drilling operations could attract seals and hence polar bears (Stirling 1988) (See CHAPTER 3). As the ice breaks up and recedes north in summer, most of the bears move north with it.

Depending on the location, time of year, local ice conditions, and duration of drilling, each offshore drilling operation could experience a few to a few hundred approaches by polar bears. Many of these would represent multiple approaches by individual bears.

Drilling platforms that have high vertical sides—CIDS, CRI, SSDC, and drill ships—are relatively secure from polar bears (LGL 1990). Bears are unlikely to threaten humans on such a rig and these facilities do not need a detection system around the perimeter. Icebreakers likewise have steep sides, but care should be taken to remove ladders or other means of bear access when these are anchored in polar bear habitat.

To protect people entering and leaving secure sites such as these, floodlights should be used ideally in combination with a formal detection system. The lights should be set up around any sea-level access points to these facilities. A temporary detection system could be necessary for on-ice activities such as spill drills or re-supply operations. If ice rubble builds up to the point where a bear could use it as a ramp to gain access to a structure, special precautions are necessary.

Barges, tugs, and other work boats that transport personnel and supplies to and from drilling platforms during open water periods may be accessible to bears. Operators of these boats, particularly when near floating ice, must be alert to the possibility that bears could try to enter, and that the bears could approach from nearby ice or from open water. Appointing a monitor to watch for bears may be necessary.

People at drilling operations on gravel or ice islands run the greatest risk of close encounters with bears. In the Canadian Beaufort Sea, 75% of bears killed by industry personnel and most incidents where bears had to be frightened away were at artificial islands, although only 10% of the drilling was conducted from these islands (Stirling 1988). These types of operations should maintain a relatively sophisticated bear deterrent

and detection system (Chapters 4 and 5) and give close attention to personnel training (See CHAPTER 6).

These types of structures would also be used to support production facilities. Most of the operating principals, rules, and recommendations about site design and operations described in the first part of the chapter should be applied to permanent production facilities. Bear proof fencing, incinerators, and detection and deterrent systems should all be installed. During initial planning for a permanent facility, care should be given to site layout and physical aspects of the bear protection and control plan. It is more cost effective and far easier to build these things into a permanent site than to try and retrofit the site later.

At times, crews may have to work outside any facility or rig. Some precautions and actions to take when crews are working at ice-level or away from camp are as follows:

- Make sure a polar bear monitor accompanies or monitors the crew.
- Keep garbage away from areas where people will be working.
- Return to the main camp to eat, or if this is too far, store, cook, and eat food in designated bear-proof vehicles.
- Keep vehicles and trailers nearby as escape places for workers in the event a bear is sighted.
- Keep work sites and surrounding areas well lit.
- Follow standard response protocol if a bear is sighted (See CHAPTER 9).

Temporary Camps

The bear had destroyed the cooking tent and chewed on anything that resembled food. The bear had not touched our sleeping tent or working tent. We had never brought food into the sleeping tent or working tent (D. Thomson, unpubl. observ., Austin Channel, NWT).

Temporary camps present some special problems (Fig. 8-10). Barriers to prevent bears from entering the camps are usually impractical. The best line of defense is avoidance: reduce the attractiveness of the camp to bears and develop a plan to warn everyone if a bear enters. Some general precautions follow (Bromley 1985):

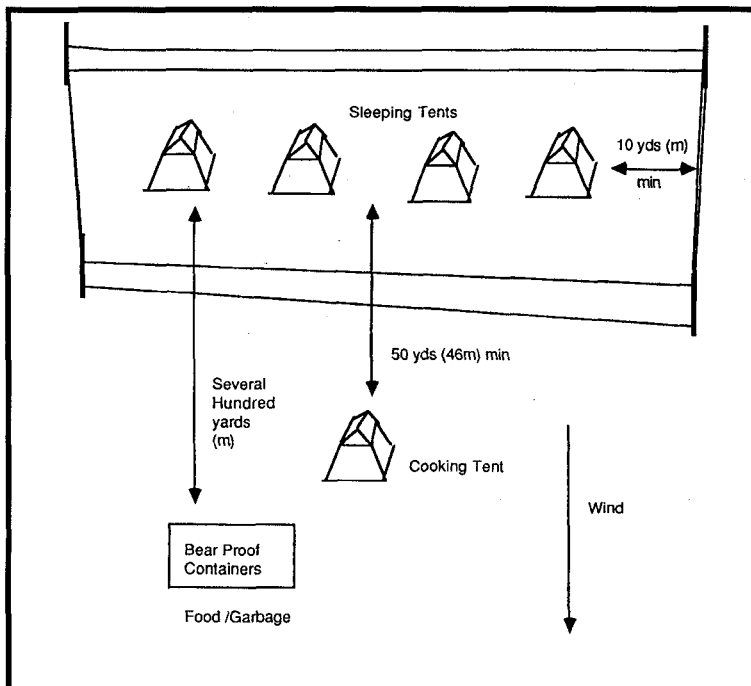

Figure 8-10. Idealized temporary camp.

-
- Locate cooking trailers or tents at least 50 yards (46 m) away from the sleeping and working areas, but easily visible from them.
 - Set up trip-wire perimeters around the camp.
 - Keep deterrent devices, portable spotlights, and large flashlights in camp.
 - Keep a firearm at each tent or trailer; if possible store it outside in winter to prevent condensation from jamming the action.
 - Use odorless foods—freeze dried and dry—if possible, and avoid food with strong odors such as bacon and fish.
 - Confine cooking and eating to specific food preparation and eating areas.
 - Make sure that cooking odors do not get onto clothes and sleeping bags or into sleeping areas.
 - Wear a hat while cooking to keep food odors out of your hair, and do not sleep or work in clothes that you wore while cooking.
 - Clean up immediately after eating and keep the camp clean.
 - Store all food, eating utensils, stoves, and clothes worn while cooking in bear-proof vehicles or containers at least 200 yards (180 meters) from camp.
 - Burn garbage and send it away daily or store it with the food.

Winter Roads

During construction of the Trans-Alaska Pipeline, one grizzly bear developed the ability to remove windshields from trucks to obtain the lunches stored in the cab (Follmann and Hechtel 1990).

In winter, supplies are often transported to and from sites by surface vehicles. Some considerations for placement of roads and operation of vehicles are as follows:

- Avoid known polar bear denning areas during the period when dens are usually in use (between late November and mid-April) and avoid approaching within 1 mile of known dens.
- Make sure when eating en route that garbage is stored in bear-proof and odorless containers, food is stored in inaccessible parts of vehicles, and food is not stored or eaten in the open.
- Check with the supervisor or bear monitor by radio before working outside vehicles to ensure that bears have not been sighted in the intended work area.
- Report any bear sightings to the supervisor or bear monitor immediately; then remain in a vehicle and continue the journey, watching the bear until it is out of sight.
- Remind personnel and post notices indicating that it is illegal under the Marine Mammal Protection Act to approach or pursue a bear.
- Scan the work site with floodlights or vehicle lights before leaving the protection of a vehicle.

Aircraft Operations

It was a nice sunny day in spring. While waiting for you fellows to finish up, I took a nap in the front seat. A rear door of the helicopter was open. I felt the helicopter sway a little and thought that it was you fellows putting your gear on board. I turned and saw that it was a polar bear trying to crawl in the back door (Helicopter pilot, Wellington Channel, NWT, pers. comm.).

A polar bear can easily demolish a light airplane or helicopter. When transferring food to or from an aircraft do not leave the aircraft or unloaded food unattended. To minimize disturbance to bears when flying, keep aircraft at least 1,500 feet (457 m) above sea level. Aircraft should not change course to view or photograph bears; this could be considered illegal under the Marine Mammal Protection Act (Lentfer 1990).

LITERATURE CITED

- Amstrup, S.C., and D.P. DeMaster. 1988. Polar bear, *Ursus maritimus*. Pages 39-56 in J.W. Lentfer (ed.), Selected marine mammals of Alaska: species accounts with research and management recommendations. Marine Mamm. Comm., Washington, D.C.
- _____, and G. Gardner. 1989. Polar bear research in the Beaufort Sea. Draft operations report, spring 1989. Alaska Fish and Wild. Res. Ctr., Alaska. 31pp.
- Bromley, M. 1985. Safety in bear country: a reference manual. NWT Dept. Renew. Resources, Yellowknife. Various p.
- Fleck, S., and S.H. Herrero. 1988. Polar bear-human conflicts. Parks Canada, Prairie Region, and NWT Dept. Renew. Resources, Yellowknife. 155pp.
- Follmann, E.H., and J.L. Hechtel. 1990. Bears and pipeline construction in Alaska. *Arctic* 43:103-109.
- Herrero, S., and S. Fleck. 1990. Injury to people inflicted by black, grizzly, or polar bears: recent trends and new insights. *Int. Conf. Bear Res. Manage.* 8:25-32.
- Lentfer, J.W. 1990. Workshop on measures to assess and mitigate the adverse effects of arctic oil and gas activities on polar bears. Rep. for Marine Mamm. Comm., Washington, D.C. NTIS PB91-127241 39pp.
- LGL. 1990. Petition for promulgation of regulations pursuant to section 101 (a)(5) of the Marine Mammal Protection Act (Exploration Operations during the ice-covered period, Beaufort Sea): Polar Bear (*Ursus maritimus*). Report by LGL Alaska Research Associates, Anchorage, for BP Exploration (Alaska) Inc., Anchorage.
- Stenhouse, G.B., L.J. Lee, and K.G. Poole. 1988. Some characteristics of polar bears killed during conflicts with humans in the Northwest Territories, 1976-86. *Arctic* 41:275-278.
- Stirling, I. 1988. Attraction of polar bears *Ursus maritimus* to offshore drilling sites in the eastern Beaufort Sea. *Polar Record* 24:1-8.

CHAPTER 9. RESPONSIBILITIES AND PROTOCOL FOR BEAR ENCOUNTERS

RICHARD L. TREMAINE
LGL Alaska Research Associates, Inc.
4175 Tudor Centre Drive, Suite 101
Anchorage, Alaska 99508

RESPONSIBILITIES

The polar bear encounter protocol (Fig. 9-1) discussed here is a basic outline of the procedures to be taken in the event of a bear sighting at an industrial site. The site-specific bear interaction plan (Chapter 10) will specify personnel responsibilities and the specific protocol to be followed for a particular site.

All polar bear interaction plans should follow several rules of thumb (See also Chapter 6):

- **All workers should have a responsibility to watch for polar bears.**
- Each site should have a person or persons with delegated responsibilities to watch for bears. These bear monitors must be particularly attentive.
- Each site should have a specific on-site person to whom all bear sightings are immediately reported. This may be the bear monitor, as represented in the attached chart, or another person.
- Each site should have a predetermined method of immediately notifying all personnel in the event a bear is detected.
- Each site should operate under a specific set of actions to be taken by all personnel in the event of a potential bear encounter. This will include methods for moving personnel to secure locations and for ensuring that bears cannot enter buildings.
- In the event that a bear enters a site and does not leave, the bear monitor or site supervisor should immediately contact the U.S. Fish and Wildlife Service and/or Alaska Department of Fish and Game to receive further instructions on how to deal with the situation (see below). This is important partly because it is currently unlawful for unauthorized individuals to take any action that would disturb the bear.
- Following any sighting of a bear, a sighting report should be filled out and USFWS and/or ADF&G should be notified.

PROTOCOL

The attached bear sighting protocol shows the steps that should be taken from the time a bear is sighted until it departs into the distance. A "site" could include a water or refuse site, a survey site, a main camp, or any other site of operation. "Immediate area" refers to surroundings within which a bear poses an immediate threat. This area will vary depending on many factors including site size, location, and layout.

As can be seen from the diagram, even though a bear is not an immediate threat, it should be closely monitored at all times. This ensures that it does not enter a control area unnoticed. While a bear is in the surrounding area, personnel should not leave the site unless it is absolutely necessary and they are in a secure vehicle. When a bear enters a control area, all personnel should go to secure locations immediately. In camps, secure locations consist mainly of buildings or trailers. In the field, the only available secure locations may be heavy equipment vehicles or trucks. Persons should not leave these locations until the bear leaves the control area.

AGENCY CONTACTS

Alaska Department of Fish and Game

Habitat Division
1300 College Road
Fairbanks, Alaska 99701
Phone (907) 451-6192

U.S. Fish and Wildlife Service

Marine Mammals Management
4230 University Drive, Suite 310
Anchorage, Alaska 99508
Phone (907) 271-2347

Note: Contacts with the Alaska Department of Fish and Game should be made in response to actions on State lease areas and contacts with the Fish and Wildlife Service should be made in every instance.

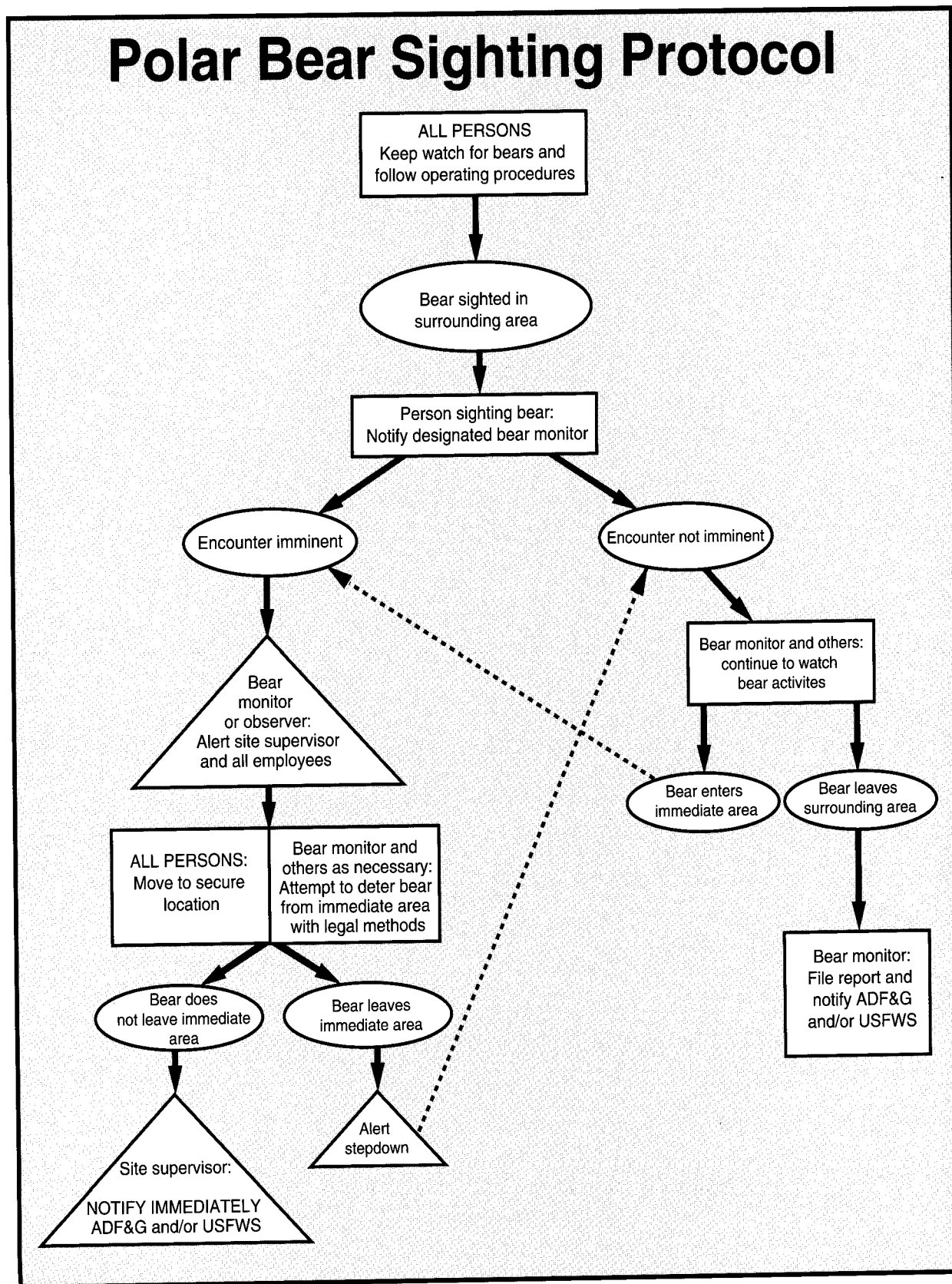

Figure 9-1. Polar Bear sighting protocol.

CHAPTER 10. PREPARATION OF SITE-SPECIFIC BEAR INTERACTION PLAN

RICHARD TREMAINE
 LGL Alaska Research Associates, Inc.
 4175 Tudor Centre Drive, Suite 101
 Anchorage, Alaska 99508

The State of Alaska requires a variety of topics to be incorporated into polar bear interaction plans. These topics are not spelled out in regulations but are considered necessary for adequate review of how operators plan to deal with bears.

What follows is an interaction plan outline that the State of Alaska distributes to those proposing to operate in polar bear habitat. Plan preparers are encouraged to follow this outline. CHAPTERS 3, 4, 5, and 6 contain detailed information to help operators prepare an interaction plan.

The State of Alaska also requires that all persons receiving a permit to operate in polar bear habitat report all encounters with polar bears. Forms are provided for this purpose so that all information is gathered in a similar manner. A copy of the polar bear observation form is attached as Appendix 10-1.

POLAR BEAR INTERACTION PLAN CONTENTS

SITE DESCRIPTION

Overview of Location (map or written)

Location Relative to Ice Conditions (e.g., fast ice, shear zone)

Location Relative to Known Zones of Denning or Individual Den Sites

Site Layout (diagram)

Prevailing Wind (to identify likely snow drifting and odor trail)

Location of Buildings

Kitchen/Dining Hall

Sleeping Quarters

Sanitary Disposal Unit (SDU) (incinerator/dumpster)

Drill Rig

Maintenance Shop(s)

Storage Areas (e.g., pipe, drilling muds/additives)

Access Roads

Vehicle Parking

Snow Disposal Areas

Potential Attractants

Kitchen/Dining Hall/Sleeping Quarters

SDU

Dumpster or Other Temporary Food or Garbage Storage (including incinerator ash)

Chemical Storage (e.g., antifreeze, drilling additives, lubricants)

Risk Assessment (e.g., areas accessible and/or potentially attractive to bears, and where camp personnel are likely to encounter bears)

High Risk Areas (attractant present and high human use — show on diagram)

Between Camp and Rig and Shops

Near SDU and Dumpster

Downwind End of Site

Medium Risk Areas
Reserve Pit and Fueling Areas
Water Site

Safe Areas
Inside Most Buildings
Inside Most Vehicles (including loaders, fork lifts, etc.)

Potential Bear Lookout Locations (e.g., weather tower)

SITE OPERATIONS

Waste Handling Methods and Equipment
Responsible Personnel or Contractor
Treatment of Kitchen Waste (temporary and final methods and intervals)
Other (i.e., lunch sacks, garbage, or food stuffs in vehicles)

Bear Detection
Personnel Responsible for Detection and Detection Equipment Maintenance
Equipment Available and Its Location

Bear Alarm Methods and Equipment
Personnel Responsibilities
Person Issuing Alarm (e.g., drilling foreman, safety/security officer, bear monitor)
Person Maintaining Equipment

Methods and Equipment
Mechanical Methods (e.g., microwave, infrared)
Animate Methods (e.g., polar bear monitor, dogs)
Relationship to Safety and to Security Communications Network

Notification of Camp Personnel
Personnel Responsibilities (e.g., drilling foreman, safety/security officer, bear monitor)
Methods of Notification (e.g., camp intercom, PA system)
[Note: All on-site personnel should be made aware of alarm/notification methods, and how they should proceed when notified.]

Deterrence (if authorized)
Authorized and Responsibilities of Deterrence Personnel

Methods
Vehicles (e.g., trucks, helicopters, front-end loaders)
Firearms (nonlethal - e.g., cracker shells, plastic slug)
Flares or Other "Scarers"
Chemical (e.g., capsaicin spray)

Contingencies for Deterrence Failure
Criteria for Worksite Abandonment
Criteria for Destruction of Bear
Disposal of Carcass (i.e., surrender hide/skull to USFWS)
Notification of Proper Authorities (i.e., USFWS, ADF&G)

OFF-SITE PROCEDURES

Personnel Responsibilities for Bear Detection
Communication with Drillsite and Among Personnel
Deterrence and Protection Equipment
Off-site Lighting System

REPORTING

Schedule
Polar Bear Observation Forms
Polar Bear Incident Forms

PERSONNEL CONTACTS

Company (On-site and Off-site)
Agency

APPENDIX 4-1

Schematic of trip wire at CONOCO's "Badami II" drillsite (courtesy Alaska Telecom and CONOCO, Inc.)

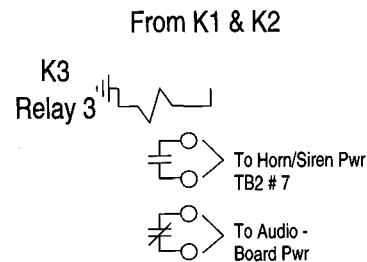
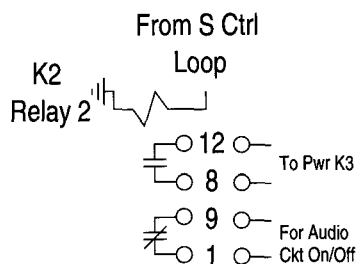
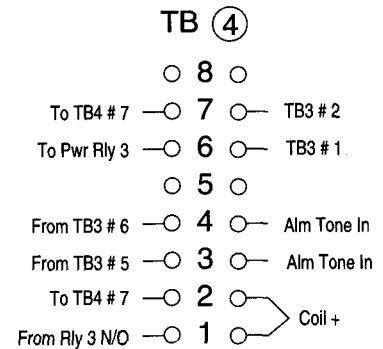
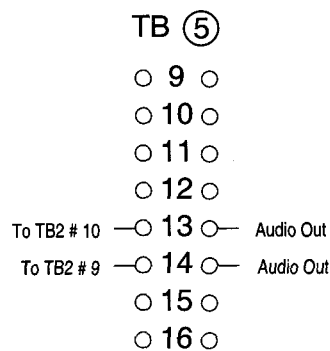
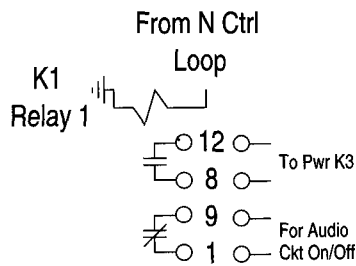
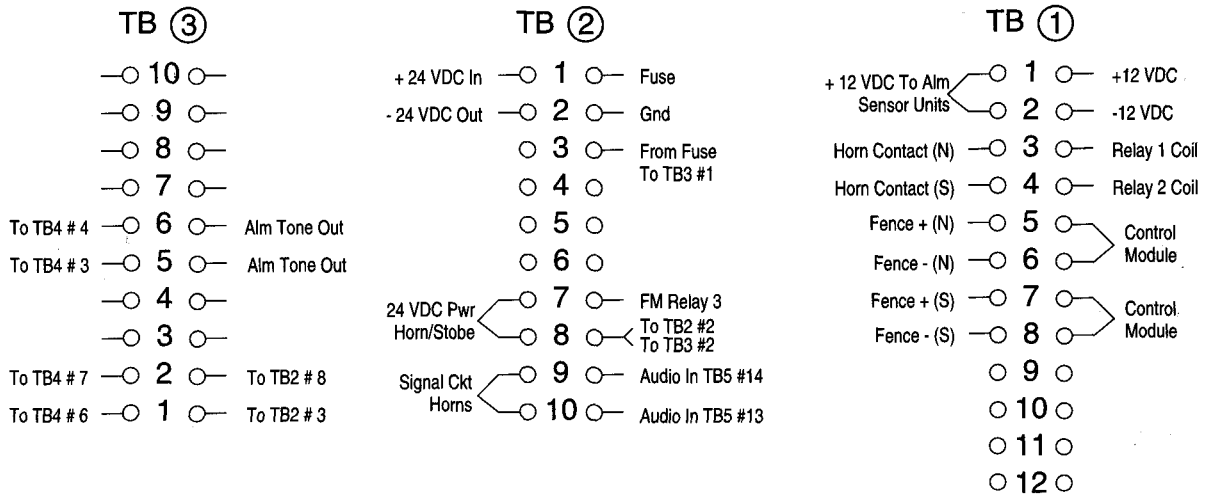

APPENDIX 4-2

Some Manufacturers of Detection Systems

Electronic Communication Company/Installed trip wire and modified base alarm for CONOCO	Alascom Telecom., Inc. P.O. Box 110541 Anchorage, AK 99511	(907) 344-1223
Visual/Auditory Alarms	Federal Signal Corp. Commercial Products 4974-A Scioto Darby Rd. Hillard, OH 43026	(614) 876-6677 FAX (800) 225-4109
Microwave Transmitter/ Receiver Links/ Microwave Transceivers Passive Infrared	Southwest Microwave 2922 S. Roosevelt St. Tempe, AZ 85282-2042	(602) 894-1731 FAX (602) 968-5995
Radar	Motorola Inc. Tactical Electr. Div. 8220 E. Roosevelt P.O. Box 9040 Scottsdale, AZ 85252	(602) 441-7737 FAX (602) 441-7749
I-R	Inframetrics 16 Esquire Road No Billerica, MA 01862-2598	(508) 670-5555 FAX (508) 667-1046
Security/ Surveillance Cameras	Cohu, Inc. Electronics Division 5755 Kearny Villa Road San Diego, CA 92123	(619) 277-6700 FAX (619) 277-0221
I-R Imaging	FLIR Systems, Inc. 16505 S.W. 72nd Avenue Portland, OR 97224	(503) 684-3731 FAX (503) 684-5452
Proximity Detection	SENSTAR, Inc. 5 Billerica Park 101 Billerica Avenue North Billerica, MA 01862	(800) 321-9804 (508) 670-0600 FAX (508) 670-9869
Trip Wire	Margo Supplies, Ltd. Site 20, Box 11, RR #6 Calgary, Alberta, Canada T2M 4L5	(403) 285-9731 FAX (403) 280-1252
Passive Infrared Telescope	Eltec Instruments, Inc. P.O. Box 9610 Daytona Beach, FL 32020	(904) 252-0411 FAX (904) 258-3791

APPENDIX 5-1

Sources for Bear Deterrents

FENCES

Alaska Power Fence
H.C.R. 35250 Schade Lane
Homer, AK 99603
(907) 235-7055 or 1-800-478-8489
(Alaska distributor of Gallagher Power Fence products)

Denali Fenceworks
2950 Van Horn Road
Fairbanks, AK 99701
(907) 474-9542 FAX (907) 479-4427
(Mechanical and electrical fence installation)

Gallagher Power Fence, Inc.
P.O. Box 708900
San Antonio, TX 78270-8900
1-800-531-5908
(National distributor of Gallagher Power Fence System,
and hi-tensile mechanical fence systems)

Margo Supplies
Site 20, Box 11, RR #6
Calgary, Alberta T2M 4L5
CANADA
(403) 285-9731 FAX (403) 280-1252
(Consultation on bearproof fence design/installation; retail
sales of mechanical and electrical fence products, scare
cartridges, plastic bullets)

North Central Plastics, Inc.
P.O. Box 248
Ellendale, MN 56026
(506) 684-3722 1-800-533-2091
(Manufacturer/distributor of "Red Snap'r" electric fence
products)

SCARE CARTRIDGES (12 ga & 15 mm)

Margo Supplies
Site 20, Box 11, RR #6
Calgary, Alberta T2M 4L5
CANADA
(403) 285-9731 (FAX) (403) 280-1252
(Wholesale/retail sales of all types of scare cartridges and
launchers)

Northern Security Supply
900 W. International Airport Road
Anchorage, AK 99518
(907) 561-5602 FAX (907) 563-3698
(Wholesale/retail sales of all types of scare cartridges
and launchers)

Pyrodyne American Corp.
P.O. Box 1436
Tacoma, WA 98401
(206) 922-0800 FAX (206) 922-2350
(Distributor of all types of scare cartridges)

PROJECTILES

AAI Corporation
Law Enforcement Division
P.O. Box 3007
Hunt Valley, MD 21030-3007
(301) 628-3458
(Manufacturer/distributor of Bear Deterrent Round™ 12
ga. plastic bullets)

Margo Supplies
Site 20, Box 11, RR #6
Calgary, Alberta T2M 4L5
CANADA
(403) 285-9731 FAX (403) 280-1252
(Manufacturer/retail sales of Strike Two™ 12 ga. plastic
bullets)

Northern Security Supply
900 W. International Airport Road
Anchorage, AK 99518
(907) 561-5602 FAX (907) 563-3698
(Retail sales of AAI Bear Deterrent Round™ 12 ga.
plastic bullets)

GARBAGE BINS

Capital Industries, Inc.
5801 3rd Avenue, SO
Seattle, WA 98108
(206) 762-5455 FAX (206) 762-5455
(Manufacturer/distributor of bearproof bins)

WOFAM, Inc.
275 Hedge Road
Menlo Park, CA 94025
(415) 322-8308 FAX (415) 322-8308
(Distributor for HaulAll refuse system, which has several
bearproof designs)

APPENDIX 5-2

DICK SHIDELER
Alaska Department of Fish and Game
1300 College Road
Fairbanks, Alaska 99701

Design of Bear-Deterrent Electric Fence Systems

Since the 1930s, electric fences have been used successfully to deter black bears from strong attractants (summarized in Follmann et al. 1980). More recently, electric fences have also successfully deterred grizzly bears (Madel and Taylor, in press).

A few fence designs have been used successfully with polar bears (e.g., Davies and Rockwell 1986), but others have met with little success. This has led to the perception that electric fence systems are not effective deterrents against polar bears. It is true that polar bears have some unique biological traits, and often inhabit areas with unique environmental conditions of snow, extreme cold, and high winds. Nevertheless, recent technological developments as well as experience with grizzly bears under roughly comparable environmental conditions suggest that electric fence systems also are promising deterrents against polar bears.

The following sections discuss the use of electric fences to deter polar bears. Section I presents some electrical concepts relevant to fence design and installation, and discusses biological and environmental considerations for fence system design. Section II describes the components of the fence system, with guidelines for selection and installation. Section III presents several designs that appear most promising for various oil and gas industry functions.

I. THEORETICAL CONSIDERATIONS

The function of an electric fence is to deliver to the bear an electric shock sufficient to induce involuntary contraction of skeletal muscle masses without interfering with heart or other body functions. Reduced to basics, an electric fence is much like other electric circuits: an electric charge, produced by a fence *charger* (also called *fencer* or *controller*), travels through the conductive fence wires into a conducting body (e.g., bear) that simultaneously touches both the charged (+) or "hot" wires and an electrically grounded surface such as a ground (-) wire or mat, or moist, bare ground.

Several problems may be encountered in field situations. Neither fences nor bears are perfect conductors; in fact, it is more useful to think of bears, especially polar bears, as *insulators* rather than conductors. Environmental features such as hoarfrost can cause a slight continuous discharge of electrical current, as can improper connections. The net result is that the current can degrade to an amount insufficient to shock a bear. Furthermore, the fence must be safe for use where humans may encounter it. Therefore, the amount and type of current produced must not exceed standards developed by national safety organizations such as the Underwriter's Laboratory (UL) in the U.S. or Canadian Standards Association (CSA) in Canada.

Four electrical concepts are relevant to understanding these problems and how to solve them. These are (1) voltage, (2) amperage, (3) pulse rate, and (4) ground.

Voltage is a measure of the potential electrical energy available to cause current to move from one conductor to another, i.e., to jump from the fence wire to a conductive surface on the bear's body. Voltage in electricity is equivalent to pressure in hydraulics. It takes 50,000-70,000 volts for current from a charged conductor to cross one inch (2.5 centimeters) of dry air to another conductor (Halliday and Resnick 1981), and over 80,000 volts to cross an equivalent thickness of dry polar bear fur (Wooldridge 1983). A wire energized to these levels arcing across to the skin of a human or bear would cause a severe burn. Therefore, fence voltages must be much less than 50,000 volts but still sufficient to complete the circuit between the fence wire and a bear's skin.

Amperage is a measure of the amount of current in the circuit, i.e., the electrical equivalent of *flow* in a

hydraulic system. Once the current is delivered through the skin, it is conducted through muscle, blood, and other tissue to the muscle masses. The current must be sufficient to innervate these muscles spontaneously without disrupting other body functions. The amount of the charge depends on the amperage and length of time the current is flowing. Most household lighting circuits are designed to carry 15-20 amps of continuous current, but this flow is dangerous to humans and bears. Thus, most fence systems are designed to deliver a pulsed current at less than 1.0 amps, and often in the range of several 1/100 to 1/10,000 of an amp (Anonymous 1989, Baker and Richard undated). Humans can feel a continuous current as a slight tingle at only 1 milliamp (1/1000 amp), lose local muscle control at 9-12 milliamps, and experience ventricular fibrillation (loss of heart function) at 100-200 milliamps (BNP 1970, OSHA 1991).

Pulse is the time component of the shock, both in terms of the length that the current is delivered per unit of time, and in terms of the number of pulses delivered per minute (the pulse rate). UL recommends a pulse length of less than 300 microseconds (<0.0003 seconds) to prevent effects on heart function. Delivering the shock in a pulsed rather than continuous fashion is necessary for two reasons: (1) it conserves electricity by not having the current on all the time; and (2) there must be a sufficient interval between pulses (UL recommends at least 3/4 second) to allow the muscle to relax so the animal (or human) can escape. However, the shock must be frequent enough that an animal will be shocked if it contacts the fence briefly. Most modern chargers have a pulse rate of 40-70 pulses per minute as the compromise between safety and effectiveness.

A *ground* is required for an electric circuit to be completed. The current flow must pass through the bear and return to the charger via the earth, or through an installed electrical grounding system. Most problems with electric fences in general, and especially electric fences used with polar bears, have been caused by lack of a good electrical ground. Methods for grounding are discussed in Section II.

Polar bears have unique biological traits that create special problems for designing an electrical fence that must meet human safety criteria and effectively deter a bear. Some of these are anatomical, others are behavioral. Anatomical traits include size, body composition, and body covering, as follows:

- Polar bears usually weigh several hundred pounds or more. Thus, a shock that meets human safety criteria is even less likely to injure a bear.
- Fat and bone, in contrast with blood and lean muscle, are poor electrical conductors (Harrison and VanItallie 1982). Bears are heavy-boned and often have a large amount of fatty tissue, including large amounts of "blubber" right under the skin. Therefore, producing a sufficient shock requires that the relatively small current required to maintain human safety must be very efficiently delivered to be effective on a bear.
- Dry polar bear skin is a poor conductor of electricity. Like many other mammals, polar bear body covering consists of several layers of dead skin cells interlaced with fat deposits. The cells are of *keratin*, the same protein material in fur and claws. Dry keratin and fat are poor conductors. Conversely, a wet bear is likely to be an efficient conductor.
- Like many other mammals, polar bears have thick keratin pads on their feet. In addition, a polar bear's pads are surrounded by long, stiff fur that can almost cover the entire foot and, thus, reduce ground contact.
- Polar bear fur is also a very poor electrical conductor. It is a physical barrier against penetration to the skin by a wire. Polar bear fur is a worse conductor than air, is dense, and is approximately 3-6 inches (7.5-15 centimeters) long. This can prevent a wire from contacting the skin. Furthermore, the "lay" of the fur on most front portions of the body is toward the rear. If there is any slack in a fence when a bear tries to crawl through it, the wire will slide over the thick fur rather than penetrating to the skin, and the bear will receive no shock.

Several aspects of bear behavior should be considered, as follows:

- Bears tend to follow ice and gravel roads. These are where gates, the weakest links in an electrical fence system, are located.
- Bears have attempted to enter fenced sites by going between or under, and only occasionally over, the wires (M. Madel, Montana Dept. Fish, Parks, and Wildlife, pers. comm.). Therefore, the narrowest distances on a multi-wire fence should be at the

- bear's head level and below.
- Grizzly and black bears that encountered an electric fence with a ground mat rather than ground wires tended to attack the mat rather than vertical wires (M. Madel, pers. comm.). Apparently the bears felt the charge more in their feet than on their torso. Bears which received a shock on their torso while partially through or under the fence sometimes thrashed around trying to escape. Such behavior, especially with portable fences, could destroy sections of fence (Hunt 1985).
 - Bears will sniff or lick wires or metallic attractors (e.g., sardine cans or foil pieces) smeared with an olfactory attractant such as seal oil, fish oil, or grease. By sniffing "baited" wires, bears contact the fence on a highly conductive surface of their body—the moist tongue or nose. When shocked on the facial area, they will also roll backwards rather than jump into the fence. (*Note: Baiting is controversial, and in some circumstances may be technically in violation of the U.S. Marine Mammal Protection Act if used with polar bears. Check with U.S. Fish and Wildlife Service, Marine Mammals Management, Anchorage, Alaska.*)

The environmental conditions in polar bear habitat also require consideration with regard to both electrical and structural integrity of the fence system. Several conditions can cause problems, as follows:

- Wind, snow, ice, and frost buildup, and extreme seasonal temperature changes, can create structural loads on fence wires such that the wires stretch and contact each other or the ground and short out, or in severe cases fall over. On hi-tensile wire fences, in-line tension springs can offset this. Applications using low-tensile strength wires, such as common barbed wire or poly wire, require frequent inspection and maintenance.
- Hoarfrost buildup can cause a slight discharge of current. Over long distances this can reduce the amount of charge so that it is below the threshold for effectiveness against a bear.
- Substrate conditions affect the efficiency of the ground surface in conducting the charge to the ground. Moist substrates provide an efficient ground. Dry conditions, such as sandy ridges or artificial gravel islands, are poor conductors. Snow, especially dry snow, is also a very poor conductor. Soils with a high proportion of clay are better conductors than other soils.
- The presence of green vegetation can enhance or detract from fence efficiency. Green vegetation provides a good electrical ground; however, tall vegetation can short out the lower wires of the fence. If tall vegetation is present, it must be clipped back.

II. FENCE SYSTEM COMPONENTS

A bear-deterrent electric fence should be thought of as a *system* wherein all the major components are integrated efficiently. The system must not only deliver a shock to an intruding bear, it also must be safe for use around humans and allow for normal human activity to occur at the site. Four components make up the system: the charger, fence, gate, and ground.

CHARGER

There have been several brands of chargers (also called *controllers* or *fencers*) used in bear deterrent fences (see Appendix 5-1). Most modern chargers have solid-state modular construction such that components can be easily replaced. Both line and battery energized models are available, and some have solar collectors to power the charger or re-charge batteries. Some models have a visual display that shows at a distance whether the charger is operating. Some models are more useful in cold temperatures than others, but experience with a variety of models is limited; most manufacturers have product support departments that may be able to help. In general, reliance on lubricated mechanical components is risky in extremely cold temperatures unless the components are de-greased or are lubricated with a low-temperature lubricant.

Chargers useful for bear deterrence generally produce a charge in the 5,000-10,000 volt range with a pulse rate of 40-80 pulses per minute, and rely on one of two methods to achieve the desired amperage. One method produces a relatively high amperage (slightly less than 1 amp) but at a very short pulse duration. The other method produces a very low amperage (300 milliamps or so) at a slightly longer pulse duration. Either method can produce sufficient total current flow to shock the bear without compromising human safety.

Guidelines for charger selection and installation follow:

- The charger should be UL or CSA approved.
- The charger should provide 5,000-10,000 volts at the farthest point.
- The charger should be grounded independently of the fence ground (see Appendix Fig. 5-2.2 for typical ground installations).
- For optimal performance, the charger should be installed equal distances from the ends of the fence.
- If possible, the charger should be powered with line current rather than batteries. This will reduce maintenance and provide a more consistent power source.

FENCE

Over the past few decades the upsurge in use of electric fence systems for livestock management has resulted in availability of a wide selection of fence products for new construction as well as for retrofitting existing fences (see Appendix Fig. 5-2.1 and Appendix 5-1 for sources). Two major recent developments are: (1) hi-tensile wire fences that can be tightened at over 400 pounds (200 kilograms) to reduce line sag over long distances; and (2) poly wire and tape that is light-weight and can be used in a number of semipermanent or portable applications. Hi-tensile fences use 12.5 gauge (2.5 millimeter) galvanized steel wire with specially designed fasteners and hangers, and in-line tension springs and tighteners to easily maintain tension over a range of rapid temperature changes and structural loads. These fences are successful in bear deterrent applications because they allow wires to be installed very close together without line sag that would cause a short circuit, and because the tighter wire is more likely than a loose wire to penetrate a bear's fur.

Poly wire and tape consist of several thin conductor wires interwoven with polyester or polyethylene strands to form either a round braid or a flat tape. These are lightweight, easy to install with a minimum of tools, and can incorporate both the hot and ground wire in the same material. This insures that, if the bear contacts the wire, it will receive both hot and ground at the same time. Furthermore, the increased visibility of this material provides the bear a visual cue. The wire, and especially the tape, can be scented easily to induce the bear to lick or sniff it (see discussion in Section I). A range of fence products such as fence posts, wire/tape, fasteners, and insulators has been developed for this system (see Appendix Fig. 5-2.1).

Several authors have attempted to solve the fur penetration problem by recommending barbed wire, under the assumption that the barb would penetrate easier than plain wire (e.g., Follmann et al. 1980, Hunt 1985). Unfortunately, barbed wire cannot be stretched as tightly as modern hi-tensile wire. Therefore, line sag could cause a short circuit if wires were spaced closely together; wires spaced apart could allow bears to enter through the fence by stretching the wires. Furthermore, the barbs tend to load with snow, hoarfrost, and ice more than does plain wire.

GROUND

The electrical ground is one of the most important components of the system, and often one of the most difficult to establish and maintain. The ground system completes the electrical circuit by returning the charge to the earth. The ground system consists of (1) the primary ground used for the charger and ground wires or mats on the fence, and (2) secondary grounds used to enhance continuity between the bear and the primary ground or the earth. In moist soils, especially those dominated by clays, the primary ground can be achieved by conventional means (see Appendix Fig. 5-2.2D), and no secondary ground is necessary because the bear can be grounded directly to the earth.

Unfortunately, most polar bear habitat has very dry or dry snow and ice—conditions where measures are needed to enhance both the primary and secondary grounds. The primary ground is enhanced by creating

a chemically enhanced interface between a stainless steel grounding rod and the surrounding soil (see Appendix Fig. 5-2.2D). Enhancement of the secondary ground can be *chemical* (e.g., by spreading water or salt on the ground immediately in front of the fence) or *mechanical* (e.g., by installing ground wires or mats). Alternating hot and ground wires have been used in several applications with grizzly bears in exceptionally dry soil where the bears could not be grounded directly to the earth (e.g., Madel and Taylor, in press). A ground mat consists of new or used chain link, hog wire, or stucco wire laid flat on the earth in front of the fence. Ground mat has been used successfully with polar bears at a research facility near Churchill, Manitoba (in Davies and Rockwell 1986). With either a ground wire or mat, in addition to a primary ground for the charger there should be an enhanced ground (Appendix Fig. 5-2.2D) for each 2500-3000 feet (800-1000 meters) of perimeter.

Guidelines for primary ground design follow (see Anonymous 1989 and Baker and Richards undated for further details).

Standard ground system for moist conditions and ice islands (Appendix Fig. 5-2.2D)

- Bury three 6-foot (2-meter) lengths of 1-inch (25-millimeter) diameter galvanized rod or pipe approximately 10 feet (3 meters) apart.
- Connect all three rods to the charger or secondary ground system with a continuous ground wire of 12.5 gauge (2.5 millimeters) galvanized wire (do not use copper as it will degrade due to electrolysis).
- Use galvanized ground clamps to fasten wire to rods.
- Maintain a 10-foot (3-meter) distance between ground system and all underground cables, underground water pipes or pipelines, or adjacent buildings on concrete or block foundations.

Enhanced ground system for dry conditions (Appendix Fig. 5-2.2D)

- Fill 3-inch (7-centimeter) diameter holes 4 feet (1.2 meters) deep and 30 feet (10 meters) apart with a bentonite/salt slurry.
- Drive a 1/2-inch (12-millimeter) x 4-foot (1.2-meter) stainless steel rod down the middle of the hole.
- Connect galvanized ground wire system as above.

GATES

The weak point in any fence system is the gate. Small portable installations can use simple commercially available hand-operated gates consisting of a long spring or plastic tape with an insulated handle connecting to an electrified hook on one end (Appendix Fig. 5-2.1). A slightly more robust model can use stanchions of PVC pipe or fiberglass supporting several strands of poly tape or braid that is electrically connected with the fence by flexible wire. For larger semipermanent installations such as exploratory drilling islands, or for permanent facilities, mechanical security gates can be electrified with add-on flexible connectors and insulators. Unfortunately, all these systems require either that a guard operate the gate for vehicle traffic or that the driver exit the vehicle. No matter what the gate design, it will be ineffective if the gate is left open; therefore, it is especially important for the gate to be easy to use and maintain. An easily-operable mechanical gate is probably more effective than an electrified gate that is hard to operate. Several gate designs for mechanical and electric fences are discussed in Follmann et al. (1980), Graf et al. (1993), and Anonymous (1989).

III. PROMISING FENCE SYSTEM DESIGNS

A number of fence systems have been used to deter bears. Systems that integrate mechanical security fences with electrical fences have been used successfully with grizzlies and black bears around permanent installations (see Follmann et al. 1980, Graf et al. 1993). The mechanical security fence provides a backup to the electric fence as well as a visual reinforcement to a bear that gets shocked by the electric fence. The latter function could probably also be achieved by installing a plastic construction barrier fence behind a hi-

tensile electric fence system.

A useful addition to any electric fence system is an audible and visual alarm that is tripped when the circuit is broken. These alarm systems are available commercially.

The following three designs are meant to present some conceptual designs for fences that could be used in polar bear habitat for different applications by the oil and gas industry.

DESIGN A: Portable, all-season fence (Appendix Fig. 5-2.2A)

- Fences used where ease of setup and transport are major requirements (for example, seismic or geological survey camps; rolligon or cat trains; temporary, small construction camps during ice island construction).
- Both hot (+) and ground (-) wires included in each section of poly tape or braid.
- Charger grounded and installed equidistant from both ends of fence—enhanced ground method used if on dry soil or gravel pad (see Appendix Fig. 5.2-2D, and Section II-GROUND above).
- Separate ground used for ground wires if total run is greater than 3000 feet (1000 meters).
- Post and wire spacing as in Fig. 5-2.2A.
- Gate an insulated spring gate or PVC stanchion gate (see GATES above).
- Fence baited as explained in CHAPTER 5 and Section I above.

DESIGN B: Permanent site, occupied only during snow-free season (Appendix Fig. 5-2.2B)

- Wires all hot (+) and secondary ground provided by horizontal mat (see GROUND above) staked to earth and independently grounded for each 3000 feet (1000 meters) of run.
- Charger independently grounded and located equidistant from ends of fence—use enhanced ground method (Fig. 5-2.2D) if on dry soil or gravel pad.
- Wires 12.5 gauge (2.5 millimeters) hi-tensile, galvanized steel, stretched to 400 pounds (200 kilograms) with in-line tension springs.
- Posts of treated wood, fiberglass, or steel spaced approximately 30 feet (10 meters) apart.
- Posts braced at corners and at gate posts at manufacturer's specifications (also see Graf et al. 1993).
- Gate conventional mechanical (see Graf et al. 1993), electrified spring, or PVC stanchion type (see GATES above).

DESIGN C: Permanent, all season (Appendix Fig. 5-2.2C)

- Wires alternating hot (+) and ground (-) 12.5 gauge (2.5 millimeters) hi-tensile, galvanized steel stretched to 400 pounds (200 kilograms) with in-line tension springs, wire spaced as shown in Fig. 5-2.2C.
- Posts of treated wood, heavy-duty fiberglass, or steel 25 feet (8 meters) apart.
- Charger independently grounded and located equidistant from ends of fence—use enhanced ground method (Fig. 5-2.2D) in dry soil or gravel pad (see Section II-GROUND).
- Posts braced at corners and at gates according to manufacturer's specifications (see also Graf et al. 1993).
- Ground (-) wires independently grounded at each 2500 feet (800 meters) of run, using enhanced grounding method (Fig. 5-2.2D) on dry soil or gravel pads; if ground wires separate from each other, they can be jumpered together (Fig. 5-2.2C) before connecting to ground rod.
- Plastic construction barricade or similar fence possibly installed behind electric fence for visual barrier.

IV. LITERATURE CITED

- Anonymous. 1989. Eighth international power fence manual. Gallagher Power Fence Systems, Inc. San Antonio, Texas. 41pp.
- Baker, J., and M. Richards. Undated. Electrical concepts for practical electric fencing. Baker Electronic Enterprises. Edmonton, Alberta., Canada. 29pp.
- Bureau of Naval Personnel. 1970. Basic electricity. U.S. Bureau of Naval Personnel Rate Training Manual 10086-B. Dept. of Defense. Washington, D.C. 490pp.
- Davies, J.C., and R.F. Rockwell. 1986. An electric fence to deter polar bears. *Wildl. Soc. Bull.* 14: 406-409.
- Follmann, E.H., R.A. Dietrich, and J.L. Hechtel. 1980. Recommended carnivore control program for the Northwest Alaskan Pipeline project, including a review of human-carnivore encounter problems and animal deterrent methodology. Final Rept. to Northwest Alaska Pipeline Company by Institute of Arctic Biology, University of Alaska, Fairbanks. Fairbanks. 113pp.
- Graf, L. H., P.L. Clarkson, and J. Nagy. 1993. Safety in bear country, a reference manual, Second edition, Dept. of Renewable Resources, Government of the Northwest Territories, Yellowknife, NWT. 146 pp.
- Halliday, D., and R. Resnick. 1981. Fundamentals of physics, second edition. John Wiley & Sons, New York. 848pp.
- Harrison, G.G., and T.B. VanItallie. 1982. Estimation of body composition: a new approach based on electromagnetic principles. *Am. J. Clin. Nutrition* 35: 1176-1179.
- Hunt, C.L. 1985. Descriptions of five promising deterrent and repellent products for use on bears. Fin. Rept. to USFWS, Office of Grizzly Bear Recovery Coordinator. Missoula, Montana. 55pp.
- Madel, M.J., and G.S. Taylor. In press. A management case of grizzly bear-human cohabitation on the Rocky Mountain Front, Montana. *Int. Conf. Bear Res. and Manage.* 9.
- Occupational Safety and Health Administration. 1991. Controlling electrical hazards. Publ. # 3075, U.S. Dept. Labor, OSHA. Washington, DC. 12pp.
- Wooldridge, D.R. 1983. Polar bear electronic detection and deterrent systems. *Int. Conf. Bear Res. and Manage.* 5: 264-269.

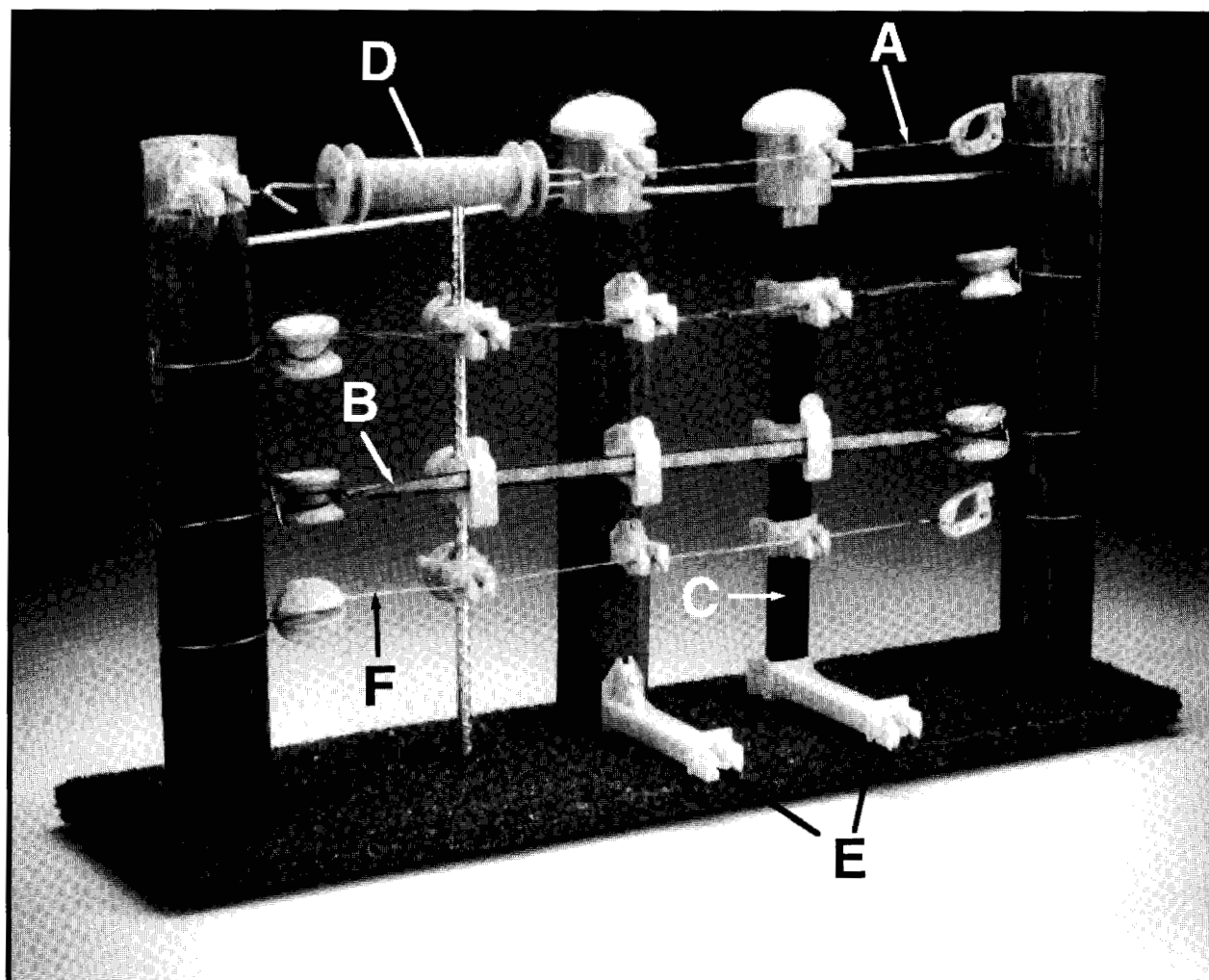

Appendix Figure 5-2.1. Selection of electric fence materials: (a) poly wire; (b) high-visibility tape; (c) fiberglass post with insulated hangers for tape and wire; (d) portable gate handle; (e) offset bracket for combining electric and barrier fence; (f) hi-tensile (12.5 ga. 2.5 mm) wire (photo courtesy North Central Plastics, Inc.).

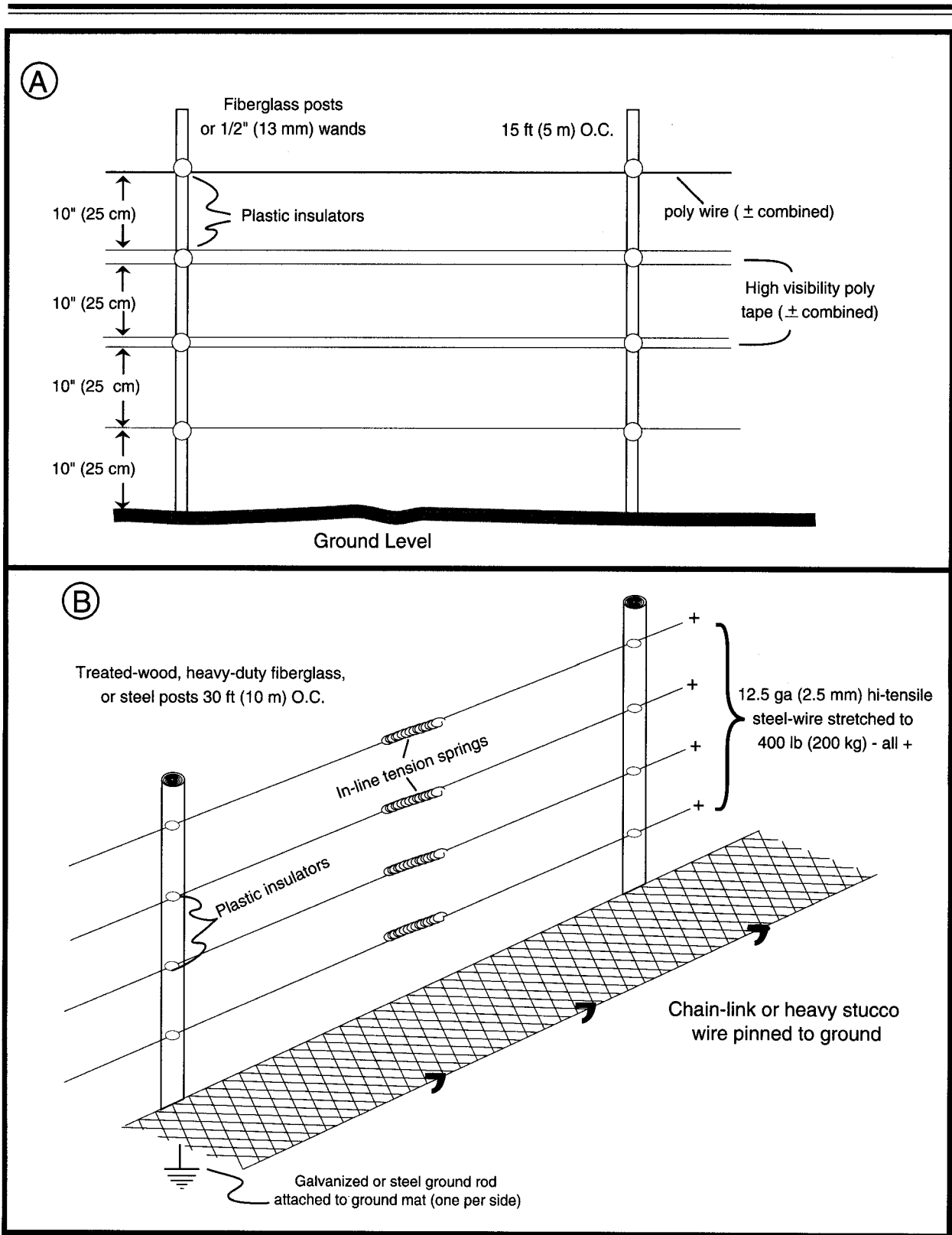

Appendix Figure 5-2.2. Typical barrier and electric fence designs that may be effective against polar bears. See appendix text for explanation.

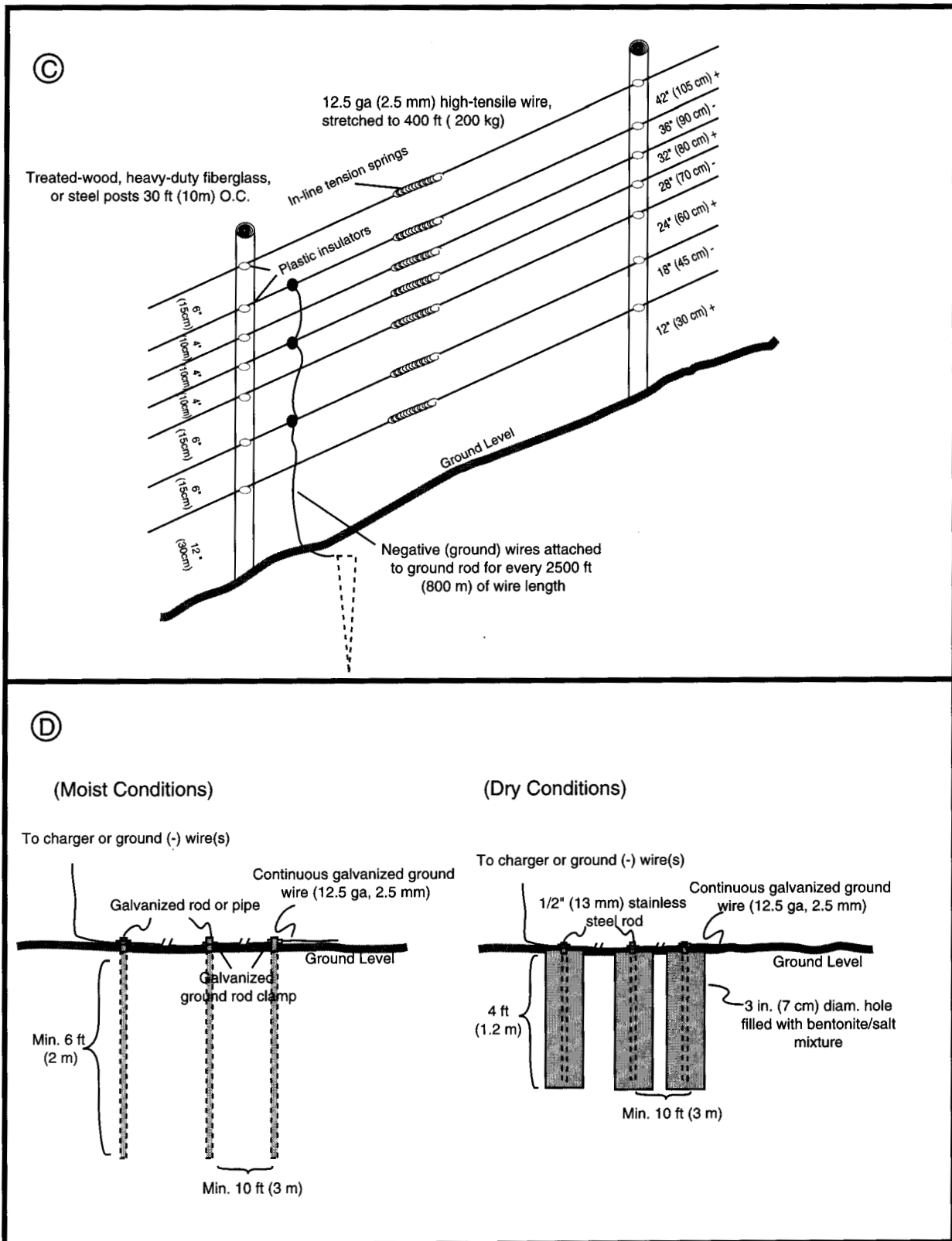

Appendix Figure 5-2.2. (continued).

POLAR BEAR OBSERVATION FORM

Observations of polar bears will increase our understanding of polar bear activity in your area, and will assist us in maintaining the safety of personnel involved in activities along the Alaska coast.

Please complete this form for each observation period even if no bears or tracks are seen. Such information will assist us in learning about the frequency of bears encountering human activities. At the end of each month, send the completed forms to : **Alaska Department of Fish and Game, Habitat Division, 1300 College Road, Fairbanks, Alaska, 99701.**

Company Name _____ Observer _____

Location (drill site name, or lat/long) _____ Date _____

Weather: Clear Snow Fog Rain Cloud Cover: 1/10-5/10 ; 6/10-9/10 ; overcast

Visibility (mi. or yds.) _____ Temp: _____ °F

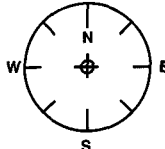
Wind direction (use arrow):  _____
 Velocity _____ mph

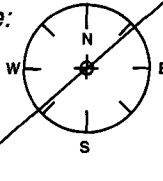
Example: 

Open water around site (in 1/10ths) _____

Time at start of observation period _____ Length of observation (hrs:min.) _____

Bears seen? Yes No Tracks only seen? Yes No

Bear(s) sighted (use separate form for each individual or group sighted)

Number, sex and age (if known) _____

Markings: Natural (scars, injuries, torn ears): _____

Manmade: Collar _____ ; Painted Number (enter number) _____

Ear tags (color): Right ear _____ Left ear _____

Location of bear(s) when first seen: direction _____ and distance _____ (yds) from site
 (or from observers if not observed at site)

When first seen, was bear(s) approaching leaving or not moving

Did bear enter site? Yes No If yes, describe how bear entered, how it acted, and what building or area it approached first (example: entered along access road and went immediately to dumpster; acted hesitant) _____

Did bear encounter people? Yes No If yes, describe encounter (e.g., how many people, what did bear and people do, where were people, how did encounter end?) _____

Other observations of bear's behavior (e.g., did it try to enter buildings, did it rest around or on site, did it act frightened or aggressive) _____

Did bear damage property? Yes No If yes, describe damage _____

How long did bear stay at site? _____ (hr: min)

Was rig or camp supervisor notified? Yes No

What personnel actions were taken? (e.g., notification over PA system, restrictions on activities or work outside) _____

Was any deterrent action (e.g., chasing) taken to make bear leave? Yes No

What type? _____

Was it successful? _____

Was bear hunting in area? Yes No If yes, what prey (e.g., seals) were in area? _____

USE THIS SPACE FOR ADDITIONAL COMMENTS, SKETCHES, ETC.