

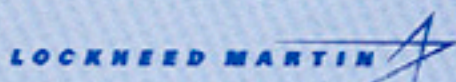

ORNL/CDIAC-81
NDP-043C

**OAK RIDGE
NATIONAL
LABORATORY**



A COASTAL HAZARDS DATA BASE FOR THE U.S. WEST COAST

Vivien M. Gornitz*
Tammy W. Beaty
Richard C. Daniels†

*Center for Climate Systems Research,
Columbia University

†Energy, Environment and Resources Center,
The University of Tennessee



MANAGED AND OPERATED BY
LOCKHEED MARTIN ENERGY RESEARCH CORPORATION
FOR THE UNITED STATES
DEPARTMENT OF ENERGY

This report has been reproduced directly from the best available copy.

Available to DOE and DOE contractors from the Office of Scientific and Technical Information, P.O. Box 62, Oak Ridge, TN 37831; prices available from (423) 576-8401, FTS 626-8401.

Available to the public from the National Technical Information Service, U.S. Department of Commerce, 5285 Port Royal Rd., Springfield, VA 22161.

This report was prepared as an account of work sponsored by an agency of the United States Government. Neither the United States Government nor any agency thereof, nor any of their employees, makes any warranty, express or implied, or assumes any legal liability or responsibility for the accuracy, completeness, or usefulness of any information, apparatus, product, or process disclosed, or represents that its use would not infringe privately owned rights. Reference herein to any specific commercial product, process, or service by trade name, trademark, manufacturer, or otherwise, does not necessarily constitute or imply its endorsement, recommendation, or favoring by the United States Government or any agency thereof. The views and opinions of authors expressed herein do not necessarily state or reflect those of the United States Government or any agency thereof.

DISCLAIMER

Portions of this document may be illegible electronic image products. Images are produced from the best available original document.

A COASTAL HAZARDS DATA BASE FOR THE U.S. WEST COAST

Contributed by

Vivien M. Gornitz
Center for Climate Systems Research, Columbia University
Goddard Institute for Space Studies
National Aeronautics and Space Administration
New York, New York

Tammy W. Beaty
Carbon Dioxide Information Analysis Center
Environmental Sciences Division
Oak Ridge National Laboratory
Oak Ridge, Tennessee

Richard C. Daniels¹
Energy, Environment and Resources Center
The University of Tennessee
Knoxville, Tennessee

Environmental Sciences Division
Publication No. 4590

Date Published: December 1997

Prepared for the
Environmental Sciences Division
Office of Biological and Environmental Research
U.S. Department of Energy
Budget Activity Number KP 12 04 01 0

Prepared by the
Carbon Dioxide Information Analysis Center
OAK RIDGE NATIONAL LABORATORY
Oak Ridge, Tennessee 37831-6335
managed by
LOCKHEED MARTIN ENERGY RESEARCH CORP.
for the
U.S. DEPARTMENT OF ENERGY
under contract DE-AC05-96OR22464

¹Current address: Shorelands and Water Resources Program, Water Division, Dept. of Ecology, Olympia, WA

TABLE OF CONTENTS

	Page
LIST OF FIGURES	v
LIST OF TABLES	vii
ABSTRACT	ix
PART 1: INFORMATION ABOUT THE DATA PACKAGE	1
1. Name of the Numeric Data Package	3
2. Contributors	3
3. Keywords	3
4. Background Information	3
5. Applications of the Data	5
6. Definition of Standard Terms and Concepts	6
7. Original Data Variables	10
7.1 Elevation	10
7.2 Geology	12
7.3 Geomorphology	15
7.4 Sea-Level Trends	18
7.5 Horizontal Shoreline Displacement (Erosion/Accretion)	21
7.6 Tidal Ranges	23
7.7 Wave Heights	24
8. Relative Risk Factors	26
9. The Coastal Vulnerability Index	28
10. Limitations and Restrictions of the Data	31
11. Data Checks Performed by CDIAC	32
12. How to Obtain the Data Package	33

13. References and Data Sources	34
13.1 Citations	34
13.2 Digital Elevation Data	37
13.3 Geology Maps	37
13.4 Topographic Maps	38
 PART 2: INFORMATION ABOUT THE COMPUTERIZED DATA FILES	 41
14. Contents of the Computerized Data Files	43
15. Contents of the Descriptive File	46
16. Listing of the FORTRAN Data Retrieval Programs	65
17. Listing of the SAS TM Data Retrieval Programs	70
18. Partial Listings of the Flat ASCII Data Files	72
19. Verification of Data Transport: Flat ASCII Data Files	75
20. Verification of Data Transport: Arc/Info TM Export Files	78
 APPENDICES	 79
APPENDIX A: THE DATA GROUPS, A QUICK REFERENCE	A - 1
APPENDIX B: GLOSSARY OF TERMS	B - 1
Glossary of Terms Used in the Geologic Classification	B - 3
Glossary of Terms Used in the Geomorphic Classification	B - 5
References	B - 7
APPENDIX C: DATA LISTING OF GEOLOGIC AND GEOMORPHIC DATA	C - 1
Geologic Data	C - 4
Geomorphologic Data	C - 14
APPENDIX D: Geologic Trends Supplement	D - 1
<i>Correction of relative sea-level trends for vertical land motions, U.S. West Coast, by V. Gornitz, 1996.</i>	D - 3
APPENDIX E: REPRINT OF PERTINENT LITERATURE	E - 1
<i>The Development of a Coastal Risk Assessment Data Base for the U.S. Southeast, by Gornitz, V., R. C. Daniels, T. W. White, and K. R. Birdwell. 1994.</i>	E - 3

LIST OF FIGURES

Figure		Page
Fig. 1.	The U.S. West Coast.	5
Fig. 2a.	Grid cells (0.25° by 0.25°) and line segments (1:2,000,000) used in the raster (ASCII) and vector (Arc/Info™) files for Washington and northern Oregon. The value shown within each cell is the grid cell identification number.	7
Fig. 2b.	Grid cells (0.25° by 0.25°) and line segments (1:2,000,000) used in the raster (ASCII) and vector (Arc/Info™) files for southern Oregon and northern California. The value shown within each cell is the grid cell identification number.	8
Fig. 2c.	Grid cells (0.25° by 0.25°) and line segments (1:2,000,000) used in the raster (ASCII) and vector (Arc/Info™) files for southern California. The value shown within each cell is the grid cell identification number.	9
Fig. 3.	The original NGDC elevation data set and the corrected coastal grid cells with calculated mean elevation values (i.e., values of 0 m) used in this NDP.	11
Fig. 4.	Example of how the geologic data were transferred from the 1:2,000,000 digitized coastline map to the 0.25° by 0.25° grid cells used in this data base.	14
Fig. 5.	Locations of the 16 sea-level gauge stations used in this NDP.	19
Fig. 6.	Example of how the shoreline displacement data were transferred to the 0.25° grid cells used in this NDP.	22
Fig. 7	Example of how the wave height data were transferred to the 0.25° by 0.25° grid cells used in this NDP.	25
Fig. 8	Example of how the Coastal Vulnerability Index (CVI ₅) may be used to identify high-risk coastlines.	30

LIST OF TABLES

Table		Page
Table 1.	Geologic classification codes assigned to the coastal geology variable. .	12
Table 2.	Geomorphology classification codes assigned to the coastal geomorphology variable.	16
Table 3.	Relative sea-level trends, U.S. West Coast, mm/year.	18
Table 4.	Assignment of relative risk factors for elevation, shoreline displacement, local subsidence trend, tidal range, and wave height.	26
Table 5.	Assignment of relative risk factors for geology.	27
Table 6.	Assignment of relative risk factors for geomorphology.	27
Table 7.	Sensitivity of different Coastal Vulnerability Indices to changes in risk class from high to low assignments for one to three variables.	29
Table 8.	List and description of the NDP-043C data files.	43
Table 9.	Variable formats for WCGRID.ASC (File 5).	49
Table 10	Variable formats for WCRISK.ASC (File 9).	54
Table 11.	Variable formats for WCLINE.ASC (File 13).	56
Table 12.	Variable formats for WCPOINT.ASC (File 17).	61
Table 13.	Sample of the vector format used for WCOAST.ASC (File 21).	65
Table 14.	Statistical characteristics of the numeric variables in WCGRID.ASC (File 5).	75
Table 15.	Statistical characteristics of the numeric variables in WCRISK.ASC (File 9)	76
Table 16.	Statistical characteristics of the numeric variables in WCLINE.ASC (File 13).	76
Table 17.	Statistical characteristics of the numeric variables in WCPOINT.ASC (File 17).	77
Table 18.	Characteristics and size, in bytes and 512-byte blocks, of WCOAST.ASC (File 21).	78
Table 19.	File size and number of attribute records in each Arc/Info™ export file.	78
Table C1.	Geologic data by grid cell.	C - 4
Table C2.	Geomorphic data by grid cell.	C - 14

ABSTRACT

GORNITZ, V. M., T. W. BEATY, and R. C. DANIELS. 1997. *A Coastal Hazards Data Base for the U.S. West Coast*. ORNL/CDIAC-81, NDP-043C, Oak Ridge National Laboratory, Oak Ridge, Tennessee. 162 pp.

This document describes the contents of a digital data base that may be used to identify coastlines along the U.S. West Coast that are at risk to sea-level rise. This data base integrates point, line, and polygon data for the U.S. West Coast into 0.25° latitude by 0.25° longitude grid cells and into 1:2,000,000 digitized line segments that can be used by raster or vector geographic information systems (GIS) as well as by non-GIS data bases. Each coastal grid cell and line segment contains data variables from the following seven data sets: elevation, geology, geomorphology, sea-level trends, shoreline displacement (erosion/accretion), tidal ranges, and wave heights. One variable from each data set was classified according to its susceptibility to sea-level rise and/or erosion to form 7 relative risk variables. These risk variables range in value from 1 to 5 and may be used to calculate a Coastal Vulnerability Index (CVI). Algorithms used to calculate several CVIs are listed within this text. The data for these 29 variables (i.e., the 22 original variables and 7 risk variables) are available as:

- (1) Gridded polygon data for the 22 original data variables. Data include elevation, geology, geomorphology, sea-level trends, shoreline displacement (erosion/accretion), tidal ranges, and wave heights.
- (2) Gridded polygon data for the seven classified risk variables. The risk variables are classified versions of: mean coastal elevation, geology, geomorphology, local subsidence trend, mean shoreline displacement, maximum tidal range, and maximum significant wave height.
- (3) 1:2,000,000 line segment data containing the 29 data variables (i.e., the 22 original data variables and the 7 classified risk variables).
- (4) Supplemental point data for the stations used in calculating the sea-level trend and tidal range data sets.
- (5) Supplemental line segment data containing a 1:2,000,000 digitized coastline of the U.S. West Coast.

These data are available as a Numeric Data Package (NDP) from the Carbon Dioxide Information Analysis Center (CDIAC). The NDP consists of this document and machine-readable files available on 8-mm tapes, quarter inch tape cartridges, IBM-formatted high-density floppy diskettes, and CD-ROM. These files are also available through the Internet using the File Transfer Protocol (FTP) from CDIAC's anonymous FTP area which can be accessed directly (cdiac.esd.ornl.gov) or through the World Wide Web (WWW) at <http://cdiac.esd.ornl.gov/>. This document provides sample listings of the data and detailed descriptions of the file formats; offers FORTRAN and SASTM retrieval program listings; describes the methods used in calculating each variable; discusses the sources, restrictions, and limitations of the data; provides five Arc/InfoTM export coverages and flat ASCII data files containing these data; and reprints pertinent literature.

SASTM is a registered trademark of the SAS Institute, Inc., Cary, NC 27511-8000.

Arc/InfoTM is a registered trademark of the Environmental Systems Research Institute (ESRI), Inc., Redlands, CA 92372.

PART 1: INFORMATION ABOUT THE DATA PACKAGE

1. Name of the Numeric Data Package

A COASTAL HAZARDS DATA BASE FOR THE U.S. WEST COAST

2. Contributors

Vivien M. Gornitz

Center for Climate Systems Research
Columbia University
Goddard Institute for Space Studies
National Aeronautics and Space Administration
2280 Broadway
New York, NY 10025

Tammy W. Beaty

Carbon Dioxide Information Analysis Center
Environmental Sciences Division
Oak Ridge National Laboratory
P.O. Box 2008
Oak Ridge, TN 37831-6407

Richard C. Daniels

Energy, Environment and Resources Center
The University of Tennessee
Knoxville, Tennessee

Current Address:

Shorelands and Water Resources Program
Water Division, Department of Ecology
P.O. Box 47690
Olympia, WA 98504

3. Keywords

Coastal hazards; risk assessment; sea-level trends; sea-level rise; elevation; geology; geomorphology; coastal landform; subsidence; erosion; accretion; tidal range; wave height.

4. Background Information

Data records accumulated over the past 100 years indicate that sea levels have been rising at a rate of 1–2 mm/yr due to the thermal expansion of the ocean and the increased melting of continental and alpine glaciers (Houghton et al. 1996). During the next 100 years, increasing atmospheric concentrations of CO₂ and other greenhouse gases may lead to an increase in the world's mean

surface air temperature of 1–5°C unless emission levels are reduced (Houghton et al. 1996 and Warrick et al. 1993). Such warming could further enhance the thermal expansion of the ocean and the melting of continental and alpine glaciers.

Changes in climate will affect the coastal zone. Short-term climatic variations have been shown to affect the maximum intensity and frequency of storms (Emanuel 1988) and can cause an acceleration or deceleration in shoreline erosion rates (Dolan et al. 1988). Unanticipated changes in these factors can result in unnecessary loss of life and/or property (Case and Mayfield, 1990). This database may be used to identify areas that are, or could be, at risk to erosion or inundation from change in climate or sea-level rise based on information on the past and current state of the coast.

In 1987, the U.S. Department of Energy's Atmospheric and Climate Research Division funded Dr. Vivien M. Gornitz (Goddard Institute for Space Studies) and the *Carbon Dioxide Information and Analysis Research Program (CDIARP), Resource Analysis Project*, at Oak Ridge National Laboratory (ORNL) in Oak Ridge, Tennessee, to develop a Coastal Hazards Data Base to provide information on the past and current state of world coastlines. The data base contains information on relative sea-level trends, elevation, vertical land movements, horizontal displacement (erosion/accretion), coastal geomorphology, and geology (Gornitz and Kanciruk 1989). CDIAC has published the following three volume series of NDPs for the continental United States: *A Coastal Hazards Data Base for the U.S. East Coast*, ORNL/CDIAC-45, NDP-043A; followed by *A Coastal Hazards Data Base for the U.S. Gulf Coast*, ORNL/CDIAC-60, NDP-043B; and finally this NDP for the U.S. West Coast (ORNL/CDIAC-81, NDP-043C) (Gornitz and White 1992, Gornitz and White 1994, and this volume). A complementary coastal data base for Canada has been developed by the Geological Survey of Canada and is described in Shaw et al. (1994).

The data in this NDP may be used to calculate the relative vulnerabilities of different areas along the U.S. West Coast to projected increases in air and sea surface temperatures and sea-level change. This data base may also be combined with the two previous coastal hazard NDPs (NDP-043A and NDP-043B) to obtain a data base that covers the entire conterminous United States. This information will be useful to researchers, government planning agencies, the private sector, and educational institutions interested in determining the present and future vulnerabilities of coastal zones to erosion and sea-level-rise.

The data base described here comprises data extracted from a variety of sources, including publications of the National Oceanic and Atmospheric Administration (NOAA), the U.S. Army Corp of Engineers, the U.S. Geological Survey (USGS), universities, and other federal and state agencies. These data varied in scale and format. To facilitate data analysis, these data have been referenced to a grid of 0.25° latitude by 0.25° longitude and to a 1:2,000,000 digitized coastline of the U.S. West. This NDP defines the U.S. West Coast as extending from the California-Mexican border to the Washington-Canadian border (Fig. 1).

Fig. 1. The U.S. West Coast.

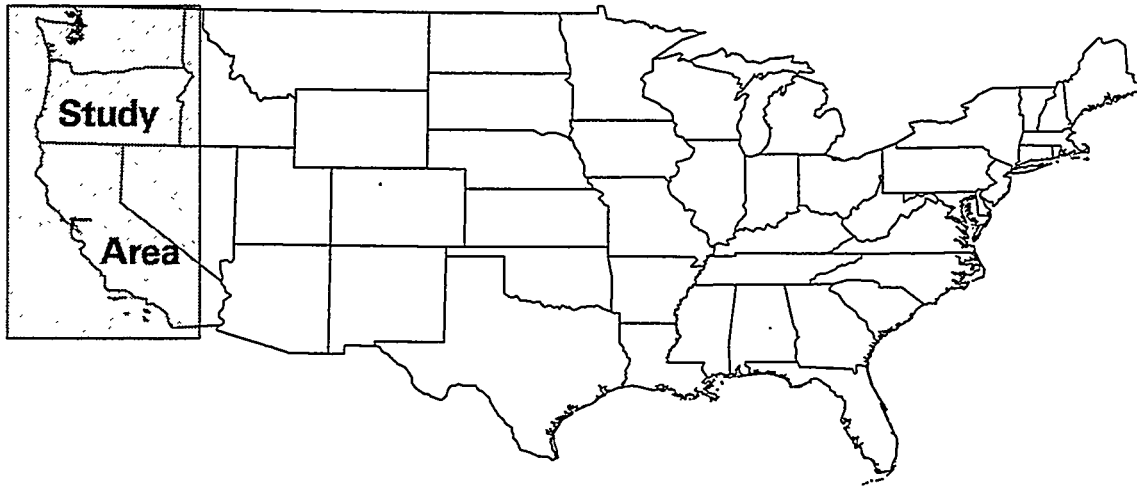

5. Applications of the Data

This coastal hazards data base contains information on elevation, bedrock geology, geomorphology (coastal landform), sea-level trends, horizontal shoreline displacement (erosion), tidal ranges, and wave heights. These data variables were selected for inclusion in this data base because of the roles they play in determining the vulnerability of coastal areas to variations in sea level and long-term erosion.

The 29 data variables in this data base effectively measure two basic risk factors, erosion and inundation. The erosion risk was determined on the basis of historical shoreline displacement, resistance to erosion (geology, geomorphology), and ocean-forcing factors (tidal ranges and wave heights). The inundation risk was estimated on the basis of sea-level trends and elevation data.

This data base and the coastal vulnerability indices (CVIs) that may be calculated with it may be used to identify coastal zones that are at risk from coastal erosion or possible changes in relative sea level.

6. Definition of Standard Terms and Concepts

The data variables within this data base have been placed into five data groups (i.e., three primary groups and two supplemental data groups). A quick reference listing of these data groups and variables is contained in Appendix A. The following terminology is used throughout this documentation.

Data variable—A single, discrete data item within a data group or data set (e.g., data set=elevation, data variable=mean elevation).

System variable—A numeric variable that geographically identifies data variables within a data group.

Data set—A collection of data variables that have been derived from a single data source, such as the mean and maximum elevation variables.

Data group—A collection of data variables that have been placed into a single Arc/Info™ export file and a comparable flat ASCII file.

Data base—All data groups within this NDP.

Original data variables—The 22 data variables from the seven data sets presented within this NDP [i.e., mean, maximum, and minimum elevation, and the number of 5' National Geophysical Data Center (NGDC) grid cells used in deriving the data values; geology; geomorphology; relative sea level trend, long-term geologic trend, corrected sea-level trend, local subsidence trend, and years of record of the gauge stations used in calculating these values; mean, maximum, and minimum shoreline displacement, and the number of 3', 7.5', or 15' grid cells used in deriving the data values; mean and maximum tidal range, mean tide level, and the number of tide gauge stations used in calculating these variables; the 20-year mean wave height, maximum significant wave height and its standard deviation].

Relative risk variables—The 7 classified risk variables derived from each of the following: mean coastal elevation, geology, geomorphology, local subsidence trend, mean shoreline displacement, mean tidal range, and maximum significant wave height.

Each of the five data groups within this NDP is stored as an exported Arc/Info™ coverage and as a flat ASCII file.

The first two primary data groups are referenced to a 0.25° latitude by 0.25° longitude grid and stored as exported Arc/Info™ polygon coverages and as flat ASCII files. The first group contains the original 22 data variables, while the second contains the 7 relative risk data variables. The grid system used covers the West Coast of the U.S. and is outlined by the following coordinates: 126°W, 32°N; 126°W, 49°N; 116°W, 49°N; and 116°W, 32°N. The grid origin (i.e., grid cell number 1) is at 126°W, 32°N, and cell identification numbers increase from left to right, bottom to top (Fig. 2a, 2b, and 2c).

Fig. 2a.

Grid cells (0.25° by 0.25°) and line segments (1:2,000,000) used in the raster (ASCII) and vector (Arc/Info™) files for Washington and northern Oregon. The value shown within each cell is the grid cell identification number.

2681	2682	2683	2684	2685	2686	2687	2688	2689	2690	2691	2692	2693	2694	2695	2696	2697	2698	2699	2700	2701	2702	2703	2704	2705	2706	2707	2708	2709	2710	2711	2712	2713	2714	2715	2716	2717	2718	2719	2720
2641	2642	2643	2644	2645	2646	2647	2648	2649	2650	2651	2652	2653	2654	2655	2656	2657	2658	2659	2660	2661	2662	2663	2664	2665	2666	2667	2668	2669	2670	2671	2672	2673	2674	2675	2676	2677	2678	2679	2680
1601	1602	1603	1604	1605	1606	1607	1608	1609	1610	1611	1612	1613	1614	1615	1616	1617	1618	1619	1620	1621	1622	1623	1624	1625	1626	1627	1628	1629	1630	1631	1632	1633	1634	1635	1636	1637	1638	1639	1640
2561	2562	2563	2564	2565	2566	2567	2568	2569	2570	2571	2572	2573	2574	2575	2576	2577	2578	2579	2580	2581	2582	2583	2584	2585	2586	2587	2588	2589	2590	2591	2592	2593	2594	2595	2596	2597	2598	2599	2600
2521	2522	2523	2524	2525	2526	2527	2528	2529	2530	2531	2532	2533	2534	2535	2536	2537	2538	2539	2540	2541	2542	2543	2544	2545	2546	2547	2548	2549	2550	2551	2552	2553	2554	2555	2556	2557	2558	2559	2560
2481	2482	2483	2484	2485	2486	2487	2488	2489	2490	2491	2492	2493	2494	2495	2496	2497	2498	2499	2500	2501	2502	2503	2504	2505	2506	2507	2508	2509	2510	2511	2512	2513	2514	2515	2516	2517	2518	2519	2520
2441	2442	2443	2444	2445	2446	2447	2448	2449	2450	2451	2452	2453	2454	2455	2456	2457	2458	2459	2460	2461	2462	2463	2464	2465	2466	2467	2468	2469	2470	2471	2472	2473	2474	2475	2476	2477	2478	2479	2480
2401	2402	2403	2404	2405	2406	2407	2408	2409	2410	2411	2412	2413	2414	2415	2416	2417	2418	2419	2420	2421	2422	2423	2424	2425	2426	2427	2428	2429	2430	2431	2432	2433	2434	2435	2436	2437	2438	2439	2440
2361	2362	2363	2364	2365	2366	2367	2368	2369	2370	2371	2372	2373	2374	2375	2376	2377	2378	2379	2380	2381	2382	2383	2384	2385	2386	2387	2388	2389	2390	2391	2392	2393	2394	2395	2396	2397	2398	2399	2400
2321	2322	2323	2324	2325	2326	2327	2328	2329	2330	2331	2332	2333	2334	2335	2336	2337	2338	2339	2340	2341	2342	2343	2344	2345	2346	2347	2348	2349	2350	2351	2352	2353	2354	2355	2356	2357	2358	2359	2360
2281	2282	2283	2284	2285	2286	2287	2288	2289	2290	2291	2292	2293	2294	2295	2296	2297	2298	2299	2300	2301	2302	2303	2304	2305	2306	2307	2308	2309	2310	2311	2312	2313	2314	2315	2316	2317	2318	2319	2320
2241	2242	2243	2244	2245	2246	2247	2248	2249	2250	2251	2252	2253	2254	2255	2256	2257	2258	2259	2260	2261	2262	2263	2264	2265	2266	2267	2268	2269	2270	2271	2272	2273	2274	2275	2276	2277	2278	2279	2280
2201	2202	2203	2204	2205	2206	2207	2208	2209	2210	2211	2212	2213	2214	2215	2216	2217	2218	2219	2220	2221	2222	2223	2224	2225	2226	2227	2228	2229	2230	2231	2232	2233	2234	2235	2236	2237	2238	2239	2240
2161	2162	2163	2164	2165	2166	2167	2168	2169	2170	2171	2172	2173	2174	2175	2176	2177	2178	2179	2180	2181	2182	2183	2184	2185	2186	2187	2188	2189	2190	2191	2192	2193	2194	2195	2196	2197	2198	2199	2200
2121	2122	2123	2124	2125	2126	2127	2128	2129	2130	2131	2132	2133	2134	2135	2136	2137	2138	2139	2140	2141	2142	2143	2144	2145	2146	2147	2148	2149	2150	2151	2152	2153	2154	2155	2156	2157	2158	2159	2160
2081	2082	2083	2084	2085	2086	2087	2088	2089	2090	2091	2092	2093	2094	2095	2096	2097	2098	2099	2100	2101	2102	2103	2104	2105	2106	2107	2108	2109	2110	2111	2112	2113	2114	2115	2116	2117	2118	2119	2120
2041	2042	2043	2044	2045	2046	2047	2048	2049	2050	2051	2052	2053	2054	2055	2056	2057	2058	2059	2060	2061	2062	2063	2064	2065	2066	2067	2068	2069	2070	2071	2072	2073	2074	2075	2076	2077	2078	2079	2080
2001	2002	2003	2004	2005	2006	2007	2008	2009	2010	2011	2012	2013	2014	2015	2016	2017	2018	2019	2020	2021	2022	2023	2024	2025	2026	2027	2028	2029	2030	2031	2032	2033	2034	2035	2036	2037	2038	2039	2040
1961	1962	1963	1964	1965	1966	1967	1968	1969	1970	1971	1972	1973	1974	1975	1976	1977	1978	1979	1980	1981	1982	1983	1984	1985	1986	1987	1988	1989	1990	1991	1992	1993	1994	1995	1996	1997	1998	1999	2000
1921	1922	1923	1924	1925	1926	1927	1928	1929	1930	1931	1932	1933	1934	1935	1936	1937	1938	1939	1940	1941	1942	1943	1944	1945	1946	1947	1948	1949	1950	1951	1952	1953	1954	1955	1956	1957	1958	1959	1960
1881	1882	1883	1884	1885	1886	1887	1888	1889	1890	1891	1892	1893	1894	1895	1896	1897	1898	1899	1900	1901	1902	1903	1904	1905	1906	1907	1908	1909	1910	1911	1912	1913	1914	1915	1916	1917	1918	1919	1920
1841	1842	1843	1844	1845	1846	1847	1848	1849	1850	1851	1852	1853	1854	1855	1856	1857	1858	1859	1860	1861	1862	1863	1864	1865	1866	1867	1868	1869	1870	1871	1872	1873	1874	1875	1876	1877	1878	1879	1880

Fig. 2b.

Grid cells (0.25° by 0.25°) and line segments (1:2,000,000) used in the raster (ASCII) and vector (Arc/Info™) files for southern Oregon and northern California. The value shown within each cell is the grid cell identification number.

1600	1601	1602	1603	1604	1605	1606	1607	1608	1609	1610	1611	1612	1613	1614	1615	1616	1617	1618	1619	1620	1621	1622	1623	1624	1625	1626	1627	1628	1629	1630	1631	1632	1633	1634	1635	1636	1637	1638	1639	1640
1761	1762	1763	1764	1765	1766	1767	1768	1769	1770	1771	1772	1773	1774	1775	1776	1777	1778	1779	1780	1781	1782	1783	1784	1785	1786	1787	1788	1789	1790	1791	1792	1793	1794	1795	1796	1797	1798	1799	1800	
1721	1722	1723	1724	1725	1726	1727	1728	1729	1730	1731	1732	1733	1734	1735	1736	1737	1738	1739	1740	1741	1742	1743	1744	1745	1746	1747	1748	1749	1750	1751	1752	1753	1754	1755	1756	1757	1758	1759	1760	
1681	1682	1683	1684	1685	1686	1687	1688	1689	1690	1691	1692	1693	1694	1695	1696	1697	1698	1699	1700	1701	1702	1703	1704	1705	1706	1707	1708	1709	1710	1711	1712	1713	1714	1715	1716	1717	1718	1719	1720	
1641	1642	1643	1644	1645	1646	1647	1648	1649	1650	1651	1652	1653	1654	1655	1656	1657	1658	1659	1660	1661	1662	1663	1664	1665	1666	1667	1668	1669	1670	1671	1672	1673	1674	1675	1676	1677	1678	1679	1680	
1601	1602	1603	1604	1605	1606	1607	1608	1609	1610	1611	1612	1613	1614	1615	1616	1617	1618	1619	1620	1621	1622	1623	1624	1625	1626	1627	1628	1629	1630	1631	1632	1633	1634	1635	1636	1637	1638	1639	1640	
1561	1562	1563	1564	1565	1566	1567	1568	1569	1570	1571	1572	1573	1574	1575	1576	1577	1578	1579	1580	1581	1582	1583	1584	1585	1586	1587	1588	1589	1590	1591	1592	1593	1594	1595	1596	1597	1598	1599	1600	
1521	1522	1523	1524	1525	1526	1527	1528	1529	1530	1531	1532	1533	1534	1535	1536	1537	1538	1539	1540	1541	1542	1543	1544	1545	1546	1547	1548	1549	1550	1551	1552	1553	1554	1555	1556	1557	1558	1559	1560	
1481	1482	1483	1484	1485	1486	1487	1488	1489	1490	1491	1492	1493	1494	1495	1496	1497	1498	1499	1500	1501	1502	1503	1504	1505	1506	1507	1508	1509	1510	1511	1512	1513	1514	1515	1516	1517	1518	1519	1520	
1441	1442	1443	1444	1445	1446	1447	1448	1449	1450	1451	1452	1453	1454	1455	1456	1457	1458	1459	1460	1461	1462	1463	1464	1465	1466	1467	1468	1469	1470	1471	1472	1473	1474	1475	1476	1477	1478	1479	1480	
1401	1402	1403	1404	1405	1406	1407	1408	1409	1410	1411	1412	1413	1414	1415	1416	1417	1418	1419	1420	1421	1422	1423	1424	1425	1426	1427	1428	1429	1430	1431	1432	1433	1434	1435	1436	1437	1438	1439	1440	
1361	1362	1363	1364	1365	1366	1367	1368	1369	1370	1371	1372	1373	1374	1375	1376	1377	1378	1379	1380	1381	1382	1383	1384	1385	1386	1387	1388	1389	1390	1391	1392	1393	1394	1395	1396	1397	1398	1399	1400	
1321	1322	1323	1324	1325	1326	1327	1328	1329	1330	1331	1332	1333	1334	1335	1336	1337	1338	1339	1340	1341	1342	1343	1344	1345	1346	1347	1348	1349	1350	1351	1352	1353	1354	1355	1356	1357	1358	1359	1360	
1281	1282	1283	1284	1285	1286	1287	1288	1289	1290	1291	1292	1293	1294	1295	1296	1297	1298	1299	1300	1301	1302	1303	1304	1305	1306	1307	1308	1309	1310	1311	1312	1313	1314	1315	1316	1317	1318	1319	1320	
1241	1242	1243	1244	1245	1246	1247	1248	1249	1250	1251	1252	1253	1254	1255	1256	1257	1258	1259	1260	1261	1262	1263	1264	1265	1266	1267	1268	1269	1270	1271	1272	1273	1274	1275	1276	1277	1278	1279	1280	
1201	1202	1203	1204	1205	1206	1207	1208	1209	1210	1211	1212	1213	1214	1215	1216	1217	1218	1219	1220	1221	1222	1223	1224	1225	1226	1227	1228	1229	1230	1231	1232	1233	1234	1235	1236	1237	1238	1239	1240	
1161	1162	1163	1164	1165	1166	1167	1168	1169	1170	1171	1172	1173	1174	1175	1176	1177	1178	1179	1180	1181	1182	1183	1184	1185	1186	1187	1188	1189	1190	1191	1192	1193	1194	1195	1196	1197	1198	1199	1200	
1121	1122	1123	1124	1125	1126	1127	1128	1129	1130	1131	1132	1133	1134	1135	1136	1137	1138	1139	1140	1141	1142	1143	1144	1145	1146	1147	1148	1149	1150	1151	1152	1153	1154	1155	1156	1157	1158	1159	1160	
1081	1082	1083	1084	1085	1086	1087	1088	1089	1090	1091	1092	1093	1094	1095	1096	1097	1098	1099	1100	1101	1102	1103	1104	1105	1106	1107	1108	1109	1110	1111	1112	1113	1114	1115	1116	1117	1118	1119	1120	
1041	1042	1043	1044	1045	1046	1047	1048	1049	1050	1051	1052	1053	1054	1055	1056	1057	1058	1059	1060	1061	1062	1063	1064	1065	1066	1067	1068	1069	1070	1071	1072	1073	1074	1075	1076	1077	1078	1079	1080	
1001	1002	1003	1004	1005	1006	1007	1008	1009	1010	1011	1012	1013	1014	1015	1016	1017	1018	1019	1020	1021	1022	1023	1024	1025	1026	1027	1028	1029	1030	1031	1032	1033	1034	1035	1036	1037	1038	1039	1040	
961	962	963	964	965	966	967	968	969	970	971	972	973	974	975	976	977	978	979	980	981	982	983	984	985	986	987	988	989	990	991	992	993	994	995	996	997	998	999	1000	
921	922	923	924	925	926	927	928	929	930	931	932	933	934	935	936	937	938	939	940	941	942	943	944	945	946	947	948	949	950	951	952	953	954	955	956	957	958	959	960	

Fig. 2c.

Grid cells (0.25° by 0.25°) and line segments (1:2,000,000) used in the raster (ASCII) and vector (Arc/Info™) files for southern California. The value shown within each cell is the grid cell identification number.

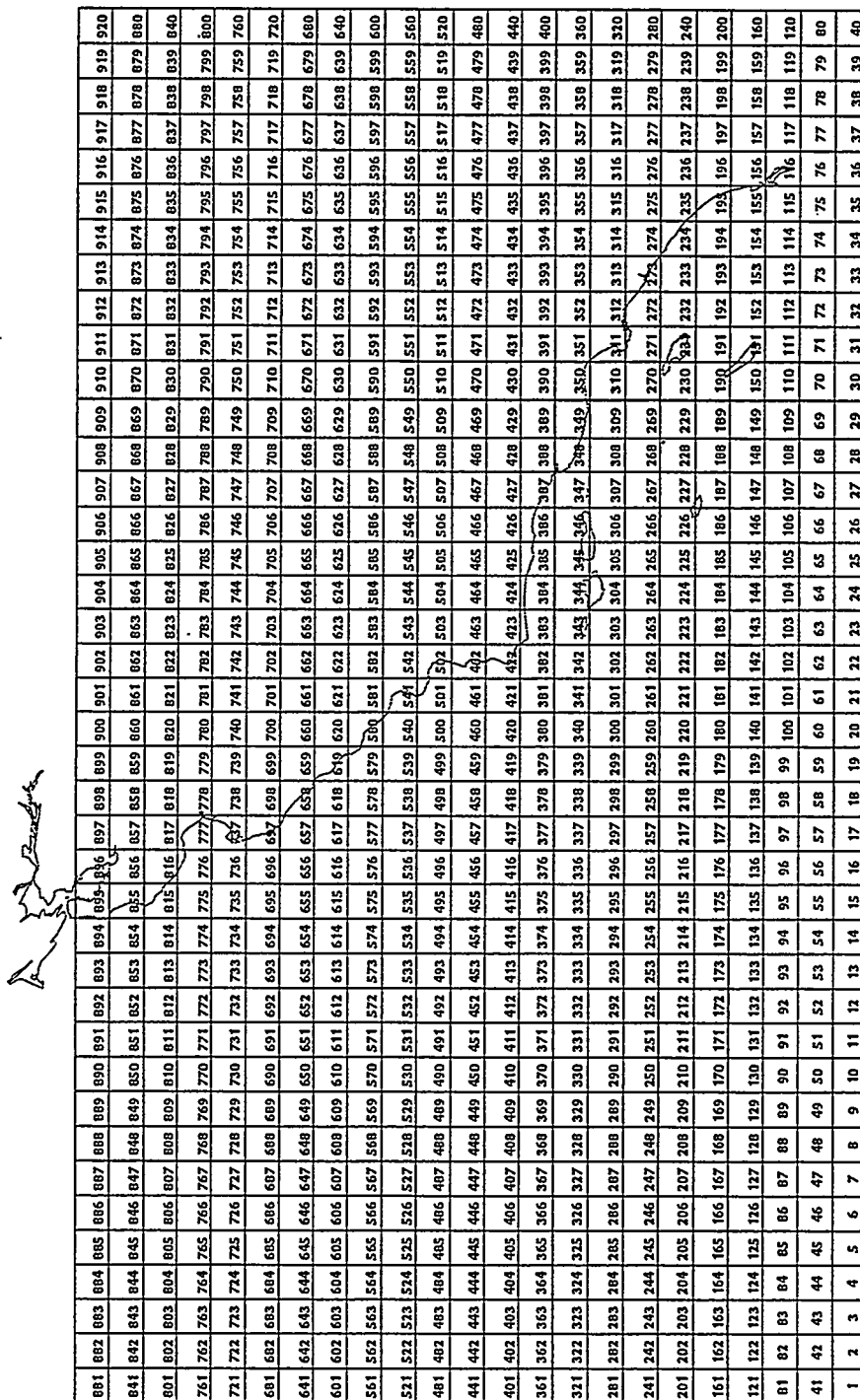

The third data group offers the 29 data variables in their original line-based format. The data values in this data group may vary slightly from those in the gridded data groups since more than one line segment often fell within a single grid cell.

Nine of the 29 data variables within this data base were originally obtained as point data, and constitute the first supplemental data group. These data variables are stored in an exported Arc/Info™ point coverage and as a flat ASCII file. Each data point is the physical location of the data measure (e.g., latitude-by-longitude location). Data variables within this group include: station name/number, latitude/longitude location, period of record, and the measurements used to derive the relative sea level trend, long-term geologic trend, corrected sea-level trend, local subsidence trend, mean tidal range, maximum tidal range, and mean-tide-level variables.

The second supplemental data group contains a 1:2,000,000 digitized coastline of the U.S. West Coast. The coastlines were extracted from a map originally digitized by the USGS. This base map is intended to be used with the gridded data to provide locational information. These data are stored as an exported Arc/Info™ line coverage and as a flat ASCII file. The line segments, and their identification numbers, are identical to those used in the first supplemental data group.

7. Original Data Variables

The data sets that comprise this data base include the following: elevation, geology, geomorphology, sea level trends, horizontal shoreline displacement (erosion/accretion), tidal ranges, and wave heights. The original data used in developing the data variables included in this NDP were obtained in a variety of scales and formats (e.g., as polygon, line, or point data). Therefore, the methods used to enter the data into the 0.25° grid cells and 1:2,000,000 digitized line segments vary by data set. The variable descriptions used in this report were extracted from annual reports submitted in April 1988, November 1988, April 1991 [Gornitz 1988a, 1988b, 1991; Gornitz and White (Beaty) 1991]; and personal correspondence between Gornitz and Beaty in 1995 and 1996. The following subsections provide a brief description of the data sources and the classification methods used in compiling each data set.

7.1 Elevation

The elevation data for this data set were obtained from the NGDC in Boulder, Colorado, as digitized land elevations (to the nearest meter) for 5' latitude by 5' longitude grid cells (i.e., ETOPO 5 data). The NGDC grid contained: < 0 (negative) values for grid cells containing no land within their boundaries; 0 (zero) values for grid cells with land at sea level; and > 0 (positive) values for grid cells with land above sea level. The NGDC grid cells lying along the West Coast were grouped into the 0.25° x 0.25° grid cells used in this data base. Minimum, mean, and maximum elevation data are provided for each 0.25° cell. Each 0.25° cell may contain as many as nine 5' grid cells. If only one 5' grid cell within a given 0.25° cell contains a positive or zero data value, then the minimum, mean, and maximum elevation variables will be identical. To calculate and transfer these data from 5' by 5' to the 0.25° grid used in this data base, the variables were calculated as follows:

- (1) The number of 5' NGDC grid cells with positive elevation values within each 0.25° grid cell was determined.
- (2) The minimum elevation was assigned by finding the minimum elevation of all non-negative 5' grid cells within each 0.25° grid cell.
- (3) The mean elevation was assigned by averaging the elevations of all non-negative 5' grid cells within each 0.25° cell.
- (4) The maximum elevation was assigned by finding the maximum elevation of all 5' grid cells within each 0.25° grid cell.

To check these data for reasonableness, the 0.25° grid cells were overlaid onto the 1:2,000,000 digitized coastline map of the U.S. West Coast. Through examination of this overlay, it was discovered that peninsulas and small islands often were not represented due to the low resolution of the NGDC grid cells (i.e., mean elevation values were rounded to the nearest whole number). To overcome this limitation, 0.25° grid cells containing islands and other low-lying landform with negative values in the NGDC data were assumed to lie near mean sea level and were assigned a mean elevation of 0 m. Cells where this correction was necessary are shown in Fig. 3.

Fig. 3. The original NGDC elevation data set and the corrected coastal grid cells with calculated mean elevation values (i.e., values of 0 m) used in this NDP.

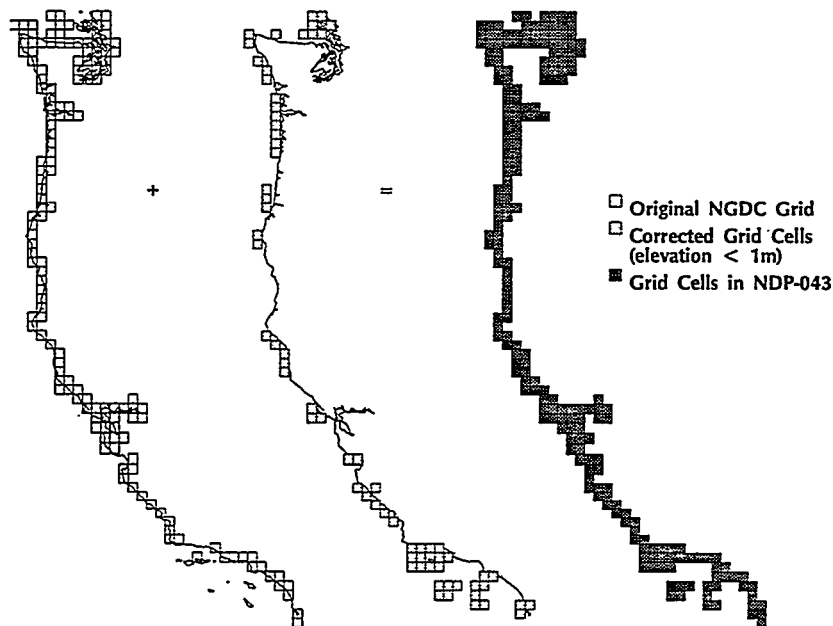

A mean elevation value of 0 m indicates that the land within the grid cell has a mean elevation of less than 1 m above sea level. Since 0 is a real data measurement, grid cells with assigned mean elevations are denoted within this data base as having a 0 value for the number of NGDC grid cells variable. A limitation of this method is that even if only a small portion of land is located within the 0.25° grid cell, the entire grid cell contains a mean elevation value of 0 m.

Mean elevation values range from 0 m to 885 m along the West Coast, while the average mean elevation is near 150 m.

7.2 Geology

The geology (lithology) variable identifies generalized rock type and is present for all coastal grid cells and line segments within this data base. The geology data were derived from state geologic maps ranging in scale from 1:250,000 to 1:1,000,000 with publication dates from 1968 to 1992 (maps used are listed in section 13.2). The geologic data were classified in terms of an ordinal scale based on the relative hardness of minerals comprising the rock. This geologic classification system was adapted in part from one used by Dolan et al. (1975). It contains 5 major groups further subdivided into 21 subgroups (Table 1).

Table 1. Geologic classification codes assigned to the coastal geology variable.

Material description	Code
I. Old Erosion Resistant Rocks (crystalline)	100
A. Igneous, volcanic (basalt, rhyolite, andesite, etc.)	110
B. Igneous, plutonic (granite, granodiorite, etc.)	130
C. Metamorphic (schists, gneisses, quartzite, serpentinite, etc.)	150
II. Sedimentary Rocks	200
A. Shale	210
B. Siltstone	220
C. Sandstone	230
D. Conglomerate	240
E. Limestone	250
F. Eolianite (calcite-sand)	260
G. Mixed or varied lithology	270

Table 1. (continued)

Material description	Code
III. Unconsolidated Sediments	300
A. Mud, Clay	310
B. Silt	320
C. Sand	330
D. Gravel, conglomerates	340
E. Glacial till	345
F. Glacial drift (fluvial-glacial)	350
G. Calcareous sediment	360
H. Mixed or varied lithology	370
IV. Recent Volcanic Materials	400
A. Lava	410
B. Ash, Tempora	420
C. Composite	430
V. Coral reef	500

Appendix B contains a glossary of the terms used in Table 1. This ranking scheme is generalized; consequently, a wide range of erodibilities exist for each rock type listed. The erodibility of each rock depends upon the mineral content, cementation (especially for sedimentary rocks), grain size (for unconsolidated sediments), and presence of planar elements (i.e., bedding, schistosity, cleavage, and fractures) within the rock. The key discriminant between the individual classes identified in Table 1 is the relative resistance of each rock type to physical and chemical weathering.

The geology data were assembled as follows:

- (1) Enlarged maps of the 1:2,000,000 digitized U.S. West Coastline included in this NDP were plotted in small sections (i.e., approximately 5° latitude by 5° longitude on 3 ft² paper).
- (2) Polygons (boxes) were drawn around each coastal segment as identified by state geologic maps (listed in Section 13.3).
- (3) The hand-drawn polygons were digitized into Arc/InfoTM using the 1:2,000,000 digitized U.S. West Coastline coverage included in this NDP as a backdrop.
- (4) These polygons were then overlaid onto the backdrop coverage with the Arc/InfoTM IDENTITY command whereby the coastal segments took on the values of the polygons.

- (5) For the gridded data groups, a 0.25° latitude by 0.25° longitude grid was overlaid onto the 1:2,000,000 digitized line coverage using an additional Arc/Info™ IDENTITY command.

Fig. 4. Example of how the geology data were transferred from the 1:2,000,000 digitized coastline map to the 0.25° by 0.25° grid cells used in this data base.

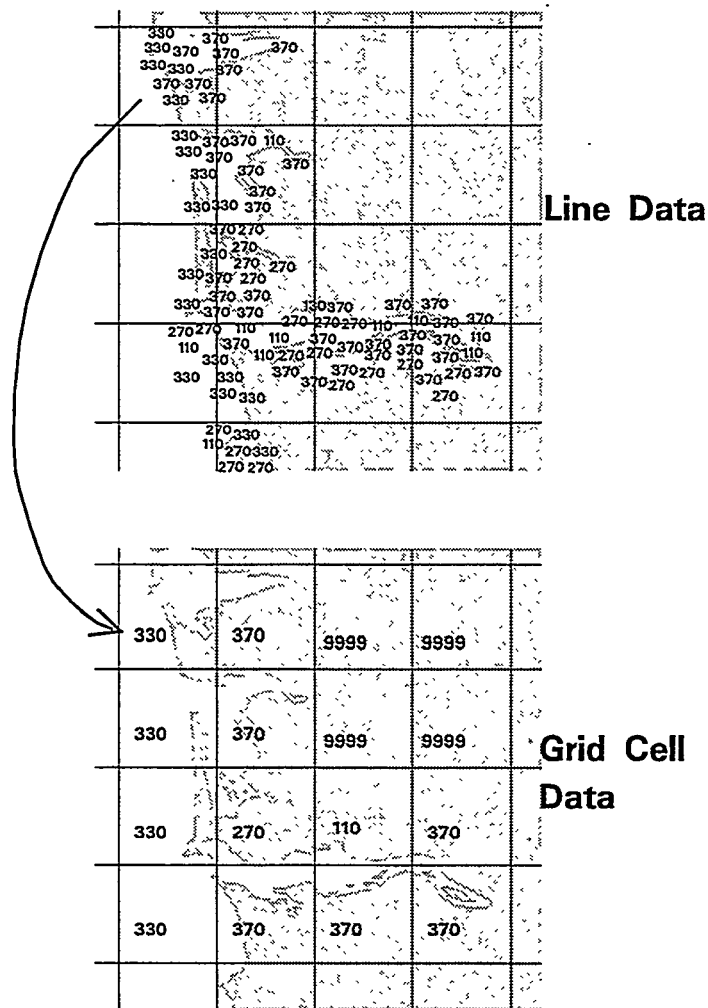

Each grid cell took on the geology code from the line segment with the greatest total length -as illustrated in Fig. 4 (e.g., four line segments in a cell with lengths and geology codes of 100 km, 350; 80 km, 300; 120 km, 310; and 50 km, 300, would yield a cell value of 300).

Appendix C gives a breakdown of the geology codes that occurred within each 0.25° by 0.25° coastal grid cell. The geology codes listed in Appendix C are identical to those found in the line segment-based data groups within this NDP.

In general the bed rock geology of the West Coast consists of five distinct zones. The coastal areas of Washington and Oregon consist of exposed basalts and sedimentary rocks that have been folded and metamorphosed. These rocks were thrust beneath less disturbed Tertiary and sedimentary and volcanic rocks during the Cenozoic uplift. In southern Oregon and northern California four overlapping thrust sheets of volcanic and sedimentary rocks have been intruded by granitic and ultramafic rocks. These sheets are upwarping and in some areas are volcanically active due to the collision of the Pacific and Farallon Plates with North America. This collision is one of the driving forces that has produced the uplift and deformation of the Coast Ranges in northern California. The San Andreas fault, and several others, traverse the Coast Ranges in the north, through the Transverse Ranges in central California, and into the Peninsular Ranges in the south. The Peninsular Ranges are composed of Paleozoic and Mesozoic granitic and metamorphic rocks while the Transverse Ranges are composed of Tertiary sedimentary rocks. The Los Angeles basin is filled with Quaternary sediments (Muhs et al. 1987)

7.3 Geomorphology

Geomorphology data are provided for all coastal grid cells in the data base. The data values were interpreted and classified from USGS 1:250,000 topographic maps (maps used are listed in section 13.4). The landforms identified from the 1:250,000 maps may omit landforms with small spatial extent. The classification system used divides the West Coast into two major groups, those formed by erosion and those formed by deposition (Table 2). These two groups are further subdivided into several categories (e.g., marine, nonmarine, glacial, nonglacial, volcanic). Appendix B contains a glossary of the terms used to describe each landform type. Appendix C gives a breakdown of the geomorphic codes found within each cell (i.e., several line segments may be found within a single cell). Several geomorphic features can occur in more than one environment. Therefore, a fourth digit was added to the three-digit feature identification code. This last digit identifies areas such as marshes, beaches, or areas that have been significantly modified by human activities, which may occur in a number of different geomorphic settings. Thus each geomorphological class is uniquely identified by a four-digit code.

Table 2. Geomorphology classification codes assigned to the coastal geomorphology variable.

Landform description	Code	Beach	Man modified
I. Erosional coasts (scoured, beaches poorly developed)	1000		
A. Marine with wave erosion and cliffs	1100		
1. Low (5–30 m)	1110	1111	1119
2. Medium (30–100 m)	1120	1121	1129
3. High (>100 m)	1130	1131	1139
B. Nonmarine (land erosion)	1200		
1. Glaciated coast	1210	1211	1219
a. Fjord (drowned valley)	1220	1221	1229
b. Indented fiard (low-lying inlet)	1230	1231	1239
mud flats	1234		
salt marsh	1235		
c. Rocky glacial coast	1240	1241	1249
salt marsh	1245		
2. Nonglacial irregular coast	1300		
a. Strongly embayed, nonrocky	1310	1311	1319
b. Strongly embayed, rocky	1320	1321	1329
c. Estuaries	1330	1331	1339
mud flats	1334		
salt marsh	1335		
mixed types	1338		
3. Ice coasts	1400		
4. Drowned karst topography	1500		
II. Depositional coasts (sediment accumulations and well-developed beaches)	2000		
A. Marine deposit	2100		
1. Coastal plain beach	2110	2111	2119
salt marsh	2115		
2. Beach rock (beach sediment cemented by carbonates)	2112		

Table 2. (concluded)

Landform description	Code	Beach	Man modified
3. Barrier coast	2120	2121	2129
a. barrier island	2122		
b. bay barrier	2123		
c. mud flats	2124		
d. salt marsh	2125		
e. cusplate foreland	2126		
f. spit	2127		
g. mixed	2128		
B. River deposits	2200		
1. Alluvial plain	2210	2211	2219
2. Delta environment	2220	2221	2229
a. mud flats	2224		
b. salt marsh	2225		
c. mixed	2228		
C. Marine/fluviial deposits (Lagoonal coast)	2250	2251	2259
1. Mud flats	2254		
2. Marsh/mangrove	2255		
3. Mixed	2258		
D. Glacial deposits			2300
1. Outwash plain	2310	2311	2319
2. Moraine	2320	2321	2329
3. Drumlin	2330	2331	2339
salt marsh	2315		
4. Drift	2340	2341	2349
salt marsh	2345		
5. Composite	2350	2351	2359
E. Biogenic	2400		
1. Reefs (coral, oysters, algal)			
a. fringing	2410	2411	2419
b. barrier	2420	2421	2429
2. Barrier reef with an associated mangrove swamp	2425		
3. Swamp/mangrove	2450	2451	2459
F. Volcanic coasts	2500		
1. Lava flows	2510	2511	2519
2. Tephra, ash	2520	2521	2529
3. Composite/caldera	2530	2531	2539

Based on Table 2, all grid cells on the West Coast have been assigned a data value, which is the code with the maximum shore length within each cell. The geomorphology data were compiled using the same procedures described for the geology data. Appendix C gives a breakdown of the geomorphology codes that occurred within each grid cell.

7.4 Sea-Level Trends

The sea level trend data set for the U.S. West Coast was derived from calculated relative sea-level trend measurements in mm/year for 16 tide-gauge stations (Woodworth 1995; Spencer and Woodworth 1993). This relative sea-level trend was calculated by a linear least-squares regression fitted to the time series of mean annual sea-level elevations for each of the 16 tide-gauge stations. Table 3 illustrates this information and Fig. 5. shows the locations of the stations listed in Table 3.

Table 3. Relative sea-level trends, U.S. West Coast, mm/yr.

Station	Latitude	Longitude	Length of Record (yr)	Sea-Level Trend (mm/yr)
Friday Harbor	48° 33'N	123° 00'W	58	1.12
Neah Bay	48° 22'N	124° 37'W	56	-1.61
Port Townsend	48° 07'N	122° 45'W	21	1.98
Seattle	47° 36'N	122° 20'W	96	2.01
Astoria	46° 13'N	123° 46'W	68	-0.60
South Beach	44° 38'N	124° 03'W	22	4.39
Crescent City	41° 45'N	124° 12'W	60	-0.72
San Francisco	37° 48'N	122° 28'W	140	1.37
Alameda	37° 46'N	122° 18'W	54	0.77
Monterey	36° 36'N	121° 53'W	21	3.11
Port San Luis	35° 10'N	120° 45'W	45	1.24
Santa Monica	34° 01'N	118° 30'W	53	1.98
Los Angeles	33° 43'N	118° 16'W	70	0.85
Newport Beach	33° 36'N	117° 53'W	35	1.65
La Jolla	32° 52'N	117° 15'W	65	2.42
San Diego	32° 43'N	117° 10'W	87	2.24

Data from Permanent Service for Mean Sea Level, Sept. 1996.

Fig. 5. Locations of the 16 sea-level gauge stations used in this NDP.

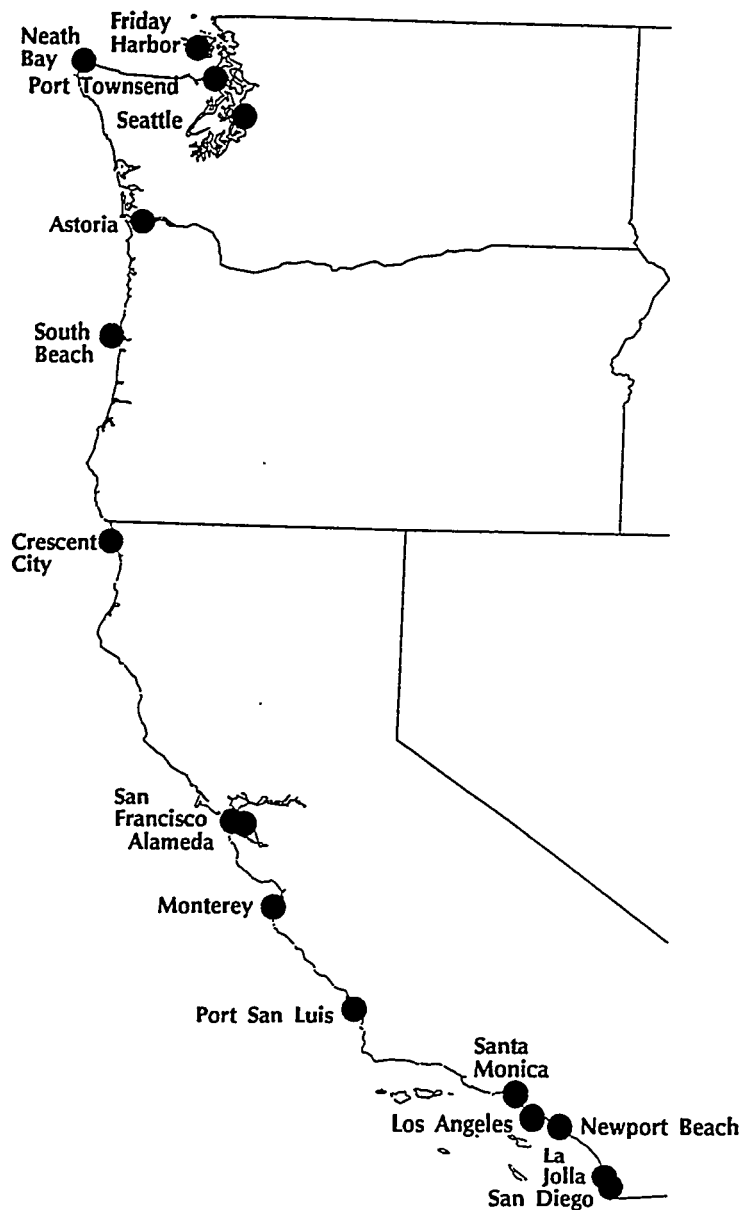

To obtain a relative sea-level trend variable for the 0.25° grid cells along the West Coast lying between tide-gauge stations, the following interpolation procedure was adopted:

- (1) The tide-gauge stations and the sea-level trends were plotted along a 1:2,000,000 digitized U.S. West coastline (Fig. 5).
- (2) The 0.25° by 0.25° grid used in this NDP was then overlaid onto the tide-gauge stations with an Arc/Info™ IDENTITY command, whereby the grid cells took on the values of the tide-gauge stations.

- (3) For each coastal grid cell without data, the difference in relative sea levels was calculated between the two nearest gauge stations (i.e., occurring east and west or north and south of the given grid cell).
- (4) The difference between the relative sea levels was then divided by the number of grid rows, plus one, occurring between the grid cells containing gauge stations. This value was called the slope factor.
- (5) The slope factor was then multiplied by the number of grid rows from the grid cell being calculated to the nearest station (i.e., western-most or southern-most station) and added to the station's relative sea-level trend.
- (6) The resultant of these five steps is the relative sea-level trend variable within the gridded data groups in this data set.

It should be noted that tide gauges measure sea-level variations in relation to a fixed benchmark on land and are therefore relative, due to vertical land movements and real changes in ocean levels. Information on long-term vertical movements along the U.S. West Coast is summarized in Appendix D. Because of active tectonism along the West Coast, which varies from place to place and can affect the relative sea-level curves, the above interpolation procedure should be used with caution. See comments in Sect. 10 and Appendix D.

The procedure for calculating the uplift or local subsidence trend variable along the U.S. West Coast differs from that used for the U.S. East and Gulf Coasts (Gornitz and Lebedeff 1987). Along the U.S. East Coast, Holocene paleosealevel indicators were used to calculate a long-term geologic trend variable (Gornitz and Seeber 1990). This geologic trend variable was then subtracted from the present relative sea-level trend (as measured by tide gauges) to provide a corrected sea-level trend variable for each 0.25° coastal grid cell. The average value of these corrected trends was used to obtain the regional eustatic trend (i.e., 1.25 mm/yr). This eustatic trend was then subtracted from the relative sea-level trend variable to yield a local subsidence trend variable for each 0.25° East Coast grid cell.

Along the U.S. Gulf Coast, Holocene paleosealevel indicators were not available, so the geologic trend variable for each 0.25° Gulf coastal grid cell was set to 0.0 for compatibility purposes between the two NDPs (i.e., NDP-043A and NDP-043B). The local subsidence factor for the Gulf Coast was calculated by assuming the global eustatic rate of sea-level rise to be 1.5 mm per year, as reported by the Intergovernmental Panel on Climate Change (IPCC) (Houghton et al. 1990), and subtracting this rate (i.e., 1.5 mm/yr) from the relative sea-level trend variable. The resultant difference along the U.S. Gulf Coast was the uplift or subsidence trend variable for each 0.25° coastal grid cell.

Along the U.S. West Coast, Holocene paleosealevel indicators are found only in a small number of coastal marshes and bays, where they record at least a half dozen discrete seismic events (Atwater 1987; Atwater et al. 1991; and Darienzo et al. 1994) and do not yield a continuous sea-level curve. Late Quaternary (i.e., $\leq 125,000$ years) raised marine terraces, which occur along much of the West Coast, integrate the permanent deformation produced over multiple earthquake cycles. Thus, raised terrace data can be used to derive long-term geologic trends for selected data points (Appendix D, Table 1).

Because of insufficient data, there are no real data values assigned to the long-term geologic trend variable in this data set. A value of 0.0 was assigned to West coastal grid cells with a data value for the calculated relative sea-level trend variable; while a value of -9999.99 was assigned to grid cells

with no data value for the calculated relative sea-level trend variable. While both values, 0.0 and -9999.99, indicate no data for the long-term geologic trend variable, a value of 0.0 serves two purposes. First, it indicates those grid cells in which the data provided in Table 1 of Appendix D may be used to calculate a long-term geologic trend variable. Secondly, it allows for compatibility among the data sets in this series of NDPs (NDP-043A, NDP-043B, and this document, NDP-043C). Consequently, the corrected sea-level trend variable within this data set contains a value that appears to be identical to the calculated relative sea-level trend variable; however, nothing has truly been corrected here [i.e., corrected sea-level trend = calculated relative sea-level trend - long-term geologic trend (0.0)].

The uplift or subsidence trend variable for the U.S. West Coast was calculated by assuming a global eustatic rate of sea-level rise of 1.5 mm/yr, as reported by the IPCC (Houghton et al. 1996), and subtracting this rate (i.e., 1.5 mm/yr) from the calculated relative sea-level trend variable. The resultant difference is the local subsidence or uplift trend variable for each 0.25° coastal grid cell along the West Coast.

The local uplift or subsidence variable gives an indication of the relative vulnerability of each coastal grid cell and line segment to sea-level rise. This variable may be used to identify areas that are uplifting or subsiding faster or slower than the regional averages. It is also added to any future projected global sea-level curves, to adjust the global curve to local conditions.

The ARC/INFO™ IDENTITY command was used to overlay the coastal 0.25° by 0.25° grid cells onto the 1:2,000,000 digitized West coastline. The resulting relative sea-level trend, geologic trend, corrected relative sea-level trend, and local uplift or subsidence trend variables are found in the line-based data groups herein.

7.5 Horizontal Shoreline Displacement (Erosion/Accretion)

The erosion/accretion data used in the development of the horizontal shoreline displacement data set were extracted and modified from the Coastal Erosion Information System (CEIS) developed by May et al. (1982, 1983) and Dolan et al. (1975, 1983, 1989). The CEIS data are limited in extent to coastlines that open into the ocean or large bays. The displacement data within the CEIS data base were originally obtained from over 500 individuals or organizations with records ranging in length from 20 to 165 years. The majority of the shoreline displacement measurements, however, were made from historic maps and aerial photographs that cover the U.S. West Coast for a minimum of 40 to 50 years. Most of the information was originally obtained from published reports or from regionally available high-resolution data sets (e.g., Dolan et al. 1980). Of the data within CEIS, 25% were obtained in raw form and converted into point measurements of erosion or accretion. In conducting the measurement and data compilation steps of the raw data, May et al. (1982) used the landward limit of wetted sand as the criteria for identifying the shoreline. This definition was selected because it produced the most consistent results in the photo-interpretation process.

By comparing present and past shorelines from maps, aerial photographs, and data from regional studies, May et al. (1982) were able to obtain rates of change, expressed in m/year, for coastal points on the West Coast. May et al. (1982) then averaged and extrapolated the point data into 3' latitude by 3' longitude grid cells (in locations with sparse data 7.5' and 15' grid cells were used) to minimize the problems associated with mapping errors, imprecise shoreline definitions, and poor temporal resolution within the original erosion/accretion data sources. These 3', 7.5', or 15' grid cells were then overlaid onto the 0.25° grid cells used in this data base to derive the following data variables (values in

m/year): minimum erosion trend, mean erosion trend, maximum erosion trend, and the number of 3', 7.5', or 15' cells used in deriving the data for each 0.25° grid cell.

To transfer this information to the 0.25° grid cells used in this data set, the erosion variables were recalculated as follows:

- (1) The number of 3', 7.5', or 15' grid cells that occur in a given 0.25° grid cell was determined. These 3', 7.5', or 15' cells were used to calculate the minimum, mean, or maximum erosion rate variables.
- (2) The minimum erosion rate for a 0.25° grid cell is the minimum erosion rate found in the 3', 7.5', or 15' grid cells within a 0.25° grid cell.
- (3) The mean erosion rate for a 0.25° grid cell is the weighted average of the erosion rates of all 3', 7.5', or 15' grid cells within a 0.25° grid cell.
- (4) The maximum erosion rate for a 0.25° grid cell is the maximum erosion rate found in the 3', 7.5', or 15' grid cells within a 0.25° grid cell.

Fig. 6 gives an example of how the overlay process was used to determine the number of data values from 3', 7.5', or 15' grid cells used in calculating the values contained in the 0.25° grid cells distributed with this NDP.

Fig. 6. Example of how the shoreline displacement data were transferred to the 0.25° grid cells used in this NDP. The variable ERNUM is the number of 3', 7.5', or 15' grid cells used in calculating the erosion variables in a 0.25° grid cell.

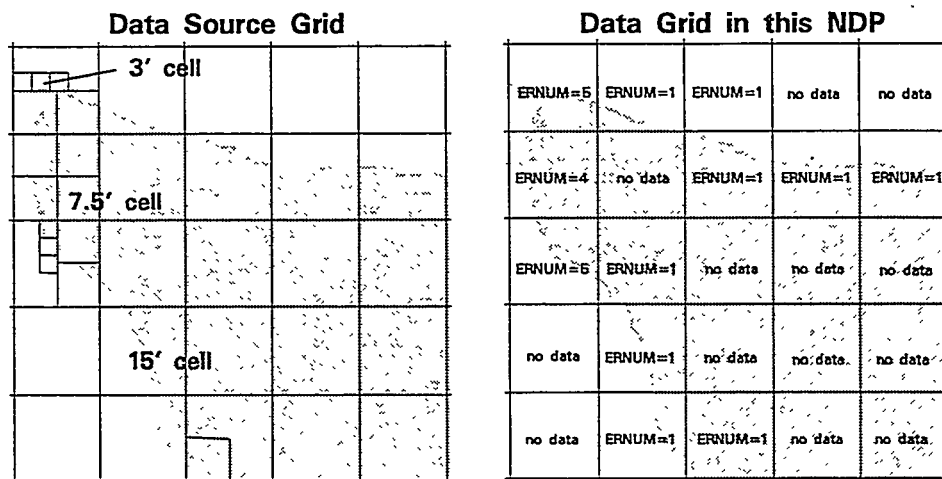

The gridded data were then overlaid onto a 1:2,000,000 digitized U.S. West Coastline to form the line segment version of these data. Based on the length of record (from 20 to 165 years, depending on location), and the errors inherent in the data, the reported shoreline displacement trends are average values that are highly variable over time; as such, rates of change less than ± 0.6 m/year are not considered significant.

7.6 Tidal Ranges

The tidal range data set was obtained from tide tables published by NOAA's National Ocean Service (NOS) for 410 stations located on the West Coast (NOS 1992). These station data were entered into the Arc/Info™ GIS as point data and are available in the supplemental data group. The supplemental data group contains the name, identification number, longitude/latitude, mean tidal range, maximum tidal range, and mean tide level for each tide-range station. The data for each station were overlaid onto the 0.25° grid cells used in this data set, and the variables calculated based on the stations that fell within each grid cell (values expressed in meters) as follows:

- (1) The number of tide stations that fell within each 0.25° grid cell was calculated. The stations within each cell were then used to derive the mean tide level and the mean and maximum tidal ranges for each 0.25° grid cell.
- (2) The mean tidal range for each grid cell is the average of the diurnal tidal ranges of all stations within a given cell.
- (3) The maximum tide range for each grid cell is the largest value found within the diurnal tide ranges of all stations within a given cell.
- (4) The mean tide level for each grid cell is the average of the mean tide levels of all stations within a given cell.

The gridded data obtained from this process were then overlaid onto the U.S. West Coastline coverage using the Arc/Info™ IDENTITY command to transfer the calculated data into the line segment version of these data.

The mean tidal range at a given tide station in this data set is defined as the difference in height between mean high water and mean low water in 1992. Tide heights vary annually, but their differences are *relatively* constant in relation to one another. The maximum tide range variable contains the "diurnal tide range." The diurnal tide range is defined as the difference in height between mean higher high water and mean lower low water (NOS 1992). The mean tide level variable is defined as a plane midway between mean low water and mean high water in 1992. This value is reckoned from chart datums. The chart datums used in the tide tables for the mean tide level variable are from the West Coast Low Water Datum.

The magnitude of the tidal range variables defined above has been linked to both inundation and erosion hazards. Although a large tidal range dissipates wave energy, it also delineates a broad zone of low-lying intertidal wetlands susceptible to inundation. Furthermore, the velocity of tidal currents in estuaries depends on the tide range, as well as the asymmetry of the tidal cycle and channel morphology. Therefore, when holding these other factors constant, high-tide ranges are associated with stronger tidal currents capable of eroding and transporting sediment offshore.

7.7 Wave Heights

This wave-height data set contains three data variables (all variables expressed in meters): the maximum significant wave height, the 20-year mean wave height, and the standard deviation of the mean). This data set was originally obtained from published documents of the Coastal Engineering Research Center (CERC), U.S. Army Corps of Engineers, *Wave Information Study (WIS)*. In the study CERC calculated wind speeds from station histories, National Weather Service surface charts, surface pressure data, ships-at-sea observations, and monthly air-sea temperature gradients, in a 3-phase process. Phase 1 hindcasted wind speeds/directions for each 120 nautical-mile-long segment while Phase 2 hindcasted wind speeds and deep ocean waves for a 30 nautical-mile spacing (Hubertz et al. 1992). In Phase 3, wind data were input into a transformation model that hindcasted near-shore wave heights for 10 nautical-mile-segments of the West Coast (Jensen 1989; Corson et al. 1987).

The 10 nautical-mile-segment data were originally received as point data which included longitude and latitude coordinates, maximum significant wave height, 20-year mean wave height, and the standard deviation of the mean wave height. To transfer this point data into the 0.25° longitude by 0.25° grid cells used in this NDP the following methodology was used:

- (1) The longitude/latitude coordinates were read into ARC/INFO™ to produce a point coverage. This point coverage was then plotted over the 1:2,000,000 digitized U.S. West coastline and checked for reasonableness.
- (2) 1.0° was added to and subtracted from the original longitude coordinates to produce a line segment coverage which defined each 10 nautical-mile line segment along the West Coast.
- 3) The Arc/Info™ BUFFER command was used on the 1:2,000,000 digitized line segment coverage, to form a polygon of the study area.
- (4) The polygon coverage produced in step 3 was read into ARCEDIT, where it was joined with the line segment coverage produced in step 2. All errors and discrepancies were corrected, and a final polygon coverage defining each 10 nautical-mile segment along the U.S. West Coast was produced.
- (5) The Arc/Info™ IDENTITY command was then used to transfer the polygon data produced in number 4 above onto the 1:2,000,000 digitized line segments used in this NDP.
- (6) Finally, the Arc/Info™ IDENTITY command was used once more to transfer the 10 nautical-mile line segment data into the 0.25° longitude by 0.25° grid cells used in this NDP.

The WIS data variables (i.e., maximum significant wave height, 20-year mean wave height, and the standard deviation of the mean) were transferred during this overlay process and are included within this NDP. Figure 7 illustrates this transformation process.

Fig. 7 Example of how the wave height data were transferred to the 0.25° longitude by 0.25° grid cells used in this NDP.

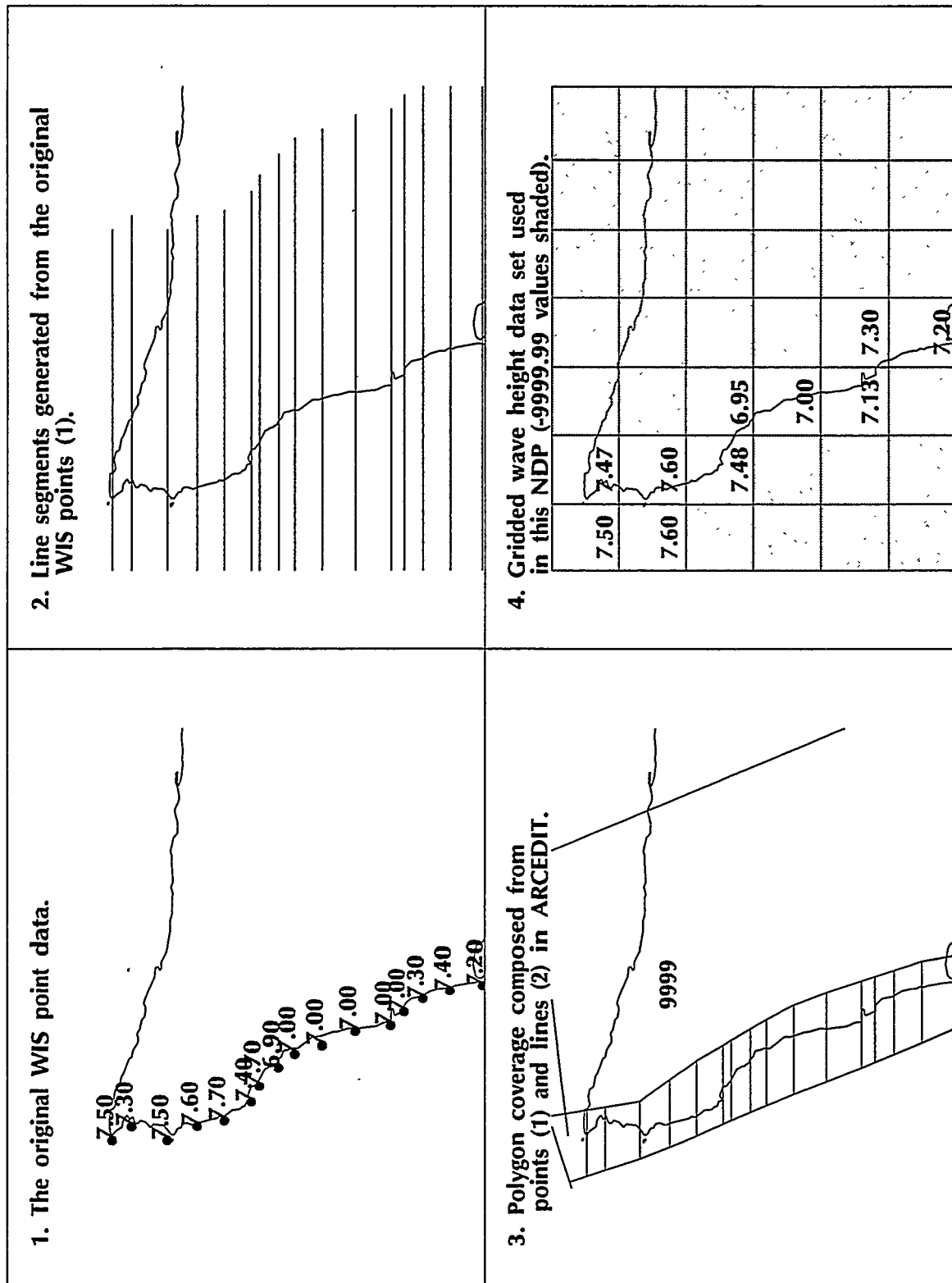

8. Relative Risk Factors

The previous section discussed how the original 22 data variables within this data base were obtained and entered into the GIS. These data were directly digitized from maps or copied from computer tapes and imported into the Arc/Info™ GIS, where the information was analyzed and the data values were incorporated into the 0.25° grid cells and 1:2,000,000 digitized line segments. The entry of these data into common formats (i.e., 0.25° grid cells and 1:2,000,000 digitized line segments) has made it possible to relate and manipulate the data to identify relationships among the different variables.

A vulnerable coastline is characterized by low coastal relief, subsidence, extensive shore line retreat, and high wave/tide energies (Gornitz et al. 1991). To simplify the manipulation process, seven of the original data variables were classified into seven new "risk" variables. Each risk variable ranges in value from 1 to 5 and indicates the cell's relative risk to erosion or inundation. The risk assignments for mean elevation, mean shoreline displacement, local subsidence trend, mean tidal range, and maximum significant wave height (i.e., the numeric data variables) are given in Table 3. The risk assignments for geology and geomorphology (i.e., the nominal data) are given in Tables 4 and 5, respectively. These risk assignments are discussed in greater detail in Gornitz et al. (1991), Gornitz and White (1991) and Gornitz et al. (1994) -reprinted in Appendix D.

Table 4. Assignment of relative risk factors for elevation, shoreline displacement, local subsidence trend, tidal range, and wave height.

Variable:	Very low 1	Low 2	Moderate 3	High 4	Very high 5
Mean elevation (m)	> 30	> 20 and ≤ 30	> 10 and ≤ 20	> 5 and ≤ 10	≥ 0 and ≤ 5
Mean shoreline displacement (m/year)	> 2.0 Accretion	> 1 and ≤ 2	> -1 and ≤ +1	> -2 and ≤ -1	≤ -2 Erosion
Local subsidence trend (mm/year)	< -1 Land rising	≥ -1 and ≤ 1	> 1 and ≤ 2	> 2 and ≤ 4	> 4.0 Land sinking
Mean tidal range (m)	< 1.0 Microtidal	≥ 1 and < 2	≥ 2 and ≤ 4	> 4 and ≤ 6	> 6.0 Macrotidal
Maximum significant wave height (m)	≥ 0 and < 3	≥ 3 and < 5	≥ 5 and < 6	≥ 6 and < 6.9	≥ 6.9

Table 5. Assignment of relative risk factors for geology.

Rank	Geology values ^a
1	100, 110, 130, 410
2	150
3	200, 210, 220, 230, 240, 250, 260, 270, 400, 430, 500
4	300, 340, 345, 370
5	310, 320, 330, 350, 360, 420

^a See Table 1 for description of geology values.

Table 6. Assignment of relative risk factors for geomorphology.

Rank	Geomorphology values ^b
1	1130, 1139, 1210, 1219, 1220, 1229, 1230, 1239, 1240, 1249, 1320, 1329, 2510, 2519
2	1120, 1129, 1131, 1211, 1221, 1231, 1234, 1235, 1241, 1245, 1310, 1319, 2511
3	1110, 1119, 1121, 1311, 1321, 1335, 1338, 2112, 2115, 2125, 2225, 2255, 2300, 2315, 2320, 2329, 2330, 2339, 2340, 2345, 2349, 2350, 2359, 2400, 2410, 2419, 2420, 2425, 2429, 2450, 2459, 2500, 2530, 2539
4	1111, 1330, 1339, 2200, 2210, 2219, 2228, 2250, 2258, 2259, 2310, 2319, 2321, 2331, 2341, 2351, 2411, 2421, 2451, 2520, 2529
5	1331, 1334, 2110, 2111, 2119, 2120, 2121, 2122, 2123, 2124, 2126, 2127, 2128, 2129, 2211, 2220, 2221, 2224, 2229, 2251, 2254, 2311, 2521, 2531

^b See Table 2 for a description of geomorphology values.

9. The Coastal Vulnerability Index

The seven relative risk variables contained within this data base may be used to formulate a coastal vulnerability index. This index may be used to identify areas that are at risk to erosion and/or permanent or temporary inundation. Grid cells and/or line segments with high index values will tend to have low reliefs, erodible substrates, histories of subsidence and shoreline retreat, and high wave and tide energies (Gornitz et al. 1991). However, when several risk factors for a given area are missing data, then any calculated index will underestimate the risk of the area in question.

The following methods for deriving such an index have been tested on a sample of 93 randomly selected coastal segments and seem to be adequate for the task when the number of risk factors that are missing data, for a given location, are less than three. The addition of new variables to this data base or the use of a different classification system for the risk variables may result in index values that differ significantly from those that would be produced using the formulas shown. These formulas were proposed and tested for the derivation of a Coastal Vulnerability Index (CVI) in Gornitz et al. (1991); CVI₅ was used in Gornitz and White (1991), Gornitz et al. (1991), and Gornitz (1990, 1991).

Product mean:
$$CVI_1 = \frac{(x_1 * x_2 * x_3 * x_4 * \dots * x_n)}{n}$$

Modified product mean:
$$CVI_2 = \frac{[x_1 * x_2 * \frac{1}{2}(x_3 + x_4) * x_5 * \frac{1}{2}(x_6 + x_7)]}{n - 2}$$

Average sum of squares:
$$CVI_3 = \frac{(x_1^2 + x_2^2 + x_3^2 + x_4^2 + \dots + x_n^2)}{n}$$

Modified product mean (2):
$$CVI_4 = \frac{(x_1 * x_2 * x_3 * x_4 * \dots * x_n)}{5^{(n-4)}}$$

Square root of product mean:
$$CVI_5 = [CVI_1]^{1/2}, \quad \text{and}$$

Sum of products:
$$CVI_6 = 4x_1 + 4x_2 + 2(x_3 + x_4) + 4x_5 + 2(x_6 + x_7).$$

Where: n = variables present
 x_1 = mean elevation
 x_2 = local subsidence trend
 x_3 = geology
 x_4 = geomorphology
 x_5 = mean shoreline displacement
 x_6 = maximum wave height
 x_7 = mean tidal range.

The relative risk variables were assigned to one of five risk classes on the basis of Tables 3, 4, and 5. Errors in the classification of any of the variables could result in a misclassification of up to one risk class for each risk variable. The sensitivity of each of the six CVI formulas to misclassification errors was tested by changing the relative risk factor of 1 to 3 risk variables from high to low (i.e., 5 to 1) while holding the others fixed at a value of 5 (Table 6). The calculated sensitivity is the percentage change from the original CVI, with all variables set to five, such that the greater the value the greater the percent change. It was found that for some CVIs, a change in two or more variables may result in more than one score. When this occurs only the maximum value is shown in Table 7.

Table 7. Sensitivity of different Coastal Vulnerability Indices to changes in risk class from high to low assignments for one to three variables.

CVI	Number of Variables Changed		
	1	2	3
CVI ₁	80	96	99
CVI ₂	80	96	99
CVI ₃	14	27	41
CVI ₄	80	96	99
CVI ₅	56	80	81
CVI ₆ ^a	16	32	48

This table indicates that CVI₁, CVI₂, and CVI₄ are highly sensitive to variations in the classification of the risk variables, whereas CVI₃ is insensitive to classification variations. CVI₅ seems to be relatively insensitive to variations in one risk factor, while still being able to produce usable results when differences occur within several factors. CVI₆ showed lower sensitivity overall to misclassification errors and missing data. Thus, CVI₆ may be preferable to CVI₅. An expanded version of CVI₆ was used in Gornitz et al. (1994).

By way of illustration, CVI₅ was calculated for the gridded data groups within this NDP, and a histogram of the data values was constructed. Based on the histogram, three risk classes were developed (i.e., low-, moderate-, and high-risk based on 33 percentile ranges). Low risk class values are those values less than 11, moderate risk values range from 11 to 22, and high risk values are greater than 22.

The aforementioned risk class assignments for the U.S. West coastline are illustrated in Figure 8.

Fig. 8. Example of how the Coastal Vulnerability Index (CVI₂) may be used to identify high-risk coastlines along the U.S. West Coast.

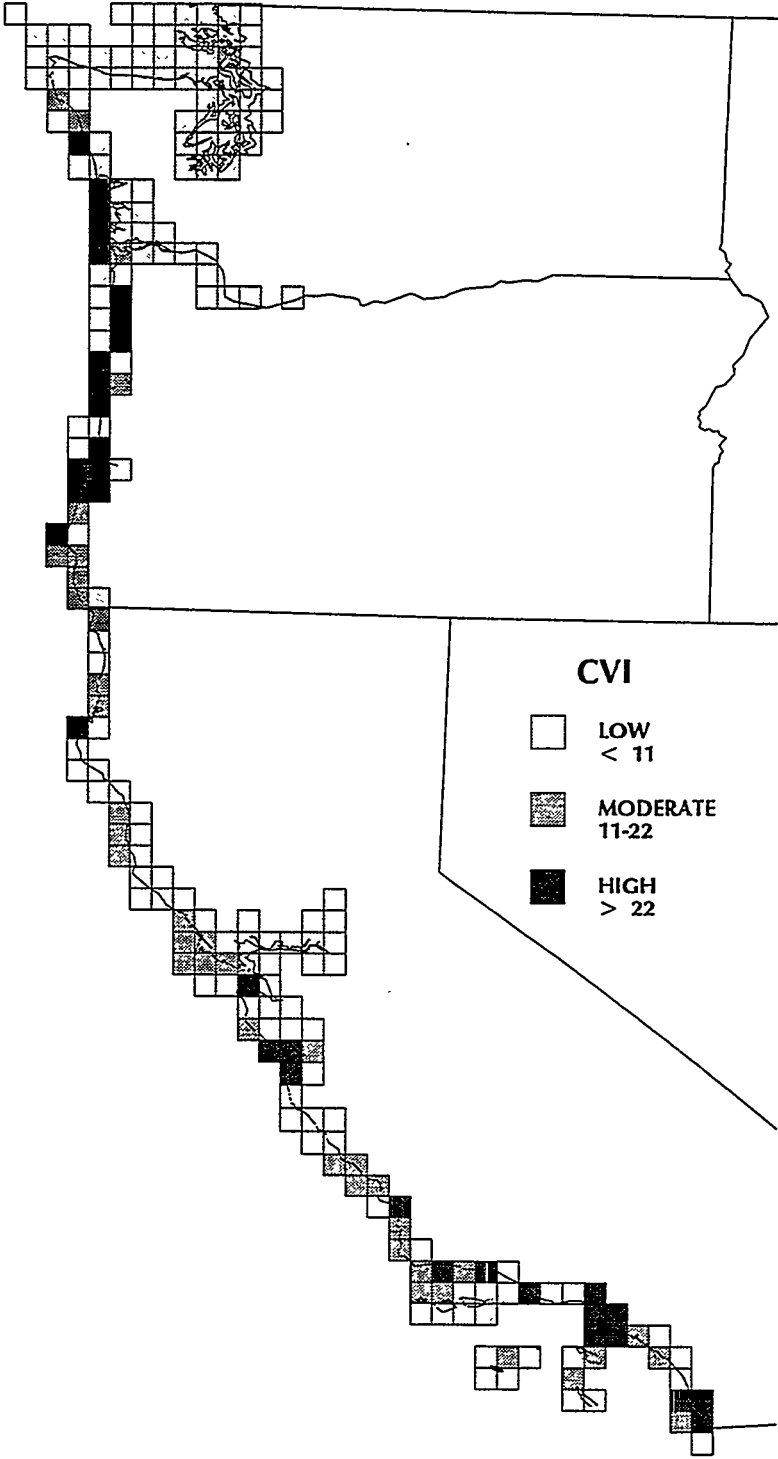

CVI₅ values range from 0.87 to 58.55 along the U.S. West Coast, with a mean value of 10.51. Although rugged relief and erosion resistant substrate reduce the overall vulnerability rating of the West coast, the highly variable topography and geologic/geomorphic setting produce a number of exceptions. Some examples are the barrier beaches of Oregon and Washington, the Monterey Bay area including Santa Cruz, Pismo Beach, and the following cities: San Francisco, Santa Barbara, Santa Monica, and San Diego. A majority of the high risk areas face west and, as a result, are directly impacted by large ocean waves. This implies that climatic variables such as wind direction and fetch length may be one of the primary forcing factors for erosion on the West coast.

10. Limitations and Restrictions of the Data

Because of the spatial extent of this data base, the period of record, sampling frequency, and scale of the source documents varied. The use of long-term averages and the use of the 0.25° grid cell as the spatial scale for these data has minimized the error that may have been introduced when these data sources were integrated into a single data base with uniform formats and scales.

The geologic data were classified in terms of an ordinal scale based on the relative hardness of minerals comprising the rock, and derived from state geologic maps. Since these characteristics cannot be deduced from the geologic maps alone, field checking would be required to obtain a more detailed classification than that used in this data set.

The sea-level trend variables (derived from long-term tide-gauge records) may have significant error due to the interpolation methods used. The tide-gauge records used for calculating the sea level trends on the West Coast were obtained from the records of the *Permanent Service for Mean Sea Level* (Pugh et al. 1987). These records have been examined and contain no identifiable errors, are of very high quality, and have been used in several sea-level-rise studies (Douglas 1991). However, the sparse station network has made it necessary to calculate the sea-level-trend variables for intervening grid cells by calculating a slope line between the two closest adjacent stations. Confidence in the accuracy of the local subsidence variable and the relative and corrected sea-level-trend variables estimated with this method decreases as the distance between grid cells that are missing data and adjacent tide-gauge stations increases. For the U.S. East and West coasts, it was found that if the distance from a grid cell with no data to the nearest two long-term gauge stations (i.e., that are east and west or north and south of the no-data grid cell) exceeds ~350 km (i.e., at that distance the r^2 of adjacent stations is 0.717), then the sea-level-trend variable derived for the no-data grid cell may be erroneous. However, the highly variable topography, geology, and geomorphology of the West Coast, together with the active tectonism suggest that interpolations of the sort proposed here should be used with caution. Whenever feasible, local subsidence (or uplift) data should be used. Some longer-term geologic trends are listed in Appendix D.

Should the user choose to apply the methods and data illustrated in Appendix D to calculate a revised local subsidence trend variable, it will be necessary to reassign a risk value as well, before calculating a coastal vulnerability index.

The statistical summations given within this NDP reflect 0.25° latitude by 0.25° longitude gridded data values and may vary slightly from those given in publications by the contributors. Another discrepancy is that the tide tables used in this document are for 1992 (NOS 1992) as were those used in NDP-043B, while the East Coast, NDP-043A tide tables were for 1988 (NOS 1988).

The coastal hazards data base presented here for the U.S. West Coast omits several factors that

may be important when determining the risk of a given area to inundation or erosion. Other variables that may be useful in the risk assessment process are: storm surge, storm frequencies, storm intensities, presence of exposed infrastructure, coastal population density, the role of sediment transport, and the risk of saltwater intrusion (Titus et al. 1991, Snedaker and Sylva 1987). Several studies have been done that consider several of these factors. Gornitz et al. (1994) conducted a pilot study with an expanded CVI based on the seven relative risk variables in this NDP and six climatic factors derived from Birdwell and Daniels (1991). A copy of the results of this study is reprinted in Appendix D.

11. Data Checks Performed by CDIAC

An important part of the data packaging process at the CDIAC is the quality assurance (QA) of the data before its distribution. Data received at CDIAC are rarely in perfect condition for immediate distribution, regardless of source. CDIAC staff members examine the data for completeness, reasonableness, and accuracy. The QA process is an important component in the value-added concept of assuring accurate, usable information for researchers. The following summarizes the QA checks performed on the various data groups presented in this document:

- (1) Data variables obtained from primary data sources were double-entered into flat ASCII computer files and proofed for discrepancies. The generated machine-readable data files were then uploaded to a Sun workstation and read into SASTM. The SASTM PROC COMPARE procedure was used to overlay the two versions and identify differences. All differences were then checked against the original data source, and any necessary corrections made.
- 2) Data variables obtained from maps (e.g., geology) were classified and transferred to coastal segments on working maps of the coastline. The working maps were then digitized, plotted at a large scale, and compared with the original working maps and data sources. All identified discrepancies were then corrected.
- (3) Maximum, minimum, and mean values were generated for all data variables and checked for reasonableness against predetermined thresholds.
- (4) The data values for each data variable were mapped using the 1:2,000,000 digitized USGS line-segment coverage of the U.S. West Coast as a backdrop to check for outliers and identifiable discrepancies. The identified data items were then recalculated, and corrected if necessary.

12. How to Obtain the Data Package

This document describes the contents of a coastal hazards data base intended for use by vector or raster GISs or non-GIS data base systems. The computerized data are available on Exabyte 8-mm tapes, QIC quarter-inch tape cartridges, or floppy diskettes. These data are also available via the File Transfer Protocol (FTP) and the World Wide Web at <http://cdiac.esd.ornl.gov>. Requests for this data package should be addressed to:

Carbon Dioxide Information Analysis Center
Oak Ridge National Laboratory
Post Office Box 2008
Oak Ridge, Tennessee 37831-6335, U.S.A.

The media and/or documentation can be ordered by telephone, fax or electronic mail using:

Telephone: (423) 574-0390 or (423) 574-3645; FAX: (423) 574-2232
INTERNET: CDIAC@ORNL.GOV

The computerized data files may be acquired over the internet from CDIAC's Anonymous FTP service as follows:

- FTP to [CDIAC.ESD.ORNL.GOV](ftp://CDIAC.ESD.ORNL.GOV) (128.219.24.36)
- Enter "ftp" as the User-ID.
- Enter your electronic mail address as the password (e.g., BIRDK@ornl.gov)
- Change to the directory `pub/ndp043c` (or `ndp043a` for the East Coast, `ndp043b` for the Gulf Coast).
- Set FTP to ASCII mode by using the ASCII command (i.e., "ascii").
- Acquire the ASCII data files (i.e., "mget *.asc").
- Acquire the FORTRAN files (i.e., "mget *.for").
- Acquire the SASTM files (i.e., "mget *.sas").
- Set FTP to binary mode by using the Binary command (i.e., "binary").
- Acquire the binary Arc/InfoTM export files (i.e., "mget *.e00").
- Exit the system by using the FTP quit command (i.e., "quit").

13. References and Data Sources

13.1 Citations

- Atwater, B. F., 1987. Evidence for great Holocene earthquakes along the outer coast of Washington State. *Science*. 236: 942-944.
- Atwater, B. F., Stuiver, M., and D. K. Yameguchi. 1991. Radiocarbon test of earthquake magnitude at the Cascadia subduction zone. *Nature*. 353: 156-158.
- Birdwell, K. R., and R. C. Daniels. 1991. *A Global Geographic Information System Data Base of Storm Occurrences and Other Climatic Phenomena Affecting Coastal Zones*. ORNL/CDIAC-40, NDP-35. Oak Ridge National Laboratory, Oak Ridge, Tennessee.
- Case, R. A., and M. Mayfield, 1990. Atlantic hurricane season of 1989. *Monthly Weather Review*. 118: 1165-1177.
- Corson, W. D., C. E. Abel, R. M. Brooks, P. D. Farrar, B. J. Groves, J. B. Payne, D. S. McAreny, and B.A. Tracy. 1987. *Pacific Coast Hindcast Phase II Wave Information*. WIS Report 16, U.S. Army Corp of Engineers, Vicksburg, Mississippi.
- Dariento, M. E., and C. D. Peterson, 1990. Episodic tectonic subsidence of late-Holocene salt marsh sequences in Netarts Bay, Oregon, Central Cascadia Margin. *Tectonics*. 9: 1-22.
- Dariento, M. E., C. D. Peterson, and C. Clough, 1994. Stratigraphic evidence for great subduction-zone earthquakes at four estuaries in northern Oregon, U.S.A. *J. Coast. Res.*, 4:850-876.
- Dolan, R., B. Hayden, and M. Vincent. 1975. Classification of coastal landform of the Americas. *Zeitschrift fuer Geomorphologic*, Supp. Bull., 22:72-88.
- Dolan, R., B. Hayden, P. May, and S. May. 1980. The reliability of shoreline change measurements from aerial photographs. *Shore and Beach*, 48:22-29.
- Dolan, R., B. Hayden, and S. May. 1983. Erosion of the U.S. shorelines. In P. D. Komar (ed.), *CRC Handbook of Coastal Processes and Erosion*. CRC Press, Inc., Boca Raton, Florida.
- Dolan, R., H. Lins, and B. Hayden. 1988. Mid-Atlantic coastal storms. *J. of Coastal Res.*, 4:417-433.
- Dolan, R., S. J. Trossbach, and M. K. Buckley. 1989. Patterns of erosion along the Atlantic coast. pp. 17-22. *Coastal Zone '89*. ASCE.
- Douglas, B. C. 1991. Global sea-level rise. *J. of Geophys. Res.* 96C:6981-92.
- Emanuel, K. A. 1988. The maximum intensity of hurricanes. *J. of Atmos. Sci.* 45:1143-55.

- Emery, K. O. and D. G. Aubrey. 1991. *Sea Levels, Land Levels, and Tide Gauges*. Springer Verlag, New York, New York.
- Gornitz, V. 1988a. *Development of a global coastal hazards data base: Annual technical report*. Oak Ridge National Laboratory, Oak Ridge, Tennessee.
- Gornitz, V. 1988b. *Development of a global coastal hazards data base: Annual technical report*. Oak Ridge National Laboratory, Oak Ridge, Tennessee.
- Gornitz, V. 1990. Vulnerability of the East Coast, U.S.A. to future sea-level rise. Proceedings of the Skagen Symposium, *J. of Coastal Res.* Special Issue No. 9.
- Gornitz, V. 1991. *Development of a global coastal hazards data base: Annual technical report*. Oak Ridge National Laboratory, Oak Ridge, Tennessee.
- Gornitz, V. and P. Kanciruk. 1989. Assessment of global coastal hazards from sea-level rise. Coastal Zone '89. pp. 1345–59. In *Proceedings of Sixth Symposium on Coastal and Ocean Management*. ASCE, Charleston, South Carolina, pp. 1345-1359.
- Gornitz, V. and S. Lebedeff. 1987. Global sea-level changes during the past century. In *Sea-Level Change and Coastal Evolution*. SEPM Special Publication No. 41.
- Gornitz, V. and L. Seeber. 1990. Vertical crustal movements along the East Coast, North America, from historic and late Holocene sea level data. *Tectonophysics*. 178:127–150.
- Gornitz, V. and T. W. White. 1994. *A coastal hazards data base for the U.S. Gulf Coast*. ORNL/CDIAC-60, NDP-043B. Oak Ridge National Laboratory, Oak Ridge, Tennessee.
- Gornitz, V. and T. W. White. 1992. *A coastal hazards data base for the U.S. East Coast*. ORNL/CDIAC-45, NDP-043A. Oak Ridge National Laboratory, Oak Ridge, Tennessee.
- Gornitz, V. and T. W. White. 1991. The global coastal hazards data base. pp. 214–224. In *Future Climate Studies and Radio-Active Waste Disposal, Safety Studies*. Norwich, England.
- Gornitz, V., T. W. White, and R. M. Cushman. 1991. Vulnerability of the U.S. to future sea-level rise. Coastal Zone '91. pp. 2354–68. In *Proceedings of Seventh Symposium on Coastal and Ocean Management*. ASCE.
- Gornitz, V., R. C. Daniels, T. W. White, and K. R. Birdwell. 1994. The Development of a Coastal Risk Assessment Database for the U.S. Southeast: Erosion and Inundation from Sea-Level Rise. pp. 327-338. In *Coastal Hazards: Perception, Susceptibility, and Mitigation*. C. W. Finkle, Jr. (ed.). *J. of Coastal Res.* Special Issue No. 12, Fort Lauderdale, Florida..
- Hubertz, J. M., B. A. Tracy, J. B. Payne, and A. Cialone. 1992. *Verification of Pacific Ocean Deepwater Hindcast Wave Information*. WIS Report 29, CERC, Vicksburg, Mississippi.
- Houghton, J. T., L. G. Meira Filho, B. A. Callender, N. Harris, A. Kattenberg, and K. Maskell, eds., 1996. *Climate Change 1995: The Science of Climate Change*, Cambridge University Press, New York, New York.

- Houghton, J. T., G. J. Jenkins, and J. J. Ephraums. 1990. *Climate Change: The IPCC Scientific Assessment*. Cambridge University Press, New York, New York.
- Jensen, R. E., J. M. Hubertz, and J. B. Payne. 1989. *Pacific Ocean Hindcast Phase III Wave Information*. WIS Report 17, CERC, Vicksburg, Mississippi.
- May, S. K., W. H. Kimball, N. Grady, and R. Dolan. 1982. CEIS: The coastal erosion information system. *Shore and Beach*. 50:19-25.
- May, S. K., R. Dolan, and B. P. Hayden. 1983. Erosion of U.S. shorelines. *EOS*. 65:521-523.
- Muhs, D. R., R. M. Thorson, J. J. Clague, W. H. Mathews, P. F. McDowell, and H. M. Kelsey. 1987. Pacific Coast and Mountain System, pp. 517-581. In *Geomorphic Systems of North America*, Vol. 2, W. L. Graf (ed.). Geologic Society of America, Boulder, Colorado.
- National Ocean Service (NOS). 1988. *Tide Tables 1988 -High and Low Water Predictions, East Coast of North and South America*. NOAA, U.S. Government Printing Office, Washington, D.C.
- NOS. 1992. *Tide Tables 1992 -High and Low Water Predictions, West Coast of North and South America*. NOAA, U.S. Government Printing Office, Washington, D.C.
- Pugh, D. T., N. E. Spencer, and P. L. Woodworth. 1987. *Data Holdings of the Permanent Service for Mean Sea Level*. Bidston Observatory, England.
- Shaw, J., R. B. Taylor, D. L. Forbes, M.-H. Ruz, and S. Solomon. 1994. *Sensitivity of the Canadian Coast to Sea-Level Rise*. Open File 2825, Geological Survey of Canada, Dartmouth, Nova Scotia.
- Spencer, N. E., and P. L. Woodworth, 1993. Data Holdings of the Permanent Service for Mean Sea Level (Nov. 1993), Birkenhead, U.K., 81 pp.
- Snedaker, S. C., and D. P. Sylva. 1987. Impacts of climate change on coastal resources: Implications for property values, commerce, estuarine environments, and fisheries, with special reference to South Florida. In *Proceedings of the Symposium on Climate Change in the Southern United States: Future Impacts and Present Policy Issues*, M. Meo (ed.). U.S. Environmental Protection Agency, Office of Policy, Planning, and Evaluation, Washington, D.C..
- Titus, J. G., R. A. Park, S. P. Leatherman, J. R. Weggel, M. S. Greene, P. W. Mausel, S. Brown, and C. Gaunt. 1991. Greenhouse effect and sea level rise: The cost of holding back the sea. *Coastal Manage*. 19:171-204.
- Warrick, R. A., E. M. Barrow, and T. M. L. Wigley, 1993. *Climate and Sea Level Change: Observations, Projections, and Implications*. Cambridge University Press, New York, New York.
- Woodworth, P. L., 1995. PSMSL Annual Report for 1995.

- U. S. Department of Energy. 1987. *Carbon dioxide and climate: Summaries of research in FY 1987*. DOE/ER-0347, Dist. Category UC-11, Washington, D.C.
- U. S. Department of Energy. 1988. *Carbon dioxide and climate: Summaries of research in FY 1988*. DOE/ER-0385, Dist. Category UC-11, Washington, D.C.
- U. S. Department of Energy. 1989. *Carbon dioxide and climate: Summaries of research in FY 1989*. DOE/ER-0425, Dist. Category UC-402, Washington, D.C.
- U. S. Department of Energy. 1990. *Carbon dioxide and climate: Summaries of research in FY 1990*. DOE/ER-0470T, Dist. Category UC-402, Washington, D.C.
- U. S. Department of Energy. 1991. *Carbon dioxide and climate: Summaries of research in FY 1991*. DOE/ER-0508T, Dist. Category UC-402, Washington, D.C.
- U. S. Department of Energy. 1992. *Global Change Research: Summaries of Research in FY 1992*. DOE/ER-0565T, Dist. Category UC-402, Washington, D.C.
- U. S. Department of Energy. 1993. *Global Change Research: Summaries of Research in FY 1993*. DOE/ER-0597T, Dist. Category UC-402, Washington, D.C.

13.2 Digital Elevation Data

Defense Mapping Agency. 1-Degree DEM Data. ESIC, Reston, Virginia.

National Geophysical Data Center. ETOPO5 Gridded World Elevations. Boulder, Colorado.

13.3 Geology Maps

Bennison, A. P. 1973. Geological highway map of the Pacific Northwest region: Washington, Oregon (Idaho in part). American Association of Petroleum Geologists with the cooperation of the United States Geological Survey, Tulsa, Oklahoma.

Feray, D. E. 1968. Geological highway map of the Pacific Southwest region: California, Nevada. American Association of Petroleum Geologists with the cooperation of the United States Geological Survey, Tulsa, Oklahoma.

Greene, H. G. and M. P. Kennedy (eds). 1986-1989. California continental margin geologic map series. Maps 1a-7a. California Division of Mines and Geology. Sacramento, California.

Schuster, J. E. and K. G. Ikerd. 1992. Geologic map of Washington. Washington State Department of Natural Resources, Division of Geology and Earth Resources, Olympia, Washington.

Walker, G. W. and N. S. Macload. 1991. Geologic map of Oregon. U.S. Geological Survey, Reston, Virginia.

13.4 Topographic Maps

Washington

- U.S. Geological Survey. 1968. Cape Flattery. 1:250,000 series (topographic), Reston, Virginia.
- U.S. Geological Survey. 1974. Victoria. 1:250,000 series (topographic), Reston, Virginia.
- U.S. Geological Survey. 1968. Copalis Beach. 1:250,000 series (topographic), Reston, Virginia.
- U.S. Geological Survey. 1974. Seattle. 1:250,000 series (topographic), Reston, Virginia.
- U.S. Geological Survey. 1974. Hoquiam. 1:250,000 series (topographic), Reston, Virginia.

Oregon

- U.S. Geological Survey. 1974. Vancouver. 1:250,000 series (topographic), Reston, Virginia.
- U.S. Geological Survey. 1977. Salem. 1:250,000 series (topographic-bathymetric), Reston, Virginia.
- U.S. Geological Survey. 1973. Coos Bay. 1:250,000 series (topographic), Reston, Virginia.

California

- U.S. Geological Survey. 1977. Crescent City. 1:250,000 series (topographic-bathymetric), Reston, Virginia.
- U.S. Geological Survey. 1977. Eureka . 1:250,000 series (topographic-bathymetric), Reston, Virginia.
- U.S. Geological Survey. 1979. Redding. 1:250,000 series (topographic), Reston, Virginia.
- U.S. Geological Survey. 1979. Ukiah. 1:250,000 series (topographic-bathymetric), Reston, Virginia.
- U.S. Geological Survey. 1980. Santa Rosa. 1:250,000 series (topographic-bathymetric), Reston, Virginia.
- U.S. Geological Survey. 1970. Sacramento. 1:250,000 series (topographic), Reston, Virginia.
- U.S. Geological Survey. 1980. San Francisco. 1:250,000 series (topographic), Reston, Virginia.
- U.S. Geological Survey. 1969. San Jose. 1:250,000 series (topographic), Reston, Virginia.
- U.S. Geological Survey. 1974. Monterey. 1:250,000 series (topographic-bathymetric), Reston, Virginia.

- U.S. Geological Survey. 1979. San Luis Obispo. 1:250,000 series (topographic-bathymetric), Reston, Virginia.
- U.S. Geological Survey. 1969. Santa Maria. 1:250,000 series (topographic), Reston, Virginia.
- U.S. Geological Survey. 1975. Los Angeles. 1:250,000 series (topographic-bathymetric), Reston, Virginia.
- U.S. Geological Survey. 1978. Long Beach. 1:250,000 series (topographic-bathymetric), Reston, Virginia.
- U.S. Geological Survey. 1978. San Clemente Island. 1:250,000 series (topographic-bathymetric), Reston, Virginia.
- U.S. Geological Survey. 1979. Santa Ana. 1:250,000 series (topographic-bathymetric), Reston, Virginia.
- U.S. Geological Survey. 1978. San Diego. 1:250,000 series (topographic-bathymetric), Reston, Virginia.

PART 2: INFORMATION ABOUT THE COMPUTERIZED DATA FILES

14. Contents of the Computerized Data Files

The following table lists the 21 data files distributed by the Carbon Dioxide Information Analysis Center (CDIAC) along with this documentation. Each listing includes the file number; a brief description including the file name; the number of number of records, file size, and record length. These files are available on 8-mm tapes, quarter inch tape cartridges, IBM-formatted floppy diskettes, and over the Internet using the File Transfer Protocol (FTP) from CDIAC's anonymous FTP area or through the CDIAC world wide web homepage at <http://cdiac.esd.ornl.gov>.

Table 8. List and description of the NDP-043C data files.

File number, description, and name	File size (bytes)	Number of records	Record length
1. General descriptive information file (NDP043C.TXT)	281,842	5265	85
2. FORTRAN retrieval program to read and print file 5 (WCGRID.FOR)	4,050	50	80
3. SAS TM code to read and print file 5 (WCGRID.SAS)	729	9	80
4. Gridded data for the 22 original data variables, all 7 data sets (Arc/Info TM export file, WCGRID.E00)	3,786,102	46,742	80
5. Gridded data for the 22 original data variables, all 7 data sets (flat ASCII file, WCGRID.ASC)	440,640	5,440	80
6. FORTRAN retrieval program to read and print file 9 (WCRISK.FOR)	2,916	36	80
7. SAS TM code to read and print file 9 (WCRISK.SAS)	486	6	80
8. Gridded data for the 7 relative risk variables: elevation, geology geomorphology, sea-level trends, erosion/accretion rates, tidal ranges, and wave heights (Arc/Info TM export file, WCRISK.E00)	2,682,396	33,116	80

Table 8. (continued)

File number, description, and name	File size (bytes)	Number of records	Record length
9. Gridded data for the 7 relative risk variables: elevation, geology, geomorphology, sea-level trends, erosion/accretion rates, tidal ranges, and wave heights (flat ASCII file, WCRISK.ASC)	217,600	2,720	33
10. FORTRAN retrieval program to read and print file 13 (WCLINE.FOR)	4,698	58	80
11. SAS TM code to read and print file 13 (WCLINE.SAS)	810	10	80
12. 1:2,000,000 digitized line segment data for the 22 original variables and 7 relative risk variables. (Arc/Info TM export file, WCLINE.E00)	1,498,986	18,506	80
13. 1:2,000,000 digitized line segment data for the 22 original variables and 7 relative risk variables. (flat ASCII file, WCLINE.ASC)	306,666	3,786	80
14. FORTRAN retrieval program to read and print file 17 (WCPOINT.FOR)	4,455	55	80
15. SAS TM code to read and print File 17 (WCPOINT.SAS)	648	8	80
16. Supplemental point data for the sea-level and tidal range data sets (Arc/Info TM export file, WCPOINT.E00)	285,444	3,524	80
17. Supplemental point data for the sea-level and tidal range data sets (flat ASCII file, WCPOINT.ASC)	103,518	1,278	80

Table 8. (concluded)

File number, description, and name	File size (bytes)	Number of records	Record length
18. FORTRAN retrieval program to read and print file 21 (WCOAST.FOR)	1,366	51	80
19. SAS™ code to read and print file 21 (WCOAST.SAS)	1,215	15	80
20. 1:2,000,000 digitized line segment coverage of the U.S. West Coast (Arc/Info™ export file, WCOAST.E00)	883,629	10,909	80
21. 1:2,000,000 digitized line segment coverage of the U.S. West Coast (flat ASCII file, WCOAST.ASC)	310,752	17,264	17
Totals	10,479,945	139,536	

Note:

Arc/Info™ export files (Version 7) are coverages converted to flat ASCII, fixed-block, files for data transfer purposes. The IMPORT command in Arc/Info™ must be used to enter these files into your system. Arc/Info™ is a registered trademark of the Environmental Systems Research Institute, Inc., Redlands, CA 92372.

SAS™ is a registered trademark of the SAS Institute, Inc., Cary, NC 27511-8000.

15. Contents of the Descriptive File

The following is a listing of the general descriptive information file (ndp043c.txt) distributed by CDIAC as part of this NDP. This file provides variable descriptions, formats, units, and other pertinent information about each file associated with this coastal hazards data base.

Title of the Data Base

A Coastal Hazards Data Base for the U.S. West Coast

Contributors

Vivien M. Gornitz

Center for Climate Systems Research, Columbia University
Goddard Institute for Space Studies, National Aeronautics and Space Administration
New York, New York

Tammy W. Beaty

Carbon Dioxide Information Analysis Center, Environmental Sciences Division
Oak Ridge National Laboratory
Oak Ridge, Tennessee

Richard C. Daniels

Energy, Environment and Resources Center, The University of Tennessee
Knoxville, Tennessee

Current affiliation:

Shorelands and Water Resources Program, Water Division, Department of Ecology
Olympia, Washington

Scope of the Data

The 29 data variables within *A Coastal Hazards Data Base for the U.S. West Coast*, and the corresponding coastal vulnerability indices that may be derived from algorithms listed within this NDP, may be used by coastal planning, research, and management agencies to identify shorelines at risk from coastal erosion and inundation. This data base should be used to identify areas where further study is necessary. In addition, these data may be used in combination with appropriate climatological data (e.g., Birdwell and Daniels 1991) to identify coastal areas that are vulnerable to coastal erosion and inundation from sea-level rise or storm surge (e.g., Gornitz et al. 1996).

This data base consists of the following data sets: elevation, bedrock geology, geomorphology, sea-level trends, horizontal shoreline movements (erosion/accretion), tidal ranges, and wave heights. For several of these data sets, minimum, mean, and maximum data values are available. These data variables may be divided into two basic classes, one that measures erosion potential and one that is related to inundation risk. The erosion risk of each coastal grid cell or line segment may be determined based on geology, geomorphology, shoreline displacement, tidal ranges and wave heights, while the inundation risk may be estimated based on sea-level trends and elevations.

Seven of the 29 data variables are classified versions of other variables within this data base. The seven classified risk variables contain "risk values" of one to five for each coastal grid cell and line segment in this data base. These risk variables may be used to calculate a coastal vulnerability index (CVI) to identify areas on the West Coast that are vulnerable to sea-level rise or coastal erosion.

Data Formats

This data base has been divided into five data groups. Each of these five data groups is provided in two different data formats. The first format is designed for use by the Arc/Info™ Geographic Information System (GIS). This format stores the data as polygons (e.g., WCGRID and WCRISK), arcs (e.g., WCLINE and WCOAST), or as points (e.g., WCPOINT). The second format contains comparable data that have been converted into flat ASCII data files for use by raster GISs or non-GIS data base systems.

The first two data groups are registered to a 0.25° latitude by 0.25° longitude grid. The first, WCGRID (Files 4 and 5) provides the 22 original data variables, while the second data group, WCRISK (Files 8 and 9) provides the seven relative risk variables.

The third data group is registered to line segments derived from a 1:2,000,000 digitized U.S. West Coast coastline. WCLINE (Files 12 and 13) provides 29 data variables (i.e., the 22 original and the seven relative risk data variables).

The fourth data group, WCPOINT (Files 16 and 17), provides the source information used in the development of the tidal-range and sea-level trends data sets. Data variables included in this data group are station names/numbers, record lengths, and longitude/latitude locations of the actual data point. These data represent the physical location of the occurring data point, and will allow the precise location of each station used in calculating the gridded tidal-range and sea-level-rise data variables within the 0.25° grid cells of data groups WCGRID and WCRISK to be identified.

Finally, the last group contains a 1:2,000,000 digitized coastline of the U.S. West Coast, WCOAST (files 20 and 21). These line segments are identical to those found in data group WCLINE; however, no data values are provided with this data group.

A description of the contents of each of the data groups and files included with this data base follows:

- (1) **WCGRID:** Gridded polygon data for the 22 original data variables. Data sets contained in this group include elevation, geology, geomorphology, sea-level trend, shoreline displacement (erosion/accretion), tide range, and wave heights.
- (2) **WCRISK:** Gridded polygon data for the seven classified risk variables. The risk variables are classified versions of the following original variables: mean coastal elevation, geology, geomorphology, local subsidence trend, mean shoreline displacement, mean tidal range, and maximum significant wave height.
- (3) **WCLINE:** 1:2,000,000 digitized line segment data for the U.S. West Coast containing the 29 data variables (i.e., the 22 original data variables and the seven classified risk

variables).

- (4) **WCPOINT:** Point data for the stations used in calculating the sea-level trend and tide-range data sets. Data include station names/numbers, record length, latitude/longitude location, and mean and maximum data values (when available).
- (5) **WCOAST:** 1:2,000,000 digitized coastline of the U.S. West Coast. The coastline was extracted from a digitized map of the United States compiled by the U.S. Geological Survey.

To improve the portability of the information in the data files, FORTRAN and SASTM input/output routines have been included with this data base for each of the flat ASCII data files. These input/output routines are intended to be used to read/write the data values contained in the flat ASCII data files [containing the gridded data base, the original point data (for the sea-level trend and tide-range variables), and the digitized U.S. West coastline].

The data groups in this data base are available as exported Arc/InfoTM coverages (Version 7). The export files **must be read into an Arc/InfoTM GIS using the IMPORT command with the COVER option** after uploading the files onto a computer. These files are in a GEOGRAPHIC projection, which means the coverages are projected in a spherical reference grid using latitude and longitude coordinates that are stored in decimal degrees (DD). The flat ASCII files contain an identical version of this data base.

The gridding method used in this data base consists of 0.25° latitude by 0.25° longitude grid cells. These cells cover the area defined by the following coordinates: 126°W, 32°N; 126°W, 49°N; 116°W, 49°N; and 116°W, 32°N. The origin of the grid is at 126°W, 32°N, and grid identifiers increase from left to right, bottom to top. The data contained within each grid cell is an average for the entire grid cell. The grid cell identification number is located in the center of each cell and although it is not the physical location of each data value, it represents averages for all data points located within the cell.

The flat ASCII versions of the files have been provided to allow use of these data by users who do not have access to Arc/InfoTM software. The format and contents of each of the flat ASCII files are described in the following section (the Arc/InfoTM coverages have the same variables and general format as described herein for the ASCII files).

Data Group WCGRID:

This data group contains gridded data for the 22 original data variables. These data variables are from the seven data sets and are as follows: mean, maximum, and minimum elevation, and the number of 5' grid cells used in deriving the data values; geology; geomorphology; relative sea-level trend, long-term geologic trend (included for compatibility within this series of NDPs), corrected sea-level trend, local subsidence trend, and the years of record of the gauge stations used in calculating these values; mean, maximum, and minimum shoreline displacement, and the number of 3', 7.5', or 15' grid cells used in deriving the data values; mean and maximum tidal range, mean tide level, and the number of tidal stations used in calculating these values; 20-year mean wave height, maximum significant wave height, and the 20-year mean wave height standard

deviation.

The names of the Arc/Info™ coverage and flat ASCII files providing these data are WCGRID.E00 (File 4) and WCGRID.ASC (File 5), respectively. File 5 is formatted as follows:

```

10 READ(5,100,END=999) ID,ELAVG,ELMAX,ELMIN,ELNUM,
  1  GL,GM,SLR,SLG,SLC,SLS,SLYR
  READ(5,110) ERAVG,ERMAX,ERMIN,ERNUM,TRAVG,
  1  TRMAX,TRLVL,TRNUM,WHAVG,WHMAX,WHSD
100 FORMAT(I5,3F8.2,3I4,4F8.2,I4)
110 FORMAT(3F8.2,I4,3F8.2,I4,3F8.2)

```

The variables in data group WCGRID (File 5) are shown in Table 9 and are listed as they appear in the file.

Table 9. Variable formats for WCGRID.ASC (File 5).

Variable name	Column		Variable type	Variable description
	Start	End		
ID	1	5	Integer	System variable - grid cell identifier.
ELAVG	6	13	Real	Data variable - mean elevation of all positive 5' by 5' grid cells within a given 0.25° grid cell; values in meters.
ELMAX	14	21	Real	Data variable - maximum elevation of all positive 5' by 5' grid cells within a given 0.25° grid cell; values in meters.
ELMIN	22	29	Real	Data variable - minimum elevation of all positive 5' by 5' grid cells within a given 0.25° grid cell; values in meters.

Table 9. (continued)

Variable name	Column		Variable type	Variable description
	Start	End		
ELNUM	30	33	Integer	Data variable - number of 5' by 5' grid cells used in calculating ELAVG, ELMIN, and ELMAX for a given 0.25° grid cell.
GL	34	37	Integer	Data variable - ordinal value indicative of the type and resistance of the rocks within a given 0.25° grid cell to erosion.
GM	38	41	Integer	Data variable - ordinal value indicative of the type and susceptibility of the landforms within a given 0.25° grid cell to inundation and erosion.
SLR	42	49	Real	Data variable - relative sea-level trend within a given 0.25° grid cell calculated from tide-gauge station measurements; values in mm/year.
SLG	50	57	Real	Data variable - long-term geologic trend. This variable is 0.0 for all 0.25° grid cells with a relative sea-level trend value and is included for compatibility within this series of NDPs.
SLC	58	65	Real	Data variable - corrected sea-level trend. Since the geologic trend variable contains values of 0.0, this variable appears identical to the relative sea-level trend variable; and is included only for compatibility within this series of NDPs.

Table 9. (continued)

Variable name	Column		Variable type	Variable description
	Start	End		
SLS	66	73	Real	Data variable - the local uplift or subsidence trend. The relative sea-level trend (SLR) corrected for the global eustatic rate of sea-level rise (i.e., 1.5 mm/year).
SLYR	74	77	Integer	Data variable - years of record used in estimating the sea-level trend for each 0.25° grid cell.
----- SECOND LINE READS AS FOLLOWS -----				
ERAVG	1	8	Real	Data variable - mean long-term erosion trend for a given 0.25° grid cell; values in meters.
ERMAX	9	16	Real	Data variable - maximum long-term erosion trend for a given 0.25° grid cell; values in meters.
ERMIN	17	24	Real	Data variable - minimum long-term erosion trend for a given 0.25° grid cell; values in meters.
ERNUM	25	28	Integer	Data variable - number of 3', 7.5', or 15' grid cells used in calculating ERAVG, ERMIN, and ERMAX for a given 0.25° grid cell.
TRAVG	29	36	Real	Data variable - average of the mean tide range for all the gauge stations that occur within a given 0.25° grid cell (mean tide range is the difference in height between mean high water and mean low water); values in meters.

Table 9. (continued)

Variable name	Column		Variable type	Variable description.
	Start	End		
TRMAX	37	44	Real	Data variable - maximum tide range measured for all gauge stations that occurred within a given 0.25° grid cell in 1988 (this value may be the "spring" or "diurnal" tide range, depending on geographic location); values in meters.
TRLVL	45	52	Real	Data variable - the average of the mean tide levels of all the gauge stations that occur within a given 0.25° grid cell (mean tide level is a plane midway between mean low water and mean high water in 1988). Values were reckoned from chart datums (i.e., the West Coast Mean Low Water Datum).
TRNUM	53	56	Integer	Data variable - number of tide gauge stations used in calculating TRAVG, TRMAX, and TRLVL for a given 0.25° grid cell.
WHAvg	57	64	Real	Data variable - 20-year mean wave height experienced within each 0.25° grid cell; values in meters.
WHMAX	65	72	Real	Data variable - maximum significant wave height for each 0.25° grid cell; values in meters.

Table 9. (concluded)

Variable name	Column		Variable type	Variable description
	Start	End		
WHSD	73	80	Real	Data variable - standard deviation of the 20-year mean wave height experienced within each 0.25° grid cell; values in meters.

Within WCGRID missing data values are identified as follows:

-9999.99 — A grid cell with real data values that is missing data for a given data variable.

9999 — A grid cell with integer data values that is missing data for a given data variable.

A value of 0.0 is a valid value for all variables. For the elevation variables 0.0 m indicates that land occurs within the given grid cell, but the mean elevation of this land is < 1.0 m. If the data variables in a given data set, such as elevation, contain data and the "number" variable is set to zero (i.e., ELNUM, ERNUM, TRNUM, or SLYR), then the data variables for the given 0.25° grid cell have been estimated.

Data Group WCRISK:

This data group contains gridded data for the seven classified risk variables. These risk variables are classified versions of the following original variables: mean coastal elevation, geology, geomorphology, local subsidence trend, mean shoreline displacement, mean tidal range, and maximum significant wave height.

The names of the Arc/Info™ coverage and flat ASCII files are WCRISK.E00 (File 8) and WCRISK.ASC (File 9), respectively. A summary of the format used in File 9 follows:

```

10 READ(5,100,END=999) ID, ELR, GLR, GMR, LSR,
1 TRR,WHR
100 FORMAT(I5,7I4)

```

The variables in data group WCRISK, listed in Table 10, are shown as they appear in File 9.

Table 10. Variable formats for WCRISK.ASC (File 9).

Variable name	Column		Variable type	Variable description
	Start	End		
ID	1	5	Integer	System variable - grid cell identifier.
ELR	6	9	Integer	Data variable - classified version of the mean elevation variable (i.e., ELAVG).
GLR	10	13	Integer	Data variable - classified version of the geology variable (i.e., GL).
GMR	14	17	Integer	Data variable - classified version of the geomorphology variable (i.e., GM).
LSR	18	21	Integer	Data variable - classified version of the local subsidence trend variable (i.e., SLS).
ERR	22	25	Integer	Data variable - classified version of the mean erosion/accretion variable (i.e., ERAVG).
TRR	26	29	Integer	Data variable - classified version of the mean tide range variable (i.e., TRAVG).
WHR	30	33	Integer	Data variable - classified version of the maximum significant wave- height variable (i.e., WHMAX).

A value of zero is used to identify missing data values within the grid cell for the risk variables. If several "no data" values occur within the same grid cell, then any calculated coastal vulnerability index that uses these relative risk factors may not accurately represent the risk of the given coastal area to sea-level rise or coastal erosion (unless some type of corrective action is taken). Grid cells that are not in the coastal zone, or are totally ocean bound, have values of zero for all seven derived risk variables.

Data Group WCLINE:

This data group contains digitized line segments obtained at a scale of 1:2,000,000. The coastline is composed of 1,262 line segments with lengths of 93 m to 88.7 km, with an average length of 5.8 km. Each of these line segments have 29 data variables (attributes) assigned to them (i.e., the 22 original and the seven relative risk data variables). Several of these variables have been directly transferred from WCGRID using the IDENTITY procedure in Arc/Info™. As such, line segment lengths do not indicate the resolution of the data.

These 29 data variables are as follows: mean, maximum, and minimum elevation, the number of 5' grid cells used in deriving the data values, and the elevation risk (i.e., the classified version of the mean elevation variable); geology and the geology risk (i.e., the classified version of the geology variable); geomorphology and geomorphology risk (i.e., the classified version of the geomorphology variable); relative sea-level trend, global-trend, corrected sea-level trend, local subsidence trend, the years of record of the gauge stations used in calculating these values, and the local subsidence trend risk (i.e., the classified version of the local subsidence trend variable); mean, maximum, and minimum shoreline displacement, the number of 3', 7.5', or 15' grid cells used in deriving the data values, and erosion risk (i.e., the classified version of the mean erosion/accretion variable); mean and maximum tidal range, mean tide level, the number of tidal stations used in calculating these values, and the tidal-range risk (i.e., the classified version of the mean tidal range); 20-year mean wave height, maximum significant wave height, the 20-year mean wave height standard deviation, and the wave-height risk (i.e., classified version of the maximum significant wave-height variable).

The names of the Arc/Info™ coverage and flat ASCII file that provide these data variables are WCLINE.E00 (File 12) and WCLINE.ASC (File 13), respectively. File 13 is formatted as follows:

```
10 READ(5,100,END=999) ID,ELAVG,ELMAX,ELMIN,ELNUM,  
1  ELR,GL,GLR,GM,GMR,SLR,SLG,SLC  
  READ(5,110) SLS,SLYR,LSR,ERA VG,ERMAX,ERMIN,  
1  ERNUM,ERR,TRAVG,TRMAX,TRLVL,TRNUM,TRR  
  READ(5,120) WHAVG,WHMAX, WHSD,WHR  
100 FORMAT(I5,3F8.2,6I4,3F8.2)  
110 FORMAT(2I4,3F8.2,2I4)  
120 FORMAT(3F8.2,I4)
```

The variables in data group WCLINE (File 13) are shown in Table 11 and are listed as they appear in the file.

Table 11. Variable formats for WCLINE.ASC (File 13).

Variable name	Column		Variable type	Variable description
	Start	End		
ID	1	5	Integer	System variable - grid cell identifier.
ELAVG	6	13	Real	Data variable - mean elevation of all positive 5' by 5' grid cells within a given 0.25° grid cell; values in meters.
ELMAX	14	21	Real	Data variable - maximum elevation of all positive 5' by 5' grid cells within a given 0.25° grid cell; values in meters.
ELMIN	22	29	Real	Data variable - minimum elevation of all positive 5' by 5' grid cells within a given 0.25° grid cell; values in meters.
ELNUM	30	33	Integer	Data variable - number of 5' by 5' grid cells used in calculating ELAVG, ELMIN, and ELMAX for a given 0.25° grid cell.
ELR	34	37	Integer	Data variable - classified version of the mean elevation variable (i.e., ELAVG).
GL	38	41	Integer	Data variable - ordinal value indicative of the resistance of the rocks to erosion.
GLR	42	45	Integer	Data variable - classified version of the geology variable (i.e., GL).

Table 11. (continued)

Variable name	Column		Variable type	Variable description
	Start	End		
GM	46	49	Integer	Data variable - ordinal value indicative of the susceptibility of the landforms to inundation and erosion.
GMR	50	53	Integer	Data variable - classified version of the geomorphology variable (i.e., GM).
SLR	54	61	Real	Data variable - relative sea-level trend calculated from tide-gauge station measurements.
SLG	62	69	Real	Data variable - long-term geologic trend. This variable is 0.0 for all line segments with a relative sea-level trend value, and is included for compatibility within this series of NDPs.
SLC	70	77	Real	Data variable - corrected sea-level trend. Since the geologic trend variable contains only values of 0.0, this variable appears identical to the relative sea-level trend variable, and is included for compatibility within this series of NDPs.

Table 11. (continued)

Variable name	Column		Variable type	Variable description
	Start	End		
----- SECOND LINE READS AS FOLLOWS -----				
SLS	1	8	Real	Data variable - the local uplift or subsidence trend. The relative sea-level trend corrected for the global eustatic rate of sea-level rise (i.e., 1.5 mm/year).
SLYR	9	12	Integer	Data variable - years of record used in estimating the sea-level trend for each 0.25° grid cell.
LSR	13	16	Integer	Data variable - classified version of the local subsidence trend variable (i.e., SLS).
ERAVG	17	24	Real	Data variable - mean long-term erosion trend for given 0.25° grid cell; values in meters.
ERMAX	25	32	Real	Data variable - maximum long-term erosion trend for a given 0.25° grid cell; values in meters.
ERMIN	33	40	Real	Data variable - minimum long-term erosion trend for a given 0.25° grid cell; values in meters.
ERNUM	41	44	Integer	Data variable - number of 3', 7.5', or 15' grid cells used in calculating ERAVG, ERMIN, and ERMAX for a given 0.25° grid cell.

Table 11. (continued)

Variable name	Column		Variable type	Variable description
	Start	End		
ERR	45	48	Integer	Data variable - classified version of the mean erosion/accretion variable (i.e., ERAVG).
TRAVG	49	56	Real	Data variable - average of the mean tide range for all gauge stations that occur within a given 0.25° grid cell (TRAVG is the difference between mean high water and mean low water in 1992); values in meters.
TRMAX	57	64	Real	Data variable - maximum tide range measured for all gauge stations that occurred within a given 0.25° grid cell in 1992 (this value may be the "spring" or "diurnal" tide range, depending on geographic location); values in meters.
TRLVL	65	72	Real	Data variable - the average of the mean tide levels of all the gauge stations that occur within a given 0.25° grid cell (mean tide level is a plane midway between mean low water and mean high water in 1992). Values were reckoned from the West Coast Mean Low Water Datum.
TRNUM	73	76	Integer	Data variable - number of tide gauge stations used in calculating TRAVG, TRMAX, and TRLVL for a given 0.25° grid cell.

Table 11. (concluded)

Variable name	Column		Variable type	Variable description
	Start	End		
TRR	77	80	Integer	Data variable - classified version of the mean tide range variable (i.e., TRAVG).
----- THIRD LINE READS AS FOLLOWS -----				
WHAvg	1	8	Real	Data variable - 20-year mean wave height experienced within each 0.25° grid cell; values in meters.
WHMAX	9	16	Real	Data variable - maximum significant wave height for each 0.25° grid cell; values in meters.
WHSD	17	24	Real	Data variable - standard deviation of the 20-year mean wave height experienced within each 0.25° grid cell; values in meters.
WHR	25	28	Integer	Data variable - classified version of the maximum significant wave-height variable (i.e., WHMAX).

Within WCLINE, missing data values are indicated as follows:

-9999.99— A line segment with real data values that is missing data for a given data variable.

9999— A line segment with integer data values that is missing data for a given data variable.

0— A line segment with missing data values for the risk variables (i.e., for variables ELR, ERR, WHR, TRR, LSR, GLR, GMR only).

A value of 0.0 is a valid value for all but the risk variables. For the elevation variables 0.0 m indicates that land occurs within the given grid cell, but the maximum elevation of this land is < 1.0 m. If the data variables in a given data set, such as elevation, contain data and the "number" variable is set to zero (i.e., ELNUM, ERNUM, TRNUM, or SLYR), then the data variables for the given 0.25° grid cell have been estimated.

Data Group WCPOINT:

This data group contains the point data for the stations used in calculating the relative sea-level trend, long-term geologic-trend, corrected sea-level trend, local subsidence trend, mean tide range, maximum tide range, and mean tide level variables contained within data group WCGRID. Data include station names, station number, record length, latitude/longitude location, and data variable values.

The names of the Arc/Info™ coverage and flat ASCII file are WCPOINT.E00 (File 16 and WCPOINT.ASC (File 17), respectively. A summary of the format used for File 17 follows:

```

10 READ(5,100,END=999) ID,SLLONG,SLLAT,SLR,SLG,
  1 SLC,SLS,SLYR
  READ(5,110) SLNAME,TRLONG,TRLAT,TRAVG,
  1 TRMAX,TRLVL
  READ(5,120) TRID,TRNAME
100 FORMAT(I5,6F8.2,I4)
110 FORMAT(A40,5F8.2)
120 FORMAT(I5,A45)

```

The variables listed in Table 12 are listed as they appear in data group WCPOINT (File 17).

Table 12. Variable formats for WCPOINT.ASC (File 17).

Variable name	Column		Variable type	Variable description
	Start	End		
ID	1	5	Integer	System variable - Point identification number.
SLLONG	6	13	Real	Data variable - longitude of the tide- gauge station used in determining the sea-level trends.
SLLAT	14	21	Real	Data variable - latitude of the tide- gauge station used in determining the sea-level trends.

Table 12. (continued)

Variable name	Column		Variable type	Variable description
	Start	End		
SLR	22	29	Real	Data variable - relative sea-level trend calculated from tide-gauge station measurements; values are expressed in mm/year.
SLG	30	37	Real	Data variable - long-term geologic trend. This variable is 0.0 for all stations with a relative sea-level trend value, and is included for compatibility within this series of NDPs.
SLC	38	45	Real	Data variable - corrected sea-level trend. Since the geologic trend variable contains values of 0.0, this variable appears identical to the relative sea-level trend variable; and is included only for compatibility within this series of NDPs.
SLS	46	53	Real	Data variable - local uplift or subsidence trend. Relative sea-level trend corrected for the global eustatic rate of sea-level rise (i.e., 1.5 mm/year).
SLYR	54	57	Integer	Data variable - years of record of the tide gauge station used in determining the sea-level trends.

Table 12. (continued)

Variable name	Column		Variable type	Variable description
	Start	End		
----- SECOND LINE READS AS FOLLOWS -----				
SLNAME	1	40	Char	Data variable - name of the tide gauge used for determining the sea-level trends.
TRLONG	41	48	Real	Data variable - longitude of a tide-gauge station used for determining the tide range variables.
TRLAT	49	56	Real	Data variable - latitude of a tide-gauge station used for determining the tide range variables.
TRAVG	57	64	Real	Data variable - difference between mean high water and mean low water for 1992; values in meters.
TRMAX	65	72	Real	Data variable - maximum tide range, maximum measured range for the gauge station in 1992 (this value may be the "spring" or "diurnal" tide range, depending on geographic location); values in meters.
TRLVL	73	80	Real	Data variable - mean tide level, a plane midway between mean low water and mean high water in 1992. Values are reckoned from the West Coast Mean Low Water Datum.

Table 12. (concluded)

Variable name	Column		Variable type	Variable description
	Start	End		
----- THIRD LINE READS AS FOLLOWS -----				
TRID	1	4	Integer	Data variable - station number (used in the 1992 Tide Tables) of a tide-gauge station.
TRNAME	5	54	Char	Data variable - name of a tide-gauge station (from the 1992 Tide Tables).

Within this data file, WCPOINT, missing data values are indicated with one of the following values:

0.0 or 0 - A sea-level or tide-range station that has not been assigned data values. This data group includes the calculated relative sea-level trend measurements in mm/yr for 16 tide-gauge stations (Woodworth 1995; Spencer and Woodworth 1993) and the tide table data for 410 NOAA stations (NOS 1992). The sea-level and tide-range stations each have unique data variables. When the 16 stations used for the calculated sea-level trend measurements are present, the tide range variables are 0.0 or 0. When the 410 NOAA stations are present, the sea-level variables are 0.0 or 0.

Data Group WCOAST:

The final data group, WCOAST (Files 20 and 21), contains a 1:2,000,000 digitized coastline of the U.S. West Coast made up of 1,262 line segments. Data in this coverage were extracted from a digitized map of the United States (originally compiled by the U.S. Geological Survey). This coastline may be overlaid onto any of the data groups previously discussed to provide locational information when plotting the data variables. The line segment identification numbers used herein are identical to the line segment identification numbers used in WCLINE.ASC. Unlike the other data groups within this data base this coverage contains no attribute values. However, such overlay commands as UNION, INTERSECT, and IDENTITY in Arc/Info™ (or other GISs) may be used to transfer the gridded data values to the coastal segments, thus simplifying the interpretation of any derived indices.

The name of the Arc/Info™ coverage where the coastline resides is WCOAST.E00 (File 20), and the flat ASCII data file with this same information is in WCOAST.ASC (File 21). Since this file is line based, the data values in WCOAST.ASC contain the line segment name, the number of points in the line, and a listing of the points that describe each line, for all 1,262 line segments that define the West Coast.

The flat ASCII version of this file contains a listing of the line segments (or arcs) that describe the coast in the BNA format. An example of the format for this file is shown in Table 13.

Table 13. Sample of the vector format used for WCOAST.ASC (File 21).

```

" 1",-6
-122.7500,48.9764
-122.7500,48.9796
-122.7524,48.9832
-122.7572,48.9852
-122.7600,48.9916
-122.7656,49.0000
" 2",-11
-122.7984,48.9724
-122.7956,48.9760
-122.7944,48.9792
-122.7920,48.9820
-122.7896,48.9848
-122.7848,48.9856
-122.7824,48.9828
-122.7864,48.9808
-122.7896,48.9780
-122.7920,48.9752
-122.7916,48.9716

```

16. Listing of the FORTRAN Data Retrieval Programs

This section lists the five FORTRAN data retrieval programs provided by CDIAC with this data base. Each program is designed to read and write the contents of one of the five flat ASCII data files.

The first program (WCGRID.FOR, File 2) is designed to read and print the file WCGRID.ASC (File 5).

```

c*****
c* fortran program to read and write wcgrid.asc (file 5) *
c*****
integer nlin
integer id, elnum, gl, gm, slyr, ernum, trnum
real elavg, elmax, elmin, slr, slg, slc, sls
real eravg, ermax, ermin, travg, trmax, trlvl
real whavg, whmax, whsd

```

```

c*****
c* initialize a counter and open files for input/output *
c*****
      nlin=0
      open(unit=5,file='wcgrid.asc',readonly,status='old')
      open(unit=6,file='wcgrid.out',status='new')
c*****
c* read/write the grid cell id and the 22 data variables *
c*****
      10 read(5,100,end=999) id, elavg, elmax, elmin, elnum,
          1   gl, gm, slr, slg, slc, sls, slyr
          read(5,110) eravg, ermax, ermin, ernum, travg,
          1   trmax, trlvl, trnum, whavg, whmax, whsd

          if (nlin.gt.32) nlin=0
          if (nlin.eq.0) write (6,120)
          if (nlin.eq.0) write (6,130)
          nlin=nlin+1

          write(6,105) id, elavg, elmax, elmin, elnum,
          1   gl, gm, slr, slg, slc, sls, slyr
          write(6,115) eravg, ermax, ermin, ernum, travg,
          1   trmax, trlvl, trnum, whavg, whmax, whsd
      20 continue
      go to 10
      100 format (i5,3f8.2,3i4,4f8.2,i4)
      105 format (1x,i5,3f8.2,3i4,4f8.2,i4)
      110 format (3f8.2,i4,3f8.2,i4,3f8.2)
      115 format (1x,3f8.2,i4,3f8.2,i4,3f8.2)
      120 format (4x,'id',1x,'elavg',3x,'elmax',3x,'elmin',1x,
          1   'elnum',2x,'gl',2x,'gm',1x,'slr',5x,'slg',5x,'slc',
          1   5x,'sls',4x,'slyr')
      130 format (2x,'eravg',3x,'ermax',3x,'ermin',1x,'ernum',
          1   1x,'travg',3x,'trmax',3x,'trlvl',1x,'trnum',1x,
          1   'whavg',3x,'whmax',3x,'whsd')
c*****
c*****      close files and exit      *****
c*****
      999 close(unit=5)
          close(unit=6)
          stop
          end

```

The second FORTRAN program (WCRISK.FOR, File 6) is designed to read and print the file WCRISK.ASC (File 9).

```

c*****
c* fortran program to read and write wcrisk.asc (file 9) *
c*****
      integer nlin
      integer id, elr, glr, gmr, lsr, err, trr, whr
c*****
c* initialize a counter and open files for input/output *
c*****

```

```

        nlin=0
        open(unit=5,file='wcrisk.asc',readonly,status='old')
        open(unit=6,file='wcrisk.out',status='new')
c*****
c* read/write the grid cell id and the 7 risk variables *
c*****
        10 read(5,100,end=999) id, elr, glr, gmr, lsr,
            1    err, trr, whr

        if (nlin.gt.63) nlin=0
        if (nlin.eq.0) write (6,110)
        nlin=nlin+1

        write(6,105) id, elr, glr, gmr, lsr,
            1    err, trr, whr
        20 continue
        go to 10
        100 format (i5,7i4)
        105 format (1x,i5,7i4)
        110 format (4x,'id',1x,'elr',1x,'glr',1x,'gmr',1x,
            1    'lsr',1x,'err',1x,'trr',1x,'whr')
c*****
c*****          close files and exit          *****
c*****
        999 close(unit=5)
        close(unit=6)
        stop
        end

```

The third FORTRAN program (WCLINE.FOR, File 10) is designed to read and print the file WCLINE.ASC (File 13).

```

c*****
c* fortran program to read and write wcline.asc (file 13) *
c*****
        integer nlin
        integer id, elnum, gl, gm, slyr, ernum, trnum
        integer elr, glr, gmr, lsr, err, trr, whr
        real    elavg, elmax, elmin, slr, slg, slc, sls
        real    eravg, ermax, ermin, travg, trmax, trlvl
        real    whavg, whmax, whsd
c*****
c* initialize a counter and open files for input/output *
c*****
        nlin=0
        open(unit=5,file='wcline.asc',readonly,status='old')
        open(unit=6,file='wcline.out',status='new')
c*****
c* read/write the line segment id and the 29 data variables *
c* including the 22 original and 7 risk data variables *
c*****
        10 read(5,100,end=999) id, elavg, elmax, elmin, elnum,
            1    elr, gl, glr, gm, gmr, slr, slg, slc
            read(5,110) sls, slyr, lsr, eravg, ermax, ermin,
            1    elnum, err, travg, trmax, trlvl, trnum, trr
            read(5,120) whavg, whmax, whsd, whr

```

```

if (nlin.gt.32) nlin=0
if (nlin.eq.0) write (6,130)
if (nlin.eq.0) write (6,140)
if (nlin.eq.0) write (6,150)
nlin=nlin+1

write(6,105) id, elavg, elmax, elmin, elnum,
1   elr, gl, glr, gm, gmr, slr, slg, slc
write(6,115) sls, slyr, lsr, eravg, ermax, ermin,
1   ernum, err, travg, trmax, trlvl, trnum, trr
write(6,125) whavg, whmax, whsd, whr
20 continue
go to 10
100 format (i4,3f8.2,6i4,3f8.2)
105 format (i4,3f8.2,6i4,3f8.2)
110 format (f8.2,2i4,3f8.2,2i4,3f8.2,2i4)
115 format (f8.2,2i4,3f8.2,2i4,3f8.2,2i4)
120 format (3f8.2,i4)
125 format (3f8.2,i4)
130 format (2x,'id',2x,'elavg',2x,'elmax',2x,'elmin',
1   1x,'elnum',2x,'elr',2x,'gl',2x,'glr',1x,'gm',
1   2x,'gmr',4x'slr',5x,'slg',5x,'slc')
140 format (3x,'sls',2x,'slyr',1x,'lsr',3x,'eravg',2x,'ermax',
1   2x,'ermin',1x,'ernum',1x,'err',3x,'travg',
1   2x,'trmax',2x,'trlvl',1x,'trnum',1x,'trr')
150 format ('whavg',3x,'whmax',3x,'whsd',5x,'whr')
c*****
c*****          close files and exit          *****
c*****

999 close(unit=5)
close(unit=6)
stop
end

```

The fourth FORTRAN program (WCPOINT.FOR, file 14) is designed to read and print the file WCPOINT.ASC (File 17).

```

c*****
c* fortran program to read and write wcpoint.asc (file 17) *
c*****
integer nlin
integer id, slyr, trid
real sllong, sllat, slr, slg, slc, sls
real trlong, trlat, travg, trmax, trlvl
character slname*40, trname*45
c*****
c* initialize a counter and open files for input/output *
c*****
nlin=0
open(unit=5,file='wcpoint.asc',readonly,status='old')
open(unit=6,file='wcpoint.out',status='new')
c*****
c* read/write the point id and the 15 station variables *

```

```

c*****
10 read (5,100,end=999) id, sllong, sllat, slr, slg,
1   slc, sls, slyr
   read(5,110) slname, trlong, trlat, travg,
1   trmax, trlvl,
   read(5,120) trid, trname

   if (nlin.gt.32) nlin=0
   if (nlin.eq.0) write (6,130)
   if (nlin.eq.0) write (6,140)
   if (nline.eq.0) write (6,150)
   nlin=nlin+1

   write(6,105) id, sllong, sllat, slr, slg,
1   slc, sls, slyr
   write(6,115) slname, trlong, trlat, travg,
1   trmax, trlvl,
   write(5,125) trid, trname

20 continue
go to 10
100 format (i5,6f8.2,i4)
105 format (i5,6f8.2,i4)
110 format (a40,5f8.2)
115 format (a40,5f8.2)
120 format (i4,a50)
125 format (i4,a50)
130 format (4x,'id',2x,'sllong',3x,'sllat',5x,'slr',
1   5x,'slg',5x,'slc',5x,'sls',1x,'slyr',1x,'slname')
140 format (3x,'trlong',3x,'trlat',3x,'travg',3x,'trmax',
1   3x,'trlvl',1x,'trid',1x,'trname')
150 format ('trid',1x,'trname')
c*****
c*****      close files and exit      *****
c*****
999 close(unit=5)
   close(unit=6)
   stop
   end

```

The last FORTRAN program (WCOAST.FOR, File 18) is designed to read and print the file WCOAST.ASC (File 21).

```

c*****
c* fortran program to read and write wcoast.asc (file 21) *
c*****
   character id*6, name*7
   character comma
   integer i, num, nlin
   real long, lat
c*****
c*      open files for input/output      *
c*****
   open(unit=5,file='wcoast.asc',readonly,status='old')

```



```

        open(unit=6,file='wcoast.out',status='new')
c*****
c* read/write the line segment id and x,y coordinates *
c*****
10 nlin=0
   read(5,100,end=999) id,comma,num
   if (comma.eq.'-') num=num*-1
   if (comma.eq.',') then
       name=id//','
   else
       name=id//' '
   end if
   write(6,130)
   write(6,110) name, num
c*****
c* read and print x,y coordinates for the line *
c*****
   do 20 i = 1, num*-1
       if (nlin.gt.77) nlin=0
       if (nlin.eq.0) write (6,140)
       nlin=nlin+1
       read (5,120) long,comma,lat
       write (6,125) long,comma,lat
20 continue
   go to 10
100 format (a6,a1,i6)
110 format (a7,i6)
120 format (f9.4,a1,f8.4)
130 format (1x,'name , number')
140 format (1x,'longitude,latitude')
c*****
c*****          close files and exit          *****
c*****
999 close(unit=5)
   close(unit=6)
   stop
   end

```

17. Listing of the SASTM Data Retrieval Programs

This section lists the five SASTM data retrieval programs provided by CDIAC with this data base. Each program is designed to read and write the contents of one of the five flat ASCII data files. The first program (WCGRID.SAS, File 3) is designed to read and print the file WCGRID.ASC (File 5).

```

options ls=80 ps=70;
data wcgrid;
infile 'wcgrid.asc';
input id 5. (elavg elmax elmin) 8.2 (elnum gl gm) (4.)
      (slr slg slc sls) (8.2) slyr 4. / (eravg ermax ermin) (8.2)
      ernum 4. (travg trmax trlvl) (8.2) trnum 4.
      (whavg whmax whsd) (8.2);
proc print noobs;
run;

```

The second SAS™ program (WCRISK.SAS, File 7) is designed to read and print the file WCRISK.ASC (File 9).

```
options ls=80 ps=70;
data wcrisk;
infile 'wcrisk.asc';
input id 5. (elr glr gmr lsr err trr whr) (4.);
proc print noobs;
run;
```

The third SAS™ program (WCLINE.SAS, File 11) is designed to read and print the file WCLINE.ASC (File 13).

```
options ls=80 ps=70;
data wcline;
infile 'wcline.asc';
input id 4. (elavg elmax elmin) (8.2) (elnum elr gl glr gm gmr) (4.)
           (slr slg slc) (8.2) / sls 8.2
           (slyr lsr) (4.) (eravg ermax ermin) (8.2) (ernum err) (4.)
           (travg trmax trlvl) (8.2) (trnum trr) (4.) /
           (whavg whmax whsd) (8.2) whr 4.;
proc print;
run;
```

The fourth SAS™ program (WCPOINT.SAS, File 15) is designed to read and print the file WCPOINT.ASC (File 17).

```
options ls=80 ps=70;
data wcpoint;
infile 'wcpoint.asc';
input id 5. (sllong sllat slr slg slc sls) (8.2) slyr 4. /
           slname $ 40. (trlong trlat travg trmax trlvl) (8.2) /
           triid 4. trname $ 50.;
proc print;
run;
```

The fifth SAS™ program (File 19) is designed to read and print the file WCOAST.ASC (File 21).

```
options ls=80 ps=70;
data wcoast;
file 'wcoast.lst';
infile 'wcoast.asc' dlm=',';
input id $ num1 @;
put @1 'ID' @9 'number of points' @30 'Longitude' @47 'Latitude';
put @1 name @15 num @;
num = num1 * -1;
array long{197};
array lat{197};
do i = 1 to num;
input long{i} lat{i};
put @30 long{i} 9.4 @45 lat{i} 9.4;
end;
run;
```

18. Partial Listings of the Flat ASCII Data Files

This section lists the first and last five data lines of each of the of the flat ASCII data files provided with this data base.

Sample listing of WCGRID.ASC (file 5).

```
1-9999.99-9999.99-9999.999999999999999999-9999.99-9999.99-9999.99-9999.999999
-9999.99-9999.99-9999.999999-9999.99-9999.99-9999.999999-9999.99-9999.99-9999.99
2-9999.99-9999.99-9999.999999999999999999-9999.99-9999.99-9999.99-9999.999999
-9999.99-9999.99-9999.999999-9999.99-9999.99-9999.999999-9999.99-9999.99-9999.99
3-9999.99-9999.99-9999.999999999999999999-9999.99-9999.99-9999.99-9999.999999
-9999.99-9999.99-9999.999999-9999.99-9999.99-9999.999999-9999.99-9999.99-9999.99
4-9999.99-9999.99-9999.999999999999999999-9999.99-9999.99-9999.99-9999.999999
-9999.99-9999.99-9999.999999-9999.99-9999.99-9999.999999-9999.99-9999.99-9999.99
5-9999.99-9999.99-9999.999999999999999999-9999.99-9999.99-9999.99-9999.999999
-9999.99-9999.99-9999.999999-9999.99-9999.99-9999.999999-9999.99-9999.99-9999.99
.....
2716-9999.99-9999.99-9999.999999999999999999-9999.99-9999.99-9999.99-9999.999999
-9999.99-9999.99-9999.999999-9999.99-9999.99-9999.999999-9999.99-9999.99-9999.99
2717-9999.99-9999.99-9999.999999999999999999-9999.99-9999.99-9999.99-9999.999999
-9999.99-9999.99-9999.999999-9999.99-9999.99-9999.999999-9999.99-9999.99-9999.99
2718-9999.99-9999.99-9999.999999999999999999-9999.99-9999.99-9999.99-9999.999999
-9999.99-9999.99-9999.999999-9999.99-9999.99-9999.999999-9999.99-9999.99-9999.99
2719-9999.99-9999.99-9999.999999999999999999-9999.99-9999.99-9999.99-9999.999999
-9999.99-9999.99-9999.999999-9999.99-9999.99-9999.999999-9999.99-9999.99-9999.99
2720-9999.99-9999.99-9999.999999999999999999-9999.99-9999.99-9999.99-9999.999999
-9999.99-9999.99-9999.999999-9999.99-9999.99-9999.999999-9999.99-9999.99-9999.99
```

Sample listing of WCRISK.ASC (File 9).

1	0	0	0	0	0	0	0
2	0	0	0	0	0	0	0
3	0	0	0	0	0	0	0
4	0	0	0	0	0	0	0
5	0	0	0	0	0	0	0
6	0	0	0	0	0	0	0
7	0	0	0	0	0	0	0
8	0	0	0	0	0	0	0
9	0	0	0	0	0	0	0
10	0	0	0	0	0	0	0
.....							
2711	0	0	0	0	0	0	0
2712	0	0	0	0	0	0	0
2713	0	0	0	0	0	0	0
2714	0	0	0	0	0	0	0
2715	0	0	0	0	0	0	0
2716	0	0	0	0	0	0	0
2717	0	0	0	0	0	0	0
2718	0	0	0	0	0	0	0
2719	0	0	0	0	0	0	0
2720	0	0	0	0	0	0	0

Sample listing of WCLINE.ASC (File 13).

1	0.00	0.00	0.00	0	5 345	42250	4	0.69	0.00	0.69		
	-0.81	0	2-9999.99-9999.99-9999.999999	0				8.60	8.60	5.25	2	5
	-9999.99-9999.99-9999.99	0										
2	0.00	0.00	0.00	0	5 345	42127	5	0.69	0.00	0.69		
	-0.81	0	2-9999.99-9999.99-9999.999999	0				8.60	8.60	5.25	2	5
	-9999.99-9999.99-9999.99	0										
3	0.00	0.00	0.00	0	5 370	42340	3	0.69	0.00	0.69		
	-0.81	0	2-9999.99-9999.99-9999.999999	0-9999.99-9999.99-9999.999999								0
	-9999.99-9999.99-9999.99	0										
.....												
1260	122.00	205.00	0.00	4	1 370	42259	4	2.24	0.00	2.24		
	0.74	87	2	0.43	2.50	-0.70	9 3	5.63	5.90	3.98	4	4
	2.50	7.70	1.00	5								
1261	122.00	205.00	0.00	4	1 330	52129	5	2.24	0.00	2.24		
	0.74	87	2	0.43	2.50	-0.70	9 3	5.63	5.90	3.98	4	4
	2.50	7.70	1.00	5								
1262	122.00	205.00	0.00	4	1 330	59999	0	2.24	0.00	2.24		
	0.74	87	2	0.43	2.50	-0.70	9 3	5.63	5.90	3.98	4	4
	2.50	7.70	1.00	5								

Sample listing of WCPOINT.ASC (file 17).

1	0.00	0.00	0.00	0.00	0.00	0.00	0.00	0			
415CROWN POINT MISSION BAY											
2	0.00	0.00	0.00	0.00	0.00	0.00	0.00	0			
413QUIVIRA BASIN MISSION BAY											
3	0.00	0.00	0.00	0.00	0.00	0.00	0.00	0			
411NATIONAL CITY SAN DIEGO BAY											
.....											
424	-122.75	48.12	1.98	0.00	1.98	0.48	21				
PORT TOWNSEND WA											
0					0.00	0.00			0.00	0.00	0.00
425	-124.62	48.37	-1.61	0.00	-1.61	-3.11	56				
NEAH BAY WA											
0					0.00	0.00			0.00	0.00	0.00
426	-123.00	48.55	1.12	0.00	1.12	-0.38	58				
FRIDAY HARBOR WA											
0					0.00	0.00			0.00	0.00	0.00

Sample listing of WCOAST.ASC (file 21).

```

" 1", -6
-122.7500,48.9764
-122.7500,48.9796
-122.7524,48.9832
-122.7572,48.9852
-122.7600,48.9916
-122.7656,49.0000
" 2", -11
-122.7984,48.9724
-122.7956,48.9760
-122.7944,48.9792
-122.7920,48.9820
-122.7896,48.9848
-122.7848,48.9856
-122.7824,48.9828
-122.7864,48.9808
-122.7896,48.9780
-122.7920,48.9752
-122.7916,48.9716
.....
"1262", -4
-117.1372,32.5800
-117.1372,32.5784
-117.1368,32.5716
-117.1332,32.5612

```

19. Verification of Data Transport: Flat ASCII Data Files.

The gridded coastal hazards data base and the original point data may be read using the FORTRAN or SASTM input/output routines provided. After these files are loaded onto the system it should be verified that the files have not been corrupted during transport. To do this, some or all of the statistics or characteristics presented in the following tables should be generated. These statistics were obtained for WCGRID, WCRISK, WCLINE, WCPOINT, and WCOAST using the SASTM statistical package (i.e., with PROC MEANS); however, these statistics may be duplicated using other statistical packages or computer languages.

These statistics are presented only as a tool to ensure proper reading of the four flat ASCII data files and should not be construed as either a summary of the data or as an indicator of trends in the data.

Table 14. Statistical characteristics of the numeric variables in WCGRID.ASC (File 5).

Variable	N	Mean	Std. dev.	Minimum	Maximum
ID	2720	1360.50	785.34	1.00	2720.00
ELAVG	2720	-9197.86	2738.93	-9999.99	885.00
ELMAX	2720	-9193.41	2754.40	-9999.99	920.00
ELMIN	2720	-9202.52	2722.85	-9999.99	850.00
ELNUM	2720	9208.89	1.21	0.00	9999.00
GL	2720	9324.84	2467.59	110.00	9999.00
GM	2720	9401.81	2188.90	1110.00	9999.00
SLR	2720	-9308.74	2441.09	-9999.99	4.39
SLG	2720	-9308.81	2440.89	-9999.99	0.00
SLC	2720	-9308.74	2441.09	-9999.99	4.39
SLS	2720	-9308.84	2440.72	-9999.99	2.89
SLYR	2720	-9308.23	3.82	0.00	9999.00
ERAVG	2720	-9628.67	1891.19	-9999.99	5.46
ERMAX	2720	-9628.65	1891.27	-9999.99	10.00
ERMIN	2720	-9628.68	1891.12	-9999.99	3.70
ERNUM	2720	9628.05	2.22	0.00	9999.00
TRAVG	2720	-9440.77	2298.98	-9999.99	14.60
TRMAX	2720	-9440.76	2299.03	-9999.99	15.00
TRLVL	2720	-9462.96	2255.31	-9999.99	10.80
TRNUM	2720	9440.38	0.94	0.00	9999.00
WHAvg	2720	-9521.94	2134.18	-9999.99	2.80
WHMAX	2720	-9521.71	2135.23	-9999.99	8.10
WHSD	2720	-9522.00	2133.91	-9999.99	1.30

Table 15. Statistical characteristics of the numeric variables in WCRISK.ASC (File 9).

Variable	N	Mean	Std. dev.	Minimum	Maximum
ID	2720	1360.50	785.34	1.00	2720.00
ELR	2720	0.19	0.83	0.00	5.00
GLR	2720	0.24	0.93	0.00	5.00
GMR	2720	0.20	0.81	0.00	5.00
LSR	2720	0.19	0.75	0.00	5.00
ERR	2720	0.11	0.56	0.00	5.00
TRR	2720	0.25	1.05	0.00	5.00
WHR	2720	0.22	1.01	0.00	5.00

Table 16. Statistical characteristics of the numeric variables in WCLINE.ASC (File 13).

Variable	N	Mean	Std. dev.	Minimum	Maximum
ID	1262	631.50	364.45	1.00	1262.00
ELAVG	1262	150.21	174.59	0.00	885.00
ELMAX	1262	204.71	214.32	0.00	920.00
ELMIN	1262	93.52	140.47	0.00	850.00
ELNUM	1262	4405.33	4957.99	1.00	9999.00
ELR	1262	2.13	1.75	1.00	5.00
GL	1262	398.19	1020.53	110.00	9999.00
GLR	1262	3.36	1.23	0.00	5.00
GM	1262	1506.37	916.87	1110.00	9999.00
GMR	1262	2.93	1.38	0.00	5.00
SLR	1262	-38.38	628.52	-9999.99	4.29
SLG	1262	-39.62	628.44	-9999.99	0.00
SLC	1262	-38.38	628.52	-9999.99	4.39
SLS	1262	-39.87	628.43	-9999.99	2.89
SLYR	1262	47.01	628.27	0.00	9999.00
LSR	1262	1.90	0.62	0.00	4.00
ERAVG	1262	-4397.81	4965.53	-9999.99	5.46
ERMAX	1262	-4397.58	4965.73	-9999.99	10.00
ERMIN	1262	-4398.04	4965.33	-9999.99	3.70
ERNUM	1262	4405.33	4957.99	1.00	9999.00
ERR	1262	1.61	1.48	0.00	5.00

Table 16. (concluded)

Variable	N	Mean	Std. dev.	Minimum	Maximum
TRAVG	1262	-2054.45	4049.01	-9999.99	14.60
TRMAX	1262	-2054.25	4049.11	-9999.99	15.00
TRLVL	1262	-2056.19	4048.12	-9999.99	10.80
TRNUM	1262	2062.74	4044.28	1.00	9999.00
TRR	1262	3.66	1.92	0.00	5.00
WHA VG	1262	-2985.69	4579.90	-9999.99	2.80
WHMAX	1262	-2982.29	4582.11	-9999.99	8.10
WHSD	1262	-2986.58	4579.31	-9999.99	1.30
WHR	1262	3.32	2.21	0.00	5.00

Table 17. Statistical characteristics of the numeric variables in WCPOINT.ASC (File 17).

Variable	N	Mean	Std. dev.	Minimum	Maximum
ID	426	213.50	123.12	1.00	426.00
SLLONG	426	-4.58	23.10	-124.62	0.00
SLLAT	426	1.50	7.70	0.00	48.55
SLR	426	0.05	0.38	-1.61	4.39
SLG	426	0.00	0.00	0.00	0.00
SLC	426	0.05	0.38	-1.61	4.39
SLS	426	-0.01	0.28	-3.11	2.89
SLYR	426	-2.23	12.69	0.00	140.00
TRLONG	426	-117.87	23.36	-125.13	0.00
TRLAT	426	40.62	9.51	0.00	49.00
TRAVG	426	-86.84	966.27	-9999.99	15.00
TRMAX	426	-465.57	2118.64	-9999.99	8.60
TRLVL	426	-300.27	1722.93	-9999.99	11.00
TRID	426	783.81	280.03	0.00	1277.00

Table 18. Characteristics and size, in bytes and 512-byte blocks, of WCOAST.ASC (File 21).

Number of lines/arcs	Size in bytes	Size in blocks
1262	310,752	607

20. Verification of Data Transport: Arc/Info™ Export Files

The five Arc/Info™ export files were created in Arc/Info™, Version 7.0.3, using the EXPORT command with the COVER and NONE options. Each export file contains an entire coverage and its associated INFO data files in a fixed-length, uncompressed format.

The exported coverages are in a GEOGRAPHIC projection, which is a spherical reference system that locates positions using latitude and longitude coordinates that are stored in decimal degrees. As a result of this, the reference grids in which the data are stored are *not* uniform in size or area.

After loading the Arc/Info™ export files onto a system, the user should verify that the files have been correctly transported. To verify the integrity of the files, the size of the export files and (after importing the data into Arc/Info™) the total number of INFO data records in each coverage should be compared with those presented in Table 18. If the file sizes differ from those presented by > 1 byte or the number of INFO data records do not match those shown in Table 18, then the coverage may have been corrupted in transport. The Arc/Info™ .E00 files may be imported into the user's Arc/Info™ system using the IMPORT command with the COVER option. The IMPORT command will automatically recognize that the export file is in an uncompressed format (files should be EXTERNALIZED after being imported [e.g., ARC> external WCGRID]).

Table 19. File size and number of attribute records in each Arc/Info™ export file.

Export file name	Tape file number	File size (bytes)	Arc/Info™ coverage type	Number of records
WCGRID.E00	4	2,923,400	Polygon	2,721
WCRISK.E00	8	1,874,584	Polygon	2,721
WCLINE.E00	12	1,211,476	Arc/Line	1,262
WCPOINT.E00	16	214,242	Point	426
WCOAST.E00	20	651,721	Arc/Line	1,262

APPENDICES

APPENDIX A: THE DATA GROUPS, A QUICK REFERENCE

THE DATA GROUPS: A QUICK REFERENCE

The following provides a listing and description of the data variables and other pertinent information for each of the five data groups. The Arc/Info™ version of these files, contain several additional variables. These additional variables are system variables. For data groups WCGRID and WCRISK, the system variables AREA, PERIMETER, COVERNAME# [i.e., cover name pound sign, an internal polygon, point, or line identification number (e.g., WCGRID#, WCPOINT#, and WCLINE# respectively)], and COVERNAME-ID [i.e., cover name dash identification number, an external polygon, point, or line identification number (e.g. WCGRID-ID, WCPOINT-ID, and WCLINE-id respectively)]. The external identification number is present in both the export (.E00) and ASCII (.ASC) files and is used to identify the 0.25° by 0.25° grid cell, point, or 1:2,000,000 digitized line segment to which the data record belongs.

- (1) **Data Group WCGRID:** Gridded polygon data for 22 data variables from the following data sets: elevation, geology, geomorphology, sea-level trend, shoreline displacement(erosion/accretion), tidal range, and wave heights. (A value of -9999.99 or 9999 indicates no data are available for the given data cell for a given data variable.)

Data Format - Arc/Info™ coverage and flat ASCII file with data values for each 0.25° latitude by 0.25° longitude grid cell on the U.S. West Coast.

File Storage - Arc/Info™ coverage name is WCGRID.E00 (File 4) ASCII file name is WCGRID.ASC (File 5).

Data Variables

ELAVG - Average elevation calculated from all positive 5' by 5' grid cells within a given 0.25° grid cell; values expressed in meters.

ELMAX - Maximum elevation of all the positive 5' by 5' grid cells for a given 0.25° grid cell; values expressed in meters.

ELMIN - Minimum elevation of all the positive 5' by 5' grid cells for a given 0.25° grid cell; values expressed in meters.

ELNUM - Number of 5' by 5' grid cells used in calculating ELAVG, ELMIN, and ELMAX for a given 0.25° grid cell.

GL - Ordinal value indicating the type and resistance of the rocks within a given 0.25° grid cell to erosion through physical and chemical weathering.

GM - Ordinal value indicating the type and susceptibility of the landforms within a given 0.25° grid cell to inundation and erosion.

SLR - Relative sea-level trend within a given 0.25° grid cell; values are expressed in mm/year. Data values are based on the point data in data group WCPOINT.

SLG - Geologic trend variable. In this data base this variable is 0.0 for all 0.25° grid cells with a relative sea-level trend value, and -9999.99 for all grid cells without a relative sea-level trend value. This data variable has been included to ensure compatibility between the data bases in this series of NDPs (i.e., NDP-043A, NDP-043B, and NDP-043C). See Appendix D for additional geologic trends based on long-term geologic data from raised marine terraces and ¹⁴C data.

SLC - Corrected sea-level trend. Since the geologic trend variable contains values of 0.0, this variable appears identical to the relative sea-level trend variable; and is included for compatibility within this series of NDPs. Some long-term geologic trends are listed in Appendix D.

SLS - Local subsidence trend derived from tide-gauge data and corrected for the global eustatic sea-level trend (i.e., 1.50); values are expressed in mm/year. Data values are based on the point data in data group WCPOINT.

SLYR - Number of years of record used in estimating the sea-level trend for each 0.25° grid cell (grid cells in which tide-gauge stations do not occur have been assigned a zero value.) Data values are based on the point data in data group WCPOINT.

ERAVG - Average of the mean long-term erosion trend values for a given 0.25° grid cell; values expressed in meters.

ERMAX - Maximum of the mean long-term erosion trends for a given 0.25° grid cell; values expressed in meters.

ERMIN - Minimum of the mean long-term erosion trends for a given 0.25° grid cell; values expressed in meters.

ERNUM - Number of 3', 7.5', or 15' grid cells (i.e., format of original data source) used in calculating ERAVG, ERMIN, or ERMAX for a given 0.25° grid cell.

TRAVG - Average of the mean-tide-range values for all tide stations occurring within a given 0.25° grid cell in 1992 (the mean tide range is the difference in height between mean high water and mean low water for 1992). Data values are expressed in meters and are based on the point data in data group WCPOINT.

TRMAX - Maximum tide range measured for all gauge stations that occurred within a given 0.25° grid cell in 1992 (this value may be the "spring" or "diurnal" tide range, depending on geographic location). Data values are expressed in meters and are based on the point data in data group WCPOINT.

TRLVL - Average of the mean-tide-level values for all tide stations occurring within a given 0.25° grid cell in 1992 (the mean tide level is a plane midway between mean low water and mean high water in 1992). Values are reckoned from chart datum, are expressed in meters, and are based on the point data in data group WCPOINT.

TRNUM - Number of tide-gauge stations used in calculating TRAVG, TRMAX, and TRLVL for a given 0.25° grid cell. Data values are based on the point data in data group WCPOINT.

WHAVG - 20-year mean wave height calculated for each 0.25° grid cell; values expressed in meters.

WHMAX - Maximum significant wave height for each 0.25° grid cell; values expressed in meters.

WHSD - Standard deviation of the mean wave heights experienced within each 0.25° grid cell; values expressed in meters.

- (2) **Data Group WCRISK:** Gridded polygon data for the seven classified risk variables. The risk variables contain values ranging from 0 to 5. A value of zero indicates no data are available for a given data variable, for a given grid cell. When the value for a given variable is greater than zero, the value indicates the relative risk of each 0.25° grid cell to inundation or erosion, with 5 indicating the greatest risk.

Data Format - Arc/Info™ coverage and flat ASCII file with data values for each 0.25° latitude by 0.25° longitude grid cell on the U.S. West Coast.

File Storage - Arc/Info™ coverage name is WCRISK.E00 (File 12) ASCII file name is WCRISK.ASC (File 13).

Data Variables

ELR - Classified version of the mean elevation data variable (i.e., ELAVG).

GLR - Classified version of the geology data variable (i.e., GL).

GMR - Classified version of the geomorphology data variable (i.e., GM).

LSR - Classified version of the local subsidence trend data variable (i.e., SLS).

ERR - Classified version of the mean erosion/accretion data variable (i.e., ERAVG).

TRR - Classified version of the mean-tide-range data variable (i.e., TRAVG).

WHR - Classified version of the maximum significant wave-height variable (i.e., WHMAX).

- (3) **Data Group WCLINE: 1:** 2,000,000 digitized line segment data for the 22 original and 7 relative risk data variables from each of the seven data sets (i.e., elevation, geology, geomorphology, sea-level trend, shoreline displacement, tidal range, and wave heights). A value of -9999.99 or 9999 indicates no data are available for the given data cell for a given data variable.)

Data Format - Arc/Info™ coverage and flat ASCII file with data values for each line segment that describes the U.S. West Coast.

File Storage - Arc/Info™ coverage name is WCLINE.E00 (File 12) ASCII file name is WCLINE.ASC (File 13).

Data Variables

ELAVG - Average elevation calculated from all positive 5' by 5' grid cells within a given 0.25° grid cell; values expressed in meters.

ELMAX - Maximum elevation of all the positive 5' by 5' grid cells for a given 0.25° grid cell; values expressed in meters.

ELMIN - Minimum elevation of all the positive 5' by 5' grid cells for a given 0.25° grid cell; values expressed in meters.

ELNUM - Number of 5' by 5' grid cells used in calculating ELAVG, ELMIN, and ELMAX for a given 0.25° grid cell.

ELR - Classified version of the mean elevation data variable (i.e., ELAVG).

GL - Ordinal value indicating the type and resistance of the rocks within a given region to erosion through physical and chemical weathering.

GLR - Classified version of the geology data variable (i.e., GL).

GM - Ordinal value indicating the type and susceptibility of the landforms within a given region to inundation and erosion.

GMR - Classified version of the geomorphology data variable (i.e., GM).

SLR - Relative sea-level trend within a given 0.25° grid cell; values are expressed in mm/year. Data values are based on the point data in data group WCPOINT.

SLG - Geologic trend variable. In this data base this variable is 0.0 for all 0.25° grid cells with a relative sea-level trend value, and -9999.99 for all grid cells without a relative sea-level trend value. This data variable has been included to ensure compatibility among the NDPs in this series (i.e., NDP-043A, NDP-043B, and NDP-043C). See Appendix D for additional geologic trends based on long-term geologic data from raised marine terraces and ¹⁴C data.

SLC - Corrected sea-level trend. Since the geologic trend variable contains values of 0.0, this variable appears identical to the relative sea-level trend variable; and is included only for compatibility within this series of NDPs. Some long-term geologic trends are listed in Appendix D.

SLS - Local subsidence trend derived from tide-gauge data and corrected for the global eustatic sea-level trend (i.e., 1.50); values are expressed in mm/year. Data values are based on the point data in data group WCPOINT.

SLYR - Number of years of record used in estimating the sea-level trend for each 0.25° grid cell (grid cells in which tide-gauge stations do not occur have been assigned a zero value.) Data values are based on the point data in data group WCPOINT.

LSR - Classified version of the local subsidence trend data variable (i.e., SLS).

ERAVG - Average of the mean long-term erosion trend values for a given 0.25° grid cell; values expressed in meters.

ERMAX - Maximum of the mean long-term erosion trends for a given 0.25° grid cell; values expressed in meters.

ERMIN - Minimum of the mean long-term erosion trends for a given 0.25° grid cell; values expressed in meters.

ERNUM - Number of 3', 7.5', or 15' grid cells (i.e., format of original data source) used in calculating ERAVG, ERMIN, or ERMAX for a given 0.25° grid cell.

ERR - Classified version of the mean erosion/accretion data variable (i.e., ERAVG).

TRAVG - Average of the mean-tide-range values for all tide stations occurring within a given 0.25° grid cell in 1992 (the mean tide range is the difference in height between mean high water and mean low water for 1992). Data values are expressed in meters and are based on the point data in data group WCPOINT.

TRMAX - Maximum tide range measured for all gauge stations that occurred within a given 0.25° grid cell in 1992 (this value may be the "spring" or "diurnal" tide range, depending on geographic location). Data values are expressed in meters and are based on the point data in data group WCPOINT.

TRLVL - Average of the mean-tide-level values for all tide stations occurring within a given 0.25° grid cell in 1992 (the mean tide level is a plane midway between mean low water and mean high water in 1992). Values are reckoned from chart datum, are expressed in meters, and are based on the point data in data group WCPOINT.

TRNUM - Number of tide-gauge stations used in calculating TRAVG, TRMAX, and TRLVL for a given 0.25° grid cell. Data values are based on the point data in data group WCPOINT.

TRR - Classified version of the mean-tide-range data variable (i.e., TRAVG).

WHAVG - 20-year mean wave height calculated for each 0.25° grid cell: values expressed in meters.

WHMAX - Maximum significant wave height for each 0.25° grid cell; values expressed in meters.

WHSD - Standard deviation of the mean wave heights experienced within each 0.25° grid cell; values expressed in meters.

WHR - Classified version of the maximum significant wave-height variable (i.e., WHMAX).

- (4) **Data Group WCPOINT:** Point data for the stations used in constructing the sea-level trend and tidal-range data sets. (Missing data values are indicated by the value 0.0 for real numbers, 0 for integers, and blank spaces [i.e., ' '] for station names.)

Data Format - Arc/Info™ coverage and flat ASCII file with data values for each point (i.e., station) on the U.S. West Coast.

File Storage - Arc/Info™ coverage name is WCPOINT.E00 (File 16) ASCII file name is WCPOINT.ASC (File 17).

Data Variables

SLLONG - Longitude of the tide-gauge station used for determining the sea-level trend variables.

SLLAT - Latitude of the given tide-gauge station used for determining the sea-level trend variables.

SLR - Relative sea-level trend for the tide-gauge station; values expressed in mm/year.

SLG - Geologic trend variable. In this data base this variable is 0.0 for all 0.25° grid cells with a relative sea-level trend value, and -9999.99 for all grid cells without a relative sea-level trend value. This data variable has been included to ensure compatibility among the NDPs in this series (i.e., NDP-043A, NDP-043B, and NDP-043C). See Appendix D for additional geologic trends based on long-term geologic data from raised marine terraces and ¹⁴C data.

SLC - Corrected sea-level trend. Since the geologic trend variable contains values of 0.0, this variable appears identical to the relative sea-level trend variable; and is included only for compatibility within this series of NDPs. Some long-term geologic trends are listed in Appendix D.

SLS - Local subsidence trend derived from tide-gauge data and corrected for the global eustatic sea-level trend (i.e., 1.50); values are expressed in mm/year.

SLYR - Period of record in years of the tide-gauge station used for determining the sea-level trend variables.

SLNAME - Station name of the tide-gauge station used for determining the sea-level trend variables.

TRLONG - Longitude of the tide-gauge station used for determining the tide-range variables.

TRLAT - Latitude of the given tide-gauge station used for determining the tide-range variables.

TRAVG - Difference (i.e., range) in height between mean high water and mean low water in 1992; values expressed in meters.

TRMAX - Difference (i.e., range) in height between the highest high tide and the lowest low tide in 1992 (this value may be the "spring" or "diurnal" tide range, depending on geographic location); values expressed in meters.

TRLVL - Mean tide level is a plane midway between mean low water and mean high water in 1992; values expressed in meters. Values are reckoned from chart datums (i.e., the West Coast Mean Low Water Datum).

TRID - Station number (as given in the 1992 Tide Tables) of the given tide gauge station used in determining the tide-range variables.

TRNAME - Station name (as given in the 1992 Tide Tables) of the given tide gauge station used in determining the tide-range variables.

(5) **Data Group WCOAST:** 1:2,000,000 digitized coastline of the U.S. West Coast.

Data Format - Arc/Info™ coverage and flat ASCII file containing the latitude-longitude coordinates of line segments that describe the U.S. West Coast.

File Storage - Arc/Info™ coverage name is WCOAST.E00 (File 20) ASCII file name is WCOAST.ASC (File 21).

Data Variables

Unlike the other data groups within this data base, this coverage contains line segments (or arcs) that are used to describe the West Coast. The coastline provided has *no data variables* associated with the line segments. However, simple overlay commands (such as INTERSECT or IDENTITY) in Arc/Info™ may be used to transfer the gridded data values to the coastal segments, thus simplifying the interpretation of any derived indices. The segment identification numbers match those used in the flat ASCII file WCLINE.ASC.

APPENDIX B: GLOSSARY OF TERMS

Glossary of Terms Used in the Geologic Classification

The following listing defines the terms that appear in the geologic classification system shown in Table 1. The codes used in the classification system are shown in parentheses. When the classification number given contains an "X" (e.g., 1XX) it is implied that the definition is valid for all subsets of the given geologic feature. This list defines only those rock types mentioned within Table 1 and should not be construed as a comprehensive set of geologic definitions.

IGNEOUS ROCK (1XX) - Rock that has crystallized from a silicate melt at high temperatures (i.e., 900 to 1600°C).

VOLCANIC (EXTRUSIVE) ROCK (OLD=11X) (NEW=4XX) - Igneous rock that has reached the Earth's surface as a result of eruptive processes in a molten or partially molten state. Since these rocks tend to cool rapidly they are usually fine-grained.

ANDESITE (110) - Grayish fine-grained volcanic rock composed of oligoclase/andesine (plagioclase feldspar), with lesser amounts of hornblende, biotite, or pyroxene. Potassium feldspar and quartz compose less than 10% of the total mineral content (plutonic equivalent is quartz diorite).

BASALT (110) - Dark fine-grained volcanic rock consisting of labradorite (plagioclase feldspar) and augite (pyroxene), with minor olivine (plutonic equivalent is gabbro).

RHYOLITE (110) - Light fine-grained volcanic rock composed essentially of alkali feldspar and quartz, with minor biotite occasionally present (plutonic equivalent is granite).

PLUTONIC (INTRUSIVE) ROCK (13X) - Igneous rock which has crystallized from molten material (magma) at depth and has reached the Earth's surface through uplift and erosion. Because cooling is generally slower, these rocks are coarser-grained than their volcanic equivalents.

METAMORPHIC ROCK (15X) - Rock derived from preexisting materials (either igneous, sedimentary, or metamorphic) when recrystallization occurs under higher temperatures, pressures, and shear stresses than normally exist at the Earth's surface.

GNEISS (150) - Metamorphic rock that exhibits alternating bands of lighter minerals (quartz, feldspars) and darker minerals (biotite, hornblende, pyroxene).

QUARTZITE (150) - Metamorphic rock composed essentially of quartz. It results from high-grade metamorphism of a quartz-rich sandstone in which recrystallization of silica has produced a tough, hard rock with interlocking quartz grains.

SCHIST (150) - Metamorphic rock characterized by a layered or foliated appearance (schistosity) caused by the planar alignment of platy minerals, such as mica together with quartz, and minor amounts of other minerals, like garnet.

SERPENTINITE (150) - Green to greenish-yellow rock composed chiefly of the mineral serpentine, derived from metamorphism of iron-magnesium-rich igneous rocks.

SEDIMENTARY ROCK (2XX) - Rock consisting of weathered or eroded fragments of preexisting rocks that have been cemented together as a result of chemical cementation, compression, or precipitation.

SHALE (210) - Sedimentary rock consisting of very fine-grained particles (≤ 0.004 mm) composed chiefly of clay minerals. It is distinguished from mudstone, by its ability to split into thin layers.

SILTSTONE (220) - Sedimentary rock consisting of fine-grained particles in the size range of 0.004 to 0.062 mm. Composed chiefly of clays and fine-grained quartz with mica.

SANDSTONE (230) - Fine to medium-grained sedimentary rock with particles in the size range between 0.062 to 2.0 mm. Typically composed of quartz, feldspars, and rock fragments, which are cemented together by silica, calcite, iron oxide, or clay. The hardness or strength of this rock depends largely on the nature and extent of the cement.

CONGLOMERATE (240) - Coarse-grained sedimentary rock composed of boulders to granule-sized particles (>2.0 mm), which are cemented together by silica, calcite, iron oxide, or clay. The hardness or strength of this rock depends largely on nature of the cement.

LIMESTONE (250) - Carbonate rock that can consist either of fragmental material, including fossils, pellets, etc., or a chemical precipitate.

EOLIANITE (260) - Layer of wind-blown beach sand often cemented by deposition of calcium carbonate. Tends to occur above the mean tide level in warm climates.

UNCONSOLIDATED SEDIMENTS (3XX) - Fragmented materials that are derived from the chemical and mechanical weathering process or from chemical precipitation and that have not yet undergone cementation and induration into a consolidated rock.

MUD, CLAY (310) - Very fine-grained particles (≤ 0.004 mm) of clay and quartz.

SILT (320) - Fine-grained particles (≤ 0.062 mm) of clay, quartz, and mica.

SAND (330) - Fine- to medium-grained particles (2.0 to 0.062 mm) of quartz, feldspar, other heavy minerals, and rock fragments.

GRAVELS, CONGLOMERATES (340) - Coarse-grained rock fragments (> 2.0 mm), usually rounded to some degree, depending on the amount of transportation before the fragments came to rest.

GLACIAL TILL (350) - Unsorted materials, ranging in size from fine-grained "rock flour" to large boulders, deposited by glaciers (also known as glacial drift).

CALCAREOUS SEDIMENT (360) - Very fine-grained to fine-grained carbonate sediment, which can be fragmental or chemically precipitated.

LAVA (410) - Geologically recent volcanic rock that has formed by extrusion of molten magma to the Earth's surface as a sheet or flow.

ASH, TEPHRA (420) - Tephra is the general term for all fragmental volcanic materials ejected through a surface-reaching vent. Ash is unconsolidated, fine-grained ejected material (coarser-grained fragments are called bombs, scoria, pumice, etc.).

CORAL REEF (500) - Mass of calcareous material consisting of the skeletal structures of corals, growing in situ, as well as coralline debris and chemically precipitated material. Reefs are generally built of coral, but calcareous algae and shells contribute to the reef structure in many areas.

Glossary of Terms Used in the Geomorphic Classification

The following list defines landforms and gives their associated classification values (shown in Table 2 on page 16). The terms are defined on the basis of the descriptions found in Bird (1984), Pethick (1984), Ritter (1986), Schwartz (1982), and Shepard and Wanless (1971). When the actual classification number contains an "X" (e.g., 222X) in the last digit, it is implied that the description is valid for all subsets of the given feature.

ALLUVIAL PLAIN SHORELINE (221X) - Intersection of broad alluvial slope, located at the base of a mountain range, with the ocean. These alluvial plains may also occur on delta coasts (222X) or outwash plains (231X).

BARRIER COASTS (212X) - In its most general sense, a barrier refers to accumulations of sand or gravel lying above high tide along a coast. These barriers may be partially or fully detached from the mainland. A barrier beach (2121) is a narrow strip of beach with a single ridge and often foredunes. A barrier island (2122) is completely surrounded by water and usually has multiple ridges, dunes, and salt marshes on the landward side of the island. It usually encloses a body of water known as a lagoon. Although barrier islands are the most common feature off the U.S. East and Gulf Coasts, they constitute 10% - 15% of the rest of the world's shorelines. A bay barrier (2123) is a beach barrier built across an embayment and is found in areas with low tide ranges, and high to moderate wave energies.

BEACH (21XX) - A beach is generally made up of sand, cobbles, or boulders and is defined as the portion of the coastal area that is directly affected by wave action and that is terminated inland by a sea cliff, a dune field, or the presence of permanent vegetation and seaward at the breaker/plunge point (the active portion of this zone varies based on wave and tide conditions).

BEACH ROCK (2112) - Cementation of beach sand by CaCO_3 in intertidal zones. Confined to warm climates.

CLIFFED COASTS (11XX) - Coasts with cliffs and other abrupt changes in slope at the ocean land interface. Cliffs indicate marine erosion and imply that the sediment supply of the given coastal segment is low. The cliffs height depends upon the topography of the hinterland, lithology of the area, and climate.

COASTAL PLAIN (211X) - Sedimentary deposits formed on a trailing-edge coast. Trailing-edge coasts are often associated with barrier beach systems and are commonly subject to subsidence.

CORAL REEF COASTS (241X, 242X) - Shoal water area built up by secretions of CaCO_3 by coral, marine algae, and other marine organisms. Reefs may form either fringing reefs that surround the shore or barrier reefs that grow at some distance from the coast and protect the coast from large waves.

CUSPATE FORELAND (2126) - Seaward projection of accumulated unconsolidated marine sand or gravel, bounded on both sides by wave-dominated coasts (indicates convergence of currents in a low-tide environment).

DELTA (222X) - Accumulations of fine-grained sedimentary deposits at the mouth of a river. The sediment is accumulating faster than wave erosion and subsidence can remove it. These are associated with mud flats (2224) and salt marshes (2225).

DROWNED KARST (1500) - Terrain with distinctive characteristics of relief and drainage arising from a high degree of rock solubility that was submerged at the end of the Wisconsin glaciation period (i.e., geologic substrate that is made of highly soluble, usually carbonate, rock).

ESTUARY COAST (133X) - Tidal mouth of a river or submerged river valley. Often defined to include any semi-enclosed coastal body of water diluted by freshwater, thus includes most bays. The estuaries are subjected to tidal influences with sedimentation rates and tidal ranges such that deltaic accumulations are absent. Also, estuaries are associated with relatively low-lying hinterlands, mud flats (1334), and salt marshes (1335).

FJORD (122X) - Narrow steep-walled, U-shaped, partially submerged glacial valley.

FIARD (123X) - Glacially eroded inlet located on low-lying rocky coasts (other terms used include sea inlets, fjardur, and firth).

ICE COAST (1400) - Coast bordered by glaciers.

LAGOON (225X) - A shallow water body separated from the open sea by sand islands (e.g., barrier islands) or coral reefs.

MANGROVE SWAMP (245X) - Coasts with tree vegetation of subtropical/tropical origin located on muddy, peaty substrates. Occur in coastal regions with low wave energies that are located in tropical and subtropical climates (occupies same ecological niche as salt marsh in temperate zones).

MUD FLATS - Located in areas with fine-grained sediments at low ends of the intertidal zone and are exposed at low tide. Found in estuaries (1334), deltaic environments (2224), and areas with marine/fluvial deposits (2254).

OUTWASH PLAIN (231X) - A river deposition coast. Deposits are derived from meltwater from the front of a glacier. Grades from gravel near the glacier edge to sand farther away. Other types of glacial deposits include moraines (2320), composed of poorly sorted till, and drumlins (2330), hills sculpted by glaciers, that are composed of well-sorted till.

SALT MARSH - Salt-tolerant vegetation that colonizes the intertidal zones of estuaries (1335), deltas (2225), and lagoons (2255). Located on slightly higher elevations than mud flats, and vegetation zonation reflects subtle changes in elevation.

SPIT (2127) - Curved or hooked depositional feature formed by longshore drift. Often has salt marshes on landward side and beach ridges marking former positions of the shoreline. Very mobile landform.

VOLCANIC COASTS (25XX) - Coasts dominated by volcanic landforms. The coasts may be built up of lava flows (251X), ash flows (252X), peninsular and island volcanoes, or calderas (253X). Often may be flanked by coral reefs (241X) if the volcano has become submerged.

References

Bird, E. C. F. 1984. *Coasts*. Basil Blackwell Publishing, New York, New York.

Pethick, J. 1984. *An Introduction to Coastal Geomorphology*. Edward Arnold Publishers, London, England.

Ritter, D. F. 1986. *Process Geomorphology*. William Brown Publishers, Dubuque, Iowa.

Schwartz, M. L. (ed.). 1982. *The Encyclopedia of Beaches and Coastal Environments*. Hutchinson & Ross Publishing, Stroudsburg, Pennsylvania.

Shepard, F. P. and H. R. Wanless. 1971. *Our Changing Coastline*. McGraw-Hill Book Company, New York, New York.

APPENDIX C: DATA LISTING OF GEOLOGIC AND GEOMORPHIC DATA

**DATA LISTING OF THE GEOLOGIC AND GEOMORPHIC DATA
OF EACH LINE SEGMENT THAT OCCURRED WITHIN
EACH COASTAL GRID CELL**

The geologic and geomorphic data contained within this data base were originally obtained for 1:2,000,000 digitized line segments. These line segments ranged in length from 93 m to 88.7 km and averaged 5.8 km in length. When plotted, these line segments are equivalent to those found in the line-based data groups within this NDP. When gridded, more than one line segment often occurred within a coastal grid cell. When this situation occurred, the geologic or geomorphic code with the greatest total shore length within the grid cell was assigned to the entire grid cell. For example, if grid cell number 396 contained two line segments, the first having geomorphic code 2255 and covering 36.86% of the shore length within the grid cell, and the other having geomorphic code 2450 and covering 63.14% of the total shore length within the grid cell, then geomorphic code 2450 was assigned to the grid cell, along with its corresponding risk value of 3.

To help the data user determine how this selection process may have affected the gridded data, the following tables were constructed. Table C-1 illustrates the geologic data. It contains the identification number of each coastal grid cell, the occurring geology codes, the shore length (in meters) in each occurring geologic code, the percent of shore line with the occurring geologic code, and the risk value of the geologic code. Table 1, in part 1 of this document, defines each geologic classification code while Table 4 illustrates the relative risk value assignment. Table C-2 illustrates the geomorphic data. It contains the identification number of each coastal grid cell, the occurring geomorphic codes, the shore length (in meters) of each occurring geomorphic code, the percent of shoreline with each code, and the risk value of the geomorphic code. Table 2 defines each geomorphic code and Table 5 shows the ranking system used for assigning the relative risk values.

TABLE C-1. GEOLOGIC DATA

GRID CELL NUMBER	GEOLOGIC CODE	LENGTH (M)	COASTLINE PERCENTAGE	RISK VALUE
115	270	6680.09	100.00	3
116	270	9288.21	12.82	3
116	330	18525.38	25.57	5
116	370	44626.46	61.60	4
150	110	22299.44	91.41	1
150	330	2096.10	8.59	5
151	110	36229.99	92.91	1
151	270	845.41	2.17	3
151	370	1918.61	4.92	4
155	270	17850.06	59.53	3
155	330	4036.00	13.46	5
155	370	8097.03	27.01	4
156	270	1293.70	10.95	3
156	330	2157.56	18.26	5
156	370	8366.17	70.80	4
186	110	7510.64	100.00	1
187	110	14308.05	100.00	1
190	110	12684.22	74.68	1
190	330	4300.43	25.32	5
195	270	4467.14	14.10	3
195	370	14057.03	44.37	4
195	9999	13158.13	41.53	0
226	110	10056.39	100.00	1
227	110	5554.16	100.00	1
228	110	8134.42	100.00	1
230	270	21044.37	93.39	3
230	370	1489.38	6.61	4
231	110	9655.93	16.45	1
231	130	13087.20	22.30	1
231	270	29191.34	49.74	3
231	370	3446.95	5.87	4
231	9999	3309.91	5.64	0
234	270	21560.05	70.34	3
234	370	9091.45	29.66	4
235	270	10771.71	100.00	3
271	130	3343.24	12.55	1
271	270	10431.73	39.17	3
271	370	12857.70	48.28	4
272	330	16417.62	66.52	5
272	370	8262.54	33.48	4
273	130	1685.73	3.49	1
273	270	13115.41	27.15	3
273	330	18614.44	38.54	5
273	370	14886.52	30.82	4
274	270	1000.04	100.00	3

TABLE C-1. GEOLOGIC DATA

GRID CELL NUMBER	GEOLOGIC CODE	LENGTH (M)	COASTLINE PERCENTAGE	RISK VALUE
304	110	1484.21	4.09	1
304	130	873.44	2.40	1
304	270	24488.00	67.42	3
304	370	9477.20	26.09	4
305	110	7620.18	29.92	1
305	270	11175.52	43.88	3
305	370	6672.36	26.20	4
306	110	9919.95	52.54	1
306	270	8960.80	47.46	3
311	130	3830.46	9.77	1
311	270	4145.39	10.57	3
311	330	24589.62	62.70	5
311	370	6650.28	16.96	4
312	330	5300.59	20.09	5
312	370	21083.14	79.91	4
343	110	11852.87	30.68	1
343	270	17438.78	45.13	3
343	330	6912.55	17.89	5
343	370	2434.45	6.30	4
344	110	1781.52	6.11	1
344	270	27382.02	93.89	3
345	110	18385.29	59.55	1
345	130	1711.54	5.54	1
345	270	4723.63	15.30	3
345	370	6052.82	19.61	4
346	110	20719.01	64.49	1
346	270	6014.97	18.72	3
346	370	2892.34	9.00	4
346	9999	2500.24	7.78	0
347	110	13865.95	69.39	1
347	330	6117.93	30.61	5
348	270	7426.48	14.62	3
348	330	38901.36	76.57	5
348	370	4252.26	8.37	4
348	9999	227.25	0.45	0
349	110	2622.15	10.17	1
349	270	11002.10	42.68	3
349	370	12156.14	47.15	4
350	270	16428.01	67.20	3
350	330	3722.60	15.23	5
350	370	4294.22	17.57	4
351	330	1546.08	100.00	5
383	270	27311.49	100.00	3
384	270	23637.05	100.00	3
385	270	20009.05	79.28	3

TABLE C-1. GEOLOGIC DATA

GRID CELL NUMBER	GEOLOGIC CODE	LENGTH (M)	COASTLINE PERCENTAGE	RISK VALUE
385	370	5229.37	20.72	4
386	270	7767.44	30.92	3
386	370	17349.99	69.08	4
387	270	11066.67	39.61	3
387	330	6101.16	21.84	5
387	370	10768.80	38.55	4
422	110	2975.50	7.86	1
422	270	28228.91	74.59	3
422	330	6642.26	17.55	5
423	270	220.06	100.00	3
462	110	6350.42	11.75	1
462	130	3145.16	5.82	1
462	270	17140.61	31.72	3
462	330	27400.52	50.71	5
501	110	2198.84	12.41	1
501	270	815.58	4.60	3
501	370	10106.95	57.06	4
501	9999	4590.90	25.92	0
502	110	3611.43	10.56	1
502	270	5535.42	16.18	3
502	330	20605.63	60.23	5
502	370	4458.00	13.03	4
540	270	5615.50	100.00	3
541	270	15276.29	31.44	3
541	330	11943.56	24.58	5
541	370	14455.30	29.75	4
541	9999	6910.60	14.22	0
579	110	1009.53	7.70	1
579	130	1992.84	15.19	1
579	270	8713.75	66.42	3
579	370	1402.40	10.69	4
580	270	25272.74	86.75	3
580	370	3861.11	13.25	4
619	130	5569.02	16.01	1
619	270	25228.14	72.54	3
619	370	3982.66	11.45	4
657	270	8413.70	100.00	3
658	110	2298.50	6.70	1
658	130	8986.31	26.19	1
658	270	20752.43	60.47	3
658	370	2279.38	6.64	4
659	270	550.73	100.00	3
697	110	1108.92	3.43	1
697	130	16.69	0.05	1
697	150	943.56	2.91	2

TABLE C-1. GEOLOGIC DATA

GRID CELL NUMBER	GEOLOGIC CODE	LENGTH (M)	COASTLINE PERCENTAGE	RISK VALUE
697	270	9960.83	30.77	3
697	330	1078.51	3.33	5
697	370	19261.41	59.50	4
737	110	851.35	1.53	1
737	130	16481.49	29.64	1
737	270	3528.83	6.35	3
737	330	25167.48	45.26	5
737	370	9300.73	16.73	4
737	9999	276.12	0.50	0
738	370	2764.81	100.00	4
776	270	17070.32	96.63	3
776	370	594.59	3.37	4
777	330	22313.58	53.02	5
777	370	19771.45	46.98	4
778	370	8624.33	100.00	4
815	270	22204.84	87.51	3
815	370	3170.61	12.49	4
816	270	11756.02	100.00	3
855	270	11211.95	33.72	3
855	370	22038.56	66.28	4
856	370	26813.02	100.00	4
857	370	5233.75	100.00	4
894	130	6418.09	49.56	1
894	270	2600.38	20.08	3
894	330	2964.98	22.90	5
894	370	966.74	7.47	4
895	130	3105.62	6.24	1
895	270	13504.94	27.15	3
895	330	7241.05	14.56	5
895	370	25891.66	52.05	4
896	370	65568.02	100.00	4
932	270	1699.64	100.00	3
933	130	5505.05	36.41	1
933	270	7612.32	50.35	3
933	370	2001.29	13.24	4
934	270	33020.63	84.61	3
934	330	6006.41	15.39	5
935	130	3304.45	2.81	1
935	270	61174.40	52.10	3
935	370	52931.45	45.08	4
936	370	4420.84	100.00	4
939	370	2524.24	100.00	4
972	270	948.87	100.00	3
973	130	31735.86	28.45	1
973	270	40984.64	36.74	3

TABLE C-1. GEOLOGIC DATA

GRID CELL NUMBER	GEOLOGIC CODE	LENGTH (M)	COASTLINE PERCENTAGE	RISK VALUE
973	330	24268.76	21.75	5
973	370	10553.03	9.46	4
973	9999	4018.26	3.60	0
974	370	10016.15	100.00	4
975	270	17937.22	18.66	3
975	370	78167.45	81.34	4
976	270	28433.13	43.04	3
976	370	37623.17	56.96	4
977	370	99615.00	100.00	4
978	370	123383.02	100.00	4
979	370	15736.66	100.00	4
1012	130	1590.32	1.96	1
1012	270	43453.27	53.47	3
1012	330	28365.42	34.91	5
1012	370	7851.50	9.66	4
1013	270	9964.62	93.88	3
1013	330	649.63	6.12	5
1050	270	2031.20	100.00	3
1051	270	34463.82	100.00	3
1052	270	2563.95	100.00	3
1090	270	30898.03	84.14	3
1090	370	5824.21	15.86	4
1129	270	1713.89	24.77	3
1129	370	5205.90	75.23	4
1130	270	101.64	0.43	3
1130	370	23306.71	99.57	4
1169	270	13889.31	44.97	3
1169	330	231.16	0.75	5
1169	370	16767.17	54.28	4
1209	270	16252.18	53.90	3
1209	330	6450.42	21.39	5
1209	370	7449.83	24.71	4
1248	270	963.74	100.00	3
1249	270	32686.37	100.00	3
1287	270	10195.06	100.00	3
1288	270	32940.84	100.00	3
1327	270	30148.16	100.00	3
1367	270	2590.88	8.28	3
1367	330	24495.04	78.26	5
1367	370	4212.45	13.46	4
1368	330	10798.95	47.02	5
1368	370	12165.96	52.98	4
1408	330	41403.97	63.35	5
1408	370	23952.61	36.65	4
1448	150	8577.19	26.82	2

TABLE C-1. GEOLOGIC DATA

GRID CELL NUMBER	GEOLOGIC CODE	LENGTH (M)	COASTLINE PERCENTAGE	RISK VALUE
1448	270	15189.12	47.50	3
1448	330	3515.40	10.99	5
1448	370	4698.48	14.69	4
1488	150	4790.49	16.78	2
1488	270	7805.96	27.34	3
1488	330	15954.30	55.88	5
1528	270	25276.71	46.90	3
1528	330	28621.60	53.10	5
1568	270	11453.60	22.48	3
1568	330	39505.15	77.52	5
1607	130	1736.40	5.60	1
1607	150	2184.02	7.04	2
1607	270	22447.36	72.39	3
1607	330	4641.11	14.97	5
1608	330	4837.61	100.00	5
1647	270	10613.16	27.10	3
1647	330	28543.86	72.90	5
1686	370	2211.27	100.00	4
1687	130	3513.65	11.05	1
1687	270	20220.26	63.57	3
1687	330	5008.62	15.75	5
1687	370	3064.67	9.64	4
1726	370	22775.15	100.00	4
1727	330	8696.41	100.00	5
1767	270	4321.96	14.83	3
1767	330	19766.14	67.84	5
1767	370	5048.78	17.33	4
1807	270	22507.69	30.21	3
1807	330	25451.26	34.16	5
1807	370	24556.65	32.96	4
1807	9999	1999.80	2.68	0
1808	270	20956.98	52.35	3
1808	330	1169.33	2.92	5
1808	370	17904.11	44.73	4
1847	330	2712.04	100.00	5
1848	270	46906.11	63.93	3
1848	330	26459.46	36.07	5
1849	270	15009.45	100.00	3
1888	270	19204.36	33.13	3
1888	330	31997.86	55.20	5
1888	370	6769.38	11.68	4
1928	110	16906.96	52.92	1
1928	330	12621.22	39.50	5
1928	370	2421.27	7.58	4
1968	110	9839.46	21.26	1

TABLE C-1. GEOLOGIC DATA

GRID CELL NUMBER	GEOLOGIC CODE	LENGTH (M)	COASTLINE PERCENTAGE	RISK VALUE
1968	130	3456.82	7.47	1
1968	270	32974.57	71.26	3
2008	110	10766.80	21.11	1
2008	270	40242.54	78.89	3
2009	270	13391.00	100.00	3
2048	110	10640.42	28.59	1
2048	270	959.97	2.58	3
2048	330	19838.93	53.31	5
2048	370	5771.69	15.51	4
2088	110	10219.15	66.95	1
2088	270	3142.16	20.59	3
2088	370	1901.85	12.46	4
2089	110	6044.94	9.94	1
2089	270	10351.76	17.03	3
2089	330	26465.72	43.53	5
2089	370	17933.56	29.50	4
2128	110	112.38	100.00	1
2129	110	13624.07	23.14	1
2129	270	4336.24	7.37	3
2129	330	28053.64	47.66	5
2129	370	12850.59	21.83	4
2169	110	4921.88	6.98	1
2169	270	17987.99	25.50	3
2169	330	26183.28	37.12	5
2169	370	21447.93	30.40	4
2209	110	7784.48	22.15	1
2209	270	18240.69	51.90	3
2209	330	9120.68	25.95	5
2248	330	3058.16	100.00	5
2249	110	4968.76	5.89	1
2249	270	14467.02	17.14	3
2249	330	30160.33	35.72	5
2249	370	34830.13	41.26	4
2250	270	12189.67	21.54	3
2250	370	44400.71	78.46	4
2251	110	14835.29	22.00	1
2251	270	8149.44	12.08	3
2251	370	44461.54	65.92	4
2288	110	11888.03	20.56	1
2288	270	4303.73	7.44	3
2288	330	34780.43	60.15	5
2288	370	6850.46	11.85	4
2289	110	4975.29	5.99	1
2289	130	2189.78	2.64	1
2289	270	39212.87	47.25	3

TABLE C-1. GEOLOGIC DATA

GRID CELL NUMBER	GEOLOGIC CODE	LENGTH (M)	COASTLINE PERCENTAGE	RISK VALUE
2289	370	36617.77	44.12	4
2290	110	13133.12	50.74	1
2290	270	6070.31	23.45	3
2290	370	6680.41	25.81	4
2291	110	1639.48	11.61	1
2291	370	12482.57	88.39	4
2328	330	39755.95	82.90	5
2328	370	8199.08	17.10	4
2329	110	4178.44	5.16	1
2329	270	470.14	0.58	3
2329	370	76266.68	94.26	4
2368	330	40644.01	50.92	5
2368	370	39178.74	49.08	4
2408	330	17064.64	37.26	5
2408	370	28730.84	62.74	4
2412	345	69526.26	100.00	4
2413	345	164886.03	100.00	4
2414	345	90515.48	100.00	4
2447	110	1969.81	6.53	1
2447	270	21833.32	72.37	3
2447	370	6364.55	21.10	4
2448	370	5481.99	100.00	4
2452	110	8772.45	13.40	1
2452	345	56707.14	86.60	4
2453	345	99894.36	100.00	4
2454	345	129866.39	100.00	4
2455	345	93634.72	93.92	4
2455	370	6062.63	6.08	4
2487	270	10926.71	36.97	3
2487	370	18627.94	63.03	4
2492	110	11031.68	68.71	1
2492	345	5023.09	31.29	4
2493	110	26019.69	33.97	1
2493	345	50584.41	66.03	4
2494	110	3331.77	2.02	1
2494	345	161394.35	97.98	4
2495	345	50201.87	73.31	4
2495	370	18276.48	26.69	4
2526	270	23039.97	79.17	3
2526	370	6063.08	20.83	4
2527	270	9447.74	100.00	3
2533	110	13897.57	31.37	1
2533	345	30403.52	68.63	4
2534	110	8259.71	7.48	1
2534	270	4032.59	3.65	3

TABLE C-1. GEOLOGIC DATA

GRID CELL NUMBER	GEOLOGIC CODE	LENGTH (M)	COASTLINE PERCENTAGE	RISK VALUE
2534	345	98199.52	88.87	4
2535	345	63948.22	100.00	4
2536	345	6263.40	100.00	4
2565	270	2380.59	100.00	3
2566	110	1952.53	5.91	1
2566	230	2289.03	6.93	3
2566	270	19140.03	57.92	3
2566	345	8520.52	25.78	4
2566	370	1145.15	3.47	4
2567	270	1806.37	100.00	3
2568	270	22529.85	100.00	3
2569	270	20146.49	100.00	3
2570	110	6455.94	30.59	1
2570	270	1697.11	8.04	3
2570	345	5700.90	27.01	4
2570	370	7253.71	34.37	4
2571	270	6413.53	22.71	3
2571	345	21821.37	77.29	4
2572	110	1146.13	2.15	1
2572	270	9685.60	18.15	3
2572	345	42546.83	79.71	4
2573	110	5513.28	7.24	1
2573	270	18822.70	24.72	3
2573	345	51808.11	68.04	4
2574	110	10820.44	7.23	1
2574	270	21276.35	14.21	3
2574	345	117590.91	78.56	4
2575	345	99540.58	99.59	4
2575	370	410.11	0.41	4
2576	345	4919.91	22.67	4
2576	370	16779.74	77.33	4
2605	270	723.43	100.00	3
2606	110	2236.99	5.47	1
2606	230	3837.19	9.38	3
2606	270	27202.92	66.47	3
2606	370	7647.95	18.69	4
2607	270	21276.53	100.00	3
2608	270	1851.11	100.00	3
2612	270	14093.54	81.50	3
2612	345	3198.97	18.50	4
2613	110	2525.17	4.53	1
2613	270	3831.04	6.88	3
2613	345	49352.07	88.59	4
2614	130	9690.60	7.78	1
2614	270	1902.62	1.53	3

TABLE C-1. GEOLOGIC DATA

<i>GRID CELL</i>	<i>GEOLOGIC</i>	<i>LENGTH</i>	<i>COASTLINE</i>	<i>RISK</i>
<i>NUMBER</i>	<i>CODE</i>	<i>(M)</i>	<i>PERCENTAGE</i>	<i>VALUE</i>
2614	345	110375.23	88.57	4
2614	370	2650.95	2.13	4
2615	270	4284.63	12.95	3
2615	345	12686.86	38.36	4
2615	370	16104.05	48.69	4
2652	130	5508.25	4.69	1
2652	270	97635.00	83.12	3
2652	345	14323.42	12.19	4
2653	130	17861.96	10.69	1
2653	270	94148.06	56.34	3
2653	345	30984.76	18.54	4
2653	9999	24126.22	14.44	0
2654	130	14880.36	11.23	1
2654	270	37691.74	28.44	3
2654	345	76584.02	57.79	4
2654	370	2807.53	2.12	4
2654	9999	558.32	0.42	0
2655	270	13855.87	49.11	3
2655	345	2565.38	9.09	4
2655	370	11792.40	41.80	4
2692	370	15319.38	100.00	4
2693	270	11343.78	26.63	3
2693	345	31248.38	73.37	4
2694	345	29315.98	86.09	4
2694	370	4738.29	13.91	4
2695	345	1180.53	100.00	4

TABLE C-2. GEOMORPHOLOGIC DATA

GRID CELL NUMBER	GEOMORPHIC CODE	LENGTH (M)	COASTLINE PERCENTAGE	RISK VALUE
115	1120	6108.50	91.44	2
115	2259	571.59	8.56	4
116	1120	8626.03	11.91	2
116	2129	15755.53	21.75	5
116	2259	45911.24	63.38	4
116	9999	2147.26	2.96	0
150	1110	8064.36	33.06	3
150	1120	15558.34	63.78	2
150	1130	772.84	3.17	1
151	1110	10863.11	27.86	3
151	1111	3185.13	8.17	4
151	1120	6318.33	16.20	2
151	1130	18627.44	47.77	1
155	1120	6135.11	20.46	2
155	1121	16804.69	56.05	3
155	2121	6678.53	22.27	5
155	2259	364.75	1.22	4
156	2259	11817.42	100.00	4
186	1110	7510.64	100.00	3
187	1110	11117.06	77.70	3
187	2127	3190.98	22.30	5
190	1110	13515.57	79.58	3
190	1120	3469.06	20.42	2
195	1111	30870.26	97.44	4
195	1121	812.04	2.56	3
226	1110	10056.39	100.00	3
227	1110	5554.16	100.00	3
228	1120	8134.42	100.00	2
230	1130	22533.76	100.00	1
231	1130	58691.32	100.00	1
234	1111	17986.85	58.68	4
234	1121	12664.66	41.32	3
235	1111	10714.78	99.47	4
235	1121	56.93	0.53	3
271	1120	14979.89	56.25	2
271	2219	11652.77	43.75	4
272	2219	24680.16	100.00	4
273	1121	15099.28	31.26	3
273	2129	6152.45	12.74	5
273	2219	7617.26	15.77	4
273	2259	19433.11	40.23	4
274	1121	1000.04	100.00	3
304	1110	5779.23	15.91	3
304	1111	1757.53	4.84	4
304	1120	27626.31	76.06	2

TABLE C-2. GEOMORPHOLOGIC DATA

GRID CELL NUMBER	GEOMORPHIC CODE	LENGTH (M)	COASTLINE PERCENTAGE	RISK VALUE
304	9999	1159.76	3.19	0
305	1110	7987.73	31.36	3
305	1120	2657.60	10.44	2
305	1130	11978.63	47.03	1
305	1131	2844.09	11.17	2
306	1130	18880.74	100.00	1
311	1111	13133.38	33.49	4
311	1119	5757.23	14.68	3
311	1120	8828.79	22.51	2
311	2211	5324.26	13.58	5
311	2219	6172.09	15.74	4
312	2219	26383.74	100.00	4
343	1110	25948.09	67.16	3
343	1111	11569.71	29.94	4
343	2127	1120.83	2.90	5
344	1111	9928.21	34.04	4
344	1120	19235.34	65.96	2
345	1120	9856.13	31.92	2
345	1130	21017.14	68.08	1
346	1120	4950.05	15.41	2
346	1130	22023.37	68.55	1
346	1131	5153.14	16.04	2
347	1130	13865.95	69.39	1
347	2211	5073.86	25.39	5
347	2219	1044.07	5.22	4
348	1130	7980.19	15.71	1
348	2127	4517.43	8.89	5
348	2211	23185.45	45.63	5
348	2219	4569.39	8.99	4
348	2259	10327.64	20.33	4
348	9999	227.25	0.45	0
349	1110	3392.95	13.16	3
349	1111	5672.18	22.00	4
349	1130	7074.98	27.44	1
349	1131	9640.30	37.39	2
350	1121	8726.81	35.70	3
350	1130	3968.74	16.24	1
350	1131	7448.48	30.47	2
350	2211	4300.80	17.59	5
351	2211	1546.08	100.00	5
383	1110	15457.55	56.60	3
383	1120	3413.54	12.50	2
383	1130	8440.40	30.90	1
384	1111	17973.20	76.04	4
384	1130	5663.85	23.96	1

TABLE C-2. GEOMORPHOLOGIC DATA

GRID CELL NUMBER	GEOMORPHIC CODE	LENGTH (M)	COASTLINE PERCENTAGE	RISK VALUE
385	1111	16832.91	66.70	4
385	1120	343.95	1.36	2
385	2121	8061.57	31.94	5
386	1111	12140.14	48.33	4
386	1120	4774.96	19.01	2
386	1130	931.77	3.71	1
386	2121	7270.56	28.95	5
387	1121	8120.94	29.07	3
387	1130	12842.95	45.97	1
387	2219	6972.75	24.96	4
422	1110	11577.39	30.59	3
422	1120	17404.72	45.99	2
422	2211	8864.55	23.42	5
423	1120	220.06	100.00	2
462	1110	10347.52	19.15	3
462	1120	10125.70	18.74	2
462	2211	33563.51	62.11	5
501	1130	13121.36	74.08	1
501	9999	4590.90	25.92	0
502	1111	8774.21	25.65	4
502	1121	6072.73	17.75	3
502	1130	1879.02	5.49	1
502	1131	5653.10	16.52	2
502	2211	11831.43	34.58	5
540	1120	5615.50	100.00	2
541	1110	7232.53	14.89	3
541	1111	5565.80	11.46	4
541	1120	10576.50	21.77	2
541	1130	629.94	1.30	1
541	2121	8372.75	17.23	5
541	2250	15323.36	31.54	4
541	9999	884.88	1.82	0
579	1110	11871.78	90.50	3
579	1130	1246.72	9.50	1
580	1110	9399.01	32.26	3
580	1120	2294.94	7.88	2
580	1121	17439.90	59.86	3
619	1130	34779.82	100.00	1
657	1120	6.01	0.07	2
657	1130	8407.69	99.93	1
658	1130	34316.63	100.00	1
659	1130	550.73	100.00	1
697	1120	10948.46	33.82	2
697	1130	21421.44	66.18	1
737	1110	17882.84	32.16	3

TABLE C-2. GEOMORPHOLOGIC DATA

GRID CELL NUMBER	GEOMORPHIC CODE	LENGTH (M)	COASTLINE PERCENTAGE	RISK VALUE
737	1111	8312.55	14.95	4
737	1130	2387.86	4.29	1
737	1335	8168.42	14.69	3
737	2211	18578.20	33.41	5
737	9999	276.12	0.50	0
738	1335	2764.81	100.00	3
776	1110	15884.52	89.92	3
776	1119	1780.39	10.08	3
777	1111	7622.01	18.11	4
777	1119	9104.69	21.63	3
777	1335	2264.04	5.38	3
777	2211	23094.30	54.88	5
778	1335	8624.33	100.00	3
815	1110	18197.50	71.71	3
815	1120	3357.93	13.23	2
815	1121	3820.01	15.05	3
816	1110	2993.79	25.47	3
816	1120	8762.23	74.53	2
855	1110	848.90	2.55	3
855	1111	20839.37	62.67	4
855	1121	11562.24	34.77	3
856	1335	26813.02	100.00	3
857	1335	5233.75	100.00	3
894	1110	912.35	7.05	3
894	1111	6791.05	52.44	4
894	1130	5246.79	40.52	1
895	1110	1545.93	3.11	3
895	1111	7241.05	14.56	4
895	1120	6683.80	13.44	2
895	1130	1072.41	2.16	1
895	1339	33200.07	66.74	4
896	1335	39414.94	60.11	3
896	1339	26153.08	39.89	4
932	1110	1104.13	64.96	3
932	1130	595.50	35.04	1
933	1120	8767.59	57.99	2
933	1121	600.62	3.97	3
933	1130	5677.34	37.55	1
933	9999	73.11	0.48	0
934	1110	5043.62	12.92	3
934	1111	3351.30	8.59	4
934	1120	17583.62	45.05	2
934	2121	5350.77	13.71	5
934	2250	7697.73	19.72	4
935	1111	6430.51	5.48	4

TABLE C-2. GEOMORPHOLOGIC DATA

GRID CELL NUMBER	GEOMORPHIC CODE	LENGTH (M)	COASTLINE PERCENTAGE	RISK VALUE
935	1120	13968.09	11.90	2
935	1330	33900.55	28.87	4
935	1339	56562.29	48.17	4
935	9999	6548.84	5.58	0
936	1339	4420.84	100.00	4
939	1330	2524.24	100.00	4
972	1110	948.87	100.00	3
973	1110	29997.69	26.89	3
973	1111	7191.99	6.45	4
973	1121	6677.75	5.99	3
973	1330	64920.76	58.19	4
973	2121	2505.72	2.25	5
973	9999	266.64	0.24	0
974	1330	10016.15	100.00	4
975	1120	2170.48	2.26	2
975	1330	83512.28	86.90	4
975	1339	10421.89	10.84	4
976	1120	7940.54	12.02	2
976	1330	58115.76	87.98	4
977	1330	99615.00	100.00	4
978	1330	123383.02	100.00	4
979	1330	15736.66	100.00	4
1012	1110	45875.77	56.46	3
1012	1111	6055.96	7.45	4
1012	1330	8114.86	9.99	4
1012	2121	7628.78	9.39	5
1012	2250	12651.40	15.57	4
1012	9999	933.72	1.15	0
1013	1110	10614.24	100.00	3
1050	1110	2031.20	100.00	3
1051	1110	34463.82	100.00	3
1052	1110	2563.95	100.00	3
1090	1110	31095.94	84.68	3
1090	2111	5626.30	15.32	5
1129	1110	6919.79	100.00	3
1130	1110	21109.49	90.18	3
1130	2111	2298.85	9.82	5
1169	1110	25485.50	82.51	3
1169	2111	5402.13	17.49	5
1209	1110	5648.08	18.73	3
1209	1130	18754.96	62.20	1
1209	2111	5749.38	19.07	5
1248	1130	963.74	100.00	1
1249	1130	32686.37	100.00	1
1287	1130	10195.06	100.00	1

TABLE C-2. GEOMORPHOLOGIC DATA

GRID CELL NUMBER	GEOMORPHIC CODE	LENGTH (M)	COASTLINE PERCENTAGE	RISK VALUE
1288	1130	30103.73	91.39	1
1288	1131	2837.11	8.61	2
1327	1130	30148.16	100.00	1
1367	1130	5915.90	18.90	1
1367	2127	2662.12	8.51	5
1367	2221	22720.35	72.59	5
1368	2127	3871.20	16.86	5
1368	2250	19093.70	83.14	4
1408	1110	29004.54	44.38	3
1408	2127	922.98	1.41	5
1408	2250	35429.07	54.21	4
1448	1110	22657.38	70.85	3
1448	2121	9322.81	29.15	5
1488	1110	6961.21	24.38	3
1488	1111	15809.98	55.38	4
1488	1120	5779.56	20.24	2
1528	1110	3955.34	7.34	3
1528	1111	17884.98	33.18	4
1528	1120	24431.60	45.33	2
1528	1330	7626.42	14.15	4
1568	1110	10898.14	21.39	3
1568	1111	33887.84	66.50	4
1568	2121	1573.77	3.09	5
1568	2250	4599.00	9.02	4
1607	1111	5022.88	16.20	4
1607	1120	14817.25	47.78	2
1607	1121	11168.76	36.02	3
1608	1111	4837.61	100.00	4
1647	1120	9840.68	25.13	2
1647	1121	19059.65	48.67	3
1647	1130	10256.69	26.19	1
1686	1110	2210.24	99.95	3
1686	1111	1.03	0.05	4
1687	1110	477.99	1.50	3
1687	1111	3431.98	10.79	4
1687	1120	22206.75	69.82	2
1687	1121	5690.48	17.89	3
1726	1110	7320.90	32.14	3
1726	1111	15454.25	67.86	4
1727	1110	8696.41	100.00	3
1767	1110	19395.55	66.57	3
1767	2111	9741.32	33.43	5
1807	1110	1483.87	1.99	3
1807	1120	15103.19	20.27	2
1807	1330	21529.55	28.89	4

TABLE C-2. GEOMORPHOLOGIC DATA

GRID CELL NUMBER	GEOMORPHIC CODE	LENGTH (M)	COASTLINE PERCENTAGE	RISK VALUE
1807	2121	7379.02	9.90	5
1807	2127	7307.75	9.81	5
1807	2250	19712.21	26.45	4
1807	9999	1999.80	2.68	0
1808	1330	36035.63	90.02	4
1808	2250	3994.80	9.98	4
1847	2121	2712.04	100.00	5
1848	1330	42939.09	58.53	4
1848	1331	7865.73	10.72	5
1848	2121	22560.75	30.75	5
1849	1330	15009.45	100.00	4
1888	1330	28611.49	49.35	4
1888	2121	25537.79	44.05	5
1888	2127	3822.31	6.59	5
1928	1110	3326.64	10.41	3
1928	1130	13725.62	42.96	1
1928	1330	4148.31	12.98	4
1928	2121	9931.02	31.08	5
1928	2127	817.85	2.56	5
1968	1110	5486.34	11.86	3
1968	1111	16574.41	35.82	4
1968	1130	7035.56	15.21	1
1968	1330	17174.52	37.12	4
2008	1110	3173.79	6.22	3
2008	1111	19878.19	38.97	4
2008	1330	22142.99	43.41	4
2008	2111	5814.37	11.40	5
2009	1330	13391.00	100.00	4
2048	1110	10640.42	28.59	3
2048	1111	15731.89	42.28	4
2048	2127	2212.78	5.95	5
2048	2250	8625.91	23.18	4
2088	1111	2281.10	14.95	4
2088	1120	2460.34	16.12	2
2088	1130	10521.73	68.94	1
2089	1110	5716.40	9.40	3
2089	1130	417.76	0.69	1
2089	1330	17817.88	29.31	4
2089	2111	23560.18	38.75	5
2089	2121	13283.74	21.85	5
2128	1120	112.38	100.00	2
2129	1120	12273.62	20.85	2
2129	1330	3714.66	6.31	4
2129	2111	21199.53	36.01	5
2129	2127	4485.78	7.62	5

TABLE C-2. GEOMORPHOLOGIC DATA

GRID CELL NUMBER	GEOMORPHIC CODE	LENGTH (M)	COASTLINE PERCENTAGE	RISK VALUE
2129	2220	3909.34	6.64	5
2129	2250	13281.63	22.56	4
2169	1130	1915.27	2.72	1
2169	1330	37707.50	53.45	4
2169	2111	4077.44	5.78	5
2169	2121	10210.38	14.47	5
2169	2122	8984.36	12.74	5
2169	2127	5266.01	7.47	5
2169	2220	2380.11	3.37	5
2209	1111	6820.96	19.41	4
2209	1120	22387.54	63.70	2
2209	1130	887.83	2.53	1
2209	2121	5049.51	14.37	5
2248	2127	3058.16	100.00	5
2249	1330	54496.28	64.55	4
2249	2121	22132.04	26.21	5
2249	2127	7797.93	9.24	5
2250	1330	56590.38	100.00	4
2251	1330	67446.28	100.00	4
2288	1111	14618.41	25.28	4
2288	1330	3763.50	6.51	4
2288	2122	4813.20	8.32	5
2288	2250	34627.54	59.89	4
2289	1330	40329.10	48.59	4
2289	2250	42666.61	51.41	4
2290	1330	25883.85	100.00	4
2291	1330	14122.04	100.00	4
2328	2121	2522.00	5.26	5
2328	2127	9024.26	18.82	5
2328	2250	36408.77	75.92	4
2329	1330	55739.71	68.89	4
2329	2250	25175.56	31.11	4
2368	1330	18618.07	23.32	4
2368	2121	30166.38	37.79	5
2368	2127	2558.66	3.21	5
2368	2250	20560.67	25.76	4
2368	2255	7918.98	9.92	3
2369	1330	31994.72	81.85	4
2369	2250	7092.59	18.15	4
2408	1111	13447.65	29.36	4
2408	2121	15142.00	33.06	5
2408	2250	9220.90	20.13	4
2408	2255	7984.92	17.44	3
2412	1220	69526.26	100.00	1
2413	1220	164886.03	100.00	1

TABLE C-2. GEOMORPHOLOGIC DATA

GRID CELL NUMBER	GEOMORPHIC CODE	LENGTH (M)	COASTLINE PERCENTAGE	RISK VALUE
2414	1220	85288.17	94.22	1
2414	2349	5227.32	5.78	3
2447	1110	6202.54	20.56	3
2447	1111	17628.86	58.44	4
2447	1130	6336.28	21.00	1
2448	1111	5481.99	100.00	4
2452	1220	65479.59	100.00	1
2453	1220	99894.36	100.00	1
2454	1220	117288.46	90.31	1
2454	2340	5781.45	4.45	3
2454	2349	6796.48	5.23	3
2455	1220	52850.65	53.01	1
2455	2340	5167.61	5.18	3
2455	2349	41679.08	41.81	3
2487	1111	16152.31	54.65	4
2487	1120	13402.34	45.35	2
2492	1220	16054.77	100.00	1
2493	1220	76604.10	100.00	1
2494	1220	164726.12	100.00	1
2495	1220	10830.94	15.82	1
2495	2349	57647.41	84.18	3
2526	1110	11004.20	37.81	3
2526	1111	13667.21	46.96	4
2526	1120	4431.64	15.23	2
2527	1120	9447.74	100.00	2
2533	1220	44301.09	100.00	1
2534	1220	102678.76	92.93	1
2534	2340	7813.06	7.07	3
2535	1220	7356.95	11.50	1
2535	2340	27842.27	43.54	3
2535	2349	28749.00	44.96	3
2536	2349	6263.40	100.00	3
2565	1110	2380.59	100.00	3
2566	1110	19404.50	58.72	3
2566	1111	13642.75	41.28	4
2567	1221	1806.37	100.00	2
2568	1220	22529.85	100.00	1
2569	1220	20146.49	100.00	1
2570	1220	8322.17	39.43	1
2570	2220	12785.48	60.57	5
2571	1220	7534.84	26.69	1
2571	1229	6572.00	23.28	1
2571	2127	9627.86	34.10	5
2571	2220	4500.21	15.94	5
2572	1220	12816.61	24.01	1

TABLE C-2. GEOMORPHOLOGIC DATA

GRID CELL NUMBER	GEOMORPHIC CODE	LENGTH (M)	COASTLINE PERCENTAGE	RISK VALUE
2572	2127	22315.55	41.81	5
2572	2220	18246.41	34.18	5
2573	1220	70758.58	92.93	1
2573	2340	5385.53	7.07	3
2574	1220	47177.51	31.52	1
2574	2340	102510.19	68.48	3
2575	2220	7790.65	7.79	5
2575	2340	92160.04	92.21	3
2576	2340	19302.17	88.95	3
2576	2349	2397.47	11.05	3
2605	1120	723.43	100.00	2
2606	1110	2426.01	5.93	3
2606	1111	11296.12	27.60	4
2606	1120	13642.19	33.33	2
2606	1220	8436.07	20.61	1
2606	1221	5124.66	12.52	2
2607	1220	17551.72	82.49	1
2607	1221	3724.93	17.51	2
2608	1220	1427.92	77.14	1
2608	1221	423.08	22.86	2
2612	1230	17292.50	100.00	1
2613	1230	54395.72	97.64	1
2613	2340	1312.53	2.36	3
2614	1110	29287.28	23.50	3
2614	1230	7237.32	5.81	1
2614	2220	1515.76	1.22	5
2614	2340	86579.05	69.47	3
2615	2220	23928.82	72.35	5
2615	2340	9146.72	27.65	3
2652	1230	117466.68	100.00	1
2653	1220	3284.94	1.97	1
2653	1230	163836.05	98.03	1
2654	1110	9851.29	7.43	3
2654	1130	11353.53	8.57	1
2654	1230	61801.84	46.64	1
2654	2127	9424.45	7.11	5
2654	2220	896.93	0.68	5
2654	2250	83.42	0.06	4
2654	2340	39110.49	29.51	3
2655	1130	9835.34	34.86	1
2655	2220	4511.54	15.99	5
2655	2250	10081.92	35.73	4
2655	2340	3784.86	13.41	3
2692	2340	15319.38	100.00	3
2693	1230	11343.78	26.63	1

TABLE C-2. GEOMORPHOLOGIC DATA

<i>GRID CELL NUMBER</i>	<i>GEOMORPHIC CODE</i>	<i>LENGTH (M)</i>	<i>COASTLINE PERCENTAGE</i>	<i>RISK VALUE</i>
2693	2127	3764.30	8.84	5
2693	2250	6616.55	15.53	4
2693	2340	20867.53	48.99	3
2694	2127	4027.58	11.83	5
2694	2220	2903.22	8.53	5
2694	2250	3258.98	9.57	4
2694	2254	3725.70	10.94	5
2694	2340	20138.78	59.14	3
2695	2340	1180.53	100.00	3

APPENDIX D: GEOLOGIC TRENDS SUPPLEMENT

Relative Sea-Level Rise and Vertical Land Motions, U.S. West Coast

Vivien Gornitz, December 1997

Introduction

Uplift or subsidence rates, as inferred from sea-level data (Woodworth 1995; Spencer and Woodworth 1993) or geodetic measurements (e.g., Mitchell et al. 1994) represent one important factor in assessing the vulnerability of a coastal segment to future sea-level rise. This appendix briefly outlines a procedure for estimating uplift or subsidence rates and correcting tide gauges for geologic factors caused by vertical land motions. Geologic data on rates of vertical land motion along the West Coast are summarized in Table 1 and Figure 1. Historical data from tide gauges are shown in Table 2 and Figure 2.

Data registered on West Coast tide gauges represent relative sea-level changes. These include long-term geologic trends of tectonic and possible glacio-isostatic origin, also more recent neotectonic motions (interseismic uplift; Mitchell et al. 1994), in addition to the mean global sea level rise of 1–2 mm/yr attributed to worldwide warming over the last 100 years (Houghton et al. 1996). The relative sea-level trend, in mm/yr, at any tide-gauge station can be expressed as:

$$(1) \quad \text{SLR} = \text{SLG} + \text{I} + \text{E} + \text{Ts}$$

where:

- SLR = Recent sea-level curve from the tide-gauge data.
- SLG = Long-term geologic trend (late Quaternary $\leq 125,000$ years), recording uplift from raised marine terrace data, or subsidence from Holocene marsh data. To conform with the signs used for relative sea-level trends, the geologic trend is taken as positive for land subsidence and negative for land uplift. Note that this convention is opposite to that used by geologists and geodesists.
- I = Glacio-isostatic component (uplift, as in Canada; subsidence, as along the U.S. East Coast).
- E = Recent (≤ 100 –150 years) global eustatic/steric component (absolute sea-level rise), taken here as 1.5 mm/yr (after Houghton et al. 1996).
- Ts = Short-term land movements, including neotectonic motions (interseismic deformation) and anthropogenically-induced subsidence, such as caused by withdrawal of subsurface gas, oil, or groundwater.

Relative Sea-Level Trends (SLR)

Sea-level data for the U.S. West Coast are obtained from 16 tide-gauge stations with records at least 20 years in length (although some records may contain discontinuities; Woodworth 1995; Spencer and Woodworth 1993). The sea-level trends are derived by fitting a linear least-squares regression line to the time series of mean annual sea-level elevations for each of the 16 tide-gauge stations (Table 2; Figure 2). The average relative sea-level trend for the West Coast is 1.39 ± 1.48 mm/yr. This value implies the prevalence of global sea-level rise and land subsidence; however, the high variability points to the presence of localized uplift (negative relative sea-level trends) in some areas, particularly in Neah Bay, WA, Astoria, OR, and Crescent City, CA. The spatial pattern of relative sea-level changes observed from tide gauges is consistent with geodetic surveys (Mitchell et al., 1994). The much higher rates of subsidence or uplift from recent relative sea-level data (Table 2; Figure 2) as compared with long-term geologic trends derived from the raised marine terraces from the same localities (Table 1; Figure 1), indicates accumulated interseismic strain and points to potential earthquake hazards (Mitchell et al. 1994).

Uplift or Subsidence Trends (SLS)

The local uplift or subsidence trend (SLS) is the difference between the relative sea-level trend (SLR) recorded by the tide gauges and the mean global eustatic (E) trend of 1.5 mm/yr.

$$(2) \quad \text{SLS} = \text{SLR} - 1.5$$

The SLS term is a composite of long-term tectonic (SLG) and isostatic components (I), as well as more recent neotectonic motions (Ts).

Assessments of coastal vulnerability are concerned with the relative sea-level rise, inasmuch as this parameter is directly related to flood hazard. But since the SLR term contains local uplift or subsidence trends in addition to the global trend, the SLS term (as estimated by Equation 2) needs to be isolated, in order to adjust the local response to future global sea-level rise. However, the further breakdown of the individual components to the total vertical land motion is not essential for hazards assessment. As shown in Table 4 (p. 26) of this NDP, coastal segments with local subsidence trends of +2 mm/yr or more are at greater risk.

Long-term Geologic Trends (SLG)

The coastal region north of the Mendocino triple junction, California, marked by the convergence of three tectonic plates (e.g., the North American, Pacific, and Juan de Fuca-Gorda Plates), is characterized by oblique, offshore crustal subduction, with convergence rates of 30–50 mm/yr. In contrast, the coast to the south of the triple junction is dominated by right-lateral strike-slip motion (up to 56 mm/yr) associated with the San Andreas fault system. Despite this pronounced difference in tectonic style of deformation, raised Quaternary marine terraces indicate uplift along most of the West Coast, both north and south of the triple junction (Figure 1), except where active transverse structures deform the coast (Goldfinger et al. 1992), often resulting in subsidence (Table 1). Evidence for subsidence caused by a number of discrete seismic events, one as recent as 1700, is recorded in sediments from marshes and bays (e.g., Atwater 1987; Atwater et al. 1991; Darienzo et al. 1994; Peterson et al. 1997; Table 1).

Late Quaternary ($\leq 125,000$ years) raised marine terraces, which occur along much of the West Coast, integrate the permanent uplift caused by multiple earthquake cycles over the last few hundred thousand years. Knowing the present elevation and age of at least one raised terrace, and the paleosea-level position at that time relative to the present mean sea level, one can calculate an average long-term uplift rate (Lajoie et al. 1991). Thus, raised terrace data can be used to derive a long-term average uplift trend. On the whole, late Quaternary uplift rates along the Pacific coast from Washington to California are low (< 0.6 mm/yr; Figure 1; Table 1), except in the vicinity of the Mendocino triple junction, the Ventura anticline and Cape Blanco.

Correction of Relative Sea-Level Trends

The corrected sea-level trend (SLC) for each tide-gauge is obtained by subtracting the long-term geologic trend (SLG), the glacial isostatic trend (I), and short-term (neotectonic) movements (Ts) from the relative sea-level trend (SLR).

$$(3) \quad \text{SLC} = \text{SLR} - \text{SLG} - \text{I} - \text{Ts}$$

In passive plate margin settings such as the U.S. East Coast, the corrected sea-level trend (SLC) provides an approximation of the recent eustatic sea-level rise (Gornitz and Seeber 1990; Gornitz 1995).

Glacial isostatic trends (I) (based on the ICE-3G model of Tushingham and Peltier 1991; Douglas 1991) are not available for all of the tide-gauge stations in Table 2. Furthermore, the residual isostatic motions predicted by the ICE-3G model are not in agreement with geological field observations which suggest little or no isostatic movements within the last 6000–7000 years in the Pacific Northwest (Mathews et al. 1970; Dethier et al. 1995). An improved glacial isostatic model, ICE-4G (Peltier 1994), has not yet been applied to

tide-gauge data. For these reasons, no isostatic corrections are made, and I is assumed to be zero. Thus, $SLC = SLR - SLG - Ts$.

On the tectonically-active West Coast, the SLC term may still include a recent neotectonic component, Ts . Satellite-based geodetic techniques, such as GPS, are being used to resolve the inherent ambiguity between sea-level variations and vertical crustal motions, by establishing the absolute land motion with respect to the earth's center (Baker 1993). These space-geodetic methods will yield an independent measure of the total vertical motion, including Ts .

References

- Atwater, B.F., 1987. *Science*, 236, 942-944.
- Atwater, B.F., et al., 1991. *Nature*, 353, 156-158.
- Baker, T.F., 1993. *Glob. & Planet. Change*, 8, 149-159.
- Bucknam, R.C. and Barnhard, T.P., 1989. *EOS*, 70 (43), 1332.
- Byrne, R. et al., 1994. *GSA Abstr. with Prog.*, 26(7), 530.
- Dariento, M.E. and Peterson, C.D., 1990. *Tectonics*, 9, 1-22.
- Dariento, M.E., et al., 1994. *J. Coast. Res.*, 10, 850-876.
- Dethier, D.P., et al., 1995. *Geol. Soc. Am. Bull.*, 107, 1288-1303.
- Douglas, B., 1991. *J. Geophys. Res.*, 96, 6981-6992.
- Goldfinger, C., et al., 1992. *Geology*, 20, 141-144.
- Gornitz, V., 1995. *J. Coast. Res.*, Spec. Issue No. 17, 287-297.
- Gornitz, V. and Seeber, L., 1990. *Tectonophys.*, 178, 127-150.
- Gornitz, V.M. and White, T.W., 1990. A Coastal Hazards Data Base for the U.S. East Coast, ORNL/CDIAC-45, NDP-043A.
- Hanson, K.L. et al., 1994. *Geol. Soc. Am. Spec. Paper* 292, 45-71.
- Houghton, J.T., et al., eds., 1996. *Climate Change 1995--the Science of Climate Change*, Cambridge University Press, Cambridge, U.K., Chap. 7, Changes in Sea Level, pp. 359-405.
- Kelsey, H.M. and Bockheim, J.G., 1994. *Geol. Soc. Am. Bull.*, 106, 840-854.
- Kelsey, H.M. et al., 1994. *J. Geophys. Res.*, 99, 12,245-12,255.
- Kelsey, H.M. et al., 1996. *Geol. Soc. Am. Bull.*, 108, 843-860.
- Kennedy, G.L. et al., 1995. *GSA Abstr. with Prog.*, 27(6), 375.
- Kern, J.P., 1977. *Geol. Soc. Am. Bull.*, 88, 1553-1566.

- Lajoie, K.R. and Sarna-Wojcicki, A.M., 1982. GSA Abstr. with Prog. 14(4), 179.
- Lajoie, K.R. et al., 1982. In: Neotectonics in Southern California, Geol. Soc. Am. Cord. Section 78th Annual Meeting, Guidebook, J.D. Cooper, compiler, pp. 43-51.
- Lajoie, K.R., et al., 1991. In: Quaternary Nonglacial Geology: Conterminous United States, Geol. Soc. Am. Decade of North Americal Geology, v. K-2, R.B. Morrison, ed., pp. 190-214.
- Mathews, W.H., et al., 1970. Can. J. Earth. Sci., 7, 690-702.
- Mayer, L., 1987. In: Cenozoic Basin Development of Coastal California, R.V. Ingersoll and W.G. Ernst, eds., Prentice-Hall, Inc. N.J., pp. 299-320.
- McInelly, G. W. and Kelsey, H.M., 1990. J. Geophys. Res., 95, 6699-6713.
- McKittrick, M.A., 1988. GSA Abstr. with Prog., 20 (3), 214.
- Merritts, D. and Bull, W.B., 1989. Geology, 17, 1020-1024.
- Mitchell, C.E., et al., 1994. J. Geophys. Res., 99, 12,257-12,277.
- Muhs, D.R. et al., 1987. GSA Abstr. with Prog., 19, 780-781.
- Muhs, D.R., et al., 1989. Quat. Int. 1, 19-34.
- Muhs, D.R., et al., 1990. J. Geophys. Res., 95, 6685-6698.
- Peltier, W.R., 1994. Science, 265, 195-201.
- Peterson, C.D., Barnett, E.T., Briggs, G.G., Carver, G.A., Clague, J.J., and Darienzo, M.E., 1997. Estimates of coastal subsidence from great earthquakes in the Cascadia subduction zone, Vancouver island, B.C., Washington, Oregon, and northernmost California: Oregon Dept. Geology and Min. Industries Open-File Report O-97-5, 44 pp.
- Phipps, J.B. and Peterson, C., 1989. EOS, 70(43), 1332.
- Sherrod, B.L. and Leopold, E.B., 1995. GSA Abstr. with Prog., 27(6), 365.
- Shlemon, R.J., 1979. GSA Abstr. with Prog., 11, 127.
- Spencer, N.E. and Woodworth, P. L., 1993. Data Holdings of the Permanent Service for Mean Sea Level (Nov. 1993), Birkenhead, U.K., 81p.
- Tushingham, A.M. and Peltier, W.R., 1991. J. Geophys. Res., 96, 4497-4523.
- Woodworth, P.L., 1995. PSMSL Annual Report for 1995.
- Wells, L.E., et al., 1994. GSA Abstr. with Prog., 26(7), 530.
- West, D.O. and McCrumb, D.R., 1988. Geology, 16, 169-172.

Table 1. Long-term geologic trends (SLG), U.S. West Coast, in mm/yr.

Locality	Latitude	Longitude	Land Motion mm/yr	Period 10 ³ yrs	References
Restoration Point, Bainbridge Is.	47 30N	122 30W	-4.1	1.7	Bucknam and Barnhard, 1989.
Restoration Point, Bainbridge Is.	47 30N	122 30W	-6.4	1.1	Sherrod and Leopold, 1995.
La Push	47 55N	124 38W	-0.5	82	West and McCrumb, 1988.
Kalaloch	47 35N	124 25W	-0.3	82	West and McCrumb, 1988.
Near Cape Elizabeth	47 30N	124 20W	-0.8	82	West and McCrumb, 1988.
Pt. Grenville	47 18N	124 15W	-0.4	82	West and McCrumb, 1988.
Average uplift	48 00N 45 00N	124 30W 123 30W	-0.4 ±0.2	82	West and McCrumb, 1988.
Grays Harbor	46 50N	124 10W	1-2	6.0	Phipps and Peterson, 1989.
Netarts Bay	45 27N	123 56W	1.1-1.3	3.3-3.8	Dariento and Peterson, 1990.
Siletz Bay-Otter Rock	44 50N	124 00W	-0.18	80	Kelsey et al., 1996.
Otter Rock-Yaquina Bay	44 39N	124 04W	-0.67	80-105	Kelsey et al., 1996.
South of Yaquina Bay	44 30N	124 04W	-0.12	105	Kelsey et al., 1996.
Central Oregon coast	45 00N 44 30N	124 00W 124 00W	-0.34	80-125	Kelsey et al., 1994.

Table 1. Continued..

Locality	Latitude	Longitude	Land Motion mm/yr	Period 10 ³ yrs	References
Central Oregon coast	44 30N 44 00N	124 00W 124 00W	-0.05	80-125	Kelsey et al., 1994.
Central Oregon coast	44 00N 43 30N	124 00W 124 15W	-0.03	80-125	Kelsey et al., 1994.
Central Oregon coast	43 30N 43 00N	124 15W 124 30W	-0.23	80-125	Kelsey et al., 1994.
Central Oregon coast	43 00N 42 30N	124 30W 124 30W	-0.26	80-125	Kelsey et al., 1994.
Central Oregon coast	42 30N 42 00N	124 30W 124 30W	-0.30	80-125	Kelsey et al., 1994.
Cape Arago	43 19N	124 24W	-0.54 to -0.7	80-105	McInelly and Kelsey, 1990.
Coquille Point	43 07N	124 26W	-0.75	80	Muhs et al., 1990.
Cape Blanco	42 50N	124 34W	-1.10	80-105	Muhs et al., 1990.
Cape Ferralo	42 05N	124 20W	-0.76	80-125	Kelsey and Bockheim, 1994.
Harbor	42 01N	125 15W	-0.12	125	Kelsey and Bockheim, 1994.
Cape Mendocino	40 30N	124 15 W	-2.9 to -3.4	100	Merritts and Bull, 1989.
Randall-Big Flat	40 15N	124 13W	-4.0	100	Merritts and Bull, 1989.
Pt. Delgada	40 00N	124 00W	-1.2	100	Merritts and Bull, 1989.
Bruhel Point- Fort Bragg	39 30N	123 45W	-0.4	100	Merritts and Bull, 1989.
Point Cabrillo	39 15N	123 45W	-0.31	102	Lajoie et al., 1991.

Table 1. **Continued..**

Locality	Latitude	Longitude	Land Motion mm/yr	Period 10 ³ yrs	References
Point Arena	38 56N	123 45W	-0.35 to -0.52	80	Muhs et al., 1990.
Petaluma marsh	38 05N	122 30W	1.5	1.5-2.0	Byrne et al., 1994.
North San Francisco Bay	37 40N	122 30W	1.5	7.0	Wells et al., 1994.
Greyhound Rock	37 00N	122 05W	-0.25	124	Lajoie et al., 1991
Molino Creek	36 59N	122 04W	-0.21	124	Lajoie et al., 1991
Majors Creek	36 58N	122 03W	-0.17	124	Lajoie et al., 1991
Monterey Peninsula	36 35N	121 57W	-0.16 to -0.20	103	McKittrick, 1988.
San Simeon	35 39N	121 11W	-0.12 to -0.27	120	Hanson et al., 1994.
Cayucos	35 28N	120 54W	0.0	120	Hanson et al., 1994.
Morro Bay	35 24N	120 50W	< 0.0	120	Hanson et al., 1994.
Point Buchon	35 15N	120 55W	-0.19 to -0.20	120	Hanson et al., 1994.
Point San Luis	35 12N	120 50W	-0.06	120	Hanson et al., 1994.
Shell Beach	35 12N	120 40W	-0.11	120	Hanson et al., 1994.
Pismo Beach-Arroyo Grande	35 10N	120 37W	-0.12	120	Hanson et al., 1994.
Goleta	34 26N	119 50W	-0.4 to -4.1	40-60	Lajoie et al., 1982.

Table 1. **Continued..**

Locality	Latitude	Longitude	Land Motion mm/yr	Period 10 ³ yrs	References
Goleta-- Point Conception	34 26N	120 15W	-0.4 to -0.6	85-120	Lajoie et al., 1982.
Carpinteria-- Pitas Point	34 25N	119 31W	0.0 to -10.0	40-60	Lajoie et al., 1982.
Ventura	34 15N	119 18W	-1.7 to -2.0	85-105	Lajoie et al., 1982.
Pacific Palisades	34 04N	118 30W	-0.7	120	Lajoie et al., 1982.
Point Dume	34 00N	118 45W	-0.2	120	Lajoie et al., 1982.
Los Angeles	33 55N	118 15W	1.5	10 ⁶	Mayer, 1987.
Venice Plain Redondo Beach-- El Segundo	33 50N	118 21W	-0.19	124	Lajoie et al., 1991.
San Pedro, Cabrillo Fault	33 45N	118 19W	-0.33	120	Muhs et al., 1989.
San Pedro	33 44N	118 20W	-0.21	124	Lajoie et al., 1991.
Laguna Beach	33 32N	117 45W	-0.02	125	Shlemon, 1979.
Dana Point	33 28N	117 40W	-0.26	125	Shlemon, 1979.
San Onofre	33 24N	117 34W	-0.10	125	Shlemon, 1979.
San Nicolas Island	33 15N	119 30W	-0.22	120	Muhs et al., 1987.
San Onofre Bluff-Torrey Pines	32 57N	117 15W	-0.19 to -0.21	118	Lajoie et al., 1991.
San Clemente Island	32 55N	118 30W	-0.13	127	Kennedy et al., 1995.

Table 1. Concluded.

Locality	Latitude	Longitude	Land Motion mm/yr	Period 10 ³ yrs	References
Soledad Mt.	32 50N	117 16W	-0.34	118	Lajoie et al., 1991.
Point Loma	32 40N	117 15W	-0.21	118	Lajoie et al., 1991.

Table 2. Relative sea-level trends, U.S. West Coast, mm/yr.

STATION	LATITUDE	LONGITUDE	SLYR	SLR
Friday Harbor	48 33N	123 00W	58	1.12
Neah Bay	48 22N	124 37W	56	-1.61
Port Townsend	48 07N	122 45W	21	1.98
Seattle	47 36N	122 20W	96	2.01
Astoria	46 13N	123 46W	68	-0.60
South Beach	44 38N	124 03W	22	4.39
Crescent City	41 45N	124 12W	60	-0.72
San Francisco	37 48N	122 28W	140	1.37
Alameda	37 46N	122 18W	54	0.77
Monterey	36 36N	121 53W	21	3.11
Port San Luis	35 10N	120 45W	45	1.24
Santa Monica	34 01N	118 30W	53	1.98
Los Angeles	33 43N	118 16W	70	0.85
Newport Beach	33 36N	117 53W	35	1.65
La Jolla	32 52N	117 15W	65	2.42
San Diego	32 43N	117 10W	87	2.24

Data from Permanent Service for Mean Sea Level, Sept. 1996.

Figure 1. Information on uplift rates, in mm/yr along the West Coast from various sources listed in Table 1.

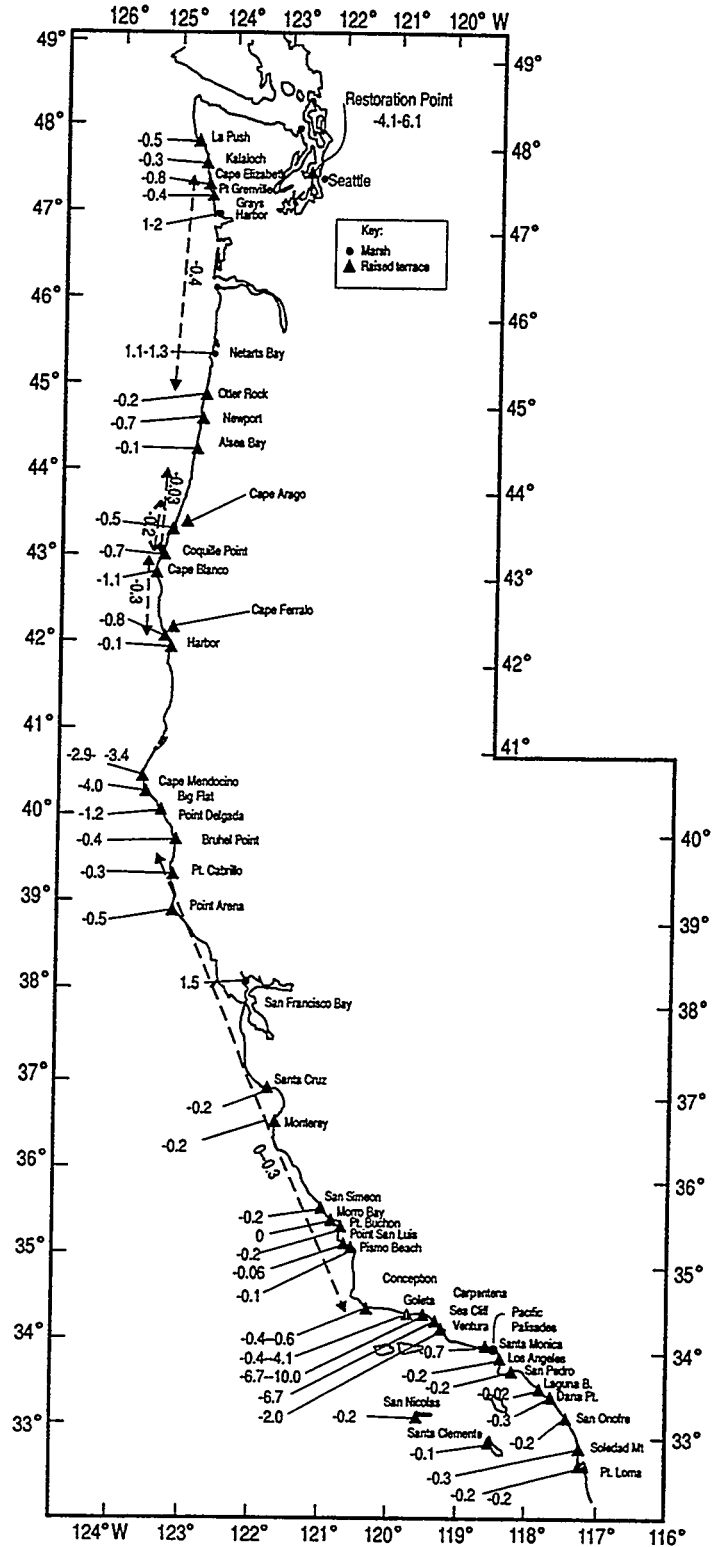
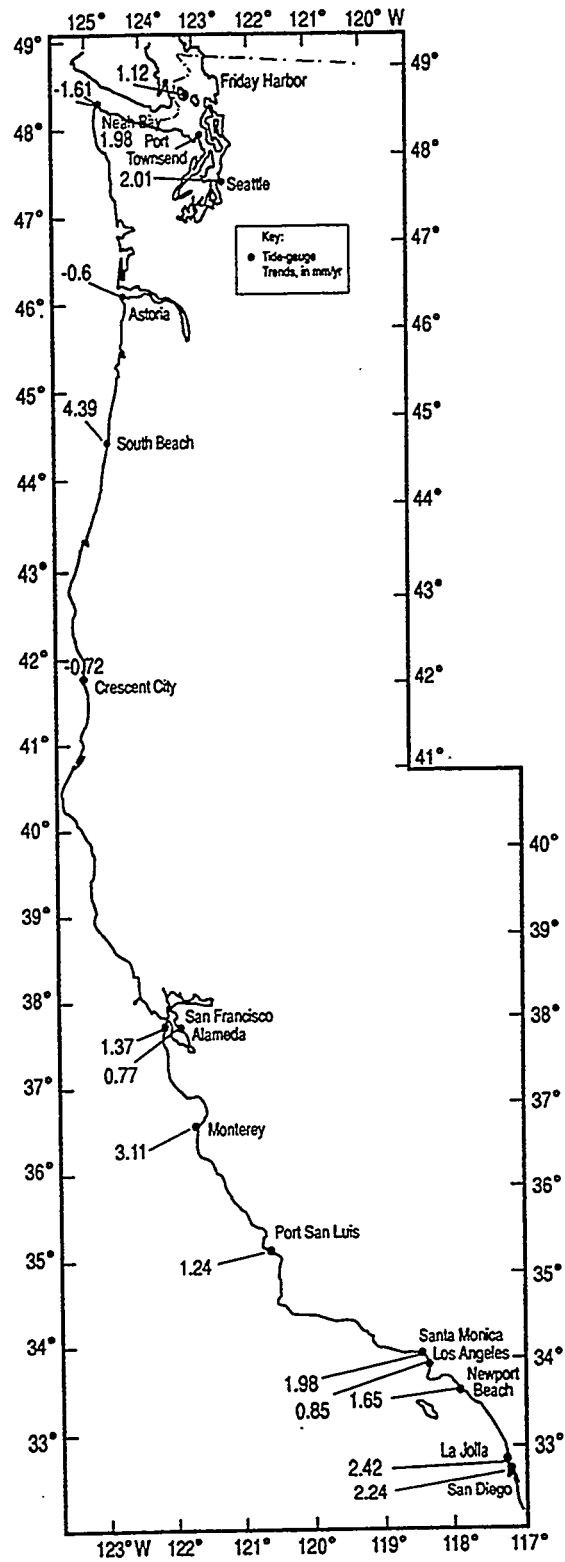

Figure 2. Relative sea-level trends (mm/yr), for each of the 16 tide-gauge stations listed in Table 2.



APPENDIX E: REPRINT OF PERTINENT LITERATURE

reprint removed.

Internal Distribution

- | | |
|---------------------|--|
| 1-5. T. W. Beaty | 16. T. E. Myrick |
| 6. T. A. Boden | 17. D. E. Reichle |
| 7. M. D. Burtis | 18. D. E. Shepherd |
| 8. R. M. Cushman | 19. D. S. Shriner |
| 9. S. G. Hildebrand | 20. L. D. Voorhees |
| 10. G. K. Jacobs | 21-120. CDIAC |
| 11. S. V. Jennings | 121. Central Research Library |
| 12. S. B. Jones | 122-124. ESD Library |
| 13. D. P. Kaiser | 125-126. Laboratory Records Department |
| 14. P. Kanciruk | 127. Laboratory Records Department |
| 15. J. M. Loar | ORNL-RC |
| | 128. Y-12 Technical Library |

External Distribution

129. S. S. Alexander, Pennsylvania State University, Department of Geosciences, 537 Deike Building, State College, PA 16802
130. R. Bidigare, University of Hawaii, Department of Oceanography, 1000 Pope Road, Honolulu, HI 96822
131. R. M. Bierbaum, Office of Science and Technology Policy, 443 Old Executive Office Bldg., 17th and Pennsylvania Avenue NW, Washington, D.C. 20500
132. C. Boelcke, P.S.S., United Nations Environment Program, P.O. Box 30552, Nairobi, Kenya
133. P. G. Brewer, Monterey Bay Aquarium Research Institute, P.O. Box 628, 7700 Sandholt Road, Moss Landing, CA 95039
134. M. Broido, Department of Energy, Office of Biological and Environmental Research, Environmental Sciences Division, ER-74, 19901 Germantown Road, Germantown, MD 20874
135. L. Brugmann, Stockholm University, Department of Geology and Geochemistry, S-106 91 Stockholm, Sweden
136. H. Croze, P.S.S., United Nations Environment Program, P.O. Box 30552, Nairobi, Kenya
137. E. G. Cumesty, ORNL Site Manager, Department of Energy, Oak Ridge National Laboratory, P.O. Box 2008, Oak Ridge, TN 37831-6269

138. G. Daneri, CEA Universidad del Mar, Dept. de Oceanografía y Biología Pesquera, Amunaategui 1838, Vina Del Mar, Chile
- 139—143. R. C. Daniels, Shorelands and Water Resources Program, Water Division, Department of Ecology, Olympia, WA 98504
144. Database Section, National Institute for Environmental Studies, Center for Global Environmental Research, 16-2 Onogawa, Tsukuba, Ibaraki 305, Japan
145. J. W. Elwood, Department of Energy, Office of Biological and Environmental Research, Environmental Sciences Division, ER-74, 19901 Germantown Road, Germantown, MD 20874
146. Energy Library (HR-832.1/GTN), Department of Energy, Office of Administration and Management, G-034, Washington, D. C. 20585
147. Energy Library (HR-832.2/WAS), Department of Energy, Office of Administration and Management, GA-138 Forrestal Building, Washington, D. C. 20585
148. G. Esser, Justus-Liebig-University, Institute for Plant Ecology, Heinrich-Buff-Ring 38, D-35392 Giessen, Germany
149. W. Ferrell, Department of Energy, Office of Biological and Environmental Research, Environmental Sciences Division, ER-74, 19901 Germantown Road, Germantown, MD 20874
150. W. Gardner, Texas A & M University, Department of Oceanography, College Station, TX 77843
151. J.-P. Gattuso, Observatoire Oceanologique Europeen, Avenue Saint-Martin, MC-98000, Monaco
- 152—156. V. M. Gornitz, National Aeronautics and Space Administration, Goddard Institute for Space Studies, 2880 Broadway, New York, NY 10025
157. D. O. Hall, University of London, Division of Biosphere Sciences, King's College London, Campden Hill Road, London W8 7AH, United Kingdom
158. A. Harashima, Japan Environment Agency, Global Environmental Research Division, 16-2 Onogawa, Tsukuba, Ibaraki 305, Japan
159. A. Hittelman, WDC-A for Solid Earth Geophysics, NOAA Code E/GC1, 325 Broadway, Boulder, CO 80303
160. H. Hodgson, British Library, Boston Spa, DSC, Special Acquisitions, Wetherby, West Yorkshire, LS23 7BQ, United Kingdom

161. Huasheng Hong, Xiamen University, Environmental Science Research Center, Post Code 361005, Mail Box 1085, Xiamen, Fujian, Peoples Republic China
162. C. A. Hood, GCRIO, 2250 Pierce Road, Bay City, MI 48710
163. J. C. Houghton, Department of Energy, Office of Biological and Environmental Research, Environmental Sciences Division, ER-74, 19901 Germantown Road, Germantown, MD 20874
164. G. Kaminsky, Washington Department of Ecology, P.O. Box 47600, Olympia, WA 98504-7600
165. T. R. Karl, National Climatic Data Center, 151 Patton Avenue, Federal Building, Room 516E, Asheville, NC 28801
166. S. Kempe, Schnittpahnstr. 9, D-64287 Darmstadt, Germany
167. K.-R. Kim, Seoul National University, Dept. of Oceanology, Seoul 151-7442, Korea
168. J. C. Klink, Miami University, Department of Geography, 217 Shideler Hall, Oxford, OH 45056
169. K. Lajoie, U. S. Geological Survey, 345 Middlefield Road, MS870, Menlo Park, CA 94025
170. D. T. Lauer, EROS Data Center, U.S. Geological Survey, Sioux Falls, SD 57198
171. P. Lunn, Department of Energy, Office of Biological and Environmental Research, Environmental Sciences Division, ER-74, 19901 Germantown Road, Germantown, MD 20874
172. T. H. Mace, U.S. Environmental Protection Agency, National Data Processing Division, 79 TW Alexander Drive, Bldg. 4201, MD-34, Durham, NC 27711
173. J. J. McCarthy, Harvard University, Museum of Comparative Zoology, 26 Oxford Street, Cambridge, MA 02138
174. M. C. McCracken, Director, Office of the U.S. Global Change Research Program, Code YS-1, 300 E. Street, SW, Washington, D. C. 20546
175. F. J. Millero, University of Miami, RSMAS, 4600 Rickenbacker Causeway, Miami, FL 33149
176. R. E. Munn, University of Toronto, Institute for Environmental Studies, Haultain Building, 170 College Street, Toronto, Ontario M5S 1A4, Canada

177. S. Nishioka, National Institute for Environmental Studies, Global Environment Research Division, 16-2 Onogawa, Tsukuba, Ibaraki 305, Japan
178. J. R. Oh, Korea Ocean Research and Development Institute, Chemical Oceanography Division, An San P.O. Box 29, Seoul 4325-600, Korea
179. C. Olsen, Office of Biological and Environmental Research, Environmental Sciences Division, ER-74, Department of Energy, 19901 Germantown Road, Germantown, MD 20874
180. B. Parra, Department of Energy, Office of Biological and Environmental Research, Environmental Sciences Division, ER-74, 19901 Germantown Road, Germantown, MD 20874
181. A. Patrinos, Department of Energy, Office of Biological and Environmental Research, Environmental Sciences Division, ER-74, 19901 Germantown Road, Germantown, MD 20874
182. G. R. Priest, Oregon Department of Geology and Mineral Industries, Suite 965, 800 NE Oregon St. #28, Portland, OR 97232
183. T.-H. Peng, NOAA/AOML, Ocean Chemistry Division, 4301 Rickenbacker Causeway, Miami, FL 33149
184. S. Railsback, PE, Lang, Railsback & Associates, Water Resource Research and Management, 250 California Avenue, Arcata, CA 95521
185. R. Y. Rand, USDA, Global Change Data and Information Management, 10301 Baltimore Boulevard, Beltsville, MD 20705
186. C. Reimers, Rutgers University, Institute of Marine and Coastal Sciences, P.O. Box 231, New Brunswick, NJ 08903
187. M. R. Riches, Department of Energy, Office of Biological and Environmental Research, Environmental Sciences Division, ER-74, 19901 Germantown Road, Germantown, MD 20874
188. J. L. Sarmiento, Princeton University, Atmospheric and Oceanic Sciences Program, P.O. Box CN710, Sayre Hall, Princeton, NJ 08544
189. G. S. Saylor, The University of Tennessee, Center for Environmental Biotechnology, 676 Dabney Hall, Knoxville, TN 37996-1605
190. M. H. C. Stoll, Netherlands Institute for Sea Research, Dept. MCG, P. O. Box 59, 1790 Ab den Burg-Texel, The Netherlands

191. E. T. Sundquist, U.S. Geological Survey, Quissett Campus, Branch of Atlantic Marine Geology, Woods Hole, MA 02543
192. T. Takahashi, Columbia University, Lamont-Doherty Earth Observatory, Climate, Environment, and Ocean Division, Rt. 9W, Palisades, NY 10964
193. J. A. Taylor, Australian National University, CRES, GPO Box 4, Canberra, ACT 0200, Australia
194. J. R. G. Townshend, University of Maryland, Dept. of Geography, 1113 Lefrak Hall, College Park, MD 20742
195. J. Tucker, Marine Biological Laboratory, Woods Hole, MA 02543
196. D. W. R. Wallace, Brookhaven National Laboratory, Oceanographic and Atmospheric Sciences Division, P.O. Box 5000, Upton, NY 11973
197. C. Watts, National Oceanic and Atmospheric Administration, Central Library, 1315 East-West Highway, 2nd Floor, SSMC 3, Silver Spring, MD 20910
198. F. Webster, University of Delaware, College of Marine Studies, Lewes, DE 19958
199. A. Winter, University of Puerto Rico, Department of Marine Sciences, Puerto Rico State Climate Office, P.O. Box 5000, Mayaguez, PR 00681
200. C. S. Wong, Government of Canada, Institute of Ocean Sciences, P.O. Box 6000, 9860 West Saanich Road, Sidney, BC V8L 4B2, Canada
201. M. Yamamuro, Geological Survey of Japan, Marine Geology Department, 1-1-3 Higashi, Tsukuba, Ibaraki 305, Japan
202. Y. Yosuka, National Institute for Environmental Studies, Center Global Environment Research, 16-2 Onogawa, Tsukuba, Ibaraki 305, Japan
203. Office of Scientific and Technical Information, P. O. Box 62, Oak Ridge, TN 37831