

CHAPTER III

CORROSION CONTROL

FEDERAL REQUIREMENTS

This chapter contains a simplified description of the corrosion control requirements contained in the pipeline safety regulations. The complete text of the corrosion control requirements can be found in 49 CFR Part 192.

Procedures and Qualifications

Operators must establish procedures to implement and maintain a corrosion control program for their piping system. These procedures should include design, installation, operation, and maintenance activities on a cathodic protection system. A person qualified in pipeline corrosion control methods must carry out these procedures.

Techniques for Compliance

The following is a list of sources where operators of small natural gas systems can find qualified personnel to develop and carry out a corrosion control program:

- There are many consultants and experts who specialize in cathodic protection. Many advertise in gas trade journals.
- Another source, especially for master meter operators, is an experienced corrosion engineer or technician working for a local gas utility company. Such experts may be able to implement cathodic protection for small operators, or refer them to local qualified corrosion engineers.
- Operators of small municipal systems can contact the transmission company that supplies their gas. A municipal corrosion engineer or technician may be able to supply information as to where to find local qualified corrosion engineers.
- OPS suggests that operators of small natural gas systems encourage their respective trade associations (such as state and local mobile home associations or municipal associations) to gather and maintain records of available consultants or contractors who are qualified in their specific region.
- The local chapter of “NACE International” (National Association of Corrosion Engineers) may be able to provide useful information.
- Operators who are unsure of a consultant’s qualification in corrosion control should contact operators who have hired the consultant in the past.

Corrosion Control Requirements for Pipelines Installed After July 31, 1971

All buried metallic pipe installed after July 31, 1971, must be properly coated and have a cathodic protection system designed to protect the pipe in its entirety.

Newly constructed metallic pipelines must be coated before installation and must have a cathodic protection system installed and placed in operation in its entirety within one year after construction of the pipeline. However, the operator must make tests no later than six months after installation to demonstrate that no corrosion control measures are necessary. If tests indicate that corrosion control is necessary, the pipeline must be cathodically protected.

OPS recommends that all operators of small natural gas systems coat and cathodically protect all new metallic pipe. It is extremely difficult and costly to prove that a noncorrosive environment exists.

Cathodic protection requirements do not apply to electrically isolated, metal alloy fittings in plastic pipelines if the alloyage of the fitting provides corrosion control, and if corrosion pitting will not cause leakage.

Corrosion Control Requirements for Pipelines Installed Before August 1, 1971

For Pipelines installed before August 1, 1971, (bare pipe or coated pipe), must be cathodically protected in areas that are determined to be active corrosion. All underground natural gas distribution systems, including underground piping related to regulating and measuring stations, must be cathodically protected in areas of active corrosion.

The operator must determine areas of active corrosion by (a) electrical survey, (b) where electrical survey is impractical, by the study of corrosion and leak history records, or (c) by leak detection surveys.

Active corrosion means continuing corrosion, which, unless controlled, could result in a condition that is detrimental to public safety.

As a guideline for operators when determining corrosion to be detrimental to public safety (active corrosion), OPS recommends the following:

- For master meter operators, all continuing corrosion occurring on metallic pipes (other than cast iron or ductile iron pipes) should be considered active and pipes should be cathodically protected, repaired, or replaced.
- For operators of small municipal gas systems, all continuing corrosion occurring on the distribution system in city limits (within 100 yards of a building intended for human occupancy, regulator stations, and at highway and railroad crossings) should be considered active and pipes should be cathodically protected, repaired, or replaced. Need to clarify what's needed.

- OPS recommends that operators of small gas systems and their consultants use these following guidelines in determining where it is impractical to do electrical surveys to find areas of active corrosion:
 - a. Where the pipeline is more than 2 feet from the edge of a paved street or within wall to wall pavement areas.
 - b. Pipelines in a common trench with other metallic structures.

Electrical surveys may prove to be impractical due to conditions other than those listed above. The operator must demonstrate the impracticability of an electrical survey.

In areas where electrical surveys cannot be run to determine corrosion, the operator should run leakage surveys on a more frequent basis. OPS recommends that these surveys be run at least once a year.

Electrical surveys to find active corrosion must be run by a person qualified in pipeline corrosion control methods.

Coating Requirements

All metallic pipe installed below ground, as a new or replacement pipeline system, should be coated in its entirety (APPENDIX B, FORM 1). Types of coatings and handling practices are discussed later in this chapter.

Examination of Exposed Pipe

Whenever buried pipe is exposed or dug up, the operator is required to examine the exposed portion of the pipe for evidence of corrosion on bare pipe or for deterioration of the coating on coated pipe. A record of this examination must be maintained. If the coating has deteriorated or the bare pipe has evidence of corrosion, remedial action must be taken (APPENDIX B, FORM 1).

Criteria for Cathodic Protection

Operators must meet one of five criteria listed in Appendix D of 49 CFR Part 192, to comply with the pipeline safety regulations for cathodic protection.

The criteria that most operators of small natural gas systems will choose to meet will be a (cathodic) voltage of at least -0.85 volt with reference to a saturated copper-copper sulphate half-cell (Appendix B, Form 14). NOTE: IR drop must be considered.

Monitoring

A piping system that is under cathodic protection must be systematically monitored. Tests for effectiveness of cathodic protection must be done at least once every year. Records of this monitoring must be maintained (APPENDIX B, FORM 14).

Short, separately protected service lines or short, protected mains may be surveyed on a sampling basis. At least 10 percent of these short sections and services must be checked each year so that

all short sections in the system are tested in a 10-year period. Examples of short, separately protected pipe in a small natural gas system would be:

- Steel service lines connected to, but electrically isolated from, cast iron mains.
- Steel service risers that have cathodic protection provided by an anode attached to a riser that is installed on plastic service lines.

OPS recommends, if a small number of isolated protection sections of pipeline exist in the system, that the operator include all sections in the annual survey.

When using rectifiers to provide cathodic protection, each rectifier must be inspected six times every year. The intervals must not exceed 2½ months, to ensure that the rectifier(s) is properly operating. Records must be maintained (APPENDIX B, FORM 15).

Operators must take prompt action to correct any deficiencies indicated by the monitoring.

Electrical Isolation

Pipelines must be electrically isolated from other underground metallic structures (unless electrically interconnected and cathodically protected as a single unit). For illustrations of where meter sets are commonly electrically insulated, see FIGURES 8, 13, and 14 in this chapter.

Test Points

Each pipeline under cathodic protection must have sufficient test points for electrical measurement to determine the adequacy of cathodic protection. Test points should be shown on a cathodic protection system map.

Internal Corrosion Inspection

Whenever a section of pipe is removed from the system, the internal surface must be inspected for evidence of corrosion. Remedial steps must be taken if internal corrosion is found. Be sure to keep records of this inspection (APPENDIX B, FORM 1).

Atmospheric Corrosion

Newly installed above ground pipelines must be cleaned and coated or jacketed with a material suitable for the prevention of atmospheric corrosion. Above ground pipe, including meters, regulators, and measuring stations, must be inspected for atmospheric corrosion once every year. Remedial action must be taken if atmospheric corrosion is found (APPENDIX B, FORM 13).

Remedial Measures

All steel pipe used to replace an existing pipe must be coated and cathodically protected. Each segment of pipe that is repaired because of corrosion leaks must be cathodically protected.

Graphitization of Cast Iron

Graphitization is the process by which the cast iron pipe corrodes, leaving a brittle sponge-like structure of graphite flakes. There may be no appearance of damage, but the affected area of the pipe becomes brittle. For example, a completely graphitized buried cast iron pipe may hold gas under pressure but will fracture under a minor impact, such as being hit by a workman's shovel. Cast iron is a metallurgical combination of iron and carbon (graphite).

Each segment of cast iron or ductile iron pipe with Graphitization (to a degree where a fracture or any leakage might result) must be replaced.

Records

Operators must maintain records or maps of their cathodic protection system. Records of all tests, surveys, or inspections required by the pipeline safety code must be maintained. See APPENDIX B for samples of records/forms.

PRINCIPLES AND PRACTICES OF CATHODIC PROTECTION

This section gives operators with little or no experience in cathodic protection, a review of the general principles and practices of cathodic protection. Common causes of corrosion, types of pipe coatings, and criteria for cathodic protection are among the topics. A checklist of steps which an operator of a small natural gas system may use to determine the need for cathodic protection is included. Basic definitions and illustrations are used to clarify the subject. This section does not go into great depth. Therefore, reading this section alone will not qualify an operator to design and implement cathodic protection systems.

Basic Terms

Corrosion is the deterioration of metal pipe. Corrosion is caused by a reaction between the metallic pipe and its surroundings. As a result, the pipe deteriorates and may eventually leak. Although corrosion cannot be eliminated, it can be substantially reduced with cathodic protection (see FIGURE III-1).

FIGURE III-1 BARE PIPE - NOT UNDER CATHODIC PROTECTION

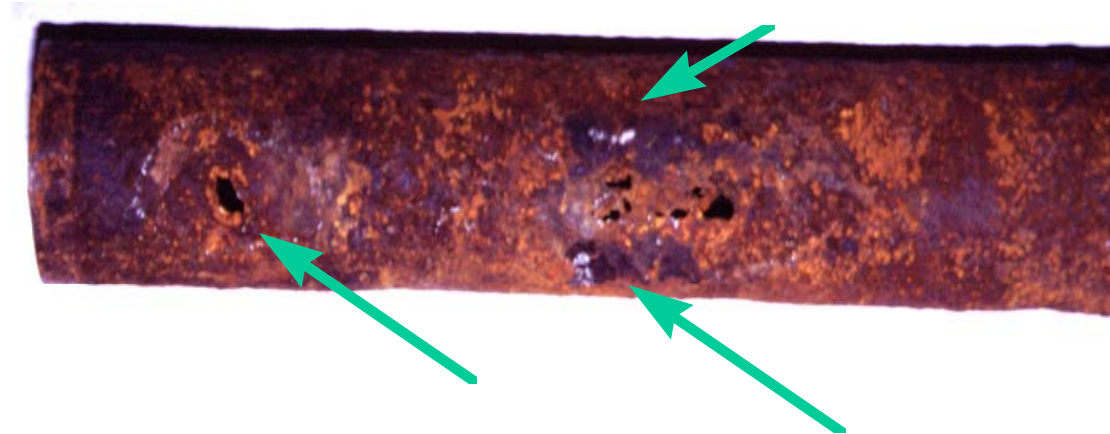

An example of bare steel pipe installed for gas service. Note the deep corrosion pits that have formed. Operators should never install bare steel pipe underground. Operators should use either polyethylene pipe manufactured according to ASTM D2513 or coated steel pipe as new or replacement pipe. If steel pipe is installed, that pipe must be coated and cathodically protected.

Cathodic protection is a procedure by which an underground metallic pipe is protected against corrosion. A direct current is impressed onto the pipe by means of a sacrificial anode or a rectifier. Corrosion will be reduced where sufficient current flows onto the pipe.

Anode (sacrificial) is an assembly consisting of a bag usually containing a magnesium or zinc ingot and other chemicals, which is connected by wire to an underground metal piping system. It functions as a battery that impresses a direct current on the piping system to retard corrosion (see FIGURE III-2).

FIGURE III-2 TYPICAL MAGNESIUM (MG) ANODE

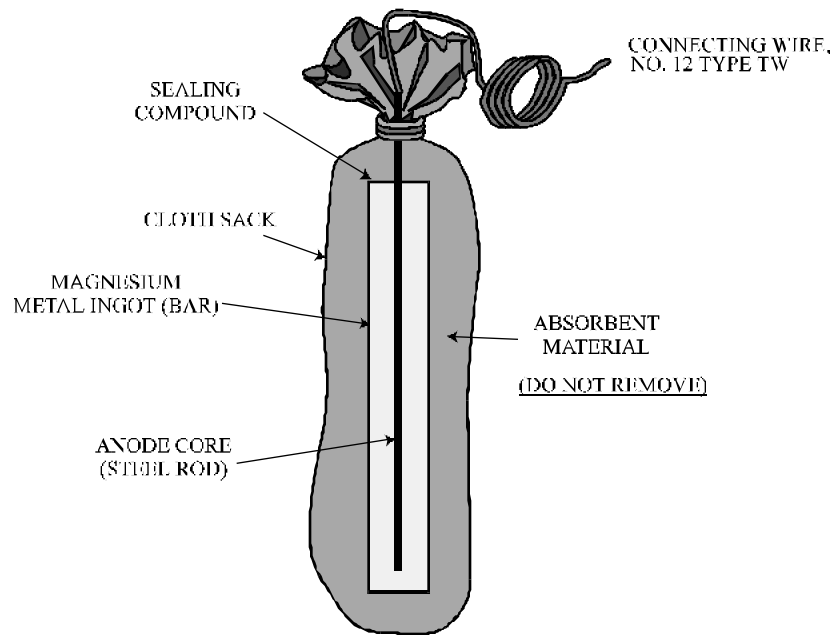

Sacrificial protection means the reduction of corrosion of a metal (usually steel in a gas system) in an electrolyte (soil) by galvanically coupling the metal (steel) to a more anodic metal (magnesium or zinc) (see FIGURE III-3). The magnesium or zinc will sacrifice itself (corrode) to retard corrosion in steel the pipe.

FIGURE III-3

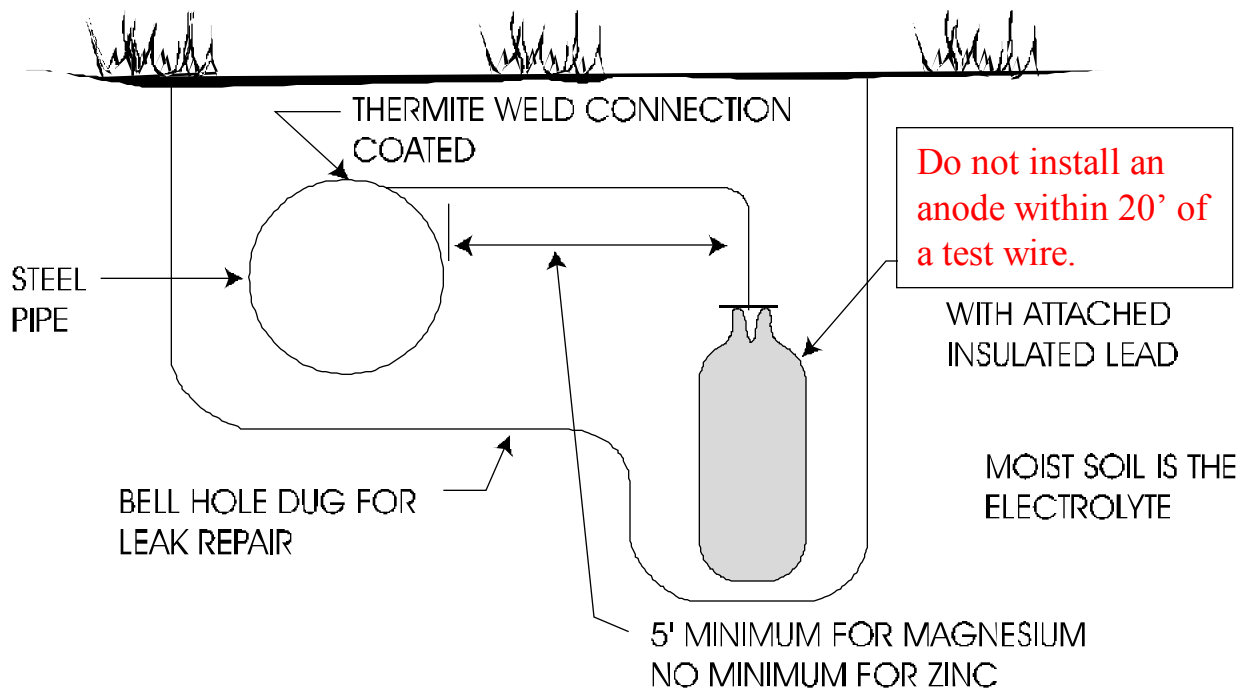

Zinc and magnesium are more anodic than steel. Therefore, they will corrode to provide cathodic protection for steel pipe.

Rectifier is an electrical device that changes alternating current (a.c.) into direct current (d.c.). This current is then impressed on an underground metallic piping system to protect it against corrosion (see FIGURE III-4).

FIGURE III-4

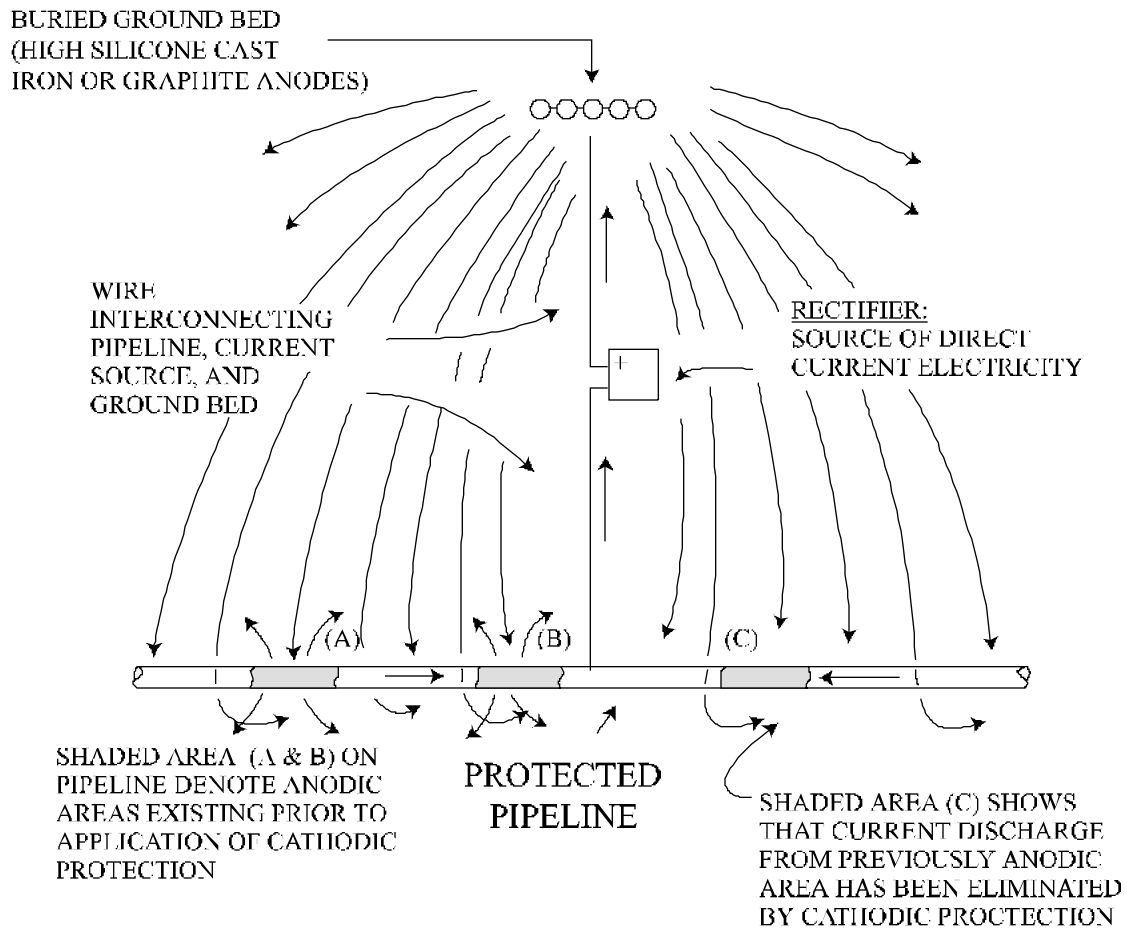

This illustrates how cathodic protection can be achieved by use of a rectifier. Make certain the negative terminal of the rectifier is connected to the pipe. **NOTE:** If the reverse occurs (positive terminal to pipe), the pipe will corrode much faster.

Potential means the difference in voltage between two points of measurement (see FIGURE III-5).

FIGURE III-5

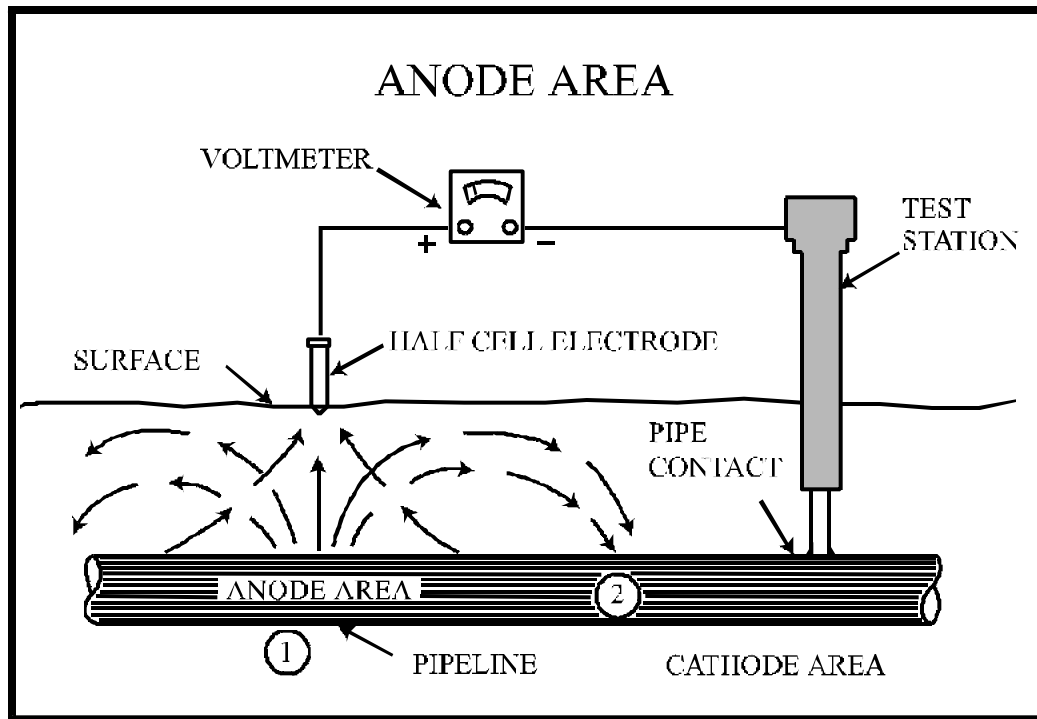

The voltage potential in this example is the difference between points 1 and 2. Therefore, the current flow is from the anodic area (1) of the pipe to the cathodic area (2). The half-cell is an electrode made up of copper immersed in copper-copper sulphate (Cu-CuSO_4).

Pipe-to-soil potential is the potential difference (voltage reading) between a buried metallic structure (piping system) and the soil surface. The difference is measured with a half-cell reference electrode (see definition of reference electrode that follows) in contact with the soil (see FIGURE III-6).

FIGURE III-6

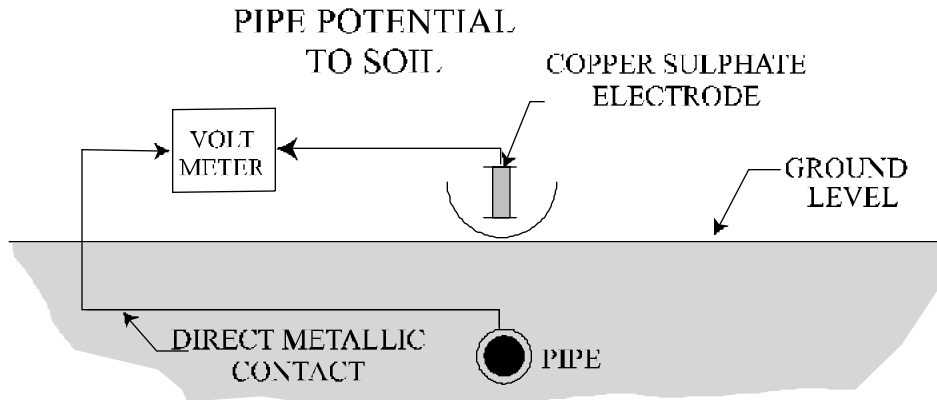

1. INVESTIGATE CORROSIVE CONDITIONS.
2. EVALUATE THE EXTENT OF CATHODIC PROTECTION

If the voltmeter reads at least -0.85 volt, the operator can usually consider that the steel pipe has cathodic protection. **NOTE:** Be sure to take into consideration the voltage (IR) drop that is the difference between the voltage at the top of the pipe and the voltage at the surface of the earth.

Reference electrode (commonly called a half-cell) is a device which usually has copper immersed in a copper sulphate solution. The open circuit potential is constant under similar conditions of measurement (see FIGURE III-7).

FIGURE III-7 REFERENCE ELECTRODE – A SATURATED COPPER-COPPER SULPHATE HALF-CELL.

(Caution Copper-Copper Sulphate is Poisonous)

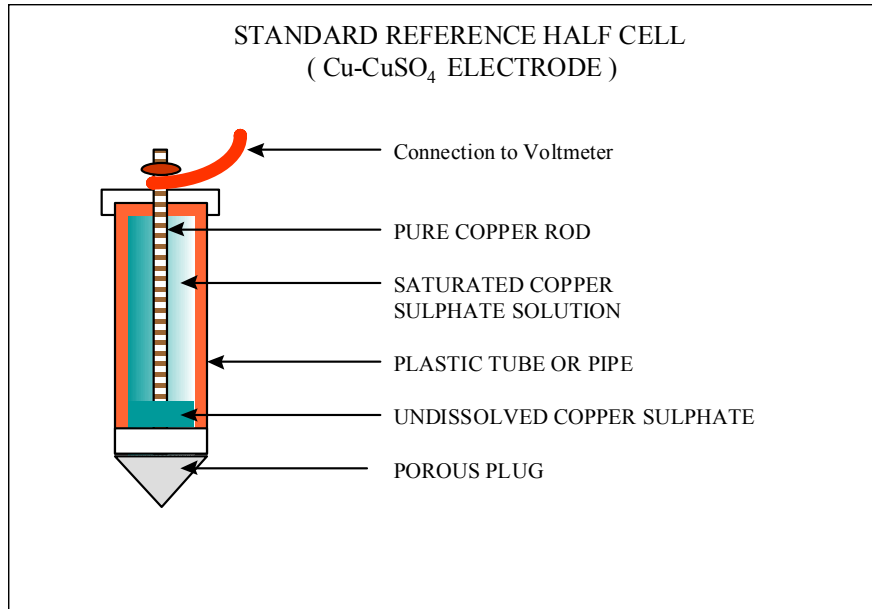

Short or corrosion fault means an accidental or incidental contact between a cathodically protected section of a piping system and other metallic structures (water pipes, buried tanks, or unprotected section of a gas piping system) (see FIGURE III-8).

FIGURE III-8 TYPICAL METER INSTALLATION ACCIDENTAL CONTACTS
(Meter Insulator Shorted Out by House Piping, etc.)

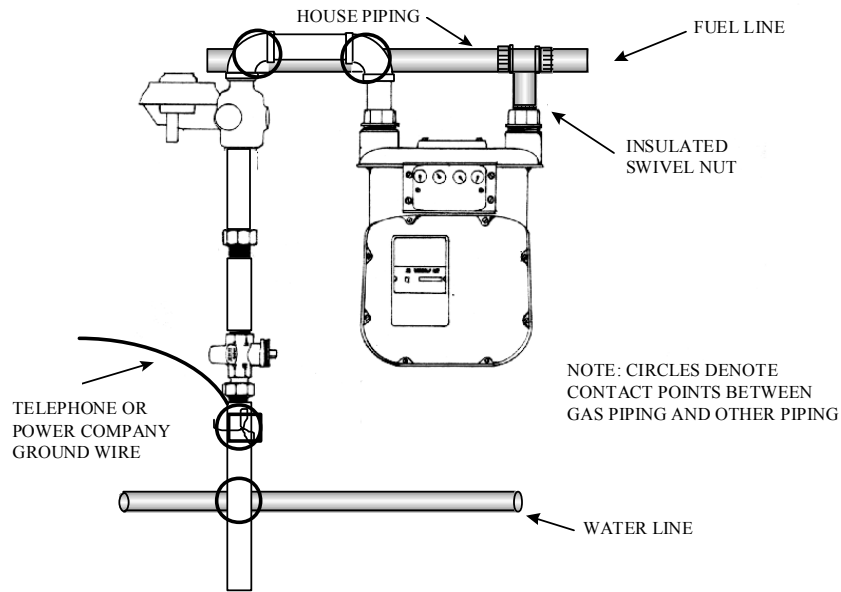

Unshaded piping shows Operators piping from service entry to meter insulator at location shown on sketch above. Shaded areas show house piping, electrical cables, etc.

The circled locations are typical points where the Operators piping (unshaded) can come in metallic contact with house piping. This causes shorting out or "bypassing" of the meter insulator.

The only way to clear these contacts permanently is to move the piping that is in contact. (The use of wedges, etc., to separate the piping is not acceptable). If the above ground piping cannot be moved, install a new insulator between the accidental contact and the service entry.

Stray current means current flowing through paths other than the intended circuit (see FIGURE III-9). If your pipe-to-soil readings fluctuate, stray current may be present.

FIGURE III-9

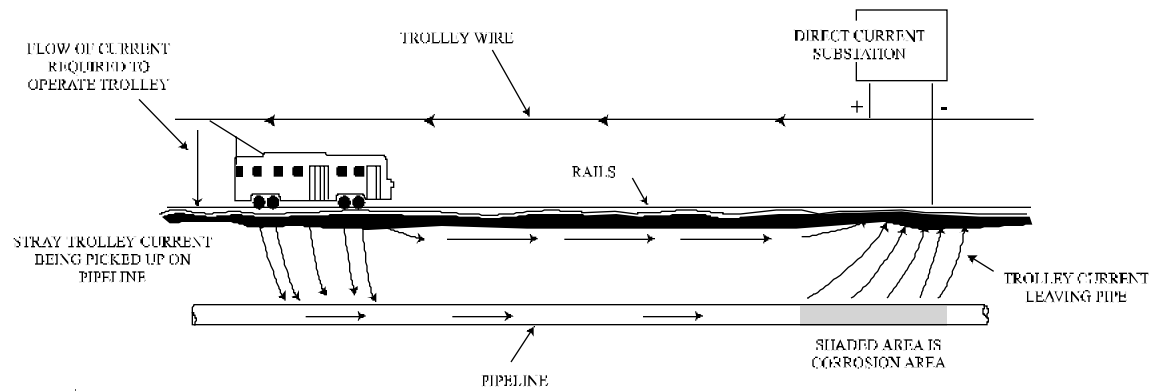

This drawing illustrates an example of stray d.c. current getting onto a pipeline from an outside source. This can cause severe corrosion in the area where the current eventually leaves the pipe. Expert help is needed to correct this type of problem.

Stray current corrosion means metal destruction or deterioration caused primarily by stray d.c. affecting the pipeline.

Galvanic series is a list of metals and alloys arranged according to their relative potentials in a given environment.

Galvanic corrosion occurs when any two of the metals in TABLE 1 (next page) are connected in an electrolyte (soil). Galvanic corrosion is caused by the different potentials of the two metals.

TABLE 1

<u>METAL</u>	<u>Potentials VOLTS*</u>		
Commercially pure magnesium	-1.75	Anodic	
Magnesium alloy (6% Al, 3% Zn, 0.15% Mn)	-1.6		
Zinc	-1.1		
Aluminum alloy (5% zinc)	-1.05		
Commercially pure aluminum	-0.8		
Mild steel (clean and shiny)	-0.5 to -0.8		
Mild steel (rusted)	-0.2 to -0.5		
Cast iron (not graphitized)	-0.5		
Lead	-0.5		
Mild steel in concrete	-0.2		
Copper, brass, bronze	-0.2		
High silicon cast iron	-0.2		
Mill scale on steel	-0.2		
Carbon, graphite, coke	+0.3		Cathodic

* Typical potential in natural soils and water, measured with respect to a copper-copper sulphate reference electrode.

When electrically connected in an electrolyte, any metal in the table will be anodic (corrode relative to) to any metal below it. That is, the more anodic metal sacrifices itself to protect the metal (pipe) lower in the table.)

FUNDAMENTAL CORROSION THEORY

In order for corrosion to occur there must be four parts: An electrolyte, anode, cathode, and a metallic return path. A metal will corrode at the point where current leaves the anode (see FIGURE III-10). NOTE: Dissimilar soils may create an environment that enhances corrosion.

FIGURE III-10

A corrosion cell may be described as follows:

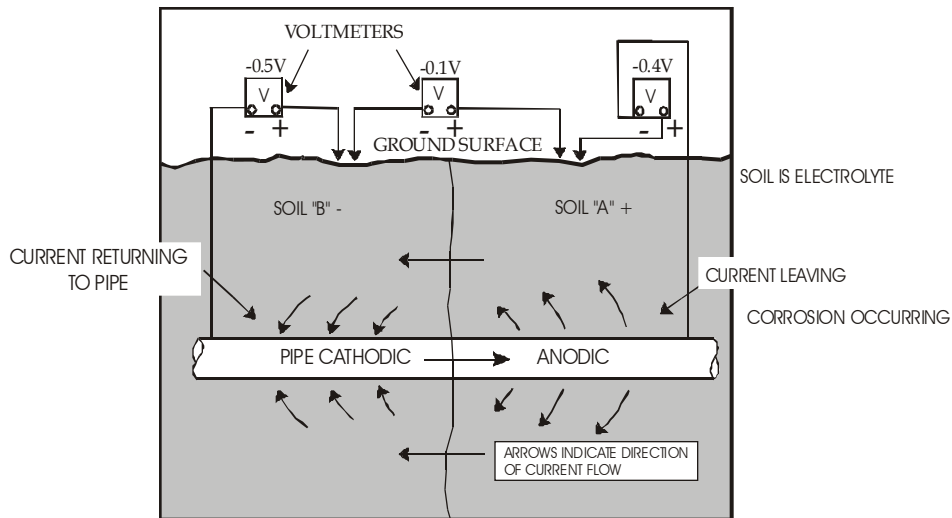

- Current flows through the electrolyte from the anode to the cathode. It returns to the anode through the return circuit.
- Corrosion occurs whenever current leaves the metal (pipe, fitting, etc.) and enters the soil (electrolyte). The area where current leaves is said to be anodic. Corrosion, therefore, occurs in the anodic area.
- Current is picked up at the cathode. No corrosion occurs here. The cathode is protected against corrosion. Polarization (hydrogen film buildup) occurs at the cathode. When the film of hydrogen remains on the cathode surface, it acts as an insulator and reduces the corrosion current flow.
- The flow of current is caused by a potential (voltage) difference between the anode and the cathode.

TYPES OF CATHODIC PROTECTION

There are two basic methods of cathodic protection: the galvanic anode system and the impressed current system.

Galvanic anodes are commonly used to provide cathodic protection on gas distribution systems. Impressed current systems are normally used for transmission lines. However, if properly designed, impressed current can be used on a distribution system (see FIGURE III-11).

FIGURE III-11

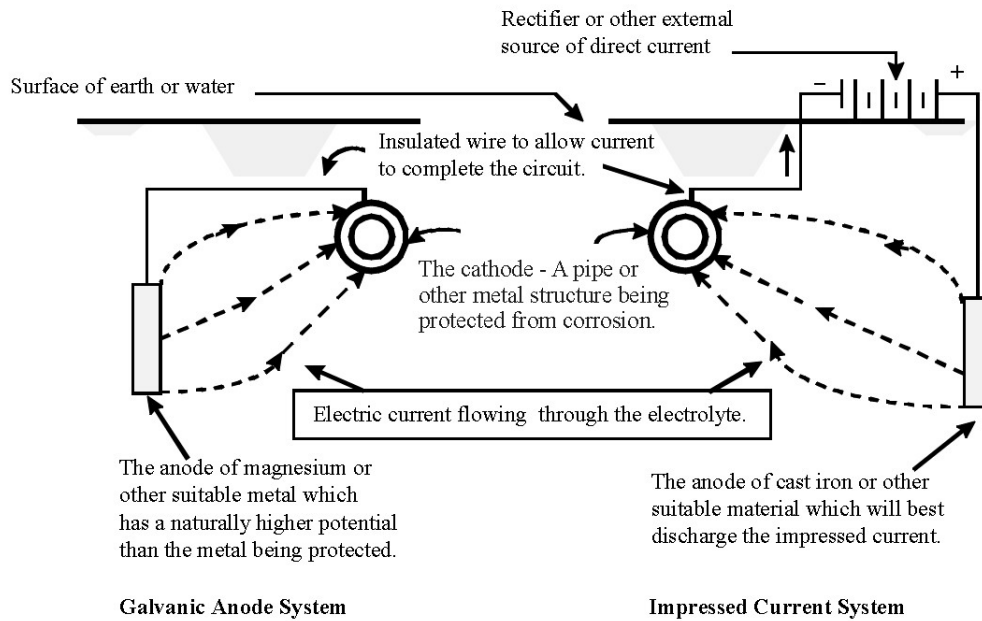

Any current, whether galvanic or stray, that leaves the pipeline causes corrosion. In general, corrosion control is obtained as follows:

Galvanic Anode System. Anodes are "sized" to meet current requirements of the resistivity of the environment (soil). The surface area of the buried steel and estimated anode life determines the size and number of anodes required. Anodes are made of materials such as magnesium (Mg), zinc (Zn), or aluminum (Al). They are usually installed near the pipe and connected to the pipe with an insulated conductor. They are sacrificed (corroded) instead of the pipe (see FIGURES III-3, III-11, AND III-12).

FIGURE III-12 TYPICAL PROCEDURE FOR INSTALLING A MAGNESIUM ANODE BY THE THERMO-WELD PROCESS

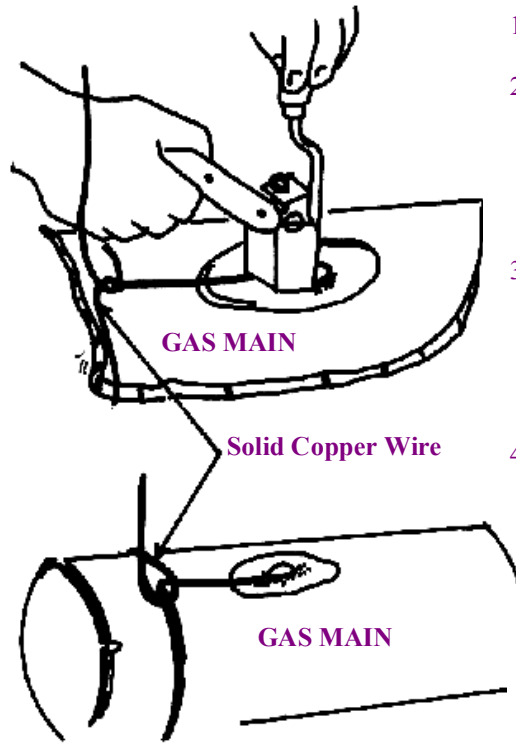

1. Loop wire as shown to avoid strain on bond.
2. Insert conductor in mold-do not push end of conductor past center of tap hole. Drop metal disc over tap hole. Remove all starting power from cartridge by tapping the inverted cartridge on lip of mold.
3. Close cover, hold mold steady. Ignite starting power with flint gun as shown. When powder fires, remove gun immediately. Hold mold steady for 10 seconds. Remove slag from weld.
4. See the manufacturer's recommendation before proceeding.

After welding, all exposed pipe should be well coated and wrapped.

Impressed Current Systems. Anodes are connected to a direct current source, such as a rectifier or generator. These systems are normally used along transmission pipelines where there is less likelihood of interference with other pipelines. The principle is the same except that the anodes are made of materials such as graphite, high silicon cast iron, lead-silver alloy, platinum, or scrap steel.

INITIAL STEPS IN DETERMINING THE NEED TO CATHODICALLY PROTECT A SMALL GAS DISTRIBUTION SYSTEM

1. Determine type(s) of pipe in system: bare steel, coated steel, cast iron, plastic, galvanized steel, ductile iron, or other.
2. Date gas system was installed:
Year pipe was installed (steel pipe installed after July 1, 1971, must be cathodically protected in its entirety).

Who installed pipe? By contacting the contractor and other operators who had pipe installed by same contractor, operators may be able to obtain valuable information, such as:

- Type of pipe in ground.
 - If pipe is electrically isolated.
 - If gas pipe is in common trench with other utilities.
3. Pipe location - map/drawing. Locate old construction drawings or current system maps. If drawings are unavailable, a metallic pipe locator may be used.
 4. Before the corrosion engineer arrives, it is a good idea to make sure that customer meters are electrically insulated. If system has no meter, check to see if gas pipe is electrically insulated from house or mobile home pipe (see FIGURE III-13).
 5. Contact an experienced corrosion engineer or consulting firm. Try to complete steps 1 through 4 before contracting a consultant.

6. Use of Consultant

A sample method, which may be used by a consultant to determine cathodic protection needs, is provided below:

- An initial pipe-to-soil reading will be taken to determine whether the system is under cathodic protection.
- If the system is not under cathodic protection, the consultant should clear underground shorts or any missed meter shorts. (The consultant will probably use a tone test.)
- After the shorts are cleared, another pipe-to-soil test should be taken. If the system is not under cathodic protection, a current requirement test should be run to determine how much electrical current is needed to protect the system.
- Additional tests, such as a soil resistivity test, bar hole examination, and other electrical tests, may be needed. The types of tests needed will vary for each gas system.

Remember to retain copies of all tests run by the corrosion engineer.

7. Cathodic Protection Design

The experienced corrosion engineer or gas consultant, will design a cathodic protection system based on the results of testing, that best suits the gas piping system.

FIGURE III-13

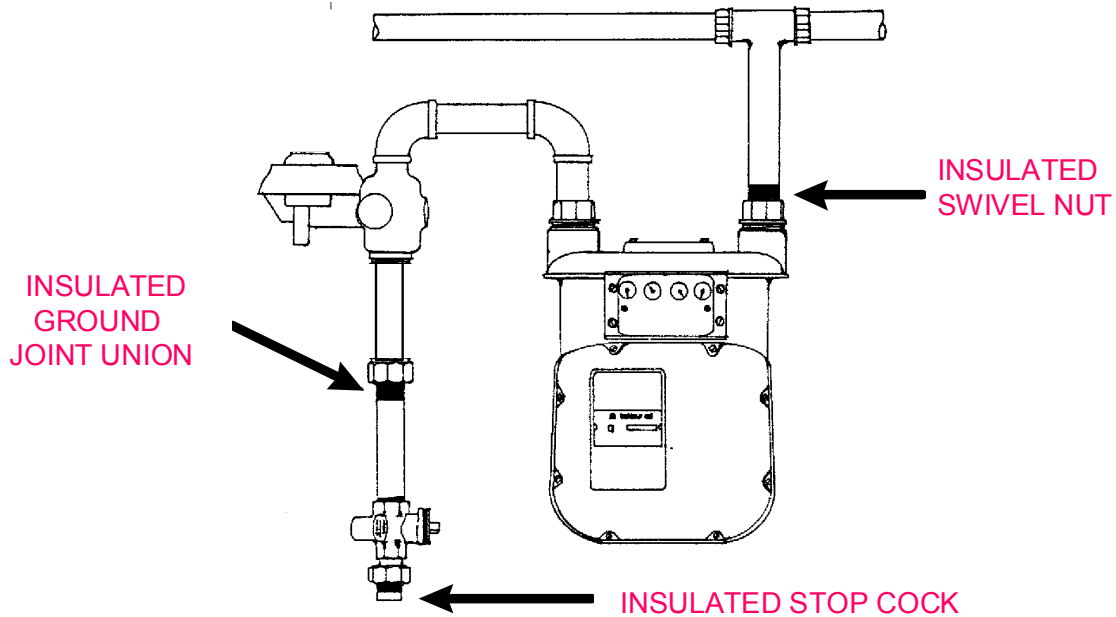

Places where a meter installation may be electrically isolated.

FIGURE III-14

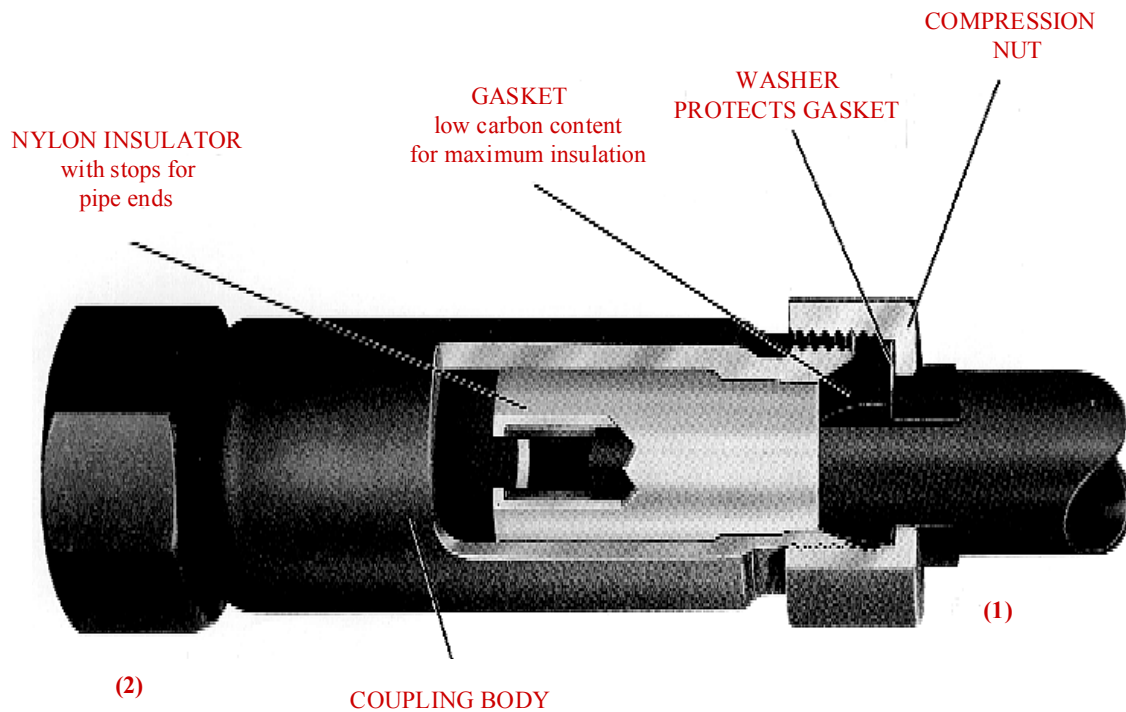
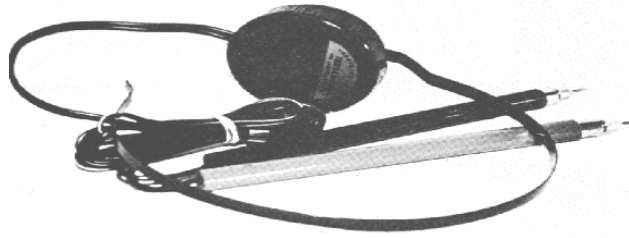

Illustration of an insulated compression coupling used on meter sets to protect against corrosion. Pipe connection by this union will be electrically insulated between the piping located on side one (1) and the piping located on side two (2).

FIGURE III-15



INSULATION TESTER

This insulation tester consists of a magnetic transducer mounted in a single earphone headset with connecting needlepoint contact probes. It is a "go" or "no go" type tester which operates from low voltage current present on all underground piping systems thus eliminating the necessity of outside power sources or costly instrumentation and complex connections. By placing the test probes on the metallic surface on either side of the insulator a distinct audible tone will be heard if the insulator is performing properly. Absence of audible tone indicates faulty insulator. Insulator effectiveness can be determined quickly using this simple, easy-to-operate tester.

CRITERIA FOR CATHODIC PROTECTION

There are five criteria listed in Appendix D of Part 192, to qualify a pipeline as being cathodic protected. Operators can meet the requirements of any one of the five to be in compliance with the pipeline safety regulations. Most systems will be designed to Criterion 1.

Criterion 1: With the protective current applied, a voltage of at least -0.85 volt measured between the pipeline and a saturated copper-copper sulfate half-cell. This measurement is called the pipe-to-soil potential reading (see FIGURE III-16).

FIGURE III-16 PIPE-TO-SOIL POTENTIAL READING.

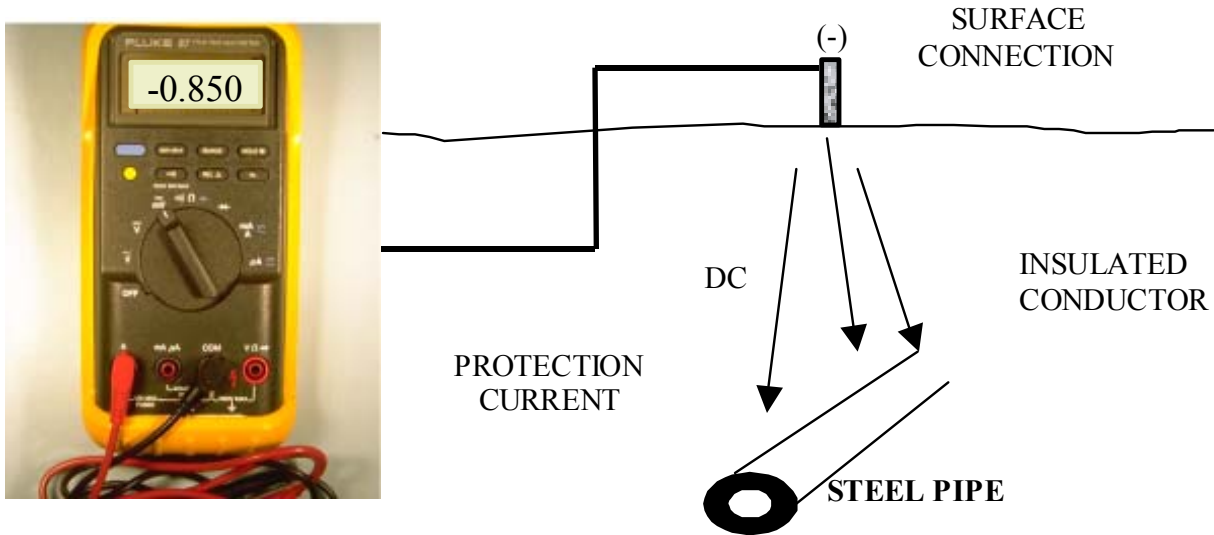

This is a pipe-to-soil voltage meter with reference cell attached. This is a simple meter to use and is excellent for simple "go-no-go" type monitoring of a cathodic protection system. If meter reaches at least -0.85 volt, the operator knows that the steel pipe is under cathodic protection. If not, remedial action must be taken promptly. **NOTE:** Be sure to take into consideration the voltage drop.

COATINGS

There are many different types of coating on the market. The better the coating application, the less electrical current is needed to cathodically protect the pipe.

Mill Coated Pipe

When purchasing steel pipe for underground gas services, operators should purchase mill coated pipe (i.e., pipe coated during manufacturing process). Some examples of mill coatings are:

- Extruded polyethylene or polypropylene plastic coatings,
- Coal tar coatings,
- Enamels,
- Mastics,
- Epoxy.

A qualified (corrosion) person can help select the best coating for a natural gas system. A local natural gas utility may be able to give master meter operators the name and location of nearby suppliers of mill coated gas pipe. When purchasing steel pipe, remember to verify that the pipe was manufactured according to one of the specifications listed in Chapter VI of this manual. This can be verified by a bill of lading or by the markings on mill coated pipe.

Patching

Tape material is a good choice for external repair of mill coated pipe. Tape material is also a good coating for both welded and mechanical joints made in the field. Some tapes in use today are:

- PE and PVC tapes with self-adhesive backing applied to a primed pipe surface,
- Plastic films with butyl rubber backing applied to a primed surface,
- Plastic films with various bituminous backings.

Consult a pipe supplier before purchasing tapes. Tapes must be compatible with the mill coating on the pipe.

Coating Application Procedures

When repairing and installing metal pipe, be sure to coat bare pipes, fittings, etc. It is absolutely essential that the instructions (supplied by the manufacturer of the coating) be followed precisely. Time and money is wasted if the instructions are not followed.

Some general guidelines for installation of pipe coatings:

- Properly clean pipe surface (remove soil, oil, grease, and any moisture),
- Use careful priming techniques (avoid moisture, follow manufacturer's recommendations),
- Properly apply the coating materials (be sure pipe surface is dry - follow manufacturer's recommendations). Make sure soil or other foreign material does not get under coating during installation,
- Only backfill with material that is free of objects capable of damaging the coating. Severe coating damage can be caused by careless backfilling when rocks and debris strike and break the coating.

COMMON CAUSES OF CORROSION IN GAS PIPING SYSTEMS

FIGURE III-17 SHORTED METER SET.



An example of a galvanic corrosion cell. The tenants of this building have "shorted" out this meter by storing metallic objects on the meter set. Never allow customers or tenants to store material on or near a meter installation.

FIGURE III-18 CORROSION CAUSED BY DISSIMILAR SURFACE CONDITIONS.

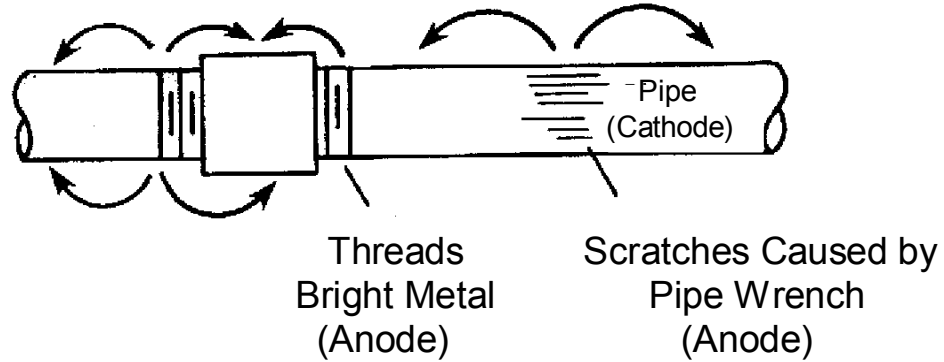

(Corrosion caused by dissimilar surface conditions.)

This pipe will corrode at the threads or where it is scratched. Remember to repair all cuts or scratches in the coating before burying the pipe. Always coat and/or wrap pipe at all threaded or weld connections before burying pipe.

FIGURE III-19 GALVANIC CORROSION

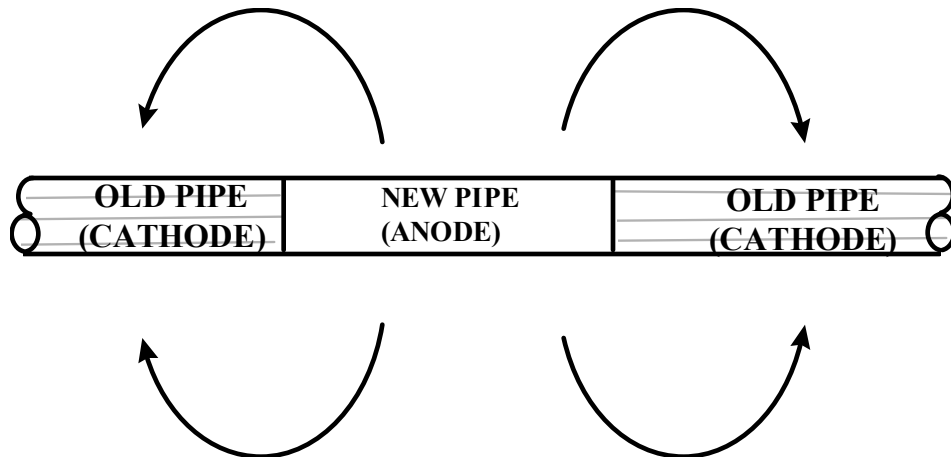

Remember, all new steel pipe must be coated and cathodically protected. The new pipe can either be electrically isolated from old pipe, or the new and old pipe must be cathodically protected as a unit.

FIGURE III-20 GALVANIC CORROSION CAUSED BY DISSIMILAR METALS.

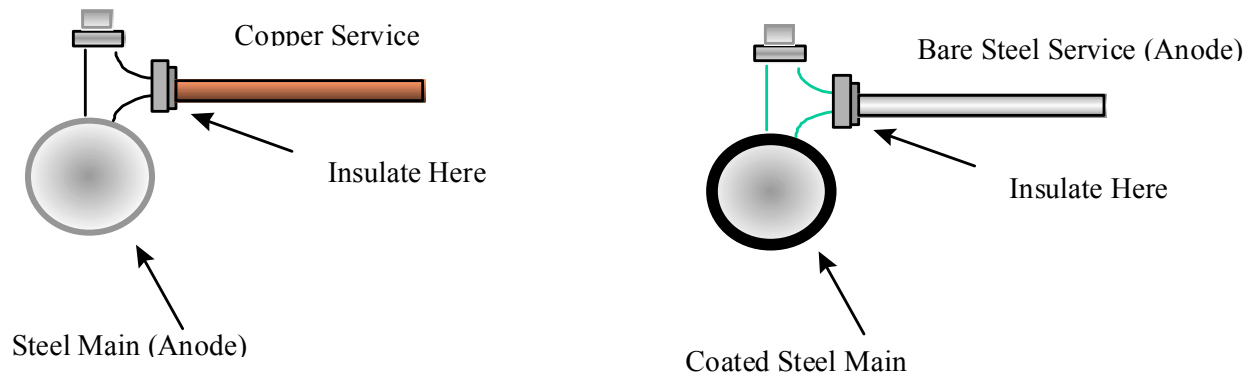

Steel is above copper in the galvanic series in TABLE 1 of this chapter. Therefore, steel will be anodic to the copper service. That means the steel pipe will corrode. The copper service should be electrically isolated from the steel main. Remember, steel and cast iron or ductile iron should not be tied in directly. Steel and cast iron should be electrically isolated. Also, coated steel pipe should be electrically isolated from bare steel pipe.

FIGURE III-21 GALVANIC CORROSION

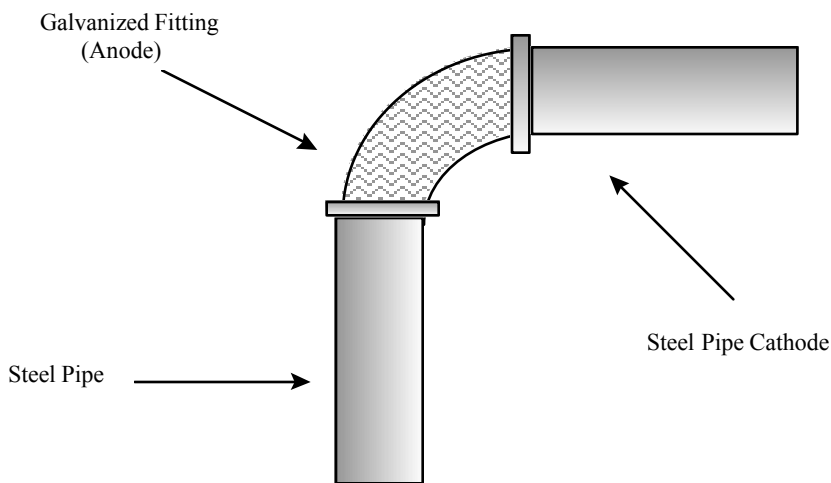

The galvanized elbow will act as an anode to steel and will corrode. Do not install galvanized pipe or fittings in system, if possible.

FIGURE III-22 GALVANIC CORROSION

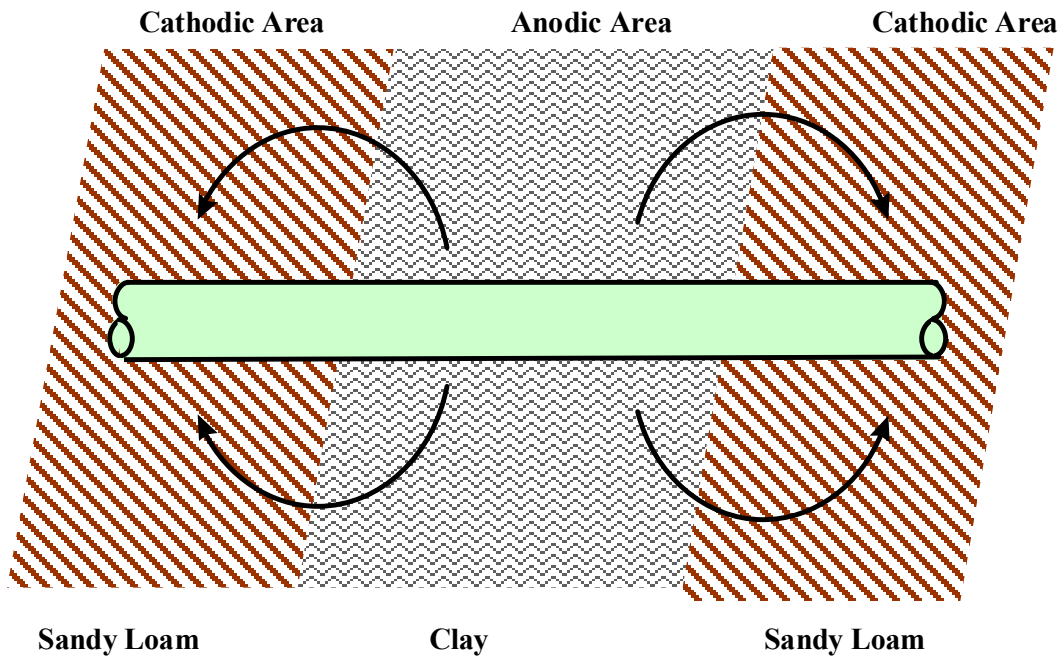

A corrosion cell can be set up when pipe is in contact with dissimilar soils. This problem can be avoided by the installation of a well-coated pipe under cathodic protection.

FIGURE III-23 POOR CONSTRUCTION PRACTICE



An example of a main which was buried without a coating or wrapping at the service connection. This corrosion problem could have been avoided by properly coating and cathodically protecting the pipe.

FIGURE III-24 ATMOSPHERIC CORROSION

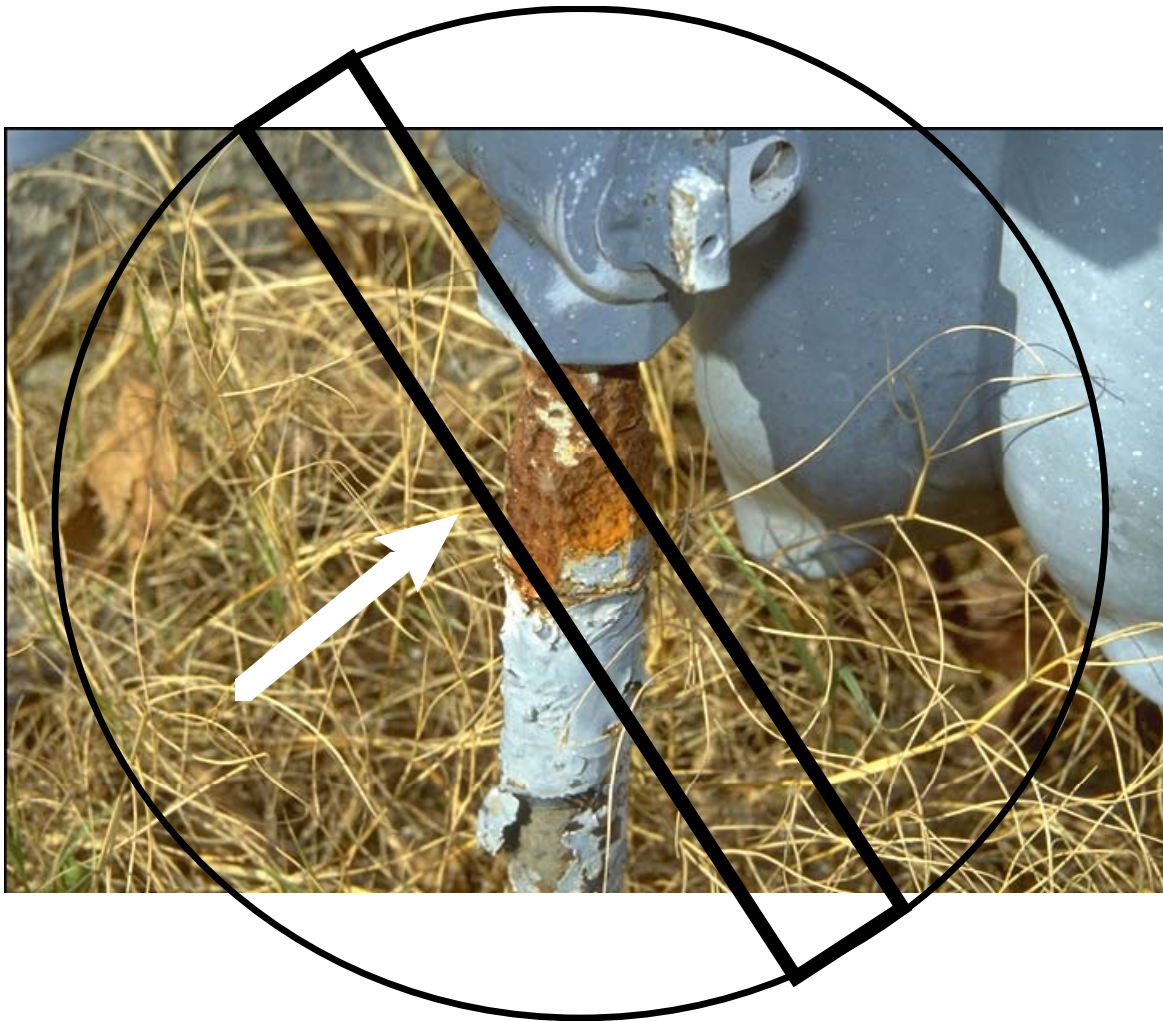

Atmospheric corrosion at a meter riser, as shown above, can be prevented by either jacketing the exposed pipe or by keeping it properly painted. Corrosion is usually more severe at the point where the pipe comes out of the ground.