

## Private Residential Pools and Spas Drowning Facts and Prevention Tips for Homeowners

*A backyard pool or spa can be lots of fun for the whole family, but there are some important things to remember before installing your new pool or spa*

### *Did You Know...*

- Among children ages 1 to 4 years, most drownings occur in residential swimming pools. Most young children who drowned in pools were last seen in the home, had been out of sight less than 5 minutes, and were in the care of one or both parents at the time. (*Washington State Dept of Health*)
- Drowning is the second leading cause of injury-related death for children ages 1-14 in the U.S.

Children are attracted to water. They can easily slip out the door and fall into the pool or spa if there is no barrier. Once a child falls in, they usually don't scream for help, they simply slip under the water quietly.



As a homeowner it is your responsibility to ensure that your pool or spa meets state and local building code requirements and is not a danger to young children. By following requirements and installing proper barriers for your new or existing pool or spa you can prevent drowning deaths.

New Washington State building code requirements for residential pools and spas are in effect as of **July 1, 2007**. These are **minimum** requirements. It is also important to contact your local building official as they may have different requirements. You have a variety of options for pool and spa barriers.

A 4-sided barrier that is **at least** 4 feet high and surrounds the pool or spa. The gate for this fence **must**

- be out of a child's reach, and
- be self-closing/self-latching.

### **Examples of fences that meet regulations**

a.) Solid barriers and fences must be **at least** 48 inches high. Gaps between the fence and ground must be less than 2 inches.

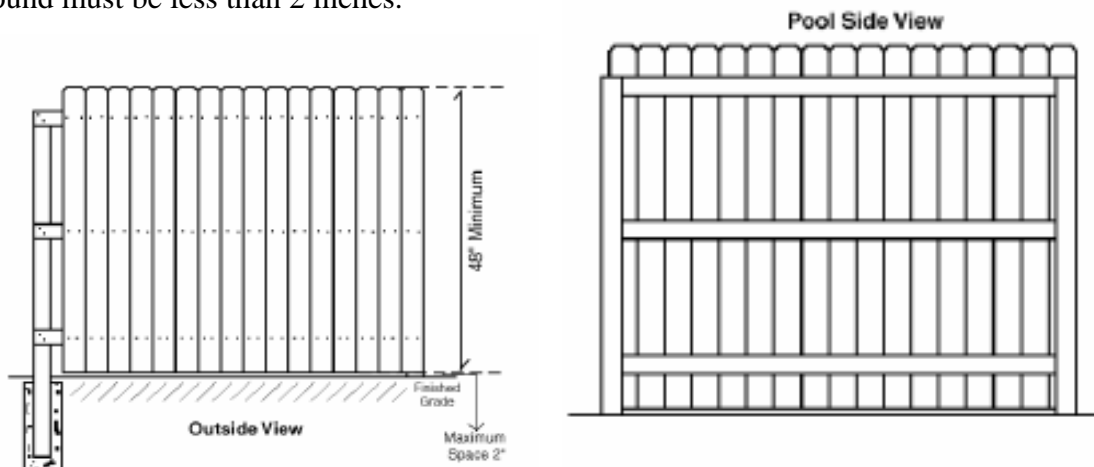

Examples of fences that meet regulations, cont.

b.) Barriers and fences with vertical spacing

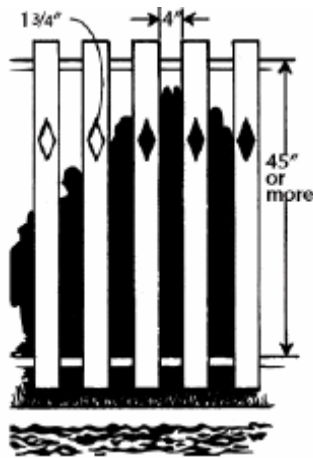

If top of horizontal members are **45 inches or more**, then the vertical members cannot be more than **4 inches**,

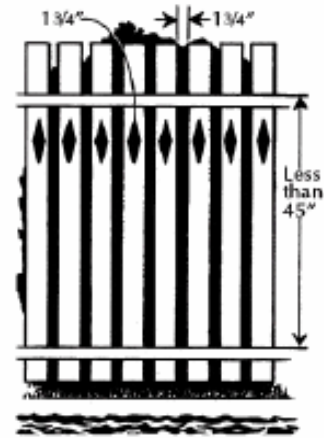

If top of horizontal members are **less than 45 inches** apart then the vertical members cannot be more than **1 3/4 inches**.

c.) Chain link or mesh fences

The **maximum** mesh size is **2.25 inches diagonal** and **3.18 inches across horizontally**. Using slats in chain link type fences can help reduce the ability for a child to climb over.

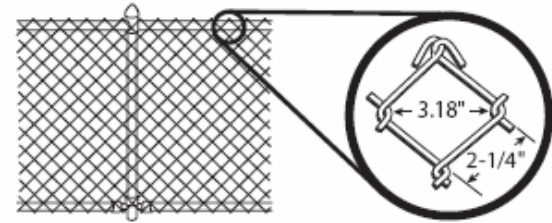

d.) Self-latching/ self-closing gates

If the release mechanism of the self-latching gate is **less than 54 inches** from the bottom of the gate, this release mechanism should be **at least 3 inches below the top of the gate on the side facing the pool**. This placement prevents a child from reaching over the top of the gate and releasing the latch. The gate should not have an opening **greater than 1/2 inch** within **18 inches** of the latch release mechanism. This also prevents a child from reaching through and releasing the gate.

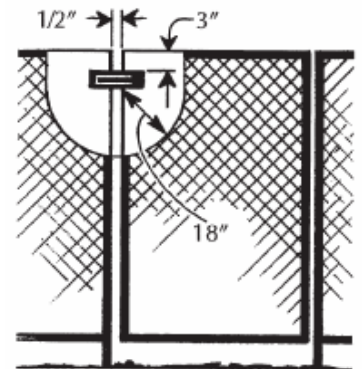

*Examples of fences that meet regulations, cont.*

### **For Above Ground Pools (water depth over 2 feet)**

These types of pools also need barriers. There are two ways to do this:

1.) The steps/ladder going up to the pool can be removed, or

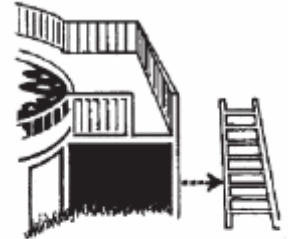

2.) The steps or ladder can be surrounded by a barrier. This barrier needs to meet regulations of the barriers described above.

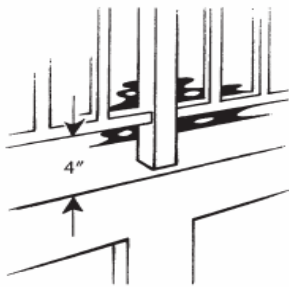

In addition, if an above-ground pool has a barrier on top of the pool, the **maximum vertical clearance between the top of the pool and bottom of the barrier should not exceed 4 inches**. Having these barriers for above-ground pools can prevent a child from climbing into them.

### **More on barriers**

Your house can serve as one side of the barrier. The other three sides must follow the same barrier regulations described above. If the house is serving as a side of the fence, the following rules apply:

- There must be an **alarm on doors that have direct access to the pool**. The alarm must sound when the door or screen is opened, and must continue for **at least 30 seconds within 7 seconds after the door is opened**.
- The alarm must be **at least 85 decibels when measured 10 feet away** and should be distinct from other household sounds (TV, doorbell, smoke alarm). The alarm can have a switch that **temporarily deactivates it for up to 15 seconds**, so adults can pass in and out of the house without setting off the alarm. The deactivation switch pad must be located **at least 54 inches** above the threshold of the door covered by the alarm (this is the reaching ability for most young children).

A power safety cover is another barrier option for pools, and a safety cover is an option for spas. This cover must support the weight of a young child and meet the safety performance requirements of the American Society for Testing and Materials Standards. If your private

pool or spa has a power safety cover or safety cover that meets all standards, additional barriers as described above would be **optional**.

### **A note about insurance policies**

As a homeowner, it is your responsibility to contact your insurance agency about your new pool or spa to ensure proper coverage from your homeowner's insurance. Your insurance agent should be aware of these new barrier regulations and how they may affect your current policy.

### **More tips on drowning prevention**

1. **RESTRICT ACCESS TO THE POOL.** The Association of Pool and Spa Professions (ASSP) recommends being aware of objects (like tables and chairs) that may allow children to climb over barriers and reach the pool or spa. In addition, tree limbs and overhanging roofs should be removed or made inaccessible in order to prevent contact with **the pool or spa**.
2. **ADULT SUPERVISION.** One of the easiest ways to prevent drowning in backyard pools and spas is supervision! According to *Safe Kids USA*, drowning is a quick and silent killer. In the time it takes to...

...cross the room for a towel (10 seconds), a child in the bathtub can become submerged.

...answer the phone (2 minutes), that child can lose consciousness.

...sign for a package at your front door (4 to 6 minutes), a child submerged in the bathtub or pool can sustain permanent brain damage.

### **Additional resources**

- **Your local building official** - <http://www.wabo.org/jurisdiction/map.html>
- **Washington State Building Code Council** - <http://www.sbcc.wa.gov/sbccindx.html>
- **Association of Pool and Spa Professionals** - [www.theapsp.org](http://www.theapsp.org)
- **U.S. Consumer Safety Product Commission**  
<http://www.cpsc.gov/cpscpub/pubs/chdrown.html>
- **Your local public health department** - <http://www.doh.wa.gov/LHJMap/LHJMap.htm>
- **Injury Fact Sheets**-[http://www.usa.safekids.org/content\\_documents/Drowning\\_facts.pdf](http://www.usa.safekids.org/content_documents/Drowning_facts.pdf)  
Clear Danger: A National Study of Childhood Drowning and Related Attitudes and Behaviors (2004) - <http://www.usa.safekids.org/NSKW.cfm>
- **Injury and Violence Prevention, Public Health- Seattle & King County, Pool and Water Safety** <http://www.metrokc.gov/HEALTH/injury/drowning.htm>
- **Children's Hospital and Regional Medical Center**  
Drowning Prevention and Water Safety Information  
[www.seattlechildrens.org/dp/](http://www.seattlechildrens.org/dp/) or [www.drowning-prevention.org](http://www.drowning-prevention.org)
- **Safe Kids USA** - <http://www.usa.safekids.org/index.cfm>