

# ***An Overview of DOE Research in the Science of Non-Defense High Energy Density Plasmas***

***Y. C. Francis Thio, Program Manager, HEDP  
Office of Fusion Energy Sciences (OFES), DOE  
[francis.thio@science.doe.gov](mailto:francis.thio@science.doe.gov)***

***Presented at the Plenary Session of the 10<sup>th</sup> Annual Symposium of the Directed Energy Professional Society, 6 Nov 2007, Huntsville, AL.***

## Key Points

- Current and upcoming experimental facilities provide opportunities for research at the frontiers of high energy density plasma science
- The US Office of Fusion Energy Sciences is conducting a program of research in high energy density laboratory plasmas (HEDLP) motivated by the science for inertial fusion energy
  - Fast ignition
  - Magneto-inertial ignition
  - Heavy ion fusion
- A new era in HED plasma physics, in directed energy and in the broader field of high energy density physics is beckoning

# The domain of high energy density plasmas

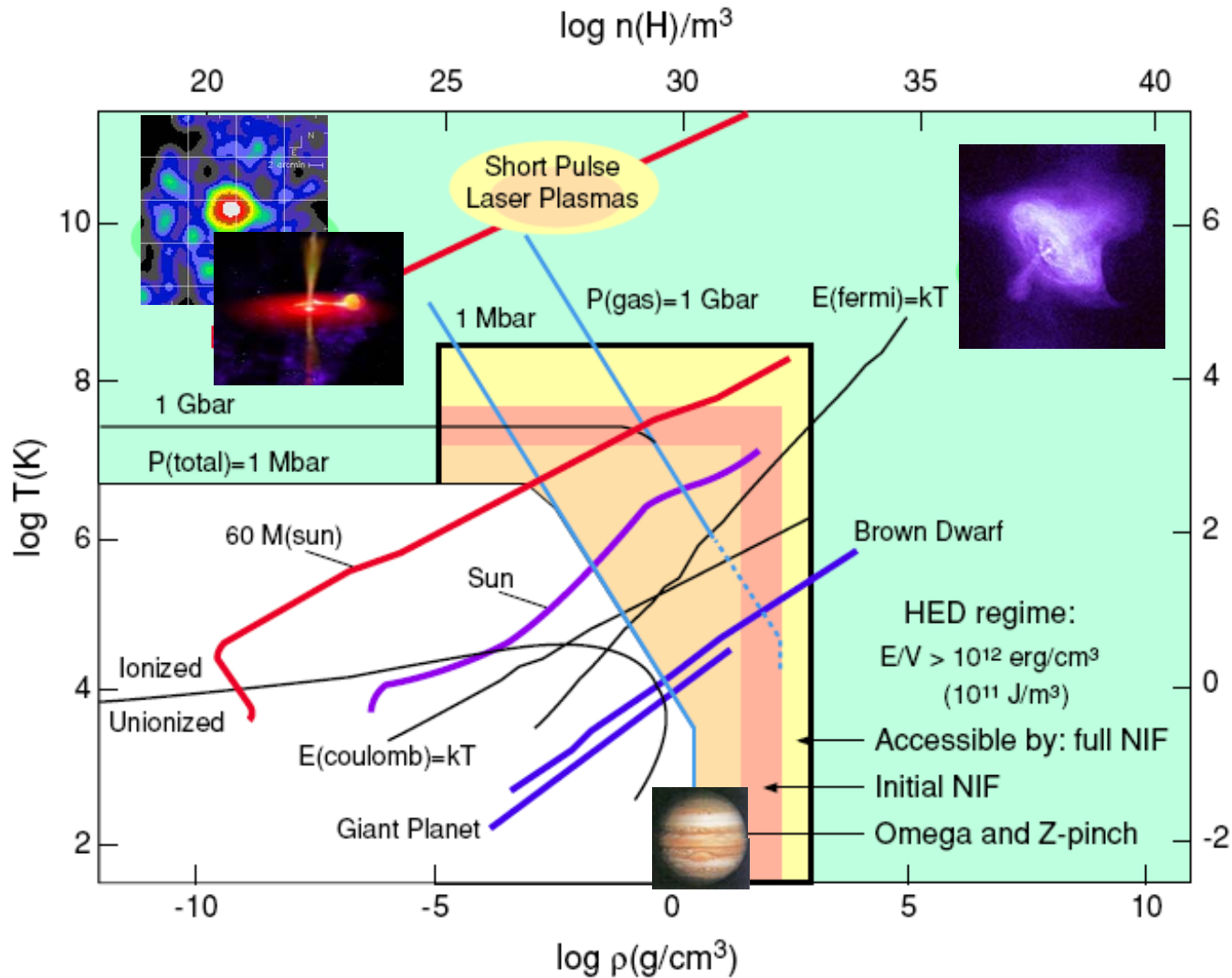

**HED Regime**  
**Pressure >**  
**~ 1 Mbar**

Enabling technologies:

- Lasers
- Particle beams
- Pulsed power
- Hypervelocity projectiles and plasma jets

# High Energy Laser – The National Ignition Facility (NIF)

Lawrence Livermore National Laboratory

NIF Laser System

- 192 Beams
- Frequency tripled Nd glass
- Energy 1.8 MJ
- Power 500 TW
- Wavelength 351 nm

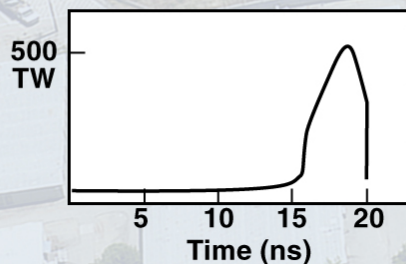

**Completion: 2009**  
**Ignition campaign: 2010 - 2012**

# OMEGA and OMEGA - EP at the University of Rochester

- OMEGA (Long pulse, ~10 ns)
  - 60 Beams, 30 kJ

- OMEGA-EP
  - Addition of 4 beams
  - 2 SP beams, 2 LP

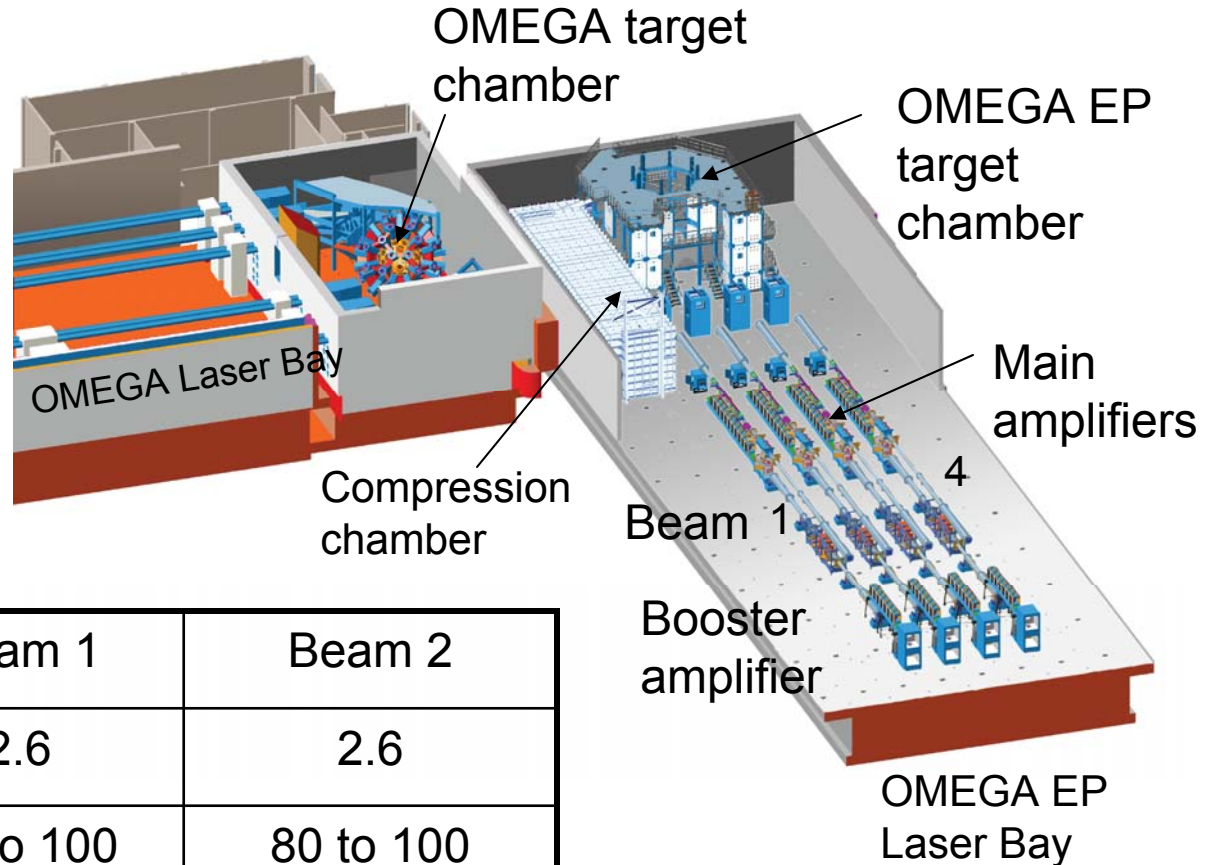

Short Pulse (SP)	Beam 1	Beam 2
IR energy (kJ)	2.6	2.6
Pulse duration at full energy (ps)	10 to 100	80 to 100
Focusing (diam)	>80% in 20 $\mu\text{m}$	>80% in 40 $\mu\text{m}$
Intensity ( $\text{W}/\text{cm}^2$ )	$3 \times 10^{20}$	$2 \times 10^{18}$



# Pulsed Power : Compact, Efficient, Cost-effective Z-R at the Sandia

Sandia National Laboratories  
Refurbished Z Pulsed Power Machine



## Major refurbishment completed 9/07

- New capacitors and laser trigger system
- Robust & optimized components
- Enhanced diagnostics infrastructure

## Designed increase in capabilities

- Variable pulse rise time: 100 to 300 ns
- Double the stored energy (20 MJ)
- 40% increase in load current (26 MA)
  - 50% increase - power radiated (350 TW)
  - 70% increase - energy radiated (2.7 MJ)
  - 40% increase - flyer plate velocity (>40 km/s)
  - 3x increase - peak ICE pressure (>10 Mbar)

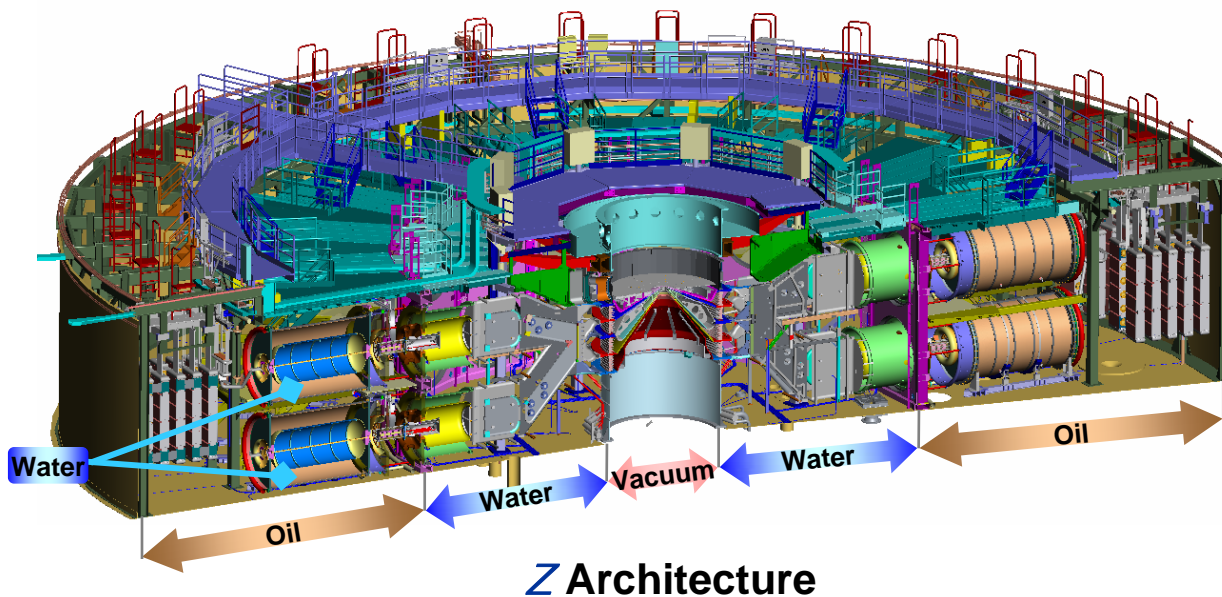

## Recent Z Accomplishments

- Dynamic material properties
  - Be & diamond melt
  - Pu
- Evaluated margins for stockpile component qualification
- Radiation flow for code validation
- Record D-D neutron yields in ICF capsules

# ***Shiva Star Pulsed Power Facility***

## ***Air Force Research Laboratory, Kirtland AFB, Alb, NM***

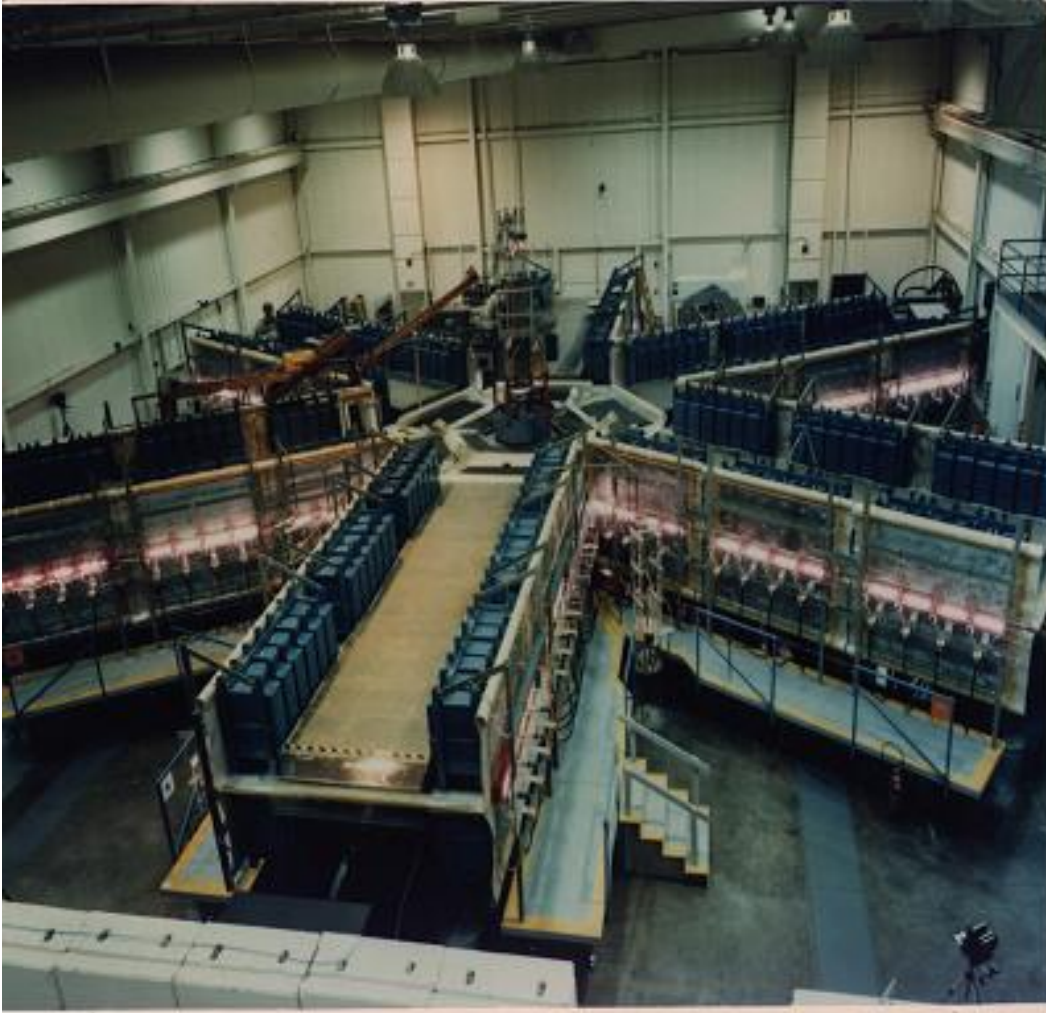

- 9-MJ stored energy at 120 kV
- 12 MA peak current with 3  $\mu$ s rise time
- Used by DOE for magneto-inertial fusion (MIF) research

# Particle Beams

- High coupling efficiency to target
- Versatile
- Induction Linac - Robust, rep-ratable technology

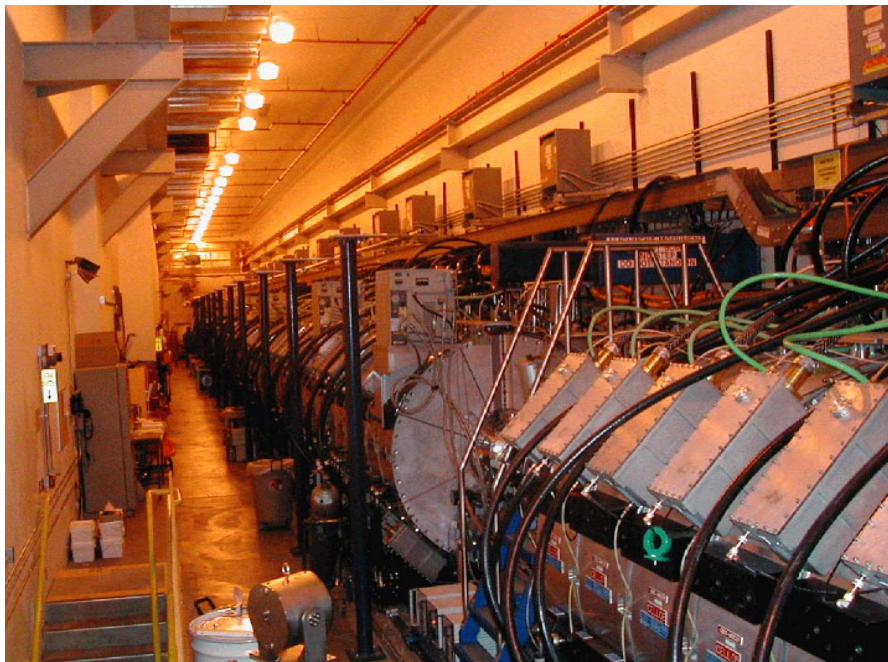
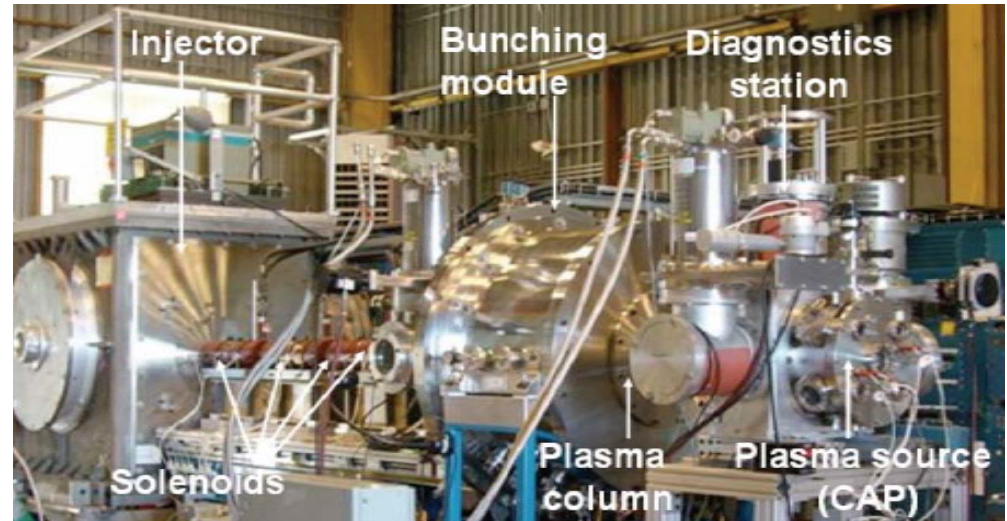

- Ballistic and velocity-ramp drift compression of ion beams with the help of a neutralizing plasma (LBNL, LLNL, PPPL)
- 1000x compression demonstrated
- Facility is ready for a beam-on-target experiment to create warm dense matter

• DARHT e-linac @>50 kJ/beam, 2 kA, 17/19 MeV – LANL, LBNL, LLNL

## ***The smaller facilities are an important part of our experimental infrastructure and capabilities ....***

- The NDCX ion beam facility at Lawrence Berkeley National Laboratory
- The COBRA pulsed power facility at Cornell (0.1 MJ, 1.2 MA, 0.5 MV, TW-class Marx bank with variable rise time from 70 ns to 250 ns)
- The Nevada Terawatt Facility (NTF) at UNR (1 MJ, 1 MA, 100 ns rise time)
- The Jupiter/Titans dual-beam PW laser facility at Lawrence Livermore National Laboratory (1 long 1 kJ, 1 short 300 J).
- The Trident laser facility at the Los Alamos National Laboratory (2 long 200 J each, 1 short 0.25 PW, 250 J).
- Texas Petawatt at the University of Texas at Austin (220 J in 150 fs)

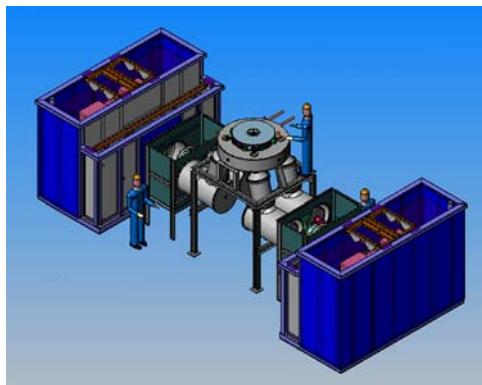

COBRA at Cornell

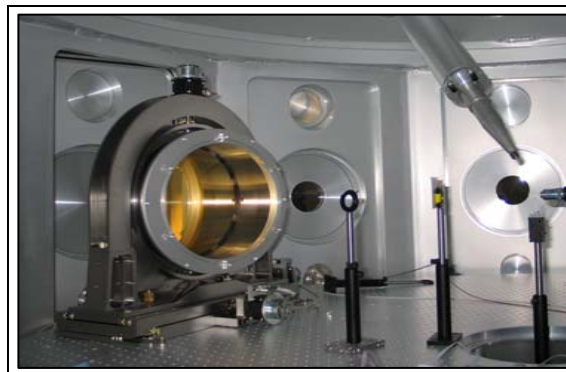

Jupiter/Titans at LLNL



Trident at LANL



# High Energy Density Plasmas in the Cosmos

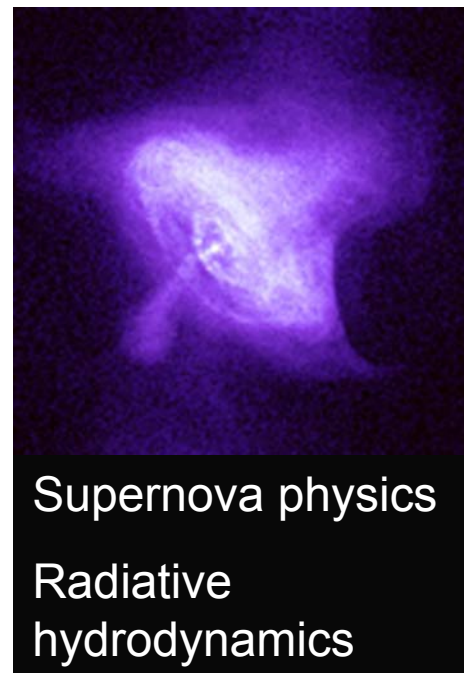
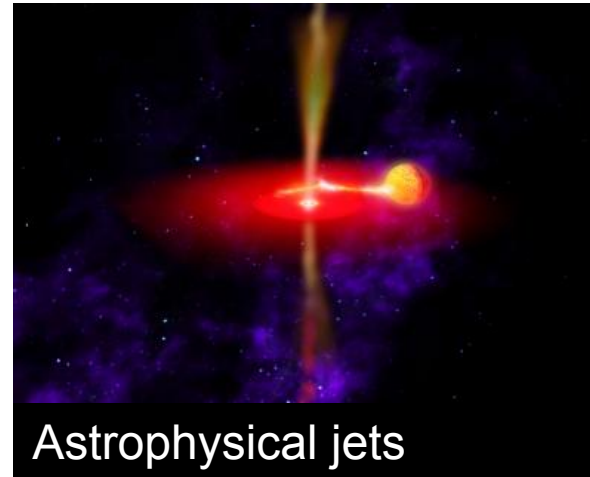
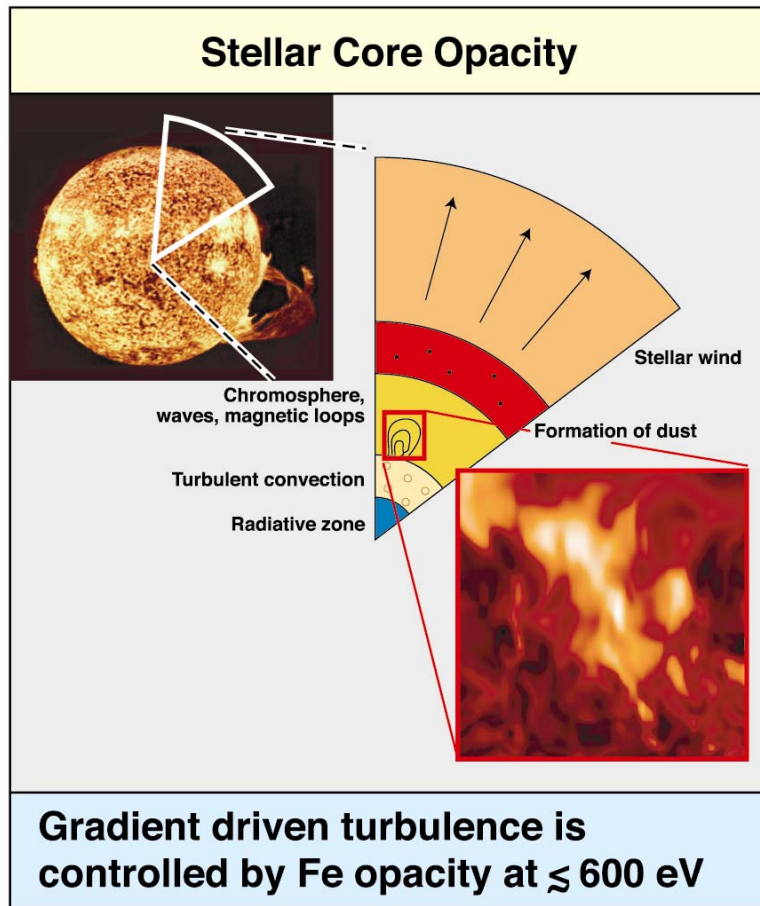

## Three DOE Missions Rely on HEDLP for Success

### National Security



- Major focus for HEDLP
- Laboratory ignition
- Boost
- “Non ignition” assessments

### Fundamental Science

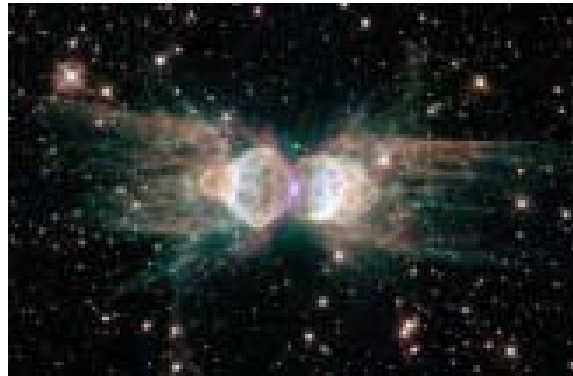

- Develop stewardship of high energy density laboratory plasma science

### Energy Science

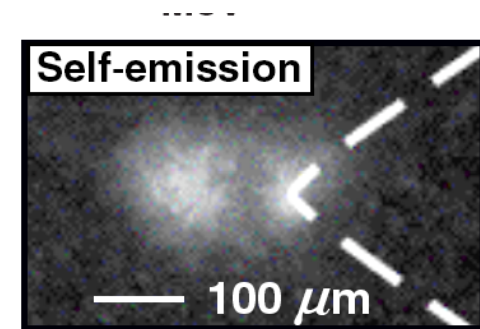

- Develop knowledge base of high energy density science for energy-related applications

**DOE five-year vision and plan in HEDLP: 2007 – 2012**

***The Office of Fusion Energy Sciences (OFES) and the National Nuclear Security Agency (NNSA) have established a Joint Program in High Energy Density Laboratory Plasmas (HEDLP)***

- **Initial main scientific themes<sup>1</sup>:**
  - Create, probe, and control new states of matter in HEDLP
  - Address challenges in inertial fusion energy sciences
- **Program evolution will be guided by Advisory Committee and community planning exercises**

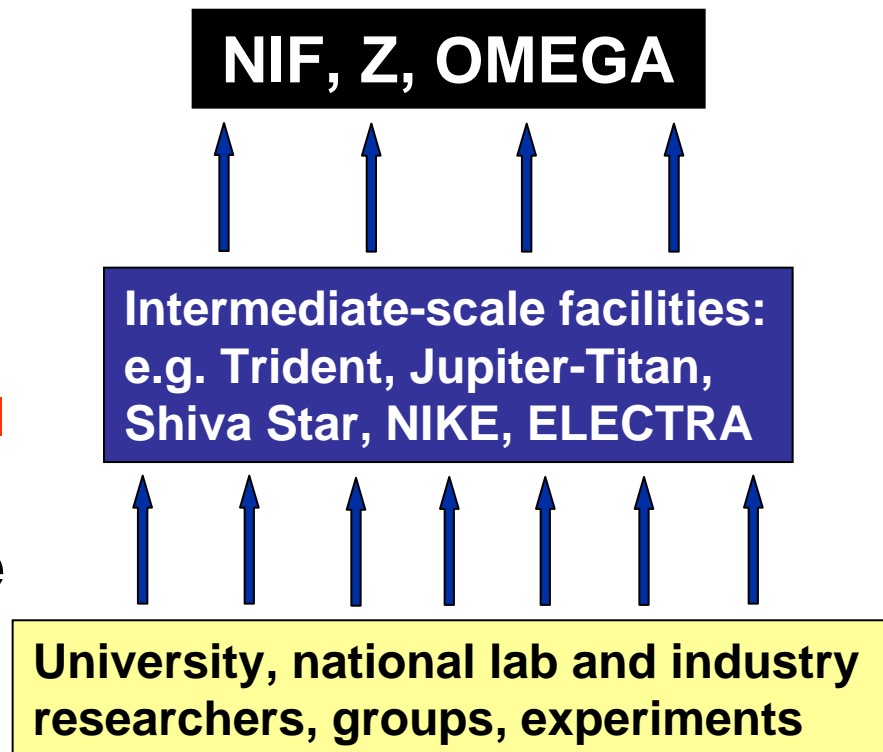

1. Recommended by community HEDLP Workshop at the Argonne National Lab (May 23–24, 2007) Chaired by Dr. Robert Rosner and Dr. John Browne

## ***Overview of Current High Energy Density Laboratory Plasma (HEDLP) Research in the OFES***

- Main program elements at present
  - Fast ignition and laser-plasma interactions
  - Magneto-inertial fusion
  - Heavy ion fusion science
- Expansion of the program to include some laboratory studies of astrophysics is under consideration
  - Astrophysical jets, gamma ray bursts, accretion discs, white and brown dwarfs, interiors of giant planets, supernova remnants, HED magnetic reconnection

# *The study of the inertial approach to create fusion reactions is one of the main source of HEDLP*

## Conventional inertial fusion

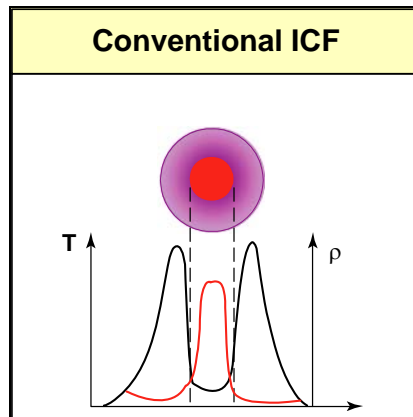
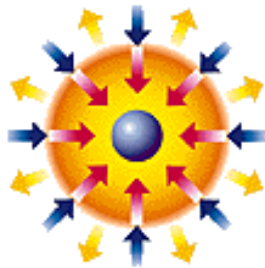

- A capsule containing a frozen mixture of deuterium and tritium is compressed
  - Create fuel with areal density  $(\rho R) > 1 \text{ g/cm}^2$
  - Create a hot spot
- The hot spot ignites the surrounding fuel, creating a fusion burn wave that propagates to the rest of the fuel
  - **Central Hot-Spot Ignition**
- Implosion velocity required  $\sim 400 \text{ km/s}$

***OFES HEDLP research explores the science motivated by the technical challenges of inertial fusion energy ....***

- Beyond NIF, for inertial fusion energy, the challenge is to produce ***ignition*** with ***sufficient gain***, repetitively for a few Hz, with suitable targets and drivers at ***reasonable cost***.
- **Potential approaches to increase fusion gain**
  - ***Lowering the implosion velocity*** in assembling the high-density plasma fuel
  - ***Increasing the coupling efficiency*** of the driver energy to the target

OFES research explores high energy density physics issues for lowering the implosion velocity, and/or increasing the coupling efficiency

- **Lowering the implosion velocity**
  1. Decoupling of ignition from fuel assembly
    - Use a second ultra-intense pulse of energy for ignition
    - **Fast ignition, impact ignition, shock ignition**
  2. Suppressing the electron thermal conduction losses from the hot spot using an ultrahigh magnetic field
    - **Magneto-Inertial Fusion**
- **Increasing the coupling efficiency**
  - Heavy ion beam drive
- ***High-risk, high-payoff research at the science frontiers of high energy density plasma physics***

# *Fast Ignition is a new scheme for inertial fusion*

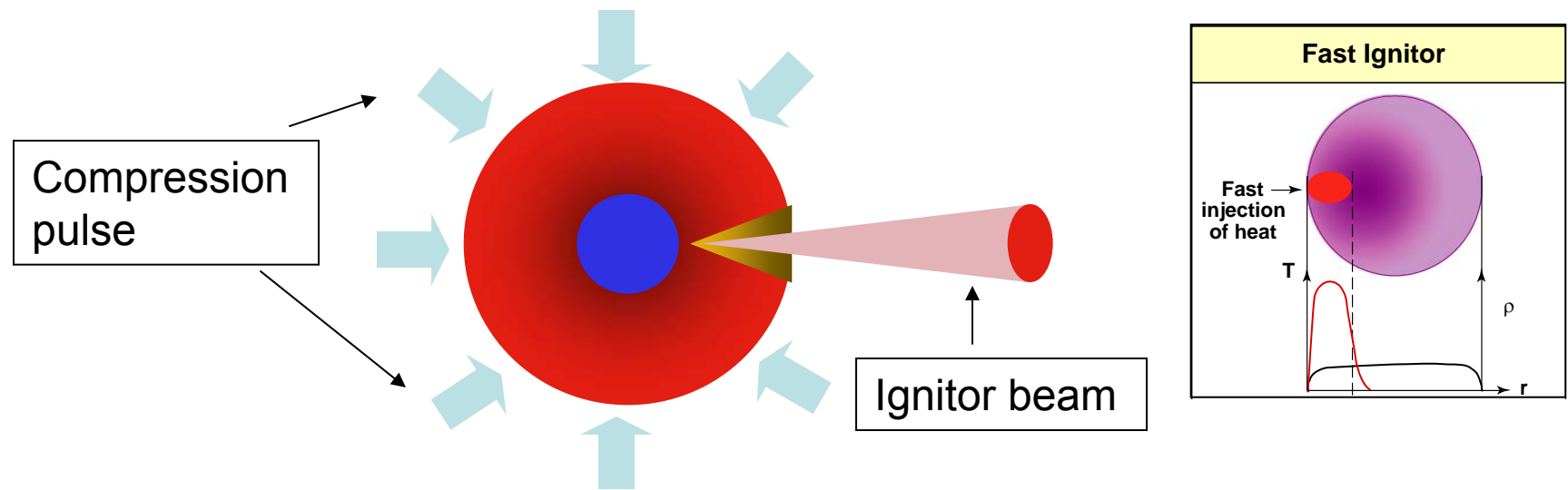

## Two pulses instead of a single pulse

- Uses a  $\sim 10$ -ns radiation pulse to compress the target to densities of several 100's g/cc (fuel assembly)
- Uses a second  $\sim 10$ -ps ultra-intense laser beam to ignite the assembled fuel.



***Fast ignition may attain higher fusion gain for the same total laser energy input***

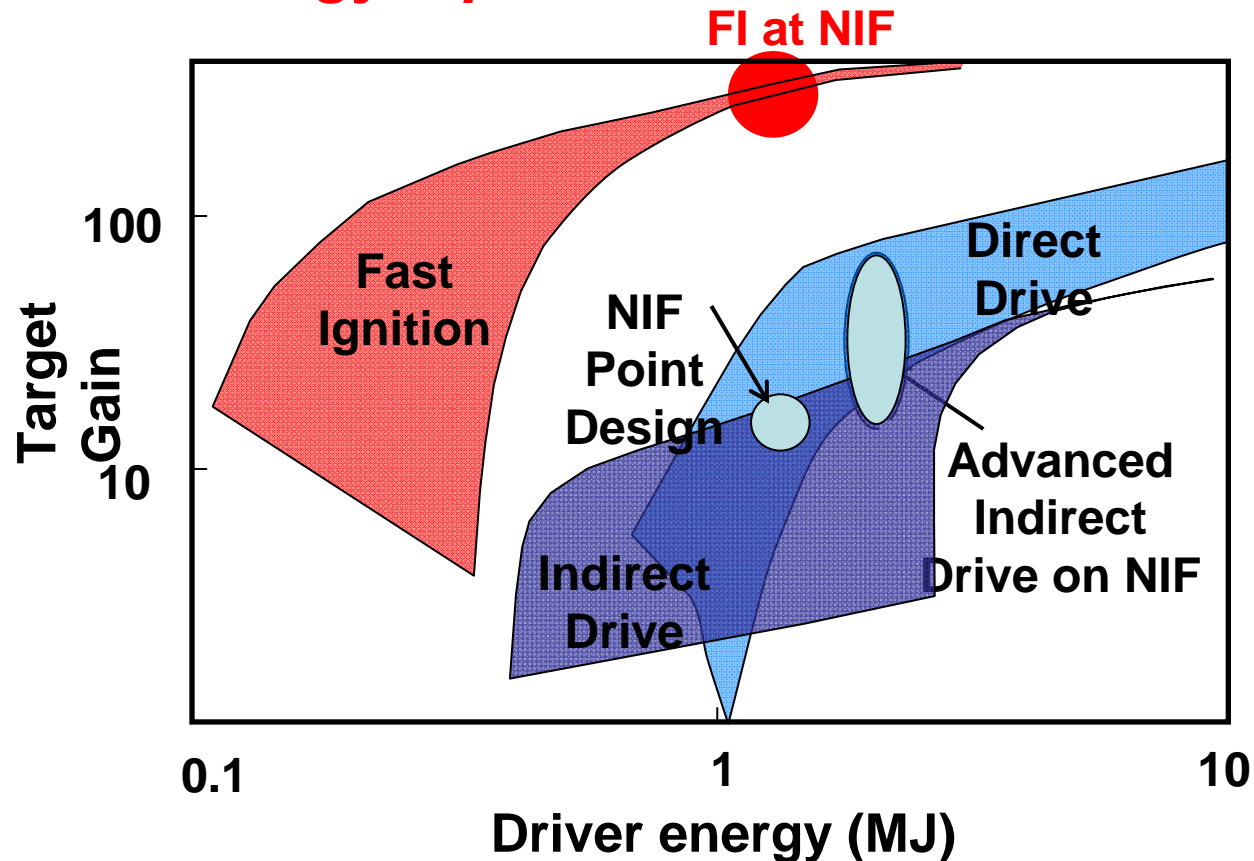

- Without the burden of ignition, the assembly of the fuel can be done slowly along a low-adiabat trajectory, with considerable saving in energy for the compression pulse
- Relaxes symmetry requirement for implosion – robustness for practical power applications

## *Fast ignition is science at the frontier of high energy density plasmas*

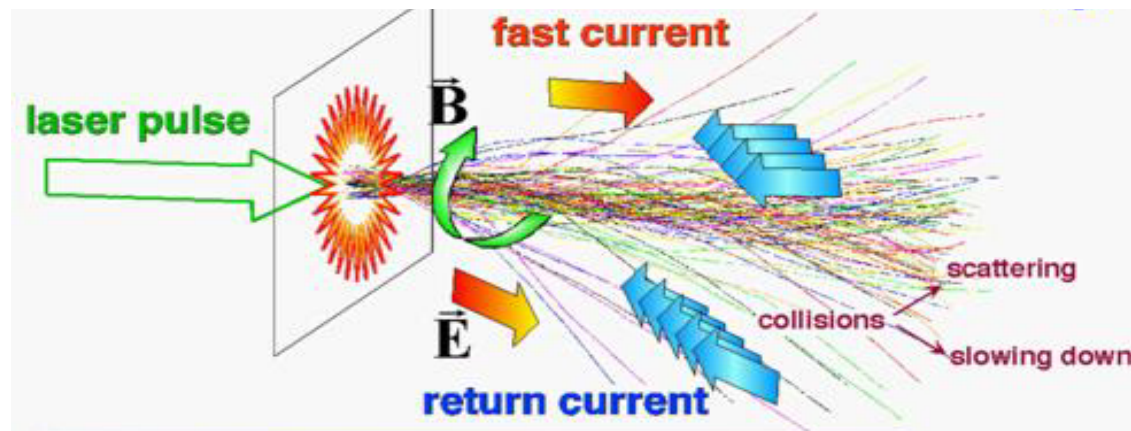

- The petawatt laser beam accelerates the electrons to relativistic energy ( $> 1$  MeV) by the ponderomotive force
- A relativistic electron jet is formed in the presence of a neutralizing plasma
- The electron jet ignites the compressed fuel
- Transport of the electron jet (the ignitor) through the compressed (dense) fuel is unexplored territory

## ***OFES Program Plan in Fast Ignition (FI)***

- **Develop scientific knowledge base to enable design of integrated FI experiment with fusion gain  $Q \sim 0.1$  (2010)**
  - Develop low-velocity, low-adiabat drive for fuel assembly
  - Unravel the physics of ignitor energy creation and transmission
  - Develop modeling capability for designing integrated FI
- **Field integrated FI experiments and demonstrate  $Q \sim 0.1$  (2012)**
- **Design and field ignition class experiments on NIF (2015)**

# OFES Program in Fast Ignition

- The program involves a number of universities, national labs and private industry
  - University (Rochester, Ohio State, UC-Davis, UC-San Diego, Nevada-Reno, MIT, Texas-Austin)
  - National Laboratory (LLNL, SNL, LANL, PPPL)
  - Industry (GA, Voss, HyperV)
- Strong collaborations with Japan and the United Kingdom



Jim King -  
adjusting Cu-K<sub>α</sub>  
imager at RAL



Joint US-Japan  
team in Gekko  
control room at ILE



PPPL

UT-Austin

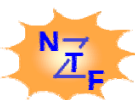
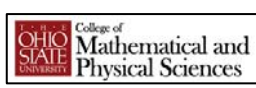

RAC



GENERAL ATOMICS



UCSD



*Low velocity, low adiabat implosions have been demonstrated at U. Rochester to achieve high areal density*



$$\rho R \sim E_L^{0.33} / \alpha^{0.55}$$

$$\rho \sim V_i / \alpha$$

$$\langle \rho \rangle \approx 300 - 500 \text{ g / cc}$$

$$\rho \sim \text{uniform}$$

Optimum density for fast ignition

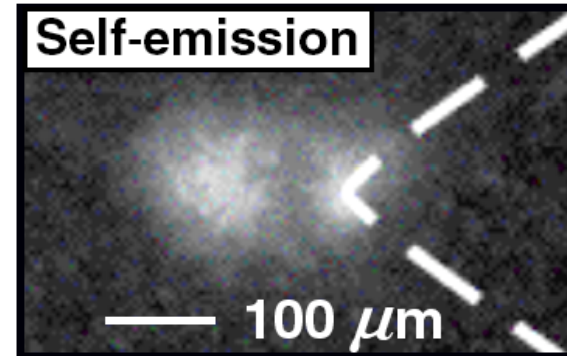

- Fusion Science Center of the U. Rochester
- Assembled CH surrogate at 0.26 g/cm<sup>2</sup>

R. Betti and C. Zhou, Phys. Plasmas 12, 110702 (2005);  
R. Betti et al, Plasma Physics Cont. Fusion 48, B153 (2006)  
R. Betti and C. Zhou, J. Phys. IV 133, 59 (2006)  
C. Zhou and R. Betti, submitted to Phys. of Plasmas

## *A predictive capability for the ignitor physics is needed*

- We do *not* yet have a predictive capability for the transport of the hot electrons through the compressed fuel
  - Equation of states
  - Transport properties
    - Electrical, thermal
    - In the presence of B fields
  - Beam and plasma instabilities
    - Weibel instabilities
- Experiments are required to guide the code development
- We are pursuing the experiments and doing the code development

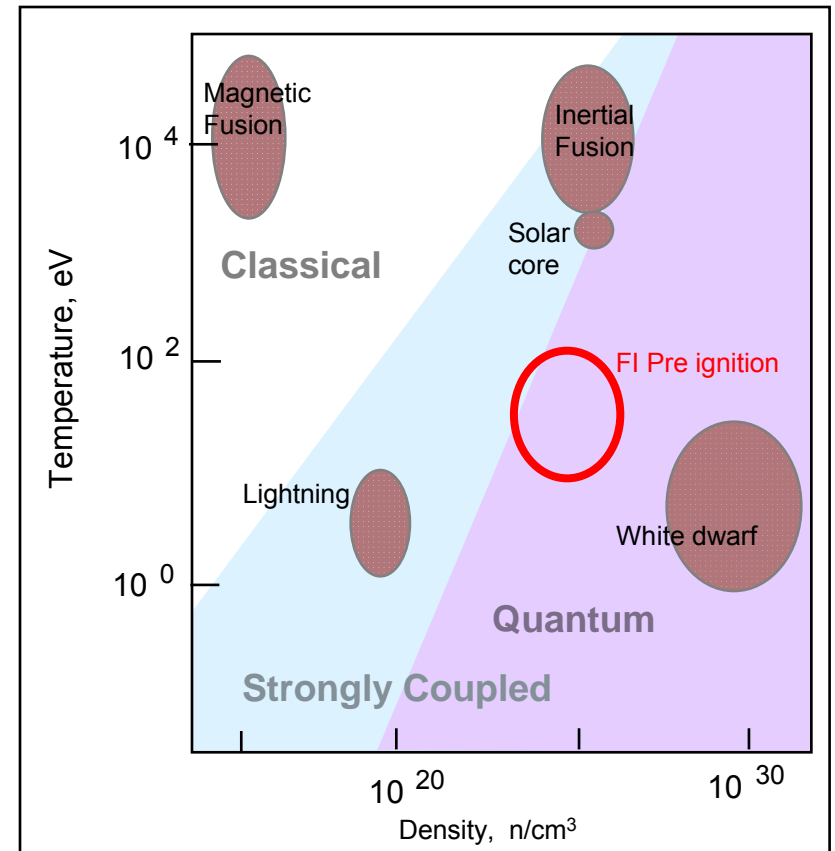

## ***Magneto-Inertial Fusion (MIF)***

***- Create, probe and control new states of plasmas in ultrahigh magnetic fields***

- Two different classes of MIF
  1. High-Gain MIF
  2. Low-to-Medium Gain MIF
- Both make use of a strong magnetic field (MGs) to suppress thermal losses from the hot spot or target plasma to the imploding shell
- But use different strategies in addressing the target and driver challenge for IFE

## ***High-Gain MIF is conventional ICF with an ultrahigh magnetic field in the hot spot***

- The target is seeded with a B-field of  $\sim 10$  T prior to implosion, and is then imploded
- The magnetic flux is frozen with the hot central part of the plasma, and is compressed with the plasma
- At peak compression, the magnetic field increases to  $\sim 1000$  T.
- Two good things happen\*:
  - The cross field thermal conductivity is reduced by  $\sim 100$ . Thermal losses from the hot spot is slowed down.
  - The gyro-radius of the alpha particles  $\sim 27 \mu\text{m}$ . Alpha deposition in the hot spot is enhanced.
- Lowers the ignition requirement for implosion velocity and power

\*With plasma conditions of NIF point design: McKenty et al.  $\rho_{\text{hs}} \sim 30 \text{ g/cc}$ ,  $T_{\text{hs}} \sim 7 \text{ keV}$ ,  $r_{\text{hs}} \sim 50 \mu\text{m}$



## **Flux compression experiments for High-Gain MIF are underway OMEGA Laser Fusion Facility of the U. Rochester**

- A seed field of  $\sim 10$  T is generated with a double coil in a cylindrical target
- 40 beams of the OMEGA laser will be used to compress the target.
- 20 beams of the laser will be used to implode a  $D+^3He$  filled glass micro-balloon to generate 14.7-MeV protons for measuring the compressed magnetic fields by deflectometry

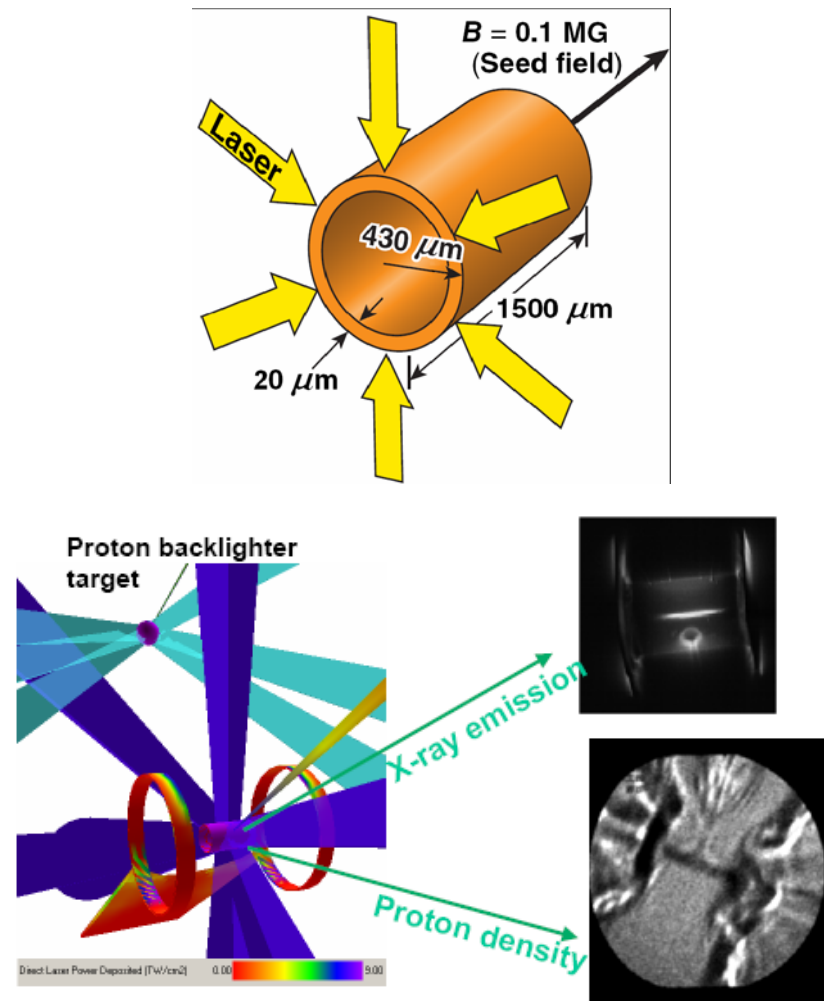

## ***Low-to-Intermediate Gain MIF***

- Trades fusion gain in favor of non-cryogenic gaseous targets and high-efficiency low-cost drivers using **direct EM pulsed power**
- ***With considerably higher wall-plug efficiency, target fusion gain needed for economic power generation can be much lower than conventional ICF.***
  - e.g.  $\eta_D \sim 30\%$ ,  $G \sim 30$  would be sufficient (vs 200 in conv. ICF)
- Larger target size  $\rightarrow$  longer confinement time
- Lower fusion gain requirement and longer confinement time available  $\rightarrow$  lower target density for burn
  - ***Gaseous initial targets instead of cryogenic solid targets***
- **By 2012, demonstrate multi-keV, multi-MG, fusing plasmas**
- **Imploding shell (liner): solid or plasma**

# Solid-Liner Driven MIF (Low-Gain MIF)

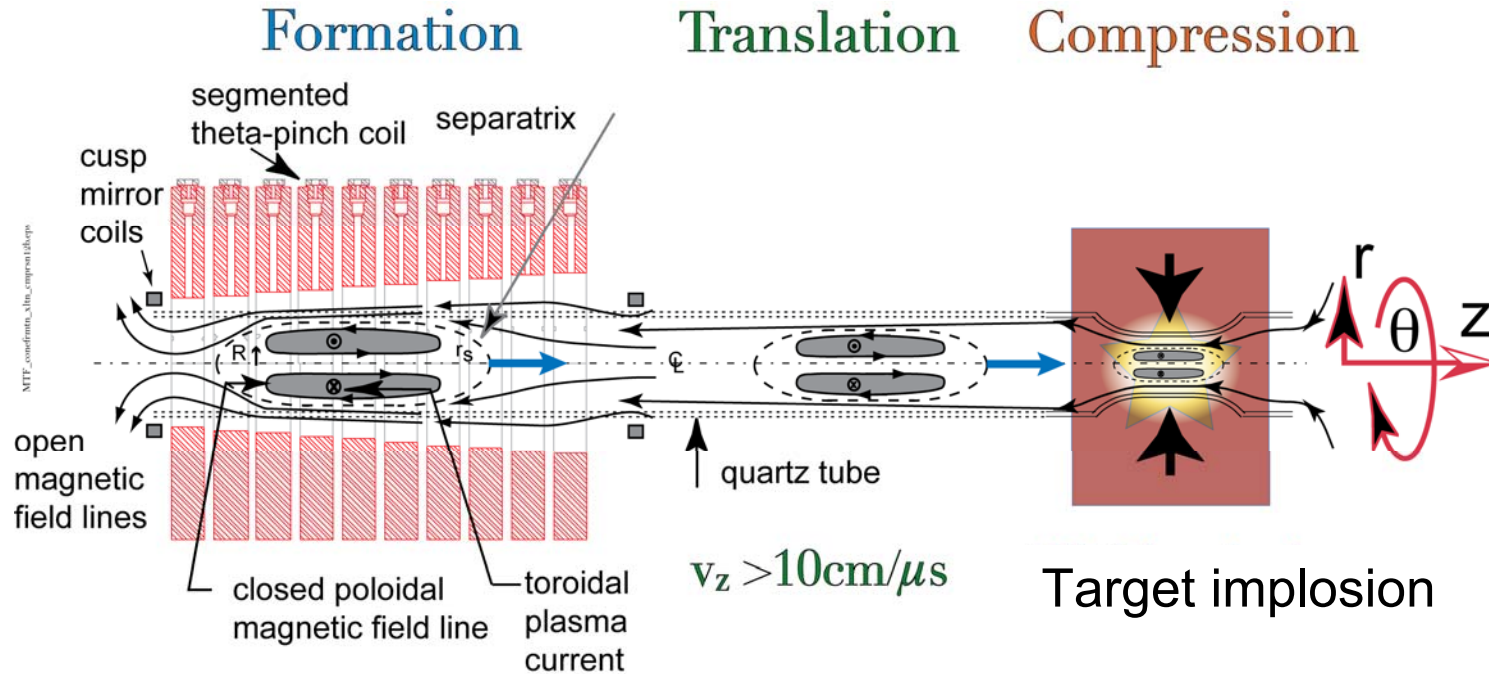

- A variety of target configurations, topologies, sizes are possible:
  - Field reversed configuration (FRC), spheromaks, z-pinch, diffuse pinches, etc.
- Initial target density:  $10^{16} - 10^{19}$  per cc
- Initial target temperature: 100 eV – 300 eV
- Radial convergence ratio:  $\sim 10$

## *The main experiment for solid-liner driven MIF*

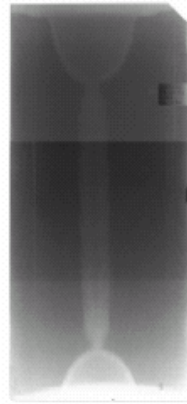
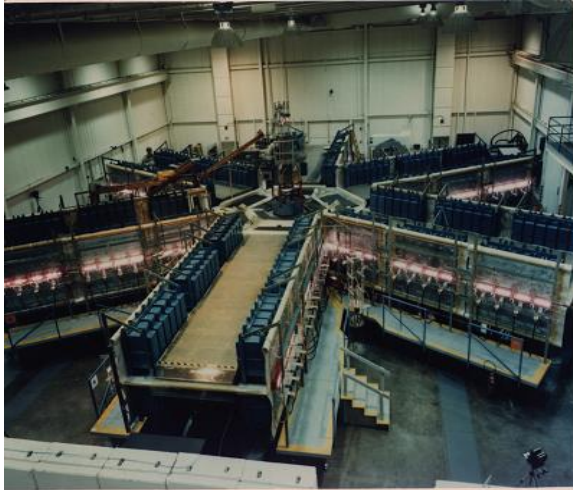

Concept exploration experiment

- Target : FRC 30 cm long x 10 cm dia
- Liner: Al shell, 30 cm long, 10 cm dia, 1 mm thick
- By 2012, (1) develop predictive understanding of the dominant physical processes governing MIF, (2) create multi-keV, multi-MG, HED plasmas

- **Shiva Star pulsed power fac**
- An Al shell, 30-cm long, 10 cm diameter, 1.1 mm thick has been imploded, achieving
  - peak implosion velocity: 0.5 cm/ $\mu$ s
  - radial convergence: 16x
  - No observable Rayleigh-Taylor

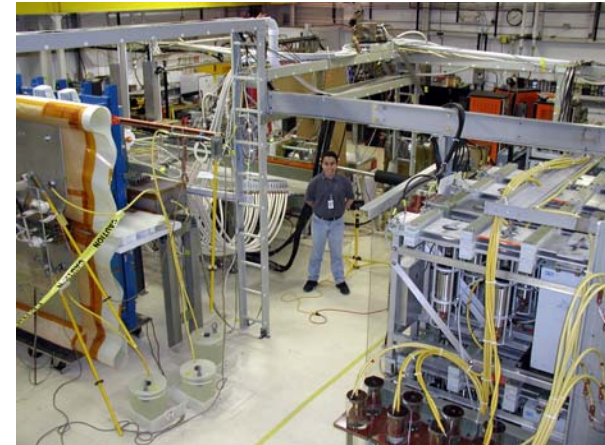

**Los Alamos National Laboratory  
FRX-L pulsed power facility**  
Demonstrated FRC  $\sim 5 \times 10^{16}$  cm<sup>3</sup>,  
300 eV,  $\sim 10$   $\mu$ s

## **Plasma-liner driven MIF** **- Intermediate gain**

- Converging array of plasma jets can be merged to form plasma shells (liners) for imploding a magnetized plasma

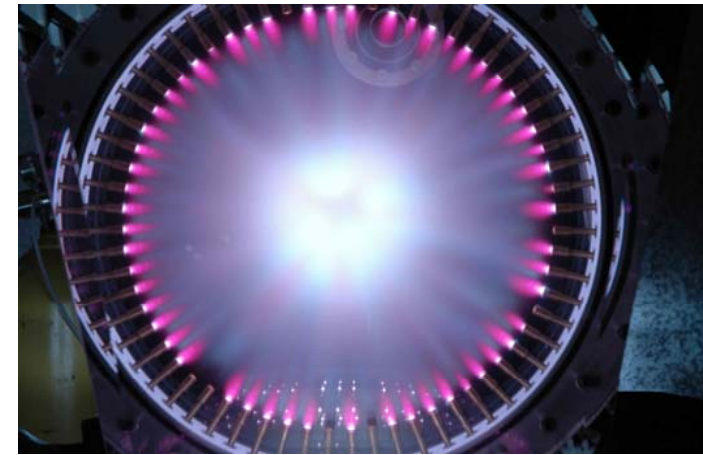
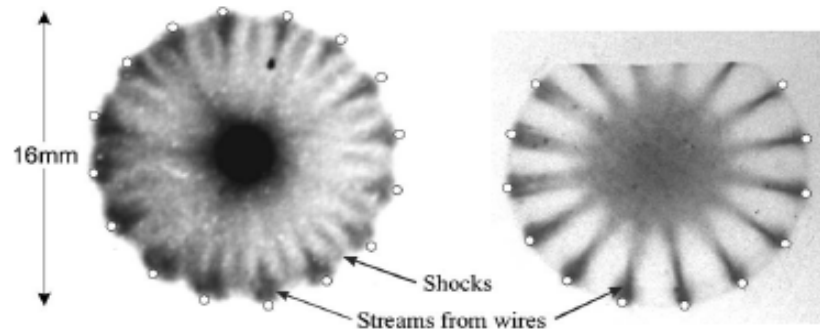

Plasma jets from capillary discharges merge to form a plasma liner (Witherspoon, 2007)

- Very high Mach-number plasma flows have been seen in wire-array Z-pinch
- Radial plasma flows stagnate on axis forming dense HED plasmas (Bott, et. al. Phys Rev E, 74, 2006)

- Address 3 major issues for low-to-intermediate gain MIF
  - Standoff delivery of liner
  - Repetitive operation
  - Liner fabrication and cost
- Plasma jets with Mach number  $> 20$ ,  $10^{17}$  per  $\text{cm}^3$ , 200 km/s, are required in order to produce implosion with radial convergence  $> 10$ , and pressures  $> 1$  Mbar

# OFES development of advanced accelerator to produce high Mach-number, high-density plasma jet is underway

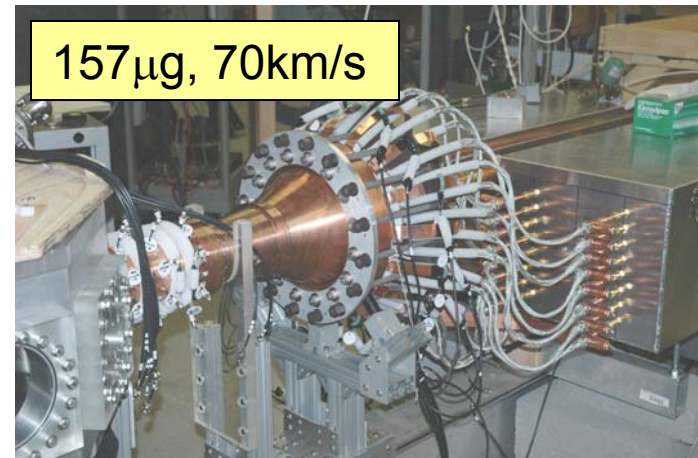
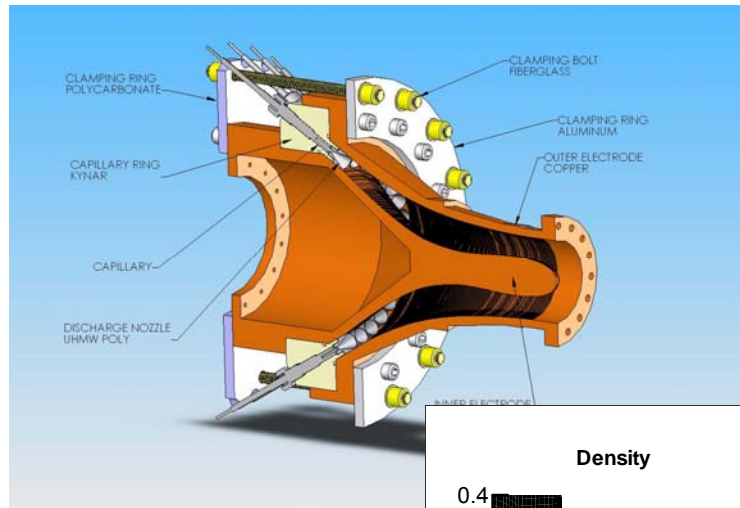

Pulsed power facility to develop advanced plasma guns at HyperV Technologies Corporation, Virginia, USA

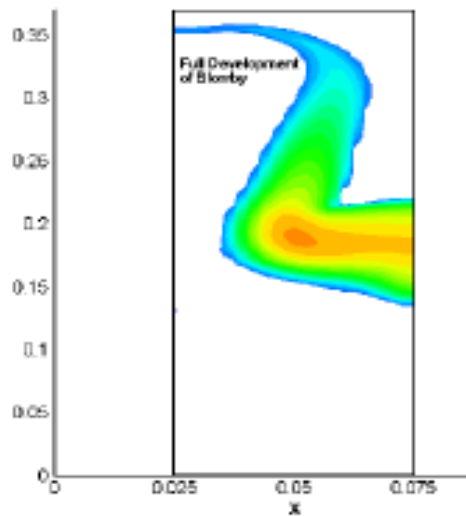

Conventional suffers from blow-by

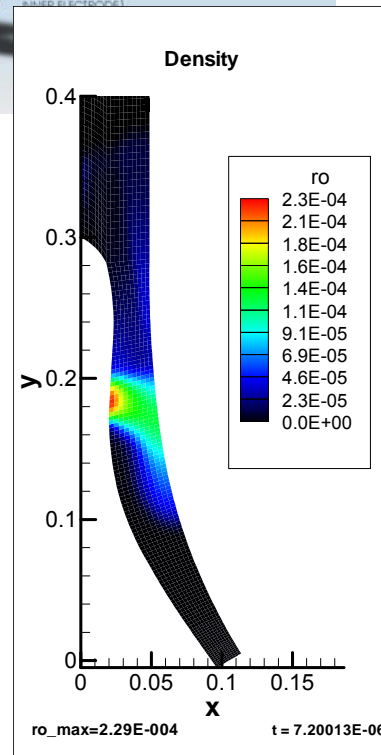

- By 2010, demonstrate Mach > 10,  $10^{16}$  per cc, 200 km/s
- If successful, (1) demo jets merging to form imploding liner, (2) demo Mach ~ 20,  $10^{17}$  per cc, 200 km/s by 2012.

## ***Experiment to study the behavior of the magnetized target plasma imploded by a plasma liner***

- $\theta$ -pinch is a convenient way of generating cylindrical plasma shell for imploding a magnetized plasma.

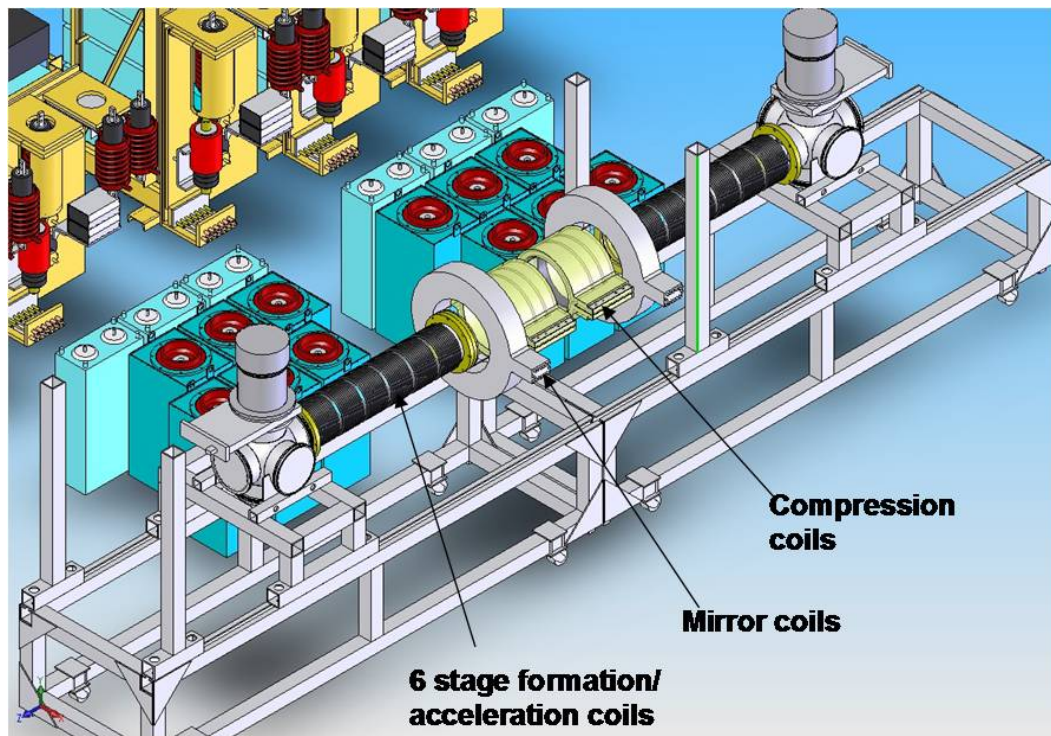

Experimental facility under development at the U. Washington – Seattle

- Create high density ( $> 10^{19}$  per  $\text{cm}^3$ ) and multi-keV magnetized plasmas over the next five years

- Two inductive plasma accelerators (IPA) have been developed, each accelerate an FRC to  $\sim 200$  km/s
- The two FRC collide forming a hot FRC of  $\sim 500$  eV
- Cylindrical plasma liners will be generated by a  $\theta$ -pinch to implode the FRC

# Heavy ion fusion science

- High coupling efficiency of the beam to target
- Robust, rep-ratable technology
- Warm dense matter and strongly coupled plasmas
- HED physics of inertial fusion energy sciences (IFES)
- Non-neutral plasma physics
- Pioneering beam compression in neutralizing plasma
  - Ballistic (transverse)
  - Velocity ramp (longitudinal)

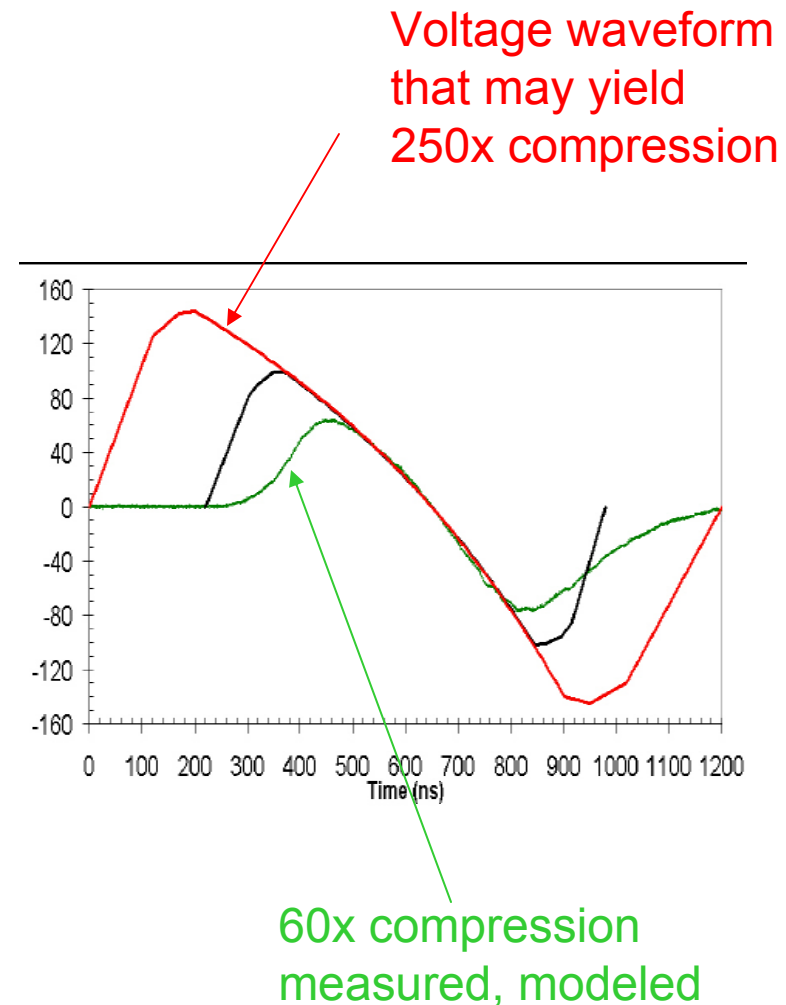



# Program Plan for Heavy Ion Fusion Science

- NDCX-I (by 2008)
  - Integrate neutralized drift compression with transverse (ballistic and magnetic) focusing
  - Demonstrate intensity amplification of  $\sim 1000X$
  - Conduct first beam-on-target WDM experiments in 2008 ( $\sim 0.5$  eV and solid density; transient darkening experiment)

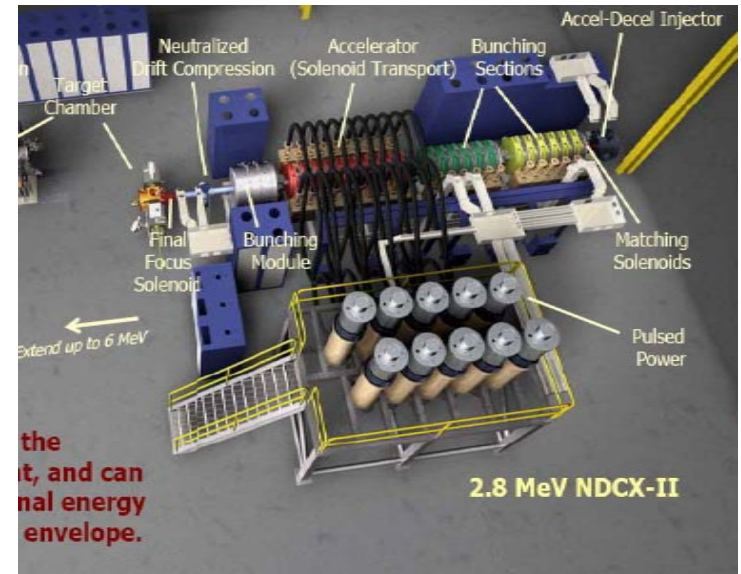

- Develop NDCX-II (2011)
  - 2.8 MeV, high-intensity beam
- WDM studies at  $\sim 1$  eV
- HED physics for inertial fusion energy sciences
  - **Hydrodynamics experiments for stability and ion ablative direct drive target physics**
  - **Explore heavy ion fusion in two-sided polar direct drive**

## *Summary*

- Current and upcoming experimental facilities provide opportunities for research at the frontiers of high energy density plasma science
- The US Office of Fusion Energy Sciences is conducting a program of research in high energy density laboratory plasmas (HEDLP) motivated by the science for inertial fusion energy
  - Fast ignition
  - Magneto-ignition
  - Heavy ion fusion
- A new era in plasma physics, in directed energy and in the broader field of high energy density physics is beckoning