

**U.S. DEPARTMENT OF COMMERCE
NATIONAL OCEANIC AND ATMOSPHERIC
ADMINISTRATION**

**U.S. DEPARTMENT OF INTERIOR
BUREAU OF RECLAMATION**

**U.S. DEPARTMENT OF ARMY
CORPS OF ENGINEERS**

**HYDROMETEOROLOGICAL REPORT NO. 57
(SUPERCEDES HYDROMETEOROLOGICAL REPORT NO. 43)**

**PROBABLE MAXIMUM PRECIPITATION -
PACIFIC NORTHWEST STATES
Columbia River (including portions of Canada),
Snake River and Pacific Coastal Drainages**

Prepared By

**E. M. Hansen, D. D. Fenn, P. Corrigan and J. L. Vogel
Water Management Information Division
Office of Hydrology
National Weather Service
and**

**L. C. Schreiner and R. W. Stodt
Flood Section, Surface Water Branch
Earth Sciences Division
Bureau of Reclamation**

**Published by
National Weather Service
Silver Spring, MD
October 1994**

TABLE OF CONTENTS

ABSTRACT	1
1. INTRODUCTION	2
1.1 Background	2
1.2 PMP Definition and Philosophy	2
1.3 Authorization	3
1.4 Study Region	3
1.5 Scope of Study	4
1.6 Method of Study	4
1.7 History and Rationale	6
1.8 Reclamation Cooperation	7
1.9 Peer Review	8
1.10 Organization of the Report	9
2. SIGNIFICANT STORMS	11
2.1 Introduction	11
2.2 Storm Data Analysis	16
3. TERRAIN	17
3.1 Subregional Analysis	17
3.2 Barrier-Elevation Map	21
4. MOISTURE ANALYSIS	24
4.1 Introduction	24
4.2 Revised Monthly Maps of 12-Hour Maximum Persisting Dew Point	25
4.3 Determination of Storm Dew Points	41
5. AUTOMATED PRECIPITATION DATA (MINI-STORM) ANALYSIS	46
5.1 Introduction	46
5.2 Grid Selection, Map Projection Selections	47
5.3 Precipitation Data Analysis Procedure	48
6. STORM SEPARATION METHOD	51
6.1 Introduction	51
6.2 Changes to the Previously Published SSM	52
7. CONVERGENCE COMPONENT OF PMP	63
7.1 Introduction	63
7.2 In-place Moisture Maximization	63
7.3 Vertical Adjustment Factor	66
7.4 Horizontal Transposition Factor	67

7.5 Analysis of FAFP	70
7.6 Controlling FAFP Storms	71
8. OROGRAPHIC FACTOR	74
8.1 Determination of T/C	74
8.2 Determination of M	76
8.3 The analysis of K	80
9. THE GENERAL STORM PMP INDEX MAP AND SEASONAL VARIATION	83
9.1 Adjustments to the General Storm Index Map	85
9.2 Monthly and Seasonal Variation of General Storm PMP Index Values	88
9.2.1 Introduction	88
9.2.2 Analysis	88
10. DEPTH-AREA-DURATION RELATIONS	100
10.1 Introduction	100
10.2 Depth-Area Development	100
10.2.1 Orographic Relations	100
10.2.2 Least-Orographic Relations	104
10.3 Depth-Duration Development	105
10.3.1 Storm Sample Approach	105
10.3.2 Adopted Depth-Duration Approach	109
11. LOCAL STORM PMP	118
11.1 Introduction	118
11.2 Record Storms	119
11.2.1 Introduction	119
11.2.2 Meteorology of Extreme Local Storms	119
11.2.3 Synoptic Study of Northwest Extreme Local Storms	125
11.3 Adjustment for Maximum Moisture	126
11.3.1 Background	126
11.3.2 Maximum Persisting 3-Hour Dew Points	126
11.4 Adjustments for In-Place Maximization	127
11.5 Adjustments for Elevation	127
11.6 Adjustment for Horizontal Transposition	135
11.7 Durational Variation	135
11.7.1 Background	135
11.7.2 Analysis	135
11.7.3 Temporal Variation	138
11.8 Depth Area Relations	142
11.8.1 Background	142
11.8.2 Additional Depth-Area Analysis	143
11.8.3 Areal Distribution Procedure	145
11.9 One-Hour, 1-mi ² Local Storm PMP Map	154

11.9.1	Introduction	154
11.9.2	Development of 1-hour, 1-mi ² Local Storm PMP Map	154
11.9.3	Analysis of Local Storm PMP Map	155
11.9.4	Comparison with Other Studies	156
12.	INDIVIDUAL DRAINAGE PMP COMPARISONS	159
13.	COMPARISON STUDY	169
13.1	Comparison to NOAA Atlas 2	169
13.2	Comparison to HMR 43	171
13.3	Comparisons Between General and Local-Storm PMP	173
13.4	Comparisons to Observed Storm Maxima	174
13.5	Comparison of PMP Change with Time	180
13.6	Comparison Between Adjoining Drainages	181
13.7	Comparison Between Neighboring Studies	182
13.7.1	Comparison to HMR 55A	182
13.7.2	Comparison to HMR 49	182
14.	CONCLUSIONS AND RECOMMENDATIONS	184
15.	COMPUTATIONAL PROCEDURE	186
15.1	Introduction	186
15.2	General Storm Procedure	188
15.3	Example of General-Storm PMP Computation	226
15.4	Local Storm Procedure	230
15.5	Example of Local-Storm PMP Computation	237
	ACKNOWLEDGEMENTS	240
	REFERENCES	241
	APPENDIX 1	252
	APPENDIX 2	259
	APPENDIX 3	295
	APPENDIX 4	310
	APPENDIX 5	336

LIST OF FIGURES

Figure 1.1.--Base map showing the Pacific Northwest region covered by this study.	5
Figure 2.1.--Distribution of storm centers in master file	12
Figure 2.2.--Distribution of the extreme storms considered in this study	14
Figure 3.1.--Mean annual precipitation (inches), based on 1961-1990 normals	18
Figure 3.2.--Least orographic (non-hatched) and orographic regions (hatched)	19
Figure 3.3.--Non-orographic regions (Numbers 30, 31, and 32) from NOAA Atlas 2	20
Figure 3.4.--Range of inflow wind directions producing large rains	22
Figure 3.5.--Barrier elevation analysis in hundreds of feet	23
Figure 4.1.--12-hour maximum persisting 1000-mb dew point analysis (°F), January . . .	26
Figure 4.2.--(see Figure 4.1), February	27
Figure 4.3.--(see Figure 4.1), March	28
Figure 4.4.--(see Figure 4.1), April	29
Figure 4.5.--(see Figure 4.1), May	30
Figure 4.6.--(see Figure 4.1), June	31
Figure 4.7.--(see Figure 4.1), July	32
Figure 4.8.--(see Figure 4.1), August	33
Figure 4.9.--(see Figure 4.1), September	34
Figure 4.10.--(see Figure 4.1), October	35
Figure 4.11.--(see Figure 4.1), November	36
Figure 4.12.--(see Figure 4.1.), December	37
Figure 4.13.--Samples of smooth seasonal curves for selected locations	38
Figure 4.14.--Seasonal subregions for maximum daily rainfalls	39
Figure 4.15.--Multi-seasonal maximum persisting dew-point analysis (1000 mb, °F) . . .	40
Figure 5.1.--Schematic flow diagram of modules created in processing storm rainfall data by the automated ministorm program. Modules are referenced in text.	49
Figure 6.1 -- Storm separation method worksheet; Module 5.	54
Figure 6.2 -- Module 1 flowchart.	57
Figure 6.3 -- Module 3 flowchart.	58
Figure 6.4 -- Schematic diagram to show relative range of stability values compared to the pseudo-adiabatic lapse rate.	60
Figure 7.1.--Factors (%) for vertical adjustment of storm amounts at selected barrier elevations and dew point temperatures.	68
Figure 7.2.--Example of FAFP (inches) analysis for western Washington (at 1000 mb - reduced from 1:1M scale).	72
Figure 7.3.--Controlling FAFP subregions for 1000-mb 10-mi ² , 24-hour maximized convergence component (see storm index numbers).	73
Figure 8.1.--100-year, 10-mi ² , 24-hour convergence analysis, C, for western Washington (from NOAA Atlas 2 total precipitation analysis).	75
Figure 8.2.--Analysis of T/C for western Washington based on NOAA Atlas 2 100-year, 24-hour data.	77

Figure 8.3.--Analysis of M factor (reduced from 1:1M scale).	81
Figure 8.4.--Analysis of orographic factor, K, for western Washington.	82
Figure 9.1.--Northwest portion of 10-mi ² , 24-hour general storm PMP index map. Refer to Maps 1 through 4 attached to this report for entire regional coverage.	84
Figure 9.2.--Comparison between 10-mi ² , 24-hour PMP index map and 100-year, 24-hour precipitation frequency analysis from NOAA Atlas 2, non- dimensional ratios (northwest portion only).	86
Figure 9.3.--Portion of ratio analysis between PMP estimates from this study and those from HMR 43 for 10-mi ² , 24 hours.	87
Figure 9.4.--Seasonal percentage variation of 24-hour, 10-mi ² , general storm PMP for October relative to all-season index maps (Maps 1-4).	91
Figure 9.5.--Same as Figure 9.4 - for November through February.	92
Figure 9.6.--Same as Figure 9.4 - for March.	93
Figure 9.7.--Same as Figure 9.4 - for April through May.	94
Figure 9.8.--Same as Figure 9.4 - for June.	95
Figure 9.9.--Same as Figure 9.4 - for July through August.	96
Figure 9.10.--Same as Figure 9.4 - for September.	97
Figure 10.1.--Comparison between averaged depth-area relations at 24 hours for three orographic subsets of storm data.	101
Figure 10.2.--Depth-area relations adopted for orographic subregions based on averages of 18 cool season United States storms.	103
Figure 10.3.--Depth-area relations based on average of two storms (106 and 143). Not adopted for least orographic subregions in this study.	106
Figure 10.4.--Depth-area relations for least-orographic conditions at 47°N, 101°W from HMR 51 (1978). Dashed curve from HMR 52 (1982).	107
Figure 10.5.--Depth-area relations adopted for least orographic subregion (Average of Figure 10.2 and Figure 10.4).	108
Figure 10.6.--Climatological subregions identified in NOAA Atlas 2 (1973). Least orographic subregions are 30, 31 and 32; others are orographic.	111
Figure 10.7.--Subregions adopted for this study.	112
Figure 11.1.--Location of major storms of record from Table 11.1.	121
Figure 11.2.--3-hour maximum persisting 1000-mb local storm dew points for April (°F).	128
Figure 11.3.--3-hour maximum persisting 1000-mb local storm dew points for May (°F).	129
Figure 11.4.--3-hour maximum persisting 1000-mb local storm dew points for June (°F).	130
Figure 11.5.--3-hour maximum persisting 1000-mb local storm dew points for July (°F).	131
Figure 11.6.--3-hour maximum persisting 1000-mb local storm dew points for Aug. (°F).	132
Figure 11.7.--3-hour maximum persisting 1000-mb local storm dew points for Sept. (°F).	133
Figure 11.8.--3-hour maximum persisting 1000-mb local storm dew points for Oct. (°F).	134
Figure 11.9.--1-mi ² local storm PMP at the Idaho/Oregon/Nevada border.	137
Figure 11.10.--Representative time distributions for front-loaded storms.	139
Figure 11.11.--Representative time distributions for mid-loaded storms.	140
Figure 11.12.--Depth-duration relationship for 1-mi ² PMP Pacific Northwest States.	141
Figure 11.13.--Depth-areal relation for thunderstorm PMP in HMR 43 and 49.	144

Figure 11.14.--Normalized 60-minute depth-area curves from Reynolds Creek dense network.	146
Figure 11.15.--Depth-area curve comparisons for 1 hour.	147
Figure 11.16.--Idealized local-storm isohyetal pattern (from HMR 49) used in this study.	150
Figure 11.17.--Isohyet profile curves.	152
Figure 11.18.--Depth-area relations for HMR 57.	153
Figure 11.19.--1-hour, 1-mi ² local storm PMP in inches for elevations to 6000 feet. . . .	157
Figure 11.20.--Map of differences between 1-hour, 1-mi ² PMP amounts from HMR 57 and HMR 43.	158
Figure 12.1.--Test basin location map. Index numbers refer to basins listed in Table 12.1. Dots are centroids of Reclamation basins and circled dots are centroids of COE basins.	160
Figure 15.1.--Base map of Pacific Northwest region included in this study.	187
Figure 15.2.--Seasonal percentage variation of PMP for October based on all-season index maps provided in this study (Section 9.2.2).	190
Figure 15.3.--Same as Figure 15.2 - for November through February (Section 9.2.2). . . .	191
Figure 15.4.--Same as Figure 15.2 - for March (Section 9.2.2).	192
Figure 15.5.--Same as Figure 15.2 - for April through May (Section 9.2.2).	193
Figure 15.6.--Same as Figure 15.2 - for June (Section 9.2.2).	194
Figure 15.7.--Same as Figure 15.2 - for July through August (Section 9.2.2).	195
Figure 15.8.--Same as Figure 15.2 - for September (Section 9.2.2).	196
Figure 15.9.--Subregions adopted for this study	197
Figure 15.10.--Adopted depth-area relations - orographic subregions (Section 10.2.1). . .	198
Figure 15.11.--Adopted depth-area relations - least orographic subregions (Sect. 10.2.2).	199
Figure 15.12.--Sample PMP time sequences (from HMR 43).	201
Figure 15.13.--Highest temperatures prior to PMP storm.	203
Figure 15.14.--Maximum winds west of the Cascade Divide (HMR 43).	204
Figure 15.15.--Seasonal variation of maximum wind speed (HMR 43).	205
Figure 15.16.--Durational variation of PMP winds by 6-hour increments (HMR 43). . . .	209
Figure 15.17.--Maximum winds east of the Cascade Divide (HMR 43).	210
Figure 15.18.--12-hour maximum persisting 1000-mb dew point analysis (°F), January.	211
Figure 15.19.--12-hour maximum persisting 1000-mb dew point analysis (°F), February.	212
Figure 15.20.--12-hour maximum persisting 1000-mb dew point analysis (°F), March. . .	213
Figure 15.21.--12-hour maximum persisting 1000-mb dew point analysis (°F), April. . .	214
Figure 15.22.--12-hour maximum persisting 1000-mb dew point analysis (°F), May. . . .	215
Figure 15.23.--12-hour maximum persisting 1000-mb dew point analysis (°F), June. . . .	216
Figure 15.24.--12-hour maximum persisting 1000-mb dew point analysis (°F), July. . . .	217
Figure 15.25.--12-hour maximum persisting 1000-mb dew point analysis (°F), August. . .	218
Figure 15.26.--12-hour maximum persisting 1000-mb dew point analysis (°F), Sept. . . .	219
Figure 15.27.--12-hour maximum persisting 1000-mb dew point analysis (°F), October. . .	220
Figure 15.28.--12-hour maximum persisting 1000-mb dew point analysis (°F), November.	221
Figure 15.29.--12-hour maximum persisting 1000-mb dew point analysis (°F), December.	222

Figure 15.30.--Variation of precipitable water with 1000-mb dew point temperature (HMR 43).	223
Figure 15.31.--Durational variation of maximum moisture (HMR 43).	224
Figure 15.32.--Decrease of temperature with elevation (HMR 43)	225
Figure 15.33.--Pressure-height relation (HMR 43)	225
Figure 15.34.--Application of PMP to drainage for Mud Mountain, Washington (402 mi ²). Scale 1:1,000,000.	228
Figure 15.35.--Depth-duration curve for basin-averaged PMP for Mud Mountain dam basin (402-mi ²), Washington.	230
Figure 15.36.--1-hour, 1-mi ² local storm PMP in inches for elevations to 6000 feet.	231
Figure 15.37.--Pseudoadiabatic decrease in column moisture for local storm basin elevations (Appendix 4).	232
Figure 15.38.--Depth-duration relationship for 1-mi ² PMP Pacific Northwest states (Section 11.7.2).	234
Figure 15.39.--Depth-area relations for local storm PMP Pacific Northwest states (Section 11.8).	235
Figure 15.40.--Idealized isohyetal pattern for local storm PMP areas up to 500-mi ² (from Hansen, et. al., 1978 - see also Section 11.8.3).	236
Figure 15.41.--Temporal distribution relation for Mud Mountain Dam	238
Figure A4.1.--Location of extreme local storms	322
Figure A4.2.--Observing stations providing data for 3-hour maximum persisting local storm dew point analysis	325
Figure A4.3.--Subregions for local storm analysis	327
Figure A4.4.--One-hour rainfall versus elevation for storms in Table A4.1	334

LIST OF TABLES

Table 1.1.--Compilation of reasons considered as basis for joint agency decision to revise HMR 43	7
Table 2.1.--Final storm sample for Pacific Northwest general storms	15
Table 4.1.--Relationships among in-place maximization factor (IPMF), moisture content ranges at 1000 mb and percentage moisture reduction for a storm site at a barrier elevation of 3,000 feet MSL	43
Table 5.1.--Example of DAD table produced by ministorm analysis program listing average depths (inches) for storm 78 (10/22-25/34)	50
Table 6.1.-- Glossary of terms modified in storm separation method	55
Table 7.1.--In-place moisture maximization factors and other criteria for storm centers in this study.	65
Table 8.1.--Storms that were used to derive the storm intensity analysis, M-factor map	79
Table 10.1.--Comparison between depth-area amounts (percent of 10-mi ² 24-hour amount) for storm numbers 80 (Olympic Mountains) and 155 (Continental Divide)	102

Table 10.2.--Adopted orographic depth-area values (Figure 10.2) for present Northwest PMP Study, based on averages of 18 storms (percent of 10-mi ² PMP)	104
Table 10.3.--Comparison (in percent of 10-mi ² amount) of orographic depth-area relations for three reports (HMRs 43, 55A and 57)	104
Table 10.4.--Comparison of least orographic depth-area relations (percent of 10-mi ² amount) between HMR 57 (Fig. 10.5) and least-orographic locations in HMR 43	109
Table 10.5.--Comparison of adopted least-orographic depth-area relations with average from storm 106 and storm 143	109
Table 10.6.--Comparison of 10-mi ² depth-duration values (percent of 24-hour amount) for orographic storms used in Figure 10.1 (<3 storm average)	110
Table 10.7.--Comparison between orographic and least-orographic depth-duration relations (percent of 24-hour amounts). Same storms used in Tables 10.2 and 10.4	110
Table 10.8.--Subregions used in this report to assist in depth-duration analysis	113
Table 10.9.--Dimensionless depth-duration curves for 24-hour extreme storms in Western Washington for 48-hour kernels and selected exceedance probabilities	114
Table 10.10.--Adopted depth-duration curves for subregions identified in Table 10.8	115
Table 10.11.--Comparison between storm data averages and adopted depth-duration curves for subregions 2 and 7	115
Table 10.12.--Percentage envelopments that PMP estimates from this study have over moisture maximized observed storm amounts for storm 80 (PMP/storm)	116
Table 10.13.--Percentage envelopments that PMP estimates from this study have over moisture maximized observed storm amounts for storm 106 (PMP/storm)	117
Table 11.1.--Major Local Storms - Pacific Northwest	120
Table 11.2.--Monthly distribution of extreme local convective storms - Pacific Northwest.	124
Table 11.3.--Frequency distribution of storm durations from the extreme local storm data base.	136
Table 11.4.--Percent of 1-hour, 1-mi ² local storm PMP for selected durations in the Pacific Northwest	142
Table 11.5.--Comparison between 1-mi ² depth-duration curve adopted for this study and that from HMR 49.	148
Table 11.6.--One (1) hour depth area relation from HMR 43 as a percent of 1-mi ²	148
Table 11.7.--Equivalent radius in miles for selected areas representing areal pattern shown in Figure 11.16.	149
Table 11.8.--Incremental Profile (% of 1-hour, 1-mi ² amount).	151
Table 11.9.--PMP Profile Values (cumulative % of 1-hour, 1-mi ² amount)	151
Table 11.10.--Depth-Area curves (percent of 1-mi ² amount).	154
Table 12.1.--PMP Test Basin Comparison Summary	162
Table 12.2.-- Percent Change in Individual Drainage PMP (Present Study vs HMR 43)	168
Table 13.1.--Comparison between HMR 57 general storm PMP estimates and 100-year precipitation frequency data from NOAA Atlas 2 for subregional analysis and selected individual locations (10-mi ²).	170

Table 13.2.--Comparison between HMR 57 local-storm PMP and NOAA Atlas 2 amounts for 1-hour, 10-mi ² for locations in Table 10.1.	171
Table 13.3.--Comparison between HMR 57 general storm PMP estimates and HMR 43 PMP estimates for subregional analysis and selected individual locations (10-mi ²).	172
Table 13.4.--Comparison between general- and local-storm PMP in this study (10-mi ²)	173
Table 13.5.--Comparison between general storm PMP and observed storm rainfalls or storms listed in Table 2.1 for selected durations and areas	175
Table 13.6.--Ten largest storms by duration for 10-mi ² observations (see Appendix 2).	177
Table 13.7.--Ranked largest storms by duration for 10-mi ² observations (see Appendix 2)	179
Table 13.8.--Ranked largest least-orographic storms by duration	180
Table 13.9.--Chronological variation of PMP estimates made for the Elk Creek drainage, Oregon (42.7°N, 122.72°W, 127-mi ²).	181
Table 13.10.--Comparison between basin-average estimates for three adjacent drainages.	181
Table 15.1.--Adopted depth-duration ratios of 24-hour amounts for subregions in Figure 15.9 (Section 10.3.2.)	189
Table 15.2.--PMP Profile Values (accumulative % of 1-hour, 1-mi ² amount).	237
Table 15.3.--Isohyetal label values for local-storm PMP, White River, WA (402-mi ²)	239
Table A1. Master Storm File for the Northwest Region	253
Table A2. Important storms located south of the Northwest Study region.	257
Table A4.1.--Extreme Local Storms in the Pacific Northwest and Adjacent Areas	318
Table A4.2.--Frequency of synoptic categories	323
Table A4.3.--Synoptic types - mean values.	323
Table A4.4.--Average monthly values of 500-mb. temperature (°C) and geopotential heights (feet) for three regional stations.	324
Table A4.5.--Subregional climatic characteristics.	328

PROBABLE MAXIMUM PRECIPITATION - PACIFIC NORTHWEST STATES - Columbia River (including portions of Canada), Snake River and Pacific Coastal Drainages

E.M. Hansen, D.D. Fenn, P. Corrigan and J.L. Vogel
Water Management Information Division
Office of Hydrology
National Weather Service
and
L.C. Schreiner and R.W. Stodt
Flood Section, Surface Water Branch
Earth Sciences Division
Bureau of Reclamation

ABSTRACT This study provides all-season general-storm probable maximum precipitation (PMP) estimates for durations from 1 to 72 hours for the Columbia River basin, the Snake River basin and drainages along the Pacific coast. This includes the states of Washington, Oregon, Idaho, western Montana, northwestern Wyoming and parts of Canada. PMP estimates and their seasonal variation are given for area sizes ranging from 10 to 10,000 square miles.

Estimates are also provided for local-storm PMP in the region, covering durations from 15 minutes to 6 hours for drainage areas from 1 to 500 square miles. In a significant departure from its predecessor, this study extends local-storm PMP estimates to areas west of the Cascade Mountain divide. Another significant change is the lowering of 6/1-hour ratios for local storms, reducing PMP at longer durations.

Step-by-step procedures are given for computing PMP for both the general- and local-storm criteria. Example computations are furnished. Numerous comparisons are presented between the results of this study, its predecessor and other extreme storm criteria such as the 100-year rainfall frequencies found in NOAA Atlas 2. These results indicate that this report provides consistent and reasonable estimates of PMP.

Several new techniques and procedures were developed in order to attain the goals of the study. Chief among these was the development of a computerized storm analysis procedure, which was used to study 28 major storms affecting the region. New 3- and 12-hour maximum persisting dewpoint climatologies were also produced in order to better assess the moisture available for precipitation.

1. INTRODUCTION

1.1 Background

Probable maximum precipitation (PMP) estimates for the Pacific Northwest states were published by the National Weather Service (NWS) in November 1966 as Hydrometeorological Report 43 and will be referred to as HMR 43 (USWB, 1966). (Other reports in this series will be similarly referenced.) The present study takes advantage of new storm data and recent developments in analytical procedures to revise the previous study and was supported by the major Federal hydrologic users of this information. While total documentation of this effort would create a report of considerable length, it was believed that a report containing information pertinent to the user would be most beneficial. As a result, this report summarizes studies made in determining the numerous aspects of this effort. Those who desire more detail should contact the NWS authors.

1.2 PMP Definition and Philosophy

The definition of PMP was changed in 1982 (Hansen et al., 1988) to read, "theoretically, the greatest depth of precipitation for a given duration that is physically possible over a given size storm area at a particular geographical location at a certain time of the year." This change to the definition used previously (American Meteorological Society, 1959), and in HMR 43, resulted from mutual agreement among the NWS, the U. S. Army Corps of Engineers (COE), and the Bureau of Reclamation (USBR) among others. The new definition stresses the independence of atmospheric control over precipitation from that relative to a particular drainage area mentioned in the earlier definition.

The foundation of PMP estimation lies in observations of rainfall amounts as observed in major storms. PMP studies deal with the potential rainfall that may be produced from the coincidence of an optimum set of atmospheric conditions and circumstances. It is important to realize that the PMP is a theoretical value that represents a limiting precipitation amount for a particular duration and area, and as such is not a quantity that is expected to be observed. Because of this concept, the PMP in this report as others should always be regarded as an estimate. Recent NWS PMP reports (Schreiner and Riedel 1978; Hansen et al., 1988) have described the procedures used to derive PMP estimates, based on observed storm rainfall maxima and atmospheric knowledge.

Two important atmospheric conditions that are considered in most PMP studies are the moisture content and the efficiency with which a storm converts moisture into precipitation. A procedure known as moisture maximization is used to approximate the highest moisture potential in storms. It is also recognized that records of observed storm rainfalls are relatively short, generally less than 100 years. One means to improve the adequacy of the storm sample has been to apply a procedure of storm transposition. By increasing the storm sample at a location through transposition, it is assumed that at least one storm in the sample

has contained maximum efficiency. This assumption is necessary because not all aspects of the physical processes resulting in the most extreme rainfall are known. PMP estimates are the result of envelopment and smoothing of a number of moisture maximized, transposed storm rainfall amounts. This report will discuss these procedures as applied to Pacific Northwest storms.

The concept of PMP as an upper limit often evokes concerns that the procedure combines maximized quantities to reach a level that cannot reasonably be expected to occur. It will be noted in this study, as in past NWS studies, that this is not the case. While moisture is indeed maximized, numerous other factors are involved at a lesser level to effectively control unreasonable compounding of extremes.

Terrain plays an important role in precipitation and can act both to enhance as well as reduce (shelter) observed rainfall. It is well known that storms that move slowly or become stalled, or reoccur over a specific location result in more precipitation falling in a particular rain gage than do rapidly moving storms. Thus, orographic effects from storm-terrain interactions to the extent that they trigger moisture release or block storm movement, play an important role in PMP studies. The Pacific Northwest has some of the most complex terrain features in the country and makes this region a difficult, although interesting, challenge for study.

1.3 Authorization

The authorization to determine an updated PMP report for the Northwest states was given by the U.S. Army Corps of Engineers Office of Civil Works in cooperation with the Bureau of Reclamation Flood Section. Appropriations supporting the NWS effort were provided through a continuing Memorandum of Understanding between NWS and COE and a redesignation of the Interagency Agreement signed by NWS and Reclamation.

The Department of Agriculture Soil Conservation Service (SCS) has continued its long participation in the joint agency group that meets every four to six months to oversee progress on NWS hydrometeorological studies. These review meetings, comprised of field and headquarter representatives from SCS, COE, Reclamation and NWS, were begun in the late 1970's to improve interagency communication on hydrometeorological studies of mutual interest and to provide a forum to discuss progress on ongoing studies. The regular attendees to these meetings are referred to as the Joint Study Team. Recently, the Federal Energy Regulatory Commission (FERC) joined this team.

1.4 Study Region

The region of study in this report is the same as that shown for HMR 43 except for an expansion of the portion of the Columbia River drainage in southern British Columbia. Through joint agency agreement, and after discussions with officials from B.C. Hydro (Canada), it was judged that the Canadian Columbia River

drainage, important to the study region, be limited to that portion of the drainage below Keenleyside Dam (formerly known as Arrow Dam) in British Columbia. Figure 1.1 shows the total region.

1.5 Scope of Study

This study recognizes two categories of storms for the region considered; general and local storms. General storms are major synoptic events that produce precipitation over areas in excess of 500 mi² and over durations often much longer than 6 hours. Local storms have durations up to 6 hours and cover areas up to 500 mi². Particularly in the western United States such local storms often occur independently from any strong synoptic weather feature. Climatological observations show that both these storm categories can occur at any time throughout the Pacific Northwest. However, general storms are least dominant during summer months and most intense west of the Cascade Mountain ridgeline. Local storms are by comparison usually a warm season feature and are most often observed east of the Cascades.

The Joint Study Team mutually agreed that the study of general-storm PMP be limited to areas of 10,000 mi² and durations of 72 hours, or less. Local-storm PMP estimates in this study are limited to areas of 500 mi² or less and durations up to 6 hours. Both general- and local-storm PMP estimates are provided for the entire region. Seasonal variations are also included. A lesser number of storms were used to evaluate the temporal distribution of incremental amounts for both general and local storms.

1.6 Method of Study

The study of general-storm PMP in this report continues the evolution of the storm separation method applied in the development of PMP for the Rocky Mountain eastern slopes (Hansen et al., 1988). The storm separation method is particularly applicable to orographic regions where the more traditional method of explicit storm transposition is inappropriate.

The storm separation method is used to examine extreme storms of record that have occurred in and near the study region. Such storms are "separated" into convergence (non-orographically influenced) and orographic (terrain influenced) components of precipitation. The convergence component of storms is treated as though no significant topographic features were present in and upwind of this storm area, and then moisture maximized and transposed within zones considered meteorologically homogeneous. The orographic component of the storms, however, is not directly used in computing total PMP. Instead, an orographic enhancement procedure is developed from relationships between an orographic factor derived from NOAA Atlas 2 (Miller et al., 1973) 100-year analyses and a storm intensity factor. These are described in considerable detail in HMR 55A (Hansen, et al., 1988), and summarized for this study in Chapter 8.

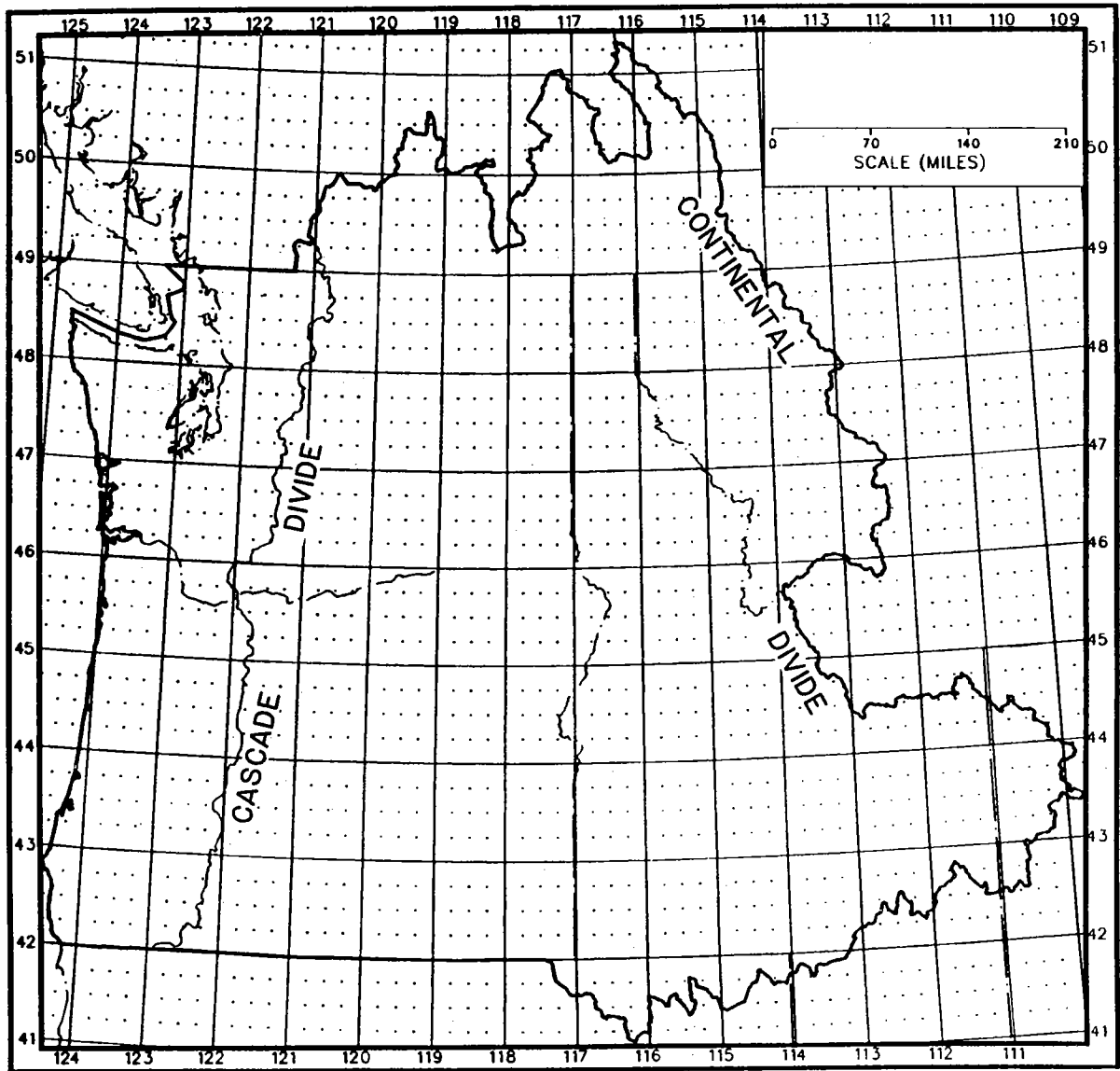

Figure 1.1.--Base map showing the Pacific Northwest region covered by this study.

The method allows for computation of general-storm PMP for an index area/duration (10 mi² and 24 hours in this study), and provides relations that enable other durations and areas to be obtained.

Local storm PMP has been developed much in the manner of past studies (Hansen, et al., 1977; Hansen, et al., 1988), where data records are searched for maximum 1-hour events, that are combined with known extreme events of 6 hours or less to form a data base. All major observed storm events are normalized to 1-hour moisture maximized values and adjusted to 1000 mb. In this study, a particular effort was made to provide local storm PMP estimates west of the Cascade Divide, where they were not provided in HMR 43 (USWB, 1966).

1.7 History and Rationale

The need to revise and update HMR 43 has developed over the intervening years as the result of a number of developments. At a meeting in San Francisco in October 1982, various Federal agency representatives discussed a wide variety of hydrometeorological topics up for consideration. There was joint agreement that revision of HMR 43 be given highest priority. Some of the reasons leading to this conclusion are given in Table 1.1.

In Table 1.1, the problem listed first was recognized by Schaefer (1980), when detailed grid comparisons were made between NOAA Atlas 2 (Miller et al., 1973) 100-year values and general-storm PMP for short durations (<6 hours) from HMR 43. NOAA Atlas 2 was completed after HMR 43. Typically, 100-year precipitation values from NOAA Atlas 2, are analyzed in checking consistency and magnitude of PMP estimates. The ratio of PMP to 100-year amount at any location is expected to be greater than one. In past studies, the ratios range between two and seven, depending on distance from moisture source(s) and type of terrain.

Another problem in Table 1.1 developed from concern about use of the laminar flow model for determining orographic precipitation in HMR 43. The model was first applied to and calibrated against the western slopes of the Sierra Nevada Mountains in California to aid in determining general-storm PMP for California in HMR 36 (USWB, 1961). Transfer of this technique to the northwest states in HMR 43 necessitated some additional adjustments that brought about concerns for the resulting adequacy of this method.

The remaining items in Table 1.1 are self explanatory. Over the period of time since HMR 43 was published, the NWS Hydrometeorological Branch has developed a new procedure for development of PMP in orographic regions. This approach has evolved through a series of studies (Miller et al., 1984; Fenn, 1985; and Hansen et al., 1988). It is this procedure that is applied to storm data in this study.

Table 1.1.--Compilation of reasons considered as basis for joint agency decision to revise HMR 43 (USWB, 1966).

1.	Instances were found where ratios of short-duration general-storm PMP to precipitation frequency values were near or below unity, particularly west of the Cascades.
2.	Questions regarding the technical adequacy of procedures used in developing HMR 43 were raised, in particular the application of the laminar flow model for orographic precipitation.
3.	Recent capability to process extreme storm data through automated techniques to obtain DAD information.
4.	Recent capability to apply new technical procedures developed over time for determining PMP in orographic regions (the storm separation method).
5.	A need to determine PMP estimates for larger basin areas throughout the region required depth-area relations to larger areas.
6.	A need to determine local storm PMP estimates west of the Cascade Divide.
7.	A need to consider storms that have occurred since the 1950's.
8.	A need to provide a better tie-in to neighboring PMP studies.
9.	A need to expand the region of coverage in southern British Columbia.

An alternative source of information about this procedure is available in somewhat less detail in the World Meteorological Organization (WMO) Operational Hydrology Report No. 1 (1986).

In mid-1985, the present study was interrupted for over two years to allow modifications to be made in the HMR 55A study. In early 1988, work on the revised Pacific Northwest PMP study resumed and culminates in the present report, referred to as HMR 57.

1.8 Reclamation Cooperation

This study is primarily the product of the NWS Hydrometeorological Branch, and represents the latest understanding and technology resulting from more than 50 years experience in developing PMP estimates. NWS wishes to acknowledge, however, that major efforts of the Reclamation Flood Section in Denver were instrumental in those areas requiring automated processing of data and maps. Some of these efforts will be noted further in the section dealing with the

automated precipitation data analysis (APDA) procedure, but it should be mentioned here that Reclamation had a major role in the completion of this study. Reclamation was responsible for providing the material contained in Chapters 5 (APDA) and 12 (Test Basin Analysis).

The cooperation between these two hydrometeorological staffs has brought an added strength to the product as well as bonding between researchers. Reclamation has played a major role in reviews and decisions concerning storm selection, storm processing, digitizing analyses, testing results, and almost every aspect of this effort. Although Reclamation is at the same time one of the primary users of these results, it is believed that this dual role has enhanced the integrity of this effort.

1.9 Peer Review

A major criticism of HMR studies in the past has been the limited internal review process. In most instances, the reviews were limited to those agencies represented on the Joint Study Team. Initially, the limitation was believed justified under the reasoning that only these agencies had sufficient knowledge and understanding to provide adequate review.

Interest in PMP and the economic consequences of structure modifications required to design for PMP required by the National Dam Inspection Act of 1972 have brought new interest in the concepts and procedures being applied. Over the last 10 to 15 years, PMP and its usage has become the subject of numerous studies and conferences (NRC, 1985; OWDC, 1986; NRC, 1988; ANCOLD, 1988; and FEMA, 1990). As a result, many more people have become familiar with the concepts and applications involved in PMP studies. Equally true is the fact that many have questioned these studies and their reliability. Some of these concerns have lead to independent studies (EPRI, 1993a; 1993b), while still others have turned away from the PMP approach preferring to seek probabilistic methods.

In view of the concerns expressed by many that the NWS studies should be subjected to more widespread review, we have offered this report to the following outside agencies:

1. Dam Safety Section
Department of Ecology (Dr. Mel Schaefer)
Water Resources Program
State of Washington

2. Hydroelectric Engineering Division
Hydrotechnical Department (Pat Neudorf)
BC Hydro and Power Authority
Canada

3. Hydroelectric Generation and Renewable Fuels
Electric Power Research Institute
Palo Alto, California (Dr. Douglas Morris)
4. Mr. Catalino Cecilio
Consulting Hydrologic Engineer
931 Park Pacifica Avenue
Pacifica, CA 94044-4414
5. Department of Water Resources
Division of Flood Management (Maurice Roos)
1416 Ninth Street - P. O. Box 942836
Sacramento, CA 94236-0001
6. North American Weather Consultants
1293 West 2200 South (Dr. Ed Tomlinson)
Salt Lake City, UT 84119
7. Canadian Climate Centre
Atmospheric Environment Service (William D. Hogg)
4905 Dufferin Street
Downsview, Ontario M3H 5T4
Canada

We extend our sincere appreciation for the competent and constructive reviews given by all reviewers. It is hoped that this report has been strengthened by the interaction with such a cross section of the hydroelectric and hydrometeorologic community.

1.10 Organization of the Report

This report follows a style used in similar studies produced by the NWS over the last 20 years. The text describes, in general, background information relating to the data, the analyses and the methods used in developing PMP index maps. In this report Chapters 2-11 provide this discussion. Chapter 12 provides results from application of the PMP estimates to 47 individual basins for the purpose of judging the overall acceptability of the results. Chapter 13 gives study results compared to other precipitation and PMP indices. Conclusions and recommendations are covered in Chapter 14.

Chapter 15 is probably the most important chapter in the report, as far as most users are concerned. This chapter provides the information, both the stepwise procedure and the tables and figures, required to make a PMP estimate for a specific site. To reduce the need for shuffling through pages in the report, all tables and figures used in the procedure have been repeated in this chapter to make it self-contained. Figures and tables are cross-indexed to the text that explains their origin should the user find the need for more information. Also,

since the general storm index maps are oversized (at 1:1,000,000 scale), they are provided separately from the main report.

Finally, the references called for in the text are given, followed by five rather extensive appendices that cover (1) storms of record considered in this study, (2) selected storm synoptic and depth-area-duration (DAD) data, (3) the storm separation method (SSM), (4) local storm details, and (5) snowmelt criteria.

The numerous references to certain past studies, such as Hydrometeorological Report 43 and NOAA Atlas 2 make it impractical to always include the technical reference. Therefore, after the initial complete reference is given, these commonly referenced works will simply be noted as HMR 43, HMR 55A, NOAA Atlas 2, etc. Less commonly referenced material will be noted by the customary author/date references.

2. SIGNIFICANT STORMS

2.1 Introduction

One of the prime reasons for undertaking the revision of the 1966 Pacific Northwest PMP study was to give greater consideration to storm data. That is, PMP development throughout the non-orographic eastern United States is based on a sample of extreme storms, while in the West so-called alternative approaches have been employed in lieu of adequate storm data. HMR 43 relied on a very limited number of storms to establish an index precipitation-to-moisture ratio (P/M) value at Portland, Oregon. A gradient of P/M ratios was established from three storms using data points in central California. No storm data were available east of the Cascades. The general pattern to provide P/M ratios throughout the region was based on a January dew point analysis. Only two storms (11/18/50, 12/21-23/55) were used to develop the parameter values used in the orographic model, which was then tested against an additional seven storms. Other storms were considered to aid in developing depth-duration and seasonal relations. HMR 43 does not include depth-area-duration (DAD) data for any storms.

For the present study, a review was made of storms that occurred throughout the Pacific Northwest from roughly 1900 to 1980. Various data sources were examined to complete a master listing of storms. Initially, the Corps of Engineers Storm Rainfall Catalog (USCOE, 1945-) provided a foundation of information from which some depth-area data were available. Most storms in this record between 1901 and 1945 (Appendix 1) came from this Storm Catalog, while Reclamation and NWS files were used to supplement the list.

These storms were primarily general storms, that is they had durations exceeding 12 hours and precipitation was widespread as a result of a major synoptic-scale disturbance (low pressure system or strong frontal activity). A few storms in the master list turned out to be local storm events, usually intense convective storms of short duration. The geographical distribution of the storms listed in the master file is shown in Figure 2.1. The list includes a few storms whose maxima occur within a couple of degrees south of the region of interest. The primary centers (see Appendix 2) for storms 156 and 165 occur in California outside the region shown on Figure 2.1.

Because of the distribution of observing stations, the maxima for a number of storms occur at common locations. In particular, numerous events are centered at Forks, Quinault, and Snoqualmie Pass, in Washington; Glenora, Valsetz, and Illahe, in Oregon; Deadwood and Roland in Idaho. It is possible that certain terrain features at each of these locations serve to enhance precipitation in passing storms. More on this will be discussed in Chapter 3 regarding orographic effects. At the same time, there are large data-sparse areas, most notably

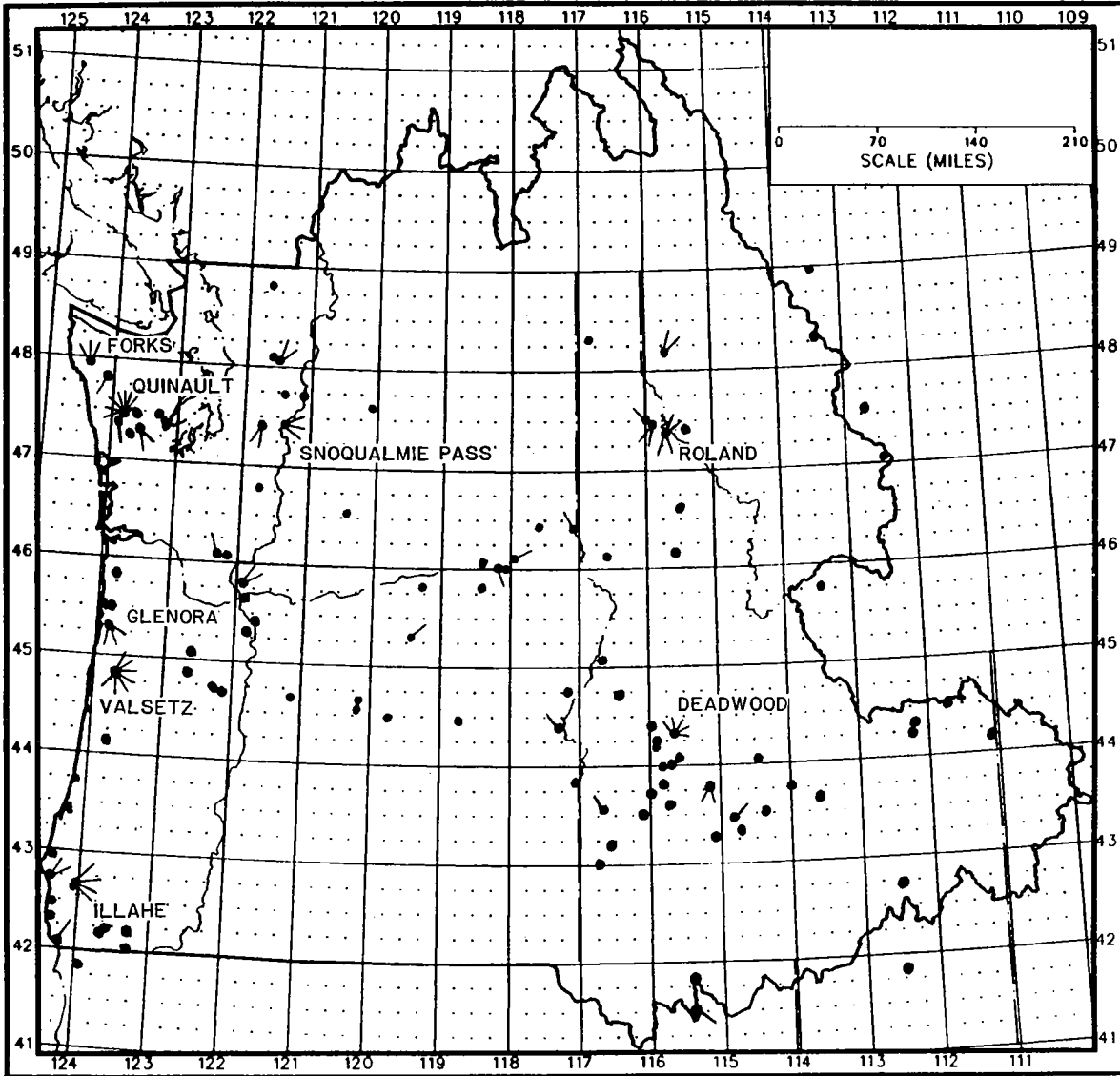

Figure 2.1.--Distribution of storm centers in master file (see Appendix 1). Multiple storms indicated by tails attached to dots.

southern Oregon (away from the coast), eastern Washington, western Montana and British Columbia. One would expect that storm tracks reaching the Pacific Coast should present a rather uniform distribution, with some increase in frequency toward the northern coast. There is, however, a significant sheltering effect by coastal mountain ranges on precipitation in the basins east of the Cascades. This may help to explain the comparative lack of data over some of the interior northwest. In Idaho and western Montana the storm concentration in the western Snake River basin appears to reflect the density of population more than any meteorological phenomena. Undoubtedly, significant rains occur within the Bitterroot Mountains to the north that go undetected.

In addition to the storms in Appendix 1, another survey was made for storms between 37 and 42°N latitudes that were considered candidate storms for transposition into the region. Primarily collected from various sources by Reclamation, Appendix 1, Table A2, lists 130 additional storms that were numbered 501 and above to distinguish them as being outside and to the south of the region. Storms 126, 156 and 165 were storms included in the initial list of major storms within the region. After study using the ministorm analysis (Chapter 5), it was discovered that the storm maximums actually occurred in California. A decision was made not to change the index numbers.

From the storms in Figure 2.1, a second selection was made to reduce the sample to those events that were the most controlling for their region. In order to make this selection, various subregions were delineated such as coastal, western Cascades, eastern Cascades, interior Washington/Oregon, Idaho and western Montana, and Continental Divide slopes. A final selection was made from the master list (Appendix 1, Table A1) to distribute the storms as much as possible through these subregions and with consideration for the magnitude of precipitation. Despite these attempts, there was some geographical clustering while large areas still have no major storms. Twenty-eight storms were finally selected for ministorm analysis and these form the foundation for the revised analysis.

The 28 priority storms (United States) are listed in Table 2.1 and their geographical distribution shown on Figure 2.2. When comparing locations (lat./long.) of maxima between Table 2.1 and the locations given in the master list (Appendix 1), one finds minor differences. The reason for these differences are that the storm analysis procedure showed that the storm maximums had different centers than previously believed (see Chapter 5).

It should also be noted that Table 2.1 includes two storms in or near British Columbia, Canada, Seymour Falls (SEY) and Mount Glacier (MTG). Since this study includes a portion of lower British Columbia, as discussed earlier (Figure 1.1), it was necessary to locate storms that may be important to this subregion. Available Canadian storm data sheets were surveyed and the Atmospheric Environment Service of Canada was contacted for updated information on major storms. A number of published reports on PMP were also

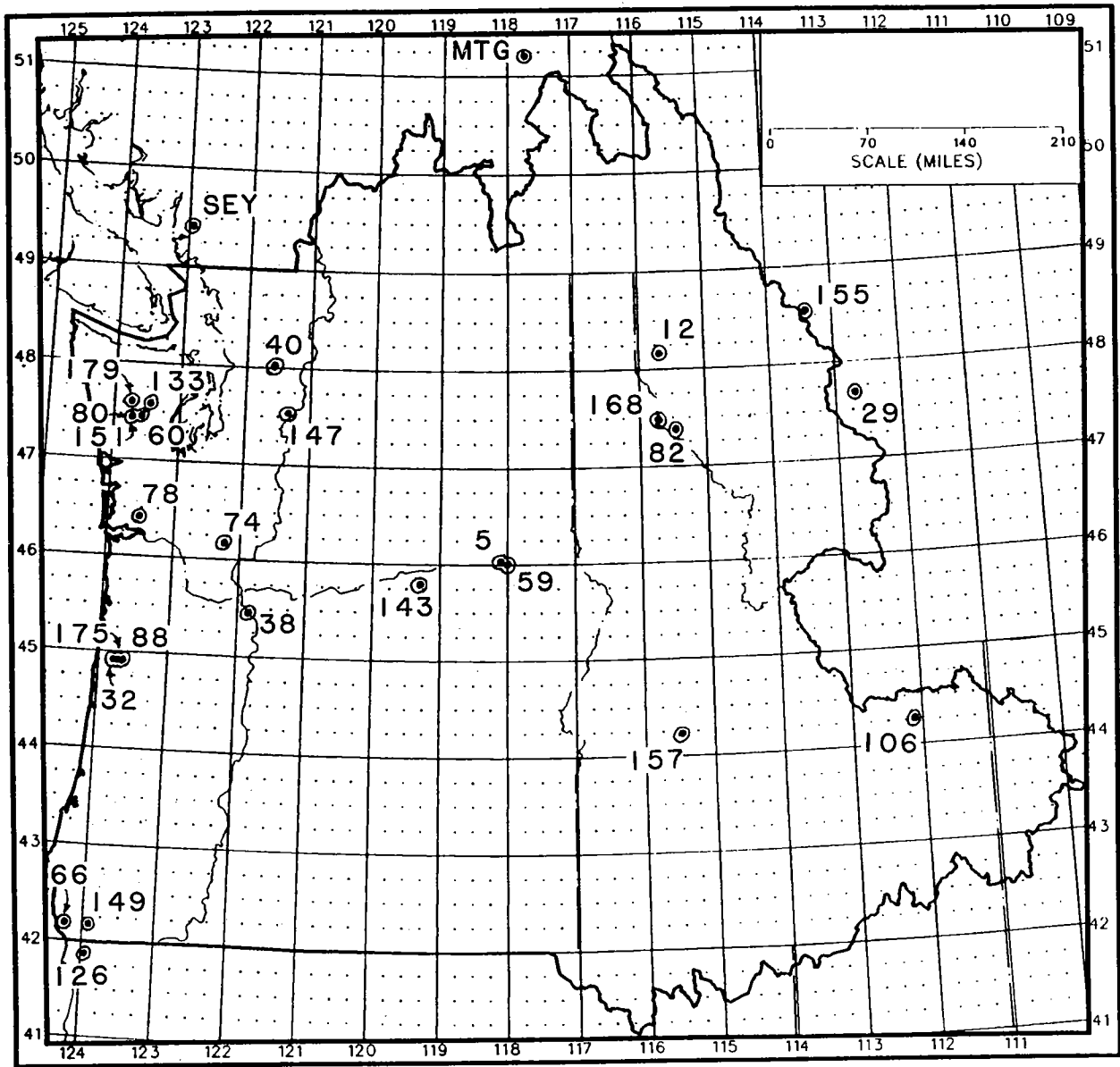

Figure 2.2.--Distribution of the extreme storms considered in this study (see Table 2.1 for identification).

Table 2.1.--Final storm sample for Pacific Northwest general storms.

Storm Number	Date	Latitude* (Deg. Min.)	Longitude* (Deg. Min.)	Barrier Elev. (ft.)	24 hr/10 mi ² avg. amt.	DAD Limits Area/Duration
5	5/28-30/06	46 01	118 04	3200	6.16	16378/48
12	11/17-19/09	48 12	115 41	5800	3.87	17344/48
29	6/19-22/16	47 41	112 43	6500	7.34#	18924/72
32	12/16-19/17	44 55	123 46	1200	10.66	33167/72
38	11/19-22/21	45 28	121 52	2800	8.30	73110/72
40	12/9-12/21	48 01	121 32	3200	8.58	27253/72
59	3/30-4/1/31	46 00	118 00	3600	4.79	32730/60
60	12/17-19/31	47 28	123 35	4500	8.06	40221/48
66	3/16-19/32	42 10	124 15	1200	9.63	42243/72
74	12/19-22/33	46 10	122 13	2600	7.98	11783/72
78	10/22-25/34	46 25	123 31	1000	6.28	20559/72
80	1/20-26/35	47 28	123 43	1800	14.45	43865/144
82	3/24-25/35	47 22	115 26	5400	4.06#	23729/24
88	12/26-30/37	44 55	123 38	1500	10.76	13869/96
106	6/26-27/44	44 16	112 04	6400	4.25	41385/24
126	10/26-29/50	41 52	123 58	2000	15.84	80511/72
133	11/2-4/55	47 34	123 28	3500	12.16	41818/48
143	10/1-2/57	45 49	119 17	2900	3.40	22002/24
147	12/14-16/59	47 33	121 20	3800	8.48	29329/48
149	11/21-24/61	42 10	123 56	2700	10.90	36321/48
151	11/18-20/62	47 28	123 43	1800	12.45	4665/48
155	6/6-8/64	48 34	113 23	7300	14.35	87054/48
156	12/21-24/64	39 55	123 35	2500	16.23	99988/72
157	12/20-24/64	44 14	115 29	7100	4.89	59661/96
165	1/14-17/74	40 20	124 06	1900	10.63	81179/72
168	1/13-16/74	47 29	115 44	5200	4.42	42267/72
175	12/24-26/80	44 55	123 44	1400	9.22	24865/48
179	11/30-12/2/75	47 37	123 44	3300	9.35	31912/72
SEY	1/14-15/61	49 26	122 58	2000	14.30	150,000/126
MTG	7/11-13/83	51 13	117 44	7300	6.75	35,000/72

*Based on Entire Storm (primary centers, see Appendix 2) (# for approximate area of 15 mi²)

reviewed that might provide additional storm information. From these varied sources, only two storms were selected as candidates to add to the master list for study based on proximity to the region. Upon further review of DAD data available for these storms (Appendix 2), it was decided that they would be considered only for transposition and not included in the DAD analysis. Although the Seymour Falls and Mount Glacier storms occurred near the study region, both the storms were considered to be a storm type that could also be found within the northern portions of the study region. Further detail on the use of the two Canadian storms will be given in the discussion on maximization and transposition (Chapter 7).

Therefore, the total general storm sample used in this study amounts to 30 storms. Although it is possible that some storms may have been missed by this process, it is unlikely that any omitted storm would affect the results.

2.2 Storm Data Analysis

The analysis of major storms for the Northwest states is an important part of deriving PMP estimates. The process of analysis involves collecting rainfall data from available sources; applying quality control that verifies outliers and deals with missing data; and compiling the data into a format for automated processing. Along with this step, a parallel effort is made to prepare a synoptic weather analysis. This analysis is important in understanding the timing of rainfall and in defining the storm's precipitation pattern. Synoptic discussions have been completed for some of the 30 storms listed in Table 2.1. These discussions cover the surface and upper-air features, the precipitation (including snow), and the dew point and/or temperatures pertinent to the storm. Excerpts from the complete synoptic analyses made for these storms are provided in Appendix 2 of this report.

The objective of the APDA or ministorm analysis is to obtain DAD information upon which to base the PMP index maps, as well as depth-area and depth-duration relations. Many of the older storms had long ago been designated as significant and were assigned storm index numbers by COE (USCOE, 1945-). These index numbers have two-lettered designators that identify the Corps region (division). Thus, the North Pacific Region storms are listed as NPxx-xx. The latter part of the assigned number refers to the Corps' catalog system and does not follow a chronological order. The fact that a storm has been assigned a catalog number does not signify that DAD data are available, only that the storm was recognized as a major event. Relatively few storms in the western states were processed to the degree that DAD data are available. Even fewer storms from this region were formalized to the point of published pertinent data sheets being included in the Storm Rainfall Catalog (USCOE, 1945-). Due to the lack of DAD data for Northwestern storms, a procedure to develop such data for the storms identified in Table 2.1 was established by consensus between the NWS, SCS, Reclamation and COE representatives. The automated procedure developed for this purpose is described briefly in Chapter 5.

3. TERRAIN

The terrain of the Northwest region is complex and largely responsible for the broad variations in the observed climate. Numerous mountain ridges, including the Cascade Range and the Rockies, lie perpendicular to the dominant moisture inflow directions resulting in enhanced precipitation on upwind slopes and significant reductions in precipitation to the leeward. Some of these characteristics are shown in the map of mean annual precipitation (NCDC, 1992) shown in Figure 3.1. Totals exceeding 130 inches occur in the Olympic Mountains dropping to less than 10 inches just east of the Cascades and in the eastern Snake River Valley. While this analysis includes the latest updates, it is a computerized analysis that does not take into account the complex terrain of the region, and provides a fairly crude picture of mean annual precipitation.

Because of the widely different terrain and its effect on precipitation, and as has been done in other NWS reports in the west, the region was divided into subregions, particularly for the analysis of depth-area-duration relations (Chapter 10). The region was further analyzed in the vertical to create a barrier elevation map from which adjustments to moisture can be made to account for such obstructions.

3.1 Subregional Analysis

Numerous attempts were made to subdivide the region to better represent meteorologically or climatologically homogeneous regions. Terrain distinctions were based on consideration of 1:1,000,000 scale topographic maps. Initially, these maps (World Aeronautical Chart series) were analyzed to delineate subregions where elevation in any direction changes less than 1,000 feet in 50 miles or more. This preliminary analysis resulted in two separate subregions (orographic and least-orographic) as approximately represented in Figure 3.2. Prominent least-orographic regions on this diagram are the Puget Sound and Willamette Valley along with the plateau regions in eastern Washington and Oregon, and the Snake River Valley in Idaho.

A comparison was made between Figure 3.2 and the subregional analysis in NOAA Atlas 2 (Figure 3.3). Subregions 30, 31, and 32 of NOAA Atlas 2 were identified as least-orographic and the similarities of the least-orographic regions are apparent. A more detailed subregional breakdown of the Northwest's terrain was made in the depth-area-duration analysis, as discussed in Chapter 10.

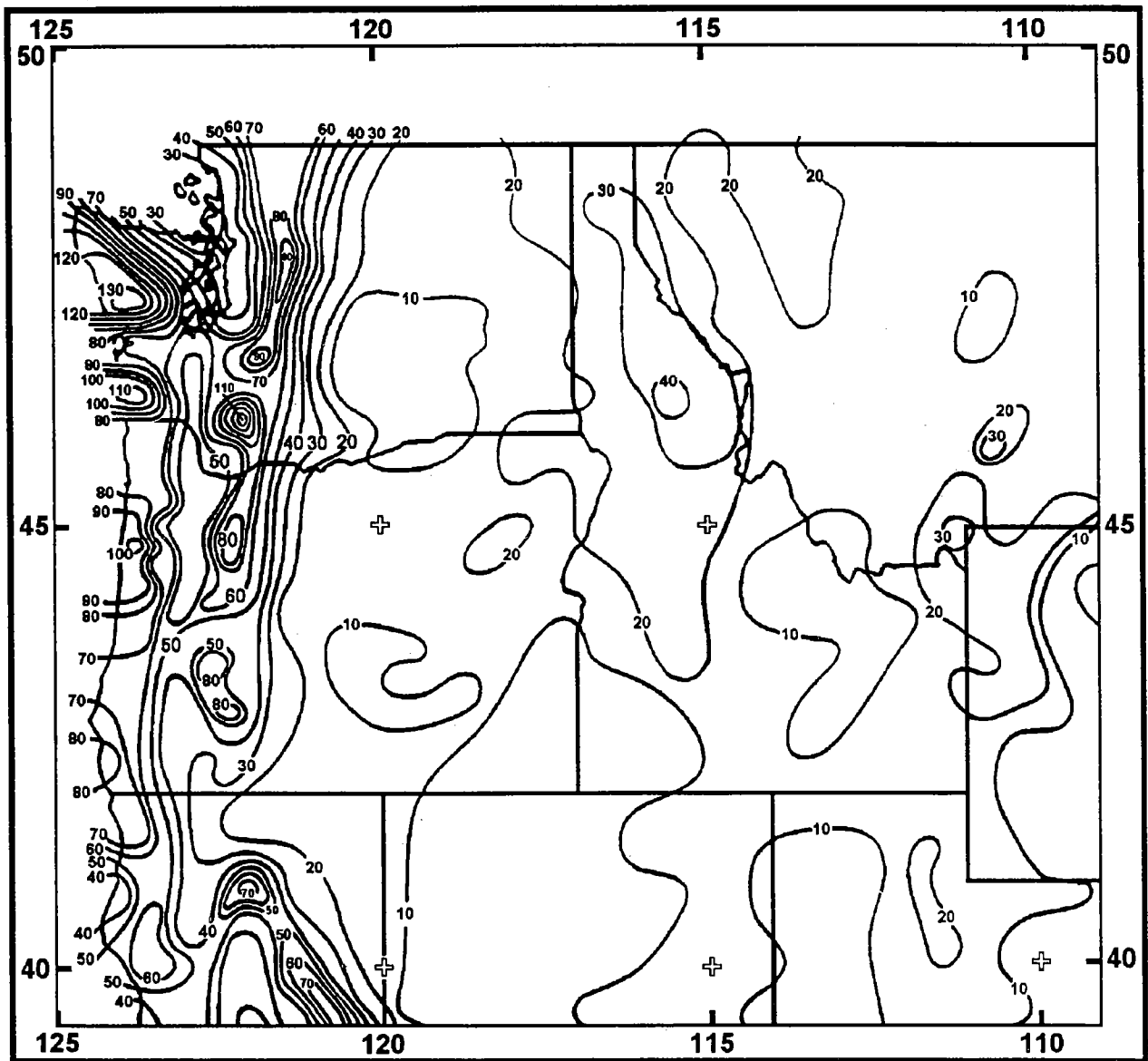

Figure 3.1.--Mean annual precipitation (inches), based on 1961-1990 normals (NCDC, 1992).

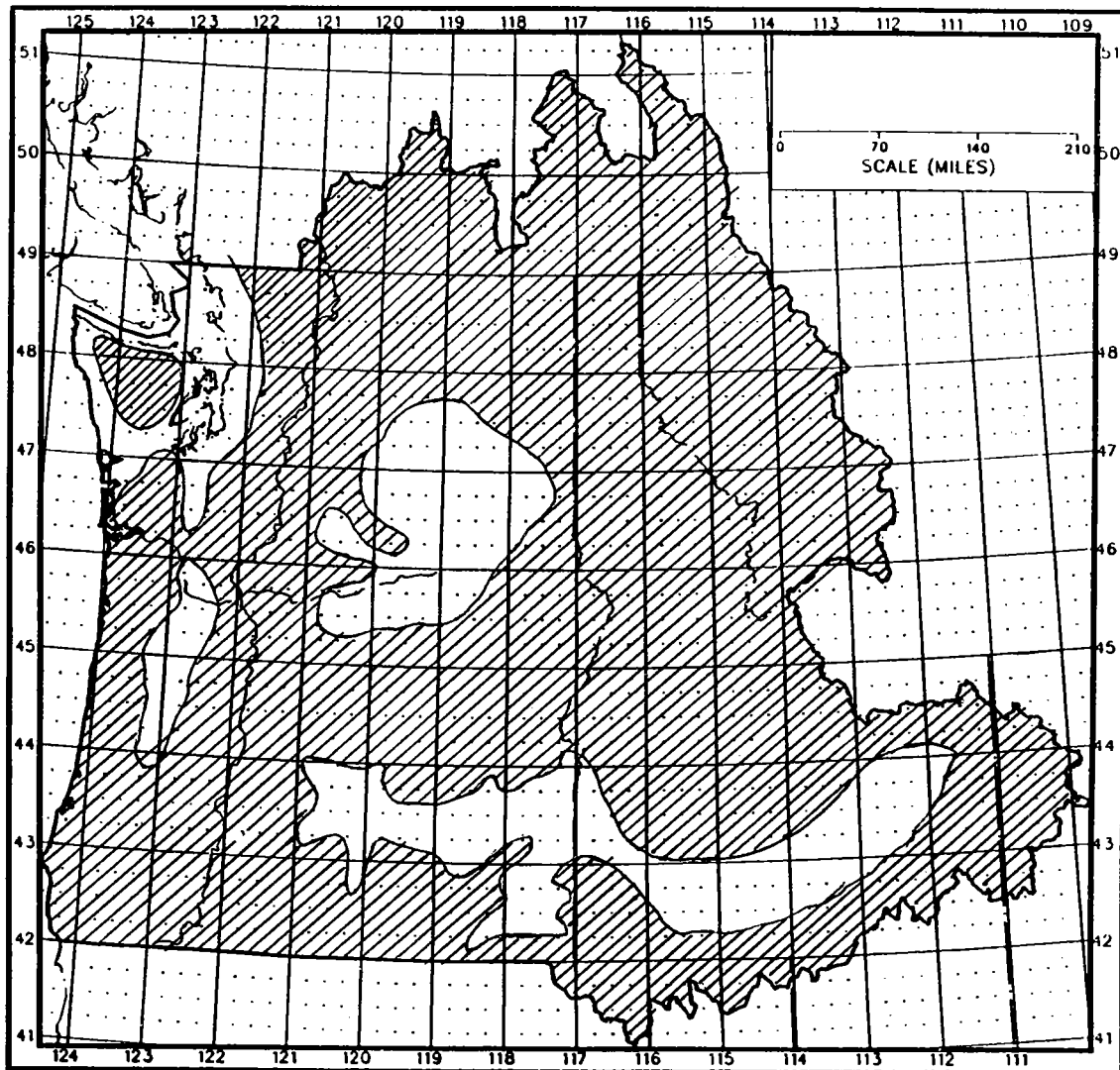

Figure 3.2.--Least orographic (non-hatched) and orographic regions (hatched).

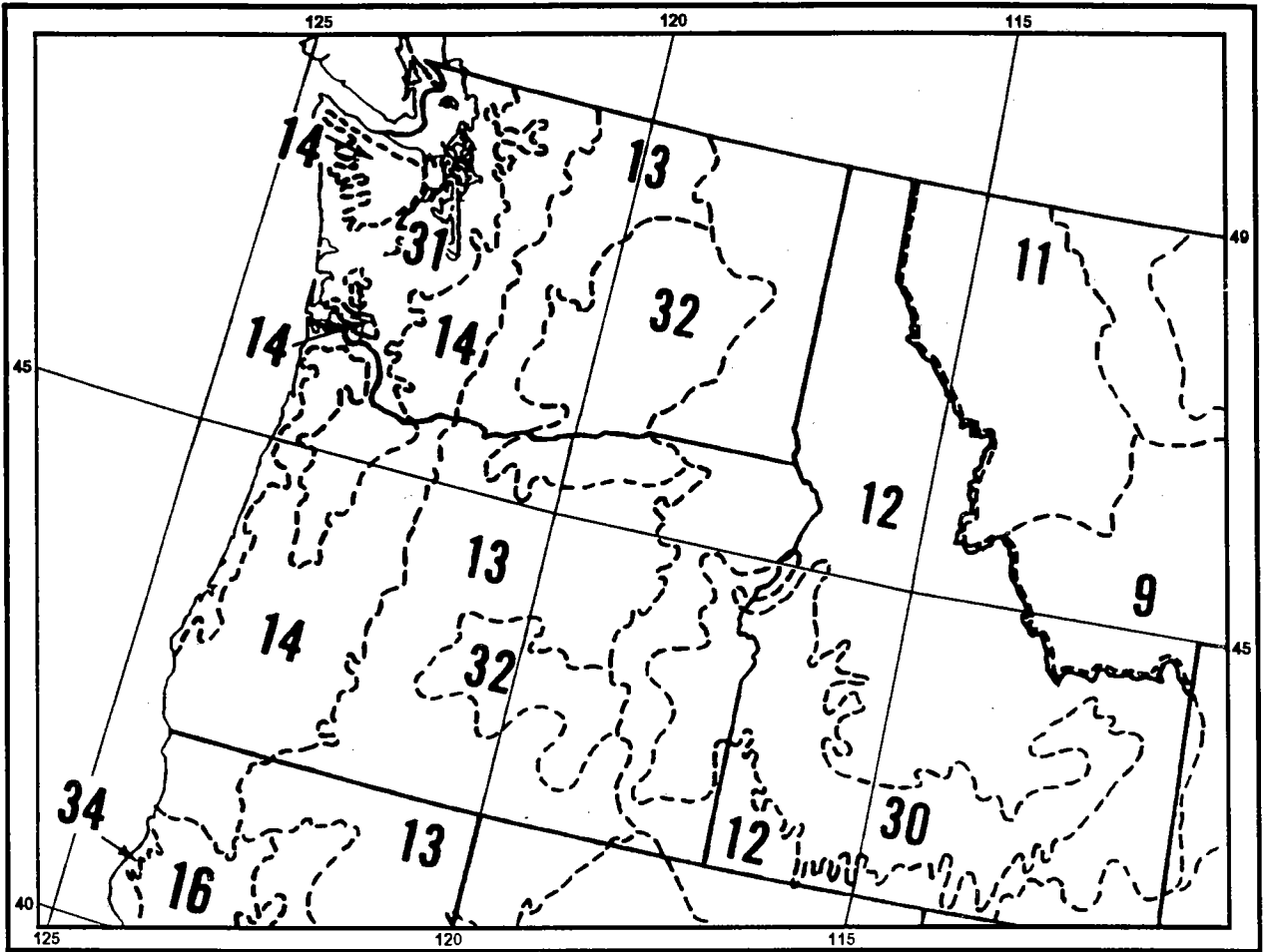

Figure 3.3.--Non-orographic regions (Nos. 30, 31, and 32) from NOAA Atlas 2.

3.2 Barrier-Elevation Map

Terrain features have a significant effect on the broadscale flow of moisture as it encounters and flows around and/or over the feature or barrier. This study followed the procedure of previous PMP studies in orographic regions by developing a barrier-elevation map. Its principal use is in making vertical adjustments to precipitation or moisture values. Barrier-elevation maps have been derived and discussed extensively in HMR 36, 43, 49 and 55A, and the technique for developing them will not be covered in as much detail here.

The analysis procedure begins with a determination of the moisture inflow directions for storms producing large precipitation amounts (Miller et al., 1973). Considering the sample of record-setting storms assembled for this report (Table 2.1), a range of optimum inflow directions was determined across the region as shown in Figure 3.4. Note that inflow winds are represented over a range of 90 degrees flowing in the direction of the arrows. As seen in Figure 3.4, most of the region receives moisture inflow from the west through the south, except in the vicinity of the Rocky and Bitterroot Mountains, where flows from the southeast through northeast dominates. At the northern end of the United States Rockies, the range of moisture inflows become more easterly to northerly. The inflows along the eastern border of the region are in agreement with those of HMR 55A. The boundary between westerly component and easterly component flows is not clearly defined, but in a broad sense runs from the United States-Canadian border near 118°W longitude southeastward to the northwest corner of Utah.

The barrier-elevation analysis in HMR 43 (Figures 3-36a and b in that report) served as a starting point for the present study. That analysis was verified using the storm inflow directions in Figure 3.4. Adjustments were made where necessary and reflected the fact that some of the directions in Figure 3.4 were not those considered in HMR 43.

North of the 49th parallel, the analysis was unique and based on extension of the approach used in the northwestern United States. No information could be found in available Canadian literature to support this analysis.

The final barrier-elevation maps were completed at 1:1,000,000 scale on which topographic features less than 10 miles in width were eliminated. A reduced scale example of this map is shown for most of the region except for southern Canada, as shown in Figure 3.5. The original hand-drawn analyses were far more detailed than the analysis in Figure 3.5, which shows only 1,000-foot intervals. This figure does show the prominent elevation maxima in the Northwest, such as the Olympic Mountains and Cascades with maximum barrier elevations exceeding 6,000 feet along the crests. Barrier elevations over 9,000 feet are found in parts of the Rockies. A rule of thumb applied to many previous studies, and applied here as well, was to close off the effects of singular barriers downwind about 1.5 times the barrier width.

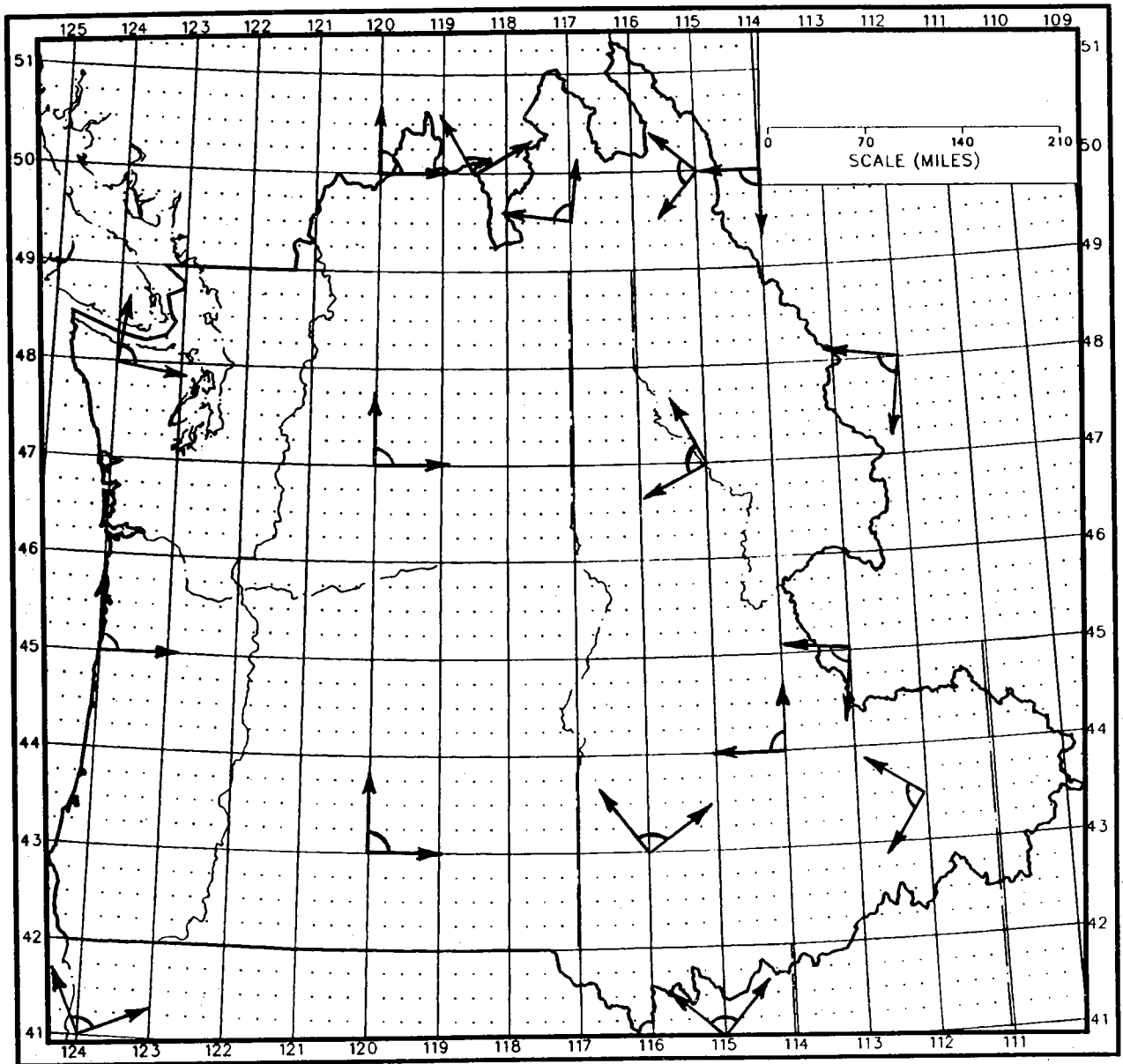

Figure 3.4.--Range of inflow wind directions producing large rains.



Figure 3.5.--Barrier elevation analysis in hundreds of feet, reduced from 1:1M scale.

4. MOISTURE ANALYSIS

4.1 Introduction

Atmospheric moisture is often represented by the surface dew point in PMP studies for several reasons. There are far more surface stations than upper-air sounding stations and observations are taken much more frequently (hourly vs. twice a day). Upper-air observations do allow the measurement of total vertical moisture in terms of precipitable water (USWB, 1951). However, the lower density of such stations does not allow spatial variations in low-level moisture to be accurately depicted. Additionally, a number of studies (Reitan, 1963; Bolsenga, 1965) have shown that surface dew point is an acceptable measure of water vapor aloft in the saturated atmosphere of storm periods.

HMR 43 described the seasonal variation of 12-hour maximum persisting 1000-mb dew points for the region providing both seasonal curves at selected locations as well as regional analyses for each month. In this study, these analyses were modified by using more recent data. The concept of maximum persisting dew point has been used in PMP studies for quite some time. It may be useful, however, to restate the definition. The maximum persisting dew point (for some specified time interval) is the value equalled or exceeded at all observations during the time period.

To derive the monthly 12-hour maximum persisting dew point maps, records at 36 locations were obtained from past studies (HMR Numbers 36, 43 and 49). Data on a series of computer tapes (Peck et al., 1977) through 1983 were examined for exceedances to the previous study records, after reduction to 1000 mb by use of the vertical adjustment process discussed in Section 7.3. When such exceedances occurred, they were verified against values in the Local Climatological Data (National Climatic Data Center, 1948-) and were also checked with synoptic weather information to ensure that the new records were set under conditions favorable for precipitation. When new dew point records occurred during precipitation sequences, the dew points were accepted provided that upwind trajectories from the site showed increasing dew points over time. Once the new records were determined, new annual curves were drawn at these stations. Values from these curves were plotted on monthly maps and new maps drawn. Maps of month-to-month changes of persisting dew point values were made and individual monthly maps redrawn where necessary to obtain a smooth monthly transition in persisting dew points across the study area. Monthly differences from the earlier reports were usually less than 2°F and did not exceed 3°F within the study region.

The monthly isodrotherm analyses were extended into British Columbia based on information in Verschuren and Wojtiw (1980), supplemented by

additional station data supplied by the Canadian Atmospheric Environment Service. These data were handled in the same manner as were the United States data.

4.2 Revised Monthly Maps of 12-Hour Maximum Persisting Dew Point

A revised set of monthly 12-hour maximum persisting 1000-mb dew point maps was prepared for this study from the data described above. The maps are shown in Figures 4.1 to 4.12. Some smoothing of the results was necessary in order to assure that a smooth transition existed between each month at all locations. To do this, numerous seasonal curves were plotted, as shown by three examples in Figure 4.13.

The 12-hour maximum persisting dew points in Figures 4.1-4.12 are an update to HMR 43 and are used in a number of applications in this study to adjust station moisture for elevation. Hogg (personal communication, 1993) has pointed out that direct analysis of precipitable water using upper-air data could also be done, since more upper-air data are now available. While it was not possible to investigate the effects of Hogg's remarks within the timelines of this study, a recommendation for further study in this area may be appropriate.

A study by Tomlinson (EPRI, 1993b) has recommended that, on the basis of studies conducted for the Great Lakes region, average maximum dew points are better indicators of inflow moisture than are 12-hour maximum persisting dew points. It was also suggested that the duration of averaging be more consistent with the length of critical precipitation. Both of these suggestions warrant additional consideration and in particular, their application to other regions needs to be addressed. However, these ideas were too late to be considered for the present study.

In Figure 4.14, the Northwest region is partitioned into cool season (October-March), warm season (April-September) and any-season (January-December) subregions. These subregions correspond to the months in which the largest daily precipitation amounts have been observed most frequently. Isodrosotherms were drawn for each of the three sections by averaging the indicated monthly dew point values at all locations within each section. The analyses were then combined by smoothing across sectional boundaries. The result was the "multi-seasonal" 12-hour maximum persisting dew point map shown in Figure 4.15. This map was used to adjust all transposed 1000-mb free atmospheric forced precipitation (FAFP) values in the region to their respective barrier elevations. It was used for the same purpose with 100-year, non-orographic precipitation values to create the orographic parameter, T/C (Chapter 7).

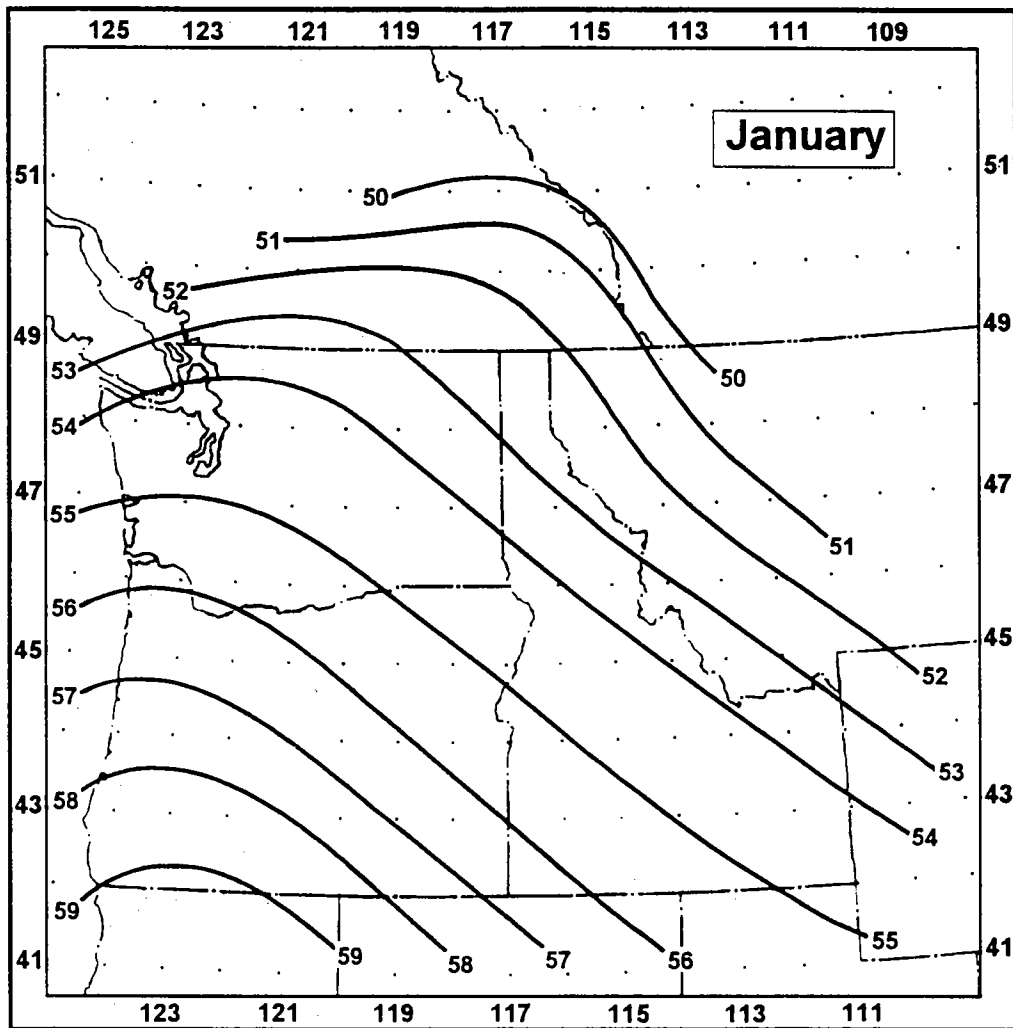

Figure 4.1.--12-hour maximum persisting 1000-mb dew point analysis (°F), January.

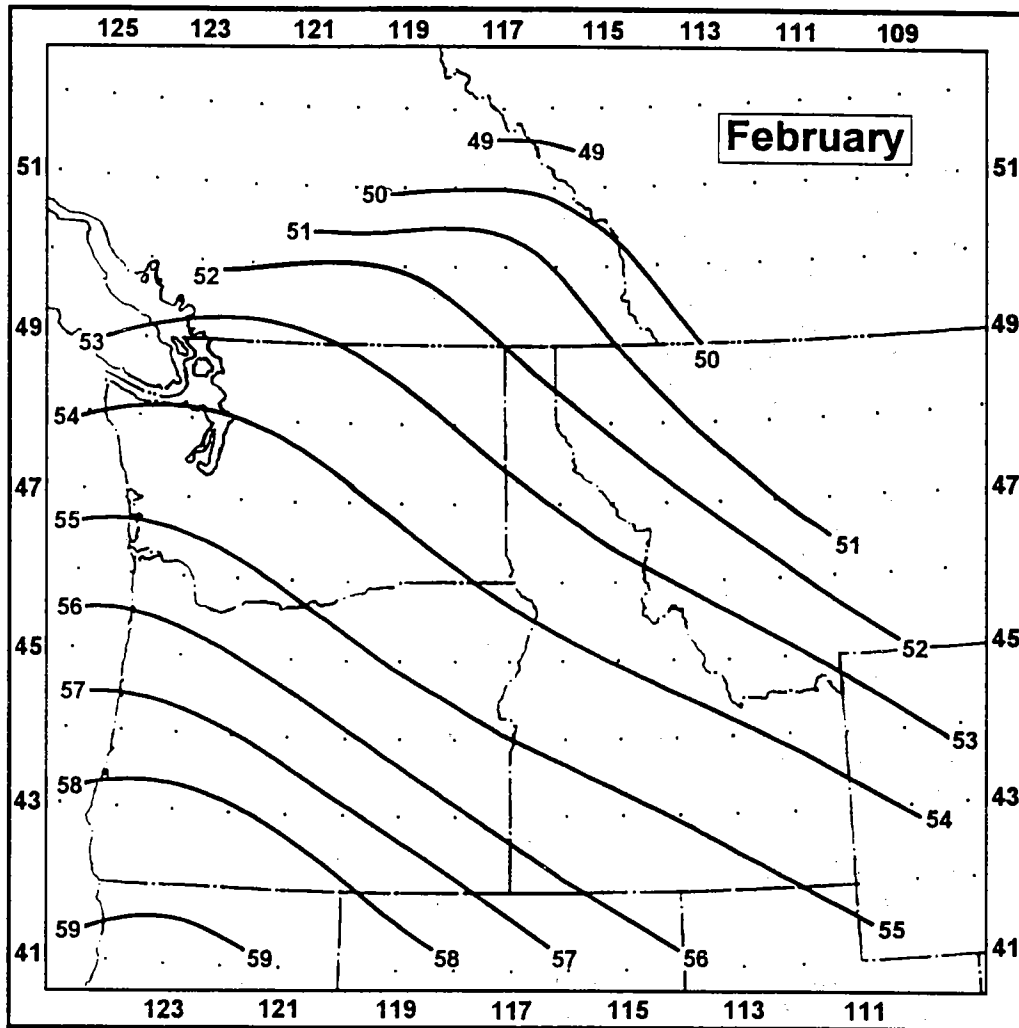

Figure 4.2.--(see Figure 4.1), February

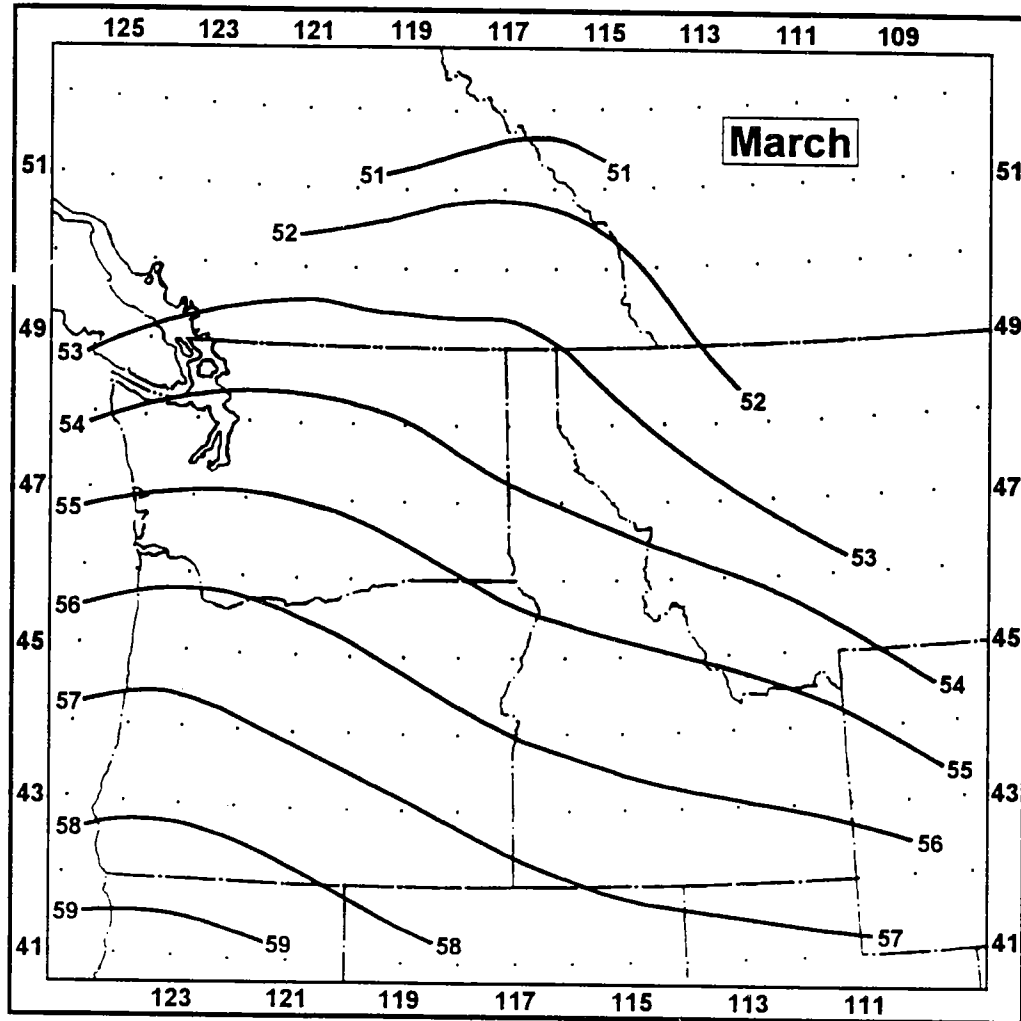

Figure 4.3.--(see Figure 4.1), March.

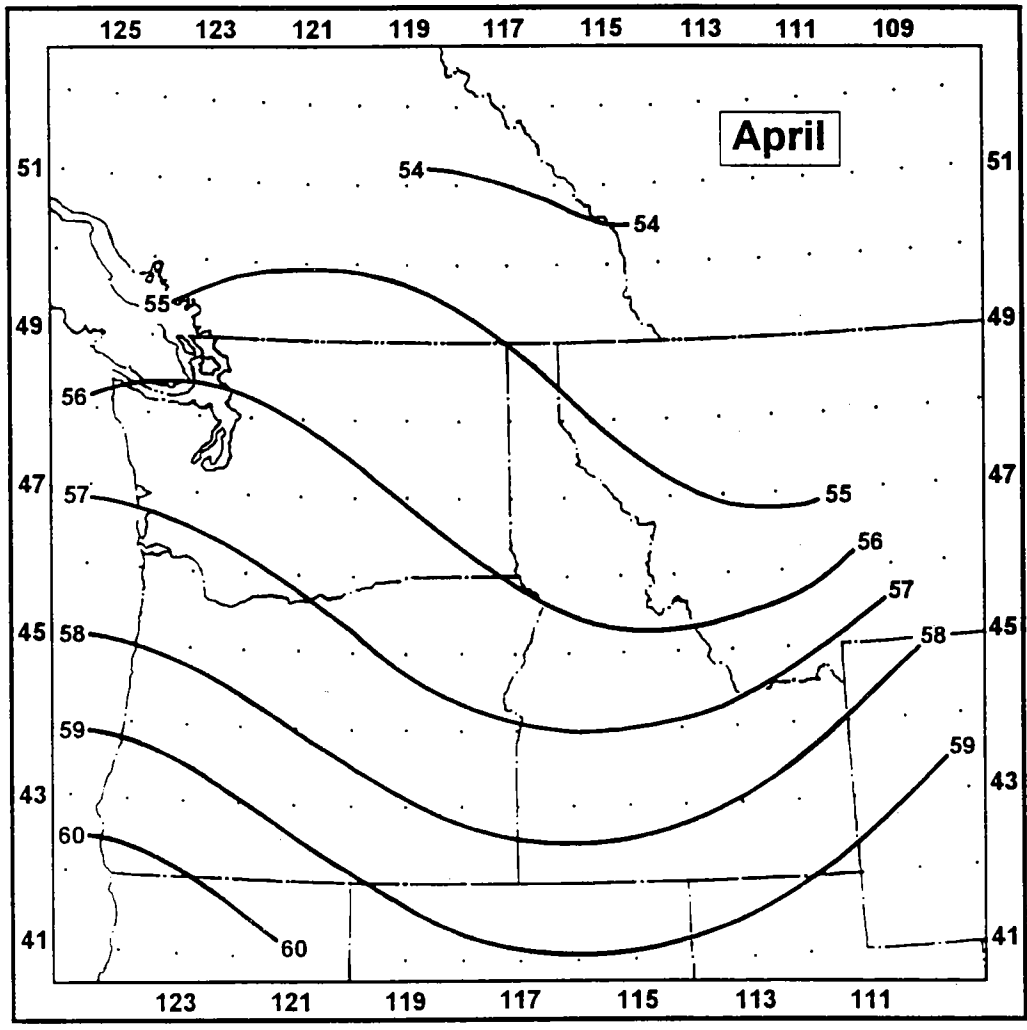

Figure 4.4.--(see Figure 4.1), April.

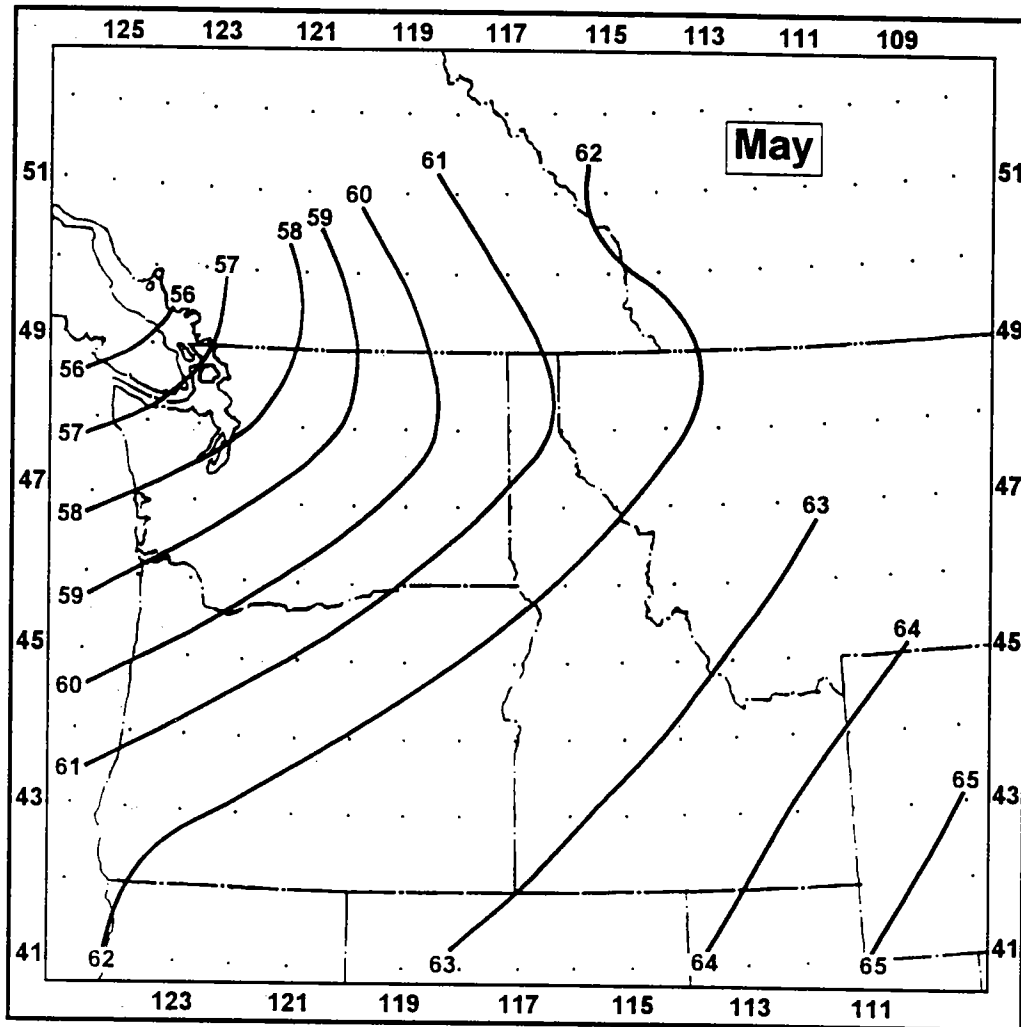

Figure 4.5.--(see Figure 4.1), May.

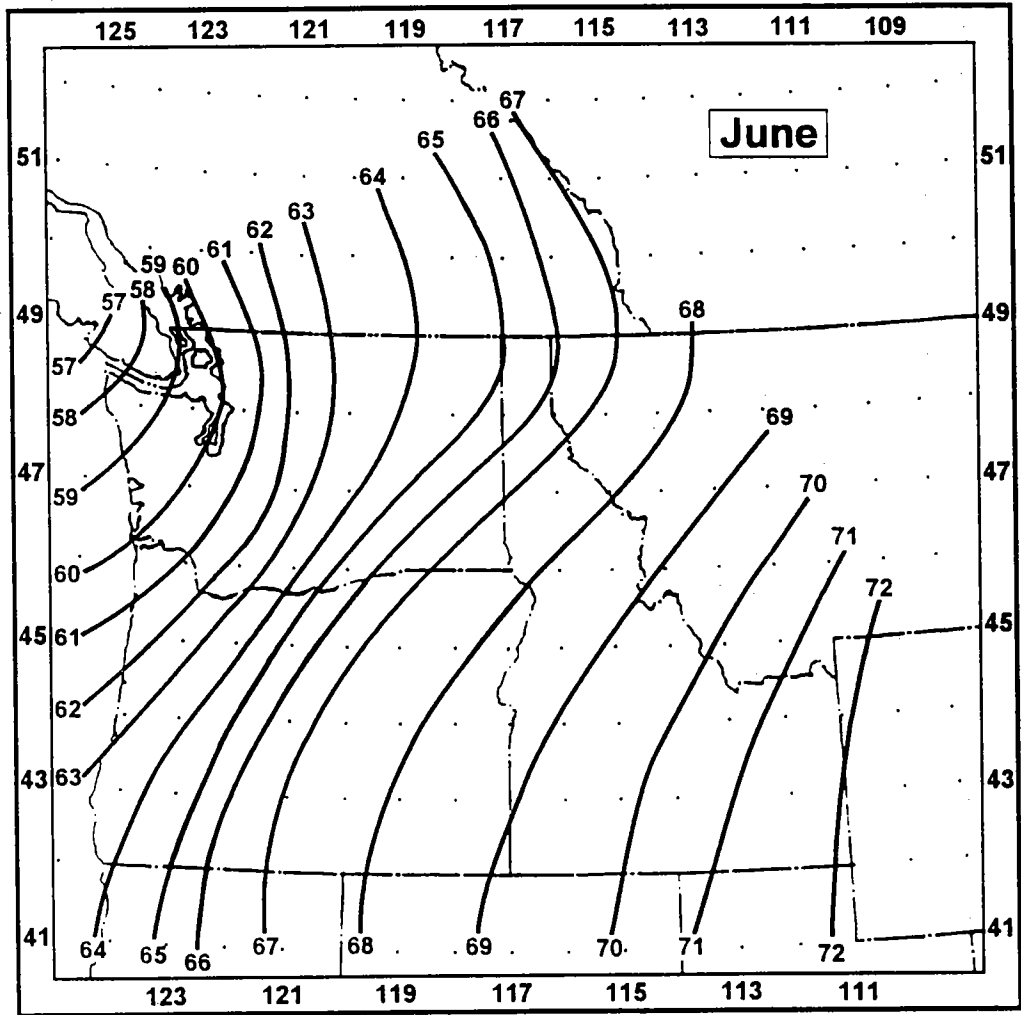

Figure 4.6.--(see Figure 4.1), June.

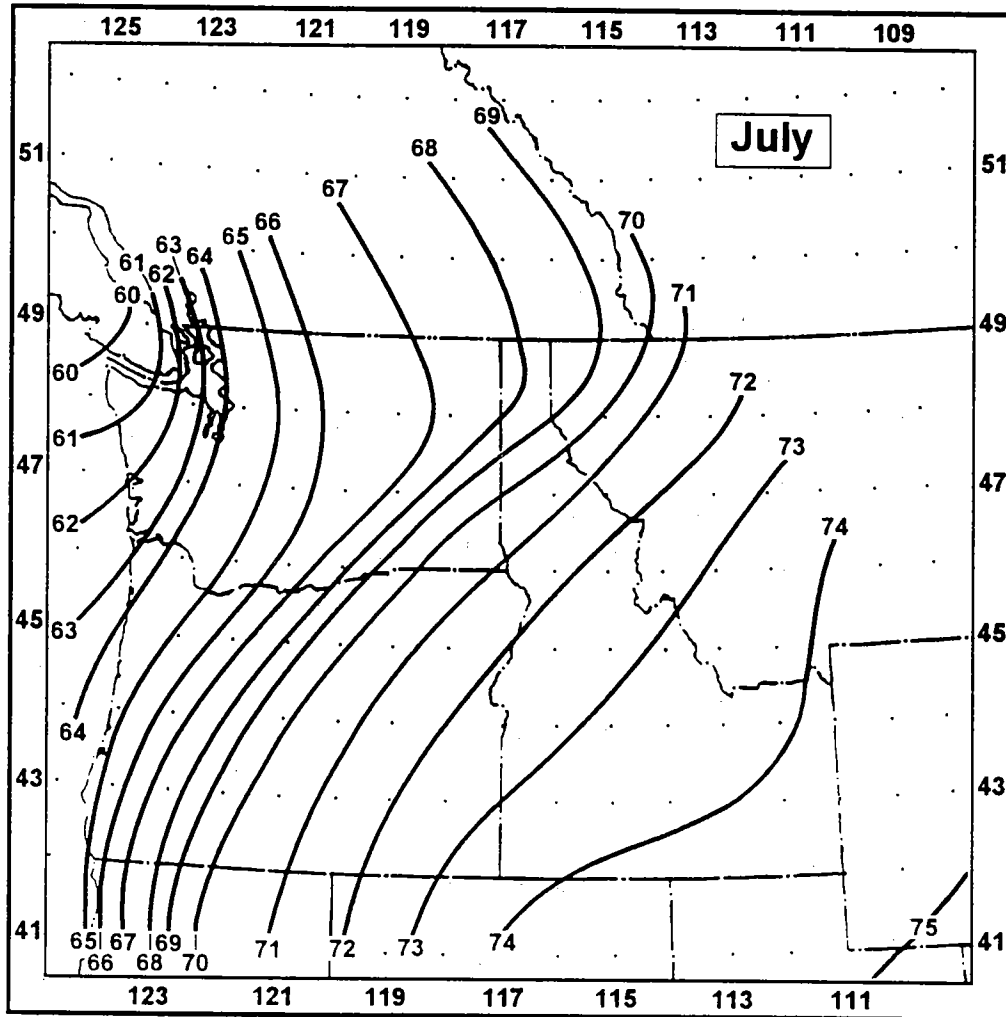

Figure 4.7.--(see Figure 4.1), July.

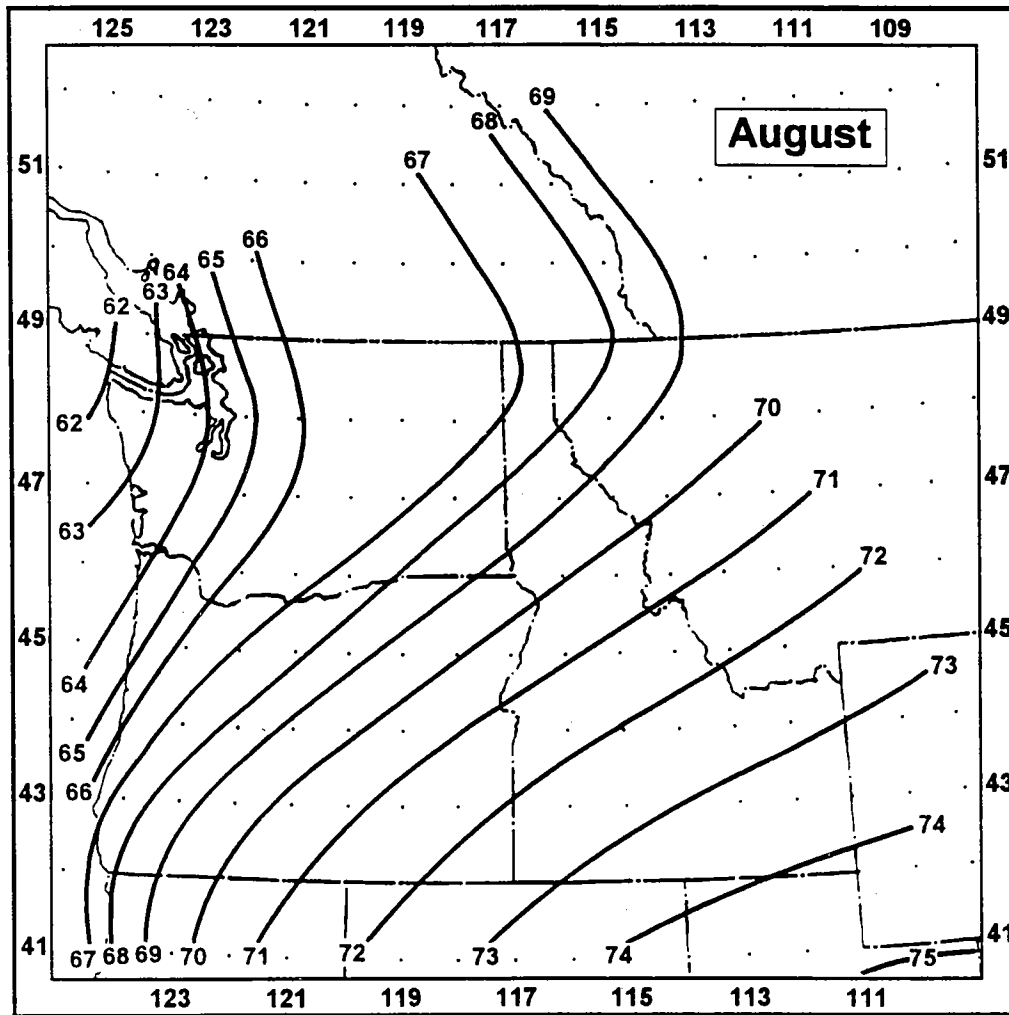

Figure 4.8.--(see Figure 4.1), August.

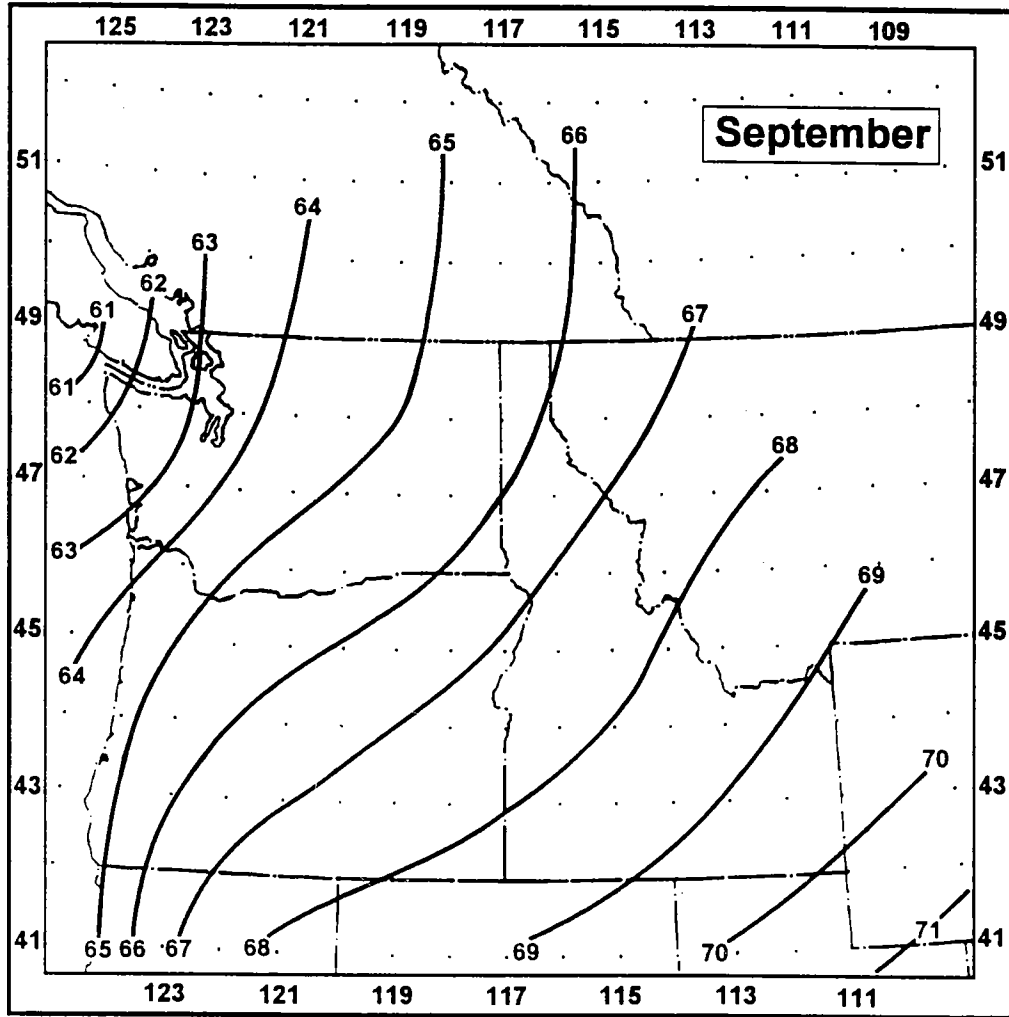

Figure 4.9.--(see Figure 4.1), September.

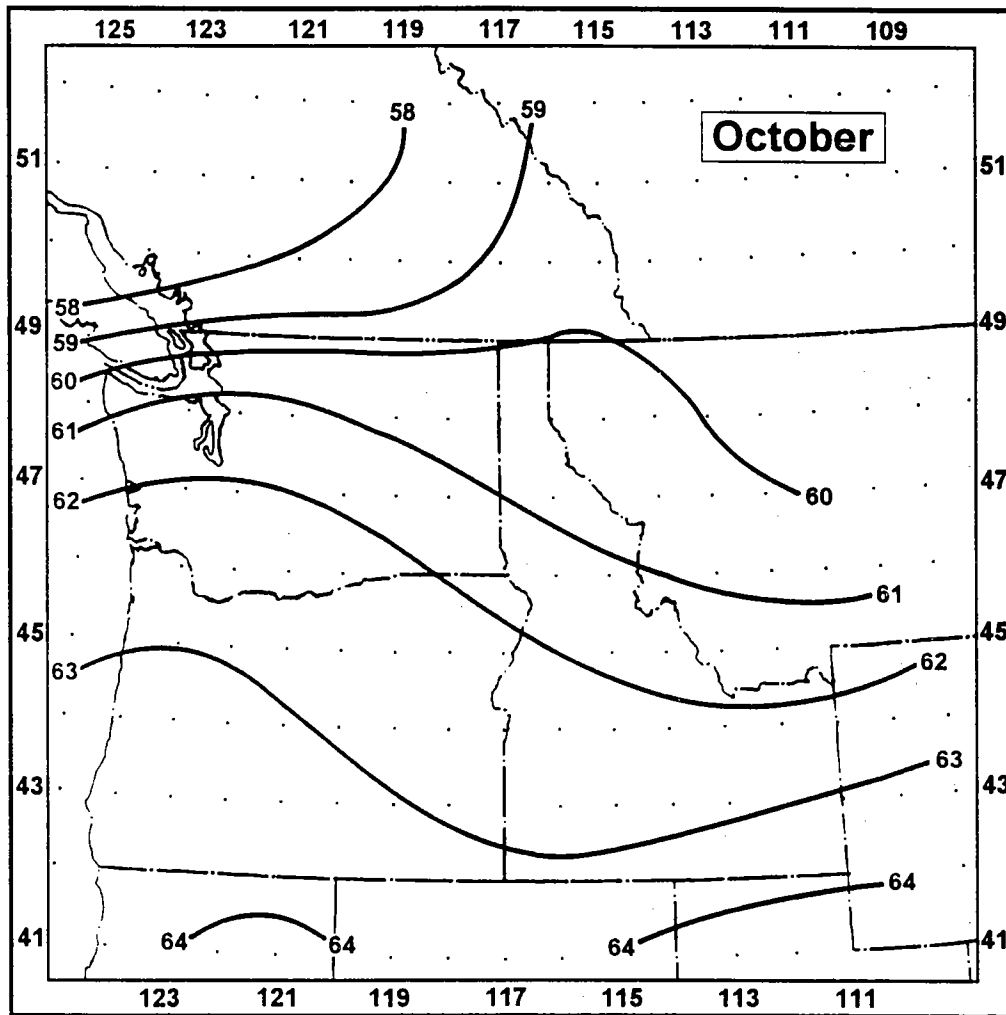

Figure 4.10.--(see Figure 4.1), October.

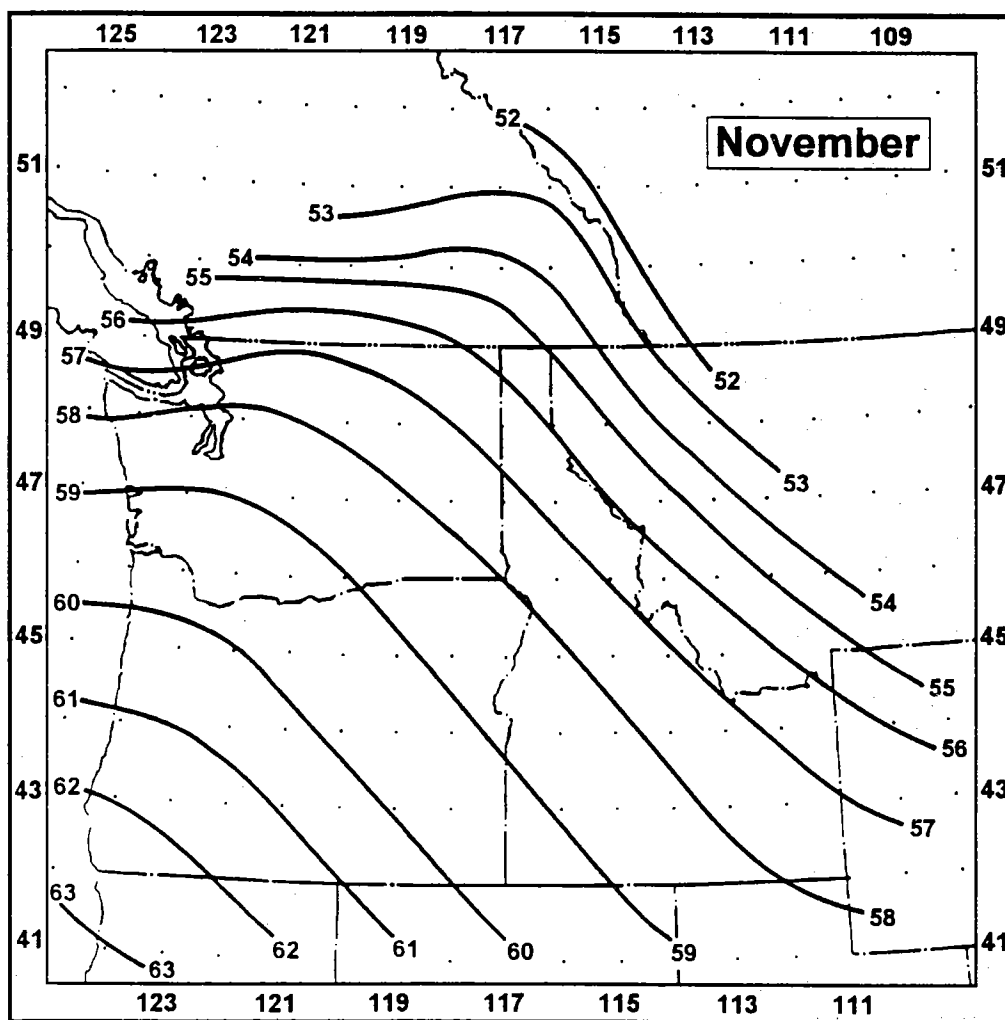

Figure 4.11.--(see Figure 4.1), November.

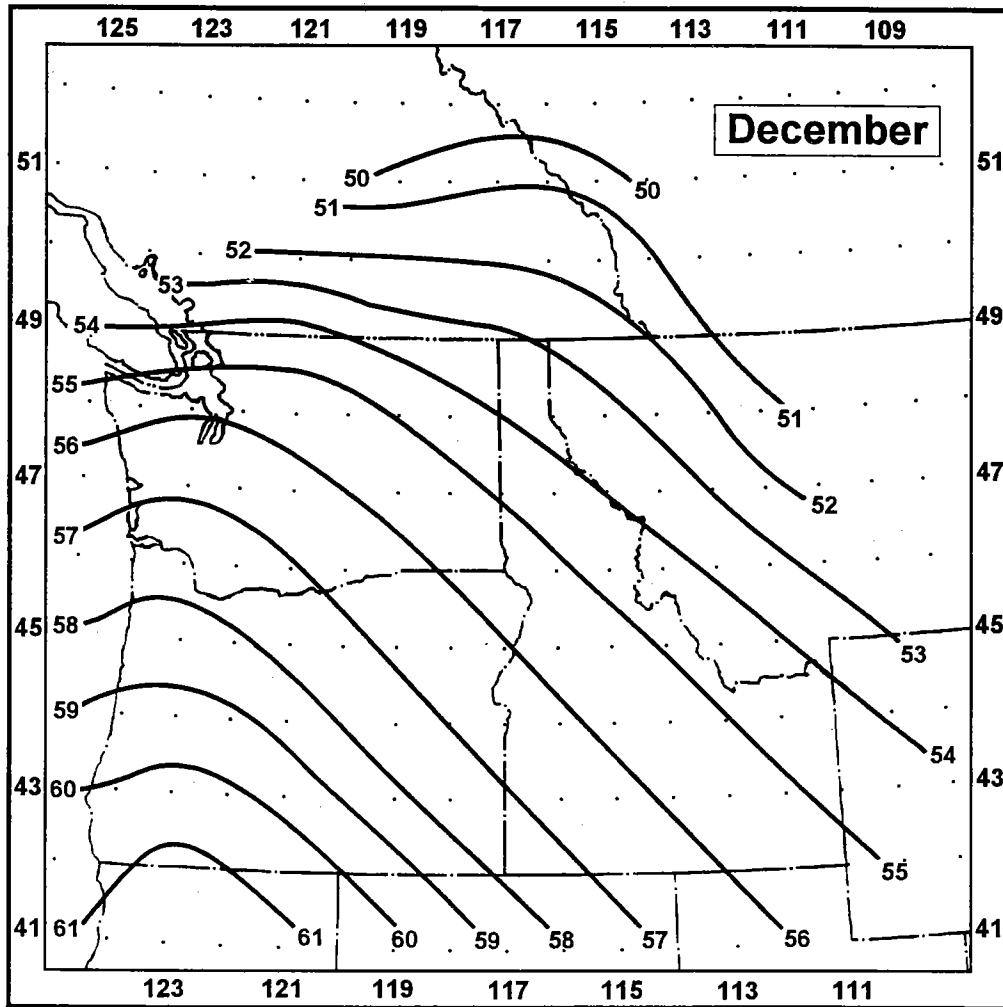

Figure 4.12.--(see Figure 4.1.), December.

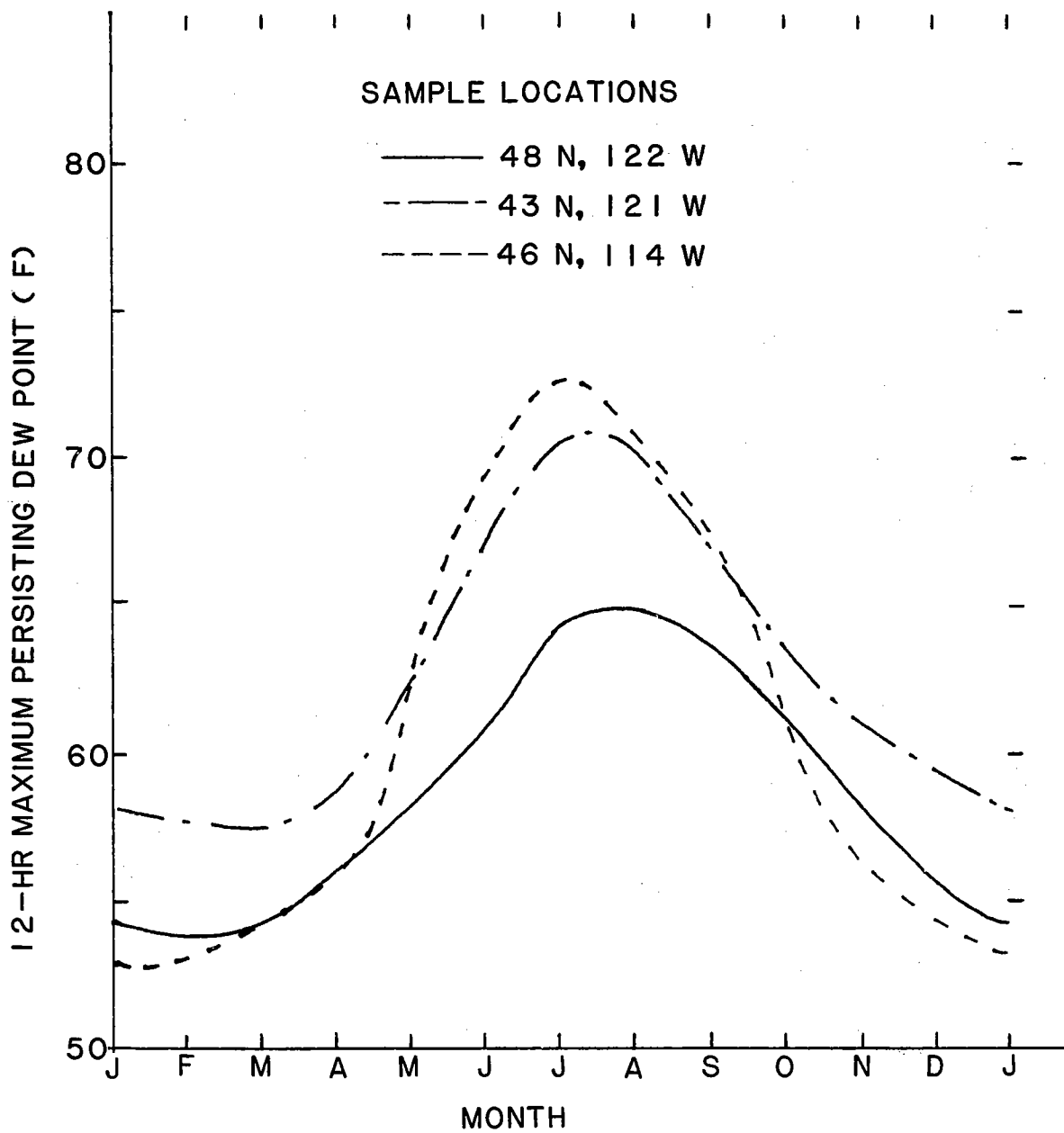

Figure 4.13.--Samples of smooth seasonal curves for selected locations (from Figs. 4.1-4.12), 1000-mb, 12-hour maximum persisting dew point (°F).

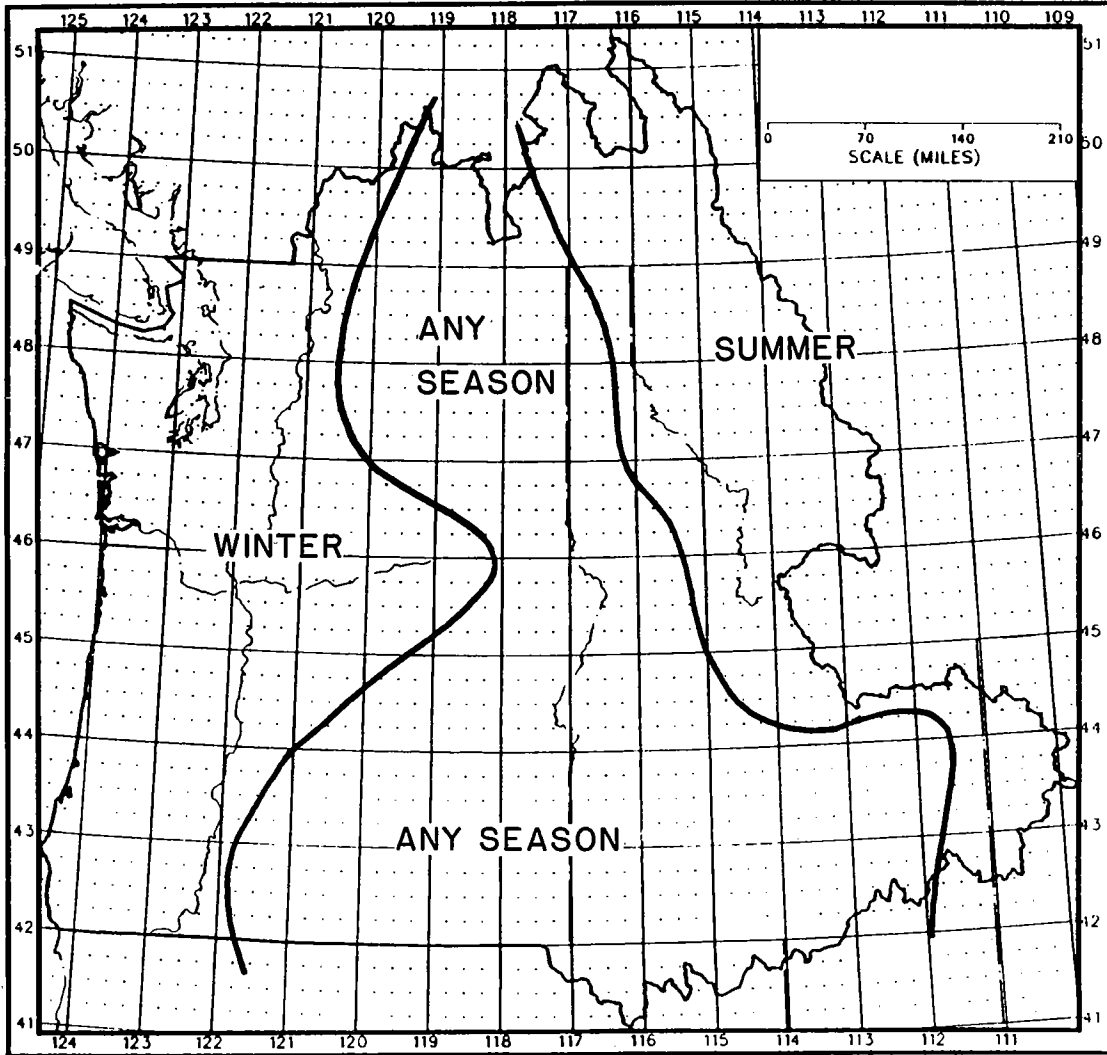

Figure 4.14.--Seasonal subregions for maximum daily rainfalls.

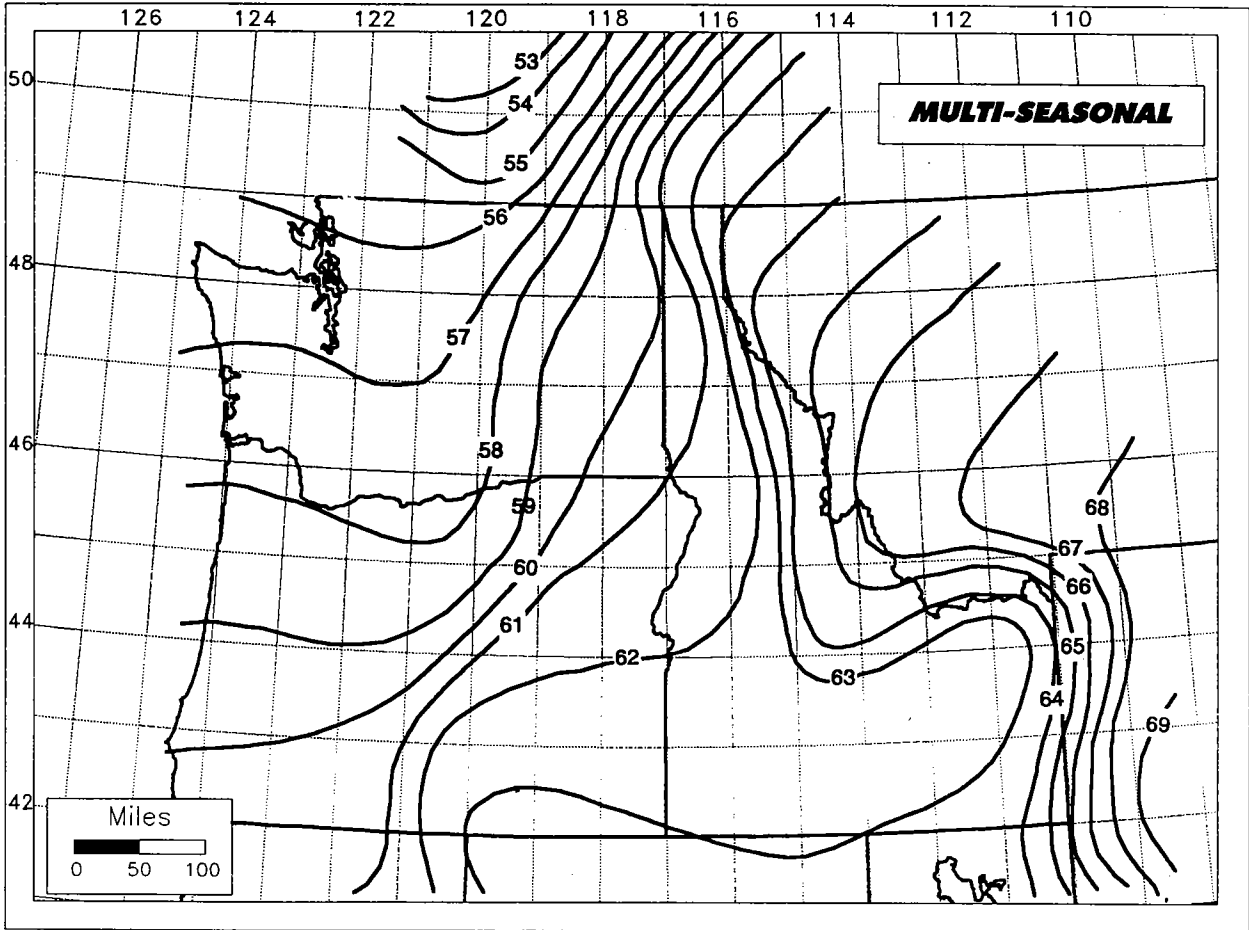

Figure 4.15.--Multi-seasonal maximum persisting dew-point analysis (1000 mb, °F).

4.3 Determination of Storm Dew Points

Just as it is important to determine the 12-hour maximum persisting 1000-mb dew points, it is equally important to obtain dew points representative of the moisture contributing to individual storms considered as major events. The ratio of maximum to storm persisting dew points (both converted into precipitable water) is taken to define the potential for precipitation increase in the storm maximization process.

In the traditional method for storm maximization, primarily in the non-orographic regions, it is customary to seek surface dew points along the inflow trajectory from a moisture source to the storm site. This effort is sometimes referred to as "finding the reference location" for a particular storm. Reference locations have been annotated in NWS files for almost all storms listed in the Storm Catalog (USCOE, 1945-). However, in mountainous or coastal regions, the likelihood of finding adequate storm reference dew points is small. Furthermore, where some reference locations have been analyzed as far as 1000 miles from the storm site (HMR Numbers 51 and 55A) for storms in the eastern United States, it is very difficult to locate adequate inflow dew points for storms located close to coastal regions, as is the case for most storms in this study.

In the past, for storms occurring along coastal zones, reference has been made to dew points taken at sea if available, but also to sea surface temperatures (SST), since it is assumed that in most high moisture situations the SST represents the maximum limit that could be reached by a dew point over the ocean.

Therefore, in this study, extensive consideration was given to SST analyses. The warm air flowing into many of the storms in the study region (those whose centers are west of about 121°W) crosses a region of persisting and relatively cold SST along the coastline and westward to around 130°W . During these crossings, the dew point representative of the warm air mass could be altered. In such situations the boundary layer air, chilled by these cold coastal currents, acts as a desiccator or sink for part of the low-level moisture flowing toward the eventual storm site. This moisture is "left behind" in the form of fog, cloud or drizzle as the inflowing air rides over the more dense boundary layer zone. Parcels of inflowing air, besides being desiccated, may also become mixed through turbulent interactions or by diffusion with parcels of lower moisture content air from the boundary layer air while in transit to the storm site. The net result of such passages is that the "representative" moisture content of the original air is reduced by some percent within its lower layer. What is not certain is how to calculate what the size of this hypothetical reduction would be, since input data from the historical storms is extremely limited or altogether lacking.

It appears, however, that the uncertainty in the precise amount of moisture reduction on a specific historical occasion is not critical in determining an in-place maximization factor, since this factor will change little from its value based on the

original, "representative" value. To demonstrate this situation, consider Table 4.1 in which a number of sample computations are presented. Table 4.1 is an example for an arbitrary barrier elevation of 3,000 feet, although other elevations would provide similar results. Various moisture contents are given in the first column ranging from a mixing ratio (W, the ratio of water vapor to dry air) of 14.0 g/kg to 4.3 g/kg, where 14.0 represents 100 percent of available moisture and 4.3 is about 31 percent. For each moisture content, there are a selection of SST differences between 12°F and 2°F listed across the table. As an example, for a mixing ratio of 14.0 g/kg, and a SST difference of 10°F (maximum SST of 68°F and an observed SST of 58°F), the in-place moisture maximization factor (IPMF) is 1.76 (ratio of precipitable water at maximum SST to precipitable water at observed SST).

What is important to see in Table 4.1 is that over the range of moisture content from 100 to about 30 percent (14.0 to 4.3 g/kg), the in-place moisture maximization factors show little variation through each column. If the SST range (upper limit to observed) is 12°F, the IPMF varies between 1.96 and 2.04, and if the SST range is 4°F, the IPMF varies between 1.25 and 1.27. The importance of this information is that if one assumes at the onset of a trajectory, there is 100 percent moisture and that as the air follows the trajectory, some amount of moisture is removed, the in-place moisture maximization factor remains essentially unchanged as long as the amount removed (the difference between maximum and observed SST) is unchanged. This finding was adopted in the current study and the IPMF observed at the trajectory reference point was used at the storm site for each of the storms in Table 2.1, with the exception of storms 29, 106, 143 and 155. Storm 155 derived its moisture from the Gulf of Mexico, while storms 106 and 143 are indicative of more intense convective storms whose moisture source is more localized. Storm 29 was probably initiated with Gulf of Mexico moisture, but no dew point data were available. Pacific moisture arrived at the site of storm 29 after the first 24 hours of the critical precipitation period (CPP). SST were therefore substituted for storm 29 maximization. CPP, a concept used in the storm analysis procedure, refers to the most significant period of rainfall within a particular storm and can vary in duration.

SST was utilized as a proxy parameter for measuring the total precipitable water content of the inflowing warm air. SST was then used in the same way persisting dew points at land locations have been used to represent total moisture content in other reports. The study relied on the standard deviation of SST as the best available approximation for setting an upper limit on precipitable water content. A marine climatic atlas of the world, (U.S. Navy, 1981), was used to obtain the mean and standard deviation information that set the upper limit of the moisture content for PMP. It was assumed that the mean SST, plus two standard deviations at a location where a reliable SST was obtained previous to the CPP of a storm, would be adequate to define the storms' upper limit or maximum moisture "charge" or availability. A reliable SST will be defined in step 2 below. The choice of two standard deviations, representing about 98 percent of normally distributed values, was intended as another case of a less-

than-extreme value being combined in developing PMP. The point to be made is that while the PMP definition calls for theoretical maximum values, actual applications are based on observed maxima. Use of the mean plus two standard deviations places the magnitude of this parameter at about the level of other estimates used in this study, e.g., the 100-year frequency values.

Table 4.1.--Relationships among in-place maximization factor (IPMF), moisture content ranges at 1000 mb and percentage moisture reduction for a storm site at a barrier elevation of 3,000 feet MSL.

S = SST range (°F) at source location W = mixing ratio (g/kg) of the listed PMP, 1,000 mb dew points...ex: 14.0 g/kg for 68°F, 4.3/kg for 38°F () = percentage reduction of W from first row							
W	S	12	10	8	6	4	2
14.0 (100)	Max. SST =	68	68	68	68	68	68
	Obs. SST =	56	58	60	62	64	66
	IPMF =	1.96	1.76	1.57	1.40	1.25	1.12
11.5 (82)	Max. SST =	63	63	63	63	63	63
	Obs. SST =	51	52	55	57	59	61
	IPMF =	1.96	1.75	1.56	1.41	1.25	1.12
9.4 (67)	Max. SST =	58	58	58	58	58	58
	Obs. SST =	46	48	50	52	54	56
	IPMF =	2.00	1.76	1.56	1.39	1.26	1.12
7.8 (56)	Max. SST =	53	53	53	53	53	53
	Obs. SST =	41	43	45	47	49	51
	IPMF =	1.97	1.76	1.58	1.41	1.27	1.12
6.3 (45)	Max. SST =	48	48	48	48	48	48
	Obs. SST =	36	38	40	42	44	46
	IPMF =	2.04	1.75	1.63	1.40	1.26	1.14
4.3 (31)	Max. SST =	38	38	38	38	38	38
	Obs. SST =	26	28	30	32	34	36
	IPMF =	2.00	1.87	1.65	1.47	1.27	1.17

The following practices were followed to obtain an in-place maximization factor:

1. Starting at the location of a maximum 10-mile² depth during the CPP, a backward-in-time trajectory was determined toward the source region of the air contributing to the precipitation. Available analyses of sea-level pressure patterns were extrapolated plus or minus one-half of a time interval between map times to establish the orientation and magnitude of trajectory elements. The speed of the gradient level flow over open water could be adequately approximated by the analyzed sea-level pressure gradient. The gradient-level wind was considered to be the appropriate wind in low-level moisture inflow. Timing marks were put on this trajectory at regular time intervals to represent the progress of air parcels toward the storm site. The timing of the trajectory generally ends at the start of the CPP; but, if the major portion of the precipitation fell in the later hours of the CPP, the start time of the backward-in-time trajectory was adjusted to coincide with the beginning of the major portion of the precipitation. The point selected to obtain a SST (the reference location) will be on the trajectory closest to the storm center.
2. A "reliable" estimate of SST was governed by the following rules:
 - a. Any SST observation based on a ship observation along the trajectory, in the absence of contrary observations, is considered reliable. The time of the ship observation nearest the trajectory should be within 24 hours of the (interpolated) time mark on the trajectory. This 24-hour limit may be extended if there is evidence that SST's have persisted for more than 24 hours at other locations in the same synoptic weather regime.
 - b. An SST isotherm crossing the backward trajectory, based on analysis of ship observations that is within 5 degrees of latitude of the reference location, is considered reliable if these observations fall within the time constraint of a. above. If either the time or the space constraint cannot be met, the analyzed SSTs on the trajectory are considered unreliable.
 - c. If a front intersects the trajectory within 6 hours of its interpolated time mark as determined in a., then SSTs along the trajectory upflow from this point are unreliable even if they conform to the rules given in a. or b. However, SST measurements downflow from such a frontal intersection point can be considered reliable. If there is evidence of persisting SSTs following frontal passage, this rule may be waived and the earlier value accepted as reliable.
3. The data used to obtain the maximum SST from the Navy Marine Climatic Atlas was the beginning day of the backward-in-time trajectory plus or minus 15 days toward the warmer month of SSTs at the selected

point. The 15-day rule parallels the time factor used in the traditional land-based maximization procedure (WMO, 1986).

4. For storms 106 and 143 that do not have extended inflow trajectories, the traditional NWS procedures were followed as described in the Manual for Estimation of Probable Maximum Precipitation (WMO, 1986).
5. Calculations of maximizing factors were made with temperatures to the nearest tenth of a degree Fahrenheit and precipitable water amounts used came from interpolation in precipitable water tables (USWB, 1951).

All trajectories were drawn using archived surface weather maps. For storms before 1950, SST measurements came from archived ship reports from the NOAA Environmental Research Laboratory (Boulder, Colorado) and from the National Oceanic Data Center, Washington, DC, supplemented by the daily weather maps. The records of land station observations from the Local Climatological Data Series were used to obtain persisting dew points for traditional maximization.

Within the process of determining the appropriate SST for individual storms, some complications arose that influenced the values adopted in this study. These complications typically involved decisions about timing of the moist air inflow. Relatively small differences in time (order of hours) could result in widely different source regions (order of degrees of latitude/longitude). At times some complications arose in determining the appropriate SST measurements for a storm, and additional analysis was required. For readers who may wish to use SST measurements, or may want added detail, they should contact the NWS authors.

5. AUTOMATED PRECIPITATION DATA (MINI-STORM) ANALYSIS

5.1 Introduction

In all previous PMP studies performed by NWS, storm depth-area-duration (DAD) data relied upon the results available from the COE Storm Rainfall Catalog, or from unofficial DAD studies performed by Reclamation or NWS. As noted previously, almost no officially completed storm studies have been carried out for the western states. The procedure to process the storm data and analyze the numerous work maps involved in these studies was given in a manual (USWB, 1946) which, in application, was a very time-consuming task (extending to more than a year for larger storms). Although storm studies for some early storms in the west were unofficially completed, and others partially completed, there was a general lack of uniformity in both the techniques used to process the data and in the output results.

The present study posed as one of its prime objectives that a sample of major historical storm events would be used to derive the revised level of PMP for the Northwest. In addition, a procedure would be developed that involved automation of the DAD analysis process to a large extent, and to accelerate the time to completion. This automated process became known as the "mini-storm" analysis procedure. Obvious benefits, among others, were to complete a number of storm analyses in a relatively short period of time and do it in a consistent manner.

Another important decision was to base the spatial distribution of storm rainfall in proportion to the 100-year frequency analyses available in NOAA Atlas 2 (Miller et al., 1973). These frequency analyses were available for each western state and showed considerable correlation with the underlying terrain features. While this choice was prompted by necessity and availability of data, it is recognized that actual storms may have quite different spatial distributions.

There was no 100-year precipitation frequency analysis comparable to NOAA Atlas 2 for the region in British Columbia. The Rainfall Frequency Atlas for Canada (Hogg and Carr, 1985) provides a 100-year precipitation frequency analysis on a fairly coarse scale that does not reflect much of the underlying topography. These results further differed from those in NOAA Atlas 2 since the Canadian Climate Center separates rainfall from snowfall data and their atlas is based solely on rainfall data. Differences occur as well in how the 100-year values were determined. The Canadian procedure fits the Gumbel distribution by the method of moments, whereas NOAA Atlas 2 used a least squares plotting position procedure by Gumbel that is dependent on the number of years of record at each station. Comparisons were made for 85 stations in southern British Columbia based on the two procedures and while roughly 80 percent of the stations showed differences of 10 percent or less, there was a 19 percent difference at two stations. The NWS methodology generally gave equal or higher values for all station comparisons.

A decision was made to maintain consistency between the United States and British Columbia portions of the drainage by using NOAA Atlas 2 results as an index for orographic PMP. In order to ensure such consistency, an analysis of the 100-year precipitation frequency for British Columbia made by Miller (1993), the primary author of NOAA Atlas 2, was accepted. Miller (currently retired from NWS) was able to provide these results because of his private involvement in PMP studies in southern British Columbia. It was therefore not difficult to obtain continuous and consistent fields across the United States-Canadian border, and achieve comparable levels of detail.

At the onset of the current study, Reclamation had invested considerable resources into initiating the automated capability needed to process large volumes of data and it was reasonable for Reclamation to tackle this aspect of the study.

Because of the number of new storm data sets which needed to be analyzed for HMR 57, it was decided to perform as much of the processing by computer as possible. The analysis process essentially follows the procedure set forth in Cooperative Studies Technical Paper Number 1 (USWB, 1946) with two exceptions. An isopercental technique was used to develop the isohyetal analysis and a 1-hour interval, instead of the recommended 6-hour interval, was used for the accumulation of precipitation to produce the depth-area-duration analysis.

Programs were written to process precipitation data and generate products similar to those produced when formal storm studies were completed by hand. These products consist of tabulated data for a specific storm period, mass curves for each station, isopercental and isohyetal analyses, depth-area-duration data, and a pertinent data sheet listing average precipitation depths at standard durations and areas. Because of the technique chosen to develop the isohyetal analysis, precipitation frequency maps published in NOAA Atlas 2 for the states in the study area were digitized and these curves were converted to gridded data files. The rest of this chapter will describe briefly the individual steps involved in the analysis of storm precipitation data for the development of HMR 57. Readers interested in greater detail about the specific programs written for this study are referred to the "Manual for Automated Depth-Area-Duration Analysis of Storm Precipitation" (Stodt, 1994).

5.2 Grid Selection, Map Projection Selections.

A Cartesian reference frame centered on the HMR 57 study area was devised so that all digitized or computed data sets were registered with each other. The coverage area for this study was limited to the Pacific Northwest, essentially the Columbia Basin and Pacific Coast drainages and adjacent areas surrounding the basin from Montana to Northern California. Initial templates for digitizing were inadvertently drawn with a slight error in the vertical. The true vertical of the drawn templates was fixed at 117.45W longitude. The map origin was an arbitrary point off the coast a sufficient distance for the entire northwest region to

be in the positive x-y quadrant. A map scale of 1:1,000,000 was chosen as a base for the final analysis, as the terrain is represented adequately at this scale to account for the observed topographic effects on precipitation patterns. A Lambert Conformal Conic projection true at 33°N and 45°N was chosen because the USGS had published a complete set of state base maps on this projection at the desired scale. The NOAA Atlas 2 precipitation frequency maps were also drawn at this scale.

Positions on the grid were referenced in inches from the origin. A grid spacing of 0.1 inch was chosen. At 1:1,000,000 scale, one grid point represents about 2-1/2 mi². It was desirable that the analysis be sufficiently accurate to allow estimation of the maximum 10-mi² precipitation, but also that the grid spacing not be so small as to demand excessive partitioning of the data sets in order to accommodate memory limitations on Reclamation's CDC CYBER computer. This grid spacing satisfied both criteria. Since locations of meteorological stations are expressed in latitude-longitude coordinates, a program was written to convert back and forth from Lambert Conformal Conic projection x-y coordinates on this grid to latitude-longitude coordinates (Stodt, 1994).

5.3 Precipitation Data Analysis Procedure

Figure 5.1 shows an overview of the analysis and decision making process involved in processing precipitation data using the automated procedure developed for HMR 57. The seven major modules are as follows: 1) Detection and correction of tabulation errors in storm data sets; 2) Computation of a 100-year NOAA Atlas 2 grid file for each storm location, area and duration; 3) Computation, plotting and checking of mass curve data; 4) Creation of an isopercental data grid file; 5) Computation and plotting of Thiessen polygons (Thiessen, 1911) and creation of a vertex file; 6) Creation of an isohyetal map and vector file; and 7) Computations of intersecting areas between storm isohyets and Thiessen polygons, depth-area-duration, and creation of the depth-area-duration plot file and pertinent data sheet information.

Detailed flow diagrams for each of these modules are presented and discussed by Stodt (1994). Figure 5.1 provides a schematic pathway that relates the modules to the final product, depth-area-duration plots and storm pertinent data information tables. In Figure 5.1, the process begins with the precipitation data that represents each particular storm period. These data are edited and corrected. Daily data are assigned to nearby recording rain gage stations in order to convert the daily amounts into approximate hourly distributions.

The automated program also was responsible for storing digitized versions of the NOAA Atlas 2 precipitation frequency maps for the region. The hard copy maps for selected 2-year and 100-year precipitation frequencies at durations of 6 and 24 hours were converted to grid data, and used to obtain frequency information for durations between 1 hour and 10 days. The program to compute 2- to 10-day data followed the procedure described by Styner (1975).

From the above files of gridded data, storm data and the recorder/non-recorder station pairs, five additional files were created. The data were processed through modules 3, 4 and 5 to get 1) individual station mass curves; 2) an isopercental analysis; and 3) Thiessen polygons. The mass curve program lists accumulated rainfall for each hour of the core period (up to 240 hours) of the storm. Plots were made of the individual mass curves for each daily station, along with their associated hourly station distribution. The isopercental analysis takes the storm data and determines ratios of observed rainfall to the 100-year information. These percentages were analyzed to develop an isopercental map that was digitized back into the data files. Module 5 performs the Thiessen polygon analysis in which a polygon surrounds each gage. Each vertex of each polygon is stored in this module.

Figure 5.1 shows that the grid data file for the isopercental analysis, along with the NOAA 100-year grid file, were combined point-by-point to determine the isohyetal vector file. The isohyetal vector file, the Thiessen polygon vector file and

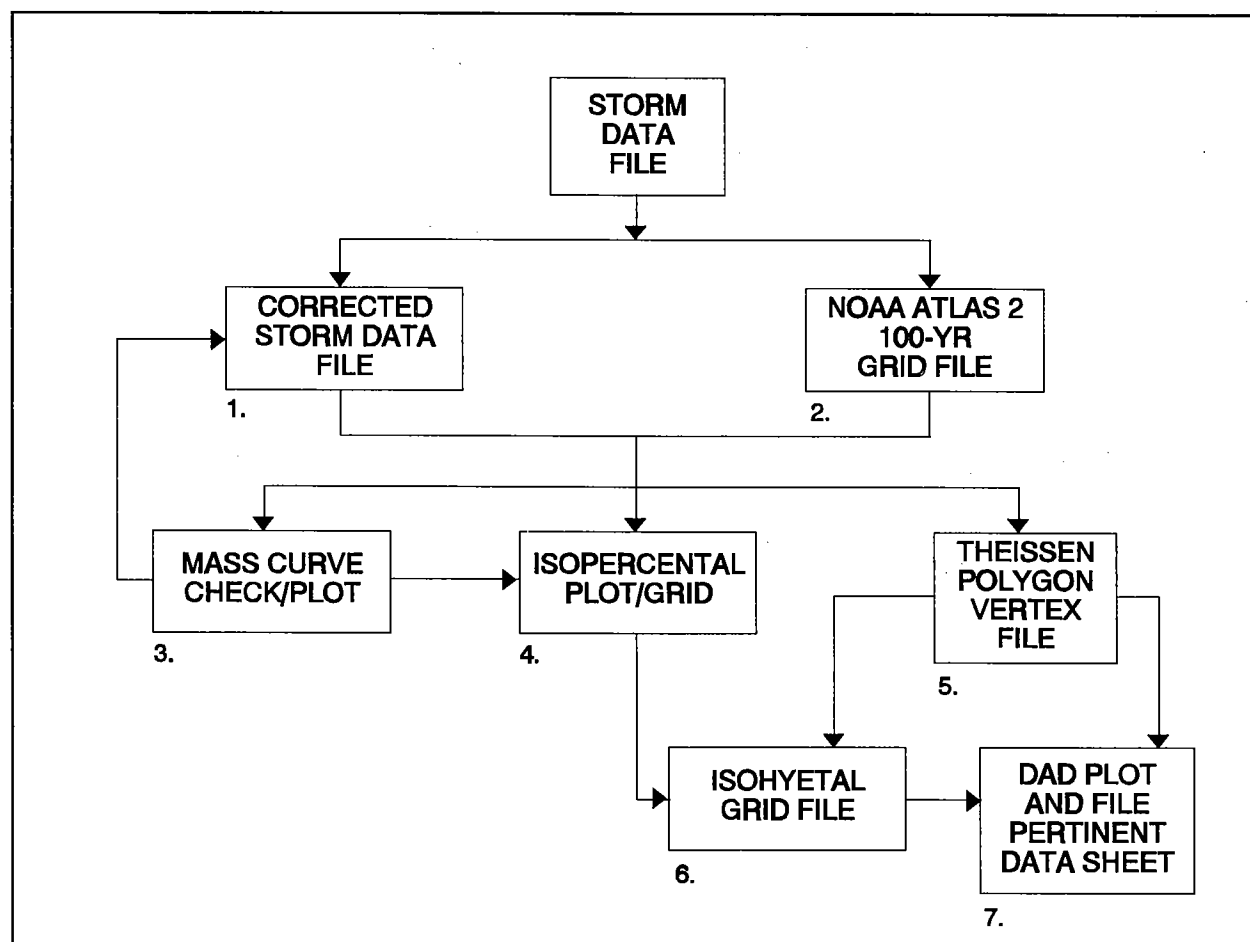

Figure 5.1.--Schematic flow diagram of modules created in processing storm rainfall data by the automated ministorm program. Modules are numbered and referenced in text.

a file containing the contour values were used to compute intersecting areas, where intersecting areas refers to the area between the polygon and each contour of the isohyetal analysis.

Module 7 in Figure 5.1 is a complex procedure beyond the scope of this report but fully documented by Stodt (1994). The output from this module is the object of the ministorm program; depth-area-duration information. The program provides plotted DAD values and fits enveloping durational curves for selected durations. It also presents a matrix of DAD data that comprises the major part of the pertinent data sheet information available for each analyzed storm in the Corps of Engineers Storm Catalog (USCOE 1945-). Table 5.1 is an example of the matrix of storm DAD for storm 78 (10/22-25/34). In developing the DAD data, there is one aspect of the present study that differs from past practice. The present program reorders hourly precipitation according to the maximum 1-hour, and then the maximum consecutive 2, 3, 6, etc. accumulations. This compares to the manual analysis procedure that used only 6-hour increments. DAD matrices for all storms (including multiple centers where noted) in this study can be found in Appendix 2.

Table 5.1.--Example of DAD table produced by ministorm analysis program listing average depths (inches) for storm 78 (10/22-25/34).													
Storm 078 - October 22-25, 1934													
CASCADES CENTER													
AREA (MI ²)	DURATION (HOUR)												
	1	6	12	18	24	30	36	42	48	54	60	66	72
1.	.81	2.91	4.28	5.84	6.24	6.50	6.88	8.06	8.74	9.12	10.26	11.02	11.02
10.	.81	2.91	4.28	5.84	6.24	6.50	6.85	8.03	8.74	9.10	10.23	10.99	10.99
50.	.78	2.82	4.11	5.62	6.02	6.30	6.60	7.79	8.56	8.85	9.93	10.67	10.67
100.	.71	2.56	3.93	5.40	5.82	6.12	6.48	7.67	8.37	8.73	9.79	10.52	10.52
200.	.64	2.29	3.75	5.18	5.63	5.95	6.21	7.32	8.19	8.37	9.36	10.06	10.06
500.	.58	1.95	3.47	4.83	5.27	5.59	5.82	6.90	7.70	7.85	8.58	9.20	9.20
1000.	.47	1.72	3.13	4.38	4.77	5.15	5.38	6.35	7.03	7.22	7.66	8.17	8.20
2000.	.37	1.48	2.68	3.76	4.23	4.66	4.93	5.76	6.42	6.63	6.87	7.26	7.40
5000.	.27	1.08	2.02	2.86	3.50	3.97	4.25	4.97	5.65	5.91	6.09	6.36	6.70
7068.	.23	.94	1.77	2.52	3.23	3.71	3.99	4.68	5.37	5.64	5.80	6.01	6.43

6. STORM SEPARATION METHOD

6.1 Introduction

The storm separation method (SSM) is an outgrowth of practices that were initiated in the late 1950's for PMP studies in orographic regions. HMR 36 (USWB, 1961) is one of the earliest reports to discuss PMP development in terms of orographic and convergence precipitation components. Convergence precipitation in this context is the product of atmospheric mechanisms acting independently from terrain influences. Conversely, orographic precipitation is defined as the precipitation that results directly from terrain influences. It is recognized that the atmosphere is not totally free from terrain feedback (the absolute level and variability of precipitation depths in some storms can only be accounted for by the variability of the terrain); but cases can be found where the terrain feedback is either too small or insufficiently varied to explain the storm precipitation patterns and in these cases, the precipitation is classified as pure convergence or non-orographic precipitation.

PMP studies, such as HMR 36, 43, and 49, were based on determination of convergence and orographic components through procedures that varied with each report. With the development of HMR 55A (Hansen et al., 1988), a technique was utilized that had some similarities to previous studies, but was based on determination of convergence amounts from observed storms. Convergence precipitation in that report was referred to as free-atmospheric forced precipitation (FAFP). The technique used in HMR 55A is complex and involves the analyst tracking through a set of modules in which knowledge of observed conditions and experience are used to arrive at estimates of the FAFP. The estimates are in turn weighted, based on the analyst's judgment of the amount and quality of overall information, to obtain a result. This process has been referred to as the storm separation method (SSM) and is described at considerable length in HMR 55A.

Since the development of the SSM in HMR 55A, the procedure has been applied in a number of subsequent studies (Fenn, 1985; Miller et al., 1984; Kennedy, et al., 1988; and Tomlinson and Thompson, 1992). Through these various developments, the SSM has undergone minor refinements. The entire development discussed in HMR 55A will not be repeated here, but readers interested in these details will find a reprint of the pertinent chapter (Chapter 7) from HMR 55A in Appendix 3 of this report. Similar information is contained in the 1986 edition of the WMO Manual for Estimation of Probable Maximum Precipitation (WMO, 1986).

The process of estimating FAFP from a storm for a given area size and duration is achieved by using the hydrometeorological information available for the storm to answer certain questions. These questions are contained within several modules which constitute the body of the SSM.

The hydrometeorological information about a storm may be missing over large areas with respect to the storm's full precipitation pattern; or the information when available may be unevenly distributed; or it may be biased or contradictory. In view of such informational dilemmas, a decision about the level of FAFP for a storm may have to accommodate a fair amount of uncertainty. The questions asked in the SSM modules are formulated in such a way that analysts with different levels of experience could estimate different amounts of FAFP. Under such circumstances a consensus among analysts often leads to the best FAFP estimate for a storm, but the consensus process is not a necessary part of the SSM.

Because of the extensive information provided by the storm analysis program and the number of storms studied, the SSM technique was considered most appropriate for the present study. The technique was applied directly according to the original guidance, subject to the modifications described in the following section.

6.2 Changes to the Previously Published SSM

The remainder of this Chapter covers modifications to the modular development presented in Appendix 3. This discussion covers specific changes in detail that may be beyond the casual reader's interest.

Several details concerning questions and procedures used in the SSM were changed in this report from their formulation in HMR 55A. For example, in Module 0, which provides guidance to the analyst regarding decisions on the adequacy of available data, the adjective "reliable" was replaced by "unbiased" in questions 5 and 6 (see Appendix 3). This was done to clarify the fact that isohyetal analyses derived from the isopercental technique, even though reliable, are created based on an assumption which Module 2 attempts to prove. The need to avoid such a fallacy is made more clear by use of the adjective "unbiased" and, consequently Module 2 was not used to analyze any of the storms in this study.

Maximization of the index values was accomplished on the storm separation worksheet (Module 5, see Figure 6.1). This figure is an updated version of Figure 7.8 from HMR 55A (Appendix 3). Some new terms introduced in Figure 6.1 of this report are explained as follows:

$IMAX_n^{1000}$ = the index value of non-orographic precipitation for the storm center, adjusted to 1000 mb and moisture maximized as obtained from the module (n) indicated by the subscripts 1, 2, 3, 4, and 5,

IPMF(SC) = In-place maximization factor applicable at the storm center,

- V.ADJC(SC) = A factor used to adjust values (to sea level) of precipitation obtained at elevations above sea level,
- IPMF(NO) = In-place maximization factor at the location of RNOVAL¹,
- BE(SC) = Barrier elevation at the storm center (SC)
BE(NO) and at the location of RNOVAL (NO),
- V.ADJ(NO) = A vertical adjustment factor used to adjust the value of RNOVAL to sea level,
- DP/SST(X) = The upper limit (X) and observed storm day (0) values
DP/SST(0) representing storm moisture content,
- H.ADJ = Horizontal adjustment factor,
- I_1^{EL} = The value of RNOVAL, not yet reduced to sea level, and
- I_2^{EL} = The calculated value of non-orographic precipitation at the storm center, not yet reduced to sea level.

Module 1 considers the observed precipitation data, where the value of RNOVAL (the highest non-orographic rainfall representative of the storm center) was adjusted to a common barrier elevation (sea level). This avoided the bias toward large values for PCT 1 (percent of storm rainfall that is non-orographic) mentioned in paragraph 7.4.1.2 of HMR 55A. If there was a gradient in the field of maximum 12-hour persisting dew points (see section 4.2) between the location of the storm center and the locations of RNOVAL, a horizontal adjustment factor, H.ADJ, was applied to RNOVAL. It has been assumed that RNOVAL is an appropriate depth of non-orographic precipitation for the area category selected in Module 0. This observation (RNOVAL) is acceptable for an area of 10 mi², but this assumption becomes less reliable for larger area sizes. This assumption is compatible with assumption 3 stated in Section 7.3.1.2 of HMR 55A.

¹See GLOSSARY, Table 6.1, for definition of terms extracted from HMR 55A Chapter 7 (enclosed as Appendix 3).

STORM ID/DATE/NAME				AT OR FOR STORM CENTER:				
				LAT		BE(SC)		
				LON		KFCTR		
0.	PARAMETER CATEGORY PD OF MOST INTENSE PRCP (MIPP) RCAT BFAC MKVATS PA PC IPMF(SC) V.ADJ(SC) V.ADJ-TEMP(F)	VALUE MI ² , HR Z - Z	EVALUATION SCALE: COL. D.0-9 COL. E. 1-9. FOR MODULES 1-3: COL. F. IS SUM OF COLS. D & E. MEANINGS: COL. D.: ADEQUACY OF THE INPUT INFORMATION FOR REQUIREMENTS SET BY MODULE'S TECHNIQUE. COL. E.: PREFERENCE LEVEL FOR ASSUMPTIONS MADE BY MODULE'S TECHNIQUE. FOR MODULE 4 SEE SELECTION RULES OVERALL RULE: SELECT INDEX VALUE WITH LARGEST COLUMN F SCORE. LARGEST SUBSCRIPT BREAKS TIES.					
1.	I_1^{EL} (RNOVAL)		AT/FOR LOCATION OF RNOVAL: LAT/LON/NAME:			D.	E.	F.
	$IMAX_1^{1000} =$ $I_1^{EL} * H.ADJ *$ V.ADJ (NO) * IPMF (NO) PCT1 = PC + $IMAX_1^{1000} / RCAT *$ V.ADJ(SC) * IPMF(SC)		LAT(DP/SST) LON(DP/SST)					
2.	A1 LOFAC A PB LOFAC HIFX DADFX PA ⁻¹ PX	$\sum(F+B)$ DADRF	PCT2 = PC + (Σ(F + B)/2n)(.95 - PC) = $I_2^{EL} = (RCAT)(PCT2) + (LOFAC) *$ (DADRF)(1 - PCT2) =		BE(NO) IPMF (NO) H. ADJ	DP/SST(X) DP/SST(O) V.ADJ (NO)		
			$IMAX_2^{1000} = I_2^{EL} * V.ADJ(SC) * IPMF(SC) =$					
			PCT22 = $IMAX_2^{1000} / RCAT * V.ADJ(SC) * IPMF(SC) =$					
3.	UP.LIM dd/ff	A B C	OBSVD . REP . GRADIENT LVL . INFLOW dd ff dd ff					
	ADJSTMT.FCTR	N/A N/A	/	Z /	/	Z /		
	REP.DIR(COMP)		/	Z /	/	Z /		
	REP.SPD(COMP)		/	Z /				
	IPMF(SC) ⁻¹		/	Z /				
	STABILITY CLASS.		/	Z /				
	OTHER		/	Z /				
		$A_0 =$	/	Z /				
SFC CHARTS U/A CHARTS RAWINSONDE RADAR SATELLITE OTHER	$P_A =$	PCT3 = PC + [P _a / (P _a + A ₀)](1 - PC) = $I_3^{1000} = RCAT * PCT3 * V.ADJ(SC) =$ $IMAX_3^{1000} = I_3^{1000} * IPMF(SC) =$						
4.	$IMAX_4^{1000} = (IMAX_1^{1000} + IMAX_3^{1000}) / 2 =$							
	$IMAX_5^{1000} = (IMAX_2^{1000} + IMAX_3^{1000}) / 2 =$							
	SELECTED $IMAX^{1000} =$							

Figure 6.1.--Storm separation method worksheet; Module 5.

Table 6.1.-- Glossary of terms modified in storm separation method.	
<u>A_o</u> :	Term for effectiveness of orographic forcing used in Module 3, (see also P _a). Varies between 0 and 95 percent.
<u>MXVATS</u> :	Average depth of precipitation for the total storm duration for the smallest analyzed area less than 100 mi ² (from pertinent data sheet for storm).
<u>I₁</u> :	That part of RCAT attributed solely to atmospheric processes and has the dimensions of depth. Subscript 1 associates application to Module 1.
<u>P_a</u> :	Term for effectiveness of actual atmospheric mechanisms in producing precipitation as compared to conceptual "perfect" effectiveness. Varies between 5 and 95 percent.
<u>PC</u> :	Used in calculations of modules to take into account the contribution of non-orographic precipitation to total FAFP (that includes contribution from orographic areas). Varies between 0 and 95 percent.
<u>PCT 3</u> :	The percentage of non-orographic precipitation in a storm from the third module based on comparison of storm features with those from major non-orographic storms.
<u>RCAT</u> :	The average precipitation depth for storm area size and duration being considered.
<u>RNOVAL</u> :	Representative non-orographic precipitation value that is the highest observed amount in the non-orographic part of the storm.
<u>W_o</u> :	A vertical displacement parameter, the product of the wind component perpendicular to the slope (for duration considered) and the slope in feet/miles.

The flowchart used for Module 1 is shown in Figure 6.2, and modified only slightly from that used in HMR 55A to reflect adjustments to sea level. Since hourly values of precipitation were available from automated analysis procedures, PCT1 did not have to be calculated from the variables RNOVAL and MXVATS. Consequently, the value of PCT1 for the total storm duration could be assumed to be the same as the index duration (24-hours). The index depth of non-orographic precipitation from Module 1, was therefore obtained directly from the depth for the index duration at the site selected for RNOVAL. However, since PCT1 is necessary in Module 4, it was derived from the relationship

$$PCT1 = PC + \frac{IMAX_1^{1000}}{(RCAT * V.ADJ(SC)*IPMF(SC))(0.95 - PC)}$$

The ratio, $IPMF(SC)^{-1}$, listed in Module 3 in Figure 6.1, is relatively large when "observed" storm moisture is close to its upper limit and vice versa. Thus, from a strictly moisture content point of view, values in Column B would be relatively large when this parameter is relatively large and vice versa.

In Module 3 shown in Figure 6.3, the orographic parameter, A_o , was derived using a somewhat revised procedure, when compared to that in Appendix 3. The vertical displacement parameter, W_o , and the elevation gradient were not used. But, the upper-limit wind speed, which was a constant in HMR 55A, was allowed to vary across the region. The variation was based on extreme wind speed data (Simiu et al., 1979) for 10 United States locations in the northwest and five locations nearby. The optimum inflow direction for orographic storms, used in setting the barrier elevations, was determined for each of the 15 locations. Then at each location, the series of annual maximum speeds and their associated directions were searched to find the largest annual wind speed coinciding with the optimum inflow wind direction. This speed became the first approximation of the upper-limit speed for the optimum inflow direction at the site. This first approximation wind speed was changed only if certain conditions were found, as given in the following rules:

- (a) If the first approximation speed was less than the mean speed for all directions in the total sample, the mean speed became the upper-limit speed, while the optimum inflow direction remained the same.
- (b) If the first approximation speed was larger than the sample mean but less than the 100-year speed, it was compared with the sample mean plus one standard deviation speed, and the larger of these two became the upper-limit speed, while the optimum inflow direction remained the same.
- (c) If the first approximation speed was greater than the 100-year speed, the 100-year speed became the upper limit speed, while the optimum inflow direction remained the same.

An analysis of 30-year return period wind speeds, prepared by Donald Boyd for the National Building Code of Canada (Newark, 1984), and kindly supplied to us by D.J. Webster, Atmospheric Environment Service, Canadian Climate Centre, provided a basis for extrapolating the upper-limit isotachs into Canada.

The component of the wind speed along the direction of optimum inflow, representative of the 24 hours of most intense precipitation, was obtained for each storm being analyzed. This speed was modified by empirical adjustment factors shown in Module 3 of the storm separation worksheet, Figure 6.1.

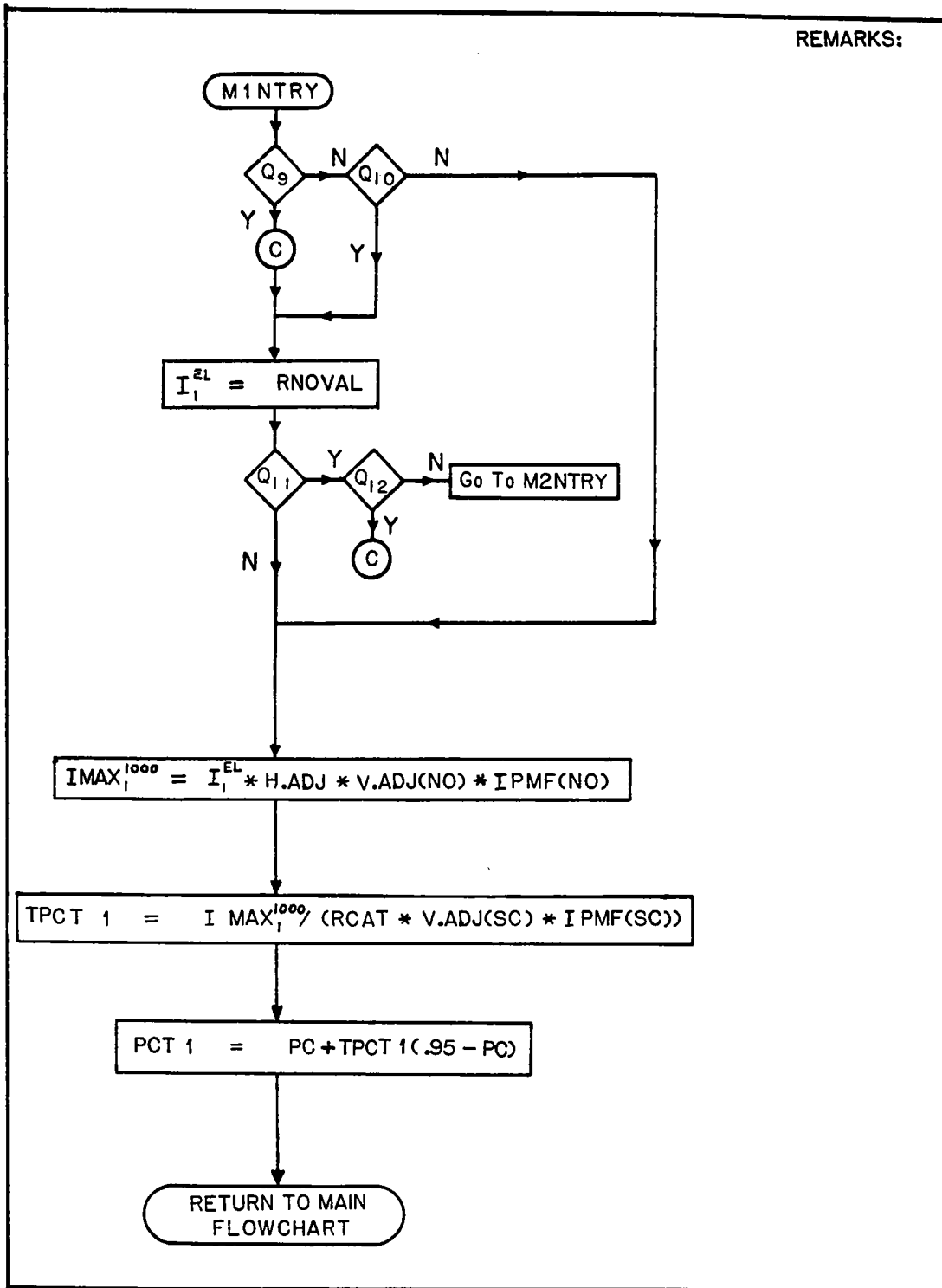

Figure 6.2.--Module 1 flowchart.

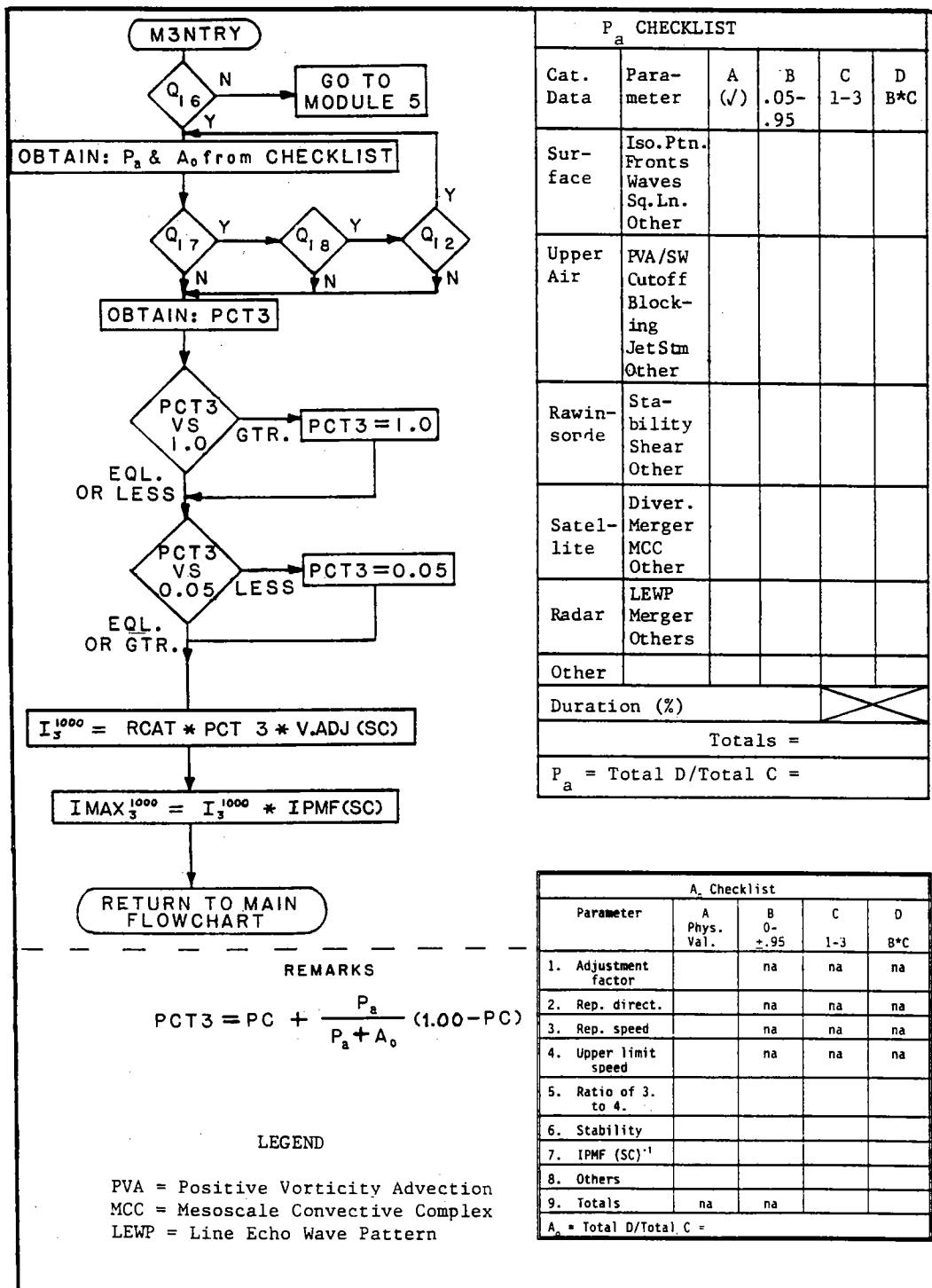

Figure 6.3.--Module 3 flowchart.

These factors were applied when, during the most intense 24 hours of precipitation, there were only one or two wind observations available at 1200 UTC. These empirical adjustment factors are in the form of ratios based on relations observed in eight recent storms from the storm list in Appendix 1.

These ratios compare the 1200 UTC wind speed(s) noted above to the average wind speeds (when all eight 3-hourly observations are available for the 24 hours of most intense precipitation). This ratio was then divided by the upper-limit speed and the resulting quotient multiplied by 0.95 and put in column B alongside the wind parameter in the A_o portion of Module 3. Because both upper-limit speed and direction (which incorporates moisture availability) are involved in the evaluation of the inflow parameter, the weight assigned to it in column C of Module 3 should be higher than for the stability parameter, assuming a good sample of inflow winds for a storm is available. Here again, the decision to use wind speeds in this section that are at a level less than the theoretical maximum was made as an attempt at limiting the compounding of maxima.

The formulation for PCT3, shown in HMR 55A (Appendix 3) as equal to the sum of the non-orographic rainfall component and a term that accounts for the effectiveness of the storm's atmospheric mechanism to produce precipitation was changed to:

$$PCT3 = PC + \frac{P_a}{P_a + A_o} (1.00 - PC).$$

This was done because, by original definition, P_a and A_o could never exceed a value of 0.95. The formulation used previously had a bias toward lower estimates of FAFP built into it in the term $(0.95 - PC)$. This bias was eliminated by replacing 0.95 by 1.00 in this term.

Figure 6.4 attempts to clarify the use of stability in setting a value for A_o in Module 3. The evaluation of the influence of the stability set in column B of the module is related to variations from the pseudo-adiabatic lapse rate and ranges from 0 to 0.95. This range may be subdivided as follows (see Figure 6.4): 0.65 to 0.95 when the observed lapse rates are optimum for producing orographic enhancement of FAFP, 0 to 0.45 when the lapse rates are least conducive for producing orographic enhancement of FAFP, and 0.45 to 0.65 for the remaining cases. The optimum cases are those where the lapse rates on average are in the range 1°C more stable to 2°C less stable than pseudo-adiabatic within 100-mb layers from the surface to 300 mb. The largest value in column B of Figure 6.3 should be associated with the less stable of these cases. Lapse rates least conducive for producing orographic enhancement of FAFP (i.e., those of greatest instability) would be those greater than -4°C from pseudo-adiabatic. The cases greater than +4°C from pseudo-adiabatic, i.e., the most stable cases, would be given the lowest scores in column B.

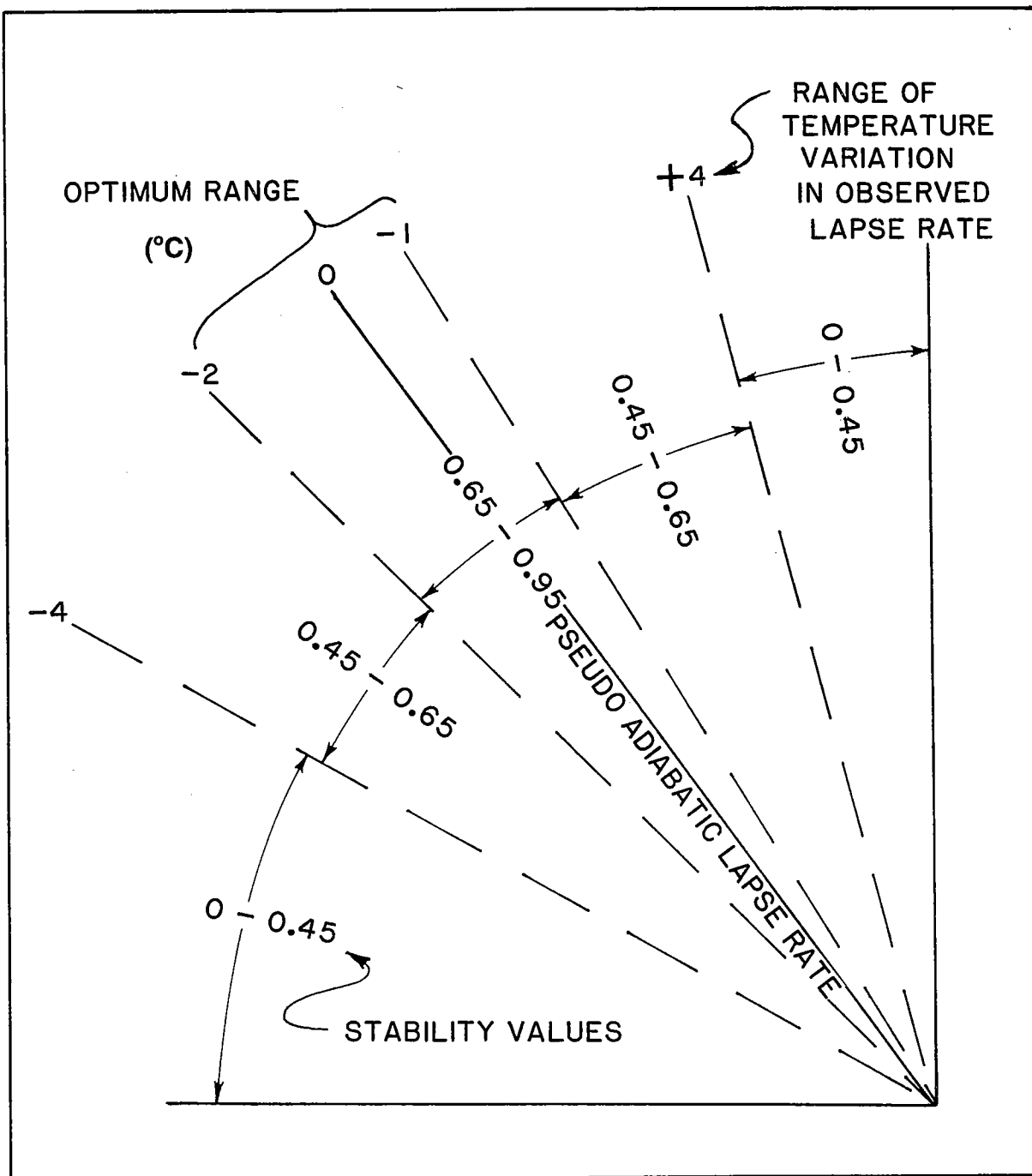

Figure 6.4--Schematic diagram to show relative range of stability values compared to the pseudo-adiabatic lapse rate.

It is reasoned that orographic enhancement of FAFP should increase up to some limit with decreasing stability. Beyond that limit (set subjectively at 2°C more unstable than pseudo-adiabatic) as lapse rates approach the dry adiabatic, there should begin decreases in moisture content sufficient to weaken the production of purely orographic precipitation.

Cotton and Anthes (1989) noted that the orographic (described as orogenic precipitation in that report) enhancement of precipitation involves complex problems in the formulation of atmospheric scale interactions and phase changes. The procedures followed to obtain A_0 in Module 3 (Figure 6.3) barely scratch the surface of these problems, but a more sophisticated approach awaits the results of continuing research by atmospheric scientists, and no change is offered here.

It is recognized that the lack of upper-air information for most of the earlier storms of record may make use of the stability parameter impossible in the formulation of A_0 . For more recent storms, however, if less than complete information was available, this condition limits the value of the weighting assigned to the stability parameter in column C of Module 3.

Finally, a routine was added to each module which asked the analyst the following question. Once a value for FAFP had been obtained, is the implied orographic factor at the storm center satisfactory in relation to the K factor, derived independently from 100-year precipitation-return intensity at the same location? If significant differences in orographic factor could not be resolved, a low valuation would be given in column D to the estimation of FAFP for the module being used. Apart from these changes, use of the SSM in this report was the same as in HMR 55A (see Appendix 3).

As mentioned above, a process related to, but not part of the SSM, was the reconciliation of differing estimates of FAFP by different analysts. Another procedure adopted for this report and related to the SSM, but not part of it was adjustment of finalized FAFP values to a common reference level of the atmosphere for all storms. The reference level used was 1000 mb. Based on the maximum persisting 12-hour 1000-mb dew point at the location of the derived FAFP, the FAFP was changed in the same proportion as the change in water available for precipitation in a saturated, pseudo-adiabatic atmosphere. No change was made in FAFP; however, for storms occurring between sea level and 1000 feet above sea level. This procedure was adopted so that direct comparisons of FAFP could be made easily among all 30 storms analyzed, and so that the sea-level analysis of the 100-year non-orographic component could be used as guidance for analysis of the field of FAFP. It was also the procedure used as part of storm transposition used in creating the index map of FAFP (refer to Chapter 7).

Since we were dealing with FAFP at sea level, the precipitation depth at the elevation of the largest enclosed isohyet might be potentially as large as the depth at a somewhat smaller valued enclosed isohyet, provided that the second center

was located at a higher elevation. In such cases, both centers were evaluated for FAFP, and the results adjusted to sea level.

From the 28 storms centered in the United States and the two storms located in Canada, FAFP values for 50 isohyetal maxima were set. At least one value was set for each storm. In five of the United States storms, one or more centers for which DAD relationships were developed were not analyzed, either because the central value was significantly smaller than that at the principal center or because the centers were very close to one another with no significant difference in value. Depth-area-duration analyses were not done for all of the isohyetal maxima examined by the storm separation method, but were done for all centers which provided controlling values in the analysis of FAFP (Appendix 2).

7. CONVERGENCE COMPONENT OF PMP

7.1 Introduction

The previous chapter highlights some of the processes for separation of storm precipitation into two components of which the convergence component, or FAFP, is part of the basis for PMP development under the SSM. In non-orographic regions, e.g., most of the region east of the 105th meridian covered by HMR 51 (Schreiner and Riedel, 1978), the inadequate distribution of observed storms is augmented through the process of transposition. Storm transposition is the movement of storms from one location to another. The transposition limits in generalized PMP studies are commonly taken to be meteorologically homogeneous regions wherein storms of similar mechanism could occur. In non-orographic regions, transposition limits are rather broad.

PMP procedures do not allow transposition of storms in orographic regions, and this has been an impediment to PMP development in mountainous regions based on storm analysis. This problem is caused by the inadequate storm data base in orographic regions that will relate individual storm rainfalls to varying terrains at every location. The primary advantage of the storm separation method (SSM) is that the convergence component (FAFP) of orographic storms can be transposed. FAFP transposition is regarded similarly to the traditional transposition considered in non-orographic regions. As in the traditional approach, transposition of the FAFP is limited by the region in which storms with a common mechanism can occur.

This chapter discusses storm transposition and the analysis of the FAFP component of PMP. The FAFP analysis for this study is developed at the 1000-mb surface. That is, the storm convergence component was maximized "in place," and then reduced in elevation to near sea level. Horizontal transposition was then imposed at the 1000-mb level to move the component amounts within the transposition limits set by common storm types. A 1000-mb FAFP analysis was drawn based on the transposed values.

7.2 In-place Moisture Maximization

Moisture maximization has been used almost from the onset of PMP studies to determine the potential for precipitation based solely on moisture availability. Traditionally, the premise is that moisture at any specific location is limited by the maximum observed 12-hour persisting dew point which varies seasonally and geographically. As indicated in Chapter 4, the seasonal variation of the two standard deviation SST represented the upper limit of moisture parameters for this report. Because of the slow variation of SST, it was assumed that a single observation of SST was sufficient for the observation time, plus or minus 6 hours, thus making it similar in nature to a 12-hour maximum persisting dew point.

The in-place moisture maximization computation is a ratio of the SST measured near the source region of the storm's moisture charge, along an upwind trajectory from the storm center, and two standard deviations above the long-term mean SST at the same location (REF). Precipitable water is that amount of water that would be accumulated if all the water vapor in a column of air of unit cross section were condensed. Precipitable water is a function of dew point temperature and elevation, and is commonly available in tables (English units in USWB, 1951; or metric units in WMO, 1986). The ratio is therefore, always equal to or larger than one. It can be represented by the following mathematical equation:

$$R_{Ip} = \frac{W_{p \max, SL, SE}}{W_{Ps, SL, SE}} \quad (7-1)$$

where,

R_{Ip}	=	In-place maximization factor
W_{ps}	=	precipitable water associated with 12-hour persisting dew point for storm, s
max	=	maximum observed
SL	=	storm location
SE	=	storm barrier elevation

Throughout general storm PMP studies, the average time period used to represent maximum moisture supplied to a storm has traditionally been set at 12 hours. After the moisture analysis for the present study was completed, the issue of using other time periods for persisting dew points was discussed in an evaluation of PMP for Wisconsin and Michigan (EPRI, 1993b).

It was concluded that the duration of the representative dew point for a particular storm should be correlated with the storm duration and should vary with an individual storm event. While this conclusion may appear reasonable, insufficient evidence exists from the Northwest study region to show significant differences from use of a singular 12-hour period. Preliminary testing led to the conclusion that because of the storm types controlling PMP in the Northwest, the reduction in persisting storm dew point in going from a 6-hour duration to a 12-hour duration is approximately proportional to the change between the 6-hour and 12-hour maximum persisting dew points. That is, the ratio of 6-hour maximum persisting dew point to 6-hour persisting storm dew point may not be much different from the ratio of 12-hour maximum persisting dew point to 12-hour persisting storm dew point, and likewise for other possible time periods.

Table 7.1 lists barrier elevations and maximization factors for each storm center. Maximization factors were also developed for those storms having

Table 7.1.--In-place moisture maximization factors and other criteria for storm centers in this study.

Storm Number	Maximization Factor	Barrier Elevation (feet)	Maximum Dew Point Degree F
5	1.70	3200	67
12	1.70	5800	57
29	1.70	6500	70
32	1.25	1200	59
38	1.30	2800	61
40	1.47	3200	57
59	1.40	3600	56
60	1.54	2200	57
66	1.53	1200	63
74	1.31	2600	58
78	1.53	1000	62
80	1.62	1800	55
82	1.60	5400	55
88	1.54	1500	58
106	1.70	6400	74
126	1.53	2000	64
133	1.42	5000	61
143	1.49	2900	66
147	1.19	3800	57
149	1.47	2700	63
151	1.54	1800	60
155	1.70	7300	68
156	1.19	2500	62
157	1.37	7100	56
165	1.23	1900	61
168	1.43	5200	54
175	1.24	1400	58
179	1.34	3300	58
Canadian Storms			
MTG	1.70	7300	68
SEY	1.37	2000	53

secondary storm centers. In all instances of multi-centered storms, the secondary maximization factors showed little variation from that of the primary storm. Maximization factors in Table 7.1 are held to an upper limit of 1.7, consistent with the considerations applied to in-place adjustments in HMR 55A. This limit has been adopted to allow for the inadequacies of the storm sample in orographic regions.

After the non-orographic value of precipitation at the principal storm center has been obtained using the SSM (see previous chapter), this value is adjusted (see Section 7.3) to 1000 mb for storm transposition. The maximum dew points shown in the last column of Table 7.1 are used for these adjustments. The dew points were taken from Figures 4.1 to 4.12 at the location of the principal storm center.

7.3 Vertical Adjustment Factor

The vertical relationship used to adjust each maximized FAFP amount to the 1000-mb level was made by imposing the vertical moisture adjustment factor otherwise used in storm transposition. The equation for this adjustment is:

$$R_{vt} = \frac{W_{p \text{ max, SL, SE, 1000 mb}}}{W_{p \text{ max, SL, SE } \pm 1000 \text{ feet}}}$$

(7-2)

where:

R_{vt}	=	vertical adjustment factor
$W_{p \text{ max}}$	=	precipitable water associated with 12-hour maximum persisting dew point
1000 mb	=	near sea level equivalent height
SE ± 1000	=	1000-foot exclusion from adjustment
SE	=	storm barrier elevation
SL	=	storm location

The ± 1000 -foot exclusion adopted in this equation was also used in HMR 55A and represents an immunity from adjustment for storms moved vertically less than 1000 feet from their observed barrier elevation. The justification for this comes from the judgment that storms of equal magnitude are possible within a layer ± 1000 feet from the level at which they are observed. A brief discussion of the basis for this judgment is given in HMR 55A (see Section 8.4.2.2 of that report).

Equation 7-2 is less than one for increases greater than 1000 feet and greater than one for decreases that are more than 1000 feet. A set of relations is given in Figure 7.1 for use in applying this adjustment. As an example, the factor to

persisting dew point of 70°F, is 1.50. Because of the 1000-foot immunity, this computation is calculated as if the vertical adjustment were between 4000 feet and sea level. It should also be noted that the computation must be reversible so that it is possible to return to the same value. In the example provided here, the adjustment applied to return to 5000 feet from the 1000-mb level is easily determined from Figure 7.1 by using the inverse of the elevation adjustment given at 70°F and 5000 feet (i.e., $1/1.50 = 0.67$). Figure 7.1 takes into account the 1000-foot immunity assumption.

7.4 Horizontal Transposition Factor

Storm transposition involves the relocation of storm properties from the place where the storm occurred to places where the storm could have the same properties. Usually the storm property transposed is thought to be the attendant precipitation, but it is actually "the mechanisms" responsible for the precipitation that are transposed. It is assumed that if virtually the same mechanisms can be assembled in another location, the only difference between the observed precipitation and the transposed precipitation would come from the differences between the quantity of water (i.e., the moisture) available for precipitation at the two locations. In this study as in others, only the non-orographic mechanisms are considered transposable. FAFP represents these mechanisms.

Classifying each storm by type is the first step in setting the horizontal limits for transposing FAFP. The storm classification system in HMR 55A (see Section 2.5 of that report) was also used in this study. Of the 30 storms examined in the Northwest, all but two were categorized as cyclonic storms. The two exceptions (storms 106 and 143) were considered to be convective storms. Within the cyclonic designation, all were extratropical storms, and in 18 of these the principal meteorological feature was the circulation itself and the attendant convergence fields. Frontal lifting was paramount in the other 10 storms.

There was no part of the Northwest region from which storms of the cyclonic type could be excluded. However, during certain months of the year, for storms in which thermal gradients were the principal forcing factor, there were regions, i.e., the southern portions in summer, where cyclonic-frontal storms had not been observed. The two storms in the convective class (storms 106 and 143) were of the complex type and occurred in late spring and early fall. Storms of this type could be excluded from most of the drainage in winter, but could be excluded from only a small portion of the drainage in the other seasons. This small portion included the coastline to the foothills of the Cascades and the region surrounding the Puget Sound. Thus, the first stage horizontal limits were much the same for storms within a given classification, and most of the drainage was within these limits regardless of the storm's classification. Since the goal of storm transposition was to create an all-season index map of precipitation, seasonal considerations did not apply at this point.

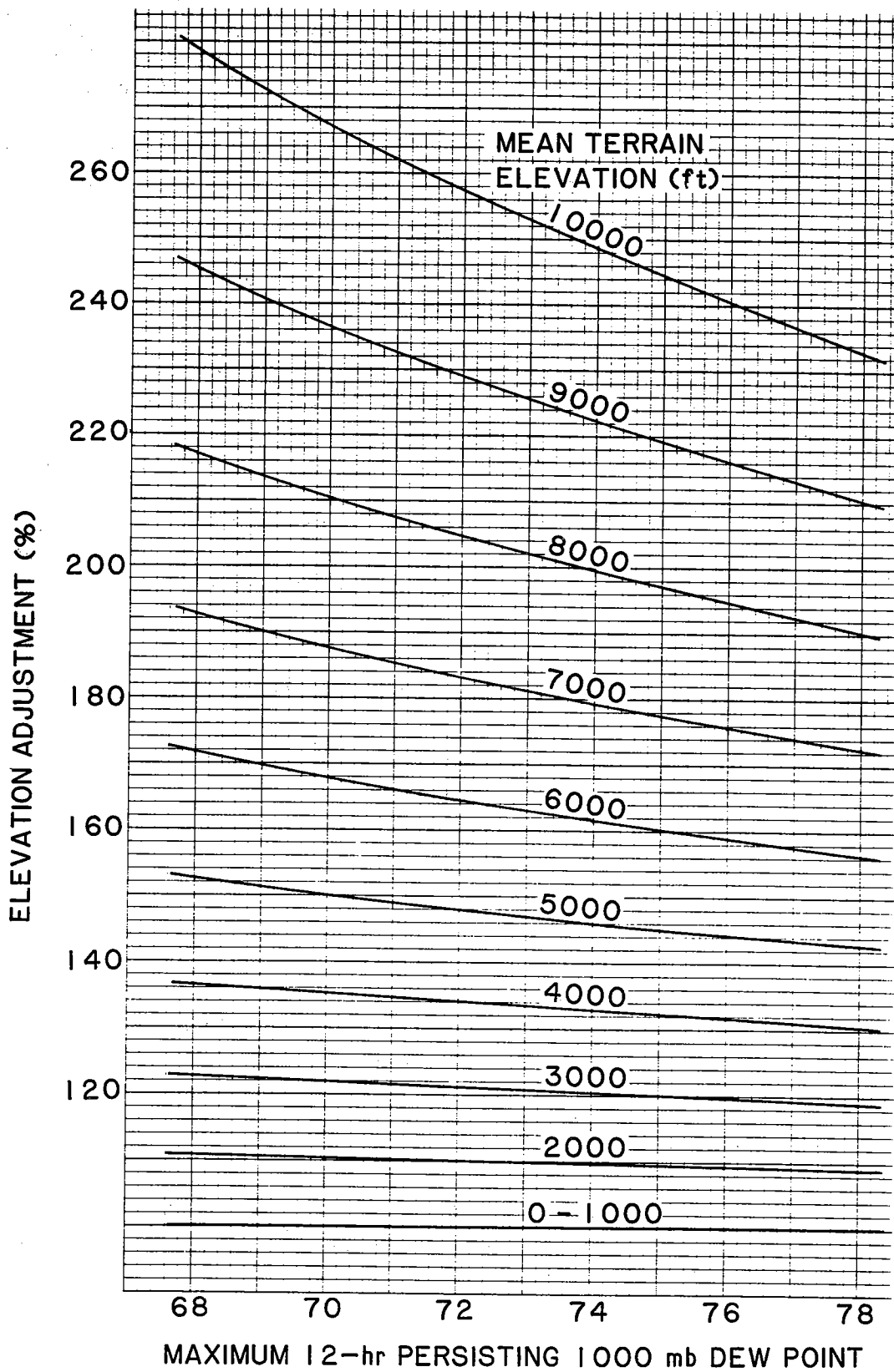

Figure 7.1.--Factors (%) for vertical adjustment of storm amounts at selected barrier elevations and dew point temperatures.

The second step of horizontal storm transposition involves limiting the range of the storm mechanism by considering the specific thermal and moisture inflow characteristics of the given storm. As in HMR 55A, if the boundary-layer moist inflow to the storm at a proposed location encounters significantly different topographic conditions than existed at the original site, the transposition would not be made. Where strong thermal gradients are involved, a transposition would not be made if between the source region of cold air and a proposed transposition location there was a significant topographic barrier. Only in a situation where such an intervening barrier was found in the original storm would the transposition be allowed.

At this second stage, the latitudinal range of transposition was limited if necessary, so that the coriolis parameter component¹ of the absolute vorticity of the system would not change by more than 10 percent (about 5-6 degrees of latitude) between the original storm site and a proposed transposition location.

A final consideration in horizontal transposition is the overall availability of record setting storms within the region. Where there are a sufficient number of such events, the procedure would be applied strictly; when there are few storms available, less restrictive application would be used.

The equation applied to the horizontal adjustment is:

$$R_{HT} = \frac{W_{p \max, TL, SE}}{W_{p \max, SL, SE}} \tag{7-3}$$

where,

- R_{HT} = horizontal transposition adjustment factor
- $W_{p \max}$ = precipitable water associated with 12-hour maximum persisting dew point
- TL = transposed location
- SL = storm location
- SE = storm barrier elevation

When equation 7-3 is applied to storms transposed toward the moisture source, R_{HT} is usually greater than one, and in transpositions away from the source of moisture, R_{HT} is usually less than one.

¹Coriolis parameter - a component equal to twice the angular velocity of the earth about the local vertical, sometimes referred to as the earth's vorticity.

Whereas these general rules for horizontal transposition of storm mechanisms have been discussed in other Hydrometeorological Reports, (e.g., HMR 55A, 51) and the Manual for Estimation of Probable Maximum Precipitation (WMO, 1986), general rules or guidelines have not been developed for setting limits to vertical transposition of storm mechanism.² For this report, the practice followed was to identify the freezing level of precipitation. First, available printed records were examined for information on the freezing level during the storm. The observed precipitation amount was assumed equally possible within 1000 feet vertically of its occurrence. This assumption was based on the highly variable precipitation measurements in mountains.

Next, an upper-air climatology (Crutcher and Meserve, 1970) was used to define the vertical limits of mixed-state precipitation, a combination of rain and frozen precipitation. The vertical limit below which only rainfall would be expected was defined based on upper-air temperatures within 4°F of freezing. The maximum vertical limit below which the storm could possibly have just rain was then determined by raising the critical temperature by one standard deviation. This provided an elevation over which either mixed or frozen precipitation would be expected, and liquid-only precipitation was not transposed above this elevation.

7.5 Analysis of FAFP

As mentioned in the section on storm separation, FAFP values for 50 precipitation maxima from the 30 storms in Table 2.1 were derived. These values were moisture maximized at each site (in-place maximization) and adjusted to 1000 mb using the vertical adjustment procedure of equation 7-2. Further inspection of the 50 values identified 20 storms that were the largest before or likely to be the largest after transposition. These values came from 18 United States and two Canadian storms.

Close to 300 transposition locations were selected, 116 of these being whole latitude/longitude intersections within the region. On occasion, as many as 16 transposition locations were used within a 1-degree latitude-longitude "square." The higher density of transposition locations came about because of their proximity with major topographic features serving as natural barriers for storm transposition. The greater density was needed to better define the gradients of FAFP. Typically, three or four, and sometimes up to seven, maximized transposed storm values could be taken to a single given location.

The largest value at each of the almost 300 transposition locations was extracted and replotted. These largest values were then manually analyzed. Envelopment of certain of these values was limited for those areas where there were many storms, but envelopment was used more freely in areas with few or no

²This is not to be confused with the vertical adjustment factor discussed in Section 7.3

storms. A portion of the finally adopted FAFP analysis appears as Figure 7.2 covering the northwest corner of the region.

Figure 7.2 has been significantly reduced from the working scale 1:1,000,000 analysis developed for this study. The rather smooth nature of FAFP analysis is shown in this figure, but as is apparent, the analysis is not totally independent of terrain features. This fact is a function of the vertical adjustment needed to create a sea level analysis.

7.6 Controlling FAFP Storms

The development of FAFP, as partially represented in Figure 7.2, makes it possible to define which storms controlled (provided the maximized amount) throughout the region. This feature may hold only marginal interest since it is the total storm controlling amounts that most likely are of greatest importance. However, Figure 7.3 shows an approximation of where specific storms controlled the convergence component of PMP. The boundaries shown in Figure 7.3 should not be confused with transposition limits. The boundaries are based on the results of transposition and determination of which storm provides the largest maximized transposed amount at any specific location.

A number of results shown in Figure 7.3 are of interest and in need of further explanation. The first is that in spite of the strength of storm 80 and the fact that it had secondary centers on the western slopes of the Cascades, it is the Seymour Falls storm in British Columbia that controls the Puget Sound Basin and the western Cascades south to the northern one-half of the Willamette Valley. Furthermore, the Seymour Falls storm explicitly controls eastward to the Cascade ridge, while to the east of the Cascades storm 143 controls. There is no storm in our sample that is transposable to the east slopes of the Cascades; therefore, implicit transposition of the Seymour Falls storm is used to fill in the spill-over region east of the Cascade ridge. A similar problem occurs along the Rocky Mountain divide in southwestern Montana. The divide in this part of the region is relatively low and poorly defined. Storm 106 implicitly controls west of the divide while no storm actually is transposable on the east slopes through this region (HMR 55A), but HMR 55A uses implicit transposition of storm 155 to fill this portion of the region. Also apparent in Figure 7.3 are the number of different storms that control portions of western Oregon. Storm 12, by far, controls the greatest portion of the region extending from the base of the eastern slopes of the Cascades eastward almost to the Rocky Mountains.

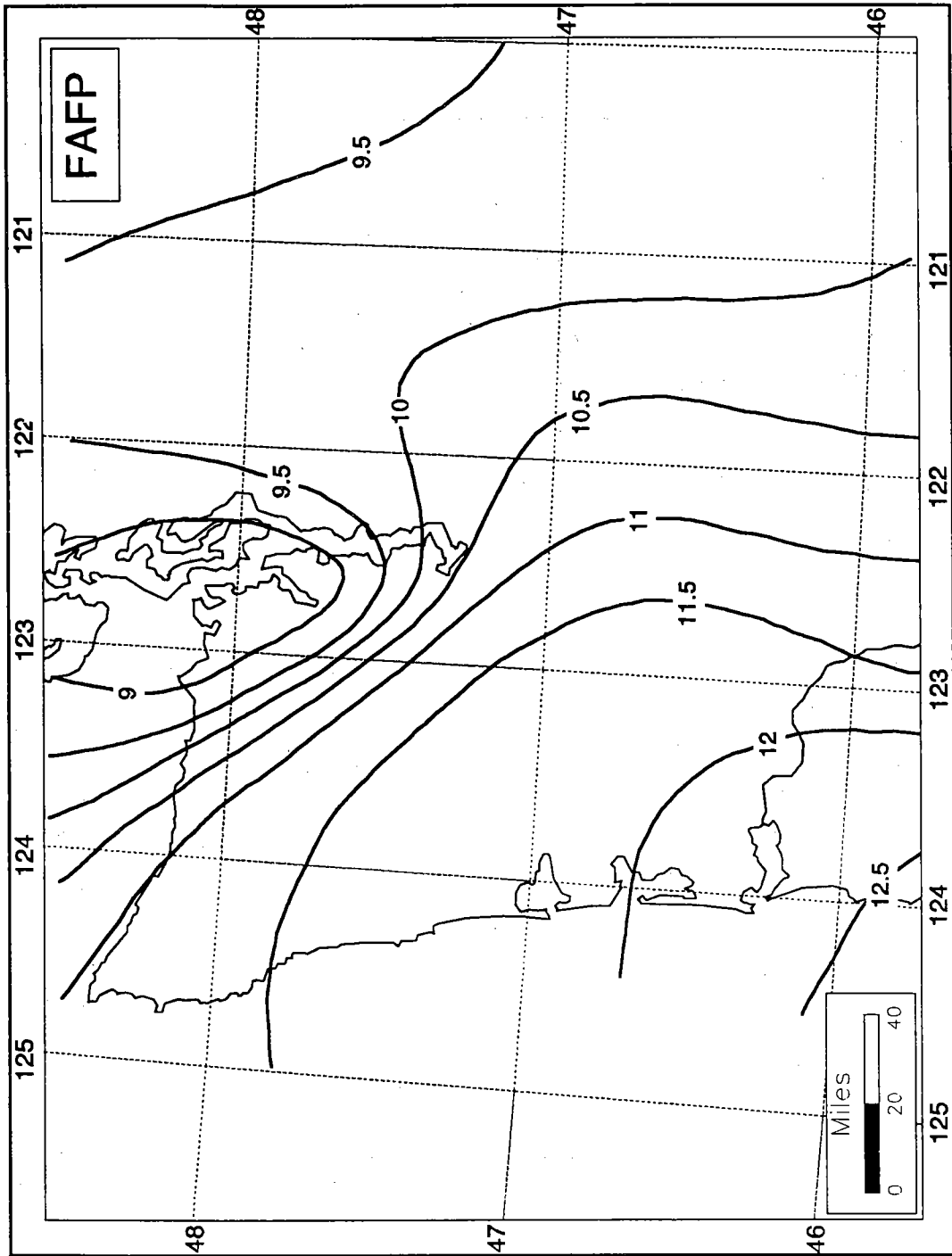

Figure 7.2.--Example of FAFP (inches) analysis for western Washington (at 1000 mb - reduced from 1:1M scale).

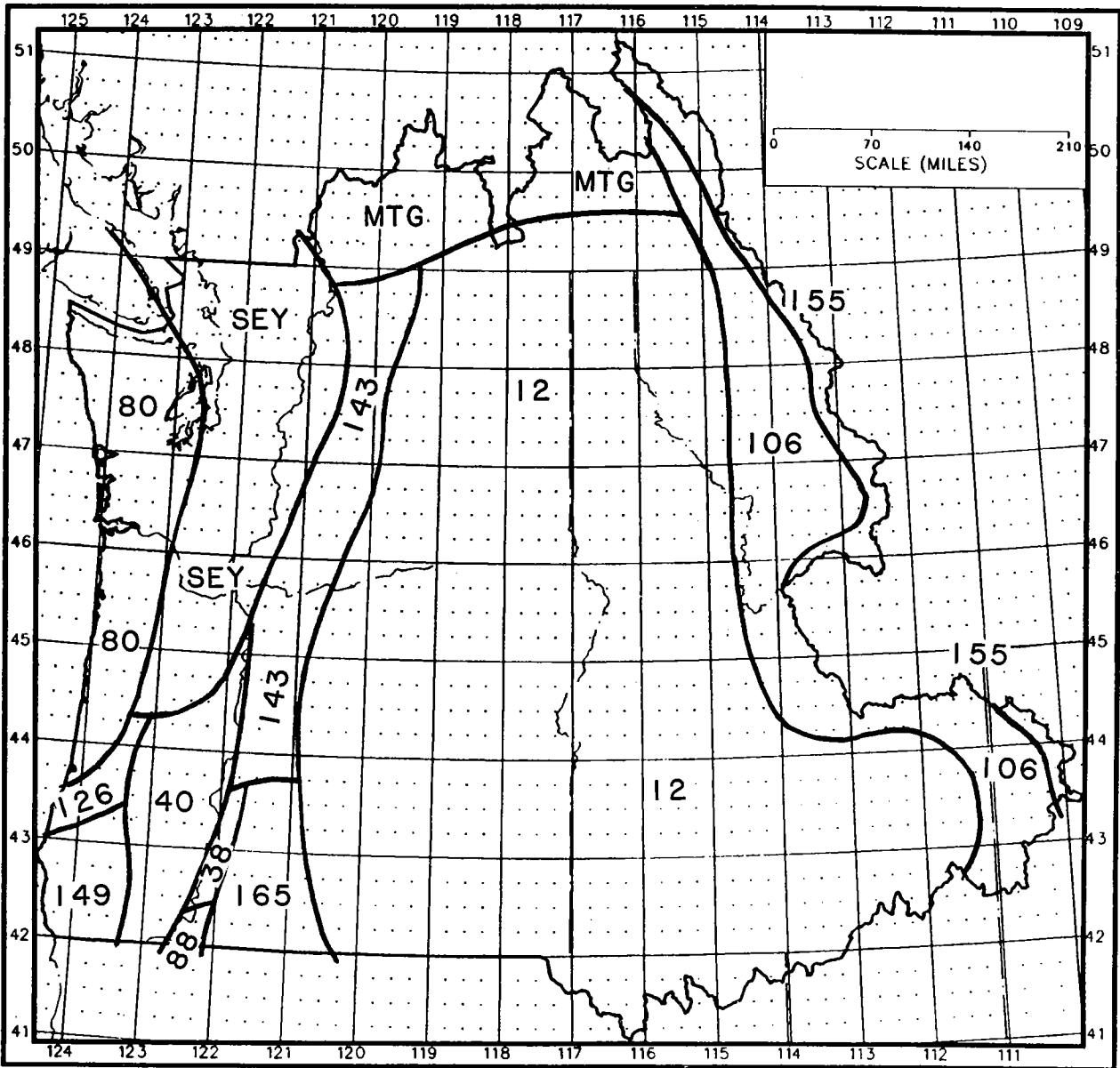

Figure 7.3.--Controlling FAFP subregions for 1000-mb 10-mi², 24-hour maximized convergence component (see storm index numbers).

8. OROGRAPHIC FACTOR

The orographic development in this study follows the procedure generally derived during the HMR 55A study. The procedure is founded in a need to evaluate the following equation:

$$K = M^2 (1 - T/C) + T/C. \quad (8-1)$$

where:

K	is the orographic factor,
M	is the storm intensification factor,
T	is the total 100-year precipitation, and
C	is the 100-year convergence component.

Equation 8-1 has been discussed in considerable detail in HMR 55A and other reports (Fenn, 1985; Miller et al. 1984; WMO, 1986). It should be made clear that K is not the orographic component of PMP, but a factor that is applied to the FAFP (the convergence component) to obtain total PMP, as in:

$$PMP = K * FAFP. \quad (8-2)$$

8.1 Determination of T/C

The key step in preparing a distribution of T/C is to identify locations where the effect of topography in determining the level of total 100-year precipitation is absent or close to absent. In general, such locations or areas were found in regions of relative minima in the field of 100-year level precipitation, a finding similar to that cited in HMR 55A. These minimum values of 100-year level precipitation were adjusted for convenience of comparison to sea level or 1000 mb using the vertical adjustment rule (equation 7-2) in combination with the persisting dew points of Figure 4.15 and the barrier elevation analysis. The resulting spatially uneven distribution of adjusted values, after initial analysis, revealed a mostly uniform and simple pattern of low values in the central sections of the Columbia drainage, with maxima along the Pacific coast and east of the Continental Divide. However, when certain of the 100-year relative minima were associated with relatively deep valleys that were much less wide than they were long, an irregular pattern was introduced into the analysis. Because the analysis in such regions was difficult to understand and therefore difficult to accept, it was decided that the precipitation in such locations must be affected by topography in some manner, and the 1000-mb adjusted values for these locations were redrawn subjectively to accommodate the simpler pattern established at surrounding locations. The resulting map of non-orographic, 1000-mb, 100-year, 24-hour precipitation becomes the denominator, C, of the T/C parameter following adjustment for the barrier elevation at which the numerator is observed. A simplified portion of C for the northwestern portion of the study region is shown in Figure 8.1.

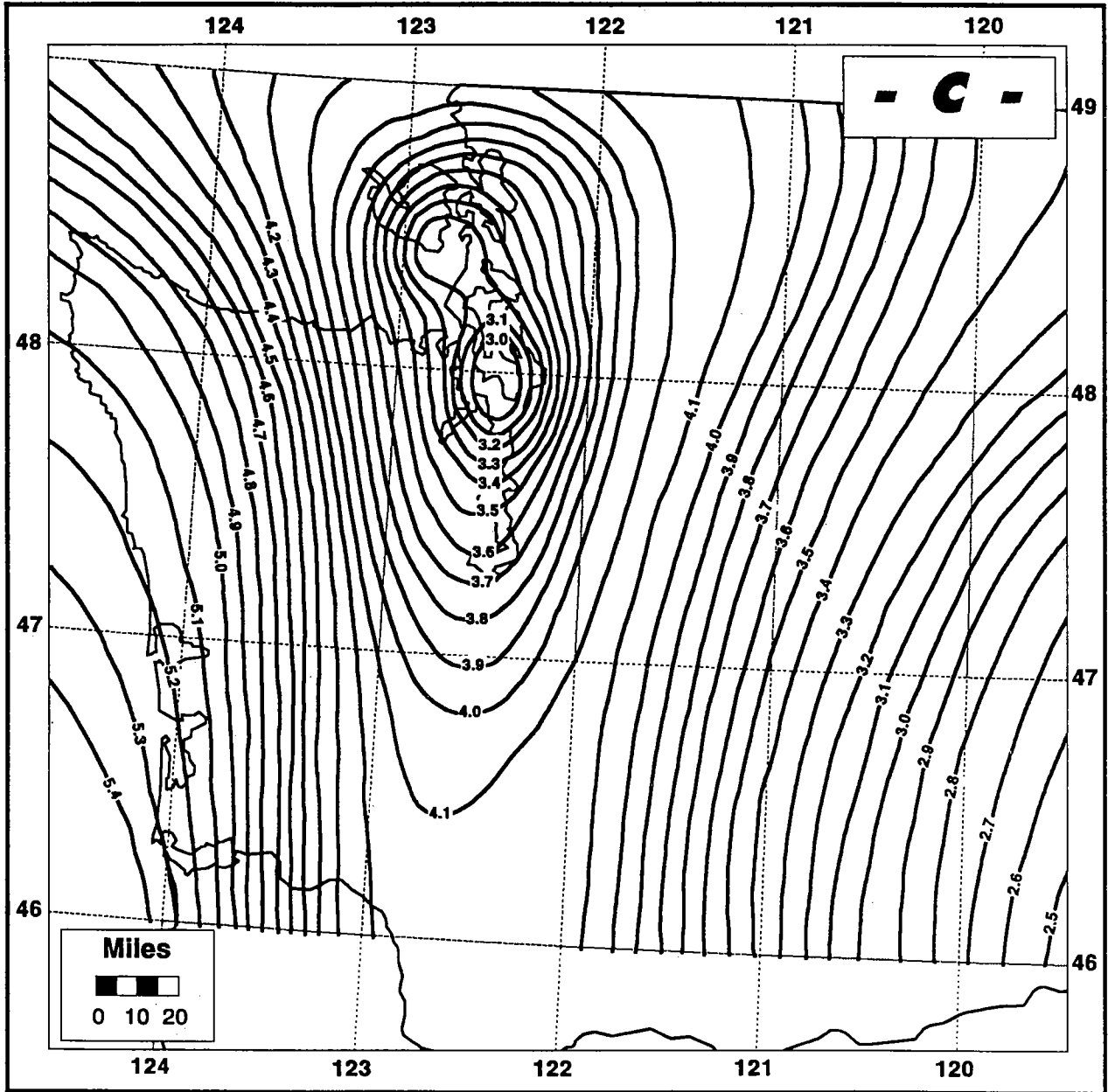

Figure 8.1.--100-year, 10-mi² 24-hour convergence analysis, C, for western Washington (from NOAA Atlas 2 total precipitation analysis).

An earlier version of this map contained a rather uniform gradient in the region between eastern Washington and Oregon and the Continental Divide. In light of the much weaker gradient of FAFP determined for the same region using the techniques of moisture maximization and transposition, it was decided to bring the separate gradients into closer conformity. Accordingly, the gradient of 100-year values was weakened while the gradient of FAFP was strengthened slightly.

T/C was analyzed in considerable detail for the purposes of calculating the orographic factor. Figure 8.2 however shows only the generalized pattern of T/C, again for the northwestern part of the study area. The level of complexity in this figure is controlled by the detail given by T, the 100-year precipitation intensity. In some limited subregions, values of T/C less than one resulted. When this occurred in places such as in the Snake River plain, where physiographic features could likely account for the low T/C values, the values were accepted. Values as low as 0.84 to the lee of the Olympic Mountains of Washington, where the mountains were believed to disrupt the resupply of boundary-layer moisture to precipitating weather systems in the Puget Sound Basin, were also accepted. Where the physiographic features were not significant, associated T/C values less than one were reanalyzed and set to unity (one).

The largest values of T/C in the region were found in the Olympic Mountains where the values exceeded 5.8 and near the crests of the Cascade Mountains in northern Washington where the values exceeded 5.2. As will be seen in Section 8.2, the M-factor in these regions is zero, thus the K-factor becomes T/C. At such places and all highly orographic areas, the topographic interaction with the atmosphere in major storms will account for more than 80 percent of the most intense 24 hours of precipitation. This occurs when convective potential is low and frontal discontinuities are absent, while boundary-layer transport of air of exceptional moisture content is very strong and maximum lifting occurs caused by terrain features.

8.2 Determination of M

The storm intensification factor, M, relates the precipitation in the most intense rain period to the total rainfall within the storm period, and therefore varies with storm type. The period of most intense rain is referred to as the core duration. M is determined from examination of the mass curves for stations near the storm center.

Fourteen storms in or near the northwest region (see Table 8.1) were identified as producers of the 18 transposable centers accounting for the largest values of 1000-mb FAFP within their respective transposition limits. The mass curves of rainfall during the most intense 24 hours of precipitation at locations of least topographic influence nearby to each of the 18 isohyetal maxima were examined

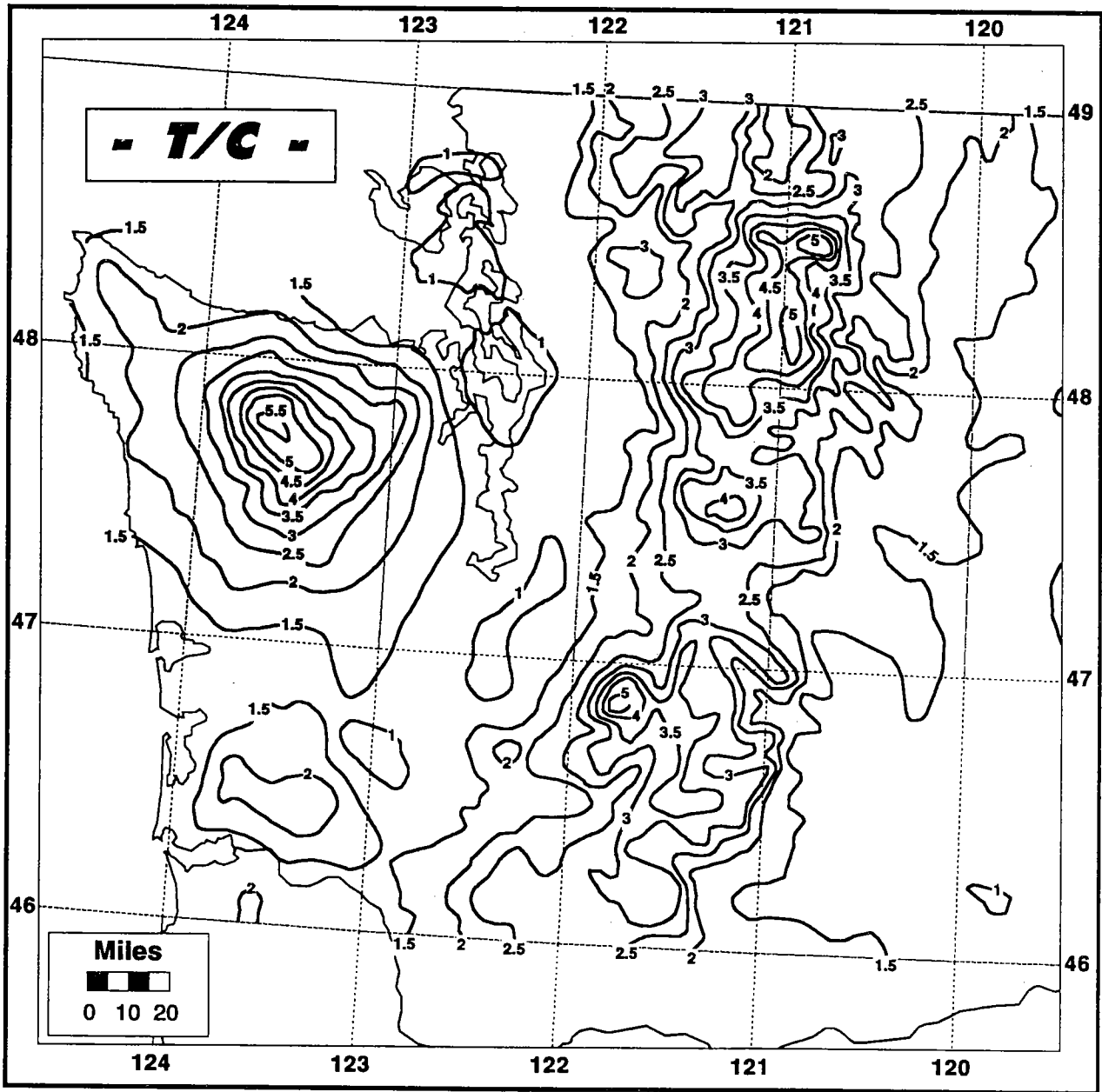

Figure 8.2.--Analysis of T/C for western Washington based on NOAA Atlas 2 100-year, 24-hour data.

significantly greater than the base rainfall rate). When least topographic locations for evidence of core-like behavior (where the rainfall intensity is too far removed from these isohyetal maxima to ensure the plausibility of the same precipitation characteristics at both places, the closest location to the maximum was selected as the place where the mass curve should be examined. In only three (Storms 82, 106 and 143) of the 14 storms was there evidence of core-like behavior. In other words, in 11 of the 14 storms, either there was no core period of most intense rain within the 24 hours of greatest precipitation. If there was a significantly different rain rate, it did not produce an accumulation sufficiently large, as compared to a long return period amount (say, 25-year), for the duration of the core. In two of the three storms (Storms 82 and 106), where both rain rates and accumulations were sufficiently large to meet core criteria, the core period was 4 hours. These two storms occurred at the end of March and June respectively, and were located near the Idaho-Montana border. A third storm occurred on the first of October and located near Hermiston, Oregon, had an 8-hour core-period.

The most recent analysis of the mass curves of rainfall associated with storm 155¹, the Gibson Dam Storm, found that the quantity of precipitation

¹Storm 155, the Gibson Dam Storm, along the ridge of the Continental Divide in Montana, has been the subject of controversy arising from discrepancies over the true nature of the event and the isohyetal analysis resulting from it. Heavy precipitation was observed on both sides of the Divide, although greater volume fell on eastern slopes. The COE prepared the original DAD and isohyetal analysis, centered somewhat east of the Divide (as shown in Figure 2-11 of HMR 43). During the preparation of HMR 55A, the USBR made another analysis that spread the maximum west of the ridge and increased both the maximum and the volume obtained from the pattern. This reanalysis was accepted at the time by the Joint PMP Study Team. For the current study, the procedure adopted for storm analysis has changed slightly from that used in HMR 55A and again storm 155 was reviewed. The emphasis once again has been placed on east of the Divide and the results more closely follow those originally determined by COE. It can be seen in Table A, that the shifts in centering and in isohyetal volumes have not resulted in appreciable variations in either depth-duration or depth-area for this storm.

Duration (hours)	1	6	12	24	30	36	48	
COE		.40	.66	1.00	1.06	1.11	1.13	
HMR 55A	.08	.41	.72	1.00	1.05	1.09	-	
HMR 57	.08	.41	.68	1.00	1.03	1.07	1.07	
Area (mi ²)	10	100	200	500	1000	2000	5000	10000
COE	100.	94.4	90.8	83.1	76.8	67.6	52.8	41.5
HMR 55A	100.	97.7	95.3	88.6	82.6	75.8	64.1	48.0
HMR 57	100.	95.1	90.3	83.1	77.1	70.3	56.7	44.4

accumulated during the 6-hour core period used in HMR 55A was too small to conform with core-like criteria. However, the M-factor for this storm from HMR 55A was accepted (rather than a value of zero) so that discontinuities in K factors at the Continental Divide between this report and HMR 55A would be avoided. Note that by having M factors greater than zero in the region near the Continental Divide so that continuity might be preserved, K factors were determined and as a consequence, PMP values were somewhat smaller than would otherwise be the case in this transitional region.

Table 8.1.--Storms that were used to derive the storm intensity analysis, M-factor map

Storm Number	Core Duration	M-factor
12	0	0
38	0	0
40	0	0
80	0	0
82	4	0.44
88	0	0
106	4	0.58
126	0	0
143	8	0.73
149	0	0
155	0	0
165	0	0*
Mount Seymour	0	0
Mount Glacier	0	0

*M-factor for storm 165 modified to 0.38, see footnote page 78

In completing the analysis of M factors, a problem arose in deciding how far southwestward from Hermiston, Oregon, to extend positive values of the M factor. The problem followed from the evaluation of storm 165 in which the M factor from the Gibson Highway Center (GIB) was analyzed as zero. This occurred because the absolute level of precipitation during the most intense 4-hour precipitation period at the representative least-orographic location for GIB was less than the 100-year precipitation. However, continuity with the positive values of M factor eastward of the Cascades crests indicated that these positive values commence

near these crests and extend into northern California near GIB. If a level less than the 100-year value had been used as a minimum requirement for core precipitation in storm 165, then a M factor of 0.38 would have resulted. The final analysis of M factors for a PMP storm occurring near GIB shows a value there of approximately 0.24, which represents a reconciliation of the information provided by storms 165 and 143. A digitized version of the M-factor analysis for the entire study region is shown in Figure 8.3.

8.3 The analysis of K

With completion of the analyses of T/C and the M factor, preparation of the K factors is straightforward. A portion of this analysis is shown in Figure 8.4. The reasonableness of this analysis is determined on the basis of meteorological experience. Figure 8.4 shows maxima exceeding 5.0 in the Olympics where it is expected that the largest orographic influence would be. Minimum orographic effects are found in the Puget Sound Basin and extending north through the San Juan Islands. Secondary orographic influences yield K values of 3.0 to 4.0 in the Cascades and there is another secondary drop off just east along the eastern base of these mountains.

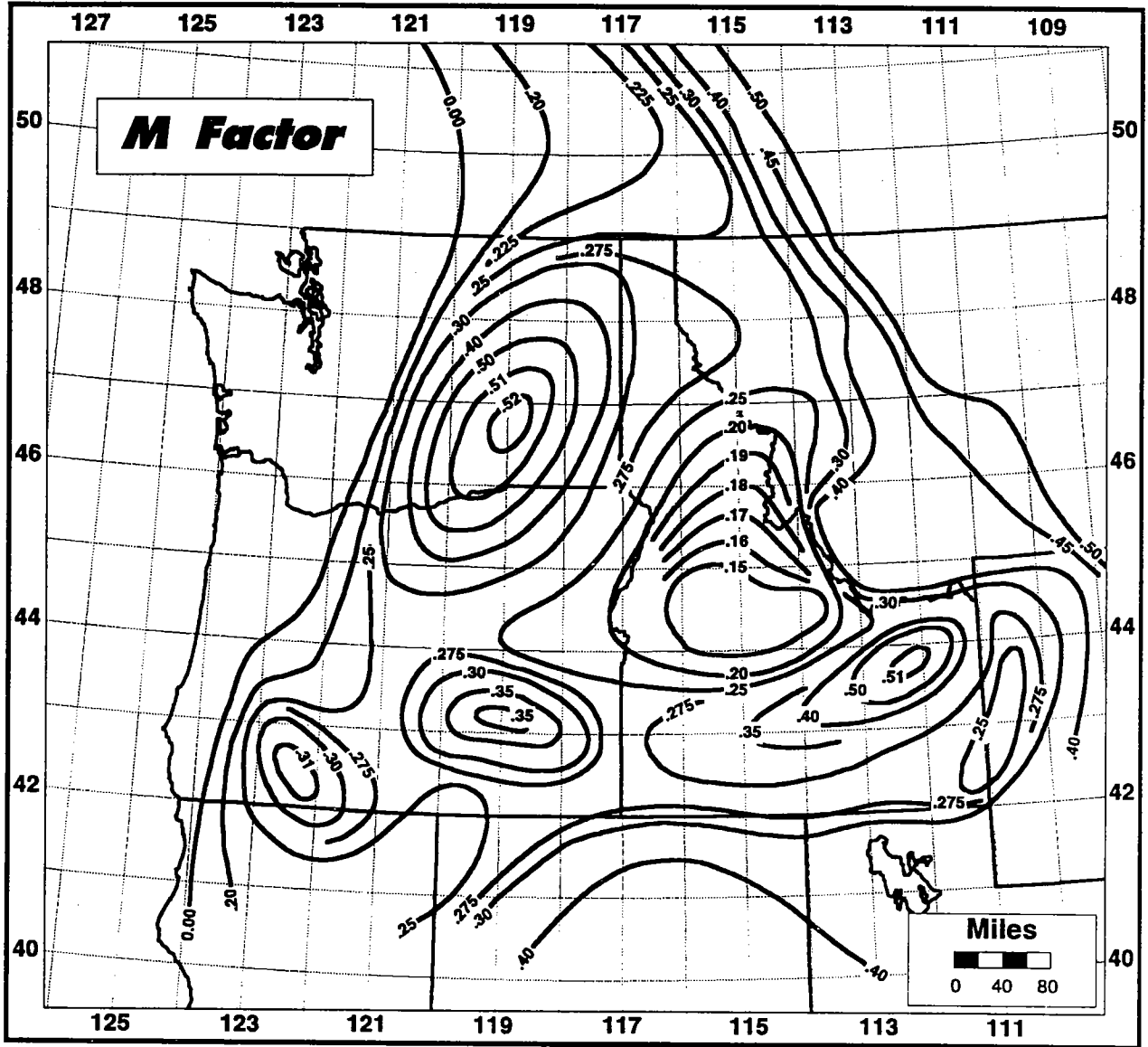

Figure 8.3.--Analysis of M factor (reduced from 1:1M scale).

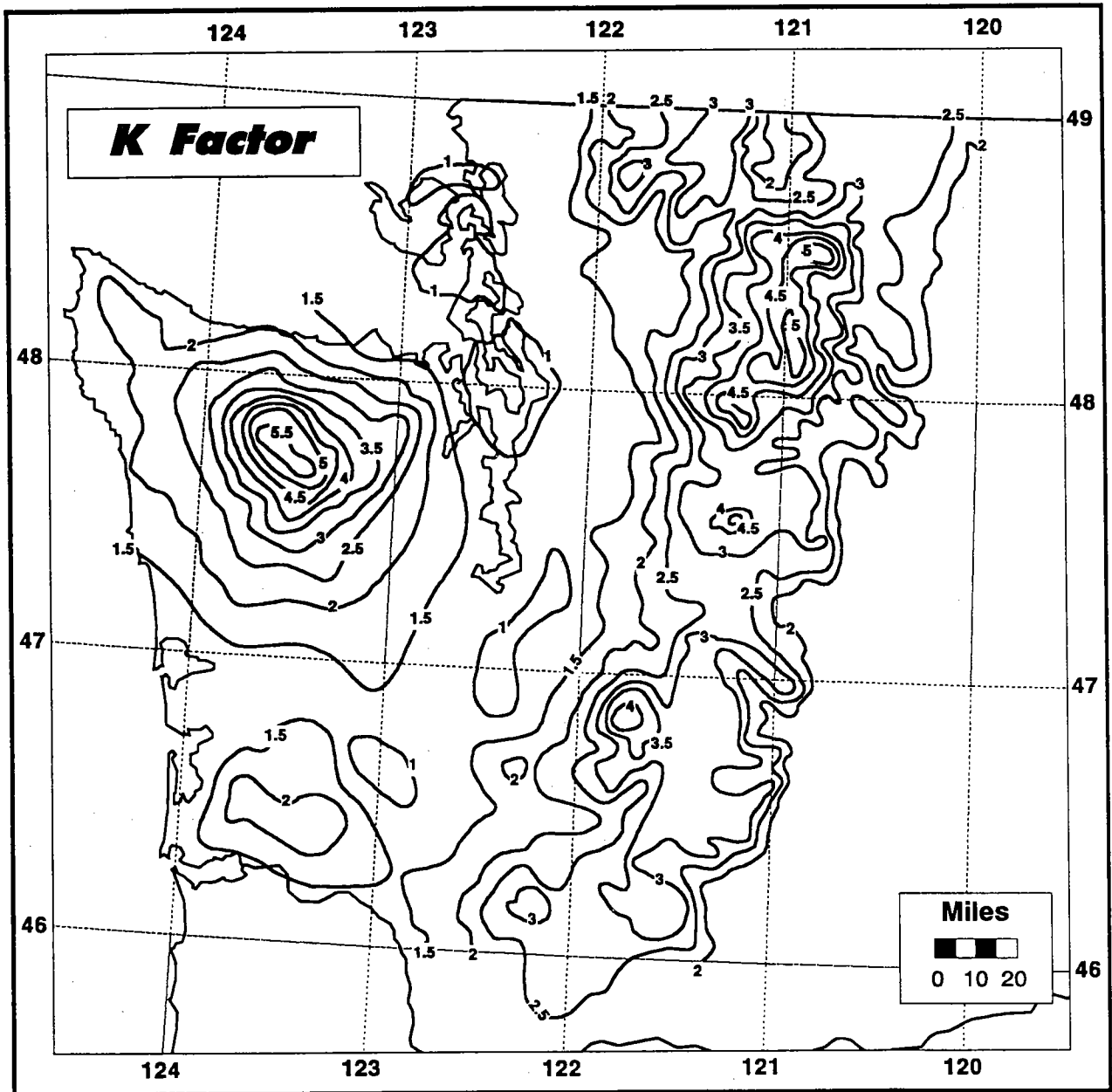

Figure 8.4.--Analysis of orographic factor, K, for western Washington.

9. THE GENERAL STORM PMP INDEX MAP AND SEASONAL VARIATION

Development of the 10-mi², 24-hour index map of general storm PMP was accomplished in two phases; the first was the specification of the orographic factor K across the region. Development and discussion of the K-factor chart is found in Section 8.3. Second was multiplication of the K-factor by the depth of non-orographic PMP at 10-mi² and 24-hours. The non-orographic PMP (or FAFP) analysis is discussed in Section 7.5. The index value of total PMP is produced by adjustment of FAFP from sea level to the barrier elevation. This procedure is much the same as that used in HMR 55A to produce the 10-mi², 24-hour index map in that study; the only significant difference being that in this report, the analysis of FAFP was done at sea level rather than on the undulating surface represented by the barrier elevation.

Computation of the general storm total PMP index map for 10-mi², 24 hours at barrier elevation was made at each grid point of the 0.1-inch grid used by Reclamation and a computer analyzed product was developed at 1:1,000,000 scale for the region of study. Typical of many computer analyses, the level of smoothing is not sufficient to eliminate all of the discontinuities. The technique also produced some features believed to be insignificant to the study, such as enclosed isolines for areas less than 10 mi². For these and other reasons, a hand-smoothed overlay was drawn to provide the final analysis of total general storm PMP for this study. Subsequently, the hand drawn analysis was digitized using the U.S. Army Corps of Engineers GRASS geographic information system.

Figure 9.1 shows a portion of the final digitized general storm PMP index map (10-mi², 24 hours) for the northwest corner of the region. The portion of the region shown in Figure 9.1 is primarily controlled by only two major storms, storm 80 through the Olympic Mountains and the Seymour Falls (British Columbia) storm through the Puget Sound basin and the Cascades. Extreme sheltering by the Olympics is noted as the maximum 10-mi², 24-hour PMP of 38 inches drops off to less than 8 inches to the immediate northeast of this barrier. The Cascades support PMP estimates as high as 29 inches, with a leeward drop-off to 8 to 9 inches.

The complete 10-mi², 24-hour total general storm PMP index maps at 1:1,000,000 scale are available as four regional maps (Maps 1-4, representing the NW, NE, SE and SW quadrants, respectively) in the package accompanying this report. These oversized maps are used with the computational procedure outlined in Chapter 15. Maps 1 through 4 were applied in the test-basin comparison study discussed in Chapter 12. The acceptance of the general level of PMP represented on these index maps was based on consideration of the Chapter 12 test-basin results, the comparison studies noted in Chapter 13, and an overall concern for reasonability relative to meteorological understanding.

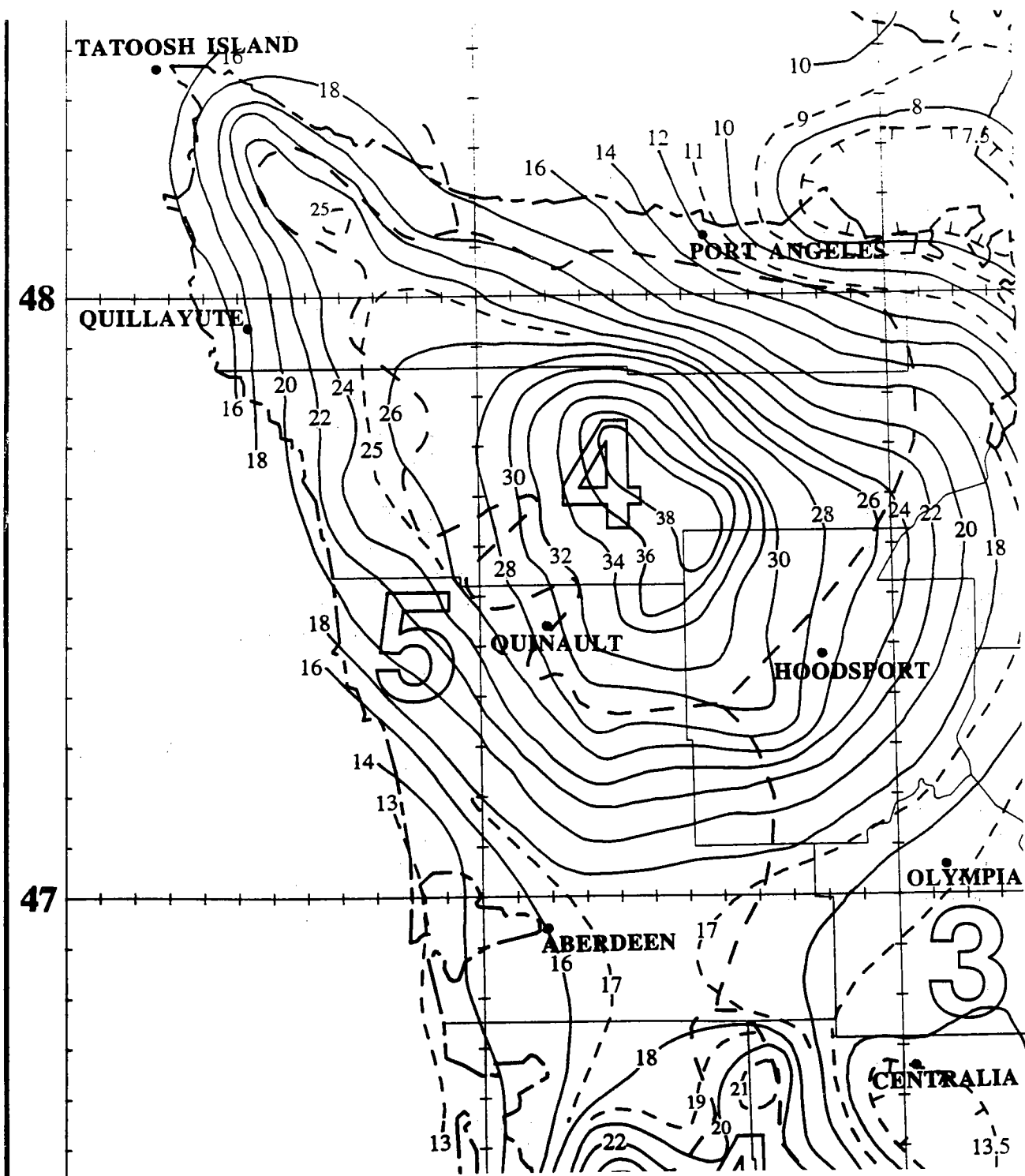

Figure 9.1.--Northwest portion of 10-mi², 24-hour general storm PMP index map. Refer to Maps 1 through 4 attached to this report for entire regional coverage.

9.1 Adjustments to the General Storm Index Map

In order to evaluate the level of total PMP shown on Maps 1-4, ratio maps (discussed in Chapter 13) were prepared comparing PMP with the 100-year, 24-hour level of precipitation from NOAA Atlas 2 (Figure 9.2). In this Figure only a portion of the total analysis is presented (reduced from its original scale) and shows the level of detail in the computer analysis based on ratios made over a 0.1-inch grid. Figure 9.3 shows a portion of the ratio analysis comparison between total PMP in this study and that from HMR 43 (also reduced from its original scale). Data from HMR 43 were readily available at only quarter-degree grid intervals, causing the isolines to take on a more jagged appearance than Figure 9.2.

Such ratio maps served as alerts to possible problem areas traceable to the methodology used in this report. The problem areas were of two types. The first involved the variability of the orographic factor K , which is brought about by the relatively fine scale of variability in the 100-year, 24-hour analyses from NOAA Atlas 2. From the comparison analysis, it was decided that troughs of lower PMP values in relatively small valleys located in orographic regions well exposed to boundary layer inflow (such as the Skagit River Valley of Washington) should be brought closer to values near the ridges. Changes of this sort were made throughout the region to reflect the understanding that moist flows could easily penetrate these valleys. The second type of problem was associated with fairly extensive areas in interior regions where lower than expected PMP to 100-year ratios were created in the preliminary analysis. Such areas were in highly orographic zones well exposed to boundary layer inflow, such as portions of British Columbia, as well as in the least orographic sections of Washington, Oregon and Idaho. In these valleys, it was believed that significant sheltering had occurred. Storms of record in, and transposable to, locations in both of these areas most likely did not have the most effective combination of mechanism and inflow wind, due to the relative isolation of these interior valleys. As such, it was reasoned that in these isolated regions, a higher than originally thought level of envelopment of the non-orographic component of PMP was warranted.

Somewhat higher than expected initial ratios of general storm PMP to 100-year precipitation and to HMR 43 values, found in western Montana and eastern Idaho, were attributed to the relatively high values of non-orographic PMP (FAFP) originally analyzed there. Initial analysis of the FAFP had placed a strong gradient of this parameter in the immediate vicinity of the Continental Divide, leaving a very relaxed gradient from eastern Washington and Oregon to the western edge of the tight gradient. This non-orographic PMP pattern was different from the gradient pattern for 100-year non-orographic precipitation. The modified analysis of non-orographic PMP brought the gradients of the two parameters into closer agreement.

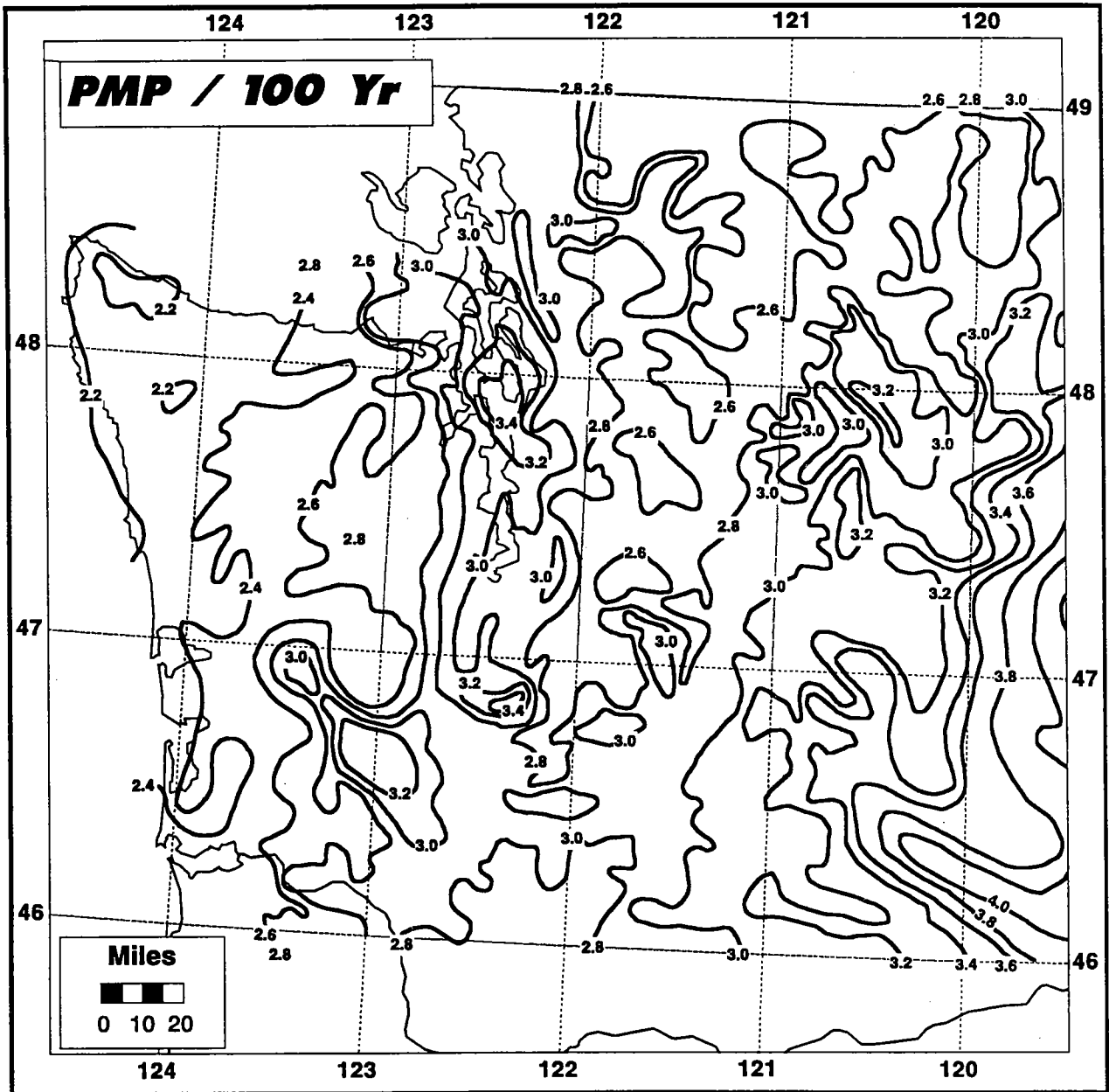

Figure 9.2.--Comparison between 10-mi², 24-hour PMP index map and 100-year, 24-hour precipitation frequency analysis from NOAA Atlas 2, non-dimensional ratios (northwest portion only).

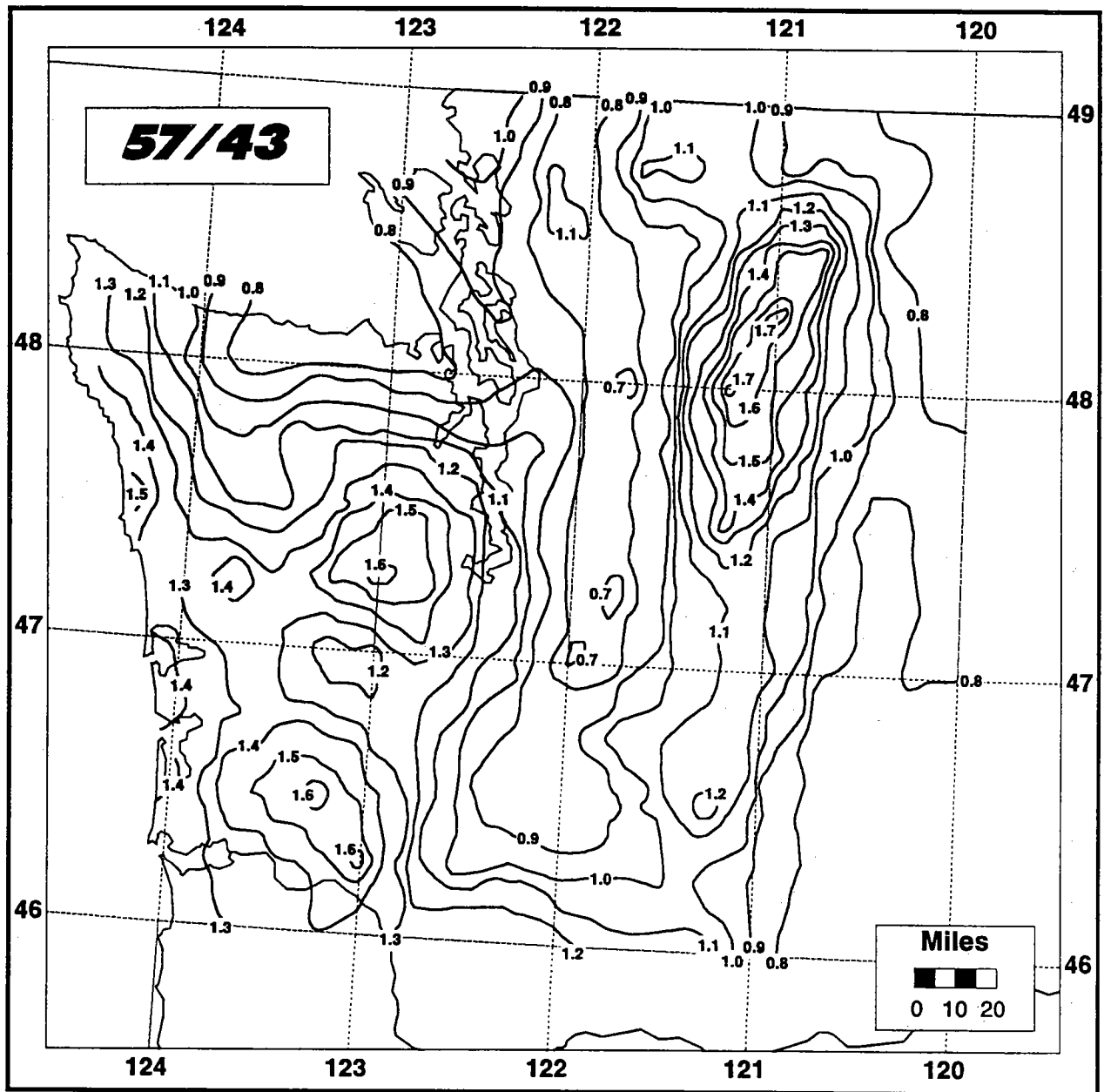

Figure 9.3.--Portion of ratio analysis between PMP estimates from this study and those from HMR 43 for 10-mi², 24 hours.

Especially in the Cascades, but also in other mountainous ranges in the study region, the computational procedure brought about a very close spatial correlation of maximum index values of total PMP and maximum values of 100-year, 24-hour precipitation. In a few instances, both the PMP and the 100-year precipitation centers were manually displaced downslope of the highest elevations in the direction of inflow associated with record-setting precipitation in that area. In these circumstances, the superposition of calculated total PMP index values and 100-year, 24-hour maxima was not changed. In some cases, especially where the maximum elevations were above 10,000 feet, the total PMP maximum was manually redrawn from its calculated location to a lower elevation, typically in the 5,000 to 9,000-foot range, in the direction of inflow moisture associated with record setting precipitation. This type of modification was brought about without making changes to either the K factors or FAFP at these locations. The implication is that an orographic factor based on 100-year data may not produce as reliable results in topographic regimes characterized by isolated steep slopes as in areas where slopes are more continuous.

It should be noted that Figures 9.2 and 9.3 are smoothed examples taken from the final ratio maps that incorporate all the adjustments discussed in this section.

9.2 Monthly Seasonal Variation of General Storm (10-mi², 24-hour) PMP Index Values

9.2.1 Introduction

In regions where significant winter precipitation falls as snow and therefore has a delayed runoff, it is necessary to consider other seasons than that containing the all-season PMP in order to obtain the probable maximum flood (PMF). Although the all-season PMP is thought of as being primarily rainfall brought about by an unusual set of relatively warm synoptic conditions, it says little about the surface it falls upon. In some high elevation locations in the west, particularly during late winter, there may be substantial snow accumulation on the ground. Because of this, the probable maximum flood may not occur from all-season PMP, but rather from a combination snowmelt and excessive precipitation. As a consequence, it is necessary to consider the seasonal variation of PMP to allow users to determine when the PMF is most likely for a specific basin. This section describes the way in which the seasonal variation of all-season PMP was determined.

9.2.2 Analysis

It was clear from an examination of records of maximum recorded daily precipitation amounts (by month) such as those contained in Technical Paper No. 16 (Jennings, 1952), "Maximum 24-Hour Precipitation in the United States," hereafter referenced as TP 16, that the observed maxima at many locations in the study area varied monthly and seasonally. It was also observed that the timing of

seasonal maxima and the degree of month-to-month variations differed both among individual stations and among broad climatological zones within the study area.

A hypothesis was developed that governed the monthly variation of index PMP. The monthly variation would be adequately represented by a smoothed regional analysis of observed monthly record setting amounts of precipitation normalized by the largest of the 12-month records at each location. Sampling of observed values were to be from regular elevation intervals within the study area. To this end, records of daily maxima were obtained for 394 locations in the study area, 12 of which were in British Columbia.

Many of these records came from stations found in TP 16 where the period of record typically ended in 1948. Most of these and other records were then updated from climatological data through 1988. The period of record was 50 years or greater at 73 percent of these locations, 70 years or greater at 48 percent of the locations, and 80 years or more at 28 percent of the locations. Fifty-five stations had periods of record at least 90 years in length, while 11 stations had periods of record in excess of 100 years. In terms of elevation, 43 percent of the stations were below 2,000 feet; 45 percent were located between 2,000 and 5,000 feet, while the remainder were above 5,000 feet. To help determine whether there was an elevation dependency in the data among stations for a given month, or group of seasonally similar months, the locations above 2,000 feet were isolated into groups by 1,000-foot intervals.

The normalized percent (each month's amount divided by the largest amount for all 12 months or all-season amount), along with the actual record monthly amount and a symbol representing the elevation of the data, were printed on individual monthly maps across the study area. Within any given month, or group of months, and for clusters of stations having similar periods of record and within a 1,000 to 2,000 foot elevation interval, a wide range of percentages were observed. Similar percentages were observed for stations within other elevation intervals. Because of the possibility of unrepresentative storm sampling within clusters of stations, it could be argued that elevation dependency categories might apply. The preponderance of information, however, indicated that the data was not elevation-dependent for a given month. Between certain months, or seasonal groups of months, a dependency was found which was incorporated as a "principle" for analysis, as discussed below (see observation 2).

The printed maps of monthly (or seasonal) percentages were analyzed according to six principles listed below. The analysis of the monthly percentages in Figures 9.4 to 9.10 was guided by the following observations:

1. A synoptic climatology of general storms showed that the maximum percentages should be expected in winter months westward of the Cascade crest and should be expected in summer months near the easternmost portions of the study area. This variation is similar to the variation of the

maxima of mean monthly precipitation given in HMR 43 and also reported in a separate study by Legates and Willmott (1990). Minimum percentages should be expected during the opposite (i.e., summer versus winter) seasonal months at these locations. It is clearly evident from this pattern that optimum conditions for orographic enhancement and large-scale convergence forced precipitation windward of the Cascades crest occurs in the winter. Conversely, in summer months west of the Cascades, boundary layer air is stabilized by passage over the cold Pacific current. Near the eastern border of the study region, convective supplementation of large-scale convergence-forced precipitation is optimized in spring-summer months by the incursion of Gulf of Mexico moisture in the lower atmospheric layers. East of the Cascades in winter months, the persistence of continental polar air, with very low temperature and humidity, minimizes precipitation potential.

2. Between the Cascade crest and the easternmost sections of the study region, there is a tendency for rainfall maxima to be observed during the late fall or early winter at the higher elevation locations and to have a summer or early fall maximum percentage at lower elevations. Summer minima at the higher elevations in this intermountain region should also be expected. This agrees with the findings of Legates and Willmott (1990), with respect to the maxima of mean monthly precipitation.
3. Relatively large gradients of seasonal percentages are acceptable within the three broad climatological regions (west of the Cascade crests, along the Rockies and between these two) mentioned above for a given month if the lower and higher values are directly associated with major topographic features. Where little or no association exists, the highest value was considered most representative and should "prevail" within nearby clusters of lower percentage data.
4. In addition to the role played by major topographic features, the subregions controlled by an individual high percentage value may vary for a number of different reasons. These include variable lengths of record, absolute magnitude of precipitation associated with the high percentage, and station density. More control was generally given to values associated with long periods of record, large absolute depths, and low density of nearby observations.
5. Certain areas were found where exceptionally large precipitation was not measured, and it was logical that within such areas, the percentages would be relatively low for many months of the year. In such subregions, a minimum threshold level was set at 40 percent.
6. Finally, at some locations, the percentages did not conform with the conceptual models in the principles cited above. These were accepted nevertheless and "drawn for."

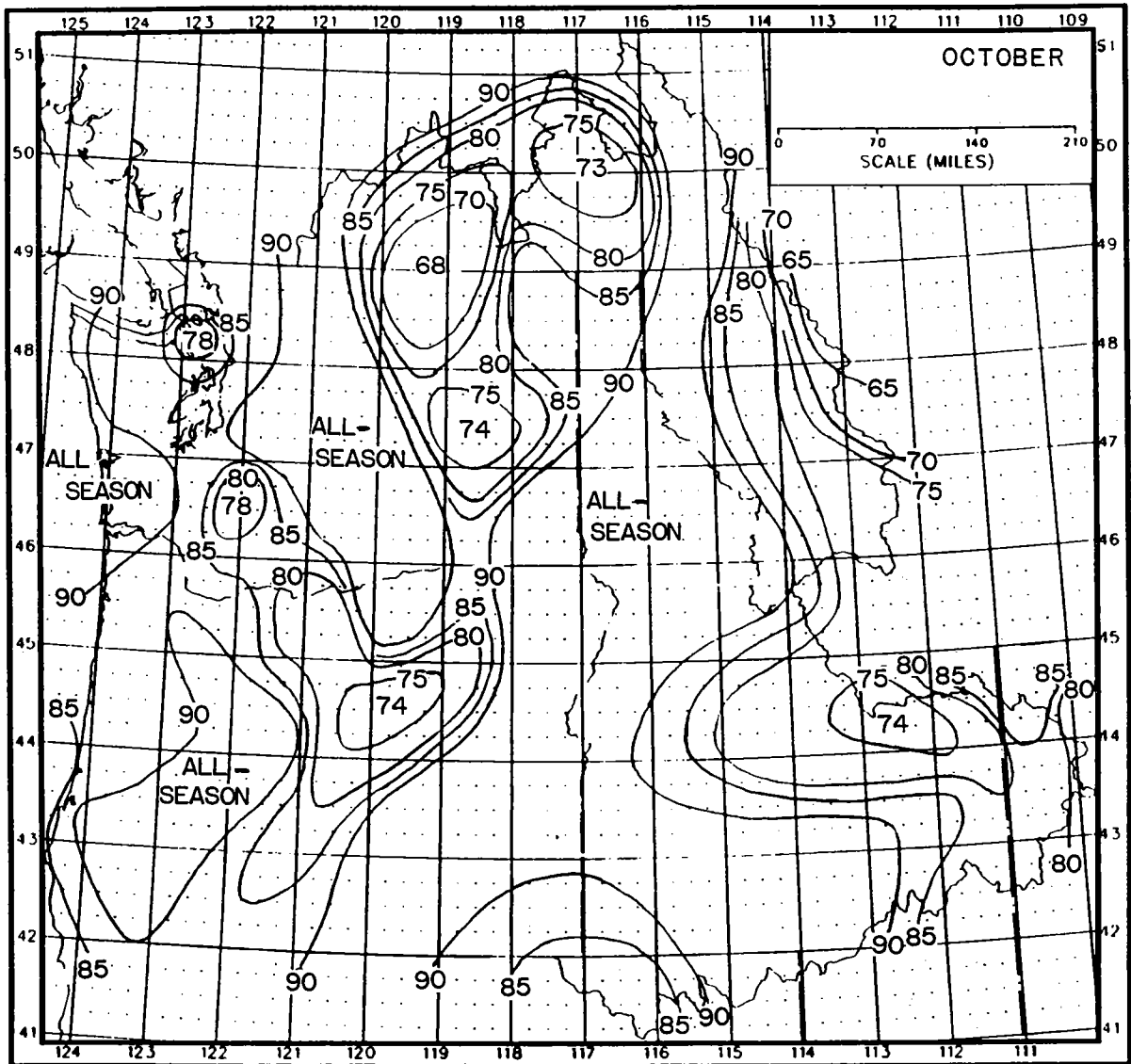

Figure 9.4.--Seasonal percentage variation of 24-hour, 10-mi², general storm PMP for October relative to all-season index maps (Maps 1-4).

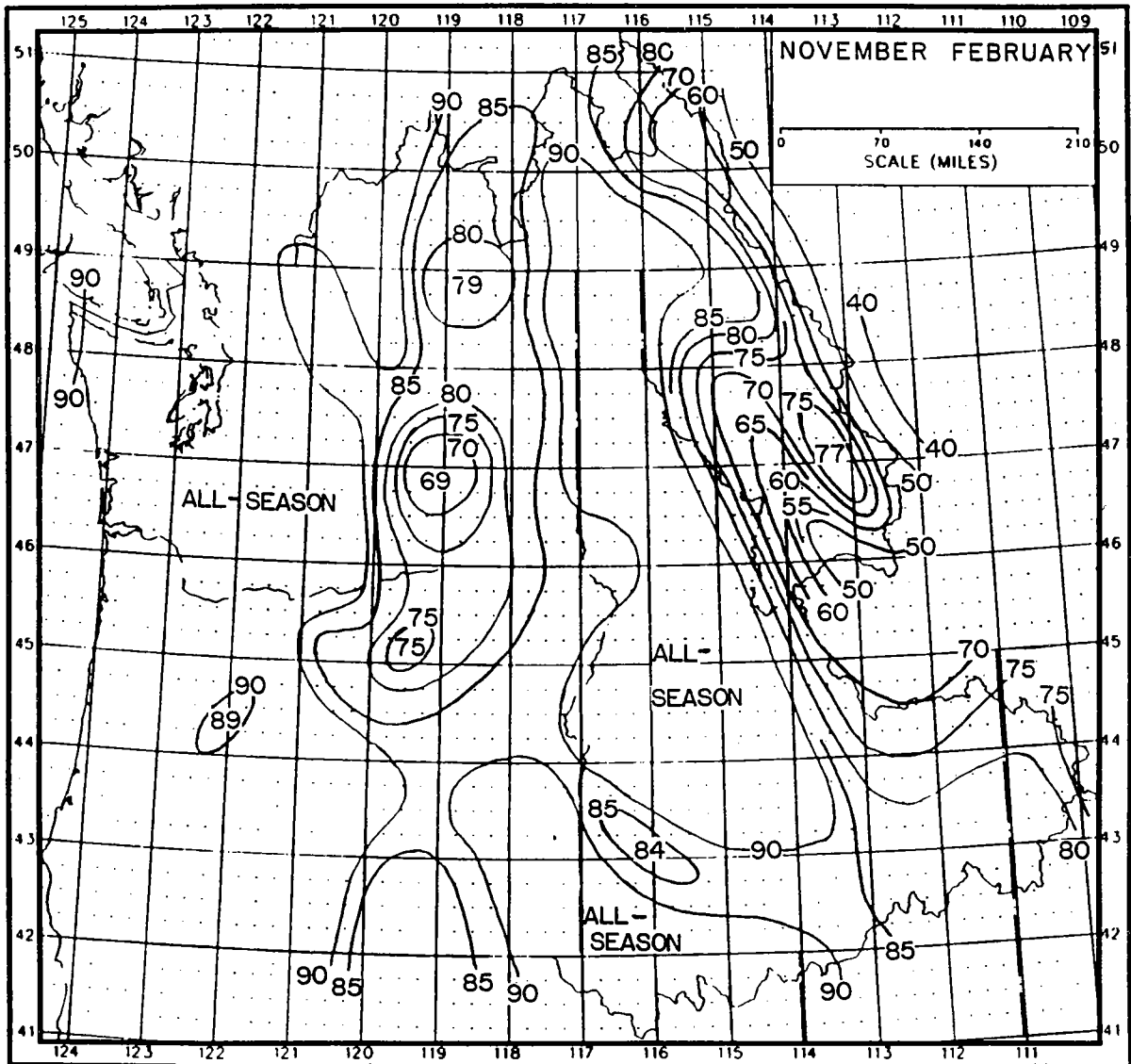

Figure 9.5.--Same as Figure 9.4 - for November through February.

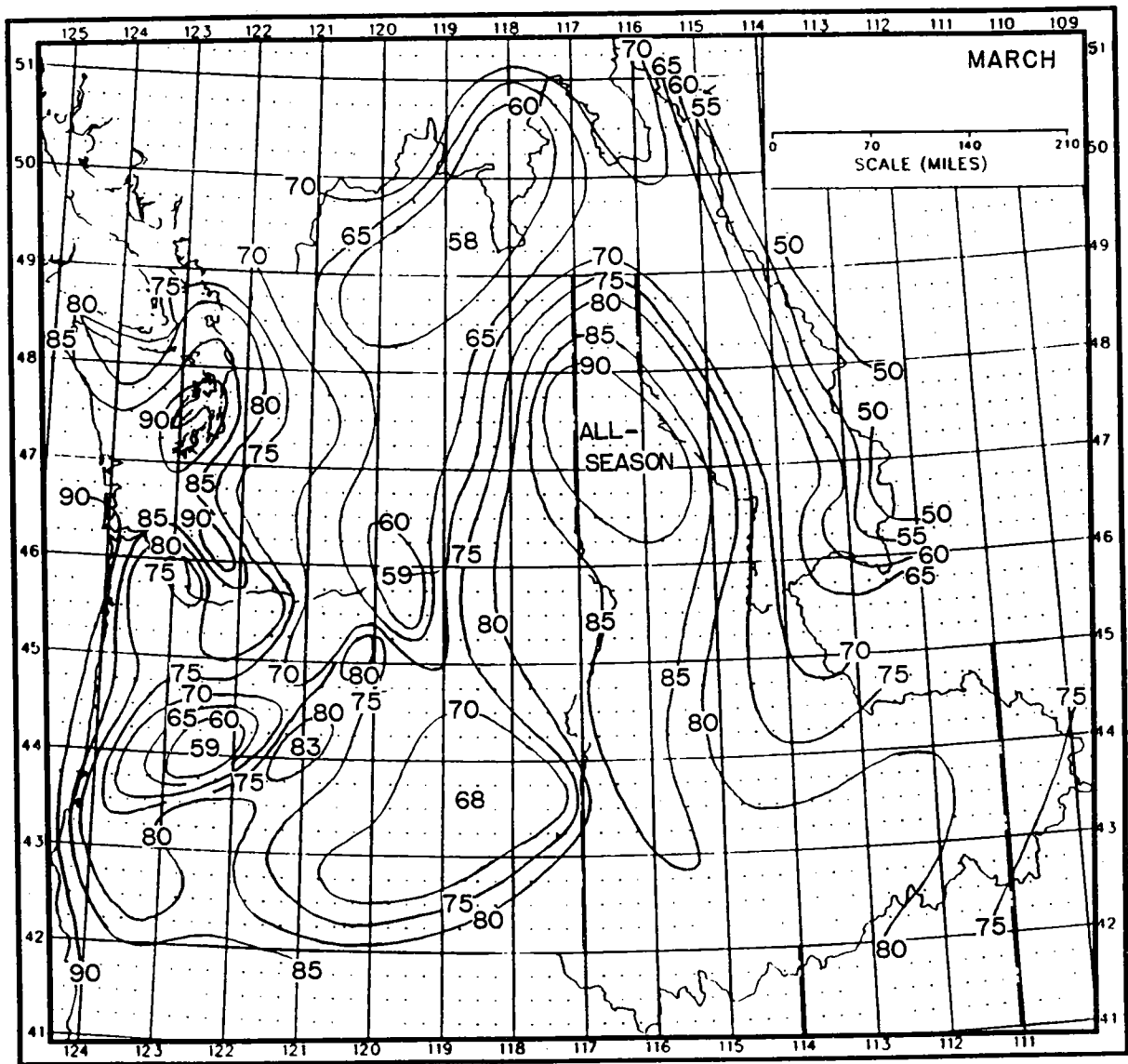

Figure 9.6.--Same as Figure 9.4 - for March.

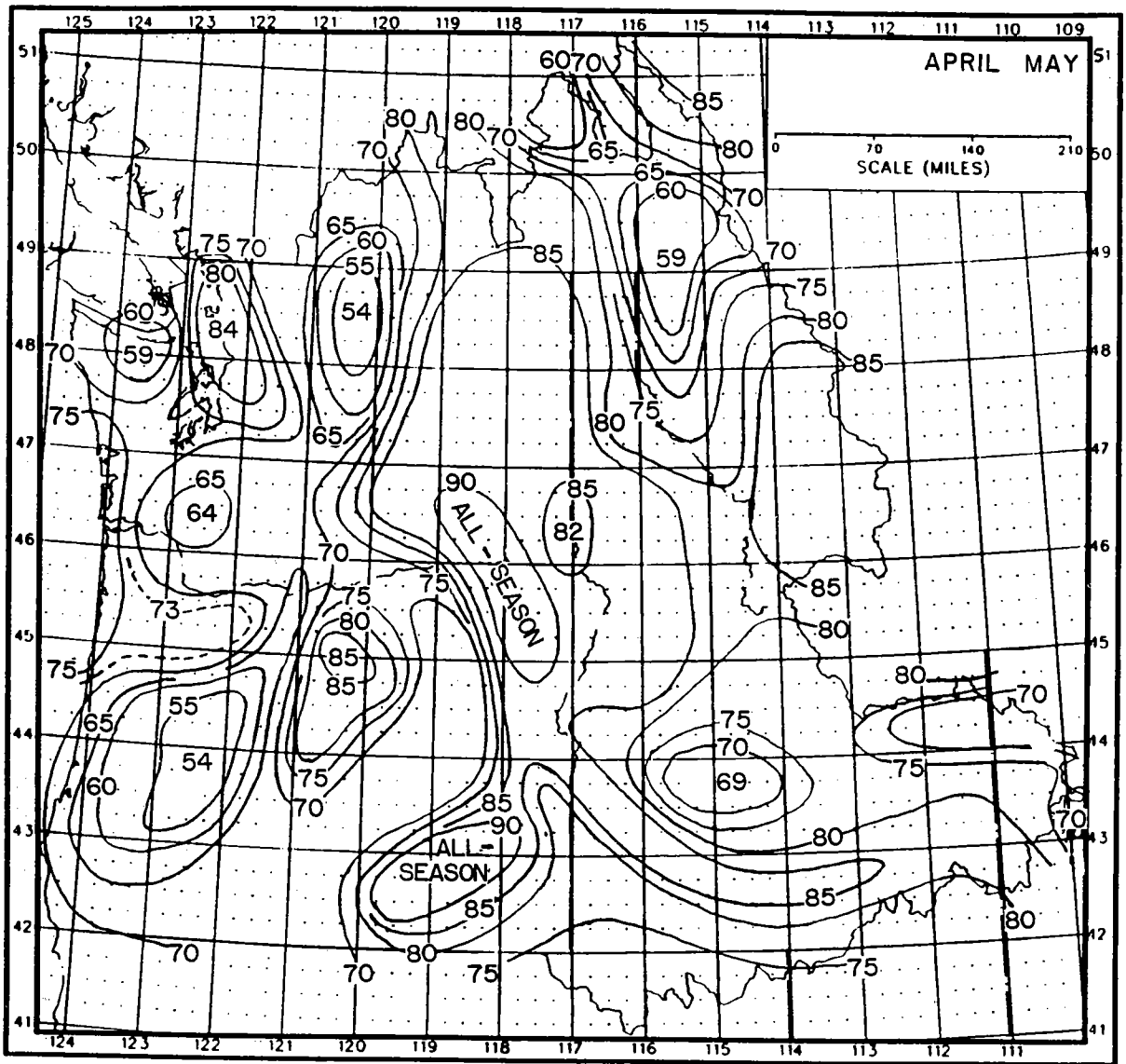

Figure 9.7.--Same as Figure 9.4 - for April through May.

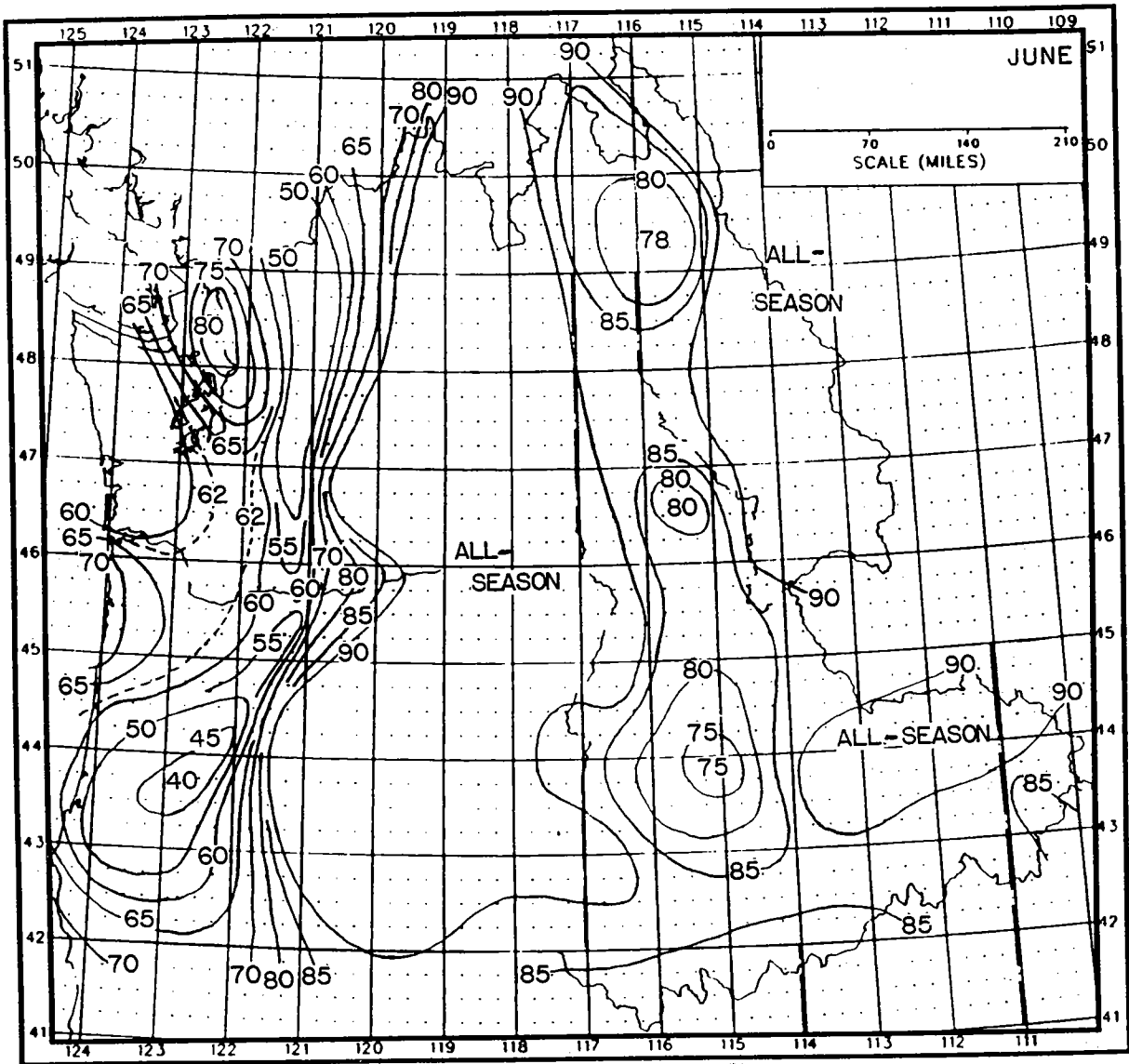

Figure 9.8.--Same as Figure 9.4 - for June.

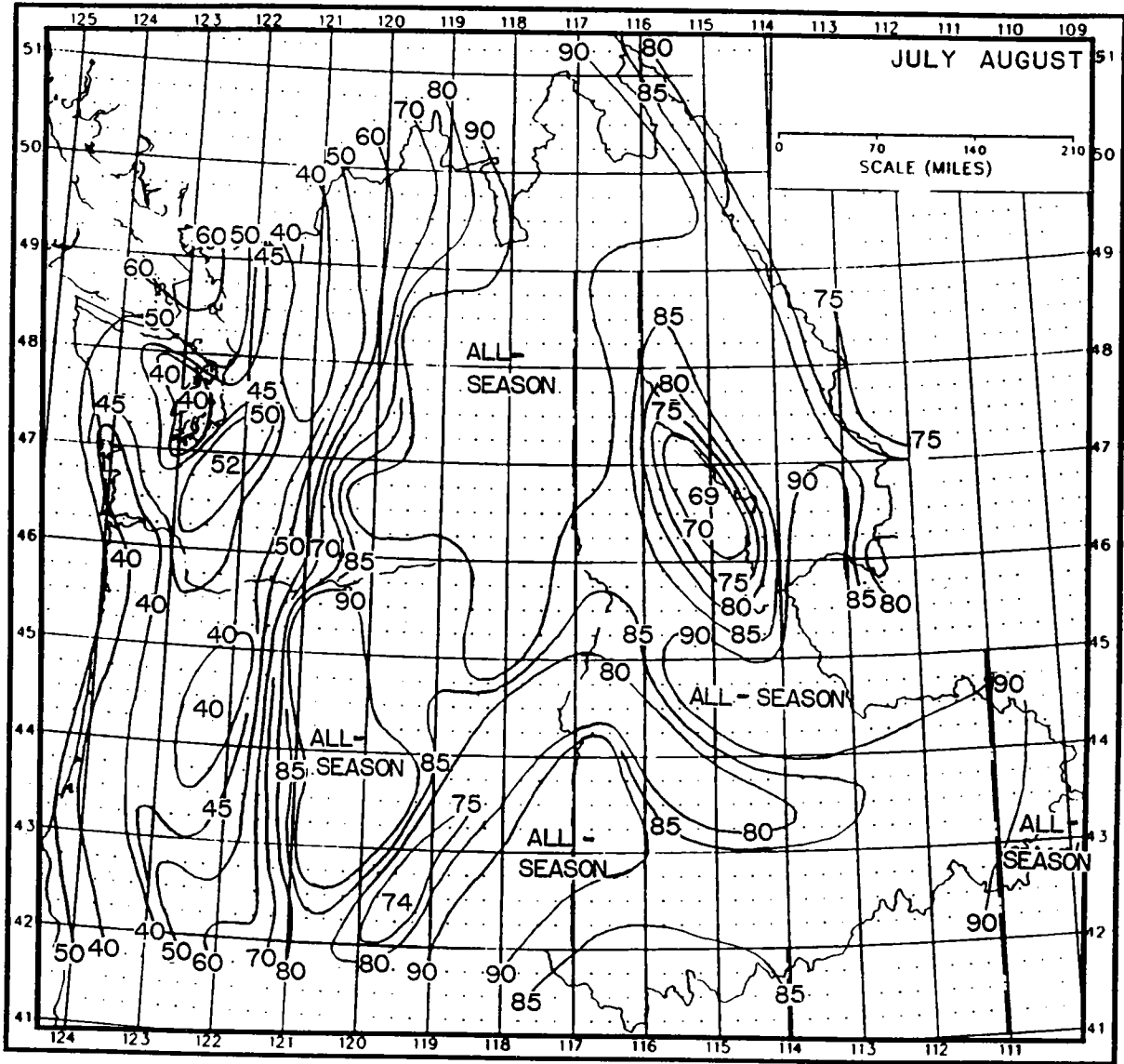

Figure 9.9.--Same as Figure 9.4 - for July through August.

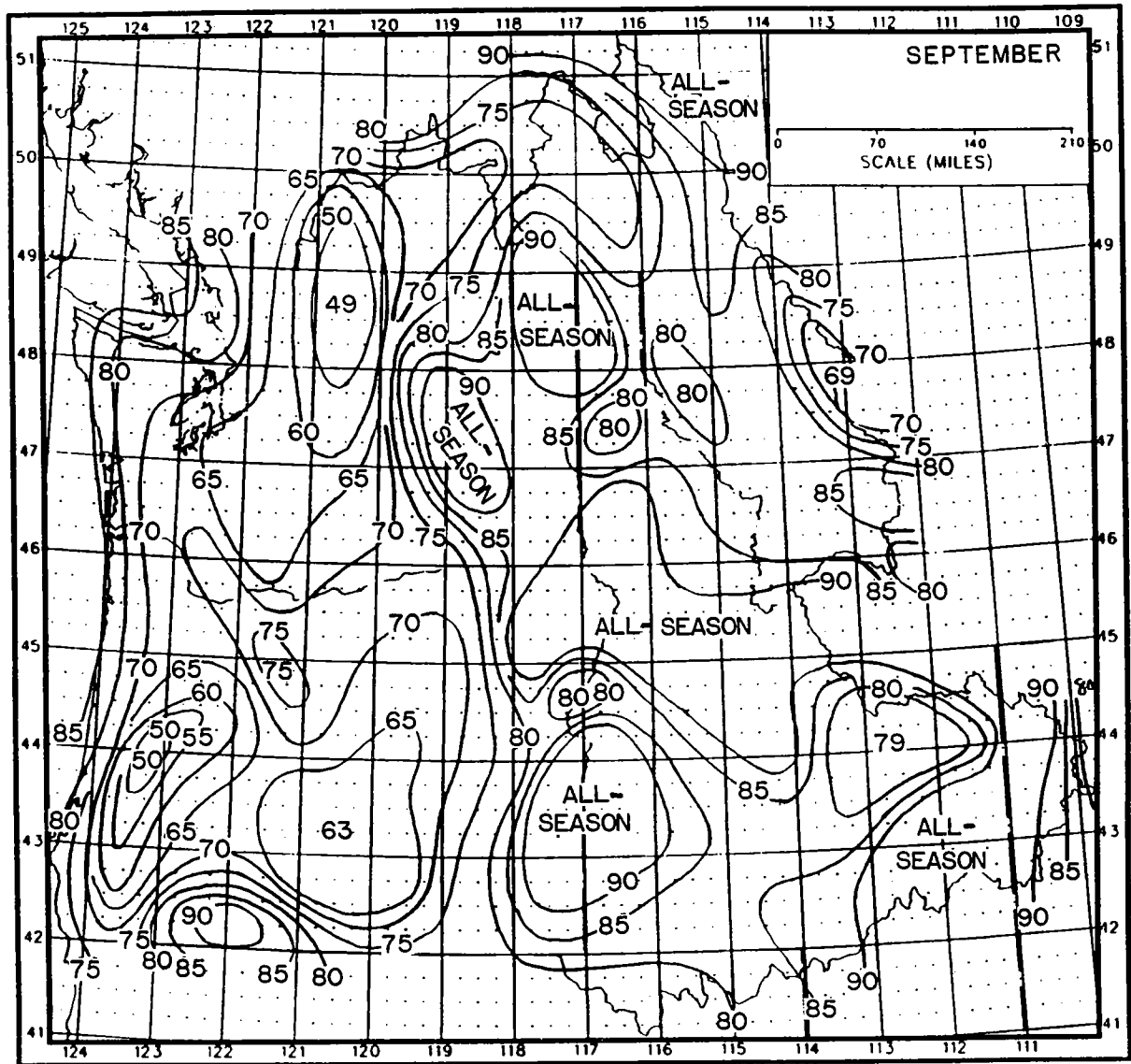

Figure 9.10.--Same as Figure 9.4 - for September.

Based on these principles, an initial analysis was accomplished for each month. Inspection of the isopercental patterns and associated values revealed similarities such that a single pattern and set of values could be used to represent more than one month. These multi-month combinations were: November through February, April and May, July and August. Thus, seven charts were drawn to depict the seasonal variation of PMP across the study region as shown in Figures 9.4 to 9.10. The scale for all seven maps is 1:8,000,000, which allows the user a relatively simple procedure to expand the scale to 1:1,000,000, the scale of the PMP index maps.

These figures show a maximum between June and August for most of the areas between 118° and 120°W. It is likely that intense local convection, occurring outside the context of general storm forcing, may have been responsible for these percentage maxima. If such were the case, these percentages would be invalid for use with an index map of general storm PMP. To investigate this possibility, a sample of twenty record setting episodes producing the maxima were reviewed for the months of June through August to determine the nature of such storms. There was insufficient information available to classify one of the older episodes, a June 1897 event. For the remaining 19 cases, four had no general storm characteristics, i.e., having both widespread, uniformly large depths of precipitation and accompanying synoptic scale convergence forcing features. Two other episodes were missing one, but not both, of these general storm characteristics.

The 13 remaining "sure" cases were believed to be sufficient to establish the likelihood that general storm forcing, with embedded intense local convection, produces maximum seasonal precipitation. From this analysis, it was concluded that PMP should also be maximized between June and August between 118° and 120°W. The synoptic context which typified many of the 13 cases of general-storm forcing, involved the boundary layer incursion of continental polar air crossing the Continental Divide from the east, accompanied by interaction with southwesterly flow aloft.

After the initial analysis was completed, percentage values at whole latitude and longitude intervals for all seven periods were extracted, plotted and examined for maxima or minima and the shape of the curve connecting the data points. Irregularities in the curves which could not be explained were eliminated by either shifting the pattern or modifying its intensity.

Figures 9.4 to 9.10 contain no percentages larger than 90. Regions where the percentages exceeded 90 have been identified as all-season for the given month or months, because it was assumed that at such places and times, the full 100-percent index level of PMP should be expected. To assure against any irregularities that may remain in Figures 9.4 to 9.10, it is recommended that, at a particular location of interest, values for all 12 months be plotted and a smooth

curve drawn. Adjustments at each data point of plus or minus 5 percent may be used to help eliminate irregularities, except when an all-season value (greater than 90 percent) is indicated.

These seasonal distributions were based on daily station data, but it is assumed that these relations hold equally at other durations and areas for general storms in this region. Any deviations from these relations are suggested only when more storms have been analyzed.

10. DEPTH-AREA-DURATION RELATIONS

10.1 Introduction

Most generalized PMP studies recently produced by the NWS concentrate on the development of an index map (for one duration and area size), usually 10-mi² and 24 hours, based on the premise that the most reliable data are available for those dimensions. Some studies have provided index maps for a number of durations (Hansen et al., 1988), while others included selected maps for numerous durations and area sizes (Schreiner and Riedel, 1978). The choice of which presentation to follow in any particular study is based largely on the availability of data and on the need to keep the process simple. In most cases, the less information available, the simpler the process.

Most studies extend the information on index map(s) to other durations and areas by a series of depth-duration and depth-area relations. This feature is one of those that distinguishes generalized studies from site-specific studies. The latter in most cases, provide results adjusted specifically for the area and physical influences of the particular basin under consideration. In the present study for the Northwest PMP, a decision was made to develop sets of depth-area and depth-duration relations that would be tied to a single PMP index map. The index map (10-mi², 24 hours) has been discussed in Chapter 9. This chapter will describe the process followed to develop the depth-area-duration relations.

10.2 Depth-Area Development

10.2.1 Orographic Relations

The sets of 28 major storm¹ depth-area-duration data (Appendix 2) were taken as the data base for this effort. Experience gained in similar development for HMR 55A indicated that there may be DAD variations regionally, seasonally, and with terrain type. Thus, the storm data set was subdivided into a number of different subsets to examine such variabilities in the Northwest. An initial distinction was made by terrain type where 26 storms were judged orographic and two non-orographic. To consider regional variation, a comparison was made among averaged 24-hour depth-area data for orographic storms in three different areas; the coastal mountains (storms 32, 60, 78, 80, 88, 133, 151, 165, 175, 179), the mountains along the Continental Divide (storms 29, 155), and in the Bitterroot and Sawtooth Mountains (in western Montana and Idaho; storms 12, 82, 157, 168), as shown in Figure 10.1. For areas between 10- and 3000-mi², very little

¹The Canadian storms were not included in this analysis since their DAD data was derived by procedures different from those explained in Chapter 5. They were, however, considered in the transposition of 10-mi², 24-hour amounts described in Chapter 7.

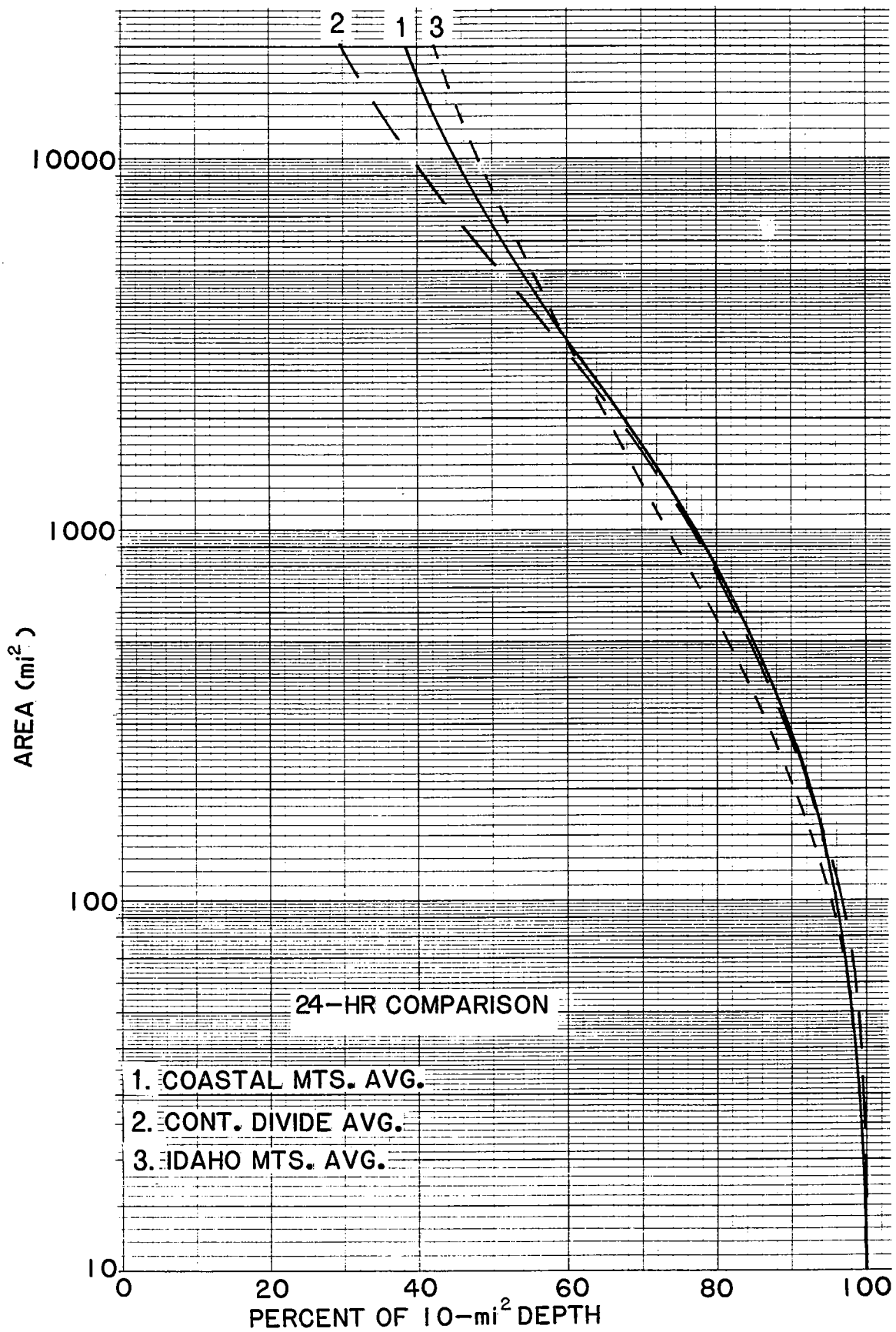

Figure 10.1.--Comparison between averaged depth-area relations at 24 hours for three orographic subsets of storm data.

variation is seen among the three average relations in this figure. Beyond 5000-mi², there are some differences, which may be attributable to the small storm sample involved in developing the indicated relations.

		Area (mi ²)								
Storm	10	50	100	200	500	1000	2000	5000	10000	20000
80	100	97.7	94.8	91.8	85.9	81.1	70.4	51.4	40.1	31.1
155	100	97.8	95.1	90.3	83.1	77.1	70.3	56.6	44.4	33.0

Table 10.1 shows the variation between 24-hour depth-area relations for two of the more significant storms, number 80 in the Olympic Mountains and number 155 just east of the Continental Divide. The comparison is surprisingly close, even for the largest area sizes, especially in light of their geographic separation.

For all the storms (including Canadian) in Table 2.1 that occur in what has been classified as orographic terrain (Figure 3.2), nineteen storms occurred in cool-season months (November-February), three in warm-season months (June-August), and six in months considered to be transition months between these seasons (March-May and September-October). The seasonality of the storms was used to aid in the development of realistic depth-area relations for this study, several groups of storm data were averaged. The Canadian storm data were not included in these averages, however, because of differences between Canadian procedures and those used in this study to obtain depth-area-duration data. Numerous comparisons were made in an attempt to discern significant differences among the 28 United States storms. Based on a number of comparisons of various subregional, seasonal, durational and terrain-related averages, it was concluded that an orographic storm average from 18 cool-season U.S. events provided the most reliable orographic depth-area relations for the entire region. The 18-storm average was smoothed to obtain the relations shown in Figure 10.2. The depth-area relations in Figure 10.2 represent all orographic regions in the Northwest region regardless of season, as supported by the similarity between the major winter storm (80) and summer storm (155) curves shown in Table 10.1.

Table 10.2 provides the tabular average values for the curves given in Figure 10.2. A comparison of these new results to values taken from HMR 43 and HMR 55A for selected areas and durations is given in Table 10.3. The HMR 57 curves are based on the 18-storm average of orographic cool-season storms, while those for HMR 43 are based on averages of computations taken near the same 18 orographic storm centers. The HMR 55A results came from the orographic "A"

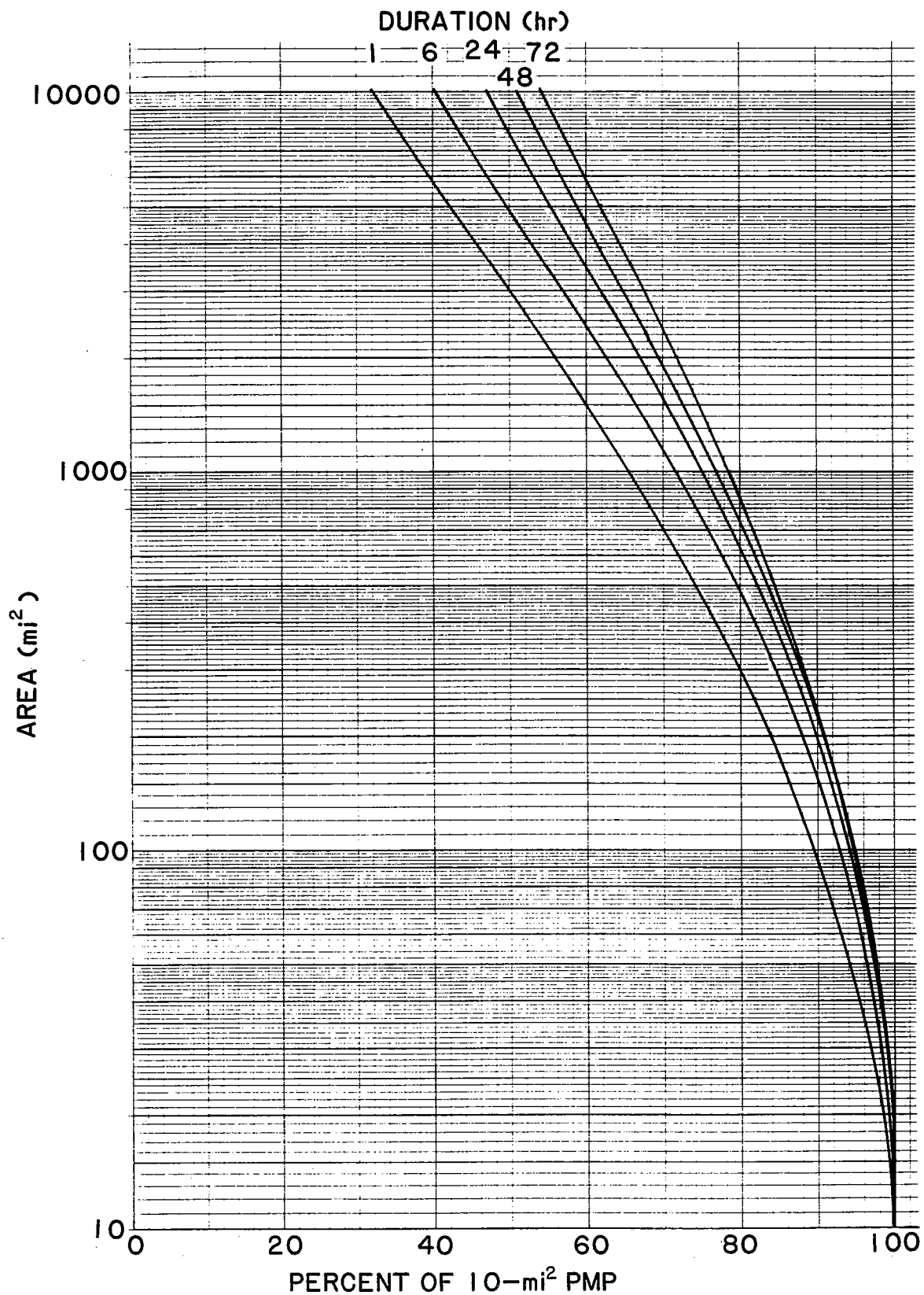

Figure 10.2.--Depth-area relations adopted for orographic subregions based on averages of 18 cool season United States storms.

curves (Figure 11.9 from that report), and represent intense summer (June) storms for that region.

Duration (Hours)	Area (mi ²)								
	10	50	100	200	500	1000	2000	5000	10000
1	100	94.2	89.5	84.0	74.2	65.5	56.0	42.2	32.2
6	100	96.5	93.0	88.1	79.8	71.8	62.7	49.7	40.2
24	100	97.3	94.3	90.1	82.3	75.1	67.0	55.3	47.0
48	100	97.7	94.8	90.7	83.6	77.2	69.7	59.0	51.0
72	100	97.8	95.2	91.2	84.6	78.8	71.9	62.0	54.3

The variation in the depth-area curves (Table 10.3) among the three reports is less as the duration increases, (especially for areas of 1000-mi² or less). Also for the larger areas, the HMR 57 depth-area relations approach the HMR 55A results by falling off more rapidly than did HMR 43. Therefore, one of the significant differences of the current storm data analysis is that for larger areas (greater than 1000-mi²), the new results are likely to be lower than in HMR 43 for comparable durations and index values. The available data indicates that there is no seasonal variation in depth-area relations for orographic regions in the Northwest.

Report	Duration (Hours)											
	6 Hours				24 Hours				72 Hours			
	Area (mi ²)				Area (mi ²)				Area (mi ²)			
	10	200	1000	5000	10	200	1000	5000	10	200	1000	5000
HMR 57	100	88.1	71.8	49.7	100	90.0	75.1	55.3	100	91.2	78.8	62.0
HMR 43	100	82.8	69.3	54.3	100	88.0	78.3	67.5	100	90.0	81.6	71.9
HMR 55A	100	79.8	62.5	44.0	100	87.0	74.0	58.0	100	90.5	79.1	64.9

10.2.2 Least-Orographic Relations

As a comparison to the orographic relations of Figure 10.2, a set of depth-area relations was developed for the least-orographic regions in this study. The data sample in Table 2.1 was very sparse; only two storms were identified as non-

orographic (106, 143). Figure 10.3 shows average relations based on these two storms and indicates little to no durational variation for areas less than 500-mi², an unusual situation. For comparison, a set of non-orographic curves was taken from HMR 51 for a representative location at 47°N, 101°W (the 1-hour curve came from HMR 52), and are shown in Figure 10.4. The shape and distribution of curves in Figure 10.4 are more typical of extreme storm data and do not agree well with those of Figure 10.3.

A number of alternative depth-area relations were examined using different data sets. The solution that was adopted for this study is shown in Figure 10.5, and results from an average of the orographic results in Figure 10.2 and the HMR 51 results from Figure 10.4. The adopted results in Figure 10.5 are compared with depth-area computations from HMR 43 (Table 10.4) for locations in least-orographic regions (areas limited to 1000-mi² or less in that report). Table 10.4 shows the adopted HMR 57 least orographic relations are somewhat in agreement with HMR 43 results for the smaller areas (less than 200-mi²), and they decline more rapidly (except at 6 hours) as area increases. The two-storm depth-area averages (Figure 10.3) are compared with the adopted relations (Figure 10.5) in Table 10.5. The only agreement between the two-storm averages and the adopted depth-area relations are for areas of 5000-mi² or greater and for a 6-hour duration. The adopted curves at all durations drop off more rapidly than is shown by the two-storm least-orographic data.

10.3 Depth-Duration Development

10.3.1 Storm Sample Approach

Initially, regional comparisons were made for depth-duration relations in a manner similar to what was done for the depth-area development. At 10-mi², Table 10.6 shows this comparison for the orographic storms used in Figure 10.1. The values in parentheses indicate averages are based on three-storms or less (not all storms had 48- and 72-hour durations). The results shown in Table 10.6 suggest that there is some regional variation in depth-duration relations, particularly between the Continental Divide and elsewhere, for durations beyond 24 hours.

Table 10.7 shows a comparison between the 18-storm winter orographic averages and the two-storm least-orographic average for durations of 24 hours and less (the least-orographic storms, 106 and 143, only lasted 24 hours). No long-duration least-orographic storms were available in the storm sample, but it is possible that storms over least-orographic regions are typically of shorter duration than orographic storms. The results in Table 10.7 show considerable disparity between the depth-duration relations for the two terrain-types, but as with the depth-area comparison, the two-storm average may not provide representative results. A meteorological rationale for these results may be because least-orographic storms would exhibit greater convection (higher 6/24-hour ratios) than orographic storms, especially since the former occurred during the warm season.

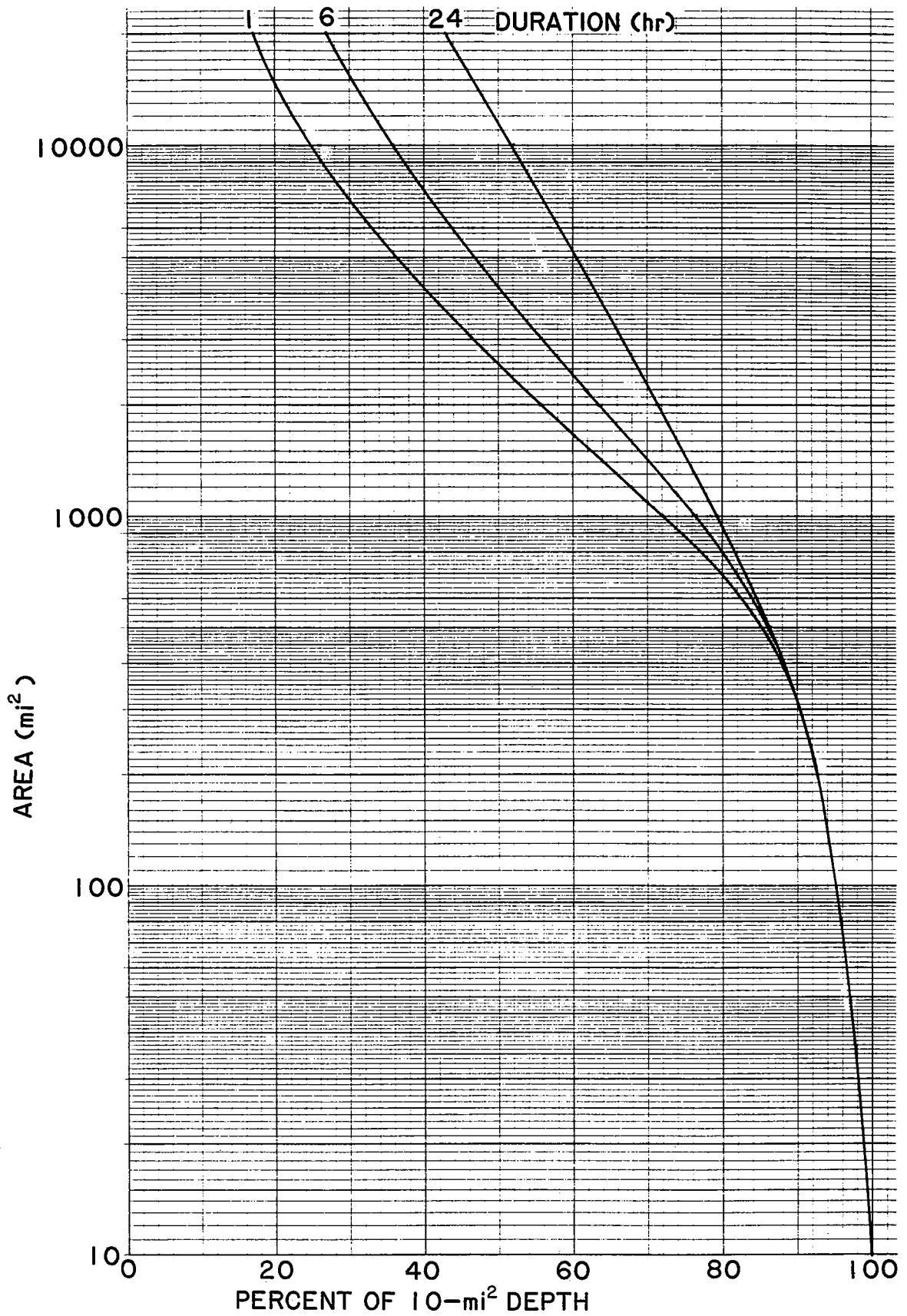

Figure 10.3.--Depth-area relations based on average of two storms (106 and 143). Not adopted for least orographic subregions in this study.

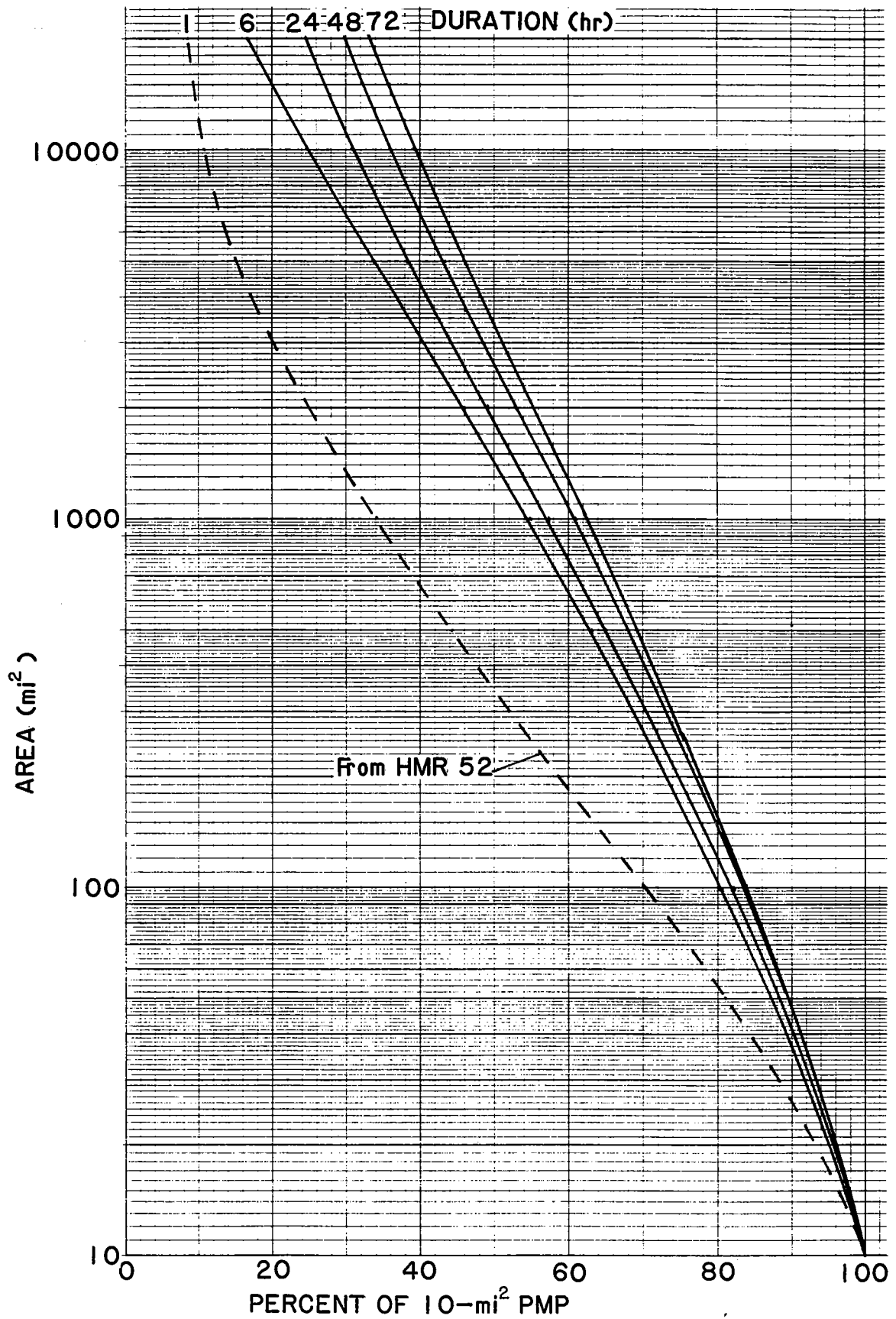

Figure 10.4.--Depth-area relations for least-orographic conditions at 47°N 101°W from HMR 51 (1978). Dashed curve from HMR 52 (1982).

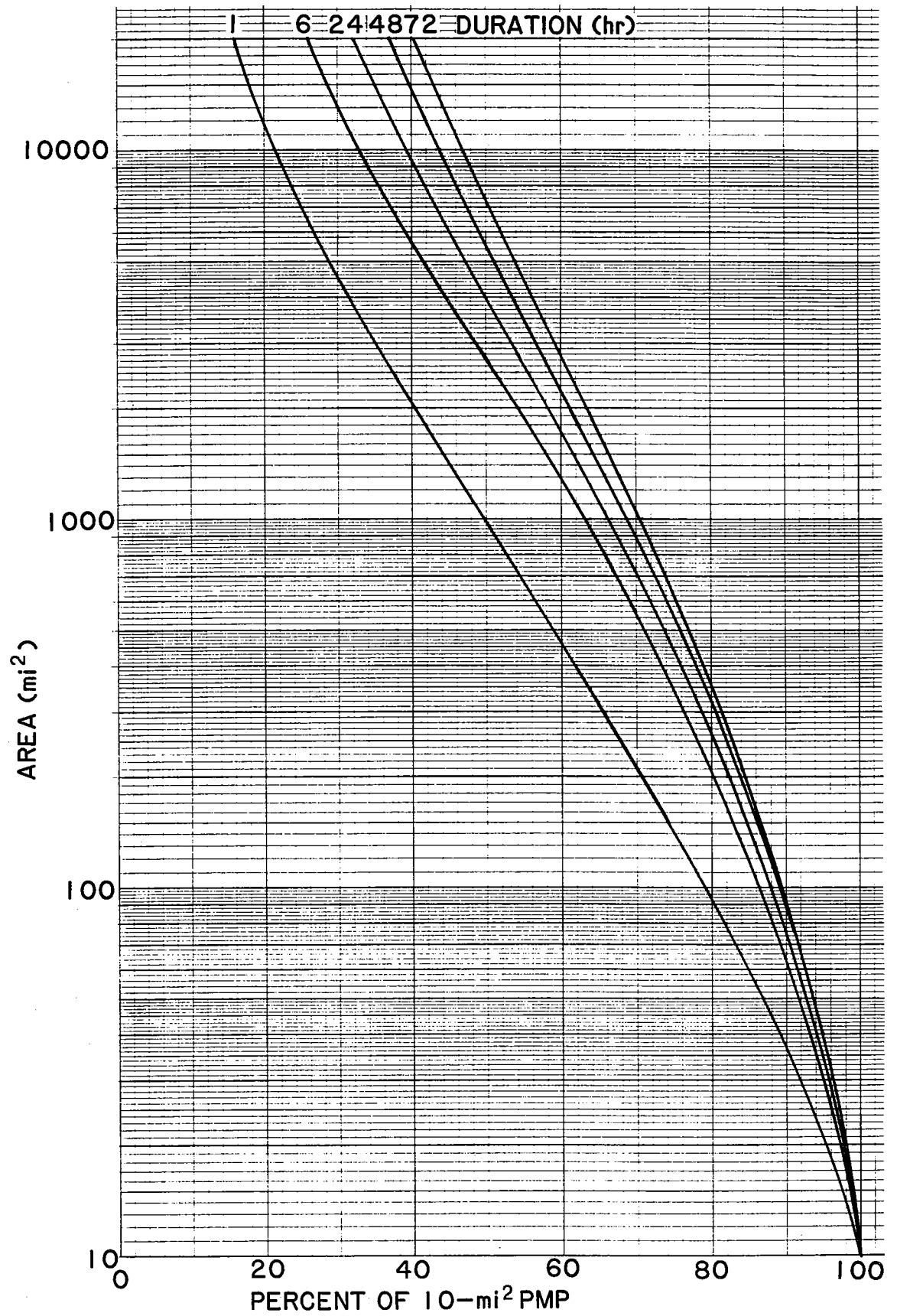

Figure 10.5.--Depth-area relations adopted for least orographic subregion (Average of Figure 10.2 and Figure 10.4).

Table 10.4.--Comparison of least orographic depth-area relations (in percent of 10-mi² amount) between HMR 57 (Figure 10.5) and least-orographic locations in HMR 43.			
(Area mi ²)			
Report	10	200	1000
HMR 57	100	80.4	63.9
6 hours HMR 43	100	77.5	62.5
HMR 57	100	82.5	66.8
24 hours HMR 43	100	84.7	73.8
HMR 57	100	84.6	70.9
72 hours HMR 43	100	88.0	79.0

Table 10.5.--Comparison of adopted least-orographic depth-area relations with average from storm 106 and storm 143.						
Area (mi ²)						
Report	10	200	1000	2000	5000	10000
HMR 57	100	80.4	63.9	54.4	41.6	32.4
6 hours two-storm average	100	92.6	76.2	63.0	46.7	36.0
HMR 57	100	82.5	66.8	58.2	47.2	39.3
24 hours two-storm average	100	92.6	79.2	71.3	60.5	51.8
HMR 57	100	84.6	70.9	63.4	54.0	46.9
72 hours two-storm average	100	92.6	79.4	72.2	61.9	54.0

10.3.2 Adopted Depth-Duration Approach

The evidence in Tables 10.6 and 10.7 indicates that there is some basis for variation in depth-duration relations across the Pacific Northwest, in contrast to the case for depth-area relations. Several alternative solutions to develop reliable depth-duration relations across the region were considered. The alternative that offered the most reasonable solution was adapted from the work of Schaefer (1989), who studied extreme precipitation events for the State of Washington.

This study accepted the separation of terrain classes for the State of Washington given by NOAA Atlas 2. Another subdivision to represent the coastal lowlands was added, based on a comparison of mean annual precipitation data (ranges and means). Based on this regional classification, Schaefer established sets of depth-duration relations (percent of 24-hour amount) for various exceedance probabilities for each terrain class and for three levels of "kernel" values (2, 6 and 48 hours). The kernel in these tables represents the duration of the major precipitation that fell in the events considered, somewhat similar to the core precipitation concept used in storm separation (see Chapter 8).

Table 10.6.--Comparison of 10-mi² depth-duration values (percent of 24-hour amount) for orographic storms used in Figure 10.1 (<3 storm average).								
Location	Duration (Hours)							
	1	6	12	24	36	48	60	72
W. Coastal Mt. Average	11.6	41.7	63.5	100.0	128.0	150.1	176.2	192.3
Idaho Mt. Average	13.5	47.0	67.1	100.0	125.6	156.7	(168.8)	(183.9)
Contin. Divide Avg.	(12.0)	(44.8)	(72.2)	(100.0)	(110.0)	(115.6)	(126.3)	(126.3)

Table 10.7.--Comparison between orographic and least-orographic depth-duration relations (percent of 24-hour amounts). Same storms used in Tables 10.2 and 10.4.				
	Duration (Hours)			
	1	6	12	24
Orographic average	12.3	40.9	61.8	100.0
Two-storm least-orographic average	19.7	60.8	80.3	100.0

Schaefer's subdivisions were extended in this study to cover the entire Northwest region, while including the subregions used in NOAA Atlas 2 (Figure 10.6). The numbers in that figure identify the subregions used in NOAA Atlas 2. Using Figure 10.6 as a starting point and Schaefer's adaptation for the State of Washington, a modified subregional breakdown was developed as shown in Figure 10.7. The modifications include a narrow coastal lowland (Zone 5), a narrow zone along the west slopes of the Rocky Mountains (Zone 6), and extensions of subregional boundaries into southern British Columbia. Table 10.8 identifies the subregions shown in Figure 10.7. The same subregional boundaries in Figure 10.7 are also shown as the dashed blue lines on the PMP index maps (Maps 1-4) attached to this report.

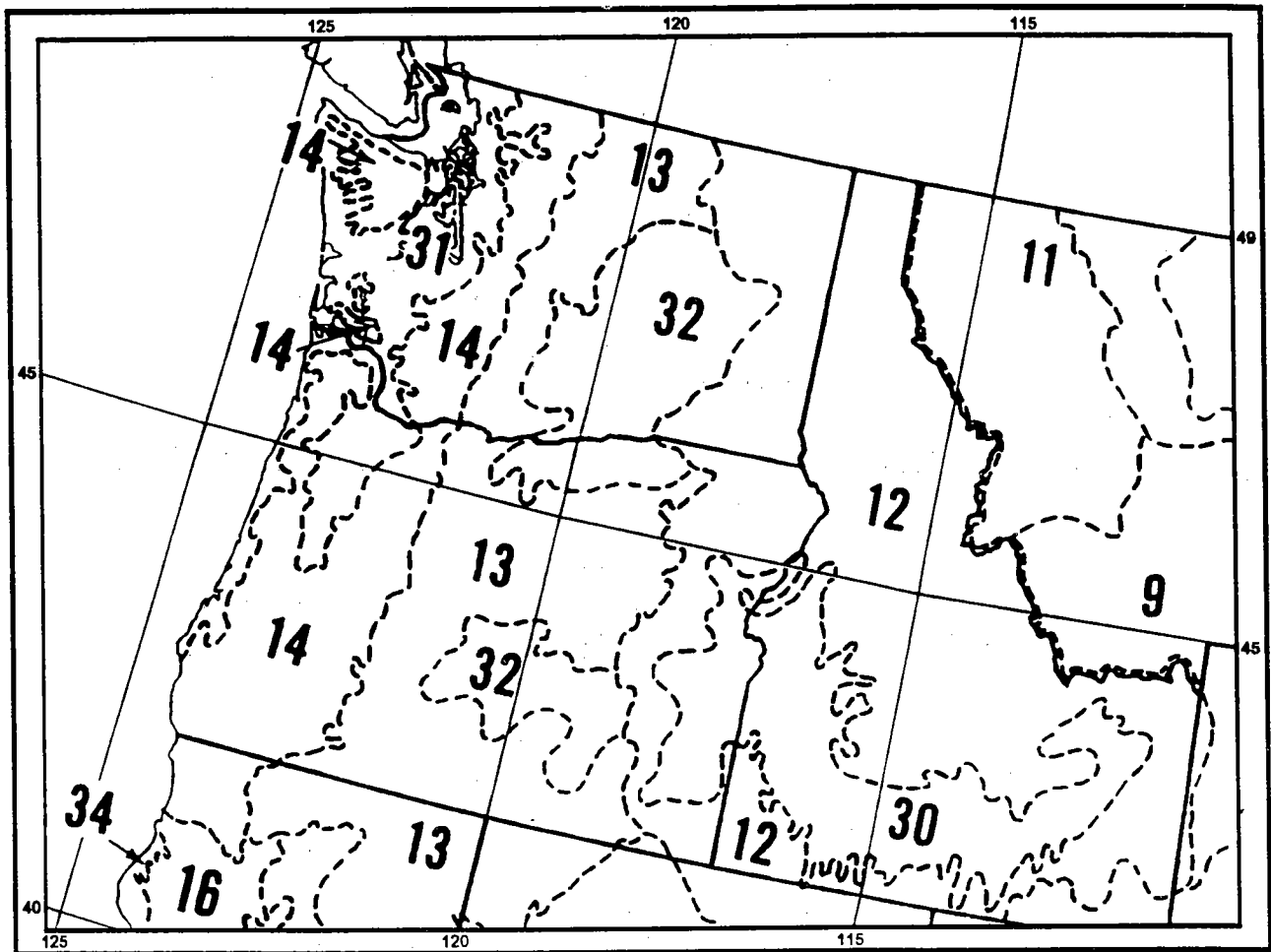

Figure 10.6.--Climatological subregions identified in NOAA Atlas 2 (1973). Least orographic subregions are 30, 31 and 32; others are orographic.

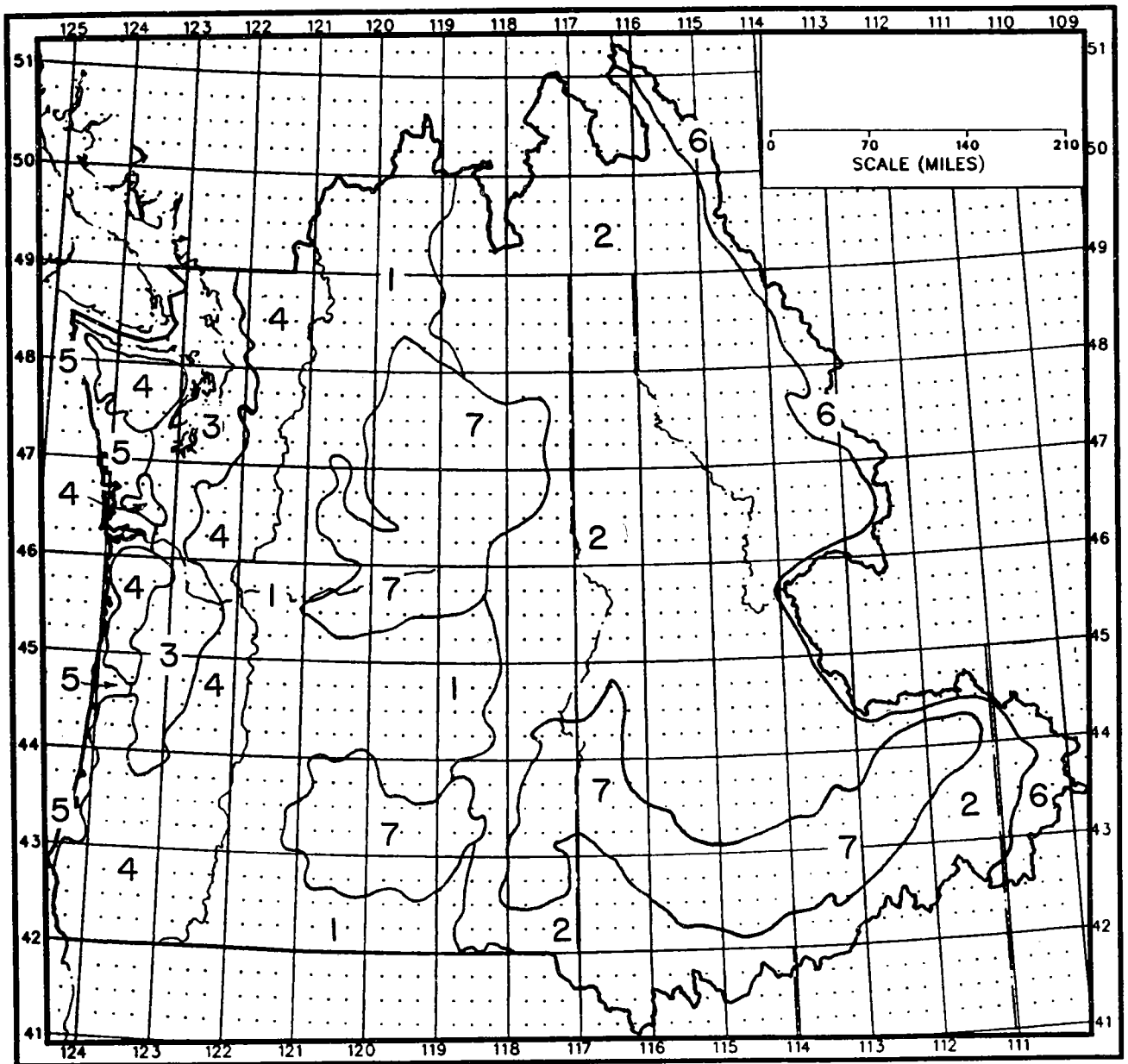

Figure 10.7.--Subregions adopted for this study.

Table 10.8.--Subregions used in this report to assist in depth-duration analysis.

Subregion	Identification
1	East of Cascades ridge to 118-119°W as noted - orographic
2	East of 119°W to west slopes of the Rockies - orographic
3	Least orographic (west of Cascades)
4	West of Cascades - orographic
5	West of Cascades - coastal orographic
6	West slopes of the Rockies - orographic
7	Least orographic - east of Cascades

In the present study, the greatest number of storms in Table 2.1 occur in subregion 4, the orographic region west of the Cascade ridgeline. There are 15 storms from November to January in this subregion and their average depths in percent of 24-hour amount are:

	<u>Duration (Hours)</u>						
	1	6	24	36	48	60	72
(%)	11.5	39.9	100.0	128.8	149.2	174.2	192.2

Schaefer presented results in the form of probabilistic depth-duration curves as in Table 10.9, which contains results for 24-hour extreme storms in the mountains of western Washington. In looking at Table 10.9, it is necessary to describe how it was used to support the present study. It was suggested by Schaefer (personal communication) that 48-hour kernel values should apply only for durations from 24 hours to 72 hours and, for durations shorter than 24 hours, ordinate values for the 6-hour kernel should be used. Combining this information and comparing it to the 15-storm orographic average depth-duration data, it was determined that the closest match occurred for an exceedance probability of about 0.15, i.e., in only 15% of the storms do the depth-duration curves exceed those values. The match was poorest beyond durations of 48 hours. After numerous trials, the 15 percent exceedance probability was adopted for this study rather than a more rare level and is an attempt to impose a degree of conservatism on the final result.

A decision was made to extend Schaefer's results for regions 1, 3, 4, 5 and 7 for the entire HMR 57 study area. Table 10.10, which is separated into subregions east and west of the Cascade ridgeline, presents these depth-duration curves. These were only minor variations from Schaefer's curves in the period between 12 and 48 hours. Table 10.10 also includes depth-duration data for

subregions 2 and 6, which were not delineated by Schaefer. Evidence from the storm data indicated that storms centered farther east from the Cascades, had a flatter temporal distribution of the depth-duration curve at longer durations. Subregion 2 accounts for this somewhat lower-tailed distribution of rainfall for durations beyond 24 hours.

Subregion 6, representing the western slopes of the Rocky Mountains, was also added to Figure 10.7. As shown in the table of adopted depth-duration curves (Table 10.10), this region has values intermediate to subregions 2 and 7. These values fit the observation that the most intense rainfall in the Rockies comes from warm-season (May-October) storms, whereas curves in subregion 2 and 7 were developed primarily using data from cool-season storms. Note that the ratios show storms in orographic regions (Zone 6) have more gradual curves at shorter durations and steeper curves at longer durations vis-a-vis storms in least orographic regions (Zone 7).

Exceedance probability for kernel	Duration (Hours)											
	0.5	1.0	2.0	3.0	6.0	12.0	18.0	24.0	36.0	48.0	60.0	72.0
.95	.052	.084	.146	.205	.362	.631	.841	1.00	1.021	1.040	1.071	1.108
.90	.051	.084	.146	.205	.361	.629	.839	1.00	1.035	1.069	1.103	1.147
.80	.051	.084	.145	.204	.360	.625	.836	1.00	1.060	1.113	1.163	1.217
.67	.050	.083	.144	.203	.358	.621	.832	1.00	1.100	1.173	1.239	1.305
.50	.050	.082	.143	.201	.356	.614	.826	1.00	1.162	1.252	1.338	1.421
.33	.050	.081	.142	.200	.353	.607	.820	1.00	1.214	1.344	1.455	1.557
.20	.048	.081	.141	.198	.350	.600	.813	1.00	1.267	1.440	1.575	1.697
.10	.048	.080	.140	.197	.348	.591	.805	1.00	1.326	1.544	1.706	1.851
.05	.048	.079	.139	.195	.345	.585	.799	1.00	1.372	1.627	1.811	1.974

Comparing the depth-duration data from storms in Table 2.1, with the information given in Table 10.10, did show some agreement. The results of a comparison are shown in Table 10.11 for two of the subregions, 2 and 7. For subregion 2, the orographic area east of 119°W, the adopted depth-duration values are compared with data for three cool-season storms (12, 157, and 168). Even better agreement occurs in subregion 7, the least orographic area east of the Cascades, between the two least orographic storms (106 and 143) and the adopted relations. Should there be a need for intermediate durational results not given in Table 10.10, the data may be plotted and a smooth curve drawn. Linear

interpolation between durations is not recommended, particularly for durations less than 24 hours.

Subregions	Duration (Hours)				
	1	6	24	48	72
West of Cascades					
4	.10	.40	1.00	1.49	1.77
5	.11	.43	1.00	1.37	1.58
3	.12	.44	1.00	1.23	1.35
East of Cascades					
1	.16	.52	1.00	1.40	1.55
2	.16	.52	1.00	1.31	1.45
6	.18	.55	1.00	1.27	1.37
7	.20	.59	1.00	1.20	1.30

Subregion	Duration (Hours)				
	1	6	24	48	72
2	.16	.52	1.00	1.31	1.45
storm average (12, 157, 168)	.14	.46	1.00	1.57	1.84
7	.20	.59	1.00	-	-
storm average (106, 143)	.20	.61	1.00	-	-

The subregion 4 (west of the Cascades-orographic) 15-storm average of 1.92 was also compared with Table 10.10, and showed that these storms produced a substantially greater 72/24-hour ratios than is given by the adopted subregion 4 value of 1.77. This apparent discrepancy owes primarily to the effect of storm 80, the most significant storm in the sample, which had a 72/24-hour ratio of 2.38.

Inclusion of this storm caused the average to be skewed upward, resulting in possibly excessive 72-hour PMP estimates. The rationale for accepting the 72/24-hour ratio of 1.77 for subregion 4 was based on storm data showing that storm 80 was only a controlling storm for 48 hours and beyond. This is demonstrated from the comparisons shown in Table 10.12, in which moisture maximized observed data for storm 80 (Appendix 2) were compared to PMP estimates using Tables 10.2 and 10.10.

For example, at 10-mi², the 24-hour depth in storm 80 is 14.45 inches (Appendix 2). The maximization factor for this storm is 1.62 (Table 7.1), so that at 24 hours and 10-mi², the PMP estimate is 23.44 inches or 141% of PMP. The 24-hour, 10-mi² estimate at the storm center is 33 inches. To obtain the 72-hour PMP estimate, this value is multiplied by 1.77 from Table 10.10 and the 72-hour, 10-mi² value is 58.41 inches. The maximized 72-hour, 10-mi² rainfall for storm 80 is 55.71 inches. The 58.41 inches divided by 55.71 inches gives 105%. Thus, storm 80 is enveloped by only 5% at 72 hours, and is indeed a controlling storm for this duration.

Table 10.12.--Percentage envelopments that PMP estimates from this study have over moisture maximized observed storm amounts for storm 80 (PMP/storm).					
Duration (Hours)					
Area (mi ²)	1	6	24	48	72
10	118	122	141	108	105
100	120	126	140	111	108
1000	100	108	131	106	106
5000	108	125	153	128	132
10000	122	136	166	143	148

A similar comparison was made for storm 106, a least-orographic storm east of the Cascades. The results shown in Table 10.13 for selected durations and areas show that the adopted PMP considerably undercuts the moisture maximized storm data. Once again, the greatest envelopments occur at 24 hours for areas less than 100-mi². The degree of undercutting in this storm has been accepted, primarily because of the high maximization factor (1.7 limit) for the storm. Had a lower factor been used for this storm, the level of undercutting would be reduced. PMP from this study at 1000-mi² and for 1 hour exceeds the observed rainfall in this storm by some 18 percent. Storm 106 also is a controlling storm for this study.

Table 10.13.--Percentage envelopments that PMP estimates from this study have over moisture maximized observed storm amounts for storm 106 (PMP/storm).

Area (mi ²)	Duration (Hours)		
	1	6	24
10	119	124	135
100	94	114	123
1000	69	97	108
5000	83	114	98
10000	100	119	95

11. LOCAL STORM PMP

11.1 Introduction

Intense localized thunderstorms during the warm season (April through October) have produced the greatest observed short-duration rainfalls over small areas in the Pacific Northwest. These storms are not usually associated with the general storms that produce widespread heavy precipitation in the cold season (November through March) in this region. This is in contrast to the eastern two-thirds of the United States, where some of the heaviest local storms are not isolated but are embedded within general and mesoscale events, even in the warm season. It is these short duration, small area storms of the Pacific Northwest that are the focus of this investigation.

Thunderstorms have been referred to in previous PMP studies as "local storms." The definition of a local storm in this study is an extreme rainfall event, not associated with widespread heavy precipitation, that produces rain for durations of 6 hours or less, and is concentrated over an area of 500-mi² or less. Previous definitions of local storms utilized in PMP reports for the Pacific Northwest, the southwestern United States and along the Continental Divide are quite similar in terms of the durational and areal limitations for local storms (HMR 43, 49 and 55A). These studies also maintained the need to distinguish between local storms and those embedded within a general storm rain pattern.

One of the notable differences between this study and HMR 43 is that local storm PMP was not provided for areas west of the Cascade Divide in the earlier study. The current study incorporates a much larger database of storms than did the previous study, including several major local storms that occurred west of the Cascade Divide. The most significant of these was the Aberdeen 20 NNE, Washington, storm of May 28, 1982 (Appendix 4). These new storms, with precipitation amounts in excess of 2 inches in an hour, were of sufficient magnitude to necessitate inclusion of local storm PMP estimates west of the Cascade Divide.

Less is known about the amount, durational characteristics, and areal extent of local storms than for general storms in the Pacific Northwest. The primary reason for this is that the network of precipitation observing stations in the region is still too sparse to provide useful data for many local storms. For example, station density in Oregon is about 435 square miles per station (in December 1984), while Illinois, a typical midwestern state, has a density of 349 square miles per station, which may also be inadequate. Secondly, general storms often produce precipitation over areas of thousands of square miles, while data for local convective storms in this region show that they typically produce heavy rainfalls over areas on the order of tens of square miles, sometimes less. Consequently, many extreme local storms do not show up as heavy rains even at observing stations, which may be relatively close to the storm center. Some records of

intense local storms are derived from "bucket surveys," which consist of extra observations in the areas of heaviest precipitation, while accurate systematic measurements of precipitation are rarely obtainable. As a result, there is comparatively little depth-duration or depth-area data available for local storms, especially in the broad expanses of the western United States.

11.2 Record Storms

11.2.1 Introduction

The typical development of PMP for an area is based in part on major rainfalls of record. The greatest measured local storm rainfalls that have occurred in or near the Northwest are listed in Table 11.1, and their locations are shown on Figure 11.1. Table 11.1 lists the location, latitude, longitude, elevation, date, duration, total storm rainfall, and data source for each storm.

Storm elevations range from 43 to 6900 feet above sea level, with little evidence of a preferred zone within this range. The geographic distribution of these storms in Figure 11.1 appears to cut a broad path across the region from the northwest to southeast corners. The seasonal distribution of storms ranged from late May to late August. All the storms occurred during the period between 1100 and 1900 LST. Both these factors highlight the importance of solar radiation in the development of such storms, a point which is discussed in the next section.

A more extensive list of major local storms which have affected the Pacific Northwest region, was also considered (Appendix 4). Those storms represent the heaviest 1-hour rainfalls from more than 350 stations, found in the Hourly Precipitation Data (National Climatic Data Center) from July 1, 1948 through the end of 1990. Altogether 13,386 station years of data were examined. At each station, the top five hourly precipitation amounts for each month and the top ten for the entire year were isolated. To ensure that only local convective storms would be included in this database, a synoptic analysis was made of each event to eliminate any general storms. The storms were further limited by accepting only hourly precipitation totals that equalled or exceeded the 50-year hourly precipitation rainfall determined from NOAA Atlas 2. This comprehensive list, referred to as the extreme storm database, includes the storms in Table 11.1, which were not all found in Hourly Precipitation Data.

11.2.2 Meteorology of Extreme Local Storms

Extreme local storms in the Pacific Northwest are convective phenomena, primarily thunderstorms. These storms represent the controlling rainfall events for short-duration (up to 6 hours) PMP, and this section briefly considers the nature of Pacific Northwest thunderstorms.

Table 11.1.--Major Local Storms - Pacific Northwest										
Location	Lat °	N ,	Lon °	W ,	Elev. (feet)	Date	Dur. Min.	Amount (in.)	Reference	
Birch Creek, OR	45	20	118	55	3000	6/22/38	20	2.50	Riedel, et al., 1966	
Skykomish IENE, WA	47	42	121	22	1030	5/25/45	30	1.78	Schaefer, 1989	
Girds Creek, OR	44	40	120	10	4000	7/13/56	30	4.00	Riedel, et al., 1966	
Simon Ranch, ID	43	15	114	45	5000	7/21/56	20	2.50	Riedel, et al., 1966	
Knapp Coulee, WA	47	49	120	08	1500	8/15/56	5-10	1.50	Hendricks, 1964	
Winthrop, WA	48	20	120	11	1755	7/29/58	60	3.00	Private communication	
Castle Rock, WA	46	16	122	55	43	8/23/63	12	0.90	NCDC, 1963	
Meridian, ID	43	37	115	25	2600	6/21/67	12	2.75	Rostvedt, 1972	
John Day, OR	44	25	118	53	3200	6/9/69	180	7.00	Reid, 1975	
Heppner, OR	45	20	114	33	2500	5/25/71	20	3.00	Bauman, 1980	
Reynolds Creek, ID	43	15	116	45	3700	7/21/75	5	0.80	USDA, 1975	
Aberdeen 20 NNE, WA	47	16	123	42	440	5/28/82	45	2.30	NCDC, 1982	
BORDERING AREA										
Morgan, UT	41	03	111	38	5150	8/16/58	60	6.75	Riedel, et al., 1966	
Elko, NV	40	50	115	47	5080	8/27/70	60	3.47	NCDC, 1970	
Opal, WY	41	45	110	15	6900	8/16/90	120	7.00	Private communication	

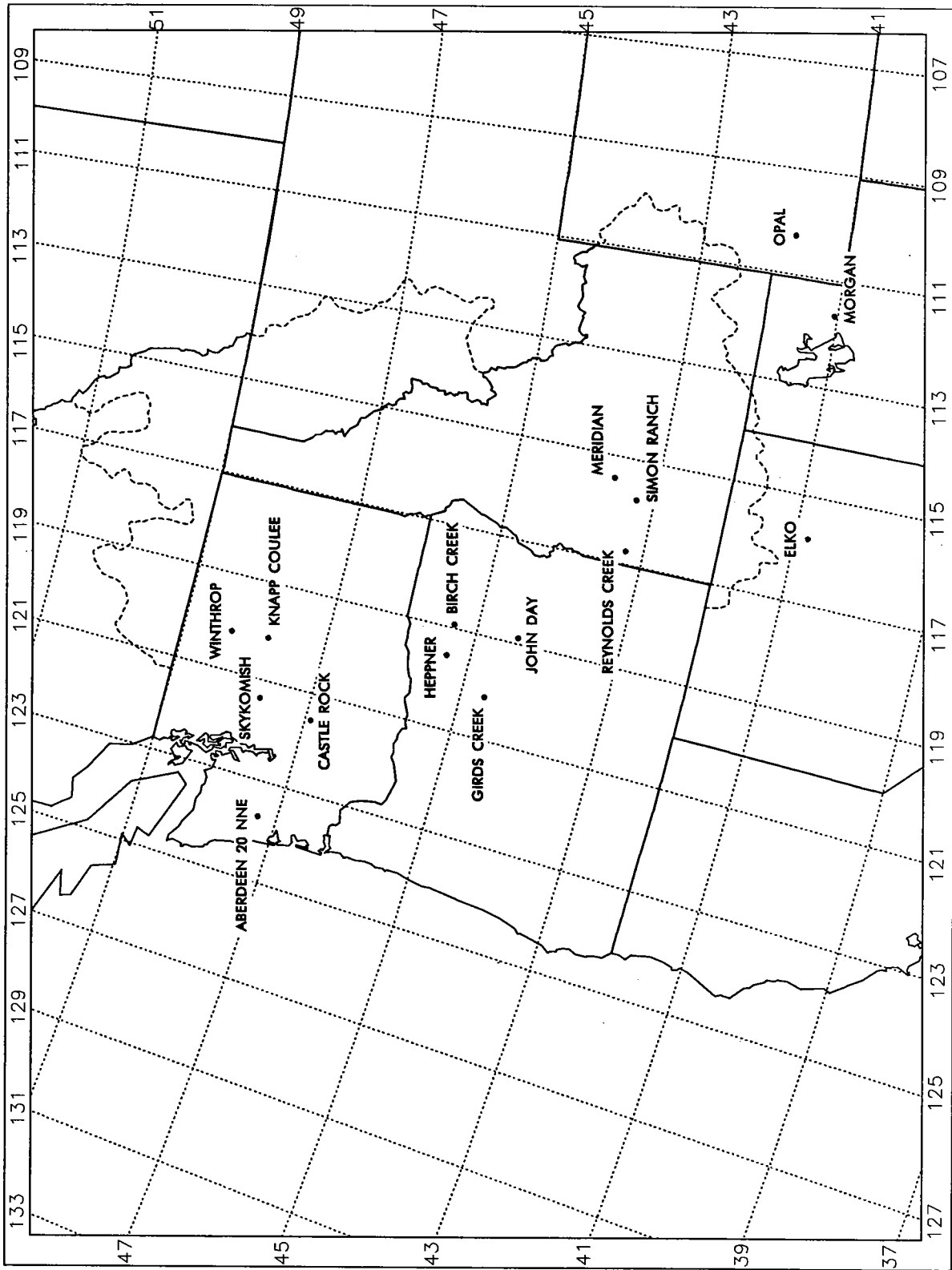

Figure 11.1.--Location of major storms of record from Table 11.1

In comparison with most of the United States (U.S.), thunderstorm activity in the Pacific Northwest is relatively infrequent (Wallace, 1975; Changnon, 1988a and 1988b). The comparative lack of thunderstorm activity in this area owes primarily to its position east of the Pacific Ocean subtropical high pressure area. In the eastern U.S., located on the western side of the subtropical high, poleward moving air has undergone a long trajectory over tropical waters. In addition, systematic rising motions are generally found on the western sides of the subtropical anticyclones. In contrast, general subsidence tends to characterize motion on the eastern sides of these highs. This drier air, in sinking, is heated by compression and usually overlies a shallow humid marine layer. Hence, a more stable atmosphere frequently exists on the eastern sides of the subtropical highs (Palmen and Newton, 1969; Barnes and Newton, 1981).

Two essential ingredients are necessary for the formation of any thunderstorm, while a host of secondary factors may influence the type and intensity of the storms that do occur. The first necessary element is for sufficient moisture to exist, and the second is for adequate vertical motion to initiate precipitation. One of these factors without the other will likely preclude the formation of a thunderstorm. These primary factors are considered in a general context and also in terms of the Pacific Northwest region and its physical environment.

Sufficient moisture is necessary so that condensation can result from any lifting or turbulent mixing that takes place in the atmosphere. The moisture for most Pacific Northwest thunderstorms arrives primarily on westerly or southwesterly currents that are not part of the humid marine layer, but rather overlie it. This low-level moist layer tends to possess a fairly low wet-bulb potential temperature due to its passage over the cool California current and is prevented from much inland penetration by the coastal mountain ranges. The moisture content of the overlying Pacific air is fairly low, but lifting and/or heating during its passage over the western plateau increases the wet-bulb potential temperature in the lower atmosphere (1-2 km above ground level) to near that of maritime tropical air. The increase of the wet-bulb potential temperature near the surface, by itself or in combination with cooling aloft, results in destabilization of the air column (Palmen and Newton, 1969; Barnes and Newton, 1981).

Research has also shown that storms in the southern portion of this region receive a substantial amount of moisture from the tropical Pacific and Gulf of California (Hales, 1972; Hansen, 1975). This airflow is typically associated with the southwest monsoon regime which advects maritime tropical air into Arizona and adjacent states in the summertime, sometimes as far north as southern Idaho. This pattern has been well documented (Bryson, 1957a and 1957b; Sellers, 1964) to account for a substantial percentage of summertime rainfall in the southwest, mostly in the form of convective storms. The southwest monsoon pattern also brings in air from the Gulf of Mexico, when the summertime Bermuda High is located west of its normal position. Moisture from the Gulf of Mexico was found to occur almost exclusively at upper levels of the atmosphere (700 to 300 mb), rather

than at low levels (below 700 mb) in a study by Reyes and Cadet (1988). Several very recent studies (Carleton et al., 1990; Hagemeyer, 1991) have also stressed the predominance of Gulf of California moisture, rather than Gulf of Mexico, in producing warm season precipitation in the west and southwest United States.

A second requisite factor for the development of convective rainfall is adequate vertical motion. Upward vertical motions in the atmosphere can occur under a wide variety of spatial and temporal scales. These range from large-scale synoptic areas ahead of long-wave troughs, frontal areas, mesoscale convergence zones down to localized thermals. The development of sufficient vertical motion relies on a number of critical factors. According to McNulty (1983), these factors include unstable air or a destabilizing influence, divergence aloft and low-level convergence. Lifting may also be caused by other factors including orography, terrain induced convergence, jet streaks, frontogenesis, positive vorticity and warm air advection, and convection due to the diurnal heating cycle.

Some large-scale meteorological patterns are more favorable for the development and maintenance of rising motions than others. At the synoptic scale, it is recognized that in the general region from an upper-level trough to the downstream ridge, there is upper-level divergence. In keeping with the law of mass continuity, there is in the lower levels general horizontal convergence with ascending motions that reach maximum values in the mid-troposphere. Such areas of large-scale ascending motions, while not generally sufficient to cause convection, can be said to "prepare the environment" for convection (Doswell, 1982). Strong upper-tropospheric divergence (above 500 mb) has also been found to be an important factor in generating the upward vertical velocities needed to support convective activity (Beebe and Bates, 1955; Bates, 1963).

The nature of convective storms depends greatly on the stability of the atmosphere in which they develop. The degree of thermodynamic instability plays a critical role on the strength of convection since it determines the capability of air to accelerate vertically. The potential of a column of air to attain the necessary thermal buoyancy for convection can be measured through a number of stability indices, a good review of which can be found in Peppler (1988). Destabilization of an initially stable air mass can occur over a period of hours, and be caused by various processes. Cooling aloft or the incursion of warm, saturated air near the ground are just two methods by which this may occur. This differential advection of various atmospheric properties in the vertical, results in net moistening at low levels and/or drying at upper levels (Doswell, 1982).

In the Pacific Northwest, it appears that direct surface heating usually plays the critical role in destabilizing the atmosphere to where convection can occur. Support for this contention lies in the seasonal and diurnal pattern of thunderstorm activity in the region. Table 11.2 shows the monthly distribution of the maximum 1-hour precipitation from the extreme storm database. The dominance of summertime storms (June, July, August) is clear and is strongly related to the seasonal heating maxima. Changery (1981) and Changnon (1988a

and 1988b) found a similar pattern in their studies of thunderstorm occurrences across the United States. Schaefer (1989), studying extreme rainfall events in Washington State, also found a strong summer maxima for short duration storms.

From an examination of the extreme storm database (Appendix 4), the diurnal frequency distribution of maximum 1-hour convective rainfall events was determined. The 2-hour period with the greatest number of occurrences ending at 1600 LST contained about 30 percent of all storms, while nearly 70 percent occurred during the period from 1400 to 2000 local time. Only 11 percent had maximum hourly rainfall between midnight and 1200 LST. The relative infrequency of nocturnal heavy thunderstorm activity is in distinct contrast to the

Table 11.2.--Monthly distribution of extreme local convective storms - Pacific Northwest.	
Month	Frequency
May	7
June	31
July	32
August	32
September	4
October	1
Total	106
Source: Extreme local storm database (Appendix 4)	

pattern over portions of the midwest (Wallace, 1975). The absence of a nocturnal low-level jet stream, an important factor in the nighttime frequency of thunderstorms in the Great Plains, contributes to the relative infrequency of heavy storms at night in the Pacific Northwest. A study of western region flash flood events using satellite imagery by Fleming and Spayd (1986), also found a strong link between solar heating and these storms. The Washington State study by Schaefer (1989) is in concurrence with this finding, with a strong afternoon maxima in the heaviest short duration storms.

The importance of divergence aloft has already been noted, but this process takes on added significance when there is concomitant low-level convergence. Low-level convergence in the form of lines, or boundaries or fronts, plays a crucial role in providing the mechanical lift necessary to bring air above the level of free convection (LFC). Terrain and boundaries are the most frequent causes of low-level convergence (House, 1963; Miller, 1967; McNulty, 1983). Low-level convergence produced by a storm's gust front may also play a critical role in the

cell redevelopment process for multicellular thunderstorm outbreaks (Weisman and Klemp, 1986).

Thunderstorms are generally classified into three basic types, single-cell, multicellular, and supercell (Browning, 1981; Doswell et al., 1990). There is a wide range of dynamic severity and precipitation intensity among these types, which of course affects the rainfall distribution. It appears that the latter two types are not frequently found in the Pacific Northwest region, especially compared to much of the eastern United States and even the southwestern United States. This conclusion is borne out by the studies of Fleming and Spayd (1986), and Maddox et al. (1980) on western United States flash flood events. In addition, mesoscale convective systems (MCS's) are comparatively infrequent across much of the western United States as discussed by Lussky (1986). The major limiting factor in preventing their occurrence seems to be the lack of a continuous source of warm, moist, unstable air feeding into the region.

11.2.3. Synoptic Study of Northwest Extreme Local Storms

Appendix 4 provides individual discussions on three extreme local storms occurring in the region and two storms that occurred near the region. Also included in this Appendix are the synoptic patterns common to most extreme convective events.

The analysis revealed that there clearly are preferred meteorological conditions under which extreme local storms develop in the Pacific Northwest. In the upper atmosphere (500-mb), the most dominant pattern conducive to the outbreak of extreme local rainfall, occurs when the station is located beneath the western side of a long-wave ridge (or east of a long-wave trough). The ascending motion characterizing the mid-tropospheric environment in these areas primes the atmosphere for convection. A short-wave perturbation moving up the ridge often aids in destabilizing the atmosphere in the vicinity. This pattern is similar to that most often found to cause flash flooding in the western United States (Maddox et al., 1980). Southerly winds associated with this pattern are also of importance in feeding the necessary moisture into the area. Other important factors operating at different scales also have an influence on the type and intensity of any storms that do develop.

Surface weather patterns favorable for local storm development are more variable than aloft, although low pressure-trough situations are most often associated with such storms. The salient point to be made in discussing heavy local storms in the Pacific Northwest is that they definitely occur under preferred synoptic conditions, but are influenced to a large degree by factors operating at the sub-synoptic and mesoscale area size as well.

11.3 Adjustment for Maximum Moisture

11.3.1 Background

Surface dew points are used as a measure of atmospheric moisture for local storms just as they are for general storms in this study. Virtually all previous PMP studies have used dew points as an indicator of atmospheric moisture, and numerous researchers have established the validity of this concept (Reitan, 1963; Berkofsky, 1967; and Bolsenga, 1965). It is especially important to have an accurate estimate of low-level moisture since it is this air which is drawn into the thunderstorm, lifted and condensed and finally falls as precipitation.

11.3.2 Maximum Persisting 3-Hour Dew Points

In this study, 3-hour 1000-mb maximum persisting dew points were used as a measure of atmospheric moisture for the maximization and transposition of local storms. All dew-point data were reduced pseudo-adiabatically to 1000-mb in order to account for variations in elevation and to provide a common level for comparison. Previous major studies (HMR 49 and 55A) have used 12-hour maximum persisting dew points for both general and local storm maximization. The 3-hour persisting dew point in a local storm situation may be higher than the 12-hour persisting dew point by several degrees (F) or more due to localized moisture convergence. McKay (1963) found that 3-hour maximum persisting dew points in the Canadian prairie provinces average about 4°F greater than the corresponding 12-hour maximum persisting dew points for dew points in the 55 to 75°F range, which are representative of high dew-point episodes. Consequently, a 3-hour maximum persisting dew point read as close as possible to the storm location better represents the localized moisture available for the storm than a 12-hour maximum persisting dew point, which would more accurately indicate the widespread moisture available for a general storm. Additionally, a high 3-hour persisting dew point is less likely to be the result of an erroneous observation, as is sometimes the case with an individual dew point measurement.

Maps of 3-hour maximum persisting local storm dew point at 1000-mb are shown for the Pacific Northwest region in Figures 11.2-11.8. They were drawn only for April through October because the extreme local storms of concern to this study occur during this period. The isolines depicted on these maps represent the broadscale moisture and temperature patterns affecting the Pacific Northwest. A brief discussion of these maps follows.

April, a transitional month from winter to spring, shows a nearly east-west orientation of the isolines. The moisture source at this time of year is almost exclusively the central or north Pacific Ocean due to the strong zonal flow that usually predominates across this area. Because there is only this single moisture source, the variation in persisting dew points across the region is quite low during this month, only about 7°F.

From May through July however, the increasing influence of both Gulf of Mexico and tropical Pacific moisture becomes evident as a less zonal upper-air flow takes hold across the region. This can be seen in the definite southwest to northeast orientation of the isolines. The persisting dew point variation across the region reaches a maximum of nearly 16°F during July, with a maximum 3-hour persisting dew point near 78°F in the extreme southeast. The northwestern sections of the region reach only the low 60's, indicating that tropical moisture rarely, if ever, penetrates this far north and west. Extreme local storms are most likely to develop during these months due to the increased moisture, less stable atmosphere and slow movement of thunderstorm cells.

September is somewhat of a transitional month, as the orientation of the isolines once again becomes more east-west and the regional variation diminishes to only 9°F. October shows a near reversal of the warm season pattern, as Gulf and tropical moisture sources are cut off with the stronger flow of autumn and polar air begins to intrude from the northeast, reducing the moisture bearing capacity of the atmosphere. The highest persisting dew points in this month are found in both the southwest and southeast and there is only a slight variation of about 5°F across the entire region.

11.4 Adjustments for In-Place Maximization

The in-place adjustment for moisture maximization of local-storm amounts is treated similarly to that for the general storm. A brief discussion of this process is given in Appendix 4 and it should be reiterated that the primary difference is in the use of 3-hour persisting dew points rather than the 12-hour persisting used in general storms. Moisture maximization is a ratio, and the use of 3-hour rather than 12-hour values, results in only minor differences, since the 3-hour persisting dew point analyses in this study roughly parallels the 12-hour persisting dew point patterns shown in HMR 43.

11.5 Adjustments for Elevation

The elevation adjustment used in local storms is the same as that described in Section 7.3 for the general storm with regard to vertical storm transposition. As described in somewhat greater detail in Appendix 4, available storm data, as well as literature, suggests that there is no evidence for variation in local-storm precipitation potential up to about 6,000 feet. Above this level, a decrease consistent with the reduction in available moisture is to be expected. This feature is consistent with the conclusion adopted in both HMR 49 and 55A.

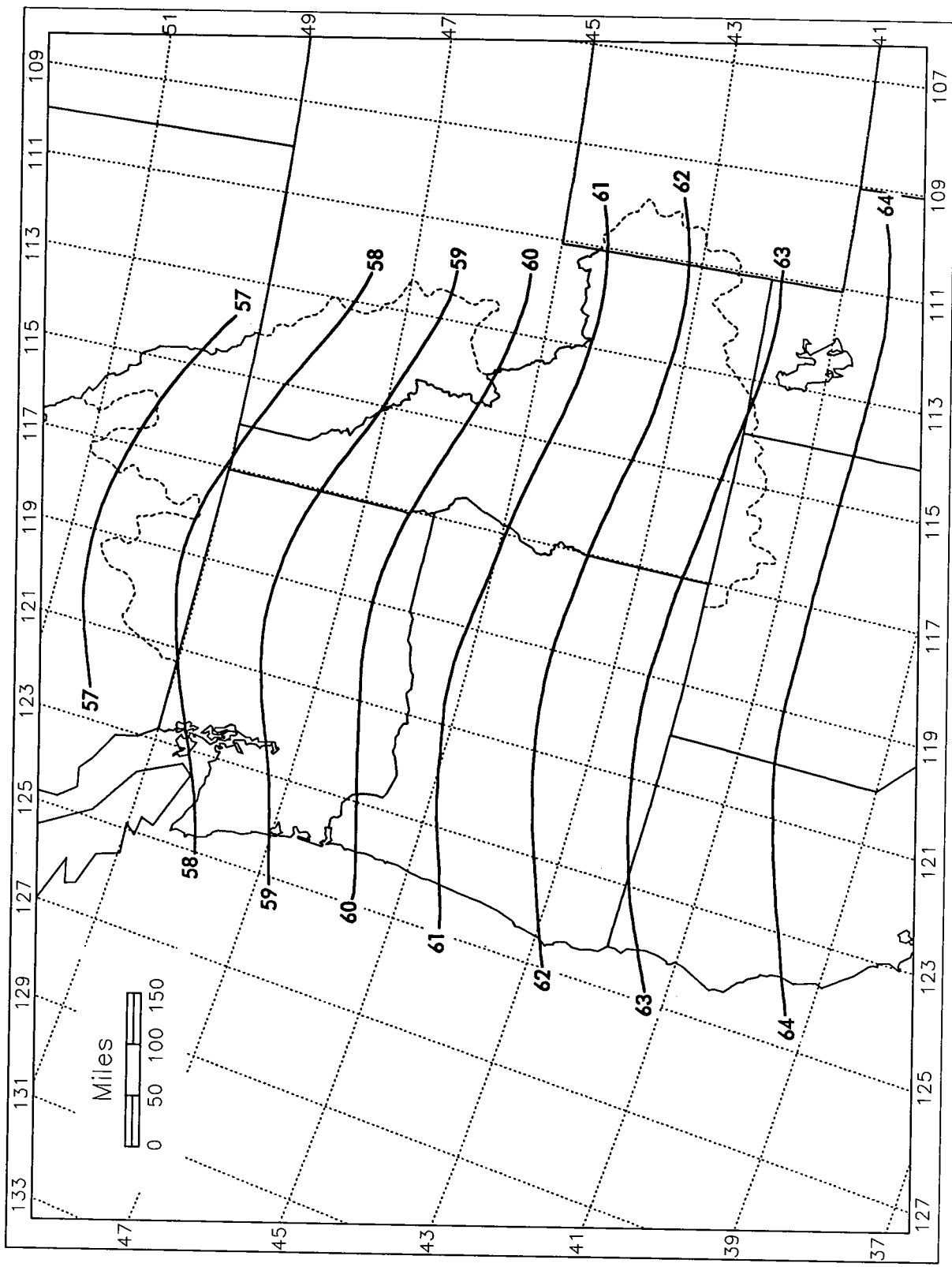

Figure 11.2.--Three-hour maximum persisting 1000 mb local storm dew points for April (°F).

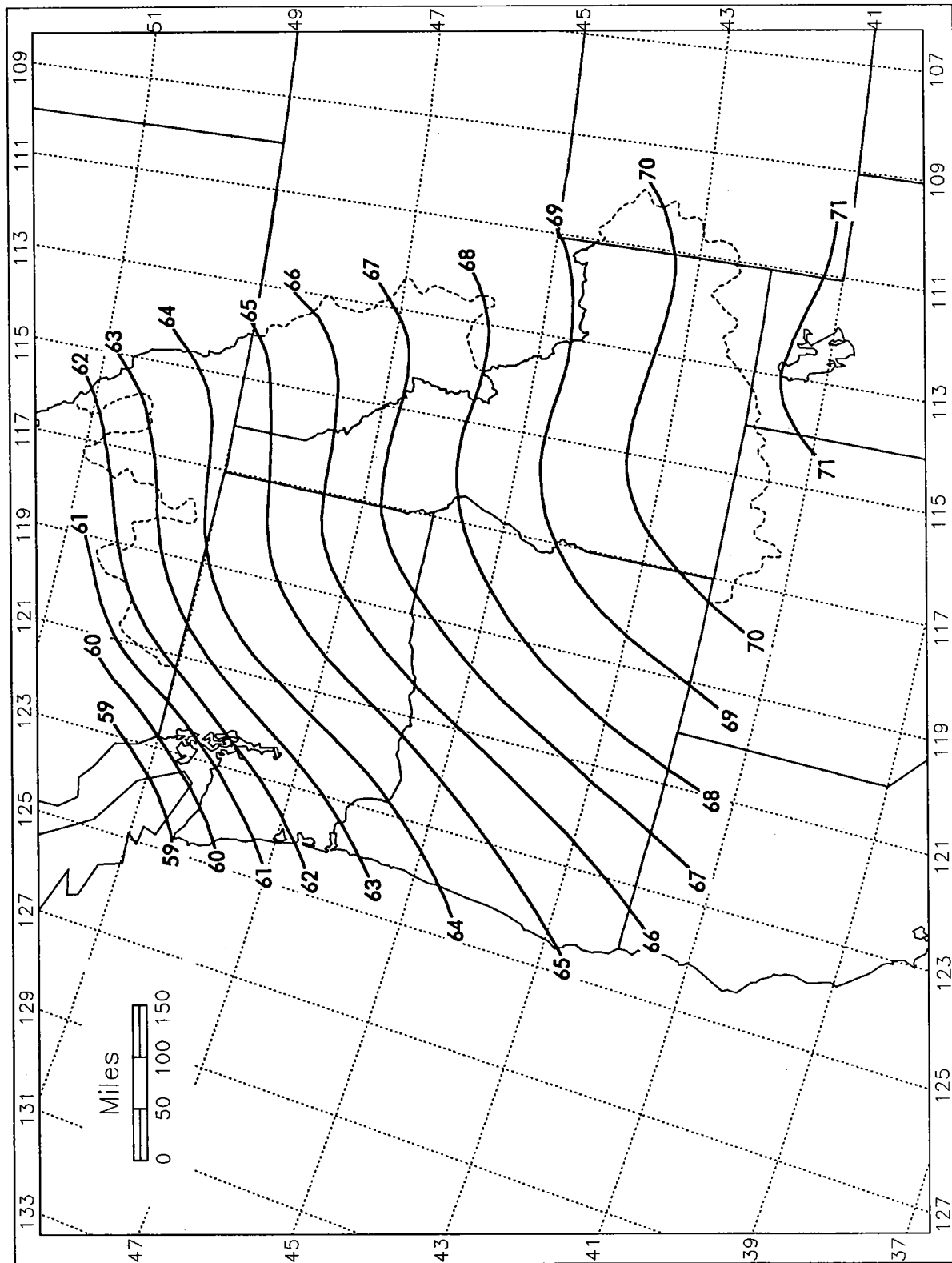

Figure 11.3.--Three-hour maximum persisting 1000-mb local storm dew points for May (°F).

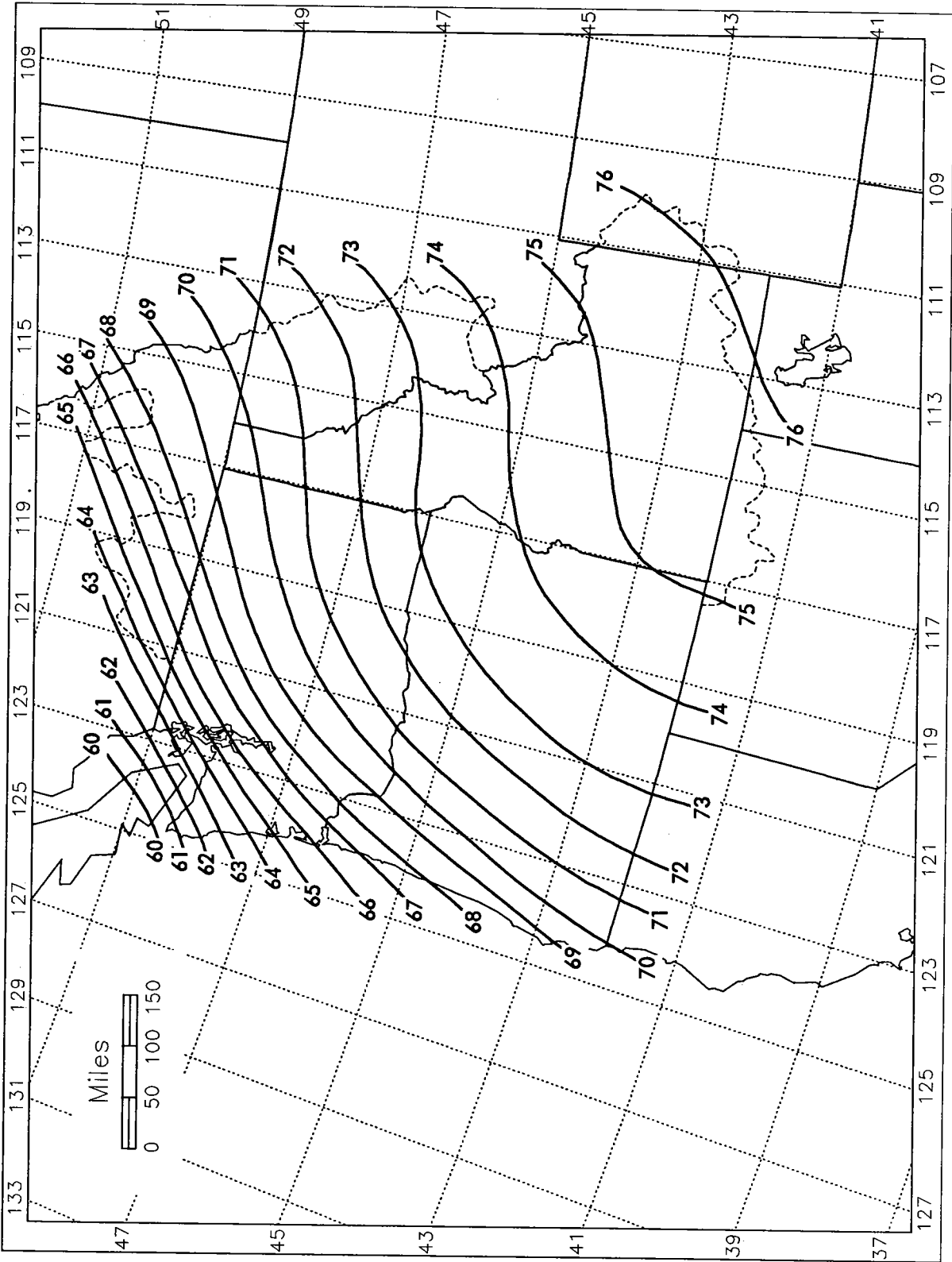

Figure 11.4.--Three-hour maximum persisting 1000-mb local storm dew points for June(°F).

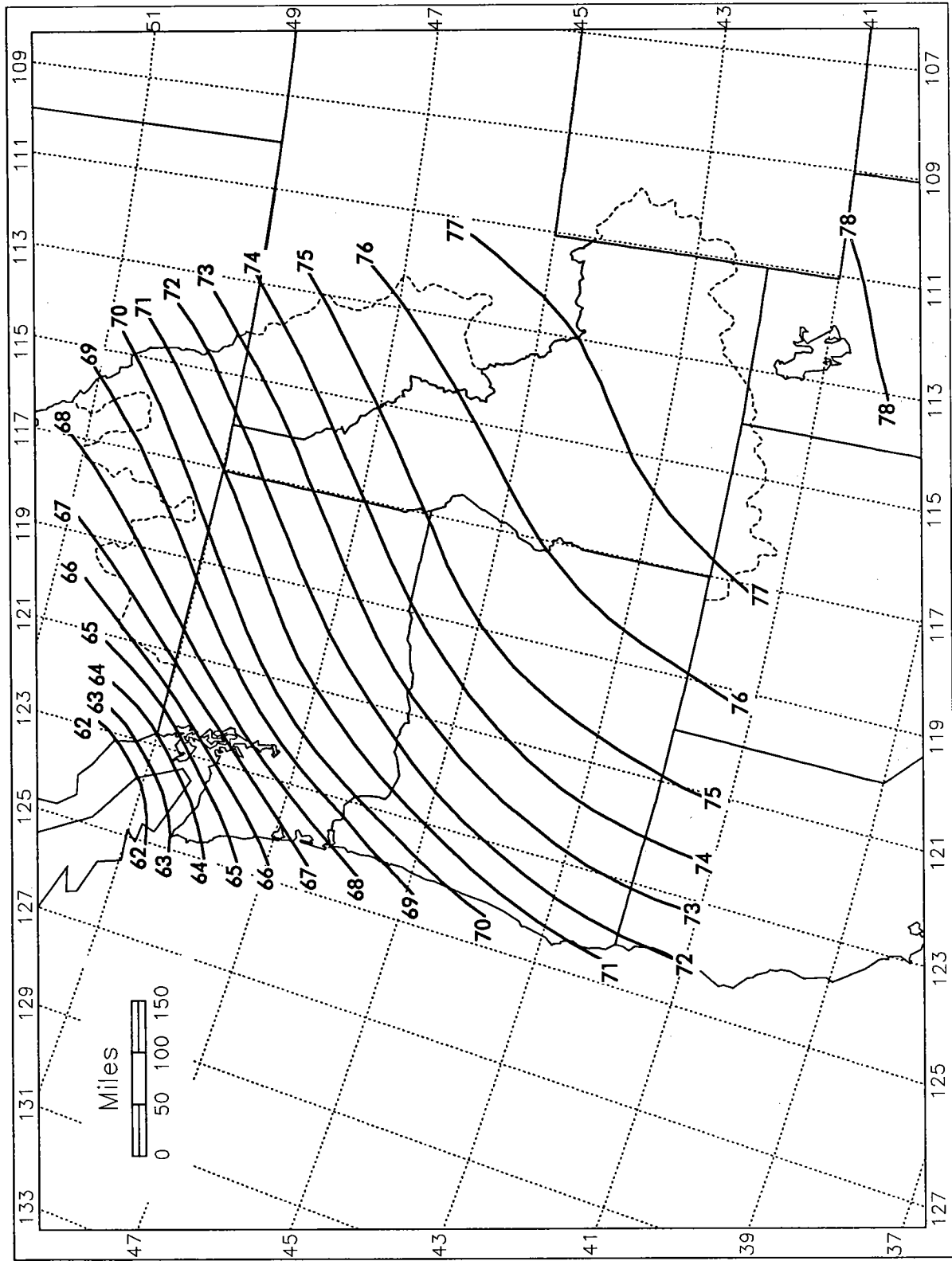

Figure 11.5.--Three-hour maximum persisting 1000-mb local storm dew points for July (°F).

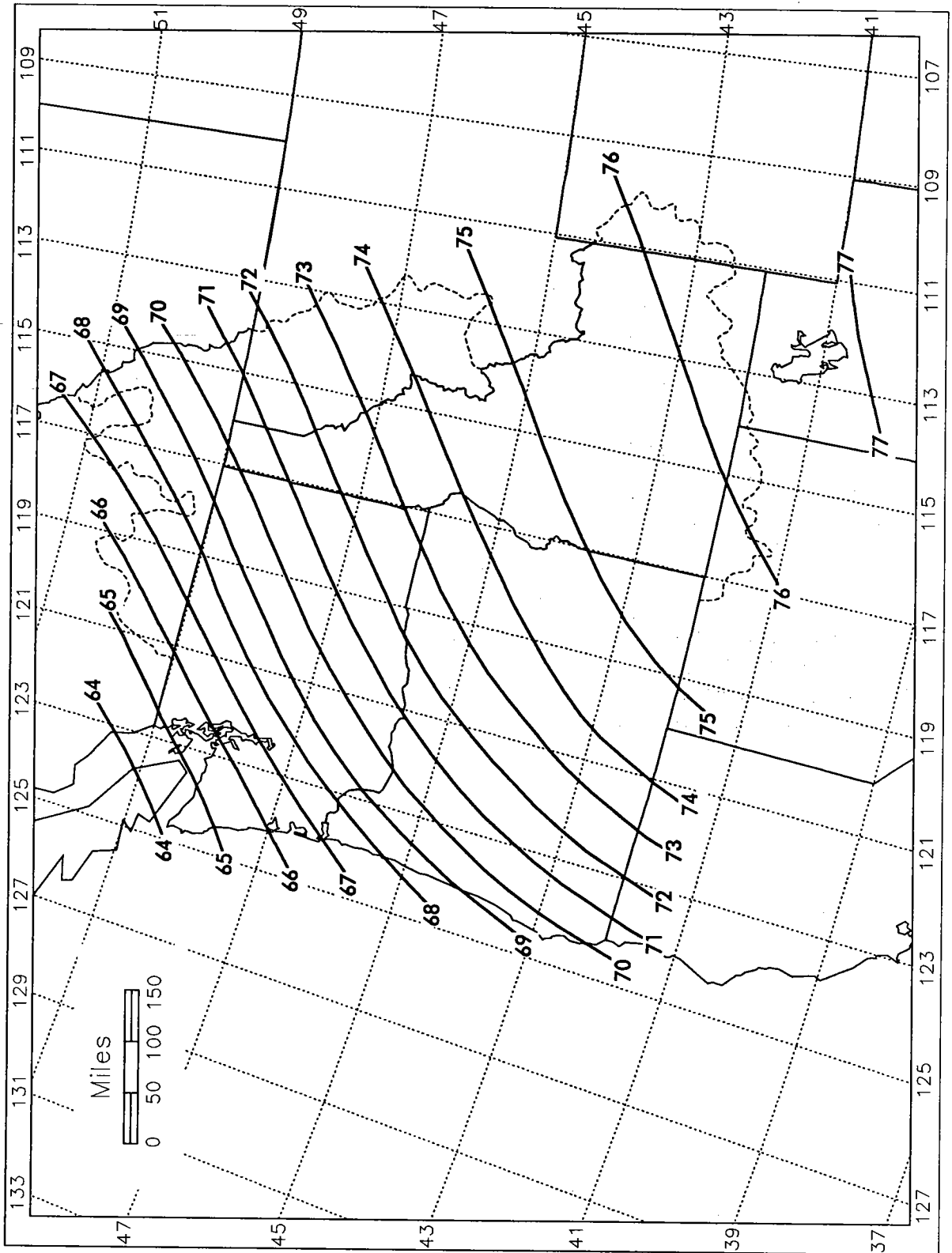

Figure 11.6.--Three-hour maximum persisting 1000-mb local storm dew points for August (°F).

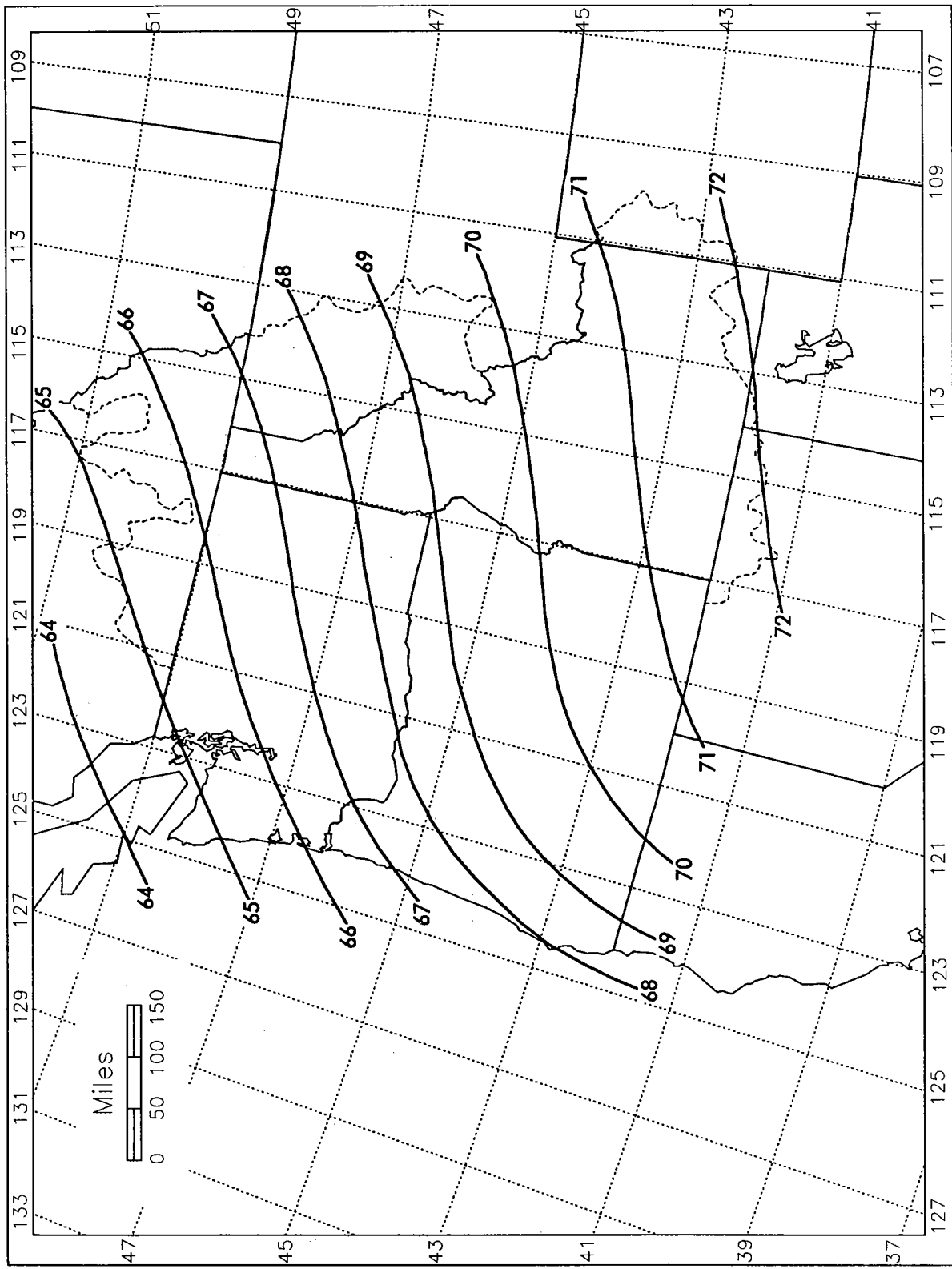

Figure 11.7.--Three-hour maximum persisting 1000-mb local storm dew points for September (°F).

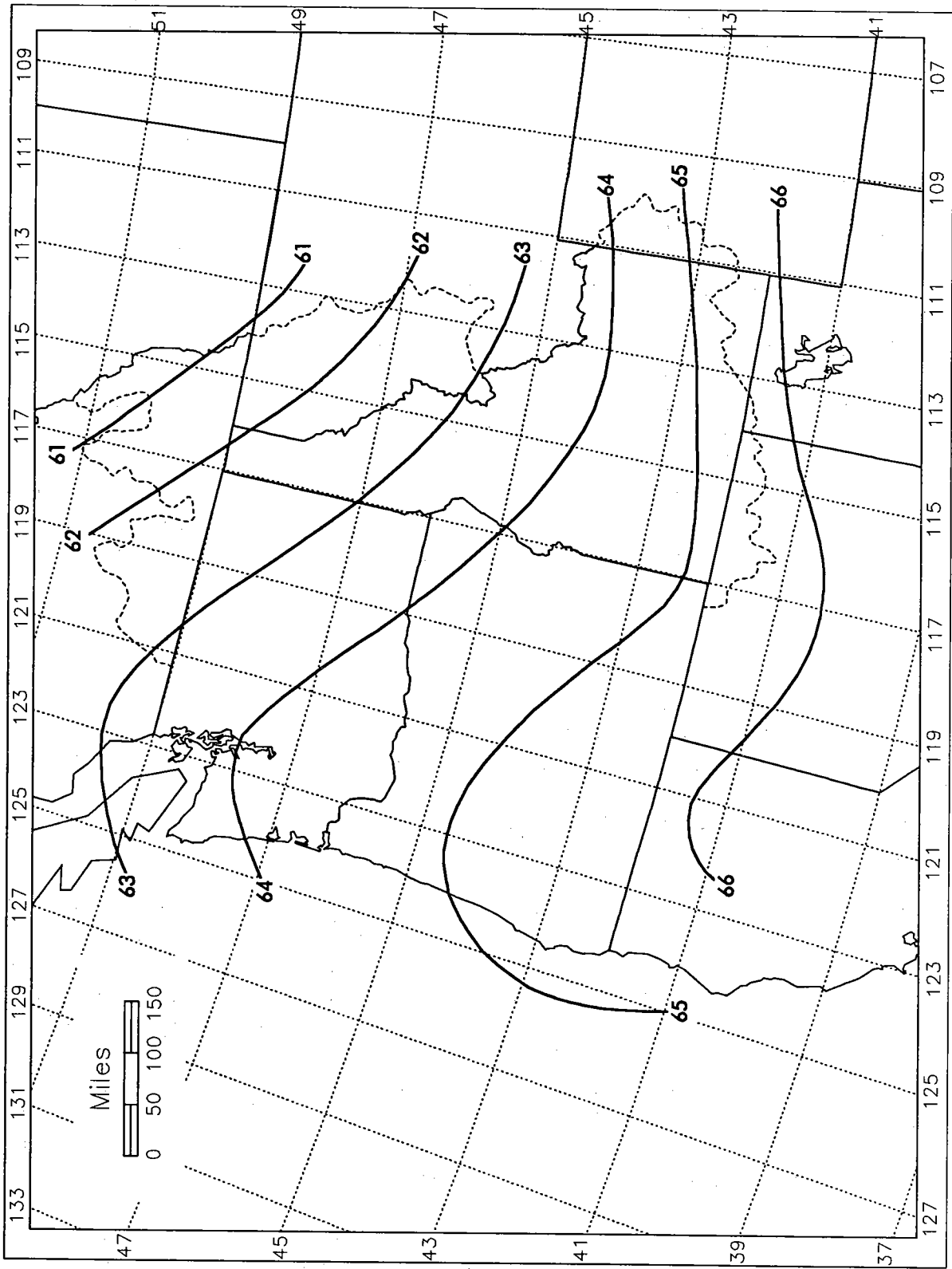

Figure 11.8.--Three-hour maximum persisting 1000-mb local storm dew points for October (°F).

11.6 Adjustment for Horizontal Transposition

Local storms were transposed in this study within the climatic zones discussed in Appendix 4, using procedures similar to those applied to the convergence component of general storms (see Section 7.4).

11.7 Durational Variation

11.7.1 Background

Research conducted into the nature of Pacific Northwest local storms has shown that they primarily draw on limited moisture, which has difficulty penetrating much of the region due to terrain obstacles. Lacking the constant replenishment of moisture, these local storms often produce their heaviest rainfall within the first hour, with total storm duration rarely exceeding 6 hours (Schaefer, 1989). For example, of the most extreme recorded local storms in Table 11.1, only two produced significant precipitation beyond 1 hour. These were the Elko, Nevada, storm of August 27, 1970 (3.47 inches in 1 hour, 4.13 inches in 4 hours) and the poorly documented John Day, Oregon, storm of June 9, 1969 (hourly precipitation unknown, 7 inches of precipitation reported in an estimated duration of 3 hours). The evidence indicates that Northwest local storm PMP would be expected to produce most of its precipitation within about the first hour.

11.7.2 Analysis

In HMR 43, a depth-duration relationship was derived from a plot of the greatest recorded local storms in and around the region, extrapolated to 6 hours. The curve was based on depth-duration data from less significant thunderstorms selected from United States Weather Bureau Technical Paper Number 15 (USWB, 1956). The 6/1-hour PMP ratio from that study was 1.43, a value which now appears to be too high based on the more recent data available for the current investigation (Vogel et.al., 1990; Schaefer, 1989).

A depth-duration plot of the greatest storms transposed to the Idaho/Oregon/Nevada intersection was used to determine a depth-duration relationship for durations up to 1 hour (Figure 11.9). For longer durations (1 to 6 hours), there was no adequate storm sample available to explicitly determine a depth-duration relationship. In HMR 49, the durational variation was determined by an analysis of regionally averaged (within 2° latitude-longitude grid units) 6-/1-hour precipitation ratios for maximum clock-hour precipitation amounts. A similar analysis of 50-years or greater return period storms in the Northwest disclosed no discernible geographical pattern. Thus, no regional variation was utilized to describe the durational characteristics of local storms across the region.

One of the problems encountered in determining a 6-/1-hour precipitation ratio for local storm PMP involved the mechanics of such heavy storms. Due to the finite moisture supply usually available for local storms in this region, it is not at

all certain that the PMP storm will behave the same way as most observed heavy storms. The depletion of available moisture as it is converted into precipitation may be significantly faster in a PMP storm than most observed storms, leaving less moisture for a longer duration event. This is especially true where only limited moisture sources exist. Unfortunately, depth-duration data for local storms of near PMP magnitude do not exist to test this hypothesis in an explicit manner.

In an effort to gain some insight into the depth-duration characteristics of heavy storms, data from the extreme local storm database (Appendix 4) were examined. Of the 106 storms in this sample, 99 had durational information. The hourly precipitation occurring 6 hours before and after the maximum hourly amount was obtained for the 99 available storms. The duration distribution of these isolated convective storms is given in Table 11.3. These frequencies were derived from clock-hour samples and may be biased toward longer durations than actually occurred, as would show up more clearly using 5- or 15-minute data. More storms (30) had a duration of 2 hours than any other single duration, and 65 of the storms had a duration of 3 hours or less. Only 6 storms had a duration beyond 6 hours, and the precipitation amounts outside the maximum hour were minor for these 6 cases (Vogel et. al, 1990).

Table 11.3.--Frequency distribution of storm durations from the extreme local storm data base.

Duration (hour)	Frequency (number of events)
1	16
2	30
3	19
4	13
5	9
6	9
>6	6
Total	99

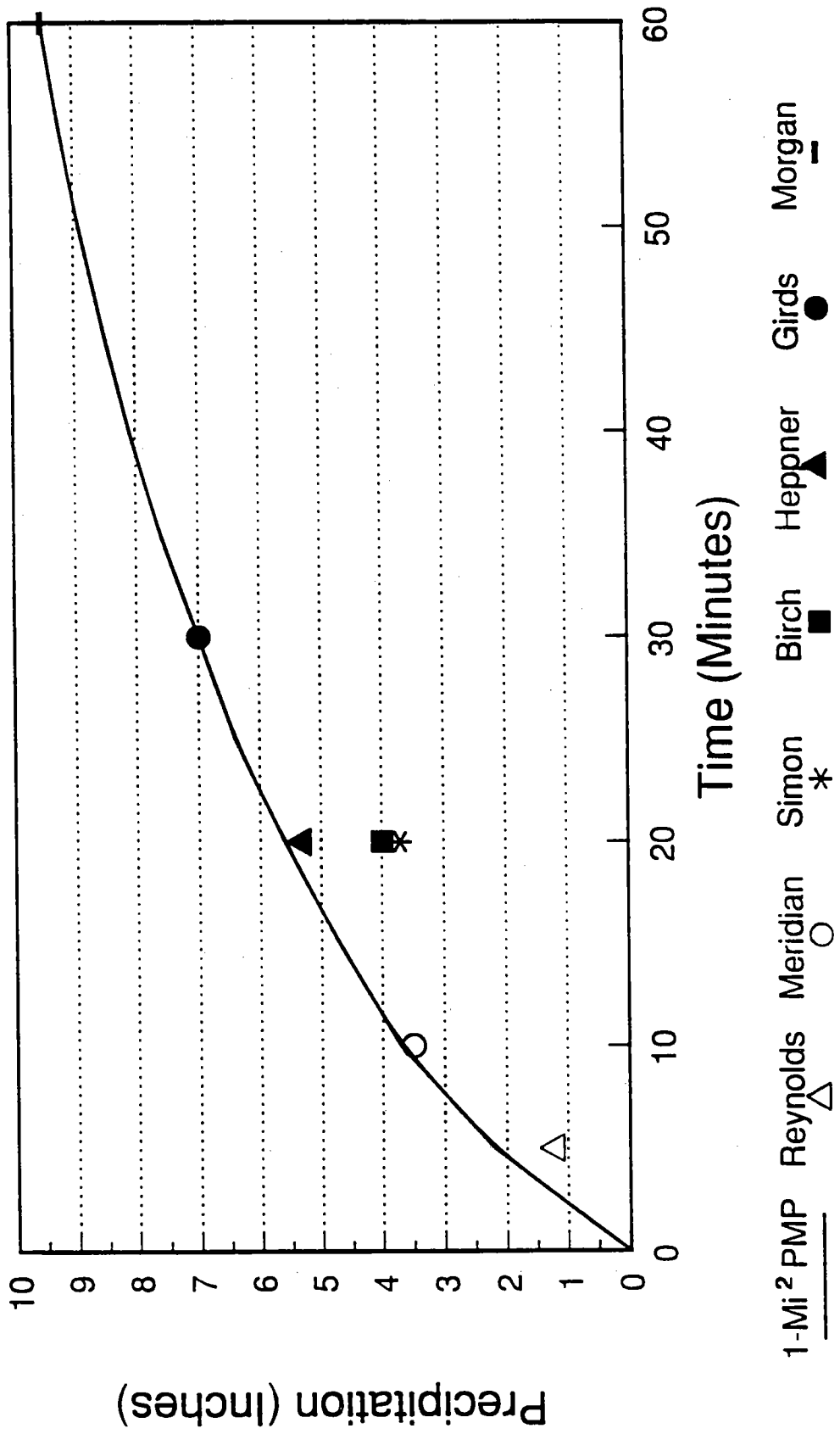

Figure 11.9.--1-mi² local storm PMP at the Idaho/Oregon/Nevada border.

No true median duration could be established for this data set, but it can be said that the median duration is 2 to 3 hours for heavy, convective storms in the Pacific Northwest. By comparison, Changnon and Vogel (1981) found that the median duration for heavy, convective rain intensities in Illinois was 3.2 hours, and durations on this order hold true for a large part of the eastern United States.

On average, the 6-hour to 1-hour ratio of rain is about 1.10 to 1.15 in the storms of the Pacific Northwest, which is considerably lower than the ratio of 1.4 found for general thunderstorms in the United States (USWB, 1947 and 1956) or compared to the 1.43 value adopted in HMR 43. The 1.10 to 1.15 values are closer to the results obtained by Schaefer (1989) in his study of heavy rainstorms in Washington State. That study, based on 2-hour extreme storms, found 6/1-hour ratios that varied between 1.01 for an exceedance probability of 0.15 (see Chapter 10) in eastern Washington to about 1.12 for the same probability in western Washington. Figure 11.12 and Table 11.4 show the adopted depth-duration ratio expands only to 1.15 for the entire Northwest region.

11.7.3. Temporal Variation

The 99 storms in the Northwest were further classified into front-, middle-, and end-loaded storms, depending upon the timing of the maximum precipitation. This classification scheme depends upon the duration of the local storm. For example, a storm with a 6-hour duration would be divided into three 2-hour segments. The 2-hour segment with the greatest precipitation amount would define whether the storm is front-, middle- or end-loaded. If the greatest precipitation is in the first two hours, then the storm is front loaded; if the greatest precipitation amount occurred in the third and fourth hours, then the storm would be middle-loaded. For a storm with a 60-minute duration, the storm would be divided into three 20-minute segments. Then if the greatest precipitation is between 20 and 40 minutes of the storm, it would be a middle-loaded storm. Thus, front-, middle- and end-loaded storms are defined by the highest rainfall amount within either the first, second, or last third of the duration of the storm. Since 1972, Fischer-Porter raingages, with 15-minute amounts, have allowed 1 or 2-hour duration storms to be classified in this way. Under this classification scheme, about 65 percent of the 99 storms considered in this study were front-loaded, 33 percent were middle-loaded and only 2 percent were end-loaded. The predominance of front- and middle-loaded extreme convective storms in the Pacific Northwest is clearly indicated by these data. The temporal distribution of the rainfall within these storms was examined using the techniques similar to those developed by Huff (1967). Figures 11.10 and 11.11 give the temporal distribution of precipitation for front- and middle-loaded storms in this study, while end-loaded storms were not considered due to their rarity. In both the front- and middle-loaded storms over 70 percent and often 90 to 100 percent of all rain occurs in 1 hour or less. A study by Farmer and Fletcher (1972) using data from two dense raingage networks in the Great Basin of Utah disclosed similar results. The most intense rainfall bursts in their studies occurred in the first quartile of storms about 80 percent of the time.

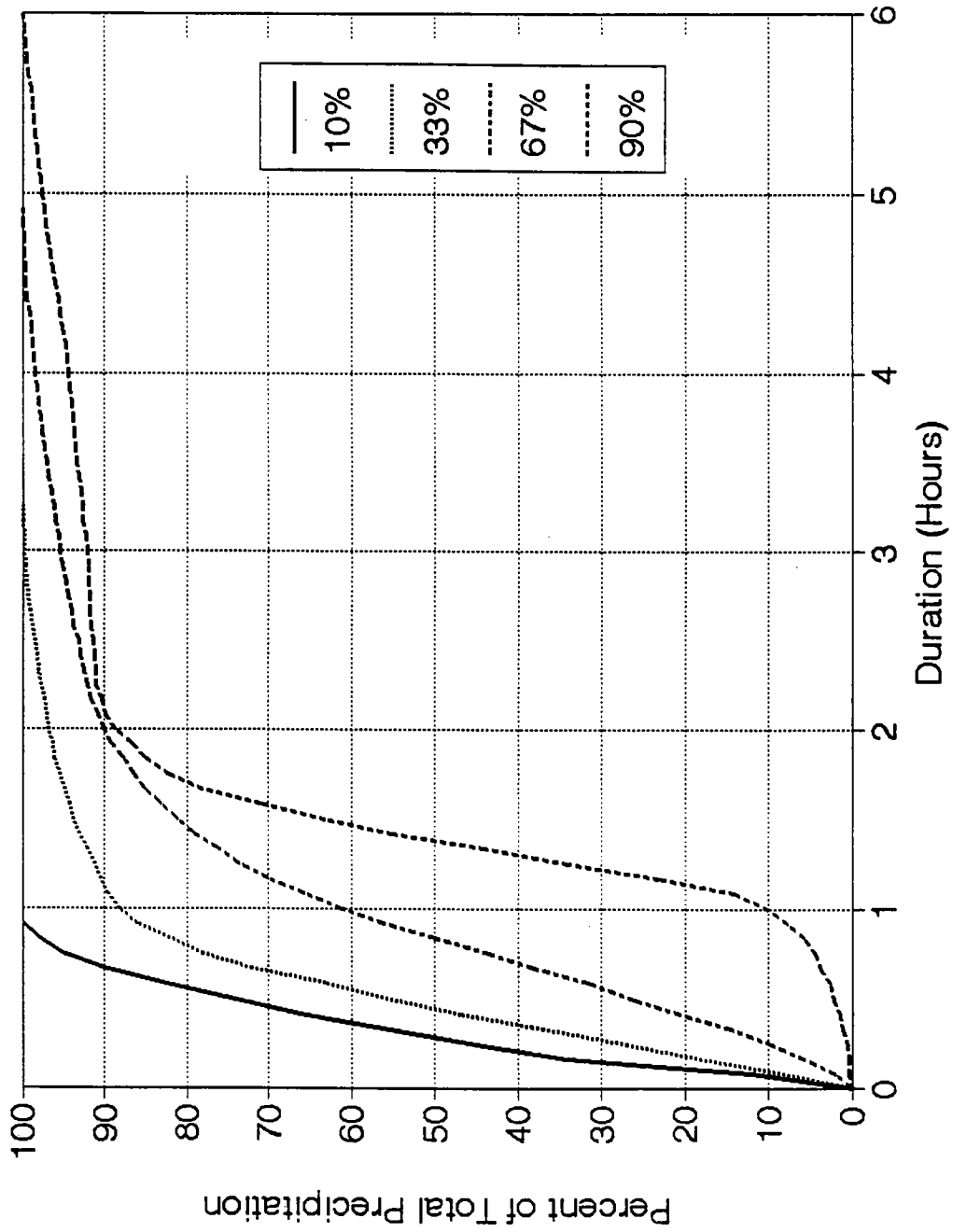

Figure 11.10.--Representative time distributions for front-loaded storms.

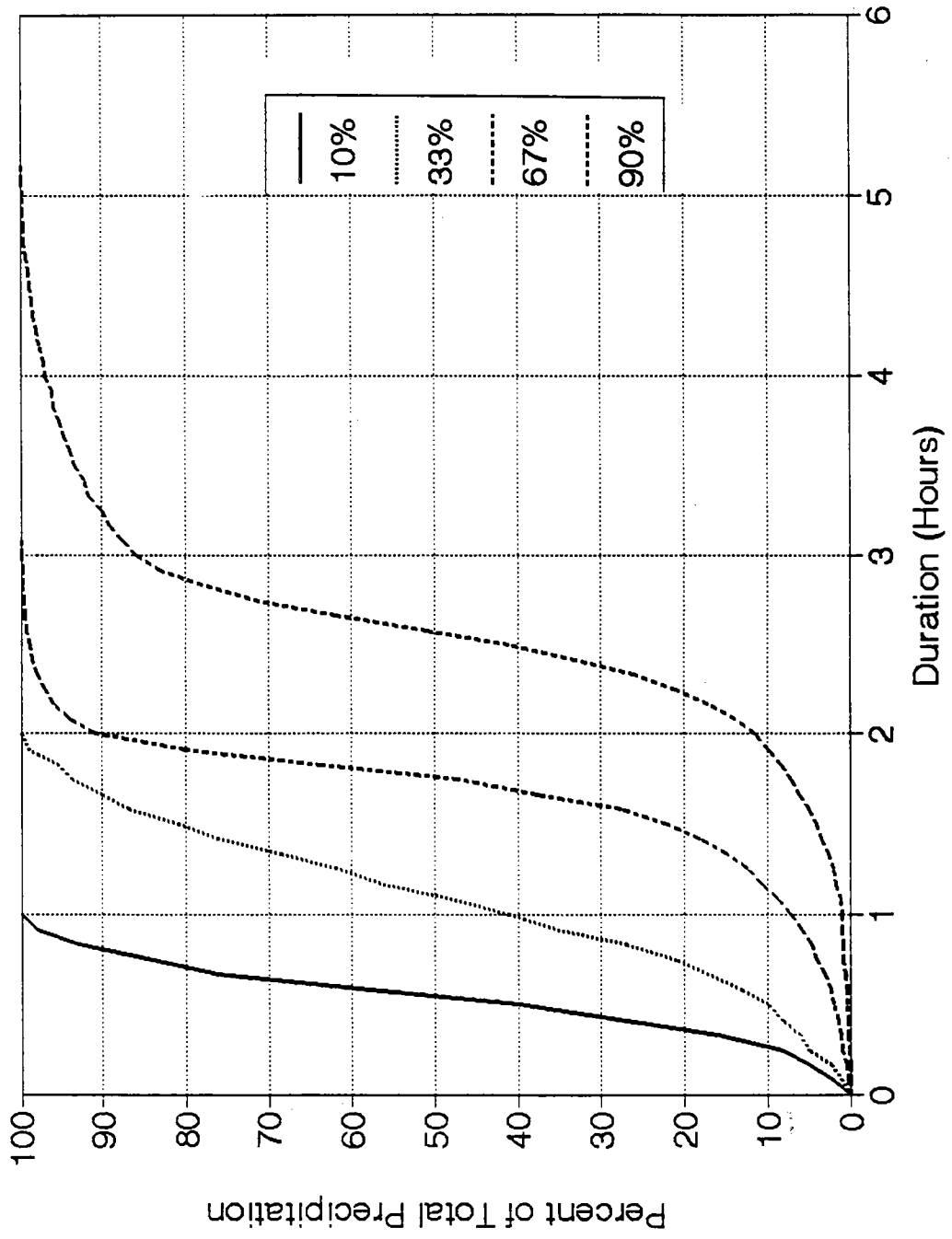

Figure 11.11.--Representative time distributions for mid-loaded storms.

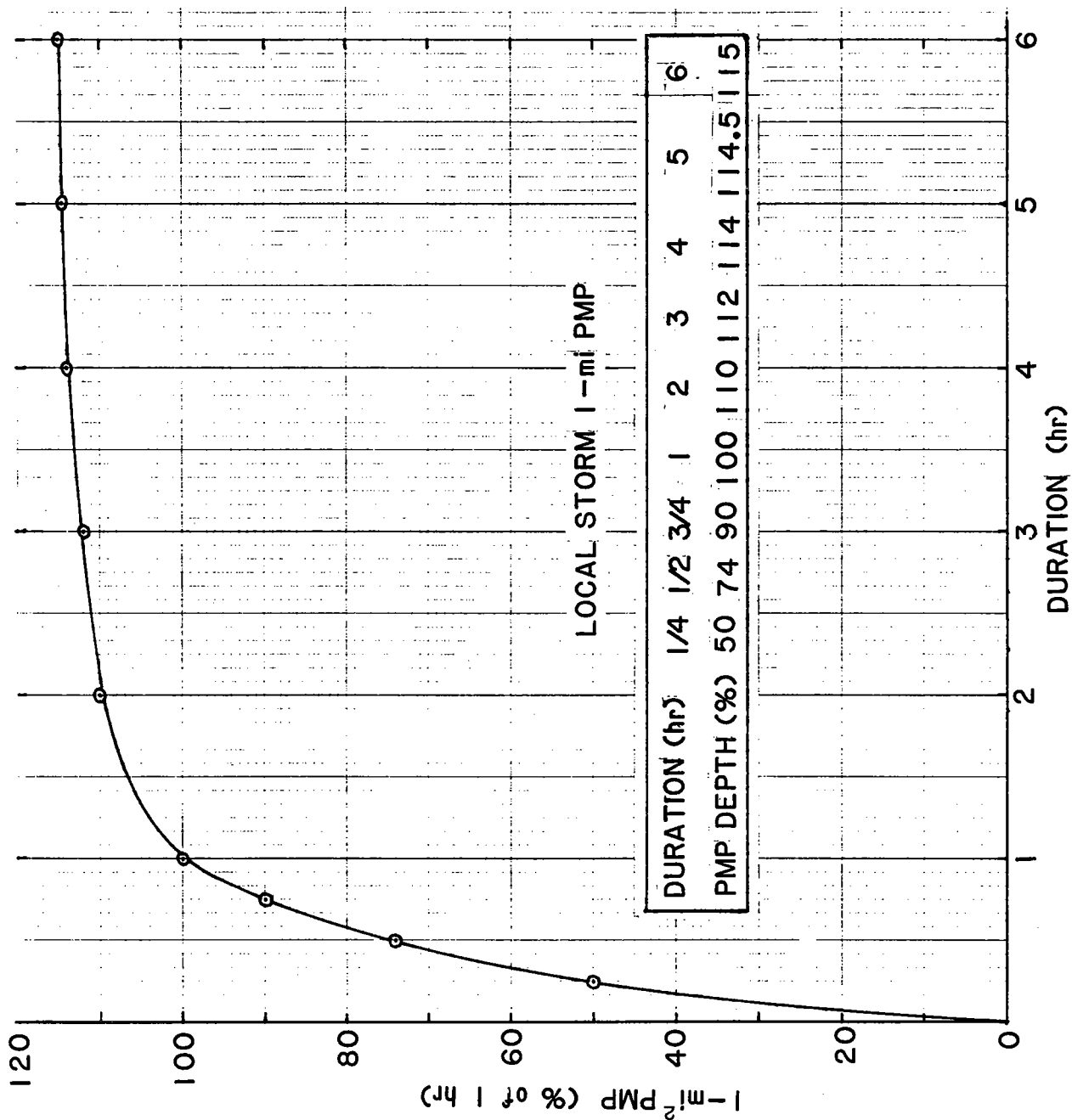

Figure 11.12.--Depth-duration relationship for 1-mi² PMP Pacific Northwest States.

Table 11.4.--Percent of 1-hour, 1-mi² local storm PMP for selected durations in the Pacific Northwest.	
Duration	Percent of 1-hour PMP
15 min	50
30 min	74
45 min	90
1 hour	100
1 hour, 30 min	107
2 hours	110
3 hours	112
4 hours	114
5 hours	114.5
6 hours	115

11.8 Depth Area Relations

11.8.1 Background

The index values (Figure 11.19) for local-storm PMP have been developed for an area size of 1-mi². PMP estimates for larger areas, up to 500-mi², also need to be developed. The index values can then be related to the average depth over a specified area at various durations.

Since the behavior of extreme local storms affecting the Pacific Northwest is different from those in the eastern United States, a review was made of Northwest data to find information more representative of the region. Previous PMP studies have used data from a number of different sources for the development of depth-area curves.

The depth-area curves developed in Technical Paper (TP) 29 (USWB, 1957-60), represented one of the early attempts to derive depth-area relations for small area watersheds (<500-mi²). In TP 29, data were obtained from 20 dense raingage networks covering areas up to 400-mi² located in the eastern half of the United States and along the west coast. Only 2 of the 20 networks were located in the Pacific Northwest, with an additional 5 located in California. These curves

became known as the National Average Depth-Area Curves and were also used in later precipitation-frequency studies, TP 40 (Hershfield, 1961) and NOAA Atlas 2 (Miller et al., 1973).

HMR 43, adopted depth-area relations based on a compromise between (1) eastern type thunderstorms, (2) data from a few intense thunderstorms west of the Continental Divide, and (3) a model thunderstorm.

In the report for the Colorado River and Great Basin drainages (Hansen et al., 1977), PMP depth-area relations were based on data from southwest rainfalls and consideration of a model thunderstorm. The adopted curves in that study envelop both the data and the model thunderstorm curves. These curves were then used for both the 1- and 3-hour durations. For 6 hours, the relations developed in HMR 43 were accepted. Figure 11.13 shows area reduction curves from HMR 43 and HMR 49.

For HMR 55A, which examined the area between the Continental Divide and the 103rd meridian (Hansen et al., 1988), new depth-area data were available for only two local storms. Therefore, information from HMR 49 was used to supplement that study. This solution was warranted because of the geographic proximity of the HMR 49 area and the similar behavior of local storms to the east in terms of storm types, 6-/1-hour ratios, and terrain.

Another study which addressed the issue of local storm depth-area relationships was documented by Osborn et al. (1980) in which new depth-area curves for Arizona and New Mexico were developed. Regional data was believed to provide a better representation of depth-area relations in the southwestern United States and similar climates than the National Average Depth-Area Curves. Results showed that precipitation diminished faster with area than the National Average Depth-Area Curves. Osborn's curves are believed to be typical of summer thunderstorm rains in southwest Arizona.

Schaefer (1989) noted that a lack of recording precipitation gages in eastern Washington State made it impossible to determine new depth-area relations. Instead, he modified slightly the curves from HMRS 43, 49, and 55A for use in Washington. The major change suggested by Schaefer was that the maximum areal coverage for a 2-hour storm is only 250-mi². However, these curves are for storms that are less intense than PMP events.

11.8.2 Additional Depth-Area Analysis

An attempt was made in this study to derive new depth-area relations using precipitation records of a dense recording raingage network in southwestern Idaho. These records consisted of breakpoint data from the Reynolds Creek Experimental Raingage Network in southwestern Idaho for the years 1962-1988. Breakpoint data is precipitation intensity dependent data, in which starting and ending times for a specific intensity are given.

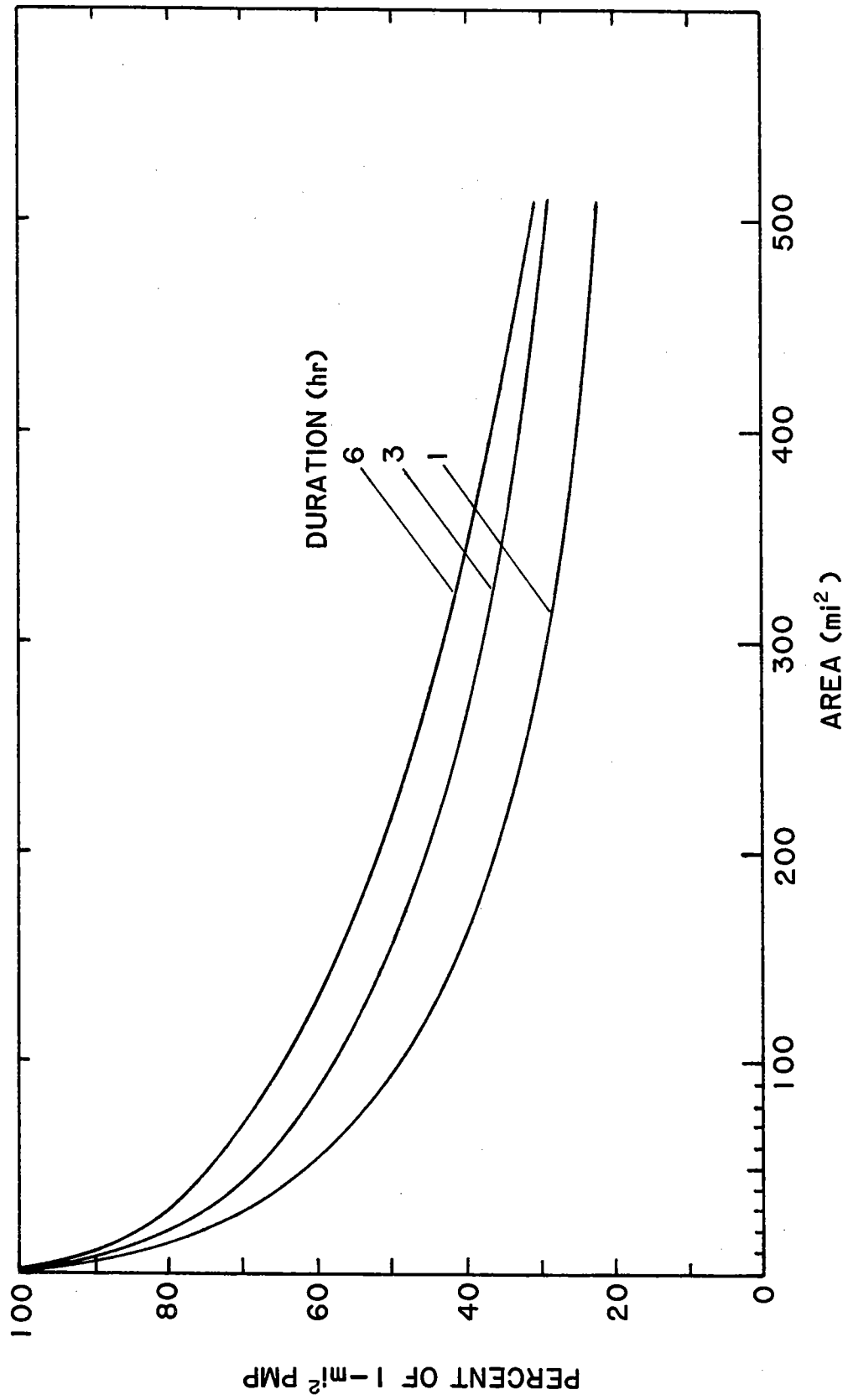

Figure 11.13.--Depth-areal relation for thunderstorm PMP in HMR 43 and 49.

The Reynold's Creek network is located on a 90-mi² watershed situated in the Owyhee Mountains about 50 miles southwest of Boise, Idaho. It is positioned at the headwaters of a north-flowing tributary of the Snake River. The elevation ranges from 3,600 to 7,200 feet above sea level with isolated peaks a few miles to the south and west rising to 8,000 feet. The network has an average density of one gage per 2-mi², and has varied over time between 12 and 31 gages.

A total of 587 station years of data were available for analysis. Only significant (>0.5 inches in 24 hours) local-storm data from April through October were selected for analysis. For each qualifying storm, a series of depth-area curves were created. Each curve was normalized by dividing the point rainfall amount by the largest (storm center) amount. This gives a Total Area Rainfall (TAR) ratio, and the curve that appears the flattest means a larger area received the bulk of the rainfall. Figure 11.14 shows normalized depth-area curves for the most significant storms, with the storm of July 21, 1975, clearly the most important. Several other storms also had relatively low TAR ratios, but were not as important due to their lower total rainfall amounts.

Figure 11.15 shows that the 1-hour curve from the July 21, 1975 storm varies only slightly from the depth-area curves from NOAA Atlas 2 up to 8-mi², then drops off appreciably at greater areas. The extremely localized nature and short duration of this storm provided insufficient justification to consider revising the overall depth-area curves from HMR 43 or HMR 49. Because not enough additional network raingage data and bucket surveys are available in the Pacific Northwest, no changes were warranted at this time. As a result, it was decided that the basic 1-hour curve used in HMR 49 is still considered valid (Figure 11.13).

11.8.3 Areal Distribution Procedure

Depth-area relations represent the average depth of precipitation (or PMP) for the respective area chosen. However, when one considers the areal distribution, the question that is asked is how should the precipitation be distributed (according to some selected isohyetal pattern) such that the same average depth is maintained. That is, assuming the precipitation falls as a single-centered storm, the areal distribution should have a maximum that is greater than the average depth given by the depth-area relation, and the minimum should be lower toward the periphery of the storm area size than the average depth. To answer this question, a rainfall pattern needs to be determined first. That is, the shape of the pattern and the distribution (number and gradient) of isohyets need to be fixed. Second, a set of depth-area relations and corresponding rainfall profiles need to be determined. If one starts from scratch, these depth-area relations may be patterned after average storm relations or from a specific controlling storm. The rainfall pattern can be circular or elliptical, concentric or eccentric. For this study, we chose the isohyetal pattern given in Figure 11.17 as being most representative of local storms applicable in the Northwest. This pattern is taken

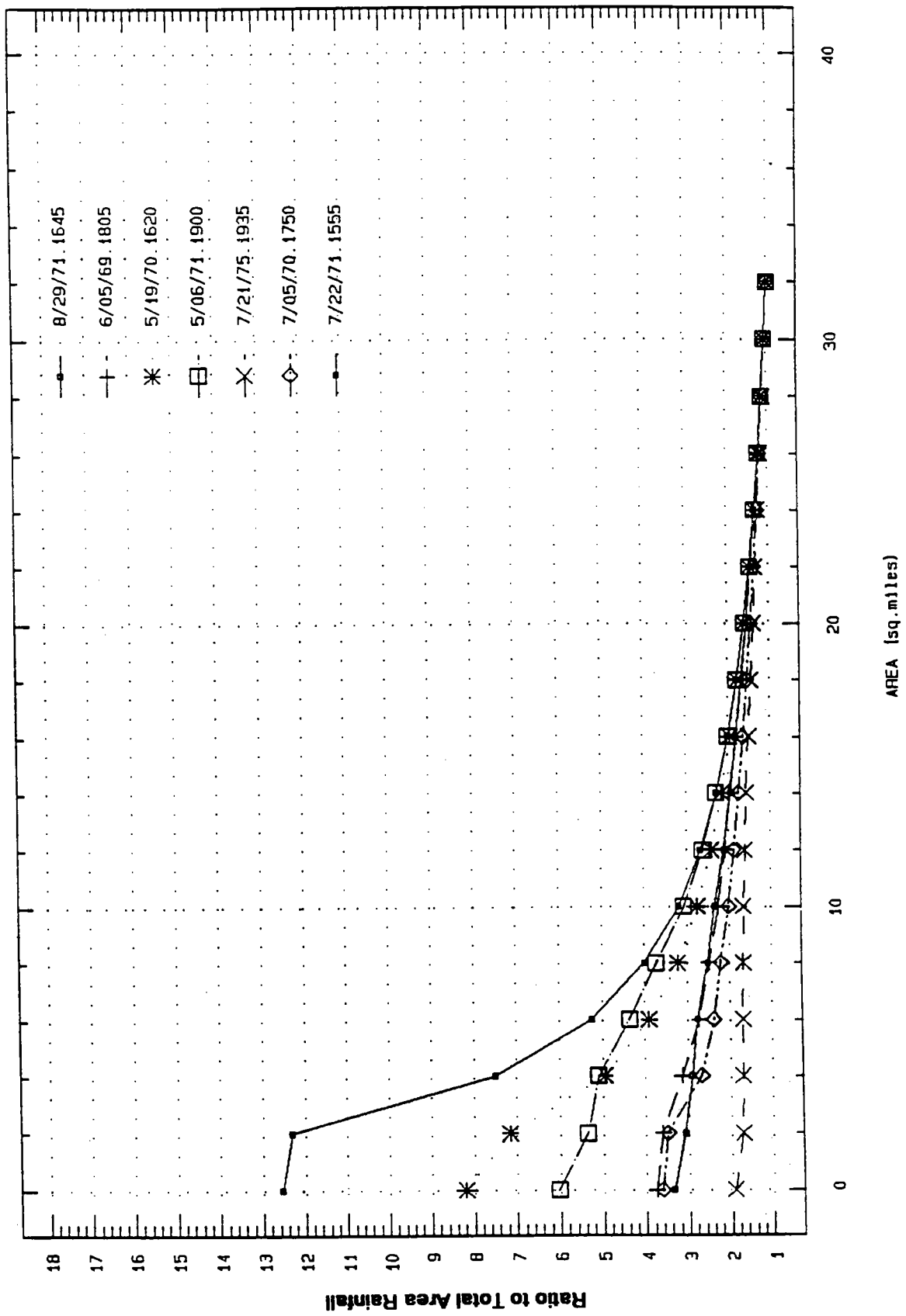

Figure 11.14.--Normalized 60-minute depth-area curves from Reynolds Creek dense network.

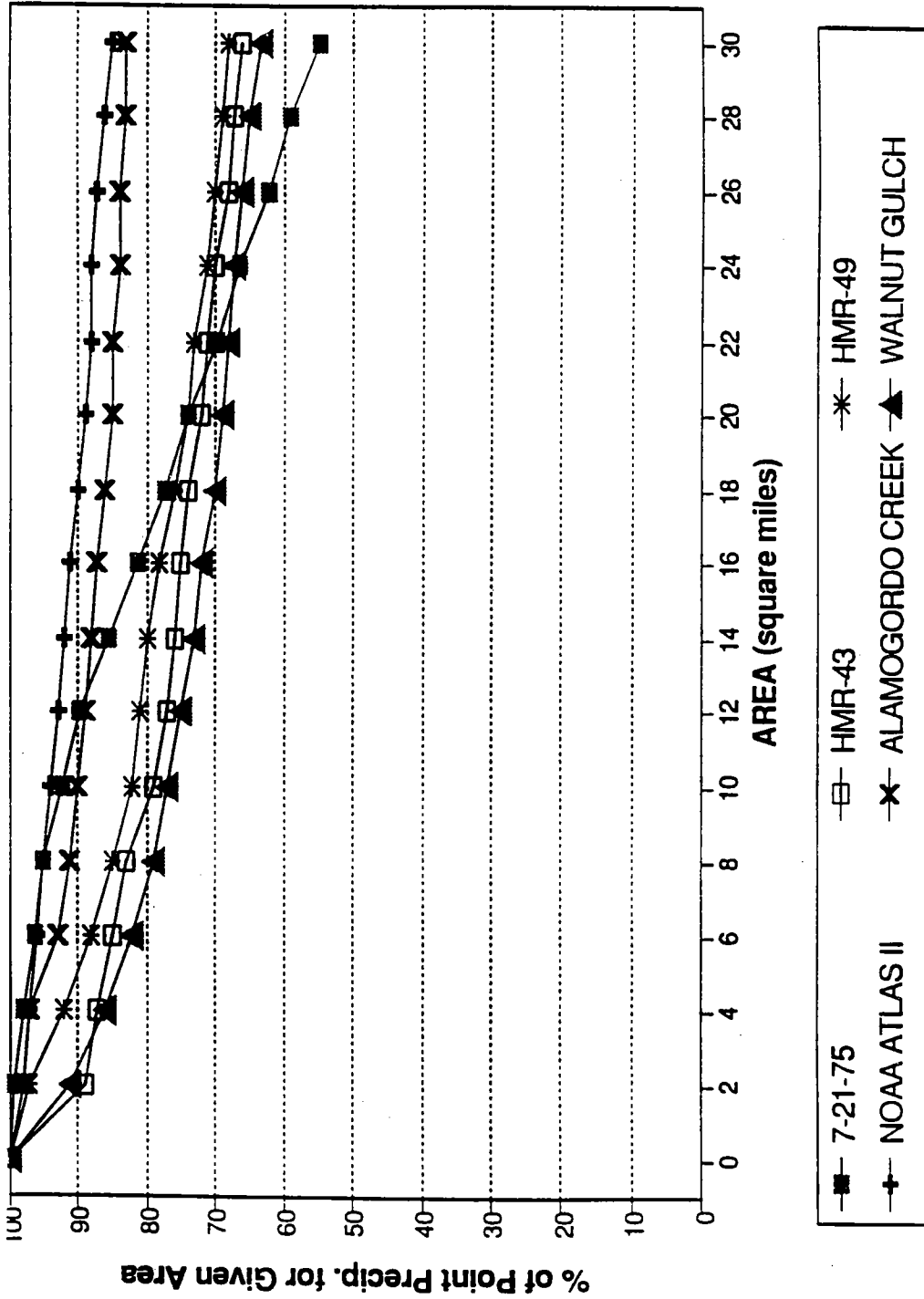

Figure 11.15.--Depth-area curve comparisons for 1 hour.

directly from HMR 49 (Figure 4.10 of that report). The isohyets (A to J) cover 500-mi² and were selected to provide a good representation through the pattern.

HMR 49 provides for multiple depth-duration curves (refer to Figure 4.3 from that publication). For the present study, we selected the adopted 1-mi² depth-duration curve from Figure 11.12 and compared it with the shape of a comparable 6/1-hour ratio curve from HMR 49 in Table 11.5. The HMR 49 curve shows considerably more intense convection, yielding higher short-duration ratios. We accept the depth-duration curve in Figure 11.12 as being more representative for this study region and maintain that data considered in this study suggest little to no variation through the region. Schaefer (personal communication, 1992) indicated that his data support different curves east and west of the Cascade Mountains. No resolution of this discrepancy was reached and further study in this area is recommended.

Duration (hour)	1/4	1/2	3/4	1	2	3	4	5	6
Depth (Figure 11.12) (% of 1 hour)	50	74	90	100	110.0	112.0	114.0	114.5	115.0
HMR 49 (for comparison)	80	91	96	100	108.5	112.0	114.0	114.5	115.0

The next step is to determine a 1-hour depth-area curve from storms or other sources. We adopted the 1-hour curve from HMR 49, which effectively is the same as the curve in HMR 43, as the basic depth-area relation for this study (Table 11.6).

Area (mi ²)	1	5	10	50	100	200	300	400	500
Depth (% of 1-mi ²)	100	89.5	82.5	61.0	48.5	36.0	29.0	25.0	22.0

Finally, it was useful to determine the "equivalent radius" of each isohyet (equivalent implies that the area enclosed is equivalent to that for a circle). This simplifies the process when patterns other than circles are considered.

Table 11.7.--Equivalent radius in miles for selected areas representing areal pattern shown in Figure 11.16.

Isohyet	A	B	C	D	E	F	G	H	I	J
Enclosed Area (mi ²)	1	5	25	55	95	150	220	300	385	500
Equiv. Radius (mi)	.564	1.25	2.82	4.18	5.50	6.91	8.37	9.77	11.07	12.62

The computational procedure leads to determining the profile¹ that corresponds to the depth-area curve. The results of this procedure produce a precipitation profile curve for 1 hour that corresponds to a specific depth-area curve. Both relations can be plotted and smooth curves drawn for each. The plot for the profile curves should be in percent of 1-mi² versus equivalent radius, as shown for three curves in Figure 11.17. These plots can be on linear or semi-log paper. The semi-log plot accentuates the smaller areas/equivalent radius, where the largest variation generally occurs.

The 1-hour relation is considered fixed and all other durations are then related to the 1-hour curve. The incremental values in Table 11.8 have been determined from smoothing the curves in HMR 49, and are used to check durational and areal consistency.

¹Profile refers to a cross section through the volume of precipitation that falls within a specific time period. A precipitation profile curve always falls off more rapidly than does the corresponding depth-area curve.

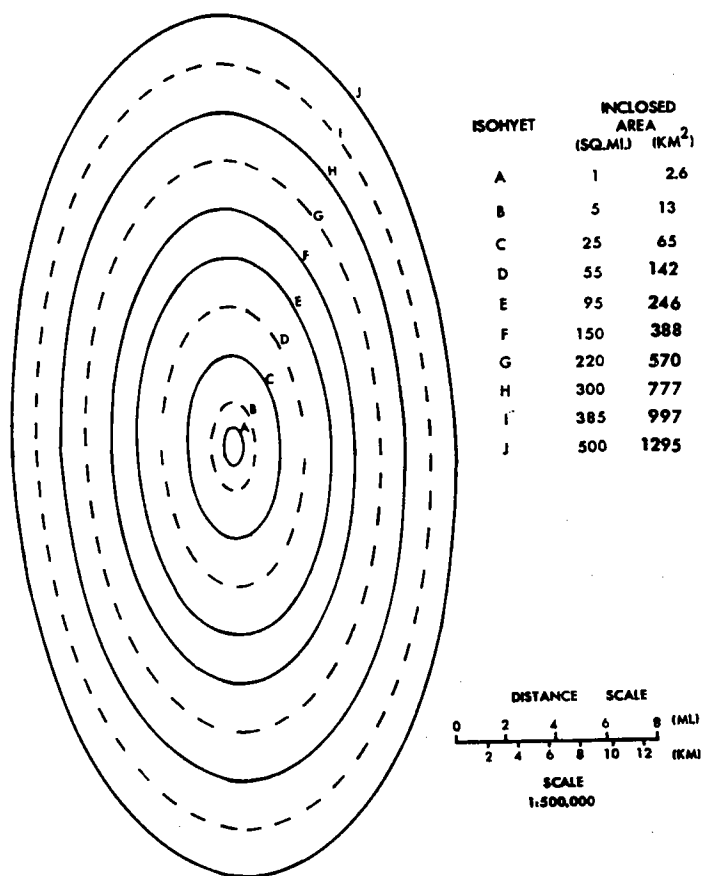

Figure 11.16.—Idealized local-storm isohyetal pattern (from HMR 49) used in this study.

Table 11.8--Incremental Profile (% of 1-hour, 1-mi² amount).									
	Duration (hours)								
Isohyet	1/4	1/2	3/4	1	2	3	4	5	6
A	-24.0	-16.0	-10.0	100.0	10.0	2.0	2.0	0.5	0.5
B	-21.0	-14.0	-7.8	74.8	8.7	2.0	2.0	0.5	0.5
C	-16.0	-11.5	-6.0	56.0	7.0	2.0	1.0	0.5	0.5
D	-11.5	-9.5	-5.0	43.0	5.0	1.5	1.0	0.5	0.5
E	-9.0	-7.0	-4.2	32.2	4.8	1.0	0.5	0.5	0.5
F	-6.5	-5.0	-3.4	22.4	2.6	0.7	0.7	0.5	0.5
G	-3.5	-3.5	-2.0	14.0	2.2	0.5	0.5	0.5	0.5
H	-1.5	-1.5	-1.5	6.5	1.8	0.5	0.5	0.5	0.5
I	-0.3	-0.3	-0.2	1.2	1.0	0.5	0.5	0.5	0.5
J	-0.1	-0.1	-0.1	0.5	0.5	0.5	0.5	0.5	0.5

From the incremental results given above, a new table of precipitation values can be derived from the 1-hour curve as the accumulated values in Table 11.9. Note that the A-isohyet percentages are those given in Table 11.4.

Table 11.9--PMP Profile Values (cumulative % of 1-hour, 1-mi² amount).									
	Duration (hours)								
Isohyet	1/4	1/2	3/4	1	2	3	4	5	6
A	50.0	74.0	90.0	100.0	110.0	112.0	114.0	114.5	115.0
B	32.0	53.0	67.0	74.8	83.5	85.5	87.5	88.0	88.5
C	22.5	38.5	50.0	56.0	63.0	65.0	66.0	66.5	67.0
D	17.0	28.5	38.0	43.0	48.0	49.5	50.5	51.0	51.5
E	12.0	21.0	28.0	32.2	37.0	38.0	38.5	39.0	39.5
F	7.5	14.0	19.0	22.4	25.0	25.7	26.2	26.7	27.2
G	5.0	8.5	12.0	14.0	16.2	16.7	17.2	17.7	18.2
H	2.0	3.5	5.0	6.5	8.3	8.8	9.3	9.8	10.3
I	0.4	0.7	1.0	1.2	2.2	2.7	3.2	3.7	4.2
J	0.2	0.3	0.4	0.5	1.0	1.5	2.0	2.5	3.0

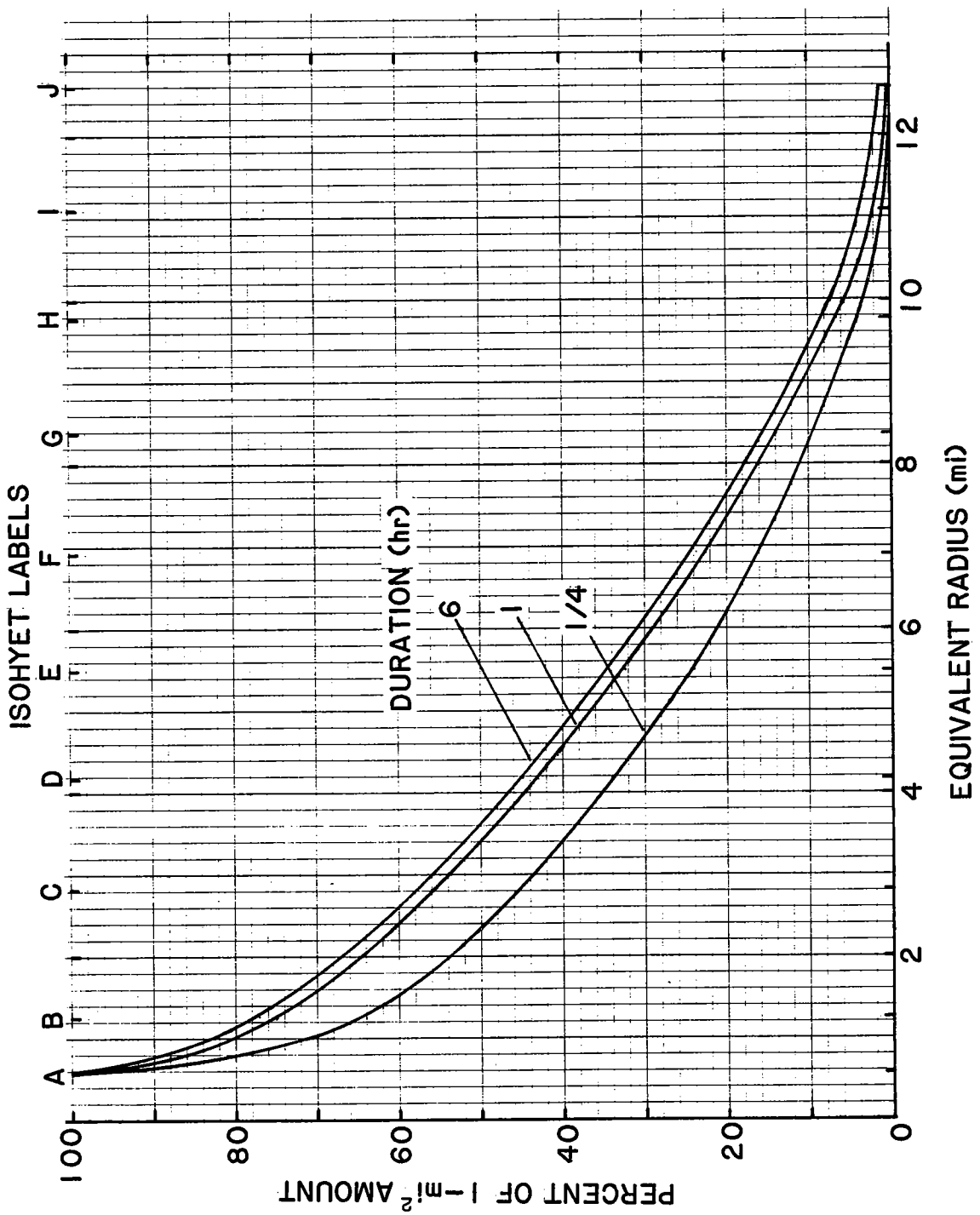

Figure 11.17.--Isohyet profile curves

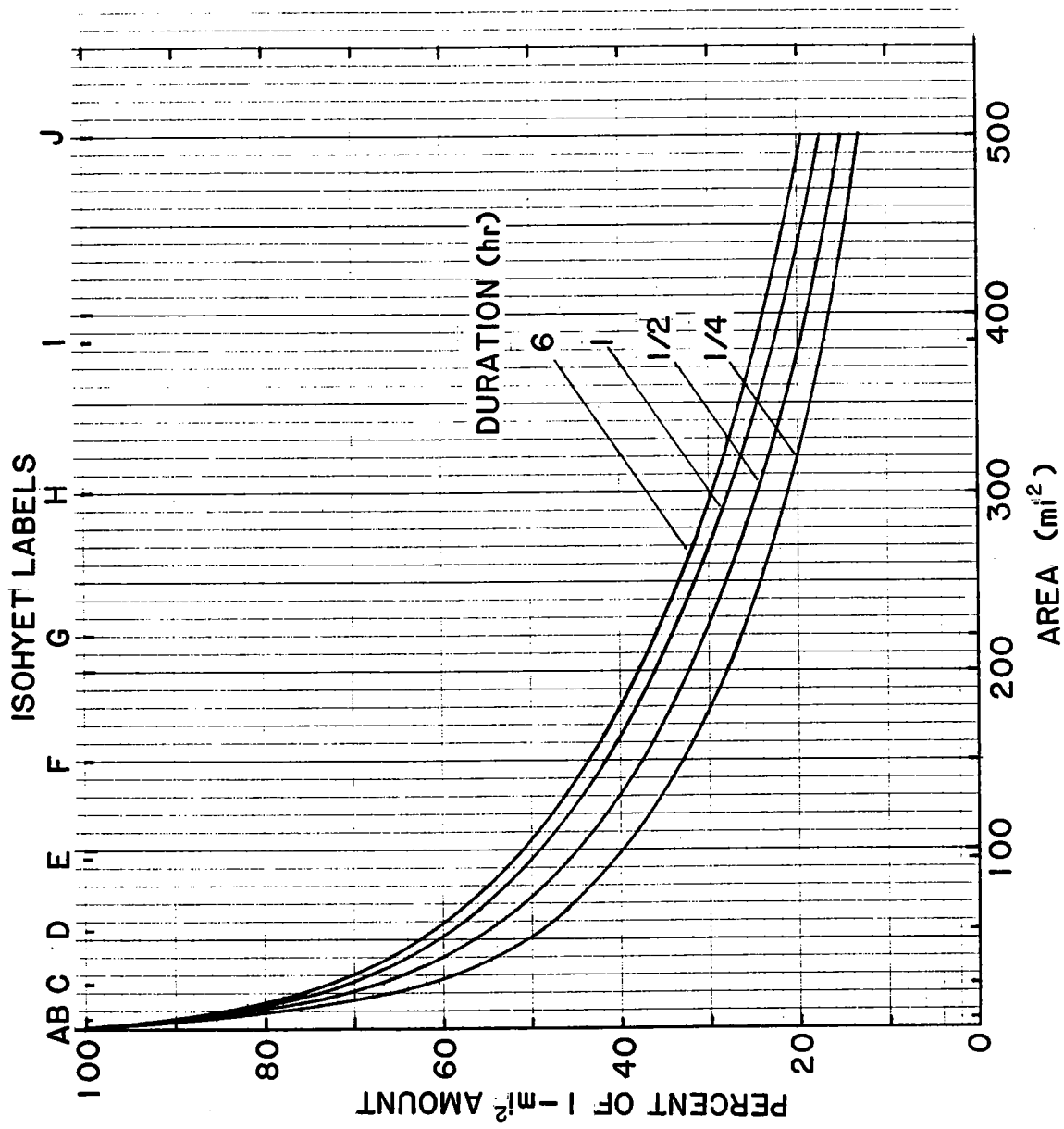

Figure 11.18.--Depth-area relations for HMR 57.

Table 11.10--Depth-Area curves (percent of 1-mi² amount).									
Duration (hours)									
Isohyet	1/4	1/2	3/4	1	2	3	4	5	6
A	100.0	100.0	100.0	100.0	100.0	100.0	100.0	100.0	100.0
B	85.6	88.6	89.8	89.9	90.4	90.6	90.7	90.7	90.8
C	60.3	66.6	69.1	70.3	71.3	71.8	72.0	72.1	72.2
D	48.7	54.6	57.5	59.0	60.0	60.4	60.6	60.8	60.9
E	40.4	45.7	48.7	50.0	51.0	51.3	51.5	51.7	51.9
F	32.7	37.6	40.4	41.6	42.6	42.9	43.0	43.3	43.5
G	26.3	30.5	33.0	34.2	35.0	35.2	35.4	35.7	36.0
H	21.2	24.5	26.7	27.8	28.6	28.9	29.1	29.4	29.7
I	17.0	19.7	21.6	22.5	23.4	23.6	23.8	24.2	24.5
J	13.2	15.3	16.8	17.5	18.3	18.6	18.9	19.2	19.6

From Table 11.9, the procedure can be worked through for each duration to obtain the corresponding depth-area curves as plotted in Figure 11.18. The results from this effort should be converted to percentages of 100 percent (percent of A-isohyet or 1-mi²) as shown. The results obtained from this process are summarized in the Table 11.10, and are the depth-area curves for this example.

11.9 One-Hour, 1-mi² Local Storm PMP Map

11.9.1 Introduction

An index map of 1-hour, 1-mi² local storm PMP for elevations up to and including 6,000 feet is provided in this study (Figure 11.19). The map was provided for this range of elevations because our research indicated that local storm PMP does not vary appreciably from sea level to this elevation. This approach is consistent with the procedure of previous PMP studies of the western United States (Hansen et al., 1977; Hansen et al., 1988) in which index maps of local storm PMP were provided through 5,000 feet.

11.9.2 Development of 1-hour, 1-mi² Local Storm PMP Map

The greatest moisture maximized 1-hour local storms from Table 11.1 were transposed according to the procedures described in Sections 11.5 and 11.6. For storms in which the most significant precipitation occurred within a period other than 1 hour, the observed precipitation amount was adjusted to an equivalent 1-hour amount using the depth-duration relationship shown in Figure 11.12 or

Table 11.4. The transposed amounts were subsequently merged as closely as possible with the 1-hour, 1-mi² 5,000-foot local storm PMP amounts for the region east of the Continental Divide (Hansen et al., 1988) and the Southwest (Hansen et al., 1977). Section 11.9.4 describes some of the variations among these studies and the reasons for them.

PMP in the central portion of the study area was controlled by the Morgan, Utah, storm of August 16, 1958, and the Girds Creek, Oregon, storm of July 13, 1956. PMP along the coastal areas was controlled by the Aberdeen 20 NNE, Washington, storm of May 28, 1982. PMP in the western Cascades and the Rockies was implicitly determined from these same storms with the Skykomish 1 ENE, Washington, (May 25, 1945) storm supporting the PMP values in the Cascades, and the Opal, Wyoming, (August 16, 1990) storm supporting the PMP values in the Rockies.

11.9.3 Analysis of Local Storm PMP Map

The highest values of local storm PMP are found over the extreme southeastern portions of the region in the Snake River basin, where a maximum near 10 inches reaches nearly to the Idaho border. It is assumed that the high moisture needed to support a local PMP-type event enters this area during southwest monsoon conditions from the Gulf of California and subtropical southeastern Pacific waters, or secondarily from the Gulf of Mexico (Hansen, 1975).

A broad maximum of 8.0 to 9.0 inches in local storm PMP is evident through the Snake River basin along the western Idaho border with a concomitant dip found over the Rockies. This occurs, despite the fact that persisting dew points are as high and thunderstorm activity is generally more common in the Rockies than in the plateau region. The causes of this may be attributable to two major reasons. First, there are lower daytime temperatures in the summer, July highs at elevations below 4,000 feet average from the low to mid 80's in the Rockies, whereas they range from the mid 80's to low 90's throughout the plateau. The lower surface temperatures engender a more stable atmosphere, which is less conducive to the development of strong convection. Second, the rough terrain of the mountains acts as a barrier for the supply of low-level moisture needed in a PMP-type storm. Although there may be some enhancement of convection due to forced lifting of the air by the mountainous terrain, it does not appear that this is enough to offset moisture limitations at higher elevations. It is recognized that the Rockies are the most data sparse area in the study region and that very heavy local rains may have been altogether missed. Future studies using paleo-flood analysis may be helpful here.

Local storm PMP values decrease generally to the north and west across the region, falling to near 6.0 inches in the Cascades east of Seattle. This is in response to both decreased moisture and the diminished intensity of solar radiation. Monsoonal and subtropical Pacific moisture has difficulty in penetrating the numerous obstacles to northward penetration as reflected in the maximum persisting dew-point maps.

The minimum in local storm PMP, about 3.0 inches, occurs along the outer tip of the Olympic Peninsula in Washington. This value increases to a little over 5.0 inches southward along the coast, at the Oregon-California border. These relatively low values are due to the stabilizing effect of the cool, moist layer of surface air that results from interaction with the cool Pacific ocean waters along the coast. Conversely, the warm, unstable air masses that produce heavy local thunderstorms over the plateau region are obstructed from westward movement by the Cascade range. Heavy local storms in the coastal areas also seem to occur under considerably different meteorological conditions than those in the interior.

11.9.4 Comparison with Other Studies

HMR 43 calculated summer thunderstorm PMP for areas of the Columbia River basin east of the Cascades. The procedures used in that study vary significantly from those utilized in the current study and are discussed at various points throughout this publication. A brief review of the salient differences in procedures and results will serve to emphasize the types of changes involved.

Figure 11.20 shows a difference map between HMR 57 and HMR 43 for 1-hour, 1-mi² PMP in inches east of the Cascades. The majority of the region falls within a one-half inch departure between the two studies. Slightly larger differences however, appear in the study area from about central Washington to the Canadian border. The new study results in PMP from 1 to 1.5 inches lower (negative values).

Comparisons were also made with adjoining studies, including HMR 49 and HMR 55A. Some of the different assumptions regarding elevation and durational characteristics have already been discussed.

Relative to HMR 49, the differences in 1-hour, 1-mi² PMP are near zero in extreme northern Utah, becoming more positive (i.e., the new values are higher) moving westward to a maximum of about +1.5 inches along the California-Oregon border area. The primary reason for this discrepancy may come from transposing the Morgan, Utah, storm throughout the southern portions of the Northwest. HMR 49 and the present study support a preferred seasonality of storms and do not attempt to apply seasonal curves or nomograms.

No significant PMP differences exist in local storm PMP between the current study and HMR 55A. No major new storms were found within this general area which would cause any increase in PMP to be made, and no evidence was revealed which might indicate a lowered estimate. Seasonality for HMR 55A showed a distinct summer maxima in extreme local storms, a finding in agreement with this study as well.

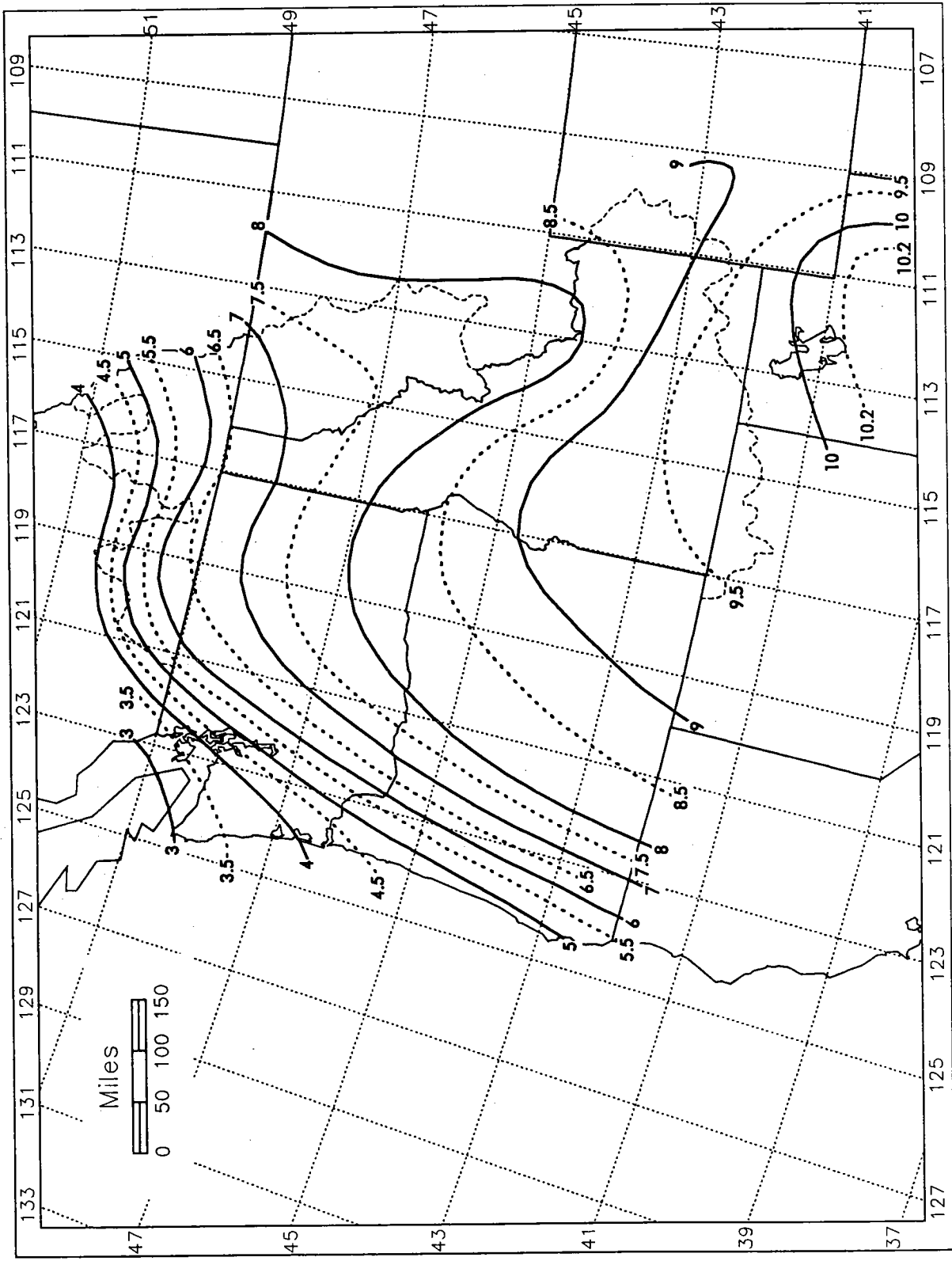

Figure 11.19.--1-hour, 1-mi² local storm PMP in inches for elevations to 6000 feet.

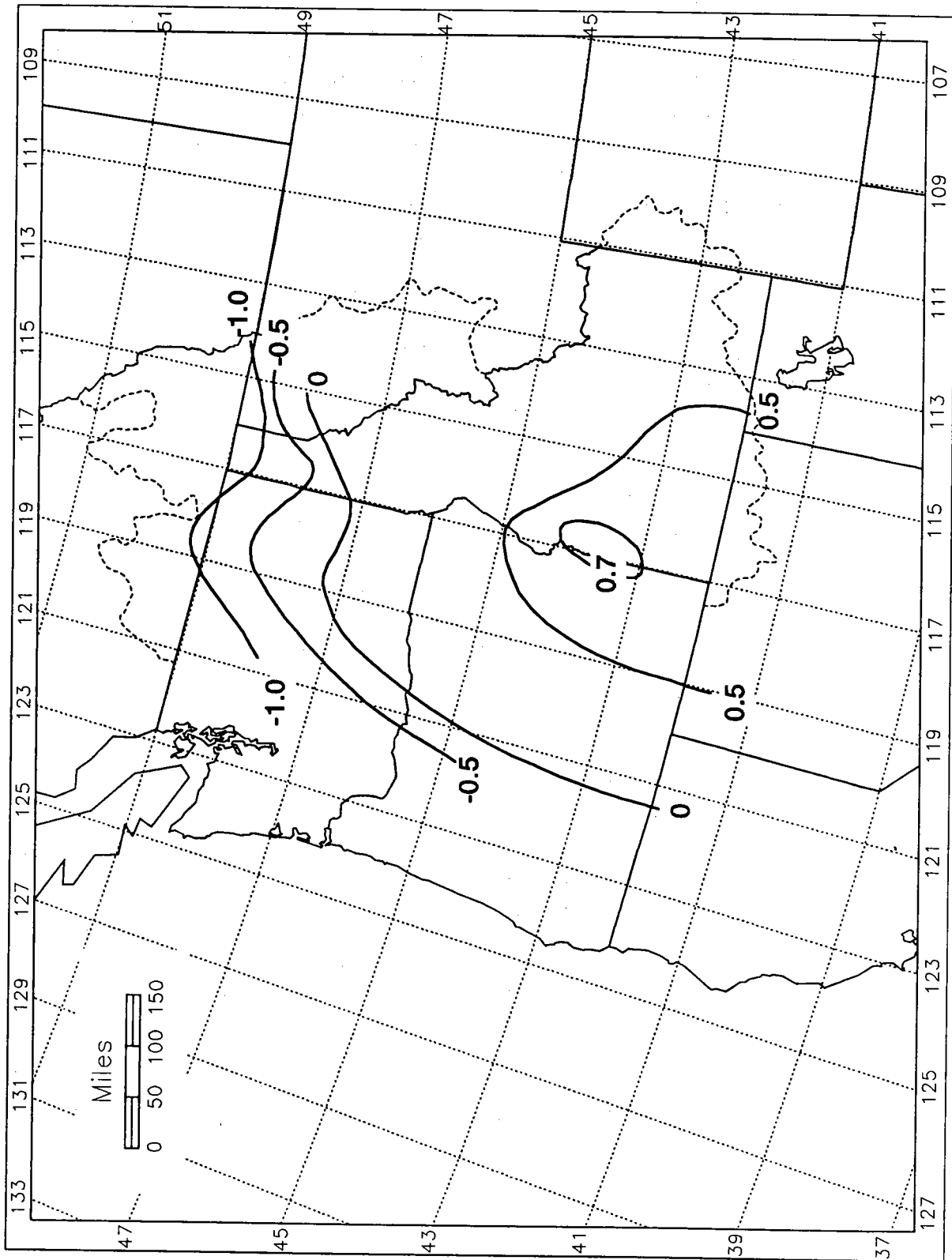

Figure 11.20.--Map of differences between 1-hour, 1-mi² PMP amounts from HMR 57 and HMR 43.

12. INDIVIDUAL DRAINAGE PMP COMPARISONS

Early in the development of criteria to redefine PMP for the northwest United States, it was recognized by the various participants and potential users of this information that comparisons between individual drainage PMP estimates, previously defined in HMR 43 and those derived from the present study, would be extremely useful. Significant differences noted would serve as a critical test bed for justification of the new data and methodologies employed. Additionally, where significant differences existed, such locations were noted as those having a major impact on both existing as well as immediately planned water control projects in the surrounding region.

Of the participating federal agencies, both COE and Reclamation were in the best position to select individual drainages for evaluation. A total of 47 individual drainages were assembled (32 Reclamation and 15 COE). Figure 12.1 portrays the general location of the selected drainages. Circled numbers represent COE basins, and dots represent Reclamation basins. The actual location of the dam site may be somewhat removed from the basin centroids shown in Figure 12.1. The selection of representative drainages was not only decided upon by immediate planning needs of the various agencies, but was based on providing a diverse array of test locations over the entire region. Judicious selection enhanced the evaluation of the level of PMP due to variations in terrain features such as elevation, exposure and drainage area size.

PMP (HMR 43 and as revised in this study) was calculated for both general and local storms (where applicable) for each of the 47 drainages. In order to reasonably control the number of possible computations, certain limits were applied to the evaluation. General storm PMP was computed only for the months of June and December and for durations of 1, 6, 24, 48, and 72 hours. In accordance with criteria from HMR 43, general storm 1-hour PMP was not evaluated for drainages greater than 200-mi² in area size. Local storm PMP was evaluated for the month of greatest potential (HMR 43), or as in the present study, only an all-season¹ local storm PMP value was determined. In accord with criteria stated in HMR 43, local storm PMP was not provided for drainages located west of the Cascade Mountain Divide. For both PMP studies (HMR 43 and present), local storm PMP was limited to those drainages comprising a total basin area of approximately 500-mi² or less. Additionally, only the 1- and 6-hour local storm PMP were evaluated.

Within the criteria described above, Table 12.1 provides a comparison of PMP for selected drainages as determined from procedures followed in this report and those from HMR 43, respectively. For the general storm comparison, months of June and December and durations of 1, 6, 24, 48, 72 hours, the change in PMP

¹All-season - Greatest PMP that could happen sometime during the year.

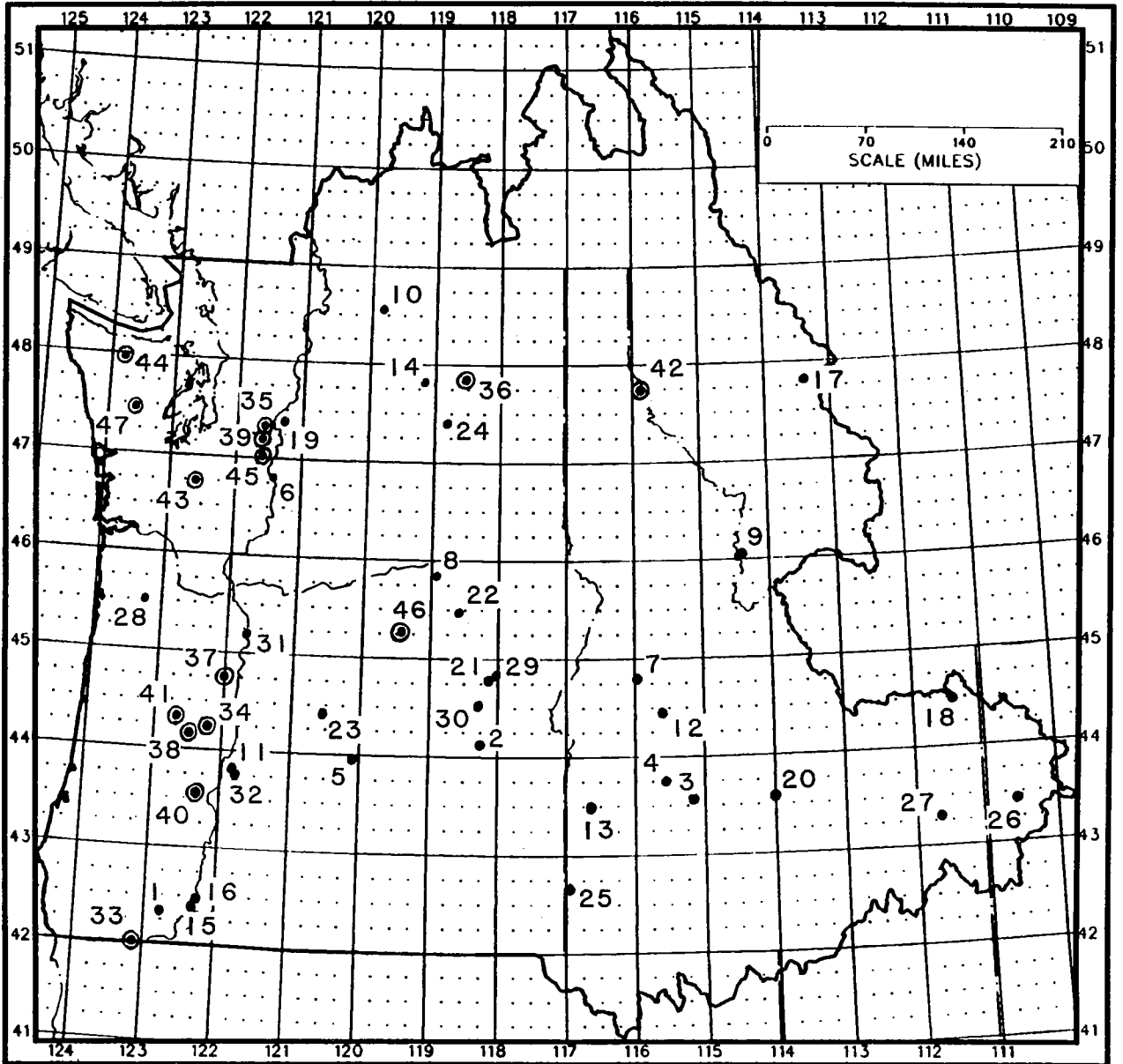

Figure 12.1.--Test basin location map. Index numbers refer to basins listed in Table 12.1. Dots are centroids of Reclamation basins and circled dots are centroids of COE basins.

ranges from a plus 98 percent (revised PMP greater than HMR 43) to a minus 63 percent (revised PMP less than HMR 43). The mean change for all 47 basins examined was minus 8 percent, indicating a moderate overall reduction in general storm PMP from that computed using HMR 43. Table 12.2 provides an overall comparison (for June and December and for 1-72 hours) of the percentage changes in general storm PMP between values computed for this study versus those values determined from HMR 43.

Similarly, changes in local storm PMP (results also shown in Table 12.1) resulted in a range of plus 12 to minus 28 percent for the 1-hour duration. The mean change in 1-hour PMP resulted in a slight reduction, minus 3 percent of local storm PMP over the study region. For 6 hours, the range varied between a minus 24 to a minus 53 percent. At 6 hours, the mean change in PMP was significantly reduced, to a minus 40 percent.

In addition to the determination of PMP from both the present and previous studies, initial estimates of PMP were converted into flood hydrographs from which peak and volume flood flows were determined. These results were not relevant to the present study, but may be obtained from Reclamation.

Table 12.1.--PMP Test Basin Comparison Summary

ID	BASIN NAME	STATE	AREA (SQ. MI)	ELEV (FT)	HMR RPT.	MONTH	STORM TYPE	CUMULATIVE PRECIPITATION (INCHES) FOR SELECTED OF DURATION (HOURS)						
								1	6	24	48	72		
BUREAU OF RECLAMATION DAMS														
1	AGATE LAKE	OR	14	2210	57	DEC	GENERAL	1.11	4.46	11.20	16.69	19.82		
							GENERAL	0.67	2.68	6.72	10.01	11.89		
							LOCAL	5.66	6.76					
					43	DEC	GENERAL	1.73	4.64	11.12	15.65	18.47		
							GENERAL	1.63	4.17	8.32	11.09	12.78		
							LOCAL							
2	AGENCY VALLEY	OR	444	5200	57	DEC	GENERAL	1.15	4.00	7.98	10.64	11.99		
							GENERAL	1.30	4.55	9.07	12.10	13.62		
							LOCAL	1.79	2.24					
					43	DEC	GENERAL	3.24	3.24	7.31	10.07	11.52		
							GENERAL	3.35	3.35	6.65	8.77	9.92		
							LOCAL	1.85	4.18					
3	ANDERSON RANCH	ID	980	7103	57	DEC	GENERAL	1.41	4.92	9.98	13.24	15.23		
							GENERAL	1.28	3.74	7.58	10.06	11.58		
							LOCAL							
					43	DEC	GENERAL	3.39	3.39	9.14	13.57	15.76		
							GENERAL	4.15	4.15	10.41	15.23	17.60		
							LOCAL							
4	ARROWROCK	ID	1230	6933	57	DEC	GENERAL	1.34	4.76	9.68	13.03	14.81		
							GENERAL	1.02	3.62	7.36	9.90	11.26		
							LOCAL							
					43	DEC	GENERAL	3.28	3.28	8.76	12.92	14.99		
							GENERAL	3.84	3.84	9.42	13.60	16.70		
							LOCAL							
5	BOWMAN	OR	2635	4000	57	DEC	GENERAL	0.65	2.59	5.04	6.93	7.84		
							GENERAL	0.67	2.67	5.19	7.14	8.00		
							LOCAL							
					43	DEC	GENERAL	2.67	2.67	6.93	9.95	11.54		
							GENERAL	2.40	2.40	5.70	7.95	9.16		
							LOCAL							
6	BUMPING LAKE	WA	70	5467	57	DEC	GENERAL	3.25	10.86	21.22	29.86	33.23		
							GENERAL	1.76	5.86	11.45	16.12	17.94		
							LOCAL	3.80	4.53					
					43	DEC	GENERAL	1.64	5.53	15.63	23.47	27.47		
							GENERAL	1.80	5.56	13.23	19.03	21.93		
							LOCAL	4.29	7.91					
7	CASCADE	ID	620	5950	57	DEC	GENERAL	1.45	5.03	10.04	13.48	15.11		
							GENERAL	1.23	4.27	8.54	11.46	12.84		
							LOCAL							
					43	DEC	GENERAL	3.59	3.59	9.27	13.56	15.69		
							GENERAL	4.28	4.28	10.12	14.45	16.63		
							LOCAL							
8	COLD SPRINGS	OR	190	1320	57	DEC	GENERAL	0.91	3.03	5.26	6.47	7.06		
							GENERAL	1.21	4.04	7.01	8.62	9.40		
							LOCAL	3.07	3.72					
					43	DEC	GENERAL	1.30	3.62	7.47	9.85	11.13		
							GENERAL	1.52	3.90	7.09	8.89	9.93		
							LOCAL	2.96	6.08					

Table 12.1.--PMP Test Basin Comparison Summary (continued)

ID	BASIN NAME	STATE	AREA (SQ. MI)	ELEV (FT)	HMR RPT.	MONTH	STORM TYPE	CUMULATIVE PRECIPITATION (INCHES) FOR SELECTED DURATION (HOURS)					
								1	6	24	48	72	
9	COMO	MT	55	6900	57	DEC	GENERAL	1.38	4.64	8.96	11.80	13.13	
						JUN	GENERAL	1.92	6.44	12.45	16.39	18.24	
						DEC	LOCAL	4.19	4.99	7.29	10.20	11.67	
						JUN	GENERAL	1.11	3.23	9.55	12.61	14.20	
10	CONCONULLY	WA	121	4489	57	AUG	LOCAL	4.50	8.17				
						DEC	GENERAL	1.26	4.29	8.33	11.79	13.06	
						JUN	GENERAL	1.13	3.86	7.50	10.61	11.74	
						DEC	LOCAL	3.05	3.63	10.53	15.34	17.89	
11	CRANE PRAIRIE	OR	183	5000	57	JUN	GENERAL	1.49	4.34	9.68	13.43	15.35	
						AUG	LOCAL	3.34	6.72	10.86	15.46	17.21	
						DEC	GENERAL	1.64	5.52	7.28	10.36	11.54	
						JUN	LOCAL	1.10	3.70	11.17	16.25	18.83	
12	DEADWOOD	ID	111	6770	57	DEC	GENERAL	1.24	3.65	8.23	11.45	13.12	
						JUN	GENERAL	1.35	4.38	11.17	16.25	18.83	
						DEC	LOCAL	3.02	2.63	12.39	16.32	18.15	
						JUN	LOCAL	1.46	5.00	9.66	12.73	14.17	
13	DEERFLAT	ID	92	2675	43	DEC	GENERAL	1.27	4.04	9.79	14.09	16.24	
						JUN	GENERAL	1.68	4.98	10.89	15.22	17.39	
						DEC	LOCAL	3.59	6.84	6.32	7.75	8.45	
						JUN	LOCAL	1.16	3.66	6.47	7.94	8.65	
14	DRY FALLS	WA	278	2325	57	DEC	GENERAL	0.82	2.61	4.91	6.08	6.67	
						JUN	GENERAL	0.98	3.38	5.92	7.33	8.04	
						DEC	LOCAL	2.18	2.66	6.86	9.25	10.58	
						JUN	LOCAL	1.55	3.95	6.88	8.86	9.88	
15	FISH LAKE	OR	19	6860	57	AUG	LOCAL	2.26	4.93	13.53	20.16	23.95	
						DEC	GENERAL	1.33	5.39	8.53	12.71	15.09	
						JUN	GENERAL	0.84	3.40	19.76	29.65	35.64	
						DEC	LOCAL	5.31	6.49	13.94	20.27	24.16	
16	FOURMILE LAKE	OR	11	6000	57	JUN	GENERAL	1.94	5.82	14.60	20.44	22.63	
						DEC	GENERAL	2.34	7.59	9.20	12.88	14.26	
						JUN	LOCAL	1.47	4.78	23.78	36.10	42.13	
						DEC	LOCAL	6.52	7.64	16.60	24.51	28.40	
					43	JUN	GENERAL	2.15	6.51	10.08			
						DEC	GENERAL	2.15	6.51				
						JUN	LOCAL	6.24	10.08				
						AUG	LOCAL	6.24	10.08				

Table 12.1.--PMP Test Basin Comparison Summary (continued)

ID	BASIN NAME	STATE	AREA (SQ. MI)	ELEV (FT)	HMR RPT.	MONTH	STORM TYPE	CUMULATIVE PRECIPITATION (INCHES) FOR SELECTED OF DURATION (HOURS)						
								1	6	24	48	72		
17	HUNGRY HORSE	MT	1654	6303	57	DEC	GENERAL	1.01	3.57	7.07	9.45	10.68		
						JUN	GENERAL	1.53	5.40	10.71	14.31	16.18		
							LOCAL							
18	ISLAND PARK	ID	522	8250	43	DEC	GENERAL	2.55	6.83	10.05	11.67			
						JUN	GENERAL	3.99	9.15	12.76	14.64			
						JUN	LOCAL							
						DEC	GENERAL	1.33	4.51	8.78	11.44	12.72		
						JUN	GENERAL	1.80	6.09	11.86	15.44	17.16		
							LOCAL	1.12	1.44					
19	KACHESS	WA	64	3560	57	DEC	GENERAL	2.91	9.70	18.84	26.52	29.52		
						JUN	GENERAL	1.45	4.85	9.43	13.27	14.76		
							LOCAL	3.71	4.43					
						DEC	GENERAL	1.78	5.88	16.54	24.74	28.96		
						JUN	GENERAL	1.92	5.81	14.06	20.22	23.28		
						AUG	LOCAL	4.31	7.88					
20	LITTLE WOOD RIVER	ID	275	6740	57	DEC	GENERAL	1.69	5.78	11.37	15.24	17.06		
						JUN	GENERAL	1.49	5.08	10.01	13.41	15.01		
							LOCAL	2.50	3.03					
						DEC	GENERAL	4.20	11.06	16.40	19.02	20.70		
						JUN	GENERAL	5.24	12.48	17.98				
						AUG	LOCAL	2.49	5.28					
21	MASON	OR	165	5233	57	DEC	GENERAL	1.37	4.66	9.22	12.14	13.52		
						JUN	GENERAL	1.60	5.42	10.72	14.12	15.72		
							LOCAL	3.51	4.20					
						DEC	GENERAL	1.50	4.83	11.78	16.96	19.58		
						JUN	GENERAL	1.89	5.90	13.91	19.99	23.01		
						AUG	LOCAL	3.24	6.60					
22	McKAY	OR	186	3006	57	DEC	GENERAL	1.22	4.10	8.16	11.49	12.79		
						JUN	GENERAL	1.55	5.26	10.47	14.73	16.40		
							LOCAL	3.19	3.83					
						DEC	GENERAL	1.35	3.97	8.62	11.75	13.41		
						JUN	GENERAL	1.57	4.25	8.11	10.56	11.88		
						AUG	LOCAL	2.96	6.20					
23	OCHOCO	OR	295	4925	57	DEC	GENERAL	1.09	3.73	7.39	10.40	11.58		
						JUN	GENERAL	1.12	3.84	7.61	10.72	11.94		
							LOCAL	2.31	2.85					
						DEC	GENERAL	4.14	10.30	14.85	17.16			
						JUN	GENERAL	3.79	8.64	12.13	13.92			
						AUG	LOCAL	2.24	5.03					
24	O'SULLIVAN	WA	3920	1752	57	DEC	GENERAL	0.35	1.53	2.91	3.77	4.24		
						JUN	GENERAL	0.47	2.04	3.88	5.03	5.65		
							LOCAL							
						DEC	GENERAL	2.24	5.79	8.13	9.45			
						JUN	GENERAL	2.39	5.39	7.23	8.28			
						JUN	LOCAL							

Table 12.1.--PMP Test Basin Comparison Summary (continued)

ID	BASIN NAME	STATE	AREA (SQ. MI)	ELEV (FT)	HMR RPT.	MONTH	STORM TYPE	CUMULATIVE PRECIPITATION (INCHES) FOR SELECTED DURATION (HOURS)						
								1	6	24	48	72		
25	OWYHEE	OR	10900	5000	57	DEC	GENERAL	0.41	1.69	3.70	5.21	6.15		
						JUN	GENERAL LOCAL	0.36	1.51	3.29	4.64	5.47		
26	PALISADES	ID	5150	8000	57	DEC	GENERAL	0.63	2.31	4.81	6.55	7.59		
						JUN	GENERAL LOCAL	0.68	2.54	5.29	7.20	8.34		
						DEC	GENERAL	1.83	5.22	7.79	9.08			
						JUN	GENERAL LOCAL	2.42	6.11	8.76	10.12			
27	RIRIE	ID	797	6300	57	DEC	GENERAL	0.81	2.83	5.73	7.65	8.72		
						JUN	GENERAL LOCAL	0.87	3.03	6.15	8.20	9.37		
						DEC	GENERAL	2.48	6.18	8.88	10.24			
						JUN	GENERAL LOCAL	3.53	7.58	10.35	11.79			
28	SCOGGINS	OR	39	1950	57	DEC	GENERAL	1.99	7.61	18.68	26.18	30.52		
						JUN	GENERAL LOCAL	1.32	5.02	12.33	17.29	20.15		
						DEC	GENERAL	3.47	4.10					
						JUN	GENERAL LOCAL	1.59	4.32	11.13	15.80	18.65		
29	THEIF VALLEY	OR	910	6066	57	DEC	GENERAL	0.98	3.56	7.25	9.72	10.95		
						JUN	GENERAL LOCAL	1.14	4.14	8.43	11.30	12.72		
						DEC	GENERAL	3.57	9.82	12.61	14.56			
						JUN	GENERAL LOCAL	4.00	9.11	12.74	14.62			
30	UNITY	OR	309	4820	57	DEC	GENERAL	1.18	4.08	8.07	10.64	11.84		
						JUN	GENERAL LOCAL	1.37	4.69	9.28	12.23	13.61		
						DEC	GENERAL	2.39	2.95					
						JUN	GENERAL LOCAL	3.81	3.99	8.81	12.34	14.17		
31	WASCO	OR	9	3750	57	AUG	LOCAL	2.24	5.04	8.13	10.90	12.36		
						DEC	GENERAL	3.07	9.97	19.17	26.84	29.71		
						JUN	GENERAL LOCAL	1.99	6.48	12.46	17.44	19.31		
						DEC	GENERAL	6.23	7.27					
32	WICKIUP	OR	97	4800	57	DEC	GENERAL	2.24	6.41	15.87	23.14	26.71		
						JUN	GENERAL LOCAL	5.48	10.27	15.87	23.14	26.71		
						DEC	GENERAL	1.58	5.38	10.44	14.69	16.36		
						JUN	GENERAL LOCAL	1.10	3.77	7.31	10.29	11.46		
					43	DEC	GENERAL	3.98	4.76	10.34	14.80	17.08		
						JUN	GENERAL LOCAL	1.38	4.23	8.53	11.84	13.56		
						DEC	GENERAL	1.34	3.84					
						AUG	GENERAL LOCAL	3.94	7.42					

Table 12.1.--PMP Test Basin Comparison Summary (continued)

ID	BASIN NAME	STATE	AREA (SQ. MI)	ELEV (FT)	HMR RPT.	MONTH	STORM TYPE	CUMULATIVE PRECIPITATION (INCHES) FOR SELECTED DURATION (HOURS)					
								1	6	24	48	72	
CORPS OF ENGINEERS DAMS													
33	APPLEGATE	OR	223	4210	57	DEC	GENERAL	1.39	5.76	14.92	22.48	27.00	
						JUN	GENERAL	0.93	3.86	9.99	15.06	18.09	
							LOCAL	2.28	2.80				
34	BLUE RIVER	OR	88	3050	57	DEC	GENERAL	1.86	7.69	19.43	29.26	34.94	
						JUN	GENERAL	0.84	3.46	8.73	13.15	15.70	
							LOCAL	3.72	4.49				
						DEC	GENERAL	2.11	7.32	20.73	31.35	37.87	
35	CEDAR RIVER	WA	81	3230	57	JUN	GENERAL	1.90	5.96	14.71	21.49	25.59	
							LOCAL						
						DEC	GENERAL	1.83	7.58	19.15	28.69	34.25	
36	CRAB CREEK	WA	1765	2150	57	JUN	GENERAL	1.06	4.40	11.11	16.63	19.86	
							LOCAL	3.37	4.01				
						DEC	GENERAL	2.18	7.85	23.56	36.17	43.84	
37	DETROIT DAM	OR	438	3718	57	JUN	GENERAL	2.13	6.71	16.94	24.93	29.75	
							LOCAL						
						DEC	GENERAL	0.52	2.08	3.79	4.73	5.27	
38	GATE CREEK	OR	46	2230	57	JUN	GENERAL	0.66	2.63	4.80	5.99	6.68	
							LOCAL						
						DEC	GENERAL	2.77	6.67	9.25	10.66		
39	GREEN RIVER	WA	221	3100	57	JUN	GENERAL	3.05	6.81	6.84	10.09		
							LOCAL						
						DEC	GENERAL	1.57	6.59	17.09	26.08	31.34	
						JUN	GENERAL	0.86	3.63	9.40	14.34	17.23	
40	HILLS CREEK DAM	OR	389	3920	57		LOCAL	1.47	1.86				
						DEC	GENERAL	1.72	6.38	19.10	29.24	34.34	
						JUN	GENERAL	4.98	4.98	13.30	19.74	22.91	
							LOCAL	3.81					
38	GATE CREEK	OR	46	2230	57	DEC	GENERAL	1.69	6.91	17.46	26.02	30.90	
						JUN	GENERAL	0.77	3.15	7.95	11.85	14.07	
							LOCAL	4.28	5.11				
39	GREEN RIVER	WA	221	3100	57	DEC	GENERAL	2.36	8.17	23.36	35.60	43.08	
						JUN	GENERAL	2.10	6.58	16.53	24.34	29.06	
							LOCAL						
						DEC	GENERAL	1.57	6.49	16.79	25.30	30.39	
40	HILLS CREEK DAM	OR	389	3920	57	JUN	GENERAL	0.85	3.51	9.07	13.66	16.42	
							LOCAL	2.22	2.69				
						DEC	GENERAL	6.31	18.87	28.85	34.95	39.95	
40	HILLS CREEK DAM	OR	389	3920	57	JUN	GENERAL	5.38	18.87	28.85	34.95	39.95	
							LOCAL						
						DEC	GENERAL	1.30	5.52	14.30	21.55	25.90	
40	HILLS CREEK DAM	OR	389	3920	57	JUN	GENERAL	0.65	2.78	7.16	10.78	12.95	
							LOCAL	1.64	2.06				
						DEC	GENERAL	6.07	17.98	27.42	32.17	37.17	
40	HILLS CREEK DAM	OR	389	3920	57	JUN	GENERAL	4.72	12.46	18.46	21.42	25.90	
							LOCAL	1.92	4.14				
						DEC	GENERAL	1.92	4.14	12.46	18.46	21.42	

Table 12.1.--PMP Test Basin Comparison Summary (continued)

ID	BASIN NAME	STATE	AREA (SQ. MI)	ELEV (FT)	HMR RPT.	MONTH	STORM TYPE	CUMULATIVE PRECIPITATION (INCHES) FOR SELECTED OF DURATION (HOURS)						
								1	6	24	48	72		
41	HOLLEY RESERVOIR	OR	105	2040	57	DEC	GENERAL	1.64	6.76	17.28	26.02	31.07		
						JUN	GENERAL	0.77	3.18	8.12	12.23	14.60		
							LOCAL	3.25	3.86					
43					43	DEC	GENERAL	1.86	6.07	16.76	24.98	30.03		
						JUN	GENERAL	1.74	5.14	12.04	17.14	20.21		
						JUN	LOCAL							
42	PLACER CREEK	ID	15	4380	57	DEC	GENERAL	1.83	6.02	11.64	15.33	16.97		
						JUN	GENERAL	1.58	5.18	10.01	13.18	14.59		
							LOCAL	5.76	6.84					
43					43	DEC	GENERAL	1.72	4.40	9.35	12.71	14.45		
						JUN	GENERAL	2.68	6.71	12.19	15.67	17.51		
						JUN	LOCAL	6.00	9.98					
43	SKOOKUMCHUCK	WA	62	1700	57	DEC	GENERAL	1.44	5.92	14.97	22.53	26.76		
						JUN	GENERAL	0.87	3.61	9.13	13.74	16.33		
							LOCAL	3.08	3.66					
43					43	DEC	GENERAL	1.77	5.43	15.08	22.23	26.60		
						JUN	GENERAL	1.78	4.92	10.97	15.27	17.85		
						JUN	LOCAL	4.28	7.81					
44	SOLEDUCK	WA	84	2900	57	DEC	GENERAL	2.08	8.60	21.73	32.73	39.28		
						JUN	GENERAL	1.22	5.08	12.82	19.30	23.17		
							LOCAL	1.83	2.20					
43					43	DEC	GENERAL	1.98	7.33	22.63	35.00	42.55		
						JUN	GENERAL	1.67	5.61	15.04	22.67	27.30		
						JUN	LOCAL							
45	WHITE RIVER	WA	402	3750	57	DEC	GENERAL	1.39	5.85	15.15	22.83	27.44		
						JUN	GENERAL	0.78	3.27	8.48	12.79	15.36		
							LOCAL	1.40	1.76					
43					43	DEC	GENERAL	6.11	18.64	28.81	35.02	35.02		
						JUN	GENERAL	5.00	13.23	19.70	23.61			
						JUN	LOCAL							
46	WILLOW CREEK	OR	96	3500	57	DEC	GENERAL	1.05	3.52	6.92	9.79	10.95		
						JUN	GENERAL	1.40	4.69	9.22	13.04	14.60		
							LOCAL	4.18	4.99					
43					43	DEC	GENERAL	1.47	4.11	8.75	11.81	13.40		
						JUN	GENERAL	1.61	4.24	7.99	10.30	11.57		
						AUG	LOCAL	3.79	7.41					
47	WYNOOCHEE RIVER	WA	40	2000	57	DEC	GENERAL	3.33	13.48	34.04	50.71	60.25		
						JUN	GENERAL	1.97	7.95	20.08	29.91	36.54		
							LOCAL	2.47	2.92					
43					43	DEC	GENERAL	2.72	9.72	29.39	45.25	54.90		
						JUN	GENERAL	2.35	7.61	19.90	29.77	35.75		
						JUN	LOCAL							

Table 12.2.--Percent Change in Individual Drainage PMP (Present Study vs. HMR 43)

Percent Change* in Individual Drainage PMP (Present Study vs HMR 43)						
Month	1	6	24	48	72	
June						
	Range	-63 to 4	-52 to 44	-52 to 48	-51 to 58	-52 to 61
	Mean	-28	-7	-13	-13	-14
December						
	Range	-42 to 98	-32 to 96	-50 to 68	-54 to 66	-55 to 63
	Mean	4	16	-5	-9	-11

* Negative percentages indicate that PMP computed from the present study is less than that obtained from HMR 43.

13. COMPARISON STUDY

The comparisons used to assess the level of PMP estimates derived in this study emulate similar evaluations made for previous studies. These comparisons provide a means for determining the range of acceptability of the final results. As in other studies, comparisons most often made are between the PMP estimates and 1) 100-year precipitation frequency amounts, 2) previous studies, 3) observed storm maxima, and 4) those for neighboring regions. Such comparisons for the Northwest are discussed in this chapter.

13.1 Comparison to NOAA Atlas 2

General storm PMP for 1, 6, and 24 hours were compared to 100-year precipitation frequency analyses from NOAA Atlas 2 for the same durations. At 72 hours, comparisons were made using a technique developed by Styner (1975). Table 13.1 presents a summary of some of the findings from this comparison and is separated west and east of 117°W longitude (this separation was made for ease in use of the oversize PMP index maps).

Table 13.1 contains two sets of comparison data: (a) the range of ratios of PMP/100-year rainfall over U. S. portions of the eastern and western PMP index maps for four durations (1, 6, 24, and 72-hours); and (b) similar ratios for ten selected locations. PMP, by definition, is larger than 100-year amounts for comparable storm types and therefore the ratios should be larger than one with few exceptions. However, the comparison is less clear when it is realized that the 100-year precipitation data comes from a composite of storm types. It is also likely that the short-duration (1-3 hours) 100-year data represents short-duration convective events, while the 24- and 72-hour data may be from general-type storms. Since storm type is not known for the NOAA Atlas 2 data, these comparisons can be misleading if improperly applied. Nevertheless, this study has accepted the 100-year data as the best precipitation frequency information available and used it extensively throughout as a basis for PMP development.

As for maximum ratios, the values of 3.2 to 7.5 shown in Table 13.1 are also found in similar comparisons from other PMP studies (Hansen et al. 1977; Hansen et al. 1988; Riedel and Schreiner, 1980). It is generally found that ratios increase with distance from the moisture source, and as the durations increase. It has also been observed that these ratios tend to increase in those regions where the frequency of large rains decreases; i.e., where the potential for PMP exists, but where, historically, rains have not been large (Riedel and Schreiner, 1980).

With this insight in mind, the results in Table 13.1 a and b were reviewed. The 1-hour PMP/100-year ratio maps (both east and west) show only one region in which the ratios are less than one, and that it is at the northeastern tip of the Olympic Peninsula. However, if the 1-hour local storm PMP are compared to 1-hour, 100-year values in these regions, ratios of 3.0 or better are obtained everywhere (see also Table 13.2).

Table 13.1.--Comparison between HMR 57 general storm PMP estimates and 100-year precipitation frequency data from NOAA Atlas 2 for subregional analysis and selected individual locations (10-mi²).

West of 117°W					East of 117°W								
<u>Range of PMP/100-year Ratios</u>													
a.		Duration (hours)				Duration (hours)		Duration (hours)					
		1	6	24	72			1	6	24	72		
Minimum		0.9	1.8	2.2	2.2	Minimum		1.2	2.2	2.6	2.5		
Maximum		3.2	3.9	4.8	5.0	Maximum		3.3	6.5	5.5	7.5		
b.		Duration (hours)				Duration (hours)		Duration (hours)					
	(Lat.)	(Long.)	1	6	24	72		(Lat.)	(Long.)	1	6	24	72
1.	48.2	123.0	0.9	1.9	2.8	3.6	7.	43.0	113.0	1.6	3.1	4.2	4.2
2.	47.5	123.5	2.4	2.6	2.6	2.6	8.	47.5	114.5	1.4	2.6	3.4	3.4
3.	45.4	123.0	1.6	2.6	2.8	3.0	9.	46.3	114.4	1.6	2.8	3.0	3.0
4.	44.6	121.8	2.0	3.8	2.8	2.6	10.	44.5	113.0	3.2	5.6	5.1	5.5
5.	47.2	119.4	1.4	3.1	4.2	4.5							
6.	45.9	118.0	2.0	3.3	3.4	5.0							
<u>Locations</u>													
<ol style="list-style-type: none"> 1. San Juan Island, Washington 2. Olympics Mountains, Washington 3. Willamette Valley, Oregon 4. Cascade Mountains, Oregon 5. Columbia River Plateau, Washington 6. Blue Mountains, Oregon 7. Snake River Valley, Idaho 8. Flathead River Valley, Montana 9. Bitterroot Mountains, Idaho 10. Bitterroot Mountains, Montana (Continental Divide) 													

Table 13.1b shows that for durations 6 hours or longer, PMP to 100-year ratios are generally between 2 and 5.5 at the locations considered. This range is clearly acceptable. With the exception of the site along the Continental Divide, the ratios show no appreciable distinction between mountain and valley locations. The largest ratios occur near and along the Continental Divide. This is the result of relatively low 100-year amounts along this boundary, while the PMP estimates both in this study and in HMR 55A are relatively high.

Table 13.2 shows comparisons between the present study (HMR 57) and NOAA Atlas 2 values for local storms at 1 hour for the same 10 locations

considered in Table 13.1. Ratios of PMP to 100-year values shown in column c. of Table 13.2 indicate that local storm PMP is everywhere more than double NOAA Atlas 2 precipitation values.

Location (Lat., Long.)	a. 1-hour PMP	b. 1-hour, 100-year	c. Ratio a/b
1. 48.2, 123.0	2.97	0.96	3.09
2. 47.5, 123.5	3.14	1.35	2.33
3. 45.4, 123.0	4.58	0.93	4.92
4. 44.6, 121.8	6.15	1.03	5.97
5. 47.2, 119.4	6.35	0.99	6.41
6. 45.9, 118.0	6.89	1.15	5.99
7. 43.0, 113.0	7.67	1.06	7.24
8. 47.5, 114.5	6.06	0.64	9.47
9. 46.3, 114.4	6.39	1.25	5.11
10. 44.5, 113.0	6.52	0.76	8.58

13.2 Comparison to HMR 43

PMP estimates from this study were also compared against PMP estimates derived from HMR 43. Since the results of HMR 43 are not readily available as a map analysis, data were available only for a 1/4° latitude-longitude grid that had been developed in the late 1960's to verify HMR 43 results. Considerably less detail was provided in this comparison in contrast to the PMP/100-year comparisons.

Table 13.3 gives results of this comparison for general storms in the same format and for the same locations as was given for Table 13.1, and therefore allows for some internal comparisons between the two sets of comparisons.

No 1-hour general storm values were available in the catalog of 1/4° grid data computed for HMR 43. Although the procedure to obtain 1-hour PMP estimates is given in HMR 43, past experience had shown that in many locations, results were exceeded by 100-year values. In fact, one of the reasons for initiating this revised study was to reevaluate the 1-hour PMP.

From Table 13.3, it is evident that at a number of locations (three of ten), the new general storm PMP estimates are lower than those obtained from HMR 43. During the planning for this study, it was stated that the revised estimates could

Table 13.3.--Comparison between HMR 57 general storm PMP estimates and HMR 43 PMP estimates for subregional analysis and selected individual locations (10-mi²).

West of 117°W				East of 117°W							
<u>Range of PMP (57)/PMP (43) Ratios</u>											
a.	Duration (hours)			Duration (hours)							
	<u>6</u>	<u>24</u>	<u>72</u>	<u>6</u>	<u>24</u>	<u>72</u>					
Minimum	0.7	0.6	0.6	Minimum	0.7	0.8	0.6				
Maximum	1.9	1.7	1.8	Maximum	2.4	2.2	1.8				
b.	Duration (hours)			Duration (hours)							
	<u>(Lat.)</u>	<u>(Long.)</u>	<u>6</u>	<u>24</u>	<u>72</u>	<u>(Lat.)</u>	<u>(Long.)</u>	<u>6</u>	<u>24</u>	<u>72</u>	
1.	48.2	123.0 [#]	0.9	0.8	0.6	7.	43.0	113.0	1.1	1.1	1.0
2.	47.5	123.5	1.3	1.1	1.1	8.	47.5	114.5	0.8	0.9	0.9
3.	45.4	123.0 [#]	1.2	1.3	1.0	9.	46.3	114.4 [#]	1.2	1.3	1.1
4.	44.6	121.8 [#]	1.3	1.1	1.0	10.	44.5	113.0	1.2	2.0	1.4
5.	47.2	119.4 [#]	0.9	0.9	0.8						
6.	45.9	119.0 [#]	1.2	1.2	0.9						
# Computed at nearest 1/4° grid point											
<u>Locations</u>											
<ol style="list-style-type: none"> 1. San Juan Island, Washington 2. Olympics Mountains, Washington 3. Willamette Valley, Oregon 4. Cascade Mountains, Oregon 5. Columbia River Plateau, Washington 6. Blue Mountains, Oregon 7. Snake River Valley, Idaho 8. Flathead River Valley, Montana 9. Bitterroot Mountains, Idaho 10. Bitterroot Mountains, Montana (Continental Divide) 											

be both higher and/or lower than HMR 43, as it was not known at that time how the results of the storm data analysis would compare to the orographic model procedure used in HMR 43. Now that this study is completed, the comparisons made here show that the new estimates are slightly higher in the mountains but lower than HMR 43 by considerable amounts elsewhere.

This conclusion might bring about concern that the new general storm values may be too low, were it not for two facts. The first is that while general storm PMP has been reduced in some locations, comparisons against NOAA Atlas 2 amounts (Table 13.1) indicate a reasonable ratio (values greater than 1.5) of PMP/100-years still prevails for all durations except less than 6 hours. The second is that the local-storm PMP to 100-year comparisons show everywhere that substantial ratios exist for shorter durations as well, as shown in Table 13.2.

13.3 Comparisons Between General and Local-Storm PMP

The comparisons discussed in Section 13.1 suggest that the local-storm PMP is everywhere larger than the general-storm PMP at the shorter durations. The information in Table 13.4 shows comparisons between general- and local-storm PMP for this study at 1 and 6 hours for the 10 specified sites used previously (see Table 13.1). In Table 13.4 for 1 hour, only the location at the top of the Olympic Mountains shows a ratio greater than one. At 6 hours (although the value from the Continental Divide comes close), most locations show a ratio greater than one. While the comparison involves all-season general-storm PMP, it can be assumed the local-storm PMP applies primarily to the summer months. One can see from Figures 9.4 to 9.10 that summer general-storm values are fractions of the all-season amounts, so that the ratios shown for the first four sites in Table 13.4 would be somewhat lower had the comparison been made for June, for example.

Location (Lat. Long.)	a. 1-hour general storm PMP	b. 1-hour local storm PMP	Ratio a/b	c. 6-hour general storm PMP	d. 6-hour local storm PMP	Ratio c/d
1. 48.2, 123.0	0.90	2.97	0.30	3.30	3.42	0.96
2. 47.5, 123.5	3.60	3.14	1.15	14.40	3.61	3.99
3. 45.4, 123.0	1.52	4.58	0.33	5.59	5.27	1.06
4. 44.6, 121.8	2.59	6.15	0.42	10.36	7.07	1.47
5. 47.2, 119.4	1.56	6.35	0.25	4.60	7.30	0.63
6. 45.9, 118.0	2.46	6.89	0.36	8.01	7.92	1.01
7. 43.0, 113.0	1.68	7.67	0.22	4.96	8.82	0.56
8. 47.5, 114.5	1.55	6.06	0.26	5.04	6.97	0.72
9. 46.3, 114.4	2.13	6.39	0.33	6.92	7.35	0.94
10. 44.5, 113.0	3.96	6.52	0.61	12.10	7.50	1.61

13.4 Comparisons to Observed Storm Maxima

Observed major storms listed in Table 2.1 have been compared to the general-storm PMP derived in this study in Table 13.5. Ratios of PMP to observed amounts and PMP to in-place moisture maximized amounts are given in columns a and b, respectively. Selected durations and areas were chosen at which to make the comparisons in this table. PMP for storms 59, 82 and 126 have been adjusted by the seasonal percentages in Figures 9.4 to 9.10. Storms 29 and 155 take their PMP from HMR 55A, and storms 156 and 165 are in California beyond the reach of the analyzed index maps. Similarly, the two Canadian storms in Table 2.1 are outside the region of this analysis. A number of interesting results are apparent. Some of these are:

1. The general uniformity of ratios across the selected durations and areas. It does not appear that PMP envelops moisture maximized observed storm amounts by any greater or lesser degree as one varies duration and/or area. This implies that the depth-area-duration relations adopted in this study are reasonable representations of storm behavior.
2. Ratios of PMP to observed storm amounts shown in column a are generally larger than 2.0. Storm 126 (at 1 and 24 hours, 10-mi²) and storms 38 and 80 (at 1-hour, 10-mi²) have ratios between 1 and 2. A ratio between 1 and 2 also occurs for storm 106 (at 24 hours, 1000-mi²). It should be noted that while most of the ratios of PMP to observed amounts are over 2, this is not necessarily typical of ratios for these storms at durations and areas not given in this table. It can be stated that PMP everywhere exceeds the observed storm amounts for all durations and areas.
3. Storms 80 and 126 are the most significant storms in the sample relative to their moisture maximized values. They exert the greatest control over the level of PMP in this study. In Table 13.5 (Column b), the moisture maximized storm 80 is enveloped by 18-50 percent for the durations/areas shown. A check of the 48-hour and 72-hour, 10-mi² amounts for storm 80 (Table 10.12) shows the envelopments over moisture maximized values are as small as 8 and 5 percent, respectively. The envelopments of observed precipitation for storm 126 are the lowest of any storm in the sample and at 1-hour, 10-mi², the moisture maximized amount is the PMP estimate. These are very minimal envelopments, and reflect that this study indeed recognizes the importance of storms 80 and 126.

Table 13.5.--Comparison between general storm PMP and observed storm rainfalls or storms listed in Table 2.1 for selected durations and areas: (a) ratio of PMP to observed; (b) ratio of PMP to moisture maximized storm amount.

Storm No.	Lat. (Deg.)	Long. (Min.)	10mi ² , 1 hour		10mi ² , 24 hours		1000mi ² , 24 hours		10,000mi ² , 72 hours	
			(a)	(b)	(a)	(b)	(a)	(b)	(a)	(b)
5	46 01	118 04	5.38	3.16	2.56	1.51	2.72	1.60	-	-
12	48 12	115 41	3.35	1.96	2.97	1.75	3.53	2.08	-	-
29	47 41	112 43	6.17*	3.63*	3.68*	2.16*	3.56*	2.09*	-	-
32	44 55	123 46	2.29	1.83	3.14	2.51	3.07	2.46	3.71	2.97
38	45 28	121 52	1.64	1.26	3.04	2.34	2.76	2.13	2.65	2.04
40	48 01	121 32	2.00	1.36	3.03	2.06	2.70	1.84	2.54	1.73
59 [#]	46 00	118 00	2.48	1.76	2.71	1.94	2.73	1.95	-	-
60	47 28	123 35	2.96	1.92	4.47	2.91	4.37	2.84	-	-
66	42 10	124 15	2.84	1.86	2.80	1.83	2.86	1.87	4.29	2.80
74	46 10	122 13	3.16	2.42	3.76	2.87	3.46	2.64	3.13	2.20
78	46 25	123 31	3.23	2.11	4.17	2.73	3.71	2.42	3.78	2.47
80	47 28	123 43	1.95	1.18	2.29	1.41	2.12	1.31	2.40	1.48
82	47 22	115 26	3.67	2.29	2.54	1.58	3.17	1.98	-	-
88	45 55	123 38	2.93	1.91	3.19	2.07	4.00	2.60	3.64	2.37
106	44 16	112 04	2.02	1.19	2.28	1.35	1.84	1.08	-	-
126 [#]	41 52	123 58	1.53	1.00	1.77	1.16	2.27	1.48	2.12	1.49
133	47 34	123 28	3.19	2.25	3.13	2.20	2.74	1.93	-	-
143	45 49	119 17	3.05	2.05	2.56	1.72	2.19	1.47	-	-
147	47 33	121 20	4.19	3.53	3.46	2.90	3.13	2.63	-	-
149	42 10	123 56	3.43	2.33	2.96	2.01	2.88	1.96	2.81	1.91
151	47 28	123 43	3.15	2.04	2.66	1.73	2.65	1.72	-	-
155	48 34	113 23	5.77*	3.39*	1.81*	1.07*	1.74*	1.02*	-	-
157	44 14	115 29	2.58	1.89	3.07	2.24	2.52	1.84	2.12	1.54
168	47 29	115 44	4.58	3.23	2.78	1.95	2.63	1.84	1.98	1.39
175	44 55	123 44	3.43	2.78	3.61	2.91	4.92	3.96	-	-
179	47 37	123 44	3.42	2.56	3.69	2.75	3.78	2.82	3.27	2.44

*From HMR 55A

#Seasonally adjusted using Figures 9.4-9.10

Comparison of storms from Table 2.1 versus PMP from this study can be shown in another format as in Table 13.6. In Section A of this table, the 10 greatest observed 10-mi² rainfall amounts (in inches) from the storm sample in Table 2.1 (west of the Cascade Mountains) were compared and have been ranked from highest to lowest for each duration from 1 to 72 hours and listed according to storm index numbers. In Section B, the observed amounts are given corresponding to the ranked order of storms in Section A. In the third set of data, Section C, values of PMP have been determined from the 10-mi² index map and depth-duration curves from Table 10.10 for the region corresponding to storm sites in Section A. Finally, in Section D, comparative ratios for PMP-observed storm values are given (Section C/Section B). Blanks occur for those storms not centered in the region (156 and 165).

The storms comprising Table 13.6 all occurred in the orographic region of the Cascades (Zone 4) and therefore the same depth-duration curve (Table 10.10) is applied to the 10-mi² index PMP values to obtain PMP estimates for the other durations in Section C. It was necessary to plot values and fit a smooth curve to get intermediate durations. One of the interesting features of this comparison is shown in Section D, where the ratios of PMP to observed storm data are listed. The ratios at each duration show a gradual increase, with some exceptions, as the storm rank increases from 1 to 10. The overall range of ratios is between 1.5 and 3.8 and is believed meteorologically reasonable.

Table 13.7 shows comparisons analogous to those in Table 13.6, but for orographic storms east of the Cascade Mountains. Only five storms (12, 59, 82, 157 and 168) are available in this storm sample. The range of PMP to observed storm ratios is 2.2 to 4.6, and is somewhat higher than those for storms west of the Cascades, at least for the highest ranked storms. Comparison of both the observed and PMP amounts (Section B and C) in this table against those in Table 13.6 shows a substantial decrease for the eastern storms.

From this comparison, it is concluded that the PMP analysis developed in this study provides a reasonable reflection of the maximized historical general type storms observed through the orographic part of the study region.

Although only two storms (106 and 143) have been considered as least orographic types in the storm sample, a comparison is made in Table 13.8, similar to those for the orographic storms. While the observed storm amounts are quite comparable to the orographic storms east of the Cascades in Table 13.7, the PMP estimates are lower between 12 and 24 hours. This results in the lower ratios of PMP to observed amounts shown in Section D. It has already been shown in Table 10.4 that local storm PMP at this site will provide adequate maximization.

Table 13.6.--Ten largest storms by duration for 10-mi² observations (see Appendix 2).

**WEST OF THE CASCADES
Duration (Hours)**

A	1	6	12	18	24	30	36	42	48	54	60	66	72
RANK	Storm Numbers												
1	156	80	126	126	156	156	156	80	80	80	80	80	80
2	126	126	80	156	126	126	80	156	156	156	156	156	156
3	80	32	156	80	80	80	126	126	126	126	126	126	126
4	38	156	133	151	151	133	133	88	133	88	179	88	88
5	32	151	151	133	133	88	88	133	88	165	165	179	40
6	40	66	32	165	149	151	32	179	32	179	32	165	179
7	165	133	165	149	88	149	179	60	179	32	88	40	165
8	60	165	66	32	32	32	149	32	165	149	149	32	32
9	133	38	149	88	165	165	151	165	149	66	40	149	149
10	88	60	88	66	66	179	165	149	60	74	74	74	74
B	Observed depths (10-mi²) corresponding to above ranked storms												
1	2.05	6.65	11.47	13.47	16.23	18.53	20.74	25.20	28.07	29.79	30.12	31.68	34.39
2	1.84	6.44	9.17	13.08	15.84	16.50	20.10	24.21	26.13	27.13	27.42	27.89	30.29
3	1.70	6.41	8.76	12.69	14.45	16.39	17.96	18.96	19.37	19.98	20.69	20.93	21.17
4	1.54	5.70	8.02	10.45	12.45	13.36	15.12	16.19	17.27	17.26	17.69	19.49	20.36
5	1.46	4.74	7.91	10.15	12.16	13.13	15.05	16.10	17.26	16.89	17.62	18.90	19.31
6	1.30	4.50	7.58	9.11	10.90	12.96	13.55	14.27	15.32	15.58	17.41	18.83	19.28
7	1.27	4.28	7.19	8.89	10.76	12.01	13.17	14.00	15.29	15.49	17.26	17.67	19.02
8	1.22	4.21	6.71	8.45	10.66	11.95	13.00	13.84	14.95	15.46	16.43	17.43	17.43
9	1.19	4.01	6.27	8.26	10.63	11.20	12.98	13.80	14.72	14.72	16.14	16.74	16.85
10	1.17	3.82	5.80	8.20	9.63	10.86	12.38	13.67	14.24	14.23	14.98	16.02	16.66

Table 13.6.--(continued)

Duration (Hours)

	1	6	12	18	24	30	36	42	48	54	60	66	72
C	10-mi² PMP (at the corresponding storm site) from HMR 57 index map and depth-duration curves)												
1	-	13.24	17.98	23.32	-	-	-	46.34	49.32	51.97	54.28	56.60	58.59
2	2.81	11.40	21.18	-	28.10	32.60	42.70	-	-	-	-	-	-
3	3.31	13.40	-	27.47	33.10	38.40	36.25	39.34	41.87	44.12	46.08	48.05	49.74
4	2.52	-	24.32	27.47	33.10	44.08	49.02	48.02	56.62	53.85	56.58	58.65	60.71
5	3.35	13.24	21.18	31.54	38.00	39.79	44.25	53.20	51.11	-	-	58.00	46.02
6	2.60	10.80	21.44	-	32.20	38.40	43.22	48.30	49.92	54.17	54.94	-	61.06
7	-	15.20	-	26.73	34.30	37.35	44.51	50.54	51.40	52.60	56.25	44.46	-
8	3.61	-	17.28	27.80	33.50	38.86	41.54	46.90	-	50.55	52.81	57.28	59.30
9	3.80	10.08	20.61	28.47	-	-	42.70	-	47.98	42.39	42.64	55.06	57.00
10	3.43	14.44	21.95	22.41	27.00	40.02	-	45.08	53.79	47.10	49.20	51.30	53.10
D	Ratio 10-mi² PMP to observed or C/B												
1	-	1.99	1.57	1.73	-	-	-	1.84	1.76	1.74	1.80	1.79	1.70
2	1.53	1.77	2.31	-	1.77	1.98	2.12	-	-	-	-	-	-
3	1.95	2.09	-	2.16	2.29	2.34	2.02	2.07	2.16	2.21	2.23	2.30	2.35
4	1.64	-	3.03	2.63	2.66	3.30	3.24	2.97	3.28	3.12	3.20	3.01	2.98
5	2.29	2.79	2.68	3.11	3.13	3.03	2.94	3.30	2.96	-	-	3.12	2.38
6	2.00	2.40	2.83	-	2.96	2.96	3.19	3.38	3.26	3.48	3.16	-	3.17
7	-	3.55	-	3.01	3.19	3.11	3.38	3.61	3.36	3.40	3.26	2.52	-
8	2.96	-	2.58	3.29	3.14	3.25	3.20	3.39	-	3.27	3.21	3.29	3.40
9	3.19	2.51	3.29	3.44	-	-	3.29	-	3.26	2.88	2.64	3.29	3.38
10	2.93	3.78	3.78	2.73	2.80	3.68	-	3.30	3.78	3.31	3.28	3.20	3.19

Table 13.7.--Ranked largest storms by duration for 10-mi² observations (see Appendix 2).

**EAST OF THE CASCADES
Duration (Hours)**

A	1	6	12	18	24	30	36	42	48	54	60	66	72
RANK	Storm Numbers												
1	157	157	157	157	157	59	157	157	157	157	157	157	157
2	59	59	59	59	59	157	59	59	168	168	168	168	168
3	12	82	82	82	168	168	168	168	12	59	59	-	-
4	82	168	168	168	82	12	12	12	59	-	-	-	-
5	168	12	12	12	12	-	-	-	-	-	-	-	-
B	Observed depths (10-mi²) corresponding to above ranked storms												
1	0.93	3.20	3.43	3.68	4.89	5.49	6.37	7.53	7.87	8.13	8.26	8.40	8.87
2	0.84	2.06	3.14	3.50	4.79	5.32	5.79	5.87	6.43	6.92	7.45	7.95	8.24
3	0.55	2.03	3.01	3.44	4.42	4.91	5.42	5.84	6.34	6.00	6.00	-	-
4	0.45	1.52	2.82	3.43	4.06	4.19	4.79	5.57	5.96	-	-	-	-
5	0.43	1.47	2.20	3.05	3.87	-	-	-	-	-	-	-	-
C	10-mi² PMP (at the corresponding storm site) from HMR 57 index map and depth duration curves												
1	2.40	7.80	10.95	13.20	15.00	13.20	17.70	18.75	19.65	20.40	20.85	21.30	21.75
2	1.92	6.24	8.76	10.56	12.00	16.50	14.16	15.00	16.11	16.73	17.10	17.47	17.84
3	1.84	5.36	7.52	9.06	12.30	13.53	14.51	15.38	15.07	16.32	16.68	-	-
4	1.65	6.40	8.98	10.82	10.30	12.65	13.57	14.38	15.72	-	-	-	-
5	1.97	5.98	8.40	10.12	11.50	-	-	-	-	-	-	-	-
D	Ratio - 10-mi² PMP to observed storm (or C/B)												
1	2.58	2.44	3.19	3.59	3.07	2.40	2.78	2.49	2.50	2.51	2.52	2.54	2.45
2	2.29	3.03	2.79	3.02	2.50	3.10	2.45	2.56	2.51	2.42	2.30	2.20	2.17
3	3.35	2.64	2.50	2.63	2.78	2.76	2.68	2.63	2.38	2.72	2.78	-	-
4	3.67	4.21	3.18	3.15	2.54	3.02	2.83	2.58	2.64	-	-	-	-
5	4.58	4.07	3.82	3.32	2.97	-	-	-	-	-	-	-	-

Table 13.8.--Ranked largest least-orographic storms by duration.							
DURATION (HOURS)							
	RANK	1	6	12	18	24	36
A	Storm Numbers						
	1	106	106	106	106	106	-
	2	143	143	143	143	143	-
B	Depths (10-mi²) corresponding to above ranks (observed)						
	1	0.96	2.70	3.04	3.91	4.25	-
	2	0.57	1.98	3.03	3.21	3.40	-
C	10-mi² PMP from HMR 57 index map						
	1	11.94	5.72	7.86	8.92	9.70	-
	2	1.74	5.13	7.05	8.00	8.70	-
D	Ratio 10-mi² PMP to observed storm (or C/B)						
	1	2.02	2.12	2.58	2.28	2.28	-
	2	3.05	2.59	2.33	2.49	2.56	-

13.5 Comparison of PMP Change with Time

Both as a point of interest and as a means of understanding the level of PMP finally achieved in this study, it was decided to examine the chronological variation in PMP estimates for at least one specific drainage within this region. The Elk Creek Lake Basin (127-mi²) is a tributary to the Rogue River in western Oregon (orographic subregion 4). Table 13.9 lists PMP estimates that have been made by the NWS over time for this drainage.

Table 13.9 is interesting from the standpoint that over the 28-year history of PMP estimates for the Elk Creek Lake Basin, the latest estimates are on the order of some of the earlier estimates (3/65 and 8/67). This does not however, justify the correctness of the result, but is an unplanned consequence of the study, and is offered as an example that PMP estimates do not always increase over time.

Table 13.9.--Chronological variation of PMP estimates made for the Elk Creek drainage, Oregon (42.7°N, 122.72°W, 127-mi²).

Date	Duration				Reference
	6	24	48	72	
3/65	5.90	15.70	23.40	28.10	Myers, 1965
11/66	6.19	16.67	25.09	30.37	HMR 43
8/67	4.61	10.38	19.53	24.00	COE ltr, 1982
12/82	7.80	19.50	27.10	32.50	Miller, 1982
10/93	5.56	14.06	21.13	25.21	HMR 57

13.6 Comparison Between Adjoining Drainages

Another comparison made possible by the selection of drainages by Reclamation in Chapter 12, is that between the Cedar River, the Green River and the White River (Mud Mountain Dam), in western Washington. These three basins adjoin one another from north to south along the west slopes of the Cascades to the north of Mount Rainier. Their areas are 81-, 221- and 402-mi², respectively. A comparison was made in the course of the evaluations discussed in Chapter 12, between results obtained from the present study, from HMR 43, and from NOAA Atlas 2, as shown in Table 13.10.

Table 13.10.--Comparison between basin-average estimates for three neighboring drainages.

Drainage	Study	Duration (hours)		
		1	6	24
Cedar River (81-mi ²)	HMR 43	2.18	7.85	23.56
	HMR 57	2.12	7.29	18.40
	NOAA Atlas 2	0.88	3.15	7.52
Green River (221-mi ²)	HMR 43	*	6.31	18.87
	HMR 57	1.77	6.09	15.76
	NOAA Atlas 2	0.78	2.52	5.89
White River (402-mi ²)	HMR 43	*	6.11	18.64
	HMR 57	1.62	5.67	14.71
	NOAA Atlas 2	0.73	2.32	5.00

* HMR 43 does not give 1-hour PMP for areas >100-mi²

The comparisons shown in Table 13.10 are not as significant as others, but can be used more to check consistency. In this regard, ratios can be formed between the individual PMP estimates and the NOAA Atlas 2 amounts. It is reasonable to expect that these ratios should show a degree of consistency.

13.7 Comparison Between Neighboring Studies

The Northwest study region is surrounded by the Pacific Ocean, Canada, and the remainder of the United States. HMR 55A, HMR 49 and HMR 36 cover the United States portion of the region bordering the Northwest and have already been referred to many times throughout this study. This section will show how well the new results agree with two of these neighboring studies; HMR 36 is currently undergoing revision and comparisons to HMR 36 at this point were not made.

13.7.1 Comparison to HMR 55A

One of the ground rules in the development of this study was that it was to be done independently of its neighboring studies. However, the techniques used in its development closely followed those used in preparation of HMR 55A. Storms 29 and 155 occurred along the western limits of HMR 55A in Montana and were included in the current storm sample (Table 2.1) to establish some continuity between these two studies.

After the initial 10-mi², 24-hour PMP index analysis was drawn, minor adjustments were made along the mutual border with HMR 55A to provide continuity. A number of comparisons were made along the mutual border (Continental Divide) in order to evaluate the differences. Close agreement was found between the results from HMR 55A and the present study for all durations 24 hours and longer, at all area sizes. Differences were noted at shorter durations, where current 1-hour results were as much as 30 percent lower to 15 percent higher than results in HMR 55A, depending on area size. This occurs because of differences in short duration depth area and depth-duration decisions made between the two studies.

Comparisons were also made between local storm PMP estimates determined along the Continental Divide from the two studies. Although the current local storm index map was based on information available from Northwest storms, the 1-hour, 1-mi² index values are in reasonable agreement (less than 5 percent differences). However, the decision to go with a 6-/1-hour ratio of 1.15 for the present study (as compared to the 1.35 used in HMR 55A) will result in significant differences at 6 hours between the two studies.

13.7.2 Comparison to HMR 49

A comparison was also made between PMP estimates from this study and those from HMR 49 in a manner similar to that described for HMR 55A. Here the

common border essentially follows 42°N, but varies somewhat toward the eastern limits as it follows the Snake River drainage bounds.

HMR 49 was not derived from a base of storm DAD data and therefore close agreement was not expected. Furthermore, HMR 49 does not permit 1-hour general storm PMP estimates to be determined directly. Between 6 and 72 hours and for areas to 1000-mi², differences on the order of ± 20 percent were determined.

Local storm PMP estimates were compared for the common border between this study and HMR 49. At 1 hour, the variation between studies is about 20 percent near the California border, decreasing to near 5 percent near the Idaho-Utah border. As with the HMR 55A comparison, the low 6-/1-hour ratio in the present study results in lower 6-hour values than are found in HMR 49. However, the differences are only on the order of 3 to 10 percent since the 1-hour local storm PMP in the present study are everywhere higher than in HMR 49.

14. CONCLUSIONS AND RECOMMENDATIONS

This report has provided the rationale and procedure by which the PMP for the Northwestern states and southern British Columbia has been revised. The method of analysis has generally followed the process developed for HMR 55A, PMP for the east slopes of the Rocky Mountains (Hansen et al., 1988). The report includes extensive comparisons of basin PMP between this study and its predecessor, HMR 43 (Chapter 12). PMP estimates from this study are also compared against a number of other indices (Chapter 13), with the intent of evaluating the level of magnitude derived.

Among the important achievements and conclusions established by this study are the following:

1. Established a computerized procedure to routinely analyze major storms that have affected the region. The storm analysis procedure was carried out for 28 major storms affecting the Pacific Northwest in a consistent, detailed way.
2. Developed depth-area-duration and mass curves for the 28 U.S. major storms and for multiple centers within each storm where applicable in and near the Pacific Northwest (Appendix 2).
3. Provide all-season general storm PMP estimates. Developed seasonal adjustments to PMP using historical precipitation data from as early as the late 19th century. Separate maps are included that provide seasonal adjustments to PMP.
4. Developed new climatologies of 12- and 3-hour maximum persisting dew points.
5. Established PMP for the Pacific Northwest that is consistent at the interface with the PMP for HMR 55A.
6. General storm PMP estimates from this study are larger than HMR 43 estimates in most orographic regions, while being somewhat lower than HMR 43 estimates in least orographic regions.
7. Extended local-storm PMP estimates to west of the Cascade Mountains.
8. Conducted extensive climatic research to establish a new 6/1-hour ratio for local storms in the region. Developed a basic synoptic climatology of conditions favorable for extreme local storms in the Pacific Northwest.
9. Used 3-hour persisting 1000-mb dew points to better estimate the moisture available for local storms.

10. Local storm PMP for 1 hour are somewhat higher in the southern portion of the study area than was provided in HMR 43, and slightly less in the north. At 6 hours PMP is usually less, owing to the reduced 6/1-hour ratio.

11. The ratios between PMP and 100-year precipitation values from NOAA Atlas 2 are consistent with similar comparisons made in other parts of the western U.S.

12. The PMP generated by this study represents the best available estimates for the region, and should be applied to all future design studies.

13. The estimates available from this study represent generalized basin results and should form the basis for site-specific applications.

14. The procedures provided in Chapter 15 are relatively simple to apply, and cover both general storm and local storm PMP applications.

As a consequence of this study, the following recommendations are made:

1. That future effort be made to determine appropriate procedures to enable areal and temporal distribution to be developed based on input from this study.

2. That information be determined that will provide seasonal snowmelt and temperature sequences that can be combined with PMP estimates from this study. Similar interest may require that a future study consider the probable maximum snowpack and the corresponding maximum rainfall that can be combined for that season.

3. That NWS develop the automated capability to process storms to determine the appropriate depth-area-duration information. The joint effort between NWS and USBR used in this study, although practical as an "interim" measure, is awkward and inefficient for future studies.

4. That studies on antecedent precipitation be carried out for this region. This study would look at basin and storm area sizes, seasonality and geographic variation of antecedent precipitation.

15. COMPUTATIONAL PROCEDURE

15.1 Introduction

This chapter is intended to provide the user with specific information through a stepwise format that leads to determination of both general and local storm PMP for a particular location within the Pacific Northwest (Figure 15.1). All the tables and figures contained in this chapter have been presented in previous chapters, and are repeated here to aid in making expedient estimates.

The information in this chapter is applicable to general storm PMP for durations between 1 and 72 hours over areas between 10 and 10,000-mi², and to local storms between 1/4 and 6 hours for areas between 1 and 500-mi². When making PMP estimates for basins less than 500-mi² in an area, it is recommended that both general and local storm PMP be calculated. The larger of the two estimates should be taken to represent the basin PMP in most cases. Since the decisions regarding which results are most critical to the basin involve hydrological considerations applicable to the probable maximum flood (PMF), further clarification is left to the end users. This study is limited to aspects of PMP determination only.

Seasonal variation, temperature and wind distributions, along with limited information on temporal and spatial distributions, has also been included in this chapter. This information may aid the user in applications where snowmelt/PMP considerations are important, or in deciding where to place storm maxima within a basin or in establishing temporal sequences. The temporal and snowmelt information for general storms contained here was taken directly from HMR 43, since it was not one of the stated objectives of the present study to update this material. It remains for further study to provide improved procedures regarding snowmelt, and general storm temporal and spatial distributions.

The computational procedure developed for this study has been kept simple and straightforward. Index PMP maps were drawn for the general storm at 1:1,000,000 scale for user convenience. These index PMP maps are presented as Maps 1 to 4. Each map includes overlaps of at least 1/2 degree with its neighboring map(s). These oversized maps are located in a folder accompanying this report.

The index PMP maps contain substantial background information to aid the user in determining relative locations. To this end, latitude and longitude marks are included, as are county boundaries, the Cascade Mountain ridgeline and selected major cities and towns. In addition, each index map contains the respective subregional boundaries (identified in Chapter 10) used in depth-duration computations.

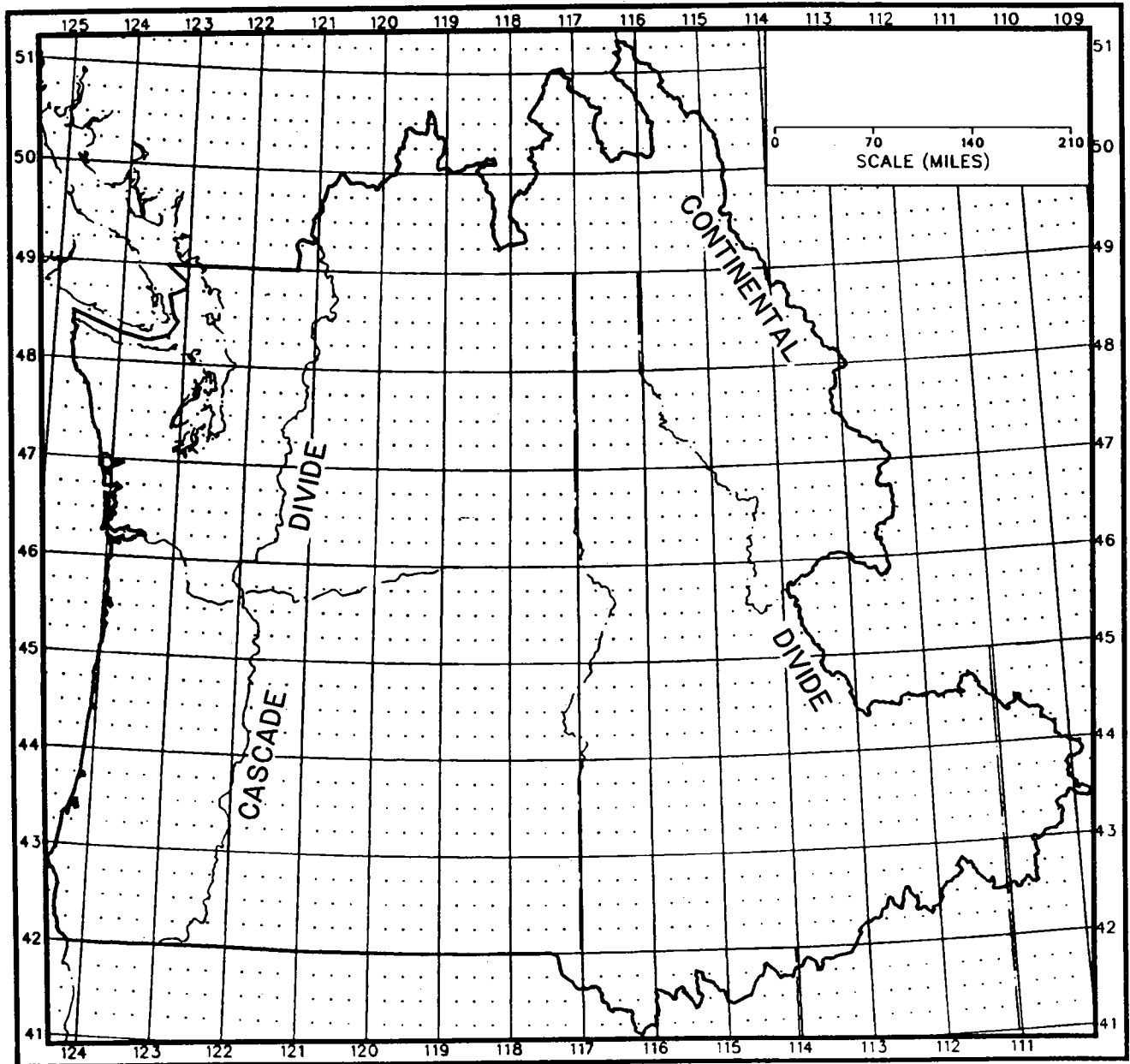

Figure 15.1.--Base map of Pacific Northwest region included in this study.

The following sections present the individual stepwise procedures for determining both general and local storm PMP, together with a worked example for each. Although the examples are meant to clarify the recommended steps for this study, they may not demonstrate every complication to be encountered in this region. The user is cautioned that this procedure is a general guide to PMP for the region and specific basins may need to be examined in more detail. In such instances, the user needs to consult with the Hydrometeorological Branch staff of the National Weather Service.

15.2 General Storm Procedure

Step

1. **Drainage outline**

Trace the outline of the drainage (at 1:1,000,000 scale) onto a transparent overlay.

2. **User decision**

Decide which result is needed for the application of interest; all-season PMP (then step 4 can be skipped) or seasonal PMP.

3. **All-season index PMP estimate**

Place the drainage overlay from step 1 on the corresponding all-season 10-mi², 24-hour PMP index map section (Charts 1 to 4 attached to this report), and make a uniform grid that covers the drainage. Obtain index map estimates of PMP for each grid point and determine the drainage average 10-mi², 24-hour PMP amount. The choice of grid size is left to the user, but consideration should be given to the gradient of PMP throughout the particular drainage, such that the grid spacing will provide reasonably representative results. For drainages with steep or irregular gradients and for drainages larger than about 1000 mi², the 24-hour PMP isohyets can be traced on the overlay to allow computation of an integrated areal average. Software is also available commercially that can be used to determine the areal average depths.

4. **Seasonal index PMP estimates**

Use of this option implies some knowledge of seasonal snowmelt that will be combined with seasonal PMP estimates. If the seasonal variation of PMP is needed, the procedure recommended is to obtain monthly drainage average PMP estimates using the seasonal maps in Figures 15.2-15.8 in the manner described for all-season estimates in step 3. These maps are reproduced at 1:8,000,000 scale to facilitate enlargement to the scale of the index maps. This should allow better estimate of the corresponding average percentage for

the drainage of interest. The resulting monthly estimates can be plotted and a smooth curve drawn to verify consistency and provide for temporal interpolation. The user is reminded that in Figures 15.2-15.8, any portion of a drainage covered by an isoline of 90 percent or higher is treated as equivalent to the all-season value. Multiply the all-season PMP average from step 3 by the percentage determined from this step.

5. Depth-duration

As discussed in Section 10.3, depth-duration varies according to regional subdivisions shown in Figure 15.9. These subregions are also delineated on charts 1 to 4. For the subregion containing the drainage of interest, read the corresponding depth-durational ratios from Table 15.1 and multiply each by the 24-hour results obtained from either step 3, or step 4. In the event that a particular drainage involves more than one subregion, obtain proportionately weighted results.

Subregion	Duration (hours)				
	1	6	24	48	72
West of Cascades					
4	.10	.40	1.00	1.49	1.77
5	.11	.43	1.00	1.37	1.58
3	.12	.44	1.00	1.23	1.35
East of Cascades					
1	.16	.52	1.00	1.40	1.55
2	.16	.52	1.00	1.31	1.45
6	.18	.55	1.00	1.27	1.37
7	.20	.59	1.00	1.20	1.30

6. Areal reduction factors

Take the 1-, 6-, 24-, 48- and 72-hours, 10-mi² basin average estimates from step 5, and use Figure 15.10 (orographic) or Figure 15.11 (least orographic) to determine areal reduction percentages for the drainage of interest. Multiply these reduction percentages by the corresponding 10-mi² amounts from step 5. If a particular drainage includes both orographic and least orographic subregions, again use proportionately weighted results.

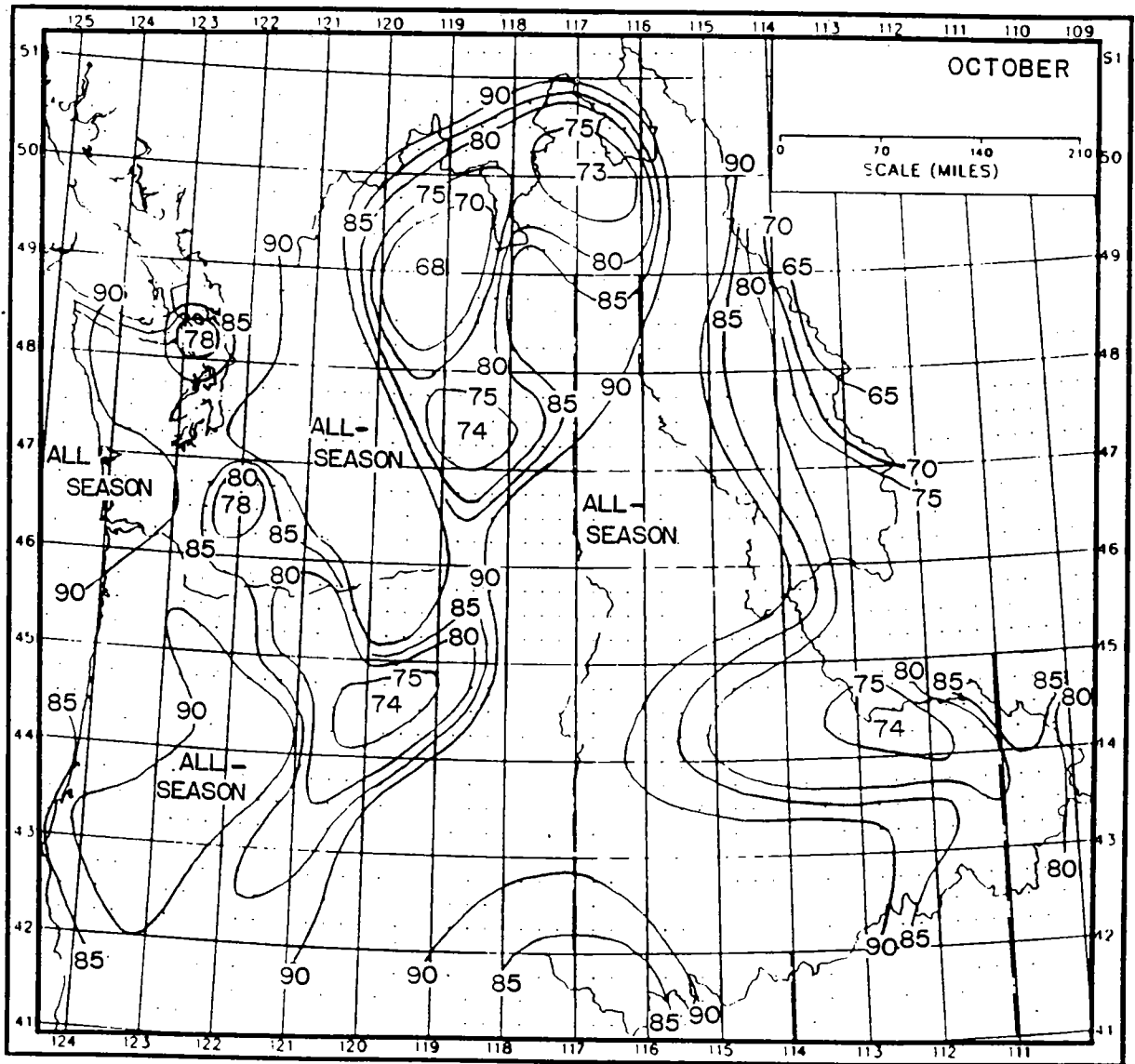

Figure 15.2.--Seasonal percentage variation of PMP for October based on all-season index maps provided in this study (Section 9.2.2).

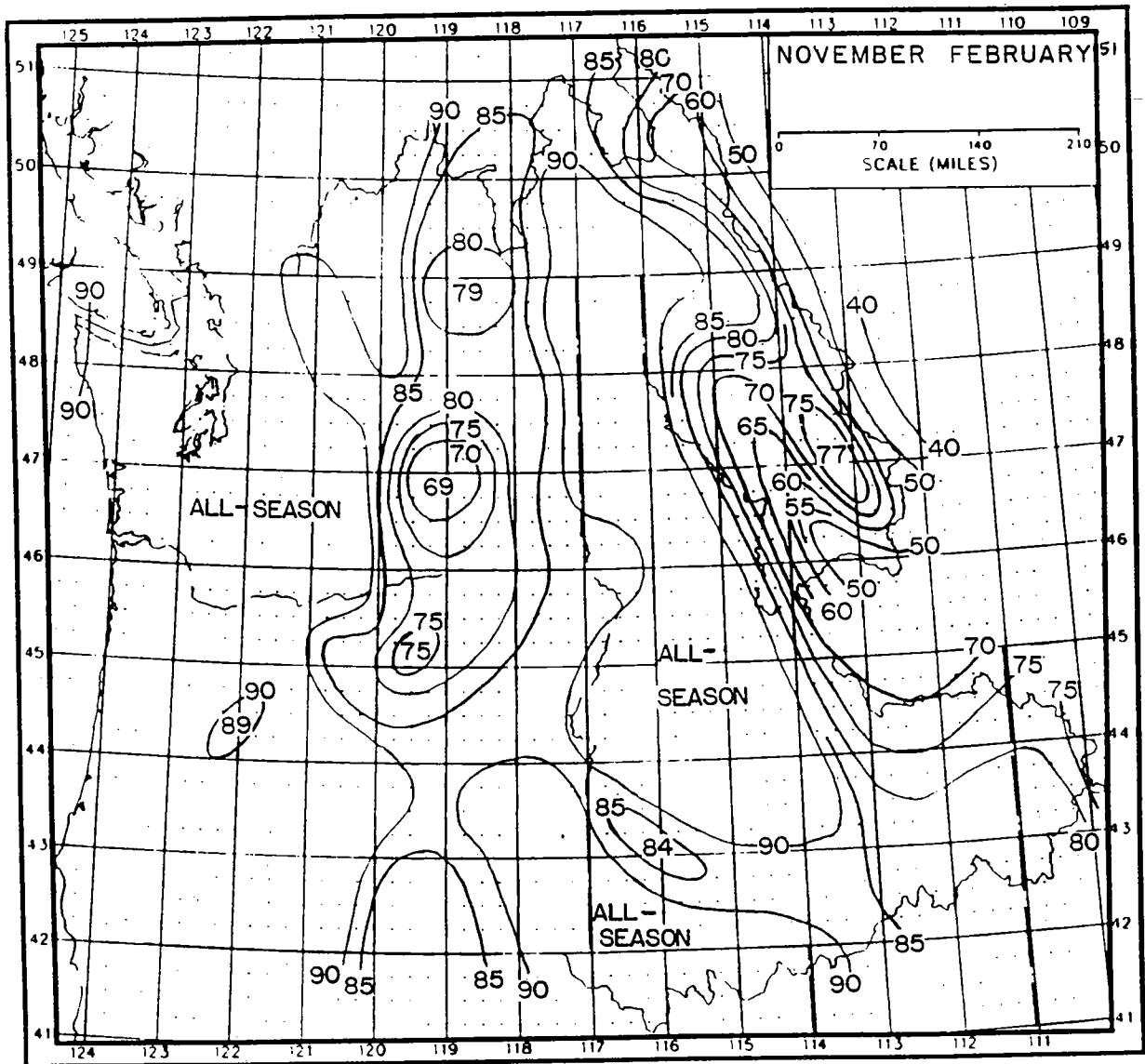

Figure 15.3.--Same as Figure 15.2 - for November through February (Section 9.2.2).

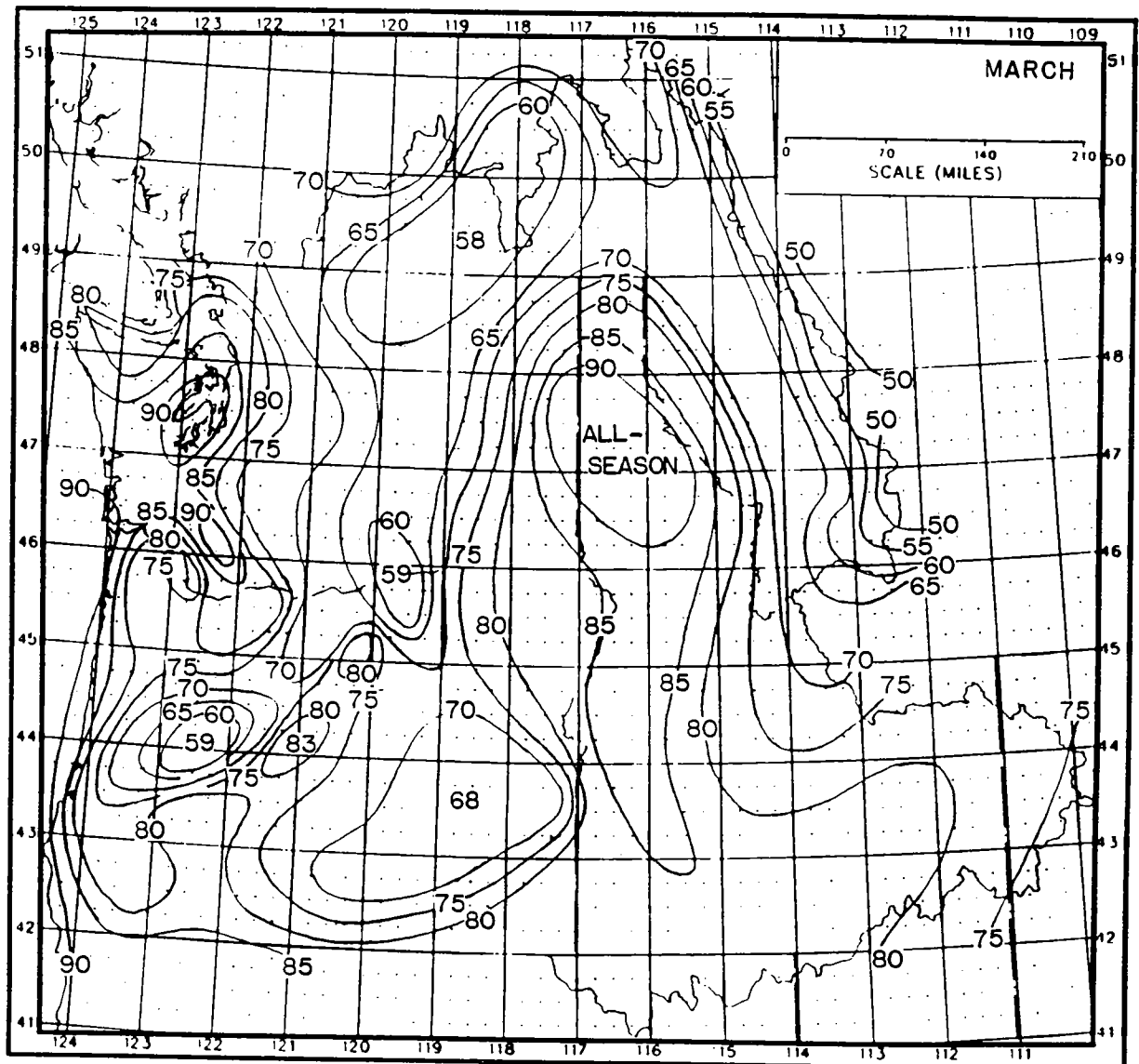

Figure 15.4.--Same as Figure 15.2 - for March (Section 9.2.2).

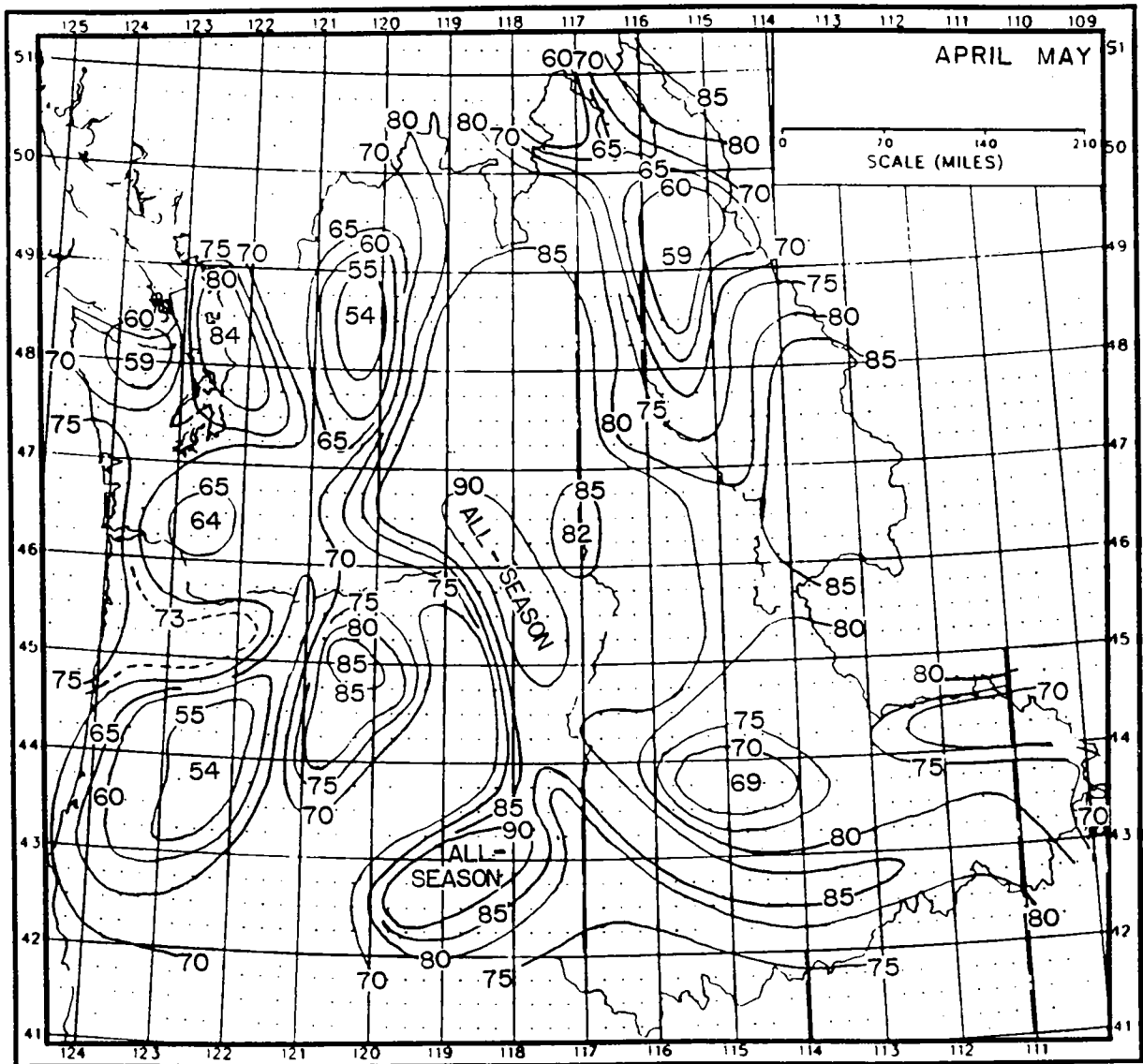

Figure 15.5.--Same as Figure 15.2 - for April through May (Section 9.2.2).

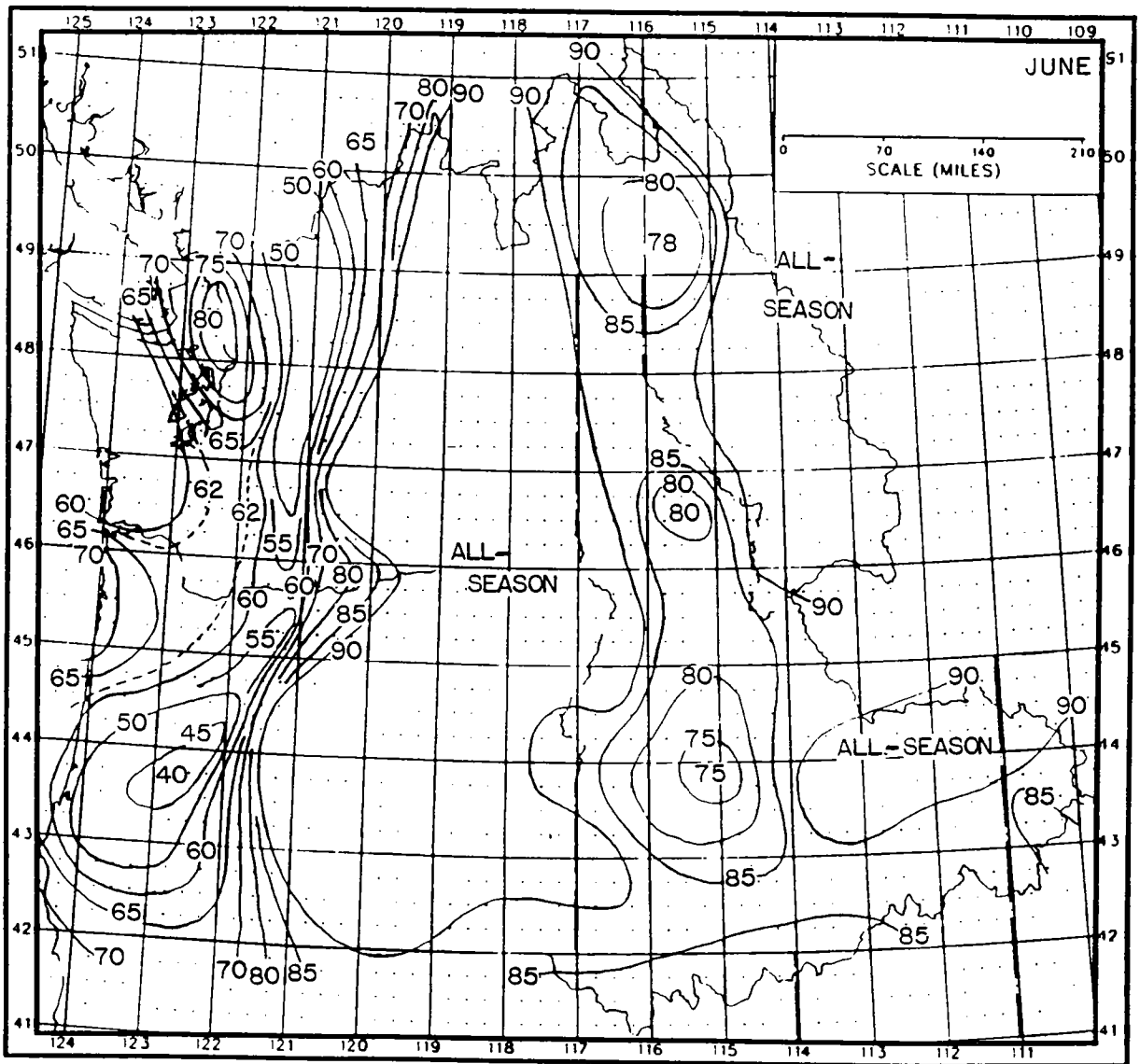

Figure 15.6.--Same as Figure 15.2 - for June (Section 9.2.2).

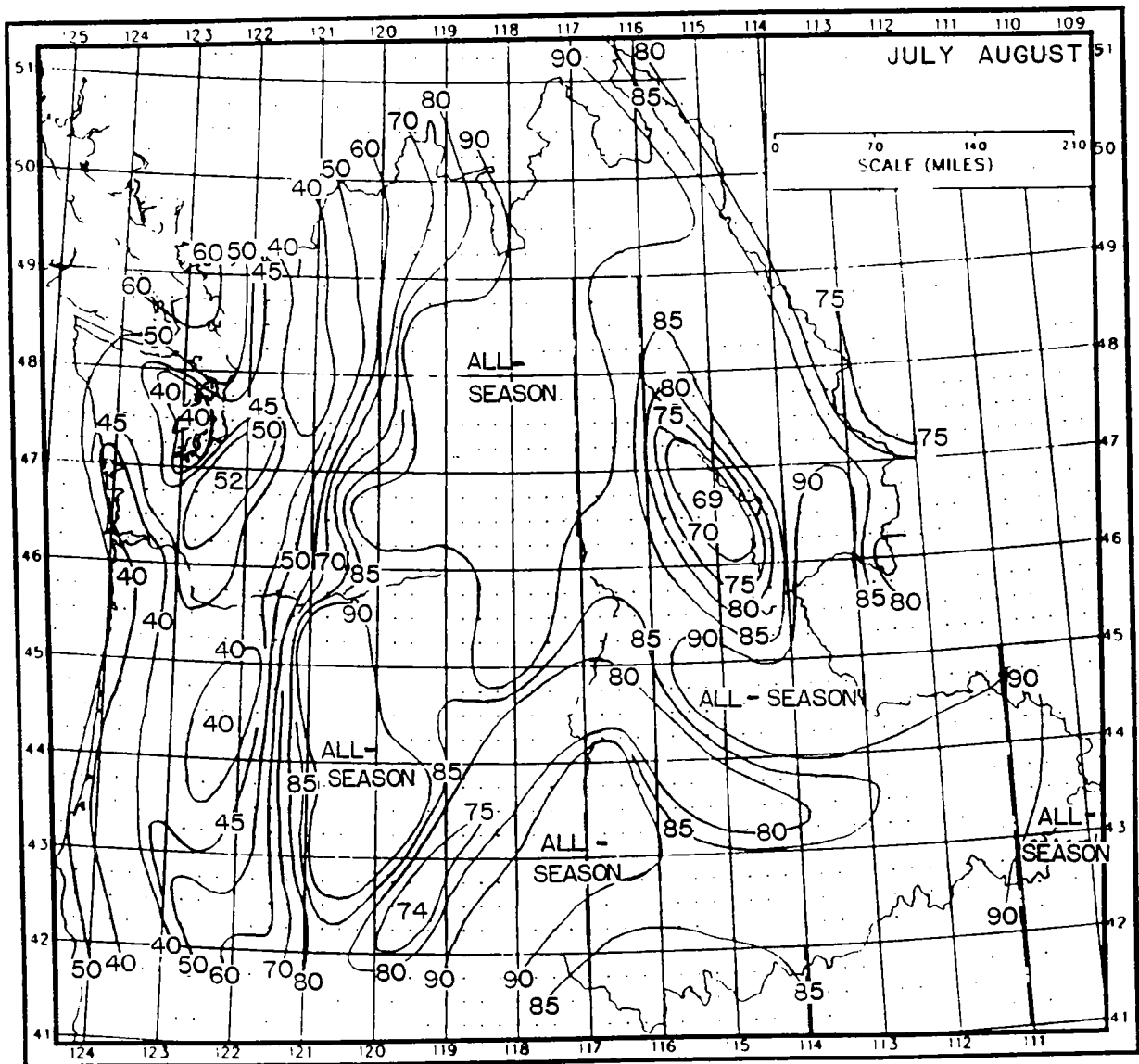

Figure 15.7.--Same as Figure 15.2 - for July through August (Section 9.2.2).

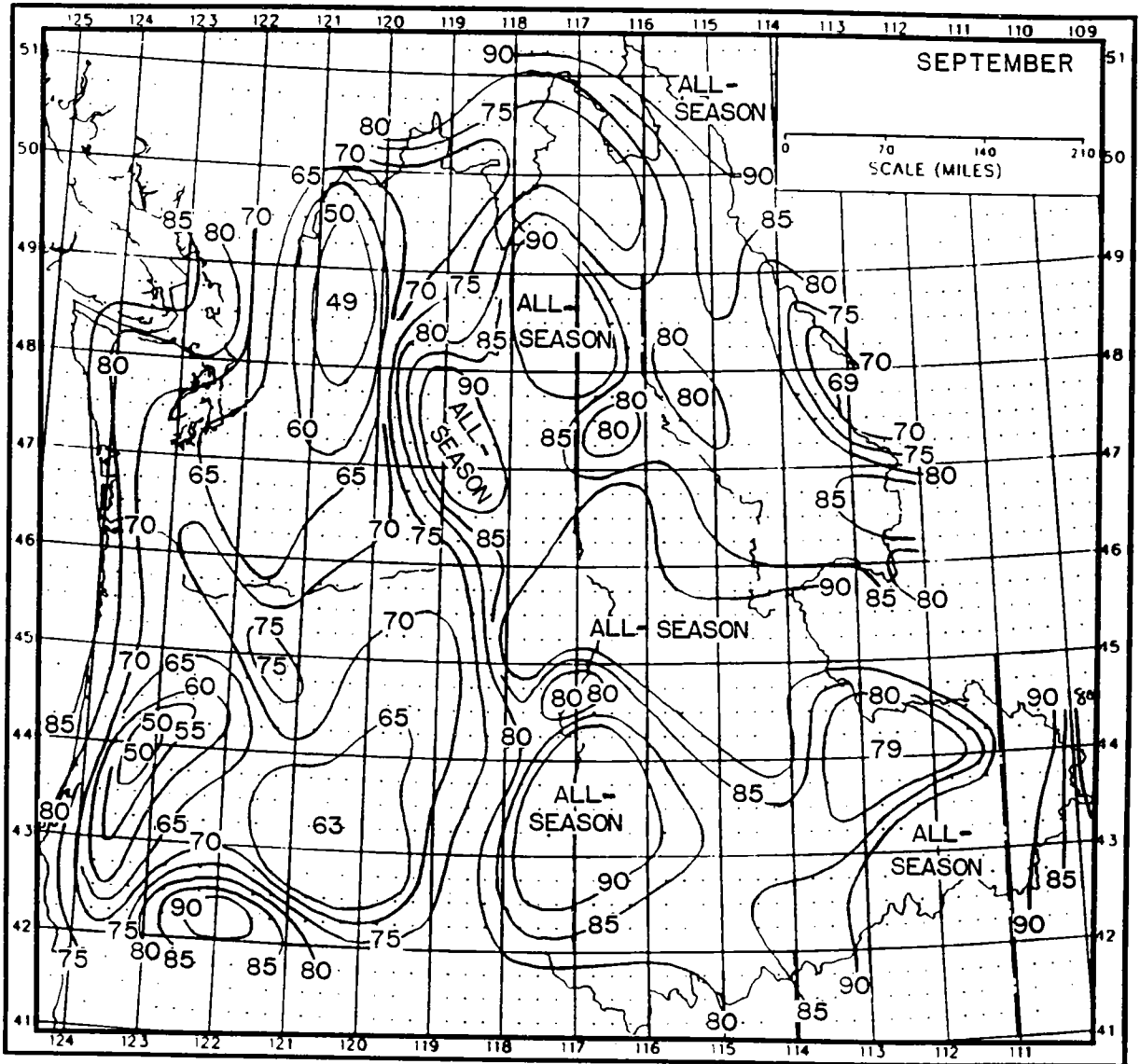

Figure 15.8.--Same as Figure 15.2 - for September (Section 9.2.2).

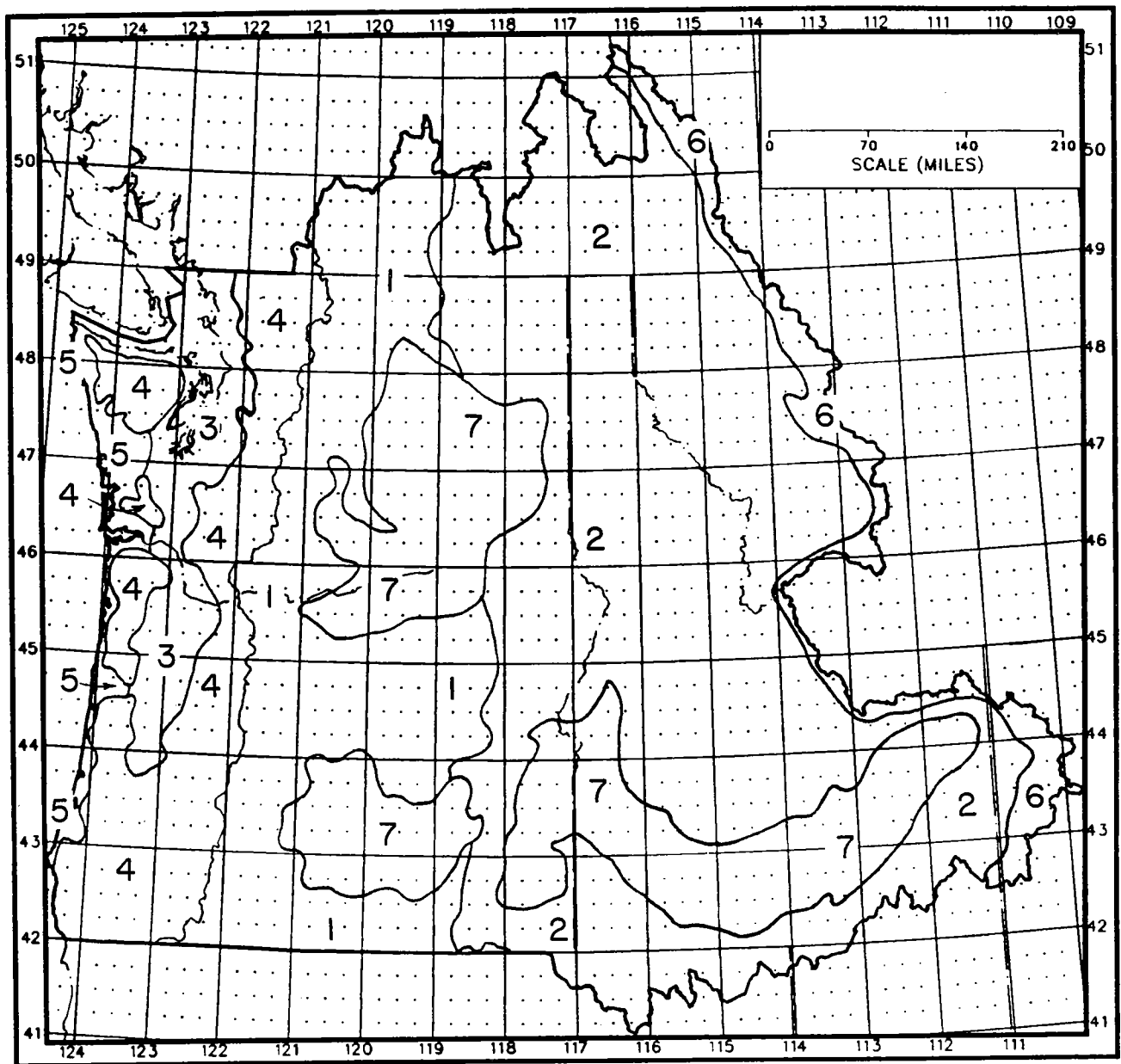

Figure 15.9.--Subregions adopted for this study; 1 = east slopes of the Cascades, orographic; 2 = orographic; 3 = least orographic, west of the Cascades; 4 = orographic, west of Cascades ridgeline; 5 = coastal orographic; 6 = west slopes of the Rockies, orographic, and 7 = least orographic, east of the Cascades (Section 10.3.2).

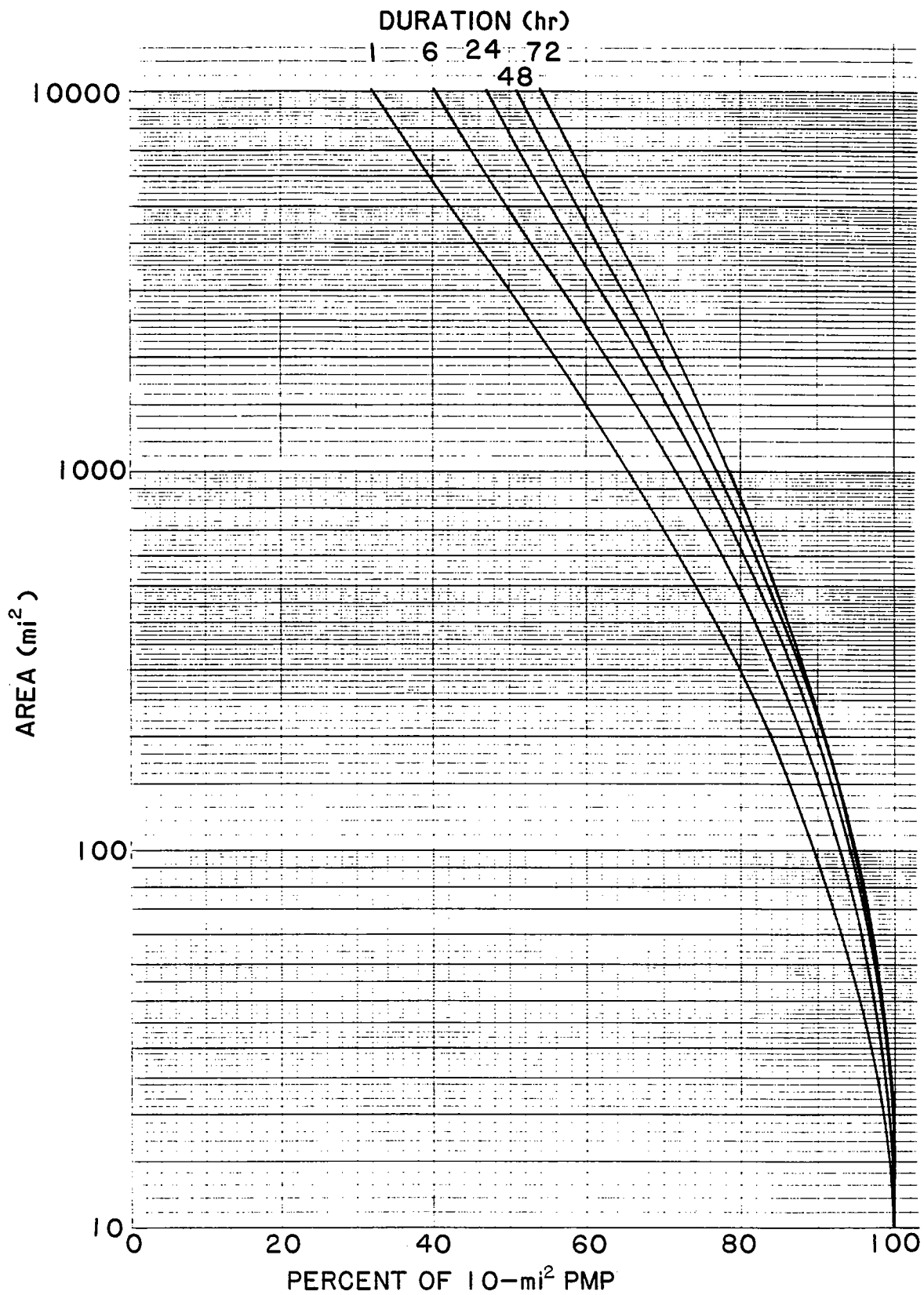

Figure 15.10.--Adopted depth-area relations for orographic subregions (Section 10.2.1).

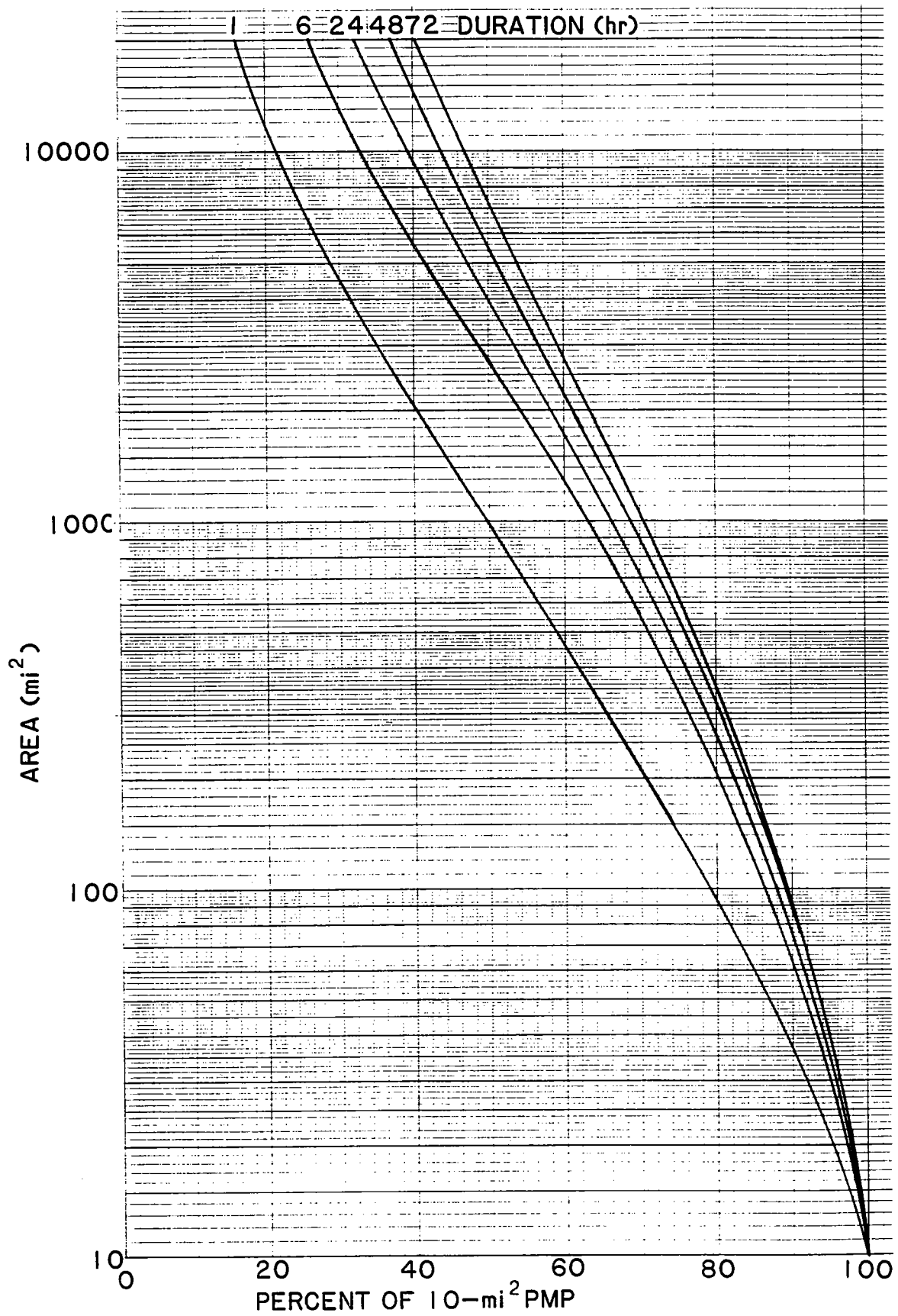

Figure 15.11.--Adopted depth-area relations for least orographic subregions (Section 10.2.2).

7. **Incremental estimates**

If incremental values for the various durations are desired, it is necessary to plot the results from step 6 and draw a smooth curve in order to read off intermediate 6-hour values. Subtract each 6-hour depth from the depth of the next longer duration. Some applications may require hourly increments (user decision), and are obtained from smooth depth duration curves, as for 6-hour values.

8. **Temporal distribution (from Section 6-B, HMR 43)**

The temporal distribution represents the sequential order of increments of PMP that is considered most critical for determining the probable maximum flood hydrograph. The order of increments is referred to as follows: The largest increment (customarily for 6 hours) is referred to as the first increment and the lowest or smallest increment is the 12th (for a 72-hour sequence). Similar rankings are used when hourly increments are needed. Storm sequences have been examined to identify certain characteristic groupings of increments and are presented here as guidelines the user may follow in developing the most critical sequence for a specific application.

(a) Group the four largest 6-hour increments (in a 72-hour sequence) together, the middle four increments in another group and the lowest four increments in a third group.

(b) Within each of these 24-hour groups, arrange the four increments such that the second largest increment is next to the largest, the third largest is joined to the first pairing and the fourth largest is at either end. In most 72-hour storms (although not discussed in HMR 43), the evidence indicates that the highest 24-hour group does not occur in the first 24 hours of the sequence.

(c) Arrange the three 24-hour groups so that the second highest 24-hour group adjoins the highest 24-hour group, with the third group at either end.

A series of examples are shown in Figure 15.12 that demonstrate some of the possible combinations resulting from these guidelines. It is left to the user to identify which sequence will provide the temporal distribution most critical to the specific drainage of interest.

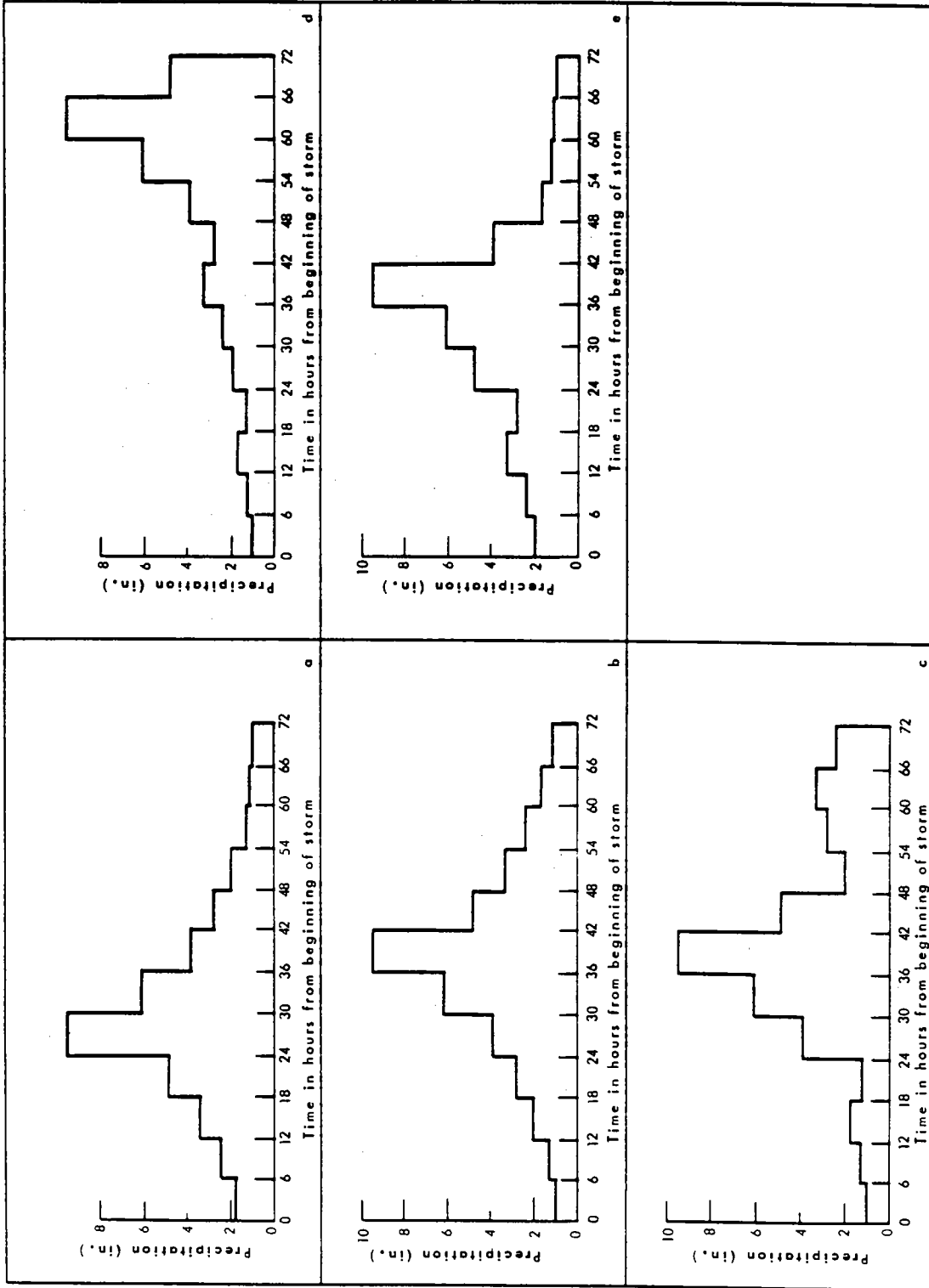

Figure 15.12.--Sample PMP time sequences (from HMR 43).

9. **Areal distribution of general storm PMP**

This study does not provide a specific procedure that enables the user to obtain the areal distribution of PMP for the general storm. The complexity of the orographic terrain makes the development of such a procedure extremely difficult, in comparison to that devised for the non-orographic United States east of the 105th meridian (Hansen et al., 1982). Nevertheless, as an interim measure in the interest of providing some guidance, it is recommended that an approximate distribution may be derived by developing an isopercental analysis based on the 100-year precipitation frequency maps from NOAA Atlas 2 (Miller et al., 1973). This approximation was used to develop the individual storm analyses for this study, and has been used on other occasions to represent storm distributions.

Another approximation may be used for those instances where a significant storm has been observed that has a sufficient number of observations to allow a storm pattern to be drawn over the specific basin of interest. If such a storm has been observed, then the storm pattern can be used to set an isopercental analysis for the PMP distribution. However, only a few such storms have occurred in the northwestern states that have sufficient observations to allow a meaningful isohyetal analysis to be drawn.

It is left to a future study to resolve the issue of how to distribute general storm PMP throughout a basin. Hopefully, as more information becomes available and with the use of geographical information systems (GIS), better understanding and insight into this problem will evolve.

10. **Temperature and wind for snowmelt (from Chapter 8 of HMR 43)**

If the contribution from snowmelt is of interest, the following guidance has been taken from HMR 43 (see Appendix 5 of this report for a worked example). Figure 15.13 shows the recommended 72-hour temperature sequences for the period before the PMP storm either west or east of the Cascades for selected seasonal periods. Dew points prior to the PMP storm are determined from the dew-point difference curves also shown in Figure 15.13, and are applicable to all months.

Figure 15.14 shows maximum January 6-hour winds west of the Cascade Divide. HMR 43 suggests that for sheltered drainages, a factor less than 0.75 be used; and for exposed locations at high elevations (above 3000 feet estimated), a factor greater than 0.75 is recommended. Seasonal variation of maximum winds is shown in Figure 15.15. To determine the durational variation of PMP winds by 6-hour increments, refer to Figure 15.16. East of

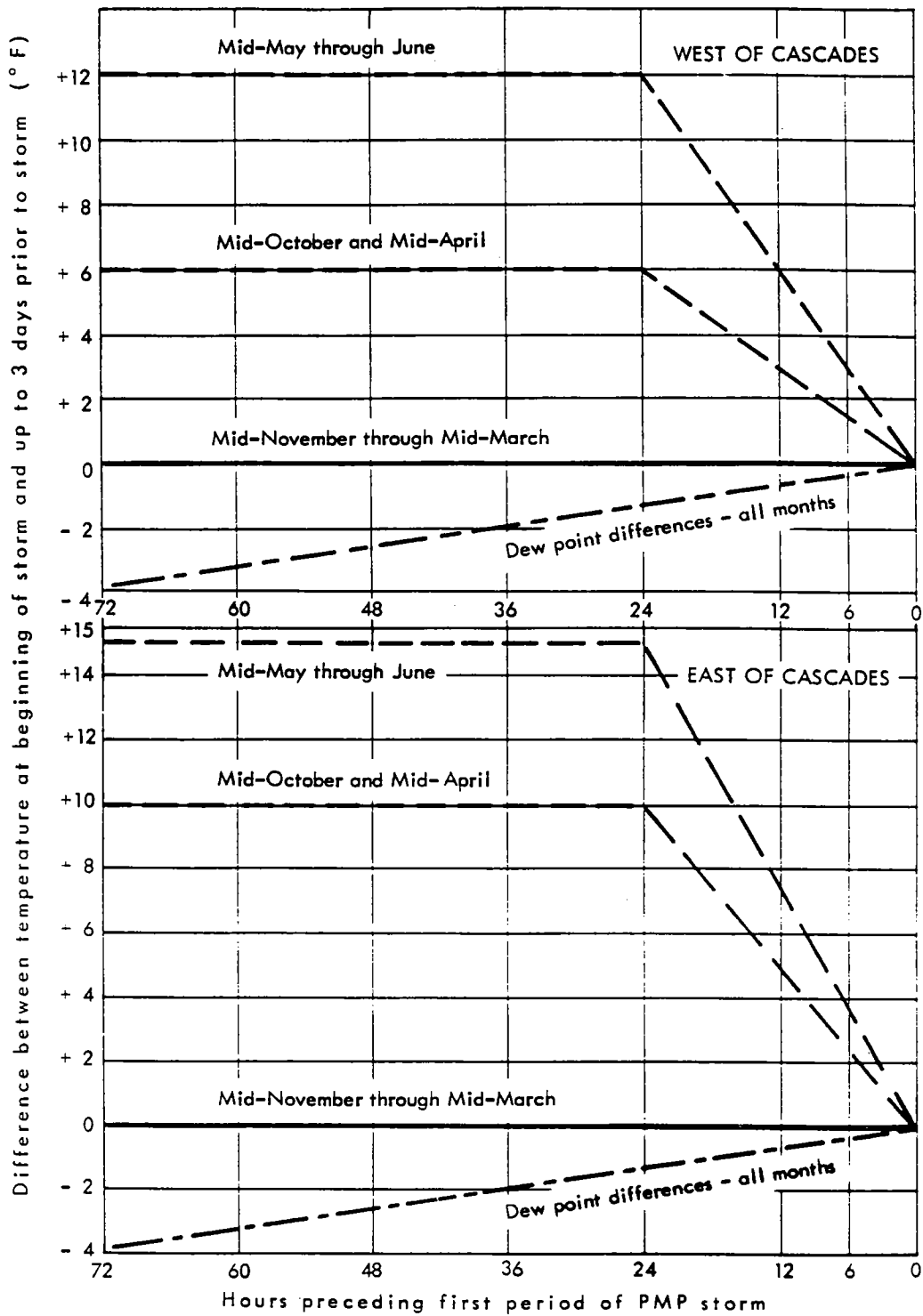

Figure 15.13.--Highest temperatures prior to PMP storm.

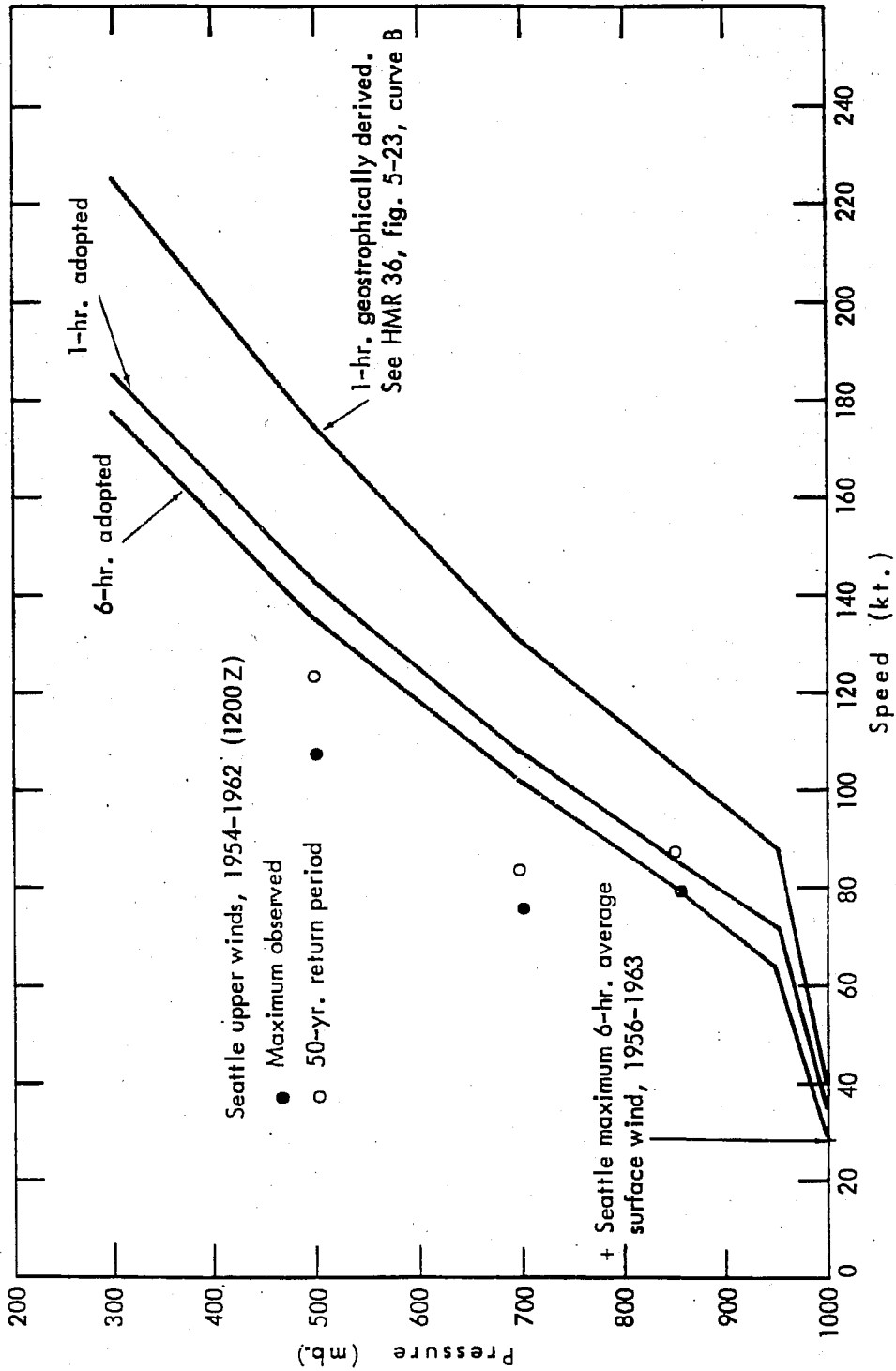

Figure 15.14.--Maximum winds west of the Cascade Divide (HMR 43).

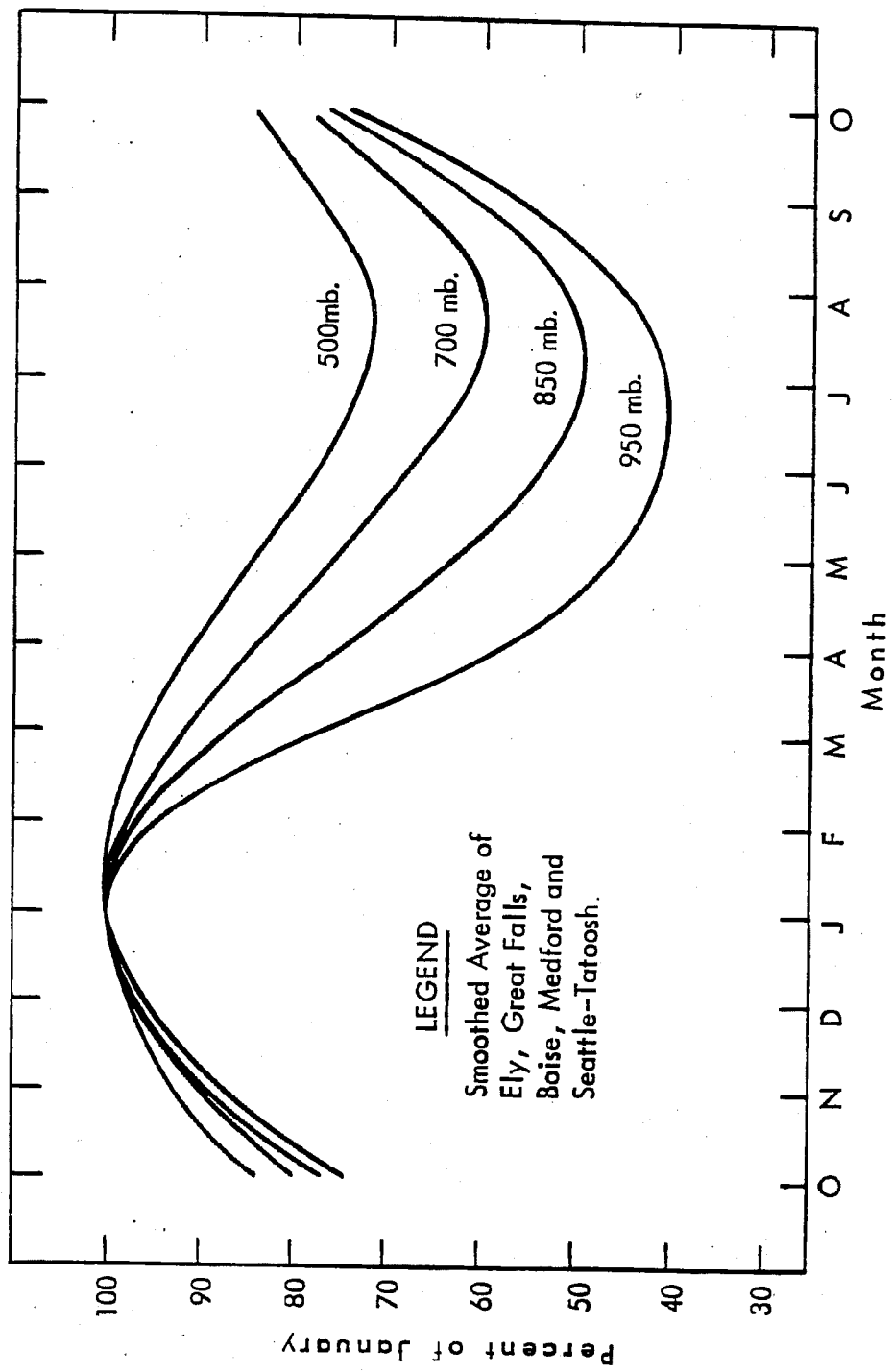

Figure 15.15.--Seasonal variation of maximum wind speed (HMR 43).

the Cascades, use Figures 15.15, 15.16, and 15.17 for these wind estimates. In Figure 15.17, a few selected locations are identified as guidance for elevation effects on winds east of the Cascades, as represented by the dashed curve.

The following steps are taken from HMR 43 (as given in Appendix 5 of this report) to obtain temperature, dew point, and wind sequences prior to and during a PMP storm.

A. Temperature and dew points during PMP storm

- (1) Read the 12-hour, 1000-mb dew point (temperature) from Figures 15.18 to 15.29 for desired month at the basin location.
- (2) Obtain the precipitable water (W_p) corresponding to this temperature from Figure 15.30. Enter this figure with the 12-hour temperature on the abscissa and read the corresponding W_p on the ordinate.
- (3) Read the percentage ratios of W_p for each of the twelve 6-hour periods to W_p for the maximum 12-hour dew point from Figure 15.31.
- (4) Multiply the 12-hour W_p by the percentages from step A (3). This gives W_p for each 6-hour increment during the PMP storm.
- (5) Using the W_p values from step A (4), enter Figure 15.30 to obtain the corresponding 1000-mb temperatures for each duration for the required month.
- (6) Adjust these temperatures to the elevation of the area of interest. This is accomplished by use of Figure 15.32. Starting with the 1000-mb temperature on the abscissa, proceed parallel to the sloping lines to the basin elevation and read the adjusted temperature on the abscissa.
- (7) Rearrange temperatures in A (6) to conform to the adopted PMP storm sequence.

B. Temperatures prior to PMP storm

- (1) From A (7) find the temperature for the first 6-hour period of the storm in sequence.
- (2) Read the difference between the temperature at the storm beginning and the temperature at each 6-hour duration prior to storm from Figure 15.13.
- (3) Add the differences determined in B (2) to the first 6-hour temperature to determine the temperatures for each antecedent 6-hour period.

C. Dew points prior to PMP storm

- (1) From the dew point curve of Figure 15.13, determine the differences between the first period dew point and the dew point for each duration prior to storm.
- (2) Subtract the differences from the temperature (dew point) determined in B (1).

D. Winds during PMP storm

- (1) To use the figures pertaining to wind relationships, transform the basin average elevation to pressure by the pressure-height relation shown in Figure 15.33.
- (2) a. West of the Cascade Divide Basin. Determine the January maximum free-air wind at basin pressure from Figure 15.14.

b. East of the Cascade Divide Basin. Determine the January maximum surface wind at basin pressure from dashed curve on Figure 15.17.
- (3) Figure 15.15 shows the adopted seasonal variation of maximum wind expressed in percent of the mid-January value. These percent ratios apply either east or west of the Cascades.
- (4) Multiply windspeed of D (2) by ratio for the desired month from D (3).
- (5) Obtain durational wind factors given in Figure 15.16.

- (6) Multiply the maximum 6-hour windspeed of D (4) by the D (5) ratios to obtain all 6-hour speeds for the 3-day storm. For west of the Cascade Divide Basins, multiply these by 0.75 to obtain anemometer-level winds.
- (7) Arrange 6-hour winds to conform to the selected PMP storm sequence.

E. Winds prior to PMP storm

The least of the twelve windspeeds calculated in D (6) may be maintained for the 72-hour period prior to the PMP storm.

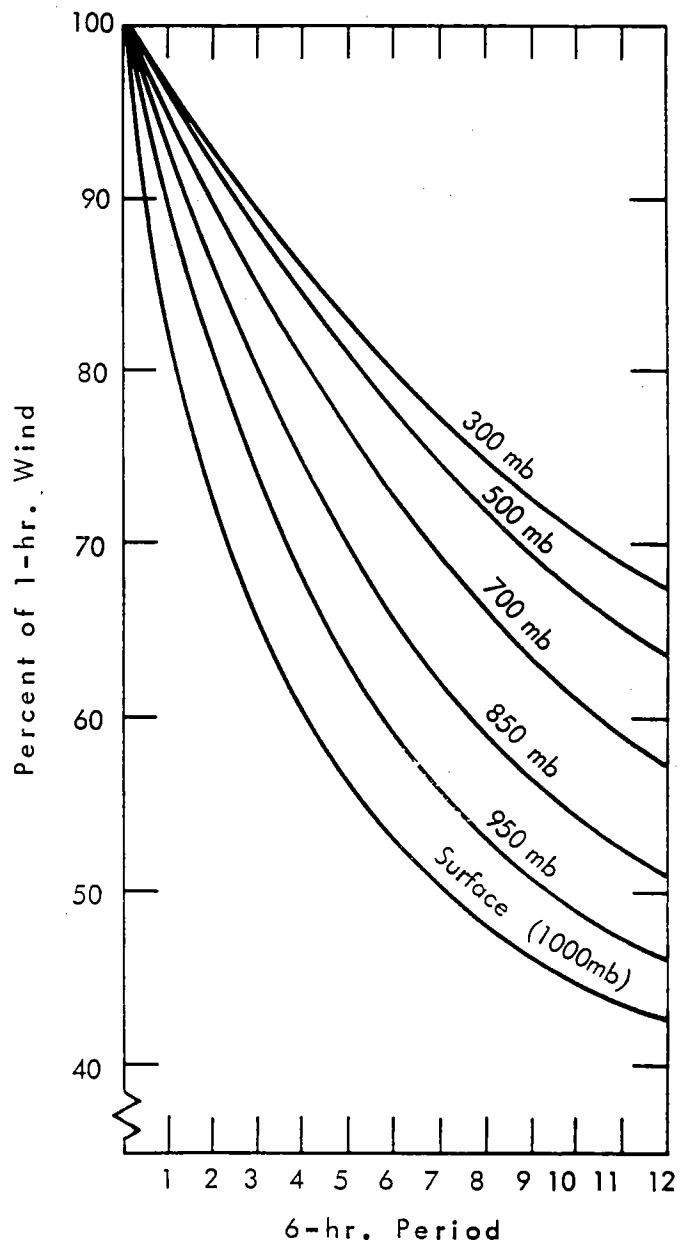

Figure 15.16.--Durational variation of PMP winds by 6-hour increments (HMR 43).

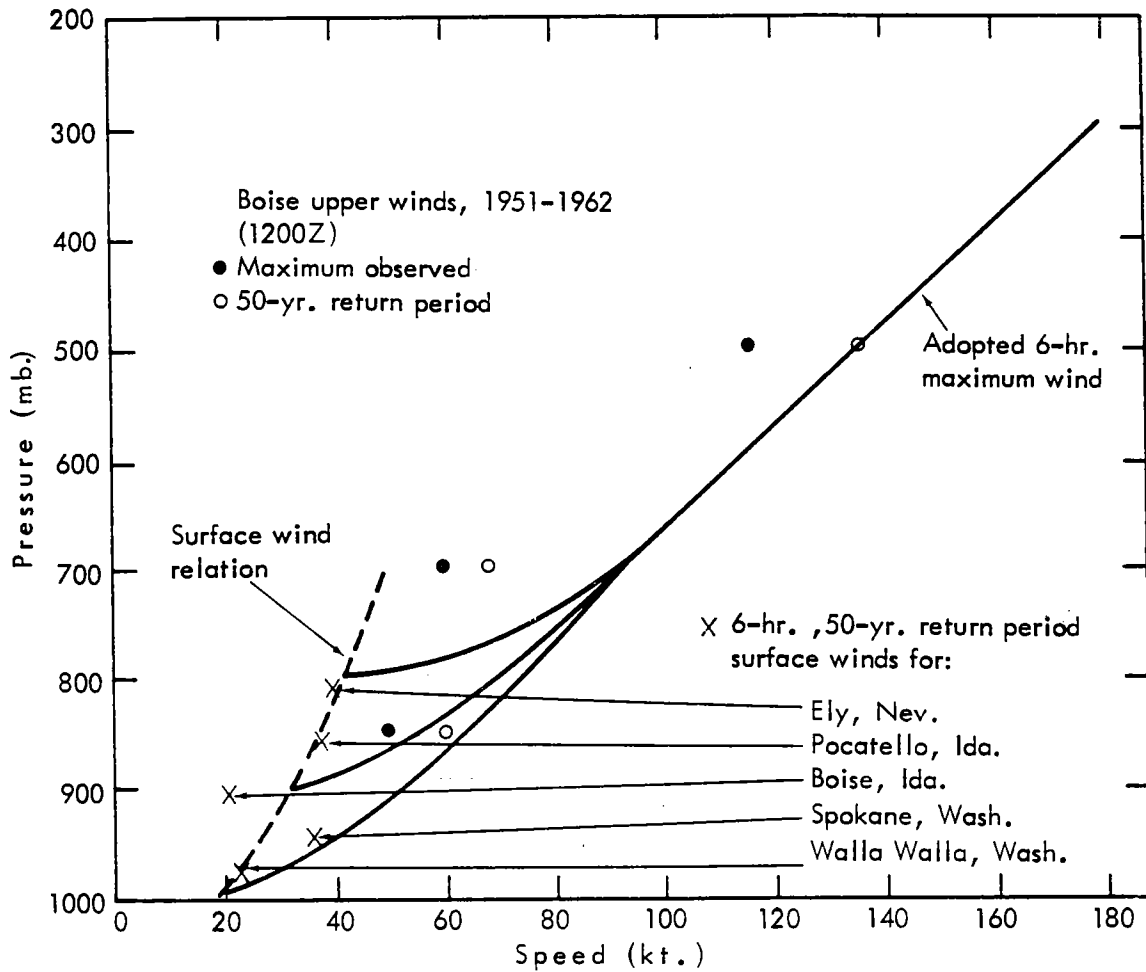

Figure 15.17.--Maximum winds east of the Cascade Divide (HMR 43).

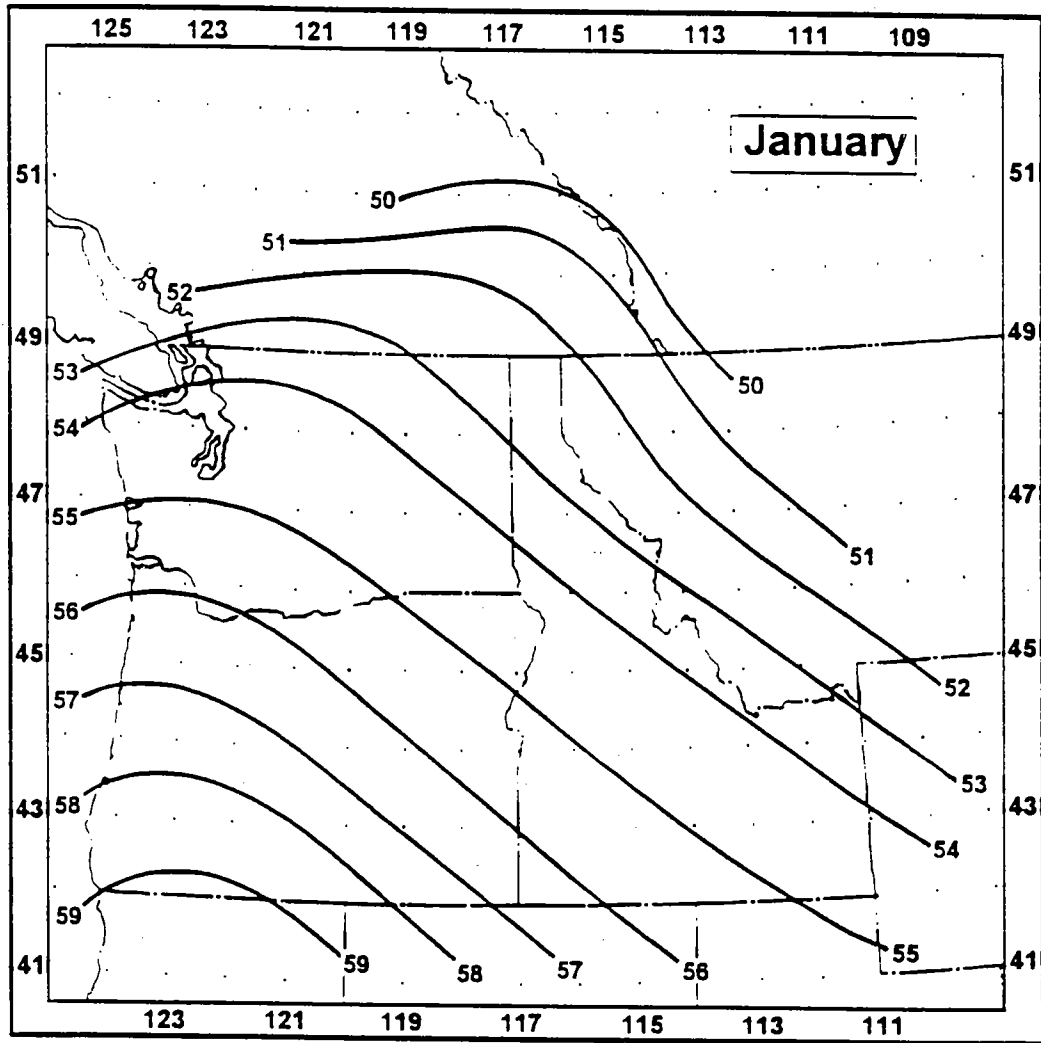

Figure 15.18.--12-hour maximum persisting 1000-mb dew point analysis (°F), January.

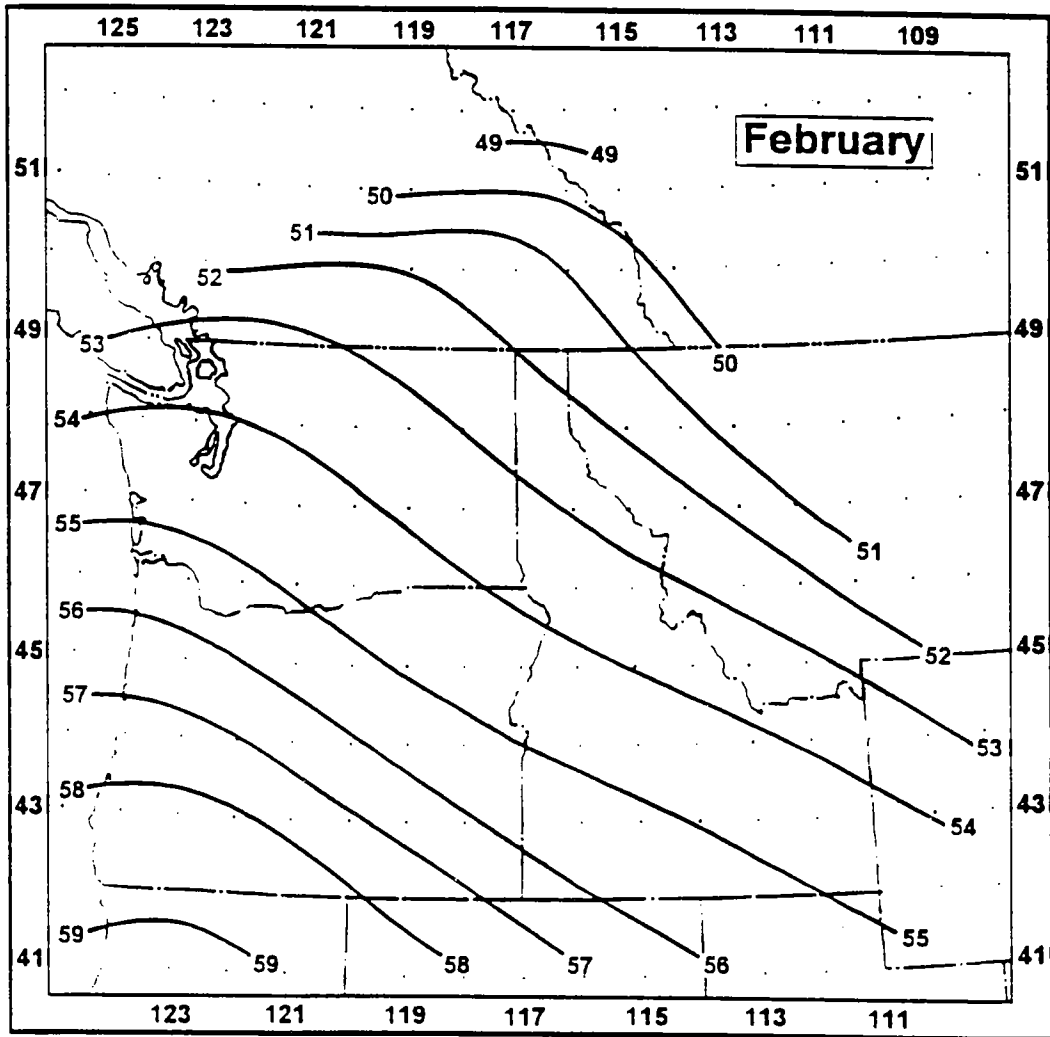

Figure 15.19.--12-hour maximum persisting 1000-mb dew point analysis (°F), February.

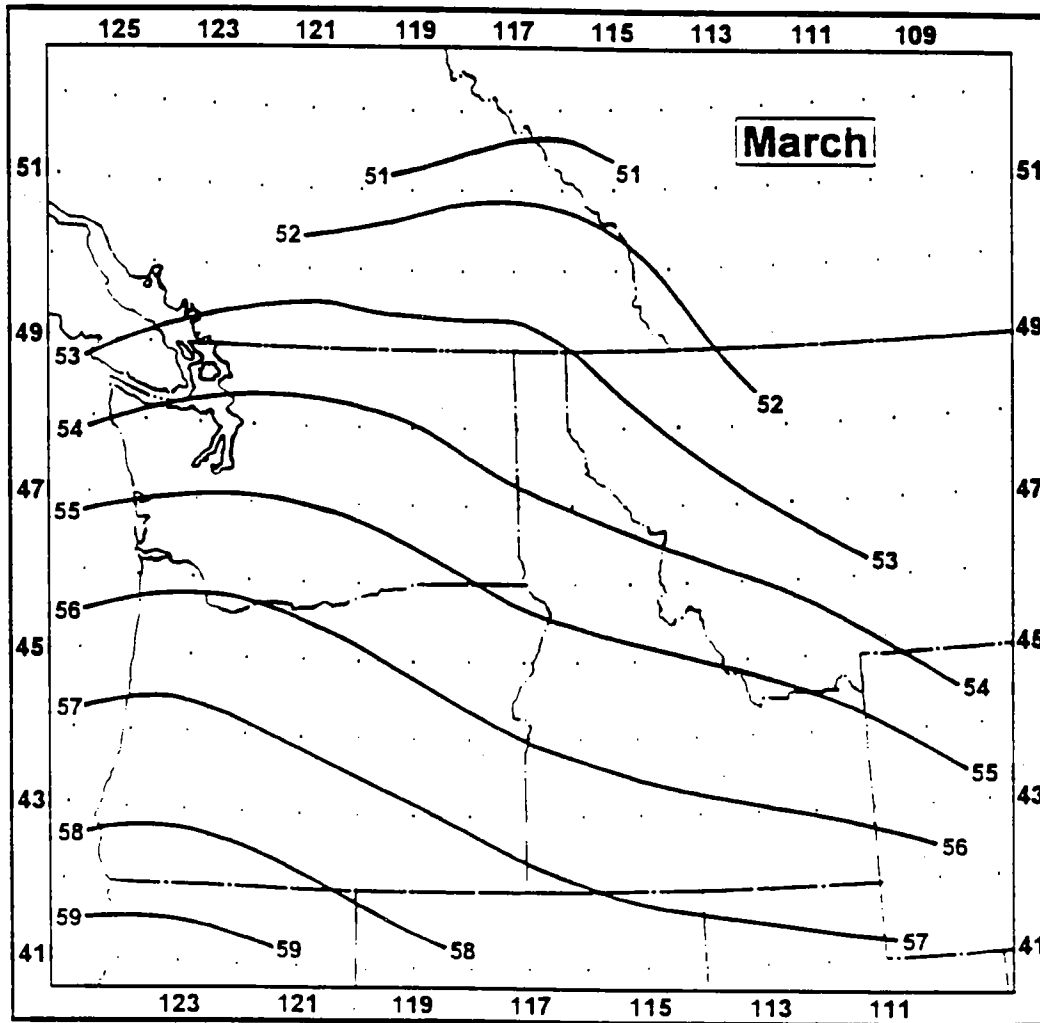

Figure 15.20.--12-hour maximum persisting 1000-mb dew point analysis (°F), March.

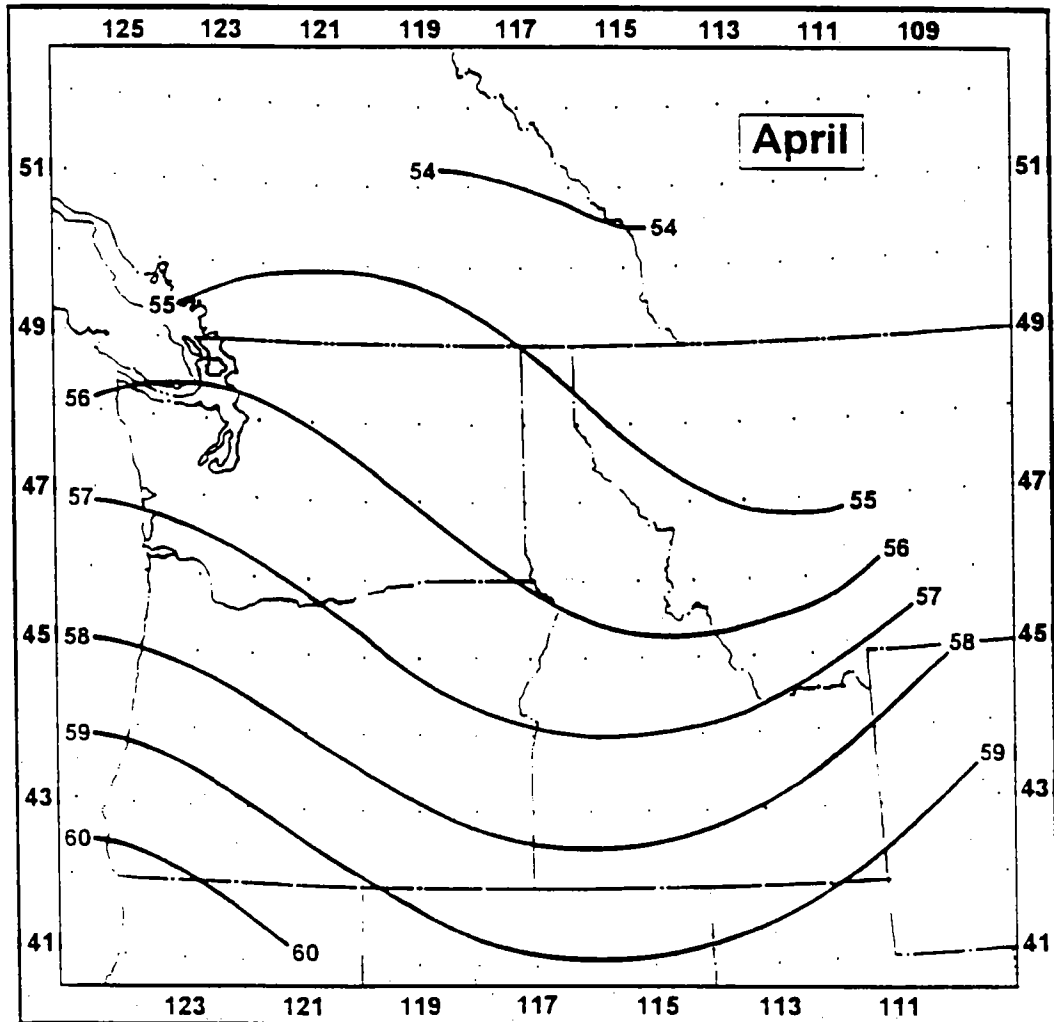

Figure 15.21.--12-hour maximum persisting 1000-mb dew point analysis (°F), April.

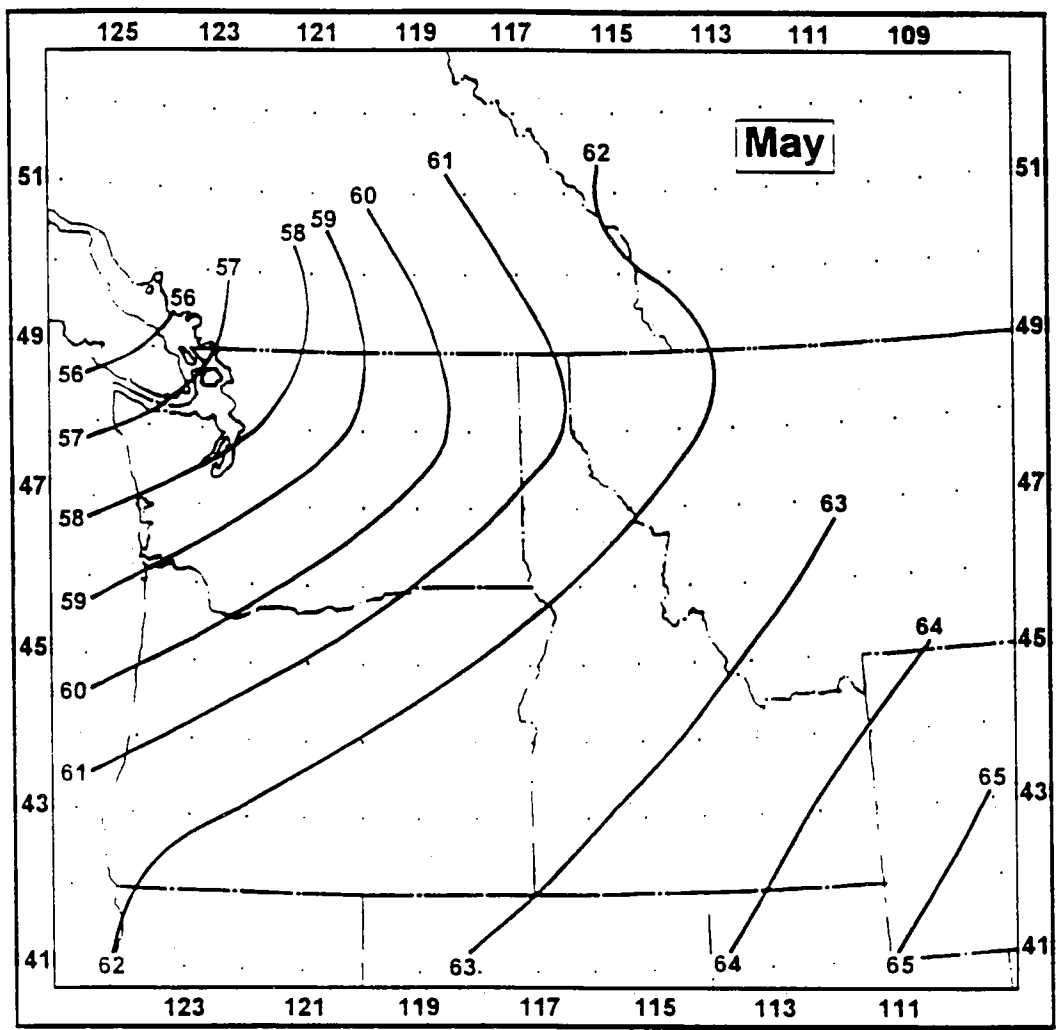

Figure 15.22.--12-hour maximum persisting 1000-mb dew point analysis (°F), May.

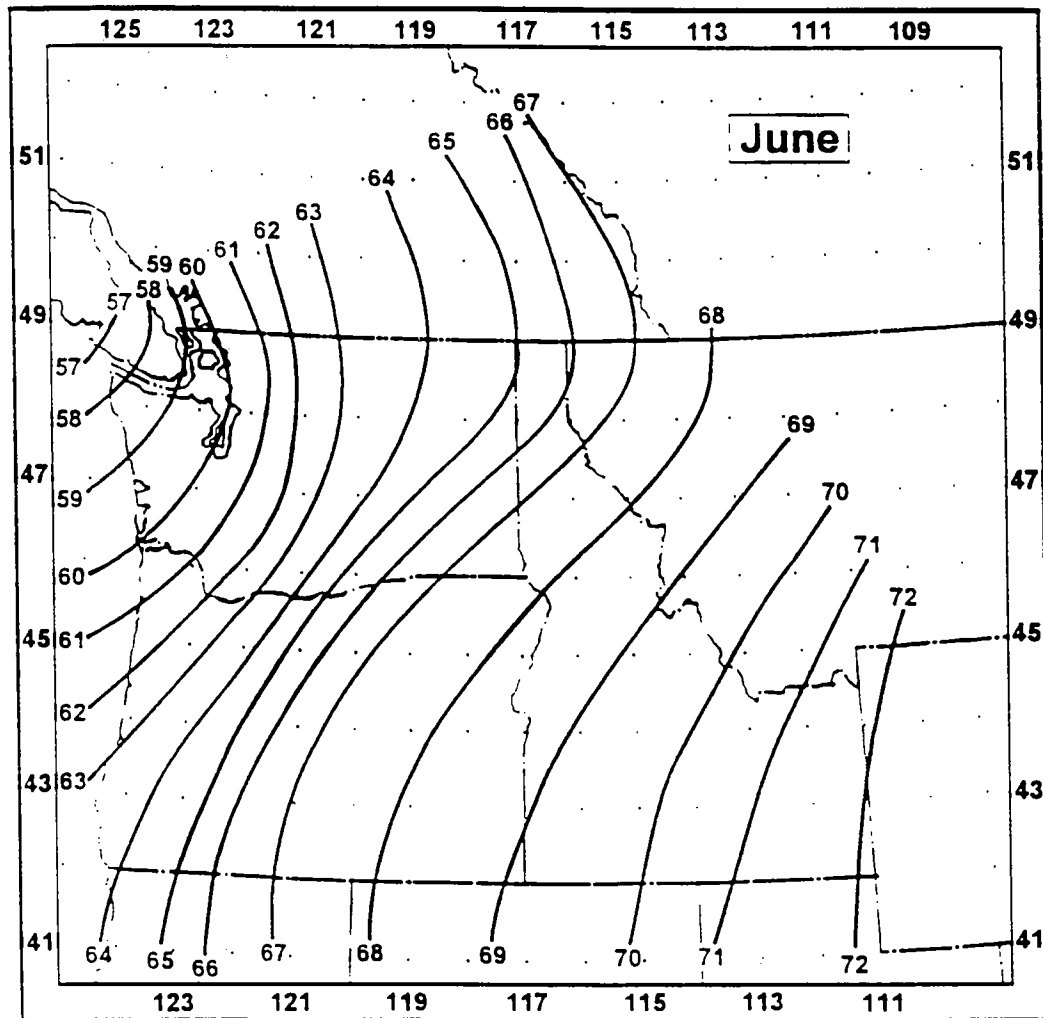

Figure 15.23.--12-hour maximum persisting 1000-mb dew point analysis (°F), June.

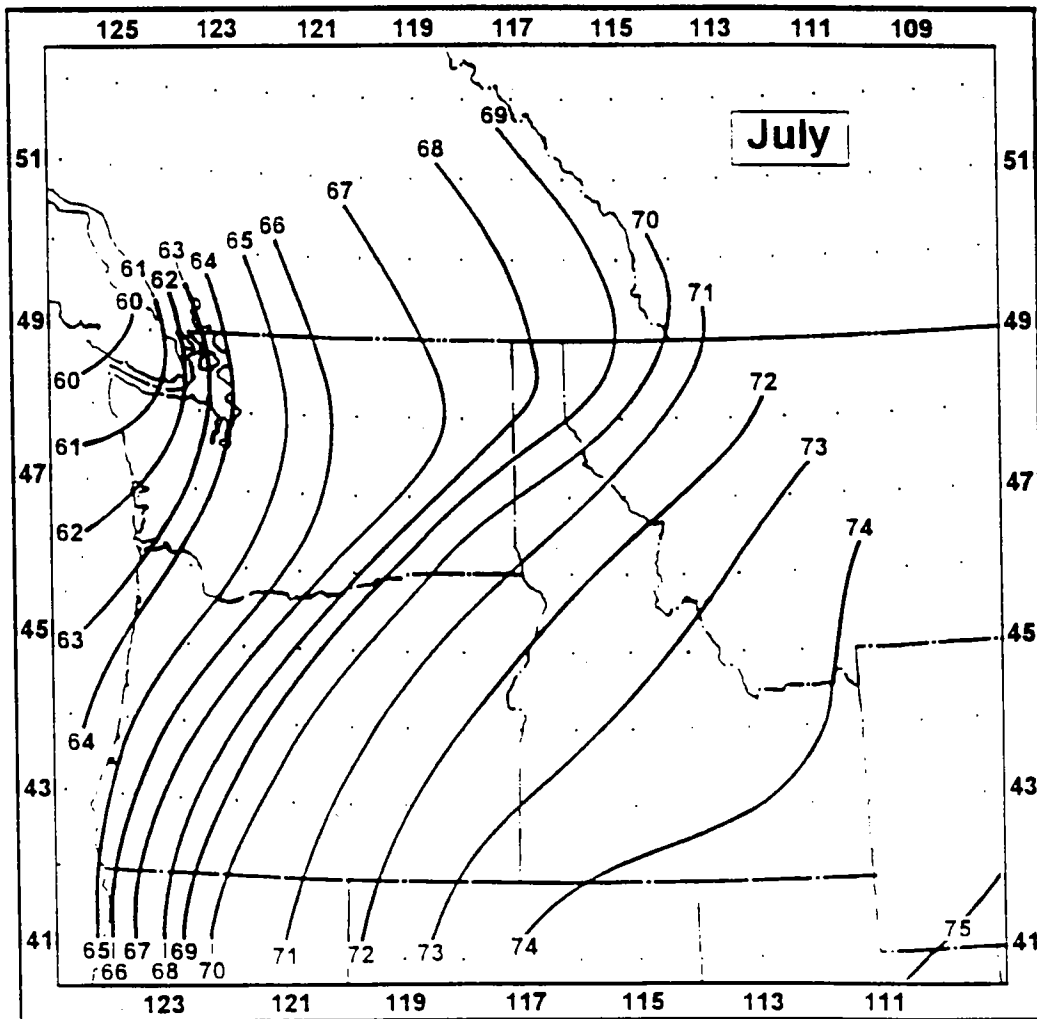

Figure 15.24.--12-hour maximum persisting 1000-mb dew point analysis (°F), July.

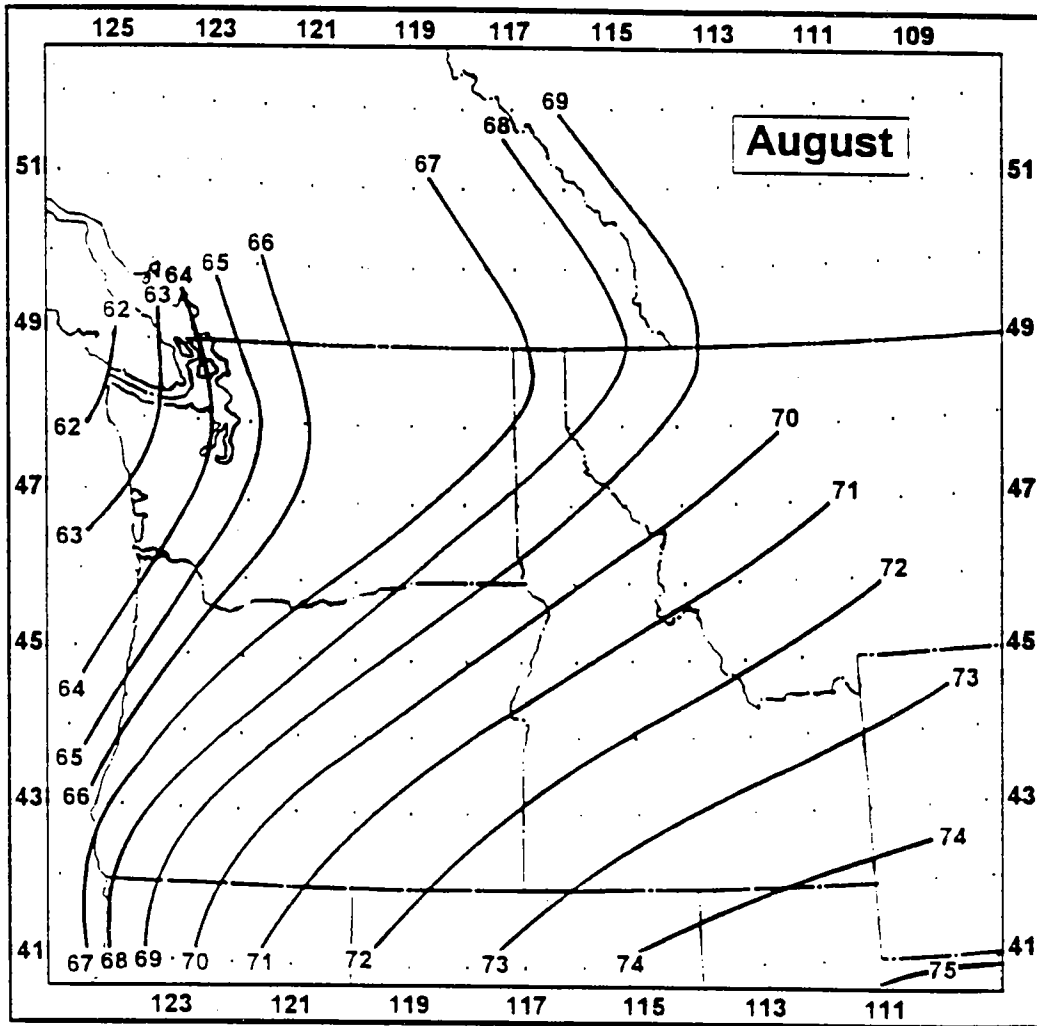

Figure 15.25.--12-hour maximum persisting 1000-mb dew point analysis (°F), August.

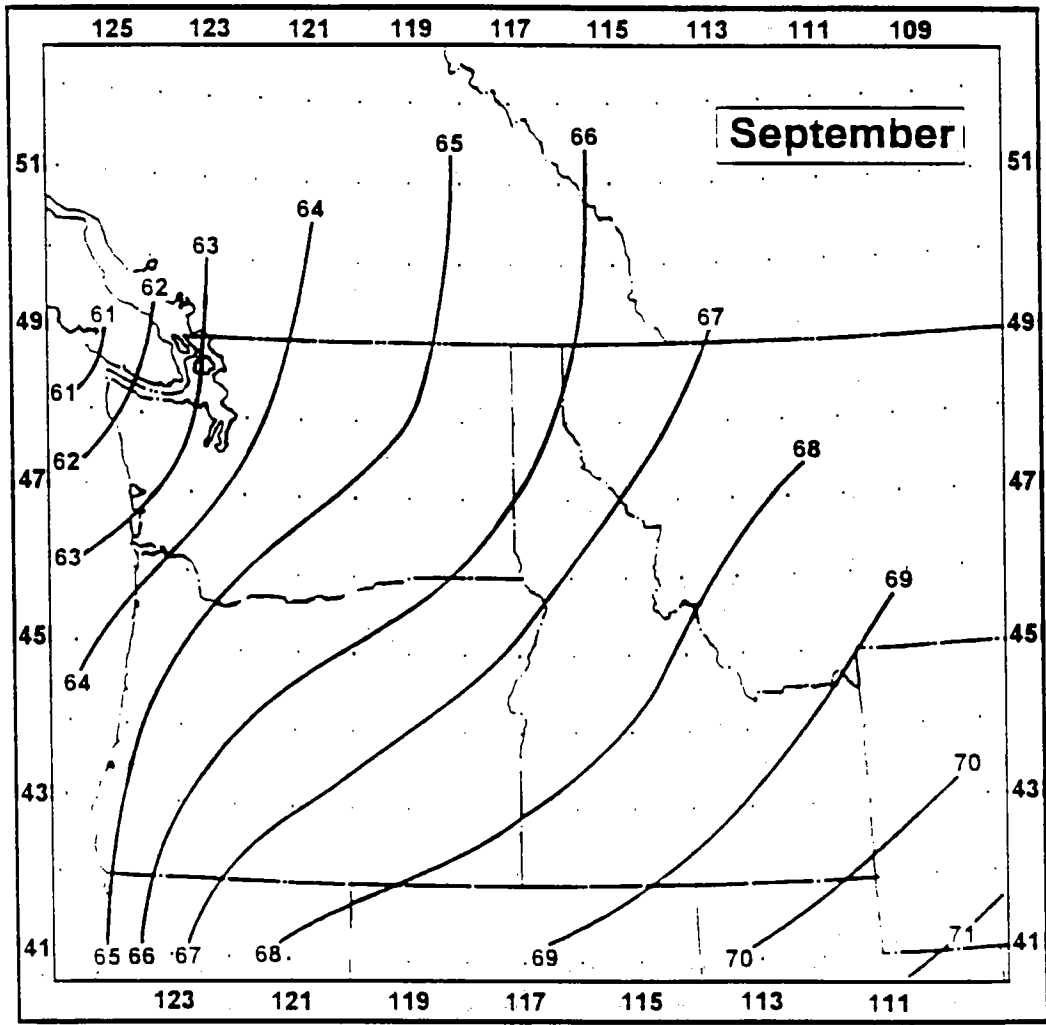

Figure 15.26.--12-hour maximum persisting 1000-mb dew point analysis (°F), September.

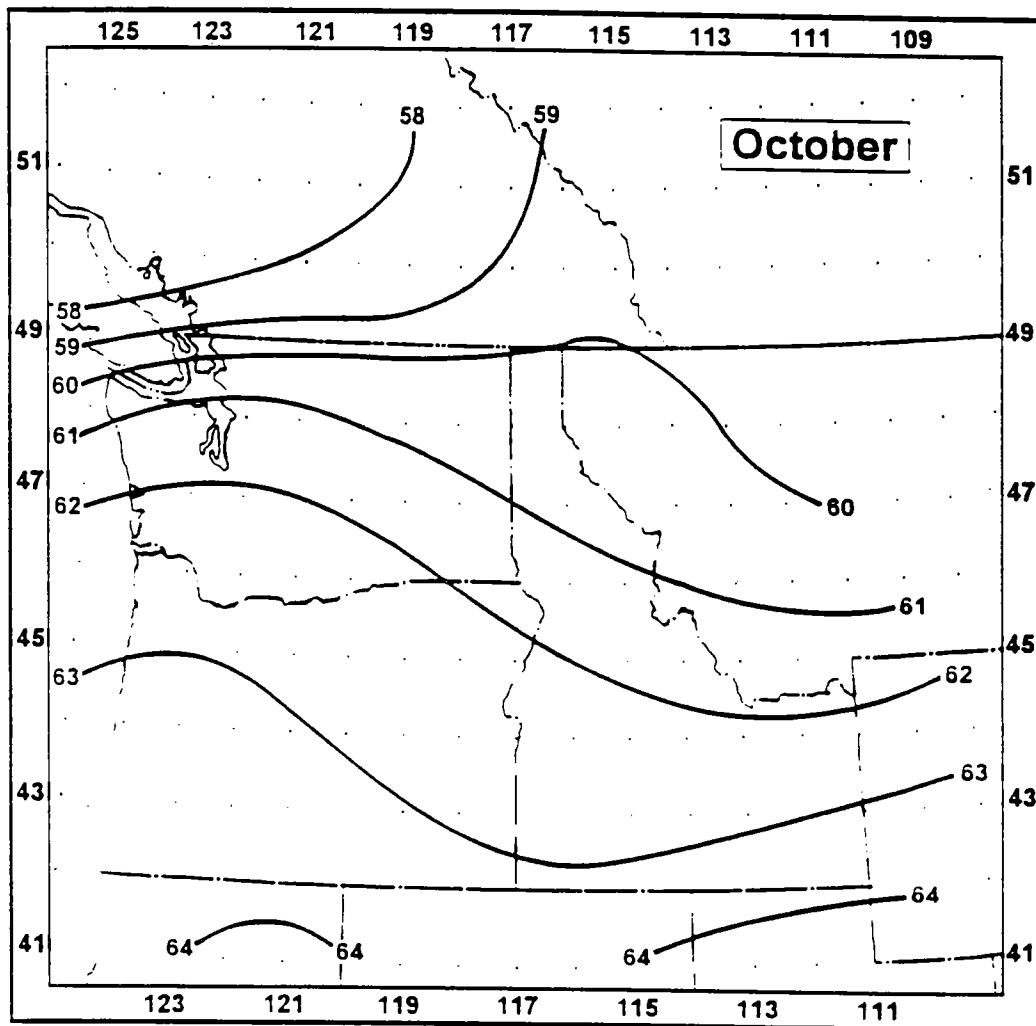

Figure 15.27.--12-hour maximum persisting 1000-mb dew point analysis (°F), October.

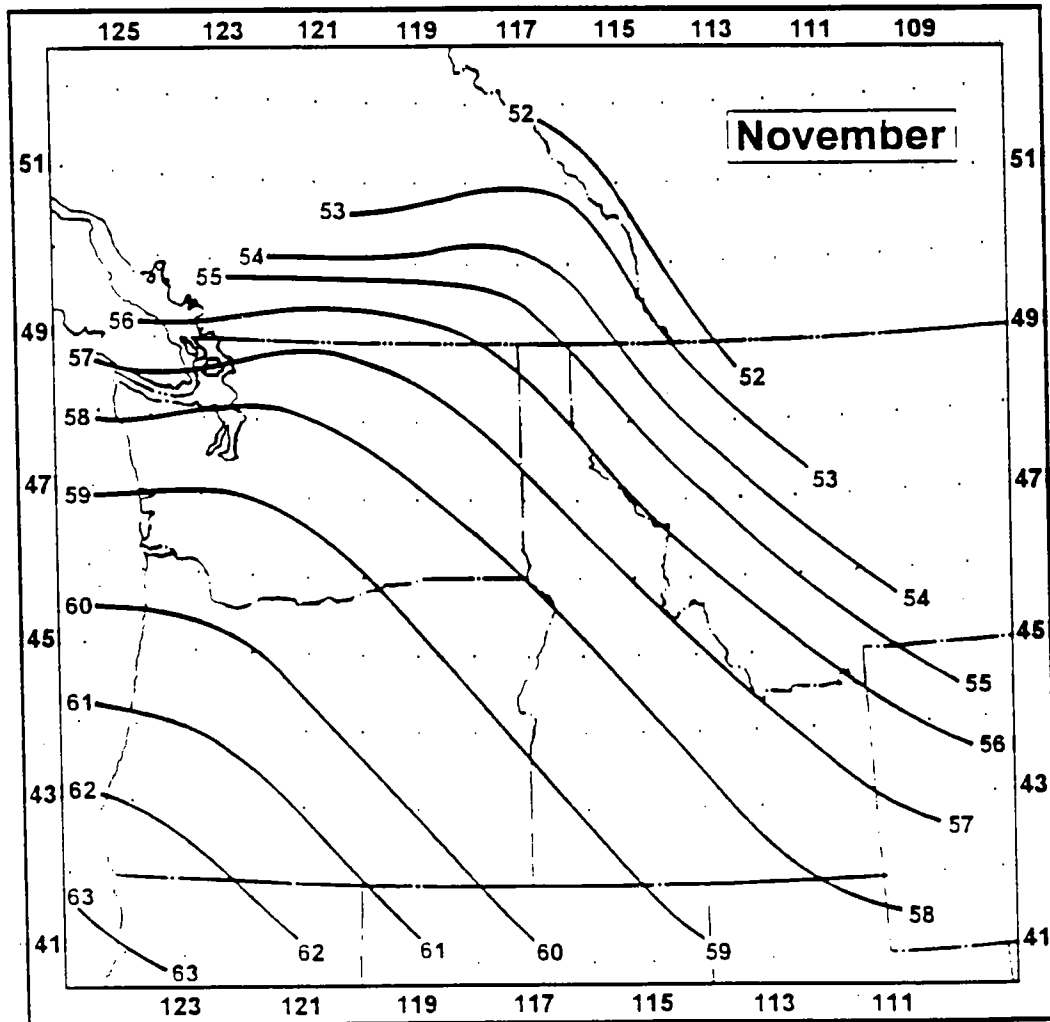

Figure 15.28.--12-hour maximum persisting 1000-mb dew point analysis (°F), November.

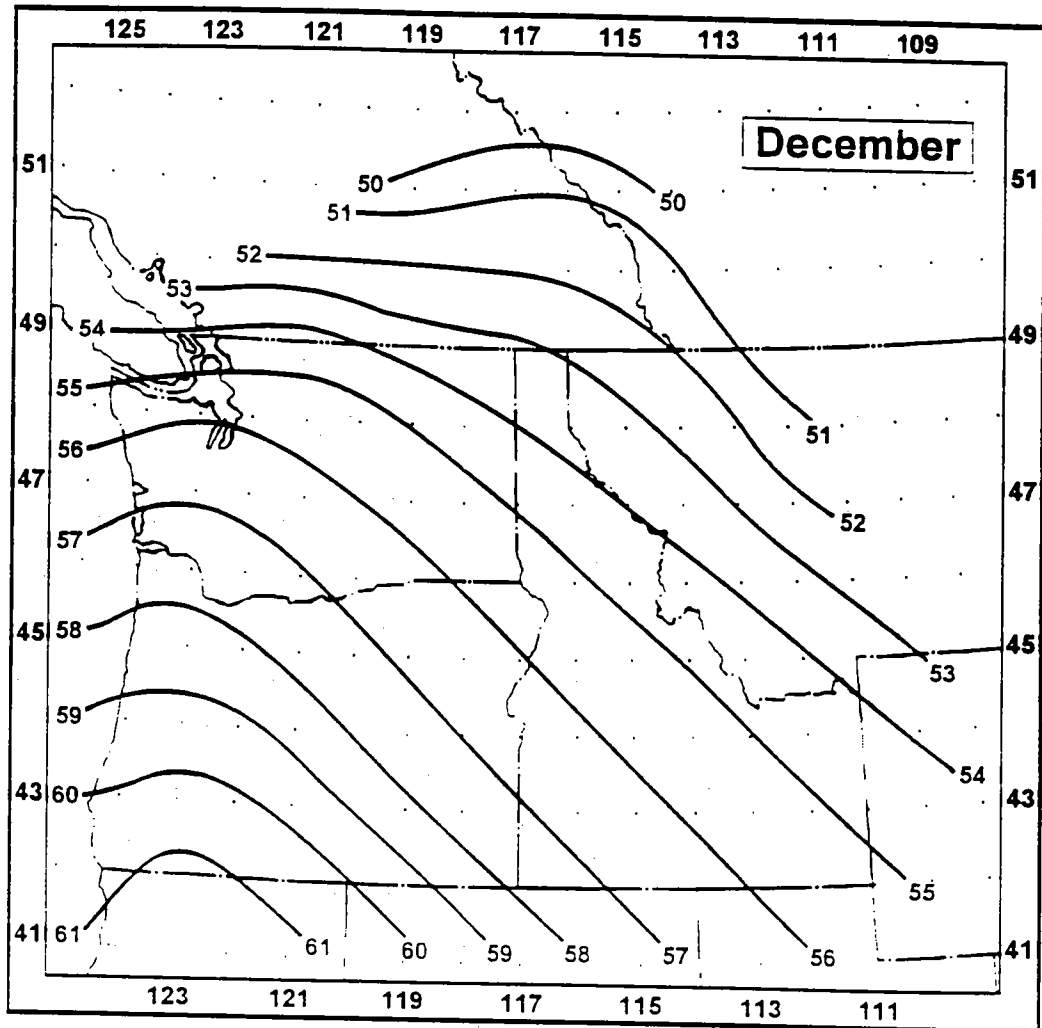

Figure 15.29.--12-hour maximum persisting 1000-mb dew point analysis (°F), December.

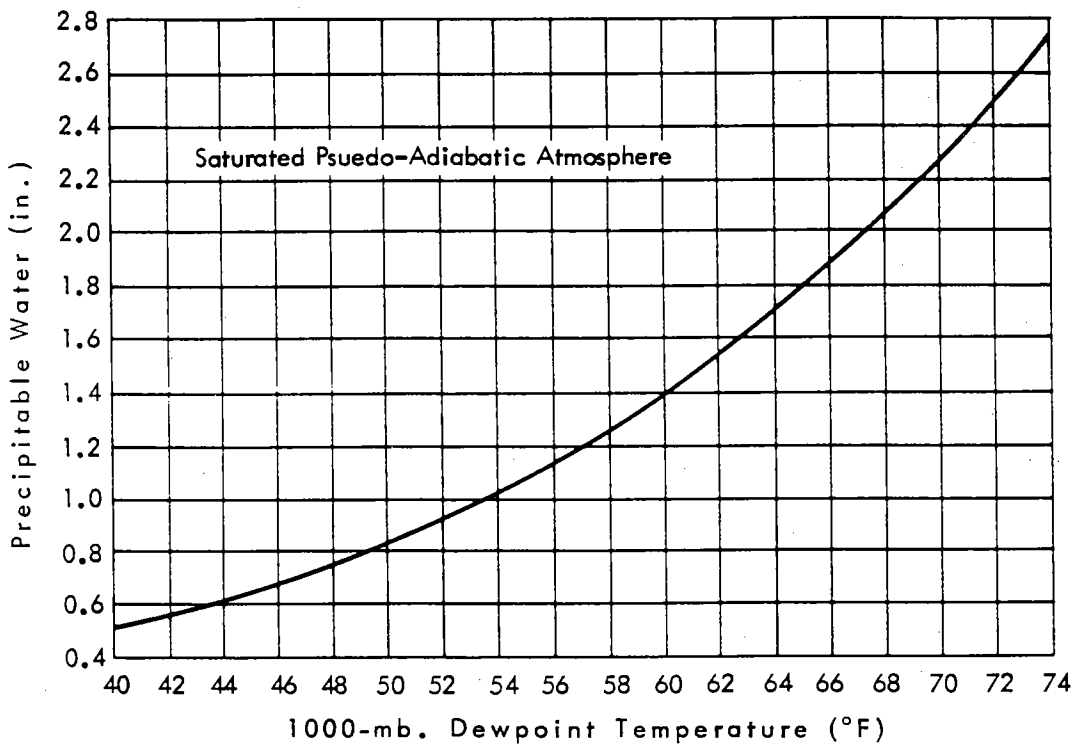

Figure 15.30.--Variation of precipitable water with 1000-mb dew point temperature (HMR 43).

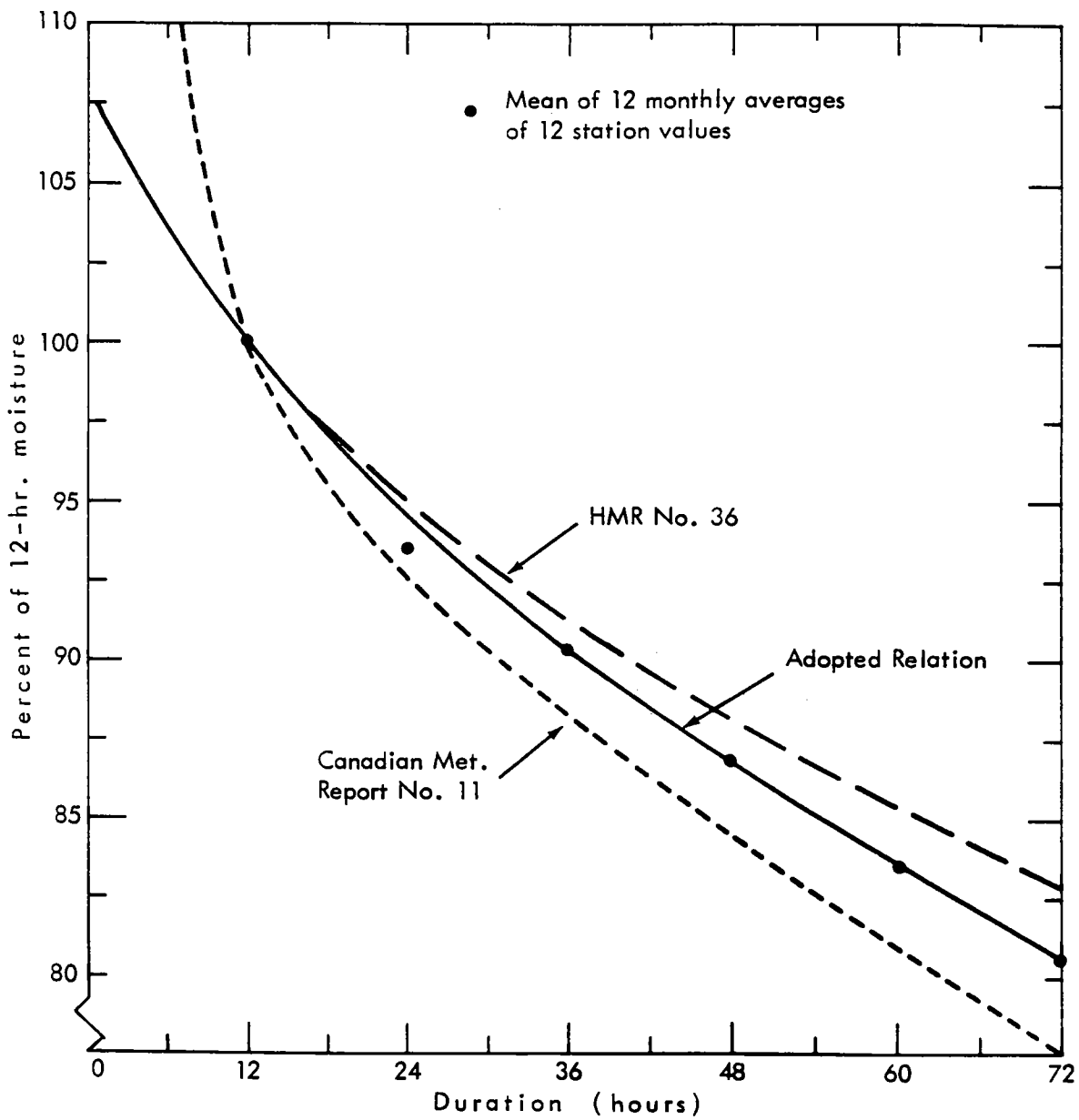

Figure 15.31.--Durational variation of maximum moisture (HMR 43).

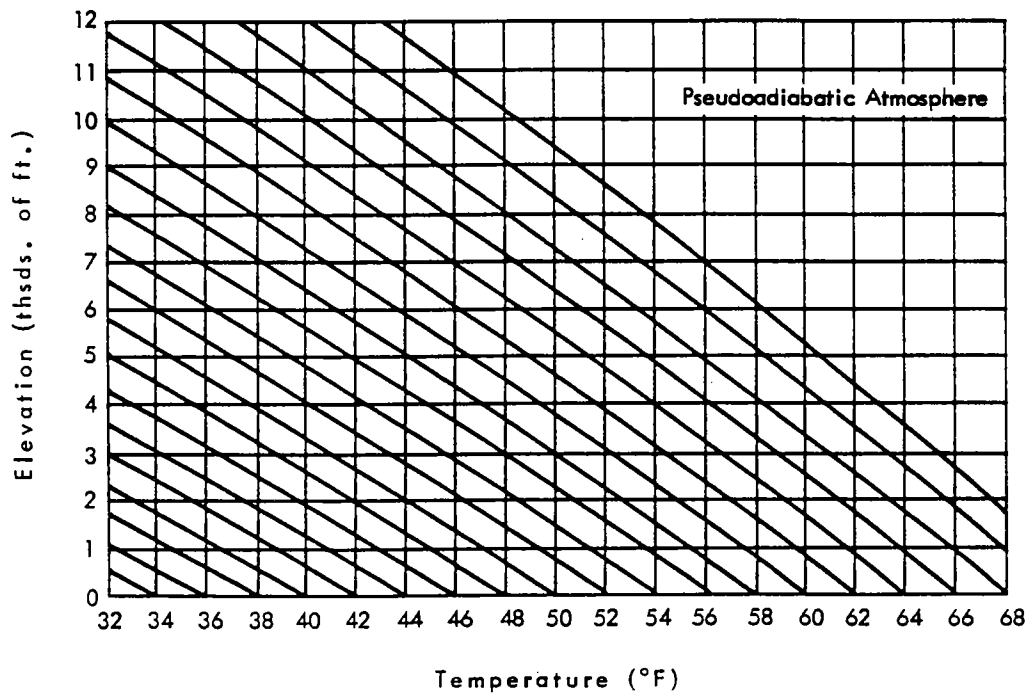

Figure 15.32.--Decrease of temperature with elevation (HMR 43).

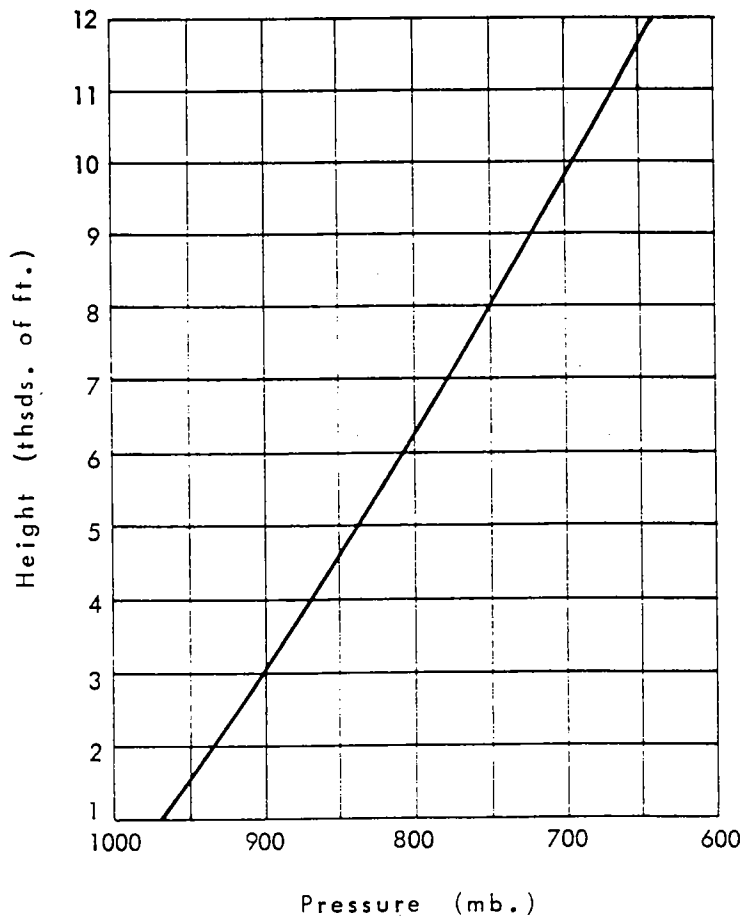

Figure 15.33.--Pressure-height relation (HMR 43).

15.3 Example of General-Storm PMP Computation

As an example of the application of the simple stepwise procedure outlined above, the White River basin above Mud Mountain Dam in Washington State has been chosen. This basin (402-mi²) was one of the 47 identified in Chapter 12. The White River basin lies directly north and northeast of Mount Rainier (14,411 feet), the tallest peak in the Cascades. This peak is permanently snow covered above about 10,000 feet, and therefore, poses some interesting questions.

Because of the permanent snow cover, the high elevation portions of the basin would not be expected to contribute to runoff in a PMP storm, so a decision needs to be made as to the elevation limit of contributing runoff. The elevation of snow cover varies seasonally. For this example, the all season snow line has not been considered here. This choice is to be made by the hydrologist.

Step

1. Drainage outline

The outline for the White River drainage above Mud Mountain Dam (402-mi²) is shown in Figure 15.34a, at 1:1,000,000 scale. Elevation contours for this same drainage are presented in Figure 15.34b for comparison.

2. User decision

We will limit this example to all-season PMP. From Figure 15.3, it can be seen that all season PMP occurs from November through February.

3. All-season index PMP estimate

Figure 15.34c shows the drainage outline relative to the 10-mi², 24-hour index PMP field from Chart 1 (from attached folder to this report). Note the sheltering influence provided by Mount Rainier relative to the moisture bearing southwesterly inflows. A uniform grid was developed for this drainage that resulted in 43 grid points within the drainage. Reading index values at these points and averaging gave a drainage averaged 10-mi², 24-hour value of 18.16 inches.

4. Not applicable in this example

5. Depth-duration

Using Chart 1, the White River drainage falls completely within subregion 4, orographic terrain west of the Cascades. Table 15.1 gives the following durational estimates as a ratio of 24-hour amount.

Duration (hours)	1	6	24	48	72
Ratio to 24 hours (from Table 15.1)	0.10	0.40	1.00	1.49	1.77
Depth (inches) (Step 3 x ratios)	1.82	7.26	18.16	27.06	32.14

6. Areal reduction factors

From Figure 15.10 for orographic depth-areal relations at 402-mi², we read the following areal reduction percentages by which to multiply the corresponding depths from step 5:

Duration (hours)	1	6	24	48	72
Areal reduction (%) (from Figure 15.10)	76.7	82.0	84.3	85.2	86.3
Depth (inches) (Step 5 x percentages)	1.40	5.95	15.31	23.06	27.74

These results are plotted in Figure 15.35 and fitted by a smooth curve that represents the drainage averaged all-season PMP for this example. Comparison of these results with those computed for December by Reclamation in Table 12.1 shows differences of about one percent. It is to be expected that different analysts will get slightly different basin average depths when using the index charts, but the differences should be negligible.

Note that in the event that answers were needed for April, as an example, reference should be made to Figure 15.5. A weighted average adjustment factor of 0.68 is estimated for this drainage and would be applied to the 18.16-inch drainage average estimate to get 12.35 inches in step 4. This reduced value would then be used to complete steps 5 and 6.

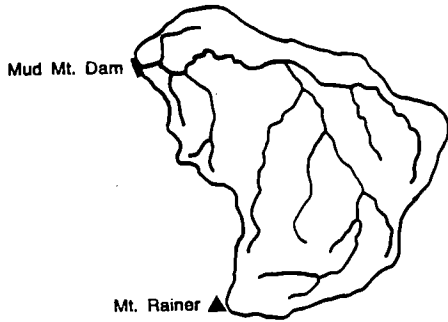

Figure a. Mud Mountain drainage; dam and White River tributaries.



Figure b. Elevation contours in thousands of feet.

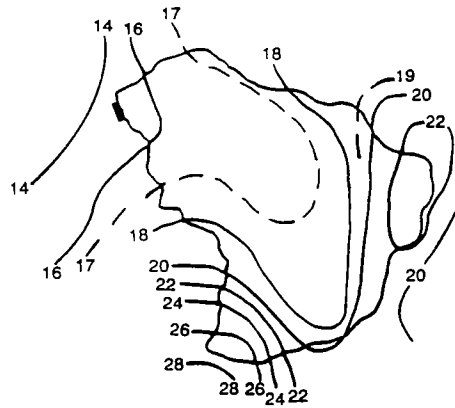

Figure c. 10 mile sq. 24hr PMP from index map on Mud Mt. drainage.

Figure 15.34.--Application of PMP to drainage for Mud Mountain, Washington (402-mi²). Scale 1:1,000,000.

7. Incremental estimates

The smooth curve in Figure 15.35 is used to read off estimates at 6-hour intervals as follows:

	Duration (hours)											
PMP (inches)	6	12	18	24	30	36	42	48	54	60	66	72
	5.75	9.45	12.50	15.30	17.70	19.75	21.50	23.00	24.35	25.55	26.65	27.75

To obtain 6-hour increments, subtract each durational amount from the next longer amount (e.g., 6 hours from 12 hours, 12 hours from 18 hours, etc.), to get:

6-hour intervals	1	2	3	4	5	6	7	8	9	10	11	12
PMP increment (inches)	5.75	3.70	3.05	2.80	2.40	2.05	1.75	1.50	1.35	1.20	1.10	1.10

8. Temporal distribution

Rank the results from step 7 from high to low in a sequence following the guidelines given for temporal distribution in step 8. The hydrologically most critical sequence for a drainage requires information from the user. However, an example of a sequence that may be critical using results from step 7 above is:

6-hour intervals	1	2	3	4	5	6	7	8	9	10	11	12
PMP increment (inches)	1.75	2.40	2.05	1.50	2.80	3.70	5.75	3.05	1.35	1.20	1.10	1.10

9. Areal distribution of general storm PMP

This step is left to the user because of individual practices applied by various agencies.

10. Temperature and wind for snowmelt

This step is left to the user. Guidance to the stepwise procedure recommended in HMR 43 is given in Appendix 5 of this report.

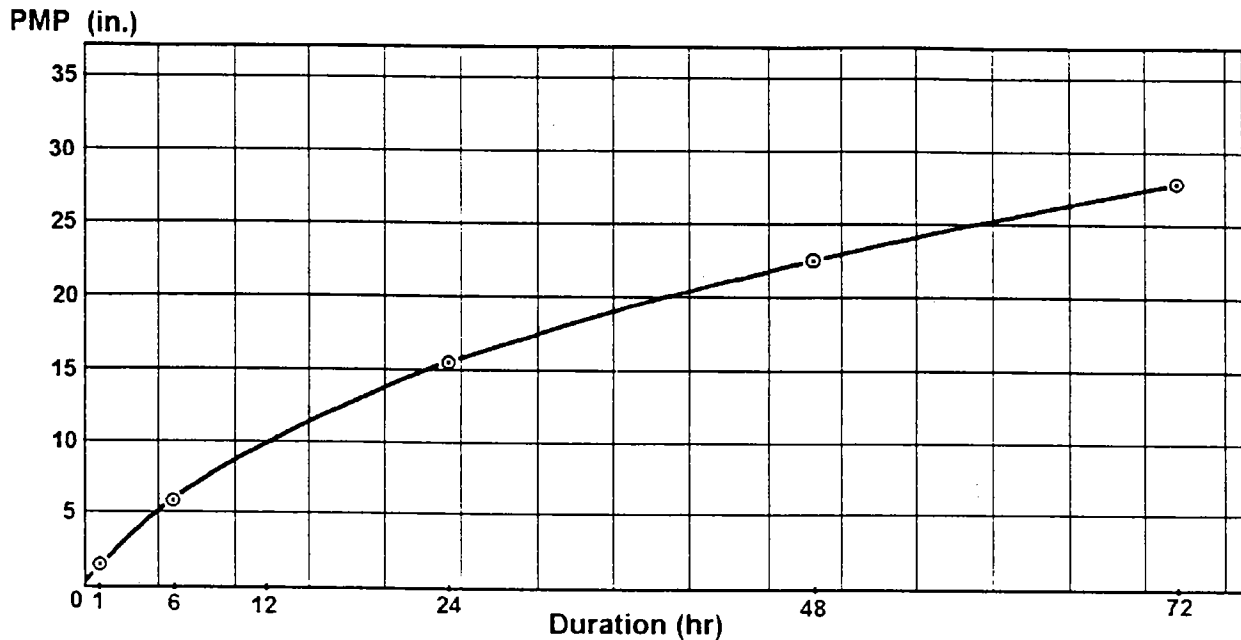

Figure 15.35.--Depth-duration curve for basin-averaged PMP for Mud Mountain dam basin (402-mi²), Washington.

15.4 Local Storm Procedure

The background for the various figures and tables used in this procedure are discussed in detail in Chapter 11.

Step

1. 1-hour, 1-mi² PMP for elevations at or below 6,000 feet

Locate the basin on Figure 15.36 and determine the basin average 1-hour, 1-mi² local storm index PMP. Linear interpolation is assumed to apply.

2. Adjustment for mean drainage elevation

Determine the mean elevation of the drainage in question. No adjustment is necessary for elevations of 6,000 feet or less. If the mean elevation is greater than 6,000 feet, reduce the index PMP from Step 1 by 9 percent for every 1,000 feet above the 6,000-foot level. Figure 15.37 can also be used to graphically determine this value.

An example of the elevation adjustment is as follows: Take a basin with a mean elevation of 8,700 feet, (2,700 feet above 6,000 feet). The reduction factor would be 24.3 percent (or $2.7 \times .09$ in this case), yielding an elevation-

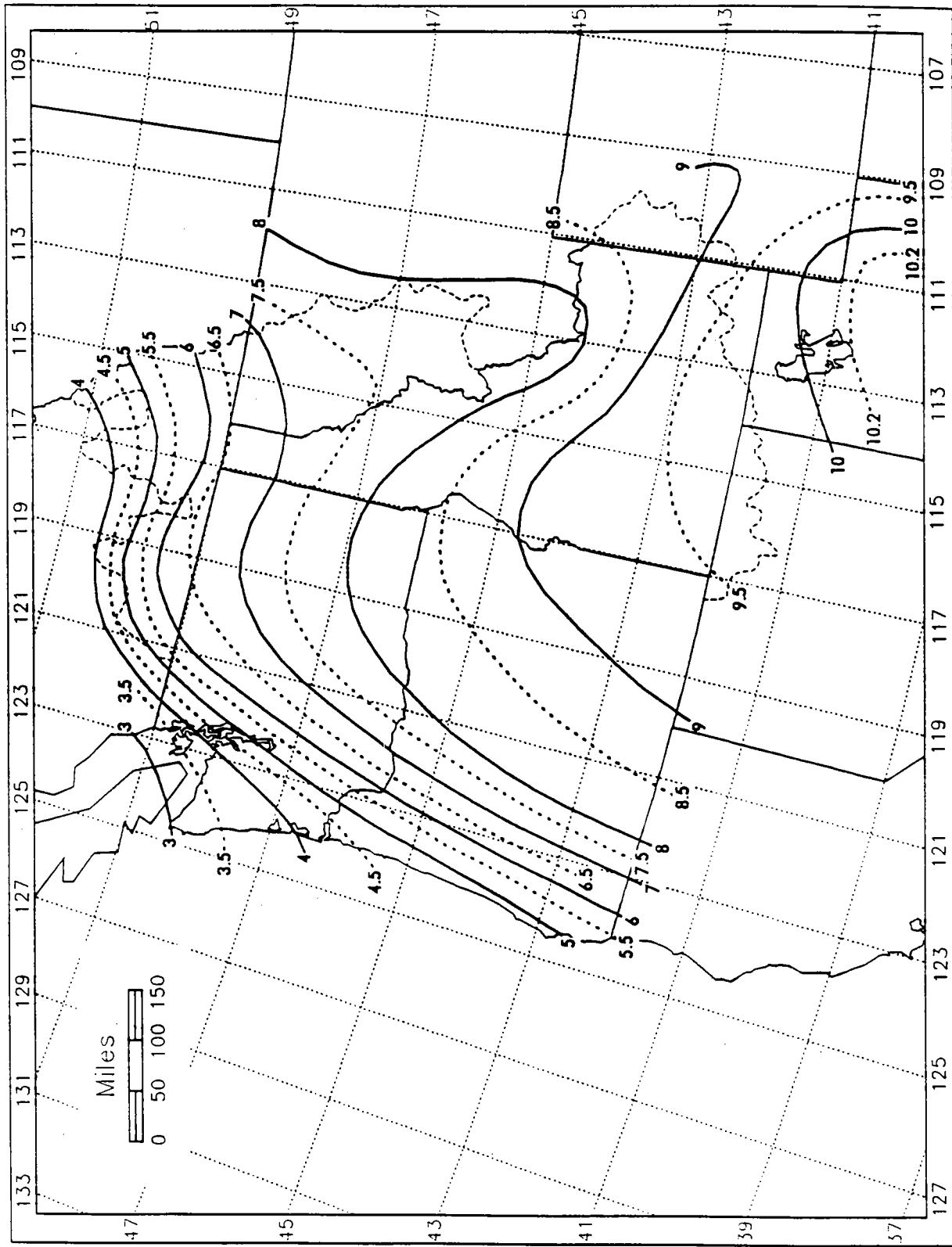

Figure 15.36.--1-hr 1-mi² local storm PMP in inches for elevations to 6000 ft.

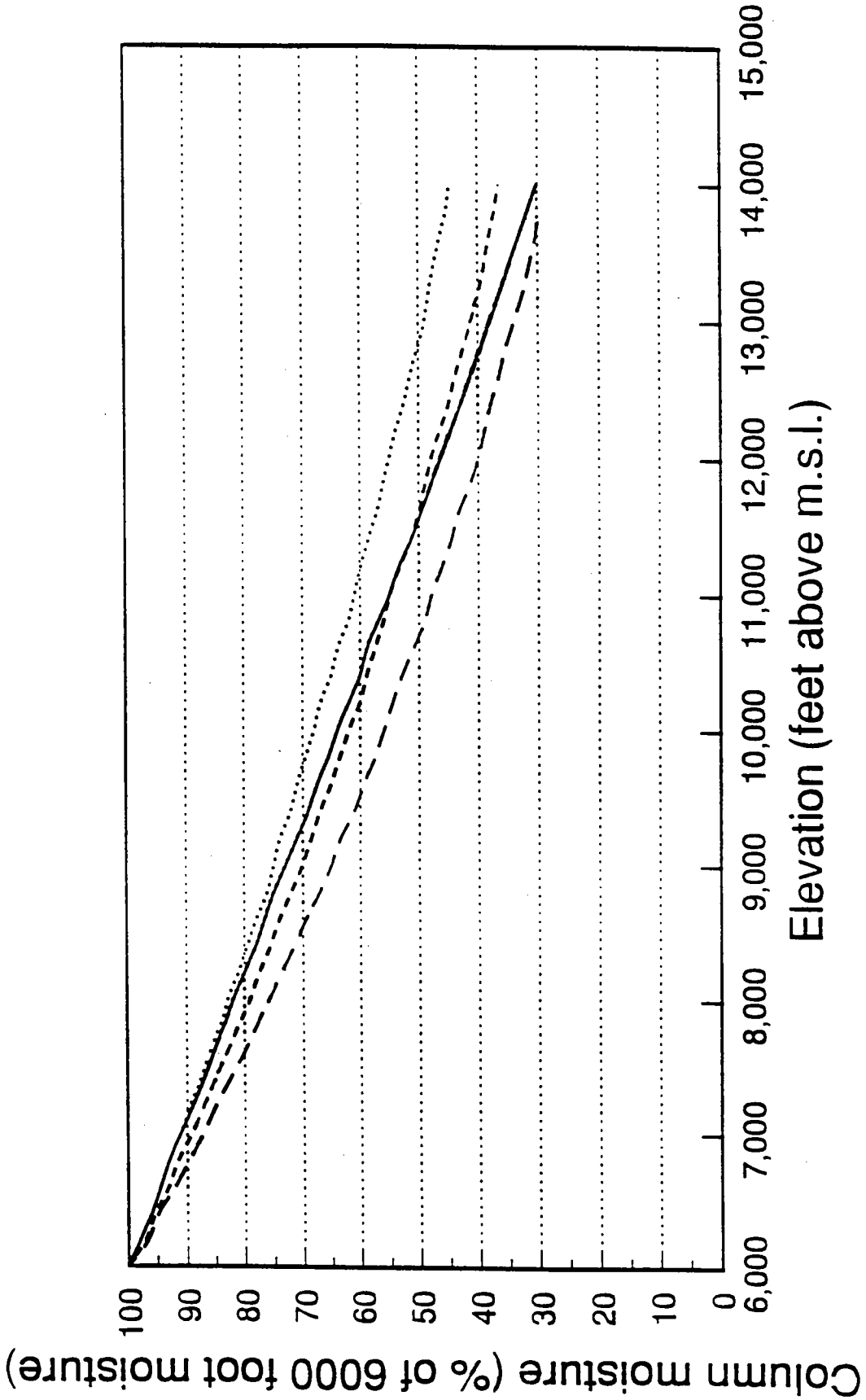

Figure 15.37.--Pseudoadiabatic decrease in column moisture for local storm basin elevations (Appendix 4).

adjusted index PMP of 76 percent (rounded) of full PMP at 6,000 feet. Had Figure 15.37 been used, a value of about 76 percent is read off the line labeled pseudoadiabat for an elevation of 8700 feet.

3. Adjustment for duration

1-mi² local storm PMP estimates for durations less than one hour and up to 6 hours are obtained from Figure 15.38, as a percentage of the 1 hour amount from step 2. Amounts for certain specific durations are also specified in the table contained in this figure.

4. Adjustment for basin area

Determine the basin area in square miles. Figure 15.39 shows the depth-area relationship, which gives the areal reduction in PMP to 500-mi². The percentage reductions at 1/4, 1/2, 3/4, 1, 3, and 6-hours for the area of the basin from the figure are to be multiplied by the respective results from step 3, and a smooth curve drawn for the plotted values in order to obtain estimates for durations not specified.

5. Temporal distribution

Review of local storm temporal distributions for this region show that most storms have durations less than 6 hours and that the greatest 1-hour amount occurs in the first hour. The recommended sequence of hourly increments is as follows: arrange the hourly increments from largest to smallest as directly obtained by successive subtraction of values and read from the smooth depth-duration curve.

6. Areal distribution for local-storm PMP

The elliptical pattern in Figure 15.40, along with the tabulated percentages in Table 15.2, are to be used in deriving the areal distribution of local storm PMP. In the event of choosing this option, steps 3 and 4 can be ignored and the results from step 2 (or 1, if no elevation adjustment is made) are multiplied by each of the percentage factors in Table 15.2. The products represent the labeled isohyets of the idealized pattern placed over the specific drainage. The example in 15.4 should clarify this application.

Once the labels have been determined for each application, the pattern can be moved to different placements on the basin. In most instances, the greatest volume of PMP will be obtained when the pattern is centered in the drainage. However, peak flows may actually occur with placements closer to the drainage outlet. Regardless of where the storm is centered, it should be remembered that the results from step 4 give "PMP for the basin" regardless of the spatial distribution.

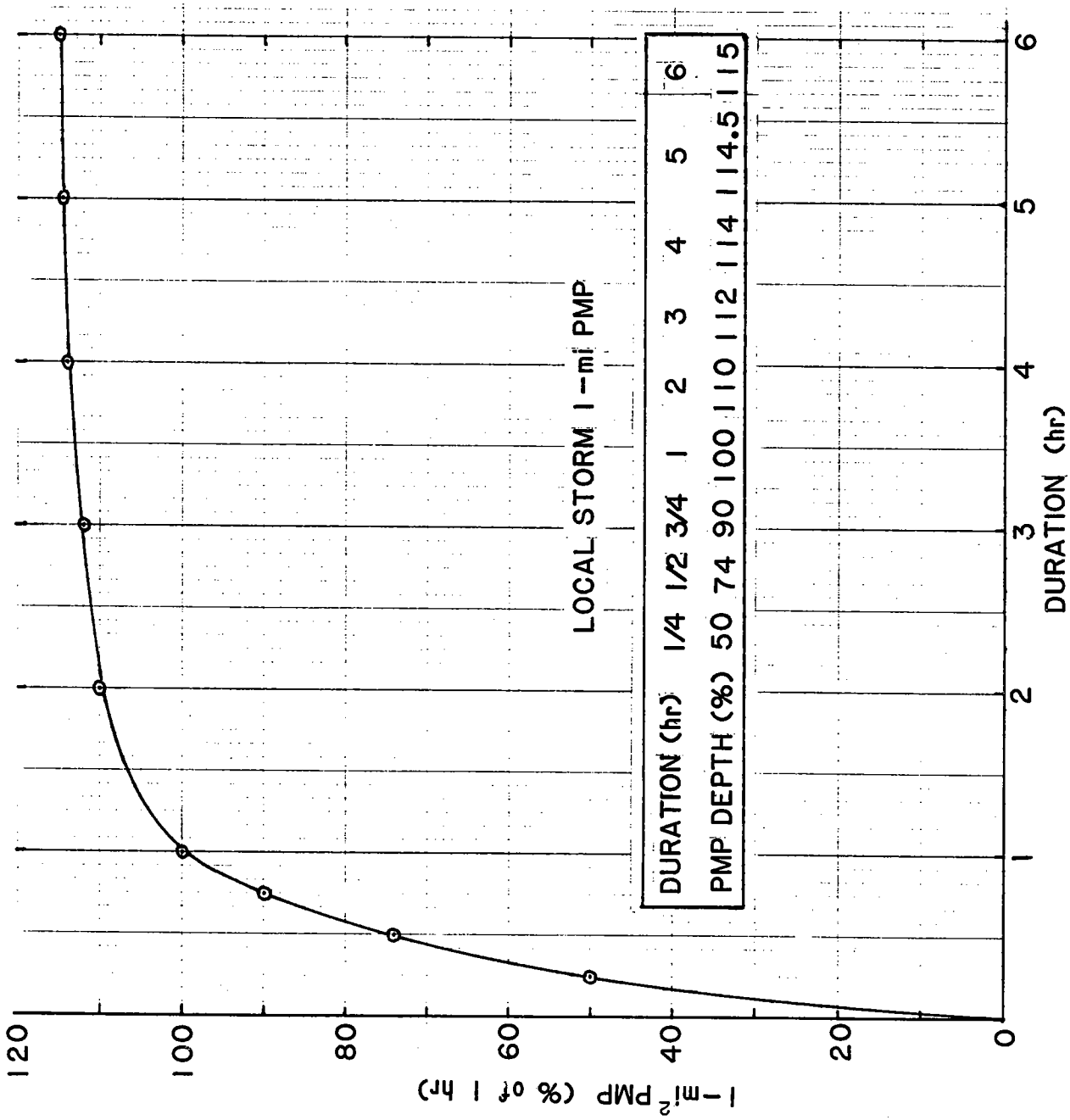

Figure 15.38.--Depth-duration relationship for 1-mi² PMP Pacific Northwest states (Section 11.7.2).

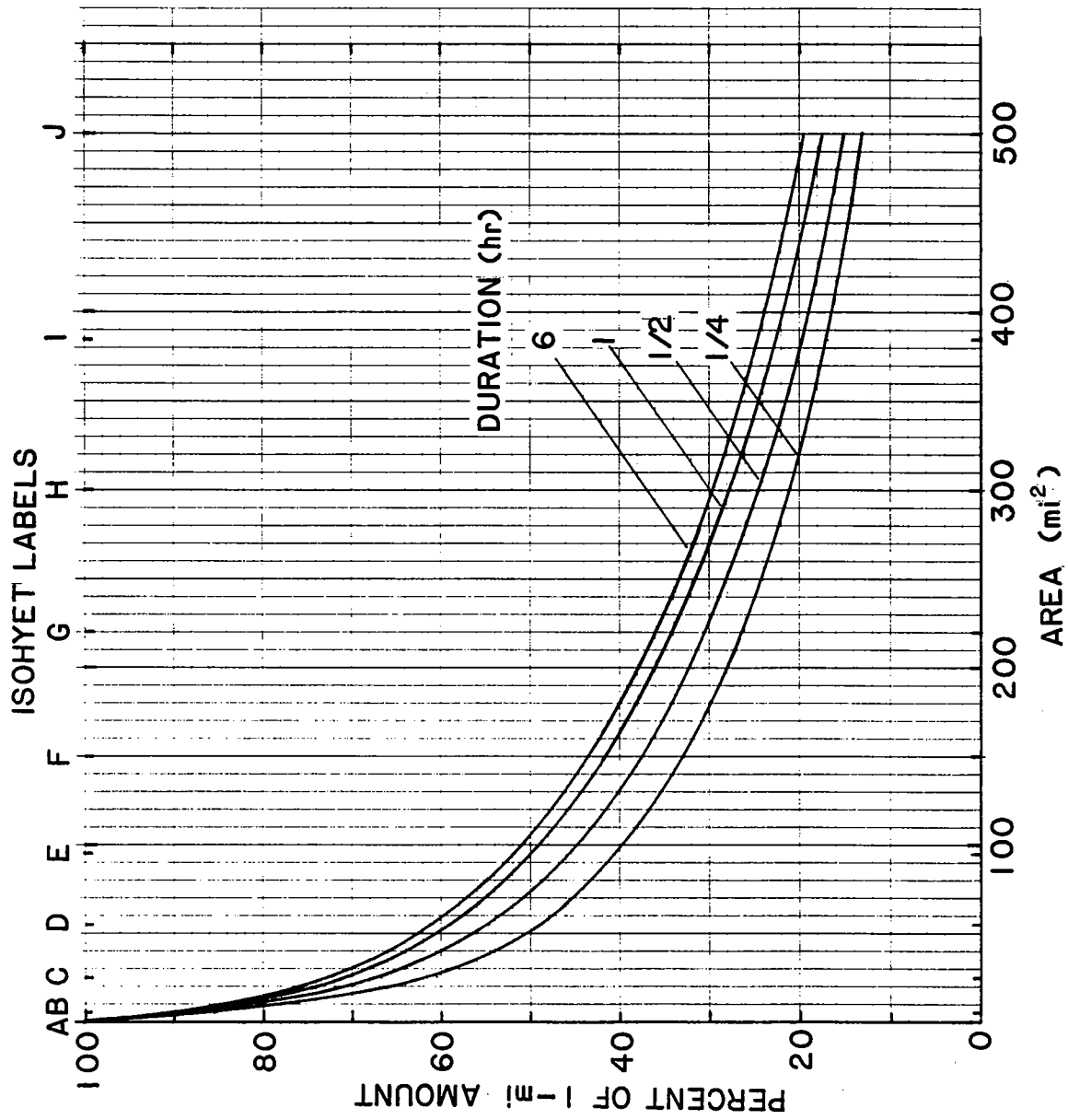

Figure 15.39.--Depth-area relations for local storm PMP Pacific Northwest states (Section 11.8).

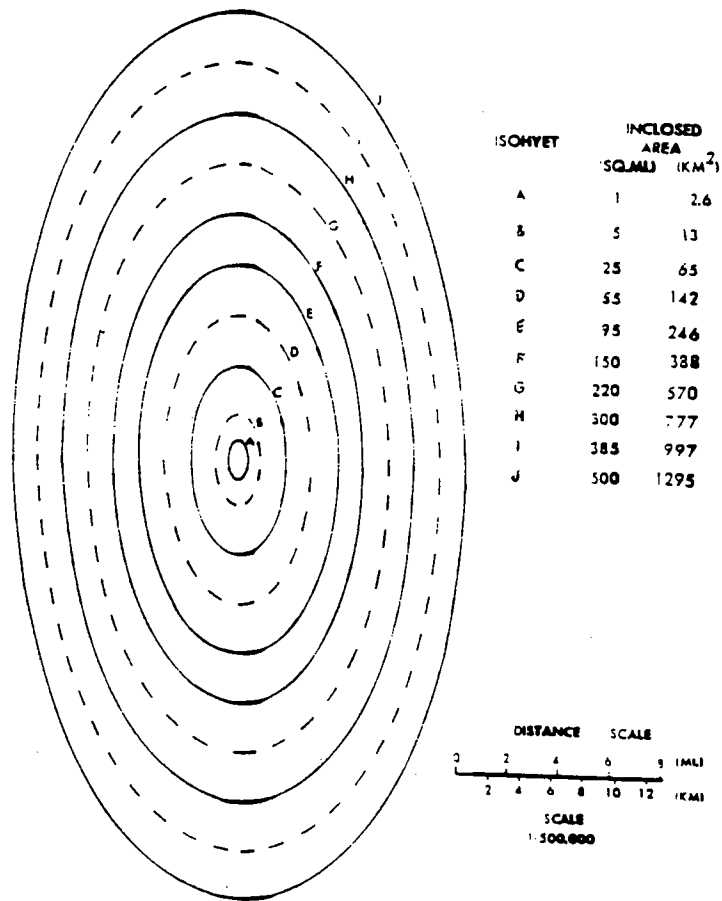

Figure 15.40.--Idealized isohyetal pattern for local storm PMP areas up to 500 mi² (from Hansen, et. al., 1978 - see also sect. 11.8.3)

Table 15.2--PMP Profile Values (accumulative % of 1-hour, 1-mi² amount).									
Duration (hours)									
Isohyet	1/4	1/2	3/4	1	2	3	4	5	6
A	50.0	74.0	90.0	100.0	110.0	112.0	114.0	114.5	115.0
B	32.0	53.0	67.0	74.8	83.5	85.5	87.5	88.0	88.5
C	22.0	37.5	48.0	56.0	63.0	65.0	66.0	66.5	67.0
D	17.0	28.5	38.0	43.0	48.0	49.5	50.5	51.0	51.5
E	12.0	21.0	28.0	32.2	37.0	38.0	38.5	39.0	39.5
F	7.5	14.0	19.0	22.4	25.0	25.7	26.2	26.7	27.2
G	5.0	8.5	12.0	14.0	16.2	16.7	17.2	17.7	18.2
H	2.0	3.5	5.0	6.5	8.3	8.8	9.3	9.8	10.3
I	0.4	0.7	1.0	1.2	2.2	2.7	3.2	3.7	4.2
J	0.2	0.3	0.4	0.5	1.0	1.5	2.0	2.5	3.0

15.5 Example of Local-Storm PMP Computation

If the White River basin above Mud Mountain Dam (402-mi²) is again chosen, this time to determine the local storm PMP, follow the steps outlined in Section 15.4.

Step

1. The basin outline is placed on Figure 15.36 and the basin average 1-mi², 1-hour PMP is read as 6.35 inches.
2. The average drainage elevation is below 6,000 feet although higher elevations occur near the border of the basin. No adjustment is needed for this basin.
3. Durational 1-mi² values are obtained from Figure 15.38 as follows:

	<u>Duration (hours)</u>									
	1/4	1/2	3/4	1	2	3	4	5	6	
(%)	50	74	90	100	110	112	114	114.5	115	
PMP (inches)	3.18	4.70	5.72	6.35	6.99	7.11	7.24	7.27	7.30	

4. The areal reduction factors are obtained from Figure 15.39 for 402-mi² to give basin average PMP at the durations indicated. Multiply the respective factor times the results of step 3.

	<u>Duration (hours)</u>					
	1/4	1/2	3/4	1	3	6
Factor (%)	16.0	19.0	21.0	22.0	23.0	24.0
PMP (inches)	0.51	0.89	1.20	1.40	1.64	1.75

The areally reduced PMP in step 4 needs to be plotted on a depth-duration diagram and a smooth curve drawn in order to determine PMP for any other intermediate duration.

- The temporal distribution is given by plotting the results of step 4, such as shown in Figure 15.41 and reading off smoothed hourly values. Note that the smoothed values may differ slightly from the calculated values.

<u>Hourly intervals</u>	1	2	3	4	5	6
PMP (inches)	1.38	1.55	1.64	1.70	1.73	1.75
Increments (inches)	1.38	0.17	0.09	0.06	0.03	0.02

These increments are arranged in the recommended sequence for front-loaded local-storm PMP. It is also possible that the storm could be mid-loaded. See Chapter 11 for more details about possible temporal distributions for local storms.

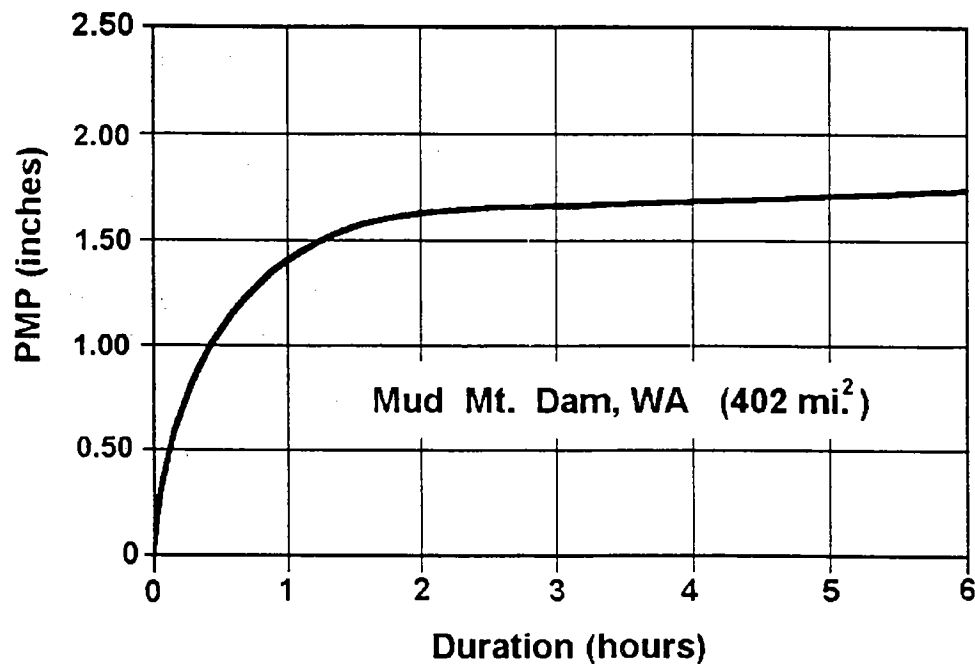

Figure 15.41.--Temporal distribution relation for Mud Mountain Dam.

6. In the event the areal distribution provided by the idealized elliptical pattern in Figure 15.40 is needed, the isohyet labels (A, B,) are determined by reference to Table 15.2. In this example, the step 1 result of 6.35 inches is multiplied by each of the percentages in Table 15.2 to get the label values in inches in Table 15.3.

Table 15.3.--Isohyetal label values for local-storm PMP, White River, Washington (402-mi²).									
Isohyet (mi ²)	Duration (hours)								
	1/4	1/2	3/4	1	2	3	4	5	6
A (1)	3.18	4.70	5.72	6.35	6.99	7.11	7.24	7.27	7.30
B (5)	2.03	3.37	4.25	4.75	5.30	5.43	5.56	5.59	5.62
C (25)	1.40	2.38	3.05	3.56	4.00	4.13	4.19	4.22	4.25
D (55)	1.08	1.81	2.41	2.73	3.05	3.14	3.21	3.24	3.27
E (95)	0.76	1.33	1.78	2.04	2.35	2.41	2.44	2.48	2.51
F (150)	0.48	0.89	1.21	1.42	1.59	1.63	1.66	1.70	1.73
G (220)	0.32	0.54	0.76	0.89	1.03	1.06	1.09	1.12	1.16
H (300)	0.13	0.22	0.32	0.41	0.53	0.56	0.59	0.62	0.65
I (385)	0.03	0.04	0.06	0.08	0.14	0.17	0.20	0.23	0.27
J (500)	0.01	0.02	0.03	0.03	0.06	0.10	0.13	0.16	0.19

The isohyet label values given in Table 15.3 are to be applied to the isohyetal pattern shown in Figure 15.40 for each duration. The pattern may be placed over the drainage to maximize the precipitation volume into the drainage or positioned to obtain a maximized peak runoff.

It is apparent that the general storm at about 6 inches (for 6 hours) is dominant for this drainage, when compared to the local storm PMP estimate of 1.75 inches. It is believed that this dominance is typical for large orographic basins west of the Cascade Mountain ridgeline. Note that these results are also in agreement with those given in Chapter 12 for basin comparisons.

ACKNOWLEDGEMENTS

As with all undertakings of this magnitude and especially so with studies that extend over a period of years, there are numerous individuals who have contributed or influenced in one way or another, the effort. Probably most responsible for the outcome of this study has been John L. Vogel, Chief of the Hydrometeorological Branch, who has provided guidance, direction and leadership with the day to day development of the project. Without John's firm control and understanding of the data processing for storms used in this study, the storm analysis program, upon which this study is founded, may not have been successful.

The efforts of Frank Bartlo and Henry Feingersh in the early portions of the local-storm and storm analysis studies, respectively, are appreciated, although these two meteorologists have since left the National Weather Service. Thanks also to Roxanne Johnson and Keith Bell, meteorological technicians, who helped in the early portions of the study.

The endless typing and retyping of drafts by the now retired Helen Rodgers, editorial assistant, is recognized by the excellence of the current report. Her word processing skills were always one step ahead of our needs. Secretary Aileen Wishnow, now retired, also helped with typing in the early stages. Special thanks to our current secretary, Barbara Turner, who has been involved in preparation of the final document. To Susan Gillette, Dan Romberger, Jennifer Hanson and Paul Hrebenach and other staff of the Water Information Division, the authors extend their thanks for the many contributions needed to bring this study to an end. John McGovern provided invaluable support in the digitization and preparation of the final index maps as well as helping with other figures.

Finally, the authors acknowledge the input of the peer reviewers (listed in Chapter 1) who offered many helpful suggestions that improved the overall context of the report. Data supplied by Clayton Hanson of the Dept. of Agriculture was valuable in the local storm studies. Similarly, the cooperation of the Joint Hydrometeorological Study Team participants and the strong support (financial and other) given by the Corps of Engineers and Bureau of Reclamation to this project is sincerely appreciated.

REFERENCES

- Abbs, D.J. and R.A. Pielke, 1986: Thermally forced surface flow and convergence patterns over northeast Colorado. Monthly Weather Review, 114, 2281-2296.
- American Meteorological Society, 1959: Glossary of Meteorology, Boston, MA, 638 pp.
- Australian National Committee on Large Dams (ANCOLD), 1988: Workshop on Spillway Design Floods. Conference proceedings for workshop held February 4, 1988 in Canberra, Australia. Published by the Water Authority of Western Australia, Leederville, Australia, 81 pp.
- Barnes, S.L. and C.W. Newton, 1981: Thunderstorms in the synoptic setting. Thunderstorms: A Social, Scientific and Technological Documentary, Vol. 2, E. Kessler, Ed., U.S. Department of Commerce, NOAA, ERL, pp. 109-170.
- Bates, F.C., 1963: The mechanics of Great Plains tornadoes. Conference Review of Third Conference on Severe Local Storms. Amer. Meteor. Soc., Boston, MA, 7 pp.
- Bauman, D.J., 1980: Profile of a flash flood-prone community--Heppner, OR. Preprints, Second Conference on Flash Floods, Amer. Meteor. Soc., Atlanta, GA, pp. 80-84.
- Beebe, R.G. and F.C. Bates, 1955: A mechanism for assisting in the release of convective instability. Monthly Weather Review, 83, 1-10.
- Berkofsky, L., 1967: Comments on "Note on the relationship between total precipitable water and surface dew point." Journal of Applied Meteorology, 6, 959-960.
- Bolsenga, S.J., 1965: The relationship between total atmospheric water vapor and surface dew point on a mean daily and hourly basis. Journal of Applied Meteorology, 4, 430-432.
- Boner, F.C., and Stermitz, F., 1967: Floods of June 1964 in Northwestern Montana. U.S. Geological Survey Water-Supply Paper 1840-B, Washington, DC, 242 pp.
- Browning, K.A., 1968: The organization of severe local storms. Weather, 23, 634-639.
- Browning, K.A., 1981: General circulation of mid-latitude thunderstorms. In Thunderstorms: A Social, Scientific and Technological Documentary, Vol. 2, E. Kessler, ed., U.S. Department of Commerce, NOAA, ERL, pp. 211-247.

- Bryson, R.A., 1957a: The annual march of precipitation in Arizona, New Mexico and northwestern Mexico. University of Arizona Institute of Atmospheric Physics, Technical Report No. 6, Tucson, AZ, 24 pp.
- Bryson, R.A., 1957b: Some factors in Tucson summer rainfall. University of Arizona Institute of Atmospheric Physics, Technical Report No. 4, Tucson, AZ, 26 pp.
- Carleton, A.M., D.A. Carpenter and P.J. Weser, 1990: Mechanisms of interannual variability of the southwest United States summer rainfall maximum. Journal of Climate, 3, 999-1015.
- Carlson, T.N., S.J. Benjamin, G.S. Forbes and Y.F. Li, 1983: Elevated mixed layers in the regional severe storm environment: Conceptual model and case studies. Monthly Weather Review, 111, 1453-1473.
- Changery, M.J., 1981: National thunderstorm frequencies for the contiguous United States. U.S. Nuclear Regulatory Commission Report, NUREG/CR-2252, Washington, DC, 22 pp.
- Changnon, S.A., 1988a: Climatography of thunder events in the conterminous United States, Part I: Temporal aspects. Journal of Climate, 1, 389-398.
- Changnon, S.A., 1988b: Climatography of thunder events in the conterminous United States, Part II: Spatial aspects. Journal of Climate, 1, 399-405.
- Changnon, S.A., F.A. Huff, P.T. Schickedanz, and J.L. Vogel, 1977: Summary of METROMEX, Volume 1: Weather anomalies and impacts. Illinois State Water Survey, Urbana, IL, Bulletin 62, 260 pp.
- Changnon, S.A. and J.L. Vogel, 1981: Hydroclimatological characteristics of isolated severe rainstorms. Water Resources Research, 17, 1694-1700.
- Chappell, C.F., 1986: Quasi-stationary Convective Events in Mesoscale Meteorology and Forecasting, Peter Ray, Ed., Amer. Meteor. Soc., Boston, MA, 793 pp.
- Chappell, C.F. and D.M. Rodgers, 1988: Meteorological Analysis of the Cheyenne, Wyoming Flash Flood and Hailstorm of 1 August 1985. NOAA Technical Report ERL 435-FSL 1, US Department of Commerce, NOAA, Environmental Research Laboratories, Boulder, CO, 51 pp.
- Cooper, C.F., 1967: Rainfall intensity and elevation in southwestern Idaho. Water Resources Research, 3, 131-137.

- Corrigan, P. and J.L. Vogel, 1993: Meteorological analysis of a local flash flood near Opal, Wyoming, 16 August 1990. Preprints 13th Conference on Weather Analysis and Forecasting, August 2-6, 1993, Vienna, VA, pp. 375-378.
- Cotton, W.R. and R.A. Anthes, 1989: Storm and cloud dynamics. Academic Press, San Diego, CA, 883 pp.
- Crutcher, H.L. and J.M. Meserve, 1970: Selected level heights, temperatures and dewpoints for the northern hemisphere, Naval Weather Service Command, Washington DC.
- Dietrich, T.L. 1979: Occurrence and Distribution of Flash Floods in the Western Region. NOAA Technical Memorandum NWS WR-147, 43 pp.
- Doswell, C.A., III, 1982: The operational meteorology of convective weather, Vol. I: Operational Mesoanalysis. NOAA Technical Memorandum, NWS-NSSFC-5, Kansas City, MO.
- Doswell, C.A. III, A.R. Moller and R. Przybylinski, 1990: A unified set of conceptual models for variations on the supercell theme. Preprints, 16th Conference on Severe Local Storms, Kananaskis Park, Alberta, Canada, Amer. Meteor. Soc., Boston, MA, 40-45.
- Doswell, C.A. III and D.L. Keller, 1990: An analysis of the temporal and spatial variation of tornado and severe thunderstorm watch verification. Preprints, 16th Conference on Severe Local Storms, Kananaskis Park, Alberta, Canada, Amer. Meteor. Soc., Boston, MA 294-299.
- Easterling, D.R. and P.J. Robinson, 1985: The diurnal variation of thunderstorm activity in the United States. J. Climate Appl. Meteor., 24, 1048-1058.
- Electrical Power Research Institute (EPRI), 1993a: New techniques and data sources for probable maximum precipitation. Vols. 1-5. Studies performed by Climatological Consulting Corporation under contract RP 3113-01, Palo Alto, CA (in preparation).
- Electrical Power Research Institute (EPRI), 1993b: Probable maximum precipitation study for Wisconsin and Michigan, Vol. 1. Research Report No. TR-101554, (prepared by North American Weather Consultants), Palo Alto, CA, 88 pp.
- Farmer, E.E. and J.E. Fletcher, 1972: Some intra-storm characteristics of high intensity rainfall bursts. In Distribution of Precipitation in Mountainous Areas, World Meteorological Organization, Geilo, Norway, pp. 525-531.

- Federal Emergency Management Agency (FEMA), 1990: Probable maximum precipitation and probable maximum flood workshops. Proceedings of workshop held May 1-4, 1990, Berkeley Springs, WV, Washington, DC, 25 pp.
- Fenn, D.D., 1985: Probable maximum precipitation estimates for the drainage above Dewey Dam, John's Creek, Kentucky. NOAA Technical Memorandum, NWS HYDRO #41, National Weather Service, U.S. Department of Commerce, Silver Spring, MD, 33 pp.
- Flanagan, R.P., 1982: Elk Creek Lake project, spillway design. U.S. Army Corps of Engineers' letter to Commander, North Pacific Division, 4 pp.
- Fleming, E.L. and L.E. Spayd, 1986: Characteristics of western region flash flood events in GOES imagery and conventional data. NOAA Technical Memorandum, NESDIS 13, 82 pp.
- Gabriel, R.K. and S.A. Changnon, Jr., 1989: Temporal features in thunder days in the United States. Climatic Change, 15, 455-477.
- Hagemeyer, B.C., 1991: A lower-tropospheric thermodynamic climatology for March through September: Some implications for thunderstorm forecasting. Weather and Forecasting, 6, 254-270.
- Hales, J.E., 1972: Surges in maritime tropical air northward over the Gulf of California. Monthly Weather Review, 100, 298-306.
- Hambidge, R.E., 1967: "K" Chart Application to Thunderstorm Forecasts over the Western United States. ESSA Technical Memorandum, WRTM 23.
- Hansen, E.M., 1975: Moisture source for three extreme local rainfalls in the southern intermountain region. National Weather Service Technical Memorandum, NWS HYDRO 26, 57 pp.
- Hansen, E.M., D.D. Fenn, L.C. Schreiner, R.W. Stodt and J.F. Miller, 1988: Probable Maximum Precipitation Estimates--United States Between the Continental Divide and the 103rd Meridian. Hydrometeorological Report Number 55A, National Weather Service, National Oceanic and Atmospheric Administration, U.S. Department of Commerce, Silver Spring, MD, 242 pp.
- Hansen, E.M. and F.K. Schwarz, 1981: Meteorology of Important Rainstorms in the Colorado and Great Basin Drainages. Hydrometeorological Report Number 50, U.S. Department of Commerce, National Weather Service, Silver Spring, MD, 167 pp.

- Hansen, E.M., L.C. Schreiner and J.F. Miller, 1982: Application of Probable Maximum Precipitation Estimates--United States East of the 105th Meridian. Hydrometeorological Report Number 52, National Weather Service, National Oceanic and Atmospheric Administration, U.S. Department of Commerce, Washington, DC, 168 pp.
- Hansen, E.M., F.K. Schwarz and J.T. Riedel, 1977: Probable Maximum Precipitation Estimates, Colorado River and Great Basin drainages. Hydrometeorological Report Number 49, National Weather Service, National Oceanic and Atmospheric Administration, U.S. Department of Commerce, Silver Spring, MD, 161 pp.
- Haurwitz, B. and J.M. Austin, 1944: Climatology, McGraw-Hill Book Company, Inc., New York and London, 409 pp.
- Hendricks, E.L., 1963: Summary of Floods in the United States During 1957. U.S. Geological Survey Water Supply Paper 1652-C, U.S. Government Printing Office, Washington, DC, 98 pp.
- Hendricks, E.L., 1964: Summary of floods in the United States during 1956. U.S. Geological Survey Water Supply Paper 1530, Washington, DC, 85 pp.
- Hershfield, D.M., 1961: Rainfall Frequency Atlas of the United States. Technical Paper Number 40, U.S. Weather Bureau, U.S. Department of Commerce, Washington, DC, 61 pp.
- Henz, J.F., 1974: Colorado High Plains Thunderstorm Systems - A Descriptive Radar-Synoptic Climatology. Master of Science Thesis, Department of Atmospheric Science, Colorado State University, Fort Collins, CO, 82 pp.
- Henz, J.F. and R.A. Kelly, 1989: Survey of Thunderstorm Rainfall Characteristics in the Colorado Central Front Range Above 7500 Feet From 1979 to 1988 (Storm Data). Report for Colorado Water Conservation Board, Denver, CO.
- Hogg, W.D. and D.A. Carr, 1985: Rainfall Frequency Atlas for Canada. Canadian Government Publishing Center, 94 pp.
- Hosking, J.R.M., 1990: L-moments: Analysis and Estimation of Distributions Using Linear Combinations of Order Statistics. Journal of Statistics, Soc. B., 51, 3 pp.
- Hosking, J.R.M. and J.R. Wallis, 1991: Some statistics useful in regional frequency analysis. IBM Research Report RC 17096, Yorktown Heights, NY, 23 pp.

- House, D.C., 1963: Forecasting tornadoes and severe thunderstorms. In Severe Local Storms, Meteorological Monograph 5, Amer. Meteor. Soc., 141-155.
- Hudson, H.R., 1971: On the relationship between horizontal moisture convergence and convective cloud formation. Journal of Applied Meteorology, 10, 755-762.
- Huff, F.A., 1967: Time Distribution of Rainfall in Heavy Storms. Water Resources Research, 3, 1007-1019.
- Jarrett, R.D., 1989: Hydrology and Paleohydrology Used to Improve the Understanding of Flood Hydrometeorology in Colorado. Proceedings of the International Symposium on Design of Hydraulic Structures, American Society of Civil Engineers, Fort Collins, CO, June 26-29, 1989.
- Jarrett, R.D. and J.E. Costa, 1986: Evaluation of the Flood Hydrology in the Colorado Front Range Using Streamflow Records and Paleoflood Data for the Big Thompson River Basin. International Symposium on Flood Frequency and Peak Analyses, May 14-17, 1986, American Water Resources Association.
- Jennings, A.H., 1952: Maximum 24-hour Precipitation in the United States. U.S. Weather Bureau, Technical Paper Number 16, U.S. Department of Commerce, Washington, DC, 284 pp.
- Kelly, D.L., Schaefer, J.T. and C.A. Doswell, III, 1985: Climatology of Non-Tornadic Severe Thunderstorm Events in the U.S. Monthly Weather Review, 113, 1997-2014.
- Kennedy, M.R., J. Pearce, R.P. Canterford and L.J. Minty, 1988: The Estimation of Generalized Probable Maximum Precipitation in Australia, ANCOLD Bulletin Number 79, Leederville, Western Australia 6007, pp. 6-16.
- Lee, R.F. 1973: A Refinement of the Use of K-values in Forecasting Thunderstorms in Washington and Oregon. NOAA Technical Memorandum NWS WR-87, 21 pp.
- Legates, D.R. and C.J. Willmott, 1990: Mean Seasonal and Spatial Variability in Gauge-Corrected, Global Precipitation. International Journal of Climatology, 10, 111-127.
- Ludlam, F.H., 1963: Severe Local Storms: A Review. Meteorol. Monogr., 5, Amer. Meteor. Soc., Boston, MA.
- Lussky, G.R., 1986: The MCC--An Overview and Case Study on its Impact in the Western United States. NOAA Technical Memorandum, NWS WR-193, Salt Lake City, UT, 50 pp.

- Maddox, R.A., L.R. Hoxit and F. Canova, 1980: Meteorological characteristics of heavy precipitation and flash flood events over the western United States. NOAA Technical Memorandum, ERL-APCL 23, Boulder, CO.
- McKay, G.A., 1963: Persisting dew points in the prairie provinces. Canadian Department of Agriculture, Prairie Farm Rehabilitation Administration Meteorological Report Number 11, 23 pp.
- McNulty, R.P., 1983: Some basic elements of thunderstorm forecasting. NOAA Technical Memorandum, NWS-CR-69, 13 pp.
- Miller, J.F., 1993: Probable Maximum Precipitation Estimates for Columbia River Basin above the Lower Border Dam Site below Confluence with the Pend D'Oreille River. B. C. Hydroelectric Report No. H 2719, 46 pp. plus tables figures and appendices.
- Miller, J.F., 1982: PMP estimate for Elk Creek, Oregon. National Weather Service Office Memorandum For The Record, 2 p.
- Miller, J.F., R.H. Frederick and R.J. Tracey, 1973: Precipitation frequency atlas of the western United States, Vol. I, Montana; Vol. V, Idaho; Vol. IX, Washington, and Vol. X, Oregon. NOAA Atlas 2, National Weather Service, National Oceanic and Atmospheric Administration, U.S. Department of Commerce, Silver Spring, MD.
- Miller, J.F., E.M. Hansen and D.D. Fenn, 1984: Probable maximum precipitation for the Upper Deerfield River drainage, Massachusetts/Vermont. NOAA Technical Memorandum, NWS HYDRO 39, National Weather Service, U.S. Department of Commerce, Silver Spring, MD, 36 pp.
- Miller, R.C., 1967: Notes on analysis and severe storm forecasting procedures of the Air Force Global Weather Center. Technical Report 200, Air Weather Service, Scott AFB, IL.
- Myers, V.A., 1965: Estimates of probable maximum precipitation for Elk Creek, Lost Creek and Applegate River, Oregon. U.S. Weather Bureau Office Memorandum, 3 pp.
- National Climatic Data Center (NCDC), 1948- : Local Climatological Data (Station). NESDIS, U.S. Department of Commerce, Asheville, NC (ongoing publication).
- National Climatic Data Center (NCDC), 1951- : Hourly Precipitation Data (State). NESDIS, U.S. Department of Commerce, Asheville, NC (ongoing publication).

- National Climatic Data Center (NCDC), 1992: Maps of annual 1961-90 normal temperature, precipitation and degree days. *Climatology of the United States Number 81 - Supplement Number 3*. U.S. Department of Commerce, Asheville, NC, 6 pp.
- National Research Council (NRC), 1985: Safety of dams, floods and earthquake criteria. *Water Science and Technology Board*, National Academy Press, Washington, DC, 321 pp.
- National Research Council (NRC), 1988: Estimating probabilities of extreme floods, methods and recommended research. *Water Science and Technology Board*, National Academy Press, Washington, DC, 141 pp.
- National Weather Service, 1981: Revision of April 1981 to Hydrometeorological Report Number 43. Office Note, U.S. Department of Commerce, Silver Spring, MD, 5 pp.
- Newark, M.J., 1984: Canadian wind data. Paper presented at the Fourth Canadian Workshop on Wind Engineering, Toronto, Canada, November 19-20, 1984.
- Office of Water Data Coordination (OWDC), 1986: Feasibility of assigning a probability to the probable maximum flood. Hydrology Subcommittee of the Interagency Advisory Committee on Water Data, Washington, DC, 79 pp.
- Osborn, H.B., L.V. Lane and V.A. Myers, 1980: Rainfall/watershed relationships for southwestern thunderstorms. Transactions, American Society of Agricultural Engineers, 23, pp. 82-91.
- Palmen, E. and C.W. Newton, 1969: Atmospheric Circulation Systems. Academic Press, New York, NY, 603 pp.
- Peck, E.L., J.C. Monro and M.L. Snelson, 1977: Hydrometeorological data base for the United States. Proceedings of Second Conference on Hydrometeorology, October 25-27, 1977, Toronto, Ontario, Canada, pp. 75-78.
- Peppler, R.A., 1988: A review of static stability indices and related thermodynamic parameters. Illinois State Water Survey, Champaign, IL, 87 pp.
- Randerson, D. 1986: A Mesoscale Convective Complex Type Storm Over the Desert Southwest. NOAA Technical Memorandum NWS WR-196, 53 pp.
- Reid, J.K., 1975: Summary of Floods in the United States During 1969. U.S. Geological Survey Water Supply Paper 2030, Washington, DC, 173 pp.

- Reitan, C.H., 1963: Surface dew point and water vapor aloft. Journal of Applied Meteorology, 2, pp. 776-779.
- Reyes, S. and D.L. Cadet, 1988: The southwest branch of the North American monsoon during summer 1979. Monthly Weather Review, 116 pp.
- Riedel, J.T. and L.C. Schreiner, 1980. Comparison of generalized estimates of PMP with greatest observed rainfalls. NOAA Technical Report NWS-25, 66 pp.
- Rostvedt, J.O., 1972: Summary of Floods in the United States During 1967. U.S. Geological Survey Water Supply Paper 1880-C, Washington, DC, 114 pp.
- Sampson, R.J., 1978: Surface II Graphics System. Kansas Geological Survey, Lawrence, KS, 240 pp.
- Schaefer, M.G., 1980: Personal communication.
- Schaefer, M.G., 1989: Characteristics of extreme precipitation events in Washington State. Washington State Department of Ecology Report 89-51, 109 pp.
- Schaefer, M.G., 1990: Regional Analyses of Precipitation Annual Maxima in Washington State. Water Research Resources, 20, 119-131.
- Schreiner, L.C. and J.T. Reidel, 1978: Probable Maximum Precipitation Estimates--United States East of the 105th Meridian. Hydrometeorological Report Number 51, National Weather Service, National Oceanic and Atmospheric Administration, U.S. Department of Commerce, Silver Spring, MD, 87 pp.
- Sellers, W.D., 1964: Arizona Climate. University of Arizona Press, Phoenix, AZ, 60 pp.
- Simiu, E., M.J. Changery and J.J. Filliben, 1979. Extreme Wind Speeds at 129 Stations in the Contiguous United States. National Bureau of Standards Building Science Series 118, U.S. Department of Commerce, Washington, DC, 15 pp.
- Stodt, R.W., 1994: Manual for Automated Depth-Area-Duration Analysis of Storm Precipitation. U.S. Bureau of Reclamation Technical Report (in preparation).

- Styner, W.H., 1975: Use of National Weather Service revised precipitation-frequency maps and estimation of 10-day precipitation values. TSC Technical Note - Hydrology PO-6 (Rev. 2), Engineering and Watershed Planning Unit, Regional Technical Service Center, Soil Conservation Service, Department of Agriculture, Portland, OR.
- Tomlinson, E.M. and C.S. Thompson, 1992: Probable Maximum Precipitation in New Zealand. Report produced by the New Zealand Meteorological Service for the Electricity Corporation of New Zealand, Ltd., 273 pp.
- Trewartha, G.T. and L.H. Horn, 1980: An Introduction to Climate, McGraw-Hill Book Company, New York, NY, 416 pp.
- Uccellini, L.W., 1990: The relationship between jet streaks and severe convective Systems. Preprints, 16th Conference on Severe Local Storms, Kananaskis Park, Alberta, Canada, Amer. Meteor. Soc., Boston, MA, 121-130.
- U.S. Army Corps of Engineers (USCOE), 1945-1980: Storm rainfall in the United States, depth-area-duration data. Washington, D.C.
- U.S. Army Corps of Engineers (USCOE), 1982: Elk Creek Lake Project, Spillway Design. Office Memorandum, North Pacific Division, 16 August 1982, 4 pp.
- U.S. Department of Commerce, 1968: Climatic Atlas of the United States. Environmental Science Services Administration, Washington, DC, 80 pp.
- U.S. Navy Marine Climatic Atlas of the World (NAVAIR50-1C-65), Volume IX, Naval Oceanographic Command Detachment, Asheville, NC, May 1981.
- U.S. Weather Bureau (USWB), 1896- : Climatological Data (State). NOAA, U.S. Department of Commerce, Asheville, NC (ongoing publication).
- U.S. Weather Bureau (USWB), 1946: Manual for depth-area-duration analysis of storm precipitation. Cooperative Studies Technical Paper Number 1. U.S. Department of Commerce, Washington, DC, 73 pp.
- U.S. Weather Bureau (USWB), 1947. Thunderstorm rainfall. Hydrometeorological Report 5, Washington, DC.
- U.S. Weather Bureau (USWB), 1951: Tables of precipitable water and other factors for a saturated pseudo-adiabatic atmosphere. Technical Paper Number 14, U.S. Department of Commerce, Washington, DC, 27 pp.
- U.S. Weather Bureau (USWB), 1953: Critical meteorological conditions for design floods in Snake River basin. Technical Bulletin Number 10, Washington, DC.

- U.S. Weather Bureau (USWB), 1956: Maximum station precipitation for 1, 3, 6, 12 and 24 hours. Technical Paper Number 15. U.S. Department of Commerce, Washington, DC, 23 parts.
- U.S. Weather Bureau (USWB), 1957-1960: Rainfall intensity-frequency regime. Technical Paper Number 29, Washington, DC, 5 Parts.
- U.S. Weather Bureau (USWB), 1960: Generalized Estimates of Probable Maximum Precipitation West of the 105th Meridian. Technical Paper Number 38, Washington DC.
- U.S. Weather Bureau (USWB), 1961: Interim Report, Probable Maximum Precipitation in California. Hydrometeorological Report Number 36, U.S. Department of Commerce, Washington, DC, 202 pp.
- U.S. Weather Bureau (USWB), 1966: Probable Maximum Precipitation, Northwest States. Hydrometeorological Report Number 43, Environmental Science Services Administration, U. S. Department of Commerce, Washington, DC, 228 pp.
- Verschuren, J.P. and Wojtiw, L., 1980: Estimate of the maximum possible precipitation for Alberta River Basins. University of Alberta press.
- Vogel, J.L., F. Bartlo and P. Corrigan, 1990: Climatological characteristics of heavy convective storms in the Pacific Northwest. Preprints - Eighth Conference on Hydrometeorology, Amer. Meteor. Soc., October 22-26, 1990, Kananaskis Park, Alberta, Canada, pp. 225-228.
- Wallace, J.M., 1975: Diurnal variations in precipitation and thunderstorm frequency over the conterminous United States. Monthly Weather Review, 103, 406-419.
- Weisman, M.L. and J.B. Klemp, 1986: Characteristics of isolated convective storms. In Mesoscale Meteorology and Forecasting, Peter Ray, ed., Amer. Meteor. Soc., Boston, MA, pp. 331-358.
- World Meteorological Organization (WMO), 1986: Manual for estimation of probable maximum precipitation. Operational Hydrology Report Number 1, WMO Number 332, Geneva, Switzerland, 269 pp.

APPENDIX 1

MASTER STORM LIST

Table A1 comprises the master listing of general-type storms compiled at the onset of this study to revise PMP for the Pacific Northwest. The list was derived from storms that had been listed by the Corps of Engineers, National Weather Service or the Bureau of Reclamation. They cover a period of record between 1901 and 1975. A check was made in the daily precipitation files of Climatological Data and in Storm Data published reports for storms since 1975, but none were found of a magnitude sufficient for inclusion in this study. The master storm list is organized as follows:

- Column 1. - storm number
- 2. - date(s) of significant rainfall
- 3. - latitude
- 4. - longitude
- 5. - town identified with storm maximum
- 6. - reference source (Corps of Engineers index number, National Weather Service (NWS), Bureau of Reclamation (USBR))

The Corps of Engineers (COE) index numbers are assigned according to COE division: NP = North Pacific Division, etc. Storms are assigned index numbers to identify them in the event a storm study is done. A storm study normally concludes with the development of a matrix of depth-area-duration (DAD) data and a brief storm synoptic description. In the western United States, although a number of major storms were identified and assigned index numbers, few were officially completed.

The list is dominated by storms in Washington, Oregon and Idaho, with the addition of a few storms that occurred in western Montana, northwestern Wyoming and the northern parts of Utah, Nevada and California.

A secondary listing of 130 storms (Table A2) reported in northern California (37° N - 42° N) has been assigned numbers exceeding 500. Only date and latitude/longitude is given to these storms and none were transposed into the region of this study.

Table A1. Master Storm File for the Northwest Region

Storm Number	Date	Latitude	Longitude	Nearest Town	Ref. Source
1	1/1-3/01	42°03	122°36	Siskiyou, OR	USBR
2	7/2-4/02	48°21	116°50	Priest River, ID	NP 1-26
3	1/20-24/03	42°10	123°39	Buckhorn Farm, OR	NP 3-2
4	6/14/03	45°19	119°24	Heppner, OR	USBR/NWS
5	5/26-30/06	45°50	118°25	Nr. Weston, OR	NP 4-1
6	11/11-16/06	45°20	123°50	Glenora, OR	NP 1-1
7	1/28-2/5/07	42°26	124°25	Gold Beach, OR	NP 3-3
8	2/1-5/07	41°28	115°25	Charleston, NV	NWS-CS
9	10/13-14/08	48°12	115°41	Snowshoe, MT	NP 2-19
10	11/1-4/09	45°20	123°50	Glenora, OR	NWS
11	11/2-5/09	48°12	115°41	Snowshoe, MT	NWS
12	11/18-19/09	48°12	115°41	Snowshoe, MT	NP 2-18
13	11/17-22/09	45°20	123°50	Glenora, OR	NP 1-2
14	11/18-23/09	43°37	115°44	Rattlesnake Ck, ID	NP 4-6
15	11/26-12/1/09	47°28	123°51	Quinalt, WA	NP 1-3
16	2/25-3/2/10	45°20	123°50	Glenora, OR	NP 3A-5
17	1/16-19/11	44°07	123°44	Greenleaf, OR	NP 1-17
18	5/15/11	43°02	116°44	Silver City, ID	NWS-CS
19	10/10-11/11	45°46	113°28	Bowen, MT	USBR
20	11/16-20/11	47°28	123°51	Quinalt, WA	NP 1-5
21	11/16-20/11	47°25	121°44	Snoqualmie Pass, WA	NP 1-5
22	1/5-8/12	44°41	122°07	Hoover, OR	USBR
23	7/30-31/12	43°32	116°04	Boise, ID	NP 4-15
24	7/23-26/13	43°38	116°41	Caldwell, ID	NWS-CS
25	7/23-26/13	42°44	112°29	Pocatello, ID	NWS-CS
26	7/23-26/13	44°30	111°44	Yellowstone Pk, ID	NWS-CS
27	10/24/13	44°21	117°16	Huntington, OR	USBR
28	3/29-4/3/15	47°29	123°16	Lk. Cushman, WA	NP 1-18
29	6/19-22/16	47°38	112°42	Sun River Can., MT	NP 1-27
30	2/23-25/17	43°28	114°48	Soldier Creek, ID	NWS
31	12/11-15/17	47°25	121°44	Cedar Lake, WA	NP 1-6
32	12/16-19/17	45°48	121°56	Wind River, WA	NP 1-7
33	12/16-20/17	47°28	115°55	Wallace, ID	NP 4-17
34	2/28-3/3/19	44°15	115°55	Sheep Hill, ID	NWS-CS
35	8/28-29/20	47°25	121°25	Snoqualmie Pass, WA	USBR
36	9/11-14/20	47°25	121°25	Snoqualmie Pass, WA	USBR
37	11/18-22/21	44°24	115°59	Alpha, ID	NP 4-7
38	11/18-22/21	45°48	121°56	Wind River, WA	NP 3-6
39	12/8-13/21A	47°57	124°22	Forks, WA	NP 1-10
40	12/8-13/21B	48°05	121°35	Silverton, WA	NP 1-10
41	1/4-7/23	43°18	115°03	Hill City, ID	NP 4-14
42	1/4-8/23	45°40	121°54	Cascade Locks, OR	NP 3-7
43	1/6-8/24	47°57	124°22	Forks, WA	NP 2-21
44	2/10-12/24	47°57	124°22	Forks, WA	NP 1-19
45	6/7/24	48°56	113°21	Babb, MT	NP 2-21
46	10/27-30/24	45°05	116°42	Cuprum, ID	NP 4-13
47	10/28-11/2/24	42°55	124°26	Willow Ck., OR	NP 3-8
48	2/16-21/27	43°28	114°48	Soldier Ck., ID	NP 4-8
49	2/17-21/27	44°21	117°16	Huntington, OR	USBR
50	2/17-21/27	44°12	115°58	Pyle Ck., ID	USBR

Table A1. Continued

Storm Number	Date	Latitude	Longitude	Nearest Town	Ref. Source
51	2/18-22/27	45°23	121°42	Bull Run Lake, OR	NP 3-9
52	9/10-14/27	46°01	118°07	Mill Creek, WA	NP 4-2
53	11/6-10/27	44°00	115°50	Grimes Pass, ID	NP 4-9
54	11/24-29/27	46°07	117°56	Touchet Ridge, WA	NP 4-3
55	11/12-17/30	47°21	115°40	Roland, ID	NWS
56	11/12-17/30	41°28	115°25	Charleston, NV	USBR
57	3/28-4/1/31	44°51	123°40	Valsetz, OR	NWS
58	3/30-4/2/31A	46°09	115°36	Pete King RS, ID	NP 3-10
59	3/30-4/2/31B	46°01	118°07	Mill Creek, WA	NP 4-4
60	12/16-19/31B	48°04	121°31	Big Four, WA	NP 4-4
61	12/16-19/31A	47°20	123°39	Wynoochee Oxbow, WA	NP 2-16
62	12/23-29/31	44°19	115°38	Deadwood, ID	NP 2-16
63	2/23-27/32B	47°25	121°25	Snoqualmie Pass, WA	USBR
64	2/23-27/32A	47°28	123°51	Quinalt, WA	NP 1-12
65	3/15-19/32	44°09	111°03	Bechler River, WY	NP 1-12
66	3/16-19/32	42°03	124°17	Brookings, OR	RI 1-29A
67	3/16-20/32	46°09	115°36	Pete King RS, ID	NP 3-11
68	11/11-16/32	47°25	121°25	Snoqualmie Pass, WA	NP 4-12
69	6/8-9/33	42°03	124°17	Brookings, OR	NP 1-13
70	12/5-12/33	47°20	123°39	Wynoochee, WA	NP 3-12
71	12/6-12/33	47°21	115°40	Roland, ID	NP 3A-3
72	12/17-22/33	45°29	123°51	Tillamook, OR	NP 2-8
73	12/17-19/33	47°21	115°40	Roland, ID	NP 3-13
74	12/18-23/33	45°48	121°56	Wind River, WA	NP 2-9
75	12/18-23/33	47°21	115°40	Roland, ID	NP 1-20
76	12/21-26/33	47°28	115°56	Wallace, ID	NP 2-22
77	12/21-26/33	46°07	117°56	Touchet Ridge, WA	NP 4-5
78	10/21-26/34	46°04	122°17	Nr. Cougar, WA	NP 4-5
79	11/2-7/34	46°04	122°17	Nr. Cougar, WA	NP 1-14
80	1/20-25/35	47°28	123°51	Quinalt, WA	NP 1-15
81	1/21-24/35	47°21	115°40	Roland, ID	NP 1-21
82	3/24-26/35	47°23	115°24	Haugan, MT	NP 2-11
83	4/7-9/35	44°03	114°28	Baker Ranch, ID	NP 2-12
84	1/10-15/36	42°44	124°30	Port Orford, OR	USBR
85	2/11-14/36	43°48	115°08	Atlanta, ID	NP 3-14
86	10/26-28/37	48°52	121°41	Mt. Baker Lodge, WA	NP 4-11
87	12/9-12/37	44°01	115°50	Grimes Pass, ID	NP 1-22
88	12/25-30/37	44°51	123°40	Valsetz, OR	NP 4-10
89	12/28-30/37	48°04	121°31	Big Four, WA	NP 3-16
90	6/22/38	44°30	119°45	Birch Creek, OR	NP 3-16
91	12/13-17/39	47°20	123°38	Wynoochee, WA	NWS
92	3/25-4/1/40	44°44	116°26	Council, ID	NP 1-23
93	11/12-17/41	48°04	121°31	Big Four, WA	NWS-CS
94	11/12-17/41	46°38	115°30	Bungalow RS, ID	R1, 1-20
95	12/1-4/41	43°48	115°08	Atlanta, ID	R1, 1-20
96	12/14-20/41	44°19	115°38	Deadwood, ID	NWS-CS
97	10/30-11/4/42	47°25	121°44	Cedar Lake, WA	R1, 2-2A
98	*				R1, 1-22
99	12/26/42-1/2/43	42°39	124°04	Illahe, OR	NP 3A-6
100	12/27/42-1/2/43	43°43	116°00	Sheep Hill, ID	R1, 2-3
	*Eliminated				

Table A1. Continued

Storm Number	Date	Latitude	Longitude	Nearest Town	Ref. Source
101	1/19-23/43	44°19	115°35	Deadwood, ID	R1, 1-23A
102	1/20-23/43	43°45	114°00	Hyndman Park, ID	NWS-USBR
103	6/8/43	42°02	123°18	Copper, OR	USBR
104	6/10-13/43	41°52	115°26	Jarbridge, NV	USBR
105	6/7-12/44	43°40	113°35	Nr. Grouse, ID	R1, 1-24
106	6/26-27/44	44°14	112°14	Dubois, ID	USBR
107	6/3-10/45	44°21	112°11	Spencer, ID	R1, 2-5A
108	12/25-27/45	46°00	118°03	Walla Walla, WA	R1, 1-25
109	12/26-30/45	41°52	123°58	Gasquet, CA	NP 3A-7
110	10/1-2/46	43°48	115°08	Atlanta, ID	USBR
111	11/17-20/46	44°19	115°38	Deadwood, ID	NWS-USBR
112	11/18-20/46	43°31	114°21	Sun Valley, ID	R1, 1-26
113	12/8-15/46	46°03	112°12	Peterson's Ranch, WA	USBR
114	6/8-12/47	40°44	111°55	Terminal, UT	R4, 1-30
115	9/16-18/47	44°05	115°37	Lowman, ID	NWS-CS
116	9/16-18/47	41°52	112°28	Blue Creek, UT	USBR
117	9/25-27/47	46°25	117°01	Lewiston, ID	USBR
118	10/15-16/47	44°19	115°35	Deadwood, ID	R1, 1-28
119	1/1-7/48	42°39	124°03	Ilaha, OR	USBR
120	1/1-8/48	47°30	116°00	Mullen, ID	NWS-CS
121	6/10-13/48	47°39	120°04	Waterville, WA	USBR
122	5/12-17/48	47°49	124°04	Spruce, WA	USBR
123	2/13-18/49	47°49	124°04	Spruce, WA	USBR
124	8/22/49	43°34	116°43	Moose Creek, ID	USBR
125	6/17/50	46°28	117°35	Nr. Pomeroy, WA	USBR
126	10/26-29/50	42°12	123°37	Kerby, OR	NWS
127	2/7-12/51	47°28	123°51	Quinalt, WA	NWS-USBR
128	8/10/52	46°34	120°25	Moxee City, WA	USBR
129	1/15-20/53	42°39	124°04	Ilaha 1 W, OR	USBR
130	11/21-23/53	42°12	123°17	Williams 1 SW, OR	USBR
131	6/15/54	44°46	117°10	Richland, OR	NWS
132	10/25/55	47°28	123°51	Quinalt, WA	NWS
133	11/3-4/55	47°28	123°51	Quinalt, WA	NWS
134	12/18-21/55	42°44	124°30	Port Orford, OR	NWS
135	12/25-27/55	44°53	122°39	Silver Ck. Falls, OR	NWS
136	12/25-27/55	42°26	124°25	Gold Beech, OR	NWS
137	1/1-6/56	44°51	123°40	Valsetz, OR	NWS
138	7/13/56	44°40	120°10	Girds Creek, OR	NWS
139	7/13/56	44°35	120°11	Mitchell, OR	NWS
140	7/21/56	43°19	114°43	Simon Ranch, ID	NWS
141	12/8-10/56	47°48	124°04	Spruce, WA	NWS-USBR
142	2/23-26/57	47°25	123°13	Cushman Dam, WA	NWS-USBR
143	9/30-10/3/57	45°49	119°17	Hermiston 2 S, OR	NWS-USBR
144	11/17-24/59	46°47	121°44	Mt. Rainier, WA	NWS-USBR
145	11/19-23/59	47°22	123°36	Camp Grisdale, WA	COE
146	12/14-16/59	47°27	123°53	Amanda Park, WA	NWS
147	12/14-15/59	47°44	121°25	Grotto, WA	NWS-COE
148	2/9-12/61	44°50	123°40	Valsetz, OR	NWS
149	11/20-24/61	42°38	124°03	Ilaha, OR	NWS-USBR
150	6/19/62	43°13	116°34	Nr. Murphy, ID	NWS-USBR

Table A1. Continued

Storm Number	Date	Latitude	Longitude	Nearest Town	Ref. Source
151	11/18-21/62	47°27	123°53	Amanda Park, WA	NWS-USBR
152	12/1-3/62	44°44	122°15	Detroit Dam, OR	NWS-USBR
153	1/29-2/3/63	43°50	115°50	Idaho City, ID	NWS
154	2/3-7/63	46°03	118°24	Walla Walla, WA	NWS
155	6/6-8/64	48°19	113°21	Summit, MT	COE-USBR
156	12/19-24/64	42°39	124°04	Ilaha, OR	USBR
157	12/20-25/64	44°19	115°38	Deadwood Dam, ID	NWS-USBR
158	1/23-30/65	44°51	123°40	Valsetz, OR	NWS-USBR
159	12/27-30/65	42°38	124°03	Ilaha, OR	NWS-USBR
160	6/6-15/67	47°04	112°22	Rodgers Pass, MT	NWS-USBR
161	8/20/68	43°52	117°00	Nyssa, OR	NWS
162	6/8-9/69	44°40	121°09	Machas, OR	NWS
163	6/9/69	44°28	118°44	Prairie City, OR	NWS-USBR
164	5/25/71	45°20	119°24	Heppner, OR	USBR
165	1/11-18/74	44°51	123°40	Valsetz, OR	NWS
166	1/11-18/74	47°22	123°00	Hoodsport, WA	NWS
167	1/12-19/74	42°45	124°30	Port Orford 5 E, OR	NWS
168	1/13-16/74	47°30	116°00	Mullen, ID	NWS
169	12/19-22/74	44°51	123°40	Valsetz, OR	NWS
170	1/23-26/75	45°18	121°51	Gov't. Camp, OR	NWS-USBR
171	*				
172	12/1-7/75	47°28	123°51	Quinalt, WA	NWS-USBR
173	2/13-15/79	47°30	115°53	Wallace, ID	
174	12/13-16/79	47°57	124°22	Forks, WA	
175	12/24-27/80	44°51	123°40	Valsetz, OR	
176	11/30-12/4/75	47°44	121°05	Stevens Pass, WA	
177	11/30-12/4/75	47°16	123°42	Aberdeen 20 NNE, WA	
178	11/30-12/4/75	45°49	123°46	Nehalem 9 NE, OR	
	*Eliminated				

Table A2. Important storms located south of the Northwest Study region.

Storm Number	Date	Latitude	Longitude	Storm Number	Date	Latitude	Longitude
501	12/19-20/1866	37°46	122°28	551	5/11-14/1941	39°30	121°00
502	11/22/1874	38°31	123°15	552	9/18-23/1941	37°41	108°02
503	4/20/1880	38°35	121°30	553	11/15-19/1942	39°00	120°30
504	1/30/1888	40°15	124°11	554	1/19-24/1943	37°35	119°25
505	8/11/1890	37°27	117°42	555	1/20-24/1943	38°49	106°37
506	10/10-15/1899	39°23	108°06	556	1/21-23/1943	37°36	115°14
507	2/12/1904	37°57	122°33	557	5/4-9/1943	40°21	106°55
508	1/12-19/1906	40°00	122°00	558	5/31-6/5/1943	40°36	111°35
509	2/1-5/1907	41°40	115°25	559	6/1-3/1943	39°33	107°20
510	3/15-27/1907	39°55	121°25	560	6/10-13/1943	41°40	115°25
511	12/14-17/1908	37°30	108°30	561	1/30-2/3/1945	37°35	119°30
512	1/11-16/1909	39°00	120°25	562	8/17-19/1945	37°37	114°30
513	8/28-9/2/1909	39°30	110°50	563	12/27/1945	37°54	112°34
514	9/3-7/1909	37°34	107°48	564	10/27-29/1946	37°25	114°07
515	1/23-31/1911	39°55	121°25	565	5/9-14/1947	40°45	109°40
516	5/18/1911	39°41	120°59	566	6/4-5/1947	40°30	121°15
517	10/4-6/1911	37°53	107°39	567	6/8-12/1947	41°09	111°55
518	3/19-21/1912	39°01	107°31	568	11/15-21/1950	39°10	120°30
519	8/4/1913	39°34	111°39	569	11/20/1950	41°22	124°01
520	12/3-6/1913	40°06	105°50	570	7/19/1955	37°44	118°15
521	12/29/1913- 1/3/1914	39°55	121°25	571	12/21-23/1955	39°30	119°47
522	1/23-2/2/1915	41°10	121°00	572	12/21-24/1955	39°36	121°06
523	5/9/1915	40°23	112°12	573	8/16/1958	41°03	111°38
524	5/9-11/1915	39°45	121°15	574	9/18/1959	40°36	122°23
525	1/1-4/1916	39°50	121°35	575	10/11-13/1962	39°42	121°18
526	2/20-22/1917	37°35	119°35	576	1/31-2/1/1963	40°19	111°34
527	3/4-9/1918	38°49	106°37	577	12/19-23/1964	39°42	121°12
528	9/12/1918	37°08	121°55	578	8/1/1968	37°49	109°23
529	9/13-14/1918	40°10	122°14	579	8/27/1970	40°50	115°40
530	11/18/1920	38°31	123°15	580	9/3-7/1970	37°38	109°04
531	4/14-15/1921	40°06	105°50	581	8/7/1971	38°59	119°50
532	8/3/1924	37°12	108°29	582	2/7-8/1909	40°39	111°30
533	4/5-6/1925	41°45	115°25	583	1/24-31/1911	40°39	111°30
534	6/26-29/1927	37°30	107°10	584	5/27-28/1913	39°28	119°04
535	9/6-10/1927	37°33	107°49	585	11/25-30/1919	37°29	107°10
536	3/22-27/1928	40°00	122°00	586	3/25-26/1920	40°36	111°35
537	10/11-14/1928	40°20	110°30	587	8/25-27/1920	39°28	119°04
538	7/27-8/7/1929	37°33	107°49	588	8/17-25/1921	37°08	107°38
539	12/8-13/1929	41°05	122°10	589	8/21-22/1921	37°29	107°10
540	11/12-17/1930	41°40	115°25	590	9/15-19/1923	37°29	107°10
541	8/25-29/1932	37°49	107°40	591	4/7-8/1935	38°35	121°30
542	2/1-3/1936	40°36	111°36	592	7/8-13/1937	41°36	109°13
543	2/19-24/1936	40°36	111°36	593	7/16/1940	38°40	108°59
544	12/9-12/1937	38°51	122°43	594	6/24/1943	38°52	106°58
545	12/9-12/1937	37°35	119°30	595	7/30/1945	40°46	111°54
546	2/27-3/4/1938	37°36	115°14	596	8/11-14/1943	37°29	107°10
547	2/28-3/5/1938	37°24	112°30	597	8/13/1946	40°06	108°48
548	6/20-23/1938	38°52	106°58	598	6/11-12/1947	38°52	106°58
549	8/31-9/3/1938	38°49	106°37	599	6/18/1949	41°14	112°02
550	2/24-29/1940	39°55	121°25	600	11/13-20/1950	39°19	120°38
				601	10/12-15/1957	39°31	107°47

Table A2. Continued

Storm Number	Date	Latitude	Longitude	Storm Number	Date	Latitude	Longitude
602	6/6/1958	39°07	108°32				
603	7/13/1962	40°46	111°54				
604	10/8-15/1962	39°21	120°39				
605	1/29-2/2/1963	38°00	119°50				
606	7/18/1965	40°27	111°43				
607	7/30/1965	40°46	111°54				
608	8/21/1965	40°46	111°54				
609	9/5-6/1965	40°46	111°54				
610	9/1/1965	40°46	111°54				
611	8/7/1967	38°52	107°35				
612	9/5/1967	37°41	108°02				
613	1/8-27/1970	40°59	121°59				
614	6/21/1970	40°46	111°54				
615	9/5/1970	40°46	111°54				
616	7/19/1971	40°46	111°54				
617	8/28/1971	40°46	111°54				
618	6/31/1972	40°46	111°54				
619	1/15-19/1973	39°34	121°06				
620	5/25/1973	40°46	111°54				
621	7/13/1973	40°46	111°54				
622	7/19/1973	40°46	111°54				
623	3/25-4/2/1974	40°43	122°25				
624	7/8-9/1974	39°19	120°38				
625	7/17/1974	40°46	111°54				
626	10/7/1975	40°46	111°54				
627	7/15/1977	37°46	108°54				
628	8/18/1977	41°44	111°49				
629	6/4/1978	39°34	107°20				
630	1/3-4/1982	37°45	122°30				

APPENDIX 2

DEPTH-AREA-DURATION TABLES and SYNOPTIC DESCRIPTIONS

This appendix contains depth-area-duration (DAD) tables computed by the ministorm procedure (see Chapter 5) for each of the United States storms listed in Table 2.1. These 28 storms were selected from the master storm listing given in Appendix 1 (Table A1), and believed to be the most significant storms affecting the Northwest region, depending on magnitude, location and season of occurrence. Synoptic descriptions for some of the storms in Table 2.1 follow the DAD tables in this Appendix.

Half of the 28 storms in this sample have multiple centers, and DAD results are given for both the "Entire Storm" and for any additional centers. Latitude and longitude (in degrees/minutes) of the various centers have been annotated on the DAD printouts for convenience. It should be noted that the location of these centers, as well as those in Table 2.1, may be somewhat different from the positions shown for the same storms in Appendix 1 (Table A1). The locations shown on the DAD tables and in Table 2.1 were taken from the isopercental centers for each storm, while those in Appendix 1 (Table A1) represent the location of the observed rainfall maxima prior to the reanalysis of this study. It should also be noted that in rows where "0" square miles is the lowest area size shown (such as the entire storm 32 table), the actual area size being represented is some value ranging from a point to less than 1 square mile.

STORM 5 - MAY 28-30, 1906

ENTIRE STORM

46 01'N 118 04'W

AREA (SQ. MI.)	DURATION (HR)								
	1	6	12	18	24	30	36	42	48
7	0.47	2.47	4.18	5.33	6.16	7.15	8.26	8.71	9.29
10	0.47	2.47	4.18	5.33	6.16	7.15	8.26	8.71	9.29
50	0.47	2.47	4.18	5.33	6.16	7.15	8.26	8.71	9.29
100	0.47	2.46	4.16	5.30	6.14	7.13	8.23	8.68	9.27
200	0.43	2.27	3.84	4.89	5.75	6.76	7.88	8.33	8.95
500	0.38	1.98	3.35	4.27	5.13	6.13	7.23	7.68	8.29
1000	0.31	1.64	2.77	3.57	4.36	5.33	6.37	6.80	7.39
2000	0.25	1.18	1.99	2.73	3.34	4.30	5.25	5.69	6.22
5000	0.19	0.88	1.55	2.17	2.54	3.04	3.71	4.10	4.44
10000	0.14	0.68	1.22	1.69	2.06	2.44	2.76	3.13	3.34
16378	0.14	0.57	1.00	1.40	1.72	2.05	2.29	2.56	2.71

STORM 12 - NOV 17-19, 1909

ENTIRE STORM

48 12'N 115 41'W

AREA (SQ. MI.)	DURATION (HR)								
	1	6	12	18	24	30	36	42	48
7	0.55	1.47	2.20	3.05	3.87	4.19	4.79	5.57	6.34
10	0.55	1.47	2.20	3.05	3.87	4.19	4.79	5.57	6.34
50	0.53	1.42	2.13	2.95	3.74	4.06	4.64	5.39	6.14
100	0.50	1.34	2.01	2.78	3.53	3.83	4.38	5.08	5.79
200	0.45	1.23	1.81	2.50	3.17	3.44	3.95	4.60	5.23
500	0.41	1.13	1.56	2.16	2.74	3.01	3.51	4.08	4.63
1000	0.39	1.08	1.39	1.92	2.44	2.72	3.22	3.73	4.22
2000	0.37	1.02	1.22	1.68	2.13	2.43	2.92	3.39	3.82
5000	0.30	0.88	1.02	1.34	1.68	1.99	2.38	2.78	3.14
10000	0.22	0.74	0.84	1.06	1.32	1.55	1.84	2.19	2.49
17344	0.16	0.58	0.65	0.83	1.05	1.20	1.42	1.71	1.96

STORM 29 - JUNE 19-22, 1916

ENTIRE STORM

47 41'N 112 43'W

AREA (SQ. MI.)	DURATION (HR)												
	1	6	12	18	24	30	36	42	48	54	60	66	72
14	1.20	3.54	5.60	6.91	7.34	7.93	8.31	8.86	9.14	9.25	9.27	9.27	9.27
50	1.20	3.54	5.60	6.91	7.34	7.93	8.31	8.86	9.14	9.25	9.27	9.27	9.27
100	1.18	3.46	5.50	6.79	7.21	7.80	8.18	8.74	9.03	9.14	9.16	9.16	9.16
200	1.11	3.28	5.24	6.50	6.91	7.48	7.85	8.45	8.76	8.87	8.89	8.89	8.89
500	0.98	2.89	4.69	5.92	6.29	6.85	7.24	7.88	8.22	8.33	8.35	8.36	8.36
1000	0.85	2.49	4.08	5.25	5.61	6.14	6.55	7.21	7.55	7.67	7.69	7.70	7.70
2000	0.68	2.00	3.32	4.34	4.68	5.13	5.51	6.13	6.47	6.59	6.62	6.64	6.65
5000	0.43	1.29	2.24	2.95	3.33	3.67	3.99	4.46	4.83	5.03	5.08	5.16	5.18
10000	0.28	0.90	1.63	2.13	2.51	2.81	3.05	3.40	3.77	4.01	4.06	4.15	4.18
18924	0.18	0.69	1.25	1.66	1.99	2.21	2.42	2.64	2.97	3.20	3.24	3.31	3.34

STORM 32 - DEC 16-19, 1917
 WESTERN OREGON CENTER
 44 55'N 123 46'W

AREA (SQ. MI.)	DURATION (HR)												
	1	6	12	18	24	30	36	42	48	54	60	66	72
0	1.46	6.41	7.58	8.45	10.66	11.95	13.55	13.84	15.32	15.49	17.41	17.43	17.43
10	1.46	6.41	7.58	8.45	10.66	11.95	13.55	13.84	15.32	15.49	17.41	17.43	17.43
50	1.41	6.21	7.34	8.18	10.32	11.69	13.11	13.47	15.11	15.33	17.16	17.22	17.23
100	1.37	6.02	7.11	7.93	10.01	11.09	12.71	12.99	14.58	14.89	16.53	16.67	16.70
200	1.29	5.66	6.71	7.52	9.54	10.21	12.14	12.45	13.57	13.92	15.38	15.57	15.60
500	1.11	4.87	5.88	6.74	8.76	9.38	11.19	11.67	12.47	13.10	14.24	14.38	14.42
1000	0.97	4.27	5.26	6.16	8.17	8.84	10.47	11.09	11.73	12.61	13.50	13.60	13.65
2000	0.78	3.42	4.29	5.06	6.82	7.50	8.81	9.40	10.29	11.11	12.09	12.19	12.24
5000	0.53	2.34	2.94	3.49	4.82	5.76	6.35	7.04	8.18	8.70	9.71	9.79	9.83
5444	0.51	2.23	2.82	3.35	4.63	5.59	6.12	6.83	7.94	8.43	9.41	9.51	9.54

STORM 32 - DEC 16-19, 1917
 ENTIRE STORM
 44 55'N 123 46'W

AREA (SQ. MI.)	DURATION (HR)												
	1	6	12	18	24	30	36	42	48	54	60	66	72
0	1.46	6.41	7.58	8.45	10.66	11.95	13.55	13.84	15.32	15.49	17.41	17.43	17.43
10	1.46	6.41	7.58	8.45	10.66	11.95	13.55	13.84	15.32	15.49	17.41	17.43	17.43
50	1.41	6.21	7.34	8.18	10.32	11.69	13.11	13.47	15.11	15.33	17.16	17.22	17.23
100	1.37	6.02	7.11	7.93	10.01	11.09	12.71	12.99	14.58	14.89	16.53	16.67	16.70
200	1.29	5.66	6.71	7.52	9.54	10.21	12.14	12.45	13.57	13.92	15.38	15.57	15.60
500	1.11	4.87	5.88	6.74	8.76	9.38	11.19	11.67	12.47	13.10	14.24	14.38	14.42
1000	0.97	4.27	5.26	6.16	8.17	8.84	10.47	11.09	11.73	12.61	13.50	13.60	13.65
2000	0.78	3.42	4.29	5.06	6.82	7.50	8.81	9.40	10.29	11.11	12.09	12.19	12.24
5000	0.53	2.34	3.11	3.99	4.82	5.76	6.35	7.04	8.18	8.70	9.71	9.79	9.83
10000	0.40	1.76	2.57	3.48	4.22	4.99	5.52	6.17	7.19	7.64	8.47	8.58	8.63
20000	0.30	1.23	2.14	2.99	3.74	4.29	4.85	5.41	6.34	6.73	7.39	7.53	7.59
33167	0.24	0.98	1.84	2.72	3.38	3.81	4.35	4.73	5.40	5.75	6.32	6.44	6.50

STORM 32 - DEC 16-19, 1917
 CASCADES CENTER
 45 29'N 121 52'W

AREA (SQ. MI.)	DURATION (HR)												
	1	6	12	18	24	30	36	42	48	54	60	66	72
2	1.07	4.00	5.75	7.73	8.13	9.34	9.86	9.86	10.70	11.76	12.48	12.93	13.08
10	1.07	4.00	5.72	7.59	7.98	9.17	9.68	9.68	10.51	11.56	12.25	12.68	12.82
50	0.92	3.51	5.16	6.93	7.29	8.37	8.84	8.84	10.21	11.36	12.02	12.45	12.57
100	0.84	3.22	4.80	6.45	6.79	7.79	8.23	8.23	9.97	11.08	11.73	12.14	12.25
200	0.76	2.93	4.51	6.06	6.37	7.32	7.72	7.82	9.52	10.57	11.20	11.58	11.70
500	0.64	2.56	4.15	5.56	5.85	6.74	7.12	7.26	8.82	9.77	10.35	10.70	10.79
1000	0.56	2.30	3.89	5.20	5.47	6.36	6.71	6.89	8.30	9.18	9.70	10.01	10.08
2000	0.48	2.03	3.47	4.59	4.94	5.78	6.14	6.34	7.71	8.44	8.98	9.28	9.35
5000	0.38	1.60	2.69	3.49	4.08	4.79	5.17	5.78	6.82	7.39	7.91	8.16	8.24
8374	0.30	1.36	2.26	2.87	3.59	4.23	4.62	5.48	6.43	6.88	7.40	7.61	7.70

STORM 38 - NOV 19-22, 1921
 ENTIRE STORM
 45 28'N 121 52'W

AREA (SQ. MI.)	DURATION (HR)												
	1	6	12	18	24	30	36	42	48	54	60	66	72
1	1.56	4.06	4.84	5.98	8.30	9.71	11.23	12.15	12.57	12.88	13.47	13.75	14.18
10	1.54	4.01	4.84	5.98	8.30	9.71	11.23	12.13	12.44	12.79	13.23	13.70	14.18
50	1.44	3.76	4.71	5.86	8.11	9.53	11.02	11.93	12.25	12.62	13.07	13.55	14.03
100	1.28	3.33	4.29	5.62	7.72	9.15	10.59	11.50	11.84	12.27	12.72	13.24	13.71
200	1.28	3.33	3.98	5.26	7.31	8.53	9.89	10.79	11.15	11.67	12.12	12.69	13.14
500	1.24	3.21	3.70	5.07	7.09	8.13	9.23	10.15	10.52	11.02	11.49	11.91	12.39
1000	1.14	2.96	3.50	4.86	6.83	7.87	8.89	9.52	9.76	10.24	10.68	11.21	11.55
2000	0.95	2.50	3.26	4.50	6.35	7.31	8.30	8.90	9.11	9.58	9.98	10.44	10.81
5000	0.75	2.07	3.02	4.03	5.64	6.62	7.64	8.29	8.57	8.99	9.34	9.84	10.19
10000	0.60	1.74	2.72	3.60	4.96	5.80	6.76	7.36	7.63	7.95	8.34	8.77	9.10
20000	0.45	1.41	2.35	3.17	4.14	4.81	5.70	6.23	6.44	6.70	7.25	7.52	7.86
50000	0.28	0.95	1.59	2.13	2.69	3.11	3.69	4.06	4.29	4.78	5.25	5.43	5.66
73110	0.22	0.76	1.26	1.69	2.13	2.47	2.94	3.26	3.49	3.87	4.28	4.45	4.66

STORM 40 - DEC 9-12, 1921
 WASHINGTON CASCADES CENTER
 48 01'N 121 32'W

AREA (SQ. MI.)	DURATION (HR)												
	1	6	12	18	24	30	36	42	48	54	60	66	72
2	1.30	3.58	5.35	6.79	8.61	10.66	11.82	12.57	12.57	13.92	16.14	17.67	19.31
10	1.30	3.58	5.35	6.79	8.59	10.66	11.82	12.57	12.57	13.92	16.14	17.67	19.31
50	1.27	3.48	5.26	6.68	8.34	10.36	11.49	12.24	12.24	13.53	15.69	17.17	18.76
100	1.23	3.37	5.12	6.50	8.16	10.14	11.24	11.96	11.96	13.19	15.31	16.76	18.29
200	1.16	3.19	4.89	6.22	7.89	9.80	10.87	11.56	11.56	12.64	14.72	16.09	17.52
500	1.01	2.78	4.60	5.89	7.47	9.28	10.28	10.96	10.96	11.58	13.64	14.87	16.05
1000	0.90	2.54	4.38	5.64	7.21	8.95	9.93	10.60	10.60	10.90	12.94	14.06	14.98
2000	0.78	2.36	4.16	5.37	6.91	8.57	9.56	10.20	10.20	10.36	12.29	13.27	13.93
5000	0.63	2.06	3.59	4.62	5.91	7.39	8.33	8.92	8.92	8.95	10.63	11.43	11.90
8662	0.49	1.72	3.02	3.94	4.96	6.24	7.05	7.57	7.57	7.61	8.96	9.62	10.02

STORM 40 - DEC 9-12, 1921
 COASTAL WASHINGTON CENTER
 47 40'N 123 26'W

AREA (SQ. MI.)	DURATION (HR)												
	1	6	12	18	24	30	36	42	48	54	60	66	72
1	1.05	3.25	4.96	6.55	7.68	9.32	10.77	11.61	11.61	11.61	12.48	12.84	13.14
10	1.05	3.06	4.96	6.55	7.39	9.32	10.77	11.61	11.61	11.61	12.48	12.84	13.14
50	1.05	2.94	4.83	6.39	7.26	9.32	10.77	11.61	11.61	11.61	12.48	12.84	13.14
100	1.05	2.87	4.73	6.26	7.10	9.08	10.57	11.42	11.43	11.43	12.31	12.66	12.96
200	0.96	2.72	4.54	6.01	6.91	8.79	10.32	11.19	11.22	11.22	12.11	12.45	12.75
500	0.83	2.37	4.08	5.42	6.42	8.22	9.75	10.67	10.70	10.72	11.74	12.09	12.38
1000	0.73	2.09	3.59	4.82	5.88	7.67	9.13	10.12	10.14	10.18	11.37	11.75	12.04
2000	0.63	1.91	3.30	4.49	5.39	7.15	8.54	9.56	9.59	9.66	10.98	11.38	11.66
5000	0.47	1.58	2.78	3.92	4.87	6.35	7.54	8.46	8.50	8.57	9.68	10.05	10.29
9243	0.30	1.23	2.31	3.42	4.49	5.65	6.58	7.45	7.56	7.60	8.45	8.76	8.94

STORM 40 - DEC 9-12, 1921

ENTIRE STORM

48 01'N 121 32'W

AREA
(SQ. MI.)

	DURATION (HR)												
	1	6	12	18	24	30	36	42	48	54	60	66	72
1	1.30	3.58	5.35	6.79	8.61	10.66	11.82	12.57	12.57	13.92	16.14	17.67	19.31
10	1.30	3.58	5.35	6.79	8.58	10.66	11.82	12.57	12.57	13.92	16.14	17.67	19.31
50	1.27	3.48	5.26	6.68	8.34	10.36	11.49	12.24	12.24	13.53	15.69	17.17	18.76
100	1.23	3.37	5.12	6.50	8.16	10.14	11.24	11.96	11.96	13.19	15.31	16.76	18.29
200	1.16	3.19	4.89	6.22	7.89	9.80	10.87	11.56	11.56	12.64	14.72	16.09	17.52
500	1.01	2.77	4.60	5.89	7.47	9.28	10.28	10.96	10.96	11.58	13.64	14.87	16.05
1000	0.90	2.54	4.38	5.64	7.21	8.95	9.92	10.60	10.60	10.90	12.94	14.06	14.98
2000	0.78	2.36	4.16	5.37	6.91	8.57	9.56	10.20	10.20	10.36	12.29	13.27	13.93
5000	0.63	2.06	3.59	4.62	5.91	7.39	8.33	8.92	8.92	8.95	10.63	11.43	11.90
10000	0.46	1.66	2.93	3.85	4.86	6.09	6.90	7.45	7.50	7.53	8.80	9.41	9.80
20000	0.31	1.36	2.50	3.43	4.35	5.39	6.19	6.89	6.94	6.95	7.98	8.44	8.73
27253	0.25	1.22	2.28	3.17	3.99	4.92	5.66	6.35	6.41	6.42	7.30	7.68	7.93

STORM 59 - MAR 30 - APR 1, 1931

ENTIRE STORM

46 00'N 118 00'W

AREA
(SQ. MI.)

	DURATION (HR)										
	1	6	12	18	24	30	36	42	48	54	60
1	0.84	2.06	3.14	3.50	4.79	5.49	5.79	5.87	5.96	6.00	6.00
10	0.84	2.06	3.14	3.50	4.79	5.49	5.79	5.87	5.96	6.00	6.00
50	0.83	1.97	3.12	3.39	4.66	5.35	5.64	5.72	5.81	5.85	5.85
100	0.79	1.93	3.00	3.34	4.60	5.28	5.58	5.65	5.74	5.78	5.78
200	0.75	1.82	2.88	3.17	4.39	5.04	5.32	5.39	5.48	5.52	5.52
500	0.70	1.59	2.70	2.93	3.94	4.52	4.77	4.84	4.91	4.95	4.95
1000	0.64	1.44	2.49	2.71	3.57	4.09	4.33	4.39	4.45	4.48	4.48
2000	0.56	1.28	2.18	2.42	3.07	3.54	3.77	3.85	3.89	3.92	3.92
5000	0.35	0.97	1.64	2.03	2.59	3.11	3.37	3.47	3.50	3.52	3.54
10000	0.22	0.77	1.27	1.71	2.23	2.73	2.97	3.08	3.11	3.12	3.14
20000	0.16	0.65	0.98	1.33	1.80	2.18	2.38	2.46	2.49	2.51	2.52
32730	0.12	0.52	0.79	1.06	1.44	1.74	1.91	1.98	2.02	2.03	2.05

STORM 59 - MAR 30 - APR 1, 1931

BLUE MOUNTAINS CENTER

46 00'N 118 00'W

AREA
(SQ. MI.)

	DURATION (HR)										
	1	6	12	18	24	30	36	42	48	54	60
11	0.75	2.06	2.60	3.50	4.79	5.49	5.79	5.87	5.96	6.00	6.00
50	0.71	1.97	2.51	3.39	4.66	5.35	5.64	5.72	5.81	5.85	5.85
100	0.69	1.93	2.47	3.34	4.60	5.28	5.58	5.65	5.74	5.78	5.78
200	0.64	1.82	2.34	3.17	4.39	5.04	5.32	5.39	5.48	5.52	5.52
500	0.52	1.59	2.10	2.86	3.94	4.52	4.77	4.84	4.91	4.95	4.95
1000	0.42	1.44	1.92	2.64	3.57	4.09	4.33	4.39	4.45	4.48	4.48
1923	0.35	1.28	1.71	2.34	3.09	3.56	3.79	3.85	3.91	3.94	3.94

STORM 59 - MAR 30-APR 1, 1931
 NORTH CENTRAL IDAHO CENTER
 46 20'N 115 38'W

AREA (SQ. MI.)	DURATION (HR)										
	1	6	12	18	24	30	36	42	48	54	60
1	0.84	1.84	3.14	3.32	3.53	3.98	4.87	5.07	5.08	5.08	5.08
10	0.84	1.84	3.14	3.32	3.53	3.98	4.87	5.07	5.08	5.08	5.08
50	0.83	1.83	3.12	3.31	3.52	3.97	4.86	5.06	5.07	5.07	5.07
100	0.79	1.74	3.00	3.21	3.43	3.84	4.73	4.95	4.96	4.96	4.97
200	0.75	1.65	2.88	3.11	3.33	3.71	4.61	4.84	4.86	4.86	4.86
500	0.70	1.53	2.70	2.93	3.15	3.50	4.35	4.58	4.60	4.60	4.60
1000	0.64	1.43	2.49	2.71	2.92	3.31	4.06	4.26	4.27	4.27	4.27
2000	0.56	1.28	2.18	2.42	2.64	3.07	3.70	3.85	3.87	3.87	3.87
2288	0.54	1.24	2.11	2.35	2.57	3.02	3.62	3.76	3.78	3.78	3.78

STORM 60 - DEC 17-19, 1931
 ENTIRE STORM
 47 28'N 123 35'W

AREA (SQ. MI.)	DURATION (HR)									
	1	6	12	18	24	30	36	42	48	
1	1.22	3.82	5.31	6.79	8.06	9.64	11.79	14.00	14.24	
10	1.22	3.82	5.31	6.79	8.06	9.64	11.79	14.00	14.24	
50	1.18	3.70	5.30	6.75	7.98	9.51	11.54	13.73	13.96	
100	1.13	3.54	5.25	6.67	7.85	9.32	11.21	13.36	13.59	
200	1.06	3.30	5.08	6.45	7.54	8.91	10.60	12.67	12.89	
500	0.89	2.82	4.75	5.98	6.91	8.05	9.40	11.23	11.42	
1000	0.76	2.52	4.30	5.40	6.19	7.17	8.27	9.88	10.05	
2000	0.64	2.15	3.67	4.60	5.28	6.11	7.03	8.39	8.54	
5000	0.44	1.52	2.56	3.28	3.88	4.54	5.17	6.13	6.29	
10000	0.29	1.12	1.83	2.44	3.02	3.55	3.95	4.62	4.82	
20000	0.19	0.93	1.45	1.95	2.49	2.97	3.21	3.65	3.89	
40221	0.13	0.67	1.01	1.39	1.81	2.18	2.32	2.57	2.78	

STORM 66 - MAR 16-19, 1932
 ENTIRE STORM
 42 10'N 124 15'W

AREA (SQ. MI.)	DURATION (HR)												
	1	6	12	18	24	30	36	42	48	54	60	66	72
4	0.95	4.54	6.76	8.26	9.69	10.51	11.42	13.34	14.17	14.82	14.89	15.06	15.07
10	0.95	4.50	6.71	8.20	9.63	10.44	11.34	13.25	14.08	14.72	14.79	14.96	14.97
50	0.92	4.40	6.56	8.02	9.41	10.21	11.09	12.95	13.76	14.39	14.45	14.62	14.63
100	0.90	4.31	6.42	7.85	9.21	9.99	10.85	12.67	13.46	14.08	14.14	14.31	14.32
200	0.86	4.10	6.11	7.47	8.77	9.51	10.35	12.03	12.76	13.38	13.44	13.62	13.63
500	0.77	3.68	5.48	6.72	7.88	8.53	9.29	10.71	11.35	11.94	12.01	12.19	12.19
1000	0.70	3.31	4.93	6.05	7.08	7.66	8.36	9.59	10.16	10.71	10.79	10.95	10.96
2000	0.60	2.85	4.25	5.22	6.11	6.64	7.22	8.22	8.75	9.25	9.35	9.50	9.51
5000	0.42	2.00	3.02	3.70	4.42	4.93	5.42	6.12	6.57	7.02	7.19	7.37	7.40
10000	0.29	1.23	1.90	2.41	2.96	3.45	3.85	4.27	4.79	5.30	5.61	5.92	6.02
20000	0.21	0.85	1.46	1.95	2.38	2.72	3.13	3.46	3.93	4.38	4.74	5.05	5.21
42243	0.16	0.59	1.06	1.45	1.74	1.93	2.25	2.51	2.94	3.27	3.57	3.82	3.97

STORM 74 - DEC 19-22, 1933

ENTIRE STORM

46 10'N 122 13'W

AREA
(SQ. MI.)

	DURATION (HR)												
	1	6	12	18	24	30	36	42	48	54	60	66	72
0	0.95	2.73	4.70	6.56	8.17	9.23	10.38	12.41	13.57	14.75	15.57	16.43	17.02
10	0.95	2.67	4.70	6.31	7.98	8.93	9.96	11.97	13.07	14.23	14.98	16.02	16.66
50	0.85	2.59	4.68	6.16	7.83	8.71	9.67	11.66	12.72	13.85	14.56	15.69	16.37
100	0.81	2.54	4.63	6.04	7.64	8.46	9.38	11.31	12.33	13.44	14.11	15.30	15.99
200	0.78	2.47	4.55	5.91	7.43	8.19	9.06	10.92	11.90	12.97	13.61	14.83	15.53
500	0.70	2.33	4.34	5.64	7.06	7.75	8.57	10.29	11.18	12.18	12.77	13.96	14.64
1000	0.65	2.13	3.98	5.19	6.50	7.17	8.03	9.52	10.35	11.26	11.81	12.91	13.53
2000	0.59	1.94	3.41	4.53	5.81	6.49	7.60	8.67	9.42	10.22	10.70	11.67	12.21
5000	0.43	1.54	2.68	3.59	4.63	5.29	6.30	7.01	7.59	8.26	8.69	9.48	9.96
10000	0.35	1.26	2.21	3.02	3.83	4.54	5.38	6.20	6.94	7.63	8.11	8.70	9.15
11783	0.33	1.19	2.10	2.89	3.64	4.36	5.16	6.00	6.78	7.48	7.97	8.52	8.96

STORM 78 - OCT 22-25, 1934

ENTIRE STORM

46 25'N 123 31'W

AREA
(SQ. MI.)

	DURATION (HR)												
	1	6	12	18	24	30	36	42	48	54	60	66	72
1	0.81	3.14	4.28	5.84	6.28	7.41	7.51	8.06	9.51	10.38	10.69	11.02	11.18
10	0.81	3.14	4.28	5.84	6.28	7.41	7.51	8.03	9.51	10.38	10.69	10.99	11.18
50	0.78	3.14	4.11	5.62	6.24	7.41	7.51	7.79	9.51	10.38	10.69	10.69	11.18
100	0.71	2.97	3.93	5.40	6.24	7.41	7.51	7.67	9.51	10.38	10.69	10.69	11.18
200	0.64	2.69	3.75	5.18	5.97	7.18	7.28	7.46	9.23	10.06	10.37	10.37	10.89
500	0.58	2.30	3.47	4.83	5.64	6.79	6.89	6.99	8.61	9.34	9.65	9.65	10.19
1000	0.47	1.93	3.13	4.38	5.30	6.22	6.30	6.40	7.75	8.35	8.72	8.72	9.34
2000	0.40	1.71	2.68	3.76	4.53	5.36	5.43	5.76	6.91	7.48	7.86	7.86	8.53
5000	0.34	1.43	2.08	2.90	3.61	4.30	4.36	4.97	5.92	6.46	6.81	6.81	7.49
10000	0.27	1.14	1.79	2.48	3.19	3.78	3.85	4.48	5.30	5.76	6.04	6.07	6.62
20000	0.18	0.84	1.56	2.23	2.87	3.41	3.54	4.10	4.88	5.27	5.47	5.55	6.03
20559	0.18	0.83	1.55	2.22	2.86	3.39	3.53	4.08	4.86	5.25	5.45	5.53	6.00

STORM 78 - OCT 22-25, 1934

CASCADES CENTER

46 08'N 122 22'W

AREA
(SQ. MI.)

	DURATION (HR)												
	1	6	12	18	24	30	36	42	48	54	60	66	72
1	0.81	2.91	4.28	5.84	6.24	6.50	6.88	8.06	8.74	9.12	10.26	11.02	11.02
10	0.81	2.91	4.28	5.84	6.24	6.50	6.85	8.03	8.74	9.10	10.23	10.99	10.99
50	0.78	2.82	4.11	5.62	6.02	6.30	6.60	7.79	8.56	8.85	9.93	10.67	10.67
100	0.71	2.56	3.93	5.40	5.82	6.12	6.48	7.67	8.37	8.73	9.79	10.52	10.52
200	0.64	2.29	3.75	5.18	5.63	5.95	6.21	7.32	8.19	8.37	9.36	10.06	10.06
500	0.58	1.95	3.47	4.83	5.27	5.59	5.82	6.90	7.70	7.85	8.58	9.20	9.20
1000	0.47	1.72	3.13	4.38	4.77	5.15	5.38	6.35	7.03	7.22	7.66	8.17	8.20
2000	0.37	1.48	2.68	3.76	4.23	4.66	4.93	5.76	6.42	6.63	6.87	7.26	7.40
5000	0.27	1.08	2.02	2.86	3.50	3.97	4.25	4.97	5.65	5.91	6.09	6.36	6.70
7068	0.23	0.94	1.77	2.52	3.23	3.71	3.99	4.68	5.37	5.64	5.80	6.01	6.43

STORM 78 - OCT 22-25, 1934

COASTAL CENTER

46 25'N 123 31'W

AREA
(SQ. MI.)

DURATION (HR)

	1	6	12	18	24	30	36	42	48	54	60	66	72
1	0.76	3.14	3.99	4.73	6.28	7.41	7.51	7.57	9.51	10.38	10.69	10.69	11.18
10	0.76	3.14	3.99	4.73	6.28	7.41	7.51	7.57	9.51	10.38	10.69	10.69	11.18
50	0.76	3.14	3.99	4.73	6.24	7.41	7.51	7.57	9.51	10.38	10.69	10.69	11.18
100	0.71	2.97	3.85	4.73	6.24	7.41	7.51	7.57	9.51	10.38	10.69	10.69	11.18
200	0.63	2.69	3.62	4.51	5.97	7.18	7.28	7.46	9.23	10.06	10.37	10.37	10.89
500	0.52	2.30	3.28	4.32	5.64	6.79	6.89	6.99	8.61	9.34	9.65	9.65	10.19
1000	0.44	1.93	2.83	4.09	5.30	6.22	6.30	6.39	7.75	8.35	8.72	8.72	9.34
2000	0.39	1.71	2.47	3.45	4.53	5.36	5.43	5.67	6.91	7.48	7.86	7.86	8.53
5000	0.34	1.43	2.05	2.73	3.61	4.30	4.36	4.86	5.92	6.46	6.81	6.81	7.49
7221	0.31	1.28	1.90	2.59	3.35	3.95	4.00	4.56	5.50	5.99	6.31	6.31	6.90

STORM 80 - JAN 20-26, 1935

ENTIRE STORM

47 28'N 123 43'W

AREA
(SQ. MI.)

DURATION (HR)

	1	6	12	18	24	30	36	42	48	54	60	66	72
0	1.72	6.74	9.29	12.86	14.62	16.58	20.34	25.50	28.41	30.15	30.48	32.06	34.80
10	1.70	6.65	9.17	12.69	14.45	16.39	20.10	25.20	28.07	29.79	30.12	31.68	34.39
50	1.59	6.22	8.60	11.87	14.12	15.71	19.08	24.05	26.87	28.54	28.87	30.41	33.09
100	1.55	6.06	8.35	11.56	13.70	15.19	18.30	23.13	25.86	27.49	27.80	29.30	31.91
200	1.51	5.92	8.16	11.29	13.27	14.76	17.91	22.58	25.23	26.81	27.11	28.56	31.08
500	1.46	5.72	7.89	10.91	12.41	14.10	17.29	21.66	24.13	25.62	25.91	27.25	29.62
1000	1.36	5.35	7.49	10.27	11.72	13.26	16.07	19.85	22.02	23.41	23.70	24.83	26.92
2000	1.14	4.56	6.52	8.83	10.17	11.53	13.91	17.00	18.82	20.07	20.41	21.25	23.04
5000	0.78	3.23	4.77	6.31	7.43	8.58	10.36	12.54	13.89	14.87	15.27	15.70	16.94
10000	0.56	2.40	3.71	4.77	5.80	6.83	8.26	9.88	10.89	11.73	12.09	12.33	13.21
20000	0.41	1.79	2.84	3.55	4.49	5.41	6.57	7.77	8.54	9.21	9.53	9.70	10.20
43865	0.24	1.08	1.70	2.14	2.87	3.50	4.23	4.90	5.38	5.85	6.08	6.20	6.40

AREA
(SQ. MI.)

DURATION (HR)

	78	84	90	96	102	108	114	120	126	132	138	144
0	38.10	38.80	39.87	40.43	40.85	41.77	42.43	42.74	42.91	43.03	43.11	43.11
10	37.65	38.34	39.40	39.95	40.36	41.27	41.93	42.23	42.40	42.52	42.60	42.60
50	36.30	36.97	38.01	38.55	38.99	39.96	40.61	40.92	41.14	41.28	41.36	41.36
100	35.04	35.68	36.70	37.22	37.67	38.64	39.28	39.57	39.81	39.96	40.03	40.03
200	34.10	34.73	35.71	36.21	36.63	37.55	38.16	38.45	38.66	38.79	38.87	38.87
500	32.47	33.08	34.01	34.50	34.89	35.77	36.36	36.64	36.83	36.95	37.02	37.02
1000	29.48	30.13	30.99	31.49	31.84	32.68	33.28	33.63	33.83	33.95	34.01	34.01
2000	25.25	25.91	26.69	27.24	27.53	28.33	28.94	29.37	29.66	29.83	29.90	29.90
5000	18.50	19.12	19.70	20.19	20.55	20.89	21.44	21.80	22.16	22.36	22.48	22.51
10000	14.39	15.17	15.74	16.30	16.59	16.74	17.21	17.61	17.90	18.07	18.17	18.21
20000	11.01	11.73	12.20	12.68	12.92	13.02	13.31	13.60	13.85	13.98	14.05	14.08
43865	6.79	7.21	7.53	7.79	7.93	7.99	8.11	8.27	8.42	8.48	8.52	8.54

STORM 80 - JAN 20-26, 1935
 OLYMPIC PENINSULA CENTER
 47 28'N 123 43'W

AREA
 (SQ. MI.)

	DURATION (HR)												
	1	6	12	18	24	30	36	42	48	54	60	66	72
1	1.72	6.74	9.29	12.86	14.62	16.58	20.34	25.50	28.41	30.15	30.48	32.06	34.80
10	1.70	6.65	9.17	12.69	14.45	16.39	20.10	25.20	28.07	29.79	30.12	31.68	34.39
50	1.59	6.22	8.60	11.87	14.12	15.71	19.08	24.05	26.87	28.54	28.87	30.41	33.09
100	1.55	6.06	8.35	11.56	13.70	15.19	18.30	23.13	25.86	27.49	27.80	29.30	31.91
200	1.51	5.92	8.16	11.29	13.27	14.76	17.91	22.58	25.23	26.81	27.11	28.56	31.08
500	1.46	5.72	7.89	10.91	12.41	14.10	17.29	21.66	24.13	25.62	25.91	27.25	29.62
1000	1.36	5.35	7.49	10.27	11.72	13.26	16.07	19.85	22.02	23.41	23.70	24.83	26.92
2000	1.14	4.56	6.52	8.83	10.17	11.53	13.91	17.00	18.82	20.07	20.41	21.25	23.04
5000	0.78	3.23	4.77	6.31	7.43	8.58	10.36	12.54	13.89	14.87	15.27	15.70	16.94
5987	0.72	2.98	4.42	5.81	6.87	7.97	9.64	11.62	12.85	13.75	14.17	14.50	15.60

AREA
 (SQ. MI.)

	DURATION (HR)											
	78	84	90	96	102	108	114	120	126	132	138	144
1	38.10	38.80	39.87	40.43	40.85	41.77	42.43	42.74	42.91	43.03	43.11	43.11
10	37.65	38.34	39.40	39.95	40.36	41.27	41.93	42.23	42.40	42.52	42.60	42.60
50	36.30	36.97	38.01	38.55	38.99	39.96	40.61	40.92	41.14	41.28	41.36	41.36
100	35.04	35.68	36.70	37.22	37.67	38.64	39.28	39.57	39.81	39.96	40.03	40.03
200	34.10	34.73	35.71	36.21	36.63	37.55	38.16	38.45	38.66	38.79	38.87	38.87
500	32.47	33.08	34.01	34.50	34.89	35.77	36.36	36.64	36.83	36.95	37.02	37.02
1000	29.48	30.13	30.99	31.49	31.84	32.68	33.28	33.63	33.83	33.95	34.01	34.01
2000	25.25	25.91	26.69	27.24	27.53	28.33	28.94	29.37	29.66	29.83	29.90	29.90
5000	18.50	19.12	19.70	20.19	20.55	20.89	21.44	21.80	22.16	22.36	22.48	22.51
5987	16.99	17.60	18.12	18.58	18.95	19.17	19.72	20.06	20.40	20.62	20.75	20.80

STORM 80 - JAN 20-26, 1935
 NORTH CASCADES CENTER
 48 00'N 121 28'W

AREA
 (SQ. MI.)

	DURATION (HR)												
	1	6	12	18	24	30	36	42	48	54	60	66	72
0	1.15	3.92	5.88	7.73	8.53	9.25	10.20	11.53	12.50	13.26	14.20	15.62	17.26
10	1.11	3.76	5.65	7.43	8.20	8.98	9.90	11.19	12.14	13.26	14.20	15.01	16.61
50	1.02	3.47	5.32	7.13	7.87	8.41	9.44	10.71	11.57	13.12	14.05	14.64	16.19
100	0.98	3.35	5.17	7.01	7.73	8.14	9.14	10.55	11.41	12.70	13.60	14.31	15.99
200	0.94	3.20	4.96	6.74	7.44	7.84	8.89	10.25	11.09	11.86	12.70	13.83	15.47
500	0.79	2.66	4.28	6.02	6.66	7.50	8.53	9.77	10.58	11.10	11.36	12.73	14.41
1000	0.66	2.24	3.61	5.07	5.90	6.75	7.86	9.01	9.81	10.31	10.56	11.25	12.71
2000	0.60	2.06	3.26	4.52	5.20	6.09	7.22	8.20	9.03	9.73	10.07	10.41	11.66
4279	0.48	1.65	2.62	3.69	4.40	5.40	6.44	7.31	8.11	8.84	9.21	9.30	10.12

AREA
 (SQ. MI.)

	DURATION (HR)											
	78	84	90	96	102	108	114	120	126	132	138	144
0	18.43	19.75	21.53	22.80	22.80	23.16	24.61	26.26	26.26	26.26	26.26	26.26
10	17.89	19.75	21.53	22.80	22.80	23.16	24.61	26.26	26.26	26.26	26.26	26.26
50	17.56	19.55	21.30	22.57	22.57	22.92	24.35	25.99	25.99	25.99	25.99	25.99
100	16.98	18.89	20.59	21.81	21.83	22.16	23.52	25.10	25.12	25.13	25.13	25.13
200	16.41	17.61	19.18	20.32	20.36	20.66	21.90	23.36	23.40	23.43	23.44	23.44
500	15.40	16.47	17.86	18.52	18.56	18.76	19.03	20.23	20.31	20.36	20.38	20.38
1000	13.63	14.67	16.06	16.70	16.74	16.92	17.16	18.05	18.15	18.21	18.24	18.24
2000	12.50	13.63	14.98	15.67	15.73	15.89	16.19	16.94	17.03	17.08	17.10	17.10
4279	10.86	12.02	13.21	13.89	13.96	14.12	14.39	15.11	15.18	15.22	15.23	15.23

STORM 82 - MAR 24-25, 1935

ENTIRE STORM

47 22'N 115 26'W

AREA
(SQ. MI.)

DURATION

	1	6	12	18	24
15	0.45	2.03	3.16	3.61	4.06
50	0.43	1.94	3.01	3.44	3.87
100	0.41	1.85	2.88	3.29	3.70
200	0.38	1.72	2.68	3.06	3.44
500	0.32	1.43	2.23	2.54	2.86
1000	0.27	1.21	1.88	2.15	2.44
2000	0.22	1.00	1.55	1.78	2.04
5000	0.18	0.70	1.18	1.40	1.67
10000	0.15	0.49	0.91	1.12	1.39
20000	0.11	0.37	0.68	0.85	1.08
23729	0.10	0.34	0.62	0.78	1.01

STORM 88 - DEC 26-30, 1937

ENTIRE STORM

44 55'N 44 55'N

AREA
(SQ. MI.)

DURATION

	1	6	12	18	24	30	36	42	48	54	60	66	72
0	1.17	3.38	5.90	8.40	10.94	13.35	15.31	16.47	17.56	17.56	17.56	19.83	20.71
10	1.17	3.32	5.80	8.26	10.76	13.13	15.05	16.19	17.26	17.26	17.26	19.49	20.36
50	1.12	3.23	5.64	8.03	10.46	12.76	14.63	15.74	16.78	16.78	16.78	18.95	19.79
100	1.02	3.07	5.40	7.66	9.98	12.21	14.01	15.07	16.05	16.05	16.05	18.13	18.95
200	0.90	2.84	4.96	6.95	9.09	11.14	12.80	13.75	14.62	14.62	14.62	16.51	17.31
500	0.74	2.44	4.20	5.72	7.40	9.12	10.53	11.37	12.02	12.06	12.14	13.64	14.58
1000	0.58	2.18	3.58	4.84	6.43	7.72	8.91	10.15	10.72	11.04	11.59	12.53	13.27
2000	0.54	2.02	3.19	4.43	5.89	7.17	8.19	9.10	9.60	9.85	10.39	11.23	12.00
5000	0.45	1.69	2.59	3.70	4.87	5.95	6.82	7.59	7.99	8.07	8.51	9.17	9.92
10000	0.34	1.33	2.31	3.33	4.31	5.23	6.00	6.65	7.00	7.13	7.54	8.18	8.99
13869	0.29	1.16	2.18	3.16	4.04	4.89	5.63	6.22	6.55	6.70	7.10	7.72	8.57

AREA

(SQ. MI.)

DURATION

	78	84	90	96
0	22.67	24.80	26.80	27.08
10	22.28	24.38	26.34	26.61
50	21.67	23.71	25.62	25.88
100	20.80	22.78	24.63	24.88
200	19.10	20.95	22.67	22.90
500	16.12	17.75	19.25	19.49
1000	14.55	15.97	17.24	17.71
2000	13.13	14.51	15.70	16.15
5000	10.92	12.15	13.22	13.55
10000	9.90	10.93	11.81	12.18
13869	9.44	10.37	11.16	11.55

STORM 88 - DEC 26-30, 1937
 COASTAL OREGON CENTER REVISED
 44 55'N 123 30'W

AREA (SQ. MI.)	DURATION (HR)												
	1	6	12	18	24	30	36	42	48	54	60	66	72
0	1.17	3.38	5.90	8.40	10.94	13.35	15.31	16.47	17.56	17.56	17.56	19.83	20.71
10	1.17	3.32	5.80	8.26	10.76	13.13	15.05	16.19	17.26	17.26	17.26	19.49	20.36
50	1.12	3.23	5.64	8.03	10.46	12.76	14.63	15.74	16.78	16.78	16.78	18.95	19.79
100	1.02	3.07	5.40	7.66	9.98	12.21	14.01	15.07	16.05	16.05	16.05	18.13	18.95
200	0.90	2.84	4.96	6.95	9.09	11.14	12.80	13.75	14.62	14.62	14.62	16.51	17.31
500	0.74	2.44	4.20	5.72	7.40	9.12	10.53	11.37	12.02	12.02	12.14	13.64	14.58
1000	0.58	2.18	3.58	4.84	6.43	7.72	8.91	10.15	10.72	11.04	11.59	12.53	13.27
2000	0.54	2.02	3.19	4.43	5.89	7.17	8.19	9.10	9.60	9.85	10.39	11.23	12.00
5000	0.45	1.69	2.59	3.70	4.87	5.95	6.82	7.59	7.99	8.07	8.51	9.17	9.92
5103	0.44	1.68	2.58	3.68	4.84	5.91	6.77	7.54	7.94	8.01	8.45	9.11	9.85

AREA (SQ. MI.)	DURATION (HR)			
	78	84	90	96
0	22.67	24.80	26.80	27.08
10	22.28	24.38	26.34	26.61
50	21.67	23.71	25.62	25.88
100	20.80	22.78	24.63	24.88
200	19.10	20.95	22.67	22.90
500	16.12	17.75	19.25	19.49
1000	14.55	15.97	17.24	17.71
2000	13.13	14.51	15.70	16.15
5000	10.92	12.15	13.22	13.55
5103	10.85	12.07	13.13	13.46

STORM 88 - DEC 26-30, 1937
 CASCADES CENTER REVISED MASS CURVES NEAR COUGAR, WA
 46 05'N 122 18'W

AREA (SQ. MI.)	DURATION (HR)												
	1	6	12	18	24	30	36	42	48	54	60	66	72
1	0.69	2.96	5.08	6.38	7.35	8.37	9.59	10.15	11.31	11.99	12.75	13.31	14.05
10	0.64	2.96	5.08	6.24	7.30	8.37	9.59	10.15	11.31	11.99	12.75	13.31	14.05
50	0.58	2.67	4.53	5.81	6.73	7.70	8.86	9.93	10.53	11.08	12.13	12.55	13.04
100	0.55	2.45	4.17	5.55	6.45	7.33	8.28	9.72	10.31	10.85	11.88	12.33	12.88
200	0.53	2.14	3.79	5.19	6.11	7.07	8.04	9.39	9.95	10.48	11.48	11.97	12.62
500	0.47	1.78	3.41	4.66	5.61	6.55	7.49	8.61	9.16	9.66	10.54	11.08	12.14
1000	0.40	1.58	3.00	4.13	4.93	5.77	6.63	7.52	8.00	8.44	9.22	10.11	11.27
2000	0.32	1.37	2.58	3.58	4.41	5.05	5.74	6.43	6.82	7.23	8.13	9.20	10.29
4685	0.22	1.11	2.06	2.92	3.77	4.58	5.36	6.03	6.38	6.71	7.45	8.32	9.17

AREA (SQ. MI.)	DURATION (HR)			
	78	84	90	96
1	14.80	15.36	16.37	17.39
10	14.80	15.33	16.37	17.39
50	13.97	14.93	16.37	17.39
100	13.84	14.79	16.19	17.21
200	13.64	14.59	15.90	16.92
500	13.18	14.14	15.24	16.20
1000	12.27	13.19	14.10	14.95
2000	11.25	12.07	12.85	13.55
4685	9.99	10.62	11.36	11.88

STORM 106 - JUNE 26-27, 1944

REVISED ENTIRE STORM

44 16'N 112 04'W

AREA (SQ. MI.)	DURATION (HR)				
	1	6	12	18	24
4	0.97	2.71	3.05	3.93	4.27
10	0.96	2.70	3.04	3.91	4.25
50	0.94	2.63	2.96	3.81	4.14
100	0.92	2.58	2.92	3.75	4.07
200	0.89	2.50	2.83	3.64	3.95
500	0.84	2.37	2.68	3.45	3.75
1000	0.76	2.17	2.47	3.18	3.48
2000	0.60	1.77	2.15	2.84	3.15
5000	0.36	1.23	1.77	2.23	2.68
10000	0.26	0.97	1.51	1.92	2.36
20000	0.17	0.75	1.24	1.67	2.06
41385	0.12	0.57	0.99	1.34	1.68

STORM 126 - OCT 26-29, 1950

ENTIRE STORM

41 52'N 123 58'W

AREA (SQ. MI.)	DURATION (HR)												
	1	6	12	18	24	30	36	42	48	54	60	66	72
0	1.84	6.44	11.47	13.47	15.84	16.50	17.96	18.96	19.37	19.98	20.69	20.93	21.17
10	1.84	6.44	11.47	13.47	15.84	16.50	17.96	18.96	19.37	19.98	20.69	20.93	21.17
50	1.77	6.20	11.05	13.00	15.31	15.98	17.42	18.46	18.89	19.47	20.19	20.46	20.72
100	1.58	5.63	10.12	11.98	14.21	14.95	16.47	17.68	18.30	18.88	19.56	19.97	20.35
200	1.31	4.80	8.76	10.51	12.62	13.49	15.14	16.61	17.51	18.19	18.71	19.33	19.89
500	1.01	3.91	7.05	9.03	11.02	11.78	13.69	15.65	16.88	17.71	17.90	18.73	19.18
1000	0.86	3.13	5.57	7.52	9.29	9.99	12.19	14.55	15.97	17.02	17.17	17.90	18.29
2000	0.72	2.68	4.85	6.32	7.77	9.00	11.34	13.24	14.57	15.73	15.90	16.62	17.03
5000	0.56	2.30	4.14	5.40	6.59	8.02	9.62	10.96	12.17	13.17	13.39	14.17	14.57
10000	0.45	1.89	3.41	4.58	5.68	7.02	8.41	9.51	10.56	11.26	11.47	12.23	12.65
20000	0.34	1.49	2.71	3.83	4.88	6.17	7.44	8.35	9.25	9.74	9.96	10.67	11.15
50000	0.20	1.02	1.93	2.79	3.65	4.42	5.29	5.93	6.54	6.89	7.11	7.67	8.18
80511	0.14	0.75	1.42	2.09	2.75	3.28	3.88	4.36	4.75	5.02	5.34	5.78	6.21

STORM 133 - NOV 2-4, 1955

ENTIRE STORM

47 34'N 123 28'W

AREA (SQ. MI.)	DURATION (HR)								
	1	6	12	18	24	30	36	42	48
1	1.22	4.28	8.02	10.15	12.16	13.36	15.12	16.10	17.27
10	1.19	4.28	8.02	10.15	12.16	13.36	15.12	16.10	17.27
50	1.06	4.26	8.02	10.15	12.16	13.36	15.12	16.10	17.27
100	0.94	4.26	8.02	10.15	12.16	13.36	15.12	16.10	17.27
200	0.89	4.22	7.91	10.05	12.06	13.26	15.00	15.98	17.15
500	0.83	4.01	7.35	9.45	11.41	12.62	14.27	15.21	16.30
1000	0.74	3.67	6.67	8.56	10.42	11.68	13.15	14.08	15.04
2000	0.63	3.27	5.86	7.55	9.31	10.65	11.90	12.75	13.58
5000	0.47	2.51	4.55	5.93	7.35	8.43	9.48	10.09	10.74
10000	0.34	1.86	3.51	4.69	5.70	6.46	7.39	7.89	8.48
20000	0.26	1.45	2.72	3.68	4.48	5.08	5.78	6.21	6.69
41818	0.17	0.94	1.79	2.45	2.89	3.31	3.64	4.03	4.34

STORM 133 - NOV 2-4, 1955
 OLYMPIC PENINSULA CENTER
 47 59'N 121 20'W

AREA (SQ. MI.)	DURATION (HR)								
	1	6	12	18	24	30	36	42	48
1	0.90	4.26	8.02	10.15	12.16	13.36	15.12	16.10	17.27
10	0.90	4.26	8.02	10.15	12.16	13.36	15.12	16.10	17.27
50	0.90	4.26	8.02	10.15	12.16	13.36	15.12	16.10	17.27
100	0.90	4.26	8.02	10.15	12.16	13.36	15.12	16.10	17.27
200	0.89	4.22	7.91	10.05	12.06	13.26	15.00	15.98	17.15
500	0.83	4.01	7.35	9.45	11.41	12.62	14.27	15.21	16.30
1000	0.74	3.67	6.67	8.56	10.42	11.68	13.15	14.08	15.04
2000	0.63	3.27	5.86	7.55	9.31	10.65	11.90	12.75	13.58
5000	0.47	2.51	4.55	5.93	7.35	8.43	9.48	10.09	10.74
7883	0.37	1.98	3.75	5.00	6.06	6.87	7.84	8.37	8.98

STORM 133 - NOV 2-4, 1955
 NORTH CASCADES CENTER
 47 59'N 121 20'W

AREA (SQ. MI.)	DURATION (HR)								
	1	6	12	18	24	30	36	42	48
6	1.12	4.28	6.30	7.88	9.01	10.31	11.50	12.85	13.23
10	1.12	4.28	6.30	7.88	9.01	10.31	11.50	12.85	13.23
50	1.03	4.15	6.11	7.66	8.75	10.04	11.29	12.59	12.95
100	0.94	4.01	5.91	7.42	8.48	9.74	11.01	12.26	12.63
200	0.89	3.85	5.68	7.13	8.16	9.34	10.50	11.75	12.17
500	0.77	3.44	5.19	6.52	7.61	8.55	9.69	10.82	11.34
1000	0.65	2.97	4.57	5.82	6.94	7.79	8.88	9.86	10.41
2000	0.48	2.30	3.70	4.91	6.01	6.96	7.93	8.78	9.20
3997	0.35	1.79	2.97	4.09	5.02	5.83	6.64	7.30	7.62

STORM 143 - OCT 1-2, 1957
 REVISED ENTIRE STORM
 45 49'N 119 17'W

AREA (SQ. MI.)	DURATION (HR)				
	1	6	12	18	24
3	0.58	2.00	3.06	3.24	3.43
10	0.57	1.98	3.03	3.21	3.40
50	0.55	1.90	2.92	3.09	3.27
100	0.54	1.87	2.87	3.03	3.22
200	0.53	1.84	2.82	2.98	3.16
500	0.47	1.65	2.57	2.73	2.88
1000	0.37	1.44	2.30	2.46	2.62
2000	0.28	1.22	2.02	2.20	2.35
5000	0.19	0.94	1.61	1.81	1.96
10000	0.14	0.71	1.29	1.50	1.65
20000	0.09	0.51	0.94	1.13	1.28
22002	0.09	0.48	0.89	1.07	1.23

STORM 147 - DEC 14-16, 1959

ENTIRE STORM

47 33'N 121 20'W

AREA (SQ. MI.)	DURATION (HR)								
	1	6	12	18	24	30	36	42	48
1	0.70	3.41	5.33	6.57	8.48	10.00	10.77	11.04	11.18
10	0.70	3.41	5.33	6.57	8.48	10.00	10.77	11.04	11.18
50	0.69	3.41	5.33	6.57	8.44	9.95	10.72	10.99	11.12
100	0.69	3.41	5.33	6.57	8.22	9.69	10.44	10.71	10.83
200	0.69	3.41	5.33	6.57	7.94	9.36	10.07	10.35	10.46
500	0.66	3.27	5.16	6.37	7.53	8.86	9.54	9.83	9.93
1000	0.62	3.04	4.86	6.04	7.02	8.26	8.89	9.18	9.28
2000	0.52	2.49	4.31	5.43	6.40	7.49	8.04	8.33	8.41
5000	0.36	1.82	3.29	4.26	5.24	6.06	6.58	6.81	6.87
10000	0.26	1.38	2.52	3.33	4.12	4.77	5.19	5.37	5.41
20000	0.21	1.13	2.09	2.78	3.45	4.07	4.48	4.64	4.67
29329	0.18	1.00	1.85	2.48	3.07	3.69	4.08	4.24	4.26

STORM 149 - NOV 21-24, 1961

ENTIRE STORM

42 10'N 123 56'W

AREA (SQ. MI.)	DURATION (HR)												
	1	6	12	18	24	30	36	42	48	54	60	66	72
1	1.11	3.91	6.80	9.35	11.18	12.22	13.10	13.96	15.12	15.72	16.68	16.93	17.00
10	0.94	3.55	6.27	8.89	10.90	12.01	13.00	13.67	14.72	15.46	16.43	16.74	16.85
50	0.78	3.34	5.89	8.38	10.56	11.66	12.77	13.34	14.18	15.06	16.01	16.38	16.51
100	0.74	3.22	5.67	8.12	10.18	11.24	12.34	12.93	13.75	14.66	15.56	15.96	16.09
200	0.70	3.06	5.42	7.68	9.47	10.48	11.64	12.36	13.12	14.18	14.97	15.41	15.53
500	0.63	2.86	5.10	7.05	8.86	10.00	11.35	12.16	12.83	13.89	14.64	15.01	15.13
1000	0.58	2.70	4.86	6.58	8.38	9.59	11.06	11.93	12.55	13.63	14.34	14.67	14.79
2000	0.49	2.47	4.53	6.10	7.57	8.71	10.02	10.87	11.71	12.78	13.43	13.71	13.80
5000	0.34	1.94	3.62	4.95	6.42	7.61	8.57	9.40	10.30	11.22	11.81	12.09	12.17
10000	0.28	1.61	2.98	4.21	5.64	6.76	7.62	8.46	9.17	9.96	10.57	10.86	10.97
20000	0.23	1.30	2.40	3.38	4.65	5.66	6.42	7.19	7.74	8.32	8.90	9.20	9.32
20850	0.23	1.28	2.36	3.32	4.57	5.58	6.33	7.09	7.63	8.19	8.77	9.07	9.20

STORM 149 - NOV 21-24, 1961

OREGON CASCADES CENTER

43 28'N 122 56'W

AREA (SQ. MI.)	DURATION (HR)												
	1	6	12	18	24	30	36	42	48	54	60	66	72
1	1.02	3.91	6.35	7.24	8.88	9.70	10.92	11.53	12.26	12.84	13.62	13.98	14.08
10	0.89	3.54	5.78	6.66	8.23	9.35	10.39	11.53	12.26	12.84	13.62	13.98	14.08
50	0.64	2.67	4.67	6.34	8.00	9.23	10.28	11.39	12.13	12.72	13.48	13.83	13.94
100	0.62	2.56	4.52	6.17	7.83	9.06	10.12	11.21	11.95	12.56	13.29	13.64	13.76
200	0.57	2.32	4.20	5.77	7.39	8.62	9.69	10.70	11.44	12.09	12.76	13.09	13.22
500	0.49	2.06	3.80	5.16	6.67	7.86	8.88	9.84	10.58	11.21	11.83	12.15	12.28
1000	0.42	1.93	3.58	4.75	6.19	7.35	8.35	9.33	10.08	10.68	11.34	11.67	11.79
2000	0.35	1.79	3.35	4.34	5.71	6.83	7.82	8.83	9.59	10.16	10.85	11.18	11.30
3473	0.30	1.67	3.17	4.07	5.38	6.48	7.40	8.35	9.07	9.59	10.24	10.55	10.67

STORM 149 - NOV 21- 24, 1961
 SOUTH COASTAL OREGON CENTER
 42 10'N 123 56'W

AREA (SQ. MI.)	DURATION (HR)												
	1	6	12	18	24	30	36	42	48	54	60	66	72
2	1.11	3.70	6.80	9.35	11.18	12.22	13.10	13.96	15.12	15.72	16.68	16.93	17.00
10	0.94	3.55	6.29	8.89	10.90	12.01	13.00	13.67	14.72	15.46	16.43	16.74	16.85
50	0.78	3.34	5.89	8.38	10.56	11.66	12.77	13.34	14.18	15.06	16.01	16.38	16.51
100	0.74	3.22	5.67	8.12	10.18	11.24	12.34	12.93	13.75	14.66	15.56	15.96	16.09
200	0.70	3.06	5.42	7.68	9.47	10.48	11.64	12.36	13.12	14.18	14.97	15.41	15.53
500	0.63	2.86	5.10	7.05	8.86	10.00	11.35	12.16	12.83	13.89	14.64	15.01	15.13
1000	0.58	2.70	4.86	6.58	8.38	9.59	11.06	11.93	12.55	13.63	14.34	14.67	14.79
2000	0.49	2.47	4.53	6.10	7.57	8.71	10.02	10.87	11.71	12.78	13.43	13.71	13.80
5000	0.34	1.94	3.62	4.95	6.42	7.61	8.57	9.40	10.30	11.22	11.81	12.09	12.17
5936	0.32	1.84	3.44	4.71	6.13	7.30	8.21	9.02	9.87	10.76	11.35	11.65	11.73

STORM 151 - NOV 18-20, 1962
 ENTIRE STORM
 47 28'N 123 43'W

AREA (SQ. MI.)	DURATION (HR)								
	1	6	12	18	24	30	36	42	48
2	1.05	4.74	7.91	10.45	12.45	12.96	12.98	13.11	13.22
10	1.05	4.74	7.91	10.45	12.45	12.96	12.98	13.11	13.22
50	1.03	4.66	7.78	10.27	12.25	12.75	12.77	12.89	13.00
100	1.00	4.55	7.60	10.02	11.95	12.44	12.46	12.57	12.68
200	0.97	4.38	7.32	9.62	11.48	11.95	11.97	12.08	12.19
500	0.88	4.01	6.72	8.79	10.57	11.03	11.05	11.17	11.28
1000	0.73	3.50	5.89	7.68	9.37	9.87	9.90	10.05	10.18
2000	0.58	2.88	4.97	6.57	7.95	8.50	8.59	8.80	8.94
5000	0.46	2.15	3.87	5.15	6.15	6.94	7.30	7.62	7.78
10000	0.36	1.86	3.45	4.66	5.53	6.20	6.55	6.92	7.10
20000	0.29	1.56	3.04	4.16	5.09	5.60	5.90	6.20	6.41
36321	0.22	1.14	2.25	3.10	3.80	4.19	4.51	4.78	4.94

STORM 151 - NOV 18-20, 1962
 NORTH WASHINGTON CASCADES CENTER
 48 41'N 121 33'W

AREA (SQ. MI.)	DURATION (HR)								
	1	6	12	18	24	30	36	42	48
2	0.86	4.67	7.76	9.33	10.56	11.14	11.14	11.14	11.21
10	0.86	4.67	7.76	9.33	10.56	11.14	11.14	11.14	11.21
50	0.82	4.38	7.42	8.96	10.13	10.67	10.67	10.67	10.79
100	0.79	4.22	7.19	8.69	9.82	10.34	10.34	10.34	10.48
200	0.77	4.08	6.95	8.38	9.47	9.97	9.97	9.97	10.11
500	0.72	3.83	6.52	7.84	8.87	9.33	9.33	9.33	9.48
1000	0.63	3.36	5.77	7.06	7.98	8.42	8.45	8.48	8.66
2000	0.54	2.82	4.92	6.29	7.08	7.55	7.64	7.76	8.00
4960	0.41	2.16	3.88	5.16	5.81	6.22	6.36	6.58	6.83

STORM 151 - NOV 18-20, 1962
 COASTAL CENTER
 47 28'N 123 43'W

AREA (SQ. MI.)	DURATION (HR)								
	1	6	12	18	24	30	36	42	48
2	1.05	4.74	7.91	10.45	12.45	12.96	12.98	13.11	13.22
10	1.05	4.74	7.91	10.45	12.45	12.96	12.98	13.11	13.22
50	1.03	4.66	7.78	10.27	12.25	12.75	12.77	12.89	13.00
100	1.00	4.55	7.60	10.02	11.95	12.44	12.46	12.57	12.68
200	0.97	4.38	7.32	9.62	11.48	11.95	11.97	12.08	12.19
500	0.88	4.01	6.72	8.79	10.57	11.03	11.05	11.17	11.28
1000	0.73	3.50	5.89	7.68	9.37	9.87	9.90	10.05	10.18
2000	0.58	2.86	4.94	6.57	7.95	8.50	8.59	8.80	8.94
4665	0.38	1.94	3.64	5.10	6.21	7.02	7.37	7.69	7.85

STORM 151 - NOV 18-20, 1962
 SOUTH WASHINGTON CASCADES CENTER
 46 43'N 121 43'W

AREA (SQ. MI.)	DURATION (HR)								
	1	6	12	18	24	30	36	42	48
4	0.90	3.37	5.31	6.63	7.64	8.42	8.74	9.08	9.26
10	0.90	3.37	5.31	6.63	7.64	8.42	8.74	9.08	9.26
50	0.89	3.21	5.28	6.61	7.55	8.37	8.72	9.08	9.26
100	0.84	3.07	5.12	6.50	7.52	8.33	8.67	9.04	9.22
200	0.81	2.96	4.96	6.32	7.29	8.07	8.41	8.78	8.95
500	0.72	2.75	4.75	6.10	6.98	7.69	8.02	8.38	8.54
1000	0.64	2.54	4.59	5.95	6.73	7.36	7.68	8.02	8.16
2000	0.58	2.32	4.36	5.70	6.37	6.93	7.26	7.56	7.68
2710	0.57	2.21	4.15	5.45	6.07	6.61	6.94	7.23	7.35

STORM 155 - JUNE 6-8, 1964
 ENTIRE STORM
 48 34'N 113 23'W

AREA (SQ. MI.)	DURATION (HR)								
	1	6	12	18	24	30	36	42	48
1	1.11	5.93	9.78	12.80	14.35	14.81	15.31	15.31	15.31
10	1.11	5.93	9.78	12.80	14.35	14.81	15.31	15.31	15.31
50	1.09	5.80	9.56	12.52	14.04	14.49	14.98	14.98	14.98
100	1.06	5.64	9.29	12.17	13.65	14.09	14.56	14.56	14.56
200	0.99	5.26	8.77	11.50	12.96	13.40	13.87	13.89	13.89
500	0.88	4.56	7.93	10.44	11.93	12.39	12.86	12.92	12.92
1000	0.79	3.94	7.23	9.57	11.07	11.57	12.00	12.11	12.13
2000	0.70	3.38	6.59	8.70	10.09	10.61	11.02	11.17	11.27
5000	0.55	2.73	5.31	7.01	8.13	8.58	8.89	9.03	9.14
10000	0.41	2.14	4.15	5.47	6.37	6.76	6.97	7.09	7.18
20000	0.31	1.57	3.02	4.05	4.74	5.14	5.32	5.42	5.48
50000	0.20	1.03	1.88	2.61	3.06	3.38	3.52	3.60	3.67
87054	0.13	0.69	1.30	1.82	2.17	2.45	2.60	2.66	2.71

STORM 155 - JUNE 6-8, 1964
STORM PORTION WEST OF CONTINENTAL DIVIDE
LAT/LON NOT AVAILABLE

AREA (SQ. MI.)	DURATION (HR)								
	1	6	12	18	24	30	36	42	48
3	1.02	5.42	8.92	11.69	13.10	13.52	13.98	13.98	13.98
10	0.95	5.02	8.47	11.11	12.44	12.87	13.29	13.31	13.31
50	0.83	4.44	7.79	10.25	11.45	11.88	12.27	12.32	12.32
100	0.78	4.21	7.51	9.90	11.03	11.48	11.85	11.91	11.91
200	0.73	3.94	7.16	9.41	10.48	10.93	11.29	11.36	11.36
500	0.64	3.44	6.30	8.20	9.12	9.54	9.87	9.99	10.02
1000	0.54	2.89	5.35	6.90	7.68	8.06	8.35	8.53	8.58
2000	0.44	2.36	4.32	5.49	6.13	6.42	6.68	6.87	6.94
5000	0.35	1.84	3.13	3.88	4.35	4.55	4.73	4.90	4.98
10000	0.29	1.50	2.47	3.07	3.44	3.60	3.74	3.90	3.97
20000	0.23	1.15	1.85	2.31	2.57	2.70	2.81	2.94	3.02
34002	0.17	0.86	1.44	1.77	1.97	2.08	2.16	2.28	2.35

STORM 156 - DEC 21-24, 1964

ENTIRE STORM
39 55'N 123 35'W

AREA (SQ. MI.)	DURATION (HR)												
	1	6	12	18	24	30	36	42	48	54	60	66	72
0	2.05	6.11	9.74	14.26	17.32	19.39	21.65	25.42	27.14	28.04	28.41	28.85	30.32
10	2.05	5.70	8.76	13.08	16.23	18.53	20.74	24.21	26.13	27.13	27.42	27.89	30.29
50	1.93	5.39	8.59	11.83	14.99	17.53	20.10	22.94	25.05	26.05	26.24	27.06	29.22
100	1.72	5.14	8.22	11.33	14.46	17.11	19.66	22.45	24.63	25.60	25.75	26.60	28.60
200	1.59	4.90	7.76	10.86	13.94	16.64	19.06	21.76	23.94	24.87	25.01	25.82	27.64
500	1.27	4.28	7.07	9.98	12.85	15.49	17.63	20.16	22.21	23.04	23.21	23.96	25.65
1000	0.97	3.63	6.38	9.06	11.65	13.91	15.83	18.10	19.94	20.65	20.81	21.56	22.96
2000	0.71	3.21	5.97	8.48	10.77	12.69	14.50	16.61	18.36	19.04	19.61	20.27	21.73
5000	0.57	2.72	5.29	7.55	9.47	11.03	12.58	14.37	15.84	16.40	16.62	17.09	18.39
10000	0.46	2.51	4.82	7.01	8.85	10.21	11.66	13.43	14.63	15.24	15.47	15.93	17.12
20000	0.36	1.96	3.82	5.69	7.28	8.40	9.86	11.37	12.33	12.80	12.98	13.34	14.33
50000	0.28	1.54	3.02	4.44	5.72	6.69	7.78	9.05	9.97	10.59	10.80	11.21	12.19
99988	0.20	1.11	2.19	3.26	4.22	4.98	5.77	6.72	7.46	7.96	8.11	8.43	9.19

STORM 156 - DEC 21-24, 1964
NORTHWESTERN CALIFORNIA CENTER
39 55'N 123 35'W

AREA (SQ. MI.)	DURATION (HR)												
	1	6	12	18	24	30	36	42	48	54	60	66	72
0	2.05	6.11	9.74	14.26	17.32	19.39	21.65	25.42	27.14	28.04	28.41	28.85	30.32
10	2.05	5.70	8.64	13.08	16.23	18.53	20.74	24.21	26.13	27.13	27.42	27.89	30.29
50	1.93	5.21	8.15	11.83	14.99	17.53	20.10	22.94	25.05	26.05	26.24	27.06	29.22
100	1.72	5.11	8.05	11.33	14.46	17.11	19.66	22.45	24.63	25.60	25.75	26.60	28.60
200	1.59	4.90	7.76	10.86	13.94	16.64	19.06	21.76	23.94	24.87	25.01	25.82	27.64
500	1.27	4.28	7.07	9.98	12.85	15.49	17.63	20.16	22.21	23.04	23.21	23.96	25.65
1000	0.97	3.63	6.38	9.06	11.65	13.91	15.83	18.10	19.94	20.65	20.81	21.46	22.96
2000	0.71	3.04	5.97	8.48	10.77	12.69	14.50	16.61	18.36	18.94	19.11	19.65	21.03
5000	0.57	2.72	5.29	7.55	9.47	11.03	12.58	14.37	15.84	16.40	16.55	16.98	18.18
10000	0.46	2.51	4.82	7.01	8.85	10.21	11.66	13.43	14.63	15.24	15.47	15.93	17.12
20000	0.36	1.96	3.82	5.69	7.28	8.40	9.86	11.37	12.33	12.80	12.98	13.34	14.33
20120	0.36	1.95	3.81	5.68	7.27	8.38	9.83	11.34	12.30	12.77	12.95	13.31	14.30

STORM 156 - DEC 21-24, 1964
 NORTH COASTAL OREGON CENTER
 44 55'N 123 36'W

AREA (SQ. MI.)	DURATION (HR)												
	1	6	12	18	24	30	36	42	48	54	60	66	72
2	0.85	3.23	5.60	7.52	8.84	10.63	12.59	13.12	15.39	16.19	16.19	17.15	18.31
10	0.85	3.23	5.60	7.52	8.84	10.63	12.59	13.12	15.39	16.19	16.19	17.15	18.31
50	0.81	2.79	5.16	7.15	8.36	10.17	12.01	12.58	14.85	15.64	15.65	16.60	17.84
100	0.76	2.67	4.89	6.76	7.90	9.69	11.41	12.04	14.24	15.01	15.03	15.95	17.19
200	0.66	2.57	4.48	6.15	7.38	9.11	10.46	11.24	13.27	13.98	14.00	14.86	16.03
500	0.55	2.27	3.95	5.59	6.86	8.47	9.16	10.09	11.58	11.85	11.86	12.57	14.13
1000	0.51	2.11	3.53	4.94	6.00	7.40	8.25	9.10	10.54	11.07	11.09	11.76	12.83
2000	0.47	1.97	3.31	4.61	5.56	6.81	7.84	8.72	9.98	10.45	10.46	11.08	12.23
2757	0.45	1.91	3.21	4.46	5.36	6.54	7.65	8.54	9.73	10.16	10.17	10.77	11.95

STORM 156 - DEC 21-24, 1964
 OREGON CASCADES CENTER
 44 40'N 121 49'W

AREA (SQ. MI.)	DURATION (HR)												
	1	6	12	18	24	30	36	42	48	54	60	66	72
1	1.29	3.62	6.04	7.84	9.40	10.75	12.43	14.17	15.03	16.73	17.47	18.64	20.33
10	1.26	3.61	6.02	7.81	9.38	10.72	12.40	14.13	14.99	16.69	17.42	18.58	20.28
50	1.19	3.42	5.70	7.40	8.88	10.16	11.75	13.39	14.21	15.81	16.51	17.62	19.22
100	1.14	3.17	5.33	6.92	8.27	9.58	11.06	12.55	13.41	14.91	15.58	16.69	18.21
200	1.00	2.82	4.80	6.23	7.77	8.94	10.07	11.36	12.26	13.61	14.23	15.32	16.72
500	0.75	2.44	4.31	5.69	7.19	8.18	9.33	10.53	11.52	12.76	13.31	14.54	15.90
1000	0.63	2.16	3.97	5.30	6.76	7.69	8.81	9.95	11.02	12.20	12.69	14.07	15.40
2000	0.50	1.97	3.54	4.97	6.33	7.29	8.18	9.36	10.34	11.49	11.85	13.12	14.50
5000	0.34	1.75	3.25	4.53	5.76	6.76	7.76	8.91	9.88	10.90	11.23	12.04	13.35
9580	0.29	1.55	2.90	4.05	5.18	6.01	6.95	8.10	8.94	9.84	10.12	10.75	11.90

STORM 156 - DEC 21-24, 1964
 SIERRA NEVADA CENTER
 39 38'N 120 59'W

AREA (SQ. MI.)	DURATION (HR)												
	1	6	12	18	24	30	36	42	48	54	60	66	72
1	1.05	5.50	8.76	11.43	13.50	15.72	17.91	20.41	22.38	23.25	23.90	24.92	26.17
10	1.05	5.50	8.76	11.43	13.50	15.72	17.91	20.41	22.38	23.25	23.90	24.77	26.17
50	1.03	5.39	8.59	11.21	13.24	15.42	17.57	20.03	21.96	22.82	23.46	24.14	25.69
100	0.98	5.14	8.22	10.71	12.84	14.89	17.09	19.57	21.47	22.32	22.94	23.69	25.15
200	0.89	4.67	7.49	9.78	12.56	14.52	16.21	18.76	20.62	21.49	22.05	23.20	24.65
500	0.79	4.00	6.54	9.57	12.16	14.07	15.53	17.76	19.64	20.61	21.25	22.55	23.99
1000	0.69	3.56	6.21	9.05	11.50	13.31	14.85	16.99	18.84	19.83	20.21	21.56	22.91
2000	0.59	3.21	5.76	8.27	10.36	12.04	14.07	16.14	17.90	19.04	19.61	20.27	21.73
5000	0.44	2.51	4.68	6.68	8.29	9.69	11.62	13.48	15.02	16.10	16.62	17.09	18.39
9903	0.35	1.86	3.63	5.17	6.48	7.48	8.63	10.13	11.28	12.16	12.56	13.03	14.07

STORM 156 - DEC 21-24, 1964
 ELK VALLEY REGION, NORTHWESTERN CALIFORNIA REGION
 41 52'N 123 40'W

AREA (SQ. MI.)	DURATION (HR)												
	1	6	12	18	24	30	36	42	48	54	60	66	72
2	2.05	5.35	7.62	10.02	14.05	15.83	17.10	20.33	21.11	22.56	23.23	25.04	26.28
10	2.05	5.35	7.62	10.02	14.05	15.83	17.10	20.33	21.11	22.56	23.23	25.04	26.28
50	1.93	5.21	7.39	9.81	13.83	15.44	16.64	19.93	20.78	22.03	22.64	24.37	25.60
100	1.72	5.11	7.23	9.65	13.67	15.24	16.31	19.64	20.55	21.75	22.26	23.87	25.16
200	1.59	4.90	6.96	9.33	13.25	14.74	15.74	19.05	19.94	21.09	21.56	23.05	24.36
500	1.27	4.28	6.27	8.50	12.11	13.39	14.48	17.56	18.36	19.37	19.80	20.94	22.37
1000	0.97	3.63	5.64	7.86	11.04	12.14	13.42	16.12	16.90	17.83	18.25	19.11	20.57
1923	0.72	2.98	5.02	7.25	9.83	10.81	12.26	14.51	15.30	16.15	16.57	17.27	18.69

STORM 156 - DEC 21-24, 1964
 LAYTONVILLE REGION, NORTHWESTERN CALIFORNIA REGION
 39 41'N 123 35'W

AREA (SQ. MI.)	DURATION (HR)												
	1	6	12	18	24	30	36	42	48	54	60	66	72
1	1.44	6.11	9.74	14.26	17.32	19.39	21.65	25.42	27.14	28.04	28.41	28.85	30.32
10	1.35	5.70	8.64	13.08	16.23	18.53	20.74	24.21	26.13	27.13	27.42	27.90	30.29
50	1.22	5.17	8.15	11.83	14.99	17.53	20.10	22.94	25.05	26.05	26.24	27.06	29.22
100	1.13	4.78	8.05	11.33	14.46	17.11	19.66	22.45	24.63	25.60	25.75	26.60	28.60
200	1.00	4.37	7.76	10.86	13.94	16.64	19.06	21.76	23.94	24.87	25.01	25.82	27.64
500	0.90	3.88	7.07	9.98	12.85	15.49	17.63	20.16	22.21	23.04	23.21	23.96	25.65
1000	0.72	3.43	6.38	9.06	11.65	13.91	15.83	18.10	19.94	20.65	20.81	21.46	22.96
2000	0.62	3.04	5.97	8.48	10.77	12.69	14.50	16.61	18.36	18.94	19.11	19.65	21.03
5000	0.54	2.70	5.29	7.55	9.47	11.03	12.58	14.37	15.84	16.40	16.55	16.98	18.18
5140	0.54	2.69	5.27	7.52	9.43	10.98	12.52	14.30	15.76	16.32	16.47	16.90	18.09

STORM 157 - DEC 20-24, 1964

ENTIRE STORM

44 14'N 115 29'W

AREA (SQ. MI.)	DURATION (HR)												
	1	6	12	18	24	30	36	42	48	54	60	66	72
1	0.93	3.20	3.43	3.68	4.89	5.32	6.37	7.53	7.87	8.13	8.26	8.40	8.87
10	0.93	3.20	3.43	3.68	4.89	5.32	6.37	7.53	7.87	8.13	8.26	8.40	8.87
50	0.90	3.10	3.34	3.65	4.89	5.32	6.37	7.53	7.87	8.13	8.26	8.40	8.87
100	0.86	2.99	3.24	3.56	4.84	5.27	6.29	7.43	7.76	8.01	8.14	8.28	8.74
200	0.83	2.87	3.14	3.49	4.75	5.17	6.16	7.25	7.57	7.81	7.93	8.07	8.52
500	0.75	2.63	2.94	3.38	4.61	5.02	5.91	6.89	7.18	7.40	7.52	7.65	8.05
1000	0.63	2.22	2.62	3.26	4.46	4.85	5.65	6.54	6.81	7.01	7.13	7.27	7.65
2000	0.50	1.80	2.33	3.13	4.27	4.62	5.33	6.14	6.39	6.57	6.70	6.85	7.23
5000	0.38	1.42	2.05	2.86	3.87	4.16	4.69	5.34	5.56	5.70	5.84	5.99	6.35
10000	0.31	1.21	1.84	2.42	3.34	3.62	4.01	4.51	4.80	4.95	5.11	5.21	5.55
20000	0.23	0.95	1.52	1.90	2.67	2.96	3.25	3.63	3.96	4.17	4.36	4.44	4.75
50000	0.14	0.58	0.99	1.29	1.75	2.14	2.37	2.59	2.79	3.05	3.21	3.35	3.54
59661	0.13	0.51	0.89	1.19	1.60	1.99	2.20	2.40	2.58	2.80	2.95	3.10	3.28

AREA (SQ. MI.)	DURATION (HR)			
	78	84	90	96
1	9.60	9.88	10.16	10.20
10	9.60	9.88	10.16	10.20
50	9.60	9.88	10.16	10.20
100	9.46	9.73	10.01	10.04
200	9.21	9.48	9.74	9.78
500	8.67	8.91	9.15	9.18
1000	8.22	8.44	8.66	8.70
2000	7.79	8.00	8.19	8.23
5000	6.83	7.00	7.15	7.19
10000	5.96	6.09	6.19	6.25
20000	5.10	5.21	5.30	5.40
50000	3.80	3.90	3.97	4.05
59661	3.51	3.60	3.68	3.75

STORM 165 - JAN 14-17, 1974

ENTIRE STORM

40 20'N 124 06'W

AREA (SQ. MI.)	DURATION (HR)												
	1	6	12	18	24	30	36	42	48	54	60	66	72
0	1.27	4.30	7.19	9.18	10.71	11.27	12.48	13.90	14.98	17.01	17.75	18.97	19.17
10	1.27	4.21	7.19	9.11	10.63	11.20	12.38	13.80	14.95	16.89	17.62	18.83	19.02
50	1.19	3.89	6.88	8.62	10.08	11.08	12.23	13.56	14.66	16.05	16.75	17.84	18.02
100	1.11	3.74	6.53	8.18	9.63	10.86	12.00	13.23	14.28	15.28	16.37	16.94	17.09
200	0.94	3.46	5.58	7.81	9.35	10.33	11.57	12.65	13.64	14.79	15.72	16.21	16.27
500	0.70	3.06	5.15	7.27	8.90	9.57	10.63	12.00	12.91	14.12	14.92	15.42	15.48
1000	0.57	2.61	4.95	6.98	8.49	9.09	9.72	11.42	12.22	13.63	14.36	14.88	14.95
2000	0.48	2.34	4.48	6.32	7.70	8.25	8.88	10.43	11.18	12.63	13.31	13.74	13.79
5000	0.43	1.96	3.77	5.44	6.68	7.21	7.90	9.17	9.87	11.11	11.84	12.15	12.20
10000	0.38	1.66	3.25	4.72	5.85	6.31	6.95	8.09	8.71	9.91	10.57	10.82	10.87
20000	0.33	1.47	2.52	3.74	4.79	5.47	6.24	7.24	7.65	8.77	9.34	9.57	9.67
50000	0.25	1.22	2.03	2.81	3.70	4.56	5.46	6.22	6.58	7.46	7.96	8.21	8.35
81179	0.22	1.09	1.82	2.56	3.31	4.04	4.82	5.46	5.93	6.69	7.17	7.40	7.57

STORM 165 - JAN 14-17, 1974
 GIBSON HWY MTCE STATION REGION, NORTHWESTERN CALIFORNIA CENTER
 41 08'N 122 16'W

AREA
(SQ. MI.)

	DURATION (HR)												
	1	6	12	18	24	30	36	42	48	54	60	66	72
1	1.13	3.85	5.99	8.88	10.52	11.20	12.33	13.79	14.95	15.67	17.10	17.20	17.20
10	1.13	3.85	5.90	8.65	10.27	11.20	12.33	13.79	14.95	15.67	17.10	17.20	17.20
50	1.00	3.38	5.65	8.25	9.75	11.08	12.23	13.56	14.66	15.38	16.70	16.79	16.79
100	0.92	3.20	5.55	8.14	9.63	10.86	12.00	13.23	14.28	15.01	16.23	16.32	16.32
200	0.79	3.09	5.32	7.81	9.27	10.33	11.57	12.65	13.64	14.49	15.54	15.64	15.64
500	0.65	2.68	4.85	7.09	8.42	9.32	10.63	11.61	12.49	13.43	14.33	14.44	14.44
1000	0.57	2.36	4.41	6.43	7.63	8.52	9.60	10.66	11.47	12.25	13.20	13.40	13.42
2000	0.46	2.08	4.01	5.82	6.96	7.70	8.65	9.74	10.40	11.15	12.07	12.32	12.36
2272	0.44	2.03	3.93	5.70	6.81	7.52	8.49	9.56	10.19	10.94	11.84	12.09	12.13

STORM 165 - JAN 14-17, 1974
 OLYMPIC PENINSULA CENTER
 47 47'N 123 41'W

AREA
(SQ. MI.)

	DURATION (HR)												
	1	6	12	18	24	30	36	42	48	54	60	66	72
6	0.95	4.30	6.10	6.84	8.91	9.52	10.09	11.35	13.34	15.98	16.82	17.12	17.12
10	0.95	4.21	5.99	6.78	8.86	9.49	10.09	11.35	13.24	15.75	16.75	17.02	17.02
50	0.95	3.89	5.59	6.56	8.66	9.39	10.09	11.35	12.86	14.90	16.52	16.67	16.68
100	0.94	3.74	5.40	6.44	8.54	9.31	10.05	11.31	12.67	14.52	16.37	16.48	16.49
200	0.82	3.46	5.10	6.10	8.09	8.89	9.64	10.86	12.22	13.96	15.72	15.95	15.98
500	0.68	3.06	4.56	5.47	7.28	8.06	8.80	9.91	11.17	12.69	14.27	14.57	14.62
1000	0.57	2.61	3.97	4.77	6.39	7.13	7.82	8.81	9.96	11.27	12.68	13.03	13.08
2000	0.48	2.23	3.40	4.09	5.50	6.15	6.78	7.62	8.61	9.71	10.90	11.23	11.28
4596	0.37	1.73	2.63	3.11	4.20	4.74	5.25	5.86	6.62	7.44	8.27	8.55	8.61

STORM 165 - JAN 14-17, 1974
 SOUTH WASHINGTON CASCADES CENTER
 46 11'N 121 31'W

AREA
(SQ. MI.)

	DURATION (HR)												
	1	6	12	18	24	30	36	42	48	54	60	66	72
4	0.80	2.97	5.35	7.33	8.11	8.46	9.68	10.18	10.68	11.46	11.91	12.13	12.13
10	0.78	2.92	5.25	7.20	7.96	8.31	9.50	10.00	10.49	11.25	11.70	11.91	11.91
50	0.73	2.70	4.87	6.67	7.40	7.77	8.93	9.47	9.92	10.71	11.18	11.43	11.43
100	0.67	2.52	4.55	6.23	6.94	7.37	8.51	9.13	9.55	10.40	10.92	11.20	11.21
200	0.62	2.35	4.24	5.80	6.49	6.97	8.09	8.79	9.18	10.09	10.65	10.98	10.98
500	0.56	2.11	3.82	5.23	5.89	6.43	7.54	8.34	8.68	9.67	10.30	10.69	10.69
1000	0.51	2.01	3.64	4.90	5.58	6.10	7.11	7.90	8.33	9.25	9.86	10.22	10.29
2000	0.44	1.88	3.41	4.52	5.21	5.67	6.59	7.27	7.79	8.60	9.16	9.46	9.60
4920	0.32	1.54	2.81	3.71	4.29	4.74	5.45	5.93	6.48	7.11	7.56	7.85	8.00

STORM 165 - JAN 14-17, 1974
NORTHWESTERN CALIFORNIA CENTER
40 20'N 124 06'W

AREA (SQ. MI)	DURATION (HR)												
	1	6	12	18	24	30	36	42	48	54	60	66	72
1	1.27	3.85	7.19	9.18	10.71	11.27	12.48	13.90	14.98	17.01	17.75	18.97	19.17
10	1.27	3.85	7.19	9.11	10.63	11.21	12.38	13.81	14.95	16.89	17.62	18.83	19.02
50	1.19	3.65	6.88	8.62	10.08	11.08	12.23	13.56	14.66	16.05	16.75	17.84	18.02
100	1.11	3.47	6.53	8.18	9.63	10.86	12.00	13.23	14.28	15.28	16.23	16.94	17.09
200	0.94	3.09	5.58	7.81	9.35	10.33	11.57	12.65	13.64	14.79	15.69	16.21	16.27
500	0.70	2.68	5.15	7.27	8.90	9.57	10.63	12.00	12.91	14.12	14.92	15.42	15.48
1000	0.57	2.56	4.95	6.98	8.49	9.09	9.72	11.42	12.22	13.63	14.36	14.88	14.95
2000	0.47	2.34	4.48	6.32	7.70	8.25	8.88	10.43	11.18	12.63	13.31	13.74	13.79
5000	0.37	1.96	3.77	5.44	6.68	7.21	7.90	9.17	9.87	11.11	11.84	12.15	12.20
10000	0.32	1.65	3.25	4.72	5.85	6.31	6.95	8.09	8.71	9.91	10.57	10.82	10.87
18947	0.29	1.31	2.56	3.81	4.86	5.52	6.28	7.29	7.70	8.84	9.41	9.64	9.73

STORM 165 - JAN 14-17, 1974
CENTRAL OREGON CENTER
44 56'N 123 38'W

AREA (SQ. MI)	DURATION (HR)												
	1	6	12	18	24	30	36	42	48	54	60	66	72
5	0.82	3.20	5.57	6.93	8.80	10.21	11.28	12.57	13.59	14.71	15.52	16.17	16.23
10	0.80	3.20	5.57	6.93	8.80	10.21	11.28	12.57	13.59	14.71	15.52	16.17	16.23
50	0.78	2.74	4.86	6.45	7.88	9.26	10.95	12.30	13.02	14.42	15.22	15.86	15.92
100	0.75	2.65	4.54	6.22	7.49	8.78	10.57	11.88	12.57	13.91	14.69	15.30	15.37
200	0.67	2.53	4.20	5.76	7.03	8.24	9.81	11.02	11.75	12.88	13.70	14.48	14.57
500	0.56	2.36	3.87	5.08	6.37	7.48	8.61	10.19	10.93	11.70	12.77	13.54	13.65
1000	0.52	2.26	3.72	4.92	6.04	7.01	8.20	9.65	10.30	11.03	11.99	12.67	12.75
2000	0.48	2.11	3.54	4.65	5.68	6.51	7.70	8.94	9.53	10.25	11.04	11.65	11.73
5000	0.43	1.79	3.12	4.23	5.03	5.78	6.74	7.71	8.18	8.88	9.53	10.02	10.12
7714	0.40	1.72	3.01	4.05	4.82	5.51	6.44	7.32	7.75	8.47	9.06	9.50	9.60

STORM 165 - JAN 14-17, 1974
NORTH CASCADES CENTER
48 19'N 121 05'W

AREA (SQ. MI)	DURATION (HR)												
	1	6	12	18	24	30	36	42	48	54	60	66	72
0	0.86	3.01	4.86	5.87	7.48	9.33	11.40	11.92	12.70	13.76	14.37	14.98	15.32
10	0.71	2.99	4.83	5.75	7.45	8.95	10.24	11.52	12.70	13.76	14.37	14.98	15.32
50	0.61	2.68	4.56	5.59	7.08	8.71	10.09	11.52	12.70	13.76	14.37	14.98	15.32
100	0.59	2.53	4.33	5.43	7.08	8.71	10.09	11.52	12.70	13.76	14.37	14.98	15.32
200	0.55	2.35	4.04	5.23	6.81	8.42	9.87	11.23	12.45	13.52	14.16	14.82	15.14
500	0.47	2.09	3.65	4.97	6.45	7.75	9.33	10.45	11.75	12.77	13.49	14.23	14.50
1000	0.42	1.88	3.32	4.67	6.09	7.24	8.83	9.84	11.08	12.04	12.72	13.44	13.69
2000	0.37	1.63	2.90	4.10	5.32	6.42	7.84	8.66	9.68	10.60	11.17	11.85	12.07
5000	0.26	1.24	2.20	3.20	4.04	5.02	6.10	6.67	7.31	8.04	8.44	8.97	9.17
5875	0.25	1.17	2.09	3.04	3.79	4.71	5.74	6.27	6.87	7.54	7.92	8.41	8.61

STORM 165 - JAN 14-17, 1974
 UPPER MATTOLE REGION, NORTHWESTERN CALIFORNIA CENTER
 40 20'N 124 06'W

AREA (SQ. MI.)	DURATION (HR)												
	1	6	12	18	24	30	36	42	48	54	60	66	72
6	0.89	3.38	6.44	9.18	10.71	11.27	12.48	13.90	14.98	17.01	17.75	18.97	19.17
10	0.88	3.35	6.39	9.11	10.63	11.18	12.38	13.80	14.87	16.89	17.62	18.83	19.02
50	0.79	3.16	6.06	8.62	10.08	10.61	11.69	13.09	14.12	16.05	16.75	17.84	18.02
100	0.71	2.98	5.75	8.18	9.56	10.30	11.04	12.85	13.92	15.28	16.02	16.94	17.09
200	0.63	2.79	5.41	7.67	9.35	10.07	10.60	12.61	13.64	14.79	15.69	16.21	16.27
500	0.56	2.66	5.15	7.27	8.90	9.57	10.13	12.00	12.91	14.12	14.92	15.42	15.48
1000	0.52	2.56	4.95	6.98	8.49	9.09	9.72	11.42	12.22	13.63	14.36	14.88	14.95
2000	0.47	2.34	4.48	6.32	7.70	8.25	8.88	10.43	11.18	12.63	13.31	13.74	13.79
2895	0.44	2.14	4.12	5.83	7.12	7.62	8.25	9.67	10.37	11.81	12.45	12.82	12.87

STORM 168 - JAN 13-16, 1974
 ENTIRE STORM
 47 29'N 115 44'W

AREA (SQ. MI.)	DURATION (HR)												
	1	6	12	18	24	30	36	42	48	54	60	66	72
3	0.44	1.53	2.84	3.43	4.42	4.91	5.42	5.84	6.43	6.92	7.45	7.95	8.24
10	0.43	1.52	2.82	3.43	4.42	4.91	5.42	5.84	6.43	6.92	7.45	7.95	8.24
50	0.41	1.43	2.65	3.43	4.42	4.91	5.42	5.84	6.43	6.92	7.45	7.95	8.24
100	0.40	1.39	2.57	3.43	4.42	4.91	5.42	5.84	6.43	6.92	7.45	7.95	8.24
200	0.38	1.33	2.47	3.36	4.31	4.79	5.27	5.71	6.28	6.75	7.27	7.76	8.03
500	0.35	1.24	2.30	3.13	3.98	4.39	4.81	5.31	5.83	6.25	6.69	7.14	7.39
1000	0.32	1.13	2.12	2.79	3.51	3.87	4.22	4.77	5.25	5.61	5.97	6.38	6.63
2000	0.28	1.02	1.91	2.52	3.11	3.41	3.78	4.31	4.74	5.05	5.39	5.78	6.01
5000	0.22	0.86	1.65	2.26	2.70	2.91	3.37	3.84	4.20	4.44	4.80	5.20	5.38
10000	0.18	0.74	1.44	2.05	2.38	2.54	3.05	3.47	3.77	3.95	4.33	4.71	4.85
20000	0.15	0.62	1.21	1.74	2.01	2.15	2.62	2.95	3.21	3.35	3.66	3.96	4.08
42267	0.11	0.46	0.90	1.28	1.49	1.61	1.91	2.16	2.33	2.45	2.69	2.88	2.97

STORM 175 - DEC 24-26, 1980
 ENTIRE STORM
 44 55'N 123 44'W

AREA (SQ. MI.)	DURATION (HR)								
	1	6	12	18	24	30	36	42	48
1	0.97	2.93	4.99	7.07	9.22	10.84	11.27	11.27	11.27
10	0.97	2.93	4.99	7.07	9.22	10.84	11.27	11.27	11.27
50	0.95	2.88	4.89	6.94	9.05	10.66	11.12	11.12	11.12
100	0.87	2.76	4.59	6.56	8.53	10.11	10.62	10.63	10.63
200	0.80	2.62	4.11	5.90	7.63	9.09	9.65	9.67	9.67
500	0.70	2.24	3.22	4.66	5.96	7.17	7.80	7.82	7.82
1000	0.58	2.06	2.77	3.99	5.08	6.18	6.84	6.87	6.87
2000	0.47	1.76	2.46	3.57	4.56	5.64	6.29	6.32	6.32
5000	0.36	1.36	2.00	2.95	3.78	4.78	5.38	5.41	5.41
10000	0.29	1.11	1.67	2.52	3.16	4.04	4.55	4.60	4.60
20000	0.23	0.90	1.43	2.19	2.68	3.48	3.95	4.03	4.03
24865	0.21	0.83	1.35	2.08	2.53	3.30	3.77	3.85	3.86

STORM 175 - DEC 24-26, 1980
 COASTAL OREGON CENTER
 44 55'N 123 44'W

AREA (SQ.MI.)	DURATION (HR)								
	1	6	12	18	24	30	36	42	48
15	0.97	2.93	4.99	7.07	9.22	10.84	11.27	11.27	11.27
50	0.95	2.88	4.89	6.94	9.05	10.66	11.12	11.12	11.12
100	0.87	2.76	4.59	6.56	8.53	10.11	10.62	10.63	10.63
200	0.80	2.62	4.11	5.90	7.63	9.09	9.65	9.67	9.67
500	0.70	2.27	3.22	4.66	5.96	7.17	7.80	7.82	7.82
1000	0.58	2.06	2.77	3.99	5.08	6.18	6.84	6.87	6.87
2000	0.47	1.76	2.46	3.57	4.56	5.64	6.29	6.32	6.32
5000	0.36	1.36	2.00	2.95	3.78	4.78	5.38	5.41	5.41
6325	0.34	1.26	1.84	2.74	3.47	4.41	4.95	4.98	4.98

STORM 175 - DEC 24-26, 1980
 CASCADES CENTER
 45 50'N 122 05'W

AREA (SQ.MI.)	DURATION (HR)								
	1	6	12	18	24	30	36	42	48
11	0.47	2.00	3.26	4.28	5.38	6.52	7.98	8.05	8.05
50	0.47	2.00	3.06	4.19	5.15	6.38	7.71	7.78	7.78
100	0.46	1.97	2.97	4.16	5.05	6.31	7.59	7.66	7.66
200	0.46	1.85	2.89	4.12	4.95	6.25	7.46	7.54	7.54
500	0.42	1.69	2.70	3.80	4.58	5.76	6.90	6.96	6.96
1000	0.39	1.56	2.44	3.50	4.20	5.43	6.32	6.39	6.39
2000	0.33	1.37	2.15	3.11	3.74	4.92	5.57	5.63	5.63
5000	0.27	1.17	1.75	2.60	3.23	4.22	4.65	4.69	4.69
7160	0.25	1.10	1.60	2.40	3.03	3.96	4.31	4.34	4.34

STORM 179 (176+178) - NOV 30-DEC 2, 1975
 ENTIRE STORM
 47 37'N 123 44'W

AREA (SQ.MI.)	DURATION (HR)												
	1	6	12	18	24	30	36	42	48	54	60	66	72
2	1.13	3.58	6.17	8.06	9.35	10.88	13.17	14.27	15.29	15.58	17.69	18.90	19.28
10	1.01	3.58	5.73	8.06	9.35	10.86	13.17	14.27	15.29	15.58	17.69	18.90	19.28
50	0.82	3.44	5.58	7.90	9.16	10.64	12.90	13.98	14.98	15.27	17.33	18.52	18.89
100	0.78	3.31	5.50	7.71	8.93	10.38	12.58	13.64	14.61	14.89	16.91	18.07	18.43
200	0.76	3.17	5.41	7.44	8.62	10.02	12.16	13.18	14.11	14.39	16.33	17.45	17.80
500	0.64	2.71	4.85	6.78	7.89	9.36	11.27	12.19	13.08	13.37	15.16	16.16	16.56
1000	0.53	2.32	4.21	5.78	6.84	8.40	9.92	10.71	11.54	11.88	13.41	14.27	14.78
2000	0.47	2.12	3.63	4.78	5.98	7.51	8.76	9.58	10.60	11.15	11.91	13.18	14.05
5000	0.40	1.79	3.07	3.94	5.11	6.53	7.68	8.46	9.30	9.77	10.55	11.55	12.25
10000	0.34	1.58	2.65	3.27	4.03	4.95	5.69	6.53	7.36	7.76	8.52	9.44	10.10
20000	0.27	1.35	2.26	2.75	3.41	4.18	4.84	5.49	6.15	6.59	7.20	8.00	8.55
31912	0.22	1.18	2.00	2.46	3.05	3.81	4.48	5.19	5.77	6.25	6.76	7.46	7.93

STORM 179 (176+178) - NOV 30-DEC 2, 1975
 CASCADES CENTER (STORM 176 PORTION)
 47 59'N 121 20'W

AREA
 (SQ. MI.)

	DURATION (HR)												
	1	6	12	18	24	30	36	42	48	54	60	66	72
2	1.13	3.15	6.17	7.08	8.83	10.88	12.56	13.39	13.94	14.33	15.73	16.39	17.11
10	1.01	2.98	5.72	6.71	8.64	10.62	12.27	13.08	13.62	14.09	15.36	16.01	17.07
50	0.82	2.82	5.04	6.35	8.23	10.22	11.77	12.54	13.14	13.60	14.68	15.60	16.70
100	0.78	2.74	4.76	6.13	7.92	9.94	11.43	12.18	12.86	13.31	14.28	15.33	16.43
200	0.70	2.59	4.47	5.83	7.36	9.37	10.80	11.60	12.48	12.93	13.78	14.87	15.92
500	0.57	2.46	4.15	5.47	6.91	8.63	9.97	10.84	11.97	12.42	13.12	14.42	15.38
1000	0.51	2.29	3.84	5.13	6.45	8.08	9.36	10.23	11.43	11.88	12.53	13.89	14.78
2000	0.47	2.12	3.51	4.70	5.98	7.54	8.79	9.61	10.60	11.15	11.91	13.18	14.05
5000	0.40	1.79	2.95	3.94	5.11	6.53	7.68	8.46	9.30	9.77	10.55	11.55	12.25
10000	0.31	1.28	2.15	3.08	3.98	4.94	5.68	6.53	7.36	7.76	8.52	9.44	10.10
13720	0.27	1.06	1.85	2.72	3.50	4.30	4.80	5.67	6.47	6.87	7.56	8.44	9.05

STORM 179 (176+178) - NOV 30-DEC 2, 1975
 COASTAL CENTER (STORM 178 PORTION)
 47 37'N 123 44'W

AREA
 (SQ. MI.)

	DURATION (HR)												
	1	6	12	18	24	30	36	42	48	54	60	66	72
5	0.85	3.58	5.73	8.06	9.35	10.86	13.17	14.27	15.29	15.58	17.69	18.90	19.28
10	0.85	3.58	5.73	8.06	9.35	10.86	13.17	14.27	15.29	15.58	17.69	18.90	19.28
50	0.81	3.44	5.58	7.90	9.16	10.64	12.90	13.98	14.98	15.27	17.33	18.52	18.89
100	0.78	3.31	5.50	7.71	8.93	10.38	12.58	13.64	14.61	14.89	16.91	18.07	18.43
200	0.76	3.17	5.41	7.44	8.62	10.02	12.16	13.18	14.11	14.39	16.33	17.45	17.80
500	0.64	2.71	4.85	6.78	7.89	9.36	11.27	12.19	13.08	13.37	15.16	16.16	16.56
1000	0.53	2.31	4.21	5.78	6.84	8.40	9.92	10.71	11.54	11.84	13.41	14.27	14.73
2000	0.46	2.02	3.63	4.78	5.91	7.11	8.18	8.95	9.61	9.96	11.27	12.02	12.49
5000	0.39	1.76	3.07	3.92	4.68	5.32	6.07	7.07	7.96	8.59	9.50	10.30	10.96
10000	0.34	1.58	2.65	3.27	3.99	4.73	5.34	6.04	6.70	7.16	7.83	8.44	8.92
12997	0.32	1.52	2.49	3.02	3.74	4.52	5.17	5.77	6.32	6.69	7.25	7.77	8.17

SYNOPTIC DESCRIPTIONS

The following synoptic descriptions cover storms from the sample in Table 2.1 considered most significant to this study, and are included to give insight to the types of conditions supporting these major events. None of the storm analyses attempted here have created cross sections or involved isentropic analysis that would show in temporal detail the relative moisture flows. Such analysis of vertical sounding data is more time consuming than could be justified for this study. Similarly, synoptic discussions in other hydrometeorological reports have included maps that depict the position of pressure centers and major fronts. Such maps have not been included in this study because of the time needed to draft them and it was believed that their importance could be replaced by the word descriptions that follow.

STORM: 12
DATE: 11/18 - 19/09
LOCATION: Western Montana near Snowshoe
DURATION: 48 hours

SYNOPTIC DESCRIPTION: The setting for this storm showed deep continental polar air settled over the intermountain region with a well established high pressure cell centered over southwestern Utah. A series of short waves originating well off the coast, moved eastward toward the surface ridge. These waves formed into occluded fronts with long south to southwest fetches into the region.

The first wave moved onshore and over the storm region on the 17th. This brought generally light to moderate precipitation to the area. The occlusion dissipated with eastward movement and the southwesterly flow was reestablished by the high pressure cell prior to the onset of the next wave.

Vertical motions due to the orographic lifting became important as the maritime Pacific air moved across land. Additional lifting was supplied by the colder polar air mass. On the 19th, the moisture trajectory became more westerly as the next front passes through the area and brings an end to the supply of moisture into this storm.

Precipitation began on the morning of the 17th and the precipitation moved eastward across Idaho and into Montana by about 1600 LST of the same day. The heaviest reported rainfall was recorded on Snowshoe, Montana, at 7.05 inches. The most intense rainfall fell with the second impulse, which apparently included slightly stronger vertical motions.

STORM: 38
DATE: 11/18 - 22/21
LOCATION: North central Oregon near the Cascade Mountains
DURATION: 72 hours

SYNOPTIC DESCRIPTION: Continental polar air drifted southward over Washington and into Oregon as an approaching low pressure system moved across the Gulf of Alaska and a ridge built up off the California coast near 35N, 135W. The polar air became stalled in central Washington and the major push went southeastward. The offshore ridge shifted gradually to the east, while taking on a more northeast-southwest orientation. The main energy of the Pacific disturbance continued its easterly movement and became well defined by the 18th.

Minor shortwaves traveled east along the Washington/Oregon border bringing some precipitation to the interior. The southwesterly flow moving into the coast was forced over the stationary polar front, in addition to the orographic lifting. These strong flows continued until the 21st when a cold front associated with the low pressure system finally moved onshore. Heaviest precipitation appeared to be associated with the strong southwesterly flows that had their origin in tropical latitudes. Temperatures in the southwesterly air were in the 50's, while to the north of the front they were below freezing.

Winds increased with the approach of the low pressure system. Precipitation appeared to have been focused by the stationary front and the lifting provided by the Cascades. Rainfall was heaviest in northwestern Oregon and southwestern Washington, with the highest observed amount at Wind River, Washington, where over 15 inches was reported. The precipitation began as light rain early on the 18th, becoming heavy that evening, and continuing early on the 20th. Thereafter, moderate rainfall prevailed through the 21st becoming light again on the 22nd.

STORM: 40
DATE: 12/9 - 12/21
LOCATION: North Central Cascades
DURATION: 72 hours

SYNOPTIC DESCRIPTION: A broad area of high pressure extended over the Great Basin and southwestward into the Pacific off of California. Substantial flows of moist air on the backside of this ridge followed a trajectory from near Hawaii to the coastal area of Washington on the 9th. Over the Aleutians, a low pressure system moved to the north-northeast, with a trailing cold front.

The cold front became occluded as it pushed onshore through British Columbia, with surface winds increasing to over 30 kt along the Washington coast. The low pressure system intensified very quickly as it moved toward the northeast on the 10th. A second front moved onshore on the 11th causing a momentary shift in winds to the west before returning to the southwest ahead of the next system.

Winds increased to 40 kt along the coast on the 12th as a result of the occluded front and the intensified pressure gradient. This appeared to have produced the heaviest precipitation in the core region. The rainfall came to an end on the 13th.

The cause of heavy rainfall was attributed to the strong southwesterly flow encountering the coastal and Cascade Mountains during the 10th and 11th, supported by a strong pressure gradient. The rainfall occurred in two surges; the first and lesser surge was from the afternoon of the 9th to the morning of the 10th, while the heavier surge fell between late on the 10th through the morning of the 12th. The heaviest rainfall was reported at Silverton, Washington, where 15.38 inches occurred.

STORM: 80
DATE: 1/20 - 25/35
LOCATION: Olympic Mountains
DURATION: 144 hours

SYNOPTIC DESCRIPTION: The conditions leading to this storm developed on the 16th and 17th when a quick moving storm passed through western Washington to the Great Basin by the 19th. This passage was followed by ridge development and the merging of an eastern Pacific High, with a strong continental polar anticyclone centered in the Yukon Territory. Over the next few days, this joint high pressure system intensified to create an effective block to subsequent storms moving to the east. As the next storm wave approached the coast from the Gulf of Alaska, the combined pressure ridge served to intensify the gradient of SSW flows toward the Washington Coast and the Olympic Mountains.

Extremely cold temperatures were observed over Washington and Oregon, with below zero readings reported in eastern parts of the two states. Beginning on the 21st, the strong southwesterly flows brought warming temperatures and moisture to the coast where the mountains forced lifting that was intensified by convergence in the numerous valleys. These conditions led to a period of continuous rains for several days. Rain rates of 12 inches a day were noted on the 21st and 22nd, indicative of release of conditional instability. It was estimated that gradient level flows in excess of 60 kt impacted the mountainous slopes to produce vertical velocities ten times the normal 0.3 fps for general storms.

Quinault Ranger Station on the southwest corner of the Olympics measured over 37 inches of rainfall during the 144 hours of this storm.

Precipitation began as snow on the 21st, but changed to rain early on the 22nd in western Washington. Unusually deep snows were observed east of the Cascade ridge, with 52 inches measured at Winthrop. Dew point temperatures rose to the 40's and low 50's by the 23rd, matching the air temperatures near the coast. As an indication of the subtropical air flowing into the region, Mount Baker Lodge recorded a temperature of 70°F on the 25th, within 2° of the all-time high for January in the state.

STORM: 88
DATE: 12/26 - 30/37
LOCATION: Coastal Mountains of Washington, Oregon
DURATION: 96 hours

SYNOPTIC DESCRIPTION: This storm brought moist flows into the coastal mountains of Oregon and Washington, with numerous rainfall centers in excess of 10 inches. The largest observed amount occurred near Valsetz, Oregon, where some 25 inches fell on the southwest facing slopes. The mountains in this region rise to levels between 3500 and 4000 feet.

The primary storm of the 28th to 30th followed a series of quick moving, low pressure centers that passed through western Washington to the east. On the 26th, a low moved into the Gulf of Alaska and rapidly deepened during the next 30 hours. This resulted in both a slowing of movement and an intensification of the onshore gradient that increased the winds to the coastal mountains. A quasi-stationary front developed along the Washington/Oregon border. Several short waves passed along this surface that provided rain impulses during the storm. Movement of the frontal surface southward and then back northward may have contributed to the maximum rains occurring in Oregon.

By the 30th, the front had been displaced eastward and the rains ceased along the coastal mountains except for a few showers. Most of the mass curves for this storm show rain occurring in two bursts separated by about 30 hours. It is also apparent from these curves that little convective activity was associated with this event.

From the Northern Hemisphere Daily Weather Maps, dew points appear to be in the low 40's, with air temperatures ranging between 55° and 61° F. Temperatures at this level are indicative of trajectories from subtropical latitudes at this time of year.

STORM: 106
DATE: 6/26 - 27/44
LOCATION: Eastern end of Snake River Valley
DURATION: 24 hours

SYNOPTIC DESCRIPTION: This is a somewhat perplexing storm in that from study of the synoptic conditions, there is little to distinguish events occurring during this period from those that occur in a number of other storms. Nevertheless, this storm produced rains that exceeded the level of 1-percent chance rains for June. A rather weak stationary front existed across eastern Washington, and into Montana on the 25th. During the next 24 hours, pressure fell in central Idaho and formed a small low pressure system that intensified and moved into the Dakotas by the 27th. It was within this development that rains lasting to 14 hours occurred in southern Idaho and western Montana. The maximum observed rains approached 4 inches in eastern Idaho. Some of this rain appeared to be convective early in the period, followed by continuous light rain. Other parts of the storm had mass curves without convective traces evident. It would appear from this limited examination that the convective cells were imbedded in the more general-type event. Also, it would appear that in other parts of the storm, orographic lifting may be responsible for the majority of rainfall.

It was difficult to determine the source of moisture for this storm in that there was no evidence of any gradient flow from the Pacific during or preceding the rain period. Likewise, there was no strong push of moisture from the Gulf of Mexico shown on these maps and it must be concluded that the moisture arrived at levels above the surface. It was also possible that some of the moisture was residual, although the period preceding the storm shows little evidence of past rains. Speculation was that the moisture was the result of a surge or surges that have pushed northward through the Great Basin from subtropical sources west of the Continental Divide. This track for intermountainous moisture has been determined for a number of local storm events in the region and was difficult to detect without extensive analysis (moisture cross sections, etc.).

This storm would not be significant when compared with the other storms in this sample were it not for the location of the largest rainfall. There have been few storms reported that resulted in rains of this magnitude in least orographic regions.

STORM: 126
DATE: 10/25 - 30/50
LOCATION: Western Washington, Oregon and northern California
DURATION: 72 hours

SYNOPTIC DESCRIPTION: Numerous rainfall records were set during this 5-day period in northern California and southern Oregon. Gasquet Ranger Station measured 26.1 inches, Eureka, California, had 13.04 inches and 34 of 37 stations in California set new October records.

The critical storm period for this storm occurred between mid-day of the 26th and mid-day of the 29th, with the bulk of the rain falling from two primary rain sequences. The first impulse of 6 to 12-hour duration occurred early in the period, while the second impulse occurred near the end of the sequence. This 5-day event was discussed at length by Smith (Monthly Weather Review, October 1950), who described it as one of the strongest storms to hit the coastal region from mid-California north to British Columbia. Extensive damage as well as loss of life occurred from the high winds and flooding throughout the area. Aside from the record rains, this storm period brought a number of record low pressure readings to the three coastal states. Tatoosh Island, Washington, reported an all-time October minimum pressure of 971.6 mb, while Eureka, California, reported a record low of 986.8 mb.

Smith reported that the sequence of storms was preceded by a mass of very cold air that moved out of Siberia on the 22nd. By the 24th, this cold air had passed over Tatoosh Island and formed a large pool of cold air at low levels that was overlain by relatively warm air that intensified the frontal boundary and strengthened the low pressure systems. The first low pressure center entered the coast near the center of Oregon, associated with a cold front that draped through northern California. This storm moved rapidly eastward, while a second low moved into position in the Gulf of Alaska. Late on the 27th, this second storm moved southeastward and entered the coast near the U.S./Canadian border.

A brief comment can be made concerning dew points. Only a limited amount of data existed to indicate that dew points were near normal (upper 30's to low 50's) during the period, having come from moist air believed to originate around 30° N latitude. Some of the mass curves suggested that convective bursts were included in the otherwise general type rains. Widespread convection was not evident, however.

STORM: 143
DATE: 10/1 - 2/57
LOCATION: North-central Oregon
DURATION: 24 hours

SYNOPTIC DESCRIPTION: This storm resulted in the largest rainfalls (3.49 inches) near Hermiston, Oregon, a least orographic region, and like storm 106, it resulted from conditions that were not well organized. That is, a small thermal low moved into southeastern Oregon on the 1st and widespread convective activity was noticed throughout Oregon and eastern Washington. By October 2nd, a weak cold front had passed through western Washington and trailed into Oregon near Portland. Rain was reported ahead of this front and appeared to be associated with the upper level trough. It was concluded that the rains were the result of local convergence that released instability in the resident air mass over the Great Basin.

It was not clear where the moisture came from, as the surface maps gave no indication of moist tongues from the south. Locally, Pendleton, Oregon, had a persisting dew point of 51° F, which when adjusted to 1000 mb gives 59° F, not unusual for this date. At Hermiston, the rain occurred over a period of about 12 hours, while at most of the other stations, the rain appeared as bursts of 4 to 8-hour lengths, indicative of the convective nature of this storm.

STORM: 149
DATE: 11/21 - 24/61
LOCATION: Southwestern Oregon
DURATION: 72 hours

SYNOPTIC DESCRIPTION: A deep low pressure center, located over southwestern Alaska on the 20th, moved toward the southeastern Alaskan coast by the 21st. Central pressure was less than 970 mb, and an occluded front trailed southward along the coast to the southern end of Vancouver Island. Here, a warm front branched off and into the Oregon coast that initiated a three-day period of rainfall over western Washington and Oregon. By the 22nd, the warm front was replaced by a cold front that rotated clockwise to align itself east-west across the coast between the 22nd and 23rd. The tight gradient through this sequence pulled strong southwesterly winds onshore into the coastal mountains. Heavy snow was reported throughout the mountains, causing power outages and some road closings. The heaviest rains were noted along the coast with Brookings, Oregon, recording over 10 inches. Precipitation ended the morning of the 24th, as a wave passed along the front, pulling it southward into California.

It is possible that some of the moisture entering this storm was pulled northward from the remnants of tropical storm Dot; however, available synoptic analyses were insufficiently clear off the coast to support this claim. Moisture from such a source would more than account for the high rains observed.

Most of the precipitation fell in the western portions of the two states. It was believed that the combination of strong convergent flows and orographic lifting concentrated most of the heavy rains against the major mountain slopes. Unseasonably cold temperatures preceded the passage of the warm front into the region. This undoubtedly accounted for the heavy snows reported in the mountains.

STORM: 155
DATE: 6/7 - 9/64
LOCATION: Northern Montana Rockies
DURATION: 48 hours

SYNOPTIC DESCRIPTION: This storm was known as the Gibson Dam storm because of the extreme runoff that caused runoff to overtop the dam, substantially. The synoptic analysis for this event has been described in both HMR 43 and HMR 55A, and will not be repeated here. However, recent review of some features in the analysis have brought about a few additional comments that are worth noting, as follows.

In the initial discussion of this event by Dightman (Bonner and Stermitz, 1967), easterly winds of 30 kt were claimed responsible for vertical velocities needed to support the observed rains. Using the best upper air station relative to this event (Great Falls) to get weighted averages for various layers below 20,000 feet, does not support winds of 30 kt. At best, winds around 15 kt are possible from about 60°. In that Great Falls probably is representative of winds to the southern part of the storm, it is still possible that stronger winds, of the magnitude suggested by Dightman, occurred to the north.

In reviewing the moisture trajectory to this storm, it is noted that there were multiple inflows possible, depending upon the time considered. HMR 55A states that the major moisture flows into the storm came from a reference location in western Kansas (Grand Island). Radar reports, on the other hand, appear to support inflow to the storm site through northeast Colorado. This source region seems to dominate during the 15 hours between 00 and 15 GMT on the 8th. Prior to this period, a Pacific source region appeared to be effective, while after 15 GMT, the best moisture flows came from the vicinity of Regina in Canada. Certainly, a three-source moisture inflow has to be considered unusual, but considering the significance of this storm, it is difficult to determine the importance of this feature to the observed rains.

Furthermore, examination of the 200-mb temperatures and lower level temperature changes suggest that stratospheric warming occurred during the course of this event. The dynamics of the atmosphere were therefore more representative of winter, although the surface flows provided summer-like moisture to the region. This combination may represent the optimum conditions for maximizing orographic effects and support the particular significance of the Gibson Dam storm.

STORM: 165
DATE: 1/13 - 17/74
LOCATION Coastal Washington and Oregon
DURATION: 72 hours

SYNOPTIC DESCRIPTION: A strong high pressure system prevailed over the Gulf of Alaska, representing a block to storms entering the west coast on the 10th. Very cold arctic air from the north and northeast persisted across the coastal states. Severe negative temperature departures were observed over portions of Washington and Oregon, with below zero temperatures reported throughout the region east of the Cascades. The blocking high began to regress westward by the 11th, allowing a surge of warm air to enter the coast at the southern end of the region. Both temperatures and dew point temperatures rose significantly during a 24-hour period beginning the 12th. Rapid cyclogenesis developed in the Gulf in place of the high pressure system, and a number of short waves moved around the trough at the time of the increasing temperature and moisture flows. Early snowfall changed to rain that intensified with time as the gradient increased and as the orographic influences took over.

Coastal winds were reported at 60 mph along the Washington coast, increasing to 75-100 mph along the Oregon coast. Winds of such magnitude cause considerable damage but also support the strong orographic effects noted in the precipitation pattern for this storm. Beginning on the 16th, a second short wave began to push through the region, bringing an end to this period of heavy rains.

Mount Shasta, California, set an all-time 24-hour rainfall of 6.97 inches during this storm, and Sexton Summit, Oregon, set 12-, 24- and 72-hour records of 3.39, 5.98 and 11.52 inches, respectively. Over 9 inches fell on a large portion of western Oregon, while a few stations had maxima of nearly 13 inches.

STORM: 179
DATE: 11/29 - 12/4/75
LOCATION: Western Washington and Oregon
DURATION: 72 hours

SYNOPTIC DESCRIPTION: Storm 179 is a combination of storms 176 and 178, effectively joining a northern and southern portion to what was considered two large precipitation patterns. What was storm 177, covering a subportion of storm 176 for the Olympic Mountains, is included, as well.

The temporal and spatial distribution of the precipitation associated with this storm was controlled by several factors. Initially, the development and subsequent movement of a classic, well-defined warm front and its associated dynamics were the primary mechanisms responsible for widespread heavy precipitation throughout the region. After the 30th, precipitation was caused by a combination of a strong surface to 700-mb onshore flow, orographic effects, and the relative closeness of a quasi-stationary surface frontal system acting as a focusing mechanism.

A series of short waves moved through the west coastal zone prior to the 28th, leading to the deepening of an upper level pressure trough along the western states. A strong jet stream edged southward during the period, with core winds up to 100 kt. The jet stream was aligned north-northwest to south-southeast and this became more westerly after the 30th.

The deep trough along the coast moved to the east beginning the 30th, creating a more zonal pattern aloft during the first few days of December. The jet stream remained over northern Washington through the storm period, finally moving into Canada at the end of the rains. The movement of the jet stream coincided with the surface movement of the polar front. North of the front were unseasonably cold temperatures, while to the south was relatively warm maritime air. Warming at all levels took place through the period of intense precipitation during this storm. Although the origin of the warm air was difficult to trace, the temperatures entering the coast were 50-60° F. Precipitation was concentrated along the frontal slopes and was further focused by the various orographic features encountered. Prior to the warm front, most all the precipitation fell as snow. After the front moved in, mostly rain was reported throughout the region. Rain was not constant through the period, but appears to have come in two primary bursts. The first burst occurred early in the period and the second, particularly in the northern stations, fell on the 2nd to 3rd. Weak high pressure built back into the region after the 4th ending this storm.

STORM: SEYMOUR FALLS
DATE: 1/12 - 17/1961
LOCATION: Southwestern British Columbia, Canada
DURATION: 126 hours

SYNOPTIC DESCRIPTION: Depth-area-duration analysis for this storm was officially made by Environment Canada, who determined that the Seymour Falls rain amounted to some 20.87 inches, beginning late on the 12th and tailing off late on the 15th, essentially making this a 72-hour storm. Bear Creek, on the lower end of Vancouver Island, received 15.93 inches during the same period, but was not part of the isohyetal pattern analyzed for the Seymour Falls center.

This storm is interesting in that conditions favorable for a sequence of frontal waves to pass into southern British Columbia at 24-hour intervals, produced the significant rains observed at Seymour Falls. At 00 GMT, on each of the 13th, 14th and 15th, a front moves through the Pacific coastal region. The last of the sequence moved slowest and produced the most intense rains. The fronts appeared to be spun off from an intense low pressure system that was anchored in the Gulf of Alaska. Strong pressure gradients were set up through Washington and British Columbia that caused convergence of flows north of a ridge of high pressure that extended in north-central California. The trajectory of moist warm air, feeding into the storm area ahead of the fronts, can be traced back along the north side of the ridge to latitudes of 30° F or lower.

The upper air pattern supported low latitude flows, as a trough occurred off the coast, with ridging along the western states. Strong warm air advection occurred ahead of the trough. This pattern appears to remain fixed throughout the period of this storm. The inflowing moist air encountered strong uplifting when crossing the coast and striking the coastal mountains of northwest Washington and southern British Columbia.

APPENDIX 3

STORM SEPARATION METHOD

The Storm Separation Method (SSM) was developed in Hydrometeorological Report (HMR) 55A as method to obtain the convergence component of PMP and a corresponding orographic factor, and provided a means to obtain total PMP. The discussion in Chapter 6 essentially describes the modifications made to the SSM for the present study.

As a convenience to the reader of this report, and for those who may not have access to HMR 55A, the entire Chapter 7 of HMR 55A that describes the SSM has been reprinted in this appendix. The SSM is a complex analytical process that has been tested by numerous meteorologists during its original development. The results indicated that an acceptable level of comparability between results was possible when analysts had considerable experience in storm analysis.

7. STORM SEPARATION METHOD

7.1 Introduction

In order to establish PMP in the CD-103 region, it was considered necessary to find a property of observed major storm precipitation events that is only minimally effected by terrain so transposition of observed precipitation amounts would not be limited to places where the terrain characteristics are the same as those at the place where the storm occurred. The name given to this idealized property is "free atmospheric forced precipitation" (FAFP) which has been called "convergence only" precipitation in publications such as HMR No. 49 (Hansen et al. 1977). For a more complete definition of FAFP, see the Glossary of Terms in section 7.2. It is emphasized that FAFP is an idealized property of precipitation since no experiment has yet been devised to identify in nature which raindrops were formed by orographic forcing and which by atmospheric forcing. This chapter explains how FAFP may be estimated for specific storms. Background information is provided on the development of the storm separation method (SSM).

7.2 Glossary of Terms

Terms frequently used in the SSM are listed alphabetically.

A₀: See P_a. It is the term for the effectiveness of orographic forcing used in module 3.

AI: The analysis interval, in inches, for the isohyets drawn for a storm.

B_i: See PCT2. It is the term representing the "triggering effects" of orography. It is used in module 2. B_i is a number between 0 and 1.0 representing the degree of FAFP implied by the relative positioning of the 1st through i-th isohyetal maxima with those terrain features (steepest slopes, prominences, converging upslope valleys) generally thought to induce or "stimulate" precipitation. A high positive correlation between terrain features and isohyetal maxima yields a low value for B_i. For each isohyetal maximum there is just one

B-type correlation and, thus, if the area covered by a given maximum is extensive enough so that more than one area category is contained within its limits, the B correlations are determined using all isohyets comprising a particular maximum. For the larger-area/shorter-duration categories, the B_i correlation may need to be made in widely separated, noncontiguous areas.

When available, the chart of maximum depth-area-duration curves from the Part II Summary of the storm analysis, along with its associated documentation, is the primary source for determining how many centers (n) and which isohyetal maxima were used to determine the average depth for the area being considered.

BFAC: 0.95 (RCAT). It represents an upper limit for FAFP in modules 2 and 5. See also the definition for PX.

DADRF: The depth-area-duration reduction factor is the ratio of two average depths of precipitation.

DADRF = RCAT/MXVATS

DADFX: DADFX = (HIFX)(DADRF). It is used in module 2 to represent the largest amount of nonorographic precipitation caused by the same atmospheric mechanism that produced MXVATS.

F_i: See PCT2. It is the term for the "upsloping effects" of orography and it is used in module 2. It is a number between 0 and 1.0, which represents the degree of atmospheric forcing implied by the orientation of the applicable upwind segments of the isohyets with elevation contours (high positive correlation of these parameters means a low value for F_i) for the 1st through i-th maxima. For an isohyetal maximum there is just one F-type correlation, and if the area covered by a given maximum is extensive enough so that more than one area category is contained within its limits, the F correlations are the same for each of the area categories. F-type correlations are determined using all isohyets comprising a particular maximum. As with B-type correlations, maximum depth-area-duration curves from the Part II of the storm report should be used to determine which precipitation centers are involved in the isohyetal maximum.

* A depth-area-duration storm analysis is separated into two parts. The first part develops a preliminary isohyetal map and mass curves of rainfall for all stations in the storm area. The second part includes a final isohyetal map, computation of the average depth of rainfall over all isohyetal areas and determination of the maximum average depth for all area sizes up to the total storm area. The complete procedure used for making depth-area-duration analysis is described in "Manual for Depth-Area-Duration Analysis of Storm Precipitation" (World Meteorological Organization 1986).

there would have been a poor correlation and the value of LOFACA would have been zero for this storm.

The significance of LOFACA is that precipitation depths at and below this value are assumed to have been produced solely by atmospheric forces without any additional precipitation resulting from topographic effects; i.e., they represent the "minimum level" of FAPP for the storm. If more than one isohyetal center exists for the area size selected, the procedure is followed for each center. If the value of LOFACA is different for two or more of these centers, the lowest of the values is used as the one and only value of LOFACA for that storm and area size.

$$\text{LOFAC} = \text{LOFACA} + \frac{\text{AI}}{2} \left(\frac{\text{AI}}{\text{PB}^2 - 1} \right)$$

It is a refinement to LOFACA based on the concept that AI may prejudice the assigning of a minimum level of FAPP.

MXVATS: The average depth of precipitation for the total storm duration for the smallest area size analyzed, provided that it is not larger than 100 mi². It is obtained from the pertinent data sheet (P.D.S.) for the storm included in "Storm Rainfall" (Corps of Engineers 1945 -). It is used in several modules to calculate percentages of FAPP. If the area criterion cannot be met, the storm is not used in the study.

n: When used in module 2 it is the number of analyzed isohyetal maxima used to set the average depth of precipitation for a given area size.

OSL: Orographic Separation Line is a line which separates the CD-103 region into two distinct regions, where there are different orographic affects on the precipitation process. In one region, the nonorographic, it is assumed no more than a 5-percent change (in either increasing or decreasing the precipitation amount for any storm or series of storms) results from terrain effects. In contrast, the other region is one where the influence of terrain on the precipitation process is significant. An upper limit of 95 percent and a lower limit of no less than 5 percent is allowed. The line may exist anywhere from a few to 20 miles upwind (where the wind direction is that which is judged to prevail in typical record setting storms) of the point at which the terrain slope equals or exceeds 1,000 ft om 5 miles or less with respect to the inflowing wind direction (sec. 3.2).

P_a: P_a (and A₀) is a ratio in which the effectiveness of an actual storm in producing precipitation is compared with a conceptualized storm of "perfect" effectiveness. In such a conceptual model, features known by experience to be highly correlated with positive vertical motions, or an efficient storm structure, would be numerous and exist at an optimum (not always the largest or strongest) intensity level.

Thus,

$$P_a = \frac{\text{Effectiveness of Actual Atmospheric Mechanisms}}{100}$$

where the numerator is a number between 5 and 95

$$A_0 = \frac{\text{Effectiveness of Actual Orographic Mechanisms}}{100}$$

where the numerator is a number between 0 and #95.

It would have been desirable to express both P_a and A₀ in physically meaningful units; however, this was not considered practical because the available meteorological data for most of the storms of concern are generally extremely limited. Hence, the present formulation is expressed in terms of subjective inferences about physical parameters known to be effective in the production of precipitation either in major storms in nonorographic regions or by considering the results of flow of saturated air against orographic barriers. This type of formulation is required, because of the limited availability of meteorological information for the storms, but is considered adequate for the purposes of this report. Mechanically, the effectiveness of the particular storm is derived by using the checklists in module 3.

PA: The ratio of the nonorographic area containing precipitation to the total storm precipitation area is given by PA. Its inverse is used when setting a realistic upper limit for I₂ and I₅ (see definition for PX on the following page). Areas in which the depth of precipitation is less than 1 in. are not used in forming the ratio. In contrast to PC, PA does not depend upon the area size being considered in the storm separation method.

PB: When the LOFACA isohyet does not extend from the orographic part into the nonorographic part of the storm, it is the ratio of the sum of the areas in the nonorographic part containing amounts equal to or greater than LOFACA (the numerator) to the total nonorographic area in which precipitation depths associated with the storm are 1 in. or more. When the LOFACA isohyet does extend into the nonorographic part of the storm, the numerator is increased by an amount representing the area bounded by the LOFACA isohyet and the OSL. It is used in module 2 in setting a value for LOFAC. Note: when LOFACA is zero, PB will be one and LOFAC will also equal zero.

PC: It is used in the formulations of PCTI, PCT2, and PCT3 to take into account the contribution of nonorographic precipitation to total FAPP (which includes FAPP contributions from orographic areas). It is expressed as a number between 0 and 0.95. The value of the upper limit is 0.95 because no storm in which more than 95 percent of the precipitation fell in nonorographic areas was considered. Thus, some storms from the list of important storms were not considered since they occurred in the nonorographic region.

If, for the area size being considered, part of the total volume of precipitation occurred in a nonorographic area, PC is the ratio of

that partial volume to the total volume. If none of the total volume was nonorographic, PC = 0. The ratio of volumes is obtained by forming the ratio of the corresponding area sizes first, then multiplying that ratio by an estimate of the average depth in the nonorographic area, and finally dividing this result by the average depth for the total area, both of these depths occurring at maximum duration.

PX: is the smaller of either BFAC or DADFX multiplied by (PA)⁻¹ except when PA = 0, in which case PX = BFAC. Once selected, PX serves to define what is a realistic upper limit for I₂ and I₅.

PCT1: = PC + $\frac{\text{RNOVAL}}{\text{MKVATS}} (0.95 - \text{PC})$.

MKVATS is used only for the smallest area size on the P.D.S. (provided that it is not greater than 100 mi²) because the average depth at larger area sizes is influenced by how isohyets were drawn.

PCT2: = PC + $\left(\frac{\sum_{i=1}^n (F_i + B_i)}{2n} \right) (0.95 - \text{PC})$

It is a number between 0 and 0.95 where n is the number of isohyetal maxima in the orographic part of the storm applicable to the area/duration category being considered. Estimates of F- and B-type correlations are dependent upon the quality of the isohyetal analysis and upon proper identification of the precipitation centers involved in the area category under consideration. When there is no Part II storm study information available, the analyst must decide whether a reasonable estimate can be made for n. When there are just a few maxima, each at a different depth, a reasonable estimate is likely, whereas when there are numerous maxima all of which are for the same depth and which enclose about the same area, it is less likely that a reliable value for PCT2 can be calculated. When the latter is the case, the answer to question I3 in module 2 will be "no" and the analyst documents this situation in module 5 after completing modules 3 and 4.

PCT22: This is the ratio I₂/RCAT where I₂ is the total amount of RCAT that is FAPP. I₂ is defined by the relationship:

$$I_2 = [\text{LOFAC} + (\text{MKVATS} - \text{LOFAC}) \text{PCT2}] \text{DADRF}$$

Substitution of these terms into the definition for PCT22 leads to the relationship:

$$\text{PCT22} = \text{PCT2} + \left(\frac{\text{LOFAC}}{\text{MKVATS}} \right) (1 - \text{PCT2})$$

$$\text{PCT3:} \quad \text{PCT3} = \text{PC} + \left(\frac{P_a}{P_a + A_o} \right) (0.95 - \text{PC})$$

It is a dimensionless number usually between 0.05 and 0.95, representing the percent of the total depth of precipitation for a given area/duration category attributable to the atmospheric

processes alone. It is obtained not only by considering primarily meteorological information, but also by considering the following minimal list of additional information: a P.D.S. for the storm (DAD data) including the location of the storm center; a chart of smoothed contours of terrain elevation; and precipitation data sufficient to define where precipitation did or did not occur. More detailed precipitation information is used, when available.

The range of 0.05 to 0.95 is considered reasonable, because it is postulated that the orographic influence never completely vanishes, and when the orographic influence is predominant, precipitation would not continue without some contribution from atmospheric forcing mechanisms. Though not expected to occur, it is conceivable that PCT3 may exceed 0.95 if the estimated orographic forcing was downslope, actually decreasing the total possible precipitation. This matter is discussed further in the section dealing with module 3. The formulation for PCT3 is meant to apply only to major storms and definitely not to minor storms where negative terrain forcing on lee slopes might approach, or exceed, the magnitude of the atmospheric forcing.

RCAT: The average depth of precipitation for the selected category. The "CAT" indicates that the parameter R is a variable depending on category definition.

RNOVAL: Representative nonorographic value of precipitation. It is the highest observed amount in the nonorographic part of the storm. The value of RNOVAL is not adjusted to the elevation at which MKVATS is believed to have occurred. RNOVAL and MKVATS must result from the same atmospheric forces (storm mechanism).

7.3 Background

The SSM was developed in the present format because four distinct sets of precipitation information were available for record-setting storms in the CD-103 region. These were:

1. Reported total storm precipitation, used in module 1.
2. Isohyet and depth-area-duration analyses of total storm precipitation, including Part I and Part II Summaries, used in module 2.
3. Meteorological data and analyses therefrom, used in module 3.
4. Topographic charts, used in all modules.

Since the quantity and quality of the information in the first three of these sets would vary from storm to storm, it was concluded that a method which relied on just one of the first three sets (along with topographic charts) might be quite useless for certain storms. Alternatively, one could have a SSM which always combined information from the first three sets. This choice was rejected since, for most of the storms, one or more of the sets might contain no useful information and bogus data would have to be used. Clearly, the SSM depends on the validity of the input information.

Four sets of information are used in the SSM to produce up to five estimates of FAPP for area categories up to 5,000 mi² and durations up to 72 hr for storms with major rainfall centers in areas classified as "orographic." The mechanics of the procedure used to arrive at one numerical value of FAPP for any relevant area/duration (A/D) category for any qualifying storm are accomplished by completing the tasks symbolically represented in a MAIN FLOWCHART for the SSM (fig. 7.2) along with its associated SSM MODULE FLOWCHARTS (fig. 7.3 to 7.7) with references to the following items:

1. Glossary of Terms (sec. 7.2).
2. Concepts for use of the modules (sec. 7.3.1).
3. Specific questions to be answered in the MAIN FLOWCHART and the MODULE FLOWCHARTS.

7.3.1 Basic Concepts

The validity of the techniques in the SSM depends on the validity of the concepts upon which they are based. Evaluation of these concepts is crucial to the application of the procedure. A relative evaluation of the validity of the concepts underlying the individual modules will govern which of the five possible values will be used for FAPP for a given A/D category. The evaluation is formalized in module 5 (column E) of the SSM based on the analysis of the various concepts. Several concepts are basic to acceptance of the procedure as a whole (all modules) while others relate to the evaluation of individual modules.

7.3.1.1 Overall Method. The total depth of precipitation for a given A/D category is composed of precipitation that results from atmospheric forces and from the added effect of orography. The method assumes that the effect of orography may either contribute to or take away from the amount of precipitation that is produced by the atmosphere. When the orographic effect is positive (expressed as a percentage contribution to total precipitation), it may not be less than 5 percent. If it is also assumed that the terrain surrounding the location where a given storm of record occurred had been transparent; i.e., had no effect on the atmospheric forces acting there, the resulting total precipitation would be the same as the free air forced component of precipitation for the actual storm.

It is assumed that the FAPP never completely disappears in storms of record, and the total volume may contain contributions over both the orographic and nonorographic areas. The further assumption is made that, when no other information is available at the shorter durations, inferences made from precipitation depths valid at maximum storm duration for a given area are equally valid for the same area at shorter durations down to and including the minimum duration category.

7.3.1.2 Module 1. There are three components that underlie the use of precipitation observations in the estimation of the contribution of the atmosphere to the precipitation amounts in storms. These are:

1. If free atmospheric forcing in the nonorographic part of the storm had been smaller than it was, the value of the maximum depth of precipitation would have been proportionally less.

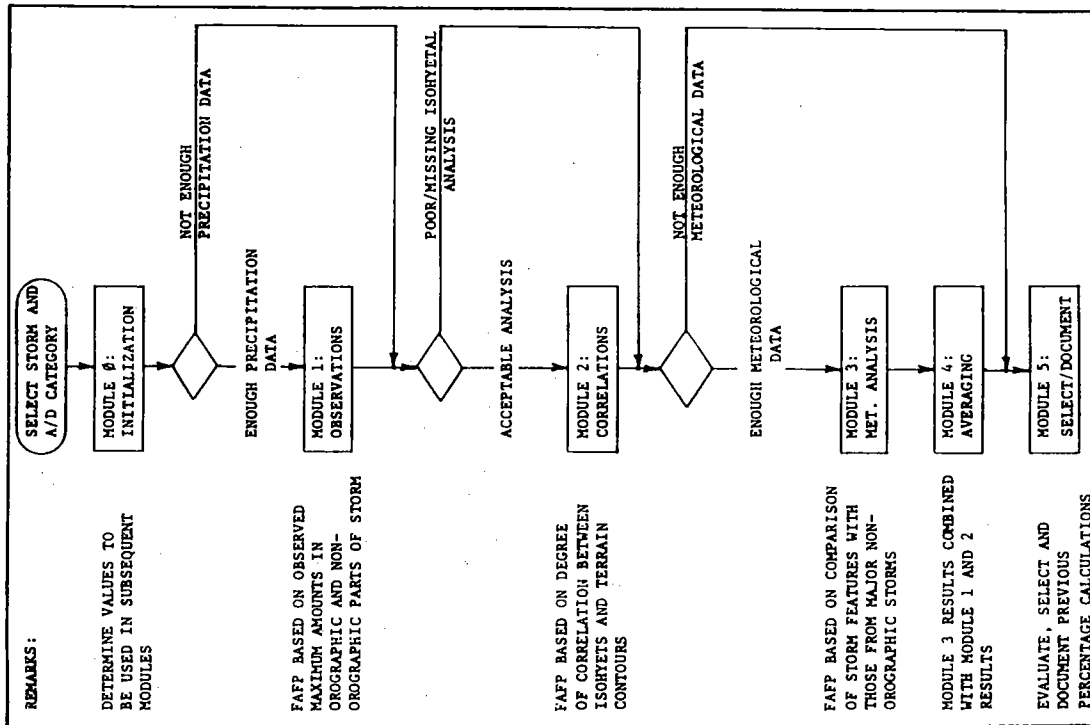

Figure 7.2.—Main flowchart for SSM.

2. The FAPP in the orographic region of the storm is approximated by the maximum precipitation depths in the nonorographic region, as long as the same atmospheric forces are involved at each location.
3. Estimates of the FAPP based on assumptions 1 and 2 are better for small rather than intermediate or large area sizes.

7.3.1.3 Module 2. This module uses an isohyetal analysis of the precipitation data to evaluate the free air forced component of precipitation. Inherent in the use of this module is the existence of an isohyetal analysis based on adequate precipitation information and prepared without undue reliance on normal annual precipitation or other rainfall indices which may induce a spurious correlation between the precipitation amounts and topography. In addition, there are five other concepts underlying this module. These are:

1. One or more than one level of LOFACA may exist in the orographic part of a storm. When more than one storm center is contained in a given area category, the lowest level of LOFACA found is used for that area size.
2. LOFACA exists when there is a good correlation between some isohyetal and elevation contours.
3. Upsloping and triggering (F- and B-type correlations) are of equal significance in determining the percentage of precipitation above LOFACA which is terrain forced.

For an orographic storm (centered in the orographic portion of the region), the larger the nonorographic portion becomes (in relation to the total storm area), the more likely that the observed largest rainfall amount in the nonorographic portion (as represented by DADFX) is the "true" upper limit to FAPP in the orographic part of the storm.

5. Estimates of FAPP using the above assumptions are better at intermediate and large rather than small area sizes.

7.3.1.4 Module 3. This module makes use of the meteorological analysis and the evaluation of the interaction of dynamic mechanisms of the atmosphere with terrain to estimate the FAPP. There are seven basic concepts underlying the use of this module. These are:

1. Estimates of FAPP made using the techniques of this module may be of marginal reliability if the storms considered are those producing moderate or lesser precipitation amounts.
2. A variety of storms exist, each one of which has an optimum configuration for producing extreme precipitation.
3. The more closely the atmospheric forcing mechanisms for a given storm approach the ideal effectiveness for that type of storm, the larger the effectiveness value (P_a) for that storm becomes.
4. The FAPP is directly proportional to the effectiveness of atmospheric forcing mechanisms and inversely proportional to the effectiveness of orographic forcing mechanisms.

5. If the effectiveness of the orographic forcing mechanisms is of opposite sign to the effectiveness of the atmospheric forcing mechanisms and of equal or larger magnitude, little or no precipitation should occur.
6. The FAPP of storms of record is arbitrarily limited to no more than 100 percent of the maximum precipitation depth for the area/duration category under consideration.
7. Estimates of FAPP using the above assumptions are better at large rather than at intermediate or small area sizes.

7.3.1.5 Module 4. A basic assumption underlying the use of module 4 is that better results can be obtained by combining information; i.e., averaging the percentages obtained from the isohyetal analysis with the meteorological analysis and those obtained from analysis of the precipitation observations with the meteorological analysis. Better estimates are produced by averaging when there is little difference in the expressed preference for any one of the techniques or sources of information and, also, when the calculated percentage of FAPP from each of the modules exhibits wide differences.

Little is to be gained from use of the averaging technique over estimates produced by one of the individual analyses of modules 1, 2, or 3 when:

1. There are large differences in the expressed preference for the techniques of one module.
2. The sources of information for one of the individual modules is definitely superior.
3. The calculated percentages among the modules are in close agreement.

7.4 Methodology

The SSM was developed in a modular framework. This permits the user to consider only those factors for which information is available for an individual storm. A MAIN FLOWCHART of the SSM is shown in figure 7.2.

The MAIN FLOWCHART gives the user an overview of the SSM. Modules 1, 2, and 3 are designed to use the first three information sets mentioned in section 7.3 as indicated by the remarks column at the left side of the flowchart. A decision must be made initially for any storm and category as to which modules can be appropriately used, module 1, 2, or 3. The decision is based on a minimum level of acceptability of the information required by the module in question. The decisions are formalized for each of these three modules in module 0. The heart of the SSM procedure is module 5 where documentation is made of the SSM process, thereby permitting traceability of results. Though module 5 can be reached on the flowchart only after passing through each of the other modules, it is recommended that the steps in each module be documented in the record sheet of module 5 as the analyst proceeds. Transposition and moisture maximization of the index value of precipitation follows the completion of the SSM and will be discussed in chapter 8.

7.4.1 Module Flowcharts

There is a flowchart for each module. These were developed to aid the analyst in following the procedures in the SSM.

7.4.1.1 Module 0 Procedure (fig. 7.3). It is important in this module to decide on the adequacy of the available data. The results of this assessment are entered in column D of figure 7.8. The following rules concerning criteria are used:

1. For modules 1, 2, or 3, if there are no data available for the given technique (module), assign 0 to column D.
2. If the data are judged to be highly adequate, assign a value of either 7, 8, or 9, where 9 is the most adequate.
3. If the quantity, consistency, and accuracy of the information are judged to be adequate, assign a value of either 4, 5, or 6 to column D.
4. If the input information are judged as neither highly adequate, adequate, or missing, a value of either 1, 2, or 3 must be assigned to column D. A value of 1 is the lowest level of adequacy consistent with affirmative responses to questions 3, 5, and 7 in module 0.

An evaluation of a technique is not appropriate when there is insufficient information available for it to be used. Assigning an effective value of zero to column D under these circumstances eliminates the possibility.

The Glossary of Terms provides all required information needed to give numerical values to the five variables in the first step of the module 0 procedure. Note: In this module and in modules 1, 2, and 3, the connector symbol (C) applies only within the given module; i.e., when one is sent to a connector symbol it is always the one that is found in that module.

The following questions need to be answered in this module:

- Q.1. Is PC equal to or greater than 0.95?
- Q.2. Is there a MXVATS for an area size equal to or less than 100 mi² on the Pertinent Data Sheet for this storm?
- Q.3. Are the quantity, quality, and distribution of the nonorographic observations sufficient to select a reliable value for RNOVAL?
- Q.4. Is an isohyetal analysis available?
- Q.5. Is the isohyetal analysis reliable?
- Q.6. Is a reliable isohyetal analysis easily accomplished?
- Q.7. Are the meteorological data sufficient to make a reliable estimate of P_a and A₀?
- Q.8. Is RNOVAL equal to zero?

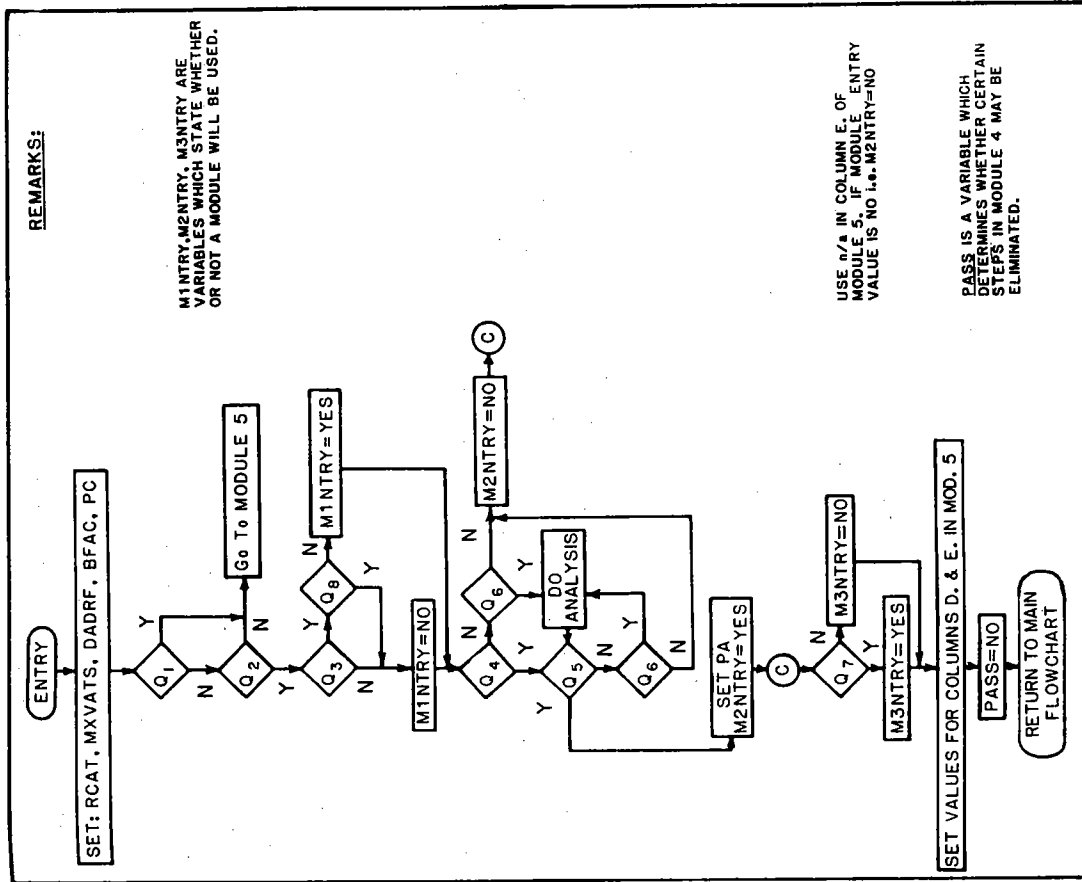

Figure 7.3.—Flowchart for module 0, SSM.

actual values selected depend on the placement of the OSL (sec. 3.2.1) in the vicinity of the storm under consideration. Additionally, an analytical judgment must be made concerning the storm mechanism that resulted in MXVATS and RNOVAL. If there is more than one storm mechanism involved in the storm, the value selected for RNOVAL must result from the same mechanism that produced MXVATS.

The following questions are asked in module 1:

Q.9. Is this the first time in this module for this storm?

Q.10. Has the analyst just arrived here from module 4 to do a review?

Q.11. Is RNOVAL equal to MXVATS?

Q.12. Is a review of the data and assigned values for the variable needed?

If it is a good assumption that RNOVAL will usually be observed at a lower elevation than MXVATS, then there is a bias toward relatively large values for PCT1 in relation to the other percentages from the other modules, since total or cumulative precipitable water usually decreases with increasing elevation. The viability of PCT1 depends on the density of good precipitation observations on the date the storm occurred.

7.4.1.3 Module 2 Procedure (fig. 7.5). In this module, the average depth of precipitation for a given area-duration category is conceived of as a column of water composed of top and bottom sections (where the bottom section can contain from 0 to 95 percent of the total depth of water). The limit to the top of the bottom section is set by the parameter LOFAC. The bottom section is conceived to contain only a minimum level of FAPP for the storm. The top section contains precipitation that results from orographic forcing, and perhaps additional atmospheric forcing. The percent (if any) of the top section that results from atmospheric forcing is determined by the P-type and B-type correlations. The value computed for LOFAC is sensitive to the accuracy of the isohyetal analysis for the storm. This sensitivity must be taken into account when evaluating module 2 procedures in column E of module 5.

The procedure in which the precipitation is divided into two sections, is represented also in the expression for PCT22, which may be rewritten as:

$$PCT22 = PCT2 \left(1 - \frac{LOFAC}{MXVATS} \right) + \frac{LOFAC}{MXVATS}$$

There are three terms on the right-hand side of the above equation. The rightmost of these terms is the minimum level of FAPP for the whole column expressed as a percent of the total and is the bottom section of the idealized column described above. The product of the first two terms on the right-hand side of the equation describes the top section of the idealized column, where PCT2 is the percent of the top section arising from atmospheric forcing and the second term is the depth of total precipitation minus the minimum level of FAPP expressed as a percent.

LOFACA is set to zero and LOFAC becomes zero when a good correlation cannot be found between any of the isohyets and the elevation contours upwind of the storm center. Zero is the numerical value that is appropriate for a minimum level of FAPP for the storm. Here it is assumed that the bottom section of the idealized

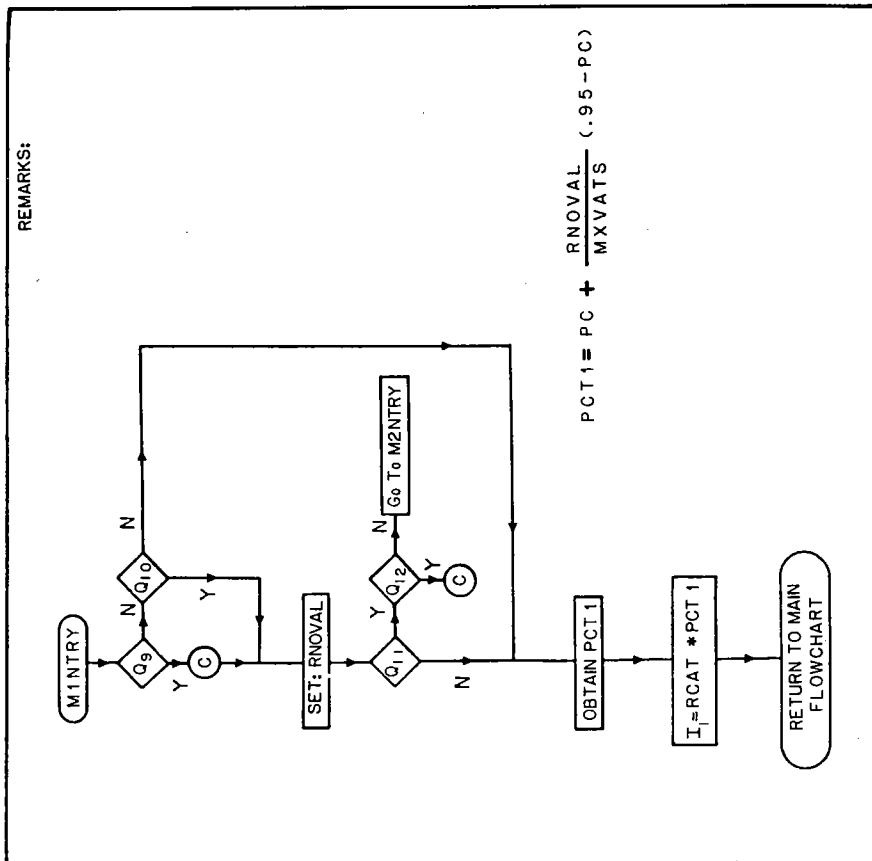

Figure 7.4.--Flowchart for module 1, SSM.

7.4.1.2 Module 1 Procedure (fig. 7.4). This module comes closer than any other in estimating a value for FAPP based on observed precipitation data. The key variables RNOVAL and MXVATS are based on direct observation, even though in some circumstances uncertainty surrounds the accuracy of these observations. The

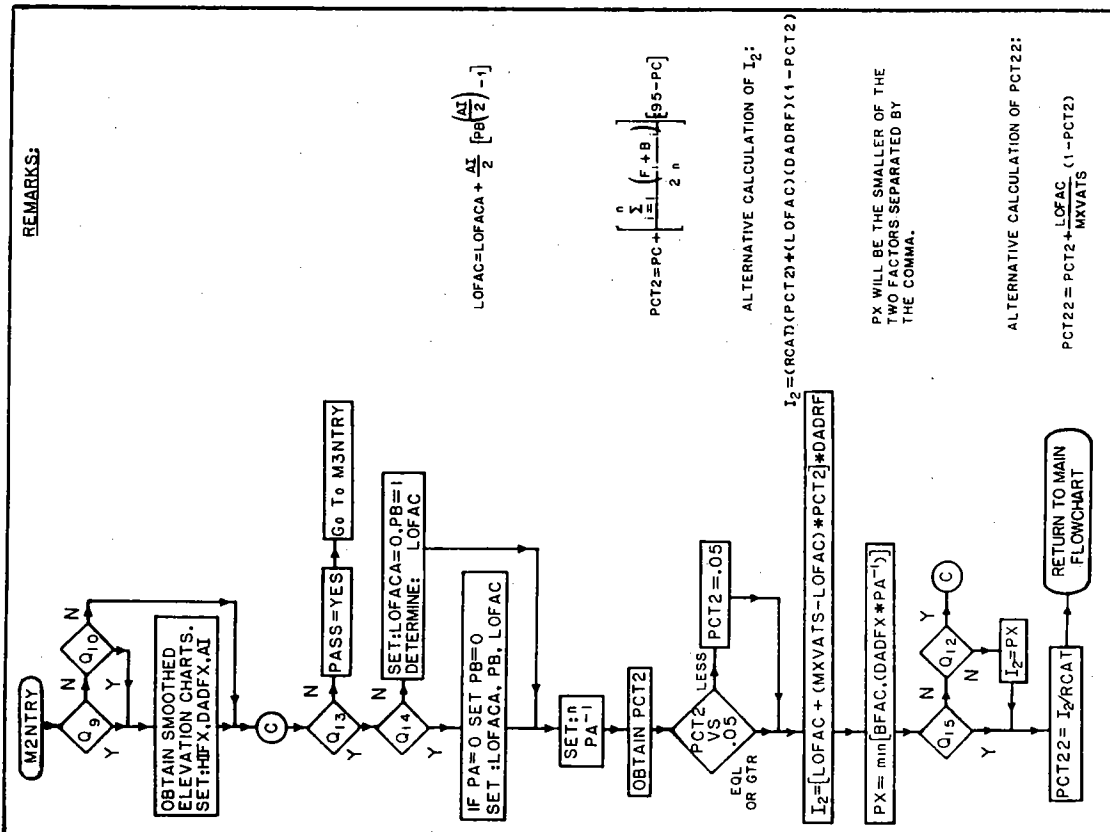

Figure 7.5.--Flowchart for module 2, SSM.

column is empty (minimum level of FAPP = 0), and both F-type and B-type correlations will determine the appropriate level of FAPP for the storm. The F and B correlations, to properly establish the appropriate FAPP, are determined nearby and upwind from the storm center.

As in module 1, an analytical judgment must be made on storm mechanism. In module 1, it was required that MXVATS and RNOVAL are the result of the same dynamic process. In module 2, it is necessary to determine that RNOVAL and HIFX are the result of the same atmospheric forces (storm mechanism).

The following questions are asked in module 2:

Q.9. Is this the first time in this module for this storm?

Q.10. Has the analyst just arrived here from module 4 to do a review?

Q.12. Is a review of the data and assigned values for the variable needed?

Q.13. Can it be determined which isohyetal maxima control(s) the average depth for the category selected?

Q.14. Is there good correlation between some isohyet and the elevation contours in the orographic part of the storm near the storm center?

Q.15. Is I_2 less than or equal to PX ?

A feature of module 2 not to be overlooked is the consequence of a negative response to question 15 accompanied by a negative response to question 12. In this case an arbitrarily defined upper limit is set on PCT2 and I_2 . The upper limit will be the smaller of two numbers. The selection of BFAC as one of these numbers is obvious when one considers that orographic forcing may be either positive or negative. The second factor is a consequence of the concept that the larger PA becomes, the more likely the second factor represents the true level of FAPP, since with a large value of PA the largest observed rainfall amount in the nonorographic portion is more likely to represent a true upper limit.

LOFAC is always a number equal to or slightly less than LOFACA. This is so because it is possible that the minimum level of FAPP is reached before the arbitrarily set analysis interval allows it to be "picked up." It is reasoned that the larger the area "occupied" by the LOFACA isohyet in the nonorographic part of the storm, the more likely that the analysis interval has "picked up" the described depth. When there is no nonorographic portion to the storm, the parameter PB, used to set a value for LOFAC, becomes undefined (see definition of PB). Consequently, in the module 2 FLOWCHART it must be determined whether a nonorographic portion of the storm exists when there is an affirmative response to question 14. If so, a reasonable value for PB is zero. The consequence of a negative response to question 14 is that LOFACA must be zero. Regardless of whether or not a nonorographic part of the storm exists, LOFAC must not be less than zero and this is ensured by setting PB equal to 1.

7.4.1.4 Module 3 Procedure (fig. 7.6). This module uses meteorological and terrain information to evaluate an appropriate level of FAPP. This is accomplished through evaluation of P_a and A_0 .

The following guidelines are provided to aid in the evaluation of P_a on the checklist given in the flowchart (fig. 7.6):

1. Use column A to indicate (by a checkmark) the presence of one or more features which infer positive vertical motion, or which may contribute toward an efficient storm structure.
2. Take as a basis for comparison an idealized storm which contains the same features or phenomena that were checked off in column A and indicate in column B, by selecting a number between 0.05 and 0.95, the degree to which the effectiveness of the selected actual storm features/phenomena (in producing precipitation) approaches the effectiveness of the same features/phenomena in the idealized storm. Where more than one feature/phenomenon is selected for a given category of meteorological information, it is the aggregate effectiveness which is considered and recorded in column B.
3. Repeat steps 1. and 2. for each category (surface, upper air, ..., others) of meteorological data.
4. If the quantity and quality of the information permits, the degree of convective-scale forcing may be distinguished from forcing due to larger scale mechanisms. If convective-scale forcing predominates for some area/duration categories and larger scale forcing at others, then the value assigned in column B may vary by area/duration category; i.e., the same effectiveness value may be different for each category of a given storm.
5. In column C an opportunity is given to assign one category a greater influence on P_a in relation to the others by assigning weighted values. For each applicable category the value in column D is the product of columns B and C. P_a is obtained by dividing the total of column D by the total of column C.
6. Meteorological data categories, for which there is not sufficient information from a particular storm, are disregarded in P_a calculations for that storm.
7. When effectiveness changes with the selected duration, the resulting value in column B is weighted by duration; this process is to be distinguished from the weighting mentioned in (5) above.

A_0 is a measure of the effectiveness of the orographic forcing effects. The following guidelines are used to aid in evaluating A_0 :

1. Indicate in column A the value (in physical units) for the first five parameters. If any of these parameters change significantly during the duration category selected, indicate in the duration box the percent of time each of the values persists. To obtain the largest value in column B (largest effectiveness) observe the joint occurrence of tightly packed isobars (high wind speed) perpendicular to steep slopes for 100 percent of the duration category selected. Another way to look at this is to combine the first three parameters into a vertical displacement parameter, W_0 , from the formula $W_0 = V * S$, where V is the

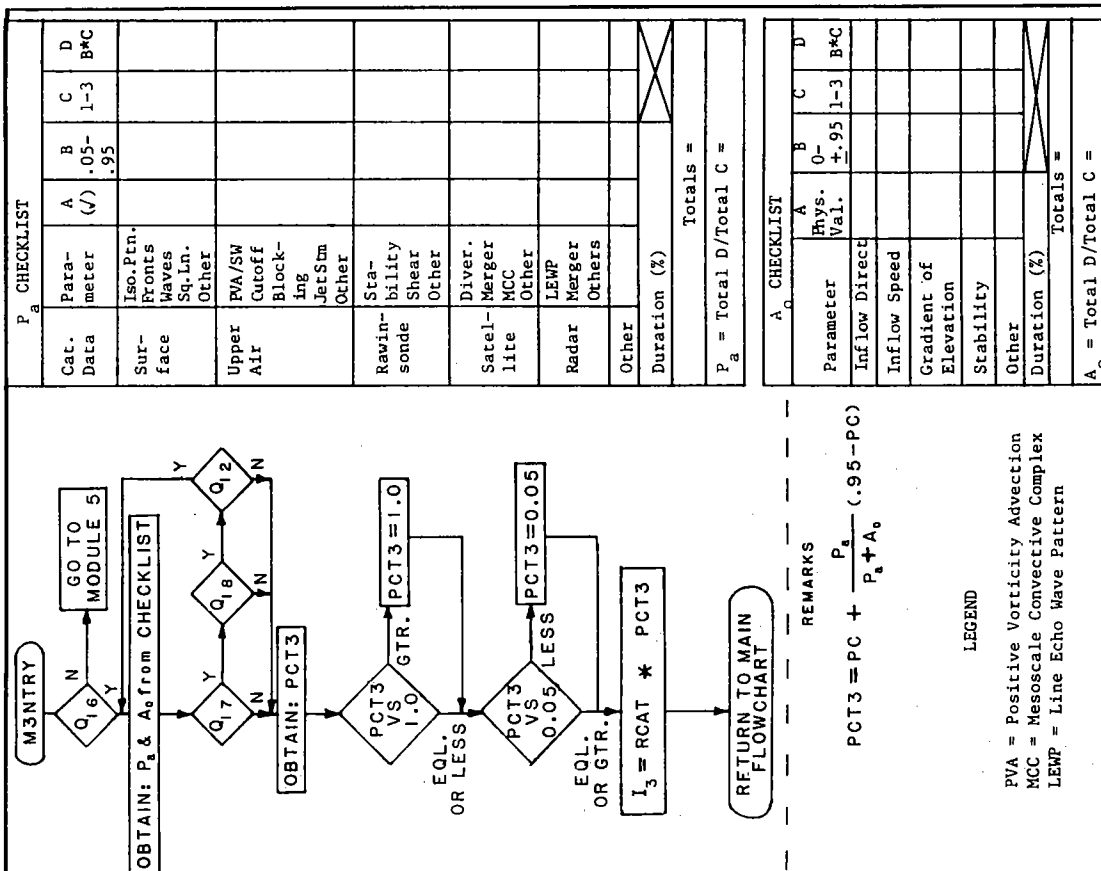

Figure 7.6.—Flowchart for module 3, SSM.

component of the wind perpendicular to the slopes for the duration being considered in kt and S is the slope of the terrain in ft/mi. The effectiveness of W_0 is then compared with an idealized value representing 100 percent effectiveness. The measured steepness of the slopes in the CD-103 region depends on the width across which the measurement is made. For a small distance (less than 5 mi.) a value of 0.25 is about the largest to be found, while for a large distance (greater than 80 mi.) a value of 0.06 is about the largest. A component of sustained wind normal to such slopes of 60 kt is assumed to be about the largest attainable in this region. Therefore, a W_0 of 15 kt for small areas and of 3.5 kt for large areas are the values which would be considered highly effective.

None of the orographic storms studied occurred in places where the measured steepness of the slopes came near to the values just mentioned. Consequently, the vertical displacements observed for small areas were from .02 kt up to near 2 kt and proportionally smaller for the larger areas for these storms. Therefore, the effectiveness value used in the top box in column B was scaled to the values observed in the storms of record; i.e., a W_0 of close to 2 kt was considered highly effective for small areas.

The inflow level for the storm is assumed to be the gradient wind level, and it is further assumed that the surface isobaric pattern gives a true reflection of that wind; i.e., the direction of the inflow wind is parallel to the surface isobars and its speed proportional to the spacing of the isobars as measured at the storm location. When rawinsonde observations are available in the immediate vicinity of the storm, they are used as the primary source of information for wind direction and speed.

When there is a sufficiently large number of wind observations, the average values of direction and speed are used for the duration considered. If the level of wind variability is large for the duration considered, the representativeness of the data is scored low in column C of module 5.

The fourth parameter, stability, must be considered in combination with the first three or W_0 . Highly stable air can have a dampening effect on the height reached by initially strong vertical displacement (and consequently, the size to which cloud droplets can grow). In a highly unstable condition, vertical displacements of less than 2 kt can, through buoyancy, reach great height, thereby producing rainfall-sized droplets. The effectiveness value for stability is placed in the second box from the top in column B. Weighted values corresponding to the two top boxes of column B are placed in the two top boxes of column C to reflect the combined effects of W_0 and stability; i.e., in the case where instability causes moderately weak displacements to grow, the stability "effectiveness" would be weighted strongly (given a 3) and the combined first three parameters weighted weakly (given a 1).

Entries in the other considerations box (for example, the shape of terrain features which may cause "fixing" of rainfall) need not be considered as dependent on the first four parameters.

2. The value for A_0 is then obtained in the same manner as described in guideline 5 for P_a .

3. When evidence indicates that the orographic influence is negative; i.e., taking away from total possible precipitation, the values in column B are made negative and when the conditions are borderline between positive and negative, they are made zero. Negative orographic influence, when occurring in a storm where the atmospheric forcing approaches its conceptually optimum state, may cause some category values of PCT3 to exceed 1.0 resulting in FAPP larger than the total storm average depth for that category. The conventions of module 3, however, do not permit values of PCT3 to exceed 1.0.

4. The remarks section of module 5 should be used to document where the elevation gradients (ΔZ) were measured. For small areas, this would typically be at a point upwind of the largest report/isohyet. For larger areas, the average value from several locations may be used, or if one location is representative of the average value, it alone may be used. Sometimes the gradient is measured both upwind and downwind of the storm center (where inflow wind is used) if the vertical wind structure is such that a storm updraft initiated downwind may be carried back over the storm location by the winds aloft to contribute additional amounts to the "in place" amounts.

The overriding importance of applying this module only to major storms cannot be overstressed. The consequence of "running through" a frequently observed set of conditions is that, by definition, the values for both P_a and A_0 will have to be quite small. When both parameters are small (less than about .4) a sensitivity study (not included here) showed that small differences in the values assigned to P_a and A_0 (the independent variables) would produce large differences in the value of the dependent variable (PCT3). However, it does not follow that the definition of P_a which permits a lower limit of zero is incorrect. A storm can reasonably be postulated in which the extreme amounts were traceable to exceptional orographic forcing and, thus, both terms would not be small (PCT3 in this case is 5 percent). Not only are "infinite" values for PCT3 removed by the FLOWCHART constraints, but a value of zero in the denominator of the ratio $P_a/(P_a + A_0)$ is a violation of the concept that if the orographic forcing negated the atmospheric forcing, no matter how large, little or no precipitation should occur.

The "model" envisioned in module 3 (as distinguished from the "model" of module 2 just discussed) follows from the concept that FAPP is directly proportional to the effectiveness of atmospheric forcing and inversely proportional to the effectiveness of the orographic forcing mechanisms. The rate at which an imaginary cylinder fills up (whose cross-sectional area is the same as the area category being used) is directly proportional to the condensation rate producing the precipitation which falls into the cylinder. The paramount factor determining the condensation rate is the vertical component of the wind resulting from both atmospheric (P_a) and orographic (A_0) forcing.

The following questions are asked in this module:

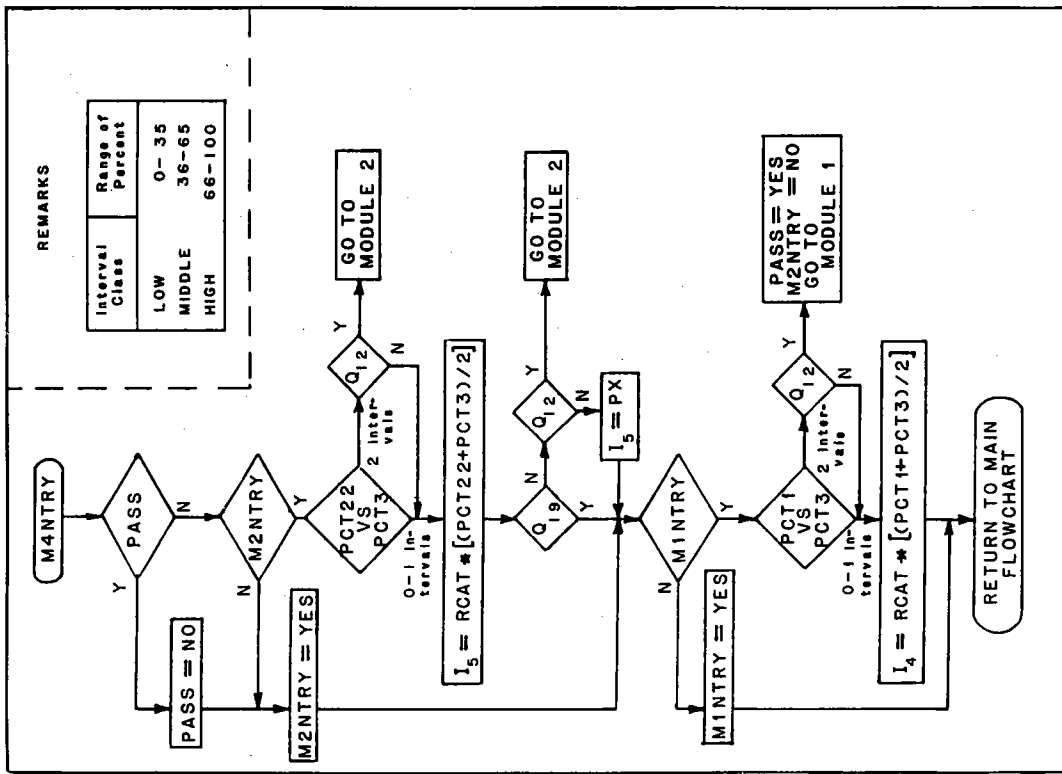

Figure 7.7.—Flowchart for module 4, SSM.

- Q.12. Is a review of the data and assigned values for the variable needed?
- Q.16. Does there exist, or is there sufficient information available to construct, a map of where at least 1 in. of precipitation did or did not occur for this storm?
- Q.17. Is A_0 less than zero?
- Q.18. Is (are) the storm center(s) incorrectly located on the terrain map?

The remaining portions of the module 3 FLOWCHART, not discussed above, are simple and straightforward.

7.4.1.5 Module 4 Procedure (fig. 7.7). It is not contemplated that a computer program will be coded from the MAIN or MODULE FLOWCHARTS because the determination of the appropriate PCT's and I's is done easily manually. There is no real requirement for the variable PASS to be in the module 4 FLOWCHART. It is included only to make it obvious that the first part of the FLOWCHART should be skipped when returning to module 4 from a review of data in modules 1 and 3. The purpose of this module is simply to create two additional indices of FAPP on the assumption that an averaged value may be a better estimate than one produced in modules 1, 2, or 3.

A preliminary test of the SSM by six analysts each using six different storms showed that it was quite rare that one analyst would select a high (low) value for a PCT when other analysts were selecting low (high) values given that the interval range was the one shown in the right-hand remarks section of the module 4 FLOWCHART. Thus, a review is required of relevant information when an average percentage is to be created from individual percentages differing by two intervals.

PCT1 was not averaged with PCT2 because modules 1 and 2 conceive of the idealized column of precipitation representing the average depth for a given area-duration category in different ways; i.e., there is no minimum level of FAPP considered in module 1.

The following questions are asked in this module:

- Q.12. Is a review of the data and assigned values for the variable needed?
- Q.19. Is I_5 less than or equal to PX?

Those concepts of the module 4 FLOWCHART not discussed above are straightforward.

7.4.1.6 Module 5 Documentation (fig. 7.8). It should be noted again that even though the MAIN FLOWCHART shows that module 5 is not used until module 2 and/or module 4 have been completed, this was done only to keep the diagramming of the MAIN FLOWCHART and the MODULE FLOWCHARTS relatively uncluttered by variables not related to the task at hand. Even though documentation can await completion of module 2 and/or module 4, it is preferable to document the value assigned to a variable as soon as it is determined.

DOCUMENTATION AND INDEX SELECTION

STORM ID/DATE, REMARKS:	MODULE	PARAMETER CATEGORY	VALUE	EVALUATION SCALE: COL D 0-9; COL E 1-9 MODULES 1-3: COL F IS THE SUM OF COLS. D&E. COL D: HOW ADEQUATE IS THE INPUT INFORMATION FOR THE REQUIREMENTS SET BY MODULE'S TECHNIQUE. COL E: HOW LIKELY IT IS THAT THIS TECHNIQUE WILL ESTIMATE THE CORRECT INDEX VALUE BASED ON ITS ASSUMPTIONS? FOR MODULE 4 SEE SELECTION RULE. OVERALL RULE: SELECT INDEX VALUE WITH LARGEST COL. F SCORE. LARGEST SUBSCRIPT BREAKS TIES. REMARKS	D	E	F
	0	RCAT BFAC MXVATS DADRF PA PC					
	1	RNOVAL PCT1 I1					
	2	AI LOFACA PB LOFAC HIFX DADFX PA ⁻¹ PX $\sum_{i=1}^n (F_i + E_i)$ PCT2 I2 PCT22					
	3	COLUMN INFLW DIR. INFLW SPD. GRAD. ELEV. V ₀ STABILITY A ₀ SURFACE UPPER AIR RAOB SATELLITE RADAR F _a PCT3 I3 $(PCT22 + PCT3)/2$ I5 $(PCT1 + PCT3)/2$ I4	A B C				
	4						RETURN TO MAIN FLOWCHART

Figure 7.8.—Documentation form for SSM, module 5.

Values were assigned to column D during the review in module 0. This was necessary in the evaluation of the adequacy of data for application of modules 1, 2, and 3 to a particular storm. After completion of the first four modules, it is appropriate to review the values assigned for the adequacy of the data. In some cases, changes in values assigned to column D for some modules are appropriate. Any changes in values assigned in column D should be documented.

Assigning of values to columns E in module 5 involves subjectivity which must be the case because the "correct" value cannot be known and, hence, there is no way to know which of the various techniques used produces "correct" results most frequently. After the storm has been evaluated in each of the modules, all the information is available to assign a value for column E for modules 1 through 3. At this point, the value assigned to column E results from answering this question: For the type of storm selected and for the area/duration category chosen, what is the degree of confidence (i.e., how likely is it) that the particular technique (based on the validity of the assumptions underpinning it) will produce the "correct" result? The scheme for assigning values to column E is:

- For modules 1, 2, and 3, if confidence is high, assign a value of either 7, 8, or 9 (9 being the highest of all) to column E.
- If confidence is low, assign a value of either 1, 2, or 3 (where 1 is lowest, zero is not valid).
- If the level of confidence is other than high or low, you must assign a value of either 4, 5, or 6.
- If the entry value for the module under consideration is 0 in column D, an entry of n/a is made in column E and a value of zero used when calculating a column F.
- It is unnecessary to evaluate columns D and E separately for module 4. Values to be assigned in column F for I₄ and I₅ can be determined from the following:

Level of agreement between modules (difference in index percentages)	Overall preference (difference in values assigned column F)		
	Little (0-2)	Some (3-5)	Strong (> 6)
Little (> .31)	A	B	B
Some (.16 - .30)	A	AB	B
Large (0 - .15)	A	A	B

Where:

- A = use the higher of the values from column F for I₄ or I₅.
- B = use the lower of the values from column F for I₄ or I₅.
- AB = use either the higher or the lower value from column F for I₄ or I₅.

DOCUMENTATION AND INDEX SELECTION

STORM ID/DATE, REMARKS: **Gibson Dam, MT (75) 6/6-8/64**

MODULE	PARAMETER CATEGORY	VALUE	EVALUATION SCALE: COL.D 0-9; COL.E 1-9 MODULES
0	RCAT	10 mi ² /24 hr	1-3: COL.F IS THE SUM OF COLS. D&E. COL.D: HOW ADEQUATE IS THE INPUT INFORMATION FOR THE REQUIREMENTS SET BY MODULE'S TECHNIQUE. COL.E: HOW LIKELY IT IS THAT THIS TECHNIQUE WILL ESTIMATE THE CORRECT INDEX VALUE BASED ON ITS ASSUMPTIONS? FOR MODULE 4 SEE SELECTION RULE.
	BFAC	14.9	OVERALL RULE: SELECT INDEX VALUE WITH LARGEST COL. F SCORE. LARGEST SUBSCRIPT BREAKS TIES.
	HKVATS	16.4	REMARKS
	DADRF	.91	
	PA	.40	
	PC	0	
1	RNOVAL	7.5	
	PCT1	6.4	
2	AI	1.0	
	LOFACA	6.0	
	PB	.1	
	LOFAC	5.7	
	HIFX	6.0	
	DADFX	5.5	
	PA ⁻¹	2.5	
	PX	13.7	
	n	1	
	$\sum(F_i + B_i)$.8 + .4 = 1.2	
3	PCT2	.57	
	I ₂	10.7	
4	PCT22	.72	
	COLUIN	A B C	
	INFLOW DIR.	1080	
	INFLOW SPD.	2.3 ms ⁻¹	
	GRAD. ELEV.	.0255 .8	
	W0	1.0	
	STABILITY	Ma .6	
	A ₀	Ma .7	
	SURFACE	.7	
	UPPER AIR	.85	
	RAOB	.6	
	SATELLITE	NA	
	RAOAR	NA	
	P _a	.75	
	PCT3	.49	
I ₃	7.3		
(PCT22 + PCT3)/2	.61		
I ₅	9.1		
(PCT1 + PCT3)/2	.46		
I ₄	6.9		
RETURN TO MAIN FLOWCHART			

Ma = moist adiabatic saturated
 Ma = not applicable
 Grad. Elev measured upwind of anemometer
 MAX between 6000 and 7000 Ft

Figure 7.9.—Completed module 5 documentation form for Gibson Dam, MT storm (75) of June 6-8, 1964.

Obviously, the scheme is designed to permit selection of I₁, I₂ or I₃ when there is a strong preference for one of them and to select I₄ or I₅ when there is little overall preference. In the case where there is some preference for a given module and some agreement between the index values generated therefrom, the analyst must make a decision as to which index is to be preferred. The range of values used to represent index agreement categories was based on values actually selected in a test involving six different analysts working with six different storms.

The final value selected for FAPP is determined by the largest value in column F. If the same value has been computed for more than one index value, the index with the largest subscript is selected (I₂ over I₁, I₃ over I₂).

7.5 Example of Application of SSM

One of the most critical storms for determining the PMP in the CD-103 region occurred at Gibson Dam, MT on June 6-8, 1964 (75). Figure 7.9 shows the completed module 5 worksheet for this storm for the 24-hr 10-mi² precipitation. The final percentage selected for this storm was 61 percent for PCT5. This gave an FAPP of 9.1 in.

7.6 Application of SSM to this Study

The SSM was used in this study to estimate FAPP for just one category, 10 mi² and 24 hr. This category was selected as the key (index) category for this study for several reasons. The first reason relates to area size. In determination of the effects of orography on precipitation, it is easiest to isolate these effects for the smaller areas. In addition, if larger area sizes were used, the determination of the orographic effects for computation of the final PMP values would have been very complicated. At some transposed location, the increase in precipitation as a result of orographic effects for a very small area can be determined with little ambiguity. If a larger area (e.g., 1,000 mi²) was used, the effect of terrain at a transposed location would be related directly to the shape and orientation of the 1,000-mi² area selected. This factor, therefore, indicated use of the 10-mi² area as most appropriate.

The 24-hr duration was selected because of the reliability of data for this duration. For storms before 1940, the amount of recording rain gauge information is relatively sparse. Determination of amounts for durations less than 24 hr for these storms is based on only limited data. This indicates use of a storm duration of 24 hr or longer. A review of the important storms in this region shows several that did not last the entire 72-hr time period of interest in the present study. Most notable of these are the Gibson Dam, MT storm (75) and the Cherry Creek (47), Hale (101), CO storms. These two factors made selection of the 24-hr duration most appropriate. Selection of this duration also had the advantage of minimizing the extrapolation required to develop PMP estimates for the range of durations required in the study.

APPENDIX 4

EXTREME LOCAL STORMS

Chapter 11 of this report discusses development of local storm PMP for the Pacific Northwest based on a survey of significant storm events. In the course of that effort, additional information was compiled that may be of interest or provide clarification to some of the results obtained in the study. While this additional information was considered in the report's development, the detailed discussion was believed unnecessary to the chapter and has been relegated to this appendix. The interested reader may wish to refer to Chapter 11 while considering the information contained in this appendix.

Extreme Local Storm Discussions

A brief discussion of some of the more important PMP controlling storms is presented in this section. Some of the distinctive characteristics and significant aspects regarding these storms are given.

Aberdeen 20 NNE, Washington - May 28, 1982

The extreme local storm at Aberdeen 20 NNE, Washington, occurred under comparatively rare synoptic conditions for the development of extreme local storms in the Pacific Northwest.

Aberdeen 20 NNE, Washington, is located some 25 miles inland from the Pacific Ocean at an elevation of 435 feet in the foothills of the Olympic Mountains to the northeast. West and southwest of the station to the Pacific is essentially free of barriers, so that the moisture source for storms is almost exclusively from this body of water. During the storm of May 28, 1982, 2.4 inches fell in a sixty-minute period ending at 1530 LST, with 2.3 inches in 45 minutes, 1.8 inches in 30 and 1.1 inches in the most intense 15-minute period. The occurrence of the storm in May was also somewhat untypical of extreme Pacific Northwest storms, although this pattern may not hold true along the coast.

Many of the synoptic features present in other extreme local storms in the Pacific Northwest were absent prior to the Aberdeen storm. The position of the storm event relative to the 500-mb trough (or closed low, in this case) was to the west of it both before and after, with upper-level winds from the north-northwest. This was a very infrequent occurrence among the extreme storms; in fact no other storm had due north winds at 500 mb, although several had west-northwest winds. An unseasonably deep low (546 dm versus seasonal mean height of 564 dm) at 500 mb, moved into Washington on the 27th. Scattered light rainfall

associated with this system fell statewide on the 26th and 27th, although no heavy rains were reported. On the 28th the low drifted slowly southeastward, filling slightly. Close inspection of the 500-mb map also reveals a jet maxima of 45 kt. near Vancouver Island, which appeared to be working its way down the west side of the trough and may have been a cause of strong wind shear, an important factor in many severe thunderstorms (Browning, 1968; Doswell, 1982). Examination of the 12-hour, 500-mb height and vorticity maps from NMC reveals the existence of a very strong positive vorticity maxima ($16 \times 10^{-5} \text{ sec}^{-1}$) probably associated with this jet streak, located very nearly over Aberdeen near the time of the storm. Both these factors were likely important contributors to the rapid destabilization of the atmosphere. Very cold temperatures aloft (-25°C at 500 mb versus normal of -19°C) were also found over the area, creating sharp lapse rates and adding to the instability of the air mass.

The surface weather maps from May 28 showed a weak low (1013 mb) in central Idaho, causing rain and even some snow as far east as Montana. A weak ridge was located across the Olympic Peninsula into Vancouver Island. A strong surface high (1036 mb) was also well entrenched over the eastern Pacific Ocean near 50°N 145°W . Subsidence which is often found on the eastern side of a high pressure area may have contributed to the existence of a capping inversion over the area. Such a feature has been generally recognized as one of the important pre-severe storm indicators (Carlson, et. al., 1983). The removal of this lid to moist convection is often caused by either strong vertical motions or surface heating, both of which were present in the vicinity of Aberdeen.

Surface winds on the 0400 LST map showed a variable inflow direction to Aberdeen, indicating that low-level convergence was possible at a number of locations in the region. Although the storm took place in the mid-afternoon (beginning about 1430 LST), diurnal heating does not appear to have been a major causal factor in the development of this storm. Maximum temperatures were only in the mid 60's ($^{\circ}\text{F}$), with partly cloudy skies prevailing much of the day. Synoptic observations from nearby stations confirm that thunderstorm activity was present across the region, although it seems to have been fairly scattered. Hoquiam FAA AP, Washington, 20 miles southwest of Aberdeen, received a thunderstorm of 36 minutes duration beginning at 1446 LST, which was reported as having moved in from the northeast. This was most likely the same storm which affected Aberdeen 20 NNE earlier. The direction of movement is consistent with the 500-mb windflow. Olympia WSO, Washington, 40 miles southeast of Aberdeen, also reported cumulonimbus to the northwest and southwest moving toward the south, but no rain fell at Olympia WSO.

In terms of moisture conditions and sources, the storm was also somewhat atypical. Although the ultimate moisture source must have been the Pacific Ocean, the northerly flow around the low brought relatively cool maritime air to the region. Surface dew points at Aberdeen and nearby stations ranged from the

mid 40's to low 50's (°F) throughout the day of the storm. These values, while close to seasonal normals, were still well below the maximum values which have been observed for this area.

In summary, this was a storm characterized by the strong dynamical forcing of a vigorous upper-level low, very cold air aloft and a well-defined jet maxima with strong positive vorticity advection. At the surface, a weak flow favoring localized convergence was combined with a moderate supply of moisture and the normal diurnal heating of late May.

Girds Creek/Mitchell, Oregon - July 13, 1956

The local storm near Girds Creek/Mitchell, Oregon, on July 13, 1956, about 1700 LST, produced about 4 inches of rain in 30 minutes at the former location and 3.5 inches in the same time period (between 1600-1700 LST) at Mitchell. Located in north central Oregon at an average elevation of 4000 feet and rising southward to a plateau of 6000 feet, there is the potential for some orographic effect on storms in this area, although the influence of elevation on extreme local storms remains uncertain.

The synoptic situation prevailing up to and during this storm was one which has occurred in a significant number of extreme local storms in the Pacific Northwest. This pattern features a low or trough at the surface and a position east of an upper trough axis, usually at the 500-mb level. A deep upper low just off the California coast late on the 12th moved slowly onshore during the 13th, pulling considerable Pacific moisture inland across the northwestern states. A westward extension of the Bermuda High, centered over New Mexico, interacted with this trough to augment the northward flow of moisture across the region. The low-latitude position in mid-July of the low off California was the most climatologically unique aspect of the upper-level airflow leading up to this storm. An analysis of 700-mb moisture flow around these two features revealed a clear tongue of moisture wrapping around to the north of the closed low, with a dry slot east of the low. The axis of moist air was located in a position just to the south of the Girds Creek/Mitchell area. Surface dew points analyzed for this event showed that the 12-hour persisting dew point was 65°F, while a 3-hour persisting dew point of 67°F has been calculated. This would place the 12-hour value within 5°F of the maximum persisting dew point for that time frame.

The surface weather map features associated with this local storm were, as noted earlier, a weak low or trough and no large-scale synoptic forcing. A northward extension of the southwestern U.S. thermal low reached into Oregon and Washington on the 12th. A low (1004 mb) developed over Washington early on the 13th in response to the short wave energy moving through the base of the British Columbia upper trough. No frontal activity was evident during this period, although a trough of low pressure may have caused enough low-level convergence to act as a triggering mechanism for thunderstorm activity. The late

afternoon timing of the storm indicates that solar heating again played a role in the initiation of convection in the area, with maximum temperatures reaching the low 80's.

Heppner, Oregon - May 25, 1971

The Heppner, Oregon, storm of May 25, 1971, produced rainfall totals estimated by the U.S. Army Corps of Engineers of 3.0 inches in approximately 20 minutes. The storm occurred about 1500 local time and was quite localized. The town of Heppner itself recorded only .20 inches in the quarter-hour after 1500 LST, while the very heavy precipitation fell southeast of the town.

Heppner, Oregon, which has a history of disastrous flash floods (Bauman, 1980), is located in north central Oregon along Willow Creek, some 40 miles south of the Columbia River. The town is at an elevation of about 2000 feet, while the terrain rises rapidly to the south onto a high plateau of 3000-5000 feet. Northward, the terrain slopes gently downward to the Columbia River.

The synoptic conditions associated with the Heppner storm on May 25, 1971, were similar to the Maddox Type I (Maddox et al., 1980) flash flood event. These storm are characterized by a 500-mb short wave moving up the western side of a long wave ridge. Extreme local storms in the Pacific Northwest often occur under a similar upper-level configuration. The 500-mb pattern was undergoing rapid amplification, with a digging trough off the Washington-Oregon coast and a downstream long-wave ridge building over Montana and Alberta. This trough was quite strong for late spring. Winds over the Heppner region backed from westerly to southerly during the period leading up to the storm and increased sharply from near 10 kts. to 40 kts., creating the potential for significant wind shear. The presence of such wind shear generated by jet streaks has been found to augment the intensity of the convection (Ucellini, 1990). The increasing southerly flow aloft also induced a substantial rise in low to mid-level (from the surface to 450 mb) moisture. The relative humidity over a large area including northern Oregon during the 24 hours leading up to the storm increased from about 60 percent to over 90 percent. In addition, National Meteorological Center (NMC) vertical velocity maps for this same period showed a widespread area of positive vertical motion over the Pacific Northwest, including over the Heppner area. Another ingredient for the development of strong storms was the fact that 500-mb height surface fell some 60 meters in 12 hours, from 570 to 564 dm, indicating cooling aloft and added instability. Combined with the strong upper-level diffluence ahead of the approaching Pacific trough, these elements created a very favorable situation for strong thunderstorms.

The surface weather maps during the period leading up to the Heppner storm showed the approach and passage of a weak low and associated cold front. Significant rains were reported at many other stations across the state during the day, and were also probably associated with this front. The Heppner storm occurred well after the passage of this front in the comparatively cool sector

behind it. The cooling aloft however, combined with the strong late May sun, resulted in a very unstable atmosphere even behind this front. The destabilization of the atmosphere during the day is indicated by the successive development of cumulus, cumulus congestus, and finally cumulonimbus clouds at reporting stations across the region. A series of weak low pressure areas moved along the front south of Heppner during the day and provided an additional component of surface convergence, helping to focus the thunderstorm activity.

Morgan, Utah - August 16, 1958

The Morgan, Utah storm, although it occurred just outside the boundaries of the HMR-57 study area, is one of the most important storms in terms of setting the PMP for this region. It was also used in HMR 49 and HMR 55A as an extreme local storm and a detailed discussion of the meteorology can be found in HMR 50 (Hansen and Schwarz, 1981).

Opal, Wyoming - August 16, 1990

An extremely heavy local storm occurred near Opal, Wyoming, on the late afternoon of August 16, 1990. The storm produced approximately seven inches of rain in slightly less than two hours, over a very small area (Corrigan and Vogel, 1993). Although the storm took place outside the boundaries of the HMR 57 region, its proximity and location west of the Continental Divide make it an important storm nonetheless.

Opal, Wyoming, is located in southern Lincoln County in the southwest corner of the state. The coordinates are 41° 45'N, 110° 15'W, about 70 miles west of the Continental Divide. The terrain in the Opal area is generally high plateau of 6800-7000 feet above sea level, rising gently to the west. Sixty miles to the south rise the Uinta Mountains of northern Utah, while a southern extension of the Teton Range known as Commissary Ridge is located 30 to 40 miles to the northwest.

That this was truly an extreme "local" storm was evident from an examination of the 24-hour rainfall for stations within about a 60-90 mile radius of Opal. This showed that there was precipitation scattered throughout this area on the 16th, but of an extremely variable nature. Kemmerer, Wyoming, only 10 miles west of Opal, picked up only 0.10 inch on the same afternoon and Fontenelle Dam (20 miles north) received only 0.17 inch. Some more significant amounts were reported at stations in Utah and Idaho, the largest being 1.89 inches at Pine View Dam, Utah (70 miles west southwest), and 0.80 inch at Topaz, Idaho (85 miles west northwest). Hourly rainfall at nearby stations from 1400 through 1900 LST, a period encompassing the entire duration of the Opal storm, also showed little rainfall. The nearest hourly station, Mountainview, Wyoming, about 35 miles south, measured 0.10 inch ending at 1700 LST, about the time the Opal storm

began. Evanston, Wyoming, 50 miles southwest had 0.20 inch over the two-hour period ending at 1500 LST. Big Piney, Wyoming, 60 miles north, had no rainfall during this period or for the day.

The meteorological conditions approximately twelve hours prior to the storm were typical of a midsummer pattern over the U.S., although certain important ingredients for heavy rainfall were undoubtedly present. The 500-mb chart for August 16 at 1200 UTC contains some important features necessary to understand the development of this storm. There is a cold core low off the northwest coast, with its associated jet maxima of about 35 kts. reaching northeastward through Oregon and Washington. More importantly however, is the short-wave trough sagging southward through Utah. The negative tilt ridge to the east, combined with this trough, are pulling extremely moist air northward into Utah and southwestern Wyoming, west of the Continental Divide. This is clearly evident from the axis of low dew point depressions extending from Ely, Nevada, northeastward to Lander, Wyoming. Opal, Wyoming, is located directly beneath this axis. It is worth noting that three other important mid-western flash flood events took place under negative tilt ridges; 1972 Rapid City, South Dakota, 1976 Big Thompson, Colorado, and 1985 Cheyenne, Wyoming (Chappel and Rogers, 1988).

The track of the 500-mb short-wave trough was clearly evident from the Nested Grid Model (NGM) height/vorticity analyses from August 16 and August 17. These depict the slow progress and intensification of the short-wave trough as it moved from southwest Utah to a position near Salt Lake City (SLC) in 24 hours (August 17 0000 UTC). The absolute vorticity increased to $12 \times 10^{-5} \text{ sec}^{-1}$ over a small area of northeast Utah and southwest Wyoming very close to the time of the Opal storm. Clearly, the upper-air dynamics were at a maximum in both time and space very close to Opal. The 700-mb analysis map approximately 12 hours prior to the storm (16 August 1200 UTC) showed a large pool of moisture, with 6°C dew point air through western New Mexico extending northward to about Grand Junction, Colorado (GJT). The northern edge of this moisture was marked by the -2°C dew point at Lander, Wyoming (LND), just east of the Continental Divide. Relative humidity at low and mid-levels (mean of surface to 450 mb) showed an increase from 50 percent to 70 percent during this time.

The 500-mb analysis for August 17 0000 UTC shows an upper low centered along the Utah-Wyoming border, with the short-wave trough rotating through the area. A broad pool of moisture is evident from the low dew point depression air covering all of Utah, western Wyoming, and Colorado. The precipitable water (surface to 500 mb) at SLC was 1.14 inches or 185 percent of normal and at GJT 1.08 inches or 165 percent of normal. Average relative humidity (surface to 500 mb) was also highest over northeast Utah and southwest Wyoming, with 86 percent measured at SLC. A sharp transition to lower humidity occurred east of the Continental Divide, as shown by a rapid decline in relative humidity at LND, strong confirmation of the hypothesis that the air had Pacific moisture origins.

Mid-level moisture (700 mb) was also high over most of Utah, and was moving slowly northeast with time. The 700-mb analysis for August 17 at 0000 UTC showed the highest dew point temperatures to be located over extreme southwest Wyoming, eastern Utah, and western Colorado. The thermal ridge was still centered across Wyoming, as shown by the 14°C reading at Lander, the warmest in the U.S. This is convincing evidence of the subtropical origins of the air in the region when the storm occurred. Miller (1967), in his treatise on severe storm forecasting, has stated that the 700-mb 10-14°C isotherm in summer is a favored area for significant thunderstorm outbreaks. The 700-mb wind field at this time was quite weak, with light (10 kts.) southerly winds at Grand Junction (GJT) and light and variable indicated at LND. This certainly lends support to the idea that most of the thunderstorms which developed on this day were of the single-cell variety. The importance of strong wind shear to the development of multicellular or supercell thunderstorms is well recognized; the winds in the Opal vicinity did not appear to be nearly vigorous enough for this type of storm development.

At 850 mb on August 17 0000 UTC, a pocket of 14°C dew point air was cut off over extreme northeast Utah and southwestern Wyoming. This moisture appears to have been the low-level source for the storm at Opal and the numerous other scattered storms that were reported on the 16th, mostly in northern Utah. A thermal ridge across western Wyoming was evident by the 30°C 850-mb reading at LND, while SLC is at only 16°C. Miller (1967) also points out the importance of hot air intrusion at 850 mb for the development of severe summer thunderstorms. The large temperature difference between the two stations is a result of the mid-level cloudiness over most of northern Utah, while southwest Wyoming was mostly under clear skies, adding to the potential for destabilization over Wyoming.

The surface weather map for August 16 at 1200 UTC, the morning of the storm, showed a typically disorganized summer pattern across the western U.S. The usual southwestern U.S. thermal trough extended north from Baja California, while a very weak surface low and associated trough was moving across southern Idaho, and western Utah. Weak high pressure was centered over western Oregon and the four corners area. Later in the day (2100 UTC, 1500 local) several surface developments were noted which may have contributed to the Opal deluge: 1) the eastward progression of the weak trough across Utah which assisted in scattered thunderstorm development in the state. This trough was likely an important ingredient in the surface convergence necessary for thunderstorm development at Opal as well; 2) the buildup of a large and impressively moist pool of air over northern Utah, southeast Idaho, and southwest Wyoming over the course of the day. The bulk of this moisture is concentrated over the Great Salt Lake Basin and the surrounding area and it seems reasonable to assume that some of the high dew point air in the Salt Lake vicinity reached extreme southwest Wyoming.

The most likely ingress of high surface moisture from northern Utah into southwest Wyoming appears to be through the valley of a tributary of the Bear River northeast of SLC. Isodrosotherms (for 1000 mb) drawn from hourly surface

observations showed at least 70°F (21°C) dew points in southwest Wyoming. This compares with a three-hour maximum persisting dew point of 76.5°F for August, but is still at least 15°F above normal for the season, a substantial departure for the summertime.

In addition to high moisture, another essential ingredient for strong thunderstorms is adequate vertical motion, which can occur in very unstable air masses. The K index (George, 1960), best used as an indicator of summertime air mass thunderstorms, without frontal or cyclonic activity, was calculated for the surrounding radiosonde stations. Its value at 00Z August 17 ranged from 43 at Grand Junction, Colorado, to 24 at BOI. The K index was used by Lee (1973) and Hambidge (1967) in analyses of thunderstorm probability in the western U.S. Values over 40 represent nearly a 100 percent probability of thunderstorm occurrence, while above 30 gives a 80-90 percent probability of thunderstorms. It is evident that the area was well primed for the development of thunderstorms on August 16. The Showalter Index, one of the most frequently applied stability indices, fell to -2 at LND and nearly -1 at SLC, values generally associated with a high probability of severe thunderstorms. Although no severe thunderstorm watches or warnings were in effect on the afternoon of the 16th, there was some evidence that severe weather did occur. The most compelling indication was the statement from the observer at SLC at 1505 LST (2205 UTC), noting a report of a tornado touchdown five miles west of SLC. The infrequency of tornado occurrences in this region (Doswell and Keller, 1990) is an indicator of the exceptional conditions associated with this air mass.

Synoptic Study of Pacific Northwest Extreme Local Storms

In order to better understand the nature of local storms in the Pacific Northwest region, a study was undertaken to determine basic weather patterns associated with these extreme convective events. The sources for this study included the Daily Weather Map Series, hourly surface observations and supplemental meteorological data where it was readily available. These data included 3-, 6-, and 24-hourly surface maps, 500-mb height and vorticity maps, and 700-mb relative humidity and vertical velocity maps.

A total of 106 (for which adequate data and maps were available) precipitation events were selected (Table A4.1 and Figure A4.1) for study, which had at least a 50-year return period rainfall, based on data from NOAA Atlas 2 (Miller et al., 1973), and met the criteria set for local storms. A simple classification scheme was developed based on the surface and upper-air patterns which were in existence at the time the storm occurred.

Three basic surface patterns were recognized; these were 1) low pressure or trough; 2) frontal; 3) high pressure or air mass. In the mid-troposphere, usually 500-mb level, three basic upper-air patterns were also identified, resulting in a total of nine categories when the two were combined. The upper air patterns trough axis; 2) east of ridge/west of trough axis; 3) zonal.

Table A4.1.--Extreme Local Storms in the Pacific Northwest and Adjacent Areas.

LOCATION	LAT o , o ,	LONG o , o ,	ELEVATION (Feet)	DATE	RAINFALL (Inches) Max. 1-Hour	RAINFALL (Inches) Max. 6-Hour
<u>IDAHO</u>						
1. ANDERSON DAM 1 SW	43 20	115 29	3870	08/21/65	1.27	1.69
2. ARROWROCK DAM	43 36	115 55	3240	06/16/84	1.00	1.90
3. BENTON DAM	48 21	116 50	2640	07/29/58	0.90	0.97
4. BIG CREEK	45 06	115 20	5740	07/15/54	0.90	1.04
5. BOISE LUCKY PEAK DAM	43 33	116 04	2830	08/09/68	1.50	1.90
6. BURLEY FACTOR	42 33	113 48	4140	08/30/63	0.96	1.20
7. CLARKIA RS	47 01	116 16	2810	07/07/58	1.35	2.22
8. COEUR D'ALENE RS	47 46	116 49	2160	08/01/48	1.09	1.19
9. COTTONWOOD 2 SW	46 02	116 23	3600	08/01/48	1.50	2.10
10. COUNCIL 2 NNE	44 44	116 26	3150	07/18/76	1.60	2.80
11. GRASMERE 8 S	42 18	115 53	5200	06/08/77	1.10	1.80
12. HENRY	42 54	111 31	6350	07/21/73	1.30	1.50
13. IDAHO FALLS 6 NE	43 29	111 40	4840	07/14/54	1.13	1.13
14. IDAHO FALLS 16 SE	43 21	111 47	5710	06/15/62	0.91	1.09
15. IDAHO FALLS 43 NW WB	43 36	112 54	4780	06/13/58	1.15	1.20
16. LEADORE	44 41	113 22	6100	07/21/77	1.22	1.23
17. LEADORE	44 41	113 22	6100	08/12/63	1.14	1.19
18. MALAD	42 11	112 15	4420	07/29/69	1.00	1.22
19. MCCALL	44 54	116 07	5030	07/27/84	1.80	1.90
20. PALISADES DAM	43 21	111 13	5390	08/25/61	0.95	1.11
21. PIERCE	46 30	115 48	3190	08/15/72	1.15	1.30
22. PRAIRIE	43 30	115 35	3190	08/06/63	1.20	1.36
23. WALLACE WOODLAND PK	47 30	115 53	2950	08/12/64	1.12	1.28
24. REYNOLDS CREEK	43 15	116 45	3700	07/21/75	1.28	1.47
25. SIMON RANCH	43 15	115 45	5000	07/21/56	2.50	2.50
26. MERIDIAN	43 37	115 25	2600	06/21/67	2.75	2.75

Table A4.1.-Extreme Local Storms in the Pacific Northwest and Adjacent Areas (Cont.).

LOCATION	LAT 0 ,	LONG 0 ,	ELEVATION (Feet)	DATE	RAINFALL (Inches) Max. 1-Hour	RAINFALL (Inches) Max. 6-Hour
<u>OREGON</u>						
27. AUSTIN	44 35	118 30	4210	08/21/86	1.00	1.70
28. BEND	44 04	121 19	3599	08/08/50	1.24	1.58
29. BAKER 1 S	44 45	117 49	3490	06/19/69	1.03	1.16
30. BLY RS	42 24	121 03	4360	07/12/56	1.46	1.90
31. BLY RS	42 24	121 03	4360	06/07/77	1.15	1.36
32. BUNCOM 2 SE	42 09	122 59	1930	05/12/69	1.20	2.10
33. BUNCOM 2 SE	42 09	122 59	1930	06/07/83	1.45	2.66
34. BURNS WB CITY	43 35	118 57	4140	06/03/48	0.90	1.70
35. BUTTE FALLS 1 SE	42 32	122 33	2500	10/01/76	1.10	1.50
36. BUTTE FALLS 1 SE	42 32	122 33	2500	06/20/82	1.10	1.20
37. COPPER 2 NE	42 04	123 06	1780	07/20/83	1.70	1.80
38. COUGAR DAM	44 08	122 15	1260	07/10/75	1.80	2.30
39. EUGENE WB AP	44 07	123 13	360	08/21/79	1.11	1.82
40. FERN RIDGE DAM	44 07	123 18	380	06/28/84	1.50	1.60
41. GLENDALE 2 NE	44 44	123 26	1500	07/19/83	1.30	1.60
42. HILLS CREEK DAM	43 43	122 26	1280	05/31/64	0.92	1.34
43. IMNAHA	45 34	116 50	1850	08/26/66	1.15	1.32
44. IMNAHA	45 34	116 50	1850	07/27/84	1.00	1.30
45. JORDAN VALLEY	42 59	117 04	4260	08/01/65	1.20	1.20
46. JOSEPH RS	45 23	117 14	4020	07/12/75	1.10	1.20
47. LACOMB 1 WNW	44 38	122 44	610	08/16/78	1.10	1.50
48. LEE'S CAMPS	45 36	123 31	600	07/14/83	1.10	1.10
49. MARION FORKS FISH H	44 36	121 57	2450	08/05/53	1.09	1.30
50. MEDFORD WB AP	42 23	122 53	1310	05/18/56	1.40	1.67
51. MEDFORD WB AP	42 23	122 53	1310	09/05/53	1.27	1.32
52. OWYHEE DAM	43 38	117 13	2400	06/14/64	1.20	1.39
53. SALEM WB AP	44 55	123 01	200	06/10/50	1.24	1.56
54. SEXTON SUMMIT WB	42 37	123 22	3848	06/28/78	1.87	2.14
55. TILLER RS	42 56	122 57	1040	06/28/78	1.30	2.50
56. TRAIL 15 NE	42 46	122 37	2100	08/02/58	1.89	1.90
57. UKIAH	45 08	118 56	3340	07/09/75	1.90	2.10
58. UNION	45 13	117 53	2770	06/16/63	1.02	1.12
59. UPPER STEAMBOAT CK	43 29	122 36	1860	06/18/82	1.10	1.20

Table A4.1.--Extreme Local Storms in the Pacific Northwest and Adjacent Areas (Cont.).

LOCATION	LAT o , o ,	LONG o , o	ELEVATION (Feet)	DATE	RAINFALL (Inches) Max. 1-Hour	RAINFALL (Inches) Max. 6-Hour
60. GIRDS CREEK	44 40	120 10	4000	07/13/56	4.00	4.00
61. HEPPNER	45 20	119 33	3000	07/13/56	3.00	3.00
62. BIRCH CREEK	45 20	118 55	3000	06/22/38	2.50	2.50
63. JOHN DAY	44 25	118 53	3200	06/09/69	5.00	7.00
<u>WASHINGTON</u>						
64. CINEBAR 2 E	46 36	122 30	1000	06/09/53	1.20	1.99
65. CAMP GRISDALE	47 22	123 36	820	06/25/68	1.20	1.30
66. CHIEF JOSEPH DAM	48 00	119 39	820	07/25/87	0.90	1.00
67. DAYTON 2 SE	46 18	118 00	1750	07/07/78	1.20	1.20
68. DIABLO DAM	48 43	121 09	890	09/04/86	1.00	1.20
69. EASTON	47 15	121 11	2170	08/26/83	1.80	1.10
70. MAZAMA	48 37	120 27	2180	07/16/85	0.90	1.10
71. METHOW	48 08	120 00	1160	08/10/48	1.08	1.08
72. NACHES 10 NW	46 52	120 46	2380	07/07/82	1.20	1.20
73. OROVILLE 1 S	48 56	119 26	920	06/11/64	1.27	1.27
74. PULLMAN 2 NW	46 46	117 12	2545	06/16/63	1.35	1.47
75. RANDLE 1 E	46 32	121 56	950	08/28/57	1.20	1.47
76. REPUBLIC RS	48 39	118 44	2630	08/09/62	1.21	1.29
77. REPUBLIC RS	48 39	118 44	2630	07/05/58	1.00	1.10
78. SILVERTON	48 04	121 34	1480	08/05/77	1.10	1.34
79. WALLA WALLA WB CITY	46 02	118 20	950	05/26/71	0.98	1.84
80. WILSON CREEK	47 25	119 07	1280	06/18/50	1.47	1.53
81. ABERDEEN 20 NNE	47 16	123 42	440	05/28/82	2.40	2.50
82. SKYKOMISH	47 42	121 22	1030	05/25/45	1.78	1.78
83. WENATCHEE EXP STN	47 26	120 21	806	08/10/52	1.25	1.29
84. CASTLE ROCK	46 16	122 55	43	08/23/63	1.06	1.12
85. KNAPP COULEE	47 49	120 08	1500	08/15/58	1.50	1.50
86. WINTHROP 1 WSW	48 20	120 11	1755	07/29/58	3.00	3.00
<u>CALIFORNIA</u>						
87. ALTURAS	41 30	120 33	4460	06/06/52	1.13	1.20
88. ETNA	41 28	122 54	2910	06/07/77	1.40	1.80

Table A4.1.--Extreme Local Storms in the Pacific Northwest and Adjacent Areas (Cont.).

LOCATION	LAT o ' 0 "	LONG o ' 0 "	ELEVATION (Feet)	DATE	RAINFALL (Inches) Max. 1-Hour	RAINFALL (Inches) Max. 6-Hour
<u>UTAH</u>						
89. FARMINGTON WHESE STA	40 58	111 53	4330	06/01/63	1.75	2.24
90. LOGAN USAC	41 45	111 48	4780	08/11/83	1.10	1.30
91. OGDEN PIONEER PH	41 15	111 57	4350	08/18/79	1.30	1.40
92. OGDEN SUGAR FACTORY	41 14	112 02	4280	09/08/67	1.20	1.20
93. OGDEN WBO	41 12	111 58	4440	06/18/49	1.04	1.26
94. MORGAN	41 03	111 38	5150	08/16/58	6.75	6.75
95. NORTH OGDEN	41 20	111 55	4800	09/07/91	1.75	5.50
<u>NEVADA</u>						
96. CONTACT	41 47	114 45	5370	06/13/83	1.00	1.20
97. ELKO	40 50	115 47	5080	08/27/70	3.47	4.13
<u>MONTANA</u>						
98. AUGUSTA	47 29	112 23	4070	07/05/51	1.80	1.83
99. CAMERON	45 12	111 41	5500	07/01/65	1.55	2.26
100. CUT BANK CAA AP	48 23	112 22	3840	07/11/56	1.30	1.37
101. DUTTON 6 ESE	47 51	111 35	3590	07/02/66	2.15	2.89
102. KALISPELL WB AP	48 18	114 16	2970	06/29/82	2.57	2.68
103. LIVINGSTON FAA AP	45 42	110 27	4690	08/24/79	2.63	3.19
104. STEVENSVILLE	46 31	114 06	3370	07/31/83	1.70	1.90
105. WISDOM	45 37	113 27	6060	06/17/50	1.20	1.36
<u>WYOMING</u>						
106. OPAL	41 45	110 15	6900	08/16/90	5.75	7.00

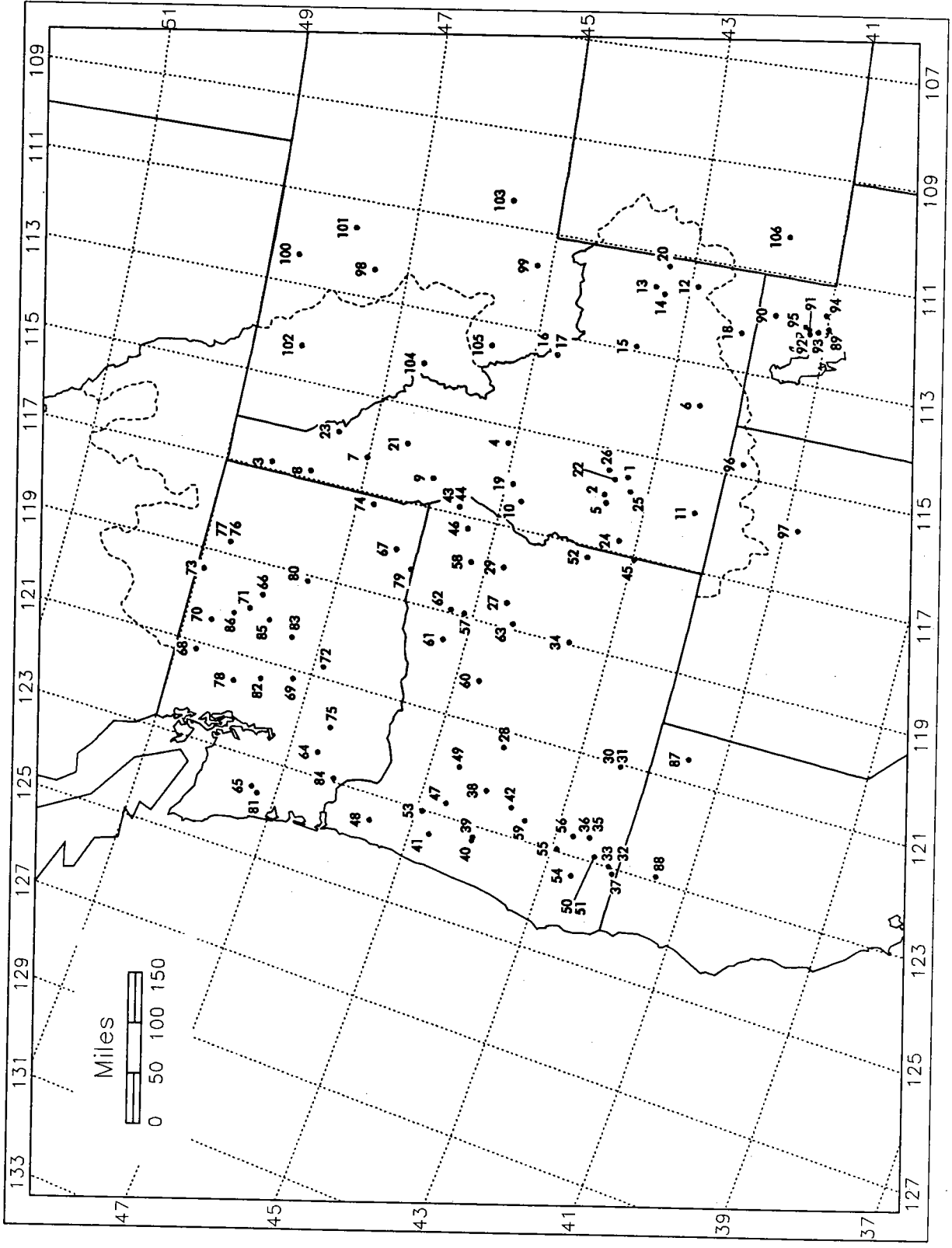

Figure A4.1.--Location of extreme local storms.

Table A4.2 shows the frequency of occurrence of the nine categories selected and Table A4.3 shows the mean values for selected meteorological variables within each group. For comparison, Table A4.4 shows mean height and temperature at 500 mb for three selected stations in the region.

Synoptic Pattern: SFC/UA	1. W of Ridge/ E of Trough	2. E of Ridge/ W of Trough	3. Zonal	Total
1. Low; trough	45	2	4	51
2. Frontal	19	3	5	27
3. Air Mass; High	19	3	3	25
Total	83	8	12	103

Source: Extreme local storm database

Type/ Means (#)	1-hour Prec. (in.)	500- mb ht. (feet)	500-mb temp. (C)	500-mb wind speed & dir. (kts. and deg.)	Max. sfc. temp (F)	24-hour per. dew point (F)	Maximum dew point (F)
11 (45)	1.67	18835	-14.1	23.7 215	84.3	55.6	60.1
12 (2)	1.05	19000	-13.0	13.5 230	94.0	58.0	62.5
13 (4)	1.27	18950	-13.7	22.0 275	88.3	57.0	60.8
21 (19)	1.23	19000	-12.0	21.4 228	84.2	56.6	62.0
22 (3)	1.17	18767	-14.3	18.3 280	84.7	51.7	65.0
23 (5)	1.39	18940	-12.0	23.0 268	78.8	51.0	57.8
31 (19)	1.75	19213	-9.7	21.5 234	87.6	57.9	62.6
32 (3)	1.76	18450	-21.0	26.0 330	66.0	47.7	51.7
33 (3)	1.85	18833	-14.7	19.3 277	76.3	54.7	56.0

Station	May	June	July	August	September	October
Boise, ID	-18.31 18580	-14.10 18841	-10.45 19150	-11.25 19101	-12.81 18950	-15.43 18783
Medford, OR	-18.46 18572	-13.99 18829	-10.33 19110	-11.20 19065	-11.66 18986	-14.45 18799
Spokane, WA	-21.06 18346	-17.54 18563	-15.15 18829	-14.41 18802	-14.52 18750	-18.54 18458

Source: Crutcher, H. L. and J. M. Meserve, "Selected Level Heights, Temperatures and Dew Points for the Northern Hemisphere" Naval Weather Service Command, Washington, D.C., 1970

Persisting Dew Point Data

In order to develop maps of persisting 3-hour dew points, data for the period from 1948-1974 were extracted from hourly data tapes for 27 stations in or near the study region (Figure A4.2). From this data base, periods of elevated dew points were selected for analysis.

These high dew point episodes were examined meteorologically to insure that only those that occurred under conditions favorable for the development of local storms were included. High dew points resulting from highly stable, inversion conditions, or when rain was occurring at the point of observation were not considered for further analysis for several reasons. First, an air mass that is too stable is very unlikely to be associated with the strong upward vertical velocity needed to produce heavy rain. Second, extremely high moisture in an inversion situation may become trapped in the lowest layers of the atmosphere, leading to an overestimate of the vertical moisture distribution and inaccurate in-place adjustments. Third, hourly precipitation data were checked for the occurrence of scattered short-duration afternoon and evening rainfalls, typically the result of local storm rainfalls. Rain at the time of the observation could give an unrealistically high value for that station. Hourly observations for individual weather stations were also examined to check for potential observational error in the dew point measurements and to obtain more detailed information about the synoptic situation.

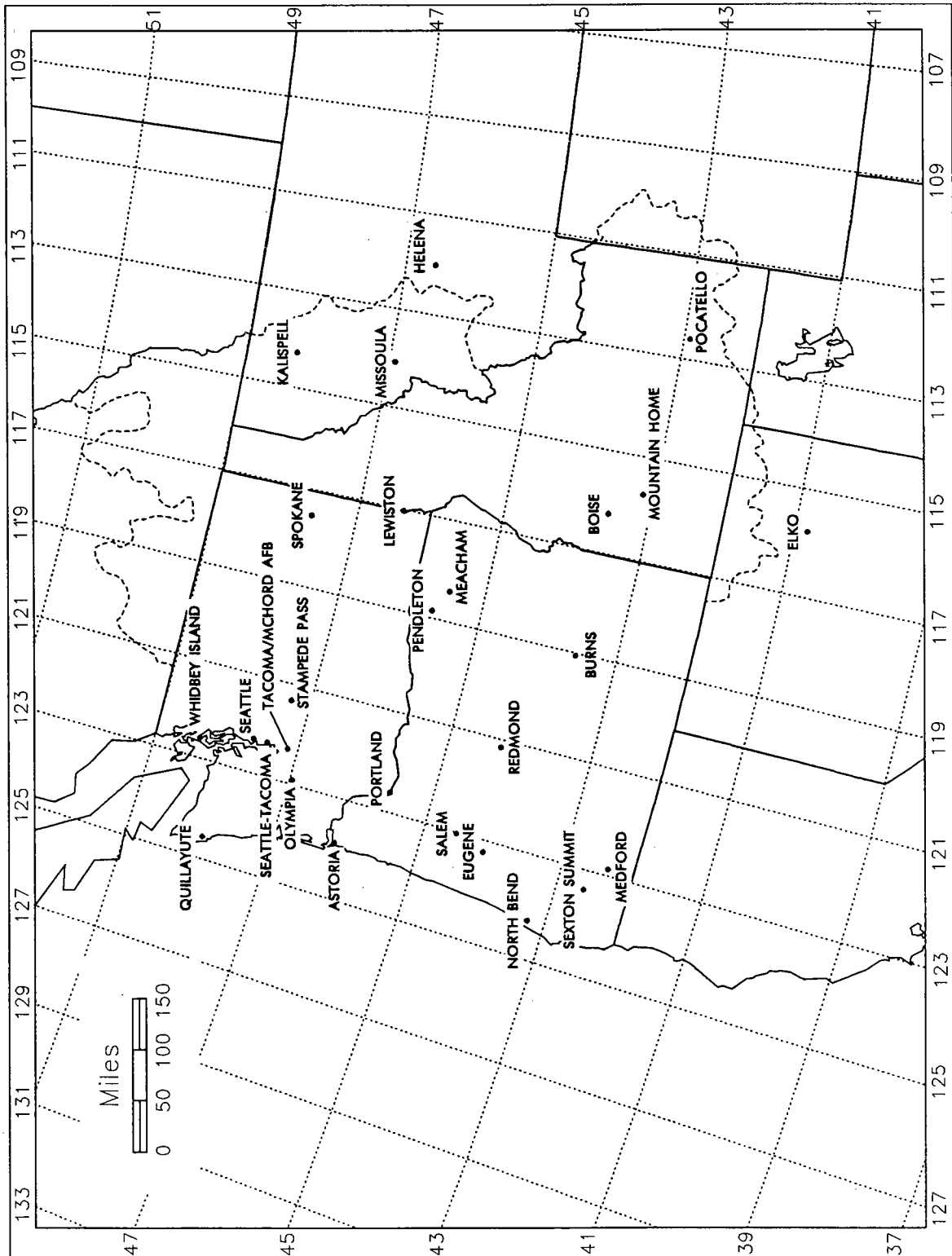

Figure A4.2.--Observing stations providing data for 3-hr maximum persisting local storm dew point analysis.

Subregional Classification

A subregional classification scheme was developed to help overcome the relative paucity of high dew point episodes on days also favorable for local storms. This enhanced the utility of the dew point analysis by grouping the available data within similar climatic zones. Figure A4.3 shows the subregional boundaries, which are based on:

- 1) climatological variations (discussed below),
- 2) significant topographical barriers

In order to develop and compare the climatic characteristics of the individual subregions, the ranges of important climatic variables were tabulated and can be found in Table A4.5. This table includes the annual range of daily temperature maxima, the mean annual daily temperature range, the annual range of 12-hour maximum persisting general storm dew point, the mean annual number of thunderstorm days, the average percentage of the annual thunderstorms occurring from May through September, and the average annual precipitation. Data for Table A4.5 was obtained from Local Climatological Data for individual stations (National Climatic Data Center, 1984), the Climatic Atlas of the U.S. (U.S. DOC, 1968) and from the climatological studies of Trewartha and Horn (1980), Haurwitz and Austin (1944), Easterling and Robinson (1985), Changnon, (1988, a and b) and Gabriel and Changnon (1989).

A discussion of the subregional climatic characteristics, including the data list in Table A4.5, follows:

Subregion 1, which is restricted to the lowland coastal strip inland to the crest of the coast ranges, has a moist, maritime climate with 40-240 inches of mean annual precipitation (MAP), dominated by unmodified Pacific Ocean air masses which move generally unobstructed across the subregion. The thermal influence of the Pacific air is illustrated by the narrow temperature range (about 15°F daily [ΔT_{dly}] and 20-25°F for annual highs [$\Delta \max T$]), and the low annual variation of 12-hour maximum persisting dew point [ΔmTd] (less than 10°F).

As noted by Trewartha and Horn (1980), summertime in this area is dominated by the eastern limb of the Pacific anticyclone with its attendant subsidence and the very low (3-10) average number of thunderstorm days per year [TSTM]. Much of the activity that does occur is associated with cold season general storms, as only 25 percent of the annual thundershowers occur from May through September [%TMS = 25]. At Astoria, Oregon, for example, of the 9 thunderstorm days per year, only two occur in July and August (one each month). Only two of the 106 heavy precipitation events in the extreme storm database occurred in subregion 1.

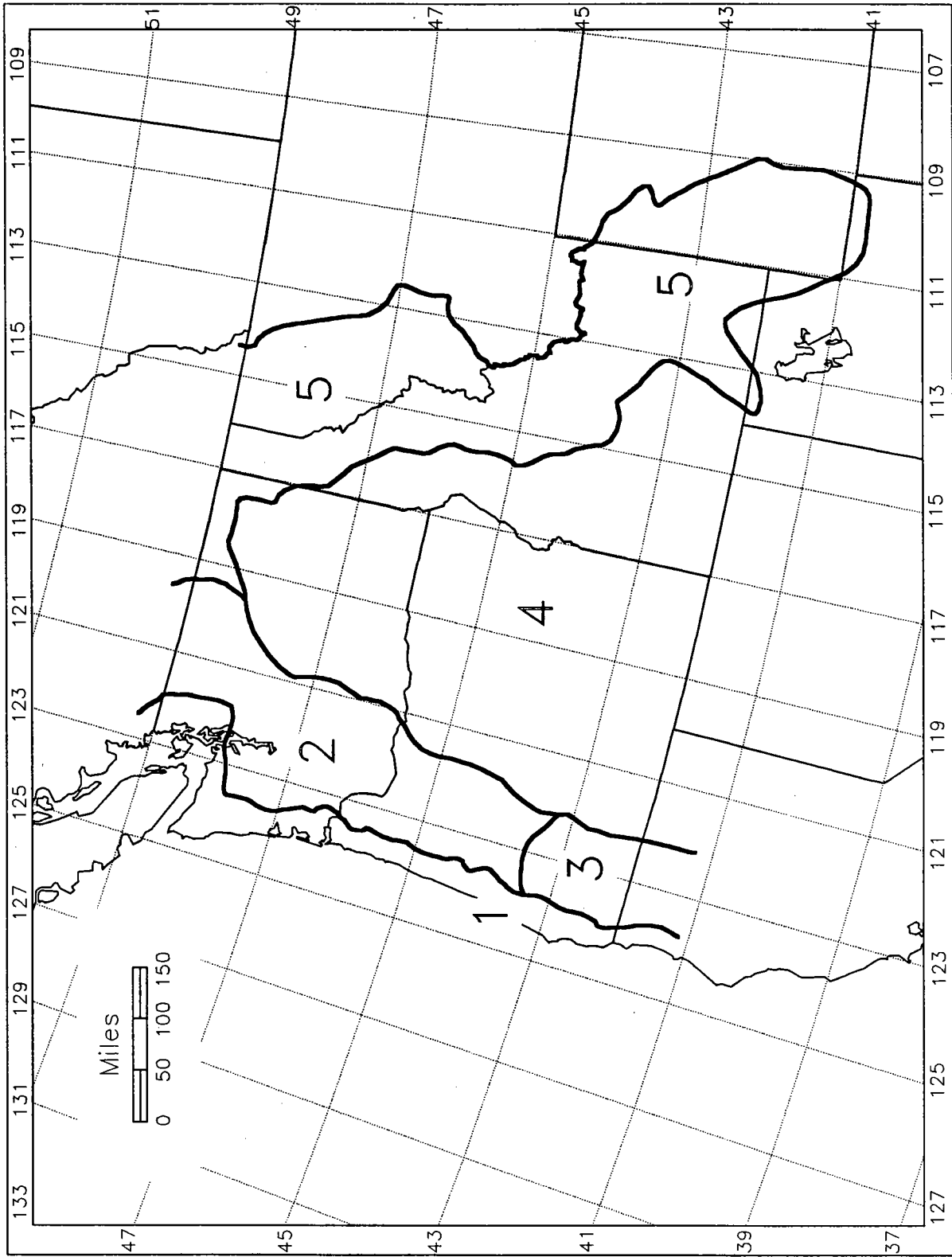

Figure A4.3--Subregions for local storm analysis

Subregion 2 encompasses the area from the coast range crests inland across the Willamette Valley and Puget Sound to the Cascade crestline. This region also has a moist climate (35-180 MAP) which is dominated by air of Pacific origin. Modification of these air masses does take place however, as precipitation is wrung out on the windward side of the coast mountains. This explains the very wide range in MAP, with a pronounced "rain shadow" effect to the east. Conversely, orographic precipitation is enhanced along the windward slopes of the higher Cascade Range. The stabilizing effect of the Pacific is sufficient to keep thunderstorm occurrences [TSTM] at less than 10 per year, but there is a marked shift in their seasonal frequency, with 70 percent occurring during the warm season. The maritime influence is still reflected by the low annual variation of maximum persisting dew point [ΔmTd] but the change in annual temperature maxima [$\Delta maxT$] are considerably greater than in subregion 1, at 30-40°F.

Table A4.5.--Subregional climatic characteristics.

Sub-Region	$\Delta maxT(^{\circ})$	$\Delta Tdly(^{\circ})$	$\Delta mTd(^{\circ})$	TSTM	%TMS	MAP (in.)
1	20-25	14-16	8-9	3-10	25	40-240
2	30-40	10-22	5-8	5-8	70	35-180
3	40	15-27	5-10	5-10	85	15-50
4	50	18-27	10-15	10-15	85	10-20
5	55	23-35	20-35	20-35	95	10-50

$\Delta maxT$
Difference between average January and July daily high temperatures

$\Delta Tdly$
Difference between mean annual daily high and low temperatures

ΔmTd
Difference between annual highest and lowest values of 12-hour maximum persisting general storm dew point

TSTM
Mean annual thunderstorm days

%TMS
Average percentage of annual thunderstorms occurring from May through September

MAP Mean annual precipitation

Subregion 3, comprises a relatively small area stretching from the southern edge of the Willamette Valley into the higher coastal ranges of Oregon and northern California. The chief differences between this area and subregion 2 are the rougher topography and the influence of lower latitude on the development of heavy storms. The climate is similar to subregion 2, but there is less rainfall in most areas (MAP of 15-50 inches) and a slightly greater temperature range. The most important distinction however, seems to be the greater importance of summer thunderstorm activity (85 percent versus 70 percent). The reasons for this increase in convective storm frequency are most likely related to the rugged terrain which serves to enhance differential solar heating, increases low level convergence and imparts additional upward motion on air parcels. The stabilizing influence of the Pacific Ocean is also significantly reduced in this rough terrain.

Subregion 4 extends from the Cascade Range crests eastward across the broad interior of Washington, Oregon, and southeast Idaho, into the foothills of the Rockies. This expansive area has a dry to nearly arid climate of low annual rainfall (10-20 inches) and extremes in temperature [$\Delta_{\max}T$], typically about 50°F. Despite the low annual rainfall amounts, thunderstorm activity [TSTM] is more frequent than in subregions 1, 2, and 3, at about 10-15 thunderstorms per year for any particular station. Eighty-five percent of these occur from May through September [%TMS]. It is notable that 10 of the 15 extreme local storms listed in Table A4.1 occurred in this subregion. This region is effectively shielded from the Pacific by the coastal and Cascade barriers, reducing moisture inflow from the west. The southern portion of this area is periodically affected by Gulf of California or possibly Gulf of Mexico moisture when there is a northward extension of the southwest monsoon pattern.

Subregion 5 covers the area from the foothills of the Rockies to the Continental Divide where the study area terminates. This is also an interior climate, but most of the area is mountainous, so there is a great deal of variability within the subregion itself. The annual temperature range [$\Delta_{\max}T$] is even greater than that of subregion 4, averaging about 55°F. There is also significant moisture variability, with a ΔmTd range of 20-35°F across this area.

The southern portions of this region may also be affected by the southwest monsoon pattern. Summer thunderstorm activity is at a maximum for the entire northwest in this subregion, with 20-35 thunderstorms per year [TSTM], 95 percent of them occurring in the warm season [%TMS]. Similar to subregion 3, it appears that terrain has a marked impact on the development of local storm activity in this area. An examination of the extreme storm database showed that three thunderstorms with hourly precipitation exceeding 2 inches occurred in this subregion, out of a total of 10 for the entire study area.

Analysis

The initial step in preparation of persisting 3-hour dew point maps, was to group extreme dew point cases within their respective subregions. Initial dew-point patterns were then drafted within each subregion, relying on 12-hour persisting dew-point patterns from previous studies for general guidance. The monthly maps were subsequently analyzed for the study region as a whole, smoothing subregional transition areas and shaping the overall patterns to account for the major moisture sources, significant topographic barriers, and seasonal air temperature and pressure patterns.

Seasonal and regional consistency checks were performed to eliminate any anomalous or spurious data and to ensure that a relatively smooth dew-point pattern emerged. The difference field between the 3-hour maximum persisting local storm dew points and the 12-hour maximum persisting general storm dew points was also prepared. The 3-hour local storm dew points were found to exceed the 12-hour general storm dew points by 2-7°F, which is consistent with McKay's (1963) analysis as described earlier.

In-Place Maximization

The in-place adjustment for maximum moisture for local convective storms is the ratio of the precipitable water for the maximum persisting 3-hour (reduced to 1000 mb) dew point at a particular location to that for the representative persisting 3-hour (1000 mb) dew point for the individual storm site. The local storm moisture adjustment procedure differs from the general storm procedure because of the often highly localized character of local storms and the relatively disorganized nature of their moisture inflow. The primary procedural difference is that representative dew points for local storms are taken as near as possible to the storm in any direction from the storm location, because it is assumed that local storms can occur independently of any sustained moisture inflow (Hansen et al., 1988). This is different from the procedure for general storms in which a distinct inflow direction is specified. The maximum persisting dew point is read at the storm location for the time of year in which it occurred.

Secondly, the in-place adjustment for any local storm is restricted to a maximum of 1.50, the same upper limit adopted by Hansen et al. (1988). This is because the synoptic and mesoscale conditions of major local storms do not appear to be capable of accommodating more moisture than this. In addition, the network of stations providing dew-point observations may be too sparse to fully represent the moisture field in the vicinity of such highly localized storms. It is possible under such conditions that more moisture could be present at the storm site than at the location of the storm dew-point measurement. This would result in an underestimated actual storm dew point and an unrealistically high moisture maximization.

Adjustment for Elevation

Background

Both HMR 43 and HMR 49 studies used 5,000 feet as a maximum elevation, above which a steady, systematic decrease was assumed for local storm PMP. For the region between the Continental Divide and 103°W, no variation was expected within 1000 feet of 5000 feet, with a decrease above that level based on a percentage of the decrease in precipitable water with altitude (Hansen et al., 1988). In the study for the southwest, 6-hour recorder rainfall maxima versus elevation for stations in Nevada, Utah, and Arizona showed a decrease in the among-station maximum precipitation above 4000 to 5,000 feet, although a possible reason for the decrease was a smaller data sample at the higher elevations.

Due to the decrease in atmospheric moisture and temperature with height, a reduction in the local storm precipitation with elevation can be expected at some point. How this decrease in moisture might be offset by increased local storm efficiency due to high terrain is not clear. Factors contributing to intensified convection at higher elevations include increased vertical velocities, strong differential heating of slopes, and enhanced convergence.

One study examining the influence of elevation on the intensity of rainfall in the Pacific Northwest was that of Cooper (1967). Using data from 93 rain gages in the Reynolds Creek watershed in southwest Idaho, he determined that there was no discernible relationship between elevation and peak intensity or total amount of rainfall at elevations from 3600 to 7200 feet.

Several researchers have noted the tendency for there to be enhanced convection over mountainous terrain. Abbs and Pielke (1986) found that areas of upslope flow and increased convergence of moist, unstable air become preferred regions for convective development. Such areas tended to maximize in the high terrain near the Continental Divide in Colorado. Toth and Johnson (1985) found that elevated locations were zones of convergence maxima in Colorado and correlate well with areas favored for deep convective development. An earlier study by Henz (1974) also documented the tendency for preferred thunderstorm formation zones to exist over elevated areas in the Colorado Front Range.

Heavy thunderstorm rainfall (intensities of 2 inches per hour or greater) at 7500 feet or higher in the Colorado Front Range from 1965-1988 were studied by Henz and Kelly (1989). Using information from the NOAA publication Storm Data, they found 24 cases of thunderstorm rainfall of 2 inches or greater from April to September during the period from 1979 through 1988. All were short duration events, usually less than two hours and 83 percent occurred at least partially above 8000 feet. Among the factors cited as contributing to heavy rains at high altitude was a tendency for the storms to remain stationary or move very slowly over their formation zones.

Recent studies by Jarrett (1990) and Jarrett and Costa (1989) have utilized paleohydrologic techniques to estimate the frequency of high elevation flood-producing storms in Colorado. These works tend to discount the existence of very heavy rainfall above 8000 feet, while contending that such storms are not infrequent below 7500 feet, implying a very rapid decrease above a certain critical elevation threshold. Clearly, further study will be needed to verify the validity of these findings.

Analysis

In an effort to understand how thunderstorm rainfall diminishes with elevation in the Pacific Northwest, an investigation was conducted using the data base of heavy local storms in Table A4.1. There was no clear evidence of an elevation-dependent change in local storm precipitation to about 5,000-6,000 feet. While the maximum observed local storm precipitation does decrease somewhat above 5,000 feet, such a decrease could also be explained by a relative lack of station coverage. For example: in 1975, (the chronological mid-point of available recorder data), out of 256 recorder stations with at least 10 years of data in the study region, only 25 were at an elevation of 5,000 feet or greater, and merely 4 were at an elevation of 6,000 feet or greater. Furthermore, there are relatively little bucket survey data above 5,000 feet because of low population density.

A statistical regression analysis using the local storms found in Table A4.1 showed no significant variation throughout an elevation range of 43 to 6,350 feet above sea level. A plot of these data is shown in Figure A4.4. This supports a possibility of maximum local storm precipitation to at least 6,000 feet, but it is important to note that only 4 of the 105 thunderstorms in the data set occurred at or above 6,000 feet. While this indicates that the data set at high elevations is too sparse to provide very reliable statistical information, it is also true that the percentage of 50-year return-period storms at or above 6000 feet ($4/105 = 3.8$ percent) is greater than the percentage of 1965-75 recorder stations at or above 6,000 feet ($4/256 = 1.6$ percent) by a factor of 2.4. This tends to support a greater likelihood of heavy local storms above 6,000 feet than at lower elevations.

It is also important to note that the storm which produced the greatest hourly precipitation in or near the study area (Morgan, Utah, August 16, 1958: 6.75 inches in 1 hour) occurred at an elevation of 5,150 feet, which also provides justification for taking maximum local storm precipitation potential to elevations exceeding 5,000 feet. In addition, the extreme local storm at Opal, Wyoming, on August 16, 1990 (7.0 inches in 2 hours), occurred at an elevation of about 6,900 feet. The forgoing analysis suggests that 6,000 feet may be a more accurate approximation of the elevation above which local storm precipitation will begin to decrease, at least in this region of the country. This conclusion, based on a much expanded data base from within and around the study region, reflects the lack of clear evidence of any elevation-dependent decrease of maximum local storm precipitation potential in the 5,000-6,000 foot range.

For elevations above 6,000 feet, a decrease in local storm PMP of 9 percent per thousand feet above 6,000 feet was utilized, approximating a pseudo-adiabatic decrease in the moisture available for convective activity. Figure 15.37 (Chapter 15) compares the moisture variation based on this approximation to the change of column moisture, with elevation in a saturated pseudo-adiabatic atmosphere for 1000-mb dew points of 60, 70 and 80 degrees (F). The adopted elevation adjustment was also based on the assumption that the surface dew point would be representative of total column moisture and that the effectiveness of local storm mechanisms would not change appreciably with height above 6,000 feet. This procedure for elevation adjustment of local storm PMP above 6000 feet is consistent with the procedure adopted in the PMP study of the region between the Continental Divide and 103°W (Hansen et. al., 1988), in which an explicit saturated pseudo-adiabatic moisture adjustment was adopted above 5,000 feet.

Indirect empirical support for the validity of this approach may be found in the study by Henz and Kelly (1989). He reported rainfall amounts as great as 1.9 inches in 10-15 minutes at 8,500 feet and 2.25 inches in 25 minutes at 9,000 feet. These amounts were less than PMP would be at their respective areas of occurrence, using the elevation adjustment procedure just described in Hansen et. al. (1988), about 5.5 and 6 inches, respectively. With no other data supporting the idea of even heavier rains at very high elevations, it was assumed that this adjustment would yield an adequate reduced estimate of PMP in higher terrain.

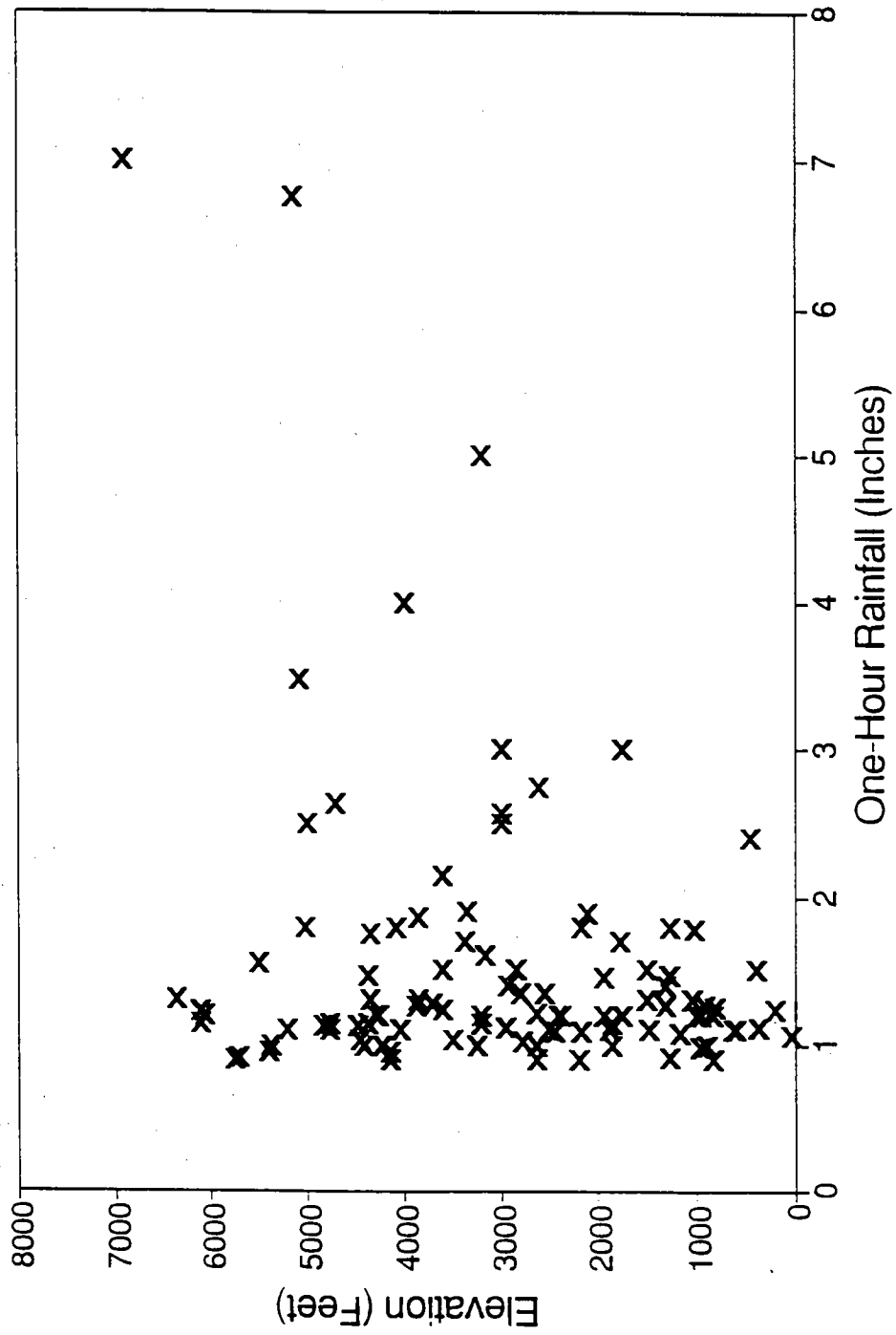

Figure A4.4.--One-hour rainfall versus elevation for storms in Table A4.1

HORIZONTAL TRANSPOSITION

Background

As in the general storm analysis, transposition is defined as the process of transferring observed precipitation rainfalls from their location of occurrence to another location where a storm with essentially the same rainfall mechanism is thought to be possible. In transposition, the rainfall is adjusted to account for the difference in moisture availability, based on the persisting dew point maps, between the original storm site and the transposed location.

Analysis

The transposition procedure for Pacific Northwest local storms is the same as that for general storms, with the following exceptions:

- 1) the elevation adjustment follows the procedure outlined in this Appendix (no adjustment below 6,000 feet), and
- 2) no adjustment for barrier elevation is made for local storms because local storms often result from highly localized accumulations of moisture rather than large-scale inflow.
- 3) the climatic subregions were adopted as general guidelines for transposition, but not as strict boundaries.

The key concept here was that the climatic zones limits should not constitute rigid barriers in the atmosphere, but would represent transitional regimes. For instance, it was not considered acceptable that a storm in zone 4 could be transposed into zone 1, whereas transposition from zone 4 storm into portions of zone 2 was allowed, using terrain for additional guidance.

As in the general storm procedure, no elevation adjustment is made for the first 1,000-foot or lower elevation increase when a storm is transposed to a higher elevation. This procedure for local storm transposition is consistent with the most recent major PMP study covering the adjacent area from the Continental Divide to 103° W area (Hansen et. al., 1988).

APPENDIX 5

This appendix provides some background information and an example of the procedure for using the snowmelt and wind criteria for a basin. The background and procedure is extracted directly from Chapter VIII of HMR 43, with the exception that the figure numbers have been changed to refer to those in Chapter 15 of this report (Computational Procedure).

Introduction

Evaluation of runoff involves the contribution of snowmelt. Snowmelt computations require generalized temperature and wind sequences during the 3-day PMP storm and for 3 days prior.

Temperatures and Dew Points During the PMP Storm

Temperatures during the PMP storm are equal to maximum dew points, using the simplifying assumption of a saturated adiabatic atmosphere. Maximum storm dew points were determined in Chapter 4.

Temperature and Dew Points Prior to PMP Storm

For combined rain and snowmelt flood determinations, a sequence of high temperatures for several days prior to rain storms is generally the most critical situation. With this in mind, highest temperatures observed prior to major storms in the Northwest were determined. An envelope of the difference between these prior temperatures and the temperatures during the storms was then assumed applicable to PMP temperatures at the beginning of the PMP storm.

Sources of storms surveyed included preliminary Corps of Engineers storm data, the controlling storms listed in the Cooperative Studies Snake River Report Number 11 (U.S.W.B., 1953) and Weather Bureau Technical Paper Number 38 (U.S.W.B., 1960), as well as storms giving record 24-hour rainfall amounts. Daily mean temperatures and precipitation amounts were obtained from a mountain station near the 24-hour heavy rain center and from a nearby upwind first-order valley station. For a particular season and region, the critical temperature differences were approximately the same at the two stations.

Temperature differences for establishing the critical upper envelope plotted by dates of occurrence showed significant seasonal trends. These trends and the range of temperature differences depended on whether the storm was east or west of the Cascade Divide. Durational curves of the temperature differences throughout three days were therefore drawn for each region. These curves are shown in Figure 15.13. As this Figure shows, cool-season antecedent

temperatures are at least as low as those observed during the storm. In late spring and early autumn, antecedent temperatures are higher than during the storm.

Example of Snowmelt Winds and Temperatures for a Basin

As an example, snowmelt data for mid-May for the Blackfoot River drainage above Blackfoot Reservoir, Idaho, will be determined.

Basin average elevation: 7000 feet

Lettered and numbered steps in this example are identical to those in the outlined procedure discussed in Chapter 15 (pages 206-208).

A. Temperature and Dew points During PMP Storm

- (1) Average 12-hour mid-May maximum dew point over basin (Figure 15-22): 63.0 °F.
- (2) Precipitable water (W_p) for 63.0 °F (Figure 15.30): 1.59 inches.

	6-hour period											
	1st	2nd	3rd	4th	5th	6th	7th	8th	9th	10th	11th	12th
(3) Ratios of W_p each 6-hour period to maximum 12-hour W_p (Figure 15.31)	1.04	1.00	0.97	0.95	0.92	0.90	0.89	0.87	0.85	0.84	0.82	0.81
(4) = (2) x (3) W_p (ins.)	1.65	1.59	1.54	1.51	1.46	1.43	1.42	1.38	1.35	1.34	1.30	1.29
(5) Mid-May 1000-mb. temperatures (°F) each period (Figure 15.30):	63.6	63.0	62.4	61.9	61.4	61.0	60.6	60.2	59.8	59.4	59.0	58.7
(6) Mid-May temperatures (°F) reduced to 7000 feet (Figure 15.32):	45.4	44.7	44.0	43.2	42.5	41.9	41.3	40.8	40.3	39.9	39.4	39.0
(7) Rearrangement of temperatures to conform to sequence of PMP increments (sequence (a) of Figure 15.12 used in this example): °F	40.3	41.3	42.5	44.0	45.4	44.7	43.2	41.9	40.8	39.8	39.4	39.0

B. Temperatures Prior to PMP Storm

- (1) Temperature for first 6-hour period of PMP storm from A(7): 40°F

	Hours Prior to Storm											
	6	12	18	24	30	36	42	48	54	60	66	72
(2) Mid-May differences between temperatures at indicated times prior to first 6-hour period of storm (Figure 15.13):	4	7	11	15	15	15	15	15	15	15	15	15
(3) Sum of (1) and (2) °F	44	47	51	55	55	55	55	55	55	55	55	55

C. Dew Points Prior to PMP Storm

	Hours Prior to Storm											
	6	12	18	24	30	36	42	48	54	60	66	72
(1) Difference between dew point at beginning of storm and at indicated times prior to storm (Figure 15.13) °F	0	1	1	1	2	2	2	3	3	3	4	4
(2) = B(1) - C(1) °F	44	47	51	55	55	55	55	55	55	55	55	55

D. Winds During PMP Storm

- (1) Basin average elevation: 7000 feet. Basin average pressure (Figure 15.33): 775 mb.
- (2-b) 6-hour January anemometer-level winds at 775 mb. (Figure 15.17): 45 kts.
- (3) May 6-hour percentage of January wind (Figure 15.15): 69%
- (4) Wind of D(2-b) x percent of D(3) = 31 kts.

	6-hour period											
	1st	2nd	3rd	4th	5th	6th	7th	8th	9th	10th	11th	12th
(5) Duration factor for each 6-hour period (Figure 15.16 and p. 102)	1.00	.93	.87	.83	.77	.73	.69	.66	.64	.61	.59	.57
(6) Anemometer winds in descending order D(4) x D(5) kts.	31	29	27	26	24	23	21	20	20	19	18	18
(7) Windspeeds rearranged after PMP sequence (a) of Figure 15.12. Kts.	20	21	24	27	31	29	26	23	20	19	18	18

E. Winds Prior to PMP Storm

Lowest windspeed during mid-May PMP storm period over Blackfoot Basin is 18 kts. from D (6). This value continues for 72 hours prior to beginning of storm.