

**HYDROMETEOROLOGICAL REPORT NO. 55A**

(SUPERCEDES HYDROMETEOROLOGICAL REPORT NO. 55)

**Probable Maximum Precipitation Estimates-United States  
Between the Continental Divide and the 103rd Meridian**

**U. S. DEPARTMENT OF COMMERCE  
NATIONAL OCEANIC AND ATMOSPHERIC ADMINISTRATION  
U. S. DEPARTMENT OF ARMY  
CORPS OF ENGINEERS  
U. S. DEPARTMENT OF INTERIOR  
BUREAU OF RECLAMATION**

**Silver Spring, Md.**

**June 1988**

**U.S. DEPARTMENT OF COMMERCE**  
NATIONAL OCEANIC AND ATMOSPHERIC ADMINISTRATION

**U.S. DEPARTMENT OF ARMY**  
CORPS OF ENGINEERS

**U.S. DEPARTMENT OF INTERIOR**  
BUREAU OF RECLAMATION

**HYDROMETEOROLOGICAL REPORT NO. 55A**  
(SUPERCEDES HYDROMETEOROLOGICAL REPORT NO. 55)

**Probable Maximum Precipitation Estimates-United States  
Between the Continental Divide and the 103rd Meridian**

Prepared by  
E. M. Hansen and D. D. Fenn  
Water Management Information Division  
Office of Hydrology  
National Weather Service  
and  
L. C. Schreiner and R. W. Stodt  
Flood Section, Surface Water Branch  
Earth Sciences Division  
Bureau of Reclamation  
and  
J. F. Miller, Consulting Meteorologist

**Silver Spring, Md.**  
**June 1988**





## TABLE OF CONTENTS

	Page
<b>PREFACE TO REVISED EDITION.....</b>	xvi
<b>ABSTRACT.....</b>	1
1. Introduction.....	1
1.1 Background.....	1
1.2 Authorization.....	2
1.3 Study region.....	3
1.4 Method of study.....	3
1.5 Definitions.....	5
1.6 Terrain review.....	7
1.7 Previous PMP estimates for the CD-103 region.....	7
1.8 Application of HMR No. 52 to PMP from this study.....	7
1.9 Organization of the report.....	9
2. Meteorology of major storms in the CD-103 region.....	11
2.1 Introduction.....	11
2.2 Major storms of record.....	11
2.3 Important storms.....	15
2.4 Meteorological analyses of storms.....	17
2.4.1 Extratropical storms.....	17
2.4.1.1 Warrick, Montana - June 6-8, 1906 (10).....	17
2.4.1.2 Penrose, Colorado - June 2-6, 1921 (31).....	21
2.4.1.3 Springbrook, Montana - June 17-21, 1921 (32).....	23
2.4.1.4 Savageton, Wyoming - September 27-October 1, 1923 (38).....	26
2.4.1.5 Cherry Creek (47) - Hale (101), Colorado - May 30-31, 1935.....	30
2.4.1.6 Gibson Dam, Montana - June 6-8, 1964 (75).....	33
2.4.1.7 Plum Creek, CO - June 13-20, 1965 (76).....	36
2.4.1.8 Big Elk Meadow, Colorado - May 4-8, 1969 (77).....	42
2.4.1.9 Big Thompson, Colorado - July 31- August 1, 1976 (81).....	44
2.4.2 Tropical storms.....	47
2.4.2.1 Rancho Grande, New Mexico - August 29- September 1, 1942 (60).....	47
2.4.2.2 Vic Pierce, Texas - June 23-28, 1954 (112).....	50
2.5 Storm classification.....	55
2.5.1 Storm classification system.....	55
2.5.1.1 Characteristics of storm classes.....	55
2.5.2 Example of application of storm classification system.....	57
2.5.2.1 Convective/cyclonic.....	57
2.5.2.2 Simple/complex.....	59
2.5.3 Classification of storms by type.....	59
3. Terrain classification system.....	64
3.1 Introduction.....	64
3.2 Classification.....	64
3.2.1 Orographic/nonorographic line.....	64
3.2.2 First upslopes.....	65
3.2.3 Sheltered least orographic subdivisions.....	66

	Page	
3.2.4	Sheltered orographic subdivisions.....	67
3.3	Barrier/effective elevation map.....	67
4.	Maximum persisting 12-hr 1000-mb dew points.....	69
4.1	Background.....	69
4.2	Data collection.....	70
4.3	Analysis.....	72
4.4	Other studies.....	75
4.5	Revised seasonal maps.....	76
5.	Representative persisting 12-hr 1000-mb storm dew points...	83
5.1	Introduction.....	83
5.2	Criteria for selecting representative storm dew points...	83
5.3	Selection of representative storm dew points.....	83
5.4	Storm moisture maximization factors.....	88
6.	Approaches.....	94
6.1	Introduction.....	94
6.2	Orographic models.....	94
6.3	Traditional approach.....	94
6.4	Storm separation method.....	95
6.5	Depth-area relations.....	95
6.6	Local-storm PMP.....	96
7.	Storm separation method.....	96
7.1	Introduction.....	96
7.2	Glossary of terms.....	96
7.3	Background.....	103
7.3.1	Basic concepts.....	105
7.3.1.1	Overall method.....	105
7.3.1.2	Module 1.....	105
7.3.1.3	Module 2.....	106
7.3.1.4	Module 3.....	106
7.3.1.5	Module 4.....	107
7.4	Methodology.....	107
7.4.1	Module flowcharts.....	108
7.4.1.1	Module 0 procedure.....	108
7.4.1.2	Module 1 procedure.....	110
7.4.1.3	Module 2 procedure.....	111
7.4.1.4	Module 3 procedure.....	113
7.4.1.5	Module 4 procedure.....	118
7.4.1.6	Module 5 documentation.....	118
7.5	Example of application of SSM.....	122
7.6	Application of SSM to this study.....	122
8.	Storm transposition.....	124
8.1	Introduction.....	124
8.2	Transposition limits.....	124
8.2.1	Transposition limits by storm type.....	124
8.2.2	Final transposition limits of storms for individual total storm precipitation.....	127
8.2.2.1	Gibson Dam, Montana storm - June 6-8, 1964 (75).....	127

8.2.2.2	Cherry Creek, Colorado storm - May 30-31, 1935 (47)..	128
8.2.3	Transposition limits of FAFP.....	128
8.3	System used to select transposition locations.....	129
8.4	Moisture maximization and transposition procedures.....	130
8.4.1	In-place moisture adjustment.....	130
8.4.1.1	Limitations to in-place moisture adjustment.....	131
8.4.2	Transposition adjustments.....	132
8.4.2.1	Horizontal transposition adjustment.....	132
8.4.2.2	Vertical transposition adjustment.....	132
8.4.3	Distance-from-coast adjustment for tropical storms.....	133
8.4.4	Total transposition adjustment.....	134
8.5	FAFP map.....	135
9.	Other factors.....	135
9.1	Introduction.....	135
9.2	Orographic factor, T/C.....	137
9.3	Storm intensity factor, M.....	140
9.4	Computational equation for total PMP.....	141
10.	Generalized 1-, 6-, 24- and 72-hr PMP maps.....	144
10.1	Duration ratio maps.....	144
10.1.1	6-/24-hr ratio map.....	144
10.1.2	1-/6-hr ratio map.....	145
10.1.3	72-/24-hr ratio map.....	146
10.2	Computer computation of index PMP maps.....	146
10.3	Final analysis of 10-mi <sup>2</sup> general-storm PMP maps.....	148
10.3.1	24-hr 10-mi <sup>2</sup> PMP map.....	148
10.3.2	6-hr 10-mi <sup>2</sup> PMP map.....	149
10.3.3	1-hr 10-mi <sup>2</sup> PMP map.....	150
10.3.4	72-hr 10-mi <sup>2</sup> PMP map.....	152
11.	Depth-area-duration relations.....	152
11.1	Introduction.....	152
11.2	Data .....	152
11.3	Method .....	153
11.3.1	Topographic subdivisions.....	153
11.3.2	River basin subregions.....	153
11.3.3	DAD relations.....	155
11.3.3.1	Nonorographic subdivisions.....	155
11.3.3.2	Minimum nonorographic subdivision.....	155
11.3.3.3	Orographic subdivision.....	155
11.3.3.4	Sheltered least orographic subdivision.....	162
11.3.3.5	Sheltered orographic subdivision.....	166
11.4	Comparison with major storm data.....	166
11.5	Conclusions on DAD relations.....	179
12.	Local-storm PMP.....	179
12.1	Introduction.....	179
12.1.1	Local-storm definition.....	180
12.1.2	Meteorology of local storms.....	181
12.2	Record storms.....	181
12.2.1	Introduction.....	181

	Page	
12.2.2	Local storms.....	184
12.2.2.1	Las Cruces, New Mexico - 8/29-30/35 (48).....	184
12.2.2.2	Masonville, Colorado - 9/10/38 (55).....	185
12.2.2.3	Golden, Colorado - 6/7/48 (67).....	187
12.2.2.4	Morgan, Utah - 8/16/58.....	190
12.2.3	Important non-local storms.....	190
12.2.3.1	Virsylvania, (Cerro), New Mexico - 8/17/22 (35).....	190
12.2.3.2	White Sands, New Mexico - 8/19/78 (82).....	191
12.2.3.3	Big Thompson Canyon, Colorado - 7/31/76 (81).....	193
12.3	1-hr 1-mi <sup>2</sup> PMP approach.....	193
12.3.1	Introduction.....	193
12.3.2	Data .....	193
12.3.2.1	Adjustment for duration.....	194
12.3.2.2	Adjustment for maximum moisture.....	194
12.3.2.3	Horizontal transposition.....	196
12.3.2.4	Adjustment for elevation.....	197
12.4	1-hr 1-mi <sup>2</sup> local-storm PMP map.....	197
12.4.1	Introduction.....	197
12.4.2	Analysis of 1-hr 1-mi <sup>2</sup> local-storm PMP map.....	197
12.4.3	1-hr 1-mi <sup>2</sup> PMP index maps.....	198
12.5	Durational variation.....	198
12.5.1	Data and analysis for PMP for longer than 1 hr.....	198
12.5.2	PMP for durations less than 1 hr.....	201
12.6	Depth-area relation.....	201
12.7	Temporal distribution of incremental PMP.....	201
12.8	Seasonal distribution.....	204
13.	Consistency checks.....	205
13.1	Comparison with storm data.....	205
13.2	Comparison with individual-drainage PMP estimates.....	207
13.3	Comparison to other generalized PMP studies in the CD-103 region.....	207
13.4	Comparison between local-storm and general-storm PMP.....	209
13.5	Comparison with NOAA Atlas 2 amounts.....	210
13.6	Comparison with adjoining PMP studies.....	211
13.7	Conclusions from consistency checks.....	212
14.	Procedures for computing PMP.....	213
14.1	Stepwise procedure, general storm.....	213
14.2	Example of general-storm PMP computation.....	214
14.3	Stepwise procedure, local storm.....	218
15.	Future studies.....	220
15.1	Seasonal variation.....	220
15.2	Permissible snowpack with PMP and snowmelt criteria.....	220
15.3	Individual-drainage estimates of PMP.....	221
15.4	Temporal variation.....	221
15.5	Antecedent rainfall.....	221
15.6	Summary.....	222

	Page
Acknowledgments.....	222
References.....	223
Appendix A Generalized PMP studies for conterminuous United States.....	227
Appendix B Storms important for estimates of PMP in CD-103 region.....	228
Appendix C Table of precipitable water.....	241

#### LIST OF FIGURES

Number		Page
1.1	Regions of the conterminuous United States for which PMP estimates are provided in indicated Hydrometeorological Reports.....	4
1.2	General topography of CD-103 region with track of overflights shown.....	8
2.1	Location of major storms that have occurred in and near the CD-103 region.....	16
2.2	Synoptic surface weather maps for June 4-8, 1906 - the Warrick, MT storm (10).....	20
2.3	Isohyetal map for the Warrick, MT storm (10) for period June 6-8, 1906.....	21
2.4	Synoptic surface weather maps for June 2-6, 1921 - the Penrose, CO storm (31).....	22
2.5	Isohyetal map and selected mass rainfall curves for June 2-6, 1921 - the Penrose, CO storm (31).....	24
2.6	Synoptic surface weather maps for June 17-21, 1921 - the Springbrook, MT storm (32).....	25
2.7	Isohyetal map for June 17-21, 1921 - the Springbrook, MT storm (32).....	27
2.8	Synoptic surface weather maps for September 27-October 1, 1923 - the Savageton, WY storm (38).....	28
2.9	Isohyetal map for September 27-October 1, 1923 - the Savageton, WY storm (38).....	29
2.10	Synoptic surface weather maps for May 29-June 1, 1935 - the Cherry Creek (47) - Hale (101), CO storm.....	31
2.11	Isohyetal map for the Cherry Creek (47) - Hale (101), CO storm for period May 30-31, 1935.....	32



Number		Page
2.12	Synoptic surface weather maps and 500-mb charts for June 6-7, 1964 - the Gibson Dam, MT storm (75).....	33
2.13	Synoptic surface weather maps and 500-mb charts for June 8-9, 1964 - the Gibson Dam, MT storm (75).....	34
2.14	Isohyetal map for June 7-8, 1964 - the Gibson Dam, MT storm (75).....	35
2.15	Synoptic surface weather maps and 500-mb charts for June 13-15, 1965 - the Plum Creek, CO storm (76).....	37
2.16	Synoptic surface weather maps and 500-mb charts for June 16-18, 1965 - the Plum Creek, CO storm (76).....	38
2.17	Synoptic surface weather maps and 500-mb charts for June 19-20, 1965 - the Plum Creek, CO storm (76).....	39
2.18	Representative radiosonde observations for June 15-16, 1965 - the Plum Creek, CO storm (76).....	40
2.19	Isohyetal map for June 16-17, 1965 - Plum Creek, CO storm (76) .....	41
2.20	Synoptic surface weather maps and 500-mb charts for May 4-5, 1969 - the Big Elk Meadow, CO storm (77).....	42
2.21	Synoptic surface weather maps and 500-mb charts for May 6-8, 1969 - the Big Elk Meadow, CO storm (77).....	43
2.22	Isohyetal map for May 4-8, 1969 - the Big Elk Meadow, CO storm (77).....	45
2.23	Synoptic surface weather maps and 500-mb charts for July 31- August 2, 1976 - the Big Thompson, CO storm (81).....	46
2.24	Isohyetal map of intense 4-hr precipitation for July 31, 1976 - the Big Thompson, CO storm (81).....	48
2.25	Synoptic surface weather maps for August 29- September 1, 1942 - the Rancho Grande, NM storm (60).....	49
2.26	Isohyetal map for August 29-September 1, 1942 - the Rancho Grande, NM storm (60).....	50
2.27	Synoptic surface weather maps and 500-mb charts for June 23-25, 1954 - the Vic Pierce, TX storm (112).....	51
2.28	Synoptic surface weather maps and 500-mb charts for June 26-28, 1954 - the Vic Pierce, TX storm (112).....	53
2.29	Isohyetal map for June 24-29, 1954 - the Vic Pierce, TX storm (112).....	54

Number		Page
2.30	Schematic illustrating the storm classification system.....	57
2.31	Location of table 2.2 storms by storm type.....	62
2.32	Tracks of tropical storms affecting the southern part of CD-103 region.....	63
3.1	Study region showing line separating orographic and nonorographic regions (orographic separation line - OSL).....	65
3.2	Approximate boundaries of terrain subdivisions used in this study.....	66
3.3	Range of inflow wind directions for PMP type storm.....	67
3.4	Barrier/smoothed elevation map (in 1,000's of ft) for a 2° latitude band (38° to 40°N) through Colorado.....	68
4.1	Location of weather stations used to revise maximum persisting 12-hr 1000-mb dew points.....	71
4.2	Seasonal persisting 12-hr dew-point curve for Roswell, NM.....	73
4.3	Regional smoothing and consistency checks for maximum persisting 12-hr 1000-mb dew points along the 103rd meridian.....	75
4.4	Comparison of mid-July maximum persisting 12-hr 1000-mb dew points from Climatic Atlas of the United States and present study.....	76
4.5	Maximum persisting 12-hr 1000-mb dew points (°F) for January.....	77
4.6	Maximum persisting 12-hr 1000-mb dew points (°F) for February.....	77
4.7	Maximum persisting 12-hr 1000-mb dew points (°F) for March.....	78
4.8	Maximum persisting 12-hr 1000-mb dew points (°F) for April.....	78
4.9	Maximum persisting 12-hr 1000-mb dew points (°F) for May.....	79
4.10	Maximum persisting 12-hr 1000-mb dew points (°F) for June.....	79
4.11	Maximum persisting 12-hr 1000-mb dew points (°F) for July.....	80

Number		Page
4.12	Maximum persisting 12-hr 1000-mb dew points (°F) for August.....	80
4.13	Maximum persisting 12-hr 1000-mb dew points (°F) for September.....	81
4.14	Maximum persisting 12-hr 1000-mb dew points (°F) for October.....	81
4.15	Maximum persisting 12-hr 1000-mb dew points (°F) for November.....	82
4.16	Maximum persisting 12-hr 1000-mb dew points (°F) for December.....	82
5.1	Example of the selection of representative persisting 12-hr storm dew point for the Cherry Creek, CO storm (47) of May 30-31, 1935.....	87
7.1	Schematic illustrating determination of LOFACA.....	99
7.2	Main flowchart for SSM.....	104
7.3	Flowchart for module 0, SSM.....	109
7.4	Flowchart for module 1, SSM.....	110
7.5	Flowchart for module 2, SSM.....	112
7.6	Flowchart for module 3, SSM.....	114
7.7	Flowchart for module 4, SSM.....	119
7.8	Documentation form for SSM, module 5.....	120
7.9	Completed module 5 documentation form for Gibson Dam, MT storm (75) of June 6-8, 1964.....	123
8.1	Convective storm locations.....	125
8.2	Limits of tropical storm influence.....	126
8.3	Transposition limits for Gibson Dam, MT storm (75) of June 6-8, 1964.....	127
8.4	Transposition limits for Cherry Creek, CO storm (47) of May 30-31, 1935.....	128
8.5	Example of geographic distribution of points used in the transposition of total storm precipitation and FAFP for Colorado.....	131

Number		Page
8.6	Distance-from-coast adjustment for tropical storms.....	134
8.7	FAFP (in.) map for Colorado (10 mi <sup>2</sup> 24 hr).....	136
9.1	Convergence 100-yr 24-hr rainfall (in.) for New Mexico between the Continental Divide and the orographic separation line.....	138
9.2	T/C analysis for a portion of Colorado (10 mi <sup>2</sup> 24 hr).....	139
9.3	M factor analysis for Montana (10 mi <sup>2</sup> 24 hr).....	142
10.1	Example of percentage change in 1-hr 10-mi <sup>2</sup> general-storm PMP index map for current study relative to that given in HMR No. 55 (1984), for Colorado. Considerable smoothing applied to example over detailed analysis.....	151
11.1	Location of minimum nonorographic subdivision and five subregions in the CD-103 region.....	154
11.2	Schematic diagram of subdivision/subregion system used in developing DAD relations.....	154
11.3	DAD relation, A nonorographic subunit.....	156
11.4	DAD relation, B to D nonorographic subunit.....	157
11.5	DAD relation, E nonorographic subunit.....	158
11.6	DAD relation, A minimum nonorographic subunit.....	159
11.7	DAD relation, B to D minimum nonorographic subunit.....	160
11.8	DAD relation, E minimum nonorographic subunit.....	161
11.9	DAD relation, A orographic subunit.....	163
11.10	DAD relation, E orographic subunit.....	164
11.11	DAD relation, C orographic subunit.....	165
11.12	DAD relation, B orographic subunit.....	167
11.13	DAD relation, D orographic subunit.....	168
11.14	DAD relation, A sheltered least orographic subunit.....	169
11.15	DAD relation, E sheltered least orographic subunit.....	170
11.16	DAD relation, C sheltered least orographic subunit.....	171
11.17	DAD relation, B sheltered least orographic subunit.....	172

Number		Page
11.18	DAD relation, D sheltered least orographic subunit.....	173
11.19	DAD relation, A sheltered orographic subunit.....	174
11.20	DAD relation, E sheltered orographic subunit.....	175
11.21	DAD relation, C sheltered orographic subunit.....	176
11.22	DAD relation, B sheltered orographic subunit.....	177
11.23	DAD relation, D sheltered orographic subunit.....	178
12.1	Synoptic surface weather maps for August 29 and 30 1935, - the Las Cruces, NM storm (48).....	185
12.2	Precipitation map, Masonville, CO storm (55) - September 10, 1938.....	186
12.3	Synoptic surface weather maps for September 10 and 11, 1938 - the Masonville, CO storm (55).....	187
12.4	Linearly interpolated synoptic surface weather map for 1800 GMT - September 11, 1938.....	187
12.5	Synoptic surface weather maps and 500-mb charts for June 6 and 7, 1948 - the Golden, CO storm (67).....	188
12.6	Precipitation map, June 7, 1948 - the Golden, CO storm (67).....	189
12.7	Synoptic surface weather maps and 500 mb charts for August 16 and 17, 1958 - the Morgan, UT storm.....	191
12.8	Precipitation map, Morgan, UT storm - August 16, 1958.....	192
12.9	Mass curve of rainfall for Agricultural College - the Las Cruces, NM storm (48).....	195
12.10	Depth-duration curve for 6-/1-hr ratio of 1.35.....	200
12.11	Depth-area data for the Golden, CO (67) local storm and local-storm depth-area data from other regions compared with adopted curve from HMR No. 49 and model thunderstorm depth-area relation.....	202
12.12	Depth-area relations adopted for local-storm PMP in the CD-103 region.....	203
14.1	Outline of the drainage for the Pecos River above Los Esteros Dam, NM (2,479 mi <sup>2</sup> ) showing position of DAD subdivision boundaries.....	215

Number		Page
14.2	Depth-duration curve for PMP estimates for Pecos River drainage above Los Esteros Dam, NM (2,479 mi <sup>2</sup> ).....	217
14.3	Adjustment for elevation for local-storm PMP based on procedures developed in the report and maximum persisting 12-hr 1000-mb dew point (F).....	219

**LIST OF TABLES**

2.1	List of major storms of record considered in CD-103 study.....	12
2.2	Storms important to determination of PMP for the CD-103 region.....	18
2.3	List of storms of record considered for CD-103 region by storm type.....	59
2.4	Dates of tropical storms affecting southern portion of CD-103 region.....	61
4.1	Stations used in revision of maximum persisting 12-hr 1000-mb dew-point charts.....	70
4.2	Persisting 12-hr dew points 2°F or more above existing criteria on date of occurrence.....	74
5.1	Representative persisting 12-hr 1000-mb storm and maximum dew points for important storms in and near study region.....	85
5.2	Index to stations used to determine representative persisting 12-hr 1000-mb storm dew points.....	86
5.3	In-place moisture maximization factors (percent) for important storms in and near the CD-103 region.....	89
5.4	Ten largest storm depths within CD-103 region for 6-, 24-, and 72-hr durations for 10, 1,000, and 10,000-mi <sup>2</sup> areas - observed and moisture maximized in-place, ranked from highest to lowest in each category.....	91
9.1	Ratios of 6-/24-hr precipitation for major storms used as guidance for M analysis.....	141
9.2	Values of orographic influence parameter, K, relative to variations in M and T/C.....	143
11.1	Major river basin subregions within the CD-103 region.....	154
12.1	Candidate local-storm list.....	182

Number		Page
12.2	Extreme local storms in CD-103 region.....	183
12.3	In-place local-storm moisture maximizations.....	196
12.4	Percent of 1-hr local-storm PMP for selected durations for 6-/1-hr ratio of 1.35.....	200
12.5	Recommended chronological distribution of 1-hr incremental rainfall amounts for 6-hr local-storm PMP .....	204
12.6	Recommended chronological distribution of 15-min incremental rainfall amounts for 1-hr local-storm PMP....	204
12.7	Distribution of month of maximum 1-hr storm amounts for recording gage stations.....	205
13.1	Comparisons between general- or local-storm PMP and observed and moisture-maximized rainfall depths (in.) from selected important storms for 10 mi <sup>2</sup> .....	206
13.2	Comparison of ranges in general-storm PMP (in.) estimates from Technical Paper No. 38 and the CD-103 study.....	208
13.3	Comparison of ranges in PMP estimates (in.) from the Upper Rio Grande study and the CD-103 study.....	208
13.4	Maximum and minimum ratios of 10-mi <sup>2</sup> PMP estimates (in.) to 100-yr precipitation-frequency point values (in.) at 1, 6, and 24 hr.....	210
13.5	Comparison between PMP values along the Continental Divide from HMR No. 55A and HMR No. 43 or 49.....	212

## PLATES

(Plates are provided in separate envelope)

Plate I	1-hr 10-mi <sup>2</sup> PMP
Plate II	6-hr 10-mi <sup>2</sup> PMP
Plate III	24-hr 10-mi <sup>2</sup> PMP
Plate IV	72-hr 10-mi <sup>2</sup> PMP
Plate V	Regional limits for terrain classifications
Plate VI	Local storm PMP



## PREFACE TO REVISED EDITION

Hydrometeorological Report (HMR) No. 55 was published in 1984. This report was the first serious attempt to develop a PMP procedure for the highly orographic region between the Continental Divide and the 103rd meridian (CD-103 region). It superseded Technical Paper No. 38 (U.S. Weather Bureau 1960) west of the 105th meridian, where only broad-scale effects of terrain were considered, and HMR No. 51 (Schreiner and Riedel 1978) between the 103rd and 105th meridians.

The procedure used in HMR No. 55 is highly complex involving a number of subjective decisions based on meteorological experience and understanding. The procedure for orographic intensification in HMR No. 55 represented new thinking and was intended to provide a foundation for a technique that would be applicable to other complex orographic regions. Some of the concepts have since been adopted in NWS HYDRO 39 (Miller et al. 1984) and 41 (Fenn 1985), as well as HMR No. 56 (Zurndorfer et al. 1986).

Since the release of HMR No. 55 in early 1984, considerable controversy has developed regarding potentially high values in both general and local storm PMP estimates at higher elevations. It is these higher elevation storms where detailed observations and knowledge are lacking. In response to these concerns, the National Weather Service and the Bureau of Reclamation authors reexamined those parts of the study that might have influenced the results in these areas of concern. A number of decisions were made in HMR No. 55 that controlled the level of PMP estimates. Upon subsequent review, three areas were found where alternate decisions could be made. In combination, these alternate decisions significantly reduce the PMP estimates for small areas and short durations at higher elevations. These changes have been incorporated into this revised report, to be known as HMR No. 55A. Because some of the changes have resulted in significant differences to the 1984 results, copies of HMR No. 55 should be discarded to avoid confusion.

The following decisions were made:

1. To provide local-storm PMP estimates for the entire CD-103 region as opposed to the three sheltered geographic zones given in HMR No. 55. In HMR No. 55, we chose to restrict such estimates to the most sheltered zones. It appears reasonable that local-storm estimates can be provided throughout the region and allow the results to delineate the extent of control between local and general storm. This has been done and is discussed in chapter 12.
2. In HMR No. 55, the vertical moisture adjustment for local-storm PMP transposition somewhat departed from past practice. Use of one-half the liquid water variation observed in precipitable water tables (for a saturated pseudo-adiabatic atmosphere) considerably increased the estimates of PMP at higher elevation. The authors have changed this adjustment in HMR No. 55A to conform to previous studies that allow for the full moisture adjustment presented by the change in precipitable water with elevation.

3. HMR No. 55 treated the variation of 1- to 6-hr and 6- to 24-hr ratios in general storms with elevation such that the ratios were either constant or increasing with increasing elevation. In HMR No. 55A, the elevation variation of these ratios is treated differently, particularly on the most steep east-facing slopes of the Wind River and Big Horn range, and along the Rocky Mountains near Pikes Peak and portions of the Sangre de Cristo Mountains. For the most part the ratios drop off with increased elevation throughout the steep slope region.

The combined effect of these changes is discussed in section 10.3.3, where it is shown that general-storm reductions up to 40 percent are realized at some locations. Somewhat lower reductions (10-25 percent) are obtained from the local-storm procedure presented in section 12.4. Numerous other changes have been made to the text to make the discussion compatible with the changes mentioned above. Additional changes of a lesser nature have been included to correct typographical errors and other features noted in HMR No. 55 since its publication.

Because of user concern that this report be a stand-alone reference tool, the text has been prepared to read as an original study report, and only limited reference is made to differences from that presented in HMR No. 55. It is the authors' sincere intent that these modifications result in a minimum inconvenience in terms of their impact on design applications. The authors hope that this report has been strengthened by having taken the time to make the changes.

The reader is reminded that, as in the 1984 report, the results presented in this study represent a reasonable use of available storm data and state-of-the-art procedures. Knowledge of the many factors that influence the quantity of precipitation to fall at any specific location is still incomplete. Much research remains to be done in the area of orographic precipitation processes. As additional understanding develops, perhaps in the form of physical based models, or additional storm data, some changes to the present study may become necessary. While it is recognized there are some who consider these results to be overly conservative or highly controversial, the authors believe they have provided the best response to the definition of PMP available for this region at this time.



**PROBABLE MAXIMUM PRECIPITATION ESTIMATES - UNITED STATES BETWEEN  
THE CONTINENTAL DIVIDE AND THE 103RD MERIDIAN**

E.M. Hansen, and D.D. Fenn  
Water Management Information Division  
Office of Hydrology  
National Weather Service, NOAA,  
and

L.C. Schreiner and R.W. Stodt  
Flood Section, Surface Water Branch  
Earth Sciences Division  
Bureau of Reclamation

and  
J.F. Miller, Consulting Meteorologist

**ABSTRACT** This study provides all-season general-storm probable maximum precipitation (PMP) estimates for durations from 1 to 72 hr for the region between the Continental Divide and the 103rd meridian. For the nonorographic portions of eastern Montana, Wyoming, North and South Dakota, Colorado, New Mexico and western Texas, estimates are available for area sizes from 10 to 20,000 mi<sup>2</sup>. For orographic regions of these states east of the Continental Divide estimates are available for area sizes from 10 to 5,000 mi<sup>2</sup>.

The study also provides estimates of local-storm PMP for the region. These estimates cover durations from 15 min to 6 hr and drainage areas between 1 and 500 mi<sup>2</sup>.

A step-by-step procedure for computing PMP is presented for both the general- and local-storm criteria. An example has been worked out for the general-storm criteria.

## **1. INTRODUCTION**

### **1.1 Background**

Previously, generalized estimates of probable maximum precipitation (PMP) have been available for portions of the study region (United States between the Continental Divide and the 103rd meridian) in Technical Paper No. 38 (U.S. Weather Bureau 1960) and east of the 105th meridian in Hydrometeorological Report No. 51 (Schreiner and Riedel 1978) and 52 (Hansen et al. 1982). Technical Paper No. 38 (TP 38) applied to the region west of the 105th meridian but PMP values were restricted to areas less than 400 mi<sup>2</sup> and to durations up to 24 hr. Hydrometeorological Report No. 51 and 52 (HMR No. 51 and 52) provided PMP estimates for the region east of the 105th meridian, except the zone between the 103rd and 105th meridian was stippled to indicate an area where estimates may be

deficient, because terrain influences were not evaluated. Areas as large as 20,000 mi<sup>2</sup> and durations up to 72 hr were covered in these reports.

Additionally, estimates of PMP for individual drainages between the Continental Divide and the 103rd meridian have been prepared by the National Weather Service (NWS) on occasions where the prevailing generalized reports were believed to inadequately treat orographic influences. Throughout the United States, including the present study, the NWS has prepared generalized studies of PMP as requested by the Corps of Engineers (COE), the U.S. Bureau of Reclamation (USBR), the Soil Conservation Service (SCS), and the Tennessee Valley Authority (TVA).

The concept of generalized PMP studies should not connote a level of detail any less than that for the individual basin studies. The term generalized, in the sense of its use here, is to describe a study that covers a broad region involving numerous drainages. The primary advantages to generalized studies are to be found in the consistency of development and between results when determined for one drainage versus another. One disadvantage is the time required to complete such studies, in many instances taking up to three years.

The increasing development of the CD-103 region has caused renewed interest in the expansion of available water resources and in flood control. There is also concern for the hydrologic adequacy of many existing structures. The need existed, therefore, to review the estimates of precipitation potential for the region between the Continental Divide and the 103rd meridian and to expand the areas and durations covered in the previous study. The present study provides criteria for estimating PMP for durations from 1 to 72 hr for storm areas from 10 to 20,000 mi<sup>2</sup> in the eastern or nonorographic portion of this region and from 1 to 5,000 mi<sup>2</sup> in the more mountainous western portion.

In regions west of the Continental Divide, investigations have shown that PMP for small areas and short durations are not likely to occur in a general storm. The concept of a local storm has been used in western PMP studies to describe an intense, small-area, short-duration isolated event. East of the 105th meridian, previous studies have concluded that the general storm controls PMP for all durations. Since no known local storms have exceeded general storms in the east, it is assumed that the general storm includes sufficient convective bursts to envelop all local storms in that region.

In the present study, local-storm PMP has been defined for areas of 1 to 500 mi<sup>2</sup> and for durations of 15 min to 6 hr. Both local- and general-storm PMP are provided for the entire region between the Continental Divide and the 103rd meridian. It is incumbent upon the user to evaluate which storm type gives the controlling PMP for a specific area, duration, and location.

## **1.2 Authorization**

Authorization for the study was the result of agreements among the U.S. Army Corps of Engineers, the U.S. Bureau of Reclamation, and the National Oceanic and Atmospheric Administration's (NOAA) National Weather Service (NWS). Financing was provided by the COE through their continuing Memorandum of Understanding with the NWS and by the USBR under an Interagency Agreement with the NWS dated September 11, 1980.

### 1.3 Study Region

The northern and southern boundaries of the region are the borders of the United States with Canada and Mexico. HMR No. 51 provides generalized estimates of PMP for durations and areas east of the 105th meridian. In much of the region between the 103rd and 105th meridians, the PMP maps in HMR No. 51 were stippled to indicate some degree of uncertainty that could be resolved only when the region between the Continental Divide and the 105th meridian was studied. In the present report, PMP criteria for this two-degree-wide region have been included as a result of the present investigations, and the PMP estimates from this report supersede the criteria given in HMR No. 51. The eastern boundary of the study region is the 103rd meridian, while the western boundary is the Continental Divide.

West of the Divide, PMP estimates can be determined from Hydrometeorological Report No. 43, "Probable Maximum Precipitation Estimates, Northwest States" (U.S. Weather Bureau 1966), hereafter referred to as HMR No. 43, from Hydrometeorological Report No. 49, "Probable Maximum Precipitation Estimates, Colorado River and Great Basin Drainages" (Hansen et al. 1977), hereafter referred to as HMR No. 49, or from Hydrometeorological Report No. 36, "Interim Report -- Probable Maximum Precipitation in California" (U.S. Weather Bureau 1961). Figure 1.1 shows the regions covered by the present report and the other reports mentioned. See Appendix A for a description of the geographic region and scope of each report.

The study region contains all or part of several major river basins. The entire Yellowstone and Powder River basins are within the study region. Only partially within this study region are the upper reaches of the Missouri, North and South Platte, Arkansas, Canadian, Pecos River basins, and the Rio Grande basin.

In summary, the study region extends from the Canadian to the Mexican borders between the Continental Divide and the 103rd meridian. For convenience, the study region will be referred to hereafter in this report as CD-103.

### 1.4 Method of Study

Procedures developed for PMP analysis must reflect the varied terrain effects throughout the CD-103 region. Terrain varies from the relatively flat regions of eastern Montana, Wyoming, Colorado, New Mexico, and western Texas to the mountainous region that approaches the Continental Divide. It was necessary to develop a procedure which would enable this diverse terrain to be analyzed in a consistent fashion. The adopted procedure is similar in basic development to that used in other studies in the western United States. The procedure separates total PMP into convergence and orographic components of precipitation. The convergence portion of the major storms in the region is determined to enable the estimation of convergence PMP throughout the region.

It is necessary to increase the estimates of convergence PMP for variations in orographic effects over the region to determine total PMP. In this report, an orographic factor, T/C, is derived from 100-yr 24-hr maps of NOAA Atlas 2 (Miller et al. 1973). Since the strength of atmospheric forces in the storm varies from the most intense 1-, 2-, 3-, or 6-hr period through the end of the storm, an intensity factor, M, was developed. This factor reduced the effect of orography

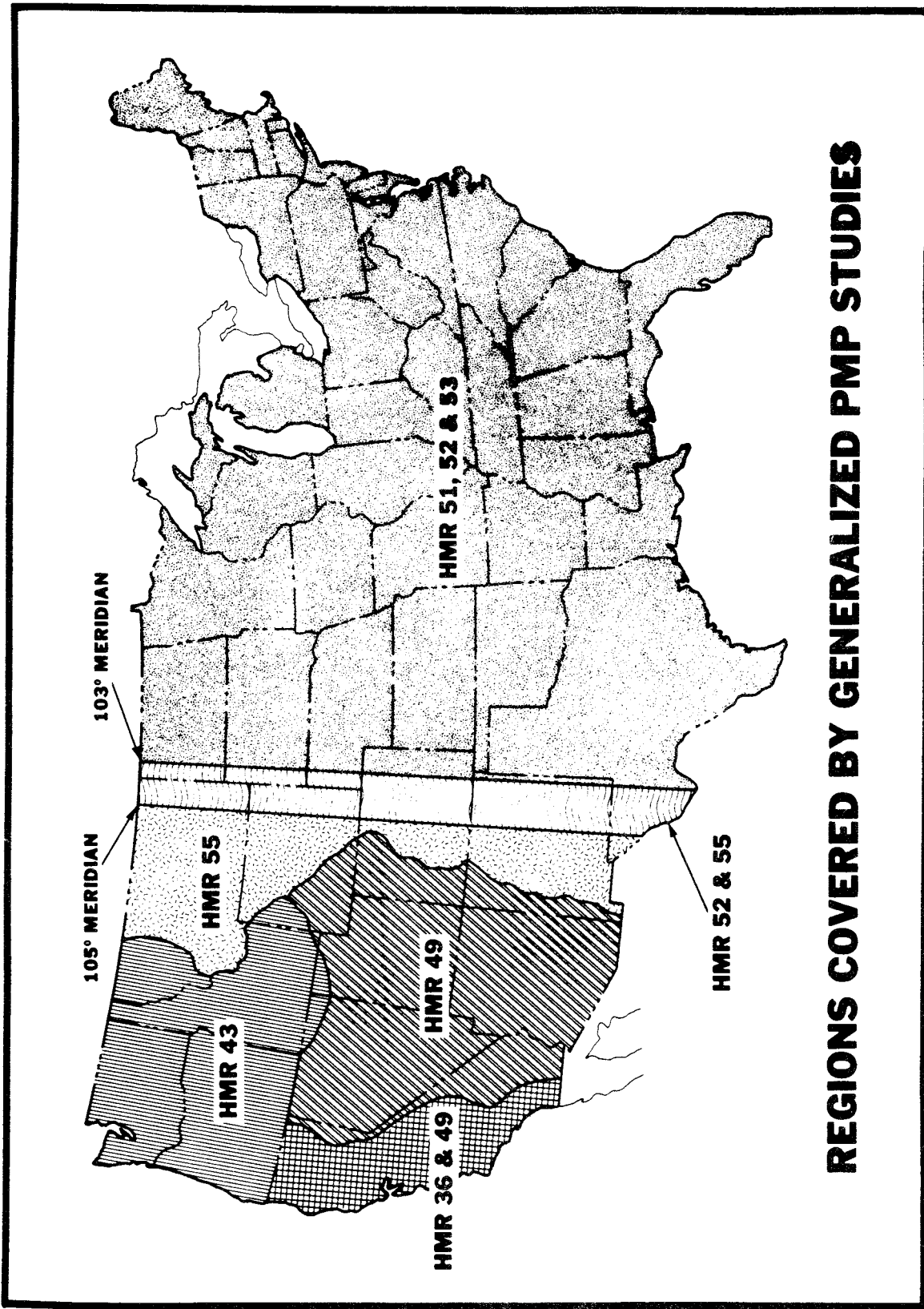

## REGIONS COVERED BY GENERALIZED PMP STUDIES

Figure 1.1.—Regions of the conterminous United States for which PMP estimates are provided in indicated Hydrometeorological Reports. See Appendix A for description of geographical region covered and scope of each report.

during the maximum 6-hr period of the maximum 24 hr of the storm. After determination of the 10-mi<sup>2</sup> 24-hr PMP, 6-/24- and 72-/24-hr ratio maps were used to develop PMP values for the 10-mi<sup>2</sup> area for these other two key durations. A 1-hr 10-mi<sup>2</sup> general-storm PMP map was developed using a 1-/6-hr ratio map. The resulting 1-, 6-, 24-, and 72-hr 10-mi<sup>2</sup> PMP maps provide the key estimates of PMP for the region. Depth-area relations were developed to enable the user to provide estimates for other area sizes. The depth-area relations are based upon the depth-area characteristics of major storms in and near the region.

Local-storm criteria were developed from moisture maximization and transposition of major local-storm amounts throughout the study region. All observed major local storms were transposed to a common 5,000-ft elevation. Procedures are provided to adjust the PMP index values to other elevations. Depth-area and depth-duration relations keyed to the 1-mi<sup>2</sup> 1-hr PMP map at 5,000 ft are provided.

### 1.5 Definitions

**All Season.** The largest or smallest value of a meteorological variable without regard to the time of the year it occurred. In this report, the largest PMP estimate determined without regard to the time of the year it may occur.

**Among Storm.** A storm characteristic determined when values of various parameters may be determined from different storms. For example, a 6-/24-hr ratio, where the 6-hr value is taken from a different storm than the 24-hr value.

**Atmospheric Forces.** The forces that result only from the pressure, temperature and moisture gradients and their relative changes with time over a particular location.

**Basin Shape.** The physical outline of the basin as determined from topographic charts or field survey.

**Dew Point.** The temperature to which a given parcel of air must be cooled at constant pressure and constant water-vapor content in order for saturation to occur.

**Effective Elevation.** The elevation at a point determined from a chart where topographic contours have been smoothed to reflect the effect of terrain on the precipitation process for a particular magnitude of storm. The actual elevation at the point may be either higher or lower than the effective elevation.

**Effective Storm Duration.** The time period within which 90 percent of the total storm precipitation occurs.

**Generalized.** When used as an adjective to modify names such as PMP or estimates or charts, is to be taken in the sense of "comprehensive," i.e., pertaining to all things belonging to a group or category. Thus, a generalized PMP map for a specific area and duration defines PMP for all points in the region; no location is excluded.

**General Storm.** A storm event which usually produces precipitation over areas in excess of 500 mi<sup>2</sup> and durations longer than 6 hr and is associated with a major synoptic weather feature.



Individualized. As applied to drainage estimates, indicates studies for specific drainages that include considerations for possible local influences. In the sense of applications to specific basins, it is commonly implied that information obtained from a generalized study will be processed and result in specific drainage-averaged values.

Local Storm. A storm event restricted in time and space. Precipitation rarely exceeds 6 hr in duration and the area covered by precipitation is less than 500 mi<sup>2</sup>. Frequently local storms will last only 1 or 2 hr and precipitation will occur over only 100 or 200 mi<sup>2</sup>. Precipitation in local storms is considered isolated from general-storm rainfall.

Module. A self-contained unit of a complex procedure.

Orographic Separation Line (OSL). A line separating regions where there are different orographic effects on precipitation. In one region, the nonorographic region, the only factors producing precipitation are atmospheric forces. In contrast, in the orographic region, precipitation results from a combination of atmospheric forces and lifting of air by terrain.

Probable Maximum Precipitation (PMP). Theoretically the greatest depth of precipitation for a given duration that is physically possible over a given size storm area at a particular geographic location at a certain time of the year.

Spatial Distribution. The geographic distribution of PMP for the storm area according to a storm with an idealized pattern.

Storm Centered. A characteristic of a storm that is always determined in relation to the maximum observed value in the storm as compared to the same factor for some other duration and area of the storm. For example, a storm-centered depth-area ratio relates the average depth over some specific isohyetal area of the storm that encloses the center of the storm to the amount at the storm center.

Temporal Distribution. The order in which incremental PMP amounts are arranged within the PMP storm. The time distribution within the local storm period is provided. The distribution of PMP values within the general storm is not discussed.

Total Storm Area and Total Storm Duration. The largest area size and longest duration for which depth-area-duration data are available for major storm rainfalls of record (sec. 2.2).

Within Storm. A storm characteristic determined when values of various parameters are required to be from the same storm. For example, a 6-/24-hr ratio where the values for each duration are always selected as the maximum values for the particular duration in the same storm (see also Among Storm).

Several additional terms that are used only in chapter 7 are defined at the beginning of that chapter.

## 1.6 Terrain Review

The region between the Continental Divide and the 103rd meridian is topographically one of the most complex regions in the conterminous United States. It is a region of steep slopes, narrow enclosed valleys, and open plains. To gain a greater understanding of this complex region, several of the study participants undertook an aerial reconnaissance of the entire region. Of particular importance was the topography at the locations of some of the more significant rainstorms that have occurred within the region: Gibson Dam, Warrick and Springbrook, MT; Savageton, WY; Big Thompson, Cherry Creek, Plum Creek, and Penrose, CO; and McColleum Ranch, NM. This aerial survey took place on three separate flights, and was conducted approximately 2,000-4,000 ft above the terrain. Figure 1.2 shows a schematic of the flight paths. A photographic record was made during these overflights. These photographs were referred to during early stages of the study to aid in understanding relative terrain influence.

## 1.7 Previous PMP Estimates for the CD-103 Region

The PMP values for this study are termed generalized or comprehensive estimates. By this it is meant isolines of PMP are given on index maps and depth-area relations are provided allowing determination of average storm-centered PMP for any drainage within the region. The present study has combined the latest storm data and current knowledge of the precipitation process to develop these estimates of PMP. Results from Weather Bureau Technical Paper No. 38 (U.S. Weather Bureau 1960), for the region between the Continental Divide and the 105th meridian, and HMR No. 51, for the region between the 105th and 103rd meridians, have been superseded by the present study.

Through the years, the Hydrometeorological Branch has provided PMP estimates for particular basins often referred to as individual drainage estimates. These estimates were provided if generalized PMP studies were not available, or if available generalized PMP estimates did not provide estimates for area sizes as large as the drainage under investigation. Of the more recent individual studies in the region considered in this report, only the one for the South Platte River, Hydrometeorological Report No. 44, "Probable Maximum Precipitation over South Platte River, Colorado, and Minnesota River, Minnesota (Riedel et al. 1969) has been published. In some situations, because of basin shape, unusual orographic considerations, areal or spatial distribution developed for the individual basin specific estimate, or other factors, the individual drainage estimate may take precedence. However, the applicability of the individual drainage estimate must be carefully evaluated on a case-by-case basis by a qualified hydrometeorologist, as the need arises.

## 1.8 Application of HMR No. 52 to PMP from this Study

Hydrometeorological Report No. 52, "Application of Probable Maximum Precipitation Estimates - United States East of the 105th Meridian" (HMR No. 52) (Hansen et al. 1982), was completed as an aid "...in adapting or applying PMP estimates from HMR No. 51 to a specific drainage." The procedures in HMR No. 52 are intended for application to nonorographic generalized PMP estimates and were done essentially independent of the base level PMP analyses. The present CD-103 study has introduced new delineations that limit the extent of nonorographic PMP within the 103°-105° region. This delineation is represented by the orographic

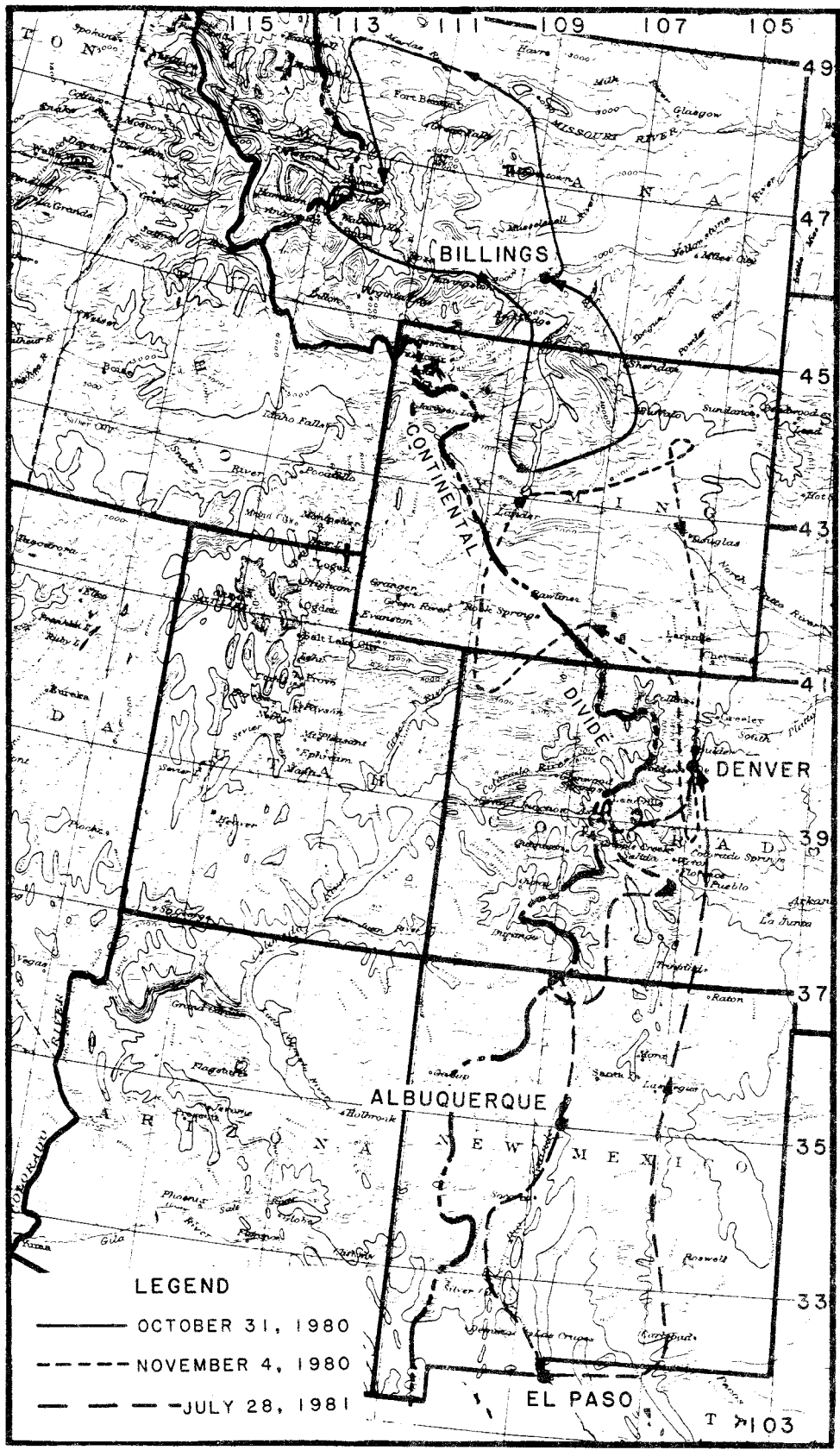

Figure 1.2.—General topography of CD-103 region with track of overflights shown.

separation line (sec. 3.2.1 and fig. 3.1). Since the western limit to the application of HMR No. 52, the 105th meridian, was set to be consistent with the geographical limits of HMR No. 51, consideration was given here to the reasonableness of changing the western limit to HMR No. 52.

The review led to the conclusion that a more appropriate western limit would be the orographic separation line. HMR No. 52 should be applied to PMP estimates from the present study between the 103rd meridian and the orographic separation line. However, for those nonorographic regions that lie west of the 105th meridian, yet east of the orographic separation line, notably in eastern Montana and Wyoming, the application of HMR No. 52 procedures should be considered tentative. Incomplete consideration was given to storms within this region to permit use of HMR No. 52 procedures without additional study. Such study will be a part of recommended future considerations discussed in chapter 15.

### **1.9 Organization of the Report**

This report has been organized to provide a complete and logical progression through the various concepts, procedures, or methodologies used to develop the PMP estimates for the region. Sufficient background material is included in each chapter to give an understanding of the material without reference to other sources.

An important factor, basic to the development of any PMP estimate, is an understanding of the meteorology of major rain storms that have occurred in the region. Chapter 2 provides this information. Major storms that have occurred in and near the region are listed. A brief description is given of the weather situations and time and space distributions of the precipitation associated with some of the more important storms. The review of major storms leads to a storm classification system. This system differs from others that have been presented in previous hydrometeorological studies in that it is directed solely toward classifying storms on the basis of the primary causative factor for the precipitation over the region.

Chapter 3 presents a discussion of the topography of the region. The slope, elevation of the terrain, and intervening barriers to moist airflow are considered. The inflow directions of moist air in major storms discussed in chapter 2 were used to develop a terrain classification system and prepare an effective elevation and barrier map in chapter 3.

Moisture supply available for producing precipitation is among the more important factors in development of PMP estimates. The maximum available moisture within the region is discussed in chapter 4. Chapter 5 provides a discussion of the moisture that was available in the major storms that have occurred in and near the CD-103 region.

Chapter 6 provides an overview of the procedures used to develop the PMP estimates of this report.

Precipitation in the CD-103 region is produced by a combination of both orographic lifting and atmospheric forcing functions. In chapter 7, a procedure is explained that uses a comparison of individual precipitation observations,

isohyetal analysis, evaluation of terrain, and evaluation of meteorological factors to estimate the relative contribution of atmospheric forces and terrain influences on precipitation in individual storms.

The traditional approach to developing PMP estimates is to maximize observed precipitation amounts for moisture and transpose these maximized values to other locations. The traditional approach to moisture maximization and transposition, as well as some modifications to these procedures, are discussed in chapter 8. Several different approaches were examined, each of which has advantages and disadvantages. These approaches were developed to extend the usefulness of the maximization and transposition procedure in orographic regions.

The basic procedure provides estimates of the amount of precipitation that results from free atmospheric forcing effects. These amounts were transposed throughout the CD-103 region. The amount of intensification that would occur at various locations as the result of terrain lifting was then estimated. The method of evaluating this orographic contribution and how it should be used to modify the convergence PMP is the subject of chapter 9.

An explanation of the development of the general-storm PMP index maps is given in chapter 10. Primary focus was given to 24-hr 10-mi<sup>2</sup> precipitation amounts, since station daily rainfall observations are most plentiful and modified transposition techniques can be developed with the greatest reliability for such small areas. Estimates were also developed for 1-, 6-, and 72-hr durations for the 10-mi<sup>2</sup> area.

To provide estimates for the range of area sizes and durations needed for this report, depth-area and depth-duration relations are required. Development of the depth-area relations is discussed in chapter 11. These procedures provide PMP estimates for 1, 6, 24, and 72 hr for area sizes to 20,000 mi<sup>2</sup> in nonorographic portions and 5,000 mi<sup>2</sup> in the orographic portions. These can be used to prepare depth-duration curves for any area size within the limits of the report.

The intermountain region between a generalized crestline of the Sierra Nevada and Cascade Mountains and the Continental Divide is relatively isolated from major moisture sources. Large precipitation amounts for very small areas and short durations in this region do not result from general storms. Within this region a local convective event, isolated in time and space, produces the maximum precipitation amount for these short durations and small areas. Chapter 12 discusses the development of the local-storm criteria.

The consistency and reliability of PMP estimates for various durations and area sizes are discussed in chapter 13. General comparisons are made with previous individual drainage estimates and generalized estimates within the region previously prepared by NWS. Comparisons are made with some major storm rainfall amounts. A final comparison is made with 100-yr return period values from NOAA Atlas 2 (Miller et al. 1973).

Chapter 14 focuses on the procedures for computing PMP for specific drainages. This chapter summarizes procedures developed and discussed in the earlier chapters of the report.

Chapter 15 provides some concluding remarks and suggestions for future studies. Particular attention is focused on studies which are needed to enhance the usefulness of the estimates developed in this and other PMP reports.

## 2. METEOROLOGY OF MAJOR STORMS IN THE CD-103 REGION

### 2.1 Introduction

The basic requirement for any study of the upper limits of precipitation within a region is the review of the major storms that have occurred in and near the study area. In a region so geographically extensive and so topographically diverse as the CD-103, the causes of major rainstorms have been many and varied. In the southern part of the region some of the major storms of record are a result of tropical storms that have crossed the Texas Gulf Coast and moved northwestward before recurving eastward. In Montana, the major storms are extratropical cyclones. Important throughout the region are extratropical storms that have embedded large convective cells, especially for small area sizes and short durations. In this study, we have made meteorological analyses of all of these various storm types to gain a more complete understanding of the meteorology of major rainstorms within the CD-103 region. This chapter describes a number of these storms to provide a basic knowledge of the causes of major storms in the CD-103 region.

### 2.2 Major Storms of Record

A survey was made of all the major storms that have occurred in and near the CD-103 region. The 82 major storms that occurred in this region are listed in chronological order in table 2.1. Location of the greatest rainfall amount from each of these storms is indicated in figure 2.1. The table provides an identifying storm number, name of location where the storm center occurred, date of occurrence, assignment number from the agency conducting the storm study (COE, USBR, and Atmospheric Environment Service of Canada), and the latitude and longitude of the center of rainfall. The storm identification numbers given in table 2.1 will be used throughout this report to identify the individual storms.

Table 2.1 also provides a chronological list of 35 additional major storms (supplemental storms, numbers 83-117) that occurred in the region just to the east of the CD-103 region (to 99°W). Locations of the rainfall centers of these storms are also plotted in figure 2.1. Some of these major storms are important to the estimation of PMP within the CD-103 region.

For most of these storms, depth-area-duration (DAD) data are available from Storm Rainfall in the United States (U.S. Corps of Engineers 1945- ) or reviewed and approved by Bureau of Reclamation storm studies. An exception is the Gibson Dam storm, where a detailed reanalysis of isohyetal maps by the Bureau of Reclamation gave us the DAD data used in this study from a preliminary analysis. Complete storm studies are not available for those storms in which a dash appears under the heading Assignment Number in Table 2.1, where as a rule, the storms are for short durations (Virsylvania, Las Cruces, etc.).

It is apparent from examination of figure 2.1 that for large portions of the CD-103 region there are no major storms in the data base. The state of Wyoming is one such large region. Lack of sufficient storm data has always been a problem for most PMP studies and especially for arid and mountainous regions. One method employed in past hydrometeorological studies to resolve this deficiency is transposition of storms from other locations, i.e., assuming that the precipitation amounts that have occurred in another location could occur in

**Table 2.1.--List of major storms of record considered in CD-103 study**

Storm Number	Name	Storm Date	Assignment No.*	Latitude (°) (')	Longitude (°) (')
Continental Divide-103° 00'					
1.	Ward District, CO	5/29-31/94	MR 6-14	40 04	105 32
2.	Adel, MT	6/29-7/1/98	MR 5-9	47 00	111 40
3.	Big Timber, MT	4/22-24/00	MR 5-10	45 50	109 57
4.	Canyon Ferry, MT	5/11-13/00	MR 5-11	46 38	111 42
5.	Kipp, MT	5/19-20/02	MR 5-12	48 30	112 45
6.	Boxelder, CO	5/1-3/04	MR 4-6	40 59	105 11
7.	Spearfish, SD	6/2-5/04	MR 4-8	44 29	103 47
8.	Rociada, NM	9/26-30/04	SW 1-6	35 52	105 20
9.	Elk, NM	7/21-25/05	GM 3-13	32 56	105 17
10.	Warrick, MT	6/6-8/06	MR 5-13	48 04	109 39
11.	Fort Meade, SD	6/12-13/07	MR 4-10	44 35	103 20
12.	Choteau, MT	6/21-23/07	MR 5-14	47 49	112 10
13.	Evans, MT	6/3-6/08	MR 5-15	47 11	111 08
14.	Norris, MT	5/22-24/09	-	45 35	111 41
15.	Half Moon Pass, MT	6/7-8/10	MR 5-17	46 39	109 18
16.	Knobles Ranch, MT	9/3-6/11	MR 5-18	48 55	111 33
17.	Bowen, MT	10/10-11/11	-	45 45	113 27
18.	Arnegard, ND	4/11-14/12	MR 5-19	47 50	103 25
19.	Fort Union, NM	6/6-12/13	SW 1-14	35 56	105 05
20.	Clayton, NM	4/29-5/2/14	SW 1-16	36 20	103 06
21.	Malta, MT	6/12-14/14	MR 5-20	48 21	107 53
22.	Adel, MT	6/1-5/15	MR 5-21	47 00	111 40
23.	Tajique, NM	7/19-28/15	SW 1-18	34 46	106 20
24.	Sun River Canyon, MT	6/19-22/16	R6-1-8	47 37	112 45
25.	Lakewood, NM	8/7-8/16	SW 1-20	32 38	104 21
26.	Pine Grove, MT	7/14-15/18	MR 5-23	46 50	109 05
27.	Meek, NM	9/15-17/19	GM 5-15B	33 41	105 11
28.	Browning, MT	9/27-28/19	MR 5-24	48 34	113 01
29.	Vale, SD	5/9-12/20	MR 4-17	44 37	103 24
30.	Fry's Ranch, CO	4/14-16/21	MR 4-19	40 43	105 43
31.	Penrose, CO	6/2-6/21	SW 1-23	38 27	105 04
32.	Springbrook, MT	6/17-21/21	MR 4-21	47 18	105 35
33.	Denver, CO	8/17-25/21	R4-1-8A	39 45	105 01
34.	Grover, CO	7/27-8/3/22	R4-1-9	39 45	105 32
35.	Virsylvania, NM (Cerro)	8/17/22	-	36 47	105 38

**Table 2.1.--List of major storms of record considered in CD-103 study (continued)**

Storm Number	Name	Storm Date	Assignment No.*	Latitude (°) (')	Longitude (°) (')
Continental Divide-103° 00'					
36.	Hays, MT	6/16-21/23	MR 5-25	48 02	108 43
37.	Sheridan, WY	7/22-26/23	MR 4-22	44 55	106 55
38.	Savageton, WY	9/27-10/1/23	MR 4-23	43 52	105 47
39.	Sentinel Butte, ND	5/29-30/29	MR 4-27	46 57	103 49
40.	Beach, ND	6/6-7/29	MR 4-28	46 57	104 00
41.	Cheesman, CO	7/19-24/29	R4-1-15	39 13	105 17
42.	Valmora, NM	8/6-11/29	SW 2-27	35 49	104 56
43.	Gallinas Plt. St., NM	9/20-23/29	SW 2-28	35 09	105 39
44.	Porter, NM	10/9-12/30	SW 2-6	35 12	103 17
45.	Westcliffe, CO	4/19-22/33	R4-1-18	38 08	105 28
46.	Kassler, CO	9/9-11/33	R7-1-25A	39 30	105 06
47.	Cherry Creek, CO	5/30-31/35	MR 3-28A	39 13	104 32
48.	Las Cruces, NM	8/29-30/35	-	32 19	106 47
49.	Ragland, NM	5/26-30/37	GM 5-17	34 49	103 44
50.	Circle, MT	6/11-13/37	MR 5-29	47 30	105 34
51.	Leadville, CO	7/27/37	-	39 15	106 18
52.	Big Timber, MT	5/17-20/38	MR 5-6	45 50	109 57
53.	Loveland, CO	8/30-9/4/38	MR 5-8	40 23	105 04
54.	Waterdale, CO	8/31-9/4/38	R4-1-23	40 25	105 12
55.	Masonville, CO	9/10/38	-	40 26	105 13
56.	Prairieview, NM	5/20-25/41	GM 5-18	33 07	103 12
57.	Campbell Farm Camp, MT	9/6-8/41	MR 6-20	45 25	107 55
58.	McColleum Ranch, NM	9/20-23/41	GM 5-19	32 10	104 44
59.	Tularosa, NM	9/27-29/41	SW 3-1	33 04	106 02
60.	Rancho Grande, NM	8/29-9/1/42	SW 2-29	34 56	105 06
61.	Dooley, MT	3/13-17/43	MR 6-11	48 53	104 23
62.	Colony, WY	6/2-5/44	R6-1-23	44 56	104 12
63.	Dovetail, MT	6/14-18/44	R6-1-24	47 21	108 12
64.	Gering, NE	6/17-18/47	MR 7-16	41 49	103 41
65.	Plentywood, MT	8/10-13/47	R6-2-2	48 45	104 25
66.	Fort Collins, CO	5/30/48	MR 7-18	40 35	105 05
67.	Golden, CO	6/7/48	MR 7-19	39 44	105 14
68.	Dupuyer, MT	6/16-17/48	-	48 12	112 30
69.	Prospect Valley, CO	6/12-14/49	R7-2-5	40 05	104 26
70.	Marsland, NE	7/27-28/51	MR 10-7	42 36	103 06
71.	Belt, MT	6/1-4/53	-	47 25	110 50
72.	Buffalo Gap, Sask.	5/30/61	SASK-5-61	49 06	105 18
73.	Lafleche, Sask.	6/12-13/62	SASK-6-62	49 30	106 35
74.	Bracken, Sask.	7/13-14/62	SASK-7-62	49 10	108 10
75.	Gibson Dam, MT	6/6-8/64	-	48 32	113 33



**Table 2.1.--List of major storms of record considered in CD-103 study (continued)**

Storm Number	Storm Name	Storm Date	Assignment No.*	Latitude (°) (')	Longitude (°) (')
Continental Divide-103° 00'					
76.	Plum Creek, CO	6/13-20/65	-	39 05	104 20
77.	Big Elk Meadow, CO	5/4-8/69	-	40 16	105 25
78.	Rapid City, SD	6/9/72	-	44 12	103 31
79.	Broomfield, CO	5/5-6/73	-	39 55	105 06
80.	Wheatridge, CO	7/16/75	-	39 48	105 03
81.	Big Thompson, CO	7/31-8/1/76	-	40 25	105 26
82.	White Sands, NM	8/19/78	-	32 47	106 11
Supplemental storms (103°00'-99°00')					
83.	Springfield, CO	4/4-5/00	-	37 24	102 37
84.	Wakeeney, KS	9/20-24/02	MR 1-8	39 01	99 53
85.	Knickerbocker, TX	8/4-6/06	GM 3-14	31 17	100 48
86.	May Valley, CO	10/18-19/08	SW 2-23	38 03	102 38
87.	Knickerbocker, TX	12/8-10/11	-	31 17	100 38
88.	Hazelton, ND	6/25-28/14	MR 4-14A	46 29	100 17
89.	Onida, SD	2/12-14/15	-	44 42	100 04
90.	Woodward, OK	9/29-10/2/23	MR 3-1B	36 30	99 25
91.	Eagle Pass, TX	5/27-29/25	GM 4-21	28 43	100 30
92.	Belvidere, SD	5/5-9/27	MR 4-25	43 50	101 16
93.	Berthold Agency, ND	7/5-8/28	UMV 1-18	48 20	101 46
94.	Wakeeney, KS	7/28-30/28	MR 3-18	39 01	99 53
95.	Hollis, OK	3/26-28/29	-	34 38	99 55
96.	Tribune, KS	6/2-6/32	SW 2-7A	38 28	101 46
97.	Mountain Home, TX	6/30-7/2/32	GM 5-1	30 10	99 21
98.	Abilene, TX	9/5-7/32	GM 5-16B	32 26	99 41
99.	Stratton, NE	9/11-12/33	R7-1-25B	40 08	101 13
100.	Cheyenne, OK	4/3-4/34	SW 2-11	35 37	99 40
101.	Hale, CO	5/30-31/35	°	39 36	102 08
102.	Segovia, TX	6/10-15/35	GM 5-2	30 22	99 38
103.	Tilston, Man.	6/29-7/1/35	MAN-6-35	49 23	101 19
104.	Ballinger, TX	9/2-7/35	GM 5-3	31 46	99 57
105.	Broome, TX	9/14-18/36	GM 5-7	31 47	100 50
106.	Sharon Springs, KS	5/30-31/38	MR 3-29	38 54	101 45
107.	Eldorado, TX	7/19-25/38	GM 5-10	30 46	100 44

**Table 2.1.--List of major storms of record considered in CD-103 study (continued)**

Storm Number	Name	Storm Date	Assignment No.*	Latitude (°) (')	Longitude (°) (')
103°00' - 99°00'					
108.	Snyder, TX	6/19-20/39	-	32 44	100 55
109.	Kanton, OK	4/17-21/42	SW 3-6	36 55	102 58
110.	Brewster, NE	10/3-5/46	SW 3-2	41 57	99 52
111.	Del Rio, TX	6/23-24/48	-	29 22	100 37
112.	Vic Pierce, TX	6/23-28/54	SW 3-22	30 22	101 23
113.	Brandon, Man.	6/15-62	-	49 20	100 50
114.	Glen Ullin, ND	6/24/66	-	47 21	101 19
115.	Sombreretillo, Mex.	9/19-24/67	SW 3-24	26 18	99 55
116.	Medina, TX	8/1-4/78	-	29 55	99 21
117.	Albany, TX	8/1-4/78	-	32 45	99 20

\* Assignment No's MR X-XX, GM X-XX, SW X-XX, and NP X-XX indicate formal storm studies completed by the U.S. Army Corps of Engineers, RX-X-XX indicates formal studies completed by Bureau of Reclamation, and SASK-X-XX indicates studies done by the Hydrometeorological Services Section, Atmospheric Environment Service, Canadian Department of the Environment. Where no number appears, the storm was studied by the Hydrometeorological Branch, National Weather Service as part of this or other hydrometeorological investigations.

° This center is part of the Cherry Creek, CO storm (47) and was contained in MR 3-28A. For the purposes of this study a separate analysis was made (see Appendix).

the region for which there is limited data. Justification for such transposition is based on the existence of meteorological homogeneity of storm conditions between the actual and transposed locations. Homogeneity implies that the storm mechanisms that operate in the regions of storm occurrence are comparable to the storm mechanisms that occur throughout the portions of the region where there is a paucity of large storm rainfall amounts. Further discussion of storm transposition is given in chapter 8.

### 2.3 Important Storms

From the list of major storms in table 2.1, a preliminary selection was made of the storms believed to be most important for the purpose of estimating PMP within the CD-103 region. The selection was based on the examination of DAD data and storm location, as well as from experience gained in previous studies. Forty-three storms were selected as important storms to consider when determining PMP over the CD-103 region. These storms are listed in table 2.2 and depth-area-duration data for most of the general storms in this list are given in Appendix B. The other storms were studied less intensively, primarily to define the regions of meteorological homogeneity. These storms are of lesser importance in determining the controlling level of PMP in the study region. The storm

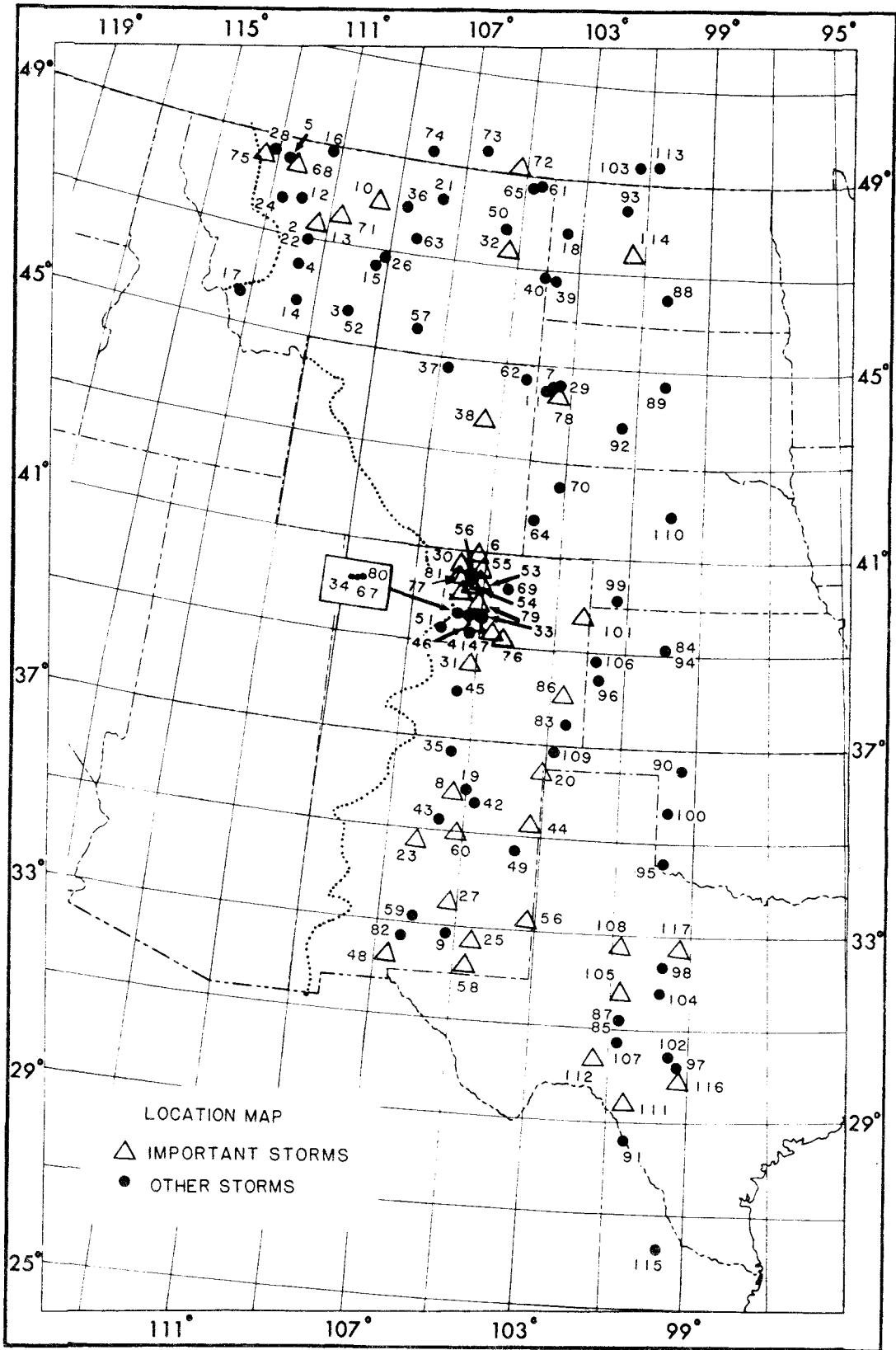

Figure 2.1.—Location of major storms that have occurred in and near the CD-103 region.

numbers used in table 2.2 are the same as those in table 2.1, and are therefore not sequential.

Table 2.2 provides the name of a city or town nearest the storm center, date of the storm, latitude and longitude, elevation, and 1,000-mi<sup>2</sup> 24-hr and 10-mi<sup>2</sup> 6-hr observed precipitation amounts. Precipitation values are given to provide some indication of the magnitude of the storm selected. For a few storms, no data are available for these specific area sizes and durations. Dashes are shown in the table for these storms. The elevations given in table 2.2 are not actual elevations at the location of the storm center, but are read from the barrier/effective elevation analysis (chapt. 3). When a barrier occurs upwind of the storm location, it is noted in table 2.2 by the letter "B" after the elevation.

## 2.4. Meteorological Analyses of Storms

The storms within this region can be grouped into two separate categories: (1) those associated with extratropical cyclones or extratropical convective activity and (2) those that are either the direct result of tropical cyclones or have as a primary moisture source the remnants of tropical cyclones that have crossed the Texas coast. In this section, the weather situation associated with some of the more important general storms will be discussed. The meteorological analyses of these and other major storms form the basis for the storm classification system described in section 2.5. The meteorological situations associated with local storms is discussed in Chapter 12.

### 2.4.1 Extratropical Storms

There are nine extratropical storms that are considered most important in the development of the PMP for the CD-103 region. The meteorological situation associated with each of these storms is discussed in this section.

**2.4.1.1 Warrick, Montana - June 6-8, 1906 (10).** During the period June 6-8, 1906, extensive rainfall occurred over most of Montana and western North Dakota, causing flooding with extensive damage to agricultural interests. At Warrick, MT (48° 04'N, 109° 39'W, elevation 4700), a total of 13.3 in. of rain was recorded during a 54-hr period beginning at 1:00 a.m. on June 6, and ending at 7:00 a.m. on June 8. On the morning of June 7, the heaviest rainfall occurred, 5.3 in. in a 6-hr period. Synoptic weather charts for 0600 MST (all times referred to in this report will be Mountain Standard Time) for the period June 4-8, 1906, are shown in figure 2.2. On the morning of June 4, a weak low pressure system was centered in western Canada, just north of Montana. A cold front extended southward through the United States toward the southern part of Nevada. As this Canadian low pressure system continued to move eastward, a weak Low formed on the Nevada-Utah border. This Low moved northeastward to east-central Montana. By the morning of June 6 it had split, and one Low was located over the Canada-Montana border at about 105°W, and a second Low was over the Wyoming-South Dakota border in the vicinity of Rapid City. A warm front extended almost due eastward from this second Low toward the Great Lakes. The cold front from that Low extended south and then southwestward through Nebraska, eastern Colorado, central New Mexico, into Arizona. General rains fell north of the warm front and extended westward from the Low well past the Continental Divide. Ahead of the cold front, southerly flow brought warm moist air from the Gulf of Mexico up through the Midwest and into the northern tier of states. This warm moist air

**Table 2.2.--Storms important to determination of PMP for the CD-103 region**

Storm Number	Name	Date	Lat. (°) (')		Long. (°) (')		Elev.# (ft)	1000 mi <sup>2</sup> 24 hr	10 mi <sup>2</sup> 6 hr
1.	Ward District, CO	5/29-31/94	40	04	105	32	9600	4.6	1.7
6.	Boxelder, CO	5/1-3/04	40	59	105	11	7000	3.4	2.1
8.	Rociada, NM	9/26-30/04	35	52	105	20	7700	5.4	3.8
10.	Warrick, MT	6/6-8/06	48	04	109	39	4700	6.7	6.0
13.	Evans, MT	6/3-6/08	47	11	111	08	5000 B	5.3	1.9
86.	May Valley, CO	10/18-19/08	38	03	102	38	3800	5.9	4.2
20.	Clayton, NM	4/29-5/2/14	36	20	103	06	4800	7.9	5.3
23.	Tajique, NM	7/19-28/15	34	46	106	20	7500	4.1	4.6
25.	Lakewood, NM	8/7-8/16	32	38	104	21	3600	5.2	4.8
27.	Meek, NM	9/15-17/19	33	41	105	11	6700	5.0	3.8
30.	Fry's Rch., CO	4/14-16/21	40	43	105	43	8000	4.8	2.2
31.	Penrose, CO	6/2-6/21	38	27	105	04	5800	7.8	10.4
32.	Springbrook, MT	6/17-21/21	47	18	105	35	2900	11.3	10.5
35.	Virsylvania, NM (Cerro)	8/17/22	36	47	105	38	8800 B	-	-
38.	Savageton, WY	9/27-10/1/23	43	52	105	47	5100	6.6	6.0
44.	Porter, NM	10/9-12/30	35	12	103	17	4100	7.2	5.7
46.	Kassler, CO	9/9-11/33	39	30	105	06	5900	3.3	3.9
47.	Cherry Creek, CO	5/30-31/35	39	13	104	32	6900	7.2	20.6
101.	Hale, CO	5/30-31/35	39	36	102	08	4000	7.2	16.5
48.	Las Cruces, NM	8/29-30/35	32	19	106	47	4000 *	-	7.4
105.	Broome, TX	9/14-18/36	31	47	100	50	2400	13.8	16.0
53.	Loveland, CO	8/30-9/4/38	40	23	105	04	5000	3.1	6.4
55.	Masonville, CO	9/10/38	40	26	105	13	6000 *	-	-
108.	Snyder, TX	6/19-20/39	32	44	100	55	2400	-	18.8
56.	Prairieview, NM	5/20-25/41	33	07	103	12	4000	4.9	3.8
58.	McColleum Rch., NM	9/20-23/41	32	10	104	44	5800	6.3	10.1
60.	Rancho Grande, NM	8/29-9/1/42	34	56	105	06	5700	6.8	3.2
66.	Ft. Collins, CO	5/30/48	40	35	105	05	5000	-	7.8
67.	Golden, CO	6/7/48	39	44	105	14	6000 *	-	-
68.	Dupuyer, MT	6/16-17/48	48	12	112	30	4200	5.6	4.4
111.	Del Rio, TX	6/23-24/48	29	22	100	37	1100	17.9	13.2
71.	Belt, MT	6/1-4/53	47	25	110	50	4100	5.4	-
112.	Vic Pierce, TX	6/23-28/54	30	22	101	23	2200	18.4	16.0
72.	Buffalo Gap, Sask.	5/30/61	49	06	105	18	2900	-	-
75.	Gibson Dam, MT	6/6-8/64	48	32	113	33	7500 B	12.3	6.0

**Table 2.2--Storms important to determination of PMP for the CD-103 region (continued)**

Storm Number	Name	Date	Lat.		Long.		Elev.# (ft)	1000 mi <sup>2</sup>	
			(°)	(')	(°)	(')		24 hr	6 hr
76.	Plum Creek, CO	6/13-20/65	39	05	104	20	6700	9.5	11.5
114.	Glen Ullin, ND	6/24/66	47	21	101	19	2000	-	11.1
77.	Big Elk Meadow, CO	5/4-8/69	40	16	105	25	8000	5.5	4.0
78.	Rapid City, SD	6/9/72	44	12	103	31	4800	-	-
79.	Broomfield, CO	5/5-6/73	39	55	105	06	5700	4.7	2.9
81.	Big Thompson, CO	7/31-8/1/76	40	25	105	26	8300 B	-	-
82.	White Sands, NM	8/19/78	32	47	106	11	4600 B	-	-
116.	Medina, TX	8/1-4/78	29	55	99	21	1800	15.0	17.0

# Elevation is from smoothed barrier/effective elevation analysis.  
 "B" indicates barrier elevation.

\* Local storm elevation to nearest 100 ft.

was then pulled counterclockwise around the two low centers and westward into North Dakota and Montana. As the warm air moved northward, northwestward, and then westward around the Lows, it was forced over the cooler air mass already present in the region north of the low centers. This forced lifting of the warm moist air resulted in precipitation starting on June 6 in North Dakota and Montana.

During the next 24 hr, the two low centers appeared to merge and deepen and the storm increased in intensity. The single low center remained almost stationary over western North Dakota, occluding as the cold front continued its eastward movement into Wisconsin, Illinois, and Missouri. The intensity of the Low caused high winds and strong convergence, as well as heavy precipitation over the region. During this time, winds at several locations in Montana and North Dakota exceeded 40 mph and rainfall at Warrick, MT reached its greatest intensity. Air flow was from the northeast to the northwest in the vicinity of the rainfall center during the time of maximum rain.

By the morning of June 8, the Low began to weaken and started drifting toward the northeast, which brought a dry northwesterly flow from Canada into Montana. The cold front continued its eastward movement, resulting in an occluded front that stretched into east central Canada. Showers occurred along this front. Rainfall in Montana generally ceased by late morning of the 8th.

The isohyetal map for the storm is given in figure 2.3. This map shows that rain fell primarily in the plains areas of eastern and northern Montana. However, the maximum rainfall occurred at Warrick and fell around an isolated orographic feature, the Bear Paw Mountains. These mountains rise about 1,500 ft above the surrounding terrain. Although rainfall was significant (greater than 2 in.) throughout northeastern Montana, the rainfall at Warrick greatly exceeded other recorded amounts. This suggests that the Warrick center was a result of a local orographic influence upon thunderstorms embedded within the general-storm rainfall. This suggestion is reinforced by a rapid decrease in rainfall amounts

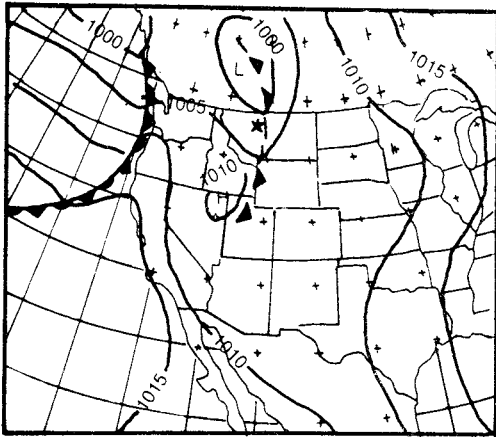

June 4 Surface 0600 MST

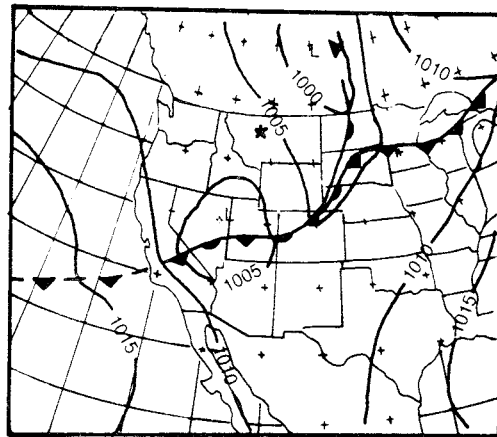

June 5 Surface 0600 MST

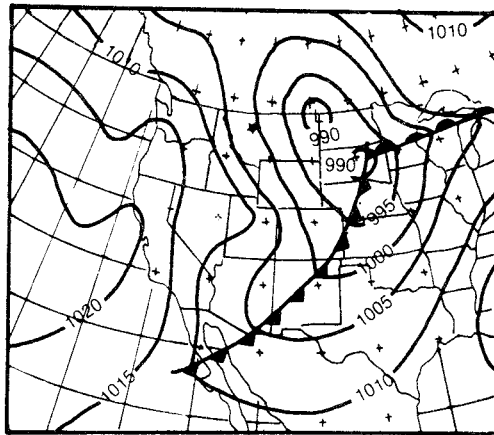

June 6 Surface 0600 MST

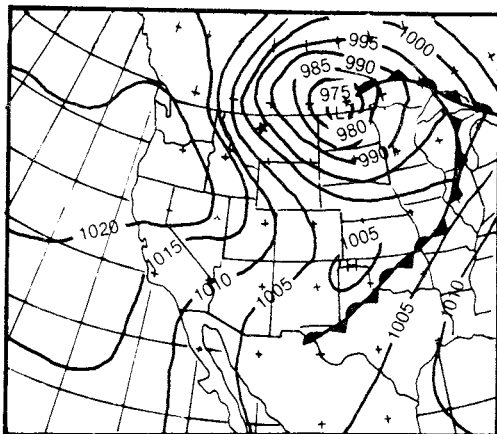

June 7 Surface 0600 MST

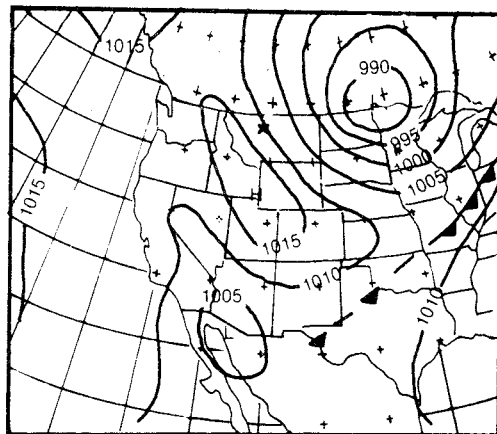

June 8 Surface 0600 MST

**Figure 2.2. Synoptic surface weather maps for June 4–8, 1906 – the Warrick, MT storm (10).**

**Note:** On this and subsequent figures showing weather patterns the location of the storm center is indicated by a star.

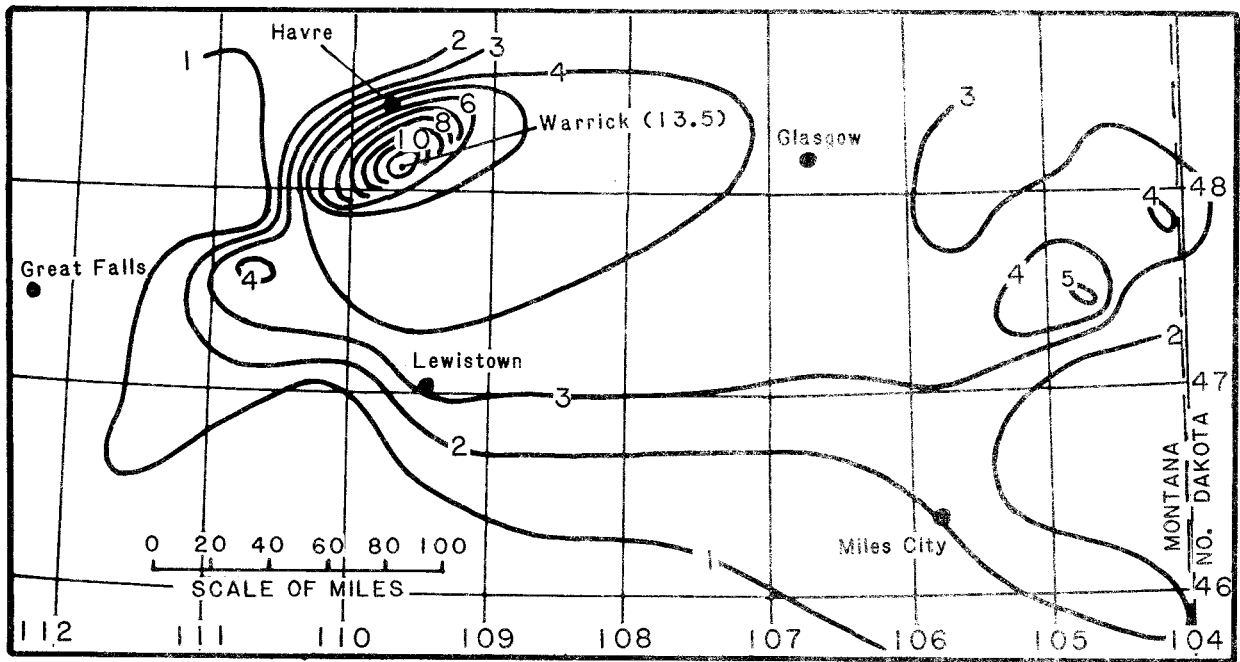

Figure 2.3.--Isohyetal map for the Warrick, MT storm (10) for period June 6-8, 1906.

away from the Warrick center. With strong northerly winds, the rainfall center at Warrick was at least partially the result of spillover rainfall. The observed rainfall center was on the southward-facing slopes of the mountains. With northerly winds, the orographic influences in this storm could undoubtedly have produced greater rainfall amounts on the northward-facing slope, though the observation network in 1906 was too sparse to confirm this idea.

**2.4.1.2 Penrose, Colorado - June 2-6, 1921 (31).** The Penrose, CO storm was a very extensive storm occurring in parts of five states. Total duration of the storm was 114 hr taking into consideration rainfall which occurred over an area of approximately 140,000 mi<sup>2</sup>. It did not rain over the entire area concurrently; rather, there were several rainfall centers located within the five state area. The Penrose center, which was the largest, recorded 12 in. in an 18-hr period beginning about 6:00 p.m. June 3 and ending around noon of June 4.

On June 3, a cold front progressed slowly southeastward across the western United States (fig. 2.4). Meanwhile, a large high pressure area moved generally southward to a position in the vicinity of the Great Lakes. On the morning of June 4, this zone of high pressure became elongated along an east-west axis and dominated the weather and flow pattern from the Great Lakes southward to the Gulf of Mexico. This east-west elongation of the High produced an easterly flow over most of the southern and midwestern United States. At the western edge of the Great Plains, the airflow turned and became southwesterly. This flow brought the moist warm air from the southern United States northwestward. The terrain caused this moist air to be lifted, at first gradually over the higher terrain of western Texas and Oklahoma and then abruptly, by the first upslopes of the Rocky Mountains. It was this moist unstable air that produced the Penrose rainfall center on the evening of June 3 and the morning of June 4.



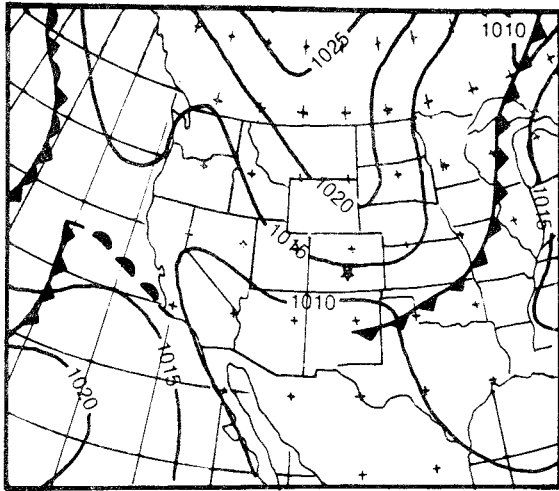

June 2 Surface 0600 MST

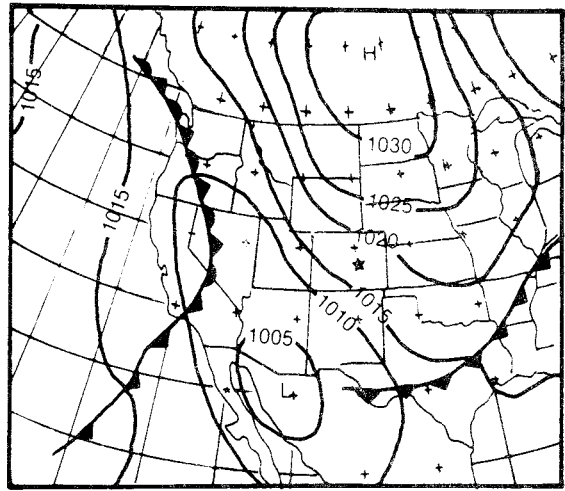

June 3 Surface 0600 MST

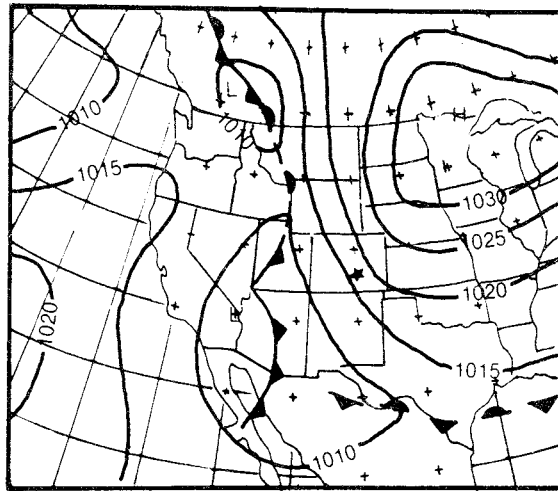

June 4 Surface 0600 MST

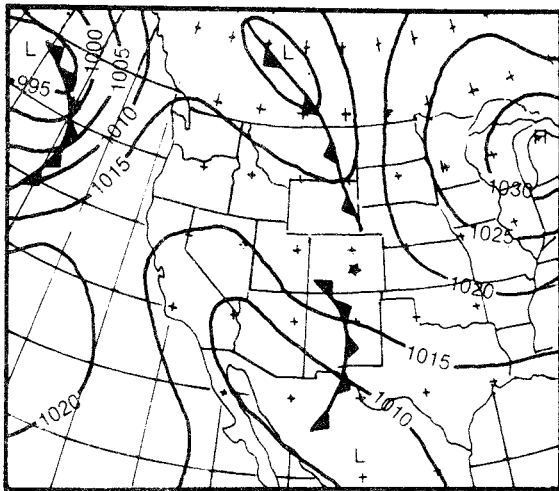

June 5 Surface 0600 MST

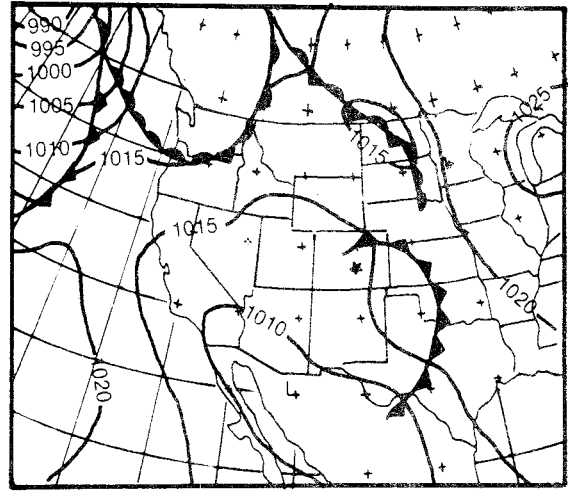

June 6 Surface 0600 MST

Figure 2.4.--Synoptic surface weather maps for June 2-6, 1921 - the Penrose, CO storm (31).

By the morning of the 5th, the high pressure center from the Great Lakes had begun to drift eastward. This resulted in reduced flow into the Penrose storm. The easterly component of the flow over the western part of the Great Plains weakened, and a more southerly component began to dominate. This reduced the lifting effect of the first upslopes of the Rockies; however, the moisture inflow was still sufficient to produce scattered rains in Colorado, New Mexico, Texas, and Oklahoma. The heaviest rains were occurring farther south in New Mexico and Texas, and were associated with a cold front that was moving into the region on the 5th and 6th. These rainfalls were not nearly as intense as those that had occurred in Colorado on the evening of the 3rd and the morning of the 4th. The High, which had been centered near the Great Lakes, continued to drift farther to the east, resulting in diminished strength of the moist airflow from the Gulf of Mexico northward. As the cold front moved through New Mexico, Texas, and Oklahoma, it pushed out the final remnants of the moist easterly flow.

The isohyetal pattern (fig. 2.5) shows rainfall centers in four states that exceeded 6 in. The centers are located at Penrose, CO (12 in.); Hope, NM (6.4 in.); Shattuck, OK (7.3 in.); and Plainview, TX (6.3 in.). A fifth center of 5.9 in. was located at Cimmaron, KS. Mass curves of rainfall for representative stations in the centers at Penrose, Hope, and Shattuck (fig. 2.5) indicate the differing natures of the precipitation in the different centers. The rainfall at the Penrose center, and other large amounts in Colorado, generally occurred over a relatively short duration (less than or equal to 24 hr). At Hope, Shattuck, and Plainview (mass curve not shown), the precipitation occurred over a longer time period, generally in excess of 48 hr. At Penrose, 87 percent of the total storm rainfall occurred in the maximum 6-hr period, while at other locations in Colorado with large precipitation amounts, the greatest 6-hr amount accounted for 60 to 85 percent of the total storm amount. The average of the greatest 6-hr amounts for Colorado stations was approximately 78 percent of the total storm rainfall. By contrast, in the other three centers of the storm, the ratios of the greatest 6-hr amounts to the total storm precipitation amounts are significantly less, being 29 percent at the Plainview, TX center, 31 percent at Hope, NM, and 47 percent at Shattuck, OK. Other reports of heavy rainfall outside of Colorado show 6-hr to total storm ratios ranging from approximately 20 to 74 percent. An average of these ratios outside of Colorado was approximately 46 percent.

**2.4.1.3 Springbrook, Montana - June 17-21, 1921 (32).** This was a large area extratropical cyclone that occurred over eastern Montana and western North Dakota. The primary rainfall center occurred at Springbrook, MT where 15.1 in. of precipitation fell in approximately 100 hr. Over 85 percent of the total storm rainfall fell in a period of about 18 hr. The precipitation centers in North Dakota were considerably smaller; 5.3 in. at Powers Lake, ND and 4.9 in. at Beach, ND.

At 0600 on June 17, a slow-moving cold front extended from eastern Montana southwestward through Arizona (fig. 2.6). Warm moist air from the Gulf of Mexico was being pumped northward by a high pressure system centered over Mississippi. A wave, which was forming on the front, was positioned in northeastern Arizona. The wave moved quickly northeastward along the front, and, by 0600 June 18, was situated in southeastern Wyoming with a warm front extending eastward along the South Dakota-Nebraska border. The moist unstable air from the Gulf of Mexico was lifted over the warm front and deflected around the Low in Wyoming. Convective activity was occurring in the vicinity of both the warm and cold fronts.

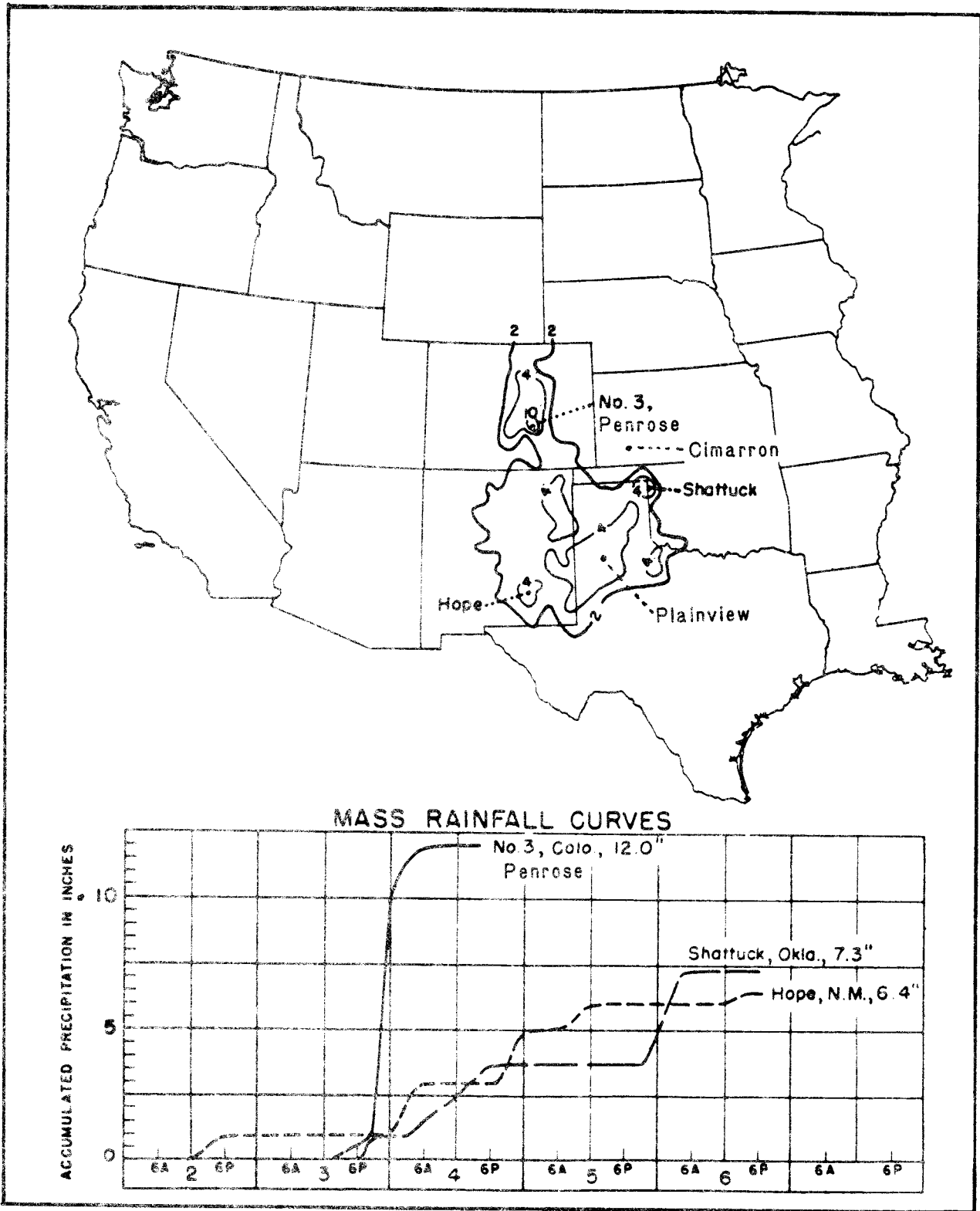
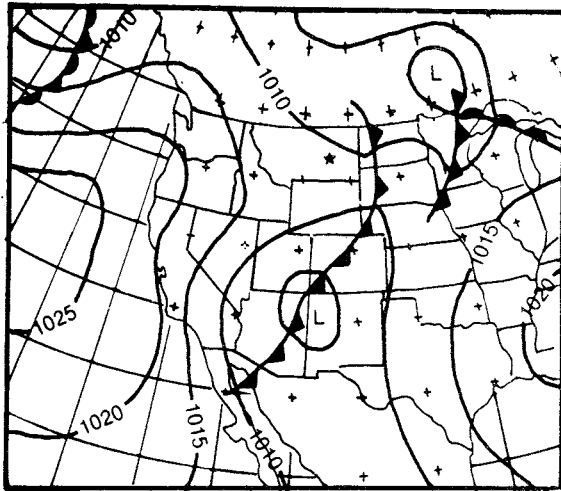
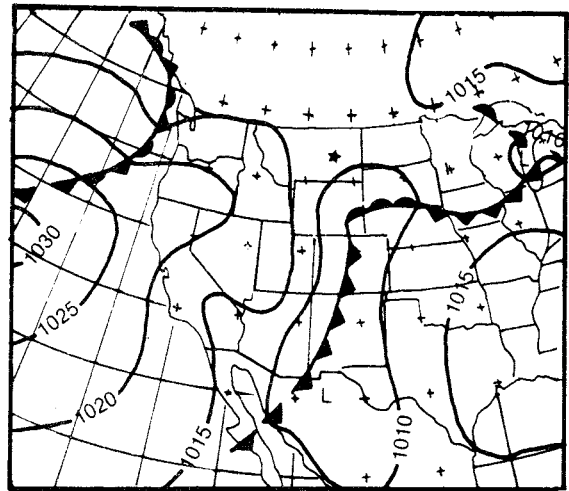

Figure 2.5.--Isohyetal map and selected mass rainfall curves for June 2-6, 1921 - the Penrose, CO storm (31).



June 17 Surface 0600 MST



June 18 Surface 0600 MST

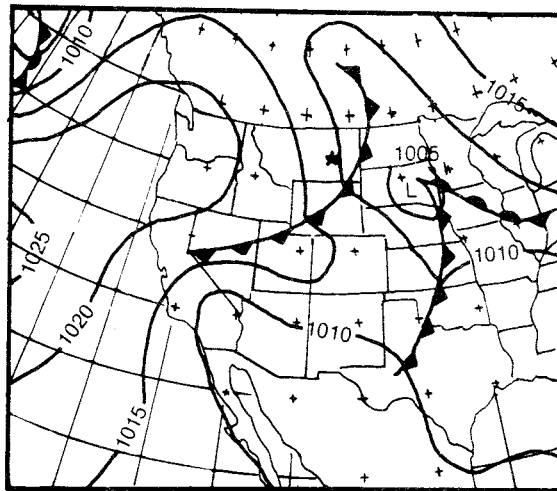

June 19 Surface 0600 MST

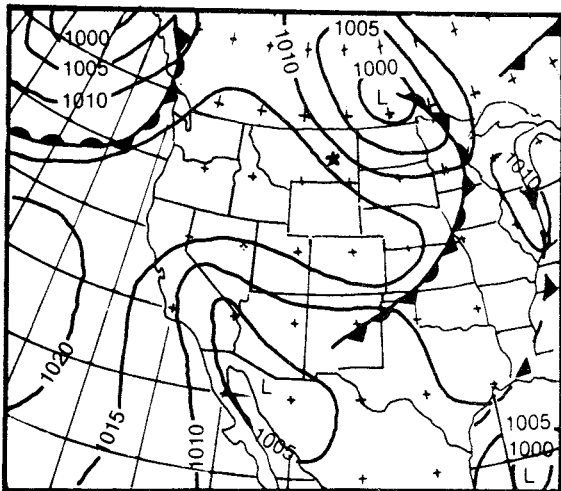

June 20 Surface 0600 MST

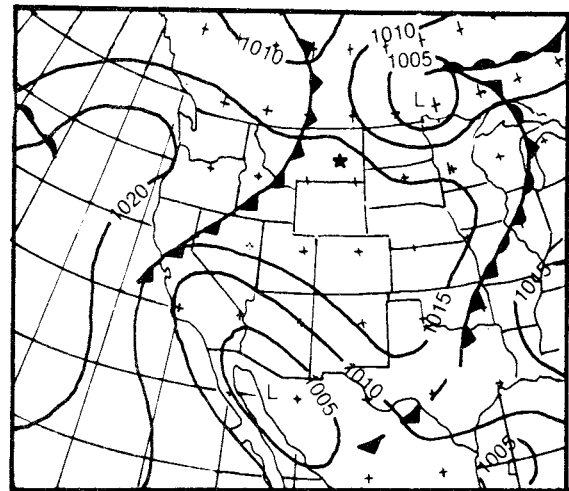

June 21 Surface 0600 MST

**Figure 2.6.--Synoptic surface weather maps for June 17-21, 1921 - the Springbrook, MT storm (32).**

By the morning of June 19, the Low (fig. 2.6) had occluded and was centered in western South Dakota with a trough of low pressure extending northwestward over southeastern Montana. The moist tropical air continued to flow cyclonically around the occluded system. Meanwhile, another rapidly moving cold front from the Pacific Ocean, associated with a Low moving from the Pacific Ocean across northern Canada, crossed into Montana and provided additional lifting of the warm moist air. Upon reaching the trough in southeastern Montana, this system regenerated and a new Low developed. The older Low moved southeastward and dissipated as the new Low deepened and traveled northeastward. By the evening of June 19, it was centered over northwestern North Dakota. The sharp cyclonic lifting and turning of the tropical air around the Low caused intense heavy rainfall over northeastern Montana during the afternoon and night of June 19. On June 20 and 21, the new Low gradually moved eastward along the United States-Canada border. As the system moved out of the region, drier air replaced it and the rainfall ended except for scattered convective showers.

The circular shape of the isohyets drawn around the maximum rainfall center (fig. 2.7) is probably a reflection of the sparsity of measurements. The maximum value of 15.1 in. at Springbrook, MT is 2.5 times greater than the next largest recorded value of 5.9 in., which occurred over 40 mi away. If a greater number of measurements had been made in this region, the structure of the isohyetal pattern probably would have been more complicated. It is also possible that a larger rainfall center would have been discovered. The 2-in. isohyet (fig. 2.7) encompasses a large area including parts of Wyoming, Montana, North Dakota, and Canada. The storm amounts are those measured for a 108-hr period, although the majority of the rain fell during roughly 15 hr in two bursts, one during midday of the 18th, and the second during midday of the 19th through the early morning of the 20th.

**2.4.1.4 Savageton, Wyoming - September 27-October 1, 1923 (38).** A significant feature of the Savageton, WY storm was the cyclonic circulation of the low pressure system which produced widespread convergence. Another important factor was the strong flow of warm moist air northward from the Gulf of Mexico into the region of heavy precipitation. The heaviest precipitation occurred at Savageton, WY in the northeastern portion of the state. The maximum precipitation for this 108-hr storm period was 17.1 in.

On the morning of September 25, the low pressure system which would affect the Savageton, WY area was positioned just off the northern California coast. An accompanying front extended eastward from the Low across California and Nevada through Utah, and northeastward to join another Low in North Dakota. A High was centered over Lake Ontario and was pumping warm moist air northward from the Gulf of Mexico through Texas and as far north as Minnesota. A stationary front oriented south to north from western Texas to North Dakota marked the western border of the humid air mass at the surface.

The Low over the Pacific moved inland to northern Utah by 0600 September 26. The accompanying warm front stretched eastward to Nebraska and into Canada. The High strengthened while moving eastward and maintained the steady flow of warm moist air from the Gulf of Mexico. Meanwhile, the stationary front was dissipating so the warm moist air was able to penetrate further to the north and west. By the morning of September 27, the Low had traveled to southeastern Colorado (fig. 2.8) and the warm front associated with the Low extended eastward through northern Missouri. The cold front associated with the Low extended southward

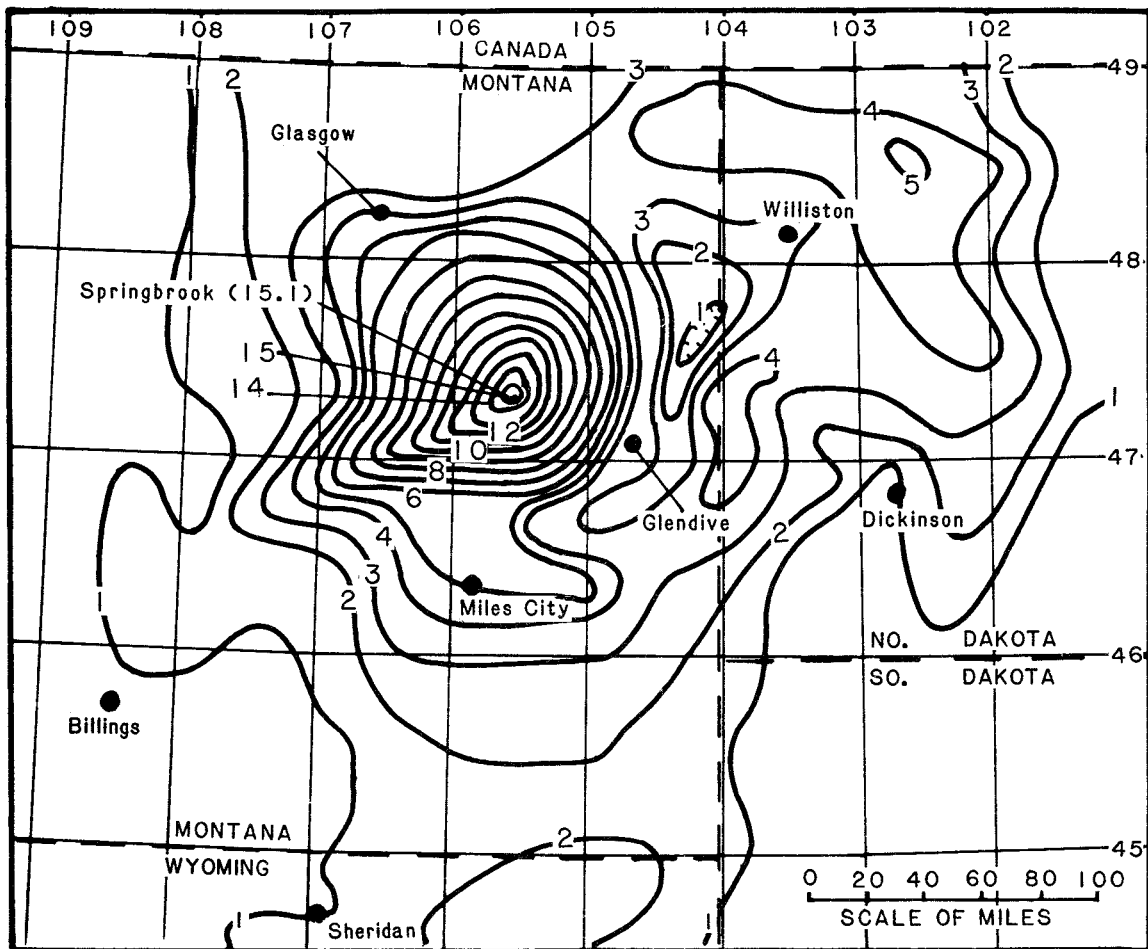

**Figure 2.7.--Isohyetal map for June 17-21, 1921 - the Springbrook, MT storm (32).**

through New Mexico, Texas, and into Mexico near El Paso. The High continued to strengthen as it drifted southeastward into the Atlantic Ocean. Circulation around the High persisted over the west central Plains and continued to move the warm moist Gulf of Mexico air northward to the vicinity of the Low and fronts. In the northern Rocky Mountains, a mass of cold air was moving from north to south immediately to the rear of the Low. Although some precipitation associated with this low pressure system occurred as the storm crossed California, the heavy rains east of the Continental Divide began on the 27th as warm moist air from the Gulf was lifted over the cold air, while the pronounced cyclonic circulation produced a strong level of convergence.

The Low moved very little in the 24 hr from the morning of the 27th through the morning of the 28th and, at 0600 on the 28th, was centered in northwestern Kansas. The accompanying warm front from the Low had moved slightly northward to the Iowa-Missouri border, while the cold front still trailed southward through Oklahoma, the Texas Panhandle, and through the Big Bend country of Texas. The high pressure system started to weaken as it drifted further southeastward; however, the flow from the Gulf of Mexico northward remained strong. The heavy rains in Wyoming continued as circulation around the Low stayed intense.

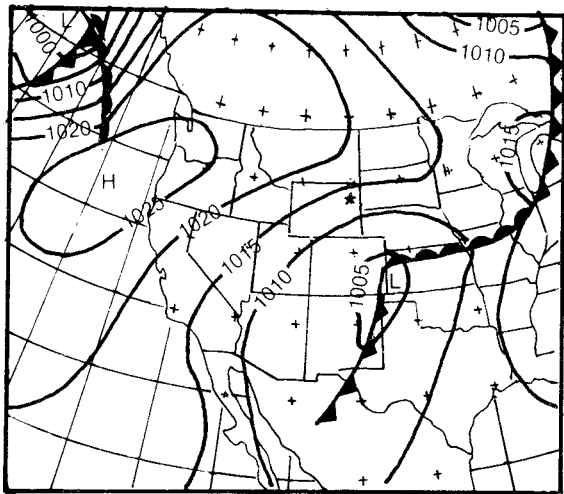

September 27 Surface 0600 MST

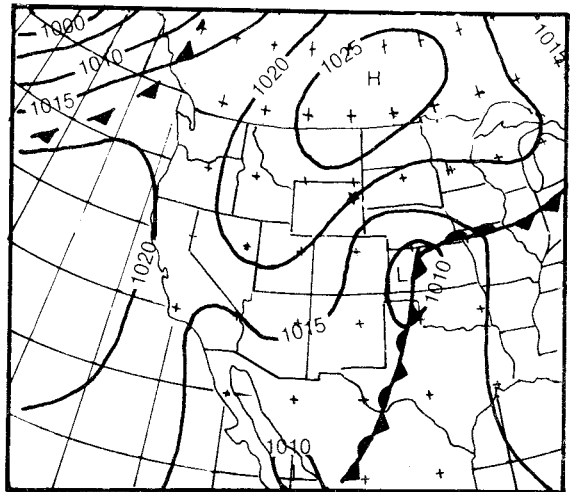

September 28 Surface 0600 MST

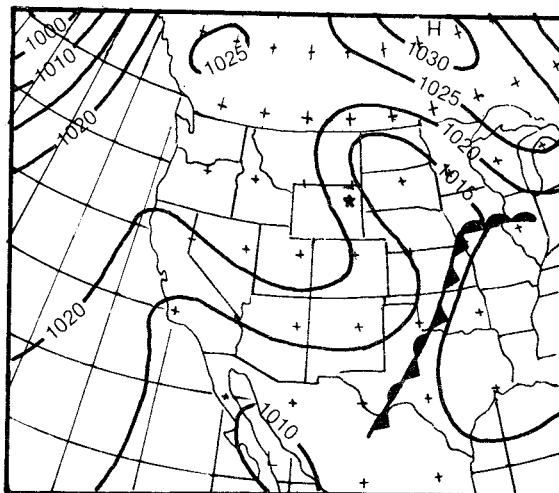

September 29 Surface 0600 MST

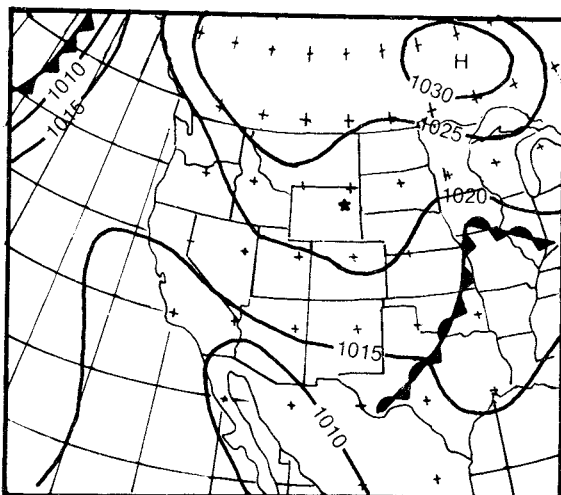

September 30 Surface 0600 MST

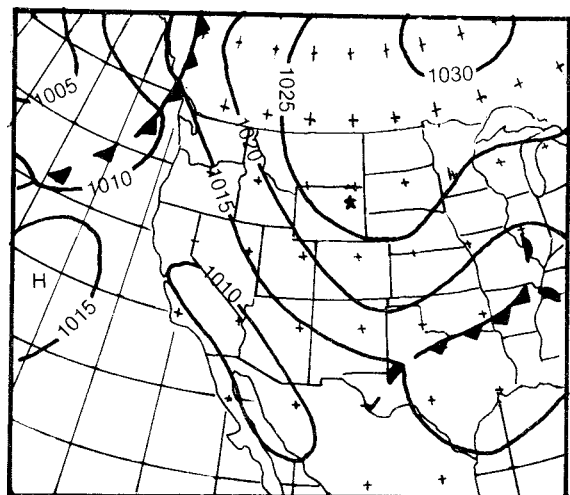

October 1 Surface 0600 MST

Figure 2.8.--Synoptic surface weather maps for September 27–October 1, 1923 – the Savageton, WY storm (38).

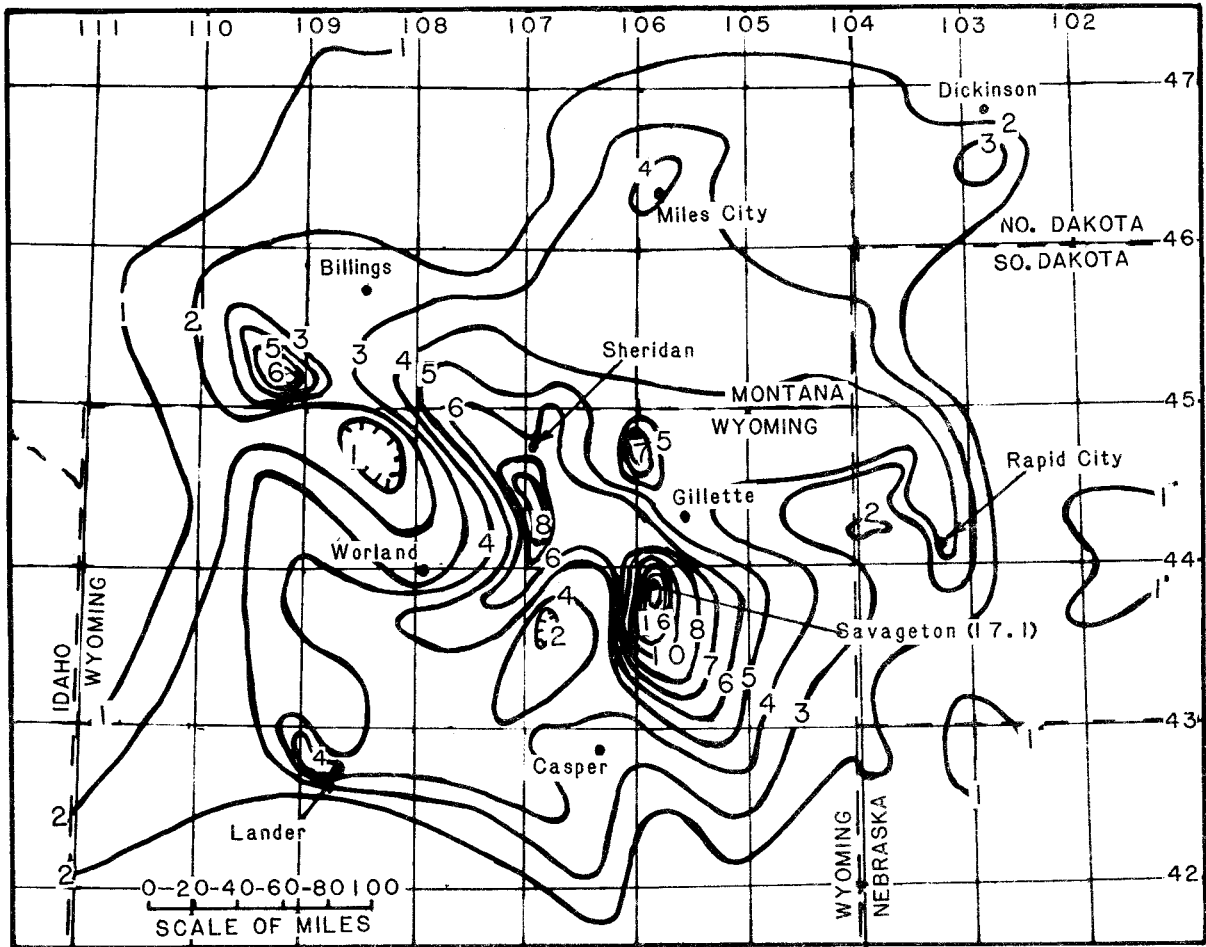

Figure 2.9.--Isohyetal map for September 27–October 1, 1923 - the Savageton, WY storm (38).

The storm began to decrease during the 28th, and by the morning of the 29th a distinct closed circulation pattern was no longer evident. The rainfall began to diminish significantly in Wyoming. What remained of the system was a rather diffuse region of low pressure that extended from eastern Nebraska northwestward into west central South Dakota. The eastward movement of this region of low pressure was blocked by a ridge of high pressure which had built southeastward from Manitoba into Ohio. A tropical storm off the coast of South Carolina had caused the eastern High to weaken and move eastward into the Atlantic. This resulted in disruption of the southerly flow across the Gulf States and limited the flow of air northward from the Gulf of Mexico.

On September 30 and October 1, the precipitation which occurred was in the form of isolated rain and snow showers. The remnants of the low pressure system moved into southeastern Nebraska. Warm moist airflow from the Gulf of Mexico had been completely shut off.

The maximum precipitation for the 108-hr storm period was 17.1 in. at Savageton, WY. Another large amount in Wyoming was 8.3 in. at Hunters Station, while 8.0 in. fell at Arvada, CO. The area receiving at least 2 in. of precipitation was equivalent in size to the entire state of Wyoming (fig. 2.9).



The maximum average depth of rainfall was 6.6 in. for 24 hr. over 1,000 mi<sup>2</sup>. Since the storm was primarily the result of convergence from the low pressure system, the total isohyetal pattern was basically oriented from southwest to northeast, roughly paralleling the track of the storm. Along the mountain ranges maxima tended to be influenced by the mountain slopes and were located on the eastern slopes.

**2.4.1.5 Cherry Creek (47) - Hale (101), Colorado - May 30-31, 1935.** During a 24-hr period beginning at 6:00 a.m. on May 30 and ending at 6:00 a.m. on May 31, heavy convective rainfall broke out at several locations along a line from the foothills of the Rocky Mountains of eastern Colorado east-northeastward to the Kansas border. These storms were small in areal extent, but of extreme intensity, with point rainfall amounts as high as 24 in. in a 6-hr period. The rains caused much flash flooding in the Cherry, Kiowa and Bijou Creek basins just east of the foothills of the Rocky Mountains in Colorado, and on other small basins to the east near Hale, CO.

The surface weather map (fig. 2.10) for the morning of May 30 shows the presence of a weak low pressure center with associated cold and warm fronts. The Low was centered over northern Utah with a warm front extending eastward south of the area of heavy precipitation. Warm moist air flowed into the region from the Gulf of Mexico. As the morning wore on, the warm front drifted northward to a position almost directly over the Cherry Creek-Hale, CO area. The Low drifted southeastward, and the center was located in northern New Mexico. The intersection of the cold and warm fronts was just west and south of the precipitation center. North of the warm front a strong High was centered over the Canada-United States border. The presence of these dissimilar air masses caused the outbreak of the extreme convective activity along the warm front in the late morning. The storm then moved east northeastward along the warm front, feeding on the low level moist air that was moving northward from the Gulf of Mexico and on instability released as warm air moved up over the cold air associated with the high pressure system. This continued until the early morning hours of the 31st when the storm dissipated.

The many reports of hail are witness to the intensity of these storms. Some reports indicated hail as large as baseballs. It is also likely that low level winds near the storm and along the warm front were very strong. The report of a heavy dust storm near the Colorado-Kansas border during the storm period supports this conclusion.

There were several rainfall centers in the storm as shown on the isohyetal map (fig. 2.11). The two largest centers with greatest rainfall depths are the Kiowa center and the Hale center, both reaching 24 in. Because flooding on Cherry Creek was more critical to Denver, the storm is generally referred to as the Cherry Creek storm in the literature, whereas the largest rain amounts actually fell on the Kiowa and Bijou Creek basins. The Kiowa center (39°13'N 104°32'W), at an elevation of 6,900 ft, occurred in an orographic region known as the Palmer Ridge, while the Hale center (39°36'N 102°08'W) occurred at an elevation of 4,000 ft in essentially flat nonorographic terrain. This suggests that, although the Kiowa center may have been initiated and enhanced by orography, this storm as a whole was not dependent on strong orographic lifting.

Timing of the rainfall determined by mass curve analysis (not shown) shows that the heavy rain began in the Kiowa, Bijou, and Cherry Creek areas about midmorning

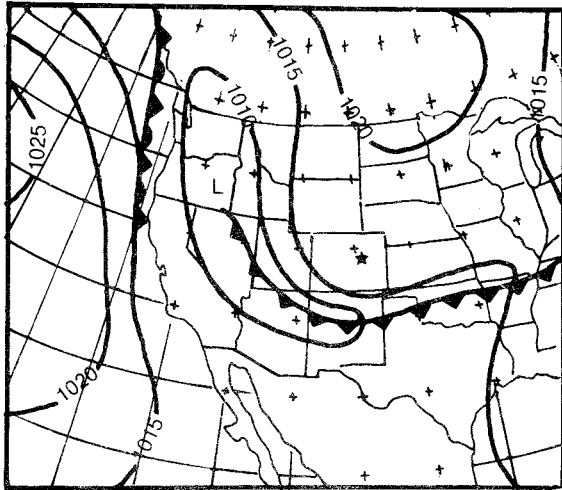

May 29 Surface 0600 MST

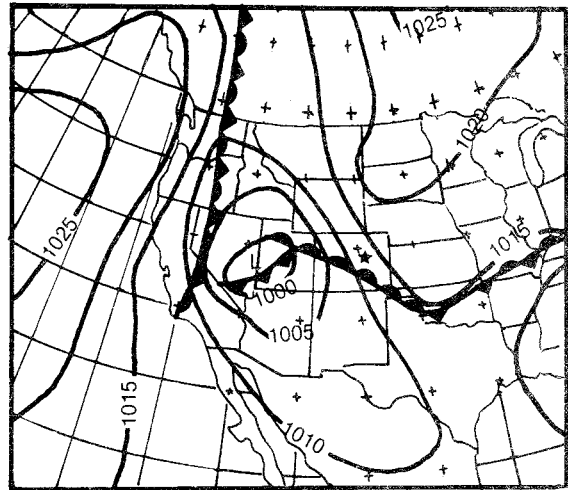

May 30 Surface 0600 MST

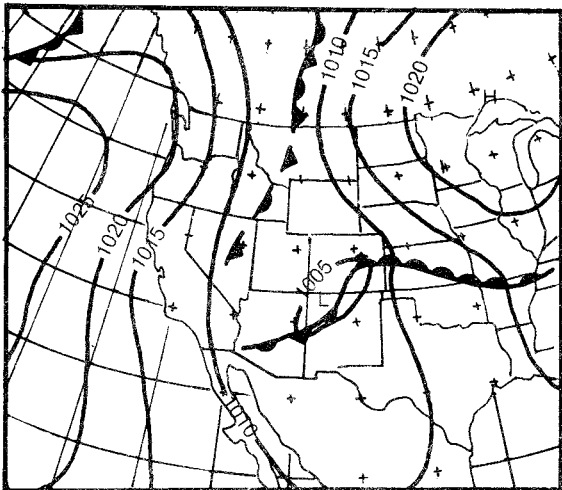

May 31 Surface 0600 MST

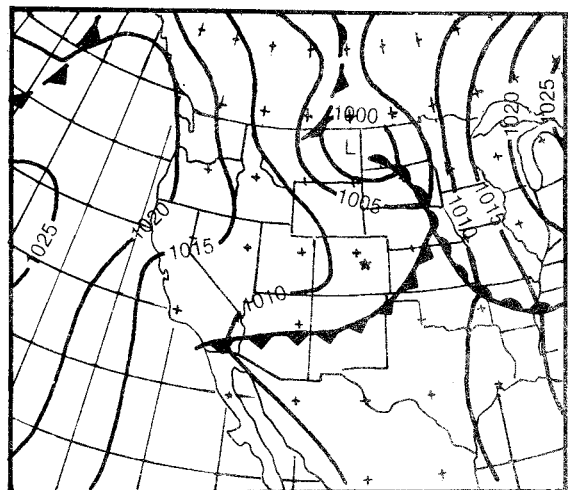

June 1 Surface 0600 MST

**Figure 2.10.--Synoptic surface weather maps for May 29-June 1, 1935 - the Cherry Creek (47) - Hale (101), CO storm.**

of May 30. The time of beginning of rainfall became later and later on the 30th in an eastward progression from the Kiowa Creek area. At the Hale center rainfall began about 6:00 p.m. on the 30th. Rainfall had effectively stopped over the Kiowa center by that time. This timing factor suggests that there was an east-northeastward propagation of the severe instability and of the primary tongue of moisture that caused the heavy storms that had developed late in the morning of the 30th over Kiowa.

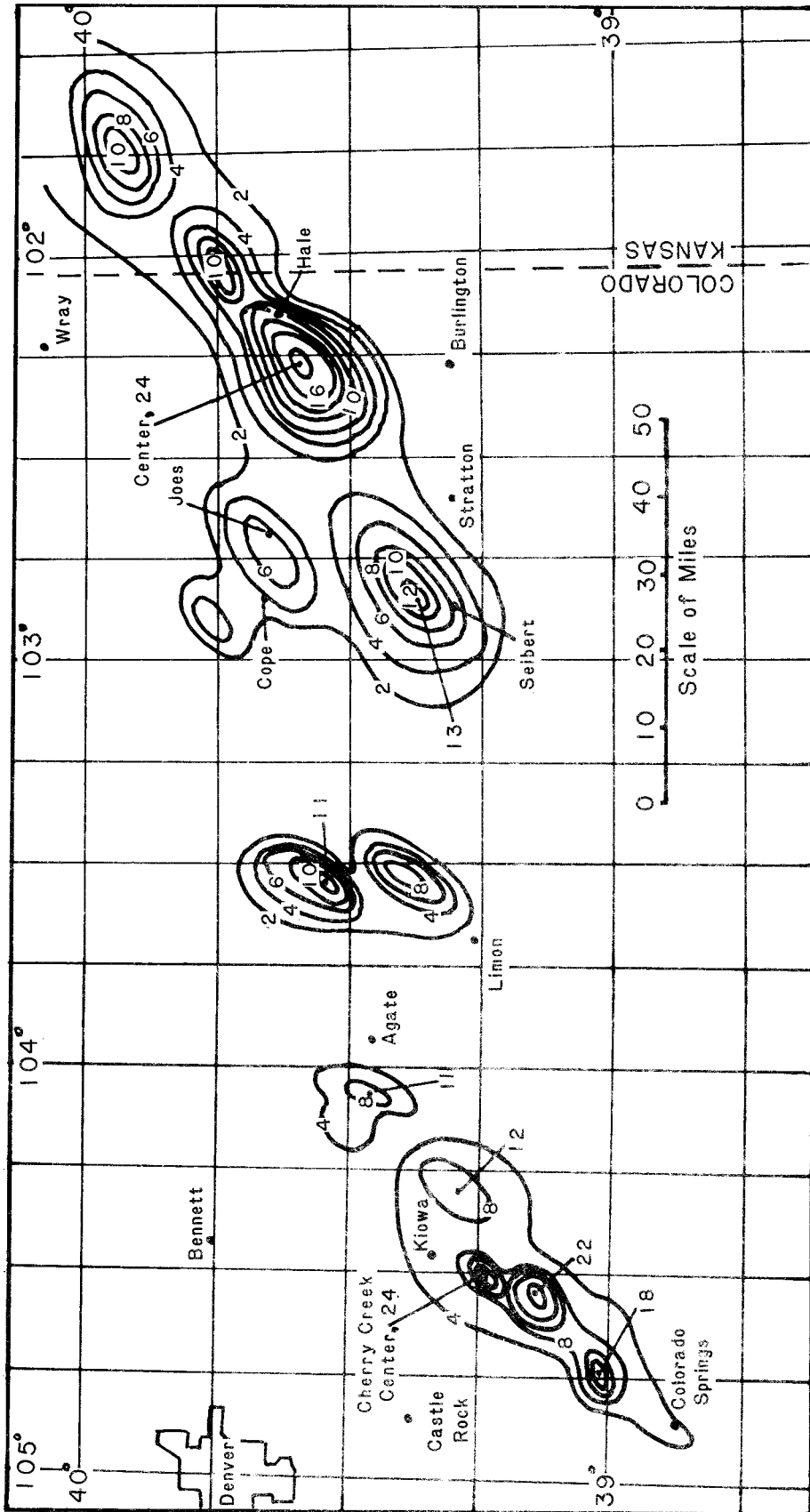
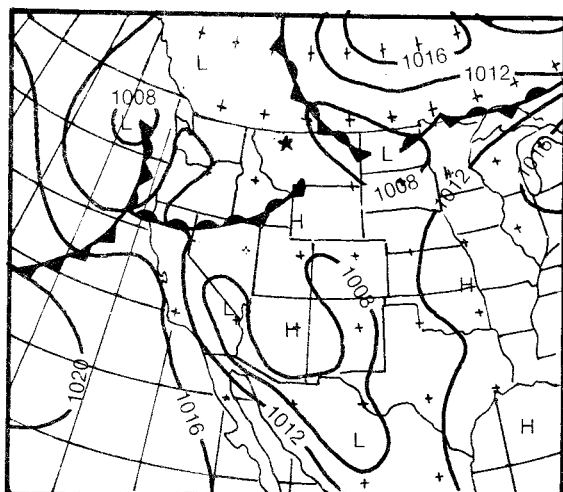
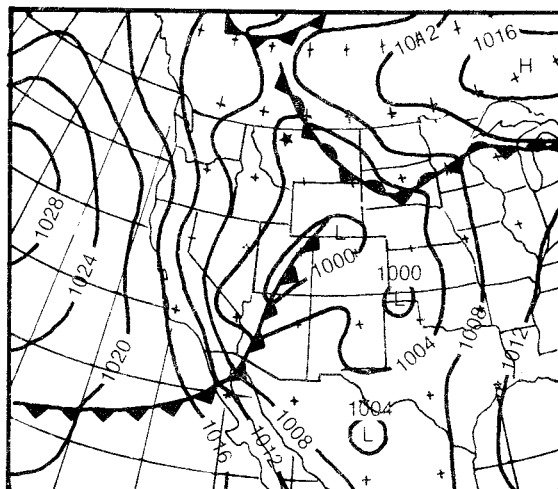

Figure 2.11.—Isohyetal map for the Cherry Creek (47) - Hale (101), CO storm for period May 30-31, 1935.



June 6 Surface 0500 MST



June 7 Surface 0500 MST

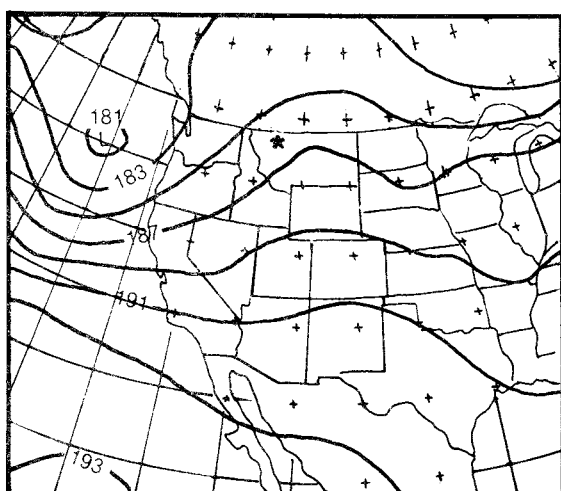

June 6 500 MB 0500 MST

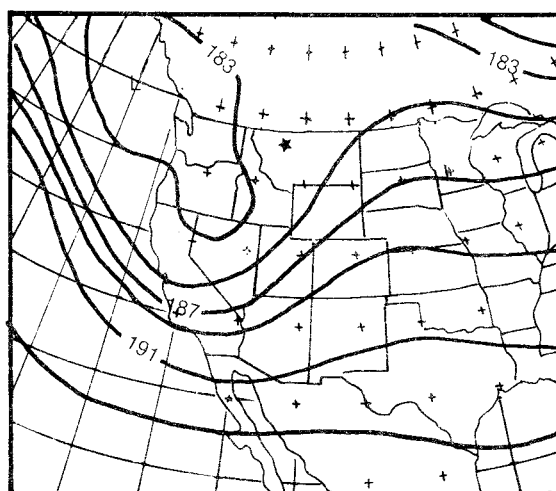

June 7 500 MB 0500 MST

**Figure 2.12.**—Synoptic surface weather maps and 500-mb charts for June 6–7, 1964 – the Gibson Dam, MT storm (75).

**2.4.1.6 Gibson Dam, Montana – June 6–8, 1964 (75).** Beginning in the early morning hours on June 7, 1964, rainfall occurred over the mountainous region of western Montana\* causing severe flooding over a large portion of the Missouri river basin of west-central Montana. The storm continued until the late evening of June 8, with a total storm duration of about 36 hr. A maximum storm amount of 16.2 in. has been determined from an isohyetal analysis.

The storm is discussed at length in U.S. Geological Survey Water Supply Paper 1840-B (Boner and Stermitz 1967); therefore, only a brief discussion is included here. The surface and 500-mb weather patterns are shown in figures 2.12 and

\*Note: The maximum analyzed rainfall in this storm occurred at 48°32'N 113°33'W or about 16 mi northwest of East Glacier Park, MT, rather than near Gibson Dam. However, this storm has continued to be referred to as the Gibson Dam storm because of a preliminary analysis.

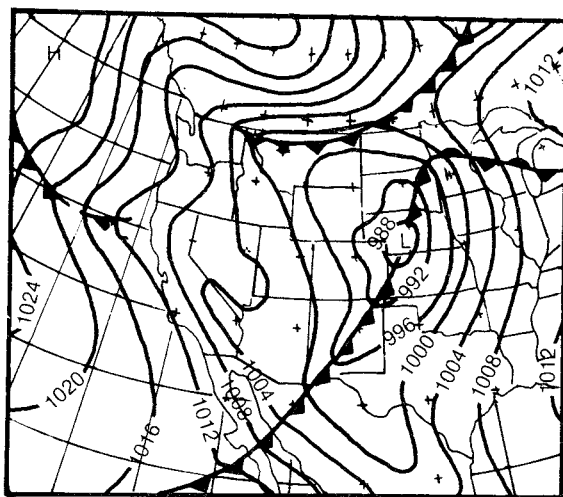

June 8 Surface 0500 MST

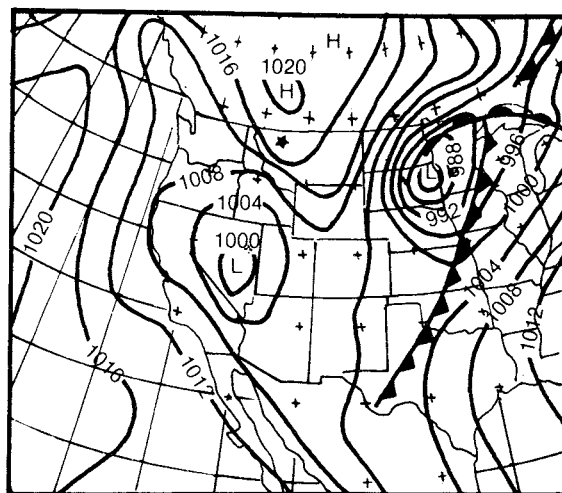

June 9 Surface 0500 MST

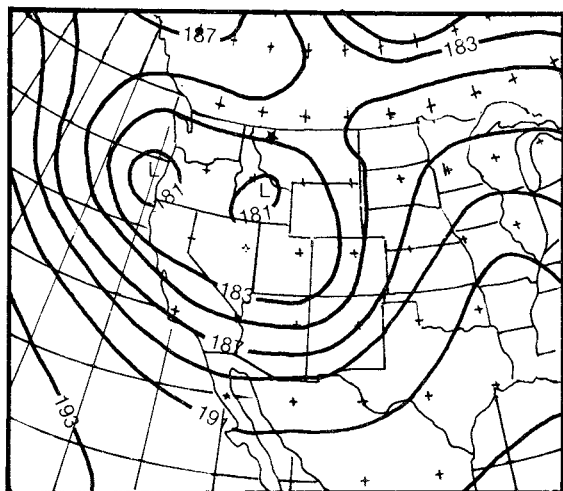

June 8 500 MB 0500 MST

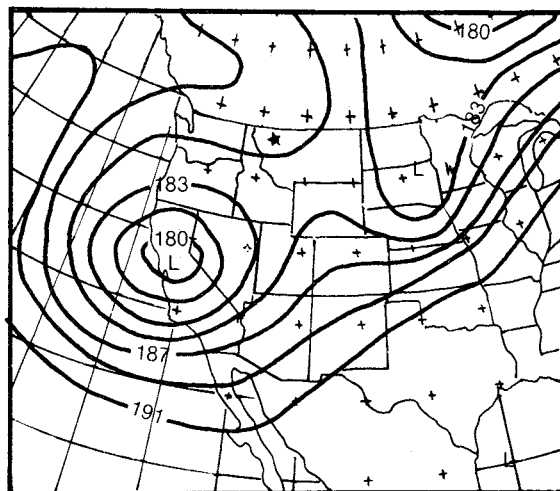

June 9 500 MB 0500 MST

**Figure 2.13.--Synoptic surface weather maps and 500-mb charts for June 8-9, 1964 - the Gibson Dam, MT storm (75).**

2.13. It is evident from an examination of the surface weather charts that the main feature of this storm was a strong low pressure center, which passed to the south and southeast of the storm location. The circulation around the Low brought moist air from the Gulf of Mexico northward across the Great Plains and then westward over Montana into the storm region. As the moist air turned westward around the north side of the Low, it was carried up and over the mountains of western Montana. The rainfall was the result of both the convergence around the Low and lifting by the mountain slopes.

The isohyetal pattern in figure 2.14 was analyzed considering, in a general sense, the orographic lifting of the storm. The location of the major rainfall centers, however, was dictated by rainfall observations and streamflow records. All of the major centers are located in the mountains of western Montana. This shows the significance of the topography in the rainfall process for this storm. The amounts decreased to the east as the orographic influence became less and less. The heaviest rainfall during the Gibson Dam storm (75) occurred on the morning of the 8th, during the time of a strongest easterly flow.

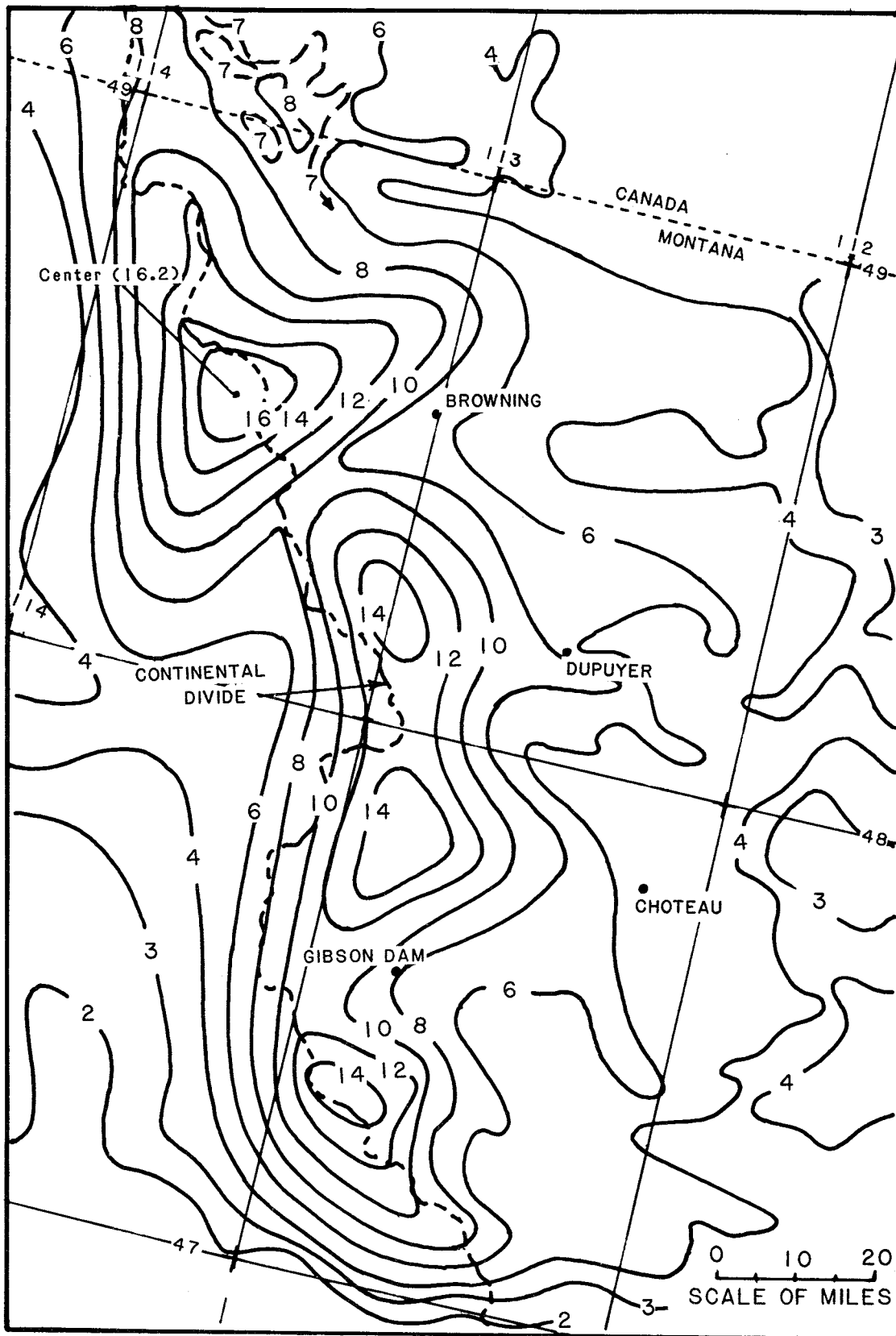

Figure 2.14.—Isohyetal map for June 7-8, 1964 - the Gibson Dam, MT storm (75).

**2.4.1.7 Plum Creek, Colorado - June 13-20, 1965 (76).** During the period of June 13-20, 1965, heavy rains fell over the eastern foothills of Colorado, very near the location of the Cherry Creek storm (47) (sec. 2.4.1.5). These rains reached total amounts of over 10 in. at many locations during the period, with the greatest point rainfall amount recorded being 18.1 in. The heaviest rains during the storm period occurred primarily in severe convective storms during the afternoons and evenings. Strong advection of unstable moist air from the Gulf of Mexico provided low level moisture for the storm.

On the 13th through the 16th (fig. 2.15-2.16), weak frontal systems were present in the Colorado region. The convective storms developed in the warm moist southerly air flow. The cold front to the west gradually ceased its eastward movement and became a stationary front by the morning of the 15th. The warm front gradually dissipated as a high pressure system moved rapidly southward from Canada. By the morning of the 16th, the center of the High was near the northern edge of the Great Lakes. The 500-mb chart (fig. 2.16) showed a trough over the west slowly intensifying as a closed Low center moved southward to a position over the California-Nevada border. Over the storm area the wind gradually backed, becoming easterly, and increasing in strength.

During the 17th, 18th, and 19th, (fig. 2.16-2.17) the surface High continued to move southward and by the morning of the 19th was centered over eastern Tennessee. The circulation around the High continued to bring warm moist air northward over the western Great Plains and eastern Colorado. The weak stationary front, located along the east-facing slopes of the Rocky Mountains, marked the westward extent of the moist air. At 500 mb, the closed Low over the California-Nevada border weakened, but an elongated trough remained over the western United States, while through the Great Plains a weak ridge extended from the Gulf of Mexico northward to the Canadian border. The air flow over the western and central United States was southerly from the surface to 500 mb. Moisture was flowing into the region through a deep layer of the atmosphere.

During the 19th, the north-south circulation began to break down. The surface High began moving eastward through Canada. This permitted the cold front extending southward from a Low over northern Canada to move into Colorado, causing the wind flow over western Colorado to shift to the northeast. At 500 mb, the trough and ridge both weakened and the flow over Colorado veered to westerly. These changes in the circulation ended the precipitation over Colorado.

The instability of the air mass over Colorado along the moisture inflow path at the surface is evidenced by the vertical variation in temperature and dew points shown in radiosonde observations taken at various stations during the storm. Representative soundings are shown in figure 2.18. These soundings show deep layers of conditionally unstable air that required only minimal lifting to release the instability. This initial lifting was readily available in Colorado as a result of diurnal heating and both terrain and frontal lifting.

Thunderstorms initially broke out over eastern Colorado on the afternoon of the 13th. Severe storms occurred every day with many reports of large hail and funnel clouds over the next 5 days. Squall lines can be detected on the afternoon and evening surface synoptic maps (not shown) on several days during this period. Although not always detectable with the synoptic scale weather

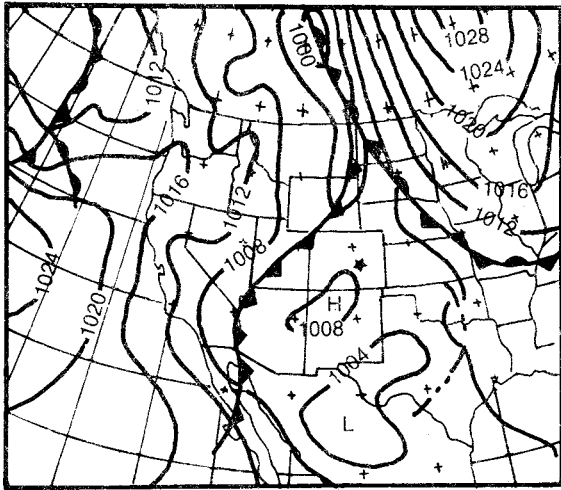

June 13 Surface 0500 MST

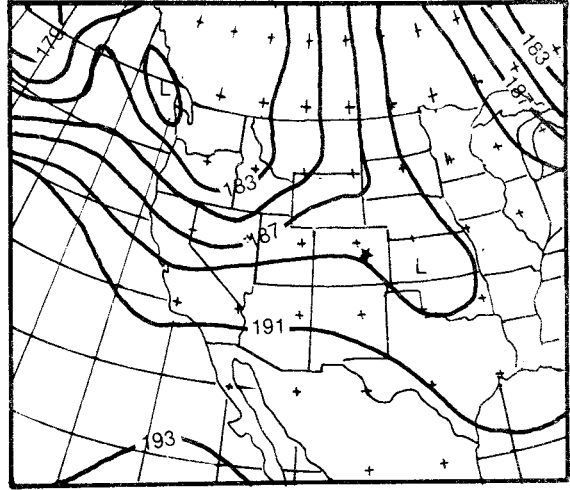

June 13 500 MB 0500 MST

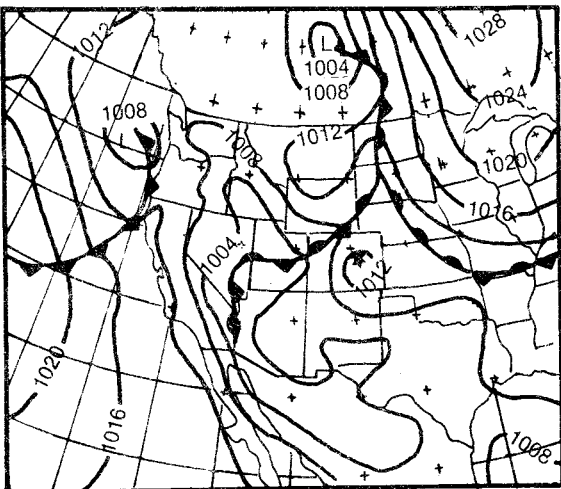

June 14 Surface 0500 MST

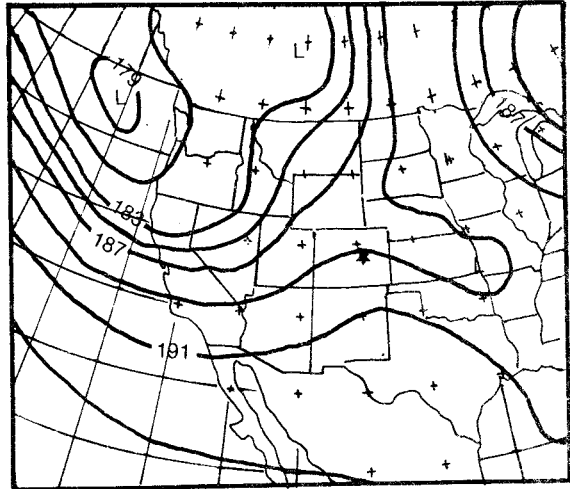

June 14 500 MB 0500 MST

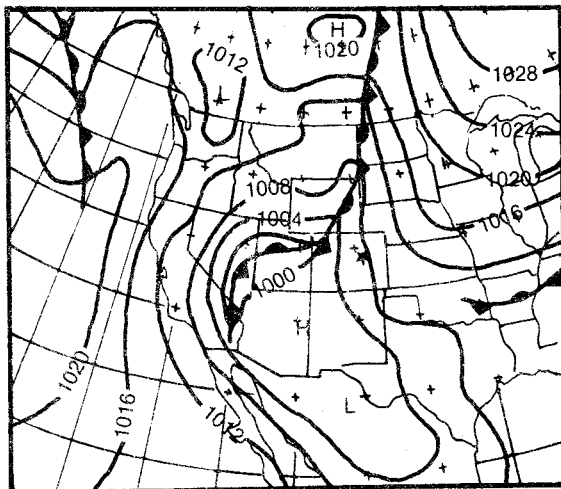

June 15 Surface 0500 MST

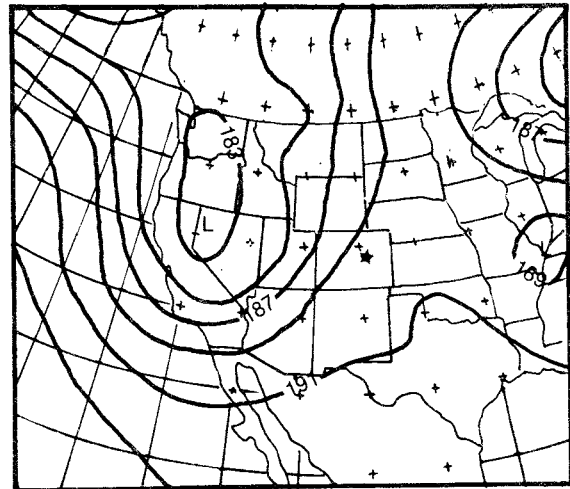

June 15 500 MB 0500 MST

Figure 2.15.--Synoptic surface weather maps and 500-mb charts for June 13-15, 1965 - the Plum Creek, CO storm (76).



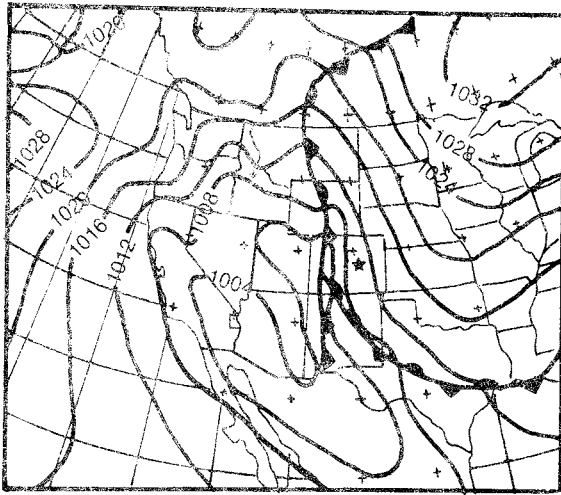

June 16 Surface 0500 MST

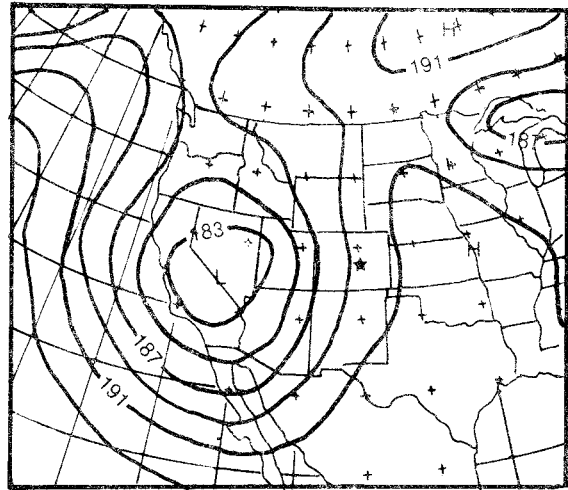

June 16 500 MB 0500 MST

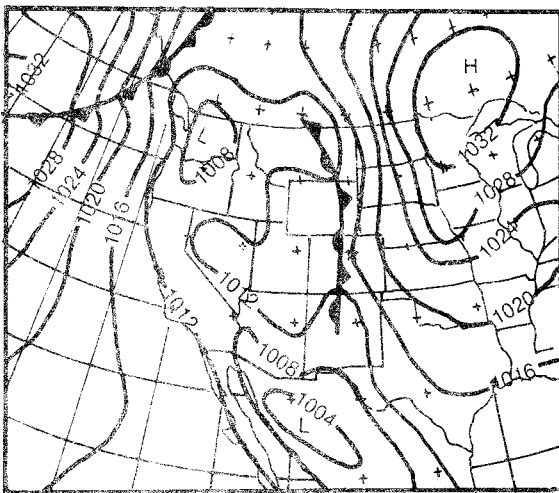

June 17 Surface 0500 MST

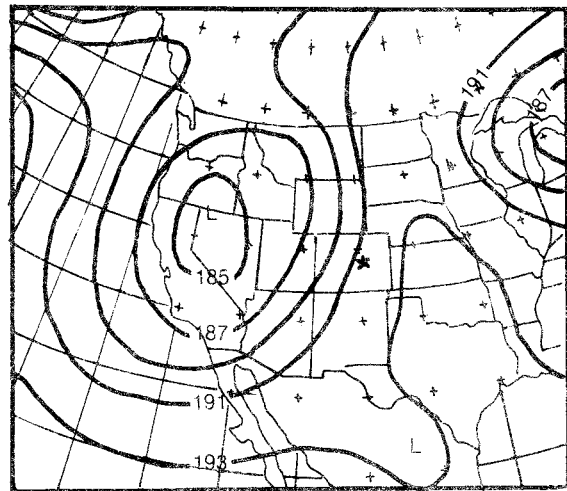

June 17 500 MB 0500 MST

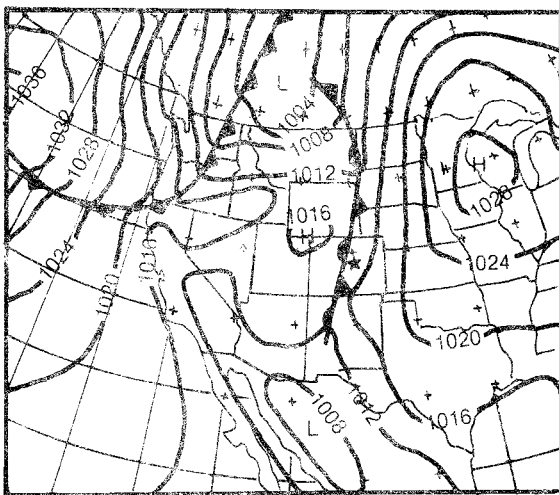

June 18 Surface 0500 MST

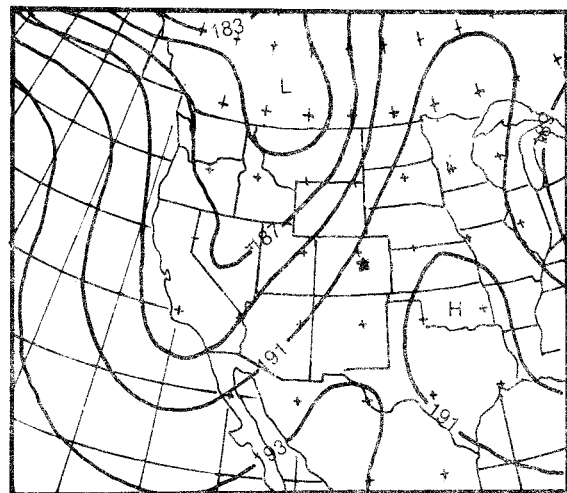

June 18 500 MB 0500 MST

Figure 2.16.—Synoptic surface weather maps and 500-mb charts for June 16-18, 1965 - the Plum Creek, CO storm (76).

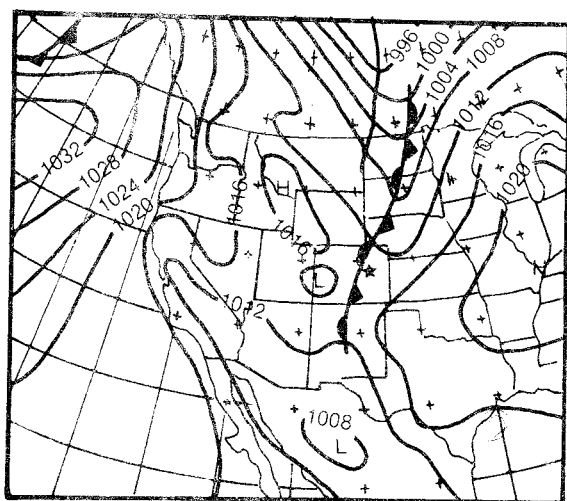

June 19 Surface 0500 MST

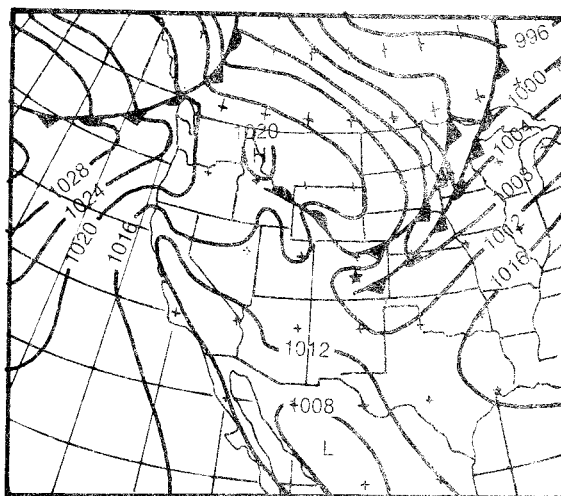

June 20 Surface 0500 MST

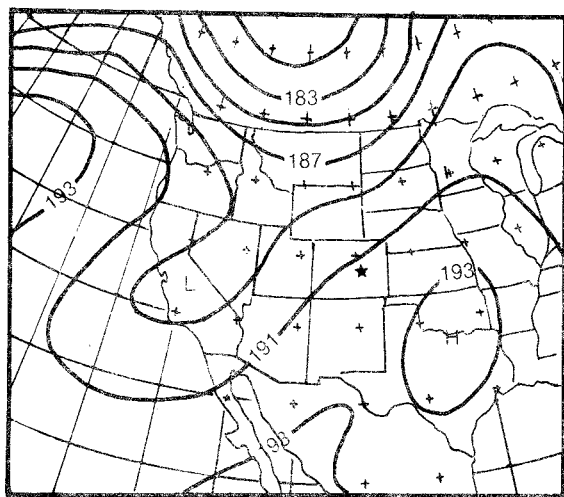

June 19 500 MB 0500 MST

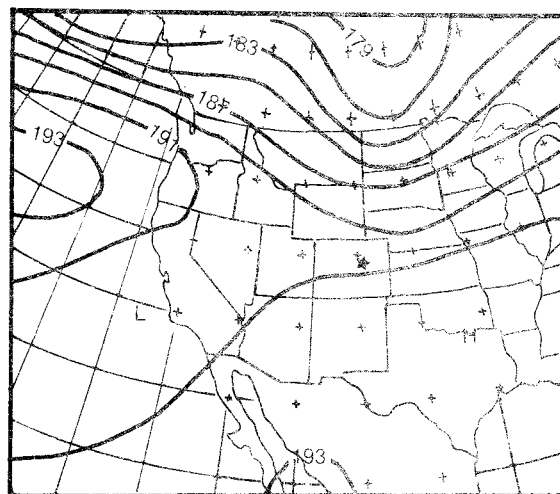

June 20 500 MB 0500 MST

**Figure 2.17.**—Synoptic surface weather maps and 500-mb charts for June 19-20, 1965 - the Plum Creek, CO storm (76).

observation network, lines of severe storms were probably present in Colorado on all days during this storm period. During the afternoon of the 16th and into the 17th, rainfall became excessive over much of eastern and southeastern Colorado. Rainfall amounts of over 5 in. were common in the storm area for the 24-hr period ending in the late afternoon of the 17th. Extreme rainfalls reported by the State Engineers Office, USBR, and COE, showed rainfall amounts up to 14 in. in Douglas County on the 16th and in Elbert County on the 17th. A total storm isohyetal map is shown in figure 2.19. Other extreme amounts reported included 6 in. in 4 hr in El Paso County on the 17th and 6 in. in 30 min in Elbert County on the 15th. The 14-in. values on the 16th were estimated to have occurred in a few hours.

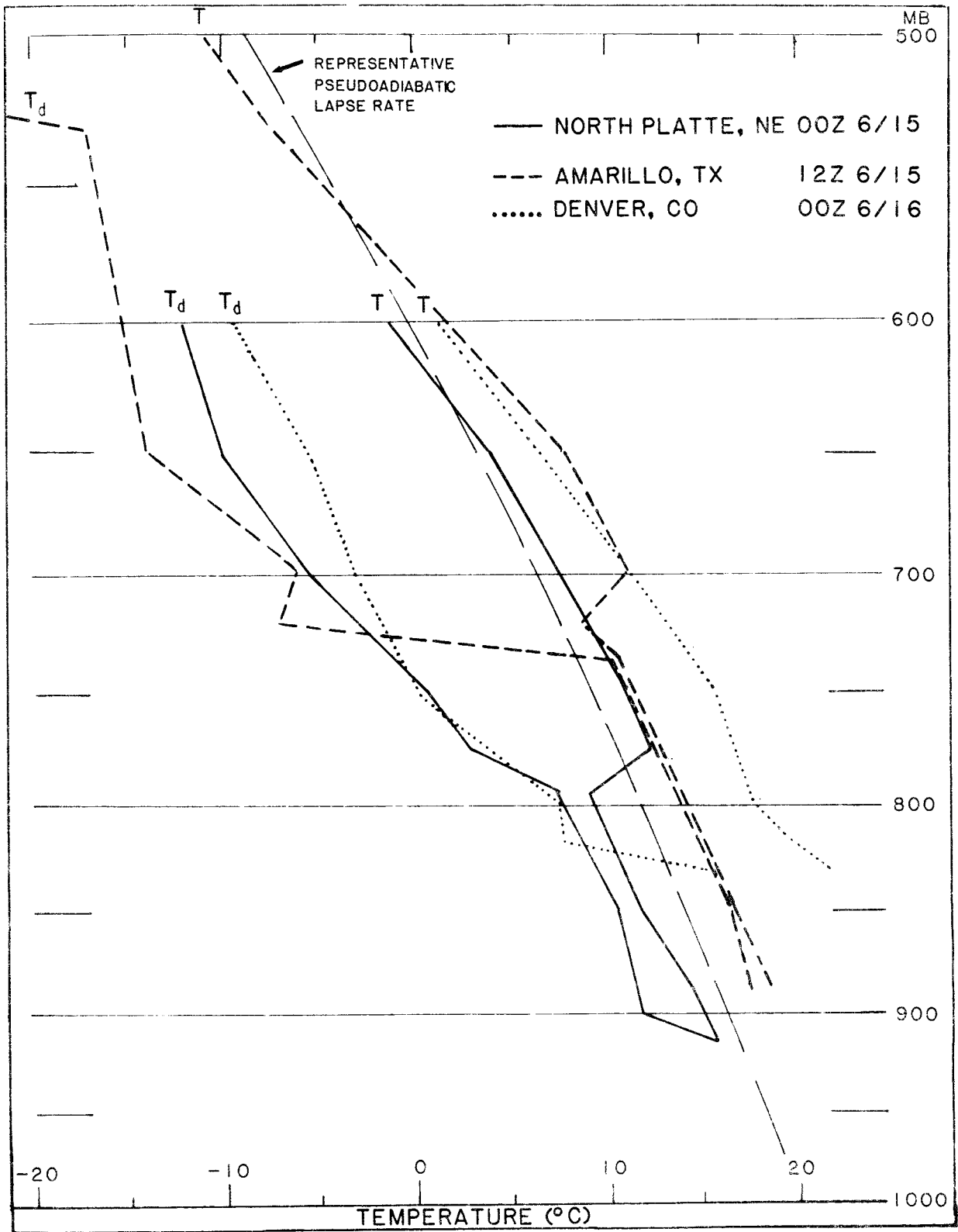

Figure 2.18.--Representative radiosonde observations for June 15-16, 1965 - the Plum Creek, CO storm (76).

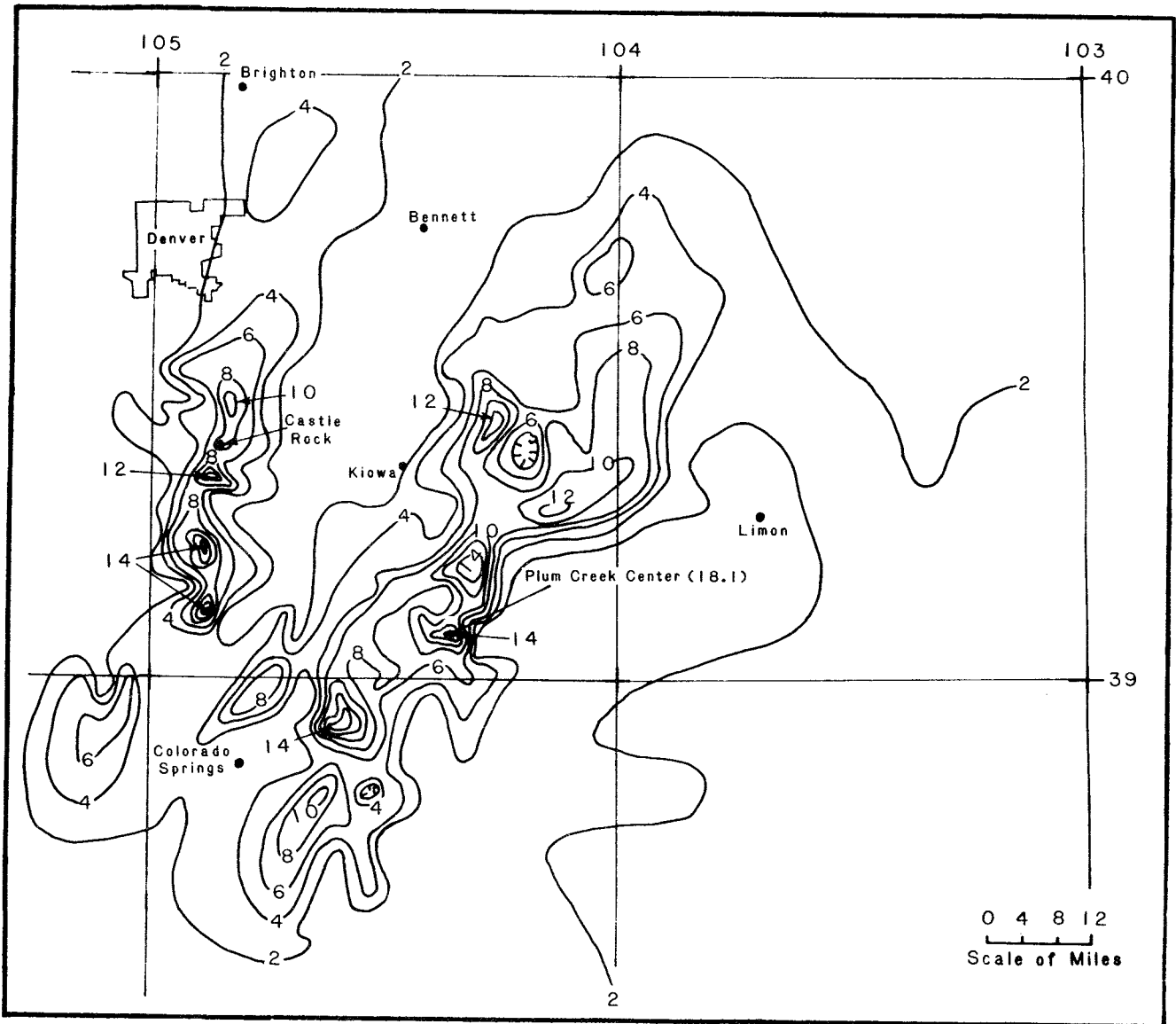
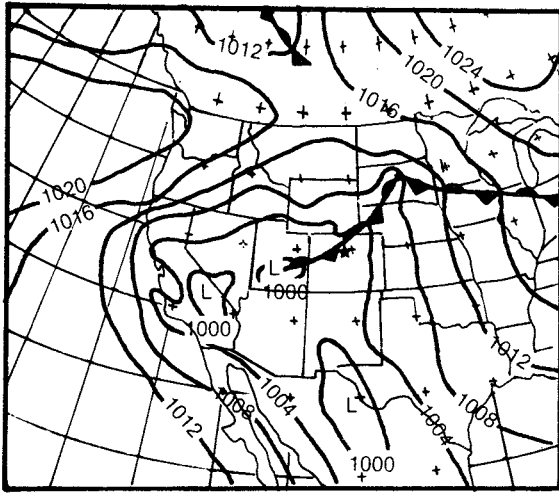

Figure 2.19.—Isohyetal map for June 16-17, 1965 - the Plum Creek, CO storm (76).

Convective storms became less prevalent after the 17th. Movement of the high pressure center to the southeastern United States reduced the strength of moist air inflow into Colorado, and allowed the cold front to move slowly to the east. This cold front weakened over the Plains States; however, severe weather was still reported over portions of the Midwest on the nights of the 20th and 21st.

Reduction in rains over eastern Colorado was also signaled by the weakening of the closed Low aloft on the 18th. This weakening also greatly reduced the inflow of moisture into the air column over eastern Colorado. By late afternoon on June 19 upper air flow over Colorado had become westerly.



May 4 Surface 0500 MST

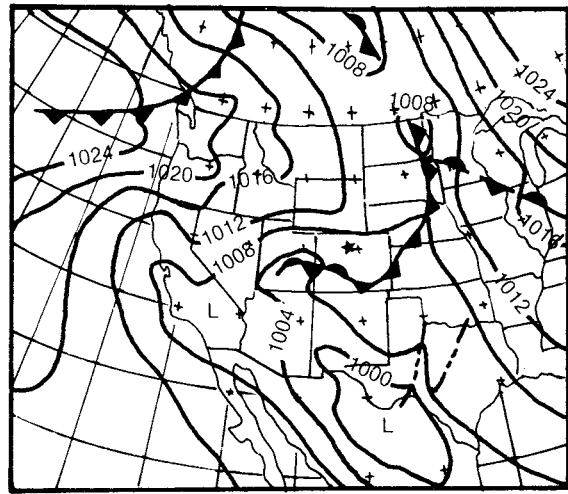

May 5 Surface 0500 MST

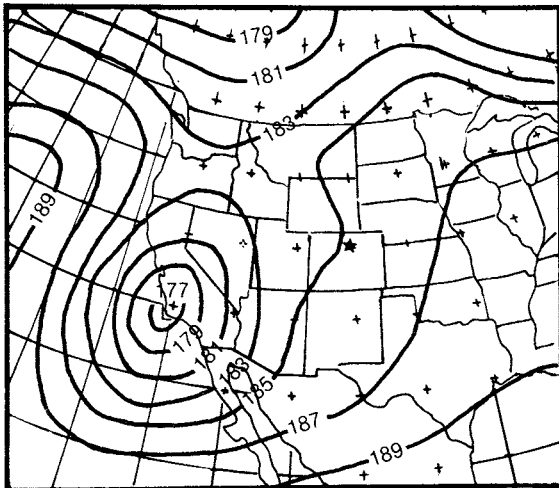

May 4 500 MB 0500 MST

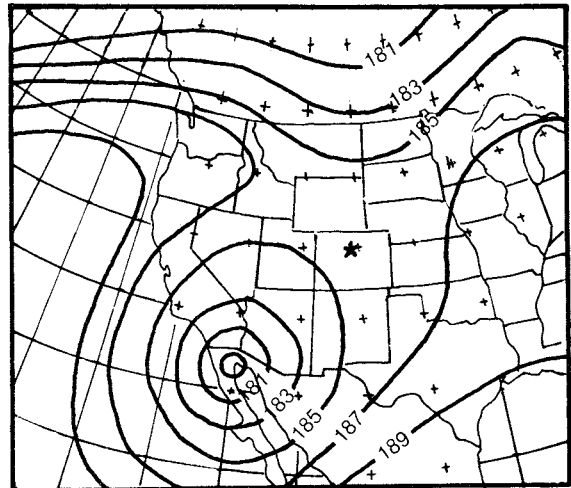

May 5 500 MB 0500 MST

**Figure 2.20.--Synoptic surface weather maps and 500-mb charts for May 4-5, 1969 - the Big Elk Meadow, CO storm (77).**

**2.4.1.8 Big Elk Meadow, Colorado - May 4-8, 1969 (77).** Beginning on the afternoon of May 4, 1969, general rains began to fall over the first upslopes of the Rocky Mountains. The rain continued until the early morning of May 8, finally halting around 11:00 a.m. Rainfall was heaviest in a band from about 25 mi southwest of Denver northward to Estes Park.

The surface and upper air weather patterns for the storm period are shown in figures 2.20 to 2.21. Early in the storm a persistent southeasterly flow from the Gulf of Mexico transported moist air into Texas, Colorado, and the Plains States. This flow was a result of a High near the mid-Atlantic coast and a weak Low center over northern Mexico at the surface. Aloft, a ridge was present over the Atlantic coast with a closed Low over the southwest. This circulation is conducive to drawing air from over the Gulf of Mexico and transporting it northward and northwestward. A weak cold front and Low were also present in Colorado when rain began on the evening of the 4th. Initial rains were probably the result of the warm moist air being forced over the cold front. It appears

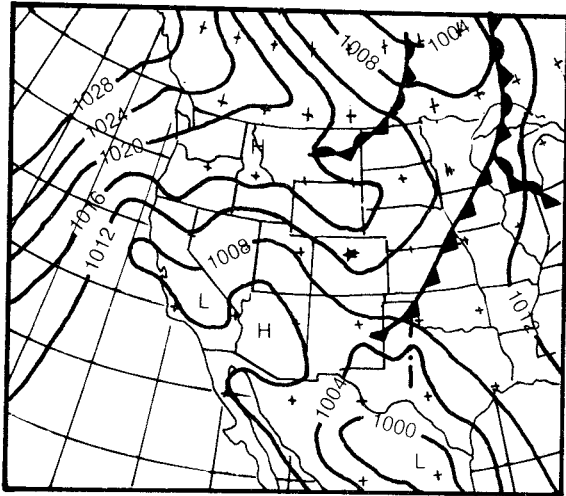

May 6 Surface 0500 MST

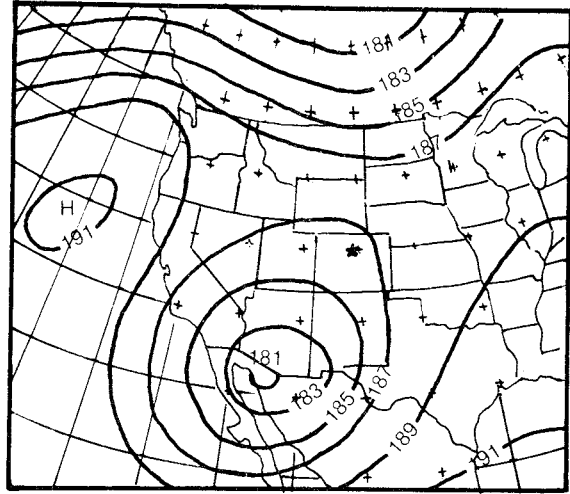

May 6 500 MB 0500 MST

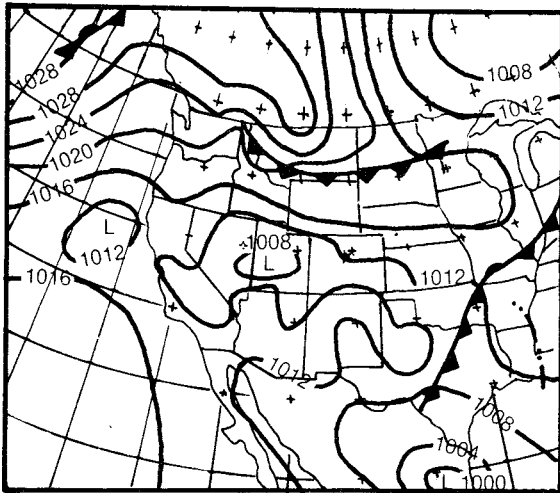

May 7 Surface 0500 MST

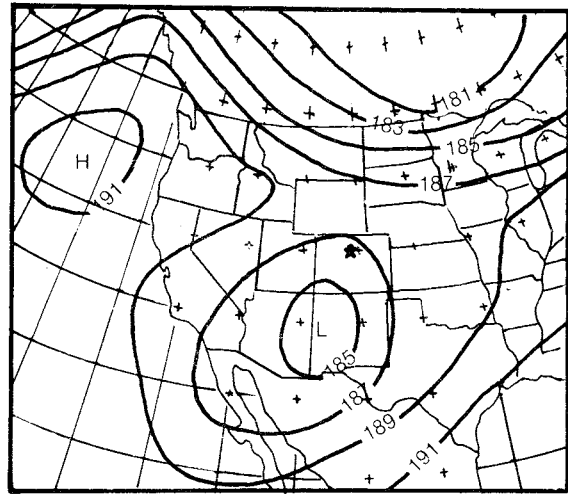

May 7 500 MB 0500 MST

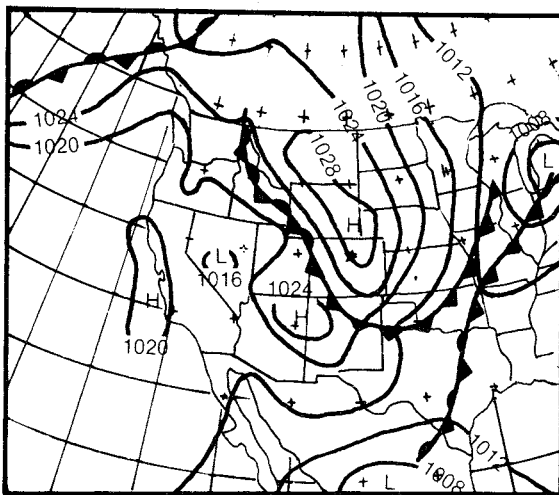

May 8 Surface 0500 MST

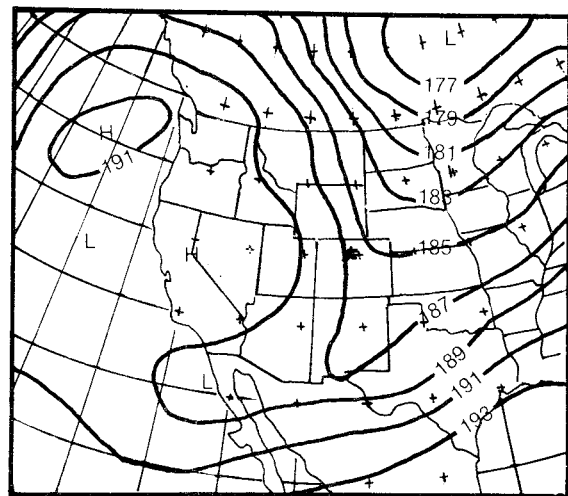

May 8 500 MB 0500 MST

**Figure 2.21.--Synoptic surface weather maps and 500-mb charts for May 6-8, 1969 - the Big Elk Meadow, CO storm (77).**

the importance of the cold front diminished as it drifted slowly to the southeast. Orographic lifting, resulting from northeasterly flow across the Plains and onto the Rocky Mountains, became increasingly important during the storm period. This flow was a result of a High building to the north in the Montana-Dakota region beginning on May 5. As the High became stronger and the cold front moved further to the southeast, the easterly component of the flow behind the front and across Colorado became stronger. This brought the moist air already over the Midwest to the first upslopes. As the air was lifted by the mountains, the rainfall became more intense. The flow became strongest and the rainfall heaviest during the 6th and the 7th. Winds at the surface were predominantly from the east across Colorado and nearly normal to the mountains. The formation of a weak wave along the cold front in southwest Missouri on the 7th, probably served to reinforce the easterly component of the flow.

This pattern persisted until late on the 7th when a second cold front, with a High to the north, began pushing southward toward the storm area. This cold front brought northerly flow and colder, drier air behind it. As the front moved through Colorado on the night of the 7th and the morning of the 8th, it displaced the moist Gulf of Mexico air. This change in air mass stopped the rainfall over the Colorado region by midmorning of the 8th.

The consistent nature of these rains is evidenced by the hourly precipitation record. These data show that the rainfall, once started, continued throughout the storm with very few breaks. Near Boulder, CO, rainfall was first reported on May 4, at 11:00 p.m. After that, rainfall amounts were recorded nearly every hour until 8:00 p.m., May 7th, for a total of 69 hrs of recorded rain. The rainfall was very steady over this time period. Most available hourly reports show 1-hr rainfall maximums to be less than 1 in. This suggests that convective instability was not present, but rather that the rain was the result of a consistent lifting caused by the flow against the mountain. An isohyetal analysis of the storm (fig. 2.22) shows centers to be located along the first upslopes. As in most major storms, the largest amounts were determined by a "bucket survey" over the storm area. The survey yielded many reports of 10 in. or more. The largest total storm report of 20 in. was located at Big Elk Meadow Resort (40°16'N 105°25'W). Several other locations received amounts up to approximately 15 in.

**2.4.1.9 Big Thompson, Colorado - July 31-August 1, 1976 (81).** Disaster struck in the form of severe flash flooding east of Estes Park in the canyon section of Larimer County in north-central Colorado on the night of July 31, 1976. The flood took the lives of 139 people and caused many millions of dollars in property damage. The greatest loss of life occurred in the Big Thompson Canyon where campers were swept away by the "wall of water" tumbling through the narrow canyon.

The Big Thompson storm has been well documented by several authors. Details on particulars, such as precipitable water, dew points, radar summaries, etc., are provided by McCain et al. (1979), and Caracena et al. (1979). The following storm description is summarized from these sources.

The flash floods were a result of a complex system of thunderstorms that had begun to develop over the Colorado-New Mexico region on the afternoon of July 31. The storms formed in the humid Gulf of Mexico air that had circulated around a double frontal system extending from eastern Colorado eastward into

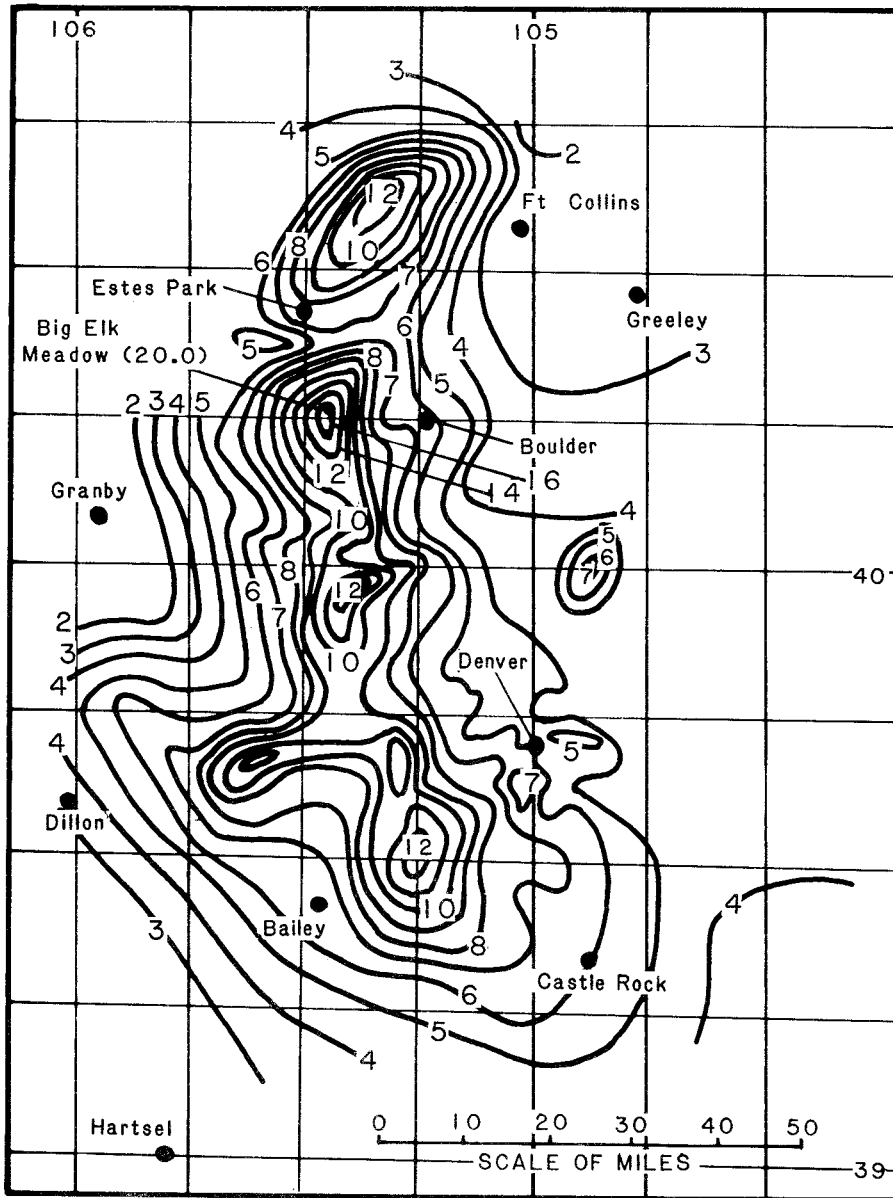
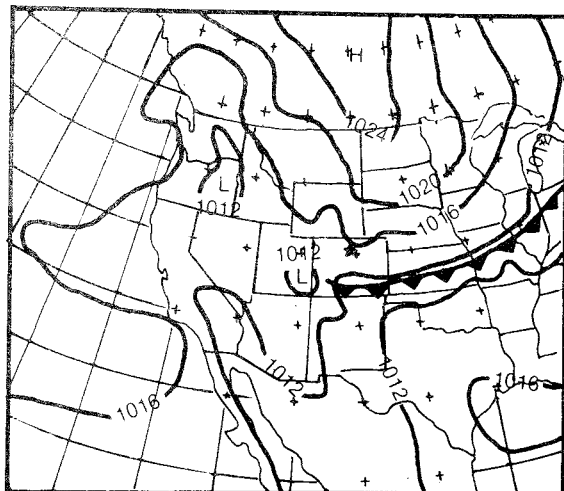

**Figure 2.22.**—Isohyetal map for May 4-8, 1969 - the Big Elk Meadow, CO storm (77).

Kansas (fig. 2.23). Weak pressure gradients at the surface probably contributed to the quasi-stationary nature of the fronts in Colorado. The fronts were very close together and can only be detected by an analysis that is more detailed than synoptic scale analysis. On the synoptic scale charts of figure 2.23 they are shown as a single front. For simplicity, in this report a single front will be used for reference.

Dew-point analyses over the south indicated that moist air had moved northward from the Gulf of Mexico and then turned with an easterly component of flow over the Plains States. This easterly flow carried the moist air to the front slopes of the Rocky Mountains in Colorado where it was lifted by both terrain and atmospheric processes. During the afternoon of the 31st, thunderstorms formed in several locations along the first upslopes of the Rockies and along the front





July 31 Surface 0500 MST

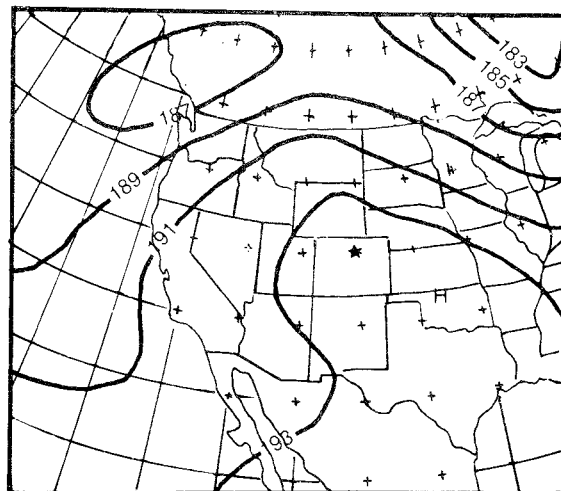

extending to the east. The timing of the growth indicates that insolation probably played a role in the development of the thunderstorms. Radar summaries and satellite pictures (not shown) indicate that the thunderstorms were growing rapidly and becoming locally intense in the Big Thompson area by 1700. Up to this time rainfall had been light and scattered over Colorado.

By 1730, rain had started over the Big Thompson basin. During the next 4 hr, heavy cloudburst-type rains fell in or near the Big Thompson basin as these severe storms remained nearly stationary over the area. Rainfall was heaviest from about 1830-2100. This was due to the apparent merging of storm cells over the area as depicted by radar summaries. Light winds aloft during the storm period also contributed to the severity of the storms by providing little entrainment of dry air from the surrounding upper levels. The light flow also permitted the storm cells to form and reform over nearly the same location. A short wave trough at 500 mb, moving north along the western edge of the ridge, was also making its way into the storm area during this time (fig. 2.23). This trough aloft probably enhanced the development of the thunderstorms, increasing their severity. Rainfall diminished over the Big Thompson basin around 9:30 p.m. on the night of July 31. Other heavy rainfall occurred between 11:00 p.m. and 3:00 a.m. on August 1 in areas to the north-northeast of the Big Thompson basin. These storms were not as severe as those over the Big Thompson basin. The heaviest precipitation occurred in a 10-mi-wide band from 8 mi south-southeast of Estes Park north-northwestward to the Colorado-Wyoming border. Maximum rainfall amounts of 12 in. of rain occurred between 5:30 p.m. and 9:30 p.m. July 31 (Miller et al. 1978). A point maximum of 12.5 in. in 4 hr (40°25'N 105°26'W, elevation 8,000 ft) has been accepted for this storm. The rainfall drops off quickly in all directions from the storm centers, exhibiting the local nature of the individual storm centers.

A storm isohyetal map is shown in figure 2.24. The map covers the most intense part of the storm and is for the maximum 4-hr rainfall on July 31, 1976. It shows the amounts from the local thunderstorm cells that resulted in heavy flash floods.

## **2.4.2 Tropical Storms**

The southern part of the study region, from the Mexican border to approximately 37°N, has been affected by the remnants of several tropical storms. Throughout this southern portion of the study region these storms are a major producer of heavy rainfall, and could be considered a prototype for the PMP storm.

**2.4.2.1 Rancho Grande, New Mexico - August 29-September 1, 1942 (60).** The rainfall during the Rancho Grande, NM storm was associated with a tropical storm which moved inland from the Gulf of Mexico on the morning of August 30. The circulation of the storm was still identifiable as it entered New Mexico. Large-scale convergence from the cyclonic motion was a primary mechanism causing the precipitation. Thunderstorm activity preceded and followed passage of the disturbance into New Mexico.

The storm originated as a tropical depression in the eastern Caribbean Sea near the Gulf of Venezuela on August 21, 1942. It strengthened while moving westward, and by the evening of August 24 achieved winds of hurricane force. The hurricane veered slightly at this time, taking on a west-northwestward movement. The hurricane crossed the tip of the Yucatan Peninsula during the night of

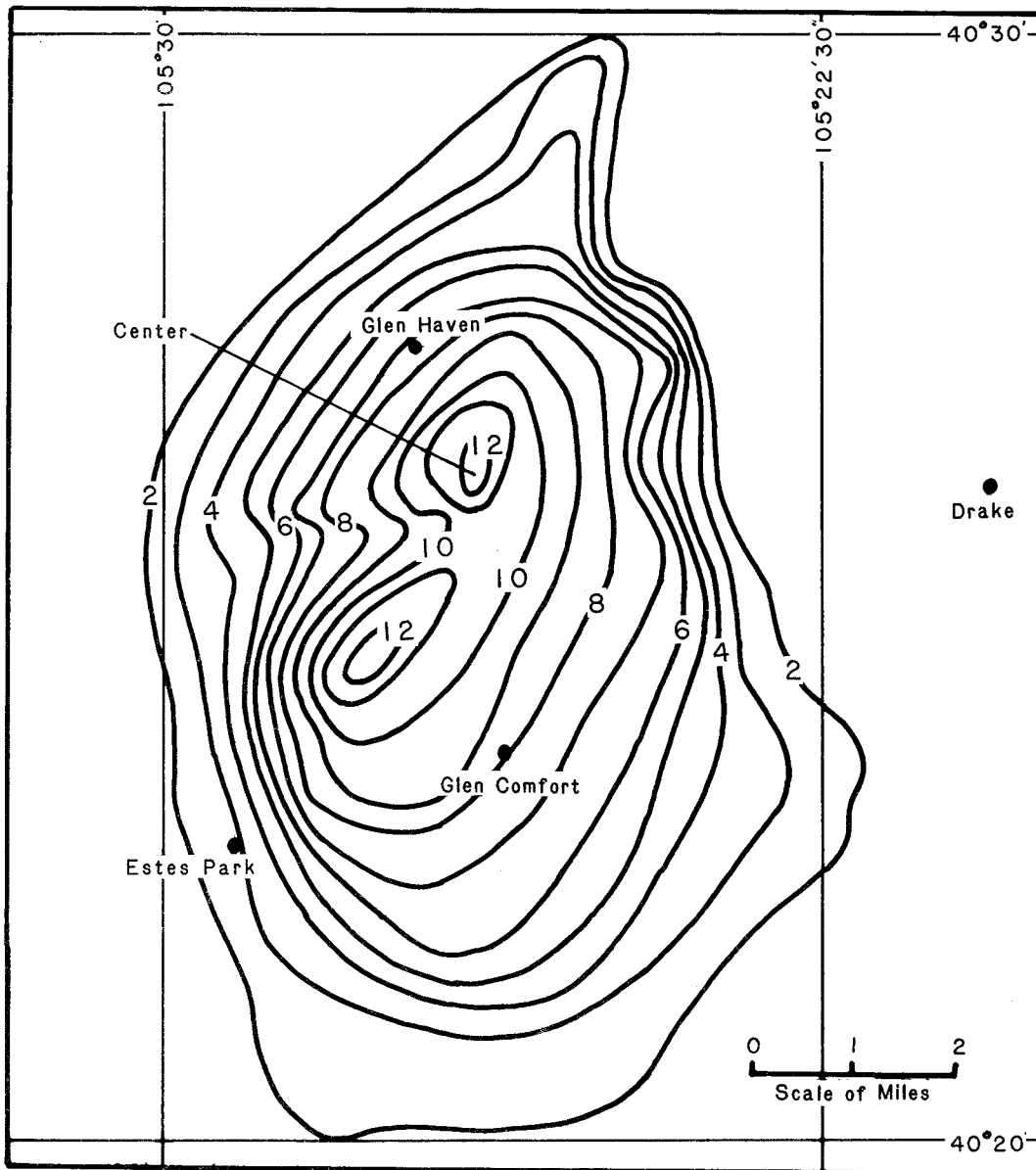

**Figure 2.24.—Isohyetal map of intense 4-hr precipitation for July 31, 1976 - the Big Thompson, CO storm (81).**

Mexico. By the morning of August 29, the surface winds along the Texas coast reflected the proximity of the approaching storm.

On August 29, a large maritime tropical air mass covered the eastern United States, while a polar mass of high pressure dominated eastern Canada. A weak Low was centered over the Great Basin and a polar air mass covered the Pacific northwest. During the afternoon of the 29th, thunderstorm activity began over eastern New Mexico as tropical air from the Gulf of Mexico was forced over the terrain. A few stations reported over an inch of rain by the end of the day. Thunderstorm activity decreased on the 30th, as the surface wind shifted to northeasterly under the influence of the tropical cyclone.

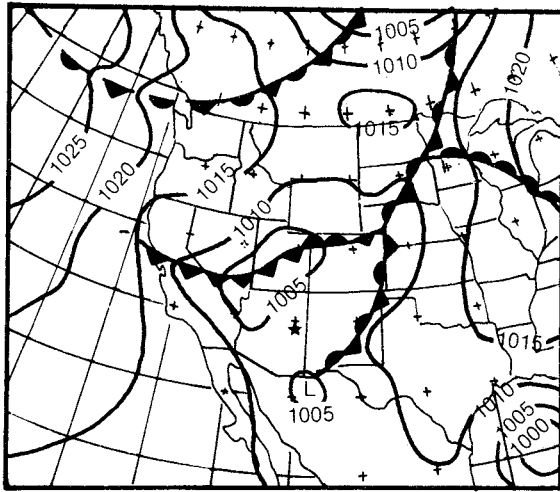

August 29 Surface 0530 MST

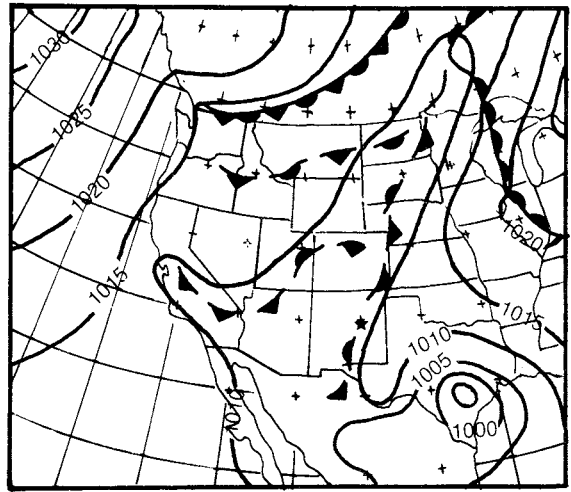

August 30 Surface 0530 MST

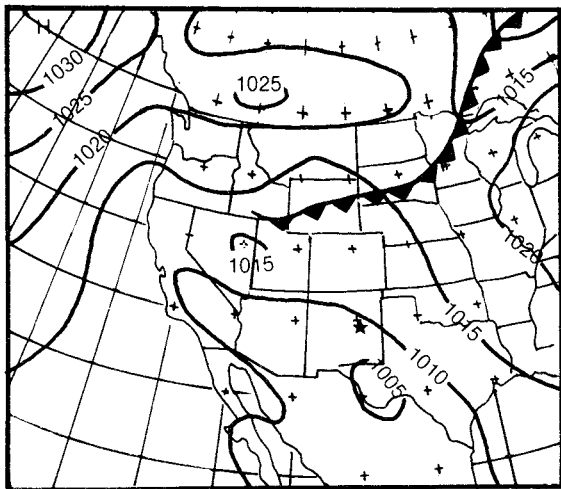

August 31 Surface 0530 MST

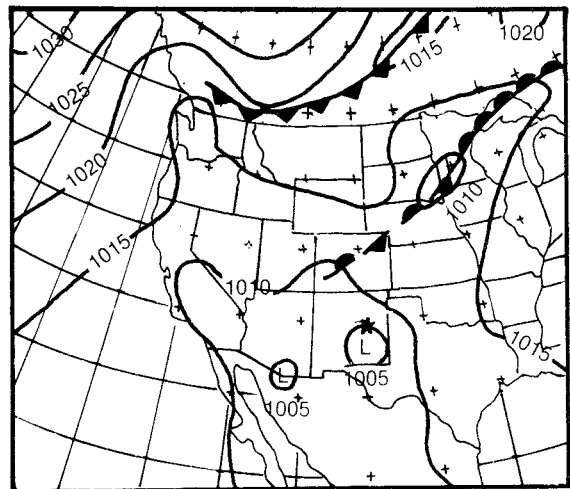

September 1 Surface 0530 MST

**Figure 2.25.--Synoptic surface weather maps for August 29–September 1, 1942 – the Rancho Grande, NM storm (60).**

The hurricane continued on the straight northwestward course and reached the Texas coast near Matagorda Bay slightly before 5:30 a.m. the morning of the 30th (fig. 2.25). Its movement remained northwestward at a speed of approximately 15 mph and its intensity decreased from hurricane strength to that of a tropical storm. The rain area accompanying the storm reached southeastern New Mexico late on the 30th and advanced steadily northward enveloping most of the lower Pecos Valley by the early morning on the 31st. The storm center itself entered New Mexico on the morning of the 31st and remained nearly stationary south of Roswell during the remainder of the day, with steady moderate rain north of the center. Late in the day, the storm began to move north-northeastward, steadily losing intensity. When it reached Tucumcari early on the following morning – September 1 – a cyclonic circulation was still evident. By this time rainfall had spread northward into southeastern Colorado and ended in the region south of an Albuquerque, NM – Amarillo, TX line. The final burst of rain in the storm consisted of scattered thunderstorms preceding and accompanying a cold front which approached from the north. The front moved across Colorado on September 1, and continued southward across Texas and New Mexico.

This storm was remarkable in that after traveling more than 700 mi over land, it still maintained a well defined strong cyclonic circulation, although no longer of hurricane intensity. Not a single station in the path of the storm reported thunder at the time of the heavy rain, indicating that large-scale convergence rather than local convection was the principal cause of precipitation.

The maximum precipitation for the 84-hr storm was 8.0 in. at three sites: Rancho Grande, Maxwell, and Chico, NM (fig. 2.26). The 2-in. isohyet encompassed over 35,000 mi<sup>2</sup>, most of which was in the state of New Mexico. The maximum average depth of rainfall over a 1,000-mi<sup>2</sup> area for 24 hr was 6.8 in. The isohyetal analysis for this storm showed an orientation of the rainfall pattern from south-southwest to north-northeast, approximately paralleling the track of the storm and the mountain ranges.

**2.4.2.2 Vic Pierce, Texas - June 23-28, 1954 (112).** The depth of precipitation reported at Vic Pierce, TX for 10 mi<sup>2</sup> and 24 hr was 26.7 in. Precipitation from this storm was a direct result of the movement of Hurricane Alice from the Gulf of Mexico up the Rio Grande Valley. Heaviest rains occurred about 90 mi northwest of Del Rio, TX, during the period when the storm was losing its warm-core tropical storm structure.

On June 24, 1954 (fig. 2.27), a small hurricane in the western Gulf of Mexico 300 mi southeast of Brownsville was discovered by ship personnel. This hurricane, named Alice, moved from its birthplace on a track toward the northwest typical for this season and region. The storm crossed the coast some 50 mi south of the mouth of the Rio Grande, at about noon on the 25th (fig. 2.27), and proceeded up the short distance south of Brownsville, Larado and Del Rio, TX. The surface wind at Brownsville rose to nearly 50 mph while a pilot balloon measurement of wind speeds aloft showed a speed of 130 mph from the southeast at 3,500 ft. As the center passed Del Rio at noon on the 26th, the highest surface wind was 33 mph (the fastest single mile of wind). The low-level

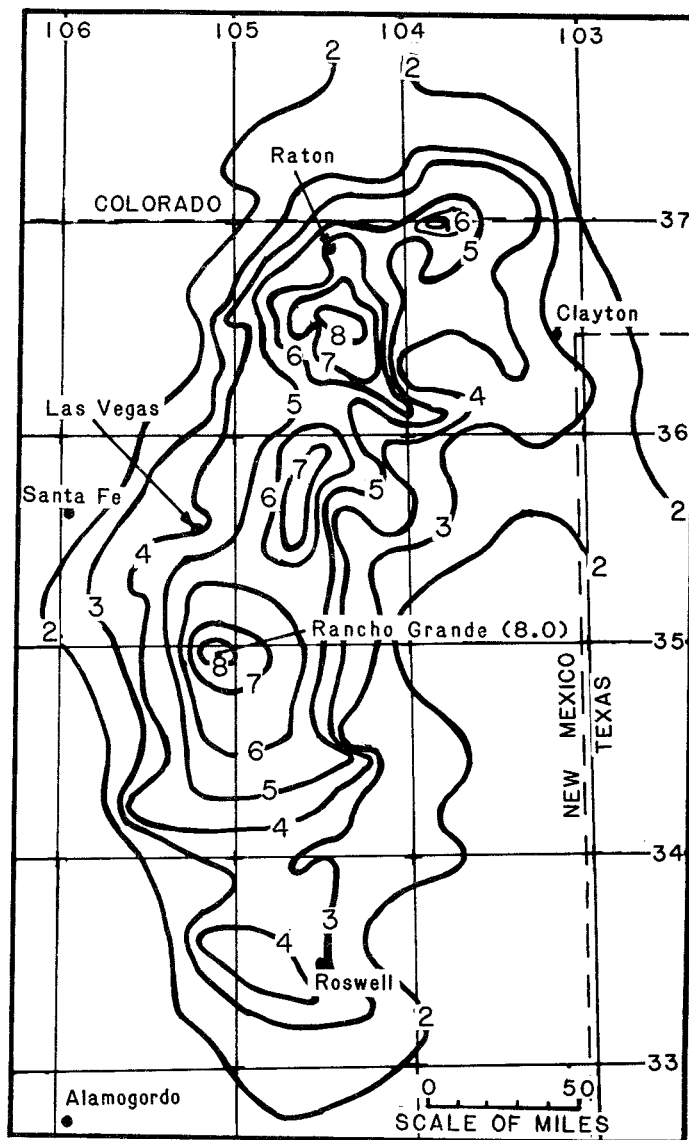

**Figure 2.26.--Isohyetal map for August 29-September 1, 1942 - the Rancho Grande, NM storm (60).**

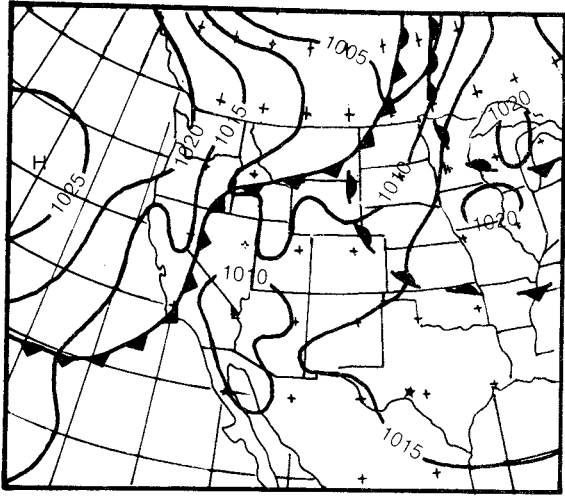

June 23 Surface 0530 MST

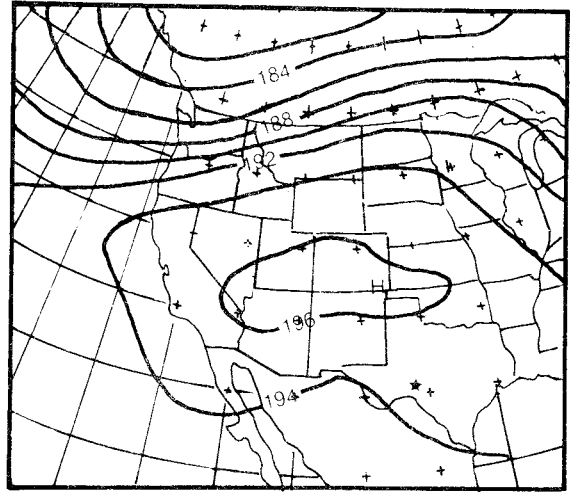

June 23 500 MB 0800 MST

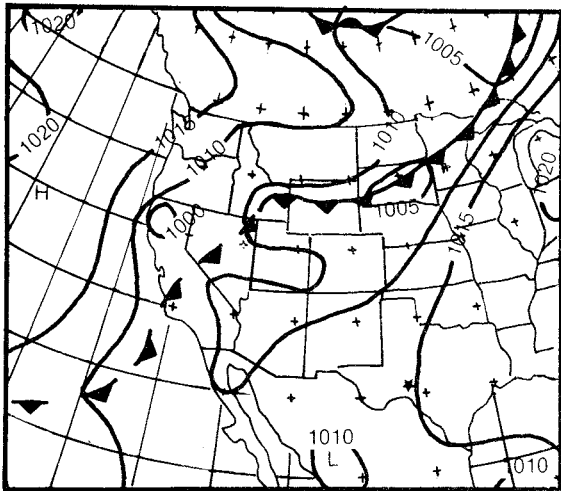

June 24 Surface 0530 MST

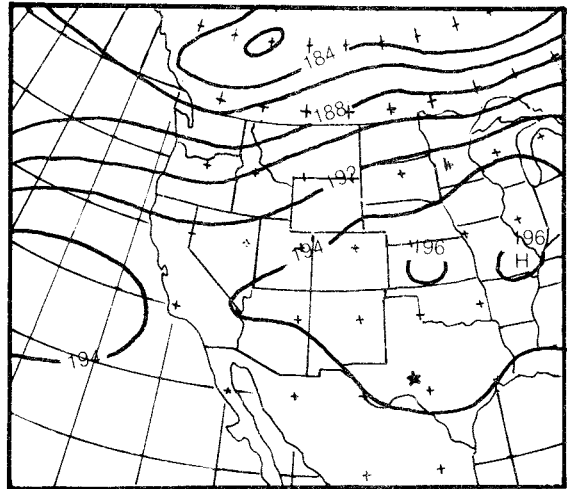

June 24 500 MB 0800 MST

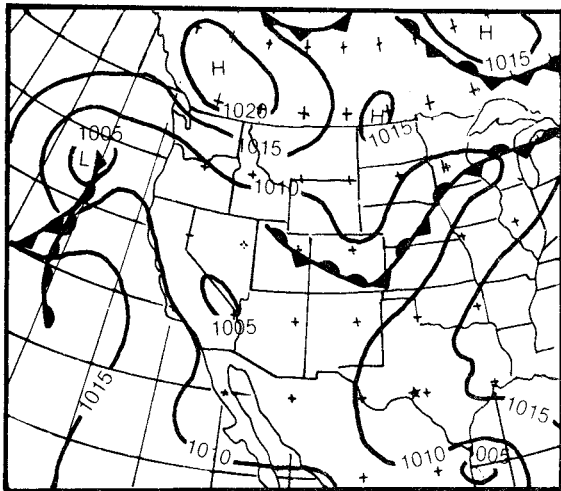

June 25 Surface 0530 MST

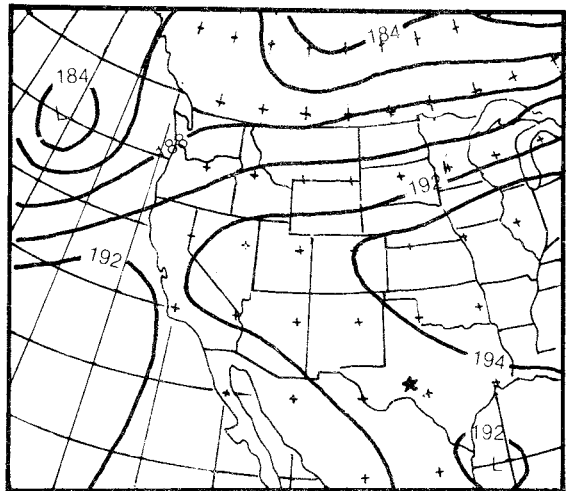

June 25 500 MB 0800 MST

**Figure 2.27.—Synoptic surface weather maps and 500-mb charts for June 23-25, 1954 - the Vic Pierce, TX storm (112).**

jet winds also diminished. The highest speed revealed by the 8:00 a.m. pilot balloon observation was 48 mph at 3,000 ft above sea level. However, the storm on this day still maintained its warm core as evidenced by the 500-mb temperature at Del Rio.

Continuing on its northwestward track, the storm crossed the Rio Grande to the region between the Big Bend of the Rio Grande and lower Pecos River. It stalled there during the night of the 26th and remained nearly stationary through the 27th. Early on the 28th (fig. 2.28), the storm remnants were barely discernible as a cyclonic wind circulation with a weak low pressure center. At this time it began to move across the lower Pecos River and finally lost its identity in north Texas. After it passed Del Rio, the cyclonic circulation of the storm was more distinct at 5,000 ft than at the surface. This is typical of decadent hurricanes. The storm was further identified at 5,000 ft by the temperature at the core of the disturbance which, by that time, was some 4°C colder than its surroundings. The warm anticyclone aloft and at the surface was quite strong and persistent from Florida across the Gulf Coast States into New Mexico while the storm was moving up the Rio Grande Valley. There were some weak indications in the 500-mb wind field that the storm interacted with a wave in the westerlies extending south from Montana as it was producing the record rainfall northwest of Del Rio.

During the progress of the storm over the relatively flat country of the Rio Grande Valley below Del Rio, rains were only moderate for a hurricane. In Texas, there was a 6-in. center at Hebronville, about 130 mi northwest of Brownsville, TX, and another center in excess of 6 in. near Uvalde, about 270 mi northwest of Brownsville. Stations along the Rio Grande experienced total precipitation ranging from a fraction of an inch to 4.5 in. (fig. 2.29). In Mexico, south of the storm track, precipitation was very light. Northwest of Del Rio, some orographic effect was apparent in the reported precipitation amounts. The storm encountered the steepest slopes of the narrowing valley of the Rio Grande between the Serranias del Burro in Mexico and the tip of the Balcones Escarpment in Texas. The first of the very heavy rains, near Langtry, TX, however, began as the center of the decadent hurricane arrived there. Detailed information on the wind flow is lacking, but it is reasonable to suppose that the prevailing flow into the area of heaviest rain was from the southeast.

Several hours after the passage of the hurricane center, the rain at Langtry slacked off and stopped altogether soon after noon on the 27th. The principal activity then shifted 30-60 miles north, to the region between Pandale and Ozona, TX. A succession of thunderstorm cells released very heavy rains along this axis for as long as the center of the transforming hurricane was located a short distance to the west of the axis. The precipitation ended over this region only after the storm center moved to the north. There are two rainfall centers shown on the isohyetal analysis at which the total accumulated precipitation for the storm, according to unofficial measurements, was 35 in. The location of one (Everett) is in a saddle near the Pecos River at the head of a general slope up from the south, 1,700 ft above sea level. The other (Vic Pierce Ranch) is near a rim of a plateau at an elevation of 2,200 ft.

The heavy rains are most closely related to the stalling of the northwestward movement of the hurricane remnants while it was transformed into a cold-core system when interacting with a weak wave in the westerlies. Although the overall precipitation pattern can be associated with the generally southward-facing

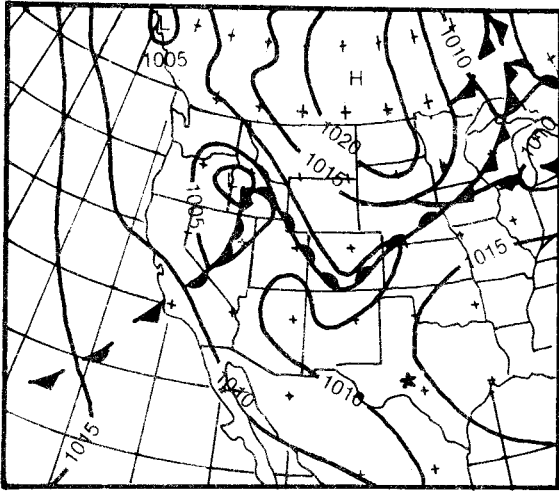

June 26 Surface 0530 MST

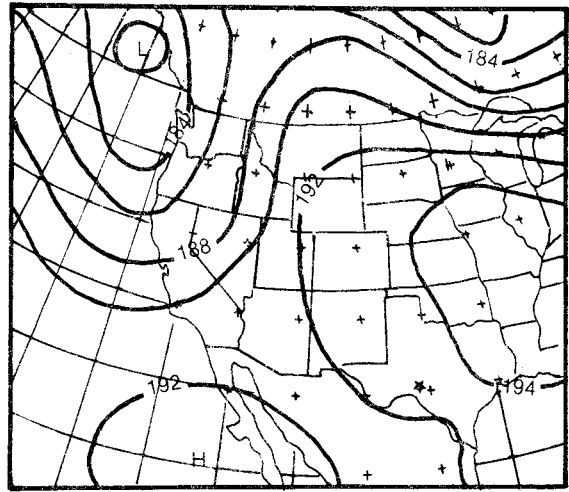

June 26 500 MB 0800 MST

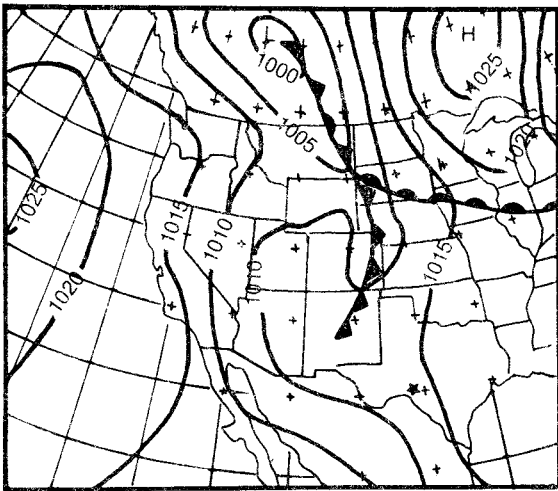

June 27 Surface 0530 MST

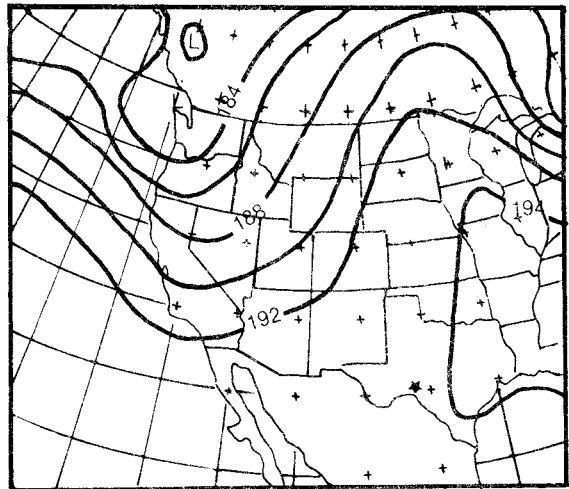

June 27 500 MB 0800 MST

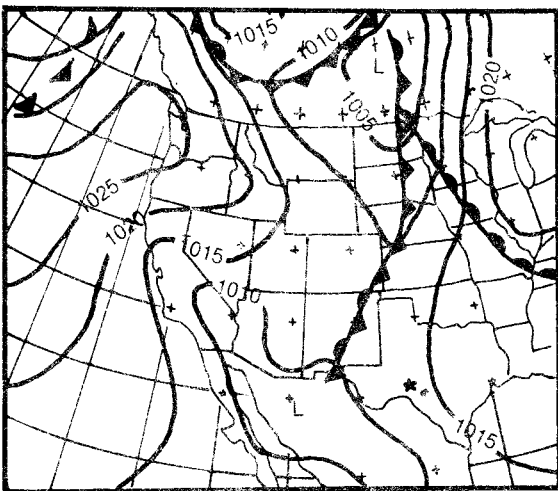

June 28 Surface 0530 MST

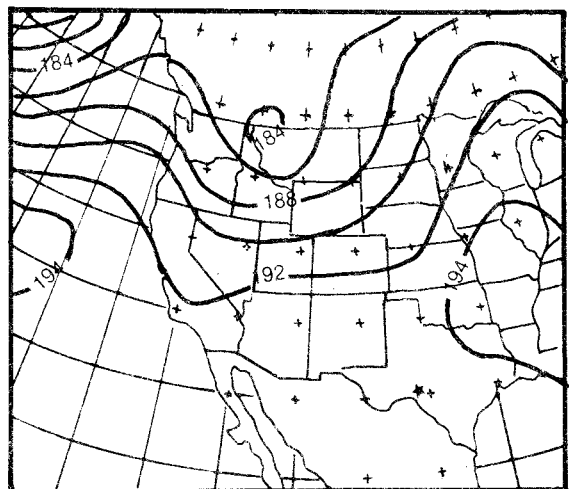

June 28 500 MB 0800 MST

Figure 2.28.--Synoptic surface weather maps and 500-mb charts for June 26-28, 1954 - the Vic Pierce, TX storm (112).



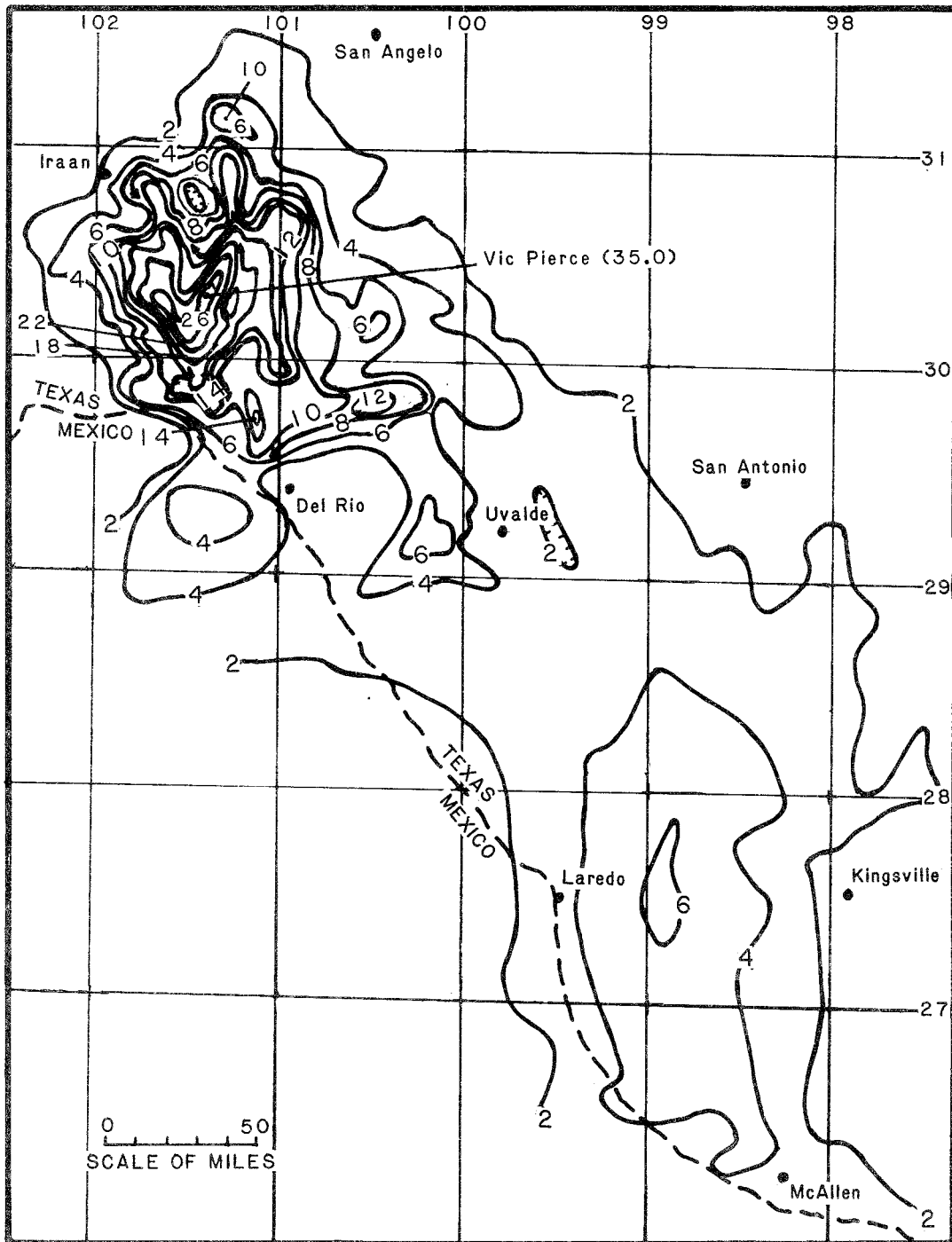

Figure 2.29.--Isohyetal map for June 24-29, 1954 - the Vic Pierce, TX storm (112).

slopes of the Edwards Plateau in the area northwest of Del Rio, specific isohyetal maxima and minima appear poorly correlated with places where the slopes are most pronounced.

## **2.5 Storm Classification**

One objective of a comprehensive study of the meteorological situations surrounding major storms is the development of a classification or grouping system. The system may then be used to determine in which regions similar storms have occurred. Once these regions have been decided, transposition limits for individual major storms can be more easily determined. The system was developed from the study of the major rain storms in the region, some of which have been discussed in section 2.4.

### **2.5.1 Storm Classification System**

Development of a storm classification system, based upon the factors most important for occurrence of an extreme rainfall event, is complicated by the existence of more than one factor that can be assigned in most storms. In the system developed, only one factor can be assigned to each storm. The first separation is between general cyclonic and convective storms. Within the convective storm grouping, storms are further subdivided into complex and simple systems. Within the cyclonic storm classification, the storms are grouped into tropical and extratropical storms. The extratropical storms are further classified as those in which the precipitation results primarily from frontal action and those in which the precipitation results primarily from convergence around a low pressure system.

**2.5.1.1 - Characteristics of Storm Classes.** Convective precipitation is caused primarily by vertical motion within an extended mass of air where the air is warmer than its environment. Convective precipitation is usually limited in areal extent and of relatively higher intensity, and produces greater amounts over smaller areas than that resulting solely from large-scale cyclonic activity. Convective storms are sometimes accompanied by thunder. Frequently in these storms, periods of intense rainfall are separated by periods of little or no precipitation. The fundamental unit is the storm cell. Diameter of this mass of air is about 10 mi or less and typically forms a single cumulonimbus cloud. The affected area is greater when a group of related convective events are considered together.

The classification system includes both simple and complex convective storms. Simple convective storms are those isolated in both time and space. The duration is usually less than 6 hr and the total storm area is generally less than 500 mi<sup>2</sup>. When precipitation is caused by a group of simple convective storms, the event is classified as a complex convective storm. Generally the duration will be longer than 6 hr and the total storm area will be greater than 500 mi<sup>2</sup>. It should be remembered that, in a complex convective case, the total duration of all storm events combined is less than 24 hr, and the total storm area, generally, is only a few thousand square miles.

Cyclonic precipitation is primarily caused by the large scale vertical motion associated with synoptic scale weather features such as pressure systems and fronts. The vertical motion is related to the horizontal convergence of velocity near the surface. The extent of the total storm area, as reflected by the

isohyetal pattern, is typically larger than 10,000 mi<sup>2</sup>. The total duration of the storm is one or more days. The precipitation is steady rather than high intensity bursts or showers.

The distinction between an extratropical and tropical cyclonic storm is in the location of storm origin. While extratropical storms originate at a latitude greater than 30°N, tropical storms all originate in a latitude band between 5°N and 30°N. Tropical storms affecting the CD-103 region originate in either the Gulf of Mexico, the Caribbean Sea or the Atlantic Ocean. Adequate supplies of both real and latent heat are necessary conditions for the formation of tropical storms. These conditions are met over the three tropical regions mentioned. In this study, only those storm events are included as tropical cyclones where the precipitation can be attributed to a tropical storm circulation, or where the track of the center of moisture can be matched with storms found in "Tropical Cyclones of the North Atlantic Ocean - 1871 - 1980" (Neumann et al. 1981).

Rainfall events from cyclonic storms of extratropical origin can be further subdivided into those resulting from circulation around low pressure centers and those associated with frontal systems. The rainfall associated with low pressure centers results from cyclonic flow close to the surface over an area near, and generally to the north of, the low pressure center. The low pressure center is generally moving eastward through the area of concern. The effective storm duration is generally about three days. Generally, cold fronts cause most of the extreme rainfall associated with frontal systems in this region. Such a front represents the leading edge of a mass of cooler air moving from northwest to southeast through the region. The heaviest precipitation is associated with the cold front as it passes through the region. The associated low pressure system is at least 100 mi from the precipitation center. Precipitation generally is of shorter duration than that associated with low pressure centers.

The descriptions in the previous paragraphs present idealized situations. Most storms result from a variety of causes. Since the adopted procedures allow only one classification to be assigned to each storm, a method has been developed to select the appropriate type when various causative factors are present. The storm is examined in terms of the total precipitation volume. The percentage of this volume contributed by each storm type is estimated. The storm type contributing the greatest percentage is used as the basis for storm classification. Simple convective storms cannot occur in combination, or as a portion of other storm types. In some portions of the region, these storms provide the maximum precipitation amounts for short durations and small areas. Outside these regions, combinations of convective and cyclonic types can occur. When determining the duration as discussed in the various storm types, an effective storm duration is used. This duration is defined as the shortest period of time in which at least 90 percent of the total rainfall has occurred for the majority of the storm area. This is generally determined from pertinent data sheets from "Storm Rainfall in the United States" (U.S. Army Corps of Engineers 1945 -), hereafter referred to as "Storm Rainfall." The classification of the storm type is a step-by-step process in which a decision is made on the most general categories first. A second decision follows, and for some storm types a third decision is made. The schematic for classification of storms, figure 2.30, illustrates this process.

# CLASSIFICATION OF STORMS

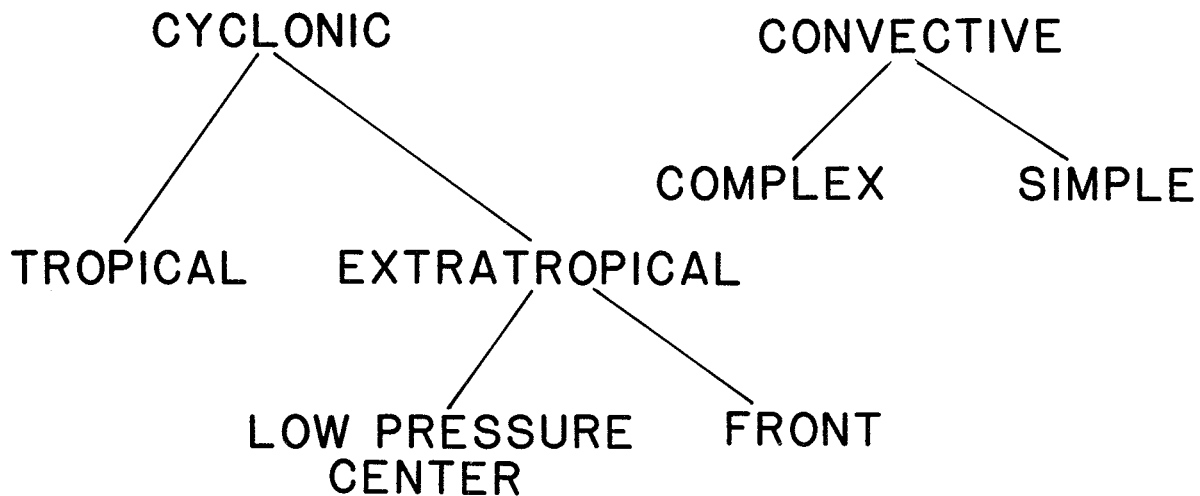

Figure 2.30.—Schematic illustrating the storm classification system.

## 2.5.2 Example of Application of Storm Classification System

The application of the storm classification system can be understood by examination of a particular important storm. The storm selected for this example was centered at Penrose, CO on June 2-6, 1921 (31).

**2.5.2.1 Convective/Cyclonic.** Five different criteria can be examined to classify a storm as cyclonic or convective. These are: 1) weather maps; 2) mass curves of rainfall; 3) isohyetal pattern; 4) effective storm duration; and 5) total storm area. An interpretive judgment will be made regarding each of these criteria.

The surface synoptic weather maps are examined for storm criteria. Figure 2.4 shows the weather maps for June 2-6, 1921. Although two cold fronts passed through the region during this storm period, one on June 1-2 and the other on June 5-6, their passage was not reflected by much rainfall. Most of the rain occurred on the night of June 3-4 at times when these fronts were at least 150 mi away. Low pressure centers were not present in the region during the period. Heavy amounts of rain were recorded at some stations, while neighboring stations observed little rain. The above features indicate that rainfall was of a convective nature.

The second criterion to examine is the mass curves of rainfall for the storm. Selected mass curves are shown in figure 2.5. These curves are examined in terms of shape and magnitude. The curves exhibit fairly short periods of intense rainfall which are separated by longer periods without rain. The spatial correlation of precipitation with distance diminishes rapidly. The rainfall also was not of a steady nature. Therefore, the criteria for mass curves indicate the storm to be a convective rainfall event.

The isohyetal pattern of the storm also provides clues to the type of rainfall event. Figure 2.5 showed an isohyetal pattern for this storm. The pattern displays a very large area of rainfall with several separate centers. These two criteria eliminate the simple convective event. The ratio of the width of the isohyetal pattern to the length is slightly less than 0.8 based on the 2-in. isohyet. Cyclonic storms tend to have isohyetal patterns which are somewhat elliptical as compared to complex convective storms, whose patterns are characterized by isolated centers, each of which is nearly circular. Rainfall between centers is not uniform and indicates the analysis could have been done in separate parts. Therefore, the isohyetal pattern for this storm is not clearly of any single group. Preponderance of evidence indicates a group within the convective class.

The effective storm duration can be determined from information provided on the pertinent data sheet in "Storm Rainfall." The total storm area, or an area size that includes at least 90 percent of the volume of storm rainfall, is used for this determination. Using the larger area sizes, the effective duration for the Penrose, CO storm is 2.5 days. This is longer than the key duration of one day for a convective storm. This criteria implies cyclonic precipitation.

The total storm area can be determined from the 2 in. isohyet on the isohyetal pattern already presented (fig. 2.5). An alternative source is the storm area information presented on the pertinent data sheet from "Storm Rainfall." For the Penrose, CO storm, the storm area from the pertinent data sheet is 144,000 mi<sup>2</sup>. This factor also indicates a cyclonic-type storm.

Three of the five criteria considered have supported the selection of the convective group. However, the criteria should not be weighted equally. In weighting the criteria, the effects of the terrain over the region must be considered. The CD-103 region contains some areas where orography contributes to the volume of precipitation in storms. It is particularly important in considering the mass curves of rainfall and the isohyetal pattern. In the review of the Penrose, CO storm, the first three criteria should be considered more important than the final two criteria. This is considered valid even though this storm occurred over both orographic and nonorographic regions. The latter two criteria were de-emphasized because the limits for convective storms, of one day duration and 10,000-mi<sup>2</sup> area, should be relaxed when a group of related convective events are considered together as one storm. Clearly the mass rainfall curves demonstrate that the Penrose storm fits in this category. Additionally, no cyclonic weather system is present near the area of heavy rainfall at the time. Based on the examination of the five criteria it is concluded that the Penrose storm belongs in the convective group.

**2.5.2.2 Simple/Complex.** Having placed the storm in the convective group, the final decision is a choice between a complex or simple storm. The effective storm duration and total storm area were much greater than the limiting values of 6 hr and 500 mi<sup>2</sup> for simple convective storms. The total storm area was 144,000 mi<sup>2</sup>. Examination of mass curves of rainfall and the isohyetal pattern indicate that the storm could have been analyzed in several sections, though each of these sections would also have exceeded the 6-hr and 500-mi<sup>2</sup> criteria for a simple convective storm. The Penrose storm was given a final classification as a complex convective storm.

### 2.5.3 Classification of Storms by Type

All important storms (table 2.2) considered in developing PMP estimates for the study region were examined and classified by storm type. Some additional storms from the more comprehensive list of major storms (table 2.1) were also classified by storm type to aid in the initial determination of storm transposition limits. The storms are listed in table 2.3, grouped by appropriate storm type. Within each storm type, the storms where orography played a significant role in the precipitation process are grouped separately from those where orography

**Table 2.3.--List of storms of record considered for CD-103 region by storm type**

Storm number	Name	Date
	<u>Low Pressure System</u>	<u>(Orographic)</u>
1.	Ward District, CO	May 29-31, 1894
3.	Big Timber, MT	April 22-24, 1900
6.	Boxelder, CO	May 1-3, 1904
7.	Spearfish, SD	June 2-5, 1904
10.	Warrick, MT	June 6-8, 1906
12.	Choteau, MT	June 21-23, 1907
13.	Evans, MT	June 3-6, 1908
14.	Norris, MT	May 22-24, 1909
19.	Ft. Union, NM	June 6-12, 1913
28.	Browning, MT	September 27-28, 1919
30.	Fry's Ranch, CO	April 14-16, 1921
36.	Hays, MT	June 16-21, 1923
45.	Westcliffe, CO	April 19-22, 1933
50.	Circle, MT	June 11-13, 1937
52.	Big Timber, MT	May 17-20, 1938
68.	Dupuyer, MT	June 16-17, 1948
71.	Belt, MT	June 1-4, 1953
75.	Gibson Dam, MT	June 6-8, 1964
79.	Broomfield, CO	May 5-6, 1973
	<u>Low Pressure System</u>	<u>(Least Orographic)</u>
86.	May Valley, CO	October 18-19, 1908
16.	Knobles Ranch, MT	September 3-6, 1911
20.	Clayton, NM	April 29-May 2, 1914
32.	Springbrook, MT	June 17-21, 1921
38.	Savageton, WY	September 27-Oct. 1, 1923
58.	McColleum Ranch, NM	September 20-23, 1941
61.	Dooley, MT	March 13-17, 1943

Table 2.3.--List of storms of record considered for CD-103 region by storm type -  
(continued)

Storm number	Name	Date
	<u>Cold Front</u>	<u>(Orographic)</u>
8.	Rociada, NM	September 26-30, 1904
23.	Tajique, NM	July 19-28, 1915
33.	Denver, CO	August 17-25, 1921
35.	Virsylvania, NM	August 17, 1922
37.	Sheridan, WY	July 22-26, 1923
57.	Campbell Farm Camp, MT	September 6-8, 1941
59.	Tularosa, NM	September 27-29, 1941
77.	Big Elk Meadow, CO	May 4-8, 1969
	<u>Cold Front</u>	<u>(Least Orographic)</u>
15.	Half Moon Pass, MT	June 7-8, 1910
25.	Lakewood, NM	August 7-8, 1916
44.	Porter, NM	October 9-12, 1930
56.	Prairieview, NM	May 20-25, 1941
62.	Colony, WY	June 2-5, 1944
	<u>Tropical Cyclone</u>	<u>(Orographic)</u>
27.	Meek, NM	September 15-17, 1919
60.	Rancho Grande, NM	Aug. 29-Sept. 1, 1942
	<u>Tropical Cyclone</u>	<u>(Least Orographic)</u>
105.	Broome, TX	September 14-18, 1936
112.	Vic Pierce, TX	June 23-28, 1954
116.	Medina, TX	August 1-4, 1978
117.	Albany, TX	August 1-4, 1978
	<u>Complex Convective</u>	<u>(Orographic)</u>
11.	Ft. Meade, SD	June 12-13, 1907
29.	Vale, SD	May 9-12, 1920
31.	Penrose, CO	June 2-6, 1921
41.	Cheesman, CO	July 19-24, 1929
46.	Kassler, CO	September 9-11, 1933
53.	Loveland, CO	Aug. 30-Sept. 4, 1938
54.	Waterdale, CO	Aug. 31-Sept. 4, 1938
66.	Ft. Collins, CO	May 30, 1948
78.	Rapid City, SD	June 9, 1972
81.	Big Thompson, CO	July 31-Aug. 1, 1976
	<u>Complex Convective</u>	<u>(Least Orographic)</u>
21.	Malta, MT	June 12-14, 1914
40.	Beach, ND	June 6-7, 1929
42.	Valmora, NM	August 6-11, 1929
43.	Gallinas Plant Station, NM	September 20-23, 1929

**Table 2.3.--List of storms of record considered for CD-103 region by storm type - (continued)**

Storm number	Name	Date
47.	Cherry Creek, CO	May 30-31, 1935
101.	Hale, CO	May 30-31, 1935
49.	Ragland, NM	May 26-30, 1937
108.	Snyder, TX	June 19-20, 1939
111.	Del Rio, TX	June 23-24, 1948
72.	Buffalo Gap, Sask.	May 30, 1961
73.	Lafleche Sask	June 12-13, 1962
74.	Bracken, Sask	July 13-14, 1962
76.	Plum Creek, CO	June 13-20, 1965
114.	Glen Ullin, ND	June 24, 1966
82.	White Sands, NM	August 19, 1978
	<u>Simple Convective</u>	<u>(Orographic)</u>
48.	Las Cruces, NM	August 29-30, 1935
67.	Golden, CO	June 7, 1948
	<u>Simple Convective</u>	<u>(Least Orographic)</u>
55.	Masonville, CO	September 10, 1938

played a minimal role. The simple convective storms listed at the end of the table are among those which are considered appropriate for use in determining local storm criteria. Development of the local storm criteria is discussed more completely in chapter 12. The locations of the important storms (table 2.2) for determining PMP, identified by appropriate storm type, are shown in figure 2.31.

Tracks of tropical storms listed in table 2.4, are shown in figure 2.32. The tracks are composed of two segments. Solid lines are tracks extracted from Neumann et al. (1981), and dashed line segments are extrapolated using either surface weather observations at 0600 or from reported precipitation amounts. The

**Table 2.4.--Dates of tropical storms affecting southern portion of CD-103 region**

From Neumann et al. (1981)	Plotted in figure 2.32	From Neumann et al. (1981)	Plotted in figure 2.32
7/13-22/09	7/21-26/09	9/10-14/36	9/13-14/36
8/20-28/09	-	9/11-16/41	-
6/22-28/13	6/27-28/13	8/21-31/42	8/29-9/1/42
8/12-19/16	8/18-21/16	8/24-29/45	8/27-31/45
9/12-15/19	9/14-18/19	7/31-8/2/47	-
6/12-16/22	-	6/24-26/54	6/25-28/54
9/6-7/25	-	6/14-16/58	6/15-16/58
6/26-29/29	6/28-7/1/29	7/22-27/59	-
8/11-14/32	-	8/5-8/64	-
7/21-26/34	-	7/30-8/5/70	8/3-5/70



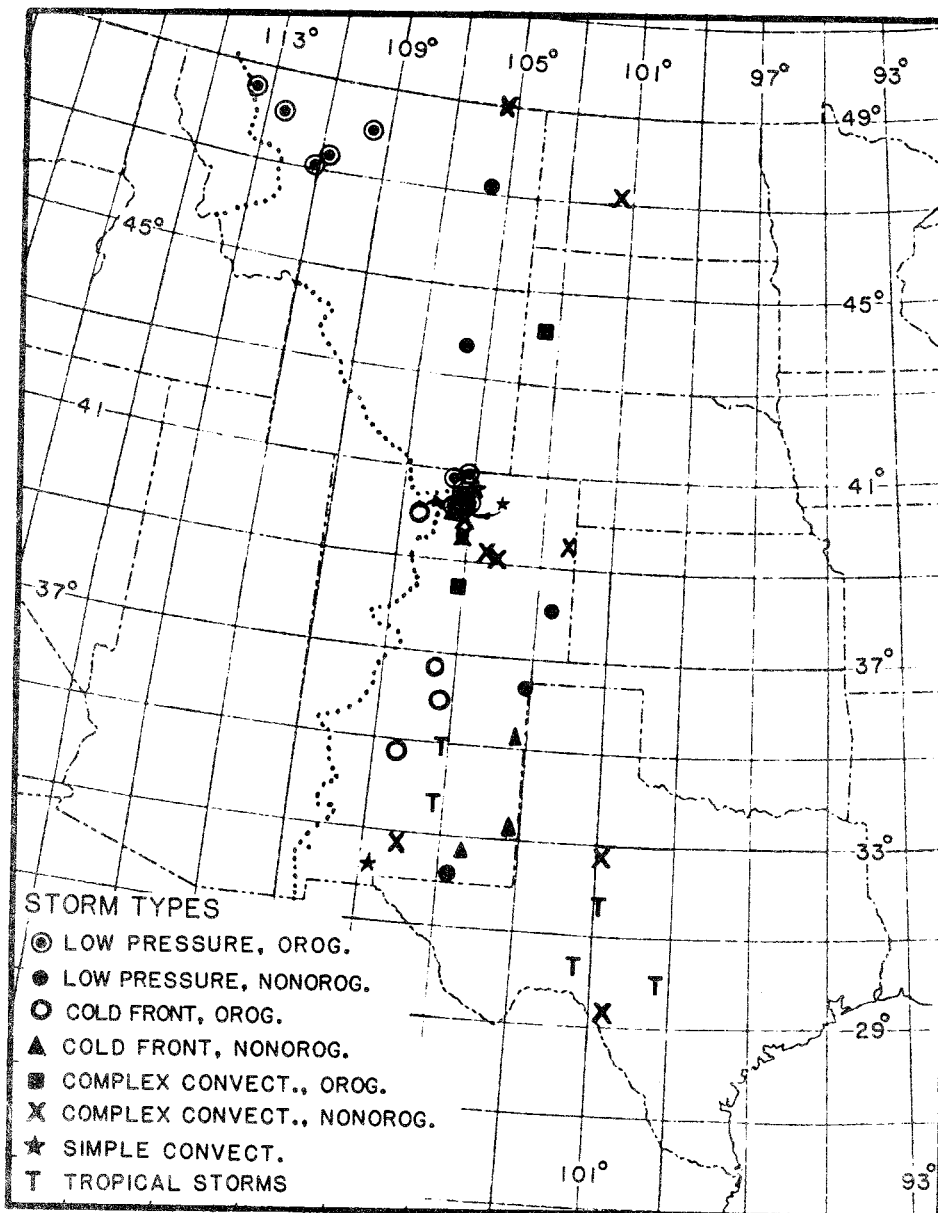

Figure 2.31.--Location of table 2.2 storms by storm type.

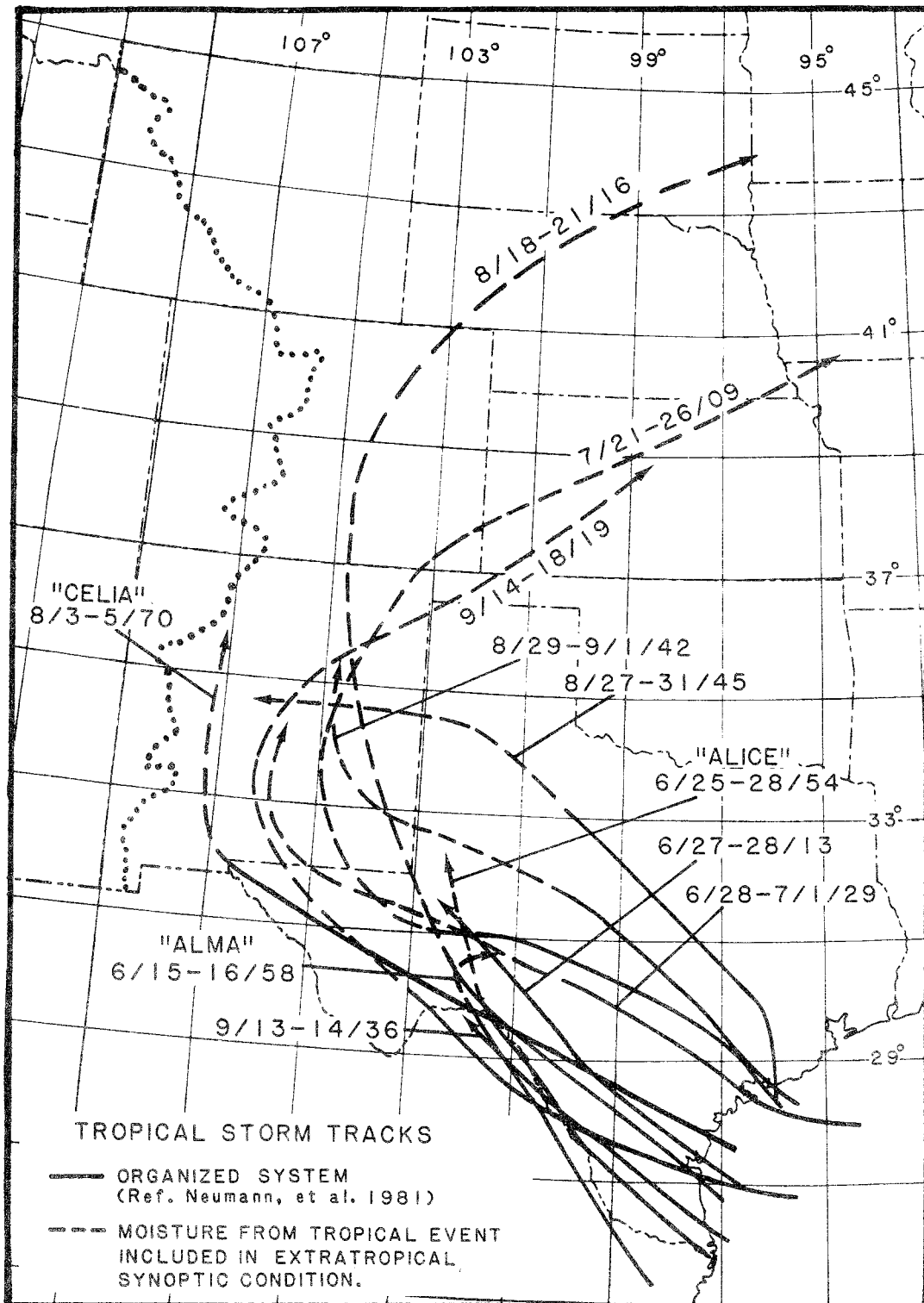

Figure 2.32.--Tracks of tropical storms affecting the southern part of CD-103 region.

precipitation was typically an accumulation over a 3-day time span, but could be for a period as short as 24 hr, or for as long as 6 days. Precipitation was always clearly associated with the tropical storm. Where possible, rainfall maxima were determined near the coast, the east-central region and the western third of Texas, to provide some idea of the change of potential rainfall for a storm.

### **3. TERRAIN CLASSIFICATION SYSTEM**

#### **3.1 Introduction**

At the onset of the CD-103 study, it was recognized that terrain within the region was extremely complex. It was useful, therefore, to subdivide the region according to some classification system. This would allow for consideration of different approaches to developing PMP within different subdivisions that might have varying degrees of orographic effects, or aid in defining storm transposition limits.

#### **3.2 Classification**

The terrain classification system that evolved recognized several different types of terrain influence. Of most importance was the separation into orographic and nonorographic regions. Within the orographic region, it was important to recognize the differences in effect of first and second upslopes.

##### **3.2.1 Orographic/Nonorographic Line**

First, it was necessary to develop a division between orographic and non-orographic regions. The Great Plains region is a relatively flat region with elevations generally increasing to the north and west. In HMR No. 51, a gentle upslope correction was applied to account for the loss of moisture at higher elevations. In the present study, this factor is considered in the moisture adjustment procedure. Within this region, there are no prominent orographic features which would stimulate or enhance precipitation in a storm of the magnitude of the PMP. This region is considered nonorographic in the study. Exactly how far westward this nonorographic region should extend is subject to question, although the Rocky Mountains are certainly orographic. The influence of orography on moist air inflow from the Gulf of Mexico was chosen as the key criteria. Inflow winds would be essentially from the east and would be minimally affected by terrain until they encountered the first upslopes in the CD-103 region. Upslopes in this study were represented by changes in elevation greater or equal to 1,000 ft in 5 mi or less. A smooth line was drawn connecting locations that satisfied the base level of this gradient.

Second, orographic stimulation is a term applied when the effects of terrain influence on the atmosphere in producing precipitation appear at some distance upwind of any actual terrain feature. In this sense, the effect occurs in what could be considered a nonorographic environment. The distance over which such effects occur is not well known since they are influenced by the steepness of the slope, height and lateral extent of the barrier and direction of inflow wind in major storms against the barrier. A distance of about 20 mi was considered reasonable to represent the extension of orographic influence into surrounding nonorographic terrain. Stimulation was also considered in HMR No. 43 where it

was applied to the regions west of the Cascade Divide. Distance intervals used in HMR No. 43 are larger than in the present study, because of generally stronger winds within more stable air in that region.

As a result of stimulation considerations, another smooth enveloping line was drawn from the Canadian border to the Mexican border, roughly 20 mi east of the base of the first upslopes, and this line was eventually adopted as representing a logical division between orographic and nonorographic regions. The adopted location of the orographic separation line (OSL) is shown in figure 3.1. An additional orographic subdivision was necessary in Montana to delineate the orographic region enclosing the Bear Paw Mountains. Another subdivision of similar nature was drawn around the Black Hills in South Dakota.

It should be noted that in following the rather simple guidelines for locating the orographic separation line, placement was somewhat obvious through Montana and Colorado. In Wyoming, however, placement is not always as clear. This is especially the case in the central part of the state where no notably steep slopes occur and the flow is more along the barriers than normal to them. In this region, the outline of the Wind River Valley (fig. 3.1) was followed.

### 3.2.2 First Upslopes

After separating the broadscale orographic/nonorographic regions, the orographic region was examined for possible further subdivision. One readily apparent subregion was the first upslopes. When considering the flow of moist air in passing over such terrain, the first upslopes generally have the greatest effect in producing precipitation. The secondary upslopes, behind the first upslopes, are effective in producing precipitation only to the extent that they rise higher than the first upslopes, or that the air can descend and be lifted again when encountering the second slopes.

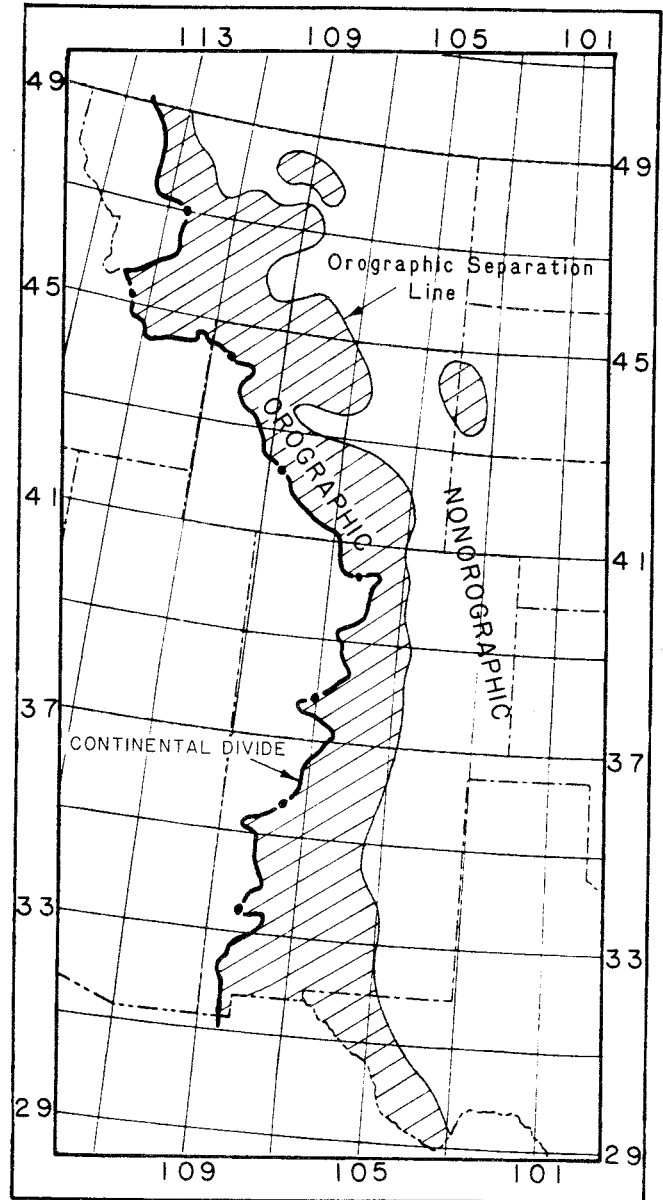

**Figure 3.1.--Study region showing line separating orographic and nonorographic regions (orographic separation line - OSL).**

flow of moist air in passing over such terrain, the first upslopes generally have the greatest effect in producing precipitation. The secondary upslopes, behind the first upslopes, are effective in producing precipitation only to the extent that they rise higher than the first upslopes, or that the air can descend and be lifted again when encountering the second slopes.

Terrain maps were again analyzed to designate the limit of first upslopes. A broadscale consideration was to place this limit at the Continental Divide, unless multiple ridgelines occurred upwind. The dashed line in figure 3.2 shows the result of these considerations. It should be emphasized that this separation was based on major crests, not minor interruptions to a general upslope. The portion to the east of this dashed line in the CD-103 region is referred to as the first upslope subdivision, while the region west of this line contains secondary orographic slopes. Particularly in Wyoming, the placement of the dashed line was poorly defined by the terrain. A number of choices were possible and the selection shown in figure 3.2 was considered to be the most logical.

### 3.2.3 Sheltered Least Orographic Subdivisions

For much of Wyoming and some parts of Montana, Colorado and New Mexico, it was apparent that there would be subdivisions of sheltered conditions to the west of the first upslope subdivision. As an approach to locating such subdivisions, the horizontal gradient of terrain was considered. A tentative sheltered least orographic subdivision was designated when the terrain gradient was essentially flat over a distance exceeding 10 mi, to the west of the first upslope subdivision. It was further examined on the basis of the apparent effect the terrain gradient (upslope) had on the 100-yr 24-hr precipitation. The subdivisions tentatively designated sheltered least orographic were found to be somewhat consistent with zones having less than or equal to 3.0 in. of 100-yr 24-hr precipitation (Miller et al. 1973). On this basis, portions of the CD-103 region, where the 100-yr 24-hr precipitation was less than or equal to 3.0 in., and located west of the limit of the first upslopes, were designated as sheltered least orographic. An exception to this apparent agreement occurs in New Mexico, south of about 36°N, where 100-yr 24-hr precipitation is generally greater than 3.0 in. Nevertheless, a sheltered least orographic subdivision was designated in southern New Mexico (fig. 3.2). This decision was in part a result of observations made during the aerial reconnaissance of this region (sec. 1.6).

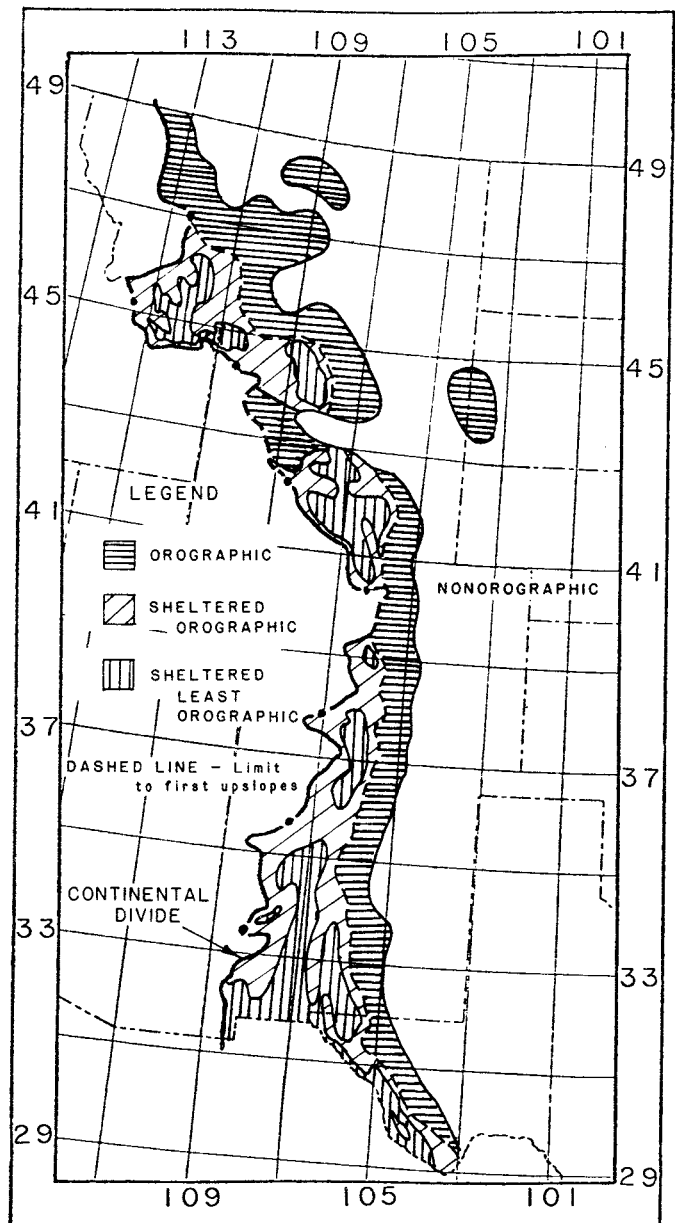

Figure 3.2.--Approximate boundaries of terrain subdivisions used in this study.

### 3.2.4 Sheltered Orographic Subdivisions

The region between the sheltered least orographic subdivision and the orographic subdivision boundary line (limit of the first upslopes) was designated as sheltered orographic. These sheltered orographic slopes exert less influence on moisture flows than do similar slopes in the orographic subdivision.

### 3.3 Barrier/Effective Elevation Map

It is customary when discussing moist air flow in orographic terrain to consider the effect of the terrain on the moisture. One of the primary effects is that in passing over a major ridgeline, saturated air will lose moisture through precipitation. Thus, when considering conditions in the lee of major ridges, the moisture potential is reduced. In hydrometeorological applications, it is assumed that 100 percent of the moisture available beneath the height of the ridge is lost by the air passing across the ridge. Thus, the ridge is referred to as a barrier.

To determine where such barriers exist in the CD-103 region, the inflow directions that would prevail in PMP-type storms were considered. It was assumed that such storms can be approximated by major storms of record, and the mean winds for such storms in the CD-103 region were evaluated. In the southern portion of the region, moist inflows are southerly. In the northern portion of the region, moisture inflow to some storms appears to have a northerly component. Reference to the discussion of major storms (chapt. 2) clarifies this situation.

Inflow directions can be represented by a range of roughly 90 degrees throughout the study region. Figure 3.3 shows the results of the review of inflow directions to major storms. A gradual variation from southerly to easterly to northerly directions with increasing latitude has been smoothed into the results shown.

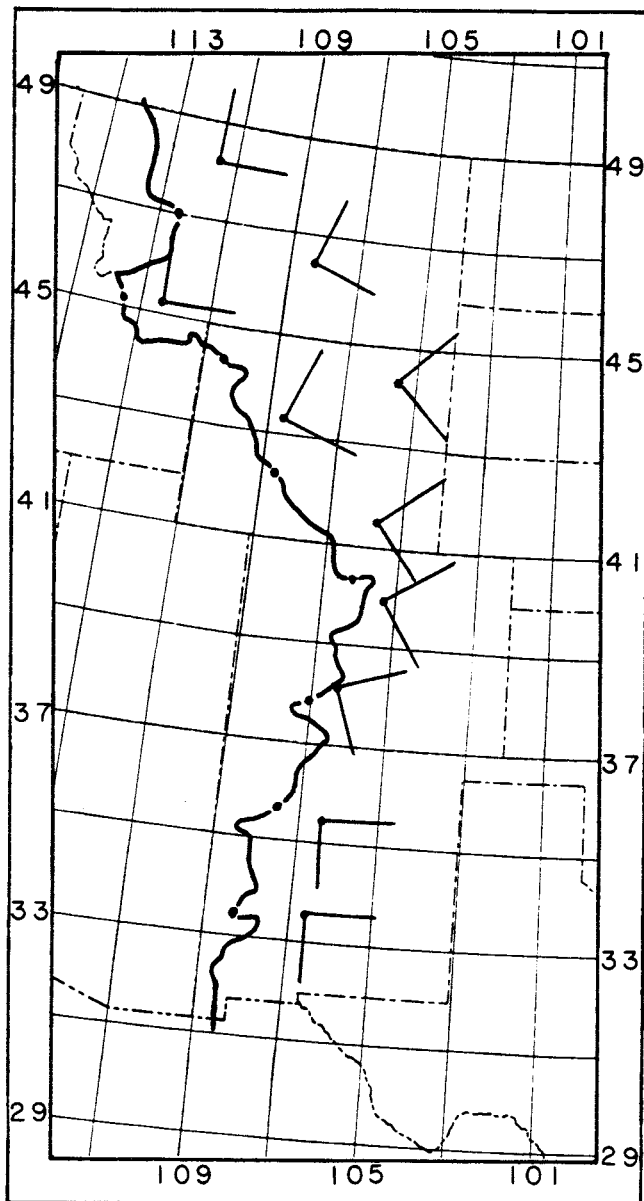
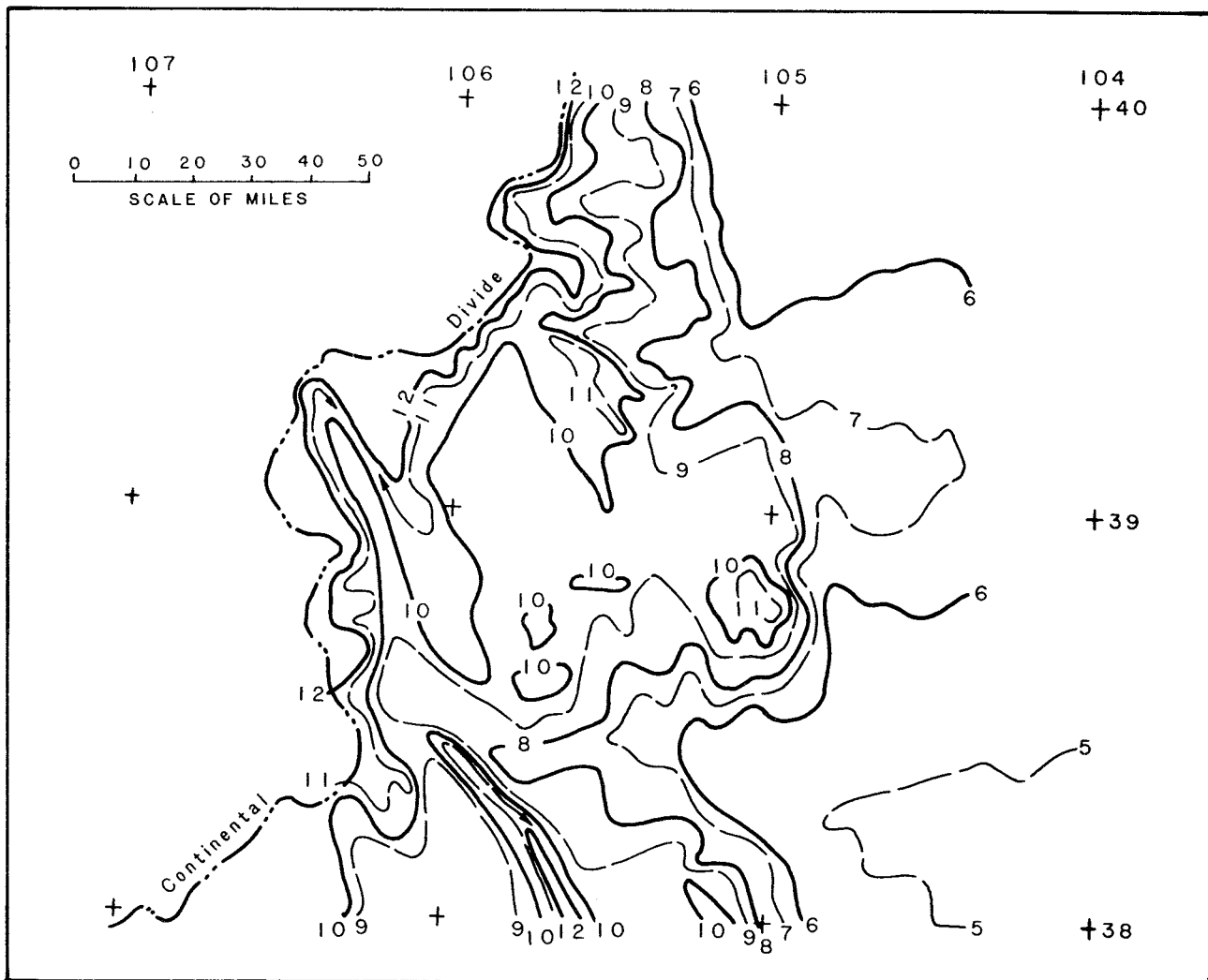

Figure 3.3.--Range of inflow wind directions for PMP type storm.



**Figure 3.4.—Barrier/smoothed elevation map (in 1,000's of ft) for a 2° latitude band (38° to 40°N) through Colorado.**

The next step was to consider terrain elevations. It was impractical to consider the detail in elevation contours found on maps of the scale of 1:250,000, or less. A map scale of 1:1,000,000 was chosen for a basic work chart. Contours of elevation had previously been extracted, with a small degree of smoothing, for the development of NOAA Atlas 2 (Miller et al. 1973). These contour maps were used as the first approximation to the base maps in this study. Some additional smoothing was made to the NOAA Atlas 2 elevation contours by eliminating topographic features on the order of 10 mi or less. The degree of smoothing decreased, however, as elevation increases.

A barrier map was prepared by considering inflow directions and their affect on air encountering the smoothed elevation contours. In the atmosphere, air not only flows over ridges, it flows also around the ends of such obstacles. Therefore, it is necessary to judge how moist air flow affects the region behind a barrier. This consideration is important primarily for smaller barriers (order of less than 100 mi in breadth). In such situations, the rule applied in the HMR No. 49 study was used in this study. This rule states that airflow around these obstacles would be brought together on the leeside of the obstacle at a distance 1.5 times the breadth of the barrier.

With these considerations in mind, the entire CD-103 region was analyzed to produce a barrier/effective elevation map. Because of the difficulty in showing detail at page-size scale, only a portion of the map for Colorado has been shown in figure 3.4, as an example. Elevation ranges of meteorologically significant barriers are between 4,000 and 12,000 ft in Colorado. The flow can be perpendicular as well as parallel, to the ridge lines. This is particularly true in New Mexico. Where this is true, ridges were considered ineffective as barriers.

#### 4. MAXIMUM PERSISTING 12-HR 1000-MB DEW POINTS

##### 4.1 Background

The basic steps leading to precipitation are: (1) sufficient atmospheric moisture, (2) cooling of the air, (3) condensation of water vapor into liquid or solid form, and (4) growth of condensation products to precipitation size. The measure of water vapor in the air used in hydrometeorological studies is precipitable water. Two measures of moisture are needed in PMP studies; the amount in individual storms and the maximum amount that can occur. Since the precipitable water measurements are not directly available prior to the 1940's and since even the current measurements do not always provide an adequate geographic coverage, a surface measurement of moisture has been used. Dew-point data were selected for use since they are: 1) good measures of moisture in storm situations, (particularly in the lowest layers), 2) observed at a dense network of stations, and 3) available for a long period of record.

Maximum persisting 12-hr 1000-mb dew points are used as a measure of the maximum precipitable water that can be expected in various regions of the United States in various months. The initial dew-point study was completed in the early 1940's. For the western United States, maximum persisting 12-hr 1000-mb dew points for individual stations for durations from 12 to 96 hr were published in Weather Bureau Technical Paper No. 5, "Maximum Persisting Dew Points in the Western United States," (U.S. Weather Bureau 1948). Subsequently, maps of maximum persisting 12-hr dew points for the entire United States were published in the "Climatic Atlas of the United States" (Environmental Data Services 1968). For most of the United States, the maps were based on records from selected Weather Bureau first order stations from the beginning of observations to 1946. For New York and New England, they were updated using data through 1952 with some consideration given to maximum sea-surface temperatures in shaping the dew-point lines. For California, updated maps were prepared using data through 1958 for the months of October through April, when PMP studies were done for that region (U.S. Weather Bureau 1961). In subsequent studies, the maps of maximum persisting dew points were updated for the Pacific Northwest (U.S. Weather Bureau 1966) and the Colorado River and Great Basin in Hydrometeorological Report No. 50, "Meteorology of Important Rainstorms in the Colorado River and Great Basin Drainages" (Hansen and Schwarz 1981).

For the present study, it was considered desirable to update the maps appearing in the Climatic Atlas of the United States. Moisture flow for the major storms in this region primarily originates over the Gulf of Mexico and moves northward across the midwestern portion of the country. Thus, surface dew points were examined for stations in the central portion of the United States.



**Table 4.1.--Stations used in revision of maximum persisting 12-hr 1000-mb dew-point charts**

---

1.	Aberdeen, SD	41.	Kansas City, MO
2.	Abilene, TX	42.	Lander, WY
3.	Alamosa, CO	43.	Lewistown, MT
4.	Albuquerque, NM	44.	Little Rock, AR
5.	Alexandria, LA	45.	Lubbock, TX
6.	Amarillo, TX	46.	Mason City, IA
7.	Austin, TX	47.	Midland, TX
8.	Billings, MT	48.	Miles City, MT
9.	Bismarck, ND	49.	Minot, ND
10.	Brownsville, TX	50.	Missoula, MT
11.	Casper, WY	51.	Norfolk, NE
12.	Cheyenne, WY	52.	North Platte, NE
13.	Clayton, NM	53.	Oklahoma City, OK
14.	Columbia, MO	54.	Omaha, NE
15.	Colorado Springs, CO	55.	Port Arthur, TX
16.	Concordia, KS	56.	Pierre, SD
17.	Corpus Christi, TX	57.	Pueblo, CO
18.	Cut Bank, MT	58.	Rapid City, SD
19.	Dallas, TX	59.	Rock Springs, WY
20.	Del Rio, TX	60.	Roswell, NM
21.	Denver, CO	61.	Roswell, Walker AFB, NM
22.	Dillon, MT	62.	Salina, KS
23.	Dodge City, KS	63.	San Angelo, TX
24.	Eagle, CO	64.	San Antonio, TX
25.	El Paso, TX	65.	Scottsbluff, NE
26.	Enid, OK	66.	Sheridan, WY
27.	Fargo, ND	67.	Shreveport, LA
28.	Fort Smith, AR	68.	Sioux City, IA
29.	Galveston, TX	69.	Sioux Falls, SD
30.	Glasgow, MT	70.	Spokane, WA
31.	Goodland, KS	71.	Springfield, MO
32.	Grand Forks, ND	72.	St. Joseph, MO
33.	Grand Island, NE	73.	St. Louis, MO
34.	Grand Junction, CO	74.	Topeka, KS
35.	Great Falls, MT	75.	Tulsa, OK
36.	Havre, MT	76.	Vichy, MO
37.	Helena, MT	77.	Victoria, TX
38.	Huron, SD	78.	Waco, TX
39.	Houston, TX	79.	Wichita, KS
40.	Kalispell, MT	80.	Wichita Falls, TX
		81.	Williston, ND

---

#### 4.2 Data Collection

The basic data for this part of the study were obtained from the synoptic weather reports for 74 stations between the 94th meridian and the Continental Divide and 7 stations west of the Continental Divide. The 81 stations are listed in table 4.1 and their locations are shown in figure 4.1. Data for these

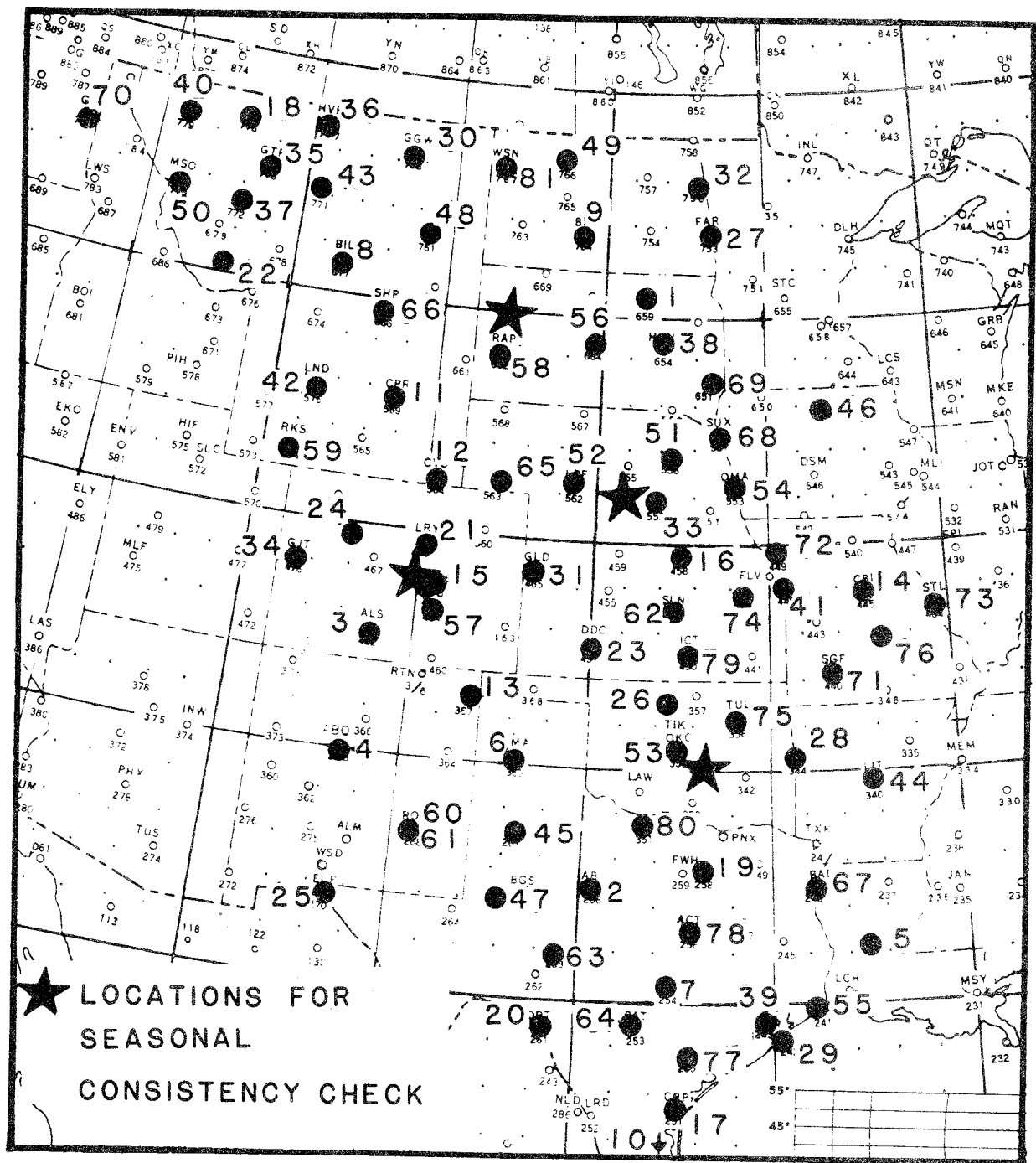

Figure 4.1.--Location of weather stations used to revise maximum persisting 12-hr 1000-mb dew points.

stations are available on a series of computer data tapes (Peck et al. 1977) maintained by the Office of Hydrology.

The first step in collecting the data was to determine current seasonal variation of maximum persisting 12-hr dew points at each of these stations. For this purpose, the mid-month value was determined for each station for each month

from the existing maps of maximum persisting 12-hr 1000-mb dew points (Environmental Data Service 1968). The values were adjusted to the station elevation by the pseudoadiabatic lapse rate, approximately  $-2.4^{\circ}\text{F}$  per 1,000 ft, and a seasonal variation curve drawn for each station. From these curves, the minimum value was determined for each station for each month and established as a threshold value. This dew point was the lowest value along the seasonal variation curve and occurred on either the first or last of the month. For example (fig. 4.2), for Roswell, NM a value of  $55^{\circ}\text{F}$  was determined for the station dew-point value for the first of April.

Thirty-one years of data, from 1948 through 1978, on the data tapes were searched with additional checks made for known instances of significant precipitation and moisture through 1981. For each station, those 12-hr periods were listed where the dew point continually equalled or exceeded the threshold value for a particular month. Since the data were at 3-hr intervals, this meant the lowest dew point of five consecutive values was used as the maximum persisting 12-hr value. Minimum temperatures were checked to insure the temperature did not fall below the selected dew point between observation times. If more than one of the five reports was missing the series was rejected. All values which exceeded the smooth seasonal curve by more than  $2^{\circ}\text{F}$  for each station, listed in table 4.2, for the date of occurrence, were verified. The first check of the values was to examine the values published in the Local Climatological Data (National Climatic Data Center 1948 -) to insure that correct values had been entered on the data tape. A second and more significant check was made with the Historical Daily Weather Maps (Environmental Data Service 1899-1971) for the date of occurrence. Maximum persisting 12-hr dew points are assumed to be representative of storm conditions. The general weather situations were examined to insure that they were favorable for supporting high moisture that could contribute to large precipitation amounts.

### 4.3 Analysis

New seasonal curves were prepared for each station. Figure 4.2 shows an example of such a curve. In the example, the values which exceed the previous curve are shown by the small squares and the revision to the existing seasonal curve is shown by the dashed line. In developing these analyses, consideration was given to data at surrounding stations, while still attempting to maintain a minimum envelopment of the individual station data. The next step was to read the values at mid-month for each station for each month. These values were then plotted on the original dew-point charts and the isolines redrawn for the new seasonal mid-month values.

After the maps for all 12 months were completed it was necessary to insure that regional and seasonal consistency was maintained. Seasonal curves were drawn at 4-degree intervals of latitude along the 97th, 101st, 103rd, 105th and 109th meridians, and at selective points along the Continental Divide and throughout the region. Figure 4.3 shows an example of these curves along the 103rd meridian for 31, 35, 39, 43 and 47 degrees latitude. The dashed lines are the results of the initial analysis. The curves along the meridians were then used to adjust and modify the initial analysis into a consistent set of regional and seasonal curves. The revisions are shown as the solid lines on figure 4.3. Where only dashed lines are shown, the initial analysis did not require further smoothing. The final step was to compare the mid-month values from the revised maps with the data on the original set of station seasonal curves. These mid-month values are

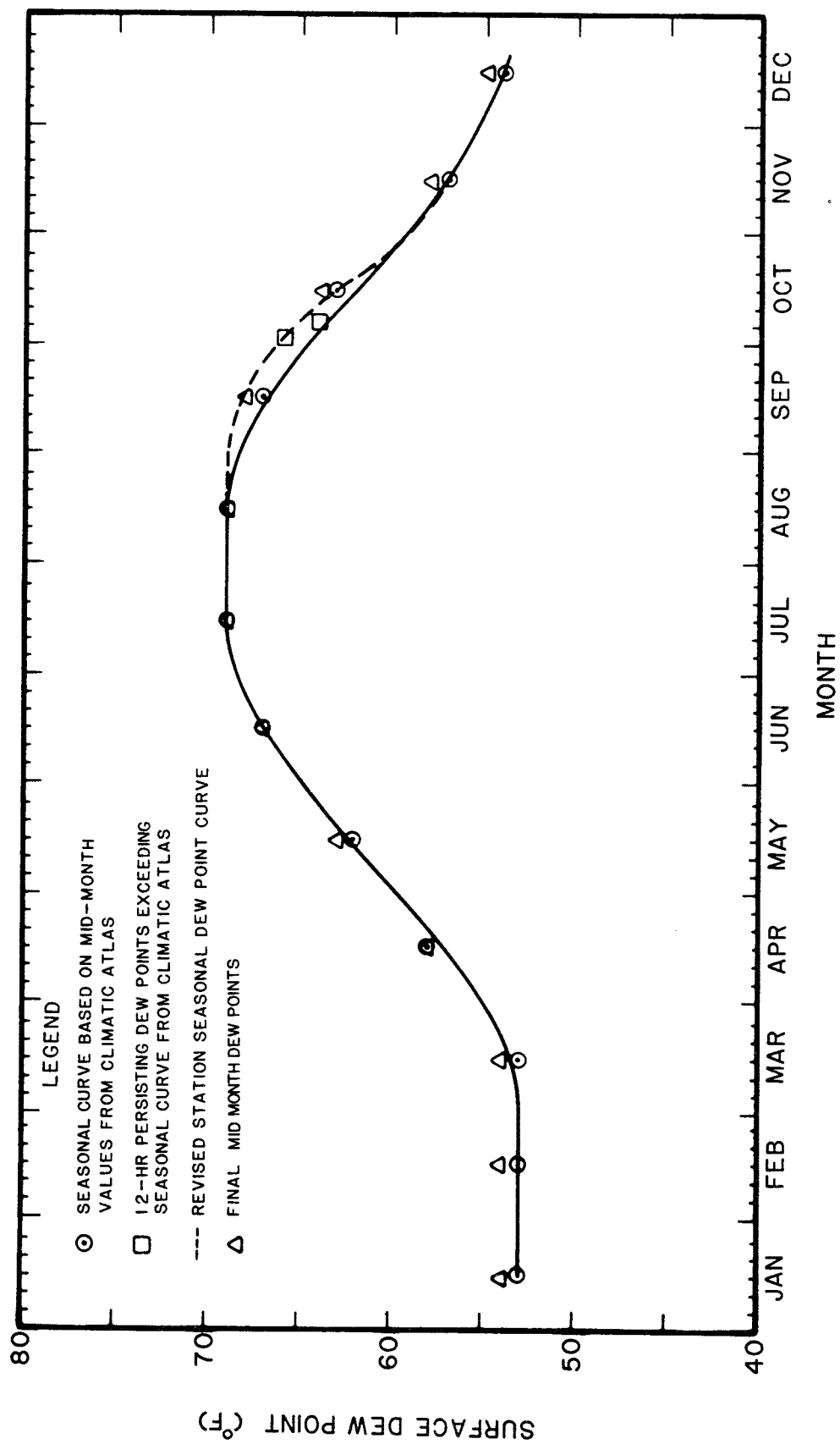

Figure 4.2.--Seasonal persisting 12-hr dew-point curve for Roswell, NM (Walker AFB).

**Table 4.2.--Persisting 12-hr dew points 2°F or more above existing criteria on date of occurrence**

Station	Date of Occurrence	Station dew point
Sioux City, IA	July 12, 1969	79°
	July 19, 1966	77°
Vichy, MO	Aug. 20, 1952	78°
	Dec. 15, 1948	62°
Omaha, NE	June 11, 1953	77°
	Dec. 11, 1965	59°
Miles City, MT	June 11, 1953	69°
Wichita, KS	Jan. 12, 1960	58°
Port Arthur, TX	Nov. 22, 1973	75°
San Antonio, TX	May 18, 1966	76°
Galveston, TX	June 28, 1952	81°
	June 26, 1952	80°
	Aug. 28, 1951	80°
	Sept. 1, 1954	80°
	Sept. 27, 1958	80°
Grand Island, NE	Aug. 28, 1954	74°
Aberdeen, SD	July 1, 1953	74°
	July 27, 1949	75°
St. Louis, MO	Dec. 15, 1948	62°
Topeka, KS	July 12, 1969	77°
	July 17, 1969	77°
	Jan. 12, 1960	59°
Kansas City, KS	Aug. 6, 1962	77°
	Jan. 12, 1960	59°
	Jan. 30, 1968	58°
Tulsa, OK	Dec. 15, 1948	65°
San Angelo, TX	Apr. 29, 1954	71°
Del Rio, TX	May 23, 1966	75°
Dallas, TX	May 17, 1966	76°
Enid, OK	July 2, 1957	76°
	July 6, 1949	76°
	July 7, 1949	76°
Burlington, IA	July 23, 1965	77°
North Platte, NE	Aug. 29, 1951	71°
Rapid City, SD	June 11, 1953	68°
Victoria, TX	Nov. 27, 1973	75°
Corpus Christi, TX	Sept. 13, 1978	80°
	Sept. 15, 1978	80°
Cut Bank, MT	Jan. 21, 1968	38°

shown as triangles on the example shown in figure 4.2. This was done to insure that excessive envelopment of station data did not occur and that the shape of the curves conformed to the shape determined from the station data.

Figure 4.4 shows comparison of the two analyses for the month of July, the old analysis (dashed lines), and the new analysis (solid lines). In preparing the analysis, three criteria were considered: a) the minimum envelopment possible for the dew-point values from the station curves was desired and considering that

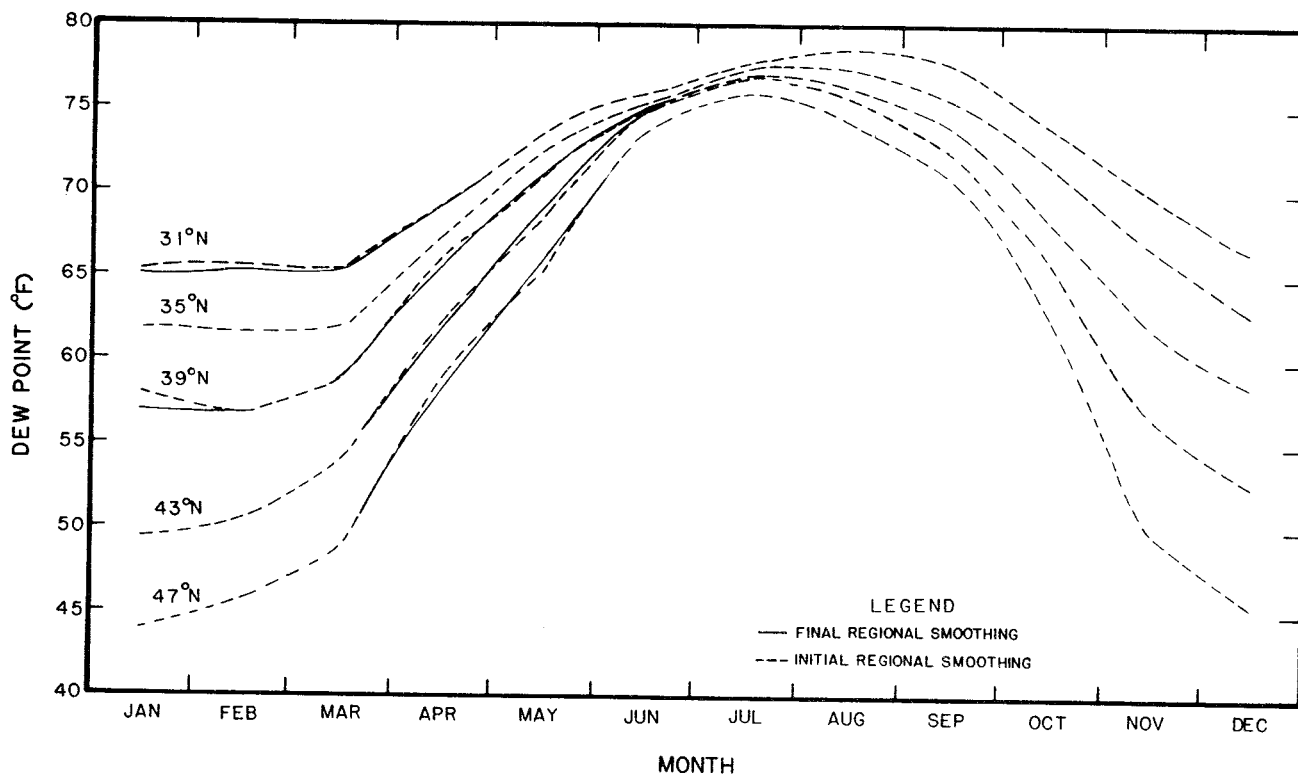

**Figure 4.3.--Regional smoothing and consistency checks for maximum persisting 12-hr 1000-mb dew points along the 103rd meridian.**

values were plotted only to whole degrees, a variation from the isolines of plus or minus a half degree from station values was allowed; b) values had to be supported by more than a single station within a region; and c) an upper limit of 80 degrees was the highest persisting 12-hr dew point that would be accepted.

Previous analyses have accepted an upper limit of 78 degrees. Earlier, it was considered that the sea-surface temperatures of the warm waters of the Gulf of Mexico in excess of 78 degrees were not sufficient in extent to support moisture through depth for a higher surface dew point. Examination of precipitable water charts for recent periods when surface dew points along the gulf coast were 80 degrees or higher suggested that this lower limit was too restrictive. In particular, the period of mid-September 1978, and early September 1954 suggested that a limit for the maximum dew point of 80 degrees would be appropriate.

#### 4.4 Other Studies

As discussed in section 4.1, maps of maximum persisting 12-hr 1000-mb dew points for the region west of the Continental Divide had been revised in HMR No. 43 (U.S. Weather Bureau 1966) and HMR No. 50 (Hansen and Schwarz 1981). These maps were used as input values along the western edge of the analysis for the present study.

In the case of HMR No. 50, two sets of maps were prepared, one for the general storm and one for the local storm (April to October only). The assumption was

made in preparing these two analyses that the local storm resulted partly from a more limited moisture source, that is, recharge from prior precipitation into the local area provided a significant input. Therefore, the moisture charge may be locally larger than for the general storm which required a broad sustained inflow from a moisture source region. Although we have continued the two-storm concept into the region east of the Continental Divide, we chose not to extend the double set of dew point analyses as the differences would be minimal. For those regions where the local storm controls, it is believed that moisture results from inflow somewhat similar to that in the general storm, though in the local storm situation it is more limited in duration and width.

In the Pacific Northwest, the dichotomy between moisture available for the local and general storm was not present and only one set of dew-point charts was prepared. Comparison between dew point values determined from HMR No. 43, in general, showed good agreement with values from the present study. Differences in the dew-point values between the two maps could be attributed to the longer length of record in the present study.

#### 4.5 Revised Seasonal Maps

Revised maps of maximum persisting 12-hr 1000-mb dew points are shown in figures 4.5 through 4.16. These maps were used in the moisture maximization and transposition of storms in the study region. They should be used in any future study for this region until alternate procedures are developed for estimating moisture charge in storms.

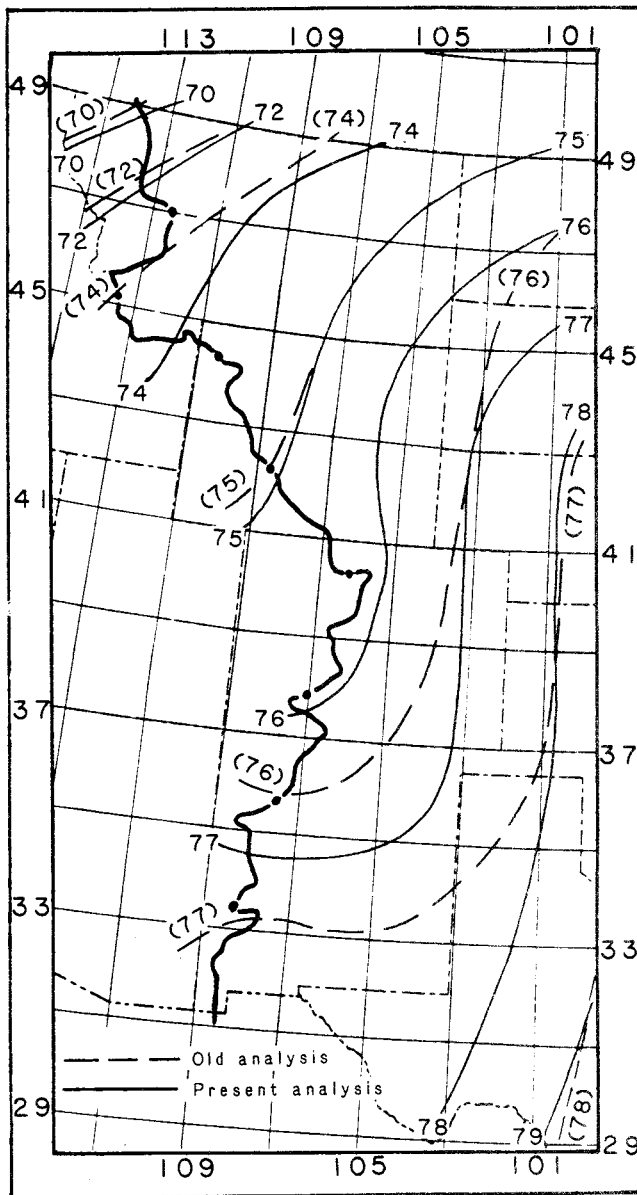

Figure 4.4.--Comparison of mid-July maximum persisting 12-hr 1000-mb dew points from Climatic Atlas of the United States and present study.

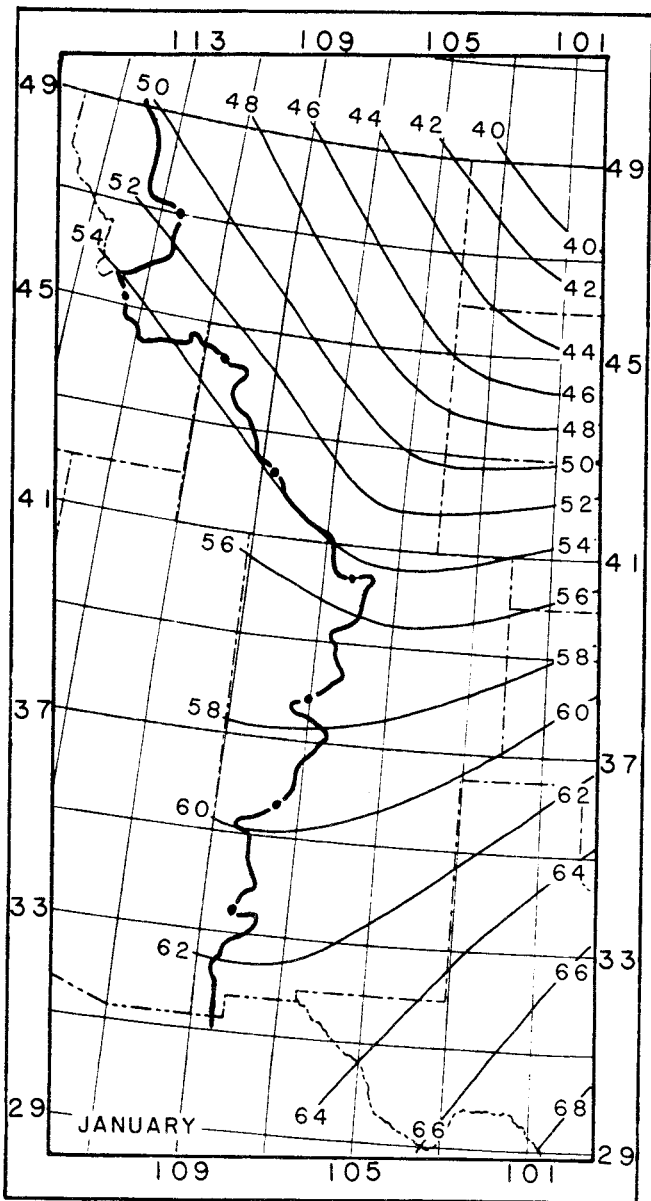

Figure 4.5.--Maximum persisting 12-hr 1000-mb dew points ( $^{\circ}\text{F}$ ) for January.

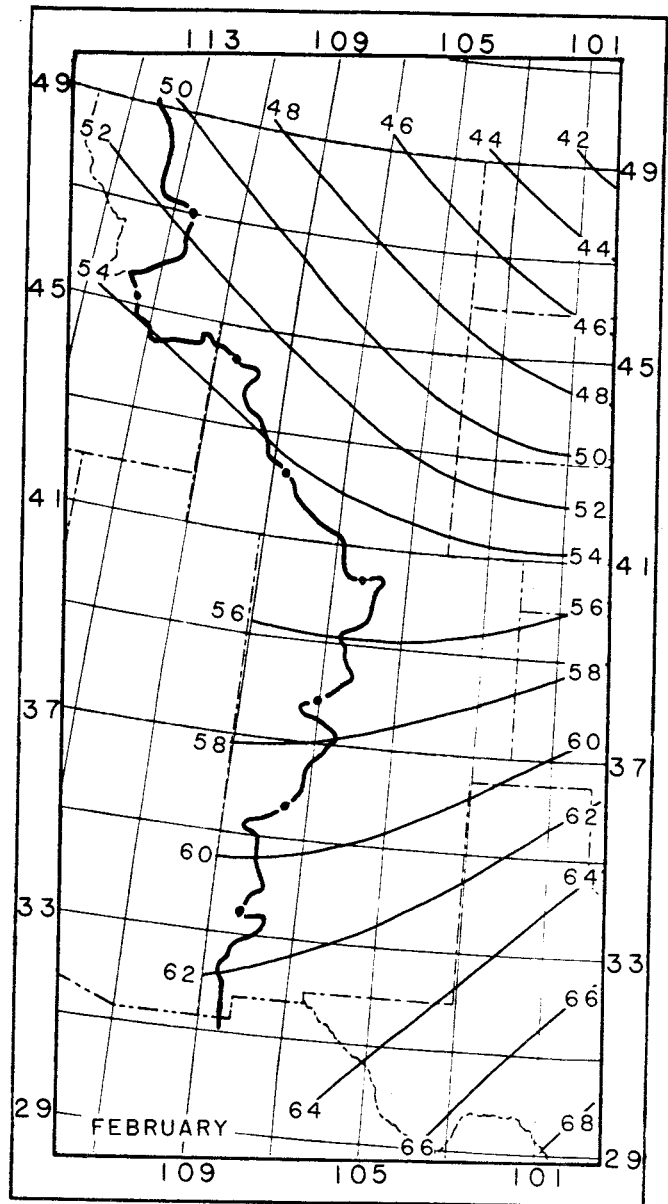

Figure 4.6.--Maximum persisting 12-hr 1000-mb dew points ( $^{\circ}\text{F}$ ) for February.



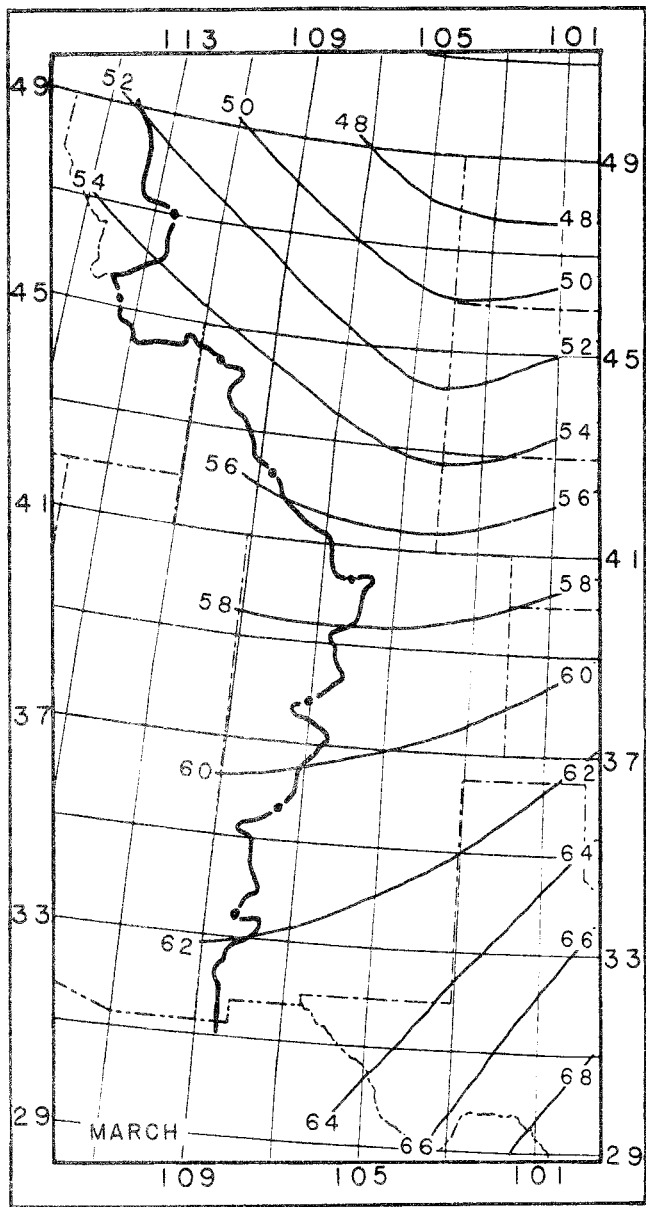

Figure 4.7.—Maximum persisting 12-hr 1000-mb dew points (°F) for March.

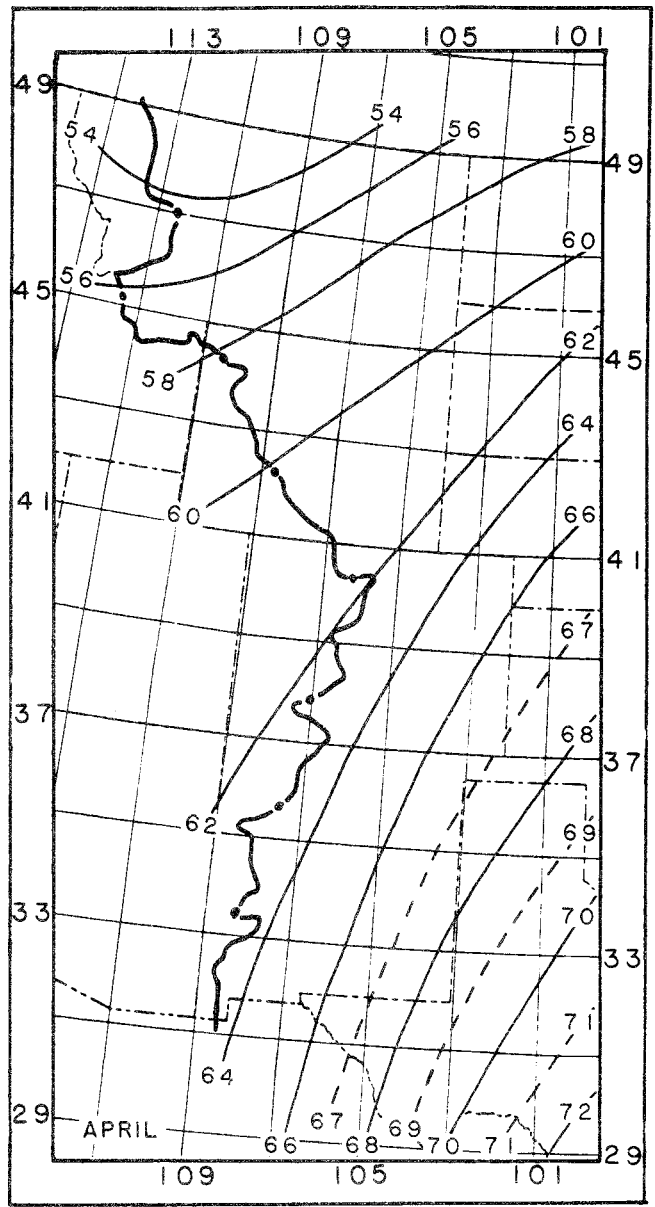

Figure 4.8.—Maximum persisting 12-hr 1000-mb dew points (°F) for April.

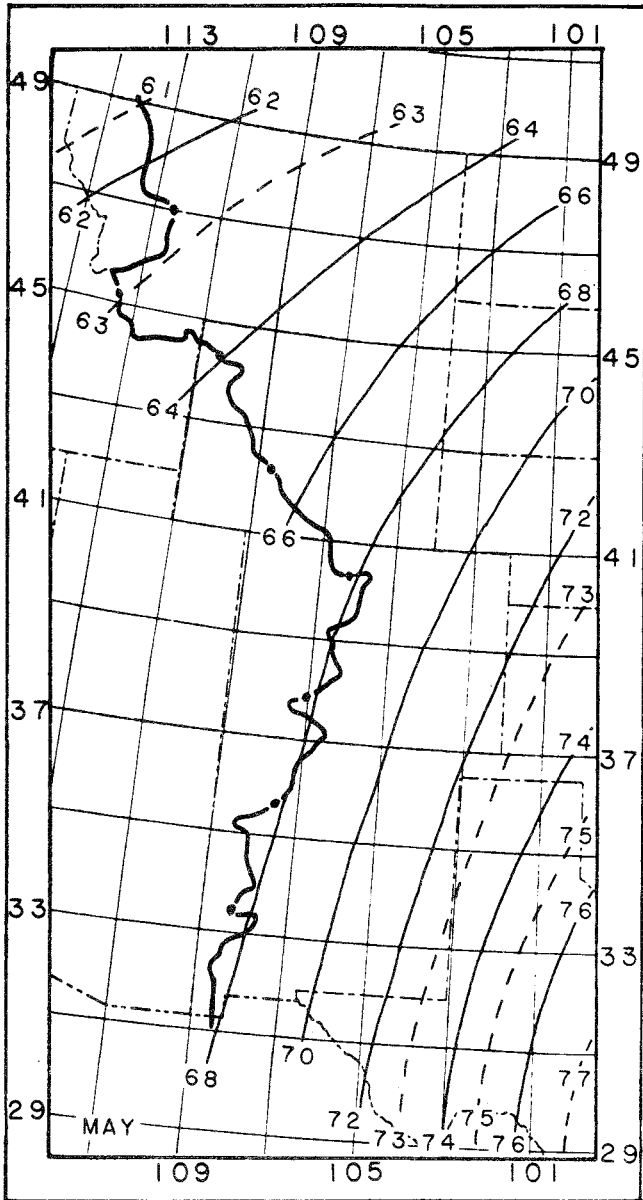

Figure 4.9.--Maximum persisting 12-hr 1000-mb dew points (°F) for May.

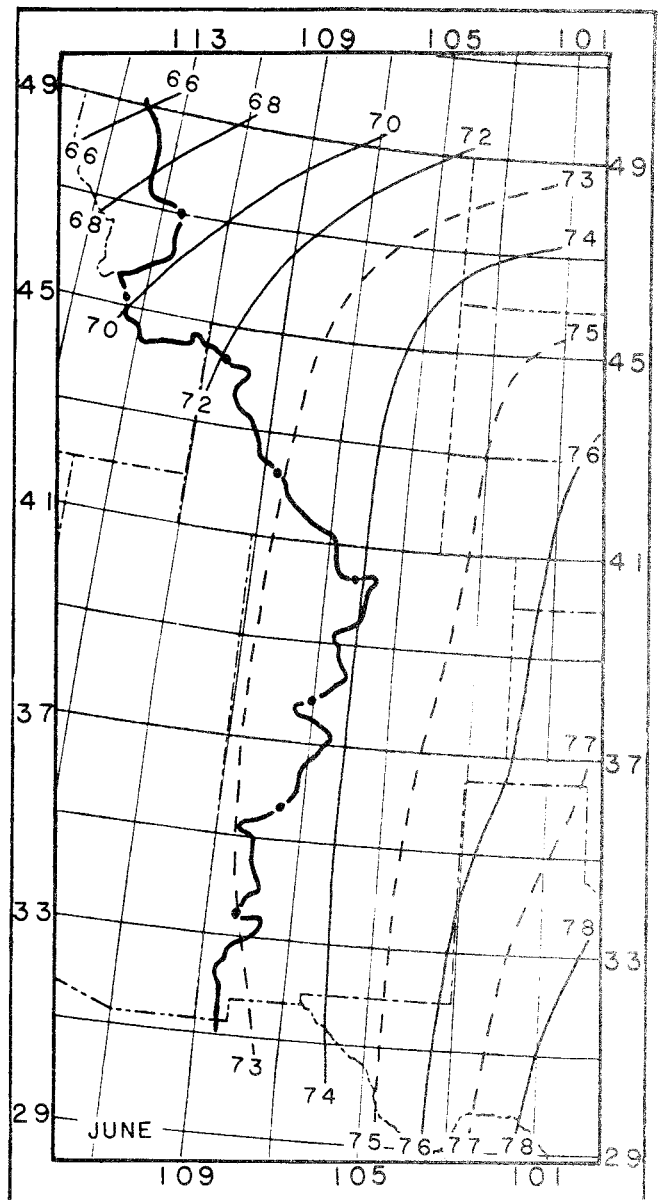

Figure 4.10.--Maximum persisting 12-hr 1000-mb dew points (°F) for June.

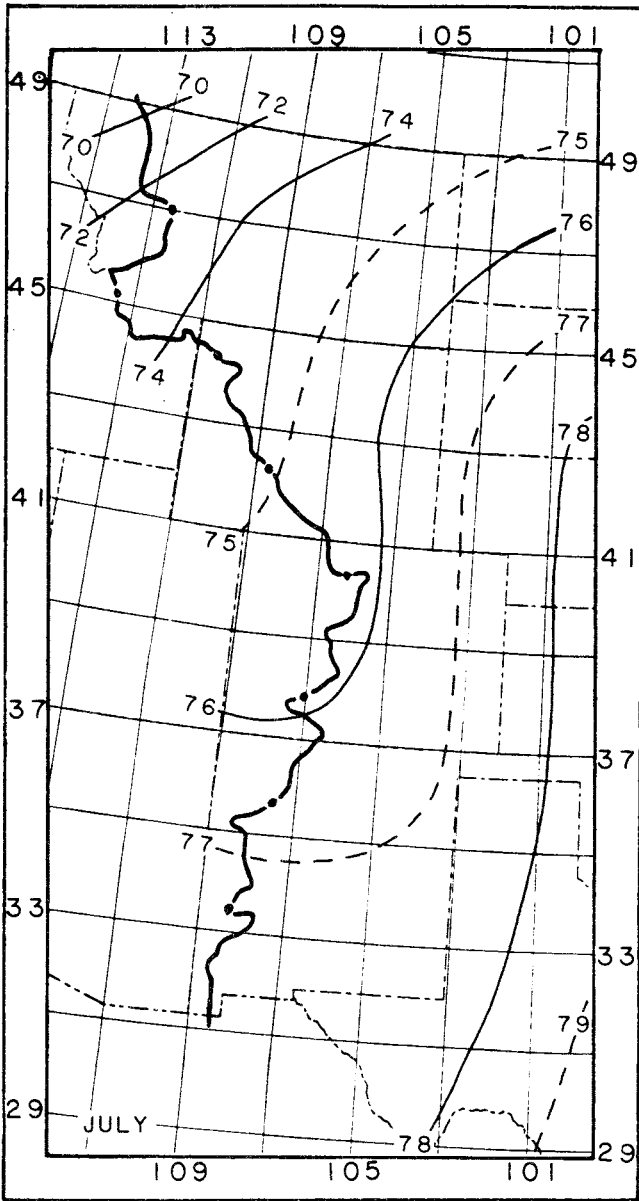

Figure 4.11.--Maximum persisting 12-hr 1000-mb dew points ( $^{\circ}\text{F}$ ) for July.

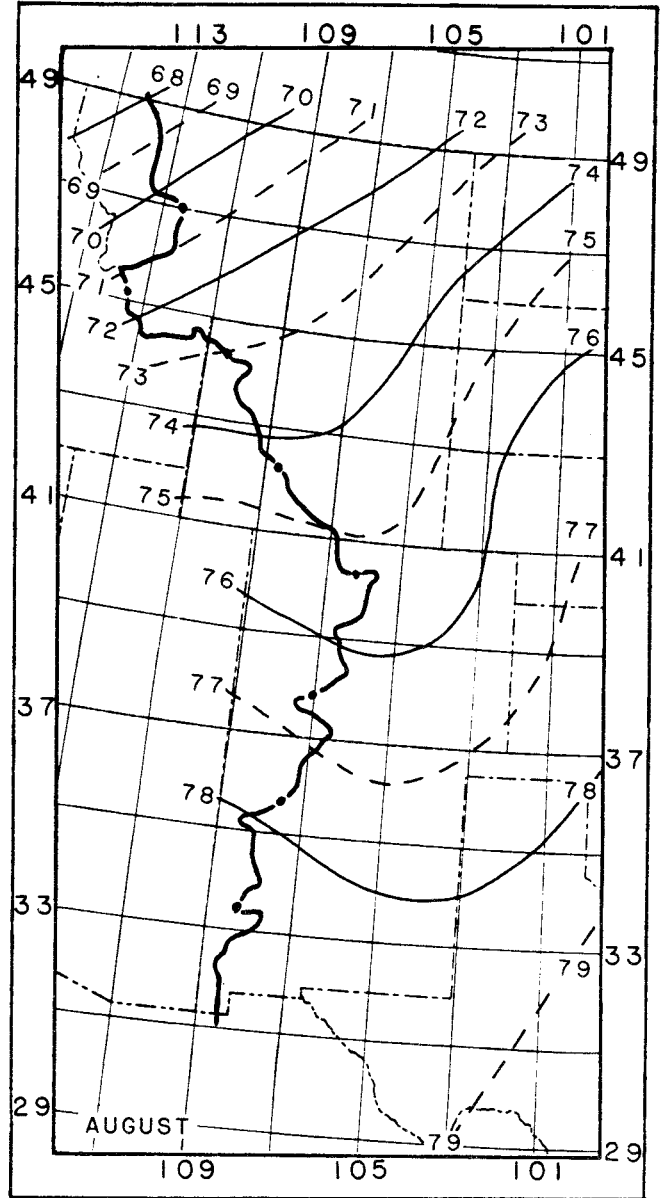

Figure 4.12.--Maximum persisting 12-hr 1000-mb dew points ( $^{\circ}\text{F}$ ) for August.

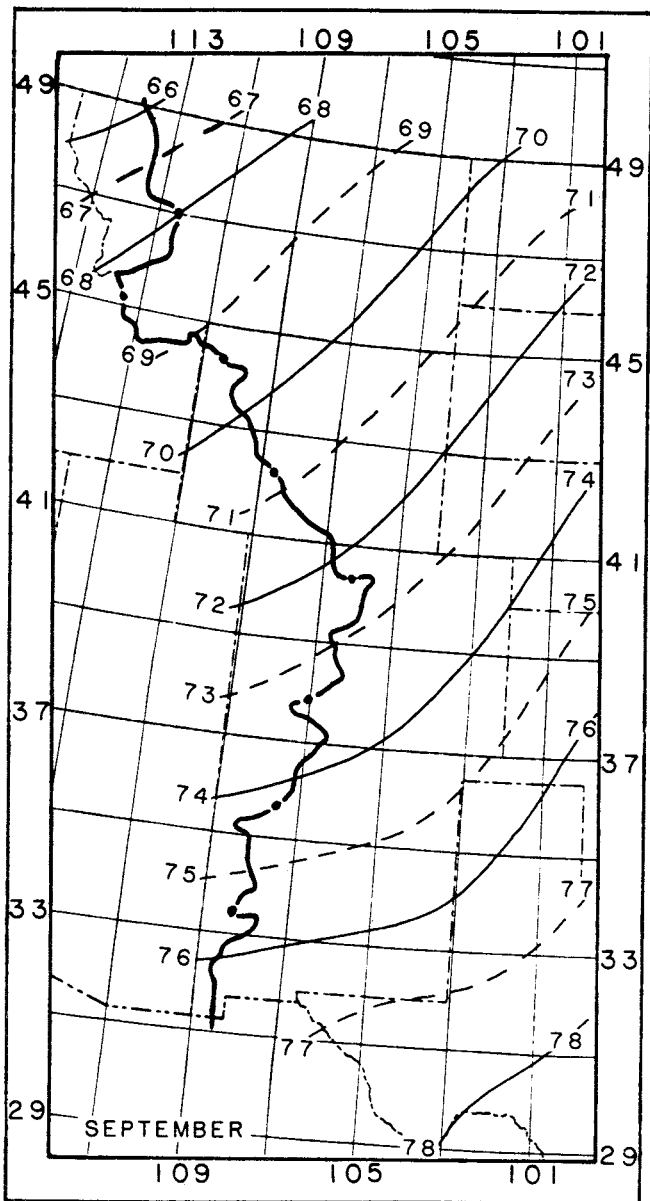

Figure 4.13.—Maximum persisting 12-hr 1000-mb dew points (°F) for September.

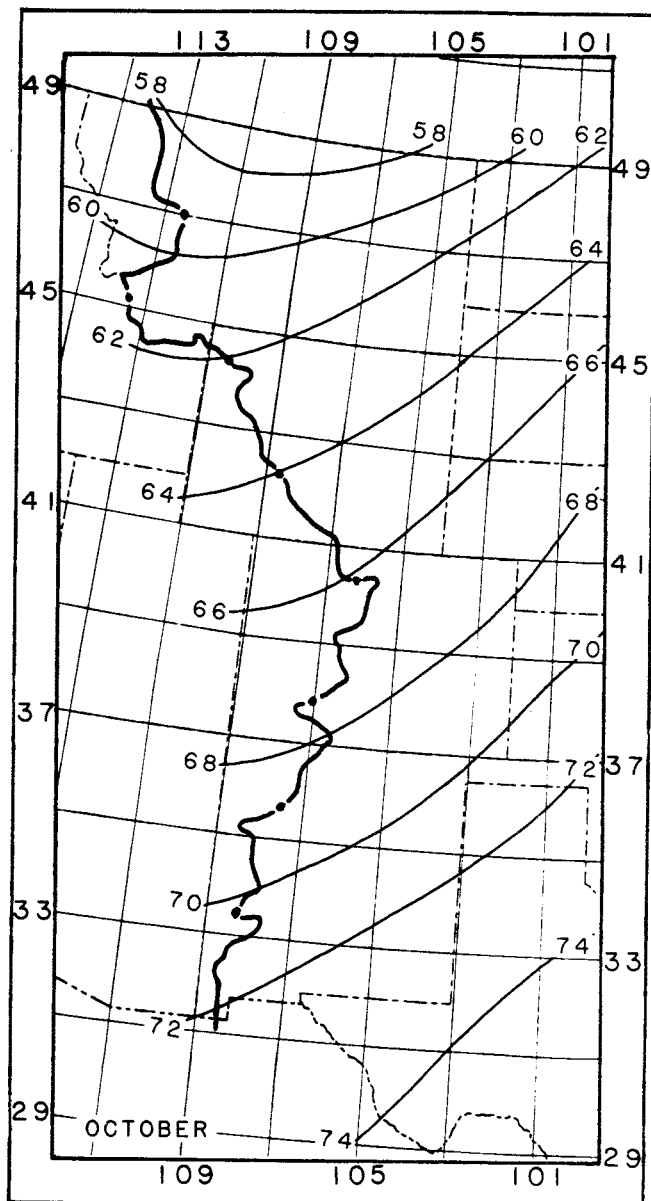

Figure 4.14.—Maximum persisting 12-hr 1000-mb dew points (°F) for October.

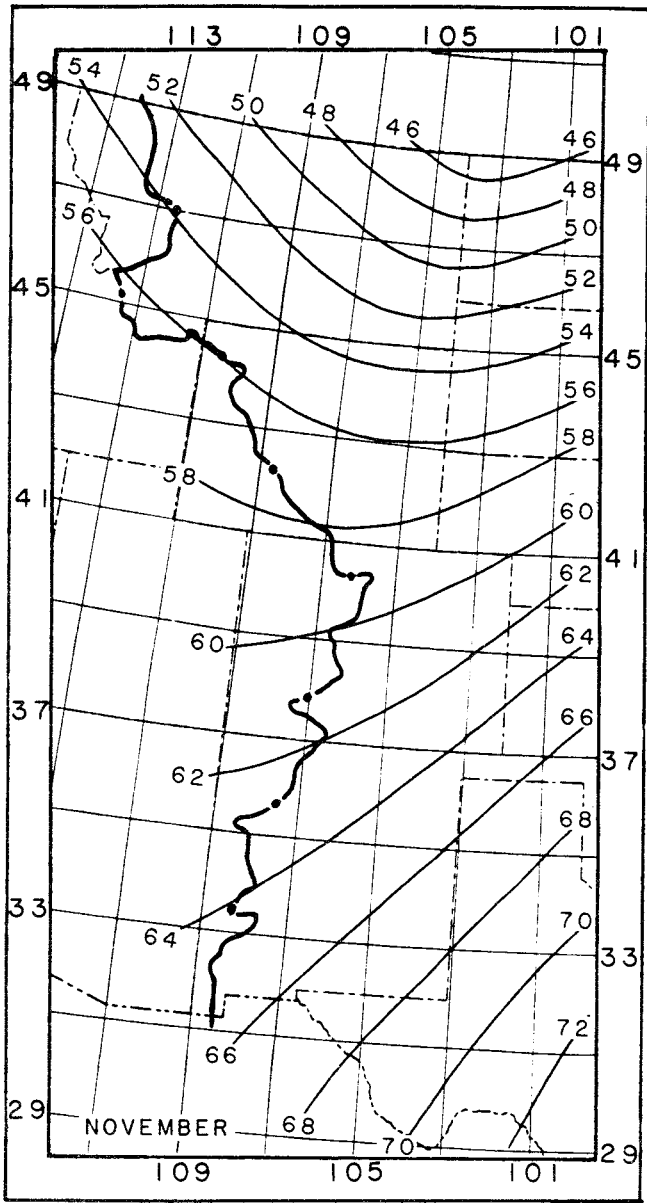

Figure 4.15.—Maximum persisting 12-hr 1000-mb dew points (°F) for November.

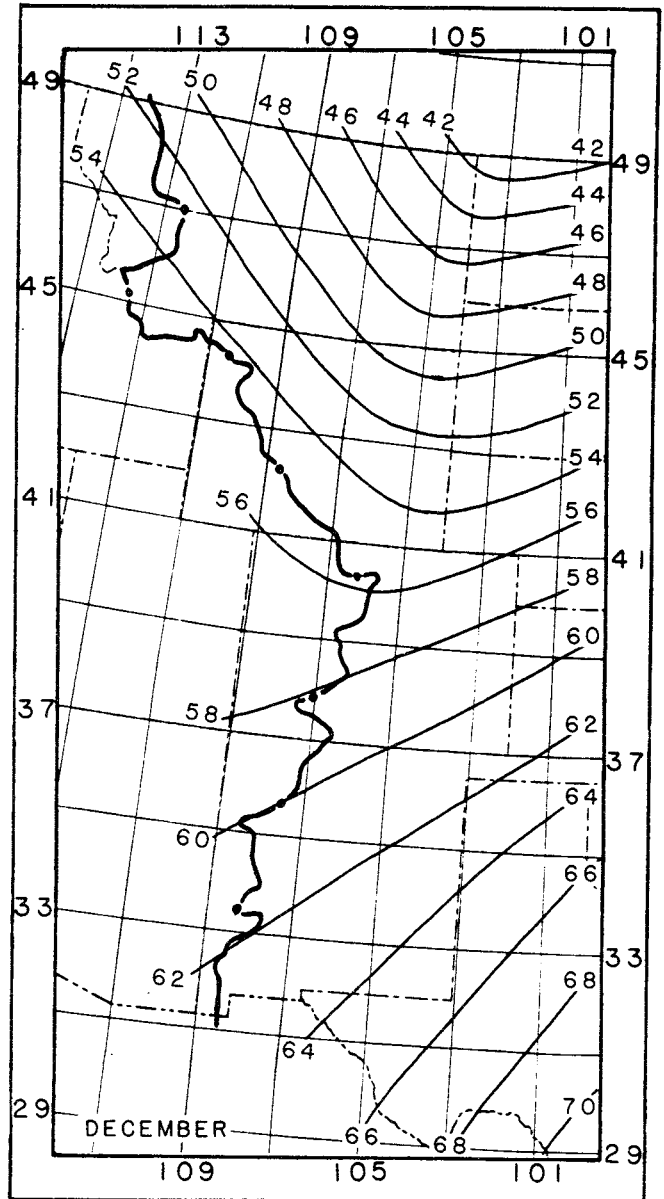

Figure 4.16.—Maximum persisting 12-hr 1000-mb dew points (°F) for December.

## **5. REPRESENTATIVE PERSISTING 12-HR 1000-MB STORM DEW POINTS**

### **5.1 Introduction**

Representative storm dew points were available from other hydrometeorological studies for most of the storms important for determining PMP in the CD-103 region. These dew points were determined at different times by different analysts. Although the same general guidelines were followed, some variability existed in the criteria used. As a result of concern for possible inconsistencies, it was decided that for the present study, all important storms would be reviewed to determine an appropriate representative storm dew point.

### **5.2 Criteria for Selecting Representative Storm Dew Points**

Specific guidelines were formulated for selecting stations used to determine the representative storm dew point in each storm. The guidelines used were:

1. A dew point that was equaled or exceeded for a period of 12 hr, as with previous studies, was selected for each station.
2. A minimum of two stations were to be used. The fewer stations used in averaging the data, the higher the storm dew point obtained, but it was believed that using only one station could be unrepresentative. A single station would be accepted in those cases, however, when the station appeared to represent a narrow tongue of moisture inflow to a small-area precipitation pattern as is typically the case for local storms (chapt. 12), or when no other representative data exist.
3. Stations were to be outside the rain area and along the inflow trajectory. The representative moisture is that which is not influenced by precipitation.
4. Stations in the upwind direction at a time that generally allows transport of the moisture to the precipitation site during a reasonable interval compatible with observed winds in the storm were to be selected.
5. The distance to the stations selected for determining the storm dew point were to be limited to that of synoptic scale phenomena (an outside limit of 1,000 mi has been placed on the reference distance, although almost all storms considered had distances well short of this limit).
6. Stations being evaluated must show observations for almost all reporting periods during the 12-hr period under consideration. This is to say that a station which had missing data for more than half of the 12-hr period being considered could not be included.

### **5.3 Selection of Representative Storm Dew Points**

Using these guidelines, each storm considered important for determining PMP in this region was reviewed. First the synoptic maps were examined to confirm a general inflow trajectory. Then the stations which could be used to obtain a

representative persisting 12-hr dew point were judged relative to the trajectory and magnitude of surface dew points (reduced to 1000 mb).

Table 5.1 documents the representative storm dew points that resulted from this review. Additional information is provided for previous storm dew points, date of beginning of the maximum 12-hr period, reference location, representative persisting 12-hr 1000-mb storm dew points for each storm, and the maximum persisting 12-hr 1000-mb dew point (sec. 4.5). A standard practice in hydrometeorological studies is to select the maximum persisting 12-hr 1000-mb dew point 15 days toward the warm season from the date of the storm (Schreiner and Riedel 1978). This was done in this study. This practice recognizes that the date of storm occurrence is not fixed and could be earlier or later than the actual date. The practice will increase the moisture maximization factor 10 to 15 percent.

In table 5.1, "old" refers to the values that were used for these storms prior to this study, whereas "new" refers to the revised value from this study. Twenty-three of the 32 storms with previous storm dew points were revised in some manner. For those storms with no values listed under "old," no previous representative storm dew point was available. The final column in this table lists the code letters for stations averaged to obtain storm dew points. Table 5.2 provides a list of the station names corresponding to the coded entries.

In table 5.1, in addition to those for local storms (chapt. 12), the Belt, MT (71), Virsylvania, NM (35), and Rapid City, SD (78) storm dew points are single station values. As justification for the Belt storm, the station at Glasgow (GGW) was the only station available along a narrow inflow trajectory. No other acceptable data were available for the Virsylvania, NM storm. For the Rapid City storm, the station at Rapid City (RAP) provided the storm dew point. Although the reference distance is particularly short, the dew points at this station satisfied the guidelines set for this study. The dew points were taken prior to the time precipitation began at Rapid City. Again, a relatively narrow moisture band was involved in this storm (Schwarz et al. 1975).

As an example of the process followed in determining storm dew points, figure 5.1 shows the situation for the Cherry Creek, CO storm (47) of May 30-31, 1935. The open arrow depicts the inflow trajectory of maximum moisture showing a rather direct flow from the Gulf of Mexico to the storm location. Four stations, Wichita Falls, Waco, Abilene and Ft. Worth, TX were selected to represent the region of maximum atmospheric moisture. The centroid of the figure formed by connecting these stations is the reference location for this storm. It is 540 mi southeast of the storm site.

The data listed in figure 5.1 give the surface dew points at the four stations reduced to 1000 mb for the period 0000 to 2100, May 30. Before and after this period the dew points are less than those shown. For each observation time the four station values are averaged. The highest 12-hr set of averages occurs between 0600 and 1800. The representative storm dew point is the highest value common to all averaged values for the period. For the Cherry Creek storm, the new storm dew point is 71°F.

**Table 5.1.--Representative persisting 12-hr 1000-mb storm and maximum dew points for important storms in and near study region**

Storm		Storm T <sub>d</sub>			Ref.	Loc.	Max. T <sub>d</sub>		Stations
No.	Name	Old	New	Date+	Old	New	Old	New	
1.	Ward District, CO	62	64	30	325SE	350SE	75	77	AMA, DDC
6.	Boxelder, CO	60	60	4	350SE	320SE	72	74	DEN, PUB, DDC, OKC, ICT
8.	Rociada, NM	72	72	28	170SSE	300ESE	76	77	ABI, AMA
10.	Warrick, MT	64	64	6	380ESE	380ESE	73	75	ISN, PIR
13.	Evans, MT	65	65	4	510ESE	510ESE	75	76	BIS, RAP, PIR, VTN, HON
86.	May Valley, CO	67	67	18	450SSE	450SSE	76	76	AMA, ABI, FTW, SAT
20.	Clayton, NM	68	69	1	550SE	560SSE	76	77	SAT, DRT, CRP
23.	Tajique, NM	69	69	21	80SE	160SSE	77	78	ELP, ROW
25.	Lakewood, NM	-	76	7	-	350SE	-	79	DRT, SAT
27.	Meek, NM	72	72	15	390ESE	400ESE	78	79	AMA, ABI, FTW, OKC, SAT, GBK
30.	Fry's Ranch, CO	56	63	15	550ESE	700SE	71	74	FWH, DAL
31.	Penrose, CO	67	70	4	400SE	350SE	77	77	AMA, OKC
32.	Springbrook, MT	71	72	18	500ESE	370ESE	76	77	PIR, HON, FAR
35.	Virsylvania, NM (Cerro)	-	66	17	-	120SW	-	77	ABQ
38.	Savageton, WY	68	72	28	550SE	530SE	75	76	FRI, CNK
44.	Porter, NM	70	71	11	540SE	380SE	78	77	DRT, AUS, FTW, ABI
46.	Kassler, CO	71	66	10	440SE	420SE	77	77	OKC, DDC
47.	Cherry Creek, CO	72	71	30	540SE	560SE	76	79	ABI, ACT, FTW, SPS
101.	Hale, CO	72	71	30	540SE	560SE	76	79	ABI, ACT, FTW, SPS
48.	Las Cruces, NM*	-	71	30	-	-	-	78	ELP
105.	Broome, TX	77	77	14	350SSE	350SSE	78	80	CRP, BRO
53.	Loveland, CO	71	71	1	180SE	210SE	76	76	PUB, GLD
55.	Masonville, CO*	-	65	10	-	-	-	74	AKO
108.	Snyder, TX	73	75	19	100SE	340SSE	78	79	SAT, CRP
56.	Prairieview, NM	70	73	20	390SE	370SE	77	78	SAT, AUS
58.	McColleum Ranch, NM	72	72	21	50SE	300SE	77	79	ELP, DRT, SAT, CRP
60.	Rancho Grande, NM	74	75	31	250SE	250SE	77	78	LBB, BGS, ABI
66.	Ft. Collins, CO	66	67	30	570SE	600SE	78	78	GAG, TUL
67.	Golden, CO*	65	65	7	-	-	76	75	AMA



**Table 5.1.--Representative persisting 12-hr 1000-mb storm and maximum dew points for important storms in and near study region (continued)**

Storm No.	Name	Storm T <sub>d</sub>			Ref. Old	Loc. New	Max. T <sub>d</sub>		Stations
		Old	New	Date+			Old	New	
68.	Dupuyer, MT	63	63	17	600ESE	600ESE	76	77	RAP, MBG, HON, PIR
111.	Del Rio, TX	74	74	24	220SE	220SE	78	80	LRD, BRO, CRP
71.	Belt, MT	-	64	2	-	200ENE	-	71	GGW
112.	Vic Pierce, TX	75	75	26	250SE	250SE	78	80	BRO, CRP, LRD, SAT, DRT, ALI, HRL
72.	Buffalo Gap, Sask.	-	64	29	-	520S	-	74	CYS, BFF
75.	Gibson Dam, MT	64	66	8	310ESE	1000ESE	72	77	CNK, DDC
76.	Plum Creek, CO	71	72	17	300SE	180SSE	76	76	TAD, DHT
114.	Glen Ullin, ND	-	68	24	-	180SE	-	76	HON, ABR
77.	Big Elk Meadow, CO	-	65	7	-	300ESE	-	74	CNK, GLD, DDC
78.	Rapid City, SD	72	72	9	15SE	15SE	74	75	RAP
79.	Broomfield, CO	-	60	6	-	130SE	-	71	PUB, GLD
81.	Big Thompson, CO	-	71	31	-	210ESE	-	77	AKO, GLD, HLC
82.	White Sands, NM	-	67	19	-	60E	-	78	ROW, ELP
116.	Medina, TX	78	77	2	210SE	170SE	78	80	CRP, VCT

Maximum T<sub>d</sub> selected 15 days into warm season (see text)

\*Criteria for maximum persisting 12-hr 1000-mb dew points were selected at the storm location (sec. 12.3.2.2).

+Date for new storm dew point. See table 2.1 for complete storm date

**Table 5.2.--Index to stations used to determine representative persisting 12-hr 1000-mb storm dew points**

Three letter ID	Station name	Three letter ID	Station name	Three letter ID	Station name
ABI	Abilene, TX	DDC	Dodge City, KS	ISN	Williston, ND
ABQ	Albuquerque, NM	DEN	Denver, CO	LBB	Lubbock, TX
ABR	Aberdeen, SD	DHT	Dalhart, TX	LRD	Laredo, TX
ACT	Waco, TX	DRT	Del Rio, TX	MBG	Mobridge, SD
AKO	Akron, CO	ELP	El Paso, TX	MLS	Miles City, MT
ALI	Alice, TX	FAR	Fargo, ND	OKC	Oklahoma City, OK
AMA	Amarillo, TX	FRI	Ft. Riley, KS	PIR	Pierre, SD
AUS	Austin, TX	FTW	Ft. Worth, TX	PUB	Pueblo, CO
BFF	Scottsbluff, NE	GAG	Gage, OK	RAP	Rapid City, SD
BGS	Big Springs, TX	GBK	Grosbeck, TX	ROW	Roswell, NM
BIL	Billings, MT	GGW	Glasgow, MT	SAT	San Antonio, TX
BRO	Brownsville, TX	GLD	Goodland, KS	SPS	Wichita Falls, TX
CNK	Concordia, KS	HLC	Hill City, KS	TAD	Trinidad, CO
CRP	Corpus Christi, TX	HON	Huron, SD	TUL	Tulsa, OK
CYS	Cheyenne, WY	HRL	Harlingen, TX	VCT	Victoria, TX
DAL	Dallas, TX	ICT	Wichita, KS	VTN	Valentine, NE

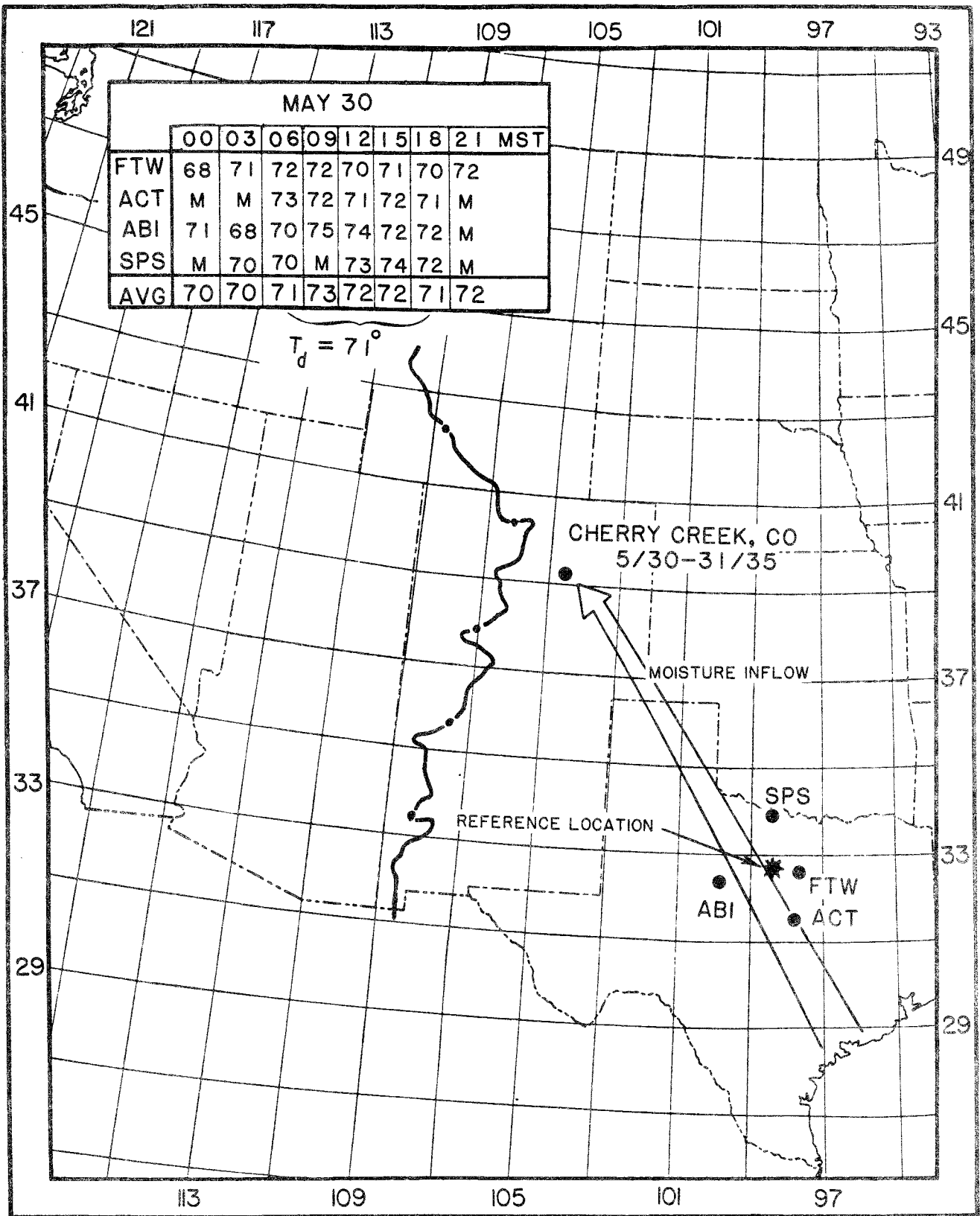

Figure 5.1.—Example of the selection of representative persisting 12-hr storm dew point for the Cherry Creek, CO storm (47) of May 30-31, 1935.

## 5.4 Storm Moisture Maximization Factors

It has been the practice in hydrometeorology to compute an in-place moisture maximization factor for a storm based on the ratio of precipitable water equivalent of the maximum persisting 12-hr 1000-mb dew point for the date of storm occurrence (plus 15 days) to that of the representative persisting 12-hr 1000-mb dew point. To do so assumes that the storm locations will be at a relatively low elevation (up to about 1500 ft), so that any correction for elevation above 1000 mb will be relatively insignificant. This assumption has been used in many PMP studies and was used for HMR No. 51 (Schreiner and Riedel 1978).

In order to make comparisons with the previously determined moisture maximization factors, new values were computed using the ratio of precipitable water values associated with maximum and representative persisting 12-hr 1000-mb dew points uncorrected for elevation for the storms in table 2.2. This adjustment is shown in table 5.3 (column 2) as the "new" value in percent. The "old" value (column 1) is the one which had previously been used, based on precipitable water values associated with earlier determinations of representative storm and maximum persisting dew points. Since most storms of interest to this study occur at elevations above 3,000 ft, it was necessary to include an elevation consideration in the maximization computations. The maximization factor is a ratio of precipitable waters as before, but the amount of the precipitable water below the effective elevation of the storm site is subtracted. As an example, consider the first storm in table 5.3, Ward District, CO, which occurs at 9,600 ft. From table 5.1, the storm dew point is 64°F at the reference location (reduced to the equivalent 1000-mb value), and the maximum persisting dew point is 77°F (also at the reference location, and 1000-mb elevation). From tables of precipitable water (U.S. Weather Bureau 1951), the precipitable water equivalents for these dew points are 1.69 and 3.19 in., respectively. The ratio of larger to smaller value, uncorrected for elevation, is 189 percent. Considering the elevation of 9,600 ft., precipitable water amounts of 1.92 and 1.17 in. must be subtracted from the numerator and denominator, respectively. Forming the new ratio of 1.27 divided by 0.52 in. results in a maximization factor of 244 percent, a considerable increase from the factor uncorrected for elevation. The elevation corrected adjustment factors for all 43 storms are listed in table 5.3 (column 3).

Concern was expressed in HMR No. 51 for the upper limit to which moisture maximization factors appeared reasonable. In HMR No. 51, factors greater than 150 percent were accepted if the maximized value could be supported reasonably well by surrounding storm depths with lesser adjustments. If no support from surrounding storms was found, a limit of 150 percent was imposed. In the present study a similar consideration was made, and in the nonorographic region east of the orographic separation line the same limit was used. Because of the effect of the elevation correction in raising most adjustment factors, in the more mountainous regions (west of the orographic separation line) a limit was set at 170 percent. In the case of the adjustment factor computed for the example at Ward District, CO, the factor of 244 percent is limited to 170 percent (column 4). The reason for this limitation is discussed more fully in chapter 8.

Table 5.4 lists the 10 largest observed and in-place moisture maximized storm depths for three selected durations and area sizes. The moisture maximized values were obtained by multiplying the observed DAD data by the corresponding moisture adjustment factors from column 3 or 4 of table 5.3, as appropriate. A

**Table 5.3.--In-place moisture maximization factors (percent) for important storms in and near the CD-103 region**

Storm No.	Name	In-place Moisture maximization adjustment			
		Sea level or 1000 mb		Barrier/elevation	
		old (1)†	new (2)†	actual (3)†	limited (4)†
1.	Ward District, CO	189	189	244	170
6.	Boxelder, CO	181	200	200	170
8.	Rociada, NM	122	128	138	-
10.	Warrick, MT	155	172	188	170
13.	Evans, MT	156	164	191	170
86.	May Valley, CO	155	155	165	-
20.	Clayton, NM	148	148	158	-
23.	Tajique, NM	148	155	177	170
25.	Lakewood, NM	-	115	117	-
27.	Meek, NM	134	140	170	170
30.	Fry's Ranch, CO	210	171	185	170
31.	Penrose, CO	163	141	151	-
32.	Springbrook, MT	128	128	131	-
35.	Virsylvania, NM (Cerro)	-	170	205	170
38.	Savageton, WY	141	122	126	-
44.	Porter, NM	148	134	140	-
46.	Kassler, CO	134	171	193	170
47.	Cherry Creek, CO	122*	147	163	150
101.	Hale, CO	122*	147	156	150
48.	Las Cruces, NM	-	141	148	-
105.	Broome, TX	105	116	117	-
53.	Loveland, CO	128	128	134	-
55.	Masonville, CO	-	156	183	150#
108.	Snyder, TX	128	121	123	-
56.	Prairieview, NM	141	128	132	-
58.	McColleum Ranch, NM	128	140	151	-
60.	Rancho Grande, NM	116	116	119	-
66.	Ft. Collins, CO	179	171	189	170
67.	Golden, CO	172	164	185	150#
68.	Dupuyer, MT	189	199	220	170
111.	Del Rio, TX	121	134	135	-
71.	Belt, MT	-	141	148	-
112.	Vic Pierce, TX	116	127	130	-
72.	Buffalo Gap, Sask.	-	164	172	150
75.	Gibson Dam, MT	148	170	200	170
76.	Plum Creek, CO	128	122	128	-
114.	Glen Ullin, ND	-	148	152	150
77.	Big Elk Meadow, CO	-	156	182	170
78.	Rapid City, SD	110	116	120	-
79.	Broomfield, CO	-	172	194	170

**Table 5.3.--In-place moisture maximization factors (percent) for important storms in and near the CD-103 region (continued)**

Storm No.	Name	In-place Moisture maximization adjustment			
		Sea level or 1000 mb		Barrier/elevation	
		old (1) <sup>†</sup>	new (2) <sup>†</sup>	actual (3) <sup>†</sup>	limited (4) <sup>†</sup>
81.	Big Thompson, CO	-	134	148	-
82.	White Sands, NM	-	171	186	170
116.	Medina, TX	110	116	117	-

\* Adjustment determined using maximum persisting 12-hr 1000-mb dew point on storm date.

# See section 12.3.2.2 for discussion on limitation to moisture adjustment for local storms.

- † (1) In-place adjustment based on storm dew points used before this study; assumes station elevation at sea level.
- (2) In-place adjustment based on storm dew points as revised and updated for this study; assumes station elevation at sea level.
- (3) In-place adjustment in column 2 adjusted for actual elevation of station.
- (4) In-place adjustment limit imposed on adjustments in column 3 when limit exceeded.

storm was only shown for a particular area size and duration in table 5.4 if the storm lasted that long or extended to that area size. For example, the Cherry Creek, storm (47) is not shown for the 10-mi<sup>2</sup> area for a duration of 72 hr because the storm only lasted for 24 hr. Similarly for the Gibson Dam, MT storm (75), the total storm duration was only 36 hr. Thus, it is not shown for the 72 hr duration at 10 mi<sup>2</sup> even though the 24-hr moisture maximized amount is larger than all but two of the values listed. Other significant storms such as those at White Sands, NM (82) and over Big Thompson Canyon, CO (81) are not included because of the short duration of the heavy rainfall. Of interest from results shown in table 5.4 is the fact that the three highest ranked storms in each category are comprised of only 10 different storms. These are storms at Cherry Creek, Penrose, Plum Creek and Big Elk Meadow, CO; Springbrook and Gibson Dam, MT; Savageton, WY; and McColleum Ranch, Porter and Clayton, NM. It is reasonable to consider these 10 storms to be the more important storms in the region. Only storms that occurred within the region were ranked; therefore, storms at Hale, CO, Broome and Vic Pierce, TX and Glen Ullin, ND are not included.

**Table 5.4.--Ten largest storm depths within CD-103 region for 6-, 24-, and 72-hr durations for 10-, 1,000-, and 10,000-mi<sup>2</sup> areas - observed and moisture maximized in-place, ranked from highest to lowest in each category**

Storm number	Name	Amt.	Storm number	Name	Amt.
<u>Observed</u>			<u>Moisture Maximized</u>		
6-hr duration					
<u>10 mi<sup>2</sup></u>					
47.	Cherry Creek, CO	20.6	47.	Cherry Creek, CO	30.9
76.	Plum Creek, CO	11.5	31.	Penrose, CO	15.7
32.	Springbrook, MT	10.5	58.	McColleum Ranch, NM	15.2
31.	Penrose, CO	10.4	76.	Plum Creek, CO	14.7
58.	McColleum Ranch, NM	10.1	32.	Springbrook, MT	13.8
48.	Las Cruces, NM	7.4	48.	Las Cruces, NM	11.0
53.	Loveland, CO	6.4	10.	Warrick, MT	10.2
38.	Savageton, WY	6.0	75.	Gibson Dam, MT	10.2
10.	Warrick, MT	6.0	53.	Loveland, CO	8.6
75.	Gibson Dam, MT	6.0	68.	Dupuyer, MT	7.5
<u>1,000 mi<sup>2</sup></u>					
32.	Springbrook, MT	7.4	32.	Springbrook, MT	9.7
47.	Cherry Creek, CO	5.8	47.	Cherry Creek, CO	8.7
31.	Penrose, CO	5.4	31.	Penrose, CO	8.2
76.	Plum Creek, CO	5.0	75.	Gibson Dam, MT	7.8
75.	Gibson Dam, MT	4.6	76.	Plum Creek, CO	6.4
44.	Porter, NM	4.1	20.	Clayton, NM	6.2
20.	Clayton, NM	3.9	23.	Tajique, NM	6.1
58.	McColleum Ranch, NM	3.8	10.	Warrick, MT	6.0
38.	Savageton, WY	3.7	58.	McColleum Ranch, NM	5.7
23.	Tajique, NM	3.6	44.	Porter, NM	5.7
<u>10,000 mi<sup>2</sup></u>					
32.	Springbrook, MT	3.0	75.	Gibson Dam, MT	4.2
75.	Gibson Dam, MT	2.5	32.	Springbrook, MT	3.9
44.	Porter, NM	2.3	31.	Penrose, CO	3.2
31.	Penrose, CO	2.1	44.	Porter, NM	3.2
76.	Plum Creek, CO	2.0	20.	Clayton, NM	3.2
20.	Clayton, NM	2.0	58.	McColleum Ranch, NM	3.0
58.	McColleum Ranch, NM	2.0	10.	Warrick, MT	2.9
10.	Warrick, MT	1.7	79.	Broomfield, CO	2.4
60.	Rancho Grande, NM	1.7	27.	Meek, NM	2.7
38.	Savageton, WY	1.6	76.	Plum Creek, CO	2.6*

Table 5.4.--Ten largest storm depths within CD-103 region for 6-, 24-, and 72-hr durations for 10-, 1,000-, and 10,000-mi<sup>2</sup> areas - observed and moisture maximized in-place, ranked from highest to lowest in each category (continued)

Storm number	Name	Amt.	Storm number	Name	Amt.
<u>Observed</u>			<u>Moisture Maximized</u>		
24-hr duration					
<u>10 mi<sup>2</sup></u>					
47.	Cherry Creek, CO	22.2	47.	Cherry Creek, CO	33.3
75.	Gibson Dam, MT	14.9	75.	Gibson Dam, MT	25.3
32.	Springbrook, MT	13.3	77.	Big Elk Meadow, CO	20.1
76.	Plum Creek, CO	13.2	58.	McColleum Ranch, NM	18.3
58.	McColleum Ranch, NM	12.1	31.	Penrose, CO	18.1
31.	Penrose, CO	12.0	32.	Springbrook, MT	17.4
77.	Big Elk Meadow, CO	11.8	10.	Warrick, MT	17.3
10.	Warrick, MT	10.2	76.	Plum Creek, CO	16.9
44.	Porter, NM	9.9	68.	Dupuyer, MT	14.6
38.	Savageton, WY	9.5	20.	Clayton, NM	14.2
<u>1,000 mi<sup>2</sup></u>					
75.	Gibson Dam, MT	12.3	75.	Gibson Dam, MT	20.9
32.	Springbrook, MT	11.3	32.	Springbrook, MT	14.8
76.	Plum Creek, CO	9.5	20.	Clayton, NM	12.5
20.	Clayton, NM	7.9	76.	Plum Creek, CO	12.2
31.	Penrose, CO	7.8	31.	Penrose, CO	11.8
47.	Cherry Creek, CO	7.2	10.	Warrick, MT	11.4
44.	Porter, NM	7.2	47.	Cherry Creek, CO	10.8
60.	Rancho Grande, NM	6.8	44.	Porter, NM	10.1
10.	Warrick, MT	6.7	68.	Dupuyer, MT	9.5
38.	Savageton, WY	6.6	58.	McColleum Ranch;, NM	9.5
<u>10,000 mi<sup>2</sup></u>					
75.	Gibson Dam, MT	7.2	75.	Gibson Dam, MT	12.2
32.	Springbrook, MT	5.6	20.	Clayton, NM	8.2
20.	Clayton, NM	5.2	32.	Springbrook, MT	7.3
60.	Rancho Grande, NM	4.9	58.	McColleum Ranch, NM	6.3
44.	Porter, NM	4.5	44.	Porter, NM	6.3
58.	McColleum Ranch, NM	4.2	27.	Meek, NM	6.1
76.	Plum Creek, CO	3.9	1.	Ward District, CO	6.0
8.	Rociada, NM	3.8	13.	Evans, MT	5.8
31.	Penrose, CO	3.6	10.	Warrick, MT	5.8
27.	Meek, NM	3.6	60.	Rancho Grande, CO	5.8

**Table 5.4.--Ten largest storm depths within CD-103 region for 6-, 24-, and 72-hr durations for 10-, 1,000-, and 10,000-mi<sup>2</sup> areas - observed and moisture maximized in-place, ranked from highest to lowest in each category (continued)**

Storm number	Name	Amt.	Storm number	Name	Amt.
<u>Observed</u>			<u>Moisture Maximized</u>		
72-hr duration					
<u>10 mi<sup>2</sup></u>					
58	McColleum Ranch, NM	21.2	58.	McColleum Ranch, NM	32.0
77.	Big Elk Meadow, CO	17.8	72.	Big Elk Meadow, CO	30.3
38.	Savageton, WY	16.9	76.	Plum Creek, CO	21.4
76.	Plum Creek, CO	16.7	38.	Savageton, WY	21.3
32.	Springbrook, MT	14.6	32.	Springbrook, MT	19.1
31.	Penrose, CO	12.0	31.	Penrose, CO	18.1
53.	Loveland, CO	10.6	53.	Loveland, CO	14.2
56.	Prairieview, NM	8.4	13.	Evans, MT	13.6
60.	Rancho Grande, NM	8.0	56.	Prairieview, NM	11.1
13.	Evans, MT	8.0	23.	Tajique, NM	11.0
<u>1,000 mi<sup>2</sup></u>					
32.	Springbrook, MT	12.5	72.	Big Elk Meadow, CO	17.3
76.	Plum Creek, CO	12.3	32.	Springbrook, MT	16.4
38.	Savageton, WY	11.8	76.	Plum Creek, CO	15.7
77.	Big Elk Meadow, CO	10.0	38.	Savageton, WY	14.9
58.	McColleum Ranch, NM	9.6	58.	McColleum Ranch, NM	14.5
31.	Penrose, CO	8.7	31.	Penrose, CO	13.1
56.	Prairieview, NM	7.5	23.	Evans, MT	11.7
60.	Rancho Grande, NM	7.2	56.	Prairieview, NM	9.9
13.	Evans, MT	6.9	23.	Tajique, NM	9.0
8.	Rociada, NM	6.5	8.	Rociada, NM	9.0
<u>10,000 mi<sup>2</sup></u>					
32.	Springbrook, MT	7.7	58.	McColleum Rch., NM	10.6
58.	McColleum Ranch, NM	7.0	32.	Springbrook, MT	10.1
38.	Savageton, WY	6.3	31.	Penrose, CO	8.3
76.	Plum Creek, CO	6.1	13.	Evans, MT	8.0
56.	Prairieview, NM	5.9	38.	Savageton, WY	7.9
60.	Rancho Grande, NM	5.7	76.	Plum Creek, CO	7.8
8.	Rociada, NM	5.6	56.	Prairieview, NM	7.8
31.	Penrose, CO	5.5	8.	Rociada, NM	7.7
13.	Evans, MT	4.7	60.	Rancho Grande, NM	6.8
53.	Loveland, CO	3.5	23.	Tajique, NM	4.9



## 6. APPROACHES

### 6.1 Introduction

Estimation of PMP in orographic regions is difficult. Storm data are limited. This is the result of a low population density that restricts the number of regular observing stations and also limits the effectiveness of supplementary precipitation surveys. In addition, the complicating effects of terrain on storm structure and precipitation must be considered. In the present study, several procedures were investigated, but primary reliance was placed on a procedure that separates the effect of orography from the dynamic effects of the storm.

### 6.2 Orographic Models

Orographic models based on laminar flow assumptions were evaluated. The Rhea model (1978) was considered as an alternative approach to computing PMP for this region. That model is a modification and improvement of the model used in Hydrometeorological Report No. 36 "Interim Report - Probable Maximum Precipitation in California" (U.S. Weather Bureau 1961). It is a steady-state, two-dimensional model which accounts for the vertical wind profile by using multilayer bands. Although the model is strictly orographic, effects of large scale vertical motion are added to topographic effects. The model was used to replicate the precipitation distribution in recent major storms. Most effort was directed toward evaluation of the June 6-8, 1964 Gibson Dam, MT storm (75). The results did not compare well to the manual analysis of observed precipitation (fig. 2.14). The primary difficulty probably resulted from the inability to incorporate low-level easterly upslope flow with the predominate westerlies in the upper levels of the atmosphere. Another problem area related to the difficulty of including appropriate time and space variations of the input parameters to accurately define the detailed variation of rainfall over this geographic region. These difficulties led to the abandonment of this approach as a method for estimating PMP for this region. Some model runs were considered, however, to provide qualitative information on relative distribution of rainfall along various slopes.

### 6.3 Traditional Approach

The primary method developed for estimating PMP in relatively flat regions is the moisture maximization and transposition of observed storm amounts. This procedure was used to a very limited extent in this region. The primary usefulness was in the relatively flat plains regions of eastern Montana, Wyoming, Colorado, New Mexico, and western Texas. In these regions there is little variation in topography and the methods used in the development of HMR No. 51 are applicable. The reader is referred to that publication for a detailed discussion of the methodology.

In addition to the plains region, the technique is appropriate for estimating PMP in the immediate vicinity of the most extreme storms in orographic regions. In limited other portions of the region where similar topography exists, the observed storm amounts may be transposed. Usually an index map, such as a mean annual precipitation or rainfall-frequency (e.g., 100-yr 24-hr) map is used to extend the range of possible transposition locations. Generally, transpositions are limited additionally by requiring the index values at the storm location and the transposed location to agree within a few percent. The 100-yr 24-hr map from NOAA Atlas 2 (Miller et al. 1973) was used as the rainfall index in this study for transposition of observed rainfall amounts.

#### 6.4 Storm Separation Method

The terrain of the study region had a marked effect upon the procedures used to develop PMP estimates. The terrain varies from the relatively flat plains in eastern Montana, Wyoming, Colorado, New Mexico, and western Texas to the complex and rugged mountain ranges and valleys through the western portion of the region. It was necessary to find a procedure which would enable the precipitation potential for this diverse terrain to be analyzed in a consistent fashion. The adopted procedure has some similarities to those used in other studies for the western United States. The precipitation that results from atmospheric forces (convergence precipitation) involved in the major storms in the region is defined. Convergence precipitation amounts were determined for the 24-hr 10-mi<sup>2</sup> precipitation amounts for all major storms in the region. These adjusted rainfall values were moisture maximized and transposed to locations where similar storms have occurred. These moisture maximized, transposed values were then analyzed to develop a generalized map of convergence PMP throughout the region.

Values of convergence rainfall were increased for orographic effects that occur over the region. The orographic intensification factor is developed from the 100-yr 24-hr precipitation-frequency amounts of NOAA Atlas 2 (Miller et al. 1973). Since the dynamic strength of a storm varies from the most intense 1-, 2-, 3-, or 6-hr period through the end of the storm, it is not appropriate to apply the same orographic intensification factor throughout the entire storm. To vary this intensification factor, a storm intensity factor was developed. Since it had been decided to place primary reliance on developing the 24-hr 10-mi<sup>2</sup> PMP, it was necessary to define a "core" or most intense portion of this storm. The characteristic length of the most intense rainfall period for this region for the 24-hr storm was determined to be 6 hr. The storm intensification factor reduced the effect of the orographic factor during the most intense rainfall period of the maximum 24 hr of the storm. The basic orographic influence is retained, undiminished, during the remaining hours. After determining the 24-hr 10-mi<sup>2</sup> PMP, 6-/24- and 72-/24-hr ratio maps were used to develop PMP values for these two other index durations for the 10-mi<sup>2</sup> area. Finally, a 1-hr 10-mi<sup>2</sup> PMP map was developed using a 1-/6-hr ratio map. These four maps provide the key estimates of general-storm PMP for the region.

#### 6.5 Depth-Area Relations

The technique discussed in sections 6.3 and 6.4 provide 10-mi<sup>2</sup>, or point, estimates of general-storm PMP for four index durations. For most applications, values for larger areas are required. Depth-area relations were developed utilizing data from the important storms of record in and near the study region to permit estimates for larger areas. These relations provide percentages to estimate PMP for areas as large as 5,000 mi<sup>2</sup> west of the orographic separation line and to 20,000 mi<sup>2</sup> east of that line.

Since the storm types capable of producing PMP rainfall are different in the northern and southern portions of the region, different depth-area relations are required for these disparate regions. Differences also exist between orographic and nonorographic portions of the study region. These differences resulted in a set of depth-area relations. The development of these relations is presented in chapter 11.

## 6.6 Local-Storm PMP

Local-storm PMP has been developed for the CD-103 region in a manner similar to that for local storms in HMR No. 49 (Hansen et al. 1977). These storms occur independently from storms considered in the general-storm category. Although local-storm PMP has been developed throughout the region in this study, there is no evidence to indicate significant (controlling) local storms have occurred east of the 103rd meridian. Therefore, it was reasoned that the controlling influence of the local storm west of the Continental Divide disappears somewhere within the CD-103 region. Chapters 12 and 13 discuss where this occurs as a result of the development undertaken in this report. Local storms are short duration (<6 hr), small area (<500 mi<sup>2</sup>), isolated events that occur seemingly independent of synoptic scale features. The methodology used for this development was moisture maximization and transposition of the major local-storm amounts that have occurred in the region between the Continental Divide and the 103rd meridian. The development of local-storm PMP is discussed in chapter 12.

## 7. STORM SEPARATION METHOD

### 7.1 Introduction

In order to establish PMP in the CD-103 region, it was considered necessary to find a property of observed major storm precipitation events that is only minimally effected by terrain so transposition of observed precipitation amounts would not be limited to places where the terrain characteristics are the same as those at the place where the storm occurred. The name given to this idealized property is "free atmospheric forced precipitation" (FAFP) which has been called "convergence only" precipitation in publications such as HMR No. 49 (Hansen et al. 1977). For a more complete definition of FAFP, see the Glossary of Terms in section 7.2. It is emphasized that FAFP is an idealized property of precipitation since no experiment has yet been devised to identify in nature which raindrops were formed by orographic forcing and which by atmospheric forcing. This chapter explains how FAFP may be estimated for specific storms. Background information is provided on the development of the storm separation method (SSM).

### 7.2 Glossary of Terms

Terms frequently used in the SSM are listed alphabetically.

- $A_0$ : See  $P_a$ . It is the term for the effectiveness of orographic forcing used in module 3.
- AI: The analysis interval, in inches, for the isohyets drawn for a storm.
- $B_i$ : See PCT2. It is the term representing the "triggering effects" of orography. It is used in module 2.  $B_i$  is a number between 0 and 1.0 representing the degree of FAFP implied by the relative positioning of the 1st through i-th isohyetal maxima with those terrain features (steepest slopes, prominences, converging upslope valleys) generally thought to induce or "stimulate" precipitation. A high positive correlation between terrain features and isohyetal maxima yields a low value for  $B_i$ . For each isohyetal maximum there is just one

B-type correlation and, thus, if the area covered by a given maximum is extensive enough so that more than one area category is contained within its limits, the B correlations are determined using all isohyets comprising a particular maximum. For the larger-area/shorter-duration categories, the  $B_i$  correlation may need to be made in widely separated, noncontiguous areas.

When available, the chart of maximum depth-area-duration curves from the Part II Summary of the storm analysis\*, along with its associated documentation, is the primary source for determining how many centers (n) and which isohyetal maxima were used to determine the average depth for the area being considered.

BFAC: 0.95 (RCAT). It represents an upper limit for FAFP in modules 2 and 5. See also the definition for PX.

DADRF: The depth-area-duration reduction factor is the ratio of two average depths of precipitation.

$$DADRF = RCAT/MXVATS$$

DADFX:  $DADFX = (HIFX)(DADRF)$ . It is used in module 2 to represent the largest amount of nonorographic precipitation caused by the same atmospheric mechanism that produced MXVATS.

$F_i$ : See PCT2. It is the term for the "upsloping effects" of orography and it is used in module 2. It is a number between 0 and 1.0, which represents the degree of atmospheric forcing implied by the orientation of the applicable upwind segments of the isohyets with elevation contours (high positive correlation of these parameters means a low value for  $F_i$ ) for the 1st through i-th maxima. For an isohyetal maximum there is just one F-type correlation, and if the area covered by a given maximum is extensive enough so that more than one area category is contained within its limits, the F correlations are the same for each of the area categories. F-type correlations are determined using all isohyets comprising a particular maximum. As with B-type correlations, maximum depth-area-duration curves from the Part II of the storm report should be used to determine which precipitation centers are involved in the isohyetal maximum.

---

\*A depth-area-duration storm analysis is separated into two parts. The first part develops a preliminary isohyetal map and mass curves of rainfall for all stations in the storm area. The second part includes a final isohyetal map, computation of the average depth of rainfall over all isohyetal areas and determination of the maximum average depth for all area sizes up to the total storm area. The complete procedure used for making depth-area-duration analysis is described in "Manual for Depth-Area-Duration Analysis of Storm Precipitation" (World Meteorological Organization 1986).

FAFP: Free Atmospheric Forced Precipitation is the precipitation not caused by orographic forcing; i.e., it is precipitation caused by the dynamic, thermodynamic, and microphysical processes of the atmosphere. It is all the precipitation from a storm occurring in an area where terrain influence or forcing is negligible, termed a nonorographic area. In areas classified as orographic, it is that part of the total precipitation which remains when amounts attributable to orographic forcing have been removed. Factors involved in the production of FAFP are: convergence at middle and low tropospheric levels and often, divergence at high levels; buoyancy arising from heating and instability; forcing from mesoscale systems, i.e., pseudo fronts, squall lines, bubble highs, etc.; storm structure, especially at the thunderstorm scale involving the interaction of precipitation unloading with the storm sustaining updraft; and lastly, condensation efficiency involving the role of hygroscopic nuclei and the heights of the condensation and freezing levels.

HIFX: The largest isohyetal value in the nonorographic part of the storm. The same atmospheric forces (storm mechanism) must be the cause of precipitation over the areas covered by the isohyet used to determine HIFX and MXVATS.

$I_m$ : That part of RCAT attributed solely to atmospheric processes and having the dimension of depth. Since it is postulated that FAFP cannot be directly observed in an orographic area, some finite portion of it was caused by forcing other than free atmospheric. The FAFP component of the total depth must always be derived by making one or more assumptions about how the precipitation was caused. The subscript "m" identifies the single assumption or set of assumptions used to derive the amount designated by  $I$ . For example, a subscript of 2 will refer to the assumptions used in module 2. The key assumptions of all the modules are detailed in section 7.3.1. Refer to the schematic for each module in figures 7.3 to 7.6 for the specific formulation for each  $I_m$ .

LOFACA: LOFACA is the lowest isohyetal value at which it first becomes clear to the analyst that the topography is influencing the distribution of precipitation depths. Confirmation of this influence is assumed to occur when good correlation is observed between the LOFACA isohyet and one or more elevation contours in the orographic part of the storm.

How is LOFACA found? A schematic isohyetal pattern is shown by the solid lines in figure 7.1 to illustrate this procedure. Start at the storm center and follow the inflow wind direction out to the lowest valued isohyet in the analysis (no lower than 1 in.) located in the orographic part of the storm. If the storm pattern is oddly shaped, it may be necessary to use a direction slightly different from the exact inflow direction. Any direction within  $\pm 22.5$  degrees either side of the inflow direction which allows comparisons of the sort described above is acceptable. The vector CL in the schematic of figure 7.1 represents the path in this storm that is parallel to the inflow wind and directed at the lowest valued isohyet. Next, draw

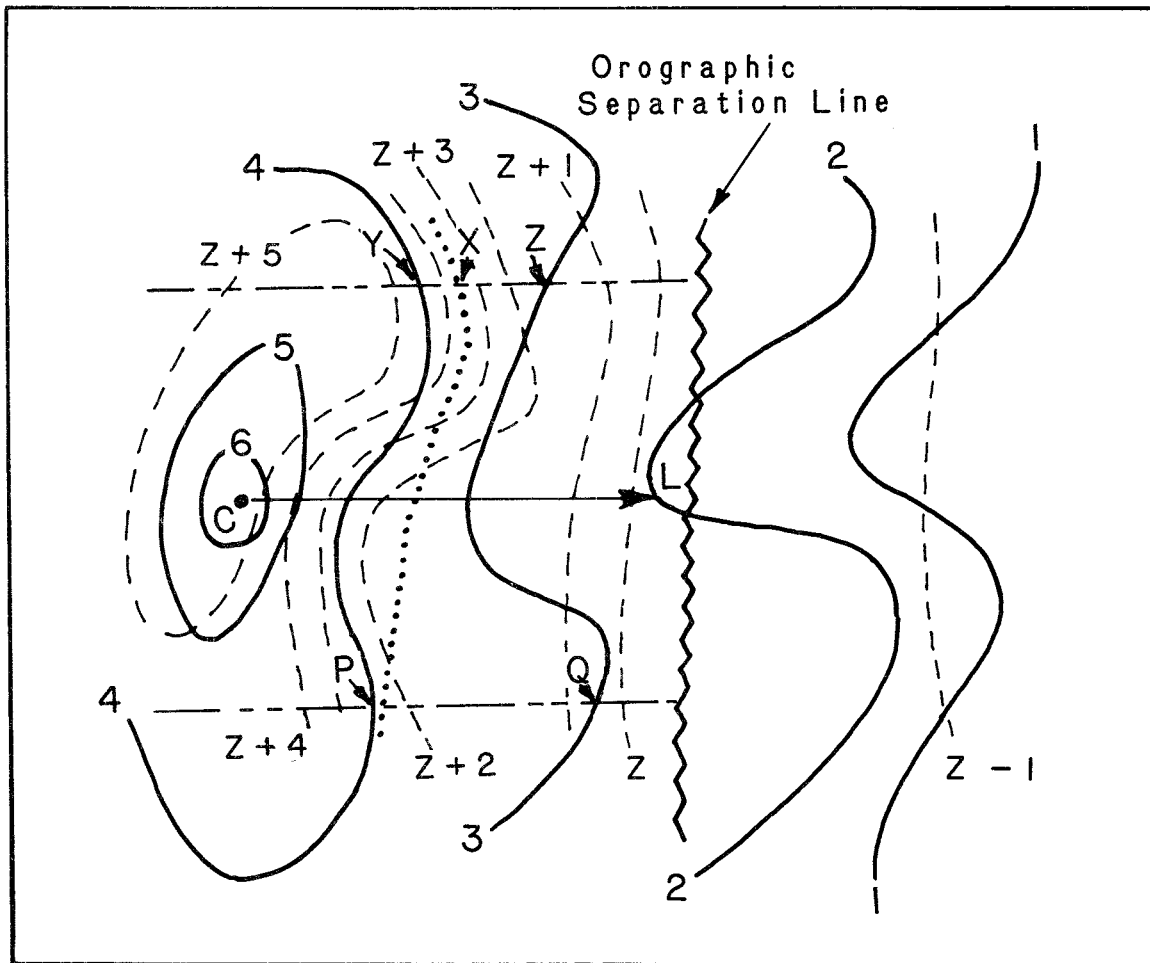

**Figure 7.1.--Schematic illustrating determination of LOFACA.**

two lines parallel to and either side of the vector CL. Each of the parallel lines will be drawn at a distance from CL of 1/2 the length of CL. These lines are the dash-dot lines in figure 7.1. These lines will be called "range lines." The range lines end at the orographic separation line (the saw-toothed line in figure 7.1) since only correlations in the orographic part of the storm are important in determining LOFACA.

The next step is to examine those isohyets which intersect the range lines down wind of the storm center of isohyetal maximum. Such segments are considered candidate isohyetal segments (CIS) and they are depicted by the segments of the isohyets PY and QZ in figure 7.1. The objective is to determine which CIS has a good correlation with topographic features indicated by the dashed lines. A good correlation is a CIS that parallels one of the smoothed elevation contours along one-half or more of its length. When no isohyet is found meeting the criterion, LOFACA is defined to be zero. As depicted in the schematic, the 4-in. CIS indicated by the solid line (from P to Y) shows a good correlation with the Z + 2 and Z + 3 contours, so the value of LOFACA is 4 in. If the 4-in. isohyet in figure 7.1 had been along the dotted line from P to X,

there would have been a poor correlation and the value of LOFACA would have been zero for this storm.

The significance of LOFACA is that precipitation depths at and below this value are assumed to have been produced solely by atmospheric forces without any additional precipitation resulting from topographic effects; i.e., they represent the "minimum level" of FAAP for the storm. If more than one isohyetal center exists for the area size selected, the procedure is followed for each center. If the value of LOFACA is different for two or more of these centers, the lowest of the values is used as the one and only value of LOFACA for that storm and area size.

LOFAC: 
$$\text{LOFAC} = \text{LOFACA} + \frac{\text{AI}}{2} \left( \frac{(\text{AI})}{\text{PB}^2 - 1} \right).$$

It is a refinement to LOFACA based on the concept that AI may prejudice the assigning of a minimum level of FAAP.

MXVATS: The average depth of precipitation for the total storm duration for the smallest area size analyzed, provided that it is not larger than 100 mi<sup>2</sup>. It is obtained from the pertinent data sheet (P.D.S.) for the storm included in "Storm Rainfall" (Corps of Engineers 1945 - ). It is used in several modules to calculate percentages of FAAP. If the area criterion cannot be met, the storm is not used in the study.

n: When used in module 2 it is the number of analyzed isohyetal maxima used to set the average depth of precipitation for a given area size.

OSL: Orographic Separation Line is a line which separates the CD-103 region into two distinct regions, where there are different orographic affects on the precipitation process. In one region, the nonorographic, it is assumed no more than a 5-percent change (in either increasing or decreasing the precipitation amount for any storm or series of storms) results from terrain effects. In contrast, the other region is one where the influence of terrain on the precipitation process is significant. An upper limit of 95 percent and a lower limit of no less than 5 percent is allowed. The line may exist anywhere from a few to 20 miles upwind (where the wind direction is that which is judged to prevail in typical record setting storms) of the point at which the terrain slope equals or exceeds 1,000 ft om 5 miles or less with respect to the inflowing wind direction (sec. 3.2).

P<sub>a</sub>: P<sub>a</sub> (and A<sub>o</sub>) is a ratio in which the effectiveness of an actual storm in producing precipitation is compared with a conceptualized storm of "perfect" effectiveness. In such a conceptual model, features known by experience to be highly correlated with positive vertical motions, or an efficient storm structure, would be numerous and exist at an optimum (not always the largest or strongest) intensity level.

Thus,

$$P_a = \frac{\text{Effectiveness of Actual Atmospheric Mechanisms}}{100}$$

where the numerator is a number between 5 and 95

$$A_o = \frac{\text{Effectiveness of Actual Orographic Mechanisms}}{100}$$

where the numerator is a number between 0 and ±95.

It would have been desirable to express both  $P_a$  and  $A_o$  in physically meaningful units; however, this was not considered practical because the available meteorological data for most of the storms of concern are generally extremely limited. Hence, the present formulation is expressed in terms of subjective inferences about physical parameters known to be effective in the production of precipitation either in major storms in nonorographic regions or by considering the results of flow of saturated air against orographic barriers. This type of formulation is required, because of the limited availability of meteorological information for the storms, but is considered adequate for the purposes of this report. Mechanically, the effectiveness of the particular storm is derived by using the checklists in module 3.

PA: The ratio of the nonorographic area containing precipitation to the total storm precipitation area is given by PA. Its inverse is used when setting a realistic upper limit for  $I_2$  and  $I_5$  (see definition for PX on the following page). Areas in which the depth of precipitation is less than 1 in. are not used in forming the ratio. In contrast to PC, PA does not depend upon the area size being considered in the storm separation method.

PB: When the LOFACA isohyet does not extend from the orographic part into the nonorographic part of the storm, it is the ratio of the sum of the areas in the nonorographic part containing amounts equal to or greater than LOFACA (the numerator) to the total nonorographic area in which precipitation depths associated with the storm are 1 in. or more. When the LOFACA isohyet does extend into the nonorographic part of the storm, the numerator is increased by an amount representing the area bounded by the LOFACA isohyet and the OSL. It is used in module 2 in setting a value for LOFAC. Note: when LOFACA is zero, PB will be one and LOFAC will also equal zero.

PC: It is used in the formulations of PCT1, PCT2, and PCT3 to take into account the contribution of nonorographic precipitation to total FAFP (which includes FAFP contributions from orographic areas). It is expressed as a number between 0 and 0.95. The value of the upper limit is 0.95 because no storm in which more than 95 percent of the precipitation fell in nonorographic areas was considered. Thus, some storms from the list of important storms were not considered since they occurred in the nonorographic region.

If, for the area size being considered, part of the total volume of precipitation occurred in a nonorographic area, PC is the ratio of



that partial volume to the total volume. If none of the total volume was nonorographic,  $PC = 0$ . The ratio of volumes is obtained by forming the ratio of the corresponding area sizes first, then multiplying that ratio by an estimate of the average depth in the nonorographic area, and finally dividing this result by the average depth for the total area, both of these depths occurring at maximum duration.

PX: is the smaller of either BFAC or DADFX multiplied by  $(PA)^{-1}$  except when  $PA = 0$ , in which case  $PX = BFAC$ . Once selected, PX serves to define what is a realistic upper limit for  $I_2$  and  $I_5$ .

PCT1: 
$$PCT1 = PC + \frac{RNOVAL}{MXVATS} (0.95-PC).$$

MXVATS is used only for the smallest area size on the P.D.S. (provided that it is not greater than  $100 \text{ mi}^2$ ) because the average depth at larger area sizes is influenced by how isohyets were drawn.

PCT2: 
$$PCT2 = PC + \left( \frac{\sum_{i=1}^n (F_i + B_i)}{2n} \right) (0.95 - PC)$$

It is a number between 0 and 0.95 where  $n$  is the number of isohyetal maxima in the orographic part of the storm applicable to the area/duration category being considered. Estimates of F- and B-type correlations are dependent upon the quality of the isohyetal analysis and upon proper identification of the precipitation centers involved in the area category under consideration. When there is no Part II storm study information available, the analyst must decide whether a reasonable estimate can be made for  $n$ . When there are just a few maxima, each at a different depth, a reasonable estimate is likely, whereas when there are numerous maxima all of which are for the same depth and which enclose about the same area, it is less likely that a reliable value for PCT2 can be calculated. When the latter is the case, the answer to question 13 in module 2 will be "no" and the analyst documents this situation in module 5 after completing modules 3 and 4.

PCT22: This is the ratio  $I_2/RCAT$  where  $I_2$  is the total amount of RCAT that is FAFP.  $I_2$  is defined by the relationship:

$$I_2 = [LOFAC + (MXVATS - LOFAC)PCT2]DADRF$$

Substitution of these terms into the definition for PCT22 leads to the relationship:

$$PCT22 = PCT2 + \left( \frac{LOFAC}{MXVATS} \right) (1-PCT2)$$

PCT3: 
$$PCT3 = PC + \left( \frac{P_a}{P_a + A_o} \right) (0.95-PC)$$

It is a dimensionless number usually between 0.05 and 0.95, representing the percent of the total depth of precipitation for a given area/duration category attributable to the atmospheric

processes alone. It is obtained not only by considering primarily meteorological information, but also by considering the following minimal list of additional information: a P.D.S. for the storm (DAD data) including the location of the storm center; a chart of smoothed contours of terrain elevation; and precipitation data sufficient to define where precipitation did or did not occur. More detailed precipitation information is used, when available.

The range of 0.05 to 0.95 is considered reasonable, because it is postulated that the orographic influence never completely vanishes, and when the orographic influence is predominant, precipitation would not continue without some contribution from atmospheric forcing mechanisms. Though not expected to occur, it is conceivable that PCT3 may exceed 0.95 if the estimated orographic forcing was downslope, actually decreasing the total possible precipitation. This matter is discussed further in the section dealing with module 3. The formulation for PCT3 is meant to apply only to major storms and definitely not to minor storms where negative terrain forcing on lee slopes might approach, or exceed, the magnitude of the atmospheric forcing.

RCAT: The average depth of precipitation for the selected category. The "CAT" indicates that the parameter R is a variable depending on category definition.

RNOVAL: Representative nonorographic value of precipitation. It is the highest observed amount in the nonorographic part of the storm. The value of RNOVAL is not adjusted to the elevation at which MXVATS is believed to have occurred. RNOVAL and MXVATS must result from the same atmospheric forces (storm mechanism).

### 7.3 Background

The SSM was developed in the present format because four distinct sets of precipitation information were available for record-setting storms in the CD-103 region. These were:

1. Reported total storm precipitation, used in module 1.
2. Isohyet and depth-area-duration analyses of total storm precipitation, including Part I and Part II Summaries, used in module 2.
3. Meteorological data and analyses therefrom, used in module 3.
4. Topographic charts, used in all modules.

Since the quantity and quality of the information in the first three of these sets would vary from storm to storm, it was concluded that a method which relied on just one of the first three sets (along with topographic charts) might be quite useless for certain storms. Alternatively, one could have a SSM which always combined information from the first three sets. This choice was rejected since, for most of the storms, one or more of the sets might contain no useful information and bogus data would have to be used. Clearly, the SSM depends on the validity of the input information.

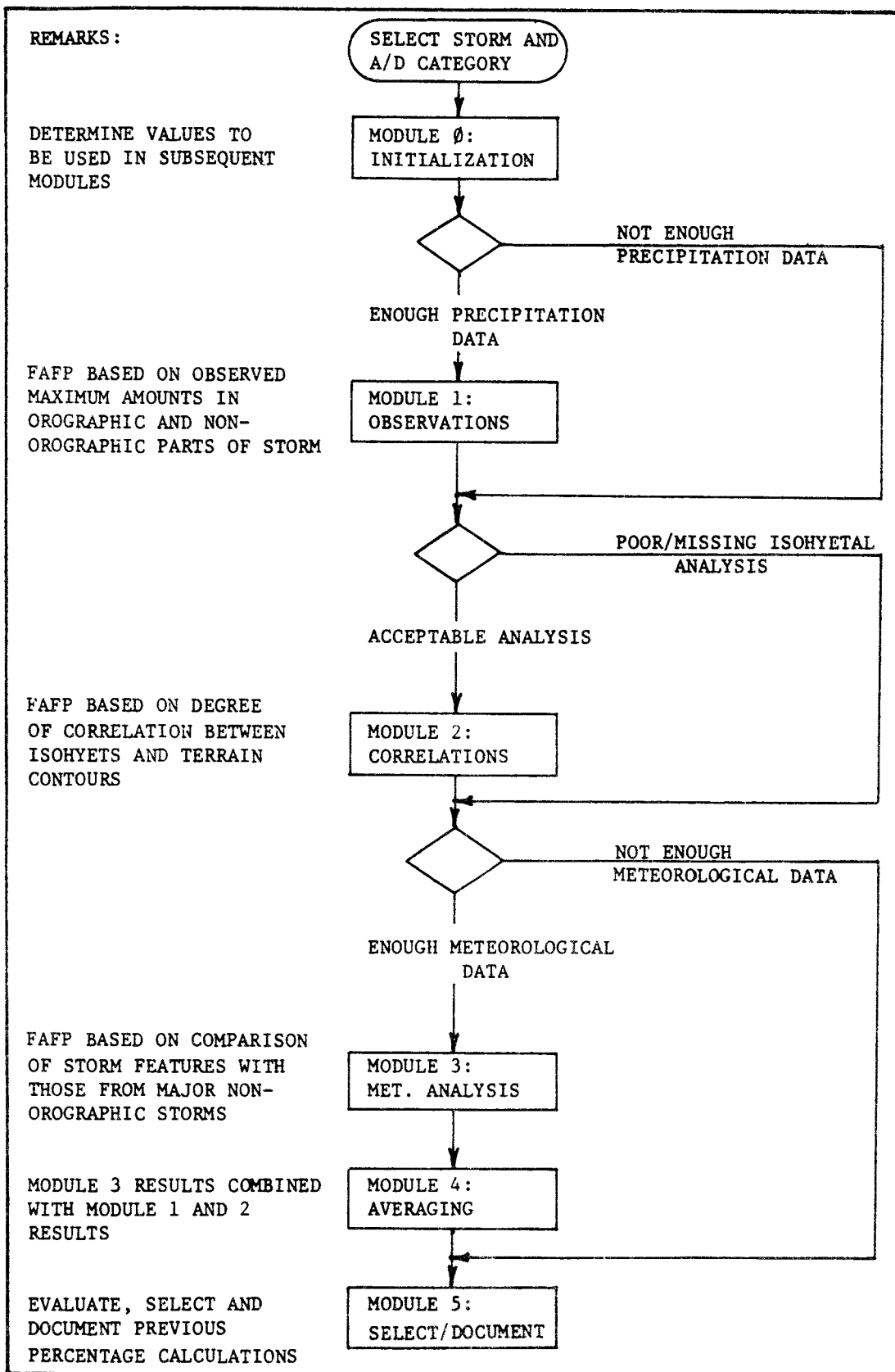

Figure 7.2.--Main flowchart for SSM.

Four sets of information are used in the SSM to produce up to five estimates of FAFP for area categories up to 5,000 mi<sup>2</sup> and durations up to 72 hr for storms with major rainfall centers in areas classified as "orographic." The mechanics of the procedure used to arrive at one numerical value of FAFP for any relevant area/duration (A/D) category for any qualifying storm are accomplished by completing the tasks symbolically represented in a MAIN FLOWCHART for the SSM (fig. 7.2) along with its associated SSM MODULE FLOWCHARTS (fig. 7.3 to 7.7) with references to the following items:

1. Glossary of Terms (sec. 7.2).
2. Concepts for use of the modules (sec. 7.3.1).
3. Specific questions to be answered in the MAIN FLOWCHART and the MODULE FLOWCHARTS.

### 7.3.1 Basic Concepts

The validity of the techniques in the SSM depends on the validity of the concepts upon which they are based. Evaluation of these concepts is crucial in the application of the procedure. A relative evaluation of the validity of the concepts underlying the individual modules will govern which of the five possible values will be used for FAFP for a given A/D category. The evaluation is formalized in module 5 (column E) of the SSM based on the analysts evaluation of the various concepts. Several concepts are basic to acceptance of the procedure as a whole (all modules) while others relate to the evaluation of individual modules.

**7.3.1.1 Overall Method.** The total depth of precipitation for a given A/D category is composed of precipitation that results from atmospheric forces and from the added effect of orography. The method assumes that the effect of orography may either contribute to or take away from the amount of precipitation that is produced by the atmosphere. When the orographic effect is positive (expressed as a percentage contribution to total precipitation), it may not be less than 5 percent. If it is also assumed that the terrain surrounding the location where a given storm of record occurred had been transparent; i.e., had no effect on the atmospheric forces acting there, the resulting total precipitation would be the same as the free air forced component of precipitation for the actual storm.

It is assumed that the FAFP never completely disappears in storms of record, and the total volume may contain contributions over both the orographic and nonorographic areas. The further assumption is made that, when no other information is available at the shorter durations, inferences made from precipitation depths valid at maximum storm duration for a given area are equally valid for the same area at shorter durations down to and including the minimum duration category.

**7.3.1.2 Module 1.** There are three components that underlie the use of precipitation observations in the estimation of the contribution of the atmosphere to the precipitation amounts in storms. These are:

1. If free atmospheric forcing in the nonorographic part of the storm had been smaller than it was, the value of the maximum depth of precipitation would have been proportionally less.

2. The FAFP in the orographic region of the storm is approximated by the maximum precipitation depths in the nonorographic region, as long as the same atmospheric forces are involved at each location.
3. Estimates of the FAFP based on assumptions 1 and 2 are better for small rather than intermediate or large area sizes.

**7.3.1.3 Module 2.** This module uses an isohyetal analysis of the precipitation data to evaluate the free air forced component of precipitation. Inherent in the use of this module is the existence of an isohyetal analysis based on adequate precipitation information and prepared without undue reliance on normal annual precipitation or other rainfall indices which may induce a spurious correlation between the precipitation amounts and topography. In addition, there are five other concepts underlying this module. These are:

1. One or more than one level of LOFACA may exist in the orographic part of a storm. When more than one storm center is contained in a given area category, the lowest level of LOFACA found is used for that area size.
2. LOFACA exists when there is a good correlation between some isohyet and elevation contours.
3. Upsloping and triggering (F- and B-type correlations) are of equal significance in determining the percentage of precipitation above LOFACA which is terrain forced.
4. For an orographic storm (centered in the orographic portion of the region), the larger the nonorographic portion becomes (in relation to the total storm area), the more likely that the observed largest rainfall amount in the nonorographic portion (as represented by DADFX) is the "true" upper limit to FAFP in the orographic part of the storm.
5. Estimates of FAFP using the above assumptions are better at intermediate and large rather than small area sizes.

**7.3.1.4 Module 3.** This module makes use of the meteorological analysis and the evaluation of the interaction of dynamic mechanisms of the atmosphere with terrain to estimate the FAFP. There are seven basic concepts underlying the use of this module. These are:

1. Estimates of FAFP made using the techniques of this module may be of marginal reliability if the storms considered are those producing moderate or lesser precipitation amounts.
2. A variety of storms exist, each one of which has an optimum configuration for producing extreme precipitation.
3. The more closely the atmospheric forcing mechanisms for a given storm approach the ideal effectiveness for that type of storm, the larger the effectiveness value ( $P_a$ ) for that storm becomes.
4. The FAFP is directly proportional to the effectiveness of atmospheric forcing mechanisms and inversely proportional to the effectiveness of orographic forcing mechanisms.

5. If the effectiveness of the orographic forcing mechanisms is of opposite sign to the effectiveness of the atmospheric forcing mechanisms and of equal or larger magnitude, little or no precipitation should occur.
6. The FAFP of storms of record is arbitrarily limited to no more than 100 percent of the maximum precipitation depth for the area/duration category under consideration.
7. Estimates of FAFP using the above assumptions are better at large rather than at intermediate or small area sizes.

**7.3.1.5 Module 4.** A basic assumption underlying the use of module 4 is that better results can be obtained by combining information; i.e., averaging the percentages obtained from the isohyetal analysis with the meteorological analysis and those obtained from analysis of the precipitation observations with the meteorological analysis. Better estimates are produced by averaging when there is little difference in the expressed preference for any one of the techniques or sources of information and, also, when the calculated percentage of FAFP from each of the modules exhibits wide differences.

Little is to be gained from use of the averaging technique over estimates produced by one of the individual analyses of modules 1, 2, or 3 when:

1. There are large differences in the expressed preference for the techniques of one module.
2. The sources of information for one of the individual modules is definitely superior.
3. The calculated percentages among the modules are in close agreement.

#### **7.4 Methodology**

The SSM was developed in a modular framework. This permits the user to consider only those factors for which information is available for an individual storm. A MAIN FLOWCHART of the SSM is shown in figure 7.2.

The MAIN FLOWCHART gives the user an overview of the SSM. Modules 1, 2, and 3 are designed to use the first three information sets mentioned in section 7.3 as indicated by the remarks column at the left side of the flowchart. A decision must be made initially for any storm and category as to which modules can be appropriately used, module 1, 2, or 3. The decision is based on a minimum level of acceptability of the information required by the module in question. The decisions are formalized for each of these three modules in module 0. The heart of the SSM procedure is module 5 where documentation is made of the SSM process, thereby permitting traceability of results. Though module 5 can be reached on the flowchart only after passing through each of the other modules, it is recommended that the steps in each module be documented in the record sheet of module 5 as the analyst proceeds. Transposition and moisture maximization of the index value of precipitation follows the completion of the SSM and will be discussed in chapter 8.

### 7.4.1 Module Flowcharts

There is a flowchart for each module. These were developed to aid the analyst in following the procedures in the SSM.

**7.4.1.1 Module 0 Procedure (fig. 7.3).** It is important in this module to decide on the adequacy of the available data. The results of this assessment are entered in column D of figure 7.8. The following rules concerning criteria are used:

1. For modules 1, 2, or 3, if there are no data available for the given technique (module), assign 0 to column D.
2. If the data are judged to be highly adequate, assign a value of either 7, 8, or 9, where 9 is the most adequate.
3. If the quantity, consistency, and accuracy of the information are judged to be adequate, assign a value of either 4, 5, or 6 to column D.
4. If the input information are judged as neither highly adequate, adequate, or missing, a value of either 1, 2, or 3 must be assigned to column D. A value of 1 is the lowest level of adequacy consistent with affirmative responses to questions 3, 5, and 7 in module 0.

An evaluation of a technique is not appropriate when there is insufficient information available for it to be used. Assigning an effective value of zero to column D under these circumstances eliminates the possibility.

The Glossary of Terms provides all required information needed to give numerical values to the five variables in the first step of the module 0 procedure. Note: In this module and in modules 1, 2, and 3, the connector symbol (C) applies only within the given module; i.e., when one is sent to a connector symbol it is always the one that is found in that module.

The following questions need to be answered in this module:

- Q.1. Is PC equal to or greater than 0.95?
- Q.2. Is there a MXVATS for an area size equal to or less than 100 mi<sup>2</sup> on the Pertinent Data Sheet for this storm?
- Q.3. Are the quantity, quality, and distribution of the nonorographic observations sufficient to select a reliable value for RNOVAL?
- Q.4. Is an isohyetal analysis available?
- Q.5. Is the isohyetal analysis reliable?
- Q.6. Is a reliable isohyetal analysis easily accomplished?
- Q.7. Are the meteorological data sufficient to make a reliable estimate of P<sub>a</sub> and A<sub>o</sub>?
- Q.8. Is RNOVAL equal to zero?

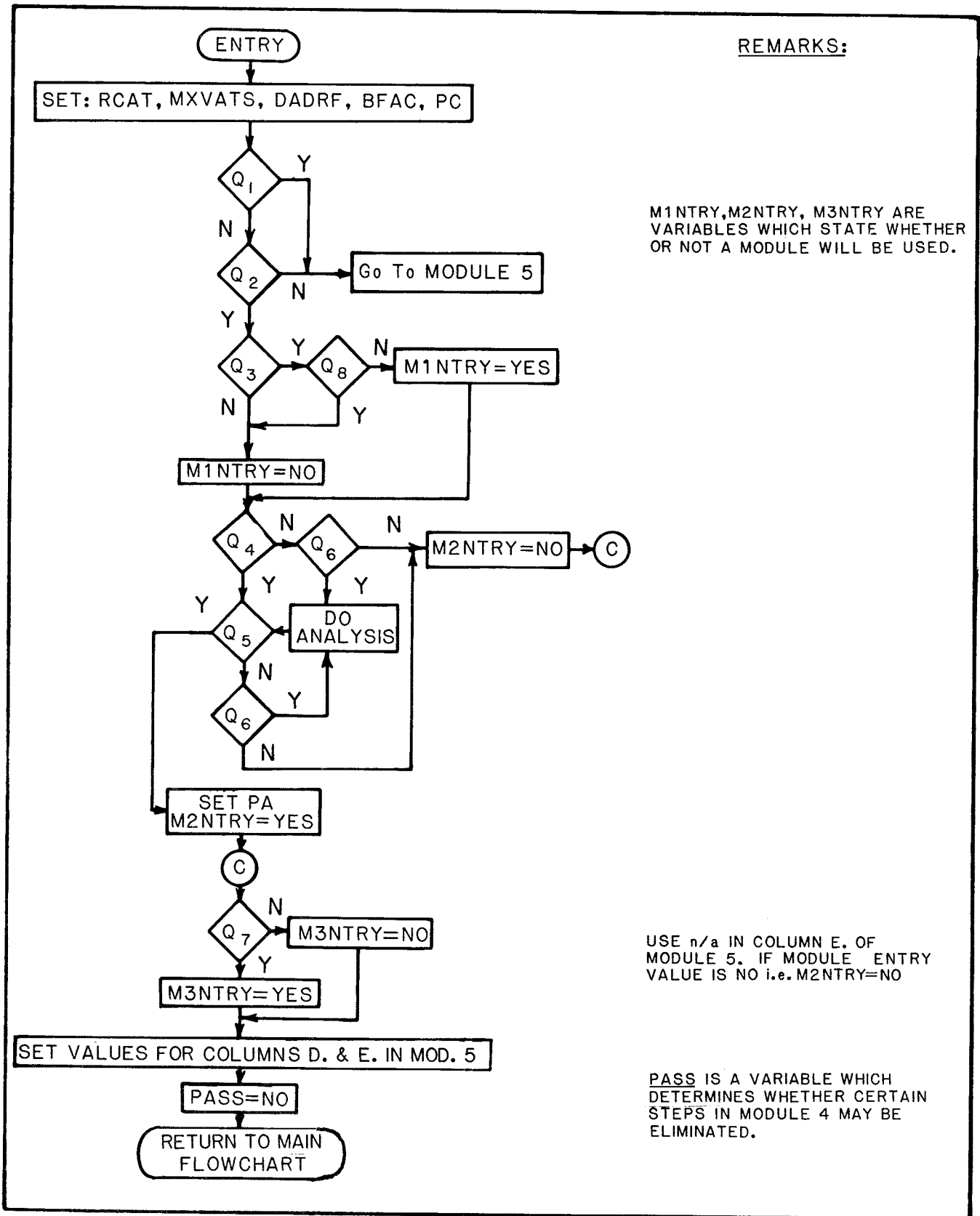

Figure 7.3.--Flowchart for module 0, SSM.



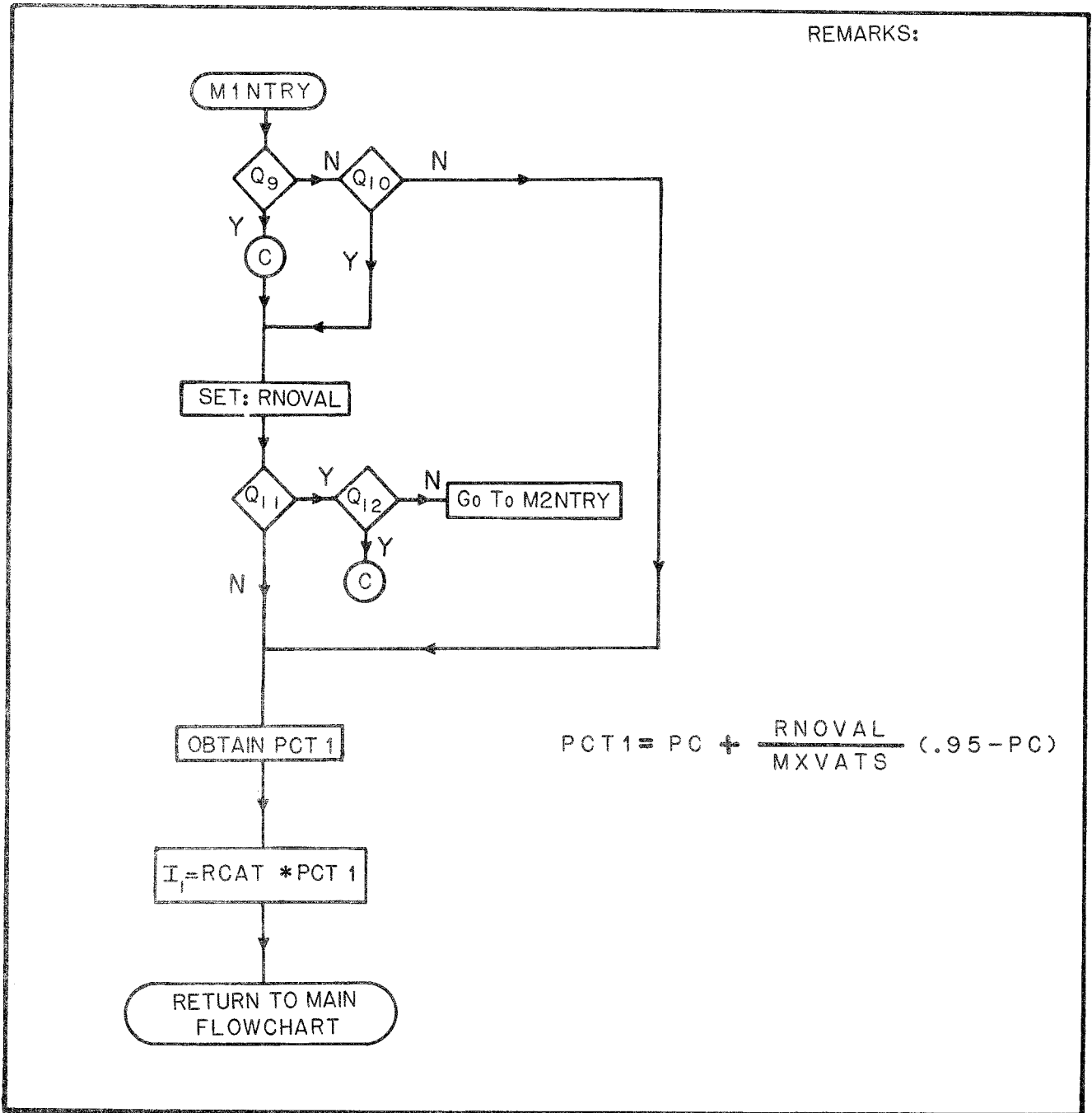

Figure 7.4.--Flowchart for module 1, SSM.

7.4.1.2 **Module 1 Procedure (fig. 7.4).** This module comes closer than any other in estimating a value for FAPP based on observed precipitation data. The key variables RNOVAL and MXVATS are based on direct observation, even though in some circumstances uncertainty surrounds the accuracy of these observations. The

actual values selected depend on the placement of the OSL (sec. 3.2.1) in the vicinity of the storm under consideration. Additionally, an analytical judgment must be made concerning the storm mechanism that resulted in MXVATS and RNOVAL. If there is more than one storm mechanism involved in the storm, the value selected for RNOVAL must result from the same mechanism that produced MXVATS.

The following questions are asked in module 1:

- Q.9. Is this the first time in this module for this storm?
- Q.10. Has the analyst just arrived here from module 4 to do a review?
- Q.11. Is RNOVAL equal to MXVATS?
- Q.12. Is a review of the data and assigned values for the variable needed?

If it is a good assumption that RNOVAL will usually be observed at a lower elevation than MXVATS, then there is a bias toward relatively large values for PCT1 in relation to the other percentages from the other modules, since total or cumulative precipitable water usually decreases with increasing elevation. The viability of PCT1 depends on the density of good precipitation observations on the date the storm occurred.

**7.4.1.3 Module 2 Procedure (fig. 7.5).** In this module, the average depth of precipitation for a given area-duration category is conceived of as a column of water composed of top and bottom sections (where the bottom section can contain from 0 to 95 percent of the total depth of water). The limit to the top of the bottom section is set by the parameter LOFAC. The bottom section is conceived to contain only a minimum level of FAFP for the storm. The top section contains precipitation that results from orographic forcing, and perhaps additional atmospheric forcing. The percent (if any) of the top section that results from atmospheric forcing is determined by the F-type and B-type correlations. The value computed for LOFAC is sensitive to the accuracy of the isohyetal analysis for the storm. This sensitivity must be taken into account when evaluating module 2 procedures in column E of module 5.

The procedure in which the precipitation is divided into two sections, is represented also in the expression for PCT22, which may be rewritten as:

$$PCT22 = PCT2 \left( 1 - \frac{LOFAC}{MXVATS} \right) + \frac{LOFAC}{MXVATS}$$

There are three terms on the right-hand side of the above equation. The rightmost of these terms is the minimum level of FAFP for the whole column expressed as a percent of the total and is the bottom section of the idealized column described above. The product of the first two terms on the right-hand side of the equation describes the top section of the idealized column, where PCT2 is the percent of the top section arising from atmospheric forcing and the second term is the depth of total precipitation minus the minimum level of FAFP expressed as a percent.

LOFACA is set to zero and LOFAC becomes zero when a good correlation cannot be found between any of the isohyets and the elevation contours upwind of the storm center. Zero is the numerical value that is appropriate for a minimum level of FAFP for the storm. Here it is assumed that the bottom section of the idealized

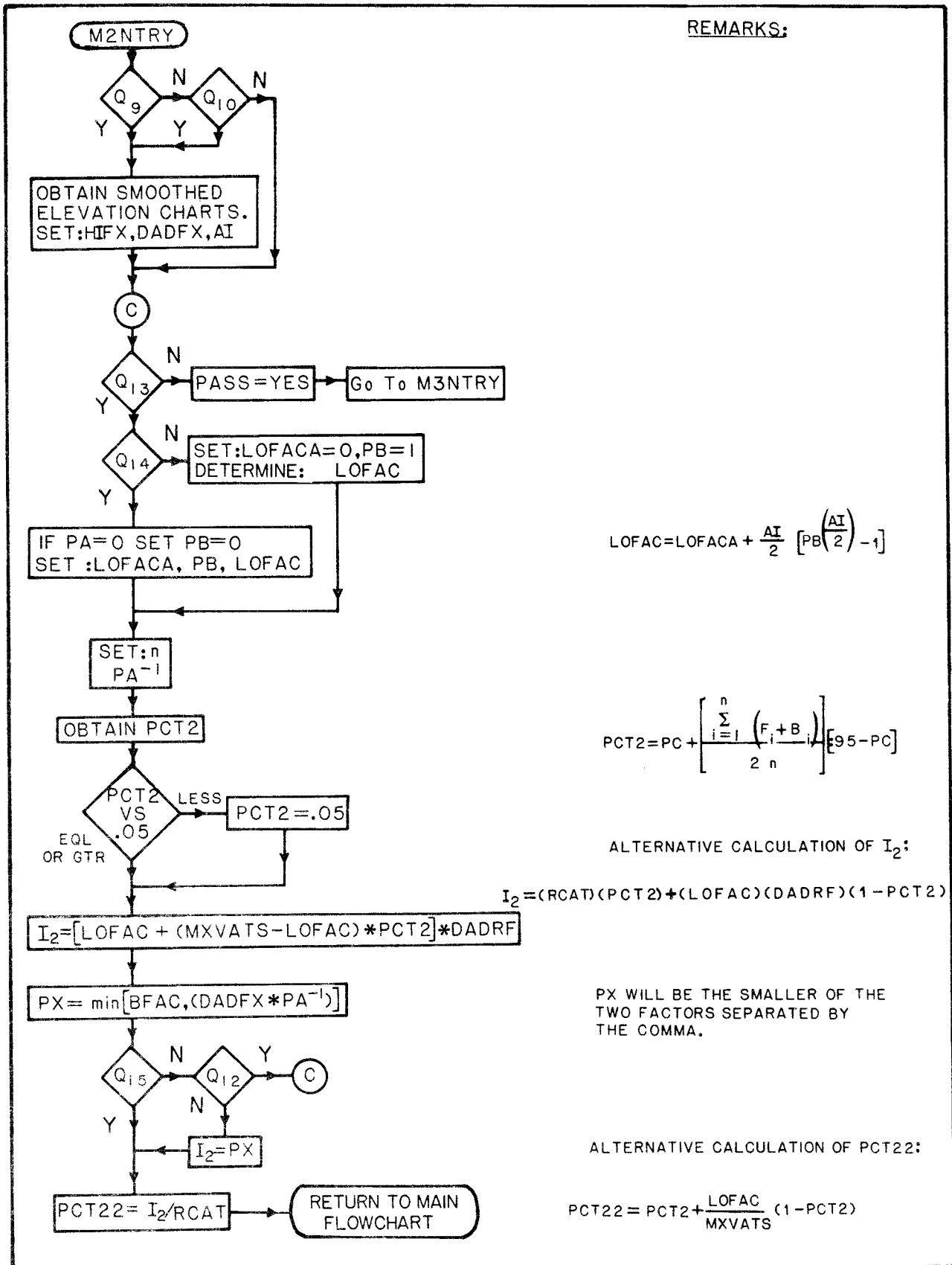

Figure 7.5.--Flowchart for module 2, SSM.

column is empty (minimum level of FAFP = 0), and both F-type and B-type correlations will determine the appropriate level of FAFP for the storm. The F and B correlations, to properly establish the appropriate FAFP, are determined nearby and upwind from the storm center.

As in module 1, an analytical judgment must be made on storm mechanism. In module 1, it was required that MXVATS and RNOVAL are the result of the same dynamic process. In module 2, it is necessary to determine that RNOVAL and HIFX are the result of the same atmospheric forces (storm mechanism).

The following questions are asked in module 2:

- Q.9. Is this the first time in this module for this storm?
- Q.10. Has the analyst just arrived here from module 4 to do a review?
- Q.12. Is a review of the data and assigned values for the variable needed?
- Q.13. Can it be determined which isohyetal maxima control(s) the average depth for the category selected?
- Q.14. Is there good correlation between some isohyet and the elevation contours in the orographic part of the storm near the storm center?
- Q.15. Is  $I_2$  less than or equal to PX?

A feature of module 2 not to be overlooked is the consequence of a negative response to question 15 accompanied by a negative response to question 12. In this case an arbitrarily defined upper limit is set on PCT22 and  $I_2$ . The upper limit will be the smaller of two numbers. The selection of BFAC as one of these numbers is obvious when one considers that orographic forcing may be either positive or negative. The second factor is a consequence of the concept that the larger PA becomes, the more likely the second factor represents the true level of FAFP, since with a large value of PA the largest observed rainfall amount in the nonorographic portion is more likely to represent a true upper limit.

LOFAC is always a number equal to or slightly less than LOFACA. This is so because it is possible that the minimum level of FAFP is reached before the arbitrarily set analysis interval allows it to be "picked up." It is reasoned that the larger the area "occupied" by the LOFACA isohyet in the nonorographic part of the storm, the more likely that the analysis interval has "picked up" the described depth. When there is no nonorographic portion to the storm, the parameter PB, used to set a value for LOFAC, becomes undefined (see definition of PB). Consequently, in the module 2 FLOWCHART it must be determined whether a nonorographic portion of the storm exists when there is an affirmative response to question 14. If so, a reasonable value for PB is zero. The consequence of a negative response to question 14 is that LOFACA must be zero. Regardless of whether or not a nonorographic part of the storm exists, LOFAC must not be less than zero and this is ensured by setting PB equal to 1.

**7.4.1.4 Module 3 Procedure (fig. 7.6).** This module uses meteorological and terrain information to evaluate an appropriate level of FAFP. This is accomplished through evaluation of  $P_a$  and  $A_o$ .

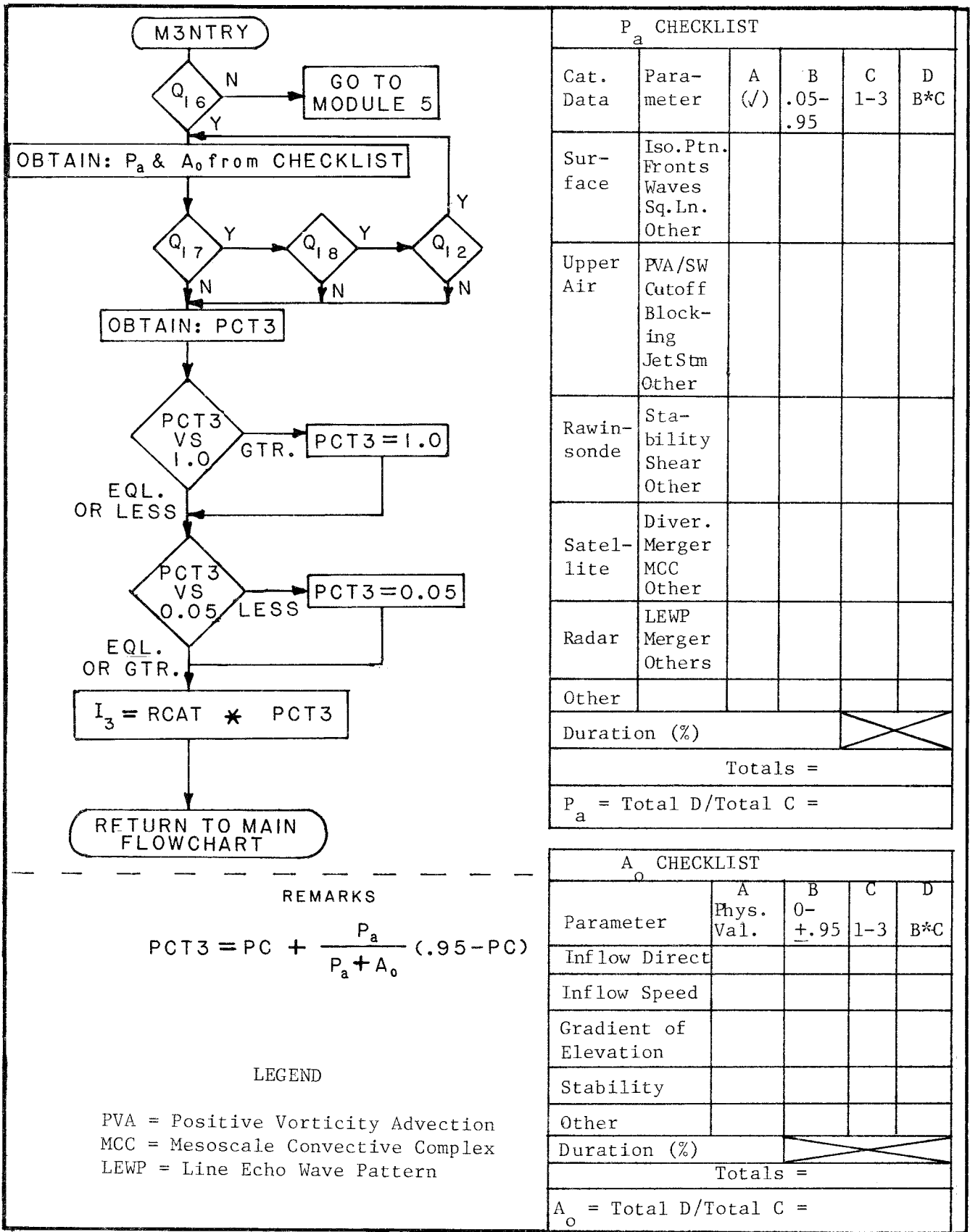

P <sub>a</sub> CHECKLIST					
Cat. Data	Parameter	A (✓)	B .05-.95	C 1-3	D B*C
Surface	Iso.Ptn. Fronts Waves Sq.Ln. Other				
Upper Air	PVA/SW Cutoff Block- ing JetStm Other				
Rawin- sonde	Sta- bility Shear Other				
Satel- lite	Diver. Merger MCC Other				
Radar	LEWP Merger Others				
Other					
Duration (%)				<del>XXXX</del>	
Totals =					
P <sub>a</sub> = Total D/Total C =					

A <sub>0</sub> CHECKLIST				
Parameter	A Phys. Val.	B 0-+.95	C 1-3	D B*C
Inflow Direct				
Inflow Speed				
Gradient of Elevation				
Stability				
Other				
Duration (%)				<del>XXXX</del>
Totals =				
A <sub>0</sub> = Total D/Total C =				

REMARKS

$$PCT3 = PC + \frac{P_a}{P_a + A_0} (.95 - PC)$$

LEGEND

PVA = Positive Vorticity Advection  
 MCC = Mesoscale Convective Complex  
 LEWP = Line Echo Wave Pattern

Figure 7.6.—Flowchart for module 3, SSM.

The following guidelines are provided to aid in the evaluation of  $P_a$  on the checklist given in the flowchart (fig. 7.6):

1. Use column A to indicate (by a checkmark) the presence of one or more features which infer positive vertical motion, or which may contribute toward an efficient storm structure.
2. Take as a basis for comparison an idealized storm which contains the same features or phenomena that were checked off in column A and indicate in column B, by selecting a number between 0.05 and 0.95, the degree to which the effectiveness of the selected actual storm features/phenomena (in producing precipitation) approaches the effectiveness of the same features/phenomena in the idealized storm. Where more than one feature/phenomenon is selected for a given category of meteorological information, it is the aggregate effectiveness which is considered and recorded in column B.
3. Repeat steps 1. and 2. for each category (surface, upper air, ..., others) of meteorological data.
4. If the quantity and quality of the information permits, the degree of convective-scale forcing may be distinguished from forcing due to larger scale mechanisms. If convective-scale forcing predominates for some area/duration categories and larger scale forcing at others, then the value assigned in column B may vary by area/duration category; i.e., the same effectiveness value may be different for each category of a given storm.
5. In column C an opportunity is given to assign one category a greater influence on  $P_a$  in relation to the others by assigning weighted values. For each applicable category the value in column D is the product of columns B and C.  $P_a$  is obtained by dividing the total of column D by the total of column C.
6. Meteorological data categories, for which there is not sufficient information from a particular storm, are disregarded in  $P_a$  calculations for that storm.
7. When effectiveness changes with the selected duration, the resulting value in column B is weighted by duration; this process is to be distinguished from the weighting mentioned in (5) above.

$A_o$  is a measure of the effectiveness of the orographic forcing effects. The following guidelines are used to aid in evaluating  $A_o$ :

1. Indicate in column A the value (in physical units) for the first five parameters. If any of these parameters change significantly during the duration category selected, indicate in the duration box the percent of time each of the values persists. To obtain the largest value in column B (largest effectiveness) observe the joint occurrence of tightly packed isobars (high wind speed) perpendicular to steep slopes for 100 percent of the duration category selected. Another way to look at this is to combine the first three parameters into a vertical displacement parameter,  $W_o$ , from the formula  $W_o = V * S$ , where V is the

component of the wind perpendicular to the slopes for the duration being considered in kt and S is the slope of the terrain in ft/mi. The effectiveness of  $W_o$  is then compared with an idealized value representing 100 percent effectiveness. The measured steepness of the slopes in the CD-103 region depends on the width across which the measurement is made. For a small distance (less than 5 mi.) a value of 0.25 is about the largest to be found, while for a large distance (greater than 80 mi.) a value of 0.06 is about the largest. A component of sustained wind normal to such slopes of 60 kt is assumed to be about the largest attainable in this region. Therefore, a  $W_o$  of 15 kt for small areas and of 3.5 kt for large areas are the values which would be considered highly effective.

None of the orographic storms studied occurred in places where the measured steepness of the slopes came near to the values just mentioned. Consequently, the vertical displacements observed for small areas were from .02 kt up to near 2 kt and proportionally smaller for the larger areas for these storms. Therefore, the effectiveness value used in the top box in column B was scaled to the values observed in the storms of record; i.e., a  $W_o$  of close to 2 kt was considered highly effective for small areas.

The inflow level for the storm is assumed to be the gradient wind level, and it is further assumed that the surface isobaric pattern gives a true reflection of that wind; i.e., the direction of the inflow wind is parallel to the surface isobars and its speed proportional to the spacing of the isobars as measured at the storm location. When rawinsonde observations are available in the immediate vicinity of the storm, they are used as the primary source of information for wind direction and speed.

When there is a sufficiently large number of wind observations, the average values of direction and speed are used for the duration considered. If the level of wind variability is large for the duration considered, the representativeness of the data is scored low in column C of module 5.

The fourth parameter, stability, must be considered in combination with the first three or  $W_o$ . Highly stable air can have a dampening effect on the height reached by initially strong vertical displacement (and consequently, the size to which cloud droplets can grow). In a highly unstable condition, vertical displacements of less than 2 kt can, through buoyancy, reach great height, thereby producing rainfall-sized droplets. The effectiveness value for stability is placed in the second box from the top in column B. Weighted values corresponding to the two top boxes of column B are placed in the two top boxes of column C to reflect the combined effects of  $W_o$  and stability; i.e., in the case where instability causes moderately weak displacements to grow, the stability "effectiveness" would be weighted strongly (given a 3) and the combined first three parameters weighted weakly (given a 1).

Entries in the other considerations box (for example, the shape of terrain features which may cause "fixing" of rainfall) need not be considered as dependent on the first four parameters.

2. The value for  $A_0$  is then obtained in the same manner as described in guideline 5 for  $P_a$ .
3. When evidence indicates that the orographic influence is negative; i.e., taking away from total possible precipitation, the values in column B are made negative and when the conditions are borderline between positive and negative, they are made zero. Negative orographic influence, when occurring in a storm where the atmospheric forcing approaches its conceptually optimum state, may cause some category values of PCT3 to exceed 1.0 resulting in FAFP larger than the total storm average depth for that category. The conventions of module 3, however, do not permit values of PCT3 to exceed 1.0.
4. The remarks section of module 5 should be used to document where the elevation gradients ( $\Delta Z$ ) were measured. For small areas, this would typically be at a point upwind of the largest report/isohyet. For larger areas, the average value from several locations may be used, or if one location is representative of the average value, it alone may be used. Sometimes the gradient is measured both upwind and downwind of the storm center (where inflow wind is used) if the vertical wind structure is such that a storm updraft initiated downwind may be carried back over the storm location by the winds aloft to contribute additional amounts to the "in place" amounts.

The overriding importance of applying this module only to major storms cannot be overstressed. The consequence of "running through" a frequently observed set of conditions is that, by definition, the values for both  $P_a$  and  $A_0$  will have to be quite small. When both parameters are small (less than about .4) a sensitivity study (not included here) showed that small differences in the values assigned to  $P_a$  and  $A_0$  (the independent variables) would produce large differences in the value of the dependent variable (PCT3). However, it does not follow that the definition of  $P_a$  which permits a lower limit of zero is incorrect. A storm can reasonably be postulated in which the extreme amounts were traceable to exceptional orographic forcing and, thus, both terms would not be small (PCT3 in this case is 5 percent). Not only are "infinite" values for PCT3 removed by the FLOWCHART constraints, but a value of zero in the denominator of the ratio  $P_a/(P_a + A_0)$  is a violation of the concept that if the orographic forcing negated the atmospheric forcing, no matter how large, little or no precipitation should occur.

The "model" envisioned in module 3 (as distinguished from the "model" of module 2 just discussed) follows from the concept that FAFP is directly proportional to the effectiveness of atmospheric forcing and inversely proportional to the effectiveness of the orographic forcing mechanisms. The rate at which an imaginary cylinder fills up (whose cross-sectional area is the same as the area category being used) is directly proportional to the condensation rate producing the precipitation which falls into the cylinder. The paramount factor determining the condensation rate is the vertical component of the wind resulting from both atmospheric ( $P_a$ ) and orographic ( $A_0$ ) forcing.

The following questions are asked in this module:



- Q.12. Is a review of the data and assigned values for the variable needed?
- Q.16. Does there exist, or is there sufficient information available to construct, a map of where at least 1 in. of precipitation did or did not occur for this storm?
- Q.17. Is  $A_0$  less than zero?
- Q.18. Is (are) the storm center(s) incorrectly located on the terrain map?

The remaining portions of the module 3 FLOWCHART, not discussed above, are simple and straightforward.

**7.4.1.5 Module 4 Procedure (fig. 7.7).** It is not contemplated that a computer program will be coded from the MAIN or MODULE FLOWCHARTS because the determination of the appropriate PCT's and I's is done easily manually. There is no real requirement for the variable PASS to be in the module 4 FLOWCHART. It is included only to make it obvious that the first part of the FLOWCHART should be skipped when returning to module 4 from a review of data in modules 1 and 3. The purpose of this module is simply to create two additional indices of FAFP on the assumption that an averaged value may be a better estimate than one produced in modules 1, 2, or 3.

A preliminary test of the SSM by six analysts each using six different storms showed that it was quite rare that one analyst would select a high (low) value for a PCT when other analysts were selecting low (high) values given that the interval range was the one shown in the right-hand remarks section of the module 4 FLOWCHART. Thus, a review is required of relevant information when an average percentage is to be created from individual percentages differing by two intervals.

PCT1 was not averaged with PCT2 because modules 1 and 2 conceive of the idealized column of precipitation representing the average depth for a given area-duration category in different ways; i.e., there is no minimum level of FAFP considered in module 1.

The following questions are asked in this module:

- Q.12. Is a review of the data and assigned values for the variable needed?
- Q.19. Is  $I_5$  less than or equal to PX?

Those concepts of the module 4 FLOWCHART not discussed above are straightforward.

**7.4.1.6 Module 5 Documentation (fig. 7.8).** It should be noted again that even though the MAIN FLOWCHART shows that module 5 is not used until module 2 and/or module 4 have been completed, this was done only to keep the diagramming of the MAIN FLOWCHART and the MODULE FLOWCHARTS relatively uncluttered by variables not related to the task at hand. Even though documentation can await completion of module 2 and/or module 4, it is preferable to document the value assigned to a variable as soon as it is determined.

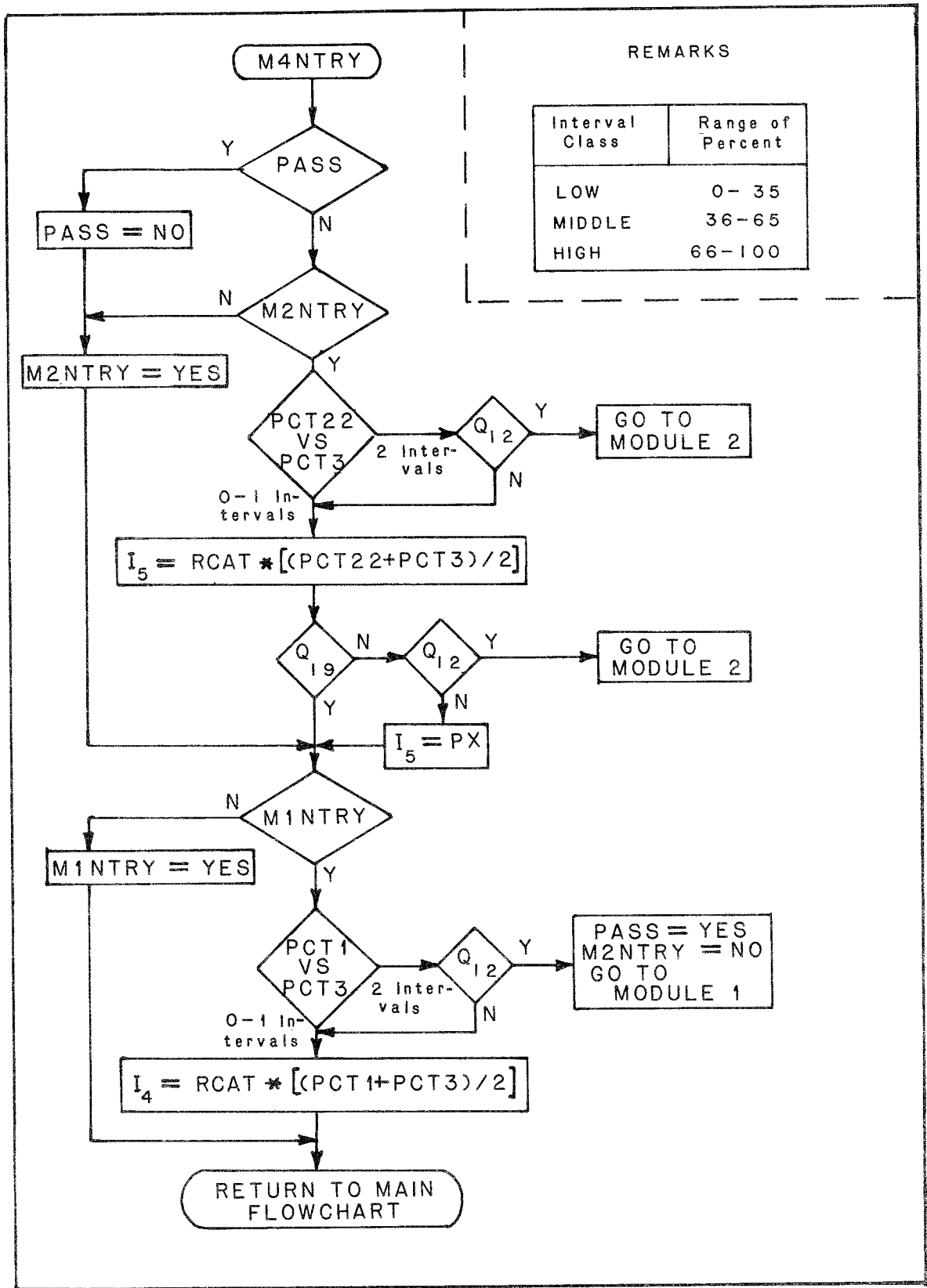

Figure 7.7.--Flowchart for module 4, SSM.

DOCUMENTATION AND INDEX SELECTION

STORM ID/DATE, REMARKS:

MODULE	PARAMETER	VALUE			EVALUATION SCALE: COL.D 0-9; COL.E 1-9 MODULES 1-3: COL.F: IS THE SUM OF COLS. D&E. COL.D: HOW ADEQUATE IS THE INPUT INFORMATION FOR THE REQUIREMENTS SET BY MODULE'S TECHNIQUE. COL.E: HOW LIKELY IT IS THAT THIS TECHNIQUE WILL ESTIMATE THE CORRECT INDEX VALUE BASED ON ITS ASSUMPTIONS? FOR MODULE 4 SEE SELECTION RULE. OVERALL RULE: SELECT INDEX VALUE WITH LARGEST COL. F SCORE. LARGEST SUBSCRIPT BREAKS TIES.	D	E	F
∅	CATEGORY RCAT BFAC MXVATS DADRF PA PC				REMARKS			
1	RNOVAL PCT1 $I_1$							
2	AI LOFACA PB LOFAC HIFX DADFX $PA^{-1}$ PX n $\sum(F_i + B_i)$ PCT2 $I_2$ PCT22							
3	COLUMN	A	B	C				
	INFLOW DIR.	---						
	INFLOW SPD.	---						
	GRAD. ELEV.	---						
	$W_0$							
	STABILITY							
	$A_0$							
	SURFACE							
	UPPER AIR							
	RAOB							
SATELLITE								
RADAR								
$P_a$								
PCT3 $I_3$								
4	$(PCT22 + PCT3)/2$				RETURN TO MAIN FLOWCHART			
	$I_5$							
	$(PCT1 + PCT3)/2$							
	$I_4$							

Figure 7.8.--Documentation form for SSM, module 5.

Values were assigned to column D during the review in module 0. This was necessary in the evaluation of the adequacy of data for application of modules 1, 2, and 3 to a particular storm. After completion of the first four modules, it is appropriate to review the values assigned for the adequacy of the data. In some cases, changes in values assigned to column D for some modules are appropriate. Any changes in values assigned in column D should be documented.

Assigning of values to columns E in module 5 involves subjectivity which must be the case because the "correct" value cannot be known and, hence, there is no way to know which of the various techniques used produces "correct" results most frequently. After the storm has been evaluated in each of the modules, all the information is available to assign a value for column E for modules 1 through 3. At this point, the value assigned to column E results from answering this question: For the type of storm selected and for the area/duration category chosen, what is the degree of confidence (i.e., how likely is it) that the particular technique (based on the validity of the assumptions underpinning it) will produce the "correct" result? The scheme for assigning values to column E is:

1. For modules 1, 2, and 3, if confidence is high, assign a value of either 7, 8, or 9 (9 being the highest of all) to column E.
2. If confidence is low, assign a value of either 1, 2, or 3 (where 1 is lowest, zero is not valid).
3. If the level of confidence is other than high or low, you must assign a value of either 4, 5, or 6.
4. If the entry value for the module under consideration is 0 in column D, an entry of n/a is made in column E and a value of zero used when calculating a column F.
5. It is unnecessary to evaluate columns D and E separately for module 4. Values to be assigned in column F for  $I_4$  and  $I_5$  can be determined from the following:

		Overall preference (difference in values assigned column F)		
		Little (0-2)	Some (3-5)	Strong ( <u>&gt;</u> 6)
Level of agreement between modules (difference in index percentages)	Little ( <u>&gt;</u> .31)	A	B	B
	Some (.16 - .30)	A	AB	B
	Large (0 - .15)	A	A	B

Where:

- A = use the higher of the values from column F for  $I_4$  or  $I_5$ .
- B = use the lower of the values from column F for  $I_4$  or  $I_5$ .
- AB = use either the higher or the lower value from column F for  $I_4$  or  $I_5$ .

Obviously, the scheme is designed to permit selection of  $I_1$ ,  $I_2$  or  $I_3$  when there is a strong preference for one of them and to select  $I_4$  or  $I_5$  when there is little overall preference. In the case where there is some preference for a given module and some agreement between the index values generated therefrom, the analyst must make a decision as to which index is to be preferred. The range of values used to represent index agreement categories was based on values actually selected in a test involving six different analysts working with six different storms.

The final value selected for FAFP is determined by the largest value in column F. If the same value has been computed for more than one index value, the index with the largest subscript is selected ( $I_2$  over  $I_1$ ,  $I_3$  over  $I_2$ ).

### 7.5 Example of Application of SSM

One of the most critical storms for determining the PMP in the CD-103 region occurred at Gibson Dam, MT on June 6-8, 1964 (75). Figure 7.9 shows the completed module 5 worksheet for this storm for the 24-hr 10-mi<sup>2</sup> precipitation. The final percentage selected for this storm was 61 percent for PCT5. This gave an FAFP of 9.1 in.

### 7.6 Application of SSM to this Study

The SSM was used in this study to estimate FAFP for just one category, 10 mi<sup>2</sup> and 24 hr. This category was selected as the key (index) category for this study for several reasons. The first reason relates to area size. In determination of the effects of orography on precipitation, it is easiest to isolate these effects for the smaller areas. In addition, if larger area sizes were used, the determination of the orographic effects for computation of the final PMP values would have been very complicated. At some transposed location, the increase in precipitation as a result of orographic effects for a very small area can be determined with little ambiguity. If a larger area (e.g., 1,000 mi<sup>2</sup>) was used, the effect of terrain at a transposed location would be related directly to the shape and orientation of the 1,000-mi<sup>2</sup> area selected. This factor, therefore, indicated use of the 10-mi<sup>2</sup> area as most appropriate.

The 24-hr duration was selected because of the reliability of data for this duration. For storms before 1940, the amount of recording raingage information is relatively sparse. Determination of amounts for durations less than 24 hr for these storms is based on only limited data. This indicates use of a storm duration of 24 hr or longer. A review of the important storms in this region shows several that did not last the entire 72-hr time period of interest in the present study. Most notable of these are the Gibson Dam, MT storm (75) and the Cherry Creek (47), Hale (101), CO storms. These two factors made selection of the 24-hr duration most appropriate. Selection of this duration also had the advantage of minimizing the extrapolation required to develop PMP estimates for the range of durations required in the study.

DOCUMENTATION AND INDEX SELECTION

STORM ID/DATE, REMARKS: Gibson Dam, MT (75) 6/6-8/64								
MODULE	PARAMETER	VALUE			EVALUATION SCALE: COL.D 0-9; COL.E 1-9 MODULES 1-3: COL.F: IS THE SUM OF COLS. D&E. COL.D: HOW ADEQUATE IS THE INPUT INFORMATION FOR THE REQUIREMENTS SET BY MODULE'S TECHNIQUE. COL.E: HOW LIKELY IT IS THAT THIS TECHNIQUE WILL ESTIMATE THE CORRECT INDEX VALUE BASED ON ITS ASSUMPTIONS? FOR MODULE 4 SEE SELECTION RULE. OVERALL RULE: SELECT INDEX VALUE WITH LARGEST COL. F SCORE. LARGEST SUBSCRIPT BREAKS TIES.			
REMARKS					D	E	F	
0	CATEGORY RCAT BFAC MXVATS DADRF PA PC	10mi <sup>2</sup> /24 hr 14.9 14.2 16.4 .91 .40 0						
1	RNOVAL PCT1 I <sub>1</sub>	7.5 .43 6.4						
2	AI LOFACA PB LOFAC HIFX DADFX PA <sup>-1</sup> PX n Σ(F <sub>1</sub> +B <sub>1</sub> ) PCT2 I <sub>2</sub> PCT22	1.0 6.0 .1 5.7 6.0 5.5 2.5 13.7 1 .8+.4=1.2 .57 10.7 .72						
3	COLUMN INFLOW DIR. INFLOW SPD. GRAD. ELEV. W <sub>0</sub> STABILITY A <sub>0</sub> SURFACE UPPER AIR RAOB SATELLITE RADAR P <sub>a</sub> PCT3 I <sub>3</sub>	A	B	C	ma = moist adiabatic saturated na = not applicable Grad. Elev measured upwind of isohyetal max between 6000 and 7000 ft	8	7	15
		.8		1				
		.7		1				
		.85		2				
		.6		1				
		na						
		na						
		.75						
		.49						
		7.3						
4	(PCT22 + PCT3)/2 I <sub>5</sub> (PCT1 + PCT3)/2 I <sub>4</sub>	.61 9.1 .46 6.9						15
RETURN TO MAIN FLOWCHART								15

Figure 7.9.—Completed module 5 documentation form for Gibson Dam, MT storm (75) of June 6-8, 1964.

## **8. STORM TRANSPOSITION**

### **8.1 Introduction**

The outstanding rain storms in and near a region are a very important part of the historical evidence on which the PMP estimates must be based. The transfer of total storm rainfall amounts from the location where they occurred to other areas where they could occur (storm transposition), is an important tool in the standard methodology for defining the precipitation potential within a region. In this study, transposition limits, or the outer boundaries of the region where a particular storm could occur, were determined for all storms important to PMP estimates within this region. These limits were based on the studies of major storms in the region that were listed in table 2.2.

Values of FAFP or convergence precipitation were transposed throughout the region with the same limits as determined for total storm precipitation, except for the direct consideration of terrain effects. Since, as discussed in chapter 7, FAFP is the result solely of atmospheric processes, the transposition limits should be as independent of terrain features as are storms in nonorographic regions. Limitations to the application of this notion are discussed in section 8.2.3.

### **8.2 Transposition Limits**

The first approximations to individual storm transposition limits were determined by consideration of the region within which similar storm types have occurred. Determination of these limits was developed using the storm classification system developed for this study as the primary limitation (sec. 2.5). In addition to the transposition limits determined by storm type, the range of elevations through which individual storm total precipitation amounts were transposed was restricted to plus or minus 1,500 ft from the average elevation of the encompassing isohyet for the area size of concern at the storm location. Initial transposition limits permitted a storm to be transposed only within the same terrain classification (sec. 3.2).

#### **8.2.1 Transposition Limits by Storm Type**

Figure 8.1 shows the distribution of simple and complex storms. Convective storms have occurred throughout the region. In the southern part, a simple convective storm occurred at Las Cruces, NM, August 29-30, 1935 (48), and in the central portion of the region the storm at Masonville, CO, September 10, 1938 (55) was classified as a simple convective event. Complex convective storms have occurred at Ragland, NM, May 26-30, 1937 (49) and Galinas Plant Station, NM, September 20-23, 1929 (43), as well as at Buffalo Gap, Sask., May 30, 1961 (72). Perhaps the most notable complex convective storms were the Cherry Creek, CO storm of May 30-31, 1935 (47), and the Plum Creek, CO storm of June 13-20, 1965 (76). Thus, the transposition limits for convective storms includes the entire region.

Certain cyclonic type storms have occurred over a more limited geographic region. Tropical storms that affect the region between the Continental Divide and the 103rd meridian are formed over the tropical Atlantic Ocean and Gulf of Mexico and cross the coast of Texas or northeast Mexico on a northwesterly

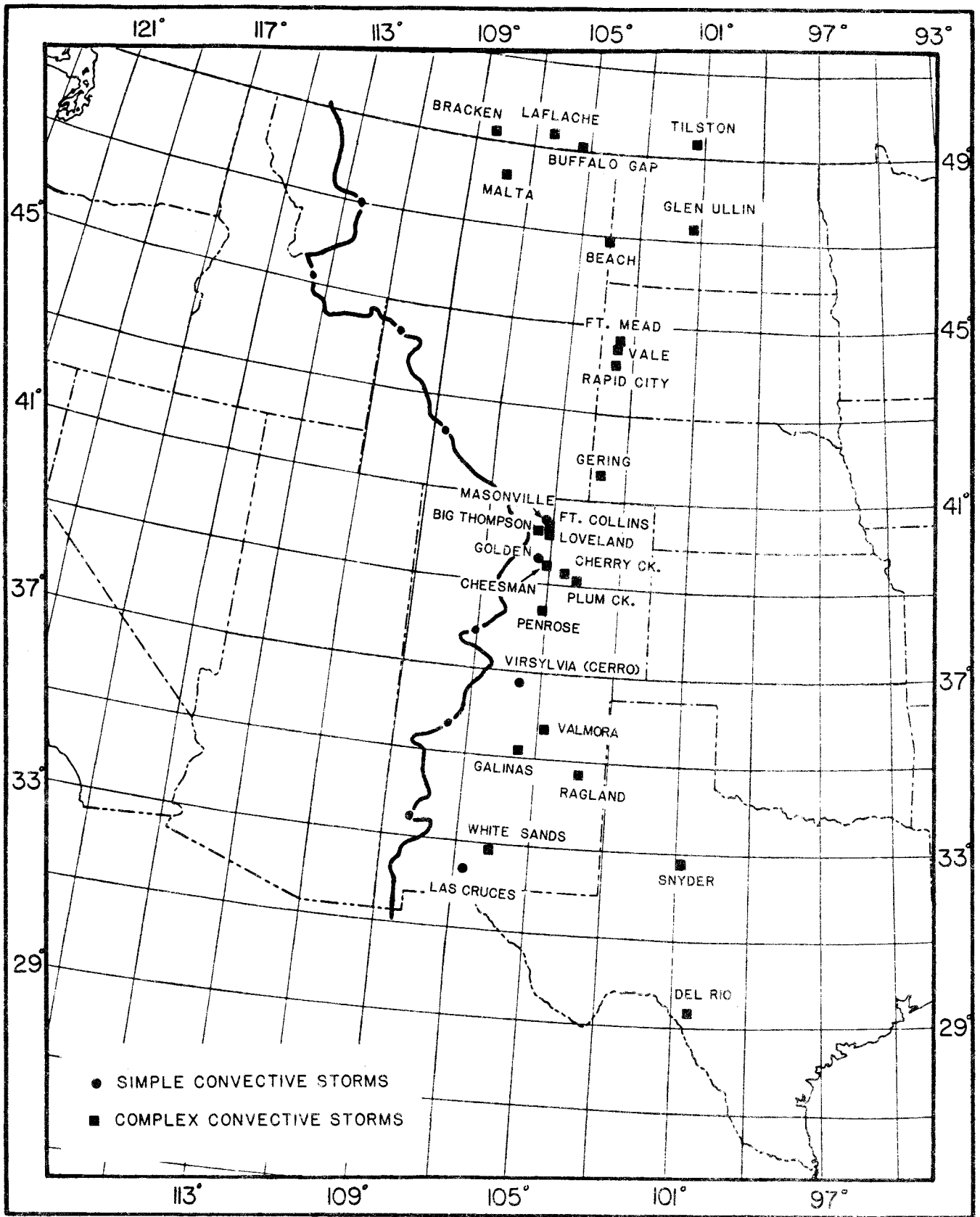

Figure 8.1.—Convective storm locations.



course. Only a few storms with a recognizable circulation have penetrated as far as New Mexico. However, it is the moisture associated with a tropical storm or a remnant of the convergence mechanism (with the surface and lower level circulation having become too diffuse to be recognized), that are the important factors in producing major precipitation events. Even these remnants of a tropical storm cannot be identified too far north and, in general, are restricted to a line south of the southern border of Colorado. Figure 8.2 shows a line extending from the Continental Divide in a generally easterly direction, across the southern tip of Sangre de Cristo Mountains and then northeastward into eastern Colorado. Only south of this line has evidence of tropical cyclone rainfall been observed. Therefore, transposition of this storm type is restricted to the region south of this line.

Precipitation from extratropical cyclones has been further subdivided into that associated with closed low pressure systems and that with frontal systems. In extratropical cyclones classified as low pressure systems, the precipitation is associated with well-defined closed Lows centered along or near the east-facing slopes of the Rockies. The surface Low is generally associated with upper level features and particularly with the southern penetration of the jet stream. In this study, interest is in major storms capable of producing the all-season PMP event. Such storms will not occur from late fall through early spring. In these seasons, the moisture supply is not sufficient. During the period when the all-season PMP event could occur, such systems have not formed in northern Mexico, nor have they been observed crossing the mountains south of the United States-Mexico border. Storm experience shows this storm type occurring through Montana, Wyoming, Colorado, and in extreme northern New Mexico. Thus, transposition of this storm type is restricted to the region between the Canadian border and approximately the southern border of Colorado. Diagrams (not shown) were also prepared showing locations where cyclonic storms have occurred.

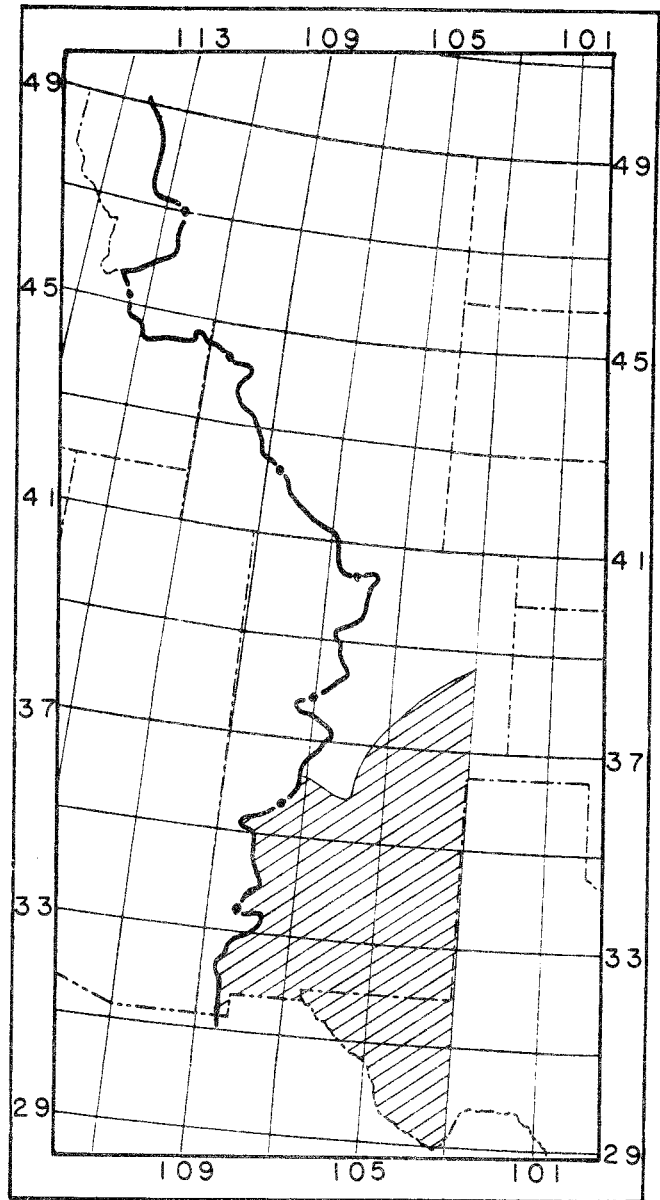

Figure 8.2.—Limits of tropical storm influence.

During the period when the all-season PMP event could occur, such systems have not formed in northern Mexico, nor have they been observed crossing the mountains south of the United States-Mexico border. Storm experience shows this storm type occurring through Montana, Wyoming, Colorado, and in extreme northern New Mexico. Thus, transposition of this storm type is restricted to the region between the Canadian border and approximately the southern border of Colorado. Diagrams (not shown) were also prepared showing locations where cyclonic storms have occurred.

Precipitation as a result of frontal systems in this region is generally associated with cold fronts which extend southward from a low pressure center. This boundary between cold and warm air can extend quite far south of the low pressure center. Storms associated with this type of rainfall have occurred in all parts of the study region. Therefore, these storms were transposed without limit as with the convective storms.

### 8.2.2 Final Transposition Limits of Storms for Individual Total Storm Precipitation

Determination of final transposition limits was based on individual consideration of each storm. Among the features that need to be considered are: the direction of moisture inflow, characteristics of the terrain in the vicinity of the storm, and particular meteorological characteristics of individual storms that might inhibit transposition to some locations. The following sections discuss two storms to illustrate the factors considered in each storm.

**8.2.2.1 Gibson Dam, Montana Storm - June 6-8, 1964 (75).** The meteorological conditions associated with this storm were discussed in section 2.4.1.6. In brief, this storm occurred centered on the ridge of the first upslopes as a result of a warm moist air flow from the Gulf of Mexico turning westward and being lifted both by convergence around the Low and topography.

The first limiting factor considered in this storm was topography. The primary rainfall center occurred along the ridge of the first upslopes. It was considered inappropriate to transpose the total precipitation from this storm to secondary upslopes. Second, the slopes in the vicinity of the major precipitation centers were examined. Though relatively steep, they were not within regions considered to be the steepest upslopes. This factor did not limit transposition within the first upslopes of the orographic regions.

Meteorological factors to be considered are moisture flow from the Gulf of Mexico, the formation of a well organized low pressure system, and a relatively stable air mass. These combined features can be found through the entire CD-103 region north of approximately 37°N. Figure 8.3 shows the transposition limits determined for the Gibson Dam storm.

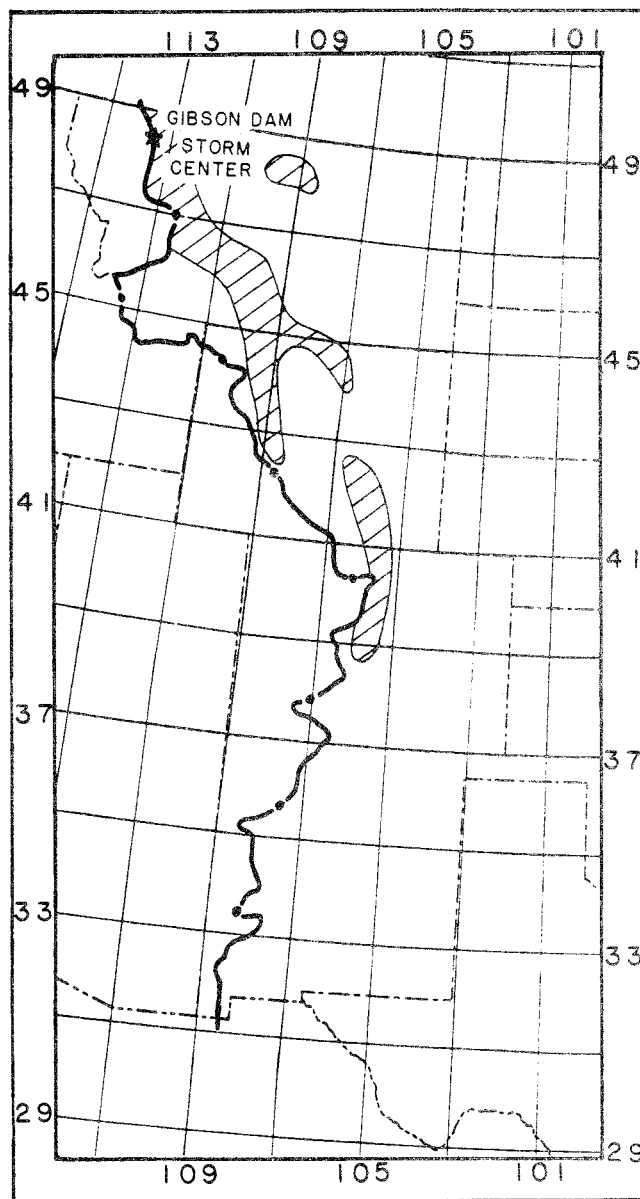
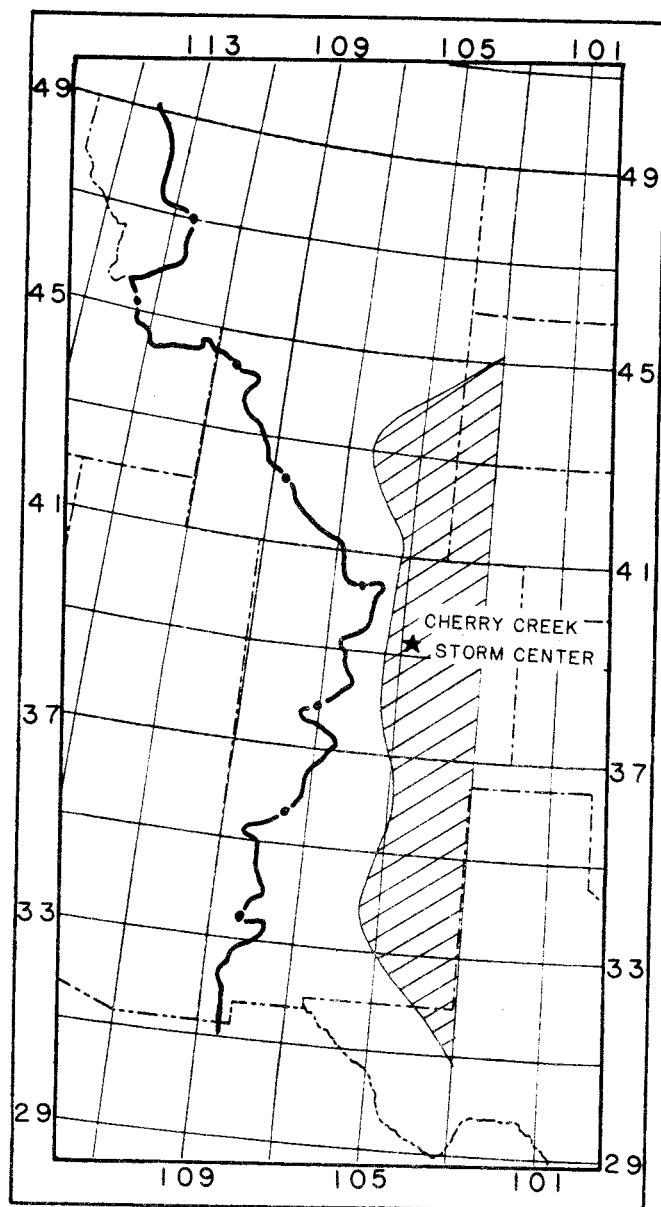

Figure 8.3.--Transposition limits for Gibson Dam, MT storm (75) of June 6-8, 1964.

**8.2.2.2 Cherry Creek, Colorado Storm - May 30-31, 1935 (47).** The meteorological conditions associated with this storm are discussed in section 2.4.1.5. The most important meteorological feature that limits transposition of this storm is the need for a strong deep continuous flow of warm moist air from the Gulf of Mexico. This restricts transposition of this storm to the region east of the first ridgeline. Transposition of this storm is further restricted to those regions where the moist air can reach the location in a direct, concentrated flow. It was necessary, therefore, to restrict transposition to a line extending northward from the mountains of Colorado. Another significant factor in this storm was a strong temperature contrast between a continental polar and a maritime tropical air mass. It is difficult to determine an exact northern limit where the maritime tropical air would be sufficiently modified to reduce any temperature gradient below that necessary for this storm. In this study, a northern limit of approximately  $44^{\circ}\text{N}$  has been adopted. The transposition limits for the Cherry Creek storm are shown in figure 8.4.

### 8.2.3 Transposition Limits of FAFP

In contrast to transposition limits for total storm precipitation, it was assumed that FAFP could be transposed more widely. The FAFP was developed as a property of a storm that is essentially independent of topography. In this section, the following question was considered: Given that the same initial atmospheric conditions are found at two separate locations where the topographic features are substantially different, will the resulting storms produce the same amount of FAFP at both locations? The answer to the question just asked should be yes. But, what the SSM actually does is to estimate FAFP from, or out of, a very particular storm occurring at a place of unique terrain characteristics. The precipitation occurring there happened only because a storm with a certain structure developed at that place and the question must be asked whether the same storm structure could evolve in the same manner in radically different terrain. Certainly, FAFP is a more "transposable" quantity than is total precipitation for storms occurring in areas of significant orographic influence, but it is unlikely that storm evolution is completely independent of its orographic context.



**Figure 8.4.—Transposition limits for Cherry Creek, CO storm (47) of May 30-31, 1935.**

While admitting that not much is understood about how terrain feedback does or does not determine the way in which a storm develops or evolves\*, it seems that very radically different terrain settings would promote different feedback and different kinds of storms would evolve with the consequent likelihood of different amounts of FAFP. As the FAFP component of a storm is transposed into a region of substantially different topographic features, the more likely it is that the transposition process is less reliable. For example, as a storm is transposed from the foothills of the Rockies closer to the Continental Divide, the larger the uncertainty that must attend the associated FAFP value, and it must be admitted that there is no method known as yet to "improve" or modify the transposed values. Some subjective interpretation and evaluation of such transposed values in an analysis of FAFP still seems to be required in the more "remote" portions of the CD-103 region.

The basic transposition limits for FAFP were determined by the consideration of storm type transposition limits (sec. 8.2). Some additional limitations were based on synoptic scale features such as large scale temperature gradients. The primary consideration, however, was the moisture flow. The FAFP for a given storm may not be transposed to a proposed location if the topographic conditions encountered by the warm moist air flow into the storm at the proposed location differ significantly from those encountered upwind of the original location. This can be determined when synoptic scale features are considered. A trajectory was constructed from the moisture source to the transposed location that was the same as that to the storm location. This proposed trajectory was expanded 22.5° either side of the original bearing of the moisture trajectory and considered to be a distance equivalent to that of the reference storm dew-point location from the storm center. If there were significant differences in barriers to moisture inflow, the storm was not transposed to those locations.

### 8.3 Systems Used to Select Transposition Locations

In previous reports, various techniques have been used to determine the locations to which storms were transposed. In some cases, a grid of points at latitude/longitude intersections was used. In other studies, storms were transposed to the extremes of the limits of the region of transposability. In this study, both a grid method and transverses or cross sections across the mountain ranges were used. In the nonorographic regions, a uniform grid with points at 1° latitude/longitude intersections was established. Total storm precipitation has been transposed to these points for every storm that met the criteria for transposability (sec. 8.2 and 8.4). In the orographic region, this technique would not provide adequate representation of the varied terrain that was necessary. For this region then, cross section lines across the mountain barriers, beginning with the edge of the orographic region (OSL), were drawn normal to the mountain region extending to the Continental Divide. These lines were drawn at frequent intervals so that all major terrain classifications were adequately represented. Points were then selected along these lines at specific

---

\*Note: An article by Cotton et al. (1983) has helped to explain the orogenic function of terrain for storms that eventually achieve maturity some distance from their place of origin. These studies, thus far, have not produced results which could be incorporated into the results of the present study.

elevations. These elevations were so selected that several storms could be transposed to each point considering the limitations imposed on storm transposition to different elevations (sec. 8.4). An example of the geographic distribution of points to which storms and FAFP were transposed are shown in figure 8.5 for Colorado.

#### 8.4 Moisture Maximization and Transposition Procedures

Moisture maximization and transposition of major storms of record comprise the traditional method for developing estimates of PMP in nonorographic regions. In this procedure each storm is first increased proportionately as much as possible for maximum moisture potential at the location of occurrence (in-place). Then the difference in potential moisture available at the storm location is compared to that which might be available at the location to which it is desired to move the storm. The procedures used in this study are discussed in this section.

##### 8.4.1 In-Place Moisture Adjustment

The moisture maximization factor is based upon the ratio of precipitable water associated with the maximum persisting 12-hr 1000-mb dew point to that of the precipitable water associated with the representative persisting 12-hr 1000-mb dew point in the storm situation (World Meteorological Organization 1973, and Schreiner and Riedel 1978). This can be expressed mathematically as:

$$R_{IP} = \frac{W_{P_{\max, SL, SE}}}{W_{P_{\text{storm}, SL, SE}}} \quad (8-1)$$

where

$R_{IP}$  = the in-place moisture adjustment,

SL = storm location,

SE = storm/barrier elevation,

$W_{P_{\max, SL, SE}}$  = precipitable water above the storm/barrier elevation associated with the maximum persisting 12-hr 1000-mb dew point, and

$W_{P_{\text{storm}, SL, SE}}$  = precipitable water above the storm/barrier elevation associated with the representative persisting 12-hr 1000-mb dew point.

In computing the precipitable water associated with either dew point, use the elevation of the storm location or any intervening higher barrier between the storm location and the moisture source (World Meteorological Organization 1973). The storm/barrier elevation is determined from the map discussed in section 3.3. The maximum persisting 12-hr 1000-mb dew point is determined at the same geographic location as the representative storm dew point.

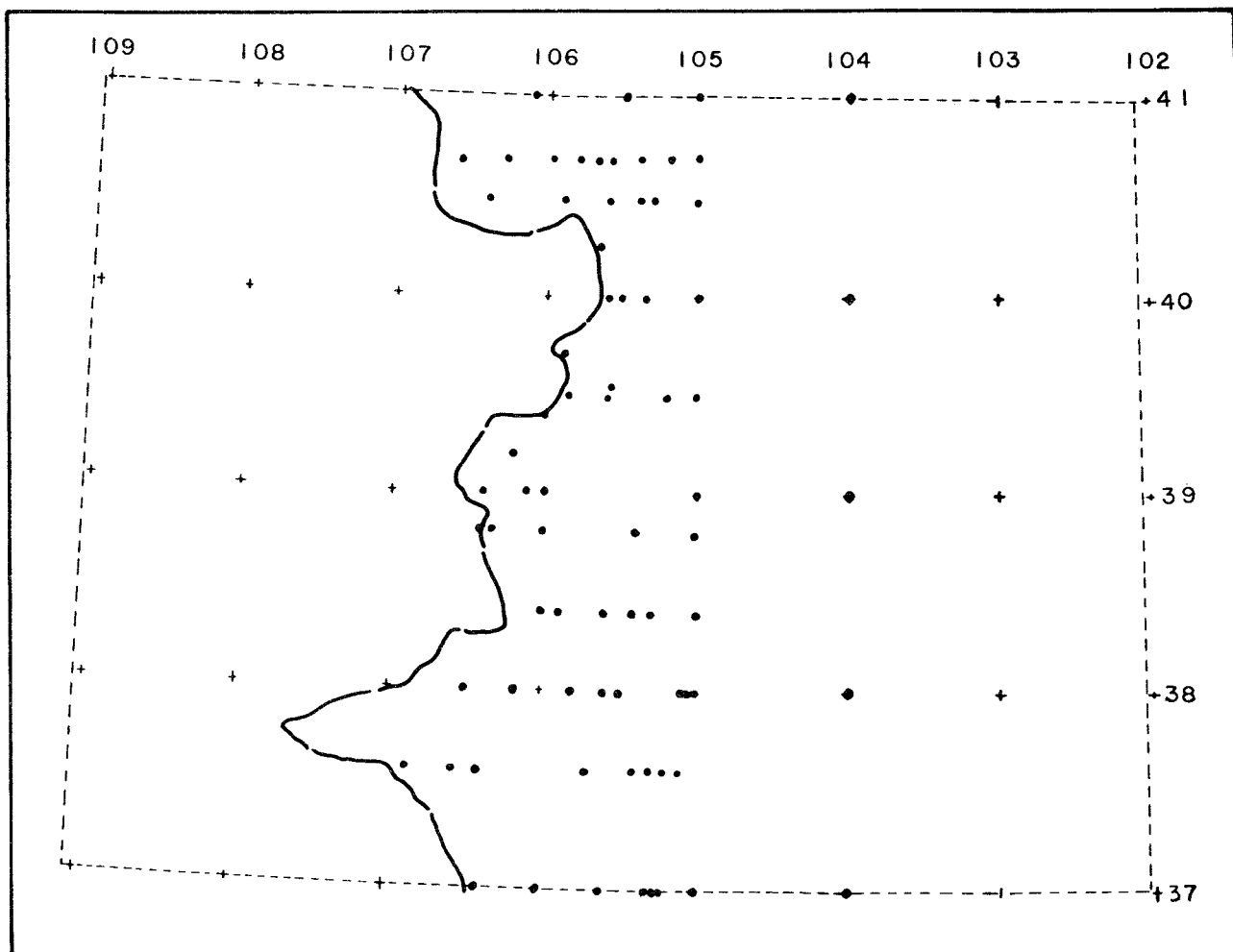

Figure 8.5.--Example of geographic distribution of points used in the transposition of total storm precipitation and FAFP for Colorado.

**8.4.1.1 Limitations to In-Place Moisture Adjustment.** In the studies for the eastern United States (Schreiner and Riedel 1978), moisture adjustments greater than 1.50 were not accepted unless the resulting maximized precipitation amounts were supported by moisture maximized values for other storms with lesser adjustments. In the present study, the nonorographic region east of the OSL is considered essentially similar to the eastern United States and the 1.50 limitation was accepted for this study. In the orographic region, the sample of storm data is less plentiful and transposition is more limited, even with the FAFP concept. For this reason, limitations were relaxed and values as high as 1.70 were accepted.

A basic assumption underlying the concept of moisture maximization is the unchanging nature of the storm. That is, the moisture supply for an individual storm can be increased without altering the dynamic structure of the storm. If the moisture increase is too great, the validity of this assumption diminishes. This further supports the need for a limitation on the in-place moisture adjustment.

## 8.4.2 Transposition Adjustments

The procedure for developing PMP estimates involves the transposition of total storm precipitation and FAFP values to a grid of points over the region. The transposition of both values requires adjustment for variation in availability of moisture. Differences in orographic effects in transposing total storm precipitation were based on consideration of ratios to the 100-yr 24-hr precipitation values between storm and transposed location. For the FAFP values, differences in orographic effects are accounted for by use of T/C and M factors (chapt. 9).

**8.4.2.1 Horizontal Transposition Adjustment.** Geographic or horizontal variations in precipitation are accounted for solely by differences in moisture availability based upon the variation in the maximum persisting 12-hr 1000-mb dew points. The adjustment is based upon the ratio of precipitable water associated with two maximum persisting 12-hr dew points. The numerator is the precipitable water associated with the maximum persisting 12-hr 1000-mb dew point at the transposed location, and the denominator is the precipitable water associated with the maximum persisting 12-hr 1000-mb dew point for the storm location. In each case the dew point is selected at the same distance and direction from the point as the representative storm dew point. Again, precipitable water is computed above the storm/barrier elevation. This can be expressed mathematically:

$$R_{HT} = \frac{W_{P_{\max, TL, SE}}}{W_{P_{\max, SL, SE}}} \quad (8-2)$$

where

$R_{HT}$  = horizontal moisture transposition adjustment,

TL = transposed location, and

$W_{P_{\max, TL, SE}}$  = precipitable water associated with the maximum persisting 12-hr 1000-mb dew point above the storm/barrier elevation.

and,  $W_{P_{\max, SL, SE}}$  is as defined for equation 8-1. This adjustment is limited to an increase of 20 percent or a factor of 1.2. This limitation was adopted to avoid the unduly increasing of storm moisture beyond reasonable limits. There is no limit, other than zero, for  $R_{HT}$  less than 1.

**8.4.2.2 Vertical Transposition Adjustment.** Numerous plots of maximum observed precipitation amounts versus elevations do not disclose any consistent increase or decrease relations with elevation. Attempts to use exposure, slope, roughness parameters, etc., have not been successful in developing any useful relation. It is recognized that, in general, precipitation potential is reduced with elevation. Accordingly, the vertical transposition adjustment used is based upon the variation in precipitable water relative to maximum persisting 12-hr 1000 mb dew points.

In HMR No. 51, no adjustments were made for elevation east of the Mississippi River. Variations in elevations between storm and transposed locations were generally small, less than 1,000 ft. In the western plains region of HMR No. 51,

for area sizes larger than 1000 mi<sup>2</sup>, a "gentle upslope" reduction was applied. This reduction of 6 to 10 percent per 1,000 ft was based upon the variation of precipitable water with height. No adjustment was made in that study for precipitation amounts for area sizes less than 1,000 mi<sup>2</sup>. In the present study, the same procedure was adopted in transposing FAFP for small areas by making no adjustment for the changes in elevation of 1,000 ft or less. For larger changes in elevation, the traditional adjustment is to consider the complete variation in precipitable water. This results in large adjustments for relatively small differences in elevation. These changes in precipitation amounts seem unrealistic.

We noted that the atmosphere produced equal magnitudes of rainfall in the May 31, 1935 storm at Cherry Creek (6,900 ft) and at Hale (4,000 ft). Our concern for the effects of incorporating the traditional vertical adjustment (based upon total variation of precipitable water), particularly in transposing to lower elevations, led us to adopt a change to previous studies. In this study we make a consensus decision to adopt a vertical moisture adjustment one-half the traditional adjustment in an attempt to control unrealistic maximizations in general storms. The result, incorporating the immunity from adjustment of the first 1,000 ft, is expressed in the following equation:

$$R_{VT} = 0.5 + 0.5 \left( \frac{W_{P_{\max, TL, TE}}}{W_{P_{\max, TL, (SE \pm 1,000)}}} \right), \quad (8-3)$$

where

$R_{VT}$  = the vertical transposition adjustment,

$TE$  = transposed/barrier elevation: the elevation of the transposed location or any higher barrier to moist air flow,

$W_{P_{\max, TL, (SE \pm 1,000)}}$  = precipitable water associated with the maximum persisting 12-hr 1000-mb dew point considering one-half the increase (decrease) in precipitable water for the difference in elevation greater than  $\pm 1000$  ft from the storm/barrier elevation, and

$W_{P_{\max, TL, TE}}$  = precipitable water associated with the maximum persisting 12-hr 1000-mb dew point above the transposed/barrier elevation.

The adjustment is limited to a maximum increase of 20 percent. The decrease is considered to be unlimited.



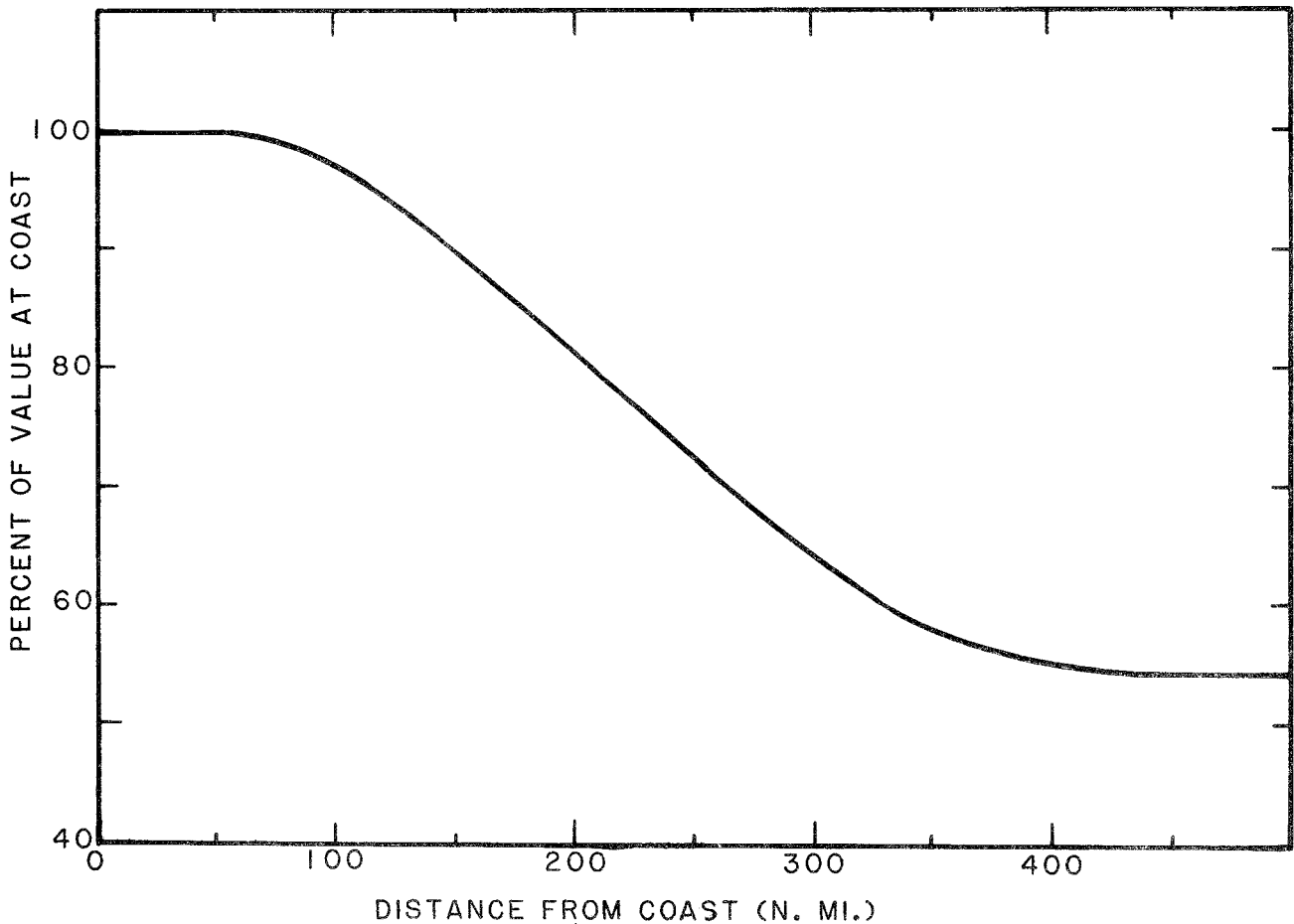

Figure 8.6.--Distance-from-coast adjustment for tropical storms (Schreiner and Riedel 1978).

#### 8.4.3 Distance-From-Coast Adjustment for Tropical Storms

Tropical storms are generated and sustained over warm tropical waters. As the storm moves over land, it begins to weaken and generally becomes less efficient in producing precipitation. This effect has been discussed in HMR No. 51 (Schreiner and Riedel 1978) and the relation developed there has been used in this study (fig. 8.6).

#### 8.4.4 Total Transposition Adjustment

The total adjustment for the transposition of the convergence component of storms used in this study was a combination of the adjustments discussed in sections 8.4.1 and 8.4.2. Mathematically, the total adjustment can be expressed as follows:

$$\text{For FAFP, } R_T = R_{IP} \cdot R_{HT} \cdot R_{VT} \quad (8-4)$$

$$R_T = \left( \frac{W_{P \text{ max, SL, SE}}}{W_{P \text{ storm, SL, SE}}} \right) \left( \frac{W_{P \text{ max, TL, SE}}}{W_{P \text{ max, SL, SE}}} \right) \left[ 0.5 + 0.5 \left( \frac{W_{P \text{ max, TL, TE}}}{W_{P \text{ max, TL, (SE } \pm 1, 000)}} \right) \right] \quad (8-5)$$

The distance-from-coast adjustment (sec. 8.4.3) from figure 8.6 is combined with the adjustment of equation 8-5, where applicable.

## 8.5 FAFP Map

The 24-hr 10-mi<sup>2</sup> FAFP values for all critical storms were moisture maximized (sec. 8.4.1) and transposed (sec. 8.4.2) to all grid points (sec. 8.3) within their limits of transposition (sec. 8.2). It was possible to transpose the FAFP values for several storms to each grid point. The maximum and near-maximum values were plotted at each point. Isohyets were drawn through the CD-103 region enveloping these moisture maximized values.

The isohyetal analysis showed generally a north-south orientation with the values decreasing toward the west. This decrease, in general, was similar to the geographic variation in the maximum persisting 12-hr 1000-mb dew points. An additional factor was the decrease in FAFP reflecting a decrease in moisture with increasing elevation. This latter effect was primarily a factor in determining variations of FAFP over limited geographic regions of individual mountain ranges. In a few cases, notably along the Continental Divide in Colorado, and the Wind River Range in Wyoming, moisture maximized transposed values were undercut by small amounts, less than 10 percent, to maintain smooth isohyets with consistent gradients. The final 24-hr 10-mi<sup>2</sup> FAFP map for Colorado is shown in figure 8.7.

## 9. OTHER FACTORS

### 9.1 Introduction

In this section the development of the the orographic component of PMP for the study region is discussed. In such a rugged and complex terrain, as occurs in this region, it is expected that orographic effects will be large and that the orographic component will be a significant proportion of the total PMP. The methods followed to obtain an orographic intensification factor have some similarity to those used in other studies of PMP for the western United States (U.S. Weather Bureau 1966, Hansen et al. 1977), but for the most part it is the new aspects of consideration that are of interest in this study. One of these new considerations is a storm intensification factor that varies with duration and interacts with the orographic factor. Another consideration is the relation developed to explain how the orographic and storm intensification factors are combined with the convergence component in computing total PMP.

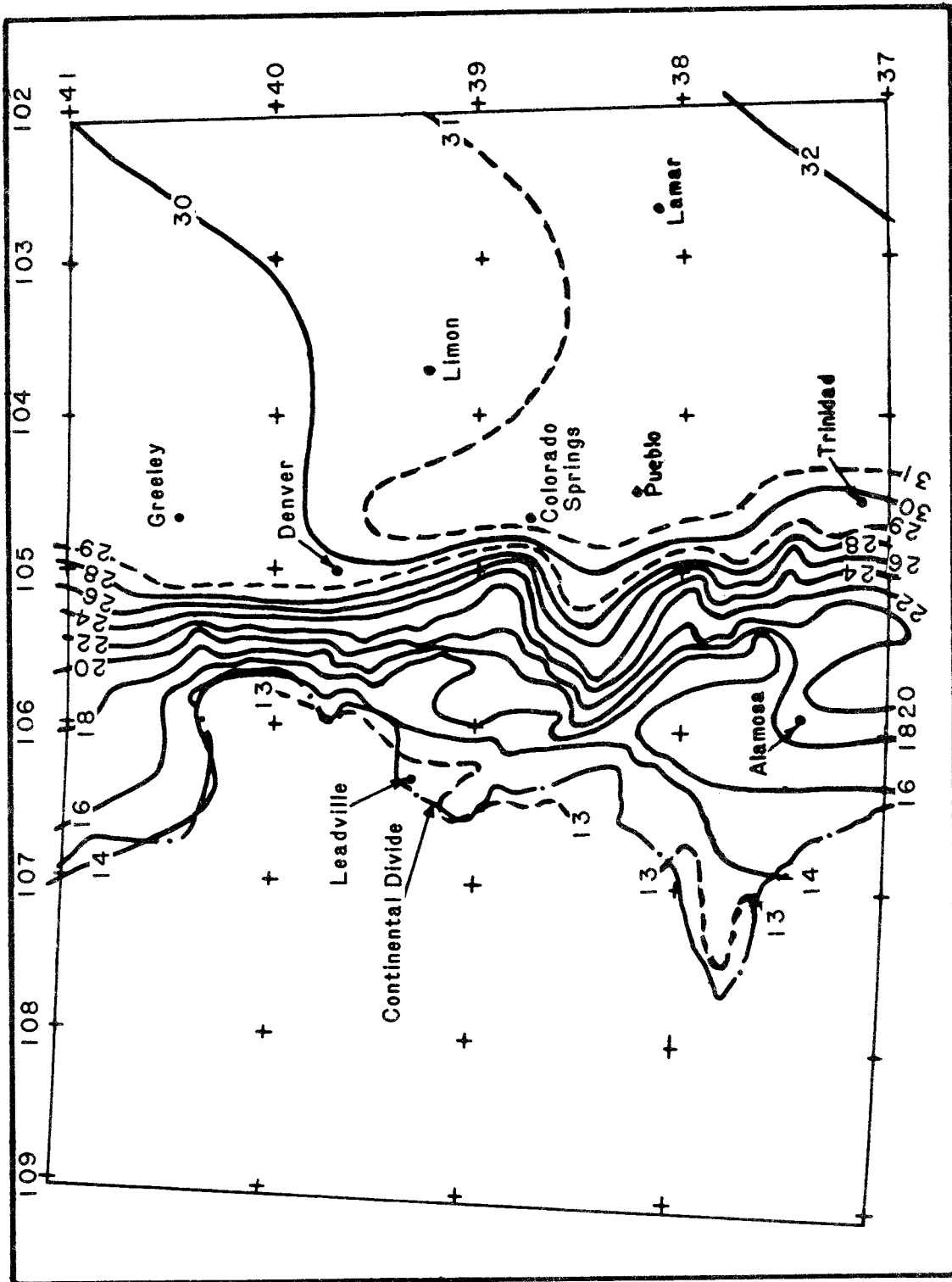

Figure 8.7.—FAFP (in.) map for Colorado (10 mi<sup>2</sup> 24 hr).

## 9.2 Orographic Factor, T/C

In HMR No. 49 (Hansen et al. 1977), the first approximation analysis of the orographic component to PMP was based on 100-yr 24-hr precipitation. A similar concept using a slightly different procedure was adopted for this study. Maps of 100-yr 24-hr precipitation (Miller et al. 1973) for the individual western states were used to form a ratio of total 100-yr to convergence component 100-yr rainfall, T/C, and it was assumed that this ratio is related to a ratio of similar parameters for PMP. The ratio of T/C for the 100-yr 24-hr rainfall can be used as a representative index of the orographic effects for the present study. One of the reasons for adapting this index is the degree of detail available in the 100-yr analyses. In hydrometeorological studies by the National Weather Service it has always been assumed that the level of detail in the PMP analysis is somewhat less than that for the 100-yr precipitation. If PMP is to have any detail in orographic regions, the 100-yr analysis must be sufficiently detailed.

The availability of the 100-yr 24-hr maps provides only part of the needed ratio, the total rainfall or numerator in the fraction, and it remains to determine how to obtain the convergence component, C. The rationale followed was that isopleths of the convergence component would exhibit a smooth, gradually varying geographic pattern. The gradients and general geographic variation would be somewhat similar to the FAFP component discussed in chapter 8. In part, support for this conclusion is found in the similarity of smooth PMP lines given for the United States east of the 105th Meridian (Schreiner and Riedel 1978), assumed to be convergence only PMP, and the smooth 100-yr 24-hr isopluvials of the "Rainfall Frequency Atlas of the United States" (Hershfield 1961), which are also assumed to be convergence only.

In the CD-103 region, it was proposed to look at the 100-yr precipitation analyses for the pertinent states with the intent of locating zones of least orographic effect, i.e., the least complex terrain. The approach followed was to assume that the 100-yr precipitation in these least-orographic zones was 100 percent convergence precipitation as in the Great Plains. These zones would then be tied together in some form of smooth analysis. It should be recognized that implicit in this approach is the fact that it did not allow for any consideration of negative orographic effects, zones where the convergence component was less than 100 percent. It was believed that any negative orographic effects would be small and have no significant affect on the study.

By isolating locations in which the convergence component was 100 percent of the 100-yr precipitation, it was possible to sketch a rough pattern of smooth contours through a major portion of the western United States that suggested how the analysis should appear. It was evident that the gradient of convergence 100-yr precipitation obtained by this method changed significantly for values less than 2.4 in. As a result, a relatively flat gradient (for isohyets <2.4 in.) was drawn over the intermountain region with an intense gradient from roughly the Continental Divide eastward to the western Plains. Figure 9.1 provides a schematic example of the final 100-yr convergence component analysis for New Mexico.

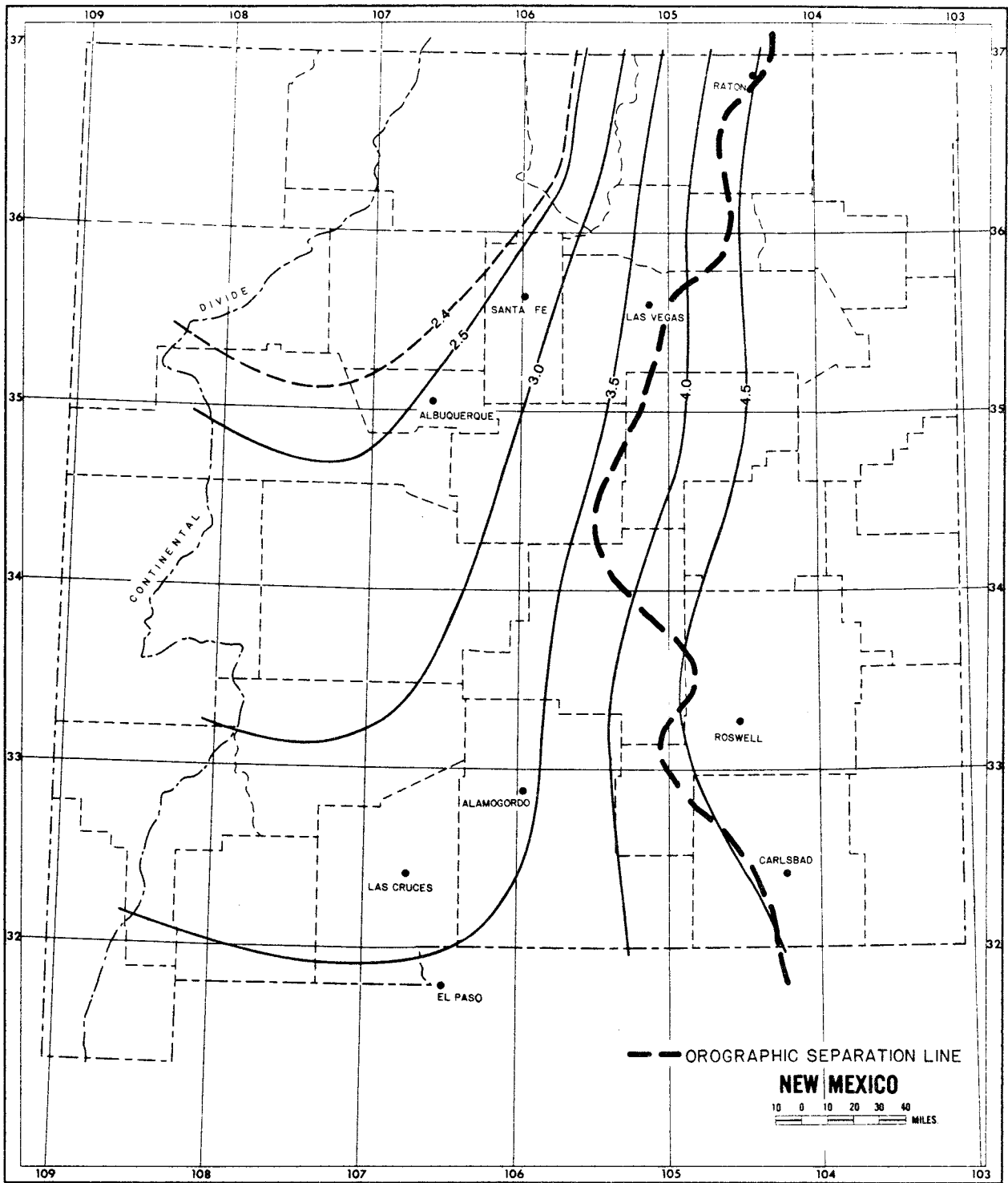

Figure 9.1.--Convergence 100-yr 24-hr rainfall (in.) for New Mexico between the Continental Divide and the orographic separation line.

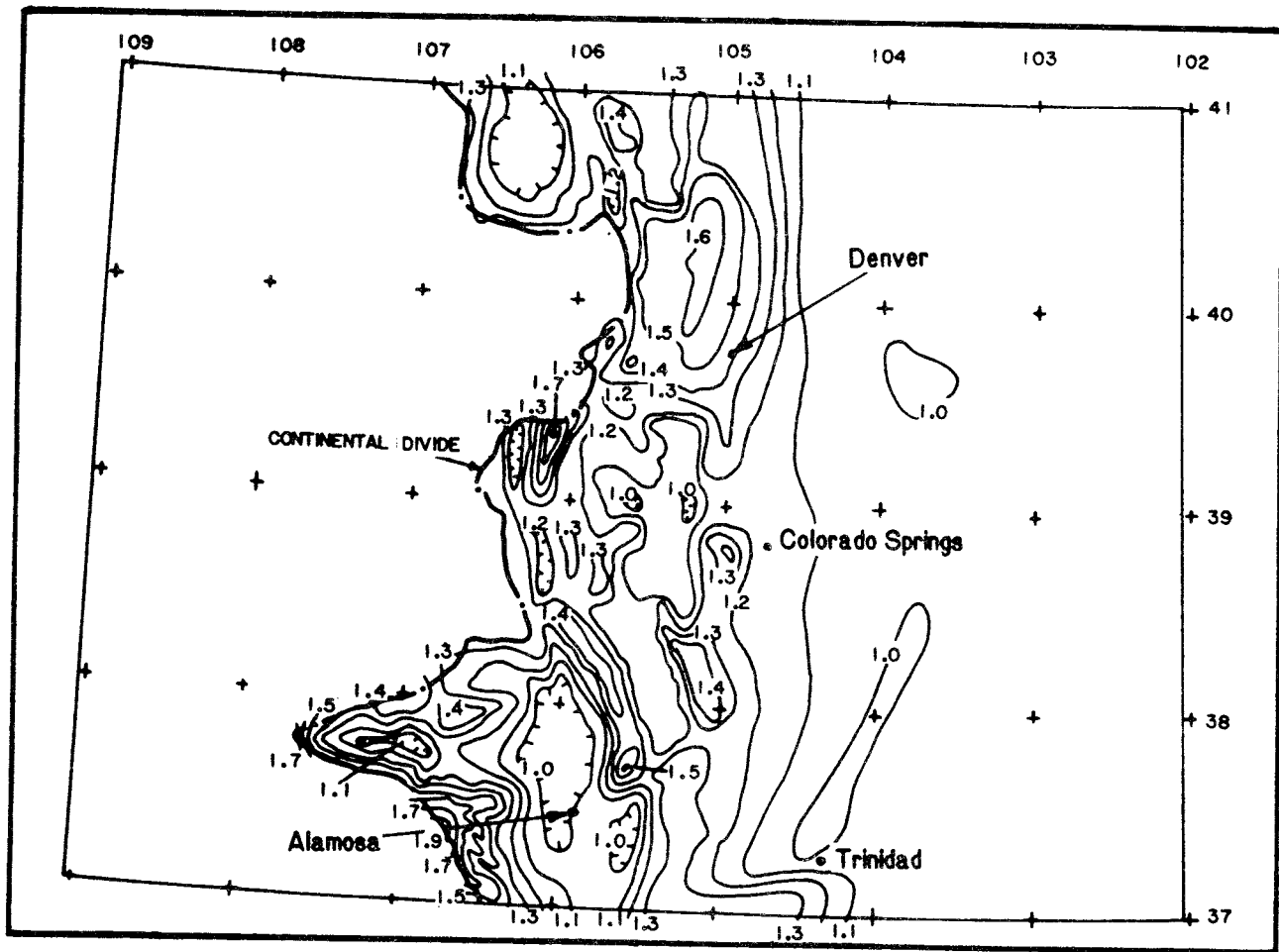

Figure 9.2.--T/C analysis for a portion of Colorado (10 mi<sup>2</sup> 24 hr).

Although the evaluation of 100-yr convergence precipitation in figure 9.1 was done independently for the CD-103 study, a check was made against the working papers used in developing HMR No. 49, and it was found that with only minor adjustments to the analysis the patterns in the two studies would be compatible. The significance of this realization lies in the fact that although derived somewhat differently, the results lead to a comparable and consistent result. This tends to give confidence that the rationale proposed in HMR No. 49 and followed in this study can be applied over a broader region, and may have some universal applications, provided suitable 100-yr analyses are available.

Having obtained an analysis for the convergence component of the 100-yr precipitation, it was a relatively simple task to determine 100-yr values for T/C for as many points as believed necessary to establish the pattern for an analysis of these ratios. The analysis closely resembled the basic 100-yr 24-hr analyses and the ratio analysis was made simple by overlaying grid values on the original 100-yr maps, for guidance. The resulting ratio analyses are slightly smoothed by this process from the original level of 100-yr detail. Figure 9.2 shows a portion of the T/C analysis for Colorado as an example of results obtained by this procedure. In general, it was found that the orographic separation line defined in chapter 3 was in approximate agreement with the 1.1 ratio line on the

T/C analyses. This result was interpreted as providing independent support for the choice made in positioning this line. Ideally, it is expected that to the east of this separation line there would be little or no orographic influence, but practically, it can be expected that small effects (less than 10 percent) that are found in the T/C analysis are realistic in the rolling terrain of the eastern portion of the study region and acceptable in this study. The T/C map for extreme western Texas was developed by extrapolating relations from southern New Mexico, since this region is not covered by NOAA Atlas 2 (Miller et al. 1973).

### 9.3 Storm Intensity Factor, M

In initial application of the orographic factor to the convergence PMP represented by the FAFP, 24-hr 10-mi<sup>2</sup> PMP values in excess of 50 in. were estimated in parts of Wyoming and Montana. Analysis of the PMP values computed for a grid of points placed some local isopleth centers on lee slopes. These results implied a regionally varying adjustment was needed. This adjustment to T/C was resolved through consideration of the variation of dynamic forces within major storms as they apply throughout the region. The adjustment was termed the storm intensity factor, M, since it related the amount of precipitation that could be expected during the most intense precipitation period (within the duration under consideration) to the total amount of precipitation for that duration. This factor, thus, would vary with storm type.

In this study, the 24-hr period was selected as the base duration for determining PMP. It was necessary to determine the appropriate interval for the most intense period of this duration. The examination of major storms in this region indicates 6 hr was the appropriate shorter duration. The storm intensity factor was then defined as the ratio of rainfall in the maximum 6-hr period of the storm to the rainfall in the basic 24-hr period. M should be determined by dividing the FAFP for 6 hr by the FAFP for 24 hr. M was obtained by using total storm precipitation. This approximation assumes the FAFP component of the 6- and 24-hr amounts for 10 mi<sup>2</sup> are the same percentage of the total precipitation for those durations and area sizes. For these durations in this region, this is an acceptable approximation.

Major storms throughout the region were considered for guidance in determining the magnitude and distribution of this ratio. The most important storms gave the ratios shown in table 9.1. From these and other storm considerations, guidelines were established that permitted maps of M to be drawn for the region. One such guideline was that M was about 40 percent along the Continental Divide in Montana, Wyoming, and Colorado, increasing to about 50 percent along the Divide in New Mexico. This reflects the lower overall elevations along the Divide to the south, and the fact that more convective rain events are likely at these elevations in New Mexico, than in the north. Along the nonorographic zone at the eastern limit of the study region, the record of observed precipitation data suggested an M of 80-90 percent. A third major guideline was related to the gradient of maximum available moisture. Within the constraints just mentioned, the geographic variation of M was to be similar to the maximum persisting 12-hr 1000-mb dew points. Another guideline was based on the premise that longer duration rather than shorter duration precipitation is enhanced in those places of relatively high elevation or where a relatively strong elevation gradient occurs. In such places, the local modification acts to diminish the broadscale M. The opposite is assumed for places of low elevation and/or small elevation gradient. This interaction can also be thought of as an inverse relation between the probability that a dominating convective event occurs and

**Table 9.1.--Ratios of 6-/24-hr precipitation for major storms used as guidance for M analysis**

Storm Identification No.	Storm	Date	6-/24-hr ratio
75	Gibson Dam, MT	6/6-8/64	.40
47	Cherry Creek, CO	5/30-31/35	.93
101	Hale, CO	5/30-31/35	.74
112	Vic Pierce, TX	6/26-28/54	.60

the degree of orographic influence in the 100-yr frequency precipitation analyses. That is, when a 6-hr convective event dominates the total precipitation amount (high 6-/24-hr ratio), the orographic influence is most likely weak. Figure 9.3 is an example of the M analysis for Montana. This figure shows the analysis to be relatively smooth as expected when considering the availability of major storm data and knowledge of storm dynamics.

#### 9.4 Computational Equation for Total PMP

The combining of the results of FAFP, T/C, and M was done through an empirical relation rooted in the assumption that total PMP was the product of the convergence component PMP and an orographic influence parameter, K:

$$\text{PMP} = (\text{FAFP}) (K) \quad (9-1)$$

where K is a function of the orographic factor, T/C, and FAFP is the free atmospheric forced precipitation (sec. 7.2). The convergence component of PMP is represented as the sum of two parts representing the core, A (the maximum 6-hr amount) and B (the remaining 18-hr period), so that:

$$\text{PMP} = AK_1 + BK_2 \quad (9-2)$$

where A = (FAFP) (M)

B = (FAFP) (1-M)

$K_1$  = orographic factor during most intense 6-hr increment of 24-hr period

$K_2$  = orographic factor during remaining 18-hr of 24-hr period

Assuming  $K_2$  to be equal to the T/C developed from the 100-yr 24-hr precipitation frequency values (sec. 9.2),  $K_1$  can be represented by:

$$K_1 = 1 + P (T/C - 1) \text{ where } 0 \leq P \leq 1 \quad (9-3)$$

Equation 9-2 can then be rewritten as:

$$\text{PMP} = (\text{FAFP}) \{ M [1 + P (T/C - 1)] \} + (\text{FAFP})(1 - M) (T/C) \quad (9-4)$$



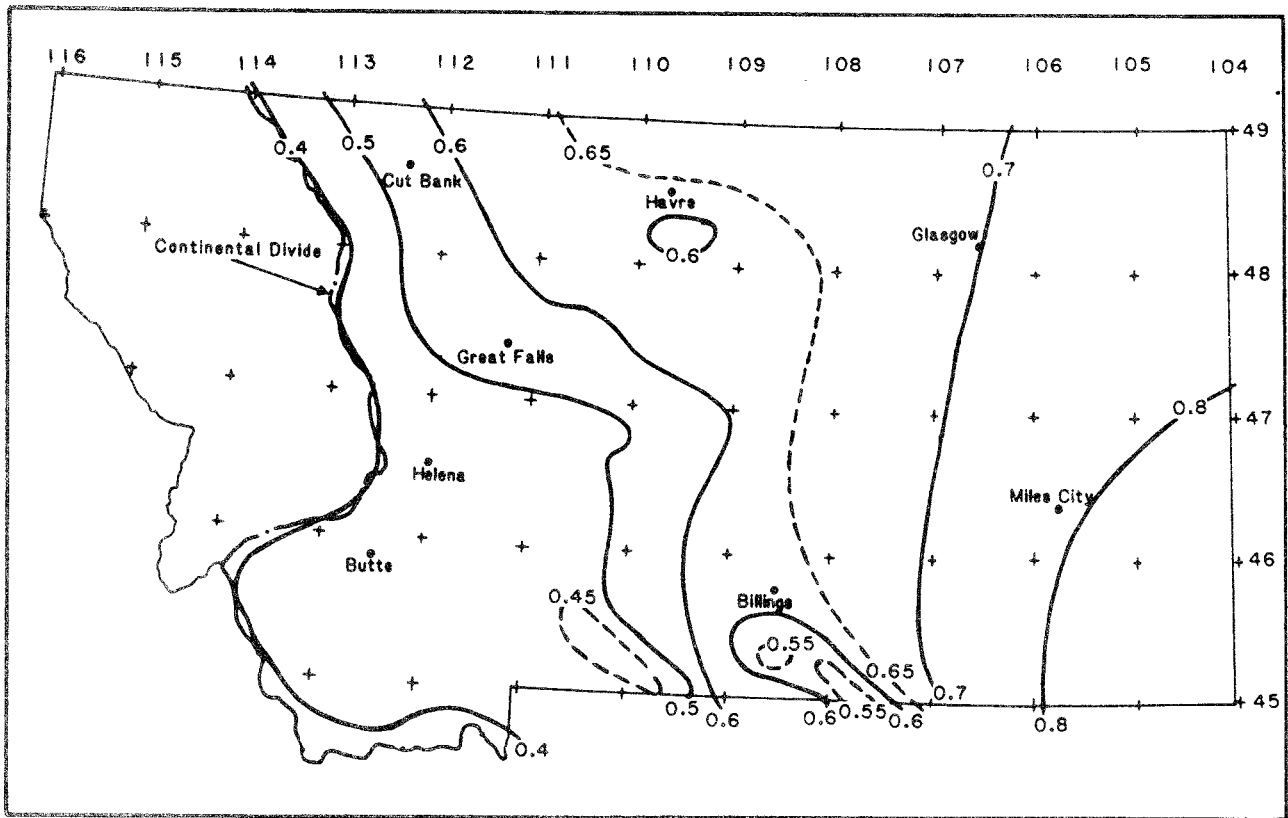

Figure 9.3.—M factor analysis for Montana ( $10 \text{ mi}^2 \text{ 24 hr}$ ).

To evaluate equation 9-4, a method for determining P must be developed. The value of P determines the percentage of T/C that is applied to the most intense or core portion of the 24-hr FAFP. It seemed reasonable for P to vary across the region, being most important in regions of strong orographic controls and least important in the Plains regions. This variation is in the opposite sense to the variation of M. Thus, a simple approximation was adopted:

$$P = 1 - M \quad (9-5)$$

Substituting equation 9-5 into equation 9-4 yields:

$$\text{PMP} = (\text{FAFP})[M^2 (1 - T/C) + T/C] \quad (9-6)$$

where the expression in brackets represents the orographic influence parameter, K, in equation 9-1. It can be seen from equation 9-6 that as M and T/C increase, K increases; however, as shown in table 9.2, K increases faster at lower M than at higher M. Computations of PMP using equations 9-4 and 9-6 show that estimates of PMP are not sensitive to errors introduced by using the approximation of equation 9-5, when typical values of FAFP and T/C are used.

From equation 9-6, the effect of the orographic intensification factor decreases as the storm becomes more convective. In regions where more generally uniform rainfall prevails (smaller M), such as is characteristic of steep mountain slopes, T/C becomes increasingly important. Equation 9-6 has been used to compute total PMP for  $10 \text{ mi}^2$  and the 24-hr duration in this study.

Table 9.2.—Values of orographic influence parameter, K, relative to variations in M and T/C

M	T/C													
	1.0	1.1	1.2	1.3	1.4	1.5	1.6	1.7	1.8	1.9	2.0	2.1	2.2	2.3
.400	1.0	1.084	1.168	1.252	1.336	1.420	1.504	1.588	1.672	1.756	1.840	1.924	2.008	2.092
.425	1.0	1.082	1.164	1.246	1.328	1.410	1.492	1.574	1.656	1.737	1.819	1.901	1.983	2.065
.450	1.0	1.080	1.160	1.239	1.319	1.399	1.479	1.558	1.638	1.718	1.798	1.877	1.957	2.037
.475	1.0	1.077	1.155	1.232	1.310	1.387	1.465	1.542	1.620	1.697	1.774	1.852	1.929	2.007
.500	1.0	1.075	1.150	1.225	1.300	1.375	1.450	1.525	1.600	1.675	1.750	1.825	1.900	1.975
.525	1.0	1.072	1.145	1.217	1.290	1.362	1.435	1.507	1.580	1.652	1.724	1.797	1.869	1.942
.550	1.0	1.070	1.140	1.209	1.279	1.349	1.419	1.488	1.558	1.628	1.698	1.767	1.837	1.907
.575	1.0	1.067	1.134	1.201	1.268	1.335	1.402	1.469	1.536	1.602	1.669	1.736	1.803	1.870
.600	1.0	1.064	1.128	1.192	1.256	1.320	1.384	1.448	1.512	1.576	1.640	1.704	1.768	1.832
.625	1.0	1.061	1.122	1.183	1.244	1.305	1.366	1.427	1.488	1.548	1.609	1.670	1.731	1.792
.650	1.0	1.058	1.116	1.173	1.231	1.289	1.347	1.404	1.462	1.520	1.578	1.635	1.693	1.751
.675	1.0	1.054	1.109	1.163	1.218	1.272	1.327	1.381	1.436	1.490	1.544	1.599	1.653	1.708
.700	1.0	1.051	1.102	1.153	1.204	1.255	1.306	1.357	1.408	1.459	1.510	1.561	1.612	1.663
.725	1.0	1.047	1.095	1.142	1.190	1.237	1.285	1.332	1.380	1.427	1.474	1.522	1.569	1.617
.750	1.0	1.044	1.088	1.131	1.175	1.219	1.263	1.306	1.350	1.394	1.438	1.481	1.525	1.569
.775	1.0	1.040	1.080	1.120	1.160	1.200	1.240	1.280	1.320	1.359	1.399	1.439	1.479	1.519
.800	1.0	1.036	1.072	1.108	1.144	1.180	1.216	1.252	1.288	1.324	1.360	1.396	1.432	1.468
.825	1.0	1.032	1.064	1.096	1.128	1.160	1.192	1.224	1.256	1.287	1.319	1.351	1.383	1.415
.850	1.0	1.028	1.056	1.083	1.111	1.139	1.167	1.194	1.222	1.250	1.278	1.305	1.333	1.361
.875	1.0	1.023	1.047	1.070	1.094	1.117	1.141	1.164	1.188	1.211	1.234	1.258	1.281	1.305
.900	1.0	1.019	1.038	1.057	1.076	1.095	1.114	1.133	1.152	1.171	1.190	1.209	1.228	1.247

## 10. GENERALIZED 1-, 6-, 24-, AND 72-HR PMP MAPS

The general storm 24-hr 10-mi<sup>2</sup> PMP is developed from procedures discussed in the preceding chapters. The FAFP values (sec. 8.5) were adjusted for topographic effects by use of the orographic factor (T/C) (sec. 9.2) and the storm intensity factor (M) (sec. 9.3) in the computational equation developed in section 9.4. The 10-mi<sup>2</sup> general-storm PMP for the 6- and 72-hr durations were developed by applying durational ratios to the basic 24-hr PMP map. The 1-hr general-storm PMP map was developed using a 1-/6-hr ratio and the 6-hr PMP map. The development and analysis of these index maps is discussed in this chapter.

### 10.1 Duration Ratio Maps

Duration ratio maps were developed for 6-/24-, 72-/24-, and 1-/6-hr. The basic data used for these maps were:

1. Within-storm ratios for storms in the list of important storms (table 2.2).
2. Ratios computed for 100-yr return period amounts determined from NOAA Atlas 2 (Miller et al. 1973), Weather Bureau Technical Papers No. 40 (Hershfield 1961) or No. 49 (Miller 1964), or NOAA Technical Memorandum NWS HYDRO 35 (Frederick et al. 1977).
3. Ratios determined from maximum values of record for each duration for recording gage stations within the region.
4. Ratios based on PMP estimates for each duration from HMR No. 51 (Schreiner and Riedel 1978), HMR No. 52 (Hansen et al. 1982), HMR No. 49 (Hansen et al. 1977), and HMR No. 43 (U.S. Weather Bureau 1961).
5. Ratios between controlling storm values for each duration.

With these values available, analyses were prepared for each of the required ratios.

#### 10.1.1 6-/24-hr Ratio Map

The first analysis was for the 6-/24-hr ratio. It was necessary to distinguish between the various data used to develop the analysis. Ratios based on 100-yr 24-hr amounts and on maximum-of-record amounts tend to be "among storm" values, i.e., different storms or storm types may control the 6- and 24-hr values. Other values, e.g., those from a major storm of record, are "within storm" ratios. The appropriate value to be used in the analysis must be based on the consideration of whether 6- and 24-hr PMP amounts would come from the same or different storms. Tests conducted during preparation of HMR No. 51 showed that for the region covered by that study, the PMP for all durations for a specified area size could come from the same storm. In this respect, interduration ratios from HMR No. 51 can be considered within-storm ratios. In this region, as in HMR No. 51, the premise was accepted that for a given area size, amounts for all durations between 1 and 72 hr can come from the same storm. Along the 103rd meridian, all within storm depth-duration ratios from extreme storm data agreed

well with the ratios from HMR No. 51. This was to be expected, since the same storm types are controlling for all the various indices used in the study region and for HMR No. 51. At the western edge of the study region, there were some differences between ratios from HMR No. 43 and No. 49 and those within the CD-103 region, since there are greater differences in storm types east and west of the Continental Divide. In the CD-103 region, there appears to be more convective activity than west of the Continental Divide. This is particularly true northward from approximately 41°N. A primary criterion followed in the analysis of the 6-/24-hr ratio map, as well as the 72-/24- and 1-/6-hr ratio maps, was to maintain relatively smooth, linear gradients. Any change in the isoline gradient would have to be related to identifiable major topographic features. Another criterion developed from examination of the rainfall indices was that the lowest 6-/24-hr ratios were associated with the regions of steepest slopes. This is meteorologically reasonable since it is within these regions that the increased orographic effect would most tend to increase rainfall amounts beyond the maximum 6 hr.

HMR No. 55A further increased the rate at which the 6-/24-hr ratios decreased with increasing elevation. Where HMR No. 55 had shown only minor or little variation in ratios with elevation based on reasoning that increased convective potential at higher elevations compensated for moisture decrease, we now believe convective potential is much less significant at higher elevations in general storms. This has led us to reduce 6-/24-hr ratios on the order of 20 percent at the highest ridgelines. Somewhat similar gradients of ratios with elevation are found in the 6-/24-hr ratios along some of the west-facing slopes in HMR No. 43, a region that is also highly orographic in which overall convection is a minimum.

There is a tendency for the 6-/24-hr ratio to decrease from the southern portion of the study region northward toward Canada. While this overall general trend is present, there were local maxima where, for some distance, the opposite relation could be found.

#### 10.1.2 1-/6-hr Ratio Map

The second map analyzed was for the 1-/6-hr ratio. Although the same data sources were used to develop all three ratio maps, little data were available for the 1-hr duration for the major observed storms within the region. As a first approximation, it was decided to use the pattern of the 6-/24-hr ratio. Most of the same considerations appropriate to the 6-/24-hr ratio map are appropriate for this ratio. An important additional consideration is the reduction in orographic controls. As the duration decreases, the effect of orography on extreme events tends to diminish. Thus, the 1-/6-hr ratio map (not shown) shows a lesser amount of variation than the corresponding 6-/24-hr ratio map. Since the 1-/6-hr ratios are controlled primarily by the dynamic atmospheric forces, the decrease in ratios across the OSL are less than for the 6-/24-hr ratio.

As in the 6-/24-hr ratio discussion, the 1-/6-hr ratios were also adjusted in HMR No. 55A. These ratios do not show much fall-off with elevation, as was also the case in HMR No. 55. In developing these ratios, consideration was given near the Continental Divide to 1- to 6-hr ratios in HMR's 43 and 49. Even with consideration of the ratios west of the Continental Divide, substantial general storm differences exist across the Divide. See discussion in section 13.6 to understand the consequences of these differences.

### 10.1.3 72-/24-hr Ratio Map

In developing the final ratio map for the 72-/24-hr duration, as with the 1-/6-hr ratio map, the 6-/24-hr ratio map was used as a first approximation to the isopleth pattern. However, in this case, the minima (maxima) in the 6-/24-hr ratio analysis became maxima (minima) in the 72-/24-hr ratio analysis (not shown). Also as a converse to the relation between topography and 1-hr amounts, the 72-hr values are more closely related to topographic variables than the 24-hr values. Therefore, somewhat greater variation in values can be expected on this ratio map. With these criteria and also using criteria similar to that discussed in relation to the 6-/24-hr ratio analysis, isolines were drawn for the data.

### 10.2 Computer Computation of Index PMP Maps

To develop a 24-hr 10-mi<sup>2</sup> PMP estimate, it was necessary to combine the values for the 3 parameters, FAFP (chapt. 7 and sec. 8.5), T/C (sec. 9.2) and M (sec. 9.3) through use of equation 9-6 (sec. 9.4):

$$\text{PMP} = \text{FAFP} [M^2(1 - T/C) + T/C] \quad (9-6)$$

Computer facilities at the Bureau of Reclamation (USBR), Denver, were employed to rapidly and accurately process these data. Adequate delineation of the geographic variation of PMP required use of a dense grid over the CD-103 region. This was done by digitizing each of the individual parameter maps over the study region. Values from the maps were read into the computer by digitizing points along each isoline, interpolating to a rectilinear grid that approximated 17 by 18 units per geographic degree and then storing the interpolated values. Values were interpolated from these maps by use of the following equation:

$$G = \frac{\left( \sum_{i=1}^n \frac{X_i}{d_i^P} \right)}{\left( \sum_{i=1}^n \frac{1}{d_i^P} \right)} \quad (10-1)$$

where:

- G = grid value;
- X<sub>i</sub> = i-th digitized value;
- d<sub>i</sub> = distance from grid point to location of i-th digitized value;
- P = selected power (weighting factor); and
- n = number of digitized points within specified area around grid point [specified area is defined in terms of number of grid units on each side (horizontal) or top and bottom (vertical) of the grid point in question].

In order to obtain the best set of representative grid-point values for each of the parameter maps, it was necessary to make several adjustments to the number of isolines on the basic maps or to the size area which was searched for isolines to use in equation 9-6 for regions where sharp changes in gradients occurred or where gradients were so lax that suitable digitizing points were not available to accurately define a grid-point value. First, additional isolines were drawn on the base maps such as those of figures 8.7, 9.2 and 9.3. This step added the

required definition for determination of a grid value where a rather lax gradient existed. Second, changes to the specified area (range in space that was searched for digitized points in order to compute an individual grid value), as well as to the power factor P, were allowed in order to better calculate grid values in regions of steep or varying changes in map parameter isolines.

The specified area and power factor used for determining grid-point values for any particular analyzed map were typically represented as:

(4 X 4, 3.0)

where: 4 = Represents the number of horizontal, east-west, units searched;

4 = Represents the number of vertical, north-south, units searched;  
and

3.0 = Selected power factor.

A graphical representation of the above code is shown as:

Hatched area is  
the area where  
digitized points  
are used to  
calculate grid  
points in question

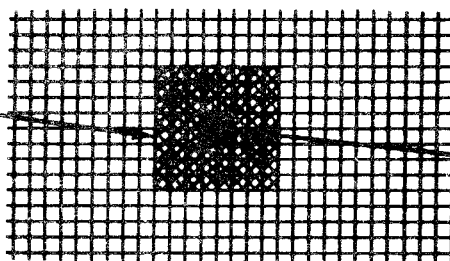

Grid lines

Grid point  
being  
calculated

Because of the numerous regions where steep changes in gradient, or centers of maxima/minima occurred on the T/C analysis, the grid spacing and power factor (weighting) used to determine a grid-point value were (1 X 1, 5.0). For all other parameter maps a criteria of (4 X 4, 3.0) was set.

Maps (referred to as number plots or numplots) that indicated gridded values of the three parameters, and various ratio maps, were prepared for each state. Another set of numplots was computed which combined the gridded data from the map representing each parameter in equation 9-6 to produce PMP values for 24 hr 10 mi<sup>2</sup>. Finally, a machine analysis based on a linear interpolation of the 24-hr 10-mi<sup>2</sup> PMP grid-point data was prepared.

After the 24-hr 10-mi<sup>2</sup> maps were completed the 6-/24- and 72-/24-hr ratio maps, which had been digitized in a similar manner, were used to make the 6- and 72-hr 10-mi<sup>2</sup> PMP maps. In the development of these maps, the grid spacing and power factor (weighting) used were (4 X 4, 3.0). Numplots and machine analyses were made for the 6- and 72-hr 10-mi<sup>2</sup> PMP maps.

The 6-hr map and the 1-/6-hr ratio maps were used to develop the 1-hr 10-mi<sup>2</sup> PMP map. The procedure used and the types of products produced were the same as for the 6- and 72-hr maps.

### 10.3 Final Analysis of the 10-mi<sup>2</sup> General-Storm PMP Maps

The USBR machine analyses provided the basis for preparation of the final PMP maps. Each map was carefully reviewed and some changes were made. These changes were primarily to reflect topographic features, which in the judgment of the analysts were not adequately reflected in the machine analysis. In addition, the computer digitization, grid-point interpolation, and machine analysis procedures resulted in slightly irregular, "wavy" lines, particularly over the eastern plains portion of the study region. Although these could have been eliminated by a filter in the analysis program, it was decided to remove these by subjective smoothing during the review phase.

#### 10.3.1 24-hr 10-mi<sup>2</sup> PMP Map

The 24-hr 10-mi<sup>2</sup> PMP is basic to all PMP estimates of this report. This duration was selected since more data are available for this duration than for shorter periods and use of amounts for this duration would minimize extrapolation to other durations. The initial estimates were made for the 10-mi<sup>2</sup> area because of the relative ease of relating differences in orographic effects between location. When considering larger area sizes, e.g., 1,000 mi<sup>2</sup>, the shape and orientation of the 1,000-mi<sup>2</sup> area centered at a location could have a significant impact on the magnitude of the orographic effect.

The initial review of the computer analyzed 24-hr 10-mi<sup>2</sup> PMP map focused on the relative magnitude of the isohyetal centers on the more exposed slopes. Among the steepest slopes are those just northwest of Denver, from around Boulder northward to about Loveland. This is the approximate region of the Big Thompson storm (81) of July 31 - August 1, 1976. Other slopes nearly as steep occur west of Canon City, CO, southwest of Raton, NM, in the Big Horn and Wind River Ranges of Wyoming, and along the first upslopes of the Absaroka and Flathead Ranges in Montana.

The values shown on the 24-hr 10-mi<sup>2</sup> map at these locations were considered to be of the appropriate order of magnitude except near Boulder, CO. At this location, a small 37-in. center was present. Examination of the numplots showed only two grid points with values slightly in excess of 37 in. In this instance, as in other locations, centers supported by three or fewer grid-point amounts less than 0.5 in. larger than surrounding amounts were eliminated. Another modification in this region involved the 34-in. isohyet. The machine analysis showed this isohyet as discontinuous along the beginnings of the first upslopes. After examination of the numplots for all the input parameters and considering the terrain features, it was decided to make the 34-in. isohyet continuous from south of Pueblo, CO to about Fort Collins.

The only other region where significant changes from the computer-analyzed 24-hr 10-mi<sup>2</sup> PMP map were made was the Rio Grande Valley north of El Paso, TX. Considering the lower magnitude of southerly moist air inflow winds discussed in "Probable Maximum Precipitation for the Upper Rio Grande Valley," (U.S. Weather Bureau 1967) and the effect of the Guadalupe and Sacramento Mountains on tropical storm circulations, it was decided to reduce values west of the limit of first upslopes by 10 percent. This required some subjective smoothing across the crest lines of the first upslopes.

The final 24-hr 10-mi<sup>2</sup> PMP estimates are shown as plate III at the end of this report. Relative maxima are found in western Texas, northern New Mexico, near Boulder, Colorado, and near some of the first upslopes in Wyoming and Montana. Centers near the Big Horn and Wind River Mountains are 11 percent lower than the maximum values in western Texas and near Boulder of 36 in. These ranges are directly exposed to moisture bearing winds from the Gulf of Mexico as the moist air turns and moves westward north of a Low centered in central or southern Wyoming. Since both ranges are equally exposed to moisture bearing winds, equal values for those centers were considered appropriate. A slightly lower value, 30 in., was accepted for the Black Hills in South Dakota, because the terrain effects would be lessened by the limited lateral extent of the mountains. Maximum values in Montana are highest in the Absaroka Range in the south central portion of the state and along the Flathead Mountains near the Continental Divide. Maximum values on the Bear Paw and Little and Big Belt Mountains are less because of their limited areal extent. The Gravelly and Meridian Ranges and the Pioneer Mountains are located west of the limit of first upslopes, and maximum amounts are less for similar slopes and elevations in this region than on the first upslope region.

At the 24-hr duration, almost all moisture-maximized storm data are enveloped when the limits to maximization are considered. Just east of the study area, the moisture-maximized value of Hale, CO (101) exceeds the PMP in HMR No. 51 by 8 percent. The Cherry Creek, CO storm (47) of May 30-31, 1935 is a very extreme storm with a moisture maximization factor limited to 150 percent (sec. 5.4). With this limitation the PMP analysis equals the limited moisture-maximized amount. PMP for this location is still 50 percent larger than the observed amount.

The degree of detail shown in the isohyetal map is considered appropriate for variation of an event of PMP magnitude. The maps show less attention to topographic variation than mean annual precipitation or rainfall-frequency analyses. It is considered appropriate that, as the magnitude of the precipitation event increases, the scale of the topographic feature that would affect the precipitation pattern would also increase.

### 10.3.2 6-hr 10-mi<sup>2</sup> PMP Map (Revised)

The 6-hr 10-mi<sup>2</sup> PMP map is shown on plate II. This map was developed by applying the values from the 6-/24-hr ratio map (sec. 10.1.1) to the final values from the 24-hr 10-mi<sup>2</sup> PMP map over a dense grid of points.

The broad maximum defined by the 25-in. isohyet at 6 hr in Colorado and New Mexico matches well with the broad 32-in. maximum shown at 24 hr even though the 36- and 34-in. maxima at 24 hr have no counterparts at 6 hr. The 6-hr 26-in. center in western Texas is consistent with location of the comparable 24-hr center. In general, the axis of the "ridge" of maximum values at 6 hr is slightly downslope of the axis on the 24-hr analysis. The centers on the Big Horn and Wind River Ranges are not equal, as they were at 24 hr. This is attributable to the somewhat greater convective character of the storms in the eastern portion of the study region. For the same reason, the values on the Black Hills in South Dakota are larger than those in the Wind River Range and the Big Horn Range. In Montana, the maximum precipitation centers show a further decrease from the 6-hr amounts in Wyoming and Colorado. The lower values here reflect the changing characteristics of major storms as the distance from the



moisture source increases and the orographic effects increase and the strong convective activity characteristic of the Great Plains decreases in importance. The relation between topographic features and the isohyetal pattern is less at the 6-hr duration than at the 24 hr, because the orographic effect is less pronounced when the most intense portion of the storm occurs (see discussion for M, sec. 9.3).

In central Colorado, the isohyetal analysis undercuts the moisture-maximized storm amount for the Cherry Creek storm (47). At this duration, the undercutting is 15 percent of the storm amount moisture maximized by the 150 percent limitation (see sec. 5.4). The observed amount is still enveloped by 28 percent. The Hale (101) and White Sands (82) moisture-maximized storms are undercut at 6 hr by 1 and 5 percent, respectively. The undercutting at White Sands was considered acceptable because of uncertainty in the proper 1- to 4-hr ratio and difficulty in assigning a moisture maximization factor to use for this storm.

Though specific tests similar to those done in HMR No. 51 have not been conducted, it is considered appropriate for the 6-hr general-storm amount to occur in the same storm as the 1-, 24-, and 72-hr amounts. The data shown in table 5.4 support this assumption, where data for eight storms provide the largest values for the various durations at any specific area size.

The maximum 6-hr value for small areas may not be the result of a general storm. At some locations, particularly in the orographic regions, for a PMP of less than 500 mi<sup>2</sup>, it will be necessary to compute values from both the local- and general-storm criteria. Hydrologic tests will be required to see which of the two results will be most critical for any particular application.

### 10.3.3 1-hr 10-mi<sup>2</sup> PMP Map (Revised)

The 1-hr 10-mi<sup>2</sup> general-storm PMP map (plate I) was developed in the same manner as the map for the 6-hr duration. The 1- to 6-hr ratio map (sec. 10.1.2) formed the initial guidance. In addition, 1- to 24-hr ratio maps were drawn to provide guidance here. The correspondence with the terrain features follows the trend established with the 6-hr PMP map. Maximum centers again tend to be displaced slightly downslope from those on the 6-hr map. The shift in axis is somewhat lessened since the orographic effect had already been considerably diminished at the 6-hr duration. The smallest 1-hr values occur within regions where there is the most sheltering from direct moisture inflow. What was said of the 6-hr 25-in. isohyet in section 10.3.2 may also be said of the 15-in. isohyet at 1 hr. There is no center at 1 hr in western Texas corresponding to the centers indicated at 6 and 24 hr even though this same area is encompassed by a broad precipitation ridge at 1 hr. Throughout the study region, many of the other closed isohyetal centers can still be identified, but where the value within the closed isohyet on the 6-hr PMP map is not greatly different than the surrounding values a closed center generally no longer exists on the 1-hr map. An example of this can be seen in the northern Flathead Mountains in the vicinity of Gibson Dam, MT. In this region, a closed 14-in. isohyet was present on the 6-hr map, while at 1 hr only the slight indication of a ridge of higher values can be detected.

Four critical storms occur at 1 hr that control the level of 1-hr 10-mi<sup>2</sup> general-storm PMP: Buffalo Gap (72), Virsylvia (35), White Sands (82) and Big Thompson (81). The first of these storms occurred about 6 mi north of the United

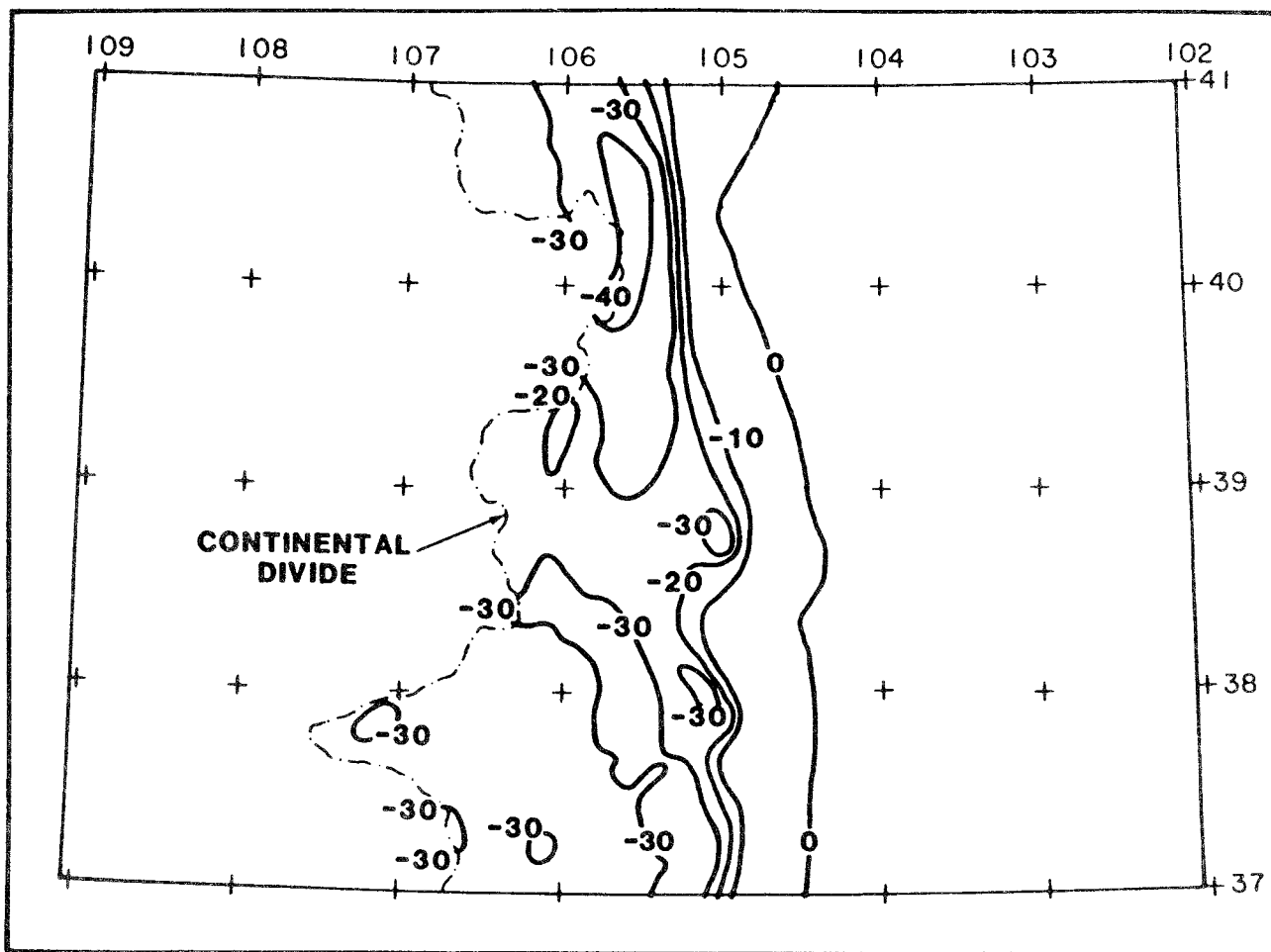

Figure 10.1.--Example of percentage change in 1-hr 10-mi<sup>2</sup> general-storm PMP index map for current study relative to that given in HMR No. 55 (1984), for Colorado. Considerable smoothing applied to example over detailed analysis.

States-Canada border. The observed 1-hr 10-mi<sup>2</sup> amount at Buffalo Gap of 7.0 in. was maximized in-place by 150 percent for moisture to obtain 10.5 in. The moisture-maximized value is enveloped by 6 percent in plate I. At the location of the Big Thompson storm, PMP from plate I envelops the 1-hr 10-mi<sup>2</sup> moisture-maximized value by 3 percent. Both the Virsylvania and White Sands moisture-maximized amounts are undercut in plate I by 8 percent. As noted for 6 hr, this degree of undercutting has been accepted since there is some uncertainty in the 1- to 4-hr ratios and the moisture maximization factor used to determine 1-hr values for these storms.

As with the 6-hr PMP estimates, the user needs to consider local-storm PMP values. The local-storm PMP estimates can be larger for small area sizes and may provide more critical hydrologic design criteria.

Figure 10.1 provides a representation (considerable smoothing applied) for Colorado of the percentage change resulting from the modifications made to the 1-hr 10-mi<sup>2</sup> general-storm PMP maps. Changes exceeding 40 percent are noted in the vicinity of the Continental Divide between 40 and 41°N latitude. In the

detailed maps, somewhat smaller centers of 40 percent change occur at other high elevation locations in the Sangre de Cristo Mountains in Colorado and in the Wind River and Big Horn Mountains in Wyoming (not shown). This figure also shows that significant changes (>10 percent) for the most part are limited to the orographic portion of the study region, and generally increase with increasing elevation.

#### 10.3.4 72-hr 10-mi<sup>2</sup> PMP Map

Plate IV provides the 72-hr 10-mi<sup>2</sup> general-storm PMP. These estimates were developed in the same manner as the 1- and 6-hr estimates. Values of the 72-/24-hr ratio (sec. 10.1.3) were determined for a dense grid (sec. 10.2) and applied to the 24-hr 10-mi<sup>2</sup> PMP estimates (sec. 10.3.1). A numplot and computer analysis were prepared as the initial step. The computer analysis formed the basis for the final 72-hr 10-mi<sup>2</sup> PMP map. The degree of correspondence between terrain features and the isohyets on the 72-hr map is somewhat greater than for the 24-hr map. This is to be expected since the terrain has a greater "fixing effect" on the lower intensities at the beginning and end of the storm than on the most intense 24-hr period. It also follows as a consequence of these considerations that the maximum centers on the 72-hr PMP map will tend to be displaced slightly upslope from those on the 24-hr map. The basic pattern on this map is similar to that shown on the 24-hr map. Increases over 24-hr amounts are greatest in the orographic regions.

### 11. DEPTH-AREA-DURATION RELATIONS

#### 11.1 Introduction

In HMR No. 51, maps were prepared for several durations and area sizes. From this set of maps depth-area-duration (DAD) curves can be drawn to provide results for other area sizes and durations. The approach taken in this study is to provide DAD relations that are to be used in conjunction with the 10-mi<sup>2</sup> index maps to obtain PMP for other durations and area sizes. The DAD relations developed were based on depth-area relations for critical storms in and near the CD-103 region. Also, it was believed the complexities of the terrain would make it very difficult to follow consistently the procedure used to obtain 10-mi<sup>2</sup> PMP for all the necessary area sizes. As a result, the approach followed in this study is similar to that used in HMR No. 33, "Seasonal Variation of the Probable Maximum Precipitation - East of the 105th Meridian for areas from 10 to 1,000 Square Miles and Durations of 6, 12, 24, and 48 Hours" (Riedel et al. 1956), and in an "Interim Probable Maximum Precipitation Study" (National Weather Service 1980a, 1980b) for this region.

#### 11.2 Data

The data used in development or verification of the DAD relations were taken from DAD summaries available for almost all storms on the list of storms important to developing PMP for the CD-103 region (table 2.2). These DAD summaries appear on the pertinent data sheet for storms reviewed by the Corps of Engineers (1945- ), the Bureau of Reclamation, and the Hydrometeorological Branch, NWS. For easy access, summaries of the DAD information for the important major storms have been tabulated in Appendix B to this study.

### 11.3 Method

One of the first considerations in developing DAD relations is examination of how these results vary regionally. It would be convenient if there was no regional variation, and one set of relations applied everywhere. This is often the case for relatively small area studies, e.g., individual drainage estimates or generalized estimates for moderate size river basins. However, over as large a region as the CD-103, it is more realistic to expect that the DAD relations would have some regional variation. It is not necessary to develop a depth-area-duration relation for every location since there is some local homogeneity. Terrain and storm type have a predominant effect on DAD relations. Therefore, a finite number of additional subdivisions should be adequate for the CD-103 region.

#### 11.3.1 Topographic Subdivisions

Initial subdivision followed the terrain classification system described in chapter 3. To recap here, there was a basic division between orographic and nonorographic regions as denoted by the orographic separation line. Within the orographic portion of the region, further division resulted in first upslopes (or orographic), secondary sheltered orographic, and sheltered least orographic subdivisions (fig. 3.2).

For HMR No. 51, studies were made to determine the longitudinal variation of storm magnitude. This study supported a greater decrease in precipitation with increasing area size and with increasing longitude. Presumably, this is due to the difficulty of sustaining large area moisture inflows as the western edge of that study (105th meridian) is approached. This suggests that DAD relations in the nonorographic regions west of the HMR No. 51 region should decrease with increasing area size at an even faster rate than they do within the HMR No. 51 region. DAD relations in HMR No. 51 are viewed as an important guide to how larger area data relate to  $10\text{-mi}^2$  PMP over the eastern portion of the study region. The fact that they are the result of storm envelopments from a much larger sample of available storms is significant.

As a result of the concepts stated above, an additional subdivision was developed in the nonorographic portion of the CD-103 region in which DAD relations have greater slopes (more rapid decrease with area) than those in HMR No. 51. In figure 3.2, terrain features were used to distinguish between subdivisions. For the new subdivision, which is a minimum nonorographic region, the western boundary is the OSL, and there was no such basis to identify or limit the eastern bound. The subdivision is limited on the east by a line placed according to where the uniform gradient of isopleths of PMP extending from HMR No. 51 changes direction on the index PMP maps for this study. This eastern boundary is somewhat arbitrary, but is considered reasonable. The dotted line in figure 11.1 shows the location of the eastern limit to this subdivision.

#### 11.3.2 River Basin Subregions

The results of the subdivision analysis shown in figure 3.2 provide a variation that is essentially east-west. Considering these variations together with the fact that the  $10\text{-mi}^2$  PMP index maps were based on major controlling storms that are distributed generally north-south, it was concluded that additional divisions were needed for DAD relations. Initially, the concern for controlling storms led to a division between extratropical and tropical storms (see discussion in

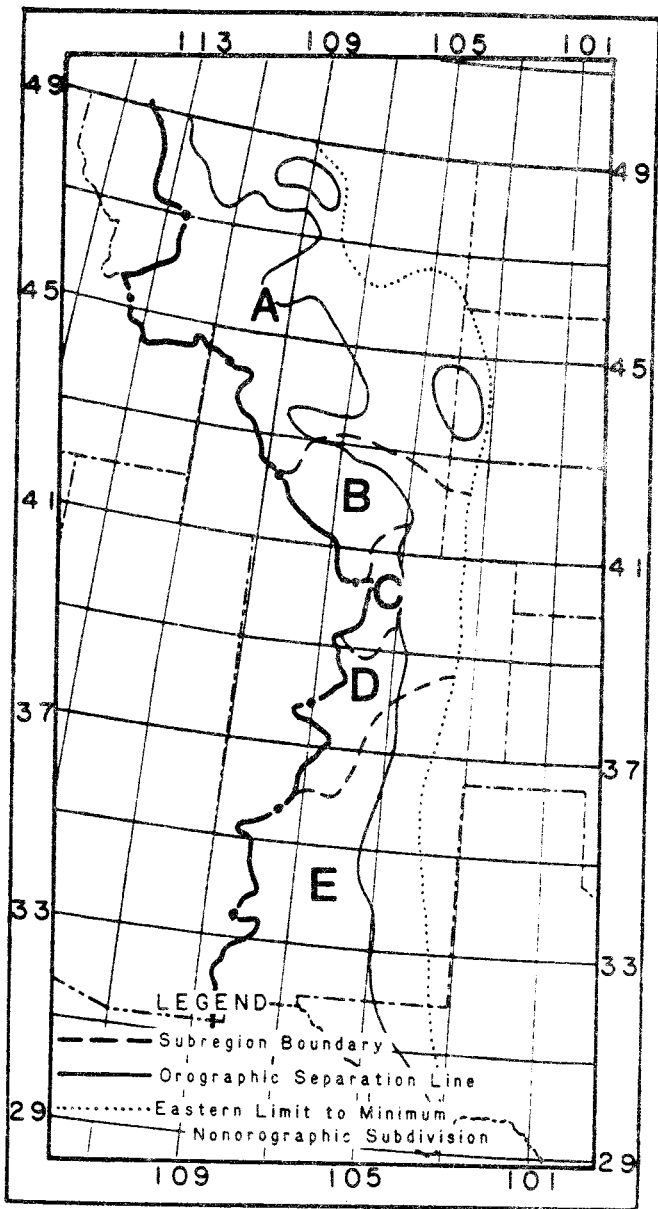

Figure 11.1.--Location of minimum nonorographic subdivision and five subregions in the CD-103 region.

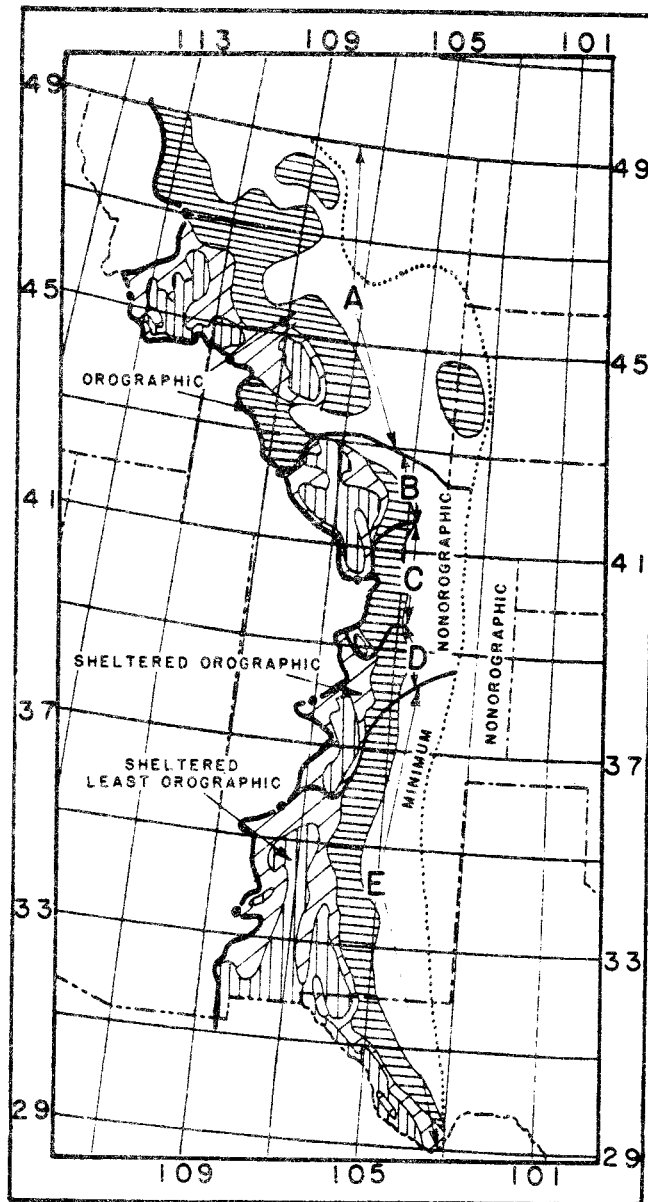

Figure 11.2.--Schematic diagram of subdivision/subregion system used in developing DAD relations.

Table 11.1.--Major river basin subregions within the CD-103 region

Subregion	Drainage
A	Missouri and Yellowstone Rivers
B	North Platte River
C	South Platte River
D	Arkansas River and Upper Rio Grande
E	Pecos and Canadian Rivers and Middle Rio Grande

chapt. 2). However, the wide difference between DAD relations for the Gibson Dam, MT (75), Cherry Creek, CO (47) and Vic Pierce, TX (112) storms brought about the need for intermediate zones. Additional zones were established, therefore, in accord with major drainage boundaries rather than with geographic latitudes. This was done to facilitate the use of the DAD relations. Five zones, called subregions to distinguish them from the terrain related subdivisions of chapter 3, were chosen as listed in table 11.1. These are designated by the letters A to E to simplify notation.

The five subregions are shown in figure 11.1. The boundary between D and E cuts across the Rio Grande near 36°N and across the Arkansas River near 104°W. This was a somewhat arbitrary decision that preserves the limits set for tropical-extratropical storms in chapter 2. In the sense of the development that follows, subregions B, C and D represent transition zones between A and E storm data.

### 11.3.3 DAD Relations

Figure 11.2 shows the results of combining the subregions of figure 11.1 and the subdivisions of figure 3.2, plus the new minimum nonorographic subdivision. A system of DAD relations was developed to reflect the variations among these 21 subunits. The map of figure 11.2 is intended to give the user a general overview of location of the various subunits. Plate V provides outlines of these subunits on the same scale as the four general-storm PMP maps (plates I-IV). Plate V should be used to determine the appropriate DAD relations to use. Comparable outlines of these same subunits are included as part of the base maps (black background lines) printed on each PMP map.

**11.3.3.1 Nonorographic Subdivisions.** For the nonorographic zone between the 103rd meridian and the dotted line designating the eastern limit to the minimum nonorographic subdivision, DAD relations developed from HMR No. 51 apply. These relations were based on averages of data along the 103rd Meridian. The use of three such averages is considered adequate, since little variation with latitude occurs in HMR No. 51. The three sets of DAD relations for subregions A, B-D and E, are shown in figures 11.3 to 11.5. In these figures, the 6-, 24-, and 72-hr relations represent averages within the latitudes of the respective regions from HMR No. 51. The 1-hr relations are all the same and were obtained from HMR No. 52.

**11.3.3.2 Minimum Nonorographic Subdivision.** As stated in section 11.3.1, this subdivision was created to reflect a region where average depth decreases with area at a more rapid rate than indicated by relations for the western border of HMR No. 51. No specific information exists on which to base the magnitude of this accelerated decrease with area size. At smaller area sizes (<500 mi<sup>2</sup>), the relations should not differ from those derived for the nonorographic subdivision in section 11.3.3.1. The choice of how the remainder of the relation was shaped required judgment. The adopted curves are roughly 20 percent lower than the nonorographic relations at 2,000 mi<sup>2</sup>. The curves (fig. 11.6 to 11.8) have a reversal of curvature to approximate the slope of the nonorographic curves at larger area sizes.

**11.3.3.3 Orographic Subdivision.** The Gibson Dam, MT (75) storm of 1964 was considered to be the best example for a prototype orographic storm for the Missouri and Yellowstone River Basins. As such, the orographic DAD relations for

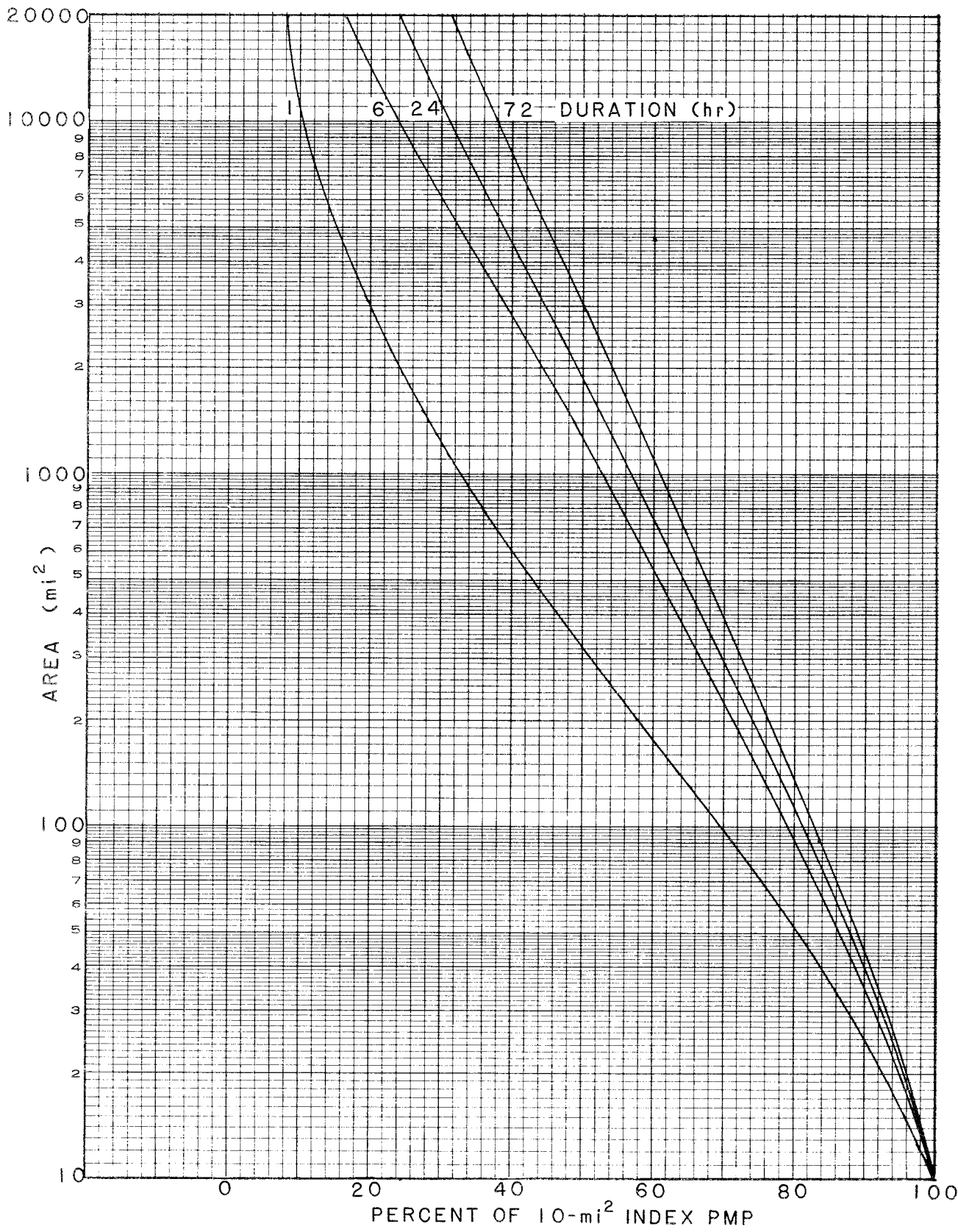

Figure 11.3.--DAD relation, A nonorographic subunit.

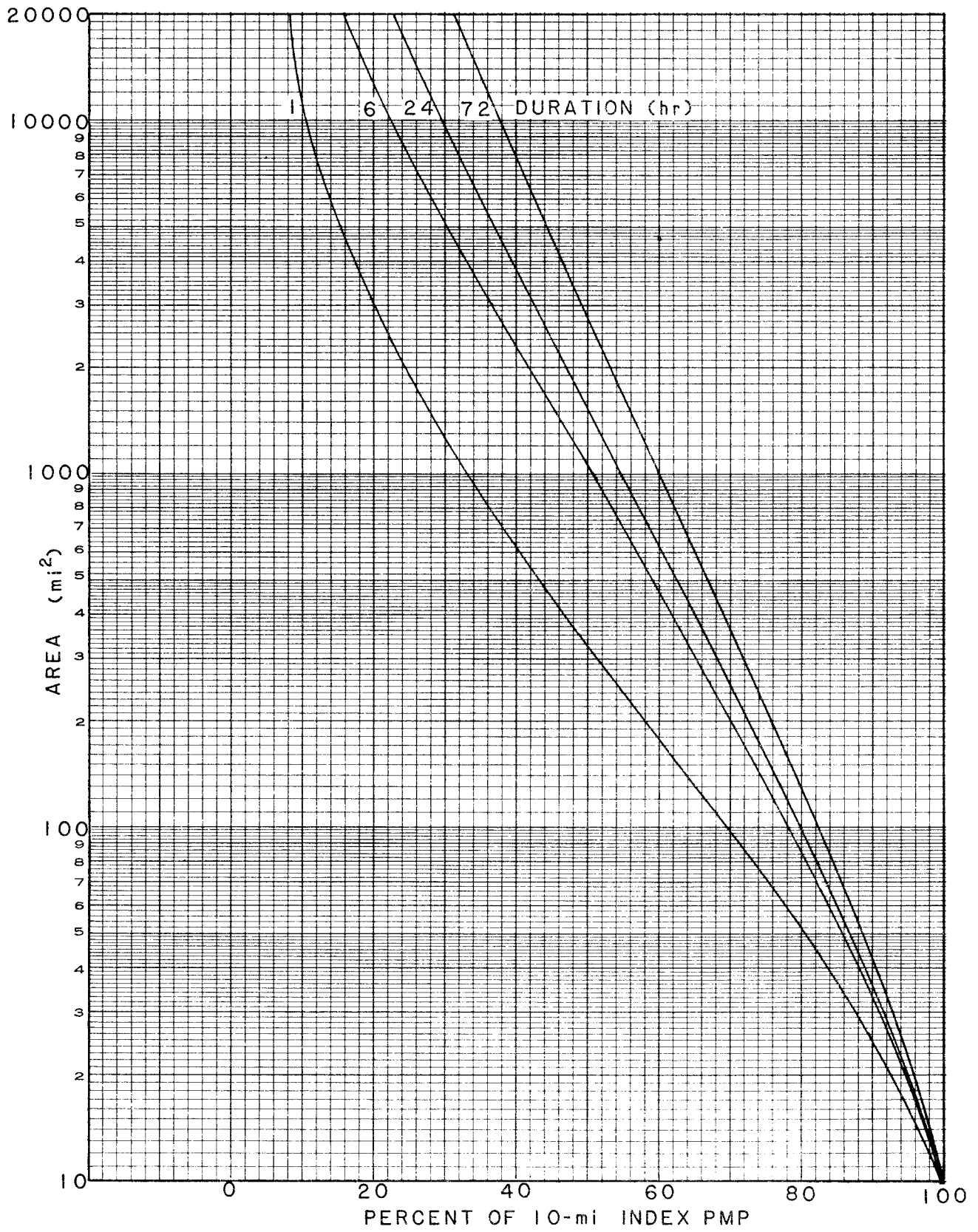

Figure 11.4.--DAD relation, B to D nonorographic subunit.



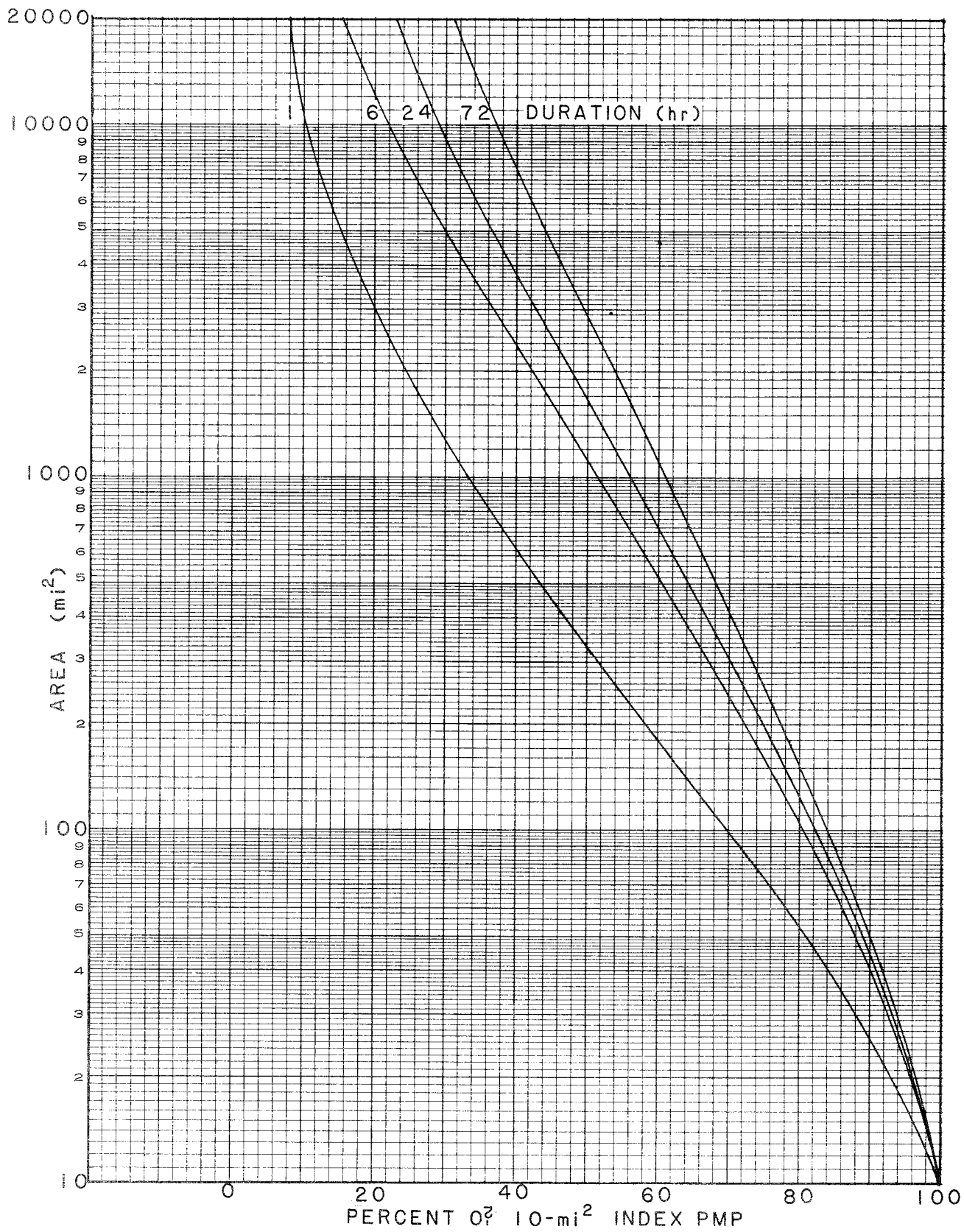

Figure 11.5.—DAD relation, E nonorographic subunit.

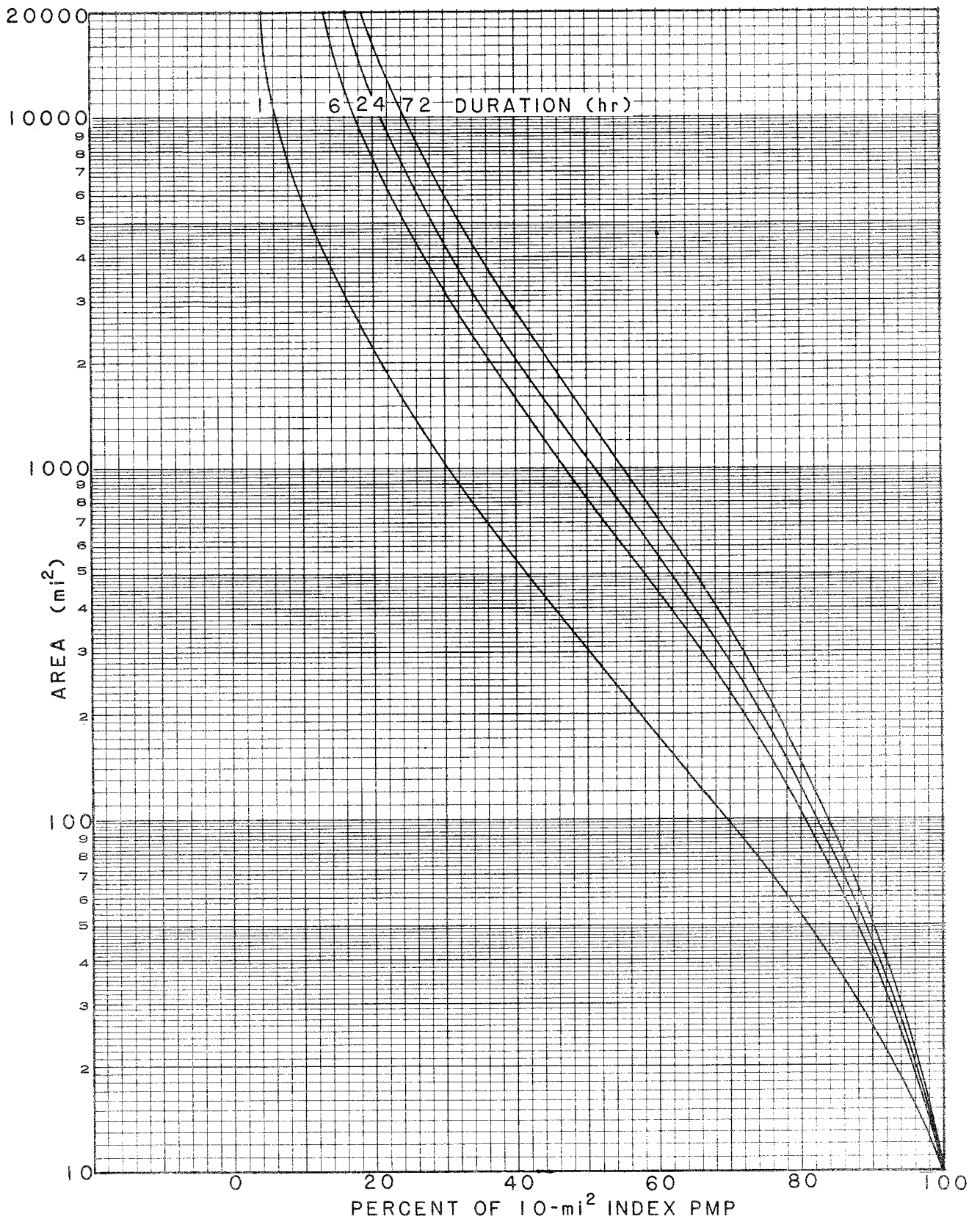

Figure 11.6.—DAD relation, A minimum nonorographic subunit.

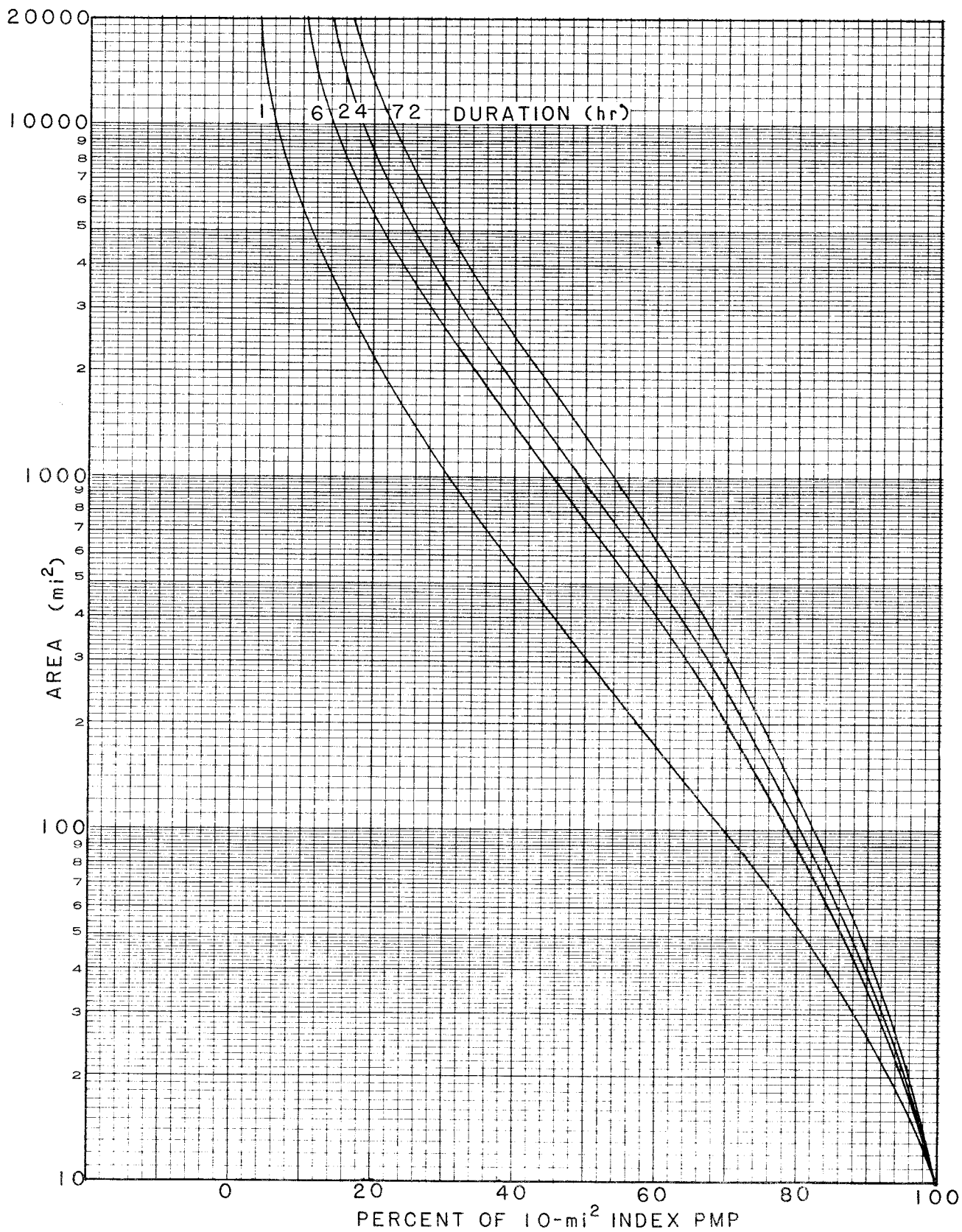

Figure 11.7.—DAD relation, E to D minimum nonorographic subunit.

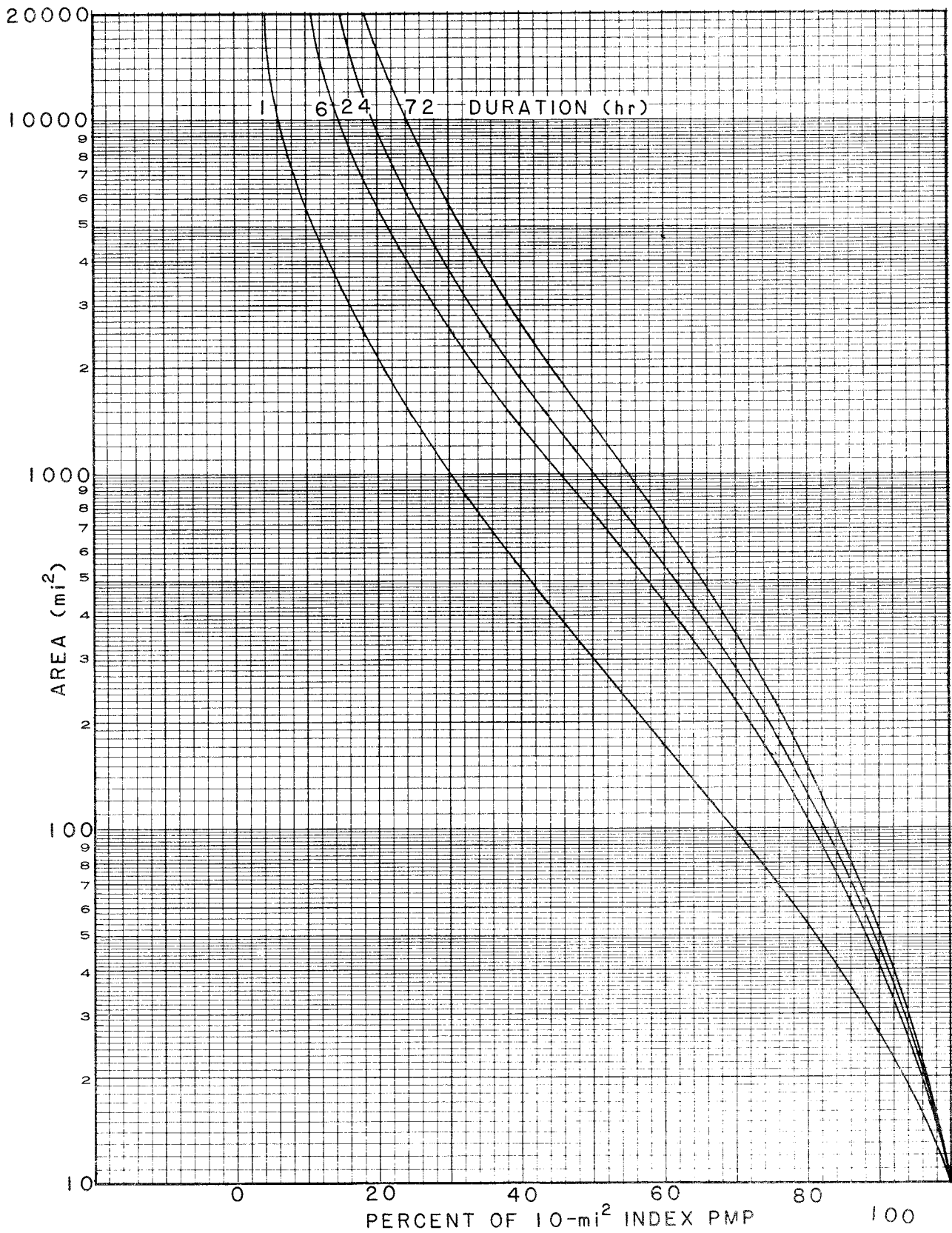

Figure 11.8.—DAD relation, E minimum nonorographic subunit.

the subregion should reflect those found in this storm. The moisture-maximized areal values of this storm were considered as key values that the orographic PMP DAD relations should closely envelop. A trial process was used to develop the set of relations for 1-, 6-, 24-, and 72-hr shown in figure 11.9. The relations show noticeably less fall off with increasing area than shown in the nonorographic and minimum nonorographic relations. They result in close envelopment of the maximized Gibson Dam storm data for areas between 1,000 and 3,000 mi<sup>2</sup>. The envelopment is somewhat larger below 1,000 mi<sup>2</sup>, but the moisture-maximized amounts are still enveloped by less than 10 percent.

No other major orographic storms in the CD-103 region were of sufficient magnitude to consider in setting the level of DAD relations for this subregion. Therefore, to develop relations for the other orographic subregions, the following question was considered. How should the orographic DAD curves vary toward southern latitudes (subregion E)? Orography should play a significant role at both northern and southern latitudes. However, for the northern latitudes, the likelihood that storms will stagnate, move slowly, or persist in effectiveness is somewhat greater than in the south. In the south, storms are more transient and thus not as effective in producing large areally-averaged precipitation amounts. On this premise, the level of the E orographic subregion relation (at 2,000 mi<sup>2</sup>) was set at two-thirds the level of the A subregion that was based on the Gibson Dam storm data.

It was not possible to take a constant fraction of the Gibson Dam relations throughout all area sizes, because this would have resulted in curves that had slopes with greater fall off with area than the nonorographic curves in the smaller area sizes. Orographic relations were developed that give slightly less decrease with area than nonorographic relations at all areas, and somewhat parallel the orographic relations of Gibson Dam at larger areas (>1000 mi<sup>2</sup>), as shown in figure 11.10 for subregion E.

These relations were tested against storm data from major storms in the area. Storms at McColleum Ranch (58), Meek (27), Rancho Grande (60), NM and the transposed Vic Pierce, TX (112) storm were all considered. In each case, the orographic relations were sufficient to allow envelopment of the moisture-maximized areal data.

In the absence of other information, the A and E orographic relations were averaged to obtain a set of relations for the C subregion (fig. 11.11). These relations in turn, were tested against such important storms as Big Elk Meadow (77), Fry's Ranch (30), and Ward District (1), CO to ensure that the results enveloped the in-place moisture-maximized amounts at all areas.

Following this pattern, the orographic relations in subregions B and D were obtained from averages of A and C, and C and E data, respectively (fig. 11.12 and 11.13). This process resulted in a system that essentially divided the difference between the A and E orographic relations into five equally spaced relations for each duration. Subregion D relations were evaluated relative to important storms at Penrose, CO (31) and Rociada, NM (8). Maximized data were enveloped at all area sizes. No storm data was available to verify relations for subregion B.

**11.3.3.4 Sheltered Least Orographic Subdivision.** No analyzed storm data were available for guidance west of the orographic subdivision (sec. 11.3.3.3), limit

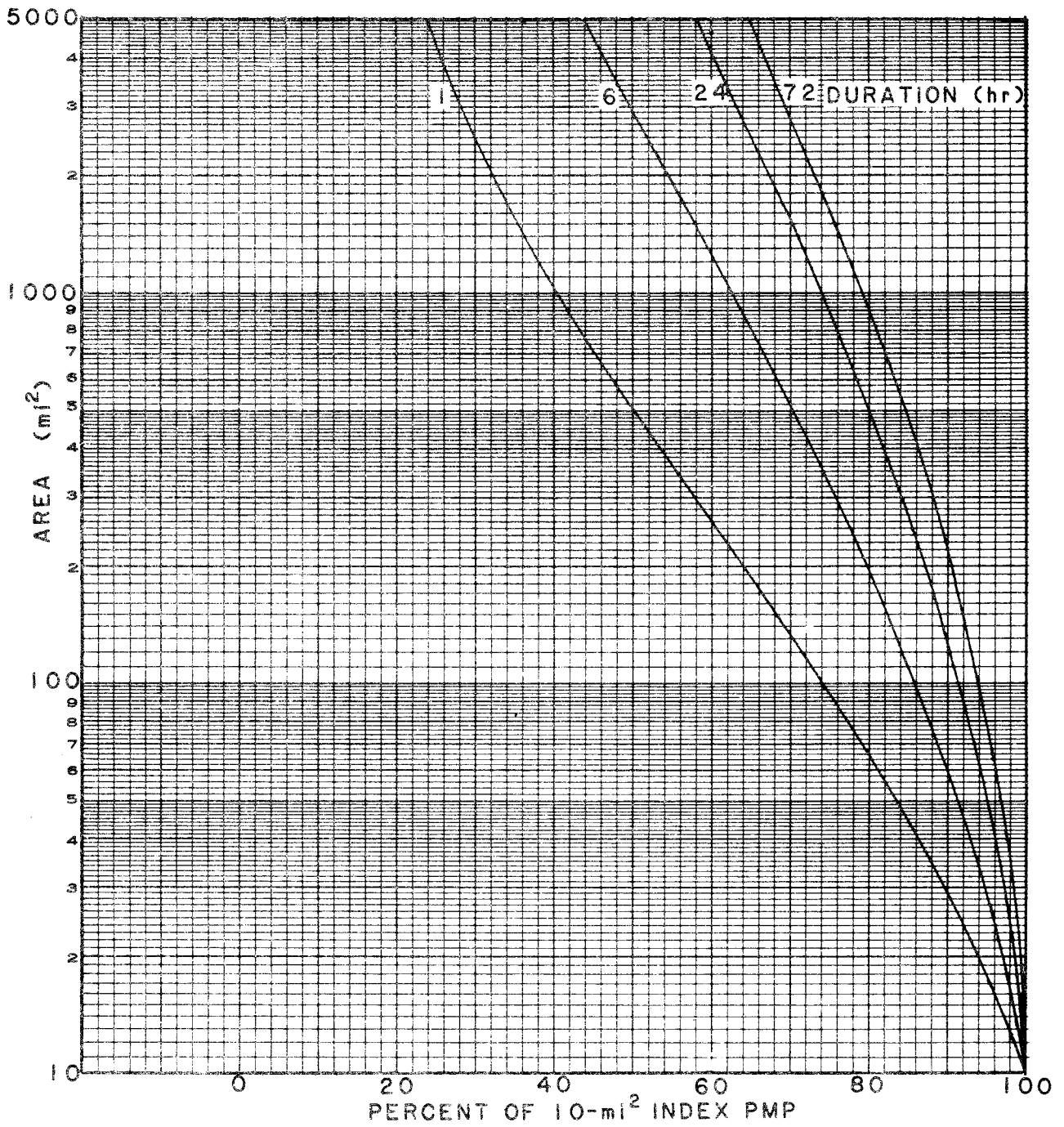

Figure 11.9.--DAD relation, A orographic subunit.

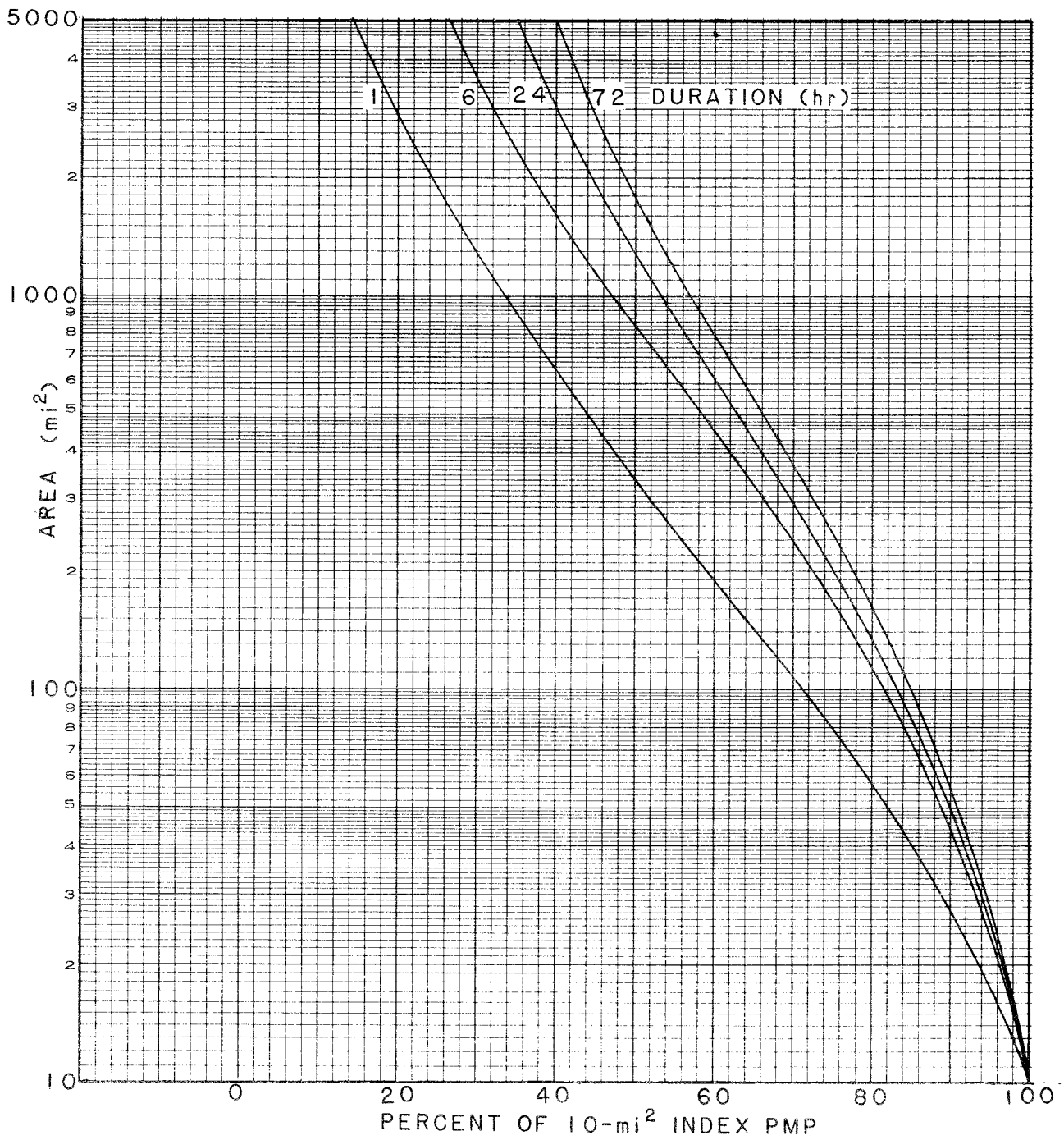

Figure 11.10.--DAD relation, E orographic subunit.

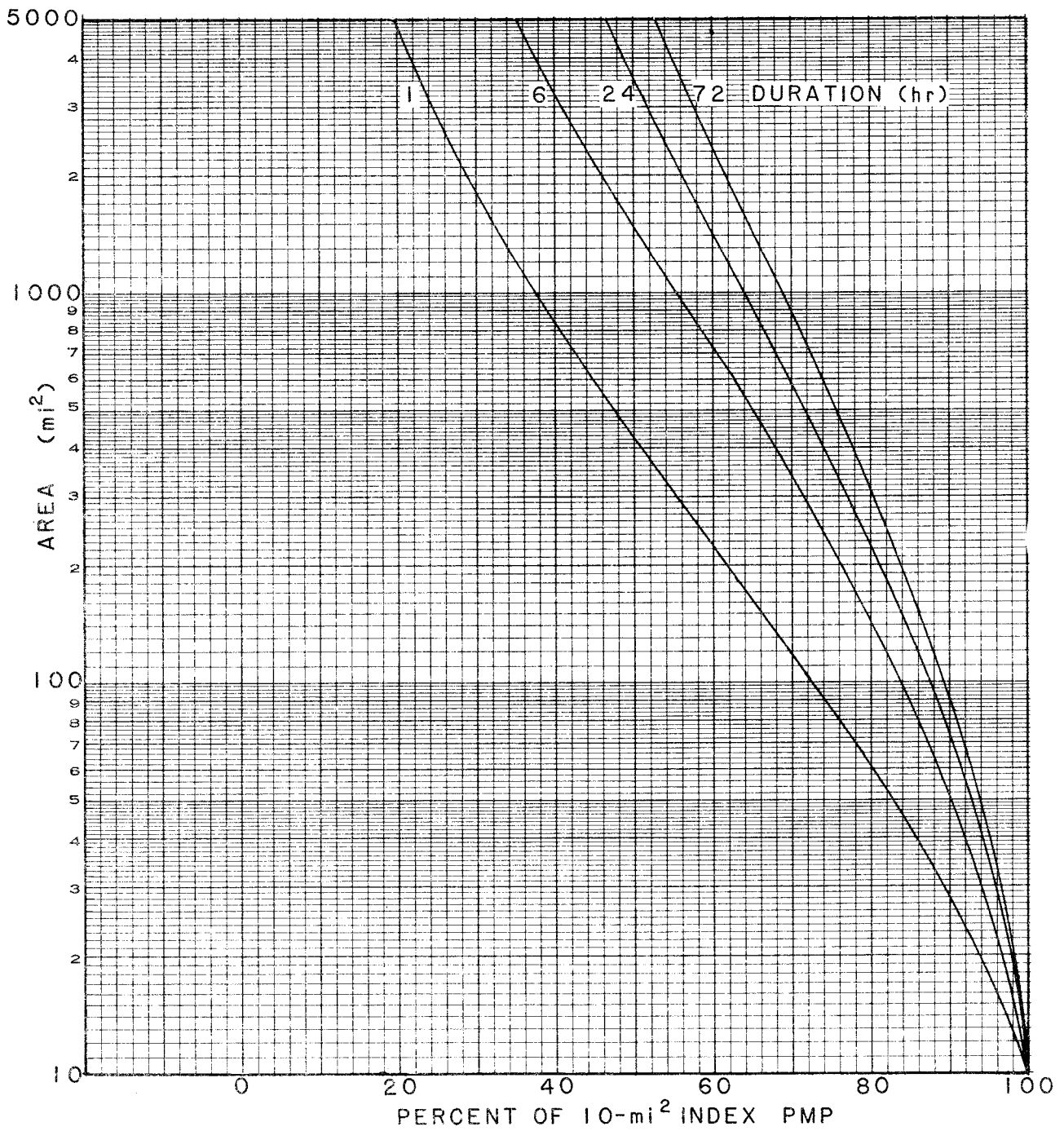

Figure 11.11.—DAD relation, C orographic subunit.



of first upslopes, on which to base DAD relations for the sheltered subdivisions. It was necessary, therefore, to develop a process to relate curves for these subdivisions to the others already developed. For the sheltered least orographic subdivision, the relations should decrease more rapidly than the orographic relations, but perhaps not to the degree of the minimum nonorographic curves. The curves adopted were an average of the minimum nonorographic and orographic relations within the A subregion, and similarly within the E subregion. Subregional averages were then made to get the relations for C, B, and D as was done for the orographic curves. Figures 11.14 to 11.18 show these curves.

**11.3.3.5 Sheltered Orographic Subdivision.** The relations for this subdivision were developed in a similar manner to those for the sheltered least orographic subdivision in section 11.3.3.4. Averages were made between the orographic and sheltered least orographic relations in subregion A and in subregion E, and then subregional averages of these results were made to obtain relations for subregions C, B, and D. These DAD relations are shown in figures 11.19 to 11.23.

#### 11.4 Comparison With Major Storm Data

In this section, concern is given to how well the depth-area-duration relations described in this chapter compare to the observed moisture-maximized data from major storms. Obviously, it would be easy to develop a set of DAD relations that enveloped all available storm data. Such a result would lead to overly conservative PMP estimates. If, however, the storm sample is reasonably representative of major storms, it is expected that, when moisture maximized, there should be instances where the PMP DAD relations envelop the storm data by 10 percent or less.

The DAD for storms in table 5.3 for which DAD data were available (see Appendix B) were moisture maximized and plotted for 6-, 24- and 72-hr durations. These results were then compared to the results derived from this study, as follows. Isohyetal maps for the respective storms were positioned in place of occurrence over the 10-mi<sup>2</sup> PMP index maps and areal average values determined for selected areas (usually 10, 200, 1,000 and 5,000 mi<sup>2</sup>). These areal-averaged 10-mi<sup>2</sup> values were then combined with the DAD relations in this chapter, weighted appropriately, and plotted to give PMP depth-area relations for 6, 24 and 72 hr.

The following comments are given regarding those storms whose maximized areal amounts were considered controlling (closely enveloped).

1. Gibson Dam (75). The 24-hr moisture-maximized depth-area relation was used to define the "A" orographic relation (fig. 11.9) and thereby is enveloped by 10 percent or less for all areas through 5,000 mi<sup>2</sup>. At 6 hr, envelopment is 10 percent or less for areas between 400 and 5,000 mi<sup>2</sup>. This storm is the only large area storm in the region for which 1-hr data are available, and all moisture-maximized 1-hr values are well enveloped by the 1-hr relation given in figure 11.9.
2. Springbrook (32). At 24 hr, the moisture-maximized data are enveloped by 10 percent or less for areas between 200 and 5,000 mi<sup>2</sup>. Envelopment by 10 percent or less occurs at 6 and 72 hr between 400 and 5,000 mi<sup>2</sup> (fig. 11.3).

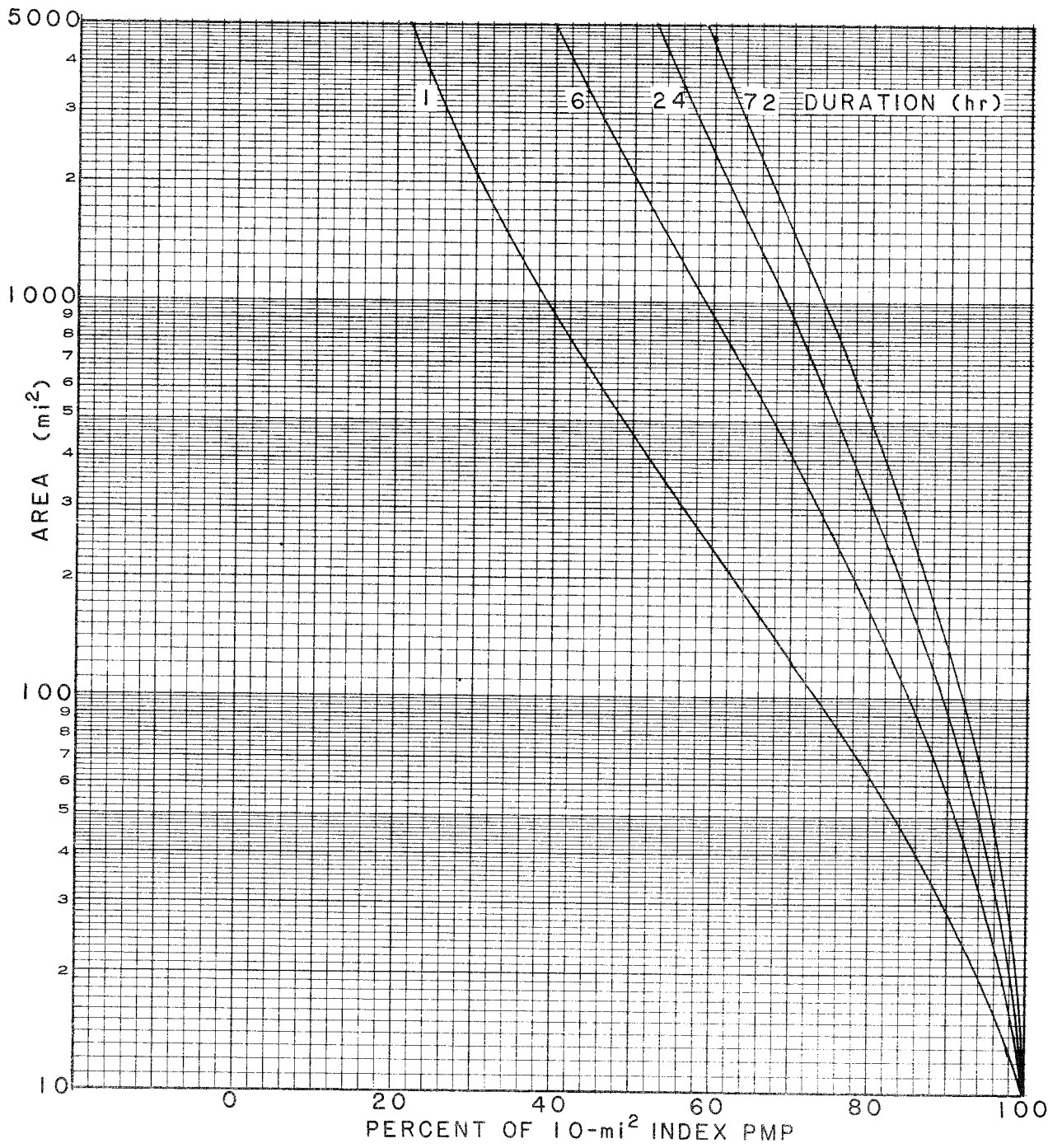

Figure 11.12.—DAD relation, B orographic subunit.

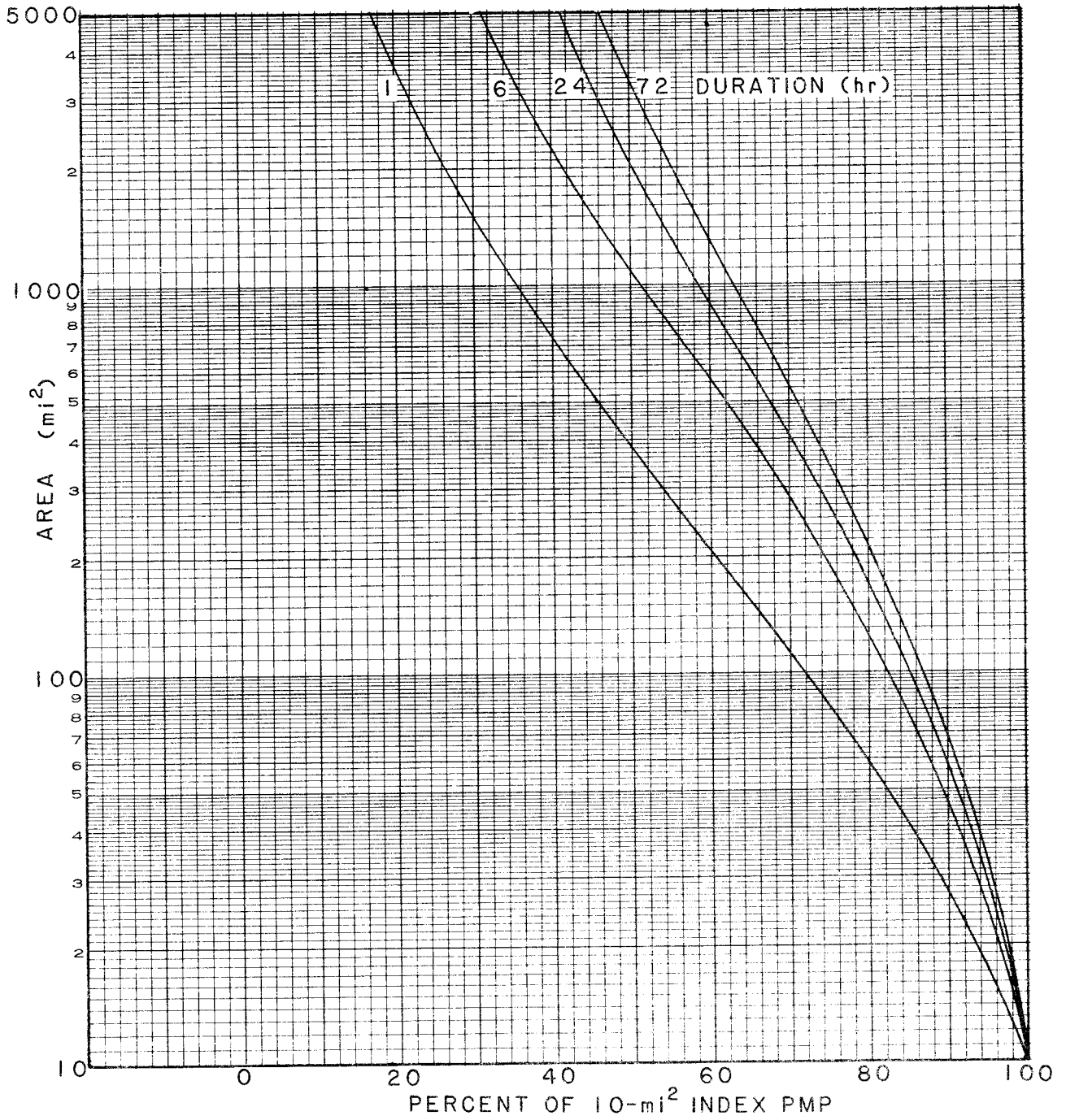

Figure 11.13.—DAD relation, D orographic subunit.

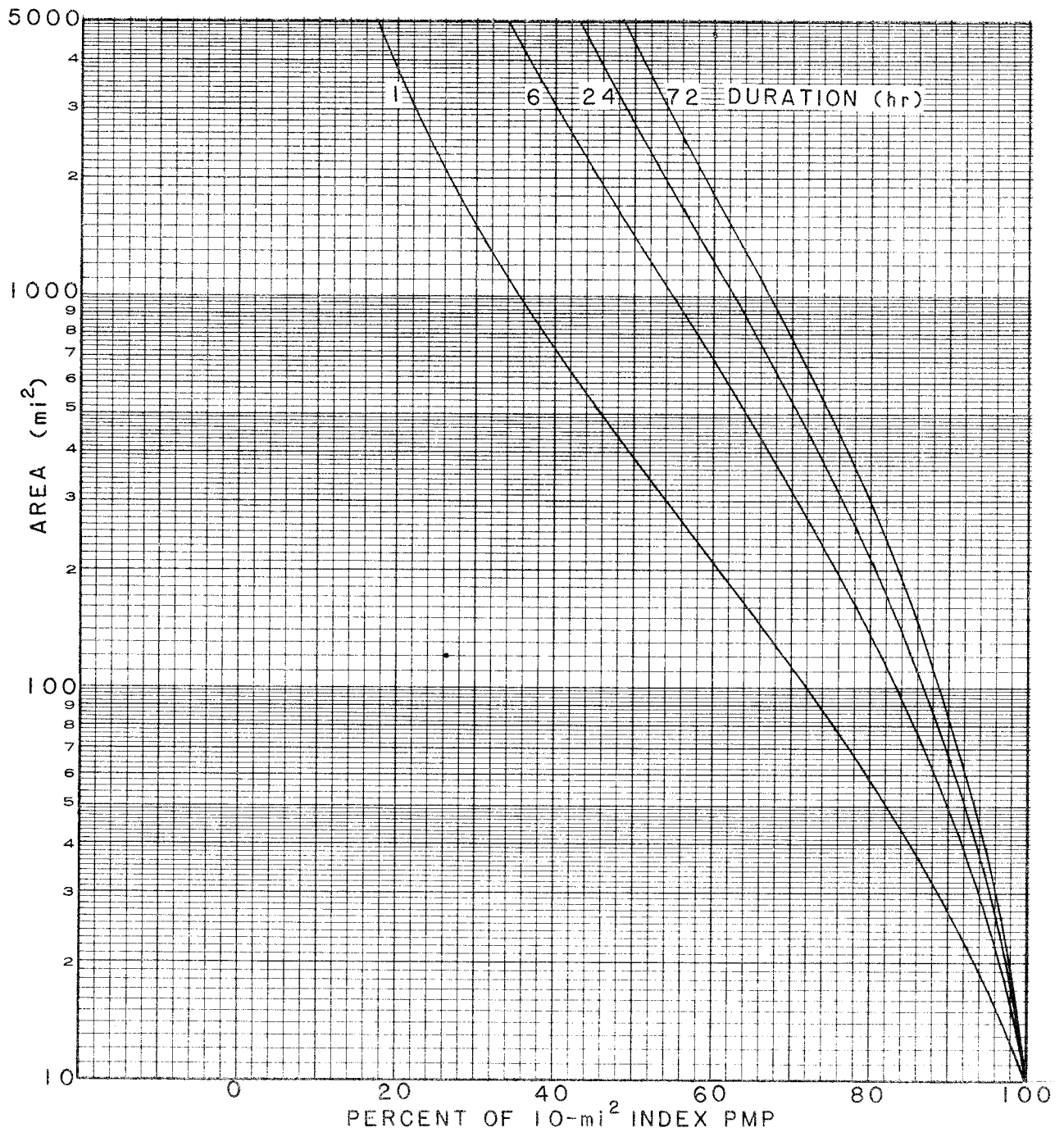

Figure 11.14.—DAD relation, A sheltered least orographic subunit.

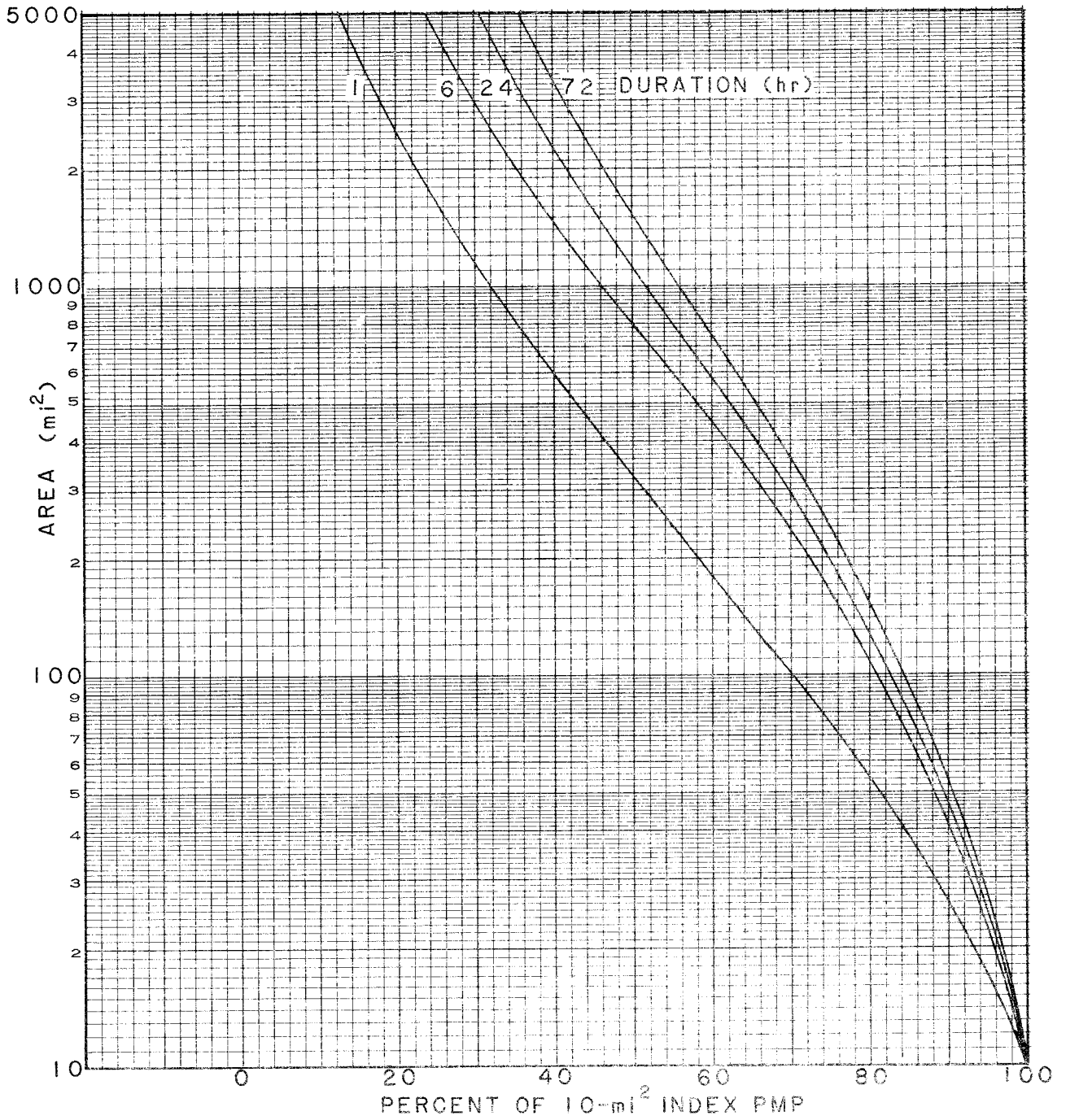

Figure 11.15.—DAD relation, E sheltered least orographic subunit.

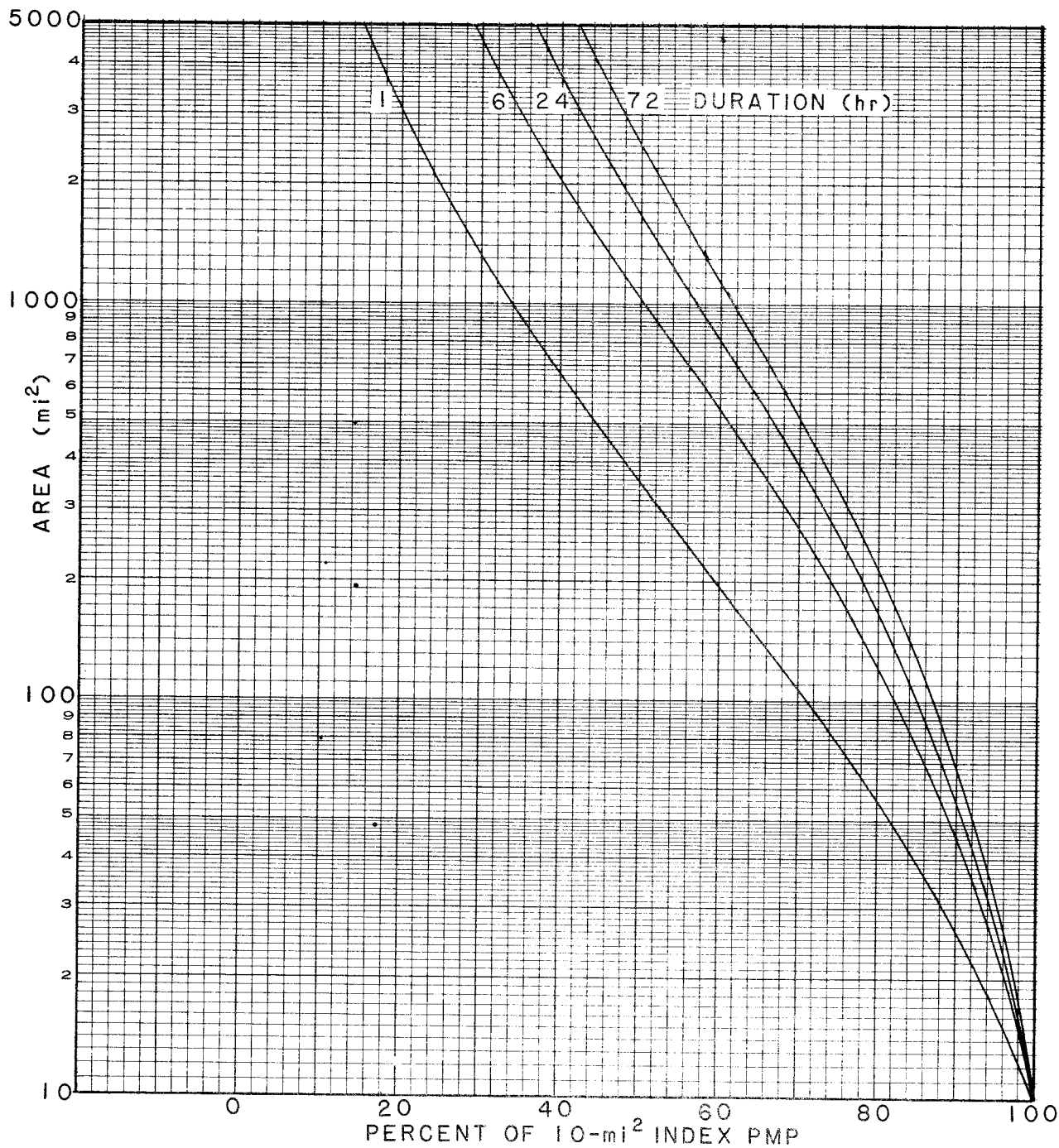

Figure 11.16.—DAD relation, C sheltered least orographic subunit.

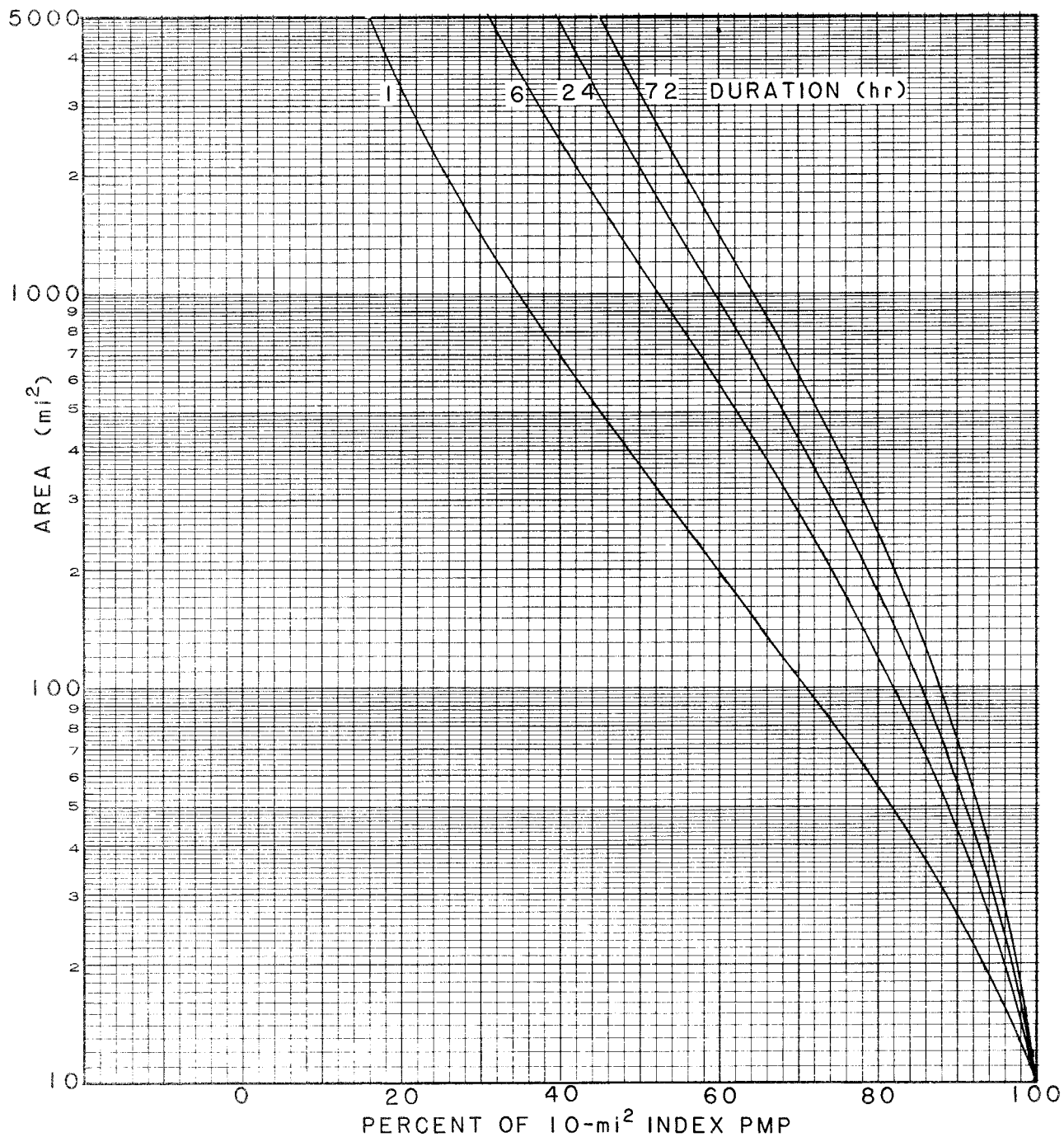

Figure 11.17.—DAD relation, B sheltered least orographic subunit.

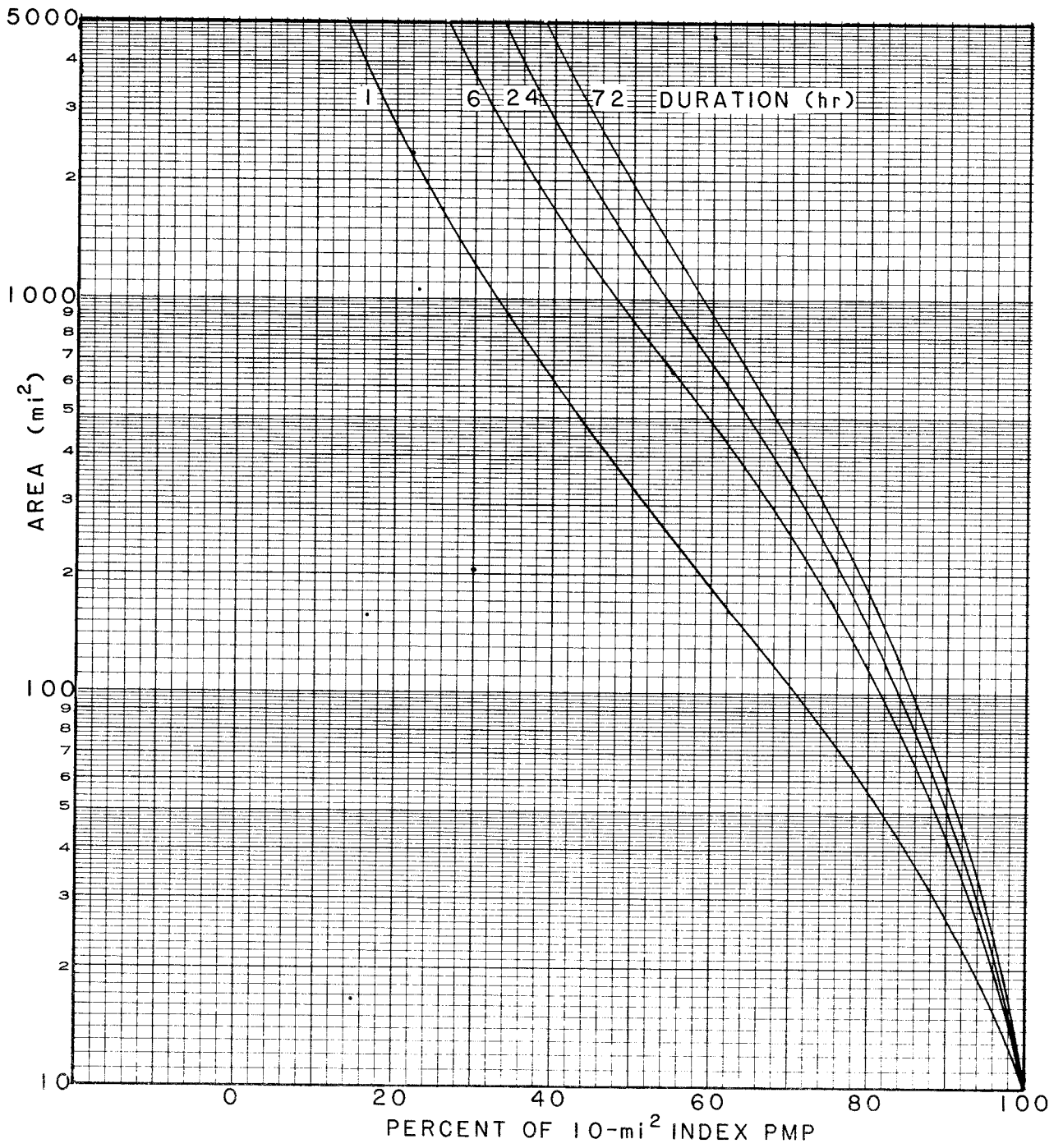

Figure 11.18.—DAD relation, D sheltered least orographic subunit.



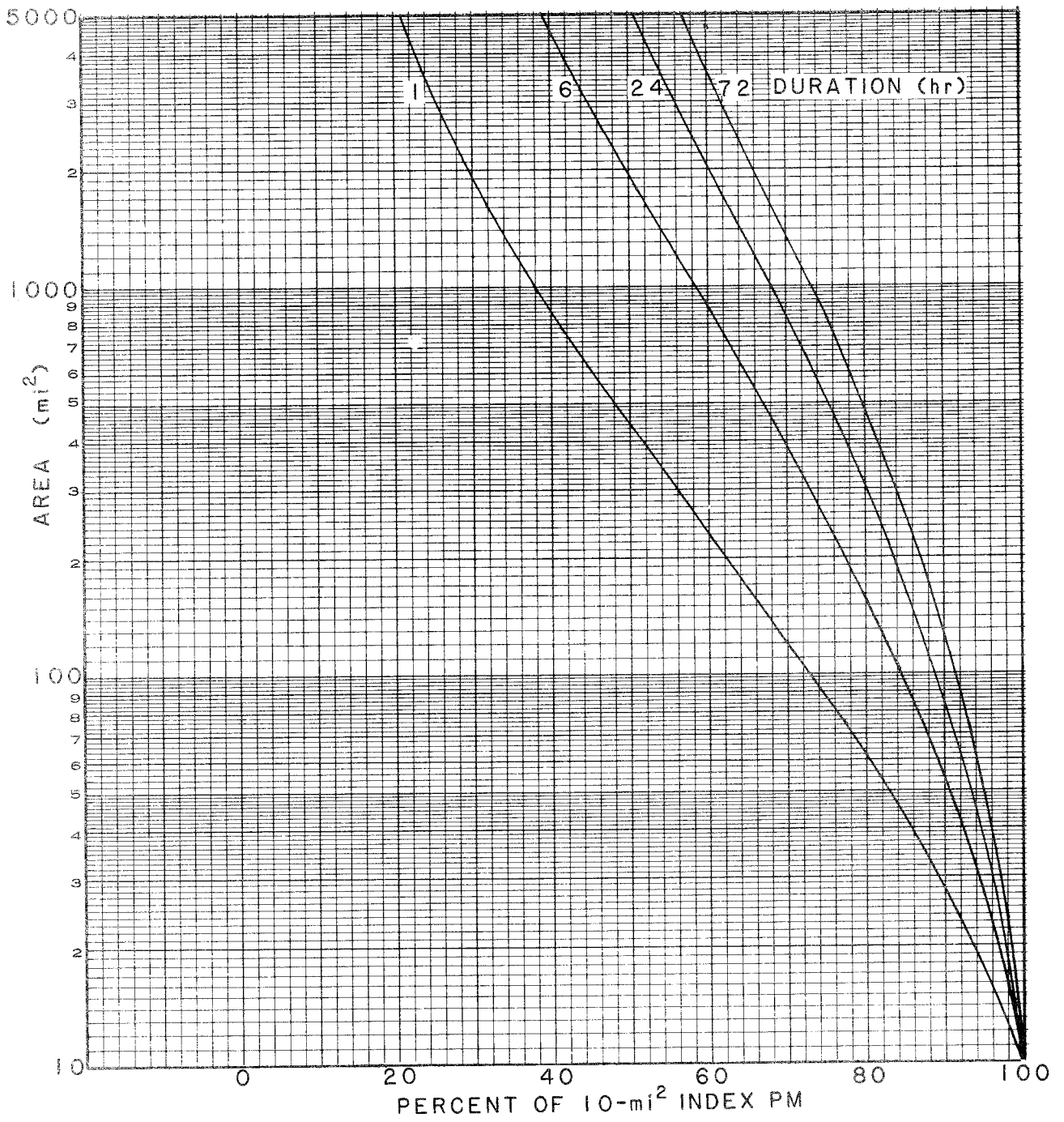

Figure 11.19.—DAD relation, A sheltered orographic subunit.

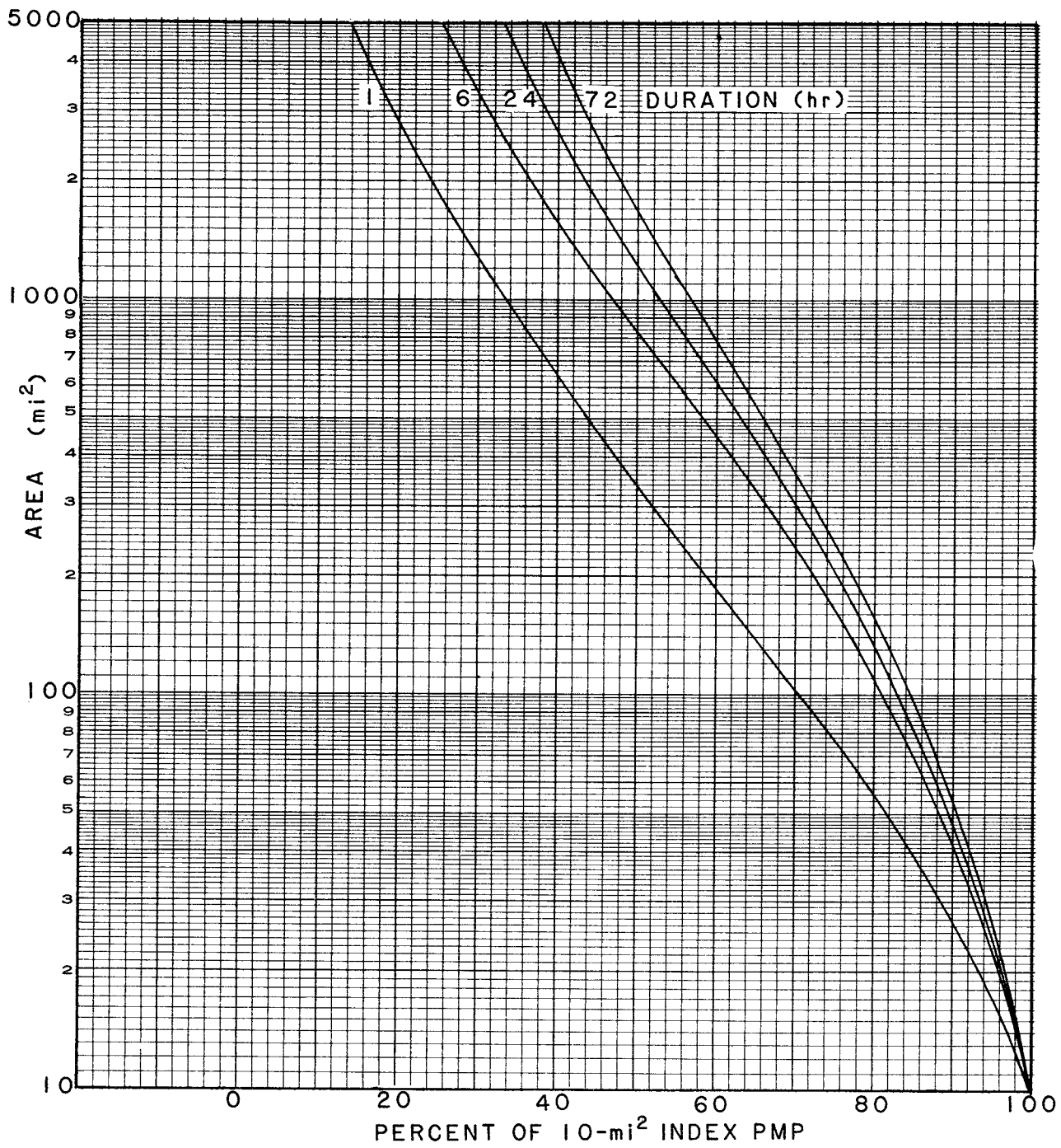

Figure 11.20.—DAD relation, E sheltered orographic subunit.

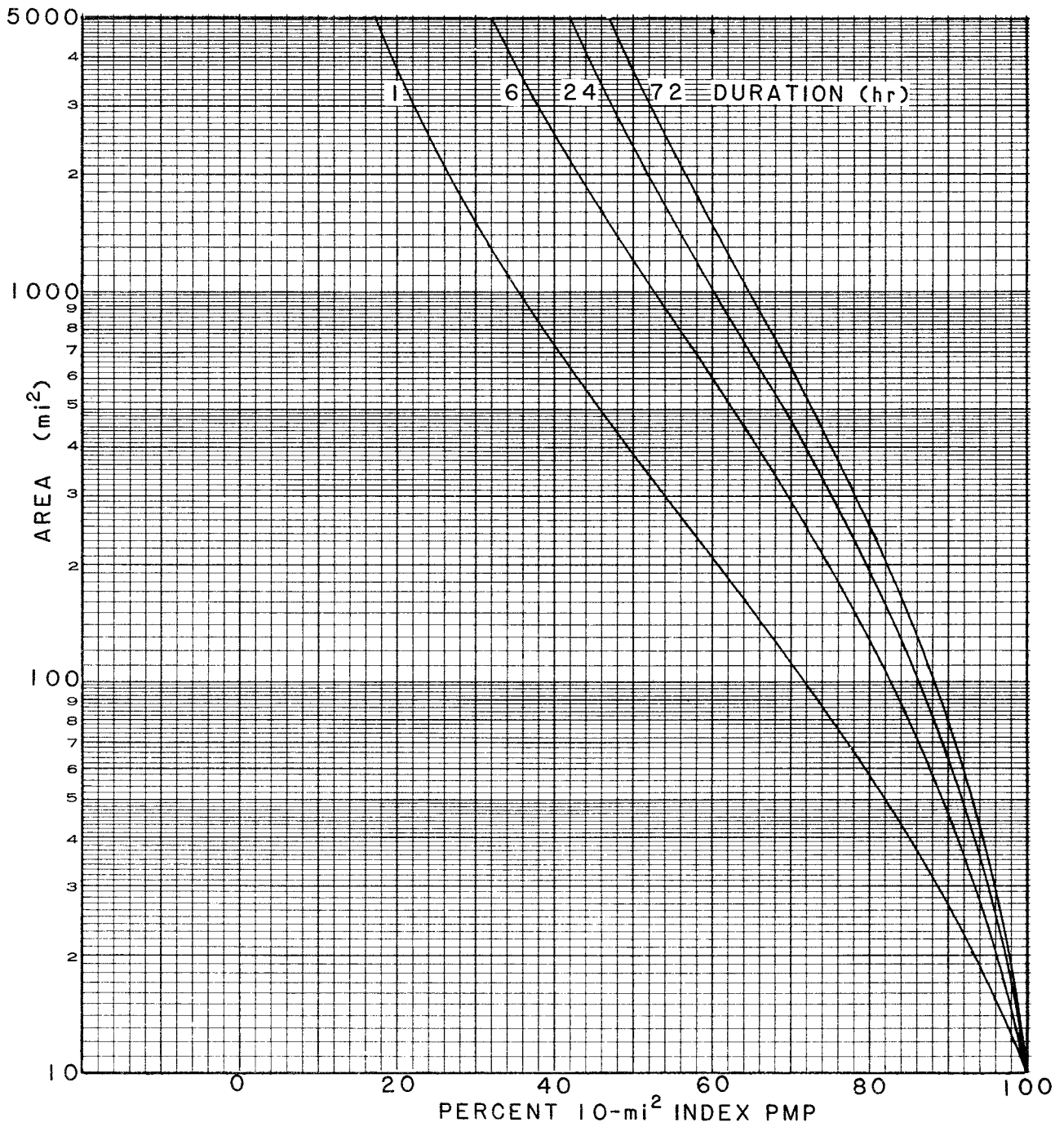

Figure 11.21.—DAD relation, C sheltered orographic subunit.

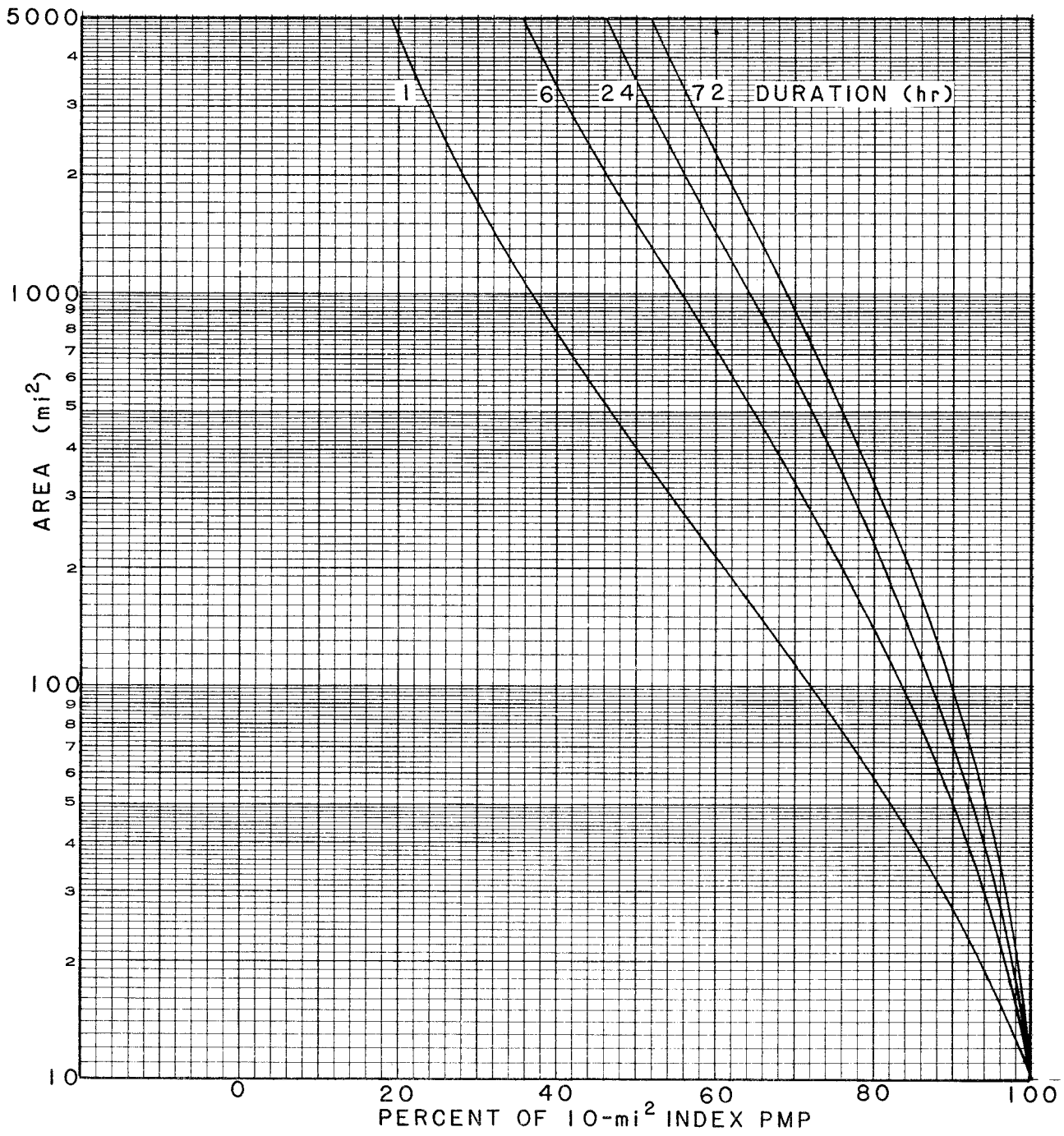

Figure 11.22.—DAD relation, B sheltered orographic subunit.

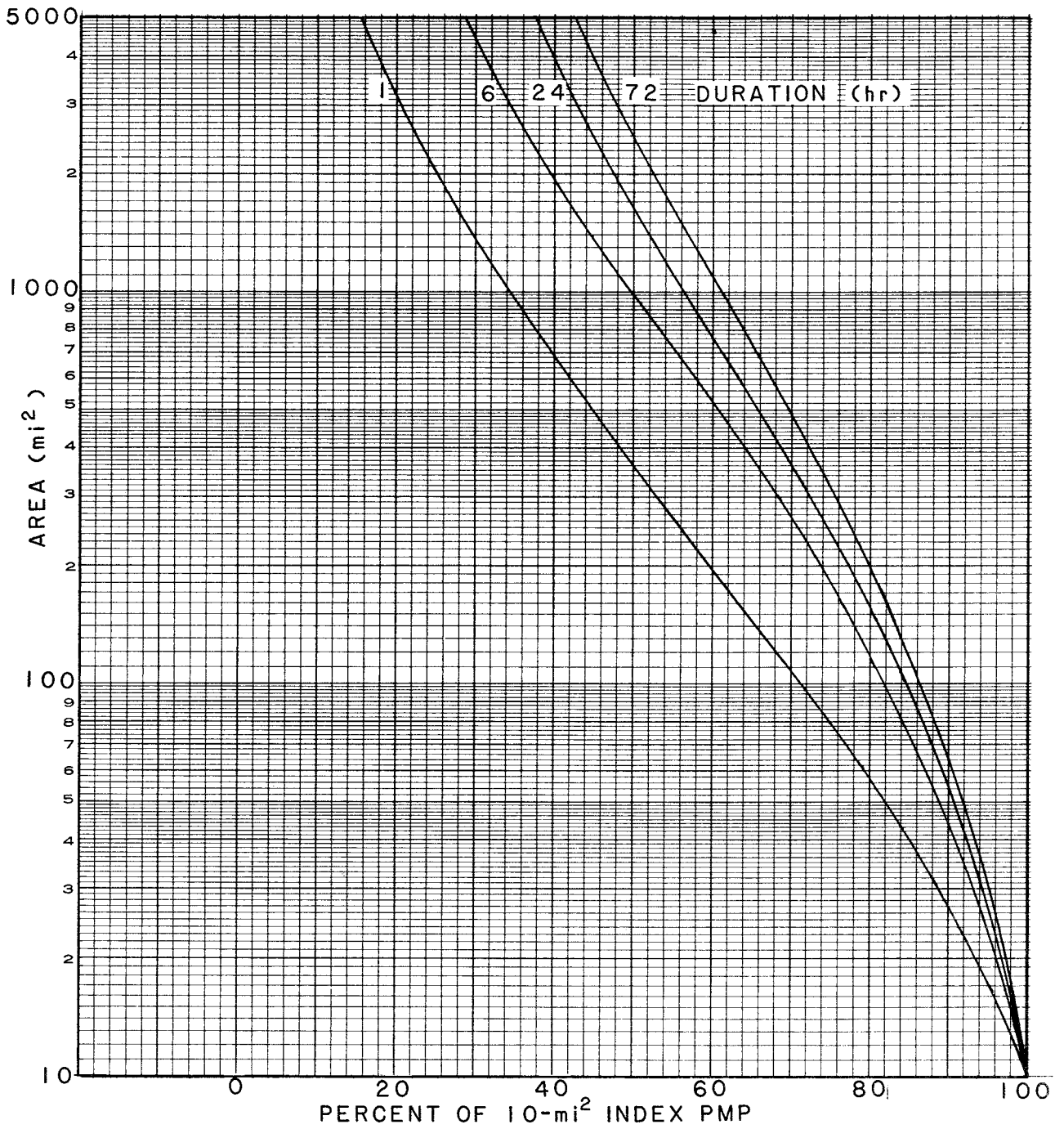

Figure 11.23.—DAD relation, D sheltered orographic subunit.

3. Cherry Creek (47). The 24-hr moisture-maximized data for this storm comes within 10 percent or less of the weighted relations in figures 11.7 and 11.11 for areas up to 100 mi<sup>2</sup>. At 6 hr, moisture-maximized values for areas less than 100 mi<sup>2</sup> are undercut, although observed data are enveloped. Envelopment by 10 percent or less occurs between 100 and 200 mi<sup>2</sup>.
4. McColleum Ranch (58). Weighted DAD from figures 11.8, 11.15 and 11.20 appear to well envelop the moisture-maximized data at 6, 24 and 72 hr for this storm at areas less than 5,000 mi<sup>2</sup>. However, the trend is such that envelopments of 10 percent or less may occur at larger areas had such information been available.
5. Vic Pierce (112). This storm was transposed without rotation to 35°N 105°W. The 24-hr moisture-maximized values are enveloped by 10 percent or less for areas between 1,000 and 3,000 mi<sup>2</sup>, and at 72 hr between 300 and 5,000 mi<sup>2</sup>. At 6 hr for all areas envelopment exceeds 10 percent (fig. 11.8 and 11.10).

### 11.5 Conclusions on DAD Relations

A system for developing DAD relations for 21 subunits of the CD-103 region is described in this chapter. The system is based on available storm data used in a semi-objective methodology. It is substantiated by how well the derived PMP values compare with moisture-maximized storm values. The sets of DAD relations provided in figures 11.3 to 11.23 represent the best available set of DAD relations for the CD-103 region. The use of these procedures will be discussed in chapter 14.

## 12. LOCAL-STORM PMP

### 12.1 Introduction

The objective of this chapter is to develop the probable maximum precipitation (PMP) for local storms in the CD-103 region and to provide generalized estimates of these values. Local storms, because of their intense short-duration nature, are believed to be potentially significant when judging the level of PMP for areas less than 500 mi<sup>2</sup> and durations less than 6 hr. Major local storms of record and the method used to determine the magnitude of local-storm PMP are discussed. An index map (Plate VI) is provided for the 1-hr 1-mi<sup>2</sup> PMP, along with relations to obtain PMP for other durations and area sizes.

Previous generalized PMP studies have found regional differences in the environment that produces intense convective storms. In HMR No. 49 (Hansen et al. 1977), which covers an area of substantial topographic relief and sheltering, local storms were shown to be strongest when not embedded within general type storms. Conversely, in the region covered by HMR No. 51 (Schreiner and Riedel 1978), an area of relatively little topographic relief, convective storms were strongest when embedded in general type storms.

In the CD-103 region, HMR No. 55 considered the single-storm (general storm that included significant short-duration convection) and the two-storm (local and general storm are independent) approaches. A decision was made in HMR No. 55 to restrict the two-storm approach to three sheltered regions along the Continental Divide. This restriction brought about some difficulty along boundary zones that

was resolved at the time by manual smoothing. This smoothing produced some artificially higher levels of general-storm PMP than would otherwise have been obtained at these locations.

During the review of HMR No. 55, one consideration tested was to determine the consequences of providing local-storm PMP throughout the CD-103 region. The feasibility and advantages of this modification were discussed by the various federal agencies involved with this study, and it was agreed that the local-storm PMP should be determined everywhere in the region. The following sections describe the process used to obtain local-storm PMP for HMR No. 55A. Comparisons of some major local storms are presented in chapter 13.

### 12.1.1 Local-Storm Definition

The local storm is a small, isolated cell or group of cells commonly referred to as a thunderstorm. When a local storm becomes highly developed through convective uplifting of unusually moist air, it is capable of producing high rainfall intensities and excessive precipitation amounts over small areas in short periods of time.

For the purpose of this study, the duration of these extreme local storms is usually thought of as being less than 3 hr; however, they may extend to 6 hr, or slightly more with the merging of individual cells. A lower threshold of 3 in. of precipitation in 1 hr was placed on all extreme local storms considered. This is an arbitrary limit designed to screen out less important storms. For some of the observed storms the 1-hr amount was not explicitly given. In those cases reasonable judgment based on accepted durational relations was applied to obtain an estimate.

To apply the above definition to storms in the CD-103 region, a set of criteria was developed to classify storms as local. These criteria were:

1. The duration of the storm is short (less than 6-hr).
2. The area of the rainfall pattern is limited ( $<500 \text{ mi}^2$ ) with little or no surrounding rain where the reports could be grouped into clusters. This was to ensure that the storm was indeed isolated. A clear case of isolation would be one where there is a large point rainfall amount with no surrounding rain. However, because of the sparse network of observing stations it was decided to allow no more than 50 percent of the stations in an area of about  $70,000 \text{ mi}^2$  surrounding the local storm to be reporting rain. Data sources were primarily Climatological Data (U.S. Weather Bureau 1899 - ), and Hourly Precipitation Data (National Climatic Data Center 1951 - ).
3. There is no apparent correlation between the storm and distinguishable rain-producing synoptic weather features. This was to ensure that the storm was not embedded in a larger, general type of storm. Generally, fronts and low-pressure systems were not closer than 200 mi from a candidate local storm. However, this distance was sometimes modified, depending on the particular characteristics of the synoptic situation. Such characteristics may include the moisture content, strength of feature, and rate at which a feature propagated downstream, among others.

These three basic criteria were used to evaluate candidate storms for classification as local storms in the CD-103 region.

### **12.1.2 Meteorology of Local Storms**

The source of moisture for the CD-103 region, and therefore for the local storms of the region, is the Gulf of Mexico. Large, high pressure centers over the central United States work in conjunction with the thermal low pressure, which forms over northern Mexico, to pump Gulf of Mexico air into the region. The southeasterly flow into the region carries moisture-laden air, which, when it meets the cooler drier mountain air, increases the degree of conditional instability. As low level air is heated during the day, and, in some instances, forced upwards by the mountains, the conditional instability is released, causing frequent local storms during the late afternoon and early evening. This suggests that insolation plays an important role in the release of the conditional instability. Because identification of the track of moisture to a specific local event is difficult, the actual moisture source for most local storms is somewhat less certain than for generalized type storms.

There appears to be no clear pattern at the 500-mb level indicative of the outbreak of strong local storms. Often times at 500 mb there is a ridge over the area where an extreme local storm has occurred; however, ridges at this altitude (approximately 20,000 ft) are broad, large-scale features, covering tens of thousands of square miles; their importance is, therefore, difficult to assess relative to the much smaller (<500 mi<sup>2</sup>) local storm.

## **12.2 Record Storms**

### **12.2.1 Introduction**

PMP is based on significant storms of record. Such storms provide a basis for the determination of the PMP level by presenting realistic weather situations to be analyzed. There are only a few examples of severe local storms in the CD-103 region among the storms for which data were available in the National Weather Service (NWS) Hydrometeorological Branch. Primarily this is because of the small spatial coverage of local storms and the sparsity of population in the region. Only a few local storms in the region have been documented. An extensive search was conducted for storms from other sources that might supplement the established storm record. From a group of 12 candidate extreme storms, four were selected as shown in table 12.1. Some of the other candidates have been listed under general storms because they could not be shown to be isolated from surrounding precipitation (see sec. 12.1.1). Three of these extreme local storms are listed along with additional pertinent data in table 12.2. In addition to the three storms from the CD-103 region listed in table 12.2, data on the local storm that occurred at Morgan, UT on August 16, 1958 is provided and used in this study for comparison purposes.

The storms shown in table 12.2 are from a period of record which covers roughly 90 years. The last 48 years provided all three of the extreme local storms that occurred in the CD-103 region. This is probably due to better documentation and



**Table 12.1.--Candidate local-storm list**

Storm No.	Storm name	Lat. (°) (')	Long. (°) (')	Elev. (ft)	Date	Duration (Hr)	Amt.	Ref*
48.	Las Cruces, NM	32 19	106 47	3900	8/29-30/35	9	10.0	5
51.	Leadville, CO	39 15	106 18	10200	7/27/37	.75	4.25 <sup>A</sup>	3, 4
55.	Masonville, CO	40 26	105 13	6000	9/10/38	1	7.0	1
67.	Golden, CO	39 44	105 14	5993	6/7/48	2 <sup>B</sup>	6.0	2

\*Reference

1. Water supply paper 997
2. From Storm Rainfall in the U.S. (Corps of Engineers)
3. Climatological Data
4. Station Report, station history
5. Hydrometeorological Branch files

Notes:

- A. Questionable amount, see discussion p. 183
- B. Two-hour storm, but at 1 mi<sup>2</sup> the 1- and 2-hr values were the same.

increased observation potential as population increased in the region. This may, at first glance, not appear to be well supported in table 12.2, since only one local storm (Morgan, Utah) listed in the table occurred later than 1948. However, there were also storms of a local nature that do not appear in table 12.1 or table 12.2, because they did not meet the lower limit rainfall criteria in the local-storm definition. The majority of these smaller "local storms" occurred within the last 20 years of the period of record.

All major occurrences of local storms (sec. 12.1.1) that were known were considered. Some storms of possible local nature were excluded because of a lack of critical data. The Sweetwater, CO storm of July 12, 1976 was such a storm. Although an amount exceeding 10 in. was claimed, investigation showed this to be only an estimate not based on supportable data. Therefore, the Sweetwater, CO storm was not included in table 12.1.

The Leadville, Colorado, storm (51) of July 27, 1937, is an interesting situation. Leadville, at an elevation of 10,200 ft, experienced a significant local storm that was recorded as 4.25 in. in about 45 minutes, having started about 1:15 in the afternoon. Only rarely has any appreciable rainfall been recorded at such elevation (see for example discussion of Chiatovich Flat event (Hansen and Schwarz, 1981)). The local newspaper described the storm as being one of the worst in many years, while noting some of the damage to rail lines and the debris deposited at the alluvial outflow.

Table 12.2.—Extreme local storms in CD-103 region \*

Storm no.	Location of storm center	Storm date and time	Lat.		Long.		Elev. (ft.)	Storm duration and amount (in.)/(hr.)	Persisting 12-hr 1000-mb		Storm dew point location	
			(°)	(')	(°)	(')			1-hr amt. (in.)	dew point max. (°F)		
48	Las Cruces, NM	8/29-30/35 11:05 p.m. -8:05 a.m.	32	19	106	47	3900	10/9	4.2	71	78	El Paso, TX
55	Masonville, CO	9/10/38	40	26	105	13	6000	7/1	7	65	74	Akron, CO
67	Golden, CO	6/7/48 12 mid- 2 a.m.	39	44	105	14	5993	6/2#	6#	65	75	310 mi. SE of storm loca- tion
	Morgan, UT*	8/16/58 4-5 p.m.	41	03	111	38	5115	6.75/1	6.75	67	75	Salt Lake City, UT

\*The Morgan, UT storm has been included for comparison in the local storm evaluations, since the type of terrain features and synoptic conditions for this storm were believed similar to those of local storms in the CD-103 region.

#See footnote B, table 12.1

Crow\* analyzed the Leadville record of precipitation data in considerable detail and showed evidence that the extreme amount was likely to be erroneous due to improper design and/or installation of a wind shield on the gage for a period of time that included this major storm event. We accept Crow's conclusion and have chosen therefore not to use these data in this study (thus it does not appear in table 12.2). Nevertheless, we acknowledge that an unusual local-storm event did occur at this elevation on this date although the magnitude of the amount is questionable.

It is noteworthy that none of the accepted extreme local storms listed in table 12.2 occurred in the northern half (north of 41°N) of the study region. This does not necessarily reflect a lack of local-storm occurrence in this portion of the region. The sparsity of the population in the northern half reduces the chance that local-storm events will be reported. The aerial survey of this northern portion of the region (sec. 1.6) showed it to contain some of the most desolate terrain. It is believed, however, that sufficient meteorological potential exists for the occurrence of local storms in this portion of the region.

\*L. Crow, "The case of invalid summer precipitation data at Leadville, 1919-1938 and evidence that snowmelt is the overwhelming source of peak stream flow." (Unpublished manuscript, believed to be 1984).

## 12.2.2 Local Storms

In the following sections, a brief description is given of each of the local storms listed in table 12.2. Information regarding the storm occurrence and the factors considered in satisfying the conditions for local storms are discussed. Some information is also given about significant storms that were not regarded as local storms. The dew points referred to in this section have all been reduced to the equivalent 1000-mb value.

**12.2.2.1 Las Cruces, New Mexico - 8/29-30/35 (48).** During a heavy storm over Las Cruces, NM, 6.46 in. of rainfall was measured between the hours of 11:05 p.m. and 8:05 a.m. on August 29-30, 1935, at a local cooperative observation station, Agricultural College. This station is located about 2 mi southeast of Las Cruces, and about 8 mi west of the Organ Mountains which rise to about 9,000 ft. The elevation at Las Cruces and at Agricultural College is about 4,000 ft. Precipitation records in Climatological Data (U.S. Weather Bureau 1899 - ) were accessed for the period of the storm. Many stations reported precipitation on the 30th, making the Las Cruces storm a marginal case; however, no data are available on the timing of other station rainfall. This, coupled with the lack of an apparent surface synoptic feature which could be related to the precipitation, led to acceptance of the storm as an extreme local storm.

The most unusual characteristic of this storm was its length. As a 9-hr storm, it represents an exception to the previously stated 6-hr duration limit imposed on local storms. It is important to recognize that most of the rain at the observation site (5.85 in.; 90%) fell within the first 3.5 hr. Subsequent rainfall was probably from lingering storm cells in the area.

An estimate of maximum point rainfall for this storm is 10 in. in 9 hr (U.S. Corps of Engineers 1945). This amount was accepted based on consideration of other recorded rainfall amounts from unpublished supplementary precipitation surveys, published rainfall amounts, and the resulting isohyetal pattern.

Storm dew points were determined from persisting 12-hr dew points for stations surrounding the storm area. Dew-point data were generally checked for the 24-hr period leading up to, and including, the storm period. This procedure was followed for all the storms considered in this portion of the study. The representative storm dew point for the Las Cruces storm (48) was based on dew-point data from El Paso, TX. This station lies along a moisture inflow path that reaches Las Cruces from the Gulf of Mexico. The representative persisting 12-hr 1000-mb storm dew point was 71°F.

Northern Hemisphere synoptic surface weather maps (Environmental Data Service, 1899 - ) for August 29 and 30, 1935, are shown in figure 12.1. The August 30 chart depicts the synoptic surface situation about 2 hr before the end of the storm. Of particular interest are the thermal low pressure center over Mexico, and the high pressure center over the Plains States. These two features pumped moisture-rich air from the Gulf of Mexico into New Mexico. This process is noted as being prevalent in local storms in section 12.1.2. The result was an outbreak of storms on the night of the 29th and early morning of the 30th, the largest recorded precipitation amount was from the Las Cruces storm (48).

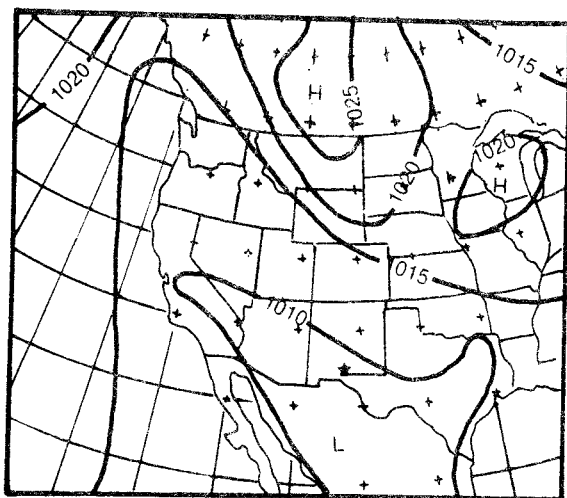

August 29 Surface 0600 MST

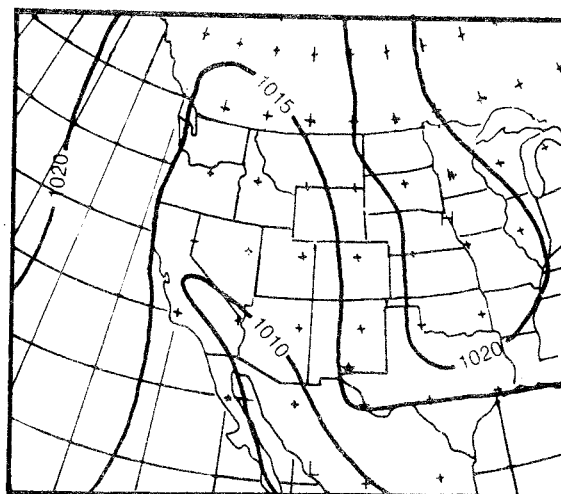

August 30 Surface 0600 MST

**Figure 12.1.--Synoptic surface weather maps for August 29 and 30, 1935 - the Las Cruces, NM storm (48).**

A lack of surface weather fronts in the entire western United States suggests that the storm was not related to any particular synoptic weather feature. Upper air data to support this observation were not available. The storm was probably accompanied by the passage of a trough at the 500-mb level (U.S. Weather Bureau 1967).

The Las Cruces storm does not play a significant role in the determination of 1-hr 1-mi<sup>2</sup> PMP in the CD-103 region. Moisture-maximized transposed amounts were generally less than 50 percent of those of the controlling storm at each transposed location. Since the storm is of little significance, no precipitation pattern for the storm is included.

**12.2.2.2 Masonville, Colorado - 9/10/38 (55).** The Masonville, CO storm on September 10, 1938 is the most important local storm in this study. This is because of the large amount of precipitation (7 in.) that fell in a relatively short period of time (1 hr) in this storm.

The storm actually occurred about 3 mi south of Masonville, near the Missouri Canyon in northern Colorado at an elevation of about 6,000 ft. It has been referred to as the Missouri Canyon storm in other literature (Hansen et al. 1978). The only records of this storm came from a handful of ranchers in the area. Of these, one rancher reported "...about 7 in. within a half hour." Another rancher, approximately one-half mile from the first, reported "...about 5 in., which occurred between 6 and 7 p.m., most of it within 20 minutes..." (Follansbee and Sawyer 1948). Words such as "about" and "most" make evaluating these reports difficult. In light of the fact that rain lasted approximately 1 hr only one-half mile from the 7-in. report and the vagueness surrounding the 7-in. amount, it was decided to accept the Masonville storm as 7 in. in 1 hr. The 1- to 30-min ratio from typical local storms in HMR No. 49 (see table 12.4) is 1.16 (1.0/0.86). On this basis, if the 7-in. depth actually accumulated in 30 min, a typical value for the 1-hr depth would be 8.1 in. This is 14 percent greater than the 1-hr value of 7 in. chosen for this storm. This would suggest that the decision to use 1 hr for this storm amount is not excessively conservative.

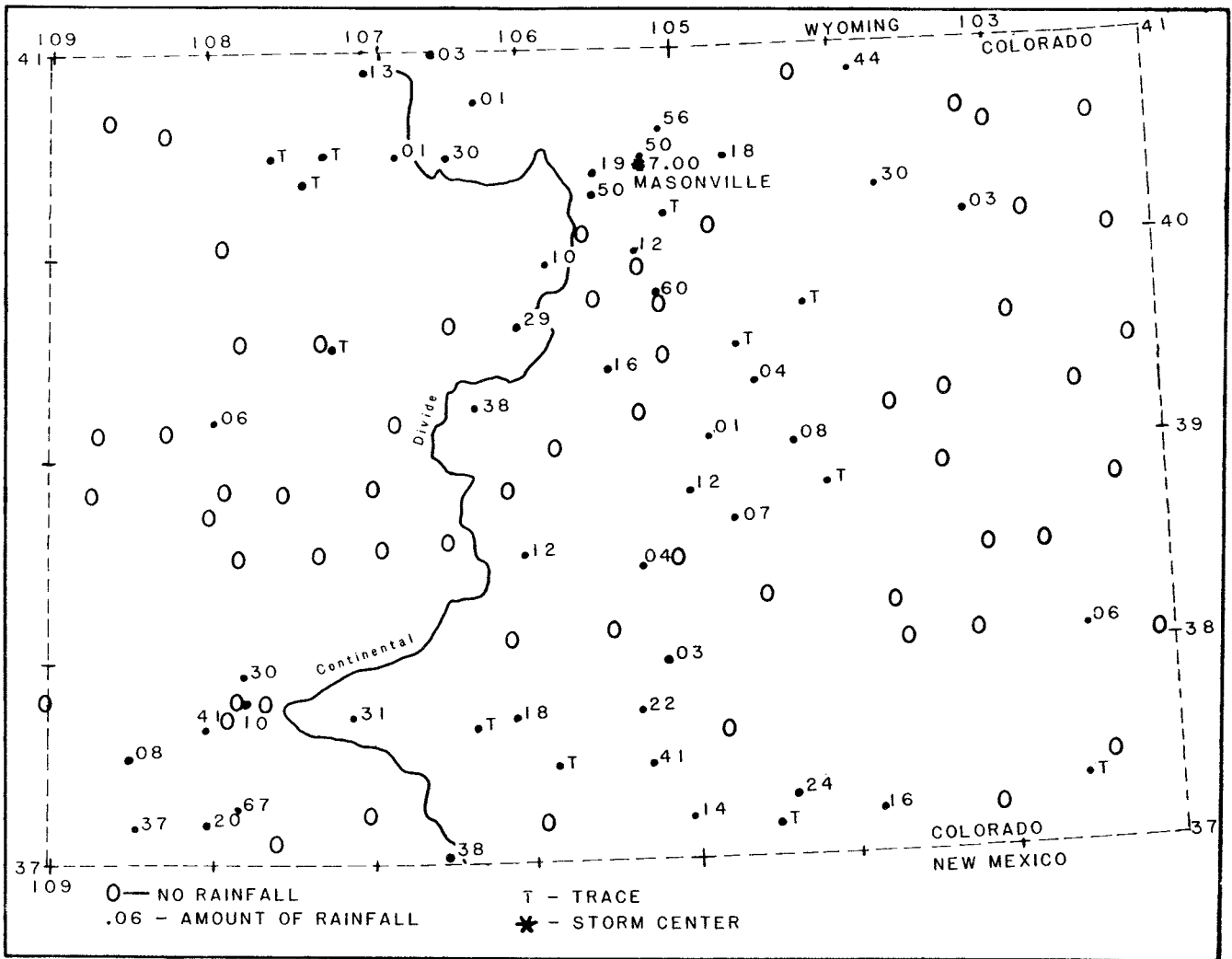
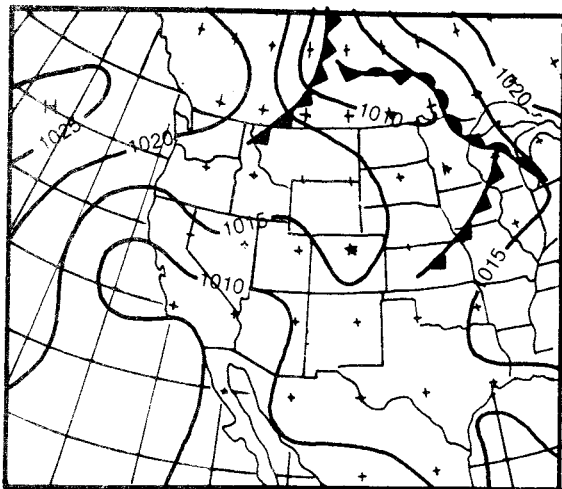

Figure 12.2.--Precipitation map, Masonville, CO storm (55) - September 10, 1938.

The representative persisting 12-hr storm dew points for the Masonville storm were sought using dew-point data from first-order reporting stations. Dew points were checked at Denver and Pueblo, CO, and Cheyenne, WY. Low representative storm dew points obtained from these cities prompted further investigation. Supplemental storm data were obtained for stations at Akron, Dover, Greeley, and Fort Collins, CO. All of these locations except Akron are within 50 mi of Masonville (Akron is about 100 mi east). Dew points at Fort Collins and Akron, CO, on the morning and afternoon of September 10 were several degrees (F) higher than those at other locations. Unfortunately, a gap of about 8 hr occurred in the Fort Collins data for the 10th. In light of this fact, and the favorable wind direction at Akron for advecting moisture towards the storm location, the Akron dew point (65°F) was accepted as most representative of the Masonville storm moisture. The Fort Collins dew point (64°F) supports the Akron dew point.

The geographic distribution of the rainfall surrounding the Masonville storm is shown in figure 12.2. The plotted data show the pattern as mostly disorganized on the 10th. Rainfall was scattered around the state in the form of numerous isolated storms, as shown by the large number of stations that reported no rainfall on the 10th. There were no reports of extreme or unusual amounts of rainfall other than for the Masonville storm (55).



September 10 Surface 0600 MST

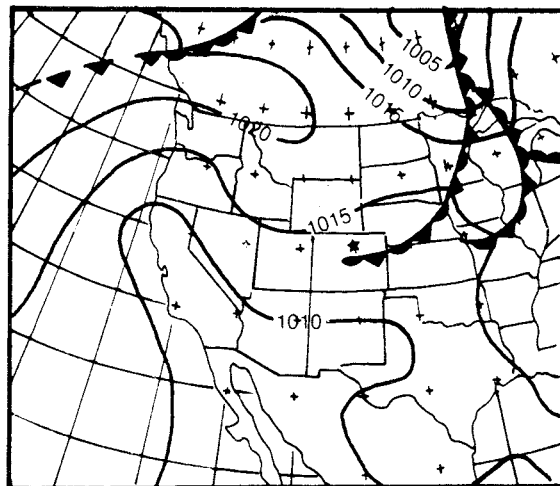

September 11 Surface 0600 MST

**Figure 12.3.--Synoptic surface weather maps for September 10 and 11, 1938 - the Masonville, CO storm (55).**

Only daily synoptic surface weather maps were produced in 1938. The 6:00 a.m. synoptic charts are shown in figure 12.3 for September 10 (approximately 12 hr prestorm) and September 11 (approximately 12 hr post storm). The analysis shows a front propagating rapidly southeastward from the northwest on the 10th to a position almost directly over Denver, CO, on the morning of the 11th. A linear interpolation between the two surface weather maps led to the conclusion that the Masonville storm occurred ahead of the approaching front. The interpolation shown in figure 12.4 is for 6:00 p.m. on the 11th, or about the time the Masonville storm ended. As can be seen in figure 12.4, the front was still a good distance to the northwest at the end of the storm, far enough away to conclude that the Masonville storm precipitation was not frontal in nature.

#### 12.2.2.3 Golden, Colorado - 6/7/48

(67). The Golden, CO storm occurred early on the morning of June 7, 1948, and plays a supporting role in this study. Golden is located just west of Denver on the first upslopes of the Rocky Mountains. The storm elevation was 6,000 ft. The storm amount was reported as 6 in. in 2 hr by the Corps of Engineers (1945 - ).

A representative storm dew point of 65°F was obtained as the result of the averaging of dew-point data from reporting stations approximately 310 mi southeast of the storm location. Dew-point data from several closer stations (Denver and Pueblo, CO; Cheyenne, WY) were also examined. These dew points were found to be unrealistically low. Based on available information, the storm dew point of 65°F for the Golden, CO storm (67) was accepted.

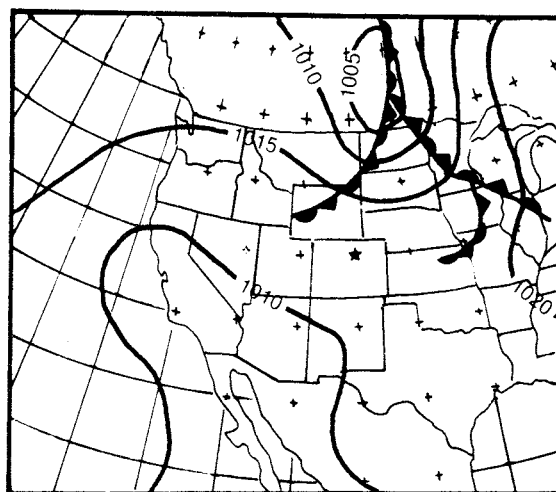

September 10 Surface 1700 MST

**Figure 12.4.--Linearly interpolated synoptic surface weather map for 1800 GMT - September 11, 1938.**

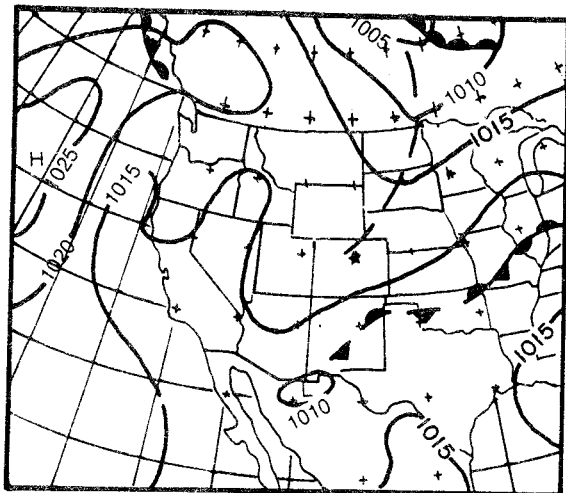

June 6 Surface 0530 MST

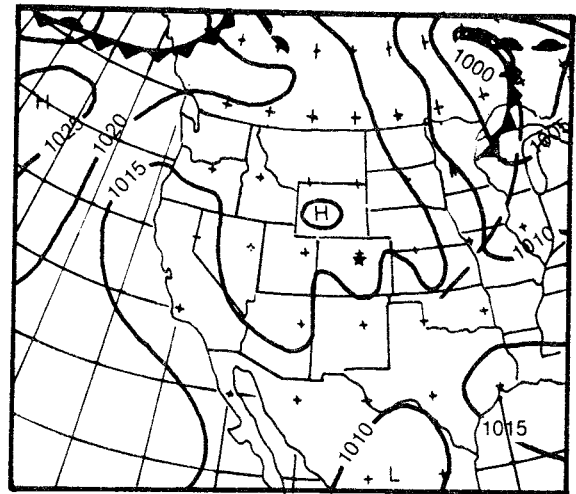

June 7 Surface 530 MST

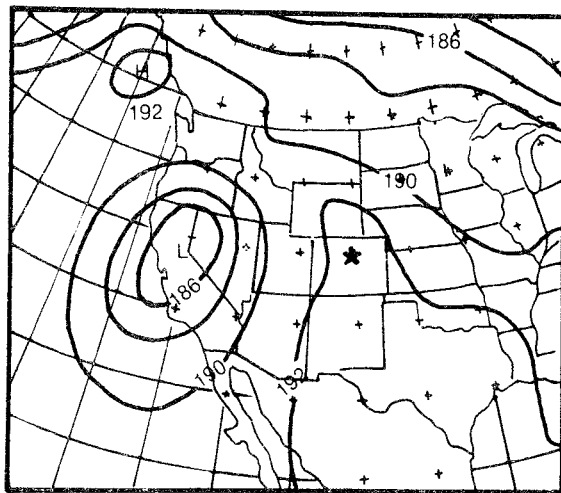

June 5 500 MB 2000 MST

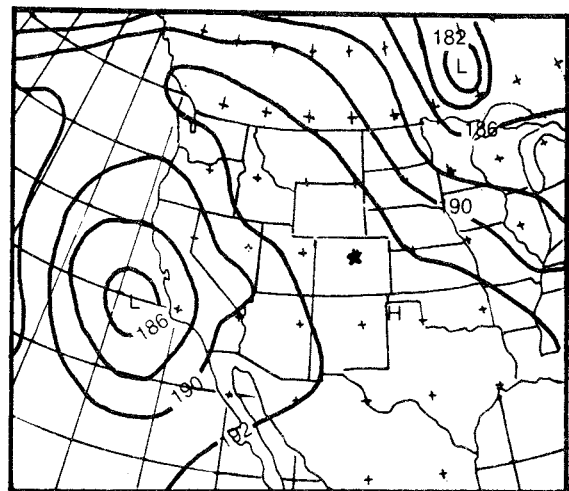

June 6 500 MB 2000 MST

**Figure 12.5.--Synoptic surface weather maps and 500-mb charts for June 6 and 7, 1948 - the Golden, CO storm (67).**

The storm occurred between midnight and 2:00 a.m. on the morning of June 7. Surface weather maps in figure 12.5 for June 6th show a low pressure center in central Canada with an associated trough extending into the Rocky Mountain region of Colorado about 20 hr prior to the storm. The trough passed through the storm area and continued eastward into Kansas. Available data suggest that this trough passed over the storm area approximately 12 hr prior to the actual storm occurrence. This period of time is believed sufficiently long to disassociate the storm from the trough.

The isobaric gradient over the Colorado region was weak. A small area of high pressure was shown in the analysis for the 7th (fig. 12.5). The thermal Low over northern Mexico, a seasonal occurrence, caused onshore flow from the Gulf of Mexico. This type of flow is prevalent during many less intensive storms in the CD-103 region, as mentioned in section 12.1.2. However, significant moisture

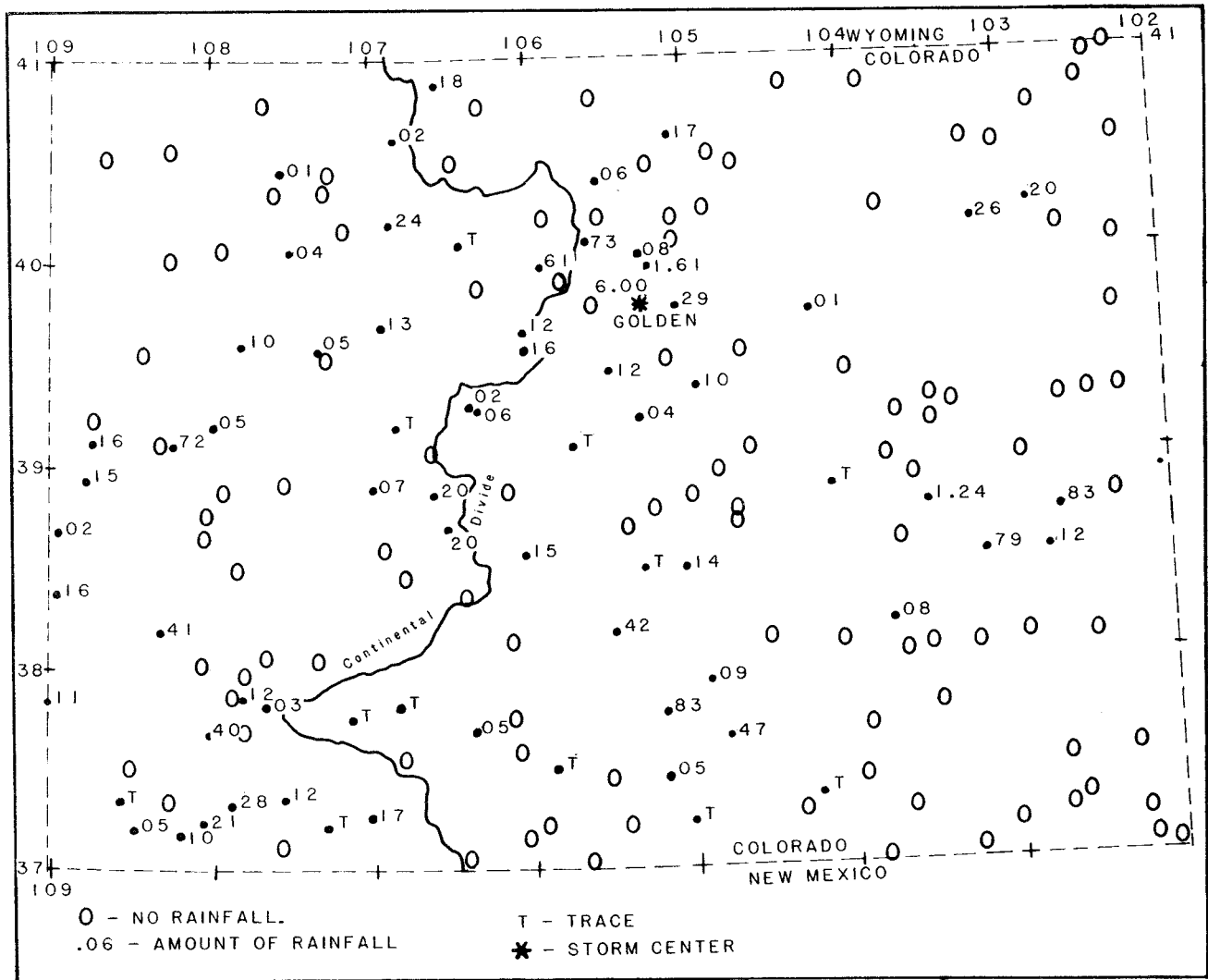

Figure 12.6.--Precipitation map, June 7, 1948 - the Golden, CO storm (67).

input to the storm is not well supported by the weak isobaric gradient over the Southwestern region. This fact may account for the low dew points that were observed at some stations.

At the 500-mb level, a ridge occurred over the region with a closed Low off the coast of California. Winds were generally light in the ridge showing little synoptic scale organization. However, it should be pointed out that a lack of upper air data for many of the storms in this study has made it difficult to derive any meaningful generalized relations between upper air data and local-storm occurrence.

The geographic rainfall distribution pattern on the day of the storm is shown in figure 12.6. The data are taken from the Climatological Data (U.S. Weather Bureau 1899- ) for the 24-hr period, primarily from sunset (approximately 7:30 p.m.) June 6th to sunset June 7th, encompassing the storm occurrence. The rainfall distribution is generally disorganized with spotty precipitation scattered around the state. The 6-in. report at Golden, CO stands far above any other report for the period. This pattern provided strong evidence that the Golden, CO storm is an extreme local storm event.



**12.2.2.4 Morgan, Utah - 8/16/58.** The Morgan, UT storm of August 16, 1958, occurred outside the CD-103 region at an elevation of 5,115 ft and dumped 6.75 in. of rain between 4 and 5 p.m. This storm was used in the HMR No. 49 study as an extreme local storm. Upon review, it was decided to include this local storm for comparison purposes within the CD-103 study. This decision was based on terrain and related moisture inflow considerations. First of all, the terrain of a significant part of the CD-103 study area is very similar to that of the HMR No. 49 study. Secondly, the Continental Divide east-northeast of Morgan is less abrupt and lower in elevation than along other portions of the Divide. The Continental Divide east of Morgan does not represent the major barrier to moisture from the east-northeast that other portions of the Divide represent. Based on these arguments, the Morgan storm was transposed into the CD-103 region.

The meteorology of the Morgan storm has been discussed in HMR No. 50 (Hansen and Schwarz 1981); therefore, a lengthy discussion is not included here. Synoptic surface weather maps and 500-mb charts, and the geographic rainfall distribution for the day of the storm appear in figures 12.7 and 12.8, respectively. A weak isobaric gradient is apparent upon review of the surface charts, as was the case in the Golden, CO storm (sec. 12.2.2.3). No weather fronts were in the vicinity of the storm. At the 500-mb level, a ridge over the western United States showed generally light winds. This was also present in the Golden, CO storm.

The rainfall pattern, taken from Climatological Data for the 24-hr period generally ending around 8:00 p.m., shows a disorganized scattering of rain around the state. The 6.75 in. report stands far above all other reports for that day. A report of 7 in. was not accepted in this storm.

The synoptic conditions for the Morgan, UT storm parallel in many respects those for the Golden, CO storm. This may suggest a general environment that is receptive to the development of extreme local storms. It also suggests some degree of uniformity between local storms in the CD-103 region and those in the HMR No. 49 region. This similarity supports transposition of the Morgan, UT storm into the CD-103 region.

The Morgan storm plays a comparative and supportive role in the determination of local-storm PMP in the CD-103 region. Its moisture-maximized transposed amounts are slightly less than the corresponding values for the Masonville storm. These supporting values lend credibility to the levels of PMP dictated by the Masonville storm.

### **12.2.3 Important Non-local Storms**

Some discussion is warranted of three storms, which were investigated as being local storms but were found to be embedded in general storms. These storms were considered to be potentially important storms to the CD-103 region. It is important to keep in mind the local-storm definition discussed in section 12.1.1.

**12.2.3.1 Virsylvia, (Cerro), New Mexico - 8/17/22 (35).** This storm occurred over a 4-hr period on August 17, 1922 at Virsylvia, NM where 7.5 in. of rain was observed. The station is located in the San Luis Valley in extreme northern New Mexico at an elevation of 7,500 ft near the present town of Cerro.

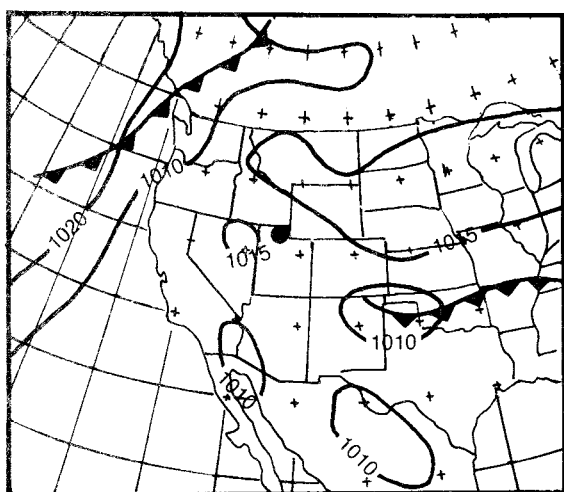

August 16 Surface 0500 MST

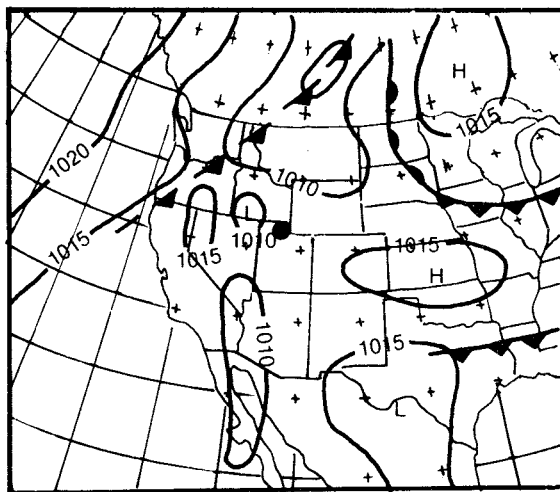

August 17 Surface 0500 MST

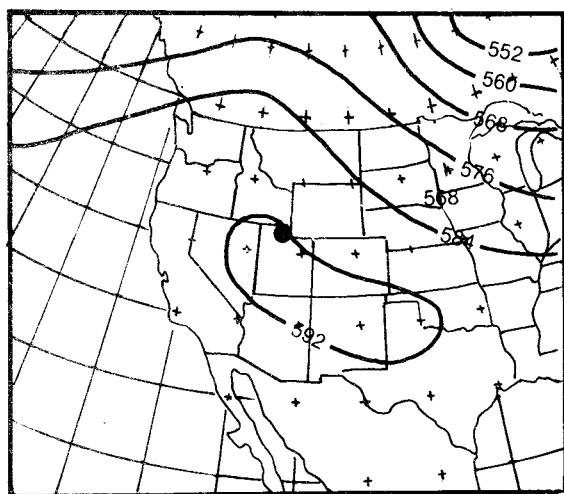

August 16 500 MB 0500 MST

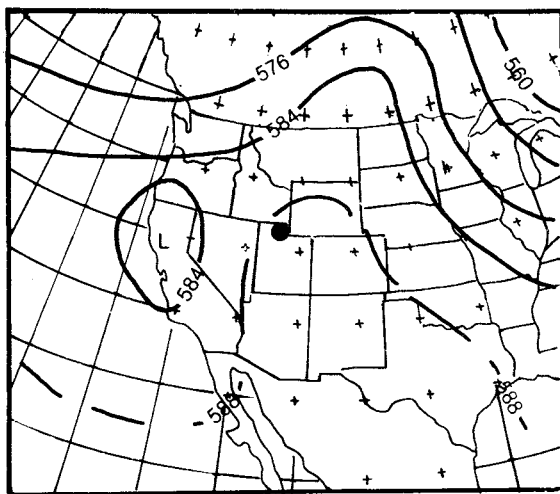

August 17 500 MB 0500 MST

**Figure 12.7.—Synoptic surface weather maps and 500 mb charts for August 16 and 17, 1958 - the Morgan, UT storm.**

The observed rainfall was taken from a station report as having occurred between the hours of noon and 4:00 p.m. on the 17th. A review of the surface synoptic situation in the Northern Hemisphere Synoptic Weather Map series (Environmental Data Service 1899-) revealed that a front that had been semistationary over Colorado early on the morning of the 17th started drifting slowly southward to a position across central New Mexico on the morning of the 18th. Although the exact time of frontal passage at the Virsylvania (Cerro) station is unknown, it is highly likely that the front, based on an interpolated position, was very close to the station on the afternoon of the 17th. This implies a close relationship between the storm and the cold front. Because of this relationship, the Cerro storm was not accepted as an isolated local storm.

**12.2.3.2 White Sands, New Mexico - 8/19/78 (82).** A heavy line of thunderstorms dumped 10 in. of rain in 4 hr (5:00 p.m. to 9:00 p.m.) at White Sands, NM (elevation 4,000 ft.) on August 19, 1978. The storm caused locally heavy flash flooding that resulted in the deaths of five people.

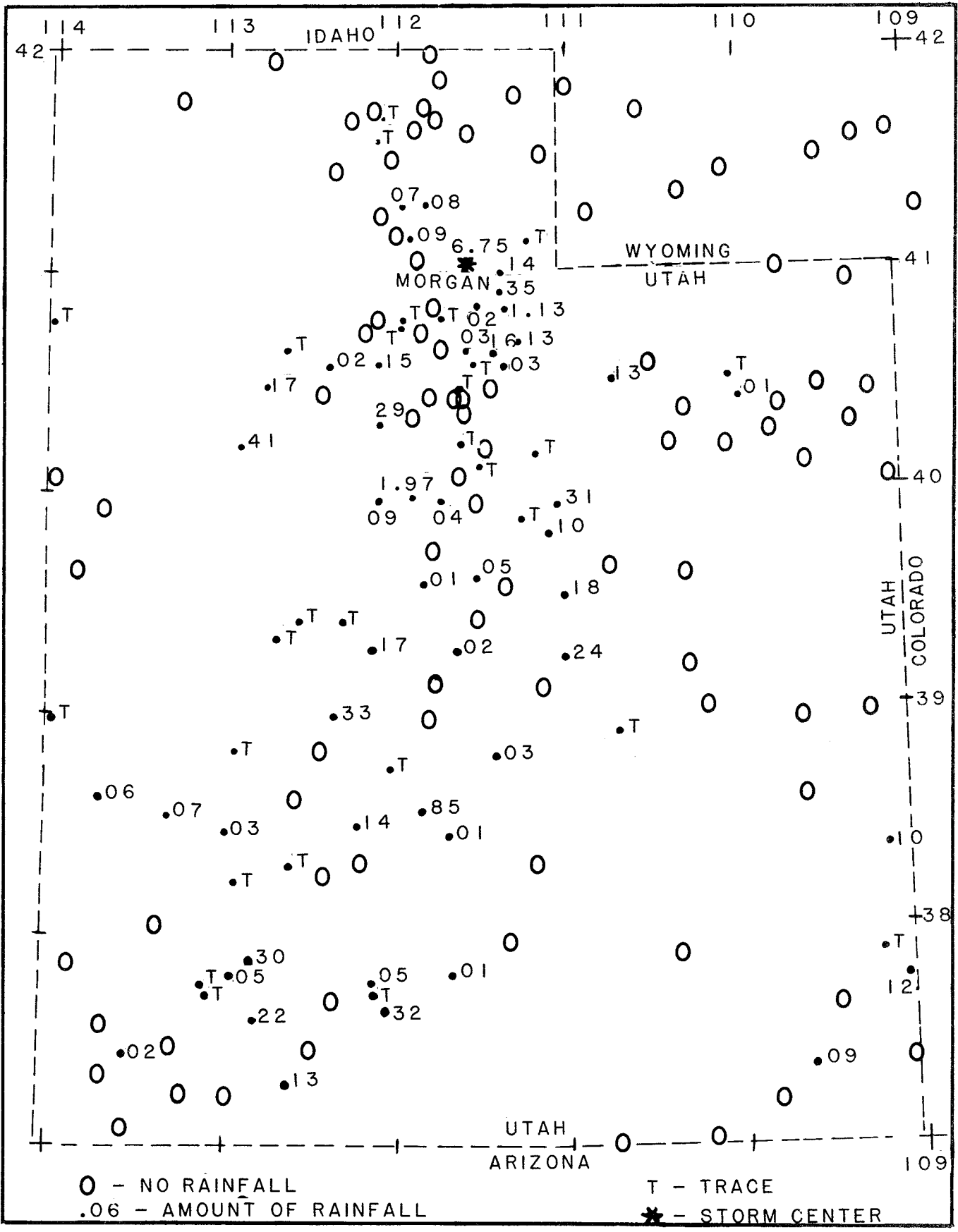

Figure 12.8 ---Precipitation map, Morgan, UT storm - August 16, 1958.

The 0600 surface synoptic analysis for August 19 and August 20 showed no apparent correlation between the rainfall and any fronts. A weakening cold front was located in southern Texas; however, it was believed that this front, having already passed White Sands prior to the storm, was not responsible for the storms.

The rainfall pattern indicated that an organized line of severe thunderstorms, possibly a squall line, had moved from southwestern New Mexico to the northeast past White Sands. Rain amounts from Hourly Precipitation Data (National Climatic Data Center 1951- ) showed several significant rainfalls throughout the southwestern portion of the state that occurred at the same time as the White Sands storm. Many of these rainfalls were in excess of 1 in. in less than 2 hr. The magnitude and intensity of the rains concurrent with the White Sands storm, along with the apparent organization of a squall line of severe thunderstorms, led to the rejection of the White Sands storm as a local storm.

**12.2.3.3 Big Thompson Canyon, Colorado - 7/31/76 (81).** The Big Thompson Canyon storm of July 31, 1976, is discussed in section 2.4.1.9. The Big Thompson storm was not accepted as a local storm because of the stationary cold front that prevailed through the middle of Colorado. The storm developed very near this front, and, therefore, the extreme short duration rainfall event is considered to be part of a general storm.

## 12.3 1-hr 1-mi<sup>2</sup> PMP Approach

### 12.3.1 Introduction

As was stated in section 12.1, the local-storm PMP was derived for the entire CD-103 region in this revised study. This decision was a significant change from that followed in HMR No. 55, as discussed in that section. The present approach is similar to that used in developing the local-storm PMP in HMR No. 49 (Hansen et al. 1977). In this approach one of the first indices considered was an analysis of maximum 1-hr point rainfall. These data, obtained from a search of the hourly precipitation data tapes\* (period 1948-1978), were plotted and analyzed to establish an approximate pattern and gradient. Extreme local-storm data was maximized and transposed throughout the region to set the level of magnitude of PMP. For convenience, a common-level index map was set at 5,000 ft and the results smoothed and manually adjusted to blend into the analysis west of the Divide. Cross-Divide comparisons of these results are discussed in chapter 13.

### 12.3.2 Data

Data tapes available to the Office of Hydrology contain hourly precipitation for the period 1948 to 1978. Data were processed for recorder stations in the region that had a minimum of 15 years data. Maximum 1-hr values were listed for each station and synoptic maps and original records reviewed to verify the reports as well as to determine which data most closely met the conditions of the local-storm definition. The maximum station values were then adjusted to

---

\* Hourly precipitation tapes maintained by the Office of Hydrology.

5,000 ft by use of the saturated adiabatic equivalent ratio of precipitable water (U.S. Weather Bureau 1951). A rough analysis was made of the 5,000 ft data to establish the basic gradient.

The four major local storms listed in table 12.2 were adjusted for duration and elevation, and moisture maximized to obtain 1-hr moisture-maximized 5,000-ft amounts. These were transposed within rather liberal north-south transposition limits to set the level of PMP throughout the region. Smoothing was then done where necessary to tie into 1-hr local-storm 5,000-ft analyses west of the Divide. Each adjustment, along with any restrictions, is discussed separately in the following sections.

**12.3.2.1 Adjustment for Duration.** An adjustment for duration was applied to those extreme local storms that did not explicitly have a 1-hr amount. One-hr amounts were available for the Golden (67) and Masonville (55), CO, and Morgan, UT storms. Therefore, it was not necessary to adjust those storms. However, 1-hr amounts were not reported for the Las Cruces, NM (48) storm.

Depth-duration information, if it existed for a local storm, was considered of primary importance. Data are available for a mass curve of rainfall only for the Las Cruces, NM storm (48). From this, a depth-duration relation was constructed from the record at the Agricultural College and is shown in figure 12.9. From this relation, a 1-hr percentage of total-storm amount (42 percent) was obtained. From field survey measurements, it was estimated that the maximum point rainfall in the Las Cruces, NM storm was 10 in. Applying the 1-hr to total-storm percentage from the Agricultural College record to this estimated amount produced a 1-hr value of 4.2 in.

**12.3.2.2 Adjustment for Maximum Moisture.** The adjustment for maximum moisture is the ratio of precipitable water for the maximum persisting 12-hr 1000-mb dew point to that for the representative persisting 12-hr 1000-mb storm dew point. The adjustment is basically the same as that for the general storm discussed in chapter 8. Representative storm dew points for local storms are preferably taken from stations within close proximity (<50 mi) to the storm location. These stations are considered to be the most representative of the moisture situation at the storm location because the localized nature of the storm precludes a well organized inflow of moisture. In reality, close proximity dew points are not always available. In their absence, dew points were accepted from more distant locations, with some loss in reliability.

For the local storm, it is permissible to proceed in any direction from the storm location to find a representative storm dew point. This is in contrast to the general storm where the representative dew point must be located in the moisture inflow direction for the storm. The multidirectional approach is considered satisfactory for the local storm because the local storm is assumed to occur independent of any sustained moisture inflow.

Representative storm dew points must persist for 12 hr or more at a station. This is required to remove any aberrations in the station dew-point data. Dew points that occur in a reported rainfall situation are also generally not accepted. The representative storm dew points for each of the local storms appear in table 12.2 and are discussed for each local storm in section 12.2.2.

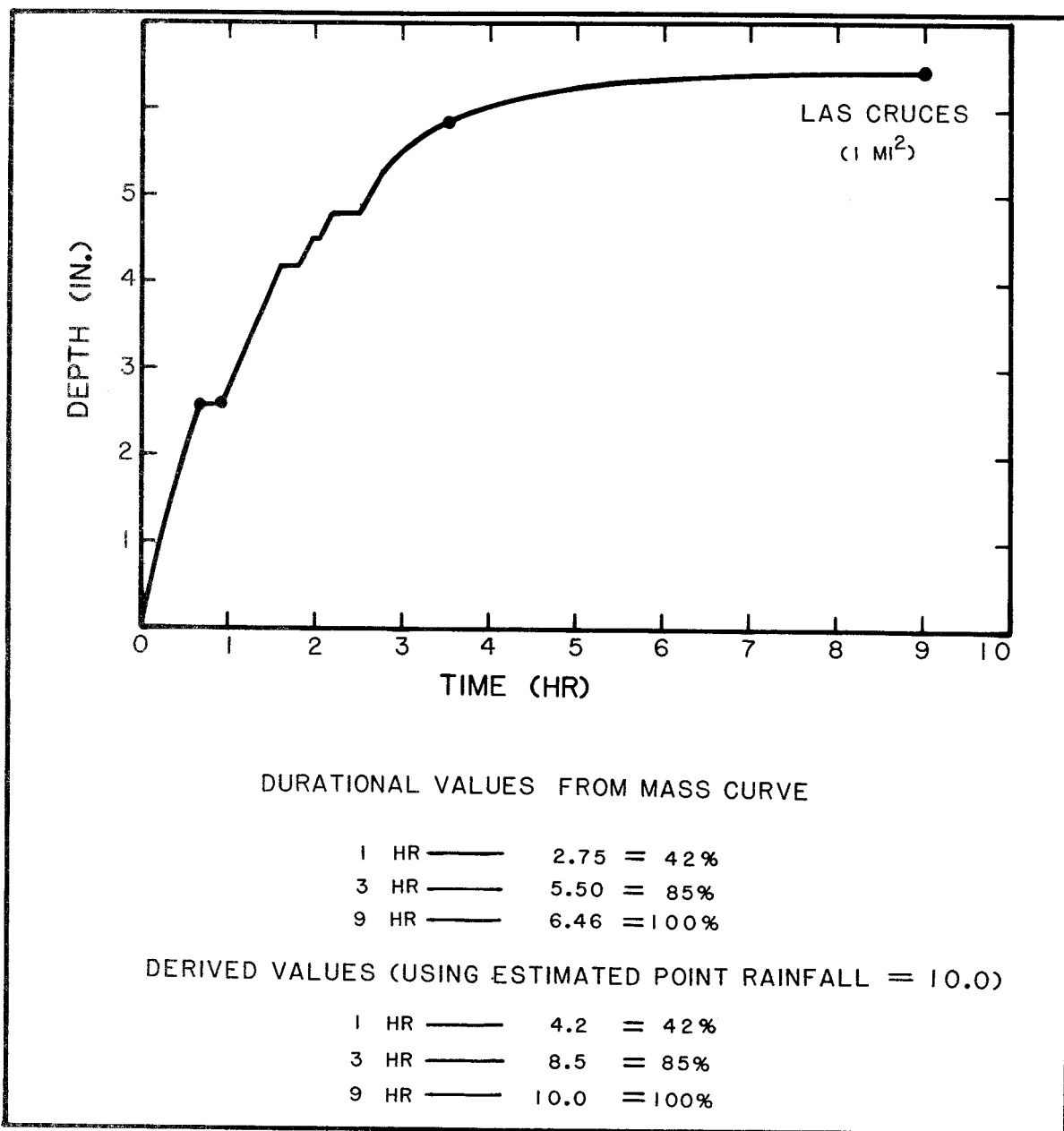

Figure 12.9.--Mass curve of rainfall for Agricultural College - the Las Cruces, NM storm (48).

Maximum persisting 12-hr 1000-mb dew points were taken from the revised dew-point charts prepared for this study (chapt. 4). The local-storm maximum persisting 12-hr 1000-mb dew point is read 15 days into the warm season at the location of the storm, not at some reference distance from the storm, as is done for the general storm. This should provide a better representation of maximum moisture available for the local storm.

Moisture maximization of extreme local storms is done in-place, that is, at the storm site location. An upper limit restriction of 1.5, or 150 percent, was placed on the in-place moisture-maximization adjustment. This restriction has the effect of reducing the allowable moisture difference between precipitable water obtained from the representative storm dew point, and precipitable water obtained from the maximum persisting 12-hr 1000-mb dew point. The restriction is

**Table 12.3.--In-place local-storm moisture maximizations**

Storm no.	Storm	Unrestricted in-place moisture adjustment (percent)	Restriction applied moisture adjustment (percent)
48.	Las Cruces, NM	148	148
55.	Masonville, CO	183	150
67.	Golden, CO	185	150
-	Morgan, UT	158	150

intended to minimize excessive adjustments. The limitation is lower than was used for the general storm in orographic regions for two reasons. First, extremely large changes in moisture supply for these isolated events may result in a change to the storm structure. Second, the ability of available moisture to be adequately sampled by the limited observational network was a concern. Low representative storm dew points produce unreasonably high adjustments for moisture maximization. This is more of a problem with local storms where there is no sustained moisture inflow, and where dew points must be selected within a relatively small region, than with general storms where observations at a considerable distance may be used.

The restriction of 150 percent on the adjustment for moisture maximization affected three out of the four extreme local storms in table 12.2. The only storm not affected was the Las Cruces, NM storm (48). Table 12.3 lists the unrestricted in-place moisture-maximization adjustment and the restricted adjustment that was used in PMP calculations.

**12.3.2.3 Horizontal Transposition.** Transposition, as for the general storm, refers to the process of taking storm precipitation amounts from one location to another location. The amount is adjusted for differences in the moisture available between the storm location and the transposed location.

Numerous transposition locations were chosen in the CD-103 region. Some locations were chosen because of their low elevations in valleys, canyons, etc. Other locations were chosen to represent middle and high elevations as well as nonorographic and minimum nonorographic areas. Locations were chosen to provide adequate representation for northern, as well as southern areas.

The necessary climatic ingredients for the development of extreme local storms are potentially present throughout the CD-103 region during the May to September season. The four extreme local storms in table 12.2 occurred during this season. A survey of clock-hour rainfall showed that short-duration maximum 1-hr rainfall most likely occurs during this season (see discussion in sec. 12.8).

Some areas, due to moisture availability, terrain considerations, etc., are likely to produce more local storms than other areas. The question of frequency of local-storm occurrences is not relevant to estimating the level of local-storm PMP, as long as it is concluded that local storms do indeed occur.

In transposing local storms from one location to another, the same upper restriction of 1.2, or 120 percent, was used as in transposing general storms. In reality, this restriction turned out to have no effect, as no horizontal moisture adjustment for any of the local storms considered exceeded 1.2.

**12.3.2.4 Adjustment for Elevation.** The adjustment for elevation is an adjustment for the differences in available moisture at different elevations. Discussion of this adjustment is also given relative to general storms in section 8.4.2.2.

No adjustment to moisture was imposed on local storms within the first 1,000-ft elevation change, as was also the case for general storms. However, unlike the general storms, the traditional full moisture adjustment was used for differences beyond the first 1,000 ft in local-storm transposition considerations. Use of the full moisture adjustment resulted in significant decreases to some of the high-elevation local-storm PMP estimates.

The traditional moisture adjustment was used because we find no evidence that local storm events are sustained by inflow moisture advected over long distances in the sense that general storms are. Initiation of local-storm convection derives its moisture from that available in the immediate vicinity, possibly accumulated from evaporation of prior rainfall.

Regarding the difference in vertical adjustments applied to local- and general-storm amounts in this study, the precedent has already been established in HMR No. 43 and 49. However, the adjustments used in the present study are in accord with those described in most previous hydrometeorological studies.

An overall upper restriction of 1.2, or 120 percent, was placed on the adjustment of moisture due to elevation. The transposition adjustments for the four storms were well within the 1.2 restriction.

It was decided not to include an adjustment for the effect of barrier elevations on moisture. This agrees with WMO procedures (1973) and with HMR No. 49.

## **12.4 1-hr 1-mi<sup>2</sup> Local-Storm PMP Map (Revised)**

### **12.4.1 Introduction**

All extreme local storms were transposed to a random selection of grid locations in the region. The 1-hr 1-mi<sup>2</sup> values are for a constant elevation of 5,000 ft. This was so the gradients of PMP would not be obscured by elevation changes, and is consistent with the local-storm PMP analysis produced in HMR No. 49 (Hansen et al. 1977).

### **12.4.2 Analysis of 1-hr 1-mi<sup>2</sup> Local-Storm PMP Map**

Evaluating the 1-hr 1-mi<sup>2</sup> map at a constant elevation of 5,000 ft reduced the amount of detail necessary in the analysis, and also served to point out the nature of the 1-hr PMP gradient across the region. The constant elevation of 5,000 ft also facilitated smoothing between the local-storm PMP for the CD-103 region and the local-storm PMP west of the Continental Divide (Hansen et al. 1977).



With elevation removed as an influence upon the analysis of the 1-hr 1-mi<sup>2</sup> PMP map, moisture availability played a major role in the analysis. Moisture manifested itself in two ways in the analysis. First of all, maximum persisting 12-hr 1000-mb dew points had a strong influence on the transposed values at each location. Second, the dew point gradients were used to provide additional guidance on how isopleths of PMP should be oriented on the 1-hr 1-mi<sup>2</sup> PMP map. This guidance was obtained through observing the gradient of isolines of maximum persisting 12-hr 1000-mb dew points on the charts for the months of May-September (fig. 4.9 to 4.13). These are the months of local-storm occurrence (see table 12.7).

The transposed and adjusted storm values showed that the Masonville storm dominated throughout almost all of the region. In Wyoming and southwestern Montana, the Masonville amounts were matched or slightly exceeded by the transposed Morgan, Utah storm values. This was viewed as support for the overall level established by this process.

The enveloping analysis of maximized 5,000 ft station data drawn for 1 hr and 1 mi<sup>2</sup> was then smoothed to tie into the local-storm analysis from HMR No. 49 as closely as possible. The need to tie into the local-storm results in HMR No. 43 were considered less important since this report is presently being revised and the published local-storm results may change. Nevertheless, quite close agreement to HMR No. 43 values was not difficult to obtain (see discussion in section 13.6)

#### **12.4.3 1-hr 1-mi<sup>2</sup> PMP Index Maps**

The results of the procedure described above appear in plates VI a-c. As stated in an earlier section, significant barriers were given little attention in this study, since it was assumed local storms are not inflow dependent. Lowest values of local-storm PMP occur in northwestern Montana and increase in a generally uniform manner to the southeast, reaching a maximum of 13.0 in. in western Texas.

Although local-storm PMP is analyzed throughout the region, nowhere east of the 105th meridian were we able to find a location where the local-storm value exceeded the 1-hr general-storm value.

### **12.5 Durational Variation**

Since it is assumed that a local storm exists independent of sustained inflow, it is reasonable that the duration of a PMP-type local storm would be unlikely to exceed 6 hr. It is also reasonable to expect that most of the rain and, therefore, the greatest intensities of rainfall would occur in the first 1-3 hr, and then decrease as the storm depleted its moisture.

#### **12.5.1 Data and Analysis for PMP for Longer Than 1 hr**

With the above considerations in mind, a study of 6-/1-hr rainfall ratios was undertaken to determine how local-storm PMP would vary with duration. Recorder station maxima were accessed for 1- and 6-clock-hour monthly maximum amounts. The following restrictions were placed on the data.

1. The maximum 1-hr rainfall for each month was determined.

2. The maximum 6-hr amount surrounding the 1-hr value was determined.
3. Rainfall adjacent to the 6-hr rainfall period was tested to determine if the storm was isolated in time at this station.

The process was accomplished in the following manner. First, a 1-hr maximum was found, then the maximum 6-hr amount around the 1-hr maximum was determined. Three-hour periods were then checked on both sides of the 6-hr amount for precipitation amounts ( $>.1$  in.). If there was no precipitation in excess of the criterion, the rainfall was accepted as short duration. If larger precipitation amounts were present, then the 6-hr period around the 1-hr maximum was shifted by 1 hr and the 3-hr periods on both sides of the new 6-hr period were checked. This process continued until an acceptable 6-hr period could be found, or until all 6-hr periods were tested and were considered unacceptable. In the former case, the 1-hr maximum and acceptable surrounding 6-hr period were recorded. In the latter case, the 1-hr maximum was eliminated and the next highest 1-hr period for that month was tested in the same manner. In most cases, if the maximum 6-hr amount surrounding the 1-hr maximum was determined to be unacceptable, attempts to find an acceptable 6-hr period around that 1-hr maximum also proved fruitless. However, in some cases, when short burst storms occurred within a short time of each other, an acceptable 6-hr period could be found where the 1-hr maximum occurred.

Corresponding monthly 1-hr maxima from different years (May 1948, May 1949, May 1950, etc.) were compared to obtain a period-of-record 1-hr maximum for each month of the year at each station. The highest 1-hr amount of record was then selected at each station and compared with its surrounding 6-hr amount to obtain a 6-/1-hr within-storm ratio for the station. In this manner 6-/1-hr within-storm ratios were obtained for all the stations within the local-storm areas of the CD-103 region. These ratios were, by definition of the selection criteria previously outlined, taken from short-duration type precipitation events.

The ratios were grouped according to proximity, similarity of topographical characteristics, and position with respect to geographical boundaries. The ratios range from around 1.1 to around 1.2. On a comparative basis, average 6-/1-hr ratios in HMR No. 49 ranged from 1.1 to 1.8, with ratios to the east of the Sierra Nevada ranging from 1.1 to 1.4. Near the Rocky Mountains, ratios tended to be between 1.2 and 1.3. The lack of range in the averaged 6-/1-hr ratios for the CD-103 region and for the adjacent eastern portion of HMR No. 49, suggests a homogeneity of the local-storm depth-duration characteristics, both within the CD-103 region, and between the CD-103 region and the adjacent eastern portion of HMR No. 49. The Las Cruces, NM storm (48) was the only local storm in the region for which depth-duration estimates could be made. The 6-/1-hr ratio for this storm was approximately 2.4, significantly larger than suggested by the hourly precipitation data.

It was decided that the entire CD-103 region could be represented by a single 6-/1-hr ratio. The ratio chosen was 1.35, for which a smooth depth-duration curve is shown in figure 12.10, and appropriate ratios for durations between 1 and 6 hr are given in table 12.4. The 1.35 ratio is skewed towards the higher 6-/1-hr ratios within the CD-103 region to provide a reasonable envelopment of the 6-/1-hr ratios shown. The use of the ratio of the Las Cruces storm would have resulted in unreasonable 6-hr 1-mi<sup>2</sup> local-storm PMP.

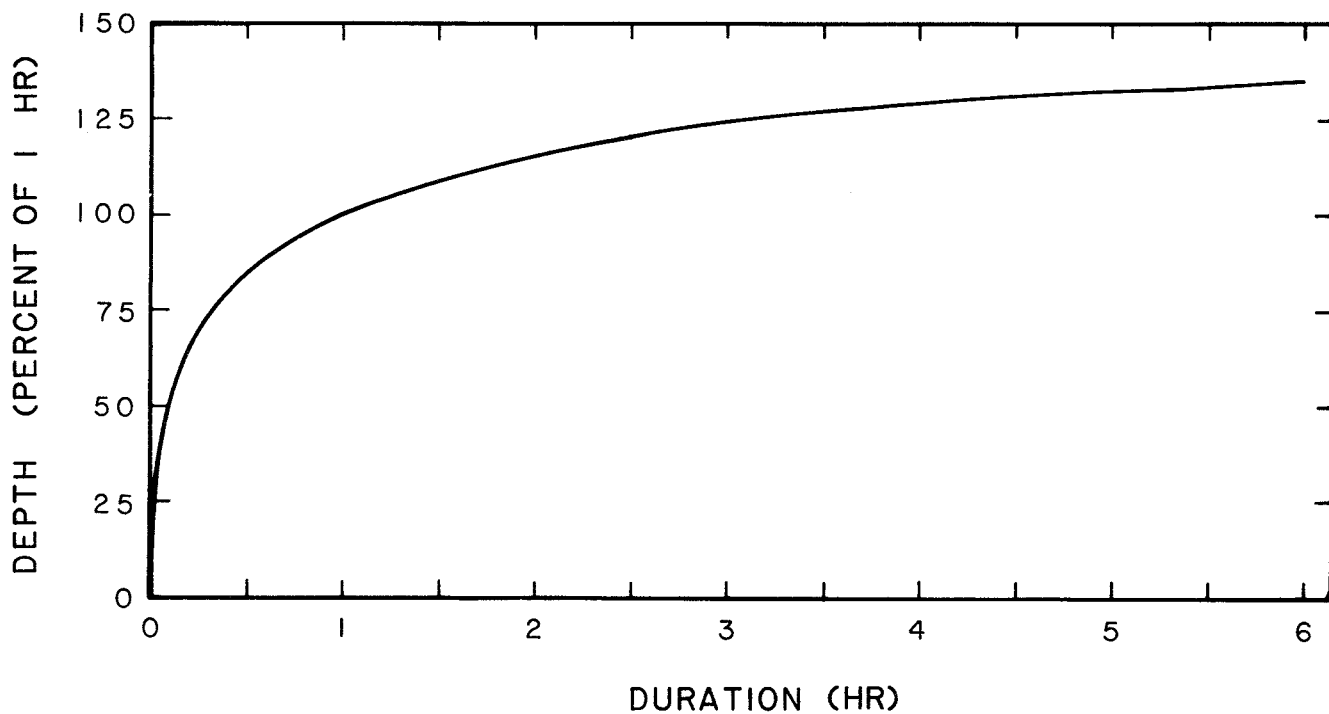

Figure 12.10.--Depth-duration curve for 6-/1-hr ratio of 1.35.

Table 12.4.--Percent of 1-hr local-storm PMP for selected durations for 6-/1-hr ratio of 1.35 (HMR No. 49)

Duration (hr)	Percent of 1 hr
1/4	.68
1/2	.86
3/4	.94
1	1.00
2	1.16
3	1.23
4	1.28
5	1.32
6	1.35

### 12.5.2 PMP for Durations Less Than 1 hr

There are no data available in the meaningful relationships for PMP of less than 1 hr. As stated earlier, a large proportion of the 6-hr 1-mi<sup>2</sup> PMP local storm is expected to fall within 1 hr. This expectation is borne out by the analysis of 6-/1-hr ratios and subsequent depth-duration curve in figure 12.10. Without better resolution, it was decided that the depth-duration relationship in figure 12.10 was applicable to all durations, both less than and greater than 1 hr. These procedures are in line with previous local-storm study procedures (Hansen et al. 1977). A listing of short duration percentages of the 1-hr local storm derived from figure 12.10 is shown in table 12.4.

### 12.6 Depth-Area Relation

Thus far in the development of local-storm PMP, only PMP for an area size of 1 mi<sup>2</sup> has been considered. It is necessary to develop relations to enable PMP estimates to be made for larger areas. Unfortunately, depth-area data were available for only the Golden, CO (67) and Morgan, UT storms. Both of these storms were of very limited areal extent. The data do not permit a comprehensive study of depth-area relations. Therefore, data were sought from other sources. The depth-area data from HMR No. 49 were chosen as a likely and comparable data source.

Figure 12.11 shows depth-area relations for 1- and 3-hr durations for storms in HMR No. 49, plus the Golden, CO storm. Most of the data in figure 12.11 are a result of analysis of bucket surveys and other unofficial observations.

Given the lack of available data for the CD-103 region, it was decided to represent depth-area relations with the relations developed in HMR No. 49. This is an acceptable alternative, as there are many parallels between the local storms in HMR No. 49 and in the CD-103 region study (storm type, 6-/1-hr ratios, terrain, etc.).

The adopted depth-area-duration relations from HMR No. 49 are shown in figure 12.12. The general shape of the relations are given from the analysis of the 1- and 3-hr curves in figure 12.11. The 6-hr curve was estimated (as in HMR No. 49) from a group of selected storms in the eastern United States. Using the 1-, 3-, and 6-hr curves as a foundation, intermediate durations were interpolated and durations less than 1 hr were approximated.

### 12.7 Temporal Distribution of Incremental PMP

There is little information available regarding the time sequence of incremental 1- and 6-hr rainfalls for extreme local storms in the CD-103 region. Of the four storms listed in table 12.2, only two storms have durations greater than 1 hr; the duration of the Las Cruces, NM storm is 9 hr and the Golden, CO storm is 2 hr.

The Las Cruces storm is the only storm on the list that provides time distribution measurements. This information was derived from the mass curve of

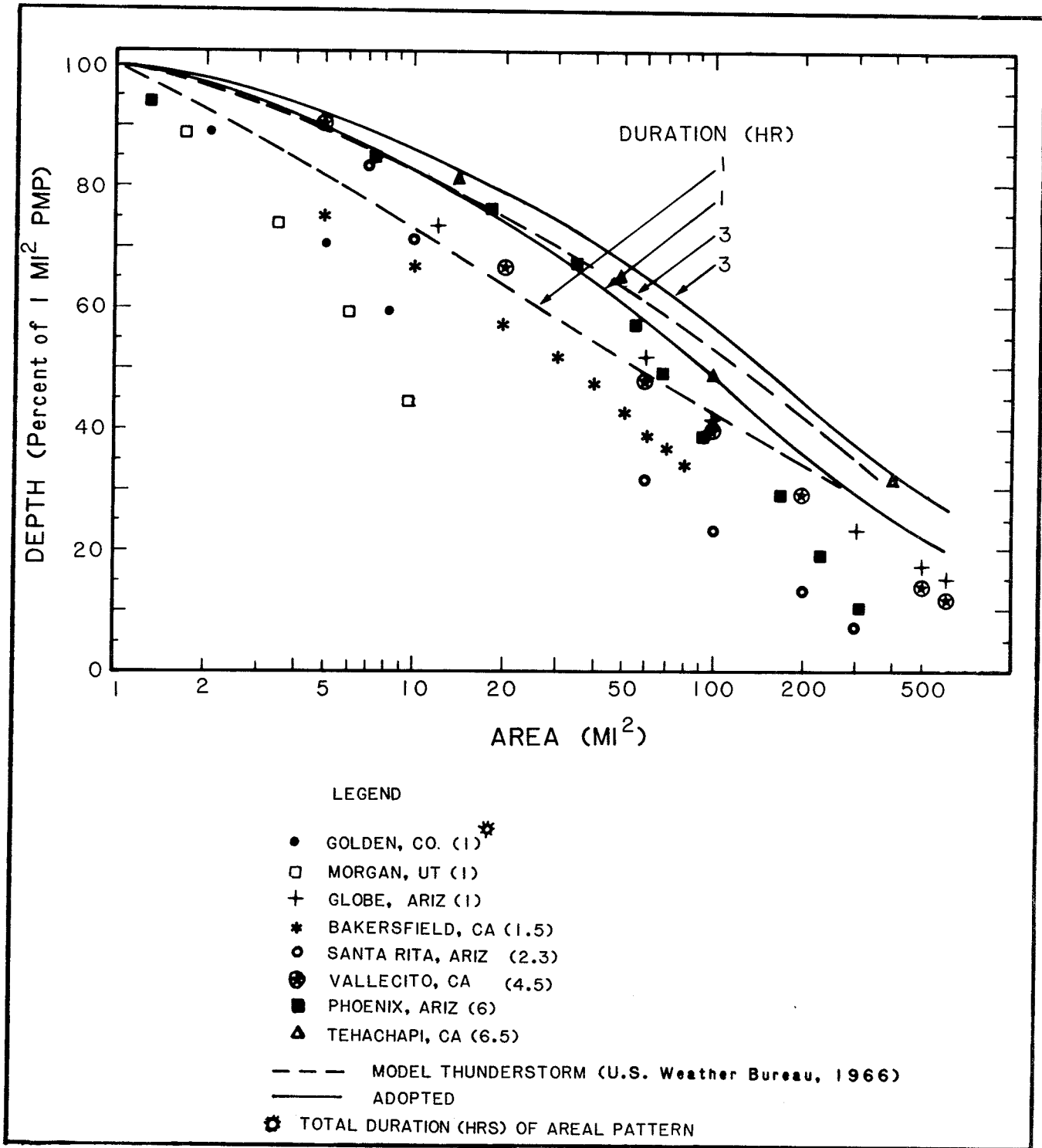

Figure 12.11.—Depth-area data for the Golden, CO (67) local storm and local-storm depth-area data from other regions compared with adopted curve from HMR No. 49 and model thunderstorm depth-area relation.

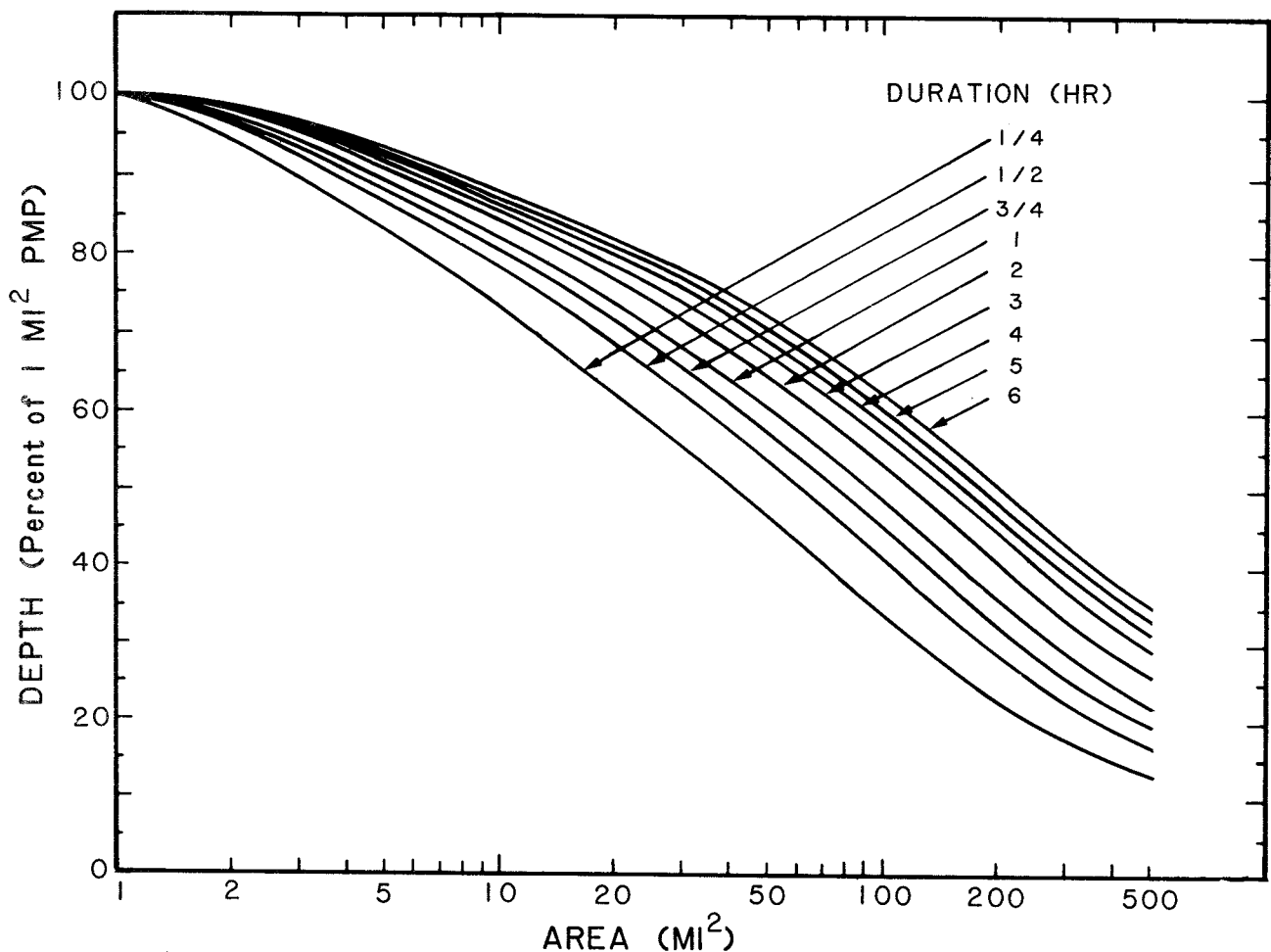

Figure 12.12.--Depth-area relations adopted for local-storm PMP in the CD-103 region (Hansen et al. 1977).

the storm in figure 12.9 that was constructed from a written account of the storm. The sequence of the hourly incremental rainfall for the storm shows that the storm decreased each succeeding hour after the first hour. However, meaningful conclusions cannot be drawn from this one example.

To supplement the lack of available data in the CD-103 region, data from HMR No. 49 was utilized. These data are presented in table 12.5 and include time distribution measurements from 6-hr storms, as utilized by the U.S. Weather Bureau (1947) and by the U.S. Army Corps of Engineers (1965). The choice of which of the two to apply is left to the user, as one sequence may be more critical than the other in a specific case.

There were no data available for the extreme local storms in the CD-103 region from which to determine the sequence of 15-min increments in the 1-hr storm. The 15-min incremental sequence taken from HMR No. 49 is, therefore, recommended. This incremental sequence appears in table 12.6. It is the result of percentages of total rainfall for thunderstorm rainfall determined by the U.S. Weather Bureau (1947).

**Table 12.5.--Recommended chronological distribution of 1-hr incremental rainfall amounts for 6-hr local-storm PMP (Hansen et al. 1977)**

Increment	Sequence position	
	HMR No. 5*	EM1110-2-1411#
Largest hourly increment	third	fourth
Second largest	fourth	third
Third largest	second	fifth
Fourth largest	fifth	second
Fifth largest	last	last
Least	first	first

\* U.S. Weather Bureau 1947

# U.S. Corps of Engineers, Standard Project Flood Determinations, March 1952, revised March 1965

### 12.8 Seasonal Distribution

A brief analysis was undertaken to determine the season of occurrence of the local storm in the CD-103 region. The analysis took the form of recording the maximum 1-hr event at recorder stations throughout the CD-103 region (sec. 12.5.1). The period of record totaled 31 years (1948-78); however, many stations had fewer years than this maximum period of record. It was decided to use only stations that had 20 or more years of precipitation record. This removed stations whose data may not have been representative of the true conditions at the station because of an insufficient period of record.

Table 12.7 shows the seasonal distribution of the maximum 1-hr events at selected stations in the CD-103 region. Most of the maxima occur in the summer months of June, July, and August. These months represent the months of greatest potential moisture influx into the region, as shown by the maximum persisting 12-hr 1000-mb dew-point charts of chapter 4. The months of May and September show fewer recorded maximum 1-hr events, while April and October show the least. No other months in the year produced maximum 1-hr events of record for this period. These results are not unlike those found in HMR No. 49.

**Table 12.6.--Recommended chronological distribution of 15-min incremental rainfall amounts for 1-hr local-storm PMP (Hansen et al. 1977)**

Increment	Sequence position
Largest 15-min increment	first
Second largest	second
Third largest	third
Fourth largest	fourth

**Table 12.7.--Distribution of month of maximum 1-hr storm amounts for recording gage stations\***

	Month							Total
	A	M	J	J	A	S	O	
Montana	2	4	16	14	10	3	0	49
Wyoming	0	4	2	14	5	1	0	26
Colorado	1	0	0	10	5	0	1	17
New Mexico	0	1	6	10	8	2	0	27
Totals	3	9	24	48	28	6	1	119

\* All stations have 20 or more years of records

The seasonal distribution data suggest that extreme local storms most likely occur during the summer months of June, July, and August in the CD-103 region. There is also an indication that such storms are possible during the late spring and early fall. The adopted season of occurrence for the local-storm data in this report is the May-September period. No attempt was made to describe regional variation of the seasonal distribution because of limited data.

### 13. CONSISTENCY CHECKS

As has been noted in many hydrometeorological reports, evaluation of PMP estimates relies on comparisons against numerous forms of data and other PMP studies. There is no absolute standard to judge the adequacy of the level of PMP. The primary comparison is made against observed storm precipitation. For example, support for the level of PMP in HMR No. 51 is demonstrated by comparisons given in Technical Report NWS 25 (Riedel and Schreiner 1980).

In this chapter a number of comparisons will be discussed relative to the level of PMP obtained for the CD-103 study. The significance of each comparison is left to the reader. In the judgment of the authors, they support the level of PMP presented in this report.

#### 13.1 Comparison With Storm Data

Many comments regarding the use of storm data in the development of the CD-103 PMP index maps have already been made (chapt. 8, 10, 11, and 12). In section 11.4, reference was made to maximized observed depths in establishing and verifying the areal reduction relations recommended for PMP. Five major storms controlled the PMP depth-area relations for some area size, duration, and location. Considering the geographic extent of the study region, this is comparable with other PMP studies.

The level of general-storm PMP in the 10-mi<sup>2</sup> index maps is controlled by seven storms (table 13.1). Cherry Creek (47) and Hale (101), Gibson Dam (75), Buffalo Gap (72), Virsylvania (35), White Sands (82), and Big Thompson (81). The first two storms are essentially the same event (sect. 2.4.1.5) and have been moisture maximized by 150 percent. Table 13.1 shows that at both 6 and 24 hr, the PMP undercuts or equals the moisture-maximized amounts for these two storms. Outside the region, a small undercutting at Hale would be necessary to meet the PMP established in HMR No. 51. The 15 percent undercutting at 6 hr at Cherry



**Table 13.1.--Comparison between general- or local-storm PMP and observed and moisture-maximized rainfall depths (in.) from selected important storms for 10 mi<sup>2</sup>**

Storm (No.)	Duration											
	1 hr			6 hr			24 hr			72 hr		
	Obs.	Max.	PMP	Obs.	Max.	PMP	Obs.	Max.	PMP	Obs.	Max.	PMP
Gibson Dam (75)	1.1	1.9	5.8	6.0	10.2	11.0	14.9	25.3	26.0	-	-	34.5
Springbrook (32)	-	-	12.0	10.5	13.8	19.0	13.3	17.4	25.0	14.6	19.1	28.0
Savageton (38)	-	-	12.4	6.0	7.6	21.7	9.5	12.0	28.2	16.9	21.3	32.2
Big Elk Meadow (77)	1.1	1.9	7.8	4.0	6.8	17.9	11.8	20.1	30.3	17.8	30.3	37.7
Cherry Creek (47)	9.0 <sup>A</sup>	13.5	15.6	20.6	30.9	26.3	22.2	33.3	33.3	-	-	37.6
Hale (101)	-	-	15.5 <sup>A</sup>	16.5	24.8	24.5 <sup>B</sup>	22.2	33.3	30.8 <sup>B</sup>	-	-	35.6
Penrose (31)	-	-	13.2	10.4	15.7	24.4	12.0	18.1	31.8	12.0	18.1	38.0
Plum Creek (76)	-	-	15.4	11.5	14.7	25.6	13.2	16.9	32.0	16.7	21.4	35.9
Rancho Grande (60)	-	-	14.5	3.2	3.8	24.0	7.9	9.4	30.7	8.0	9.5	35.6
McColleum Ranch (58)	-	-	14.5	10.1	15.3	25.1	12.1	18.3	33.5	21.2	32.0	39.1
Buffalo Gap (72)	7.0	10.5	11.1	-	-	17.3	-	-	-	-	-	-
Masonville (55)	5.8 <sup>C</sup>	8.7	8.9 <sup>D</sup>	-	-	12.0 <sup>D</sup>	-	-	-	-	-	-
Virsylvania (35)	3.8 <sup>E</sup>	6.5	6.0	6.8 <sup>F</sup>	11.6	12.0	-	-	-	-	-	-
White Sands (82)	5.4 <sup>G</sup>	9.2	8.5	9.0 <sup>F</sup>	15.3	14.5	-	-	-	-	-	-
Las Cruces (48)	3.5 <sup>H</sup>	5.2	10.1 <sup>D</sup>	8.8 <sup>I</sup>	13.0	13.6 <sup>D</sup>	-	-	-	-	-	-
Big Thompson (81)	4.8	7.1	7.3	10.1 <sup>J</sup>	14.9	17.0	-	-	-	-	-	-
Golden (67)	4.3 <sup>C</sup>	6.4	8.9 <sup>D</sup>	-	-	12.0 <sup>D</sup>	-	-	-	-	-	-

A. Estimated in HMR No. 52

B. From HMR No. 51

C. 1 hr 1 mi<sup>2</sup> X 0.825 to get 10 mi<sup>2</sup> for local storm

D. Local-storm PMP

E. 4 hr 1 mi<sup>2</sup> X .56 = 1 hr 1 mi<sup>2</sup> X .9 = 1-hr 10-mi<sup>2</sup> general storm

F. 4 hr 1 mi<sup>2</sup> X .9 = 4 hr 10 mi<sup>2</sup>

G. 4 hr 1 mi<sup>2</sup> X .6 = 1 hr 1 mi<sup>2</sup> X .9 = 1-hr 10-mi<sup>2</sup> general storm

H. 9 hr 1 mi<sup>2</sup> X .43 (fig. 12.9) = 1 hr 1 mi<sup>2</sup> X .825 = 1-hr 10-mi<sup>2</sup> local storm

I. 9 hr 1 mi<sup>2</sup> = 6 hr 1 mi<sup>2</sup> (fig. 12.9) X .88 = 6-hr 10-mi<sup>2</sup> local storm

J. 4-hr 10-mi<sup>2</sup> general storm

Creek was accepted to avoid an unreasonable increase in PMP at this location and its subsequent effects on a much larger region. The small envelopment of the Gibson Dam storm at 6 and 24 hr confirms that this storm served as a key to the analysis of PMP at that location.

At the shorter durations (1 and 6 hr), the White Sands moisture-maximized amounts are undercut by 8 and 5 percent, respectively (see discussion in section 10.3.2). The Virsylvania storm is undercut at 1 hr by 8 percent (see discussion in section 10.3.1). For 1 hr, the storms at Buffalo Gap and Big Thompson also are controlling, being enveloped by 6 and 3 percent, respectively.

For local storms, table 13.1 shows that the 1-hr PMP closely envelops the moisture-maximized Masonville amount, while at 6 hr, the moisture-maximized Las Cruces storm is enveloped by 5 percent. The comparable 1- and 6-hr general-storm PMP at Masonville, Las Cruces and Golden are 14.0, 8.0, 11.7 in. and 26.1, 14.3, 24.0 in., respectively. Only at Las Cruces does the local-storm PMP exceed general-storm PMP of all the storms compared in table 13.1.

The PMP index maps provide a realistic envelopment of the observed moisture-maximized storm data. No storms control for the 72-hr duration. However, the degree of envelopment of storm data by the 10-mi<sup>2</sup> index PMP for the Big Elk Meadow, CO (77) and McColleum Ranch, NM (58) storms is less than 25 percent, which is not considered an unusually large envelopment.

### **13.2 Comparison With Individual-Drainage PMP Estimates**

The Hydrometeorological Branch, in the absence of appropriate generalized studies (sec. 1.7), have from time to time prepared individual-drainage PMP estimates. Since these estimates have been prepared over a period of years, the available storm sample and procedures for estimating PMP are not the same in all cases as those used in the present report. In addition, most of these estimates include, at least implicitly, a reduction that results from the difference between the storm centered isohyetal pattern that forms the basis for this report and the shape of the basin. Additional problems are encountered with explicit transposition limits when developing individual-drainage PMP estimates.

Some general comparisons can be made with estimates prepared since the mid-1960's. Differences between the recent individual-drainage estimates and the results of this report are less than 20 percent for all durations with no apparent bias toward either higher or lower estimates from this study. The estimates reviewed cover a range in area sizes from less than 10 mi<sup>2</sup> to over 7,000 mi<sup>2</sup>. Though the majority of the estimates reviewed were in the southern half of the study area, no regional bias was apparent. These comparisons can only be viewed in a qualitative manner, since both estimates were developed using much of the same data and basic procedures.

### **13.3 Comparison to Other Generalized PMP Studies in the CD-103 Region**

Weather Bureau Technical Paper No. 38 (TP-38) (U.S. Weather Bureau 1960) provided generalized PMP estimates for the United States west of the 105th meridian for areas less than 400 mi<sup>2</sup> and durations of 24 hr or less. TP-38 established PMP for this entire orographic region and provided a broadscale analysis of PMP in comparison to more recent studies (U.S. Weather Bureau 1961 and 1966, Hansen et al. 1977, and the present study). TP-38 presents maps of 1-,

**Table 13.2.--Comparisons of ranges in general-storm PMP (in.) estimates from Technical Paper No. 38 and the CD-103 study**

	1 hr		6 hr		24 hr	
	TP 38	CD-103	TP 38	CD-103	TP 38	CD-103
Montana	5-12.5	3.5-12.7	9.5-19.0	6.5-21.4	14.0-25.0	15.5-31.5
Wyoming	5-12.5	4.0-14.0	9.8-20.5	9.0-23.4	12.0-26.2	15.5-32.5
Colorado	7-14.1	3.5-15.5	13.8-23.0	7.0-26.7	17.0-28.2	14.8-36.5
New Mexico	8.8-15.5	4.0-14.6	13.5-25.0	8.5-25.2	17.0-31.0	14.9-34.3

6-, and 24-hr 10-mi<sup>2</sup> PMP which have been used to make comparisons with general storm amounts from the present study. Table 13.2 shows ranges of values from these analyses for the individual states. From each report, the maximum and minimum values were determined for general-storm PMP in the region between the Continental Divide and the 105th meridian (limit of TP-38). These are not always the maximum or minimum values within a particular state from either report.

From table 13.2, it is apparent that generally larger PMP estimates are given in the CD-103 study at 24 hr 10 mi<sup>2</sup> than were given in TP-38. This is partially a result of greater attention to orographic features in the current study, since many of the larger amounts are related to orographic features that were not well defined in TP-38. Another factor is the review and revision of the maximum persisting 12-hr 1000-mb dew points for both the maximum moisture and storm situations for the present study. Another factor is that TP-38 includes a mixture of generalized local storms under the definitions used in the present study. A final factor is additional storm data. Several major storms have occurred since TP-38 was completed, e.g., the June 6-8, 1964 (75) storm in Montana. At 1 and 6 hr, the PMP values appear comparable between the two studies.

Another study covering part of the CD-103 region was made by NWS for the Upper Rio Grande drainage (U.S. Weather Bureau 1967). In this study, generalized charts of PMP were presented for two index levels--6 hr 1 mi<sup>2</sup> and 24 hr 1 mi<sup>2</sup>. Areal reduction relations were given to obtain PMP for other areas to 400 mi<sup>2</sup>. Table 13.3 shows a comparison of the ranges in PMP estimates for 6 and 24 hr 10 mi<sup>2</sup>. The values from the CD-103 study are all from the general-storm PMP, whereas the Rio Grande study does not distinguish between local and general storms. The ranges in PMP estimates are greater in this study than in the Upper Rio Grande study. Minimum values for the 6-hr duration could be slightly higher

**Table 13.3.--Comparison of ranges in PMP estimates (in.) from the Upper Rio Grande study and the CD-103 study**

	6 hr		24 hr	
	Upper Rio Grande study	CD-103	Upper Rio Grande study	CD-103
Colorado	13.2-16.3	8.0-18.0	16.2-20.2	15.5-29.2
New Mexico	13.2-17.2	9.0-21.5	16.2-21.2	15.5-29.5

if the local storm was considered. The range would still be larger than for the Upper Rio Grande study. Reasons for these changes are somewhat similar to those cited in comparisons between this report and TP-38. In addition, some of the largest values in both studies are along the eastern edge of the basin and result from a reappraisal of the effects of spillover from east to west.

#### 13.4 Comparison Between Local-Storm and General-Storm PMP

Differences between the local-storm and general-storm PMP at 1 hr 10 mi<sup>2</sup> were taken throughout the CD-103 region. This was done as follows: Points were taken at a sufficient density to cover the significant features of the terrain and the general-storm PMP field. Local-storm index PMP values at 5,000 ft were adjusted to the smoothed surface elevation and to 10 mi<sup>2</sup> at each point.

A definite relationship between terrain and controlling storm type was observed. The general storm controlled the "nonorographic" and "minimum nonorographic" areas, with the exception of a small, isolated area in central Wyoming where there is a break in the first upslopes to the south of the Big Horn Mountains. The general storm also controls most of the first upslopes (classified as "orographic" regions). The situation is different in the sheltered areas (classified as "sheltered orographic" and "sheltered least orographic"), with the local storm controlling a vast majority of these regions, the most notable exceptions being at very high elevations (generally above 10,000 ft), and the western portion of Texas.

The degree of general storm control over the local storm in nonorographic areas is governed principally by the agreed-upon transposition limits for the prototype PMP general storm with the degree of exceedance decreasing from the region where the storm occurred out towards the limits of transposition. The distribution of maximum persisting 12-hr 1000-mb dew points, and elevation variation in the exposed nonorographic areas, appear to be poor discriminators for level of control since similar effects are produced on each storm type by elevation and dew point. Hence, there is a rather smooth variation of level of general storm control in the nonorographic areas. The effect of transitioning into the orographic first upslope areas beyond the transposition limits is, in general, to reduce the dominance of the prototype PMP general storm mechanism over a purely convective, local mechanism, since the general storm mechanisms cannot be supported by the same degree of horizontal convergence forcing available in the nonorographic areas. This arises, in part, by upstream orographic "raining out" as well as by local orographic "stimulation" of convection.

As a result of this comparison, the general storm controls at all durations along the eastern part of the CD-103 region. This result is in agreement with what was expected for this region, and supports the fact that local storms are not controlling in the midwestern plains.

In the sheltered areas, however, the effect of upstream depletion of storm moisture for the general storm is very significant; hence, the local storm controls most of these areas, since it need not draw upon moisture at a distance. In some of the higher "sheltered orographic" areas the general storm regains control due to a significant reduction in convective-only potential at these elevations.

**Table 13.4.--Maximum and minimum ratios of 10-mi<sup>2</sup> PMP estimates (in.) to 100-yr precipitation-frequency point values (in.) at 1, 6, and 24 hr**

Duration (hr) State	Smallest Value			Largest Value		
	1	6	24	1	6	24
MT	3.4	4.1	4.9	6.8	8.8	8.3
WY	2.8	4.2	5.0	6.9	9.4	9.8
CO	2.2	3.0	4.2	6.9	9.0	8.8
NM	2.2	3.0	4.4	5.8	8.0	8.1

### 13.5 Comparison with NOAA Atlas 2 Amounts

Ratios of PMP at 10 mi<sup>2</sup> to 100-yr precipitation depths at durations of 6 and 24 hr across the United States, east and west of the CD-103 region have been published (Riedel and Schreiner 1980). In that publication, calculated ratios, especially those west of the Continental Divide, show a considerable variation within small sub-areas of the overall study region. For example, large variation occurs from the crests of the Sierra Nevada in California northeastward into the Granite Spring Valley in western Nevada; from the crests of the Cascades eastward into the area surrounding Moses Lake in Washington; and also from the higher elevations of the Sawtooth Mountains southeastward into the Snake River Plain in Idaho. Though somewhat smaller, significant variation of this ratio can be found from the crests of the Appalachians north and westward into the Ohio River Valley and St. Lawrence River Valley.

Similar variations in this ratio should be expected in the CD-103 region at those places where similar range crest-to-valley/plain topographic features are found. State-to-state or regional consistency of this ratio should be expected only to the extent that topographic variation is consistent from state-to-state in the region. What should be expected, however, in the absence of consistent state-to-state variation of topography, is that the extreme values of this ratio should not depart much from previously determined values unless some unique topographic reason can be found. Consistent relationships between topographic crests and valleys and ratio minima and maxima should also be expected.

Small ratio values, less than two for a particular location, are usually regarded as signifying a strong likelihood that PMP is approaching an observed depth of precipitation for a given duration. It is more difficult to agree upon what is too large a ratio. It would seem that an upper ratio value three times the lower value found in a region of an apparently related broadscale topographic feature and for a given duration is not too high based upon the published precedents (Riedel and Schreiner 1980).

The largest and smallest ratio values at 1, 6, and 24 hr were determined for each state in the CD-103 region, except Texas, western North Dakota, South Dakota and Nebraska, and are shown in table 13.4. The specific locations for extreme values were determined through visual inspection of the PMP and frequency charts and it is possible that there are some places where even smaller or larger values exist which were overlooked inadvertently.

The identified smallest values at the indicated durations are about what would be expected from the published precedent (Riedel and Schreiner 1980) except at 24 hr where the values seem somewhat high. At 24 hr the largest ratio values, especially in Wyoming and Colorado, in absolute value are without precedent. In those instances, the ratio values are considered to be somewhat anomalous in the sense that they result from the apparently chance juxtaposition of rather small 100-yr depths with a broadscale maximum in PMP distribution. It was considered desirable to retain these anomalies rather than change the overall distribution of PMP across the region. In neither case, however, was the extreme high value more than three times the topographically related low value. In brief, the data of table 13.4 indicate that PMP within the CD-103 region is neither too small nor too large based upon relationships and values already developed and published (Riedel and Schreiner 1980). This conclusion is reinforced by the possibility that the smallest ratio values would have been larger if the local storm rather than the general storm had set the level of PMP. Chances are extremely small, however, that a convective-only local storm will set the level of PMP near the orographic separation line (see sect. 1.5) where the highest ratios occur. Hence, comparisons with Riedel and Schreiner in terms of the high value not being more than three times the topographically-related low value are valid even when local-storm values are considered.

### 13.6 Comparison with Adjoining PMP Studies

The CD-103 PMP study represents the last major generalized PMP study to complete coverage of the conterminous United States. As such, it fills the space between previously completed PMP studies; HMR No. 51 and 52 to the east, and HMR No. 43 and 49 to the west. During the initial considerations to the development of HMR No. 55, the authors decided that the nonorographic eastern portions of the region should represent extensions of the HMR No. 51 and 52 results into this region. For the most part the isohyets in Plates I-IV tie into those to the east for all durations along the 103rd meridian.

Along the Continental Divide, however, initial considerations were set such that the CD-103 study should be developed independently of the studies to the west. The reasoning here was that HMR No. 55 results should not be influenced by the western results, and also, plans to update HMR No. 43 may bring about a change from the current level of PMP in the northwest. HMR No. 55 was published essentially independent from the western studies with the explanation that some discontinuity east to west was acceptable, because of differing meteorological environments to either side of the Divide.

The present study reconsidered this process particularly for the local storm but also with regard to the general storm. For the local storm, a 5,000-ft index map was developed to essentially tie into PMP for HMR No. 49. Although not specifically considered, the CD-103 local storm analysis in Montana appears to have good agreement with the local-storm results from HMR No. 43. The general-storm comparisons still show somewhat significant differences across the Divide, with the CD-103 values always being the greater.

To better represent the proper form of comparison, PMP was computed for each 15 minutes of latitude along the Divide from each study. At each location for 1 and 6 hr, the higher of the local- or general-storm amount was used in this comparison, since this represents the level of PMP that should be used at that duration. For HMR No. 43 and 49 at both 1 and 6 hr, the local-storm amounts

**Table 13.5.--Comparison between PMP values along the Continental Divide from HMR No. 55A and HMR No. 43 or 49**

Comparison Ratios	Duration (hr)					
	1		6		24	
Agreement	<10%	<20%	10%	<20%	<10%	<20%
HMR 55A/HMR 43 (23 pts.)	82.6%	100 %	30.4%	56.5%	0	0
HMR 55A/HMR 49 (48 pts.)	70.8%	87.5%	56.2%	77.1%	6.2%	16.7%

exceed the general-storm amounts. In only 60 percent of the 1-hr and 85 percent of the 6-hr amounts in HMR No. 55A are 1-hr local-storm amounts greater than general-storm amounts.

Table 13.5 shows the comparison between east (HMR No. 55A) and west (HMR No. 43 and 49) procedures in producing comparable PMP for points along the Continental Divide and at selected durations. The results in table 13.5 show that between 70 and 80 percent of the points along the Continental Divide show agreement within 10 percent at 1 hr. At 6 hr, agreement within 10 percent drops to between 30 and 60 percent, while at 24 hr there is almost no agreement within 10 percent. A similar degree of variability occurs at 72 hr as well, although this information was not included in table 13.5.

### 13.7 Conclusions from Consistency Checks

From the above considerations, adequate comparisons have been made against other data sources to judge the consistency of the CD-103 results. Both regionally and areally, the comparisons support the results from the present study. There have been several comparisons made. The primary measure of the adequacy of PMP estimates is a comparison with moisture-maximized storm precipitation amounts. Table 13.1 shows a number of storms for the 10-mi<sup>2</sup> area where the PMP is equivalent to moisture-maximized storm amounts. Both the number of storms and their geographic distribution throughout the region are comparable with results found in other studies. Comparison of PMP values for various area sizes determined using the index maps and appropriate depth-area relations also show results comparable to other regions.

Within the CD-103 region, there have been previous PMP estimates prepared. The present study uses many of the same techniques as the other investigations. Differences between the studies are attributable to several factors. Among these are: differences in available storm sample; revision of representative storm dew points; update and revision of maximum available moisture based on maximum persisting 12-hr 1000-mb dew points; and the amount of consideration given to topographic features. Nonetheless, the results are considered mutually supportive.

While PMP estimates are a result of deterministic methods as opposed to a stochastic or probabilistic approach, the comparisons between PMP and 100-yr values from NOAA Atlas 2 provide some guidance to regional consistency. The results indicate the PMP estimates are consistent within the study region and also with the results from surrounding regions.

Finally, comparison between results from this study and PMP from adjoining studies shows close agreement at 1 hr and decreasing agreement at longer durations. Some improvement may be possible when HMR No. 43 is revised.

#### 14. PROCEDURES FOR COMPUTING PMP

The procedures developed in this report for computing general-storm averaged PMP estimates are straightforward. They are based on use of four 10-mi<sup>2</sup> PMP index maps (1-, 6-, 24-, and 72-hr analyses) and 21 sets of depth-area-duration relations developed in this study. The results obtained from use of these procedures represent storm-centered average depths applicable to a specific drainage of interest. At this time, no procedure is available that provides techniques to distribute the average depth throughout the drainage, nor are recommendations provided on temporal sequences for this region\*. Such information will be the subject of a future study regarding individual drainage applications of the PMP values developed in this report.

Separate index maps have been provided for the local-storm PMP for the CD-103 region. Depth-area and depth-duration relations enable results to be obtained for basins up to 500 mi<sup>2</sup> and for up to 6 hr. The hydrologist should compute values for the basin by both procedures. The results from both procedures should be used in hydrologic trials to determine appropriate design values.

##### 14.1 Stepwise Procedure, General Storm

###### Step

1. Drainage map outline

Trace the outline of the drainage (at 1:1,000,000 scale) onto a transparent overlay.

2. Determination of 1-, 6-, 24-, and 72-hr index PMP estimates

Place the overlay of drainage shape on each of the 1-, 6-, 24-, and 72-hr 10-mi<sup>2</sup> PMP index maps in plates I to IV<sup>#</sup> and read off sufficient point values to obtain a representative index average depth at each duration. Although greater accuracy may be obtained by planimetering the index map analyses for the drainage area, this effort is generally unnecessary for most drainages less than 1,000 mi<sup>2</sup>. In highly complex regions of PMP and for larger drainages, planimetering may be necessary.

---

\*For PMP estimates east of the orographic separation line (nonorographic region shown in fig. 3.1), HMR No. 52 procedures may be applied to areally and temporally distribute PMP obtained from this report. As cautioned in section 1.8, for the nonorographic region west of the 105th meridian, HMR No. 52 procedures are tentative and it may be necessary to derive modifications to the procedures upon further study.

---

<sup>#</sup>Plates I and II as revised 3/87.



3. Selection of appropriate subregion and subdivision

From plate V determine the subdivision/subregion that contains the drainage in order to select the appropriate set of depth-area-duration relations. If the drainage is large enough, or so placed, that it involves more than one subdivision, determine the proportionate amount of the drainage that lies in each classification. This consideration will be clarified in the examples given in section 14.2.

4. Determine areal reduction factors

Select the depth-area-duration relations (fig. 11.3 through 11.23, as appropriate) that correspond to the subdivision(s) and/or subregion(s) obtained in step 3, and determine the appropriate reductions (in percent of average 10-mi<sup>2</sup> amount) to apply to the index average depths from step 2 for the drainage area. Weight the percentage amounts by the proportionate areas determined from step 3, if the drainage covers more than one subunit.

5. Computation of average 1-, 6-, 24-, and 72-hr PMP estimates for drainage

Multiply the resulting percentage reduction(s) from step 4 corresponding to the area of the drainage by the average index PMP estimates from step 2.

6. Depth-duration curve for drainage

Plot the results obtained in step 5 on linear graph paper as depth vs. duration, and draw a smooth curve of best fit.

7. PMP estimates for intermediate durations

Interpolate PMP estimates from the curve in step 6 for other durations, as needed.

8. Incremental PMP estimates

If incremental depths are desired, subtract each durational depth in step 7 from the depth at the next longer duration.

### 14.2 Example of General-Storm PMP Computation

The Pecos River above Los Esteros Dam will be used in an example of the procedures outlined in section 14.1. The drainage shown in figure 14.1 covers 2,479 mi<sup>2</sup>. When considered relative to plate Vc, this drainage is separated into two subdivisions, orographic and minimum nonorographic, of the E subregion. The procedural steps are as follows:

1. Drainage map outline

A drainage outline was determined from a topographic chart and is shown in figure 14.1.

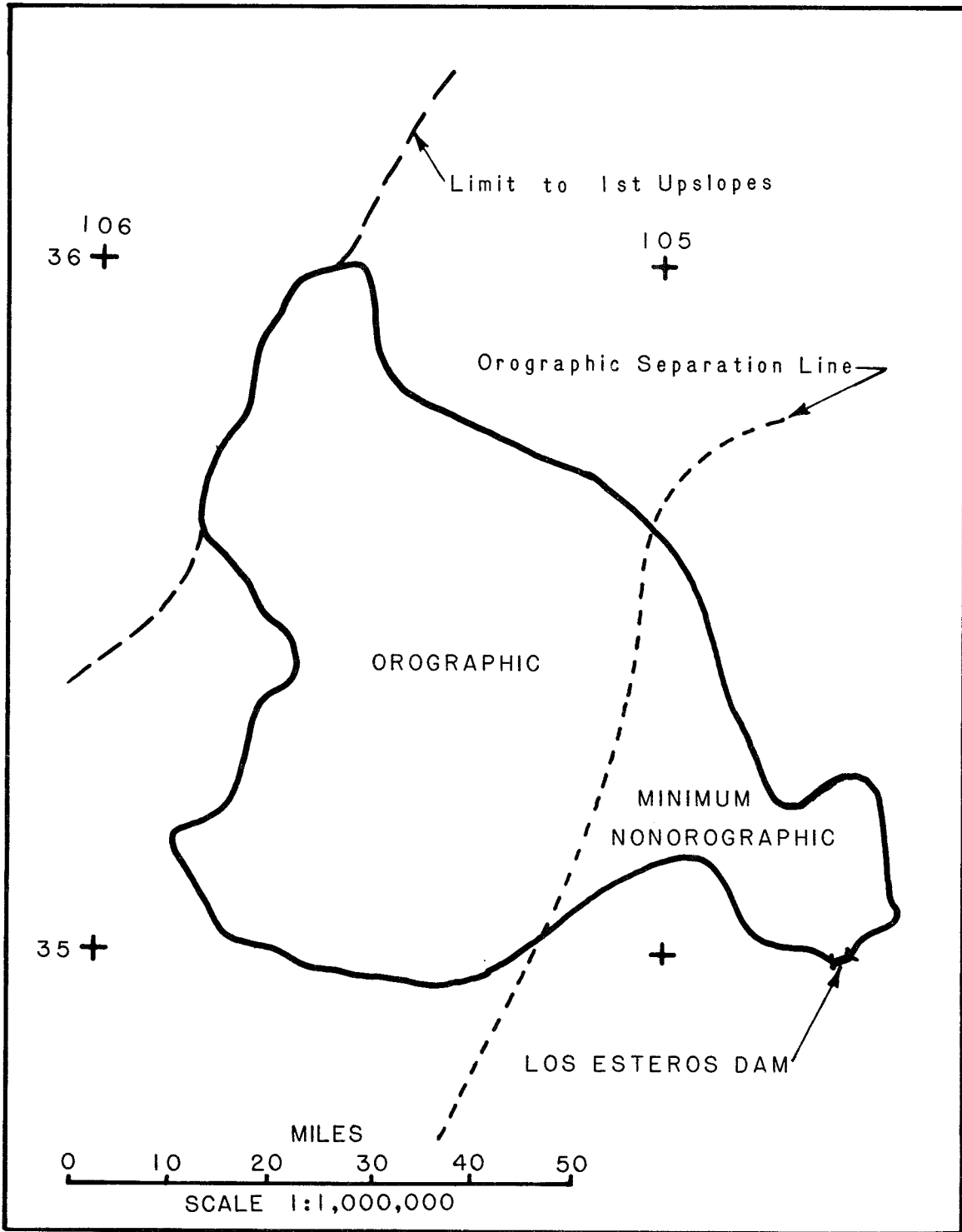

Figure 14.1.--Outline of the drainage for the Pecos River above Los Esteros Dam, NM (2,479 mi<sup>2</sup>) showing position of DAD subdivision boundaries.

2. Determination of 1-, 6-, 24-, and 72-hr index PMP estimates

The drainage shape on figure 14.1 was placed over the individual PMP index maps, plates Ic to IVc, and a sufficient number of grid-point values read off to obtain the index average depth estimates for each of the four durations:

Duration (hr)	1	6	24	72
PMP (in.)	12.20*	21.00	29.17	33.92

3. Selection of appropriate subregion and subdivision

Placing the drainage shape over the subdivision/subregion map (place Vc, at 1:1,000,000 scale), this drainage covered portions of both the E orographic and E minimum nonorographic subunits. It was estimated that approximately 75 percent of the drainage was in the orographic subdivision and the remaining 25 percent in the minimum nonorographic subdivision.

4. Determine areal reduction factors

Using the DAD relations in figures 11.10 (orographic) and 11.8 (minimum nonorographic), reduction factors were read at the area of the drainage, 2,479 mi<sup>2</sup>;

Duration (hr)	1	6	24	72
orographic (%)	21.8	34.5	42.2	46.6
min. nonorog. (%)	18.2	30.7	35.8	41.2
Weighted percentage				
75% [orographic (%)]	16.4	25.9	31.6	35.0
25% [min. nonorog. (%)]	<u>4.6</u>	<u>7.7</u>	<u>9.0</u>	<u>10.3</u>
Sum (%)	21.0	33.6	40.6	45.3

5. Computation of average 1-, 6-, 24-, and 72-hr PMP estimates for drainage

Multiply the results from step 4 by the drainage average index PMP depths from step 2,

Duration (hr)	1	6	24	72
Areal-adj. PMP (in.)	2.56	7.06	11.84	15.36

\* Values should be read from the maps only to the nearest tenth of an inch. Hundredths obtained from the average are for computational convenience in this example. The user should be aware of the degree of precision possible in applying the procedures of this report.

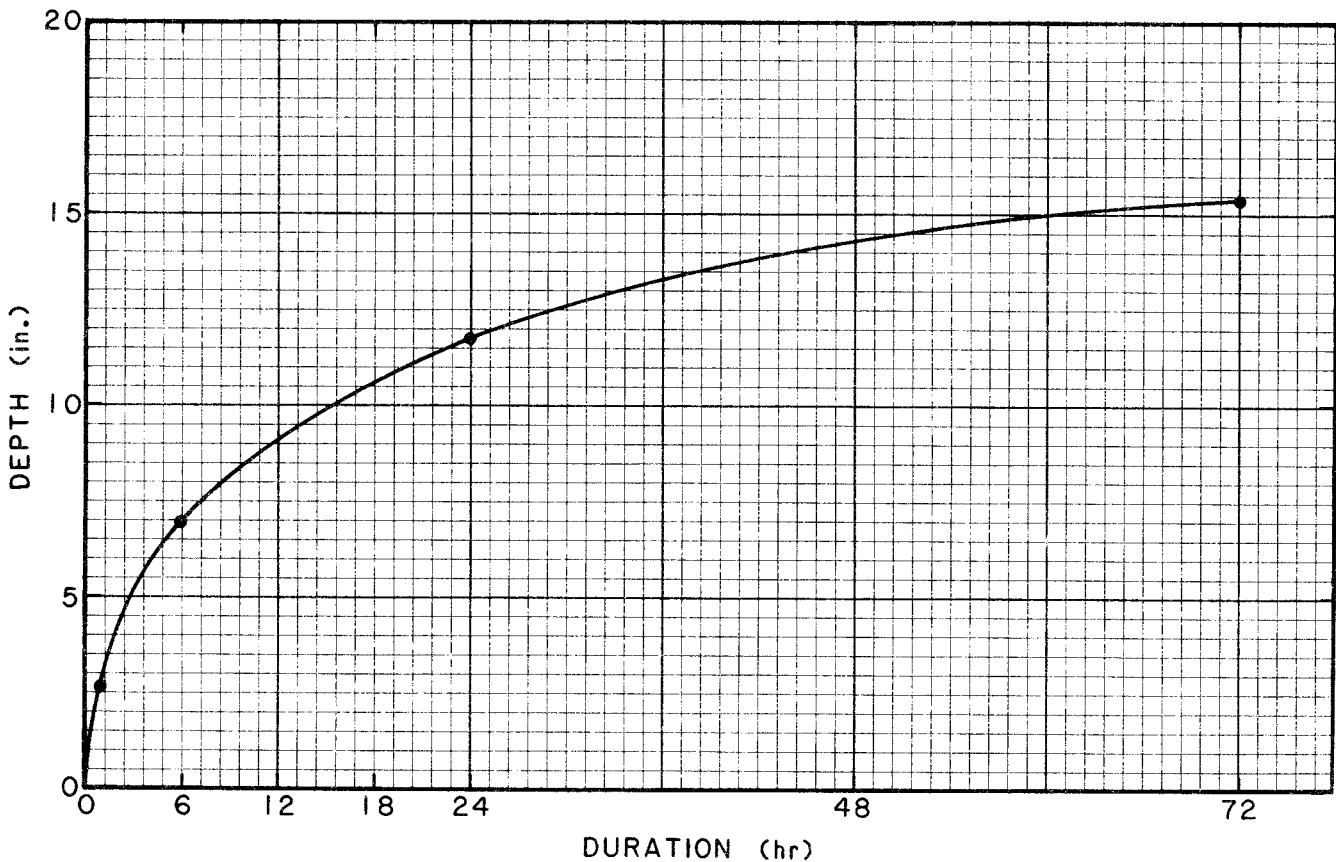

Figure 14.2.--Depth-duration curve for PMP estimates for Pecos River drainage above Los Esteros Dam, NM (2,479 mi<sup>2</sup>).

6. Depth-duration curve for drainage

The PMP estimates from step 5 have been plotted and a depth-duration curve drawn as shown in figure 14.2.

7. PMP estimates for intermediate durations

Intermediate 6-hr depths are read from the smooth curve in figure 14.2.

Duration (hr)	6	12	18	24	30	36	42	48	54	60	66	72
PMP (in.)	7.0	9.0	10.6	11.8	12.6	13.3	13.9	14.3	14.7	15.0	15.2	15.4

8. Incremental PMP estimates

Incremental PMP depth from step 7 are:

Duration (hr)	6	12	18	24	30	36	42	48	54	60	66	72
PMP (in.)	7.0	2.0	1.6	1.2	0.8	0.7	0.6	0.4	0.4	0.3	0.2	0.2

### 14.3 Stepwise Procedure, Local Storm

1. Index 1-hr 1-mi<sup>2</sup> PMP estimate at 5,000-ft elevation

Locate the drainage in Plate VI a-c, and determine the drainage average index 1-mi<sup>2</sup> 1-hr PMP in inches at 5,000 ft. This is readily accomplished by eye because of the smooth gradient, and linear interpolation is assumed to apply.

2. Adjustment for mean elevation of drainage

Determine the mean drainage elevation to the nearest 100 ft. An adjustment needs to be determined and applied to the depth from step 1 if this elevation differs from 5,000 ft by more than 1,000 ft. If the mean terrain elevation of the drainage is greater than 6,000 ft or less than 4,000 ft, the correct vertical adjustment factor can be obtained by reference to figure 14.3. This is a nomogram of vertical elevation adjustments as discussed in section 12.3.2.4. To use the nomogram, enter the horizontal scale (abscissa) at the maximum persisting 12-hr 1000-mb dew point obtained from figure 4.11 for the location of the drainage. Move vertically in the figure to intersect the mean elevation of the drainage (to the nearest 100 ft) and read off the adjustment factor on the vertical scale (ordinate).

As an example of this determination, take a drainage that has a mean elevation of 7,800 ft and a maximum persisting 12-hr dew point of 70°F. Entering figure 14.3 at 70° on the abscissa and moving vertically to 7,800 ft, an adjustment factor of 0.82 is read from the ordinate.

3. Index 1-hr 1-mi<sup>2</sup> PMP estimate at mean elevation of drainage

Multiply the adjustment factor determined in step 2, if needed, by the index 1-mi<sup>2</sup> 1-hr depth from step 1 to obtain a representative surface adjusted index PMP estimate.

4. Depth-duration curve for 1 mi<sup>2</sup>

Refer to table 12.4 to obtain the 1-mi<sup>2</sup> factors for durations up to 6 hr. Multiply these factors by the estimate from step 3. These can be plotted on linear graph paper and a smooth curve drawn to obtain intermediate durational amounts if these are needed for the 1-mi<sup>2</sup> area.

5. Areal reduction factors

To obtain areal reduction factors, use the relations provided in figure 12.20. Find the drainage area on the abscissa and read the corresponding reduction factors as percent of the 1-mi<sup>2</sup> PMP.

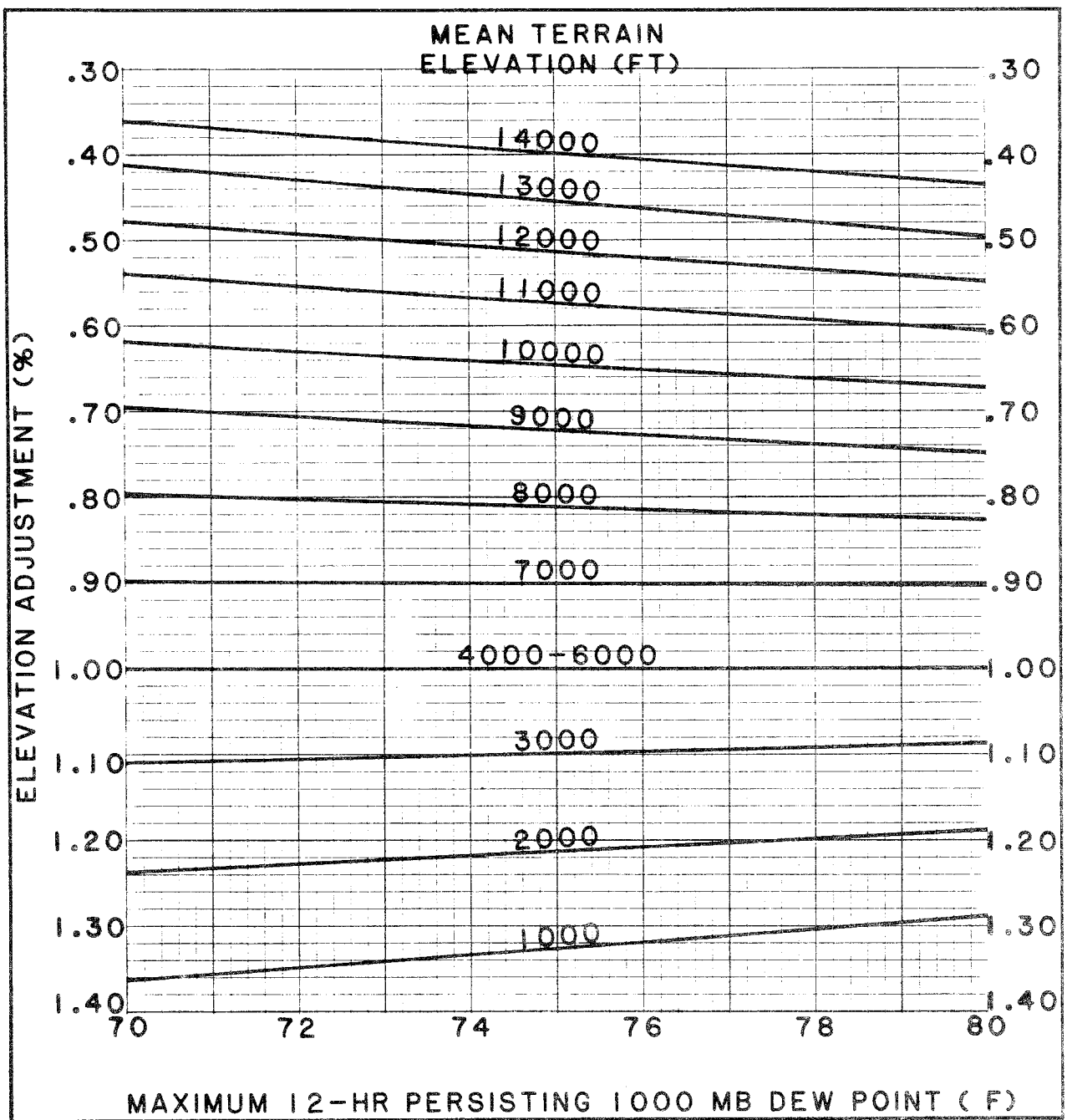

Figure 14.3.--Adjustment for elevation for local-storm PMP based on procedures developed in the report and maximum persisting 12-hr 1000-mb dew point (F).

6. PMP estimates for basin

Multiply percentages of step 5 by the index PMP amounts from step 4. These values should be plotted on linear graph paper and a smooth curve drawn through the points. Values for the intermediate durations may be determined from this curve.

7. Incremental PMP amounts

If needed, local-storm PMP incremental amounts obtained through subtraction of adjacent amounts in step 6 may be arranged in temporal sequences recommended in tables 12.5 and 12.6.

No example is believed necessary for local-storm PMP determination, as the adjustment for elevation is the only complex element in the determination, and an example calculation of this factor is given in step 2.

## 15. FUTURE STUDIES

There are several problems involved in the development of design estimates that should be resolved. The purpose of this chapter is to briefly discuss these needed future studies.

### 15.1 Seasonal Variation

In the present study, it has been possible to develop only all-season PMP estimates. Although no attempt has been made to define the season of occurrence, some observations are possible. In the northern portion of the study region among the more important storms are Gibson Dam, MT (75), June 6-8, 1964; Warrick, MT (10), June 6-8, 1906; Springbrook, MT (32), June 17-21, 1921; and Savageton, WY (38), September 27-October 1, 1923. Through the central portion of the study region, Cherry Creek (47) and Hale (101), CO, May 30-31, 1935, Plum Creek (76), CO, June 13-20, 1965, Big Elk Meadow (77), CO May 4-8, 1969, and Big Thompson, July 31, 1976 are important in determining PMP estimates. In the extreme southern part of the study region, tropical storms or their remnants will be the causative mechanism for the longer duration PMP event. Such storms as Rancho Grande (60), NM, August 26-September 1, 1942, and Meek (27), NM, September 15-17, 1919 are typical of these events. Shorter duration storms similar to that at White Sands, NM, August 19, 1978 are important in this region. These storm dates suggest that the all-season PMP event will occur from early summer through fall. In those portions of the study region where snowmelt can be a critical factor, the probable maximum flood (PMF) may be the result of the lesser magnitude spring PMP event and accompanying snowmelt. The definition of the seasonal variation of PMP is, therefore, a necessary addition to the present report.

### 15.2 Permissible Snowpack With PMP and Snowmelt Criteria

To adequately evaluate the spring PMF, two additional factors are required. The first is an evaluation of the snowpack that could exist prior to the PMP event. The question to be answered is the depth and extent of the snow cover. Could, for example, the probable maximum snowpack (PMSP) occur just prior to the

PMP, or would there be some lesser limit. If the latter is the case, it is necessary to define a rainfall event compatible with the PMSP.

The second factor, snowmelt criteria, such as temporal sequences of wind, temperature, and dew-point, are needed to develop the PMF from a combination of rainfall and snowmelt. It might be necessary to develop dual criteria--one set appropriate for the spring PMP together with an appropriate snowpack, and a second consistent with the PMSP and the accompanying rainfall event. The need for dual criteria can be determined only after adequate investigation.

### 15.3 Individual-Drainage Estimates of PMP

PMP estimates from this report are storm centered all-season estimates, as are those of HMR No. 51 (Schreiner and Riedel, 1978). HMR No. 52 (Hansen et al. 1982), provides procedures to develop estimates for individual drainages east of the OSL, though application to nonorographic regions west of the 105th meridian in eastern Montana and eastern Wyoming should be done with caution. The procedures of HMR No. 52 were developed for nonorographic regions. It will be necessary to develop similar procedures for the entire CD-103 region. Techniques developed for an application manual to apply to the CD-103 region would be required to deal with orographic problems in a generalized manner.

### 15.4 Temporal Variation

The procedures in this report provide only a depth-duration curve of general-storm PMP rainfall. The computation of a basin discharge hydrograph requires knowledge of the appropriate time distribution of the rainfall. In HMR No. 52, recommendations are made for appropriate temporal distributions in the nonorographic portions of the CD-103 region.\* The necessary time distribution must be determined from studies of major storms. Because of the diversity of storm types and terrain throughout the CD-103 region, the time distribution could vary from Montana to New Mexico. This regional variation would have to be considered in any future studies of this problem.

### 15.5 Antecedent Rainfall

The only published study of rainfall antecedent to a PMP event was concerned with small basins in Texas (Miller and Ho, 1988). This study restricted consideration to values appropriate for basins of less than 400 mi<sup>2</sup> and for a limited geographic region, only a small portion of which was in the present study region. A comprehensive study of antecedent rainfall for this region would consider the area size of both the basin and the storm, the season of occurrence of PMP, the possibility of geographic variation of antecedent rainfall amounts, and the possible varying percentages of antecedent rainfall based upon the dry interval between the PMP event and the antecedent rainfall.

---

\*Since storms west of the 105th meridian were not fully evaluated in preparing HMR No. 52, care should be exercised in using these time distributions west of the 105th meridian.



## 15.6 Summary

This study produced estimates of all-season PMP for durations from 1 to 72 hr for area sizes to 20,000 mi<sup>2</sup> in nonorographic regions, and 5,000 mi<sup>2</sup> in orographic regions. These studies provide valuable information for hydrologists and engineers. However, additional information may be needed before a complete evaluation can be made of the PMF. Some of these additional pieces of information are the areal distribution and seasonal variation of PMP, snowpack and snowmelt criteria, and antecedent rainfall.

## ACKNOWLEDGMENTS

The authors express their appreciation to the many who have contributed to this revision and to its predecessor HMR No. 55. In particular, Mr. John F. Miller, senior author of HMR No. 55 and at the time Chief of the Water Management Information Division, National Weather Service. He retired from that position in 1985, and has been closely involved with the efforts to revise the study while a consulting meteorologist for the U.S. Bureau of Reclamation. We also wish to acknowledge the efforts and advice of Dr. Don T. Jensen, as a coauthor of HMR No. 55. He left the U.S. Bureau of Reclamation in 1983 for a position with the Soil Conservation Service.

Mr. Eugene Stallings, NWS (formerly with the U.S. Army Corps of Engineers); Mr. Arthur Cudworth, Bureau of Reclamation (since retired); and Mr. Wendell Styner, Soil Conservation Service have been major sources of help during the many meetings held during the course of this study. Mr. Chris Moeller and Mr. Roger Watkins (both no longer with NWS) contributed to the investigations in HMR No. 55, some of which have been carried over into this revision. Mr. Moeller was responsible for the initial local-storm PMP, while much of the revised local storm was done by Mr. Frank Bartlo, NWS. Mr. Watkins contributed to the study of storms, maximum persisting dew points and storm transposition. Technical assistance was provided by Mr. Keith Bell, Mrs. Marion Choate (retired NWS), and Ms. Roxanne Johnson. Without their able assistance these reports would not have been possible. We also acknowledge the assistance of Mr. Scott Kroczyński in proofing and handling the publishing of this report. The many drafts along with the final camera-ready versions of both reports were under the control of Mrs. Helen V. Rodgers.

Finally, HMR No. 55 was reviewed by many hydrologists, meteorologists and hydrometeorologists within the four cooperating agencies. While it is not possible to name all these individuals, they have made a significant contribution to the results of this study by their review of both the final manuscript and many of the earlier versions. HMR 55A has come about from the comments and reviews of many of these same individuals along with users of HMR No. 55, and it is hoped by the current authors that the cooperative spirit that produced this report has yielded an improved study.

## REFERENCES

- Boner, F.C., and Stermitz, F., 1967: Floods of June 1964 in Northwestern Montana. Geological Survey Water-Supply Paper 1840-B, U.S. Geological Survey, U.S. Department of the Interior, Washington, D.C., 242 pp.
- Caracena, F., Maddox, R.A., Hoxit, L.R., and Chappell, C.F., 1979: Mesoanalysis of the Big Thompson Storm. Monthly Weather Review, 107, 1-17.
- Cotton, W.R., George, R.L., Wetzel, P.J., and McAnelly, R.L., 1983: A Long-Lived Mesoscale Convective Complex. Part I: The Mountain-Generated Component. Monthly Weather Review, 111, 1893-1918.
- Environmental Data Service, 1899-1971: Daily Series Synoptic Weather Maps. National Oceanic and Atmospheric Administration, U.S. Department of Commerce, Asheville, NC.
- Environmental Data Service, 1968: Climatic Atlas of the United States. Environmental Science Services Administration, U.S. Department of Commerce, Washington, D.C., 80 pp.
- Fenn, D.D., 1985: Probable Maximum Precipitation Estimates for the Drainage Above Dewey Dam, John's Creek, Kentucky. NOAA Technical Memorandum NWS HYDRO 41, U.S. Department of Commerce, Silver Spring, MD, 33 pp.
- Follansbee, R., and Sawyer, L.R., 1948: Floods in Colorado. Geological Survey Water-Supply Paper 997, U.S. Geological Survey, U.S. Department of the Interior, Washington, D.C., 151 pp.
- Frederick, R.H., Myers, V.A., and Auciello, E.P., 1977: Five- to 60-Minute Precipitation Frequency for Eastern and Central United States. NOAA Technical Memorandum NWS HYDRO 35, National Weather Service, National Oceanic and Atmospheric Administration, U.S. Department of Commerce, Silver Spring, MD, 33 pp.
- Hansen, E.M., Schwarz, F.K., and Riedel, J.T., 1977: Probable Maximum Precipitation Estimates, Colorado River and Great Basin Drainages. Hydrometeorological Report No. 49, National Weather Service, National Oceanic and Atmospheric Administration, U.S. Department of Commerce, Silver Spring, MD, 161 pp.
- Hansen, E.M., and Schwarz, F.K., 1981: Meteorology of Important Rainstorms in the Colorado River and Great Basin Drainages. Hydrometeorological Report No. 50, National Weather Service, National Oceanic and Atmospheric Administration, U.S. Department of Commerce, Silver Spring, MD, 167 pp.
- Hansen, E.M., Schreiner, L.C., and Miller, J.F., 1982: Application of Probable Maximum Precipitation Estimates - United States East of the 105th Meridian. Hydrometeorological Report No. 52, National Weather Service, National Oceanic and Atmospheric Administration, U.S. Department of Commerce, Washington, D.C., 168 pp.

- Hansen, W.R., Chronic J., and Matelock, J., 1978: Climatography of the Front Range Urban Corridor and Vicinity, Colorado. Geological Survey Professional Paper 1010, U.S. Geological Survey, U.S. Department of the Interior, Washington, D.C., 57 pp.
- Hershfield, D.M., 1961: Rainfall Frequency Atlas of the United States. Technical Paper No. 40, U.S. Weather Bureau, U.S. Department of Commerce, Washington, D.C., 115 pp.
- McCain, J.F., Hoxit, L.R., Maddox, R.A., Chappell, G.F., and Caracena, F., 1979: Storm and Flood of July 31 - August 1, 1976, in the Big Thompson River and Cache la Poudre River Basins, Larimer and Weld Counties, Colorado - Part A. Geological Survey Professional Paper No. 1115, U.S. Geological Survey, U.S. Department of the Interior, Washington, D.C., 85 pp.
- Miller, D.L., Everson, C.E., Mumford, J.A., and Bertle, F.A., 1978: Peak Discharge Estimates Used in Refinement of the Big Thompson Storm Analysis. Preprints, Conference on Flash Floods Hydrometeorological Aspects, American Meteorological Society, Boston, MA, 135-142.
- Miller, J.F., 1964: Two- to Ten-Day Precipitation for Return Periods of 2 to 100 Years in the Contiguous United States. Technical Paper No. 49, U.S. Weather Bureau, U.S. Department of Commerce, Washington, D.C., 29 pp.
- Miller, J.F., Frederick, R.H., and Tracey, R.J., 1973: Precipitation Frequency Atlas of the Western United States, Vol. I: Montana; Vol. II: Wyoming; Vol. III: Colorado; and Vol. IV: New Mexico. NOAA Atlas 2, National Weather Service, National Oceanic and Atmospheric Administration, U.S. Department of Commerce, Silver Spring, MD.
- Miller, J.F., Hansen, E.M., and Fenn, D.D., 1984: Probable Maximum Precipitation for the Upper Deerfield River Drainage Massachusetts/Vermont. NOAA Technical Memorandum NWS HYDRO 39, U.S. Department of Commerce, Silver Spring, MD, 36 pp.
- Miller, J.F., and Ho, F.P., 1988: Precipitation Antecedent to the 24-Hour Probable Maximum Precipitation for Small Basins in Texas.
- National Climatic Data Center, 1948- : Local Climatological Data (Station). National Environmental Satellite, Data, and Information Service, National Oceanic and Atmospheric Administration, U.S. Department of Commerce, Asheville, NC. (Ongoing publication.)
- National Climatic Data Center, 1951- : Hourly Precipitation Data (Station). National Environmental Satellite, Data, and Information Service, National Oceanic and Atmospheric Administration, U.S. Department of Commerce, Asheville, NC. (Ongoing publication.)
- National Weather Service, (Office of Hydrology, National Oceanic and Atmospheric Administration, U.S. Department of Commerce), 1980a: Interim All-Season Probable Maximum Precipitation Estimates, Missouri River Drainage West of the 105th Meridian, 10 pp. (Unpublished manuscript.)

- National Weather Service, (Office of Hydrology, National Oceanic and Atmospheric Administration, U.S. Department of Commerce), 1980b: Interim All-Season Probable Maximum Precipitation Estimates, 105th Meridian to the Continental Divide South of 39°N Latitude, 16 pp. (Unpublished manuscript.)
- Neuman, C.J., Cry, G.W., Caso, E.L., and Jarvinen, B.R., 1978 (revised 1981): Tropical Cyclones of the North Atlantic Ocean 1871-1980. National Weather Service - Environmental Data and Information Service - Environmental Research Laboratories, National Oceanic and Atmospheric Administration, U.S. Department of Commerce, Asheville, NC, 174 pp.
- Peck, E.L., Monro, J.C., and Snelson, M.L., 1977: Hydrometeorological Data Base for the United States. Preprints, Second Conference on Hydrometeorology, American Meteorology Society, Boston, MA., 75-78.
- Rhea, J.O., 1978: Orographic Precipitation Model for Hydrometeorological Use. Atmospheric Science Paper No. 287, Colorado State University, Fort Collins, CO., 198 pp.
- Riedel, J.T., Appleby, J.F., and Schloemer, R.W., 1956: Seasonal Variation of the Probable Maximum Precipitation East of the 105th Meridian for Areas of 10 to 1,000 Square Miles and Durations of 6, 12, 24, and 48 Hours. Hydrometeorological Report No. 33, U.S. Weather Bureau, U.S. Department of Commerce, Washington, D.C., 58 pp.
- Riedel, J.T., Schwarz, F.K., and Weaver, R.L., 1969: Probable Maximum Precipitation Over South Platte River, Colorado, and Minnesota River, Minnesota. Hydrometeorological Report No. 44, U.S. Weather Bureau, Environmental Science Services Administration, U.S. Department of Commerce, Washington, D.C., 114 pp.
- Riedel, J.T., and Schreiner, L.C., 1980: Comparison of Generalized Estimates of Probable Maximum Precipitation with Greatest Observed Rainfalls. NOAA Technical Report NWS 25, National Weather Service, National Oceanic and Atmospheric Administration, U.S. Department of Commerce, Washington, D.C., 66 pp.
- Schreiner, L.C., and Riedel, J.T., 1978: Probable Maximum Precipitation Estimates - United States East of the 105th Meridian. Hydrometeorological Report No. 51, National Weather Service, National Oceanic and Atmospheric Administration, U.S. Department of Commerce, Silver Spring, MD., 87 pp.
- Schwarz, F.K., Hughes, L.A., Hansen, E.M., Petersen, M.S., and Kelley, D.B., 1975, The Black Hills - Rapid City Flood of June 9-10, 1972: A Description of the Storm and Flood. Geological Survey Professional Paper 877, U.S. Geological Survey, U.S. Department of the Interior, Washington, D.C., 47pp.
- U.S. Army Corps of Engineers, 1945 - : Storm Rainfall in the United States, Depth-Area-Duration Data. Washington, D.C. (Ongoing publication.)
- U.S. Army Corps of Engineers (Albuquerque District Office, U.S. Department of the Army), 1945: Survey for Flood Control Report. (Unpublished manuscript.)

- U.S. Army Corps of Engineers, 1965: Standard Project Flood Determinations. Civil Engineer Bulletin 52-8, Office of Chief of Engineers, Washington, D.C., 33 pp.
- U.S. Weather Bureau, 1897 - : Climatological Data (by state). National Oceanic and Atmospheric Administration, U.S. Department of Commerce. (Ongoing publication.)
- U.S. Weather Bureau, 1947: Thunderstorm Rainfall. Hydrometeorological Report No. 5, U.S. Department of Commerce, Washington, D.C., 330 pp.
- U.S. Weather Bureau, 1948: Highest Persisting Dew Points in Western United States. Technical Report No. 5, U.S. Department of Commerce, Washington, D.C., 27 pp.
- U.S. Weather Bureau, 1951: Tables of Precipitable Water. Technical Paper No. 14, U.S. Department of Commerce, Washington, D.C., 27 pp.
- U.S. Weather Bureau, 1960: Generalized Estimates of Probable Maximum Precipitation for the United States West of the 105th Meridian. Technical Paper No. 38, U.S. Department of Commerce, Washington, D.C., 66 pp.
- U.S. Weather Bureau, 1961: Interim Report - Probable Maximum Precipitation in California. Hydrometeorological Report No. 36, U.S. Department of Commerce, Washington, D.C., 202 pp.
- U.S. Weather Bureau, 1966: Probable Maximum Precipitation Estimates - Northwest States. Hydrometeorological Report No. 43, Environmental Science Services Administration, U.S. Department of Commerce, Washington, D.C., 228 pp.
- U.S. Weather Bureau, (Office of Hydrology, U.S. Department of Commerce) 1967: Probable Maximum Precipitation for the Upper Rio Grande Valley, 8 pp. (Unpublished manuscript.)
- World Meteorological Organization, 1969: Manual for Depth-Area-Duration Analysis of Storm Precipitation. WMO No. 237. TP 129, Geneva, Switzerland, 114 pp.
- World Meteorological Organization, 1986: Manual for Estimation of Probable Maximum Precipitation. Operational Hydrology Report No. 1, WMO No. 332, Geneva, Switzerland, 269 pp.

APPENDIX A

Generalized PMP Studies for Conterminous United States

Hydrometeorological Report	Geographical Region	Scope
No. 36 (U.S. Weather Bureau 1961 Revision, U.S. Weather Bureau 1969)	Pacific coast drainage of California	General-storm PMP; areas up to 5,000 mi <sup>2</sup> , 6 to 72 hr, seasonal values October through April
No. 43 (U.S. Weather Bureau 1966 addendum 1981)	Columbia River and coastal drainages of Oregon and Washington	General-storm PMP, areas up to 5,000 mi <sup>2</sup> west of Cascades Ridge, areas up to 1,000 mi <sup>2</sup> east of Cascades Ridge, 6 to 72 hr, seasonal values October through June. Local-storm PMP east of Cascades Ridge, areas up to 500 mi <sup>2</sup> , durations to 6 hr, seasonal values May through September.
No. 49 (Hansen et al. 1977)	Colorado River and Great Basin drainage. Also provides local storm for all of California	General-storm PMP, areas up to 5,000 mi <sup>2</sup> , 6 to 72 hr, monthly values. Local-storm PMP, areas up to 500 mi <sup>2</sup> , durations up to 6 hr, all season values.
No. 51 (Schreiner and Riedel 1978)	U.S. east of 103rd meridian	PMP from 10 to 20,000 mi <sup>2</sup> , 6 to 72 hr, all season values.
No. 52 (Hansen et al. 1982)	U.S. east of 105th meridian	PMP from 10 to 20,000 mi <sup>2</sup> , duration $\leq$ 6 hr all season values (Application report).
No. 53 (Ho and Riedel 1980)	U.S. east of 103rd meridian	PMP for 10 mi <sup>2</sup> , 6 to 72 hr, monthly values.
No.* (Miller et al. 1984) (Revised 1987, HMR No. 55A)	U.S. between Continental Divide and 103rd meridian	General-storm PMP, areas 10 to 20,000 mi <sup>2</sup> in nonorographic regions and 10 to 5,000 mi <sup>2</sup> in orographic regions, 1 to 72 hr, all-season values. Local-storm PMP, for selected portions of study region, up to 500 mi <sup>2</sup> , durations < 6 hr, all-season values.

\* Reports 51, 52, and 53 originally provided PMP for the U.S. east of the 105th meridian, PMP between the 103rd and 105th meridian from these reports are now superseded by HMR 55. Application portion of HMR 52 is valid for Eastern U.S. out to the 105th meridian.

## APPENDIX B

### Storms Important for Estimates of PMP in CD-103 Region

This appendix contains a listing of the maximum observed average areal rainfall depths for the storms important to development of general-storm PMP estimates in the CD-103 region. The storms included are the storms listed in table 2.2, except those short-duration storms for which DAD data for 6 hr or more and 10 mi<sup>2</sup> or larger are not presently available. Average depths are given for selected area sizes and durations. The area sizes selected are those considered in HMR No. 51 with the addition of 2,000 mi<sup>2</sup>. Orographic storms provide data to 5,000 mi<sup>2</sup>, while areas to 20,000 mi<sup>2</sup> are given for least orographic storms. It should be noted that for some storms, additional data are available on the original pertinent data sheets (contact NWS authors). Other information in the listing is:

- a. Storm index number. The number used throughout this report for storm identification, assigned by the authors.
- b. Date of storm.
- c. Storm assignment number. This number is assigned by the U.S. Army Corps of Engineers, Bureau of Reclamation, or the Hydrometeorological Service Section of the Atmospheric Environment Service, Canadian Department of the Environment, to storms included in their respective formal storm study programs. Those storms without an assignment number are part of the unofficial storm studies conducted by the Hydrometeorological Branch, NWS.
- d. Name of nearest town or habitation to the maximum rainfall center.
- e. Latitude and longitude of the maximum rainfall center (approximate).
- f. In-place moisture adjustment (see table 5.3).

The locations of these storms are shown in figure 2.1, where each storm is identified by the storm index number.

---

Storm Index No. 1	Date - 5/29-31/1894	Storm Assignment No. MR 6-14
Max. Rainfall Center:	Ward District, CO.	Lat. 40°04' Long. 105°32'
	Moisture Adjustment 244	

---

Area (mi <sup>2</sup> )	Maximum average depth of rainfall in inches						
	Duration of rainfall in hours						
	6	12	18	24	36	48	60
10	1.7	3.3	4.7	5.6	7.3	8.2	8.5
100	1.7	3.2	4.3	5.2	6.5	7.3	7.5
200	1.7	3.1	4.2	5.0	6.3	7.0	7.2
500	1.7	3.0	4.0	4.8	5.9	6.6	6.8
1000	1.6	2.9	3.8	4.6	5.7	6.3	6.5
2000	1.6	2.7	3.6	4.4	5.3	5.9	6.1
5000	1.5	2.5	3.2	3.9	4.7	5.3	5.5

---



---

Storm Index No. 6	Date - 5/1-3/1904	Storm Assignment No. MR 4-6
Max. Rainfall Center:	Boxelder, CO	Lat. 40°59' Long. 105°11'
	Moisture Adjustment 200	

---

Area (mi <sup>2</sup> )	Maximum average depth of rainfall in inches					
	Duration of rainfall in hours					
	6	12	18	24	36	48
10	2.1	2.8	3.5	4.3	6.2	6.4
100	2.0	2.5	3.3	3.9	5.8	6.1
200	1.9	2.4	3.2	3.8	5.7	6.0
500	1.7	2.2	2.9	3.6	5.3	5.5
1000	1.6	2.1	2.7	3.4	4.8	5.0
2000	1.4	1.9	2.5	3.1	4.3	4.5
5000	1.0	1.7	2.1	2.6	3.6	3.9

---



---

Storm Index No. 8	Date - 9/26-30/1904	Storm Assignment No. SW 1-6
Max. Rainfall Center	Rociada, NM	Lat. 35°52' Long. 105°20'
	Moisture Adjustment 138	

---

Area (mi <sup>2</sup> )	Maximum average depth of rainfall in inches								
	Duration of rainfall in hours								
	6	12	18	24	36	48	60	72	90
10	3.8	4.2	5.2	6.6	7.3	7.3	7.3	7.3	7.9
100	3.1	3.8	4.7	6.3	7.0	7.0	7.0	7.0	7.6
200	2.9	3.7	4.6	6.2	6.8	6.9	6.9	6.9	7.5
500	2.6	3.5	4.3	5.8	6.5	6.5	6.6	6.7	7.3
1000	2.4	3.3	4.1	5.4	6.2	6.4	6.4	6.5	7.2
2000	2.2	3.1	3.9	5.0	5.9	6.1	6.2	6.3	7.0
5000	1.8	2.8	3.5	4.4	5.5	5.7	5.8	6.0	6.8

---



---

Storm Index No. 10	Date - 6/6-8/1906	Storm Assignment No. MR 5-13
Max. Rainfall Center:	Warrick, MT	Lat. 48°04' Long. 109°39'
	Moisture Adjustment 188	

---

Area (mi <sup>2</sup> )	Maximum average depth of rainfall in inches						
	Duration of rainfall in hours						
	<u>6</u>	<u>12</u>	<u>18</u>	<u>24</u>	<u>36</u>	<u>48</u>	<u>60</u>
10	6.0	7.8	8.4	10.2	11.6	13.1	13.3
100	5.0	7.1	7.6	9.2	10.5	11.8	12.2
200	4.6	6.6	7.1	8.7	9.9	11.2	11.5
500	4.0	5.9	6.3	7.8	8.8	10.0	10.3
1000	3.5	5.0	5.4	6.7	7.6	8.7	8.9
2000	2.9	4.0	4.2	5.4	6.1	7.1	7.3
5000	2.1	3.0	3.2	4.2	4.9	5.7	5.9

---



---

Storm Index No. 13	Date - 6/3-6/1908	Storm Assignment No. MR 5-15
Max. Rainfall Center:	Evans, MT	Lat. 47°11' Long. 111°08'
	Moisture Adjustment 191	

---

Area (mi <sup>2</sup> )	Maximum average depth of rainfall in inches							
	Duration of rainfall in hours							
	<u>6</u>	<u>12</u>	<u>18</u>	<u>24</u>	<u>36</u>	<u>48</u>	<u>60</u>	<u>72</u>
10	1.9	3.7	5.5	6.5	6.9	7.9	8.0	8.0
100	1.8	3.6	5.0	6.2	6.7	7.5	7.7	7.7
200	1.7	3.5	4.8	6.0	6.5	7.3	7.5	7.6
500	1.7	3.3	4.6	5.7	6.2	7.0	7.1	7.3
1000	1.6	3.0	4.3	5.3	5.7	6.5	6.6	6.9
2000	1.5	2.7	3.9	4.7	5.1	5.9	6.0	6.3
5000	1.2	2.3	3.3	3.8	4.3	4.7	4.8	5.3

---



---

Storm Index No. 86	Date - 10/18-19/1908	Storm Assignment No. SW 2-23
Max. Rainfall Center:	May Valley, CO	Lat. 38°03' Long. 102°38'
	Moisture Adjustment 165	

---

Area (mi <sup>2</sup> )	Maximum average depth of rainfall in inches				
	Duration of rainfall in hours				
	<u>6</u>	<u>12</u>	<u>18</u>	<u>24</u>	<u>36</u>
10	4.2	6.0	6.3	6.3	6.3
100	4.1	5.9	6.3	6.3	6.3
200	4.0	5.9	6.2	6.3	6.3
500	3.8	5.6	6.1	6.2	6.2
1000	3.5	5.4	5.8	5.9	5.9
2000	3.2	5.0	5.5	5.6	5.6
5000	2.7	4.5	5.1	5.2	5.3
10000	2.4	4.0	4.6	4.7	4.9
20000	2.1	3.4	4.0	4.2	4.4

---

---

Storm Index No. 20	Date - 4/29-5/2/14	Storm Assignment No. SW 1-16
Max. Rainfall Center:	Clayton, NM	Lat. 36°20' Long. 103°06'
	Moisture Adjustment 158	

---

Area (mi <sup>2</sup> )	Maximum average depth of rainfall in inches					
	Duration of rainfall in hours					
	<u>6</u>	<u>12</u>	<u>18</u>	<u>24</u>	<u>36</u>	<u>48</u>
10	5.3	6.8	8.6	9.0	9.0	9.6
100	4.8	6.7	8.2	8.8	8.9	9.4
200	4.6	6.5	8.0	8.7	8.8	9.3
500	4.2	6.2	7.8	8.3	8.5	9.0
1000	3.9	5.8	7.4	7.9	8.2	8.7
2000	3.5	5.0	6.7	7.2	7.6	8.1
5000	2.8	3.8	5.4	6.2	6.8	7.3
10000	2.0	3.0	4.5	5.2	6.0	6.5
20000	1.4	2.3	3.5	4.2	5.1	5.6

---



---

Storm Index No. 23	Date - 7/19-28/15	Storm Assignment No. SW 1-18
Max. Rainfall Center:	Tajique, NM	Lat. 34°46' Long. 106°20'
	Moisture Adjustment 177	

---

Area (mi <sup>2</sup> )	Maximum average depth of rainfall in inches							
	Duration of rainfall in hours							
	<u>6</u>	<u>12</u>	<u>18</u>	<u>24</u>	<u>36</u>	<u>48</u>	<u>60</u>	<u>72</u>
10	4.6	4.9	5.1	5.2	6.2	6.2		6.5
100	4.5	4.8	5.0	5.0	6.0	6.0		6.4
200	4.4	4.7	4.9	4.9	5.8	5.8		6.2
500	4.1	4.3	4.6	4.6	5.5	5.5		5.8
1000	3.6	3.8	4.1	4.1	5.0	5.0		5.3
2000	2.7	3.0	3.3	3.3	4.0	4.1		4.5
5000	1.7	2.1	2.4	2.4	2.8	3.0		3.4

---



---

Storm Index No. 25	Date - 8/7-8/16	Storm Assignment No. SW 1-20
Max. Rainfall Center:	Lakewood, NM	Lat. 32°38' Long. 104°21'
	Moisture Adjustment 117	

---

Area (mi <sup>2</sup> )	Maximum average depth of rainfall in inches			
	Duration of rainfall in hours			
	<u>6</u>	<u>12</u>	<u>18</u>	<u>24</u>
10	4.8	5.2	5.8	6.0
100	3.9	4.9	5.8	6.0
200	3.6	4.8	5.6	5.9
500	3.1	4.5	5.2	5.6
1000	2.8	4.2	4.7	5.2
2000	2.4	3.6	4.2	4.6
5000	1.8	2.6	3.2	3.7
10000	1.1	2.0	2.6	3.2

---

---

Storm Index No. 27	Date - 9/15-17/19	Storm Assignment No. GM 5-15B
Max. Rainfall Center:	Meek, NM	Lat. 33°41' Long. 105°11'
	Moisture Adjustment 170	

---

Area (mi <sup>2</sup> )	Maximum average depth of rainfall in inches					
	Duration of rainfall in hours					
	<u>6</u>	<u>12</u>	<u>18</u>	<u>24</u>	<u>36</u>	<u>48</u>
10	3.8	4.5	6.2	7.4	9.1	9.5
100	3.2	4.2	5.1	6.4	7.9	8.3
200	3.0	4.1	4.7	6.0	7.5	7.9
500	2.7	3.8	4.3	5.4	7.0	7.3
1000	2.5	3.4	4.0	5.0	6.5	6.9
2000	2.2	3.1	3.6	4.6	6.0	6.5
5000	1.9	2.7	3.2	4.0	5.3	5.9

---



---

Storm Index No. 30	Date - 4/14-16/21	Storm Assignment No. MR 4-19
Max. Rainfall Center:	Fry's Ranch, CO	Lat. 40°43' Long. 105°43'
	Moisture Adjustment 185	

---

Area (mi <sup>2</sup> )	Maximum average depth of rainfall in inches				
	Duration of rainfall in hours				
	<u>6</u>	<u>12</u>	<u>18</u>	<u>24</u>	<u>36</u>
10	2.2	4.3	6.1	7.3	7.5
100	2.1	4.2	5.7	6.9	7.2
200	2.0	3.9	5.4	6.6	6.9
500	1.7	3.4	4.6	5.6	5.8
1000	1.6	3.0	4.0	4.8	5.2
2000	1.4	2.6	3.4	4.2	4.4
5000	1.1	2.3	3.1	3.8	4.1

---



---

Storm Index No. 31	Date - 6/2-6/21	Storm Assignment No. SW 1-23
Max. Rainfall Center:	Penrose, CO	Lat. 38°27' Long. 105°04'
	Moisture Adjustment 151	

---

Area (mi <sup>2</sup> )	Maximum average depth of rainfall in inches							
	Duration of rainfall in hours							
	<u>6</u>	<u>12</u>	<u>18</u>	<u>24</u>	<u>36</u>	<u>48</u>	<u>60</u>	<u>72</u>
10	10.4	11.3	12.0	12.0	12.0	12.0	12.0	12.0
100	8.8	10.4	11.0	11.1	11.1	11.2	11.2	11.2
200	7.9	9.7	10.3	10.4	10.5	10.7	10.7	10.7
500	6.5	8.4	9.0	9.1	9.4	9.6	9.7	9.7
1000	5.4	7.1	7.8	7.8	8.2	8.6	8.7	8.7
2000	4.2	5.4	6.1	6.2	6.9	7.1	7.4	7.4
5000	2.7	4.0	4.3	4.4	5.6	5.7	6.0	6.2

---

Storm Index No. 32	Date - 6/17-21/21	Storm Assignment No. MR 4-21
Max. Rainfall Center:	Springbrook, MT	Lat. 47°18' Long. 105°35'
	Moisture Adjustment 131	

Area (mi <sup>2</sup> )	Maximum average depth of rainfall in inches							
	Duration of rainfall in hours							
	6	12	18	24	36	48	60	72
10	10.5	11.7	12.9	13.3	13.4	14.2	14.5	14.6
100	8.5	11.1	12.6	13.0	13.3	14.1	14.2	14.4
200	8.3	10.8	12.3	12.7	13.0	13.8	13.9	14.2
500	7.9	10.3	11.6	12.0	12.3	13.0	13.2	13.4
1000	7.4	9.6	10.8	11.3	11.5	12.1	12.3	12.5
2000	6.6	8.5	9.7	10.1	10.4	11.0	11.2	11.4
5000	4.9	6.2	7.3	7.7	8.0	9.0	9.3	9.5
10000	3.0	4.3	5.1	5.6	5.8	7.3	7.6	7.7
20000	1.6	2.7	3.4	3.9	4.2	5.2	5.5	5.8

Storm Index No. 38	Date - 9/27-10/1/23	Storm Assignment No. MR 4-23
Max. Rainfall Center:	Savageton, WY	Lat. 43°52' Long. 105°47'
	Moisture Adjustment 126	

Area (mi <sup>2</sup> )	Maximum average depth of rainfall in inches							
	Duration of rainfall in hours							
	6	12	18	24	36	48	60	72
10	6.0	9.1	9.3	9.5	16.5	16.9	16.9	16.9
100	5.1	8.4	8.7	9.0	15.5	15.9	15.9	15.9
200	4.9	8.0	8.4	8.6	14.8	15.2	15.2	15.2
500	4.3	7.1	7.5	7.7	13.2	13.4	13.6	13.7
1000	3.7	6.2	6.4	6.6	11.4	11.6	11.7	11.8
2000	3.0	5.0	5.3	5.5	9.5	9.7	9.8	9.9
5000	2.2	3.6	3.8	4.0	7.0	7.2	7.4	7.6
10000	1.6	2.5	2.7	3.0	5.3	5.7	6.1	6.3
20000	1.2	1.8	2.1	2.5	3.9	4.7	5.1	5.5

Storm Index No. 44	Date - 10/9-12/30	Storm Assignment No. SW 2-6
Max. Rainfall Center:	Porter, NM	Lat. 35°12' Long. 103°17'
	Moisture Adjustment 140	

Area (mi <sup>2</sup> )	Maximum average depth of rainfall in inches					
	Duration of rainfall in hours					
	6	12	18	24	36	48
10	5.7	6.3	8.5	9.9	9.9	9.9
100	5.3	5.9	7.6	9.1	9.1	9.1
200	5.1	5.7	7.2	8.7	8.7	8.7
500	4.6	5.3	6.5	7.9	8.0	8.0
1000	4.1	4.9	6.0	7.2	7.4	7.4
2000	3.6	4.4	5.4	6.5	6.7	6.8
5000	2.9	3.7	4.6	5.4	5.8	5.9
10000	2.3	3.2	3.9	4.5	5.1	5.2
20000	1.7	2.5	3.2	3.6	4.3	4.4

Storm Index No. 46	Date - 9/9-11/33	Storm Assignment No. R7 1-25A
Max. Rainfall Center:	Kassler, CO	Lat. 39°30' Long. 105°06'
	Moisture Adjustment 193	

Area (mi <sup>2</sup> )	Maximum average depth of rainfall in inches						
	Duration of rainfall in hours						
	<u>6</u>	<u>12</u>	<u>18</u>	<u>24</u>	<u>36</u>	<u>48</u>	<u>60</u>
10	3.9	4.0	4.0	4.2	4.4	4.5	4.5
100	3.8	3.9	3.9	4.1	4.3	4.4	4.4
200	3.7	3.8	3.8	4.0	4.2	4.3	4.3
500	3.4	3.5	3.5	3.7	3.9	4.0	4.1
1000	3.0	3.2	3.2	3.3	3.6	3.7	3.9
2000	2.5	2.8	2.8	2.8	3.3	3.4	3.6
5000	1.8	2.0	2.0	2.1	2.7	2.8	3.0

Storm Index No. 47	Date - 5/30-31/35	Storm Assignment No. MR 3-28A
Max. Rainfall Center:	Cherry Ck., CO	Lat. 39°13' Long. 104°32'
	Moisture Adjustment 163	

Area (mi <sup>2</sup> )	Maximum average depth of rainfall in inches			
	Duration of rainfall in hours			
	<u>6</u>	<u>12</u>	<u>18</u>	<u>24</u>
10	20.6	22.2	22.2	22.2
100	13.7	15.4	15.4	15.4
200	11.2	12.6	12.6	12.6
500	7.8	9.3	9.3	9.3
1000	5.8	7.2	7.2	7.2
2000	4.1	5.3	5.5	5.5
5000	2.4	3.5	3.8	4.0

Storm Index No. 101	Date - 5/30-31/35	Storm Assignment No. MR 3-28A
Max. Rainfall Center:	Hale, CO	Lat. 39°36' Long. 102°08'
	Moisture Adjustment 156	

Area (mi <sup>2</sup> )	Maximum average depth of rainfall in inches			
	Duration of rainfall in hours			
	<u>6</u>	<u>12</u>	<u>18</u>	<u>24</u>
10	16.5 <sup>x</sup>	22.2	22.2	22.2
100	11.0 <sup>x</sup>	15.4	15.4	15.4
200	9.9 <sup>x</sup>	12.6	12.6	12.6
1000	4.6 <sup>x</sup>	7.2	7.2	7.2
5000	1.9 <sup>x</sup>	3.5	3.8	4.0

<sup>x</sup>From original depth-area analysis of total storm pattern

---

Storm Index No. 105	Date - 9/14-18/36	Storm Assignment No. GM 5-7
Max. Rainfall Center:	Broome, TX	Lat. 31°47' Long. 100°50'
	Moisture Adjustment 117	

---

Area (mi <sup>2</sup> )	Maximum average depth of rainfall in inches							
	Duration of rainfall in hours							
	6	12	18	24	36	48	60	72
10	16.0	22.0	24.1	26.0	26.0	27.6	28.0	30.0
100	10.9	15.4	18.3	20.4	21.7	23.5	25.8	28.6
200	9.5	13.6	16.5	18.5	20.0	21.4	24.5	27.7
500	7.7	11.2	14.0	15.8	17.2	18.2	22.1	25.7
1000	6.4	9.5	12.0	13.8	14.8	15.4	19.9	23.6
2000	5.2	7.9	9.9	11.6	12.3	13.0	17.1	20.9
5000	3.7	5.8	7.3	8.7	9.4	10.2	13.5	16.5
10000	2.7	4.3	5.5	6.7	7.4	8.4	11.1	13.2
20000	1.9	3.0	3.9	4.9	5.8	6.8	8.9	10.4

---



---

Storm Index No. 53	Date - 8/30-9/4/38	Storm Assignment No. MR 5-8
Max. Rainfall Center:	Loveland, CO	Lat. 40°23' Long. 105°04'
	Moisture Adjustment 134	

---

Area (mi <sup>2</sup> )	Maximum average depth of rainfall in inches							
	Duration of rainfall in hours							
	6	12	18	24	36	48	60	72
10	6.4	6.8	7.0	7.0	9.9	9.9	10.6	10.6
100	4.4	4.8	5.2	5.2	8.9	8.9	9.4	9.4
200	3.6	4.2	4.6	4.6	7.8	7.9	8.4	8.4
500	2.3	3.1	3.1	3.4	6.1	6.2	6.6	6.7
1000	1.6	2.9	2.9	3.1	5.0	5.1	5.4	5.7
2000	1.3	2.4	2.5	2.7	4.0	4.1	4.4	4.6
5000	1.0	1.6	1.7	2.1	3.2	3.4	3.6	3.8

---



---

Storm Index No. 108	Date - 6/19-20/1939	Storm Assignment No. -
Max. Rainfall Center:	Snyder, TX	Lat. 32°44' Long. 100°55'
	Moisture Adjustment 123	

---

Area (mi <sup>2</sup> )	Maximum average depth of rainfall in inches
	Duration of rainfall in hours
	6
10	18.8
100	14.2
200	11.9
500	8.6
1000	6.5
2000	4.7
5000	-

---

Storm Index No. 56	Date - 5/20-25/41	Storm Assignment No. GM 5-18
Max. Rainfall Center:	Prairieview, NM	Lat. 33°07' Long. 103°12'
	Moisture Adjustment 132	

Area (mi <sup>2</sup> )	Maximum average depth of rainfall in inches							
	Duration of rainfall in hours							
	6	12	18	24	36	48	60	72
10	3.8	4.8	6.0	6.5	7.0	7.4	7.4	8.4
100	3.0	4.0	5.2	6.3	6.8	6.9	7.0	8.1
200	2.7	3.7	4.7	6.0	6.6	6.7	6.9	8.0
500	2.3	3.3	4.1	5.4	6.1	6.4	6.7	7.7
1000	2.1	3.0	3.7	4.9	5.7	6.1	6.4	7.5
2000	1.8	2.7	3.2	4.3	5.2	5.7	6.1	7.2
5000	1.4	2.2	2.7	3.5	4.4	5.0	5.6	6.6
10000	1.2	1.9	2.2	2.9	3.7	4.4	5.0	5.9
20000	0.9	1.5	1.8	2.3	3.0	3.7	4.3	5.1

Storm Index No. 58	Date - 9/20-23/41	Storm Assignment No. GM 5-19
Max. Rainfall Center:	McColleum Ranch, NM	Lat. 32°10' Long. 104°44'
	Moisture Adjustment 151	

Area (mi <sup>2</sup> )	Maximum average depth of rainfall in inches							
	Duration of rainfall in hours							
	6	12	18	24	36	48	60	72
10	10.1	11.2	11.5	12.1	16.9	18.7	21.0	21.2
100	5.9	8.3	8.7	9.0	11.7	13.0	14.7	15.0
200	5.2	7.3	7.8	8.1	9.7	10.8	12.4	12.7
500	4.4	6.2	6.8	6.9	7.9	9.1	10.2	10.5
1000	3.8	5.5	6.1	6.3	7.1	8.3	9.4	9.6
2000	3.3	4.8	5.5	5.6	6.4	7.5	8.6	8.8
5000	2.6	3.9	4.6	4.8	5.6	6.6	7.5	7.8
10000	2.0	3.2	4.0	4.2	4.9	5.9	6.7	7.0
20000	1.5	2.6	3.3	3.7	4.4	5.2	5.9	6.2

Storm Index No. 60	Date - 8/29-9/1/42	Storm Assignment No. SW 2-29
Max. Rainfall Center:	Rancho Grande, NM	Lat. 34°56' Long. 105°06'
	Moisture Adjustment 119	

Area (mi <sup>2</sup> )	Maximum average depth of rainfall in inches							
	Duration of rainfall in hours							
	6	12	18	24	36	48	60	72
10	3.2	5.9	7.0	7.9	8.0	8.0	8.0	8.0
100	2.7	5.2	6.7	7.6	8.0	8.0	8.0	8.0
200	2.6	5.1	6.7	7.6	8.0	8.0	8.0	8.0
500	2.4	4.7	6.5	7.4	7.7	7.8	7.8	7.8
1000	2.3	4.2	6.1	6.8	7.2	7.2	7.2	7.2
2000	2.1	4.0	4.9	5.8	6.4	6.4	6.4	6.5
5000	1.9	3.6	4.5	5.5	6.0	6.0	6.0	6.1

Storm Index No. 112	Date - 6/23-28/54	Storm Assignment No. SW 3-22
Max. Rainfall Center:	Vic Pierce, TX	Lat. 30°22' Long. 101°23'
Moisture Adjustment 130		

Area (mi <sup>2</sup> )	Maximum average depth of rainfall in inches							
	Duration of rainfall in hours							
	6	12	18	24	36	48	60	72
10	16.0	20.1	22.5	26.7	32.0	34.6	34.6	34.6
100	12.6	16.5	19.7	23.6	29.2	31.5	31.5	31.5
200	10.9	14.9	18.6	22.5	27.5	29.5	29.5	29.5
500	8.4	12.0	16.6	20.5	24.5	26.3	26.3	26.3
1000	6.6	9.7	14.6	18.4	21.5	23.0	23.0	23.0
2000	4.8	7.5	11.8	14.7	17.6	19.4	19.4	19.4
5000	2.8	4.9	7.4	8.9	11.9	13.7	14.3	14.3
10000	1.7	3.2	4.7	5.7	8.0	9.8	10.4	10.5
20000	1.2	2.0	2.8	3.6	5.2	6.5	7.0	7.2

Storm Index No. 75	Date - 6/6-8/64	Storm Assignment No. -
Max. Rainfall Center:	Gibson Dam, MT	Lat. 48°33' Long. 113°32'
Moisture Adjustment 200		

Area (mi <sup>2</sup> )	Maximum average depth of rainfall in inches				
	Duration of rainfall in hours				
	6	12	18	24	36
10	6.0 <sup>x</sup>	10.6 <sup>x</sup>	13.6 <sup>x</sup>	14.9 <sup>x</sup>	16.4 <sup>x</sup>
100	5.8 <sup>x</sup>	10.2 <sup>x</sup>	13.2 <sup>x</sup>	14.6 <sup>x</sup>	16.0 <sup>x</sup>
200	5.6 <sup>x</sup>	10.0 <sup>x</sup>	12.8 <sup>x</sup>	14.2 <sup>x</sup>	15.5 <sup>x</sup>
500	5.1 <sup>x</sup>	9.1 <sup>x</sup>	11.8 <sup>x</sup>	13.2 <sup>x</sup>	14.4 <sup>x</sup>
1000	4.6 <sup>x</sup>	8.4 <sup>x</sup>	11.0 <sup>x</sup>	12.3 <sup>x</sup>	13.4 <sup>x</sup>
2000	4.2 <sup>x</sup>	7.6 <sup>x</sup>	10.0 <sup>x</sup>	11.3 <sup>x</sup>	12.3 <sup>x</sup>
5000	3.4 <sup>x</sup>	6.4 <sup>x</sup>	8.2 <sup>x</sup>	9.6 <sup>x</sup>	10.4 <sup>x</sup>

Storm Index No. 76	Date - 6/13-20/65	Storm Assignment No. -
Max. Rainfall Center:	Plum Creek, CO	Lat. 39°05' Long. 104°20'
Moisture Adjustment 128		

Area (mi <sup>2</sup> )	Maximum average depth of rainfall in inches							
	Duration of rainfall in hours							
	6	12	18	24	36	48	60	72
10	11.5 <sup>x</sup>	12.5 <sup>x</sup>	12.6 <sup>x</sup>	13.2	14.6	15.4	16.2	16.7
100	7.7 <sup>x</sup>	8.5 <sup>x</sup>	8.7 <sup>x</sup>	12.4	13.6	14.4	15.1	15.6
200	6.9 <sup>x</sup>	7.8 <sup>x</sup>	8.0 <sup>x</sup>	11.9	13.0	13.8	14.5	14.8
1000	5.0 <sup>x</sup>	5.6 <sup>x</sup>	5.7 <sup>x</sup>	9.5	10.6	11.2	11.8	12.3
5000	2.8	3.4	4.0	6.0	7.0	7.1	7.6	8.0
10000	2.0	2.5	3.0	3.9	4.8	5.2	5.8	6.1
20000	1.4	1.7	2.1	2.4	3.1	3.5	4.2	4.4

<sup>x</sup> from USBR analysis



---

Storm Index No. 68	Date - 6/16-17/48	Storm Assignment No. -
Max. Rainfall Center:	Dupuyer, MT	Lat. 48°12' Long. 112° 30'
	Moisture Adjustment 220	

---

Area (mi <sup>2</sup> )	Maximum average depth of rainfall in inches					
	Duration of rainfall in hours					
	<u>6</u>	<u>12</u>	<u>18</u>	<u>24</u>	<u>36</u>	<u>48</u>
10	4.4	6.1	8.3	8.6	8.9	9.3
100	(4.0)	(5.1)	(6.9)	(7.3)	(7.9)	(8.8)*
1000	1.8	3.7	5.1	5.6	6.0	7.0
2000	1.6	3.1	4.3	4.7	5.1	5.9

---

\*Interpolated

---

Storm Index No. 111	Date - 6/23-24/48	Storm Assignment No. -
Max. Rainfall Center:	Del Rio, TX	Lat. 29°22' Long. 100°37'
	Moisture Adjustment 135	

---

Area (mi <sup>2</sup> )	Maximum average depth of rainfall in inches			
	Duration of rainfall in hours			
	<u>6</u>	<u>12</u>	<u>18</u>	<u>24</u>
10	13.2	20.7	25.2	26.2
100	11.3	18.2	22.5	23.8
200	10.3	16.9	21.1	22.5
500	8.8	15.2	19.0	20.2
1000	7.7	13.6	16.8	17.9
2000	6.3	11.4	14.1	15.1
5000	4.7	8.0	9.9	10.8
10000	3.2	5.5	6.8	7.2

---



---

Storm Index No. 71	Date - 6/1-4/53	Storm Assignment No. -
Max. Rainfall Center:	Belt, MT	Lat. 47°25' Long. 110°50'
	Moisture Adjustment 148	

---

Area (mi <sup>2</sup> )	Maximum average depth of rainfall in inches				
	Duration of rainfall in hours				
	<u>6</u>	<u>12</u>	<u>18</u>	<u>24</u>	<u>36</u>
10		5.8	7.7	8.6	10.4
100		5.1	6.8	7.5	9.0
200		4.7	6.2	7.0	8.4
500		4.0	5.5	6.1	7.5
1000		3.4	4.8	5.4	6.8
2000		2.8	4.0	4.4	5.9
5000		2.3	3.1	3.5	4.8

---

Storm Index No. 114	Date - 6/24/66	Storm Assignment No. -
Max. Rainfall Center:	Glen Ullin, ND	Lat. 47°21' Long. 101°19'
	Moisture Adjustment 152	

Area (mi <sup>2</sup> )	Maximum average depth of rainfall in inches	
	Duration of rainfall in hours	
	6	12
10	11.1	11.9
100	9.6	10.1
200	8.6	9.1
500	6.9	7.5
1000	5.4	5.9

Storm Index No. 77	Date - 5/4-8/69	Storm Assignment No. -
Max. Rainfall Center:	Big Elk Meadow, CO	Lat. 40°16' Long. 105°25'
	Moisture Adjustment 182	

Area (mi <sup>2</sup> )	Maximum average depth of rainfall in inches							
	Duration of rainfall in hours							
	6	12	18	24	36	48	60	72
10	4.0	7.2	9.6	11.8	14.0	15.1	16.9	17.8
100	3.0	5.4	7.1	8.6	10.7	11.8	12.9	14.0
200	2.7	4.8	6.3	7.8	9.7	10.7	11.7	12.8
500	2.2	4.0	5.3	6.5	8.3	9.2	10.2	11.2
1000	1.9	3.4	4.6	5.5	7.2	8.1	9.0	10.0
2000	1.5	2.9	3.8	4.6	6.0	7.0	7.8	8.7
5000	1.1	2.1	2.7	3.4	4.6	5.5	6.1	6.9

Storm Index No. 78	Date - 6/9/72	Storm Assignment No. -
Max. Rainfall Center:	Rapid City, SD	Lat. 44°12' Long. 103°31'
	Moisture Adjustment 120	

Area (mi <sup>2</sup> )	Maximum average depth of rainfall in inches	
	Duration of rainfall in hours	
	6	12
10		14.9
100		12.4
200		10.9
500		8.6
1000		6.7
2000		5.0

---

Storm Index No. 79	Date - 5/5-6/73	Storm Assignment No. -
Max. Rainfall Center:	Broomfield, CO	Lat. 39°55' Long. 105°06'
	Moisture Adjustment 194	

---

Area (mi <sup>2</sup> )	Maximum average depth of rainfall in inches				
	Duration of rainfall in hours				
	<u>6</u>	<u>12</u>	<u>18</u>	<u>24</u>	<u>36*</u>
10	2.9	4.9	5.9	6.3	6.3
100	2.4	4.8	5.2	5.8	5.8
500	2.1	3.8	4.8	5.1	5.2
1000	2.0	3.5	4.3	4.7	4.8
5000	1.7	2.8	3.4	3.8	3.9

---

\* 30 hr

---

Storm Index No. 116	Date - 8/1-3/78	Storm Assignment No. -
Max. Rainfall Center:	Medina, TX	Lat. 29°55' Long. 99°21'
	Moisture Adjustment 117	

---

Area (mi <sup>2</sup> )	Maximum average depth of rainfall in inches						
	Duration of rainfall in hours						
	<u>6</u>	<u>12</u>	<u>18</u>	<u>24</u>	<u>36</u>	<u>48</u>	<u>60<sup>#</sup></u>
10	17.0	20.8	23.8	27.2	31.9	40.0	42.5
100	15.3	19.9	21.8	23.8	27.1	31.6	32.6
200	13.8	17.9	19.4	21.5	24.1	28.5	29.4
500	11.3	14.5	15.8	17.8	20.0	24.3	25.0
1000	9.1	12.0	13.1	15.0	16.9	20.5	21.1
2000 <sup>x</sup>	7.1	9.9	10.9	12.6	14.2	16.8	17.3

---

# 55 hr

x 1800 mi<sup>2</sup>

# APPENDIX C

## Table of Precipitable Water

DEPTH OF PRECIPITABLE WATER (W, .01 in.)  
 BETWEEN 1000-MB SURFACE AND INDICATED HEIGHT (H, 1000 ft.) ABOVE 1000-MB SURFACE,  
 AS A FUNCTION OF 1000-MB TEMPERATURE (T1000, F),  
 IN A SATURATED ATMOSPHERE WITH PSEUDOADIABATIC LAPSE RATE

Height 100's ft.	Temperatures at 1000 mb																				
	60	61	62	63	64	65	66	67	68	69	70	71	72	73	74	75	76	77	78	79	80
1	02	02	02	02	02	02	02	02	02	02	02	02	02	02	03	03	03	03	03	03	03
2	03	03	03	04	04	04	04	04	04	04	05	05	05	05	05	05	05	06	06	06	06
3	05	05	05	05	05	06	06	06	06	06	07	07	07	07	07	07	08	08	08	08	09
4	06	06	07	07	07	07	08	08	08	08	09	09	09	10	10	10	10	11	11	11	12
5	08	08	08	09	09	09	10	10	10	11	11	11	12	12	12	13	13	14	14	15	15
6	09	10	10	10	11	11	11	12	12	13	13	13	14	14	15	15	16	16	17	17	18
7	11	11	12	12	12	13	13	14	14	15	15	16	16	17	17	18	18	19	19	20	21
8	12	13	13	14	14	15	15	16	16	17	17	18	18	19	20	20	21	21	22	23	24
9	14	14	15	15	16	16	17	17	18	19	19	20	21	21	22	23	23	24	25	26	27
10	15	16	16	17	17	18	19	19	20	21	21	22	23	23	24	25	26	27	28	28	29
11	17	17	18	19	19	20	20	21	22	23	23	24	25	26	27	28	28	29	30	31	32
12	18	19	19	20	21	22	22	23	24	25	26	27	28	29	30	31	32	33	34	34	35
13	20	20	21	22	22	23	24	25	26	27	28	29	30	31	32	33	34	35	36	37	38
14	21	22	22	23	24	25	26	27	28	29	30	31	32	33	34	35	36	37	38	39	41
15	22	23	24	25	26	27	28	29	30	31	32	33	34	35	36	37	38	39	41	42	43
16	24	25	26	26	27	28	29	30	31	32	33	35	36	37	38	39	41	42	43	45	46
17	25	26	27	28	29	30	31	32	33	34	35	37	38	39	40	41	43	44	45	47	49
18	26	27	28	29	30	32	33	34	35	36	37	39	40	41	43	44	45	47	48	50	52
19	28	29	30	31	32	33	34	35	37	38	39	41	42	43	45	46	48	49	51	53	54
20	29	30	31	32	34	35	36	37	38	40	41	42	44	45	47	48	50	52	53	55	57
21	30	32	33	34	35	36	38	39	40	42	43	44	46	47	49	51	52	54	56	58	60
22	32	33	34	35	37	38	39	41	42	44	45	46	48	49	51	53	55	56	58	60	62
23	33	34	36	37	38	39	40	42	44	45	47	48	50	52	53	55	57	59	61	63	65
24	34	36	37	38	40	41	42	44	45	47	48	50	52	54	56	57	60	61	63	65	68
25	36	37	38	40	41	43	44	46	47	49	50	52	54	56	58	60	62	64	66	68	70
26	37	38	40	41	43	44	46	47	49	50	52	54	56	58	60	62	64	66	68	70	73
27	38	40	41	43	44	46	47	49	51	52	54	56	58	60	62	64	66	68	71	73	75
28	39	41	42	44	45	47	49	50	52	54	56	58	60	62	64	66	68	70	73	75	78
29	41	42	44	45	47	49	50	52	54	56	57	60	62	64	66	68	70	73	75	78	80
30	42	43	45	47	48	50	52	54	55	57	59	61	64	66	68	70	73	75	78	80	83
31	43	45	46	48	50	51	53	55	57	59	61	63	65	68	70	72	75	77	80	83	85
32	44	46	48	49	51	53	55	57	59	61	63	65	67	69	72	74	77	79	82	85	88
33	45	47	49	51	52	54	56	58	60	62	64	67	69	71	74	77	79	82	84	87	90
34	46	48	50	52	54	56	58	60	62	64	66	69	71	73	76	79	81	84	87	90	93
35	48	50	51	53	55	57	59	61	64	66	68	70	73	75	78	81	83	86	89	92	95
36	49	51	53	55	56	59	61	63	65	67	70	72	75	77	80	83	85	88	91	94	97
37	50	52	54	56	58	60	62	64	66	69	71	74	76	79	82	85	88	90	94	97	100
38	51	53	55	57	59	61	63	66	68	70	73	75	78	81	84	87	90	92	96	99	102
39	52	54	56	58	60	63	65	67	70	72	74	77	80	83	86	89	92	95	98	101	105
40	53	55	57	60	62	64	66	69	71	73	76	79	82	84	87	90	94	97	100	103	107
41	54	56	59	61	63	65	68	70	73	75	78	81	84	87	90	94	98	101	104	107	111
42	56	58	60	62	64	67	69	72	74	77	80	83	86	89	92	96	99	102	106	109	113
43	57	59	61	63	66	68	70	73	76	78	81	84	87	90	93	97	100	103	107	110	114
44	58	60	62	64	67	69	72	74	77	80	82	85	88	92	94	98	102	105	109	112	116
45	59	61	63	66	68	71	73	76	79	81	84	87	90	93	97	100	104	107	111	114	118
46	60	62	64	67	69	72	74	77	80	83	86	89	92	95	98	102	105	109	113	117	121
47	61	63	65	68	70	73	76	78	81	84	87	90	93	97	100	104	107	111	115	119	123
48	62	64	67	69	72	74	77	80	83	86	89	92	95	98	102	106	109	113	117	121	125
49	63	65	68	70	73	76	78	81	84	87	90	93	97	100	104	107	111	115	119	123	127
50	64	66	69	71	74	77	80	82	86	88	92	95	98	102	105	109	113	117	121	125	129
55	69	71	74	77	80	83	86	89	92	95	99	103	106	110	114	118	122	127	131	135	140
60	73	76	79	82	85	89	92	95	99	102	106	110	114	118	122	127	131	136	141	145	150
65	78	81	84	87	91	94	97	101	105	109	113	117	121	125	130	135	140	145	150	155	160
70	82	85	88	92	95	99	103	107	111	115	119	124	128	133	138	143	148	153	159	164	170
75	86	89	93	96	100	104	108	112	117	121	125	130	135	140	145	150	156	161	167	173	179
80	89	93	97	101	105	109	113	117	122	126	131	136	141	146	152	157	163	169	174	182	188
85	93	97	101	105	109	113	118	122	127	132	137	142	147	153	159	164	171	177	184	190	197
90	96	100	104	109	113	117	122	127	132	137	142	148	153	159	165	171	178	184	191	198	205
95	99	103	108	112	117	121	126	131	137	142	147	153	159	165	171	178	184	191	198	206	213
100	102	107	111	116	120	125	130	135	141	146	152	158	164	170	177	184	191	198	206	213	221
105	105	109	114	119	124	129	134	139	145	151	157	163	169	176	183	190	197	204	212	220	228
110	108	112	117	122	127	132	138	143	149	155	161	168	174	181	188	195	203	211	219	227	235
115	110	115	120	125	130	135	141	147	153	159	165	172	179	186	193	201	209	217	225	233	242
120	112	117	122	127	133	139	144	150	157	163	169	176	183	190	198	206	214	222	231	240	249
125	115	119	125	130	136	141	147	154	160	166	173	180	187	195	203	211	219	228	237	246	255
130	116	122	127	133	138	144	150	157	163	170	177	184	191	199	207	215	224	233	242	251	261
135	118	124	129	135	141	147	153	159	166	173	180	188	196	203	212	220	229	238	248	257	267
140	120	125	131	137	143	149	156	162	169	176	183	191	199	207	216	224	233	243	253	262	273
145	122	127	133	139	145	151	158	165	172	179	186	194	202	211	220	228	238	247	257	267	278
150	123	129	135	141	147	153	160	167	174	182	189	197	206	214	223	232	242	252	262	272	283
155	125	130	136	142	149	155	162	169	177	184	192	200	209	217	227	236	246	256	266	277	288
160	126	132	138	144	151	157	164	172	179	187	195	203	212	220	230						

## Appendix C

### Table of Precipitable Water (continued)

DEPTH OF PRECIPITABLE WATER (W, .01 IN.)  
BETWEEN 1000-MB SURFACE AND INDICATED HEIGHT (H, 1000 FT) ABOVE 1000-MB SURFACE,  
AS A FUNCTION OF 1000-MB TEMPERATURE (T<sub>1000</sub>, F),  
IN A SATURATED ATMOSPHERE WITH PSEUDOADIABATIC LAPSE RATE

Height 100's ft	Temperature at 1000 mb																									
	60	61	62	63	64	65	66	67	68	69	70	71	72	73	74	75	76	77	78	79	80					
230	136	142	150	157	165	173	181	190	199	208	218	228	238	249	261	273	285	298	311	325	339					
235	136	143	150	157	165	173	182	190	200	209	219	229	239	250	262	274	287	299	313	327	341					
240	136	143	150	158	166	174	182	191	200	209	219	230	240	251	264	275	288	301	315	329	343					
245	137	143	151	158	166	174	183	192	201	210	220	230	241	252	265	277	289	303	316	330	345					
250	137	144	151	158	166	175	183	192	201	211	221	231	242	253	266	278	291	304	318	332	347					
255	137	144	151	159	167	175	184	192	202	211	221	232	243	254	267	279	292	305	319	334	349					
260	137	144	151	159	167	175	184	193	202	212	222	233	244	255	268	280	293	306	321	335	350					
265	137	144	152	159	167	175	184	193	203	212	223	233	244	256	269	281	294	308	322	336	352					
270	138	144	152	159	168	176	185	194	203	213	223	234	245	257	269	282	295	309	323	338	353					
275	138	145	152	160	168	176	185	194	204	213	223	234	245	257	270	282	296	310	324	339	355					
280	138	145	152	160	168	176	185	194	204	213	224	235	246	258	271	283	297	311	325	340	356					
285	138	145	152	160	168	176	185	194	204	214	224	235	246	258	271	284	297	311	326	341	357					
290	138	145	152	160	168	176	185	195	204	214	225	235	247	259	272	284	298	312	327	342	358					
295	138	145	152	160	168	177	186	195	205	214	225	236	247	259	272	285	299	313	328	343	359					
300	138	145	152	160	168	177	186	195	205	214	225	236	247	260	273	285	299	314	329	344	360					
305	138	145	152	160	168	177	186	195	205	215	225	236	248	260	273	286	300	314	329	344	361					
310	138	145	152	160	169	177	186	195	205	215	225	236	248	260	274	286	300	315	330	345	362					
315	138	145	153	160	169	177	186	195	205	215	226	237	248	260	274	287	301	315	330	346	363					
320	138	145	153	160	169	177	186	195	205	215	226	237	248	261	274	287	301	316	331	346	363					
325	138	145	153	160	169	177	186	195	205	215	226	237	249	261	274	287	302	316	331	347	364					
330	138	145	153	160	169	177	186	196	205	215	226	237	249	261	275	288	302	316	332	347	364					
335	138	145	153	160	169	177	186	196	206	215	226	237	249	261	275	288	302	317	332	348	365					
340	138	145	153	161	169	177	186	196	206	215	226	237	249	261	275	288	302	317	333	348	365					
345	138	145	153	161	169	177	186	196	206	216	226	237	249	262	275	288	303	317	333	349	366					
350	138	145	153	161	169	177	186	196	206	216	226	238	249	262	275	288	303	318	333	349	366					
355	138	145	153	161	169	177	186	196	206	216	226	238	249	262	275	289	303	318	333	349	366					
360	138	145	153	161	169	177	186	196	206	216	226	238	249	262	276	289	303	318	334	350	367					
365	138	145	153	161	169	177	186	196	206	216	227	238	250	262	276	289	303	318	334	350	367					
370	138	145	153	161	169	177	186	196	206	216	227	238	250	262	276	289	303	318	334	350	367					
375	138	145	153	161	169	177	186	196	206	216	227	238	250	262	276	289	304	318	334	350	368					
380	138	145	153	161	169	177	186	196	206	216	227	238	250	262	276	289	304	319	334	350	368					
385	138	145	153	161	169	177	186	196	206	216	227	238	250	262	276	289	304	319	334	350	368					
390	138	145	153	161	169	177	186	196	206	216	227	238	250	262	276	289	304	319	335	351	368					
395	138	145	153	161	169	177	186	196	206	216	227	238	250	262	276	289	304	319	335	351	368					
400	138	145	153	161	169	177	186	196	206	216	227	238	250	262	276	289	304	319	335	351	368					
405	138	145	153	161	169	177	186	196	206	216	227	238	250	262	276	289	304	319	335	351	368					
410	138	145	153	161	169	177	186	196	206	216	227	238	250	262	276	289	304	319	335	351	369					
415	138	145	153	161	169	177	186	196	206	216	227	238	250	262	276	289	304	319	335	351	369					
420	138	145	153	161	169	177	186	196	206	216	227	238	250	262	276	289	304	319	335	351	369					
425	138	145	153	161	169	177	187	196	206	216	227	238	250	262	276	289	304	319	335	351	369					
430				161	169	177	187	196	206	216	227	238	250	262	276	290	304	319	335	351	369					
435				161	169	177	187	196	206	216	227	238	250	262	276	290	304	319	335	351	369					
440				161	169	177	187	196	206	216	227	238	250	262	276	290	304	319	335	351	369					
445					169	177	187	196	206	216	227	238	250	262	276	290	304	319	335	351	369					
450						177	187	196	206	216	227	238	250	262	276	290	304	319	335	351	369					
455							187	196	206	216	227	238	250	262	276	290	304	319	335	351	369					
460							187	196	206	216	227	238	250	262	276	290	304	319	335	351	369					
465								206	216	227	238	250	262	276	290	304	319	335	351	369						
470									216	227	238	250	262	276	290	304	319	335	351	369						
475										216	227	238	250	262	276	290	304	319	335	351	369					
480											216	227	238	250	262	276	290	304	319	335	369					
485												238	250	262	276	290	304	319	335	351	369					
490													250	262	276	290	304	319	335	351	369					
495														250	262	276	290	304	319	335	369					
500															250	262	276	290	304	319	335	369				
505																276	290	304	319	335	351	369				
510																	290	304	319	335	351	369				
515																		319	335	351	369					
520																			319	335	351	369				
525																				319	335	351	369			
530																					319	335	369			
535																						335	369			
540																							335	369		
545																								335	369	
550																									335	369



75 Years Stimulating America's Progress  
1913-1988