

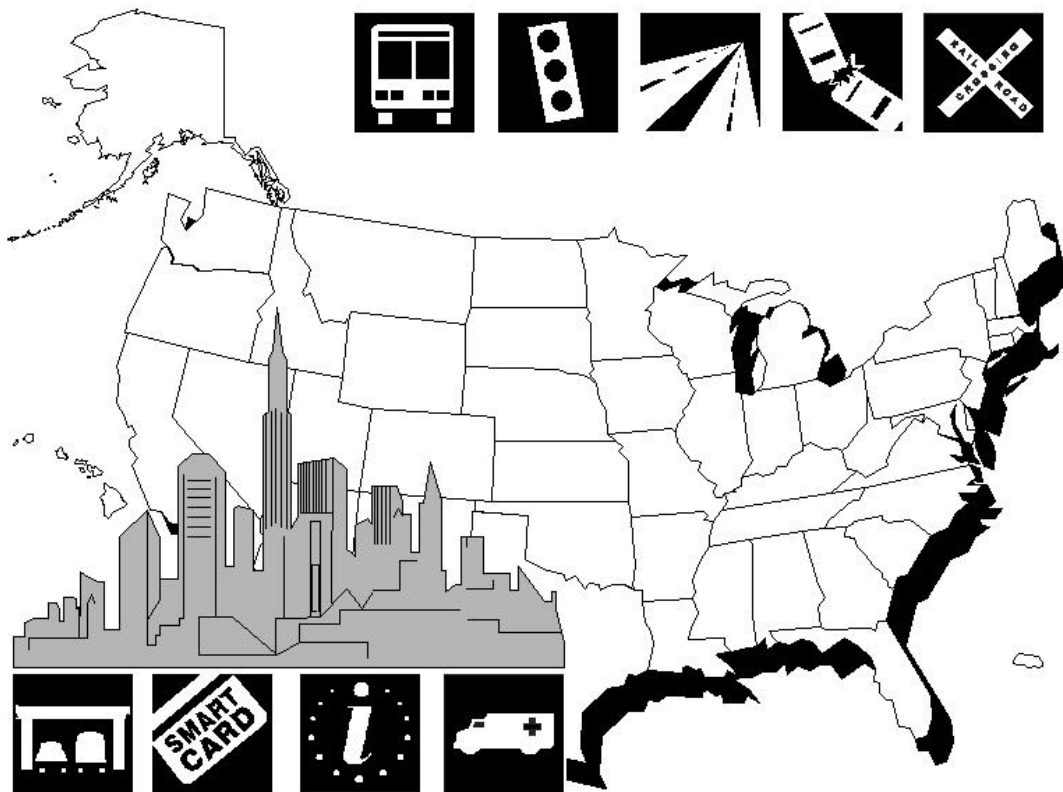

U.S. Department
of Transportation

Tracking the Deployment of the Integrated Metropolitan Intelligent Transportation Systems Infrastructure in the USA: FY 1997 Results



September 1998

Prepared for:

ITS Joint Program Office
Federal Highway Administration
Washington, D.C.

Notice

This document is disseminated under the sponsorship of the Department of Transportation in the interest of information exchange. The United States Government assumes no liability for its content or use thereof.

1. Report No. FHWA-JPO-99-001	2. Government Accession No.	3. Recipient's Catalog No.	
4. Title and Subtitle Tracking the Deployment of the Integrated Metropolitan Intelligent Transportation Systems Infrastructure in the USA: FY 1997 Results		5. Report Date September 1998	
		6. Performing Organization Code	
7. Author(s) Steve Gordon and Jeffrey Trombly		8. Performing Organization Report No.	
9. Performing Organization Name and Address Oak Ridge National Laboratory P.O. Box 2008, Bldg 4500N, MS 6206 Oak Ridge, TN 37831-6206 Science Applications International Corporation 301 Laboratory Road Oak Ridge, TN 37831		10. Work Unit No. (TRAIS)	
		11. Contract or Grant No. DTFH61-95-Y-00105	
12. Sponsorship Agency Name and Address Department of Transportation FHWA ITS Joint Program Office 400 Seventh Street, S.W. - Room 3422 Washington, D.C. 20590		13. Type of Report and Period Covered.	
		14. Sponsoring Agency Code HVH-1	
15. Supplementary Notes Contact person at JPO - Joseph Peters			
16. Abstract This report describes the results of a major data gathering effort aimed at tracking deployment of nine infrastructure components of the metropolitan ITS infrastructure in 78 of the largest metropolitan areas in the nation. The nine components are: Freeway Management, Incident Management, Traffic Signal Control, Electronic Toll Collection, Electronic Fare Payment, Transit Management, Highway-Rail Intersections, Emergency Management, and Regional Multimodal Traveler Information. Deployment is tracked through the use of indicators tied to the major functions of each component. In addition, integration of components is tracked through examining the transfer of information between components and the use of that information once transferred. The report summarizes results at a national level and includes information on the number of metropolitan areas deploying selected technologies related to the indicators.			
17. Key Words Intelligent Transportation Systems, ITS, Integration, Deployment Tracking, ITS Component Indicators, Regional ITS Planning, National ITS Infrastructure		18. Distribution Statement No restrictions. This document is available to the public from: National Technical Information Service Springfield, Virginia 22161	
19. Security Classif.(of this report) Unclassified	20. Security Classif. (of this page) Unclassified	21. No. of Pages 87	22. Price

Preface

This report presents the results of a major nationwide data gathering effort to track the deployment of the metropolitan Intelligent Transportation Systems (ITS) Infrastructure in the largest metropolitan areas of the United States. Tracking deployment of ITS infrastructure is an important element of ITS program assessment since implementation of ITS is an indirect measure of effectiveness of the ITS program. Information regarding deployment activities provides feedback on progress of the program that can help stakeholders establish strategies for continued market growth. Understanding the rate of ITS deployment in various metropolitan areas can lead to insights regarding future program changes, redefinition of goals, or maintenance of current program direction.

The methodology followed to complete this effort is based on the development of deployment indicators designed to capture the most important functions provided by a particular ITS component. The nine components tracked include: Freeway Management, Incident Management, Traffic Signal Control, Transit Management, Electronic Fare Payment, Electronic Toll Collection, Highway-Rail Intersections, Emergency Management, and Regional Multimodal Traveler Information. In addition, indicators were developed to capture the level of integration of these components.

Development of plans for future data collection are underway to update and improve the data and methodology presented in this report. Questions or comments concerning the material presented in this report are encouraged and can be directed to:

Joseph I. Peters
ITS Joint Program Office
Federal Highway Administration (HVH-1)
400 Seventh Street, SW
Washington, DC 20590
(202) 366-2202
E-mail: joe.peters@fhwa.dot.gov

Table of Contents

EXECUTIVE SUMMARY	ES-1
Purpose	ES-1
Metropolitan ITS Component Indicators	ES-1
National Summary Indicators	ES-1
Component Indicators	ES-2
Integration of Components	ES-8
Traffic Management Integration	ES-9
Traveler Information Integration	ES-10
Transit Management Integration	ES-11
Emergency Response Integration	ES-11
Conclusions and Next Steps	ES-13
I - INTRODUCTION	1-1
Background	1-1
Metropolitan ITS Infrastructure Components	1-2
Relationship of the Metropolitan Infrastructure to the ITS Architecture	1-3
Integration of Metropolitan ITS Components	1-4
Measuring Deployment	1-5
Freeway and Arterial Coverage Statistics	1-6
Measuring Component Deployment	1-7
Measuring integration	1-8
Metropolitan Areas Tracked	1-12
Organization of Report	1-12
II - ITS INFRASTRUCTURE COMPONENT DESCRIPTION AND	
FY97 SURVEY RESULTS	2-1
FREEWAY MANAGEMENT	2-2
Freeway Management Functions	2-2
Freeway Management Indicators	2-2
INCIDENT MANAGEMENT	2-6
Incident Management Functions	2-6
Incident Management Component Indicators	2-6
TRAFFIC SIGNAL CONTROL	2-9
Traffic Signal Control Functions	2-9
Traffic Signal Control Component Indicators	2-9
ELECTRONIC TOLL COLLECTION	2-12
Electronic Toll Collection Functions	2-12
Electronic Toll Collection Indicator	2-12
ELECTRONIC FARE PAYMENT	2-14
Electronic Fare Payment Functions	2-14
Electronic Fare Payment Component Indicators	2-14
TRANSIT MANAGEMENT	2-16
Transit Management Functions	2-16

Transit Management Indicators	2-16
HIGHWAY-RAIL INTERSECTION	2-19
Highway-Rail Intersection Functions	2-19
Highway-Rail Intersection Indicator	2-19
EMERGENCY MANAGEMENT	2-21
Emergency Management Functions	2-21
Emergency Management Indicators	2-21
REGIONAL MULTIMODAL TRAVELER INFORMATION	2-23
Regional Multimodal Traveler Information Functions	2-23
Regional Multimodal Traveler Information Indicators	2-23
III - ITS INFRASTRUCTURE INTEGRATION INDICATOR DESCRIPTION AND FY97	
SURVEY RESULTS	3-1
Traffic Management Integration	3-3
Traveler Information Integration	3-9
Transit Management Integration	3-12
Emergency Response Integration	3-15
IV - CONCLUSIONS AND NEXT STEPS	4-1
APPENDIX A: INSTRUCTIONS FOR DOWNLOADING DOCUMENTS FROM THE ITS ELECTRONIC DOCUMENT LIBRARY	A-1

List of Figures

Figure ES.1 Summary Indicators of Infrastructure Deployment	ES-2
Figure ES.2 Freeway Management Component Indicators	ES-3
Figure ES.3 Freeways Incident Management Component Indicators	ES-3
Figure ES.4 Arterials Incident Management Component Indicators	ES-4
Figure ES.5 Traffic Signal Control Component Indicators	ES-4
Figure ES.6 Electronic Toll Collection Component Indicator	ES-5
Figure ES.7 Transit Management Component Indicators	ES-5
Figure ES.8 Electronic Fare Payment Component Indicators	ES-6
Figure ES.9 Emergency Management Component Indicators	ES-6
Figure ES.10 Highway Rail Intersections Component Indicator	ES-7
Figure ES.11 Regional Multimodal Traveler Information Component Indicators	ES-7
Figure ES.12 Integration of ITS Components	ES-8
Figure ES.13 Traffic Management Integration Links	ES-9
Figure ES.14 Traffic Management Integration Links (Continuation)	ES-10
Figure ES.15 Traveler Information Integration Links	ES-11
Figure ES.16 Transit Management Integration Links	ES-12
Figure ES.17 Emergency Management Integration Links	ES-12
Figure 1.1 Integration of Components	1-8
Figure 2.1. Freeway Management Component Indicator	2-3
Figure 2.2. Freeway Management Types of Communication	2-3
Figure 2.3. Freeway Management Surveillance	2-4
Figure 2.4. Freeway Management Traffic Control	2-4
Figure 2.5. Freeway Management Information Display	2-5
Figure 2.6 Freeway Incident Management Component Indicators	2-6
Figure 2.7 Arterial Incident Management Component Indicators	2-7
Figure 2.8 Incident Management Detection	2-7
Figure 2.9 Incident Management Verification	2-8
Figure 2.10 Freeway Incident Management Response	2-8
Figure 2.11 Arterial Incident Management Response	2-8
Figure 2.12 Traffic Signal Control Component Indicators	2-9
Figure 2.13 Traffic Signal Surveillance	2-10
Figure 2.14 Traffic Signal Control	2-11
Figure 2.15 Traffic Signal Display	2-11
Figure 2.16 Electronic Toll Collection Component Indicator	2-12
Figure 2.17 Electronic Toll Collection Control and Technologies	2-13
Figure 2.18 Electronic Fare Payment Component Indicators	2-14
Figure 2.19 Electronic Fare Payment Fixed Route Bus and Light Rail	2-15
Figure 2.20 Electronic Fare Payment Heavy Rail	2-15
Figure 2.21 Transit Management Component Indicators	2-16
Figure 2.22 Transit Management. AVL, Maintenance, Paratransit, and Display	2-17
Figure 2.23 Highway-Rail Intersection Component Indicator	2-19
Figure 2.24 Highway-Rail Intersections Surveillance	2-20
Figure 2.25 Emergency Management Component Indicator	2-21

Figure 2.26 Emergency Management Dispatch and Guidance	2-22
Figure 2.27 Regional Multimodal Traveler Information Component Indicators	2-24
Figure 3.1 Integration of ITS Components	3-2
Figure 3.2 Traffic Management Integration Links	3-3
Figure 3.3 Traveler Information Integration	3-9
Figure 3.4 Transit Management Integration Links	3-12
Figure 3.5 Emergency Management Integration	3-15

List of Tables

Table 1.1 Summary of Integration Links	1-10
Table 1.2 Metropolitan Areas Tracked	1-13
Table 2.1 Media Used to Display Traveler Information	2-25
Table 3.1 Traffic Management Integration	3-4
Table 3.2 Traveler Information Integration Links	3-10
Table 3.3 Transit Management Integration Links	3-13
Table 3.4 Emergency Management Integration Links	3-16

Acronym List

AVI	Automatic Vehicle Identification
AVL	Automatic Vehicle Location
FHWA	Federal Highway Administration
FTA	Federal Transit Administration
HAR	Highway Advisory Radio
HAZMAT	Hazardous Material
HPMS	Highway Performance Monitoring System
ISP	Information Service Provider
ITS	Intelligent Transportation Systems
IVS	In-Vehicle Signing
JPO	ITS Joint Program Office
MPO	Metropolitan Planning Organization
MSA	Metropolitan Statistical Area
ORNL	Oak Ridge National Laboratory
PIAS	Personal Information Access System
RTS	Remote Transfer Support
U.S.DOT	United States Department of Transportation
VMS	Variable Message Sign
MMDI	Metropolitan Model Deployment Initiative
ATMS	Advanced Traffic Management System
ADOT	Arizona Department of Transportation
CCTV	Closed Circuit Television
CBD	Central Business District
ETC	Electronic Toll Collection
CAD	Computer Aided Dispatch
RMTI	Regional Multimodal Traveler Information
TM	Transit Management
TSC	Traffic Signal Control
IM	Incident Management
HRI	Highway-Rail Intersections
FM	Freeway Management
EM	Emergency Management
EFP	Electronic Fare Payment

EXECUTIVE SUMMARY

Purpose

This report describes the results of a major data gathering effort to track deployment of components of the metropolitan Intelligent Transportation Systems (ITS) infrastructure in 78 of the largest metropolitan areas in the nation. Data are included that describe: Freeway Management, Incident Management, Traffic Signal Control, Electronic Toll Collection, Electronic Fare Payment, Transit Management, Highway-Rail Intersections, Emergency Management, and Regional Multimodal Traveler Information. In addition, integration of components is being tracked by examining the transfer of information between components and the use of that information once transferred.

Metropolitan ITS Component Indicators

Deployment of individual components is being tracked through the use of indicators tied to major functions of each component. For example, in the case of Freeway Management, three basic functions were defined: surveillance, traffic control, and information display. The three indicators developed to reflect these functions are: percentage of freeway centerline miles under electronic surveillance (surveillance function), percentage of freeway entrance ramps managed by ramp meters (control function), and percentage of freeway centerline miles covered by permanent Variable Message Signs (VMS), Highway Advisory Radio (HAR), or In-Vehicle Signing (IVS) (display function). Individual component indicators were combined into a single summary indicator for each component. These summary indicators were derived by averaging individual component indicators.

Example: Calculating Component Indicators for Freeway Management

Consider a metropolitan area with 100 miles of freeway and 25 freeway entrance ramps. The area has no ramp meters or lane control, 10 freeway miles for which traffic data are collected electronically and 5 freeway miles which are covered by HAR.

The component indicator for surveillance is calculated as $(10/100)$ or 10%.

The component indicator for control is $(0/25)$ or 0%.

The component indicator for display is $(5/100)$ or 5%.

The component summary indicator for the freeway management is calculated as $(10\% + 0\% + 5\%)/3 = 5\%$.

National Summary Indicators

Figure ES.1 presents the nine national summary component indicators. The results portrayed are based on a survey return rate of 81% and generally reflect conditions through FY97.

The summary indicators presented in Figure ES.1 were derived through simple averaging of individual indicators, which described in subsequent sections of this report. The summary indicators suggest that Electronic Toll Collection (36% of deployment opportunity) and Electronic Fare Payment (43% of deployment opportunity) have achieved the highest level of deployment in the metropolitan areas surveyed. Among remaining components, Emergency Management (22% of deployment opportunity), Incident Management Freeway (23% of deployment opportunity) and Traffic Signal Control (18% of deployment opportunity) have the highest levels of deployment. The lowest levels of deployment are observed for Freeway Management (17% of deployment opportunity), Regional Multimodal Traveler Information (15% of deployment opportunity), Incident Management Arterial (11% of deployment opportunity) and Highway-Rail Intersections (5% of deployment opportunity).

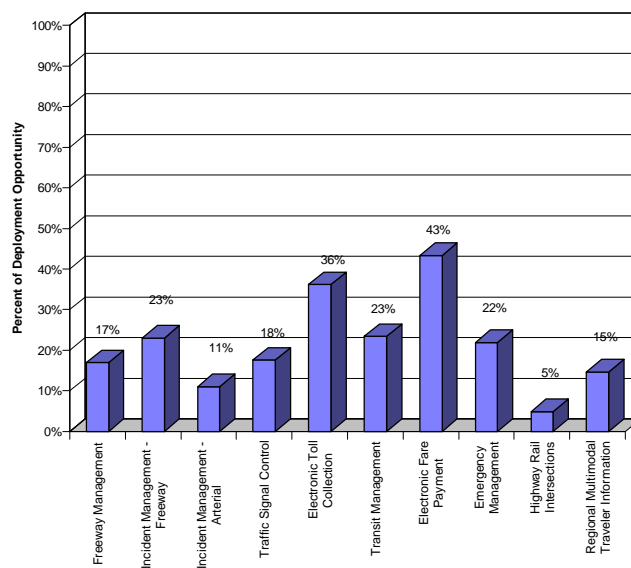

Figure ES.1 Summary Indicators of Infrastructure Deployment
(Based on a survey response rate of 81%)

Component Indicators

The indicators developed for the deployment tracking effort are surrogates that do not necessarily reflect the full breadth of metropolitan ITS deployment activity. The indicators selected were chosen primarily to assist in providing simple and intuitive measures of deployment that can be counted and tracked over time. Therefore, because deployment goals have not been established, these indicators should not be read as a comparison of what is deployed versus eventual deployment goals. Instead, they only reflect what is deployed compared to full market saturation, i.e., the full opportunity for deployment within the entire planning areas of the metropolitan planning organization associated with the 78 metropolitan areas.

Figures ES.2 through ES.11 summarize results for the complete set of component indicators. These figures are based on data collected as of August 1998, and generally reflect FY 1997 conditions.

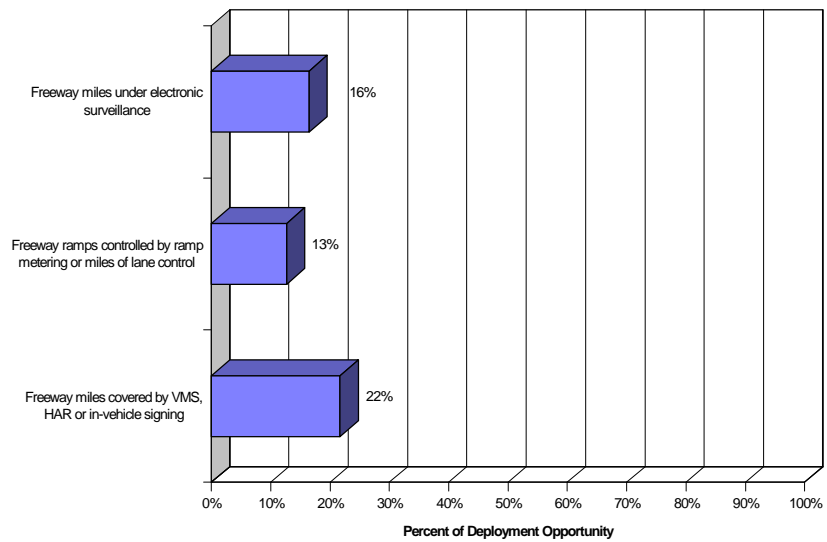

Figure ES.2 Freeway Management Component Indicators
(Based on survey response rate of 89%)

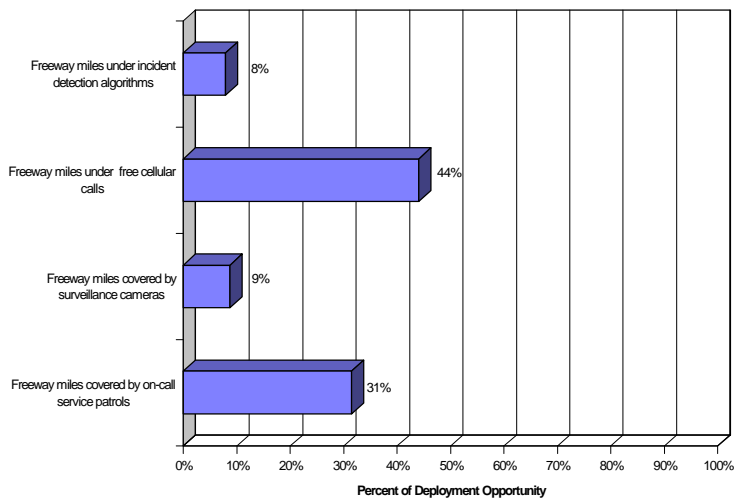

Figure ES.3 Freeways Incident Management Component Indicators
(Based on survey response rate of 90%)

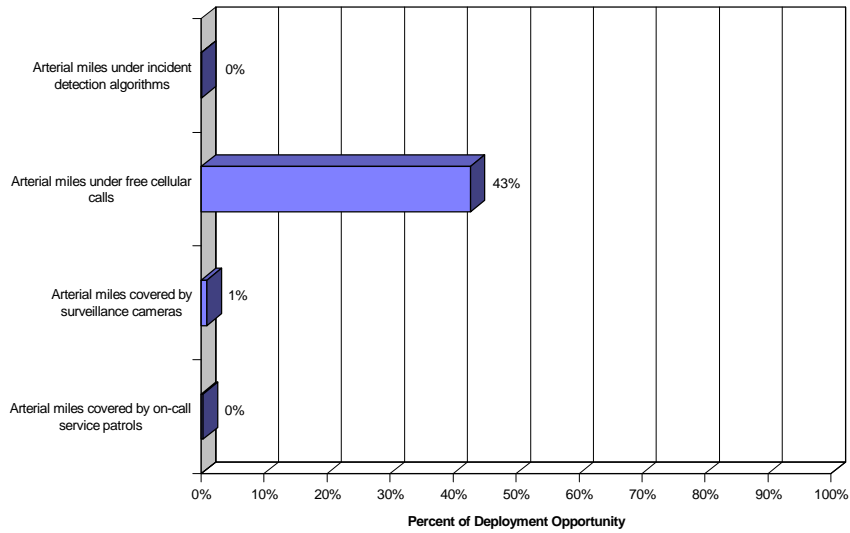

Figure ES.4 Arterials Incident Management Component Indicators
(Based on survey response rate of 90%)

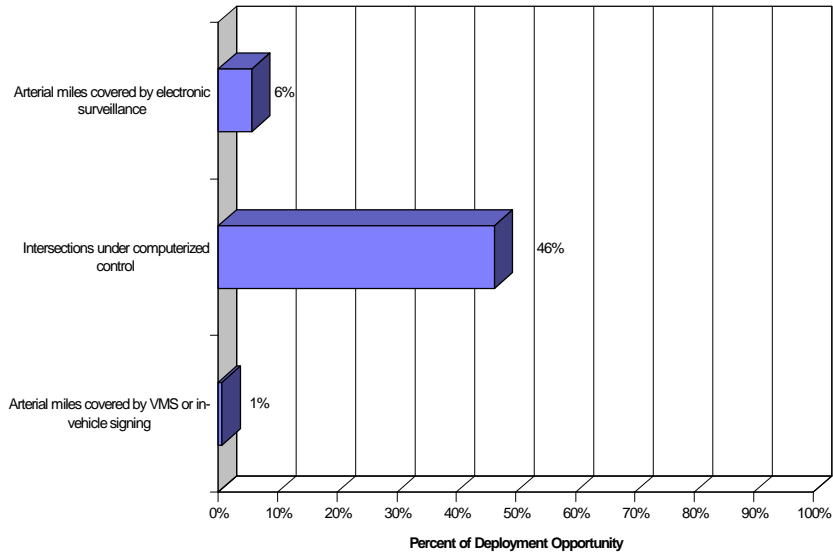

Figure ES.5 Traffic Signal Control Component Indicators
(Based on survey response rate of 70%)

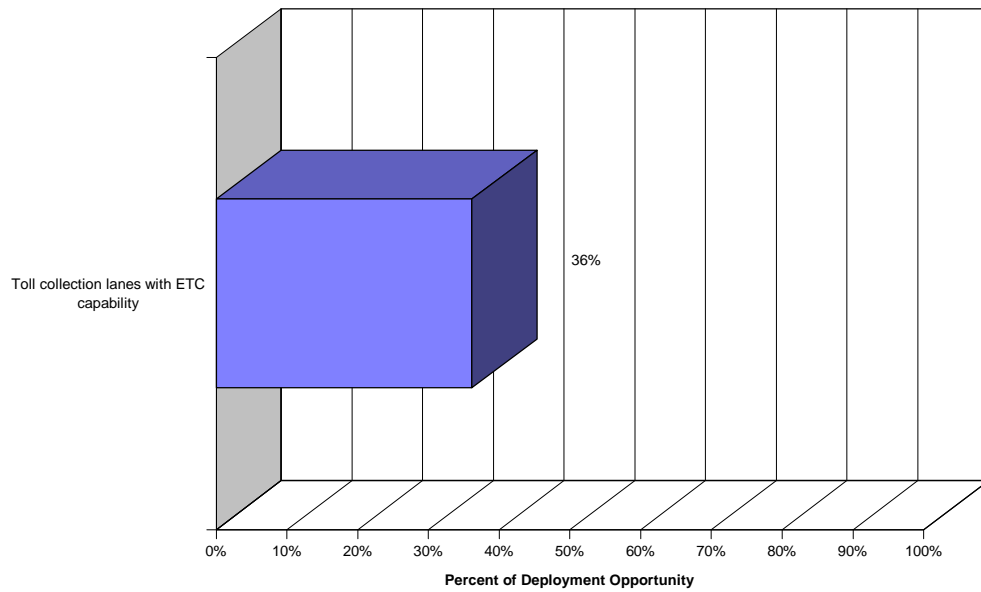

Figure ES.6 Electronic Toll Collection Component Indicator
(Based on survey response rate of 89%)

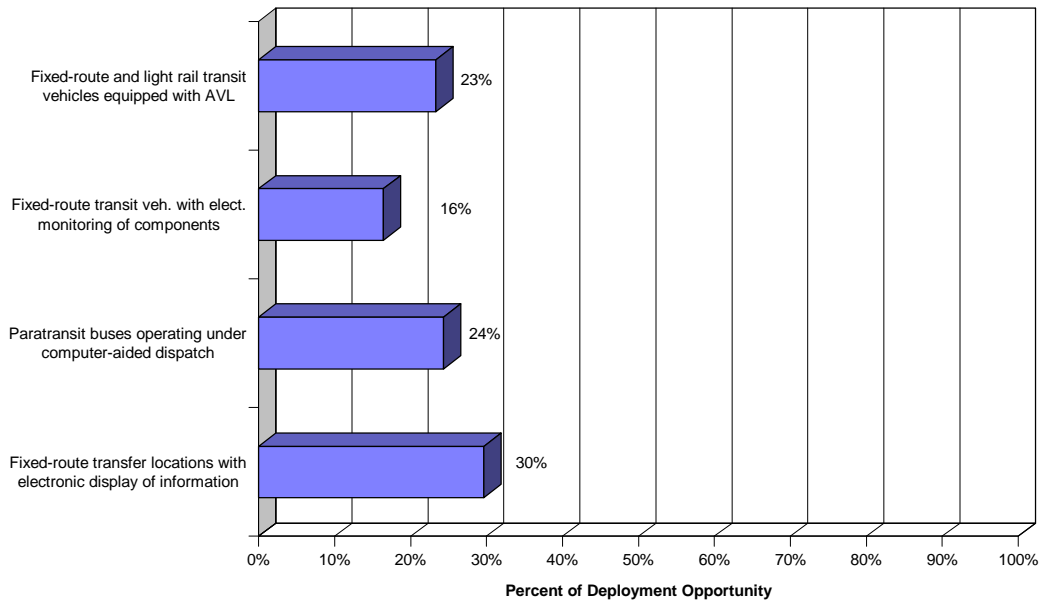

Figure ES.7 Transit Management Component Indicators
(Based on survey response rate of 81%)

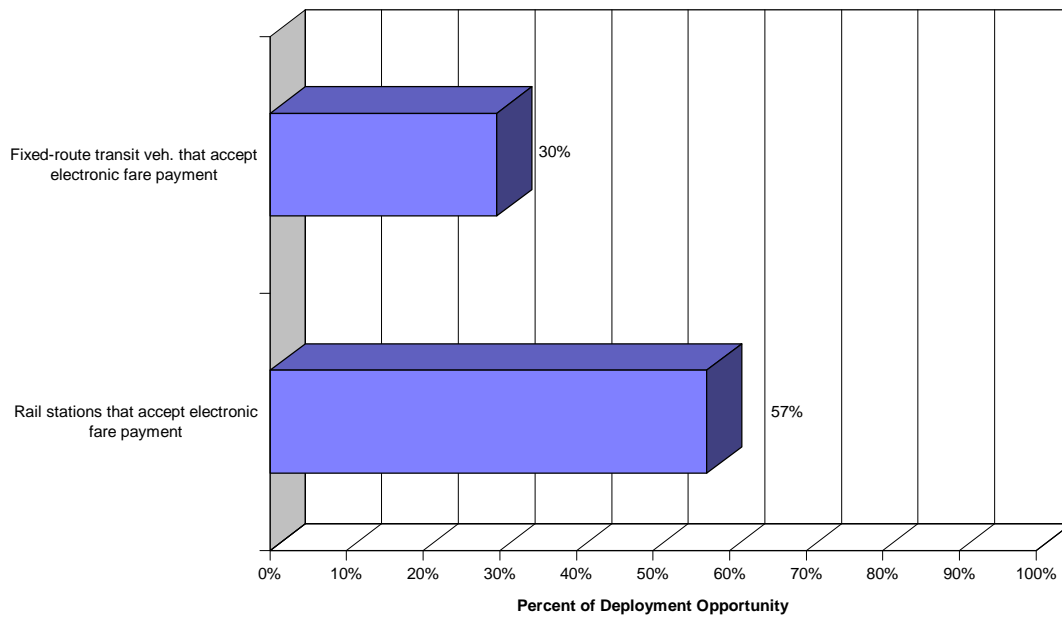

Figure ES.8 Electronic Fare Payment Component Indicators
(Based on survey response rate of 81%)

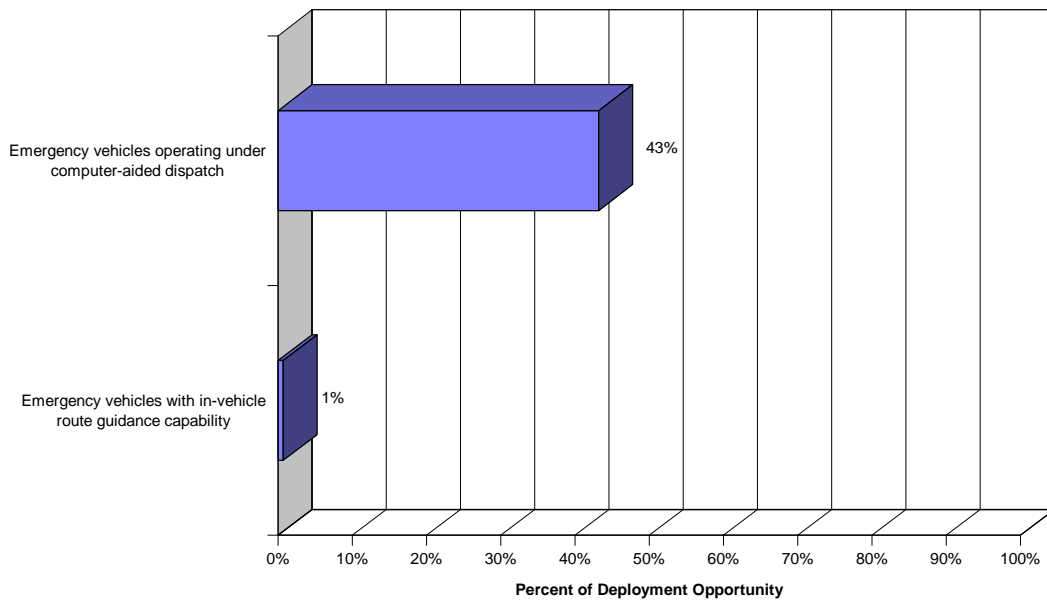

Figure ES.9 Emergency Management Component Indicators
(Based on survey response rate of 94%)

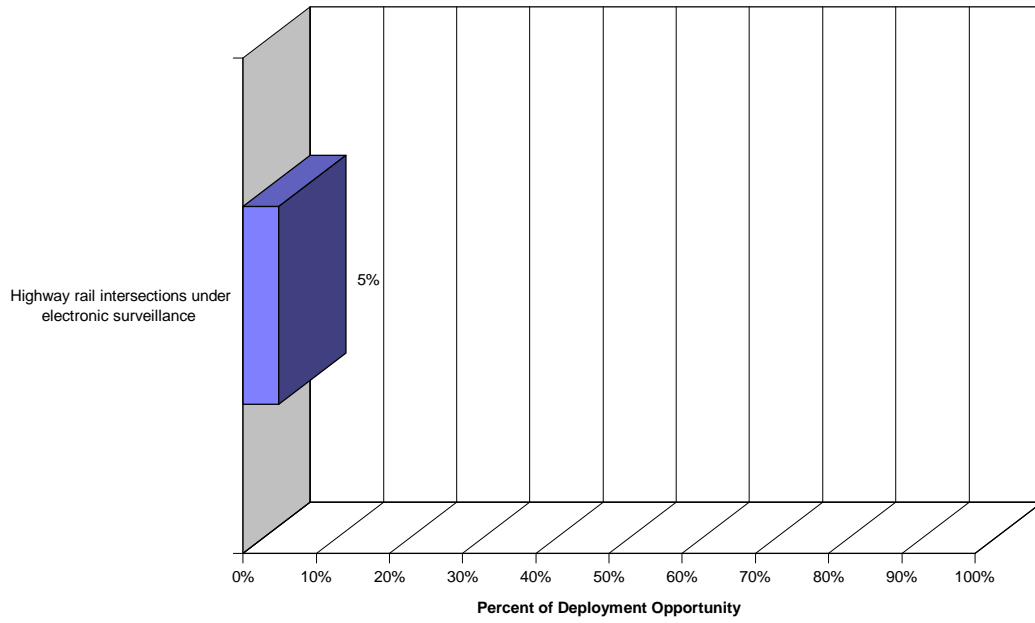

Figure ES.10 Highway Rail Intersections Component Indicator
(Based on survey response rate of 64%)

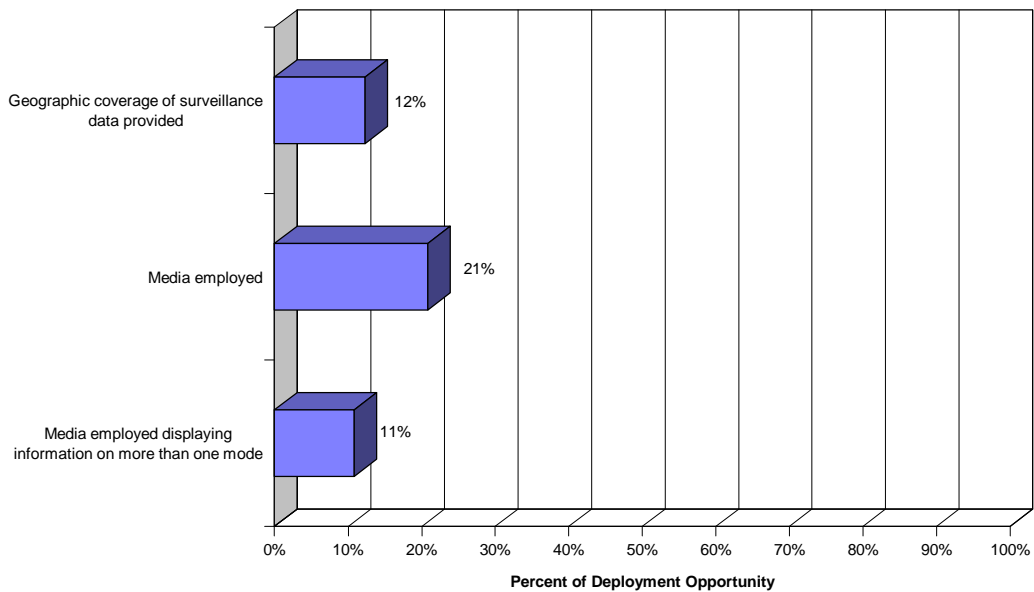

Figure ES.11 Regional Multimodal Traveler Information Component Indicators
(Based on survey response rate of 92%)

Integration of Components

Three factors were used to measuring the level of integration present in a metropolitan area: (1) the extent that infrastructure is shared between or within components; (2) the nature and magnitude of information exchange among components; and, (3) the nature and magnitude of the use of data for control. Information exchange is generally defined as the electronic transfer of information from one component to another, where the recipient component can use the information to structure its response to changing travel conditions more efficiently. Control is defined as the manner and use of information that is transferred to the recipient component.

To provide a context for measuring integration, links between components required to provide integrated transportation management were identified. A total of 32 links between components were defined and are shown in Figure ES.12. It was determined that two types of integration links are possible: (1) integration between different components; and, (2) integration between different elements of the same component. An example of the first is link 2, the transfer of data from the Traffic Signal Control component to Freeway Management concerning traffic conditions on the arterials (i.e. inter-component). An example of the second is link 26, the integration of traffic signal timing along the length of an arterial street that passes through multiple jurisdictions (i.e., intra-component).

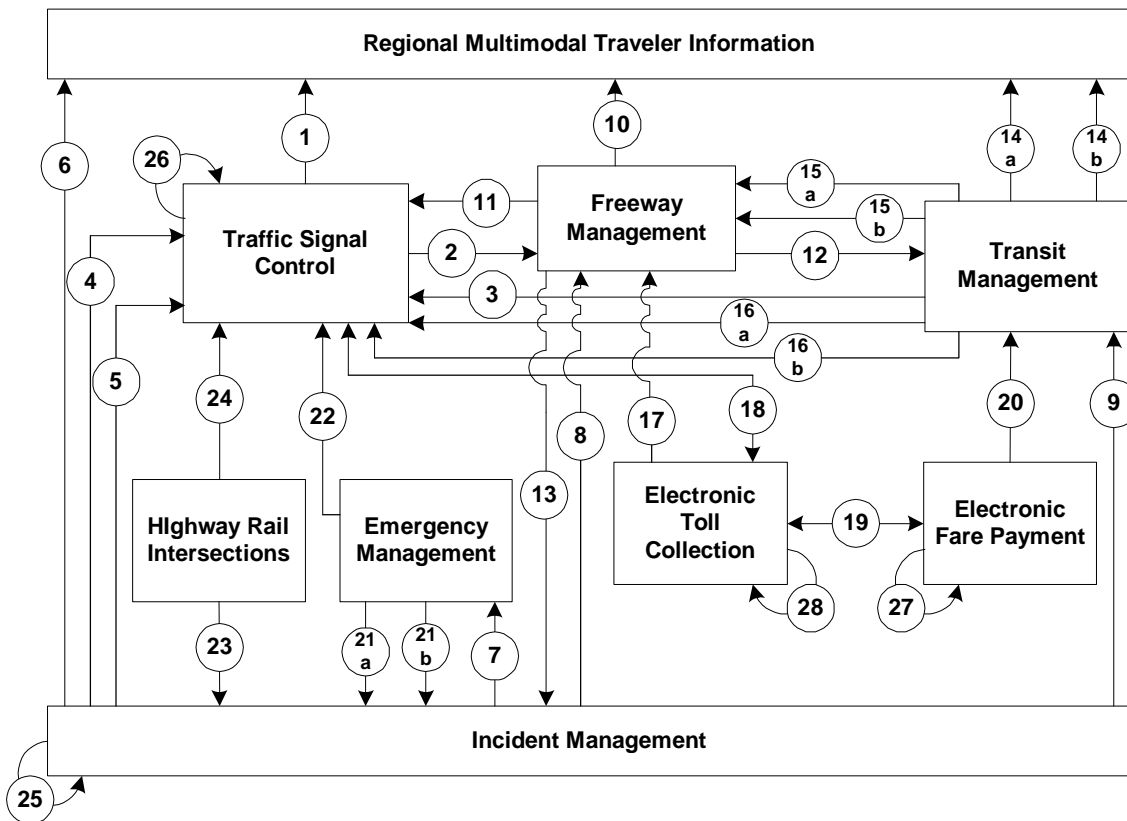

Figure ES.12 Integration of ITS Components

In order to make the discussion of individual links clearer, links have been grouped into four broad categories:

- Traffic Management Integration
- Traveler Information Integration
- Transit Management Integration
- Emergency Management Integration

Traffic Management Integration

Traffic management integration enables the implementation of coordinated traffic management strategies among operating agencies responsible for Freeway Management, Incident Management, and Traffic Signal Control within a metropolitan area. Key characteristics of traffic management integration include the following:

- Collection of real-time traffic and incident data on the freeway and arterial street network.
- Coordination of management actions in response to changes in traffic flow.
- Collaboration among operating agencies to optimize the strategies available to improve traffic flow.

Figures ES.13 and ES.14 present an overview of metropolitan areas reporting the presence of a particular traffic management integration link.

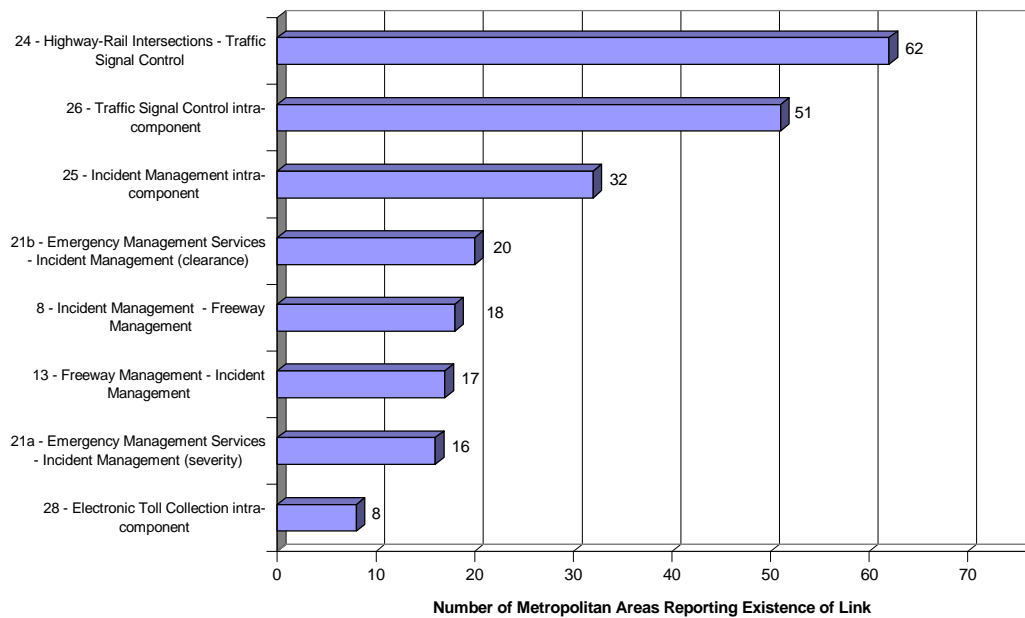

Figure ES.13 Traffic Management Integration Links

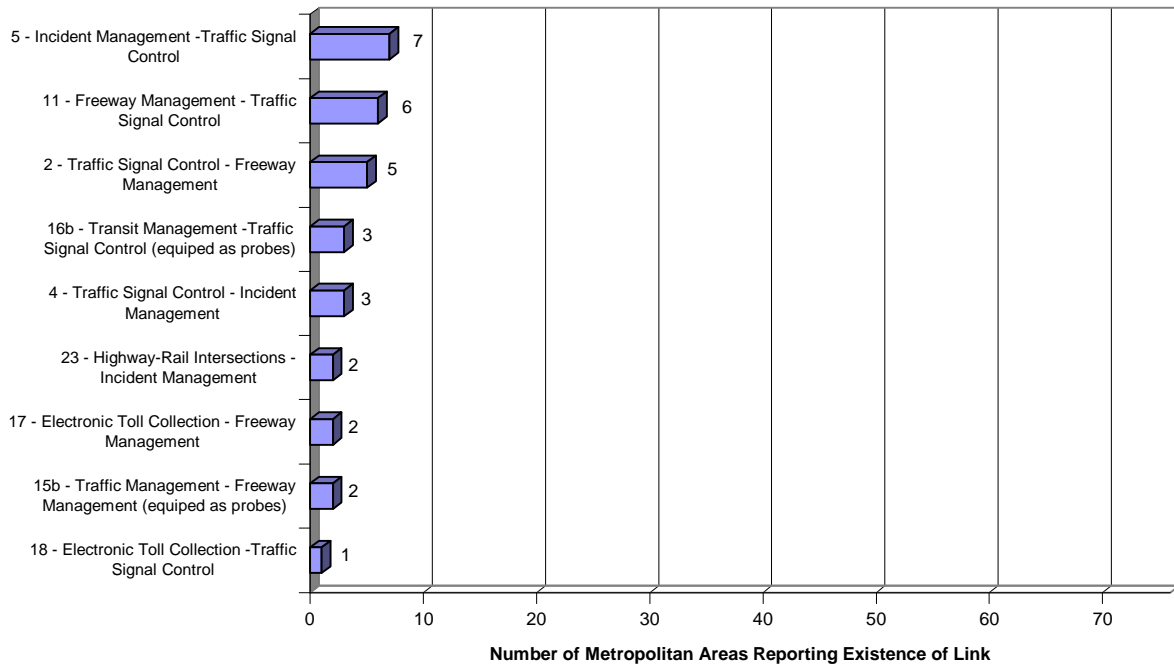

Figure ES.14 Traffic Management Integration Links (Continuation)

Traveler Information Integration

The collection, processing, and distribution of timely information related to the performance of the transportation system is a byproduct of integrating selected metropolitan ITS components. Information gathered by Freeway Management, Incident Management, Traffic Signal Control, and Transit Management components is fused to create a region-wide traveler information database. Information in the database is then transferred to various media for display to travelers. Travelers receiving this information can make better informed decisions regarding when, where, and how to travel, which may lead to an increase in travel efficiency and a reduction in travel congestion and delay. Figure ES.15 presents an overview of the integration links that define traveler information integration.

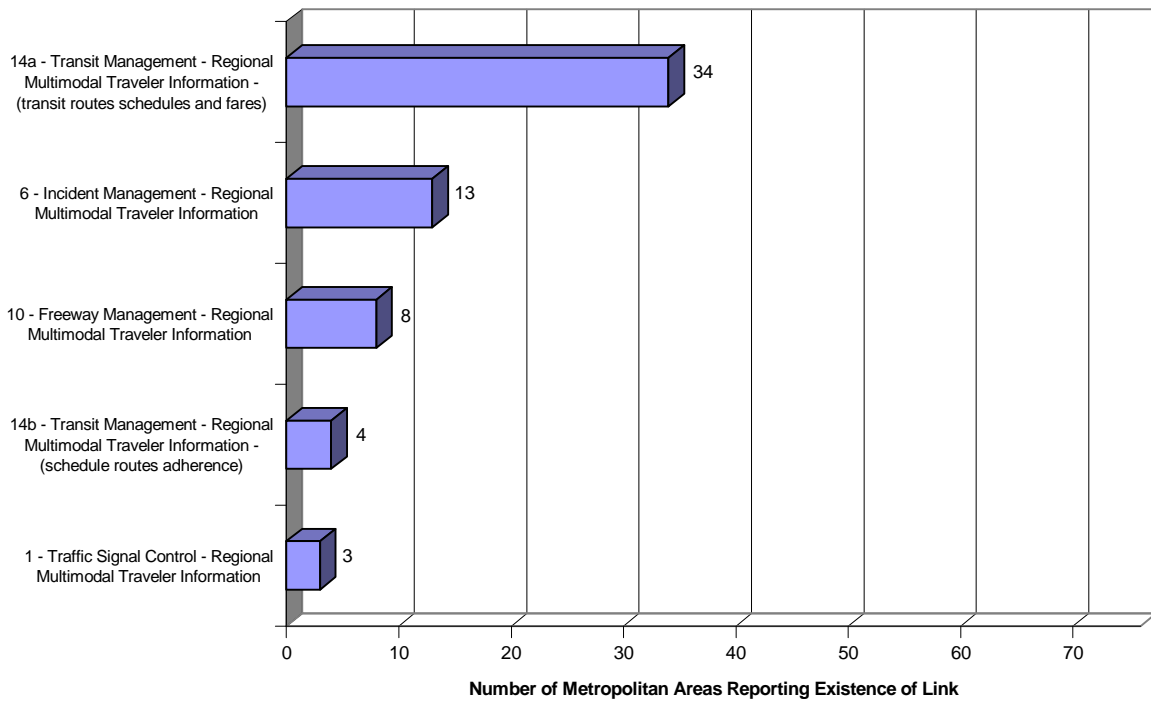

Figure ES.15 Traveler Information Integration Links

Transit Management Integration

Transit management integration provides public transit operators with information and control capabilities to better manage transit system on-time performance. Transit management integration also exploits the use of electronic fare payment media to improve the efficiency of route planning and financial management. Figure ES.16 presents an overview of the integration links that define transit management integration.

Emergency Response Integration

Emergency management integration increases emergency response capabilities through improved incident notification from Incident Management and traffic signal pre-emption provided by Traffic Signal Control. Figure ES.17 presents an overview of the integration links that define emergency response integration.

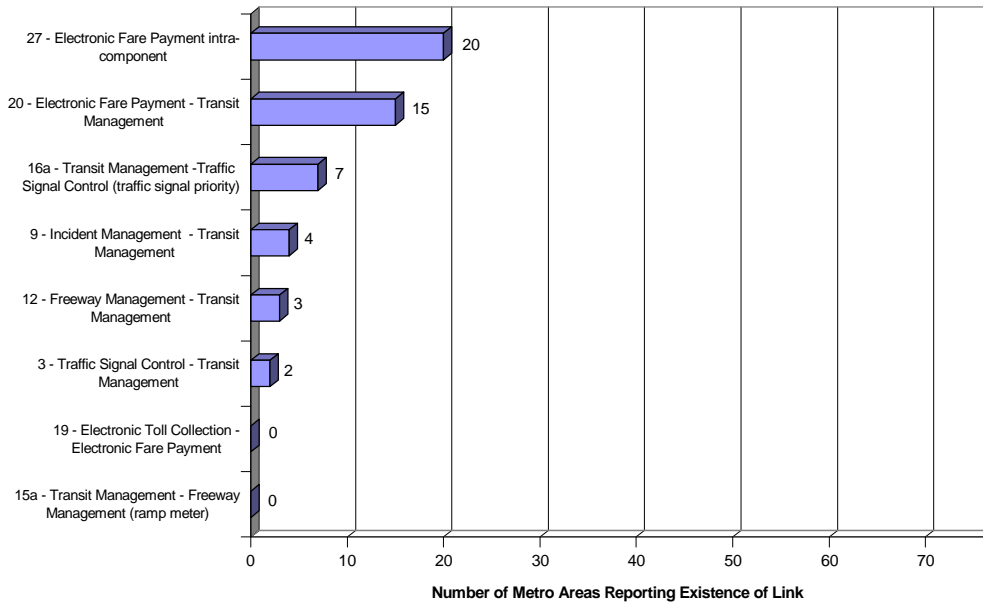

Figure ES.16 Transit Management Integration Links

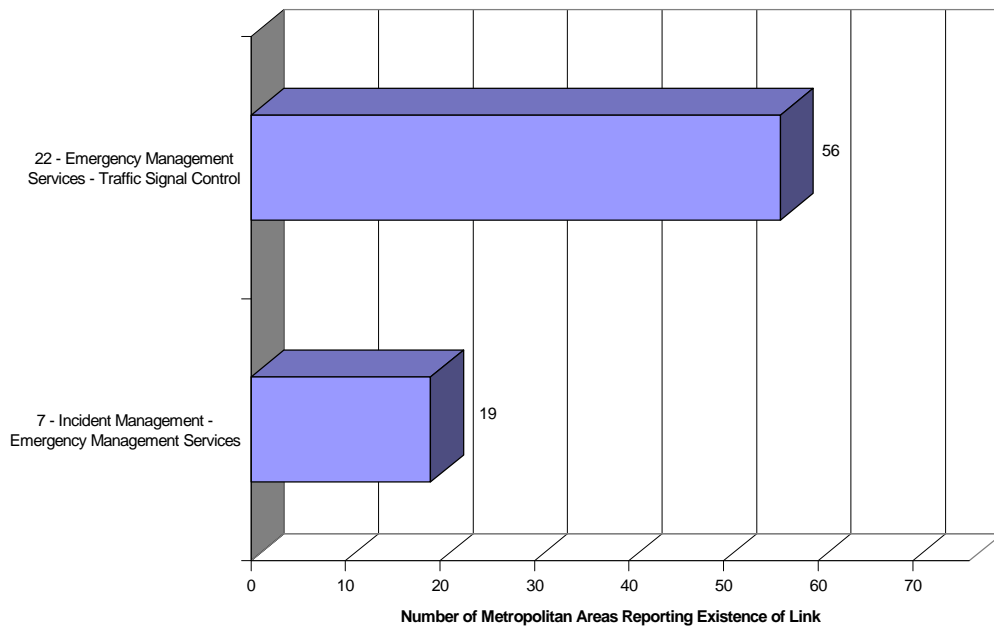

Figure ES.17 Emergency Management Integration Links

Conclusions and Next Steps

Methodology

The deployment indicators appear to be successful in providing a quick and intuitive picture of the state of deployment. The definitions, drawn to provide essential functions for which countable indicators could be developed, have been widely reviewed and commented on and appear to work well in practice. Deployment indicators, while necessarily limited in level of detail concerning the richness of the extent of deployment, appear to provide a clear picture of what is going on. This is particularly true in the ability of the indicators to display relative differences between the level of deployment of related indicators and sub-indicators. This methodology will also be capable of displaying changes over time in a simple and clear manner.

Response to the surveys has generally been positive as a result of widespread coordination with FHWA and FTA headquarters and field staff. In addition, the data gathering has been characterized by extensive direct contact with responders, including initial and follow-up phone calls to explain the purpose of the surveys and to address any questions concerning the data being requested. Nevertheless, several concerns have been consistently expressed by various stakeholders that need to be acknowledged:

Use of the data as a report card. Although deployment tracking is not intended in any way to be used in the process of allocating federal funds, many responders have expressed this concern. Carried to an extreme, this fear could lead to either overstatement or understatement of deployment progress, depending on the perception concerning how the 'report card' would be used. The actual use of the data will become clear over time and this perception should change. Another aspect of the report card concern is the concern that in some cases the indicators give a false impression of the level of ITS activity. This is due to the fact that the indicators display only what has been deployed as of the time of the survey and do not account for any progress short of actual deployment. Several metropolitan areas with strong ITS programs that have advanced significantly in planning for deployment were concerned that this critical background work is not taken into account in the methodology. An answer to this concern which is under consideration is to develop a standard method for reporting planning for deployment that can be consistently applied to all metropolitan areas.

Boundary definition. The deployment opportunity used in the component indicators is based on the metropolitan planning area boundary. This was done to provide a consistent and repeatable measure and to provide a context for monitoring deployment progress as metropolitan areas experience growth. Some responders have pointed out that this may include roadways that are yet to be developed or rural areas that will not receive ITS treatment. Stakeholders suggest that a much smaller boundary area should be used that includes primarily the urbanized portions of a metropolitan region. The eventual solution to this problem will be the development of the 'should' case in which indicators will be measured against the portion of the roadway targeted for ITS deployment based on local conditions and need.

Averaging of sub-indicators. Summary indicators are useful in providing a single set of aggregated results to portray the level of ITS deployment. Currently, summary indicators are simple averages of sub-indicators for each component. This was done because of the absence of established norms for ranking the relative importance of the various sub-indicators. Responders have pointed out that this may create a distorted view of the actual state of deployment by giving equal weight to sub-indicators that are not necessarily equally important. Until a generally accepted weighting scheme for the sub-indicators can be developed, the most accurate picture of the state of deployment of individual components is that provided by the portrayal of all sub-indicators, rather than the summary indicators.

A more detailed description of the methodology including copies of the surveys and an explanation of how individual indicators are calculated is included in the report, "Measuring ITS Deployment and Integration," which is available for download at the ITS Electronic Library at: <http://www.its.dot.gov/cyberdocs/welcome.htm>. Search for document number 4372. If you are not familiar with the ITS Electronic Library please read appendix A.

Results

In reviewing the relative level of deployment of sub-indicators, it is apparent that so far, deployment in many cases does not reflect a coordinated regional focus. Levels of deployment sub-indicators that would be expected to be coordinated, such as incident management detection, verification, and clearance, show widely different levels. This reflects the early state of deployment, but may also be an indication of the need for consideration of deployment within the context of a regional architecture.

A further indicator of a lack of a regional focus is the fact that integration lags behind component deployment. This is particularly true for shared control, which would be expected to be part of a regionally integrated transportation system.

Next Steps

An update of the data will be conducted in FY99 to identify deployment progress. It is anticipated that the results of this new initiative will yield comparison data for use in program management.

I - INTRODUCTION

Background

This report is the result of a body of work conceived and executed to track deployment of the metropolitan Intelligent Transportation System (ITS) infrastructure in the largest metropolitan areas across the nation. This is being carried out for a variety of reasons including monitoring progress toward the *Operation Timesaver* deployment goal set by the Secretary of Transportation, supporting the ITS Joint Program Office (JPO) program management, and creating a source of information on ITS deployment to support research and outreach. Tracking deployment of the ITS infrastructure is an important element of ITS program assessment since implementation of ITS technologies, products, and services is an indirect measure of the ITS program effectiveness. Information regarding deployment provides feedback on progress of the program that can help stakeholders establish strategies for planning, financing, and implementing the ITS program. In addition, understanding the rate of ITS deployment in various metropolitan areas can lead to insights regarding future program changes, redefinition of goals, or maintenance of current program direction.

This work is being accomplished in three steps. The first step defines individual infrastructure components to identify the basic functions performed by each and to develop key indicators tied to each function. Although each metropolitan ITS component is a complex collection of technologies and institutional arrangements, the focus of deployment tracking is limited to individual components that can be counted and monitored over time. As a result, deployment tracking is centered on a relatively small number of indicators that can be used to effectively provide accurate assessments of the level of deployment of infrastructure components. The second step measures the levels for these indicators in the major metropolitan areas through the use of surveys to gather information. In the absence of established goals, deployment is measured by comparing levels to the opportunity for deployment. The third step is to work with Federal, state and local municipality partners to develop deployment goals for major metropolitan areas based on the indicators that will be used to monitor progress.

The first two steps in this process have been accomplished, resulting in a collection of data that provide a consistent picture of the level of deployment in major metropolitan areas. This was accomplished through the development of a set of survey questionnaires to collect the required data. Deployment tracking boundaries coincident with the planning area boundaries established by the Metropolitan Planning Organization (MPO) were defined for each metropolitan area. Within the tracking boundary area, selected operating agencies were administered questionnaires. Agencies targeted for surveys included State Department of Transportation offices, operators of public transportation, and local traffic engineering and emergency management agencies. The completed surveys were entered into an electronic data base and the results were assembled in a set of individual reports for each metropolitan area surveyed. These reports were distributed for review by Federal Highway Administration and Federal Transit Administration staff for completeness and accuracy. Revisions were made as required and the electronic data base was finalized. Work is currently underway on the third step of the process. The deployment tracking indicators are being assessed as a means for setting deployment goals in metropolitan areas.

Metropolitan ITS Infrastructure Components

The metropolitan ITS infrastructure consists of the following nine components:



Freeway Management. This component monitors traffic conditions on the freeway system, identifies recurring and non-recurring flow impediments, implements appropriate control and management strategies (such as ramp metering or lane control), and provides critical information to travelers using dissemination methods such as Variable Message Signs (VMS) and Highway Advisory Radios (HAR).

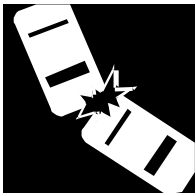

Incident Management. This component includes an organized system for quickly identifying and responding to incidents that occur on area freeway and major arterials. The objectives are to rapidly respond to incidents with the proper personnel and equipment, to aid accident victims, and to facilitate the rapid clearance of the accident from the roadway. To accomplish this, real-time input from the freeway and arterial surveillance systems and the agencies responsible for managing them is critical.

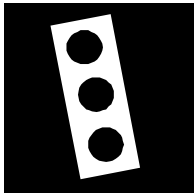

Traffic Signal Control System. This component provides coordinated traffic signal control across the metropolitan area. Traffic information is shared between jurisdictional systems as necessary to support the extended coordination area. Variations in control sophistication range from automated generation of timing plans to adaptive traffic signal control.



Electronic Toll Collection System. This component includes roadside and in-vehicle hardware and software that allow drivers to pay tolls without stopping. The system performs automated vehicle identification, automatic determination of tolls for differing classes of vehicles, automated enforcement of violations, and flexibility in financial arrangement.



Electronic Fare Payment. This component includes hardware and software for roadside, in-vehicle, and in-station electronic payment of transit fares, parking fees, etc. Both debit and credit systems are included. The system eliminates the need for travelers to carry exact fare amounts and facilitates the subsequent implementation of a single fare payment medium.

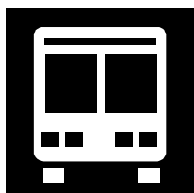

Transit Management. This component provides reliable and timely bus position information. In addition, on-board sensors automatically monitor data such as passenger loading, fare collection, drive-line operating conditions, etc., providing for real-time management response.



Highway-Rail Intersections. This component monitors traffic conditions at Highway-Rail Intersections to provide coordination between nearby traffic signals and Highway-Rail intersections.



Emergency Management Services. This component supports coordination of emergency services across jurisdictional boundaries and makes emergency fleet management more efficient through application of Automatic Vehicle Location (AVL) and dispatch-support systems.

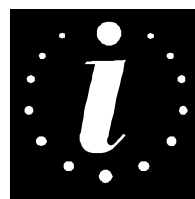

Regional Multimodal Traveler Information. This component is a repository for current, comprehensive, and accurate roadway and transit performance data. It directly receives data from a variety of public and private sector sources, combines and packages data, and provides the resulting information to travelers and other customers via a variety of distribution channels. The system may be a single physical facility or an inter-connected set of facilities.

Relationship of the Metropolitan Infrastructure to the ITS Architecture

The intent behind the conceptual formation of an ITS infrastructure based on nine components is to provide a high level way of thinking about ITS that is relatively simple to convey to state and local transportation officials, as well as, to the general public. The relationship between the metropolitan ITS infrastructure and the National ITS Architecture is a complementary one that allows for introductory conceptualizations through the infrastructure with more detailed planning and execution by using the National ITS Architecture as a tool for local decisions. The U.S. Department of Transportation developed the National ITS Architecture through a collaborative process with state and local decision-makers. The National ITS Infrastructure defines the functions that are performed in implementing ITS, where their functions reside, and the information flows that are exchanged between subsystems. The National ITS Architecture is a useful tool in supporting, planning, and project development activities, particularly in the area of integration.

Those interested in learning more about the National ITS Architecture are referred to: “The National Architecture for ITS: A Framework for Integrated Transportation into the 21st Century” (Publication Number: FHWA-JPO-96-012). Other sources of information about ITS and the National Architecture are: (1) U.S. Department of Transportation, Joint Program Office for Intelligent Transportation Systems, 400 Seventh St., SW (HVH-1), Washington, DC 20590, Phone: 202-366-9536, Fax: 202-366-3302, Web: <http://www.its.dot.gov>; or, (2) ITS America, 400 Virginia Ave., SW, Suite 800, Washington, DC 20024-2730, Phone: 202-484-4847, Fax: 202-484-3483, Web: <http://www.itsa.org>.

Integration of Metropolitan ITS Components

A critical aspect of ITS that provides much of its capability is the integration of individual components to form a unified regional transportation management and control system. Individual ITS components routinely collect information that is used for purposes internal to that component. For example, the Traffic Signal Control component monitors arterial conditions to revise signal timing and to convey these conditions to travelers through such technologies as Variable Message Signs and Highway Advisory Radio. Other ITS components can make use of this information in formulating their control strategies. For example, Transit Management may alter routes and schedules based on real-time information on arterial traffic conditions, and Freeway Management may alter ramp metering or diversion recommendations based on the same information.

Deploying integrated systems is inherently more complex and requires a higher level of coordination between different organizations than deploying systems in isolation. Therefore, integrating ITS infrastructure components is likely to be a multi phase process, with each phase requiring progressively greater levels of technical and institutional coordination. This document identifies three progressively more complex phases of integration. They are *shared infrastructure*, which is probably the simplest, *shared information*, and *coordinated control*, which requires substantial technical and institutional sharing between agencies. These definitions offer a means for transportation officials to assess the level of ITS integration in their region.

Shared Infrastructure: Sharing physical infrastructure refers to the joint use by different transportation agencies of the same equipment. For example, an area might share ITS infrastructure by constructing a regional communication spine to support interactions between ITS elements. The common communication link would eliminate the need to build numerous point-to-point links, each of which has an associated cost.

Sharing infrastructure requires technical coordination to make certain that the equipment can be integrated and adheres to applicable ITS standards. Sharing infrastructure also entails institutional coordination, as agencies must work together to create a technically sound system that addresses each individual agency's needs. Decision-makers planning such integration should understand both the technical and institutional barriers and benefits of integration to ensure the success of the project.

Example: In San Antonio, TX, two agencies are sharing a single fiber-optic cable. The Travel Speed Database uses the cable to maintain a record of network speed information. The Lifelink project will equip ambulances with video conferencing capabilities, using the same cable to allow emergency room doctors at the hospitals to remotely monitor patients' vital signs and interact with the paramedic personnel while the ambulance is in transit.

Shared Information: Sharing information refers to the transfer of data between agencies. The types of information that may be transferred include traffic conditions, incident information, incident response actions, traffic control actions, etc. For example, traffic management personnel may share incident information gleaned from video surveillance with emergency responders.

Sharing information requires overcoming a more complicated set of technical and institutional barriers than those associated with sharing infrastructure. However, this increased level of coordination leads to an increased level of ITS efficacy. As is the case for shared infrastructure, it is important that planners and officials commit to the success of data-sharing and invest in equipment that meets ITS standards to enable information exchange.

Example: In Seattle, WA, 19 jurisdictions will share information collected as part of the Smart Trek Metropolitan Model Deployment Initiative (MMDI). This project will compile data from key traffic corridors with information from the North, South and East side Advanced Traffic Management System (ATMS). The information from this electronic database will be shared among the 19 jurisdictions to complete a regional traffic management overview. Historical traffic and transit data will be stored as it is captured for planning and research purposes.

Coordinated Control. Coordinated control refers to the most complete type of integration. This phase occurs when one transportation agency uses shared information to make control decisions from a broader perspective than that of the individual agency. Where agencies merely sharing information may alter their control strategies based on data received from another agency, agencies coordinating control *jointly* plan and execute activities. For example, in anticipation of traffic congestion which may be caused by a special event, such as a professional football game, neighboring municipalities may jointly set traffic signals to improve the systemwide ability to clear out the congestion.

Coordinated control requires overcoming the highest levels of technical and institutional barriers. While in all phases of integration, it is likely that the institutional impediments will prove more challenging than the technical ones, that fact is especially true when an agency must give up some of their decision making ability. However, as with the other phases, overcoming these barriers leads to proportionally greater levels of ITS efficacy. Once again, it is imperative that planners and decision-makers commit themselves to the success of the integration project. In this case, that commitment requires agencies operating ITS infrastructure components to adopt a joint or regional, rather than local focus.

Example: In Phoenix, AZ several agencies are integrating ITS technologies to coordinate traffic management control activities. There, the AZTech Smart Corridor arterial traffic signal control system and the Arizona Department of Transportation (ADOT) Freeway Management System are being integrated to create a seamless traffic management system in the expanding metropolitan area. In addition to day-to-day coordination, traffic control and management plans for incidents and special events will also be created.

Measuring Deployment

Survey Coverage

The information presented in this report is based on data collected within the 78 largest metropolitan areas of the nation beginning in the summer of 1997 and ending in the summer of 1998. Deployment tracking boundaries, coincident with the transportation planning area

boundaries established by the Metropolitan Planning Organization (MPO), were defined for each metropolitan area for the following reasons:

- This boundary is used for transportation planning activities in a region and is therefore more likely to be the basis for other similar inventory efforts.
- This boundary identifies the concentration of planning and programming for a region and therefore will be the focus of ITS planning and programming over the next decade.
- This boundary is established without regard to municipal jurisdiction and provides a regional basis to describe an area.

Within the tracking boundary area, selected operating agencies were administered data collection questionnaires. Once specific operating and planning agencies were identified, surveys were distributed following the general guidelines outlined below. In some cases, these rules were not strictly followed based on discussions with Region and Division FHWA and FTA staff. In most cases, however, distribution of surveys followed these guidelines.

Emergency Management, Highway-Rail Intersection, and Traffic Signal Control surveys were administered to the following agencies:

- County government agencies located wholly or partially within the metropolitan area for which the metropolitan transportation planning process is conducted for at least 50,000 persons.
- City government agencies with a population of 50,000 or more persons within the metropolitan area.
- State DOT.

Transit Management and Electronic Fare Payment questionnaires were distributed to each operator of public transportation in the metropolitan area as reported in the National Transit Database (formally, Section 15).

Freeway Management, Incident Management, Electronic Toll Collection and Regional Multimodal Traveler Information surveys were distributed to state transportation departments and toll operators, as appropriate.

Freeway and Arterial Coverage Statistics

Rather than rely on survey data to collect coverage information describing the extent of the freeway and arterial roadway system within a metropolitan area, freeway and arterial coverage (generally including the miles of freeway and arterial used as the denominator values in various tracking indicators) was based on statistics contained within the Highway Performance Monitoring System (HPMS) defined as follows:

- Freeway and arterial miles contained within counties for which the metropolitan transportation planning process is conducted for 85% or greater of the population; and
- Freeway and arterial miles located within the urbanized area boundary within counties for which the metropolitan transportation planning process is conducted for less than 85% of the population.

Measuring Component Deployment

Prior to developing survey questionnaires for each metropolitan ITS component, an operational definition was developed for each component. The development of these definitions provided a basis for identifying key functions of each component that served as the basis for constructing a set of deployment tracking indicators. For example, in the case of Freeway Management, three basic functions were defined: surveillance, traffic control, and information display. The three indicators developed to reflect these functions are: percentage of freeway centerline miles under electronic surveillance (surveillance function), percentage of freeway entrance ramps managed by ramp meters (control function), and percentage of freeway centerline miles covered by permanent VMS, HAR, or IVS (display function). In some cases, different “levels” have been developed for indicators to provide additional refinement for the measure. For more information on indicator levels, see the report “Measuring ITS Deployment and Integration.” This report is available for download at: <http://www.its.dot.gov/cyberdocs/welcome.htm>. Search for document number 4372. If you are not familiar with the ITS Electronic Library please read appendix A.

Example: Calculating Component Indicators for Freeway Management

Consider a metropolitan area with 100 miles of freeway and 25 freeway entrance ramps. The area has no ramp meters or lane control, 10 freeway miles for which traffic data are collected electronically and 5 freeway miles which are covered by HAR.

The component indicator for surveillance is calculated as $(10/100)$ or 10%.

The component indicator for control is $(0/25)$ or 0%.

The component indicator for display is $(5/100)$ or 5%.

The component summary indicator for the freeway management is calculated as $(10\% + 0\% + 5\%)/3 = 5\%$.

The indicators developed for purposes of deployment tracking were chosen primarily to assist in providing simple and intuitive measures of deployment and do not necessarily reflect the full breadth of deployment activity. Therefore, because deployment goals have not been established, these indicators should not be read as a comparison of what is deployed versus eventual deployment goals. Instead, the indicators presented reflect what could be deployed and not what should be deployed in a particular metropolitan area.

Measuring integration

A set of links was chosen to track the level of integration that is occurring in the nation’s largest metropolitan areas. These links are illustrated in Figure 1.1. The process of identifying these links evolved from an examination of data flows identified in “Building the ITI: Putting the National Architecture into Action,” as well as discussions with FHWA and FTA staff. While additional links are possible, the selected links were characterized as key integration indicators that are commonly defined and periodically measured in the designated major metropolitan areas.

Two types of integration links are possible: (1) integration between different components, and (2) integration between elements of the same component. An example of the first is the transfer of information from the Traffic Signal Control Component to the Freeway Management component concerning traffic conditions on the arterials (i.e., inter-component integration). This link is identified as link “2” in Figure 1.1. An example of the second is the integration of traffic signal timing along the length of an arterial that passes through multiple jurisdictions (i.e., intra-component). This link is identified as link “26” in Figure 1.1.

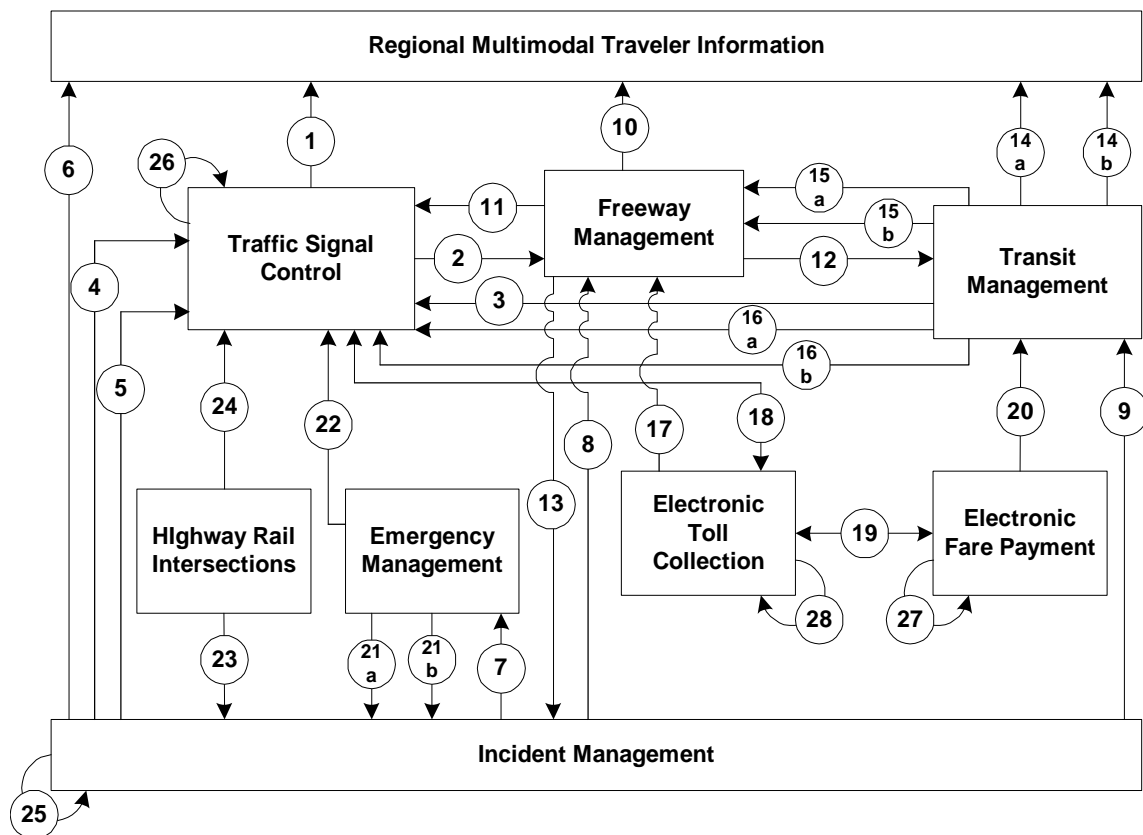

Figure 1.1 Integration of Components

The links in Figure 1.1 can also be used to assess the level of coordinated control in a metropolitan area. For example, operators of the Freeway Management component may be allowed to adjust Traffic Signal Control on parallel arterials in order to comprehensively manage traffic flow throughout a corridor. These types of arrangements are currently not widely

practiced; however, as integration of components progresses, the technology and institutional barriers to coordinated control can be better managed.

Examples of the type of information that may be passed between components and the use of the data by the receiving component, as illustrated in Figure 1.1, are shown in Table 1.1. This is not necessarily an exhaustive list of all possible information transfers, but is included to provide a high level picture of the data being transferred among components in a regional transportation management system. This provides a high level means of describing and assessing integration in a particular metropolitan area. Results of the data gathering for integration using this methodology are included in section III of this report.

Table 1.1
Summary of Integration Links

Link	From-To	Information Shared	Information Use
1	TSC to RMTI	arterial travel times, speeds, and conditions	display to travelers via RMTI media
2	TSC to FM	arterial travel times, speeds, and conditions	adjust freeway ramp meters, VMS, or HAR
3	TSC to TM	arterial travel times, speeds, and conditions	adjust transit routes and schedules
4	TSC to IM	arterial travel times, speeds, and conditions	detect incidents and manage incident response activities
5	IM to TSC	incident severity, location, and type	adjust traffic signal timing
6	IM to RMTI	incident severity, location, and type	display to travelers via RMTI media
7	IM to EM	incident severity, location, and type	incident notification
8	IM to FM	incident severity, location, and type	adjust freeway ramp meters, VMS, or HAR
9	IM to TM	incident severity, location, and type	adjust transit routes and schedules
10	FM to RMTI	freeway travel times, speeds, and conditions	display to travelers via RMTI media
11	FM to TSC	freeway travel times, speeds, and conditions	adjust traffic signal timing
12	FM to TM	freeway travel times, speeds, and conditions	adjust transit routes and schedules
13	FM to IM	freeway travel times, speeds, and conditions	detect incidents and manage incident response

EFP - Electronic Fare Payment
EM - Emergency Management
ETC - Electronic Toll Collection
FM - Freeway Management
HAR - Highway Advisory Radio
HRI -Highway-Rail Intersections

IM - Incident Management
RMTI - Regional Multimodal Traveler Information
TM - Transit Management
TSC - Traffic Signal Control
VMS - Variable Message Sign

Table 1.1 (continued)
Summary of Integration Links

Link	From-To	Information Shared	Information Use
14a	TM to RMTI	routes, schedules, and fares	display to travelers via RMTI
14b	TM to RMTI	transit schedule adherence	display to travelers via RMTI
15a	TM to FM	transit vehicle ramp priority	adjust ramp meters
15b	TM to FM	transit vehicle probe data	determine freeway conditions
16a	TM to TSC	transit vehicle signal priority	adjust traffic signals
16b	TM to TSC	transit vehicle probe data	determine arterial conditions
17	ETC to FM	vehicle probe data	adjust freeway ramp meters, VMS, or HAR
18	ETC to TSC	vehicle probe data	adjust traffic signal timing determine arterial conditions
19	ETC to/from EFP	fare or toll payment credit information	share fare and toll payment media
20	EFP to TM	rider origin/destination information	transit service planning
21a	EM to IM	incident notification	incident detection
21b	EM to IM	incident clearance	manage incident response
22	EM to TSC	emergency vehicle signal preemption	adjust traffic signals
23	HRI to IM	crossing status	incident detection
24	HRI to TSC	crossing status	adjust signal timing
25	IM (intra)	incident severity, location, type	incident detection and response
26	TSC (intra)	traffic signal timing	adjust traffic signal timing
27	EFP (intra)	fare payment credit information	fare payment
28	ETC (intra)	toll payment credit information	common toll payment method

EFP - Electronic Fare Payment
EM - Emergency Management
ETC - Electronic Toll Collection
FM - Freeway Management
HRI -Highway-Rail Intersections

IM - Incident Management
RMTI - Regional Multimodal Traveler Information
TM - Transit Management
TSC - Traffic Signal Control

Metropolitan Areas Tracked

Table 1.2 contains a list of the metropolitan areas that are the focus of deployment tracking efforts. The list includes the 1990 population and the survey return rate for each metropolitan area. Overall, the survey return rate is 81%.

Organization of Report

This report is divided into five parts: Executive Summary, Introduction, ITS Infrastructure Component Description and FY97 Survey Results, ITS Infrastructure Integration Indicator Description and FY97 Survey Results, and Conclusions.

Table 1.2 Metropolitan Areas Tracked

Rank	Metropolitan Area	State	1990 Population	Survey Return Rate
1	New York-Northern New Jersey-Southwestern Connecticut	NY	17,918,917	61%
2	Los Angeles-Riverside-Orange County	CA	14,531,529	79%
3	Chicago-Gary-Kenosha	IL	8,239,820	95%
4	San Francisco-Oakland-San Jose	CA	6,253,311	83%
5	Philadelphia-Wilmington-Atlantic City	NJ	6,218,761	62%
6	Boston-Worcester-Lawrence	MA	5,455,403	71%
7	Detroit-Ann Arbor-Flint	MI	5,187,171	89%
8	Washington	DC	4,223,495	82%
9	Dallas-Ft Worth	TX	4,037,282	91%
10	Houston-Galveston-Brazoria	TX	3,731,131	87%
11	Miami-Ft Lauderdale	FL	3,192,582	100%
12	Seattle-Tacoma-Bremerton	WA	2,970,328	90%
13	Atlanta	GA	2,959,950	82%
14	Cleveland-Akron	OH	2,859,644	85%
15	Minneapolis-St. Paul	MN	2,538,834	73%
16	San Diego	CA	2,498,016	65%
17	St. Louis	MO	2,492,525	79%
18	Pittsburgh	PA	2,394,811	73%
19	Baltimore	MD	2,382,172	68%
20	Phoenix-Mesa	AZ	2,238,480	96%
21	Tampa-St. Petersburg-Clearwater	FL	2,067,959	94%
22	Denver-Boulder-Greeley	CO	1,980,140	63%
23	Cincinnati-Hamilton	OH	1,817,571	61%
24	Portland-Salem	OR	1,793,476	78%
25	Milwaukee-Racine	WI	1,607,183	96%
26	Kansas City	MO	1,582,875	82%
27	Sacramento-Yolo	CA	1,481,102	71%
28	Hampton Roads	VA	1,443,244	94%
29	Indianapolis	IN	1,380,491	79%
30	Columbus	OH	1,345,450	100%
31	San Antonio	TX	1,324,749	100%

Table 1.2 Metropolitan Areas Tracked (Continued)

Rank	Metropolitan Area	State	1990 Population	Survey Return Rate
32	New Orleans	LA	1,285,270	83%
33	Orlando	FL	1,224,852	100%
34	San Juan	PR	1,221,000	56%
35	Buffalo-Niagara Falls	NY	1,189,288	92%
36	Charlotte-Gastonia-Rock Hill	NC	1,162,093	100%
37	Hartford	CT	1,157,585	92%
38	Providence-Fall River-Warwick	RI	1,134,350	66%
39	Salt Lake City-Ogden	UT	1,072,227	90%
40	Rochester	NY	1,062,470	100%
41	Greensboro-Winston Salem-High Point	NC	1,050,304	92%
42	Memphis	TN	1,007,306	100%
43	Nashville	TN	985,026	100%
44	Oklahoma City	OK	958,839	83%
45	Dayton-Springfield	OH	951,270	66%
46	Louisville	KY	948,829	91%
47	Grand Rapids-Muskegon-Holland	MI	937,891	90%
48	Jacksonville	FL	906,727	95%
49	Richmond-Petersburg	VA	865,640	65%
50	West Palm Beach-Boca Raton	FL	863,518	94%
51	Albany-Schenectady-Troy	NY	861,424	94%
52	Raleigh-Durham-Chapel Hill	NC	855,545	80%
53	Las Vegas	NV	852,737	100%
54	Austin-San Marcos	TX	846,227	100%
55	Birmingham	AL	840,140	58%
56	Honolulu	HI	836,231	56%
57	Greenville-Spartanburg-Anderson	SC	830,563	80%
58	Fresno	CA	755,580	45%
59	Syracuse	NY	742,177	87%
60	Tulsa	OK	708,954	95%
61	Tucson	AZ	666,880	100%
62	Omaha	NE	639,580	95%

Table 1.2 Metropolitan Areas Tracked (Continued)

Rank	Metropolitan Area	State	1990 Population	Survey Return Rate
63	Scranton-Wilkes Barre-Hazleton	PA	638,466	81%
64	Toledo	OH	614,128	88%
65	Youngstown-Warren	OH	600,895	74%
66	Allentown-Bethlehem-Easton	PA	595,081	60%
67	El Paso	TX	591,610	86%
68	Albuquerque	NM	589,131	#
69	Harrisburg-Lebanon-Carlisle	PA	587,986	60%
70	Springfield	MA	587,884	67%
71	Knoxville	TN	585,960	78%
72	Bakersfield	CA	543,477	36%
73	New Haven	CT	530,180	90%
74	Baton Rouge	LA	528,264	100%
75	Little Rock-North Little Rock	AR	513,117	100%
76	Charleston- North Charleston	SC	506,875	68%
77	Sarasota-Bradenton	FL	489,483	100%
78	Wichita	KS	485,270	100%

Surveys for Albuquerque are currently being distributed and are not available for this report.

II - ITS INFRASTRUCTURE COMPONENT DESCRIPTION AND FY97 SURVEY RESULTS

This section presents deployment tracking indicators for each of the nine metropolitan ITS components. The following information is provided for each component:

1. A description of the basic functions performed by each component.
2. A description of the deployment tracking indicators used to measure each function.
3. Data gathering results for each indicator displayed in a set of graphs based on the size of metropolitan areas. The 78 metropolitan areas are divided into thirds on the basis of population in the following manner: The largest 26 areas (over 1,500,000 population), the next 26 largest areas (855,000 to 1,499,999 population), and the 26 smallest areas (under 855,000 population). Nationwide indicators are also displayed. The horizontal bar graph that portrays results is expressed as a percent of deployment opportunity achieved for each indicator. The deployment opportunity reflects the total potential deployment and does not necessarily reflect actual need. For example, freeway management indicators are compared to a deployment opportunity consisting of the entire freeway system and are not corrected for any assessment of how local conditions might limit the scope of deployment to a portion of the freeway system. These indicators are single surrogates that do not necessarily reflect the full breadth of ITS deployment activity.
4. Additional survey results used to evaluate the extent that related technologies have been adopted by individual metropolitan areas. This information is displayed in graphs that show the number of metropolitan areas reporting the presence of a particular technology that supports a component. In many cases, metropolitan areas have more than one of these technologies.

FREEWAY MANAGEMENT

Freeway Management Functions

Freeway Management provides the following traffic management functions:

1. Capability to monitor traffic conditions on the freeway system in real-time (i.e, traffic surveillance).
2. Capability to implement appropriate traffic control and management strategies (such as ramp metering and lane control) in response to recurring or non-recurring flow impediments (i.e., traffic control).
3. Capability to provide critical information to travelers through infrastructure-based dissemination methods such as Variable Message Signs, Highway Advisory Radio, or In-vehicle Signing (i.e., information display).

Freeway Management Indicators

Three indicators have been developed to measure the presence of these key functions:

1. Percentage of freeway centerline miles under electronic surveillance for monitoring traffic flow.
2. Percentage of freeway centerline miles managed by lane control or percentage of freeway entrance ramps managed by ramp meters. This indicator is calculated by determining for each metropolitan area the percent of entrance ramps controlled by ramp meters and the number of miles controlled by lane control devices. The greater of the two is the indicator for the metropolitan area. To compute the national indicator, the metropolitan indicators are weighted by the freeway miles in each metropolitan area and averaged.
3. Percentage of freeway centerline miles covered by permanent VMS, or HAR, or IVS. If a metropolitan area has more than one of these methods to disseminate information, the method with the most coverage is used to compute the indicator. To compute the national indicator, the metropolitan indicators are weighted by the freeway miles in each metropolitan area and averaged together.

The Freeway Management component indicators are shown in Figure 2.1.

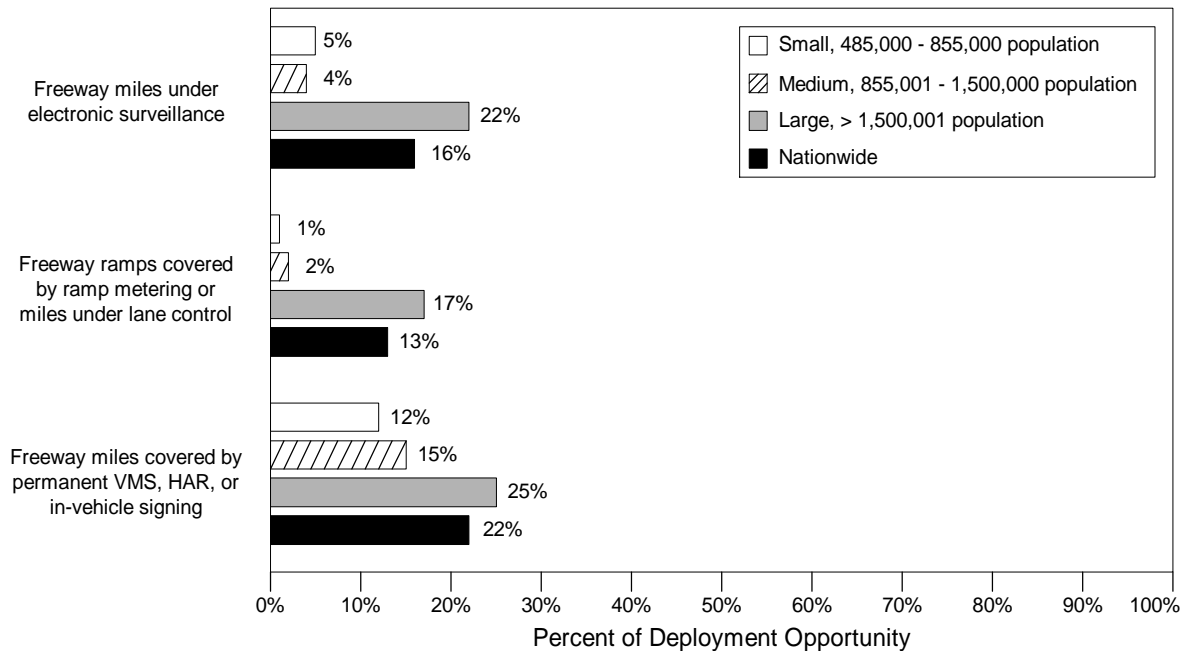

Figure 2.1. Freeway Management Component Indicator
(Based on survey return of 89%)

Type of Communication

Four types of communication are commonly used by Freeway Management to transfer information among widely dispersed system elements.

Figure 2.2 contains the number of metropolitan areas that use these types of communication. Some metropolitan areas use more than one technology. The most frequently used communication technology is fiber optic cable, followed by twisted pair cable, coaxial cable, and microwave radio.

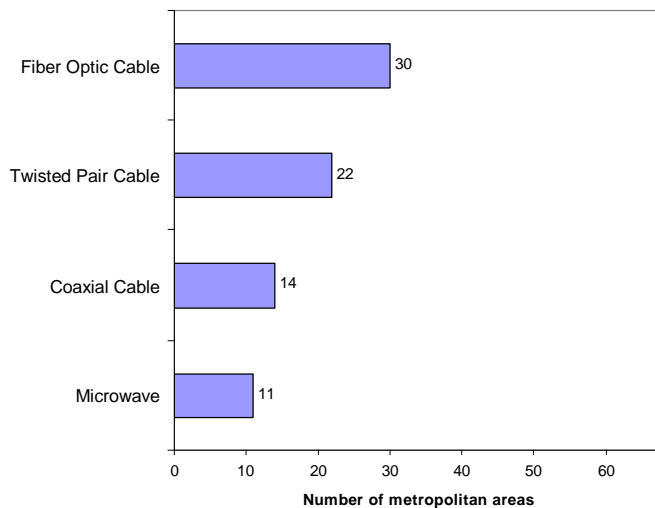

Figure 2.2. Freeway Management Types of Communication

Traffic Surveillance

Closed-circuit television and an array of sensors are used to electronically monitor freeway conditions in real-time.

Figure 2.3 contains the number of metropolitan areas that use various surveillance technologies. Some metropolitan areas use more than one technology. The most frequently used electronic surveillance technology is loop detectors, followed by Closed Circuit Television (CCTV), and radar detectors.

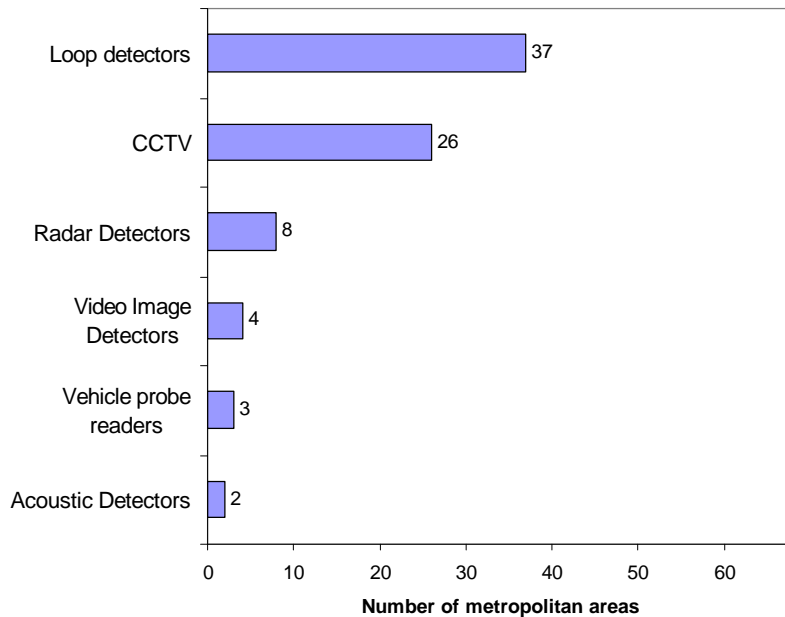

Figure 2.3. Freeway Management Surveillance

Traffic Control

Traffic condition data are analyzed to identify the cause of a flow impediment and to formulate an appropriate response in real-time. Traffic control devices, such as ramp meters or lane control devices, may be proactively applied to provide a better balance between freeway travel demand and capacity during congested conditions.

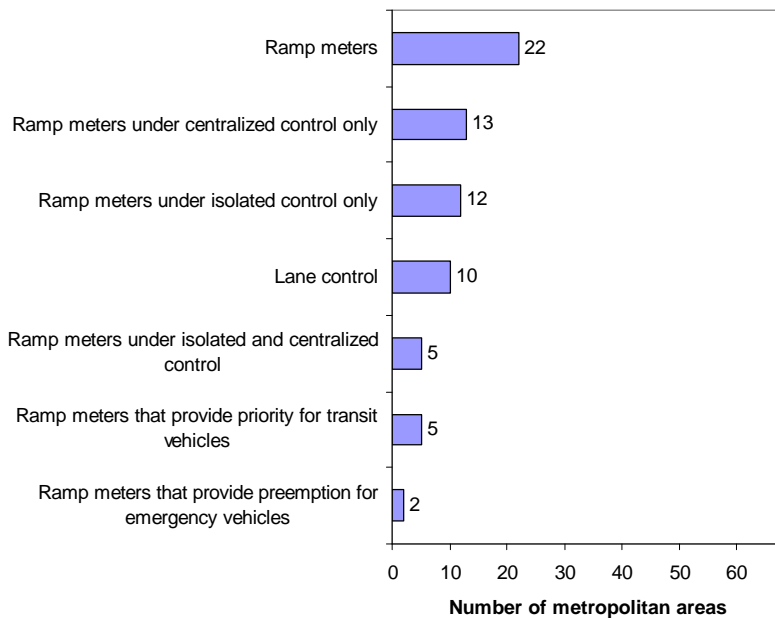

Figure 2.4. Freeway Management Traffic Control

Figure 2.4 contains the number of metropolitan areas that use lane control or ramp metering, the type of ramp meter control used, and the number of metropolitan areas that have ramp meter pre-emption for emergency vehicles and priority for transit vehicles.

Information Display

Information may be provided to travelers through roadside traveler information devices such as Variable Message Signs, Highway Advisory Radio, and In-Vehicle Signing.

Figure 2.5 contains a summary of the number of metropolitan areas reporting the use of information display technologies. The most frequently used technology is VMS, followed by HAR. No metropolitan areas report using IVS.

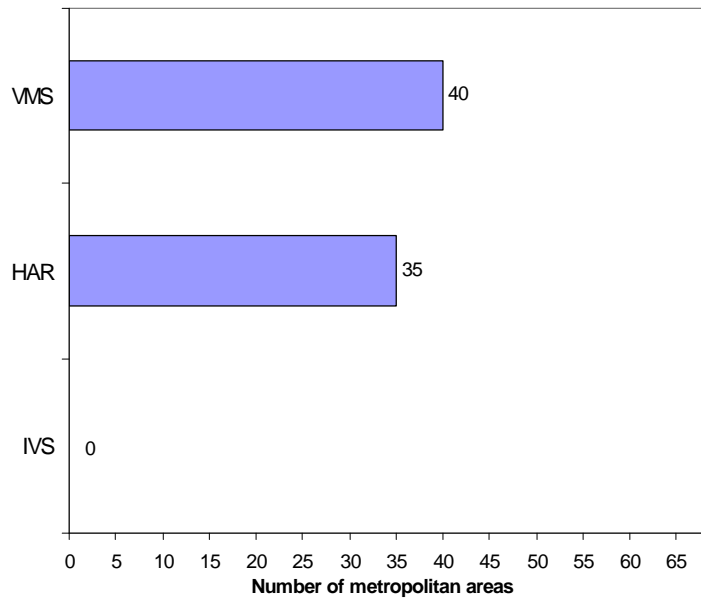

Figure 2.5. Freeway Management Information Display

INCIDENT MANAGEMENT

Incident Management Functions

Incident Management provides the following traffic management functions in real-time:

1. Capability to detect incidents on the freeway and arterial roadway system (i.e., incident detection).
2. Capability to verify incidents on the freeway and arterial roadway system (i.e., incident verification).
3. Capability to respond to incidents on the freeway and arterial roadway system (i.e., incident response).

Incident Management Component Indicators

Four indicators have been developed to measure the presence of these key functions:

1. Percentage of highway miles covered by incident detection algorithms.
2. Percentage of highway miles covered by free cellular phone calls to a dedicated number.
3. Percentage of highway miles covered by surveillance cameras.
4. Percentage of highway miles covered by on-call publically sponsored service patrols or towing services.

The Freeway Incident Management Component Indicators are shown in Figure 2.6.

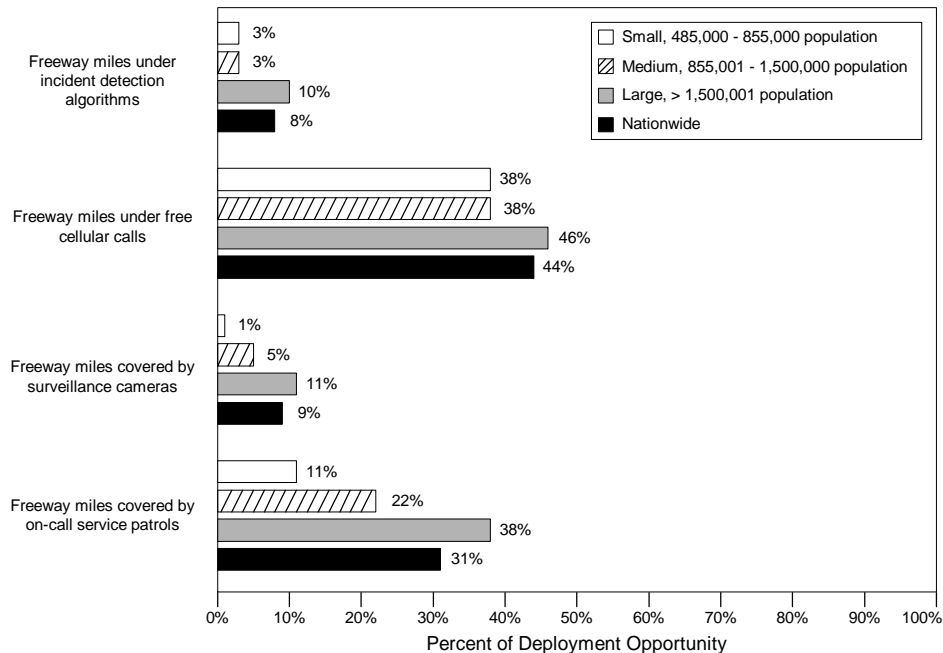

Figure 2.6 Freeway Incident Management Component Indicators
(Based on survey return of 90%)

The Arterial Incident Management Component Indicators are shown in Figure 2.7.

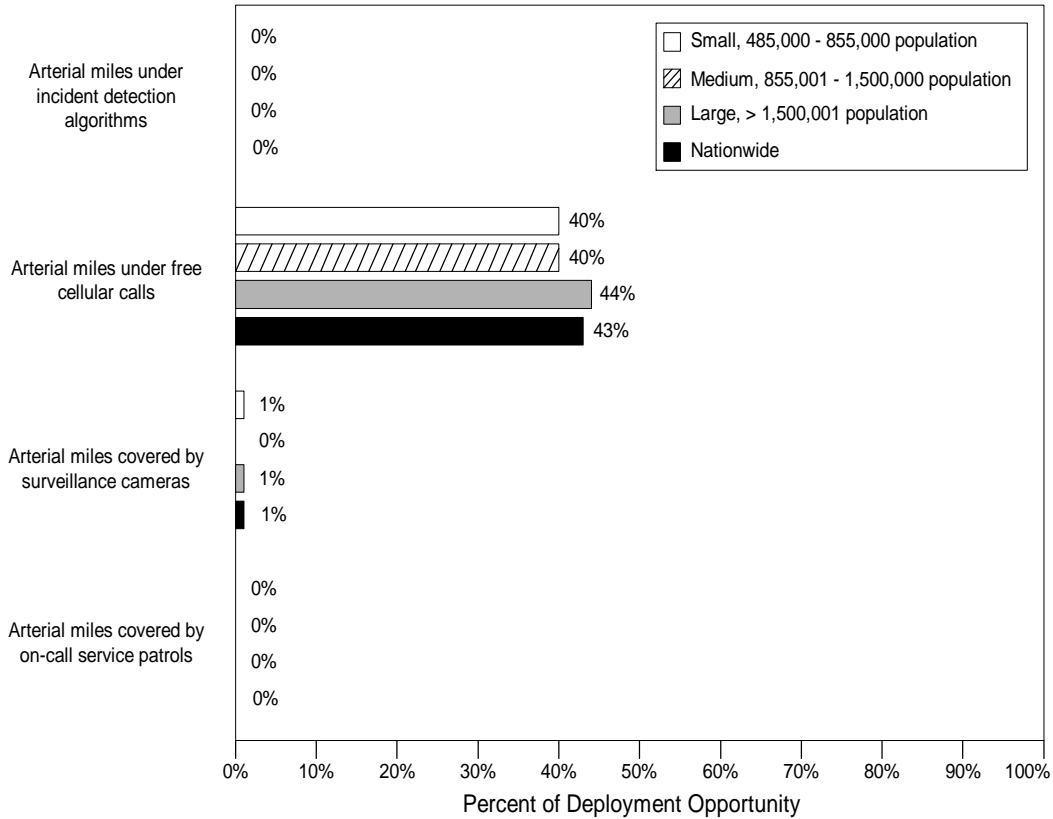

Figure 2.7 Arterial Incident Management Component Indicators
(Based on survey return of 90%)

Incident Detection

Monitoring of freeway conditions for the purpose of incident management is usually integrated with Freeway Management, with notification of the presence of an incident provided to the Incident Management component.

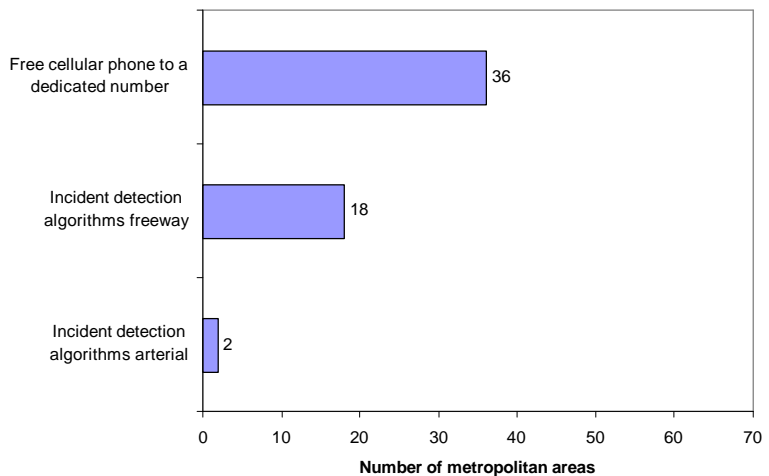

Figure 2.8 Incident Management Detection

Figure 2.8 contains the number of metropolitan areas that use various incident detection methods. Use of free cellular phone to a dedicated number is the most commonly used method. Incident detection algorithms are also used in freeways and arterials.

Incident Verification

Incident verification is typically accomplished through observation by cameras.

Figure 2.9 contains the number of metropolitan areas that use surveillance cameras for incident verification on arterials and freeways.

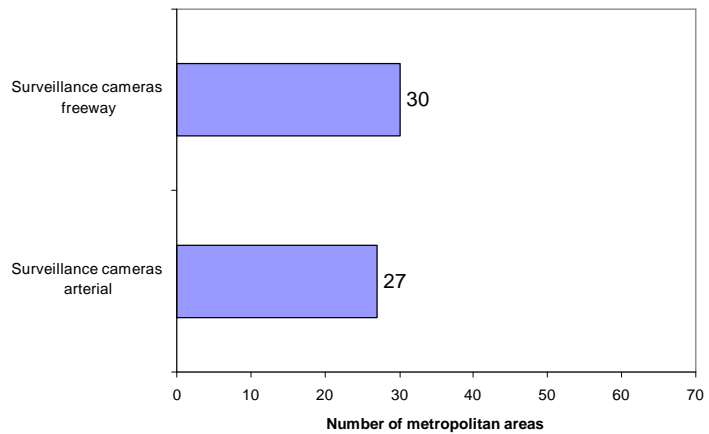

Figure 2.9 Incident Management Verification

Incident Response

Roadways are cleared and flow restored as rapidly as possible, minimizing frustration and delay to travelers while at the same time meeting the requirements and responsibilities of the agencies involved.

Figure 2.10 contains the number of metropolitan areas that use various incident response methods in freeways. More than half of the metropolitan areas reporting use publicly operated service patrols.

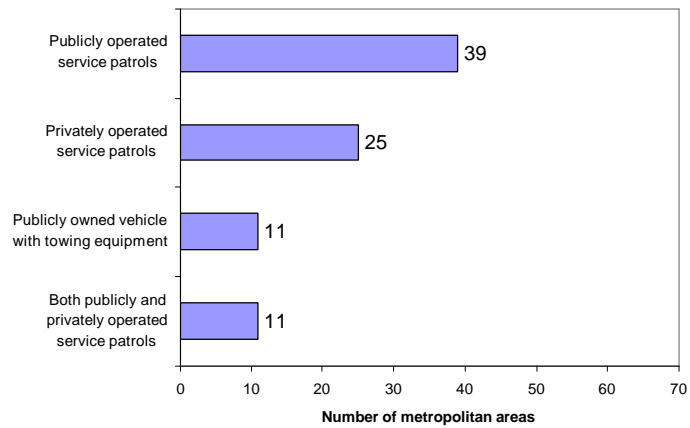

Figure 2.10 Freeway Incident Management Response

Figure 2.11 contains the number of metropolitan areas that use various incident response methods in arterials. Although not widely deployed, the most commonly used method is the use of publicly operated service patrols.

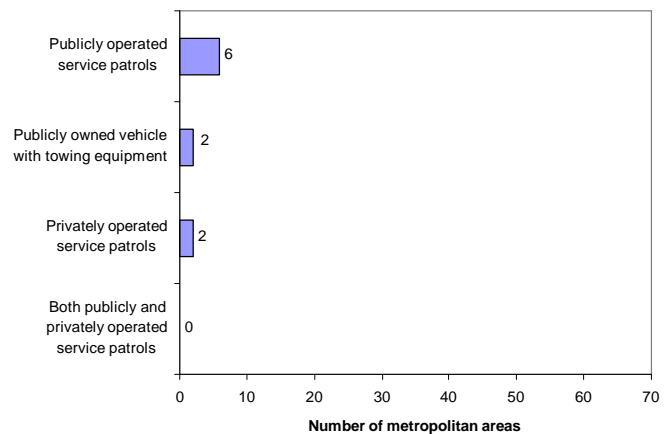

Figure 2.11 Arterial Incident Management Response

TRAFFIC SIGNAL CONTROL

Traffic Signal Control Functions

Traffic Signal Control provides for the following traffic management functions:

1. Capability to monitor traffic flow conditions on arterials in real-time (i.e., traffic surveillance).
2. Capability to implement traffic signal timing patterns that are responsive to traffic flow conditions (i.e., traffic control).
3. Capability to provide critical information to travelers through infrastructure based dissemination methods such as VMS, HAR, or IVS (i.e., information display).

Traffic Signal Control Component Indicators

Three indicators have been developed to measure the presence of these key function:

1. Percentage of signalized arterial and CBD centerline miles covered by electronic surveillance for monitoring traffic flow.
2. Percentage of arterial and CBD signalized intersections under closed loop or centralized control.
3. Percentage of signalized arterial and CBD miles covered by VMS, HAR, or IVS.

The Traffic Signal Control Management Component Indicators are shown in Figure 2.12.

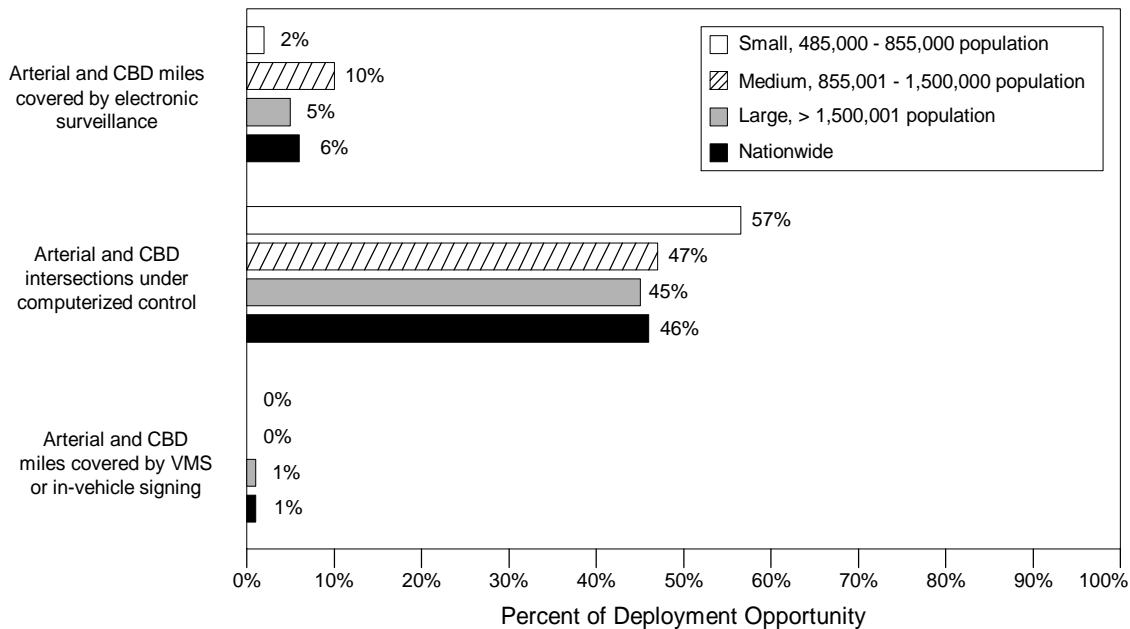
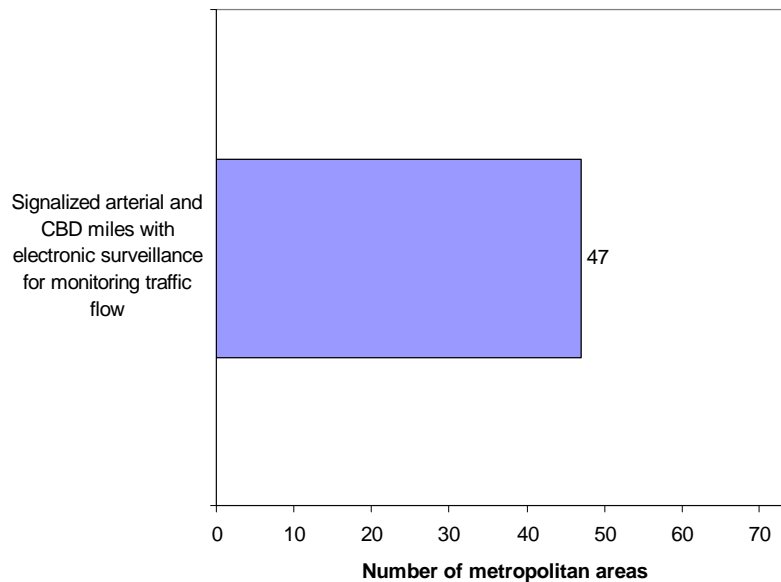

Figure 2.12 Traffic Signal Control Component Indicators
(Based on survey return of 70%)

Traffic Surveillance

Traffic signal control may incorporate peripheral elements which are not essential to the task of traffic control per se, but which may enhance overall traffic management capabilities in an area. These elements could include closed circuit TV surveillance, motorist information and/or traveler information components, a database management system to support analysis and development of management strategies, and data exchange with other traffic management systems including freeway management and incident management.

Figure 2.13 contains the number of metropolitan areas that use electronic surveillance on arterials. More than half of the metropolitan areas reporting have signalized arterial miles with electronic surveillance for monitoring traffic flow.



Traffic Control

Traffic Signal Control

Traffic Signal Control is responsible for the coordinated control of traffic signals along urban arterials, networks, and the CBD. Traffic Signal Control provides the capability to adjust the amount of green time for each street and coordinate operation between each signal in response to changes in demand patterns. Traffic signal timing patterns may be executed in response to pre-established “time of day” or “special event” plans, based on historical traffic conditions, or may be executed in response to real-time traffic conditions using “traffic adaptive” algorithms. Coordination can be implemented through a number of techniques including time-based and hard-wired interconnection methods. Coordination of traffic signals across agencies requires development of data sharing and traffic signal control agreements. Therefore, a critical institutional component of Traffic Signal Control is the establishment of formal or informal arrangements to share traffic control information as well as actual control of traffic signal operation across jurisdictions.

Figure 2.13 Traffic Signal Surveillance

Figure 2.14 contains a summary of metropolitan areas that use various control technologies. All of the metropolitan areas reporting have signalized arterial miles under centralized or closed loop control. Most of the metropolitan areas reporting use closed loop control. Some metropolitan areas reporting have signals with real-time traffic adaptive control. More metropolitan areas report having more signals with preemption for emergency vehicles than priority for transit vehicles.

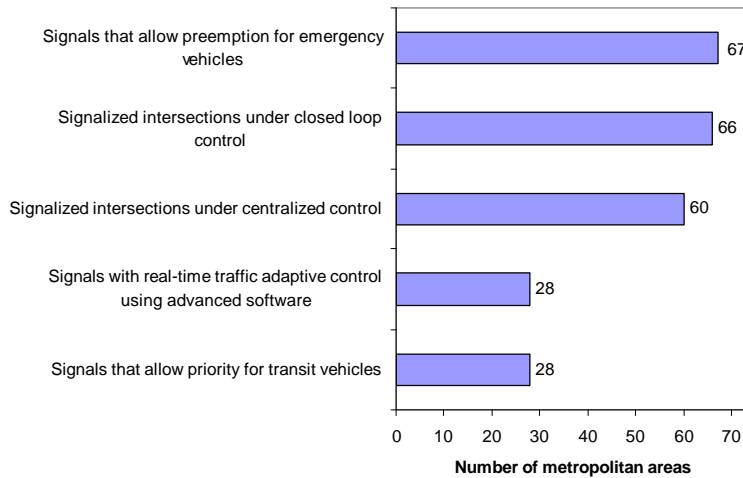

Figure 2.14 Traffic Signal Control

Information Display

Information may be provided to travelers through roadside traveler information devices such as VMS, HAR, and IVS.

Figure 2.15 contains a summary of metropolitan areas that use various display technologies. VMS is the method used most often followed by HAR and IVS.

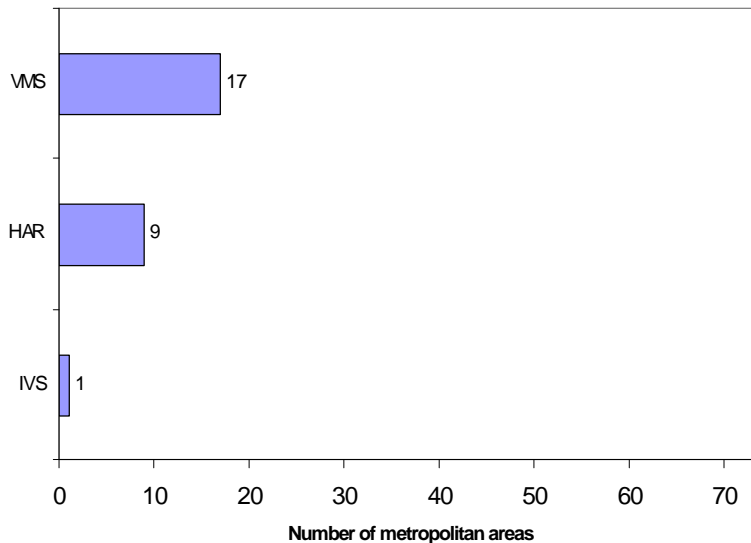

Figure 2.15 Traffic Signal Display

ELECTRONIC TOLL COLLECTION

Electronic Toll Collection Functions

Electronic Toll Collection (ETC) provides for the following traffic management function:

1. Automatically collect toll revenue through the application of in-vehicle, roadside, and communication technologies to process toll payment transactions (i.e., electronically collect tolls).

Electronic Toll Collection Indicator

One indicator has been developed to measure the presence of this capability:

1. Percentage of toll collection lanes with ETC capability.

The Electronic Toll Collection Component Indicator is shown in Figure 2.16.

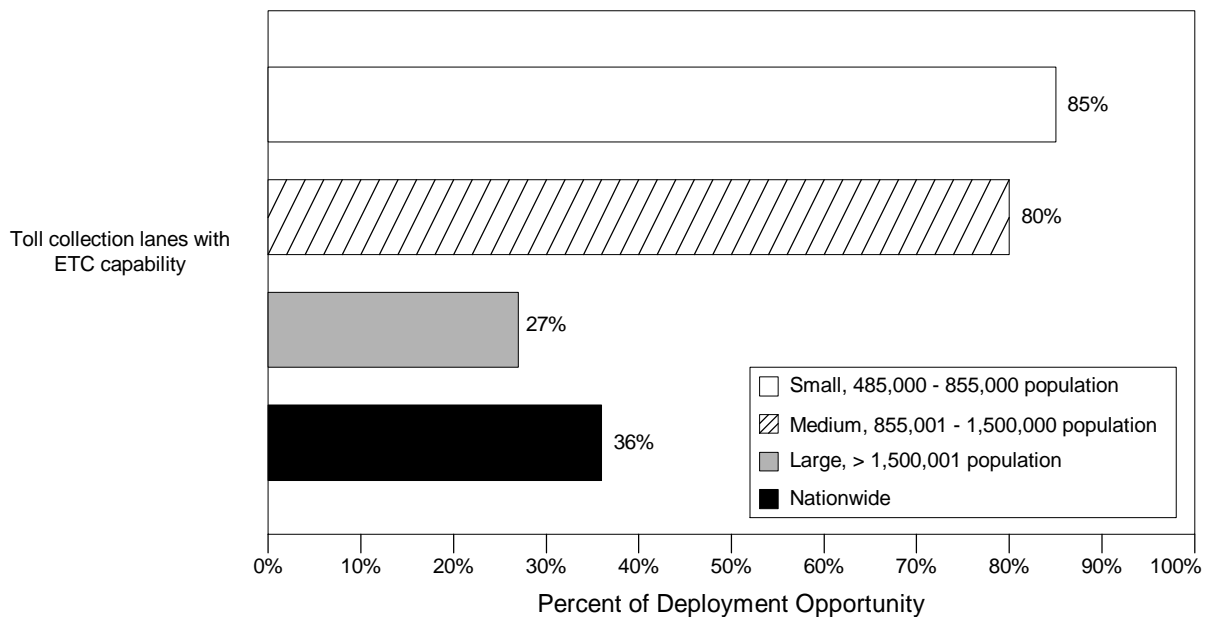

Figure 2.16 Electronic Toll Collection Component Indicator
(Based on survey return of 89%)

Figure 2.17 contains the number of metropolitan areas that use various toll collection control and technologies. A total of nineteen metropolitan areas have dedicated or mixed ETC lanes. Most areas use a distributed overhead antennae with tag based in-vehicle equipment.

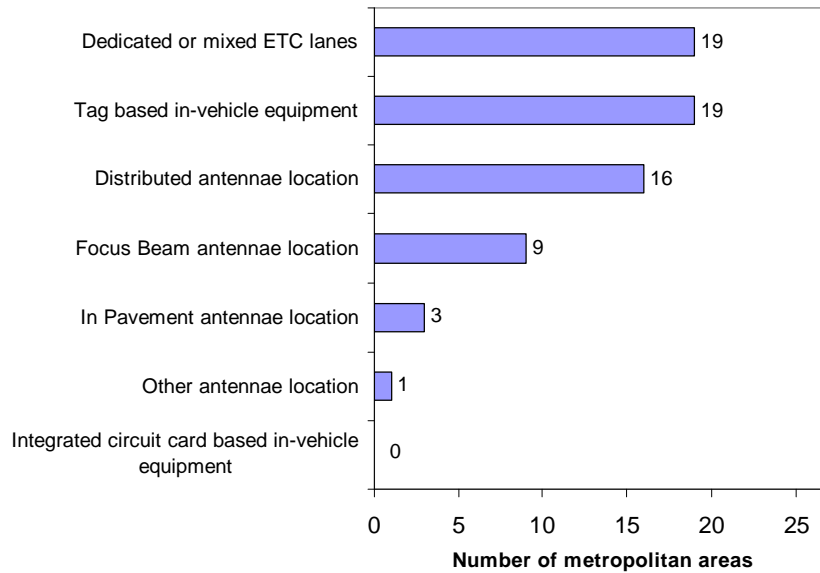

Figure 2.17 Electronic Toll Collection Control and Technologies

ELECTRONIC FARE PAYMENT

Electronic Fare Payment Functions

Electronic Fare Payment provides for the following fare payment functions:

1. Capability to pay public transit fares on fixed route bus and light-rail transit vehicles using electronic fare payment media.
2. Capability to pay public transit fares at heavy-rail transit stations using electronic fare payment media.

Electronic Fare Payment Component Indicators

Two indicators have been developed to measure the presence of these key functions:

1. Percentage of fixed route bus and light-rail transit vehicles that accept electronic payment of fares.
2. Percentage of heavy-rail transit stations that accept electronic payment of fares.

The Electronic Fare Payment Component Indicators are shown in Figure 2.18.

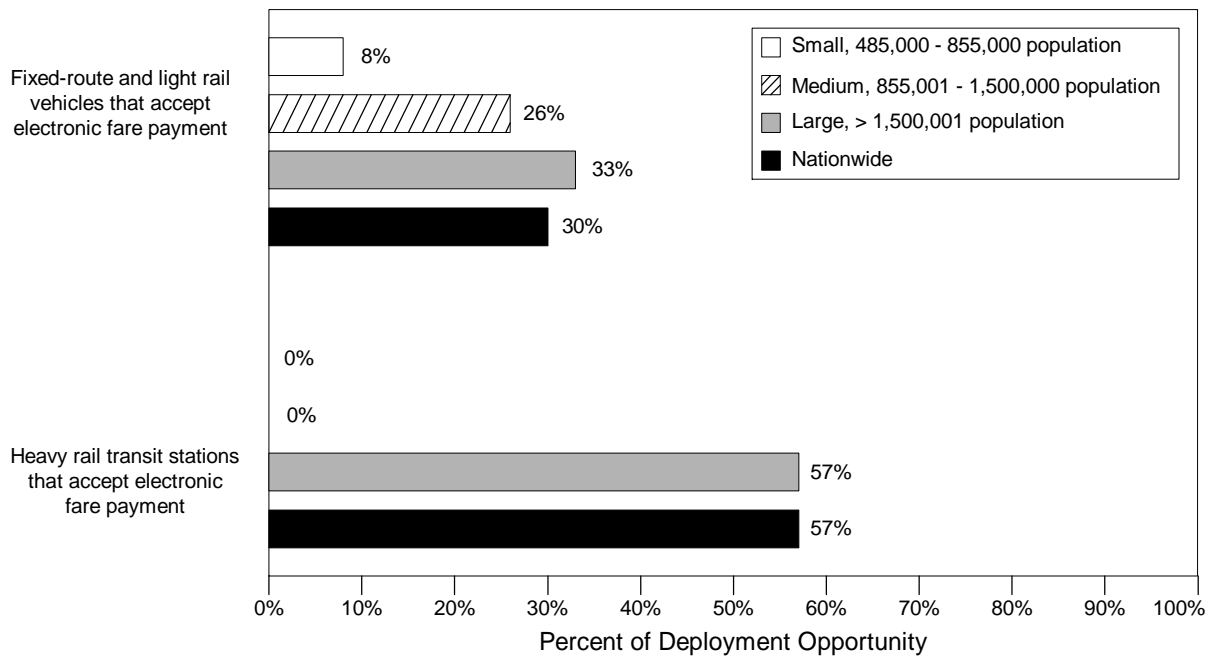

Figure 2.18 Electronic Fare Payment Component Indicators
(Based on survey return of 81%)

Figure 2.19 contains the number of metropolitan areas that use electronic fare payment media for fixed route bus services and light rail. Only one metropolitan area uses smart cards.

Figure 2.20 contains the number of metropolitan areas that use electronic fare payment for heavy rail.

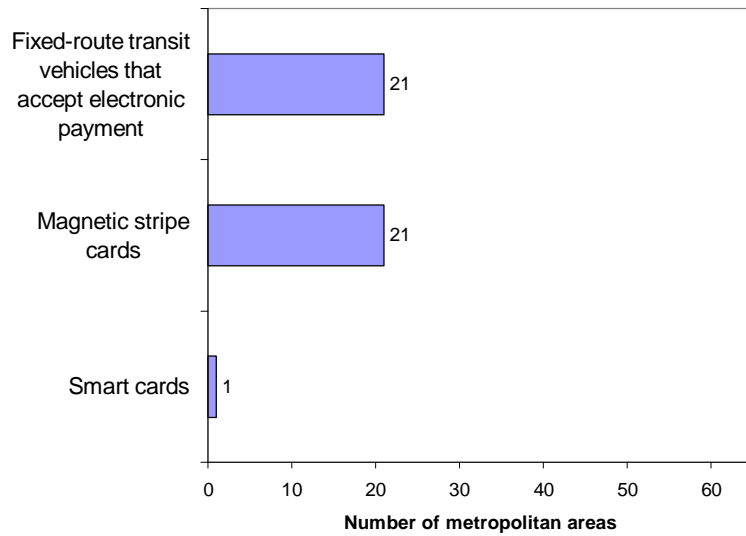

Figure 2.19 Electronic Fare Payment Fixed Route Bus and Light Rail

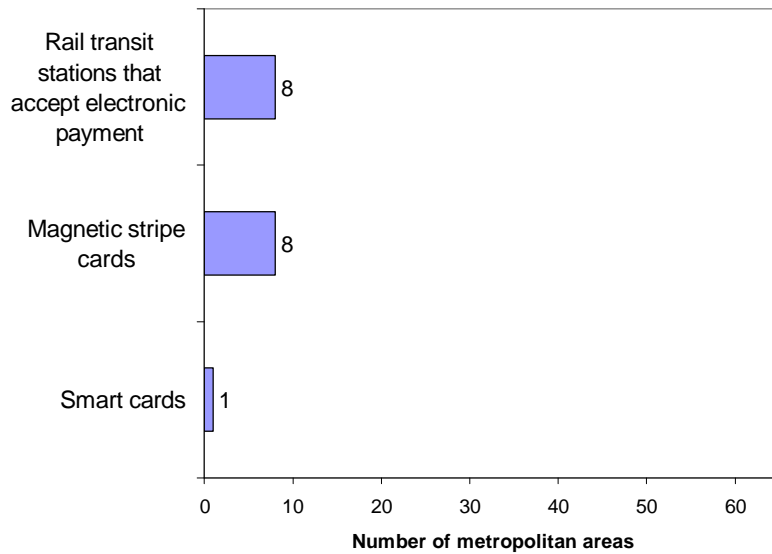

Figure 2.20 Electronic Fare Payment Heavy Rail

TRANSIT MANAGEMENT

Transit Management Functions

Transit Management provides for the following functions:

1. Capability to monitor the location of transit vehicles to support schedule management and emergency response (i.e., Automatic Vehicle Location [AVL]).
2. Capability to monitor maintenance status of the transit vehicle fleet (i.e., vehicle maintenance monitoring).
3. Capability to provide demand responsive flexible routing and scheduling of transit vehicles (i.e., paratransit management).
4. Capability to provide real-time, accurate transit information to travelers (i.e., information display).

Transit Management Indicators

A total of four indicators have been developed to measure the presence of these key functions:

1. Percentage of fixed-route transit vehicles equipped with AVL.
2. Percentage of fixed-route transit vehicles equipped with electronic monitoring of vehicle components.
3. Percentage of paratransit vehicles under Computer Aided Dispatch (CAD).
4. Percentage of fixed-route transit locations with electronic display of transit information.

The Transit Management component indicators are shown in Figure 2.21.

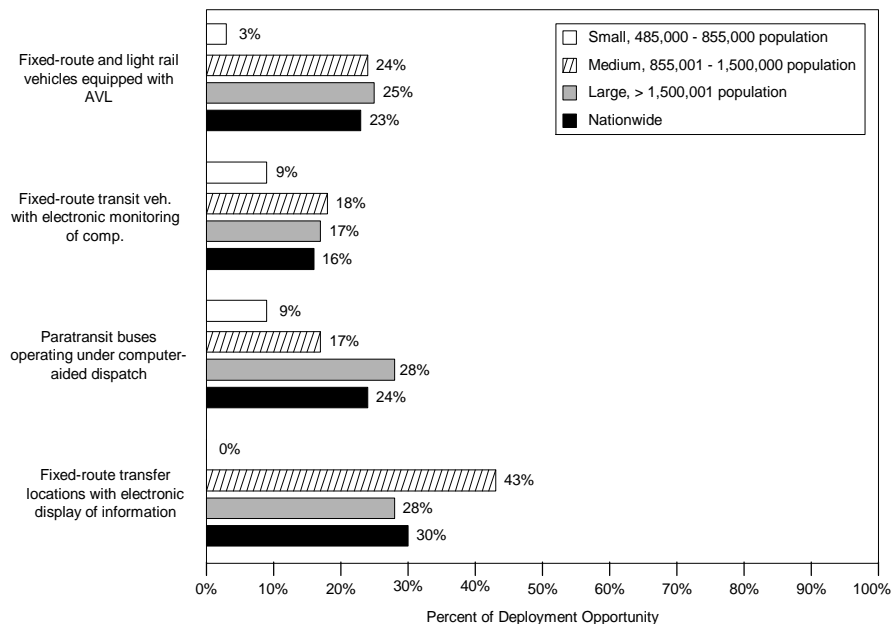

Figure 2.21 Transit Management Component Indicators
(Based on survey return of 81%)

Automatic Vehicle Location

Transit Management supports management of the transit fleet by electronically monitoring vehicle locations in real time. Transit vehicles equipped with AVL technology provide the basis for vehicle tracking. Information on the current location of a transit vehicle is transmitted to a centralized dispatcher who then compares the actual location with the scheduled location. Depending on the variance between the actual and scheduled locations, actions may be taken to improve schedule adherence and to transfer information to travelers. This also supports emergency response by providing real time information on vehicle locations in emergency situations.

Vehicle Maintenance Monitoring

Transit management includes electronic monitoring of vehicle performance parameters using in-vehicle sensors. This involves monitoring of usage statistics such as mileage and status of routine scheduled maintenance. In addition, this permits automatic monitoring of vehicle condition including key parameters such as oil and fuel levels and tire pressure.

Paratransit Vehicle Dispatching

The use of AVL also supports advanced demand-responsive computer-aided routing and scheduling. Transit dispatchers can combine real-time information on vehicle location and status with advanced computer aided dispatching systems to provide optimal vehicle assignment and routing to meet non-recurring public transportation demand.

Transit Information Display

Schedule information can be disseminated in near real-time to travelers through a variety of methods directly controlled by the transit management agencies, such as information kiosks, radio and television, and the world wide web.

Figure 2.22 contains the number of metropolitan areas reporting the use of AVL on fixed route services, the use of electronic vehicle maintenance monitoring systems and CAD for paratransit vehicle dispatching. In addition, the figure also contains the number of metropolitan areas where transit schedule and fare

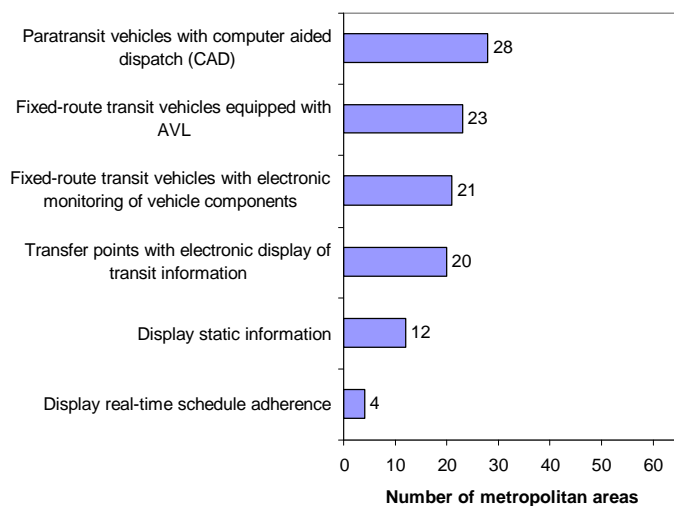

Figure 2.22 Transit Management, AVL, Maintenance, Paratransit, and Display

information is displayed at major bus transfer points and at rail transfer stations. Two types of display are reported: published routes, schedules and fares; and real-time schedule adherence.

HIGHWAY-RAIL INTERSECTION

Highway-Rail Intersection Functions

Highway-Rail Intersection provides for the following function:

1. Electronically monitor highway-rail intersections to: a) coordinate rail movements with the traffic control signal systems, b) provide travelers with advanced warning of crossing closures, and c) improve and automate warnings at highway-rail intersections.

Highway-Rail Intersection Indicator

A single component indicator has been developed to measure the presence of this capability:

1. Percentage of highway-rail intersections under electronic surveillance.

The Highway-Rail Intersection Component indicator is shown in Figure 2.23.

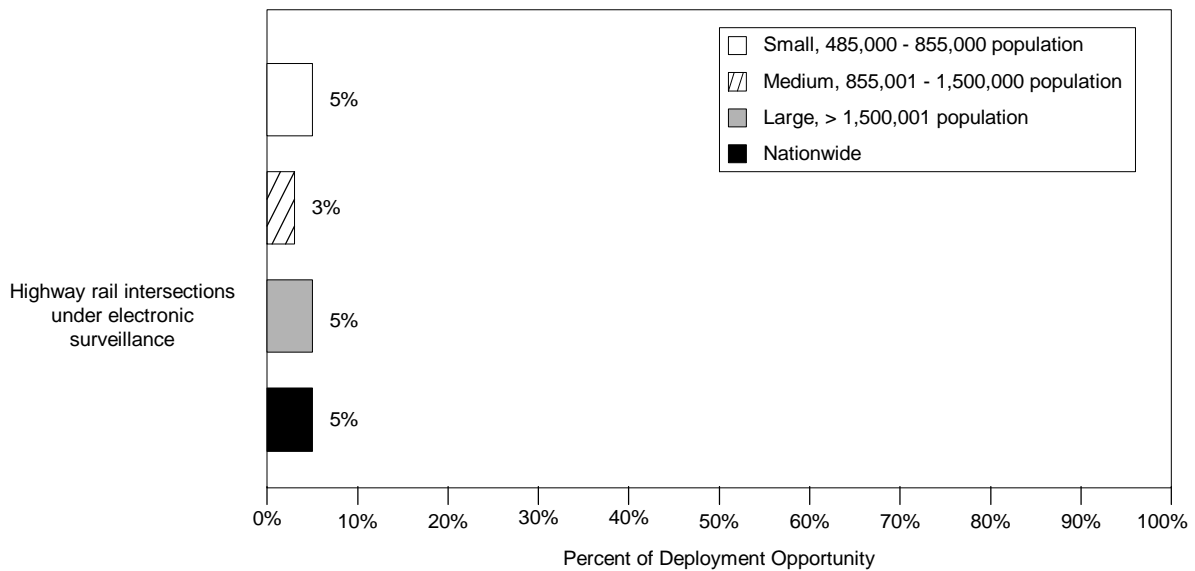

Figure 2.23 Highway-Rail Intersection Component Indicator
(Based on survey return of 64%)

Electronic Surveillance

At-grade highway-rail intersection is a special form of roadway intersection where a roadway and one or more railroad tracks intersect. At a highway-rail intersection, the right-of-way is shared between railroad vehicles and roadway vehicles, with railroad vehicles typically being given preference. Railroad trains, which travel at high speeds and can take up to a mile or more to stop, pose special challenges. As a result, automated systems are now becoming available that allow the deployment of safety systems to adequately warn drivers of crossing hazards.

The Highway-Rail Intersection component involves electronic surveillance of grade crossings to detect vehicles within the crossing area, either through video or other means such as loop detectors. This may eventually support real-time information on train position and estimated time of arrival at a crossing and interactive coordination between roadway traffic control centers and train control centers.

Figure 2.24 contains the number of metropolitan areas reporting the use of video and other than video surveillance as well as electronic traffic violator devices. The purpose of the latter is to enforce crossing restrictions by identifying violators.

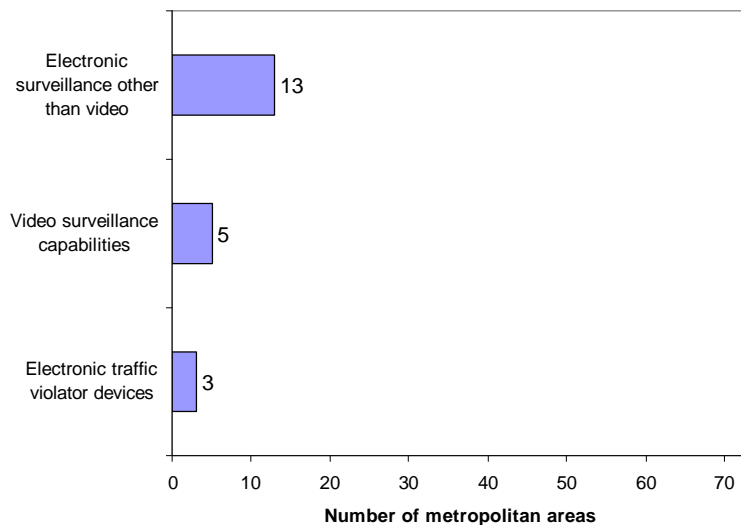

Figure 2.24 Highway -Rail Intersections Surveillance

EMERGENCY MANAGEMENT

Emergency Management Functions

Emergency Management provides the following capabilities:

1. Capability to operate public sector emergency vehicles under CAD.
2. Capability to provide public sector emergency vehicles with in-vehicle route guidance capability.

Emergency Management Indicators

Two indicators have been developed to measure the presence of these capabilities:

1. Percentage of public sector emergency vehicles operating under CAD.
2. Percentage of public sector emergency vehicles with in-vehicle route guidance capability.

The Emergency Management component indicator is shown in Figure 2.25.

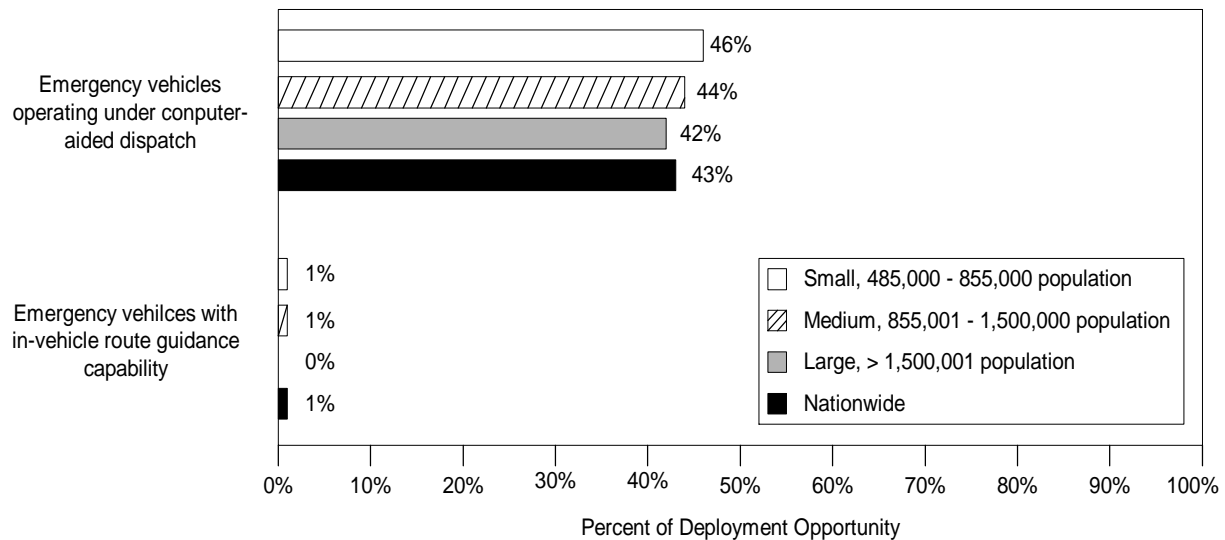

Figure 2.25 Emergency Management Component Indicator
(Based on survey return of 94%)

Computer Aided Dispatch

Emergency vehicle fleet management utilizes AVL equipment to provide computer-aided dispatching of vehicles. Through the use of real-time information on vehicle location and status, emergency service dispatchers can make optimal assignment of vehicles to incidents.

Route Guidance

The installation of route guidance equipment in emergency service vehicles provides improved directional information for drivers and improves responsiveness of emergency services.

Figure 2.26 contains the number of metropolitan areas with emergency management vehicles dispatch and guidance technologies.

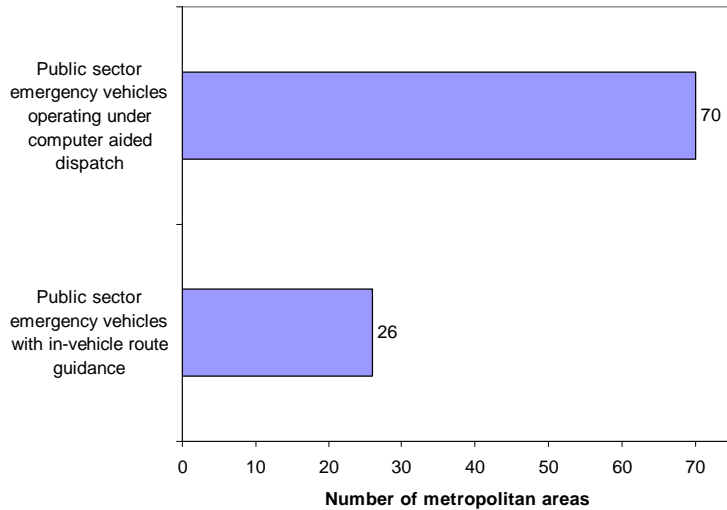

Figure 2.26 Emergency Management Dispatch and Guidance

REGIONAL MULTIMODAL TRAVELER INFORMATION

Regional Multimodal Traveler Information Functions

Regional Multimodal Traveler Information provides for the following capabilities:

1. Collect current, comprehensive, and accurate roadway and transit performance data for the metropolitan area.
2. Provide traveler information to the public via a range of communication techniques (broadcast radio, FM subcarrier, the Internet, cable TV) for presentation on a range of devices (home/office computers, television, pagers, personal digital assistants, kiosks, radio) (i.e., media).
3. Provide multimodal information to the traveler to support mode decision-making.

Regional Multimodal Traveler Information Indicators

Three component indicators have been developed to measure the presence of the above capabilities:

1. Percentage of geographic coverage of surveillance data provided from Freeway Management, Incident Management, Traffic Signal Control, and Transit Management.
2. Percentage of total possible media types used to display information to travelers.
3. Percentage of total possible media types that display information of two or more modes to travelers.

The Regional Multimodal Traveler Information component indicators are shown in Figure 2.27.

Geographic Coverage of Traveler Information

The Regional Multimodal Traveler Information component of the metropolitan ITS infrastructure receives roadway and transit system surveillance and detection data from a variety of sources provided by both public and private sector entities. It has the capability to combine data from different sources, package the data into various formats, and provide the information to a variety of distribution channels.

Media Employed.

Agencies or organizations use many methods to disseminate traveler information to the public. Indicator calculations are based on a deployment opportunity of eight media: dedicated cable TV, telephone systems, web sites, pagers, interactive TV, kiosks, e-mail, and in-vehicle navigation.

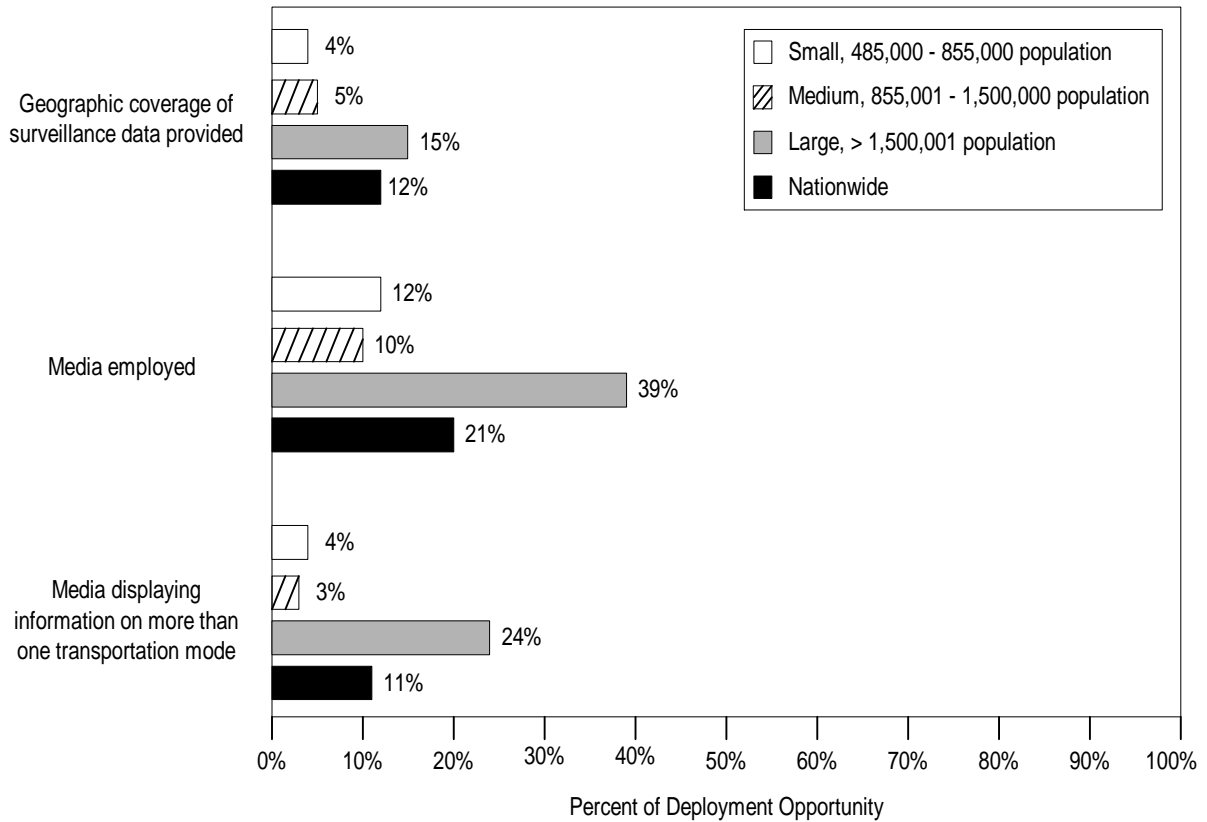

Figure 2.27 Regional Multimodal Traveler Information Component Indicators
(Based on survey return of 92%)

Media displaying information on more than one transportation mode

Traveler information on more than one transportation mode may be displayed on a single medium. For example: Transit schedules and fares as well as freeway travel times, speeds, or conditions, may be displayed on a web site

Table 2.1 shows the number of metropolitan areas that display information in each medium.

**Table 2.1 Media Used to Display Traveler Information
(Number of metropolitan areas)**



Information Displayed	Media							
	Dedicated cable TV	Telephone system	Web site	Pagers	Inter-active TV	Kiosks	E-mail	In-vehicle navigation
Freeway travel times, speeds, and conditions	6	16	19	4	3	5	6	4
Arterial travel times, speeds, and conditions	4	7	5	0	2	1	2	4
Transit routes, schedules, or fares	2	15	13	2	1	6	0	0
Real-time schedule adherence	1	3	3	1	0	1	1	1
Intercity bus or rail schedules	1	5	5	0	0	3	0	0
Airline schedules	1	4	4	1	1	1	0	0

III - ITS INFRASTRUCTURE INTEGRATION INDICATOR DESCRIPTION AND FY97 SURVEY RESULTS

A critical aspect of ITS that provides much of its capability is the integration of individual components to form a unified regional traffic control system. Individual ITS components routinely collect information that is used for purposes internal to that component. For example, the Traffic Signal Control component monitors arterial conditions to revise signal timing and to convey these conditions to travelers through such technologies as VMS and HAR. Other ITS components can make use of this information in formulating their control strategies. For example, Transit Management, especially for paratransit vehicles, may alter routes and schedules based on real-time information on arterial traffic conditions, and Freeway Management may alter ramp metering or diversion recommendations based on the same information. In order for infrastructure components to be considered integrated from the viewpoint of deployment tracking, information must be both transferred between components and used effectively by the recipient component, or infrastructure must be shared (e.g., fare common payment medium).

With this definition in mind, two factors were used in measuring existing integration: (1) information exchange and (2) control. Information exchange is defined as the physical transfer of information from one component to another, where the recipient component can use the information to structure its response to changing travel conditions more efficiently. Information exchange is measured with a "flow metric," which considers how much of available information is being exchanged to other components. The second factor, control, identifies the manner and use of information that is transferred to the recipient component.

As with the component indicators, definitions for inter- and intra-component integration were developed for each component, and indicators, derived from these definitions, were produced for each. A total of 32 individual integration indicators were specified and are portrayed in Figure 3.1. Each integration indicator has been assigned a number and an origin/destination path from one ITS infrastructure component to another. For example, the integration of information from the Freeway Management component to the Regional Multimodal Traveler Information component is identified by the number "10." This labeling convention is used throughout the main body of this report (Note: Four of the 28 numbered indicators have "a" and "b" indicators making the total 32).

In order to make the discussion of individual links clearer, links have been grouped into four broad categories: (1) Traffic Management integration, (2) Traveler Information integration, (3) Transit Management integration, and (4) Emergency Management integration. In figures 3.2 to 3.5, the combined level of flow and control is indicated by the shading in the circles associated with each link (e.g.,  100%,  50%,  25%).

Example: Calculating Integration between Freeway Management and Traffic Signal Control

Consider a metropolitan area with 50 miles of freeway, 10 of which have traffic data collected electronically. The component indicator for electronic surveillance is calculated as 20%.

For the purpose of measuring integration, only the 10 miles currently under electronic surveillance are considered as the amount available for integration with other components. Therefore, if data for all 10 miles of freeway are transferred to another component, the flow metric is assigned a value of 100%.

Suppose that the 10 miles of freeway surveillance data are transferred to the Traffic Signal Control component and used to revise signal timing plans, then the control metric is assigned a value of 100%.

The combined indicator for integration is the average of the flow metric and the control metric or $(100\% + 100\%)/2 = 100\%$.

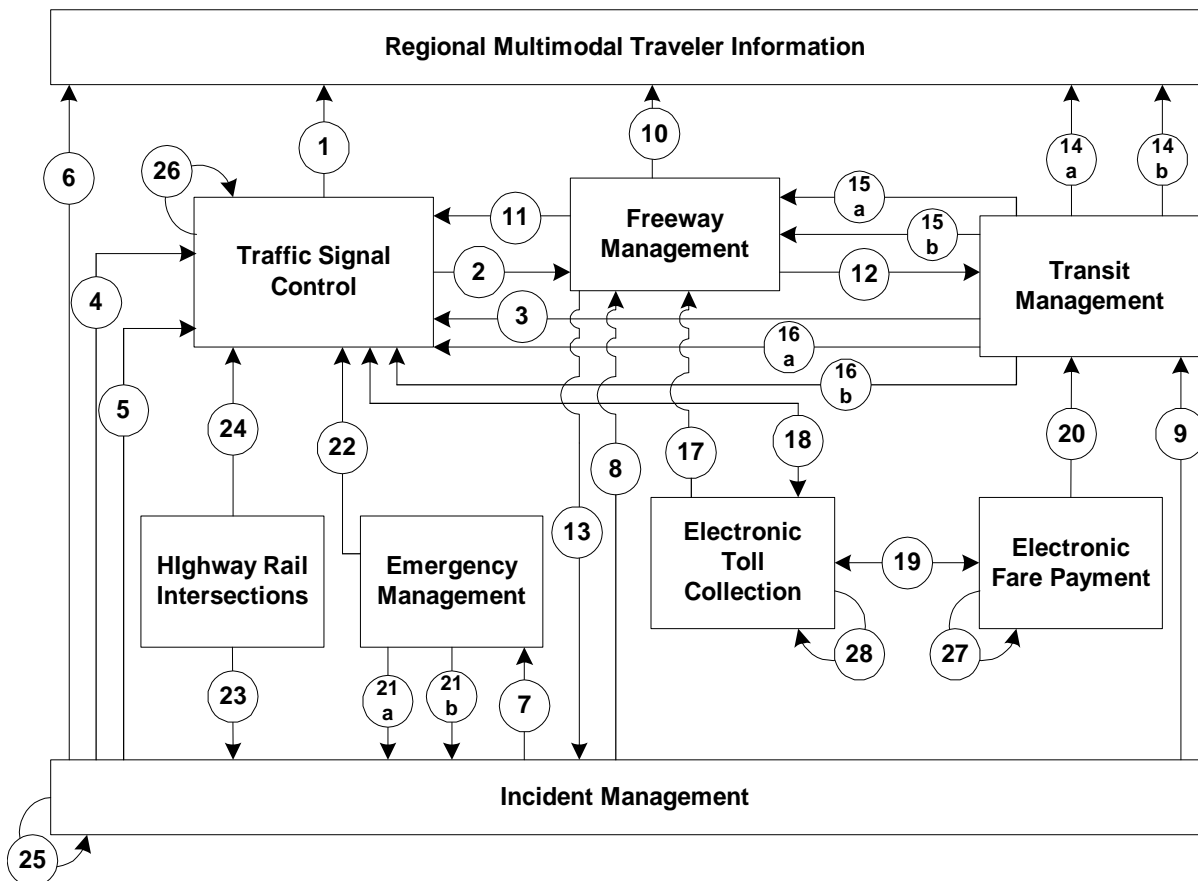

Figure 3.1 Integration of ITS Components

Traffic Management Integration

Traffic Management integration enables the implementation of coordinated traffic management strategies among operating agencies responsible for Freeway Management, Incident Management, and Traffic Signal Control within a metropolitan area. Key characteristics of traffic management integration include the following:

1. Collection of real-time traffic and incident data on the freeway and arterial street network.
2. Coordination of management actions in response to changes in traffic flow.
3. Collaboration among operating agencies to optimize the strategies available to improve traffic flow.

Figure 3.2 presents an overview of the integration links that define traffic management integration.

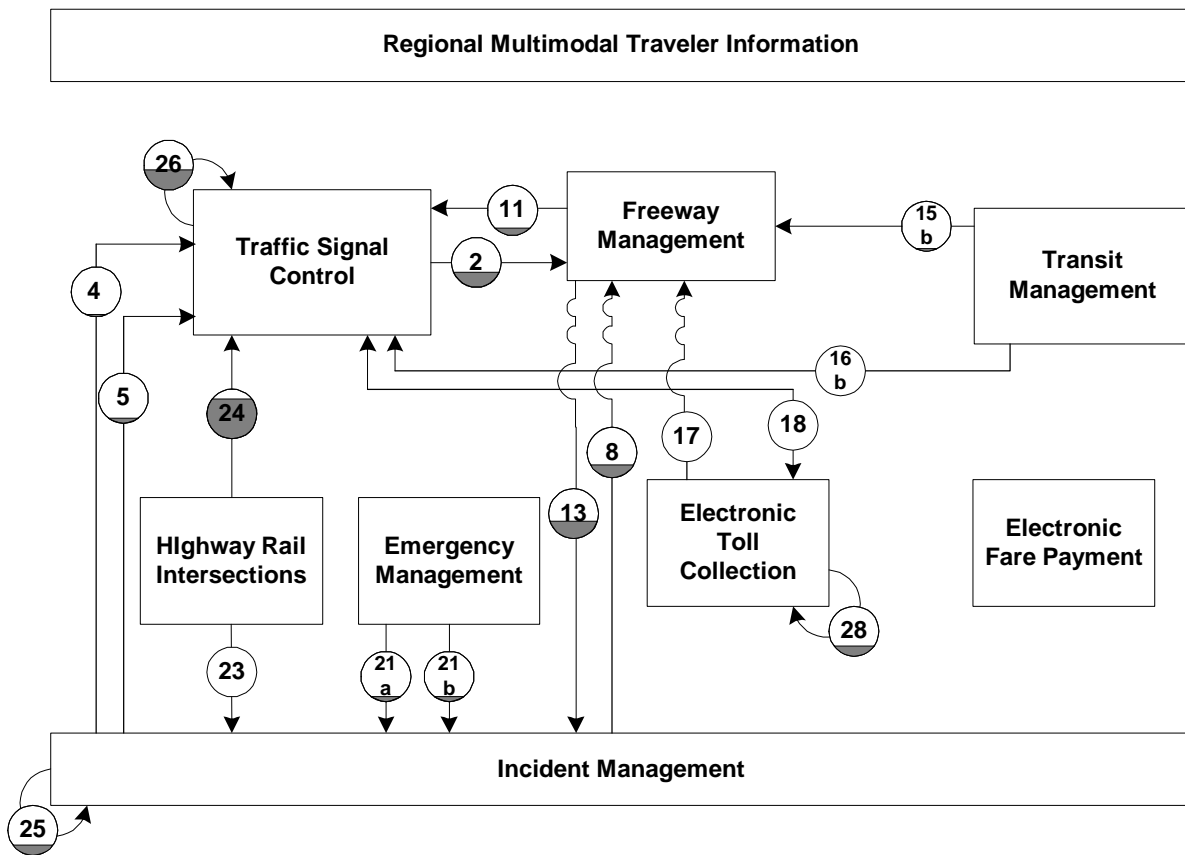

Figure 3.2 Traffic Management Integration Links

Table 3.1 presents a description of each of these links along with a summary of the survey results for each link.

Table 3.1 Traffic Management Integration

Link	From/To	Description	Survey Response
2	Traffic Signal Control to Freeway Management	Freeway Management Center monitors arterial travel times, speeds, and conditions using data provided from Traffic Signal Control to adjust ramp meter timing, lane control or HAR in response to changes in real-time conditions on a parallel arterial.	Traffic condition information is collected for 5,168 arterial miles. Information on 475 miles (9%) of this total is transferred to Freeway Management. A total of 51% of the information transferred is used to adjust ramp meter timing or lane control, or disseminated to travelers through VMS, HAR or IVS. The Indicator is the average of the two: 30%.
4	Traffic Signal Control to Incident Management	Incident Management monitors real-time arterial travel times, speeds, and conditions using data provided from Traffic Signal Control to detect arterial incidents and manage incident response activities.	Traffic information is collected for 5,168 arterial miles. Information collected on 321 miles (6%) is transferred to Incident Management. Of the arterial miles under Incident Management, 6% of this information is used to detect arterial incidents. The Indicator is the average of the two: 6%.
5	Incident Management to Traffic Signal Control	Traffic Signal Control monitors incident severity, location, and type information collected by Incident Management to adjust traffic signal timing or provide information to travelers in response to incident management activities.	There are 9,911 freeway plus arterial miles under a formal incident management program. Information for 1,799 miles (18%) of the total describing incident severity, location and type is transferred to Traffic Signal Control. A total of 5% of this information is used to adjust traffic signal timing in near real-time. The Indicator is the average of the two: 11%.

Link	From/To	Description	Survey Response
8	Incident Management to Freeway Management	Incident severity, location, and type data collected by Incident Management are monitored by Freeway Management for the purpose of adjusting ramp meter timing, lane control or HAR messages in response to freeway or arterial incidents.	There are 9,911 freeway plus arterial miles under a formal incident management program. Information for 4,273 miles (43%) of the total describing incident severity, location, and type is transferred to Freeway Management. A total of 12% of this information is used to adjust ramp meter timing or lane control, or display to travelers through VMS, HAR or IVS. The Indicator is the average of the two: 27%.
11	Freeway Management to Traffic Signal Control	Freeway travel time, speeds, and conditions data collected by Freeway Management are used by Traffic Signal Control to adjust arterial traffic signal timing or arterial VMS messages in response to changing freeway conditions.	Traffic condition information is collected for 2,789 freeway miles. A total of 342 miles (12%) is transferred to Traffic Signal Control. Of the traffic signals that receive this information, 22% use it to adjust traffic signal timing. The Indicator is the average of the two: 17%.
13	Freeway Management to Incident Management	Incident Management monitors freeway travel time, speed, and condition data collected by Freeway Management to detect incidents or manage incident response.	Traffic condition information is collected for 2,789 freeway miles. A total of 1,580 miles (57%) is transferred to Incident Management. Of the miles of freeway under Incident Management, 16% use this information to detect or otherwise help manage incidents. The Indicator is the average of the two: 37%.

Link	From/To	Description	Survey Response
15b	Transit Management to Freeway Management (transit vehicles equipped as probes)	Transit vehicles equipped as probes are monitored by Freeway Management to determine freeway travel speeds or travel times.	Of the 34,706 transit vehicles, 2,200 are equipped as freeway probes (6%). None of the information collected by these probe vehicles is used to adjust ramp meter timing or lane control or displayed to travelers through VMS, HAR or IVS. The Indicator is the average of the two: 3%.
16b	Transit Management to Traffic Signal Control (transit vehicles equipped as probes)	Transit vehicles equipped as probes are monitored by Traffic Signal Control to determine arterial speeds or travel times.	Of the 34,706 transit vehicles, 800 are equipped as arterial probes (2%). A total of 1% of the traffic signals have their signal timing adjusted in near real-time based on information collected by these probes. The Indicator is the average of the two: 1%.
17	Electronic Toll Collection to Freeway Management (ETC equipped vehicles as probes)	Vehicles equipped with electronic toll collection (ETC) tags are monitored by Freeway Management to determine freeway travel speeds or travel times.	Traffic condition information is collected for 2,789 freeway miles. A total of 23 miles is monitored with vehicle probes equipped using ETC-issued tags (1%). A total of 0% of the information collected is used to adjust ramp meter timing or lane control or displayed to travelers through VMS, HAR or IVS. The Indicator is the average of the two: 1%
18	Electronic Toll Collection to Traffic Signal Control (ETC equipped vehicles as probes)	Vehicles equipped with electronic toll collection (ETC) tags are monitored by Traffic Signal Control to determine arterial travel speeds or travel times.	There are 2510 arterial miles covered by probe readers over which travel times are developed. 10 arterial miles are monitored with vehicle probes using ETC-issued tags (0.4%). Zero traffic signal control agencies use this data to adjust signal timing. The Indicator is the average of the two: 0.2%.

Link	From/To	Description	Survey Response
21a	Emergency Management to Incident Management (Incident location, severity and type)	Incident Management is notified of incident location, severity and type by Emergency Management to identify incidents on freeways or arterials.	A total of 10% of emergency response agencies participate in a formal incident management program and report incident severity, location and type data to Incident Management.
21b	Emergency Management to Incident Management (Incident clearance activities)	Incident Management is notified of incident clearance activities by Emergency Management to manage incident response on freeways or arterials.	A total of 12% of emergency response agencies participate in a formal incident management program and report incident clearance activities to Incident Management.
23	Highway-rail intersection to Incident Management	Incident Management is notified of crossing blockages by Highway-rail intersection to manage incident response.	A total of 6 out of 9,717 (0.06%) highway-rail intersections are under electronic surveillance to determine the presence of an incident blocking the crossing.
24	Highway-rail intersections to Traffic Signal Control	Highway-rail intersection and Traffic Signal Control are interconnected for the purpose of adjusting traffic signal timing in response to train crossing.	A total of 1,438 out of 1,792 (80%) traffic signals within 200 feet of a highway-rail intersection have the capability of adjusting their signal timing response to a train crossing.
25	Incident Management intra-component	Agencies participating in formal working agreements or incident management plans coordinate incident detection, verification, and response.	There are 21% of all local police, fire, and EMS agencies participating in a formal incident management plan/team.

Link	From/To	Description	Survey Response
26	Traffic Signal Control intra-component	Agencies operating traffic signals along common corridors sharing information and possibly control of traffic signals to maintain progression on arterial routes.	Of 350 agencies responsible for traffic signals, 146 (41%) are under cooperative agreement to share traffic signal timing for coordinated response.
28	Electronic Toll Collection intra-component	Electronic Toll Collection agencies share a common toll tag for the purpose of facilitating "seam less" toll transactions.	Nationwide, 11 out of 58 toll operators (19%) report that they use a common toll tag technology with other operators within the same metropolitan area.

Traveler Information Integration

The collection, processing, and distribution of timely information related to the performance of the transportation system is a byproduct of integrating selected metropolitan ITS components. Information gathered by Freeway Management, Incident Management, Traffic Signal Control, and Transit Management components is fused to create a region-wide traveler information database. Information in the database is then transferred to various media for display to travelers. Travelers receiving this information can make better informed decisions regarding if, when, where, and how to travel which may lead to an increase in travel efficiency and a reduction in travel congestion and delay. Figure 3.3 presents an overview of the integration links that define traveler information integration.

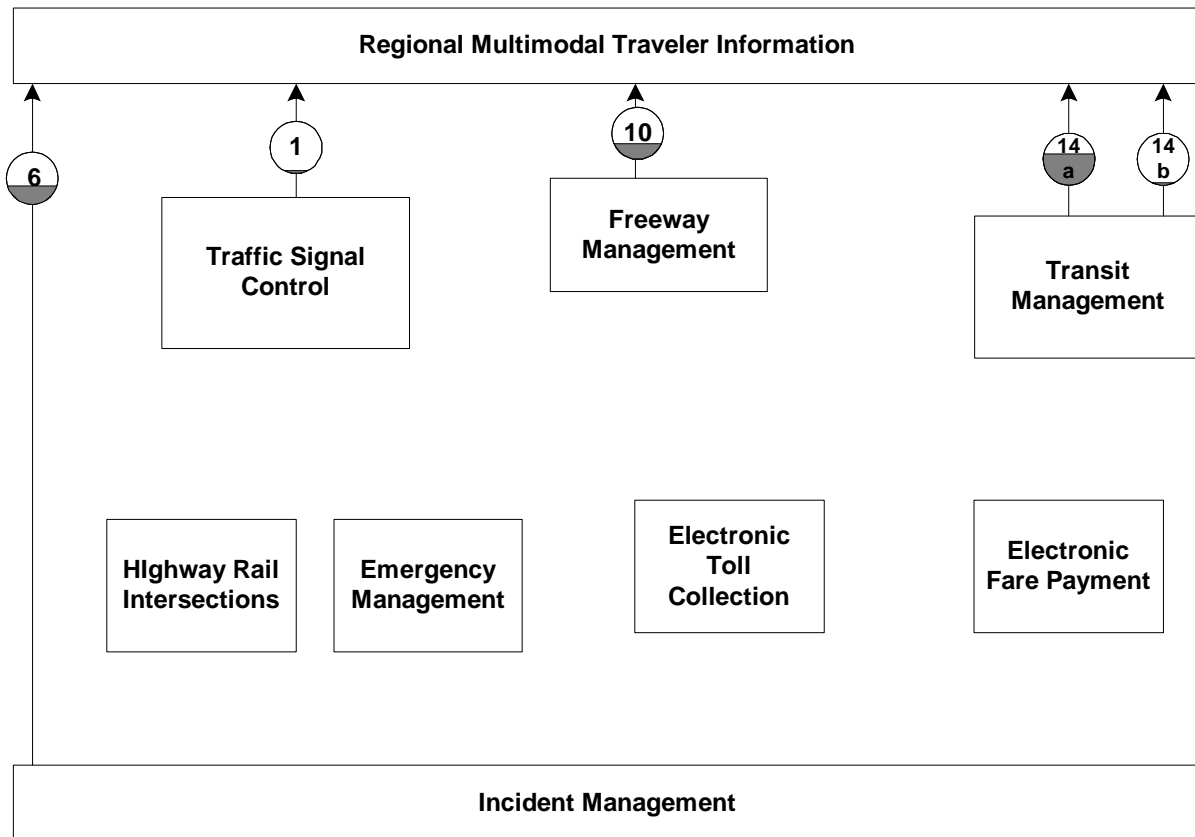

Figure 3.3 Traveler Information Integration

Table 3.2 presents a description of each of these links along with a summary of the survey results for each link.

Table 3.2 Traveler Information Integration Links

Link	From/To	Description	Survey Response
1	Traffic Signal Control to Regional Multimodal Traveler Information	Arterial travel time, speed and condition information are displayed by Regional Multimodal Traveler Information media.	Traffic condition information is collected for 5,168 arterial miles. A total of 192 miles (4%) of this total is transferred to Regional Multimodal Traveler Information for dissemination to travelers.
6	Incident Management to Regional Multimodal Traveler Information	Incident location, severity and type information are displayed by Regional Multimodal Traveler Information media.	There are 9,911 freeway plus arterial miles under a formal incident management program. Information describing incident severity, location, and type for a total of 3,288 miles (33%) of this total is transferred to Regional Multimodal Traveler Information for dissemination to travelers.
10	Freeway Management to Regional Multimodal Traveler Information	Freeway travel time, speed and condition information are displayed by Regional Multimodal Traveler Information media.	Traffic condition information is collected 2,789 freeway miles. A total of 848 miles (30%) is transferred to Regional Multimodal Traveler Information for dissemination to travelers.
14a	Transit Management to Regional Multimodal Traveler Information (transit routes, schedules, and fares)	Transit routes, schedules, and fare information are displayed on Regional Multimodal Traveler Information media.	Information describing transit routes, schedules, and fares for 34,726 out of 57,373 transit route miles (61%) is transferred to Regional Multimodal Traveler Information for dissemination to travelers.

Link	From/To	Description	Survey Response
14b	Transit Management to Regional Multimodal Traveler Information (schedule adherence)	Transit schedule adherence information is displayed on Regional Multimodal Traveler Information media.	Information describing schedule/route adherence for 4,191 out of 57,373 transit route miles (7%) is transferred to Regional Multimodal Traveler Information for dissemination to travelers.

Transit Management Integration

Transit management integration provides public transit operators with information and control capabilities to better manage transit system on-time performance. Transit management integration also exploits the use of electronic fare payment media to improve the efficiency of route planning and financial management. Figure 3.4 presents an overview of the integration links that define transit management integration.

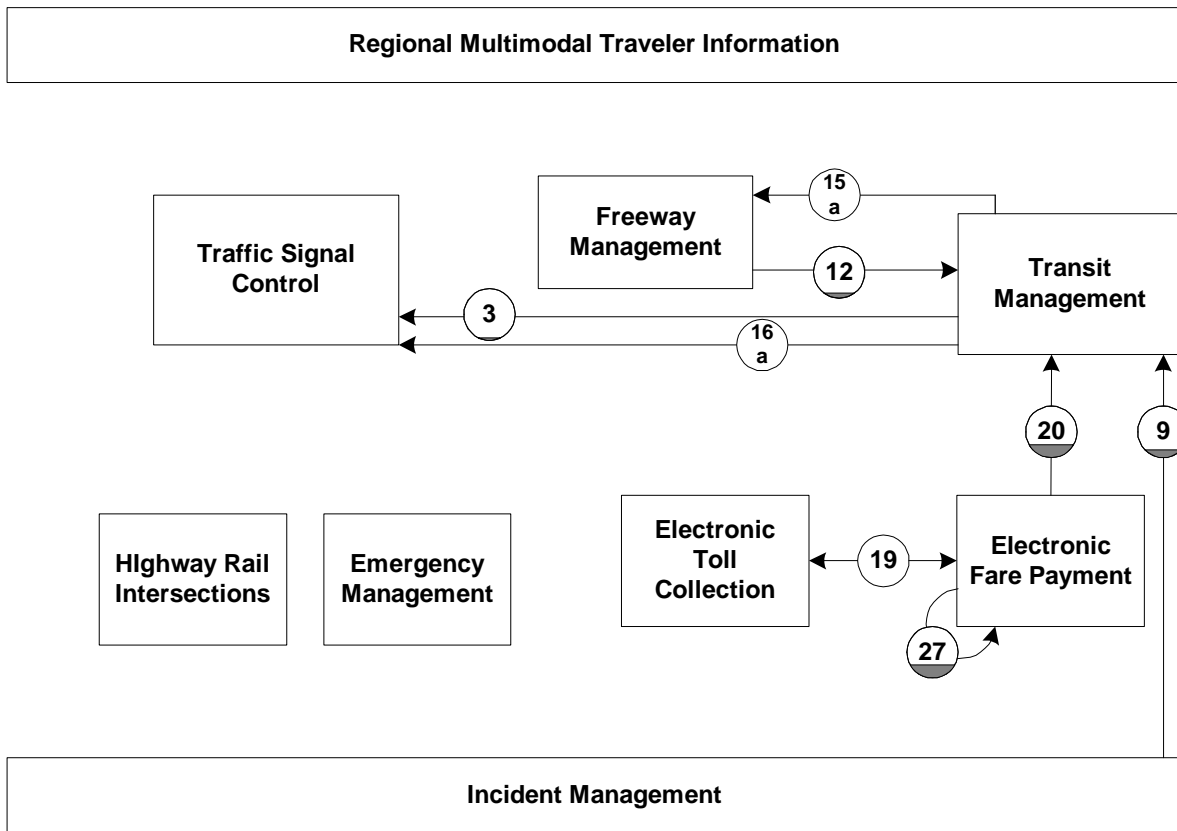

Figure 3.4 Transit Management Integration Links

Table 3.3 presents a description of each of these links along with a summary of the survey results for each link.

Table 3.3 Transit Management Integration Links

Link	From/To	Description	Survey Response
3	Traffic Signal Control to Transit Management	Transit Management adjusts transit routes and schedules in response to arterial travel times, speeds, and conditions information collected as part of Traffic Signal Control.	Traffic condition information is collected for 5,168 arterial miles. A total of 201 miles (4%) is transferred to Transit Management. A total of 0% of this information is used to adjust transit routing or scheduling. The Indicator is the average of the two: 2%.
9	Incident Management to Transit Management	Transit Management adjusts transit routes and schedules in response to incident severity, location, and type data collected as part of Incident Management.	There are 9,911 freeway plus arterial miles under a formal incident management program. Information for 442 miles (4%) of the total describing incident severity, location, and type is transferred to Transit Management. A total of 28% of the data transferred is used to adjust transit scheduling and routing. The Indicator is the average of the two: 16%.
12	Freeway Management to Transit Management	Transit Management adjusts transit routes and schedules in response to freeway travel times, speeds, and conditions information collected as part of Freeway Management.	Traffic condition information is collected for 2,789 freeway miles. A total of 246 miles (9%) is transferred to Transit Management. Of the information that is transferred, 11% is used by Transit Management to adjust vehicle routing or scheduling. The Indicator is the average of the two: 10%.

Link	From/To	Description	Survey Response
15a	Transit Management to Freeway Management (ramp meter priority)	Freeway ramp meters are adjusted in response to receipt of transit vehicle priority signal.	Of the 34,706 transit vehicles, none are equipped with ramp meter priority capability (0%). A total of 508 out of 25,242 ramp meters (2%) have signal priority capability for transit. The Indicator is the average of the two: 1%.
16a	Transit Management to Traffic Signal Control (traffic signal priority)	Traffic signals are adjusted in response to receipt of transit vehicle priority signal.	Of the 34,706 transit vehicles, 127 (0.4%) are equipped with traffic signal priority capability. A total of 675 out of 108,837 traffic signals (1%) have traffic signal priority capability for transit. The Indicator is the average of the two: 1%.
19	Electronic Toll Collection to Electronic Fare Payment	Transit operators accept ETC-issued tags to pay for transit fares.	None of the 261 transit and toll operators with a common electronic fare media.
20	Electronic Fare Payment to Transit Management	Rider ship details collected as part of Electronic Fare Payment are used in transit service planning by Transit Management.	A total of 871,302 out of 3,186,847 (27%) of the transit fares paid electronically are used in transit service planning.
27	Electronic Fare Payment intra-component	Operators of different public transit services share common electronic fare payment media.	Of 202 transit operators, 32 (16%) have a common fare media that can be used on more than one transit service (within that transit operator or with another transit operator).

Emergency Response Integration

Emergency Management integration increases emergency response capabilities through improved incident notification from Incident Management and traffic signal pre-emption provided by Traffic Signal Control. Figure 3.5 presents an overview of the integration links that define emergency response integration.

Table 3.4 presents a description of each of these links along with a summary of the survey results for each link.

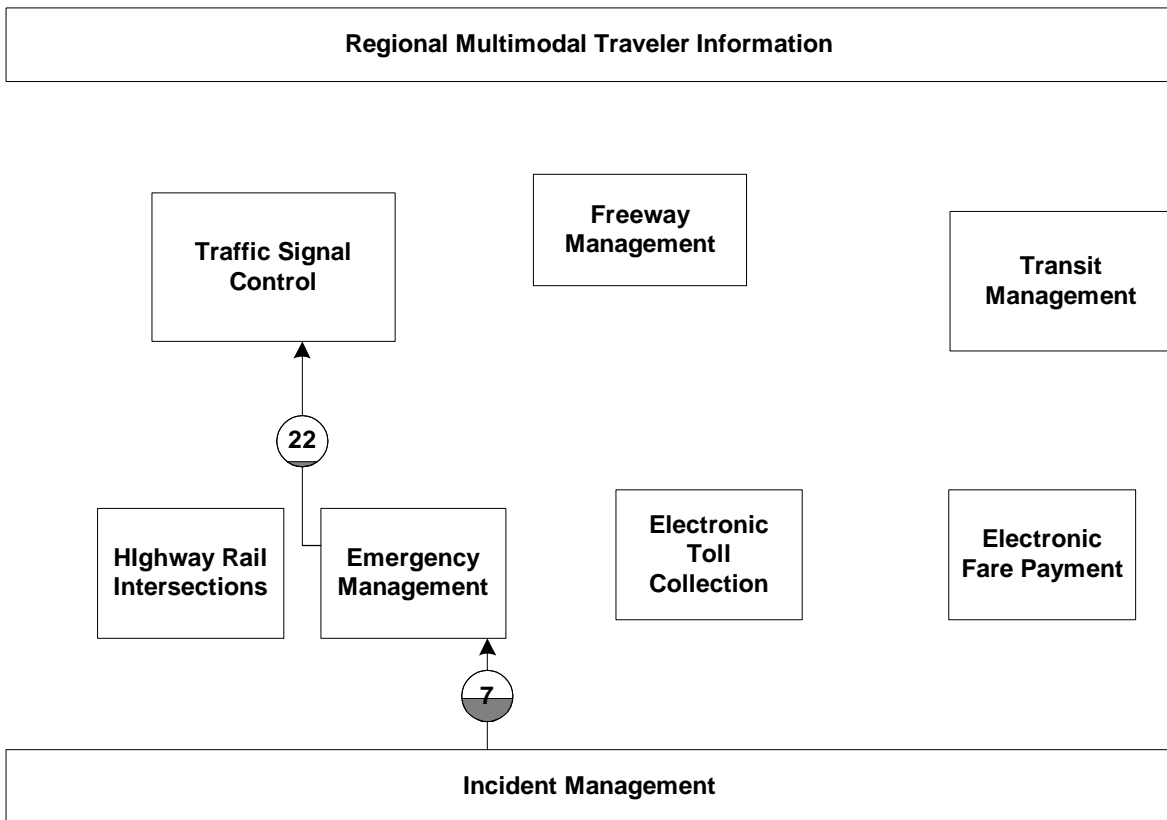

Figure 3.5 Emergency Management Integration

Table 3.4 Emergency Management Integration Links

Link	From/To	Description	Survey Response
7	Incident Management to Emergency Management	Incident severity, location and type data collected as part of Incident Management are used to notify Emergency Management for incident response.	There are 9,911 freeway and arterial miles under a formal incident management program. Information for 4,418 miles of the total (45%) describing incident severity, location, and type is transferred to Emergency Management.
22	Emergency Management to Traffic Signal Control	Emergency Management vehicles are equipped with traffic signal priority capability.	Of the 111,209 emergency response vehicles, 3,697 are equipped with traffic signal preemption capability (3%). A total of 13,727 out of 109,273 traffic signals are equipped to permit traffic signal preemption by emergency vehicles (13%). The Indicator is the average of the two: 8%.

IV - CONCLUSIONS AND NEXT STEPS

Methodology

The deployment indicators appear to be successful in providing a quick and intuitive picture of the state of deployment. The definitions, drawn to provide essential functions for which countable indicators could be developed, have been widely reviewed and commented on and appear to work well in practice. Deployment indicators, while necessarily limited in level of detail concerning the richness of the extent of deployment, appear to provide a clear picture of what is going on. This is particularly true in the ability of the indicators to display relative differences between the level of deployment of related indicators and sub-indicators. This methodology will also be capable of displaying changes over time in a simple and clear manner.

Response to the surveys has generally been positive as a result of widespread coordination with FHWA and FTA headquarters and field staff. In addition, the data gathering has been characterized by extensive direct contact with responders, including initial and follow-up phone calls to explain the purpose of the surveys and to address any questions concerning the data being requested. Nevertheless, several concerns have been consistently expressed by various stakeholders that need to be acknowledged:

Use of the data as a report card. Although deployment tracking is not intended in any way to be used in the process of allocating federal funds, many responders have expressed this concern. Carried to an extreme, this fear could lead to either overstatement or understatement of deployment progress, depending on the perception concerning how the 'report card' would be used. The actual use of the data will become clear over time and this perception should change. Another aspect of the report card concern is the concern that in some cases the indicators give a false impression of the level of ITS activity. This is due to the fact that the indicators display only what has been deployed as of the time of the survey and do not account for any progress short of actual deployment. Several metropolitan areas with strong ITS programs that have advanced significantly in planning for deployment were concerned that this critical background work is not taken into account in the methodology. An answer to this concern which is under consideration is to develop a standard method for reporting planning for deployment that can be consistently applied to all metropolitan areas.

Boundary definition. The deployment opportunity used in the component indicators is based on the metropolitan planning area boundary. This was done to provide a consistent and repeatable measure and to provide a context for monitoring deployment progress as metropolitan areas experience growth. Some responders have pointed out that this may include roadways that are yet to be developed or rural areas that will not receive ITS treatment. Stakeholders suggest that a much smaller boundary area should be used that includes primarily the urbanized portions of a metropolitan region. The eventual solution to this problem will be the development of the 'should' case in which indicators will be measured against the portion of the roadway targeted for ITS deployment based on local conditions and need.

Averaging of sub-indicators. Summary indicators are useful in providing a single set of aggregated results to portray the level of ITS deployment. Currently, summary indicators are simple averages of sub-indicators for each component. This was done because of the absence of established norms for ranking the relative importance of the various sub-indicators. Responders have pointed out that this may create a distorted view of the actual state of deployment by giving equal weight to sub-indicators that are not necessarily equally important. Until a generally accepted weighting scheme for the sub-indicators can be developed, the most accurate picture of the state of deployment of individual components is that provided by the portrayal of all sub-indicators, rather than the summary indicators.

A more detailed description of the methodology including copies of the surveys and an explanation of how individual indicators are calculated is included in the report, "Measuring ITS Deployment and Integration," which is available for download at the ITS Electronic Library at: <http://www.its.dot.gov/cyberdocs/welcome.htm>. Search for document number 4372. If you are not familiar with the ITS Electronic Library please read appendix A.

Results

In reviewing the relative level of deployment of sub-indicators, it is apparent that so far, deployment in many cases does not reflect a coordinated regional focus. Levels of deployment sub-indicators that would be expected to be coordinated, such as incident management detection, verification, and clearance, show widely different levels. This reflects the early state of deployment, but may also be an indication of the need for consideration of deployment within the context of a regional architecture.

A further indicator of a lack of a regional focus is the fact that integration lags behind component deployment. This is particularly true for shared control, which would be expected to be part of a regionally integrated transportation system.

Next Steps

An update of the data will be conducted in FY99 to identify deployment progress. It is anticipated that the results of this new initiative will yield comparison data for use in program management.

References

“Building the ITI: Putting the National Architecture into Action,” Federal Highway Administration, FHWA-JPO-96-011, April 1996. (ITS Electronic Document Library document number 415).

“Measuring ITS Deployment and Integration,” Oak Ridge National Laboratory, August 1998 (ITS Electronic Document Library document number 4372).

“Intelligent Transportation Systems: The National Architecture, A Framework for Integrated Transportation into the 21st Century” (Publication Number: FHWA-JPO-96-012) (ITS Electronic Document Library document number 4847).

United States Department of Transportation. “Highway Performance Monitor Guide Field Manual,” Federal Highway Administration, August 1993.

“1990 Census of Population and Housing”, U.S. Department of Commerce, U.S. Bureau of The Census, 1993.

U.S. DOT/Federal Transit Administration(FTA). “National Transit Database,” Federal Transit Administration, Washington, 1995.

APPENDIX A. INSTRUCTIONS FOR DOWNLOADING DOCUMENTS FROM THE ITS ELECTRONIC DOCUMENT LIBRARY

The ITS Electronic Document Library (ITS EDL) is an on-line web accessible library of ITS technical reports and other documents published by the U.S. Department of Transportation. To obtain a copy of the documents contained in the ITS EDL, complete the following steps:

1. Access ITS EDL Web Page at: <http://www.its.fhwa.dot.gov/cyberdocs/welcome.htm>

Note: You must have the Adobe Acrobat Reader installed to read documents in the ITS EDL. If you do not, select **Download** under the “Get Acrobat Reader” icon and follow instructions to download a copy of the reader software.

2. If you are a first time user, select: **First Time User** and follow instructions.
3. If you are not a first time user, select: **Library**.
4. Select: **EDL**.
5. Select: **Guest**.
6. Select: **Search**.
7. Enter the document number, 5883, in the space provided following, **Document Number**.
8. Select: **Search**.
9. To view the document, click on the document name link.

Depending on the browser version and the user’s configuration, the Adobe Acrobat Reader plug-in will either automatically launch and open the file, or prompt the user to “Open” or “Save” the file.

To access an electronic version of this publication
and other ITS related publications visit the

ITS Electronic Document Library (EDL):
<http://www.its.fhwa.dot.gov/cyberdocs/welcome.htm>

Document Number: 5883

Visit Our ITS WEB site
ITS Joint Program Office: <http://www.its.dot.gov>

Publication NO. FHWA-JPO-99-001
HVH-1/9-98