

PPPL Highlights for FY2003

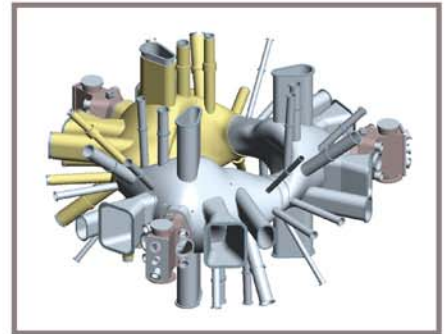
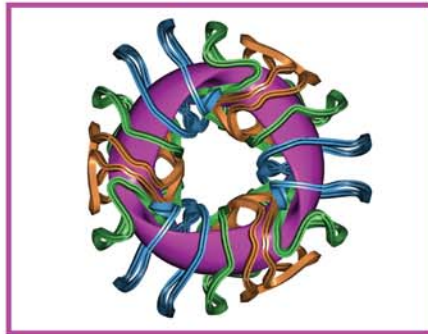
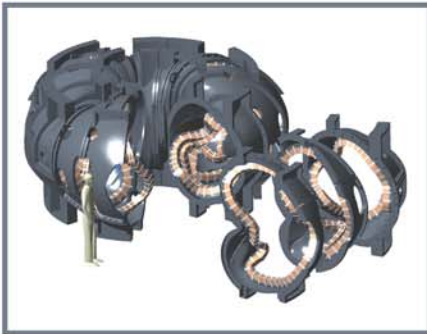
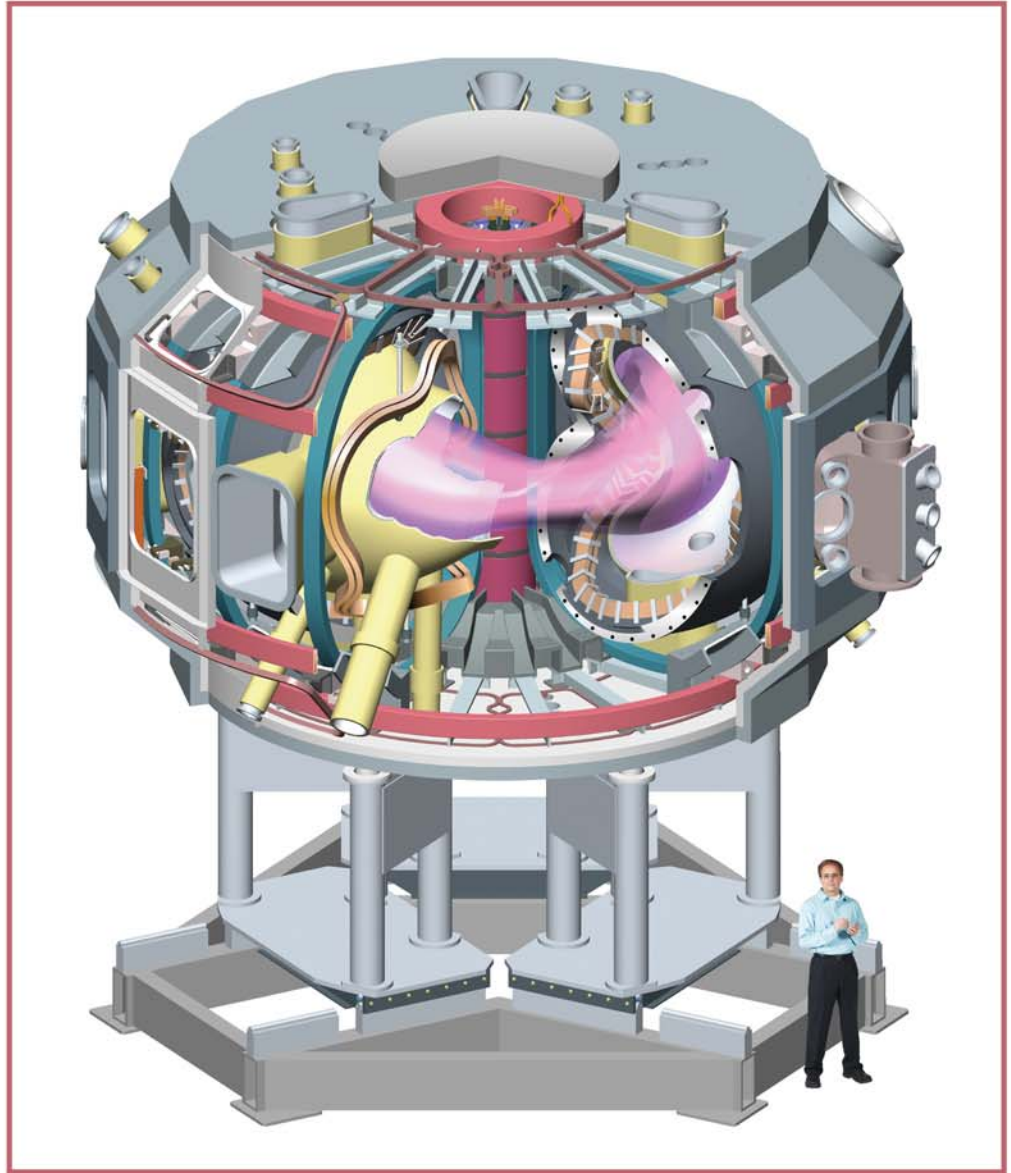
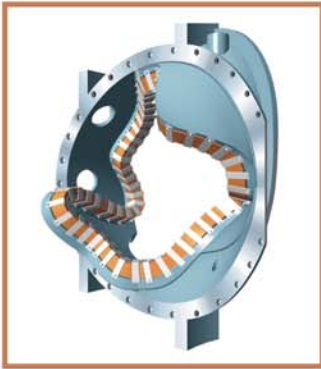
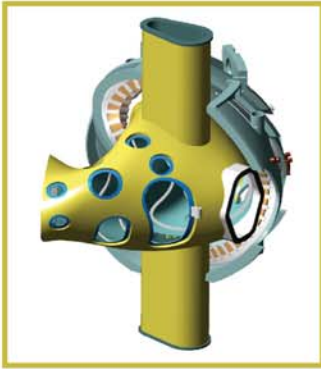

About PPPL

Established in 1951, the Princeton Plasma Physics Laboratory (PPPL) is dedicated to developing the scientific and technological knowledge base for fusion energy as a safe, economical, and environmentally attractive energy source for the world's long-term energy requirements. It was the site of the Tokamak Fusion Test Reactor which completed a historic series of experiments using deuterium-tritium fuel in April 1997. A new innovative facility, the National Spherical Torus Experiment, came into operation in 1999, ahead of schedule and on budget.

Princeton University manages PPPL under contract with the U.S. Department of Energy. The fiscal year 2003 budget was approximately \$66.5 million. The number of full-time regular employees at the end of the fiscal year was 420, not including approximately 30 subcontractors and limited duration employees, 35 graduate students, and visiting research staff. The Laboratory is sited on 88 acres of Princeton University's James Forrestal Campus, about four miles from the main campus.

Through its efforts to build and operate magnetic fusion devices, PPPL has gained extensive capabilities in a host of disciplines including advanced computational simulations, vacuum technology, mechanics, materials science, electronics, computer technology, and high-voltage power systems. In addition, PPPL scientists and engineers are applying knowledge gained in fusion research to other theoretical and experimental areas including the development of plasma thrusters and propagation of intense beams of ions. The Laboratory's Office of Technology Transfer assists industry, other universities, and state and local government in transferring these technologies to the commercial sector.

The Laboratory's graduate education and science education programs provide educational opportunities for students and teachers from elementary school through postgraduate studies.

On The Cover

A new experimental device, the National Compact Stellarator Experiment (NCSX), is being constructed at the Princeton Plasma Physics Laboratory in partnership with the Oak Ridge National Laboratory. NCSX is the centerpiece of a national program to develop the compact-stellarator plasma-confinement concept. During fiscal year 2003, the NCSX fabrication project officially started. Good progress on its design permitted the project to advance from conceptual design to a level of maturity sufficient to establish the cost and schedule baseline for project execution.

A computer-generated cutaway rendition of NCSX is shown with individual key components. From the upper left are: one field-period subassembly, a modular coil subassembly, a toroidal-field coil subassembly, the modular coil assembly, an NCSX plasma and the modular coils, and the NCSX vacuum vessel assembly with thermal insulation.

This publication highlights activities at the Princeton Plasma Physics Laboratory for fiscal year 2003 — 1 October 2002 through 30 September 2003.

Mission

The U.S. Department of Energy's Princeton Plasma Physics Laboratory is a Collaborative National Center for plasma and fusion science. Its primary mission is to develop the scientific understanding and the key innovations which will lead to an attractive energy source.

Associated missions include conducting world-class research along the broad frontier of plasma science and technology, and providing the highest quality of scientific education.

Vision

Deepening the understanding of plasmas and creating key innovations to make fusion power a practical reality.

Advantages of Fusion Energy

- Worldwide availability of inexhaustible low-cost fuel.
- No chemical combustion products and therefore no contribution to acid rain or global warming.
- No runaway reaction possible.
- Materials and by-products unsuitable for weapons production.
- Radiological hazards thousands of times less than from fission.

Table of Contents

From the Director	vii
Research	
National Spherical Torus Experiment	1
Current Drive Experiment-Upgrade	15
Magnetic Reconnection Experiment	23
Theory and Advanced Simulations	31
Computational Plasma Physics	47
Off-site Research	57
Doublet-III-D Collaborations	57
Alcator C-Mod Collaborations	61
International Collaborations	67
Space Plasma Physics	73
Basic and Applied Physics Experiments	81
Hall Thruster Experiment	81
Magnetic Nozzle Experiment	83
FRC/RMF Experiment	85
Nonneutral Plasmas and High-intensity Accelerators	86
Diagnostic Development	91
Liquid Metal Experiment	94
Advanced Fusion Devices and Studies	
National Compact Stellarator Experiment	97
Fusion Ignition Research Experiment	105
Engineering and Technical Infrastructure	113
Environment, Safety, and Health	125
Applied Research and Technology Transfer	127
Patents and Invention Disclosures	137
Education	
Graduate Education	139
Science Education	143
Awards and Honors	149
The Year in Pictures	153
Financial Summary	157
Organization and Staffing	159
PPPL Advisory Council	161
Publications	163
Abbreviations, Acronyms, and Symbols	201

From the Director

On January 30, 2003, President Bush announced “that the United States will join ITER, an ambitious international research project to harness the promise of fusion energy. The results of ITER will advance the effort to produce clean, safe, renewable, and commercially available fusion energy by the middle of this century. Commercialization of fusion has the potential to dramatically improve America’s energy security while significantly reducing air pollution and emissions of greenhouse gases.”

On the same day, Secretary of Energy Spencer Abraham visited the Princeton Plasma Physics Laboratory (PPPL) and stated, “By the time our young children reach middle age, fusion may begin to deliver energy independence... and energy abundance... to all nations rich and poor. Fusion is a promise for the future we must not ignore. But let me be clear, our decision to join ITER in no way means a lesser role for the fusion programs we undertake here at home. It is imperative that we maintain and enhance our strong domestic research program — at Princeton, at the universities and at our other labs. Critical science needs to be done in the U.S., in parallel with ITER, to strengthen our competitive position in fusion technology.”

With this degree of support at the highest levels in the Administration, FY03 was a heady year for fusion research. At PPPL we continued to make important advances in both the experimental and theoretical research needed to create the future envisioned by our leaders.

The National Compact Stellarator Experiment passed three closely spaced major reviews, preparing it for the cost and schedule baseline of Critical Decision Two, early in F04. Theoretical analyses and new ex-



Robert J. Goldston

perimental results from PPPL collaboration at the W7-AS stellarator in Germany continue to indicate that this will be a very exciting experiment. The remarkable steadiness of stellarator plasmas in W7-AS, even at high beta, is very impressive.

Despite loss of eight experimental runweeks on the National Spherical Torus Experiment (NSTX), due to a coil joint failure, very good progress was made on bringing new capabilities on line, including an extremely high-resolution instrument for measuring plasma ion temperature and toroidal rotation, which will allow unprecedented detail in determining the effects of magnetic structures on rotating plasmas — and vice versa. Thermal confinement and fast-ion data also provided new insight into the physics of the spherical torus configuration. The NSTX underwent a very successful five-year plan review, outlining the NSTX scientific program, including both research goals and new facility capabilities that are needed to accomplish them.

Our off-site experimental research continued to make important advances. On DIII-D at General Atomics in California, we found the first indications of direct

feedback control of Resistive Wall Modes and, on Alcator C-MOD at the Massachusetts Institute of Technology, the Gas Puff Imaging technique that is also being applied to NSTX revealed new physics in the scrape-off layer. We have developed new understanding of fast-ion instabilities on the Joint European Torus (JET), and we have new diagnostic systems in preparation for JET's next deuterium-tritium phase of operations, to follow on from our own deuterium-tritium experience on the Tokamak Fusion Test Reactor.

On PPPL's smaller experiments, we have also made rapid progress. The Current Drive Experiment-Upgrade facility has shown very positive results from the use of a liquid lithium limiter, and will be modified now to test this approach more extensively as the Lithium Tokamak Experiment. The Magnetic Reconnection Experiment has had a breakthrough year. For the first time ever, anywhere, turbulence has been identified which may explain the source of the anomalous resistivity that allows rapid magnetic reconnection both in the laboratory and in space. The Paul Trap Simulator Experiment has demonstrated its potential for the study of intense ion beams by containing an intense single-species cesium plasma for more than 300 msec, the equivalent of 20 km of travel in an accelerator.

This has been a banner year for theory and computation at PPPL as well. Breakthrough understanding was achieved in the role of turbulence "spreading" to explain the transition between Bohm (unfavorable) and gyro-Bohm (favorable) confinement scaling, as plasma systems get larger in the most powerful simulations. New advances were made in understanding MHD stability, particularly in the presence of fast ions. For example, the connection between the Global and Compression Alfvén Eigenmode instabilities was elucidated on NSTX. Another dramatic

advance was achieved: a definitive set of hybrid fluid-kinetic calculations explains the dynamics of the Field-reversed Configuration at large gyro-radius, including both the anomalous stabilization of the $n = 1$ tilt mode and the consequent destabilization of the rotational $m = 2$ mode, just as seen in experiments.

Continuing efforts to apply the latest computational techniques to fusion simulations have paid off, for example with the application of Adaptive Mesh Refinement techniques to the large M3D code. A substantial computer cluster was brought on line to test the cluster approach to providing the fusion community with capacity computing. It has supported nonlinear turbulence calculations in strong support of our off-site research efforts. We have also made the mature PPPL TRANSP data analysis code available to the international magnetic fusion research community, through the Fusion Collaboratory. Of 1,662 TRANSP code runs accomplished at PPPL in FY03, 717 were in support of NSTX and the rest supported experiments around the world. The Collaboratory environment and the National Transport Code Collaboration Modules Library are providing models for future national and international collaboration in computational plasma physics.

All of the exciting results discussed here would not have been possible without the consistent support of our Engineering and Technical Infrastructure, as well as Environment, Safety, and Health teams. We are especially pleased at the successful redesign and manufacture of the NSTX toroidal-field central bundle and joints, which promises to support a full and exciting experimental run in FY04. We also continue to put the highest priority on safety at PPPL. With continued leadership support, as we had in FY03, we will need all hands on deck, healthy and energized, to accomplish our ambitious goals.

National Spherical Torus Experiment

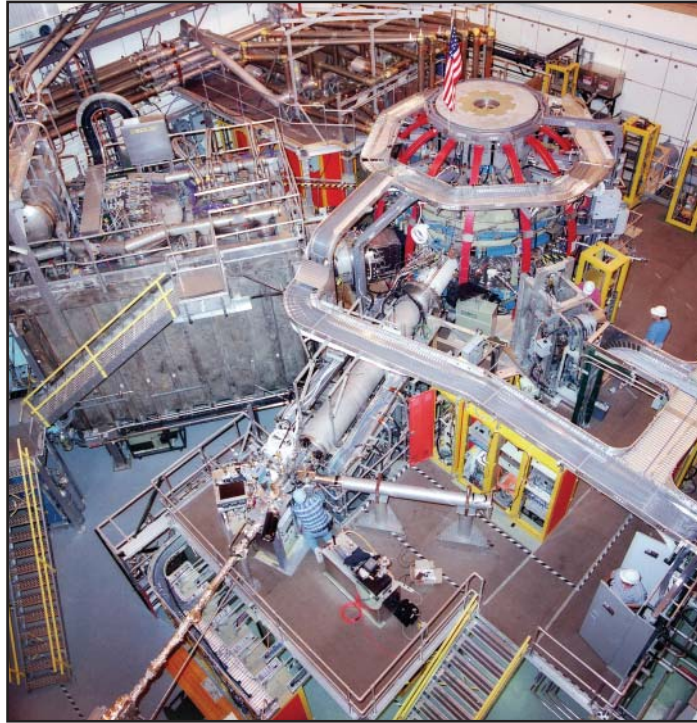

National Spherical Torus Experiment

With the National Spherical Torus Experiment (NSTX) poised to begin physics experiments in earnest after several weeks of discharge development and device and auxiliary heating systems conditioning, the experimental run was unexpectedly terminated due to a failure of the toroidal-field (TF) lower inner leg-to-flag joint. As depicted in Figure 1, the flag joint provides a removable connection between the inner and outer TF leg assemblies, which permits removal of the entire TF inner leg and center stack assembly for maintenance. The demountable TF assembly is one of the most challenging

engineering aspects of the spherical torus (ST) magnetic confinement configuration.

The failure occurred on February 14, 2003, following the morning test shots. Analysis of the event identified shortcomings in the structural design of the joint which led to failure after some 7,200 machine pulses, with a limited number at the full rating of 6 kG. As shown in Figure 2, the stiffness of the hub assembly was not adequate, and repeated application of the electromagnetic loads led to unanticipated loads in the bolts, and high local current density that eventually led to failure of the assembly.

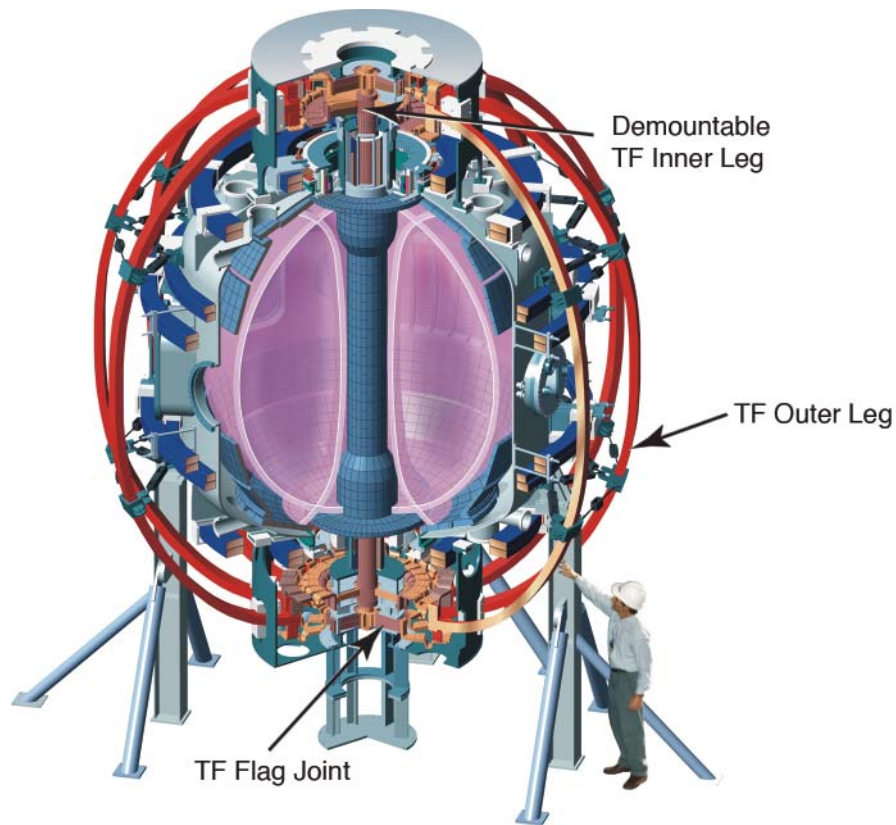

Figure 1. Isometric view of the NSTX showing demountable toroidal-field coil and toroidal-field flag joint.

Due to the extensive damage, it was not possible to recover the original TF inner leg assembly. Furthermore, it was clear that an improved design was needed. Therefore a recovery effort was initiated, beginning with the development of a new design. The new design (Figure 3) incorporates features that address all of the shortcomings of the original design, including the following:

- hub assembly stiffness is dramatically increased,
- flags are contained in steel boxes with injected epoxy filling the space between,
- flag fasteners are larger diameter and tightened to twice the force of the original,

- shear keys are added to resist the vertical electromagnetic force, and
- voltage probes are provided in-situ to measure the resistance of every joint.

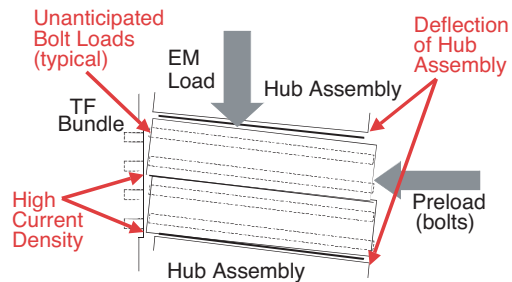

Figure 2. Repeated application of electromagnetic loads led to structural failure of lower toroidal-field flag joint.

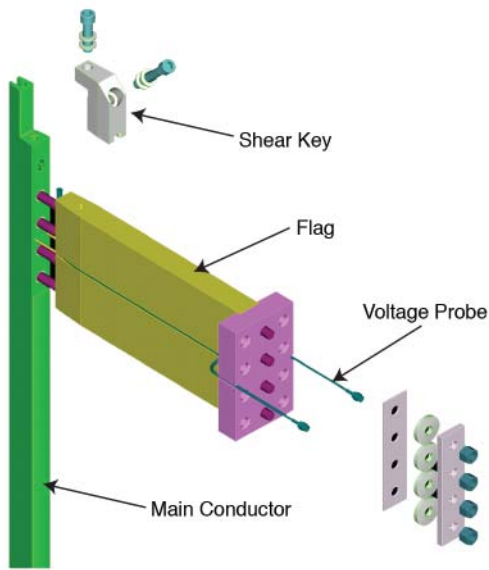

Figure 3. Isometric view of the new toroidal-field flag joint from a CAD model.

Extensive engineering resources were applied to the redesign effort to ensure a successful outcome while minimizing the time duration of the recovery period. Finite element analysis was performed to develop an understanding of the structural and thermal behavior of the joint and to guide the development of the new design. Two technical reviews were conducted by teams of magnet experts from other fusion laboratories. Tests were performed to characterize the electrical resistivity of the joint versus pressure, the friction coefficient of the joint, the pull-out strength of the fasteners, and other features. In addition, a mechanical prototype was exercised at the rated number of cycles of full mechanical loads at elevated temperature, and an electrical prototype was tested at full current for the full-time duration at full mechanical loads.

Based on the new design, the successful prototype testing, and the improved instrumentation that includes a new fiber-optic strain, temperature, and displacement monitoring system, reliable operation at full-rated parameters is ful-

ly anticipated. Although the failure was unfortunate, it has led to an improved understanding of the TF joint behavior which is directly applicable to the design of next-step ST devices.

Upgrades and Outage Maintenance Activities

Taking advantage of the longer outage schedule due to the TF repair, the NSTX engineering and research operations teams were able to perform a number of important upgrades and preventive maintenance tasks above and beyond what a normal outage would permit.

The outage enabled the neutral-beam-injection (NBI) team to repair the duct bellows which had developed intermittent leaks, particularly during bakeout. This repair will improve the effectiveness of bakeout cycles and speed the return to normal operation after major openings. The NBI team also utilized this opportunity to perform preventive maintenance on the main NBI torus isolation valve and a compressor in the helium refrigerator. The team also replaced the NSTX control room floor tiles to address safety issues. In addition to these tasks, the NBI team contributed strongly to the TF repair work as needed. The radio-frequency (rf) operations team has worked on the improvement and maintenance of the High-harmonic Fast-wave (HHFW) system.

During a normal machine outage, the diagnostic operations team typically performs about three weeks of post-run diagnostic calibrations. Because of the extended outage, the diagnostic team was able to perform more extensive calibrations, including detailed spatial and photometric calibrations of multipulse Thomson scattering, the newly installed 51-channel Charge-exchange Recombination Spectroscopy (CHERS),

and the edge rotation diagnostics. Using the vacuum-vessel bakeout system, the divertor infrared (IR) camera was calibrated for analyzing the heat loads on the divertor plasma-facing components (PFCs). Detailed measurements were made of the geometry of the resistive wall mode (RWM) detection coils and the sightlines of the neutral-particle analyzer. The frequency response of the Mirnov coils was also measured. A number of diagnostic improvements were made. The RWM sensor shielding was improved against radio-frequency pickup. The upper and lower secondary passive plate flux loops were repaired and improved in preparation for the higher elongation plasma expected in the FY04 run. Preparations for the future deployment of the poloidal CHERS diagnostic and a neutron collimator were also accelerated.

In the area of research facility upgrades, more extensive laboratory work was performed to characterize and optimize the multi-barrel lithium pellet injector and the supersonic gas injector to be ready for the FY04 run. To implement the recently discovered “transient coaxial helicity injection (CHI)” technique in collaboration with the Helicity Injected Torus (HIT-II) group at the University of Washington, Seattle, WA, a new capacitor bank power supply was designed and will be implemented in FY04. Finally, in preparation for the FY04 campaign to achieve higher plasma elongation, the time response of the NSTX real-time plasma control system was significantly improved by reducing the time delay by a factor of four.

The extended outage also allowed the implementation of a Peripheral Component Interconnect (PCI)-based timing system, fully compatible with the CAMAC-based system now in use on

NSTX. PCI digitizers and signal conditioning boards were also designed for use in this control system for an inexpensive data acquisition framework which does not depend on CAMAC.

Physics Research

During the shortened FY03 experimental campaign, plasma experiments were performed on 22 days with 488 successful plasma discharges. Two hundred and nine discharges were with NBI heating and 140 with radio-frequency heating. A total of eight NSTX experimental proposals and seven machine proposals received experimental run time. The facility rapidly returned to reliable plasma operation in FY03, as evidenced by the achievement of long-pulse double-null divertor discharges at high plasma current (1 MA, 0.35 s flattop duration). Despite the shortened run, a number of key tasks were accomplished in addition to making several important experimental observations. Furthermore, the prolonged outage gave researchers the opportunity to analyze and understand the previous years’ data more fully.

Considerable progress towards facilitating more finely tuned plasma equilibrium control was made through commissioning of the real-time EFIT (rtEFIT) code. Good agreement was obtained between the plasma equilibrium determined by the rtEFIT code and the more sophisticated implementation of EFIT run on a more extensive set of input data between discharges. Double-null divertor discharges were developed with all the poloidal-field currents controlled in real-time to match a preprogrammed shape for the plasma boundary. This work helped pave the way for developing other plasma shapes and the more sophisticated forms of control needed to reach the project’s experimental goals.

In the area of noninductive plasma start-up, the capability for CHI was re-established with the new absorber insulator that had been installed in the preceding outage. Using the prescription developed in earlier experiments, toroidal currents up to 150 kA were produced in discharges lasting up to 150 ms. A new “transient CHI” technique, developed on the HIT-II device, was tested for the first time in NSTX. Short pulses of CHI were obtained on some discharges, and improvements needed to the control of the CHI power supply were identified.

Following the modifications to the radio-frequency power feed-throughs of the NSTX antenna during the 2002 outage, the performance of the HHFW heating system improved markedly. Antenna voltages up to 15 kV were achieved compared to a limit of 12 kV in the previous experimental run. The highest HHFW power was 5.1 MW and there were 29 discharges with power above 3 MW. Good electron heating was observed, producing peak electron temperatures above 2.5 keV. With early application of the radio-frequency power, the temperature rise was slow, but the electron temperature profile then remained peaked for about 50 ms.

The HHFW current-drive experiments were carried out at $k_{\parallel} = 7.6 \text{ m}^{-1}$, and the results of co-versus-counter antenna-phasing comparisons indicated loop voltage differences of approximately 200 to 300 mV lasting for 200 ms. Modeling of these experiments indicated that an radio-frequency-driven current difference (co-versus-counter) of $\sim 100 \text{ kA}$ was consistent with this voltage difference, demonstrating the ability of the radio-frequency to drive sustained current. Future experiments will focus on developing the means to increase the amount of driven current.

Fascinating behavior in the plasma edge was observed during HHFW heating by a new diagnostic, the Edge Rotation Diagnostic (ERD), which simultaneously measures the poloidal and toroidal rotation, temperature, and density of both C^{2+} and He^{+1} ions at the plasma edge. The diagnostic uncovered an unsuspected coupling between the launched radio-frequency waves and the edge ions. A hot ($\sim 0.5 \text{ keV}$), poloidally rotating (50 km/s) component of the majority helium ions was seen to develop over a period of about 300 ms during HHFW heating (Figure 4), but then decayed rapidly over 30 ms after the HHFW was switched off. The temperature of the hot component was higher when viewed poloidally than toroidally. It is believed that parametric decay of the HHFW wave was responsible for the heating, and tests to verify this hypothesis are planned for the FY04 experimental campaign.

During the FY02 outage, a repositioning of the poloidal-field coil that provides the vertical field eliminated an error field caused by this coil. This error field had given rise to mode-locking that severely impacted plasma performance. The reduction of the error field reduced dra-

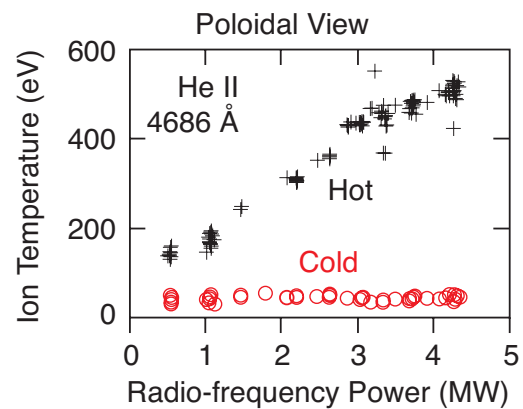

Figure 4. The hot and cold temperature components of HeII measured at the plasma edge by the Edge Rotation Diagnostic.

matically, but did not eliminate entirely, the mode-locking, and the dynamics of these MHD modes were investigated. In ohmically heated plasmas, the locking of a rotating tearing mode was found to be very sensitive to plasma density. A decrease of the line-average density by less than 5% caused a mode, initially rotating in the counter-plasma-current direction, to lock and grow. When neutral-beam heating was added, the mode grew more rapidly and locked sooner, possibly because the accompanying beam torque opposed the intrinsic mode rotation.

The effect of MHD activity on the confinement of fast ions was studied under a variety of conditions using the Neutral Particle Analyzer (NPA) diagnostic. Rapid ion heating of the fast particles was observed in the NPA spectrum following reconnection events in NSTX. In ohmically heated plasmas, both deuterium (the majority ion) and hydrogen (a minority ion, 2-5%) neutral particles showed nearly Maxwellian tails with effective temperatures of 1-4 keV after a reconnection event, compared with a temperature typically 0.3 keV before the event. In neutral-beam-heated plasmas, the deuterium spectrum showed an effective tail temperature up to 8 keV following the reconnection event, and it is possible that a redistribution of unthermalized beam ions contributed to the apparent tail in this case. The NPA also observed accelerated MHD-induced energetic ion loss in NSTX high-confinement mode (H-mode) discharges. The magnitude of this loss decreased with increasing neutral-beam-injection energy, toroidal field, and tangency radius of the NPA sightline. Increasing each of these parameters reduced the fraction of trapped particles that is either present in the plasma or viewed by the NPA. The TRANSP code modeling suggests that

the high density and broad density profile characteristic of H-modes cause the loss through the following mechanism: the evolution of the current profile destabilizes pressure-driven low- n MHD activity (n is the toroidal mode number) while the beam deposition profile broadens to feed trapped ions into the region where they can be expelled by the MHD activity.

Theory and modeling advances have led to a better understanding of the equilibrium and stability properties of NSTX plasmas; of particular importance is the role of the observed rapid rotation. For instance, the large in-out asymmetry in the measured density profile is consistent with a simple MHD force balance that includes the measured rotational effects. Because of the importance of this rotation, the EFIT magnetic reconstruction code has been upgraded to include this measurement, as well as other plasma properties, as a constraint. Figure 5 shows the flux surfaces and pressure surfaces computed by this upgraded EFIT code; the effect of the rotation is seen in the shift of the pressure surfaces with respect to the flux surfaces. A complementary approach has been to develop the FLOW code in collaboration with the University of Rochester in New York, which also solves for the internal equilibrium using plasma, beam, and rotation profiles. While EFIT is a free-boundary solution, FLOW is fixed boundary.

NSTX has achieved high toroidal beta up to 35% and high normalized beta up to 6.5. Experiments have shown a modest increase of the achievable beta with triangularity (at constant elongation) over the range from $\delta = 0.4$ to 0.8. The highest toroidal beta discharges obtained at high normalized current are computed to be ideally unstable to $n = 1$ pressure-driven internal kink instabilities, and experi-

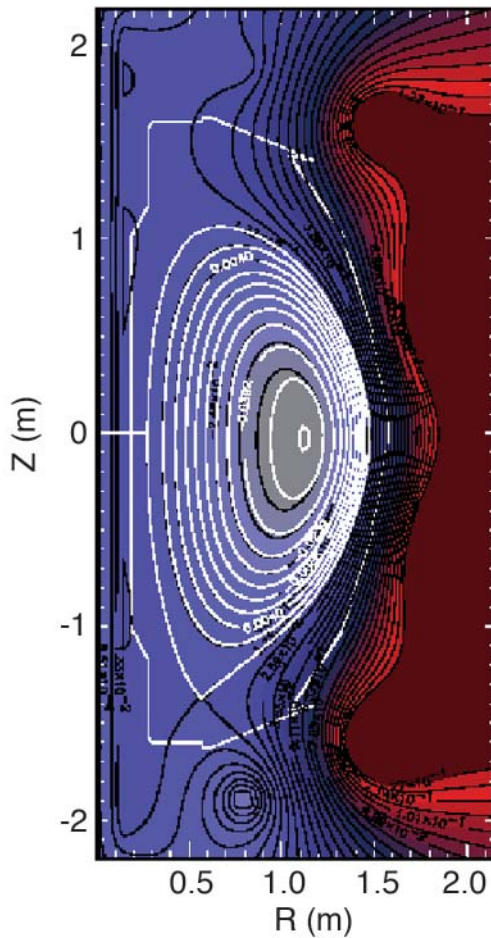

Figure 5. The EFIT code reconstruction of NSTX plasma showing the flux surfaces (black) and surfaces of constant pressure (white).

mentally the onset of $m/n = 1/1$ activity is observed near the computed instability threshold. However, these instabilities can saturate in amplitude for beta values well above the computed ideal no-wall limit. An important element in this saturation above the no-wall limit appears to be the high toroidal rotation and strong rotational shear in some plasmas with neutral-beam heating. The multi-level physics, massively-parallel simulation code M3D has been used to study these phenomena. Toroidal flow shear is calculated to reduce the linear growth rate of the internal kink by up to a factor of three. Simulations carried into the

nonlinear phase find that the flow profile typically flattens during the reconnection process, consistent with the measured evolution of the rotation profile from the charge-exchange recombination diagnostic. Rapid rotation, large initial rotational shear, and potentially reduced MHD linear growth rates in high-beta ST plasmas are all likely to contribute to the nonlinear saturation of core kink instabilities at beta values above the no-wall limit.

NSTX experiments revealed a rich variety of beam-driven Alfvén instabilities over a wide range of frequencies. In the sub-ion cyclotron frequency range (≤ 1 MHz), global Alfvén eigenmodes have been simulated using the HYM code. Results of these calculations show that the most unstable modes are at low-to-moderate toroidal mode number, and they can have a large compressional component near the edge. The M3D code was recently enhanced to handle generalized 3-D geometry. M3D was used to study toroidal Alfvén instabilities (~ 100 's kHz), and linear calculations showed that the dominant $n = 2$ mode frequency “chirps” down as it moves out radially (Figure 6), consistent with experimental observations. Initial nonlinear simulations with multiple modes show similar behavior.

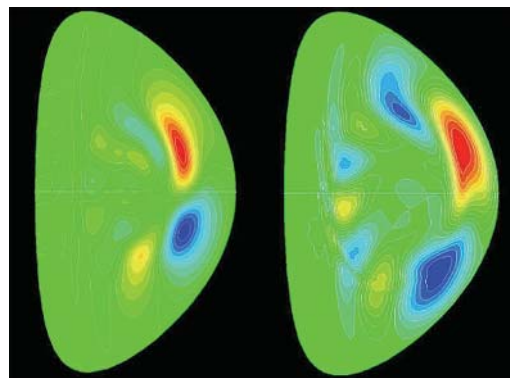

Figure 6. Linear (left) and nonlinear (right) mode structure of $n=2$ toroidal Alfvén eigenmode mode as computed by M3D code.

Significant progress has also been made in understanding the confinement and transport properties of NSTX plasmas. Local transport analysis, using the TRANSP code, has been performed on a large collection of both the low-confinement mode (L-mode) and H-mode discharges. Fast-ion stored energies and losses are calculated by TRANSP, and this allows the determination of thermal energy confinement times. These results are shown in Figure 7, where the thermal energy confinement time (τ_E) is plotted against the ITER H-mode scaling value. As can be seen, H-mode discharges on average have higher τ_E 's than L-modes, reaching values of approximately 30% over the scaling value.

Detailed studies were undertaken to determine the transport coefficients and their uncertainties for the electrons and the ions using the most up-to-date set of reduced data and physics assumptions. Uncertainties in the thermal diffusivities are generated by uncertainties in the data and their gradients as well as in the plasma equilibrium and data mappings. The results of this uncertainty analysis indicate a high level of confidence in the heat

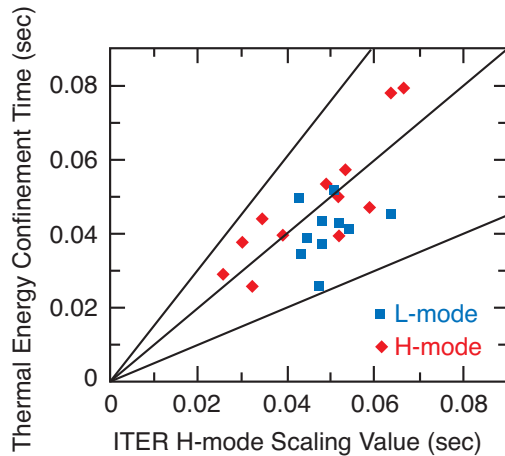

Figure 7. Experimental thermal energy confinement time plotted against the ITER scaling value for L-mode (blue) and H-mode (red) plasmas.

transport coefficients within the spatial region from $r/a = 0.2$ to 0.65 . Outside this region, however, large uncertainties make it difficult to draw any conclusions. Within the high confidence region, however, it is clear that electrons dominate the heat loss in NBI-heated discharges, with $\chi_i \ll \chi_e$ where χ_i and χ_e are the ion and electron thermal diffusivity time, respectively (see Figure 8). The ion thermal diffusivity is at or above the level predicted by neoclassical theory.

Uncertainties in the core and edge thermal transport coefficients will most likely be reduced using data from a new, 51-channel CHERS diagnostic, which was commissioned and took data during the abbreviated run. The data has been analyzed during the outage, taking into account the complex structure observed in the distribution of the background emission and including various atomic physics corrections that become significant in the plasma conditions of NSTX.

A regime of improved electron confinement, in which the core χ_e decreased several fold, was observed in low-density L-mode discharges with early neutral-beam injection. Analysis of the ultrasoft X-ray data, as well as TRANSP code calculations using magnetic diffusion, indicates the formation of a region of low or negative magnetic shear in the core of these discharges. At the same time as the reduction in electron transport, a significant increase is estimated in the ion thermal and particle transport. The energy confinement in the low-density/shear-reversed NSTX discharges significantly increased compared to the normal situation, possibly opening a path towards high-performance ST regimes.

The basis of energy and particle transport processes in these L- and H-mode experiments on NSTX was examined with flux tube geometry, gyrokinetic sim-

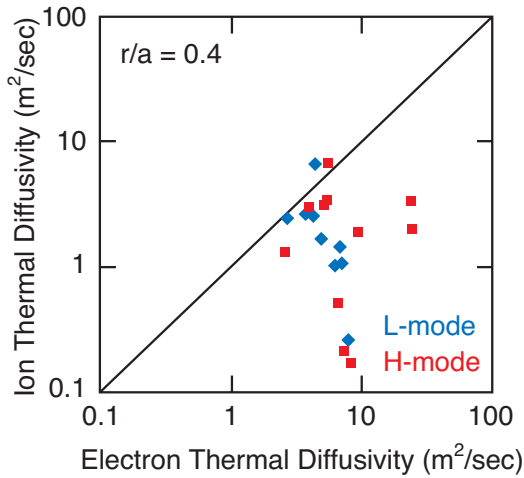

Figure 8. Ion thermal diffusivity confinement time plotted against the electron thermal diffusivity confinement time for L-mode (blue) and H-mode (red) plasmas.

ulations using the massively parallel code GS2. Linear microinstability calculations performed with GS2 predict strong suppression of short-wavelength electron temperature gradient (ETG) modes by low or negative magnetic shear in the core, consistent with the improvement of core electron confinement in the low density, NBI-heated L-mode plasmas. Near the edge in the H-mode plasmas, the ETG modes are found to be unstable, as are microtearing modes. Microtearing modes have never been found to be the fastest growing mode in any experimental tokamak simulations, but they appear to be such in NSTX simulations. Their connection with high electron transport losses has been hypothesized for decades and is the subject of intense present research. In both the L- and the H-mode cases, the long-wavelength ion temperature gradient (ITG) modes are predicted to be likely stabilized by the strong rotational shear, consistent with the inference that the ion thermal diffusivity is near the neoclassical value.

The edge plasma is important since it determines the plasma-wall interaction

and the boundary conditions for global confinement. Experiments and analysis were performed to study the edge plasma characteristics, including fueling and turbulence, and to develop techniques to study and control the particle and power deposition on plasma-facing components. This last issue was addressed by measuring hydrocarbon deposition on plasma-facing surfaces using two quartz-crystal microbalances installed 0.77 m outside the last closed flux surface of NSTX in a configuration that mimics a typical diagnostic window or mirror. Time-resolved measurements over the FY03 experimental run recorded a total of 123 nm of deposition on the exposed surface. Interestingly, however, 67 nm of material loss occurred in seven discharges. Ion beam analysis showed the deposits to be dominantly composed of carbon, oxygen, and deuterium. The net deposited mass of $13.5 \mu\text{g}/\text{m}^2$ matched the deposition monitor measurements results within the 10% experimental uncertainty.

An experiment was conducted to measure the effect of the location of the gas injector on H-mode access and quality. For the lower-single null divertor configuration, good H-modes were reestablished with gas injection from the center-stack at the midplane, but not from the center-stack upper corner, the outboard midplane, or the lower divertor X-point locations, confirming that injector poloidal location does affect H-mode access. In contrast, for the double-null divertor configuration, H-modes were obtained with fueling from either the midplane or upper corner on the center stack, indicating that H-mode quality and access are less sensitive to fueling variations along the center stack for this configuration. Edge toroidal rotation was higher (more co-plasma current) just prior to the L-H transition time for fueling from the cen-

ter-stack midplane location than the other locations in lower-single null configuration, qualitatively consistent with a recent neoclassical theory and Monte-Carlo calculations.

Another experiment was conducted to control the density rise during the H-mode phase by pre-conditioning the plasma contact area with a series of helium discharges. The conditioning discharges produced a modest 40% reduction in D_α -line emission which is a measure of the deuterium influx, and some reduction was observed during the H-mode phase on the density at the inner “ear” of the profile measured by the Thomson scattering diagnostic. A larger D_α reduction was obtained following helium discharges heated by HHFW in which the current ramp down was controlled to avoid a terminal reconnection event. It appears these reconnection events may undo the beneficial effect of helium conditioning.

Plasma fluctuations and transport at the edge of NSTX have recently been measured with various diagnostics, and it was found that the edge was normally very turbulent, at least near the outer midplane. Consequently, the cross-field edge particle and heat transport is normally very large, which is actually favorable for reducing the local heat load on the divertor plate surfaces. Langmuir probe measurements by the University of California at San Diego group have shown that these edge fluctuations in NSTX were strongly “intermittent” and often had fluctuation levels near 100% in the scrape-off layer. These fluctuations have also been seen with the gas puff imaging diagnostic as localized coherent structures that formed in the edge and moved outward at high speed. Such data from NSTX is being analyzed and compared with theoretical simulations of edge turbulence made us-

ing the BOUT three-dimensional turbulence code by Lawrence Livermore National Laboratory.

Gas puff imaging, or GPI, experiments on NSTX provided information on edge turbulence and spatial structures, and they also provided an interesting challenge to theory and modeling. The DEGAS 2 Monte Carlo neutral transport code was used to simulate helium atom behavior in these measurements on NSTX. These detailed simulations permit direct comparison of the code output with the images obtained from the GPI camera. Visualizations of the information input to and output from DEGAS 2 have provided a better understanding of the spatial relationships of the physical objects, such as convective cell structures, in the experiment (Figure 9).

Collaborations and International Cooperation

In addition to PPPL scientists, the NSTX research team comprises researchers from more than 30 institutions both in the United States and abroad. For example, researchers from Japan, China, Italy, France, the United Kingdom, Israel, and South Korea, have all been involved in NSTX experiments during the past several years. These scientists are involved in diagnostic development, numerical simulation and analysis, enabling technology development, machine operation, and research program planning. Some of the major facility and diagnostic contributions that had significant collaborator involvement include:

- installation of a new insulator and set of coils for CHI,
- modification of power feed-throughs for the high harmonic fast wave antenna,

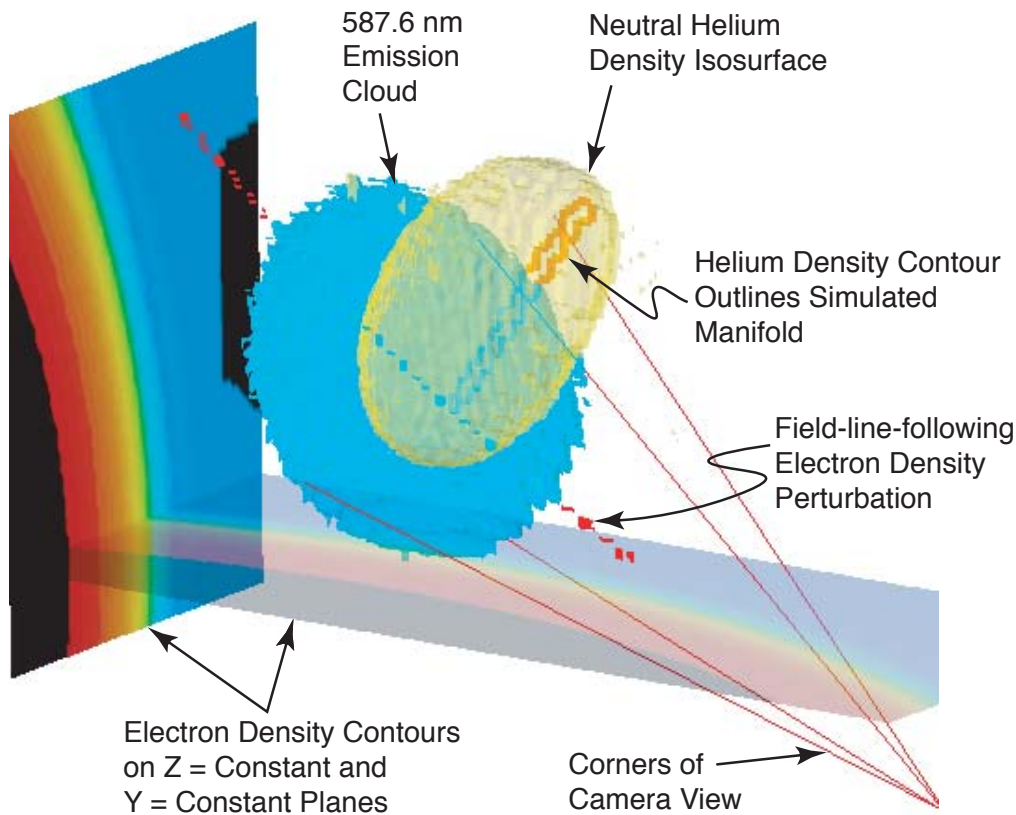

Figure 9. Experimental setup for viewing and modeling clouds of neutral density using the Gas Puff Imaging Diagnostic.

- installation of a supersonic gas injector for fueling control,
- design of an active control system for reducing stray magnetic fields and for suppressing beta-limiting external modes,
- design of Motional Stark Effect diagnostic for measuring the plasma current profile,
- development of the real-time EFIT control algorithm,
- upgrades to interferometers, reflectometers, and reciprocating probe for profile and fluctuation measurements, and
- installation of Langmuir probe arrays for diagnosing scrape-off plasma characteristics.

The NSTX program also had strong ties to other projects both nationally and internationally. NSTX researchers participated actively on ST-related experiments at the University of Washington (HIT-II), at PPPL [Current-Drive Experiment-Upgrade (CDX-U), and in the United Kingdom [Mega-ampere Spherical Torus (MAST)]. There was strong participation by NSTX researchers in the International Tokamak Physics Activities as part of the ITER process.

The NSTX Research Plan

In FY03, the NSTX research team developed a five-year plan. This activity sharpened the vision of NSTX research, in part by quantifying the research tool requirements. Following a strong endorsement from an international review

panel, the plan is being implemented and is aimed in part at developing the science for demonstrating ambitious research and performance goals during a five-year period from 2004 through 2008, assuming that the budgetary support is similar to that assumed for the planning process.

The research program set out in the five-year plan consists of three phases:

1. Extending the stable operating space and duration of the pulse length of high-confinement high-beta plasmas and developing the basis for fully solenoid-free plasma start-up and sustainment. MHD modes will be passively stabilized with the assistance of driven rotation.
2. Developing advanced control tools to optimize further high-beta plasma performance. Detailed experiment/theory comparisons and advanced diagnostics will also be the cornerstones in developing a scientific basis for this development.
3. Integrating solenoid-free start-up and sustainment and control strategies for generating high-beta plasmas to enable long-pulse high-confinement high-beta operations.

The upgrades required to support the achievement of these goals can be divided into three categories:

Diagnostic Upgrades

- Motional Stark Effect to measure current profile modifications from both inductive and noninductive current drive processes, and the radial electric field for flow shear studies.
- Very high toroidal mode number magnetics.

- Neutron collimator array to measure the beam ion deposition profile for power balance studies.
- Higher time resolution (90 Hz) and spatial resolution (30 channels) Thomson scattering diagnostic for electron temperature and density profile measurements.
- Microwave imaging reflectometry to measure long-wavelength (ion-temperature-gradient mode) turbulence, and microwave scattering to measure short-wavelength (electron-temperature-gradient mode) turbulence.
- Poloidally viewing Charge-Exchange Recombination Spectroscopy diagnostic to measure poloidal rotation velocities for flow shear studies.

Facility Upgrades

- Coil sets to control actively stray error fields and external MHD.
- Reconfiguration of the passive plates for enhanced vertical stability control.
- Electron-Bernstein waves as a tool for local noninductive current drive.
- Cryopump and/or lithium surface module for active particle and density control.
- Deuterium pellet injection for core fueling and profile modification.

Plasma Control

- Further development of the iso-flux control algorithm of the real-time EFIT code to improve boundary shape control during the plasma discharge.

In addition to these upgrades, development of theoretical and modeling tools, along with increased theory/experiment coupling in all physics areas will help develop the understanding to allow us to achieve more easily our integrated programmatic goals.

NSTX Astrophysics Project

The goal of this astrophysics project is to measure density-sensitive line ratios from helium- and neon-like ions, which are used for the diagnosis of stellar flares, in a controlled plasma environment within the NSTX.

For this purpose, a high-resolution X-ray crystal spectrometer covering the wavelength range from 4 to 24 Å was installed at NSTX with a PC-based data acquisition system. First measurements

were made on NSTX in February 2003. However, these were interrupted by the early termination of the fiscal year 2003 NSTX experimental campaign. The measurements will be resumed in February/March 2004.

The break in the NSTX research schedule was used for upgrades of the spectrometer's vacuum system and to publish or submit for publication several articles on stellar flare plasmas. (See the Publications section of this Annual Highlights Report for a listing of these and other relevant papers.) In particular, a thin foil was installed to separate the NSTX vacuum from the spectrometer vacuum. This will prevent a pressure increase inside the spectrometer during hydrogen pre-fill of the NSTX vacuum vessel that was noted during the operation in February 2003.

Current Drive Experiment-Upgrade

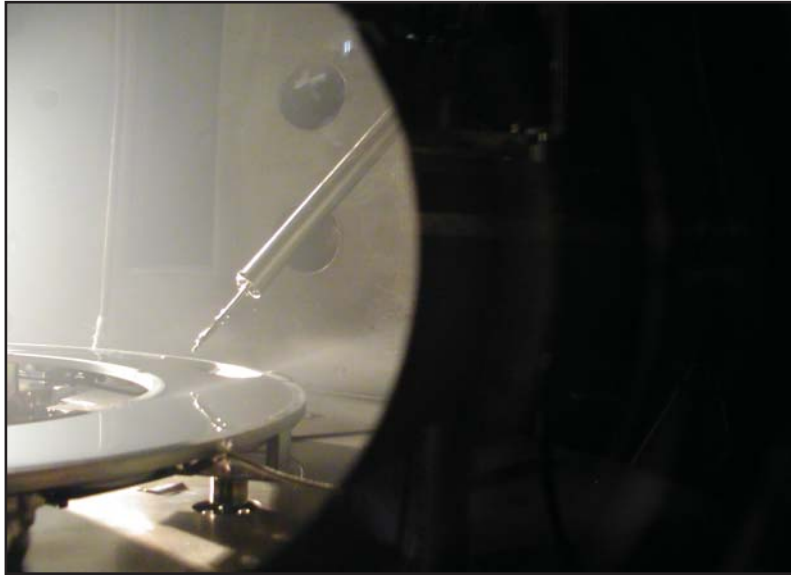

Filling the liquid lithium tray limiter in the Current Drive Experiment-Upgrade.

Technological progress and advances in fusion science have always gone hand-in-hand. One of the major technological problems facing the eventual commercial development of fusion energy is the design of a reactor wall that can survive the high heat and neutron fluxes generated by an ignited plasma. A novel and exciting recent development which promises to solve this longstanding engineering problem, while offering great physics benefits, is the development of the liquid-metal wall concept.

Reactor designs for inertial fusion reactors have relied for some time on the concept of a flowing liquid wall to guar-

antee survivability under conditions of repetitive micropellet ignition and burn. However, flowing liquid-metal walls have only recently been proposed for magnetic fusion. In a spherical torus or a tokamak, a flowing metal wall of liquid lithium may provide not only heat removal, but plasma stabilization to unprecedented high values of plasma beta, which is a measure of the plasma pressure relative to that of the confining magnetic field.

Liquid-lithium walls would also greatly reduce the uncontrolled recycling of cold gas back into the plasma edge, thus promising high plasma performance under reactor conditions. Production of high-performance plasmas with lithium-

coated walls was first tested on the Tokamak Fusion Test Reactor (TFTR) and resulted in the highest fusion power and gain (Q_{DT}) obtained on that device. All these factors combine to make the concept of a tokamak reactor with flowing liquid-lithium walls very attractive for fusion energy production.

The Current Drive Experiment-Upgrade (CDX-U), Figure 1, was the world's first fusion experiment to operate with large area liquid-lithium plasma-facing components (PFCs). The liquid-lithium PFC program involves collaborations with numerous universities and national laboratories, including the University of California at San Diego (UCSD), Oak Ridge National Laboratory (ORNL), Sandia National Laboratories, and the Lawrence Livermore National Laboratory. Other institutions are also participating through the Energy Advanced Liquid Plasma-facing Surface (ALPS) and Advanced Power Extraction (APEX) programs of the U.S. Department of Energy (DOE).

Facility Description

The CDX-U is a small spherical torus (ST), with a major radius of 34 cm, a minor radius of 22 cm, and a plasma elongation of 1.6. The toroidal field is 2.2 kG, and the maximum plasma current is 100 kA. The plasma pulse length is limited to 20 ms by the ohmic power supply, which is used to drive the plasma current inductively. This supply is undergoing the first of a series of upgrades that will increase both the maximum plasma current and the pulse duration. Although the ohmic power supply is based on a capacitor bank, the toroidal-field coils and the poloidal-field coil set are powered by six large 12-phase computer-controlled power supplies which can provide up to 18 MW for several hundred ms. Radio-frequency power of 300 kW at 8 MHz is also available for auxiliary heating. Diagnostics for the device include a 12-point Thomson scattering system, a 140-GHz interferometer, a number of Langmuir probes, and many edge and core plasma spectroscopic diagnostics covering the

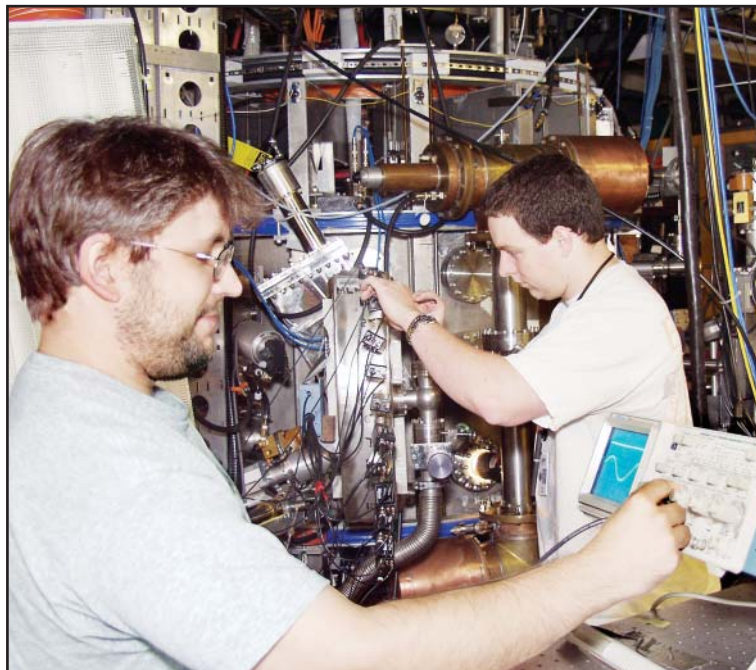

Figure 1. Current Drive Experiment-Upgrade.

visible to soft X-ray regions of the spectrum.

Experiments with Lithium Limiters

The first experiments involving the use of solid and liquid lithium as a plasma limiter in CDX-U took place in FY00, utilizing a lithium-covered rail 5 cm in diameter and 20-cm long, which was developed at UCSD. The lithium limiter was inserted or removed via a double gate valve airlock system to prevent exposure of the lithium to air. When the limiter was fully inserted, it formed the upper limiting surface for the plasma discharge and was intended to define the last closed flux surface for the discharge. When the limiter was retracted, ceramic boron carbide rods formed the upper limiting surface for the discharge. The limiter had an internal heater and was operated in contact with the plasma over the temperature range of 20-300 °C.

The rail limiter experiments demonstrated that an ST plasma could successfully operate with a liquid-lithium PFC

and were instrumental in identifying numerous problems and safety concerns with lithium operations. However, the surface area of the rail limiter was small (approximately 300 cm², less than half of which is in contact with the plasma), and so the effects of the lithium-coated limiter on the discharge itself were minimal. In FY01 the lithium PFC experiments on CDX-U entered a second phase, when the toroidal liquid-lithium belt limiter was placed in operation.

The toroidal belt limiter is shown in Figure 2. It consists of a shallow, heated toroidal tray, with a radius of 34 cm and a width of 10 cm, which is filled with lithium to a depth of a few millimeters. If completely filled with lithium, the belt limiter presents an exposed area of 2,000 cm² to the plasma. First operation of CDX-U with the lithium belt limiter yielded clear indications of the ability of a liquid-lithium limiter to reduce impurities, despite difficulties in obtaining a uniform fill of the tray with lithium and the rapid development of oxide and hydroxide layers on the surface of the lithium.

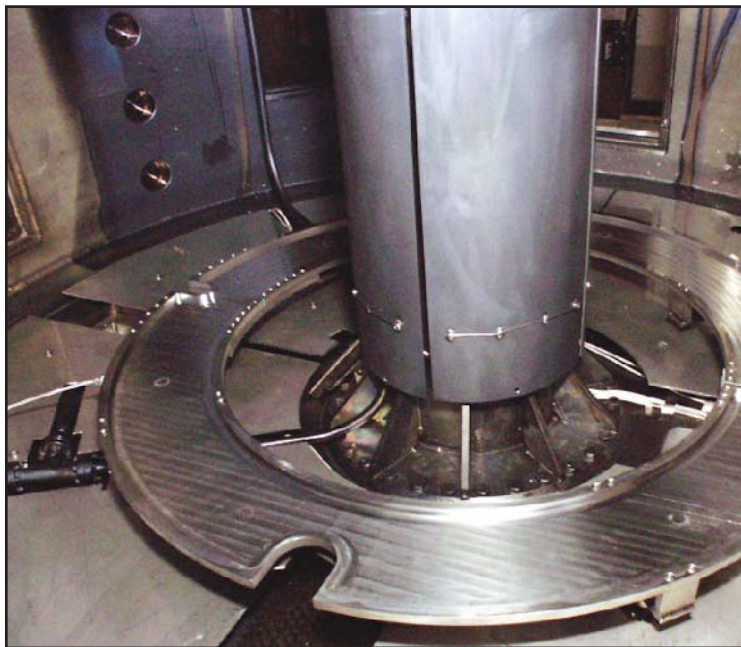

Figure 2. Interior of the CDX-U showing the (empty) toroidal liquid-lithium belt limiter.

During the first lithium tray campaign (FY02-03) the tray was loaded with solid lithium at room temperature, after which it was heated to 300 °C to melt the lithium (which melts at 180 °C). This method of filling the tray proved difficult and resulted in incomplete coverage of the tray with lithium, as well as oxidized surface conditions. It is estimated that at most 50% of the tray was covered with lithium. Despite these difficulties, the primary predictions for the utility of lithium as a plasma-facing component were verified. Plasma recycling was reduced to very low levels at the surface of the lithium. The impurity content of lithium-limited discharges dropped significantly. These results provided motivation for further efforts to improve the quality and quantity of the liquid-lithium PFC in CDX-U.

In FY03 CDX-U was vented, the limiter tray and vessel interior were cleaned, and the tray was reinstalled in the vacuum vessel. A new lithium-filling technique was tested at UCSD and implemented on CDX-U. This new approach involved injecting liquid lithium onto a very hot (500 °C) tray to obtain immediate wetting and spreading of the liquid lithium in the tray. A photograph of the

filling process is used as the frontispiece to this report. The liquid-lithium injector is the cylindrical object entering the field of view from the upper right.

This approach proved very successful. The lithium immediately covered 80% of the tray with visibly clean, metallic lithium. Subsequent cycles of heating and discharge cleaning led to 100% tray coverage with the highly reflective liquid metal.

The liquid-lithium fill had an immediate effect on CDX-U plasma operations, as indicated by the plot of plasma discharge peak current versus time of discharge in Figure 3. For the several weeks of plasma operations prior to the lithium fill, plasma current was limited to less than 60 kA. Within a half-hour of resuming plasma operations after the lithium fill, the maximum plasma current had increased to nearly 80 kA. In addition, the amount of deuterium gas required to fuel the plasma increased by a factor of four, indicating that recycling on the liquid lithium was significantly reduced, in comparison to the bare tray.

A photograph of the tray taken immediately after the first day of plasma operations is shown in Figure 4. It is clear

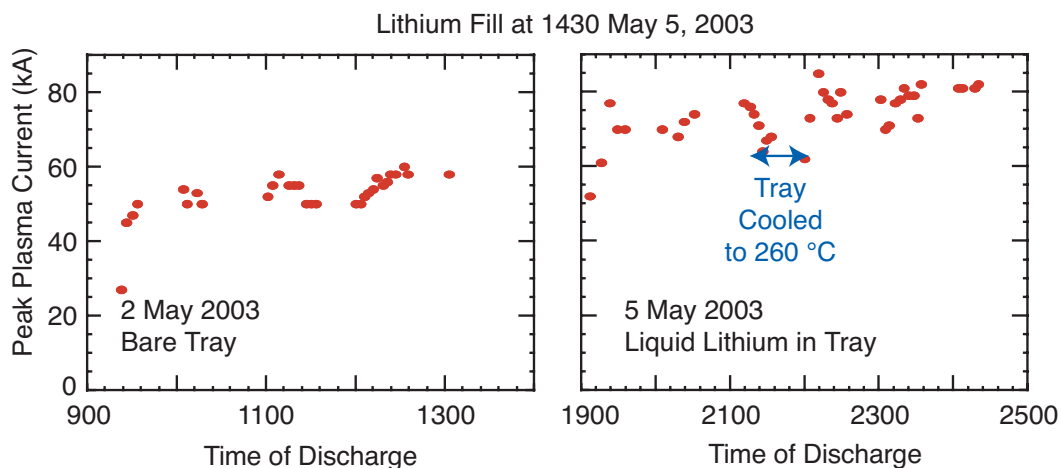

Figure 3. Peak plasma current as a function of plasma discharge time for an experimental run preceding the lithium tray and for a run immediately following the tray fill.

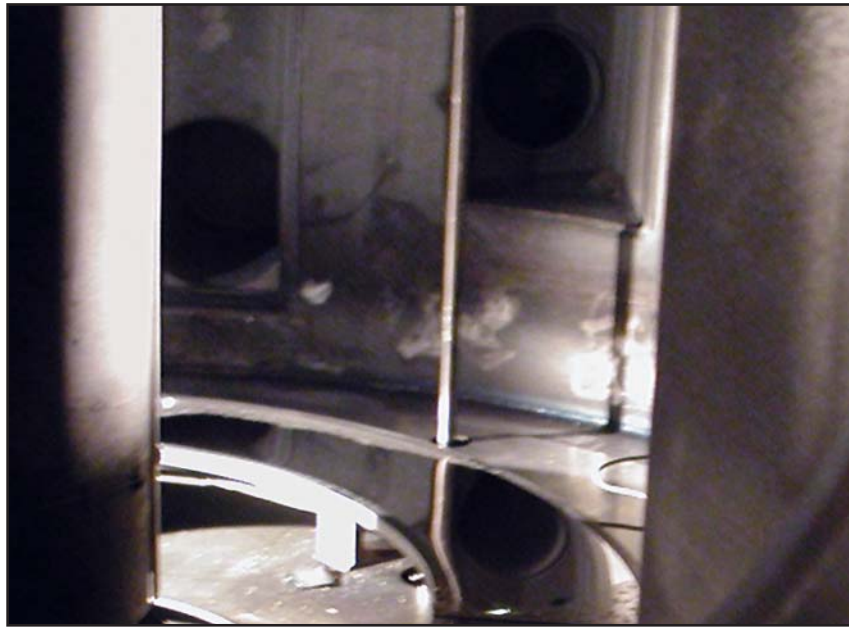

Figure 4. The liquid-lithium filled tray limiter after 40 plasma discharges.

that no surface coatings were formed as a result of the 40 plasma discharges performed, indicating that any lithium deuteride impurity which formed as a result of plasma contact remained dissolved in the liquid lithium.

The effect of a large liquid lithium PFC on the loop voltage required to maintain the plasma current and on the gas required to fuel the plasma is indicated in Figure 5. The loop voltage required to maintain the plasma current drops by a factor of four or more for the lithium discharge. Such a large reduction in loop voltage is unprecedented in small tokamak research.

Future Plans

The last cycle of operations with the lithium-filled tray will be completed in FY04. After tray experiments are completed, the tray system will be removed and replaced with a liquid-lithium-coated limiter system, which is prototypical of a divertor target system under consideration for the National Spherical Torus Experiment (NSTX). This thin liquid

lithium film system is also prototypical of the wall design for the Lithium Tokamak Experiment (LTX), presently being designed. The CDX-U will be disassembled at the end of FY05, and LTX (to be operational in FY06) will be installed in its place. The LTX will explore tokamak plasma operations with a fully nonrecycling liquid lithium wall.

Collaborations and Graduate Studies

The first liquid-lithium system installed in CDX-U was a rail limiter designed and constructed by collaborators at UCSD. The PISCES Group at UCSD was closely involved with the rail limiter experiments, and designed the new lithium filling system for the CDX-U limiter tray. The UCSD personnel continue to participate in the lithium-filled tray experiments.

Researchers at Sandia National Laboratories have contributed surface analysis of wall samples and have provided and set up an infrared camera to moni-

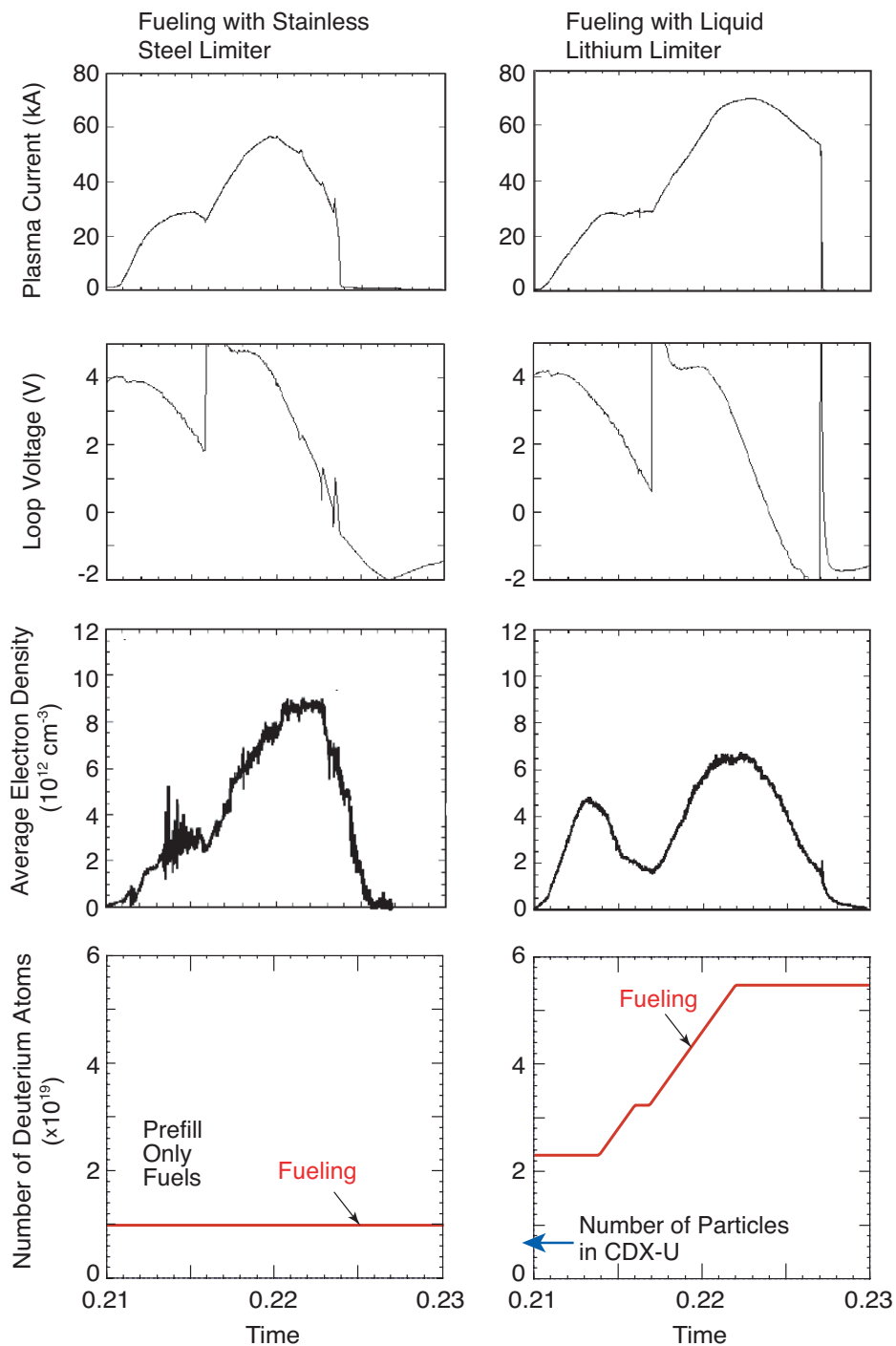

Figure 5. The use of a liquid-lithium limiter results in higher plasma currents, lower voltage required to drive the current (greater efficiency), and good density control — fueling of the plasma is no longer dominated by uncontrollable plasma-wall interactions.

tor the surface temperature of the lithium during plasma discharges. Numerous other scientists in the DOE Advanced Liquid Plasma-facing Surface and Advanced Power Extraction programs have

been participants in the experiments, and they will continue to be involved in the future.

The CDX-U Group and the Plasma Spectroscopy Group at Johns Hop-

kins University plan to continue their long-term collaboration in the area of ST diagnostic development. The CDX-U Group also maintains ongoing collaborations with the University of Wisconsin at Madison, the University of Tokyo in Japan, the A.F. Ioffe Physical-Technical Institute at St. Petersburg in the Russian Federation, and the Hebrew University in Israel. In addition, CDX-U scientists have worked actively with ST researchers from the Mega-Amp Spherical Tokamak (MAST) Experiment at Culham Laboratory in England.

A number of collaborations with ORNL are underway. These include an ongoing collaboration on spectroscopic diagnostics of lithium and impurity concentrations at the lithium limiter. These diagnostics have proved invaluable for measuring the effects of lithium on the edge plasma.

The Lithium Tokamak Experiment (LTX) project will further involve UCSD and ORNL. One of the co-principal investigators for the LTX proposal is from UCSD. A key feature of the LTX project is core fueling of the plasma, which will be provided by a pellet injector constructed at ORNL.

A primary role of CDX-U has been to serve as a training ground for students. Presently three Princeton University graduate students, two from the Astrophysical Sciences Department and one from the Physics Department, are pursuing research on CDX-U. Two of these students intend to use the LTX for their thesis topics. In 2003, two Drexel University students spent their co-op terms working in the CDX-U Group. The involvement of both graduate and undergraduate students will continue as the LTX becomes operational.

Magnetic Reconnection Experiment

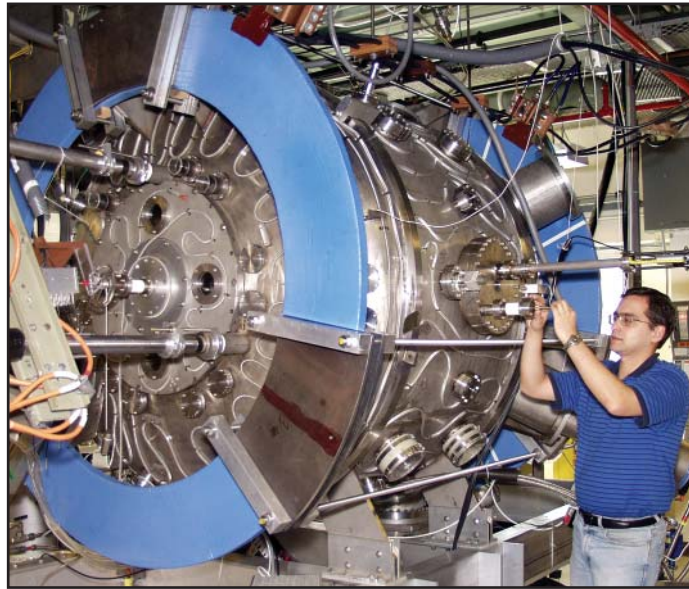

Magnetic Reconnection Experiment

The Magnetic Reconnection Experiment (MRX), shown above, was built to study magnetic reconnection as a fundamental plasma process in a controlled laboratory environment. Magnetic Reconnection — the topological breaking, annihilation, and reconnection of magnetic field lines — can occur in virtually all magnetized plasmas, both in the laboratory and in nature (Figure 1).

Despite its omnipresence, reconnection is not a well-understood phenomenon. In laboratory fusion plasmas, such as tokamaks, reconnection manifests itself as “sawtooth” oscillations in electron temperature, affecting plasma confinement. In sawtooth oscillations, the re-

connection rate is often greatly enhanced over collision-based classical resistivity. In nature, reconnection plays an important role in the evolution of solar flares, coronal heating, and in the dynamics of the Earth’s magnetosphere. Reconnection at the dayside magnetopause is often considered as the onset and trigger of such events as auroral substorms and geomagnetic storms. In recent years, the solar satellite TRACE has provided the best views yet that reconnection is involved in solar flare energy release (Figure 2). However, the rate of energy release is not well resolved by the present understanding of reconnection physics. The observed “fast reconnection” has made magnetic reconnection a very active area of research.

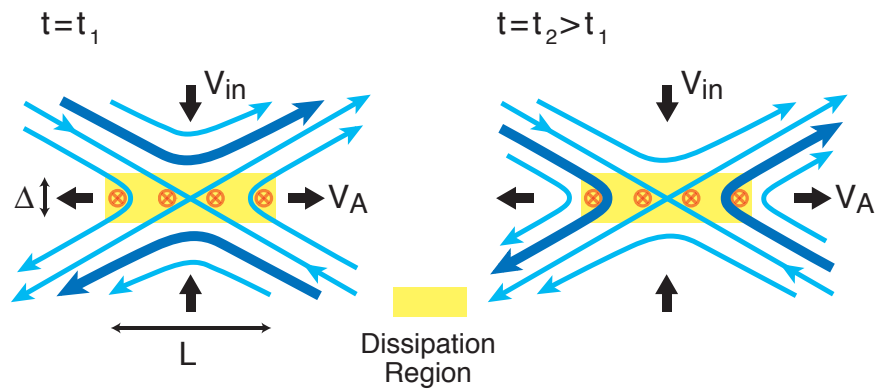

Figure 1. Evolution of the magnetic field lines during reconnection.

Experiments on the MRX have provided crucial data with which the theoretical and observational research communities can compare their work. Cross-disciplinary interactions have led to fertile discussions and useful reassessments of the present understanding. Indeed, experimental research on the MRX has created renewed interest in magnetic reconnection unseen for some decades.

Because of the strong impact of MRX research on many fields of study, it is

jointly funded by the U.S. Department of Energy, the National Science Foundation, and the National Aeronautics and Space Administration.

Research Objectives

The primary purpose of the MRX is the comprehensive analysis of magnetic reconnection and related physics, which are crucial for understanding self-organization phenomena of fusion plasmas as well as solar and magnetospheric plas-

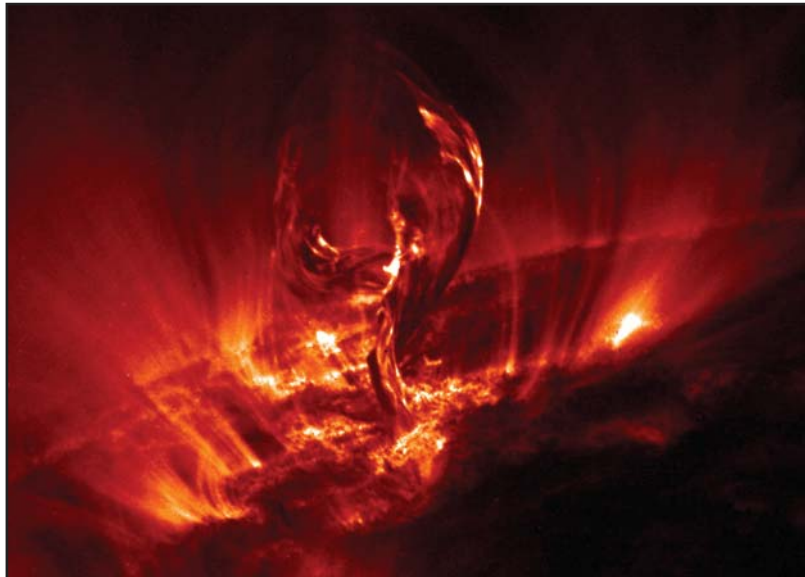

Figure 2. Image of the sun taken by the TRACE satellite. [The TRACE (Transition Region and Coronal Explorer) satellite is a mission of the Stanford-Lockheed Institute for Space Research and part of the National Aeronautics and Space Administration Small Explorer Program.]

mas. The analysis focuses on the coupling between local microscale features of the reconnection layer and global properties such as external driving force, magnetohydrodynamic (MHD) flows, and the evolution of plasma equilibrium.

The MRX has the following research goals:

- Experimentally test two-dimensional (2-D) and three-dimensional (3-D) theoretical models of the reconnection layer;
- Investigate the role of non-MHD physics, including turbulence, in the reconnection layer;
- Study global MHD issues including evolution of magnetic helicity;
- Determine the circumstances under which 3-D effects dominate;
- Identify the mechanisms by which magnetic energy is efficiently converted to plasma kinetic and thermal energy;
- Explore the fruitful utilization of reconnection to fusion concepts, such as application to self-organized plasmas.

These studies will contribute to the advancement of plasma physics and fusion energy research and will directly impact the physics understanding of reconnection in fusion plasmas, the solar atmosphere, the earth's magnetosphere, and related astrophysical phenomena.

Experimental Setup and Past Major Results

Two plasma toroids with identical toroidal currents are formed using inductive electric fields generated from two sets of coil windings. The two plasma toroids are then merged together by pro-

gramming an applied external magnetic field. MRX was designed to achieve a variety of merging geometries and magnetic field topologies. Two types of reconnection have been studied: null-helicity and co-helicity. In the former there is no toroidal magnetic field in the reconnection layer, and in the latter there is a sizable toroidal field. Qualitative differences in the reconnection layer arise depending on the presence of the toroidal field.

A set of carefully chosen diagnostics provides insight into the physics of magnetic reconnection and real-time monitoring of MRX plasmas. These include Langmuir probes (electron density and temperature), spectroscopic probe (ion temperature and flows), and arrays of magnetic probes (spatial profiles of the local magnetic field vector).

The Sweet-Parker model of magnetic reconnection is a resistive MHD model that assumes a 2-D incompressible, steady-state plasma. It captures many of the essential local features of the magnetic reconnection layer and predicts reconnection rates faster than that of resistive diffusion, but still much slower than those observed in solar flares. For nearly 50 years, the merits and shortcomings of this model have been debated. The first laboratory experiments on the Sweet-Parker model were performed on MRX. Null-helicity experimental data indicated a reconnection speed consistent with a generalized Sweet-Parker model, which includes the effects of plasma compressibility, finite pressure in the downstream region of the field lines, and nonclassical plasma resistivity. The measured plasma resistivity was found to be enhanced over the classical Coulomb-collision value by up to a factor of ten; this enhancement is thought to play a crucial role in determining the reconnection rate. These re-

sults suggest that the Sweet-Parker model with nonclassical resistivity may explain the fast reconnection required to be consistent with solar flare observations.

In MRX the precise profile of the magnetic field in the current sheet has been measured by a very high-resolution magnetic probe array. The measured magnetic profiles fit very well the Harris solution, which was developed in 1962. This agreement is remarkable since the Harris theory does not take into account the electric fields and dissipation associated with reconnection. The sheet thickness is found to be on the order of the ion skin depth, which agrees with a generalized Harris theory incorporating non-isothermal electron and ion temperatures and finite electric field. Interestingly, the same scaling has been observed both in the magnetotail and the magnetopause of the Earth's magnetosphere.

Conversion of magnetic field energy to plasma kinetic and thermal energy is a primary consequence of reconnection. This process is believed to play an important role in coronal heating, solar flares, and acceleration of auroral jets in the magnetosphere. Ion heating during reconnection has been studied on MRX. Using an ion dynamics spectroscopy probe, local ion temperature and flows were measured. An ion temperature increase during reconnection has been observed, and the ion heating mechanism is a subject of current research.

Highlights of Recent Results

Studies of Fluctuations in MRX Current Sheets

Current sheets formed in MRX contain strong gradients in plasma density and cross-field currents, both of which can drive unstable fluctuations and result in turbulence. The role of turbulence in magnetic reconnection has been a con-

troversial subject in the theoretical literature with some claiming that it is necessary to provide anomalous resistivity for fast reconnection, while others claim that it is not essential and may even slow down the process. There have been very few experimental studies of turbulence in current sheets, and none have investigated fluctuations in current sheets in MHD plasmas where the ion gyroradius is much smaller than the experimental apparatus.

Previous measurements of the electrostatic component of the lower-hybrid drift instability (LHDI) resulted in the conclusion that it did not play a significant role in reconnection on MRX. Although the LHDI was identified at the low-beta region of the current sheet, electrostatic fluctuations did not correlate well with the reconnection process in their temporal and spatial behavior. The fluctuation amplitude was also found to be relatively insensitive to the collisionality of the plasma, in contrast with the strong dependence of the anomalous resistivity on collisionality.

Recently found electromagnetic fluctuations, however, do correlate well with reconnection. Those measurements are done using a Hodogram probe capable of measuring polarization based on all three spatial components of the fluctuating magnetic field acquired at the same location with a frequency response up to 40 MHz. Typical raw signals and spectrograms which display the fluctuation power in the time frequency domain are shown in Figure 3. The fluctuation amplitude is similar for the three components, and the spectrum is peaked near the lower-hybrid frequency (shown by the solid line in the spectral plots). The amplitude is highest during the time of reconnection (260-280 μ s). The radial spatial profile measurements show that

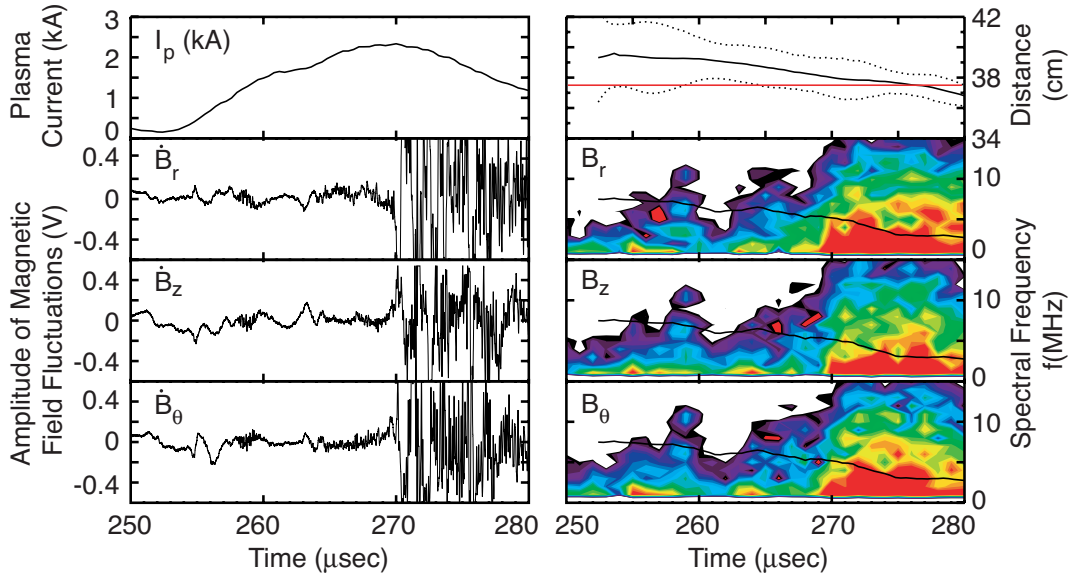

Figure 3. Traces of typical raw signals during reconnection represented by plasma current (top left panel). Spectrograms are shown on the lower-right panels where fluctuations powers are color coded (decreasing power by order of red, yellow, green, blue, and white) in the time-frequency domain. The black lines indicate lower-hybrid frequency. The top right panel displays locations of the probe (red line) and the current sheet (center as black solid line and edges as dashed lines). When the current sheet center moves close to the probe, high-frequency magnetic fluctuations are detected. Experimental parameters are: radius $R = 37.5$ cm, toroidal angle $\theta = 22.5^\circ$, gas = H_2 , fill pressure = 2.6 mTorr, $z = 0$, and capacitor bank voltages = 12 kV and 10 kV.

the magnetic fluctuation amplitude is strongly peaked near the center of the current profile which is in sharp contrast with the electrostatic fluctuations.

To identify the observed electromagnetic waves, it is crucial to measure their propagation characteristics. The acquisition of all three components of the fluctuating magnetic field permits a Hodogram analysis. It is concluded that the observed magnetic fluctuations are right-hand polarized, whistler-like waves propagating obliquely to the magnetic field. The magnitude of the wave vector is determined using the phase shift between two spatial points. It is found that magnetic fluctuations propagate mainly in the current direction along with electron drift.

It is found that the amplitude of magnetic fluctuations is sensitive to plasma density or, equivalently, collisionality

[Figure 4(a)]. Since resistivity enhancement also strongly depends on the plasma collisionality, a clear positive correlation between magnetic fluctuations in the lower-hybrid frequency range and resistivity enhancement is established in the low-collisionality regimes [Figure 4(b)].

Fine Magnetic Structure in the MRX Current Sheet

An alternative scenario to explain fast reconnection invokes non-MHD effects such as the Hall effect to modify the structure of the reconnecting current sheet. Recent numerical simulations show that the inclusion of the Hall term into the generalized Ohm's law speeds up reconnection. When the current sheet width becomes comparable to the ion skin depth, the ions are no longer magnetized and decouple from magnetic field.

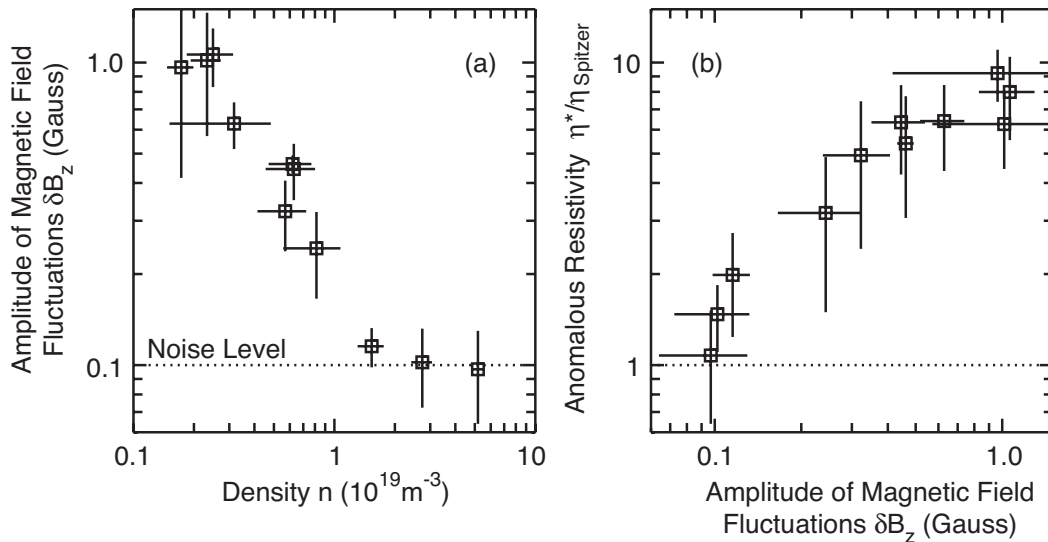

Figure 4. Magnetic fluctuations amplitude versus density measured by Langmuir probe (a) and resistivity enhancement at the current sheet center (b). Experimental parameters are: radius $R = 37.5$ cm, toroidal angle $\theta = 22.5^\circ$, Time $t = 266\text{-}276 \mu\text{s}$.

On the other hand, electrons remain magnetized until they reach the inner region, called the electron diffusion region, whose width is proportional to the electron skin depth. It is the decoupling of the electrons and ions that makes the Hall term important. It has to be noted that although this theory became quite popular in the recent years, there is no convincing laboratory experimental data to assure the importance of Hall effects in driving fast reconnection.

To probe the structure of the reconnecting current sheet on a scale length comparable to the electron diffusion region, new diagnostics must be developed. One such diagnostic is the “fine structure” probe, which consists of a linear array of 71 variably spaced magnetic pick-up coils (Figure 5). In the center, the coils are spaced 1.25-mm apart, giving a spatial resolution comparable to the electron skin depth which is one to three mm in MRX. The signals from the coils are integrated in hardware and digitized at a rate of 2.5 MHz. This allows the measurement of the radial profile of the magnetic field at high space and time resolu-

tion. By rotating the probe, the measured component of the magnetic field can be changed.

One feature which is observed in highly collisional plasmas is the formation of a bifurcated current sheet. Figure 6 shows the radial profile of the reconnecting magnetic field measured by the fine structure probe at six time points during pull reconnection. As the current sheet begins to narrow, two dips are seen in the magnetic field. Each dip can be modeled as a separate Harris current sheet with its

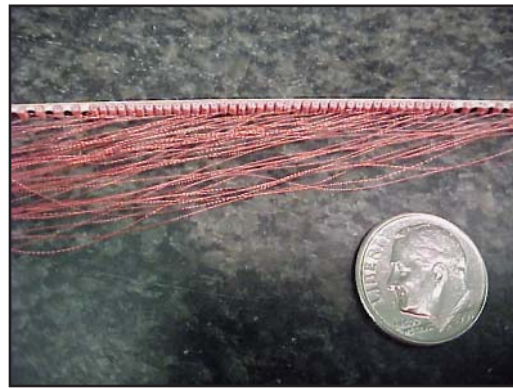

Figure 5. The new MRX fine-structure magnetic probe. The dime helps show the relative size.

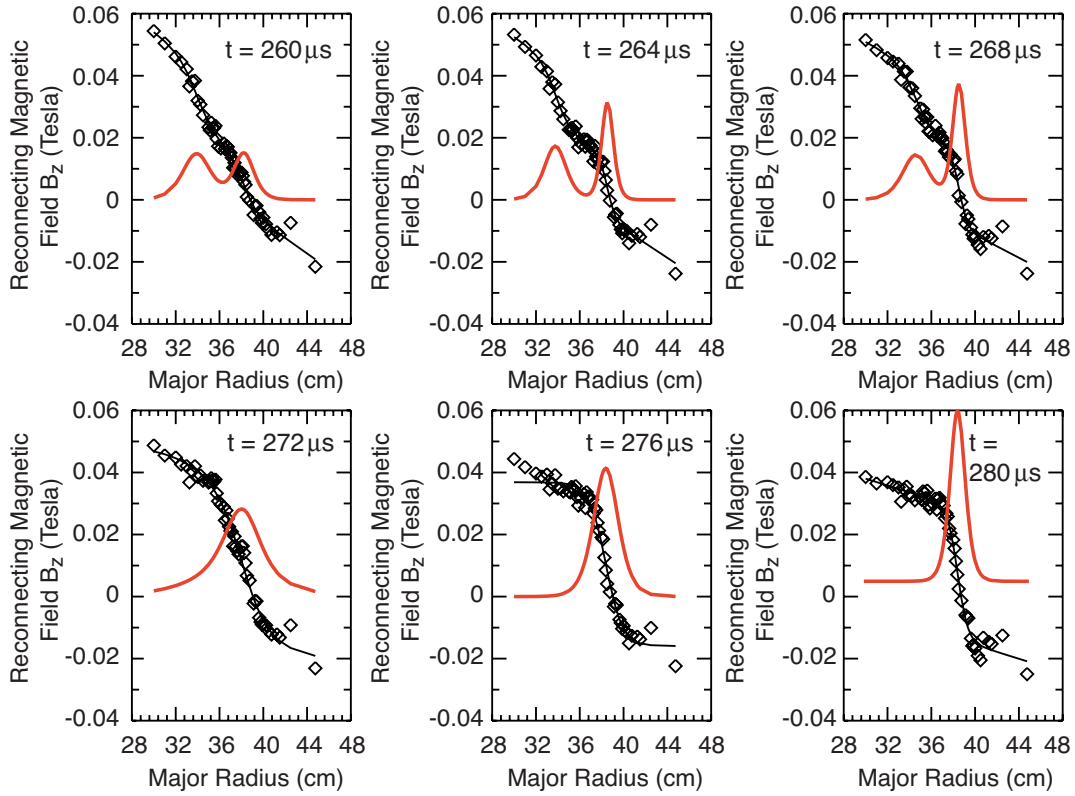

Figure 6. The time evolution of the reconnecting magnetic field profile as measured by the fine-structure probe and the derived current profile (red) for the high-collisionality regime.

characteristic hyperbolic tangent magnetic field profile. The dips in the magnetic field profile correspond to two separate current channels (shown in red on Figure 6). As reconnection continues, the two current channels are observed to merge together over a time scale of a few Alfvén times to form a single current sheet. The double-peaked current density structure is seen near the quadrupole null point as well. However, this data is not enough to rule out an X-point-like structure, since the center of the X-point could be displaced away from the axis by the probe.

The double-peaked current sheet shows a clear dependence on collisionality, occurring in discharges with high fill pressure and plasma density. However, the Harris sheet width depends on the ion skin depth. Therefore, it is possible that the double peak exists at low plas-

ma density, but the two channels are so wide in the low density regime that they overlap and appear to be a single current sheet. The merging behavior is robust and occurs even when the driving force for reconnection is removed by crowbaring the poloidal coil current. This has the effect of holding the flux constant and preventing field lines from being pulled toward the coils. The crowbar was fired many Alfvén times before current sheet formation, and merging behavior was always observed. This indicates that the X point structure is unstable and will collapse to a single current sheet in a few Alfvén times.

Graduate Studies and Science Education

The small size and rich plasma physics of the MRX make it an ideal facility

to study basic science and to train graduate students. Aleksey Kuritsyn (Princeton University) is presently completing his thesis on optical studies of the neutral sheet physics in the MRX. Yang Ren (Princeton University) has begun his research on experimental studies of the Hall term driven reconnection. The MRX project also participates in the summer student programs such as the U.S. Department of Energy National Undergraduate Fellowship program. Under this program during the summer of 2003, the MRX project hosted Kevin Dusling, from Cooper Union College in New York City, who studied the dependence of the current sheet width on collisionality and boundary conditions for different gases.

Future Work

The search for the mechanism behind fast reconnection in MRX current sheets will continue in order to ascertain

the role of non-MHD effects in the current sheet. Study of the fine-scale magnetic structures in the neutral sheet will go on with the help of a high-resolution fine-structure probe which is fully operational now. A more systematic study of magnetic fluctuations in the current sheet is planned, and any relationship between these fluctuations and the reconnection rate or ion heating will be the subject of future research. Advanced diagnostics will be brought to bear on these studies, including the use of planar laser-induced fluorescence to obtain 2-D images of the ion density in MRX current sheets. Further studies of the global MHD aspects of reconnection and investigation of the importance of boundary conditions and 3-D perturbations to the current sheet geometry are planned. The results from these efforts should bring us closer to understanding the important process of magnetic reconnection.

Theory and Advanced Simulations

The fusion energy sciences mission of the Princeton Plasma Physics Laboratory (PPPL) Theory Department is to help provide the scientific foundations for establishing magnetic confinement fusion as an attractive, technically feasible sustainable energy source. Research advances described here highlight how improvements in understanding the basic mechanisms associated with magnetically confined plasmas have helped enable significant progress in the fusion program during FY03.

Continuing improvements in diagnostic techniques together with extensions of experimental operating regimes in devices such as the National Spherical Torus Experiment (NSTX) have stimulated more realistic comparisons of experimental results with theoretical models. The resultant improvements in the fidelity of the physics-based models should help accelerate the pace of technical advances. In particular, the theory activities have positively impacted the interpretation of results from experimental facilities such as the NSTX and have played a major role in the efficient and reliable design of attractive new facilities such as the National Compact Stellarator Experiment.

During the course of the past year, the PPPL Theory Department has continued to add to its internationally appreciated contributions of seminal concepts, as well as to its innovative development and

maintenance of the comprehensive set of toroidal design and analysis codes. It has advanced toward its mission goals by:

- Generating the physics knowledge required for the interpretation and extrapolation of present experimental results.
- Suggesting new approaches to stimulate experimental campaigns to improve performance.
- Developing improved theoretical analysis capabilities that are fundamentally sound.
- Contributing to the innovative design of new experimental devices.
- Providing a stimulating research environment that effectively enables the Laboratory to attract, train, and retain the young talent essential for the scientific excellence of the plasma sciences.

As it moves forward, the PPPL Theory Department can be expected to continue to introduce innovative ideas, to make advances in analytical capabilities, and to provide validation and active applications of the best existing theoretical tools for interpretation and design. Contributions to the areas highlighted below illustrate the impact of theory on the fusion program.

MHD Studies in Toroidal Systems

Advances in the area of magnetohydrodynamic (MHD) studies in toroidal systems during the past year have featured progress in: (i) improved understanding of the effects of plasma pressure on the “current hole” phenomenon observed in tokamaks and spherical tori (ST’s); (ii) the ability to realistically simulate energetic particle dynamics in ST’s such as NSTX; and (iii) realistic modeling of feedback stabilization of resistive wall modes in tokamaks.

Effects of Plasma Pressure on the Current Hole in Tokamaks and Spherical Tori

The multilevel physics, parallel processing plasma simulation code M3D has been used to study the current hole phenomena in tokamaks and ST’s in the presence of plasma pressure and rotation. It was previously reported that at low beta (ratio of plasma pressure to magnetic field pressure), if the current in the center of the torus were forced to decrease through magnetic induction, a recon-

nection would occur, effectively clamping it at zero before it could become negative. This phenomena was called the “axisymmetric sawtooth.”

However, with a plasma beta as low as 1%, the simulations using the “standard” resistive MHD model show that this axisymmetric sawtooth mode can saturate due to pressure peaking in the island, which makes complete reconnection energetically unfavorable. This behavior persists both in the MHD model and in a more complete plasma model in which the plasma ions are represented as a collection of particles obeying the kinetic equations.

In contrast, when “two-fluid” (i.e., electrons and ions treated as separate but interacting fluids) effects are retained in the simulation model, the reconnecting plasma begins to spontaneously rotate (Figure 1). This rotation breaks the symmetry, allowing the complete reconnection to occur, even at relatively large values of the plasma beta. Extensive simulation studies have shown this two-fluid induced rotation to be a robust effect, leading to repeated, successive axisym-

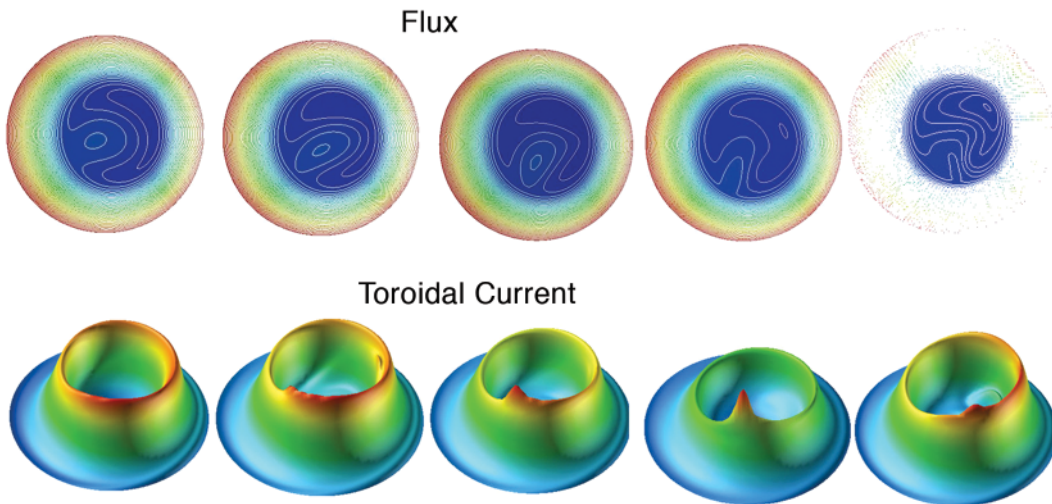

Figure 1. Two-fluid effects cause the axisymmetric island to rotate, breaking the symmetry and allowing reconnection.

metric sawtooth crashes for virtually all experimentally relevant values of plasma pressure.

Hybrid Simulations of Energetic Particle Modes in a Spherical Torus

Recent NSTX results show rich beam-driven Alfvén instabilities in neutral-beam-heated plasmas. The M3D code was applied to simulate the beam-ion-driven Alfvén instabilities in NSTX. The M3D code is a multi-level extended MHD code which treats the thermal species as a single fluid or as two fluids and treats energetic ions as drift-kinetic or gyrokinetic particles. Recent extension of the M3D hybrid code to general three-dimensional (3-D) geometry and to massively parallel platforms makes this calculation possible. In the linear regime with an isotropic beam ion distribution, the M3D simulation results show unstable Toroidal Alfvén Eigenmodes (TAEs) with frequencies consistent with experimental observations in NSTX. For a

more realistic anisotropic distribution, the dominant linear $n = 2$ mode has a significantly lower frequency, as compared to the TAE's frequency. This is also in agreement with the experimental results, where low-frequency modes similar to the “fishbone” mode were observed in addition to TAEs. In the nonlinear regime, the M3D simulations show that the $n = 2$ mode's frequency chirps down as it moves out radially (Figure 2). Initial nonlinear simulations with multiple modes show similar behavior.

Feedback Stabilization of the Resistive Wall Mode in Tokamaks

The model of the feedback stabilization of resistive wall modes (RWM) in tokamaks has now progressed to incorporate feedback coils internal to the resistive vacuum vessel (I-coils) in accordance with the corresponding modification of the DIII-D device at General Atomics. These new coils add much more flexibility to the feedback capabilities, but at the

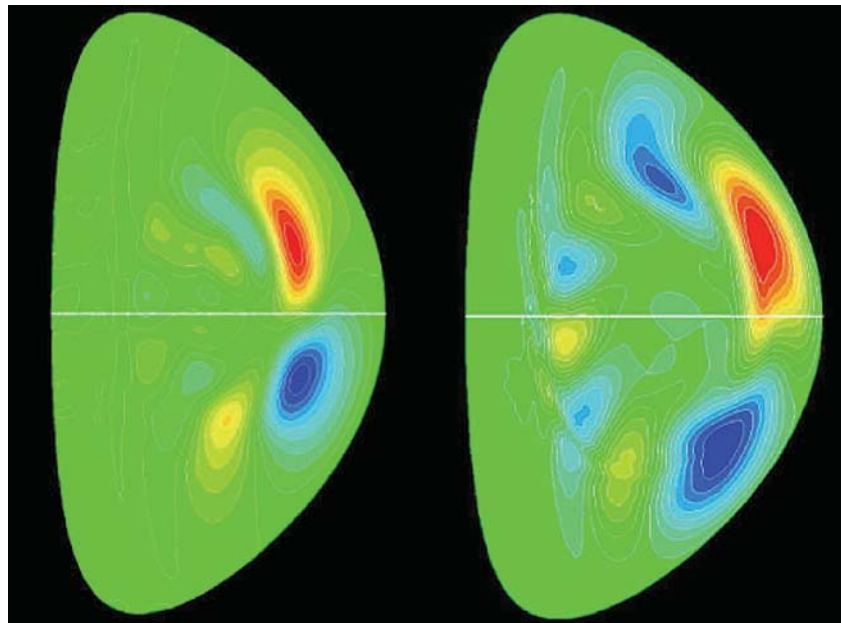

Figure 2. Linear (left) and nonlinear (right) mode structure of $n = 2$ Toroidal Alfvén Eigenmode mode.

same time add more complexity to the analysis. Whereas the external mid-plane coil (C-coil) current path of the previous configuration was designed primarily to sustain the stabilizing eddy current in the shell, the new coils can be tailored to affect the MHD modes more efficiently with appropriate relative phasing of the coils. The previous analysis using a normal mode approach with the DCON-VACUUM codes has been extended for this study.

Figure 3 shows the calculated shell current distributions of the unstable RWM and the two least stable modes of the open loop system, noting the differing helicities of the configurations. The upper and lower I-coils must be phased to match the RWM.

The feedback modeling has been performed for a range of normalized beta and other equilibrium parameters. The optimal phase shifts of the sensor loops, and of the upper and lower I-coils, relative to the C-coil for stabilizing the RWM have been calculated. It is found that the relative effectiveness of the I-coils is about 3-4 times that of the C-coils as judged by the ratios of the energizing currents and sensor signals. This simulation closely

models the experiment. A relative phase shift of roughly $2\pi/3$ between the coils is seen in the model and also experimentally. The relative currents in the coils also agree.

Turbulence and Transport Studies: Theoretical Analysis and Gyrokinetic Simulations

Over the past year, advances in turbulence and transport studies in toroidal systems have featured progress in: (i) the ability to realistically simulate the neoclassical properties for general geometry in toroidal plasmas and (ii) cross-code validation of trends observed in massively parallelized full torus gyrokinetic particle simulations of microturbulence;

Comprehensive Simulations of Neoclassical Transport in Toroidal Plasmas

Neoclassical transport is routinely compared with experimental results. In assessing the confinement properties of toroidal plasma, it is important to accurately calculate the neoclassical dynamics which set the irreducible minimum level of transport in such systems. A global particle-in-cell (PIC) code, GTC-Neo,

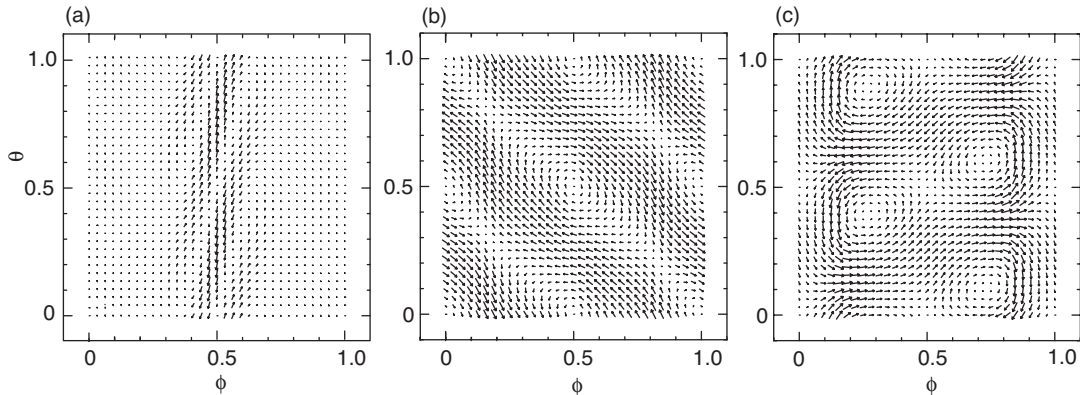

Figure 3. The current distributions on the (ϕ, θ) plane of the resistive shell of the three least stable open loop (i.e., with feedback turned off) eigenfunctions. Only the one shown on the left is unstable. Typically the code uses about 40 eigenmodes. The phase of the unstable mode matches the phases of the feedback coils.

has been developed to systematically study neoclassical physics and equilibrium electric field dynamics of realistic toroidal plasmas. The associated simulation model incorporates the comprehensive influence of general geometry, finite ion orbit width effects, a self-consistent ambipolar electric field, plasma rotation, and an accurate model to represent like-particle collisions.

This newly developed computational capability allows us to assess the irreducible minimum transport level, bootstrap current, and large-scale radial electric field of a real machine for experimental comparison, directly using the three measured plasma profiles: density, temperature, and toroidal rotation angular velocity. The code has been rigorously benchmarked against neoclassical theory in the limit of large aspect ratio with small orbit size. It has been used to study the interesting finite orbit physics of neoclassical transport associated with non-standard orbit topology near the magnetic axis and with steep plasma profiles.

Applications to shaped plasmas, including those for NSTX and DIII-D, found that the ion thermal transport exhibits a nonlocal and nondiffusive character in the region close to the magnetic axis. Specifically, the ion heat flux is almost constant, independent of the value of the local temperature gradient. Compared to standard neoclassical theory (local transport picture), the ion heat transport calculated here can be much lower than the neoclassical level in the presence of a significant temperature gradient. This basically verifies earlier simulation results. However, for relatively flat temperature profiles, the ion heat flux obtained from GTC-Neo can be close to or even much larger than the usual theoretical prediction. Figure 4 shows this nonlocal picture of ion thermal transport for

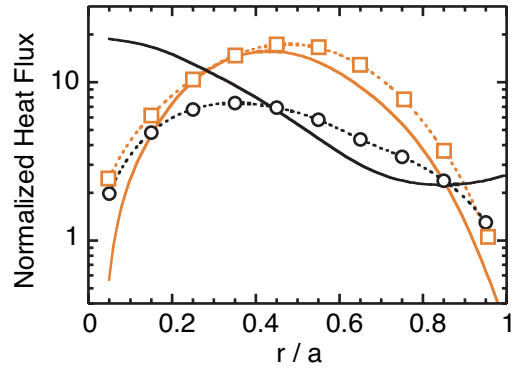

Figure 4. Normalized heat flux from GTC-Neo simulations (dashed curves) compared to standard (Chang-Hinton) neoclassical estimates (solid curves) for large (black curves) and flat (orange curves) temperature gradient (in inner region only) cases in a NSTX plasma.

a NSTX plasma. In both the large and flat temperature gradient cases, the actual values for the ion heat flux are almost the same, indicating an overall global (nonlocal) trend. It is also shown that large ion temperature gradient can increase the bootstrap current; but a steep density gradient does little. When plasma rotation is taken into account, the rotation gradient can drive additional bootstrap current either positive or negative, depending on the gradient direction. However, for typical experimental situations, this change of bootstrap current is found to be insignificant (less than 20%). The largest modification of bootstrap current is found near the magnetic axis. Typically, at $r/a = 0.05$ it is about two times the value from neoclassical theory estimates.

Full Torus Gyrokinetic Particle Simulations of Microturbulence

Massively parallelized full torus gyrokinetic particle simulations have been carried out for large-scale device-size scans and successfully benchmarked both linearly and nonlinearly against flux-tube (local) gyrokinetic results. These valida-

tion studies support previously reported important results addressing the critical question of transport with respect to device size for toroidal plasmas. These were obtained from applications of the three-dimensional particle-in-cell gyrokinetic toroidal code (GTC) in general geometry and made efficient use of the full computing power available from the IBM-SP massively parallel computer at the National Energy Research Supercomputer Center (NERSC). The GTC code is the representative of the Fusion Energy Sciences Program in the NERSC benchmark suite of codes which will be tested on the most advanced computational platforms such as Japan's Earth Simulator Computer, the world's fastest supercomputer.

The GTC code can presently run on the IBM SP at NERSC with more than 2,000 processors with excellent parallel efficiency. Simulation results from GTC have also been complemented by the development of a nonlinear theoretical model which shows that nonlocal physics associated with turbulence spreading into the linearly stable region can cause the gradual transport scaling change from Bohm to gyro-Bohm observed in the simulations. For the relevant parameters studied, this critical transition occurs as the minor radius exceeds around 400 ion gyroradii. To help enable the implementation of more complete physics in these simulations, the feasibility of the electrostatic split-weight scheme with trapped electrons in toroidal geometry has been demonstrated using an algebraic multi-grid solver.

Deeper physical understanding of the size scaling of transport results from the previous massively parallel global gyrokinetic particle simulation of ion temperature gradient (ITG) turbulence using the GTC code has been gained by analytic

work on a simple dynamical theory and comprehensive diagnostics of the simulation results in collaboration with the University of California, Irvine, and the University of California, San Diego. It is shown that while the transport driven by microscopic fluctuations (with a radial correlation length on the order of several ion gyroradii) is diffusive, the transport scaling can deviate from the gyro-Bohm scaling since the fluctuation intensity in the linearly unstable zone can be reduced by nonlocal effects caused by turbulence spreading into the linearly stable zone. As shown in Figure 5, the radial profile of the ion thermal diffusivity is remarkably close to that of the fluctuation intensity. As the system size gets smaller, the extent of radial spreading of turbulence into the linearly stable zone gets wider relative to the system size, allowing deviation from gyro-Bohm scaling of transport. It scales with the gyroradius $\sim 25\rho_i$, while the simple analytic theory predicts $\sim 18\rho_i$.

Theoretical Studies of Energetic Particle Physics

In view of the increased interest in burning plasma physics properties in devices such as ITER, advances in energet-

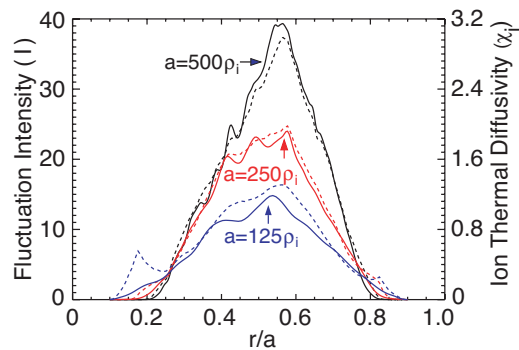

Figure 5. Fluctuation intensity profiles (I in solid lines) and ion thermal diffusivity (χ_i in dashed lines), both in gyro-Bohm units, after nonlinear saturation for $a = 125\rho_i$, $250\rho_i$, and $500\rho_i$.

ic particle studies in toroidal systems are particularly timely. Research on this topic over the past year has featured progress in: (i) providing a viable explanation of fast-particle-driven Alfvénic instabilities in higher beta toroidal plasma such as produced in NSTX; (ii) simulations of Alfvén instabilities in ITER, and (iii) high sub-ion cyclotron frequency instabilities in toroidal plasmas.

Low-frequency Alfvénic Instabilities in Toroidal Plasmas

Alfvénic instabilities driven by the neutral-beam-injected (NBI) fast ions in NSTX plasmas have been observed. A low-field, low aspect-ratio device such as NSTX is an excellent testbed to study the ITER-relevant burning plasma physics of fast particle confinement. The low Alfvén speed in NSTX offers a window in the super-Alfvénic regime expected in ITER (“The Way” in Latin). Effects such as large finite Larmor radius, orbit width, plasma shaping and high thermal and fast-ion betas make this effort a greater challenge. Low-frequency MHD activities, ~ 100 kHz on NSTX, are often observed and identified as the toroidicity-induced Alfvén Eigenmodes (TAE’s) driven by NBI ions. They are often accompanied by beam ion losses (up to 15% neutron signal drop) in high-confinement-mode plasmas with high safety factor at the magnetic axis. The numerical analysis of TAE stability using the NOVA-K code has shown good agreement with the observed TAE data. Furthermore, by creating very similar plasma conditions on NSTX and the DIII-D tokamak, similarity experiments were designed to verify the theoretical predictions that the toroidal mode number of the most unstable TAEs scales with the machine size. The NOVA-K analysis subsequently validated these similarity experiments. In particular, the NSTX TAE’s

were observed with $n = 1-2$ (n is the toroidal mode number), whereas in DIII-D $n = 2-7$. The confirmation of the n -scaling helped to validate the predictive capabilities of the NOVA-K code for studying ITER plasmas. The analysis predicts that the main damping mechanisms are radiative processes and ion Landau damping, which can be balanced against the destabilizing effects from the beam ion pressure gradient in determining the stability threshold of the TAE modes.

Simulations of Alfvénic Instabilities in ITER

To study TAE stability in ITER plasmas, the nonperturbative, fully kinetic HINST code for shorter wavelength (medium to high toroidal mode number) modes and the global NOVA/NOVA-K hybrid ideal-MHD/kinetic codes for longer wavelengths (low to medium toroidal mode number) modes were employed. From the HINST code calculations, the TAE growth rate due to alpha particles is found to be on the order of a few percent of the real frequency, in agreement with the global NOVA-K calculations. However, due to the global TAE mode structure, NOVA-K usually predicts more stable modes than HINST.

Application of the NOVA/NOVA-K codes to ITER plasmas shows an unstable domain of TAEs with toroidal mode numbers spanning $8 < n < 20$. The proposed 1-MeV negative neutral-beam ions can contribute as much to the instability drive as the fusion alphas. However, if the beam injection energy is lowered to 500 keV, TAEs can be stabilized. The background plasma temperature of $T_{i0} = 20$ keV appears to be the threshold for stable plasma operations, and with $T_{i0} > 20$ keV, TAEs will be unstable. Figure 6 shows the dependence of the ratio of the driving term to the total damping of the

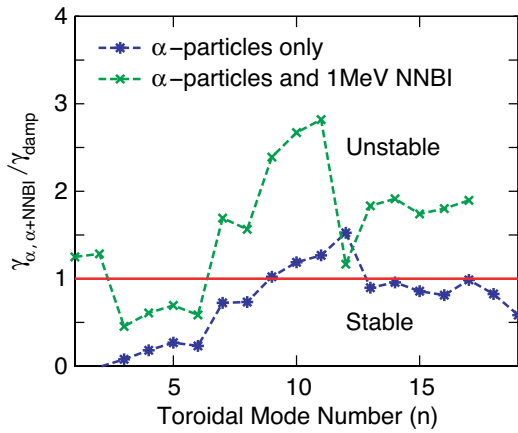

Figure 6. Predicted linear Toroidal Alfvén Eigenmode stability in ITER. More than ten toroidal mode numbers could be unstable.

TAE. The curve with stars represents the case when only alphas are included in the driving term, whereas the curve with “x” points corresponds to the case when both alphas and beam ions are included in the driving term.

High Sub-ion Cyclotron Frequency Instabilities in Toroidal Plasmas. In the high-frequency range of Alfvén instabilities, recent observations of rich sub-ion cyclotron frequency MHD activity in NSTX plasmas suggested an additional new instability, which is identified as the Global Alfvén Eigenmode (GAE). Similar to the Compressional Alfvén Eigenmodes (CAEs), the GAEs are destabilized by the Doppler-shifted cyclotron resonance in the presence of 80-keV NBI ions. To simulate GAE/CAEs in realistic NSTX plasma conditions, an analytical theory and a nonlinear hybrid kinetic-MHD code, HYM, which is capable of computing the mode structure, saturation, and energetic particle transport has been developed. The theory predicts that GAEs are formed with frequencies below the minimum of the Alfvén continuum, and that the eigenmode frequency is determined by the product of the Alfvén velocity and the parallel wavenumber.

The GAE is radially localized near the minimum of the Alfvén continuum and is dominated by a single poloidal harmonic. Due to tangential neutral-beam injection in NSTX, the distribution function of beam ions has a positive gradient in the velocity space and forms a “bump on tail” in the velocity space direction perpendicular to the magnetic field, which provides the energy source for the instability to develop. When beam ions are in Doppler-shifted cyclotron resonance with the modes, GAEs are unstable if beam ions are strongly super-Alfvénic, as in the case of NSTX plasmas. Three-dimensional hybrid simulations using the HYM code have been employed to study the excitation of these higher-frequency Alfvén eigenmodes by energetic ions in NSTX.

The HYM code is a nonlinear, global stability code in toroidal geometry, which includes a fully kinetic ion description. Beam ions are treated with full orbits with the delta-f method, while the background plasma is treated with the one-fluid resistive MHD model. The dynamics of these two plasma components are coupled via a current coupling scheme. The effects of the beam ion toroidal and poloidal currents are included nonperturbatively to account for the anisotropic fast-ion pressure tensor and to calculate self-consistent equilibria, which serve as an initial condition for the 3-D simulations. HYM simulations for typical NSTX parameters confirm that, for large injection velocities of beam ions and strong anisotropy in the pitch-angle distribution, there are unstable high-frequency Alfvén modes. It is found that the most unstable modes with low toroidal mode numbers, $2 < n < 7$, are GAE modes. These modes are found to be localized near the magnetic axis, and have large parallel wavenumbers to satisfy the dispersion relation. The computed poloi-

dal velocity has a vortex-like structure, which is characteristic for shear Alfvén waves. However, in NSTX these modes have a significant compressional component, due to strong coupling to the compressional Alfvén wave.

Plasma Boundary Physics

The objective of the NSTX “gas puff imaging” (GPI) experiments is to provide high spatial and temporal resolution data on edge plasma turbulence. While the geometry of the diagnostic is designed to optimize the quality of those data, the three-dimensional nature of the experimental configuration complicates interpretation and utilization of the results, as illustrated in Figure 7. As a result, 3-D simulations of the GPI experiments with the DEGAS 2 Monte Carlo neutral transport code have been devel-

oped. Visualizations of the information input to and output from DEGAS 2 have provided a better understanding of the spatial relationships of the physical objects in the experiment. Direct comparisons of the experimental and simulated GPI camera images allow the consistency of the available diagnostic data to be assessed, as shown in Figure 8. The neutral density computed by DEGAS 2 in simulations validated in this way can then be used in other GPI-related studies. For example, J. Myra and D. D’Ippolito of Lodestar Research have developed a procedure utilizing the DEGAS 2 neutral density that allows the time-dependent, turbulent plasma parameters underlying the GPI emission to be inferred. These plasma data are being used to test theories of the evolution of edge plasma turbulence.

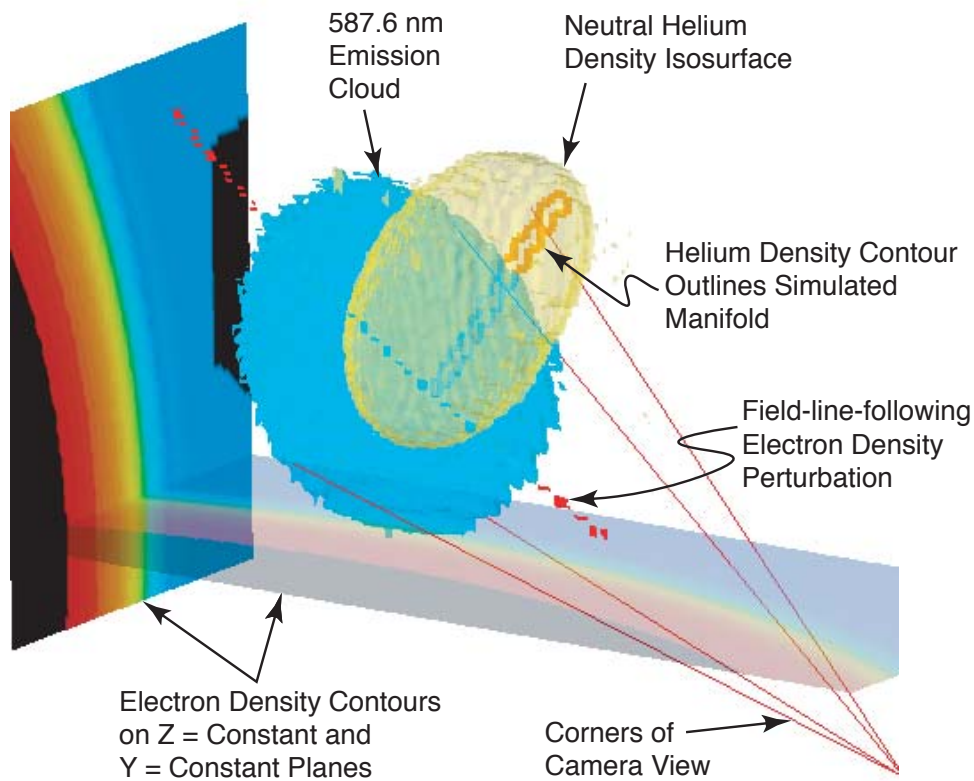

Figure 7. Visualization of the three-dimensional DEGAS 2 code gas puff imaging simulation.

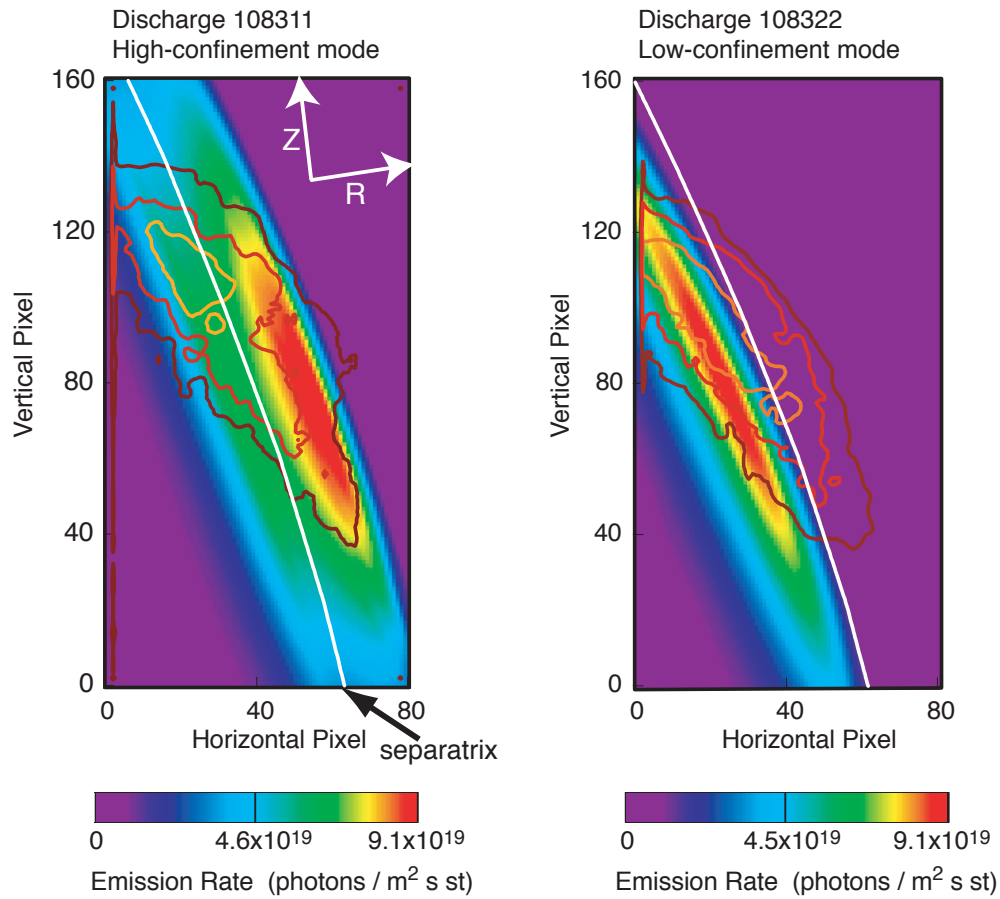

Figure 8. Comparisons of simulated (color images) and experimental (line contours) gas puff imaging emission clouds.

The DEGAS 2 gas puff imaging simulations have been made possible by continued improvements in the code. The ability to treat toroidally segmented problems was added to the DEGAS 2 geometry setup code, 3-D extensions to the specification of neutral sources were added, and 3-D graphics were developed. The geometry setup code was subsequently modified to handle 3-D objects consisting of two-dimensional (2-D) shapes rotated through a limited range of toroidal angle. A new set of helium atomic physics data has also been obtained and adapted for use in DEGAS 2. These data are the result of a state-of-the-art model developed by M. Goto of Japan's National Institute for Fusion Science.

Theory Support for the NSTX

The PPPL Theory Department continued to play a major role in the analysis and modeling of NSTX in the topical areas of MHD, transport and turbulence, boundary physics, and the interactions of energetic particles with MHD.

Understanding the effect of the observed rapid rotation in NSTX plasma on MHD equilibrium and stability is an ongoing topic of research. In collaboration with the University of Rochester in New York equilibrium modeling with flow shows density asymmetries comparable to the observations, as rotation shifts particles off flux surfaces. The high velocities also contribute to reduced-mode growth rates. A new observation from the simu-

lations of sawtooth reconnection is, that in addition to the flattening of the pressure profile, the toroidal velocity profile is also flattened inside the island. This result is consistent with the limited experimental data available.

As described above in the Turbulence and Transport Studies section, a global particle-in-cell code, GTC-Neo, has been developed to systematically study neoclassical physics and equilibrium electric field dynamics of realistic toroidal plasmas. The simulation model incorporates the comprehensive influence of: general geometry, finite ion orbit width effects, a self-consistent ambipolar electric field, and an accurate model to represent like-particle collisions. Application of GTC-Neo to NSTX using an equilibrium representing an NSTX discharge has produced an interesting physics trend. Specifically, the ion thermal transport is found to exhibit a nonlocal and nondiffusive character in the region close to the magnetic axis due to nonstandard orbit topology, a feature characteristic of spherical tori.

Gas puff imaging experiments on NSTX provide an interesting challenge to theory and modeling. The DEGAS 2 Monte Carlo neutral transport code has been used to simulate helium atom behavior in these experiments on NSTX. These detailed simulations permit direct comparison of the code output with the images obtained from the GPI camera. Furthermore, visualizations of the information input to and output from DEGAS 2 have provided a better understanding of the spatial relationships of the physical objects in the experiment. Additional detail on this work is provided above in the Plasma Boundary Physics section.

As noted in the highlights of progress in the energetic particles studies area, new

observations of a sub-ion cyclotron frequency range instability in NSTX have also motivated theory developments. The instability is found to be driven by beam ions in the positive gradient region of the beam distribution function in velocity space. These ions excite a cavity mode, which is identified as a global shear Alfvén eigenmode. The predicted mode dispersion is consistent with experimental observations.

Progress has also been made in the simulation of sub-cyclotron frequency modes driven by the energetic neutral beam ions in NSTX, using the HYM code. Hybrid MHD/delta-f particle simulations show the excitation of Global Alfvén Eigenmodes (GAE), which are the most unstable modes at low n ($2 < n < 7$) with growth rates of the order of 1% of the cyclotron frequency (Figure 9). For each toroidal mode number, several (dominant) poloidal modes are unstable. Simulations for $n > 7$ show edge-localized modes with a large compressional component (CAE). CAE modes have smaller growth rates $\sim 0.001-0.003$ of the cyclotron frequency, and larger poloidal mode numbers ($m \sim 8-10$).

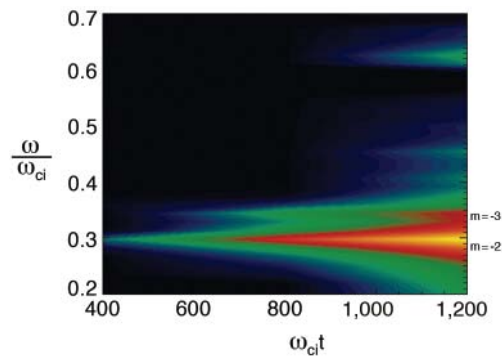

Figure 9. Results from HYM code simulations. Time evolution of spectrum of unstable modes for toroidal mode number $n = 4$. Lower-frequency modes are Global Alfvén Eigenmodes with poloidal mode numbers $m = -2$ and $m = -3$.

Stellarator Theory

The PPPL Theory Department continued to have a critical lead role in addressing and resolving physics issues relating to the design of the National Compact Stellarator Experiment (NCSX). As the NCSX Project moves forward to its construction phase, work in the theory group is turning to new studies motivated by the long-term needs of the NCSX program, and to further adaptation and application of tokamak tools and expertise to stellarators. In particular, the stellarator capabilities of the PIES and M3D codes have been further upgraded this year, and the codes have been applied to several physics and modeling issues. A new tool has been developed for studying ballooning stability, and a new equilibrium reconstruction code has been created.

PIES Code Applications and Development

The PIES code is being used to study flux surface issues in the W7-AS stellarator in Germany, and the results of calculations thus far correlate well with the attainable betas in W7-AS experiments. For the purposes of this study a modified version of the PIES code was produced, allowing the specification of a fixed, experimentally determined pressure profile and applying an appropriate model for the pressure-driven current in stochastic regions. The modified code has been applied to a series of experiments which studied the influence of control coil current on the attainable beta.

A new package has been developed for the free-boundary version of the PIES code that allows the code to use a divertor-like boundary condition, in addition to the limiter boundary condition previously used. Primarily, German collaborators at Greifswald have done this work. The new version of the code is being ap-

plied to edge modeling on NCSX by collaborators at Livermore.

The PIES collaboration with the Spanish TJ-II group, which has been in abeyance for several years, was revived this year. The most recent version of the PIES code was ported to Spain for use in the analysis of TJ-II data.

The NCSX field error calculations have been done with the PIES code to benchmark the results of quasi-analytic estimates of field error tolerances and show a significant reduction in field error magnitude due to self-consistent plasma effects not included in the quasi-analytic estimates.

M3D Code Calculations

The two-fluid plasma model in the M3D code has been applied to study limits on stellarator high-beta steady states, with emphasis on NCSX. Two-fluid effects are found to fundamentally change the fast, MHD-time-scale quasi-steady states, compared to MHD. They effectively stabilize the high-mode-number resistive ballooning/interchange modes that limit beta in MHD for fixed plasma boundaries, well above the MHD limit (7-8% beta compared to 4%, for NCSX). The two-fluid terms produce some effects similar to those of the neoclassical parallel viscous stress. They drive a steady-state radial electric field similar to the neoclassical electric field driven at low collisionality. A rapid increase in island growth with beta, at higher beta, suggests that one stellarator beta limit is determined by deteriorating plasma confinement due to large magnetic islands, rather than intrinsic turbulence or catastrophic instability.

New Code Development

A new computational tool for studying the ballooning stability properties of

stellarator equilibria has seen continued development. By perturbing the pressure gradient and shear at a selected surface, marginal stability diagrams for ballooning modes are constructed for stellarators that are analogous to the diagrams constructed for tokamaks in terms of the magnetic shear (s) and pressure gradient (α) parameters. This method shows that, in particular, an increasing pressure gradient alters the local shear. This effect leads to the phenomenon of second-stability in both tokamaks and stellarators. Results from this procedure are illustrated in Figure 10.

A new 3-D equilibrium reconstruction code is also being developed. An earlier formal result, generalizing a 2-D method of Christiansen and Taylor to 3-D systems such as stellarators, is now being implemented in a code, to test whether the method can be used as a novel diagnostic for stellarators, allowing practical reconstruction of 3-D stellarator equilib-

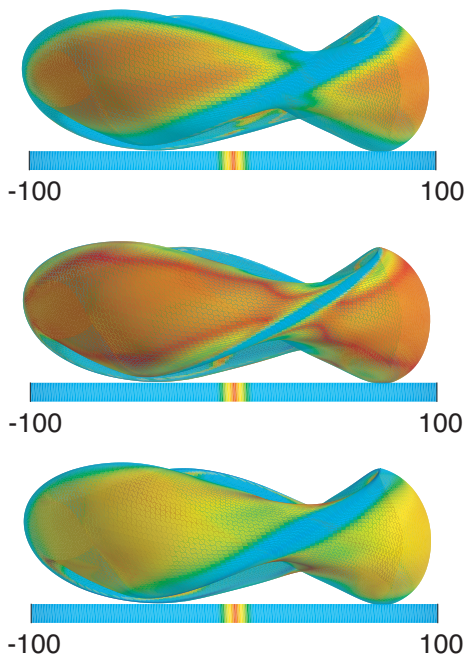

Figure 10. Local magnetic shear on a flux surface for three configurations similar to the NCSX design, with varying pressure gradient.

ria from emissivity data. The code presently operates on 2-D equilibria, and the 3-D features of the code are now being debugged.

Field-Reversed Configuration Stability Studies

Stability properties of field-reversed configurations (FRCs) have been studied using the 3-D nonlinear hybrid and magnetohydrodynamic (MHD) simulation code HYM. A new parallelized version of the HYM code has been developed using 3-D domain decomposition. In addition, single-processor optimization has been completed, and the data layout and structure of the HYM code has been modified using modern Fortran-90 language features to improve in-cache performance and portability and maintainability of the code. Both the MHD and the delta-f particle versions of the HYM code have been parallelized. Flexibility of the model allows use of independent 1-D to 3-D domain decomposition of the particle grid and the field grid to achieve the best parallel performance and load balancing for various problem sizes and different applications. For a prescribed, small-size problem, very good parallel scaling has been obtained for up to 30 processors. The HYM code has been ported to the NERSC IBM SP computer.

Recent accomplishments include: (a) study of the effects of finite electron pressure on FRC stability properties; (b) initial 3-D MHD simulations of counter-helicity spheromak merging and FRC formation in support of the SSX-FRC experiment at Swarthmore College; (c) development of a new parallelized Grad-Shafranov equilibrium solver FRCIN, which allows calculation of self-consistent kinetic equilibria for arbitrary ion distribution functions; (d) nonlinear

study of the evolution of the tilt mode in FRC configurations with different values of the elongation and the FRC kinetic parameter \bar{s} , which measures the number of ion gyroradii in the configuration. It has been demonstrated that, contrary to the usually assumed stochasticity of the ion orbits in the FRC, a large fraction of the orbits are regular in long kinetic configurations. A stochasticity condition is found (Figure 11), and the number of regular orbits is shown to scale as $1/\bar{s}$.

The nonlinear evolution of MHD instabilities has been studied for a wide range of \bar{s} values. The linear and nonlinear stability of MHD modes with toroidal mode numbers $n \geq 1$ has been investigated, including the effects of ion spin-up and finite electron pressure. A modified delta-f scheme has been developed that allows switching dynamically from the delta-f method to the conventional (i.e., full-f) particle-in-cell method, as the perturbation amplitude becomes large. The results of nonlinear hybrid simulations offer a definitive explanation of the stability properties observed in low- \bar{s} FRC experiments. It has been demonstrated that, although the $n = 1$ tilt mode is linearly the most unstable mode for nearly all experi-

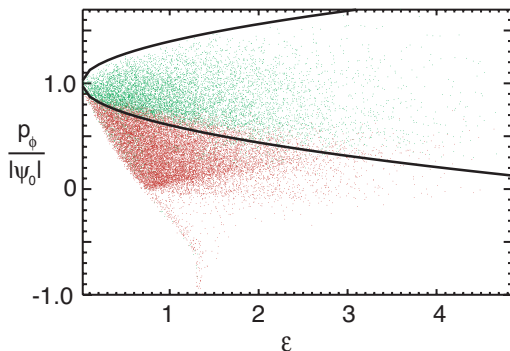

Figure 11. Scatter plot of the particle distribution in (ϵ, p_ϕ) phase space. Color is used to mark the regular-orbit (green) and ergodic-orbit (red) particles. The solid line corresponds to the analytical stochasticity condition.

mentally relevant FRC equilibria, it saturates nonlinearly without destroying the configuration, provided the FRC kinetic parameter is sufficiently small. The saturation of the $n = 1$ tilt instability occurs in the presence of ion toroidal rotation, and is accompanied by the growth of $n \geq 2$ rotational instabilities (Figure 12), which are often seen in experiments. The saturation of the $n = 1$ tilt instability occurs due to the nonlinear change in the ion distribution function, and the stabilizing effects of ion sheared rotation and the nonlinear interaction with growing $n \geq 2$ rotational modes. Large- \bar{s} simulations show no saturation of the tilt mode, and there is a slow nonlinear evolution of the instability after the initial fast linear growth. Overall, the hybrid simulations demonstrate the importance of nonlinear effects, which are responsible for the saturation of instabilities in low- \bar{s} configurations, and also for the increase in FRC lifetime compared to MHD models in high- \bar{s} configurations.

Fusion Energy Science Pilot Computing Facility

The PPPL pilot Fusion Computational Center (FCC) began operation during FY03. This jointly funded Fusion Energy Science (FES) facility was established with resources from the Department of Energy (DOE) and Princeton University, including the University's Princeton Institute for Computational Science and Engineering (PICSciE). Complementary to its involvement in "capability computing" activities on the most powerful available supercomputing platforms at major centers (e.g., at the National Energy Research Scientific Computing Center (NERSC) and at Oak Ridge National Laboratory), the FCC addresses important "capacity computing" issues by examining the cost-effective utilization of

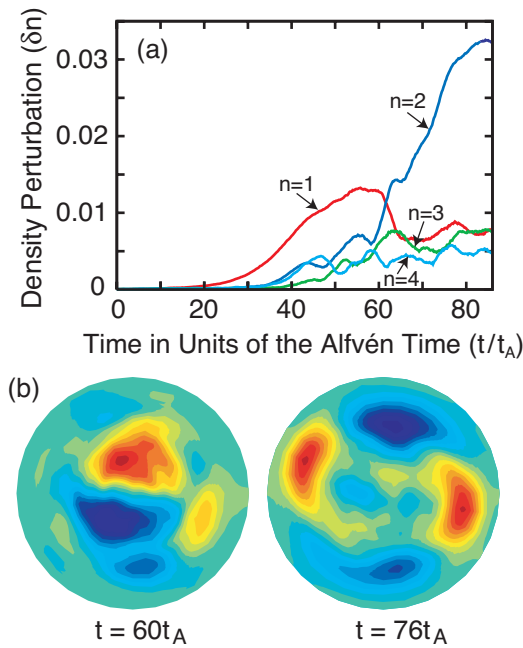

Figure 12. Results from nonlinear HYM simulations of field-reversed configuration plasmas: (a) Time evolution of the $n = 0-4$ Fourier harmonics of the ion density perturbation and (b) contour plots of the perturbed number density at the toroidal cross section at $t = 60t_A$ and $t = 76t_A$, where A is the Alfvén time.

commodity clusters dedicated to key FES applications. This impacts FES participation in the DOE Office of Science’s Scientific Discovery through Advanced Computing (SciDAC) program in that it involves collaborations with several SciDAC teams, including the Plasma Microturbulence Project, the Extended MHD Project, and the Fusion Collaboratory. In addition, the facility includes the strong involvement of Princeton University, which provided matching funds, and the National Oceanic and Atmospheric Administration’s Geophysical Fluid Dynamics Laboratory in “grid computing” explorations. Grid computing is a distributed computing infrastructure for advanced physics and engineering applications involving large-scale resource sharing. This includes not only

file exchange, but direct common access to computers, software, data, and other resources. In general, knowledge gained through this pilot project about capability as well as capacity computing issues can be usefully applied toward planning future FES investments in computational infrastructure. Nevertheless, the main rationale behind the creation of the PPPL Fusion Computational Center was, and still is, to provide to the fusion community a dedicated system based on capacity computing. As NERSC moved towards a policy that favors large simulations from codes that can scale to more than 1,000 processors, it makes the FCC even more relevant, if not essential. NERSC is now, for the most part, a “capability computing” center, handling the most challenging calculations requiring extremely large resources. The FCC has proven to be an invaluable tool for running smaller calculations or some of the codes that use a significantly smaller number of processors and do not require such large resources. This effectively helps relieve the NERSC supercomputer.

As part of the FCC, a new 128-processor PC cluster has been extensively used in the past year. Transport studies involving applications of the GS2 microturbulence code (from the SciDAC Plasma Microturbulence Project) have been carried out almost daily on this cluster. The 64-processor GS2 simulations run at comparable speed to the NERSC systems due to the relatively low sensitivity of GS2 to latency. The Gyrokinetic Toroidal Code (GTC) has also been run on this cluster for smaller, but just as relevant, calculations as the ones done on the NERSC system as illustrated in Figure 13. In support of GTC, the Globus GRID software has been installed to take advantage of the parallel multi-streaming I/O software developed at PPPL by its Computa-

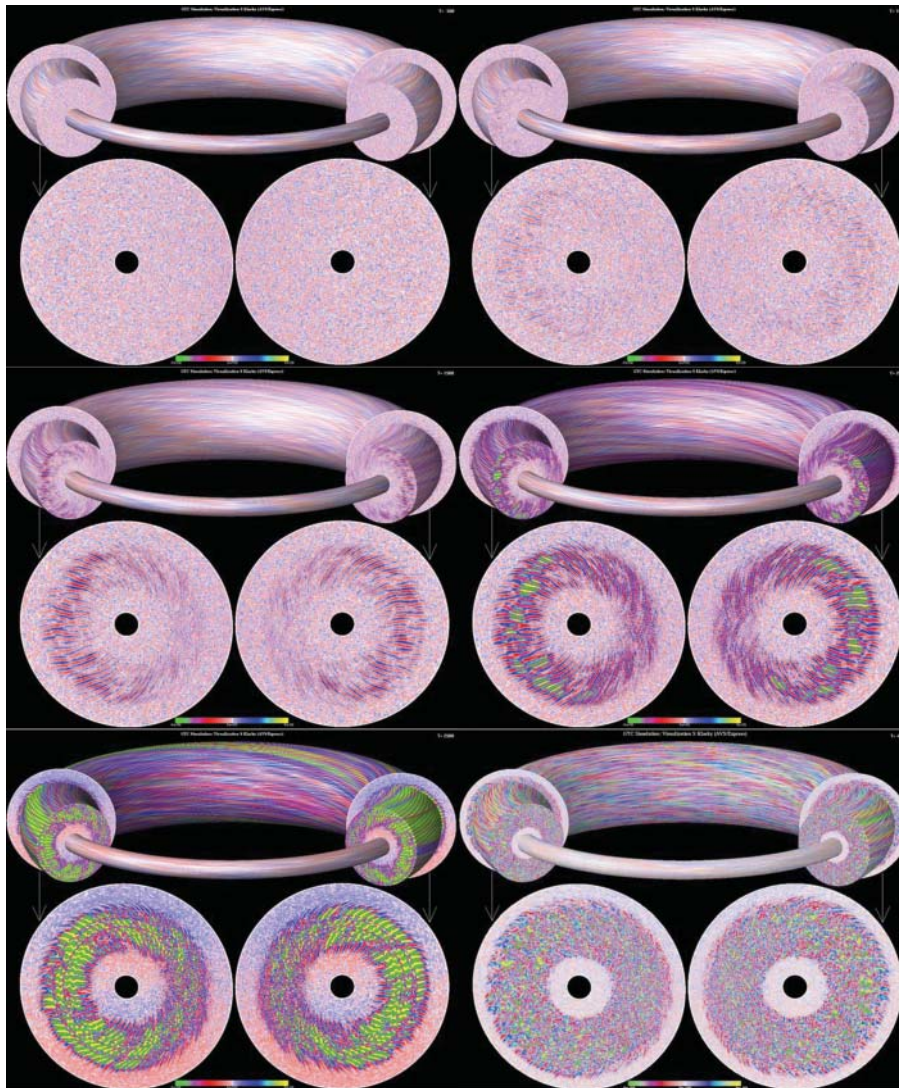

Figure 13. Results of nonlinear GTC simulation showing breakup of convective-cell eddies by zonal flow, limiting turbulent transport.

tional Plasma Physics Group. This software solves the important and difficult issue of data management on PC clusters without requiring an expensive data storage system directly attached to the compute nodes. Another aspect of the pilot studies was to examine the effectiveness of grid computing for data management for the larger codes in the FES portfolio (such as the GTC code). In the initial experiments, the GTC code was run on the grid-cluster located at Princeton

University's Main Campus. By threading and buffering the I/O layer, it was found that GTC ran faster on this cluster when the data streaming techniques were used compared to writing out data locally on their cluster. The underlying transfer mechanism was Globus GridFTP, which was able to stream data across the Princeton microwave link at a rate of over 98 Mbs. These important new findings were highlighted at the national Supercomputing 2003 Conference.

Computational Plasma Physics

The Princeton Plasma Physics Laboratory (PPPL) Computational Plasma Physics Group (CPPG) continued in its role of advancing and disseminating modern computational methods throughout PPPL and the fusion community. The accomplishments described in the subsequent sections include (1) improving the efficiency of the production high-end theory simulation codes M3D and GTC, (2) further development and support of the transport analysis code TRANSP as a National Fusion Collaboratory service, (3) further enhancement and maintenance of the National Transport Code Collaboration (NTCC) Modules Library, (4) developing new advanced numerical techniques based on adaptive mesh refinement and Gabor wave packets, and exploring their application to fusion problems, and (5) providing a high-end visualization display wall and developing practical methods for viewing very large remote data sets. Details are given in the subsequent sections.

Improvements in Theory Simulation Codes

Symmetric Solver in M3D

The coefficient matrices in the massively parallel extended MHD code, M3D, have been reformed to take advantage of their symmetric structures, and this has allowed solution by a more efficient linear solver that takes this sym-

metry into account. The time to solution for a M3D simulation is dominated by the time it takes to solve 13 elliptic equations each time step. These elliptic equations can be categorized into three types that correspond to: a weak diagonally dominant matrix, a moderate diagonally dominant matrix, and a strong diagonally dominant matrix.

Previously, there was no alternative to the Generalized Minimum Residual (GMRES) solution procedure for a general sparse matrix. However, by taking into account the underlying symmetric structure of the coefficient matrices, another, more efficient linear solver, Incomplete Cholesky Conjugate Gradient (ICCG), was able to be implemented. The efficiency of a direct Gauss LU solver was evaluated for comparison purposes. Figure 1 illustrates the time to solution for these three solver types for each of the three matrix types typical of M3D. Note that less time is better in these comparisons. It is observed that ICCG (CG) greatly accelerates the solution process as compared to GMRES, especially for the weak diagonally dominant matrix. In the weak diagonally dominant case, 4 to 44 times speedup was achieved when the matrix order ranges from about 10 to 10,000. For the moderate diagonally dominant case, there is a 4 to 24 times speedup. For the strong diagonally dominant case, an average two times speedup is observed. Converting to the symmetric structure and using the ICCG

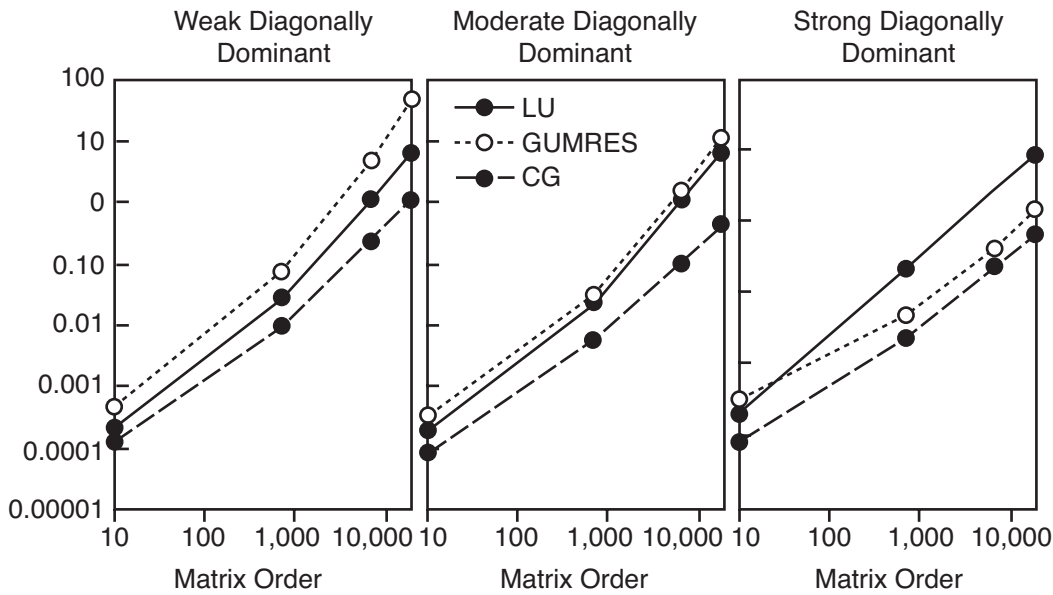

Figure 1. The M3D linear equations are now being solved by a the ICCG method (CG) that takes advantage of the underlying symmetric structure and greatly reduces time to solution.

algorithm has thus led to over a factor of two speedup in the M3D code.

GTC Optimization

The gyrokinetic microturbulence simulation code GTC has been ported to the Japanese-made NEC SX-6 vector supercomputer as part of the National Energy Research Supercomputer Center (NERSC) benchmark suite of codes for the evaluation of new systems. The NEC SX-6 node is the building block of the much larger and much publicized Earth Simulator computer in Japan. The impressive performance achieved in 2002 by the 5120-processor Earth Simulator (35 Tflops on Linpack, 87% of peak) has revived the interest of computational scientists in vector processors. Although the theoretical peak performance of the super-scalar processors (such as are available at NERSC) rivals their vector counterparts, most scientific codes cannot obtain these speeds due to memory bandwidth and latency limitations, and typically run only at a few percent of peak performance (less than 10%).

With some modifications to adapt to the vector structure, many of the same scientific codes that do not perform well on super-scalar computers can reach up to 75% of peak performance on vector supercomputers such as the NEC SX-6. The purpose of the on-going study has been to evaluate the work and reward ratio involved in vectorizing the GTC code on the latest parallel vector machines, such as the NEC SX-6 and also the U.S.-made CRAY-X1. This evaluation was initially carried out on the 8-CPU SX-6 located at the Arctic Region Supercomputing Center (ARSC), and has since been extended to 64 CPUs at the Earth Simulator center in Japan. Present performance results reveal that the GTC code runs more than five times faster per CPU on the SX-6 vector processor compared to the NERSC IBM Power 3 super-scalar processor. More work is being done to further improve this performance and to evaluate performance on the new CRAY-X1 located at the Oak Ridge National Laboratory.

To improve the data management for GTC, Globus-based parallel streaming

I/O routines have been developed and tested for real simulations. By taking advantage of GRID technology and software, the large amount of data generated by GTC can now be transferred in parallel, while the calculation is performed, to the location where the data is analyzed. Furthermore, this method has very little impact on the simulation performance.

Transport Analysis Code Development

Significant improvements to both physics modeling and operational capabilities were achieved in the widely used TRANSP experimental data-analysis code this year.

In operations, the transition to the FusionGrid TRANSP production system was completed. This system automatically responds to run requests from authorized users anywhere in the world via the internet. More than 1,600 runs were generated in 2003 for numerous experiments (Figure 2). Because the actual computations take place locally, PPPL experts can monitor the system and debug runs that encounter problems. There are now 38 magnetic fusion energy research users from seven institutions with electronic FusionGrid Certificates and authorization to produce TRANSP runs on PPPL compute servers. TRANSP is the first operational compute service, <http://www.fusiongrid.org>, of the National Fusion Collaboratory SciDAC project.

Remote TRANSP users employ client software tools to request runs from their local computing systems so that they do not need to log on to PPPL machines directly. Users can track the progress of their runs via the TRANSP site web site <http://w3.pppl.gov/TRANSP>. This site links to the General Atomics “FusionGrid Monitor,” which gives a summary of status of active and recently completed runs.

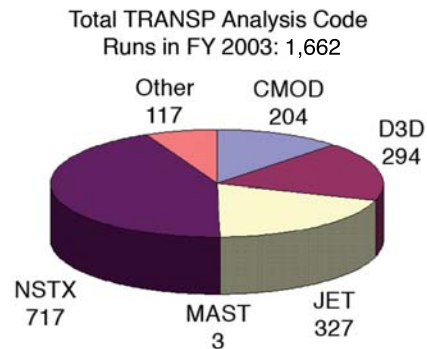

Figure 2. Fiscal year 2003 TRANSP code run production statistics. CMOD = Alcator C-Mod tokamak at the Plasma Science and Fusion Center, Massachusetts Institute of Technology, Cambridge, Massachusetts; D3D = Doublet DIII-D tokamak at General Atomics in San Diego, California; JET = Joint European Torus in the United Kingdom; MAST = Meg Amp Spherical Torus at the Culham Laboratory, United Kingdom; NSTX = National Spherical Torus Experiment at the Princeton Plasma Physics Laboratory, Princeton, New Jersey. Fiscal years 2000-2002 production (under the old system) averaged 950 runs per year.

Associated with each run listing are further links to the run’s log files and graphical monitoring data. A new feature of the system, utilizing PPPL’s “EIVis” scientific graphics package, allows user-selected data to be monitored in graphical displays that are dynamically updated “during execution,” giving early feedback on run results. Figure 3 illustrates the procedure from a user standpoint.

Another operational improvement to the code is the option to accept the plasma geometry and fields (i.e., the MHD equilibrium file) from a data source and hold these fixed in time. This enables the code to run faster, by removing the requirement to recalculate the equilibrium and associated geometric information time dependently. This mode of operation has been used as the basis for a prototype time-slice “between-shots” analysis capa-

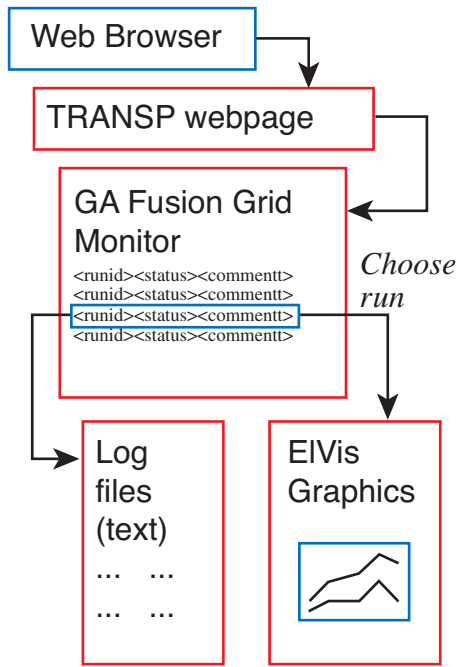

Figure 3. Web-accessible information on executing TRANSP code runs.

bility. For several cases from the General Atomics DIII-D tokamak, a time-slice analysis with full Monte Carlo neutral-beam injected fast ions could be completed in about three minutes on commodity hardware — well within the 20-minute shot cycle time for DIII-D. Multiple FusionGrid compute servers can be employed to process multiple time points simultaneously. By using EIVis monitoring, useful run results can be seen even before run completion.

There has also been significant progress on TRANSP physics packages. The National Transport Code Collaboration (NTCC), <http://w3.pppl.gov/NTCC>, received an upgraded version of NUBEAM, TRANSP’s Monte Carlo fast-ion module, which has now been installed in General Atomic’s ONETWO transport code. In collaboration with Lehigh University, a detailed description of the NUBEAM package was completed. Fortran-90 and precision improvements enabled removal of the upper limit on the number of

Monte Carlo ions used in NUBEAM simulations.

NUBEAM now supports a neutral particle analyzer (NPA) simulator, which has been deployed to study data from the National Spherical Torus Experiment (NSTX) (Figure 4). The toroidal location of neutral beams and NPA detectors are specified so, for the first time, the NPA simulator looks at charge-exchange neutral e-flux generated from the three-dimensional beam-injected fast neutrals in addition to the one-dimensional flux-surface-averaged thermal background neutrals. Multiple diagnostic channels and neutral particle species are supported in the simulation. The radio-frequency ray-tracing codes CURRAY and GATORAY were installed in TRANSP and are undergoing validation. CURRAY was validated for certain regimes of high-harmonic fast-wave heating (HHFW) on NSTX and was used for time-dependent HHFW studies this year.

The TRANSP Group’s collaboration with the authors of TORIC (Institut für Plasmaphysik, Garching, Germany) con-

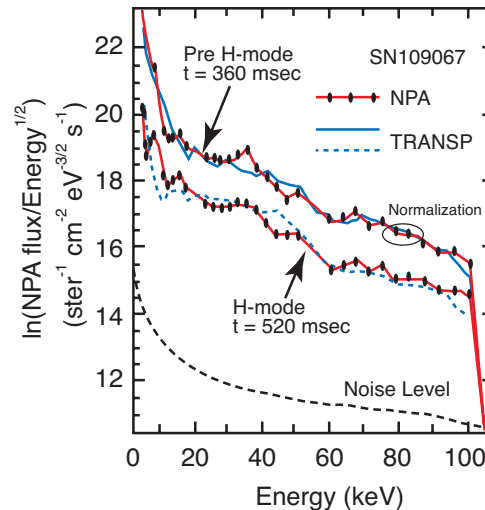

Figure 4. TRANSP neutral particle analyzer simulations (versus particle energy) compared to measurements on the National Spherical Torus Experiment.

tinued. A modular interface for communication of TORIC's wave-field solution to the Fokker-Planck fast-ion solver was defined and is being implemented.

Collaboration with Joint European Torus (JET) physicists resulted in the development, installation, and validation of a new, generalized geometry fast analytic neoclassical resistivity module. The contributions by the JET team were made over the internationally shared TRANSP code development collaboration system, which has been operational for more than twelve years.

The maximum radial resolution of TRANSP has been increased from 100 to 400 zones, with various performance improvements made for high-resolution operation. The floating-point precision of the entire TRANSP kernel — hundreds of subroutines — was systematically increased from 32-bits to 64-bits, using porting and conversion tools (fpreproc and ftoken) supplied in the National Transport Code Collaboration (NTCC) modules library.

In summary, the TRANSP effort, well supported by the PPPL experimental projects (NSTX and collaborations), along with allied efforts in the NTCC and in the SciDAC Fusion Collaboratory, continues to make progress over a wide range of research activities.

National Transport Code Collaboration Modules Library

In FY03, PPPL continued to make contributions to the NTCC Modules Library and to support the library website, <http://w3.pppl.gov/NTCC>. In this role, PPPL not only submits its own contributions but also receives and packages contributions from other laboratories. There have been numerous downloads of NTCC software, both nationally and internationally. Many of the more gener-

al-purpose packages have been picked up and acknowledged by scientific users outside the magnetic confinement fusion research community.

In the early years of the NTCC project, a foundation was laid in the form of basic tools needed for collaborative scientific computing, such as packages to aid the creation of portable software, as well as basic numerical tools such as interpolation. As the project has matured, more sophisticated and larger integrated physics packages are being collected in the library.

In FY03, the following new modules were contributed:

- CURRAY: ion-cyclotron range-of-frequencies ray-tracing code.
- GA-TORAY: electron-cyclotron heating and electron-cyclotron current-drive ray-tracing code.
- CYTRAN: cyclotron radiation transport package.
- FRANTIC: simplified geometry very fast neutral atom transport package.
- TR-CLIENT: client tools for TRANSP Collaboratory users.

NTCC Modules are subject to a review process. A standing committee selects reviewers and votes to approve reviewed modules; the approval status of modules is clearly marked at the website. In FY03, the following modules were reviewed and approved:

- NUT: fast, semi-analytic three-dimensional code for neutral atom transport in plasmas.
- ESC: toroidal magnetohydrodynamic equilibrium solver.

Authors can, and frequently do, supply significant upgrades to existing modules. In FY03, significant upgrades were received for:

- EZCDF: easy interface to NetCDF portable file format.
- GLF23: predictive transport model.
- NUBEAM: Monte Carlo fast-ion package from TRANSP.
- PEDESTAL: H-mode pedestal/edge model.
- R8SLATEC: library of special functions and mathematical tools.

The Princeton Plasma Physics Laboratory has contributed slightly more than half the modules currently in the NTCC library, and is committed to responding to user requests for assistance with this software. In FY03, significant assistance was given to Institut für Plasmaphysik, Garching, Germany, General Atomics, and the Lawrence Livermore National Laboratory.

The NTCC has proven to be a very useful venue for software sharing. Experience gained in the NTCC project will be extremely useful in larger software collaborations planned for the future, such as the Fusion Simulation Project.

Advanced Numerical Techniques Adaptive Mesh Refinement Model of Pellet Injection into Tokamaks

An AMR (adaptive mesh refinement) MHD code using the Chombo framework (website: <http://seesar.lbl.gov/ANAG/chombo/>) has been developed in collaboration with researchers at the Lawrence Berkeley National Laboratory. The code uses an eight-wave unsplit upwinding numerical method coupled with

Hodge projection to preserve the solenoidal property of the magnetic field. This code is currently being utilized in studies of pellet injection in tokamaks, in studies of magnetic reconnection, and to evaluate other possible uses of AMR in fusion applications.

To simulate pellet injection in tokamaks, a trajectory for a spherical pellet of frozen hydrogen is prescribed and an existing pellet ablation model employed. The result of the calculation is that the ablated pellet mass is redistributed in the tokamak plasma due to large-scale MHD processes. Preliminary results of HFS (high-field-side) and LFS (low-field-side) launches are shown in Figure 5. The top and middle images show a density isosurface for the HFS and LFS launch respectively. The isosurfaces shown in the computational domain (right column, top and middle rows) are superimposed with the outlines (white) of the various grids which indicates that the mesh has been adapted to follow the motion of ablated mass in the domain. The bottom panel shows density contours in a poloidal slice intersecting the center of the pellet. It is evident that the dominant transport of the pellet ablated mass is along the magnetic field lines. Nevertheless, mass transport across flux surfaces in the outward radial direction for both the HFS and LFS launches is observed. This is in qualitative agreement with the experimental observation of the differences in efficiency between HFS and LFS pellet launches. Detailed comparisons are presently being made of these simulations and the corresponding experimental data from the Tokamak Fusion Test Reactor (TFTR) and the Joint European Torus (JET).

The AMR technique has proven itself to be extremely useful for enabling the

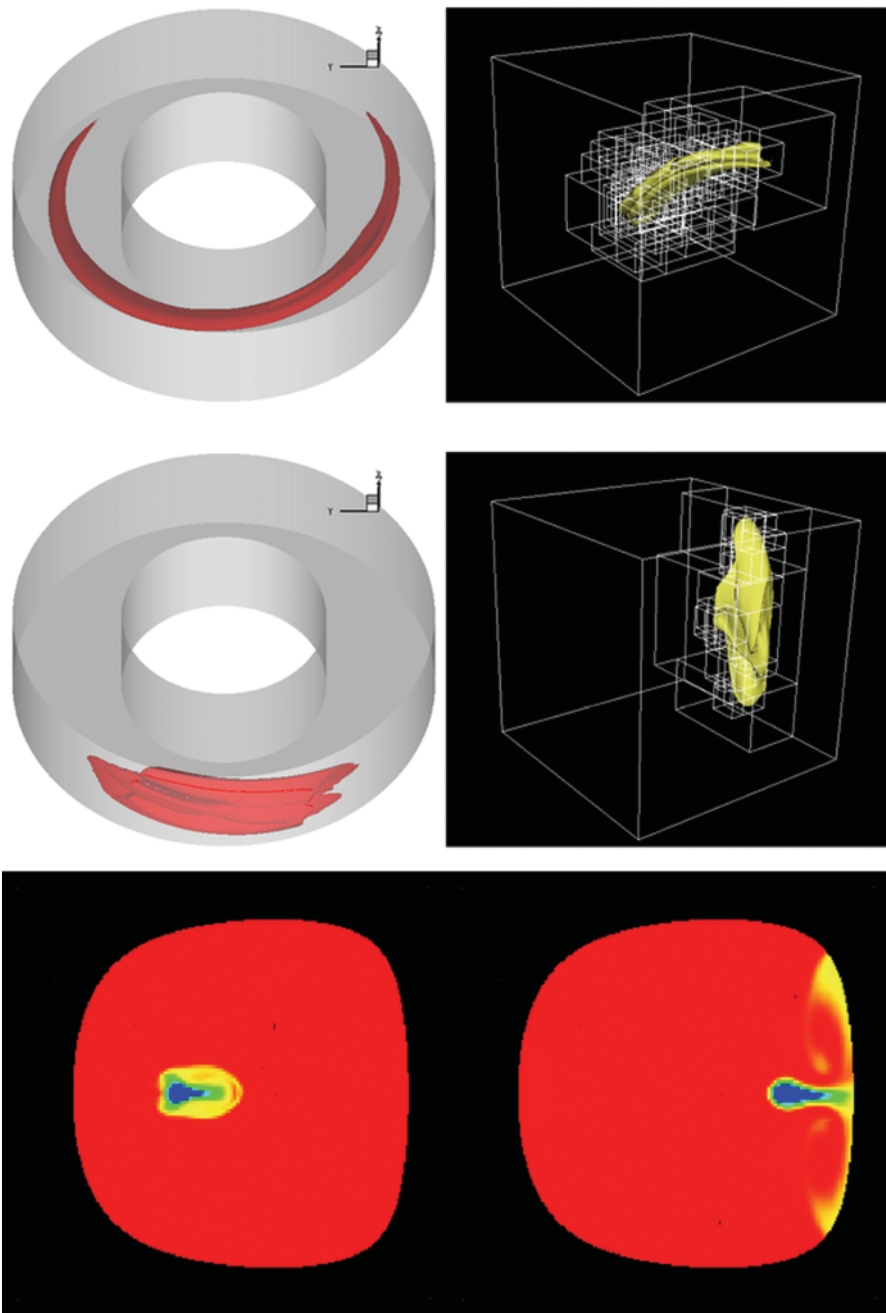

Figure 5. Top images show density contours associated with high-field-side pellet injection. Middle images show corresponding contours for low-field-side injection. Bottom image shows a poloidal projection contrasting high-field-side (left) and low-field-side (right) injection.

calculation of certain localized phenomena in fusion experiments that would otherwise be very costly or impossible to compute. Further developments in this area will include an improved treatment of anisotropic heat conduction, implicit

solves to allow larger time steps, and the incorporation of more complete extended-MHD models of the plasma. These will enable much more realistic and efficient calculations of both reconnection and pellet fueling.

GACO: Solving Differential Equations using Wave Packets

Many challenging plasma wave propagation problems give rise to solutions that exhibit localized, fine-scale structures. It is well known that short wavelength features can occur in mode conversion problems. For instance, the conversion of magnetosonic into Bernstein waves requires the resolution of waves with dramatically different wavelengths. A similar situation arises with toroidally coupled Alfvén eigenmodes when Larmor radius corrections are included.

A numerical code (GACO) has been developed that is based on the collocation method and expanding the solution in sinusoidal wave packets known as Gabor functions. The Gabor functions have optimal localization properties in both Fourier (unlike low-order finite elements) and real space (unlike global spectral methods) in the sense of minimizing Heisenberg’s uncertainty principle. Similar to spectral methods, the Gabor basis functions are smooth and infinitely differentiable, allowing equations of arbitrary order to be solved, at least in principle. Because the Gabor functions effectively have finite support, the resulting matrix system is sparse. Thus, Gabor functions combine the best of spectral methods and finite elements.

The Gabor functions require far fewer degrees of freedom to capture oscillatory solutions than the linear finite element method (FEM). This can be seen in Figure 6 which shows that when solving an equation similar to the Airy equation, which mimics a wave equation with a linear cut-off, the method can be quite powerful. Due to the high value of the wave number ($kL \sim 50\pi$) in the propagating region, as many as 2,000 uniformly distributed nodes are required for the FEM to enter the quadratic convergence

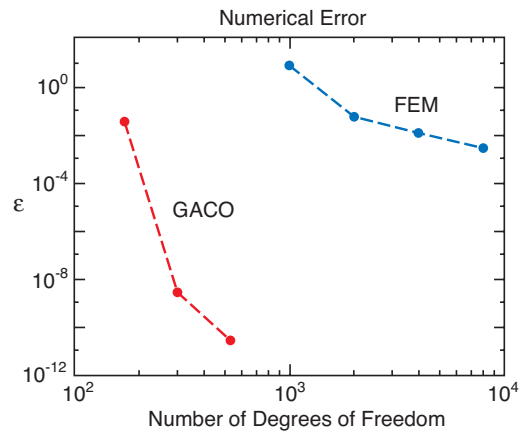

Figure 6. A comparison of the accuracy of the of the linear finite element method (FEM) and the GACO code method when using the same number of elements in application to the solution of a test problem whose solutions are similar to Airy functions.

regime. The estimated number of FEM nodes that would be required to match GACOS’s accuracy obtained using only 300 degrees of freedom, can be estimated to be about 4 million.

Visualization and Data Streaming

The Computational Plasma Physics Group (CPPG) has been working with data from several theory codes, including M3D and GTC, as well as from experimental analysis codes such as TRANSP and TSC. To accommodate such a wide range of codes, PPPL scientists have been developing and utilizing several types of visualization software ranging from EIVis (for code monitoring) to Ensign Gold (for parallel visualization) running from the display wall software. Furthermore, to handle the large volumes of data which are being moved over to PPPL, researchers have been working on data management strategies to help assist this task.

The EIVis software, being developed by the Computational Plasma Physics Group, has now been integrated within

the TRANSP code production system. Users can visually monitor the data being computed as a job runs. Their input data is also displayed visually for verification. Data monitoring is fully integrated with the FusionGrid Monitor so users can display their data in a browser and access it on the Internet from anywhere. The National Fusion Collaboratory prepared a demonstration of this visualization capability for data monitoring for the 2003 Supercomputing Conference (SC03).

Scientists at the Princeton Plasma Physics laboratory are now routinely using high-end commercial software packages to produce visualizations. The SciDAC codes, GTC and M3D, are using AVS/Express to produce visualizations. This visualization capability has become an essential part of the computational progress for these researchers. The Computational Plasma Physics Group is also investigating other software packages, including ParaView, VTK, and OpenDX. In collaboration with NERSC, Enight Gold is now running on the PPPL visualization cluster and being tested with very large datasets generated by the GTC code. The Laboratory has obtained a license for Enight Gold, and it has been used remotely to visualize data that was produced at and resides at NERSC using their 12 processor SGI Onyx. This approach is being investigated further.

Data management has emerged as a key aspect to visualizing large datasets. Fusion scientists are computing very large simulations on remote supercomputers and clusters. Data transfer has been a significant limitation to their work. In response to this problem, the CPPG has developed techniques for high-speed transmission of data from the remote machines to local storage. This work on parallel streaming, illustrated in Figure 7, was prepared for publication at SC03 and has been in-

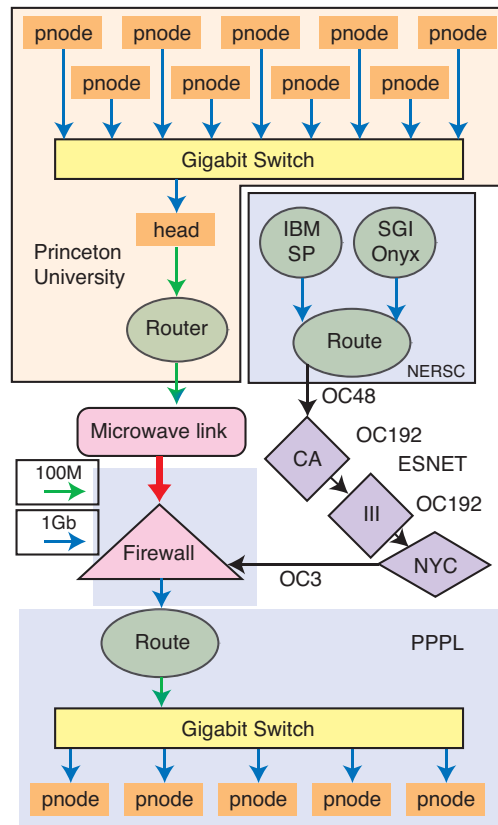

Figure 7. Illustration of high-speed data streaming between three locations: Princeton University (top), NERSC (middle right), and PPPL's local cluster (bottom). The first architecture is a cluster of nine dual processor AMD 2100MP nodes with a gigabit infrastructure. The second is the IBM SP and SGI at NERSC. The third is a cluster local to PPPL with 18 dual processor nodes where only five nodes are shown. PPPL has an OC3 (155-Mbit) connection to the ESNET and a 100-Mbit connection to the cluster at Princeton University.

tegrated with the GTC code. To enable the data streaming, several APIs in C with Fortran-90 hooks have been built. This allows streaming data from a live GTC simulation on a remote supercomputer to a cluster which is local to the user. The system is built on top of the Globus toolkit, namely the APIs which are used for GridFTP. In the system POSIX pthreads are used to thread the I/O layer. Data is copied from the main program to a buf-

fer. The thread is then activated and starts to stream a small piece of this data using GridFTP APIs. Data is then streamed from the supercomputer to our local cluster on which each node runs a GridFTP server. Typically, ten GridFTP streams per processor are sent. Data is written to disk on the nodes of the local cluster.

The Computational Plasma Physics Group has also designed and started deployment of a new collaborative Display Wall for the NSTX Control Room.

Workstations will be networked to the Display Wall and integrated via the Virtual Network Computer software. Applications displayed on the workstations will also be shown on the Display Wall.

The Access Grid node is operational, several network problems having been resolved. Scientists can attend research forums, meetings, and seminars and collaborate with other institutions over the Access Grid.

Off-site Research

The Princeton Plasma Physics Laboratory's (PPPL's) Off-site Research Department seeks to answer key scientific questions in magnetic fusion research by working as members of multi-institutional teams and by bringing PPPL's tools and understandings to leading fusion programs worldwide. The resultant teams exploit the synergies of the integrated institutions, using the best facilities and tools for answering the questions. The PPPL researchers are not mere suppliers to the remote programs — they are partners on integrated teams both at the remote facility and via remote access to the experimental equipment and data. They compare and contrast phenomena at different scales and in different configurations and extend innovations and discoveries to other facilities. They bring PPPL's strengths in experiment design, diagnostics, data analysis, experiment and theory comparison, engineering design, and operations support to the remote collaborations.

PPPL's major efforts have included studies of the control of large-scale instabilities at high plasma pressure on the DIII-D tokamak at General Atomics in San Diego; control and measurement of the profiles of plasma properties, especially by lower-hybrid and current-profile measurements on the Alcator C-Mod tokamak at the Plasma Science and Fusion Center at the Massachusetts Institute of Technology; and discovery of new modes of interaction between the plasma and energetic particles, such as the alpha

particles produced by the fusion reactions in the Joint European Torus (JET) in England. Areas of special topical emphasis include transport and turbulence in larger-scale high-temperature plasmas, large-scale stability, heating and current drive, and energetic particle effects. The topical research is pursued on a range of configurations including both tokamaks and stellarators, which share the toroidal topology with closed magnetic field lines in the plasma core, eliminating the losses along the field lines.

PPPL's enabling tools include diagnostics, computational simulation and analysis codes, and antennas for launching and receiving waves in frequencies ranging from the ion-cyclotron to the lower-hybrid to the electron-cyclotron frequencies. The waves are typically launched with the capability of both heating and current drive.

DIII-D Collaborations

The collaboration with General Atomics' DIII-D in FY03 continued to make major contributions toward the development of the Advanced Tokamak (AT) reactor concept through active control of resistive wall modes, optimized shaping studies for high plasma beta operation, fast-wave hardware enhancements for plasma current profile control, diagnostic upgrades and scientific advances for understanding microturbulence and plasma rotation. In addition, PPPL has provided operations support both for the DIII-D tokamak and for the auxiliary-

heating and current-drive systems on the machine.

Stability

An extensive study of the effect of plasma shaping on ideal-MHD stability for DIII-D AT-like plasmas was performed in FY03. Shaping of the plasma boundary is a critical variable to optimize plasma stability, along with the profiles of the plasma current and plasma pressure. A study was performed which varied the elongation, triangularity, and outer squareness of the plasma, assuming 100% noninductive current fraction composed of neutral-beam current drive (NBCD), electron-cyclotron current drive (ECCD), and bootstrap current. The $n = 1, 2, 3$ and $n = \text{infinity}$ ideal-MHD modes were examined where n is the toroidal mode number. It was found that enhanced elongation is the most effective way to raise the plasma pressure, since it raises the critical pressure for the onset of all the mode numbers, and it also enhances the bootstrap current fraction. The study found that triangularity increases the pressure threshold for low- n kink modes; however, its effect on high- n modes is less pronounced. An interesting outcome of this study is that the $n = 2$ and $n = 3$ modes always have lower stable pressure values than the $n = 1$ mode with wall stabilization. In principle, the lower threshold for $n = 2, 3$ modes should limit access to high-beta regimes, however it is not clear how the $n = 2$ and $n = 3$ modes manifest themselves. This will be a subject of experimental study in FY04.

In addition to the modeling of detailed shape, experiments were performed to determine the beta limits in AT plasma discharges as a function of plasma shape. Double-null discharges were found to have beta limits 10-15% higher than the standard upper single-

null plasmas. Ideal stability calculations performed for these discharges are in good agreement with the experimental scaling of normalized beta with shaping and show that these plasmas routinely operate above the calculated $n = 1$ no-wall limit and disrupt near the ideal-wall beta limit. The calculations indicate that further profile and shape optimization is needed to increase the normalized beta well above four as desired for enhanced AT performance.

In practice, the finite resistivity of the plasma boundary limits the attainable pressure when compared to calculations assuming a perfectly conducting wall. Finite wall resistivity gives rise to new edge modes that need to be stabilized. In order to stabilize these resistive wall modes (RWMs) a resonant field perturbation needs to be induced using external coils, and this resonant field needs to feed back on the growing boundary modes. So far the DIII-D program has demonstrated control of the RWMs by maintaining rapid plasma rotation; this rotation prevents the growth of modes, and the rotation is better maintained when nonaxisymmetric error fields are minimized. Some indication of direct feedback control of the RWM was obtained in FY03 with the new I-coils, however much is left to do to demonstrate the stabilization of these modes by external currents. This will be a key objective of the FY04 campaign.

Confinement and Transport

The plasma pressure attainable within a particular magnetic geometry depends critically on the nature of the heating profile and the microinstabilities and collisional transport processes which determine the rate of energy loss from the plasma. In addition, microinstabilities can be strongly modified by and can also strong-

ly affect plasma rotation, and this rotation can have a profound effect on plasma stability. To understand the interaction between plasma turbulence, pressure-profiles, and rotation-profiles, fundamental studies of the turbulence properties and associated transport are required.

A key collaboration effort between PPPL and General Atomics (GA) has been the development of a central Charge-exchange Recombination (CER) system for plasma-rotation measurements (Figure 1). The system can measure profiles of both toroidal and poloidal rotation of the plasma. However, detailed modeling is required to separate out atomic physics effects from the true rotation of the plasma. Rapid progress has been made in FY03 to allow for the accurate determination of the poloidal rotation from

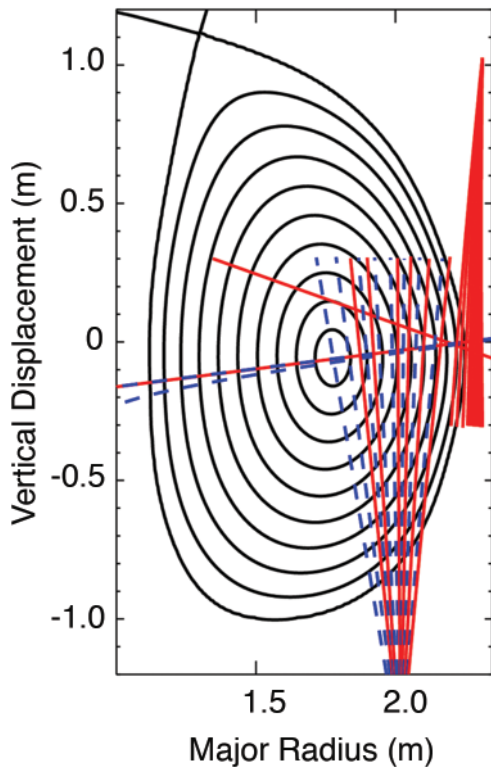

Figure 1. Vertical and toroidal sightlines of the central Charge-exchange Recombination (CER) system on the DIII-D tokamak at General Atomics.

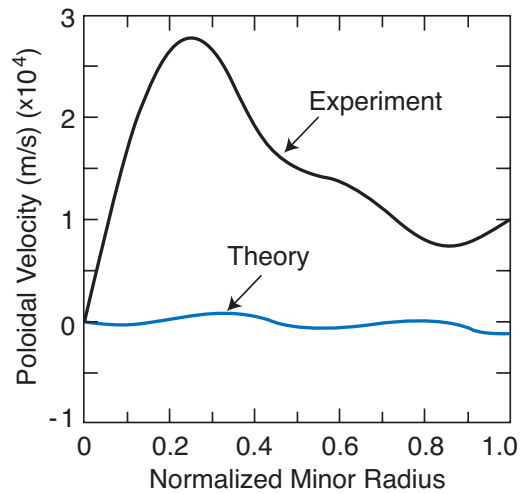

Figure 2. Inferred poloidal velocity profiles from CER measurements in a quiescent high-confinement mode plasma (black) and the neoclassical estimate (blue).

CER measurements. Detailed modeling has led to a relatively simple upgrade to the existing CER viewing system on DIII-D, which will allow for much more precise poloidal-rotation measurements in FY04. Preliminary comparison of the neoclassically predicted poloidal velocity with the fully corrected CER measurements for a quiescent high-confinement mode (H-mode) plasma discharge in Figure 2 indicates an order of magnitude discrepancy between the two. The origin of this discrepancy will be the subject of extensive study in FY04.

In addition to the CER measurement of plasma rotation, data from poloidal turbulence velocity measurements using the University of California at Los Angeles (UCLA) reflectometer were analyzed using the two-dimensional (2-D) full-wave reflectometer code, FWR2D, developed at PPPL. The poloidal turbulence velocities compared well to the $\mathbf{E} \times \mathbf{B}$ velocity obtained from the edge CER diagnostic on DIII-D (Figure 2). Future plans include the detailed comparison of reflectometer and CER estimates of poloidal rotation in the plasma core.

A new collaboration was begun in FY03 to understand the behavior of microfluctuations in DIII-D through a collaboration with UCLA on poloidal-correlation reflectometry. By launching microwaves into the plasma and seeing the reflection of waves from a plasma cutoff, it is possible to infer the properties of the microinstabilities at the reflecting layer. If an array of these receivers is arranged in the vertical direction (Figure 3), then the poloidal propagation of the reflected waves can be inferred. This in turn reveals the radial-electric field in the plasma. Figure 3 shows the geometry of the poloidal correlation reflectometer system on DIII-D. One launcher and two receivers allow for the poloidal propagation velocity of the fluctuations to be inferred from the time-delay correlation of the signals measured on the pair of poloidally displaced receivers. Modeling of the reflected waves is performed using a 2-D full-wave analysis developed at PPPL. The modeling al-

lows the properties of the microfluctuations to be inferred from the properties of the measured electric field at the antenna shown in Figure 3. A comparison of the poloidal-rotation velocity measured using Beam Emission Spectroscopy (BES), Poloidal Reflectometry, and CER is shown in Figure 4. The figure indicates that the poloidal rotation measured using the CER system is in qualitative agreement with the poloidal rotation of the turbulent fluctuations, while the BES disagrees.

Plasma transport modeling and applications of the TRANSP code is another important area of activity for PPPL researchers. TRANSP analysis of DIII-D discharges is now being done using the PPPL TRANSP servers via the Fusion Grid tools developed by the Department of Energy Office of Science's Scientific Discover through the Advanced Computing Program (DOE SciDAC)-funded National Fusion Collaboratory Proj-

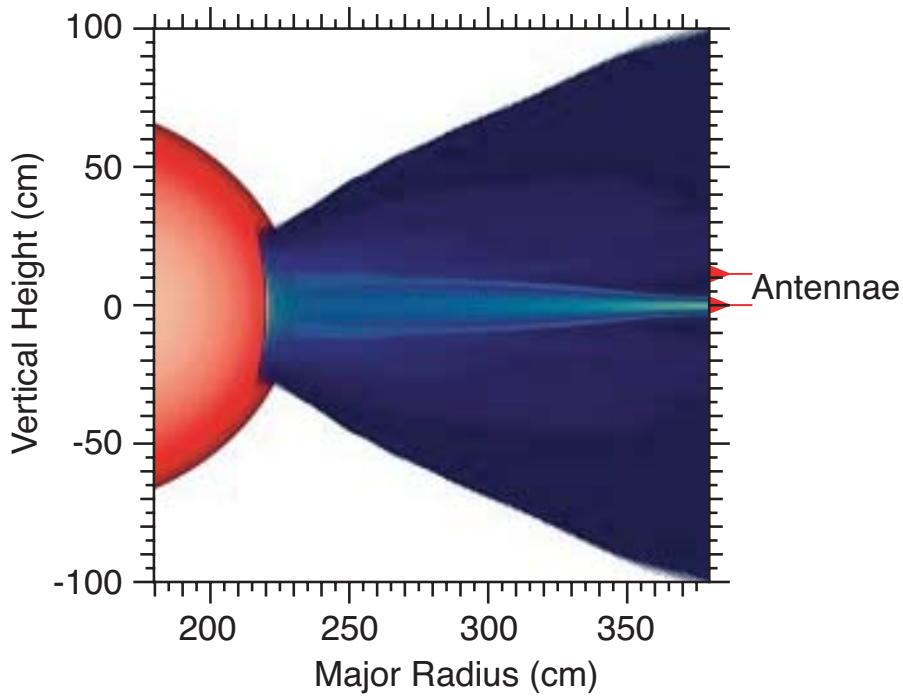

Figure 3. Plasma density profile (orange) together with incoming and outgoing microwave beam (blue). The microwaves reflect from the plasma and are received on two detectors (antennae) outside the plasma.

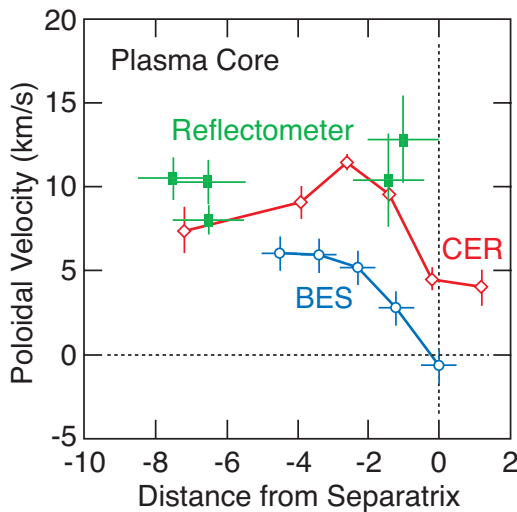

Figure 4. Reflectometer measurement of poloidal rotation (green) compared to the charge-exchange recombination measurements (red), and the beam emission spectroscopy measurements (blue).

ect. The new tools allow researchers to submit runs remotely (from GA), allow the calculations to proceed at PPPL, and permit easy access to the results from an MDSplus server located on site at GA using the “Globus” Computational Grid software.

A new collaboration activity aimed at identifying the physical causes and effects of fine-scale instabilities known as electron temperature gradient (ETG) modes was also initiated in FY03. This work is in collaboration with UCLA physicists who are leading the effort to measure the short-scale instabilities with high- k scattering diagnostics. PPPL’s role is in the detailed microstability modeling of these plasmas.

Wave-plasma Interactions

The key element of PPPL’s role in wave-particle interactions on DIII-D is in current-drive and current-profile control. Advanced Tokamak research seeks to replace inductive (finite duration) plasma currents with steady-state noninductively driven current. A key element of

PPPL’s research in this area is the recommissioning and upgrading of the fast-wave systems operating at 60 and 117 MHz. This collaboration is now in its initial stages, and represents a combined effort involving three research laboratories: the Oak Ridge National Laboratory (ORNL), PPPL, and GA. Initial success was achieved in establishing operation of the 60-MHz and one of the 117-MHz launchers, allowing antenna-loading and voltage-standoff studies to be performed.

Operations Support

PPPL continues to provide valuable on-site support of tokamak operations on DIII-D. In addition, PPPL has undertaken the role of supporting the operation of the fast-wave systems on DIII-D in collaboration with GA and ORNL researchers.

Alcator C-Mod Collaborations

PPPL’s research collaboration on the Alcator C-Mod tokamak at the Plasma Science and Fusion Center at the Massachusetts Institute of Technology (MIT) continued to advance understanding in areas key to ITER (“The Way” in Latin) and to improve the attractiveness of the tokamak as a possible reactor. The following accomplishments are particularly significant:

- PPPL researchers contributed substantially to the fusion program’s scientific knowledge of radio-frequency (rf) heating this year. As the hardware-intensive modifications to the ion-cyclotron range-of frequencies (ICRF) antennas have approached maturity, substantially greater emphasis has been given to the physics of radio-frequency heating and the study of wave-particle interactions. Operational support contin-

ued with both PPPL physics and engineering presence and input.

- Participation in the study of the effects of high-power heating on plasma transport and stability was extended through the use of nonlinear simulation codes and diagnostic upgrades and detailed comparisons between predictions and observations.
- The Gas Puff Imaging diagnostic was further improved, allowing direct visualization of the macroscopic structure of edge turbulence. Modeling of the turbulence images has been extended.
- Nonlinear simulations of the effect of plasma turbulence on core transport continued, as have simulations of the role of instabilities on the formation of internal transport barriers in off-axis-heated H-mode plasma discharges.
- Two new higher-frequency channels of the C-Mod microwave reflectometer became operational allowing the measurement of plasma fluctuation farther up the edge pedestal.
- The Motional Stark Effect diagnostic became operational, and careful calibrations are in progress to determine its range of usefulness when coupled with the present diagnostic neutral beam.
- The lower-hybrid launcher design-and-fabrication project was completed in April, 2003. Subsequent preoperational tests revealed manufacturing defects that are being corrected.
- The National Spherical Torus Experiment (NSTX) X-ray crystal

spectrometer was installed on Alcator C-Mod during the NSTX downtime and initial measurements were made.

Radio-frequency Heating

PPPL physicists and engineers have continued to be strongly involved in the Alcator C-Mod ICRF program, including hardware improvements and participation in experiments, as well as modeling of wave-particle interactions. The PPPL-designed and jointly modified four-strap ICRF antenna (Figure 5) now operates with up to ~ 3 MW of radio-frequency power into the plasma. It has been operated at high power in heating phasing ($0^\circ, 180^\circ, 0^\circ, 180^\circ$) and both co- ($0^\circ, 90^\circ, 180^\circ, 270^\circ$) and counter- ($0^\circ, -90^\circ, -180^\circ, -270^\circ$) current-drive phasing. The plasma heating efficiency was identical for the three-phasing configurations (Figure 6), and equal to the equivalent heating power efficiency from either of the other two antennas. Total ICRF heating power using all three antennas is now up to 5 MW for 0.5 seconds.

Wave-particle interaction studies have focused mostly on D(H) minority heating and mode conversion. Alcator C-Mod's set of ICRF antennas and its ex-



Figure 5. The PPPL-designed four-strap ion-cyclotron radio-frequency antenna, as installed and modified in conjunction with the Plasma Science and Fusion Center at the Massachusetts Institute of Technology.

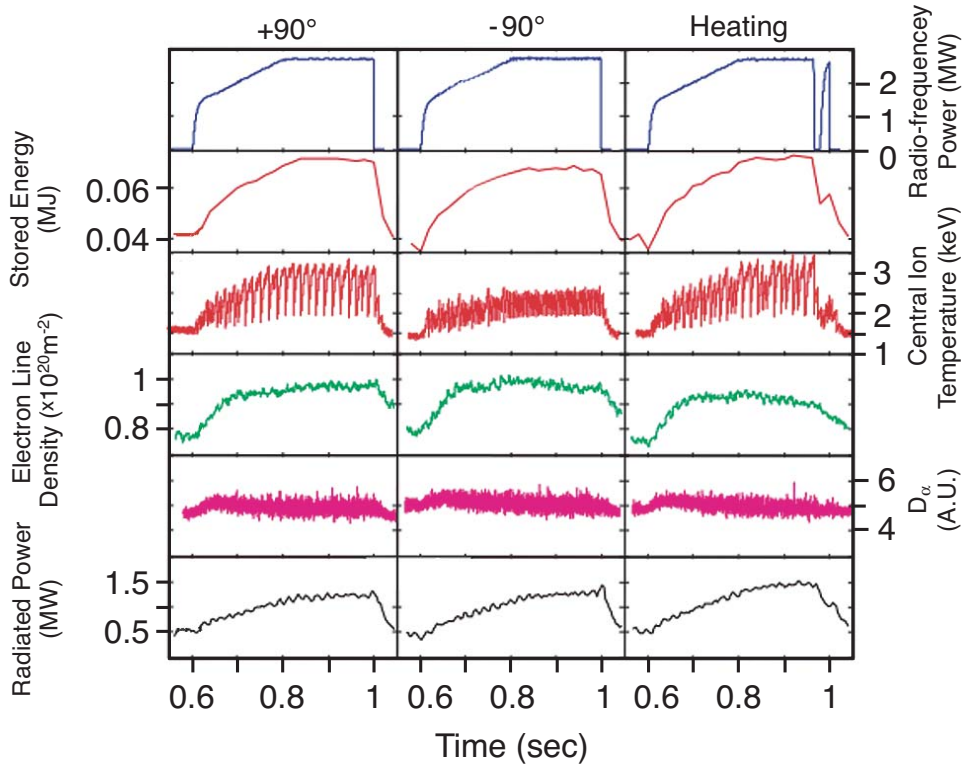

Figure 6. Comparison of antenna performance and plasma response to three different antenna phasing settings: $+90^\circ$ current drive, -90° current drive, and heating. The plasma stored energy, density rise, edge light, and radiated power are the same. The sawtooth period is changed.

cellent set of diagnostics (high-precision electron-cyclotron emission to determine wave power deposition through electron heating and phase contrast imaging to detect wave propagation through density fluctuations) make it the premier experimental facility to study wave propagation and absorption in the ion-cyclotron range of frequencies. The first experimental observation of the mode conversion of an incoming fast wave to an ion cyclotron wave, first predicted theoretically by F.W. Perkins in 1977, was made (Figure 7). The dispersion curves showing the location of the conversions processes are shown in Figure 8. These extended measurement capability and improvements to the full-wave simulation code TORIC, benchmarked against the one-dimensional PPPL code METS, indicate that the mode-conversion process is con-

siderably richer in phenomena than previously thought (Figure 9).

PPPL radio-frequency engineers continued to work closely with their counterparts at MIT and traveled to Alcator C-Mod to participate in transmitter re-tuning and frequency response optimiza-

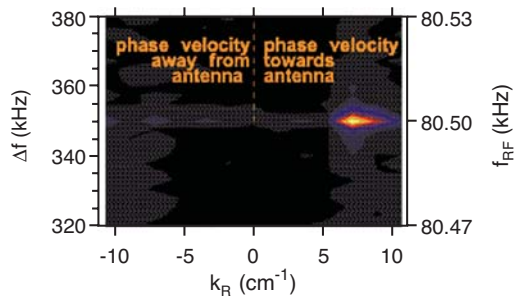

Figure 7. Contour plot of the Fourier-analyzed Phase Contrast Imaging (PCI) data. The bright area indicates an ion-cyclotron wave propagating back towards the antenna. (From Y. Lin, MIT.)

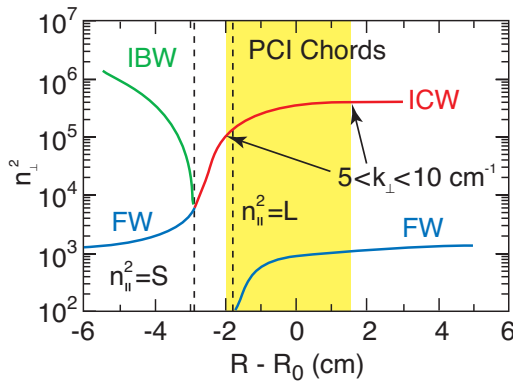

Figure 8. Wave dispersion diagram near the mode-conversion region of the plasma. The fast wave (FW) is launched from the antenna at the right edge of the diagram. It is partially mode-converted to an ion-Bernstein wave (IBW) and an ion-cyclotron wave (ICW) near the ion-cyclotron layer. The Phase Contrast Imaging (PCI) diagnostic's chords allow density fluctuation associated with wave propagation to be measured in the shaded area. (From Y. Lin, MIT.)

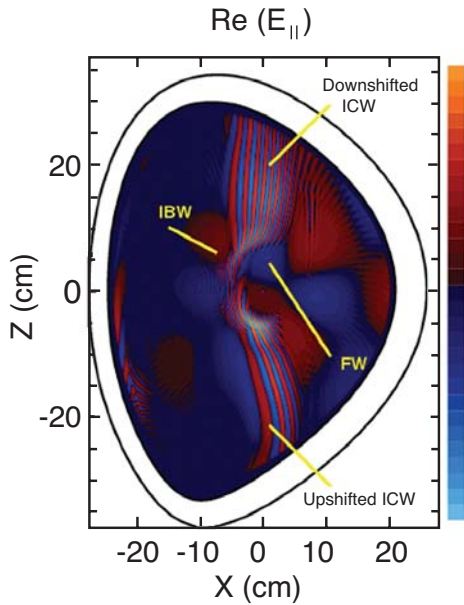

Figure 9. Plasma cross section with superposed wave electric fields calculated with the TORIC simulation code. Shown are the fast wave (FW) propagating toward the center from the antenna at the right edge of the plasma, the mode-converted ion-Bernstein wave (IBW), and the mode-converted ion-cyclotron wave (ICW). (From J.C. Wright, MIT.)

tion. Frequent exchanges of information and ideas have occurred throughout the year.

Plasma Turbulence Studies

Turbulence is considered to be of prime importance in the transport of energy and particles out of the plasma. Since turbulence appears to dominate the edge plasma conditions, and the edge conditions have a strong influence on plasma core stability and plasma-wall interactions, turbulence measurements at the plasma edge utilizing the Gas Puff Imaging diagnostic (Figure 10) have been extended. Figure 11 is a fast camera photograph of edge plasma light looking radially inward. Figure 12 shows a movie of a edge plasma “blob” moving outwards. The observed image structure was compared with several theoretical models of edge turbulence, and good agreement is seen with both the Drift Ballooning Mode (DBM) code of Hallatschek and Rogers and the BOUT code of Xu and Nevins, which uses experimental profiles and realistic magnetic geometry.

Turbulence studies from the plasma edge inward toward the plasma core were enhanced with the addition of 130 and 140-GHz channels (higher frequency, greater penetration) to the existing Alcator C-Mod microwave reflectometer diagnostic. Plasma discharges into which lithium pellets were injected were studied during the first experimental phase. Initial measurements indicate that fluctuations in the plasma core are much lower in frequency than those at the plasma edge.

Nonlinear modeling of the effect of turbulence on transport in the plasma core continued. Theoretical transport predictions were compared with experimental data to determine whether drift-type instabilities could be predicted to

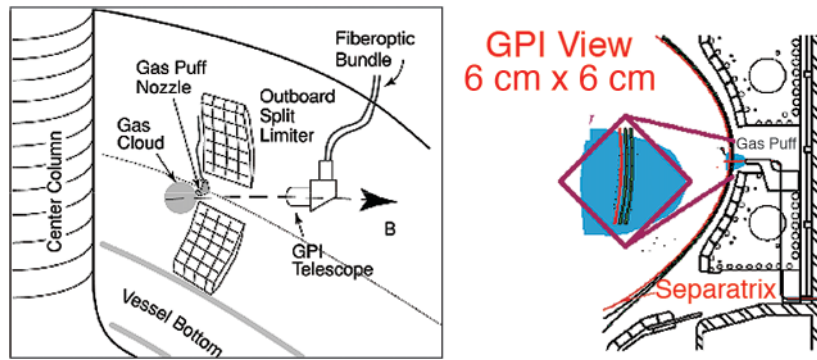

Figure 10. Sketch of the Gas Puff Imaging diagnostic. Gas is puffed radially into the plasma from the outer wall. A telescope near the edge of the vacuum vessel looks along the magnetic field and views the light emitted from the gas due to electron impact excitation. The resulting light pattern is brought outside the vessel through a coherent fiber-optic bundle and photographed with a fast camera.

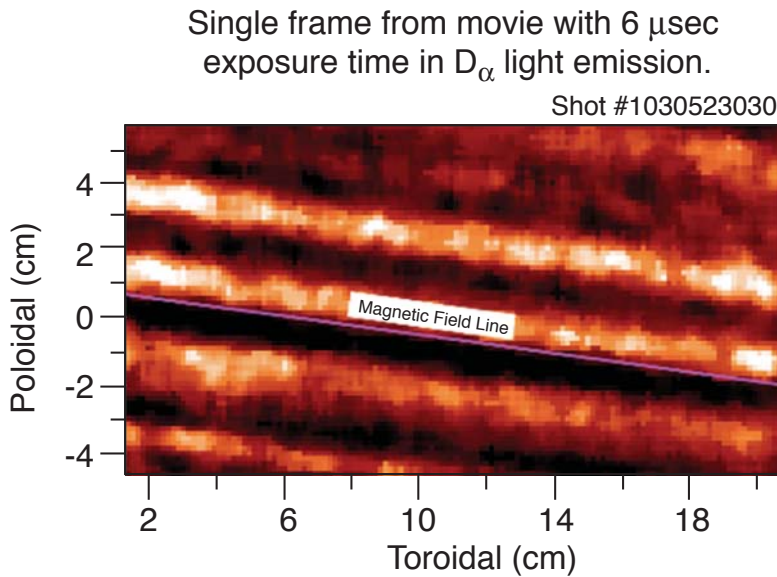

Figure 11. Photograph of the Alcator C-Mod plasma edge looking radially inward. The short exposure time of six microseconds clearly reveals edge turbulence in the form of striations oriented along the magnetic field.

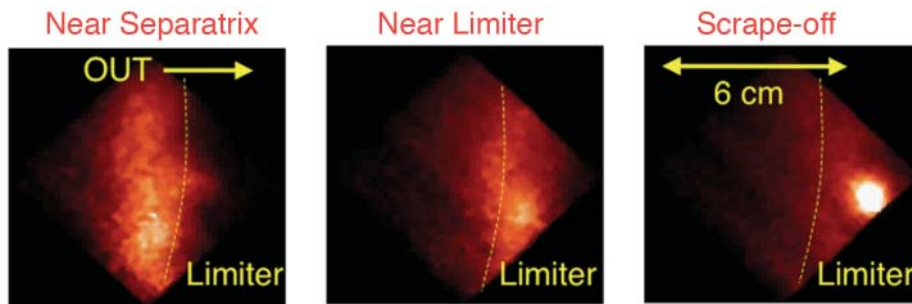

Figure 12. Movie of plasma edge turbulence taken with the Gas Puff Imaging diagnostic. As the bright “blob” moves outward, it becomes more compact and evolves into the striation seen in the radial view (Figure 11).

be responsible for transport in the core of typical H-mode plasmas in Alcator C-Mod. A number of nonlinear gyrokinetic simulations of turbulent transport due to long wavelength electrostatic drift-type instabilities were performed. Simulations of core turbulent transport in an Alcator C-Mod enhanced D-alpha H-mode plasma were extended to higher wave numbers and finer resolution. The results did not change appreciably, indicating that the results are well converged. A number of very long simulations (with lower resolution) have provided “test data” used to develop an algorithm for estimating the uncertainty in the predicted fluxes. These calculations were carried out on the Fusion Energy Science Pilot Topical Computing Facility at PPPL, and kept essentially all of the 128 CPUs occupied for most of several months.

Gyrokinetic simulations of plasma turbulence with the GS2 code are being carried out to examine H-mode, rf-heated experiments that exhibit internal transport barriers (ITBs). Simulations are focused on the trigger time shortly before the internal transport barrier is established. Linear calculations show stable long wavelength turbulence at the barrier, without invoking suppression by $E \times B$ shear. At the internal transport barrier, no strongly growing trapped-electron mode (TEM) nor ion temperature gradient (ITG) mode is found, although an electron temperature gradient (ETG) mode is present. Outside the internal transport barrier, clear signatures are found for toroidal ITG and ETG modes. In the plasma core, TEM modes are unstable in the electron drift direction, but not ITG, nor ETG. Reduced instability growth rates predicted at the barrier are consistent with the observed reduced transport. Nonlinear simulations were performed which reproduce the linear results and agree with

the experiment at the trigger time (Figure 13).

Current Profile Measurements

MIT’s installation of a Novosibirsk-built diagnostic beam on loan from the an experiment at the University of Padua, Italy, has resulted in sufficient signal from the Motional Stark Effect diagnostic that analysis and attempts to extract current density information are under way with emphasis on the outer region, where the signal is strongest. Several iterations in mounting internal optical elements to withstand disruption shock appear to have been successful. Initial beam-into-gas experiments have been carried out, with pre-set and precisely known toroidal and poloidal magnetic fields determining the magnetic pitch angle. These calibrations have revealed perturbation by unpolarized and circularly polarized light created by the beam, and plans are underway for an extremely precise in-vessel calibration at the next Alcator C-Mod opening.

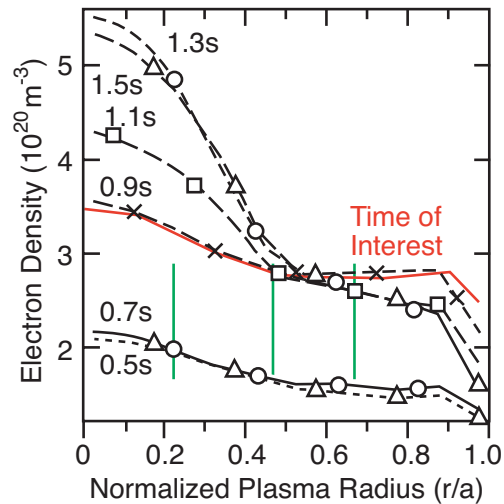

Figure 13. Evolution of an internal transport barrier in the Alcator C-Mod plasma. Density starts to rise in the plasma core at the “time of interest” when the barrier is established. The three vertical green stripes indicate the radial locations at which the stability calculations are performed.

Lower Hybrid Current Drive

PPPL undertook the design and fabrication of a lower-hybrid wave launcher (Figures 14, 15, and 16) capable of driving current in the Alcator C-Mod plasma off-axis in order to modify the internal magnetic field profile in such a fashion as to extend Alcator C-Mod operation into the Advanced Tokamak regime. The launcher was delivered to MIT in April, 2003, but preoperational inspection and testing revealed defective electroplating. Rework of the window assembly is pres-

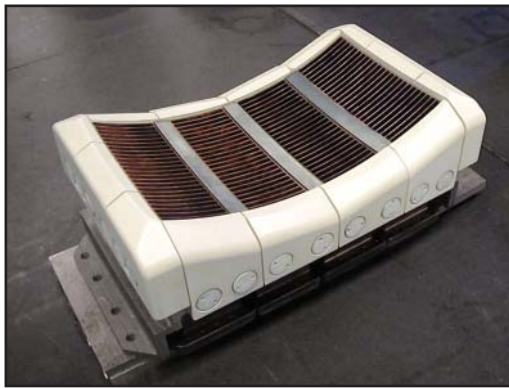

Figure 14. The lower-hybrid launcher's coupler, the component adjacent to the plasma. The microwave grill is surrounded by boron nitride protective tiles to shield it from plasma heating.



Figure 15. The lower-hybrid launcher's forward waveguide on the PPPL vacuum test stand. This component includes a radial drive system to vary the coupler/plasma separation and optimize microwave power deposition in the plasma.



Figure 16. The lower-hybrid launcher's rear waveguide following assembly at PPPL. This component includes interfaces to the microwave power sources, microwave power splitter, directional couplers to measure forward and reflected microwave power, and phase shifters to provide the proper wave front to the plasma.

ently in progress with MIT, with completion and installation on Alcator C-Mod now anticipated for May 2004.

X-ray Crystal Spectrometer

An X-ray crystal spectrometer designed to measure ion temperature and poloidal rotation on NSTX was installed on the Alcator C-Mod tokamak during the NSTX downtime (Figure 17). Initial argon X-ray spectra were obtained (Figure 18) and analysis of the data is in progress. The resolution of technical problems with high X-ray backgrounds and detector count rate limitation found on C-Mod helped to qualify the equipment for use on NSTX.

International Collaborations

It has long been recognized that fusion research can benefit from international collaboration. The U.S. Department of Energy (DOE) has invested significant effort in developing international collaborations with facilities that present unique opportunities for U.S. scientists to advance fundamental un-



Figure 17. The NSTX X-ray crystal spectrometer installed on the Alcator C-Mod at the Massachusetts Institute of Technology. The Alcator C-Mod tokamak is at the top middle of the picture, the X-ray crystal spectrometer is under the circular plate at the lower left, and the position-sensitive X-ray detectors and electronic equipment are outside the picture to the right.

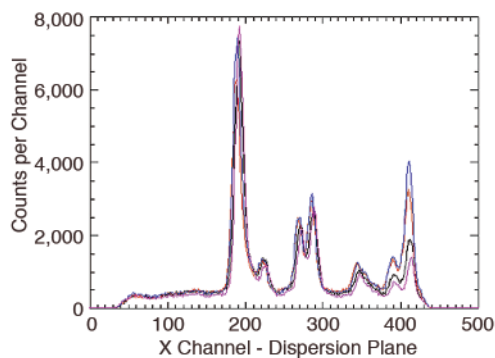

Figure 18. Energy spectrum of argon X-rays emitted by an argon gas-puff-injected into the Alcator C-Mod plasma. This spectrum is an overlay of four spectra from different vertical positions in the plasma. The horizontal axis represents X-ray energy, and consists of primary plus satellite X-ray lines.

Understanding in strategically important areas for the development of fusion energy. Key among these is the pursuit of burning plasma science in facilities that approach the dimensionless parameters relevant to a future burning plasma experiment such as ITER. Fully superconducting tokamaks now under construc-

tion also present a major opportunity for the U.S. to advance steady-state plasma research. In addition, the development of a strong stellarator program in the U.S. will benefit from close coupling with researchers on large-scale stellarator facilities worldwide.

Joint European Torus Collaboration

The primary goal of the Joint European Torus (JET) collaboration is to address burning plasma physics issues on a scale and in a parameter regime not accessible to domestic fusion facilities. Now that the Tokamak Fusion Test Reactor has been decommissioned, JET is the only facility in the world capable of carrying out deuterium-tritium experiments in the near term (5-10 years), with the potential to advance fundamental understanding of alpha-particle-driven instabilities.

Fast-particle Research: A key element of the JET collaboration is the understanding of fast-ion behavior in the plasma. In a deuterium-tritium (D-T) power plant, highly energetic alpha particles will be produced and these will be the dominant heating source for the plasma. It is therefore essential to determine if the alpha particles produced by the D-T reactions will be confined for the time required to impart their energy to the plasma. Understanding the physics of instabilities driven by fusion alpha particles is a key element of the PPPL collaboration on JET.

Gerrit Kramer (PPPL), in collaboration with JET scientists, has recently analyzed Toroidal Alfvén Eigenmodes (TAEs) on JET, revealing the first evidence for the existence of odd-parity TAE modes. Odd-parity TAEs are predicted to exist alongside even-parity TAEs, but are usually much more strongly damped than the even mode. The work demonstrated

the first clear evidence for the existence of such modes consistent with long-standing theoretical predictions.

More recently, a joint experiment between PPPL and JET scientists revealed the existence of a very large number of Cascade modes, based on interferometric measurements taken of the plasma interior. Cascade modes are driven by energetic ions in reverse magnetic shear plasmas and may be excited in a fusion power plant. The large number of observed modes is shown in Figure 19. Magnetic diagnostics are not capable of observing these modes, due to the localization of the modes in the plasma core. This suggests that a future burning plasma experiment will need to detect such modes using interferometers rather than magnetic probes.

Theoretical analysis of fast-ion phenomena must be matched by enhanced diagnostics aimed at revealing the behavior of energetic ions in the plasma. As part of the PPPL and U.S. collaboration on fast-ion physics, a new fast-ion-loss diagnostic is being developed in collaboration with the Colorado School of Mines, the United Kingdom Atomic Energy Agen-

cy (UKAEA), and the Max Plank Institute in Garching, Germany. The project leader is Doug Darrow of PPPL. The diagnostic will measure lost energetic ions and alpha particles in JET using scintillation and Faraday cup detectors located at the plasma boundary. Installation of the diagnostic is expected during the 2004 machine opening.

On the theory front, a new nonperturbative version of the NOVA code called NOVA-KN (Kinetic Nonperturbative NOVA) was applied to JET plasmas in which $n = 1$ MHD activity was driven using high-energy ICRH H-minority ions. NOVA-KN identifies both $n = 1$ resonant and ideal-MHD modes, consistent with the two distinct aspects of this mode. The predicted mode frequency of the resonant branch corresponds to the fast-ion drift precession frequency, which is characteristic of fishbone modes first identified on the Poloidal Divertor Experiment (PDX) tokamak. The NOVA-KN mode is being developed by N. Gorelenkov and C.Z. Cheng of PPPL.

Radio-frequency Technology Development: As part of the JET Enhancements Program (JET-EP) a new ITER-

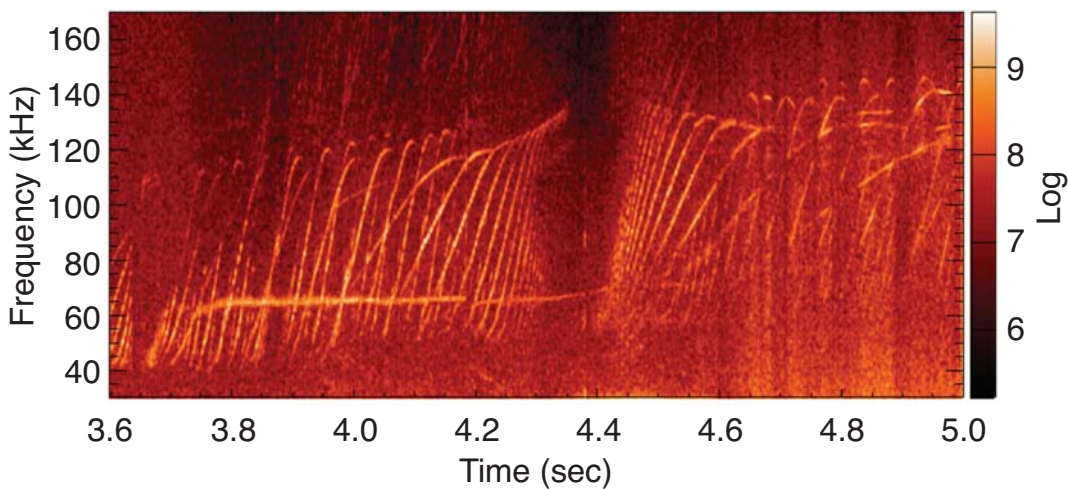

Figure 19. Spectrum of interferometer data versus time for a plasma discharge in which strong Cascade modes are induced. The Cascades chirp in frequency as the minimum q -value decreases.

relevant ICRF antenna is to be added to JET during the 2004 opening. This project, a multi-institutional collaboration between PPPL, ORNL, and the European Union, was initiated to prototype the new antenna design to be used on JET. PPPL is responsible for the design and construction of the prototype antenna enclosure box, Faraday shield, and protective tiles. The radio-frequency technology development group at PPPL completed construction and assembly of these items, and extensive testing was carried at a special test facility at ORNL.

Divertor Physics and Impurity Screening: One issue in a future burning plasma experiment is whether the core contamination will be adequately small. Impurities (particularly from carbon tiles) lead to the dilution of the plasma which degrades fusion performance. The Laboratory has been a major contributor to the science of divertors on JET. James Strachan (PPPL) led the JET carbon screening experiments performed using methane gas injection. In fiscal year 2003, the earlier carbon screening experiments in low-confinement mode (L-mode) plasmas were extended to reverse magnetic-field plasmas. The methane screening results indicate that similar screening was seen in forward-and-reverse magnetic fields in spite of the fact that the scrape-off layer (SOL) flow changed dramatically. In support of these observations, simulations using the EDGE2D code actually indicate a small effect of the SOL flow on the carbon screening magnitude. Another result of the EDGE2D calculations has been the development of a size-scaling relationship for the carbon content of an all-carbon tokamak. Assuming other machines were composed of the same materials, conditioned in the same manner as JET, then the carbon content per sputtered carbon atom and effec-

tive impurity particle confinement time should increase with the fraction of sputtered carbon ionized in the main chamber SOL, and decrease with machine size and SOL density.

Transport Physics: Reliable prediction of the thermal transport in proposed next-step burning plasma experiments is a key task confronting the international fusion community. Because of its large size and its use of strong radio-frequency heating, JET provides an ideal opportunity for testing our predictive transport models against experiments in regimes where momentum and energy input can be decoupled. Microstability analysis of JET plasmas using the GS2 code performed by R. Budny of PPPL suggests that the $E \times B$ shearing rate is unnecessary to stabilize microturbulence in reverse-magnetic-shear plasmas. The analysis indicates that turbulence-suppression can be accomplished with equilibrium current profile control. This has major implications for sustaining internal transport barriers in future ITER plasmas.

In addition, PPPL has been collaborating with JET and the Meg Ampere Spherical Torus (MAST) Group by providing and maintaining the TRANSP plasma analysis code (using it to analyze plasmas) and by training physicists at JET and MAST to run TRANSP at PPPL via the FusionGrid. Recently TRANSP is being used to determine the transport of trace tritium from recent gas-puff and neutral-beam-blip experiments.

JT-60U Collaboration

The collaboration with the Japan Atomic Energy Research Institute (JAERI) on the JT-60U tokamak centers on negative-ion-beam development. Observations by the JT-60U neutral-beam group in collaboration with PPPL's Larry Grisham revealed that the horizontal

beamlet steering in the JT-60U negative ion sources was not producing the desired focusing of the overall beam envelope. It was concluded that this must be due to the asymmetric space charge forces arising from the beam compression. An experiment was designed in fiscal year 2003 to determine whether the space charge responsible for the lack of focusing originated in the drift region after the acceleration grids, or in the accelerator grid region. The experiment showed that the space charge causing the lack of focusing is in the accelerator, where it cannot be compensated. Since the space charge parameters for the ITER beam design will be similar to the JT-60U parameters, and since the present ITER design reportedly uses a similar aperture displacement beamlet steering technique, this suggests that the ITER beamlet steering design may need to be revised.

Stellarator Collaboration

With the rise of the compact stellarator program in the U.S., there is renewed interest in international collaboration on existing large-scale facilities in Japan and Europe. In FY03, the PPPL collaboration centered on the Wendelstein-7 Advanced Stellarator (W7-AS) in Garching, Germany. In 2003, the collaboration focused on analyzing the 2002 experiments, where plasmas were maintained quiescently at or near the pressure limit for more than 100 energy confinement times. The limiting pressure appears to not be due to macroscopic instabilities, as often observed in tokamaks, but rather to a saturation in confinement. MHD instabilities, when observed, saturate and do not inhibit access to higher pressures. The maximum pressure is observed to depend on the equilibrium magnetic configuration, and scales like an equilibrium limit in some cases.

A key element of our collaboration is analysis of the W7-AS equilibrium using the PIES code, developed at PPPL, which self-consistently includes magnetic islands and stochastic regions. The preliminary PIES results thus far show a correlation between the attainable pressure values in the W7-AS experiment and the onset of magnetic stochasticity in the outer part of the plasma. The analysis suggests that the beta limits attained on W7-AS correspond to the breakdown of good flux surfaces. For the purposes of this study, a modified version of the PIES code was produced, allowing the specification of a fixed, experimentally determined pressure profile, and applying an appropriate model for the pressure-driven current in stochastic regions. The modified code has been applied to a series of experiments for studying the influence of control coil current on the attainable beta. The control coils, installed to control the island divertor, are expected to influence the integrity of the flux surfaces in the experiment. A series of PIES calculations has been performed for two different values of the control-coil current and for a range of beta values. The configuration with higher attainable beta is calculated by the code to sustain better flux surface quality as beta is raised.

KSTAR Collaboration

The Korea Superconducting Tokamak Advanced Research (KSTAR) device will be the one of the world's first tokamaks to be fully superconducting. The proposal to establish KSTAR as an international user facility for the advancement of steady-state tokamak physics is an exciting prospect for the world fusion program. The device will begin operation in late 2005, and active efforts are being made to involve the international com-

munity early in the KSTAR program to accelerate the development of the project and its attainment of peak performance parameters. In FY03, PPPL completed the designs for the electron-cyclotron Mi-

crowave Launcher needed for initial plasma breakdown and current-drive studies (Figure 20). In 2004 the launcher fabrication will begin and launcher delivery is planned for 2005.

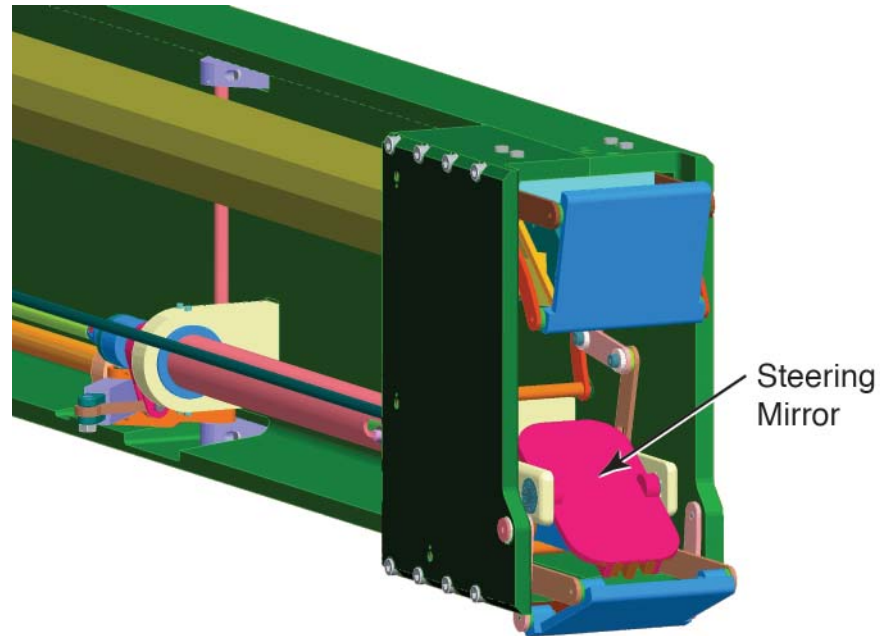

Figure 20. A three-dimensional rendering of the Microwave Launcher being fabricated by PPPL for delivery to KSTAR in 2005. Shown is the steering mirror that will direct the microwave beam into the plasma.

Space Plasma Physics

Research in the Space Physics Group at the Princeton Plasma Physics Laboratory (PPPL) emphasizes understanding solar and magnetospheric activity and how coupling between solar activity, the magnetosphere, and ionosphere can affect the dynamical evolution of the solar-terrestrial system. Progress in four areas is described in this report: (1) information-dynamical modeling of the magnetosphere, (2) self-consistent ion cyclotron heating in the auroral ionosphere, (3) kinetic ballooning instabilities for substorm onset, and (4) flux rope acceleration and enhanced magnetic reconnection in solar flares.

Information-dynamical Modeling of the Magnetosphere

One of the problems of greatest practical importance in the area of space physics is that of predicting the magnetospheric response to solar wind input. This is an area of active research in space physics and is of great importance because space weather can: (a) impact scientific, communication, and defense satellite operations and (b) disrupt power grids and ground communications. Therefore, there is a high demand for models that can predict geomagnetic activity accurately based on solar wind parameters as input, a demand that will likely to increase even more with the nation's increasing reliance on space technologies.

Most data gathered by satellites and ground-based instruments are in the form of time series. Time series information is analyzed nonparametrically to detect the

existence of nonlinear dependencies in the time series and the predictability of the system. The approach taken to detect higher-order nonlinear statistical dependencies is to examine the cumulants of the probability distribution of an embedding vector that captures the underlying dynamics of the system. By comparing these cumulants with "surrogate" data constructed to share various statistical properties with the original data set, it is possible to test various hypotheses about the data.

To illustrate how the method can be applied to magnetospheric data, hourly averaged time series of Kp indices is considered. The Kp index is a measure of the planetary disturbance level. Kp ranges from 0 to 9 with increments of 1/3. Higher Kp values mean more intense disturbance levels and the scale is logarithmic. The Kp index is based upon the spread during the stated time interval between the largest upward and downward excursions of magnetometer readings over a number of ground-based stations. The years 1975 and 1987 are representative of a solar minimum while 1980 and 1990 are representative of a solar maximum and the responses are shown in Figure 1. During a solar minimum, sunspot activity is significantly reduced and the solar wind is steadier, consequently, one expects the dynamical response of the magnetosphere to be less governed by solar wind dynamics and more governed by the highly nonlinear internal dynamics.

In Figure 2, is shown the windowed significance for the year 1974. Note that

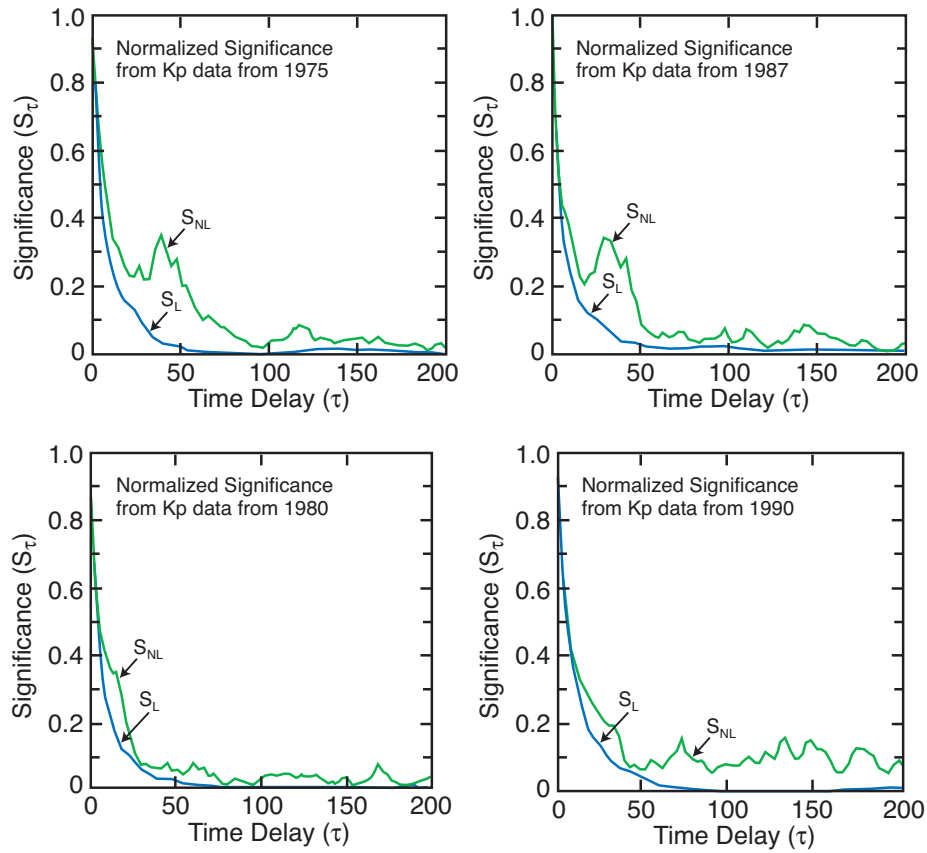

Figure 1. The normalized linear and nonlinear significance, S_L and S_{NL} , obtained from the $[Kp(t), Kp(t-\tau)]$ embedding for two solar minima (1975 and 1987) and two solar maxima (1980 and 1990) as a function of time delay τ in hours. S_L is obtained considering only second order cumulants while S_{NL} is obtained including up to fourth order. It is obvious that for solar minimum there is a strong nonlinear response on the time scale of 40 hours, while for solar maximum there is a more linear response.

the significance is often quite large, as it is computed for extended periods of time (10-20 days). As such, the Kp time series should be reasonably predictable during those periods. On the other hand, the evolution of the significance indicates that the underlying dynamics are rather variable; therefore, any predictive model would need to be able to accommodate such changes in the underlying dynamics.

In this study, information-dynamical techniques to the Kp indices have been applied. Using the cumulant-based significance, it has been established that the underlying dynamics of Kp evolution is, in general, nonlinear exhibiting a

quasiperiodicity which is detectable only if nonlinear correlations are taken into account. As such one expects that linear models commonly used to predict magnetospheric response should be inaccurate. Local-linear models (which include slow evolution of parameters) and nonlinear models that fail to capture the inherent nonlinearity are also likely to fail where the dynamics suddenly change.

Self-Consistent Ion Cyclotron Heating in the Auroral Ionosphere

Recently, it has been demonstrated that ion cyclotron waves excited in the auroral electron acceleration region could propagate into the ionosphere where they

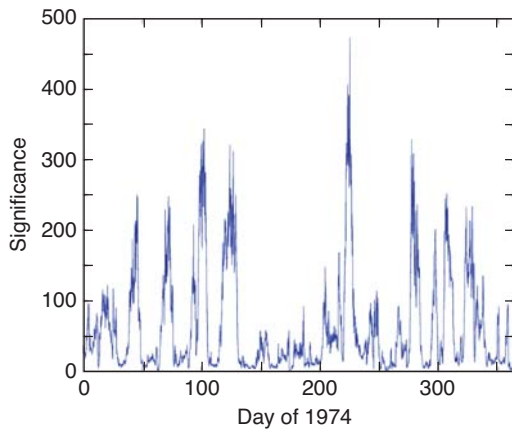

Figure 2. Significance as a function of time for Kp indices during 1974. An embedding dimension 3 is used with a time lag of one hour. All quantities were computed for a slicing window of 300 hours every five hours.

could heat ions that would then flow out of the ionosphere. As the ions flow upwards into the magnetosphere, the background densities are modified. As the background profiles change, the wave propagation also changes significantly because wave absorption depends critically on the minor ion concentrations. These modifications to wave propagation and absorption feed back on the out-flowing ions.

In order to account for the coupling between the waves and ions, we solve iteratively. Based on the wave spectrum in the auroral acceleration region, wave propagation and absorption are computed as a function of altitude. Monte Carlo test particle calculations are then performed to determine the ion distributions given the wave heating rate. Moments of the distribution are used to compute an iterated plasma profile, which then is used for a new wave propagation calculation. The process is iterated until a convergent ion profile is found.

It is found that after seven iterations the system has reached a limit cycle that does not change significantly. The helium density quickly attains its final profile,

while the oxygen density iterates more slowly. Although this is not a temporal simulation, it would be natural to draw the conclusion that helium first bleeds off the ionosphere and when its density is reduced sufficiently, oxygen can be efficiently heated.

In Figure 3 is shown the final profiles for oxygen and helium. Note that the energy increases in steps for the helium profile corresponding to peaks in the heating rate which occur due to interference of the reflected wave from the ionosphere. Lower-frequency waves with longer wavelength heat oxygen (which has a lower gyrofrequency at a given altitude), so there are no peaks in the oxygen heating rate at this altitude.

It should be noted that the helium ions are heated significantly more than the oxygen because (a) absorption at the helium resonance is more efficient and (b) the helium absorption bleeds off wave energy that could potentially heat oxygen at lower altitudes.

This result is in agreement with observations shown in Figure 4 that show helium heating dominates oxygen heating for most observed ion cyclotron wave events. The observations were considered surprising because it was believed that oxygen heating would be more efficient as the quasilinear heating rate scaled with mass to a positive power.

Kinetic Ballooning Instabilities for Substorm Onset

One of the key issues in space physics is understanding the physical mechanism that leads to violent disruptions of the magnetosphere called substorms. The substorm onset is observed to be associated with the growth of a low-frequency instability that is observed in the late substorm growth phase just prior to substorm onset with a wave period of 50-75

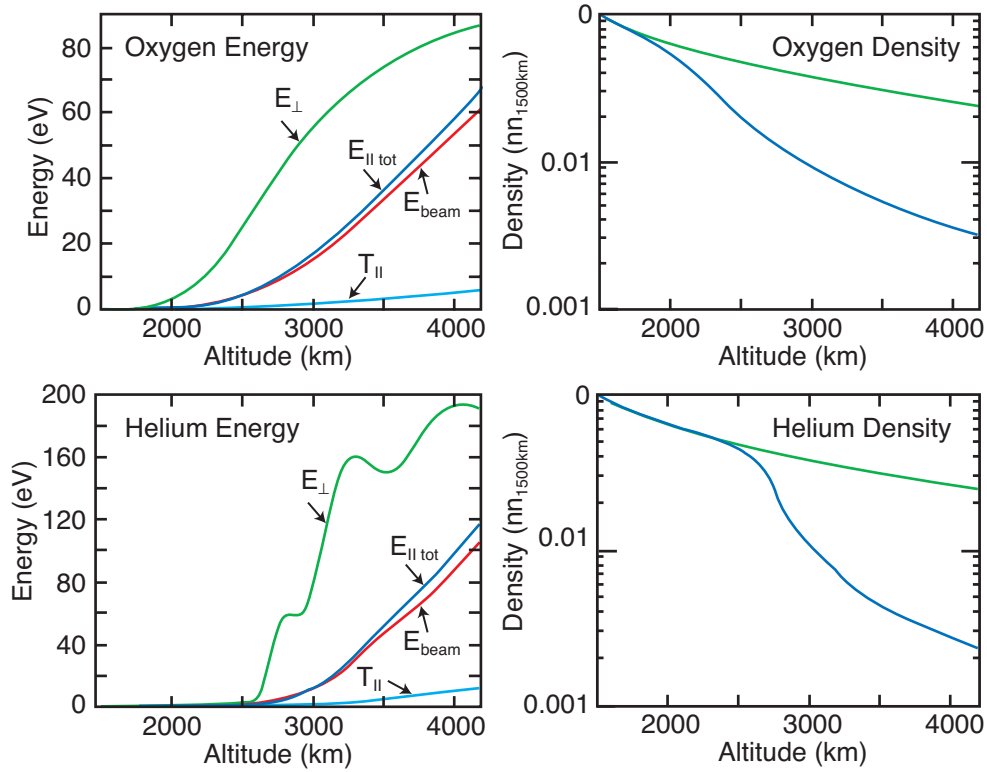

Figure 3. Energy and density profiles for oxygen and helium assuming a relative concentration of 5% and 1% of the ambient plasma. Note the step-like heating of the helium and gradual heating of the oxygen. The bulk helium is heated more than oxygen.

seconds. This low-frequency mode is also observed to persist during the substorm expansion phase, indicating that it plays an important role in the depolarization process.

The observed low-frequency instability is identified as the kinetic ballooning instability based on an analytical theory. However, numerical investigations of the ballooning instability have been performed only based on the ideal-MHD model using simplified two-dimensional magnetic field geometries and simplifying assumptions about the plasma compressibility. It was found that the ballooning stability depends critically on the equilibrium field structure and the assumptions concerning the plasma compressibility. Moreover, stability calculations based on different simplifying assumptions about the physical model

or magnetotail configuration yield completely different results. If nothing else, these results have demonstrated the importance of modeling the plasma com-

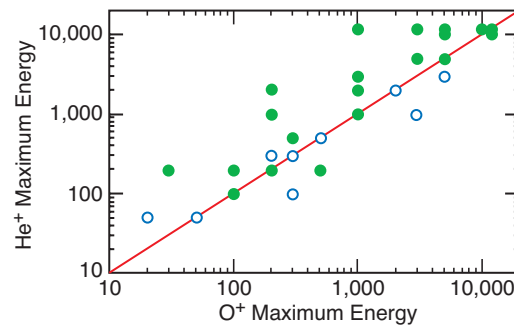

Figure 4. Observations of ion heating events associated with ion cyclotron wave are shown in green (Lund et al., 1998). Note that, in general, helium is heated more strongly than oxygen, consistent with the model results. The open circles are heating events that are not associated with ion cyclotron waves.

compressibility correctly and using realistic equilibrium fields.

Recently, three-dimensional numerical equilibrium solutions of the magnetosphere during the substorm growth phase have been obtained, which includes a strong cross-tail current sheet in the near-Earth plasma sheet region. The ballooning instability is expected to be most unstable in the cross-tail current sheet region. The ideal-MHD eigenmode equations have been derived without making assumptions about the plasma compressibility. Two equations describing the coupling between shear Alfvén-type modes and slow magnetosonic modes are obtained. The coupling occurs because of terms involving magnetic field curvature and plasma pressure.

The coupled equations were simplified using the WKB-ballooning formalism and solved using standard variational methods for a realistic three-dimensional growth phase equilibrium obtained from

our three-dimensional equilibrium code. Figures 5 and 6 show the color plot in the equatorial plane and contours in the northern polar ionosphere of the squared eigenfrequency (negative values indicate instability).

Also shown in Figure 5 are the contours of the azimuthal current density and in Figure 6 is the color plot of the field-aligned current density. Note that all field lines beyond $X \approx -6R_E$ down the tail in the night side are unstable. The region of the most unstable modes tracks well with the strong cross-tail current sheet region, consistent with expectations based on substorm onset observations. The region of maximum growth rate is located in the tailward side of the strong cross-tail current region. In the polar ionosphere, the field lines in the peak ballooning instability growth rate region map to the transition region between the region-1 and region-2 currents. Although the ideal-MHD model

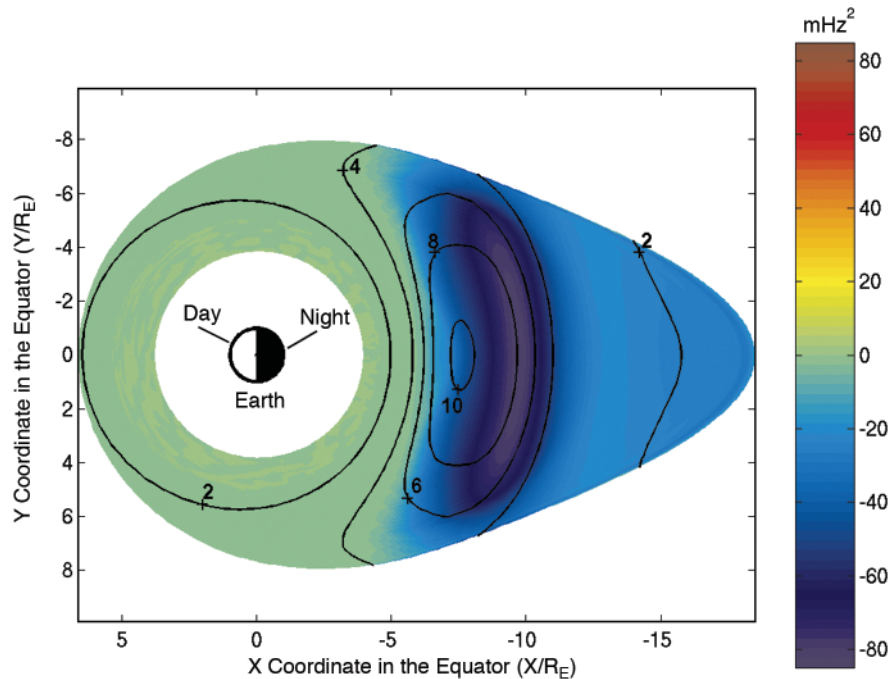

Figure 5. The square of ballooning-mode frequency (in mHz^2) is shown in color in the equatorial plane with the full MHD model. The azimuthal current density (in nA/m^2) contours are also plotted to show the location of the most unstable region relative to the strong cross-tail current region.

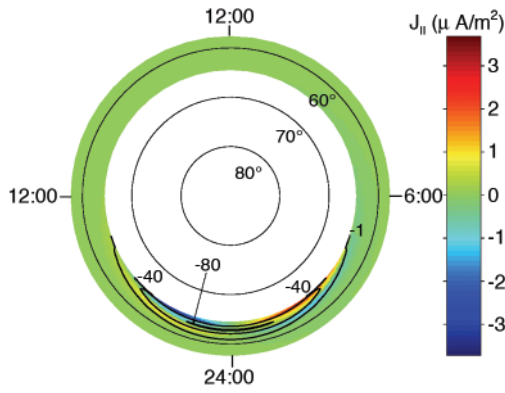

Figure 6. The contours of the square of ballooning-mode frequency (in mHz^2) are plotted over the northern polar ionosphere for the full MHD model. The field-aligned current density (in color) is plotted to show that the most unstable ballooning instability region is located at the transition region between the region-1 and region-2 currents.

over estimates the instability growth rate due to the lack of particle kinetic effects, the results show the field lines where the ballooning free energy is largest and the most unstable ballooning mode is located. Including the particle kinetic effects, the unstable region is expected to be reduced to in the strong cross-tail current sheet region mainly, consistent with sub-storm observations.

Flux Rope Acceleration and Enhanced Magnetic Reconnection in Solar Flares

A solar flare is intense, abrupt release of energy in the low solar corona. Coronal mass ejections (CMEs), another type of grand-scale solar eruptive phenomena, are often accompanied by major X-ray flares. Recent studies have revealed that rapid acceleration of a CME in the low corona is associated with the flare rise phase. The most intense peak in hard X-rays (≥ 25 keV) observed by the Reuven Ramaty High Energy Solar Spectroscopic Imager (RHESSI) occurs at the time of

the maximum acceleration of the CME. On the other hand, in small flares that are not associated with CMEs, soft X-ray ejecta are often observed. In the pre-flare phase, the rising motion of an X-ray ejecta is rather slow, but it is highly accelerated in the flare impulsive phase, in which hard X-ray emission is detected. It is generally accepted that both CMEs and small-scale X-ray ejecta contain a magnetic flux rope structure. But what physical connection lies between the flare energy release and the flux rope acceleration?

The investigation is based on resistive MHD simulations of a magnetic arcade undergoing field line footpoint shearing and magnetic reconnection under non-uniform resistivity. When the magnetic shear exceeds a critical value, a flux rope is generated by magnetic reconnection of line-tied arcade fields. By a continuing shearing process, another flux rope can be created in the lower-lying arcade. The new flux rope, attracted by the upper one, is accelerated upward and the two flux ropes merge by magnetic reconnection. During the fast upward motion of the new flux rope and the integrated one, the arcade field lines below form a very thin current sheet, where a fast magnetic reconnection is induced. This magnetic reconnection endows the flux rope above with momentum and magnetic flux. Consequently, the flux rope is further accelerated, and this again facilitates enhancement of magnetic reconnection. These sequential feedback processes can be repeated as long as the active region is replenished with magnetic shear. There are a total of four flaring (reconnection) events in our simulation run.

The MHD modeling results show that the flux rope acceleration rate and the enhanced reconnection rate in the current sheet under the new flux rope rely cru-

cially on the dependence of the anomalous resistivity on the current density. With a quadratic dependence of the anomalous resistivity on the current density, the modeling results agree well with X-ray observations of two specific flare events.

The simulation results of a fast reconnection event were first compared with the flare-CME observations of the No-

vember 24, 2000, X1.8 (large) X-ray flare (see Figure 7). With realistic physical parameters employed, the height, speed, and acceleration profiles of the model flux rope match well with the corresponding time profiles of the observed filament (in the lower corona) and CME (in the upper corona). The maximum reconnection rate of the model occurs almost coincidentally with the observed

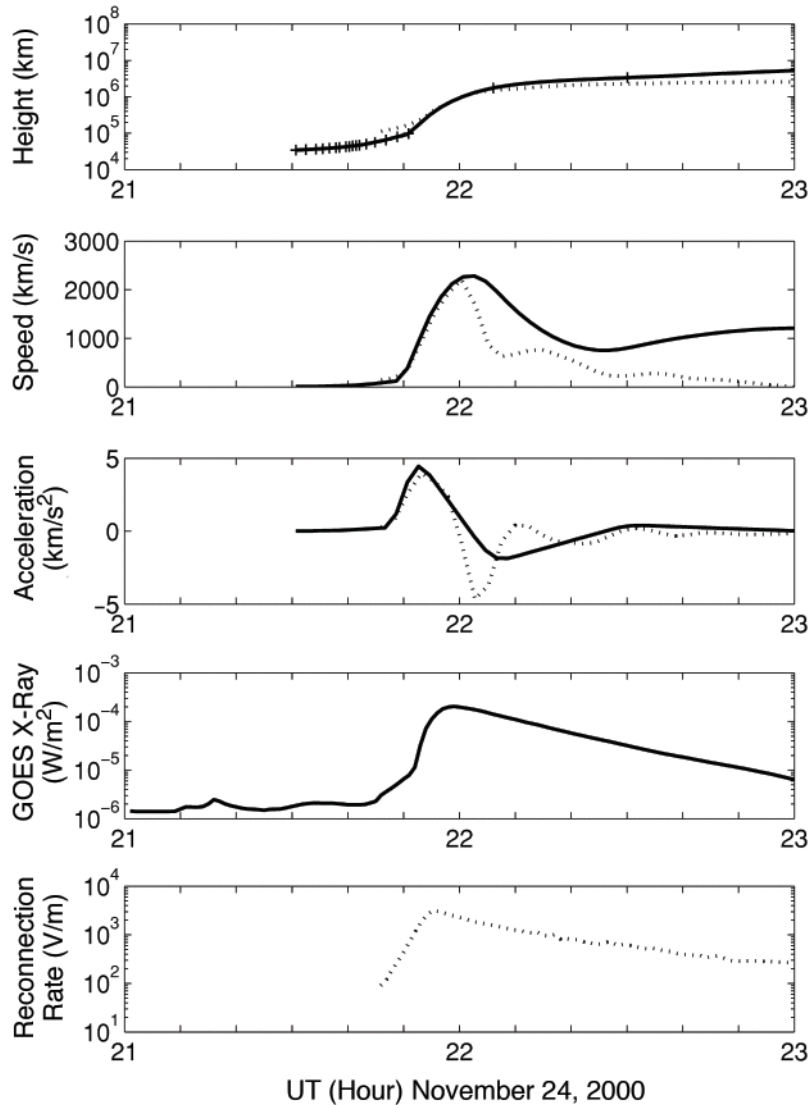

Figure 7. The solid curves in the top three panels show the time profiles of the height (from the solar limb), speed, and acceleration of the erupting filament in the low corona and the coronal mass ejection in the outer corona associated with the November 24, 2000, X1.8 flare. The dotted curves in the top three panels show the respective time profiles of the model flux rope. The solid curve in the fourth panel shows the corresponding GOES X-ray flux, and the dotted curve in the fifth panel shows the reconnection electric field in the model.

peak CME acceleration and impulsive hard X-ray emission, which occur during the rise phase of the observed GOES satellite X-ray profile. The reconnection electric field in the model is as large as 1000 V/m, which is way above the Dreicer electric field of $\sim 10^{-2}$ V/m. With that field-aligned electric field, electrons can be accelerated to 10^3 keV in a field-aligned distance of mere one kilometer. Also compared are the result of a slower reconnection event with the Yohkoh observation of the November 11, 1993, C9.7 (smaller) X-ray flare, which showed soft X-ray ejecta acceleration and hard X-

ray emission. In this case also, the simulation result agrees well with the observed time profile of the ejecta.

These two encouraging quantitative comparisons support the flare model, in which the magnetic reconnection and the flux rope acceleration exert a feedback effect to each other, and nonuniform, anomalous resistivity plays a crucial role in determining the reconnection rate and flux rope acceleration rate. Also it strongly suggests that the flare X-ray emission is generated by electrons accelerated along field lines by the reconnection electric field.

Basic and Applied Physics Experiments

The Princeton Plasma Physics (PPPL) has an active program in Basic and Applied Plasma Physics which supports the Laboratory's mission to create new knowledge in plasma science and to use this knowledge to develop new plasma technologies. These projects generally consist of small experiments focused on a specific topic of interest. All of these projects have strong graduate and undergraduate participation, and many of them have ties to work being done in the PPPL Theory and Advanced Simulations Department.

Some of these basic physics experiments lie at the frontiers of fusion research. For example, the novel Field-reversed Configuration experiment is designed to create a remarkably efficient magnetic confinement system which could eventually be used to burn advanced fusion fuels, while the heavy ion fusion research aims to create and focus extremely high-intensity ion beams onto an inertial fusion target. These and all the other small experiments are strongly coupled to plasma physics research at other national laboratories and universities.

These experiments also have an important role in creating links between plasma physics and other areas of science and technology. For example, the work on high-intensity accelerators is directly applicable to future experiments in high energy physics, and the Hall Thruster Experiment may develop into a technology

which could improve satellite communication systems.

Hall Thruster Experiment

A Hall Thruster is a plasma-based propulsion system for space vehicles. The vast majority of satellites worldwide have relied on chemical thrusters. The amount of fuel that must be carried on board by a satellite depends on the speed that the thruster is able to eject it. Chemical rockets have very limited fuel exhaust speed. Plasmas can be ejected at much higher speeds, therefore less fuel need be carried by the satellite. Until recently, the Hall Thruster approach had been pursued most vigorously in Russia; during the past twenty years, the Russians placed about 100 Hall Thrusters in orbit.

In FY99, a Hall Thruster Experiment was established at the Princeton Plasma Physics Laboratory (PPPL). The PPPL effort was the result of a collaborative theoretical research effort with the Center for Technological Innovation at Holon, Israel. This study, initially funded by the U.S. Air Force Office of Scientific Research (AFOSR), identified improvements that might make Hall Thrusters more attractive for commercial and military applications. After demonstrating state-of-the-art thruster operation, including decreased plasma plume, the project acquired broader support. In addition to support from AFOSR, the program now enjoys support from the De-

fense Advanced Research Projects Agency (DARPA), the New Jersey Commission on Science and Technology, and the U.S. Department of Energy. The facility is pictured in Figure 1.

Hall Thruster Operation

A conventional ion thruster consists of two grids, an anode and a cathode, between which a voltage drop occurs. Positively charged ions accelerate away from the anode toward the cathode grid and through it. After the ions get past the cathode, electrons are added to the flow, neutralizing the output. A thrust is exerted on the anode-cathode system, in a direction opposite to that of the flow. Unfortunately, a positive charge builds up in

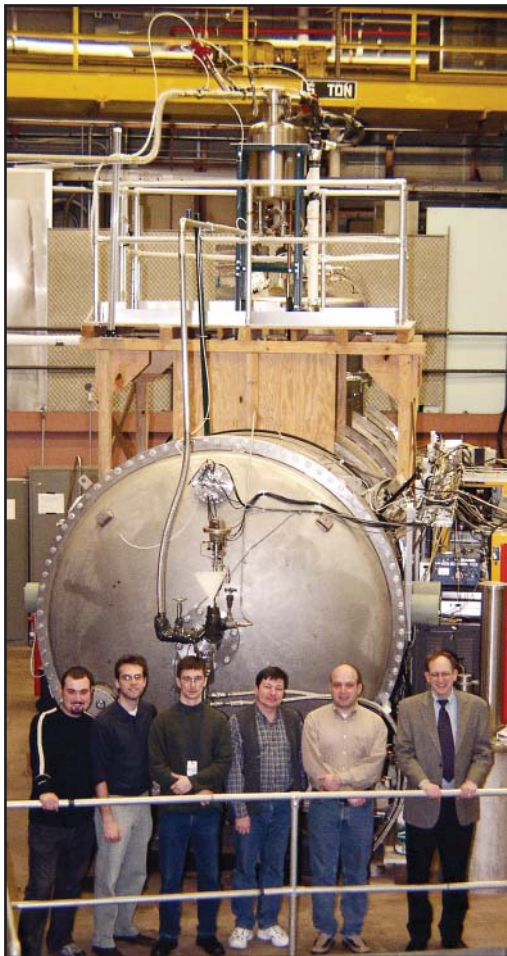

Figure 1. The PPPL Hall Thruster Experiment and research team.

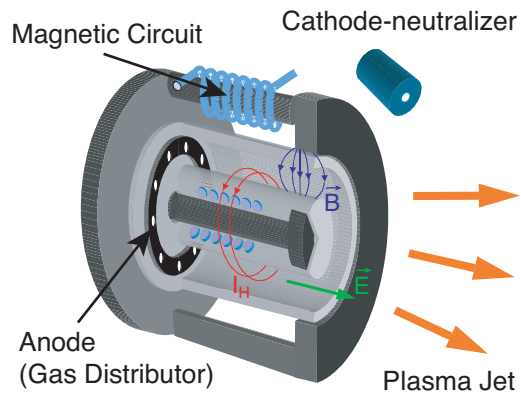

Figure 2. The Hall Thruster concept.

the space between the grids, limiting the ion flow and, therefore, the magnitude of the thrust that can be attained.

In a Hall Thruster, electrons inject into a radial magnetic field neutralize the space charge. The magnitude of the field is approximately 200 gauss, strong enough to trap the electrons by causing them to spiral around the field lines. The magnetic field and a trapped-electron cloud together serve as a virtual cathode (Figure 2). The ions, too heavy to be affected by the field, pass through the virtual cathode. The movement of the positive and negative electrical charges through the system results in a net force on the thruster in a direction opposite that of the ion flow.

Plasma thrusters for present-day space applications generally employ xenon propellant. Xenon is relatively easy to ionize and store on board the spacecraft. It also has a high atomic number (54), which means a lot of mass per ionization energy expended. The ionization energy is an unavoidable inefficiency. In the range of exhaust velocities most useful for present-day space applications, about 15 km/sec, the energy loss for once-ionized xenon is less than 10 percent of the exhaust energy. (If the weight per atom were half, this percentage would double.)

Hall Thruster Applications

Thrusters are used to compensate for atmospheric drag on satellites in low-earth orbit, to reposition satellites in geosynchronous orbit, or to raise a satellite from a lower orbit to geosynchronous orbit. As a rule of thumb, for each kilogram of satellite mass, one or two watts of on-board power must be made available. PPPL has a medium-size Hall Thruster, which consumes several hundred watts of power, making it suitable for a satellite with a mass in the range of a few hundred kilograms.

Hall Thruster Results

An important facility upgrade occurred in FY02: the PPPL Hall Thruster facility was equipped with cryopumps, making possible experiments with power levels higher than the sub-kW levels previously employed; PPPL researchers can now operate a segmented electrode Hall Thruster at greater than 2 kW. The cryopumps also produce a cleaner vacuum, so surface-sensitive effects can be better explored. New diagnostics were installed in FY03 to explore both the channel and the plume physics.

In the last year, key advances were made both for medium-power thrusters and for low-power thrusters. By segmenting the channel of a medium-power Hall Thruster, with each segment held at a specific electric potential, researchers at PPPL were able to control exactly where the voltage drop occurs along the length of the thruster. In some regimes, this has been used to decrease the plume divergence. A small plume divergence is a very important design feature for Hall thrusters for facilitating spacecraft integration. At PPPL, detailed measurements of the electric potential in the interior of the Hall thruster were carried out and related to changes in the plume divergence.

One of the interesting observations made in FY03 was an ion focusing effect.

In addition to imagining larger and more powerful thrusters capable of accelerating satellites more quickly or powering larger satellites, scientists also envision a large satellite discharging hundreds of the smaller ones for the exploration of a planet or as a spaced-based radar array. The Hall Thruster may be too power hungry for this application, but answers to these and other questions may emerge from research underway at PPPL.

PPPL physicists are now developing for AFOSR and for DARPA such smaller thrusters, or "Hall micro-thrusters," which operate with power outputs in the 100-watt range, useful for very small satellites with masses of 50 to 100 kilograms. The scaling to low power is by no means straightforward, as the power density tends to grow at small sizes, just as the smaller feature sizes are more susceptible to heat loading. In attacking these technological constraints, PPPL scientists proposed and are now developing a cylindrical variation of the Hall Thruster in which the central magnetic pole is almost eliminated (Figures 3 and 4).

In the last year, using unique plasma diagnostics inside the micro-thruster channel, several interesting phenomena were discovered, including a density peak near the thruster axis. Understanding and further exploring these phenomena is an ongoing part of the PPPL micro-thruster program.

Magnetic Nozzle Experiment

The Magnetic Nozzle Experiment (MNX) studies the properties of magnetized linear plasmas expanding through regions of converging and diverging magnetic field lines. During FY03, experiments were also performed on plasmas expanding through mechanical (materi-

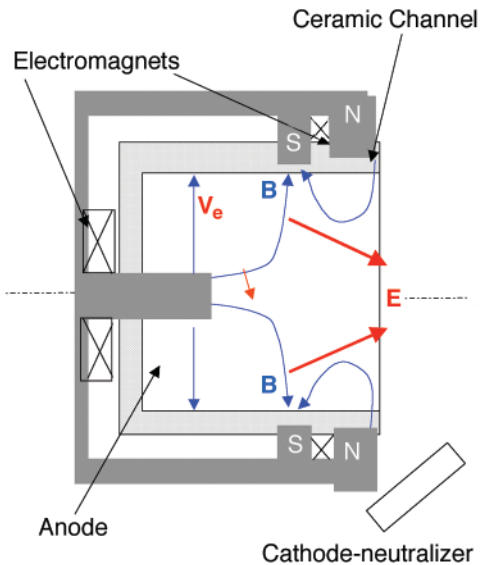

Figure 3. Schematic of the cylindrical Hall Thruster.

al) nozzles. In both configurations, novel atomic and plasma physics phenomena occurred. The result of most relevance to spacecraft-propulsion applications was the acceleration of argon (Ar) plasma ions to a specific impulse of 1,400 seconds, a 40% improvement over the maximum observed during the previous year.

Ion speed measurements were performed with a laser-induced fluorescence (LIF) diagnostic, procured under a U.S. Department of Energy (DOE) contract and loaned to PPPL by Professor Earl Scime of West Virginia University (WVU). Mr. Xuan Sun, a WVU graduate student, participated extensively in the experiments and theoretical interpretation of the results. The LIF system uses a compact, tunable, 15-mW solid-state-diode laser to excite metastable argon (Ar^{+*}) ions in the plasma. Fluorescence from Ar^{+*} was detected in both the main chamber and the expansion region and on both sides of mechanical apertures positioned co-axial to the plasma flow. With the mechanical aperture in the main chamber, the ions were

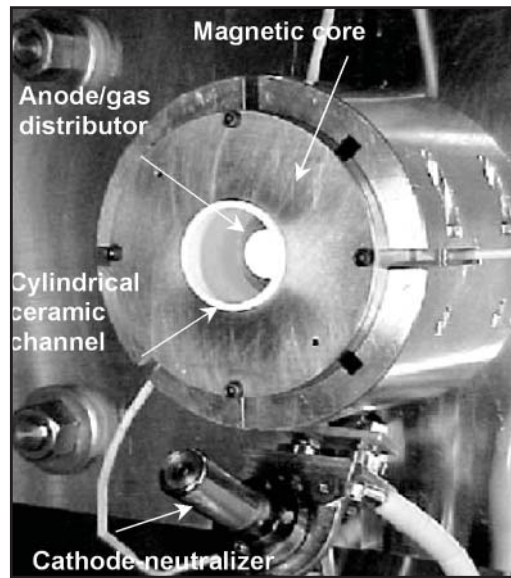

Figure 4. The 2.6-cm-diameter cylindrical Hall Thruster.

seen to accelerate from their thermal energy, approximately 0.4 eV, to the sonic value, $E_i \sim T_e \sim 7$ eV, at the entrance to the mechanical aperture. As the Ar^{+*} ions flowed beyond a mechanical aperture positioned upstream of the magnetic nozzle, their energy increased to more than 60 eV. With the mechanical aperture downstream of the nozzle, increase of the (upstream) nozzle magnetic field increased the LIF signal but reduced the argon ion energy (Figure 5). This behavior is consistent with magnetic-mirror reflection of high perpendicular-energy electrons formed by the helicon plasma-heating system.

One of the surprising atomic physics phenomena observed was an asymmetry to the $+\sigma$ and $-\sigma$ Zeeman peaks of the supersonic ions observed in the expansion region. This asymmetry, up to a factor of three, was seen to depend most strongly on the nozzle magnetic field strength. Through a series of experiments and theoretical analyses, this effect was explained as the optical pumping of upstream metastable argon ions

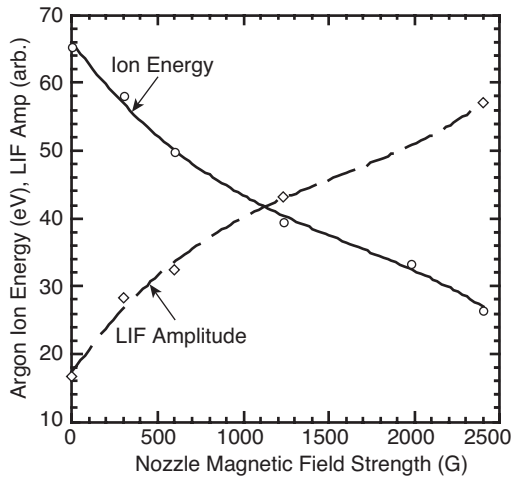

Figure 5. The dependence of ion energy and ion density [laser-induced fluorescence (LIF) amplitude] on the nozzle magnetic field measured at a position 4 cm downstream of the magnetic nozzle. The strength of the Helmholtz axial field was ~ 600 G in the main chamber.

by the counter propagating laser beam. This effect is important to the determination of plasma density from LIF amplitude.

FRC/RMF Experiment

The Field-reversed Configuration/Rotating Magnetic Fields (FRC/RMF) experiment is designed to study the effects of odd-parity rotating magnetic fields (RMF_o) on magnetized plasmas. The experiment was first motivated by the prediction that odd-parity RMF would maintain the closed field lines of the field-reversed configuration and hence would improve energy confinement compared to conventional even-parity rotamaks. The second motivation was the theoretical prediction that RMF in the ion-cyclotron-range-of-frequencies (ICRF) would heat ions and electrons to thermonuclear energies by a stochastic heating process.

In FY03, experiments on plasma production and sustainment by odd-parity

RMF were performed at the 10-kW power level at axial magnetic field strengths near 100 G. The RMF was able to break down the helium gas pre-fill with no pre-ionization and to sustain discharges for times exceeding 1 ms. Plasma density, measured with both 35-GHz and 170-GHz interferometers, reached 10^{12} cm⁻³. The electron temperature, inferred from a collisional-radiative model for helium-line ratios, exceeded 20 eV. From spectral measurements, plasma contamination was less than 1%.

Theoretical studies of ion dynamics in FRCs using Hamiltonian and symplectic techniques continued in collaborations with A. Glasser of Los Alamos National Laboratory and G. Zaslavsky of the Courant Institute for Mathematical Sciences, New York University. A paper, to appear in *Physics of Plasmas*, gave a detailed classification of orbit shapes and looked at the adiabatic limit that results for highly elongated FRC devices, thereby establishing a criterion for separatrix crossing which leads to adiabatic chaos. A second paper, to appear in *Communications in Nonlinear Science and Numerical Simulation*, applied a novel averaging scheme for the radial and axial Hamiltonians to derive conditions for resonance and incipient stochasticity. The Chirikov criterion was then applied to find conditions for the transition to strong chaos.

Figure 6 shows a Poincaré plot for ions in a spherical FRC without RFM. The dimensionless energy and azimuthal canonical momentum are set to 0.063 and 0.258, respectively. Nonlinear resonance for figure-8 orbits are clearly seen as necklaces of islands, bounded by Kolmogorov-Arnold-Moser (KAM) surfaces. Lowering either the canonical azimuthal momentum or the FRC elon-

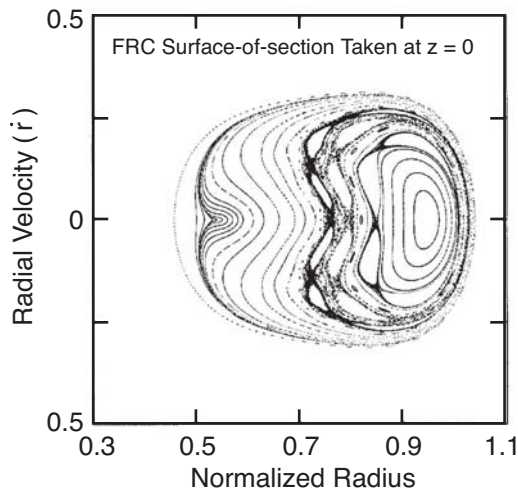

Figure 6. Poincaré plot of ion dynamics in a spherical field-reversed configuration without rotating magnetic field.

gation would result in greater chaos, i.e., disappearance of the KAM surfaces.

Nonneutral Plasmas and High-intensity Accelerators

A nonneutral plasma is a many-body collection of charged particles in which there is not overall charge neutrality. Such systems are characterized by intense self-electric fields and, in high-current configurations, by intense self-magnetic fields. Nonneutral plasmas, like electrically neutral plasmas, exhibit a broad range of collective properties, such as plasma waves and instabilities. The intense self-fields in a nonneutral plasma can have a large influence on detailed plasma equilibrium, stability, and confinement properties, as well as on the nonlinear dynamics of the system.

There are many practical applications of nonneutral plasmas. These include:

- improved atomic clocks;
- positron and antiproton ion sources;
- antimatter plasmas, with application to antihydrogen production;

- coherent electromagnetic radiation generation, including free electron lasers, cyclotron masers, and magnetrons;
- advanced accelerator concepts with high-acceleration gradients; and
- investigation of nonlinear collective processes and chaotic particle dynamics in high-intensity charged-particle beams.

Research on nonneutral plasmas and high-intensity accelerators at PPPL focuses on three areas:

- basic experimental investigations of nonneutral plasmas confined in a Paul trap with oscillatory wall voltages, used to simulate intense beam propagation through a periodic quadrupole field configuration;
- analytical and numerical studies of the nonlinear dynamics and collective processes in intense nonneutral beams propagating in periodic-focusing accelerators and transport systems, with particular emphasis on next-generation accelerators for heavy ion fusion, spallation neutron sources, and high-energy physics applications; and
- experimental investigations of radio-frequency plasma sources for beam space-charge neutralization, experimental and theoretical studies of multielectron loss events, and optimization of negative ion beams for heavy ion fusion drivers.

Paul Trap Simulator Experiment

The Paul Trap Simulator Experiment (PTSX) is a compact experiment that simulates intense beam propagation through periodic focusing magnetic alternating-gradient transport systems over

distances of kilometers. The simulation is possible because the transverse dynamics of the particles is equivalent in the PTSX and the periodic focusing magnetic alternating-gradient transport systems.

Planned experimental studies include investigations of beam mismatch and envelope instabilities, collective wave excitations, chaotic particle dynamics and production of halo particles, and mechanisms for emittance growth. The PTSX linear Paul trap confines cesium ions in the transverse plane by applying oscillatory voltages to the four quadrants of a 2-m long, 40-cm diameter, segmented primary cylinder. Applied static voltages on the 40-cm long end cylinders provide axial confinement. The temporal frequency of the oscillating voltage in the PTSX corresponds to the spatial frequency of the magnets in the actual transport system.

In FY03, the PTSX demonstrated the ability to simulate beams with normalized intensities of up to 80%. Furthermore, the data in Figure 7 shows that the plasma can be confined, relatively unchanged, for hundreds of milliseconds. This corresponds to equivalent propagation distances of tens of kilometers. These achievements show that the PTSX is a flexible, low-cost alternative to per-

forming intense beam propagation experiments in long alternating-gradient transport systems.

High-intensity Accelerators

Temperature anisotropies that develop naturally in accelerators during the acceleration phase may provide the free energy to drive a Harris-type instability in intense particle beams and lead to a deterioration of beam quality. For example, if the nonlinear response of the beam particles is to develop a sufficiently large axial velocity spread, this may provide a limit on the minimum spot size achievable in heavy ion fusion experiments. To determine the linear and nonlinear dynamics of the temperature anisotropy instability in intense beams, the Beam Equilibrium Stability and Transport (BEST) code has been used to determine the detailed three-dimensional (3-D) stability properties over a wide range of temperature anisotropy and beam intensity. The low-noise feature of the nonlinear delta-f simulations permits a thorough characterization of the instability growth rate, mode structure, and nonlinear saturation mechanism. It is found in the case of extreme temperature anisotropy that the beam is stable at low-to-moderate intensities, but

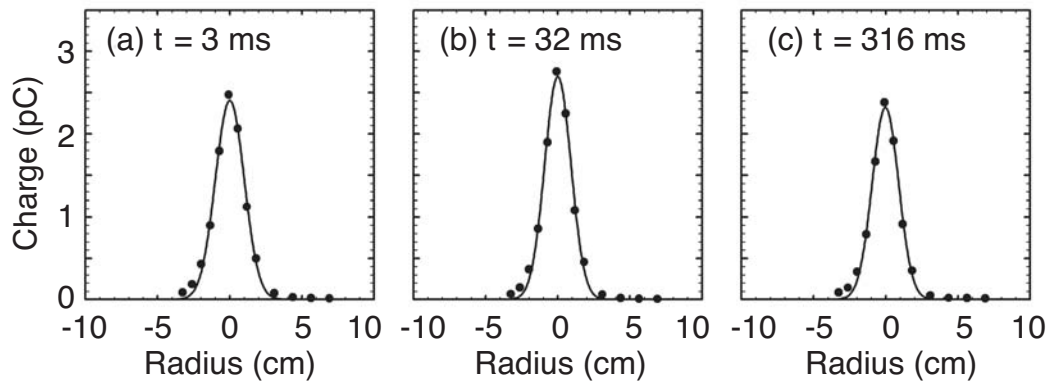

Figure 7. The radial profile of a moderate-intensity trapped plasma (normalized intensity of 18%) changes only slightly after 316 ms. For the parameters in this experiment, this corresponds to more than 20 km of equivalent beam propagation.

can exhibit a strong Harris-type instability for larger space-charge intensities. Moreover, the instability saturates nonlinearly through the development of an axial velocity spread and resonant wave-particle interactions (Landau damping) by the tail ions. Detailed stability properties have been calculated for azimuthal mode excitations $m = 0, 1, 2, 3$, revealing that the dipole mode excitation ($m = 1$) is the most unstable mode. Finally, the ranges of temperature anisotropy and beam intensity corresponding to stable (quiescent) beam propagation have been determined.

In the presently envisioned configurations for heavy ion fusion, it is necessary to longitudinally compress the beam bunches by a large factor after the acceleration phase. Because the space-charge force increases as the beam is compressed, a larger focusing force is needed to confine the beam in the transverse direction. It is necessary to have a non-periodic quadrupole lattice along the beam path. Recently, an innovative design concept for such a focusing lattice has been developed using the transverse envelope equations for an intense charged-particle beam. Four time-dependent magnets are introduced in the region upstream of drift compression to focus the entire beam pulse onto the same focal spot. Drift compression and final focusing schemes have been developed for a typical heavy ion fusion driver and for the Integrated Beam Experiment (IBX) presently being designed by the Heavy Ion Fusion Virtual National Laboratory. Shown in Figure 8 are the beam envelope dynamics during the drift compression and final focus together with the non-periodic lattice and four final focus magnets for a typical heavy ion fusion beam.

Knowledge of ion-atom ionization cross sections is of great importance for

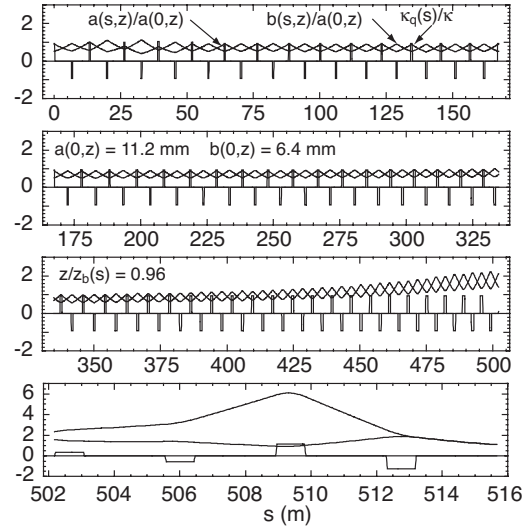

Figure 8. Beam envelope dynamics during the drift compression and final focus for a typical heavy ion fusion beam. The shown envelope dynamics are for a beam slice near the front end of the charge bunch.

many accelerator applications. To study the range of validity of both the Born approximation and the classical trajectory calculation, theoretical and experimental investigations of the stripping of more than 18 different pairs of projectile and target particles in the range of 3-38 MeV/amu have been done. In most cases, both approximations give similar results. However, for fast projectile velocities and low ionization potentials, the classical approach is not valid and can overestimate the stripping cross sections by neutral atoms by an order-of-magnitude. When experimental data and theoretical calculations are not available, approximate formulas are frequently used. Based on experimental data and theoretical predictions, a new fit formula for ionization cross sections by fully stripped ions has been proposed. The resulting plots of the scaled ionization cross sections of hydrogen by fully stripped ions are shown in Figure 9. The new fit formula was also applied to the ionization cross sections

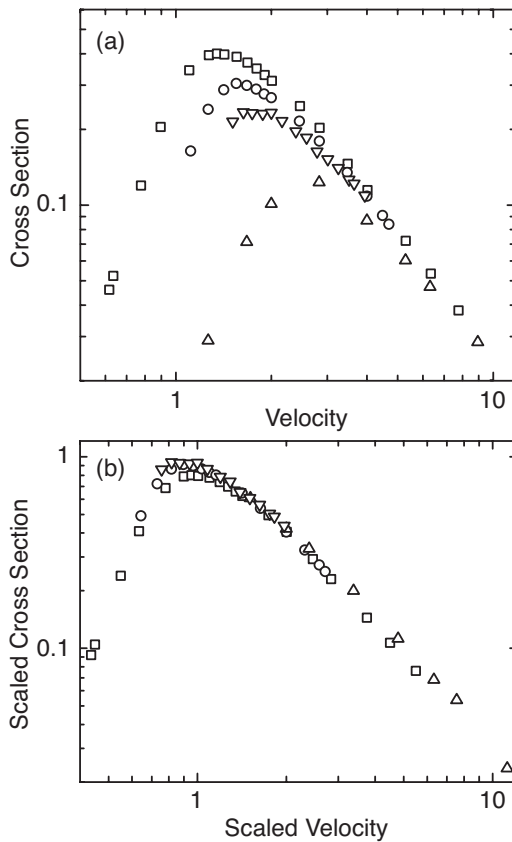

Figure 9. Ionization cross sections of hydrogen by fully stripped ions of hydrogen (squares), helium (circles), lithium (overturned triangles), and carbon (triangles) as a function of projectile velocity in atomic units of (a) experimental data and (b) the same data scaled according to the new fit formula.

of helium. Again, all of the experimental and theoretical results merged close together on the scaled plot.

Presently, there are many other research activities in the high-intensity accelerator area. For example, in a recent calculation using the Vlasov-Maxwell equations, the classical resistive-wall instability has been extended to the cases of arbitrary azimuthal mode number and arbitrary space-charge intensity. Studies in the high-intensity accelerator area are providing valuable guidance in the design and planning of future accelerator experiments.

Charge Neutralization Experiments

Heavy ion fusion research has developed reactor design concepts requiring multiple heavy ion beams to be focused to small spot size (millimeter-scale) in the target chamber. The Neutralized Transport Experiment (NTX) at the Lawrence Berkeley National Laboratory is investigating the most promising charge neutralization methods to achieve this level of focusing. One neutralization approach utilizes large-volume plasma to charge neutralize the heavy ion beam. The charge neutralization process has been modeled theoretically as a heavy ion beam pulse propagating through a highly ionized cylindrical plasma column. The background plasma ion motion is neglected, and electrons from the background plasma move into the ion beam channel, reducing the net positive beam space charge over the larger volume of the plasma channel. Ion beam densities are expected to be in the range of 10^{10} - 10^{11} cm^{-3} . Present calculations require the plasma to exceed one meter in length with an electron density in the range of 1 to 100 times the beam density.

PPPL researchers have developed plasma sources to support the charge neutralization studies conducted on the NTX. In some regimes of operation, the sources are well characterized and have been applied to plasma processing of semiconductor devices. One of the plasma sources developed at PPPL is a radio-frequency plasma source that operates at 13.6 MHz. For radio-frequency waves, the skin depth is on the order of one centimeter. Therefore, the radio-frequency antenna is placed as close as possible to the interaction-region with the ion beam. Operating in a pulsed mode, the source is able to produce plasma densities exceeding 10^{11} cm^{-3} at background gas pressures in the few microTorr range.

The radio-frequency plasma source was installed on NTX (Figure 10) and collaborative experiments are being carried out to determine the effectiveness of background plasma in neutralizing the ion beam space charge. Initial results look promising, as beams with initial radii of centimeters are successfully focused down to a few millimeters after passing through a neutralizing plasma.

Negative Ion Driver Beams for Heavy Ion Fusion

Inertial confinement fusion concepts employing heavy ion beam drivers have traditionally assumed the use of positively charged ions. However, negative ions have recently attracted interest after a feasibility study by PPPL researchers suggested that modest extrapolations of existing technologies might result in a viable alternative. Unlike positive ions, negative ions will not collect electrons from surfaces they pass, which changes their focusing characteristics, and negative ions can readily be converted to neutral atoms by laser photodetachment as they enter the target chamber. Although they will be ionized in crossing the cham-



Figure 10. PPPL researchers Andy Carpe (left) and Erik Gilson visit the Lawrence Berkeley National Laboratory to prepare a radio-frequency plasma source for installation on the Neutralized Transport Experiment (NTX).

ber medium, neutrals should reduce the beam space-charge-expansion. Halogens' large electron affinities make them the best candidates for high brightness negative ion sources.

PPPL recently joined with researchers at Lawrence Berkeley National Laboratory (LBNL) and the Virtual National Laboratory for Heavy Ion Fusion to conduct a proof-of-concept experiment at LBNL using chlorine in a radio-frequency-driven ion source. Without introducing any cesium (which is required to enhance negative ion production in hydrogen ion sources), a negative chlorine current density of 45 mA/cm^2 was obtained under the same conditions that gave 53 mA/cm^2 of positive chlorine. This suggests the presence of nearly as many negative ions as positive ions in the plasma near the extraction plane. The negative ion spectrum was 99.5% atomic chlorine ions, with only 0.5% molecular chlorine, and essentially no impurities. Even without the electron suppression technology used in negative hydrogen extraction, the ratio of co-extracted electrons to negative chlorine ions was as low as 7 to 1, much lower than the ratio of their mobilities, suggesting few electrons in the near-extractor plasma. This, along with the near-equivalence of the positive and negative ion currents, suggests that the plasma in this region was mostly an ion-ion plasma.

Planning is presently underway for a follow-up experiment to be conducted on a test stand at the Lawrence Livermore National Laboratory, where higher radio-frequency power capability will allow the observed linear current density scaling to be followed to higher levels, along with a test of a multiple-beamlet negative chlorine ion source, and direct comparisons of positive and negative ion beam emittance (optical quality)

with a more sophisticated measurement system.

Diagnostic Development

Electron-Bernstein

Wave Emission Diagnostic

Spherical torus (ST) and other magnetically confined plasmas that operate at relatively high plasma densities and low-confining magnetic fields cannot use conventional electron cyclotron emission (ECE) electron temperature diagnostics. In these “overdense” plasmas, mode-converted electron-Bernstein wave (EBW) emission may be used as an electron temperature profile diagnostic with similar temporal and radial resolution to a conventional ECE diagnostic. The key to developing a viable EBW electron temperature diagnostic is to characterize and control the mode-conversion efficiency of EBWs to electromagnetic waves. This conversion generally occurs near the plasma edge of these overdense plasmas. Once the EBW emission is mode-converted it can be measured by a microwave radiometer.

Recent EBW radiometer research on PPPL’s Current Drive Experiment-Upgrade (CDX-U) ST has demonstrated controlled mode conversion of EBWs to extraordinary mode, electromagnetic radiation using a local limiter at efficiencies near 100%. As a result, the electron temperature profile was measured. The potential for measuring the plasma internal magnetic profile using the mode-converted EBW emission spectrum was also demonstrated. During FY03, an EBW diagnostic, designed based on the CDX-U EBW emission research, was installed on the National Spherical Torus Experiment (NSTX) to demonstrate this diagnostic technique on a larger ST plasma and to contribute to the NSTX plasma physics program (Figure 11).

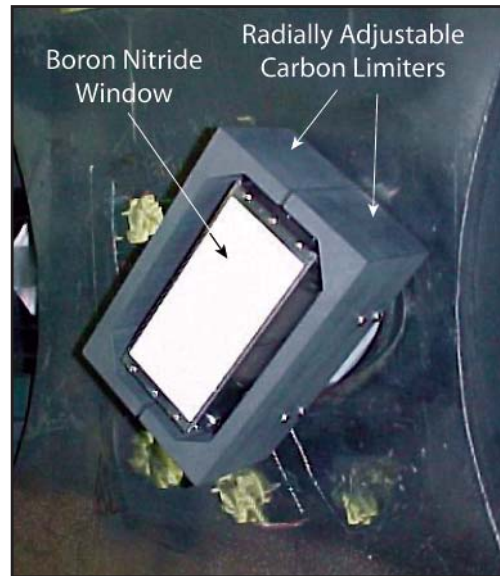

Figure 11. The NSTX electron-Bernstein wave radiometer.

3-D Microwave Imaging Diagnostic

The 3-D imaging diagnostic system consists of a combined Microwave Imaging Reflectometer (MIR) and an Electron Cyclotron Emission Imaging radiometer (ECEI) for plasma fluctuation measurements. The diagnostic utilizes large optics to simultaneously collect launched microwaves reflected from the cut-off layer and intrinsic electron cyclotron microwave emission. This is in contrast to conventional systems, which employ small waveguides to collect the signals. The goal of this 3-D imaging system is a simultaneous measurement of fluctuations of density and temperature within the focal depth of the designed imaging system.

It has been demonstrated theoretically and in laboratory tests that the MIR system potentially provides significantly more accurate characterizations of density fluctuations compared with the conventional systems. It will also provide a unique opportunity to measure poloidal wavenumbers (16 channels) of density fluctuations simultaneously. The ECEI system is also a multichannel ‘imaging’

system consisting of 128 (16 poloidal by 8 radial) channels.

PPPL worked with researchers from the University of California at Davis (UC Davis) and the FOM Institute for Plasma Physics in the Netherlands to complete the design and fabrication of the MIR system culminating with installation on the TEXTOR tokamak in Jülich, Germany, in fiscal year 2003. Debugging and initial operation of this system during FY03 demonstrated that the signal level was suitable for analysis as indicated by the quadrature signals shown in Figure 12. The high signal level of the MIR system, due to the newly developed, sensitive hybrid detector array provided by the UC Davis team, permitted use of a simple beam splitter for the ECEI system instead of an alternate and more difficult dichroic plate design. In the ECEI system, FY03

efforts concentrated on absolute calibration of the system and on successful two-dimensional imaging of MHD-level temperature perturbations, before attempting to image random temperature fluctuations.

X-ray Spectroscopy for NSTX

A new type of a high-resolution X-ray imaging crystal spectrometer was installed at NSTX for the experimental campaign in FY03 to measure ion and electron temperature profiles from spatially resolved spectra of helium-like argon, ArXVII. This instrument does not require the injection of a neutral beam, making it particularly valuable for diagnosing radio-frequency-heated plasmas. It consists of a spherically bent quartz crystal and a 10-cm by 30-cm two-dimensional position sensitive multi-wire proportional counter and it creates a de-

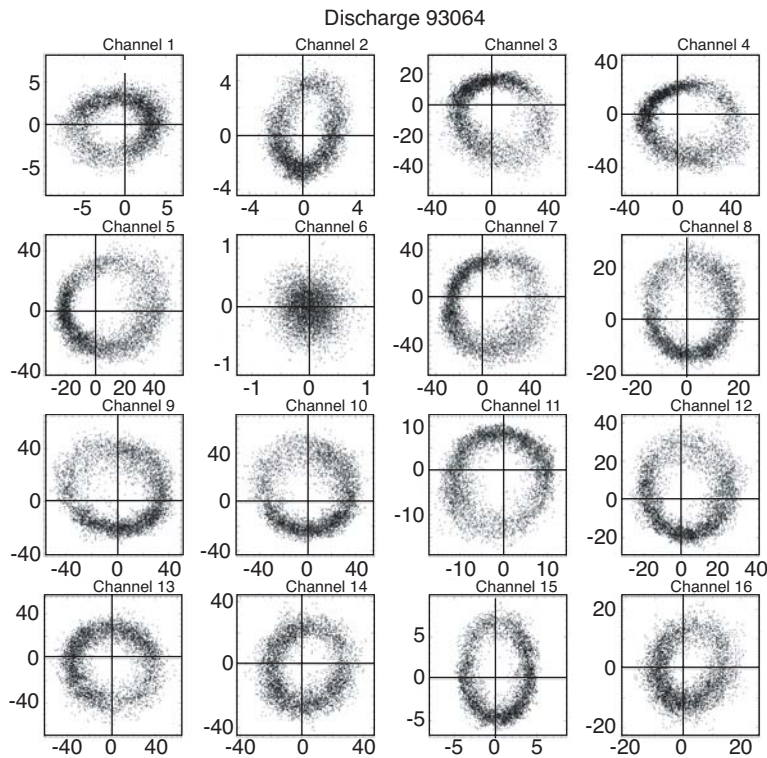

Figure 12 Quadrature signals from the microwave imaging reflectometer multi-channel detector array.

magnified image of a 80-cm-high plasma cross section onto the detector. The spatial resolution in the plasma is about one centimeter and is solely determined by the height of the crystal, its radius of curvature, and the Bragg angle. The detector and data acquisition system were developed by Dr. S.G. Lee at the Korea Basic Science Institute for the X-ray crystal spectrometers on the Korea Superconducting Tokamak Advanced Research (KSTAR) device. The X-ray crystal spectrometers were designed in collaboration with PPPL. The experimental results obtained from NSTX experiments, or from other devices, are therefore also a valuable test of the X-ray crystal spectrometer design for KSTAR.

Because of the early termination of the NSTX experimental campaign in FY03, the spectrometer was reinstalled on the Alcator C-Mod tokamak where the first proof-of-principle experiments were performed in June-July 2003. Figure 13 shows a spatially resolved spectrum of ArXVII obtained from ohmically heated Alcator C-Mod plasma discharges. The experimental data from the Alcator C-Mod will now be analyzed and the spectrometer will be reinstalled on NSTX for the FY04 experimental campaign.

In 2003, the analysis of argon spectra, which were obtained from previous NSTX experimental campaigns, was completed. The analysis of these spectra revealed an inconsistency in the the-

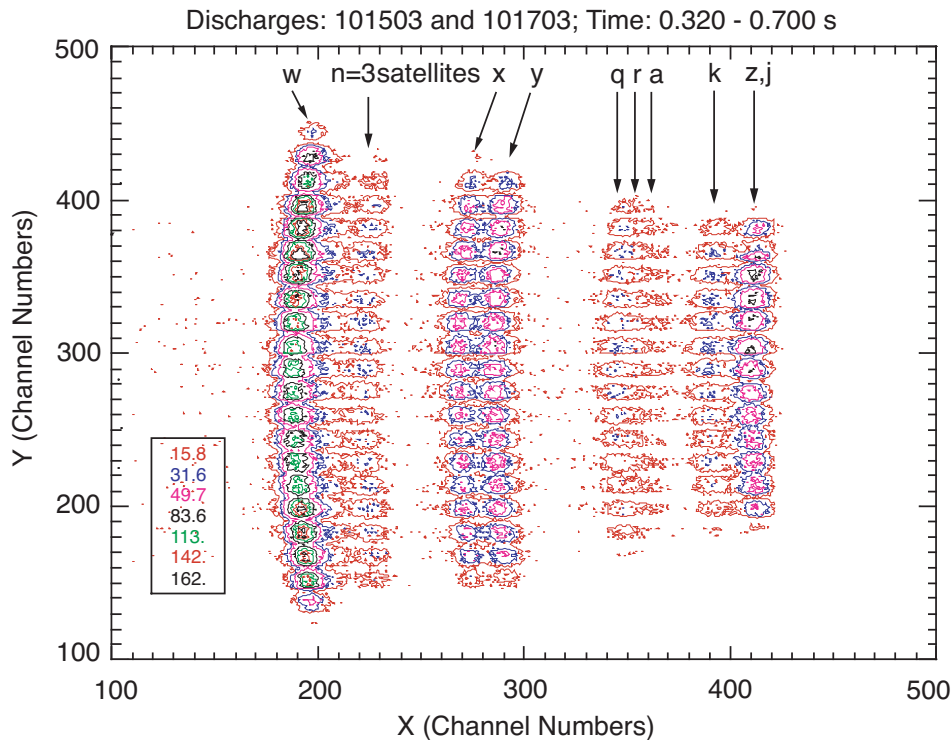

Figure 13. Spatially resolved contour plot spectrum of ArXVII accumulated from two very similar, ohmically heated, Alcator C-mod plasma discharges. The spectrum consists of the helium-like lines w, x, y, and z of ArXVII and the associated $n = 2$ and $n = 3$ satellites. Due to the different experimental arrangement of the spectrometer at Alcator C-mod, the spectrum represents a 1:1 image of the plasma. The shadows in the horizontal direction are caused by the 2-mm-wide supporting ribs on the beryllium entrance window of the detector. The separation between adjacent ribs is 1 cm. Color numbers indicate contour values.

oretical predictions for the $n = 2$ and $n = 3$ dielectronic satellites in the widely used atomic modeling code of Vainshtein and Safronova. This inconsistency was removed in new atomic modeling calculations by M.F. Gu. These improved calculations are in agreement with the observed spectral data, and the derived electron temperature values are also in good agreement with the central electron temperature values measured by Thomson scattering. The results from NSTX are also of interest for the interpretation of astrophysical spectra.

Liquid Metal Experiment

A small-scale laboratory experiment at PPPL is studying the fundamental physics of magnetohydrodynamic (MHD) effects on surface waves and turbulence in liquid metal. MHD turbulence has been regarded as an essential element of many intriguing phenomena observed in space and laboratory plasmas, and it has been a primary subject of basic plasma physics research. Recent interests in the application of liquid metal to fusion devices also add new demands for a better understanding of MHD physics of electrically conducting fluids. This experiment focuses on MHD effects on fluid turbulence and surface waves using liquid gallium, which can be well approximated by MHD models. Three basic physics issues will be addressed. (1) When and how do MHD effects modify surface stability, either in linear regimes or nonlinear regimes such as solitary waves? (2) When and how do MHD effects modify a free-surface flow, such as by surface deformation? (3) When and how do MHD effects modify thermal convection?

In neutral fluids such as water, depending on wavelength, gravity force and surface tension force are dominant

restoring forces for a surface wave. When a liquid metal is subjected to a magnetic and/or electric field, the Lorentz force adds to the wave complexity, leading to possible new instabilities. In the experiment, an external wave driver with varying frequency and amplitude is used to excite surface waves in the liquid metal. Reference cases are established using water and gallium without magnetic and electric fields. MHD effects can be examined by imposing an external magnetic field and/or electric current with varying amplitudes and angles with respect to wave propagation direction. A laser reflection system combined with a gated ICCD camera is used to measure dispersion relation and wave amplitudes.

It is found that the driven waves are not affected by a magnetic field applied in the perpendicular direction of wave propagation, while the waves are damped with a parallel magnetic field. A linear theory, which takes into account MHD effects, predicts magnetic damping of surface waves, in good agreement with the experimental results. Two-dimensional waves are made by shaking the liquid vertically (Faraday waves), and the MHD effects are investigated when a direct current magnetic field is imposed horizontally. Figure 14 shows images taken during a preliminary experiment, which indicate possible effects on the pattern formation due to the magnetic field.

Experiments on liquid gallium flow across an imposed magnetic field have begun using a newly constructed gallium loop. Existence of a free surface distinguishes this problem apart from the traditional Hartman flow, which has been intensively studied. Stability of such flows bears important consequences to the fusion reactor application. Interfacial sta-

bility is also relevant to the mixing processes in many astrophysical phenomena. When a flowing layer of light material sits on top of a layer of heavy material, the interface can be unstable due to reso-

nance with the gravity waves to efficiently mix light and heavy materials. Collaborations on this topic are under way with Professor R. Rosner of the University of Chicago.

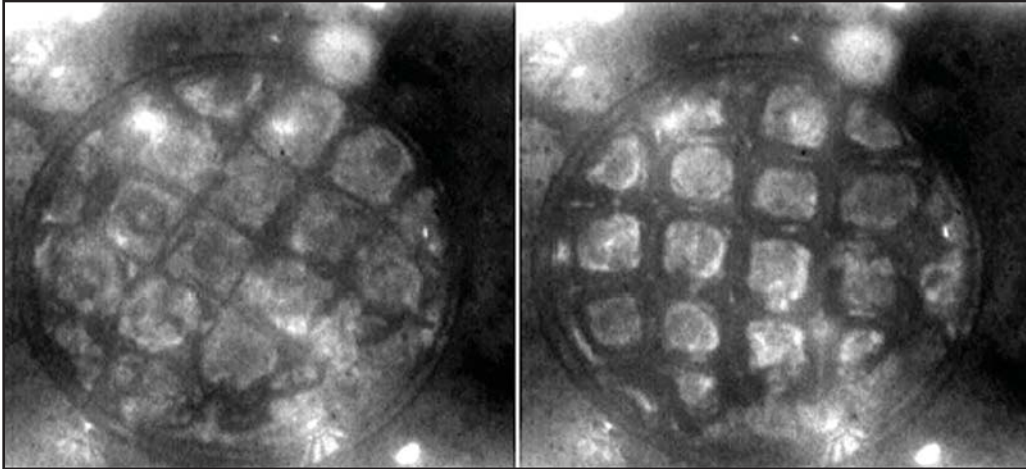
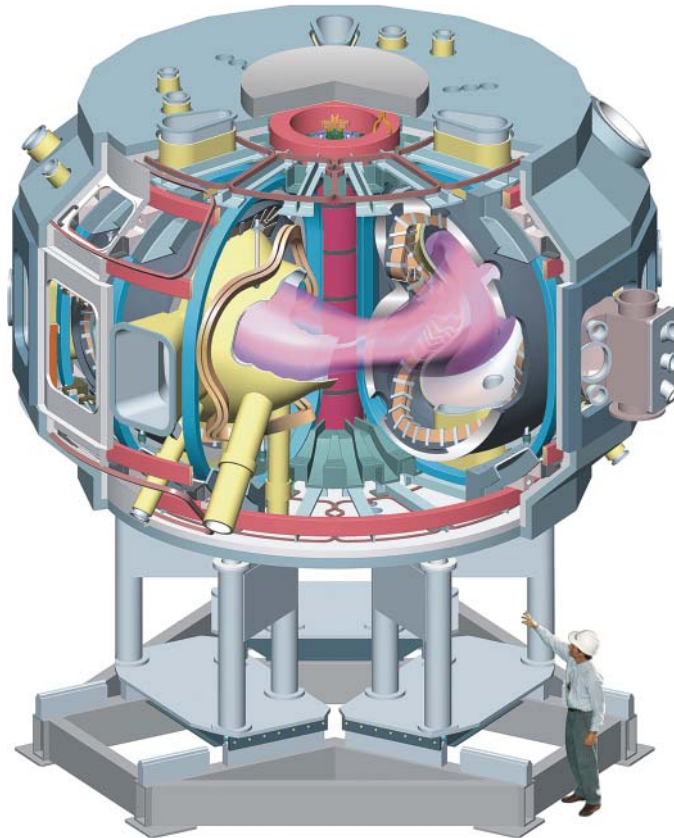

Figure 14. Images taken during a vertical shaking (25 Hz) of a liquid gallium alloy dish. Square patterns (left) form without magnetic field. When a magnetic field of about 1,300 G is imposed parallel to the liquid surface, the patterns are seen to align with the magnetic field (right).

National Compact Stellarator Experiment



National Compact Stellarator Experiment

A key goal for fusion energy research is to develop physics solutions for practical magnetic fusion power plants. Stellarators, a family of three-dimensional toroidal magnetic configurations, are of interest because they solve the major problems — achieving steady-state operation and avoiding plasma disruptions. There is a substantial effort in stellarator research worldwide, including Japan's Large Helical Device

and Germany's Wendelstein-7X experiments, large facilities that use superconducting magnets. United States researchers have focused on a new variant, the compact stellarator, which shares the attractive properties of existing stellarators but also has additional advantage.

The compact stellarator concept is a result of major advances in plasma physics understanding and computation over the past decade. For the first time, research-

ers are able to design stellarator configurations that are stable without active feedback control or current drive, have low aspect ratio ($A \leq 4.5$, where A is the ratio of the torus radius to plasma radius) compared to previous stellarator designs ($A \leq 10$), and have a quasi-symmetric magnetic field structure.

A quasi-symmetric magnetic configuration has, in spite of its three-dimensional geometry, an approximate symmetry direction in the field strength, as experienced by charged particles drifting along magnetic field lines in the system. In a quasi-axisymmetric stellarator, such as the National Compact Stellarator Experiment, the single particle trajectories and plasma flow damping are similar to those in tokamaks, which are axisymmetric in both geometry and magnetic structure. Based on this fundamental similarity, quasi-axisymmetric stellarators are expected to share the tokamak's good confinement performance. Their physics link with tokamaks should enable compact stellarators to advance rapidly and economically, building on advances in the more mature tokamak concept, including the expected advances in burning plasma physics and technology from ITER.

A new experimental device, the National Compact Stellarator Experiment (NCSX), is being constructed at the Princeton Plasma Physics Laboratory (PPPL) in partnership with the Oak Ridge National Laboratory as the centerpiece of a national program to develop compact stellarators. During FY03, the NCSX fabrication project officially started. Good progress on its design permitted the project to advance from the conceptual design level to a level of maturity sufficient to establish the cost and schedule baseline for project execution. A Preliminary Design Report was prepared, documenting the project's designs, plans, and

estimates in detail. Three in-depth project reviews were conducted to assess the project's progress as documented in the Preliminary Design Report. They unanimously concluded that NCSX was ready to be baselined in the U.S. Department of Energy (DOE) system, and recommended DOE approval of Critical Decision 2 (CD-2), Approval of the Project Baseline.

NCSX Mission

The NCSX is an integral part of the DOE's Office of Fusion Energy Sciences program, its mission being to acquire the physics knowledge needed to evaluate compact stellarators as a fusion concept and to advance the physics understanding of three-dimensional plasmas for fusion and basic science. In addition, the technological innovations and developments that are produced in the course of the fabrication project are making important contributions to fusion technology, including publications in major conference proceedings. The device (shown on page 95) is designed to test compact stellarator physics in a high-beta ($\beta > 4\%$), low aspect ratio ($A \leq 4.4$) quasi-axisymmetric stellarator (QAS) plasma configuration, which obtains about one-fourth of its edge rotational transform from the self-generated bootstrap current. Modular coils (Figure 1) provide the externally generated three-dimensional stellarator magnetic fields for the three-period configuration. The QAS concept was chosen for NCSX because its connection with the tokamak enables it to build on the tokamak database as well as the stellarator database.

NCSX Technical Advances

The NCSX design is built upon the robust machine concept that was documented in the 2002 Conceptual Design

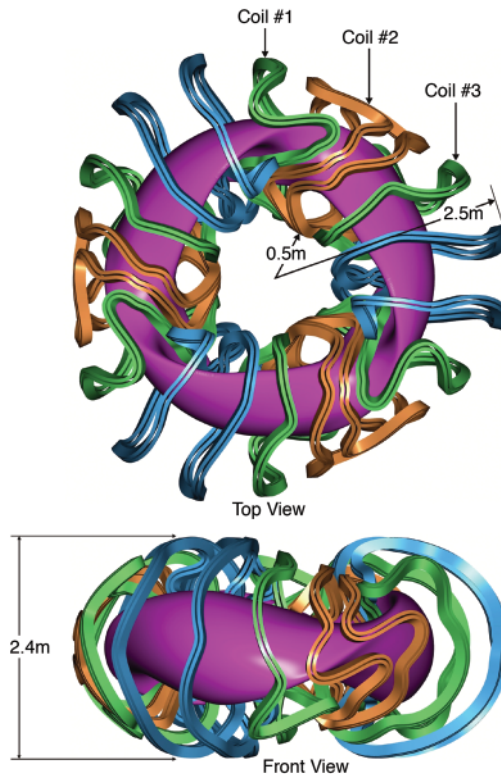

Figure 1. The NCSX uses three-dimensional modular coils to produce a three-dimensional plasma shape.

Report. At the core of the device are the modular coils and the vacuum vessel, the two most critical components. The eighteen modular coils will be fabricated at PPPL on steel winding forms manufactured in industry to precise shape specifications. The finished coils will be assembled over segments of the vacuum vessel, also manufactured in industry, to form three identical field-period sub-assemblies. These components and assembly steps are illustrated schematically in Figure 2. In final assembly, the field-period subassemblies will be joined together on a support base to form a vacuum-tight vessel surrounded by a toroidal shell structure, made up of the eighteen winding forms, that supports the modular coils. Additional control coils, associated structures and services, and a cryostat will then be installed to complete the stellarator core assembly.

During FY03, the project completed its advanced conceptual design and preliminary (Title I) design phases. Subcontracts for manufacturing development of the modular coil winding forms and vacuum vessel were awarded to four industrial teams. They proceeded to develop detailed plans and cost and schedule estimates for fabricating these highly developmental components. An in-house program was initiated to develop the processes for fabricating the modular coils on the winding forms, to develop the metrology methods required to measure these complex shapes, and to quantify the composite material properties of the conductor pack. Details of the technical advances made in FY03 are described in the Engineering and Technical Infrastructure section of this Annual Highlights Report. In summary, in FY03 the technical basis for NCSX advanced considerably in

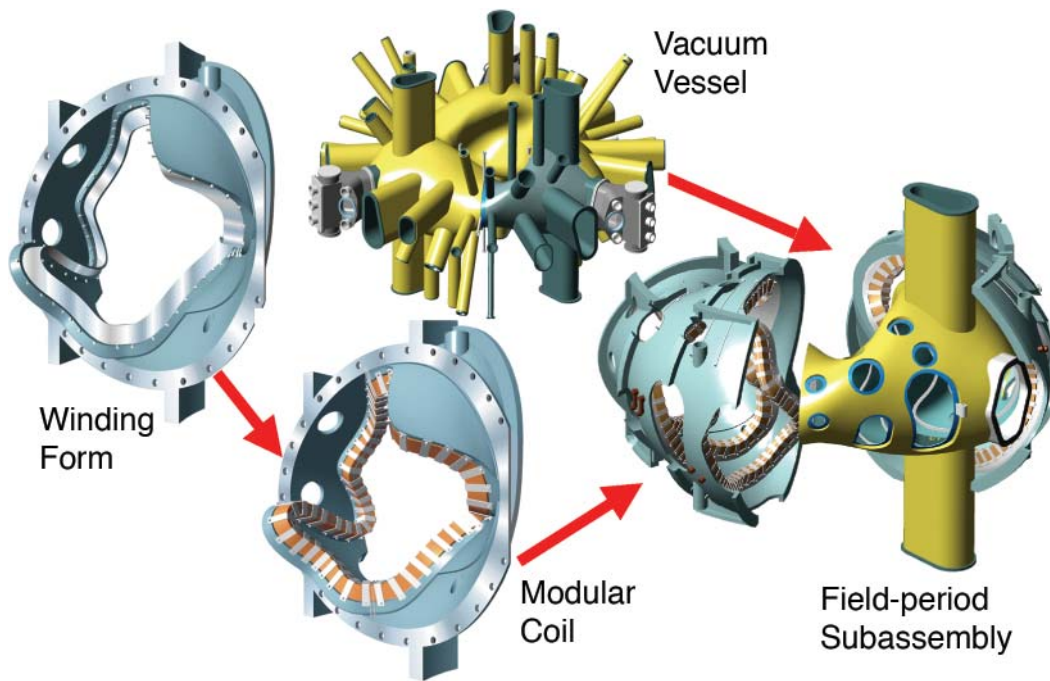

Figure 2. Manufacture and assembly of the NCSX modular coils and vacuum vessel into field-period subassemblies.

its degree of detail and self-consistency. The cost and schedule estimates for all work packages were updated, based on these advances, to support the baselining of the project.

Risk Management

Risk is an element of any project, but especially so in the fabrication of a unique science research facility such as NCSX. The identification and evaluation of project risks and their consequences and the incorporation of risk mitigation measures in the project baseline are key parts of the project planning process. Both DOE and PPPL are increasingly emphasizing risk mitigation in their project management approaches.

The NCSX risk management approach, critical risks, and mitigation plans were documented to support the project baselining. Here is described some of the project-level risk mitigation measures that have been included in the NCSX project plans.

Mitigating the Risk of Major Operational Outages

Access to critical NCSX components, for example the modular coils, will be difficult in the assembled device. Recovery from a coil failure would likely involve a costly and lengthy engineering effort to remove a large amount of equipment and would severely impact the ongoing research program. The risk of a mechanical coil failure is mitigated by engineering analysis, conservative design criteria, and an active coil protection system. Independent groups using different codes and models perform critical analyses, such as electromagnetic load, stress, and deflection calculations and thermal stress calculations. The stresses are compared to allowable values documented in the NCSX Structural Design Criteria. The materials chosen for the coil winding form have been demonstrated to have extremely high tensile strength, which provides additional margin. Conductor pack properties are determined through testing.

The risk of electrical failure is addressed via careful control of the coil winding process. It will be performed and overseen by Laboratory staff experienced in fusion magnet fabrication and operation. The process will be developed and the staff will be qualified through the winding development program. Ample quality assurance and control will be provided. Lessons learned from previous fusion magnet-related failures have been applied. For example, the project has added resources and organizational visibility in the area of technical assurance to provide extra attention to the analysis and testing activities that will be performed to verify the adequacy of the coil design.

Mitigating the Risk of Cost and Schedule Overruns

Failure to execute the NCSX project within the planned schedule and funding envelope could delay or limit the scientific output from NCSX and impact other parts of the fusion program that are depending on it. The primary means of minimizing NCSX cost and schedule risks is to base the estimates on a mature design that is amply supported by analysis and manufacturing development. In keeping with current DOE project management practices, the NCSX baseline has been established at the preliminary design stage so that the costs and risks to meet project requirements are well understood. Industrial manufacturers have provided estimates for the highest-risk components based on detailed processing plans, which they have developed.

The NCSX project management has implemented a system engineering program to provide timely identification and analysis of requirements, system-level assessments of design choices, design integration, and control of interfaces. A physics analysis activity is maintained

to assess implications of design tradeoffs on physics performance. Adequate budgets for these activities, which are important for minimizing downstream surprises and controlling risks, are included in project plans.

Competition for major production contracts is maintained by qualifying two suppliers each for the modular coil winding forms and vacuum vessel. Each supplier is developing its own processes for manufacturing the components and will demonstrate those processes by fabricating full-scale prototypes. The production suppliers will be selected based on their overall performance, evaluation of their prototypes, and their production proposals.

Finally, adequate budget and schedule contingencies, both important elements of risk mitigation, are included in the baseline. The budget contingency is 26% of remaining work scope at the time of baselining, supported by the work package managers' analyses of risks at the component and subsystem level. A schedule contingency of five and one-half months is included to mitigate the risk of schedule delays along the critical path. Incentive contracts for component manufacture and the use of two winding lines are also available as measures to mitigate schedule risks.

Value Engineering

In preparation for establishing the baseline, a value engineering study of the design was conducted using a task force composed of both members and non-members of the NCSX team. The task force was charged to identify possible changes in the NCSX project plans that could reduce estimated costs without significantly impacting or delaying performance. They analyzed and reviewed major systems in the NCSX project for the

purpose of achieving the required functions at the lowest cost.

The value engineering team conducted a series of brainstorming meetings with work package managers and project management. During each meeting, the scope, design, and estimated cost of lower-level work elements were reviewed and discussed. Alternative methods for achieving the necessary functionality were proposed and explored. Many of the ideas discussed were quickly shown to not be advantageous and were discarded. Changes that appeared viable and promising were identified for further investigation and analysis. Follow up meetings were held to discuss the results of the investigations, modify and iterate the proposed changes, and clarify whether they were advantageous or not. Examples of changes evaluated in the value engineering study are briefly summarized below.

- **Local Control of Equipment.** Since the NCSX control room will be adjacent to the NCSX torus hall, control systems can make greater use of local control than was originally planned. The change to local controls was accepted, since they are easier and less costly to implement than remote controls, resulting in a \$1.5-million savings.
- **Simplified Residual Gas Analyzer and Gas Handling.** Simplified residual gas analyzer and gas handling systems were proposed, making use of the local access and control opportunities afforded by NCSX. This change was accepted, resulting in a \$130-thousand cost savings.

In all, the task force documented savings of approximately \$3.4 million from changes that were proposed and accepted. In addition, several of the accepted

changes reduced risk or increased confidence in achieving project design goals.

Cost and Schedule Baseline

As the final step in preparing the Preliminary Design Report, an updated cost and schedule estimate for completing the NCSX project was developed. The estimates and associated contingency requirements were developed by the work package managers based on well-established technical requirements for each system. The estimating basis includes detailed design data, a detailed work breakdown, a manufacturing analyses for the critical stellarator core systems, test results showing that legacy equipment to be used on the project is in good condition, and actual cost and schedule data for equipment items that are new but based on proven designs. The estimate included costs of activities planned to mitigate identified risks, such as manufacturing development, system engineering, and a construction work control center. The project budget of \$86.3 million at the time of CD-2, including contingency of 26% on the work remaining, is summarized in Table 1.

The schedule critical path runs primarily through the design and fabrication of the modular coils, field-period and machine assembly, and integrated system testing. Vacuum vessel fabrication is close to the critical path. Project completion is scheduled for May 2008, including an overall schedule contingency of five and one-half months to mitigate schedule risks. The summary schedule is shown in Figure 3.

Summary and Project Status

The progress made in NCSX design and manufacturing development in FY03 established a high degree of design maturity and self-consistency in the

Table 1. The National Compact Stellarator Experiment Project Budget.

WBS	Work Package	Budget (\$M)
1	Stellarator Core	42.3
2	Heating, Fueling, and Vacuum	1.6
3	Diagnostics	1.7
4	Electrical Power	5.3
5	Central I&C and Data Acquisition	2.6
6	Facility Systems	2.0
7	Test Cell Preparation and Machine Assembly	4.3
8	Project Management and Integration	10.6
	Subtotal	70.4
	Contingency (26% of work remaining at CD-2)	15.9
	Total Estimated Cost	86.3

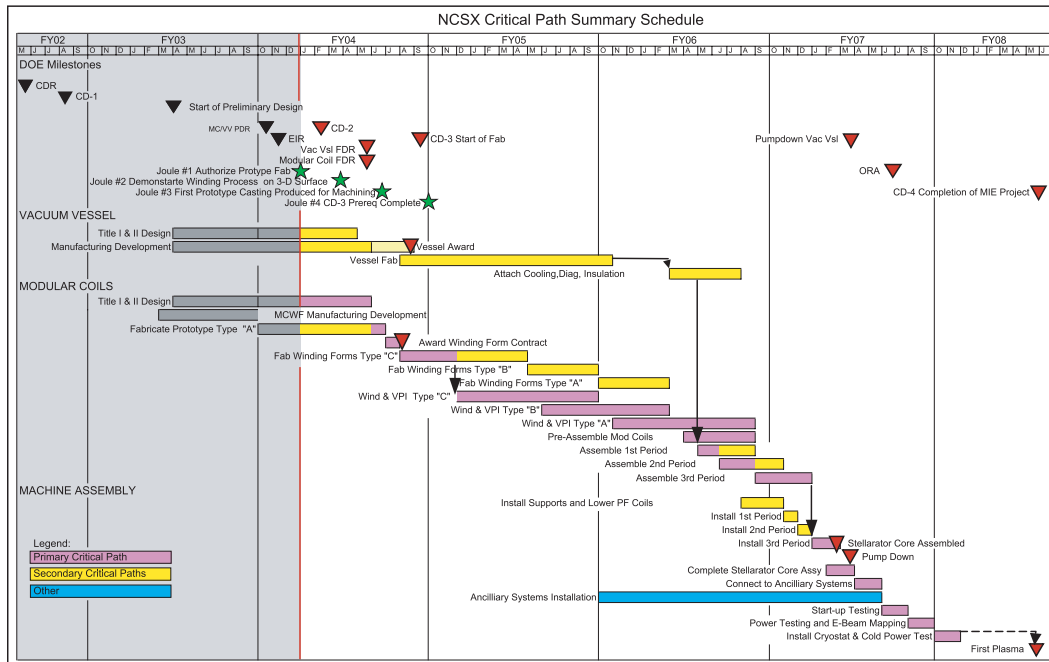
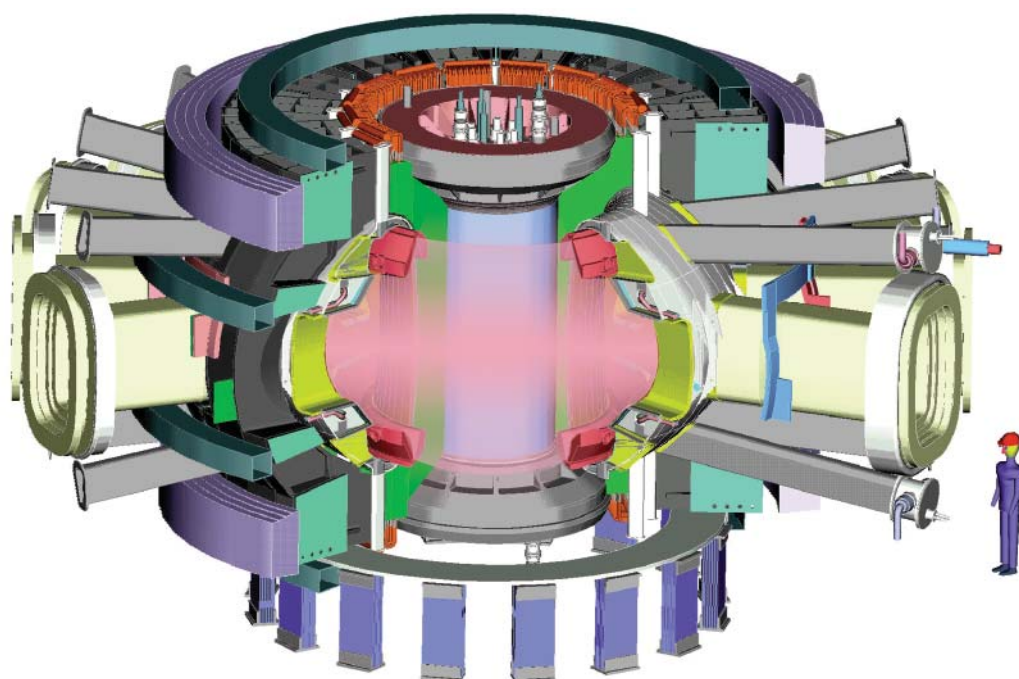

Figure 3. The National Compact Stellarator Experiment Project Schedule.

NCSX technical basis. Special attention was given to identifying project risks, including measures to mitigate those risks in the project estimates. The value engineering methodology was used to reexamine the system design and assure that it provided the required functions at the lowest cost. Significant cost savings were found. The project cost and schedule es-

timates were updated at the end of fiscal year 2003 in preparation for a series of project reviews. Following the reviews, which unanimously concluded that the project was ready to be baselined, the U.S. Department of Energy established a baseline budget of \$86.3 million with project completion scheduled for May 2008.

Fusion Ignition Research Experiment



Fusion Ignition Research Experiment

The National Research Council (NRC) under the auspices of the National Academies formed a Burning Plasma Assessment Committee (BPAC) in 2002 that found:

“A burning plasma experiment is critically needed to advance fusion science,” and recommended that: “The United States should participate in a burning plasma experiment. Participation in a burning plasma experiment is a critical missing element in the U.S. fusion program. The scientific and technological case for adding a burn-

ing plasma experiment to the U.S. fusion science program is clear. There is now high confidence in the readiness to proceed to the burning plasma step because of the progress made in fusion science and technology. Progress toward the fusion energy goal requires this step, and the tokamak is the only fusion configuration ready for implementing such an experiment.”

In accordance with the NRC-BPAC and the Fusion Energy Sciences Advisory Committee (FESAC) recommendations, the U.S. has joined international nego-

tiations to determine the site, cost sharing, and management structure of ITER (“The Way” Latin). In addition, pre-conceptual design work on the Fusion Ignition Research Experiment (FIRE), a back-up burning plasma experiment, is being carried out in the U.S. as recommended by the FESAC, and in accordance with recommendations of the NRC-BPAC to “develop other options for a burning plasma experiment in case ITER construction is not approved by the negotiating parties.”

The goal of the FIRE preconceptual design study is to define a low-cost burning plasma experiment to attain, explore, understand, and optimize magnetically confined fusion-dominated plasmas. The key technical objectives for FIRE are to address the critical burning plasma issues of an attractive magnetic fusion power plant as envisioned by the Advanced Reactor Innovation Evaluation Studies (ARIES). The FIRE Design study has been undertaken as a national collaboration with more than 50 participants from more than 15 U.S. institutions, and is managed through the Virtual Laboratory for Technology. The technical work on FIRE has been guided by a Next-step Option Program Advisory Committee (NSO-PAC), with members from 12 U.S. fusion institutions and Europe and Japan.

Burning Plasma Physics Relevant to an Advanced Fusion Reactor

The Advanced Reactor Innovation Evaluation Studies (ARIES) have shown that an economically attractive tokamak power plant will require more than 80% plasma self-heating, with more than 90% of the confining magnetic field self-generated. The overall theme of FIRE is to test the advanced tokamak features identified by ARIES as essential to the devel-

opment of an attractive tokamak power plant. The basic parameters of FIRE were chosen to make it a 40% scale model test of the ARIES-Reversed Shear (ARIES-RS) physics design (Table 1). The projected FIRE plasma parameters are close to those of ARIES-RS and would provide a valuable facility for exploring the physics of reactor-like burning plasmas.

Since Snowmass, significant progress has been made in improving the physics basis for FIRE. Results from ongoing tokamak experiments continue to indicate that strong plasma shaping, as present in FIRE, promotes increased H-mode confinement, enhances beta limits, and reduces the deleterious edge-localized mode (ELM) to a more benign form.

The area of greatest progress on FIRE has been the development of a “steady-state” high-beta advanced tokamak configuration. This configuration in FIRE relies on ion-cyclotron range-of-frequencies (ICRF) fast-wave (FW) on-axis current drive and lower-hybrid (LH) off-axis current drive. With the existing two-strap antenna design, the on-axis ICRF/FW system can provide 200 kA of current by injecting 20 MW of power. Typical advanced tokamak plasmas require less than 200 kA. Upgrades to four-strap antennas would improve the current-drive efficiency. Off-axis current drive in FIRE is critical for establishing and controlling the safety factor profile and is accomplished using up to 30 MW of lower-hybrid current drive (LHCD) at 5 GHz. The experience developed on the planned Alcator C-Mod advanced tokamak experiment (at the Massachusetts Institute of Technology) with LHCD will strengthen the basis for FIRE projections.

Bootstrap-consistent equilibrium and stability analyses show that the high toroidal mode number n ballooning lim-

Table 1. Comparison of FIRE Advanced Tokamak Parameters with ARIES-RS Parameters.

Parameters	FIRE	ARIES-RS
Plasma Elongation (κ_x)	2.0	2.0
Plasma Triangularity (δ_x)	0.7	0.7
Plasma Aspect Ratio (R/a)	3.6	4.0
Divertor Configuration	Double Null	Double Null
Normalized Beta (β_N), AT Mode	~ 4	4.8
Bootstrap Fraction (f_{bs}), AT Mode	$\sim 80\%$	88%
Noninductive Current Drive	100%	100%
Plasma Current Profile Equilibration	86 to 99%	100%
Toroidal Magnetic Field (B_T)	6.5 to 10 T	8 T
Major Radius (R)	2.14 m	5.5 m
Minor Radius (a)	0.59 m	1.38 m
Plasma Volume	27 m ³	350 m ³
Fusion Power Density	5.6 MW/m ³	6.2 MW/m ³
Neutron Wall Loading	2.7 MW/m ²	4 MW/m ²
Divertor Target Material	Tungsten	Tungsten

it for typical plasmas consistent with external current drive is beta normalized $\beta_N > 4.7$. With no wall, the ideal-MHD beta-normalized limits for $n = 1, 2,$ and 3 are 2.7, 3.6, and 4.0, respectively. With a wall located at $b/a = 1.35$ on the outboard side only, the ideal-MHD beta-normalized limits for $n = 1, 2,$ and 3 are 6.1, 5.3, and 5.1, respectively.

In FIRE, there are 16 large (0.75-m by 1.5-m) ports at the outboard midplane that are then filled by a first-wall neutron-shield assembly that can also contain a resistive wall mode (RWM) coil, radio-frequency launcher, and diagnostics. Calculations show that feedback coils, located near the front face of the first-wall neutron-shield assembly in every other midplane port, could stabilize

the $n = 1$ resistive wall mode up to 80-90% of the “with wall” limit. The analysis of the resistive wall mode stabilization is benefiting from the experimental progress on the DIII-D tokamak at General Atomics in California. The plasma configurations targeted have safety factor values above 2.0 everywhere, so that the $m/n = 5/2$ and $3/1$ are the lowest-order neoclassical tearing modes of interest. Stabilization of the neoclassical tearing modes using electron cyclotron current drive from the low-field side at a toroidal field of 6.5 T would require frequencies of 140-170 GHz, which is close to the range of achieved values in the high-power long-pulse gyrotron research and development program. The LHCD system could also be used by launching two

spectra, one for bulk current drive and the other for neoclassical tearing mode suppression.

H-Mode Operating Space

A wide range of H-mode plasmas have been examined using a global systems analysis code. The major radius (R), minor radius (a), elongation (κ), triangularity (δ), and aspect ratio (A) are fixed at the reference edge-localized H-mode inductively driven design point:

$$\begin{aligned} R &= 2.14 \text{ m,} \\ a &= 0.595 \text{ m,} \\ \kappa_x &= 2.0, \\ \delta_x &= 0.7, \text{ and} \\ A &= 3.6. \end{aligned}$$

The analysis used for operating point calculations incorporated plasma power and particle balance, in addition to several other global parameter relations. In particular, ITER98(y,2) scaling is assumed for the global energy confinement time. The plasmas considered spanned the ranges:

$$\begin{aligned} 5 &\leq Q \leq 30, \\ 5 &\leq P_{\text{aux}} \text{ (MW)} \leq 30, \\ 1.05 &\leq n(0)/\langle n \rangle \leq 1.25, \\ 0.3 &\leq n/n_{\text{Gr}} \leq 1, \text{ and} \\ 1.5 &\leq \beta_{\text{N}} \leq 3, \end{aligned}$$

where Q is the ratio of the fusion power produced to the power used to heat a plasma, P_{aux} is auxiliary heating power, $n(0)/\langle n \rangle$ is the density profile peaking, n/n_{Gr} is the Greenwald density, and β_{N} is beta normalized. In addition, the impurity concentrations in the plasma core were varied over 1 to 3% for beryllium and 0.0 to 0.3% for argon, allowing higher radiated power fractions to more optimally distribute the exhaust power.

Viable solutions must be within the engineering limits set by the heating of the cryogenically cooled toroidal-field coils, stresses due to nuclear heating of the vacuum vessel, a temperature limit of 600 °C for the first-wall beryllium tiles, particle power to the outboard divertor (<28 MW), and the radiated power load on the divertor and baffle (<6-8 MWm⁻²). Increasing the radiated power in the divertor reduced the particle heat load and expanded the operating space significantly.

For most H-mode plasmas at 10 T, the toroidal-field coil limited the plasma duration to 20 s, which is $2\tau_{\text{CR}}$ (the current redistribution time) for the reference operating point and is the same as the reference ITER H-mode duration. The nominal operating point, shown as the circle at 150 MW with a 20-s flat-top in Figure 1, has significant margin to handle increased fusion power. If plasmas up to the no-wall stability limit of $\beta_{\text{N}} \approx 3$ can be attained, fusion power levels of 350 MW could be sustained for 10 s. High-Q (15 to 30) operation could be attained for cases with low impurity content (1-2% beryllium), modest density peaking $n(0)/\langle n \rangle = 1.25$, Greenwald density $n/n_{\text{Gr}} = 0.7$ to 1.0, and H-mode scaling multiplier $H98(y,2) = 1.03$ to 1.1.

AT Mode Operating Space

A similar global analysis has been used to determine the operating space for 100% noninductive advanced tokamak modes in FIRE. An expression for the bootstrap current fraction is included, and the current drive power is given by:

$$P_{\text{CD}} = [nRI_p(1-f_{\text{bs}})]/\eta_{\text{CD}},$$

where n is density, R is major radius, I_p is plasma current, f_{bs} is bootstrap current, and η_{CD} is current drive efficiency.

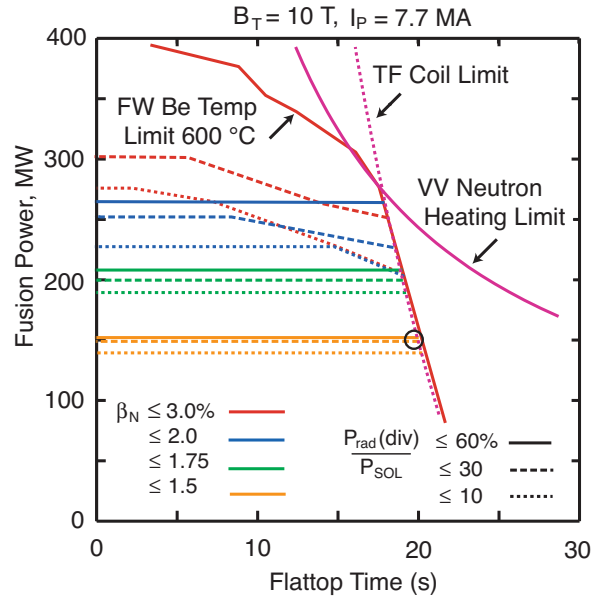

Figure 1. Operating space for conventional inductively driven high-confinement modes in FIRE.

The on-axis current drive is fixed at 200 kA from ICRF/FW, so that LHCD must make up any current not driven by the bootstrap effect. The current-drive efficiency used in these scans is $\eta_{CD} = 0.2$ and 0.16 A/Wm^2 for ICRF/FW and LH, respectively, and is based on detailed LH and ICRF/FW analysis for FIRE. The operating space was scanned for cases with $Q = 5$, at:

$$\begin{aligned}
 B_T &= 6.5 \text{ T}, \\
 P_{LH} &\leq 30 \text{ MW}, \\
 P_{ICRF} &\leq 30 \text{ MW}, \\
 1.05 &\leq n(0)/\langle n \rangle \leq 2, \\
 2 &\leq T(0)/\langle T \rangle \leq 3, \\
 0.3 &\leq n/n_{Gr} \leq 1, \\
 3.25 &\leq q_{95} \leq 5, \text{ and} \\
 3 &\leq \beta_N \leq 4.5.
 \end{aligned}$$

where B_T is the toroidal magnetic field, P_{LH} is lower-hybrid heating power, P_{ICRF} is ICRF heating power, and q_{95} is the edge safety factor.

Attainment of $\beta_N \approx 3$ will require feedback stabilization of the resistive wall modes. In addition, the impurity con-

centrations are varied between 1 to 3% for beryllium and 0.0 to 0.3% for argon, allowing higher radiated power fractions. The operating space can be expanded by increasing argon in the plasma to radiate more power in the divertor and on the first wall resulting in $1.5 \leq Z_{eff} \leq 2.3$. The fraction of power radiated in the divertor to power exhausted into the scrape-off layer was allowed to vary to 10%, 30% and 60%. The same power-handling limits were imposed as for the H-mode described above. The nominal operating point has 150 MW of fusion power for 32-s flattop. The flattop burn times for these advanced tokamak plasmas are limited primarily by the nuclear heating in the vacuum vessel rather than toroidal-field coil heating.

Imposing these constraints, the system study found that FIRE could attain high-beta high-bootstrap advanced tokamak plasmas with near steady-state conditions for up to $5\tau_{CR}$, as shown in Figure 2. If the vacuum vessel/shield was modified to withstand the nuclear heating induced stresses, the reference advanced tokamak pulse length could be extended to $\approx 50 \text{ s}$

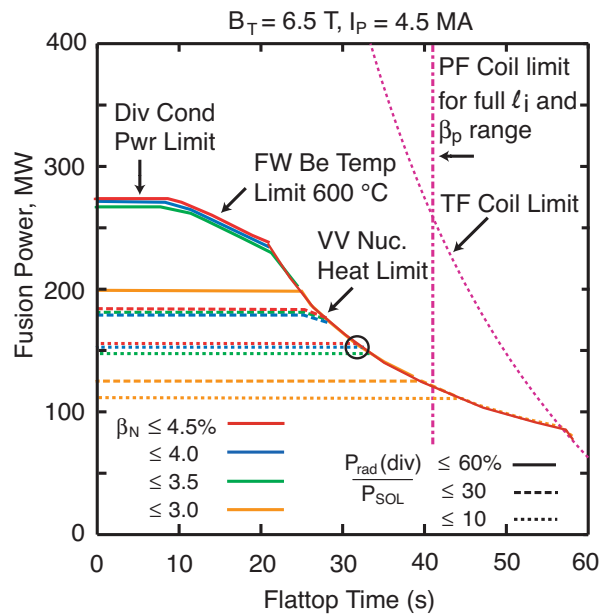

Figure 2. Operating space for “steady-state” (100% noninductive) high-beta advanced tokamak modes in FIRE.

($5-6\tau_{CR}$). These $Q = 5$ plasmas require confinement corresponding to $H98(y,2)$ ranging from 1.4 to 1.8 similar to those required in ITER. At the higher ranges of confinement, $H98(y,2) = 1.6$ to 2.0, $Q = 10$ plasmas are produced that have a reduced duration of $1-3\tau_{CR}$.

Computer Simulation of Burning Plasma Phenomena

The rapid growth in computing power is enabling more realistic simulations of complex plasma phenomena. The Scientific Discovery through Advanced Computing Program (SciDAC) simulations of steady-state high-beta advanced tokamak plasma discharges with 100% noninductive current composed of fast-wave, lower-hybrid, and bootstrap currents that are sustained for more than $3\tau_{CR}$ have been done for FIRE using the Tokamak Simulation Code. This is accomplished by programming the heating and current-drive sources so that the inductive contribution to the plasma current is reduced to zero by the end of the ramp up, so the safety factor profile has no significant change

during the flattop burn phase. A simulation of the plasma response to a perturbation (Figure 3) produced by a drop in the lower-hybrid current drive shows that the plasma duration is sufficient to study the evolution of a fusion dominated plasma on the current evolution time scale.

FIRE Engineering Activities

The FIRE engineering design was reviewed in detail at Snowmass, and the assessment team found that there were no feasibility issues with respect to the construction of FIRE. It was noted that the FIRE magnet design has the least complex magnet structure of the three proposed burning plasma experiments, and increased complexity often leads to decreased reliability. FIRE researchers have provided a detailed project cost estimate based upon industrial vendor and in-house quotes. The FIRE total project cost estimate of \$1.186 B (FY 2002), including 25% contingency, was found to be reasonable by the Snowmass Assessment team. The cost estimate of the tokamak assembly (everything inside the

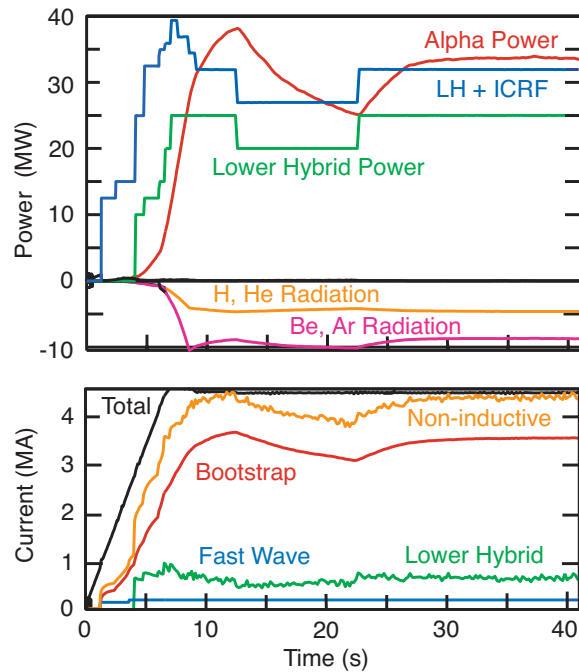

Figure 3. Simulation of the evolution of a current pulse perturbation in a “steady-state,” high-beta, advanced tokamak mode in a FIRE plasma discharge.

cryogenic Dewar) is \$280 M without contingency.

There were a number of technical issues identified at the Snowmass meeting that will require additional work including: power handling during edge-localized modes and plasma disruptions, verification of lower-hybrid capability for neo-classical tearing mode stabilization, increased advanced tokamak capability and pulse length, and pulse repetition rate.

FIRE scientists have modified the design of the toroidal-field coils to include a second cooling tube that would increase the repetition rate to once per hour at full field and pulse length. Several approaches are being investigated to increase the number of pulses (total fusion energy yield) including a Small Business Innovative Research Program (SBIR) to develop improved inorganic magnet insulation that would be compatible with fusion reactor requirements. The operating space for advanced tokamak plasmas has been established showing that up to $5\tau_{CR}$ can

be accessed within the engineering limitations of the device. Improved disruption calculations and minor modifications to divertor/vacuum vessel support show that the FIRE design is sufficient to withstand plasma disruptions.

FIRE Outreach Program

The FIRE project continued its proactive outreach program with 14 presentations at fusion institutions and meetings, active participation in the International Tokamak Physics Activity, the 2002 American Physical Society Division of Plasma Physics Meeting, the 2003 American Physical Society Spring Meeting, the 18th Symposium on Fusion Engineering, the 30th European Physical Society Conference on Plasma Physics and Controlled Fusion, and the 19th International Atomic Energy Agency Fusion Energy Conference. In addition, the FIRE website was maintained as a site of FIRE documentation and information for the fusion program.

Engineering and Technical Infrastructure

The Princeton Plasma Physics Laboratory (PPPL) Engineering and Technical Infrastructure Department is responsible for managing the Laboratory's engineering resources. This includes a staff of engineers, technicians, and support staff organized functionally (Mechanical; Electrical; Computer; and Fabrication, Operations, and Maintenance Divisions) to support the Laboratory's research endeavors. The Department is responsible for the technological infrastructure of the Laboratory's experiments as well as the "caretaking" of the C- and D-site experimental facilities.

NSTX Engineering Engineering Operations

Prior to the start of the National Spherical Torus Experiment (NSTX) FY03 experimental run, maintenance and upgrades to improve the operational reliability of technical subsystems were completed. Extensive maintenance of the field coil power conversion rectifiers was performed and the current feedback devices (Halmars) were reconfigured to provide consistent signal definition for different operating modes. High-speed voltage transient monitoring and over-voltage protection systems were installed on the vacuum vessel segments in preparation for upcoming coaxial helicity injection experiments.

The FY03 NSTX experimental run period started on schedule and during the early weeks operated at more than 90%

availability — the highest attained at the beginning of any NSTX operating period. During the first four weeks, NSTX had 603 plasma attempts and took data on 515 plasmas. At the end of the fourth week, however, a bolted joint in the toroidal-field (TF) circuit failed, ending the experimental run for FY03. Recovery required a redesign of the TF hub and joint assembly and the manufacture of a new TF center conductor (see below).

During the break-in operations for the design and fabrication of the new TF center conductor, time was taken to make improvements to various NSTX subsystems. A reconfiguration of the ohmic-heating (OH) rectifiers was completed that allows for a more symmetric OH power supply configuration and makes available an additional power supply for the future resistive wall mode coils. This reconfiguration will also provide the option for bipolar operation of poloidal-field (PF) coil set five (PF5), as well as the powering of the PF4 coil set. A new inner wall gas injection system was designed and installed, and engineering reviews were completed for performing vacuum vessel boronization during bake-out. Hardware and software upgrades were completed that will reduce the plasma control system latency, ultimately enabling higher plasma elongation.

Toroidal-field Redesign

One of the key features, but also one of the most challenging engineering as-

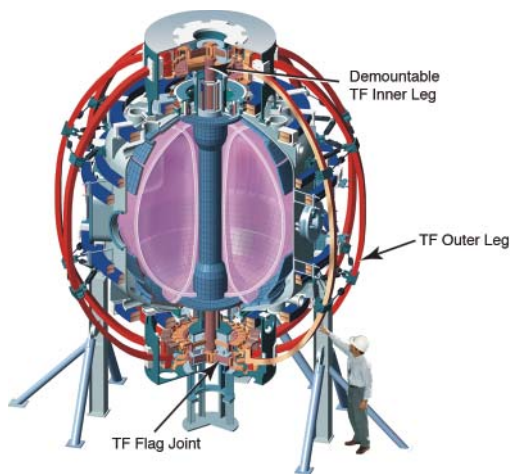

Figure 1. Cutaway view of the National Spherical Torus Experiment showing the demountable toroidal-field coil and flag joint.

pects, of the spherical torus (ST) is the demountable toroidal-field assembly. As depicted in Figure 1, the so-called flag joint provides a removable connection between the inner and outer leg assemblies, which permits removal of the entire inner leg and center stack assembly for maintenance.

On February 14, 2003, following the morning test shots, the NSTX toroidal-field inner leg assembly failed at the lower inner leg-to-flag joint. Analysis of the event identified shortcomings in the structural design of the joint, which led to failure after some 7,200 machine pulses, with a limited number at the full magnetic-field rating of 6 kG. As depicted in Figure 2, the stiffness of the hub assembly

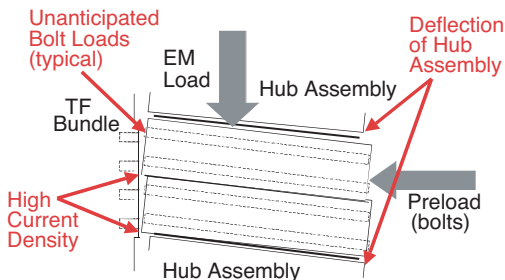

Figure 2. Drawing of how the repeated application of electromagnetic loads led to structural failure of the lower TF flag joint.

was not adequate, and repeated application of the electromagnetic loads led to unanticipated loads in the bolts and high local current density, which eventually led to failure of the assembly.

Due to extensive damage, it was not possible to recover the original TF inner leg assembly. Furthermore, it was clear that an improved design was needed. Therefore a recovery effort was initiated, beginning with the development of a new TF inner leg assembly design.

The new design (Figure 3) incorporates features which address all of the shortcomings of the original design, including the following:

- hub assembly stiffness is dramatically increased,
- flags are contained in steel boxes with injected epoxy filling the space between,
- flag fasteners are larger diameter and tightened to twice the force of the original design,
- shear keys are added to resist the vertical electromagnetic force, and

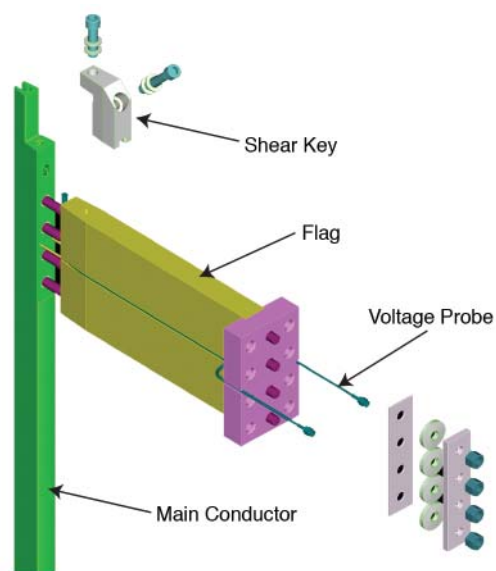

Figure 3. CAD model of the TF flag joint.

- voltage probes are provided in-situ to measure the resistance of every joint.

Extensive engineering resources were applied to the redesign effort to ensure a successful outcome while minimizing recovery time. An extensive finite element analysis was performed to develop an understanding of the structural and thermal behavior of the joint and to guide the development of the new design. Teams of magnet experts from other fusion labs conducted two technical reviews. Tests were performed to characterize the electrical resistivity of the joint versus pressure, the friction coefficient of the joint, the pull-out strength of the fasteners, and other features. In addition, a mechanical prototype was exercised at the rated number of cycles of full mechanical loads at elevated temperature, and an electrical prototype was tested at full current for the full-time duration at full mechanical loads.

Based on the new design, the successful prototype testing, and the improved

instrumentation which includes a new fiber-optic strain, temperature, and displacement monitoring system, reliable operation at full-rated parameters is fully anticipated. Although the failure was unfortunate, it has led to an improved understanding of the TF joint behavior, which is directly applicable to the design of next-step ST devices.

Toroidal-field New Center Bundle Manufacture

The new toroidal-field inner bundle and support structure (Hub) was designed and fabricated at the PPPL facility. The bundle is constructed of thirty-six insulated copper conductors, which are water-cooled via a copper tube soldered along the conductor length. Each conductor was sandblasted, primed and hand insulated using a B-stage epoxy impregnated tape. The conductors were then press molded at curing temperature into their final configuration using a press mold in a new oven that was designed and fabricated at PPPL for this operation (Figure 4).



Figure 4. The new oven designed and built at PPPL for the press molding and curing of NSTX's redesigned TF inner bundle.

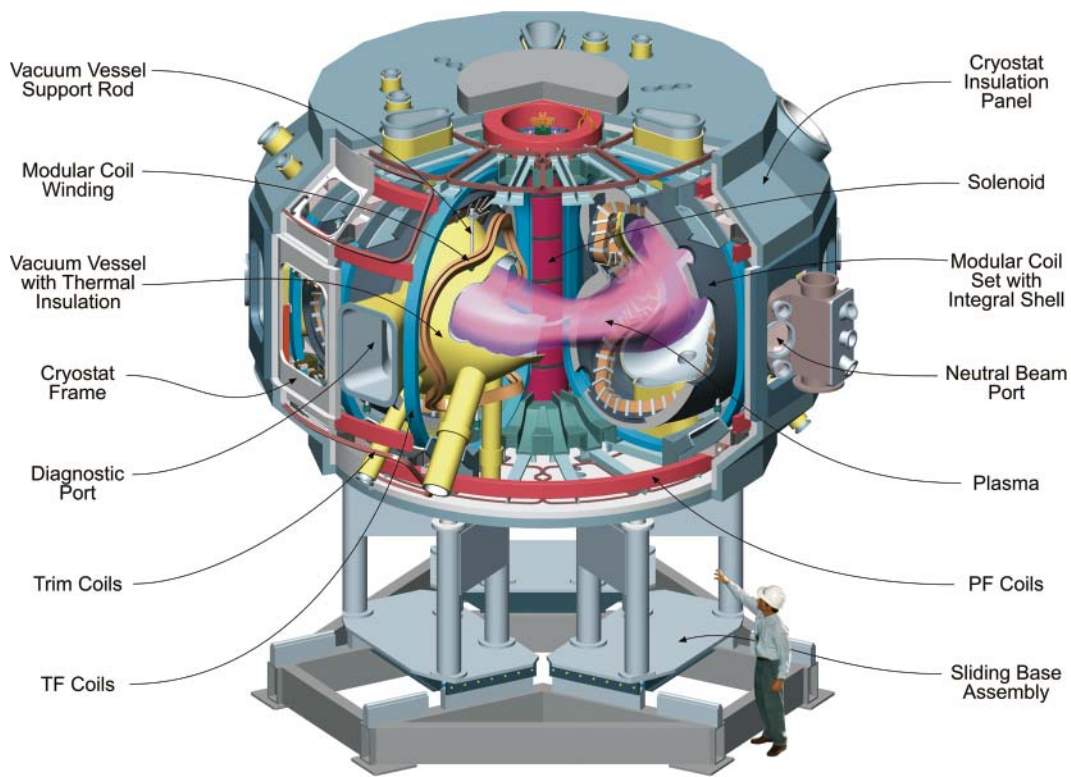

Figure 5. Cutaway view showing the major components of the National Compact Stellarator Experiment.

NCSX Engineering

During FY03, tremendous progress was made on the engineering design of the National Compact Stellarator Experiment (NCSX) in preparation for the Preliminary Design Review scheduled for the first week of FY04. A successful Preliminary Design Review will allow the final design to proceed on schedule.

Figure 5 is a cutaway view showing the key components of the NCSX. Robust engineering designs were developed for all major systems of NCSX's core, including the vacuum vessel, modular coils, TF coils, and PF coils.

NCSX's highly shaped vacuum vessel, shown in Figure 6, will be fabricated of press-formed 0.375-inch Inconel-625 panels welded together. The vessel will consist of three identical 120-degree segments that will be joined by welding via "spool pieces" machined just prior to as-

sembly to assure accurate fit-up. This segmentation allows for installation of the modular coils.

The modular coil system, shown in Figure 7, consists of 18 coils (six each of three coil types) wound directly onto

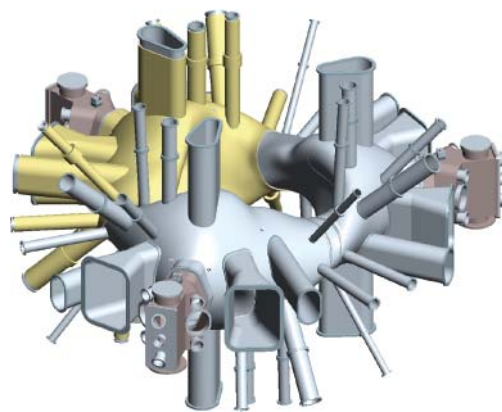

Figure 6. National Compact Stellarator Experiment vacuum vessel assembly with thermal insulation.



Figure 7. National Compact Stellarator Experiment modular coil assembly.

cast and machined stainless steel winding forms. Coil system designs were very carefully optimized for physics performance while being consistent with engineering constraints, such as stress and temperature rise, and access requirements for neutral-beam injection and diagnostics. The coils are wound of compacted stranded cable which is vacuum pressure impregnated with epoxy directly on the forms to form a strong monolithic structure capable of reacting electromagnetic loads as high as 7,000 pounds per inch. The winding forms are joined together by bolting, resulting in a very rigid, continuous shell structure. The coils are conduction cooled by liquid-nitrogen chill plates located on both sides of the windings.

The TF system consists of 18 identical, wedged, copper windings supported by cast stainless steel structures that are, in turn, supported by the modular coil shell. The TF generated by these coils supplements the TF component of the modular coils to provide operational flexibility. Six pairs of copper PF coils surround the TF coils. They provide inductive current drive as well as physics flexibility.

Requirements, work scopes, and schedules were developed for both the core and ancillary systems. Cost estimates were developed using a combination of internal

estimates, vendor estimates, and projections from similar PPPL experimental devices. The estimated cost of NCSX is \$86 million including a 26% contingency.

Although much of NCSX is conventional design and construction, two of NCSX's key components, the vacuum vessel and modular coils, are unusual and challenging due primarily to their geometric complexity. Consequently, particular emphasis is placed on these two components to mitigate technical, schedule, and financial risks. Limited industrial studies of the vacuum vessel and modular coils were performed during the conceptual design phase. This year, two industrial supplier teams in both of these areas were awarded contracts for detailed manufacturing studies that will culminate in prototypes in mid-FY04 and proposals for the "production" manufacturing efforts. The vessel prototype consists of a 20-degree segment with a vacuum port assembly. The winding-form prototype is a full-scale, full-featured winding form of the most complex of the three winding forms. The modular coils will be wound at PPPL. Consequently, significant R&D efforts were undertaken focusing on key issues: vacuum-pressure impregnation, winding methods required to meet the NCSX's stringent dimensional accuracy, and development of winding details.

NCSX Coil Winding R&D

There were a number of R&D and design activities in support of the NCSX project during FY03. These centered around the compacted copper rope conductor being used for the modular coils, as well as the associated epoxy system that will be used to impregnate those coils. Some of the R&D activities included conductor Keystone tests (Fig-



Figure 8. Conductor keystone test done on the NCSX modular coils.

ure 8), which helped define the conductor size, determine tolerance control and develop manufacturing processes. Development of the epoxy-impregnation system included the design of a “Bag Mold” to handle the complex geometry of the modular coils (Figure 9). In addition, test specimens were fabricated to determine the mechanical and thermal properties of epoxy-impregnated conductors.

PPPL staff will fabricate the modular coils in-house. The former Tokamak Fusion Test Reactor (TFTR) test cell will be utilized for winding the modular coils, as well as assembling the field-period subassemblies. The design of the tooling and development of a manufacturing plan for modular coil fabrication was initiated this year. An autoclave, an oven chamber that can operate under vacuum or pressure environments, will be used during the epoxy impregnation of the modular coils. The main components of the autoclave, such as the domes and chamber,

were supplied by industry and delivered to PPPL shops where the final fabrication and assembly will be completed. The autoclave will be operational in March 2004. The remaining tooling, such as the turning fixtures, conductor payout spools, winding clamps, etc. are in various stages of design and fabrication. The complete winding facility will be operational by June 2004, in time for winding the first prototype modular coil.

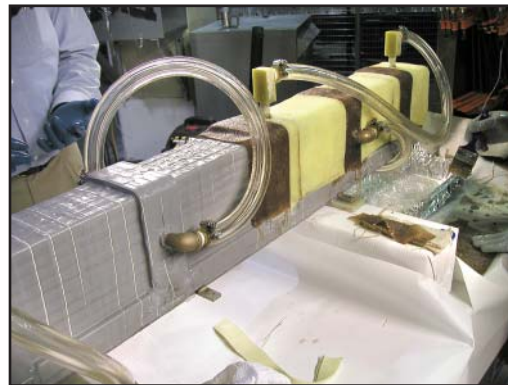

Figure 9. The NCSX modular coil epoxy-impregnation system.

FIRE Engineering

The engineering design of the Fusion Ignition Research Experiment (FIRE) with a 2.14-m major radius, adopted in FY02 in response to Snowmass Summer Study recommendations, was updated during FY03. The updated design is shown in Figure 10.

To enhance FIRE's experimental productivity, cooling is now provided on both sides of the inner TF coil leg. This change permits a tripling of the pulse repetition rate from one pulse every three hours to one pulse every hour. A quasi-steady-state ARIES-like mode has been developed (normalized beta $\beta_N \sim 4$; bootstrap fraction $f_{bs} \sim 80\%$) for FIRE. The pulse length of the Advanced Tokamak (AT) modes has been doubled up to $5\tau_{CR}$. The TF coil design is robust, with the pulse length limitation being dictated primarily by nuclear heating of the vacuum vessel and first wall. The TF insulation radiation dose is 3×10^{10} rads. This is within the expected limits of radiation-resistant insulation systems being developed in Small Business Innovative Research studies currently underway. The PF design continues to evolve in parallel with studies of a wide variety of AT operating modes. Fatigue limits of the central solenoid are the limiting factor for some of the AT modes. Remote removal and replacement of the central solenoid at a safe fraction of its fatigue life is judged to be a possible (and practical) method of addressing this issue. Actively cooled inner-divertor and baffle modules and independently cooled outer-divertor modules will be utilized for improved thermal performance. Remote-handling details are currently being updated for the new design. Plasma disruption load and stress calculations are currently underway for the larger vessel, which has reduced wall loading and improved cooling. An ex-

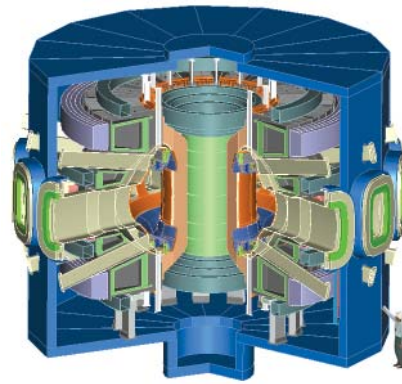

Figure 10. Updated design configuration of FIRE with a 2.14-m major radius.

tended four-strap ion-cyclotron radio-frequency (ICRF) antenna with movable in-vacuum tuning is being evaluated. This would be capable of providing 20 MW of ICRF, operable over the range of 70-120 MHz for heating and on-axis current drive. Resistive wall mode coils have been incorporated into the port plugs in the new design. A movable port plug design is being evaluated for the baseline pumping configuration. In-board pellet injection has been incorporated; this is an extremely high-leverage item for efficient tritium use, density profile peaking, and burn control.

FIRE's engineering improvements have been driven by studies of a wide variety of operating modes. The engineering report is currently being updated in preparation for a Physics Validation Review planned for FY04.

NSST Engineering

The rapid progress and scientific foundation now being established by the NSTX "Proof-of-Principle" experiment, along with the completion of Decontamination and Decommissioning (D&D) of TFTR, leads toward the possibility of construction of a next-step "Performance Extension" spherical torus (ST) experiment at PPPL. Within the constraints of the fa-

cility, preliminary design point studies indicate that a device with modest power gain ($Q \sim 2$) and a pulse length of five seconds can be realized. The level of plasma performance for the Next Step Spherical Torus (NSST), Figure 11, would be of the same order as that required for a Component Test Facility, thereby providing a key link to the first practical application of fusion technology.

The key issues for the ST are (1) characterization of stability limits and confinement, (2) power and particle handling, and (3) noninductive current start-up and sustainment. NSST would aim to extend the knowledge base in these areas beyond the levels achieved on NSTX to a much larger scale, approaching burning plasma conditions with significant alpha particle heating via a deuterium-tritium campaign toward the end of the NSST research program.

To arrive at a design point for NSST, parametric studies were performed using a systems code which includes an analysis of the plasma along with engineering algorithms which calculate the stress,

temperature rise, power, and energy consumption of the toroidal-field, ohmic-heating, and poloidal-field magnets. Using this tool an optimization was performed which aimed to maximize Q and minimize major radius within the constraint of the engineering allowables, including the power (800 MW) and energy (4.5 GJ) available from the existing motor-generator system. Auxiliary heating power was limited to 30 MW, which is available from existing equipment ($P \leq 32$ MW, neutral-beam injection at 120 keV) and radio-frequency ($P \leq 10$ MW at 30 MHz). The primary target of the optimization was the fully inductive $Q = 2$ scenario, but a long-pulse noninductive scenario has also been identified. At present, the design point stands at major radius $R_0 = 1.5$ m, toroidal magnetic field $B_T = 2.6$ T, aspect ratio $A = 1.6$, plasma current $I_p = 10$ MA, and flattop time $T_{\text{flat}} = 5$ s. It may be appropriate to adjust the design point as the NSTX progresses toward higher performance regimes.

Work has begun to develop engineering and physics concepts which satis-

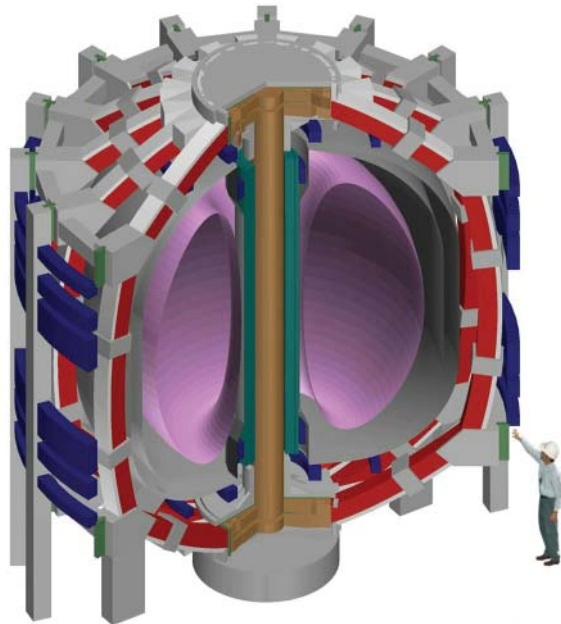

Figure 11. The Next Step Spherical Torus (NSST) experiment.

fy the design point identified by the systems code. The objectives are to confirm feasibility, identify physics issues, develop a cost and schedule, and provide a linkage to the NSTX research program (see Figure 12).

The engineering studies have focused on ten key issues:

- (1) TF inner leg torque reaction and shear stress in the inner-leg turn insulation;
- (2) TF inner-leg-to-outer-leg interface, allowing for axial thermal displacement of the inner legs, and vertical separating force on outer legs, without excessive tension and compression;
- (3) TF joint and connector scheme;
- (4) TF outer-leg positioning, field ripple, neutral-beam injection access;
- (5) OH coil performance optimization;
- (6) TF and OH coil cooling;

- (7) Plasma-facing component heat loads and technologies;
- (8) Handling of center stack within the physical constraints of the existing test cell;
- (9) Neutron flux, fluence, and shielding requirements; and
- (10) Overall power and energy match to the PPPL site.

PBX-M Removal

During FY03, the removal of the Poloidal Beta Experiment-Modification (PBX-M), formerly the Poloidal Divertor Experiment (PDX), was completed safely, on-schedule, and within budget. The electrical safing and removal of components saved for reuse occurred between February 2002 and early June 2003. This included neutral-beam heating systems, select fusion diagnostic systems, and PBX-M control room equipment. Following electrical safing, all items in the PBX-M and the adjacent Princeton Large Torus control room and the lower-hybrid current-

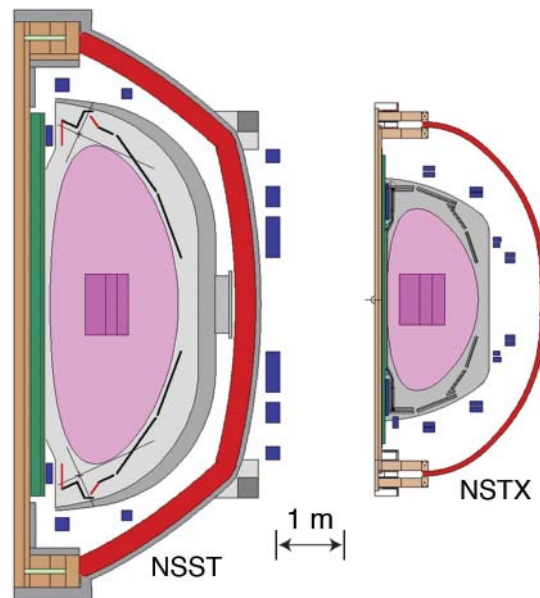

Figure 12. Comparison of the NSST and the NSTX cross section.

drive power supply area were completely removed.

Shielding blocks were removed to facilitate the bulk removal of the PBX-M device. A subcontractor team, Project Enhancement Corporation and the Decommissioning and Environmental Management Company, removed the device between June and August 2003. More than 352 tons of metal was recycled during this phase of the project in a total of 19 shipments. The final shipment, the

entire vacuum vessel, was the largest at 57,000 lbs (Figures 13, 14 and 15).

Computer Infrastructure

Business and Financial Computing

In FY01 a decision was made to replace PPPL's legacy business application systems and mainframe with a mid-level Enterprise Resource Planning Business Computing System from Microsoft's Great Plains Software. Business Management International, a consulting firm and reseller of Great Plains Software, was contracted to implement the new system, which utilizes client-server technology running on Microsoft's Windows 2000



Figure 13. The Poloidal Beta Experiment-Modification before (left) and during (right) disassembly.

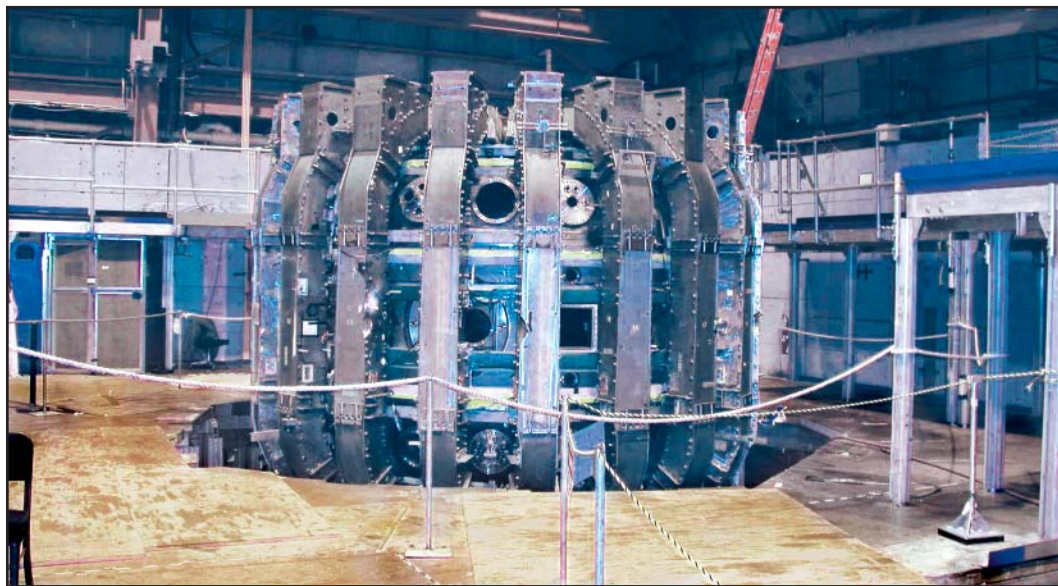

Figure 14. The PBX-M with torque frame and upper shelf removed.



Figure 15. The PBX-M test cell following the completion of its removal.

Server and SQL Server 2000 as the database management system. Implementation commenced in early F02. After completing a detailed specification, it became clear that a higher degree of customization than originally anticipated would be required to meet DOE's requirements and PPPL's business needs.

In fiscal year 2003 significant progress was made. Modules that could be launched in a "stand-alone" manner were released for general use. These included modules for web-generated requisitions, monthly timesheets, and the Micromain Corporation MS2000 Facilities Maintenance Management System. Most other modules were delivered and accepted by PPPL Business Operations, including those for managing projects and budgets, procurement, accounts payable, stockroom, time and labor reporting, asset management, excess property and spare parts, fixed assets, petty cash, and phone expenses. Remaining to be completed in FY04 are modules for general ledger, purchase cards, and the web travel system. Additionally in FY03, the "Anyview Browser" was implemented as the primary tool to access Business Systems data

over the internet. The project remains on track for final cut-over and acceptance during the second quarter of FY04.

Cyber Security

Computer security at PPPL continues to be an important issue. The number of known machines worldwide, which have been infected by both worms and viruses has grown to the hundreds of thousands. Every minute of every day the PPPL firewall drops attempted connections numbering in the hundreds. Our automated firewall virus protection is also very busy, picking off nearly one hundred e-mail attached viruses daily. Much of the effort in the cyber security area in FY03 was targeted at addressing computer security alerts, installing the latest patches, and ensuring that all users have the latest virus protection.

PPPL had no detected cyber security breaches in FY03. However, the effort to keep viruses and worms from infecting PPPL systems was significant. A major initiative utilizing Microsoft's Group Policy was undertaken to assure systems are patched properly and managed by the PPPL domain, so that future Windows

vulnerabilities can be patched more effectively and efficiently. An internal policy was implemented to require all Windows systems at PPPL to be centrally managed, unless specifically exempted by supervisory approval.

Commercial site filtering software, Websense, was enabled in FY03. Additionally a commercial password management tool, P-Sync, was implemented, to allow users to seamlessly change and synchronize numerous passwords.

Work For Others

Electron Beam Transmission Window (“Hibachi”) for IFE

During this past year significant progress was made in the development of an electron beam transmission window for use in a repetitively pulsed e-beam pumped laser for Inertial Fusion Energy (IFE) development. The PPPL electron beam transmission window employs novel components, which include single-crystal silicon and nanocrystalline diamond. The window has been successfully tested at PPPL and at the Naval Research Laboratory’s Electra KrF Laser Facility. The silicon nanocrystalline diamond window is a robust device, which provides greater than 80% electron beam transmission efficiency in the 150 to 750-keV range.

Currently PPPL is collaborating with the Naval Research Laboratory on the fabrication of a multi-window device, which will be tested at the Electra KrF Laser Facility.

Miniature Integrated Nuclear Detection System

Interest in the PPPL Miniature Integrated Nuclear Detection System (MINDS) for Homeland Security purposes has been strong over the past year with approximately \$250 K of funds being provided to PPPL by Picatinny Arsenal for the development of the MINDS technology. The system is designed for rapid and accurate detection and identification of radionuclides that could be deployed in a radiological weapon (i.e., dirty bomb). MINDS was tested in a variety of configurations, including the entrance of a radiological facility and outside a cargo container. The system performed exceedingly well. A demonstration held at PPPL in August 2003 for law enforcement and various transportation authorities led to an invitation by representatives of the New York City Metropolitan Transportation Authority-Bridge and Tunnel Authority to deploy MINDS at the Holland Tunnel. This test is being planned for FY04.

Environment, Safety, and Health

The Princeton Plasma Physics Laboratory's (PPPL) Environment, Safety, and Health (ES&H) performance continued to show significant improvement in each of three key occupational injury indicators during FY03: Days Away/Restricted/Transferred (DART) Case Rate, Total Recordable Case (TRC) Rate, and Cost Index.

The following are some highlights of the improved safety performance experienced in FY03:

- The number of total recordable injury and illness cases was reduced 50% in FY03 compared with FY02, and by almost 80% compared with FY01 (Figure 1).
- The PPPL Cost Index average of 4.01 for FY03 marked a significant

improvement over the 19.35 and 89.03 averages for FY02 and FY01, respectively, and was below the average for U.S. Department of Energy (DOE).

The second annual PPPL "Safety Forum" was held in October 2002. During the Forum, workers identified significant ES&H issues and provided suggestions for improvement. In addition to continuing ES&H initiatives that were begun in FY02, the following actions were taken in FY03 to improve PPPL ES&H performance:

- PPPL hosted a comprehensive Occupational Safety and Health Administration (OSHA) inspection visit for industrial and worker safety.

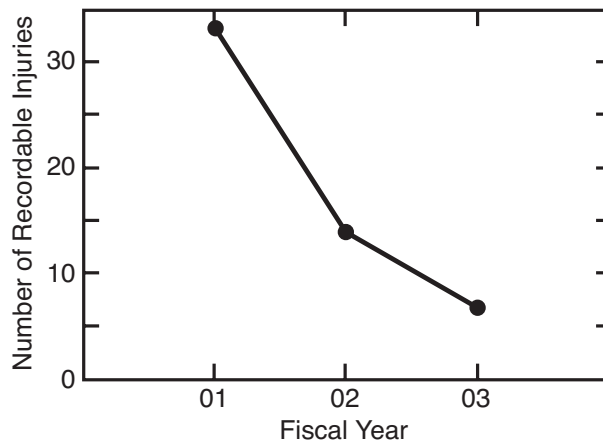

Figure 1. Princeton Plasma Physics Laboratory recordable injuries versus fiscal year. The number of injuries decreased by almost 80% between FY01 and FY03.

- The Princeton Plasma Physics Laboratory hosted an inspection visit by the Nuclear Regulatory Commission (NRC) for radiation safety.
- An internal OSHA “competent person” program was developed to designate individuals who can act in this role for PPPL construction projects. The competent person is defined as the person who, by virtue of formal training and experience, can recognize existing and predictable safety hazards and has the authority to take prompt corrective action.
- Increased OSHA-related training opportunities were provided for PPPL staff members.
- Expansion and refinement of the Lab-wide “Job Hazard Analysis” program.
- Performance of more than two dozen Management Safety Walk-throughs to examine workplace safety programs.
- Publication of Lab-wide ES&H Newsletters that enhanced employee awareness of selected worker safety and health issues.
- Facility infrastructure improvements designed to improve workplace lighting, walking surfaces, and safety-related signage.

PPPL worked with DOE’s Princeton Area Office to develop and implement a comprehensive plan and schedule for the assessment of ES&H functions at PPPL. The resulting Assessment Schedule integrates a variety of oversight activities ranging from DOE surveillances to Quality Assurance Audits to internal self-assessments. The schedule is used to help evaluate PPPL’s overall Integrated Safety Management performance, and subsequently to determine what assessments are warranted for future years.

Applied Research and Technology Transfer

The transfer of technology to private industry, academic institutions, and other federal laboratories is one of the missions of the Princeton Plasma Physics Laboratory (PPPL). The Laboratory is currently working with a number of partners in scientific research and technology development. These collaborations are Cooperative Research and Development Agreements (CRADAs) or Work For Others (WFOs) projects and primarily involve applications of science and technology developed for PPPL's fusion program. In addition to CRADAs and WFOs the Laboratory also uses Licensing Agreements, Personnel Exchanges, and Technology Maturation Projects to promote the transfer of PPPL technology.

A CRADA, which is a contractual agreement between a federal laboratory and one or more industrial partners, enables industry and PPPL researchers to work on programs of mutual interest. Costs and project results are generally shared between PPPL and the partner. Work for Others arrangements may involve either federal or non-federal partners. The partners pay for the work performed at PPPL. In the Personnel Exchange Program, researchers from industry assume a work assignment at the Laboratory, or PPPL staff may visit the industrial setting. In a Technology Maturation Project, a Laboratory researcher may work on technologies of interest

to industry, where further development is required before a formal collaboration can begin. In addition to the above technology transfer mechanisms, the PPPL Technology Transfer Office encourages the development of technologies that are potentially relevant to commercial interests. These projects are funded by PPPL as Laboratory Program Development Activities.

The PPPL Technology Transfer Office works closely with the Laboratory's Budget Office and with the Princeton University Office of Research and Project Administration (ORPA). PPPL technology is licensed through ORPA, and PPPL inventions are processed through ORPA. The Laboratory works closely with the University for the patenting and protection of PPPL intellectual property.

Small Business Innovative Research Workshop

On August 21, 2003, the PPPL Technology Transfer Office hosted a one-day workshop for small businesses interested in the Small Business Innovative Research (SBIR) Program and the Small Business Technology Transfer (STTR) Program. The workshop, which was jointly sponsored by the Federal Laboratory Consortium and the New Jersey Technology Council (NJTC), attracted more than 125 participants (Figure 1). The topics included:



Figure 1. Attendees gathering literature at the Small Business Innovative Research Workshop held at PPPL in August 2003.

- An overview of the SBIR/STTR programs.
- Services available through the NJTC for New Jersey businesses.
- Information on the U.S. Department of Energy's SBIR programs.
- The Navy's SBIR program at Lakehurst Naval Air Warfare Center.
- The Army's SBIR programs at Picatinny Arsenal and at Fort Monmouth.
- Collaborative opportunities available at the Princeton Plasma Physics Laboratory.
- An overview of training, resources, and free consultations available from the Technology Commercialization Center of the New Jersey Small Business Development Center.
- How to write effective SBIR and STTR abstracts.
- Assistance available from Princeton University on SBIR/STTR proposals, with examples of successfully commercialized University technologies.

Legal experts provided an overview of intellectual property issues such as patents, trade secrets, copyrights and trademarks. Other topics included government rights and legal issues related to intellectual property with respect to SBIRs, STTRs, and CRADAs, and government contracts in general.

Micro Air Vehicles

During FY03, work continued on PPPL's Micro Air Vehicles (MAV) project in support of the Naval Research Laboratory (NRL) Micro Air Vehicle Program. The Naval Research Laboratory's MAV Program involves fundamental research and development on the unconvention-

al aerodynamics of miniature air vehicles and feasibility demonstrations of mission-useful MAVs.

One effort focused on a technology demonstration of the Samara concept. The Samara combines the slow flying and near vertical ascent capabilities of rotary wing operation with the fast, efficient flight of fixed wing aircraft. During FY03, new automatic control systems were investigated for the Samara aircraft, including mass shifting in response to very sensitive airspeed instrumentation. The Samara mass shifting system will be tested in FY04.

In addition to the Samara project, much work was done in FY03 on the Tandem-winged Clapper (TWC) (Figure 2) — a vehicle capable of multiple modes of locomotion. A TWC was designed and built. This prototype exhibited controlled flight in addition to ground travel

capability. A second, smaller prototype of the TWC was designed and will be built in FY04 utilizing more sophisticated materials. It will have enhanced control in both travel modes, and testing will begin next year. Micro Air Vehicle experimental research was coupled with ongoing computational fluid dynamics and flight control system simulations that are continuing at NRL.

Miniature Integrated Nuclear Detection System

During FY03, PPPL scientists continued development of the Miniature Integrated Nuclear Detector System (MINDS) (Figure 3), which is designed to detect and identify specific radionuclides for counter terrorism. The MINDS, which was supported by funding from Picatinny Arsenal during FY03, would be used by Police, security personnel, the

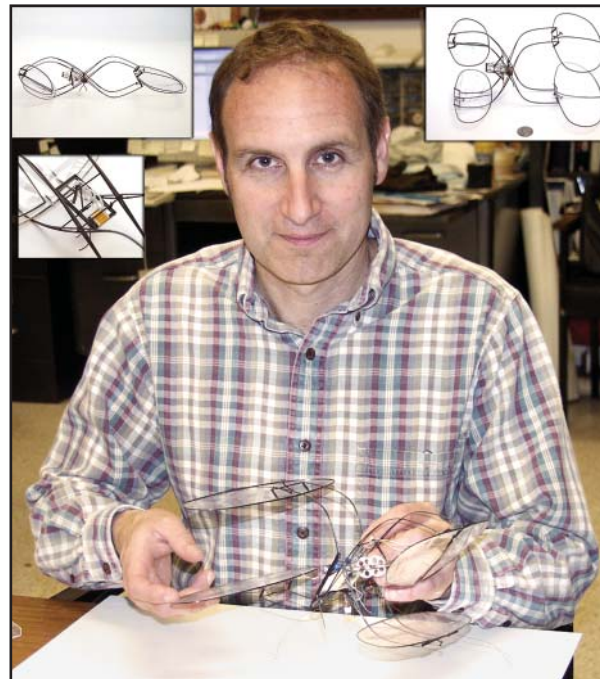

Figure 2. Dave Cylinder holds the latest version of the Tandem-winged Clapper. The new model has an enhanced control system and is constructed with composite materials. The inserts going from left clockwise show: (1) a close up of the motor and transmission, (2) the micro air vehicle with its wings “clapped” together, and (3) with its wings in the open position.

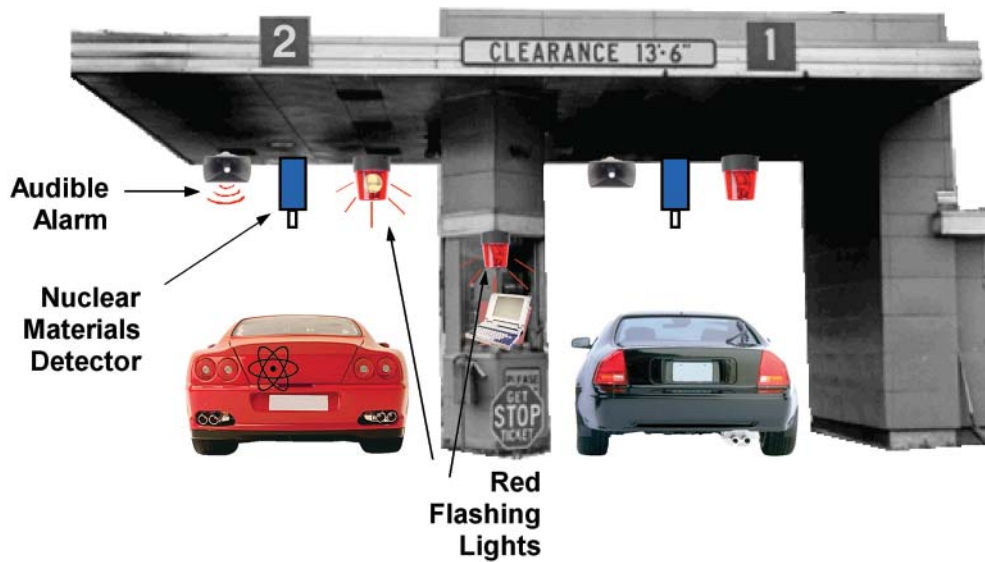

Figure 3. Miniature Integrated Nuclear Detection System (MINDS) conceptual configuration.

National Guard, the Coast Guard, and other agencies involved in homeland security or transportation rule compliance. The MINDS could detect potential nuclear threats from a weapon of mass destruction or from nuclear contamination, such as a “dirty bomb.” The objective is to detect and identify nuclear material entering a site, passing through a toll booth, placed inside of a shipping container, or hidden in other ways, under realistic conditions. The full system, which employs mostly off-the-shelf components, will be capable of detecting X-rays, soft gammas, gammas, and neutrons. A major feature is the ability to compare the energy spectrum of the detected radionuclide with the spectrum of particular radiological materials that might be used in weapons. The MINDS can be programmed to respond only to those signatures, thus eliminating false positive alarms resulting from the movement and transportation of approved radionuclides, such as medical and industrial shipments. The presence of false positives is a major concern of security personnel.

PPPL researchers are working with faculty and students from Rutgers University’s Center for Advanced Information Processing (CAIP) to develop computer hardware and detection algorithms. Researchers are combining PPPL’s library of the radionuclide spectra with CAIP’s advanced neural-network-based detection software known as the Vigilant Decision Machine (VDM). The software is capable of learning the specific signals associated with various radionuclides and distinguishing those signals from background noise and other interference. VDM software has been proven to detect rare events amidst complex signals found in real-world environments.

An initial proof-of-principle demonstration was performed in August 2002, in which MINDS demonstrated the detection of a small quantity of radionuclides in a stationary shipping container. On August 6, 2003, MINDS’ ability to detect similar material in a moving vehicle was demonstrated to representatives of Picatinny Arsenal, the New York/New Jersey Port Authority, the New Jersey Of-

Office of Counter Terrorism, the Rutgers Center for Advanced Information Processing, the New York City Metropolitan Transportation Bridge and Tunnel Authority, and other State and municipal representatives. Discussions are currently underway with parties interested in licensing the technology for commercial development.

Plasma Sterilization Experiment

Hundreds of billions of plastic food and beverage containers are manufactured each year in the U.S. All of these packages must undergo sterilization, which at present is done using high temperatures or chemicals. Both of these methods have drawbacks. Chemicals often leave a residue that can affect the safety and taste of the product and produce undesirable waste. Heat is effective and sufficiently rapid, but necessitates the use of costly heat-resistant plastics that can withstand sterilization temperatures. Consequently it would be of great benefit if a new method could be found that eliminated the need for chemicals or heat-resistant plastics.

During FY03, a team of PPPL scientists conducted preliminary small-scale experiments studying plasma sterilization. The researchers modified old equipment that had once been used to study radio-frequency (rf) waves for fusion applications. It consists of a vacuum chamber equipped with an radio-frequency source (Figure 4). A brass sphere measuring one inch in diameter is mounted at the center of the chamber. In preparation for experiments, the sphere is removed and sent to a commercial biological testing laboratory where a known number of spores of bacillus subtilis, a nonpathogenic microbe commonly used as a standard in lab testing, are placed on its surface. Following an experiment, the sphere is returned to the testing laboratory

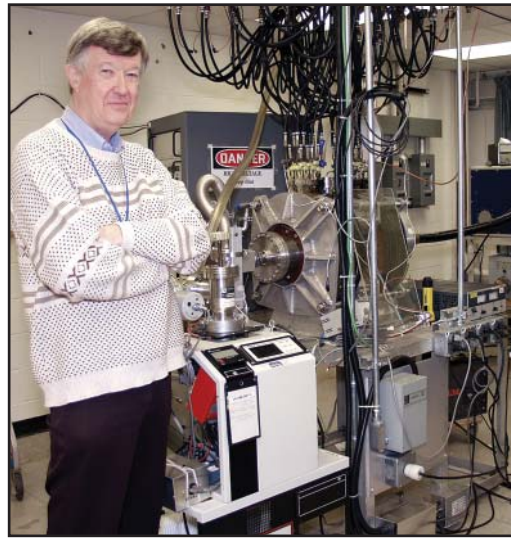

Figure 4. John Schmidt, lead scientist for PPPL's Plasma Sterilization Experiment, with the apparatus.

where technicians determine the number of spores killed in the process.

Fusion experiments at PPPL have generated plasmas with temperatures in the hundreds of millions of degrees centigrade. For killing spores, the PPPL researchers start with "low-temperature" hydrogen plasmas in the range of 50,000 degrees centigrade. At that temperature, the hydrogen ions are moving much too slowly to kill spores quickly. Rapidly pulsing a 50-kilovolt potential between the sphere and the vacuum chamber solves the problem. The sphere is charged negatively and the vessel is at ground. Under these circumstances, the positively charged hydrogen ions accelerate toward the sphere in pulses energetic enough for the ions to pierce the hard outer shell and soft inner core of the spores. These high-energy hydrogen ions stop very quickly and consequently deposit all their energy over a very small distance, a few microns, which, as it turns out, is the size of the spores. So relatively modest currents of energetic hydrogen ions can do a large amount of damage inside the spores by destroying their DNA.

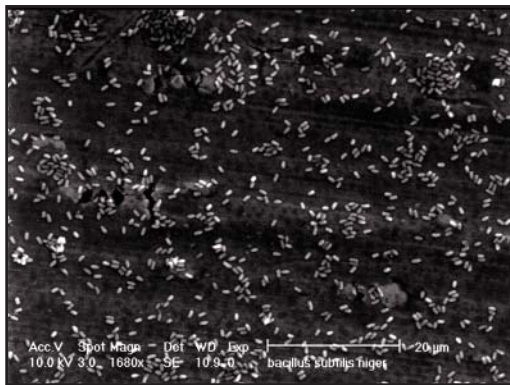

Figure 5. Shown is an example of the spores used in the plasma sterilization experiment. The image, made by a scanning electron microscope, is of bacillus subtilis var Niger spores magnified approximately 1,700 times. It illustrates the typical spore density on the surface of the brass sphere that is inserted into the sterilization apparatus, and shows that the spores are fairly evenly distributed over the surface to be sterilized.

Experiments during FY03 employed 4,000 10-microsecond pulses, which reduced the population of live spores by a factor of 100-1,000 — the kill ratio (Figures 5 and 6). Further experimentation is needed to confirm the number of 10-microsecond pulses necessary to reach the required kill ratios for relevant microbes. It is estimated that a few seconds' processing time per container would make the system feasible for the assembly line.

Work For Others

Other Work for Others projects funded during FY03 included:

Title: Experimental and Theoretical Studies of Nonneutral Plasmas

Sponsor: Office of Naval Research

Scope: This program includes a theoretical and experimental program in critical problem areas related to the equilibrium, stability, and nonlinear properties of nonneutral plasmas.

Start Date: April 1, 1996

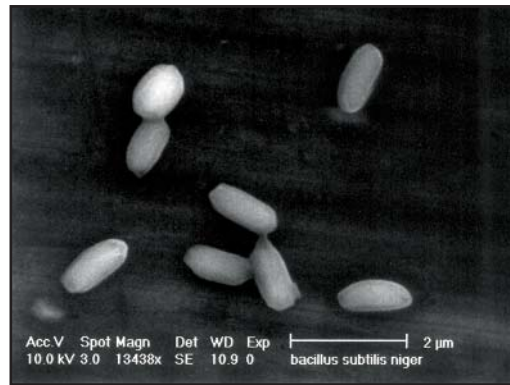

Figure 6. Shown is a scanning electron microscope image of a small group of bacillus subtilis var Niger spores magnified approximately 13,500 times. The image shows that the spores are approximately 1 μm long and approximately 0.5 μm in diameter.

Completion Date: September 30, 2003

Title: Sterilization of Liquid Foods

Sponsor: U.S. Department of Agriculture

Scope: The purpose of this project is to develop new pasteurization methods that use radio-frequency (rf) waves and microwave heating. These heating techniques, also used to warm plasma in a fusion device, are being tested for pasteurizing raw liquid foods such as eggs, fruit juices, and milk. Radio-frequency waves offer advantages over the traditional pasteurization method of directly heating raw liquid foods. The direct method often heats foods unevenly, possibly resulting in incomplete pasteurization in lower temperature regions and in denaturing foods in overheated regions. Using radio-frequency waves in the appropriate wavelength may allow pasteurization without heating liquid foods to temperatures that cause food deterioration.

Start Date: October 1, 1997

Completion Date: September 30, 2003

Title: Low-frequency MHD Waves in the Magnetosheath-Magnetopause

Sponsor: National Science Foundation

Scope: This program involves the systematic study of the generation, propagation, and structure of low-frequency MHD waves and their effects on plasma transport in the magnetosheath-magnetopause region for quasi-perpendicular bow shocks.

Start Date: September 15, 1999

Completion Date: May 31, 2003

Title: Magnetic Reconnection Experiment

Sponsor: National Aeronautics and Space Administration

Scope: A basic plasma physics research facility, the Magnetic Reconnection Experiment (MRX), is studying the physics of magnetic reconnection — the topological breaking and reconnection of magnetic field lines in plasmas. Scientists hope to understand the governing principles of this important plasma physics process and gain a basic understanding of how it affects plasma characteristics such as confinement and heating. The results of these experiments will have relevance to solar physics, astrophysics, magnetospheric physics, and fusion energy research.

Start Date: October 1, 1995

Completion Date: September 30, 2003

Title: Korea Superconducting Tokamak Advanced Research, Phase II

Sponsor: Korean Basic Science Institute

Scope: The Princeton Plasma Physics Laboratory is coordinating a U.S. team in supporting the design of the Korea Su-

perconducting Tokamak Advanced Research (KSTAR) device. KSTAR is the flagship project of the Korean National Fusion Program that was launched officially in January, 1996. The KSTAR device will be built at the National Fusion R&D Center at the Korean Basic Science Institute in Taejon, Republic of Korea.

Start Date: October 1, 1999

Completion Date: November 30, 2003

Title: Novel Materials for Electra's "Hibachi" Electron Beam Windows

Sponsor: Naval Research Laboratory

Scope: Study, design, and produce thin "hibachi" windows fabricated from silicon or other novel materials for the Electra KrF laser system and perform a systems engineering study for Electra.

Start Date: October 1, 2000

Completion Date: December 31, 2003

Title: Raman Pulse Compression of Intense Lasers

Sponsor: Defense Advanced Research Projects Agency

Scope: A moderately intense, but long, laser pulse can be scattered into short, very intense counter-propagating pulses in plasma through a variety of related mechanisms. The simplest and most efficient method is the well-studied stimulated Raman backscatter effect. In principle, fluences tens of thousands of times higher can be handled in plasma, making feasible significantly more intense lasers. In a collaboration involving the University of California, Berkeley, and Princeton University, scientists at the Princeton Plasma Physics Laboratory are assessing the practical realization of the plasma-based pulse compression schemes. Preliminary experimental results show

apparent amplification of the counter-propagating wave.

Start Date: October 1, 2000

Completion Date: March 16, 2004

Title: Energy Transport and Dissipation of Electromagnetic Ion Cyclotron Waves in Magnetosphere/Ionosphere

Sponsor: National Aeronautics and Space Administration

Scope: Electromagnetic ion cyclotron waves in plasmas are generated by electron-beam driven instabilities. These waves play an important role in magnetosphere-ionosphere coupling. They are thought to be responsible for heating ionospheric ions, modulating auroral electron precipitation, populating the magnetosphere with energetic heavy ions during substorms, as well as producing parallel electric fields and electrostatic shock signatures. This program involves the development of solutions to full wave equations for electromagnetic ion cyclotron waves using a nonlocal theory which includes kinetic effects and ionospheric collisions. The solutions can provide specific predictions of global electromagnetic ion cyclotron wave structure, wave polarization, and Poynting fluxes which are observables that can be compared directly with spacecraft measurements.

Start Date: October 1, 2000

Completion Date: April 30, 2003

Title: Self-consistent Model for Regions of Downward Auroral Current

Sponsor: National Science Foundation

Scope: The objective of this program is to develop a self-consistent understanding of the plasma and field properties of downward auroral currents.

Start Date: March 13, 2002

Completion Date: February 28, 2004

Title: Vacuum Ceramic Multi-Window in Titanium Flange

Sponsor: Institute for Plasma Research, Gujarat, India

Scope: The Institute for Plasma Research (IPR) is enhancing its capability on the SST1 Tokamak in Gujarat, India, and has contacted PPPL to fabricate and supply two multi-channel, ceramic vacuum windows. It is intended that PPPL staff will work with the cognizant staff at IPR to determine the final configurations of the ceramic window flanges in order to complete fabrication drawings, procure the necessary materials and services, and to assemble and test the final ceramic window assemblies at PPPL before shipment to IPR.

Start Date: October 1, 2002

Completion Date: September 30, 2003

Title: Testing of the Detritiation of the JET Tiles by Heating with the Oxy-Gas Burner

Sponsor: United Kingdom Atomic Energy Authority, England

Scope: The United Kingdom Atomic Energy Authority wants to investigate the removal of co-deposited tritium from the Joint European Torus (JET) graphite tiles employing localized heating. In general the tile samples will first be characterized for tritium content and tritium depth profile. After such analysis, the tile sample will be subjected to direct heat from a burner to liberate the co-deposited tritium from the tile. After the application of localized heat, the tile will be re-analyzed to determine the effectiveness of the techniques employed.

Start Date: October 1, 2002

Completion Date: December 20, 2003

Title: Kinetic Ballooning Instability as a Mechanism for Substorm Onset in the Near Earth Plasma Sheet

Sponsor: National Aeronautics and Space Administration

Scope: The objective of the project is to study the onset mechanism of substorms which occur in the near-Earth plasma sheet region of the magnetosphere. Theoretical predictions will be compared with satellite observations to clarify unresolved physics issues.

Start Date: October 1, 2002

Completion Date: May 31, 2004

Title: Concept Exploration of Novel Hall Thruster Configurations: Staged Hall-Ion Thruster with Cylindrical Configuration

Sponsor: Defense Advanced Research Projects Agency

Scope: The objective of this project is to explore several novel plasma propulsion configurations with an aim to evaluating potential performance, including high-power (10-20 kW), mid-power (1-5 kW), low power (under 100 W), moderate specific impulse (1,500-2,500 s), high specific impulse (more than 3,000 s), and desirable features such as throttling, lifetime, or variable thrust.

Start Date: October 1, 2002

Completion Date: September 30, 2003

Title: Accretion onto Massive Black Holes in Low-luminosity Galactic Nuclei

Sponsor: National Aeronautics and Space Administration

Scope: Most galaxies in the universe contain supermassive black holes at their centers; and yet most galactic nuclei emit very little radiation indicative of active accretion. The purpose of this work is to investigate this issue using low-radiative-efficiency accretion flow models, including advection-dominated and convection-dominated accretion flows.

Start Date: October 1, 2002

Completion Date: August 14, 2004

Title: Low Power Hall Thruster

Sponsor: (U.S.) Air Force Office of Scientific Research

Scope: Hall thrusters hold considerable promise for propellant savings for space vehicles. The annular design of the conventional Hall thruster, however, does not naturally scale to low power. This project is exploring a family of Hall thrusters of cylindrical, rather than annular design, with a cusp-like magnetic field, making use not only of the cylindrical design, but of other advanced features such as emissive segmented electrodes and central localizing of the cathode neutralizer.

Start Date: October 1, 2003

Completion Date: September 30, 2006

Patents and Invention Disclosures

Patent Application

Miniature Nuclear Detection System (MINDS)

— *Charles Gentile, George Ascione, Andrew Carpe, Stephen Langish,
and John Parker*

Provisional Patent

Radio Frequency Electric Field Pasteurization Chamber

— *Christopher Brunkhorst, David J. Geveke, and Andrew B. W. Bigley*

Invention Disclosures

Feedback Elimination in Hearing Aids and Sound Systems

— *Lewis Meixler*

Development of Thin Films for the Mitigation of Particulate Associated
with Biological and Industrial Hygiene Hazards

— *Margaret E. Lumia and Charles A. Gentile*

Massively Parallel Interactive Data Language (MPIDL)

— *Dana Mastrovito*

Out-board 'Ohmic Induction' Coil for Low-aspect-ratio Toroidal Plasma Start-up

— *Masayuki Ono and Wonho Choe*

Silicon/Nanocrystalline Diamond Electron Beam Transmission Window

— *Charles A. Gentile, Robert F. Parsells, and James E. Butler*

Collaborative Scientific visualization

— *Eliot Feibush, Scott Klasky, and Douglas McCune*

Use of Multiple Frequency Pumps in Optimizing Pulse Compression

— *Alexey Balakin, Gennady Fraiman, Nathaniel J. Fisch, and Vladimir Malkin*

Radio Frequency Electric Field Pasteurization Chamber

— *Christopher Brunkhorst, David J. Geveke, and Andrew B. W. Bigley*

Current Drive in a Ponderomotive Potential with Sign Reversal

— *N.J. Fisch, J.M. Rax, and I.Y. Dodin*

Electrostatic Dust Detector

— *Charles Skinner*

Contaminated Surface Cleaner

— *John Desandro, Mike Kalish, Jim Kukon, and Mike Anderson*

A New Instrument for Simultaneous Measurement of Toroidal and Poloidal Plasma
Rotation Velocity Profiles

— *M. Bitter, K.W. Hill, L. Roquemore, B. Stratton, S.G. Lee, J.E. Rice,
and E. Marmor*

Graduate Education

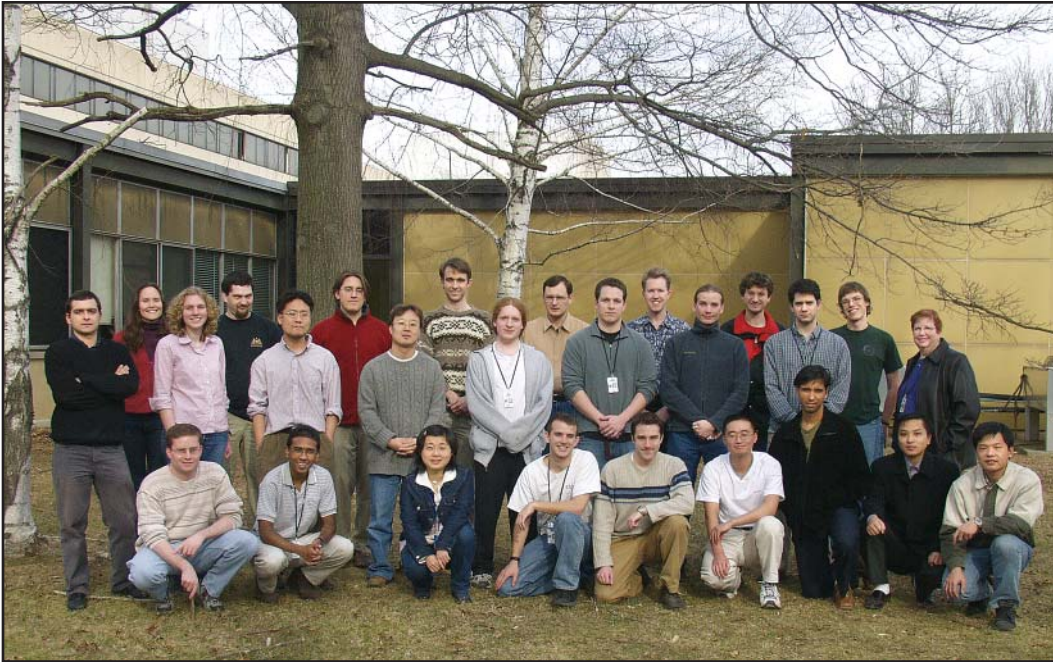

Program in Plasma Physics graduate students for academic year 2003-2004. Standing left to right: Alexey Kuritsyn, Jill Foley, Steffi Diem, Phil Marfuta, Seunghyeon Son, Adam Sefkow, Moses Chung, Tom Kornack, Dan Raburn, Ilya Dodin, Tim Gray, Tom Jenkins, Ethan Schartman, Kyle Morrison, Nate Ferraro, Tim Stoltzfus-Dueck, Barbara Sarfaty, Administrator. Kneeling left to right: Dave Smith, Mahmood Miah, Yansong Wang, Pat Ross, Ian Parrish, Yang Ren, Prateek Sharma, Wei Liu, and Weihua Zhou.

Graduate education at the Princeton Plasma Physics Laboratory (PPPL) is supported through the Program in Plasma Physics and the Program in Plasma Science and Technology. Students in the programs receive advanced degrees from Princeton University. In the Program in Plasma Physics, Doctoral (Ph.D.) degrees are given through the Department of Astrophysical Sciences while in the Program in Plasma Science and Technology, Masters

(M.S.E.) or Doctoral (Ph.D.) degrees are given through the departments of Astrophysical Sciences, Chemical Engineering, Chemistry, Civil Engineering, Computer Science, Electrical Engineering, Mechanical and Aerospace Engineering, and Physics.

Program in Plasma Physics

The Princeton University Plasma Physics Laboratory supports graduate education through the Program in Plas-

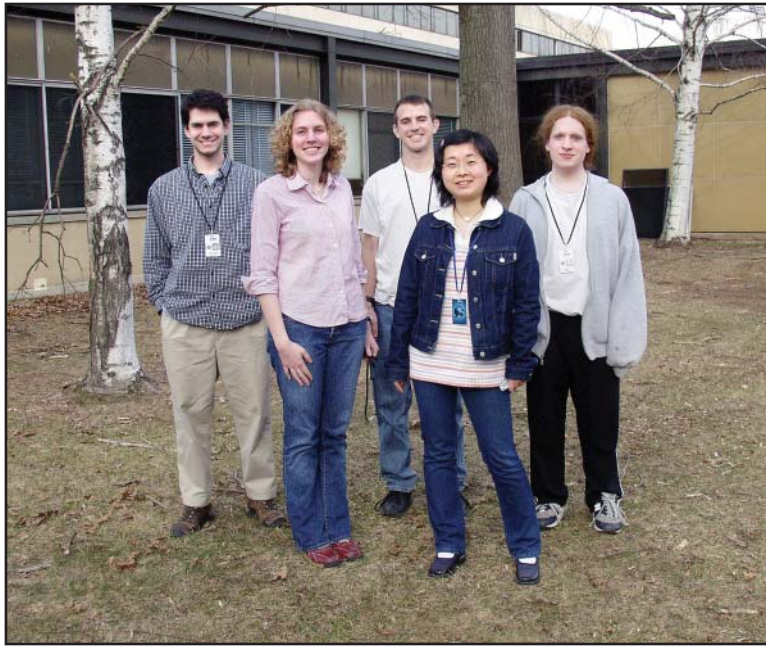

First year graduate students from left to right are: Nate Ferraro, Steffi Diem, Pat Ross, Yansong Wang and Dan Raburn.

ma Physics in the Department of Astrophysical Sciences of Princeton University. Students are admitted directly to the Program and are granted degrees through the Department of Astrophysical Sciences. With more than 215 graduates since 1959, the Program has had a significant impact on the field of plasma physics, providing many of today's leaders in the field of plasma research and technology in academic, industrial, and government institutions.

Both basic physics and applications are emphasized in the Program. There are opportunities for research projects in the physics of the very hot plasmas necessary for controlled fusion, as well as for projects in solar, magnetospheric and ionospheric physics, plasma processing, plasma thrusters, plasma devices, nonneutral plasmas, lasers, materials research, and in other important and challenging areas of plasma physics.

In FY03, there were 35 graduate students in residence in the Program in Plas-

ma Physics, holding between them three U.S. Department of Energy Magnetic Fusion Energy Science Fellowships, one National Defense and Science Engineering Graduate Fellowship, and one Hertz Fellowship.

Five new students (Table 1) were admitted in FY03, one from China and four from the United States. Three students graduated (Table 2) during the year, two accepting positions at Lawrence Livermore National Laboratory and Los Alamos National Laboratory. One student won the prestigious American Physical Society Congressional Fellowship and is working in the office of Senator Bingaman (New Mexico) in Washington, D.C.

Program in Plasma Science and Technology

Applications of plasma science and technology meld several traditional scientific and engineering specialties. The Program in Plasma Science and Technology

Table 1. Students Admitted to the Program in Plasma Physics in FY03.

<u>Student</u>	<u>Undergraduate Institution</u>	<u>Major Field</u>
Stephanie J. Diem	University of Wisconsin, Madison	Physics
Nathaniel M. Ferraro	Dartmouth College	Physics
Daniel L. Raburn	University of California, Berkeley	Physics
Patrick W. Ross	Brigham Young University	Physics
Yansong Wang	University of Science and Technology, China	Plasma Physics

Table 2. Recipients of Doctoral Degrees in FY03.

Clark, Daniel	
Thesis:	Investigations of Raman Laser Amplification in Preformed and Ionizing Plasmas
Advisor:	Nathaniel J. Fisch
Employer:	Lawrence Livermore National Laboratory
Rosenberg, Adam	
Thesis:	Ion Absorption of the High Harmonic Fast Wave in the NSTX
Advisors:	Jonathan Menard and J. Randy Wilson
Employer:	American Physical Society Congressional Fellowship Senator Bingaman's Office (New Mexico)
Zaharia, Sorin	
Thesis:	3-D Magnetospheric Structures and Energetic Particle Injection
Advisor:	C.Z. Cheng
Employer:	Los Alamos National Laboratory

(PPST) provides strong interdisciplinary support and training for graduate students working in these areas. The scope of interest includes fundamental studies of plasmas, their interaction with surfaces and surroundings, and the technologies associated with their applications.

Plasmas are essential to many high-technology applications, such as gas-

eous lasers, in which the lasing medium is plasma. X-ray laser research is prominent in the PPST. Another example is fusion energy for which the fuel is a high-temperature plasma. Lower temperature plasmas are used for a growing number of materials fabrication processes, including the etching of complex patterns for micro-electronic and micro-optical compo-

nents and the deposition of tribological, magnetic, optical, conducting, insulating, polymeric, and catalytic thin-films. Plasmas are also important for illumination, microwave generation, destruction of toxic wastes, chemical synthesis, space propulsion, control system theory and experiment, and advanced-design particle accelerators.

The PPST provides support for M.S.E. and Ph.D. students who concentrate on a specific research topic within the field of plasma science and technology, while acquiring a broad background in relevant engineering and scientific areas. Departments in the program are Astrophysical Sciences, Chemical Engineering, Chemistry, Civil Engineering, Computer Science, Electrical Engineering, Mechanical and Aerospace Engineering, and Physics. In fiscal year 2003, eleven graduate students received support from the PPST during the academic year and/or summer. They co-authored more than a dozen refereed publications. Four PPST-supported stu-

dents received Ph.D. degrees from their respective departments.

Professor R. Rosner was the distinguished speaker at the PPST public lecture series held to inform the Princeton community of contributions made by plasma science and technology to our society. In a talk entitled, "Burning Stars in One's Office: The Physics of Astrophysical Nuclear Flames," Dr. Rosner, Distinguished Service Professor, Astronomy and Astrophysics and Physics Departments, University of Chicago, described similarities between laboratory-scale combustion fronts and processes in supernova.

To maintain this strong graduate program, increased efforts were made to develop appreciation for plasma physics in Princeton undergraduates. Through a summer internship program, five Princeton undergraduates worked on plasma-related projects. One summer intern, a history major investigating seminal ideas in fusion plasma physics, was able to get one of the last interviews given by Dr. Edward Teller.

Science Education

The goals of the Science Education Program (SEP) are to provide a comprehensive portfolio of initiatives that use the unique resources of the Princeton Plasma Physics Laboratory (PPPL) along with a plasma-based education strategy to create significant learning opportunities for undergraduate college students and K-12 teachers and students. Through these opportunities, the SEP strives to: (1) contribute to the training of the next generation of scientists and engineers, (2) to collaborate with teachers on ways to improve science

instruction using an inquiry-based approach to learning, and (3) to improve the scientific literacy of the community at large. These initiatives are led by SEP staff in conjunction with PPPL volunteers, master teachers, and local education experts.

Plasma Science Education Laboratory

The center of all SEP activities is the Plasma Science Education Laboratory (PSEL). A fusion of research between education and plasma science, this unique

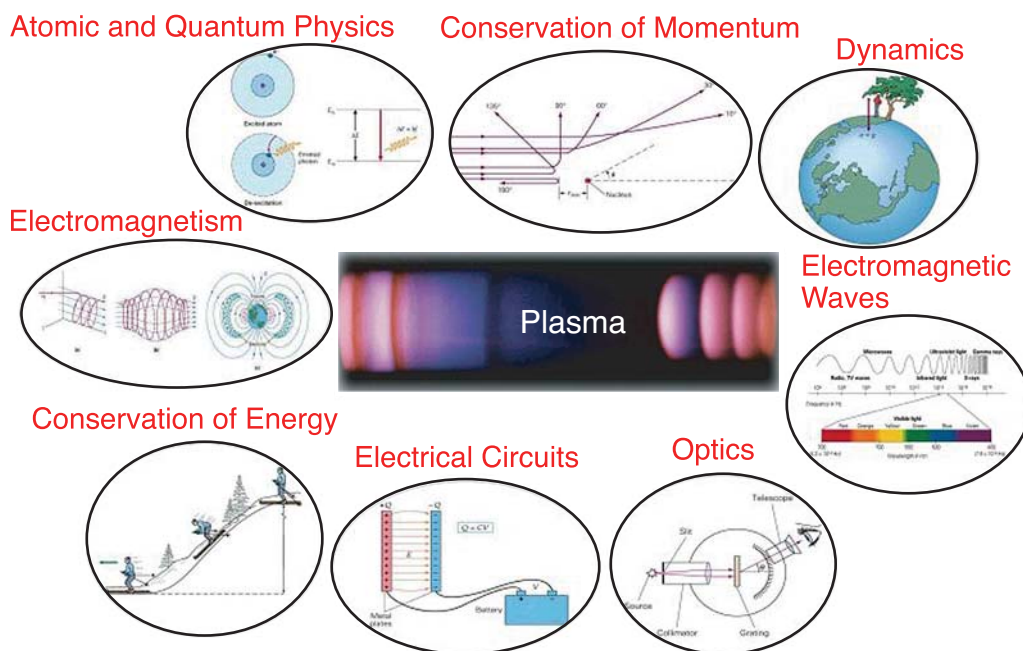

The Science Education program uses a plasma-based education strategy that recognizes that plasmas are superb for generating questions, stimulating curiosity, and increasing personal relevance of learning for students of all ages. (This graph is from Master Teacher S. Gershman's American Physical Society Division of Plasma Physics Meeting presentation titled "The Use of a Glow Discharge Source for Teaching Introductory Physics.")

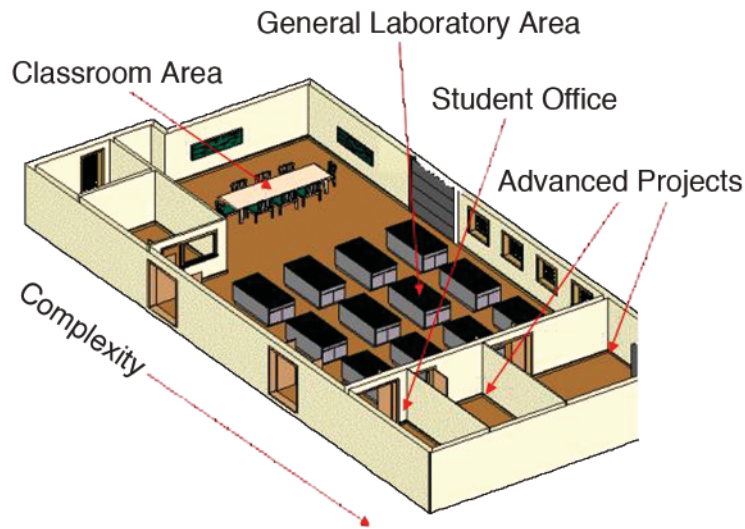

The Plasma Science Education Laboratory at PPPL.

facility includes a classroom, general laboratory space for educational workshops, and areas for advanced plasma physics research. The experimental activities performed in the PSEL simulate a research environment while remaining primarily student centered. Undergraduate and advanced high school students plan all work, formulate research goals, assemble all apparatus, collaborate with scientists and engineers, critique and evaluate each

other's work, write papers, and make oral and poster presentations. Simultaneously, the PSEL's open layout for educational workshops fosters communication between participants, master teachers, and student researchers to create a unique learning environment for teachers and students of all abilities.

Research projects conducted in the PSEL during FY03 included the study of dusty plasmas in a DC glow discharge

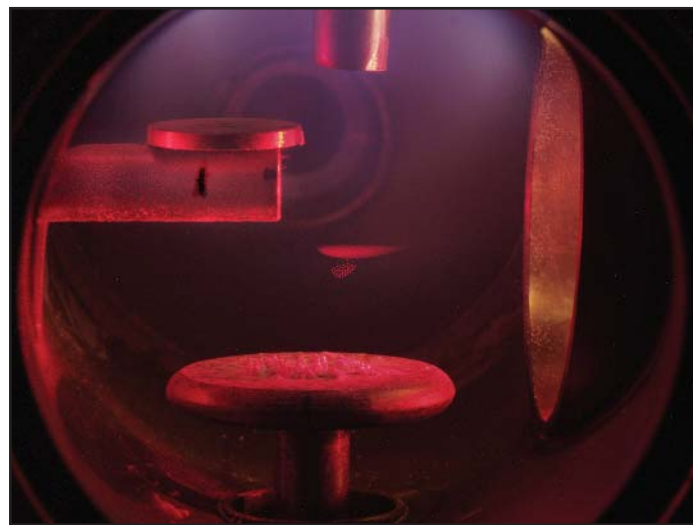

Photograph of a levitating dust cloud in an argon plasma discharge. The cloud, approximately one centimeter high, is illuminated by a 2.5 mW helium-neon laser.

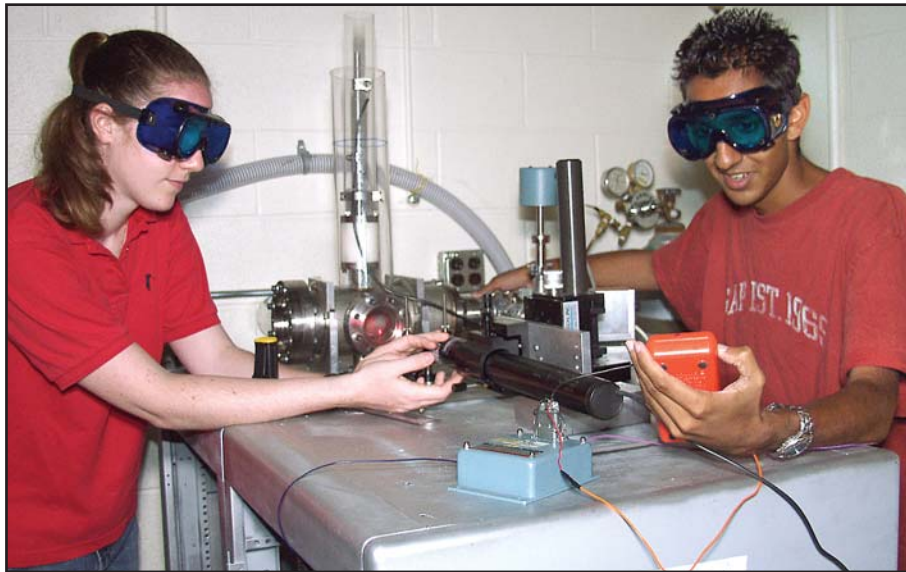

High school research interns from The Peddie School and West Windsor-Plainsboro High School North adjust the laser and gas pressure in the Dusty Plasma Experiment.

plasma source, the characterization of an electron cyclotron resonance system for plasma processing, and the study of the relationship between a plasma double layer and ion transport across a biological cell membrane.

Two students presented their work at American Physical Society meetings. Dartmouth College Junior Laura Berzak presented “A Study of a Striated Positive Column after Ethanol Impurity Injection in an Air DC Glow Discharge” and West Windsor-Plainsboro High School Senior Niraj Sheth presented “Experimental Investigations of Dust Levitation in a DC Glow Discharge.” Additionally, SEP Lead Scientist Andrew Post-Zwicker presented a summary of SEP research and educational activities in an invited talk, “Recent Results from the Plasma Science Education Laboratory.”

Educational workshops conducted in the PSEL during FY03 included the annual Plasma Camp for high school teachers and Plasma Academy for high school students. The PSEL also provided laboratory space for physics classes from The

Lewis School and a variety of single-day workshops for teachers and students.

Undergraduate Research Programs

In FY03, nine students from the U.S. Department of Energy’s (DOE’s) Science Undergraduate Laboratory Internship (SULI) program and 19 from the DOE National Undergraduate Fellowship (NUF) program, completed their summer research at PPPL, other DOE Laboratories, and U.S. colleges and universities. The DOE Office of Science Workforce Development and Office of Fusion Energy Sciences support the research programs, respectively. In both programs, students attend a one-week introductory course at PPPL in the basic elements of plasma physics, after which they travel to the sites for a nine-week research project. Student research topics ranged from “The Development of an Electrostatic Dust Detector for use in a Tokamak Reactor” to “Wavelet Analysis of Probe Data in DIII-D,” with scientists and engineers serving as mentors.

Select students were given the opportunity in the Fall to present their work at the Annual American Physical Society's Division of Plasma Physics Meeting.

Pre-college Activities **Lewis School Collaboration**

An ongoing collaboration for students with atypical learning styles of The Lewis School was formalized with the goal of supplementing the existing physical science curriculum with new topics taught at PPPL in the Plasma Science Education Laboratory, including solar and fusion energy. In FY03, the eleventh grade physics class visited the PSEL throughout the school year designing and building solar-powered devices and learning about renewable energy.

Energy in the 21st Century

In FY03, a new collaboration with the Academy for the Advancement of Science and Technology in Bergen County began. High school juniors spent one week at PPPL in the PSEL studying solar energy, hydrogen fuel cells, plasmas, and fusion energy. The program will be



Physics students from The Lewis School perform a plasma spectroscopy experiment.

repeated in FY04 and expanded to include a plasma physics laboratory in the school.

Plasma Camp

For the sixth year, high school physics teachers from around the country participated in "Plasma Camp." At Plasma Camp teachers study plasmas and ways to weave plasma physics into existing curricula. Each year a mixture of new and veteran teachers work collaboratively on de-



Plasma Camp teacher Duane Nickell (Franklin High School, Indianapolis, Indiana) measures the spectrum from a plasma ball before writing a lesson plan for his high school physics students.

veloping new plasma-based lessons and hands-on projects.

Scientist-in-Residence

In FY03, PPPL continued the Scientist-in-Residence Program for elementary schools. A PPPL scientist worked with an entire grade of students for an extended period of time to increase their scientific literacy and teach scientific methodology using topics that complement the school's existing curriculum. Students worked in small collaborative groups on a research topic, supported by their teacher and the PPPL scientist. During the residency, a variety of activities supporting student projects are used to foster critical thinking skills, as well as increase understanding of the current topic. This year, an eight-week "Scientist-in-Residence" program was conducted for the fifth grade of the Woodrow Wilson Elementary School in Westfield, New Jersey. The focus was on the sun, the solar system, and solar energy.

Science Bowl

Twenty-five teams from 20 area schools competed in the New Jersey Regional Competition of the National Science Bowl®. This was the eleventh year PPPL hosted the Jeopardy-like tournament in which all the categories are disciplines of science. Each team is made up of four students, a student alternate, and a teacher who serves as an advisor and coach. The Academy for the Advancement of Science and Technology in Bergen County won the competition.

Trenton Partnership

PPPL has a long tradition of utilizing the unique resources of the laboratory to aid in the improvement of science instruction for students and teachers in the Trenton, New Jersey public school district. In FY03, PPPL began a collaboration with Princeton University called "Teaching Math Counts." The focus of the program is the integration of science, mathematics, language arts, and technol-



Congressman Rush Holt (Democrat, New Jersey 12th District), far left, and the winning Science Bowl team from The Academy for the Advancement of Science and Technology, Bergen County, New Jersey.

ogy for teachers in grades kindergarten through eighth grade.

Other Activities

PPPL supported the New Jersey Institute of Technology's Mount Laurel's Women in Technology Program. This four-week course is designed to introduce female students to careers in engineering and technology. It is open to students who have completed seventh grade and have at least a B average in mathematics. In FY03, PPPL sponsored students from Trenton and Burlington area schools to attend the program.

Each year, the Douglass Science Institute Program visits PPPL for a Summer Science Exploration Day. Douglas College offers pre-college women who are interested in math, science and engineering



High school students from the Douglass College Summer Science Institute in the Plasma Science Education Laboratory.

a day of hands-on activities, a laboratory tour, and lunch with female scientists and engineers. Approximately 40 students participate in this event each year.

Awards and Honors

2002 PPPL Employee Recognition Award Recipients



Honored by their co-workers for their “personal qualities and professional achievements,” fifteen PPPLers received 2002 Employee Recognition Awards. Along with PPPL Director Rob Goldston (far right) are the recipients attending the awards ceremony. From left are: (kneeling) Elle Starkman, Patti Wieser, Evelyne Mirville, Scott Gifford, and Goldston; (standing) Jerry Siegel, Ron Davidson, Andrew Post-Zwicker, Ronnie Koon, Nevell Greenough, John DeSandro, and Steve Langish.

Individual Honors

Marc Cohen

Outstanding Co-operative Education Partner Award
Drexel University Alumni Association

John DeLooper

Distinguished Associate Award
U.S. Department of Energy

Ilya Dodin

Harold W. Dodds Honorific Fellowship
Princeton University

Nathaniel Fisch

Outstanding Mentor
U.S. Department of Energy

Hantao Ji

Award for Excellence in Plasma Physics Research
American Physical Society

Stan Kaye

Fellow
American Physical Society

John Krommes

PPPL Distinguished Research Fellow
Princeton Plasma Physics Laboratory

Robert Parsells

PPPL Distinguished Engineering Fellow
Princeton Plasma Physics Laboratory

Erik Perry

Kaul Foundation Prize for Excellence
in Plasma Physics and Technology Development
Princeton University

Andrew Post-Zwicker

Certificate of Recognition
Sigma Xi, the Scientific Research Society
Princeton Chapter

Adam Rosenberg

Congressional Science Fellowship
American Physical Society

Prateek Sharma

Thomas H. Stix '54 Plasma Physics Prize
Princeton University

Robert Simmons

Engineering and Technology Management Leadership Award
American Society of Mechanical Engineers

Ronald Strykowski
Kaul Foundation Prize for Excellence
in Plasma Physics and Technology Development
Princeton University

Masaaki Yamada
Award for Excellence in Plasma Physics Research
American Physical Society

Laboratory Honors

Gold Award
United Way
For PPPL's "Outstanding Service to the People of Our Community"

Honorable Mention Citation
U.S. Department of Energy
For PPPL's "Excellence in Project Management" for the
Tokamak Fusion Test Reactor Decontamination and Decommissioning



Princeton University physics professor and University Research Board Chair Will Happer and PPPL Director Rob Goldston present the PPPL Distinguished Research and Engineering Fellow Awards and the Kaul Foundation Prize for Excellence in Plasma Physics and Technology Development during an awards ceremony at the Laboratory. From left are Happer, Engineering Fellow recipient Robert Parsells, Goldston, Kaul Prize recipients Erik Perry and Ronald Strykowski, and Research Fellow recipient John Krommes.

The Year in Pictures

Energy Secretary Spencer Abraham visited PPPL in January with exciting news for the entire fusion community: the U.S. was joining the negotiations for ITER, a major international magnetic fusion research project. The visit included addressing staff and the media, where the Energy Secretary made the announcement, and a tour of the experimental facilities.



At left, PPPL Director Rob Goldston shows the National Spherical Torus Experiment to (from left) U.S. Congressman Rush Holt, Energy Secretary Spencer Abraham, U.S. Congressman Rodney Frelinghuysen, U.S. Department of Energy Office of Science Director Raymond Orbach, and Princeton University President Shirley Tilghman.



At right, Secretary Abraham addresses PPPL staff and friends in the Gottlieb Auditorium.



PPPL Chief Scientist Bill Tang (far right), joined by Laboratory officials and friends, cut the ribbon on the Pilot Topical Computing Facility in October. The goal of the pilot is to determine the best configuration for a full Topical Computing Facility for the Fusion Energy Science community. The facility will support computing throughout the fusion community, offering a unique capability that joins advanced computing and modeling with theory and experiment to improve advancements in the field of fusion. From left are Oak Ridge National Laboratory's Lee Berry, PPPL's Darren Wah, Geophysical Fluid Dynamics Laboratory's Brian Gross, PPPL's Steve Jardin, PPPL Director Rob Goldston, Lawrence Livermore National Laboratory's Bill Nevins, and PPPL's Doug McCune, Ernie Valeo, Steve Davis, and Tang.

PPPL's Site Protection staff showed off their finest gear and gave demonstrations at the Laboratory during Fire Prevention Week, celebrated the second week of October. With the theme, "Team UP for Fire Safety," the firefighters encouraged employees to recognize the role they play in keeping their homes — and workplace — fire safe. The Lab's firefighters offered fire extinguisher training in the Cafeteria Courtyard, as well as distributed handouts about fire safety and exhibited fire fighting clothing and equipment. PPPL Site Protection staff members Michael Loh (left) and Kevin Rhoades work at the Fire Prevention Week displays.



In October, the Laboratory celebrated "America Recycles Day" with a special program in the MBG Auditorium. The program featured a skit about recycling, as well as a report about PPPL's performance in recycling and buying recycled-content items in 2002. PPPL's Thomas McGeachen (left) and Bob Tucker participate in the skit.



On December 6, 2002, PPPL Director Rob Goldston delivered his annual “State-of-the-Lab” address to staff, discussing PPPL’s scientific programs, internal operations, and the future. “A following wind may be rising,” said Goldston, thanking the Laboratory’s line of “great supporters” in Congress, the Department of Energy, and the White House.



In March, PPPL hosted the U.S. Department of Energy’s Regional Science Bowl® competition. Twenty-nine teams and more than 40 volunteers participated in this event. PPPL Deputy Director Richard Hawryluk (standing) serves as a science judge while the East Brunswick team (at left) takes on the Academy for the Advancement of Science and Technology team from Hackensack.



In June, the Laboratory honored 33 inventors for fiscal year 2002 during the annual Patent Awareness Program Recognition Dinner at Princeton University’s Prospect House. Those attending the dinner and receiving awards were, from left, Charles Gentile, Philip Efthimion, Andrew Carpe, David Staack, Yevgeny Raitses, Charles Skinner, John Desandro, Eliot Feibush, Stephen Jardin, Scott Klasky, Erik Perry, George Ascione, John Schmidt, Kenneth Hill, Geoff Gettelfinger, Keith Rule, Robert Parsells, Irving Zatz, and Robert Woolley.



A team of PPPL staff and subcontractors safely dismantled and removed the Princeton Beta Experiment-Modification (PBX-M) during the summer. PBX-M, which operated from 1989 to 1994, also operated as PBX from 1985 to 1989 and as the Poloidal Divertor Experiment from 1978 to 1985. The cleared space is now ready for the National Compact Stellarator Experiment, which is expected to begin operations in 2008. The PBX-M vacuum vessel, loaded onto a flat-bed truck, is taken from the PPPL site. Insert shows workers securing the vessel for its journey.



In September, Department of Energy Office of Science Director Ray Orbach attended the PPPL On-site Review, which focused on the Laboratory's vision for the next decade. Facing the camera, from left, are Orbach, Toni Joseph, Director, Office of Laboratory Policy for the Department of Energy Office of Science, and PPPL Director Rob Goldston (standing). At far right with his back to the camera is PPPL Chief Scientist Bill Tang.

PPPL Financial Summary by Fiscal Year
(Thousands of Dollars)

	<u>FY99</u>	<u>FY00</u>	<u>FY01</u>	<u>FY02</u>	<u>FY03</u>
Operating Costs					
Fusion Energy Sciences					
NSTX	\$13,737	\$18,248	\$20,538	\$19,894	\$25,604
TFTR	3,640	12,101	17,402	14,936	717
NCSX	2,840	3,644	3,156	3,608	3,109
Theory and Computation	5,161	5,823	5,757	6,201	6,749
Off-site Collaborations	9,281	8,342	7,722	7,601	9,121
Off-site University Research Support	697	719	871	742	819
CDX-U	680	876	771	822	743
MRX	221	600	513	462	673
Heavy Ion Fusion	415	513	1,078	1,191	1,410
Next-step Options	1,365	900	771	749	589
Science Education Programs	652	515	593	624	667
Waste Management*	-	-	3,086	2,790	-
ITER	488	-	-	-	705
Other Fusion	784	1,077	1,369	1,442	1,700
Total Fusion Energy Sciences	\$39,961	\$53,358	\$63,627	\$61,062	52,606
Environmental Restoration and Waste Mgt					
Advanced Scientific Computing Research	\$3,564	\$3,036	\$95	\$123	-
Basic Energy Sciences	92	21	72	547	437
High Energy Physics	534	608	391	161	79
Safeguards and Security**	80	98	316	341	181
Science Laboratories Infrastructure	-	-	1,670	1,617	1,623
Other DOE	-	-	-	710	679
Total DOE Operating	\$58	\$34	\$120	\$185	\$87
Work for Others					
Federal Sponsors	\$666	596	1,111	1,424	1,958
Nonfederal Sponsors	1,612	515	596	130	170
Other DOE Facilities	348	150	425	235	103
TOTAL OPERATING COSTS	\$46,915	\$58,416	\$68,423	\$66,535	\$57,923
Capital Equipment Costs					
NSTX	\$8,503	\$5,532	\$2,393	\$1,995	\$976
TFTR	-	1,273	870	34	-
Off-site Collaborations	544	655	1,714	2,187	1,817
NCSX	-	-	-	-	4,796
All Other Fusion	426	242	917	966	200
All Other	58	1	177	-	-
TOTAL CAPITAL EQUIPMENT COSTS	\$9,531	\$7,703	\$6,071	\$5,182	\$7,789
Construction Costs					
General Plant Projects - Fusion	\$798	\$2,070	\$1,533	\$2,170	738
General Plant Projects - S&S	-	-	-	-	49
Energy Management Projects	15	110	77	64	28
Other DOE Construction	(2)	7	-	-	-
TOTAL CONSTRUCTION COSTS	\$811	\$2,187	\$1,610	\$2,234	\$815
TOTAL PPPL	\$57,257	\$68,306	\$76,104	\$73,951	\$66,527

*Waste Management transferred to the Fusion Energy Sciences Program from Environmental Restoration/Waste Management in FY2001. Waste Management transferred to an indirect funded activity in FY2003.

**Safeguards and Security became a direct funded activity in FY2001; funded through overhead prior to FY2001.

PPPL Organization

<p>Directorate</p> <p>Robert J. Goldston Director</p> <p>Richard J. Hawryluk Deputy Director</p> <p>William M. Tang Chief Scientist</p> <p>Nathaniel J. Fisch Associate Director for Academic Affairs</p> <p>John W. DeLooper Associate Director for External Affairs</p> <p>Steven M. Iverson Head, Human Resources</p> <p>Susan E. Murphy-LaMarche Deputy Head, Human Resources</p> <p>PPPL Director's Cabinet</p> <p>Robert J. Goldston Director</p> <p>Richard J. Hawryluk Deputy Director</p> <p>William M. Tang Chief Scientist</p> <p>William Happer Chair, Princeton University Research Board</p>	<p>Departments</p> <p>Advanced Projects John A. Schmidt, Head G. Hutch Neilson, Deputy</p> <p>Off-Site Research Ned R. Sauthoff</p> <p>Plasma Science and Technology Philip C. Efthimion</p> <p>National Spherical Torus Experiment Martin Peng, Program Director* Edmund J. Synakowski, Deputy Prog Dir Masayuki Ono, Project Director Michael D. Williams, Deputy Proj Dir</p> <p>Theory William M. Tang, Head Ronald C. Davidson, Deputy</p> <p>Experiment Joel C. Hosea</p> <p>Engineering and Technical Infrastructure Michael D. Williams</p> <p>Business Operations Edward H. Winkler</p> <p>Environment, Safety, and Health and Infrastructure Support John W. Anderson</p> <p><i>* from Oak Ridge National Laboratory, residing at PPPL.</i></p>
--	--

PPPL Staffing Summary by Fiscal Year

	<u>FY99</u>	<u>FY00</u>	<u>FY01</u>	<u>FY02</u>	<u>FY03</u>
Faculty	3	3	3	3	3
Physicists	89	91	97	95	94
Engineers	74	85	82	82	77
Technicians	139	197	210	166	157
Administrative	69	77	73	72	73
Office and Clerical Support	19	21	20	18	16
Total	<u>393</u>	<u>474</u>	<u>485</u>	<u>436</u>	<u>420</u>

PPPL Advisory Council

The Princeton Plasma Physics Laboratory Advisory Council advises Princeton University on the plans and priorities of the Laboratory. Members of the Advisory Council are appointed by the Board of Trustees and are chosen from other universities and organizations, and from the Board of Trustees. The Council meets annually and reports to the University President through the Provost.

Dr. Norman R. Augustine
Lockheed Martin Corporation

Dr. David E. Baldwin
General Atomics

Dr. Jonathan M. Dorfan
Stanford Linear Accelerator Facility

Professor Edward A. Frieman
Scripps Institution of Oceanography

Mr. Robert I. Hanfling
Putnam Hayes & Bartlett

Dr. William L. Kruer
Lawrence Livermore National Laboratory

Dr. Jerry D. Mahlman
Princeton University

Dr. Barrett Ripin
Research Applied

Professor Marshall N. Rosenbluth
University of California, San Diego

Publications

*Alekseyev, A.G., Darrow, D.S., Roquemore, A.L., Medley, S.S., Amosov, V.N., Krasilnikov, A.V., Prosvirin, D.V., and Tsutskikh, A.Yu., “Application of Natural Diamond Detector to Energetic Neutral Particle Measurements on NSTX,” Rev. Sci. Instrum. **74** (March 2003) 1905-1908. Presented at the *Fourteenth APS Topical Conference on High Temperature Plasma Diagnostics* (8-10 July 2002, Madison, Wisconsin).

*§Bader, A., Skinner, C.H., Roquemore, A.L., and Langish, S., “Development of an Electrostatic Dust Detector for use in a Tokamak Reactor,” Rev. Sci. Instrum. **75** (February 2004) 370-375; Princeton Plasma Physics Laboratory Report PPPL-3866 (September 2003) 24 pp.

*Balakin, A.A., Fraiman, G.M., Fisch N.J., “Hot Electrons Production in Laser Plasmas,” in the *Proceedings of the 30th European Physical Society Conference on Controlled Fusion and Plasma Physics* (7-11 July 2003, St. Petersburg, Russia), Europhysics Conference Abstracts **27A** (European Physical Society, 2003) paper P-3.82. This conference proceedings is published on CD-ROM. Papers available in PDF format at <http://eps2003.ioffe.ru/> (as of 12 November 2003).

*Balakin, A.A., Fraiman, G.M., Fisch N.J., and Malkin, V.M., “Noise Suppression and Enhanced Focusability in Plasma Raman Amplifier with Multi-frequency Pump,” in the *Proceedings of the 30th European Physical Society Conference on Controlled Fusion and Plasma Physics* (7-11 July 2003, St. Petersburg, Russia), Europhysics Conference Abstracts **27A** (European Physical Society, 2003) paper P-3.66. This conference proceedings is published on CD-ROM. Papers available in PDF format at <http://eps2003.ioffe.ru/> (as of 12 November 2003).

*§Balakin, A.A., Fraiman, G.M., Fisch N.J., and Malkin, V.M., “Noise Suppression and Enhanced Focusability in Plasma Raman Amplifier with Multi-frequency Pump,” Phys. Plasmas **10** (December 2003) 4856-4864; Princeton Plasma Physics Laboratory Report PPPL-3824 (June 2003) 9 pp.

*§Barnard, J.J., Ahle, L.E., Bieniosek, F.M., Celata, C.M., Davidson, D.P., Henestroza, E., Friedman, A., Kwan, J.W., Logan, B.G., Lee, E.P., Lund, S.M., Meier, W.R., Sabbi, G.-L., Seidl, R.A., Sharp, W.M., Shuman, D.B., Waldron, W.L., W.R., Qin, H., and Yu, S.S., “Integrated Experiments for Heavy

*First author is from another institution. PPPL co-authors are underlined.

†Paper presented at a conference in fiscal year 2003; published in fiscal year 2004.

§Submitted for publication in fiscal year 2003; published in fiscal year 2004.

Ion Fusion — The Integrated Beam Experiment and the Integrated Research Experiment,” *Laser and Particle Beams* **21** (October 2003) 553-560.

*Barnes, D.C., Belova, E.V., Davidson, R.C., Ishida, A., Ji, H., Milroy, R., Parks, P., Ryutov, D., Schaffer, M., Steinhauer, L., Yamada, M., “Field-Reversed Configuration (FRC) Equilibrium and Stability,” presented at the *Nineteenth IAEA Fusion Energy Conference* (14-19 October 2002, Lyon, France).

*Beidler, C.D., Kasilov, S.V., Kernbichler, W., Maaßberg, H., Mikkelsen, D.R., Murakami, S., Nemov, V.V., Schmidt, M., Spong, D.A., Tribaldos, V., Wakasa, A., and White, R.B., “Neoclassical Transport in Stellarators — Results from an International Collaboration,” in the *Proceedings of the 30th European Physical Society Conference on Controlled Fusion and Plasma Physics* (7-11 July 2003, St. Petersburg, Russia), *Europhysics Conference Abstracts* **27A** (European Physical Society, 2003) paper P-3.2. This conference proceedings is published on CD-ROM. Papers available in PDF format at <http://eps2003.ioffe.ru/> (as of 12 November 2003).

*Beiersdorfer, P., Bitter, M., May, M.J., and Roquemore, L., “High-resolution Soft X-ray Spectrometer for the NSTX Tokamak,” *Rev. Sci. Instrum.* **74** (March 2003) 1974-1976. Presented at the *Fourteenth APS Topical Conference on High Temperature Plasma Diagnostics* (8-10 July 2002, Madison, Wisconsin).

*Bekris, N., Skinner, C.H., Berndt, U., Gentile, C.A., Glugla, M., Schweigel, B., “Tritium Depth Profiles in 2D and 4D CFC Tiles from JET and TFTR,” *J. Nucl. Mater.* **313-316** (March 2003) 501-

506. Presented at the *15th International Conference on Plasma Surface Interactions in Controlled Fusion Devices (PSI-15)* (27-31 May 2002, Gifu, Japan).

*§Belikov, V.S., Kolesnichenko, Ya. I., and White R.B., “Destabilization of Fast Magnetoacoustic Waves by Circulating Energetic Ions in Toroidal Plasmas,” *Phys. Plasmas* **10** (December 2003) 4771-4775; Princeton Plasma Physics Laboratory Report PPPL-3855 (August 2003) 15 pp.

*Bell, A.C., Gentile, C.A., Lasser, R.L.K., and Coad, J.P., “Tritium Inventory Control — The Experience with DT Tokamaks and Its Relevance for Future Machines,” *Fusion Eng. Des.* **66-68** (September 2003) 91-102.

Belova, E.V., Davidson, R.C., Ji, H., and Yamada, M., “Kinetic Effects on the Stability Properties of Field-reversed Configurations: I. Linear Stability,” *Phys. Plasmas* **10** (June 2003) 2361-2371; Princeton Plasma Physics Laboratory Report PPPL-3773 (January 2003) 46 pp.

Belova, E.V., Davidson, R.C., Ji, H., and Yamada, M., “Nonlinear and Non-ideal Effects on FRC Stability,” Princeton Plasma Physics Laboratory Report PPPL-3759 (October 2002) 6 pp. Presented at the *2002 U.S.-Japan Workshop New Directions in Controlling and Sustaining Compact Toroids* (9-11 September 2002, Osaka, Japan).

Belova, E.V., Gorelenkov, N.N., and Cheng, C.Z., “Self-consistent Equilibrium Model of Low Aspect-ratio Toroidal Plasma with Energetic Beam Ions,” *Phys. Plasmas* **10** (August 2003) 3240-3251; Princeton Plasma Physics Laboratory Report PPPL-3802 (March 2003) 49 pp.

Belova, E.V., Gorelenkov, N.N., Cheng, C.Z., and Fredrickson, E.D., "Numerical Study of Instabilities Driven by Energetic Neutral Beam Ions in NSXT," in the Proceedings of the *30th European Physical Society Conference on Controlled Fusion and Plasma Physics* (7-11 July 2003, St. Petersburg, Russia), Europhysics Conference Abstracts **27A** (European Physical Society, 2003) paper P-3.102. This conference proceedings is published on CD-ROM. Papers available in PDF format at <http://eps2003.ioffe.ru/> (as of 12 November 2003). Princeton Plasma Physics Laboratory Report PPPL-3832 (July 2003) 6 pp.

Bernabei, S., Hosea, J., Kung, C., Loesser, D., Rushinski, J., Wilson, J.R., and Parker, R., "Design of a Compact Lower Hybrid Coupler for Alcator C-mod," *Fusion Sci. Technol.* **43** (March 2003) 145-152; Princeton Plasma Physics Laboratory Report PPPL-3638 (December 2001) 14 pp (title: A Third Generation Lower Hybrid Coupler).

†Biewer, T.M., Bell, R.E., Darrow, D.S., Phillips, C.K., and Wilson, J.R., "Observations of Anisotropic Ion Temperature during RF Heating in the NSTX Edge," *AIP Conference Proceedings* **694** (15 December 2003) 193-196; Princeton Plasma Physics Laboratory Report PPPL-3813 (May 2003) 4 pp. Presented at the *15th AIP Topical Conference on Radio Frequency Power in Plasmas* (19-21 May 2003, Grand Teton National Park, Moran, Wyoming).

§Biewer, T.M., Bell, R.E., Feder, R., Johnson, D.W., and Palladino, R.W., "An Edge Rotation and Temperature Diagnostic on NSTX," *Rev. Sci. Instrum.* **75** (March 2004) 650-654; Princeton

Plasma Physics Laboratory Report PPPL-3862 (August 2003) 6 pp.

§Bitter, M., Gu, M.F., Vainshtein, L.A., Beiersdorfer, P., Bertschinger, G., Marchuk, O., Bell, R., LeBlanc, B., Hill, K.W., Johnson, D., and Roquemore L., "New Benchmarks from Tokamak Experiments for Theoretical Calculations of the Dielectronic Satellite Spectra of Helium-like Ions," *Phys. Rev. Lett.* **91** (31 December 2003) 265001/1-4; Princeton Plasma Physics Laboratory Report PPPL-3860 (August 2003) 13 pp.

Bitter, M., Hill, K., Roquemore, L., Beiersdorfer, P., Thorn, D., and Gu, Ming Feng, "Results from the NSTX X-ray Crystal Spectrometer," *Rev. Sci. Instrum.* **74** (March 2003) 1977-1981; Princeton Plasma Physics Laboratory Report PPPL-3766 (January 2003) 19 pp. Presented at the *Fourteenth APS Topical Conference on High Temperature Plasma Diagnostics* (8-10 July 2002, Madison, Wisconsin).

*Blagojevic, B., Stutman, D., Finkenthal, M., Moos, H.W., Kaita, R., and Majeski, R., "Imaging Transmission Grating Spectrometer for Magnetic Fusion Experiments," *Rev. Sci. Instrum.* **74** (March 2003) 1988-1992. Presented at the *Fourteenth APS Topical Conference on High Temperature Plasma Diagnostics* (8-10 July 2002, Madison, Wisconsin).

*Bourdelle, C., Dorland, W., Garbet, X., Hammett, G.W., Kotschenreuther, M., Rewoldt, G., Synakowski, E.J., "Stabilizing Impact of High Gradient of Beta on Microturbulence," *Phys. Plasmas* **10** (July 2003) 2881-2887.

Breslau, J., Chen, J., Fu, G., Held, E., Jardin, S., Kruger, S., Park, W., Parker, S., Samtaney, R., Schnack, D., Sovinec,

C., Sugiyama, L., and Strauss, H., "Nonlinear Plasma Simulation Studies of Tokamaks, STs, and Stellarators," in the *Proceedings of the 30th European Physical Society Conference on Controlled Fusion and Plasma Physics* (7-11 July 2003, St. Petersburg, Russia), Europhysics Conference Abstracts **27A** (European Physical Society, 2003) paper P-2.103. This conference proceedings is published on CD-ROM. Papers available in PDF format at <http://eps2003.ioffe.ru/> (as of 12 November 2003).

Breslau, J.A. and Jardin, S.C., "A Parallel Algorithm for Global Magnetic Reconnection Studies," *Comput. Phys. Commun.* **151** (1 March 2003) 8-24.

Breslau, J.A. and Jardin, S.C., "Global Extended MHD Studies of Fast Magnetic Reconnection," *Phys. Plasmas* **10** (May 2003) 1291-1298; Princeton Plasma Physics Laboratory Report PPPL-3751 (September 2002) 16 pp.

Breslau, J.A., Jardin, S.C., and Park, W., "Simulation Studies of the Role of Reconnection in the 'Current Hole' Experiments in the Joint European Torus," *Phys. Plasmas* **10** (May 2003) 1665-1669; Princeton Plasma Physics Laboratory Report PPPL-3770 (January 2003) 10 pp.

Budny, R.V., "Fusion Alpha Parameters in Tokamaks with High DT Fusion Rates," *Nucl. Fusion* **42** (December 2002) 1383-1393; Princeton Plasma Physics Laboratory Report PPPL-3674 (February 2002) 25 pp.

Budny, R.V., Andre, R., Challis, C.D., Dorland, W., Dux, R., Ernst, D.R., Giroud, C., Gowers, C.W., Greenfield, C.M., Hawkes, N., Hammett, G.,

Houlberg, W., Luce, T.C., Makowski, M.A., Mikkelsen, D., Murakami, M., Prentice, R., Staebler, G., Stratton, B., Wade, M., West, W.P., and contributors to the EFDA-JET and DIII-D Work Programs, "Microturbulence, Heat, and Particle Fluxes in JET and DIII-D ITB Plasmas with Highly Reversed Magnetic Shear," in the *Proceedings of the 30th European Physical Society Conference on Controlled Fusion and Plasma Physics* (7-11 July 2003, St. Petersburg, Russia), Europhysics Conference Abstracts **27A** (European Physical Society, 2003) paper O-3.4A. This conference proceedings is published on CD-ROM. Papers available in PDF format at <http://eps2003.ioffe.ru/> (as of 12 November 2003). Princeton Plasma Physics Laboratory Report PPPL-3841 (July 2003) 4 pp.

*Bush, C.E., Bell, M.G., Bell, R.E., Boedo, J., Fredrickson, E.D., Kaye, S.M., Kubota, S., LeBlanc, B.P., Maingi, R., Maqueda, R.J., Sabbagh, S.A., Soukhanovskii, V.A., Stutman, D., Swain, D.W., Wilgen, J.B., Zweben, S.J., Davis, W.M., Gates, D.A., Johnson, D.W., Kaita, R., Kugel, H.W., Lee, K.C., Mastrovito, D., Medley, S., Menard, J.E., Mueller, D., Ono, M., Paoletti, F., Park, H., Paul, S.J., Peng, Y-K.M., Raman, R., Roney, P.G., Roquemore, A.L., Skinner, C.H., Synakowski, E.J., Taylor, G., for the NSTX team, "Configuration and Heating Power Dependence of Edge Parameters and H-mode Dynamics in National Spherical Torus Experiment (NSTX)," *Phys. Plasmas* **10** (May 2003) 1755-1764.

*Cecil, F.E., Aakhus-Witt, A., Hawbaker, J., Sayers, J., Bozek, A., Heidbrink, W.W., Darrow, D.S., Debey, T.M., and Marmor, E., "Thin Foil Faraday Collectors as a Radiation Hard Fast Lost-

ion Diagnostic,” *Rev. Sci. Instrum.* **74** (March 2003) 1747-1749. Presented at the *Fourteenth APS Topical Conference on High Temperature Plasma Diagnostics* (8-10 July 2002, Madison, Wisconsin).

*Celata, C.M., Bieniosek, F.M., Henestroza, E., Kwan, J.W., Lee, E.P., Logan, G., Prost, L., Seidl, P.A., Vay, J.-L., Waldron, W.L., Yu, S.S., Barnard, J.J., Callahan, D.A., Cohen, R.H., Friedman, A., Grote, D.P., Lund, S.M., Molvik, A., Sharp, W.M., Westenskow, G., Davidson, R.C., Efthimion, P., Gilson, E., Grisham, L.R., Kaganovich, I., Qin, Hong, Startsev, E.A., Bernal, S., Cul, Y., Feldman, D., Godlove, T.F., Harber, I., Harris, J., Kishek, R.A., Li, H., O’Shea, P.G., Quinn, B., Reiser, M., Valfells, A., Walter, M., Zou, Y., Rose, D.V., and Welch, D.R., “Progress in Heavy Ion Fusion Research,” *Phys. Plasmas* **10** (May 2003) 2064-2070.

Chance, M.S., Chu, M.S., Glasser, A.H., Okabayashi, M., Perkins, F.W., Garofalo, A., Navratil, G., Jackson, G., LaHaye, R., Reimerdes, H., Scoville, T., Strait, E., and Edgell, D., “Modeling of the Feedback Stabilization of the Resistive Wall Mode in Tokamaks,” in the *Proceedings of the 30th European Physical Society Conference on Controlled Fusion and Plasma Physics* (7-11 July 2003, St. Petersburg, Russia), *Europhysics Conference Abstracts* **27A** (European Physical Society, 2003) paper P-2.109. This conference proceedings is published on CD-ROM. Papers available in PDF format at <http://eps2003.ioffe.ru/> (as of 12 November 2003).

*§Chen, Liu; White, Roscoe B.; and Zonca, F., “Zonal Flow Dynamics and Size-scaling of Anomalous Transport,” *Phys. Rev. Lett.* **92** (20 February 2004)

075004/1-4; Princeton Plasma Physics Laboratory PPPL-3847 (July 2003) 9 pp.

§Cheng, C.Z., Ren, Y., Choe, G.S., and Moon, Y.-J., “Flux Rope Acceleration and Enhanced Magnetic Reconnection Rate,” *Astrophys. J. Lett.* **596** (20 October 2003) 1341-1346; Princeton Plasma Physics Laboratory PPPL-3799 (March 2003) 19 pp.

*Chu, M.S., LaHaye, R.J., Austin, M.E., Lao, L.L., Lazarus, E.A., Pletzer, A., Ren, C., Strait, E.J., Taylor, T.S., and Waelbroeck, F.L., “Study of a Low Beta Classical Tearing Mode in DIII-D,” *Phys. Plasmas* **9** (November 2002) 4584-4590.

Chu, T.K., “On the Node in the Current Density Profile during Current Peaking in a Sawtooth Oscillation,” *Phys. Plasmas* **9** (October 2002) 4383-4384.

Clark, Daniel S. and Fisch, Nathaniel J., “Operating Regime for a Backward Raman Laser Amplifier in Preformed Plasma,” *Phys. Plasmas* **10** (August 2003) 3363-3370; Princeton Plasma Physics Laboratory Report PPPL-3780 (February 2003) 9 pp.

§Clark, Daniel S. and Fisch, Nathaniel J., “Simulations of Raman Laser Amplification in Ionizing Plasmas,” *Phys. Plasmas* **10** (December 2003) 4837-4847; Princeton Plasma Physics Laboratory Report PPPL-3829 (June 2003) 12 pp (title: Particle-in-cell Simulations of Raman Laser Amplification in Ionizing Plasmas).

§Clark, Daniel S., and Fisch, Nathaniel J., “Particle-in-cell Simulations of Raman Laser Amplification in Preformed

Plasmas,” *Phys. Plasmas* **10** (December 2003) 4848-4855; Princeton Plasma Physics Laboratory Report PPPL-3830 (June 2003) 8 pp.

Cohen, S.A., Siefert, N.S., Stange, S., Boivin, R.F., Scime, E.E., and Levinton, F.M., “Ion Acceleration in Plasmas Emerging from a Helicon-heated Magnetic-mirror Device,” *Phys. Plasmas* **10** (June 2003) 2593-2598; Princeton Plasma Physics Laboratory Report PPPL-3793 (March 2003) 10 pp

*Cooper, W.A., Ferrando, I., Margalet, S., Allfrey, S.J., Isaev, M.Yu., Mikhailov, M.I., Shafranov, V.D., Subbotin, A.A., Narushima, Y., Okamura, S., Suzuki, C., Yamazaki, K., Fu, G.Y. Ku, L.P., Monticello, D.A., Redi, M.H., Reiman, A.H., Zarnstorff, M.C., Nuhrenberg, J., and Todd, T.N., “Bootstrap Current Destabilization of Ideal MHD Modes in Three-dimensional Reactor Configurations,” *Plasma Phys. Control. Fusion* **44** (December 2002) B357-373. Presented at the *29th European Physical Society on Plasma Physics and Controlled Fusion* (17-21 June 2002, Montreux, Switzerland).

*Cortes, S.R., Hawkes, N.C. Lotte, P., Fenzi, C., Stratton, B.C., Hobirk, J., DeAngelis, R., Orsitto, F., and Varandas, C.A.F., “Measurement of the Plasma Radial Electric Field by the Motional Stark Effect diagnostic on JET Plasmas,” *Rev. Sci. Instrum.* **74** (March 2003) 1596-1600. Presented at the *Fourteenth APS Topical Conference on High Temperature Plasma Diagnostics* (8-10 July 2002, Madison, Wisconsin).

Darrow, D.S., Medley, S.S., Roquemore, A.L., Heidbrink, W.W., Alekseyev, A.,

Cecil, F.E., Egedal, J., Goloborod’ko, V.Ya., Gorelenkov, N.N., Isobe, M., Kaye, S., Miah, M., Paoletti, F., Redi, M.H., Reznik, S.N., Rosenberg, A., White, R., Wyatt, D., and Yavorskij, V.A., “Measurements of Prompt and MHD-induced Fast Ion Loss from National Spherical Torus Experiment Plasmas” Princeton Plasma Physics Laboratory Report PPPL-3754 (October 2002) 5 pp. Presented at the *Nineteenth IAEA Fusion Energy Conference* (14-19 October 2002, Lyon, France).

Davidson, R.C., “Frontiers in High Energy Density Physics: The X-Games of Contemporary Science,” Committee on High Energy Density Plasma Physics (R.C. Davidson, Chair) Plasma Science Committee/Board on Physics and Astronomy Division on Engineering and Physical Science/Nation Research Council of the National Academies (National Academies Press, Washington, DC, 2003).

Davidson, R.C., Kaganovich, I.D., Lee, W.W., Qin, H., Startsev, E.A., Tzenov, S., Friedman, A., Barnard, J.J., Cohen, R.H., Grote, D.P., Lund, S.M., Sharp, W.M., Celata, C.M., de Hoon, M., Henestroza, E., Lee, E.P., Yu, S.S., Vay, J.-L., Welch, D.R., Rose, D.V., and Olson, C. L., “Overview of Theory and Modeling in the Heavy Ion Fusion Virtual National Laboratory,” *Laser and Particle Beams* **20** (July 2002) 377-384; Princeton Plasma Physics Laboratory Report PPPL-3804 (April 2003) 18 pp.

Davidson, Ronald C., Qin, Hong, and Lund, Steven, M., “Truncated Thermal Equilibrium Distribution for Intense Beam Propagation,” *Phys. Rev. ST Accel. Beams* **6** (February 2003) Article No.

024402 (8 pages); Princeton Plasma Physics Laboratory Report PPPL-3790 (February 2003) 16 pp.

Davidson, Ronald C.; Qin, Hong; and Shvets, Gennady, "Wall-impedance-driven Collective Instability in Intense Charged Particle Beams," *Phys. Rev. ST Accel. Beams* **6** (October 2003) Article No. 104402 (12 pages).

Davidson, Ronald C.; Qin, Hong; Tzenov, Stephan I.; and Startsev, Edward A., "Kinetic Description of Intense Beam Propagation Through a Periodic Focusing Field for Uniform Phase-space Density," *Phys. Rev. ST Accel. Beams* **5** (August 2002) Article No. 084402 (16 pages); Princeton Plasma Physics Laboratory Report PPPL-3789 (February 2003) 35 pp.

Davis, W. and Mastrovito, D., "DbAccess: Interactive Statistics and Graphics for Plasma Physics Databases," Princeton Plasma Physics Laboratory Report PPPL-3880 (October 2003) 6 pp. Presented at the *4th IAEA Technical Committee Meeting on Control, Data Acquisition, and Remote Participation for Fusion Research* (21-23 July 2003, San Diego, California); proceedings to be published by Fusion Engineering and Design.

*Deng, B.H., Chen, H.C., Domier, C.W., Johnson, M., Lee, K.C., Luhmann, N.C., Jr., Nathan, B.R., and Park, H., "Development of a Multichannel Far-infrared Tangential Interferometer/Polarimeter for the National Spherical Torus Experiment," *Rev. Sci. Instrum.* **74** (March 2003) 1617-1620. Presented at the *Fourteenth APS Topical Conference on High Temperature Plasma Diagnostics* (8-10 July 2002, Madison, Wisconsin).

Dodin, I.Y. and Fisch, N.J., "Relativistic Electron Acceleration in Focused Laser Fields after Above-threshold Ionization," *Phys. Rev. E* **68** (18 November 2003) 056402/1-8; Princeton Plasma Physics Laboratory Report PPPL-3805 (April 2003) 12 pp (title: GeV Electrons Acceleration in Focused Laser Fields after Above-threshold Ionization).

Dodin, I.Y., Fisch, N.J., and Fraiman, G.M., "Drift Lagrangian for Relativistic Particle in Intense Laser Field," *JETP Lett.* **78** (2003) 202; Princeton Plasma Physics Laboratory Report PPPL-3778 (February 2003) 5 pp with the title: "Lagrangian Formulation of Relativistic Particle Average Motion in a Laser Field of Arbitrary Intensity."

*Dodin, I.Y., Fraiman, G.M., Malkin, V.M., and Fisch, N.J., "Amplification of Short Laser Pulses by Raman Back-scattering in Capillary Plasmas," *J. Exp. Theor. Phys. (Russian)* **95** (October 2002) 625-638 [Russian citation: *Zh. Eksp. Teor. Fiz.* **122** (October 2002) 723-737].

Dorf, L., Raitses, Y., and Fisch, N.J., "Diagnostic Setup for Characterization of Near-anode Processes in Hall Thrusters," Princeton Plasma Physics Laboratory Report PPPL-3817 (May 2003) 4 pp. Presented at the *28th International Electric Propulsion Conference (IEPC 2003)* (17-21 March 2003, Toulouse, France). Proceedings published on CD-ROM.

Dorf, L., Raitses Y., and Fisch, N.J., "Diagnostic Setup for Characterization of Near-anode Processes in Hall Thrusters," Princeton Plasma Physics Laboratory Report PPPL-3864 (September 2003) 17

pp; to be published in the May 2004 issue of Review of Scientific Instruments with the title "Electrostatic Probe Apparatus for Measurements in the Near-anode Region of Hall Thrusters."

*Drevlak, M., Heyn, M.F., Kalyuzhnyj, V.N., Kasilov, S.V., Kernbichler, W., Monticello, D., Nemov, V.V., Nührenberg, J., and Reiman, A., "Effective Ripple for the W7-X Magnetic Field Calculated by the PIES Code," in the *Proceedings of the 30th European Physical Society Conference on Controlled Fusion and Plasma Physics* (7-11 July 2003, St. Petersburg, Russia), Europhysics Conference Abstracts **27A** (European Physical Society, 2003) paper P-1.12. This conference proceedings is published on CD-ROM. Papers available in PDF format at <http://eps2003.ioffe.ru/> (as of 12 November 2003).

*Drevlak, M., Heyn, M.F., Kasilov, S.V., Kernbichler, W., Monticello, D., Nemov, V.V., Nührenberg, J., and Reiman, A., "Bootstrap Current for Neoclassically Optimized Stellarator Systems," in the *Proceedings of the 30th European Physical Society Conference on Controlled Fusion and Plasma Physics* (7-11 July 2003, St. Petersburg, Russia), Europhysics Conference Abstracts **27A** (European Physical Society, 2003) paper P-4.15. This conference proceedings is published on CD-ROM. Papers available in PDF format at <http://eps2003.ioffe.ru/> (as of 12 November 2003).

Dunaevsky, A. and Fisch, N.J., "Measuring the Plasma Density of a Ferroelectric Plasma Source in an Expanding Plasma," *J. Appl. Phys.* **95** (May 2004) 4621-4626.

Dunaevsky, A., Raitses, Y., and Fisch, N.J., "Ferroelectric Cathodes in Transverse

Magnetic Fields," *J. Appl. Phys.* **93** (15 March 2003) 3481-3485; Princeton Plasma Physics Laboratory Report PPPL-3731 (July 2002) 12 pp.

Dunaevsky, A., Raitses, Y., and Fisch, N.J., "Secondary Electron Emission from Dielectric Materials of a Hall Thruster with Segmented Electrodes," *Phys. Plasmas* **10** (June 2003) 2574-2577; Princeton Plasma Physics Laboratory Report PPPL-3787 (February 2003) 16 pp.

Dunaevsky, A., Raitses, Y., and Fisch, N.J., "Yield of Secondary electron Emission from Ceramic Materials of Hall Thruster with Segmented Electrodes," presented at the *28th International Electric Propulsion Conference (IEPC 2003)* (17-21 March 2003, Toulouse, France). Proceedings published on CD-ROM.

Efthimion, P.C., Davidson, R.C., Gilson, E.P., Grisham, L.R., Yu, S.S., and Logan, B. Grant, "RF Plasma Source for Heavy Ion Beam Charge Neutralization," in the *Proceedings of the 2003 Particle Accelerator Conference (PAC2003)* **4** (12-16 May 2003, Portland, Oregon) 2661-2663.

Efthimion, Philip C.; Gilson, Erik; Grisham, Larry; Kolchin, Pavel; Davidson, Ronald C.; Yu, Simon; and Logan, B. Grant, "ECR Plasma Source for Heavy Ion Beam Charge Neutralization," *Laser and Particle Beams* **21** (January 2003) 37-40.

Efthimion, P.C., Taylor, G., Jones, B., Munsat, T., Hosea, J.C., Kaita, R., Majeski, R., Spaleta, J., Wilson, J.R., Rasmussen, D.A., Wilgen, J., Bell, G., Ram, A.K., Bers, A., Decker, J., Harvey, R.W., Smirnov, A.P., Lashmore-Davies, C.N., "Application of Electron Bernstein Wave Heating and Current Drive to High

β Plasmas,” presented at the *Nineteenth IAEA Fusion Energy Conference* (14-19 October 2002, Lyon, France).

*Egedal, J., Redi, M.H., Darrow, D.S., and Kaye, S.M., “Efficient Evaluation of Beam Ion Confinement in Spherical Tokamaks,” *Phys. Plasmas* **10** (June 2003) 2372-2381.

Ethier, S. and Lin, Z., “Porting the 3D Gyrokinetic Particle-in-cell Code GTC to the CRAY/NECSX-6 Vector Architecture: Perspectives and Challenges,” *Plasma Physics Laboratory Report PPPL-3869* (September 2003) 4 pp. Presented at the *18th International Conference on Numerical Simulation of Plasmas (ICNSP '03)* (7-10 September 2003, Cape Cod, Massachusetts).

*Federici, G. and Skinner, C.H., “Tritium Inventory in the Materials of the ITER Plasma Facing Components,” in the *Proceedings of the IAEA Technical Meeting on Atomic and Plasma-Material Interaction Data for Fusion Science and Technology* (28-31 October 2002, FZ Jülich, Germany). Springer Publishing Company (Heidelberg) Series on Atoms and Plasmas Editors R. Clark (IAEA) and D. Reiter (FZJ) (summer 2003).

Fisch, N.J. and Malkin, V.M., “Generation of Ultrahigh Intensity Laser Pulses,” *Phys. Plasmas* **10** (May 2003) 2056-2063; Princeton Plasma Physics Laboratory Report PPPL-3821 (June 2003) 10 pp.

§Fisch, N.J., Rax, J.M., and Dodin, I.Y., “Current Drive in a Ponderomotive Potential with Sign Reversal,” *Phys. Rev. Lett.* **91** (14 November 2003) 205004/1-4; Princeton Plasma Physics Laboratory Report PPPL-3846 (July 2003) 5 pp.

Fredrickson, E.D., Cheng, C.Z., Darrow, D., Fu, G., Gorelenkov, N.N., Kramer, G., Medley, S.S., Menard, J., Roquemore, L., Stutman, D., and White, R.B., “Wave Driven Fast Ion Loss in the National Spherical Torus Experiment,” *Phys. Plasmas* **10** (July 2003) 2852-2862; Princeton Plasma Physics Laboratory Report PPPL-3774 (January 2003) 31 pp.

Fredrickson, E.D., Cheng, C.Z., Darrow, D., Fu, G., Gorelenkov, N.N., Kramer, G., Medley, S.S., Menard, J., Roquemore, L., Stutman, D., and White, R.B., “Wave Driven Fast Ion Loss in the National Spherical Torus Experiment,” in the *Proceedings of the 30th European Physical Society Conference on Controlled Fusion and Plasma Physics* (7-11 July 2003, St. Petersburg, Russia), *Europhysics Conference Abstracts* **27A** (European Physical Society, 2003) paper P-3.99. This conference proceedings is published on CD-ROM. Papers available in PDF format at <http://eps2003.ioffe.ru/> (as of 12 November 2003). Princeton Plasma Physics Laboratory Report PPPL-3851 (August 2003) 4 pp.

Fredrickson, E.D., White, Roscoe, and Chen, Liu, “Bounce Precession Fishbones in the National Spherical Tokamak Experiment,” *Nucl. Fusion* **43** (October 2003) 1258-1264; Princeton Plasma Physics Laboratory Report PPPL-3715 (June 2002) 12 pp.

*Fujita, T., Aniel, T., Barbato, E., Behn, R., Bell, R.E., Field, A.R., Fukuda, T., Gohil, P., Ida, K., Imbeaux, F., Kirneva, N.A., Laborde, L., Litaudon, X., Mazon, D., Peng, Y-K.M., Razumova, K.A., Rice, J.E., Sakamoto, Y., Sips, A.C.C., Suzuki, T., Takenaga, H., the ITPA Topical Group on Transport and ITB Physics, and the International ITB Database

Working Group, "Key Quantities for ITB Formation and Sustainment," in the *Proceedings of the 30th European Physical Society Conference on Controlled Fusion and Plasma Physics* (7-11 July 2003, St. Petersburg, Russia), Europhysics Conference Abstracts **27A** (European Physical Society, 2003) paper P-2.131. This conference proceedings is published on CD-ROM. Papers available in PDF format at <http://eps2003.ioffe.ru/> (as of 12 November 2003).

*Gao, Qingdi; Li, Fangzhu; Zhang, Jinhua; and Budny, R.V., "Establishment of Transport Barriers by Profile Control in HL-2A⁺," in the *Proceedings of the 30th European Physical Society Conference on Controlled Fusion and Plasma Physics* (7-11 July 2003, St. Petersburg, Russia), Europhysics Conference Abstracts **27A** (European Physical Society, 2003) paper P-1.149. This conference proceedings is published on CD-ROM. Papers available in PDF format at <http://eps2003.ioffe.ru/> (as of 12 November 2003).

*Garbet, X., Baranov, Y., Bateman, G., Benkadda, S., Beyer, P., Budny, R., *et al.*, "Micro-stability and Transport Modelling of Internal Transport Barriers in JET," presented at the *Nineteenth IAEA Fusion Energy Conference* (14-19 October 2002, Lyon, France).

Gates, D.A., for the NSTX Research Team, "High Beta, Long Pulse, Bootstrap Sustained Scenarios on the National Spherical Torus Experiment (NSTX)," *Phys. Plasmas* **10** (May 2003) 1659-1664; Princeton Plasma Physics Laboratory Report PPPL-3791 (February 2003) 31 pp.

Gentile, C.A., Fan, H.M., Hartfield, J.W., Hawryluk, R.J., Hegeler, F., Heitzenroeder, P.J., Jun, C.H., Ku,

L.P., LaMarche, P.H., Myers, M.C., Parker, J.J., Parsells, R.F., Payen, M., Raftopoulos, S., and Sethian, J.K., "Development of a Silicon Based Electron Beam Transmission Window for use in a KrF Excimer Laser System," *Fusion Sci. Technol.* **43** (May 2003) 414-419; Princeton Plasma Physics Laboratory Report PPPL-3760 (November 2002) 20 pp. Presented at the *Second IAEA Technical Committee Meeting on Physics and Technology of Inertial Fusion Energy Targets and Chambers* (17-19 June 2002, San Diego, California).

Gilson, E., Davidson, R.C., Efthimion, P., Majeski R., and Qin, H., "Paul Trap Simulator Experiment," *Laser and Particle Beams* **21** (October 2003) 549-552.

Gilson, E.P., Davidson, R.C., Efthimion, P.C., Majeski R., and Qin, H., "Recent Results from the Paul Trap Simulator," in the *Proceedings of the 2003 Particle Accelerator Conference (PAC2003)* **4** (12-16 May 2003, Portland, Oregon) 2655-2657.

†Gilson, E.P., Davidson, R.C., Efthimion, P.C., Majeski R., Qin, H., and Startsev, E.A., "Modeling Intense Beam Propagation in the Paul Trap Simulator Experiment (PTSX)," *AIP Conference Proceedings* **692** (2 December 2003) 211-220. Presented at the *2003 Workshop on Non-neutral Plasmas* (7-11 July 2003, Santa Fe, New Mexico).

Gorelenkov, N.N., Berk, H.L., Budny, R., Cheng, C.Z., Fu, G.-Y., Heidbrink, W.W., Kramer, G.J., Meade, D., and Nazikian, R., "Study of Thermonuclear Alfvén Instabilities in Next Step Burning Plasma Proposals," *Nucl. Fusion* **43** (July 2003) 594-605.

Gorelenkov, N.N., Fredrickson, E., Belova, E., Cheng, C.Z., Gates, D., and White R., "Sub-cyclotron Instability of Alfvén Eigenmodes due to Energetic Ions in Low Aspect Ratio Plasmas," in the *Proceedings of the 30th European Physical Society Conference on Controlled Fusion and Plasma Physics* (7-11 July 2003, St. Petersburg, Russia), Europhysics Conference Abstracts **27A** (European Physical Society, 2003) paper P-3.103. This conference proceedings is published on CD-ROM. Papers available in PDF format at <http://eps2003.ioffe.ru/> (as of 12 November 2003). Princeton Plasma Physics Laboratory Report PPPL-3857 (August 2003) 4 pp.

Gorelenkov, N.N., Fredrickson, E., Belova, E., Cheng, C.Z., Gates, D., Kaye, S., and White, R., "Theory and Observations of High Frequency Alfvén Eigenmodes in Low Aspect Ratio Plasma," *Nucl. Fusion* **43** (April 2003) 228-233; Princeton Plasma Physics Laboratory Report PPPL-3828 (June 2003) 17 pp.

Gorelenkov, N.N., Gondhalekar, A., Korotkov, A.A., Sharapov, S.E., Testa, D., and Contributors to the EFDA-JET Workprogramme, "Mechanism of Radial Redistribution of Energetic Trapped Ions Due to $m=2/n=1$ Internal Reconnection in Joint European Torus Shear Optimized Plasmas," *Phys. of Plasmas* **10** (March 2003) 713-725; Princeton Plasma Physics Laboratory Report PPPL-3653 (January 2002) 31 pp.

Gorelenkov, N.N., Mantsinen, M.J., Sharapov, S.E., Cheng, C.Z., and the JET-EFDA Contributors, "Modeling of ICRH H-minority-driven $n=1$ Resonant Modes in JET," in the *Proceedings of the 30th European Physical Society Conference on Controlled Fusion and Plasma Physics*

(7-11 July 2003, St. Petersburg, Russia), Europhysics Conference Abstracts **27A** (European Physical Society, 2003) paper P-2.100. This conference proceedings is published on CD-ROM. Papers available in PDF format at <http://eps2003.ioffe.ru/> (as of 12 November 2003). Princeton Plasma Physics Laboratory Report PPPL-3858 (August 2003) 4 pp.

Gorelenkov, N.N., Zakharov, L.E., and Gorelenkova, M.V., "Toroidal Plasma Thruster for Interplanetary and Interstellar Space Flights," *AIAA Journal* **42** (May 2003) 774-784; Princeton Plasma Physics Laboratory Report PPPL-3592 (July 2001) 30 pp.

*Graves, J.P., Sauter, O., Gorelenkov, N.N., "The Internal Kink Mode in an Anisotropic Flowing Plasma with Application to Modeling Neutral Beam Injected Sawtooth Discharges," *Phys. Plasmas* **10** (April 2003) 1034-1047.

*Greenfield, C.M., Ferron, J.R., Murakami, M., Wade, M.R., Budny, R.V., Burrell, K.H., Casper, T.A., DeBoo, J.C., Doyle, E.J., Garofalo, A.M., Jayakumar, R.J., Kessel, C., Lao, L.L., Lohr, J., Luce, T.C., Makowski, M.A., Menard, J.E., Petrie, T.W., Petty, C.C., Pinsker, R.I., Prater, R., Politzer, P.A., St. John, H.E., Taylor, T.S., West, W.P., and the DIII-D National Team, "Progress Toward Fully Noninductive, High Beta Discharges in DIII-D," in the *Proceedings of the 30th European Physical Society Conference on Controlled Fusion and Plasma Physics* (7-11 July 2003, St. Petersburg, Russia), Europhysics Conference Abstracts **27A** (European Physical Society, 2003) paper P4.92. This conference proceedings is published on CD-ROM. Papers available in PDF format at <http://eps2003.ioffe.ru/> (as of 12 November 2003).

Grisham, L.R., "Potential Roles for Heavy Negative Ions as Driver Beams" to appear in GSI Plasma Physics Scientific Report "High Energy Density in Matter," Chapter 4 (2003), and in *Laser and Particle Beams* **21** (October 2003) 545-548, proceedings of the Heavy Ion Fusion Conference (May 2002, Moscow, Russia).

Grisham, Larry R., "Evaluation of Negative-Ion-Beam Driver Concepts for Heavy Ion Fusion," *Fusion Sci. Techn.* **43** (March 2003) 191-199; Princeton Plasma Physics Laboratory Report PPPL-3643 (January 2002) 18 pp.

Grisham, L.R., Hahto, S.K., Hahto, S.T., Kwan, J.W., Leung, K.N., "Proof-of-Concept Experiments for Negative Ion Driver Beams for Heavy Ion Fusion," in the *Proceedings of the 2003 Particle Accelerator Conference (PAC2003)* **5** (12-16 May 2003, Portland, Oregon) 3309-3311; Princeton Plasma Physics Laboratory Report PPPL-3811 (May 2003) 3 pp.

*Hahto, S.K., Hahto, S.T., Kwan, J.W., Leung, K.N., and Grisham, L.R., "Negative Chlorine Ions from Multicusp Ratio Frequency Ion Source for Heavy Ion Fusion Applications," *Rev. Sci. Instrum.* **74** (June 2003) 2987-2991.

§Hammett, G.W., Jardin, S.C., and Stratton, B.C., "Non-existence of Normal Tokamak Equilibria with Negative Central Current," *Phys. Plasmas* **10** (October 2003) 4048-4052; Princeton Plasma Physics Laboratory Report PPPL-3788 (February 2003) 5 pp (title: On the Existence of Tokamak Equilibria with Negative Central Current).

*Heidbrink, W.W., Fredrickson, E., Gorelenkov, N.N., Hyatt, A.W., Kramer, G., and Luo, Y., "An Alfvén Eigenmode Similarity Experiment," *Plasma Phys. Control. Fusion* **45** (June 2003) 983-997.

*Heidbrink, W.W., Miah, M., Darrow, D., LeBlanc, B., Medley, S.S., Roquemore, A.L., and Cecil, F.E., "The Confinement of Dilute Populations of Beam Ions in the National Spherical Torus Experiment," *Nucl. Fusion* **43** (August 2003) 883-888.

*Hender, T.C., Sauter, O., Alper, B., Angioni, C., de Baar, M., De Benedetti, M., Belo, P., Bigi, M., Borba, D.N., Bolzonella, T., Budny, R., et al., "Sawtooth, Neo-classical Tearing Mode and Error Field Studies in JET," presented at the *Nineteenth IAEA Fusion Energy Conference* (14-19 October 2002, Lyon, France).

Hudson, S.R. and Hegna, C.C., "Marginal Stability Boundaries for Infinite-n Ballooning Modes in a Quasi-axisymmetric Stellarator," *Phys. Plasmas* **10** (December 2003) 4716-4727; Princeton Plasma Physics Laboratory Report PPPL-3871 (September 2003) 31 pp.

Hudson, S.R., Monticello, D.A., Reiman, A.H., Boozer, A.H., Strickler, D.J., Hirshman, S.P., and Zarnstorff, M.C., "Eliminating Islands in High-pressure Free-boundary Stellarator Magnetohydrodynamic Equilibrium Solutions" *Phys. Rev. Lett.* **89** (30 December 2002) 275003/1-4; Princeton Plasma Physics Laboratory Report PPPL-3762 (November 2002) 4 pp.

§Hudson, S.R., Monticello, D.A., Reiman, A.H., Strickler, D.J., Hirshman, S.P., Ku, L.-P., Lazarus, E., Brooks, A., Zarnstorff, M.C., Boozer, A.H., Fu, G.-Y., and Neilson, G.H., "Constructing Integrable High-pressure Full-current Free-boundary Stellarator Magnetohydrodynamic Equilibrium Solutions," Nucl. Fusion **43** (October 2003) 1040-1046; Princeton Plasma Physics Laboratory Report PPPL-3867 (September 2003) 19 pp.

*Isobe, M., Darrow, D.S., Kotani, J., Shimizu, A., Suzuki, C., Yoshimura, Y., Minami, T., Takahashi, C., Nagaoka, K., Nishimura, S., Toi, K., Matsuoka, K., Okamura, S., and the CHS Group, "Energy and Pitch Angle-resolved Measurements of Escaping Helically Trapped Energetic Ions at the Small Major Radius Side of the Compact Helical System," Rev. Sci. Instrum. **74** (March 2003) 1739-1742. Presented at the *Fourteenth APS Topical Conference on High Temperature Plasma Diagnostics* (8-10 July 2002, Madison, Wisconsin).

*Jackson, G.L., Anderson, P.M., Bialek, J., Cary, W.P., Campbell, G.L., Garofalo, A.M., Hatcher, R., Kellman, A.G., LaHaye, R.J., Nagy, A., Navratil, G.A., Okabayashi, M., Pawley, C.J., Reimerdes, H., Scoville, J.T., Strait, E.J., and Szymanski, D.D., "Initial Results from the New Internal Magnetic Field Coils for Resistive Wall Mode stabilization in the DIII-D Tokamak," in the *Proceedings of the 30th European Physical Society Conference on Controlled Fusion and Plasma Physics* (7-11 July 2003, St. Petersburg, Russia), Europhysics Conference Abstracts **27A** (European Physical Society, 2003) paper P-4.47. This conference proceedings is published on CD-ROM. Papers available

in PDF format at <http://eps2003.ioffe.ru/> (as of 12 November 2003).

*Jaeger, E.F., Berry, L.A., Myra, J.R., Batchelor, D.B. D'Azevedo, E. Bonoli, P.T., Phillips, C.K., Smithe, D.N., D'Ippolito, D.A., Carter, M.D., Dumont, R.J., Wright, J.C., and Harvey, R.W., "Sheared Poloidal Flow Driven by Mode Conversion in Tokamak Plasmas," Phys. Rev. Lett. **90** (16 May 2003) 195001/1-4.

Jardin, S.C., Kessel, C.E., Meade, D., and Neumeier, C.L., Jr., "Systems Analysis of a Compact Next Step Burning Plasma Experiment," Fusion Sci. Technol. **43** (March 2003) 161-175; Princeton Plasma Physics Laboratory Report PPPL-3666 (February 2002) 26 pp.

Jardin, S.C., Kessel, C.E., Menard, J., Mau, T.K., Miller, R., Najmabadi, F., Chan, V.S., Lao, L.L., Linliu, Y.R., Miller, R.L., Petrie, T., Politzer, P.A., and Turbull, A.D., "Physics Basis for a Spherical Torus Power Plant," Fusion Eng. Des. **65** (February 2003) 165-197.

Ji, Hantao; Terry, Stephen; Yamada, Masaaki; Kulsrud, Russell; Kuritsyn, Aleksey; and Ren, Yang, "Electromagnetic Fluctuations during Fast Reconnection in a Laboratory Plasma," Phys. Rev. Lett. **92** (19 March 2004) 115001/1-4; Princeton Plasma Physics Laboratory Report PPPL-3784 (February 2003) 10 pp. To be submitted to Physical Review Letters.

*Jing, J., Lee, J., Spirock, T.J., Xu, Y., Wang, H., and Choe, G.S., "Periodic Motion Along a Solar Filament Initiated by a Subflare," Astrophys. J. **584** (February 2003) L103-L106.

- §Johnson, D. and the NSTX Team, "Diagnostic Development for ST Plasmas on NSTX," *Plasma Phys. Control.* **45** (November 2003) 1975-1987; Princeton Plasma Physics Laboratory Report PPPL-3822 (June 2003) 26 pp.
- Johnson, D., Brown, T., Neilson, H., Schilling, G., Takahashi, H., Zarnstorff, M., Cole, M., Lazarus, E., and Fenstermacher, M., "Diagnostics Plan for the National Compact Stellarator Experiment," *Rev. Sci. Instrum.* **74** (March 2003) 1787-1790. Presented at the *Fourteenth APS Topical Conference on High Temperature Plasma Diagnostics* (8-10 July 2002, Madison, Wisconsin).
- Jones, B., Efthimion, P.C., Taylor, G., Munsat, T., Wilson, J.R., Hosea, J.C., Kaita, R., Majeski, R., Maingi, R., Shiraiwa, S., Spaleta, J., and Ram, A.K., "Controlled Optimization of Mode Conversion from Electron Bernstein Waves to Extraordinary Mode in Magnetized Plasma," *Phys. Rev. Lett.* **90** (25 April 2003) 165001/1-4; Princeton Plasma Physics Laboratory Report PPPL-3822 (June 2003) 26 pp.
- Kaganovich, I.D., "Anomalous Capacitive Sheath with Deep Radio-frequency Electric-field Penetration," *Phys. Rev. Lett.* **89** (23 December 2002) 265006/1-4; Princeton Plasma Physics Laboratory Report PPPL-3649 (January 2002) 17 pp.
- Kaganovich, Igor D., "How to Patch Active Plasma and Collisionless Sheath: Practical Guide," *Phys. Plasmas* **9** (November 2002) 4788-4793; Princeton Plasma Physics Laboratory Report PPPL-3741 (August 2002) 8 pp.
- Kaganovich, I.D., Davidson, R.C., and Startsev, E.A., "Ionization Cross-sections for Ion-atom Collisions in High Energy Ion Beams," in the *Proceedings of the 2003 Particle Accelerator Conference (PAC2003)* **3** (12-16 May 2003, Portland, Oregon) 1667-1669.
- Kaganovich, I.D., O'Rourke, S., Lee, Edward P., Davidson, R.C., and Startsev, E.A., "Plasma Neutralization Models for Intense Ion Beam Transport in Plasma," in the *Proceedings of the 2003 Particle Accelerator Conference (PAC2003)* **5** (12-16 May 2003, Portland, Oregon) 2975-2977.
- Kaganovich, Igor D. and Polomarov, Oleg, "Self-consistent System of Equations for a Kinetic Description of the Low-pressure Discharges Accounting for the Nonlocal and Collisionless Electron Dynamics," *Phys. Rev. E* **68** (August 2003) Article No. 026411 (11 pages); Princeton Plasma Physics Laboratory Report PPPL-3814 (May 2003) 29 pp.
- Kaganovich, Igor D.; Startsev, Edward A.; and Davidson, Ronald C., "Comparison of Quantum-mechanical and Classical Trajectory Calculations of Cross Section for Ion-atom Impact Ionization of Negative and Positive Ions for Heavy-ion Fusion Applications," *Phys. Rev. A* **68** (August 2003) Article No. 022707 (6 pages); Princeton Plasma Physics Laboratory Report PPPL-3812 (May 2003) 15 pp (title: Comparison of Quantum Mechanical and Classical Trajectory Calculations of Cross Section for Ion-atom Impact Ionization of Negative — and Positive — ions for Heavy Ion Fusion Applications).

§Kaganovich, Igor D.; Startsev, Edward A.; and Davidson, Ronald C., "Scaling Cross Sections for Ion-atom Impact Ionization," *Phys. Plasmas* **11** (March 2004) 1229-1232; Princeton Plasma Physics Laboratory Report PPPL-3819 (June 2003) 43 pp.

*Kageyama, Akira; Ji, Hantao; and Goodman, Jeremy, "Circulation in a Short Cylindrical Couette System," Princeton Plasma Physics Laboratory Report PPPL-3836 (July 2003) 32 pp; submitted to *Physics of Fluids*.

Kaita, R., Majeski, R., Boaz, M., Efthimion, P., Jones, B., Hoffman, D., Kugel, H., Menard, J., Munsat, T., Post-Zwicker, A., Soukhanovskii, V., Spaleta, J., Taylor, G., Timberlake, J., Woolley, R., Zakharov, L., Finkenthal, M., Stutman, D., Antar, G., Doerner, R., Luckhardt, S., Maingi, R., Maiorano, M., and Smith, S., "Spherical Torus Plasma Interactions with Large-area Liquid Lithium Surfaces in CDX-U," *Fusion. Eng. Des.* **61-62** (November 2002) 217-222; Princeton Plasma Physics Laboratory Report PPPL-3648 (January 2002) 12 pp. Presented at the *Sixth International Symposium on Fusion Nuclear Technology (ISFNT-6)* (7-12 April 2002, San Diego, California).

Kaita, R., Majeski, R., Doerner, R., Antar, G., Baldwin, M., Conn, R., Efthimion, P., Finkenthal, M., Hoffman, D., Jones, B., Krashenninikov, Kugel, H., Luckhardt, S., Maingi, R., Menard, J., Munsat, T., Stutman, D., Taylor, G., Timberlake, J., Soukhanovskii, V., Whyte, D., Woolley, R., and Zakharov, L., "Liquid Lithium Limiter Effects on Tokamak Plasmas and Plasma-liquid Surface Interactions" Princeton Plasma Physics Laboratory Report PPPL-3755 (October 2002) 5 pp. Presented at the *Nineteenth IAEA Fusion*

Energy Conference (14-19 October 2002, Lyon, France).

*Kawai, M., Akino, N., Ebisawa, N., Grisham, L., Hanada, M., Honda, A., Inoue, T., Kazawa, M., Kikuchi, K., Kuriyama, M., Kusanagi, N., Mogaki, K., Noto, K., Ohga, T., Ooshima, K., Tanai, Y., Umeda, N., Usui, K., Yamamoto, T., Yamazaki, H., and Watanabe, K., "Progress of Negative Ion Source Improvement in N-NBI for JT-60U," *Fus. Sci. Technol.* **44** (September 2003) 508-512. Presented at the *15th ANS Topical Meeting on the Technology Fusion Energy* (17-21 November 2002, Washington, DC).

§Kaye, S.M., Bush, C.E., Fredrickson, E., LeBlanc, B., Maingi, R., and Sabbagh, S.A., "Low- to High-mode Transitions in the National Spherical Torus Experiment," *Phys. Plasmas* **10** (October 2003) 3953-3960; Princeton Plasma Physics Laboratory Report PPPL-3845 (July 2003) 27 pp.

Kessel, C.E., Ferron, J.R., Greenfield, C.M., Menard, J.E., and Taylor T.S., "Shape Optimization for DIII-D Advanced Tokamak Plasmas," in the *Proceedings of the 30th European Physical Society Conference on Controlled Fusion and Plasma Physics* (7-11 July 2003, St. Petersburg, Russia), *Europhysics Conference Abstracts* **27A** (European Physical Society, 2003) paper P-4.44. This conference proceedings is published on CD-ROM. Papers available in PDF format at <http://eps2003.ioffe.ru/> (as of 12 November 2003). Princeton Plasma Physics Laboratory Report PPPL-3848 (July 2003) 4 pp.

Kessel, C.E., Meade, D., and Jardin, S.C., "Physics Basis and Simulation of Burning Plasma Physics for the Fusion

Ignition Research Experiment (FIRE),” *Fusion Eng. Des.* **63-64** (December 2002) 559-567; Princeton Plasma Physics Laboratory Report PPPL-3646 (January 2002) 20 pp. Presented at the *Sixth International Symposium on Fusion Nuclear Technology (ISFNT-6)* (7-12 April 2002, San Diego, California).

Klasky, S., Ethier, S., Lin, Z., Martins, K., McCune, D., and Samtaney, R., “Grid-based Parallel Data Streaming Implemented for the Gyrokinetic Toroidal Code,” in the *Proceedings of the SC2003 Igniting Innovation Conference* (15-21 November 2003, Phoenix, Arizona); Princeton Plasma Physics Laboratory Report PPPL-3868 (September 2003) 10 pp.

*Kolesnichenko, Ya.I., Marchenko, V.S., and White, R.B., “Infernal Fishbone Mode,” Princeton Plasma Physics Laboratory Report PPPL-3786 (February 2003) 9 pp; submitted to *Physics of Plasmas*.

*Kolesnichenko, Ya.I., White, R.B., and Yakovenko, Yu.V., “Precession of Toroidally Passing Particles in Tokamaks and Spherical Tori,” *Phys. Plasmas* **10** (May 2003) 1449-1457; Princeton Plasma Physics Laboratory Report PPPL-3775 (January 2003) 25 pp.

Kramer, G.J., Nazikian, R., and Valeo, E., “Correlation Reflectometry for Turbulence and Magnetic Field Measurements in Fusion Plasmas,” *Rev. Sci. Instrum.* **74** (March 2003) 1421-1425; Princeton Plasma Physics Laboratory Report PPPL-3722 (July 2002) 22 pp. Presented at the *Fourteenth APS Topical Conference on High Temperature Plasma Diagnostics* (8-10 July 2002, Madison, Wisconsin).

§Kramer, G.J., Sharapov, S.E., Nazikian, R., Gorelenkov, N.N., Budny, R., and contributors to the Joint European Torus, “Observation of Odd Toroidal Alfvén Eigenmodes,” *Phys. Rev. Lett.* **92** (9 January 2004) 015001/1-4; Princeton Plasma Physics Laboratory Report PPPL-3768 (January 2003) 10 pp (title: First Evidence for the Existence of Odd Toroidal Alfvén Eigenmodes (TAEs) from the Simultaneous Observation of Even and Odd TAEs on the Joint European Torus).

*Krasheninnikov, S.I., Zakharov, L.E., and Pereverzev, G.V., “On Lithium Walls and the Performance of Magnetic Fusion Devices,” *Phys. Plasmas* **10** (May 2003) 1678-1682.

*Krasik, Y.E., Chirko, K., Dunaevsky, A., Gleizer, J.Z., Krokmal, A., Sayapin, A., and Felsteiner, J., “Ferroelectric Plasma Sources and their Applications,” *IEEE Trans. Plasma Sci.* **31** (February 2003) 49-59.

*†Kremer, J.P., Pedersen, T.S., Pomphrey, N., Reiersen, W., and Dahlgren, F., “The Status of the Design and Construction of the Columbia Non-neutral Torus,” *AIP Conference Proceedings* **692** (2 December 2003) 320-325. Presented at the *2003 Workshop on Non-neutral Plasmas* (7-11 July 2003, Santa Fe, New Mexico).

Ku, L.P., Zarnstorff, M., White, R.B., Cooper, W.A., Sanchez, R., Neilson, H., and Schmidt, J.A., “Development of Compact Quasi-Axisymmetric Stellarator Reactor Configurations,” in the *Proceedings of the 14th International Stellarator Workshop* (22-26 September 2003, Greifswald, Germany) P.Tul3;

Proceedings to be published on a CD-ROM. Papers available at http://www.ipp.mpg.de/eng/for/veranstaltungen/workshops/stellarator_2003/SWS-CDROM/papers/papers_alphabetic.html (as of 15 May 2004). Princeton Plasma Physics Laboratory Report PPPL-3874 (September 2003) 6 pp.

*Kubota, S., Peebles, W.A., Nguyen, X.V., and Roquemore, A.L., "Automatic Profile Reconstruction for Millimeter-wave Frequency-modulated Continuous-wave Reflectometry on NSTX," *Rev. Sci. Instrum.* **74** (March 2003) 1477-1480.

Kugel, H.W., Spong, D., Majeski, R., and Zarnstorff, M., "Chapter 6: NCSX Plasma Heating Methods," Princeton Plasma Physics Laboratory Report PPPL-3792 (February 2003) 46 pp. To be published in *Fusion Science and Technology*, Special Issue - NCSX.

Kugel, H.W., Soukhanovskii, V., Bell, M., Blanchard, W., Gates, D., LeBlanc, B., Maingi, R., Mueller, D., Na, H.K., Paul, S., Skinner, C.H., Stutman, D., and Wampler, W.R., "Impact of Wall Conditioning Program on Plasma Performance in NSTX," *J. Nucl. Mater.* **313-316** (March 2003) 187-193; Princeton Plasma Physics Laboratory Report PPPL-3725 (July 2002) 14 pp. Presented at the *15th International Conference on Plasma Surface Interactions in Controlled Fusion Devices (PSI-15)* (27-31 May 2002, Gifu, Japan).

*Kuriyama, M., Akino, N., Ebisawa, N., Grisham, L.R., Honda, A., Itoh, T., Kawai, M., Kazawa, M., Mogaki, K., Ohara, Y., Ohga, T., Okumura, Y., Oohara, H., Umeda, N., Usui, K., Watanabe, K., Yamamoto, M., and Yamamoto, T., "Operation and Development of the 500

keV Negative-ion-based Neutral Beam Injection System for JT-60U," *Fusion Sci. Technol.* **42** (September-November 2002) 410-423.

LeBlanc, B.P., Bell, M.G., Bell, R.E., Bitter, M.L., Bourdelle, C., Gates, D.A., Kaye, S.M., Maingi, R., Menard, J.E., Mueller, D., Ono, M., Paul, S.F., Redi, M.H., Roquemore, A.L., Rosenberg, A., Sabbagh, S.A., Stutman, D., Synakowski, E.J., Soukhanovskii, V.A., and Wilson, J.R., "Transport in Auxiliary Heated NSTX Discharges," in the *Proceedings of the 30th European Physical Society Conference on Controlled Fusion and Plasma Physics* (7-11 July 2003, St. Petersburg, Russia), *Europhysics Conference Abstracts* **27A** (European Physical Society, 2003) paper P-3.98. This conference proceedings is published on CD-ROM. Papers available in PDF format at <http://eps2003.ioffe.ru/> (as of 12 November 2003). Princeton Plasma Physics Laboratory Report PPPL-3837 (July 2003) 4 pp.

LeBlanc, B.P., Bell, M.G., Bell, R.E., Bitter, M.L., Bourdelle, C., Gates, D.A., Kaye, S.M., Maingi, R., Menard, J.E., Mueller, D., Paul, S.F., Roquemore, A.L., Rosenberg, A., Sabbagh, S.A., Stutman, D., Synakowski, E.J., Soukhanovskii, V.A., Wilson, J.R., and the NSTX Research Team, "Confinement Studies of Auxiliary Heated NSTX Plasmas," Princeton Plasma Physics Laboratory Report PPPL-3810 (May 2003) 38 pp; submitted to *Nuclear Fusion*.

LeBlanc, B.P., Bell, R.E., Johnson, D.W., Hoffman, D.E., Long, D.C., and Palladino, R.W., "Operation of the NSTX Thomson Scattering System," *Rev. Sci. Instrum.* **74** (March 2003) 1659-1662; Princeton Plasma Physics Laboratory

Report PPPL-3745 (August 2002) 13 pp. Presented at the *Fourteenth APS Topical Conference on High Temperature Plasma Diagnostics* (8-10 July 2002, Madison, Wisconsin).

†LeBlanc, B.P., Bell, R.E., Bernabei, S.I., Indireskumar, K., Kaye, S.M., Maingi, R., Mau, T.K., Swain, D.W., Taylor, G., Ryan, P.M., Wilgen, J.B., and Wilson, J.R., “High-harmonic Fast Wave Driven H-mode Plasmas on NSTX,” AIP Conference Proceedings **694** (15 December 2003) 201-204; Princeton Plasma Physics Laboratory Report PPPL-3816 (May 2003) 4 pp. Presented at the *15th AIP Topical Conference on Radio Frequency Power in Plasmas* (19-21 May 2003, Grand Teton National Park, Moran, Wyoming).

*Lee, J., Gallagher, P.T., Gary, D.E., Nita, G.M., Choe, G.S., Bong, S.C., and Yun, H.S., “H α , Extreme-ultraviolet, and Microwave Observations of the 2000 March 22 Solar Flare and Spontaneous Magnetic Reconnection,” *Astrophys. J.* **585** (March 2003) 524-535.

*Lee, K.C., Domier, C.W., Deng, B.H., Johnson, M., Nathan, B.R., Luhmann, N.C., Jr., and Park, H., “A Stark-tuned Laser Application for Interferometry and Polarimetry on the National Spherical Torus Experiment,” *Rev. Sci. Instrum.* **74** (March 2003) 1621-1624. Presented at the *Fourteenth APS Topical Conference on High Temperature Plasma Diagnostics* (8-10 July 2002, Madison, Wisconsin).

*Lee, S.G., Bak, J.G., Bitter, M., Moon, M.K., Nam, U.W., Jin, K.C., Kong, K.N., and Seon, K.I., “Imaging X-ray Crystal Spectrometers for KSTAR,” *Rev. Sci. Instrum.* **74** (March 2003) 1997-

1200. Presented at the *Fourteenth APS Topical Conference on High Temperature Plasma Diagnostics* (8-10 July 2002, Madison, Wisconsin).

*Lee, S.G., Bak, J.G., Jung, Y.S., Bitter, M., Hill, K.W., Hoelzer, G., Wehrhan, O., and Foerster, E., “A New Method for Simultaneous Measurement of the Integrated Reflectivity of Crystals at Multiple Orders of Reflection and Comparison with New Theoretical Calculations,” Princeton Plasma Physics Laboratory Report PPPL-3803 (March 2003) 29 pp; submitted to Review of Scientific Instruments.

Lee, W.W., “Theoretical and Numerical Properties of a Gyrokinetic Plasma: Issues Related to Transport Time Scale Simulation,” Princeton Plasma Physics Laboratory Report PPPL-3873 (September 2003) 12 pp. Presented at the *18th International Conference on Numerical Simulation of Plasmas (ICNSP '03)* (7-10 September 2003, Cape Cod, Massachusetts); submitted to Computer Physics Communications.

Lee, W.W. and Qin, H., “Alfvén Waves in Gyrokinetic Plasmas,” *Phys. Plasmas* **10** (August 2003) 3196-3203; Princeton Plasma Physics Laboratory Report PPPL-3806 (April 2003) 24 pp.

§Lewandowski, J.L.V., “Gyrokinetic Simulations of Microinstabilities in Stellarator Geometry,” *Phys. Plasmas* **10** (October 2003) 4053-4063; Princeton Plasma Physics Laboratory Report PPPL-3861 (August 2003) 39 pp.

Lewandowski, J.L.V., “Improved Conservation Properties for Particle-in-cell Simulations with Kinetic Electrons,”

Plasma Phys. Control. Fusion **45** (July 2003) L39-L46; Princeton Plasma Physics Laboratory Report PPPL-3826 (June 2003) 13 pp.

Lewandowski, J.L.V., "Multigrid Particle-in-cell Simulations of Plasma Microturbulence," Phys. Plasmas **10** (August 2003) 3204-3211; Princeton Plasma Physics Laboratory Report PPPL-3823 (June 2003) 30 pp.

Lewandowski, J.L.V., "Neural Network Algorithm for Particle Loading," Princeton Plasma Physics Laboratory Report PPPL-3808 (April 2003) 15 pp; submitted to Physics Letters A.

Lewandowski, J.L.V., "Numerical Loading of a Maxwellian Probability Distribution Function," Can. J. Phys. **81** (August 2003) 989-996; Princeton Plasma Physics Laboratory Report PPPL-3798 (March 2003) 18 pp.

§Lewandowski, J.L.V., "Strange Attractors in Drift Wave Turbulence," Canadian J. Phys. **81** (December 2003) 1331-1341; Princeton Plasma Physics Laboratory Report PPPL-3807 (April 2003) 20 pp.

Lewandowski, J.L.V., "Strange Attractors in Drift Wave Turbulence," Princeton Plasma Physics Laboratory Report PPPL-3863 (September 2003) 6 pp. Presented at the *18th International Conference on Numerical Simulation of Plasmas* (7-10 September 2003, Cape Cod, Massachusetts); submitted to Computer Physics Communications.

*Litaudon, X., Bécoulet, A., Crisanti, F., Wolf, R.C., Baranov, Yu.F., Barbato, E., Bécoulet, M., Budny, R., *et al.*, "Progress Towards Steady-state Operation and Real Time Control of Internal Transport

Barriers in JET," presented at the *Nineteenth IAEA Fusion Energy Conference* (14-19 October 2002, Lyon, France).

Lukin, V.S. and Jardin, S.C., "Hall MHD Modeling of Two-dimensional Reconnection: Application to MRX Experiment," Phys. Plasmas **10** (August 2003) 3131-3138; Princeton Plasma Physics Laboratory Report PPPL-3765 (January 2003) 18 pp.

*Lund, S.M., Barnard, J.J., Davidson, R.C., and Lee, E.P., "Beam Emittance Growth from the Collective Relaxation of Space-Charge Nonuniformities," submitted for publication (2002).

*Lyon, J.F., Hirshman, S.P., Spong, D.A., Strickler, D.J., Nelson, B.E., Ware, A.S., Williamson, D.E., Berry, L.A., Cole, M.J., Fogarty, P.J., Mioduszewski, P.K., Monticello, D.A., Fu, G.Y., Mikkelsen, D., Barcikowski, E., and Westerly, D., "Overview of the QPS Project," in the *Proceedings of the 30th European Physical Society Conference on Controlled Fusion and Plasma Physics* (7-11 July 2003, St. Petersburg, Russia), Europhysics Conference Abstracts **27A** (European Physical Society, 2003) paper P-4.12. This conference proceedings is published on CD-ROM. Papers available in PDF format at <http://eps2003.ioffe.ru/> (as of 12 November 2003).

*Maddison, G.P., Brix, M., Budny, R., Charlet, M., Coffey, I., and 38 additional co-authors including J. Strachan of PPPL), "Impurity-seeded Plasma Experiments on JET," Nucl. Fusion **43** (December 2002) 49-62.

*Maingi, R., Bell, M., Bell, R., Biewer, T., Bush, C., Chang, C.S., Gates, D., Kaye, S., LeBlanc, B., Maqueda, R., Menard,

J., Mueller, D., Raman, R., Sabbagh, S., Soukhanovskii, V., and the NSTX Team, "Effect of Fueling Location on H-mode Access in NSTX," in the *Proceedings of the 30th European Physical Society Conference on Controlled Fusion and Plasma Physics* (7-11 July 2003, St. Petersburg, Russia), *Europophys Conference Abstracts* **27A** (European Physical Society, 2003) paper P-3.97. This conference proceedings is published on CD-ROM. Papers available in PDF format at <http://eps2003.ioffe.ru/> (as of 12 November 2003).

*Maingi, R., Bell, M.G., Bell, R.E., Bialek, J., Bourdelle, C., Bush, C.E., Darrow, D.S., Fredrickson, E.D., Gates, D.A., Gilmore, M., Gray, T., Jarboe, T.R., Johnson, D.W., Kaita, R., Kaye, S.M., Dubota, S., Kugel, H.W., LeBlanc, B.P., Maqueda, R.J., Mastrovito, D., Medley, S.S., Menard, J.E., Mueller, D., Nelson, B.A., Ono, M., Paoletti, F., Park, H.K., Paul, S.F., Peebles, T., Peng, Y.-K.M., Phillips, C.K., Raman, R., Rosenberg, A.L., Roquemore, A.L., Ryan, P.M., Sabbagh, S.A., Skinner, C.H., Soukhanovskii, V.A., Stutman, D., Swain, D.W., Synakowski, E.J., Taylor, G., Wilgen, J., Wilson, J.R., Wurdern, G.A., Zweben, S.J., and the NSTX Team, "Recent Results from the National Spherical Torus Experiment," *Plasma Phys. Control Fusion* **45** (May 2003) 657-669.

*Maingi, R., Bell, M.G., Bell, R.E., Bush, C.E., Fredrickson, E.D., Gates, D.A., Gray, T., Johnson, D.W., Kaita, R., Kaye, S.M., Kubota, S., Kugel, H.W., Lasnier, C.J., LeBlanc, B.P., Maqueda, R.J., Mastrovito, D., Menard, J.E., Mueller, D., Ono, M., Paoletti, F., Paul, S.J., Peng, Y.-K.M., Roquemore, A.L., Sabbagh, S.A., Skinner, C.H., Soukhanovskii, V.A., Stutman, D., Swain, D.W., Synakowski,

E.J., Tan, T., Wilgen, J.B., and Zweben, S.J., "H-mode Research in NSTX," *Nucl. Fusion* **43** (September 2003) 969-974. Presented at the *Nineteenth IAEA Fusion Energy Conference* (14-19 October 2002, Lyon, France).

*Maingi, R., Kugel, H.W., Lasnier, C.J., Roquemore, A.L., Soukhanovskii, V.A., and Bush, C.E., and the NSTX Team, "Heat Flux Scaling Experiments in NSTX," *J. Nucl. Mater.* **313-316** (March 2003) 1005-1009. Presented at the *15th International Conference on Plasma Surface Interactions in Controlled Fusion Devices (PSI-15)* (27-31 May 2002, Gifu, Japan).

Majeski, R., Boaz, M., Hoffman, D., Jones, B., Kaita, R., Kugel, H., Munsat, T., Spaleta, J., Soukhanovskii, V., Timberlake, J., Zakharov, L., Antar, G., Doerner, R., Luckhardt, S., Conn, R.W., Finkenthal, M., Stutman, D., Maingi, R., and Ulrickson, M., "CDX-U Operation with a Large Area Liquid Lithium Limiter," *J. Nucl. Mater.* **313-316** (March 2003) 625-629; Princeton Plasma Physics Laboratory Report PPPL-3727 (July 2002) 14 pp. Presented at the *15th International Conference on Plasma Surface Interactions in Controlled Fusion Devices (PSI-15)* (27-31 May 2002, Gifu, Japan).

Majeski, R., Boaz, M., Hoffman, D., Jones, B., Kaita, R., Kugel, H., Munsat, T., Spaleta, J., Soukhanovskii, V., Timberlake, J., Zakharov, L., Antar, G., Doerner, R., Luckhardt, S., Conn, R.W., Finkenthal, M., Stutman, D., Maingi, R., and Ulrickson, M., "Plasma Performance Improvements with Liquid Lithium Limiters in CDX-U," *Fusion Eng. Des.* **65** (April 2003) 443-447; Princeton Plasma Physics Laboratory Report

PPPL-3726 (July 2002) 16 pp. Presented at the *First International Workshop on Innovative Concepts for Plasma-interactive Components in Fusion Devices* (23-25 May 2002, Osaka, Japan).

*Maqueda, R.J., Wurden, G.A., Stotler, D.P., Zweben, S.J., LaBombard, B., Terry, J.L., Lowrance, J.L., Mastrocola, V.J., Renda, G.F., D'Ippolito, D.A., Myra, J.R., and Nishino, N., "Gas Puff Imaging of Edge Turbulence," *Rev. Sci. Instrum.* **74** (March 2003) 2020-2026. Presented at the *Fourteenth APS Topical Conference on High Temperature Plasma Diagnostics* (8-10 July 2002, Madison, Wisconsin).

*Mase, A., Kogi, Y., Kawahata, K., Nagayama, Y., Luhmann, N.C., Jr., Deng, B.H., Domier, C.W., Mazzucato, E., Munsat, T., and Park, H.K., "Progress in Millimeter-wave Imaging Diagnostics," *Fusion Sci. Technol.* **43** (January 2003) 237-242; Presented at the *Fourth International Conference on Open Magnetic Systems for Plasma Confinement (OS2002)* (1-4 July 2002, Jeju Island, Korea).

§Mastrovito, D., Maingi, R., Kugel, H.W., and Roquemore, A.L., "Infrared Camera Diagnostic for Heat Flux Measurements on NSTX," *Rev. Sci. Instrum.* **74** (December 2003) 5090-5092; Princeton Plasma Physics Laboratory Report PPPL-3801 (March 2003) 12 pp.

Meade, D.M., Kessel, C.E., Ulrickson, M.A., Navratil, G.A., Bialek, J., Swain, D.W., Bonoli, P., Mau, T.K., Jardin, S.C., Young, K.M., Heitzenroeder, P., Nelson, B.E., Thome, R.J., and Schmidt, J.A., "Advanced Tokamak Regimes in the Fusion Ignition Research Experiment

(FIRE)," in the *Proceedings of the 30th European Physical Society Conference on Controlled Fusion and Plasma Physics* (7-11 July 2003, St. Petersburg, Russia), *Europhysics Conference Abstracts* **27A** (European Physical Society, 2003) paper O-3.5A. This conference proceedings is published on CD-ROM. Papers available in PDF format at <http://eps2003.ioffe.ru/> (as of 12 November 2003).

Medley, S.S., Bell, R.E., Fredrickson, E.D., and Roquemore, A.L., "Energetic Ion Behavior in the National Spherical Torus Experiment," in the *Proceedings of the 30th European Physical Society Conference on Controlled Fusion and Plasma Physics* (7-11 July 2003, St. Petersburg, Russia), *Europhysics Conference Abstracts* **27A** (European Physical Society, 2003) paper P-4.96. This conference proceedings is published on CD-ROM. Papers available in PDF format at <http://eps2003.ioffe.ru/> (as of 12 November 2003). Princeton Plasma Physics Laboratory Report PPPL-3827 (June 2003) 7 pp.

Medley, S.S., Bell, R.E., Petrov, M.P., Roquemore, A.L., and Suvorin, E.V., "Initial Neutral Particle Analyzer Measurements of Ion Temperature in the National Spherical Torus Experiment," *Rev. Sci. Instrum.* **74** (March 2003) 1896-1899; Princeton Plasma Physics Laboratory Report PPPL-3718 (July 2002) 10 pp. Presented at the *Fourteenth APS Topical Conference on High Temperature Plasma Diagnostics* (8-10 July 2002, Madison, Wisconsin).

Menard, J.E., Bell, M.G., Bell, R.E., Fredrickson, E.D., Gates, D.A., Kaye, S.M., LeBlanc, B.P., Maingi, R., Mueller, D., Sabbagh, S.A., Stutman, D., Bush, C.E., Johnson, D.W., Kaita, R., Kugel,

- H.W., Maqueda, R.J., Paoletti, F., Paul, S.F., Ono, M., Peng, Y.-K.M., Skinner, C.H., Synakowski, E.J., and the NSTX Research Team, "Beta-limiting MHD Instabilities in Improved-performance NSTX Spherical Torus Plasmas," Nucl. Fusion **43** (May 2003) 330-340; Princeton Plasma Physics Laboratory Report PPPL-3815 (May 2003) 14 pp.
- Menard, J.E., Bell, M.G., Bell, R.E., Gates, D.A., Kaye, S.M., LeBlanc, B.P., Sabbagh, S.A., Fredrickson, E.D., Jardin, S.C., Maingi, R., Manickam, J., Mueller, D., Ono, M., Paoletti, F., Peng, Y.-K.M., Soukhanovskii, V., Stutman, D., Synakowski, E.J., and the NSTX research team, "Unified Ideal Stability Limits for Advanced Tokamak and Spherical Torus Plasmas," Princeton Plasma Physics Laboratory Report PPPL-3779 (February 2003) 4 pp; submitted to Physical Review Letters.
- Menard, J.E., Park, W., Bell, R.E., Fredrickson, E.D., Gates, D.A., Kaye, S.M., LeBlanc, B.P., Sabbagh, S.A., Stutman, D., and the NSTX National Research Team, "Saturation of Internal Kink Modes in High- β NSTX Plasmas," in the *Proceedings of the 30th European Physical Society Conference on Controlled Fusion and Plasma Physics* (7-11 July 2003, St. Petersburg, Russia), Europhysics Conference Abstracts **27A** (European Physical Society, 2003) paper P-3.101. This conference proceedings is published on CD-ROM. Papers available in PDF format at <http://eps2003.ioffe.ru/> (as of 12 November 2003).
- Mikkelsen, D.R., Shirai, H., Urano, H., Takizuka, T., Kamada, Y., Hatae, T., Koide, Y., Asakura, N., Fujita, T., Fukuda, T., Ide, S., Isayama, A., Kawano, Y., Naito, O., Sakamota, Y., "Stiff Temperature Profiles in JT-60U ELMy H-mode Plasmas," Nucl. Fusion **43** (January 2003) 30-39; Princeton Plasma Physics Laboratory Report PPPL-3620 (October 2001) 19 pp.
- *Moon, Y.-J., Chae, J., Wang, H., Choe, G.S., and Park, Y.D., "Impulsive Variations of the Magnetic Helicity Change Rate Associated with Eruptive Flares," Astrophys. J. **580** (November 2002) 528-537.
- *Moon, Y.-J., Choe, G.S., Wang, H., and Park, Y.D., "Sympathetic Coronal Mass Ejections," Astrophys. J. **588** (May 2003) 1176-1182.
- *Moon, Y.-J., Choe, G.S., Wang, H., Park, Y.D., and Cheng, C.Z., "Relationship Between CME Kinematics and Flare Strength," Journal of the Korean Astronomical Society **36** (June 2003) 61-66.
- *Moon, Y.-J., Choe, G.S., Wang, Haimin, Park, Y.D., Gopalswamy, N., Yang, Guo, and Yashiro, S., "A Statistical Study of Two Classes of Coronal Mass Ejections," Astrophys. J. **581** (December 2002) 694-702.
- †Morrison, Kyle A.; Paul, Stephen F.; and Davidson, Ronald C., "Measurements of Plasma Expansion due to Background Gas in the Electron Diffusion Gauge Experiment," AIP Conference Proceedings **692** (2 December 2003) 75-80; Princeton Plasma Physics Laboratory Report PPPL-3853 (August 2003) 6 pp. Presented at the *2003 Workshop on Non-neutral Plasmas* (7-11 July 2003, Santa Fe, New Mexico).
- Mueller, D., Grisham, L., Kaganovich, I., Watson, R.L., Horvat, V., Zaharakis, K.E., and Peng, Y., "Multiple Electron

Stripping of Heavy Ions Beams,” *Laser and Particle Beams* **20** (October 2002) 551-554; Princeton Plasma Physics Laboratory Report PPPL-3713 (June 2002) 12 pp.

Mueller, D., Ono, M., Bell, M.G., Bell, R.E., Bitter, M., Bourdelle, C., Darrow, D.S., Efthimion, P.C., Fredrickson, E.D., Gates, D.A., Goldston, R.J., Grisham, L.R., Hawryluk, R.J., plus 75 additional co-authors, “Results of NSTX Heating Experiments,” *IEEE Trans. Plasma Sci.* **31** (February 2003) 60-67; Princeton Plasma Physics Laboratory Report PPPL-3709 (June 2002) 13 pp. Presented at the *29th IEEE International Conference on Plasma Science* (27-30 May 2002, Banff, Alberta, Canada).

Munsat, T., Mazzucato, E., Park, H., Deng, B.H., Domier, C.W., Luhmann, N.C., Jr., Wang, J., Xia, Z.G., Donné, A.J.H., and van de Pol, M., “Microwave Imaging Reflectometer for TEXTOR (invited),” *Rev. Sci. Instrum* **74** (March 2003) 1426-1432; Princeton Plasma Physics Laboratory Report PPPL-3721 (July 2002) 8 pp. Presented at the *Fourteenth APS Topical Conference on High Temperature Plasma Diagnostics* (8-10 July 2002, Madison, Wisconsin).

Munsat, T., Mazzucato, E., Park, H., Domier, C.W., Luhmann, N.C., Jr., Donné, A.J.H., and van de Pol, M., “Laboratory Characterization of an Imaging Reflectometer System,” *Plasma Phys. Control. Fusion* **45** (April 2003) 469-487; Princeton Plasma Physics Laboratory Report PPPL-3767 (January 2003) 24 pp.

*Murakami, M., Wade, M.R., DeBoo, J.C., Greenfield, C.M., Luce, T.C., Makowski, M.A., Petty, C.C., Staebler,

G.M., Taylor, T.S., Austin, M.E., Baker, D.R., Budny, R.V., and 20 additional co-authors including D. McCune of PPPL, “Advanced Tokamak Profile Evolution in DIII-D,” *Phys. Plasmas* **10** (May 2003) 1691-1697.

*Najmabadi, F. and The ARIES Team (of which PPPL is a participant), “Spherical Torus Concept as Power Plants — The ARIES-ST Study,” *Fusion Eng. Des.* **65** (February 2003) 143-164.

Nazikian, R., Kramer, G.J., Cheng, C.Z., Gorelenkov, N.N., Berk, H.L., and Sharapov, S.E., “A New Interpretation of Alpha-particle-driven Instabilities in Deuterium-tritium Experiments on the Tokamak Fusion Reactor,” *Phys. Rev. Lett.* **91** (19 September 2003) 125003/1-4; Princeton Plasma Physics Laboratory Report PPPL-3800 (March 2003) 15 pp.

Neilson, G.H., Zarnstorff, M.C., Ku, L.P., Lazarus, E.A., Mioduszewski, P.K., Fenstermacher, M., Fredrickson, E., Fu, G.Y., Grossman, A., Heitzenroeder, P.J., Hatcher, R.H., Hirshman, S.P., Hudson, S.R., Johnson, D.W., Kugel, H.W., Lyon, J.F., Majeski, R., Mikkelsen, D.R., Monticello, D.A., Nelson, B.E., Pomphrey, N., Reiersen, W.T., Reiman, A.H., Rutherford, P.H., Schmidt, J.A., Spong, D.A., and Strickler, D.J., “Physics Considerations in the Design of NCSX” Princeton Plasma Physics Laboratory Report PPPL-3753 (October 2002) 8 pp. Presented at the *Nineteenth IAEA Fusion Energy Conference* (14-19 October 2002, Lyon, France).

Neumeyer, C., Heitzenroeder, P., Kessel, C., Ono, M., Peng, M., Schmidt, J., Woolley, R., and Zatz, I., “Next Step Spherical Torus Design Studies,” *Fusion Eng. Des.* **66-68** (September 2003) 139-

145; Princeton Plasma Physics Laboratory Report PPPL-3761 (November 2002) 4 pp. Presented at the *22nd Symposium on Fusion Technology (SOFT 2002)* (9-13 September 2002, Marina Congress Center, Helsinki, Finland).

*Noterdaeme, J.-M., Budny, R., Cardinali, A., Castaldo, C., Cesario, R., and 31 additional co-authors, "Heating, Current Drive and Energetic Particles Studies on JET in Preparation of ITER Operation," Nucl. Fusion **43** (March 2003) 202-209. Presented at the *Nineteenth IAEA Fusion Energy Conference* (14-19 October 2002, Lyon, France).

*Ohdachi, S., Toi, K., Fuchs, G., von Goeler, S., Yamamoto, S., and LHD Experiment Group, "High-speed Tangentially Viewing Soft X-ray Camera to Study Magnetohydrodynamic Fluctuations in Toroidally Confined Plasma (invited)," Rev. Sci. Instrum. **74** (March 2003) 2136-2143. Presented at the *Fourteenth APS Topical Conference on High Temperature Plasma Diagnostics* (8-10 July 2002, Madison, Wisconsin).

Okabayashi, M., Bialek, J., Chance, M.S., Chu, M.S., Fredrickson, E.D., Garofalo, A.M., Hatcher, R., Jenson, T.H., Johnson, L.C., LaHaye, R.J., Navratil, G.A., Reimerder, H., Scoville, J.T., Strait, E.J., Turnbull, A.D., and Walker, M.L., "Stabilization of the Resistive Wall Mode in DIII-D by Plasma Rotation and Magnetic Feedback," Plasma Phys. Control. Fusion **44** (December 2002) B339-B355. Presented at the *29th European Physical Society on Plasma Physics and Controlled Fusion* (17-21 June 2002, Montreux, Switzerland).

Okuda, H., Stratton, B., Meixler, L., Efthimion, P. and Mansfield, D.,

"Determination of Diameter and Index of Refraction of Textile Fibers by Laser Backscattering," Princeton Plasma Physics Laboratory Report PPPL-3842 (July 2003) 33 pp.

*Ongena, J., Suttrop, W., Bécoulet, M., Cordey, G., Dumortier, P., Eich, Th., Ingesson, L.C., Jachmich, S., Lang, P., Loarte, A., Lomas, P., Maddison, G.P., Messiaen, A., Nave, M.F.F., Rapp, J., Saibene, G., Sartori, R., Sauter, O., Strachan, J.D., Unterberg, B., Valovic, M., Alper, B., Andrew, Ph., Baranov, Y., Brzozowski, J., Bucalossi, J., Brix, M., Budny, R., *et al.*, "Towards the Realization on JET of an Integrated H-mode Scenario for ITER," presented at the *Nineteenth IAEA Fusion Energy Conference* (14-19 October 2002, Lyon, France).

*Pacella, D., Leigheb, M., Bellazzini, R., Brez, A., Finkenthal, M., Stutman, D., Kaita, R., and Sabbagh, S.A., "Soft X-ray Tangential Imaging of the NSTX Core Plasma by Means of a MPPGD Pin-hole Camera," Princeton Plasma Physics Laboratory Report PPPL-3844 (July 2003) 18 pp; submitted to Plasma Physics and Controlled Fusion.

*Pacella, D., Pizzicaroli, G., Leigheb, M., Bellazzini, R., Brez, A., Finkenthal, M., Stutman, D., Blagojevic, B., Vero, R., Kaita, R., Roquemore, A.L., and Johnson, D., "Fast X-ray Imaging of the National Spherical Tokamak Experiment Plasma with Micropattern Gas Detector Based on Gas Electron Multiplier Amplifier," Rev. Sci. Instrum. **74** (March 2003) 2148-2151. Presented at the *Fourteenth APS Topical Conference on High Temperature Plasma Diagnostics* (8-10 July 2002, Madison, Wisconsin).

Park, W., Breslau, J., Chen, J., Fu, G.Y., Jardin, S.C., Klasky, S., Menard, J., Pletzer, A., Stratton, B.C., Stutman, D., Strauss, H.R., and Sugiyama, L.E., "Nonlinear Simulation Studies of Tokamaks and STs," Nucl. Fusion **43** (June 2003) 483-489; Princeton Plasma Physics Laboratory Report PPPL-3833 (July 2003) 7 pp.

Paul, S.F., "Real-time Plasma Rotation Diagnostic for Measuring Small Doppler Shifts," Rev. Sci. Instrum. **74** (March 2003) 2098-2102.

†Paul, Stephen F.; Morrison, Kyle; and Davidson, Ronald C., "Experimental Investigation of m=1 Diocotron Mode Growth at Low Electron Densities," AIP Conference Proceedings **692** (2 December 2003) 81-86; Princeton Plasma Physics Laboratory Report PPPL-3859 (August 2003) 6 pp. Presented at the *2003 Workshop on Non-neutral Plasmas* (7-11 July 2003, Santa Fe, New Mexico).

*Pedersen, T. Sunn, Boozer, A.H., Kremer, J.P., Reiersen, W., Dahlgren, F., Pomphrey, N., Dorland, W., "The Columbia Non-neutral Torus, A New Experiment to Confine Nonneutral and Positron-electron Plasmas in a Stellarator," in the *Proceedings of the 14th International Stellarator Workshop* (22-26 September 2003, Greifswald, Germany) I.Tu2; Proceedings to be published on a CD-ROM. Papers available at http://www.ipp.mpg.de/eng/for/veranstaltungen/workshops/stellarator_2003/SWS-CDROM/papers/papers_alphabetic.html (as of 15 May 2004).

*Petty, C.C., Prater, R., Luce, T.C., Ellis, R.A., Harvey, R.W., Kinsey, J.E., Lao, L.L., Lohr, J., Makowski, M.A., and Wong, K.L., "Effects of Electron Trapping

and Transport on Electron Cyclotron Current Drive on DIII-D," Nucl. Fusion **43** (August 2003) 700-707.

†Phillips, C.K., Pletzer, A., Dumont, R.J., and Smithe, D.N., "Plasma Dielectric Tensor for Non-Maxwellian Distributions in the FLR Limit," AIP Conference Proceedings **694** (15 December 2003) 499-502; Princeton Plasma Physics Laboratory Report PPPL-3835 (July 2003) 4 pp. Presented at the *15th AIP Topical Conference on Radio Frequency Power in Plasmas* (19-21 May 2003, Grand Teton National Park, Moran, Wyoming).

*Pigarov, A.Yu., Krashennnikov, S.I., Rognlien, T.D., West, W.P., LaBombard, B., Lipschultz, B., Maingi, R., and Soukhanovsky, V., "Analysis of Non-diffusive Transport and SOL Recycling with Multil-fluid Plasma Code UEDGE," in the *Proceedings of the 30th European Physical Society Conference on Controlled Fusion and Plasma Physics* (7-11 July 2003, St. Petersburg, Russia), Europhysics Conference Abstracts **27A** (European Physical Society, 2003) paper P-3.170. This conference proceedings is published on CD-ROM. Papers available in PDF format at <http://eps2003.ioffe.ru/> (as of 12 November 2003).

*Ping, Y., Geltner, I., Morozov, A., Fisch, N.J., and Suckewer, S., "Raman Amplification of Ultrashort Laser Pulses in Microcapillary Plasma," Phys. Rev. E. **66** (October 2002) 046401/1-6.

†Pletzer, A., Phillips, C.K., and Smithe, D.N., "Gabor Wave Packet Method to Solve Plasma Wave Equations," AIP Conference Proceedings **694** (15 December 2003) 503-506; Princeton Plasma Physics Laboratory Report PPPL-

- 3825 (June 2003) 4 pp. Presented at the *15th AIP Topical Conference on Radio Frequency Power in Plasmas* (19-21 May 2003, Grand Teton National Park, Moran, Wyoming).
- Qin, H. and Davidson, R.C., "Study of Drift Compression for Heavy Ion Beams," *Laser and Particle Beams* **20** (October 2002) 565-568.
- Qin, H., Davidson, R.C., Barnard, J.J., and Lee, E.P., "Drift Compression and Final Focus of Intense Heavy Ion Beams," in the *Proceedings of the 2003 Particle Accelerator Conference (PAC2003)* **4** (12-16 May 2003, Portland, Oregon) 2658-2660.
- Qin, H., Davidson, R.C., Startsev, E.A., and Lee, W.W., "Delta-f Simulation Studies of the Ion-Electron Two-Stream Instability in Heavy Ion Fusion Beams," *Laser and Particle Beams* **21** (January 2003) 21-26.
- Qin, H., Startsev, E.A., and Davidson, R.C., "Nonlinear Perturbative Simulation Studies of Two-Stream Interactions in Intense Charged Particle Beams," presented at the *2003 Particle Accelerator Conference (PAC2003)* (12-16 May 2003, Portland, Oregon), proceedings to be published.
- Qin, Hong, "Nonlinear δf Simulations of Collective Effects in Intense Charged Particle Beams," *Phys. Plasmas* **10** (May 2003) 2078-2086; Princeton Plasma Physics Laboratory Report PPPL-3769 (January 2003) 21 pp.
- Qin, Hong, Startsev, E.A., and Davidson, R.C., "Nonlinear Perturbative Particle Simulation Studies of the Electron-proton Two-Stream Instability in High-Intensity Proton Beams," *Phys. Rev. ST Accel. Beams* **6** (January 2003) Article No. 014401 (8 pages).
- §Qin, Hong and Tang, W.M., "Pullback Transformations in Gyrokinetic Theory," *Phys. Plasmas* **11** (March 2004) 1052-1063; Princeton Plasma Physics Laboratory Report PPPL-3772 (January 2003) 32 pp.
- Raitses, Y., Keidar, M., Staack, D., and Fisch, N.J., "Effects of Segmented Electrode in Hall Current Plasma Thrusters," *J. Appl. Phys.* **92** (1 November 2002) 4906-4911; Princeton Plasma Physics Laboratory Report PPPL-3634 (December 2001) 37 pp.
- Raitses, Y., Staack, D., Dunaevsky, A., Dorf, L., and Fisch, N.J., "Preliminary Results of Plasma Flow Measurements in a 2 kW Segmented Hall Thruster," Princeton Plasma Physics Laboratory Report PPPL-3796 (March 2003) 10 pp; Presented at the *28th International Electric Propulsion Conference (IEPC 2003)* (17-21 March 2003, Toulouse, France). Proceedings published on CD-ROM.
- *Ramamurthi, B., Economou, D.J., and Kaganovich, I.D., "Effect of Non-local Electron Conductivity on Power Absorption and Plasma Density Profiles in Low Pressure Inductively Coupled Discharges," *Plasma Sources Sci. Technol.* **12** (May 2003) 170-181.
- *Raman, R., Kugel, H.W., Provost, T., Gernhardt, R., Jarboe, T.R., and Bell, M.G., "Rev. Sci. Instrum." **74** (March 2003) 1900-1904; Princeton Plasma Physics Laboratory Report PPPL-3732 (August 2002) 5 pp. Presented at the *Fourteenth APS Topical Conference on*

High Temperature Plasma Diagnostics (8-10 July 2002, Madison, Wisconsin).

Redi, M.H., Dorland, W., Bell, R., Bonoli, P., Bourdelle, C., Candy, J., Ernst, D., Fiore, C., Gates, D., Hammett, G., Hill, K., Kaye, S., LeBlanc, B., Menard, J., Mikkelsen, D., Rewoldt, G., Rice, J., Waltz, R., and Wukitch, S., "Gyrokinetic Calculations of Microturbulence and Transport for NSTX and Alcator-CMOD H-modes," in the *Proceedings of the 30th European Physical Society Conference on Controlled Fusion and Plasma Physics* (7-11 July 2003, St. Petersburg, Russia), Europhysics Conference Abstracts **27A** (European Physical Society, 2003) paper P-4.94. This conference proceedings is published on CD-ROM. Papers available in PDF format at <http://eps2003.ioffe.ru/> (as of 12 November 2003). Princeton Plasma Physics Laboratory Report PPPL-3834 (July 2003) 4 pp.

Reiersen, W., Dahlgren, F., Fan, H.-M. Neumeyer, C., and Zatz, I., "The Toroidal Field Coil Design for ARIES-ST," *Fusion Eng. Des.* **65** (February 2003) 303-322.

*Reimerdes, H., Bialek, J., Chu, M.S., Edgell, D.H., Garofalo, A.M., Jackson, G.L., Jensen, T.H., LaHaye, R.J., Navratil, G.A., Okabayashi, M., Scoville, J.T., Strait, E.J., and Turnbull, A.D., "Resistive Wall Modes and Plasma Rotation in DIII-D," in the *Proceedings of the 30th European Physical Society Conference on Controlled Fusion and Plasma Physics* (7-11 July 2003, St. Petersburg, Russia), Europhysics Conference Abstracts **27A** (European Physical Society, 2003) paper P-4.45. This conference proceedings is published on CD-ROM. Papers available in PDF format at <http://eps2003.ioffe.ru/> (as of 12 November 2003).

§Rewoldt, G. and Kinsey, J.E., "Comparison of Linear Microinstability Calculations of Varying Input Realism," *Phys. Plasmas* **11** (February 2004) 844-845; Princeton Plasma Physics Laboratory Report PPPL-3865 (September 2003) 5 pp.

Roquemore, A.L., Darrow, D., Isobe, M., and Medley, S.S., "Design Concepts for a Multichannel neutron Collimator for the National Spherical Torus Experiment," in the *Proceedings of the 30th European Physical Society Conference on Controlled Fusion and Plasma Physics* (7-11 July 2003, St. Petersburg, Russia), Europhysics Conference Abstracts **27A** (European Physical Society, 2003) paper P-4.75. This conference proceedings is published on CD-ROM. Papers available in PDF format at <http://eps2003.ioffe.ru/> (as of 12 November 2003).

Rosenberg, A.L., Gates, D.A., Pletzer, A., Menard, J.E., Kruger, S.E., Hegna, C.C., Paoletti, F., and Sabbagh, S., "Modeling of Neoclassical Tearing Mode Stability for Generalized Toroidal Geometry," *Phys. Plasmas* **9** (November 2002) 4567-4572; Princeton Plasma Physics Laboratory Report PPPL-3740 (August 2002) 20 pp.

†Rosenberg, A.L., Menard, J.E., Wilson, J.R., Medley, S., Phillips, C.K., Andre, R., Darrow, D.S., Dumont, R.J., LeBlanc, B.P., Redi, M.H., Mau, T.K., Jaeger, E.F., Ryan, P.M., Swain, D.W., Harvey, R.W., Egedal, J., and the NSTX Team, "Characterization of Fast Ion Absorption of the High Harmonic Fast Wave in the National Spherical Torus Experiment," *AIP Conference Proceedings* **694** (15 December 2003) 185-192; Princeton Plasma Physics Laboratory Report PPPL-3854 (August 2003) 8 pp. Presented at the *15th AIP Topical Conference on*

Radio Frequency Power in Plasmas (19-21 May 2003, Grand Teton National Park, Moran, Wyoming).

Rule, Keith; Kalb, Paul; and Kwaschyn, Pete, "Packaging and Disposal of Radium-beryllium Source using a Depleted Uranium Polyethylene Composite Shielding Container," Princeton Plasma Physics Laboratory Report PPPL-3782 (February 2003) 11 pp. Presented at the *Waste Management Symposium 2003* (23-27 February 2003, Tucson, Arizona).

Rule, Keith; Perry, Erik; Chrzanowski, Jim; Viola, Mike; and Strykowski, Ron, "The Innovations, Technology and Waste Management Approaches to Safely Package and Transport the World's First Radioactive Fusion Research Reactor for Burial," Princeton Plasma Physics Laboratory Report PPPL-3870 (September 2003) 5 pp. Presented at the *Ninth International Conference on Environmental Remediation and Radioactive Waste Management* (21-25 September 2003, Oxford, England).

Rule, Keith; Perry, Erik; and Parsells, R., "Diamond Wire Cutting the Tokamak Fusion Test Reactor," Princeton Plasma Physics Laboratory Report PPPL-3776 (January 2003) 9 pp. Presented at the *Waste Management Symposium 2003* (23-27 February 2003, Tucson, Arizona).

*Sakakita, H., Craig, D., Anderson J.K., Biewer, T.M., Terry, S.D., Chapman, B.E., Den-Hartog, D.J., Prager, S.C., "Behavior of Impurity Ion Velocities during the Pulsed Poloidal Current Drive in the Madison Symmetric Torus Reversed-field Pinch," *Jpn. J. Appl. Phys.* **42** (15 May 2003) L505-507 (Part 2, No. 5B).

Samtaney, Ravi, "Suppression of the Richtmyer-Meshkov Instability in the Presence of a Magnetic Field," *Phys. Fluids* **15** (August 2003) L53-L56; Princeton Plasma Physics Laboratory Report PPPL-3794 (March 2003) 14 pp.

*Sartori, R., Saibene, G., Horton, L.D., Bécoulet, M., Budny, R., Borba, D., Chankin, A., Conway, G.D., Cordey, G., McDonald, D., Guenter, K., von Hellermann, M.G., Igithkanov, Yu., Loarte, A., Lomas, P.J., Pogutse, O., and Rapp, J., "Study of Type III ELMs in JET," submitted to *Plasma Physics and Controlled Fusion*.

*Schekochihin, A.A., Cowley, S.C., Hammett, G.W., Maron, J.L., and McWilliams, J.C., "A Model of Nonlinear Evolution and Saturation of the Turbulent MHD Dynamo," *New J. Phys.* **4** (30 October 2002) Article No. 84.

*Schekochihin, A.A., Cowley, S.C., Taylor, S.F., Hammett, G.W., Maron, J.L., and McWilliams, J.C., "On the Saturated State of the Nonlinear Small-Scale Dynamo," *Phys. Rev. Lett.* **92** (27 February 2004) Article No. 084504.

†Schilling, G., Wukitch, S.J., Boivin, R.L., Goetz, J.A., Hosea, J.C., Irby, J.H., Lin, Y., Parisot, A., Porkolab, M., Wilson, J.R., and the Alcator C-Mod Team, "Analysis of 4-strap ICRF Antenna Performance in Alcator C-Mod," *AIP Conference Proceedings* **694** (15 December 2003) 166-169; Princeton Plasma Physics Laboratory Report PPPL-3849 (July 2003) 4 pp. Presented at the *15th AIP Topical Conference on Radio-frequency Power In Plasmas* (19-21 May 2003, Grand Teton National Park, Moran, Wyoming).

*Schoepf, K., Yavorskij, V.A., Darrow, D., Goloborod'ko, V.Ya., Gorelenkov, N., Holzmueller-Steinacker, U., Kaye, S.M., and Reznik, S.N., "Poincaré Mapping for Non-adiabatic Variations of NBI Ions in NSTX," in the *Proceedings of the 30th European Physical Society Conference on Controlled Fusion and Plasma Physics* (7-11 July 2003, St. Petersburg, Russia), Europhysics Conference Abstracts **27A** (European Physical Society, 2003) paper P-4.95. This conference proceedings is published on CD-ROM. Papers available in PDF format at <http://eps2003.ioffe.ru/> (as of 12 November 2003).

*Semenov, I.B., Fredrickson, E.D., Mirnov, S.V., and Vershkov, V.A., "Modes Dynamics in Precursor Phase before Disruptive Instability," in the *Proceedings of the 30th European Physical Society Conference on Controlled Fusion and Plasma Physics* (7-11 July 2003, St. Petersburg, Russia), Europhysics Conference Abstracts **27A** (European Physical Society, 2003) paper P-3.158. This conference proceedings is published on CD-ROM. Papers available in PDF format at <http://eps2003.ioffe.ru/> (as of 12 November 2003).

*Semenov, I., Mirnov, S., Darrow, D., Roquemore, L., Fredrickson, E.D., Menard, J., Stutman, D., and Belov, A., "Phenomenology of Internal Reconnections in NSTX," *Phys. Plasmas* **10** (March 2003) 664-670; Princeton Plasma Physics Laboratory Report PPPL-3702 (June 2002) 20 pp.

§Sharma, Prateek; Hammett, Gregory W.; and Quataert, Eliot, "Transition from Collisionless to Collisional MRI," *Astrophys. J.* **596** (1 October 2003) 1121-1130; Princeton Plasma Physics

Laboratory Report PPPL-3843 (July 2003) 20 pp.

*Shu, W.M., Gentile, C.A., Skinner, C.H., Langish, S., and Nishi, M.F., "The Effect of Oxygen on the Release of Tritium during Baking of TFTR D-T Tiles," *Fusion Eng. Des.* **61-62** (November 2002) 599-604. Presented at the *Sixth International Symposium on Fusion Nuclear Technology (ISFNT-6)* (8-12 April 2002, San Diego, California).

Sichta, P., Dong, J., Marsala, R., Oliaro, G., and Wertenbaker, J., "Developments to Supplant CAMAC with Industry Standard Technology at NSTX," Princeton Plasma Physics Laboratory Report PPPL-3850 (July 2003) 4 pp. Presented at the *4th IAEA Technical Committee Meeting on Control, Data Acquisition, and Remote Participation for Fusion Research* (21-23 July 2003, San Diego, California); proceedings to be published by Fusion Engineering and Design.

*Sips, A.C.C., Joffrin, E., deBaar, M., Barnsley, R., Budny, R., Buttery, R.J., Challis, C.D., Giroud, C., Gruber, O., Hender, T.C., Hobirk, J., Litaudon, X., Maggi, C.F., Na, Y.-S., Pinches, S.D., Stäbler, A., the ASDEX Upgrade Team, and the EFDA-JET contributors, "Improved H-mode Identity Experiments in JET and ASDEX Upgrade," in the *Proceedings of the 30th European Physical Society Conference on Controlled Fusion and Plasma Physics* (7-11 July 2003, St. Petersburg, Russia), Europhysics Conference Abstracts **27A** (European Physical Society, 2003) paper O-1.3A. This conference proceedings is published on CD-ROM. Papers available in PDF format at <http://eps2003.ioffe.ru/> (as of 12 November 2003).

- Skinner, C.H., Bekris, N., Coad, J.P., Gentile, C.A., and Glugla, M., "Tritium Removal from JET and TFTR Tiles by a Scanning Laser," *J. Nucl. Mater.* **313-316** (March 2003) 496-500; Princeton Plasma Physics Laboratory Report PPPL-3697 (May 2002) 13 pp. Presented at the *15th International Conference on Plasma Surface Interactions in Controlled Fusion Devices (PSI-15)* (27-31 May 2002, Gifu, Japan).
- Skinner, C.H., Bekris, N., Coad, J.P., Gentile, C.A., Hassanein, A., Reisinger, R., and Willms, S., "Thermal Response of Tritiated Codeposits from JET and TFTR to Transient Heat Pulses," *Physica Scripta* **T103** (2003) 34-37; Princeton Plasma Physics Laboratory Report PPPL-3698 (May 2002) 16 pp. Presented at the *International Workshop on Hydrogen Isotopes in Fusion Reactor Materials* (22-24 May 2002, Tokyo, Japan).
- Skinner, C.H., Coad, J.P. and Federici, G., "Tritium Removal from Carbon Plasma Facing Components," presented at the *10th International Workshop on Carbon Materials for Fusion Application* (17-19 September 2003, Jülich, Germany), proceeding to be published in a special issue of *Physica Scripta*.
- Skinner, C.H., Gentile, C.A., Ciebiera, L., and Langish, S., "Tritiated Dust Levitation by Beta Induced Static Charge," Princeton Plasma Physics Laboratory Report PPPL-3818 (June 2003) 15 pp; in press *Fusion Science and Technology*.
- Smirnov, A., Raitsev, Y., and Fisch, N.J., "Enhanced Ionization in the Cylindrical Hall Thruster," *J. Appl. Phys.* **94** (15 July 2003) 852-857; Princeton Plasma Physics Laboratory Report PPPL-3781 (February 2003) 25 pp.
- Smirnov, A., Raitsev, Y., and Fisch, N.J., "Enhanced Ionization in the Cylindrical Hall Thruster," presented at the *28th International Electric Propulsion Conference (IEPC 2003)* (17-21 March 2003, Toulouse, France). Proceedings published on CD-ROM.
- Smirnov, A., Raitsev, Y., and Fisch, N.J., "Parametric Investigations of Miniaturized Cylindrical and Annular Hall Thrusters," *J. Appl. Phys.* **92** (15 November 2002) 5673-5679; Princeton Plasma Physics Laboratory Report PPPL 3748 (September 2002) 29 pp.
- Smirnov, A., Raitsev, Y., and Fisch, N.J., "Plasma Measurements in a 100 W Cylindrical Hall Thruster," *J. Appl. Phys.* **95** (1 March 2004) 2283-2292.
- Solodov, A.A., Malkin, V.M., and Fisch, N.J., "Random Density Inhomogeneities and Focusability of the Output Pulses for Plasma-based Powerful Backward Raman Amplifiers," *Phys. Plasmas* **10** (June 2003) 2540-2544; Princeton Plasma Physics Laboratory Report PPPL-3771 (January 2003) 15 pp.
- *Soukhanovskii, V.A., Finkenthal, M., Moos, H.W., Stutman, D., Munsat, T., Jones, B., Hoffman, D., Kaita, R. and Majeski, R., "Observation of Neoclassical Impurity Transport in Ohmically Heated Plasmas of CDX-U Low Aspect Ratio Tokamak," *Plasma Phys. Control. Fusion* **44** (November 2002) 2339-2355.
- Soukhanovskii, V.A., Maingi, R., Raman, R., Kugel, H., LeBlanc, B., Roquemore, A.L., Lasnier, C.J., and NSTX Research Team, "Edge Recycling and Heat Fluxes in L- and H-mode NSTX Plasmas," in the *Proceedings of the 30th European Physical Society Conference on Controlled Fusion*

and *Plasma Physics* (7-11 July 2003, St. Petersburg, Russia), Europhysics Conference Abstracts **27A** (European Physical Society, 2003) paper P-3.179. This conference proceedings is published on CD-ROM. Papers available in PDF format at <http://eps2003.ioffe.ru/> (as of 12 November 2003). Princeton Plasma Physics Laboratory Report PPPL-3852 (August 2003) 4 pp.

Soukhanovskii, V.A., Roquemore, A.L., Skinner, C.H., Menard, J., Kugel, H.W., Johnson, D., Maingi, R., Sabbagh, S., and Paoletti, F., "High-resolution Spectroscopic Diagnostic for Divertor and Scrape-off Layer Neutral and Impurity Emission Measurements in the National Spherical Torus Experiment," *Rev. Sci. Instrum.* **74** (March 2003) 2094-2097. Presented at the *Fourteenth APS Topical Conference on High Temperature Plasma Diagnostics* (8-10 July 2002, Madison, Wisconsin).

†Spaleta, J., Majeski, R., Phillips, C.K., Dumont, R.J., Kaita, R., Soukhanovskii, V., and Zakharov, L., "Investigations of Low and Moderate Harmonic Fast Wave Physics on CDX-U," *AIP Conference Proceedings* **694** (15 December 2003) 213-218; Princeton Plasma Physics Laboratory Report PPPL-3840 (July 2003) 4 pp. Presented at the *15th AIP Topical Conference on Radio Frequency Power in Plasmas* (19-21 May 2003, Grand Teton National Park, Moran, Wyoming).

*Spong, D.A., Hirshman, S.P. Strickler, D.J., Lyon, J.F., Berry, A., Mikkelsen, D., Monticello, D., and Ware, A.S., "Confinement Physics of Quasi-poloidal Stellarators," in the *Proceedings of the 30th European Physical Society Conference on Controlled Fusion and Plasma Physics*

(7-11 July 2003, St. Petersburg, Russia), Europhysics Conference Abstracts **27A** (European Physical Society, 2003) paper P4.14. This conference proceedings is published on CD-ROM. Papers available in PDF format at <http://eps2003.ioffe.ru/> (as of 12 November 2003).

Staack, D., Raitsev, Y., and Fisch, N.J., "Electrostatic Probe with Shielded Probe Insulator Tube for Low Disturbing Plasma Measurements in Hall Thrusters," Princeton Plasma Physics Laboratory Report PPPL-3838 (July 2003) 31 pp; submitted to *Review of Scientific Instruments*.

Staack, D., Raitsev, Y., and Fisch, N.J., "Reducing Plasma Perturbations with Segmented Metal Shielding on Electrostatic Probes," Princeton Plasma Physics Laboratory Report PPPL-3752 (October 2002) 12 pp; submitted to *Review of Scientific Instruments*.

§Startsev, E.A. and Davidson, R.C., "Electromagnetic Weibel Instability in Intense Charged Particle Beams With Large Temperature Anisotropy," *Physics of Plasmas* **10** (December 2003) 4829-4836.

Startsev, E.A. and Davidson, R.C., "Intense Sheet Beam Stability Properties for Uniform Phase Space Density," in the *Proceedings of the 2003 Particle Accelerator Conference (PAC2003)* **5** (12-16 May 2003, Portland, Oregon) 2978-2980.

Startsev, E.A., and Davidson, R.C., "Kinetic Analysis of Intense Sheet Beam Stability Properties for Uniform Phase-space Density," *Phys. Rev. ST Accel. Beams* **6** (April 2003) Article No. 044401.

Startsev, E.A., Davidson, R.C., and Qin, H., "Analytical Theory and Nonlinear Delta-f Perturbative Simulations of Temperature Anisotropy Instability of Intense Charged Particle Beams," *Phys. Rev. ST Accel. Beams* **6** (August 2003) Article No. 084401 (15 pages).

Startsev, E.A., Davidson, R.C., and Qin, H., "Kinetic Studies of Temperature Anisotropy Instability in Intense Charged Particle Beams," in the *Proceedings of the 2003 Particle Accelerator Conference (PAC2003)* **5** (12-16 May 2003, Portland, Oregon) 3123-3125.

Startsev, Edward A.; Davidson, Ronald C.; and Qin, Hong, "Nonlinear Delta-f Simulation Studies of Intense Charged Particle Beams with Large Temperature Anisotropy," *Laser and Particle Beams* **20** (October 2002) 585-588.

Stotler, D.P., D'Ippolito, D.A., LeBlanc, B., Maqueda, R.J., Myra, J.R., Sabbagh, S.A., and Zweben S.J., "Three-Dimensional Neutral Transport Simulations of Gas Puff Imaging Experiments," Princeton Plasma Physics Laboratory Report PPPL-3875 (September 2003) 6 pp. Presented at the *9th International Workshop on Plasma Edge Theory in Fusion Devices* (3-5 September 2003, San Diego, California); conference proceedings to be published in *Contributions to Plasma Physics*.

Stotler, D.P., LaBombard, B., Terry, J.L., and Zweben, S.J., "Neutral Transport of Simulations of Gas Puff Imaging Experiments," *J. Nucl. Mater.* **313-316** (March 2003) 1066-1070; Princeton Plasma Physics Laboratory Report PPPL-3705 (June 2002) 10 pp. Presented at the *15th International Conference on Plasma Surface Interactions in Controlled Fusion*

Devices (PSI-15) (27-31 May 2002, Gifu, Japan).

*Strait, E.J., Bialek, J., Chance, M.S., Chu. M.S., Edgell, D.H., Ferron, J.R., Greenfield, C.M., Garofalo, A.M., Humphreys, D.A., Jackson, G.L., Jaykumar, R.J., Jernigan, T.C., Kim, J.S., LaHaye, R.J., Lao, L.L., Luce, T.C., Makowski, M.A., Murakami, M., Navratil, G.A., Okabayashi, M., Petty, C.C., Reimerdes, H., Scoville, J.T., Turnbull, A.D., Wade, M.R., Walker, M.L., Whyte, D.G., and the DIII-D Team, "Control of MHD Stability in DIII-D Advanced Tokamak Discharges," "Control of MHD Stability in DIII-D Advanced Tokamak Discharges," in the *Proceedings of the 30th European Physical Society Conference on Controlled Fusion and Plasma Physics* (7-11 July 2003, St. Petersburg, Russia), *Europhysics Conference Abstracts* **27A** (European Physical Society, 2003) paper O-3.6A. This conference proceedings is published on CD-ROM. Papers available in PDF format at <http://eps2003.ioffe.ru/> (as of 12 November 2003).

Stratton, B.C., Hawkes, N.C., Huysmans, G.T.A., Breslau, J.A., Zakharov, L.E., Alper, B., Budny, R.V., Challis, C.D., Deangelis, R., Drozdov, V., Fenzi, C., Giroud, C., Hender, T.C., Hobirk, J., Jardin, S.C., Joffrin, E., Lomas, P.J., Lotte, P., Mailloux, J., Park, W., Rachlew, E., Reyes-Cortes, S., Solano, E., Tala, T., Zastrow, K-D., and JET-EFDA Contributors, "Equilibria and Stability of JET Discharges with Zero Core Current Density," Princeton Plasma Physics Laboratory Report PPPL-3756 (October 2002) 5 pp. Presented at the *Nineteenth IAEA Fusion Energy Conference* (14-19 October 2002, Lyon, France).

Stratton, B.C., Johnson, D., Feder, R., Fredrickson, E., Neilson, H., Takahashi, H., Zarnstorff, M., Cole, M., Goranson, P., Lazarus, E., and Nelson, B., "Diagnostics for the National Compact Stellarator Experiment," in the *Proceedings of the 14th International Stellarator Workshop* (22-26 September 2003, Greifswald, Germany) P.We25; Proceedings to be published on a CD-ROM. Papers available at http://www.ipp.mpg.de/eng/for/veranstaltungen/workshops/stellarator_2003/SWS-CDROM/papers/papers_alphabetic.html (as of 15 May 2004). Princeton Plasma Physics Laboratory Report PPPL-3872 (September 2003) 6 pp.

*Stutman, D., Finkenthal, M., Bell, M.G., Bell, R.E., Bourdelle, C., Kaye, S.M., LeBlanc, B.P., Menard, J.E., Soukhanovskii, V., Synakowski, E.J., and the NSTX Team, "Correlation between Impurity Transport and Toroidal Rotation in NSTX," in the *Proceedings of the 30th European Physical Society Conference on Controlled Fusion and Plasma Physics* (7-11 July 2003, St. Petersburg, Russia), *Europhysics Conference Abstracts* **27A** (European Physical Society, 2003) paper P-3.100. This conference proceedings is published on CD-ROM. Papers available in PDF format at <http://eps2003.ioffe.ru/> (as of 12 November 2003).

*Stutman, D., Finkenthal, M., Moos, H.W., Fournier, K.B., Kaita, R., Johnson, D., Roquemore, L., "Integrated Impurity Diagnostic Package for Magnetic Fusion Experiments," *Rev. Sci. Instrum.* **74** (March 2003) 1982-1987. Presented at the *Fourteenth APS Topical Conference on High Temperature Plasma Diagnostics* (8-10 July 2002, Madison, Wisconsin).

*Swain, D.W., Carter, M.D., Wilson, J.R., Ryan, P.M., Wilgen, J.B., Hosea, J., and Rosenberg, A., "Loading and Asymmetry Measurements and Modeling for the National Spherical Torus Experiment Ion Cyclotron Range of Frequencies System," *Fusion Sci. Technol.* **43** (June 2003) 503.

Synakowski, E.J., Bell, M.G., Bell, R.E., Bigelow, T., Bitter, M., Blanchard, W., Boedo, J., Bourdelle, C., Bush, C., Darrow, D.S., Efthimion, P.C., Fredrickson, E.D., Gates, D.A., Gilmore, M., Grisham, L.R., Hosea, J.C., Johnson, D.W., Kaita, R., Kaye, S.M., Kubota, S., Kugel, H.W., LeBlanc, B.P., Lee, K., Maingi, R., Manickam, J., Maqueda, R., Mazzucato, E., Medley, S.S., Menard, J., Mueller, D., Nelson, B.A., Neumeyer, C., Ono, M., Paoletti, F., Park, H.K., Paul, S.F., Peng, Y.-K.M., Phillips, C.K., Ramakrishnan, S., Raman, R., Roquemore, A.L., Rosenberg, A., Ryan, P.M., Sabbagh, S.A., Skinner, C.H., Soukhanovskii, V., Stevenson, T., Stutman, D., Swain, D.W., Taylor, G., Von Halle, A., Wilgen, J., Williams, M., Wilson, J.R., Xu, X., Zweben, S.J., Akers, R., Barry, R.E., Beiersdorfer, P., Bialek, J.M., Blagojevic, B., Bonoli, P.T., Budny, R., Carter, M.D., Chrzanowski, J., Davis, W., Deng, B., Doyle, E.J., Dudek, L., Egedal, J., Ellis, R., Ferron, J.R., Finkenthal, M., Foley, J., Fredd, E., Glasser, A., Gibney, T., Goldston, R.J., Harvey, R., Hatcher, R.E., Hawryluk, R.J., Heidbrink, W., Hill, K.W., Houlberg, W., Jarboe, T.R., Jardin, S.C., Ji, H., Kalish, M., Lowrance, J., Lao, L.L., Lee, K.C., Levinton, F.M., Luhmann, N.C., Majeski, R., Marsala, R., Mastrovito, D., Mau, T.K., McCormack, B., Menon, M.M., Mitarai, O., Nagata, M., Nishino, N., Okabayashi, M., Oliaro,

G., Pacella, D., Parsells, R., Peebles, T., Peneflor, B., Piglowski, D., Pinsker, R., Porter, G.D., Ram, A.K., Redi, M., Rensink, M., Rewoldt, G., Robinson, J., Roney, P., Schaffer, M., Shaing, K., Shiraiwa, S., Sichta, P., Stotler, D., Stratton, B.C., Takase, Y., Tang, X., Vero, R., Wampler, W.R., Wurden, G.A., Xu, X.Q., Yang, J.G., Zeng, L., and Zhu, W., "The National Spherical Torus Experiment (NSTX) Research Program and Progress Towards High Beta, Long Pulse Operating Scenarios," Princeton Plasma Physics Laboratory Report PPPL-3758 (October 2002) 12 pp. Presented at the *Nineteenth IAEA Fusion Energy Conference* (14-19 October 2002, Lyon, France).

Takahashi, H., Schaffer, M.J., Fredrickson, E.D., Austin, M.E., Evans, T.E., Lao, L.L., and Watkins, J.G., "Observation of Current in SOL Plasma and Possible Roles Played by Associated Error Field in AT Discharges in DIII-Tokamak," in the *Proceedings of the 30th European Physical Society Conference on Controlled Fusion and Plasma Physics* (7-11 July 2003, St. Petersburg, Russia), *Europhysics Conference Abstracts* **27A** (European Physical Society, 2003) paper P-3.178. This conference proceedings is published on CD-ROM. Papers available in PDF format at <http://eps2003.ioffe.ru/> (as of 12 November 2003).

*§Takenaga, H., Higashijima, S., Oyama, N., Bruskin, L.G., Koide, Y., Ide, S., Shirai, H., Sakamoto, Y., Suzuki, T., Hill, K.W., Rewoldt, G., Kramer, G.J., Nazikian, R., Takizuka, T., Fujita, T., Sakasai, A., Kamada, Y., Kubo, H., JT-60 Team, "Relationship between Particle and Heat Transport in JT-60U Plasmas with Internal Transport Barrier," *Nucl. Fusion* **43** (October 2003) 1235-1245;

presented at the *Nineteenth IAEA Fusion Energy Conference* (14-19 October 2002, Lyon, France).

*Tanabe, T., Bekris, N., Coad, P., Skinner, C.H., Glugla, M., and Miya, N., "Tritium Retention of Plasma Facing Components in Tokamaks," *J. Nucl. Mater* **313-316** (March 2003) 478-490. Presented at the *15th International Conference on Plasma Surface Interactions in Controlled Fusion Devices (PSI-15)* (27-31 May 2002, Gifu, Japan).

†Taylor, G., Efthimion, P.C., Jones, B., Bell, G.L., Bers, A., Bigelow, T.S., Carter, M.D., Harvey, R.W., Ram, A.K., Rasmussen, D.A., Smirnov, A.P., Wilgen, J.B., and Wilson, J.R., "Electron Bernstein Wave Research on NSTX and CDX-U," *AIP Conference Proceedings* **694** (15 December 2003) 396-402; Princeton Plasma Physics Laboratory Report PPPL-3820 (June 2003) 4 pp. Presented at the *15th AIP Topical Conference on Radio Frequency Power in Plasmas* (19-21 May 2003, Grand Teton National Park, Moran, Wyoming).

Taylor, G., Efthimion, P.C., Jones, B., LeBlanc, B.P., Wilson, J.R., Wilgen, J.B., Bell, G.L., Bigelow, T.S., Maingi, R., Rasmussen, D.A., Harvey, R.W., Smirnov, A.P., Paoletti, F., and Sabbagh, S.A., "Enhanced Conversion of Thermal Electron Bernstein Waves to the Extraordinary Electromagnetic Mode on the National Spherical Torus Experiment (NSTX)" *Phys. Plasmas* **10** (May 2003) 1395-1401; Princeton Plasma Physics Laboratory Report PPPL-3757 (October 2002) 25 pp.

*Terry, J.L., Zweben, S.J., Hallatschek, K., LaBombard, B., Maqueda, R.J., Bai, B., Boswell, C.J., Greenwald, M.,

Kopon, D., Nevins, W.M., Pitcher, C.S., Rogers, B.N., Stotler, D.P., and Xu, X.Q., "Observations of the Turbulence in the Scrap-off-layer of Alcator C-Mod and Comparisons with Simulation," *Phys. Plasmas* **10** (May 2003) 1739-1747.

*Tobita, K., Kusama, Y., Shinohara, K., Nishitani, T., Kimura, H., Kramer, G.J., Nemoto, M., Kondoh, T., Oikawa, T., Morioka, A., Hamamatsu, K., Wang, S., Takeji, S., Takechi, M., Ishikawa, M., Tani, K., Saigusa, M., and Ozeki, T., "Energetic Particle Experiments in JT-60U and their Implications for a Fusion Reactor," *Fusion Sci. Technol.* **42** (September-November 2002) 315-326.

Trintchouk, F., Yamada, M., Ji, H., Kulsrud, R.M., Carter, T.A., "Measurement of the Transverse Spitzer Resistivity during Collisional Magnetic Reconnection," *Phys. Plasmas* **10** (January 2003) 319-322; Princeton Plasma Physics Laboratory Report PPPL-3750 (September 2002) 14 pp.

Tzenov, S.I. and Davidson, R.C., "Renormalization Group Reduction of the Hénon Map and Application to the Transverse Betatron Motion in Cyclic Accelerators," *New J. Phys.* **5** (June 2003) Article 67.

*Uhm, H.S. and Davidson, R.C., "Effects of Electron Collisions on the Resistive Hose Instability in Intense Charged Particle Beams Propagating through Background Plasma," *Phys. Rev. ST Accel. Beams* **6** (March 2003) Article No. 034204 (10 pages).

*Umeda, N., Grisham, L.R., Yamamoto, T., Kuriyama, M., Kawai, M., Ohga, T., Mogaki, K., Akino, N., Yamazaki,

H., Usui, K., Honda, A., Guangjiu, L., Watanabe, K., Inoue, T., Hanada, M., Kashiwagi, M., Morishita, T., Dairaku, M., and Takayanagi, T., *Nucl. Fusion* **43** (July 2003) 522-526.

*Valovic, M., Budny, R., Garzotti, L., Garget, X., Korotkov, A.A., Rapp, J., Neu, R., Sauter, O., Weisen, H., deVries, P., Alper, B., Beurskens, M., Brzozowski, J., McDonald, D., Leggate, H., Parail, V., and JET EFDA contributors, "Density Peaking in ELMy H-mode in JET," in the *Proceedings of the 30th European Physical Society Conference on Controlled Fusion and Plasma Physics* (7-11 July 2003, St. Petersburg, Russia), Europhysics Conference Abstracts **27A** (European Physical Society, 2003) paper P-1.105. This conference proceedings is published on CD-ROM. Papers available in PDF format at <http://eps2003.ioffe.ru/> (as of 12 November 2003).

*Vdovin, V.L., Wesner, F., Hartmann, D., Watari, T., and Monticello, D., "ICRF Plasma Heating in large Stellarators," in the *Proceedings of the 30th European Physical Society Conference on Controlled Fusion and Plasma Physics* (7-11 July 2003, St. Petersburg, Russia), Europhysics Conference Abstracts **27A** (European Physical Society, 2003) paper O-4.3B. This conference proceedings is published on CD-ROM. Papers available in PDF format at <http://eps2003.ioffe.ru/> (as of 12 November 2003).

*Wang, T.-S.F., Channell, P.J., Macek, R.J., and Davidson, R.C., "Centroid Theory of Transverse Electron-Proton Two-Stream Instability in a Long Proton Bunch," *Phys. Rev. ST Accel. Beams* **6** (January 2003) Article No. 014204 (17 pages).

- *Ware, A.S., Westerly, D., Barcikowski, E., Berry, L.A. Fu, G., Hirshman, S.P., Lyon, J.F., Sanchez, R., Spong, D.A., and Strickler, D.J., "Second Ballooning Stability Access in the Quasi-poloidal Stellarator," in the *Proceedings of the 30th European Physical Society Conference on Controlled Fusion and Plasma Physics* (7-11 July 2003, St. Petersburg, Russia), Europhysics Conference Abstracts **27A** (European Physical Society, 2003) paper P-4.11. This conference proceedings is published on CD-ROM. Papers available in PDF format at <http://eps2003.ioffe.ru/> (as of 12 November 2003).
- *Wheatley, V., Pullin, D.I., and Samtaney, R., "On the Regular Refraction of a MHD Shock at an Inclined Planar Density Interface," submitted to the Journal of Fluid Mechanics.
- White, R. and Zakharov, L.E., "Hamiltonian Guiding Center Equations in Toroidal Magnetic Configurations," *Phys. Plasmas* **10** (March 2003) 573-576; Princeton Plasma Physics Laboratory Report PPPL-3734 (September 2002) 10 pp.
- Wilson, J.R., Bell, R.E., Bernabei, S., Bitter, M., Bonoli, P., Gates, D., Hosea, J., LeBlanc, B., Mau, T.K., Medley, S., Menard, J., Mueller, D., Ono, M., Phillips, C.K., Pinsker, R.I., Raman, R., Rosenberg, A., Ryan, P., Sabbagh, S., Stutman, D., Swain, D., Takase, Y., Wilgen, J., and the NSTX team, "Exploration of High Harmonic Fast Wave Heating on the National Spherical Torus Experiment," *Phys. Plasmas* **10** (May 2003) 1733-1738; Princeton Plasma Physics Laboratory Report PPPL-3785 (February 2003) 26 pp.
- Wong, K.L., Budny, R., Nazikian, R., Petty, C.C., Greenfield, C.M., Heidbrink, W.W., and Ruskov, E., "Alpha Channeling Experiment in the DIII-D Tokamak," submitted to Physical Review Letters.
- *Yamada, H., Murakami, S., Yamazaki, K., Kaneko, O., Miyazawa, J., Sakamoto, R., Watanabe, K.Y., Narihara, K., Tanaka, K., Sakakibara, S., Osakabe, M., Peterson, B.J., Morita, S., Ida, K., Inagaki, S., Masuzaki, S., Morisaki, T., Rewoldt, G., and 71 additional co-authors representing 8 institutions, "Impact of Heat Deposition Profile on Global Confinement of NBI Heated Plasmas in the LHD," *Nucl. Fusion* **43** (August 2003) 749-755.
- *Yamamoto, T., and The JT-60U Team (including Grisham, L.R.), "Technological Development and Progress of Plasma Performance on the JT-60U," *Fusion Eng. Des.* **66-68** (September 2003) 39-48. Presented at the *22nd Symposium on Fusion Technology (SOFT 2002)* (9-13 September 2002, Marina Congress Center, Helsinki, Finland).
- *Yamamoto, T., Kuriyama, M., Umeda, N., Lei, G., Grisham, L.R., Kawai, M., Ohga, T., and the JT-60U NBI Team, *Plasma Fusion Research Series* **5** (2003) 474-477.
- §Yampolsky, N.A., Malkin, V.M., and Fisch, N.J., "Finite-duration Seeding Effects in powerful Backward Raman Amplifiers," *Phys. Rev. E* **69** (March 2004) Article No. 036401; Princeton Plasma Physics Laboratory Report PPPL-3839 (July 2003) 6 pp.
- *Yavorskij, V.A., Darrow, D., Goloborod'ko, V.Ya., Reznik, S.N.,

- Holzmueller-Steinacker, U., Gorelenkov, N., and Schoepf, K., "Fast Non-Adiabaticity in Spherical Tokamaks," *Nucl. Fusion* **42** (October 2002) 1210-1215; Princeton Plasma Physics Laboratory Report PPPL-3733 (August 2002) 22 pp.
- Young, Kenneth M., "Diagnostics for FIRE: A Status Report," *Rev. Sci. Instrum.* **74** (March 2003) 1761-1765; Princeton Plasma Physics Laboratory Report PPPL-3720 (July 2002) 15 pp. Presented at the *Fourteenth APS Topical Conference on High Temperature Plasma Diagnostics* (8-10 July 2002, Madison, Wisconsin).
- *Yu, S.S., Anders, A., Eylon, S., Henestroaza, E., Roy, P., Shuman, D., Waldron, W., Sharp, W., Rose, D., Welch, D., Efthimion, P.C., and Gilson, E.P., "Focusing and Neutralization of Intense Charged Particle Beams," in the *Proceedings of the 2003 Particle Accelerator Conference (PAC2003)* **1** (12-16 May 2003, Portland, Oregon) 98-101.
- Zaharia, Sorin and Cheng, C.Z., "3-D Force-balanced Magnetospheric Configurations," Princeton Plasma Physics Laboratory Report PPPL-3783 (February 2003) 18 pp; submitted to *Annales Geophysicae*.
- Zaharia, Sorin and Cheng, C.Z., "Near-earth Thin Current Sheets and Birkeland Currents during Substorm Growth Phase," *Geophys. Res. Lett.* **30** (4 September 2003) Article No. 1883; Princeton Plasma Physics Laboratory Report PPPL-3809 (April 2003) 5 pp.
- Zakharov, L.E., "Magnetic Propulsion of Intense Lithium Streams in a Tokamak Magnetic Field," *Phys. Rev. Lett.* **90** (31 January 2003) Article 045001; Princeton Plasma Physics Laboratory Report PPPL-3679 (March 2002) 12 pp.
- Zakharov, L.E., "Stabilization of Tokamak Plasma by Lithium Streams," *Phys. Plasmas* **9** (November 2002) 4591-4595; Princeton Plasma Physics Laboratory Report PPPL-3483 (August 2000) 8 pp.
- Zakharov, L.E., Gorelenkov, N.N., White, R.B., Krasheninnikov, S.I., and Pereverzev, G.V., "Plasma Physics Regimes in Tokamaks with Li Walls," Princeton Plasma Physics Laboratory Report PPPL-3856 (August 2003) 23 pp; submitted to *Fusion Engineering and Design*.
- Zakharov, L.E., Krasheninnikov, S.I., Galkin, S.A., Parks, P.B., and Fredrickson, E.D., "Negative Central Current and q_0 Equilibria and Relaxation in Tokamaks," in the *Proceedings of the 30th European Physical Society Conference on Controlled Fusion and Plasma Physics* (7-11 July 2003, St. Petersburg, Russia), Europhysics Conference Abstracts **27A** (European Physical Society, 2003) paper P-2.112. This conference proceedings is published on CD-ROM. Papers available in PDF format at <http://eps2003.ioffe.ru/> (as of 12 November 2003).
- Zatz, Irving J., "TFTR D&D Project: Final Examination and Testing of the TFTR TF-Coils," Princeton Plasma Physics Laboratory Report PPPL-3777 (January 2003) 52 pp.
- Zweben, S.J., Kornak, T.W., Majeski, D., Schilling, G., Skinner, C.H., Wilson, R., and Kuzma, N., "Evaluation of Pos-

sible Nuclear Magnetic Resonance Diagnostic Techniques for Tokamak Experiments,” *Rev. Sci. Instrum.* **74** (March 2003) 1460-1464; Princeton Plasma Physics Laboratory Report PPPL-3734 (August 2002) 14 pp. Presented at the *Fourteenth APS Topical Conference on High Temperature Plasma Diagnostics* (8-10 July 2002, Madison, Wisconsin).

§Zweben, S.J., Maqueda, R., Stotler, D.P., Keese, A., Boedo, J., Bush, C., Kaye, S., LeBlanc, B., Lowrance, J., Mastrocola, V., Maingi, R., Nishino, N., Renda, G., Swain, D., Wilgen, J., and the NSTX Team, “High Speed Imaging of Edge Turbulence in NSTX,” *Nucl. Fusion* **44** (January 2004) 134-153; Princeton Plasma Physics Laboratory Report PPPL-3795 (March 2003) 51 pp.

Abbreviations, Acronyms, and Symbols

1-D	One-dimensional
2-D	Two-dimensional
3-D	Three-dimensional
AFOSR	(U.S.) Air Force Office of Scientific Research
Alcator	A tokamak at the Plasma Science and Fusion Center at the Massachusetts Institute of Technology
C-Mod	
ALPS	(Energy) Advanced Liquid Plasma-facing Surface Program (a U.S. Department of Energy Program)
AMP	Adaptive Mesh Refinement
AMR	Adaptive Mesh Refinement
AMTEX	American Textile Partnership
APEX	Advanced Power Extraction Program (a U.S. Department of Energy Program)
ARIES	Advanced Reactor Innovation Evaluation Studies
ARL	Army Research Laboratory
ARSC	Arctic Region Supercomputing Center
AS	Advanced Stellarator
ASDEX	Axially Symmetric Divertor Experiment (at the Max-Planck- Institut für Plasmaphysik, Garching, Germany)
AT	Advanced Tokamak
B_t	Toroidal Magnetic Field
BES	Beam Emission Spectroscopy
BEST	Beam Equilibrium Stability and Transport Code
BPAC	Burning Plasma Assessment Committee (under the National Research Council)
BPX	Burning Plasma Experiment
CAD	Computer-aided Design
CADD	Computer-aided Design and Drafting
CAE	Compressional Alfvén Eigenmodes
CAIP	Center for Advanced Information Processing at Rutgers University, New Jersey
CCD	Charge-coupled Device
CD	Current Drive

CD-2	Critical Decision 2
CDR	Conceptual Design Review
CDX-U	Current Drive Experiment-Upgrade at the Princeton Plasma Physics Laboratory
CER	Charge-exchange Recombination system on DIII-D at General Atomics in California
CFC	Carbon Fiber Composite
CHE	Coaxial Helicity Ejection
CHERS	Charge-exchange Recombination Spectrometer
CHI	Coaxial Helicity Injection
CIT	Compact Ignition Tokamak
cm	Centimeter
C-Mod	A tokamak in the “Alcator” family at the Plasma Science and Fusion Center at the Massachusetts Institute of Technology
CME	Coronal Mass Ejection
CPPG	Computational Plasma Physics Group at the Princeton Plasma Physics Laboratory
CRADAs	Cooperative Research and Development Agreements
CTF	Component Test Facility
CY	Calendar Year
D-D	Deuterium-deuterium
D-T	Deuterium-tritium
D&D	Decontamination and Decommissioning
DARPA	Defense Advanced Research Projects Agency
DBM	Drift Ballooning Model
DE	Differential Evolution
DIII-D	A tokamak at the DIII-D National Fusion Facility at General Atomics in San Diego, California
DOE	(United States) Department of Energy
DWC	Diamond Wire Cutting
EAEs	Ellipticity-induced Alfvén Eigenmodes
EBW	Electron-Bernstein Wave (Heating)
ECCD	Electron Cyclotron Current Drive
ECE	Electron Cyclotron Emission
ECEI	Electron Cyclotron Emission Imaging (Radiometer)
ECH	Electron Cyclotron Heating
ECR	Electron Cyclotron Resonance
ECRH	Electron Cyclotron Resonance Heating
EDA	Enhanced D_{α} Mode
EFDA	European Fusion Development Agreement
EFIT	An equilibrium code
E-LHDI	Electrostatic Lower-hybrid Drift Instability

ELM	Edge Localized Modes
ELVS	Graphics Program
EPM	Energetic Particle Mode
ER/WM	Environmental Restoration and Waste Management
ERD	Edge Rotation Diagnostic
ERP	Enterprise Resource Planning
ES&H	Environment, Safety, and Health
ET	Experimental Task
ETG	Electron-temperature Gradient Mode
eV	Electron Volt
FAC	Field-aligned Current
FCC	Fusion Computational Center
FEAT	Fusion Energy Advanced Tokamak
FEM	Finite Element Method
FES	Fusion Energy Sciences
FESAC	Fusion Energy Sciences Advisory Committee
FIRE	Fusion Ignition Research Experiment (a national design study collaboration)
FIReTIP	Far-infrared Tangential Interferometer and Polarimeter
FLC	Federal Laboratory Consortium (for Technology Transfer)
FLR	Field-line Resonance
FPT	Fusion Physics and Technology, Inc.
FRC	Field-reversed Configuration
FTP	File Transfer Protocol
FW	Fast Wave
FY	Fiscal Year
GA	General Atomics in San Diego, California
GAE	Global Alfvén Eigenmodes
GDC	Glow Discharge Cleaning
GEM	Gas Electronic Multiplier
GFDL	Gas Fluid Dynamics Laboratory (on Princeton University's James Forrestal Campus)
GPI	Gas Puff Imaging
GTC	Gyrokinetic Toroidal Code
H-mode	High-confinement Mode
HCX	High Current Experiment at the Princeton Plasma Physics Laboratory
HFS	High-field Side
HHFW	High-harmonic Fast-waves
HIT-II	Helicity Injected Torus II at the University of Washington, Seattle, Washington

HRMIS	Human Resources Management Information System
HXR	Hard X-Ray
HYM	Hybrid and MHD Code
I_p	Plasma Current
I/O	Input/Output
IBX	Integrated Beam Experiment
ICE	Ion Cyclotron Emission
ICF	Inertial Confinement Fusion
ICRF	Ion Cyclotron Range of Frequencies
ICW	Ion-cyclotron wave
IDSP	Ion Dynamic Spectroscopy Probe; an optical probe used to measure local ion temperature and flows during magnetic reconnection
IGNITOR	Ignited Torus
IMF	Interplanetary Magnetic Field
IPP	Institut für Plasmaphysik, Garching, Germany
IPR	Institute for Plasma Research, Gujarat, India
IR	Infrared
IRE	Integrated Research Experiment at the Princeton Plasma Physics Laboratory
IRE	Internal Reconnection Event
ISS	International Stellarator Scaling
ITB	Internal Transport Barrier
ITER	“The Way” in Latin. Formerly interpreted to stand for International Thermonuclear Experimental Reactor, although this usage has been discontinued.
ITG	Ion-temperature Gradient Mode
JAERI	Japan Atomic Energy Research Institute
JET	Joint European Torus (JET Joint Undertaking) in the United Kingdom
JET-EP	Joint European Torus Enhancement Program
JFT-2M	A small Japanese tokamak
JHU	Johns Hopkins University
JT-60U	Japanese Tokamak at the Japan Atomic Energy Research Institute
kA	Kiloampere
KAM	Kolmogorov-Arnold-Moser
KAWs	Kinetic Alfvén Waves
keV	Kiloelectron Volt
kG	Kilogauss
KMB	Kinetic Ballooning Mode

KSTAR	Korea Superconducting Tokamak Advanced Research device being built in Taejon, South Korea
kV	Kilovolt
kW	Kilowatt
L-mode	Low-confinement Mode
LBNL	Lawrence Berkeley National Laboratory
LFS	Low-field Side
LH	Lower-hybrid
LHCD	Lower-hybrid Current Drive
LHD	Large Helical Device; a stellarator operating in Japan
LHDI	Lower-hybrid Drift Instability
LIF	Laser-induced Fluorescence
LLNL	Lawrence Livermore National Laboratory
LPDA	Laboratory Program Development Activities at the Princeton Plasma Physics Laboratory
LTX	Liquid Tokamak Experiment
MA	Megampere
MAST	Mega Amp Spherical Torus at the Culham Laboratory, United Kingdom
MAV	Micro Air Vehicle
MHD	Magnetohydrodynamic
MHz	Megahertz
MINDS	Miniature Integrated Nuclear Detector System
MIR	Microwave Imaging Reflectometer
MIT	Massachusetts Institute of Technology in Cambridge, Massachusetts
MLM	Multilayer Mirror
MX	Magnetic Nozzle Experiment at the Princeton Plasma Physics Laboratory
MPP	Massively Parallel Processor
MPTS	Multi-point Thomson Scattering
MRX	Magnetic Reconnection Experiment at the Princeton Plasma Physics Laboratory
ms, msec	Millisecond
MSE	Motional Stark Effect (Diagnostic)
MW	Megawatt
NASA	National Aeronautics and Space Administration
NBCD	Neutral-beam Current Drive
NBI	Neutral Beam Injection (Heating)
NCSX	National Compact Stellarator Experiment (a Princeton Plasma Physics Laboratory-Oak Ridge National Laboratory fabrication project)

NERSC	National Energy Research Supercomputer Center
NIFS	National Institute of Fusion Science (Japan)
NJTC	New Jersey Technology Council
NNBI	Negative-ion-based Neutral-beam Injection
NPA	Neutral Particle Analyzer
NRC	National Research Council
NRC	Nuclear Regulatory Commission
NRL	Naval Research Laboratory
NSF	National Science Foundation
NSO	Next-step Option
NSO-PAC	Next-step Option Program Advisory Committee
NSST	Next-step Spherical Torus
NSTX	National Spherical Torus Experiment at the Princeton Plasma Physics Laboratory
NTCC	National Transport Code Collaboration
NTM	Neoclassical Tearing Mode
NTX	Neutralized Transport Experiment
NUF	(DOE) National Undergraduate Fellowship
OFES	Office of Fusion Energy Sciences (at the U.S. Department of Energy)
OH	Ohmic Heating
ORNL	Oak Ridge National Laboratory, Oak Ridge, Tennessee
ORPA	Office of Research and Project Administration at Princeton University
OS	Optimized Shear
OSHA	Occupational Safety and Health Administration
PAC	Program Advisory Committee
PBX	Princeton Beta Experiment, predecessor to PBX-M at the Princeton Plasma Physics Laboratory (no longer operating)
PBX-M	Princeton Beta Experiment-Modification at the Princeton Plasma Physics Laboratory (no longer operating)
PDR	Preliminary Design Report
PDR	Preliminary Design Review
PDX	Poloidal Divertor Experiment, predecessor to PBX and PBX-M at the Princeton Plasma Physics Laboratory (no longer operating)
PF	Poloidal Field
PFC	Plasma-facing Component
PICSciE	Princeton Institute for Computational Science and Engineering
PLT	Princeton Large Torus at the Princeton Plasma Physics Laboratory (no longer operating)
PPPL	Princeton Plasma Physics Laboratory (Princeton University, Princeton, New Jersey)
PPST	Program in Plasma Science and Technology

PSACI	Plasma Science Advanced Scientific Computing Initiative
PSEL	Plasma Science Education Laboratory at the Princeton Plasma Physics Laboratory
PSFC	Plasma Science and Fusion Center at the Massachusetts Institute of Technology in Cambridge, Massachusetts
PTSX	Paul Trap Simulator Experiment
Q	The ratio of the fusion power produced to the power used to heat a plasma
QA	Quality Assurance
QA	Quasi-axisymmetry
QAS	Quasi-axisymmetry Stellarator
QDB	Quiescent Double Barrier
R&D	Research and Development
REs	Reconnection Event(s)
rf	Radio-frequency (Heating)
RGA	Residual Gas Analyzer
RI	Radiative-improved Confinement Mode
RMF	Rotating Magnetic Field
RSAEs	Reversed-shear Alfvén Eigenmodes
RTAE	Resonant TAE
RWM	Resistive Wall Modes
SBIR	Small Business Innovative Research (Program)
SciDAC	(The Department of Energy Office of Science's) Scientific Discovery through Advance Computing Program
SEP	Science Education Program
SOL	Scrape-off Layer
SSX	Swarthmore Spheromak Experiment located at the Department of Physics and Astronomy, Swarthmore College, Swarthmore, Pennsylvania
SSX-FRC	Swarthmore Spheromak Experiment-Field-reversed Configuration
ST	Spherical Torus
START	Small Tight Aspect Ratio Tokamak at Culham, United Kingdom
STTR	Small Business Technology Transfer (Program)
SULI	(DOE) Science Undergraduate Laboratory Internship
SXR	Soft X-ray
T	Temperature
TAE	Toroidicity-induced Alfvén Eigenmode or Toroidal Alfvén Eigenmode
TEM	Trapped-electron Mode
TEXTOR	Tokamak Experiment for Technologically Oriented Research in Jülich, Germany

TF	Toroidal Field
TFC	Topical Computing Facility
TFTR	Tokamak Fusion Test Reactor (1982-1997), at the Princeton Plasma Physics Laboratory (no longer operating)
TJ-II	A “flexible” Helic (stellarator) located at the CIEMAT Institute in Madrid, Spain
Tore Supra	Tokamak at Cadarache, France
TRACE	Transition Region and Coronal Explorer (satellite)
TSC	Transport Simulation Code
TWC	Tandem Wing Clapper
UC Davis	University of California at Davis
UCLA	University of California at Los Angeles
UCSD	University of California at San Diego
UKAEA	United Kingdom Atomic Energy Agency
ULF	Ultra-low Frequency
USDA	United States Department of Agriculture
USDOE	United States Department of Energy
UV	Ultraviolet
W7-AS	Wendelstein-7 Advanced Stellarator, an operating stellarator in Germany
W7-X	A stellarator being built in Germany
WFOs	Work For Others
WVU	West Virginia University
XP	Experimental Proposal
Y2K	Year 2000

June 2004

Editors: Carol A. Phillips and Anthony R. DeMeo

Contributors: J.W. Anderson, M. Bitter, C.Z. Cheng, S.A. Cohen, R.C. Davidson, A.R. DeMeo, P. Efthimion, N.J. Fisch, R.J. Goldston, L.R. Grisham, R.J. Hawryluk, M.T. Iseicz, S. Jardin, H. Ji, D.W. Johnson, S.M. Kaye, A. Kuritsyn, D.V. Lawson, J. Levine, R.P. Majeski, D.M. Meade, L.D. Meixler, R. Nazikian, G.H. Neilson, M. Ono, Y.-M. Peng, C.A. Phillips, A. Post-Zwicker, H. Qin, G. Rewoldt, B. Sarfaty, N.R. Sauthoff, G. Schilling, W.M. Tang, P. Wieser, M.D. Williams, M. Yamada

Cover Design: Gregory J. Czechowicz

Report Design: Carol A. Phillips

Photography: Elle Starkman

Graphics: Gregory J. Czechowicz

Layout: Gregory J. Czechowicz and Carol A. Phillips

The Princeton Plasma Physics Laboratory is funded by the U.S. Department of Energy under contract DE-AC02-76CH03073 and managed by Princeton University.

This report was prepared as an account of work sponsored by the United States Government. Neither the United States nor the United States Department of Energy nor any of their employees, nor any of their contractors, subcontractors, or their employees, makes any warranty, expressed or implied, or assumes any legal liability, or responsibility for the accuracy, completeness or usefulness of any information, apparatus, product or process disclosed, or represents that its use would not infringe privately owned rights.

For additional information contact:
Information Services
Princeton Plasma Physics Laboratory
P.O. Box 451
Princeton, NJ 08543
Phone: (609) 243-2750
Fax: (609) 243-2751
e-mail: pppl_info@pppl.gov
Internet Address: <http://www.pppl.gov/>