

## Figures

**This page intentionally left blank.**

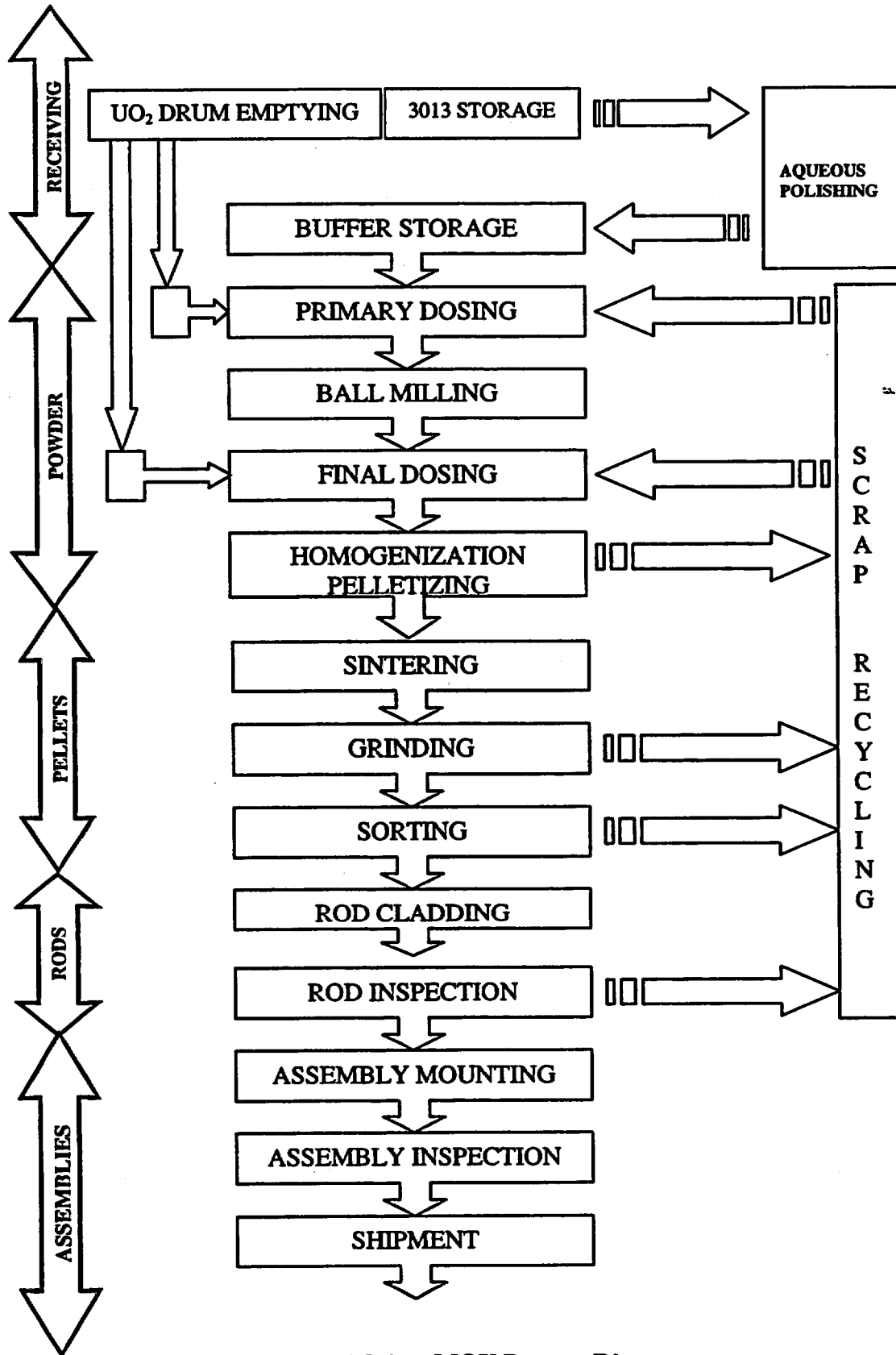

Figure 11.2-1. MOX Process Diagram

**This page intentionally left blank.**

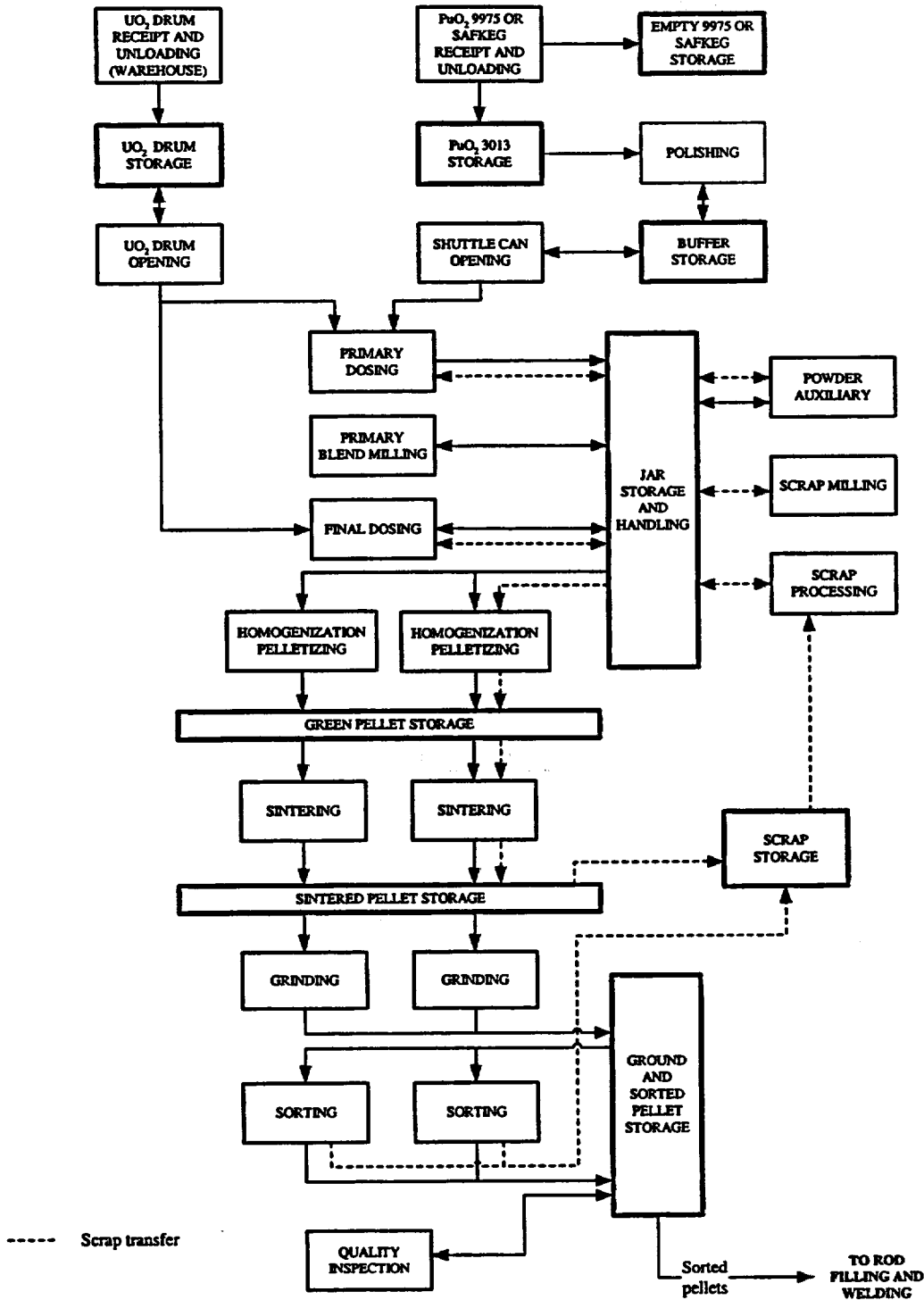
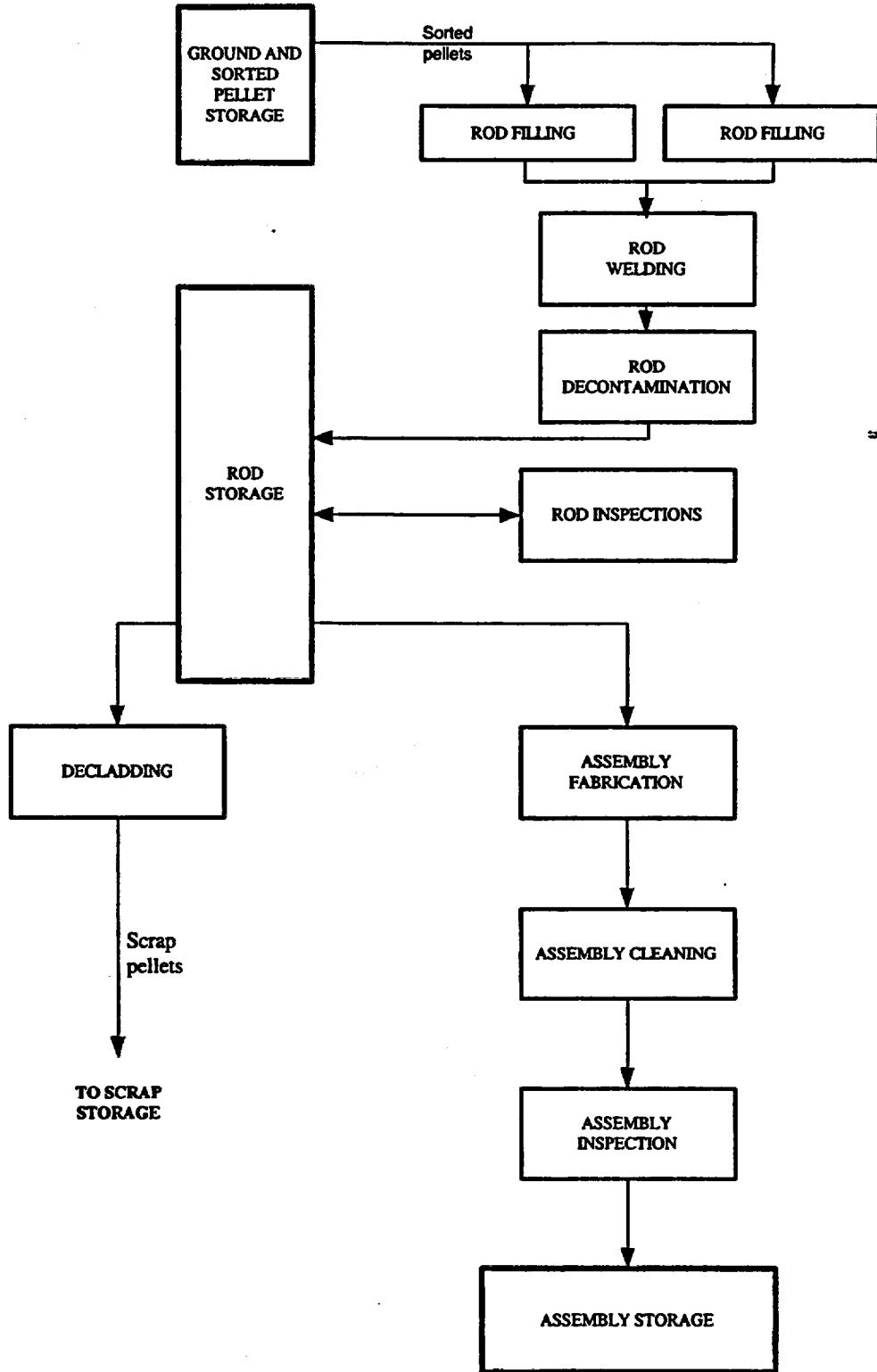

Figure 11.2-2. First Part of the Production Line – Detailed Diagram

**This page intentionally left blank.**



**Figure 11.2-3. Second Part of the Production Line – Detailed Diagram**

**This page intentionally left blank.**



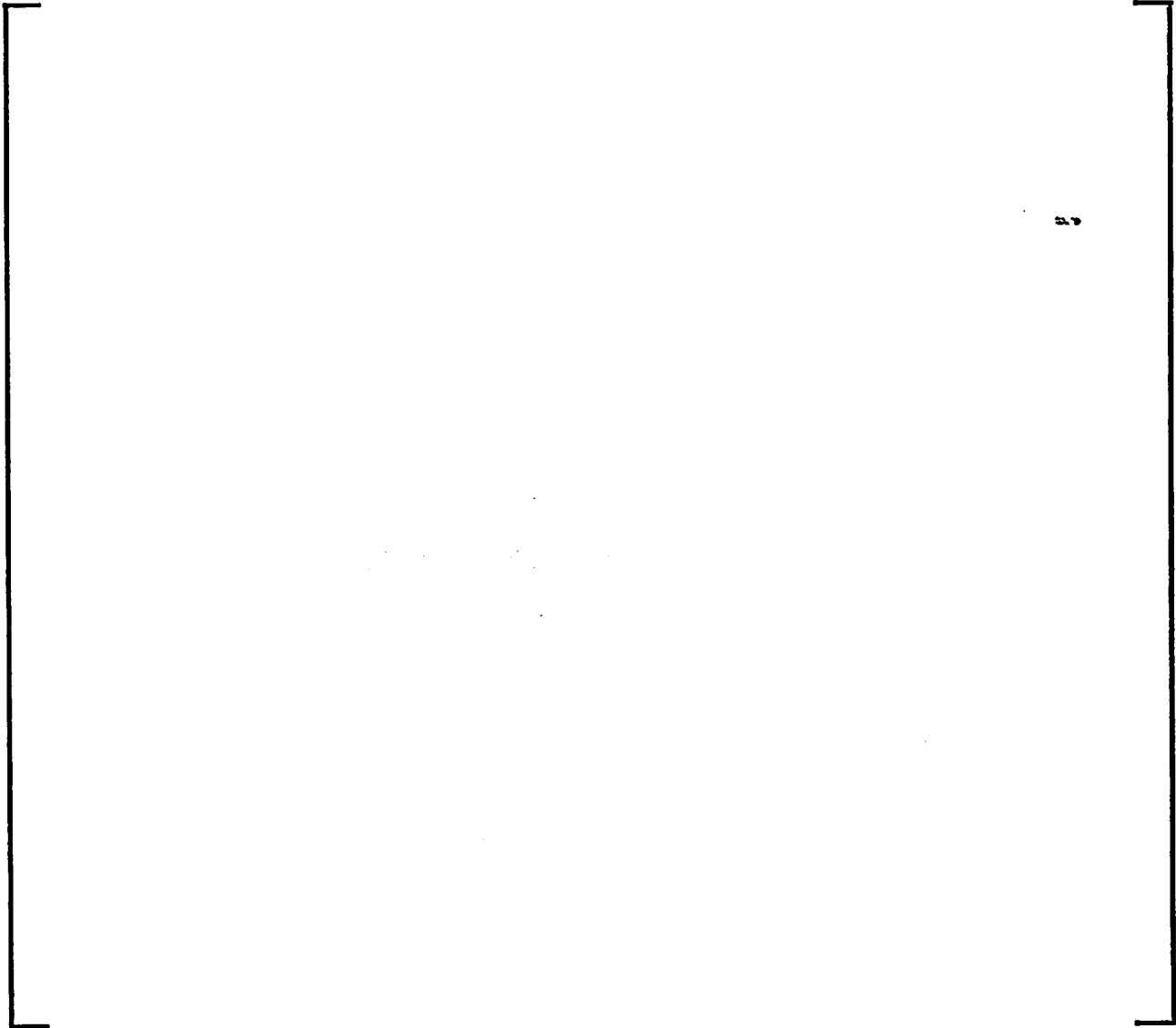

**Figure 11.2-4. UO<sub>2</sub> Drum Emptying Unit**

**This page intentionally left blank.**

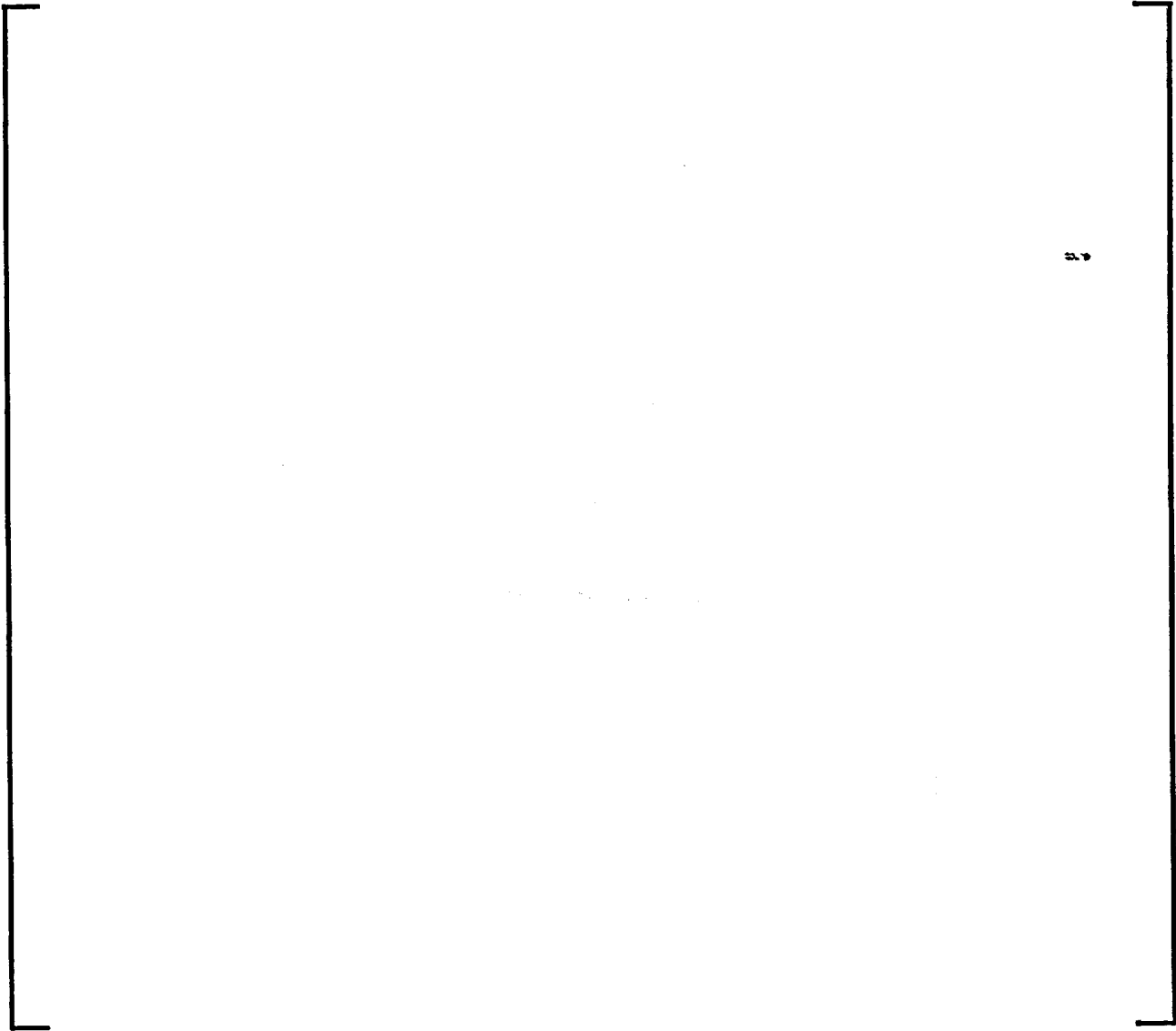

**Figure 11.2-4. UO<sub>2</sub> Drum Emptying Unit (continued)**

**This page intentionally left blank.**

Composition of a cask

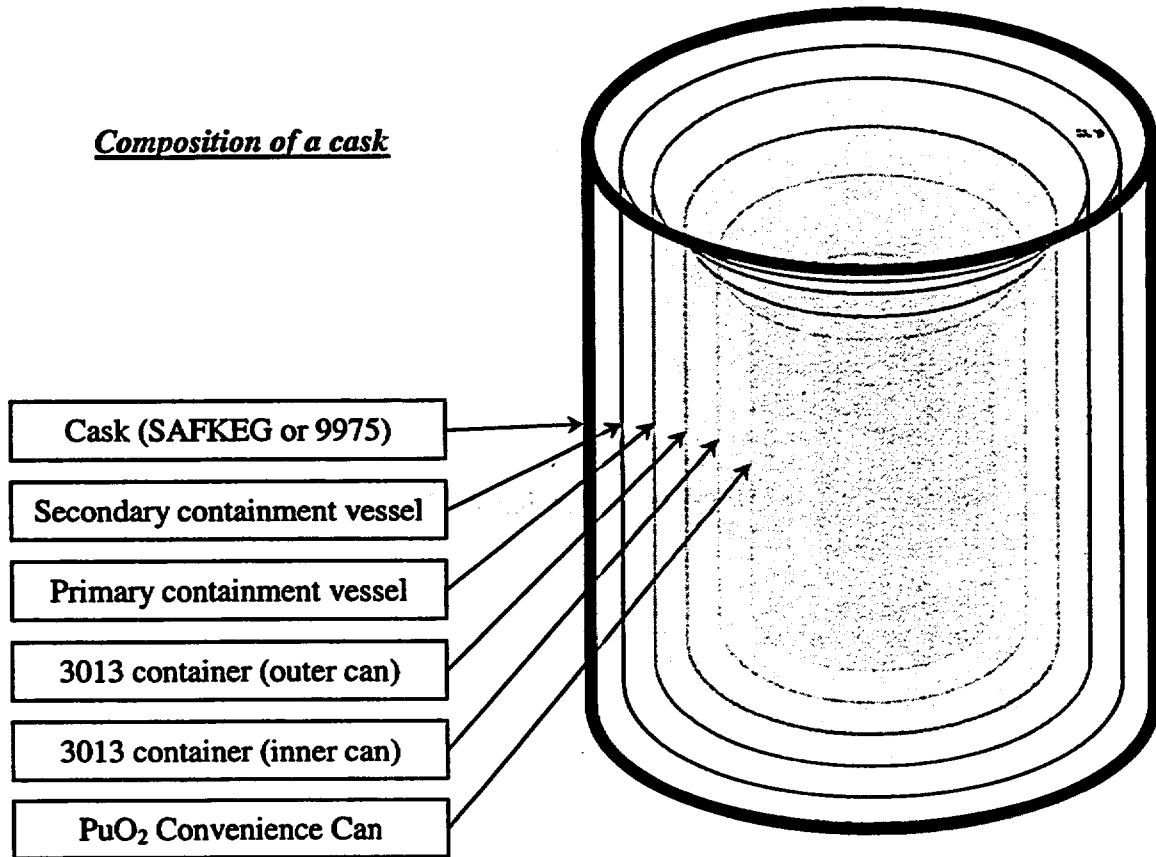
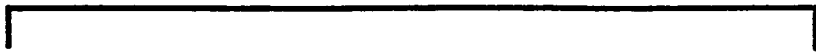

Figure 11.2-5. Composition of a Cask

**This page intentionally left blank.**



3

**Figure 11.2-6. PuO<sub>2</sub> Buffer Storage Unit**



**This page intentionally left blank.**





**Figure 11.2-6. PuO<sub>2</sub> Buffer Storage Unit (continued)**

**This page intentionally left blank.**

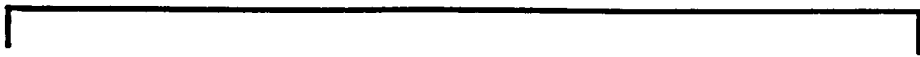

**Figure 11.2-7. PuO<sub>2</sub> Can Receiving and Emptying Unit**



**This page intentionally left blank.**

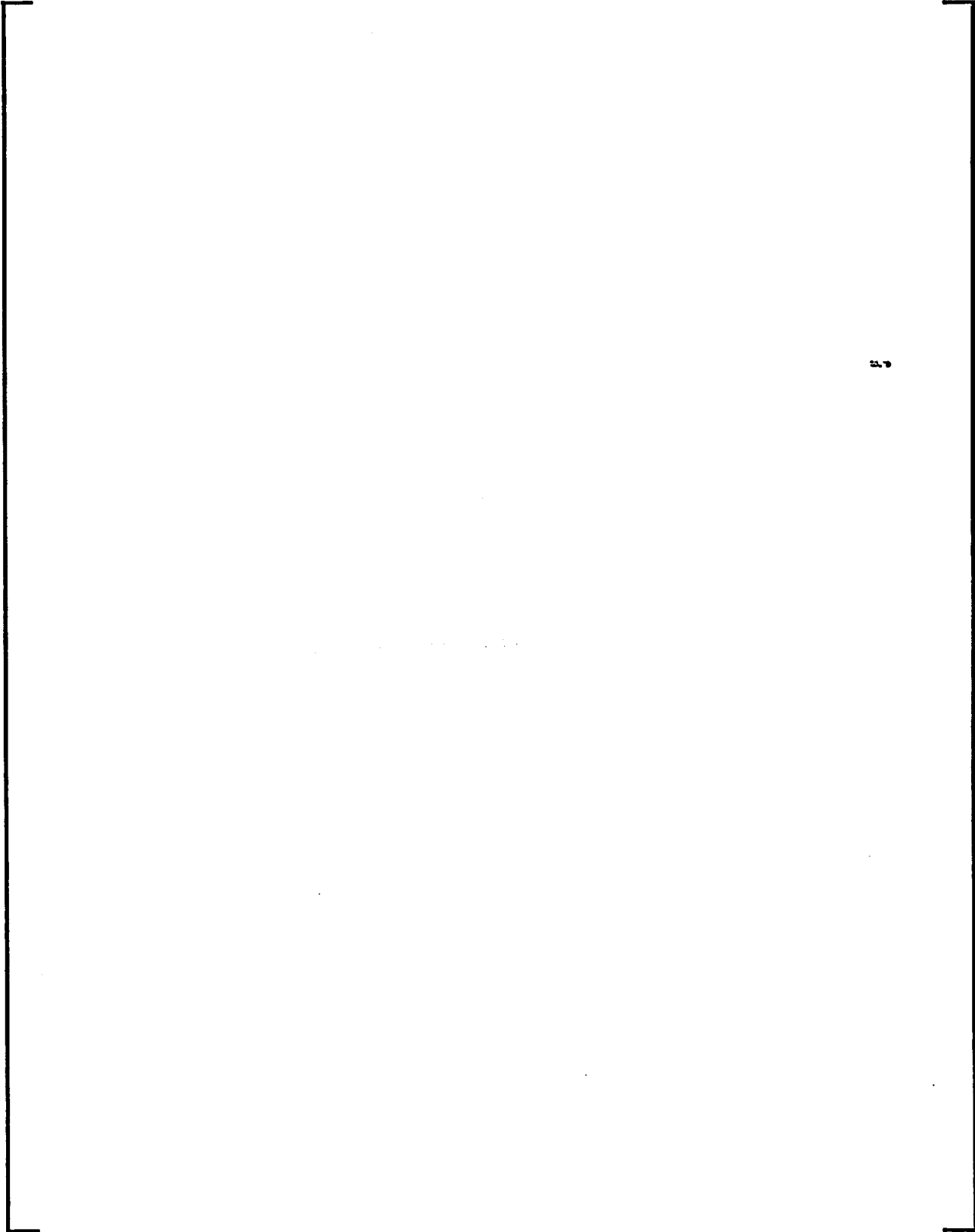

**Figure 11.2-7. PuO<sub>2</sub> Can Opening Unit (continued)**

**This page intentionally left blank.**

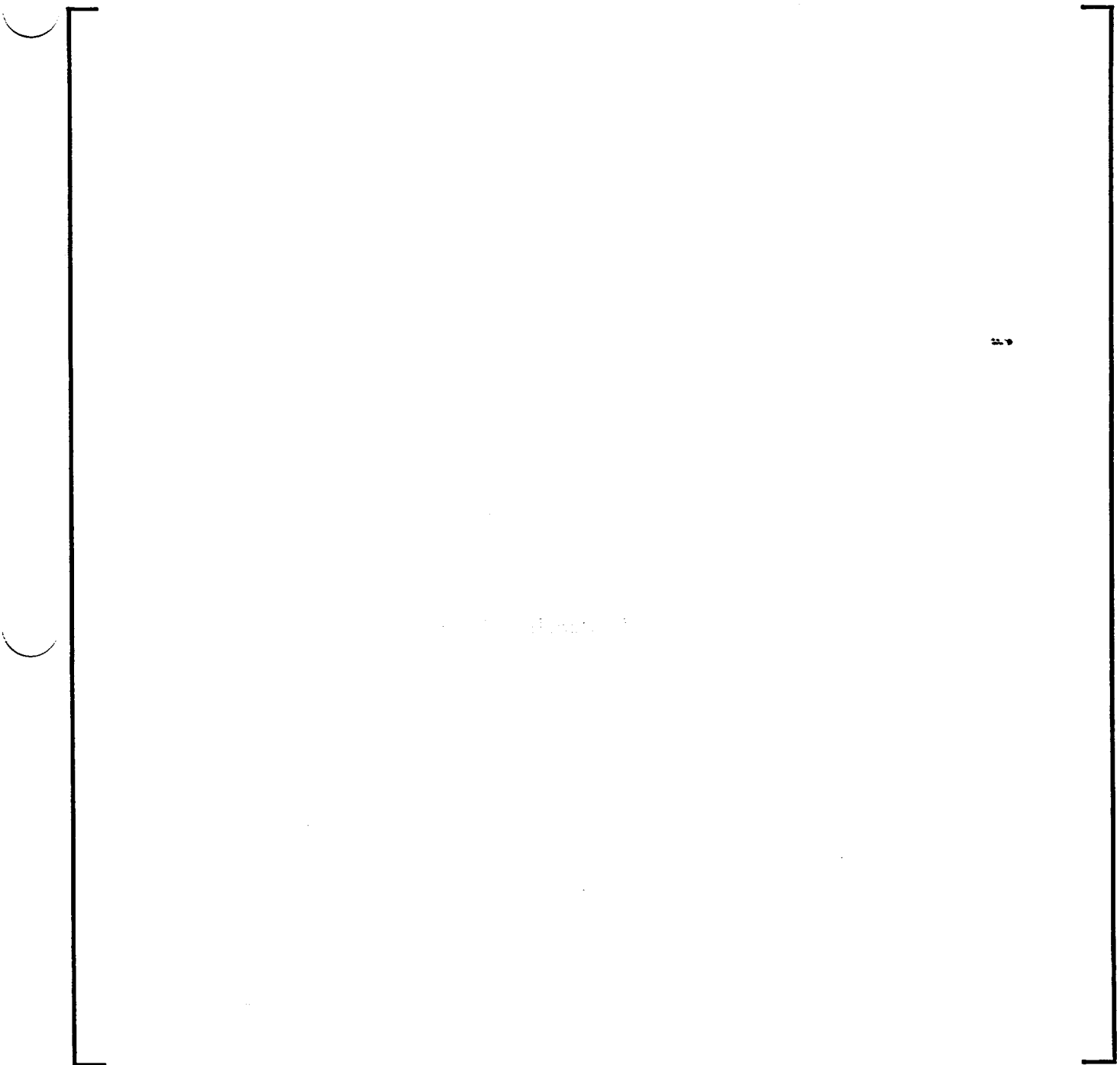

**Figure 11.2-8. Primary Dosing Unit**

**This page intentionally left blank.**



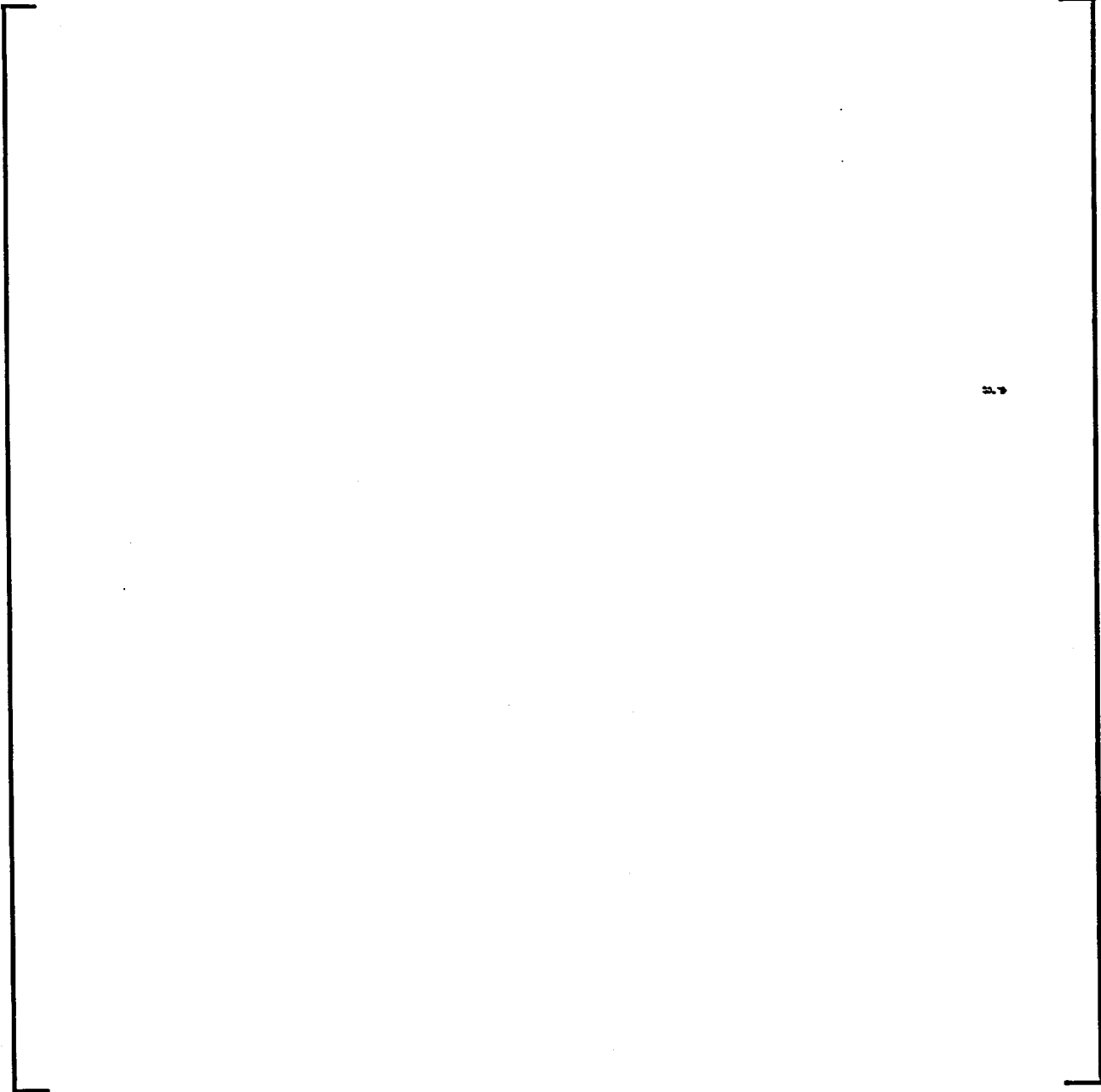

**Figure 11.2-8. Primary Dosing Unit (continued)**

**This page intentionally left blank.**



**Figure 11.2-9. Primary Blend Ball Milling Unit**

**This page intentionally left blank.**



**Figure 11.2-9. Primary Blend Ball Milling Unit (continued)**

**This page intentionally left blank.**

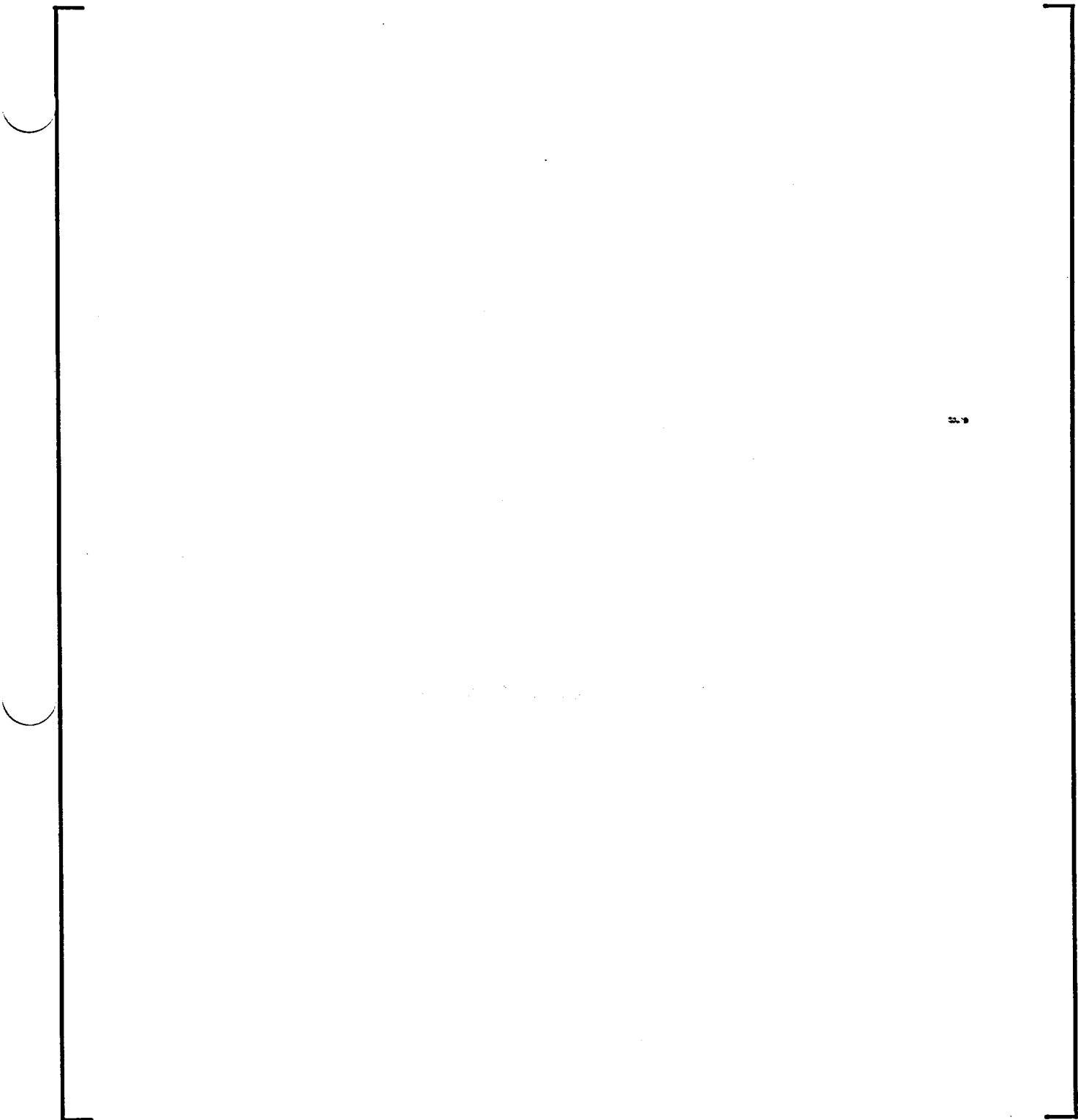

**Figure 11.2-10. Final Dosing Unit**

**This page intentionally left blank.**



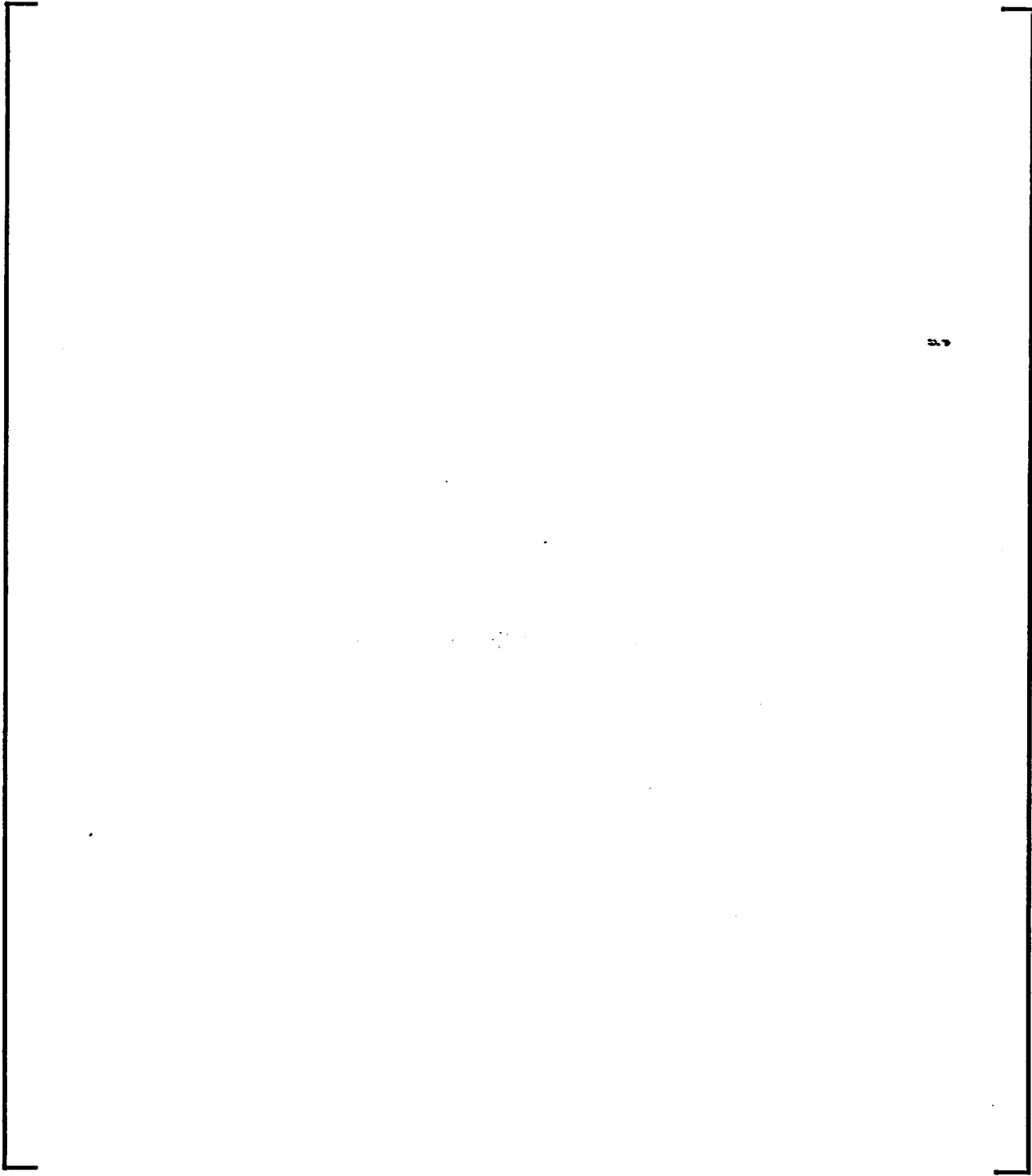

**Figure 11.2-10. Final Dosing Unit (continued)**

**This page intentionally left blank.**

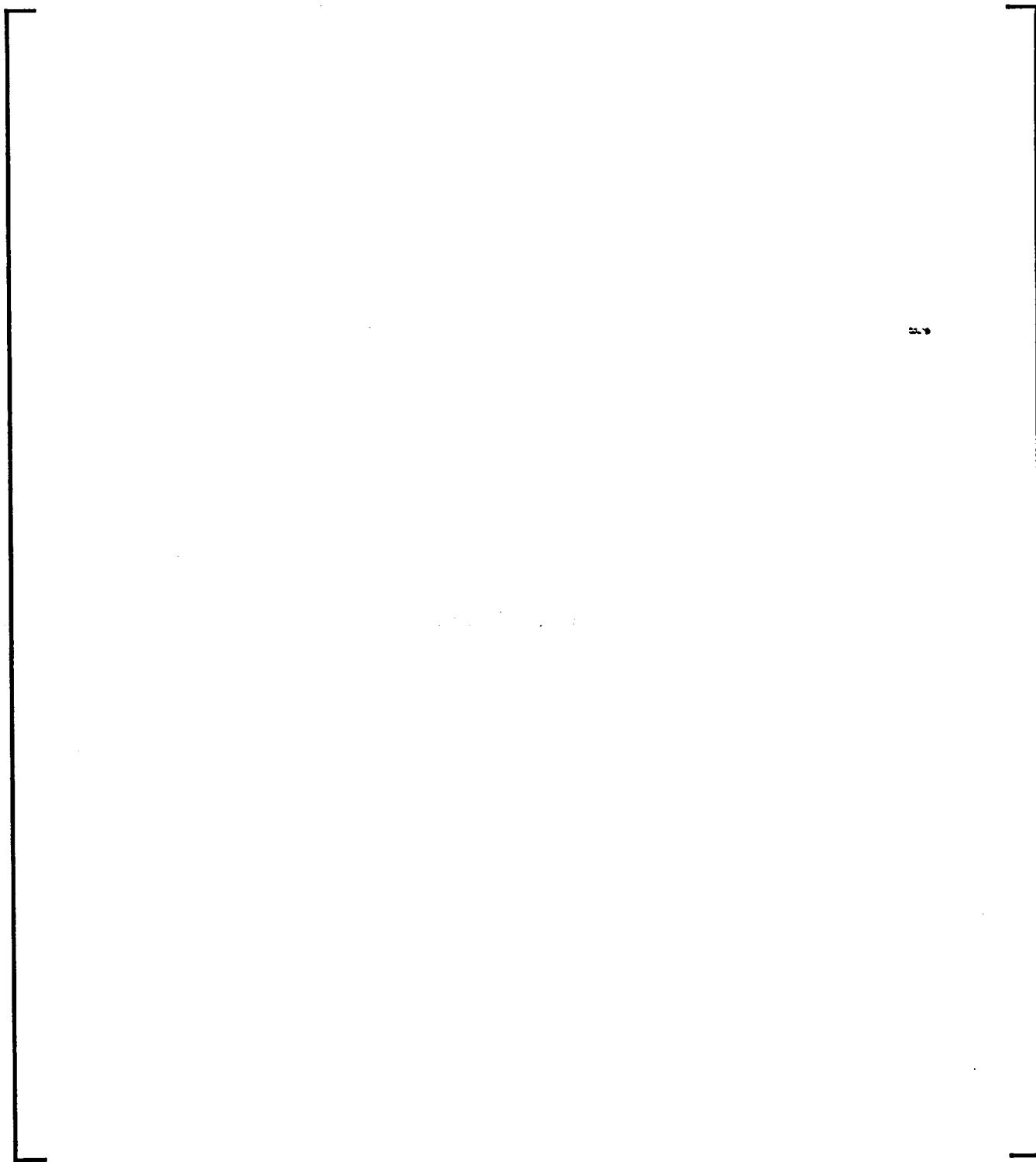

**Figure 11.2-11. Homogenization and Pelletizing Unit**

**This page intentionally left blank.**

**Figure 11.2-11. Homogenization and Pelletizing Unit (continued)**

**This page intentionally left blank.**



**Figure 11.2-12. Scrap Processing Unit**

**This page intentionally left blank.**



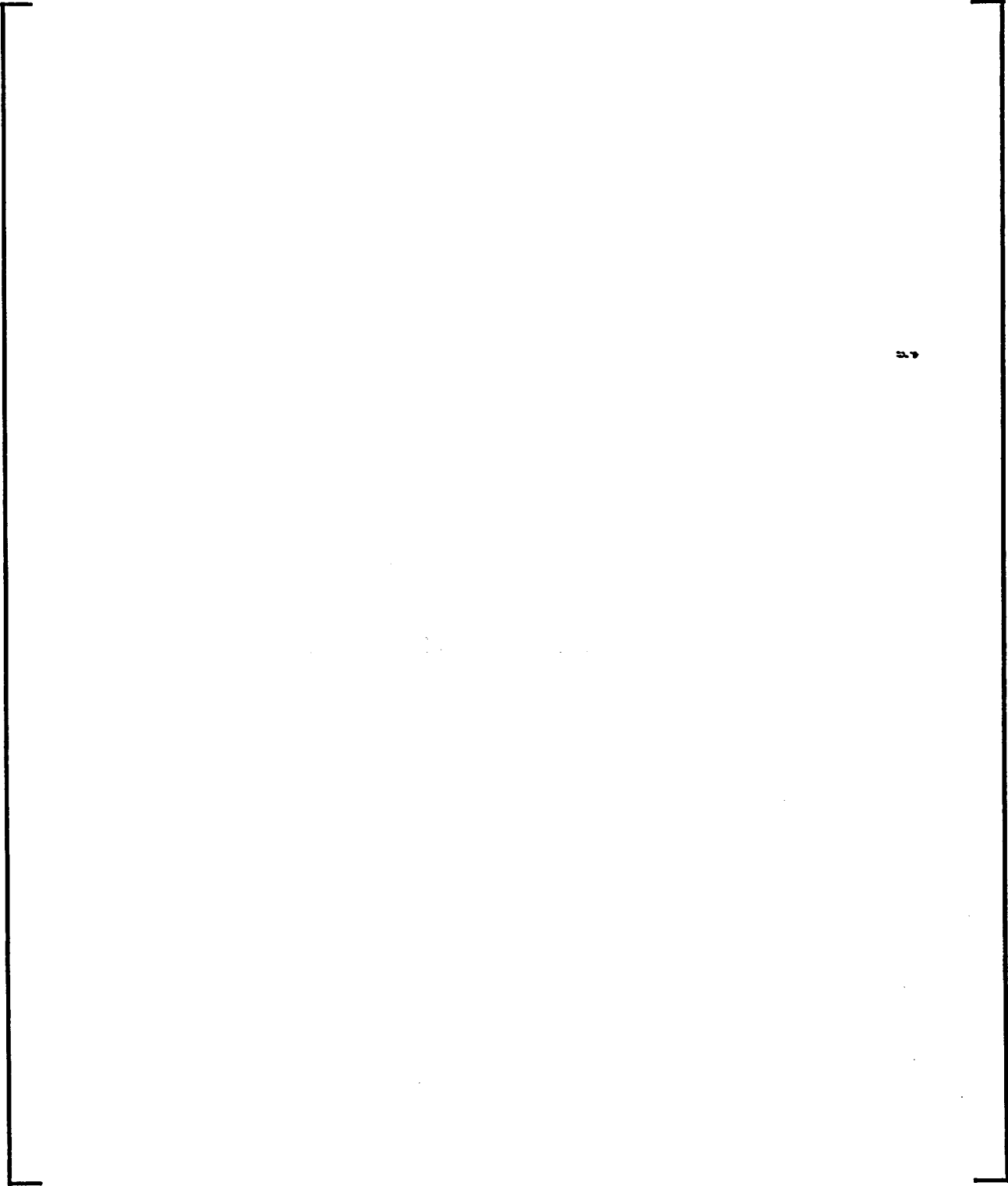

**Figure 11.2-12. Scrap Processing Unit (continued)**

**This page intentionally left blank.**

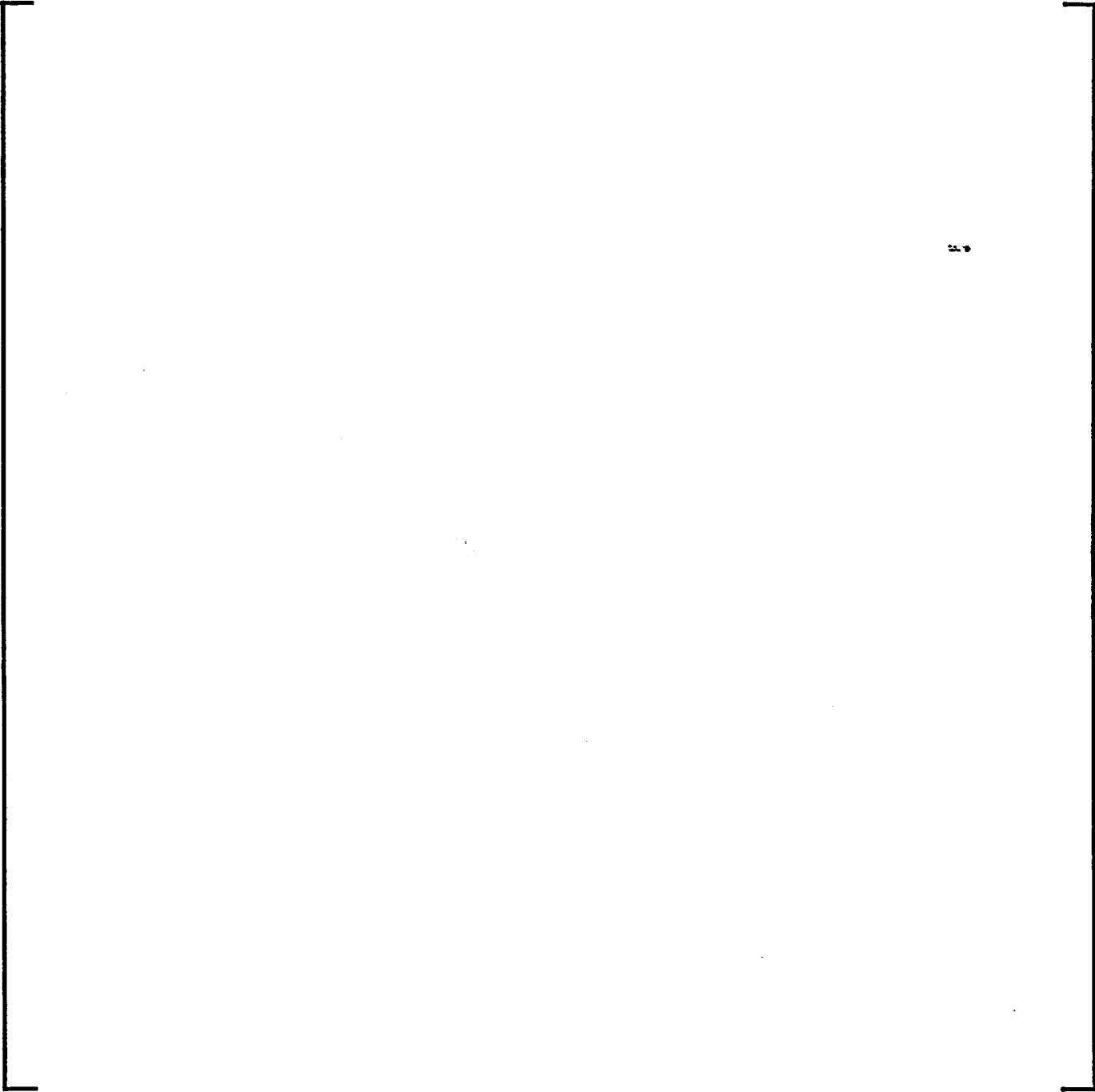

**Figure 11.2-13. Powder Auxiliary Unit**

**This page intentionally left blank.**

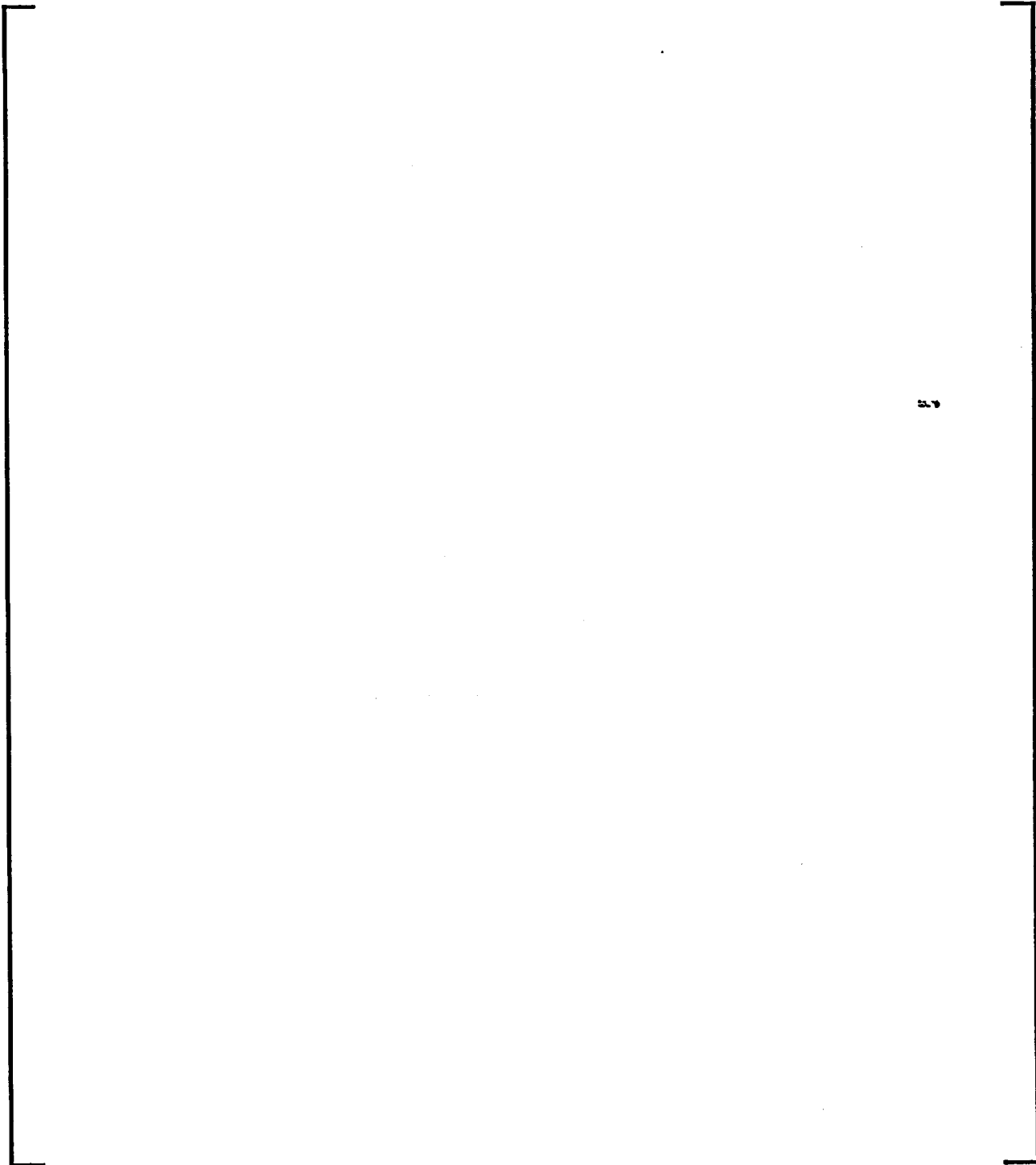

**Figure 11.2-13. Powder Auxiliary Unit (continued)**

**This page intentionally left blank.**

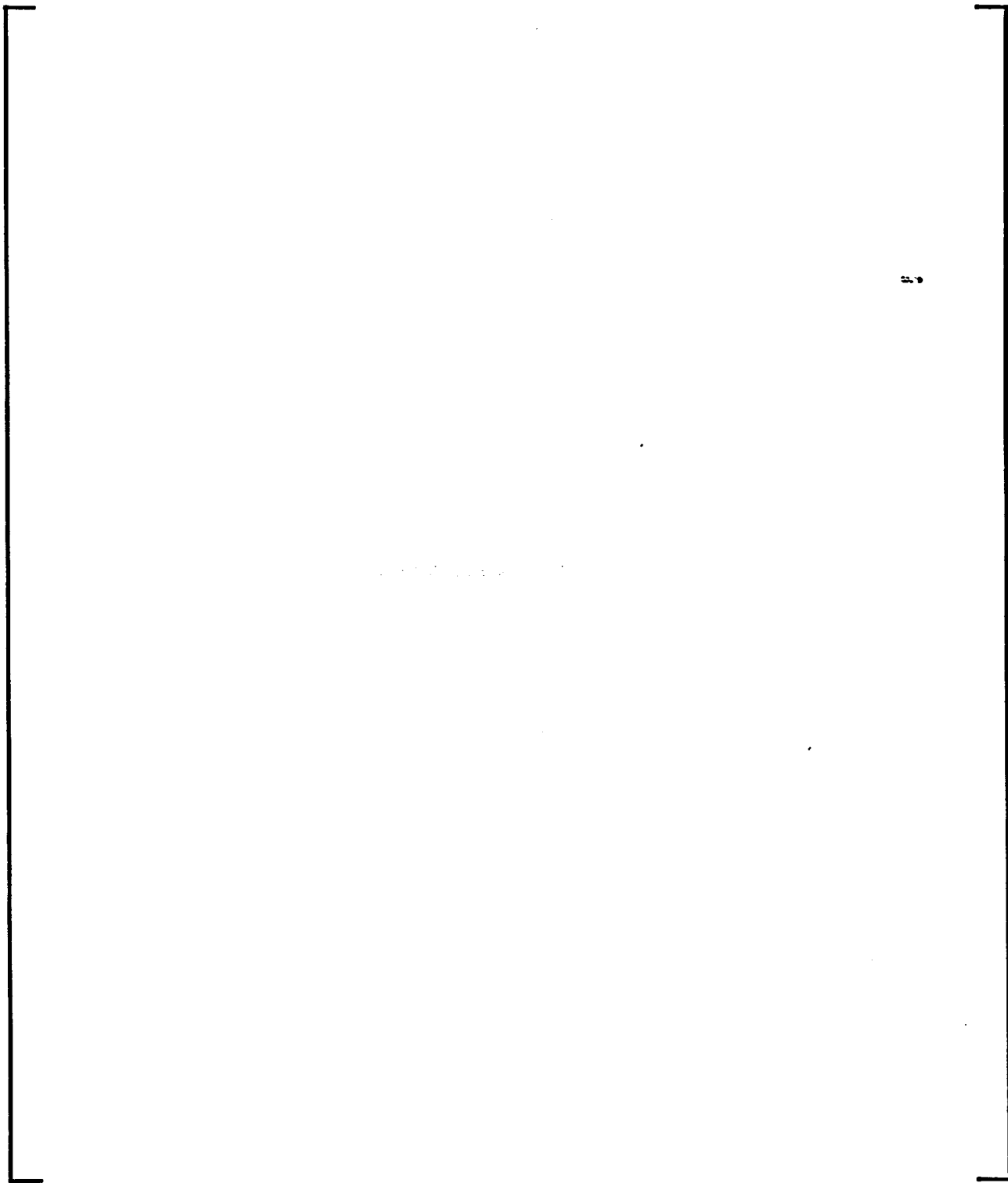

**Figure 11.2-14. Jar Storage and Handling Unit (Top View). See Figure 11.2-15 for index.**

**This page intentionally left blank.**





**Figure 11.2-15. Jar Storage and Handling Unit (Side View)**

**This page intentionally left blank.**

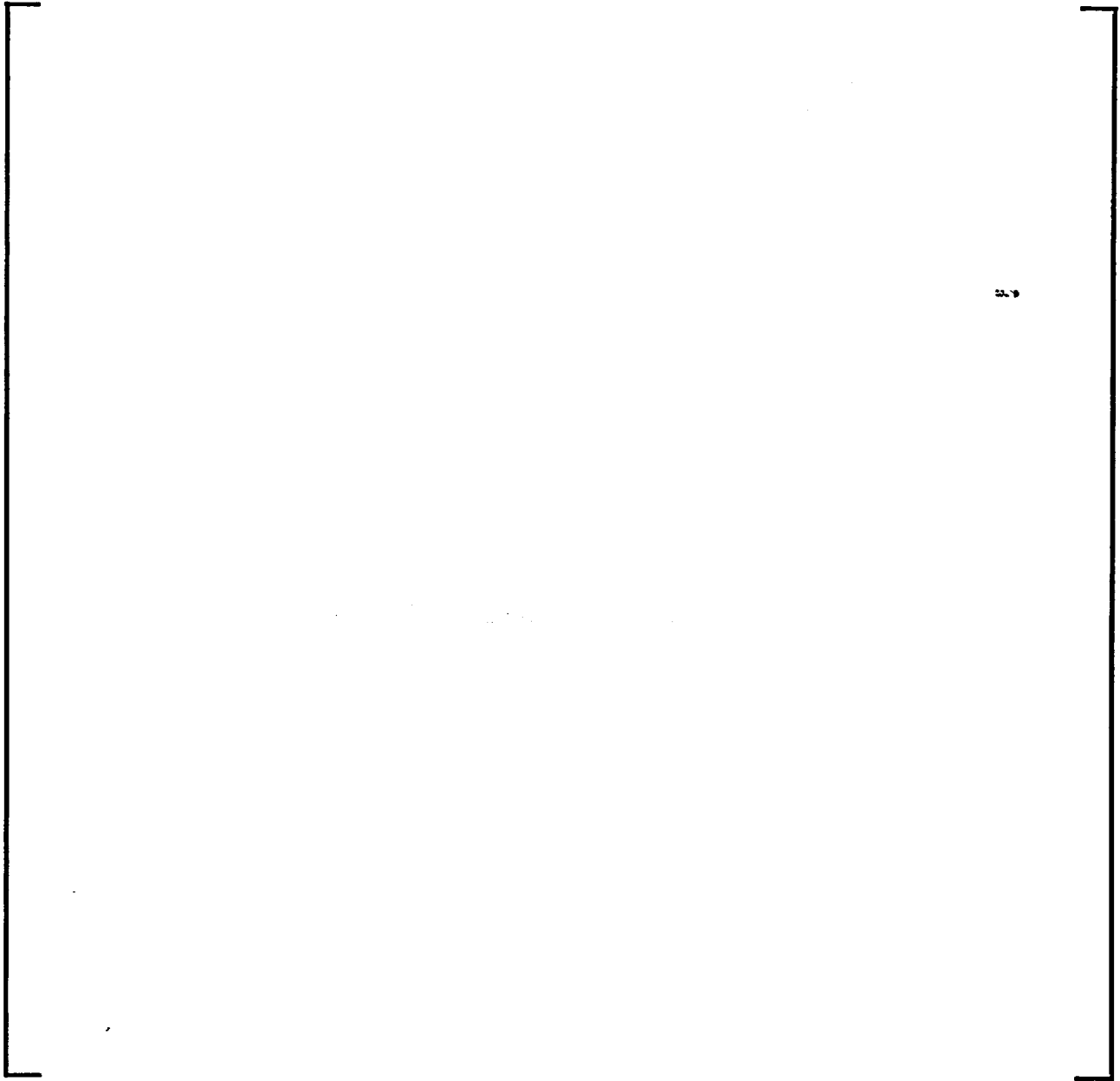

**Figure 11.2-15. Jar Storage and Handling Unit (continued)**

**This page intentionally left blank.**



**Figure 11.2-16. Green Pellet Storage Unit**

3



**This page intentionally left blank.**



**Figure 11.2-16. Green Pellet Storage Unit (continued)**

**This page intentionally left blank.**



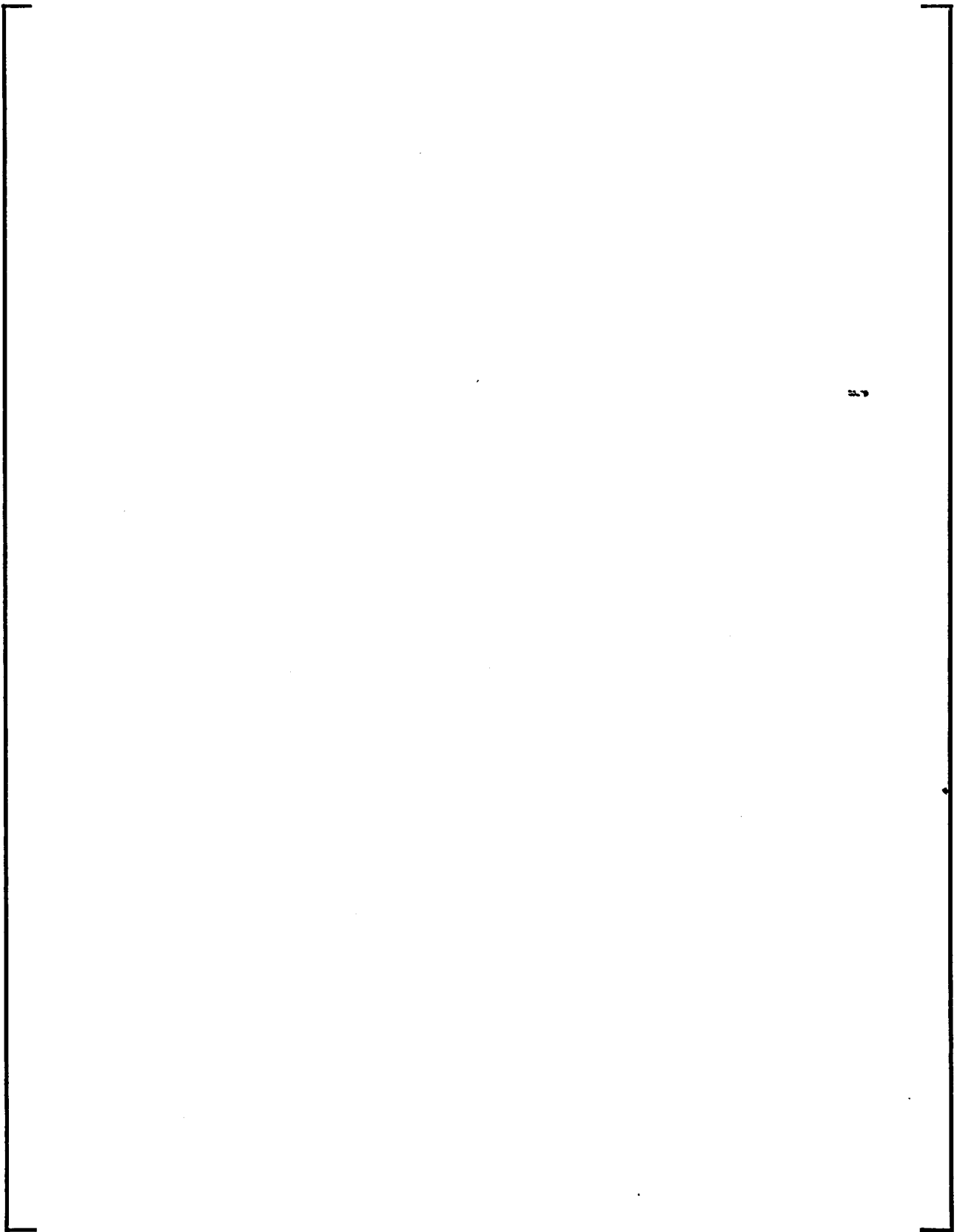

**Figure 11.2-17. Sintering Unit – Top View**

**This page intentionally left blank.**

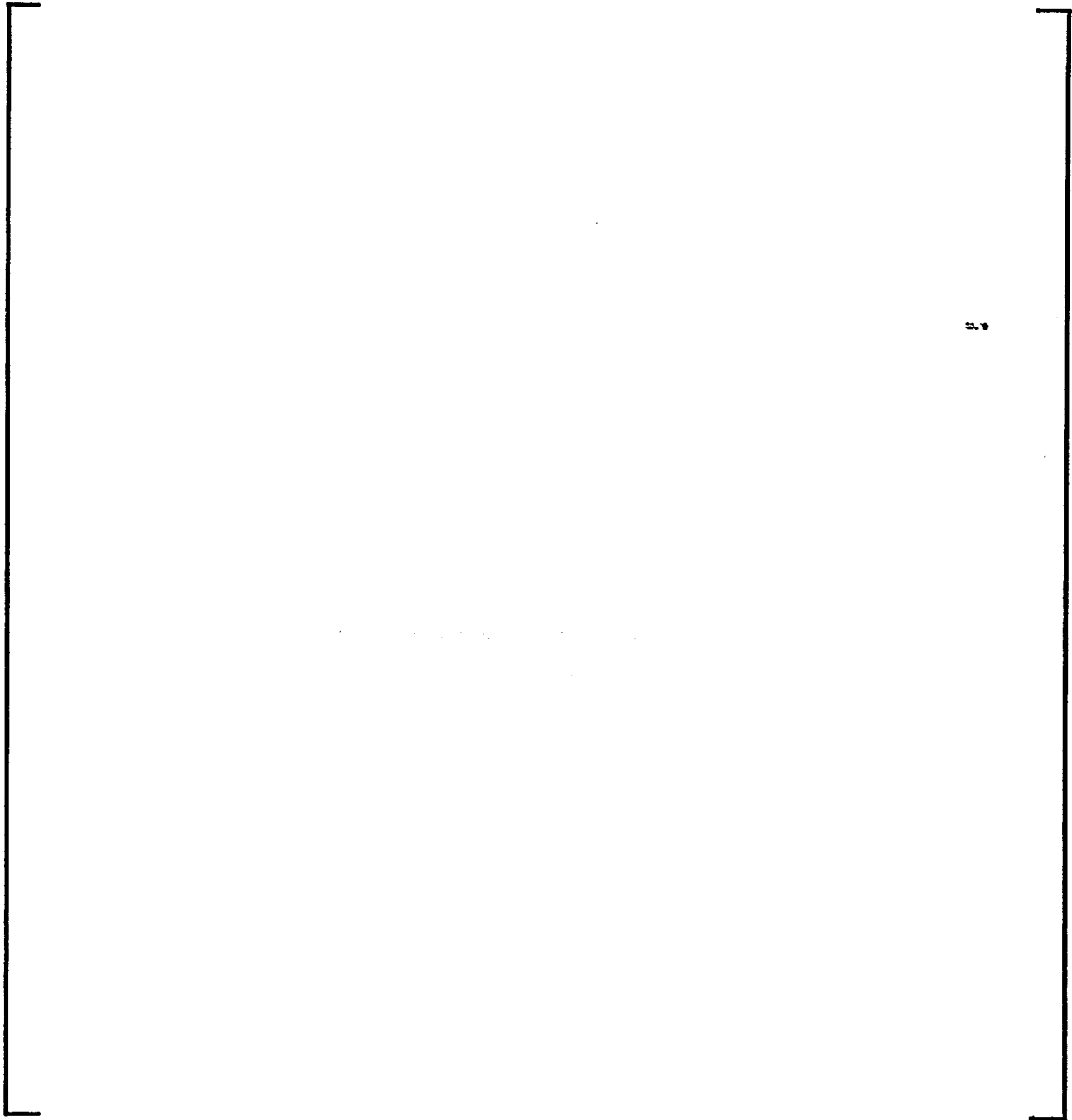

**Figure 11.2-18. Sintering Unit – Section**

**This page intentionally left blank.**

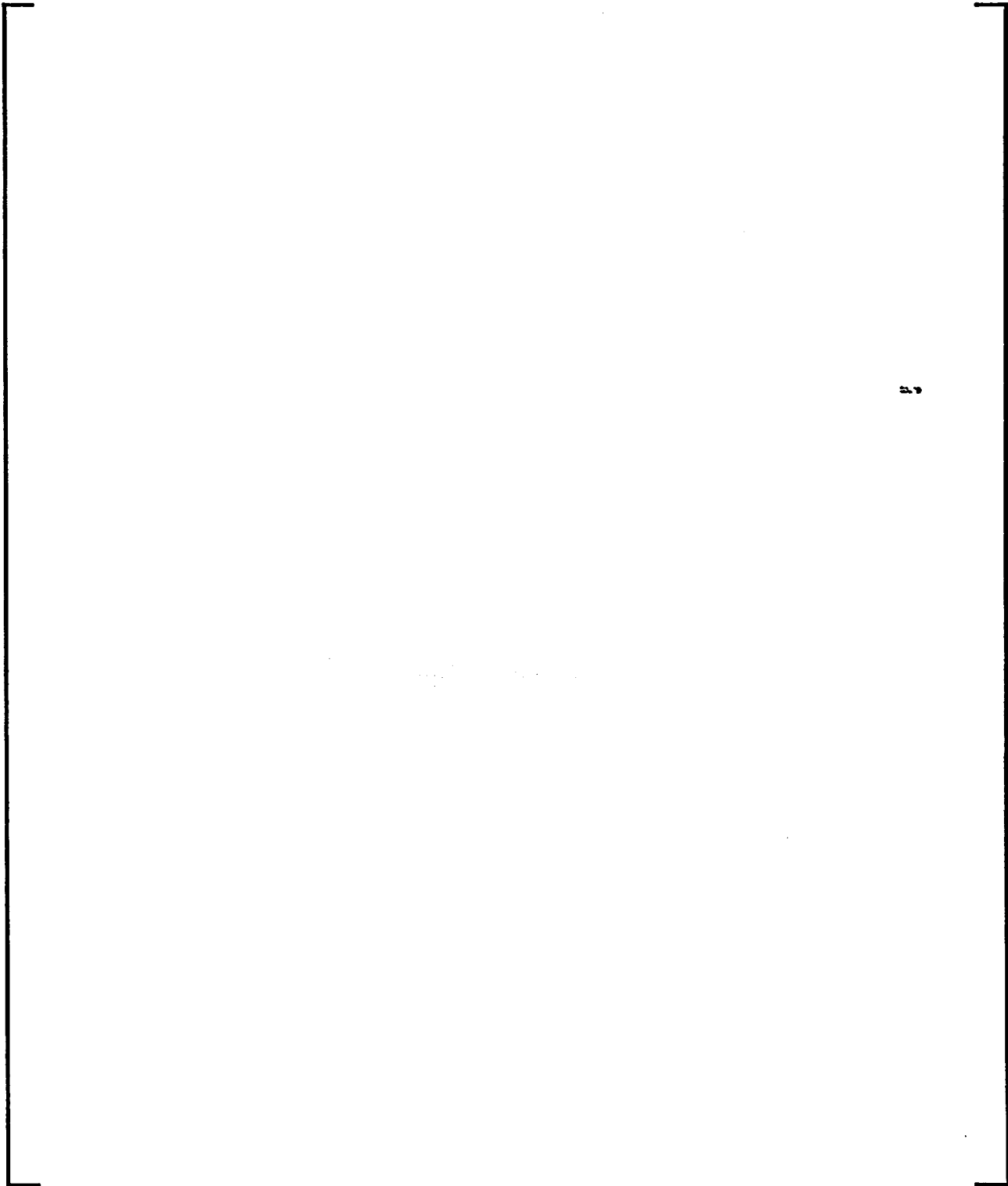

**Figure 11.2-19. Grinding Unit – Supply Glovebox**

**This page intentionally left blank.**

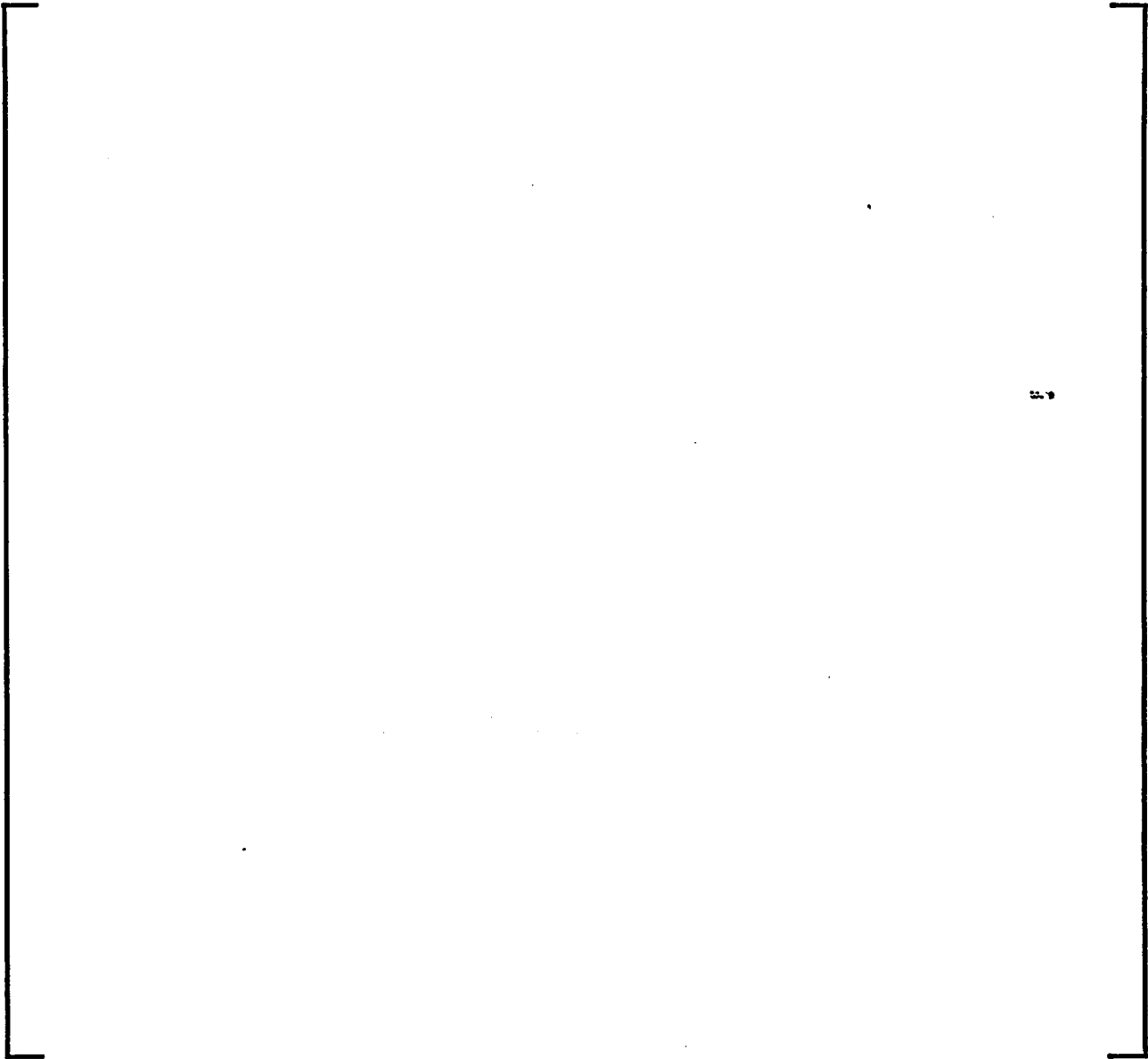

**Figure 11.2-19. Grinding Unit – Supply Glovebox (continued)**

**This page intentionally left blank.**





**Figure 11.2-20. Grinding Unit - Grinding and Laser Cleaning Gloveboxes**

**This page intentionally left blank.**

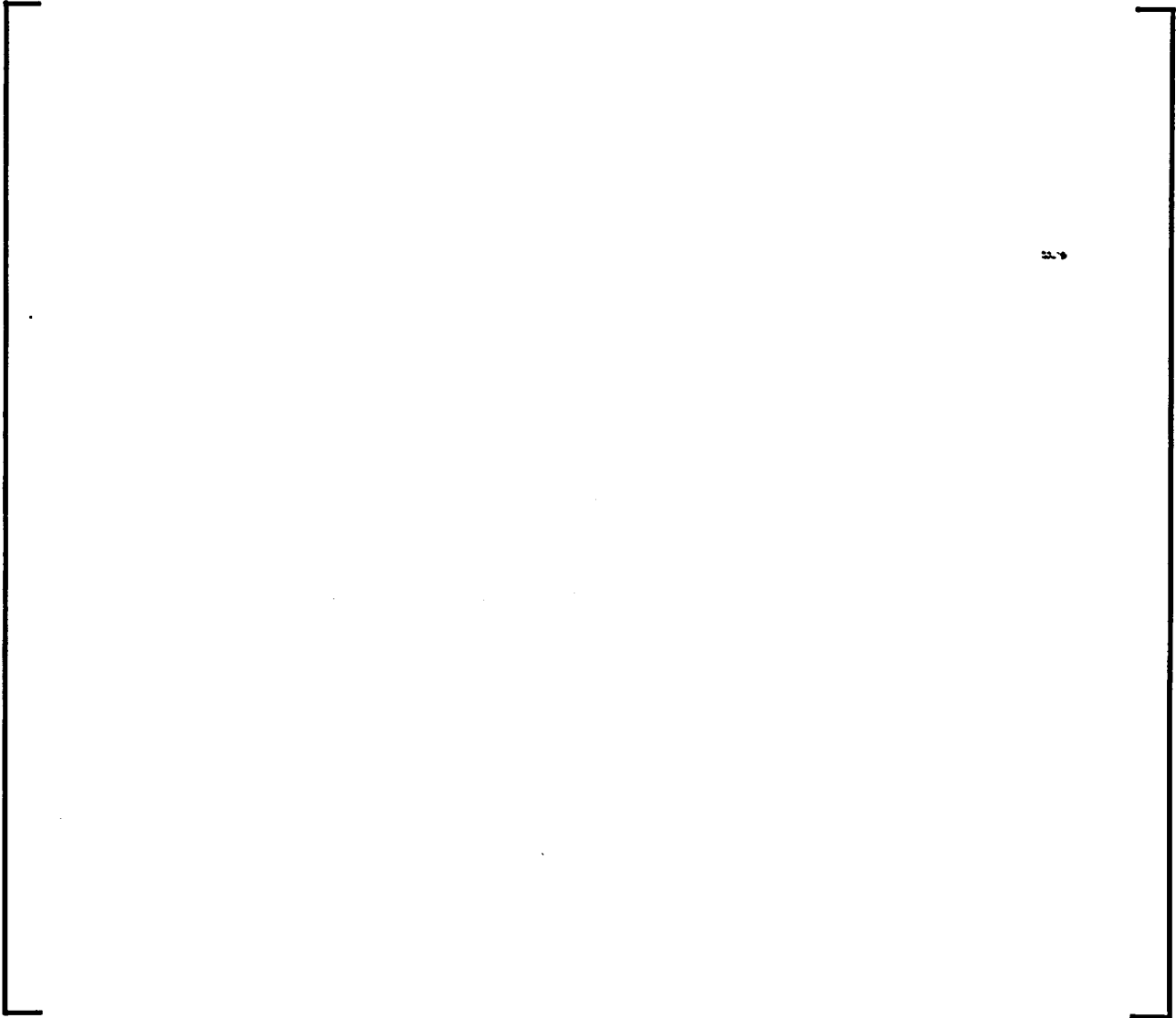

**Figure 11.2-20. Grinding Unit – Grinding and Laser Cleaning Gloveboxes (continued)**

**This page intentionally left blank.**

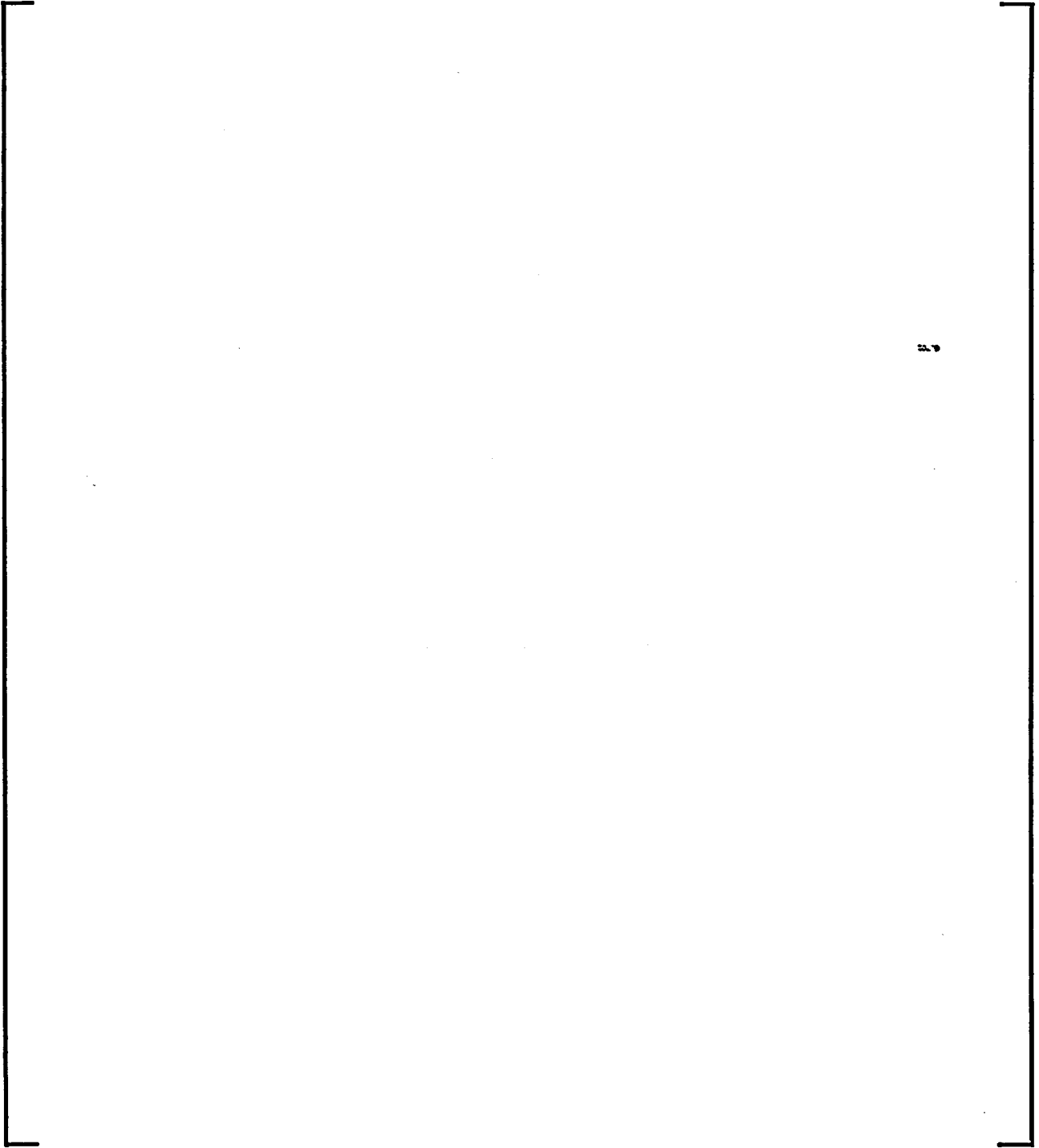

**Figure 11.2-21. Grinding Unit – Basket Filling Glovebox**

**This page intentionally left blank.**

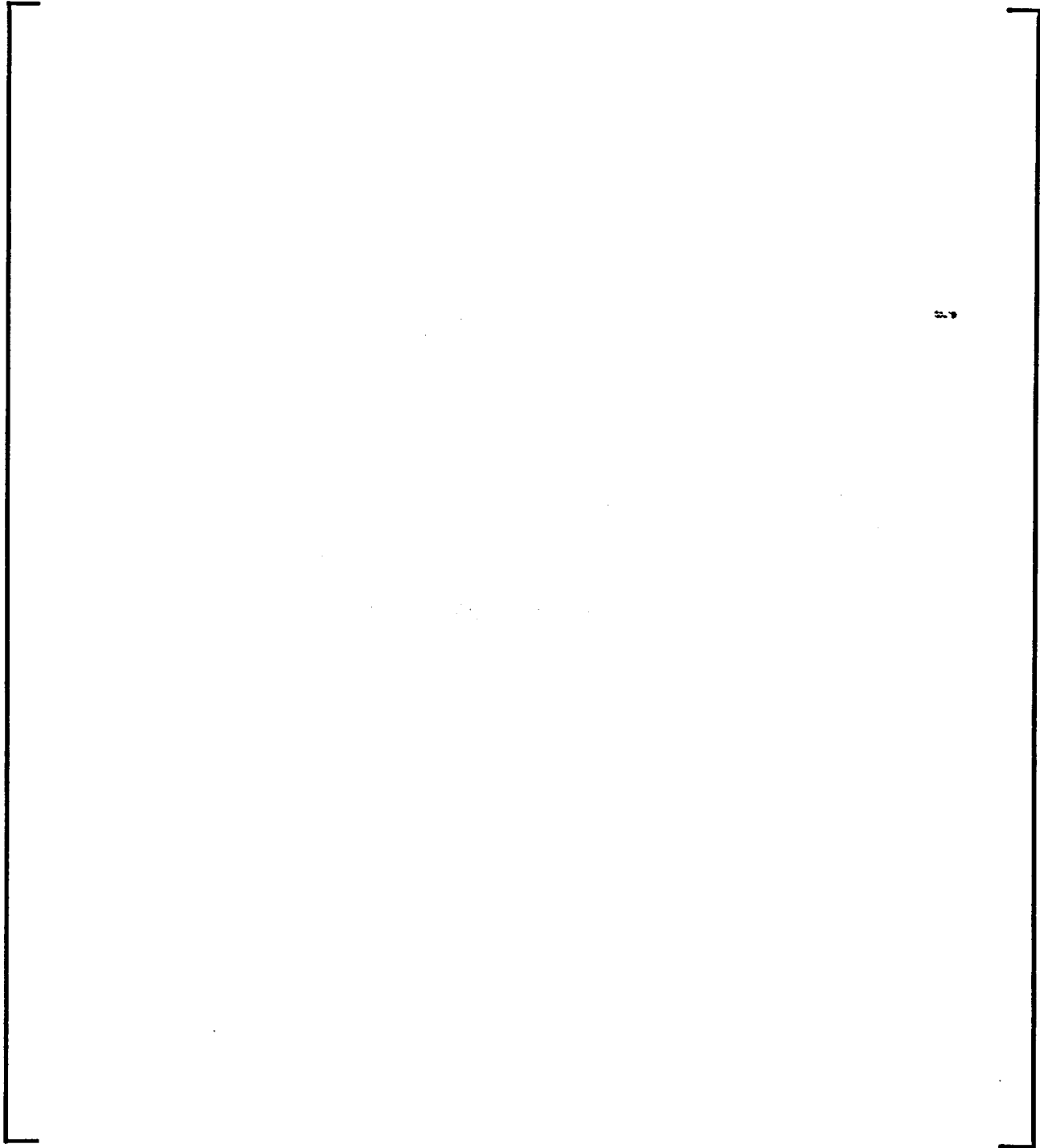

**Figure 11.2-21. Grinding Unit - Basket Filling Glovebox (continued)**

**This page intentionally left blank.**





**Figure 11.2-21. Grinding Unit – Basket Filling Glovebox (continued)**

**This page intentionally left blank.**

**Figure 11.2-22. Pellet Inspection and Sorting Unit – Sorting Glovebox**

MFFF Construction Authorization Request  
Docket No. 070-03098

Revision: 10/31/02  
Page 11.2-121

**This page intentionally left blank.**



**Figure 11.2-22. Pellet Inspection and Sorting Unit – Sorting Glovebox (continued)**

**This page intentionally left blank.**

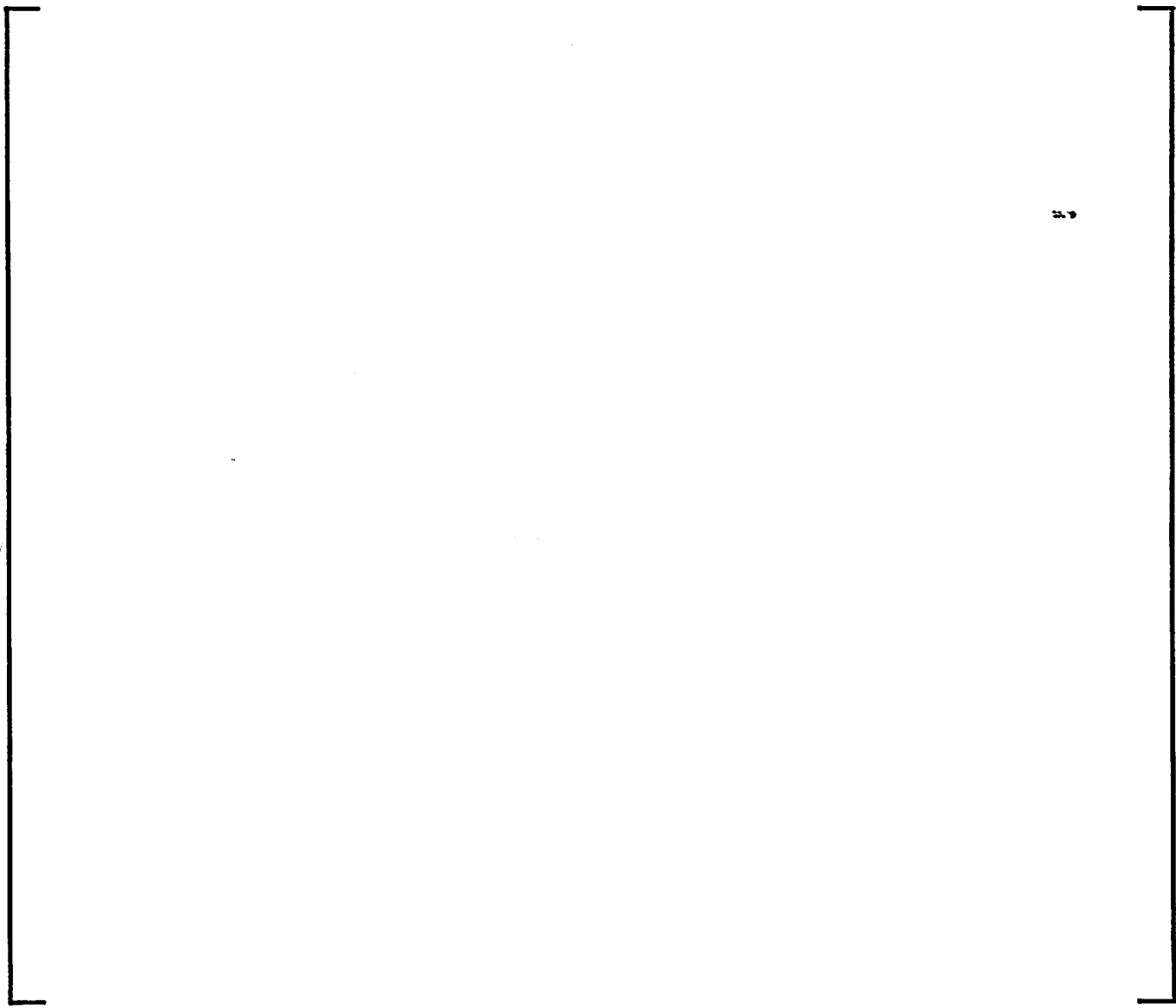

**Figure 11.2-23. Pellet Inspection and Sorting Unit – Basket Loading Glovebox**

**This page intentionally left blank.**





**Figure 11.2-23. Pellet Inspection and Sorting Unit Basket Loading Glovebox (continued)**

**This page intentionally left blank.**

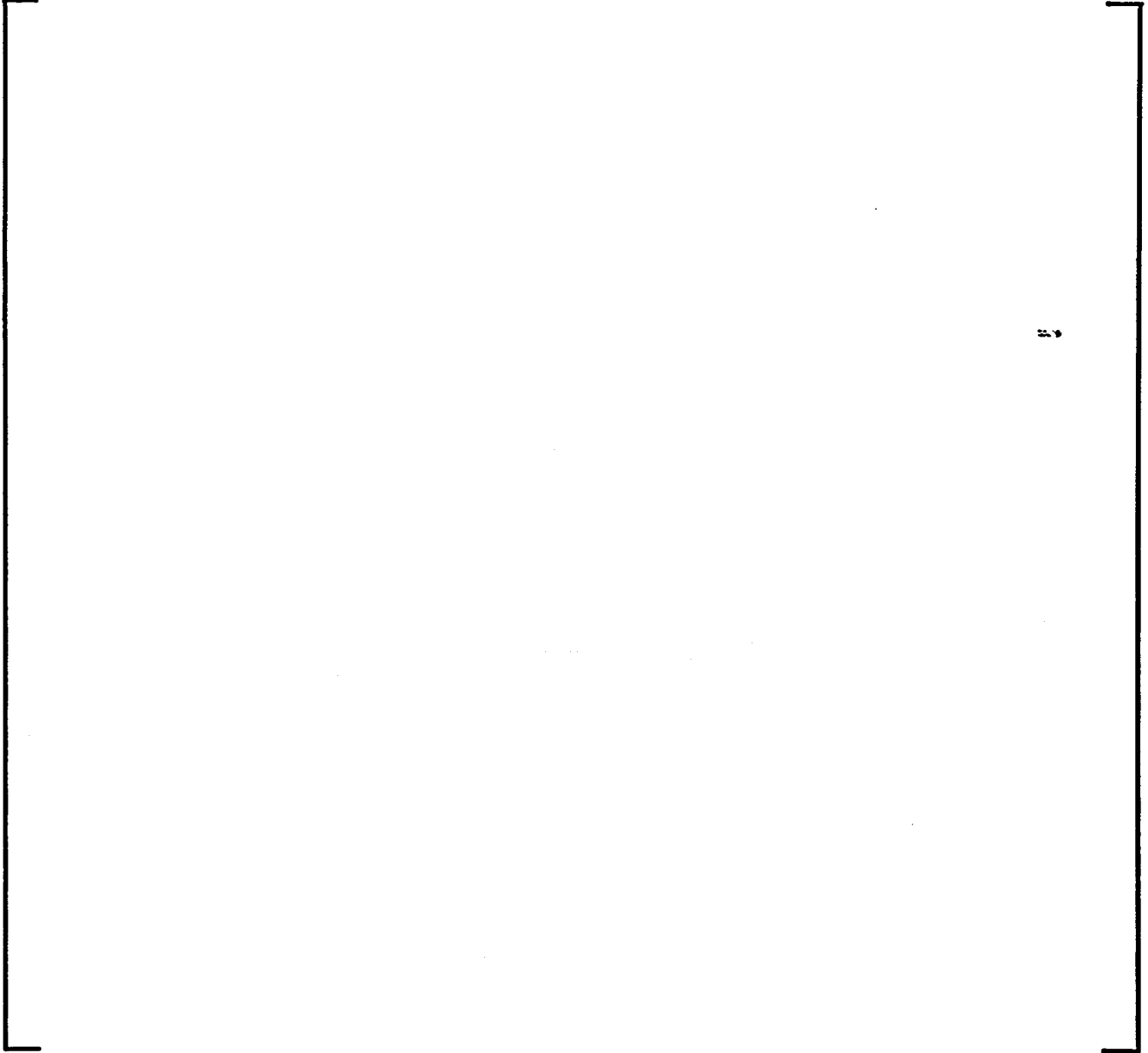

See figure 11.2-25 for references.

**Figure 11.2-24. Quality Control and Manual Sorting Unit – Handling and Re-sorting Glovebox**

**This page intentionally left blank.**



2.7



**Figure 11.2-25. Quality Control and Manual Sorting Unit - Quality Control Glovebox**



**This page intentionally left blank.**

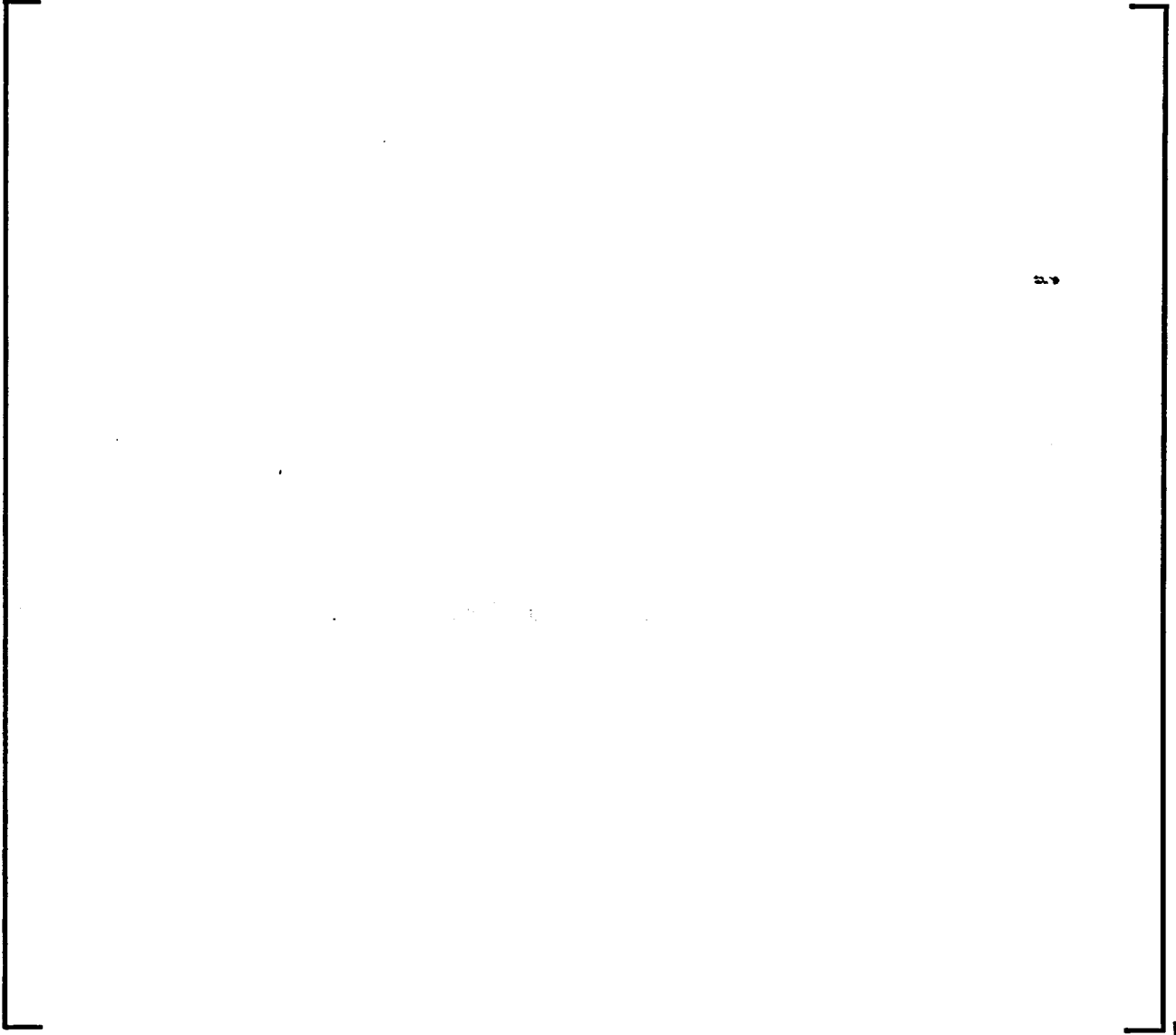

References and description for both figures 11.2-24 and 11.2-25

**Figure 11.2-25. Quality Control and Manual Sorting Unit – Quality Control Glovebox  
(continued)**

**This page intentionally left blank.**



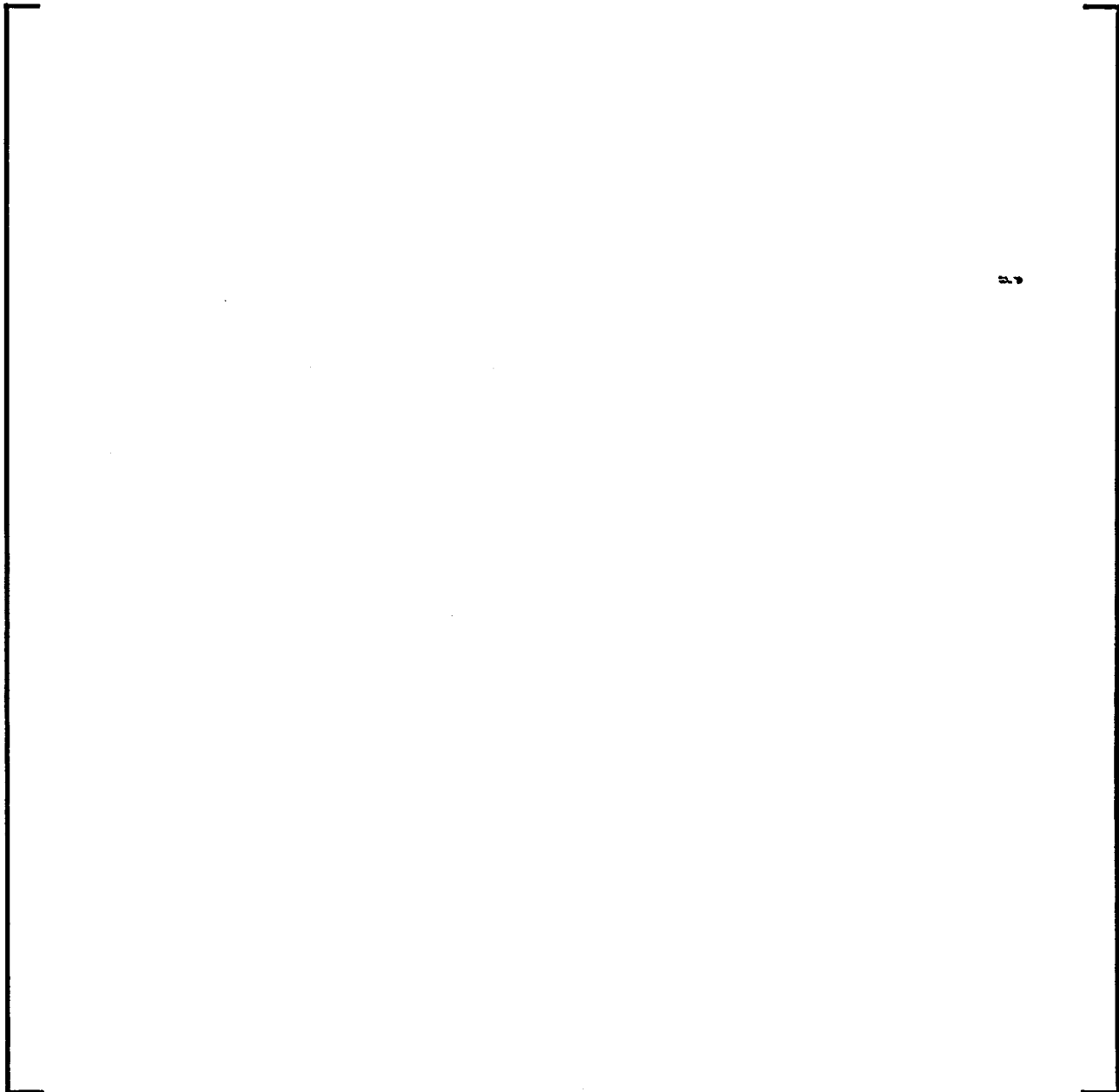

**Figure 11.2-26. Scrap Box Loading Unit**

**This page intentionally left blank.**



**Figure 11.2-26. Scrap Box Loading Unit (continued)**

**This page intentionally left blank.**

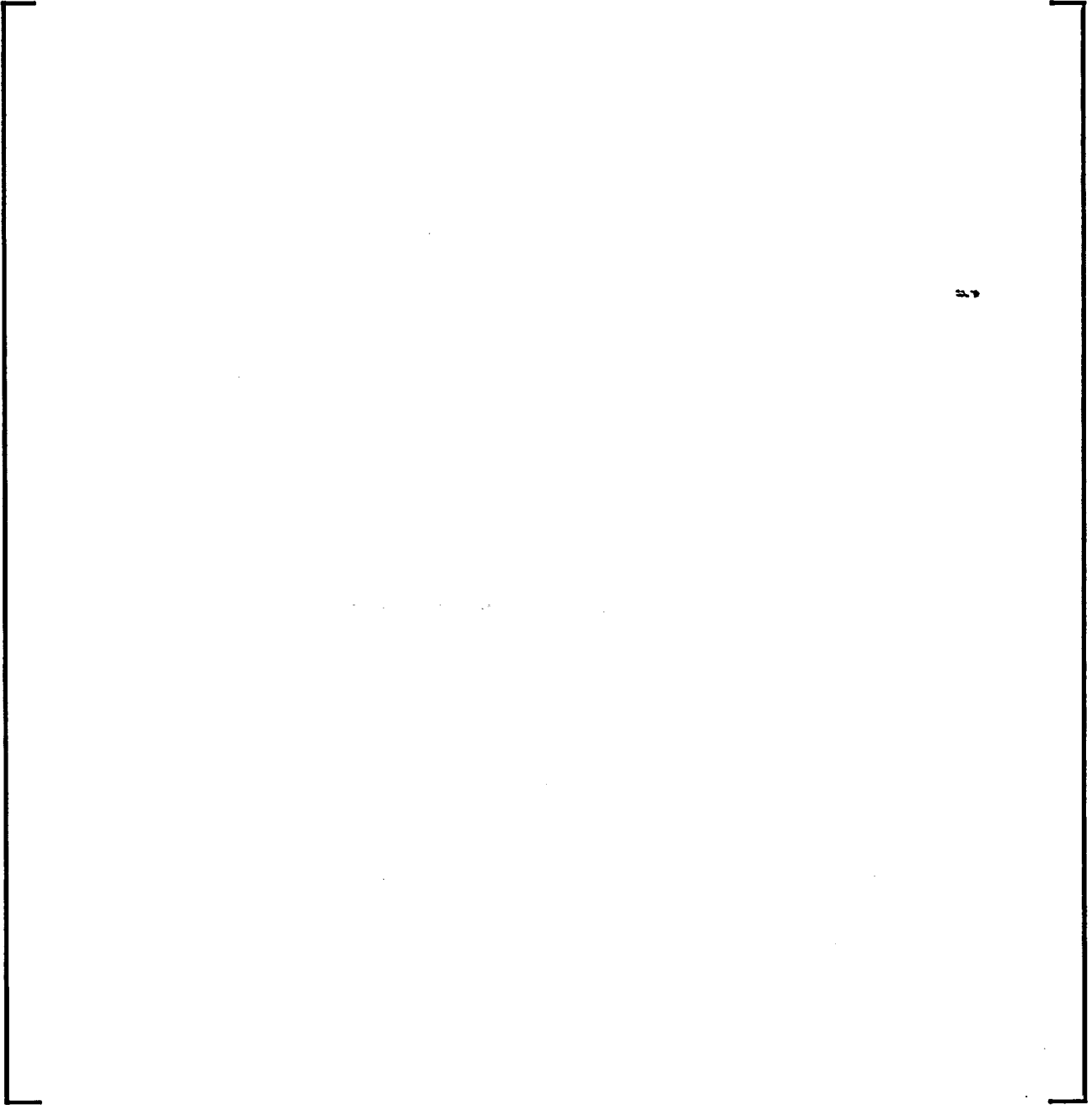

**Figure 11.2-27. Pellet Repackaging Unit**

**This page intentionally left blank.**



**Figure 11.2-27. Pellet Repackaging Unit (continued)**

**This page intentionally left blank.**





3

**Figure 11.2-28. Pellet Handling System**



**This page intentionally left blank.**



**Figure 11.2-29. Rod Cladding and Decontamination Units – General Arrangement**

**This page intentionally left blank.**



**Figure 11.2-30. Rod Cladding and Decontamination Unit – Rod Handling Glovebox**

**This page intentionally left blank.**

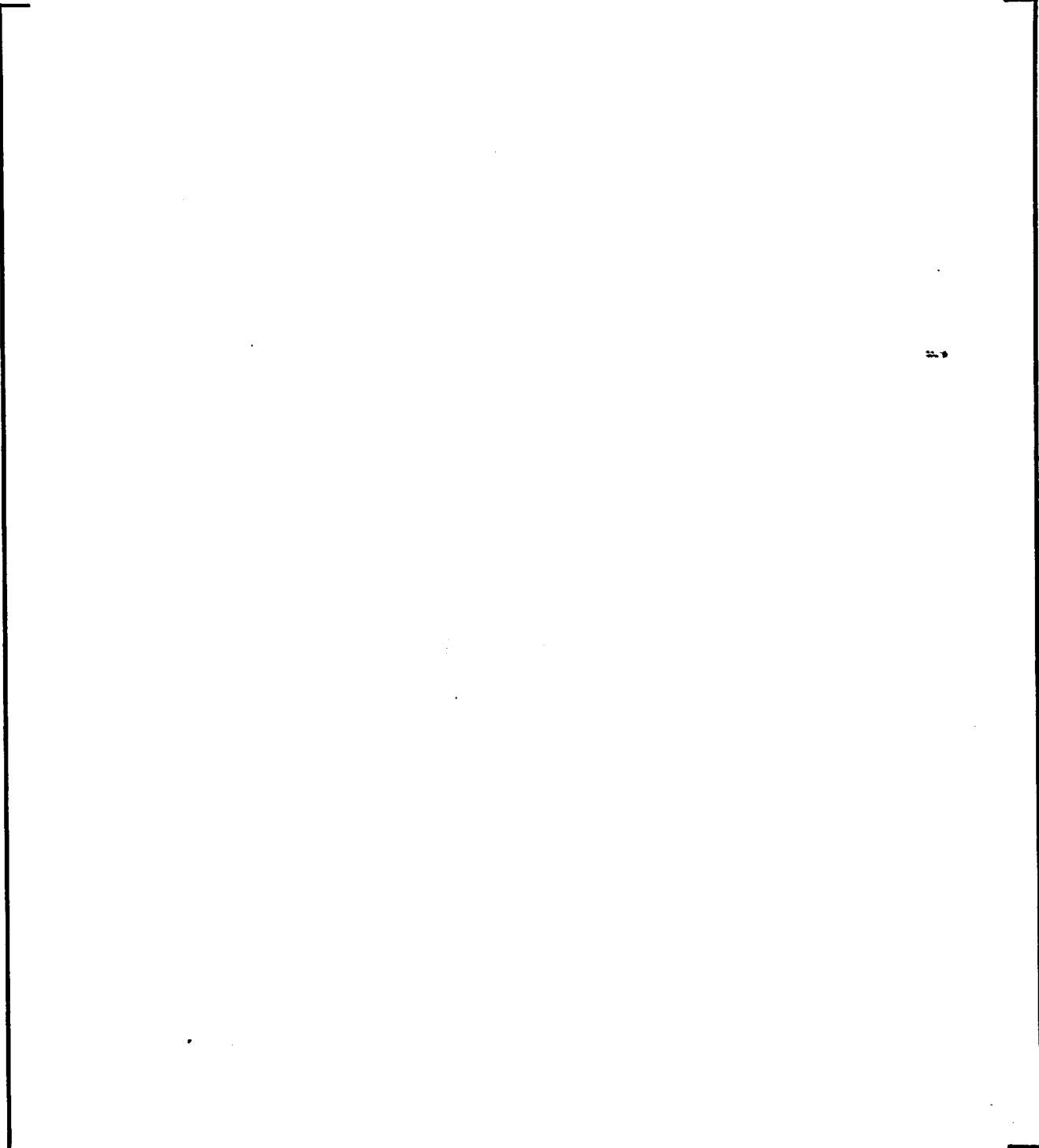

**Figure 11.2-31. Rod Cladding and Decontamination Unit – Stack Preparation Glovebox and Tube Filling Glovebox. See Figure 11.2-32 for index.**

**This page intentionally left blank.**



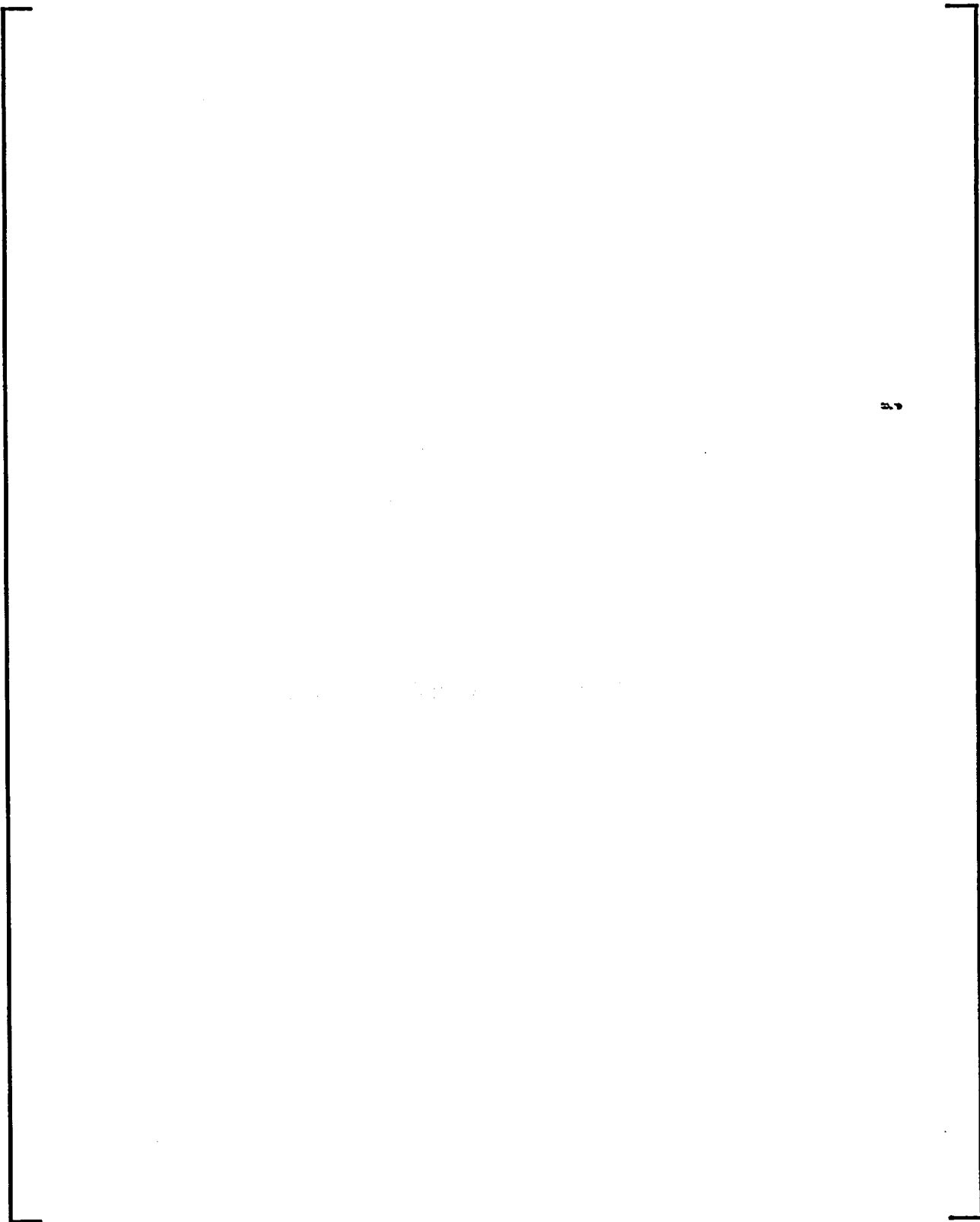

**Figure 11.2-32. Rod Cladding and Decontamination Unit – Cleaning Glovebox and Plugging Glovebox**

**This page intentionally left blank.**

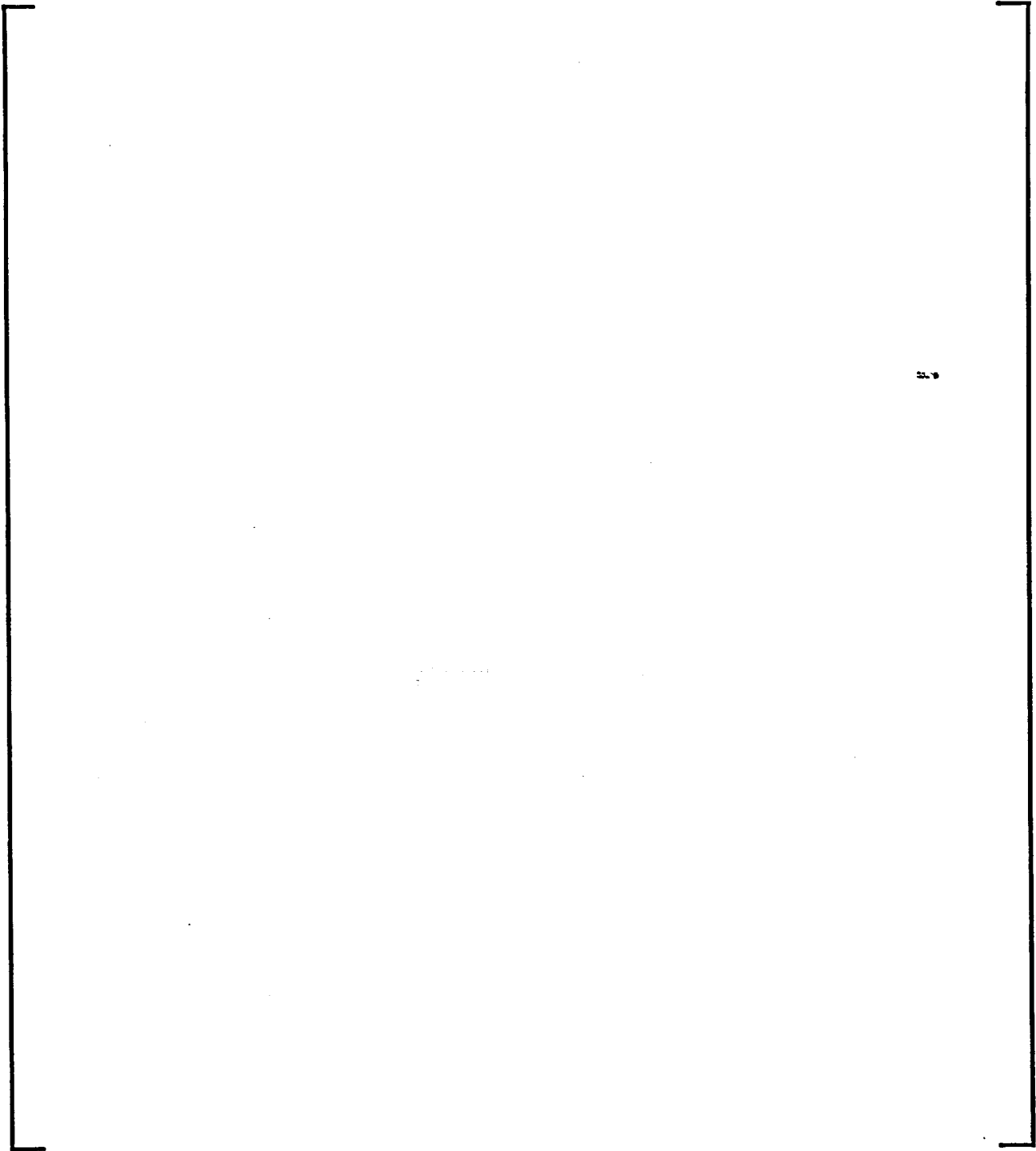

**Figure 11.2-32. Rod Cladding and Decontamination Unit (continued)**

**This page intentionally left blank.**



**Figure 11.2-33. Rod Cladding and Decontamination Unit – Welding Glovebox**

**This page intentionally left blank.**

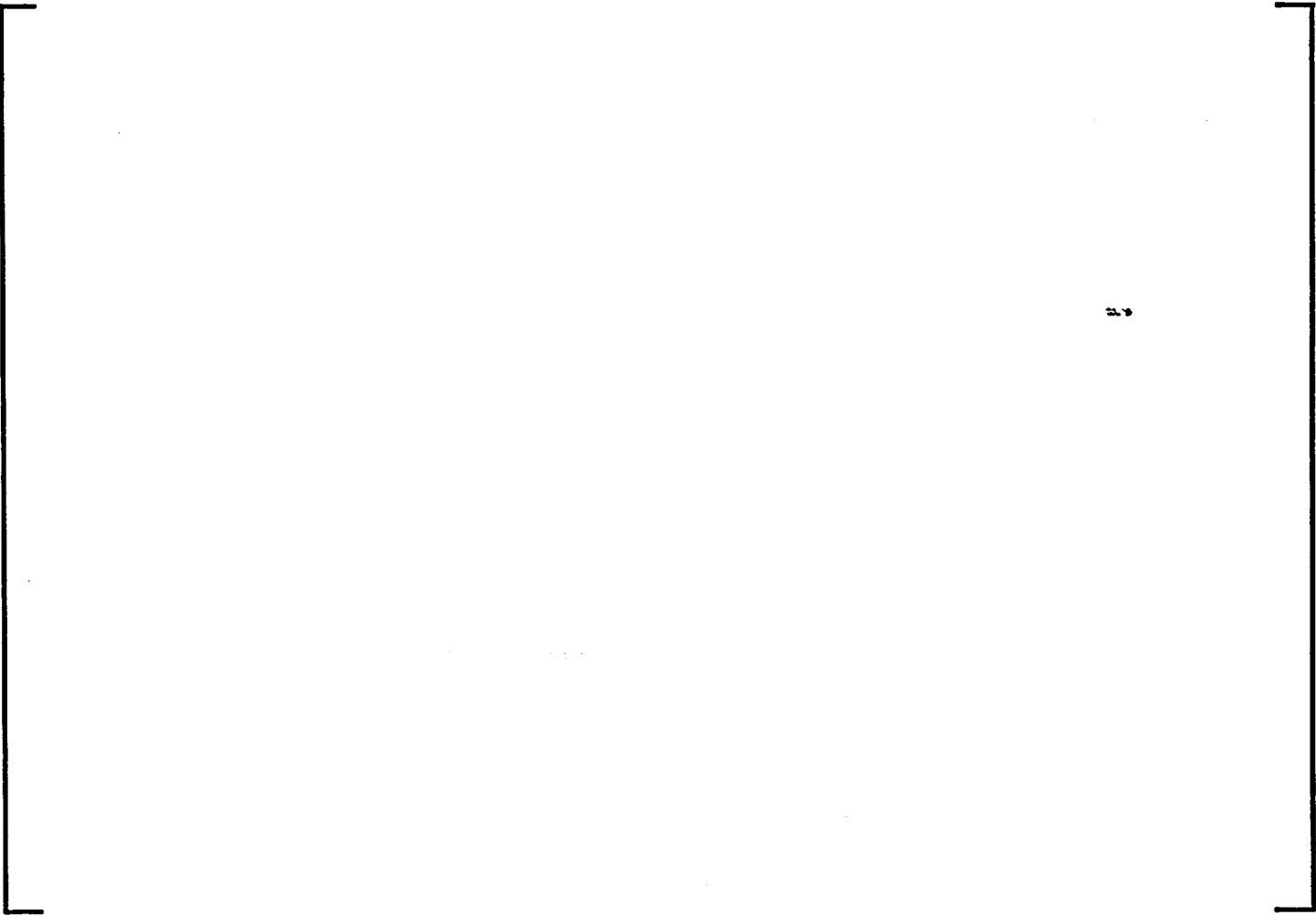

**Figure 11.2-34. Rod Cladding and Decontamination Unit – Decontamination Unit**

**This page intentionally left blank.**



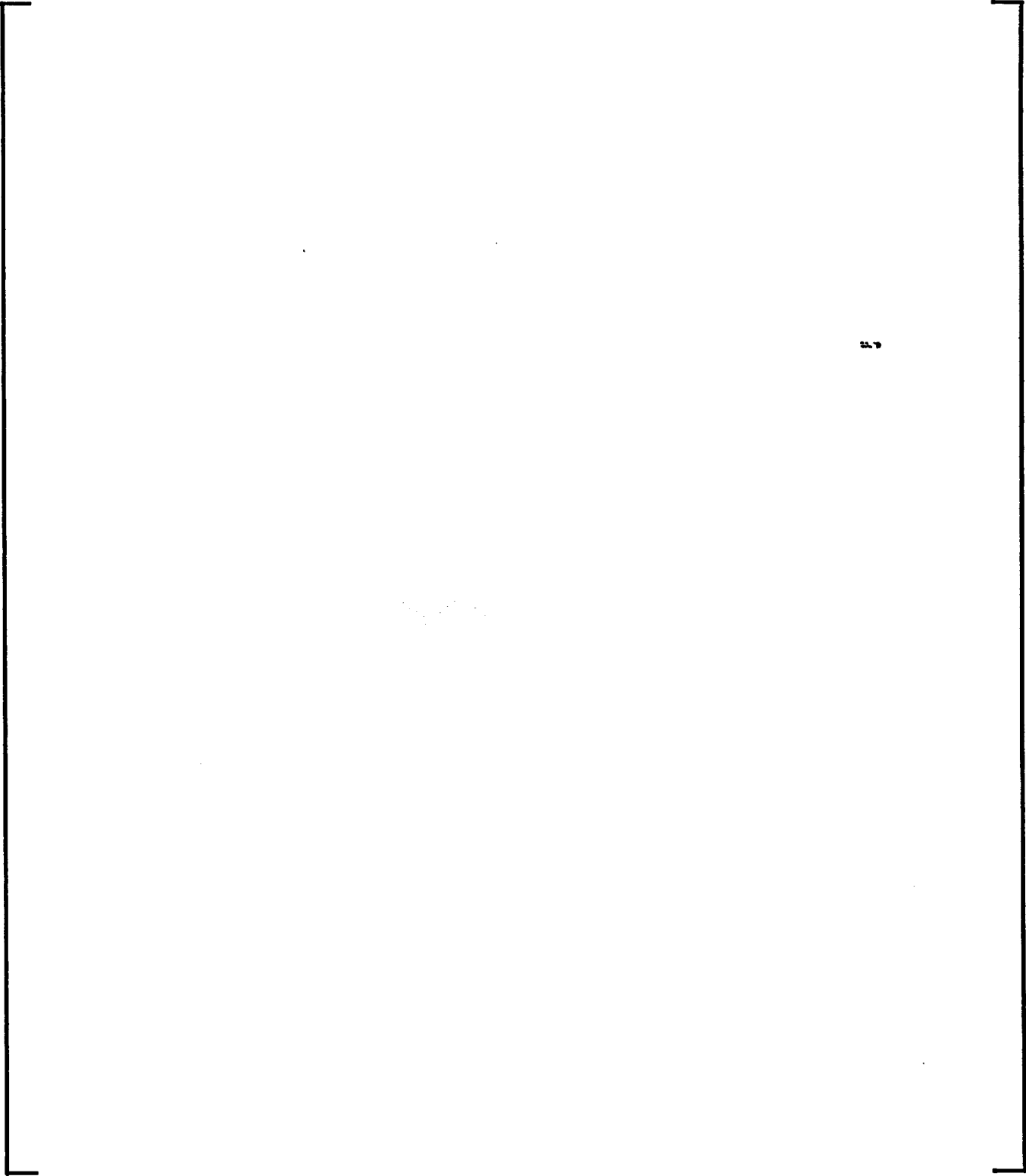

**Figure 11.2-35. Rod Cladding and Decontamination Unit – Repair Unit**

**This page intentionally left blank.**



**Figure 11.2-35. Rod Cladding and Decontamination Unit – Repair Unit (continued)**

**This page intentionally left blank.**

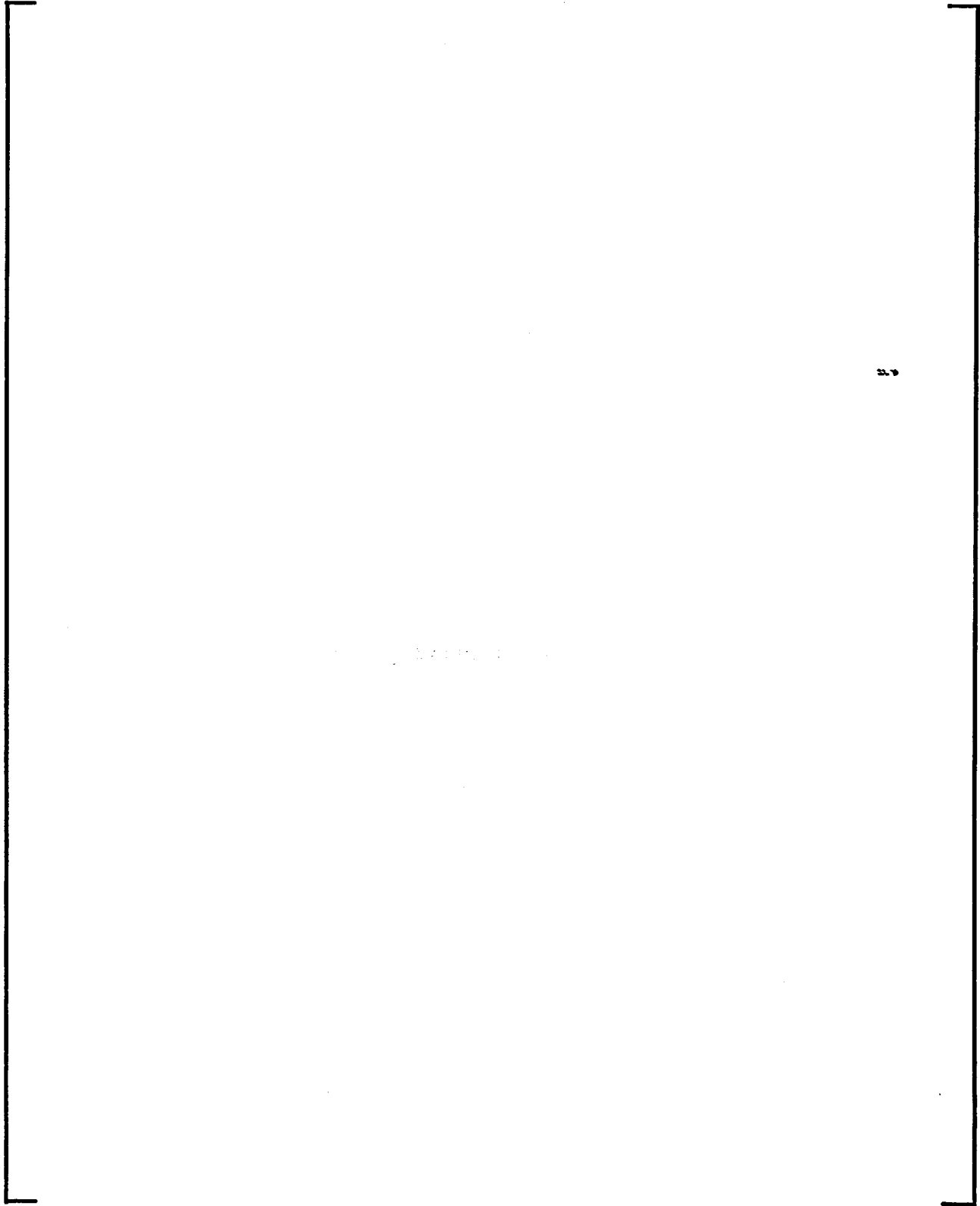

**Figure 11.2-36. Rod Cladding and Decontamination Unit – Tube Introduction Unit**

**This page intentionally left blank.**

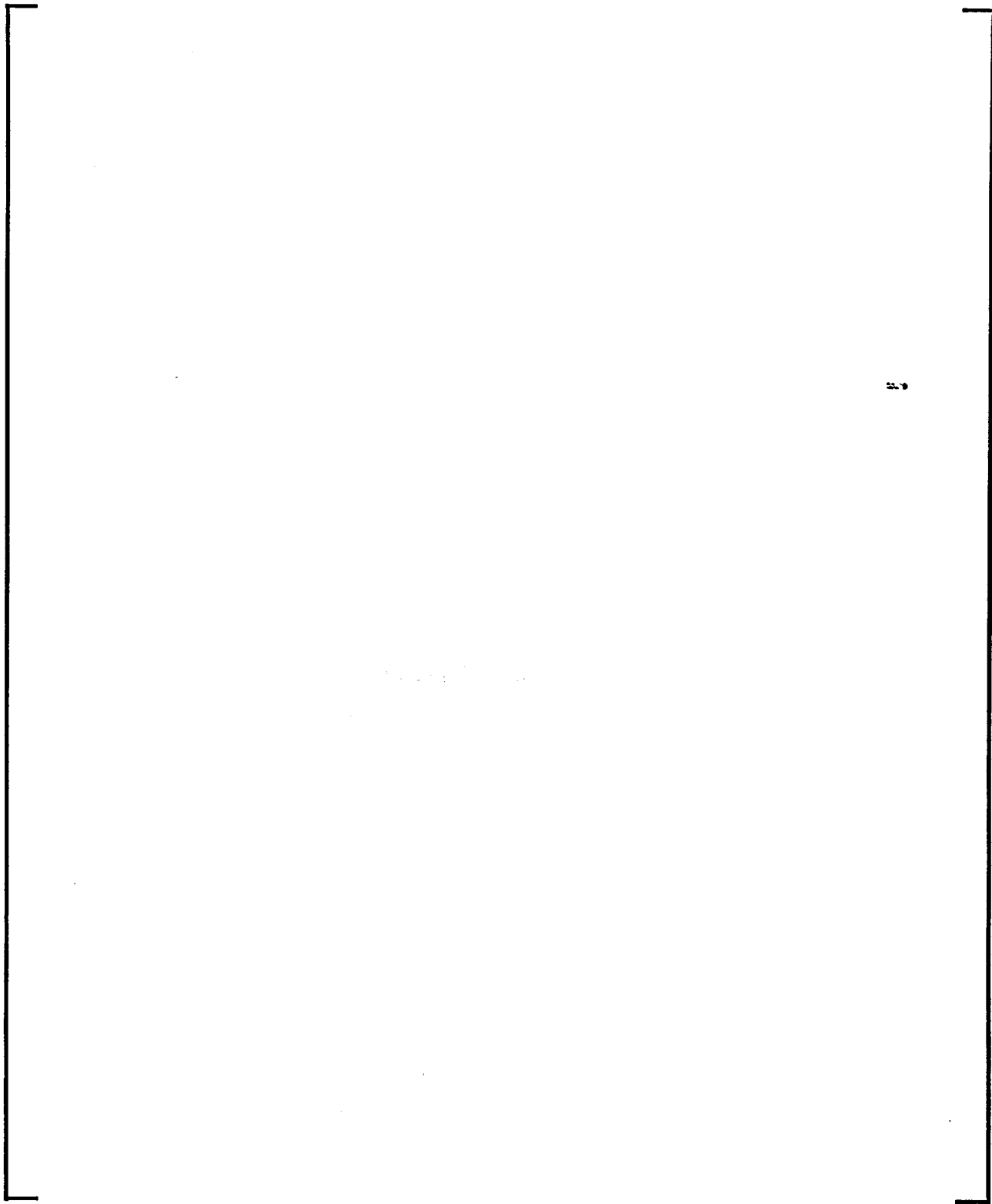

**Figure 11.2-37. Rod Storage Unit (Section).**  
**Index table: see Figure 11.2-38 continued.**

**This page intentionally left blank.**



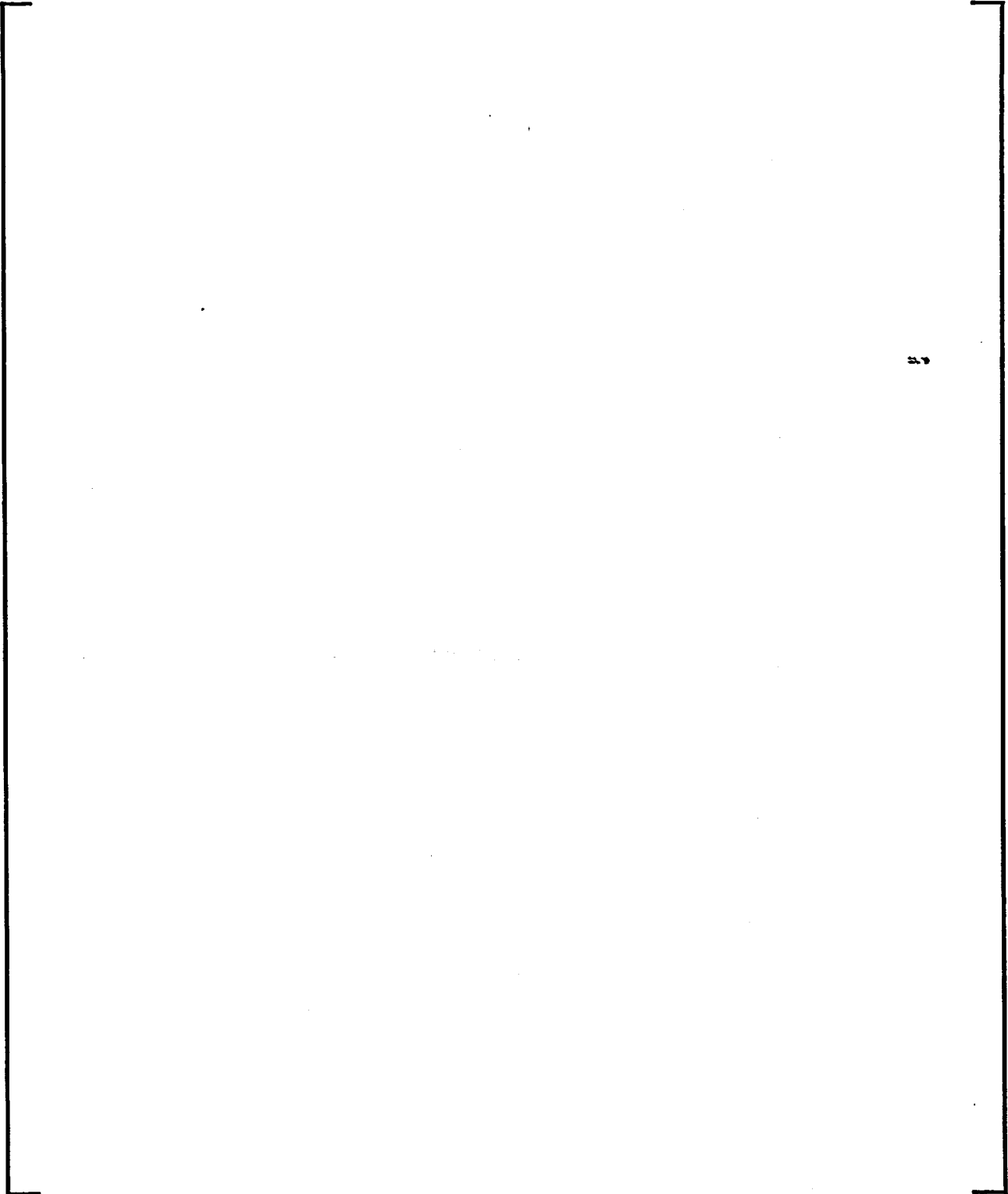

**Figure 11.2-38. Rod Storage Unit (Top View)**

**This page intentionally left blank.**



**Figure 11.2-38. Rod Storage Unit (continued)**

**This page intentionally left blank.**

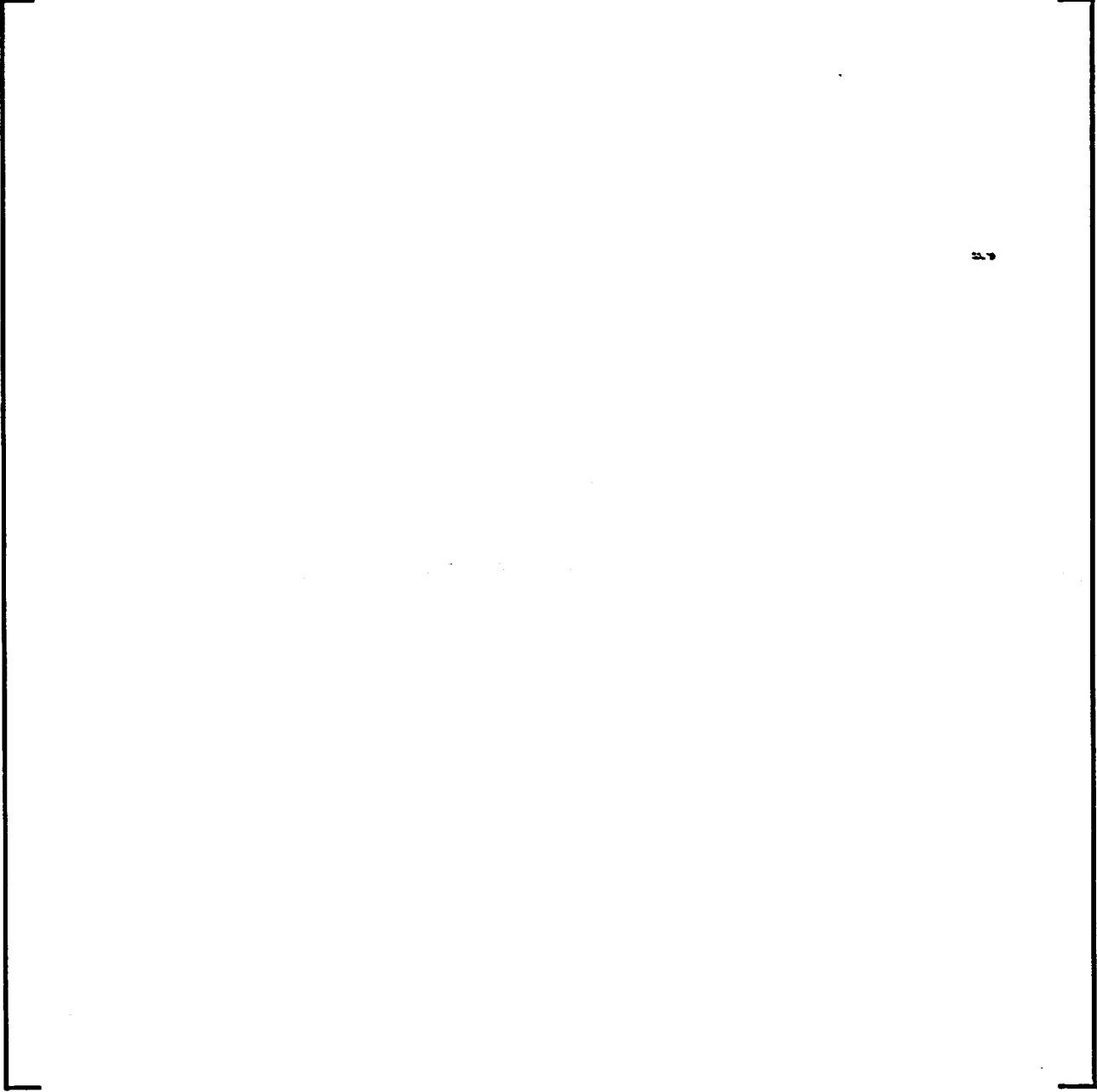

**Figure 11.2-39. Helium Leak Test Unit**

**This page intentionally left blank.**



**Figure 11.2-39. Helium Leak Test Unit (continued)**

**This page intentionally left blank.**



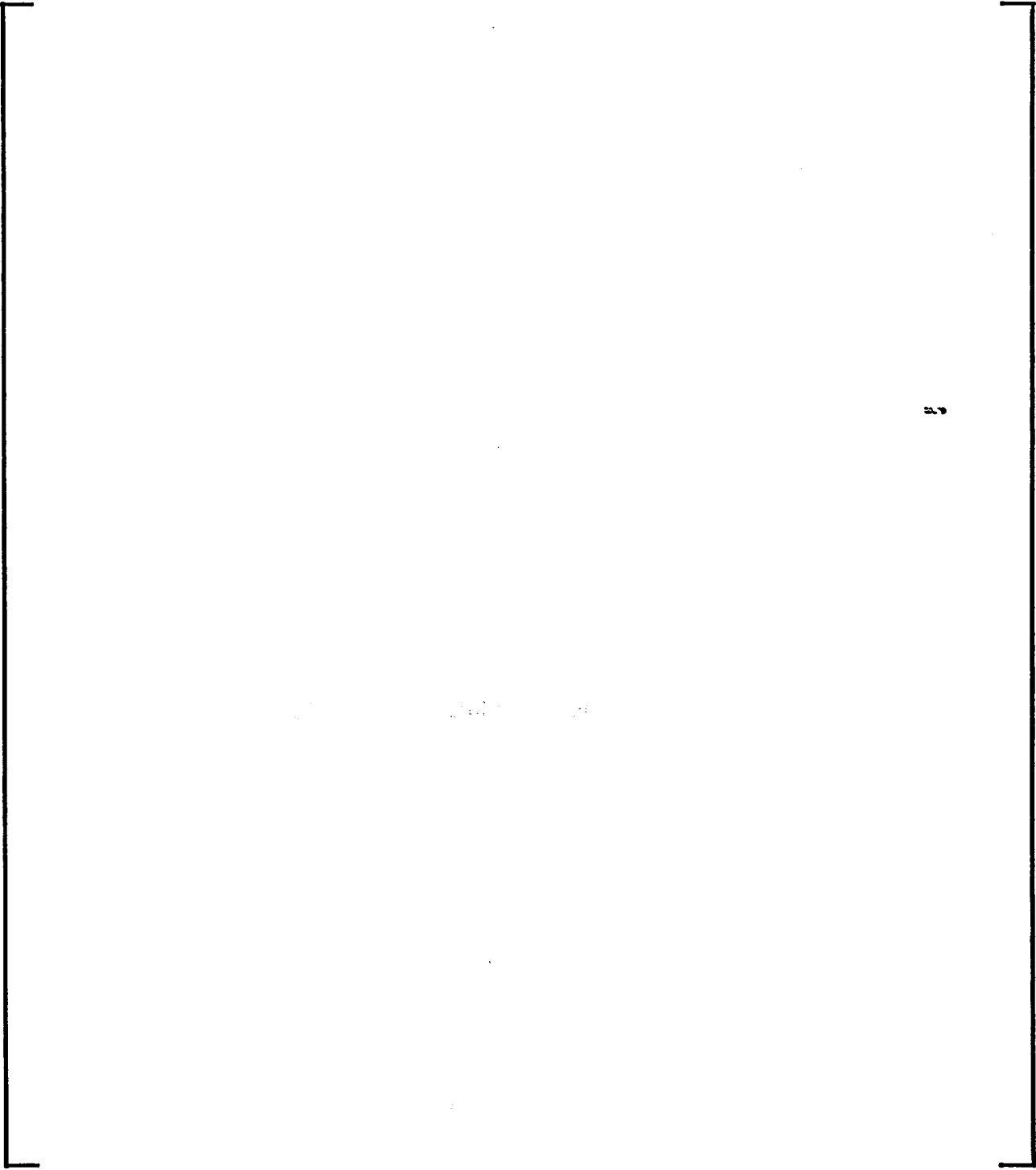

**Figure 11.2-40. X-Ray Inspection Unit**

**This page intentionally left blank.**



**Figure 11.2-40. X-Ray Inspection Unit (continued)**

**This page intentionally left blank.**

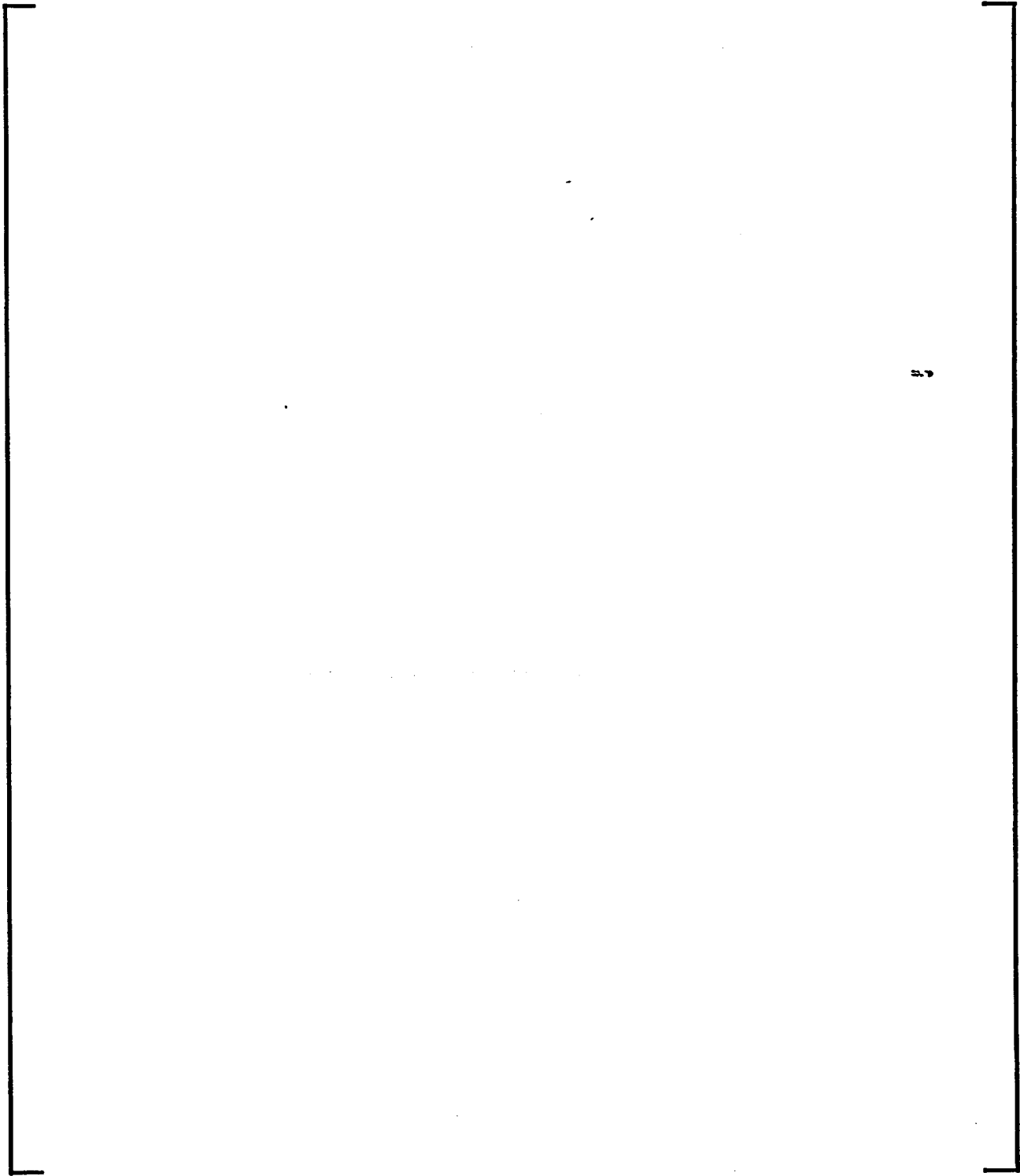

**Figure 11.2-41. Rod Scanning Unit**

**This page intentionally left blank.**



**Figure 11.2-41. Rod Scanning Unit (continued)**

**This page intentionally left blank.**



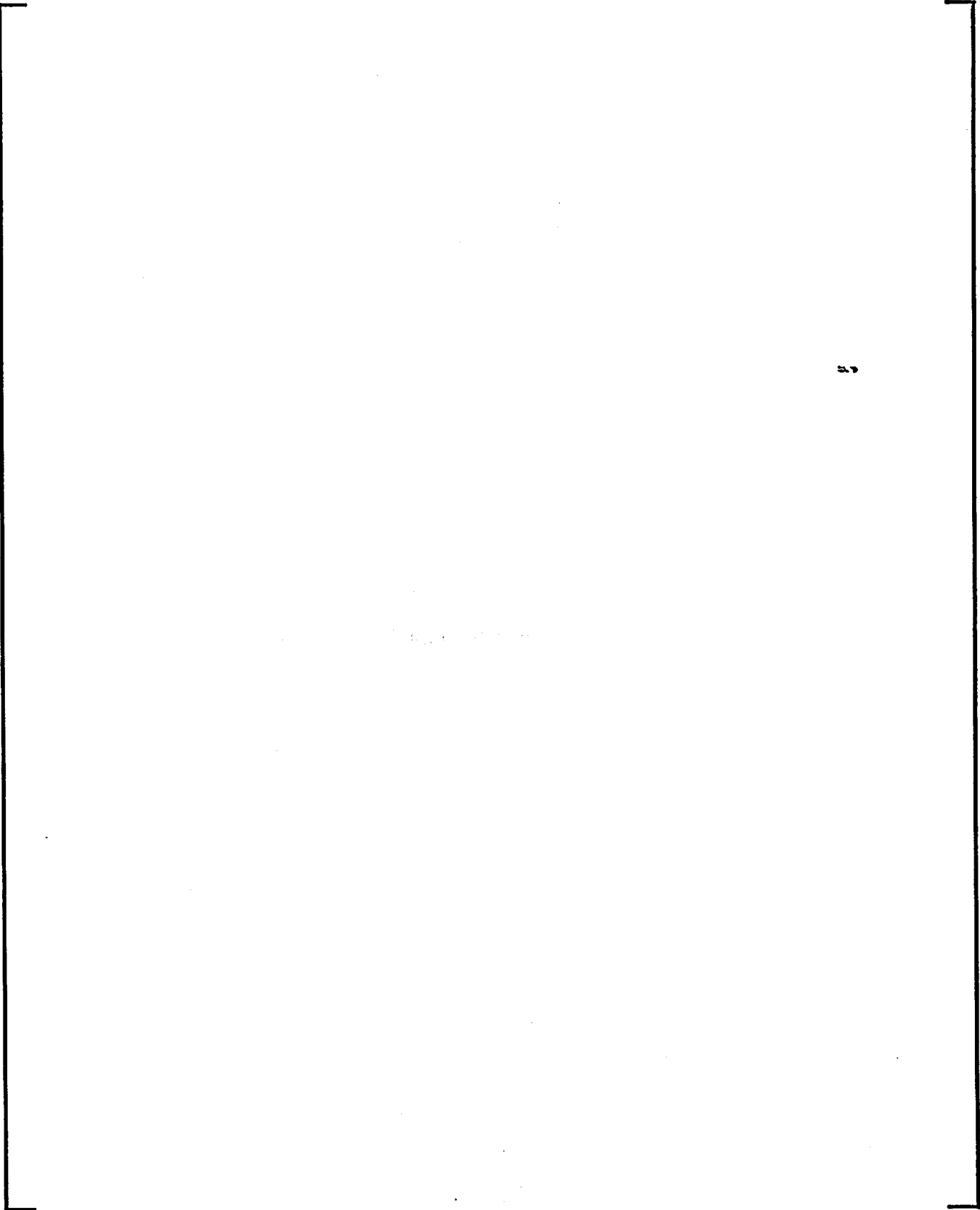

**Figure 11.2-42. Rod Inspection and Sorting Unit**

**This page intentionally left blank.**



**Figure 11.2-42. Rod Inspection and Sorting Unit (continued)**

**This page intentionally left blank.**



**Figure 11.2-43. Rod Decladding Unit**



**This page intentionally left blank.**



**Figure 11.2-43. Rod Decladding Unit (continued)**

**This page intentionally left blank.**





Figure 11.2-44. Assembly Mockup Loading Unit



**This page intentionally left blank.**



**Figure 11.2-44. Assembly Mockup Loading Unit (continued)**

**This page intentionally left blank.**



**Figure 11.2-45. Assembling Mounting Unit**



**This page intentionally left blank.**



**Figure 11.2-45. Assembly Mounting Unit (continued)**

**This page intentionally left blank.**



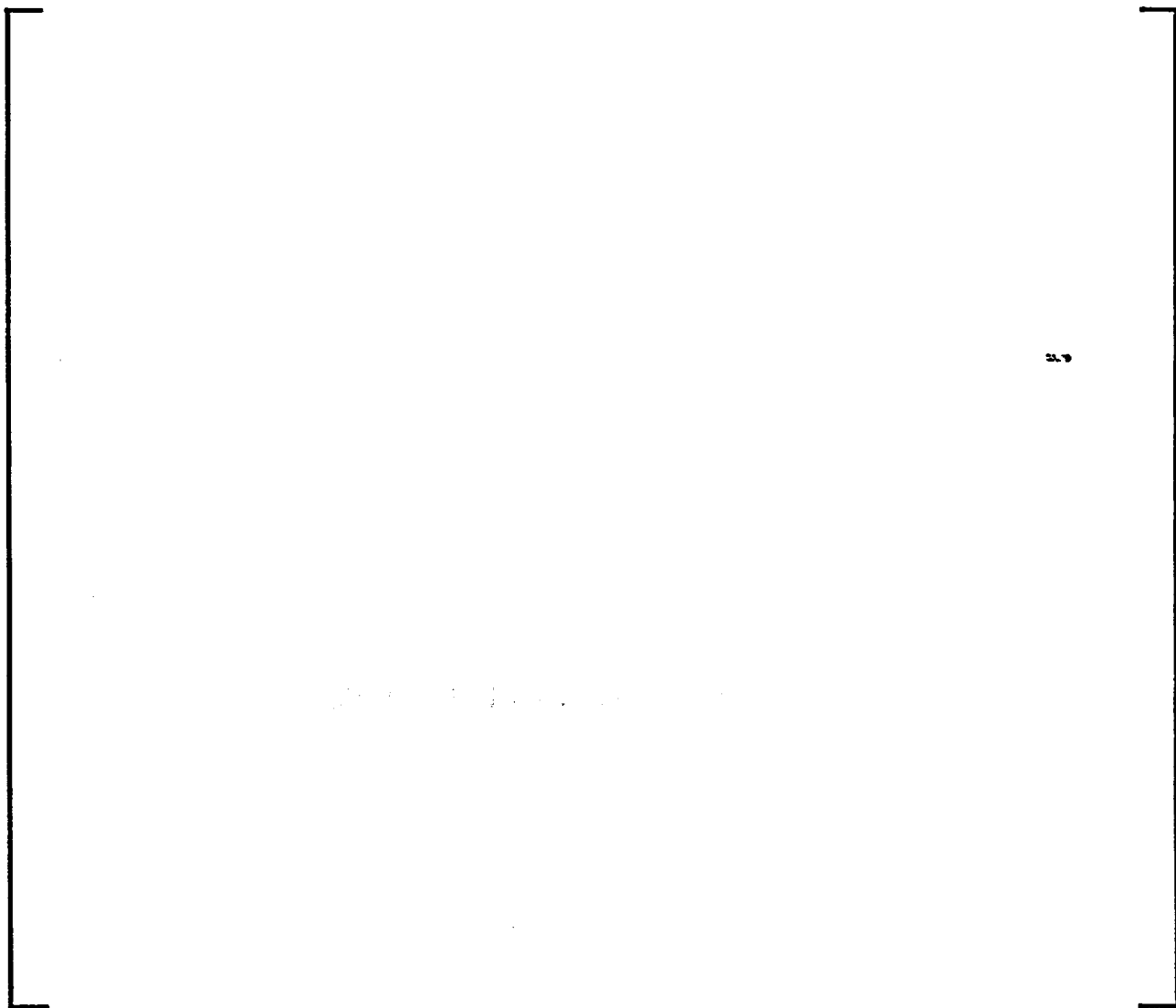

**Figure 11.2-46. Assembly Dry Cleaning Unit**

**This page intentionally left blank.**



**Figure 11.2-46. Assembly Dry Cleaning Unit (continued)**

**This page intentionally left blank.**

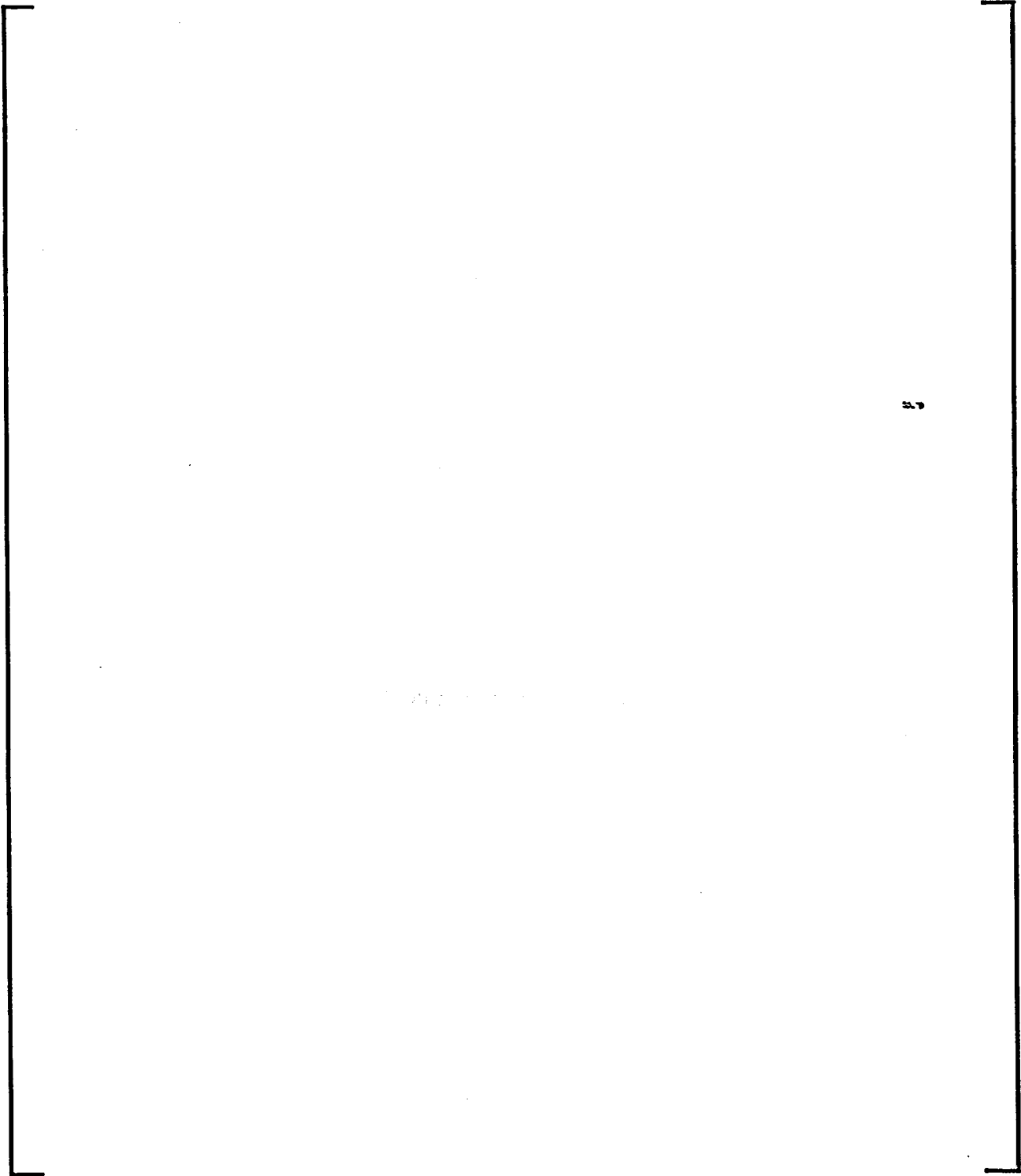

**Figure 11.2-47. Assembly Dimensional Inspection Unit**

**This page intentionally left blank.**

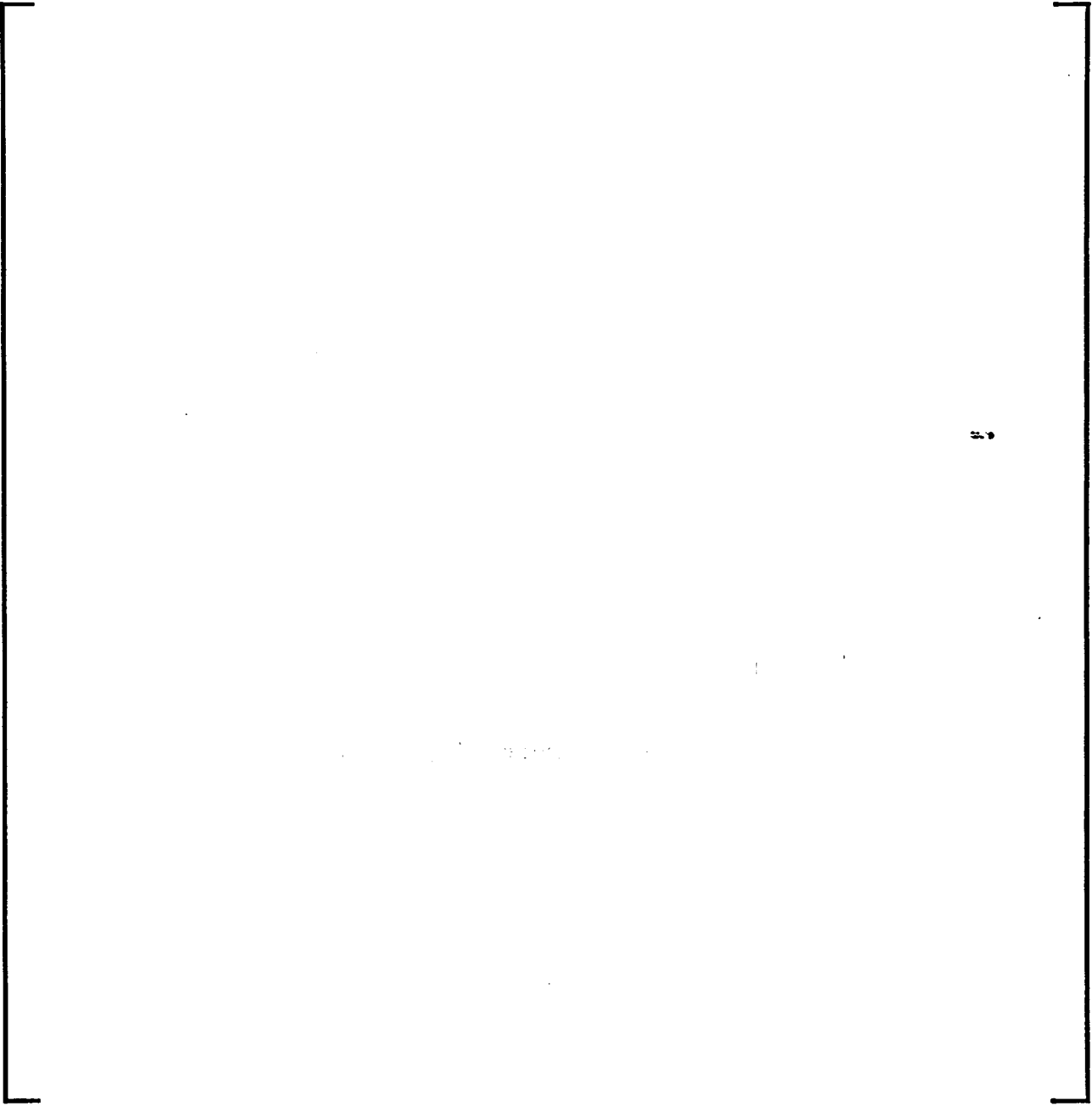

**Figure 11.2-48. Assembly Final Inspection Unit**

**This page intentionally left blank.**



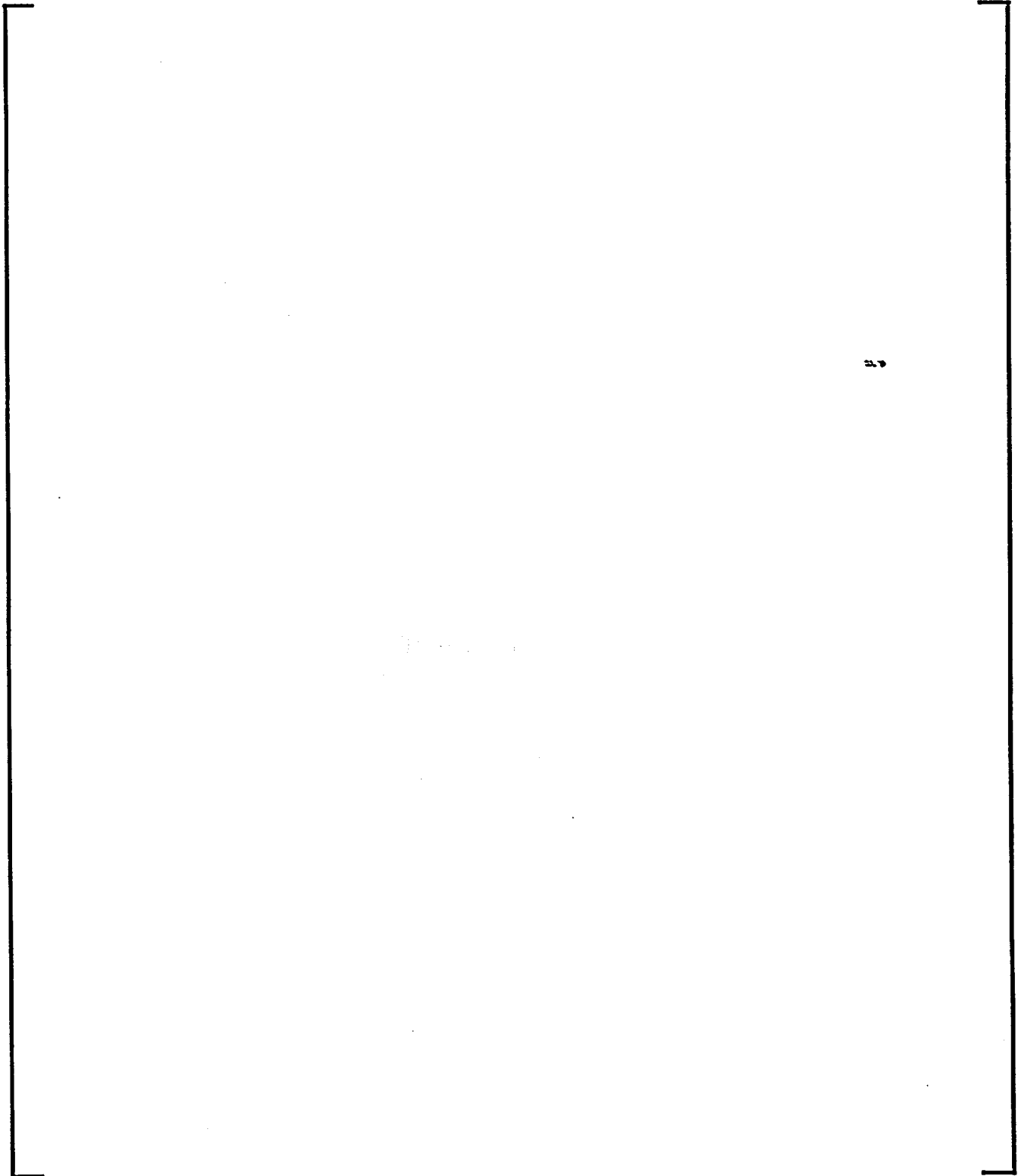

**Figure 11.2-48. Assembly Final Inspection Unit (continued)**

**This page intentionally left blank.**

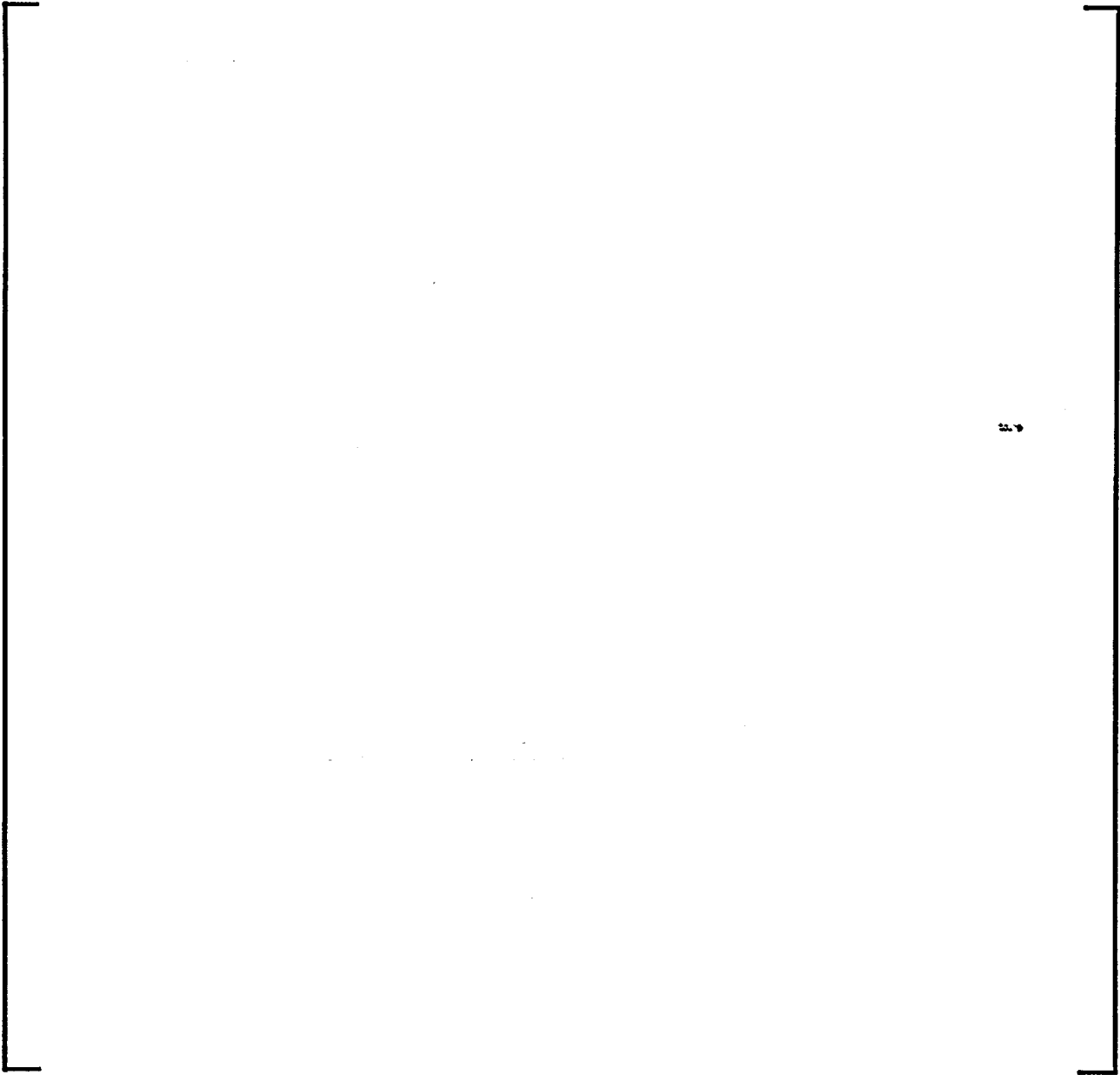

**Figure 11.2-48. Assembly Final Inspection Unit (continued)**

**This page intentionally left blank.**



**Figure 11.2-48. Assembly Final Inspection Unit (continued)**

**This page intentionally left blank.**

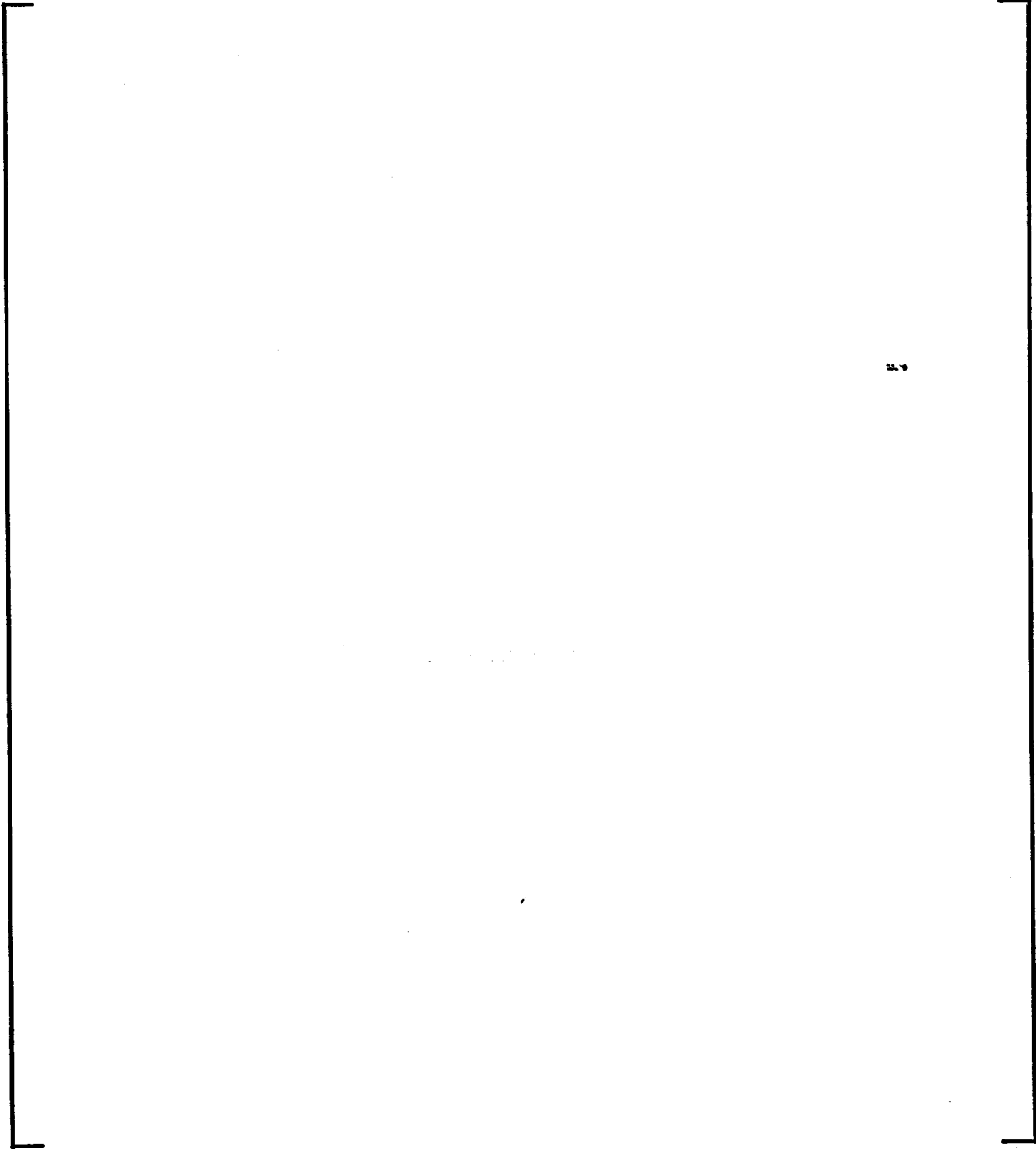

**Figure 11.2-49. Assembly Handling and Storage Unit**

**This page intentionally left blank.**



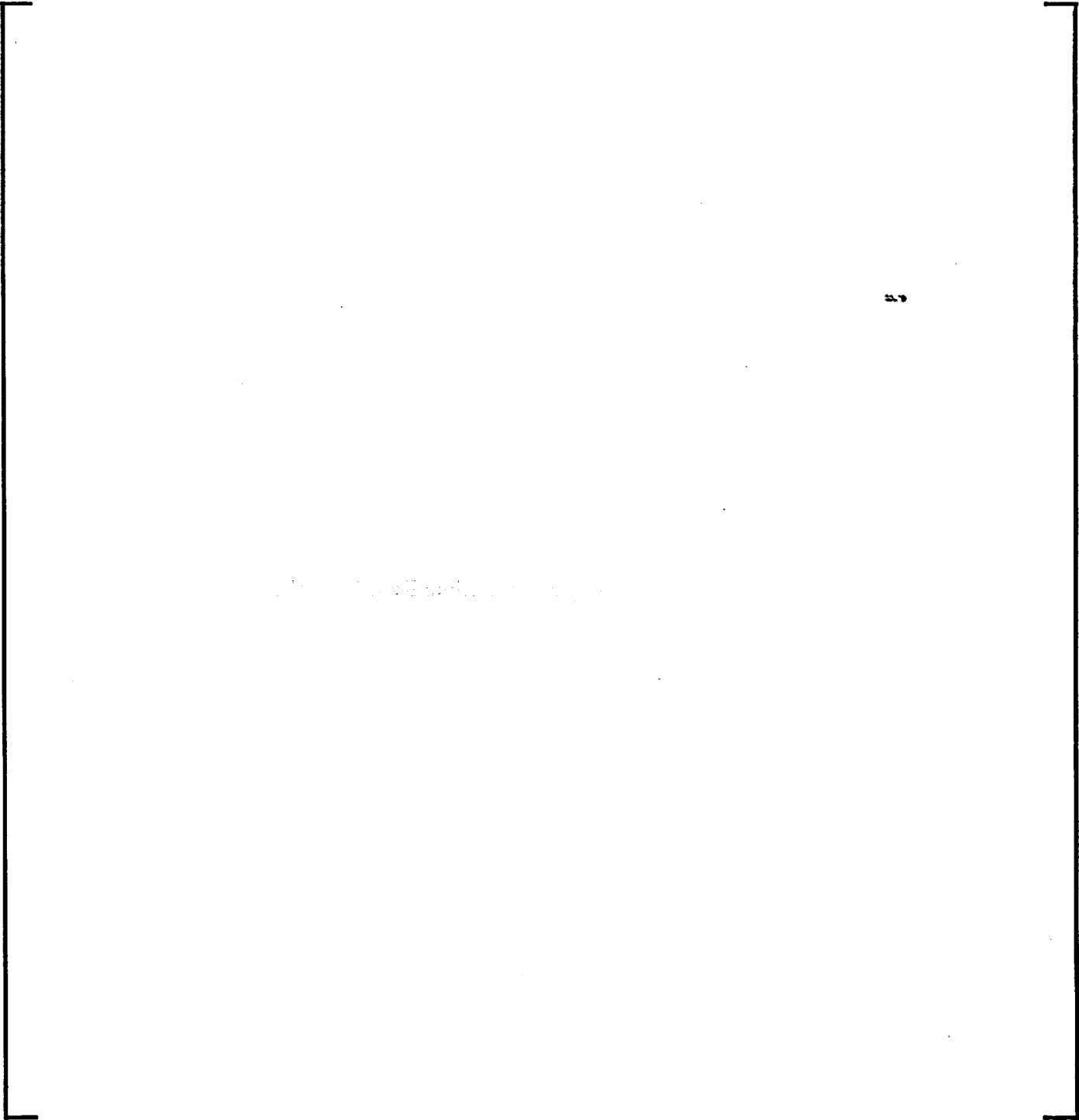

**Figure 11.2-49. Assembly Handling and Storage Unit (continued)**

**This page intentionally left blank.**



**Figure 11.2-49. Assembly Handling and Storage Unit (continued)**

**This page intentionally left blank.**

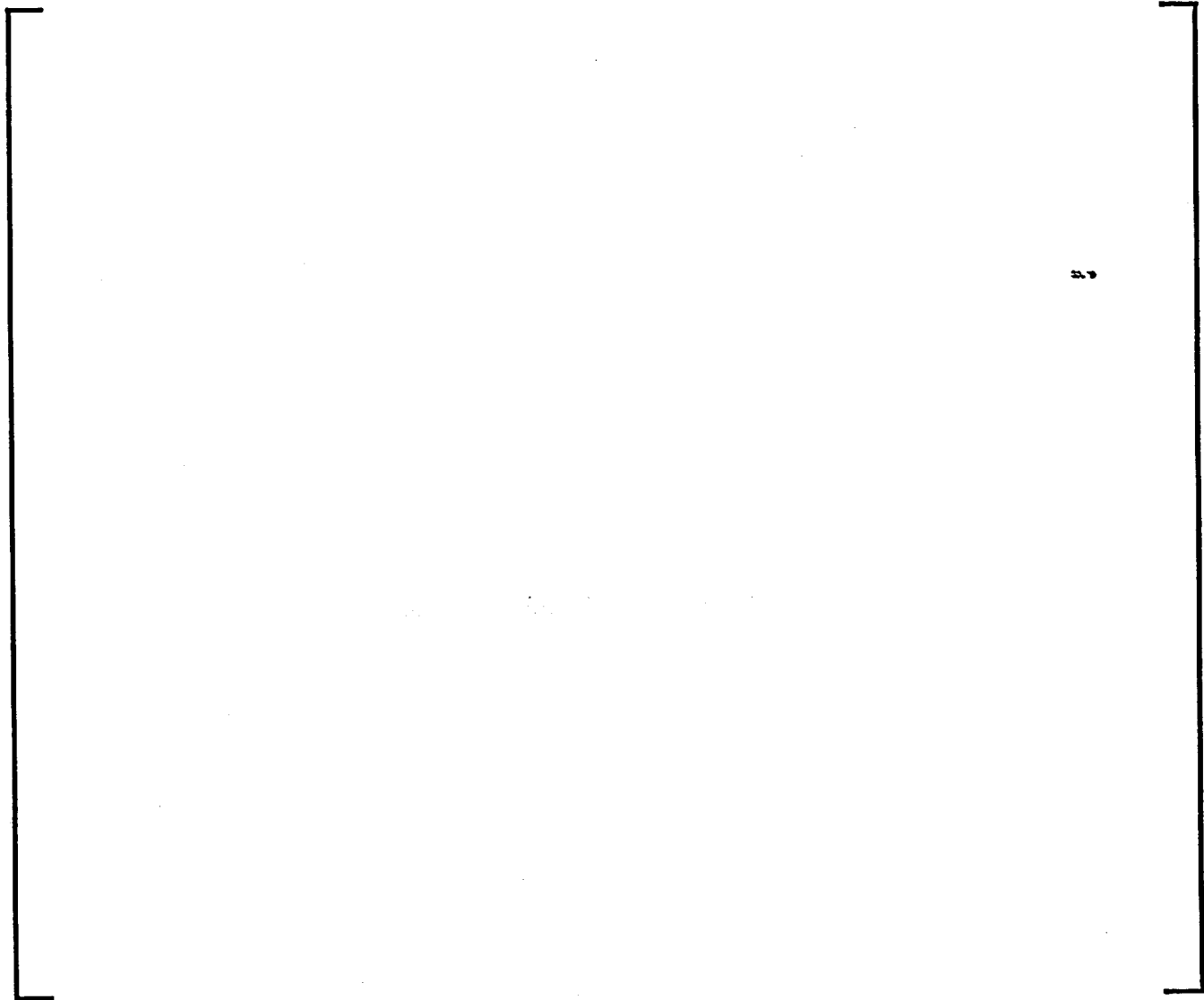

**Figure 11.2-50. Assembly Packing Unit**

**This page intentionally left blank.**

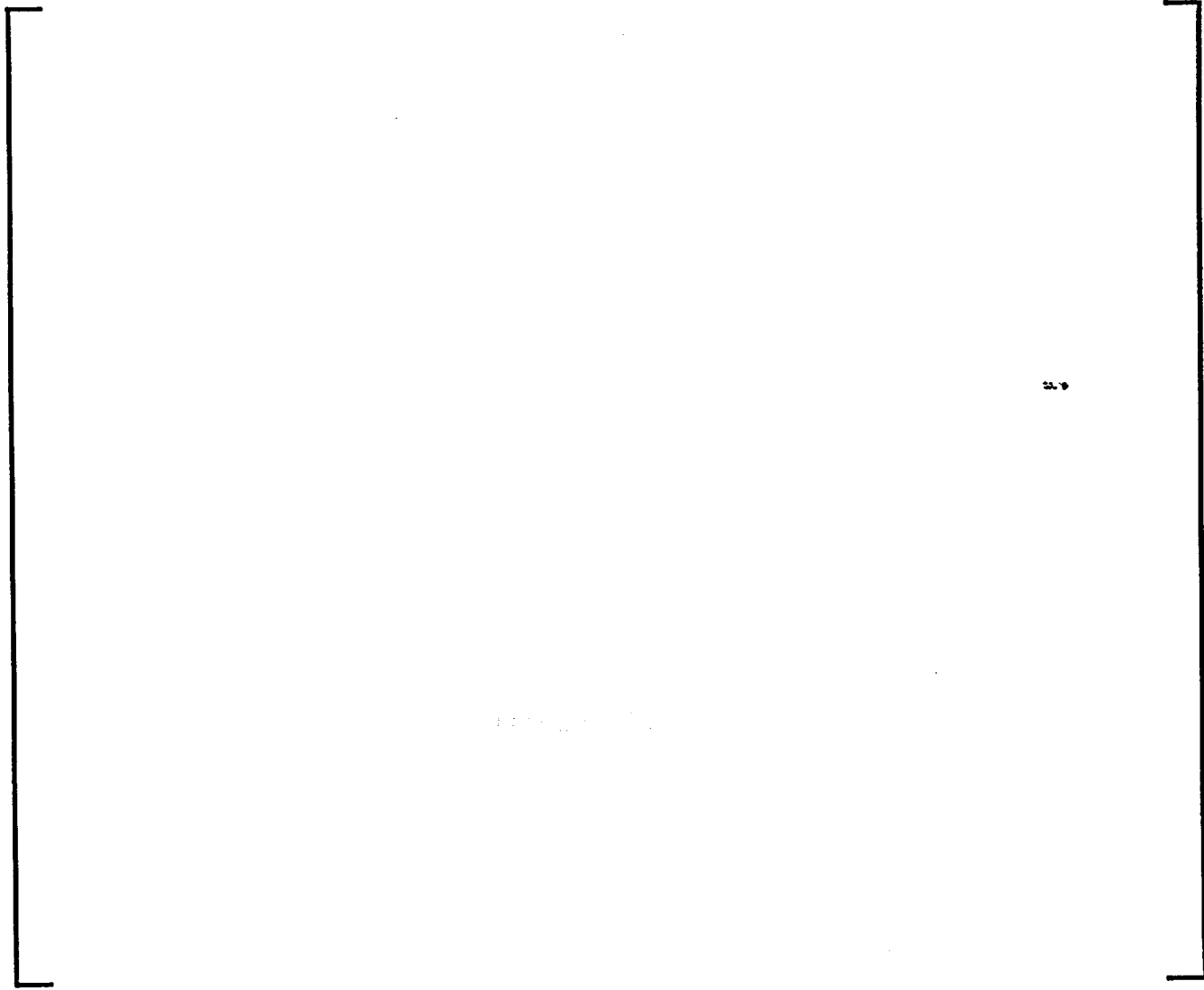
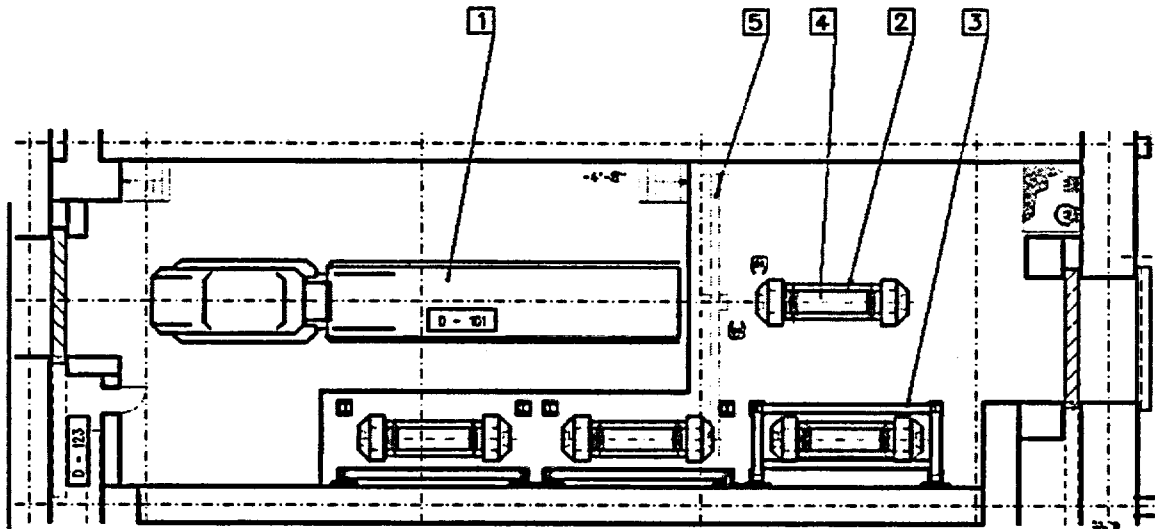

**Figure 11.2-50. Assembly Packing Unit (continued)**

**This page intentionally left blank.**



SST LOADING OPERATION



STRONGBACK LOADING OPERATION

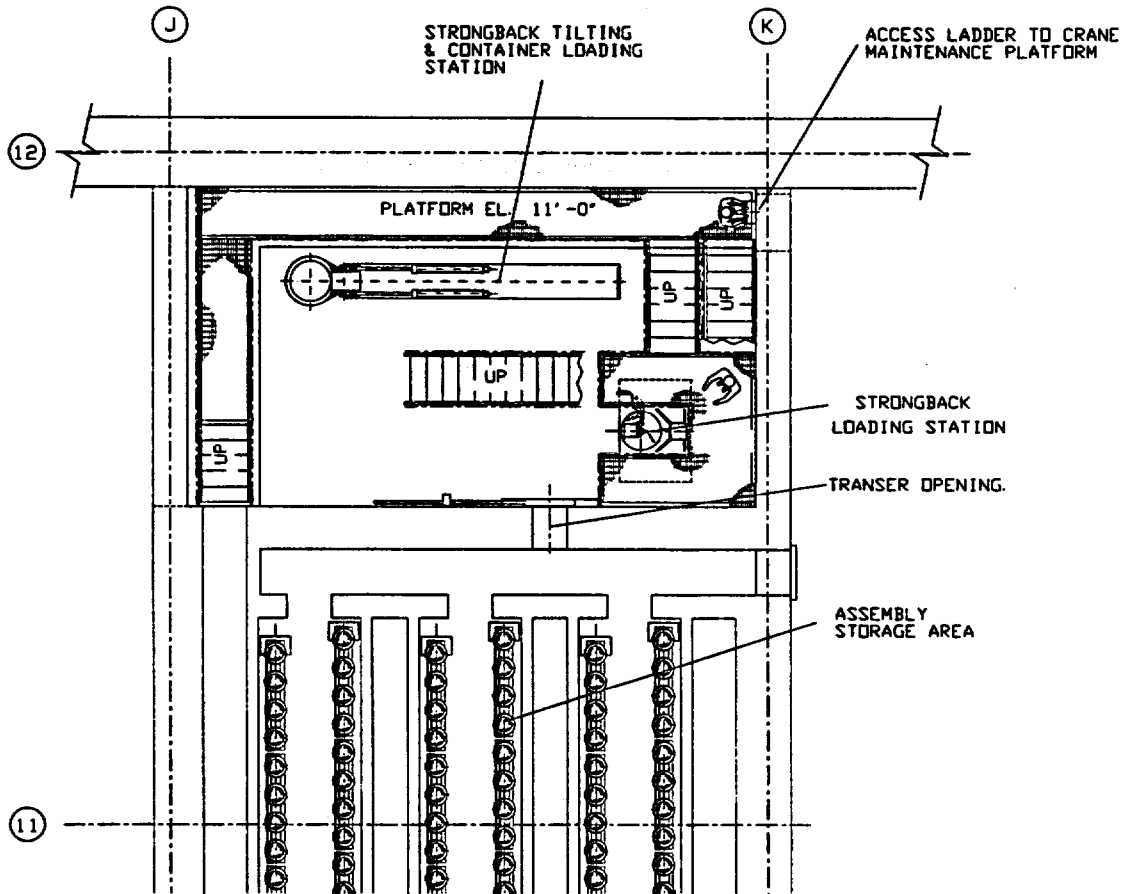

Figure 11.2-51. Assembly Packing Unit – SST Loading Operations

**This page intentionally left blank.**

### SST LOADING OPERATIONS

<b>Ref.</b>	<b>Description</b>	<b>Observation</b>
1	SST trailer	Capacity: One MOX Fresh Fuel Package
2	Air pallet	Capacity: 15,000 pounds
3	Storage rack	6 positions
4	Mox Fresh Fuel Package	Capacity: 3 MOX assemblies
5	Handling overhead crane	Capacity: 20,000 pounds

**Figure 11.2-51. Assembly Packing Unit – SST Loading Operations (continued)**

**This page intentionally left blank.**

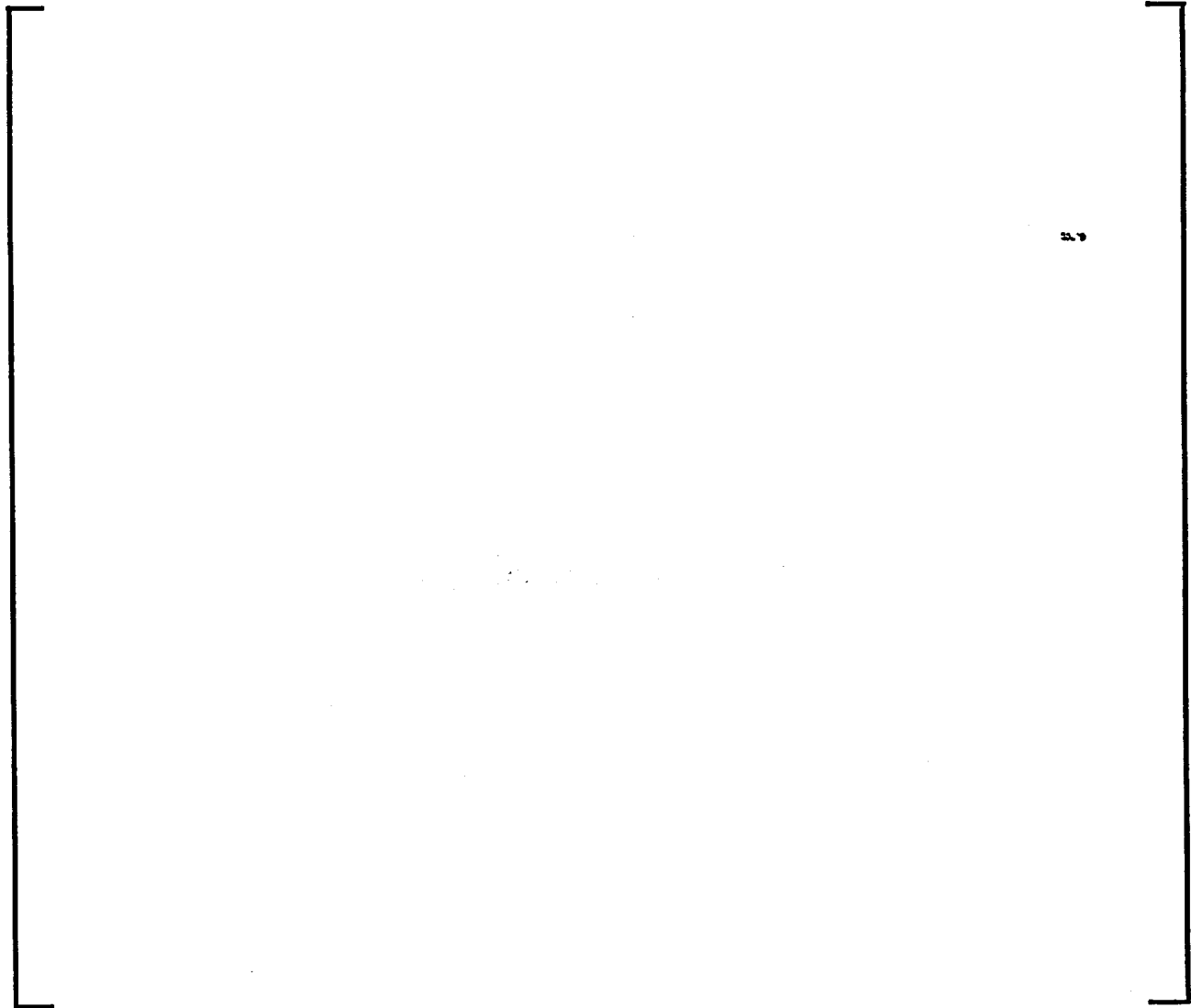

**Figure 11.2-52. Filter Dismantling Unit**

**This page intentionally left blank.**

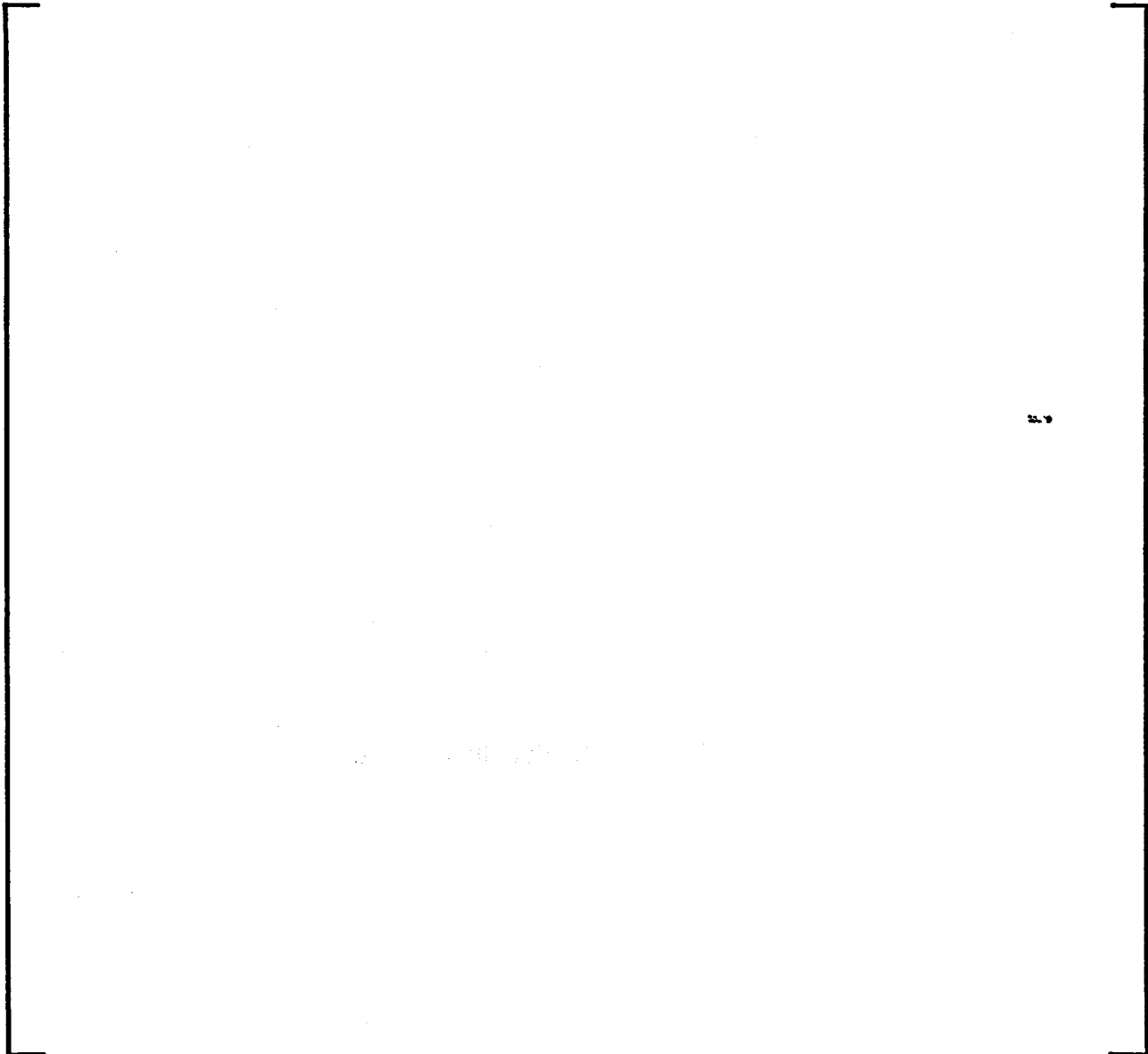

**Figure 11.2-52. Filter Dismantling Unit (continued)**

**This page intentionally left blank.**



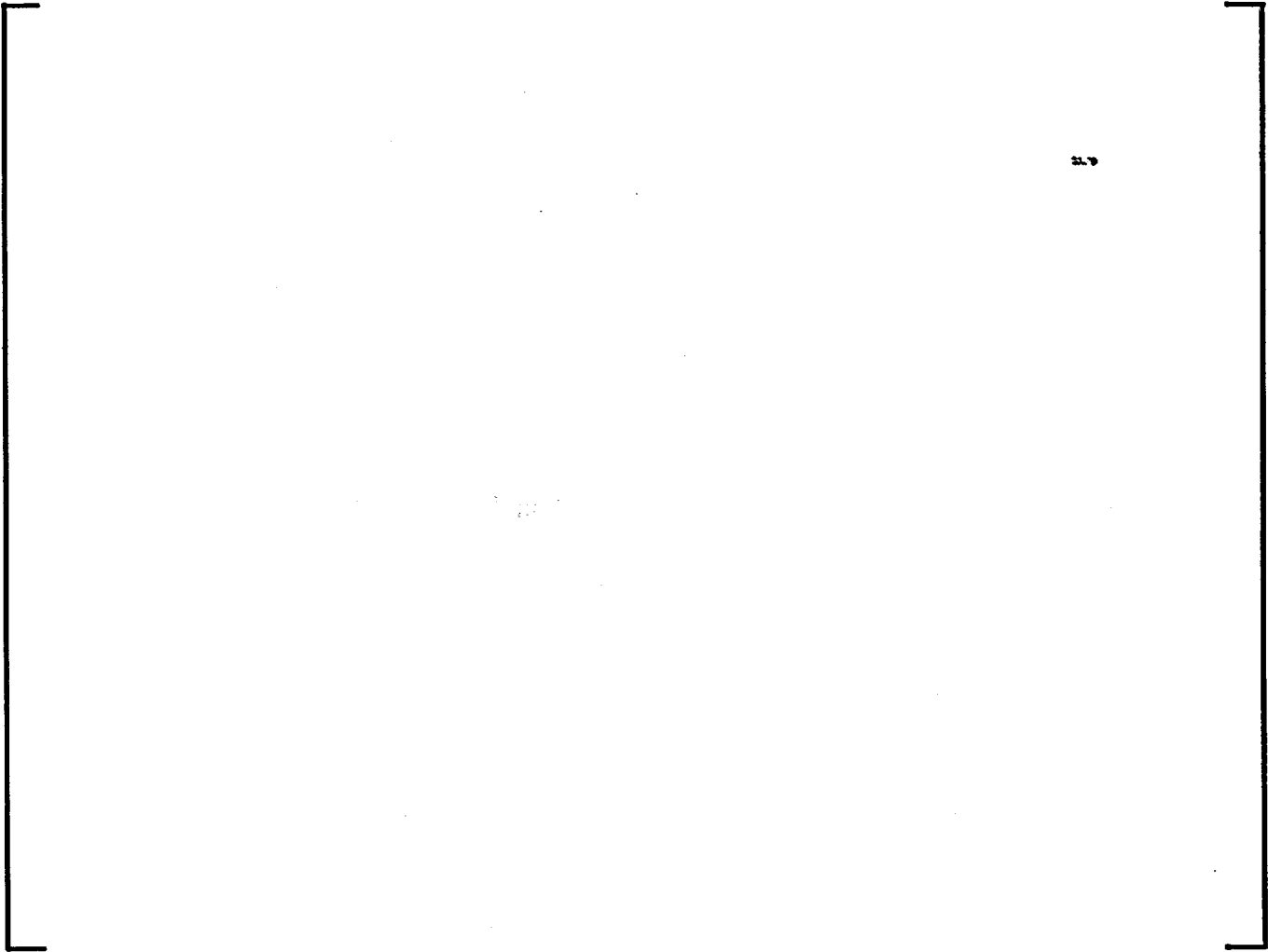

**Figure 11.2-53. Maintenance & Mechanical Dismantling Unit**

**This page intentionally left blank.**



**Figure 11.2-53. Maintenance & Mechanical Dismantling Unit (continued)**

**This page intentionally left blank.**

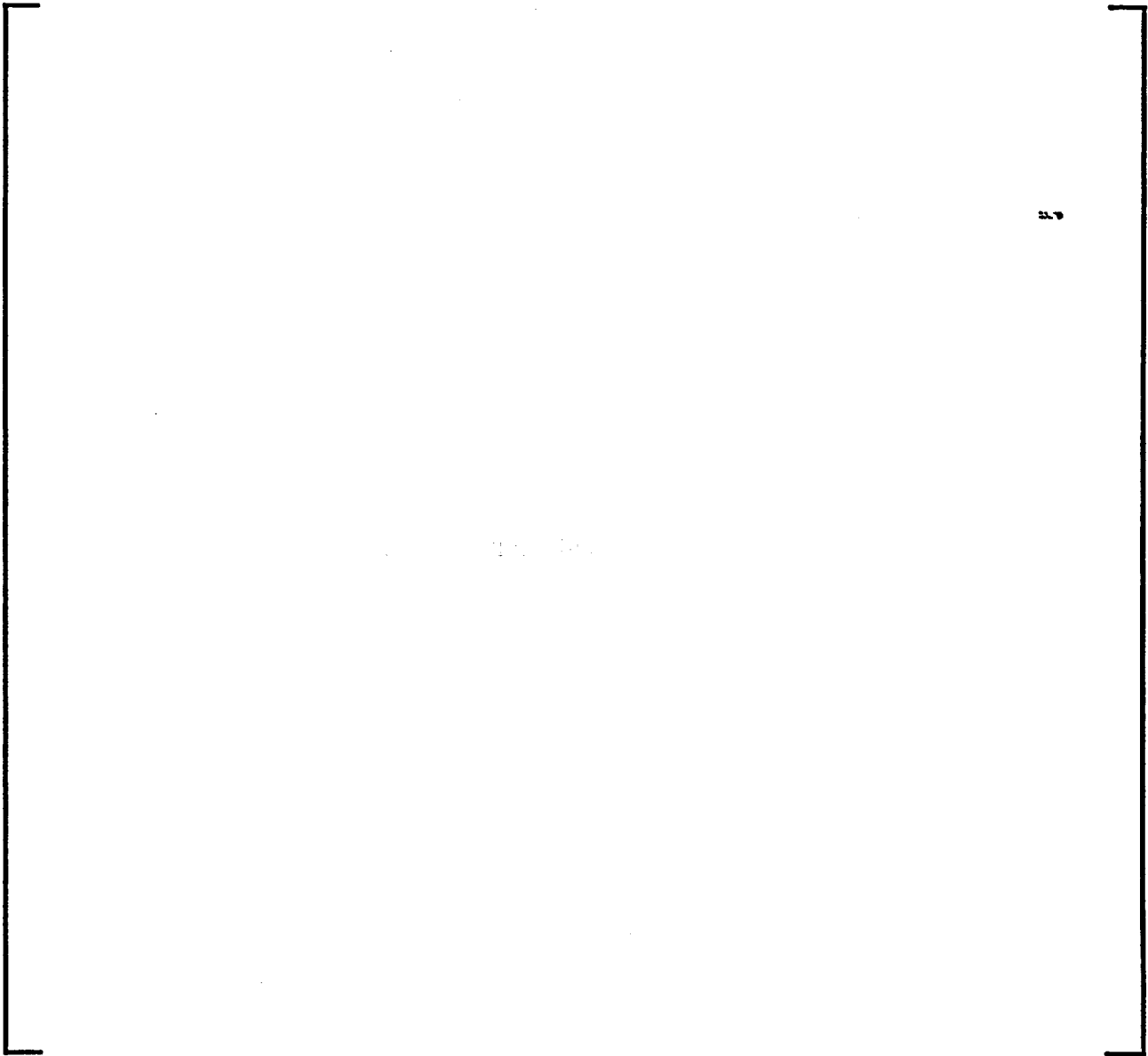

**Figure 11.2-54. Waste Storage Unit**

**This page intentionally left blank.**



**Figure 11.2-54. Waste Storage Unit (continued)**

**This page intentionally left blank.**





**Figure 11.2-55. Waste Counting Unit**

**This page intentionally left blank.**

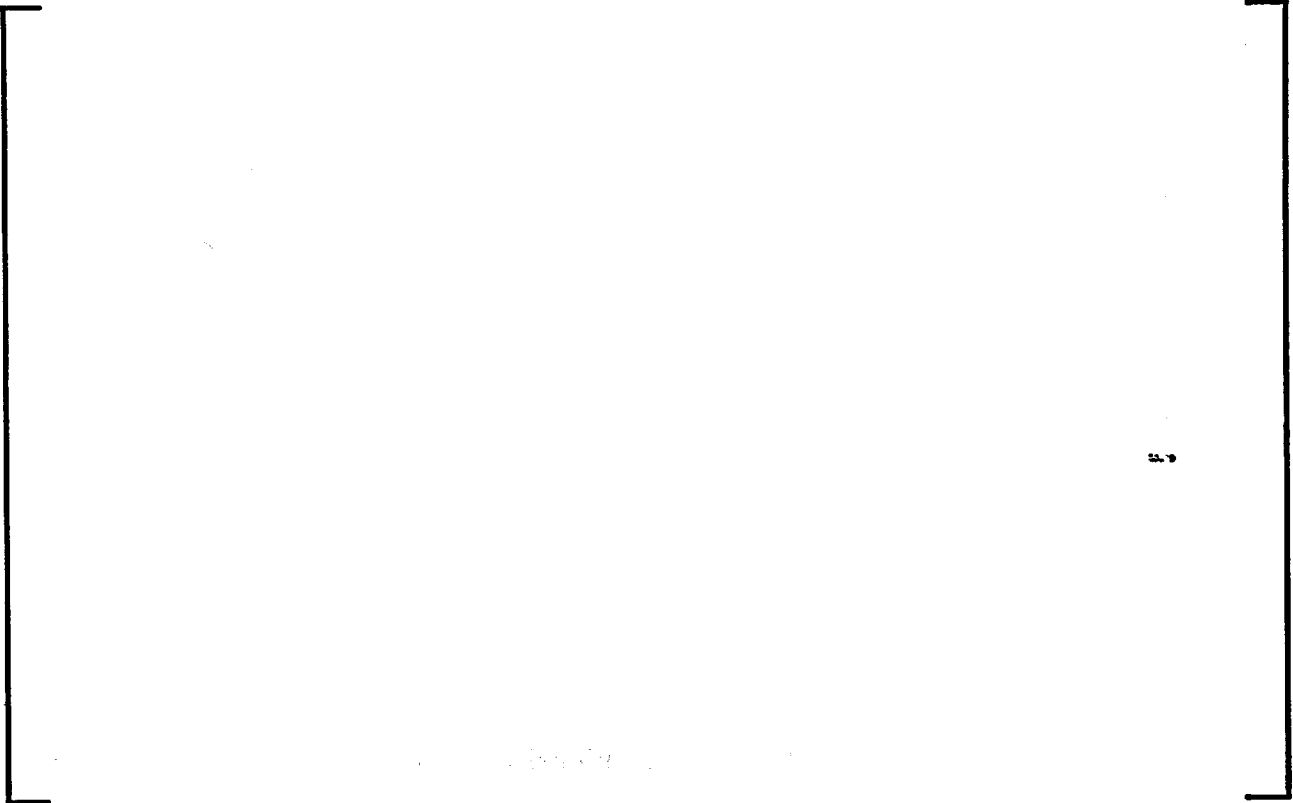

**Figure 11.2-55. Waste Counting Unit (continued)**

**This page intentionally left blank.**

## 11.3 AQUEOUS POLISHING PROCESS DESCRIPTION

This section provides a description and overview of the Aqueous Polishing (AP) Process, including design, operational, and process flow information. This information is provided to support the hazard and accident analysis provided in Chapter 5, as well as to assist in understanding the overall design and function of the AP Process.

### 11.3.1 Function

The function of the AP process is to remove impurities from the feed plutonium of the Pit Disassembly and Conversion Facility (PDCF) and of the Alternate Feedstock (AFS) for use in the MOX Processing (MP) Area. The AP process extracts impurities, predominantly gallium and americium, from the plutonium dioxide. The safety function of the principal SSCs associated with the AP process is discussed in Chapter 5.

### 11.3.2 Description

The AP process consists of 16 process units or systems (units symbols are indicated in parentheses):

- Decanning Unit (KDA)
- Milling Unit (KDM)
- Recanning Unit (KDR)
- Dissolution Unit (KDB)
- Dechlorination and Dissolution Unit (KDD)
- Purification Cycle (KPA)
- Solvent Recovery Cycle (KPB)
- Oxalic Precipitation and Oxidation Unit (KCA)
- Homogenization Unit (KCB)
- Canning Unit (KCC)
- Oxalic Mother Liquor Recovery Unit (KCD)
- Acid Recovery Unit (KPC)
- Offgas Treatment Unit (KWG)
- Liquid Waste Reception Unit (KWD)
- Uranium Oxide Dissolution Unit (KDC)
- Sampling System.

Figure 11.3-1 provides an overview of the AP process, and Figure 11.3-2 shows the AP general process diagram. In general, the AP process involves three major steps:

- **Dissolution of PuO<sub>2</sub> powder by electro-generated Ag (II)** – The dissolution step involves silver-catalyzed dissolution and filtration. This process was selected because it is very efficient and independent of PuO<sub>2</sub> powder characteristics. It results in the complete dissolution of the PuO<sub>2</sub> powder according to kinetics governed solely by the rate of Ag (II) generation. PuO<sub>2</sub> powder is dissolved by electro-generated Ag (II) in a

nitric acid medium. This process takes place at normal temperature (68°F to 104°F [20°C to 40°C]). For PuO<sub>2</sub> powder containing chlorides, a dechlorination step takes place prior to dissolution

- **Plutonium purification by solvent extraction** – The purification step involves plutonium extraction, solvent regeneration, and acid recovery. This process was selected because it yields very little plutonium leakage and has a high gallium decontamination factor.
- **Conversion into PuO<sub>2</sub> by continuous oxalate calcination** – The conversion process is a continuous oxalate conversion process. This process was selected because it yields a PuO<sub>2</sub> powder routinely used for MOX fabrication. Conversion to PuO<sub>2</sub> involves several operations: oxalic precipitation and oxidation (which includes precipitation, filtration, and drying and calcination), PuO<sub>2</sub> homogenization, PuO<sub>2</sub> canning, and oxalic mother liquor recovery.

The following sections discuss the 16 AP process units or systems.

### **11.3.2.1 Decanning Unit (KDA)**

#### **11.3.2.1.1 Function**

Three main functions are performed in the Decanning Unit:

- Density measurement by X ray (for PDCF powder only)
- Opening of outer, inner and convenience cans
- Transfer of powder in a dissolution dosing hopper (powder from PDCF) or in a reusable can to the Milling Unit (powder from AFS).

#### **11.3.2.1.2 Description**

The Decanning Unit consists of a series of workstations and gloveboxes distributed between the MP and AP Areas. The cans are transported between the two areas by a pneumatic transfer system.

- Density measurement by X Ray (for PDCF powder only)

The purpose of this operation is to determine the bulk density of powder from PDCF which is a homogeneous powder. The whole sealed 3013 container is tilted to increase powder density in order to measure tap density. The level of powder in the can is measured by X-rays. From the measured powder mass and volume, the density is calculated. If this value is well below 7 g/cc then the can will be processed by the dissolver, whereas if this value is near 7 g/cc, the can will be processed similarly to AFS powder (i.e., ball milled and density measurement performed on powder)

- Outer, inner and convenience cans opening and plutonium oxide powder transfer

The process is entirely mechanical and all can opening and powder transfer operations are fully automated.

All cans entering MFFF are packaged in 3013 standard containers.

The 3013 standard container consists of three stainless steel containers: an outer can containing an inner can that contains the convenience can with PuO<sub>2</sub> powder. The outer can and the inner can are opened in gloveboxes in the MP Area. The empty containers are removed and become low level waste.

Convenience cans coming from PDCF with a density well below 7 g/cc are transferred by a pneumatic system to the AP Area. The convenience can is opened in a glovebox in the AP Area and the contents are fed into the dosing hopper of the Decanning Unit to be processed in the electrolyzer of the Dissolution Unit.

PuO<sub>2</sub> powder coming from the AFS is usually packaged in "food cans" that may have various dimensions. Powder contained in "food cans" is repackaged into specific containers called reusable cans, whose dimensions are compatible with mechanical equipment capacities and pneumatic transfer shuttle dimensions. This powder transfer operation is performed in the Decanning Unit, after outer and inner can opening.

The reusable can is subsequently sent by pneumatic transfer to the Milling Unit where powder is milled (to reach an acceptable particle size for the dissolution process). After the milling operation the specific gravity is checked and a sample of the powder taken for laboratory analysis. Depending on the results of the analyses, one of three destinations is possible:

- If the analyses reveal the presence of chlorinated species in the powder, the reusable can is emptied in the dosing hopper of one of the two electrolyzers of the Dechlorination and Dissolution Unit.
- If the powder does not contain chloride ions, the reusable can is returned to the Decanning Unit where it is fed into the dosing hopper of the electrolyzer of the Dissolution Unit.
- If the powder contains chemical species not compatible with the AP process, the reusable can is transferred via the Decanning Unit to the Recanning Unit for repackaging.

The unit is designed to supply the electrolyzer of the Dissolution Unit (KDB) with three cans (approximately 29.7 lb. (13.5 kg)) of PuO<sub>2</sub> powder per batch and the electrolyzers of the Dechlorination and Dissolution Unit with one can (around 8.9 lb. (4 kg)) of PuO<sub>2</sub> powder per batch. The waste packages from this unit consist of:

- Outer cans and inner cans packed in vinyl and drums transferred to waste storage
- Convenience cans and "food cans" compacted and packed in vinyl and drums transferred to waste storage

- Empty reusable cans exceptionally introduced to receive discarded material packed in vinyl and removed through bag ports.

The Decanning Unit is subdivided into one workstation and nine gloveboxes. Each subassembly ensures one or more functions. The functional breakdown is as follows:

- Introduction airlock and 3013 unloading workstation
- Airlock (glovebox)
- Outer can opening glovebox
- Inner can opening glovebox
- Dispatching glovebox
- Food can opening glovebox
- Pneumatic transfer glovebox (departure)
- Pneumatic transfer glovebox (arrival)
- Convenience can opening glovebox
- Dosing hopper glovebox.

The mechanical processes implemented in the gloveboxes and pneumatic transfer system are described in Section 11.7.

Two operating modes must be considered depending on the type of powder in the container:

1. For PDCF PuO<sub>2</sub> powder containers (3013 standard), the automatic functions at the workstation include all the outer transfer can and opening operations needed to withdraw the inner can, including identification of the bar code on the outer can surface and opening of the outer can lid using a cutter wheel. The outer can is docked to the inner can opening glovebox where it is held beneath a hatch. An inflatable seal around the outer can ensures a leak tight seal, and the hatch is opened without breaching the airlock containment since the internal volume of the outer can becomes an extension of the volume of the inner can opening glovebox.

After outer and inner can opening, the convenience can is received from the pneumatic transfer arrival glovebox and weighed prior to emptying the powder. The can opening and pressing machine opens the convenience can. The tilter overturns the convenience can to empty the can of PuO<sub>2</sub> powder. The empty can with its lid placed inside is compacted with the can opening and pressing machine. The compacted cans are stored on a carrousel pending manual removal by an operator.

2. For AFS PuO<sub>2</sub> powder containers ("food cans"), the opening operations of the outer can and the inner can are similar to operations for containers with convenience cans.

The powder in the food can must be transferred to the Milling Unit because the particle size of AFS PuO<sub>2</sub> powders must be decreased. However the food can cannot be directed immediately to this unit since dimensions of the food can are not compatible with mechanical equipment capacities.



Therefore, the powder in the food can is emptied into a reusable can (in the food can opening glovebox) which is placed in a shuttle and then transferred to the Milling Unit. After milling, a density measurement and a sample are taken and depending on the results of the laboratory analyses of the sample, powder is directed to the Decanning Unit, the Milling Unit, or the Recanning Unit. After unloading the powder, the interior of the reusable can is cleaned with a dedusting system and returned to the food can opening glovebox. The outer cans and inner cans are drummed and sent to waste storage and treated as low level wastes. The "food cans" are drummed and sent to waste storage and treated as TRU wastes.

#### **11.3.2.1.3 Process Chemistry**

This section is not applicable to this unit.

#### **11.3.2.1.4 Process Equipment**

Figure 11.3-3 provides a simplified drawing of the Decanning Unit.

#### **11.3.2.1.5 Chemical Process Inventories**

The normal inventory of radionuclides involved in this unit is provided in Table 11.3-1.

#### **11.3.2.1.6 Chemical Process Ranges**

This section is not applicable to this unit.

#### **11.3.2.1.7 Chemical Process Limits**

This section is not applicable to this unit.

### **11.3.2.2 Milling Unit (KDM)**

#### **11.3.2.2.1 Function**

The functions of the Milling Unit are as follows:

- Milling AFS PuO<sub>2</sub> powders to homogenize the plutonium oxide and decrease their particle size
- Performing a density measurement on the milled PuO<sub>2</sub> powders
- Sampling the PuO<sub>2</sub> powder
- Storage of PuO<sub>2</sub> powders while analyses are performed before processing.

### **11.3.2.2.2 Description**

The Milling Unit consists of a series of gloveboxes and is designed to mill AFS PuO<sub>2</sub> powders that have been emptied into reusable cans in the Decanning Unit. After milling and sampling, powders are temporarily stored during the laboratory analyses. Depending on the results of the analyses, powders are fed into one of the two electrolyzers of the Dechlorination and Dissolution Unit, fed into the electrolyzer of the Dissolution Unit, or rejected and transferred to the Recanning Unit.

Milling is required for AFS PuO<sub>2</sub> powders to reach a particle size compatible with the dissolution process. As a result of this milling operation, the PuO<sub>2</sub> powder density decreases.

The process is entirely mechanical and all can opening and powder transfer operations are fully automatic.

The unit is designed to supply one of the two electrolyzers of the Dechlorination and Dissolution Unit with 8.9 lb. (4 kg) of PuO<sub>2</sub> powder per dissolution batch (with a maximum of 11.0 lb. (5 kg) of PuO<sub>2</sub>). It is also designed to supply the electrolyzer of the Dissolution Unit with about 29.8 lb. (13.5 kg) of PuO<sub>2</sub> powder per dissolution batch.

The waste packages from this unit consist of the empty reusable cans exceptionally introduced to receive discarded material packed in vinyl and removed through bag ports. The reusable cans are recycled.

The Milling Unit is subdivided into twelve gloveboxes and an assembly of three gloveboxes designed to perform the can transfer between each glovebox. Figure 11.3-4 shows a simplified figure of the system. Each sub-unit ensures one or more functions. The functional breakdown is as follows:

- Milling pneumatic transfer glovebox
- Pre-polishing buffer storage
- Milling glovebox (line 1)
- Milling glovebox (line 2)
- Sampling glovebox
- Sample pneumatic transfer glovebox (to Laboratory)
- Pneumatic transfer glovebox (arrival: line 1)
- Pneumatic transfer glovebox (arrival: line 2)
- Reusable can emptying glovebox (line 1)
- Reusable can emptying glovebox (line 2)
- Dosing hopper glovebox (line 1)
- Dosing hopper glovebox (line 2)
- Can transfer glovebox

This unit receives reusable cans from the Decanning Unit in a shuttle by pneumatic transfer. After identification of the bar code, cans are directed to one of the two milling stations by the CARTRAC transfer system.

The milling process consists of emptying powder from the reusable can into the ball miller and rotating the miller for a pre-determined time. Metallic uranium balls are used to perform the milling.

Following milling, the powder is loaded into reusable cans that are transferred to the density check system: a density of less than 7 g/cc is required. Each reusable can is then sampled with a sampling syringe and the sample placed in a vial. The powder sample is then sent to the sample pneumatic transfer glovebox using a specific transfer trolley and lifting gripper after weighing and identification. The sample placed in a shuttle is then transferred pneumatically to the Laboratory.

After sampling, the reusable can is directed by the CARTRAC transfer system to the pre-polishing buffer storage where it is stored until the analyses results are established. The storage capacity is 117 reusable cans. Depending on the results of the analyses, one of three destinations is possible:

- If the powder is compatible with the dissolution process, the reusable can is transferred to the Decanning Unit and then fed into the dosing hopper of the electrolyzer of the Dissolution Unit
- If the powder contains chloride ions (chloride concentration of greater than 500 µg/g), the powder is directed to the feeding station for one of the two dechlorination electrolyzer dosing hoppers. The reusable can is weighed before and after emptying of the powder. The interior of the empty can is cleaned with a dust removal system and the can is directed to the Decanning Unit for recycling. The powder is fed into one of the two electrolyzers of the Dechlorination and Dissolution Unit.
- If the powder is incompatible with the AP dissolution processes, the reusable can is redirected to the Recanning Unit to be repackaged in a 3013 container before transfer out of MFFF

#### **11.3.2.2.3 Process Chemistry**

This section is not applicable to this unit.

#### **11.3.2.2.4 Process Equipment**

Figure 11.3-4 provides a simplified drawing of the Milling Unit.

#### **11.3.2.2.5 Chemical Process Inventories**

The normal inventory of radionuclides involved in this unit is provided in Table 11.3-2.

#### **11.3.2.2.6 Chemical Process Ranges**

This section is not applicable to this unit.

### **11.3.2.2.7 Chemical Process Limits**

This section is not applicable to this unit.

### **11.3.2.3 Recanning Unit (KDR)**

#### **11.3.2.3.1 Function**

The function of the Recanning Unit is to package PuO<sub>2</sub> powders from the AFS that are not compatible with the AP process.

#### **11.3.2.3.2 Description**

The Recanning Unit consists of two workstations and two gloveboxes. The unit is designed to repackage cans containing powder not immediately compatible with the AP process into 3013 standard containers which are then stored in a vault storage area pending transfer out of the MFFF or future treatment. The functional breakdown is as follows:

- Convenience can packaging glovebox
- Inner can packaging glovebox
- Outer can packaging enclosure workstation
- Contamination check workstation.

If the results of analyses show that powder in a reusable can is not compatible with the AP process, the reusable can is retrieved from the pre-polishing buffer storage of the Milling Unit and then transferred pneumatically to the Decanning Unit.

The reusable can is then introduced into the Recanning Unit through a tunnel located between the Decanning and the Recanning Units. The content of the reusable can is transferred into a modified crimped lid convenience can. The reusable can, after a thorough cleaning by a dust removal system, is recycled to the Decanning Unit.

The convenience can is packaged into an inner can and then into an outer can. This operation includes welding, tightness and non-contamination checks. The final container is transferred to the vault storage via an unloading workstation in the Decanning Unit.

#### **11.3.2.3.3 Process Chemistry**

This section is not applicable to this unit.

#### **11.3.2.3.4 Process Equipment**

Figure 11.3-5 provides a simplified drawing of the Recanning Unit.

#### **11.3.2.3.5 Chemical Process Inventories**

The normal inventory of radionuclides involved in this unit is provided in Table 11.3-3.

### 11.3.2.3.6 Chemical Process Ranges

This section is not applicable to this unit.

### 11.3.2.3.7 Chemical Process Limits

This section is not applicable to this unit.

## 11.3.2.4 Dissolution Unit (KDB)

### 11.3.2.4.1 Function

The primary function of the Dissolution Unit is to dissolve the  $\text{PuO}_2$  powder.

### 11.3.2.4.2 Description

The  $\text{PuO}_2$  powder compatible with the dissolution process (i.e., with a chloride concentration of less than 500  $\mu\text{g/g}$ ) and compatible with the AP process (i.e., without unacceptable quantities of impurities) is electrolytically dissolved in the Dissolution Unit in preparation for separation of impurities (specifically americium, gallium, and uranium) in the Purification Cycle. The powder from the Decanning Unit dosing hopper is gradually fed into the electrolyzer by the screw conveyor.

Samples from the dilution and sampling tank are analyzed to determine the fissile material content and the required degree of dilution before being sent to the Purification Cycle feed tank via the buffer tank TK7000.

The Dissolution Unit consists of a single processing line. Two tanks are also connected to this line to allow for greater process flexibility: one tank (TK4000) is used to collect any overflows from the processing tanks of this dissolution unit and the Dechlorination and Dissolution Unit and the other tank (TK6000) can be used to receive a batch that may not be compatible, unless diluted, with the purification process (i.e., with unacceptable quantities of impurities). The contents of tank TK6000 can be distributed in small fractions (diluted by the main process stream) into the process. The cadmium-lined hopper and the screw conveyor are installed on scales in a glovebox located in the Decanning Unit. The  $\text{PuO}_2$  powder is fed into the hopper. The total and the differential weights per unit of time are continuously recorded. The instantaneous flow is computed and compared with the setpoint, and the flow rate is adjusted by varying the speed of the screw.

$\text{Ag}^{2+}$  ions are electrolytically produced in the cylindrical electrolysis compartment.

The cathode well is fed from a nitric acid slab tank by an airlift via a drip pot. The cathode well overflows into the slab tank via another drip pot. The electrolysis cell solution

flows into a complementary pot and the flat powder-receiving compartment.

The powder-receiving compartment is connected to the powder feed screw conveyor by a chute, which is provided with a branch for unblocking it, a valve to prevent moisture from rising and powder from falling in after completion of electrolysis, and impacters to facilitate powder transfer to the electrolyzer.

A stirrer is used to continuously circulate the dissolution solution.

- Draining of the anolyte circuit containing the dissolution solutions by pump, through a bag pre-filter and a Poral<sup>®</sup> filter and to receiving tank TK3000.
- Draining of the cathode well by siphon to receiving tank TK3000.
- Draining of the nitric acid storage tank TK1500 by airlift into tank TK3000

Receiving tank TK3000

In normal operation, draining solutions received in receiving tank TK3000 are transferred to dilution and sampling tank TK5000 via a pump and filter. Dilution and sampling tank TK5000 is made of 316L stainless steel and has a useful volume of 106 gal (400 L). This tank is used for diluting the dissolution solution to reduce the plutonium and <sup>235</sup>U concentrations before feeding the Purification Cycle. Dilution and sampling tank TK5000 is equipped with a depleted uranyl nitrate inlet from the Uranium Oxide Dissolution Unit, a nitric acid inlet, an emergency scavenging air inlet, sparging pipes to homogenize the solution, and a sampling line.

After dilution and sampling, the solutions are transferred via siphon to buffer tank TK7000, which receives the contents of dissolution batches (one PuO<sub>2</sub> lot) before transfer to the Purification Cycle. This tank is common to the processing lines of the Dissolution Unit and to the two lines of the Dechlorination and Dissolution Unit. The tank is made of 316L stainless steel, has a useful volume of 265 gal (1000 L), and is geometrically safe (annular). This tank is used to establish the fissile material balance, which is established from an analysis of plutonium concentration and measurement of the volume in the tank, and to store solution before transfer to the Purification Cycle. Buffer tank TK7000 is equipped with five internal mixing air-lifts to homogenize the solution, an emergency scavenging air inlet, and a sampling line.

### 11.3.2.4.3 Process Chemistry

PuO<sub>2</sub> powder, which is insoluble in a purely nitric medium, is put into solution by electrolytic dissolution with Ag<sup>2+</sup>. The electrolytic dissolution takes place in a 6N nitric acid solution at 86°F (30°C). The general process whereby PuO<sub>2</sub> is dissolved by the electrolytically produced Ag<sup>2+</sup> is as follows.

Electrolytic production of Ag<sup>2+</sup>:



Dissolution of PuO<sub>2</sub> powder:

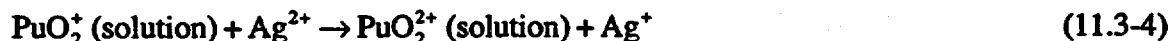

Giving the following general reaction:

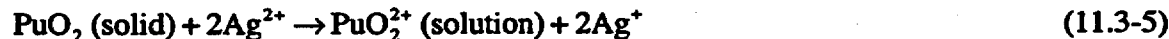

Ag<sup>+</sup> ions are oxidized at the anode. The following reduction reaction takes place at the cathode:



Dissolution occurs when a current is applied. The joule effect of the electrical power supplied is attenuated by cooling the anolyte and the catholyte.

In receiving tank TK3000, the Pu valence is adjusted and the remaining Ag<sup>2+</sup> ions are reduced by adding H<sub>2</sub>O<sub>2</sub>. The reactions are as follows:

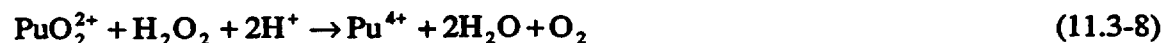



#### 11.3.2.4.4 Process Equipment

Figures 11.3-6 and 11.3-7 provide simplified drawings of the Dissolution Unit and the electrolyzer, respectively.

#### 11.3.2.4.5 Chemical Process Inventories

The normal inventories of radionuclides and chemicals involved in this unit are provided in Tables 11.3-4 and 11.3-5, respectively for both the PDCF and the AFS feeds.

#### 11.3.2.4.6 Chemical Process Ranges

The Dissolution Unit is operated in batches. The Dissolution Unit and the Dechlorination and Dissolution Unit are designed to treat 48.5 lbs/day (22 kg/day) of PuO<sub>2</sub>.

The operating range of the Dissolution Unit and the Dechlorination and Dissolution Unit is variable depending on the quantity of AFS processed. During the processing of the AFS (which may occur over the first three years of operation), the dissolution units are expected to process between 8.8 lbs/week (4 kg/week) of PuO<sub>2</sub>, which correlates to one batch from the Dechlorination and Dissolution Unit, and 284 lbs/week (129 kg/week) of PuO<sub>2</sub>, which correlates to six dissolutions per week for both lines of the Dechlorination and Dissolution Unit (4 kg/batch) and for the single line of the Dissolution Unit (13.5 kg/batch). During the processing of the PDCF feed, the Dissolution Unit is expected to process between 29.8 lbs/week (13.54 kg/week) of PuO<sub>2</sub>, which correlates to one dissolution batch by the Dissolution Unit, and 536 lbs/week (243 kg/week) of PuO<sub>2</sub>, which correlates to six dissolutions per week for all three dissolution lines (13.5 kg/batch).

The nominal flow rate to the Purification Cycle is approximately 3.8 gal/hr (14.4 L/hr).

#### 11.3.2.4.7 Chemical Process Limits

Normal operating parameters are described in Section 11.3.2.4.6. Principal SSCs are described in Chapter 5. Specific operating limits and the associated IROFS will be provided in the ISA.

### 11.3.2.5 Dechlorination and Dissolution Unit (KDD)

#### 11.3.2.5.1 Function

The functions of the Dechlorination and Dissolution Unit are to remove chloride ions from PuO<sub>2</sub> powder and then to dissolve this powder. The unit is implemented to process chlorinated feed (i.e., feed with a chloride concentration greater than 500 µg/g) and will also be used during the processing of the PDCF feed.



### 11.3.2.5.2 Description

Similar to the Dissolution Unit, the PuO<sub>2</sub> is electrolytically dissolved in this unit in preparation for the separation of impurities (specifically americium, gallium, and uranium) by the Purification Cycle. The process is nearly identical to the Dissolution Unit

After analysis to establish the density, particle size, and quantity of chloride in the powder, chlorinated feeds are retrieved from the pre-polishing buffer storage and transferred to the dosing hopper in the Milling Unit. The powder is fed from the dosing hopper into an electrolyzer by a screw conveyor. During the dechlorination step, desorbed chlorine gas is scrubbed in a washing column by a caustic solution. After the dechlorination step, the plutonium dissolution operation can start with the silver addition.

Samples from the dilution and sampling tank are analyzed to determine the fissile material content and the required degree of dilution before being sent to the Purification Cycle feed tank via the buffer tank of the Dissolution Unit. The Dechlorination and Dissolution Unit processes approximately 8.8 lbs (4 kg) of plutonium oxide with chlorides per batch and is also sized to also process approximately 26.5 lbs (13.5 kg) per batch of plutonium oxide without chlorides.

The Dechlorination and Dissolution Unit consists of two identical processing lines. The cadmium-lined hoppers and the screw conveyors are installed on scales in a glove box located in the Milling Unit. The PuO<sub>2</sub> powder is fed into the dosing hopper. The total and the differential weights per unit of time are continuously recorded. The instantaneous flow is computed and compared with the setpoint, and the flow rate is adjusted by changing the speed of the screw.

Dechlorination and dissolution take place in electrolyzer EZR1000 (or electrolyzer EZR2000). The electrolyzer and the process of dissolving the plutonium oxide is similar to that described for the electrolyzer of the Dissolution Unit

Desorbed chlorine is extracted and directed to the chlorine washing column CLMN7000 (CLMN8000) through HEPA filters. There are two washing columns: one column per processing line. The washing solution in the column is recirculated via recirculation tank TK7100 (TK8100) to scrub chlorine gas until a chloride concentration of approximately 8 g/L is reached, after

which the chlorinated solution is transferred to the chlorine waste tank TK9000 and fresh washing solution is introduced into the column. The chlorine concentration in the recirculation tank TK7100 (TK8100) is measured.

The gaseous effluents from the washing columns, the N<sub>2</sub>, and residual Cl<sub>2</sub> are discharged to the RNA Unit.

Chlorine waste tanks TK9000 and TK9500 are common to both lines of the Dechlorination and Dissolution Unit. The chlorinated washing solution is sent to waste tank TK9000 with a volume of 528 gal (2,000 L). A portion of this solution is transferred to waste tank TK9500 where the solution is diluted with water and sodium hydroxide to reach an acceptable chloride concentration for the effluents (0.75 g/L of chloride). Tank TK9500 has a volume of 528 gal (2,000 L). It is equipped with a water inlet, a sodium hydroxide inlet, and a sampling line.

After the dechlorination step, the dissolution operation starts: Ag<sup>+</sup> ions are fed into the electrolyzer and Ag<sup>2+</sup> ions are electrolytically produced. The dissolution, draining, reduction, dilution (isotopic and chemical), and sampling operations and the associated equipment for both lines of this unit are similar to those of the Dissolution Unit.

Tank TK3500 is designed to receive the catholyte from both electrolyzers, EZR1000 and EZR2000, after the dechlorination and dissolution operations and to recycle it as anolyte in the electrolyzers of the Dissolution Unit and the Dechlorination and Dissolution Unit. Tank TK3500 is made of 316L stainless steel, has a useful volume of 40 gal (150 L) and is geometrically safe (slab).

The dissolution solutions, after isotopic dilution and sampling, are transferred to the buffer tank of the Dissolution Unit (KDB-TK7000).

#### 11.3.2.5.3 Process Chemistry

The removal is based on the electrolytic oxidation of Cl<sup>-</sup> ions in 6 N nitric acid at a temperature of 140 °F (60 °C):



The dechlorination operation has an efficiency of greater than 99% (i.e., greater than 99% of the initial chlorides are removed from the feed). With the removal of the chlorine, silver nitrate solution can then be added and the dissolution process described for the Dissolution Unit can be repeated in the electrolyzer.

The chlorinated gases from the electrolytic oxidation are treated in one of the scrubbing columns (there is one scrubbing column per dissolution line). The gaseous chlorine, Cl<sub>2</sub>, is then washed in the column with a dechlorinating/neutralizing agent HEPA filters placed before the washing columns ensure that no active effluents are released to the columns. The N<sub>2</sub> gas is scavenged by

the nitric acid off-gas system treatment unit. Effluent solutions are stored in chlorine waste tanks prior to transfer to the SRS site.

#### **11.3.2.5.4 Process Equipment**

Figure 11.3-8 provides a simplified drawing of the Dechlorination and Dissolution Unit.

#### **11.3.2.5.5 Chemical Process Inventories**

The normal inventories of radionuclides and chemicals involved with the AFS powder and the PDCF feed powder in this unit are provided in Tables 11.3-6 and 11.3-7, respectively.

#### **11.3.2.5.6 Chemical Process Ranges**

The Dechlorination and Dissolution Unit is operated in batches. The operating ranges for both dissolution units are detailed in Section 11.3.2.4.6. The nominal flow rate to the Purification Cycle is approximately 3.8 gal/hr (14.4 L/hr).

The unit is sized to treat approximately 399 lbs (181 kg) of desorbed chlorine, Cl<sub>2</sub>, per year.

#### **11.3.2.5.7 Chemical Process Limits**

Normal operating parameters are described in Section 11.3.2.5.6. Principal SSCs are described in Chapter 5. Specific operating limits and the associated IROFS will be provided in the ISA.

### **11.3.2.6 Purification Cycle (KPA)**

#### **11.3.2.6.1 Function**

The main goal of the Purification Cycle is to separate plutonium from impurities contained in the flux coming out of the Dissolution Units. The main functions of the Purification Cycle are as follows:

- Receive plutonium nitrate from the Dissolution Unit and the Dechlorination and Dissolution Unit
- Receive recycled plutonium nitrate from the Oxalic Mother Liquors Recovery Unit
- Receive solutions with high plutonium content from the laboratories
- Perform plutonium extraction and impurities scrubbing
- Perform plutonium stripping and uranium scrubbing
- Perform further plutonium purification by additional plutonium stripping and diluent washing
- Adjust plutonium to the tetravalent state
- Perform plutonium stripping in plutonium barrier

- Perform scrub bed uranium stripping and diluent washing
- Control purified plutonium and transfer to the Oxalic Precipitation and Oxidation Unit or recycle to the beginning of the Purification Cycle
- Control and dilute scrubbed uranium and prepare uranium for transfer to the Liquid Waste Reception Unit
- Wash, control, and transfer raffinates to the Acid Recovery Unit
- Wash, control, and transfer solvent/diluent to the Solvent Recovery Cycle
- Destroy residual HAN/hydrazine and hydrazoic acid in the aqueous phase transferred to the Oxalic Precipitation and Oxidation Unit.

### 11.3.2.6.2 Description

The Purification Cycle is designed to treat plutonium nitrate at a nominal flow rate of 4 gal/hr (15.1 L/hr), which corresponds to 32.0 lb/day (14.5 kg/day) of plutonium. Plutonium nitrate from the Dissolution Units is received, and plutonium is extracted and scrubbed for impurities. The plutonium is then separated from the uranium by stripping via adjustment of the plutonium valence to the trivalent state. The Purification Cycle controls plutonium reception, recycle, and transfer to the Oxalic Precipitation and Oxidation Unit. The Purification Cycle also controls the solvent and diluent streams to the Solvent Recovery Cycle and the raffinate stream to the Acid Recovery Unit.

The extraction process is continuous, but the feed solutions from the Dissolution Units are received in batches. The raffinate and the plutonium nitrate solutions are transferred periodically to the Acid Recovery Unit inlet buffer storage and to the Oxalic Precipitation and Oxidation Unit inlet buffer storage, respectively. The unloaded solvent is continuously transferred to the Solvent Recovery Unit and the stripped uranium solutions are directed to the liquid waste reception unit in batches.

Plutonium nitrate solution is batched to the feed tank TK1000 for plutonium extraction and impurities scrubbing. Pu (IV) in the aqueous solution (4.5N HNO<sub>3</sub>) is extracted by the solvent (30% tributyl phosphate [TBP] in hydrogenated propylene tetramer [HPT]) in pulsed extraction column PULS2000. The impurities remain primarily in the aqueous phase. The solvent stream is scrubbed by 1.5N nitric acid in pulsed scrubbing column PULS2200 to ensure good decontamination. This acid contains aluminum nitrate to ensure fluoride decontamination. The aqueous raffinates are washed by the diluent in pulsed column PULS2100 and transferred to raffinate reception tank TK9000 after complexation of fluorides by a zirconium nitrate solution.

Extracted Pu (IV) is reduced to Pu (III) by hydroxylamine nitrate (0.46M HAN), and Pu (III) is stripped with a slightly acidic solution (0.1N HNO<sub>3</sub>) containing hydrazine in pulsed stripping column PULS3000.

The remaining uranium present in the stripped plutonium aqueous phase is separated from the plutonium by solvent extraction in pulsed column PULS3200. A bypass of column PULS3200 is

possible for batches with low uranium content. The stripped plutonium is diluent washed in pulsed column PULS3100 prior to the final valence adjustment. Remaining traces of unstripped plutonium are extracted in five-stage plutonium barrier mixer-settler MIXS4000. Hydroxylamine nitrate (0.15N HAN) and hydrazine nitrate (0.14N N<sub>2</sub>H<sub>4</sub>) are introduced via a slightly acidic solution (0.2N HNO<sub>3</sub>) in the last stage of the plutonium barrier. Hydrazine nitrate is added to act as an anti-nitrous agent and also to prevent parasitic oxidation of Pu (III) to Pu (IV) in pulsed column PULS3000. The solvent from the plutonium barrier flows to uranium-stripping mixer-settler MIXS5000.

Uranium is stripped in a slightly acidic (0.02N HNO<sub>3</sub>) solution in an eight stage uranium-stripping mixer-settler MIXS5000. The unloaded solvent from uranium-stripping mixer-settler MIXS5000 is directed to the Solvent Recovery Cycle. The stripped uranium stream is then diluent washed in the three stage mixer-settler MIXS5100. If an isotopic dilution of the uranium stream is required, the <sup>235</sup>U concentration can be decreased by the addition of depleted uranyl nitrate from the Uranium Oxide Dissolution Unit in the first stage of uranium-stripping mixer-settler MIXS5000. The aqueous phase from uranium diluent washing is sent to uranium buffer tank TK5200 then stored in tank TK5300 before being sent to the Liquid Waste Reception Unit. Depleted uranyl nitrate can also be added in TK5300 prior to this transfer.

The final valence adjustment of Pu (III) to Pu (IV) is achieved by oxidizing the Pu (III) solution with nitrous fumes in oxidation column CLMN6000. The stripped plutonium is first sent to slab settler SLAB3300 before going to oxidation column CLMN6000 to remove any residual organic materials (e.g., TBP). The settled organic phase is sent to plutonium rework tank TK8500. In the oxidizing step, aqueous plutonium solution is contacted in packed column CLMN6000 with nitrous fumes to oxidize Pu (III) to Pu (IV) and to eliminate excess HAN, hydrazine and hydrazoic acid. Then, air stripping of the plutonium solution in air-stripping column CLMN6500 destroys the remaining nitrous acid. The plutonium nitrate solution is received in plutonium reception tank TK7000 from where it is transferred to the batch constitution tanks of the Oxalic Precipitation and Oxidation Unit. In case of a process deviation, the aqueous phase from tank TK7000 is recycled through tank TK9500 after verification of hydrazine and HAN decomposition.

Tanks TK8000 and TK8500 are installed in the Purification Cycle to permit plutonium rework. These tanks also receive drain solutions from the pulsed columns and mixer settler banks. Tank TK8000 collects solutions that may contain non-extracted metal (e.g., silver) ion species from pulsed columns PULS2000, PULS2100 and PULS2200. Received solutions are then recycled into pulsed column PULS2000. Tank TK8500 collects solutions that may contain HAN, hydrazine, and hydrazoic acid from pulsed columns PULS3000, PULS3100 and PULS3200 and from mixer settlers MIXS4000, MIXS5000 and MIXS5100. The organic phase in tank TK8500 is sent to pulsed column PULS3000 for recycling while the aqueous phase is directed to tank TK9500 to be treated by oxidizing Pu (III) to Pu (IV) by bubbling NO<sub>x</sub> through the solution.

The selected aqueous-to-organic ratios in the plutonium extraction and plutonium stripping operations enable the process to obtain a plutonium concentration close to 40 g/L at the outlet of the Purification Cycle.

### 11.3.2.6.3 Process Chemistry

The following chemical equations describe the primary reactions involved in the Purification Cycle.

The extraction of plutonium from the aqueous phase to the organic phase is based on the formation of a plutonium (IV) nitrate/TBP complex and its very low solubility in aqueous solutions containing moderately strong nitric acid:



The extraction coefficient for Pu (IV) in TBP is dependent upon aqueous nitric acid concentration and temperature. The operating conditions for the feed are 4.5N nitric acid concentration and 30°C, which ensure high extraction efficiency. The diluent acts as a low density solvent for the TBP to promote good separation between the aqueous and organic streams. Most impurities remain in the aqueous phase and continue processing in the raffinate stream. Further refinement to improve the quality of plutonium is accomplished by scrubbing the loaded organic with an aqueous solution of 1.5N nitric acid and aluminum nitrate in the scrubbing column.

The relative extraction coefficients for the various valence states of plutonium are as follows: Pu(IV) > Pu(VI) >> Pu(III). Based on the very low extraction coefficient of Pu(III), the reduction of Pu(IV) to Pu(III) will cause a transfer of plutonium back into the aqueous phase in the plutonium stripping column. The plutonium reduction from valence IV to III by HAN proceeds as follows:

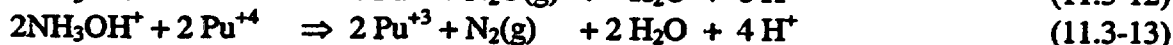

These reactions are exothermic, and proceed rapidly. Increases in temperature and concentration increase the reaction rates.

Plutonium reduction by the hydrazine in the stripping solution is also possible by the following reaction; however, this reaction is much slower than those with HAN described above:

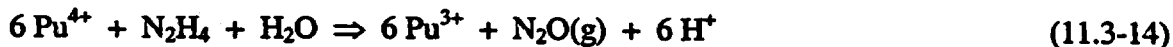

The parasitic re-oxidation of Pu(III) to Pu(IV) can occur with nitrous acid, which is always present to some extent in nitric acid, as follows:

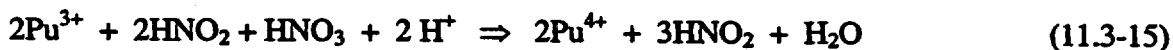

Under certain conditions, HAN can be autocatalytically oxidized by nitric acid to produce nitrous acid. This proceeds according to the following reaction:



Equation 11.3-16 is a summary of a series of reactions that actually reflect the reaction of HAN with nitrous acid, a species always present with nitric acid, and overall results in the generation of more nitrous acid than is consumed, hence its autocatalytic nature. However, HAN also reacts to scavenge nitrous acid according to the following equation:

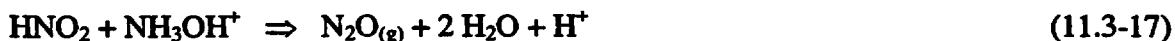

Reaction 11.3-17 is dominant at low temperatures, low nitric acid concentrations and/or high HAN concentrations, and low dissolved iron concentrations (a catalyst in the decomposition of HAN and the subsequent generation of nitrous acid), resulting in stable mixtures of HAN and nitric acid.

Hydrazine also consumes nitrous acid at a rapid rate relative to its production by equation 11.3-16 above according to the following reaction;

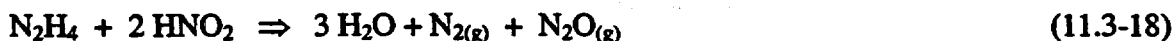

Therefore, the presence of hydrazine acts as a suppressant for HAN/nitrous acid reactions by consuming any nitrous acid that may be present. Hydrazoic acid is formed as an intermediate in association with the above reaction and may be present in small quantities in the aqueous phase.

In the oxidation column excess reducing agents, HAN and hydrazine, are destroyed according to the previously described reactions with nitrous acid. In addition, the plutonium (III) nitrate feed stream is oxidized to plutonium (IV) nitrate.

#### 11.3.2.6.4 Process Equipment

Figures 11.3-9 and 11.3-10 provide simplified drawings of the Purification Cycle and a pulsed column, respectively.

#### 11.3.2.6.5 Chemical Process Inventories

The normal inventories of radionuclides and chemicals involved in this unit are provided in Tables 11.3-8 and 11.3-9, respectively.

#### 11.3.2.6.6 Chemical Process Ranges

The Purification Cycle operates continuously. The feeding solutions from the Dissolution Units are received in batches. This cycle has a nominal capacity of 32.0 lb/day (14.5 kg/day) of plutonium. The operating range of the Purification Cycle is 24.3 to 43.0 lb/day (11 to 19.5 kg/day) of plutonium. The main flows of the Purification Cycle are provided in Table 11.3-10.

#### 11.3.2.6.7 Chemical Process Limits

Normal operating parameters are described in Section 11.3.2.6.6. Principal SSCs are described in Chapter 5. Specific operating limits and the associated IROFS will be provided in the ISA.

### 11.3.2.7 Solvent Recovery Cycle (KPB)

#### 11.3.2.7.1 Function

The functions of the Solvent Recovery Cycle are as follows:

- Recover the used solvent from the Purification Cycle to prevent the accumulation of degradation products
- Renew the solvent and adjust its TBP content
- Store the treated solvent and continuously feed the Purification Cycle
- Perform a diluent wash operation on the aqueous wastes produced by this operation to remove traces of entrained solvent. (Note: *waste* in this section refers to waste from individual process units to other process units; the MFFF discharges no radioactive liquid effluent to the environment.)

#### 11.3.2.7.2 Description

The Solvent Recovery Cycle operates continuously in conjunction with the Purification Cycle. The unit is designed to treat solvents at a nominal flow rate of 4.6 gal/hr (17.4 L/hr), which corresponds to 31.7 lb/day (14.2 kg/day) of plutonium in the Purification Cycle.

The washed solvent is collected in buffer tank TK2000 where it is cooled to maximize extraction efficiency in the Purification Cycle. The Purification Cycle is continuously fed at a controlled flow rate using a dosing pump. The excess solvent, generated by the diluent wash and the TBP content adjustment, is transferred to the Liquid Waste Reception Unit. The aqueous wastes generated by washing undergo a diluent wash in mixer-settler battery MIXS1100 (one stage) at ambient temperature to remove traces of entrained solvent. The aqueous-to-organic phase external ratio for this operation is around 100:1.

The diluent is recycled in mixer-settler MIXS1100. The recycling flow rate equals the incoming aqueous flow rate from mixer-settler bank MIXS1000. The aqueous-to-organic internal ratio is close to 1 when recycling is operated.



### 11.3.2.7.3 Process Chemistry

Solvent Recovery is performed to remove several undesirable reaction byproducts from the solvent loop that feeds the Purification Cycle. The primary undesirable reaction products are degradation products of TBP (e.g., dibutyl phosphate, monobutyl phosphate) and hydrazoic acid formed from the reaction of hydrazine with nitrous acid.

Hydrazoic acid is quite soluble in the solvent. As a result, it is necessary to remove it to avoid build-up in the solvent loop. Hydrazoic acid reacts with both sodium carbonate and sodium hydroxide to create sodium azide salt:



The introduction of sodium carbonate and sodium hydroxide into the aqueous stream of the mixer-settler banks also causes the migration of TBP degradation products (e.g., dibutyl phosphate and monobutyl phosphate) from the organic phase to the aqueous phase, where they are processed as part of the aqueous waste stream.

### 11.3.2.7.4 Process Equipment

Figures 11.3-11 and 11.3-12 provide simplified drawings of the Solvent Recovery Cycle and a mixer-settler, respectively.

### 11.3.2.7.5 Chemical Process Inventories

The normal inventories of radionuclides and chemicals involved in this unit are provided in Tables 11.3-11 and 11.3-12, respectively.

### 11.3.2.7.6 Chemical Process Ranges

The Solvent Recovery Cycle operates continuously in conjunction with the Purification Cycle. The unit is designed to treat solvents at a flow rate of 4.6 gal/hr (17.4 L/hr), which corresponds to 31.7 lb/day (14.4 kg/day) of plutonium treated in the Purification Cycle. The main flows of the Solvent Recovery Cycle are provided in Table 11.3-13.

### 11.3.2.7.7 Chemical Process Limits

Normal operating parameters are described in Section 11.3.2.7.6. Principal SSCs are described in Chapter 5. Specific operating limits and the associated IROFS will be provided in the ISA.

### 11.3.2.8 Oxalic Precipitation and Oxidation Unit (KCA)

#### 11.3.2.8.1 Function

The functions of Oxalic Precipitation and Oxidation Unit are as follows:

- Receive purified plutonium nitrate concentrated to approximately 40 g/L from the Purification Cycle and prepare uniform batches
- Precipitate out the plutonium nitrate as oxalate
- Produce PuO<sub>2</sub> after filtering, drying, and calcining the oxalate. The filtering operation includes drawing off the mother liquors, washing, and dewatering the plutonium oxalate cake
- Transfer the PuO<sub>2</sub> to the Homogenization Unit, and transfer the mother liquors and the filter washing solutions to the Oxalic Mother Liquor Recovery Unit
- Ensure reducing agents, hydrazoic acid, and Pu (VI) do not propagate into downstream processing units (e.g., the Oxalic Mother Liquor Recovery Unit).

### 11.3.2.8.2 Description

The conversion line is rated for the processing of 56.6 lbm/day (25.7 kg/day) of plutonium. Plutonium nitrate solutions arrive from the Purification Cycle where acidity and valency are adjusted. They are received in alternate batches in annular tanks TK1000 and TK2000 to form a batch with a volume of 21.2 ft<sup>3</sup> (0.6 m<sup>3</sup>) or 158.5 gal (600 L).

#### Conversion Feed

Solution from tanks TK1000 and TK2000 is transferred by air lifts and flow control valves. Each flow control valve supplies one precipitator. The solutions flow by gravity from a separation pot to the precipitators.

#### Precipitation

Precipitation takes place in two precipitators (PREC5000/PREC6000), which are connected in parallel.

injected into each precipitator.

The reagents are

The plutonium oxalate precipitate carried by the mother liquors escapes via the precipitator overflows and flows by gravity to filter FLT7000.

#### Filtration

The filter ensures that the following functions are continuously performed:

- Supply of the filter with mother liquors containing plutonium oxalate

- 
-

- Dewatering:
- Removal of the cake: the removed cake falls into a chute and enters the furnace by gravity.

### Drying and Calcination

The furnace consists of two main parts: a drying zone where the plutonium oxalate is dried, and a calcining zone where the oxalate is transformed into  $\text{PuO}_2$  in an oxidizing atmosphere of oxygen.

The furnace is heated by resistors in the drying zone and the calcining zone. Thermocouples are used to measure the temperature profile in the furnace. The temperatures of the drying and calcining zones are regulated independently. The speed of rotation of the screw is adjusted manually to maintain the required residence time in the calcining zone. Offgas (air, steam,  $\text{CO}_2$ , and  $\text{O}_2$ ) is extracted after filtration by a fan. The offgas is then sent to the very high depressurization system (see Section 11.4.2.2).

### Oxalic Mother Liquor Circuit

The oxalic mother liquors, which are collected in separator pots, flow by gravity to the Oxalic Mother Liquor Recovery Unit. The filtered mother liquors are adjusted to approximately 3.3N with recovered 13.6N nitric acid to avoid any risk of precipitation of plutonium oxalate caused by residual oxalic acid.

### Evacuation of Filter

### Furnace Offgas System

The gases produced during drying and calcination of the plutonium oxalate ( $\text{CO}_2$  and steam), the excess of oxygen, and the air from upstream and downstream of the process are removed by a negative-pressure circuit comprising a filter, a condenser, a demister, an electric heater, two HEPA filters, and two fans. Gas is extracted from the drying section of the furnace.

#### 11.3.2.8.3 Process Chemistry

The precipitation reaction is as follows:

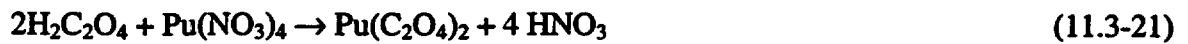

Plutonium oxalate is transformed into  $\text{PuO}_2$  in the calciner according to the following reaction:



#### 11.3.2.8.4 Process Equipment

Figures 11.3-13 through 11.3-16 provide simplified diagrams of the Oxalic Precipitation and Oxidation Unit, a precipitator, a filter, and a furnace, respectively.

#### 11.3.2.8.5 Chemical Process Inventories

The normal inventories of radionuclides and chemicals involved in this unit are provided in Tables 11.3-14 and 11.3-15, respectively.

#### 11.3.2.8.6 Chemical Process Ranges

Oxalic precipitation and oxidation equipment is designed to polish 2.3 lb/hr (1.1 kg/hr) of plutonium (i.e., 56.6 lb/day [25.7 kg/day] of plutonium). The operating range of the Oxalic Precipitation and Oxidation Unit is 0 to 1.25 kg/hr of plutonium. The main flows of the Oxalic Precipitation and Oxidation Unit are provided in Table 11.3-16.

#### 11.3.2.8.7 Chemical Process Limits

Normal operating parameters are described in Section 11.3.2.8.6. Principal SSCs are described in Chapter 5. Specific operating limits and the associated IROFS will be provided in the ISA.

### 11.3.2.9 Homogenization Unit (KCB)

#### 11.3.2.9.1 Function

The functions of the Homogenization Unit are as follows:

- Receive, homogenize, and cool the  $\text{PuO}_2$  powder produced in the Oxalic Precipitation and Oxidation Unit
- Fill cans with  $\text{PuO}_2$  in such a manner that the mass of plutonium per can is constant
- Prepare samples for laboratory analysis to characterize the batch
- Perform sample-based residual moisture measurement and gravimetric analysis (Pu content determination by gravimetry)
- Store reference samples (spare samples for laboratory analyses).

### 11.3.2.9.2 Description

The unit is designed for flows corresponding to 55.5 lb/day (25.2 kg/day) of plutonium. The PuO<sub>2</sub> produced in the Oxalic Precipitation and Oxidation Unit is continuously fed by gravity from the calcination furnace into one of the two separating hoppers (1000/1500) installed in parallel. These hoppers are continuously stirred and weighed. One hopper is filled while the other is mixed or emptied.

The latter packs the oxide in individual recyclable stainless steel cans. The plutonium balance is determined by weighing of the filled cans (Canning Unit) and by determination of the plutonium content of the hopper by powder sampling. Sampling ensures that all the finished product specifications are met in each batch of PuO<sub>2</sub> in each hopper and checks the isotopic composition of the PuO<sub>2</sub> for the finished product of each batch in each hopper.

Each sample is divided in a special fractionation glovebox at the boundary of the Homogenization Unit for the purposes of the laboratory. Spare samples are kept in a storage glovebox of the Homogenization Unit until the analysis results are established. Spare powders are then recycled into the Dissolution Unit or the Dechlorination and Dissolution Unit through the Laboratory.

### 11.3.2.9.3 Process Chemistry

This section is not applicable to this unit.

### 11.3.2.9.4 Process Equipment

Figures 11.3-17 and 11.3-18 provide simplified diagrams of the Homogenization Unit and a separating hopper, respectively.

### 11.3.2.9.5 Chemical Process Inventories

The normal inventory of radionuclides involved in this unit is provided in Table 11.3-17.

### 11.3.2.9.6 Chemical Process Ranges

The Homogenization Unit operates continuously. Each separating hopper has a capacity of about 44.1 lb (20 kg) of PuO<sub>2</sub> (maximum capacity is 55.1 lb, 25 kg, of PuO<sub>2</sub>). In nominal operating process conditions, the plutonium mass inlet flow is approximately 2.34 lb/h (1.06 kg/h) of plutonium, which corresponds to 2.6 lb/h (1.2 kg/h) of PuO<sub>2</sub>. At a rate of 55.5 lb/day (25.2 kg/day) of plutonium, the average output is approximately 48 cans of PuO<sub>2</sub> per week, each containing 5.3 lb (2.4 kg) of PuO<sub>2</sub> (with a 50 g accuracy).

### 11.3.2.9.7 Chemical Process Limits

Normal operating parameters are described in Section 11.3.2.9.6. Principal SSCs are described in Chapter 5. Specific operating limits and the associated IROFS will be provided in the ISA.

### **11.3.2.10 Canning Unit (KCC)**

#### **11.3.2.10.1 Function**

The Canning Unit is designed to package PuO<sub>2</sub> powder in reusable stainless steel cans and transfer them one by one to the MP PuO<sub>2</sub> Buffer Storage Unit to prepare the MOX powder. It is also used to establish the PuO<sub>2</sub> powder material balance.

#### **11.3.2.10.2 Description**

The nominal capacity is about 10 cans of PuO<sub>2</sub> per day, each filled with approximately 5.3 lb ± 0.11 lb (2.4 kg ± 50 g) of PuO<sub>2</sub>. The PuO<sub>2</sub> powder is gravity-fed from the homogenizer at a temperature not exceeding 302°F (150°C). PuO<sub>2</sub> powder is emptied in empty reusable cans from the MP PuO<sub>2</sub> buffer storage unit. Full PuO<sub>2</sub> cans are transferred pneumatically in a shuttle to the MP PuO<sub>2</sub> Buffer Storage Unit. Cans that are discarded due to overfilling (as indicated by weighing) or unsatisfactory laboratory results are transferred to the appropriate upstream process.

#### **11.3.2.10.3 Process Chemistry**

This section is not applicable to this unit.

#### **11.3.2.10.4 Process Equipment**

Figure 11.3-19 provides a simplified drawing of the Canning Unit.

#### **11.3.2.10.5 Chemical Process Inventories**

The normal inventory of radionuclides involved in this unit is provided in Table 11.3-18.

#### **11.3.2.10.6 Chemical Process Ranges**

The nominal flow rates are as follows:

- PuO<sub>2</sub> inlet from the Homogenization Unit: 1.2 kg/hr
- PuO<sub>2</sub> outlet: approximately 10 full reusable cans per day.

#### **11.3.2.10.7 Chemical Process Limits**

Normal operating parameters are described in Section 11.3.2.10.6. Principal SSCs are described in Chapter 5. Specific operating limits and the associated IROFS will be provided in the ISA.

### **11.3.2.11 Oxalic Mother Liquor Recovery Unit (KCD)**

#### **11.3.2.11.1 Function**

The functions of Oxalic Mother Liquor Recovery Unit are as follows:

- Continuously receive oxalic mother liquors adjusted to 3.3N with nitric acid from the Oxalic Precipitation and Oxidation Unit
- Continuously receive ventilation effluent droplets from the oxidation and degassing columns
- Concentrate the oxalic mother liquors in a subcritical evaporator to destroy the oxalic ions and to remove the plutonium from the distillates
- Check and then transfer the distillates to the Acid Recovery Unit
- Monitor and recycle, by batch, the concentrates at the top of the Purification Cycle.

### 11.3.2.11.2 Description

The nominal capacity corresponds to processing of the flows generated by precipitation of 52.9 lbs/day (24 kg/day) of plutonium. The Oxalic Mother Liquor Recovery Unit operates continuously, unlike the Oxalic Precipitation and Oxidation Unit where the oxalic mother liquors are produced. Reception tank TK1000, buffer tank TK1500, and feeding tank TK2000 provide more than three days of capacity thereby allowing for the Oxalic Precipitation and Oxidation Unit and the Oxalic Mother Liquor Recovery Unit to operate independently. The mother liquor solution flows by gravity from the Oxalic Precipitation and Oxidation Unit and Offgas Treatment Unit into feed tank TK1000. After sampling for plutonium concentration, the solution is transferred into feed tank TK2000. The contents of tank TK1000 can be transferred by siphon into buffer tank TK1500. Tanks TK1000, TK1500, and TK2000 are geometrically safe (annular) and have a volume of 264 gal (1000 L). From tank TK2000, the solution passes through a double airlift and supplies evaporator EV3000.

### Concentration of Mother Liquors and Destruction of Oxalic Ions



## Processing of Distillates

The distillates from the column of evaporator EV3000 are condensed and cooled and supplied to a passage pot. From the passage pot, the distillates may be supplied to the reflux system to the top of the evaporator at a regulated rate or to the distillates control tank TK6000 (18 gal or 68 L). The plutonium content of the distillates is monitored by on-line neutron counters located on the control tank 6000. Distillates with an acceptable plutonium concentration are transferred by overflow from the control tank to buffer tank TK7000 (660 gal or 2500 L). If the distillates have an unacceptable plutonium concentration, the evaporator switches to total reflux and the solution in the control tank is recycled to tank TK2000 in the unit.

From buffer tank TK7000, distillates are transferred periodically to the sampling tank TK7500 (660 gal or 2500 L) where samples for plutonium concentration are taken. Finally, the distillates are then either channeled to the Acid Recovery Unit if the plutonium concentration is correct or recycled to tank TK1500 if this is not the case.

## Processing of Concentrates

The concentrates are drawn off at the foot of evaporator EV3000 by an airlift and gravity-fed into concentrate reception tank TK4000 (volume is 26.4 gal [100 L]). The concentrates are drawn off discontinuously depending on the desired flow rates of the unit.

The solution is transferred by siphon into concentrate control tank TK4100 (volume is 26.4 gal [100 L]). When tank TK4100 is full and the oxalate concentration meets requirements, its contents are transferred into tank TK4200 (volume is 26.4 gal [100 L]) by siphon. Tank TK4200 distributes the concentrates to the Purification Cycle by an airlift. Tanks TK4000, TK4100 and TK4200 are geometrically safe (slab) and have a useful volume of 26.4 gal (100 L).

### 11.3.2.11.3 Process Chemistry

Plutonium oxalate is converted to plutonium nitrate and oxalic acid.

This latter decomposes itself into H<sub>2</sub>O, CO<sub>2</sub>, and NO<sub>2</sub>:

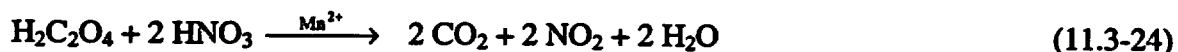
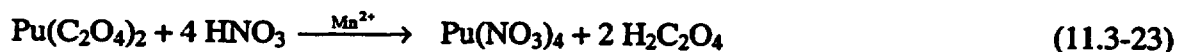

These reactions are catalyzed by Mn<sup>2+</sup> ions.

Since Pu nitrate undergoes prolonged boiling and considering the high acidity of the medium, Pu(IV) nitrate is oxidized and gives Pu(VI) (as PuO<sub>2</sub><sup>2+</sup>) nitrate as the following reaction :

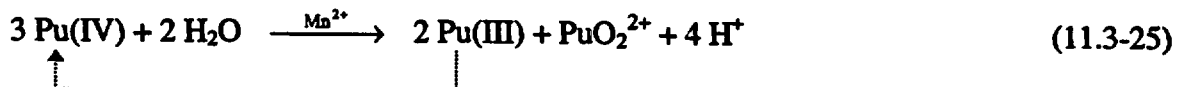



The medium being highly acid, Pu(III) is itself oxidized into Pu(IV):

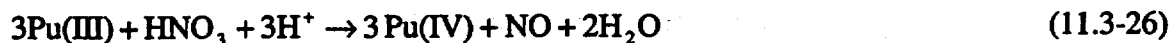

Therefore, at the end of the evaporator, the concentrates contain Pu at valency VI as  $\text{PuO}_2(\text{NO}_3)_2$ .

#### 11.3.2.11.4 Process Equipment

Figures 11.3-20 and 11.3-21 provide simplified drawings of the Oxalic Mother Liquor Recovery Unit and an evaporator, respectively.

#### 11.3.2.11.5 Chemical Process Inventories

The normal inventories of radionuclides and chemicals involved in this unit are provided in Tables 11.3-19 and 11.3-20, respectively.

#### 11.3.2.11.6 Chemical Process Ranges

This unit is designed to accommodate a flow rate of 13 gal/hr (66 L/hr) of oxalic mother liquors. The main flows of this unit are provided in Table 11.3-21.

#### 11.3.2.11.7 Chemical Process Limits

Normal operating parameters are described in Section 11.3.2.11.6. Principal SSCs are described in Chapter 5. Specific operating limits and the associated IROFS will be provided in the ISA.

#### 11.3.2.12 Acid Recovery Unit (KPC)

##### 11.3.2.12.1 Function

The functions of the Acid Recovery Unit are as follows:

- Receive extraction raffinates from the Purification Cycle, oxalic mother liquors distillates from the Oxalic Mother Liquors Recovery Unit, and effluents from laboratories in batches, and continuously receive active liquid effluents from the Offgas Treatment Unit equipment ventilation
- Concentrate the radioactivity contained in the effluents and send it to the Liquid Waste Reception Unit
- Recover concentrated acid for recycling in the process
- Recover distillates from the rectification column for use in the Offgas Treatment Unit and the Purification Cycle, with excess liquid to the Liquid Waste Reception Unit.

### 11.3.2.12.2 Description

The nominal capacity corresponds to processing 714.3 gal/day (2,700 L/day) of liquor. The system is sized to accommodate a maximum effluent flow rate of 44 gal/h (166.5 L/h). The 1,321 gal (5,000 L) buffer tank TK1000 receives the following:

- Raffinates from the Purification Cycle in batches of 397 gal (1,500 L)
- Oxalic mother liquor distillates from the Oxalic Mother Liquor Recovery Unit in batches of 660.5 gal (2,500 L)
- Recombined acid from the Offgas Treatment Unit continuously
- Effluents from the laboratory in batches.

Solutions are transferred from buffer tank TK1000 to feed tank TK1500, which also receives concentrates recycled from evaporator EV6000.

#### Evaporator EV2000

The solution is transferred from the feed tank to the boiler of evaporator EV2000. The boiler of evaporator EV2000 is of the natural recirculation thermosiphon type, and has a concentration factor of 78 for PDCF feeds and 50 for AFS feeds. The heating power is kept constant by regulating the hot water flow rate in the boiler heating loop. The mixture of liquid and vapor produced at the top of the evaporator is separated in the separator of evaporator EV2000. The concentrates from evaporator EV2000 are drained off discontinuously several times a day at a constant rate. The concentrates flow into concentrate tank TK3000. From this 132 gal (500 L) tank, the concentrates are sent to the Liquid Waste Reception Unit. The steam distillates are condensed in condenser CND2200. The condensates are fed to evaporator EV6000.

#### Evaporator EV6000

The condensed distillates from evaporator EV2000 flow to the bottom of evaporator EV6000. The boiler of evaporator EV6000 is of the natural recirculation thermosiphon type and has a concentration factor of 29. The mixture of liquid and vapor produced at the top of the evaporator is separated in the separator of evaporator EV6000. The concentrates from evaporator EV6000 are drained off discontinuously several times a day at a constant rate. The concentrates flow back by gravity into feed tank TK1500.

#### Rectification Column CLMN2500

At the outlet of the separator of evaporator EV6000, the distillates enter rectification column CLMN2500. This equipment consists of a rectification column and a boiler. The rectification column has capped trays. The boiler is of the natural recirculation thermosiphon type. Refluxed distillate flows by gravity across the bubble caps on the trays to improve process efficiency. The level in the separator of the rectification column regulates heating. The recovered acid is drawn off by airlift and cooled. The acid draw-off flow rate is regulated to maintain the desired acidity. The acid is received in recovered acid feed tank TK4000 (132 gal [500 L]). The recovered acid

is continuously transferred by pump into a reagents pot for AP recovered nitric acid solution. The excess acid recovered is drained by pump into buffer tank TK4500 (132 gal [500 L]). In tank TK4500, the solution is analyzed and temporarily stored before being transferred by pump to the Liquid Waste Reception Unit.

At the rectification column outlet, the vapors are condensed in condenser CND2800, and then the condensates flow into a pot. From this pot, the reflux system of the rectification column is regulated. The distillates are cooled in cooler COOL2900 to 104°F (40°C) and flow by gravity into distillate tank TK5000 (1,321 gal [5,000 L]). The distillate is continuously transferred by pump into a pot for AP water recycle solution feeding. Water is recycled into the Purification Cycle and the Offgas Treatment Unit. The excess recycled water is drained in batches by pump into buffer tank TK5500 (1,321 gal [5,000 L]). The excess recycle water is analyzed for activity and temporarily stored before being transferred by pump to the Liquid Waste Reception Unit.

#### **11.3.2.12.3 Process Chemistry**

This section is not applicable to this unit.

#### **11.3.2.12.4 Process Equipment**

Figure 11.3-22 provides a simplified drawing of the Acid Recovery Unit.

#### **11.3.2.12.5 Chemical Process Inventories**

The normal inventories of radionuclides and chemicals involved in this unit are provided in Tables 11.3-22 and 11.3-23, respectively.

#### **11.3.2.12.6 Chemical Process Ranges**

The Acid Recovery Unit operates continuously. This unit is designed to accommodate a nitric acid flow rate of 44.0 gal/hr (166.5 L/hr). The main flows of this unit are provided in Table 11.3-24.

#### **11.3.2.12.7 Chemical Process Limits**

Normal operating parameters are described in Section 11.3.2.12.6. Principal SSCs are described in Chapter 5. Specific operating limits and the associated IROFS will be provided in the ISA.

#### **11.3.2.13 Offgas Treatment Unit (KWG)**

##### **11.3.2.13.1 Function**

The Offgas Treatment Unit ventilation system is dedicated to process equipment potentially containing nuclear materials. The functions of this unit are as follows:

- Remove plutonium from offgases collected from the Dissolution Unit, the Dechlorination and Dissolution Unit (during the dissolution step), the Oxalic Precipitation and Oxidation

Unit, the Oxalic Mother Liquors Recovery Unit, the Acid Recovery Unit, the Liquid Waste Reception Unit, and from the oxidation and degassing columns (Purification Cycle)

- Recombine the nitrous fumes in a specific NO<sub>x</sub> scrubbing column
- Clean, by water scrubbing, the offgases collected from all the AP units
- Treat the offgas flow by HEPA filtration before release to the stack
- Maintain negative pressure in the tanks and equipment connected to the process ventilation system.

A specific Offgas Treatment Unit extraction system is dedicated to the pulsed purification columns, with similar functions:

- Treat offgases by HEPA filtration before release to the stack
- Maintain negative pressure in the pulsation system and the pulsed columns legs.

### **11.3.2.13.2 Description**

#### **Offgases from Dissolution and Oxidation and Degassing Columns**

The NO<sub>x</sub>-containing offgases are gathered downstream of cap impactor demister 1300 to remove droplets. The liquid effluent stream collected is recycled, by gravity, to reception tank 1000 in the Oxalic Mother Liquor Recovery Unit. The offgases are routed to recombination column 1000 where they are scrubbed with recycled effluents and with recovered distillates from the Acid Recovery Unit. Negative pressure in column 1000 is maintained constant. The column is fitted with capped trays and mounted on a buffer tank fitted with a cooling coil to remove heat produced during recombination. The offgases then pass through a demister. Column 1000 offgases are extracted by an air ejector. The extraction rate is regulated from pressure indication at the top of the column.

#### **Process Equipment Offgases**

Column 2000 receives the ventilation gases and those from all AP units and those from recombination column 1000. Negative pressure in column 2000 is maintained constant. The gases are scrubbed with recycled effluents and then with recovered distillates from the Acid Recovery Unit. The column is fitted with capped trays and mounted on a buffer tank with a cooling coil. Column 2000 recycles effluents from the buffer tank using an airlift. The washed gases successively pass through a cooler, a demister, an electric heater, a filtering line (consisting of two parallel filter trains, with each train containing two stages of HEPA filters), and an exhauster before being released through the stack. Details of the final filtration units are found in Section 11.4.9.

#### **Pulsed Purification Columns Extraction System**

The pulsation air from columns legs is routed to the extraction line. The air successively passes through an electric heater, a filtering line (consisting of two parallel filter trains, with each train

containing two stages of HEPA filters), and an exhauster before being released through the stack. Details of the final filtration units are found in Section 11.4.9.

#### **11.3.2.13.3 Process Chemistry**

This section is not applicable to this unit.

#### **11.3.2.13.4 Process Equipment**

Figure 11.3-23 provides a simplified drawing of the Offgas Treatment Unit.

#### **11.3.2.13.5 Chemical Process Inventories**

The normal inventories of radionuclides and chemicals involved in this unit are provided in Tables 11.3-25 and 11.3-26, respectively.

#### **11.3.2.13.6 Chemical Process Ranges**

The Offgas Treatment Unit operates continuously. The NO<sub>x</sub> scrubbing column is designed to treat approximately 20N m<sup>3</sup>/h, including additional air. The designed capacity of the column pulsation air extraction is 150N m<sup>3</sup>/h. The main ventilation line (offgas scrubbing and filters) is designed to process approximately 300N m<sup>3</sup>/h, including additional air. The main flows of this unit are provided in Table 11.3-27.

#### **11.3.2.13.7 Chemical Process Limits**

Normal operating parameters are described in Section 11.3.2.13.6. Principal SSCs are described in Chapter 5. Specific operating limits and the associated IROFS will be provided in the ISA.

#### **11.3.2.14 Liquid Waste Reception Unit (KWD)**

The Liquid Waste Reception Unit receives liquid waste from the AP process for temporary storage and pre-treatment before sending it offsite to SRS or the WSB for final treatment and disposal.

##### **11.3.2.14.1 Function**

The Liquid Waste Reception unit is dedicated to the reception, storage, and pre-treatment of the low level, high alpha, stripped uranium and organic waste streams.

- The low level liquid waste stream is comprised of the following: (1) room HVAC condensate, rinsing water from laboratories, and washing water from sanitariums which are potentially non-contaminated and are collected as low -low level liquid waste; (2) the distillate stream from the acid recovery unit which is contaminated and slightly acidic; and (3) miscellaneous floor washes from C2/C3 rooms and overflows or drip tray material from some of the reagent tanks in the AP building.

- The high alpha waste is a combination of three waste streams: americium, alkaline waste and excess acid. The americium stream collects americium and gallium nitrates and all of the silver used in the dissolution unit, along with traces of plutonium. The alkaline waste stream from the solvent recovery unit contains dilute caustic soda, sodium carbonate and traces of plutonium and uranium. The excess acid stream from the acid recovery unit contains high alpha activity excess acid.
- The stripped uranium (< 1% U-235) waste stream receives the contents of the uranium dilution tanks in the purification cycle.
- The excess solvent/organic liquid waste stream receives the organic waste constitutes from the solvent recovery unit.

### 11.3.2.14.2 Description

#### Low Level Liquid Waste

Chemical waste tank #1, TK2050, collects overflows/drip tray contents from the de-mineralized water, nitric acid, manganese nitrate, and decontamination solution systems in a common header. It also collects overflows/drip tray contents from the sodium hydroxide and sodium carbonate systems in a separate common header. The tank is equipped with 1.5 N nitric acid and 0.1N sodium hydroxide addition systems for pH adjustment, a cooling loop to provide a means to remove the heat of reaction from acid/alkali reaction, a mixer, MIX2050, to provide agitation to aid mixing in the tank, and a manual sampling point. After pH adjustment, the low level waste is pumped to tank TK1000/TK2000.

Floor wash waste tank TK2060 collects the floor washes from all the uncontaminated C2 and C3 rooms in the AP area. These streams are generated in the course of routine housekeeping activities in these rooms and are separate from the overflows/drip tray streams that are collected in tank TK2050. The tank is equipped with a manual sampling point. The low level waste is periodically pumped to tank TK1000/TK2000.

Chemical waste tank #2, TK2070, is dedicated to oxalic acid service. It collects oxalic acid overflows/drip tray contents. The tank is equipped with a manual sampling point. The low level waste is pumped to portable drums for off-site disposal. The vents from these three tanks are collected in a vent header and routed to a nitric acid system scrubbing column.

Low level waste buffer tanks TK1000 and TK2000 collect the low, low level waste from room HVAC condensate, rinsing water from laboratories, washing water from sanitariums, and the contents of tank TK2060. These tanks also collect the distillate from the acid recovery unit, seal water from the vacuum radiation monitoring system, and the chemical wastes from tank TK2050. Tanks TK1000 and TK2000 operate in parallel. Three way valves are used to direct the flow to one of the two tanks. These tanks serve as buffer tanks and transfer the material to reception tank TK3000 for pH adjustment and sampling. A set of redundant pumps are used for

the transfer. Piping and valves around the tanks and pumps allow the tank contents to be recirculated to the tanks for mixing or to spray nozzles to wash down the tanks from the inside. Mixing is provided using the recirculation stream with an eductor.

In the unlikely event of a release of firewater in the corridors, the firewater drains into a sump. A pump transfers the firewater to tank TK3000 via a seal pot. Tank TK3000 is used to adjust the pH of the material using 1.5N nitric acid and 0.1N sodium hydroxide. A cooling loop provides means to remove the heat of acid/alkali reaction. In-tank mixing is provided using a recirculation loop with an eductor. After sampling, a pump transfers the tank contents to tank TK4000 which is the final holding point before materials are pumped off-site to Savannah River Site (SRS). If the sampled material in tank TK4000 does not meet the SRS waste acceptance criteria (WAC), the stream may be recycled to acid recovery unit tank TK1500 for further processing.

### High Alpha Liquid Waste

Alkaline waste tank TK4010 receives via a steam jet alkaline waste from the solvent recovery unit. Americium reception tank TK4020 receives via a steam jet the high americium stream from the acid recovery unit. The excess acid stream from the acid recovery unit is transferred directly to tank TK4030.

The alkaline waste, americium and excess acid streams, are mixed in the batch constitution tank TK4030. Bubbling air is provided to this tank to aid in mixing its contents. The composite stream is referred to as "high alpha liquid waste." The tank is equipped with automatic sampling capabilities and a means to add 1.5N nitric acid for pH adjustment. This stream is transferred via a steam jet to tank TK4040.

The high alpha storage tank TK4040 serves as a holding point and along with TK4050, provides ninety day storage for the high alpha waste. The tank is equipped with automatic sampling capabilities and can transfer its contents via a steam jet to TK4050.

High alpha buffer tank TK4050 is the final holding point before off-site transfer for treatment. A pump is used to transfer the high alpha waste to the off-site waste solidification building. The tank is provided with a line for low level distillate from the acid recovery unit to rinse the off-site waste transfer line at the end of each transfer.

The transfer line from the liquid waste reception unit to off-site is of double piped construction and equipped with a leak detection system to provide warning of an event that requires corrective action.

All tanks in the high alpha system are vented to the offgas treatment unit's scrubbing column.

### Stripped Uranium Liquid Waste

Stripped uranium reception tank TK3010 operates in parallel with tank TK3020 and receives material from the purification unit's isotopic dilution tank. The contents of tanks TK3010 and TK3020 are transferred via steam jet to tank TK3030. Stripped uranium buffer tank TK3030 is equipped automatic sampling capabilities, a means to add 1.5N nitric acid, and bubbling air to

aid in mixing the tanks contents. The contents of TK3030 are transferred via steam jet to tank TK3040.

Stripped uranium transfer tank TK3040 is the final holding point before the stripped uranium is pumped off-site for treatment in the waste solidification building. The tank is provided with an input line for addition of low level distillate from the acid recovery unit. The distillate is used to rinse the off-site waste transfer line at the end of each transfer. The transfer line from this tank to the waste solidification building is of double pipe construction and equipped with a leak detection system.

#### Solvent/Organic Liquid Waste

Waste solvent is pumped from the solvent recovery tank KPB TK2000 to an intermediate holding tank where it is sampled to assure compliance with SRS WAC. The intermediate tank is fitted with mixing and sampling capabilities. Once the batch is confirmed to be in compliance with the SRS WAC, the solvent batch is transferred to a carboy located in a dedicated enclosure near the reagents building. The carboy is lifted and loaded onto a flatbed truck using an overhead monorail-mounted crane and driven to SRS for processing using existing procedures.

The annual amount of solvent transferred offsite ranges between 2800 to 4000 gallons. The maximum number of carboys transferred per year is 15.

#### **11.3.2.14.3 Process Chemistry**

This section is not applicable to this unit.

#### **11.3.2.14.4 Process Equipment**

Figures 11.3-23 through 11.3-26 provide simplified drawings of the Liquid Waste Reception Unit.

#### **11.3.2.14.5 Chemical Process Inventories**

The normal inventories of radionuclides and chemicals involved in this unit are provided in Tables 11.3-28 and 11.3-29, respectively.

#### **11.3.2.14.6 Chemical Process Ranges**

The Liquid Waste Reception unit operates continuously. The main flows for this unit are provided in Table 11.3-30.

#### **11.3.2.14.7 Chemical Process Limits**

Normal process parameters are described in 11.3.2.14.6. Principal SSCs are described in Chapter 5. Specific operating limits and associated IROFs will be provided in the ISA.



### **11.3.2.15 Uranium Dissolution Unit (KDC)**

#### **11.3.2.15.1 Function**

The function of the Uranium Dissolution Unit is to dissolve the UO<sub>2</sub> powder.

#### **11.3.2.15.2 Description**

The Uranium Dissolution Unit dissolves uranium oxide powder in nitric acid. The uranyl nitrate solution obtained is used to perform an isotopic dilution of uranium in the plutonium feed stream and the uranium waste stream. The isotopic dilution is performed with depleted uranium at 0.25% <sup>235</sup>U.

The first step of the dissolution process is to receive the UO<sub>2</sub> drums from the MOX building, remove the powder from its package and pour it into the receiving hopper. The second step is to dissolve the UO<sub>2</sub> in nitric acid in tank TK 2000.

At the end of dissolution, the depleted uranium solution is analyzed and transferred to the dilution tanks of the Dissolution Unit, the Dechlorination and Dissolution Unit and the Purification Cycle.

The final step is the treatment of nitrous fumes, produced during dissolution, in a NO<sub>x</sub> scrubbing column.

#### **Reception of UO<sub>2</sub> drums**

Drums containing 441 lbm (200 kg) of UO<sub>2</sub> powder are transported from the MOX Secured Warehouse by truck to the Aqueous Polishing Building. Each drum is identified, weighed, and opened manually. A standard electrical monorail brings the drum over to the pouring station and pours the contents of the drum into the pouring station.

The pouring station is equipped with a glovebox. During drum emptying into the glovebox, nitrogen is used as a scavenger to avoid UO<sub>2</sub> oxidation. There is a butterfly valve at the bottom of the glovebox. Underneath the glovebox (installed in a room on a lower level) is a receiving hopper. The receiving hopper (HPR1000) has a nominal capacity of about 992 lbm (450 kg) of UO<sub>2</sub>. The receiving hopper can be weighed by means of 3 load cells in series. It is equipped with a vibrator at the bottom. It is made of stainless steel and ventilated by nitrogen. Under the UO<sub>2</sub> receiving hopper, an alveolar valve monitors the powder amount transferred to the dissolution tank, installed in a room on a lower level.

#### **Dissolution**

Dissolution tank TK2000 receives UO<sub>2</sub> powder and is supplied by 13.6N nitric acid to perform dissolution. As the dissolution operates at 203°F (95°C), it is equipped with an electrical heating element. A mechanical stirrer mixes the powder in the solution. Tank TK2000 is made of stainless steel and has a nominal capacity of 79.2 gal (300 L).

At the end of the dissolution, after cooling of the solution, a sample is taken in order to analyze the uranium content. If the concentrations meet the requirements, the solution is transferred to a buffer tank by pump P2200, through filter FLT2300 in order to avoid the transfer of un-dissolved particles.

The buffer tank is a 198 gal (750 L) stainless steel tank. It is equipped with a bubbling ring to homogenize the solution. The buffer tank stores depleted uranium solution before transferring it by dosing pumps (P 4100, P 4200, P 4300 and P 4400) to the dilution tanks of the Dissolution Unit, the Dechlorination and Dissolution Unit and the Purification Cycle.

### **NO<sub>x</sub> recombination in column CLMN3000**

Nitrous fumes produced during dissolution are treated in a dedicated NO<sub>x</sub> scrubbing column CLMN3000. This high packed column is sprayed simultaneously by a low flow rate of demineralized water and a high recirculating flow rate of effluents from the bottom of the column. Nitrous fumes from dissolution tank TK2000 are mixed with compressed air and condensed before being introduced at the bottom of the column. Effluents are collected into a pot, which overflows in dissolution tank TK2000. Offgases are extracted and transferred to the Offgas Treatment Unit. The recombination column is designed to reach 85.8% NO<sub>x</sub> removal from the offgas. A cooler on recirculating effluents allows the removal of heat produced during recombination.

### **Ventilation**

Glove box GB 1100 and receiving hopper HPR 1000 are connected to the glove box ventilation through two HEPA filters.

Tanks TK 2000 and TK 4000 are connected to KWG unit for ventilation. The off gases from these tanks pass through the scrubbing column CLMN 3000, the demister DMST 3030, and filters before being extracted by the Offgas Treatment Unit.

### **11.3.2.15.3 Process Chemistry**

Uranium oxide dissolution in nitric acid is an oxidizing reaction of U(IV) to U(VI). The dissolution reaction consumes nitric acid and produces uranium nitrate UO<sub>2</sub>(NO<sub>3</sub>)<sub>2</sub>, nitrous vapors (NO and NO<sub>2</sub>) and water. The dissolution reaction is self-catalyzed by nitrous acid, which is an intermediary reaction product from the nitric acid degradation. Stoichiometry of the dissolution reaction of UO<sub>2</sub> is dependent on both the acidity and the temperature of the solution. The general chemical reaction is given by:

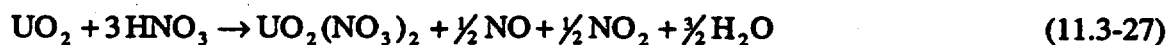

The dissolution is performed in nitric acid solution with a final acidity of 1 N at a temperature of 203°F (95°C).

Nitrous fumes produced are recombined in a dedicated NO<sub>x</sub> scrubbing column. The reaction is:



A cooling loop removes the heat generated by the recombination of nitrous fumes.

#### 11.3.2.15.4 Process Equipment

Figure 11.3-27 provides a simplified drawing of the Uranium Dissolution Unit.

#### 11.3.2.15.5 Chemical Process Inventories

The normal inventories of radionuclides and chemicals involved in this unit are provided in Tables 11.3-31 and 11.3-32, respectively.

#### 11.3.2.15.6 Chemical Process Ranges

The Uranium Oxide Dissolution unit operates in batches. The main flows of this unit are provided in Table 11.3-33.

#### 11.3.2.15.7 Chemical Process Limits

Normal operating parameters are described in Section 11.3.2.15.6. Principal SSCs are described in Chapter 5. Specific operating limits and the associated IROFS will be provided in the ISA.

#### 11.3.2.16 Sampling System

This section describes the principles of liquid sampling and basic equipment design for the AP process. The sampling system is applicable for radioactive and chemical solutions. Three liquid sampling system principles that will be used at the MFFF are direct filling, suction filling, and remote sampling.

In direct sampling, the solution is directly extracted from the process equipment by gravity flow or with a recycling pump into a vial. Direct sampling is limited to non-aggressive reagents. A large sample volume provides a lower detection limit.

In suction sampling, a vial is filled by suction through a needle by the vacuum created in a vial prior to sampling. Suction filling can be performed manually or with a moving cask. Aggressive reagents can be sampled manually but with vacuum vial filling. A moving cask is used for suction filling of active liquids. Suction filling is used for sampling of inactive but aggressive liquid and for dubious liquid in cell drip-trays. This method is not used for high activity solution like concentrated liquid waste.

With remote sampling, the solution is lifted up by an airlift (or a pump) head from which direct vacuum sampling is carried out. All the air-lift (or the pump) heads are confined in a sampling box (three boxes at MFFF) where a manipulator is installed. The manipulator handles an empty vacuum vial, sets the vial into the proper needle position, and places the filled vial at a rinsing station prior to its pneumatic transfer to the Laboratory.

For concentrated radioactive liquid waste, remote sampling under a box is required. Table 11.3-34 summarizes the sampling systems. All sampling systems will be qualified using engineering studies and/or evaluations.

### **11.3.3 Major Components**

The major components of each unit or system are described in Section 11.3.2.

### **11.3.4 Control Concepts**

The control concepts used in the AP process are based on existing control principles of COGEMA'S URP and Plutonium Finishing Facility at La Hague in France. The AP process control systems are designed to ensure that the product of the manufacturing process will conform to the product specifications with minimal waste and risk. The AP process controls are composed of the normal, protective, and safety control subsystems. The normal control subsystem controls the MFFF normal manufacturing and processing operations. The protective control subsystem provides protection for personnel and equipment. The safety control subsystem is designed to ensure that safety limits will not be exceeded. Section 11.6 discusses the MFFF I&C systems in more detail.

In general, each unit is controlled by one or several programmable logic controllers (PLCs) associated with a monitoring workstation located in the AP control room. All units are operated in an automatic mode. The operator may also intercede via a manual mode in which the interlocks are active in case of trouble in the automatic mode or for maintenance operations.

The Manufacturing Management Information System (MMIS) collects the information coming from all process units to control the position and the exchange of special nuclear material (SNM) as well as the traceability and the quality of the products.

### **11.3.5 System Interfaces**

The system interfaces of each unit or system are described in Section 11.3.2.

### **11.3.6 Design Basis for Non-Principal SSCs**

- The design of the AP process is as similar as practical to the proven design currently employed at La Hague's Plutonium Finishing Facilities. Departures from the La Hague design result from United States regulatory requirements, lessons learned at La Hague, or manufacturing and throughput requirements specific to the MFFF.

The composition and physical properties of the polished (output) plutonium are discussed in Section 11.2.6.

The AP Area is designed based on the following guidelines:

- C3b areas (as defined in Section 11.4) are surrounded by corridors, no C3b areas share a wall with the building boundaries, and an air-lock is present in each C3b area.
- Personnel and material access is through sally ports (two sally ports are dedicated to personnel access).
- BSR, MP, and AP Area roofs are lined up to facilitate construction of the hardened roof.
- The MP and AP Areas share material access at level 1.
- The emergency exit is towards a safe haven.
- Safeguard and emergency control room are shifted to the Shipping and Receiving area.
- Personnel evacuation requirements (e.g., doors, stairwells, and airlocks) are included.
- The AP and MP Areas share HVAC and electricity supply.
- 3013 outer can opening is performed in the MP Area; inner can and convenience can opening is performed in the AP Area.
- 3013 convenience cans are transferred to the AP area by pneumatic transfer.

### 11.3.7 Design Basis for Principal SSCs

The design bases for principal SSCs associated with the AP Process are included and discussed with other systems.

MFFF processes are designed to receive weapons-grade plutonium from the PDCF/ ARIES and from AFS with the chemical impurities listed in Tables 11.3-35 and 11.3-36, respectively, and the radiological impurities listed in Table 11.3-37. The plutonium isotopic composition for AFS and PDCF/ARIES feeds is as follows:

- $^{236}\text{Pu} < 1$  ppb, at the origin of pit
- $^{238}\text{Pu} < 0.05\%$
- $90\% < ^{239}\text{Pu} < 95\%$
- $5\% < ^{240}\text{Pu} < 9\%$
- $^{241}\text{Pu} < 1\%$  during lifetime of plant
- $^{242}\text{Pu} < 0.1\%$ .

In addition, the americium content for PDCF/ARIES feeds is as follows:

$$\frac{^{241}\text{Am}}{\text{Pu}_{\text{total}} + ^{241}\text{Am}} < 0.7\% \text{ during the lifetime of the plant}$$

These isotopic compositions are used to establish bounding values for criticality, shielding, and accident dose consequence evaluations.

$\text{PuO}_2$  powder entering the MFFF can have a density up to 11.46 g/cc. After receipt and storage, density measurement and, as necessary, a milling step is performed to ensure the density is less than 7 g/cc. The facility is designed to account for these different densities.

Feed materials that have an impurity content that exceeds a value listed in Table 11.3-35 (PDCF/ARIES) or Table 11.3-36 (AFS) can in some cases be processed by the MFFF, however each exceptional batch will be evaluated for impact on safety and operations prior to being accepted for processing in the MFFF.

**This page intentionally left blank.**

**This page intentionally left blank.**